

Community Water Supply: The Handpump Option

By: Saul Arlosoroff, Gerhard Tschannerl, David Grey,
William Journey, Andrew Karp, Otto Langeneffer & Robert
Roche

Published by: The International Bank for Reconstruction and Development/
THE WORLD BANK
1818 H Street NW
Washington D.C. 20433
U.S.A.

Available from: The International Bank for Reconstruction and
Development/ THE WORLD BANK
1818 H Street NW
Washington D.C. 20433
U.S.A.

Reproduced with permission.

Reproduction of this microfiche document in any form is subject to the same
restrictions as those of the original document.

COMMUNITY WATER SUPPLY

THE HANDPUMP OPTION

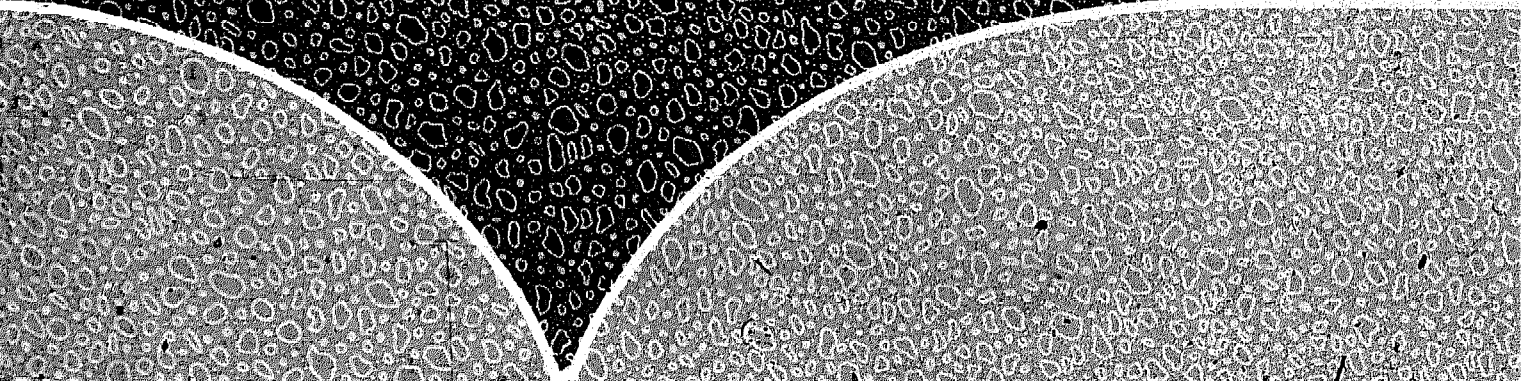
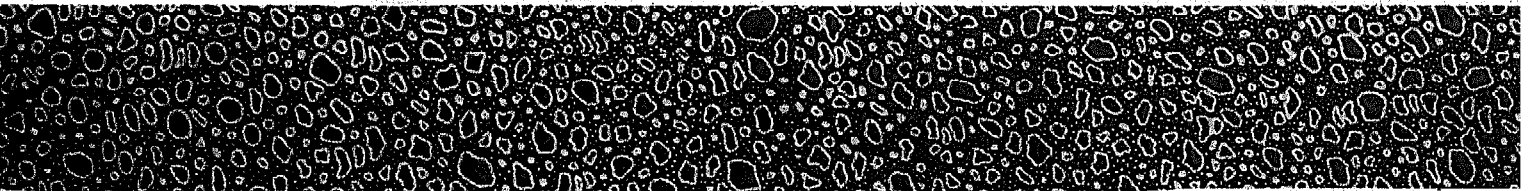
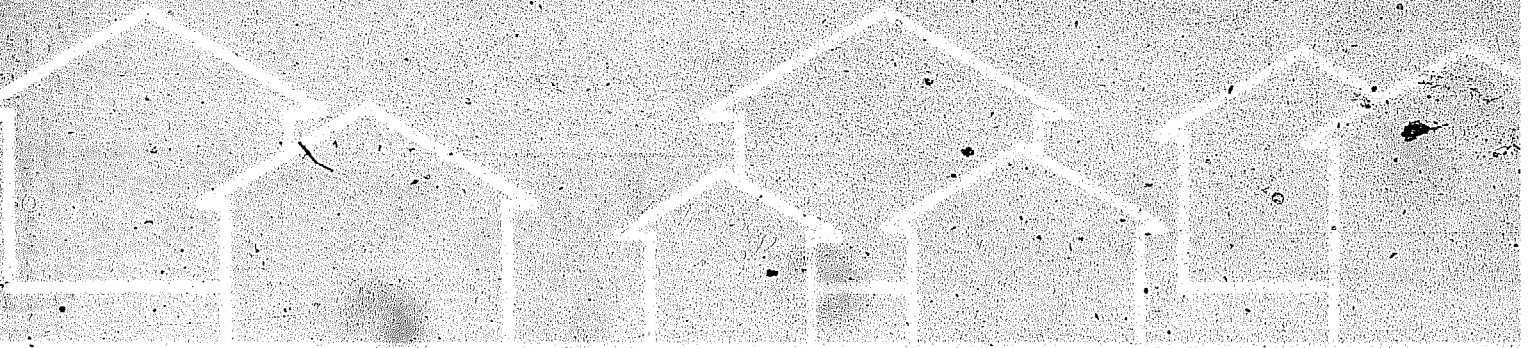

Saul Arlosoroff, Gerhard Tschannerl,
David Grey, William Journey, Andrew Karp,
Otto Langeneffer, and Robert Roche



A joint contribution by the United Nations Development Programme and the World Bank
to the International Drinking Water Supply and Sanitation Decade

Community Water Supply: The Handpump Option

**Saul Arlosoroff, Gerhard Tschannerl,
David Grey, William Journey, Andrew Karp,
Otto Langenegger, and Robert Roche**

**The World Bank
Washington, D.C.**

Copyright © 1987 by the International Bank
for Reconstruction and Development / THE WORLD BANK
1818 H Street, N.W., Washington, D.C. 20433, U.S.A.

All rights reserved
Manufactured in the United States of America
First printing May 1987

The findings, interpretations, and conclusions expressed in this study are the results of country economic analysis or research supported by the World Bank. They are entirely those of the author(s) and should not be attributed in any manner to the World Bank, to its affiliated organizations, or to members of its Board of Executive Directors or the countries they represent. Any maps that accompany the text have been prepared solely for the convenience of the readers; the designations and presentation of material in them do not imply the expression of any opinion whatsoever on the part of the World Bank, its affiliates, or its Board or member countries concerning the legal status of any country, territory, city, or area, or of the authorities thereof, or concerning the delimitation of its boundaries or its national affiliation.

The most recent World Bank publications are described in the annual spring and fall lists. The latest edition is available free of charge from Publications Sales Unit, The World Bank, Washington D.C. 20433, U.S.A.

Library of Congress Cataloging-in-Publication Data

Community water supply.

1. Hand pumps—Testing. 2. Hand pumps—Developing countries. 3. Water-supply, Rural—Developing countries. I. Arlosoroff, Saul, 1930-
TJ903.C65 1986 628.1 44 86-28214
ISBN 0-8213-0850-5

Foreword

This document presents the conclusions of five years of work devoted to the assessment of available technology and management options for the wide-scale implementation of community water supply systems. An examination of policy options for developing countries suggests that economic stability and growth can be enhanced if the rural and urban-fringe populations are adequately served with non-polluted water supplies.

An adequate water supply is one of the basic needs of life, but is often lacking in developing countries. Not only has the rate of construction of improved water supply systems been slower than the target of complete coverage originally set under the International Drinking Water Supply and Sanitation Decade, but also many of the schemes already completed are not in satisfactory operating condition. A sound investment strategy in this sector calls for low-cost and maintainable solutions to achieve wide-scale coverage of the rural and urban fringe communities in developing countries.

Among the most promising low-cost options are systems based on groundwater and handpumps. Unpolluted groundwater in sufficient quantities for manual extraction can be found in most areas of the world; a handpump is usually the most affordable and hygienic means of lifting the groundwater to the surface. The modern handpump can be maintained by the communities served and manufactured in the developing countries. In the dry regions of the world, handpumps can also be used for livestock watering and micro-irrigation.

This conclusion should not prevent the more prosperous communities from acquiring higher levels of service, provided they are institutionally and financially able to provide the necessary operation and maintenance services. For example, they may wish to have a mechanized pumping system, a pipe network or a household yardtap system, all of which reduce the time to fetch water. In executing a community water supply project, these factors must be carefully examined on a case-by-case basis to determine the appropriate type of supply for a particular community.

The report summarizes the findings of a project on the testing, and technical and managerial development of handpump-based systems. The project has been carried out jointly by the World Bank and the United Nations Development Programme, and supported by ten donors active in the sector. The report provides guidelines for the selection of the water supply technology and system that best meet the needs of a given community, and gives a detailed assessment of the different types of handpumps tested by the program. It is my hope that this report will be a useful contribution to achieving sustainable and replicable community water supplies throughout the world.

S. Shahid Husain
Vice President, Operations Policy Staff
The World Bank



Contents

Preface	ix
Acknowledgments	x
Executive Summary	1
1. Background	7
Sector Review	7
Technology Choice	8
The Handpumps Project	9
The Reliability Issue	14
Project Impact	14
Future Activities	15
2. Choice of Community Water Supply Technology	19
Technology Options	19
Investment Efficiency	20
Resource Constraints	25
The Right Choice	28
3. Handpump Project Planning and Implementation	31
The Maintenance System	31
The Community	37
The Aquifer	39
The Well	44
The Handpump	45
Finance	45
Summary of Planning Guidelines	47
4. Handpump Technology	49
History of Handpumps	49
Factors Affecting Handpump Performance	52
Handpump Design and Development	57
Standardization	66
Guidelines for VLOM Design	68
5. Pump Selection Guide	71
How to Use the Pump Selection Tables	71
Operating Conditions	72
Data Source	74
Discharge Rate	74
Ease of Maintenance	74

Reliability	75
Corrosion Resistance	76
Abrasion Resistance	77
Manufacturing Needs	77
Short List	78
Pump Selection Tables	79
6. Pump Selection: Worked Examples	89
Worked Example No. 1: Low Lift	89
Worked Examples Nos. 2 and 3: Intermediate and High Lift	91
Worked Example No. 4: VLOM Pumps for Intermediate and High Lift	91
Merit Point Evaluation	91
Handpump Compendium	97
Annex 1 Interesting Pumps Not Tested by the Project	183
Annex 2 Complete List of Pumps Tested	193
Annex 3 Comparison of Costs and Time Savings for CWS Options	195
Bibliography	199
Boxes	
Box 1.1 Laboratory Testing of Handpumps	9
Box 1.2 Field Testing of Handpumps	11
Box 1.3 The VLOM Concept	13
Box 2.1 Evaluating Technology Options: A Case Study from Thailand	21
Box 2.2 Health Benefits from Water Supply	24
Box 3.1 Village-Level Maintenance in Burkina Faso	33
Box 3.2 Handpump Maintenance: The Three-Tier System in India	34
Box 3.3 Community Involvement in Malawi's Integrated Rural Water Supply	36
Box 3.4 Bangladesh: Motorized Pumping Threatens Suction Handpumps	41
Box 3.5 Some Drilling Methods for Handpump Wells	42
Box 4.1 Handpump Types and Operating Principles	50
Box 4.2 Drawdown in Low-Yield Wells: Examples from West Africa	53
Box 4.3 Corrosion of Downhole Components and the Effects on Water Quality	54
Box 4.4 Effects of Handle Design and Cylinder Size on Pumprod Stresses	58
Box 4.5 Development of Plastic Bearings for Lever Action Handpumps	60
Box 4.6 Case Study of Handpump Development in East Africa	62
Box 4.7 Case Study of Handpump Development in Bangladesh	67
Box 5.1 The Relationship between Handpump Discharge and Pumping Lift	73
Box 5.2 Definitions of Reliability	76

“Lasting health and economic benefits for the rural and urban-fringe populations of Africa can be achieved through increased community management of water supply and sanitation systems based on proven low-cost technologies...”

All-Africa Seminar on Low-cost Rural and Urban-Fringe Water Supply, Abidjan, Cote d'Ivoire, October 1986.

Preface

The Abidjan statement quoted above reflects a growing consensus among African countries of the political commitment and implementation strategies needed to meet that continent's urgent community water supply (CWS) needs. In Africa, as in the rest of the developing world, the great majority of the rural and urban-fringe population lack safe water and proper sanitation. Many CWS systems built with foreign aid lie abandoned because they cannot be maintained. Scarcity of capital resources, a shortage of skilled people, and poorly developed organizational structures hinder progress. Fundamental changes of approach are vital if future programs are to result in sustainable and replicable projects.

The International Drinking Water Supply and Sanitation Decade (IDWSSD) brought attention to the plight of the rural poor. As part of global efforts to bring improvements, UNDP, the World Bank, and a number of major donors have collaborated in projects designed to develop and promote low-cost simple technologies which communities could afford and maintain with their own resources.

Community Water Supply: The Handpump Option is the outcome of one such project. Project INT/81/026 — Laboratory and Field Testing and Technological Development of Community Water Supply Handpumps (The Project) — has now completed five years of testing and monitoring in 17 countries, involving some 2,700 individual pumps of 70 different models. This unique data base, along with data from many more CWS projects, is the basis for the recommendations in this document, which rounds off the first phase of the Project.

The wide experience gained and the breadth of data collected have justified extension of the findings and recommendations beyond specific guidelines for handpump selection. It is clear that successful CWS programs need to be planned as a package of measures designed to make best use of available resources and to ensure that maximum benefits are achieved from completed projects. The package includes economic, financial, social and institutional elements as well as technology choice. Above all, success depends on the sustainability of the CWS system.

The Project recommendations are aimed at a wide audience, beyond those actively involved in buying,

designing or making handpumps. Policy makers and CWS program planners will find guidelines in Chapters 1 and 2 for selecting the type of water supply system most appropriate for the financial, technical and institutional resources available to the benefitting community.

Global analysis of needs and resources suggests that wells equipped with handpumps will be an appropriate choice for the majority of the 1,800 million low-income people in need of improved supplies in the remainder of this century. However, case-by-case evaluation is needed to ensure that communities with the resources to sustain mechanized pumping schemes offering higher service levels are encouraged to obtain them.

Evidence from the Project's first five years allows a measure of confidence that CWS programs designed for community management of maintenance can be sustainable and widely replicable, and that handpump projects can readily form the first step in a progressive improvement of service levels.

Even in five years of intensive testing, not everything can be measured. To make this document as complete as possible in its advice and recommendations, there have inevitably been points at which data analysis has had to be supplemented by “best judgment” of experienced Project staff. Wherever possible, such judgments have been drawn to the reader's attention and the basis of the judgment has been explained.

Throughout its first phase, the Project has been guided by an Advisory Panel drawn from UN Agencies and collaborating donors. In October 1986, the Advisory Panel endorsed a program for the next phase (1987-1991). The emphasis will now be on promoting the implementation of CWS projects incorporating the principles established during the first phase. Data from new projects will be used to continue the analysis of outstanding key issues, such as drilling cost variations, well design and construction, appropriate community management structures, water quality problems, health benefits, and government support systems for training and spare parts distribution.

Meanwhile, it is clear that the momentum generated by the Project will continue to influence governments, donors and manufacturers in the selection and provision of appropriate low-cost community water supply systems.

Acknowledgments

Results from the Project for Field and Laboratory Testing and Technological Development of Rural Water Supply Handpumps (INT/81/026), which are presented in this document, were obtained with the full collaboration of the many governments with which we have worked over the past five years. The Project has been supported by the Division for Interregional and Global Projects (DGIP), United Nations Development Programme (UNDP), and the following assistance agencies: Canadian International Development Agency (CIDA); Danish International Development Agency (DANIDA); Finnish International Development Agency (FINNIDA); Ministry of Foreign Affairs, France; German Ministry for Economic Cooperation (BMZ) and German Agency for Technical Cooperation (GTZ); Ministry of Foreign Affairs, The Netherlands; Overseas Development Administration (ODA, UK); Swiss Development Cooperation (SDC); and the Swedish International Development Authority (SIDA).

The United Nations Volunteers Organization (UNV) in Geneva, and the UNDP and UNICEF staff in the project countries have provided valuable assistance in the implementation of the Project. Major technical contributions were made by, among others, the Consumers' Association Testing and Research Laboratories (UK) and the Swiss Center for Applied Technology (SKAT). UNICEF and Crown Agents (UK) have also assisted in equipment procurement. Handpump manufacturers in both industrialized and developing countries have been provided with feed-back and responded by improving their products.

Many colleagues in the World Bank have contributed to the document. Special mention should be made of Michael Cohen, Advisor during the main period of preparation of the document, who closely followed its progress. The economic analysis was prepared by Edward Quicke and Fred Wright, both members of the Project team. The document also draws heavily on work done by staff in the Water Supply and Urban Development Department (WUD) in the preparation of a sector strategy paper for rural water supply, which is still in progress. We are indebted to our colleagues on other

UNDP-assisted projects in WUD — the Low-Cost Sanitation Project and the Training and Information Project — for their inspiration and close collaboration. We want to thank our former staff members Leif Rosenhall, Ken McLeod, Anthony Ramuglia, Melissa Burns and Nicholas Burnett for their contributions.

The members of the Advisory Panel, particularly Martin Beyer (UNICEF), its Chairman, have provided continuous advice and encouragement. The initiator of the Project was John Kalbermatten, whose vision helped to shape a number of Decade activities. William Maschler, former Director of DGIP, UNDP, was instrumental in making the Project a reality, and Timothy Rothermel, current Director, and Frank Hartvelt, Senior Programme Analyst, carry on the active support and participation of DGIP, UNDP.

We extend our gratitude to the managers and staff members of the rural water supply projects — nationals and those from abroad — as well as other professionals, who have collaborated with the Project. The material presented in this document is to a large extent a synthesis and analysis of the experience which they gained from many years of dedicated work in the field.

This Report would not have been possible without the work of our Assistant Regional Project Officers and monitoring staff in the field: San Shwe Aung, Ramon Bisco, Aung Chein, Gerry Clarke, Humberto Cordero, Joe Fonseca, Diawoye Guindo, B.P. Joshi, John Keen, Eliud Kimaro, Bent Kjellerup, Sampath Kumar, Maria Kyber, Kithsiri Liyanage, Anne Malm, K.M. Minatullah, Thint Myat, Kyaw Myint, Kyaw Nyunt, Abdallah Syed Osman, Carlos Rodriguez, David Rowsome, Joseph Saka, Khin Maung Than, Roland Titus, and M.P. Vaufreydaz.

Our warmest thanks go to Brian Appleton, Technical Writer, who wrote most of this document, based on drafts prepared by the Project team. Thanks also go to Christiane Pogany and Kedar Bryan for assisting in the preparation of the document, and to all the support staff of the Project in Washington and in the field locations, without whom this work would not have been possible.

Executive Summary

An estimated 1,800 million people need improved water supplies in the fifteen years to the end of the century, if developing countries are to reach the target of full coverage. The first half of the International Drinking Water Supply and Sanitation Decade (1981-1990) has seen increases in the percentages of the rural population with access to safe water supplies, but only in Asia has the pace been quick enough to envisage a target of essentially full coverage by the end of the century (ten years later than the original Decade goals). In Africa, present progress rates would leave half of the rural population still without safe water in the year 2000, while in Latin America, it may be ten years into the next century before full coverage is achieved unless progress improves dramatically.

Accelerated progress is hampered by financial and technical resource constraints faced by many developing countries, and the problem is aggravated by the growing number of completed projects which are broken down and abandoned, or functioning much below capacity. Attempts to increase the pace of providing improved community water supplies have often been frustrated because the technology used has proved impossible to sustain in village conditions.

To make a lasting impact on the urgent needs, community water supply (CWS) strategies must be based on sustainable and replicable programs, and must take account of the pace at which resource constraints can be overcome. Human resource development programs take time to produce results, and institutional changes can only be accomplished gradually.

The Integrated Approach

Successful CWS programs involve a combination of hardware and software — technology and institutional/organizational support elements — matched in such a way that each community recognizes the benefits of the improved supply, can afford at least the costs of operating and maintaining it, and has the skills, spare parts, materials and tools available to sustain it. To maximize health benefits, parallel investments in health education and sanitation programs should be planned alongside CWS improvements.

This "integrated approach" to CWS planning involves consideration of a number of key issues, each

individually important, and together forming a complete package for achieving dependable services:

- Effective involvement of the community in the design, implementation, maintenance and financing of planned improvements, with promoting agencies providing technical assistance and support services as needed. The community's needs and wishes have to be reconciled with its capacity and willingness to pay for the level of service planned.
- Provision for full recurrent cost recovery, with support of capital (construction) costs for poorer communities offset by full recovery where higher service levels are provided.
- Maximum involvement of in-country industry in the supply of services and materials for project construction and maintenance (e.g. supply of pumps and spare parts, servicing and repairs), with the important proviso that quality control and reliability should be assured and that costs are competitive.
- Technology chosen to match the resources available to sustain it.
- Institutional and manpower development programs matching the needs of the planned water supply system.
- Parallel programs in health education and sanitation improvements.

Service Level and Technology Choice

The decision about the level of service (i.e. the amount of water provided per capita and the convenience of obtaining it) that a particular community or district should have involves consideration of many of the issues listed above. The aim is that the technology chosen should give the community the highest service level that it is willing to pay for, will benefit from, and has the institutional capacity to sustain.

Choices may have to be made between surface water and groundwater as the principal source (sometimes supplemented with rainwater) and then from

handpumps, public standpipes, or yardtaps, as the method of distributing the water to the beneficiaries. Costs and benefits will both be linked to the number of water points provided, with improved convenience of water collection ranking high in the consumers' evaluation of potential benefits.

Groundwater has many advantages over surface water as a source for CWS improvements, the main one being that, provided wells are judiciously sited in relation to existing or future latrines, safe water should generally be assured without the need for treatment (other advantages are listed in Chapter 2). The resource demands of water treatment plants needed to make supplies from surface water sources safe to drink are beyond the reach of most communities, and use of untreated surface water frequently represents an unacceptable health risk.

In cases where an upland catchment can be protected against contamination, a gravity-fed system can be reliable and safe, but only a small percentage of the population in need of improved supplies live in such areas. It will therefore be rare for CWS programs to be based on surface water as the source, and the technology choices analysed in this report are focussed largely on groundwater-based CWS systems.

Assuming that equal system reliability can be achieved, the three main technology options – handpumps, standpipes, and yardtaps – generally represent progressively increasing service levels, and call for increasing financial and technical resources for their implementation and maintenance. The choice of appropriate technology for a particular project or program can only be made when resource constraints have been taken into account, including the capability of the users to operate and maintain the alternative systems under consideration.

The theme of *reliability* recurs throughout this document. In community water supplies, one of the most important influences on system reliability is the length of time for which pumps stand idle when they break down. The response times of centralized maintenance organizations covering dispersed communities can stretch to several months. Box 5.2 in Chapter 5 shows graphically how handpump maintenance carried out by an area mechanic within a week of breakdown makes a pump which breaks down on average every 8 months more "reliable" than one which lasts for an average of 18 months before it breaks down, but then must wait two months for the mobile maintenance team to arrive.

In considering the service level to be provided by a particular technology, reliability is an important parameter. Thus a reliable handpump supplying 30 liters per head per day for 95% of the year, will be providing a higher level of service than yardtaps designed for 150 liters per head per day but working for an average of only two hours a day because of leakage, breakdown, fuel shortages, or limited water available at the intake.

Comparisons of costs, resource needs, and benefits of the CWS options have to be based on a realistic assessment of the reliability and sustainability of each technology.

Financial Implications

Capital costs of the three technologies generally range from US\$10-30 per capita for wells equipped with handpumps to US\$30-60 per capita for motorized pumping and standpipes and US\$60-110 per capita or more for yardtap services. In global terms, that means that cost estimates for meeting rural water supply needs to the year 2000 range from US\$50,000 million to US\$150,000 million, depending on the choice of technology.

With the obvious difficulties of mobilizing financial resources for this scale of investment, rapid progress in meeting basic needs can be achieved only if a large proportion of the population in need receives services at the lower end of the cost range. Upgrading to a higher service level may then be financed by the community later, as benefits from the initial investment and from other sources increase available resources.

Analysis of data from a wide range of CWS projects indicates a similar divergence in the recurrent (operation and maintenance) costs of the three options to that already noted in the capital costs. With a centralized maintenance system, the annual per capita cost of maintenance of a handpump-based CWS system can range from US\$0.50 to US\$2.00. Well planned community-level maintenance can bring that figure down as low as US\$0.05 per capita per year (see Box 3.1 in Chapter 3). By comparison, centralized maintenance of a standpipe system with motorized pumping costs from US\$2.00 to US\$4.00 per capita per year, and for yardtap maintenance the range is US\$4.00 to US\$8.00.

There are circumstances in which communities may value the time saved due to the extra convenience of yardtaps so highly that they are willing and able to pay the extra price. The analysis method outlined in Annex 3 is designed to help identify such communities. More frequently, the serious shortage of readily available cash resources will mean that recurrent costs must be kept to a minimum, and handpumps will be the indicated choice.

Resource Needs

As with financial considerations, comparison of other resource demands of the different technologies also points to a substantial role for handpump-based systems in meeting basic human needs. The most significant difference between handpump projects and those based on standpipes or yardtaps, is the switch to motorized pumping, and the consequent need for dependable energy supplies and skilled pump mechanics, when a piped distribution system is provided.

In cases where reliable low-cost electric power is available from a central grid, an electric pump can be a relatively inexpensive and operationally simple means of lifting water. Communities which have the financial and technical means available to implement and sustain projects based on electric pumping should be given every encouragement to do so, as this frees scarce public sector funds and external aid for projects serving poorer communities. However, the number of

communities with dependable electricity supplies is presently small — well below 10% of the total rural population in Africa, only a little higher in most countries in Asia, and reaching 40-50% in China and the more developed countries of Latin America.

In the absence of reliable electric power, the alternative power source for motorized pumps is diesel engines. The logistic problems of ensuring dependable diesel supplies for dispersed communities have rarely been successfully overcome, and there are few examples of diesel-powered rural water supply systems operating successfully in the long term. The cost of trucking diesel fuel over hundreds of kilometers will usually prove prohibitive. Future developments in solar technology may eventually make solar pumping economic for drinking water supplies, but at the moment such schemes have very high initial costs and require skilled maintenance. Similar conditions apply to windmills.

Adding the institutional constraints and the severe shortage of skilled mechanics in developing countries, it is clear that systems involving motorized pumping are appropriate for only a minority of those in need of new supplies in the coming years. For the rest, it seems clear that drilled or dug wells equipped with handpumps will be the appropriate choice. This makes it vitally important that handpump-based projects are planned and implemented in ways which will ensure that they perform reliably and can be sustained in the long term and widely replicated.

The Handpumps Project

In 1981, as one of the activities in support of the International Drinking Water Supply and Sanitation Decade (IDWSSD), the United Nations Development Programme and the World Bank initiated a global/interregional project for the Laboratory and Field Testing and Technological Development of Community Water Supply Handpumps (the Project). The main objectives have been to promote the development of designs and implementation strategies which will improve the reliability of schemes based on groundwater and handpumps, and which will enable schemes to be managed by the communities and replicated on a large scale.

Technology was thought to be at the root of past problems experienced with handpump-based CWS systems, and the Project has carried out laboratory tests in the UK and field trials in 17 countries to measure the performance of a total of about 2,700 handpumps. Field trials lasted at least two years on most pumps, with some 70 different pump models represented in the trials. Test results and conclusions about the performance of each of the pump types still on the market are included in the Handpump Compendium at the end of this document. In Chapters 5 and 6, the pumps are "rated" for different operating conditions, and worked examples illustrate different pump selection applications.

From the beginning, the Project has promoted the concept of **VLOM** (Village Level Operation and Management of Maintenance) as a means of overcoming

some of the major obstacles to sustainable water supply systems. Now recognized as one of the fundamental principles of handpump design and CWS project planning, the **VLOM** concept seeks to avoid the high cost, long response time, unreliable service and other operational difficulties in the repair of handpumps through central maintenance systems.

Many past failures of CWS systems can be blamed on the inadequacies of central maintenance, in which a water authority dispatches teams of skilled mechanics with motor vehicles from a base camp, often serving a large district, to respond to requests for repairs or to carry out routine maintenance. Instead, maintenance should be a community responsibility, and this in turn means that the pump design has to be suitable for repair by a trained caretaker or area mechanic with basic tools, and that spare parts should be affordable and readily available to the community. The Project strongly advocates that pump maintenance responsibilities should be delegated to village committees, and that pumps should be selected with such maintenance in mind.

Developing country governments and donor agencies are increasingly changing their policies to include these principles in projects or programs. This is a significant departure from previous practice, particularly in Africa, where many different types of unsuitable pumps have often been brought into a country through donor assistance. Recipient agencies have thus taken on unmanageable maintenance commitments, which rely on public-sector mobile maintenance.

Planning and Implementation

Few handpump system failures can be blamed solely on the pump. Other major causes are: inadequate or unrealistic provisions for maintenance; poor management, supervision, monitoring and evaluation; poor well design or construction, allowing sand to enter and damage pumping elements; and the corrosive effects of groundwater, which are much more extensive than had previously been suspected.

Experiences in the field trials and data from many other CWS projects have enabled the Project to formulate guidelines for the planning and implementation of CWS projects using wells equipped with handpumps. The guidelines, amplified in Chapter 3, deal with six critical elements — the community; the aquifer; well design and construction; the handpump; the maintenance system; and finance.

Community Involvement

The highest potential for sustainability is achieved when the community is involved in all phases of the project, starting from the planning stage. If the scheme is to continue to operate satisfactorily, people have to recognize the need for the improved service, be able and willing to pay for the maintenance cost (and eventually the construction cost), and be willing to manage its maintenance.

Aquifer Analysis

Competing demands for other water uses, such as irrigation pumping, have to be taken into account when evaluating aquifer potential for handpump projects. To avoid unnecessarily high costs, the well needs to be deep enough to allow for seasonal and long-term lowering of the water table, but no deeper. Legislation and administrative enforcement are needed in some areas to prevent overpumping for irrigation leading to drawdown of the water table and putting existing handpumps out of service.

Well Design and Construction

Wherever the rock is not fully consolidated, screens and filter packs are essential to prevent sand and silt intrusion. Otherwise rapid damage will occur to commonly-used types of seals and valves. The right choice of drilling equipment, backed by appropriate organization of drilling, can significantly reduce drilling costs and result in more dependable wells.

Handpump Selection

A number of factors influence handpump selection, in addition to the cost of the pump itself. Among the most important are suitability for the intended maintenance system (e.g. can it be repaired by a trained pump caretaker?), durability, and discharge rate. Pump choice will depend on the required lift and the planned number of users per pump. Standardization on one or a few pump types for any one country can have a significant impact on maintenance and is an important selection criterion; and corrosion resistance has to be taken into account when groundwater is aggressive.

The Project has prepared *Draft Sample Bidding Documents* for handpump procurement, to assist governments and support agencies to take account of important pump characteristics when purchasing pumps through international competitive bidding.

Community Management of Maintenance

Under the system recommended by the Project, the community organizes and finances all repair and routine maintenance of the handpump. Work is carried out either by a designated community member with minimal training and basic tools, or by an area mechanic (usually with a bicycle or moped) covering a number of pumps. The public authority has an important role to play in the training of caretakers and mechanics, and the organization of an adequate spare parts distribution system, but should then hand over maintenance of the scheme to the beneficiaries.

Financial Management

Even when the community is willing to pay for and manage the upkeep of its water supply system, the scheme may founder unless a suitable mechanism is

found for collecting money, arranging repairs and paying caretakers or mechanics. Initial training of selected water committee members in simple accounting and financial management has been effective in a number of countries. The Project is seeking evidence of practical community-level cost recovery and management mechanisms, to add to those described in Chapter 3.

Today's Handpumps

The standard test procedures used in the laboratory and field trials revealed many shortcomings in existing handpump designs. Manufacturers responded well, by modifying their products and introducing new models, and there are now many more pumps on the market which are durable and which allow for substantial involvement of villagers in pump maintenance.

As a result, in the vast majority of developing countries, it is now possible to design a handpump-based water supply system which can be sustained in reliable operation without dependence on continual intervention by a central authority.

The Project has assisted a number of firms in developing countries to begin handpump manufacture. Manufacturers from industrialized countries are also being encouraged to combine with enterprises in developing countries to make pumps under licensing or joint-venture agreements. In-country manufacture, backed by public or private sector distribution facilities and retail outlets, strongly improves the likelihood that spare parts will be available when needed, and facilitates standardization of pump types in a country to simplify caretaker training and stocking of spare parts.

Encouraging as these developments are, there remains a scarcity of handpump models which can be described as **VLOM** and are suitable for lifting from depths of more than about 25 meters (though the majority of the population in need lives in regions where the water table is not so deep). The heavy weight of downhole components makes extraction of the complete assembly from deep wells difficult. An added problem is that handpumps deliver less water when pumping from greater depths. The pumps are therefore heavily used and so suffer rapid wear — a problem which is aggravated by the tendency for deep wells to serve more people per well, in order to spread the higher costs of the well and pump over a larger number of users.

For low lifts (up to about 12 meters), direct action pumps, like the Tara prototype developed in Bangladesh, in which the operator lifts and lowers a T-bar handle directly attached to the pump rods, have a number of advantages. Elimination of the bearings that are part of lever or flywheel-operated pumps reduces maintenance needs, and the pumps can be manufactured in developing countries at a relatively low cost. They make extensive use of plastics materials, which make the pumps light in weight and corrosion resistant. Direct action pumps have the great advantages over suction pumps that they can lift from more than the 7-meter limit for suction (important since groundwater levels are falling in many parts of the world) and that they do not

need priming and therefore avoid the risk of contaminating the well by pouring in polluted water.

For high lifts (down to about 45 meters), a below-ground design which allows extraction of the piston (and footvalve if desired) without removal of the cylinder and rising main appears to be the most promising **VLOM** design. However, only a very few low-cost, durable and corrosion-resistant **VLOM** designs for below-ground components have been used successfully in preliminary tests for lifts between 25 and 45 meters. Development of more **VLOM** pumps for use beyond 25 meters remains an important task for the next phase of the Project — and for manufacturers and implementing agencies.

To take standardization further, attempts are now being made to develop designs in which some of the same components can be used for pumps designed for different depth ranges. In East African development work, for example, a standard 50mm-diameter cylinder with the same plunger, footvalve and pumprod is being tested with different pumphead configurations for the whole range of lifts from 0 to 45 meters. For low lifts, the below-ground components are connected to a T-bar handle to be operated as a direct action pump; at higher lifts, a lever handle is used, with the handle length varying (two options) depending on the lift.

In Chapters 5 and 6, the monitoring results and experiences of Project staff and others have been used to "rate" each of the 42 handpumps tested by the Project which are still on the market, under a series of design criteria which may influence pump selection. The criteria will not always match precisely conditions under which particular pumps have been tested in the field, and in assessing pump performance over a range of conditions, Project staff have frequently had to make "best-judgment" decisions on the basis of their own experience

and the available field and laboratory evidence. A methodology is suggested for using the ratings to compile a short list of acceptable pumps for a project or program, and some worked examples illustrate application of the selection procedures in specific cases. It is clear from the worked examples that some pumps are much more suited than others to conditions in developing countries, and that as pumping lift increases, the number of pumps suitable for village-level maintenance declines rapidly.

Future Tasks

Implementation will be the central emphasis of the Project's second phase (1987-91). In their collaboration with governments and donors, Project staff will urge inclusion of the "systems approach" in CWS programs.

Every opportunity will be taken to collect data, demonstrate successful approaches, and develop detailed implementation guidelines on the critical elements identified in the first phase: drilling technology and well design; community participation; training at all levels; in-country manufacture, standardization and spare parts distribution; corrosion and water quality; complementarity of water supply, sanitation and health education; evaluation of benefits and selection of service levels; and non-domestic uses of groundwater.

Governments and donors have an important part to play, by committing resources to the implementation of low-cost CWS programs and by sharing experiences, so that lessons can be learned and model strategies developed for each element of the CWS package. Technical assistance will be made available wherever possible, to support activities aimed at furthering community management of low-cost water supply and sanitation systems.

Chapter 1

Background

Sector Review

When the member governments of the United Nations proclaimed the 1980s to be the International Drinking Water Supply and Sanitation Decade (the Water Decade), they were responding to an urgent need. An estimated 30,000 people were dying every day, many of them from diseases attributable to a lack of safe water or adequate sanitation facilities. In 1980, the World Health Organization estimated that more than 70% of the world's rural population was without access to a safe and adequate water supply; some 1,150 million villagers (China's statistics were not then available) were drinking water which was a threat to their health.

The Water Decade is more than half over, and while much has been accomplished in rural water supply, the large amount which still remains to be done re-emphasizes the urgent need to find sustainable and replicable ways of bringing clean water to rural and urban fringe communities.

Statistics on the first three years of the Decade (Table 1.1) show that progress has been achieved in all the regions. The progress in building new rural water supplies has been greatest in Asia. About 70 million people a year obtained improved water supplies in the rural areas of Asia and the Pacific in the first three years of the Decade, while the rural population grew by 15 million per year. If this trend were to continue, the region would reach essentially full coverage by the end of the

century. To maintain this goal, however, the commitment to constructing additional community water supply systems must remain strong, and the systems installed up to now must be properly maintained.

In Africa, the prognosis is less good. Provision of improved rural water supplies (for 10 million people per year) has just kept pace with the population growth rate. At that rate, no more than half of the rural population will have an adequate water supply by the end of the century.

In Latin America and the Caribbean, rural water supply services were provided at a rate of three million people served per year, or twice the population growth rate. If the same pace was maintained, it would be well into the next century before the region approached full coverage. There is a strong need for increased efforts in both Africa and Latin America.

If the Water Decade's aim of bringing safe water to all by 1990 is deferred to the end of the century, and account is taken of the progress made up to mid-Decade, the number of people to be served in the fifteen years to the year 2000 is now estimated to be 1,800 million, including 400 million in China.

The magnitude of the task is daunting, particularly when seen against the background of severe financial and technical resource constraints which faces so many developing countries. And even if such a rapid construction and investment schedule is possible, what chance is there of new systems being kept in working

Table 1.1 Water Supply Coverage 1980-1983

Region	RURAL						URBAN					
	Total population (millions)		Population served				Total population (millions)		Population served			
	1980	1983	1980		1983		1980	1983	1980		1983	
		mill.	%	mill.	%			mill.	%	mill.	%	
Africa	334	356	73	22	103	29	135	160	89	66	91	57
Asia/Pacific	1064	1109	277	26	488	44	428	493	278	65	330	67
Latin America	124	126	52	42	62	49	234	254	183	78	216	85

Source: Report of the Secretary General of the United Nations to the Economic and Social Council of the UN General Assembly — Progress in the Attainment of the Goals of the International Drinking Water Supply and Sanitation Decade. A/40/108, March 1985.

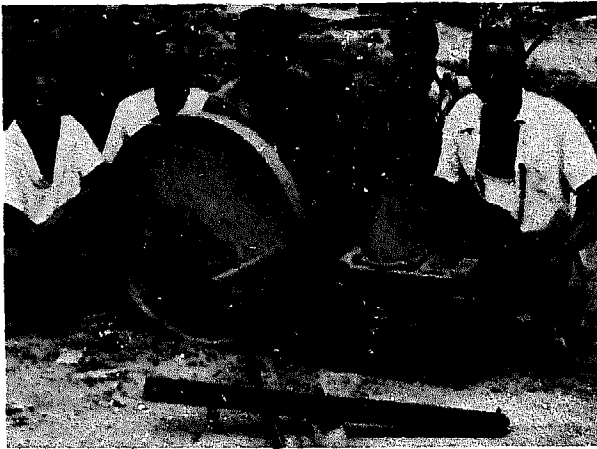

An abandoned pump means wasted investment. Proper planning will ensure that adequate resources are available for maintenance and repair, before the CWS technology is chosen.

order, when many existing installations are already broken down or abandoned?

Yet the case for providing improved water supplies is compelling. Improved health, increased agricultural production and accelerated village development bring economic and social benefits, to add to the powerful humanitarian arguments for reducing the toll of death and debilitating disease resulting from present insanitary conditions. The challenge for all developing countries, and for aid agencies seeking to assist them, is to devise a CWS strategy which matches the services provided with the resources available to sustain them — and to implement that strategy quickly and effectively. A prime objective of this document is to set out the essential elements of such a strategy.

Technology Choice

Capital costs of efficiently built CWS projects generally range from US\$10-30 per capita for groundwater schemes based on handpumps, US\$30-60 per capita for standpipe supplies, and US\$60-110 per capita for yard-tap services. In global terms, that means a difference in cost estimates for meeting water supply needs to the year 2000 of as much as US\$75-100,000 million, depending on the choice of technology. It is clear that most of the population in need of improved supplies will have to be provided initially with low-cost solutions, for financial reasons alone.

Upgrading to a potentially higher service level — e.g. by fitting motorized pumps on high-yielding wells initially equipped with handpumps and adding a piped distribution system and standpipes — may eventually follow, as the community realizes the benefits of an improved supply and is able to finance further improvements from its own resources. Immediate implementation of higher service levels can really only be justified if all, or at least most, of the capital and recurrent costs are contributed by the community. This does not mean, however, that low-cost options should

be imposed on communities which want and can afford higher service levels.

Mobilization of local cash resources may provide additional funds where the community has a strong desire for a higher level of service and the technical capacity is available to maintain such a service. A successful approach in these higher income areas involves creation of institutional mechanisms, often through the private sector, by which people can obtain the type of water system they want and are able and willing to pay for.

In Brazil and Kenya, among other countries, credit banks have established revolving funds to assist communities in the financing of new CWS projects, using revenue collected from existing schemes. In some cases, the funds are linked to other revenue earning activities, such as agricultural production, and loans may also be used for construction of schools, health centers, etc.

One important reason why CWS coverage is presently so low is that many newly built water supply systems have fallen rapidly into disrepair and been abandoned by communities unable to keep them functioning. Skills and equipment are in short supply in the poor areas of most developing countries, and technology choice has to be based on the capacity of the benefitting community or the implementing agency to operate and maintain the completed system at an affordable cost.

Most communities do not have either the skills or the organizational capacity to maintain motorized pumps. Centralized maintenance, which depends on a mobile team of skilled mechanics traveling to repair breakdowns in motor vehicles, has proved to be expensive and unreliable on all types of water supplies, including handpumps. Handpump systems enable simpler maintenance arrangements to be established.

More successful projects typically involve handpumps selected to be maintainable at the village level by a local caretaker equipped with basic tools, or by an area mechanic. The operation and maintenance demands of motorized pumping systems are greater, and it is vital that the community should have access to reliable fuel supplies and to the necessary skills and equipment for upkeep of the system, before a decision is taken to implement a CWS project based on motorized pumps.

For communities connected to a dependable electric grid, an electric submersible pump feeding standpipes or yardtaps from an elevated tank can give a reliable supply, providing that skilled pump mechanics are on

"It is clear that most of the population in need of improved supplies will have to be provided initially with low-cost solutions, for financial reasons alone."

Box 1.1 Laboratory Testing of Handpumps

A standard procedure for testing handpumps has been developed by Consumers' Association Testing and Research (CATR) Laboratories in the UK, and some 40 types of handpumps have been tested to date.

While laboratory testing cannot fully replicate pump operation in the field, it can provide valuable comparative information in a relatively short period of time. Manufacturers can thus obtain an early assessment of potential problems, before the pump is subjected to the more costly and time-consuming stage of field testing. The controlled conditions of laboratory testing also ensure that direct comparisons can be made between the performance of different pumps.

In the laboratory tests, each pump is subjected to a 4,000 hour endurance test — 2,000 hours of pumping clean hard water, followed by 2,000 hours in which a controlled concentration of abrasive materials is added. Pumps are mechanically driven at 40 strokes per minute, or the speed most appropriate to the pump design, with a simulated pumping head representing the manufacturer's recommended pumping limit. The full test corresponds to about 2 years of use in the field at an average 6 hours per day.

Before endurance testing, each pump is

inspected on delivery and packing, assembly, condition of parts and quality of installation instructions are assessed. Measurements are taken of volume flow, work input, mechanical efficiency, and footvalve leakage, at three water depths and three stroke speeds. Reactions to pump operation are obtained from different types of users (men, women and children), and the results of their performance with each pump are recorded. An engineering assessment includes evaluation of suitability for manufacture in developing countries, ease of installation, maintenance and repair, resistance to contamination or abuse, potential safety hazards, and suggested design improvements.

A brief verdict on the test results and an overall assessment of the pump is communicated to the manufacturer for comment. Full descriptions of the tests carried out and the assessments resulting from them have been reported in Project Reports 1-4 and World Bank Applied Technology Note No. 2. Report 4 (World Bank Technical Paper 29) also contains full details of the test procedures.

Laboratory test results have been used, and combined with field trial information where available, to develop the pump ratings in the Pump Selection Guide (Chapter 5), and to prepare the individual pump entries in the Handpump Compendium.

hand when repairs are needed, and an organization exists to collect charges and pay for repairs. Diesel pumps have a poor performance record in community water supplies, principally because of the logistical difficulties in many developing countries of guaranteeing fuel supplies to remote areas and the mechanical skills and spare parts needed to keep the pumps in working order.

Regardless of the technology chosen, people will operate and maintain an improved water supply only if they value it. It must provide an appreciable improvement over existing traditional sources (greater convenience, better water quality); it must be well designed (sufficient pumps for the community population to avoid long queues); and water points must be sited in consultation with the community.

The combination of financial, technical and institutional constraints and the severe shortage of skilled manpower in developing countries, mean that systems involving motorized pumping will be beyond the reach of the large majority of those in need of new supplies by the year 2000. For them, wells equipped with handpumps will be a first step. Guidelines to identify communities for which handpumps will be the right option and those for which a higher service level is more appropriate are the subject of Chapter 2.

The Handpumps Project

Recognition of the important role that handpumps would have to play in meeting Water Decade objectives prompted UNDP and the World Bank to initiate the Inter-regional Project for Laboratory and Field Testing and Technological Development of Handpumps for Community Water Supply (the Project) in 1981. Sponsored by UNDP, executed by the World Bank, and co-funded by a number of other agencies, the Project now has a program of activities extending to 1991.

The initial aims were focussed mainly on handpumps. Many of the handpumps then being used to supply as many as 500 villagers per pump in developing countries were little altered from the household pumps which served individual European and American families more than half a century ago.

The large majority of handpumps in use in developing countries today are suction pumps serving only one or a few families. There are several million in use in China, over a million in Bangladesh, and hundreds of thousands in other Asian countries. These pumps, even though they have serious drawbacks, as explained in Box 4.1 in Chapter 4, are cheaply produced by local manufacturers, are durable enough for their light use, and can easily be maintained by the users. The Project has therefore addressed itself to the more serious

FIELD TRIALS AND NUMBER OF PUMPS TESTED

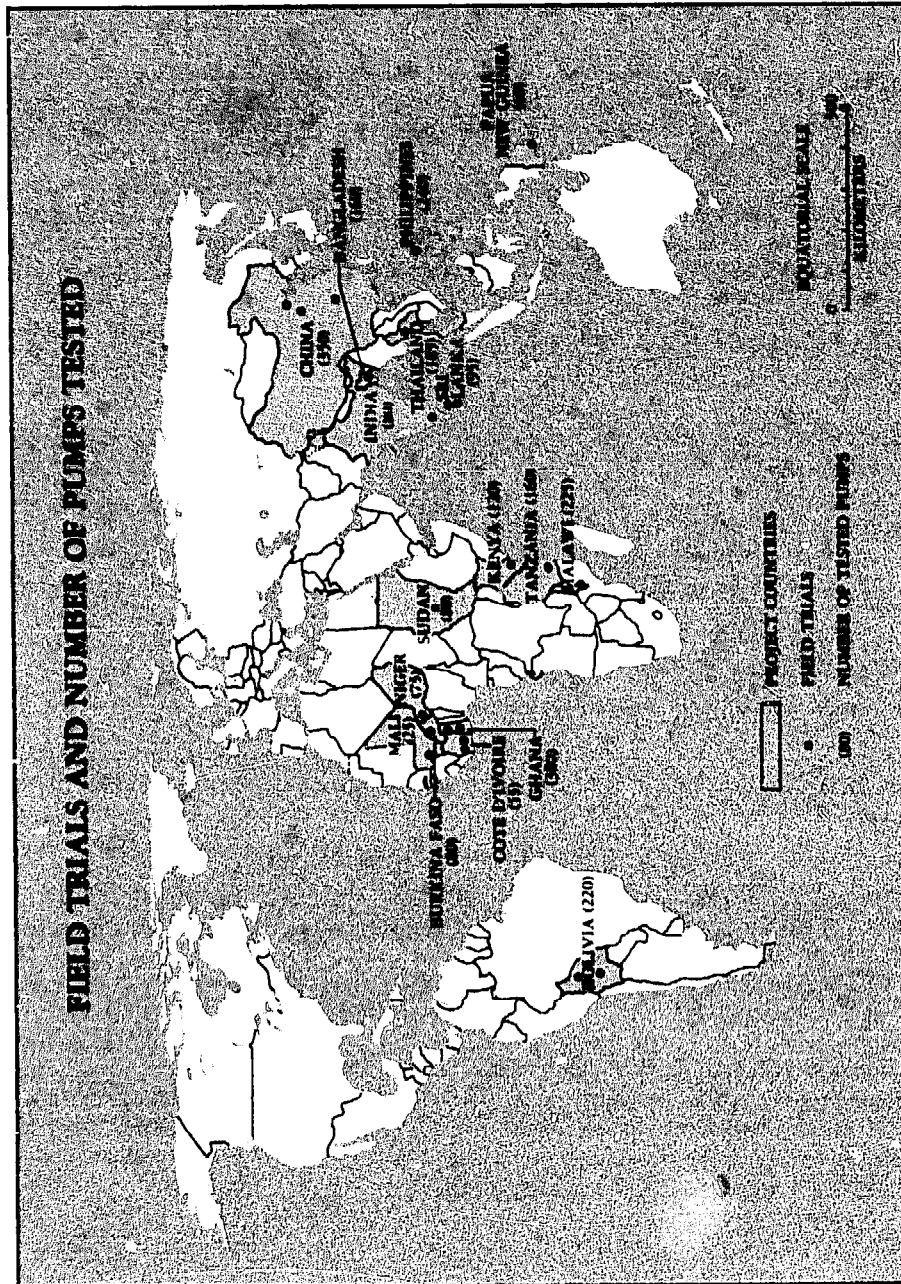

Box 1.2 Field Testing of Handpumps

By mid-1986, the Project had monitored the performance of some 2,700 handpumps in 17 countries - eight in Africa, eight in Asia, and one in Latin America (see map opposite). Most field trials have had a minimum duration of two years, during which a full-time Country Monitoring Engineer (CME) — usually a United Nations Volunteer — participated in the installation and maintenance and monitored the performance of all pumps in each field trial.

To be included in the field trial, a handpump had to meet one or more of three criteria:

- The pump type was in widespread use in developing countries.
- It was commonly used in the country of the field trial.
- It was judged by the Project to have **VLOM** potential.

In all, some 70 different pump types were tested, and it was thought that a minimum of 20 units of each type would be needed to ensure statistical validity of the results. In fact, an average of about 40 units of each pump type were installed, but it turned out that only small numbers were needed to demonstrate the difficulty of repairing some pumps, while some performed so poorly as to be totally unacceptable to the users or implementing agency and monitoring was discontinued.

The Project prepared standard monitoring forms for use in all countries, to make data comparable. The forms record well and pump characteristics, site inspection details, repair and maintenance interventions, social and cultural factors, and cost data (copies of the forms are contained in Annex E of Project Report 4 - *Handpumps Testing and Development: Progress Report on Field and Laboratory Testing* — World Bank Technical Paper 29). In particular, each breakdown/repair report includes details of the reason for the breakdown, the type of repair needed, the amount of time taken, equipment used, etc, along with descriptions of parts replaced and their cost.

In a few cases where the same pump type is produced by more than one manufacturer, each manufacturer's pump has been evaluated separately, to cover potential differences in production quality control or design modifications. Any variations in performance between different manufacturers' versions of the same pump model are noted in the Handpump Compendium at the end of this report, where the total

of 70 pump types tested are reduced to a total of 42 individual entries because some are no longer manufactured and others have been grouped with similar designs by other manufacturers.

Pumps were visited, inspected, and repaired as necessary, at intervals of one to three months, enabling the CMEs to keep track of user reaction, repair difficulties, robustness, and resistance to damage from abrasion or corrosion. The monitoring was not fully representative of actual operation in a typical community water supply, in the sense that maintenance and repair interventions were coordinated by the CMEs, so that the maintenance system was a combination of village participation and central management (Maintenance Systems A and C as defined in Chapter 5). However, efforts were made, in collaboration with the implementing agencies, to expand the scope and quality of village participation as the field trials progressed.

Data from the forms were analyzed periodically by the CME and compiled in quarterly reports for the information and comment of the Project staff and agencies collaborating in the particular field trial. The Regional Project Officers made frequent visits to each field trial area in their regions, to assess progress and results with the CME.

As the field trials progressed, some manufacturers modified their pumps, in response to information from the Project about problems identified in the laboratory or the field. If the Project staff judged that the modifications had potential for improving the field performance, modified components were retrofitted into the pumps being monitored, or in a few cases replacement pumps were installed and monitoring began again.

This clearly meant that the new installations were monitored for a shorter period than the unmodified pumps, and complicated comparison of the results. In presenting the results in this report, Project engineers closely involved in the installation and evaluation of the pumps have sometimes had to apply "best judgment" in an attempt to make all the assessments compatible.

In addition to the unique comparative data collected on handpump technology, Project personnel have been well placed to evaluate other factors which can affect handpump performance. As Chapters 3 and 4 emphasize, field trial experience has amply demonstrated that, while a suitable pump is a critical ingredient for a successful water supply, other ingredients are also vital, among them: proper well design and construction; proper pump installation; and proper planning of operation and maintenance.

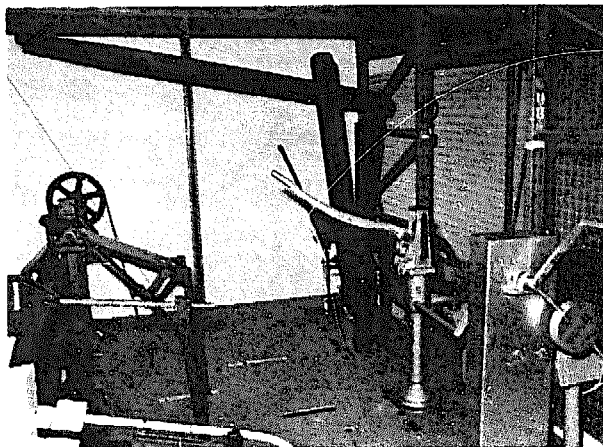

Some 40 types of handpumps have been tested so far in a specially built test tower at the CATR Laboratory in the UK.

problem of pumps for use by more than about 50 people.

Based on the supposition that high failure rates on past handpump projects were caused by inadequate pump designs, the Project set out to evaluate the major handpump types then on the market, to cooperate with researchers and manufacturers in the development of design improvements, and in new designs, and to produce guidelines to assist developing countries in the selection of appropriate pumps for specific applications.

While these initial objectives have remained at the core of the program, the focus has widened considerably, as it became clear from the early findings that handpump technology, though clearly important, was only one of several interdependent factors influencing the success or failure of community water supply projects. Other critical elements were identified, such as: the planning and organization of handpump maintenance; the design and construction of wells; and the capacity and willingness of the community to pay for the upkeep of the completed system.

Crucial elements in the evolution of the Project and in the formulation of conclusions and recommendations have been the rapid and widespread dissemination of results and conclusions, and the feedback obtained from collaborating governments, donor agencies, and manufacturers. The wide scope of the Project has made it vital that as many people as possible were kept informed about its activities and about the concepts being developed. The Project methodology therefore includes provision for regular contacts among those directly involved in Project activities, workshops to exchange experiences and ideas with others involved in the sector, and many individual contacts with handpump manufacturers.

The Project began with laboratory testing of the most commonly used handpumps in a purpose-built test rig at the Consumers' Association Testing and Research (CATR) Laboratories in Harpenden, England. CATR had previously tested 12 handpumps in a program sponsored by the Overseas Development Administration (UK), and these results provided a basis for the Project test

program. In all, some 40 pump models have been subjected to endurance tests, designed to reveal their durability and the frequency of maintenance or repair needed.

The laboratory trials also involved other tests, to assess the suitability of pumps for manufacture, operation and maintenance in developing countries (see Box 1.1). Results were reported to the manufacturers as the need arose during testing, and Project Reports 1 to 4, which include details of the CATR findings, were circulated to a wide audience in the CWS sector. The aim, achieved in many instances, was to encourage improvements to existing handpump models alongside the formulation of guidelines for new designs.

The laboratory results provide a useful quick guide to a pump's likely long-term performance, but they cannot fully simulate the conditions under which handpumps must operate in developing countries. The Project has therefore undertaken an extensive program of field testing of handpumps, creating a unique data base on the performance of most pumps in common use for community water supplies. A total of 2,700 individual handpumps have been monitored in trials covering 17 countries and spanning over two years of actual operation. Again, results have been shared with manufacturers, participating governments and donor organizations, and feedback has played an important part in the data gathering and analysis of field trial results. Box 1.2 describes the methodology of the field trials.

The initial intention to develop a new generation of handpumps specifically designed to be durable when used in developing countries was only part of the solution to performance problems on handpump projects. The field trials confirmed that, as Pacey¹ and others had written, maintenance difficulties often arose more from institutional or financial shortcomings than from technical difficulties with the pumps themselves. Pumps had been remaining idle because mechanics,

"... maintenance difficulties often arose more from institutional or financial shortcomings than from technical difficulties with the pumps themselves."

tools or spare parts were not readily available, or because there were no funds to pay for the expensive central maintenance teams to travel long distances to carry out individual repairs. And many pumps were failing because of poor well construction, allowing large

1. Pacey, Arnold. "Technology is Not Enough: The Provision and Maintenance of Appropriate Water Supplies." *Aqua* 1 (1977):1-58

Box 1.3 The VLOM Concept

An early conclusion of the Project was that strong involvement of the user community in maintenance was essential for successful projects. The Project coined the term **VLOM** — Village Level Operation and Maintenance — as a means of bringing home to handpump manufacturers and users the key issue in solving widespread problems experienced with centralized maintenance.

Experience in one country after another has shown that a central maintenance system, requiring a motor vehicle and crew to move out from a base camp, is unable to keep pumps in satisfactory operating condition. The large expense of such maintenance and the logistical and staffing needs to supply enough experienced and motivated teams of mechanics to carry out repairs promptly have proved very difficult to sustain. But the desirable alternative of village-level maintenance is only feasible if the pump design allows for it.

Initially, the **VLOM** concept was applied only to the hardware, the aim being to develop pumps specifically designed to be:

- Easily maintained by a villager caretaker, requiring minimal skills and few tools;
- Manufactured in-country, primarily to ensure the availability of spare parts;
- Robust and reliable under field conditions ; and
- Cost effective.

When the Project started, pumps meeting these needs for lifts of more than 7 meters were not readily available on the market, and their development had to

be motivated. Recognizing that central maintenance cannot be dispensed with overnight, the Project has also encouraged manufacturers to improve the durability of existing pumps, to lengthen the interval between repairs.

The **VLOM** principles were well received. Manufacturers quickly responded to reliability problems identified in laboratory and field testing, and worked to develop pumps which can be more easily repaired by handpump caretakers or local mechanics. At the same time, planners and promoters of hand-pump schemes began to pass on responsibilities for maintenance to the pump users, selecting pumps accordingly and introducing training courses for pump caretakers and area mechanics. As project experience has grown, and donors and implementing agencies have experimented with better ways to design projects, alternative maintenance systems have been assessed, and it has become clear that different models work best in different circumstances. This has led to an extension of the **VLOM** concept into software, or organizational matters.

A common feature of successful handpump projects is the emphasis on village management of maintenance, reducing the dependence on central government support of essential functions. In the extended **VLOM** concept, where **M** means Management of maintenance, these elements have been added:

- Community choice of when to service pumps;
- Community choice of who will service pumps; and
- Direct payment to repairers by the community.

quantities of sand to reach the pumping elements.

Once these critical issues became clear, the scope of the project was extended. Data has been collected from the field trials and from as many other CWS projects as possible, which would enable conclusions to be drawn about all the key elements of a handpump-based CWS system. Many of these conclusions are relevant to other CWS technologies as well as handpumps, as will become apparent in Chapter 2.

New concepts were developed, as the defects of existing systems became apparent. Data from a number of different countries showed that a major cost element in pump maintenance was transport, and the Project began to look for ways of reducing the need for expensive mobile teams. It was clear that greater involvement of the community itself in maintenance would bring both lower costs and better reliability.

This very early conclusion led to the coining of a new

term — **VLOM** — for Village Level Operation and Maintenance, which has been closely associated with the Project since 1981 and is now widely used by planners and manufacturers alike. The **VLOM** concept includes the development of handpumps specifically designed to be maintained by village caretakers, but also extends into the institutional arrangements needed to ensure that skills, tools and spare parts are available when needed (see Box 1.3). The term **VLOM** has therefore been expanded to mean Village Level *Management* of Maintenance (see Box 1.3).

Promotion of the **VLOM** concept through workshops, press articles and individual or group discussions became another element in the Project program, and spawned additional activities alongside the monitoring of field trials. To assist the development of pumps suitable for village-level maintenance, Project staff have collaborated with existing manufacturers in

the formulation of new designs. In addition, the Project has provided technical assistance to a number of manufacturers in developing countries stimulating improvements to existing designs and developing quality control procedures.

Developing country governments have been given technical assistance in the planning and implementation of handpump projects based on **VLOM** principles, and feedback from planners and designers is being incorporated in model maintenance systems developed by the Project for future field demonstration and testing. As the field trials were coming to an end, results and preliminary conclusions were submitted to the collaborating agencies, and their reactions too are being incorporated in the Project recommendations for future activities.

In the course of the field trials, a number of issues have arisen which have special importance on particular projects, and which local Project staff have investigated in some detail. Their findings will need further study before general conclusions can be drawn, but the data collected has already provided some solutions for pressing local problems. Among these special studies are: links between water supply, sanitation, and health improvements (e.g. Bangladesh); corrosion and groundwater quality (e.g. Ghana), and well construction techniques (e.g. Kenya and China).

The Reliability Issue

In comparing the performance of different handpumps in the field trials, it has become apparent that the conventional interpretation of "reliability", based on the Mean Time Before Failure (MTBF), is inappropriate. The critical item is the period of time for which many pumps stand idle while waiting to be repaired. The Project has therefore adopted a definition of *Reliability* which in the mechanical engineering industry would refer to *Availability*, i.e.

Reliability is the probability that the pump is in operating condition on any one day, calculated as the sum of the operating time before failure divided by the total time.

With this definition, it is clear, as Box 5.2 in Chapter 5 shows graphically, that a pump which breaks down on average after 18 months of operation, but then stands idle for two months each time, waiting for the mobile maintenance team to arrive, is less *reliable* than one which breaks down after 8 months, but is repaired within a week by an area mechanic.

This concept of reliability is crucial in comparing CWS technologies. The response time of maintenance organizations is critical, and reliability can only be assessed when the characteristics of the technology and the institutional support are taken into account.

Project Impact

Throughout the Project, issues brought to light by

laboratory field trials or by experiences on other projects have been brought to the attention of the Project's wide audience as quickly as possible. In this way, it has been possible to ensure that changes in technological or institutional approaches could be implemented quickly, without waiting for detailed analyses to be published in a final report. It is encouraging to note ways in which preliminary findings from the Project have influenced recent developments in the CWS sector.

- Aware of a large potential market for suitable pumps, manufacturers have responded quickly to test results, seeking to produce improved pumps, or even to undertake complete re-design. While some manufacturers withdrew pumps from the market after they performed poorly in laboratory or field trials, many chose to make changes and have been very willing to submit their new designs to the rigorous scrutiny of Project testing. One result is that recent projects in West Africa, using international procurement procedures, have attracted a large number of qualifying bids, a reflection of both increased interest in the sector and more pump models which meet performance and durability requirements. The Project has published Draft Sample Bidding Documents for the procurement of handpumps by international competitive bidding.

- To accelerate the introduction of design changes needed to produce true **VLOM** pumps, Project staff have been collaborating with manufacturers and research organizations in developing countries. Local manufacture of handpumps is growing rapidly in many countries, with joint ventures and licensing arrangements also making some existing pumps more suitable for **VLOM**. There is still a shortage of pumps which meet **VLOM** requirements and are capable of pumping from depths beyond 25 meters, but several prototypes have performed well in preliminary field tests and there are grounds for optimism that choice will be less restricted in the near future. The new prototypes make substantial use of plastics for below-ground components and for long-lasting easily-replaceable plastic bearings which are also light and cheap (see Chapter 4).

- By identifying weak elements in past handpump schemes, the Project was instrumental in creating an awareness among donors and implementing agencies that pump selection and planning of maintenance are critical to long-term success. This is beginning to lead to a tightening of pump specifications, and a recognition that a policy of tied aid involving pumps from the donor country is ultimately counter-productive, because failure of the pump jeopardizes the much larger investment in the well.

Donors now increasingly monitor handpump performance on their own projects, and are assisting with in-country manufacture of the most suitable hand-

pumps. Apart from its added development impact, the donors find that avoiding tied aid for handpumps significantly reduces the extra commitment that they have had to make in the past to continued financial and manpower support for operation and maintenance of imported pumps.

Probably the most significant impact of the Project to date, however, has been the widespread recognition that management of systems once they are installed must be a community responsibility, and that community participation must start at the planning stage. When that recognition is translated into establishment of village-based organizations to look after completed projects, dramatic improvements can be expected in the reliability of handpump-based schemes (India has already shown what can be achieved in a short time, by reducing the failure rate of village handpumps from about 70% in the mid-70s to about 20% today, with further improvements anticipated as more design modifications are made to the standard India Mark II in line with **VLOM** criteria).

- Sand pumping was found to be a major cause of handpump failure in the field trials - affecting even those pumps which had performed well in the laboratory tests. Damage to leather cup seals was the main cause of breakdown, and new designs of nitrile rubber seals are now being tested for a number of pumps, with encouraging results. At the same time, the Project has demonstrated in East Africa the dramatic impact on pump performance of improved well design and construction. The same techniques are now being introduced in other field trial areas with sand pumping problems.
- An important result of the field trials in West Africa was the extent of rising main, pumprod and other component failures caused by corrosion (as many as 60% of the failures in the southern Ghana field trials were directly attributed to corrosive well water, and galvanizing offered little protection — see Box 4.3 in Chapter 4). The findings have been combined with data from other agencies, and revealed that corrosive groundwater is much more widespread and much more damaging than previously suspected, in both Africa and Asia. Further work is planned on this important problem.

Future Activities

The first phase of the Project, during which primary emphasis was placed on the improvement of pump technology, is drawing to a close. Worldwide experience with CWS projects has established the essential elements of sustainable and replicable CWS systems.

The Project emphasis is now switching to implementation. Through technical assistance in project preparation, and collaboration in activities incorporating the concepts of community management and public agency support, the Project will be actively promoting



The potential of handpumps for micro-irrigation is largely unexplored.

widespread implementation of low-cost CWS programs. Within projects designed to take advantage of the present state of knowledge, studies will continue into issues which can be expected to lead to additional improvement in the effectiveness of future programs. Among the issues to be addressed in this second phase are:

- Community financing and management, including the role of women.
- Cost-effective drilling, well design, construction and development.
- Further development of **VLOM** handpumps.
- Human resources development at all levels in the public and private sectors.
- Establishment of maintenance systems, including selection, training and payment of caretakers.
- Project design criteria, including choice of service level.
- In-country manufacture of pumps, including quality control procedures and spare parts supply and distribution.
- Solutions to water quality-related problems, especially corrosion.
- Sanitation and health education components.
- Non-domestic water uses, such as micro-irrigation and cattle watering.

Governments and aid agencies will be offered assistance in selecting the most suitable pumps for each country or region, in institutional aspects of system management, and in ways to introduce a policy

of standardization to maintain an uninterrupted supply of spare parts. The technical assistance already being provided in some countries for manufacture is to be extended to include advice on pre-selection of designs and strengthening of internal and external quality control procedures. From manufacture, the process will be taken through, as needed, to distribution, with the establishment of networks of spare parts outlets, ultimately handled by the private sector.

The key issue of drilled-well design and construction is to be tackled by an investigation of the reasons for high well costs in Africa and guidelines on design and construction techniques. Wherever possible, new projects will serve as venues for establishing efficient drilling processes and bringing down costs.

The advantages of handpumps for rural domestic water supply are now clearly established, but limited attention has yet been given to the potential use of handpumps for micro-irrigation. Small-plot irrigation offers both subsistence and cash earnings in parts of Africa and elsewhere, but is hampered by the unreliability and high cost of motorized pumping. Combining domestic water supply with micro-irrigation and livestock watering could have appreciable economic benefits for village communities, especially, but not solely, in the dry zones. Studies are planned to assess the demand and cost-benefit of such multi-purpose use of handpumped water.

The Project has already demonstrated that CWS systems perform best when the community is involved in each stage of project planning, construction and maintenance, and when proper training has been provided for pump caretakers and mechanics. Future projects will include measures to involve the community from the beginning, and will give special emphasis to the potential role of women as pump caretakers where appropriate, and to cost recovery, contracting of maintenance staff, and involvement of the private sector.

A crucial aspect of the Project's next phase will be its collaboration with developing country institutions, to assist in building up their capacity to provide the necessary guidance and support in the long term, and to extend and replicate successful projects. This will involve the creation of action plans for institutional development, training, research and testing.

The scope of future Project activities was recently approved by its Advisory Panel. Core funding has been assured by UNDP, and several bilateral aid agencies are committed to cost sharing. The Panel emphasized however the need for other organizations, particularly donors and specialized agencies, to increase their efforts along similar lines.

Close collaboration will therefore be sought with governments and donor agencies to benefit from the combined experience gained so far, and to work towards the common goal — rapid implementation of sustainable

Table 2.1 Options for Community Water Supply

Step	Type of Service	Water source	Quality protection	Water use LPCD ^a	Energy source	Operation and maintenance needs	Costs	General remarks
5	House Connections	Groundwater Surface water Spring	Good, no treatment May need treatment Good, no treatment	100 to 150	Gravity Electric Diesel	Well-trained operator; reliable fuel and chemical supplies; many spare parts; wastewater disposal	High capital and O&M costs, except for gravity schemes	Most desirable service level, but high resource needs
4	Yardtaps	Groundwater Surface water Spring	Good, no treatment May need treatment Good, no treatment	50 to 100	Gravity Electric Diesel	Well trained operator; reliable fuel and chemical supplies; many spare parts	High capital and O&M costs, except gravity schemes	Very good access to safe water; fuel and institu- tional support critical
3	Standpipes	Groundwater Surface water Spring	Good, no treatment May need treatment Good, no treatment	10 to 40	Gravity Electric Diesel Wind Solar	Well trained operator; reliable fuel and chemical supplies; many spare parts	Moderate capital and O&M costs, except gravity schemes; collection time	Good access to safe water; cost competitive with handpumps at high pumping lifts
2	Handpumps	Groundwater	Good, no treatment	10 to 40	Manual	Trained repairer; few spare parts	Low capital and O&M costs; collection time	Good access to safe water; sustainable by villagers
1	Improved traditional sources (partially protected)	Groundwater Surface water Spring Rainwater	Variable Poor Variable Good, if protected	10 to 40	Manual	General upkeep	Very low capital and O&M costs; collection time	Improvement if traditional source was badly contaminated
0	Traditional sources (unprotected)	Surface water Groundwater Spring Rainwater	Poor Poor Variable Variable	10 to 40	Manual	General upkeep	Low O&M costs (buckets, etc); collection time	Starting point for supply improvements

a. LPCD = liters per capita per day

Chapter 2

Choice of Community Water Supply Technology

The technology choices open to planners of community water supply (CWS) programs are best characterized by the type of water points they provide: **handpumps**; **standpipes** (i.e. public taps); **yardtaps**; and others, such as dug wells without pumps. Costs and potential benefits differ for each option, and technology choice cannot realistically be made on the basis of cost alone.

Measuring benefits is difficult, involving technical, economic, behavioral, nutritional, and public health factors among others. But an estimate of benefits has to be made in order to compare technologies and select the most appropriate. The scale of benefits is influenced by two key technical factors — the **service level** (i.e. the distance water must be hauled from the water point to the dwelling, queuing plus filling time for each water hauler, and the ease of drawing water); and the **reliability** with which water is available at the water point when needed.

The low cost and simplicity of handpumps have proved attractive to government agencies and external support organizations seeking maximum impact from limited budgets, and have led to increasingly widespread implementation of handpump projects in recent years. But handpumps also have their limitations: though the haul distance will normally be shorter than from the original traditional sources, water must still be pumped by hand and carried home, with corresponding costs in time and effort; and maintenance needs, though simple when compared with motorized pumping or water supplies involving treatment facilities, may still be beyond the capabilities of the community.

If motor pumps can be reliably operated and maintained, the community may be willing to pay more for the improved service level. As pumping lift increases, handpumps produce less water and require more effort to pump, increasing comparative advantages of well-run motorized pumps with standpipes or yardtaps. The options need to be compared in a consistent economic and financial framework, which also takes account of physical and institutional resource constraints.

Close scrutiny of the reasons why past projects

have failed to live up to expectations suggests that an important factor was the choice of a CWS technology which was not sustainable with the resources available to the community. The important message for CWS planners is that:

- **The technology chosen should give the community the highest service level that it is willing to pay for, will benefit from, and has the institutional capacity to sustain.**

In general, technologies offering higher service levels place correspondingly higher resource demands on the benefiting community. The most obvious is the need for more capital investment, but equally important are operation and maintenance costs and the demands for technical skills and materials (fuel, chemicals, etc.).

Technology Options

Table 2.1 shows the different CWS technology options as a series of steps. Provided satisfactory reliability can be achieved, the level of service rises with each step, as do the total costs, the complexity of the system, and the difficulty of designing, constructing and maintaining it.

The step analogy of water supply improvements is useful, but it should not be taken too literally. When reliability is taken into account, the level of service actually provided is often much lower than planned. Also, the steps are not equal; progress is not necessarily achieved one step at a time; and not everyone will start at the bottom. Many communities may find that one of the lower steps offers a satisfactory option for the foreseeable future, while others will upgrade to a technology giving a higher service level when the community acquires operational experience and the capacity to manage a more complex system.

The main task in planning CWS improvements is to select the technology which will give the highest service level practical with the available resources:



The skills and resources needed for operation and maintenance are important considerations when selecting an appropriate water supply technology. Handpumps suitable for servicing by village caretakers stand a good chance of providing reliable service.

- **Financial resources** (for capital and recurrent costs);
- **Physical resources** (water and energy); and
- **Organizational resources** (manpower and institutional).

If that selection is right, the scheme can be expected to provide the desired service level for many years, and may later be upgraded to, or replaced with, a technology giving a higher service level. If, on the other hand, any of the resources needed for the chosen technology are not reliably present, none of the anticipated benefits may materialize after construction. Success or failure depends primarily on one factor: can the new water system be sustained?

In terms of service level, the technology options in Table 2.1 can be divided into two groups, according to the way in which water is conveyed to the users' homes. Steps 0 through 3 involve communal supplies from which the water is carried by the user, while in steps 4 and 5 pipes transport it to individual homes.

The level of service provided by communal supplies varies according to the amount of time it takes to travel to and from the source, to queue, and to fill containers; it depends too on the reliability of the supply at the source. Standpipes are more convenient than handpumps in that water is drawn from a tap rather than by manual pumping, but, unless a gravity supply is available, they must rely on motorized pumps and elevated storage to maintain supplies.

“Success or failure depends primarily on one factor: can the new water supply be sustained?”

Groundwater is usually preferred over surface water as a source, because it avoids the need for special, often unreliable, measures to safeguard water quality or improve it through treatment. If simple rules are followed about the proximity of latrines and the construction and management of well surrounds, groundwater should be safe from bacteriological contamination.

When well water is not up to drinking standards, a combination of sources may be the right answer, as the example from Thailand in Box 2.1 shows. In many areas of Thailand, none of the water sources alone satisfies domestic needs. Dug wells, with or without covers and handpumps, tend to be both chemically and bacteriologically polluted. Drilled wells have an unacceptably high mineral content, while rainwater storage provides only enough water for drinking and cooking. The program therefore uses a mix of sources for different purposes.

Investment Efficiency

When resource constraints are applied to the selection of an appropriate water supply technology, it may turn out that improvement of traditional sources (Step 1 in Table 2.1) is the only feasible option. In this rare case, no further comparison with other options is needed. In most situations, however, comparison is needed of several feasible options, in which the benefits expected from the different service levels vary, as do the costs.

A common approach is for the government, sometimes in collaboration with donors, to set a target for a desired service level, and to select the feasible system which gives the lowest total cost (annualized capital cost plus recurrent cost) for that service level. This method has often been applied, in an effort to bring small but important improvements to as many people as possible. Its weakness is that it takes no account of the different levels of benefits provided by different levels of service, and does not leave room for those communities which are willing and able to pay for a higher service level to express their preference. In other cases it may lead to the selection of an inappropriately high service level for only a few people, leaving the majority of the population without coverage.

In the Philippines, for example, even in relatively high income areas with good infrastructure, a large subsidy provided for the construction of wells with handpumps has meant a very low demand for piped schemes (offered with virtually no subsidy). Another example comes from Thailand, where a donor-assisted project initially tried to put just a single well in each village. The strategy failed because the communities did

Box 2.1 Evaluating Technology Options: A Case Study from Thailand

Of the four basic water resources available in rural Thailand — rainwater, shallow aquifers, deep aquifers, and surface water — none is able alone to provide all the needs for community water supply. A typical Thai household needs about 5 liters per person per day of safe, palatable water for drinking, cooking and cleaning teeth. Other domestic uses, such as washing, bathing and latrines, require about 50 liters per person per day. On a seasonal basis, each rural family also needs about 4000 m³ per year for supplementary irrigation.

Rainwater, collected from roof runoff and stored in jars and tanks, is generally of good quality, but barely enough to meet drinking needs. **Shallow aquifers**, tapped usually by open wells, or occasionally by a sealed well with a suction handpump, are commonly used for drinking and other domestic uses, though bacteriological quality from open wells is unacceptable for drinking, and in the water-short Northeast the wells often dry out during the dry season. **Deep aquifers**, tapped by handpumps on drilled wells provide water with acceptable bacteriological quality, but in most areas the chemical quality is poor, and the taste is unacceptable. So, though the supply is reliable, it is rarely used for drinking or for agricultural needs. **Surface water** comes from natural lakes and rivers, and from man-made ponds, irrigation ditches, weirs and reservoirs. The water is of poor quality and unsuitable for drinking, but can provide domestic and agricultural supplies.

Since 1966, Thailand's National Economic and Social Development Board (NESDB) has been implementing a national project which seeks to make

potable water available to all households throughout the year. One of NESDB's projects is the *Thai-Australia Village Water Supply Project*, which began in 1983 and has carried out studies to evaluate the effectiveness and cost of different water supply options.

Surveys showed that rainwater storage and capped shallow wells are the only facilities which consistently provide safe, palatable water, and that treatment to improve the quality of water from other sources is not practical. Handpumps on drilled wells are a major source of domestic water supply. In Khon Kaen Province, for example, 65% of the villages have a government tubewell, supplying 25% of domestic needs in the wet season and 40% in the dry season. However, only 10% of the wells are used for drinking.

Cost analyses (Box Table 2.1A) show that open shallow wells are by far the cheapest form of domestic water supply. Rainwater storage in jars is more economic than in tanks, costing about the same per household per year as a covered shallow well equipped with a suction pump. Ponds and weirs have high capital costs, while the highest cost per household is for drilled wells with handpumps.

Quality and cost criteria together have led NESDB to a strategy based on a mixture of technologies. Despite their higher costs, deep wells with handpumps are popular with villagers, because they provide convenient and reliable clean water suitable for most domestic purposes (but not drinking). Because of these benefits, Thai communities are willing to pay more for handpumped supplies.

Box Table 2.1A Costs of Rural Water Supply Options in Thailand (US\$)

Type of system	Capital cost	Maintenance cost	Total annual cost	Households served	Annual cost/household
Rainwater jar	19	0	2.50	0.31	8.15
Rainwater tank	245	1.85	29.00	1.78	16.00
Shallow dugwell without handpump	93	0	15.00	20	0.75
Shallow dugwell with handpump	540	93.00	165.00	20	8.15
Drilled deepwell with handpump	2660	93.00	440.00	20	22.00
Pond	1850	3.70	305.00	20	15.25
Weir	10000	18.50	1625.00	100	16.25

Note: Converted from Baht at US\$1.00 = Baht 27.00

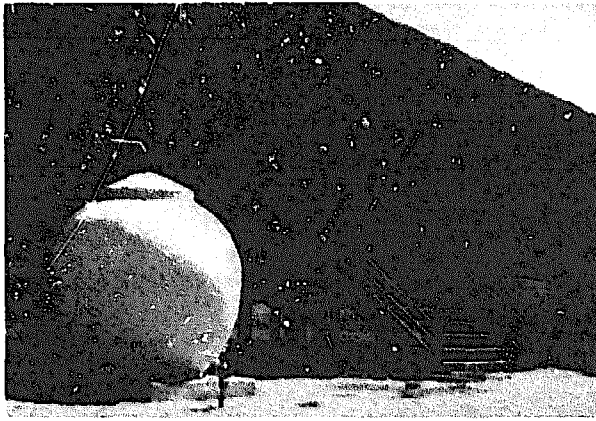

Rainwater storage can be an effective and economic option for providing drinking water, and should be analysed as a possible component of CWS programs.

not value the improvements highly enough to contribute to their maintenance. A second approach provided several standpipes dispersed around the villages, but also failed for the same reasons. Only when yardtaps were brought to most villagers did the scheme become successful. Though the yardtap plan was much more costly, households were willing to pay because they valued the extra convenience.

Costs

Capital costs of various levels of service depend very much on local conditions, but the *relative* costs of the different groundwater-based technologies are apparent even though the range of costs may be quite wide. Wells equipped with handpumps generally cost from US\$10 to US\$30 per capita; for motorized pump schemes with standpipes, the range is US\$30 to US\$60 per capita; and for yardtap services the per capita cost can be expected to range from US\$60 to US\$110 per capita. With some 1,800 million rural people in need of improved water supplies by the end of the century, the extra costs of high-level service can be justified only when beneficiaries are willing and able to pay the extra costs in full. The Project has focused on CWS systems involving wells with handpumps because the large needs and limited resources of many developing countries mean that such lower cost technologies will be the only practical first step if as many people as possible are to be served in a reasonable time period.

“... high-level service can be justified only when beneficiaries are willing and able to pay the extra costs in full.”

It would be inappropriate however to promote handpump-based water supplies in areas with good infrastructure, where people are willing and able to pay for the greater convenience of yardtaps or household wells, especially when a reliable electricity supply permits the use of electric pumps. If financial and institutional resources are available to support operation and maintenance, consideration of the higher level of service should be encouraged. Seemingly lower cost options will fail under these conditions, even when subsidized by government agencies, because the low level of service that they provide does not meet the users' aspirations and will not be accepted.

Regardless of how the capital costs of CWS projects are financed, **recurrent** costs (for operation and maintenance) should be borne by the community. The Project has provided further evidence to support the view that community involvement is a critical element in successful CWS maintenance, and that community management, including financial management, of system operation and upkeep is the only way to achieve acceptable reliability at an affordable cost.

Besides analysing costs to the direct beneficiaries, it is also necessary to consider the capital and recurrent costs which would result from the planned investment in the national perspective. For national planners to be able to make choices on economic grounds, all quantifiable costs should be included and adjusted for taxes, subsidies, price controls and exchange rate imbalances, using accepted project analysis techniques. All too often, the rural cost structure is distorted by agricultural prices, and under these conditions there is little incentive or capacity to generate locally the necessary funds for rural development without government assistance.

Incomes in rural areas of many developing countries are typically between US\$50 and US\$300 per person per year, with the distribution of cash and kind income varying widely. Even so, the annualized capital and recurrent cost of low-cost water supplies should constitute only a small proportion of that income.

Table 2.2 includes low and high cost estimates for the different technical options, to illustrate the financial resources which need to be mobilized for different types of water supply improvements. To take account of the range of cost data that was obtained under similar conditions from a large number of projects in Africa and Asia, a "low" and a "high" case are given. "Low" represents a situation of favorable hydrogeology and efficient implementation and maintenance (with community participation); "high" is based on a combination of adverse conditions which exist on some projects.

Estimation of capital and recurrent costs ahead of project implementation is difficult, especially at the beginning of a CWS program. Judgments may sometimes have to be made on the applicability of data from comparable programs in other countries, and estimates must then be refined as the program evolves, as in the example from Thailand described in Box 2.1. However, most countries have some experience of

Table 2.2 Community Water Supply Technology Costs (For a community of 400 people)

Technology	Low			High		
	Handpumps	Standpipes	Yardtaps	Handpumps	Standpipes	Yardtaps
Capital cost (US\$)						
Wells ¹	4,000	2,000	2,500	10,000	5,000	6000
Pumps (hand/motor)	1,300	4,000	4,500	2,500	8,000	9000
Distribution ²	none	4,500	16,000	none	10,000	30000
Sub-total	5,300	10,500	23,000	12,500	23,000	45000
Cost per capita	13.3	26.3	57.5	31.2	57.5	112.5
Annual cost (US\$/year)						
Annualized capital ³	700	1,500	3,200	1,400	3,000	6000
Maintenance	200	600	1,000	400	1,200	2000
Operation (fuel)	none	150	450	none	300	900
Sub-total (cash)	900	2,250	4,650	1,800	4,700	8900
Haul costs (labor) ⁴	1,400	1,100	none	3,000	2,200	none
Total (including labor)	2,300	3,350	4,650	4,800	6,900	8900
Total annualized cost per capita						
Cash only	2.3	5.6	11.6	4.5	11.8	22.3
Cash + labor	5.8	8.4	11.6	12.0	17.3	22.3

Notes:

1. Pumping water level assumed to be 20 meters. Two wells assumed for handpump system (200 persons per handpump).
2. Distribution system includes storage, piping, and taps with soakaway pits.
3. Capital costs with replacement of mechanical equipment after 10 years annualized at a discount rate of 10% over f 20 years.
4. Labor costs for walking to the water point, queuing, filling the container, and carrying the water back to the house. Time valued at US\$ 0.125/hour.

several levels of CWS technology, and careful review of total system costs can provide a basis for estimates on future projects. However good the present data base may be, monitoring and evaluation of new projects is a valuable way of improving forecasting for future schemes.

Benefits

Some benefits from CWS improvements are immediate and highly visible. Access to a convenient source of clean water brings **time savings** and **reduced drudgery** for the household water carriers — commonly women and children, while the easy availability of water for washing and bathing encourages greater cleanliness and leads to **better living conditions**. Other benefits, of which the most important is better health, may be less immediately apparent, and will often depend on additional inputs such as sanitation improvements and hygiene education if maximum impact is to be obtained from the CWS improvements.

Assessment of benefits is a critical element in CWS technology selection, as widespread implementation of improvements at the pace needed to meet global needs can only be achieved if communities are able to make a major contribution towards the costs. Contributions in cash or kind depend on the community valuing the benefits to be obtained, and will continue only for as long

as the new water supply functions reliably.

Health benefits, in terms of reduced medical care, improved productivity, etc., have often proved difficult to isolate and quantify for any single intervention like community water supply. Health impact studies have rarely been designed adequately to isolate health improvements due to provision of safe water from those brought about by other influences (nutrition, sanitation, health education, etc.).

A recent review of a large number of impact studies does show that significant health benefits can be obtained from well-designed CWS programs (Box 2.2). What emerges is that community water supply is perhaps not a sufficient intervention in itself to improve health and quality of life, but it is an essential part of any intervention package.

Protecting the source from contamination can reduce transmission of some diseases, but when water is carried from the water point to the home and stored there, recontamination occurs, as a number of studies have shown. This recontamination negates the need to insist on a high water quality standard at the source, as is the policy in the industrialized countries. Emphasis should instead be placed on improvements in hygiene through sanitation, health education and other interventions, so as to reduce disease transmission through water in the home.

A more direct benefit of improved water supply

Box 2.2 Health Benefits from Water Supply

Evaluation of health benefits resulting from an improved water supply is a subject of some controversy. A number of well-designed studies have produced substantial evidence that health benefits arise when communities receive improved water supplies, but the picture has been confused because other studies have given inconclusive results, largely because they were not properly designed to isolate compounding factors.

There is little room for doubt that water plays a key role in the realization of health improvements from combined interventions, including promotion of such measures as personal hygiene. Much more difficult to establish is the priority that improved water supply should be given in an investment program over other health interventions, such as oral rehydration, immunization and sanitation. Recent advances in methodology, particularly the introduction of the case control method, will allow impact studies to be carried out retrospectively, at lower cost.

The target group for health interventions is usually young children, as they are most susceptible to a variety of diseases, especially those causing diarrhea. It is estimated that nearly 5 million deaths a year occur in children under five years of age (the statistics do not include China), and that each child under five averages 2.5 incidences of diarrhea a year (Snyder & Merson 1982).

A recent review of impact studies from many countries shows a substantial reduction in diarrheal morbidity rates (frequency of diarrhea) in young children attributable to water supply and sanitation improvements. Improvements in water availability or excreta disposal were shown to have more impact on diarrheal morbidity than improvements in water quality, while a substantial impact (37% reduction) resulted if both quality and quantity were improved. The studies also showed a reduction in diarrhea mortality as a result of improved water supply and sanitation, but the

Box Table 2.2A Reduction in Diarrheal Morbidity Rates due to Improvements in Water Supply and Sanitation

<i>Improvement in</i>	<i>% reduction</i>
Water quality	16
Water availability	25
Both quality and availability	37
Excreta disposal	22

Source: SA Esrey, RG Feachem and JM Hughes "Interventions for the control of diarrhoeal diseases among young children. Improving water supplies and excreta disposal facilities." WHO Bulletin 63(4), 1985 pp 637-640.

magnitude of the effect varied considerably with the presence of other risk factors, such as poor feeding practices and low literacy rates (Esrey, Feachem and Hughes, 1985, pp 764-768).

Separate research on the effect of hygiene education shows that it may further increase the impact. The general conclusion to be drawn from the evidence is that:

Well-designed projects combining the availability and quality of water supply, excreta disposal, and hygiene education may achieve a reduction in diarrheal morbidity of 35-50% - and more for diarrheal mortality unless oral rehydration has been successfully introduced (p768).

As part of the Project, the International Centre for Diarrhoeal Disease Research, Bangladesh (ICDDR,B)

systems is the **reduction in the time and energy** required to collect water. Once water is available in a village, the chore of collecting it will take less than an hour a day, compared with many hours in the frequent cases where traditional sources are long distances away.

It is possible, using the method of analysis described in Annex 3, to compare the costs and benefits of the various CWS options, assessing benefits on the basis of time savings alone.

Because people readily perceive the relationship between improved water supplies and time savings, both the Inter-American Bank and the World Bank have placed increasing emphasis on the time saved in carrying water as one way of assessing the benefits of

improved supplies and suggesting the optimum level of service for given economic conditions.

Estimating the value of the time saved can be difficult since, in economic theory, it will depend not only on alternative income-producing activities but also on such things as caring for children or the value of leisure.

Some have suggested using potential income from handicrafts, street peddling, garden plots, etc., as a notional value of time; others stress that willingness to pay, measured by properly designed household surveys (or in some cases indicated by prices paid to water haulers) is the only way to obtain good estimates.

Irrespective of the precise value attributed to time, comparison of the estimated benefits from time savings with the calculated costs of proposed CWS schemes

is conducting an impact study on the effects on diarrheal morbidity in young children of combined improvements in water supply (drilled wells with handpumps), health education, and latrine construction. Preliminary results from a study area in Mirzapur, where handpumps and health education have been provided, show a reduction in diarrhea cases in children under 5 of 31% over a period of one year, when compared with a control area in the same district. Implementation and monitoring will continue, to reinforce the health messages and improve utilization of the installed facilities, and to collect more impact data.

For some diseases, water provides the only transmission route, so that improved supplies are the only way to reduce disease incidence. The best known is Guinea Worm (Dracunculiasis), a debilitating disease, occurring in India and West Africa, and transmitted by drinking water containing an organism which is a host for the Guinea Worm larvae. Provision of a safe potable water supply is a highly effective preventive measure, as documented in two towns in western Nigeria. Before the supply of piped water in 1963 and 1965, Fiditi and Igbo-Ora (combined population 30,000) recorded incidences of Guinea Worm of 20% among schoolchildren in one town and 60% among the total population in the other. No further cases were reported two years after completion of the water supplies, even though the disease was endemic in the surrounding areas (Source: R Muller: "Dracunculus and dracunculiasis". In: B Dawes, ed. "Advances in parasitology, Vol 9", New York: Academic Press, 1971, pp 73-151).

Water supply improvements have to be seen as only one of several interrelated health interventions, forming an integrated program of health care for a particular community. Unlike Guinea Worm, most diseases have multiple routes of fecal-oral transmission, including water, person-to-person

contact and contaminated food. The manner in which different risk factors interact to cause a particular disease incidence is not fully understood, but it is clear that, to realize the full health benefits from RWS improvements, sanitation and food hygiene must also be improved.

It has at times been argued that oral rehydration should be given priority over water supply improvements for cost reasons. While oral rehydration, applied through a primary health care program, is a very effective and relatively inexpensive means of reducing diarrheal mortality, other interventions are needed to reduce morbidity and to prevent or treat chronic or dysenteric diarrhea. This integrated approach to health care forms the four-part strategy of the Diarrheal Disease Control Program of the World Health Organization:

1. Improved case management, with particular emphasis on the early use of oral rehydration therapy in acute diarrhea and on appropriate feeding during illness and convalescence;
2. Improved maternal and child health care, with particular emphasis on breast-feeding, weaning practices, personal and domestic hygiene, and maternal nutrition;
3. Improved use and maintenance of drinking water and sanitation facilities, and improved food hygiene; and
4. Detection and control of epidemics.

Source: RG Feachem, RC Hogan, and MH Merson: "Diarrhoeal disease control: reviews of potential interventions". Bulletin of the World Health Organization, 61(4), 1983, pp 637-640.

can provide a useful indication of the level of service to be provided and the technology to be selected. Thus, for example, although one well per 500 persons would provide a lower cost per capita than one well per 200 persons, the additional time spent queuing would be so great that villagers would simply prefer to continue collecting water from an existing unimproved source.

Some of the main conclusions from applying cost-benefit analysis to the choice of CWS technologies are discussed in Annex 3.

Resource Constraints

Choice from the technology options is not only based on a comparison of their benefits and costs, but also on the feasibility of providing the resources required to sustain

the chosen technology: financial, physical and organizational.

Financial Resources

If CWS projects are to be implemented at the pace necessary and on a wide enough scale to match the needs of developing countries, capital and recurrent costs must be considered within a framework of limited resources. Only if a sizeable proportion of total costs are recovered from the benefiting communities, will it be possible to generate funds and replicate projects on the scale needed.

This does not mean that governments or donor agencies should stop supporting investments in community water supply, but only through mobilization of



Village Level Operation and Maintenance — VLOM — of handpumps has a substantial effect on reducing recurrent costs. The alternative of centralized maintenance is the only option for motorized pumps.

local cash resources is there hope for widespread rapid and self-sustaining improvements in the global situation.

An important difference between handpump schemes and motorized-pump systems is the degree that the latter depend on support from outside the community (it will become clear in Chapter 3 that many present handpump projects also rely on external support, but the Project has shown that the **VLOM** (Village Level Operation and Maintenance) approach can minimize or even eliminate this dependence, resulting in much higher reliability). Once that outside support is fully reflected in cost estimates, sizeable differences emerge in annual recurrent costs per capita of the CWS options.

Because of the urgent need, re-emphasized by the Water Decade, to provide all rural populations with at least a minimum level of improved supply, it will be necessary for most of the construction costs of piped systems, storage reservoirs, etc., associated with the higher levels of service in Table 2.1 to be recovered from the community. In evaluating an individual project or program, planners need to be sure that finance (sources of expenditure and repayments) is available for the service level under consideration — including the

infrastructure needed to keep it functioning reliably.

Converting the high priority for water supply improvements felt by communities into contributions towards their costs is a challenge to governments, which can be met only by good community education and participation. The principle of community involvement or participation in CWS development has been promoted for many years and most agencies have accepted that some form of participation is a prerequisite for success. There is evidence from all over the world that it is the schemes developed by the community (with technical assistance from outside) which stand the greatest chance of being sustained in good working order.

Constraints on available funds for capital and recurrent costs mean that low-cost options will be favored in an environment where maximum coverage is the goal.

“... low cost options will be favored in an environment where maximum coverage is the goal.”

Physical Resources

Water resource limitations are the first and perhaps easiest to assess of the physical resource constraints to be taken into account when comparing CWS technology options. Surface water sources (rivers, springs, etc.) need to be identified, and compared with groundwater in terms of availability and water quality.

Compared with surface water, groundwater as a source has a number of advantages:

- It yields safe water which rarely needs treatment.
- It provides a substantial storage buffer to cope with seasonal variations in supply and demand and with prolonged droughts.
- It enables a variety of relatively simple installations to supply water directly to the user at low cost, by manual, electric, diesel, wind, or solar powered pumps.
- It allows for phased development without the high “up-front” costs for storage, transmission lines, treatment plants, etc., needed to meet final demand in a surface water scheme.

Of most importance in CWS planning is the safety that groundwater usually offers. Because surface waters are prone to serious contamination, even temporary failure of the treatment system can result in an outbreak of waterborne disease. Reliable operators, spare parts and uninterrupted supplies of fuel and

chemicals are therefore a prerequisite of systems based on surface water sources.

In choosing a water source, it is far preferable to find one which supplies sufficient good quality water and to protect it, rather than to take water from a doubtful source and treat it. Springs, protected upland streams and groundwater are thus the preferred choices. There are however some situations in which groundwater may prove unsuitable. Naturally occurring salts can make the water unpalatable or aesthetically unacceptable (e.g. high iron levels impart a bitter taste and can stain food and laundry), and in some cases may be damaging to health.

The level of groundwater and the potential yield of drilled wells have to be assessed. Handpumps usually turn out to be more economic the smaller the pumping lift and the lower the cost of well construction. As figure 2.1 shows, the vast majority of rural water supply wells worldwide have pumping lifts of less than 25 meters, for which handpumps can provide very good service. However, as the pumping lift increases, the effort needed to pump water manually also rises. Below 40-50 meters, motorized pumps should be used wherever they can be maintained. The quantities of water pumped from wells for domestic water supply are small, and will rarely exceed the natural recharge capacity of an aquifer. There are however numerous examples of lowered water tables caused by prolonged pumping for irrigation (Bangladesh, India and China among others), and this can have a damaging effect on nearby CWS wells.

Hydrogeological knowledge is important in determining well yields. In the basement rocks of Africa and India for instance, it can be difficult to site wells even to draw the minimum acceptable flow for a handpump (about 0.2 liters/sec), and very large drawdown can be expected if motorized pumps are used.

To take advantage of the economies of scale that are possible with motorized pumps, wells are typically designed to provide sufficient yield to meet the total demand of a small community. Water use in a community of 400 people will be from 8 to 50 cubic meters a day, depending whether standpipes or yardtaps are installed, and that will usually mean a pump discharge rate of 1 liter/sec or more. Achieving such well yields in basement rocks can make wells very expensive, and success rates are likely to be low.

Energy Resources include primarily human, electric, diesel, wind, and solar. Any CWS system which depends on something other than human energy for its operation involves an added risk of failure through supply interruption (electricity from the grid, diesel, wind, etc.). These reliability risks can be minimized by proper design, but often this means much higher costs and forces the community to rely on external resources outside its control.

In most cases, water can be pumped for substantially less cost if an electric grid is available than if the pump must be driven by diesel, wind or solar power. Trucking diesel fuel over long distances can raise its

Figure 2.1 Pumping Lift Frequency Distribution in Field Trials

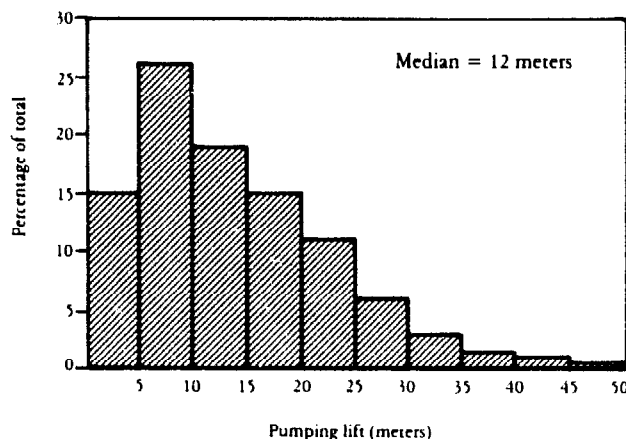

In the Project field trials, efforts were made to site wells where groundwater was as deep as possible — the aim being to develop handpumps suitable for deepwell applications. However, as the diagram shows, 75% of the wells involved pumping lifts of less than 20 meters, and 85% were less than 25 meters. It seems likely that these figures are a good reflection of the global situation in terms of groundwater depth.

price several-fold, but the actual cost of the fuel is less significant than its reliability. All too often, diesel fuel is diverted to other buyers rather than the isolated pump, or access is prevented by bad road conditions, or the delivery truck breaks down.

Successes and failures of major pumping projects based on renewable energy resources (wind or solar) are not so well documented. Renewable energy has one clear advantage over diesel, in that there is no dependence on external fuel supplies. However, wind and solar pumping schemes have substantially higher initial costs and they do share diesel's other big handicap - the need for more sophisticated and costlier maintenance skills and spare parts that are not readily available to the community. Some components of solar systems that have been introduced in developing countries cannot even be repaired at the country level, but have to be replaced with new equipment or shipped to the overseas manufacturer if a breakdown occurs - a logistically prohibitive option. Renewable energy systems also involve extra costs in comparison with handpumps, because of the back-up water supply needed to cope with times when the energy source is not available.

These constraints do not rule out motorized pumps, but they do mean that ways of ensuring reliable supplies must be worked out and costed, before the community takes the decision on the affordability of higher service levels.

Organizational Resources

These are perhaps the most difficult to evaluate in planning a CWS program, which may explain why so many projects founder because the right skills, materials

or institutional structures are not available to keep them functioning. The better trained the mechanics, the more frequent the outlets for spare parts, the closer and more reliable the fuel supply, the better the supervision of well construction, etc., the greater will be the reliability of the CWS system.

Organization and management of available skills and equipment becomes more complex as the service level increases - a powerful argument for step-by-step progress. For handpump schemes, the organizational structure needed involves creation of a mechanism such as a water committee to manage collection of charges from users, to initiate repair and maintenance activities, to pay for maintenance services, and to procure spare parts. Motorized pumping schemes include these elements and, in addition, require an operator, a reliable electric power or diesel fuel supply, a greater variety of spare parts and tools, and more advanced mechanical repair skills.

If reliable electric power is available from a central grid, an electric pump can be a relatively inexpensive and operationally simple means of lifting water. However, if the power is irregular, or available for only short periods each day, daily water demand may not be met and expensive elevated storage may have to be increased. When the supply is intermittent, users tend to leave taps open, to fill containers when power is restored. Distribution is then inequitable, with only those closest to the storage tank being able to obtain water, and there is high wastage. Automatically closing taps and flow restrictors have sometimes been successful in saving water on larger, mainly urban, schemes, but they are expensive and unpopular with users, who quickly find ways to disable them.

Diesel pumping is generally less reliable than electric pumping. In rural areas, it is difficult to ensure reliable fuel supplies; and diesel engines have more complex maintenance requirements. An example from Nigeria illustrates the resource needs. A typical installation consists of a 40m deep drilled well with a pumping lift of about 20 meters, a submersible electric pump, a diesel generator housed in a small building, and a storage tank with one day's capacity. Watchmen are employed round the clock for security and to prevent wastage, and one or two operators run the generator and carry out basic maintenance. Scheduled maintenance and major repairs are the responsibility of mechanics from the government workshop. The users are responsible for ensuring that there is enough diesel. One organizational structure involves the watchmen noting frequent users and establishing a roster of families to supply the fuel for the generator (covering transport costs as well). The system is dependent on all the inputs being reliable and is somewhat fragile, as once the one day storage is used up, users must revert to traditional sources.

Availability of skilled manpower is a critical consideration in technology choice, as it has a direct impact on the feasibility and cost of installing and sustaining any type of system. Developing countries typically have a severe shortage of trained people in the

water supply sector, particularly in rural areas. Lack of professional and semi-professional staff is one of the top constraints reported to the World Health Organization in that agency's monitoring of progress in the International Drinking Water Supply and Sanitation Decade. Evidence is easy to find: many of the disused schemes in urban and rural areas are idle because the personnel could not be found or retained to organize and carry out the repairs needed.

Assessment of organizational resources has to be carried out at both national and community level, and a decision reached on the duties for which each will take responsibility. Reliance on national organizations for regular maintenance support is not a satisfactory option, as it becomes an increasing logistical burden on central government as more and more systems are installed, and it is susceptible to future policy changes. Self reliance at the community level is the only workable alternative in the long run, and the community must assess whether it can provide the level of skills and equipment needed for a higher level of service, or opt for the lesser maintenance needs of a handpump-based system.

The Right Choice

Returning to the steps in CWS improvement presented in Table 2.1:

Step 1 — Improvement of traditional sources — offers few benefits, either in terms of time savings or improved water quality. It may nevertheless be the only choice available for communities which have not even the financial or organizational resources to manage the upkeep of a handpump.

Step 2 — Handpumps — has clear advantages over Step 1, particularly in its use of groundwater without costly or unreliable water quality protection or treatment usually associated with improvement of surface water sources. Where groundwater is not available in adequate quantity or quality for handpumps, other feasible options will need to be explored. Typically, handpump-based schemes have often had a high proportion of pumps out of order at any one time, because one or more of the important components necessary for success has been lacking. Specifically, projects have suffered from: wrong choice of handpump (low durability, unsuitable for local maintenance, poor installation, lack of spare parts, etc.); insufficient community involvement and community financing; poor borehole design and completion (sand infiltration, poor water quality, insufficient yield, etc.); central rather than community-managed maintenance (high cost, long delays). More recent schemes show a marked improvement in performance, but further improvements in the implementation of systems are still needed. The critical elements now known to be necessary for sustainable and widely replicable programs, are discussed in detail in Chapter 3.

Steps 3 and 4 — Standpipes and Yardtaps — The step



Groundwater and surface water sources need to be analysed and compared, in terms of quantity and quality.

from manual to motorized pumping is a big one, markedly increasing the complexity of the system. Put simply, the increased complexity of CWS systems designed to provide progressively higher service levels brings added risk of failure. As a result, the level of service actually provided by motorized pump schemes is often much lower than planned, though costs remain high.

Typical **problems** that arise in some projects with piped distribution systems include:

- Intermittent supply (often made worse because users leave buckets under open taps, resulting in uneven distribution and wasting a high proportion of the water when the supply is restored);
- Power supply failure (electric grid supplies can be unpredictable, while diesel trucked over long distances may be diverted for other purposes or unreliable due to transport problems);
- Prolonged system failure because complex devices cannot be repaired locally (parts, tools or skills needed from outside);
- Insufficient water available at the source for motor pumping (often a seasonal problem with springs, streams or boreholes); and
- Drainage problems arising from the higher per capita consumption and increased wastage.

The overriding message for CWS planners is that, for any system, reliability depends as much on the necessary combination of management skills and

logistical and technical support being available as it does on the selection of hardware. It means too that increasing dependence on mechanical or electrical equipment or on external supplies of spare parts, fuel or chemicals can prevent the planned service level from being achieved, unless pre-planning can guarantee that necessary skills and supplies will be reliably available. Sustainability based on community resources is a vital design parameter, if rural water supply is to expand without being a continual drain on scarce financial and human resources, and will determine the speed with which CWS programs can be implemented on a wide scale.

Assessment of CWS successes and failures throughout the developing world leads to the conclusion that experience in operation of a handpump system, and realization of the benefits of improved water supplies, can greatly enhance the chances of success with higher service levels implemented later. In exceptional cases, even the resource commitments needed for a reliable handpump system may be too great to allow immediate implementation, in which case simple improvement of traditional sources will be an essential first step.

In selecting that first step, CWS planners must work closely with the communities to be served, to evaluate the resource demands of each technology option, and compare them with available resources. The cost-benefit analysis alone may suggest that a higher service level than handpumps is appropriate, but in many parts of the world, the organizational resources do not exist to sustain such a service level. Handpumps may then be seen as a first-stage development, enabling experience to be gained at a comparatively simple level of technology, while providing the opportunity for upgrading the system later. If water resources allow, it may be both practical and economic for diesel or electric pumps to be fitted to wells originally drilled for handpumps, once the community has gained experience in managing the handpump project and has demonstrated a desire, a willingness to pay and the means to pay for the higher service level.

The premise for technology selection (Page 19) was that: *"the technology chosen should give the community the highest service level that it is willing to pay for, will benefit from, and has the institutional capacity to sustain."* The conditions may seem obvious, but all too often the caveats of sustainability, reliability and affordability are ignored in the desire of planners and donors to reach higher steps on the technology ladder. The result is allocation of limited resources to far fewer communities than could be reached with sustainable services at a more moderate level.

Chapter 3

Handpump Project Planning and Implementation

Wells equipped with handpumps are among the simplest of community water supply technologies. Compared with electric or diesel pumps, handpumps require substantially less financial and institutional resources. With the right planning, handpump-based community water supplies can be adequately managed by benefitting communities. But, regardless of whether a handpump project is initiated as a first-stage water supply development or as the long-term solution to a community's water needs, experience shows that its success depends on proper attention to six key elements of the whole system — *the community, the aquifer, the well, the maintenance system, the pump, and the finance*.

Few failures can be blamed solely on the choice of handpump. Analysis of a great many schemes which have failed to live up to expectations reveals one predominant cause — inadequate arrangements for routine operation and maintenance. Along with the choice of inappropriate pump technology, other prominent causes of failure are: badly constructed wells; lack of community involvement in project selection and implementation; designing for the wrong service level; siting pumps in the wrong place or at the wrong depth; failure to ensure an adequate spare parts supply; disregard of water quality implications (taste or corrosion); and failure to ensure funds for equipment or spares.

It is not sufficient to ensure that *most* of these problems are avoided. Failure to deal with *any one* of the key elements can jeopardize the success of the whole scheme. Long-term success in fact depends on a complete package of hardware and software elements designed to ensure that the completed scheme can be reliably sustained by the benefitting community.

Whatever manufacturers' literature may claim, the maintenance-free handpump does not exist. The Project has tested most of the internationally recognized handpumps which were on the market when the field trials got under way in 1982, more than 70 pump models in all. To date, the average period between essential interventions (actions necessary to repair breakdowns or

correct poor pump performance) over all the field trials is six months, with a wide range of values for the different pump models, depending on the water level, the number of people served, the type of pump, etc. Sturdy construction and durable materials may increase the interval between essential repairs — usually with added cost and difficulty when the repair actually is needed. But any handpump will need attention eventually.

Too many projects fail because the maintenance needs cannot be met. It follows that a key objective of any community water strategy should be to create projects which can be kept in proper working order with the resources known to be available. The fact that this apparently simple goal has proved so difficult to achieve in the past has called for a detailed analysis of the individual elements involved in water project planning and operation. The result is a series of guidelines for improving the chances of providing reliable and sustainable community water supplies based on handpumps. The guidelines cover the six interdependent parts of any handpump project — the community, the aquifer, the well, the maintenance system, the pump, and the finance. These key elements are discussed in detail in the remainder of this Chapter, beginning with the issue which has been shown to be central to overall success:

The Maintenance System

Maintenance is an inevitable requirement of any system which depends on mechanical equipment, however simple that equipment may be. Historically, handpump maintenance has been managed in many different ways, though, with few exceptions, the principle has been to repair the pump once it has broken down rather than to carry out scheduled preventive maintenance.

In most projects, a centralized mobile maintenance team run by national or regional government or a donor organization is responsible for maintenance of large numbers of widely dispersed handpumps. The central organizations, with few spares for the pumps and vehicles, few operational vehicles, and long response



Women are increasingly becoming involved in handpump maintenance, with beneficial effects on the reliability of completed schemes. Here, Bangladeshi women caretakers are replacing a plunger seal. Caretakers need to be trained in basic technical skills, and must have ready access to regularly needed spare parts.

times, are often unable to provide this service satisfactorily. Their budgets are too low, management is inadequate, and there are few incentives for staff to perform well. In the few cases where centralized maintenance is highly effective, usually with donor support, it is expensive.

In recent years, backed by strong promotion from the Project, developing country governments have recognized the shortcomings of centralized maintenance and the need for greater community involvement. The concept of village-level operation and maintenance (**VLOM** — see Box 1.3 in Chapter 1) spread quickly among handpump specialists and was adopted as a goal by a number of manufacturers (though not always with the same interpretation as the Project intended). **VLOM** designs were consciously developed from 1981 onwards, and a number have featured in the Project field trials and received technical and financial support for further development.

Possible handpump maintenance systems cover a wide spectrum, from total community management with no external intervention to complete control by the government water agency or other external organization with no involvement of the community at all. In discussing the merits of individual handpumps and their maintenance needs in the remainder of this report, it is useful to define two categories of maintenance, according to whether the decision making rests with the water authority or the community, recognizing that each category can only be an approximation to the actual situation on any particular project or program.

1. Community Management of Maintenance

The key element in this type of management is community choice. The water committee or other community

organization finances and organizes all handpump maintenance and repair. Success is related to a sense of community ownership of the well and pump and can only be achieved when the organizational capacity of the community is adequate.

For community management to be feasible, the selected pumps must be suitable for simple routine maintenance with basic tools and minimal skills. Common spare parts must be readily available in or near the community, which will usually mean that they are manufactured locally; and there must be a suitable community structure for recovering the costs of maintenance and repair operations.

The public sector has a crucial role to play in establishing the framework for community maintenance by:

- Ensuring the availability of handpump spares, by encouraging standardization, facilitating manufacture through appropriate incentives, and enforcing quality control;
- Providing extension support for handpump maintenance through initial training of community leaders in financial management and pump caretakers in basic technical skills, and periodic monitoring and refresher courses to maintain standards.

After an initial period of heavy involvement in construction and the initiation of community maintenance, the role of the public authority will greatly diminish. A backup service may be needed for extraordinary repair (e.g. in case of clogging of the drilled well), or intervention in the event that community management collapses. Periodic monitoring and refresher courses for caretakers and mechanics will also help to assure reliable operation, and should form part of long-term extension support to community development. In addition, the government has a responsibility for ensuring that quality standards are established, and to monitor compliance with such standards through periodic visits and testing procedures.

Under community management, maintenance and repair is in practice carried out either by one or more **caretakers**, or by an **area mechanic** servicing several pumps in the vicinity.

1A. Village Caretaker

Preventive maintenance and pump repair is carried out by one or more designated community members after a minimum of training. Procurement and storage of essential spare parts and provision of necessary tools and equipment for pump maintenance is a community responsibility and any external help is initiated and paid for by the community.

Costs are very low; transport is not required, except possibly to buy spare parts from the nearest outlet; breakdowns are infrequent because of preventive maintenance, and response times when breakdowns do occur are usually short; and full control of the water supply is in the hands of the community. The community collects money to create a maintenance fund, which is

Box 3.1 Village-level Maintenance in Burkina Faso

Village-level management of handpump-based community water supplies is a key feature of a rural water supply project covering two provinces in Burkina Faso (Yatenga in the north and Comoe in the south-west). Cost estimates from Yatenga indicate maintenance costs of about US\$0.05 per capita per year, and monitoring by the Handpumps Project for two years showed that 85% of the pumps were working at any given time.

The maintenance cost of the handpumps compares with an estimate of US\$0.65 per capita per year for the cost of fetching water by traditional means (bucket and rope) from Yatenga's typical well depth of 20 meters.

Financed by the European Development Fund (EDF), the rural water supply project in Burkina Faso has been modelled on principles developed by experts from African, Caribbean and Pacific countries and the European Economic Community at a consultative meeting in Bamako, Mali, in 1979. A major objective of the meeting's recommendations was that responsibility for operation and maintenance of water points should be transferred to the users. In the case of the EDF project in Burkina Faso, the aim has been to set up a system which is entirely independent of outside support (from government or donor).

Motivation of villagers to participate in maintenance of the completed project began early. The communities were directly involved in the decision making processes — choosing between dug wells without handpumps and drilled or dug wells with handpumps, and taking part in selection of well sites. Contributions were collected towards financing of the well superstructures, and villagers met the cost of handpump installation and maintenance.

Before any well construction started, the villagers were told about the technical aspects of potential water supply improvements, the advantages and disadvantages of water points equipped with handpumps, and the commitments they would be expected to fulfil in terms of financial contributions and maintenance duties.

The project helped in the organization of water

point committees with seven members, including two women and two pump caretakers, and the members were given training appropriate to their responsibilities.

At the provincial level, enough area mechanics were trained to service the pumps on the basis of one mechanic to every ten pumps. The mechanics themselves were nominated by the villagers, and were generally already involved in some type of mechanical work (bicycle/motorcycle repair, etc). The project also helped to set up a distribution network for pump spare parts.

Responsibility for project execution was given to national staff, and local well drillers were contracted to rehabilitate and deepen old dug wells using hand-operated cable-tool rigs.

Pump selection too was made with village-level maintenance in mind, and after competitive tender the foot-operated Vergnet pump was selected and 465 pumps were installed in the first phase. The Vergnet is relatively light; the pump cylinder can be pulled from the well without lifting equipment; and wearing parts can easily be replaced by trained area mechanics.

Under the management of the water committees, routine maintenance is carried out by the pump caretakers, and the area mechanics perform major repairs. Spare parts prices are controlled, while the area mechanics negotiate fees for their services with the water committees. The caretakers are generally unpaid, though in some instances they may receive cash or labor assistance in cultivating their fields.

The water point committees collect money for handpump maintenance and typically have a reserve of about US\$100 held in a cash box. The system is working well, and costs are affordable by the community. The handpumps are accepted and valued, and all the people directly involved (caretakers, area mechanics, local spare parts traders) are ready and able to take on the necessary responsibilities.

Paradoxically, the most fragile point of the maintenance system on the EDF project is not the village-managed repair operations, but the supply, distribution and cost of the imported spare parts.

used to buy necessary spare parts readily available on the market, and to pay the caretaker(s) if necessary. Caretakers may sometimes be volunteers, but an arrangement whereby they receive payment is strongly recommended, as it helps to provide lasting motivation to stay on the job. This type of maintenance was the original **VLOM** concept and it remains a long-term goal, offering the most effective way of maintaining new systems.

A comparatively recent development has been the substantial involvement of women in handpump maintenance. Concerns that training women in maintenance skills would be inappropriate to their role in rural society have proved unfounded in a number of countries. On the contrary, women caretakers have demonstrated interest, enthusiasm and ability to keep the water system working, because of their traditional role as providers of water for the family.

Box 3.2 Handpump Maintenance: The Three-tier System in India

In support of India's extensive rural water supply program, a "three-tier" system has been developed for maintenance of the India Mark II handpump. By the end of 1982, there were some 150,000 Mark IIs in operation in 14 Indian States (the figure is now approaching one million), and the Government of India, with support from UNICEF, sponsored a survey on the effectiveness of maintenance in four states - Orissa, Madhya Pradesh, Tamil Nadu and Rajasthan. The results, published in 1984, showed distinct variations from one state to another, and provided valuable information about the targets which were feasible in operation of the three-tier system.

The aim is that a village pump caretaker should be responsible for routine maintenance of a single handpump (Tier 1); a "block mechanic" (in India a "block" refers to a large area with several villages) with specialist skills and tools should be responsible for more complex maintenance and most repairs, with responsibility for 50-60 pumps (Tier 2); and a mobile team at the district level should be on hand for major repairs calling for transport of heavy parts or lifting gear. The mobile teams should cover about 500 pumps (Tier 3). The system was developed following surveys in the early 1970s, which had revealed that as many as 75% of handpumps installed in India were out of operation at any given time.

The 1984 results were much more encouraging (Box Table 3.2A), with the number of pumps out of commission in the sample ranging from 25% in Rajasthan to just 2% in Madhya Pradesh. Unfortunately, cost information is sparse, particularly in relation to transport - usually the most expensive

Box Table 3.2A Cost Data on Handpump Maintenance

	<i>Orissa</i>	<i>Madhya Pradesh</i>	<i>Tamil Nadu</i>	<i>Rajasthan</i>
Pump cost (US\$)	270	280	379	N.A.
Maintenance system	Motorized mobile team	Block mechanic + mobile team	Block mechanic + mobile team	Private mechanic + block mechanic
Percent of pumps working	95	98	78	75
<i>Annual recurrent cost (US\$, 1984)^a</i>				
Labor - local	12	43	21	10 ^b
Transport	6	13	11	
Pump spares	21	9	5	5 ^b
Other costs	1	2		
Total	40	67	37	—
Cost per capita ^c	0.20	0.34	0.19	

Notes: a. Overheads not included. b. Amount allocated by PHED to Rural Development and Panchayat. c. Based on 200 people per pump.

1B Area Mechanic

The community may contract a mechanic from nearby to fix the pump, paying for the service through a maintenance fund. A typical example involves the employment of a repairman with a bicycle who lives locally and services handpumps in a number of surrounding communities. This system reduces the need for simplicity of the pump to some degree (the repairman can be expected to carry a tool kit and to have better mechanical skills), but lightness and ready availability of spares are still important requirements of handpump design.

While maintenance carried out by a village caretaker is still relatively rare, area-mechanic maintenance has gained rapid popularity in recent years, and constitutes a substantial improvement both in cost and in the reliability of the service provided. In some projects, such

as the one in West Africa described in Box 3.1, repairs are effectively organized under community management. In other projects, the area mechanic is responsible to the government water authority, as in Malawi (Box 3.3). A similar arrangement exists in India (Box 3.2), though in some States local government units involving groups of communities are beginning to assume responsibility for maintenance with a continued subsidy from State or central government.

2. Central Management of Maintenance

A governmental or other agency maintains the handpumps, with mobile teams travelling from base camps to carry out repairs. There are two types of such maintenance, depending on whether the community participates in maintenance activities.

element of any system which depends on mobile teams. However, the data provide illustrative comparisons of different versions of the planned maintenance system (see Box Table 3.2A).

In Orissa, Mayurbhanj District was the first to introduce the three-tier system and it was not fully operational at the time of the survey. The 2,700 pumps were being maintained by three mobile units (900 pumps per unit) under the control of the Public Health Engineering and Municipal Works Department (PHED). Block mechanics had not been established and pump caretakers had been appointed in less than half of the blocks surveyed. The survey found that 95% of the pumps were working, but noted that 80% were less than four years old.

In the Jabhua District of Madhya Pradesh, 36 block mechanics and three mobile units looked after 2,130 pumps. No pump caretakers had been appointed in the survey area. Again, a high proportion of the pumps (85%) were less than four years old, and in this case 98% of the pumps were working. In Tamil Nadu, the survey was conducted in Tirunelveli District, where over 95% of the maintenance on 3,210 pumps was carried out by 31 block mechanics (104 pumps per mechanic). There were four mobile teams, each responsible for 800 pumps and pump caretakers had been appointed for three-quarters of the pumps, but their duties were limited to reporting breakdowns. Half of the pumps were more than 4 years old and the survey found that 78% were operating. Since 1982, responsibility for maintenance has been transferred from the PHED to the Government's local administrative units (Panchayat Unions).

The fourth survey area was Amjer District in Rajasthan, where a single level "one-tier system" had been implemented by training a number of private sector mechanics to carry out pump maintenance and repairs, on the basis of about 30 pumps per mechanic. At the time of the survey, about half of the repairs were actually being carried out by the private pump repair mechanics paid by the Panchayat with funds transferred from the PHED. Not all of the mechanics were being paid and several had left their jobs for other occupations. PHED block mechanics were carrying out most of the repairs on the remaining pumps, with a few being repaired privately. Overall, 75% of the pumps surveyed were working satisfactorily, but the average downtime of one month was considered by the investigators to be too long a response time.

One important conclusion from the survey is that local block mechanics can maintain India Mark II handpumps, while depending on mobile teams only for extraordinary repairs. By basing the maintenance system on local mechanics, vehicle costs can be considerably reduced, and the overall recurrent costs brought down to affordable levels. Pump caretakers were not found to be effective for carrying out maintenance. Lacking tools, grease, materials, etc, and with no financial incentives, they had little interest in the upkeep of their pumps, though their role remains important as a means of contacting the mechanics when breakdowns occur. Indeed, the survey noted a lack of any commitment by local communities towards pump maintenance, and attributed this in part to the absence of any financial contribution being required from the community towards pump maintenance.

2A Central Maintenance with Community Involvement

Responsibility for carrying out and financing operation and maintenance is divided between the community and an external agency — usually the government water authority, but sometimes a parastatal, donor or non-governmental organization. This division of responsibilities is specified in an agreement settled in discussions with community leaders in the planning phase of the project. Pump maintenance is managed by the external agency, with the community accepting certain responsibilities as part of its contribution to the scheme.

The arrangement will typically involve a designated handpump caretaker within the community undertaking some preventive maintenance and probably simple repairs, commonly limited to the pumphead and

surrounds. As with System 1, the Project recommends that such caretakers should be paid, and that the community has an organization (e.g. a water committee) responsible for funds collection and other management activities. Major repairs are usually the responsibility of the external agency, which pays the repair teams and provides the spare parts.

A degree of community participation has also made it possible in some projects to dispense with, or considerably reduce, the use of motor vehicles. Instead, government mechanics are located in areas where each can service a number of pumps (from 15 to 100 or more). These mechanics, together with village caretakers, have been able to repair pumps in countries such as India and Malawi (Boxes 3.2 and 3.3), using only a bicycle to travel between pumps and to transport tools and spares.

This form of maintenance has been coming into

Box 3.3 Community Involvement in Malawi's Integrated Rural Water Supply

The Livulezi Rural Water Supply Project in Malawi has a number of interesting features, which have helped to keep down costs and promote reliable functioning:

- Wells were only drilled if hand-dug wells could not be constructed at the particular location. Wherever feasible, existing wells were rehabilitated and, in the case of dug wells, protected.
- Drilling extended only far enough to obtain a flow into the well to support the discharge for a hand-pump. This usually meant that depths were restricted to 20-30 meters, most of it through weathered rock; little penetration was needed into basement rock.
- The cable tool rigs which were used had belonged to the government for more than 15 years, and their costs were fully depreciated.
- Drilling and dug-well construction were integrated in clearly defined projects, allowing greater production, effective supervision, and lower costs.
- Most wells were equipped with handpumps produced in Malawi to alleviate the problems associated with imported spare parts; the pumps were designed for village-level maintenance.
- Maintenance of the handpumps is decentralized. A village caretaker was appointed for each pump and is responsible for simple maintenance. Break-downs are reported to one of two government-trained mechanics, each equipped with a bicycle and living in the project area. The villagers themselves assist in transporting the tools to the pump and help the local mechanic with repairs.
- Costs of construction and maintenance have been recorded throughout the project.

Drilled wells were constructed by the Department of Lands, Valuation and Water (DLVW). The community participated in site location as well as construction. Design criteria were: 27 liters per head per day; a maximum walking distance of 500 meters; and a maximum of 125 people served by a dug well and 250 people served by a drilled well. The completed Livulezi Integrated Project consists of 200 wells (including rehabilitated wells), which serve almost 50,000 people. Its success led to similar integrated projects in other parts of Malawi, and in other countries.

At present, logistical support for the supply of spare parts depends in large measure on the United Nations Volunteer, an engineer employed by the Handpumps Project, whose main job is recording the performance of pumps being monitored in the field trials. Having a pick-up truck at his disposal, he has also been transporting spare parts and restocking

the stores held by the two mechanics. When monitoring ends, other arrangements will have to be found for supplying spare parts to the Livulezi project area. Another problem, already becoming apparent, is funding for centralized procurement of spare parts. The Malawi government does not presently seek any payments from villagers for recurrent costs.

Assuming that the wells have a life of 20 years and the pumps a life of 10 years, and with interest at 10%, the annualized cost of handpumps and drilled wells at Livulezi is about \$207 per pump, including capital and maintenance. This amounts to \$0.83 per capita per year for the 250 users per pump.

Box Table 3.3A Capital Costs of Livulezi Wells (US\$)

	<i>Drilled well plus pump</i>	<i>Dug well plus pump</i>
<i>Direct costs</i>		
Materials	300	280
Labor	70	20
Sub total	370	300
<i>Indirect costs</i>		
Camp	180	150
Transport	260	210
Other	130	60
Sub total	570	420
Total well costs	940	720
Pump and Apron (estimate)	450	a
Total Cost	1,390	720
No. of people served	250	125
Cost per person	\$5.56	\$5.75

Note: Costs are averaged over 96 drilled wells and 42 dug wells. They are based on 1982 prices in Malawi Kwacha converted to US\$ and adjusted to 1985 values. a. Included in Materials costs above.

Box Table 3.3B Maintenance Costs of Wells

	<i>Annual cost per pump</i>	<i>Annual cost per person</i>
<i>Direct costs</i>		
Spare parts	2.84	0.01
Maintenance staff	4.64	0.02
Sub total	7.48	0.03
<i>Indirect costs</i>		
Share of overhead staff	10.20	0.04
Transport	6.22	0.03
Sub total	16.42	0.07
Total	\$23.90	\$0.10

popular use since the beginning of the 1980s, and there are many encouraging success stories. Costs are lower than those of System 2B, where all maintenance is carried out by the external authority. It is also more readily achievable in political terms in many developing countries than immediate village-level management of maintenance, and can serve as a transitional form of maintenance until the community can assume full responsibility under System 1A or 1B.

The distinction between this arrangement and System 1B is that these area mechanics are managed and funded by the agency, with little chance of full recovery of maintenance costs from the community. The long-term sustainability of such an arrangement is therefore questionable. A major disadvantage too is that policy changes or budgetary restrictions could reduce the effectiveness of maintenance activities, even when the community is paying in full, if control of the funds rests with the government.

2B Central Maintenance

This remains the most common form of handpump maintenance and will continue to be needed for the more complex and heavy handpump types and for deep pump settings. The usual form consists of a public sector organization managing mobile (district) maintenance teams strategically located across the region. The teams report to a regional or national headquarters which handles overall budgets and spare parts procurement and distribution. Each team includes skilled workers equipped with special tools and a motor vehicle (sometimes a large truck with a crane). Handpumps are visited when the community reports a breakdown or, in exceptional cases, according to a regular maintenance schedule.

High cost and poor service are generally associated with the system, because:

- direct costs of vehicles are typically 50% or more of the total costs of mobile maintenance teams;
- vehicle breakdowns result in long delays in responding to reported handpump maintenance needs;
- transport management in the public sector is difficult, and the use of vehicles for other purposes than handpump maintenance may further increase costs and downtime.

In many countries where it has been introduced, central maintenance has a poor record, with response time between reported breakdown and actual repair sometimes stretching to several months. At the comm-

"In many countries where it has been introduced, central maintenance has a poor record ..."

unity level, the fact that control is in the hands of an outside agency means that there is no sense of ownership of the handpump system. Misuse and vandalism of pumps occasionally occur, leading to a vicious circle of failure and unreliability.

Maintenance Strategies

Until recently, the heavy construction and complex maintenance routines of most handpumps demanded skilled mechanics, numerous tools and lifting equipment, so central maintenance was the only practical option. Development of lighter, simpler handpumps has made it easier to pass some responsibility to the community, and to move towards area-mechanic maintenance, with significant reductions in cost and improvements in reliability.

Whichever maintenance system is in operation, several possible maintenance *strategies* are available. *Breakdown repair* remains the most common approach where central maintenance applies; *limited preventive maintenance* is frequently adopted alongside breakdown repair when the community is involved in maintenance activities, and some central maintenance systems include *routine inspections and preventive maintenance*; there is virtually no evidence of *scheduled servicing* of handpumps under any of the maintenance systems.

A strategy based solely on response to breakdowns or serious drop in performance may lead to unnecessary damage to other parts of the equipment, and more expense in the end. A good example in the case of handpumps is bearing wear, a progressive effect leading to gradual reduction in performance. Left to deteriorate until the pump becomes unusable, the resulting play in the pump handle can cause serious, sometimes irreparable pumphead damage. Even the limited preventive maintenance in which community members lubricate moving parts and tighten loose bolts can have a significant impact, by reducing the number of breakdowns and spotting the need for repair in good time.

The Community

Most communities in developing countries need assistance with the construction and maintenance of wells with handpumps, but they must be encouraged to participate to the maximum extent possible. Too often, an improved water supply has been seen as a free service that the government must provide to improve the life of its citizens. While many communities may need financial help, relegation of their role to that of recipients without significant participation has often resulted in an inappropriate choice of technology and service level, wrong location of the water point, unnecessarily high cost, inability to keep the scheme operating, and ultimately user rejection. Community participation that is limited to contribution of free labor results in nothing more than a small cost saving, without addressing other crucial issues. Strong community initiative is essential for the successful long-term maintenance of handpumps, and to achieve it, community members must be

intimately involved right from the planning stage.

In some countries (e.g. China and Guatemala), this has been standard practice; others have recognized the need for community involvement and are experimenting with ways of increasing it. The following recommendations are based on experience gained in the course of the Project field trials, and on a wealth of information gleaned from other projects. Much of what is said is geared primarily to African conditions, as the need to promote stronger community involvement is generally greatest there, but the principles apply to all developing countries.

How then should one go about establishing community **management** of a village water supply system?

a) The **institutional capacity** of the community must be evaluated. Organizational experience may be apparent from the existence of self-help groups, cooperatives, etc., but the strength of the leadership must be assessed, along with the level of education and skill. For many communities, an improved water supply will be the first time that social structures have had to adapt to the management of a service that combines organizational, technical and financial skills.

Handpumped water supplies lend themselves to maintenance by user communities with very limited technical knowledge. Nevertheless, the needs are real and must be defined and catered for if the scheme is to be reliably maintained.

A water committee may grow to form a focus within the community for other development activities — including an eventual upgrading of the water supply.

b) The **demand** for water supplies has to be established. Here, demand is taken to mean the amount of water households want to obtain each day, once they are aware of the price, including any cash amount that has to be paid and the time which will be taken up by queuing and hauling. It is still common for an external agency or government planner to determine in advance what water demand will be and to set the number of water points according to some predetermined formula. Such projects have limited chance of success. Unless the community is aware in advance of the alternatives available and the costs and benefits of each, there will be hardly any sense of ownership and little prospect of the community assuming the responsibility to manage the new system.

Demand for water from handpumps may be low if alternative sources are easily accessible, and if these existing sources are unprotected, health education may be needed to convince community members of the value of safe water. There may also be demand for water for other than household uses, such as livestock watering and small-plot irrigation. It is important that the community should take the decision itself on how much water is needed.

c) Closely linked to the demand for water is the **service level** to be provided by the new system. Part of the community's evaluation of the costs and benefits



Users have lined up some 150 water jugs while waiting to use this Volanta pump in Burkina Faso. Long queues are common in areas such as the Sahel in Africa, where drilling costs are high, and user groups must be large to spread the costs. But service level has to be assessed carefully, as intensively used pumps will break down more frequently and be rejected by users.

of different service levels will be the value of time spent queuing and hauling water. Thus the service level for a handpump project relates to the number of people served from each pump and the walking distance to the pump. As will be apparent in the discussion of pump technology later, the daily output is controlled by several factors, the most significant being the pumping lift. There are thus practical limits to the number of people who can obtain water from one pump, which vary with the depth of the water table.

The more people served by each pump, the longer will be the queues and the greater the risk that people will return to alternative traditional sources. Pump breakdown frequencies are also directly related to hours of pumping, so that greater intensity of pump use will mean more frequent needs for maintenance or repair. On the other hand, particularly where drilling costs are high, it will be necessary to spread the cost of each installation among as many users as possible. In the end, the number of wells to be provided and their location has to reflect the community's needs and desires, and this decision will have to be based on financial and technical information prepared by specialists from the sponsoring government agency.

The availability of alternative water sources will have a major influence on the number of handpumps that must be installed to provide an acceptable improved level of service. In Bangladesh, for example, where surface water is often readily available near the home, it has been found that a typical handpump should serve no more than about 75 people, or many will choose to use nearer, polluted sources. By contrast, in southwest Sudan and in northern Nigeria, where during the dry season people must often walk several kilometers to obtain water and must then wait in long queues at the source, one well and handpump can be located to serve as many as 250-300 people.

The smaller user group per handpump is affordable in Bangladesh because wells can be sunk by the "sludger" method at a cost of US\$100-200 per well (exc-

cluding the price of the pump). In India, where wells cost about US\$2,000, service levels of about 125 persons per pump are practical, but in West Africa, much larger user groups are typically necessary to spread the high drilling costs (US\$4,000-20,000) over more users and so reduce the per capita cost.

d) The **willingness** of the community to make a financial contribution — in line with its **ability to pay** — has to be assessed. One promising mechanism increasingly being used is for the community to be asked to make a material commitment (e.g. to collect enough money to cover the first year's maintenance), before any decision is taken to start drilling. When deciding on the number of pumps to be installed, a balance must be struck between what the sponsoring agency pays and what the community pays. As a minimum, the community should pay operation and maintenance costs in full for a level of service that offers a basic improvement (such as a well with a handpump), and should also be responsible for the full incremental cost of any higher service level.

e) Defining the boundary between activities for which the community can reasonably assume responsibility and those which should be part of the **public sector's role** is difficult but important. The government water agency is almost inevitably stretched to provide support services at the community level, while the range of skills and equipment available to pump caretakers is likely to be small. Difficulties arise when the community depends on outside help for all maintenance and repair work, because centralized maintenance is expensive and at times difficult to manage. If the community takes full responsibility, the danger is that spares, tools or skilled people may be absent when major breakdowns occur.

Increasingly, private mechanics are providing the critical bridge between the limits of the water agency's management capabilities, and the community's skills. Box 3.1 demonstrates well how the mutual interests of community members and private sector mechanics keep the water flowing at affordable cost.

Improved water supplies are necessary but not sufficient to bring health benefits. It is the **complementarity** of safe water, proper sanitation and good hygiene practice that is the basis of the International Drinking Water Supply and Sanitation Decade action plans. Health educators must ensure that communities benefitting from new water schemes understand the principles of disease transmission and are encouraged to improve sanitation practices and construct latrines where necessary.

The government water agency may have an important role in **health education and training** specifically directed at water supply and sanitation system management. Commitments in these fields should be recognized at the planning stage and instituted before construction starts. If missing community skills can be created through training programs implemented before and during construction, the goal of community management will be much easier to achieve. After responsibility has been handed over to the community, the govern-

ment can improve the chances of the scheme being properly maintained by organizing refresher courses for caretakers, and by encouraging the community to provide incentives to repairers.

The period of project construction provides an excellent opportunity for training in the skills necessary for the subsequent upkeep of the system. Qualified trainers from the implementing agency, supported if necessary by representatives of the pump supplier, can take advantage of the community interest in project activities to organize demonstrations of pump installation and maintenance, particularly for those selected by the community to care for the pump.

The Aquifer¹

Accessible groundwater exists under more than three-quarters of the earth's surface, but knowledge of its local characteristics (hydrogeology) is often sparse. Some engineers have preferred to develop surface water resources because they have a better understanding of the hydrology. For the reasons outlined in Chapter 2, analysis will normally lead to selection of groundwater rather than surface water development, and planners are urged to undertake the necessary studies and surveys to gather full information about aquifer potential before embarking on community water supply programs.

Though handpumps draw comparatively small amounts of water from the aquifer, their effectiveness and reliability can be significantly influenced by proper consideration of local groundwater conditions. Problems typically arise when designers fail to recognize **seasonal movements** in the water table or **competing demands** from irrigation pumps, or when low-yielding aquifers are developed without allowance being made for the **drawdown** which will arise during pumping, or when the **chemical quality** of the water makes it unpalatable or corrosive.

Any large scale national or regional community water supply program should include preparatory groundwater studies and continuous monitoring and record keeping. Much knowledge can be gained from existing well construction projects, if data on water depth and pumping rates is kept systematically. Increasing knowledge of hydrogeology will pay back the initial investment very quickly through more effective projects and avoidance of misguided developments.

The amount of information about groundwater needed to ensure reliable designs for handpump schemes varies considerably from region to region. No extensive studies are needed to show that the vast groundwater reservoirs of the Indus and Ganges basins can support community water supplies. In contrast, detailed geophysical exploration may be necessary before effective schemes can be designed for many areas of Africa and

1. An aquifer is a stratum or zone below the earth's surface which yields groundwater to a well in sufficient quantities for the required use (water supply, irrigation, etc.).

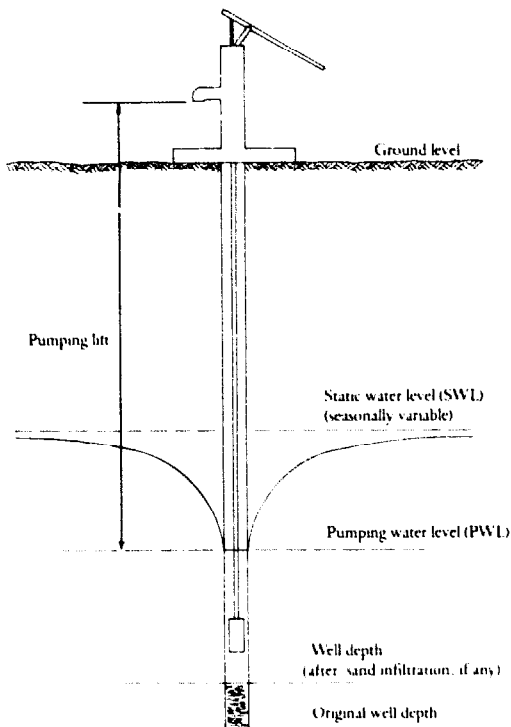

In an unconfined aquifer, the static water level in the well (without pumping) is the level of the groundwater table. After the pump has been used for some time, the water level in the well will sink to the pumping (or dynamic) water level. The difference between the two levels depends mainly on the rate of pumping, the length of time the pump has been used, and the permeability of the aquifer (the rate at which the porous medium transmits water). The pumping lift is the distance between the dynamic water level and the discharge point, though for convenience it is normally regarded as the depth of the dynamic water level below the ground surface.

India, where suitable aquifers can exist as small isolated weathered pockets in crystalline basement rocks such as gneisses and granites.

A full groundwater management strategy involves **surveys** to locate the water-bearing strata, use of special techniques to define the **aquifer geometry** (area and depth) and determine its **capacity** (reliable yield) and water quality, development of measures to **regulate** its exploitation and ensure its **protection** from contamination, and design of suitable methods of groundwater **withdrawal**.

For handpump projects, knowledge of the aquifer geometry and its capacity may limit the degree to which the community can participate in the selection of well sites, but will have the compensating benefit of reducing the number of costly or non-productive wells. Yields greater than 0.2 liters/sec are enough for handpumps, which means that many areas of the world underlain by relatively impermeable rocks not generally regarded as potential groundwater sources can be suitable if the right service level is chosen.

One crucial constraint on the use of handpumps is the pumping lift or head. While some handpumps are

advertised as suitable for pumping lifts as high as 100 meters, experiences during the Project confirm that handpumps should not be installed at heads greater than 60 meters, because their performance and reliability at those depths have not been established. Any pumping head over 45 meters must be considered to be very high, as, even at that depth, discharge will be low for an acceptable pumping effort and maintenance will be difficult. In permeable aquifers the pumping water level will be little different from the static water level, but in low-yielding aquifers drawdown of many meters may occur, resulting in high pumping heads and consequently lower delivery rates.

Handpump withdrawals alone will rarely lead to depletion of groundwater resources. Even in low rainfall areas, natural groundwater recharge is almost invariably enough to replenish the aquifer. But there are other dangers. Motorized pumps providing irrigation supplies may cause nearby wells with handpumps to run dry because of big drawdown effects in the vicinity of the well. In the longer term, widespread and indiscriminate motorized pumping may lead to "mining" of the groundwater and a progressive lowering of the water table. As well as causing environmental damage (e.g. land subsidence, loss of trees and vegetation, saline intrusion), such over-exploitation of groundwater may render low-lift handpump systems useless if the water falls below their operating limits (Box 3.4 quotes an example from Bangladesh, where suction pumps were put out of use by widespread withdrawals for irrigation).

Community water supply programs may involve the drilling of tens of thousands of wells (hundreds of thousands in the case of India or China). We have seen in Chapter 2 that handpump projects are easily upgraded and that movement to an affordable higher service level is to be encouraged. How then can one prevent future developments from undermining the widespread benefits brought by the initial handpump projects?

Regulation of groundwater exploitation is important to any country, and legislation to control groundwater withdrawals adds strength to community water supply strategies. Licensing of wells and approval of pump types and discharges may be administratively difficult, but uncontrolled exploitation of aquifers is an expensive price to pay for inaction.

In planning handpump programs, the potential for upgrading should be an important consideration. If early upgrading seems practical, deeper or larger diameter drilling in the handpump phase will normally be more economic than further drilling to accommodate motor pumps later. **Well testing** during construction of early projects and groundwater monitoring over time will provide data for long-term planning and may indicate that limits have to be imposed on future service levels and irrigation supplies if the resource is to be used equitably. Regular groundwater **monitoring** has been introduced on several projects in West Africa and is a simple and effective operation: which should be implemented for all important aquifers.

As well as protecting the aquifer from excessive withdrawals, legislation may be needed to safeguard

Box 3.4 Bangladesh: Motorized Pumping Threatens Suction Handpumps

In many ways, Bangladesh is the ideal location for extensive groundwater development. The vast deltaic plain consists of fertile alluvial soils overlying a groundwater resource replenished each year by an average of 2,000mm of rainfall and the widespread annual flooding of the Ganges and Brahmaputra rivers. The geology makes it easy to drill wells quickly and cheaply, while the shallow water table has encouraged a proliferation of suction handpumps to provide millions of rural people with low-cost clean water supplies for domestic use and small irrigation.

However, in recent years, unregulated motorized pumping for irrigation is thought to be a major factor in the lowering of the groundwater table, which is necessitating a new approach. Since the 1970s, the Department of Public Health Engineering (DPHE), with substantial support from UNICEF, has promoted and implemented a village water supply program based on the use of locally manufactured suction handpumps. The program was very successful and by the mid 1980s there were more than 800,000 such handpumps in use, all capable of lifting from a water table no more than 7 meters below ground.

Irrigation development has also been rapid, with an early emphasis on deep, high-production pumps (200 cu m/hour), giving way in the late 1970s to so-called "shallow tubewells" from which centrifugal pumps with surface-mounted diesel engines deliver 25-30 cu m/hour. There are estimated to be more than 100,000 of these in operation throughout Bangladesh. About 300,000 privately-owned handpumps are also thought to be in use for both drinking water and irrigation purposes.

The heavy irrigation pumping in the dry season undoubtedly contributes to the rapid lowering of the groundwater table during that season. The groundwater is then replenished in the rainy season and the water table rises again. Groundwater monitoring from

1970 to 1983 reveals that water tables dropped temporarily below 8 meters at some time during that period over 10% of the area in which groundwater is used for irrigation. That means that between 50,000 and 100,000 village handpumps are at risk of drying up for as much as 3 months of the pre-monsoon season each year. And a similar proportion of farmers using shallow tubewells are in the same position.

For the farmers, the problem can be rectified by digging a 2-3 meter deep pit and lowering the portable motorized pump. Villagers depending on suction handpumps for clean water have no such option, as the pumps are not designed for forcing the water the additional distance to the surface. They may be able to obtain supplies from the nearby irrigation pump, or, more likely, return to the previous unsafe surface sources, in an environment where the risk of contracting cholera or other diarrheal diseases is high.

Future handpump projects in areas of Bangladesh where the groundwater level is falling have a new technological option in the form of the Tara pump. This direct action handpump (Box 4.7 in Chapter 4) has been specially developed for local manufacture and village-level maintenance, and can lift water from 12 to 15 meter depths.

In Bangladesh, the technical solution is probably preferable to the legislative one, as regulations controlling groundwater withdrawals for irrigation would be difficult to implement in an equitable way and would interfere with the important goal of increasing agricultural production.

Few, if any, countries have such immense groundwater resources as Bangladesh, and the experience there with suction pumps is an important warning to all designers contemplating the use of such pumps. Full account must be taken of competing demands on local groundwater resources when estimating draw-down and therefore maximum seasonal pumping lift.

groundwater quality. Industrial nations provide ample evidence of damage to precious groundwater. Industrial effluent, landfill waste disposal, accidental chemical spillage, excessive application of fertilizers, and use of pesticides, are all inexorably reducing the quality of groundwater and threatening present and future drinking water supplies. In most developing countries, the risks are presently not so great, but the warnings should be noted in time. In particular, sanitation program planning must ensure that latrines are sited in such a way that they do not endanger shallow aquifers.

Groundwater quality is important for several reasons. Some naturally occurring salts, like fluorides, can make the water injurious to health. Other salts may

affect taste or color, making the water unpalatable or aesthetically unacceptable (high iron levels are not uncommon and will impart a bitter taste and stain food and laundry; sulfates can give an unpleasant smell and have a mildly laxative effect; and salinity levels may sometimes be too high for palatability). Groundwater may also be corrosive, and this can have a considerable impact on pump breakdown rates, when corrodible components like mild steel pumphods and rising mains are attacked (corrosion problems are discussed in more detail in Chapter 4).

Water quality problems such as high iron or fluoride levels can be overcome through treatment, but this will be costly and demand greater institutional strength because of the more complex management involved.

Box 3.5 Some Drilling Methods for Handpump Wells

The largest single cost item in a handpump-based community water supply (CWS) program is almost invariably the well drilling. Correct choice of drilling method can have a considerable impact on overall costs and thus on the service level (number of pumps) which can be provided.

Available drilling equipment covers a wide range. The drilling rig itself may cost as much as US\$500,000 for a large multipurpose rotary rig, or as little as US\$1,000 for a simple hand-operated device capable of drilling shallow wells in soft ground. As well as varying in price and capabilities, different drilling rigs call for widely varying skills and backup support if they are to perform efficiently.

Selection of the right equipment depends very much on local geology and anticipated drilling depths, but it is also important to recognize the constraints imposed by operational requirements for the rigs

under consideration. Box Table 3.5A lists some of the more commonly used drilling rig types, indicating their cost ranges and operational needs, as well as their drilling capabilities.

Though the waterwell drilling market is large, few drilling rigs have been specially designed for the application. The range available is mainly dictated by the needs of mineral exploration or mining. For handpump projects, drilling demands are comparatively light. Simplicity, durability and maneuverability are often important criteria, alongside cost.

The drilling duties specified in Box Table 3.5A cover most situations likely to arise on CWS programs in developing countries. Many schemes involve only shallow wells (15 meters deep or less) in unconsolidated ground; few require drilling beyond 80 meters. In hard consolidated rock, the well diameter

Box Table 3.5A Cost Comparisons for Different Technologies

	<i>Hand digging</i>	<i>Hand-operated rig</i>	<i>Cable-tool rig</i>	<i>Small air-flush rotary rig</i>	<i>Multi-purpose rotary rig</i>
Approx. capital cost range in US\$	\$1,000	\$1,000-5,000	\$20,000-100,000	\$100,000-250,000	\$200,000-500,000
Running cost	very low	low	low	medium	very high
Training needs for operation	very low	low	low-medium	medium	very high
Repair skills	very low	low	low-medium	medium	very high
Back-up support	very low	low	low-medium	medium	very high
Approx. range of penetration rates in meters per 8-hr day	0.1-2.0m	1-15m	1-15m	20-100m	20-100m
200mm* holes to 15m in unconsolidated formation	—	fast	fast	impossible	very fast†
200mm* holes to 50m in unconsolidated formation	—	slow and difficult	fairly fast	impossible	very fast†
200mm* holes to 15/50m in semi-consolidated formation	—	impossible	fairly fast	impossible	very fast†
100mm holes to 15/50m in consolidated (hard) formation (not gravel packed).	—	impossible	very slow	very fast†	very fast†

* 200mm holes to give 100mm diameter finished well after screening and gravel packing. † Constrained by logistical support.

can be restricted to the 100mm needed to accommodate a handpump cylinder, while in unconsolidated formations, allowance for casing and gravel pack will mean a diameter of 200-250mm.

The ideal drilling rig would therefore perform quickly and efficiently drilling 200-250mm diameter holes in soft rock and 100mm diameter holes in hard rock — sometimes in the same well — to a maximum

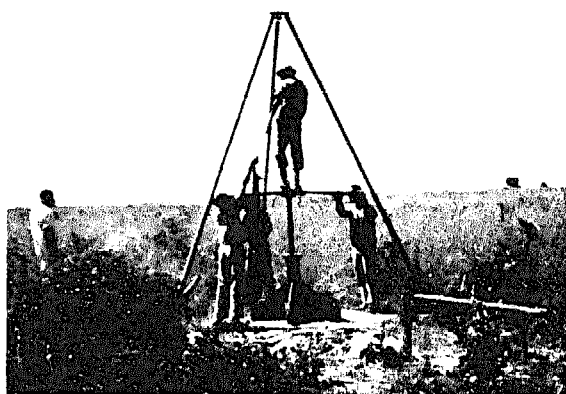

Hand-operated drilling equipment

Simple, inexpensive and highly maneuverable, hand drilling may be the most appropriate choice for shallow wells down to 15-20 meters. Beyond 20 meters, hand drilling becomes very difficult, and progress is inevitably slow. One apparent advantage — the lack of any mechanical equipment which requires servicing — is less significant than it first appears if the equipment has to be carried from well to well by motor vehicle, as the servicing needs of a light cable-tool rig are usually less than those of a motor vehicle.

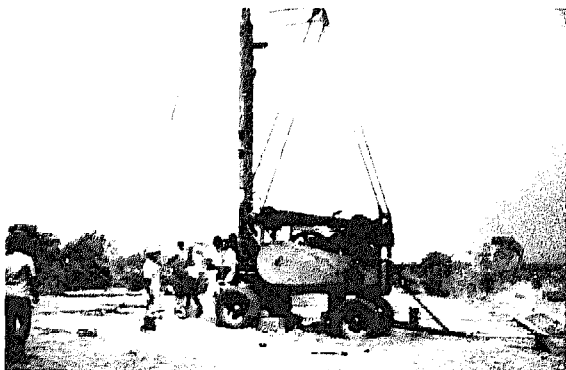

Cable-tool rigs

An old and simple design which has changed little over the years. Cable-tool rigs are generally durable and easy to service, requiring only minimally trained

depth of 80 meters. Any capabilities beyond those minimum requirements which make the rig more costly, more cumbersome, or more difficult to operate are undesirable.

In the absence of a purpose-designed rig for CWS work, the choice is inevitably a compromise. As an approximate guide to selection, the following notes amplify remarks in Box Table 3.5A.

operators. Effective in unconsolidated or semi-consolidated formations down to about 50 meters, they can offer considerable cost savings and other benefits when compared with rotary rigs. However, cable-tool rigs are not suitable for hard-rock drilling.

Small air-flush rotary rigs

Specifically designed for drilling small diameter holes quickly in hard rock, small rotary rigs are restricted to wells which will not require gravel packing. Even then, the need for a mechanically complex compressor can be a handicap for CWS work. In the hands of a capable drilling contractor, these rigs can, however, be very effective.

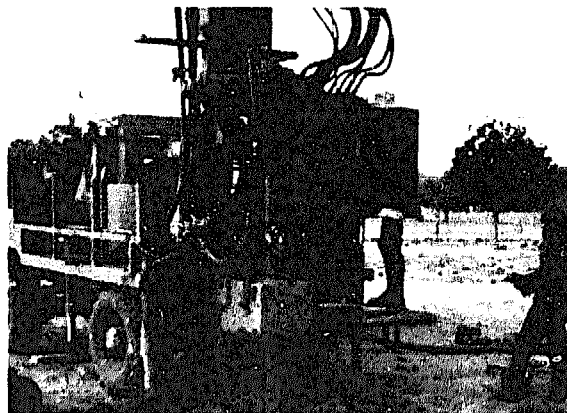

Multipurpose rotary rigs

Massively over-designed for CWS work and correspondingly expensive and complex to operate and maintain, large rigs are often provided by donors on the basis of rated performance which cannot be reproduced under field conditions. Limited maneuverability means that they are regularly bogged down on rural roads, and manning and servicing the sophisticated rigs often proves difficult for water agencies in developing countries. Though restricted choice may point to selection of these expensive machines, a smaller rotary rig for hard-rock drilling, a cable-tool rig for semi-consolidated rock drilling, or hand-operated equipment for shallow-well drilling in soft formations, are all likely to be more appropriate.

The Well

The long-term reliability of a handpump project depends to a great extent on the wells through which the pumps draw the groundwater. Analysis of breakdowns during the Project field trials demonstrates beyond doubt that even a well-designed and carefully selected handpump may not perform satisfactorily if it is installed on a badly constructed well. Sand entering pumping elements leads to rapid deterioration of valves and seals, calling for frequent repair and replacement and disenchantment among users.

Usually the most costly part of a community water scheme, wells can be designed to protect the handpumps from damage and to ensure that the potential of the aquifer is fully realized. Too often, however, promoters presume that any hole in the ground will suffice for a handpump, with the result that digging or drilling costs are wasted because the pump will perform poorly on the resulting well.

Water wells divide into two categories: *dug wells*; and *drilled wells*, and each category may then be subdivided according to whether the well is constructed by hand or by machine. For definition purposes, a dug well is a well that a person can enter to clean or deepen and will rarely be less than 800mm in diameter.

Handpumps can be installed in dug wells or drilled wells of any depth and diameter, subject only to the practical limit that the pumping water level should normally not be more than 45 meters down (60 meters in exceptional cases, if other pumping options are not feasible). Detailed discussion of actual construction methods for water wells is beyond the scope of this report, though the merits of alternative digging and drilling techniques are referred to briefly in this chapter and some examples are given in Box 3.5.

Aspects of well design and construction which can influence handpump system performance are: *siting*, *depth*, *screen design*, *development*, and *apron design*.

Well siting is a good example of the way that the advisers and the community need to share knowledge and opinions. Too often, a drilled well is sited purely on the basis of a geophysical survey, irrespective of the community's wishes. A common result is that few people make use of the new facility, regarding it as inconvenient and imposed from outside.

There are many cases in alluvial plains, where the community can have full freedom of choice in locating its wells. In Bangladesh, for instance, groundwater is ubiquitous and plentiful, and hand drilling to sandy horizons protected from pollution by overlying clays offers an almost guaranteed success. In these circumstances, householders generally choose to site wells in their *bari* (hamlet), next to their homes and the ideal hydrogeology of the region means that costs are low and risks are few (unless the well is directly adjacent to a latrine).

Technical advice becomes necessary in situations like the deeply weathered basement areas of central Africa, where adequate quantities of groundwater can be expected almost everywhere, but excessively high

ground should be avoided to reduce pumping heads, and sites should preferably be chosen away from (ideally up-gradient of) pollution threats such as latrines or cattle stockades. Here, the advisers must explain the principles of selection to the water committee, including if necessary making strong recommendations against certain sites on technical grounds. Ideally, it is the committee which must make the final decision, and only if the scheme is technically or economically impossible, should the community's wishes be overruled.

The most difficult situation arises in some of the semi-arid areas of Africa and elsewhere, where the weathered profile is thin and groundwater is found in fractures within the unweathered rock. Geophysical surveys may be the only way to locate adequate resources, and a distance of only 10 meters might make the difference between a productive well and a dry one. Here, the selection procedure is different, with the community first identifying desirable and undesirable areas and the technologists then finding the optimum drilling points within the chosen areas.

The next important consideration will be **well depth**. Wells must be deep enough to ensure reliable supplies even during prolonged droughts. The Project encountered very serious problems due to wells drying up in the long dry periods of the early 1980s in Africa. Over half of the wells in one large community water supply program became unreliable during the driest spells, when water levels fell 5 meters or more below their seasonal average levels.

Ensuring that drilled well depths are adequate is relatively simple, as drilling commonly proceeds 15 meters or more below static water levels to achieve sufficient flow of water into the well. Dug wells are a bigger problem. Dewatering during construction is difficult, and dug wells usually penetrate only a short way below the static water table, relying on well storage fed by percolation during the night to meet daily needs. Such wells are of course the first to dry out when the water table drops.

With traditional open wells, the answer is simply to dig deeper when the need arises. The same principle should be applied to dug wells fitted with handpumps. Covered access openings must be provided into the well, and must include an adequate seal against surface contamination. There is a double benefit, as the access openings provide a backup means of drawing water by bucket if the handpump breaks down and cannot be repaired quickly.

Particularly with drilled wells, there is a balance to be struck between extra reliability and cost. Drilling is an expensive operation in many parts of the world, and making excessive allowance for drawdown of the water table may lead to waste of resources. Again, knowledge of the local hydrogeology and planned irrigation developments can lead to substantial savings, and the value of record keeping on all projects cannot be stressed too highly.

Preventing **sand entry** into the well is the next task of the well designer. The problem relates mainly to drilled

wells; lining and support of a dug well is often important to prevent infill or even collapse, but it is less common for sand movement to be a threat to water quality or pump components in large diameter wells. It is, however, as has already been mentioned, a major cause of hand-pump breakdown in poorly designed and developed drilled wells.

It is frustrating for handpump specialists to witness the waste of time and effort resulting from sand damage, when relatively simple measures incorporated in the design of wells could practically eliminate the problem. It is a fundamental principle of well design that a well screen and filter pack are provided to prevent sand incursion, except in consolidated rock where there is no danger of formation movement and the designer can consider leaving the hole uncased for the rock section. Even in this type of well, the soil overlaying the rock section must be cased and grouted, to prevent abrasive particles from cascading down the hole and being drawn into the pumping elements.

The right combination of pack material and slot size can ensure that formation sand cannot move into the well to cause blockage or pump damage. In a low-cost community water supply project, there is rarely any need for individual designs for each well; knowing the aquifer type, a safe design can be chosen. Planners, consultants and contractors involved in community water supply programs in developing countries must recognize that proper design requires screens and filter packs in unconsolidated and semi-consolidated formations. Adequate supervision is needed during well construction, to ensure that installation is carried out correctly.

Malawi's Livulezi project (Box 3.3) provides a good example of the impact that good well design can have on pump reliability. Before the project began, seals were replaced on average every six months on each of over 4,000 handpumps. The project brought improved control of well quality, as a result of which 85 of the 106 pumps needed no seal replacement after an average operating period of two years.

Long-term performance of drilled wells can also be improved considerably by proper **well development**. Extensive sand pumping before the well is brought into commission, boosts the water flow into the well, avoids clogging later by removing fine material from around the screen, and reduces the amount of sand which might otherwise be working its way towards the pumping elements. The Project has found that well development is often neglected or poorly carried out, partly because there is a belief that for a handpump well it does not matter. A properly constructed well will outlast even the best handpump by many years.

The only visible part of the completed well, apart from the pump itself, is the surrounding **apron**. In simple design terms, the apron serves to protect the well from pollution caused by contaminated water flowing back into it and prevents muddy pools of standing water from forming around the pump. The pump apron also provides an opportunity to promote improved health and hygiene.

Frequently the new pump becomes a focus of community life. Its amenity value can be enhanced by adding clothes washing and bathing facilities. Many villages, encouraged and helped by government extension workers, divert drainage water from the apron to irrigate a small vegetable plot. The appearance of the pump and its surrounding apron can be a useful guide to a community's organizational strength and to its capacity to manage its own water supply system.

The Handpump

Chapter 4 deals with the different factors which can affect handpump performance, and the remainder of this document is devoted to analysis of handpumps which have been tested by the Project. If proper attention has been given to the establishment of appropriate community management; if the capacity and limitations of the aquifer have been recognized; if the well has been soundly designed and constructed; and if the maintenance capabilities of the community and the support facilities available have been critically assessed and matched to the level of skill required to maintain a chosen handpump, then conditions are right for a successful community water supply project.

Selection of the most appropriate pump for specific site conditions involves a detailed appraisal of those conditions and of the attributes of the different pumps on offer. Chapter 4 has the details.

Finance

In the years leading up to the International Drinking Water Supply and Sanitation Decade (IDWSSD), rural water supply was a badly neglected sector. Low investment, poor achievements and a weak political lobby led to the sorry coverage statistics quoted at the beginning of Chapter 1.

That situation is changing. In the course of the IDWSSD, governments have increasingly recognized the potential benefits of community water supply investments, and the pace at which improvements can be accomplished if appropriate low-cost solutions are adopted. Donors too have committed themselves to the integrated approach, and have taken initiatives to coordinate their activities in support of programs based on low-cost technologies.

The mood is now right for accelerated progress, but the needs are enormous. Continuing efforts are needed to bring down costs, and to ensure that health and economic benefits are maximized.

Well construction will normally be the biggest **capital** cost item in a handpump-based water supply program. At present, well costs can range from less than US\$200 for a 50m deep hand-drilled well in alluvial plains in South Asia to US\$20,000 or more for a machine-drilled well of the same depth in the harder formations in West Africa. Geology has a big effect on drilling costs, but even in very similar geological conditions, the Project has found that there can be a 5-10 fold difference in costs for the same kind of well in different regions.

In India, a 50 meter well drilled by a local contractor using a locally-made down-the-hole-hammer drilling rig will range in cost from about US\$1,500 to US\$2,000 — very similar to costs in the USA and other industrialized nations. In Africa, it is rare to get a 50m well for less than \$5,000 and not uncommon for the cost to exceed \$15,000.

The difference comes from the organization of well drilling and the equipment used, and can be substantially influenced by unrealistic currency exchange rates. In the past, donors have often supplied sophisticated drilling rigs, theoretically capable of drilling perhaps a well a day, but in practice achieving as little as two or three holes a month. Drilling equipment should be chosen so as to be operable and maintainable within the existing capacity of the public sector or contracting industry, and should be standardized for any one country.

The scale of water supply development needed (70% of Africa's rural population lack access to safe water) demands lower costs. Otherwise, the cost of providing sufficient wells with handpumps to give a level of service which people value will be prohibitive. There is no evident reason why costs of well drilling in Africa should not come down close to those in Asia. Achievement of reasonable well costs should be a high priority of governments and donors alike. Both must recognize the need to build up a national drilling capability, preferably in the private sector, and create a competitive climate by encouraging local contractors to purchase appropriate equipment and submit bids for drilling projects.

Part of the solution lies in using the right drilling equipment. Box 3.5 shows a few of the many different drilling technologies in use in various parts of the world. Too often though, the choice available is dictated by donor preference and the market in the industrial countries, where there is little demand for the shallow, small-diameter holes in remote places which characterize handpump programs in developing countries. Selection is usually a compromise involving cost, speed, maneuverability and technical sophistication.

The growth of indigenous rig manufacturing industries in India and Brazil is leading to innovative designs specifically for rural water supplies. There are positive signs too that, partly because of Project initiatives, major rig manufacturers from industrial countries have recognized the large market for drilling rigs designed specifically for rural water supply work.

Evaluation of drilling methods and management will be an important component of the Project's second phase, with the aim of focussing the same concentrated attention on this major cost element as has been devoted to handpump development in the first phase.

Well costs tend to dominate community water supply economics, at least in terms of capital investments. That does not mean that handpump costs should be neglected. The large competitive market now opening up, and the increasing scope for in-country manufacture of proven handpump designs, should lead to a progressive lowering of pump prices. This trend will be given added impetus if developing countries and donors use their

purchasing power effectively. Removing import duties on raw materials and other taxes for locally-manufactured handpumps will not only stimulate national industry, but also encourage potential importers to cut profit margins in order to compete. Standardization policies should also increase the competition for initial orders.

The Handpump Compendium includes indicative prices for many of the handpumps presently available on the market. The range is quite wide, with a clear price advantage in favor of pumps manufactured in developing countries. With a few notable exceptions, pumps suitable for low-lift applications should be available for less than US\$200 per unit, including rods and rising main. As pumping lift increases, prices of both the pumping unit and the rods and rising main rise, and so does the range of prices. So, for a pumping lift of 30 meters, the total cost of pump, rods and rising main can be as low as US\$500, or as high as US\$2,500.

Handpump prices can have an impact on the capital cost of projects, particularly when wells are shallow and drilling/digging costs are low. However, the right choice of handpump is even more critical in relation to **recurrent** costs. Though handpump maintenance costs vary greatly in different parts of the world, and few individual countries have examples of each type of system, the extensive data collected during the Project clearly demonstrate the general rule that the greater the involvement in maintenance activities of agencies outside the community, the higher the maintenance cost.

Malawi's Livulezi project offers a good example (Box 3.3). With 200 pumps maintained by village caretakers and repairs carried out by two trained government maintenance workers, the average annual cost of maintaining each pump during 1984 and 1985 amounted to US\$24, or US\$0.10 for each of the 250 users per pump. Significantly, two-thirds of the costs relate to overheads and transport costs for the government maintenance activities. Once pumps have been installed which are **VLOM** in both the above and below-ground components, the indications are that the resulting savings when full village-level maintenance is introduced will bring annual maintenance costs in Malawi down to 5 or 6 cents per user.

At the other end of the scale, a centralized maintenance example from another African country shows the prohibitively high transport costs (US\$135 per year) and administrative charges (US\$30) involved in maintaining each handpump. Added to a direct labor cost of US\$19 and spare parts cost of US\$9, these result in a total maintenance cost of US\$193 per pump per year. Even with the comparatively large user groups (about 400) commonly served by one handpump in that region, centralized maintenance is costing almost 50 cents per user per year.

For logistical and financial reasons, centralized maintenance is not a viable economic option for most countries. To replace a piston cupseal costing as little as US\$2, a truck with 3-4 people has to be sent out from the base camp, travelling perhaps 100km to the pump. The whole operation can end up costing US\$200-300.

The economic argument in favor of community-managed maintenance is decisive and is reinforced even further by the improved reliability of handpumps serviced at the village level. Dependable pumps are valued by users, who will be willing and able to pay the comparatively low costs involved in maintaining them. What is needed is a suitable mechanism within the community for collecting and administering maintenance funds.

Attempts to initiate simple accounting practices for the upkeep of CWS systems have not always met with success. If agricultural credit banks, post offices or farmers' cooperatives already exist in the vicinity, water committee members can be trained to take responsibility for a maintenance fund, under the guidance of such an organization. However, many communities are out of reach of convenient banking facilities, and must rely on a cash box kept by a designated community member.

Despite the risks, the Burkina Faso example in Box 3.1 shows how such a system can work successfully, while also stimulating private mechanics to spread their influence over a wider region, because of the mutual benefits. Maintenance costs are extremely low — only US\$0.05 per user per year, compared with an estimated US\$0.65 per user per year replacement costs for the alternative rope and bucket systems — yet the mechanics find the earnings attractive, and provide prompt service when there is a breakdown.

Other examples exist of workable community financing of handpump systems, but there is a need for more data. During the second phase, the Project will further analyse different maintenance arrangements and offer guidance for governments and donors.

Summary of planning Guidelines

Analysis of the six key elements in community water supply projects using handpumps points to a series of guidelines, which, with the supporting evidence outlined in this report, may lead CWS planners towards establishing the conditions for optimum performance and reliability in a handpump-based community water system:

The Maintenance System

- The trend towards increasing community management of handpump systems is soundly based, keeping down costs and improving reliability. Contracting of nearby area mechanics (or privatization of the service) will prove to be the optimum solution in many cases.
- Every element of system design should be directed towards simplifying the upkeep of the completed scheme and ensuring that skills, tools and materials will be available when needed. Spare parts and tools should be distributed to each community as part of project execution.
- Scheduled servicing, involving periodic replacement of wearing parts, should be evaluated in the project planning stage, as it is likely to reduce breakdowns,

save money, and make community management easier to achieve.

The Community

- Community participation should include involvement of a water committee in the selection of service level, well location and technology choice, as well as project construction.
- Financial and technical commitments must be shown to be within the community's capabilities, and any operational links needed between the local management and external agencies must be established before the scheme is implemented. Private sector mechanics have been shown to be an effective bridge between the central authority and the community.
- Government extension workers should be responsible for training village pump attendants and management in operation and maintenance needs and cost recovery procedures, and this should be backed up by refresher courses and project monitoring and evaluation.
- Though full community management is the ideal, transitional stages in which community members take on limited responsibilities, to reduce the load on the central agency, can have a significant impact on costs and reliability. The important criterion is that institutional, technical and financial resources match the needs of the selected system.
- The ultimate objective should be full community responsibility for management of point source supplies.

The Aquifer

- National and regional data collection on groundwater resources provides valuable information for handpump project planning and design. Existing and new wells should be monitored, to build up as complete a picture as possible of aquifer geometry, water quality and potential yields. Governments should exploit the effectiveness of available computers, as a means of establishing a groundwater data base which can be continually updated.
- Knowledge of seasonal groundwater level fluctuations and carefully executed pumping tests are especially important in low-yielding aquifers, to ensure that well depth is adequate to provide sufficient dry season yields. Selection of the right handpump and cylinder setting depend on accurate assessment of maximum drawdown (and thus maximum pumping lift). Drawdowns of tens of meters have been recorded in handpumped wells located in low-yielding aquifers.
- Regulation of aquifer development through legis-

lation is the best way to prevent handpump wells from being undermined by later developments involving motorized pumps. Legislation should also be considered as a means of protecting groundwater resources from pollution due to surface activities.

The Well

- Sand and silt ingress into pumping elements is a major cause of handpump breakdown. Properly designed screens and filter packs have been shown to reduce damage to seals and valves dramatically, and should be seen as an essential element in drilled well design for unconsolidated or semi-consolidated formations. Proper well development will also improve the long-term performance of wells and pumps.
- Though hydrogeological conditions influence the choice of well location, community preferences should be taken into account when possible sites are selected.
- Full advantage should be taken of the amenity value of the well apron, to promote improved health and hygiene. Clothes washing, bathing and small-plot irrigation can be encouraged by good apron design.
- The right drilling equipment and management can substantially reduce the well costs - commonly the largest cost element in the whole CWS system.

The Handpump

- The above guidelines are intended to establish the optimum conditions for operation and maintenance of the handpump. Final selection involves detailed consideration of the attributes of individual pumps in the particular conditions for which they are being chosen. That is the subject of Chapters 4 and 5.

Finance

- The International Drinking Water Supply and Sanitation Decade has seen a marked switch in favor of CWS strategies based on community management of low-cost technologies. Unit costs are coming

down as a result, but further reductions are necessary if needs are to be met.

- Drilling is the most significant capital cost item in a handpump project, and drilling costs remain much too high in several parts of the world, and particularly in Africa. New strategies are needed, to encourage private sector initiatives, and to develop drilling techniques appropriate for CWS programs. This will be a key element of phase 2 of the Project.
- Encouragement of handpump manufacture in developing countries can stimulate competition and bring down costs, in addition to the benefits for operation and maintenance.
- The economic argument in favor of community-managed maintenance is decisive, and the resulting improvement in system reliability increases the community's willingness to pay for the upkeep.
- Simple financing and administrative arrangements for community management of handpump-based CWS systems are proving successful in several countries, and further analysis of these arrangements will be included in the second phase of the Project.

Handpump-based community water supplies have to be seen as a package of elements, each important in its own right, but with the balance of the elements also vital to long-term success. Inadequacies in pump design or installation will lead to unsatisfactory performance, even on properly constructed wells, just as good pumps cannot be expected to function reliably on badly constructed wells. Even the best pumps need repairs sooner or later, so appropriate organization of community management of maintenance is essential; ineffective and expensive centralized or regional maintenance does not provide the needed service. The central authority does have a role to play in the setting and monitoring of standards, training of community caretakers and area mechanics, and in the organization of adequate outlets for spare parts (preferably within a bicycle ride of the village) when VLOM pumps are being used.

Chapter 4

Handpump Technology

Handpump failure rates in India dropped from about 70% in the mid-1970s to about 20% less than a decade later. This transformation came after an intensive program by Indian central and state governments and UNICEF to develop appropriate pumps and maintenance systems. It is a good demonstration of the influence that pump selection and system design can have on handpump performance. Recent and continuing handpump improvements mean that much higher success rates are achievable if enough emphasis is placed on the critical issues: choice of suitable pumps; maintenance arrangements; well construction; spares availability; and training. Progress made during the last few years has provided answers to many of the earlier problems, though a number remain to be solved.

Working conditions for handpumps in developing countries are severe. Many hours a day of pumping, rough handling, corrosive groundwater, and inadequate maintenance are among the challenges that face manufacturers attempting to offer reliable products.

Problems highlighted in India and elsewhere in the late 1970s, in preparation for the Water Decade, provided the impetus for the Project. Since 1981, field trials and laboratory tests have amassed unique comparative evidence on the performance of handpumps under widely differing conditions, enabling the Project to offer informed advice on how to choose pumps which will give the best performance. For manufacturers, the message is that the key elements of future designs should be: robustness of fixed components; easily-replaced, low-cost and readily available wearing parts; and corrosion-resistant materials.

History of Handpumps

The history of handpumps goes back a long way; McJunkin¹ reports the use of positive displacement reciprocating pumps in Ancient Rome as early as 275 BC. One of the best documented early examples of a wooden pump using metal flap valves, from Saxony, was recorded by Agricola in the 16th Century.

But most of the reciprocating handpumps in common use in developing countries today have their origins in designs developed during the late 19th and early 20th

Centuries in Europe and the United States. The Industrial Revolution brought mass production techniques for cast iron and meant that thousands of manufacturers were able to turn out handpumps to meet the huge demand for convenient water supplies at that time. It has been estimated that some 42 million handpumps were made in the USA, mostly in the period up to 1920, when electric pumps began to replace them.²

If the basic design of the reciprocating handpump has not changed much in the 20th Century, its use certainly has. European village pumps were huge structures, serving as much a monumental as a functional role, while the big market was for smaller backyard pumps used for 10-30 minutes a day by individual families or farmers. Today in the developing countries, a single pump may have to supply up to 500 villagers and be in continuous operation for 10 or more hours a day.

Though the potential market for such pumps is vast, little development work went into designing handpumps specifically for rural water supply applications in developing countries until quite recently. Manufacturers continued to supply the old backyard pumps, and rarely received any feedback about how their pumps were performing under the totally different operating conditions.

During the 1970s, other types of positive displacement pumps, commonly used for industrial applications (the diaphragm pump and the progressing cavity pump), were adapted for rural water supply use and installed in a number of developing countries. At the same time, UNICEF sponsored a great deal of research and development work in India, culminating in the first production models of the India Mark II handpump in 1978. The first Indian national standard for this pump appeared in 1979.

Box 4.1 overleaf describes the operating principles and the merits and shortcomings of the five principal

1. F.E. McJunkin, *Hand Pumps*, The International Reference Centre for Community Water Supply, The Hague, The Netherlands, 1977.

2. Bernard Ewbanks, *The Story of the Pump and Its Relatives*, 1971, Salem, Oregon, USA (private printing of 400 copies), page 171.

Box 4.1 Handpump Types and Operating Principles

Of the 42 pumps featured in the Hand-pump Compendium (i.e. all pumps which have been subjected to laboratory and/or field tests during the Project), 38 are reciprocating pumps; 2 (Mono and Moyno) are progressing cavity pumps; and 2 (Vergnet and Abi-ASM) are diaphragm pumps, both using the same down-hole components. The laboratory and field trial results do not indicate major performance differences related to mode of operation. The most useful classification for pump evaluation and selection is the depth from which particular pumps can draw water — i.e. the pumping lift.

LOW LIFT

Suction Pumps

Suction pumps draw water from shallow depths by creating a partial vacuum in the suction pipe. Depending as they do on atmospheric pressure to drive water up to the surface, their use is restricted to regions with water tables no more than 7 meters below the surface, but in those areas they have been very popular for reasons of both economy and convenience. There are more suction pumps in use in the world than any other type; over one million are known to be installed in Bangladesh and there are several million in China, mainly serving individual

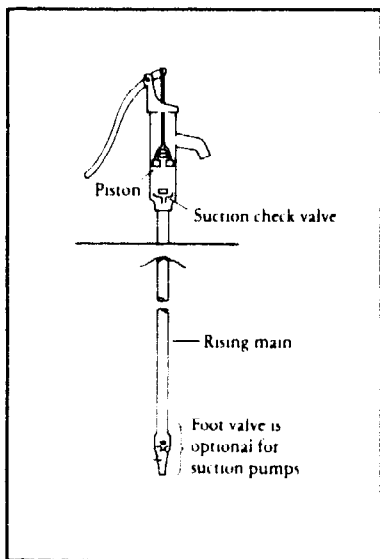

families or small groups.

All the moving parts of a suction pump are located above ground, and only the suction pipe extends down into the well. On the upstroke (illustrated) water above the plunger is forced out through the discharge spout and more is drawn into the cylinder through the open check valve. On the downstroke, the check valve closes, the plunger valve opens and water passes through the plunger to be lifted in the next cycle.

The operating limit is set by barometric pressure (equivalent at sea level to a 10.4 meter head of water) and the effectiveness of the seals, which make the practical limit only about two-thirds of full barometric pressure. This 7 meter limit on pumping lift is the biggest drawback of suction pumps. With water tables falling below that level in many parts of the world where such pumps have been installed, the pumps are becoming inoperable and must be replaced with deepwell pumps.

Another serious disadvantage of suction pumps is that they must be primed by pouring water into the space above the plunger each time that pumping recommences. Use of contaminated water for priming is an obvious health hazard, which is difficult to avoid.

In their major application as family pumps, suction pumps do not need to be as sturdy as handpumps used by larger communities, and the low lifts also subject components to less stress and reduced wear. When typical suction pump models have been subjected to community use, they have generally shown rapid wear and poor durability. In the Project trials, heavy use caused frequent problems with the Lucky, Jetmatic and New No 6 pumps. Only the SYB-100 in China proved reasonably robust in community use.

Direct Action Pumps

Suitable for pumping lifts of up to about 12 meters, direct action handpumps are reciprocating pumps which can continue to operate when the water table has fallen below the reach of suction pumps.

There is no need for priming, which is also an advantage over suction pumps. They differ from suction and deepwell pumps in that the operator's effort is applied directly to the plunger, without the mechanical advantage achieved through a lever or flywheel. This elimination of the mechanical advantage restricts application of direct action pumps to the depth from which an individual can physically lift the column of water. On the other hand, the mechanical simplicity of the pumps and the

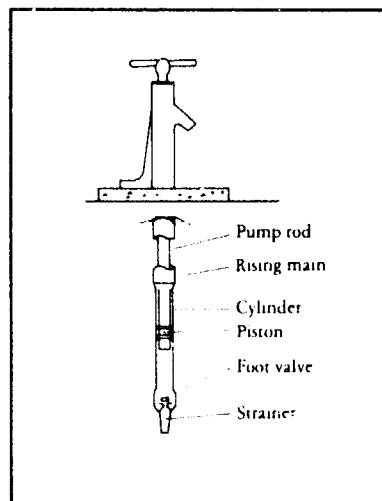

potential for low-cost, lightweight construction, makes them well equipped to meet VL0M objectives.

Use of large diameter lightweight pumprods can help to balance the effort needed on the upstroke and downstroke, and reduce the stresses on the rods and linkages. This element of direct action pump design is being studied as part of the Project, and is discussed in the section on **Pumprods** in the main text.

Though some direct action pumps are still in the development stage, there has been extensive experience in a number of countries over the past 16 years to justify the Project's optimism that such pumps can have widespread application for community water supplies, offering considerable advantages over suction pumps for low-lift applications.

INTERMEDIATE AND HIGH LIFT

Deepwell Reciprocating Pumps

In deepwell pumps, the cylinder is immersed below the water level. They are suitable for lifts down to 45 meters or more, depending on the effort that users

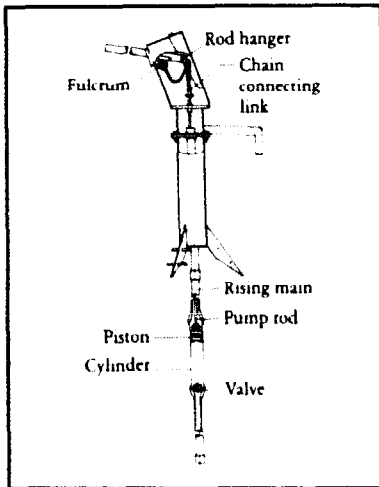

are willing to apply for progressively less water as depth increases. The submerged cylinder eliminates the need for priming, but means that repairs or maintenance involve removal of components from down the well.

Deepwell reciprocating pumps exist in a number of forms, with the operating mechanism available as a lever, a fly-wheel or a pedal, and a variety of ways of converting the operator's action into a reciprocating motion of the plunger. With economy and ease of maintenance as important selection criteria, a considerable amount of Project time has been devoted to monitoring the performance of different deepwell pump designs.

Diaphragm Pumps

The illustration shows the Vergnet foot-pump, but the same downhole components are used in the Abi-ASM, which has a conventional lever handle. In each case, the operator's applied force is

turned into a pumping action through alternate stretching and relaxing of the elastic membrane (diaphragm), which is filled with water in a closed system. Expansion of the diaphragm inside the rigid cylinder closes the suction valve and opens the delivery valve, driving water to the surface through a flexible hose rising main. When the diaphragm contracts, water is drawn in through the suction valve, as in a conventional reciprocating pump on the upstroke. The principle of the pump is attractive, because it allows the use of flexible tube for the pilot hose and rising main and is therefore easy to install or remove without the need for special tools or equipment. Diaphragm life is comparatively short, and replacement may cost as much as US\$200 in the field, beyond many villagers' capacity to pay.

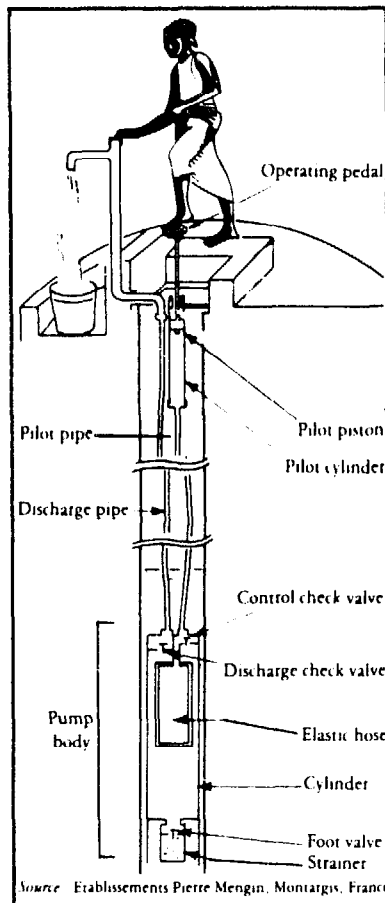

Progressing Cavity Pumps

A rotary motion provides the lifting energy in progressing cavity pumps. An accurately machined helical rotor turns in a fixed rubber stator and progressively pushes the water upwards continuously. The meshing surfaces provide their own moving seal. A gearbox transmits the operator's rotation in the

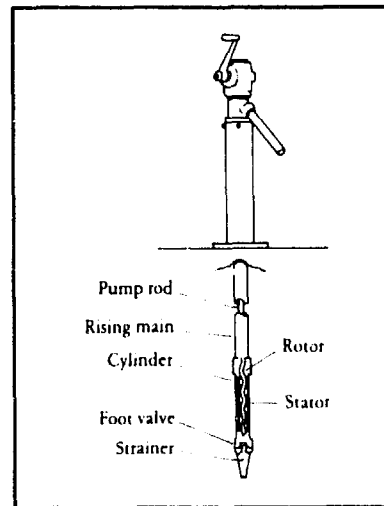

vertical plane into a horizontal plane rotation of the pumprod (a direct-drive version with the handle rotating in a horizontal plane is also available). One advantage of rotary pumps is that they are simply converted to motorized or animal power. On the other hand, the rods and rotor assembly need special lifting equipment when installed in or removed from deep wells.

These five categories cover all the pump types tested during the Handpumps Project. Pumps with other operating principles are being used for community water supplies, though the Project has not tested them. Among the options available are air or water jet pumps and pulsating (inertia) pumps.

pump types: suction pumps; deepwell reciprocating pumps; direct action piston pumps; diaphragm pumps; and progressing cavity pumps. These categories cover the majority of pumps presently on the market, and all of those tested by the Project. Other interesting designs do exist, such as air or water jet pumps, and pulsating (inertia) pumps, but models based on these operating principles have not been tested by the Project.

As UNICEF's involvement in village water supply and sanitation programs built up during the 1970s, the agency undertook monitoring exercises in a number of countries and, for the first time, a picture began to emerge of just how many handpumps were out of order. India, which had been investing heavily in rural water supplies based on handpumps from the beginning of the 1970s was found to be suffering badly from breakdowns. In 1975, UNICEF reported that at any given time 70 to 80% of the handpumps were out of order.

Other countries too were finding it impossible to keep pumps in operation. A 1977 US Peace Corps survey found that only 40% of the handpumps in Sierra Leone were working. In 1982, the International Development Research Centre (Canada) reported that in Sri Lanka only 60% of recently installed handpumps were still functioning. Few countries seemed able to keep more than 25-50% of their pumps in service at any one time.

Factors Affecting Handpump Performance

The Project field trials have produced considerable new evidence about the way that handpumps function and the factors influencing their performance and reliability. Chapter 3 dealt with the elements of the water supply system which have to be considered if the pump is to have a chance of achieving optimum reliability. In selecting the handpump itself, the designer can take advantage of Project experiences by comparing the ratings given to pumps in the Pump Selection Guide, Chapter 5 of this document. First it will be useful to examine the effects of various operating conditions on the breakdown rates and downtime of different types of pumps.

Operating Conditions

1. Pumping lift

One of the key design criteria for any handpump is the depth from which water must be lifted to the surface. In the case of suction pumps, there is a physical limit fixed by the height at which the water column can no longer be supported by atmospheric pressure. In practice that means that, at sea level, suction pumps should not be used if the pumping level will be more than 7 meters below the surface, and at higher altitudes the limit is less (down to 4.5m at 3,500 meters, the elevation of much of the Andean plateau of South America). Lift limits for other pump types are less precise, though the Project has found it convenient to categorize pumps according to their performance at maximum depths of 12m (the approximate limit for present designs of direct action pumps), 25m (beyond which lifting gear is necessary to

remove conventional downhole components), and 45m (considerable effort is needed below that depth to produce acceptable discharge rates).

A critical factor to be taken into account is the drawdown of the water table which will be caused by pumping of water from the well (in addition to any seasonal drawdown and general lowering of the water table caused by nearby motorized pumps). For high-yielding wells in permeable formations, the discharge from a handpump will cause minimal drawdown. However, where the maximum yield of the well is in the same order as the pump discharge rate, excessive drawdowns can result (drawdowns in excess of 20m have been recorded). Figure 4.2A in Box 4.2 shows the variation in drawdown over a few hours pumping in some typical low-yield wells in Southern Ghana. Average static water level in this region is 10 to 12 meters below ground, but pumping can lower it significantly, as the graph shows.

In low-permeability rocks, such as the basement rocks of Africa, high seasonal fluctuations combined with high drawdown often bring pumping water levels down to the level of the cylinder intake. When that happens, air pumping may occur, possibly accompanied by sand movement, seal damage and heavy shock loads on the pump.

Pumping tests will give an indication of likely well yields and drawdown for different pumping rates. Selection should then be restricted to pumps capable of delivering enough water at the increased pumping lift, but it may also be prudent to eliminate high discharge pumps if these would draw the water down excessively.

2. Daily output

Daily output is a convenient way to express the demand from an individual pump, as it combines domestic water consumption calculated on a per capita basis with other supplies for small-plot irrigation, animal watering, etc. Chapters 2 and 3 have dealt with the choice of service levels and the compromise which must be made on deep wells between the economic number of users per pump and the time and effort needed to raise large quantities of water from great depth.

In comparing handpumps for a specific lift and daily output, the important parameter will be the pump's actual discharge rate at the given head (in other words the number of pumping hours needed to achieve the required daily output). Project observations clearly show that, whenever there is a choice, handpump users will favor the pump which fills their containers more quickly, even if, within limits, it is heavier to operate than alternatives. Provided therefore that a high discharge pump will not cause air pumping as a result of excessive drawdown, and/or sand-flow problems in the well, its choice is the one most likely to be accepted by users.

Maintenance System

The practical and economic arguments in favor of community management of handpump-based water systems were given in Chapter 3. This principle will have an important influence on handpump selection, and it is imperative that project planners (and manufacturers)

Box 4.2 Drawdown in Low-Yield Wells: Examples from West Africa

Basement rocks, which occur across large areas of upland Africa and Asia, are essentially impermeable crystalline rocks and will transmit water only when fractured or weathered. Deep weathering is common in tropical wet areas, such as the forest belts of west, central and east Africa, and these rocks, though their permeability is low, provide an adequate aquifer for widespread development of handpump-based rural water supplies. In dry zones, like the Sahel, often only minimal weathering has occurred and groundwater is limited to fractures in the crystalline rock.

Low permeabilities can cause problems due to very high drawdown of the water level in the well during continuous pumping. Yields from wells are generally low; analysis of data from 110 positive boreholes drilled in the Liptako area of Niger shows that 14% yielded less than 1 cu m/h and another 29% produced 1-2 cu m/h. This is by no means unusual in the Sahel region, and is reasonably indicative of the situation in other dry zones.

Caution is needed when determining maximum pumping lift and selecting handpumps for low-yielding wells, because excessive drawdown can lead to sand pumping and damage to both the well and the pump. Figure 4.2A plots the drawdown and recovery of five wells with different permeabilities in Southern Ghana. Each well was pumped continuously for three hours, at the rates shown, then allowed to recover. In each case, the static water level was 10-15 meters below the surface when pumping started. The figure shows that drawdown can easily exceed 10 meters where permeabilities are low, even when pumping rates are low (curves 3, 4 and 5). Factors

Figure 4.2A Drawdown and Recovery of Five Handpumped Wells in Southern Ghana

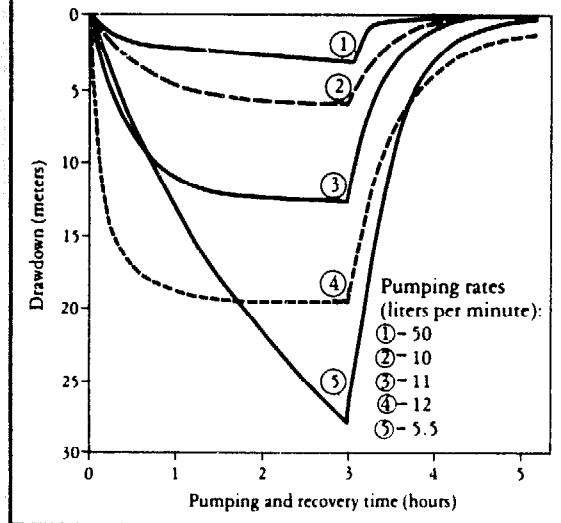

such as permeability are often more important than the pumping rate in determining drawdown, as evidenced by Curve 1, where the well with the highest pumping rate has the least drawdown.

To prevent air pumping and well and pump damage, the well depth and cylinder setting must be deep enough to cater for anticipated drawdown, and in low-yielding wells the pump chosen should have a design discharge reasonably matched with the well recharge rate.

recognize the elements of handpump design which make a pump suitable for village-level maintenance. While it is certainly true that handpump reliability suffers dramatically when the community depends on fallible external support, many projects also fail because village utilities take on maintenance commitments that are beyond their capabilities.

Much of the Project field study work has been concerned with identifying the causes of breakdown or poor performance of different handpump types in different operating conditions. In the Handpump Compendium, readers will find details of the frequency with which each field trial pump needed repair or maintenance interventions, and the pump components which caused breakdown or poor performance to occur. From this information, and knowledge of the skills and equipment needed to carry out repairs, the Project has rated pumps according to their suitability for satisfactory maintenance under each of the three typical maintenance structures - i.e. A - Village-level, B - Area-

mechanic, C - Centralized maintenance.

These classifications are chosen to represent different levels of skills, tools and equipment available for pump maintenance, as these are the ruling criteria in handpump selection. Pump performance may also be influenced by the way that the maintenance is managed (by the community or a central agency), as discussed in Chapter 3 but the choice of the pump itself will not be affected by the management system adopted but by the maintenance structure available.

Typically, a pump which needs a mechanic to remove and replace handle bearings, plunger seals, or other wearing parts will not be classified as suitable for maintenance under a Level A system, and any pump which requires heavy lifting tackle to remove the cylinder and rising main, and motorized transport to carry essential spare parts, demands a Level C system.

Pump reliability (availability) depends on both the frequency of breakdowns and the length of time for which the pump is out of service each time it needs

Box 4.3 Corrosion of Downhole Components and The Effects on Water Quality

High failure rates of galvanized rods and rising mains in the corrosive groundwaters found particularly in the West African field trials were surprising and worrying. Concern has prompted study of the factors affecting corrosion, and the effects on the taste of water drawn from affected wells.

The issue of taste is important. Overnight build-up of iron concentrations in wells with corroding rods or rising mains can be very high. Figure 4.3A shows the result of pumping tests on wells in southern Ghana where the galvanized pumprods of the Moyno

Figure 4.3A Variations in Iron Concentration during Pumping

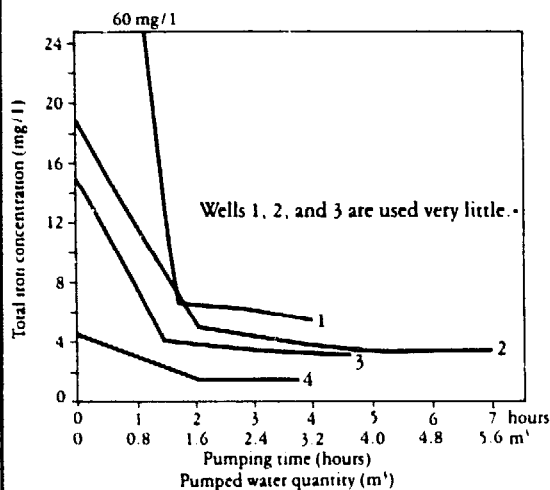

handpump were being attacked by corrosive groundwater. Natural groundwater iron content measured in wells equipped with corrosion-resistant handpumps in the West African field trial areas has generally been found to be less than 1 mg/l. The very high initial iron concentrations in the illustrated wells fell away rapidly as pumping progressed, reaching stable low levels within two hours in most cases. However, measurements in one well just three days after the test revealed that the initial iron concentration was as high as before the test, proving that accumulation of corrosion products from the pump was the major cause of high iron content.

Lightly used pumps lead to greater accumulation of corrosion products, unless they are made from corrosion resistant materials. Experience shows that the problem intensifies as the daily pumping rate drops below about 2-3 cu m/d.

Changing some Moyno pumps for Vergnet pumps, which have plastic hoses and stainless steel cylinders, produced the dramatic drop in iron

concentrations shown in Figure 4.3B, and meant that the pumps were no longer rejected by users because of unacceptable water quality.

Selection of corrosion resistant materials is therefore very important if groundwater is aggres-

Figure 4.3B Changes in Iron Concentrations in Well Water due to Substitution of Corrosion-Resistant Pumps

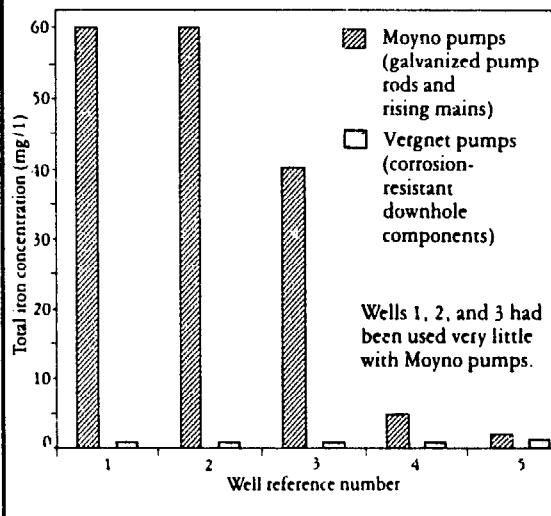

sive. But, how do we recognize aggressive groundwater? Unfortunately there is no simple answer to this question. The first obvious step is to inspect any existing installations in the project area for evidence of corrosion.

Analytical evidence can also help if there are existing wells in the area. If dug or drilled wells equipped with non-corrosion resistant handpumps show higher iron concentrations than wells without such pumps, corrosion is the most likely cause. Measurements of electrical conductivity and pH are important, to indicate whether water from different wells originates from the same aquifer. It is also important that iron analyses are performed in-situ or the water samples are carefully preserved before testing.

Assessment of the corrosivity of water is a complex matter, involving a number of inter-related water quality indicators. The pH is a valuable indicator of aggressivity and thus corrosion potential. As a rough guide, water with a pH value below 6 is likely to be highly aggressive; while above pH 7 there should be little or no corrosion. It must be stressed however that these are only guideline figures, as other factors, such as conductivity, CO₂, chloride and sulfate content, as well as the presence of bacteria, also influence corrosivity.

attention. Village-level maintenance is preferred because of its potential for a rapid response, and the fact that **VLOM** handpumps will usually be repaired very quickly, as no special tools or equipment are needed.

The presence of monitoring engineers and regular visits from Project staff inevitably means that handpumps in the field trials received prompt attention when poor performance occurred, and that all the expertise and equipment normally associated only with Level C maintenance was on hand. It is not possible therefore to use field trial results as a measure of response times for the different levels of maintenance. On the other hand, data collected during the Project from many countries, and documented case studies elsewhere, provide ample evidence that centralized maintenance means long delays when breakdown occurs, and that full village-level maintenance is very much quicker than any system depending on outside intervention.

In comparison with response time, the actual time taken to carry out repairs to the pump has much less influence on total downtime. It is however a useful indicator of the complexity of pump maintenance, and therefore the scope for villagers to carry out the work.

In West African trials on pumps set at depths of about 35 meters, for example, servicing of the cylinder on a Volanta pump was achieved in less than 30 minutes, whereas a similar operation with the India Mark II and Moyno pumps took more than five times as long, even when all the necessary equipment and staff were on hand. Recent experiments with the Afridev prototypes in East Africa have shown that it is possible for two people to change the plunger and footvalve in about half an hour.

Corrosion Resistance

Of the 150 breakdowns experienced in the first two years by a total of 275 India Mark II and Moyno handpumps equipped with galvanized rods and rising mains in the southern Ghana field trial, more than 60% were related to corrosion - an extreme, but by no means isolated case. Box 4.3 shows the effects of corrosion on various pump components in the Ghana field trials, and demonstrates the dramatic changes in drinking water quality when pumps with galvanized rods and rising mains (Moyno) were replaced with pumps using plastic hoses and stainless steel cylinders (Vergnet).

The incidence and extent of corrosion damage depends mainly on three factors - pump component materials, groundwater quality, and (often overlooked) the pumping regime. The last point is especially important in connection with a secondary effect of corrosion - its impact on the quality and taste of the water. Corrosion of steel rods and rising main leads to a buildup of total iron content and results in an unpleasant bitter taste and to discoloring of food cooked in the water and staining of laundry.

Such pumps may well be rejected, or used only rarely, and it follows that use of corrosion-resistant below ground components should be considered even if the groundwater is only mildly aggressive, as overnight accumulation of corrosion products may put off potential users.

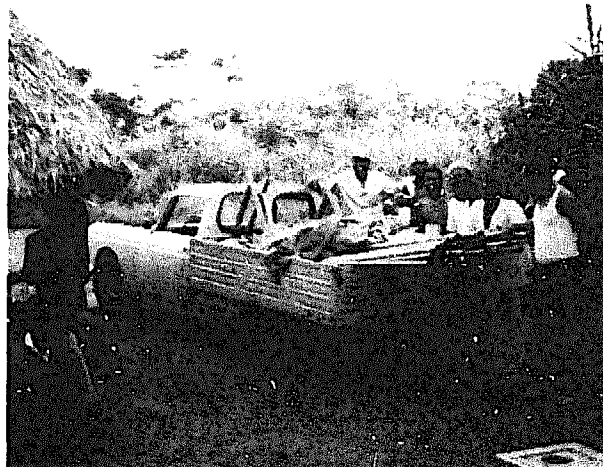

Mobile maintenance teams (Level C) may be the only way to service some of the heavier handpump types, or those installed on deep wells. Most such systems are expensive and unreliable, and pump selection should seek to achieve simpler maintenance wherever possible.

It is important to stress that galvanized steel is not immune to corrosion. Field tests have shown that galvanizing defers the onset of corrosion damage to rods and rising mains, but does not stop it, or slow its pace once the coating has gone. Typically, the use of pipe wrenches to connect galvanized rods and rising mains is enough to damage the zinc coating and initiate corrosion. When handpumps which do not use corrosion-resistant components are also non-**VLOM** pumps, corrosion has a major impact on maintenance costs because of the need for outside repair teams to replace damaged components.

Mild steel, even when galvanized, should be avoided if water is thought to be aggressive. Many manufacturers who supply galvanized rods as a standard also offer stainless steel at extra cost, so that pumps need not necessarily be rejected until this option has been explored.

Of present reciprocating handpump designs, the best corrosion resistance is provided by those using plastic rising mains, stainless steel, brass or plastic cylinders, and stainless steel, wooden, or fiber glass rods.

Ratings in the Pump Selection Guide take into account standard pump designs. Manufacturers should be contacted directly for information about availability of special corrosion-resistant options, though where the Project is aware that a particular pump can be supplied

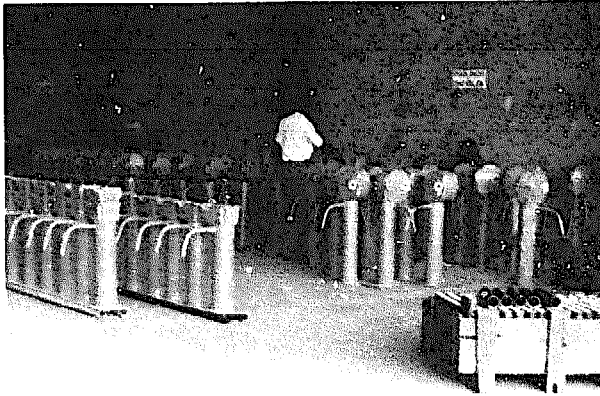

If pumps can be manufactured in the developing country, availability of spare parts is greatly improved. The photograph shows a pumphead made in Cote d'Ivoire, which is to be joined to a downhole assembly made in France.

with resistant components, this is noted in the Handpump Compendium.

Abrasion Resistance

The best way to combat abrasion damage to pumping elements is to prevent sand and silt from entering the well by incorporating carefully designed screens and filter packs (see Chapter 3). Unfortunately, experience shows that many handpumps are installed on old wells or wells which have not been adequately protected against sand ingress.

No handpump is totally immune to the accelerated wear caused by sand-laden water, but some design features will reduce the damage. Cup seals and valves are most at risk, with leather cup seals particularly prone to rapid wear. Sand becoming embedded in the seals will also abrade the cylinder wall. Best resistance to abrasion is provided by rubber or plastic seals and valves (nitrile rubber seals have performed particularly well in lab and field trials and their use may lead to substantially better handpump performance in sandy wells, which would be a major step forward in handpump technology) and stainless steel cylinders, or by designs incorporating seal-less plungers (or no plungers, as in progressing cavity pumps).

Sand can damage pumps in other ways too. In West Africa, for instance, accumulation of sand deposits, mostly entering from above ground, has led to breakdown of some Vergnet pumps, by partially filling the diaphragm and so restricting its movement that it bursts or becomes ineffective.

Manufacturers are being urged to make abrasion resistance an important criterion in future designs, but Project field observations show that this problem is most effectively tackled first by proper well design and development (see Chapter 3).

Manufacture

Readily available spare parts are a prerequisite for reliable pump maintenance. In-country manufacture improves the chances of parts being on hand when

needed, and saves on foreign exchange. One of the requirements for a pump to be described as **VLOM**, is its suitability for local manufacture, though this does not exclude importation of some parts (e.g. bearings).

Producing the entire pump, rather than just frequently used spare parts, in the country where it will be used, has the further advantage that parts which may need replacement less frequently, such as the handle or piston, will be more readily available when needed. Economic viability is an important factor in the decision about whether to undertake in-country manufacture of handpumps.

In-country manufacture has been the accepted practice in Asia for many years. Pumps such as the India Mark II, Bangladesh New No. 6, and Korat (Thailand) have been installed in such numbers that the marketing of spare parts has become a commercially attractive activity at the retail level, greatly facilitating prompt repair of pumps. In Africa, a number of pumps are now being successfully and economically manufactured.

A few examples illustrate the possibilities: a Catholic Mission workshop in Burkina Faso is currently producing about 35 Volanta pumps a month; about 10,000 pumps have been manufactured in Cote d'Ivoire, including some for export; Mali produces the standard Mark II pump from India; new manufacturers in Ghana and Niger are making handpump prototypes; several hundred Maldev (Malawi) pumps have been manufactured in Malawi; Kenyan companies have started production of the Afridev; and discussions are under way for a joint-venture company in Tanzania to produce a direct action pump. A cautionary note should however be added. It is vital to avoid the creation of a monopoly in one country, except possibly during a brief initial phase. Otherwise, the result may be higher prices and poor manufacturing quality. Manufacturers from the industrialized countries are starting to seek joint ventures and licensing arrangements, as a way to retain their involvement in the handpump market and improve distribution and maintenance support.



India Mark II handpumps presently serve more than 200 million people. The standard design requires both skill and effort when downhole components need maintenance. Modified designs aimed at simplifying maintenance are being tested in the Handpumps Project.

Countries vary greatly in their manufacturing capabilities, and a pump requiring, for example, skilled welding, iron casting or press work may be suitable for manufacture in some countries but not others. This has been taken into account in the Pump Selection Guide by rating each pump under three separate headings related to the industrial base of the country in which it is to be used.

Manufacturing capability is one aspect to be considered when deciding whether to opt for local manufacture of handpumps. Quality control is another — the Project has good evidence that inspection procedures and quality testing are essential if premature breakdowns are to be avoided with current pump designs. An important VLOM objective is to design pumps in such a way that the need for extensive and stringent quality control is reduced to a level which can be achieved in most developing countries.

Early prototype models of Malawi's Maldev pump suffered rapid ball-bearing failure. By the time that full production commenced, improved jigs and fixtures and tight quality control in pumphead manufacture had doubled bearing life. However, this quality control is not easy to sustain, and field trial data shows that field-fitted bearings have a shorter life than those fitted in the factory. The Afridev pump was designed to overcome these problems, by using plastic bearings which require less precision in pumphead manufacture and are easy to replace in the field (see Boxes 4.5 and 4.6).

Government policies on import licenses, duties and taxation can also have an impact on the decision about local manufacture of handpumps. The ex-factory prices of many pumps made in Africa include a sizeable cost component for duties on imported raw materials used in their manufacture, and sometimes also a sales tax. On the other hand, imported pumps are usually exempt from all import duty and tax, which gives foreign manufacturers an unfair advantage. Though duty and tax concessions to local handpump manufacturers may be difficult to administer, changes in national legislation are needed to permit local manufacturers to compete on level terms with importers.

User Reaction

Though pumps cannot be rated under this heading on a global basis, because much depends on local culture, religion, etc., a number of aspects of pump design can affect a community's reaction to a particular handpump. In extreme cases, villagers, especially women, may be unwilling to use pumps which require postures or movements which they regard as strenuous or undignified. Footpumps, flywheel-operated pumps and even direct action pumps have been reported as being unacceptable in isolated cases, though the Project has been unable to corroborate such reports.

If there is any doubt, pictures, films or demonstration models of proposed pumps should be used during the pump selection process, so that villagers are aware in advance of the operating procedure for each pump under consideration. Public education in the use of handpumps sometimes helps to overcome initial resistance to a newly-introduced pump.

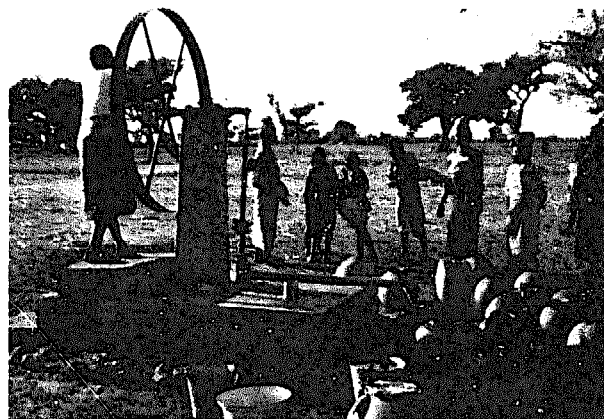

Flywheel operation of handpumps has its critics, but the Volanta pump, seen here operating in West Africa, has proved popular throughout that region.

Handpump Design and Development

A glance at the Pump Selection Tables and worked examples in Chapters 5 and 6 will show how restricted a choice is available to system designers seeking to follow the Project advice on pump selection. Past emphasis on weight and strength as the criteria for pump reliability has meant a preponderance of handpump models which are not suitable for village-level, or even area-mechanic maintenance.

The problem is particularly severe when pumping lift increases, as one of the chief impediments to local maintenance of handpumps is the difficulty of removing pistons, cylinders and foot valves from deep wells. Wherever the rising main has to be withdrawn in order to gain access to the cylinder for repair, the need for special lifting tackle will almost inevitably mean that a centralized maintenance system will have to be adopted. After many years experience with some 500,000 India Mark II pumps, Indian manufacturers have devised a system for removing long lengths of galvanized iron rising main without lifting tackle. However, the method still calls for skill and effort on the part of the mechanics and helpers involved.

A simple gantry and pulley permanently installed on the pump platform has been used to ease maintenance in at least one handpump program and may offer another kind of solution.

Most presently available pumps have essential components which require special skills or processes to produce them, or are protected by proprietary restrictions, so that local manufacture is inhibited. Finally, of the few pumps which do offer simple maintenance and readily available spare parts, not all offer resistance to corrosive or sand-laden water.

Considerable progress has been made in handpump design and development since the start of the Project, and research has been promoted into a number of promising and novel ideas. The remainder of this Chapter contains specific recommendations for handpump manufacturers and industrial researchers about the direction in which future applied research and technology

Box 4.4 Effects of Handle Design and Cylinder Size on Pumprod Stresses

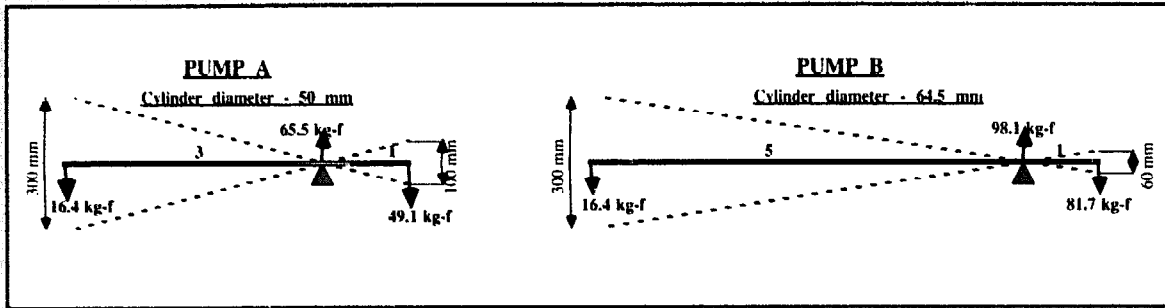

Field trial observations have shown that users of lever-action handpumps tend to move the handle end by the same amount irrespective of the total stroke length available. This constant travel distance (usually in the range of 300 to 400mm) is maintained as long as the operating force is within acceptable limits. This finding has considerable significance for handpump designers.

The diagrams show two possible designs for handpumps to raise water from a depth of 25 meters. On the left (Pump A), the pump has a handle ratio (mechanical advantage) of 3:1 and a cylinder diameter of 50mm. On the right (Pump B), the handle ratio is 5:1 and the cylinder diameter 64.5mm.

The 25 meter head of water on the 50mm diameter cylinder results in a required lifting force of 49.1 kg-f in addition to the weight of pumprods and plunger. For the 64.5mm cylinder, the required lifting force is 81.7 kg-f, again plus pumprods and plunger. After taking account of the different handle ratios, the force to be applied by the user (assuming that the pumprod weight is balanced by an appropriately counterbalanced handle) is 16.4 kg-f in each case.

For the same handle movement of 300mm, Pump A will produce a plunger movement of 100mm and a discharge of 0.2 liters from the 50mm cylinder, while Pump B's 60mm plunger movement will result in the same discharge from the 64.5mm cylinder.

To the user therefore Pumps A and B are identical: the same operating force moving the handle

through the same distance produces the same discharge. However, the pumps are subject to quite different forces, as the diagrams show. The different lifting forces mean that for a given rod diameter, the stresses in the pumprods of Pump A would be 40% less than those in Pump B.

Alternatively, the stress could be kept constant, in which case a rod of 40% less cross-sectional area, or 23% smaller diameter, could be used for the 50mm diameter pump. Such a rod would be lighter and cheaper and induce less inertia.

There are also substantial differences in the forces acting on the bearings. The hanger bearings will be subject to the same forces as the rods, with Pump A's lifting 40% less load than Pump B's, while the fulcrum bearing carries the total downward force of handle effort and pumprod force and is 33% less for Pump A.

Use of a 50mm diameter cylinder compared with one of 64.5mm diameter has therefore considerably reduced all the forces acting on the key wearing parts of the pump, providing the opportunity to use smaller and lighter materials without affecting either the pump performance or the operating action.

This is an important conclusion, which has guided Project research towards adoption of the smallest cylinder size needed to cope with the range of lifts for which a particular pump is designed - a reversal of the commonly held view that larger cylinders offer advantages.

development should be directed, to provide the most reliable pumps for a range of pumping applications. There is great scope for improvements to existing pumps as well as evolution of new designs.

The recommendations are based on principles which are now firmly established as the most effective way to achieve sustainable and replicable large-scale rural water supplies.

Pump Types

The handpump market is dominated by reciprocating pumps, and much of the research and development work

initiated by the Project has focused on improvements to the performance and serviceability of such pumps. The field trials showed that reciprocating pumps cover a wider range of discharge and head ratings than alternative designs, and their inherent simplicity makes them more amenable to local manufacture and village-level maintenance. Many of the issues discussed in this section of the report will therefore relate primarily to reciprocating pumps.

This should not discourage development of handpumps based on other pumping concepts. The Project has recognized great merits in, for instance, the Vergnet diaphragm pump, which avoids the use of pumprods,

uses flexible plastic pipes and has its plunger readily accessible at ground level. The Mono and Moyno progressing cavity pumps also have particular strengths, in that they eliminate the need for plungers and seals and are able to pump water with a significant sand loading. Further development of these and other designs (oscillating water column, water or air jet, etc.) may have considerable potential and manufacturers and researchers are encouraged to study the concepts guiding development work on reciprocating pumps, outlined in the following pages, and adapt them to their own fields of interest. The Project will be interested to hear of any promising new designs, and is willing to offer comments and suggestions in amplification of findings summarized in this Report.

Of the 42 pumps in the Handpump Compendium, 32 are lever operated, 5 are direct action (Malawi Mark V, Ethiopia BP50, Nira AF85, Blair, Tara), 3 are flywheel operated (Climax, Volanta, Duba Tropic 7), 2 are foot-pumps (Kangaroo, Vergnet), and 2 are rotary (Mono, Moyno).

Direct action pumps (see Box 4.1) are comparatively inexpensive and simple to manufacture and to maintain, and the Project is advocating widespread use of this type of pump for shallow pumping lifts (certainly to 12 meters, and possibly to 15 meters).

Flywheel operation of handpumps is a controversial topic. Advocates point to the substantial reduction in shock loading on the pump system from the progressive acceleration and deceleration of the flywheel in comparison with the rapid stress reversals which can be induced by lever-action pumping. A properly counterweighted flywheel can also build up considerable rotation speed — particularly when operated by two people — and so achieve comparatively high discharges, even when the pumping lift is high. It is this high delivery at great depth which has made the Tropic 7 popular in Niger, where its discharge from 45 meters is three times that of the India Mark II.

Critics say that the rapidly spinning heavy wheel with its protruding handles is a hazard to children and old people, though the Project has found little evidence of injuries from this source, which seem to occur only when flywheel pumps are newly introduced into a region. Another criticism is that flywheel-operated pumps are more difficult and more costly to make than lever-operated pumps, because they are heavy and need correspondingly strong (and therefore expensive) pump-heads and bearing assemblies. Average cost of the four flywheel pumps tested is more than double that of lever action pumps for the same pumping lifts.

There is a large potential use for flywheel pumps in regions where water levels are deep and high discharge is needed (pastoral applications in the Sahel are an example), but the lower cost and reduced complexity of lever operated pumps make them more appropriate for most regions.

Footpumps have sometimes been criticised on the grounds of supposed cultural objections to the posture adopted by a female operator. The Project sought evidence for this assertion, but none has come to light. In fact, the foot pumping action of the Vergnet is praised by some users, particularly where the pumping lift is less

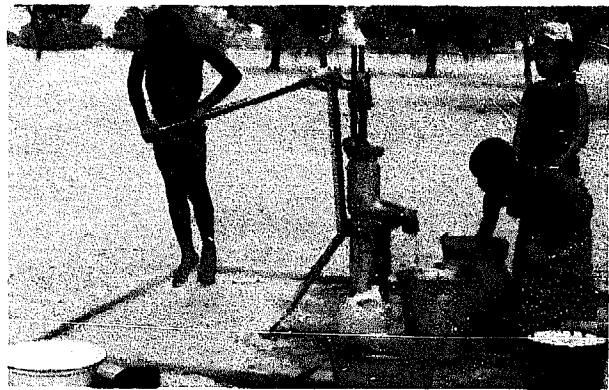

This boy has jumped in the air to bring his full weight down on the pump handle. Better designs are available, but the photograph demonstrates that users will be prepared to apply considerable effort, if the water supply is convenient and reliable.

than 20 meters. There would seem to be no reason to discourage further development of foot-powered pumps, though it is prudent to check local cultural traditions before installing pumps of this type.

A simple development of lever action which has much to recommend it is the use of a **T-bar**. A big advantage is that it encourages proper use of the handle, because users stand behind the handle and move it in a vertical plane. This contrasts with the characteristic operation of a straight lever, where users tend to stand alongside and exert lateral forces on the pump-head and bearings. T-bars make two-person operation easy and provide counterweight for the pump-rods at the optimum position.

A counterbalanced handle is a useful way of optimizing the forces needed on the upstroke and downstroke. Taking account of the lever mechanical advantage, a heavier handle, or one with counterweights attached near the end, will decrease the force which the user must apply on the downstroke, adding an equal increment to the upstroke.

As a minimum, counterweights should balance the pull of the pump-rods and plunger, which would otherwise return the handle unassisted (the India Mark II relies on this gravity return, as it uses a chain and quadrant link between handle and pump-rods). In some cases, extra counterweight, forcing a positive upstroke, can make pumping very much easier at high lifts.

Discharge Rate versus Pumping Effort

An important observation from all the field trials is that when users are able to compare different pumps under the same operating conditions, they almost invariably favor the ones with the highest discharge rate, even though the force required may be relatively high (it must not, of course, be excessive). In extreme cases, the community may reject pumps which produce low discharges irrespective of the effort applied.

A useful general principle for future designs, therefore, is that handpumps for community water supply should give high yields, even if that means comparatively high handle forces (as a rough guide, the Project

Box 4.5 Development of Plastic Bearings for Lever Action Handpumps

For the light use normally associated with the original European and US backyard pumps, mild steel pins in cast iron journals were an adequate bearing arrangement at the fulcrum and rod hanger. Heavy pump use in developing countries, however, results in very rapid pin wear quickly followed by wear of the handle and pumphead.

The India Mark II design in the mid 1970s introduced two standard replaceable ball races at the fulcrum (the Mark II has a chain and quadrant arrangement as the rod hanger). The ball bearings resulted in a greatly extended life (typically 2-4 years) and, with some difficulty, could be replaced when worn, avoiding damage to the pumphead. Other manufacturers followed suit, and many handpumps now have standard, off-the-shelf ball bearings at the fulcrum and rod hanger.

Though the improvement was substantial, ball bearings have several disadvantages for handpump applications. Designed for high-speed uni-directional rotation, they are less suited to the slow rocking action of a handpump lever; bearing housings have to be very precisely machined, calling for good quality control in manufacture; field replacement needs a special tool and some skill, and poor fitting leads to bearing damage; "sealed for life" bearings are not water or dust proof, while conventional bearings need regular lubrication. Also, failure to recognize or respond to the symptoms of bearing wear (lateral handle movement is the first sign) can still lead to pumphead damage. In the Sudan field trials, irreparable damage was done to Mark II pumpheads because of failure to replace worn bearings.

In the Maldev design (Box 4.6), an attempt was made to ease field replacement by increasing tolerances, but reduced precision led to shorter bearing life, and there was an impression, to be verified as monitoring proceeds, that wear is more rapid on the replacement bearings than on those fitted in the

factory.

The Project selected bearing development as a key research issue and has sponsored and carried out considerable laboratory and field work to produce new designs. The target was to achieve a reasonable and predictable bearing life (1-2 years) from both factory-fitted and replacement bearings. As with all the Project development work, overall objectives included simplicity and low cost in manufacture of bearings and pumpheads, as well as ease of replacement, to allow village-level maintenance.

Tests started in 1982 on dry bearings using a range of engineering plastics running on different metal counter surfaces. Low wear rates, acceptable life and easy replacement of plastic bushes were readily achieved, but a big problem was that the metal (mostly stainless steel) counter surface wore as well and eventually had to be replaced.

In early 1985, collaboration with plastics specialists from Du Pont in Geneva, Switzerland, led to a design concept involving one polyacetal bush running on a second polyamide bush. The combination exhibited barely detectable wear in laboratory and field trials and has now been developed into a design in which the two bushes snap together to form one self-contained unit that can be fitted into the pump without special tools. The injection molding process has to be closely controlled, but plastic bearing production has recently begun in Kenya.

This is an early attempt to produce plastic bearing designs specifically for handpump applications, and the results are encouraging. Mass produced, the bearings are very cheap and therefore relatively easy to hold in stock; simplicity of replacement makes scheduled servicing viable; and the Kenyan experience suggests that local manufacture is a feasible option for countries wishing to follow this route. Field trials will continue in Kenya and elsewhere.

recommends that a handle force of 20 kg-f should only be exceeded at very high pumping lifts).

Pumping Actions

The field trials have demonstrated that lever-action pump users tend to use roughly the same handle movement irrespective of the total available stroke. The movement is usually about 300-400mm and represents a comfortable operating action. Different users operate in different parts of the available handle arc, and handle design should therefore allow for comfortable use of a 300-400mm movement at various positions to suit the stature of different users.

The handle movement is more or less independent of the handle operating force, until the pump becomes

uncomfortably heavy to use. So, pump users are willing to apply quite high forces, but prefer limited movement.

Only a few manufacturers allow alteration of the handle mechanical advantage (in practice this can be accomplished by varying the handle length) as an option. Yet the right combination of mechanical advantage and cylinder size can significantly reduce the forces and therefore the stresses on pumprods and bearings. As Box 4.4 demonstrates, a 3:1 handle ratio and 50mm cylinder diameter results in the same discharge per 300mm handle stroke for the same operator effort as a 5:1 handle ratio and 64.5mm cylinder diameter, yet the pumprod and bearing loads in the former case are 40% and 33% lower respectively.

These observations tend to counter the commonly held view that the largest practical cylinder size should

be used for any particular pumping lift. This policy in the past has led many manufacturers to offer a range of cylinder sizes and multiplied the needs for stocks of spare parts. Other manufacturers make only one cylinder size, but specify their pumps for only a limited range of lifts.

The Project staff believe that, as far as practical, a single cylinder diameter should be adopted and that this should be the smallest size needed to cope with the range of pumping heads met. Discharge, and the corresponding handle force required at different pumping lifts, can then be controlled by mechanical advantage — i.e. the highest discharge is achieved by the longest stroke, using the minimum handle mechanical advantage needed to keep the force within acceptable limits.

For example, a 50mm diameter long-stroke cylinder can be used for the full range of lifts up to 50 meters, as follows:

- With direct action (1:1 mechanical advantage), the handle force can be kept below 20 kg-f for lifts up to about 12 meters by using a large diameter low-mass pumprod to distribute force and discharge between the upstroke and downstroke.
- With a suitably counterbalanced lever handle with a 3:1 mechanical advantage, the same 50mm cylinder can be used at lifts of 12 to 30 meters.
- Lengthening the handle to give a 4.5:1 mechanical advantage makes the pump suitable for lifts in the 30-50 meter range.

The Afridev pump range uses this concept (see Box 4.6). In contrast, the standard India Mark II employs a 63.5mm cylinder and a handle with a fixed mechanical advantage of 8:1 (some manufacturers of this pump offer variations for lifts outside the normal specified range).

Role of Plastics

Until very recently, handpump designs had benefited little from modern materials technology. While market forces have prompted big investments in the development of mass production items like the plastic clips for the trim panels of a motor car, the large market for handpump components has not attracted the same attention.

The Project, along with other organizations such as IDRC in Canada and the British ODA, has promoted and sponsored testing and development of handpump components made from different plastics, and sees scope for numerous beneficial applications.

The potential use of commodity plastics, like polyvinyl chloride (PVC), high-density polyethylene (HDPE), and others, for rising mains is discussed later. Engineering plastics, designed for specific purposes, are being used more and more in industrial applications, to replace metals, and should be well suited for a similar role in handpump designs. Their attractions include corrosion resistance, toughness, and guaranteed uniformity of complex parts through controlled injection molding and long-lasting dies. If demand is high, costs can be very low, as raw materials are comparatively inexpensive.

The principal wearing parts in the pumphead are the bearings, and these have proved to be the weak link in many pump designs. The Project has promoted a great deal of research and development into bearing design specifically for handpump applications (see Box 4.5 overleaf), and has concluded that engineering plastics may offer a viable solution. Bearing assemblies have been designed that are easy to fit, have a fairly long life, can cope with some dimensional variation in pumphead manufacture (compared with the tight tolerances needed in ball races), and can be mass produced at low cost. Some promising designs are under test in the field trials and early results are very encouraging.

For bearings, plungers, footvalves, rod connectors, seals, and possibly other components too, it is certain that properly designed plastic components (as opposed to plastic copies of metal components) will have a big impact on future handpump designs.

The Afridev design (Box 4.6) already incorporates engineering plastics in bearings and many below ground components. Research and development work for this application is being undertaken by plastics specialists from industrialized countries alongside the young but enthusiastic engineering plastics industry in East Africa.

Pumprods

Pumprod breakage has been a common cause of failure during the field trials, most frequently occurring at the threads where the rod is linked to the handle in the pumphead. In most lever action pumps, the rod hanger link is a fixed one, through which the lever force may be transmitted through a bearing to the rods to give a "positive downstroke" during rapid pumping. The India Mark II is an important exception, in which the rod hanger is a chain and quadrant. In this "gravity return" arrangement, the weight of pumprods and plunger effects the downstroke, and movement of the handle does not push the rod down.

Opinions differ as to the merits of gravity return. Some say that it reduces pumprod fatigue by avoiding buckling on the downstroke, while others argue that it induces greater stresses because of "snatch" in the gravity return arrangement. To help resolve this issue, the Project is conducting a laboratory-based study, which will compare pumprod stresses for gravity return and positive downstroke systems.

Conventionally, most pumprods have been made of galvanized cold-drawn mild steel rod. Galvanized pipes and wooden rods have also been used successfully, proving beneficial for lowering the starting torque of windmills, for example. The Duba Tropic handpumps use wooden pumprods, and the few tested in the field trials have operated satisfactorily, though the test period is still quite short.

Galvanized mild steel rods usually perform satisfactorily in non-aggressive groundwaters, but rapid corrosion where water is aggressive has led to widespread use of stainless steel rods in such situations. Rods normally have threaded connections with sockets and this feature, often but not necessarily coupled with corrosion, is the prime cause of rod failure.

Box 4.6 Case Study of Handpump Development in East Africa

The name Afridev has been given to a family of hand-pumps, still being developed under the sponsorship of the Project by a group of mechanical engineers working for governments and donors in several East African countries. Design concepts have evolved from experience during the Project field trials, and experimental components are being blended with proven designs in an attempt to address each of the design issues discussed in this chapter.

The main objective is to produce a family of designs which will be available in the public domain and which can be adapted for manufacture in many developing countries.

The principles guiding research and development are that pumps should be:

- modular in design, so that the same cylinder, rising mains and standard wearing parts can be used for direct action pumps to 15 meters and deepwell pumps to 50m.
 - as simple as possible to install and maintain with minimal tools, skills and effort, including an extractable piston and footvalve.
 - relatively simple to manufacture in medium-sized well-managed workshops in East Africa, requiring straightforward production engineering and minimal quality control. Designs make maximum use of stock size materials, to minimize the amount of machining required.
 - designed so that scheduled servicing should result in the virtual elimination of breakdowns and that such servicing involves only routine and simple replacement of easily accessible low-cost wearing parts, such as bearings, seals and valves.
 - suitable for use in aggressive groundwaters through the use of corrosion resistant materials below ground; and capable of resisting sand abrasion through proven seal and cylinder wall combinations and intake configurations.
- designed to minimize forces, allowing the use of lighter components which can incorporate a larger design safety factor. This can give improved fatigue life for relatively highly stressed components, such as pumprods and rising mains.
 - low cost, so that user communities can generally afford to purchase the pump (perhaps with credit) and can always afford to maintain it. Target figures are: US\$400 for a complete pump set at 25m depth, with full recurrent costs of less than US\$30 per year.

In effect, the Afridev is a continuation of development work which began in Malawi early in 1981 and resulted in the first production models of the Maldev in mid-1982. The original Maldev pumphead uses ball races the same size as the India Mark II (two in the handle fulcrum and one in the rod hanger) and was designed for use with uPVC rising mains and extractable plastic plungers and footvalves.

Problems were experienced from the start of Maldev production, mostly connected with the tight manufacturing tolerances demanded by the use of ball races. Life of the bearings was unacceptably short and field replacement unduly difficult. Though tightened quality controls overcame the initial problems to some extent, the requirement for simple field fitting meant that larger tolerances had to be allowed, and failures were still too frequent. This particular issue is explained in more detail in Box 4.5, and it led to the conclusion that further development should include alternatives to ball races in the pumphead assembly.

The new prototype, renamed the Afridev and including a fulcrum and rod hanger assembly with engineering plastic bushes in place of the ball races, was manufactured and installed in Malawi in late 1982. A year's trial was enough to confirm the merits of the plastic bearing system, and Afridev development accelerated, with Kenya becoming the center of activities.

The first machined prototypes of plastic downhole components were produced for field testing in Kwale District, on the Kenyan coast, late in 1983. Further

Rolled threads and box and pin joints go some way towards resolving this problem, but, especially for village-level maintenance, the use of threaded connections has to be questioned. It makes installation and removal inherently complex and there is a risk of damage through cross-threading or over-tightening. Also, rods with threaded connections cannot readily be cut to length in the field.

The Volanta has an innovative arrangement of

hooked stainless steel rods, which makes removal and replacement quick and easy. The Afridev system (Box 4.6) is testing prototype hooked connectors designed to eliminate lateral or vertical play and using a plastic guide to align the rods and centralize the link in the rising main.

An important development, linked with increasing use of direct action handpumps, is the use of high displacement, low mass pump rods. Lightweight rods with relatively large diameters can be formed from hollow

development work and field experiences led to second-stage, injection-molded plungers, footvalves and rod connectors, which were distributed for field testing early in 1985.

Meanwhile, an informal handpump design meeting held in Kenya, towards the end of 1984, had set design objectives for the Afridev. The fifteen participants of ten nationalities included representatives from 5 East African countries. They stressed the need for users to be able to obtain and pay for spare parts and to repair the pump themselves. The emphasis was to be on regular replacement of low-cost wearing parts rather than longer periods between more difficult and costly repairs. A general target was set of one year between spare parts replacement.

A significant breakthrough came soon afterwards, with the finalizing of dry bearing designs suitable for mass production by injection molding. That completed the pumphead design, which had altered considerably since 1982, as new ways were found of simplifying maintenance. The first substantial production run of the Afridev pumphead started towards the end of 1985.

Tests on the downhole components led to further developments, and production designs emerged from a second design meeting in Kenya early in 1986, which evaluated the full potential of engineering plastics in handpump design. Plastic bearings are now being molded in Kenya using long-run dies (also made in the country); dies for molding plungers and footvalves are being designed in Switzerland ready for mass production of cylinders in Kenya.

In the discussion of *Discharge Rate versus Pumping Effort* in the main text, reference is made to the advantages of standard long-stroke, small-diameter cylinders, to reduce forces, ease maintenance and simplify spares procurement. A decision has been taken that, for all pumping lifts, the Afridev will use a standard 50mm diameter cylinder. The operator force needed to pump from different depths will be varied by offering different mechanical advantages in the handle. For lifts up to 12 meters, a direct action handle will be recommended with high-displacement pumprods. From 12 to 30 meters, a 3:1

mechanical advantage lever is offered, and for applications involving lifts from 30 to 50 meters, the mechanical advantage is raised to 4.5:1.

At the start of the Afridev development, conventional pumprods with threaded connections were used. Problems with cut threads are well known, and these are only partly overcome by using rolled threads (see *Pumprod* discussion in main text). During 1985, the Project started experimenting with pumprods joined by a system of hooks and eyes, which allow the rods to be joined quickly and easily without the need for any tools. The hooks and eyes form hinges, and a plastic component was designed to fasten over each hinge and prevent buckling of the joint under compressive loads. The same component serves as a pumprod centralizer, preventing contact of the rods with the rising main. In three field test sites, use of the prototype system has dramatically reduced the time needed to remove and replace downhole components; a large scale field trial is now being implemented.

So far, uPVC rising mains have been used in about 50 prototype pumps, almost without failure for up to four years at pumping lifts up to 30 meters, and most recently at lifts up to 50 meters. Research is continuing into simple methods of joining uPVC pipes, which will permit easy dismantling. Solvent cement jointing, as currently used, is not considered an adequate solution.

Although the research and development program is incomplete and the field trials are continuing, the Afridev pump is achieving many of the targets set for it. Replacement of all wearing parts (bearings, plunger seals, valve bobbins) can be undertaken from a 40 meter setting (say a 30 meter water level) in substantially less than one hour by minimally trained villagers, using a simple spanner and fishing tool, and without removing a single nut from a bolt.

The pumphead is being manufactured by four companies in Kenya and prices are on target.

A Production Manual is under preparation for the Afridev, which it is hoped will make it possible for other countries to adapt design and production techniques to suit their own circumstances.

tubes of materials such as PVC or aluminum, or by surrounding a steel bar with a very low-density substance like closed-cell foam, or simply by using a uniform low-density material of which wood is the most obvious.

By displacing a big proportion of the water column in the rising main, lightweight pumprods transfer a substantial part of the total effort required from the upstroke to the downstroke. Reducing the effort on the upstroke makes the pump significantly easier to use,

and lowers the load on the rods during that stroke. There are also advantages for installation and removal of downhole components, if the rods are easy to lift.

High-displacement low-mass rods are being manufactured from standard off-the-shelf PVC pipe (though other materials can also be used), with the added advantages of economy and corrosion resistance. Tests of PVC tubes as pumprods on direct action pumps such as the Ethiopia BP50, IDRC-UM,

Blair, and Tara prototype have given mixed results. Breakages and excessive abrasion observed in some cases were probably caused by low quality of the material, wrong connector designs, insufficient pipe wall thickness, and weaknesses introduced by careless solvent cement jointing. Rods made from high-quality materials, well manufactured and epoxy cemented (e.g. the Blair and the Wavin prototype) have performed well.

The Tara development (Box 4.7) demonstrates that care is needed in balancing the advantages of high water displacement with potential wear problems if the annular space between pumprods and rising main is reduced so much that deformation or poor alignment can cause contact between the two during pumping.

A direct action system imposes special needs on the pumprod. In addition to the balancing of upstroke and downstroke forces, rods generally move at higher speeds than those in conventional lever pumps, and will be subjected to higher compressive forces. The threat of buckling may call for the use of rod guides, further reducing the flow space between pumprod and rising main. There would be considerable benefit if the rod could be a single section, strong enough and flexible enough to be bent over and laid out on the ground during installation and removal, though flexibility is in conflict with the stiffness needed to prevent buckling. Connectors, on the other hand, usually presuppose tools and may also be vulnerable to uncoupling during operation or fatigue failure.

Finding the best direct action pumprod involves a compromise among a list of desirable characteristics: low mass, high volume, high stiffness, high tensile strength, low elasticity, and high abrasion resistance.

Rising Mains

Galvanized mild steel pipes have been the conventional material for rising mains with reciprocating and progressing cavity handpumps. As with pumprods, galvanized rising main performs well if groundwater is non-aggressive, but has a short life in corrosive water. This problem is aggravated by the poor quality of rolled and galvanized pipes made in many developing countries (rising mains are often ordered locally for use with imported pumpheads, cylinders and pumprods), poor thread cutting, and poor quality pipe connectors. The heavy weight of steel pipe is another disadvantage, especially where the rising main has to be removed for routine maintenance of the cylinder.

There is therefore a need to identify satisfactory alternatives to galvanized pipes for handpump rising mains. Stainless steel has the advantage that it is corrosion resistant, but it is much more expensive. Recent quotations for large orders of 1¹/₄ inch nominal (42mm O.D.) stainless steel pipe for use with India Mark II handpumps in West Africa amounted to about \$10 per meter FOB Europe. That is a competitive price for stainless steel pipe, but would mean that 30 meters of rising main would cost almost twice as much as the FOB cost of the pumphead, cylinder and 30m of pumprod. Though stainless steel may turn out to be the only option for aggressive groundwaters, the Project and other concerned groups are actively seeking alternatives

(bearing in mind also that, if **VLOM** pumps with extractable downhole components are developed, rising main diameters will have to be much larger than 42mm).

Plastics are an obvious option and a number of pump designs are now using plastic rising mains, with varying degrees of success. Preliminary results seem to indicate that smaller diameter (up to 50mm I.D.) high-specification uPVC pipe may be sufficiently durable and inelastic to serve as a rising main at high heads. The only known success with larger diameter PVC is the Volanta, where the flywheel operation means a steady acceleration and deceleration of the rod-piston assembly. Rising mains are subjected to repeated stress reversals, and there are reservations about possible fatigue failures in plastic pipes. High longitudinal elasticity and creep are other problems, as lengthening of the rising main in relation to the pump rods would impair pumping performance and could reduce the available stroke to such an extent that damage to the plunger or upper cylinder would result. Finally, there is the "notch sensitivity" of certain plastics, a measure of the susceptibility to high stress concentrations and potential cracking if the uniform wall thickness is interrupted by threading or accidental scratching or impact.

The most common plastic rising main in use at present is uPVC, which is used in the Kardia, Volanta, SWN and Afridev deepwell pumps, as well as many shallow lift and some direct action pumps. Exceptions are the Nira AF85 direct action pump which uses high density polyethylene (HDPE) rising main (and pumprods) and the Pek direct action pump which uses a polypropylene/polyethylene mix.

PVC pipe suffers less creep than many other plastics, but is highly notch sensitive. It can also be quickly damaged by exposure to sunlight, unless additives are used to increase its resistance to ultraviolet light. HDPE is less notch sensitive and more resistant to UV attack, but has much higher creep than PVC. Polypropylene (PP) pipe has creep properties between PVC and HDPE, and an HDPE/PP mixture is said to combine the reduced creep of PP and the high notch resistance of HDPE.

Down to about 20 meters, there is enough experience of successful use of high-quality plastic rising mains to regard them as an acceptable solution. For deeper wells, critical issues remain of how to support the rising main in the well, the type of jointing used, and creep. As a simple precaution, the Afridev has nylon safety lines attached to its cylinder, in case the PVC rising main slips or breaks - a potentially disastrous breakdown, as "fishing" for the pipe in a deep well is extremely difficult, even for a skilled repair team.

Some designers maintain that long rising mains must be supported at the bottom, others use compressed rubber rings to grip the pipe from the top. Jointing is difficult. Threads cut directly into the pipe have led to pipes breaking. If threading is used, wall thickness must be increased (e.g. by a bonded sleeve), so that in the threaded section the minimum thickness is more than the standard pipe thickness, not less.

In general, threaded joints are not a good solution, because of the difficulty of making them and tightening them properly in field conditions and the nature of the materials themselves.

Solvent or epoxy cement joints are an alternative (used, for example, on the Volanta), but also have their problems, largely because of the need to follow strict procedures and use fresh solvent cement. There is also the disadvantage that if the rising main has to be removed from the well, it must be cut then re-cemented with spare sockets when it is replaced. The Project is sponsoring development and testing of new concepts for simple connection and disconnection of plastic rising mains which avoid the need for tools or special materials. As VLOM reciprocating pumps seem likely to have an open top cylinder to allow extraction of rods, plunger and footvalve without removing the cylinder, rising main removal should be a rare event, needed only if repairs have to be carried out to the cylinder itself or to the well.

Glass-fiber reinforced plastics (GRP) may be another option for rising mains, though at present they are manufactured primarily for the oil industry and are almost as expensive as stainless steel pipes.

Concern about the rising main issue has prompted inclusion of a laboratory research and development program on this subject in the next phase of the Project (1987 - 1991). The aim will be to determine whether large diameter PVC tubes (at least as large as the cylinder diameter) can be used as rising mains at lifts of 45 meters, and if so, what design features and operating conditions make it feasible. Laboratory tests will first evaluate how the stress/strain relationship in PVC rising mains is affected by changes in design and conditions of use. Based on these results, recommended systems for conventional "positive-downstroke" pumps and for gravity-return pumps like the India Mark II will be endurance tested.

Cylinders

Deepwell reciprocating pump cylinders have changed little in design for 50 years. Cylinders are still commonly manufactured using brass walls and end caps, cast brass plungers and footvalves and leather cup seals. Even the comparatively modern development of the India Mark II is modelled on the much older cylinder design, and has a brass sleeve inside a cast-iron casing. Of the plastic materials in use, uPVC is the most common, with glass-fiber reinforced plastic (GRP) also used.

Stainless steel cylinders with highly polished inner surfaces used with rubber hydraulic seals give good resistance to sand abrasion and long seal life. Softer **brass** cylinders are less resistant to the effects of abrasive particles in the pumped water. Scoring and wear of the cylinder wall occurs, particularly when leather bucket-type seals are used, which tend to trap sand particles.

uPVC cylinders have been used particularly on direct action pumps. It has the advantage of being comparatively inexpensive and widely available. As a relatively soft material, it can wear rapidly as a result of sand abrasion, though seal material and design can have an important influence on wear rate.

GRP cylinders are becoming more common and the inner surface is sometimes coated to reduce friction. The Project has no firm data yet on wear rates of GRP cylinders.

Repairs by Part Type

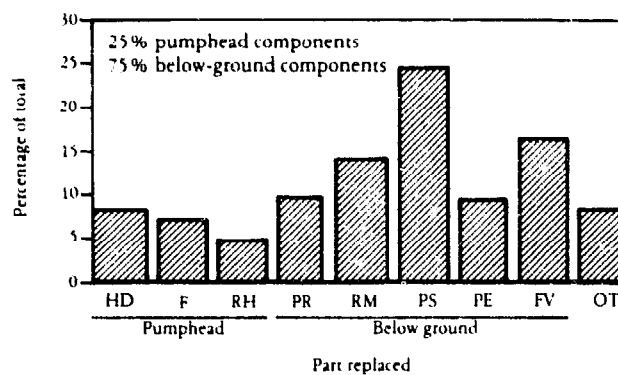

HD = Handle RH = Rod hanger RM = Rising main PE = Pumping element OT = Other
F = Fulcrum PR = Pump rod PS = Piston seal FV = Foot valve

Pump seals were the most commonly replaced components in the Project field trials, representing 25% of all parts replaced. Below ground components accounted for 75% of repairs carried out, the remaining 25% being pumphead components.

The Handpump Compendium compares repair frequency by part type for individual pumps and demonstrates how variations in seal types and materials can have a significant impact on the number of maintenance interventions needed.

Plunger seal replacement is the single most common maintenance need on conventional handpumps, yet it is also usually the most difficult task. To change a pair of seals worth US\$2 each on the standard India Mark II, the pumphead must be disconnected from the pedestal and removed; rising main and pump rods have to be lifted from the well in 3 meter lengths and disconnected. The cylinder then has to be opened and the plunger dismantled before the leather seals can be removed and replaced. The whole process must then be repeated in reverse. A typical repair involves several trained people and may take several hours. In the process, there are numerous opportunities for damage to occur to unrelated components. Galvanizing is sure to be damaged by wrenches coupling and uncoupling pipes and pumprods, and any abrasive dirt entering the open cylinder will mean an early repeat of the seal replacement.

Village-level maintenance is only practical if wearing parts can be replaced easily and quickly, with minimum risk of damage to other pump components. A first requirement is that the plunger and footvalve, if needed, should be removable without removing the rising main.

The Volanta handpump is unique in that the cylinder is located in a taper at the bottom of the rising main and it can be relatively easily extracted through the rising main. Whilst this has some advantages, such as allowing inspection and cleaning of the entire cylinder assembly, it also has the major disadvantage that it requires a large diameter rising main. In fact, the 50mm diameter Volanta cylinder needs a rising main with a diameter across the sockets of more than 100mm, which precludes its use in the economically attractive 100mm drilled wells. A modified version of the Volanta suitable for use in 100mm diameter wells is now being tested.

Open-top cylinders allow the plunger and footvalve to be withdrawn through a rising main only slightly larger

in I.D. than the cylinder itself. Such cylinders have been in production for many years and their ease of maintenance has long been recognized. Again the drawback is the need for a comparatively large diameter rising main, and this problem is aggravated if a range of cylinder sizes is offered. Use of a standard small-diameter cylinder, as recommended for other reasons in Box 4.4, has the advantage of allowing the use of standard-sized rising main, also of relatively small diameter.

Considerable work has been carried out in recent years on the hydraulic design of plungers and foot-valves. The designer has choices to make about the valve type, with, for example, flap valves, plate valves and poppet valves each offering different benefits.

Among the issues still remaining to be resolved on the subject of detailed valve design are: whether the valve should be light or heavy; what the valve port area should be as a proportion of the cylinder cross-sectional area; and what the valve lift should be. These and other questions are the subject of research under way by the Project, IDRC and others.

Seals

Easy seal replacement is an important factor affecting pump serviceability and has become a prime objective of VLOM designs. At the same time, the Project is evaluating a number of different seal designs, to determine which last longest in different circumstances, the aim being to reduce the frequency with which seals have to be replaced.

Worn or damaged seals allow pumped water to leak back past the plunger and so lead to reduced pump performance and ultimately failure. Some leakage is tolerable in handpump applications, so the watertightness of the sealing mechanism is not critical. The important point is that the seal should be able to withstand the reciprocating pumping action through millions of cycles without excessive deterioration in performance and without damaging the walls of the cylinder (for instance through abrasion caused by sand).

The laboratory and field trials have contributed a great deal of data about the behavior of most present seal designs, and have also pointed the way to further research, some of which is already showing promise.

Leather cup seals have been used for many centuries and remain the commonest form of plunger seal in today's handpumps. Leather types and shapes have evolved empirically over the years and, though there is some conflicting evidence about the optimum tanning process for handpump applications, Swedish lab tests and field trials in India favor stiffer leather tanned using chromium oxide, and little further progress is likely to be made in improving the performance of leather cup seals.

Leather has a limited shelf life. It deteriorates rapidly when subjected to extremes of humidity in storage, or to cyclical wetting and drying during operation, or to abrasion. As the field trial results for the India Mark II, among others, make clear, seal life can vary greatly depending on water quality, and particularly the amount of sand in the water. In the laboratory tests, seal life has varied from as few as 1,500 cycles to more than 10 million.

In the search for an alternative material for piston seals, nitrile rubber has shown the most promise so far. More definitive tests are under way, but first results from field trials in India indicate that nitrile cup seals are more abrasion resistant than leather seals tested under the same conditions. Nitrile rubber is sensitive to oxidation by ozone, weathering and sunlight, but otherwise is a reasonably stable material, which is not attacked by oil or by micro-organisms. An important advantage of nitrile rubber (and other elastomers) over leather is that its physical characteristics are more uniform and predictable, allowing detailed quality specifications to be drawn up.

Ring seals first appeared in handpumps in research sponsored by IDRC. Typically two split rings of a polymeric material are compressed into grooves in the plunger and fill the space between it and the cylinder wall. Polyethylene was tried, but tended to collect and retain abrasive materials. PVC filled with copper oxide was more satisfactory, and ring seals are seen as suitable for low-lift pumping, especially for direct action pumps, where moderate leakage rates are tolerable. To date, the Project is not aware of ring seals having been used at high heads.

A promising new concept in handpump design is the replacement of mechanical seals with labyrinth or diodic seals. In the latter case, the analogy is with a diode's characteristic of resisting flow (current) in one direction, while offering little resistance in the opposite direction. A similar principle can be applied to the problem of inhibiting leakage past a plunger.

Instead of a mechanical seal filling the space between the plunger and the cylinder wall, the plunger geometry is designed to induce turbulence around it as it is moved upward. Turbulent flow impedes leakage, but involves little or no mechanical friction to cause wear on the plunger.

One method is to use a long plunger which fits into the cylinder with a very small annular gap. The long restricted flow past the plunger when the plunger valve is closed on the upstroke generates enough pressure to operate the pump. The Blair and Volanta pumps have cylinders which work on this principle.

A variation is to add a convoluted wall profile (also close fitting) to increase turbulence even further. The designs are attractive in that they eliminate the rubbing seal. The concept is especially applicable for direct action pumps which have high plunger speeds and generate correspondingly high pressures.

Diodic seals have not yet been mechanically developed for handpumps, but appear to be potential. They are "solid state" devices, with no moving parts, the design of which allows virtually unimpeded flow in one direction but high resistance in the other (a valve is one example).

Standardization

Two of the greatest difficulties that developing countries face in keeping their rural water supply systems in working order are a scarcity of skilled mechanics and a lack of readily available correct spare parts. The problem is exacerbated in the rural water supply sector

Box 4.7 Case Study of Handpump Development in Bangladesh

Irrigation from pumped wells is increasingly interfering with suction handpumps in Bangladesh, by drawing down the water table below the barometric limit of about 7 meters during the dry season. It may be assumed that planners will continue to give higher priority to increased food production than to protection of existing suction handpumps, currently estimated to number more than one million. There is therefore a need for a cheap, reliable non-suction pump to substitute for those pumps which will be made inoperative and to be used in future rural water supply programs.

This prompted research and development work, supported by the Project, to develop an appropriate direct action handpump. Long-term engineering objectives of the Tara pump development include the establishment of a locally manufactured pump-and-tubewell system which is functionally adequate, acceptable to users, reliable, inexpensive, and maintainable by the users with a minimum of external assistance. To meet these objectives, strategic decisions were taken at the beginning:

a. Extensive use of finished or semi-finished mass produced items, such as standard PVC pipe, steel pipe and standard fasteners for the majority of tubewell and pump components, the aim being to reduce the complexity of manufacturing to a minimum set of processes and to use mainly off-the-shelf, locally-available items.

b. Ensuring that the tubewell module is compatible with the indigenous "sludger" drilling technique, which enables Bangladesh to construct many thousands of small-diameter tubewells each year very economically.

c. Provision of adequate pumping capacity per cycle, while keeping the required pumping effort within a range which could be accomplished by all users, including children.

d. Elimination of the need for hand tools to service the pumping elements (valves and seals), so as to maximize the potential for caretaker maintenance.

e. Protection of moving parts from damage due to abrasion or corrosion.

The Tara plunger, which has recently been fitted with a nitrile rubber cupseal, operates directly in the 54.3mm PVC rising main, which in Bangladesh also forms the well casing. The pumprod consists of 42.2mm OD PVC pipe, leaving only a small annular gap inside the rising main. The pumprod is sealed and solvent jointed to form a captive air chamber (see main text for a discussion of low-mass high-displacement pumprods). Steel pipe is used for the discharge head and for the T-bar handle.

The footvalve is seated at the lower tapered end of the cylinder, and can be captured for removal by means of a bayonet grapple on the end of the piston. Valves in the piston and footvalve assemblies are stamped from automobile tire inner tubes.

Development of the Tara is still going on. Though the basic design concept is sound, several problems remain to be solved:

1. Abrasion between the pumprod and upper well casing is beginning to cause system failures. This problem is caused by bends in both the PVC pumprod and the casing resulting in contact during operation. Even if perfectly straight pipe could be extruded, it is doubtful whether casing alignment could be maintained after installation, because of differential soil pressures. Two possibilities for overcoming the problem are being investigated — increasing the annular space between the pumprod and casing; and providing rod guides of a sacrificial material, such as nitrile rubber, spaced at suitable intervals.

More annular space can be obtained with a slightly smaller pumprod diameter (40 x 34mm) and slightly larger casing diameter (63 x 57mm), without compromising either the sludger drilling technique or the tensile strength of the pumprod. However, changing to a smaller diameter cylinder (50mm) compensates for the smaller displacement of the 40mm diameter rod, and the operating characteristics of the pump are marginally improved.

2. Footvalve location and seating are not yet positive enough to guarantee trouble free operation, especially if the assembly is removed frequently for inspection. A molded snap-fit design is under investigation.

3. A variety of piston seal types is under investigation: diodic seals, including seal-less types and ring seals; elastomer cupseals; and improved leather cupseals.

Future research will also focus on ways of eliminating metal threaded pumprod connectors and replacement of the present friction seals with seal-less plungers. To date, primary emphasis in development of the Tara has been on minimizing costs, and each prototype has been based on use of relatively simple materials and processes. It has to be recognized that solving the remaining problems may well involve increases in production costs.

The Bangladesh-made unit currently costs about US\$100 for pump, rods and rising main for an 11 meter setting.

by the variety of skills needed to cope with all the different pump types, often supplied by donor agencies. It can be much improved by standardizing on only one or a limited number of pump types, depending on the physical conditions. Training programs can then have a sharper focus, and the potential for in-country manufacture of essential pump components is very much increased.

Pumps divide conveniently into three groups, categorized by the maximum pumping lift :

- **Low lift pumps.** For lifts of up to about 12 meters, high discharges are a must, as users generally favor a pump which fills their containers quickly, and there is a variety of pumps on the market which can do so. If the lift is less than 7 meters (after allowing for any seasonal drawdown or lowering of the water table by adjacent motorized pumping), suction pumps can be considered, though the risk of contamination through priming with polluted water has to be taken into account. A cost competitive alternative, also well suited to village-level maintenance, is provided by direct action pumps. Light and easy to install and maintain, direct action handpumps also dispense with the pumphead bearings which form one of the more difficult wearing parts to replace. Even without the mechanical advantage provided by the lever handle of a conventional handpump, direct action pumps can be operated comfortably down to 12 meters, and may in future be suitable down to 15 meters.

- **Intermediate lift pumps.** For lifts of up to about 25 meters, there is a wide choice of pumps available, with increasing numbers being modified to make them more suitable for village-level maintenance. Recipient governments should resist the temptation to accept "free" pumps through grants from donors, if this will mean proliferating the number of pump types or installing unsuitable ones, and so straining maintenance capabilities. The cost of the pump itself is only a small part of any rural water supply program, but the wrong selection can have a crucial impact on the total cost and the sustainability of the system. Final choice will depend on evaluation of groundwater characteristics, the maintenance capabilities of the benefiting communities, in-country manufacturing potential, and the number of people to be served from each pump, but a key consideration for CWS planners should be to minimize the number of pump types for which adequate and correct spares have to be stocked and skilled mechanics trained. Intermediate lift pump design has progressed considerably in recent years, with the introduction of open-top cylinders offering increased scope for village-level maintenance. Some **VLOM** designs are now available for this range of lifts.

- **High lift pumps.** A large majority of the rural people in need of improved water supplies live in areas where the groundwater table is less than 25 meters below ground level, but appropriate pumps are also needed for the remainder, who live where there are deeper aquifers. Handpumps can be reliably used at lifts of 45 meters (and are used at much greater depths), but the discharge drops markedly with increasing depth and maintenance becomes more and more difficult. More expensive drilled wells call for more users per well, to spread the costs,

and the lower discharges then mean that queues lengthen. Keeping a balance between per capita cost and service level (quantity per capita and queue time) becomes more and more difficult as depth increases. The list of available pumps, particularly those suitable for village-level maintenance, gets progressively shorter as the pumping lift stretches from 25 meters to 45 meters.

Even when planned pumping applications would involve more than one of the above categories, standardization on one pump type may still be practical. The majority of intermediate lift pumps will function adequately at lower lifts, and a compromise on design objectives may well result in overall economies when operation and maintenance costs are taken into account. If the range of lifts is very high, different pumping actions may be needed, but this need not necessarily preclude use of standard downhole components. As Boxes 4.4 and 4.6 show, a standard 50mm diameter cylinder with the same component parts can be used with different handle ratios (mechanical advantage) to cover the full range of lifts from 0 to 50 meters.

Manufacturers too have an important part to play in standardization of pump components. The Project is collaborating with a number of manufacturers in an attempt to establish standard sizes for cylinders, valves, bearings, etc, so that common spare parts can become off-the-shelf items widely available in developing countries (so far efforts have focused mainly on Africa).

The Project has prepared Draft Sample Bidding Documents for the procurement of handpumps, which may assist governments and support agencies in ensuring that the important pump characteristics are taken into consideration when procuring pumps through international competitive bidding.

Guidelines for VLOM Design

Following five years of intensive study of handpump performance in laboratory and field conditions and based on information collected from rural water supply projects throughout the developing world, it is possible to set clear objectives for designers and manufacturers of handpumps intended for community water supply use. Combined with the recommendations for planning and implementation of handpump-based programs developed in Chapter 3, these technology-related guidelines form a package which it is believed can make a dramatic impact on the reliability of future community water supplies. Manufacturers, researchers, government agencies, consultants and contractors are urged to adopt these guidelines, with the background evidence contained in the earlier part of this Chapter, as a strategy for their design and planning activities to the end of the century.

1. Ease of Maintenance

Handpumps should be designed in such a way that scheduled replacement of all wearing parts can be carried out by a village caretaker after a minimum of training and with only a few basic tools. There should be no requirement for heavy lifting gear to remove pistons or foot valves and no need for any vehicle (other than

perhaps a bicycle, public bus, or transport animal) to carry tools or pump components.

2. Robustness

Non-wearing parts should be robust and durable. Within reason, they should be able to resist abuse, vandalism, the attentions of animals, climatic conditions in developing countries, and corrosive or sand-laden water.

3. Local Manufacture

Availability of spare parts, and hence handpump reliability, is substantially improved if pump components can be manufactured in the country of use. It is therefore desirable that pump components should be designed to be simple to manufacture from widely available materials. Specific and sustained attention must also be paid to the quality of manufacturing, through adequate quality control in the place of manufacture and regular external quality assurance by the purchaser.

The move towards in-country manufacture can be stimulated if developing countries ensure that import license arrangements and tax policies do not inhibit investments by local industry. Joint ventures with established manufacturers from the industrialized countries can also be encouraged by appropriate incentives.

4. Standardization

Training of caretakers and pump mechanics is complicated by the wide variety of pump types that are often used in rural water supply programs. Establishment of local manufacturing, enforcement of quality control, and effective distribution of spare parts to retail outlets are all also hampered. There are clear benefits to be gained by standardization on one or a few pumps. The issue of standardization is complex. Manufacturing monopolies may arise, bringing their own problems of quality and pricing. However, without some standardization, the difficulties of sustaining water supplies to vulnerable low-income groups in rural areas are likely to be insuperable.

The Project recommends that governments settle on a limited number of pumps for their water programs, and that, when different pumps are in use, efforts should be made to standardize dimensions, and even spare parts.

The benefits of such a policy are apparent in India.

The India Mark II is the standard deepwell pump adopted by the Indian government for its rural water supply program, and the pump is fully specified by the Indian Standards Institution. The resulting economies of scale mean low prices; quality control is facilitated; and spares availability is enhanced. Another example comes from Tanzania, where the government has established a Bureau of Standards subcommittee for standardization of handpump dimensions. By standardizing sizes such as those of the pump baseplate, different pump types can be readily interchanged.

5. Costs

VLOM pumps should be low in capital and recurrent costs. Target costs are US\$300-400 for a pump, complete with rods and rising main, to lift from 25 meters, and operation and maintenance costs should be kept below US\$0.25 per capita per year. Low-lift pumps should cost appreciably less, so that, for the same per capita cost, more frequent wells with handpumps can bring safe water nearer to people's houses, and discourage the use of alternative, polluted sources.

6. Discharge Rates

Pump models should be designed for specific ranges of pumping lift, with discharge rates selected accordingly. For low-lift applications, a high discharge must be achieved, or the pump will not be accepted by users. For high lifts, discharge will necessarily be lower, to ensure that the pump can be operated without excessive effort (Box 5.1 in Chapter 5 offers guidance on appropriate discharge rates). Two-person operation is increasingly advantageous as pumping lift increases.

Rapid progress should now be possible in the development of an increasing number of handpumps which can be described as **VLOM**. The Project will monitor these developments closely, and is willing to offer advice and comment at any time to those pursuing the objectives outlined in this Chapter. Meanwhile, selection of appropriate handpumps for rural water supply programs must be made from currently available designs.

Chapter 5 describes a methodology for pump selection making use of ratings based on each pump's performance during laboratory and field trials.

Chapter 5

Pump Selection Guide

In the course of the Project, some 70 handpump models have been evaluated (see Annex 2 for a full list). Some are no longer in production; others proved inadequate and were eliminated from further consideration; and some are included as derivatives of the "parent" pump type (e.g. only one entry is included for the Blair pump, though four variations of the original pump have been tested in different countries). The result is detailed analysis of a total of 42 pump types in this Selection Guide. The Pump Selection Tables include all the pumps for which the Project has collected sufficient data to enable judgments to be made on their suitability for the specified operating conditions, and which are still in production. Extra space is allowed at the bottom of each table for the assessment of unlisted pumps which the Analyst¹ may wish to consider. The Handpump Compendium, which follows Chapter 6, illustrates the way that ratings have been assigned to the tested pumps, and may help the Analyst to rate the extra pumps on the basis of local experience or information published by reliable sources. Some information is provided in Annex 1 on a further 17 pumps which have come to the attention of the Project during the course of the trials, but which have not been subjected to the full test procedures.

Testing under the Project has involved a combination of field trials and laboratory tests (the test procedures are described in Boxes 1.1 and 1.2 in Chapter 1), and has yielded extensive data on which to base assessments of the capabilities of each type of pump under a variety of operating conditions. The aim of this Selection Guide is to assist water supply planners and designers in developing countries to select appropriate handpumps for their own specific circumstances. These circumstances will not always match precisely conditions under which particular pumps have been tested in the field - it would clearly be quite impractical to test all pumps under all possible operating conditions.

In assessing likely pump performance over a range

of conditions, therefore, Project staff have frequently had to make "best-judgment" decisions on the basis of their own experience and the available field and laboratory evidence. Those judgments have been made in the confidence that they will be of value to many decision makers in developing countries who do not have access to the same amount of evidence. The data source for each pump has been given in the ratings tables, as an indication of the degree of confidence which can be attached to the individual ratings.

How to Use the Pump Selection Tables

In the four Pump Selection Tables at the end of this Chapter, pumps are rated according to the Project's assessment of their capability to perform satisfactorily in a range of conditions. The combinations of pumping lift and daily output have been chosen to cover most circumstances likely to arise in community water supplies in developing countries.

Possible applications of the Pump Selection Tables include:

- Selection of a single pump to meet the specified duties and operating conditions of a particular project or program.
- Preparation of a national or regional list of approved pumps, based on more generalized operating conditions, as a guide to pump standardization.
- Compilation of a list of acceptable pumps as part of the procedure for identifying potential suppliers for limited competitive bidding.
- Assistance with preparation of bidding documents and with bid evaluation.

Worked examples in Chapter 6 demonstrate typical applications.

1. Throughout Chapters 5 and 6, the term "Analyst" is used to indicate the individual applying the selection procedures.

Final selection combines the attributes of the hand-pump itself and the specific conditions of the project or program in which it will be used. Conditions may vary appreciably from one location to another, and handpumps can only be evaluated for a particular set of conditions.

Form 5.1 is a convenient way of listing the conditions and should be completed by the Analyst before using the selection tables. Note that some conditions are fixed by the planned pump location (e.g. pumping lift, corrosivity of groundwater), while others may be determined by project or country policies (e.g. maintenance system), or by international competitive bidding procedures. Guidelines for completion of Form 5.1 follow; a more detailed discussion can be found under the same sub-headings in Chapter 4.

Operating Conditions

The appropriate table for pump selection is determined by the anticipated maximum pumping lift. Figure 5.1 illustrates how evaluation of "pumping lift" should allow for any drawdown which may occur as pumping proceeds. In assessing maximum pumping lift, the Analyst must also take account of possible seasonal or longer term fluctuations in the water table (note that the pumping lift is the distance from the surface to the pumping water level; it is not necessarily related to the cylinder setting or the depth of the well).

Though static water levels may be known, pumping water levels will probably have to be estimated. Drawdown can be calculated with reasonable accuracy if aquifer permeabilities are known, or determined by pumping tests. In most geological formations, the drawdown caused by handpump discharge rates will commonly be less than 5 meters and will rarely exceed 10 meters. However, in very low permeability rocks such as granites or gneisses drawdown can be very high (see Figure 4.2A in Chapter 4), and pumping test data will be important.

The pump groupings in the tables - i.e. 7 meters, 12 meters, 25 meters and 45 meters - give an approximate guide to the maximum lifts for which manufacturers have indicated that their pumps may be applicable.

As pumping lift increases, so does the effort needed to lift water to the surface. For some pumps, the operating force required soon reaches practical limits and such pumps cannot be considered for high lift applications. There are also pumps which will only provide a reliable service when pumping relatively small amounts of water each day.

The Analyst must consider the number of people to be served from each handpump and the level of consumption likely to result (including any potential for small-plot irrigation, animal watering, etc, and taking account of any seasonal variations in demand).

Though the increased costs associated with greater depth encourage designers to plan for larger user groups when deep wells are needed, physical laws limit the amount of water which can be lifted with acceptable effort. Per capita consumption is also a critical factor affecting the population to be served. By relating the

Figure 5.1 Drawdown and Pumping Lift

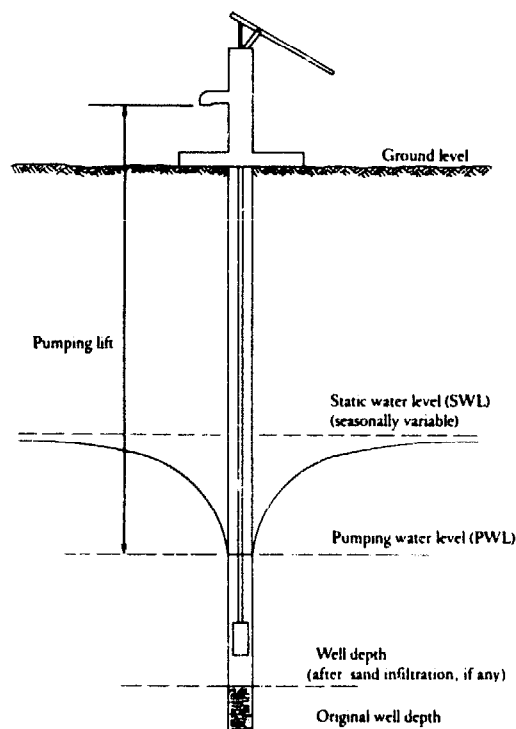

Note: In an unconfined aquifer, the static water level in the well (without pumping) is the water level of the aquifer. After the pump has been used for some time, the water level in the well will sink to the pumping (or dynamic) water level. The difference between the two levels depends mainly on the rate of pumping, the length of time the pump has been used, and the permeability of the aquifer (the rate at which the porous medium transmits water). For precision, the pumping lift should be the distance below the discharge level of the pump, but, for convenience, it is usually approximated as the distance below the ground surface.

"Reliability" ratings (Column 5 of the selection tables) to "maximum daily output", the tables allow scope for other demands in addition to domestic drinking water supply to be taken into account. If a per capita consumption of 20 liters/day is assumed, the three output categories correspond to the following number of users:

- 1.5m³/d: equivalent to 75 users per pump
- 4.0m³/d: equivalent to 200 users per pump
- 8.0m³/d: equivalent to 400 users per pump.

(allowances for uses such as irrigation pumping or cattle watering will influence the actual number of users). It must be emphasized that the Project does not recommend a daily output of 8m³/d as a design criterion, because the pump would be operating for many hours each day, resulting in a low level of service because of long queue times and frequent breakdowns. Ratings have been included for the higher output, because the demand for such installations is high, and because analysis using these ratings can help to identify the most durable pumps.

Box 5.1 The Relationship between Handpump Discharge and Pumping Lift

The amount of water which can be obtained from a given handpump depends, theoretically, on three factors: the pumping lift; the mechanical efficiency of the pump at that lift; and the power input or degree of effort applied by the pump user. In mathematical terms, the relationship is:

$$\text{Discharge} = \frac{\text{Power (watts)} \times \text{Efficiency} \times 60}{\text{Lift (meters)} \times 9.81}$$

If power and efficiency remained constant, discharge would decrease in proportion to increasing lift. This does not happen in practice, as, for most pumps, mechanical efficiency improves with increasing depth, and users typically apply more effort at higher lifts.

Figure 5.1A shows the range of discharge rates which can be expected from a typical range of pumps, as the pumping lift varies from 7 meters to 60 meters. "Adequate" discharge rates are based on normal power inputs ranging from about 50 watts at a

(oo rating in the selection tables) discharge rates are 50% greater than those defined as "adequate" (o rating in the selection tables). The better discharge can be achieved by higher mechanical efficiency and/or better ergonomics encouraging application of more power.

The lower discharge rates for higher lifts are an important consideration in the rating of pumps for different operating conditions. Field trial experiences show that pump users put a high premium on the speed with which they can fill their containers, and, given the choice, will favor a pump giving the highest discharge, even though it may require more effort than alternatives. The Project's assessment of a pump's delivery rate at the specified head is therefore a ruling factor in the ratings given for discharge adequacy in the Pump Selection Tables S.1 to S.4.

The right hand axis of the graph in Box Figure 5.1A shows the discharge rates in cubic meters per hour associated with the typical pump range, as pumping lift varies. From this scale, it is simple to calculate the number of pumping hours per day needed to achieve the daily output figure for each operating condition. The curves are the basis of ratings assigned to the pumps under the *discharge rate* heading.

For a 7 meter lift (Table S.1), pumps which cannot achieve a pumping rate of 19 liters per minute are deemed unacceptable, even though that implies that the pumps could deliver the lowest rated daily output of 1.5m³/d in only 1.3 hours. This is a true reflection of user choice. Given that most suction pumps and direct action pumps can readily accomplish the required output, pumps with lower discharge rates will be rejected by the users. For greater lifts, the number of hours for which the pump may be expected to work to deliver the specified daily output grows significantly. Thus a pump achieving the "adequate" discharge of 7 liters per minute at 45 meters head, would require a total of 9.5 pumping hours to deliver 4m³.

Under the heading of *discharge rate*, the Project has rated only capacity to achieve the specified delivery rate. This alone is not a judgment of the pump's suitability for use under these conditions. Subsequent evaluation of *reliability* may show that high daily output would result in an unacceptably high frequency of essential repairs.

Box Figure 5.1A Variations in Pump Discharge Rate with Pumping Lift

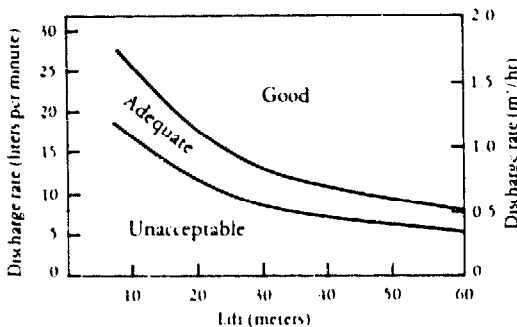

lift of 7 meters and increasing to 75 watts at a lift of 45 meters or more. Adults will usually apply over 100 watts (and sometimes over 150 watts) at high lifts in order to increase the discharge rate. A representative range of mechanical efficiencies has been used — from 45% at 7 meters to 70% at 45 meters. "Good"

Clearly, the amount of water that a pump can deliver in one day relates to the number of hours of pumping and the effort used. This issue is discussed in Box 5.1 and in the later section on *Discharge Rate*, and Analysts who are in doubt about the daily demand criteria for their particular application should read these discussions before selecting the appropriate table.

Having selected the maximum pumping lift, the

Analyst consults the table which most closely corresponds to those operating conditions.

Each table contains a list of the pumps tested by the Project which, according to the manufacturer, should be capable of achieving the specified pumping lift. For convenience, the pumps are listed alphabetically in groups which give an indication of the maximum pumping lift recommended by the manufacturer. The same sequ-

ence is used in presenting individual pump information in the Handpump Compendium.

Entries in each column of the Pump Selection Tables indicate the Project's assessment of the pump's suitability under the specific heading. Three ratings are used and the interpretation varies according to the parameter concerned, but, as a general guide:

- oo indicates that the pump is considered well suited to this application;
- o means that it has been judged adequate; and
- shows that it does not meet the minimum requirements.

A more detailed description of each individual pump, including a summary of its performance in laboratory and field tests, can be found in the Handpump Compendium, where each pump entry also contains an explanation of the assessments made by the Project staff.

Data Source

Column 2 of the Selection Tables — Data Source — contains 'L' if the pump has been tested through the Project in the Laboratory (pumps tested under a previous program funded by the British Overseas Development Administration are also included) and 'F' if it has been subjected to Project field trials. All possible operating conditions could not be replicated for every pump and so the amount of data available varies from pump to pump. In those cases where no data was collected on a particular pump under the specified operating conditions, Project experiences have been extrapolated to reach the rating indicated. In cases where the 'F' is in parentheses, ratings are based partly on limited field information (only a few pumps or extrapolated from different operating conditions) and partly on "best judgment". Inevitably, there is some subjectivity in the assignment of some pump ratings, but the Project has concluded that presentation of its findings as "best-judgment" ratings is more helpful than providing no advice at all. Details of the scope of the tests carried out on individual pumps can be found in the Handpump Compendium.

Analysts with experience of specific pumps may wish to modify the ratings, after comparing their data with the data in the Compendium. As with any other instances of individual experiences leading to different conclusions from those set out in this Report, the Project would welcome details of the changes suggested and the data on which they are based.

Discharge Rate

Under this heading, ratings are based on the delivery rate that can be achieved at the given head by typical users, who will commonly include young children.

Box 5.1 shows graphically how the discharge rate of typical pumps falls off as pumping lift increases. For this reason, the basis of the discharge adequacy ratings is

different for each lift and is noted at the head of each Pump Selection Table. The comparatively high discharge rates deemed adequate for lifts of 7 and 12 meters reflect the clear evidence from Project field trials that users will always favor high-discharge pumps and that there are many pumps capable of achieving the specified output at these heads.

Though many pumps designed for single person operation are often operated by two or more, especially when the lift is greater than 25 meters, the **discharge rate** ratings are based on one person operation, unless the pump has been specifically designed for use by more than one person.

Ratings in this column are confined to the adequacy of the pump design to achieve the specified discharge rate. They should not be interpreted alone as an indication that use of the pump under these operating conditions is advisable. That judgment can only be made after considering the "**Reliability**" of the pump and its ratings under the other headings in the table.

The discharge adequacy ratings should be interpreted as:

- oo The stated discharge rate can be readily achieved by typical users, and the pump's discharge is "good" as shown in Box Figure 5.1A.
- o The stated discharge rate is achievable by typical users, and the pump's discharge is "adequate" as shown in Box Figure 5.1A.
- The pump cannot produce the stated delivery rate, or could only do so with very high power input.

Ease of Maintenance

Chapter 3 explains why village-level management of handpump maintenance is more effective and less costly than systems which depend on external interventions. However, many of the handpumps from which selection must presently be made need tools, equipment or skills which are not readily available in rural areas. If no **VLOM** pump is found to be suitable for the proposed application, it may be necessary to involve the public water authority in pump maintenance, using district or regional mobile teams.

The three columns under this heading are an indication of the serviceability of the pumps — i.e. the ease with which they can be repaired or serviced by:

A. Village-level maintenance

All routine inspection and adjustment, and replacement of wearing parts, is carried out by a village repairer having minimal training and simple tools. Common spare parts are available to the village. This system has low costs and can operate with minimal support from outside. With control in the hands of the community, System A maintenance operates under village management (System 1A in Chapter 3). Assistance may however be required for catastrophic failure (e.g. dropped rising main/rods/cylinder, clogged screen or infilled well).

B. Area-mechanic maintenance

A locally-based trained mechanic equipped with special tools and a bicycle, moped, or other simple transportation, carries out the repair and maintenance of hand-pumps with the assistance of villagers. The mechanic has access to special spare parts and typically services several pumps in the area. Like System A, this type of maintenance can operate with a minimum of support from outside the village, except for training of the mechanics and setting up of the system. It may be implemented in the context of village-level management in which the village has responsibility for ensuring that maintenance is funded and carried out, though the mechanic may live locally outside the village (System 1B in Chapter 3). In some cases, possibly as part of a transition from centralized maintenance to village-level maintenance, area mechanics may be under the responsibility of a water authority or other agency outside the village (System 2A in Chapter 3).

C. Centralized maintenance

A team of trained technicians equipped, as a minimum, with a four-wheel motorized vehicle, special tools and workshop facilities attends breakdowns and sometimes undertakes scheduled maintenance. Administration and operating costs are significantly higher than for System A or System B, and a well-organized institutional structure is needed. The community has no involvement; all control is in the hands of the central agency (System 2B in Chapter 3).

It is important to recognize that, while any pump which can be satisfactorily maintained under System A or B can clearly also be maintained under System C, the high costs of transporting a centralized team to carry out simple repairs is unlikely to be the best solution. The Project recommends strongly that all promoters of hand-pump projects consider the possibility of establishing System A or B maintenance and selecting handpumps accordingly. It is however vital, as Chapter 3 makes clear, that the maintenance system is backed by the right management structure. Pumps rated as suitable for maintenance under System B can be very economically sustained in operation under the management of a Village Water Committee, which would contract external mechanics for major repairs.

The Analyst should select from the three categories, the maintenance system which best suits the combination of cost and institutional commitments thought to be desirable for the project or program concerned.

The ratings in columns 4A, B and C indicate the Project's assessment of the ease of carrying out repair or scheduled maintenance with the corresponding maintenance system. Interpretation of the ratings is:

oo The pump can be readily maintained using this maintenance system. In addition, under maintenance system A, this rating indicates that all parts which are expected to wear (e.g. seals and bearings) are replaceable in less than two hours by the village repairer(s), no individual replacement part costs

more than 5% of the total cost of the pump, and the annual cost of spare parts should not exceed 10% of the cost of the pump under the specified operating conditions.

- o The pump can be maintained using this maintenance system, though difficulties may arise and there is a risk of some failures. For maintenance levels A and B, this rating indicates that some repairs will require assistance at the next level (i.e. B and C respectively).
- It is unlikely that the pump can be maintained satisfactorily under this maintenance system.

Reliability

In assessing the reliability of a handpump, the critical consideration is the amount of time that it can be expected to be functioning satisfactorily. As Box 5.2 overleaf demonstrates, it is not just the length of time before failure which is important. The time taken by the maintenance organization to respond to breakdowns and carry out repairs (downtime) is at least as significant.

To combine time before failure and downtime into a single rating, the Project has established criteria linked to the type of maintenance system judged most suitable for the pump concerned. Reliability ratings have been based on the simplest maintenance system for which the pump scores a oo ("good") rating in Column 4 of the table concerned. So, in Table S.1, for example, the Column 4 ratings would mean that Pump 1 (Abi-ASM) is judged on the basis of Maintenance System B, Pump 2 (Afridev) on the basis of Maintenance System A, and Pump 5 (Climax) on the basis of Maintenance System C.

Most pump breakdowns result from wear, and the frequency of breakdown is therefore related to the intensity of pump use. In the tables, Reliability ratings are given for different daily outputs which may be applicable for each of the pumping lifts. So, in Table S.1, ratings are given for daily outputs of 1.5, 4.0, and 8.0m³/d.

Interpretation of the ratings is:

- oo Output should be sustained for at least 6 months between necessary repair or maintenance interventions where Maintenance System A is most appropriate; for at least 12 months under Maintenance System B; or for at least 24 months if Maintenance System C is necessary.
- o Output should be sustained for at least 3 months between necessary repair or maintenance interventions where Maintenance System A is most appropriate; for at least 6 months under Maintenance System B; or for at least 12 months if Maintenance System C is necessary.
- Not recommended. The frequency of necessary repair or maintenance interventions is excessive (greater than for the o rating above).

Box 5.2 Definitions of Reliability

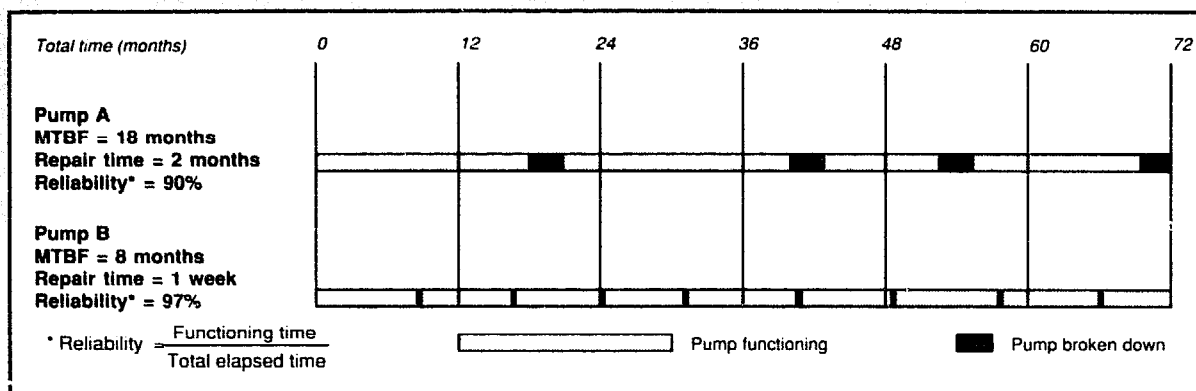

The "reliability" of mechanical equipment is commonly measured in terms of the "mean time before failure" (MTBF). Thus, Pump A which has a MTBF of 18 months would be judged to be more "reliable" than Pump B for which the MTBF is 8 months.

In community water supplies however, MTBF is rarely the most important indicator of reliability. The *mean down time* — i.e. the average period for which the pump is out of service when it does break down is at least as significant as the MTBF. So, in the example above, if Pump "A" needs a mobile team to carry out repairs, and stands idle for an average of two months each time it breaks down, pump users will not regard it as more reliable than Pump "B" which can be put right in one week, by an area mechanic.

A better indicator, adopted as a definition of *Reliability* for the Project, is what the mechanical engineering profession terms "*Availability*" — i.e. the probability that equipment will be in operating condition on any one day, calculated as the operating time as a percentage of total time. On this basis, Pump "B" has a higher reliability (97%) than Pump "A" (90%).

In rating handpumps under the heading of Reliability, the Project has estimated MTBF from the frequency of repairs recorded in the field trials for each pump (shown in the bar graphs in the Handpump Compendium), or from the laboratory results if no field data is available. However, in the field trials and laboratory tests, pump downtime was kept to a minimum, as the repairs were carried out promptly, under the guidance of the Project, and by a skilled team.

To give a more realistic appraisal of likely downtime under unsupervised conditions, the ratings have been calculated according to the pump's suitability for village-level, area-mechanic, or central maintenance. For pumps which can be satisfactorily maintained by a village caretaker, for example, two or less breakdowns per year (MTBF at least 6 months) earn a "good" (oo) rating, whereas a pump requiring the services of a mobile team should break down only once in two years (MTBF at least 24 months) to achieve the same rating. If area-mechanic maintenance is the most appropriate, one breakdown per year (MTBF at least 12 months) is the maximum allowed for the pump to earn a oo rating.

In giving comparable reliability assessments for each maintenance system, the ratings imply that downtime is twice as long if an area mechanic must be called, and twice as long again if a central team is needed. It is worth noting that this underestimates the delays commonly noted with mobile maintenance teams.

Analysts should note that the repair frequencies specified in these ratings apply specifically to the first 1-2 years of operation (older pumps may have a different repair frequency). Also, the reliability ratings do not take account of possible breakdowns due to corrosion or abrasion, which are covered by the following ratings.

Corrosion Resistance

Ratings in this column will be relevant in situations where

the groundwater is aggressive. For a full discussion of corrosion of handpump components, see Box 4.3 in Chapter 4. If expert interpretation of water quality data leads the Analyst to conclude that corrosion is not a threat, then the pump ratings for corrosion resistance will not need to be considered. However, it should be noted that the Project has encountered aggressive groundwater and associated corrosion problems far more frequently than was anticipated.

In assessing pumps under this heading, attention has focussed mainly on downhole components, but some pumps have been downgraded where experience has shown that the pumphead is susceptible to corrosion damage. Note that several pump manufacturers offer the option of alternative downhole components with higher corrosion resistance, so that low-rated pumps

may function satisfactorily under aggressive groundwater conditions if alternative materials are chosen. Interpretation of the ratings is:

- oo All downhole components are manufactured from non-corroding materials (e.g. stainless steel rods; plastic rising mains; rubber, brass, stainless steel or plastic cylinder) and no material combinations will generally induce galvanic action. The pumphead has proved resistant to corrosion damage.
- o Most downhole components are corrosion resistant, but some small, inexpensive and easily replaced components may corrode. This rating may also be given to pumps which have suffered corrosion damage only of the pumphead. Such pumps are not recommended for use in highly corrosive groundwater.
- Downhole components and/or pumphead are susceptible to corrosion (e.g. mild steel or galvanized rods, rising mains or fasteners).

Note that corrosion resistance ratings are not related to pumping lift and therefore remain the same on each of the selection tables.

Abrasion Resistance

The best protection against abrasion is provided by a well design which ensures that sand cannot enter the pumping elements. However, many handpumps operating at moderate or high daily outputs suffer frequent breakdowns because of sand ingress. In these circumstances, unless the Analyst can be confident that adequate well design and construction will be achieved, he should select a handpump which has resistance to abrasion.

Interpretation of the ratings is:

- oo The pump design minimizes the damage from abrasion (e.g. rubber seals and valves, stainless steel cylinder, localless plungers, or designs without plungers).
- o Abrasion resistance is adequate, but some key components such as valves and seals will need regular replacement. The pump may be suitable for trace sand pumping.
- Regular failure of key components is likely at moderate or high daily outputs (> 4m³/d). The pump cannot be recommended for use under such operating conditions where sand ingress is probable.

Note that only one rating is given, regardless of the intended daily output of the pump. While a — rating may be acceptable when pumps are only lightly used and only trace sand pumping is anticipated, Analysts may prefer to select pumps with at least a o rating for moderate outputs (1.5 to 4m³/d), and look for a oo

rating if heavy use is anticipated and replacement of worn components may therefore be more frequent.

The abrasion resistance ratings are not related to pumping lift and therefore remain the same in each selection table.

Manufacturing Needs

There can be substantial cost savings and maintenance benefits where pumps and spares can be manufactured in the country in which they will be used, and Analysts are urged to consider the advantages of in-country manufacture when evaluating their handpump programs. Under this heading, the ratings indicate the pump's potential for local manufacture for three different levels of national industrial development.

If local manufacture is considered desirable, the Analyst selects the category of industrial base which most closely matches that in the country or region concerned. Only pumps with acceptable ratings in the appropriate column 1, 2 or 3 should then be considered suitable.

The categories 1, 2 and 3 represent:

1. Low industrial base. Manufacturing industry is operating on a small scale, with only basic manufacturing processes available. Skill levels are generally low. Material availability is restricted and depends almost entirely on imports. Mass production is limited. No formal quality control procedures are in use. Many lower income African countries are examples of this type of industrial base.

2. Moderately developed industrial base. Manufacturing industry uses a wide range of materials and processes. Skill levels are comparatively high and skilled management is available. Most engineering materials are imported. Some processing of raw materials is available, such as rolling mills, foundries, etc. Limited quality control is employed. Some better off African countries and many Asian and Latin American countries are examples of a moderately developed industrial base.

3. Well developed industrial base. All commonly used manufacturing processes are available within the country, except for highly specialized ones. A wide range of good quality materials is available. Attention to quality control is the norm in major manufacturing establishments. Only special finished items or those with proprietary restrictions would need to be imported.

The ratings indicate how easy it would be to undertake manufacture of the particular pump in a country with the degree of industrial development denoted by the column 1, 2 or 3.

Analysts should note that the presence of foundry and processing skills in the country is not in itself enough to ensure that handpumps can be satisfactorily manufactured locally. Local industry must be willing to undertake the work and to impose the necessary degree of quality control.

Interpretation of the ratings is:

- oo The pump can be manufactured to a consistently high quality in a country with the specified level of industrial development (1, 2 or 3).
- o It should be possible to manufacture the pump in the country, with some external technical assistance to ensure satisfactory quality control, and with importation of some special materials or components.
- Local manufacture of acceptable quality is likely to be impossible to sustain.

Fuller details of the manufacturing needs for individual pumps can be found in the Handpump Compendium.

Short List

This column is provided for the Analyst to develop a primary selection of pumps which meet the minimum requirements of the project or program under analysis. The selection procedure is to trace each listed pump

from left to right across the appropriate Table, checking the rating in each column that the Analyst has judged to be relevant. If an unsatisfactory rating appears, the pump is rejected and the next pump examined. Only those which match the Analyst's chosen minimum criteria in every column receive a check mark in the Short List column.

Further analysis of the shortlisted pumps depends upon the purpose of the selection procedure, and is described in Chapter 6.

Prices

Indicative ex-factory prices were requested from manufacturers in February 1985. The prices quoted in the Handpump Compendium should be taken only as a rough guide to relative capital costs; they cannot be used for estimating purposes. When selecting pumps, up-to-date quotations must be obtained from the manufacturers or distributors, including packing, freight and insurance for the complete pump assembly, with rods and rising mains to the required depth, and with spare parts if desired.

PUMP SELECTION TABLES

The ratings in the following tables represent the "best judgment" of the Project staff. They are based in large part on laboratory and/or field data, which are summarized for each pump in the Handpump Compendium which follows Chapter 6.

GUIDE TO PUMP SELECTION TABLES

THE RATINGS

Ratings in the Pump Selection Tables are based on evaluation of pump performance in the laboratory and field trials. Three ratings are used:

- oo = Good
- o = Adequate
- = Does not meet minimum requirements

A more detailed interpretation of the ratings for specific headings can be found in the earlier part of this Chapter.

Column 1 — Pump Name

The pumps are listed alphabetically in four sections, according to the maximum pumping lift recommended by the manufacturer. The reference number which precedes each pump name indicates the order of the pumps in the Handpump Compendium.

Column 2 — Data Source

- L = The pump has been tested in the laboratory
- F = The pump has had a minimum of 2 years' field trials
- (F) = The pump has had limited field trials

Column 3 — Discharge Rate

The discharge rate deemed "adequate" for each pumping lift is noted at the top of the appropriate table. The rate reduces as depth increases, for the reasons explained in Box 5.1. Some deepwell pumps thus achieve lower ratings for low-lift applications, where users will opt for pumps giving greater discharges. A special note is made where a pump is available with a range of cylinder sizes or adjustable stroke length, to suit different depths.

Column 4 — Ease of Maintenance

Ratings indicate the ease with which maintenance can be carried out by:

- A — A village caretaker
- B — An area mechanic
- C — A mobile maintenance team

Column 5 — Reliability

Reliability ratings are an indication of the proportion of the time that the pump is likely to be functioning properly. Separate ratings are given for different daily outputs. The ratings combine judgments of the "mean time before failure" (MTBF) and the probable "downtime" when the pump is

waiting to be repaired. They thus take account of the fact that pumps which are suitable for village maintenance and can be repaired quickly may be more "reliable" than those which require more complex maintenance, even if the latter break down less frequently.

Column 6 — Corrosion Resistance

Ratings are based primarily on the materials of the downhole components. Galvanized steel pumphods and rising mains are not corrosion resistant in aggressive water and earn a — rating.

Column 7 — Abrasion Resistance

Ratings indicate the pump's capability to pump sand-laden water. Performance in laboratory and field trials is combined with assessment of the seal and valve types. For non-suction pumps, leather cupseals are rated —, though the extent of abrasion damage will be related to the daily output of the pump. Analysts may therefore accept lower rated pumps for light duty applications.

Column 8 — Manufacturing Needs

Ratings indicate the ease with which a pump could be manufactured in a developing country with the specified level of industrial development.

- 1 — Low industrial base, limited quality control
- 2 — Medium-level industry, no special processes
- 3 — Advanced industry, good quality control

Column 9 — Short List

The Analyst develops a short list by entering a check mark against those pumps meeting his selection criteria.

Column 10 — Capital Cost

Analysts should obtain current prices for short-listed pumps.

Column 11 — Remarks

Special features of individual pumps are noted in this column. Amplification of the notes is given below.

Amplification of the ratings for individual pumps can be found in the Handpump Compendium

NOTES ON TABLES

The notes relate to pumps with the same reference number — i.e. Note 14 refers to Pump 14, the Maldev. In the tables, ratings to which the note refers are highlighted

Note 1. The oo corrosion rating for the Abi-ASM is based on current models. Earlier models did suffer from corrosion.

Note 2. The o corrosion rating for the Afridev is based on the use of stainless steel pumphods, offered as an option.

Note 7. The Duba Tropic 7 is a high-discharge pump designed for two-person operation.

Notes 9 and 10. The India Mark II uses a gravity return on the plunger, and requires a minimum cylinder setting of 24 meters (one manufacturer offers a fixed-link system for shallower settings).

Note 14. The Maldev is a pumphead only. All ratings are based on the use of conventional downhole components.

Note 16. Reliability ratings for the Monolift are based on pumps with metal gears. Plastic gears were less reliable.

Note 21. The oo corrosion rating for the Vergnet is based on current models. Earlier models did suffer from corrosion.

Note 23. The oo discharge rating for the Volanta takes account of the pump's adjustable stroke length. Present designs require a minimum well diameter of 110mm.

Note 30. Downhole components of the Kangaroo are corrosion resistant. The o rating relates to the pedal return spring.

Note 40. The Rower is designed as an irrigation pump, and has a high discharge. It is widely used for domestic water supply in Bangladesh.

Table S.1

Maximum pumping lift — 7 meters
"Adequate" discharge rate — 19 liters/minute

1	2	3	4			5			6	7	8			9	10	11						
			Pump name	Data source	Discharge rate	Ease of maintenance					Reliability for (m ³ /d)						Manufacturing needs			Short list	Price (US\$)	Remarks
						A	B	C			1.5	4	8				1	2	3			
HIGH LIFT PUMPS (0-45 meters)																						
1	Abi-ASM	L (F)	—	—	00	00	00	0	—	00	0	—	0	0		See Note 1						
2	Afridev	(F)	0	00	00	00	00	0	0	0	0	0	00	00		See Note 2						
3	AID Derv. Deepwell	L F	00	—	00	00	00	0	—	—	—	—	00	00								
4	Bestobell	L	0	—	00	00	00	0	—	0	0	0	00	00								
5	Climax	L	00*	—	—	00	00	00	0	—	—	—	—	00								
6	Dragon 2	L	0	—	00	00	00	0	—	—	—	—	0	00								
7	Duba Tropic 7	F	00*	—	0	00	00	0	—	—	—	—	—	00		See Note 7						
8	GSW	L (F)	0*	—	00	00	00	00	0	—	—	—	0	00								
9	India Mark II (standard)	L F	0	—	00	00	00	00	00	—	—	—	0	00		See Note 9						
10	India Mark II (modified)	(F)	0	—	00	00	00	00	00	—	0	—	0	00		See Note 10						
11	Jetmatic Deepwell	L	0	—	00	00	00	00	0	—	—	—	0	00								
12	Kardia	L (F)	0	—	00	00	00	00	0	00	0	—	0	00								
13	Korat	L F	00*	—	00	00	00	00	0	—	—	—	00	00								
14	Maldev	L F	00*	—	00	00	00	00	0	—	—	0	00	00		See Note 14						
15	Monarch P3	L F	00*	—	00	00	00	00	0	—	—	—	0	00								
16	Monolift	L (F)	—	—	—	00	00	00	0	—	00	—	—	00		See Note 16						
17	Moyno	L F	—	—	—	00	00	00	0	—	00	—	—	0								
18	Nira AF84	L	0	—	00	00	00	00	0	00	0	—	0	00								
19	Philippines Deepset	(F)	0	—	00	00	00	0	—	—	—	0	00	00								
20	SWN 80 & 81	F	00*	—	00	00	00	00	00	00	—	—	00	00								
21	Vergnet	L F	—	0	00	00	00	00	0	00	0	—	0	0		See Note 21						
22	VEW A18	L	0	—	0	00	00	0	—	00	—	—	—	0								
23	Volanta	L F	00	0	00	00	00	00	00	00	0	0	00	00		See Note 23						
INTERMEDIATE LIFT PUMPS (0-25 meters)																						
24	Consallen LD6	L F	00*	—	00	00	00	00	0	00	0	—	0	00								
25	DMR (Dempster deriv.)	F	00*	—	00	00	00	0	—	—	—	—	00	00								
26	Nira AF76	L F	00*	—	00	00	00	0	—	—	0	—	00	00								
LOW LIFT PUMPS (0-12 meters)																						
27	Blair	F	0	00	00	00	00	0	—	00	0	0	00	00								
28	Ethiopia BP50	L	00	0	00	00	00	0	0	0	—	0	00	00		7m max. lift						
29	IDRC-UM	L	00	0	00	00	00	0	—	00	—	0	00	00								
30	Kangaroo	L F	00	—	00	00	00	0	—	0	00	—	0	00		See Note 30						
31	Malawi Mark V	F	00	0	00	00	0	—	—	00	0	0	00	00		7m max. lift						
32	Nira AF85	L F	00	00	00	00	00	00	00	0	0	0	00	00								
33	Tara	L F	00	00	00	00	00	0	—	0	—	0	00	00								
SUCTION PUMPS (0-7 meters)																						
34	AID Suction	F	00	0	00	00	00	0	—	—	0	—	00	00								
35	Bandung	L	00	00	00	00	00	00	0	0	0	—	00	00								
36	Inalsa Suction	F	00	0	00	00	00	0	—	—	—	—	00	00								
37	Jetmatic Suction	(F)	00	0	00	00	00	0	—	0	0	—	00	00								
38	Lucky	F	00	0	00	00	0	—	—	—	0	—	00	00								
39	New No. 6	L (F)	00	00	00	00	00	0	—	—	00	—	00	00								
40	Rower	L (F)	00	00	00	00	00	00	0	0	0	00	00	00		See Note 40						
41	SYB-100	F	00	0	00	00	00	00	0	0	00	—	00	00								
42	Wasp	F	00	0	00	00	00	0	—	—	0	—	00	00								
ADDITIONAL PUMPS																						
A1																						
A2																						
A3																						
A4																						

* Indicates that discharge ratings are based on choice of the correct cylinder size from a range offered by the manufacturer.

GUIDE TO PUMP SELECTION TABLES

THE RATINGS

Ratings in the Pump Selection Tables are based on evaluation of pump performance in the laboratory and field trials. Three ratings are used:

- oo = Good
- o = Adequate
- = Does not meet minimum requirements

A more detailed interpretation of the ratings for specific headings can be found in the earlier part of this Chapter.

Column 1 — Pump Name

The pumps are listed alphabetically in four sections, according to the maximum pumping lift recommended by the manufacturer. The reference number which precedes each pump name indicates the order of the pumps in the Handpump Compendium.

Column 2 — Data Source

- L = The pump has been tested in the laboratory
- F = The pump has had a minimum of 2 years' field trials
- (F) = The pump has had limited field trials

Column 3 — Discharge Rate

The discharge rate deemed "adequate" for each pumping lift is noted at the top of the appropriate table. The rate reduces as depth increases, for the reasons explained in Box 5.1. Some deepwell pumps thus achieve lower ratings for low-lift applications, where users will opt for pumps giving greater discharges. A special note is made where a pump is available with a range of cylinder sizes or adjustable stroke length, to suit different depths.

Column 4 — Ease of Maintenance

Ratings indicate the ease with which maintenance can be carried out by:

- A — A village caretaker
- B — An area mechanic
- C — A mobile maintenance team

Column 5 — Reliability

Reliability ratings are an indication of the proportion of the time that the pump is likely to be functioning properly. Separate ratings are given for different daily outputs. The ratings combine judgments of the "mean time before failure" (MTBF) and the probable "downtime" when the pump is

waiting to be repaired. They thus take account of the fact that pumps which are suitable for village maintenance and can be repaired quickly may be more "reliable" than those which require more complex maintenance, even if the latter break down less frequently.

Column 6 — Corrosion Resistance

Ratings are based primarily on the materials of the downhole components. Galvanized steel pumprods and rising mains are not corrosion resistant in aggressive water and earn a — rating.

Column 7 — Abrasion Resistance

Ratings indicate the pump's capability to pump sand-laden water. Performance in laboratory and field trials is combined with assessment of the seal and valve types. Leather cupseals are rated —, though the extent of abrasion damage will be related to the daily output of the pump. Analysts may therefore accept lower rated pumps for light duty applications.

Column 8 — Manufacturing Needs

Ratings indicate the ease with which a pump could be manufactured in a developing country with the specified level of industrial development.

- 1 — Low industrial base, limited quality control
- 2 — Medium-level industry, no special processes
- 3 — Advanced industry, good quality control

Column 9 — Short List

The Analyst develops a short list by entering a check mark against those pumps meeting his selection criteria.

Column 10 — Capital Cost

Analysts should obtain current prices for short-listed pumps.

Column 11 — Remarks

Special features of individual pumps are noted in this column. Amplification of the notes is given below.

Amplification of the ratings for individual pumps can be found in the Handpump Compendium.

NOTES ON TABLES

The notes relate to pumps with the same reference number — i.e. Note 14 refers to Pump 14, the Maldev. In the tables, ratings to which the note refers are highlighted

Note 1. The oo corrosion rating for the Abi-ASM is based on current models. Earlier models did suffer from corrosion.

Note 2. The o corrosion rating for the Afridev is based on the use of stainless steel pumprods, offered as an option.

Note 7. The Duba Tropic 7 is a high-discharge pump designed for two-person operation.

Notes 9 and 10. The India Mark II uses a gravity return on the plunger, and requires a minimum cylinder setting of 24 meters (one manufacturer offers a fixed-link system for shallower settings).

Note 14. The Maldev is a pumphead only. All ratings are based on the use of conventional downhole components.

Note 16. Reliability ratings for the Monolift are based on pumps with metal gears. Plastic gears were less reliable.

Note 21. The oo corrosion rating for the Vergnet is based on current models. Earlier models did suffer from corrosion.

Note 23. The oo discharge rating for the Volanta takes account of the pump's adjustable stroke length. Present designs require a minimum well diameter of 110mm.

Note 30. Downhole components of the Kangaroo are corrosion resistant. The o rating relates to the pedal return spring.

Table S.2

Maximum pumping lift — 12 meters
"Adequate" discharge rate — 16 liters/minute

1		2		3		4			5			6		7		8			9		10		11			
Pump name	Data source	Discharge rate	Ease of maintenance			Reliability for (m ³ /d)			Corr. res.	Abr. res.	Manufacturing needs			Short list	Price (US\$)	Remarks										
			A	B	C	1.5	4	8			1	2	3													
HIGH LIFT PUMPS (0-45 meters)																										
1	Abi-ASM	L (F)	0	—	00	00	00	0	—	00	0	—	0	0												See Note 1
2	Afridev	(F)	00	00	00	00	00	00	0	0	0	0	0	00	00											See Note 2
3	AID Deriv. Deepwell	L F	00	—	00	00	00	0	—	—	—	—	—	00	00											
4	Bestobell	L	0	—	00	00	00	0	—	0	0	0	0	00	00											
5	Climax	L	00*	—	—	00	00	00	0	—	—	—	—	—	00											
6	Dragon 2	L	0	—	00	00	00	0	—	—	—	—	—	0	00											
7	Duba Tropic 7	F	00*	—	0	00	00	0	—	—	—	—	—	—	00											See Note 7
8	GSW	L (F)	0*	—	00	00	00	00	0	—	—	—	—	0	00											
9	India Mark II (standard)	L F	0	—	00	00	00	00	00	—	—	—	—	0	00											See Note 9
10	India Mark II (modified)	(F)	0	—	00	00	00	00	00	—	0	—	—	0	00											See Note 10
11	Jetmatic Deepwell	L	0	—	00	00	00	00	0	—	—	—	—	0	00											
12	Kardia	L (F)	0	—	00	00	00	00	0	00	0	—	—	0	00											
13	Korat	L F	00*	—	00	00	00	00	0	—	—	—	—	—	00	00										
14	Maldev	L F	00*	—	00	00	00	00	0	—	—	—	—	0	00	00										See Note 14
15	Monarch P3	L F	00*	—	00	00	00	00	0	—	—	—	—	0	00											
16	Monolift	L (F)	0	—	—	00	00	00	0	—	00	—	—	—	00											See Note 16
17	Moyno	L F	—	—	—	00	00	00	0	—	00	—	—	—	0											
18	Nira AF84	L	0	—	00	00	00	00	0	00	0	—	—	0	00											
19	Philippines Deepset	(F)	0	—	00	00	00	0	—	—	—	—	—	0	00	00										
20	SWN 80 & 81	F	00*	—	00	00	00	00	00	00	00	—	—	—	00	00										
21	Vergnet	L F	—	0	00	00	00	00	0	00	0	—	—	0	0											See Note 21
22	VEW A18	L	0	—	0	00	00	0	—	00	—	—	—	—	0											
23	Volanta	L F	00	0	00	00	00	00	00	00	00	0	0	00												See Note 23
INTERMEDIATE LIFT PUMPS (0-25 meters)																										
24	Consallen LD6	L F	00*	—	00	00	00	0	—	00	0	—	—	0	00											
25	DMR (Dempster deriv.)	F	00*	—	00	00	00	0	—	—	—	—	—	00	00											
26	Nira AF76	L F	00*	—	00	00	00	0	—	—	0	—	—	00	00											
LOW LIFT PUMPS (0-12 meters)																										
27	Blair	F	0	00	00	00	00	0	—	00	0	0	00	00												
28	Ethiopia BP50	L																								7m max. lift
29	IDRC-UM	L	00	0	00	00	00	0	—	00	—	0	00	00												
30	Kangaroo	L F	00	—	00	00	00	0	—	0	00	—	—	0	00											See Note 30
31	Malawi Mark V	F																								7m max. lift
32	Nira AF85	L F	00	00	00	00	00	00	0	00	0	0	00	00												
33	Tara	L F	00	00	00	00	0	—	—	0	—	—	—	0	00	00										
ADDITIONAL PUMPS																										
A1																										
A2																										
A3																										
A4																										

Indicates that discharge ratings are based on choice of the correct cylinder size from a range offered by the manufacturer.

GUIDE TO PUMP SELECTION TABLES

THE RATINGS

Ratings in the Pump Selection Tables are based on evaluation of pump performance in the laboratory and field trials. Three ratings are used:

- ∞ = Good
- o = Adequate
- = Does not meet minimum requirements

A more detailed interpretation of the ratings for specific headings can be found in the earlier part of this Chapter.

Column 1 — Pump Name

The pumps are listed alphabetically in four sections, according to the maximum pumping lift recommended by the manufacturer. The reference number which precedes each pump name indicates the order of the pumps in the Handpump Compendium.

Column 2 — Data Source

- L = The pump has been tested in the laboratory
- F = The pump has had a minimum of 2 years' field trials
- (F) = The pump has had limited field trials

Column 3 — Discharge Rate

The discharge rate deemed "adequate" for each pumping lift is noted at the top of the appropriate table. The rate reduces as depth increases, for the reasons explained in Box 5.1. Some deepwell pumps thus achieve lower ratings for low-lift applications, where users will opt for pumps giving greater discharges. A special note is made where a pump is available with a range of cylinder sizes or adjustable stroke length, to suit different depths.

Column 4 — Ease of Maintenance

Ratings indicate the ease with which maintenance can be carried out by:

- A — A village caretaker
- B — An area mechanic
- C — A mobile maintenance team

Column 5 — Reliability

Reliability ratings are an indication of the proportion of the time that the pump is likely to be functioning properly. Separate ratings are given for different daily outputs. The ratings combine judgments of the "mean time before failure" (MTBF) and the probable "downtime" when the pump is

waiting to be repaired. They thus take account of the fact that pump which are suitable for village maintenance and can be repaired quickly may be more "reliable" than those which require more complex maintenance, even if the latter break down less frequently.

Column 6 — Corrosion Resistance

Ratings are based primarily on the materials of the downhole components. Galvanized steel pumprods and rising mains are not corrosion resistant in aggressive water and earn a — rating.

Column 7 — Abrasion Resistance

Ratings indicate the pump's capability to pump sand-laden water. Performance in laboratory and field trials is combined with assessment of the seal and valve types. Leather cupseals are rated —, though the extent of abrasion damage will be related to the daily output of the pump. Analysts may therefore accept lower rated pumps for light duty applications.

Column 8 — Manufacturing Needs

Ratings indicate the ease with which a pump could be manufactured in a developing country with the specified level of industrial development.

- 1 — Low industrial base, limited quality control
- 2 — Medium-level industry, no special processes
- 3 — Advanced industry, good quality control

Column 9 — Short List

The Analyst develops a short list by entering a check mark against those pumps meeting his selection criteria.

Column 10 — Capital Cost

Analysts should obtain current prices for short-listed pumps.

Column 11 — Remarks

Special features of individual pumps are noted in this column. Amplification of the notes is given below.

Amplification of the ratings for individual pumps can be found in the Handpump Compendium

NOTES ON TABLES

The notes relate to pumps with the same reference number — i.e. Note 14 refers to Pump 14, the Maldev. In the tables, ratings to which the note refers are highlighted

Note 1. The ∞ corrosion rating for the Abi-ASM is based on current models. Earlier models did suffer from corrosion.

Note 2. The o corrosion rating for the Afridev is based on the use of stainless steel pumprods, offered as an option.

Note 7. The Duba Tropic 7 is a high-discharge pump designed for two-

person operation.

Note 14. The Maldev is a pumphead only. All ratings are based on the use of conventional downhole components.

Note 16. Reliability ratings for the Monolift are based on pumps with metal gears. Plastic gears were less reliable.

Note 21. The ∞ corrosion rating for the Vergnet is based on current models. Earlier models did suffer from corrosion.

Note 23. The ∞ discharge rating for the Volanta takes account of the pump's adjustable stroke length. Present designs require a minimum well diameter of 110mm.

Table S.3

Maximum pumping lift — 25 meters
"Adequate" discharge rate — 10 liters/minute

		1	2	3	4	5	6	7	8	9	10	11			
Pump name	Data source	Discharge rate	Ease of maintenance			Reliability for (m ³ /d)		Corr. res.	Abr. res.	Manufacturing needs			Short list	Price (US\$)	Remarks
			A	B	C	4	8			1	2	3			
HIGH LIFT PUMPS (0-45 meters)															
1	Abi-ASM	L (F)	0	—	00	00	0	—	00	0	—	0	0		See Note 1
2	Afridev	(F)	00	00	00	00	00	0	0	0	0	00	00		See Note 2
3	AID Deriv. Deepwell	L F	0	—	0	00	—	—	—	—	—	00	00		
4	Bestobell	L	0	—	0	00	0	—	0	0	0	00	00		
5	Climax	L	00*	—	—	00	00	0	—	—	—	—	00		
6	Dragon 2	L	0	—	0	00	—	—	—	—	—	0	00		
7	Duba Tropic 7	F	00*	—	0	00	0	—	—	—	—	—	00		See Note 7
8	GSW	L (F)	00*	—	0	00	0	—	—	—	—	0	00		
9	India Mark II (standard)	L F	00	—	0	00	0	—	—	—	—	0	00		
10	India Mark II (modified)	(F)	00	—	00	00	00	0	—	0	—	0	00		
11	Jetmatic Deepwell	L	0	—	0	00	—	—	—	—	—	0	00		
12	Kardia	L (F)	00	—	00	00	0	—	00	0	—	0	00		
13	Korat	L F	00*	—	0	00	0	—	—	—	—	00	00		
14	Makdev	L F	00*	—	0	00	0	—	—	—	0	00	00		See Note 14
15	Monarch P3*	L F	00	—	0	00	0	—	—	—	—	0	00		
16	Monolift	L (F)	0	—	—	00	00	0	—	00	—	—	00		See Note 15
17	Moyno	L F	0	—	—	00	00	0	—	00	—	—	0		
18	Nira AF84	L	0	—	0	00	00	0	00	0	—	0	00		
19	Philippines Deepset	(F)	00	—	0	00	0	—	—	—	0	00	00		
20	SWN 80 & 81	F	00*	—	0	00	0	—	00	00	—	00	00		
21	Vergnet	L F	0	0	00	00	00	0	00	0	—	0	0		See Note 21
22	VEWA18	L	0	—	—	00	0	—	00	—	—	—	0		
23	Volanta	L F	00	0	00	00	00	00	00	00	0	0	00		See Note 23
INTERMEDIATE LIFT PUMPS (0-25 meters)															
24	Consallen LD6	L F	00*	—	00	00	—	—	00	0	—	0	00		
25	DMR (Dempster deriv.)	F	00*	—	0	00	—	—	—	—	—	00	00		
26	Nira AF76	L F	00*	—	0	00	—	—	—	0	—	00	00		
ADDITIONAL PUMPS															
A1															
A2															
A3															
A4															

* Indicates that discharge ratings are based on choice of the correct cylinder size from a range offered by the manufacturer.

GUIDE TO PUMP SELECTION TABLES

THE RATINGS

Ratings in the Pump Selection Tables are based on evaluation of pump performance in the laboratory and field trials. Three ratings are used:

- oo = Good
- o = Adequate
- = Does not meet minimum requirements

A more detailed interpretation of the ratings for specific headings can be found in the earlier part of this Chapter.

Column 1 — Pump Name

The pumps are listed alphabetically in four sections, according to the maximum pumping lift recommended by the manufacturer. The reference number which precedes each pump name indicates the order of the pumps in the Handpump Compendium.

Column 2 — Data Source

- L = The pump has been tested in the laboratory
- F = The pump has had a minimum of 2 years' field trials
- (F) = The pump has had limited field trials

Column 3 — Discharge Rate

The discharge rate deemed "adequate" for each pumping lift is noted at the top of the appropriate table. The rate reduces as depth increases, for the reasons explained in Box 5.1. Some deepwell pumps thus achieve lower ratings for low-lift applications, where users will opt for pumps giving greater discharges. A special note is made where a pump is available with a range of cylinder sizes or adjustable stroke length, to suit different depths.

Column 4 — Ease of Maintenance

Ratings indicate the ease with which maintenance can be carried out by:

- A — A village caretaker
- B — An area mechanic
- C — A mobile maintenance team

Column 5 — Reliability

Reliability ratings are an indication of the proportion of the time that the pump is likely to be functioning properly. Separate ratings are given for different daily outputs. The ratings combine judgments of the "mean time before failure" (MTBF) and the probable "downtime" when the pump is

waiting to be repaired. They thus take account of the fact that pumps which are suitable for village maintenance and can be repaired quickly may be more "reliable" than those which require more complex maintenance, even if the latter break down less frequently.

Column 6 — Corrosion Resistance

Ratings are based primarily on the materials of the downhole components. Galvanized steel pumprods and rising mains are not corrosion resistant in aggressive water and earn a — rating.

Column 7 — Abrasion Resistance

Ratings indicate the pump's capability to pump sand-laden water. Performance in laboratory and field trials is combined with assessment of the seal and valve types. Leather cupseals are rated —, though the extent of abrasion damage will be related to the daily output of the pump. Analysts may therefore accept lower rated pumps for light duty applications.

Column 8 — Manufacturing Needs

Ratings indicate the ease with which a pump could be manufactured in a developing country with the specified level of industrial development.

- 1 — Low industrial base, limited quality control
- 2 — Medium-level industry, no special processes
- 3 — Advanced industry, good quality control

Column 9 — Short List

The Analyst develops a short list by entering a check mark against those pumps meeting his selection criteria.

Column 10 — Capital Cost

Analysts should obtain current prices for short-listed pumps.

Column 11 — Remarks

Special features of individual pumps are noted in this column. Amplification of the notes is given below.

Amplification of the ratings for individual pumps found in the Handpump Compendium

NOTES ON TABLES

The notes relate to pumps with the same reference number — i.e. Note 14 refers to Pump 14, the Maldev. In the tables, ratings to which the note refers are highlighted

Note 1. The oo corrosion rating for the Abi-AS' 1 is based on current models. Earlier models did suffer from corrosion.

Note 2. The o corrosion rating for the Afrdev is based on the use of stainless steel pumprods, offered as an option.

Note 7. The Duba Tropic 7 is a high-discharge pump designed for two-person operation.

Note 12. The manufacturer recommends a maximum depth of 40 meters for the Kardia

Note 14. The Maldev is a pumphead only. All ratings are based on the use of conventional downhole components.

Note 16. Reliability ratings for the Monolift are based on pumps with metal gears. Plastic gears were less reliable. A 2:1 gear ratio is supplied for deepwell applications.

Note 21. The oo corrosion rating for the Vergnet is based on current models. Earlier models did suffer from corrosion.

Note 23. The oo discharge rating for the Volanta takes account of the pump's adjustable stroke length. Present designs require a minimum well diameter of 110mm.

Table S.4

Maximum pumping lift — 45 meters

"Adequate" discharge rate — 7 liters/minute

1	2		3	4			5	6	7	8			9	10	11
Pump name	Data source	Discharge rate	Ease of maintenance			Reliability for (m ³ /d) 4	Corr. res.	Abr. res.	Manufacturing needs			Short list	Price (US\$)	Remarks	
			A	B	C				1	2	3				
HIGH LIFT PUMPS (0-45 meters)															
1	Abi-ASM	L (F)	0	—	00	00	—	00	0	—	0	0			See Note 1
2	Afridev	(F)	00	00	00	00	0	0	0	0	00	00			See Note 2
3	AID Deriv. Deepwell	L F	0	—	0	00	—	—	—	—	00	00			
4	Bestobell	L	0	—	0	00	—	0	0	0	00	00			
5	Climax	L	00*	—	—	00	0	—	—	—	—	00			
6	Dragon 2	L	0	—	0	00	—	—	—	—	0	00			
7	Duba Tropic 7	F	00*	—	0	00	—	—	—	—	—	00			See Note 7
8	GSW	L (F)	00*	—	0	00	—	—	—	—	0	00			
9	India Mark II (standard)	L F	00	—	0	00	—	—	—	—	0	00			
10	India Mark II (modified)	(F)	00	—	00	00	0	—	0	—	0	00			
11	Jetmatic Deepwell	L	00	—	0	00	—	—	—	—	0	00			
12	Kardia	L (F)	00	—	0	00	—	00	0	—	0	00			See Note 12
13	Korat	L F	00*	—	0	00	—	—	—	—	00	00			
14	Maldev	L F	00*	—	0	00	—	—	—	0	00	00			See Note 14
15	Monarch P3	L F	00*	—	0	00	—	—	—	—	0	00			
16	Monolift	L (F)	0	—	—	00	0	—	00	—	—	00			See Note 16
17	Moyno	L F	0	—	—	00	0	—	00	—	—	0			
18	Nira AF84	L	0	—	0	00	0	00	0	—	0	00			
19	Philippines Deepset	(F)	00	—	0	00	—	—	—	0	00	00			
20	SWN 80 & 81	F	00*	—	0	00	—	00	00	—	00	00			
21	Vergnet	L F	0	0	00	00	0	00	0	—	0	0			See Note 21
22	VEW A18	L	0	—	—	00	—	00	—	—	—	0			
23	Volanta	L F	00	0	00	00	0	00	00	0	0	00			See Note 23
ADDITIONAL PUMPS															
A1															
A2															
A3															
A4															

* Indicates that discharge ratings are based on choice of the correct cylinder size from a range offered by the manufacturer.

Chapter 6

Pump Selection: Worked Examples

The Pump Selection Tables in Chapter 5 can be used to make a short list of pumps which meet minimum requirements. Together with the Handpump Compendium, they provide a means of selecting a pump for one particular application.

The tables can also be used as an aid to preparation of bidding documents or to evaluation of bids for the procurement of handpumps. *Draft Sample Bidding Documents for the Procurement of Handpumps*¹, designed for international competitive bidding, may also be used and are available from the World Bank. They include methods for weighting key pump attributes, so that the benefits of exceeding minimum requirements (better reliability, easier maintenance, etc.) can be taken into account alongside price.

Final selection of one or more pumps will depend on the operating conditions under which the pumps will be used, the relative importance placed on different selection criteria, and up-to-date prices. In selecting handpumps for a particular application, the important first step is a clear definition of the **operating conditions** (i.e. the range of pumping lifts, the amount of water to be pumped each day, the corrosivity of the water and the potential for sand pumping), the **maintenance system** that will be employed, and the importance placed on **local manufacture**.

Form 5.1 at the beginning of Chapter 5 is a convenient way of establishing these pump selection criteria. These minimum requirements then permit the Analyst to identify the appropriate Pump Selection Table, and then to eliminate from further consideration those pumps which would be unsuitable. The resulting Short List of pumps may then be evaluated in more detail.

The Handpump Compendium is provided as a reference for more detailed analysis of shortlisted

pumps. Information in the Compendium should be supplemented by up-to-date information on pump prices, including freight and insurance, and, where appropriate by inspection of working pumps and manufacturing facilities, or by review of working drawings of non-proprietary pumps with potential local manufacturers.

The examples which follow demonstrate how the Pump Selection Tables can be used to develop a short list of pumps. They are followed by a brief description of the merit point method of pump evaluation used in the sample bidding documents.

Worked Example No 1: Low Lift

This example is typical of an alluvial plain in Asia, with a permeable aquifer and a high groundwater level. A maximum user group of 75 people per handpump is desired, with a demand of 20 liters per person per day (i.e. each pump must supply 1.5 cubic meters of water a day). Very little drawdown is expected during pumping, but nearby motorized pumps may lower the water table locally in some areas to 10 meters below the surface. The groundwater is not corrosive, and only trace amounts of sand may enter the wells during pumping. Village-level maintenance is to be introduced, as is in-country manufacture of handpumps, in a country with a medium level industrial base. Two pumps are already widely used in the country - The India Mark II (imported) and the New No 6 (locally made).

The first step in selecting a short list of pumps for this application is to complete Form 5.1 with the specific Selection Criteria. Figure 6.1 includes a copy of the form completed according to the criteria identified by the Analyst. Note that there is no Pump Selection Table precisely matching the operating condition of 10 meters maximum pumping lift, so the Analyst opts for Table S.2 (12 meters), ensuring that the most severe conditions are met.

From the criteria listed on Form 5.1, the Analyst determines that for a pump to meet his minimum

1. Applied Research and Technology — Note No. 1, *Draft Sample Bidding Documents for the Procurement of Handpumps*, World Bank, 1986.

Figure 6.1 Handpump Selection Criteria for Worked Example No. 1

HANDPUMP SELECTION CRITERIA	
NAME OF PROJECT _____	<u>Worked Example No.1</u>
MAXIMUM PUMPING LIFT Selection Table for this lift ¹	<u>10</u> meters <u>S.2</u>
DAILY OUTPUT PER PUMP	<u>1.5</u> m³/d
MAINTENANCE SYSTEM TO BE USED (A, B, or C) Where A = Village-level maintenance B = Area-mechanic maintenance C = Centralized maintenance	<u>A</u>
MINIMUM RATING NEEDED FOR CORROSION RESISTANCE Where — = Corrosion resistance is not required o = Resistance to mildly corrosive water is required oo = Resistance to aggressive water is required	<u>—</u>
MINIMUM RATING NEEDED FOR ABRASION RESISTANCE Where — = Either there is no sand pumping anticipated, or there is a possibility of trace sand pumping and the daily output will not be greater than 1.5m ³ o = There is a possibility of trace sand pumping and the daily output will be greater than 1.5m ³ oo = There is a possibility of significant sand pumping	<u>—</u>
MANUFACTURING ENVIRONMENT (1, 2, or 3) Where 1 = The pump is to be made in the country, and there is a low-level industrial base 2 = The pump is to be made in the country, and there is a medium-level industrial base 3 = The pump may be imported or made in a country where there is a high level industrial base	<u>2</u>
PUMPS ALREADY PERFORMING SATISFACTORILY IN THE COUNTRY (* IF ALSO MANUFACTURED IN THE COUNTRY)	<u>New No.6*</u> <u>India Mark II</u>

requirements it must achieve ratings in Table S.2 as follows:

Column No. in Table S 2	Criterion	Minimum Rating
3	Discharge rate	o
4 (A)	Ease of maintenance at village level	o
5 (1.5)	Reliability for output of 1.5m ³ /day	o
6	Corrosion resistance	—
7	Abrasion resistance	—
8 (2)	Manufacturing needs in medium-level industrial base	o

Each of the pumps in Table S.2 is evaluated, to check whether it achieves these minimum ratings. Figure 6.2 shows the completed Table S.2, revealing that just six pumps met the minimum requirements (the desire for village-level maintenance and local manufacture eliminates many on the list). Neither of the pumps currently in use in the country make the Short List - the **New No. 6** is a suction pump and so cannot be considered for lifts of more than 7 meters, and the **India Mark II** is not appropriate for village-level maintenance. The six short-listed pumps therefore are: the **Afridev**, **Blair**, **IDRC-UM**, **Nira AF85**, **Tara** and **Volanta**.

This narrowing of the choice is a very important step in the selection process, as it produces a manageable list for detailed analysis in the final selection stage. In this particular example, further reduction of the short list will depend on the priority given to individual attributes, and on prices. For example, the **Blair** has a lower rating (o) than the others (oo) for discharge, the **IDRC-UM** and **Volanta** lower ratings for ease of maintenance, and the **Tara** a lower rating for reliability. Five of the pumps rank equally (oo) for local manufacture, which in this case is an important criterion. Consequently, potential manufacturers in the country should be contacted to obtain assessments of their capacities for manufacturing the six pumps under consideration, and the prices for doing so with adequate quality control.

Worked Examples Nos. 2 & 3: Intermediate and High Lift

A handpump program is being prepared for a region where maximum pumping lift, including drawdown during the pumping day, is expected to be 25 meters for the majority of the wells (Example No. 2), though lifts in areas near to the project may be as much as 40 meters (Example No. 3). Each pump is to supply 200 people with 20 liters a day — giving a total daily output of 4m³. The pump must be suitable for maintenance by area

mechanics, perhaps travelling on mopeds or bicycles. Good quality control of drilling and well construction can be assured, to prevent sand pumping, and the ground-water is not corrosive. In-country manufacture is not an immediate objective.

In completing the Selection Criteria Form for this application (Figure 6.3 Examples 2 and 3), it is prudent to consider two separate cases - one for the 25 meter lift specified for the project itself, and the other covering anticipated conditions in the nearby area, where pumps may be needed in the future, and standardization would be of benefit. The Analyst will perform his evaluation using Table S.3 for the project area and Table S.4 for the proximate area. Figure 6.3 (Examples 2 and 3) shows the completed Forms, resulting in two Short Lists.

Sixteen pumps make the short list in Example 2 (25m pumping lift) while only 5 make it in Example 3 (40m lift). The large list for Example 2 reflects the fact that trained area mechanics can successfully remove the pumping element of most conventional handpumps at pumping lifts down to 25 meters with no external assistance. However, at higher pumping lifts, this is not the case, and reliability becomes unacceptable for most pumps. The short list for Example 3 is therefore more limited.

When selecting a pump for this region, special consideration should be given to those pumps which are on both lists, so as to choose a single high-lift pump model for the region.

Worked Example No. 4: VLOM Pumps for Intermediate and High Lifts

Example No. 4 identifies those intermediate (12-25m) and high (25-45) lift pumps (**Afridev** and **Volanta**) that are most likely to be able to be maintained by village-based repairers, and that can be manufactured in countries with a low industrial base. Both the short list pumps have limitations: the **Afridev** has only limited field performance data (as indicated by (F) under Data Source in the rating tables), and is still undergoing development, as the Compendium entry (Pump 02) makes clear; the **Volanta** requires a 110mm I.D. well casing, ruling out its use in 100mm wells. A small diameter version of the **Volanta** is now being tested (See Note 23 in the rating tables). The requirements of village-based maintenance and local manufacture used in this example lead to a very limited short list, an indication of the importance of present and future development of VLOM pumps for medium and high lift applications.

Merit Point Evaluation

Whether or not full competitive bidding procedures and

* In this example, the only water use will be domestic, but the Analyst is cautioned that in some other cases allowance must also be made for animal watering or irrigation.

Figure 6.2 Compilation of Short List for Worked Example No.1

Table S.2

Maximum pumping lift — 12 meters
 "Adequate" discharge rate — 16 liters/minute

1	2	3	4			5			6	7	8			9	10	11
			Ease of maintenance			Reliability for (m ³ /d)					Manufacturing needs					
Pump name	Data source	Discharge rate	A	B	C	1.5	4	8	Corr. res.	Abr. res.	1	2	3	Short list	Price (US\$)	Remarks
HIGH LIFT PUMPS (0-45 meters)																
1	Abi-ASM	L (F)	o	—	oo	oo	oo	o	—	oo	o	—	o	o		See Note 1
2	Afridev	(F)	oo	oo	oo	oo	oo	o	o	o	o	oo	oo	√		See Note 2
3	AID Deriv. Deepwell	L F	oo	—	oo	oo	oo	o	—	—	—	oo	oo			
4	Bestobell	L	o	—	oo	oo	oo	o	—	o	o	o	oo			
5	Climax	L	oo*	—	—	oo	oo	oo	o	—	—	—	oo			
6	Dragon 2	L	o	—	oo	oo	oo	o	—	—	—	o	oo			
7	Duba Tropic 7	F	oo*	—	o	oo	oo	o	—	—	—	—	oo			See Note 7
8	GSW	L (F)	o*	—	oo	oo	oo	oo	o	—	—	—	o	oo		
9	India Mark II (standard)	L F	o	—	oo	oo	oo	oo	oo	—	—	—	o	oo		See Note 9
10	India Mark II (modified)	(F)	o	—	oo	oo	oo	oo	oo	—	o	—	o	oo		See Note 10
11	Jetmatic Deepwell	L	o	—	oo	oo	oo	oo	o	—	—	—	o	oo		
12	Kardia	L (F)	o	—	oo	oo	oo	oo	o	oo	o	—	o	oo		
13	Korat	L F	oo*	—	oo	oo	oo	oo	o	—	—	—	oo	oo		
14	Maldev	L F	oo*	—	oo	oo	oo	oo	o	—	—	o	oo	oo		See Note 14
15	Monarch P3	L F	oo*	—	oo	oo	oo	oo	o	—	—	—	o	oo		
16	Monolift	L (F)	o	—	—	oo	oo	oo	o	—	oo	—	—	oo		See Note 16
17	Moyno	L F	—	—	—	oo	oo	oo	o	—	oo	—	—	o		
18	Nira AF84	L	o	—	oo	oo	oo	oo	o	oo	o	—	o	oo		
19	Philippines Deepset	(F)	o	—	oo	oo	oo	o	—	—	—	o	oo	oo		
20	SWN 80 & 81	F	oo*	—	oo	oo	oo	oo	oo	oo	oo	—	oo	oo		
21	Vergnet	L F	—	o	oo	oo	oo	oo	o	oo	o	—	o	o		See Note 21
22	VEWA18	L	o	—	o	oo	oo	o	—	oo	—	—	o			
23	Volanta	L F	oo	o	oo	oo	oo	oo	oo	oo	o	o	oo	√		See Note 23
INTERMEDIATE LIFT PUMPS (0-25 meters)																
24	Consallen LD6	L F	oo*	—	oo	oo	oo	o	—	oo	o	—	o	oo		
25	DMR (Dempster deriv.)	F	oo*	—	oo	oo	oo	o	—	—	—	—	oo	oo		
26	Nira AF76	L F	oo*	—	oo	oo	oo	o	—	—	o	—	oo	oo		
LOW LIFT PUMPS (0-12 meters)																
27	Blair	F	o	oo	oo	oo	oo	o	—	oo	o	o	oo	oo	√	
28	Ethiopia BP50	L														7m max. lift
29	IDRC-UM	L	oo	o	oo	oo	oo	o	—	oo	—	o	oo	oo	√	
30	Kangaroo	L F	oo	—	oo	oo	oo	o	—	o	oo	—	o	oo		See Note 30
31	Malawi Mark V	F														7m max. lift
32	Nira AF85	L F	oo	oo	oo	oo	oo	oo	o	oo	o	o	oo	oo	√	
33	Tara	L F	oo	oo	oo	oo	o	—	—	o	—	o	oo	oo	√	
ADDITIONAL PUMPS																
A1																
A2																
A3																
A4																

* Indicates that discharge ratings are based on choice of the correct cylinder size from a range offered by the manufacturer.

Figure 6.3 Selection Criteria and Shortlisted Pumps for Worked Examples Nos. 1-4

HANDPUMP SELECTION CRITERIA		SELECTION CRITERIA		SELECTION CRITERIA		SELECTION CRITERIA	
Worked Example No. 1		Worked Example No. 2		Worked Example No. 3		Worked Example No. 4	
NAME OF PROJECT							
MAXIMUM PUMPING LIFT	<u>10</u> meters	<u>25</u> meters	<u>40</u> meters	<u>25 or 45</u> meters			
Selection Table for this lift	<u>S.2</u>	<u>S.3</u>	<u>S.4</u>	<u>S.3 or S.4</u>			
DAILY OUTPUT PER PUMP	<u>1.5</u> m ³ /d	<u>4</u> m ³ /d	<u>4</u> m ³ /d	<u>4</u> m ³ /d			
MAINTENANCE SYSTEM TO BE USED (A, B, or C)	<u>A</u>	<u>B</u>	<u>B</u>	<u>A</u>			
Where	A = Village-level maintenance B = Area-mechanic maintenance C = Centralized maintenance						
MINIMUM RATING NEEDED FOR CORROSION RESISTANCE	<u>---</u>	<u>---</u>	<u>---</u>	<u>---</u>			
Where	--- = Corrosion resistance is not required o = Resistance to mildly corrosive water is required oo = Resistance to aggressive water is required						
MINIMUM RATING NEEDED FOR ABRASION RESISTANCE	<u>---</u>	<u>---</u>	<u>---</u>	<u>---</u>			
Where	--- = Either there is no sand pumping anticipated, or there is a possibility of trace sand pumping and the daily output will not be greater than 1.5m ³ o = There is a possibility of trace sand pumping and the daily output will be greater than 1.5m ³ oo = There is a possibility of significant sand pumping						
MANUFACTURING ENVIRONMENT (1, 2, or 3)	<u>2</u>	<u>3</u>	<u>3</u>	<u>1</u>			
Where	1 = The pump is to be made in the country, and there is a low-level industrial base 2 = The pump is to be made in the country, and there is a medium-level industrial base 3 = The pump may be imported or made in a country where there is a high level industrial base						
PUMPS ALREADY PERFORMING SATISFACTORILY IN THE COUNTRY (* IF ALSO MANUFACTURED IN THE COUNTRY)	<u>New No.6*</u> <u>India Mark II</u>	<u>N.A</u>	<u>N.A</u>	<u>N.A</u>			

CRITERIA FOR WORKED EXAMPLES	Pumping lift:	≤12 meters	≤25 meters	≤45 meters	≤25m or ≤45m
	Maintenance system:	VLOM	Area Mechanic	Area Mechanic	VLOM
	Industrial base:	Medium	Advanced	Advanced	Low
PUMPS WHICH MEET THE ILLUSTRATED SELECTION CRITERIA		Afridev, Blair, IDRC-UM, Nira AF85, Tara, Volanta	Abi-ASM, Afridev, Bestobell, Duba Tropic 7, GSW, India Mark II (std. & mod.), Kardia, Korat, Maldev, Monarch P3, Nira AF84, Philippines Deepset, SWN 80881, Vergnet, Volanta	Afridev, India Mark II (mod.), Nira AF84, Vergnet, Volanta	Afridev Volanta

Figure 6.3 Selection Criteria and Shortlisted Pumps for Worked Examples Nos. 1-4

HANDPUMP SELECTION CRITERIA		SELECTION CRITERIA		SELECTION CRITERIA		SELECTION CRITERIA			
NAME OF PROJECT		Worked Example No. 1		Worked Example No. 2		Worked Example No. 3		Worked Example No. 4	
MAXIMUM PUMPING LIFT	<u>10</u> meters	<u>25</u> meters	<u>40</u> meters	<u>25 or 45</u> meters					
Selection Table for this lift	<u>S.2</u>	<u>S.3</u>	<u>S.4</u>	<u>S.3 or S.4</u>					
DAILY OUTPUT PER PUMP	<u>1.5</u> m ³ /d	<u>4</u> m ³ /d	<u>4</u> m ³ /d	<u>4</u> m ³ /d					
MAINTENANCE SYSTEM TO BE USED (A, B, or C)	<u>A</u>	<u>B</u>	<u>B</u>	<u>A</u>					
Where	A = Village-level maintenance B = Area-mechanic maintenance C = Centralized maintenance								
MINIMUM RATING NEEDED FOR CORROSION RESISTANCE	<u>—</u>	<u>—</u>	<u>—</u>	<u>—</u>					
Where	— = Corrosion resistance is not required o = Resistance to mildly corrosive water is required oo = Resistance to aggressive water is required								
MINIMUM RATING NEEDED FOR ABRASION RESISTANCE	<u>—</u>	<u>—</u>	<u>—</u>	<u>—</u>					
Where	— = Either there is no sand pumping anticipated, or there is a possibility of trace sand pumping and the daily output will not be greater than 1.5m ³ o = There is a possibility of trace sand pumping and the daily output will be greater than 1.5m ³ oo = There is a possibility of significant sand pumping								
MANUFACTURING ENVIRONMENT (1, 2, or 3)	<u>2</u>	<u>3</u>	<u>3</u>	<u>1</u>					
Where	1 = The pump is to be made in the country, and there is a low-level industrial base 2 = The pump is to be made in the country, and there is a medium-level industrial base 3 = The pump may be imported or made in a country where there is a high level industrial base								
PUMPS ALREADY PERFORMING SATISFACTORILY IN THE COUNTRY (* IF ALSO MANUFACTURED IN THE COUNTRY)	<u>New No.6*</u> <u>India Mark II</u>	<u>N.A.</u>	<u>N.A.</u>	<u>N.A.</u>					

CRITERIA FOR WORKED EXAMPLES	Pumping lift:	≤12 meters	≤25 meters	≤45 meters	≤25m or 45m
	Maintenance system:	VLOM	Area Mechanic	Area Mechanic	VLOM
	Industrial base:	Medium	Advanced	Advanced	Low
PUMPS WHICH MEET THE ILLUSTRATED SELECTION CRITERIA		Afridev, Blair, IDRC-UM, Nira AF85, Tara, Volanta	Abi-ASM, Afridev, Bestobell, Duba Tropic 7, GSW, India Mark II (std. & mod.), Kardia, Korat, Maldev, Monarch P3, Nira AF84, Philippines Deepset, SWN 80&81, Vergnet, Volanta	Afridev, India Mark II (mod.), Nira AF84, Vergnet, Volanta	Afridev Volanta

merit point evaluation are to be used for final pump selection, up-to-date prices are essential. The prices quoted in this document cannot be used for final stage comparisons; they are indicative of ex-factory prices only and they were obtained in 1985 and 1986. For pump selection, the Analyst must have current prices, including shipping and insurance costs for the quantities needed, and must take account of the anticipated cost of spare parts over a reasonable period of operation (say three years). The Handpump Compendium offers guidance on likely frequency of repairs, and experiences from other projects may also provide data for assessing pump performance and spares requirements.

Some Analysts may have decided to select the least expensive pump which meets the minimum requirements. Others may be using a procedure similar

to that outlined in the World Bank's sample bidding documents, where minimum requirements are specified and merit points are then awarded to those pumps which exceed the minimum requirements (ease of maintenance and availability of spare parts are examples of attributes which may be awarded additional merit points).

The full procedures of Merit Point Evaluation require lengthy explanation, and Analysts wishing to apply this method are advised to obtain a copy of the World Bank's *Sample Bidding Documents for the Procurement of Handpumps*. Table 6.1 shows the outcome of such an evaluation comparing four pumps which met all minimum requirements. From this evaluation, Pump "B" would be selected, because it has the highest total merit point score among the short-listed pumps, though it was not the lowest priced pump (that was Pump "C").

Table 6.1 Merit Point Evaluation of Four Short-Listed Pumps

Criterion	Maximum score	Pump reference			
		A	B	C	D
Price of pump	50	32	42	50	34
Price of spare parts	10	6	8	9	10
Discharge rate*	5	0	5	3	0
Reliability*	10	5	7	5	5
Ease of maintenance and repair*	10	8	8	4	4
Service and spare parts availability*	5	0	3	0	0
Abrasion resistance*	5	0	3	0	3
Standardization	5	0	5	0	0
Total Scores	100	51	81	71	56

* Denotes categories for which merit points may be awarded if a pump exceeds the minimum requirement. A zero entry means that a pump just meets the minimum requirement.

Handpump Compendium

Handpump Compendium

The Compendium contains details of the following pumps:

Pump 01	Abi-ASM	Pump 22	VEW A18
Pump 02	Afridev	Pump 23	Volanta
Pump 03	AID Derivative Deepwell	Pump 24	Consallen LD6
Pump 04	Bestobell	Pump 25	DMR (Dempster Derivative)
Pump 05	Climax	Pump 26	Nira AF76
Pump 06	Dragon 2	Pump 27	Blair
Pump 07	Duba Tropic 7	Pump 28	Ethiopia BP50
Pump 08	GSW	Pump 29	IDRC-UM
Pump 09	India Mark II (standard)	Pump 30	Kangaroo
Pump 10	India Mark II (modified)	Pump 31	Malawi Mark V
Pump 11	Jetmatic Deepwell	Pump 32	Nira AF85
Pump 12	Kardia	Pump 33	Tara
Pump 13	Korat	Pump 34	AID Suction
Pump 14	Maldev	Pump 35	Bandung
Pump 15	Monarch P3	Pump 36	Inalsa Suction
Pump 16	Monolift	Pump 37	Jetmatic Suction
Pump 17	Moyno	Pump 38	Lucky
Pump 18	Nira AF 84	Pump 39	New No.6
Pump 19	Philippines Deepset	Pump 40	Rower
Pump 20	SWN 80 & 81	Pump 41	SYB-100
Pump 21	Vergnet	Pump 42	Wasp

Handpump Compendium

The Compendium contains details of the following pumps:

Pump 01	Abi-ASM	Pump 22	VEW A18
Pump 02	Afridev	Pump 23	Volanta
Pump 03	AID Derivative Deepwell	Pump 24	Consallen LD6
Pump 04	Bestobell	Pump 25	DMR (Dempster Derivative)
Pump 05	Climax	Pump 26	Nira AF76
Pump 06	Dragon 2	Pump 27	Blair
Pump 07	Duba Tropic 7	Pump 28	Ethiopia BP50
Pump 08	GSW	Pump 29	IDRC-UM
Pump 09	India Mark II (standard)	Pump 30	Kangaroo
Pump 10	India Mark II (modified)	Pump 31	Malawi Mark V
Pump 11	Jetmatic Deepwell	Pump 32	Nira AF85
Pump 12	Kardia	Pump 33	Tara
Pump 13	Korat	Pump 34	AID Suction
Pump 14	Maldev	Pump 35	Bandung
Pump 15	Monarch P3	Pump 36	Inalsa Suction
Pump 16	Monolift	Pump 37	Jetmatic Suction
Pump 17	Moyno	Pump 38	Lucky
Pump 18	Nira AF 84	Pump 39	New No.6
Pump 19	Philippines Deepset	Pump 40	Rower
Pump 20	SWN 80 & 81	Pump 41	SYB-100
Pump 21	Vergnet	Pump 42	Wasp

Cote d'Ivoire/France

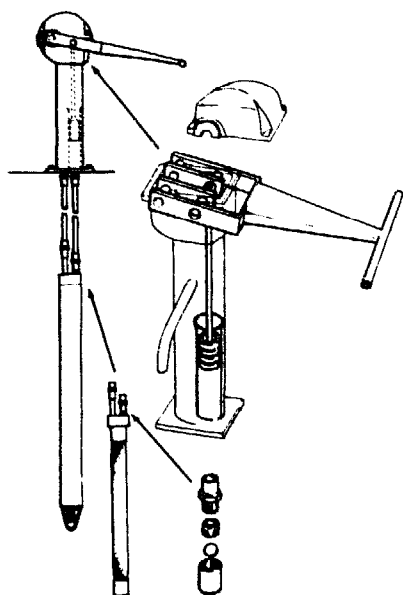

General Description

The Abi-ASM is a hybrid pump using a pumpstand manufactured in the Cote d'Ivoire and the hydraulically operated Vergnet pumping element made in France (Pump 21). There are no mechanical links between the above and below ground units. A primary cylinder in the pumpstand is connected by plastic hose to a stainless steel casing, in which a flexible rubber membrane contracts and expands to force water through a second hose to the surface.

The pumpstand is partly cast iron and partly fabricated mild steel. Fulcrum bearings are split and injection molded in nylon. Brass or stainless steel is used for the primary drive cylinder and the brass plunger has leather ring seals.

Manufacture

The pumpstand is suitable for manufacture in developing countries with foundry, fabrication and machining skills, and could be modified for all-fabricated manufacture. The below-ground pumping element requires specialized techniques, high skill levels and high quality control.

Suppliers

Abidjan Industrie, 01 BP 343, Abidjan, 01 Cote d'Ivoire.

Indicative prices — Feb 1985

Per unit	US\$ 690
Twin hose (per meter)	US\$ 3

Laboratory Tests

Date tested: 1982

Reported: Handpumps Project Report No. 3

Performance data (typical values)

Head (meters)	7	25	45
Pumping rate (cycles/min)	38	40	42
Volume/min (liters)	10	10	10
Input (watts)	82	129	175
Mechanical efficiency (%)	14	32	43
Maximum handle force (kg-f)	20	35	45
Footvalve leakage (ml/min)	No significant leakage		

The volume discharged per stroke ranged from 0.25 liters at 45 meters lift to 0.27 liters at 7 meters lift.

Evaluation

The two test pumps were well packed, but had suffered some damage. Threads on the pumphead base were damaged on one of the samples, and the baseplates were distorted on both. Handle components were not correctly aligned on either pump.

Comprehensive and well illustrated installation and maintenance instructions were supplied in French. Installation is straightforward and does not require lifting tackle. Lightweight polyethylene hoses connect the pumpstand with the pumping element.

Maintenance too is simple. Primary cylinder piston seals are likely to need frequent replacement, but the task is straightforward and quick. The lightweight hoses mean that the pumping element can be extracted by hand, without lifting tackle, and the element itself is easy to dismantle provided the appropriate hexagon keys are available. However, if the diaphragm fails, a full replacement unit is needed, at comparatively high cost.

The 4000 hour endurance test was carried out at 40 cycles per minute, with a simulated head of 45 meters, subsequently reduced to 20 meters. The original leather seals on the primary cylinder plunger wore out very early in the test. They were replaced with seals of different materials but continued to wear out rapidly. The fulcrum in the handle wore out after about a third of the test period and the bolt securing the drive piston rod to the fulcrum broke at about the same time. About half way through the endurance test, the rubber buffer in the plunger was found to have collapsed and was replaced.

In contrast with the problems experi-

enced with the above ground components, the below ground pumping element suffered no breakdowns and was still in good working order at the end of the 4000 hours.

Repeated failure of the primary cylinder plunger seals was attributed to sharp edges detected on the replenishing hole in the cylinder. The hole had not been properly deburred during manufacture — a difficult operation because of the position of the hole.

The manufacturer has changed the design of the fulcrum and the pumprod fixing since the laboratory tests.

Corrosion was detected on the plunger rod and the pumping element end caps, and inside the pumpstand.

Both the pumpstand and the handle were undamaged in the impact tests, and the pump completed the allotted 96,000 cycles of handle shock tests without failure.

Users quickly became accustomed to the rhythm required to operate the pump, but found it tiring to use because of the comparatively low discharge rate and high efforts needed.

The overall conclusion of the laboratory trials was that there is a marked contrast between the reliability of the pumpstand and above ground works and that of the below-ground pumping element. While the pumping element proved very reliable, the pumpstand was judged to be unsuitable for community water supply. Modifications have since been made to the pumpstand. If the problems can be overcome, the Abi-ASM is seen as a potential VLOM pump because of its simple installation and maintenance requirements.

Field Trials

Test conditions

Country	Number of pumps	Head range (meters)	Data available (months)
Cote d'Ivoire	8	10-30	13

The basic design concept of the Abi-ASM pump has been to combine the positive features of the Abi-MN and Vergnet pumps. The Vergnet below-ground components are easy to install and extract and have good corrosion resistance. The lever operation of the Abi is generally preferred to the foot-operated Vergnet by West African users.

The ASM pump is still being developed and improvements are needed in the pumpstand design (bearings, handle, piston/cylinder assembly). Improvements are also being sought in the diaphragm, to bring greater reliability and lower prices.

In Cote d'Ivoire, the pump has proved easy to install, requiring no heavy equipment or special tools.

Maintenance too is quick and easy. The seals of the primary cylinder plunger had to be replaced at intervals of about six months and the plastic fulcrum bearings at a similar frequency.

The diaphragm proved generally reliable, though when failure did occur it was necessary to replace it, at a cost of about US\$ 200.

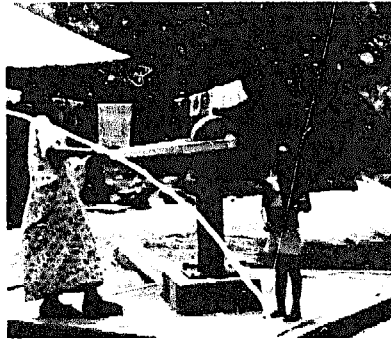

The pump's discharge rate ranged from 0.5 to 1.0 cu m/h, which was judged to be adequate by most users. There is a notable difference between discharges measured in the field and those in the laboratory. Discharge depends not only on the number of strokes per minute, but also on the rhythm applied. Villagers operate the ASM at 20-35 strokes per minute at 50-75% of full stroke. The measured discharge rates at 10, 20, 30 and 40 strokes per minute were respectively 3.2, 8.5, 15.8, and 26 liters per minute at lifts between 10m and 20m.

No problems were encountered with corrosion, and the pump does not suffer from abrasion. However, sand, silt or clay in the water do enter the diaphragm and were responsible for ruptures in several cases.

Users found the ASM's pumping action quite acceptable, and the pump has high VLOM potential.

Assessment

Ratings are based on both laboratory and field tests.

Discharge Rate

From the field trial results, the pump is clearly capable of achieving reasonable discharges when used with the right rhythm. It earns an "adequate" (o) rating for lifts of 12, 25 and 45 meters, but is below the minimum for a 7m lift.

Ease of Maintenance

The above ground components of the Abi-ASM are easily maintained by village caretakers, but the need for skilled mechanics to dismantle the pumping element means that the pump is rated "unsuitable" (—) for Level A maintenance. Absence of rods and rising mains earns the pump a "good" (oo) rating for Level B maintenance at all pumping lifts.

Reliability

Field evidence of breakdowns and repair interventions earns the pump a oo rating for reliability at a daily output of 1.5 m³/d, o for 4m³/d at 7, 12 and 25m lifts and — for 8m³/d and for 4m³/d at 45m.

Corrosion Resistance

Below ground components of the pump are made from corrosion resistant materials. Though some corrosion was experienced with earlier models, and the pumpstand, primary drive piston rod and diaphragm end caps are slightly vulnerable to corrosion, the pump now earns a oo rating.

Abrasion Resistance

The ASM pump is little affected by abrasion, as the pumping element has no seals. However, the diaphragm can rupture if sand or silt fills the element. The rating is therefore reduced to o.

Manufacturing Needs

This is a hybrid pump. The below ground components require special skills, but the pumpstand is suitable for manufacture in countries with foundry, fabrication and machining skills. Ratings for manufacturing environments 1,2 and 3 are therefore —, o and o respectively.

Kenya

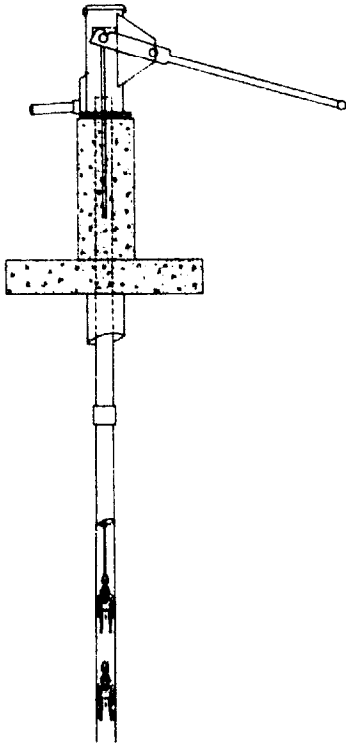

Laboratory Tests

THE AFRIDEV PUMP HAS NOT BEEN TESTED IN THE CATR LABORATORY

General Description

The Afridev is a pump design developed during the course of the Project with support from donors, research organizations and private companies. Available in the public domain, the design has aimed to demonstrate the **VLOM** concepts of easy, low-cost maintenance and suitability for manufacture in developing countries.

The present design, which began limited production in Kenya towards the end of 1985, is being modified further as a result of field experiences. Production of the pumphead has also started in small numbers in Malawi, as a second generation of its forerunner the Maldev (Pump 14).

The Afridev pumpstand is an all-steel fabrication consisting largely of stock sections, and involves a minimum of close-tolerance machining. The T-bar handle comes in two versions: a 3:1 mechanical advantage for 10-30 meters lift; and a 4.5:1 mechanical advantage for 30-45m lift. A direct action version is under

development for lower lifts. The different handles mean that the same 50mm diameter long-stroke cylinder can be used for all lifts (see Box 4.6 in Chapter 4). Handle bearings are twin bushes of proprietary plastics which snap together.

Rising main is 63mm OD solvent welded uPVC pipe suspended from the pumpstand using a compressed rubber cone. Standard pumprods are 10mm galvanized mild steel with special hooked joints which eliminate threads and need no tools for assembly or dismantling. Stainless steel pumprods are available at extra cost for corrosive groundwater.

The standard 50mm cylinder is a long stainless steel tube sleeved into uPVC pipe. Plunger and footvalve are identical components comprising two plastic moldings permanently spin-welded together (prototypes in the field were machined). A molded rubber valve bobbin snaps into the valve housing by hand. The plunger seal is also a snap fitting, which can be installed by hand and removed with the help of a household knife. A fishing tool, consisting

of a small grappling device at the end of a length of rope grips the footvalve to remove it for maintenance.

This fishing tool and a forged socket spanner are the only tools required for installation and maintenance.

Manufacture

Though "modern" materials are used in the Afridev, all components can be locally manufactured in Kenya, with the exception of the stainless steel cylinder liners which are imported.

Suppliers

The Afridev design is available in the public domain. Information on individual manufacturers is available from The Regional Project Officer, Rural Water Supply Handpumps Project, The World Bank, PO Box 3057, Nairobi, Kenya.

Indicative prices - Targets

Complete pump to	
30 meter	US\$ 450
Spares pack	US\$ 12

Field Trials

Test conditions

Country	Number of pumps	Head range (meters)	Data available (months)
Kenya	37	10-49	8
Malawi	3	10-25	12

As the Afridev design has developed, different prototypes have been tested during field trials in Kenya and Malawi, though the progressive nature of the design means that the monitoring time for newly developed components is necessarily restricted.

An important aspect of the design has been the extensive research and specialist advice on plastic components, particularly bearings.

Developments have concentrated on simplification of maintenance and measures to maximize local manufacturing potential.

Installation is simple; even at depths of 45 meters, there is no need for lifting equipment. Two skilled people can complete installation in about two hours (mainly taken up in making the solvent-cement joints in the rising mains).

In Kenya, the Afridevs were installed on wells with pumping heads of 10-50 meters, averaging 25-30 meters. These arduous test conditions led to very few breakdowns. Some early prototype plastic bearings seized due to poor dimensioning, but since the present bearings were installed at the beginning of 1986, there has been little wear, though corrosion of bearing housings has resulted in some



damage to the bearings.

Users like the Afridev. The variable handle mechanical advantage maintains a high discharge with easy operation over a range from 10 to 50 meters. Corrosion is not a problem, if stainless steel rods are used when water is aggressive. Nitrile rubber seals in the polished stainless steel cylinder lining give abrasion resistance which is further improved by the use of a large diameter suction pipe. This minimizes sand ingress by reducing water velocities at the cylinder intake.

The hooked connections on the pumprods have proved successful, enabling two people to remove and replace a plunger and footvalve from a depth of 30m in about 30 minutes without the need for lifting tackle or special tools. Some pumprod breakages have occurred, and these have been attributed to shortcomings in the production of the hooked connections. The push-fit bearings also make village maintenance very easy.

Overall, the Afridev design is now demonstrating that deepwell handpumps can be maintained by villagers, effectively and economically, and that local manufacture can produce reliable pumps at an affordable cost.

Assessment

Field testing has been carried out on pre-production models of the Afridev. Design modifications are being made continuously, most recently to overcome problems identified with bearing housing corrosion and hooked pumprod manufacture. The ratings reflect field trial performance so far, but the limited nature of these trials means that the ratings are not well substantiated at this stage.

Discharge Rate

The variable handle mechanical advantage ensures a high discharge for heads from 10 to 50m, but the "good" (oo) rating reduces to "adequate" (o) for 7m lifts, where even the shortest practical handle could not compete with discharges from direct action pumps (a direct action version of the Afridev is being developed).

Ease of Maintenance

The Afridev is a VLOM pump, and trials have confirmed its easy maintenance, justifying the oo rating at all depths for all maintenance systems.

Reliability

The combination of simple repairs and low frequency of breakdowns earns the pump a oo rating for most operating conditions, reducing to o for lifts of 45m or a daily output of 8m³/d.

Corrosion Resistance

All downhole components are corrosion resistant (if stainless steel pumprods are selected). However, corrosion of the pump-head bearing housing reduces the rating to o.

Abrasion Resistance

The nitrile seal in the polished stainless steel cylinder lining handles sand-laden water reasonably well, earning the pump a rating of "adequate" (o).

Manufacturing Needs

The Afridev uses a number of modern materials, the majority of which could be reliably processed in most developing countries. The need to import stainless steel cylinder linings and the quality control needed in plastics manufacture reduce the oo rating for Categories 2 and 3 to o for Category 1 countries.

CAUSES OF ESSENTIAL INTERVENTIONS

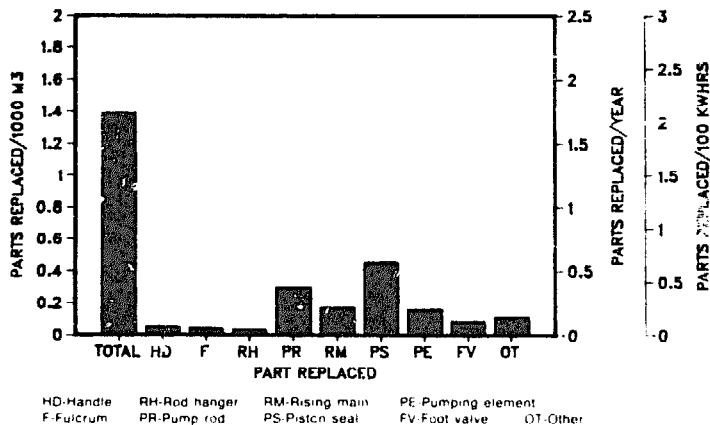

Sri Lanka

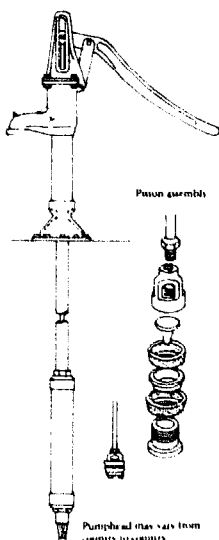

General Description

This is a deepwell version of a pump derived from a basic design developed by the Battelle Memorial Institute and Georgia Institute of Technology on behalf of USAID. The pumpstand consists of a cast iron drive head assembly and cast iron base joined by a steel tube. The fulcrum stand is pinned to the pumpstand below and the handle above, so that the fulcrum moves in an arc as the handle is operated.

The cylinder is conventional but uses uPVC tube instead of brass. The plunger is fitted with two leather cupseals and there are two footvalves — one fitted to an extension pipe below the cylinder.

Manufacture

Basic skills in foundry work, machining and leather crafting are needed to manufacture the pump and careful quality control is needed to ensure interchangeability of parts.

Suppliers

The field test pumps were supplied by Diason Pumps Ltd, 112 Isipathana Mawatha, Colombo 5, Sri Lanka.

The laboratory tests were carried out on pumps from Honduras (the Funymaq) and Indonesia (the Sumber Banyu).

Prices — Not available

The AID Derivative pumps are specifically designed to be manufactured in the developing country in which they will be used. Local prices should be obtained.

Laboratory Tests

The AID Derivative manufactured in Sri Lanka has not been tested in the CATR Laboratory. This evaluation is related to the testing of pumps based on the same design manufactured in Honduras (the Funymaq) and Indonesia (the Sumber Banyu). The pumps were tested in 1983/84 and separate reports are included in Handpumps Project Report No. 3.

Performance data (typical values)

Head (meters)	7		25		45	
	SB	FM	SB	FM	SB	FM
Pump*						
Pumping rate (cycles/min)	40	38	30	29	30	30
Volume/min (liters)	34	27	25	20	24	21
Input (watts)	67	85	145	134	229	230
Mechanical efficiency (%)	58	35	69	61	76	66
Maximum handle force (kg-f)	10	12	30	30	45	50
Footvalve leakage (ml/min)	NS	NS	0.4	NS	2.4	NS

* SB = Sumber Banyu, 78mm cylinder; FM = Funymaq, 70mm cylinder; NS = No significant leakage.

Evaluation

Though the basic design of the two pumps is the same, the Funymaq performed much better in the endurance tests than the Sumber Banyu. It would therefore be unwise to draw general conclusions about all AID Derivatives on the basis of these tests, though they do indicate pointers to be taken into consideration when evaluating the pumps.

For example, both pumps demand a substantial complement of tools and equipment for **installation and maintenance** and there was difficulty in assembling the pumps from the components supplied. In the case of the Sumber Banyu, components of the two sample pumps were not interchangeable, and the spares supplied did not fit either pump. The Funymaq pump tops did not fit the bodies (holes were drilled in the wrong positions) and the handles were stiff to operate. Clearly, good quality control is needed if pumps are to be serviceable.

The design is such that frequent lubrication of the handle and fulcrum link pivots is needed for satisfactory pump operation. Below ground maintenance involves removal of the complete assembly and therefore needs heavy lifting equipment, and frequent attention is likely to be needed to the leather cupseals and footvalves.

Initially, the 4000 hour **endurance test** on the Sumber Banyu was conducted at 40 cycles per minute with a simulated head of 45 meters. Rapid wear of linkages in the pumpstand, broken rods and worn footvalves led to five failures in

the first 1000 hours, and the head was reduced to 30 meters for the remainder of the tests.

Pumprod failures continued to occur, including two failures of the plunger rod when the footvalve leather rotted away and allowed the cast iron weight to foul the plunger. At the end of the test, the cylinder end caps were heavily **rusted**, the plunger and cupseals were still in good condition and the cylinder bore was polished but otherwise showing few signs of wear. All other parts had been replaced at some stage.

The Funymaq was tested at 30 meters simulated head from the start and performed very much better than the Sumber Banyu. Only one failure occurred during the 4000 hours, when the leather footvalve broke away and caused severe damage to the plunger and the cylinder bore. There was considerable wear in the handle bearings and guide blocks by the end of the 4000 hours, though they remained serviceable. The Funymaq was badly **corroded** at the end of the test.

The Sumber Banyu base casting broke at 400 Joules in the **impact test** but the heavier casting of the Funymaq survived without damage.

The **overall conclusion** of the laboratory tests was that the AID design has some shortcomings. In particular, the second footvalve is redundant and can actually cause worse damage than would occur without it. Good quality control is needed if the pump is to be used for community water supply, and this was not achieved on the pumps tested.

AID Derivative (Deepwell)

Field Trials

Test conditions

Country	Number of pumps	Head range (meters)	Data available (months)
Sri Lanka	9	2.6*-5.2	11

*Average head

In the Sri Lankan field trials, the deepwell pumps operated at only small pumping lifts and with comparatively low outputs. The field trials therefore yield little evidence of the pump's likely performance in high lift applications.

No instruction manual was supplied with the pumps. Skilled workers are needed for installation and they must be equipped with tools and lifting equipment. On average, it took four workers about two hours to install each pump. A concrete pedestal is desirable, to lift the operator to a comfortable position.

The exposed drive head means that frequent lubrication is needed of the pumphead moving parts (at least once a month). The whole pump assembly has to be removed for any repair to the plunger or valve assembly, and this means that a pump mechanic and two trained workers must be available with special tools and skills. Great care is needed in handling the cast iron parts. A new gasket is needed each time that the pumpstand is removed, and care is needed when dismantling the threaded cylinder cap from the uPVC cylinder.

All test pumps performed without major failure, but leather cupseals were replaced on three pumps. Plungers and

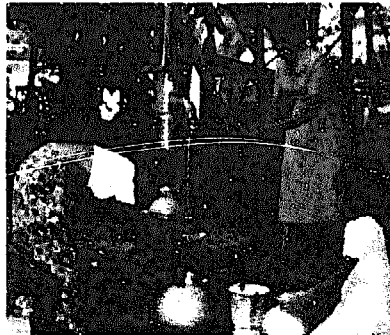

check valves remained in good condition and there were few signs of wear on the cylinders. Crosshead guides and blocks were worn but still serviceable and little wear occurred on the fulcrum and rodhanger pins, which were well lubricated during the trials.

The pumping action and relatively high delivery (24 liters per minute at 30 strokes per minute) were popular with the users, and the pumps proved well suited to this comparatively light duty. It was clear however that maintenance commitments will be quite high and call for significant resources in terms of manpower and equipment.

Laboratory problems over the interchangeability of components were not encountered in the field trials on Sri Lankan manufactured pumps.

In concluding that the pump is adequate for very low lifts and relatively light use, it must be recognized that a suction version of the pump (Pump No 34) is available for lifts up to 7 meters, and has the advantage that the cylinder does not have to be lifted out for maintenance.

Assessment

Because all AID Deepwell field trial pumps were installed in shallow wells, the laboratory tests have been especially important in rating this pump.

Discharge Rate

The pump delivers a high discharge for moderate effort at shallow lifts, and earns a "good" (oo) rating for lifts of 7 and 12 meters. The high handle force needed at higher heads reduces the rating to "adequate" (o) at 25 and 45 meters.

Ease of Maintenance

The need for lifting gear and special tools means that the pump is rated "unsuitable" (—) for Level A maintenance. At 7m and 12m, area mechanics can readily carry out maintenance, earning a oo rating for Level B, but this drops to o at 25m and 45m, where lifting gear becomes essential.

Reliability

Laboratory tests showed that the AID Deepwell pump would need excessive maintenance for anything other than low lift and low output applications. It is therefore rated — for lifts higher than 12 meters and for high output applications at all lifts.

Corrosion Resistance

Heavy corrosion occurred in the laboratory tests and some rusting was apparent in the field trials. The rating is therefore —.

Abrasion Resistance

Leather cupseals are known to be a problem when sand is present in the water, and the pump is therefore rated — for abrasion resistance.

Manufacturing Needs

Although intended for manufacture in developing countries, the AID Deepwell needs careful quality control of casting and machining. It therefore rates — for manufacturing environment 1 (low industrial development), but oo for environments 2 and 3.

CAUSES OF ESSENTIAL INTERVENTIONS

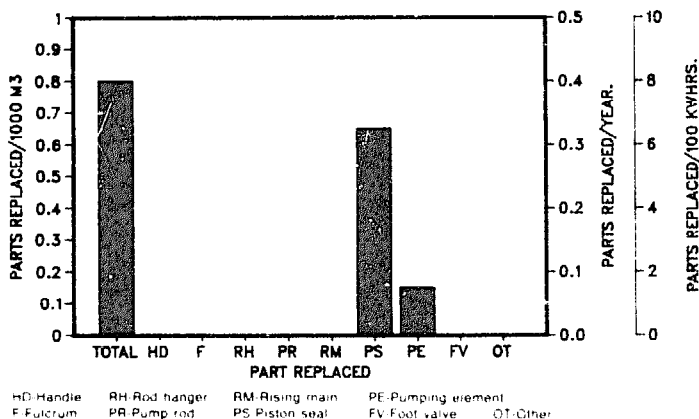



General Description

The Bestobell is a conventional lever-operated deepwell force pump, designed and manufactured in Zambia. The pumpstand and T-shaped handle are fabricated from mild steel. Handle bearings are ball races. A single spanner fits all the fastenings in the pumpstand. The pump is designed to use uPVC rising main. With 2 inch rising main, the piston may be withdrawn without moving the main. Footvalve maintenance does not require extraction of the full below ground assembly. Pumprods are 10mm steel with threaded connectors.

The cylinder is heavy duty uPVC pipe. Early models used leather ring seals, but the current design has a molded rubber seal fitted to the uPVC piston body. Piston components are also used in the footvalve, or a Socla valve is supplied as an option.

Manufacture

Above and below ground components are suitable for manufacture in many developing countries, with care needed in aligning and assembling handle bearings and cutting threads in the cylinder barrel.

Suppliers

Bestobell Zambia Ltd, 875 Zambia Road, P.O. Box 230003, Ndola, Zambia.

indicative prices - 1986

per unit, excluding US\$ 225
pumprod and rising main

Laboratory Tests

Date tested: 1986

Reported: Report not yet published

Performance data (typical values)

Head (meters)	7	25	45
Pumping rate (cycles/min)	43	40	40
Volume/min (liters)	12	11	11
Input (watts)	29	71	111
Mechanical efficiency (%)	49	63	71
Maximum handle force (kg-f)	6	15	26
Footvalve leakage (ml/min)		No significant leakage	

Evaluation

The two test pumps were securely packed in a wooden case. Bearings in one handle assembly were in poor condition, possibly as a result of damage during assembly. Otherwise, both pumps were received in good condition.

Comprehensive and helpful instructions were supplied in English. Installation is relatively easy, with no need for lifting tackle, provided that uPVC rising main is used (the pump can also be used with galvanized steel rising main).

Maintenance is also straightforward, as the plunger can be withdrawn without removing the rising main (though the whole below-ground assembly must be removed to service the footvalve). One spanner fits all the pumpstand fastenings, but care will be needed when new handle bearings have to be fitted.

The 4000 hour endurance test was carried out at 40 cycles per minute, with a simulated head of 45 meters. At the beginning of the test, the pump was fitted with a piston of the early design, with leather ring seals. There were no failures in the first 2000 hours, when pumping clean water. However, when the cylinder was dismantled for inspection, the piston body was found to have broken between the two leather seals.

The piston was replaced, but failed soon after the start of the second phase of the test, when sand and Kieselguhr had been added to the water. Sand embedded in the leather seals had caused severe wear of the cylinder bore. The footvalve had also developed a serious leak, again

due to sand contamination. A new piston, machined from uPVC and with a molded rubber seal, was fitted, along with a Socla footvalve. In this form, the pump completed the remainder of the endurance test. Both piston and footvalve were in good working order at the final inspection.

Following these tests, the manufacturer has adopted a piston design similar to that introduced in the laboratory, and intends to use the same components in the footvalve. The Socla valve will be available as an alternative.

Corrosion was detected inside the pumpstand and on the center spindle of the original piston, which was not stainless steel.

In the impact tests, the baseplate was distorted by a heavy impact on the pumpstand, and a small crack appeared at the weld. The handle fulcrum bracket broke during the handle shock test.

The pump was generally well received by users, who liked the T-handle and the relatively low efforts required. However, some adults considered that the rate of delivery was rather low.

The overall conclusion of the laboratory tests was that the Bestobell was a design with good potential for manufacture, maintenance and repair in developing countries, but requiring some additional development before it could be considered for large scale application.

The manufacturer has been hampered by the limited availability of suitable materials in Zambia, but has nevertheless demonstrated a receptive and flexible attitude.

Field Trials

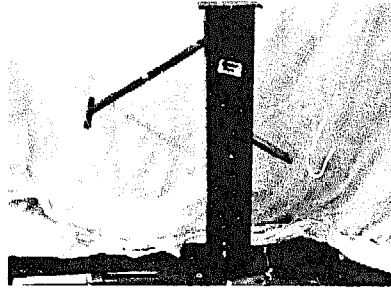

THE BESTOBELL PUMP HAS NOT BEEN TESTED IN
THE PROJECT FIELD TRIALS

Assessment

The Bestobell ratings are based on its performance in laboratory trials and on judgments of the Project staff using comparisons with pumps of similar design.

Discharge Rate

Though the pump is easy to use, it is difficult to sustain a very high output. With acceptable work inputs, it scores an "adequate" (o) rating for all lifts.

Ease of Maintenance

Even at shallow settings, the pump is not suitable for maintenance by a village caretaker (Level A), though area mechanics will find it easy to service. Lifting gear is likely to be needed for lifts of 25 meters or more. The pump therefore earns a "good" (oo) rating for Level B maintenance at 7m and 12m, reducing to "adequate" (o) at 25m and 45m.

Reliability

Replacement of the original piston with a new design improved the pump's performance in the laboratory trials. In its new form, reliability is rated as oo for an output of 1.5m³/d, and o for 4m³/d at lifts up to 25 meters. It is not considered suitable for a daily output of 8m³/d and with presently available data, it is considered prudent to rate it "unsuitable" (—) for 4m³/d at a lift of 45m.

Corrosion Resistance

With stainless steel pumprods, and piston spindle, no corrosion of downhole components occurred in the laboratory trials. Spots of rust inside the pumpstand reduce the rating to o.

Abrasion Resistance

After replacement of the leather seals with molded rubber, a little abrasion occurred in the laboratory tests, but the pump remained in good working order. It therefore earns a o rating.

Manufacturing Needs

Though the Bestobell has been designed for manufacture in a developing country, a degree of quality control is needed. This reduces the oo rating to o for manufacturing environment 1 (low level of industrial development).

United Kingdom

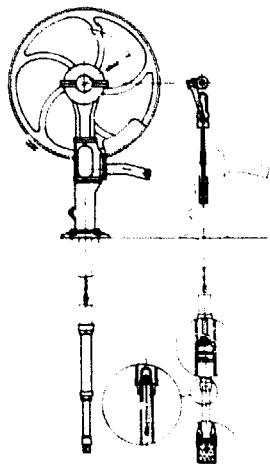

General Description

The Climax is a rotary-drive reciprocating force pump of long-standing design. The pumpstand is predominantly cast iron and has a large counterbalanced flywheel driving the pumprod via a crank and connecting rod. Twin flywheels are available as an option. Internal mechanical parts are splash lubricated from an oil bath. A moving pumprod seal in a cylinder below the crank provides a double-acting effect to smooth the flow of water.

A range of cylinder diameters is available to suit different depths. The cylinder is a brass tube with a gunmetal plunger fitted with two leather seals. An alternative model is available with extractable piston and footvalve. Wooden pumprods are supplied with the extractable valve cylinder and galvanized steel rods with the non-extractable cylinder.

Manufacture

Both pumpstand and cylinder require good iron and gunmetal foundry and machinery skills with high quality control.

Suppliers

Wildon Engineering (Worcester) Ltd, White-ladies Close, Little London, Worcester, WR1 1PZ, UK.

Indicative prices - Jul 1985

Single flywheel pump	US\$ 480
50mm rising main (per meter)	US\$ 7.50
Pumprods and connectors (m)	US\$ 3.10
Non-extractable cylinder	US\$ 90
Extractable cylinder	US\$ 105

Laboratory Tests

Date tested : 1979

Reported : O.D.A. Report 1981

Performance data (typical values) — 2.25 inch cylinder

	7		25		45	
Head (meters)						
Pumping rate (cycles/min)	29	60	29	60	29	60
Volume/min (liters)	9.3	19	9	18.5	8.7	18
Input (watts)	31	64	63	130	89	183
Mechanical efficiency (%)	33	32	58	58	73	73
Maximum handle force (kg-f)	15	25	18	20	10	15
Footvalve leakage (ml/min)	Not significant		0.8		3.5	

Note: The maximum handle force is very operator dependent and is higher when starting from rest.

Evaluation

A very heavy pump (185 kg in all for the pumpstand), which though complicated is designed to have a long life. Its weight means that **installation** and **maintenance** involve the use of heavy lifting equipment. Though the optional extractable cylinder avoids the need for rising main removal during maintenance, the pumpstand still has to be removed before the piston and valve can be extracted. The crank case oil needs periodic replenishment.

The **design** of the pump proved popular with most users. Use of a very heavy flywheel makes the pump smooth and easy to operate, even on deep wells, though the starting and stopping handle load can be as high as 35kg-f. Also, the continuing flywheel rotation after the user has stopped pumping is a hazard to any children who may stray near to the fast moving handle. The pumpstand design makes it difficult to achieve a satisfactory sanitary seal, as it is relatively easy for contaminated water to seep under the base and down inside the well casing.

There are many external fixings on the pump, mainly nuts and bolts without locking washers, which are easy to remove. The pump is not therefore resistant to vandalism or pilferage.

Leathers supplied with the sample pumps were too thick (5mm instead of 4.2mm). When the pump was installed the operation was just satisfactory, but after a few days the leathers swelled and jammed in the cylinder.

Second and third sets of leathers purchased from the manufacturer experienced the same problem, so leathers from a different source were substituted and used in all the tests. These were

satisfactory, and mechanical efficiencies up to 74% were recorded.

The **endurance test** was conducted at 40 cycles per minute with a simulated head of 45 meters. The Climax proved very reliable. There were no breakdowns during the 4000 hours of pumping and no significant wear of key components. Some leakage through the pumpstand inspection cover was easily rectified and did not recur.

The high handle loads during starting and stopping did cause fatigue failure of the handle at the threaded connection with the flywheel, where maximum bending load occurs. Repeat tests on a fatigue testing machine revealed that loads as low as 20kg-f could cause failure within a million revolutions.

Use of a brass cylinder with galvanized rising main and pumprods causes **corrosion** problems in acidic waters, and severe pitting occurred in both the pipe and the rod near the cylinder when pumping water with a high dissolved oxygen content. The pumpstand withstood the **impact tests** satisfactorily.

In comparison with other deepwell pumps, the Climax's performance was liked by users. The flywheel action gives an even discharge from the spout, and most buckets could be filled without splashing, though the relatively low spout (375mm) may mean that some containers would have to be tilted.

The **overall conclusion** of the laboratory trials was that the Climax is a well-made, easy to use and reliable pump, liked by users, but with some minor problems with the handle and leathers needing to be overcome. Its heavy construction makes it unsuitable for village-level maintenance.

Field Trials

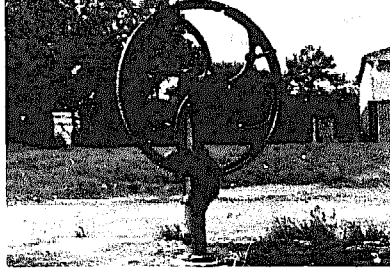

THE CLIMAX PUMP WAS NOT FIELD TESTED
BY THE HANDPUMPS PROJECT

Assessment

In the absence of field trials, ratings for the Climax pump are based mainly on performance in the laboratory tests.

Discharge Rate

A range of cylinders to suit different lifts allows the Climax to achieve "good" (oo) ratings for all pumping lifts.

Ease of Maintenance

The pump is difficult to service and requires a mobile maintenance team for installations at all depths. It is therefore rated unsuitable (—) for maintenance systems A and B.

Reliability

The pump performed relatively well in the laboratory endurance test and achieves a oo rating for reliability for depths up to 25 meters and daily outputs up to 4m³/d. The rating reduces to o for an output of 8m³/d at all lifts and for 4m³/d at 45m lift, where the operating effort and wear of moving parts is greater.

Corrosion Resistance

Corrosion occurred in the laboratory, and the Climax's downhole components are not corrosion resistant. It is therefore rated unsuitable under this heading.

Abrasion Resistance

The pump survived without breakdown in the laboratory sand-pumping tests, but use of leather cupseals means a -- rating for abrasion resistance.

Manufacturing Needs

The manufacturing facilities and skills required to make the Climax, and the degree of quality control needed, mean that it is unsuitable for manufacture in countries with low or moderate industrial development (categories 1 and 2). However, as specialist facilities are not required, the pump is rated oo for manufacture under Category 3 (high level industrial development).

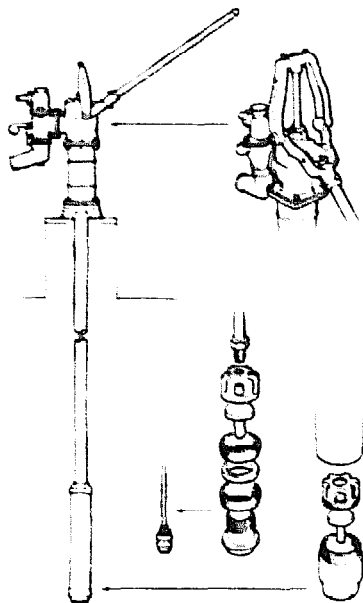

General Description

The Dragon pump is available either as a shallow well suction pump or as a deepwell force pump. The pump tested was the deepwell configuration, as illustrated. The pumpstand is principally cast iron, with a discharge valve in the spout allowing either free discharge or delivery under pressure through a hose or pipe. The tubular steel handle moves through an unusually wide arc (178°).

In the deepwell pump, the cast iron cylinder body and enamelled steel liner of the shallow well version is retained as a pedestal. The pump needs a mounting plinth at least 300mm high, to provide adequate clearance under the spout. The deepwell cylinder is conventional seamless 63mm brass tube with cast iron end caps. The plunger has two leather cup-seals and the footvalve has a rubber seat.

Manufacture

Gunmetal and iron foundry work and basic machining are required and good quality control is needed to ensure correct functioning and interchangeability of parts.

Suppliers

Kawamoto Pump Manufacturing Co, 11-39 4-chome, Ohsu, Naka-ku, Nagoya, Japan. Similar pumps made in the Philippines by Sea Commercial Inc (Jetmatic) and Malanday Machining and Manufacturing Corp (Sea Horse).

Prices — Not available

Laboratory Tests

Date tested: 1982

Reported: Handpumps Project Report No. 3

Performance data (typical values) — 63mm dia. cylinder

	7		25	45
	F*	P*		
Head (meters)				
Pumping arc*			F	F
Pumping rate (cycles/min)	40	40	40	40
Volume/min (liters)	22	11	22	21
Input (watts)	80	35	168	244
Mechanical efficiency (%)	31	34	52	63
Maximum handle force (kg-f)	8	8	18	30
Foot valve leakage (ml/min)	No significant leakage			

* At 7 meters head, tests were conducted both with the full 178° handle movement (F = Full) and with only the central 60° of movement utilized (P = Partial).

Evaluation

The two sample pumps were well packed and were received in good condition.

No installation instructions were supplied with the pumps and installation proved difficult, as the cylinder stroke length is virtually the same as the handle movement in the pumphead and careful adjustment of pumprod length is needed to avoid damage during operation. A plinth is needed to provide adequate clearance under the pump spout. Lifting tackle is required for pump installation.

Maintenance demands are likely to be high, involving regular lubrication and frequent repair or replacement of pumpstand components. Below ground maintenance involves removal of the complete assembly, which means that lifting tackle must be available.

The 4000 hour endurance test was carried out at 40 strokes per minute with a simulated head of 45 meters. The Dragon 2 failed three times during the testing: once when the handle fork broke after wear had caused it to come in contact with the fulcrum pin retaining screw; and twice as a result of breaks in the threaded section of pumprods.

After 1000 hours, the plunger had become difficult to remove because of scale in the cylinder bore; the footvalve guide and pumprod gland were worn; the spout would not swivel into the pressure delivery position, and there was some corrosion of cylinder end caps and the plunger rod. Inspection after a further

1000 hours revealed that handle fulcrum joints were badly worn and there were signs of wear on the plunger valve.

The three breakdowns occurred in the second half of the tests. The final inspection revealed that the pumpstand, cylinder and plunger were generally in good condition, but the footvalve guide was badly worn and there was some wear on the valve stem. The cylinder end caps were rusty, there was considerable corrosion on the plunger rod, and the outlet diverter valve had rusted solid.

The Dragon 2 failed the side impact test on the handle, which began to bend at the lowest impact energy (50 Joules). At 200 Joules, the base casting of the pumpstand broke.

Many users found it difficult to decide on the best operating action, because of the very large handle movement. Those who attempted a full stroke found the exaggerated body movements uncomfortable.

The overall conclusion of the laboratory trials was that the Dragon 2 seems designed for family use, perhaps serving up to 15 people, and is not sufficiently robust for community water supply. It is inexpensive, but intensive use will produce rapid wear in the moving parts of the pumpstand, and rod breakages are also likely. The diverter valve is seen as an unnecessary complication for most applications. The arc of movement is too large, particularly as there is little piston movement at each end of the handle movement.

Dragon 2

Field Trials

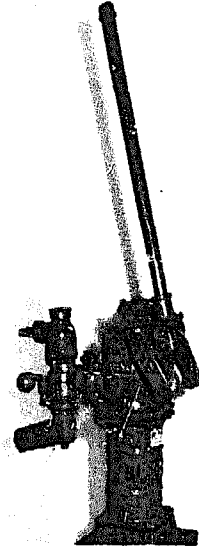

THE DRAGON 2 PUMP WAS NOT FIELD TESTED
BY THE HANDPUMPS PROJECT

Assessment

In the absence of field trials, ratings for the Dragon 2 pump are based mainly on performance in the laboratory tests. A suction version of the pump is available for lifts up to 7 meters, but these ratings are based on the deepwell version tested in the laboratory.

Discharge Rate

The Dragon 2 should be capable of comparatively high discharges over the full range of pumping lifts. However, the awkward operating action reduces the rating to "adequate" (o) in each table.

Ease of Maintenance

Though lifting tackle is not needed for shallow lifts (7 or 12 meters), the relative complexity of servicing makes it unsuitable for village-level maintenance (System A) even at these lifts. Area mechanics would need assistance for servicing at depths of 25 meters or more so that the ratings for Level B maintenance are "good" (oo) for lifts of 7m and 12m and "adequate" (o) for lifts of 25m and 45m.

Reliability

The laboratory tests showed that the Dragon is not well suited to intensive use, or to pumping lifts of 25 meters or more. For low lifts and light use, servicing needs would not be high and the pump is therefore rated oo at lifts of 7m and 12m for a daily output of 1.5m³/d, o at the same lifts for 4m³/d and --- for 8m³/d. At 25m and 45m, the rating is ---.

Corrosion Resistance

Significant corrosion was observed in the laboratory tests, and the Dragon is not suitable for use with corrosive water.

Abrasion Resistance

Use of leather cupseals earns the pump a --- rating for abrasion resistance.

Manufacturing Needs

The Dragon 2 is not suitable for manufacture in countries with a low level of industrial development (category 1) because of the need for foundry and machining skills. For categories 2 and 3, the ratings are o and oo respectively.

m

Laboratory Tests

THE TROPIC 7 PUMP WAS NOT TESTED IN THE CATR LABORATORY

ion

ting pump operated disk flywheels fitted heavy cast iron pump with one or two pump is commonly e. The flywheels are handles are at the p is at rest, and this mp water by rocking o without complete

n is transmitted to mprods through a ig rod and inter- nning in guides, all pstand. A version in which the piston gland and the pump water an extra 10 t.

umprods below the d in the pumpstand er, though stainless ble as an option. acer) at each rod r is an open-topped o leather cupseals alves. Five cylinder le. to suit different ston and footvalve out lifting out the

can be galvanized uPVC is used, a ived whereby the in is supported in a well casing. nt is available from

Manufacturer's performance data				
Head (meters)	20	30	40	60
Cylinder diameter (mm)	90	75	60	50
Well casing diameter (mm)	150	100	90	90
Pumping rate (cycles/min)	60	60	60	60
Volume/min (liters)	54	38	24	17
Input (watts)	179	186	157	164
Maximum handle force (kg-f)*	14	13	13	13

* Force shown is for one operator. With two operators, force per person is halved.

the manufacturer to enable the Tropic 7 to be driven by animal, diesel, or electric power. A sterilizer system is also available.

The pump is sold with a 5-year warranty.

Manufacture

The Tropic 7 includes a number of patented design features and its manufacture involves several highly specialized processes, which call for a high level of skill and stringent quality controls.

Manufacture in a developing country could therefore only be undertaken in collaboration with the Belgian manufacturer and then only in a country with an advanced industrial base and ready access to the necessary materials.

Suppliers

Pompes Deplechin SA, Avenue de Maire 28, B-7500 Tournai, Belgium.

Indicative prices - Feb 1985

Tropic 3 pumpstand	US\$ 980
Cylinder assembly	US\$ 230
Galvanized steel rising main per meter (in 3m lengths)	US\$ 7
Alternative uPVC rising main first 15 meters	US\$ 140
per extra 5 meters	US\$ 36
Timber pumprod and galvanized connectors per meter (in 5m lengths)	US\$ 4
Alternative 12mm stainless steel pumprod per meter (in 3m lengths)	US\$ 10
Discount:	
50 units	less 10%
500 units	less 20%

FOB Antwerp

Duba Tropic 7

Field Trials

Test conditions

Country	Number of pumps	Head range (meters)	Data available (months)
Niger	32	8-57	19

Average installation depth of the Niger test pumps is 36 meters, and all but two are on large diameter dug wells and located alongside India Mark II pumps. Depending on the static water level, the cylinder diameter used is 60 or 75mm.

The operating conditions differ from those anticipated by the manufacturer in two ways: on the dug wells, the pump rising mains are not fixed to the well linings, which means that the rising main/pumprod assembly can move laterally much more than in a drilled well; and the wells are dug only a short distance beyond the water table, so that the bottom of the cylinder is generally only 0.5 to 1.0 meters above the sandy well bottom.

Frequent failures of cupseals and valve seals can be attributed to sand drawn in by the Tropic's high delivery rate. Pumprod breakages may not have occurred in drilled wells, where lateral movements of the rising mains and pumprods are very limited. Heavy wear of the guide rod bushing also required frequent interventions, and this problem seems to be aggravated by fine sand getting into the bushing.

The high discharge achievable with the Tropic 7 proved highly popular with users, and some villages asked for the India Mark IIs to be replaced with Tropics. Typically, two men operating the Tropic 7

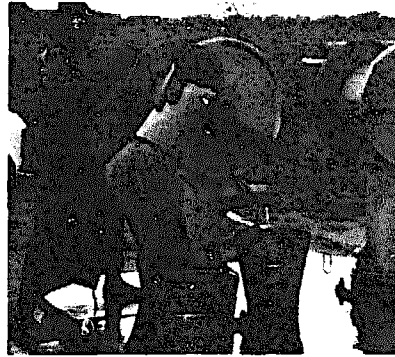

at 70 revolutions per minute were able to pump 40 liters per minute from a depth of 45 meters, whereas one man on the India Mark II achieved 13 liters per minute at 50 strokes per minute. During the dry season, Tropic 7 pumps with 75mm cylinders were estimated to be achieving maximum daily outputs as high as 25m³.

Though heavy lifting equipment is needed for pump installation, the open-top cylinder allows most maintenance of down-hole components to be carried out without special lifting tackle.

In a field trial demonstration, a local mechanic, assisted by four villagers and using only simple tools, was able to extract the piston and footvalve from a depth of 46 meters in 60 minutes and to replace them in 40 minutes.

The Niger pumps were fitted with non-galvanized steel rising mains, and this led to corrosion problems in the trials.

As the timber pumprods offer corrosion resistance, it would seem prudent to use the optional uPVC rising main wherever corrosion might be anticipated.

Assessment

Ratings are based on field trials in which pumping lifts ranged from 8 to 57 meters in predominantly large diameter dug wells.

Discharge Rate

The Duba Tropic 7 has been designed for two-person operation and achieves very high discharges. It therefore earns a "good" (oo) rating for all pumping lifts.

Ease of Maintenance

The pump is not suitable for village-level maintenance, but the open-topped cylinder does make area-mechanic maintenance feasible for routine repairs. Ratings for Maintenance systems A, B and C are therefore "unsuitable" (—), "adequate" (o), and oo respectively for all lifts.

Reliability

On the basis of the number of interventions needed in the field trials, the Tropic 7 is rated — for a daily output of 8m³/d at 25 meters lift and for 4m³/d at 45m lift. The rating is o for 4m³/d at 7m, 12m and 25m, and oo for 1.5m³/d at 7m and 12m. Ratings may well have been better if the pump had been installed on drilled wells.

Corrosion Resistance

The standard version with mild steel or galvanized rising mains is not corrosion resistant, though corrosion resistant alternatives are available as an option.

Abrasion Resistance

Use of leather cupseals means a — rating for abrasion resistance.

Manufacturing Needs

The Duba Tropic 7 requires a high level of manufacturing skill and sophisticated facilities. It is not therefore suitable for manufacture in countries with low or medium level industrial development, though for a category 3 country (high level of industrial development) the rating is oo. This would nevertheless require close collaboration with the Belgian manufacturer, because of patented design features.

CAUSES OF ESSENTIAL INTERVENTIONS

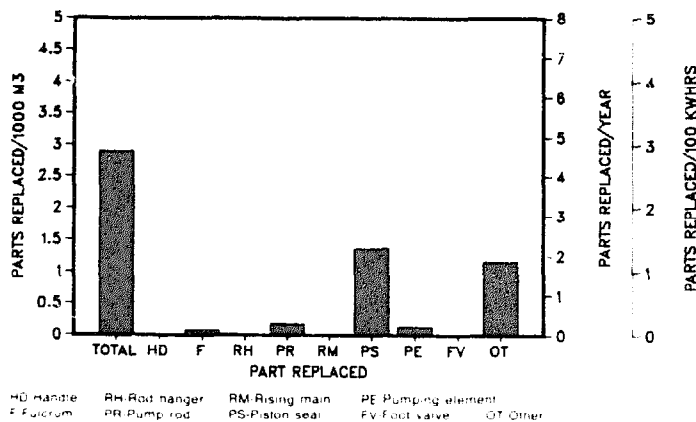

Canada

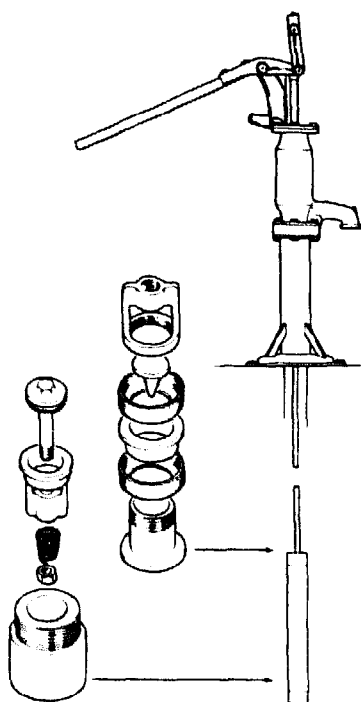

General Description

The GSW is a conventional reciprocating pump with a cast iron pumpstand supported on a fabricated steel pedestal. The intermediate pumprod slides in a guide bush and gland, and the handle is attached via a swinging link. All handle bearings are sealed ball races.

The conventional drawn brass tube cylinder has a gunmetal plunger and footvalve, the plunger being fitted with two leather cupseals. A 2 inch diameter cylinder has replaced the 2.5 inch cylinder used on earlier models.

Manufacture

Very good quality control is needed to ensure correct functioning of the pumphead and interchangeability of spare parts. Manufacture in a developing country would only be possible if good quality iron foundry work and accurate machining could be guaranteed.

Suppliers

GSW Water Products Company, 599 Hill Street West, Fergus, Ontario, Canada.

Indicative prices - Apr 1985

Pump and cylinder	US\$ 340
Pumprod per meter	US\$ 1.65
Rising main per meter	US\$ 9.00

Laboratory Tests

Date tested: 1984-85

Reported: World Bank Applied Technology Note No. 2

Performance data (typical values) — 2 inch dia. cylinder

Head (meters)	7	25	45
Pumping rate (cycles/min)	40	40	40
Volume/min (liters)	11.7	11.7	11.6
Input (watts)	25	66	100
Mechanical efficiency (%)	54	72	90
Maximum handle force (kg-f)	4	10	14
Footvalve leakage (ml/min)		One sample leaked badly Other sample no significant leakage	

Note: The volume flow was almost unchanged after the 4000 hour endurance test, but the effort had increased, lowering the efficiency by 9% at 45 meters and 30% at 7 meters lift.

Evaluation

The two sample pumps were well packed and arrived undamaged. However, one footvalve body was subsequently found to leak, one plunger rod had been poorly threaded, and the handle pivot bearings were not tight in one sample.

Installation instructions were supplied in English and contained cutaway drawings of the pumpstand and cylinder assembly. More illustration of installation procedures and less text would be more useful for developing countries.

Lifting tackle is essential for installation and skills are needed to ensure proper sealing of the well top. The pumprod may need cutting and rethreading.

Maintenance of the pumpstand demands special skills and tools, and replacement of worn or damaged parts will only be possible if manufacturing quality control has been high. Servicing of below-ground components involves extraction of the complete assembly, including rising main, so that lifting tackle is essential for deepwell installations.

The 4000 hour **endurance test** was carried out at 40 cycles per minute, with a simulated head of 45 meters. The GSW completed the test without failure. The pumpstand was noisy during the first 1000 hours, when movement of the bearings in their housings allowed some metal-to-metal contact between the handle and the fulcrum link. The noise subsided after 1000 hours.

At the end of the endurance test, the plunger rod was found to be severely **corroded** immediately above the plunger, and some handle bearings were loose in their housings. The pumprod guide bushes were in good condition, as were the plunger and footvalve. The cylinder bore was slightly scratched but showed little sign of wear.

The pumpstand was bent by some of the heavier loads applied in the **impact tests**. The pump remained serviceable, but distortion of the pumprods could be expected to accelerate wear of the guide bushes. Two handles broke early in the shock test and a non-standard solid steel handle was fitted to enable tests to be completed.

Users found the pump comfortable, and particularly easy to operate.

As a result of the testing, CATR suggested a number of design improvements, including strengthening of the handle and modifications to the fixing arrangements, strengthening of the pedestal, changes to the bearing arrangements, and a modified spout design to prevent it being readily blocked with the user's hand (a contamination risk).

In other respects, the **overall conclusion** of the laboratory trials was that the GSW was a reliable pump, easy to operate and efficient, but likely to suffer from corrosion in aggressive waters and not suitable for manufacture in most developing countries.

Field Trials



An earlier model of the GSW, which has since been modified.

**THE GSW PUMP WAS NOT FIELD TESTED
BY THE HANDPUMPS PROJECT**

Assessment

In the absence of field trials, ratings for the GSW are based on performance in laboratory tests.

Discharge Rate

The GSW produces a "good" (oo) discharge for the deeper lifts (25 and 45 meters), but is only rated "adequate" (o) when compared with high discharge pumps available for lower lifts (7 and 12 meters).

Ease of Maintenance

The need for special tools and skills to service the pumpstand makes the GSW unsuitable for village-level maintenance (System A) at any depth. At 7 and 12 meters, an area mechanic could carry out most maintenance operations, earning the pump a oo rating at these depths for System B maintenance. However, the need for lifting gear reduces the rating to o at 25m and 45m.

Reliability

More difficult maintenance at deeper settings, reduces the GSW's reliability ratings from oo at 7m and 12m lift and discharges up to 4m³/d, to o for 4m³/d at 25m lift (the same as the 8m³/d rating for the lower lifts), and the pump is rated "unsuitable" (—) for 45m lifts or for a daily output of 8m³/d at 25m lift.

Corrosion Resistance

Severe corrosion occurred in the laboratory tests, and the pump is not considered suitable for use with corrosive water.

Abrasion Resistance

Though there was little sign of abrasion damage during the laboratory tests, the use of leather cupseals earns the pump a — rating for abrasion resistance.

Manufacturing Needs

Good quality control is essential in manufacture of the GSW, which is not therefore suitable for manufacture in countries with low industrial development (category 1). No specialized processes are involved, so the pump is rated o for manufacture in a category 2 environment (medium industrial development) and oo for category 3 (high level of industrial development).

India, Mali

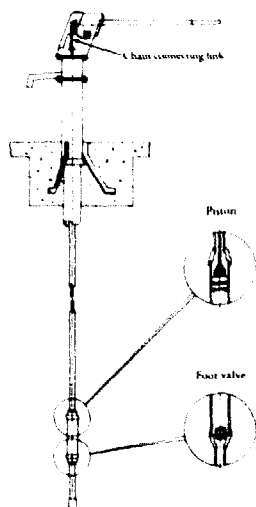

General Description

The India Mark II is a lever-action deepwell pump developed with UNICEF support and now the subject of Indian Standard IS 9301 (1984). The pump is widely used in India and is increasingly being installed in other countries.

The pumpstand and handle are galvanized steel, and the pump is distinguished by the chain and quadrant link between the handle and pumprod, which depends on a gravity return to effect the down-stroke. Ball races are used for the handle bearings. The steel pedestal is concreted into the pump apron.

The below-ground assembly is conventional with a brass-lined cast iron cylinder and a footvalve incorporated in the lower of the gunmetal endcaps. The standard pump has galvanized steel rising main. It is recommended that the pump has a 24 meter minimum setting for gravity return with the standard rods. Heavier rods are available for shallower settings.

Manufacture

The pump is made in India and Mali and calls for skills in steel fabrication and foundry work with good quality control. Limited pumphead manufacture is carried out in Kenya.

Suppliers

A list of manufacturers making the pump in India is available from UNICEF, 73 Lodi Estate, New Delhi 11003, India. Emama-Sikasso, BP 68 Sikasso, Mali.

Indicative prices - Feb 1985

Per unit for 35m depth US\$ 295

Laboratory Tests

Date tested: India Mark II - 1979; India-Mali - 1986

Reported: ODA Report 1981

Performance data (typical values) - 63.5mm cylinder

Head (meters)	7	25	45
Pumping rate (cycles/min)	40	40	40
Volume/min (liters)	12	12	12
Input (watts)	47	92	140
Mechanical efficiency (%)	30	55	65
Maximum handle force (kg-f)	13	20	30
Footvalve leakage (ml/min)	No significant leakage		

Evaluation

The test pumps from both India and Mali were securely packed in wooden crates and arrived in good condition. The Mali pumps did not have brass-lined cylinders, as specified in IS 9301, but instead had stainless steel cylinders. Both sets of pumps had minor defects: fixings for the chain inside the pumpstand were incompatible on the Indian pumps; in one Mali pump the handle pivot had been misaligned during assembly, and one handle had been incorrectly machined.

No instructions for installation and maintenance were supplied, but a comprehensive manual is now available from most manufacturers. Installation needs well-developed skills, lifting tackle, and a comprehensive tool kit, ruling out village-level maintenance.

The 4000 hour endurance test was carried out at 40 cycles per minute with a simulated head of 35 meters for the India pump and 45m for the Mali pump. Both pumps completed the test with no failures. In the final inspections, the handle pivot bearings were found to be in good condition, but the pumprod guides were worn. The Mali pump also had wear of the chain and of the pumpstand where the handle had rubbed against it.

Below ground, both pumps suffered a good deal of corrosion, particularly at

the joint between the plunger and pumprod. The cylinder bores were polished, but only lightly scored, and the cup-seals were still serviceable. The footvalve seals were worn, but also still serviceable.

Impact tests on the handle and pumpstand caused no damage, and the pump completed the handle shock test without failure.

Most users found the required efforts relatively easy to apply, though adults commented that a longer stroke would make the pump more comfortable to use and some children tended to bang the handle against the stops.

The overall conclusion of the laboratory tests was that the India Mark II is a strong, generously proportioned design, of which examples manufactured in both India and Mali proved to be robust and reliable.

Its potential for widespread application in village water supplies is limited by serious drawbacks in terms of manufacturing and maintenance. It is suitable for manufacture to a consistently high quality only in countries with moderately well developed industry and engineering skills. Maintenance also demands a high degree of skill, and lifting tackle will be required unless plastic rising main can be used.

- The modified version of the India Mark II, which has extractable downhole components, is described later (Pump 10).

India Mark II (standard)

Field Trials

Test conditions

Country	Number of pumps	Head range (meters)	Data available (months)
India	50	17-44	21
Sri Lanka†	10	2-9	22
Burkina Faso	30	10-26	33
Ghana	220	4-65	34
Niger	9	15-58	15
Sudan	75	12-38	24
Malawi	24	7-25	40
Kenya	15	16-31	17
Tanzania	22	1-25	9
Philippines	15	6-40	20
China	34	9-26	10

† Low-lift version

As befits a pump which is so widely used in India and elsewhere, the India Mark II has featured in a great many of the field trials, and has tended to be the standard against which other pumps are judged.

In India, where a million or more Mark IIs are in use throughout the country, the tests were carried out in unlined hard rock wells with cylinder settings averaging 36 meters. The pump is well accepted in the country and can be satisfactorily maintained by experienced area mechanics, though this is not the case in other countries, where mobile teams with lifting equipment are almost essential.

Chain lubrication and tightening of fasteners accounted for most of the routine maintenance operations, and plunger seal replacement was the most common repair needed in the India trials, accounting for 78% of the essential interventions. Interestingly, one manufacturer has recently replaced the standard leather cupseals with nitrile rubber cupseals, which are more abrasion resistant and do not swell (see Pump 10).

The experience of India's area mechanics means that repairs are generally carried out promptly and economically. This contrasts with the Sudan trials, where the India Mark IIs stood up well to very intensive use, but where the resources available for maintenance of such pumps are scarce. In one survey of 50 pumps needing below-ground repairs in



Sudan, trained village repairers were successful in only 10 cases, could have repaired another 9 if the parts had been available, failed in 15 cases, and made no attempt in the remaining 16.

The pump also proved difficult for mechanics in West Africa to install and maintain, though again the durability of the pump was very good, and it was well liked by users - except for Niger, where there was a strong preference for the high discharge from the Duba Tropic 7 (Pump 07).

Bearing failures accounted for a number of breakdowns, but the India Mark II's main problem in West Africa came from corrosion of below-ground components. The galvanized steel pumprods and rising mains fell victim to the region's corrosive water, to the extent that some 65% of breakdowns in the southern Ghana field trial could be put down to corrosion.

Corrosion also featured indirectly in the Sri Lanka trials, where the shallow wells were fitted with a low-lift version of the India Mark II. The pumps used six meters of 25mm diameter pumprods in place of the standard 24 meters of 12mm rods needed to achieve gravity return. Complaints from users about the taste of the water were almost certainly attributable to corrosion by-products.

The test pumps were fitted with open top cylinders and 3-inch galvanized steel rising main (three were later fitted with PVC rising mains). Though seal replacement was easier, serviceability was limited by the need to remove the large diameter rising main to gain access to the footvalve. Problems also arose from swelling of the leather seals, which interfered with the plunger downstroke.

Overall, the India Mark II proved to be a durable pump, but one which is far from easy to service when needed.

Assessment

The ratings for the India Mark II pump are based on wide-ranging and consistent data from field trials and laboratory tests.

Discharge Rate

For deep lifts, the pump achieves comparatively high discharges, scoring a "good" (oo) rating for depths of 25 and 45 meters. However, the pump cannot compete with the high outputs of direct action pumps at lower lifts, and the rating drops to "adequate" (o) for lifts of 7m and 12m.

Ease of Maintenance

The skills and tools needed to service the India Mark II preclude village-level maintenance, and the pump is rated "unsuitable" (—) under System A. Area mechanics can service the pump at shallower lifts (bearing in mind that the standard pump has a minimum cylinder setting of 24 meters to achieve gravity return), but beyond 25m lifts, the oo rating for System B reduces to o, as assistance may be needed from a mobile team.

Reliability

The India Mark II is durable, but the difficulty of maintenance at depth reduces the oo rating for reliability to o at 25m lift and 4m³/d output, and the pump rates — for 8m³/d at the same lift and for 4m³/d at 45m.

Corrosion Resistance

Use of galvanized steel rods and rising main means a — rating.

Abrasion Resistance

Leather cupseals are known to give problems in sand-laden water, and result in a — rating.

Manufacturing Needs

The India Mark II is manufactured in India and Mali. The degree of quality control needed to ensure reliable operation makes the pump unsuitable for manufacture in a country with only low industrial development (Category 1), unless intensive technical assistance is provided to the manufacturer (as was the case in Mali). It scores o and oo for Categories 2 and 3 respectively.

INTERVENTION CHARTS FOR THE INDIA MARK II
FIELD TRIALS ARE ON PAGE 116

India Mark II (standard) continued

INDIA MARK II: CAUSES OF ESSENTIAL INTERVENTIONS

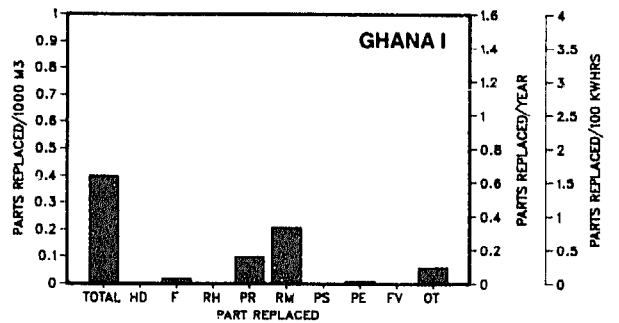
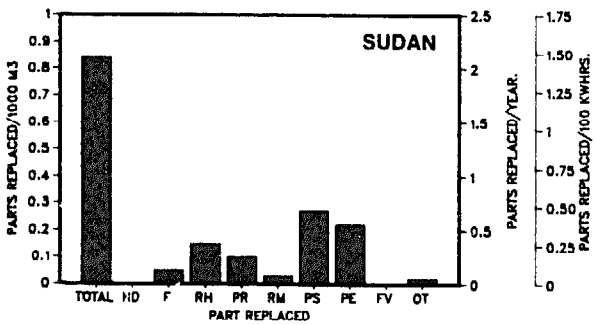
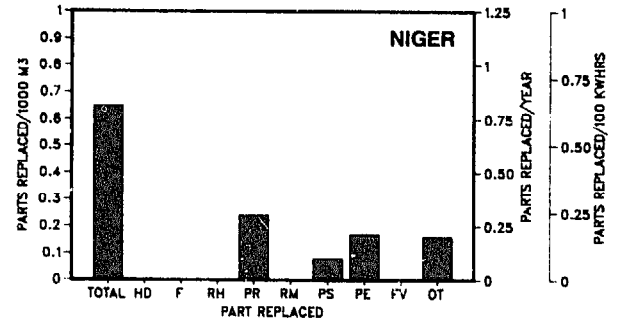
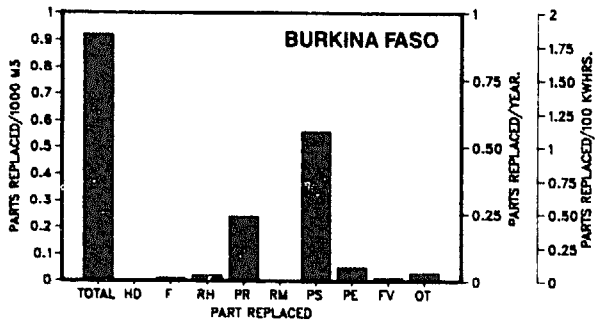
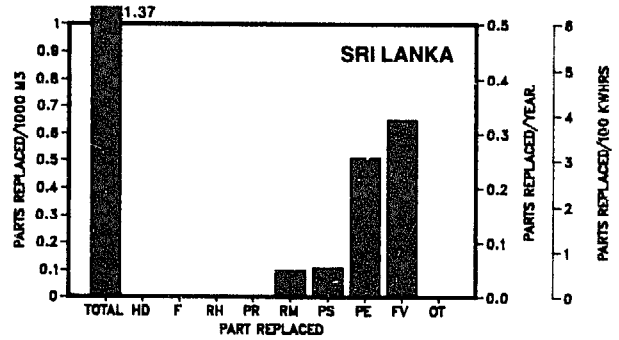
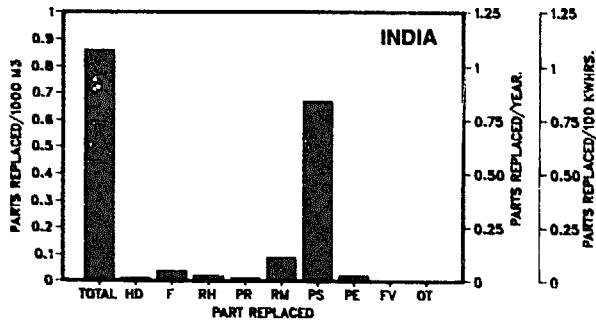

HD-Handle RH-Rod hanger RM-Rising main PE-Pumping element
 F-Fulcrum PR-Pump rod PS-Piston seal FV-Foot valve OT-Other

General Description

The modified version of the India Mark II differs from the standard version in that it has pumping elements which can be removed without having to lift out the rising main. An open-topped cylinder is used in a 2-1/2 inch galvanized steel rising main (experiments are also going on with PVC rising main).

The pump has a "quick change" drive head, and versions are being tested with fixed or removable footvalves. Some experimental pumps have also been fitted with nitrile rubber seals in place of the standard leather cupseals.

The purpose of the modifications is to make maintenance easier, by reducing the tools needed and the time taken to service downhole components. Improved seal life is expected from the nitrile plunger seals.

Field Trials

Eleven experimental pumps have been monitored for approaching two years in the Project field trials in Coimbatore District, Tamil Nadu, India. Early trials with PVC rising mains on three pumps did not come up to expectations, and galvanized steel main was substituted pending further research on PVC jointing and support.

Of the six installations with fixed footvalves, two experienced no failures in 17 months of monitoring with pumping lifts of 20-22 meters. Three pumps had leather cupseal failures, but then worked without breakdown when nitrile seals were fitted. The remaining pump suffered both ball race and rising main failure. There was no failure of the fixed footvalves.

Five pumps were fitted with footvalves designed to be extracted through the cylinder and rising main. Though the monitoring period is short (only five months data available for this report), initial indications are that the pumps are performing well. More significantly, the modifications have had a substantial impact on the time needed to service downhole components.

In a timed experiment on the deepest pump (standing water level 27 meters, cylinder setting 33 meters and operating 10 hours a day to serve 1000 beneficiaries), impressive times were set for removal and replacement of downhole components, as follows:

- Removal of the pumphead took 2 minutes
- The plunger and footvalve were lifted to the surface after a total of 17 minutes
- Replacement to water flow took 25 minutes, including the time needed to fill 27 meters of rising main.

The original nitrile seals were refitted, as there was virtually no sign of wear. The complete operation was performed by a team of four and needed no special lifting tackle. A similar operation with the standard Mark II would have spanned several hours, and required lifting gear to remove the rising main and cylinder.

In this experiment, the break-out force needed to release the footvalve was very high, partly because of galvanic action between the brass and cast iron. The design has been modified and should result in a break-out force of about 150-200kg, easily achievable through the leverage of a standard Mark II head.

Though the experimental Mark IIs have been on trial only for a short period, there are good grounds for confidence that the design can have a big impact on the pump's maintenance needs. Maintenance should be possible with one trained mechanic and unskilled help from villagers. The reduced amount of tools needed means that a bicycle or motor cycle should be the only transport needed.

It is still hoped that PVC rising main may prove suitable for use with the India Mark II. The initial problems involved failure of both solvent-cement and threaded joints. PVC tension connectors are being tried, but fretting of the rising main in the unlined hard rock boreholes still has to be overcome.

Assessment

The experimental modified versions of the India Mark II have given encouraging early results, but there are limited data (eleven pumps for less than two years in one situation). Judgments should therefore be regarded as preliminary at this stage.

Discharge Rate

The modifications do not alter the pump's discharge capacity, and ratings are the same as for the standard India Mark II (Pump 09).

Ease of Maintenance

Though the modifications still do not allow the Mark II to be regarded as suitable for village-level maintenance, it does now qualify for a "good" (oo) rating for area-mechanic maintenance (system B) at all lifts.

Reliability

The simpler maintenance and nitrile seals seem likely to reduce the pump's downtime, improving the ratings to oo at 25 meters lift and a daily output of 4m³, and to "adequate" at higher flows and at 45 meters head.

Corrosion Resistance

Galvanized pump rods and rising mains mean that the pump cannot be recommended where groundwater is corrosive, though this rating may be altered if experiments with PVC rising main are successful.

Abrasion Resistance

Replacement of leather cupseals with nitrile rubber seals earns the modified Mark II a oo rating.

Manufacturing Needs

The modifications do not affect the Mark II's suitability for manufacture in developing countries, and ratings are therefore the same as those for the standard India Mark II (Pump 09).

Philippines

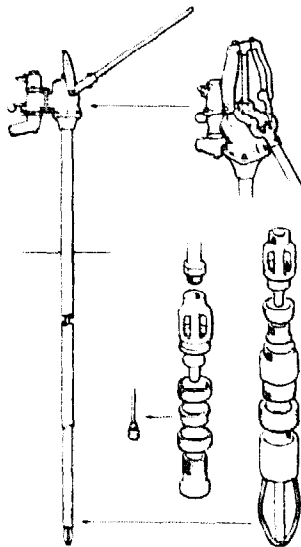

General Description

The Jetmatic is made in the Philippines to a design similar to that of Kawamoto Pumps of Japan. It is also available as a shallow well suction pump (Pump 37). The cast iron pumpstand is compact and fits on the protruding end of the rising main, which must protrude at least 440mm above ground to prevent the handle touching the ground and to provide clearance for the spout. A discharge valve in the spout allows either free discharge or pressure delivery through a hose or pipe.

The deepwell cylinder is unusually small (46mm bore), in order to fit inside 2 inch rising main. It consists of a brass tube, gunmetal plunger and leather cupseals. The plunger can be screwed on to the footvalve to remove it without removing the cylinder.

Manufacture

Gunmetal and iron foundry work and basic machining are required, with good quality control to ensure interchangeability of spare parts.

Suppliers

There are several, including Sea Commercial Co Inc, Cor. V. Cruz Street, Manila 2806, Philippines, who supplied the laboratory-tested pumps.

Indicative prices - Feb 1985

Pumpstand and cylinder	US\$35
------------------------	--------

Laboratory Tests

Date tested: 1983

Reported: Handpumps Project Report No. 3

Performance data (typical values) - 46mm cylinder

Head (meters)	7	25	45
Pumping rate (cycles/min)	40	40	40
Volume/min (liters)	12	11	11
Input (watts)	36	69	115
Mechanical efficiency (%)	36	63	72
Maximum handle force (kg-f)	4	7	11
Footvalve leakage (ml/min)	No significant leakage		

Evaluation

The two test pumps were securely packed in a wooden case and arrived in good working order.

No installation and maintenance instructions were supplied with the pumps. Rising main of 2 inch diameter is required and plastic pipe cannot be used because the pumpstand is mounted directly on the protruding rising main. Lifting tackle is likely to be needed for installation. Skill is needed to ensure that the cylinder is correctly installed in the rising main and that the pumpstand is correctly mounted. Care must be taken not to overtighten pumpstand fastenings, to avoid breaking the cast-iron flanges. The bottom of the pumpstand is threaded 1.25 inch API and not the more common ISO pipe thread.

The pumpstand may require frequent maintenance of worn handle components and the gland nut. Appropriate hand tools and a suitable stock of spare parts are therefore needed. Below ground, the cylinder is designed to be extracted without removing the rising main.

The 4000 hour endurance test was carried out at 40 cycles per minute with a simulated head of 45 meters. The internal clamp securing the cylinder within the rising main had to be tightened soon after the start of the test, but this problem did not recur. Components of the handle mechanism were replaced because of wear during the test. The pumprod broke

after about 3000 hours and again shortly before the end of the test.

In the final inspection, all the internal components of the cylinder were found to be in good condition, with few signs of wear. The gland nut in the pumpstand was badly worn however, and corrosion was observed on the piston rod, part of the cylinder clamp, and the pumpstand.

Impacts on the handle were absorbed by the pumpstand turning on its mounting thread. In the test on the body of the pumpstand, a moderate impact bent the upper portion of the rising main sufficiently to prevent movement of the pumprod. Repeated shocks on the handle damaged the mounting threads in the base casting.

Users disliked the relatively low rate of delivery and found the handle action awkward. The handle moves through an arc of about 180°, but for handle movements near the upper and lower limits of its travel there is little movement of the pumprod.

The overall conclusion of the laboratory tests was that the Jetmatic Deepwell pump would be unsuitable for community use. The delivery rate is low and intensive use will be likely to produce rapid wear, failures in the moving parts in the pumpstand, and breakages of the pumprods. Although potentially suitable for manufacture in some developing countries, the design is by no means ideal.

Jetmatic Deepwell

Field Trials

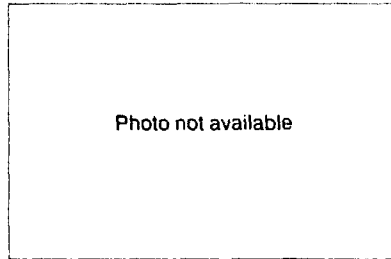

THE JETMATIC DEEPWELL PUMP WAS NOT FIELD TESTED BY THE HANDPUMPS PROJECT

Assessment

In the absence of Project field trials, the Jetmatic Deepwell's ratings are based on its performance in the laboratory and on the experience and judgment of Project staff. Ratings are for the Deepwell version; the Jetmatic Suction has been rated separately (Pump 37).

Discharge Rate

The small cylinder and awkward operating action result in only an "adequate" (o) rating for all lifts.

Ease of Maintenance

The need for special tools and lifting gear make the Jetmatic unsuitable for village-level (System A) maintenance. Area mechanics (System B) and mobile teams (System C) will find the pump relatively easy to maintain. The "good" (oo) rating for System B maintenance reduces to o for depths beyond 25 meters, as the tests revealed that the cylinder retainer may not be reliable in the long term, so that lifting gear would be needed to remove the rising main.

Reliability

The laboratory tests suggest that frequent maintenance would be needed for lifts of 25 meters or more at discharges of 4m³/d, and the pump is therefore rated "unsuitable" (—) in Tables S.3 and S.4. For 7m and 12m lifts, the pump earns a oo rating, reducing to o at 8m³/d.

Corrosion Resistance

The pump has no special protection against corrosion and suffered extensively from rusting in the laboratory tests. It cannot therefore be recommended for situations where groundwater is likely to be corrosive.

Abrasion Resistance

Use of leather cupseals means a — rating for abrasion resistance.

Manufacturing Needs

The Jetmatic Deepwell is not suitable for manufacture in countries with a low level of industrial development (category 1) because of the need for foundry and machining skills. For categories 2 and 3, the ratings are o and oo respectively.

Germany, Federal Republic of

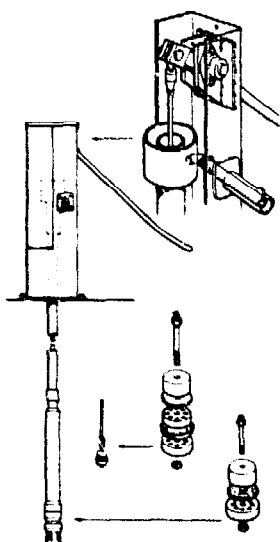

General Description

The Kardia is a deepwell force pump with a conventional reciprocating action. The piston has a proprietary molded rubber lip seal acting directly on the uPVC pipe cylinder bore. Plunger and footvalve are similar in design, machined from uPVC and fitted with flat rubber sealing washers. Two plunger seals are recommended for depths beyond 35 meters. Recommended rising main is the manufacturer's own special plastic pipe with threaded connectors and rubber sealing washers. The pumprod is stainless steel with conventional brass tube-nut couplings.

The pumpstand is fabricated from sheet steel and sections and hot-dip galvanized and the handle bearings are large proprietary ball races in flanged housings.

Manufacture

The pump could be manufactured in developing countries with steel fabrication and machining expertise, but high levels of skill and quality control are needed to produce the pumpstand. Skill is also needed in machining the plunger and footvalve components.

Suppliers

Preussag AG, Moorbeerenweg 1, Postfach 6009, D-3150 Peine, Federal Republic of Germany.

Indicative prices - Mar 1985

Per unit for 20m depth	US\$ 900
Extra pipe per meter	US\$ 14

Laboratory Tests

Date tested: 1984

Reported: Handpumps Project Report No. 4

Performance data (typical values) — 63mm dia. cylinder

Head (meters)	7	25	40
Pumping rate (cycles/min)	40	40	40
Volume/min (liters)	16	16	16
Input (watts)	38	80	128
Mechanical efficiency (%)	43	75	75
Maximum handle force (kg-f)	4	11	18
Leakage of foot valve (ml/min)		Not significant	

The volume discharged per stroke was 0.35-0.37 liters and was not affected by pumping rate.

Evaluation

The two pumps acquired for testing were well protected and both arrived in working order, though the cases were large and difficult to manhandle.

An installation manual provided concise and clear instructions. No lifting tackle is needed for installation. Rising main and pumprod are supplied to length, and tools and PTFE sealing tape are supplied with the pumps. Area-mechanic maintenance is relatively simple, as there is no requirement for lifting equipment, but the special tools supplied by the manufacturer must be retained.

The Kardia went through the 4000 hour endurance test without breakdown - the test was conducted at 40 strokes per minute, with a simulated head of 30 meters. Damage did occur to the cylinder bore and plunger seal during the first 1000 hours of pumping, but this was caused by debris from corrosion in the CATR head simulation valve, and represents a condition unlikely to arise in field conditions.

At the end of the endurance test, sand was embedded in the plunger seal and both the seal and the cylinder wall were scratched, though performance was not impaired. A slight step was noted in the cylinder bore at the top and bottom of the plunger stroke. Center holes of valve blocks in the plunger and footvalve were worn but still serviceable, and there was no corrosion. Some play was found in the joint between handle and pumprod, but again performance was unaffected and

the joint was still serviceable.

The impact tests caused distortion of the pumpstand body which was enough at 300 Joules to affect the alignment of the rising main (the manufacturer has subsequently doubled the thickness of the pumpstand base to 10mm. The handle too has been strengthened, following a failure in the laboratory shock test. The handle failed after 54,000 cycles at the welded joint between round and rectangular sections.

The Kardia consistently delivered just under 0.40 liters per stroke, both before and after the endurance tests, equivalent to a discharge of 16 liters per minute at the selected pumping rate of 40 cycles per minute.

The discharge rate remained constant for heads ranging from 7 meters to 40 meters, though the work rate clearly increased (from 38 watts at 7 meters to 128 watts at 40 meters pumping lift).

Some users thought that the Kardia's delivery rate was rather low, though most liked the smooth action of the pump, and smaller users in particular liked the moderate operating effort. The handle height and movement seem to be a good compromise between the preferences of short and tall users.

Overall, the Kardia was found to be a reliable handpump in which modern materials have been used to update a conventional plunger action design. Relatively easy to maintain and repair, the pump is seen as suitable for community water supply use for depths down to 30 meters.

Field Trials

Test conditions

Country	Number of pumps	Head range (meters)	Data available (months)
China	12	6-25	12
Burkina Faso	1		

In the China field trials, the Kardia was very popular among the villagers, who rated it as reliable but slow (low discharge). It was the only pump which could continue to operate during the severe winter of 1984/85, when freezing conditions caused others to cease to function. Ice in the upper rising main made the Kardia heavy to pump and led to handle breakages at the welding point. The problem could be avoided by drilling a small hole in the rising main a couple of meters below ground, to allow bleed back when pumping ceased.

The Kardia's plastic cylinder proved durable, but some doubts were expressed



about the long-term durability of the uPVC rising main, particularly in view of past experiences with plastic rising mains at depths beyond 25 meters.

A single Kardia pump has been monitored in the Burkina Faso field trials, where it performed well, delivering a consistent 1.4-1.7 cu m/h at 50 strokes per minute.

Further field trials are needed to provide conclusive data on the long-term performance of this pump.

Assessment

The Kardia ratings are based on laboratory test results and performance in field trials, though with a limited number of pumps.

Discharge Rate

At lifts of 25 meters and more, the Kardia achieves a "good" (oo) discharge (note that the ratings in Table S.4 are for 40m lift, which is the maximum recommended by the manufacturer). For lower lifts, the pump is only rated "adequate" (o) in comparison with the high discharge pumps available for these lifts.

Ease of Maintenance

No lifting tackle is needed for maintenance of the Kardia, which earns a oo rating under maintenance systems B and C for lifts up to 25 meters. At greater depths, area mechanics may need assistance, so the rating drops to o for system B in Table S.4.

Reliability

A combination of wear rates and more difficult maintenance at deeper settings results in the reliability ratings dropping from oo at 7m and 12m lifts for daily outputs up to 4m³/d, to o at 25m lift and 4m³/d and "unsuitable" (—) for greater depths or daily output.

Corrosion Resistance

Use of stainless steel pumprods with brass connectors and a PVC rising main, plunger and cylinder, results in a oo rating.

Abrasion Resistance

The pump did not break down during sand pumping in the laboratory trials, but sand embedded in the seals at the end of the trial, and wear in the PVC cylinder, mean a general rating of o for abrasion resistance.

Manufacturing Needs

High levels of skill and quality control are needed in the manufacture of the pump, though the design is seen as suitable for many developing countries. Ratings are oo for a country with a well-developed industrial base, o where the industrial base is moderately developed, and — where industrial skill levels are low.

CAUSES OF ESSENTIAL INTERVENTIONS

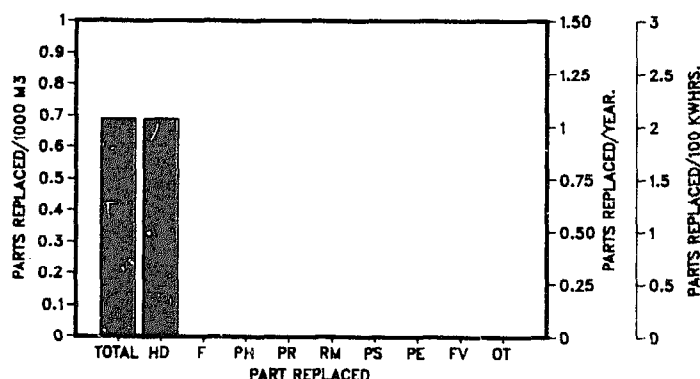

HD-Handle RH-Rod hanger RM-Rising main PE-Pumping element
 F-Fulcrum PR-Pump rod PS-Piston seal FV-Foot valve OT-Other

Thailand

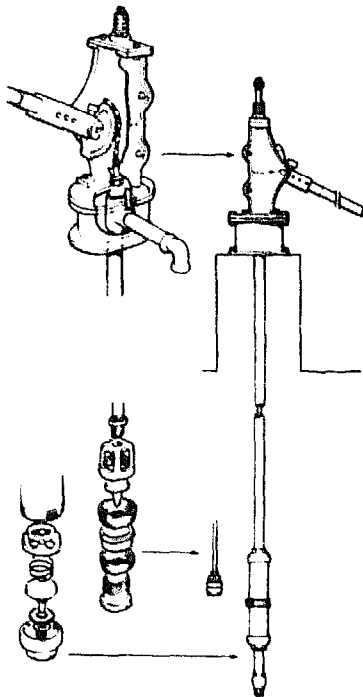

General Description

The Korat is a deepwell force pump. The pumpstand is constructed primarily from eight iron castings. It must be mounted on a plinth to provide clearance for water containers under the spout and to accommodate the full movement of the long wooden handle. Handle bearings are sealed ball races.

Below ground, the cylinder is conventional, with a drawn brass barrel and cast end caps enclosing a cast piston fitted with leather cupseals. There are two footvalves, one in the base of the cylinder and a second at the end of a short dip tube. As an alternative to the cast rack and quadrant mechanism in the pumpstand, the manufacturer now offers a chain and quadrant assembly.

Manufacture

Foundry skills are needed.

Suppliers

Saha Kolkarn Factory, 94-96 Soi Sukapiban 2, Ramintra, Bangkok, Thailand

Indicative prices - Sep 1985

Pumping unit	US\$ 150
Pumprods per meter	US\$ 1.50

Laboratory Tests

Date tested: 1983

Reported: Handpumps Project Report No. 3

Performance data (typical values) — 3 inch dia. cylinder

Head (meters)	7	25	45
Pumping rate (cycles/min)	40	40	40
Volume/min (liters)	16	14	14
Input (watts)	33	106	133
Mechanical efficiency (%)	53	53	76
Maximum handle force (kg-f)	11	20	28
Footvalve leakage (ml/min)	No leakage when new 4.8 at end of test		

Evaluation

The two test pumps were packed in wooden packing cases, one containing the pumpstands, the other the handles, rising main and pumprods. They were in working order, but had a number of defects which could have caused premature failure if not remedied before installation. In particular, it was necessary to seal the cylinder end caps with shellac, to overcome porosity in the gunmetal castings.

No instructions were supplied for installation or maintenance. If galvanized steel pipe is used, lifting tackle is needed for installation. A multi-size spanner was provided by the manufacturer, but several other tools are also necessary. The pump must be installed on a plinth at least as high as the largest water container to be placed under the spout.

Routine maintenance will involve regular lubrication, but should be easy. If adequately greased, the cast iron quadrant and rack should not wear out in less than two years. The entire below-ground assembly must be extracted for cylinder maintenance, and lifting tackle is necessary.

The 4000 hour endurance test was carried out at 40 cycles per minute with a simulated head of 45 meters. The rack guide rollers in the pumpstand seized towards the end of the test, and by the

end the rack and quadrant were completely worn out. The plunger and cylinder were also worn, though still serviceable, and there was no reduction in pump performance. The leather cupseal in the footvalve had compressed, allowing metal-to-metal contact and causing the valve to leak.

Considerable corrosion was apparent on the ferrous parts of the pump, and particularly on the lock nut between the connecting rod and the plunger.

In the impact tests, the pump was undamaged by impacts to both the handle and the pumpstand body. The Korat also completed the allotted 96,000 cycles of the handle shock test without failure.

The pump was not well received by users. The handle was long, but the stroke was short, and many people commented that the handle was uncomfortably high. As a result, most of the required effort had to be supplied by arms and shoulders.

The overall conclusion of the laboratory tests was that the Korat is an unrefined but rugged design, suitable for manufacture in developing countries with established foundry skills. Although not popular with users, it has the capacity to supply the needs of a community. Below ground maintenance is difficult, but the cylinder itself proved generally reliable.

Field Trials

Test conditions

Country	Number of pumps	Head range (meters)	Data available (months)
Thailand	94	6-23	21

The Korat 608 design is in transition. The original rack and pinion action was modified in the 608C series to a chain and quadrant, and is being modified again in the 608 CTS series. The Korat 608CTS is expected to become a standard pump in Thailand's rural water supply program, and the design is intended to be compatible with below ground components being developed for the modified India Mark II (Pump 10).

Of the 94 field trial pumps, 50 were of the original 608A1 design, 40 of the later 608C design, and 4 were of the 608CTS design. One important change has been a reduction in the manufacturing accuracy needed to ensure interchangeability of spare parts.

With its standard 3 inch cylinder, the Korat produces a high discharge, and this cylinder was used for the comparatively shallow lifts of the Project field trials. For lifts of 25 meters or more, the 3 inch



cylinder would result in high pumping efforts being required, as the laboratory test showed, and this would put extra stress on the pumphead.

For these deeper lifts, smaller cylinders are available, with correspondingly reduced discharge rates.

The Korat 608C showed great potential in the field trials, and further development of the CTS series should improve its reliability still further.

Assessment

The Korat ratings are based on both field and laboratory testing, and relate principally to the 608C series.

Discharge Rate

With the right choice of cylinder, the Korat is capable of achieving a "good" (oo) discharge over the full range of pumping lifts.

Ease of Maintenance

The pump is not suitable for village-level maintenance (System A). An area mechanic could readily carry out routine maintenance operations on pumps with 7 or 12 meter lifts, but the need for lifting gear reduces the oo rating for System B at these lifts to "adequate" (o) at 25m and 45m.

Reliability

The frequency of maintenance interventions needed and the need for assistance from a central maintenance team, reduces the Korat's reliability rating to o for a daily output of 4m³/d at 25m lift, and to "unsuitable" (—) for 8m³/d at the same lift and for 4m³/d at 45m lift.

Corrosion Resistance

The pump suffered appreciable corrosion in the laboratory tests, and is not suitable for use with corrosive water.

Abrasion Resistance

Use of leather cupseals means a — rating for abrasion resistance.

Manufacturing Needs

Successive modifications to the Korat have reduced the degree of manufacturing accuracy and quality control needed. The pump is well suited for manufacture in countries with medium or high level industrial development, scoring oo for categories 2 and 3. It requires good foundry skills, and so is rated — under category 1.

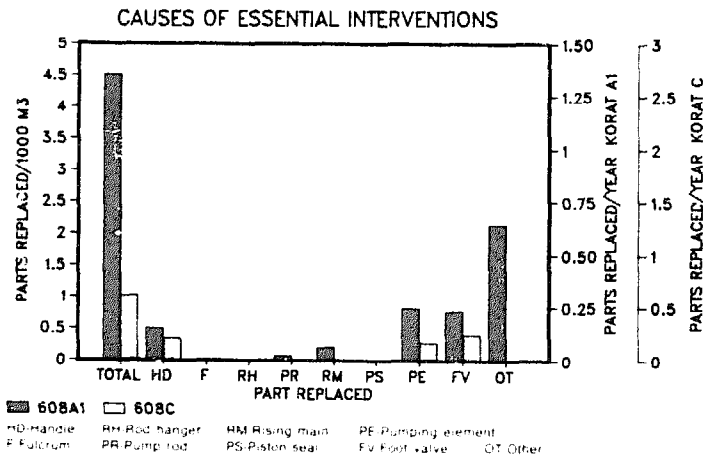

Malawi

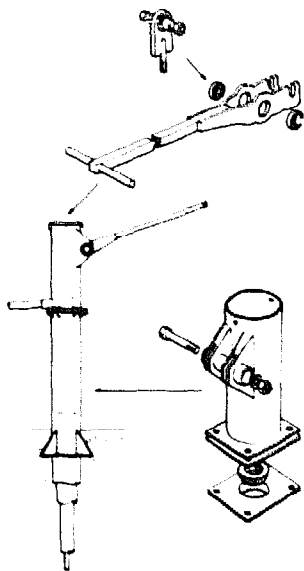

General Description

The Maldev is a reciprocating deepwell pumphead developed in Malawi, and designed for easy maintenance. It was the forerunner of the Afndev (Pump 02), and was intended to be part of a modular system. Optimum range of pumping lift is 15-30 meters, though it can be operated to 60 meters.

Fabricated steel sheet and standard pipe sections are used to make the pumphead. Bearings are sealed ball races.

Either steel or PVC rising main can be supported, depending on the adapter used, and a range of plunger diameters can be fitted. The head design allows the plunger and footvalve to be extracted through a simple access cover, if suitably sized rising main is used.

Manufacture

The pumpstand requires machining and welding of steel sheet and tubing. Facilities are straightforward, but high standards of workmanship and quality control are necessary to achieve optimum bearing performance.

Suppliers

Petroleum Services Ltd. PO Box 1900, Blantyre, Malawi.

Indicative prices - Feb 1985

Pumphead	US\$ 300
----------	----------

Laboratory Tests

Date tested: 1983/84

Reported: Handpumps Project Report No. 3

Performance

The Maldev is a pumphead designed to be coupled to any suitable cylinder assembly of about 2-1/2 inch diameter. Performance data is therefore not given. For laboratory testing, the Maldev was initially attached to a prototype all-plastic cylinder and later to a cylinder from a Funymaq Aid-derivative pump. In both cases, high levels of efficiency were measured, confirming that friction in the pumpstand was relatively low.

Evaluation

The test pumpstands were securely packed in two wooden cases, and arrived in good condition.

No instructions were supplied, but the techniques of installation and maintenance had been demonstrated in Malawi to laboratory staff. The pumpstand is straightforward to install, provided that care is taken when concreting in the column and in assembling the handle to the pumpstand body. For maintenance, a pair of purpose-made universal spanners are supplied with each pump. The most important maintenance operation is replacing the handle bearings. To remove worn-out ball races in the field, they must be driven or pressed out. If the same technique is used to install the new ball-races, it is easy to damage the bearings themselves or their housings. Only a cover plate need be removed to allow the pumprod and plunger to be extracted.

For the 4000 hour endurance test, the pump was driven at 40 cycles per minute, at a simulated head of 45 meters, using a 2-1/2 inch cylinder. Midway through the test, the rising main slipped in the compression fitting within the pumpstand. It was retightened but

persistent leaks occurred until an improved conical rubber seal was fitted. At the end of the test, considerable free play was found in the handle bearings, but they were still serviceable.

There were spots of rust inside the pumpstand, but the design is such that corrosion is very unlikely to be a cause of failure of the pump.

In the impact tests, the pump was undamaged by impacts to either the pumpstand body or the handle. The pump completed the allotted 96,000 cycles of the handle shock test without failure.

The Maldev was generally well liked by users, who all stood behind the pump and grasped the T-bar handle with one hand on each side.

The overall conclusion of the laboratory tests was that the Maldev is a very robust pump, designed with the needs of VLOM and of manufacture in a developing country in mind. However, although capital-intensive manufacturing facilities are not required, strict quality control is necessary to achieve a reliable product. Replacing the ball races with plastic bushes could make the pump easier to manufacture and to maintain.

Field Trials

Test conditions

Country	Number of pumps	Head range (meters)	Data available (months)
Malawi	117	5-27	36
Kenya	14	10-35	19
Tanzania	10	3-16	9
Philippines	35	6-40	20
China	34	9-26	10

An important result of field trials on the Maldev has been the comparison between bearing performance in the older prototype heads, constructed with poor quality jigs and fixtures and installed in 1982, and that in the later heads where both jigs and quality control were much improved. The later production heads have given ball bearing life some 2-3 times longer than in the older heads. This underlines the importance of manufacturing quality control, even in such a simple pump as the Maldev.

Although the Maldev head was designed for use with plastic rising mains and extractable cylinder components, only few of the pumps on test had this type of assembly and all were prototypes. Most test pumps used conventional downhole components, and in consequence were difficult to maintain and had

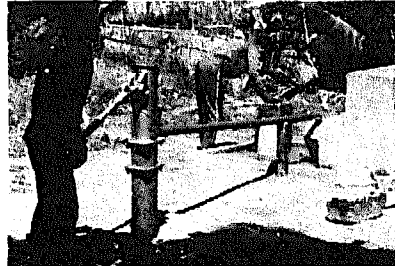

corrosion problems. The assessment of the Maldev has been based on its use with conventional downhole components.

Most pumphead breakdowns were due to ball bearing failure. If allowed to progress, bearing wear can have serious consequences. There were several examples where collapsed bearings resulted in balls falling down inside the rising main and damaging the cylinders.

The Maldev's T-bar handle was popular with users, who also liked the high discharges made possible by selection of appropriate cylinder sizes and handle lengths.

As a first attempt at development of a deepwell handpump suitable for manufacture and simple maintenance in Africa, the Maldev was mainly successful. Introduction of plastic bearings, as on the Afridev, should improve the pump's reliability and ease of manufacture.

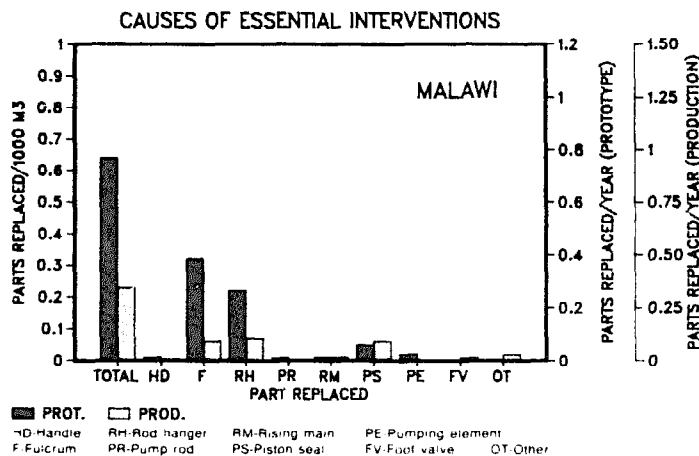

Assessment

The Maldev ratings are based on the pumphead's performance in extensive field trials and in the laboratory. Where ratings depend on downhole components, the Maldev has been rated on the basis of conventional components, as used in the majority of the field trials. Better ratings may be possible with modern downhole components.

Discharge Rate

The choice of cylinder size and variable handle length mean that high discharges are possible at all lifts, earning the pump a uniform "good" (oo) rating.

Ease of Maintenance

The conventional downhole components result in a rating of "unsuitable" (—) for village-level maintenance irrespective of depth. Area mechanics would need support from mobile teams for repairs at 25m and 45m, so that the rating for maintenance system B drops from oo to "adequate" (o) for these lifts.

Reliability

The maintenance ratings also affect the ratings under this heading, giving the pump a oo rating at 7 and 12 meters lift and daily outputs up to 4m³/d, reducing to o for higher lifts and discharges, and to — for 45m lift and for a daily output of 8m³/d at 25m lift.

Corrosion Resistance

Galvanized steel pumpheads and rising mains mean a — rating.

Abrasion Resistance

Use of leather cupseals means a — rating for abrasion resistance.

Manufacturing Needs

Judging the pumphead only, manufacturing needs for the Maldev are simple, and it earns a oo rating for manufacture in countries with moderate or high levels of industrial development (Categories 2 and 3), reducing to o for Category 1 (low industrial base), because of the demonstrated need for good quality jigs to ensure reasonable bearing performance.

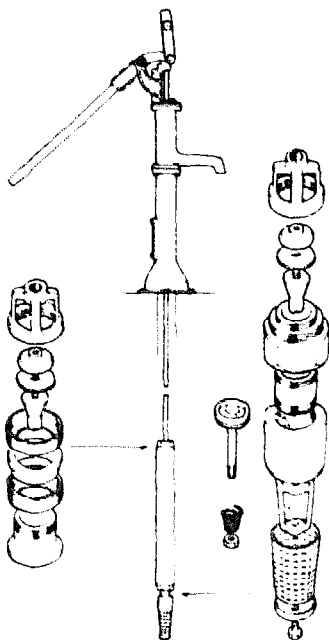

General Description

The Monarch is a conventional deepwell pump with a cast iron pumpstand and integral cast iron pedestal. A plastic guide bush and gland ensure that the upper pumprod moves in a straight line, and the steel handle is attached by a swinging link. Handle bearings are sealed ball races. A T-bar handle is offered for two-person operation at higher lifts.

The brass tube cylinder has a gunmetal plunger with two leather cupseals. A footvalve is incorporated in the lower cylinder end cap and there is a second footvalve with O-ring seal below the cylinder. Several cylinder diameters are available to suit different depth ranges, and pumprods can be supplied as galvanized steel, stainless steel, or glass fiber reinforced plastic (GRP).

Manufacture

High quality iron and gunmetal foundry work is required to ensure the interchangeability of spare parts and the correct functioning of the pumphead.

Suppliers

Monarch Industries Ltd, 889 Erin Street, Winnipeg, Manitoba, Canada.

Indicative prices - Feb 1985

Pump plus 2.25 inch cylinder	US\$ 300
Pumprod (GRP) per meter	US\$ 2.60
Rising main per meter	US\$ 8.80

Laboratory Tests

Date tested: 1984/85

Reported: World Bank Applied Technology Note No. 2

Performance data (typical values) - 2.25 inch dia cylinder

Head (meters)	7	25	45
Pumping rate (cycles/min)	40	41	40
Volume/min (liters)	14	15	14
Input (watts)	43	92	138
Mechanical efficiency (%)	37	66	76
Maximum handle force (kg-f)	6	13	20
Footvalve leakage (ml/min)	No significant leakage		

Note: The volume discharged per stroke was about 0.35 liters, and was not affected by pumping rate.

Evaluation

The Monarch handpump was originally tested by CATR in 1979/80, as part of the ODA program. Since then, the manufacturer has introduced a number of modifications. The present samples were supplied with 2.25 inch Clayton Mark cylinders.

The two samples were well packed, though the single packing case with a weight of 289 kg was difficult to manhandle and might be damaged by rough treatment. Both samples had some free movement in the handle pivot bearings, and the trunnions for attaching the pumprods to the handle link were not square with the rods.

A comprehensive instruction manual is available, in English and French and includes a useful checklist of possible troubles and remedies. For developing countries, more illustration and less text may be more appropriate.

Lifting tackle is essential for pump installation, in addition to the comprehensive tool kit supplied with the pumps. In some installations it may be necessary to cut and rethread the pumprod.

Pumpstand maintenance generally should require only basic tools, though a drift may be needed to remove and replace handle bearings. Below-ground maintenance, such as footvalve repair or replacement of leather cupseals involves extraction of the rising main and therefore requires lifting tackle. Use of two footvalves can give rise to unnecessary problems. If the upper footvalve fails but the lower one continues to function, broken parts can damage the cylinder, plunger and seals.

The 4000 hour endurance test was carried out at 40 cycles per minute, with a simulated head of 45 meters. No

breakdowns occurred in the 4000 hours. The misalignment of the pumprod trunnion caused it to move sideways at each stroke reversal, resulting in a knocking noise and wear on one side of the guide bushes.

In the final inspection, handle bearings were found to be loose in their recesses and the shoulder bolts were loose. The galvanized steel pumprod was severely corroded immediately above the plunger and the iron nipple between the cylinder base and the lower footvalve was also badly corroded. The lower leather cupseal was split, but otherwise the plunger and both footvalves were in good condition and there was little sign of cylinder wear.

In the impact test, the pumpstand broke above the baseplate at an impact of 150 Joules (the normal maximum impact is 500 Joules). The fracture appeared to originate at the inspection hole. Because of this failure, no handle impact test was carried out, but the handle completed the 96,000 cycles of the handle shock test without failure.

Users found the pump comfortable and easy to use.

The overall conclusion of the laboratory tests was that the Monarch is easier to operate at 45 meters depth than many other pumps. The cast iron pedestal needs strengthening to withstand accidental impact or abuse, but otherwise the pump proved reliable. One footvalve would be sufficient.

Corrosion can be expected to cause problems in aggressive waters, though the availability of alternative pumprod and rising main materials should alleviate some of them.

Monarch P3

Field Trials

Test conditions

Country	Number of pumps	Head range (meters)	Data available (months)
Ghana	65	6-20	22

A total of 65 Monarch P3 pumps with 3/4 inch guide rods have been monitored in the Bolgatanga region of northern Ghana. The pumps were equipped with 3 inch diameter cylinders, 7/16 inch diameter galvanized pumprods, and 1.5 inch diameter galvanized rising mains.

On installations below 15 meters, heavy lifting equipment was needed to install the pumps, which also need special tools for assembly of the pumpstand.

Maintenance of downhole components also means the use of lifting tackle, as the complete assembly has to be removed to change seals or repair valves.

The 3 inch cylinder gives the Monarch a good discharge rate — in the range of 1.0 to 2.0 m³/h, which proved popular with users. Nine pumps were fitted with water meters, and the amount of water pumped per day ranged from 2.8m³ to 10m³, with an average of 6.8m³. Those results covered the six months from April to September 1986. In March 1986, one Monarch P3 reached an average daily discharge of 16.5m³.

During the 22 months of monitoring, the 65 pumps suffered a total of 58 breakdowns and needed 61 further interventions to correct poor performance.



Breakdowns were caused mainly by disconnected pumprods, broken guide rods, broken pumprods, loose piston rods, and loose followers. The main causes of poor performance were broken shoulder bolts, poor well yield, damaged shackle bearings, defective footvalves, leakage at rising mains/couplings, leather cupseals, and damaged fulcrum bearings. The broken guide rods generally resulted from broken shoulder bolts or damaged shackle bearings, and led the manufacturer to redesign the pumphead. Since modifications were made, pumphead defects have fallen substantially.

Three of the Monarch pumps were equipped with GRP rods, which performed without breakdown for the 21 months during which they were monitored.

CAUSES OF ESSENTIAL INTERVENTIONS

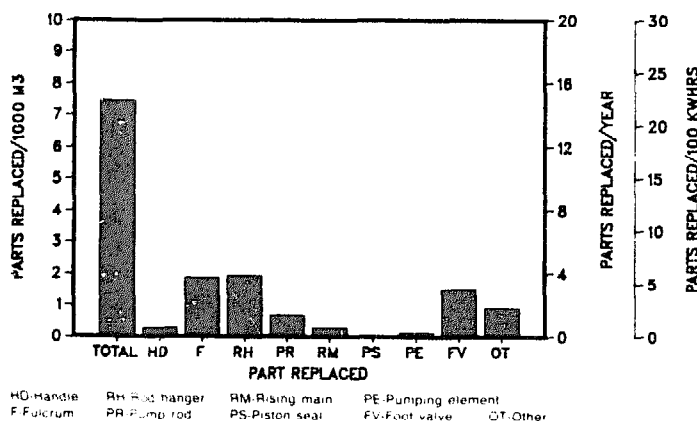

Assessment

The Monarch P3 ratings are based on laboratory and field test results.

Discharge Rate

With the right choice of cylinder size, to suit the pumping lift, the Monarch P3 is capable of achieving a "good" (oo) discharge rate for the full range of pumping lifts.

Ease of Maintenance

The relatively complicated pump-head and the need for lifting tackle and special tools makes the Monarch "unsuitable" (—) for village-level maintenance irrespective of depth. Area mechanics would need support from mobile teams for repairs at 25m and 45m. The rating for maintenance System B is therefore reduced from oo to "adequate" (o) for these lifts.

Reliability

On the basis of interventions needed during the field trials, the pump earns a oo rating for reliability at 7 and 12 meters lift and daily outputs up to 4m³/d, reducing to o for higher lifts and discharges and to — for 45m lifts and for a daily output of 8m³/d at 25m lift. The improved version of the pump is likely to achieve better ratings.

Corrosion Resistance

The standard version of the Monarch P3 is rated unsuitable for use with corrosive water because of its galvanized pumprods and rising mains. Alternative materials are available as options.

Abrasion Resistance

There were no seal failures during the laboratory tests, and few in the field trials, but use of leather cupseals means a — rating.

Manufacturing Needs

Manufacture of the Monarch P3 demands strict quality control and a high level of foundry skills. It is not therefore suitable for manufacture in a country with a low level of industrial development (Category 1). The o rating under Category 2 indicates that some external assistance may be needed with quality control. The rating for Category 3 is oo.

United Kingdom

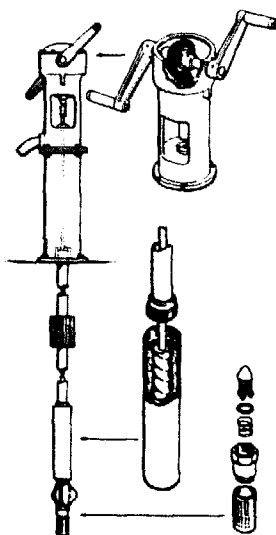

General Description

The Monolift is a positive displacement deepwell handpump of the established Mono progressing cavity design, with a double helical steel rotor and a triple helical elastomeric stator. Two rotary crank handles allow one or two people to operate the pump. Drive is through bevel gears, with a ratchet mechanism to ensure correct rotation. The pedestal is fabricated steel. Steel gears in an oil-filled gearbox were for a time replaced with thermoplastic gears requiring no lubrication, but Mono has now reverted to metal gears, this time using a long-lasting grease lubricant.

Pumping elements are designed for water temperatures of 16-40°C. A proprietary all-plastic footvalve is fitted.

A *direct drive* version of the pump, with no gearbox and the handle connected directly to the pumprod is available from Mono Pumps (Africa) in Zimbabwe and South Africa.

Manufacture

Special skills and equipment are required to make the pumping element and the gearbox.

Suppliers

Mono Pumps Ltd, Arnfield Works, Audenshaw, Manchester M34 5JA, UK.

Indicative prices - Feb 1985

Complete assembly to	
3meters depth	US\$ 353
Extra rods per 3 meters	US\$ 16

Laboratory Tests

Date tested: 1984

Reported: Handpumps Project Report No.4

Performance data (typical values)

Head (meters)	25		45		60
	3:1	2:1	3:1	2:1	
Gearbox ratio	3:1	2:1	3:1	2:1	2:1
Pumping rate (cycles/min)	40	40	40	40	40
Volume/min (liters)	16	10	16	10	9
Input (watts)	135	89	191	125	139
Mechanical efficiency (%)	48	48	59	61	65
Maximum handle force (kg-f)	15	10	20	14	15
Footvalve leakage (ml/min)	No significant leakage				

Evaluation

The Monolift was originally tested in 1983/4, when only a 3:1 gearbox was available. Performance and user tests were repeated more recently on a modified version of the pump with both 3:1 and 2:1 gearboxes, thermoplastic gears, a modified pumpstand and handle arrangement, and a new compound for the stator.

The Mono Direct Drive pump manufactured in South Africa has also been tested in the laboratory. This report combines results from the three sets of laboratory tests, to give an overall evaluation of the Mono pump types. The figures in the performance table above are from the later model of the Monolift and were generally the same as or better than those in the original trials.

Installation and maintenance of the Mono pump requires lifting equipment and skilled mechanics. Workshop facilities are needed to repair gears and pumping elements must be replaced entirely when faulty.

The older design of the Monolift was subjected to **endurance testing** at 40 cycles per minute with a simulated head of 45 meters. The pump completed the tests without failure, except for wear of an unlubricated handgrip during the first 100 hours.

At the end of the 4000 hours, the outer surfaces of the rotor helix were scratched and the inner surfaces had deposits of rubber from the stator, but the pumping element was still serviceable. There was some **corrosion** of the pumping element end caps, but otherwise no noticeable corrosion.

The pumpstand withstood the **impact tests** without damage.

Some **users**, particularly small children, found the old design difficult to operate. The shorter pedestal and handle modifications have made the new model

easier to use, and children much preferred the 2:1 gearbox (intended to extend the pump's range beyond 45 meters).

The **overall conclusion** of the laboratory trials was that the Monolift is a robust pump, suitable for community water supply use at depths of 20-45 meters, but not suitable for village-level maintenance. The optional 2:1 gearbox extends the range beyond 45 meters and the new version is more suitable for children.

The Mono Direct Drive

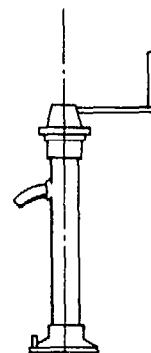

Laboratory **users** did not like the operation of the direct drive pump, finding it difficult to sustain effort through a complete revolution.

The pump also performed badly in **endurance tests**, with failures in both the drive head (now redesigned) and the pumping element, suggesting that frequent attention might be needed in community water supply use. The delivery rate was low, without the advantage of the gearbox.

The laboratory concluded that considerable further development would be needed to make the pump suitable for community water supply.

Field Trials

Test conditions

Country	Number of pumps	Head range (meters)	Data available (months)
China	10	9-60	12
Bolivia	19	10*	10

* Average lift

Only a few Monolift pumps have been monitored as part of the Project, and the field information is supplemented with reports received from other users.

In general, the Monolift is a popular pump with users, who find the discharge rate and the reliability acceptable and tend to favor the pump over equivalent lever action pumps.

In China, where the pumps were very heavily used — serving 200 users per pump and operating from sunrise to sunset — the Monolift and the Kardia (Pump 12) were the most popular pumps in the trials.

However, the China trials also revealed flaws in the thermoplastic bevel gears which were introduced for a short time by the manufacturer. The gears and the ratchet system used with them did not prove durable enough. Similar problems have been reported to the Project from the Sudan, where about 100 Monolifts with thermoplastic gears also suffered failure within four to six months of installation.

The Monolift is a pump in which key



parts — the pumping element and the gears — are replaced rather than maintained. Long service life is therefore critical in village use. The manufacturer has now ceased manufacture of pumps with thermoplastic gears and is offering replacements to existing users. The new gears are metal castings with a stainless steel shaft and a new non-return mechanism.

The pump's below ground components are durable, and the progressing cavity design is comparatively resistant to sand pumping, but maintenance when needed is difficult and requires a fully trained mobile team.

Assessment

The Monolift ratings are based on laboratory tests and limited monitoring in field trials.

Discharge Rate

For low lift applications, where overcoming friction in the pumping element represents a significant part of the pumping effort, the pump would have to be worked very hard to deliver enough water to compete with pumps designed specifically for shallow lifts. In deep wells, the Monolift can compete more readily and earns an "adequate" (o) rating for all but the 7m lift.

Ease of Maintenance

Maintenance is complex and requires special skills and equipment. The pump is not suitable for village-level or area-mechanic maintenance.

Reliability

The Monolift is a durable pump and earns a "good" (oo) rating for lifts up to 25 meters and daily outputs up to 4m³/d. For 45m lifts or for 8m³/d output its rating is reduced to o.

Corrosion Resistance

With galvanized pump rods, the Monolift is not suitable for use with corrosive water.

Abrasion Resistance

The progressing cavity design copes well with sand-laden water, and earns the Monolift a oo rating for abrasion resistance.

Manufacturing Needs

Specialized processes are involved in the manufacture of the pumping element and very tight quality control is essential. The gearbox too requires tight quality control. The Monolift is not therefore suitable for manufacture in a developing country which does not have an advanced industrial base. However, manufacture of the Direct Drive Mono pump in Zimbabwe shows that there is scope for joint-venture type manufacture, and the pump is therefore rated oo under manufacturing environment 3.

CAUSES OF ESSENTIAL INTERVENTIONS

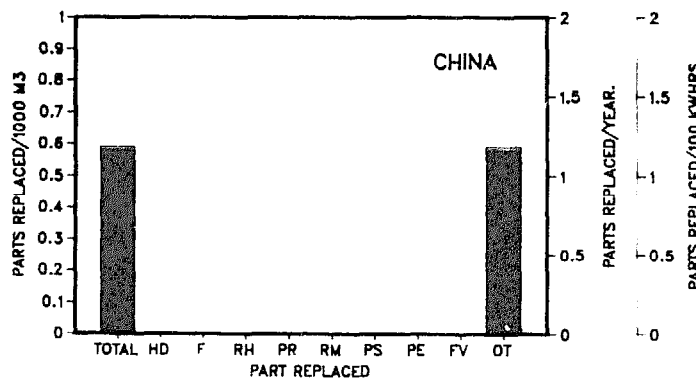

HD-Handle
F-Fulcrum
RH-Rod hanger
PR-Pump rod
RM-Rising main
PS-Piston seal
PE-Pumping element
FV-Foot valve
OT-Other

Canada, United States

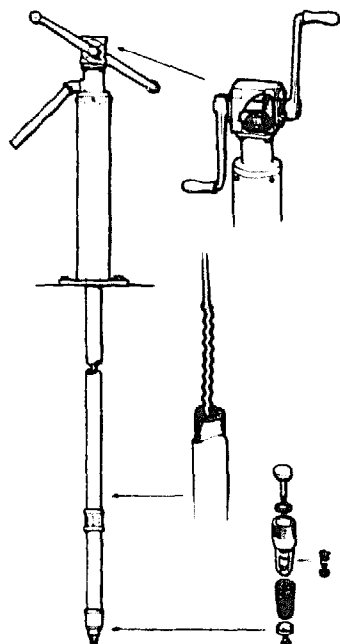

General Description

The Moyno is a progressing cavity deep-well handpump with a helical rotor turning in a double helical stator. A pair of rotary crank handles means that the pump is suited for one or two person operation. Drive is through bevel gears in a gearbox prepacked with lubricant, and a one-way clutch to ensure correct rotation.

The pumpstand is all-steel construction and very robust. The footvalve is gunmetal. The steel rotor is chrome or nickel plated. The Moyno can be installed in a 75mm diameter well, and two pumping elements are available — a single-stage for depths down to 45 meters, and a double-stage, said to be suitable to 90m.

Manufacture

Highly specialized skills and equipment are needed to manufacture the pumping element and the gearbox.

Suppliers

The current model is made in Canada, though an earlier model was made in the USA and future production could be in either country. Manufacturer is Robbins and Myers (Canada) Ltd, PO Box 280, Brantford, Ontario N3T 5N6, Canada.

Indicative prices — Aug 1986

Single-stage unit to 45m US\$ 410

Laboratory Tests

Date tested: 1983 (US model) plus 1985 engineering assessment of Canadian model.

Performance data (typical values)

Head (meters)	7	25	45
Pumping rate (cycles/min)	40	40	40
Volume/min (liters)	9	8	7
Input (watts)	45	59	91
Mechanical efficiency (%)	22	59	58
Maximum handle force (kg-f)	9	10	14
Footvalve leakage (ml/min)	No significant leakage		

Note: Operating force must be sustained throughout the working cycle.

Evaluation

The two test pumps were delivered in cartons made from heavy-duty corrugated cardboard and reinforced with a wooden pallet. Both pumps were in good working order; one footvalve was bent but was easily straightened.

No instructions were provided for installation or maintenance, though a well-illustrated Installation and Maintenance manual is available from the manufacturer. A number of tools were supplied, including a die and diestock for threading the pumprod. The weight of the below-ground assembly means that lifting tackle is essential for installation, which requires skill and understanding of the pump. It is especially important that the pumprod is cut to length and threaded accurately.

Frequent maintenance is unlikely to be required. A broken handle could be easily replaced, but repairs to the gearbox could not be undertaken in the field. If the pumping element is faulty it must be replaced as a complete unit, which requires lifting gear and the availability of a replacement unit. In general, the Moyno requires an exchange rather than a repair-based routine.

The 4000 hour endurance test was carried out at 40 cycles per minute, with a simulated head of 45 meters. The pump failed once in the test. After about 3000 hours, a rubber block, intended to prevent the rotor from striking the base of the cylinder during installation, became entangled in the rotor and caused the pump to seize. The cylinder has since

been modified to eliminate the rubber block.

Grease leaked out of the gearbox throughout the test, but plenty remained at the end. Both rotor and stator were in good condition after the test. A considerable amount of sand was lodged in the footvalve, but it was still working. There was no corrosion of the working parts of the pump, but the paint on the cylinder barrel had not stopped some rust from forming there.

Heavy impacts on the body of the pumpstand produced no damage. Users consistently disliked the pump. Most of the required effort has to come from the arms and shoulders; there is little opportunity to bring other muscle groups into play. Smaller users, with limited reach, could not maintain a smooth circular motion of the handles. Though the absolute values of the required operating force do not seem great, people found it difficult to sustain the same effort throughout the pumping cycle.

The overall conclusion of the laboratory tests was that the Moyno would not be suitable for community water supply, except in unusual circumstances. Though the pump proved reliable in the laboratory endurance test, the rate of discharge is small — significantly less than the other progressing cavity type pump tested by the Project, the Monolift (Pump 16). The Moyno is difficult and expensive to install, maintain and repair, and is unsuitable for manufacture in developing countries.

Moyno

Field Trials

Test conditions

Country	Number of pumps	Head range (meters)	Data available (months)
Burkina Faso	50	8-40	40
Cote d'Ivoire	14	10-39	12
Ghana			
Kumasi	57	1-35	33
Bolgatanga	68	5-22	31

The Moyno had technical problems in the early stages of the Burkina Faso and Ghana (Kumasi) field trials. Main failures involved scaling of the rotor nickel plating, clutch failure, and wear of handle keys. The manufacturer reverted to a previous design with chrome plating, which overcame the scaling problems.

The modified pumps proved quite reliable and were generally well accepted by the users. The outstanding remaining problem is corrosion of the galvanized pumprods and rising mains. This has led to pumprod breakages, and to corrosion particles from the pumprods and rising mains jamming the pumping element or blocking the footvalves. Taste problems caused by corrosion products have led to some pumps being disliked by users.

In the Ghana (Bolgatanga) field trial, the Moynos are equipped with 1 inch rising mains. This has led to damage to the rising mains and to pumprods and rod couplings



which rub on each other. The result has been rod disconnections or breakages and leakage through the rising mains.

In terms of pump performance, wear of the thrust spacer and leakage turned out to be the most frequent causes of essential interventions.

In field operation, the discharge rate of the Moyno is in the range of 0.5 to 0.8m³/h. The average daily output of the Bolgatanga pumps between April and September 1986 was 4.5m³. The pattern of pump use in Burkina Faso is similar to that in northern Ghana and involves much heavier use than that in southern Ghana and Cote d'Ivoire, with high seasonal fluctuations. During the dry season, maximum daily quantities pumped with Moynos in northern Ghana and Burkina Faso reached 12m³.

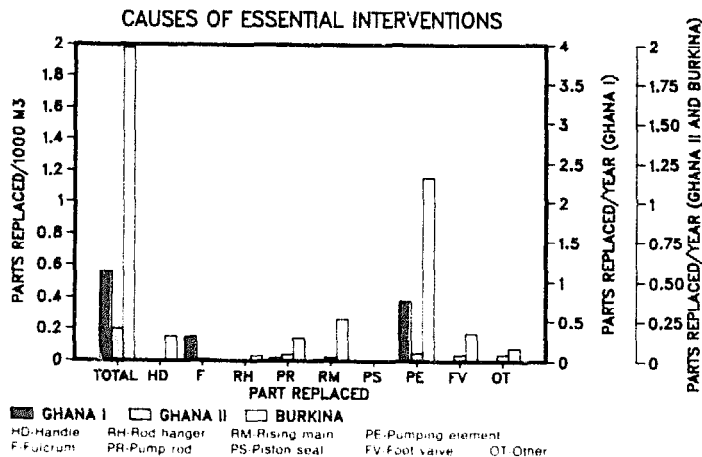

Assessment

The Moyno ratings are based on the pump's performance in both field trials and laboratory tests.

Discharge Rate

The Moyno's comparatively low discharge rate mean that it cannot compete with the many high discharge pumps available for low lift applications. For 25 and 45 meter lifts, the pump achieves an "adequate" (o) rating.

Ease of Maintenance

Servicing of the Moyno is complex and requires special tools and equipment. It is "unsuitable" (—) for village-level (system A) or area-mechanic (system B) maintenance.

Reliability

On the basis of the number of interventions needed during the field trials, the Moyno earns a "good" (oo) rating for reliability for discharges up to 4m³/d. For 45m lifts or for 8m³/d output its rating is reduced to o.

Corrosion Resistance

Use of galvanized pumprods and rising mains means a that the Moyno is unsuited for use with corrosive water.

Abrasion Resistance

The progressing cavity design copes well with sand-laden water and earns the Moyno a oo rating.

Manufacturing Needs

Specialized processes are involved in the manufacture of the pumping element and very tight quality control is needed. The gearbox is complex and also demands tight quality control. The Moyno is therefore not suitable for manufacture in a developing country which does not have an advanced industrial base, and even then would require close collaboration with the original manufacturer. The pump therefore earns a o rating only for manufacturing environment 3.

Finland

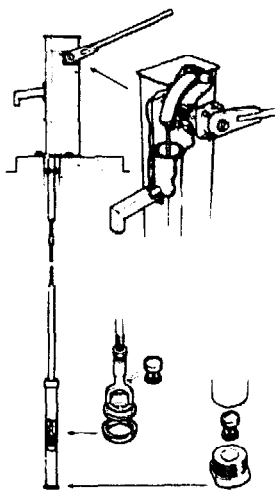

General Description

A deepwell lever-arm force pump, which can be supplied with cylinders of 60mm or 50mm. The pumpstand is mainly fabricated from steel sheet, galvanized, and enclosing a molded rubber delivery cup attached to the top of the rising main. The stainless steel pumprod is connected to the handle through a flexible strap wrapped round a quadrant, so the pump has a gravity return. Handle bearings are large ball races in flanged housings.

Stainless steel, polyethylene or galvanized steel rising main can be used. The cylinder is a drawn brass tube with gunmetal endcaps. The plunger is also gunmetal with a molded rubber cupseal. The molded polyurethane poppet valves are identical in the plunger and footvalve.

Manufacture

The pumpstand needs steel fabrication skills. Well equipped workshops with high quality control are needed for cylinder manufacture.

Suppliers

Vammalan Konepaja Inc, 38200 Vammala, Finland.

Indicative prices - Sep 1986

Per unit for 40m depth		
stainless steel rising main	US\$	1396
Polyethylene rising main	US\$	1188
Galvanized rising main	US\$	1123

Laboratory Tests

Date tested: 1986

Reported: Report not yet published

Performance data (typical values) — 60mm cylinder

Head (meters)	7	25	45
Pumping rate (cycles/min)	41	40	39
Volume/min (liters)	23	22	21
Input (watts)	90	163	223
Mechanical efficiency (%)	29	55	60
Maximum handle force (kg-f)	13	20	27
Footvalve leakage (ml/min)	No significant leakage		

Evaluation

The two test pumps were securely packed in wooden cases, and were generally in good condition on arrival, though the threaded studs on the bottom of the pumpstand delivery pipe were not straight in one sample. The manufacturer later supplied polyurethane valve poppets to replace the rubber valves in the original consignment.

Installation instructions were supplied in English and were comprehensive and helpful. A full set of tools was also provided. Installation was easy. Lifting tackle would be needed for galvanized steel rising main and for stainless steel at deep settings, but is unnecessary for polyethylene.

Maintenance instructions were very brief. The entire below ground assembly must be extracted to service the piston or footvalve, but this was easier than for many deepwell pumps because of the relatively light weight of the pumprods and rising main. The pumpstand design allows extraction of the rising main without removing the pump from the wellhead.

The 4000 hour endurance test was carried out at 40 cycles per minute, with a simulated head of 40 meters. A weight of 20kg was added to the pumprod to maintain tension in the strap connecting the rod to the handle.

There were persistent failures of the original molded rubber poppet valves, for which the included angle of the seat was 60°. The poppets tended to extrude into the valve seat under the pressure of the water column. Moldings in a harder grade of rubber were unsuccessful. In consultation with the manufacturer, the rubber valves were replaced with polyurethane moldings, both for this pump and for the Nira AF85 direct action pump (Pump 32).

At the same time, the included angle of the valve seat was increased to 90°.

At the end of the test, the plunger and cylinder were in good condition. There were few signs of wear on the valves, though cracks had begun to appear around the integral retaining rings at the base of the polyurethane poppets.

The manufacturer has since made further modifications to the valves, to eliminate the need for integral retaining rings.

There was no corrosion. The pumpstand was in good general condition, but there were signs of wear on both the connecting strap and the pumpstand body, as a result of misalignment during manufacture.

The pumpstand body proved strong in the impact tests. The handle was less robust however: heavy impacts on the handle caused it to bend slightly, though the pump could still be used without difficulty. But in the handle shock test, the handle broke at the weld near the pivot bearings after 67,000 of the allotted 96,000 cycles.

In the user test, the pump was generally well received by both adults and children. Adults tended to use a full stroke, whereas most children adopted a faster short-stroke technique.

In the overall conclusion of the laboratory tests it was noted that the AF84 requires heavy rods or a deep setting to ensure that the flexible strap connecting the handle to the pumprod remains taut while pumping.

The final design for the plunger and footvalve should make a substantial contribution to the pump's overall reliability, but the Nira AF84 is unlikely to be reliable if it is subjected to abuse or heavy-handed use.

Nira AF84

Field Trials

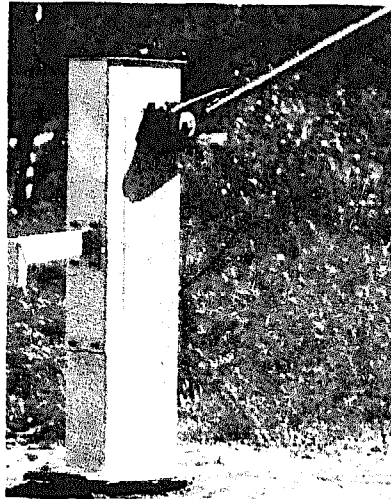

THE NIRA AF84 PUMP WAS NOT FIELD TESTED BY THE HANDPUMPS PROJECT

Assessment

In the absence of field trials, ratings for the Nira AF84 are based on performance in the laboratory tests and on the experience and judgment of Project staff.

Discharge Rate

The comparatively high effort needed to obtain high output restricts the rating to "adequate" (o) for all lifts.

Ease of Maintenance

The pump is not suitable for maintenance by a village caretaker (System A) even at shallow settings. However, area mechanics (System B) and mobile teams (System C) will find the pump straightforward. The rating for both these systems for lifts up to 12 meters is "good" (oo), reducing to o at 25 meters or more for System B, reflecting the fact that lifting tackle may be required.

Reliability

In the laboratory tests, problems with the initial rubber valves cast doubts on the pumps reliability. With the improved design, the pump is expected to be more reliable and earns a oo rating for most installations, reducing to o for a discharge of $8\text{m}^3/\text{d}$ at lifts of 7 to 25 meters and for $4\text{m}^3/\text{d}$ at 45 meters lift.

Corrosion Resistance

All parts of the pump are made from corrosion resistant materials and it earns a oo rating.

Abrasion Resistance

The pump did not suffer abrasion during the laboratory tests. The cupseal is molded rubber and the cylinder is drawn brass. The abrasion resistance rating is therefore o.

Manufacturing Needs

Manufacture of the Nira AF84 requires facilities and skills which would not be available in a country with a low industrial base (category 1). However, much of the pump could be made in countries with medium-level industrial development (category 2). The ratings for categories 2 and 3 are therefore o and oo respectively.

Philippines

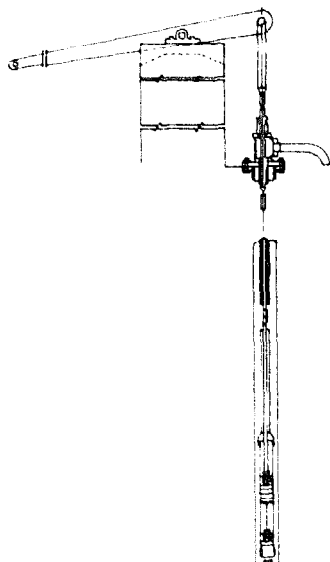

General Description

The locally made pumphead (lph) is used in the Philippines with either the locally made Eureka or the Japanese made Takasago cylinder. The lph can be made from standard "off-the-shelf" hardware and plumbing supplies, though an assembly drawing and a complete set of parts except for the wooden handle and grip can also be provided by local companies or by Takasago.

The lph consists of a concrete pedestal, a very long wooden handle, and

Laboratory Tests

The complete configuration of the local pumphead with either the Eureka or Takasago cylinders was not tested by the Project in the laboratory. However, a laboratory test of the Eureka cylinder connected to a Philippine made Jetmatic pumphead (Pump 11) was performed in 1981 and reported in Project Report No. 1.

Much of the data on the Eureka cylinder would not be applicable to the case where it is connected to a local pumphead. However, it is notable that

after only 280 hours of endurance testing, the Eureka cylinder, which was secured in the rising main with an expanding rubber bush, as specified by the manufacturer, became dislodged, preventing effective operation of the pump.

The smoothness of the brass cylinder wall was found to be excellent and the mechanical efficiency of the unit was very good (71% when operated at 30 strokes per minute with a lift of 45 meters).

some pipe fittings and bolts to form a pumphead and spout. The long handle has a high mechanical advantage and thus reduces the required operating force to a manageable level even when pumping from very high lifts (the Project has monitored lifts of over 80 meters). Handle length and mechanical advantage vary from one installation to another. In the field trials the ranges were 3.7 to 4.9 meters handle lengths and 11:1 to 15:1 mechanical advantages.

The Takasago model HW-C65 cylinder, is a conventional design, but has an open top to allow extraction of the plunger for maintenance. The 24 inch long brass cylinder has a 2-1/4 inch inside diameter and is intended for connection to a 2-1/2 inch galvanized steel rising main. The plunger is also made from brass and uses a sequence of four leather cupseals. It is specified for 5 inch nominal diameter wells and a maximum recommended lift of 45 meters (though in practice it is used for greater lifts).

The Eureka (also known as the US Champion Eureka) cylinder is similar in design to the model with the same name made by Clayton Mark in the USA. The brass cylinder is available in nominal diameters of 2, 2-1/2 and 3 inches. Those monitored by the Project had a diameter of 46mm and were designed for installation in a 2 inch rising main.

The bottom of the plunger is tapered to allow it to be screwed onto a threaded receiver protruding from the footvalve. The aim is to allow extraction of the plunger and footvalve through the open-topped cylinder without removing the rising main. A spring "dog" holds the cylinder in the rising main and it is sealed

in place by rotating the cylinder and so expanding a rubber sealing ring against the inside of the main. The footvalve fits in a taper in the bottom of the cylinder. The plunger has two leather cupseals.

Manufacture

The pumphead is specifically intended for local manufacture in the Philippines and could be made locally in other developing countries, even with only low level industrial bases.

The Eureka cylinder is manufactured in the Philippines. It demands at least a medium level of industrial development with good quality control of brass machining. The Takasago could also probably be manufactured under similar conditions, though it is presently imported from Japan (there are also some unauthorized and inferior local versions).

Suppliers

Local pumphead components: There are several manufacturers, including Atlanta Vinyl Corporation, 97 9th Avenue, Grace Park, Caloocan City, Philippines.

Eureka cylinder: Malanday Machinery & Mfg Corp, Km 15 McArthur Hi-way-A, Banco Street, Dalandaman, Valenzuela, Metro Manila, Philippines.

Takasago cylinder: Takasago Pump Co Ltd, No. 10-24 Osaki 1-chome, Shinagawa-ku, Tokyo, Japan.

Indicative prices - Apr 1985

Eureka cylinder, including plunger and footvalve	US\$ 40
--	---------

Prices not provided for other components.

Philippines Deepset

Field Trials

Test conditions

Country	Number of pumps	Head range (meters)	Data available (months)
Philippines			
Eureka	62	8-42	24
Takasago	64	1-112	24

Statistical analysis of the field data, including graphical presentation, was not considered justified, because the data were incomplete. Factors affecting the lack of data included many repairs which were carried out in the field without the presence of the Project's Country Monitoring Engineer (CME) and without consistently informing the Project. The following commentary is based on observations which can be reliably reported.

In most respects, the local pumphead performs well. It is well accepted by users, though it is very difficult for children to reach the long handle. Parts which require most frequent replacement are the wooden handle and the top guide bushing. Nuts, bolts and fulcrum pins have also required occasional replacement. Replacements are relatively simple to undertake and parts can be obtained locally. The handle is the most expensive of the commonly needed spare parts, costing about US\$7-11, depending on the length and local prices. The large concrete pedestal adds to the cost.

The Takasago cylinder has performed well. Units with this cylinder have been intensively used, despite the high lift conditions in which many of them have been installed. Typically, they have served about 20 families per pump, and during the dry season about 4.3m³/d has been pumped (with the consumption ranging from 30 to 50 liters per capita).

The most common repair needed has



been replacement of the plunger seals. Data are not conclusive, but it appears that seal replacement frequency is less than on other pumps, and in other respects too the cylinder can be rated highly.

In practice, the Takasago footvalve is not extractable after 6-12 months service, because the leather seals swell and jam it in position. Also threads on the protruding taper corrode.

The Eureka cylinder has proved somewhat problematic. Repairs to the pumping element have been required about twice a year (about 2.5 times per 1000m³ pumped). Although typically installed at lesser lifts than the Takasago, where it could be expected to be easier to operate and subject to less wear, it has in fact been less intensively used and required more repairs than the Takasago. Eureka installations have generally served about 15 families per pump, and pumped about 2.2m³/d (a consumption range of 20 to 30 liters per capita per day).

Overall, the Eureka cannot be recommended. The expanded rubber rings jammed in the rising main and made removal impossible. The design has inherent inadequacies and manufacturing quality control is doubtful.

A number of modifications could be instituted to improve the durability of the combined unit, which would also be enhanced by improved manufacturing quality control and better installation procedures.

Assessment

The ratings for the Philippines Deepset pump are generally based on the performance of the Takasago cylinder with a local pumphead. The Eureka cylinder cannot be recommended, as its performance in laboratory and field trials revealed design inadequacies and a high frequency of repairs.

Discharge Rate

For deep settings, the pump achieves a comparatively high discharge and earns a "good" (oo) rating. It cannot easily accomplish the higher discharges needed for a oo rating at lower lifts, where the rating drops to "adequate" (o).

Ease of Maintenance

Though the concept of a local pumphead and extractable cylinder and footvalve should make the pump suitable for village-level maintenance, practice shows that this is not the case. The oo rating for maintenance system B at 7m and 12m lifts, drops to o for lifts of 25m and 45m.

Reliability

For low lifts and low discharges, the Takasago cylinder and local pumphead earn a oo rating, but higher repair frequencies mean a o rating for 4m³/d output up to 25m lift, and the pump is not recommended for higher lifts or discharges.

Corrosion Resistance

The pump has no special protection against corrosion and cannot be recommended for situations where groundwater is corrosive.

Abrasion Resistance

Use of leather cupseals means a — rating for abrasion resistance.

Manufacturing Needs

The pumphead can be manufactured locally in most developing countries, earning the pump a o rating for countries with a low industrial base (level 1). Moderate industrial development should ensure satisfactory manufacture of the cylinders, giving a oo rating for levels 2 and 3.

The Netherlands

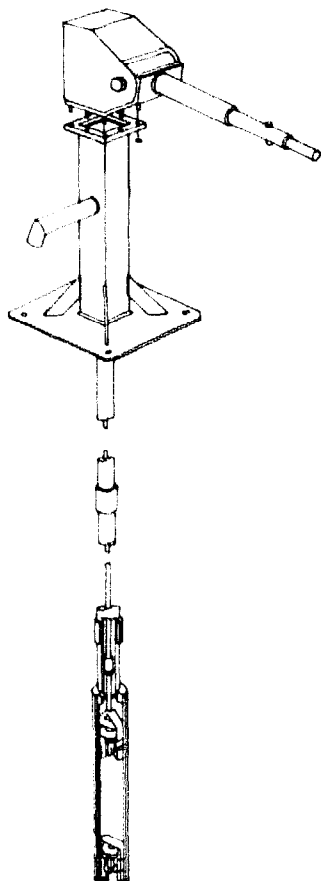

Laboratory Tests

THE SWN 80 & 81 PUMPS HAVE NOT BEEN TESTED IN THE CATR LABORATORY

General Description

The SWN is a lever-operated reciprocating deepwell pump constructed of fabricated steel. It is designed to be fitted with ball bearings or polymer journal bearings at the fulcrum and rod hanger. The manufacturer suggests that these might also be replaced in the field with locally-made hardwood bearings.

The SWN 80 is the shallow-lift version of the pump, with a recommended maximum lift of 25 meters. The SWN 81 is for deeper lifts (25-50m). It has more substantial bearing assemblies and is generally a more robust pumphead. An adjustable counterweight handle is used on the SWN 81 to balance the additional weight of pumprods at greater depth.

Below-ground components, which are also used on the Kangaroo pump (Pump 30) made by the same company, consist of a PVC cylinder, a plunger and footvalve made from stainless steel and

nylon, and a bi-directional elastomeric seal. Valves are brass, with neoprene on the sealing faces. Pumprods are encased in polyethylene tubing to prevent abrasion of the thick-walled (48/36mm) PVC rising main. In the SWN 81, the PVC cylinder is reinforced with stainless steel bands.

Conversion units are available to make the pump suitable for pressure discharge to a storage tank, or for use as a suction pump, but these have not been tested as part of the Project.

Manufacture

The pumpstand requires steel fabrication, turning and welding, with good quality control. For the below ground assembly a high level of machining skills and quality control are essential.

Suppliers

Van Reekum Materials BV, Kanaal Noord 115, Postbus 89, 7300 AB Apeldoorn, The Netherlands.

Indicative prices - Apr 1985

SWN 80	
with ball bearings	US\$ 630
with plastic bearings	US\$ 609
SWN 81	
with ball bearings	US\$ 945
with plastic bearings	US\$ 1085
Riser/rod combination in 3m lengths	US\$ 94
Cylinders	
2 inch diameter	US\$ 230
2.5 in. diameter	US\$ 287
3.5 in. diameter	US\$ 336
4 inch diameter	US\$ 575

SWN 80 & 81

Field Trials

Test conditions

Country	Number of pumps	Head range (meters)	Data available (months)
Kenya	8	10-38	24
Tanzania	31	1-18	22



Though the field trials in Tanzania involved only shallow lifts, the combined data from Kenya and Tanzania provides a good basis for judging the performance of the SWN 80 & 81. The pump is very easy to use, with a long pumping handle and the soft pumping action resulting from elastic rising mains.

Initially, several of the Tanzania test pumps suffered rod hanger breakages caused by seizure of the polymer bearings. Increased clearance on the bushes resolved the problem. In one pump installed on a deeper than average well (water level about 15 meters) there were four broken plungers in 14 months due to stress failures. In Kenya, there have been several failures of pumprod and rising main threads in the deeper wells, though overall, the pump has proved quite reliable.

Installation and maintenance are not easy. The pumphead is heavy, which adds to the already difficult operation of screwing the pre-assembled pumprods

and rising main into the pumphead. With the added weight of downhole components at deeper lifts, the operation would be even more difficult. For maintenance, when the operation is reversed, the heavy pumphead must be lifted and supported on a temporary frame while the rising main is unscrewed.

The double acting elastomeric seal is an outstanding feature of this pump. Running in a calibrated uPVC cylinder it gives exceptional wear resistance, though in time both seal and cylinder will become worn and require costly replacement. Corrosion resistance too is excellent, all the downhole components being made from resistant materials.

The availability of different cylinder sizes means that high discharges can be achieved at shallow lifts.

In general, the Project views the SWN 80 & 81 as a very promising, though expensive pump, with the major reservation that maintenance needs appear to have been neglected in the basic design.

Assessment

The SWN 80 & 81 ratings are based on field trials at comparatively shallow depths, but with enough data available to make confident judgments on the pumps likely performance in a wide range of conditions.

Discharge Rate

The available choice of cylinder sizes means a "good" (oo) rating for all pumping lifts.

Ease of Maintenance

Consideration of maintenance needs is a major shortcoming of this pump. The method of connecting and dismantling the downhole components to and from the pumphead precludes village-level maintenance at any lift. For lifts of less than 12 meters, area mechanic maintenance (system B) is quite feasible, earning the pump a oo rating, which drops to "adequate" (o) at deeper lifts.

Reliability

The difficulty of maintenance at higher lifts, combined with the need for more frequent interventions, makes the pump unsuitable for 45 meter lifts, or for a daily output of 8m³/d at 25 meters. The rating is o for lesser daily outputs at 25m, and the pump earns a oo rating at lower lifts.

Corrosion Resistance

The choice of materials for downhole components provides excellent corrosion resistance and earns a oo rating.

Abrasion Resistance

A good design and choice of materials justifies a oo rating.

Manufacturing Needs

The number of skills and the degree of quality control needed make the pump unsuitable for manufacture in developing countries with only low industrial bases (Category 1). It is however quite suitable for manufacture in countries with moderately developed industry, scoring oo for Categories 2 and 3.

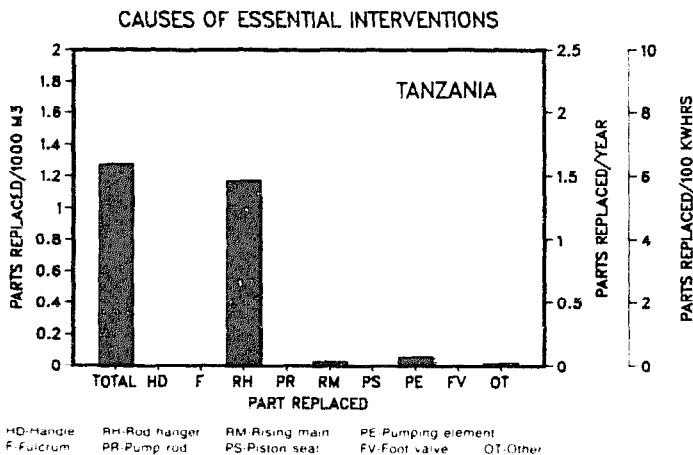

France

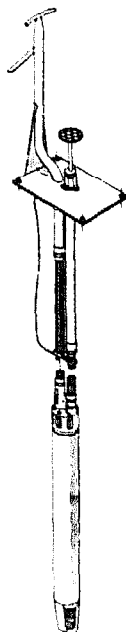

General Description

The Vergnet is a foot-operated pump working on hydraulic principles. Twin flexible polyethylene hoses connect the above and below ground units — there is no mechanical link. The pumpstand is mild steel with stainless steel and brass primary drive cylinder components. The below ground pumping element is a stainless steel cylinder with valves top and bottom and a flexible rubber diaphragm inside.

The diaphragm expands in response to internal pressure exerted by the primary drive piston in the pumpstand, displacing water from the pumping element up the delivery pipe. When foot pressure is removed, the elasticity of the diaphragm forces water back up the drive hose to lift the pedal and draws in water through the footvalve.

Manufacture

The pumpstand requires moderate skills in steel fabrication and fitting, while the pumping element demands advanced manufacturing techniques and high quality control.

Suppliers

Société Mengin, Zone Industrielle d'Amilly, 45203 Montargis, France.

Indicative prices - Feb 1985

Pumpstand and	
pumping element	US\$ 587
Twin hose (per meter)	US\$ 2.55

Laboratory Tests

Date tested: 1979

Reported: ODA Report 1981

Performance data (typical values)

	7		45	
Head (meters)				
Pumping rate (cycles/min)	36	92	24	75
Volume/min (liters)	10	24	5	14
Input (watts)	59	199	51	245
Mechanical efficiency (%)	15	14	57	44
Maximum pedal force (kg-f)	47		76	
Footvalve leakage (ml/min)	No significant leakage			

Note: The rubber pumping element has been modified since the laboratory tests, so that performance characteristics may now be different

Evaluation

At the time of the laboratory tests in 1979, the Vergnet was a relatively new design. The concept has remained essentially the same, but detailed design changes have taken place since the tests were carried out, and the laboratory findings should be viewed in that light. More recent downhole components were tested in 1982 on the ABI-ASM pump (Pump 01).

Installation of the Vergnet pump is very simple. No lifting tackle is needed, as the pumping element can be lowered down the well by hand, using the connecting polyethylene hoses. The pump is not self-priming.

The ground-level primary cylinder is also comparatively easy to **maintain**, and removal of the pumping element is a simple task, though replacement of the diaphragm with a new one is expensive. The laboratory trials indicated that the most likely maintenance needs would be replacement of the pedal rod guides and plunger seals in the primary cylinder, every 1500 to 2000 pumping hours.

The 4000 hour **endurance test** was carried out at 40 cycles per minute with a simulated head of 45 meters. The plunger guide wore badly and was replaced midway through the test, otherwise

the pump completed the test without failure. At the end of the test, there was significant leakage past the seals of the drive plunger, leading to the need to raise the pedal by hand frequently. The guides have been modified since the tests and a repriming arrangement has been added to overcome the pedal return problem.

Corrosion resistance is generally good. Some pitting did occur in the end caps of the rubber diaphragm, but again the material has subsequently been changed.

The pump requires considerable effort to operate, but full body weight can be applied to the pedal. **Users** therefore found the pump relatively easy to use, though children and smaller users could not produce the high forces needed for pumping from depth (some overcame the problem by balancing two people on the small pedal).

The pumpstand proved **robust**, and with only one external fixing seems reasonably resistant to abuse or pilferage.

Overall conclusion of the laboratory trial was that the Vergnet's novel design should prove reliable for community water supply use, though the one-off cost of replacing the diaphragm is high.

Field Trials

Test conditions

Country	Number of pumps	Head range (meters)	Data available (months)
Burkina Faso	35	14-44	26
Mali	25	9-21	27
Kenya	8	15-50	19

The Vergnet pump has undergone a number of design modifications in the course of the Project field trials, and development work is still going on to improve the pump diaphragm (current versions are supplied with a three year guarantee).

Pump installation has proved very easy, with no need for lifting equipment. The pump can be extracted from a well and re-installed within half an hour. It is also possible to install two or more pumps in a single well (a 125mm well for two pumps, or a 150mm well for three or four pumps). Only one spanner is needed to service the upper cylinder, and the down-hole pumping element can be inspected without difficulty.

In the West Africa field trials, the Vergnet proved quite reliable, though it was susceptible to solid particles entering the pumping element, either through the internal pumping circuit or via the upper cylinder assembly. When the pumping element fills with sand (or silt or clay), the diaphragm becomes inoperative and finally ruptures if it is not cleaned. A new, improved diaphragm is being field tested, and in some regions mechanics have been able to repair ruptured diaphragms.

The upper cylinder plunger seals needed regular replacement, but the task



was well within the capabilities of a local caretaker and costs very little.

A small amount of corrosion occurred on the metal parts of the diaphragm, but in general the Vergnet proved substantially corrosion resistant. This was not the experience in Kenya however, where the end caps of the pumping element suffered severe corrosion. Pedal breakage was another problem in the Kenyan trials, though rarely occurred in the lengthier West African trials.

The discharge rate of 0.6 to 1.0m³/h achieved in West Africa proved acceptable to users, but Kenyan users did not like the effort needed to pump from more than 25 meters.

Assessment

The Vergnet ratings are based on its performance in field trials and in laboratory tests carried out in 1979. The below ground components were also laboratory tested in 1982, in connection with testing of the Abi-ASM pumps.

Discharge Rate

The discharge rate achievable with acceptable pumping effort is too low to make the pump competitive for low-lift applications, and it is rated "unsuitable" (—) for pumping lifts of 7 and 12 meters. For lifts of 25 and 45 meters, the Vergnet can achieve the discharge rates needed to earn a o ("adequate") rating.

Ease of Maintenance

Below ground components of the Vergnet can be extracted from any depth without the need for special tools or equipment, and above ground maintenance is simple. However, for replacement of the diaphragm, a village caretaker might need the assistance of an area mechanic. The "good" (oo) rating for maintenance Systems B and C reduces to o for System A.

Reliability

Field performance of the Vergnet earns the pump a oo rating for lifts up to 25m and daily outputs up to 4m³. For 45m lifts or for discharges of 8m³/d, the rating drops to o.

Corrosion Resistance

The oo rating is based on performance in West Africa.

Abrasion Resistance

The Vergnet is little affected by abrasion, but the possibility of damage to the diaphragm caused by silt build up in the pumping element reduces the rating to o.

Manufacturing Needs

The Vergnet pumpstand is suitable for manufacture in a country with moderate industrial facilities, but the downhole components require specialized skills and tight quality controls and could only be manufactured in a country with a high level of industrial development (Category 3). The ratings for manufacturing environments 1, 2 and 3 are therefore —, o and o respectively.

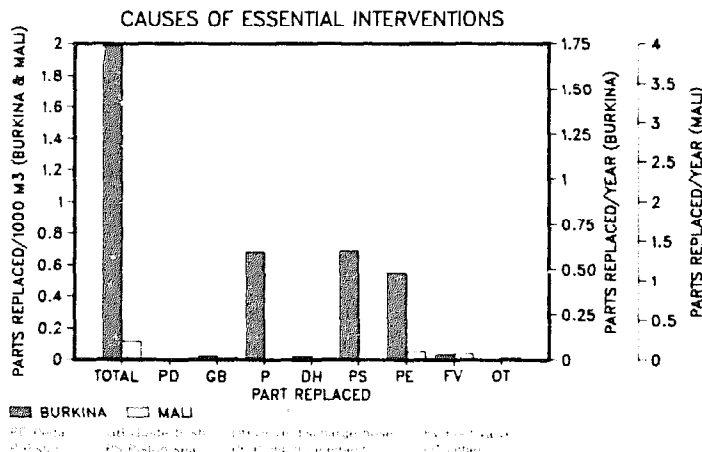

Austria

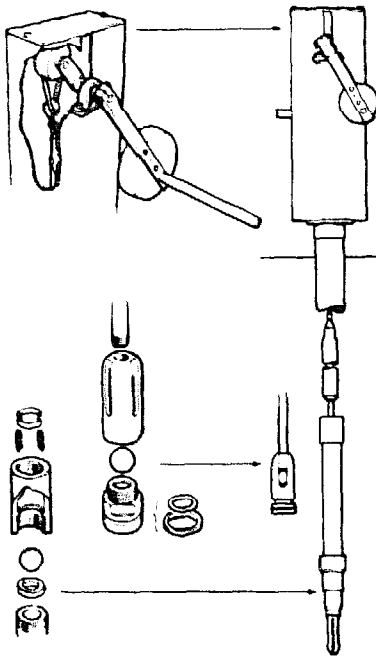

General Description

The VEW is a deepwell force pump with a rotary operating mechanism, using cable rather than rods. The pumpstand is made from varnished steel plate (stainless steel is an optional extra) and ball races are used at the crank pin journals. The cable attaches to an eye on the hanger, and a large stainless steel counterweight maintains the cable tension. Twin handles make the pump suitable for two-person operation, and each has a counterweight.

The heavy cylinder can be withdrawn through the 4 inch uPVC rising main, which has stainless steel connectors and can also form the well casing. The piston seal is PTFE backed by a concealed rubber ring, and piston and footvalves use stainless steel balls. Six cylinder diameters are available to suit different depths.

Manufacture

Both above and below ground components call for high levels of manufacturing skills and quality control.

Suppliers

Vereinigte Edelstahlwerke AG, Franz Josefs-Kai 51, A-1011 Vienna, PO Box 56, Austria.

Indicative prices - Mar 1985

Pumpstand, cable, cylinders, and spares, for 30m lift US\$ 1,400

Laboratory Tests

Date tested: 1982/83

Reported: Handpumps Project Report No. 3

Performance data (typical values) - 70mm dia. cylinder

Head (meters)	7	25	45
Pumping rate (cycles/min)	40	40	40
Volume/min (liters)	28	26	24
Input (watts)*	62	177	300
Mechanical efficiency (%)	49	59	60
Maximum handle force (kg-f)*	10	30	45
Footvalve leakage (ml/min)	No significant leakage		

* Total watts input is noted. With two operators, input and handle force per person will be half the figures indicated here.

Evaluation

The sample pumps were well packed, though unwieldy (4 meters long packing case). They arrived in good condition, but the handles of both pumps had been slightly misaligned in assembly.

Steel rising main was used in the laboratory tests, as recommended by the manufacturer at that time. Installation instructions were useful, but would have benefited from more illustrations. In fact, heavy lifting tackle and skilled people are essential for installation, as downhole components are heavy and not readily manipulated by hand. Pipe wrenches have to be big enough for 4 inch pipe.

For maintenance purposes, the cylinder can be withdrawn using the crank as a windlass. Originally, the manufacturer did not recommend on-site replacement of plunger seals, preferring replacement of the complete cylinder. More recently the cylinder has been made easier to dismantle, but seal replacement remains a skilled operation. If the cable breaks, cylinder extraction is likely to be difficult.

The 4000 hour endurance test was carried out at 40 cycles per minute, with a simulated head of 45 meters. Four breakdowns in the first 1100 hours could be attributed to inadequacies in the cable supporting arrangements and the handle and crankshaft arrangement. These resulted in the cable twisting under tension, making the bearing saddle run out of true and causing rapid wear of the saddle and the crankshaft.

The crankshaft wore out twice, the

handle broke once and the cable itself finally broke. Modified handles and crankshafts were provided rapidly by the manufacturer and a swivel was fitted in the cable. With these modifications (now permanent) the VEW completed the endurance test without further failure, though at one point the plunger jammed at top dead center and had to be freed by pulling on the cable by hand. At the end of the test, the pumpstand and cylinder were in generally good condition, but with some play evident in the crankshaft bearing. The plunger seal was excessively worn and there were signs of wear on the plunger body. The footvalve was in good condition.

There was little sign of corrosion, except for some around the cylinder snap fitting at the bottom of the rising main.

The pumpstand withstood the impact tests without damage.

Users found the VEW difficult to operate. Most did not have the strength to attain sufficient momentum to keep the handle turning smoothly. The modified handles now used make operation easier, and the VEW is well suited to two-person operation.

The overall conclusion of the laboratory trials was that the VEW is a robust but very expensive pump. It requires a lined borehole large enough to take the 4 inch uPVC rising main, or an appropriate snap fixture to be fitted to the bottom of the casing. The pump needs special skills for installation and maintenance. It is not suitable for manufacture in developing countries.

Field Trials

THE VEW PUMP HAS NOT BEEN FIELD TESTED BY THE HANDPUMPS PROJECT

Assessment

The VEW ratings are based on performance in the laboratory tests.

Discharge Rate

Though the pump is capable of high discharges at all depths, the difficulty of operation and high efforts needed keep the rating down to "adequate" (o) for all pumping lifts.

Ease of Maintenance

The pump is "unsuitable" (—) for village-level maintenance (System A) and lifting gear would be needed for maintenance at depths of 25 and 45 meters. The pump therefore earns a o rating for area-mechanic maintenance (System B) at depths of 7m and 12m only.

Reliability

Modifications have corrected the early reliability problems in the laboratory trials, but when maintenance needs are taken into account, the pump is not rated suitable for discharges greater than 4m³/d or lifts greater than 25 meters. The rating of o for other applications, rises to "good" (oo) for discharges of 1.5m³/d, where maintenance needs would be slight.

Corrosion Resistance

The pump is manufactured from corrosion resistant materials and earns a oo rating.

Abrasion Resistance

Rapid wear in the plunger seal when sand was added to the water in the endurance test results in a — rating for abrasion resistance.

Manufacturing Needs

Well-developed skills and comprehensive facilities are required for manufacture of the VEW. It could only be manufactured in a developing country with an advanced industrial base, and then only with some external support and guidance. The pump is therefore rated o under manufacturing environment 3, and — for categories 1 and 2.

The Netherlands, Burkina Faso

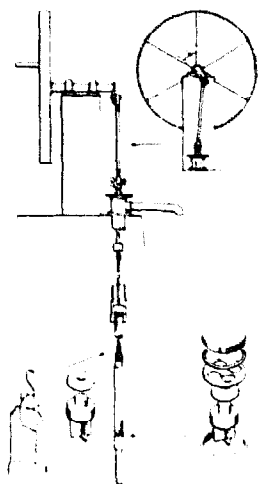

General Description

The Volanta is a deepwell reciprocating pump driven by rotation of a large flywheel. A crank and connecting rod convert the rotary motion to a reciprocating action transmitted to the plunger through stainless steel pumprods. For depths less than 30m, hook-and-eye connectors are used to join the pumprods; for greater depths, the manufacturer has recently adopted threaded connectors. The crank throw can be adjusted to suit water depth.

Crankshaft and flywheel run on ball bearings mounted on a plate which can be fixed to a steel or concrete pedestal. The cylinder is a fiberglass reinforced epoxy resin tube with a close-fitting seal-less stainless steel plunger. Molded rubber valves are used and a 0.1mm screen is fitted. The cylinder can be lifted from the well without removing the 75mm diameter PVC rising main.

Manufacture

The above-ground components of the Volanta are comparatively straightforward to manufacture. The fiberglass reinforced plastic cylinder and stainless steel plunger must be manufactured to fine tolerances.

Suppliers

Jensen Venneboer BV, Industrieweg 4, Postbus 12, 8130 AA Wijhe, The Netherlands.

Centre Sainte Famille, Saaba, BP 3905, Ouagadougou, Burkina Faso. International orders can be supplied via STAR, BP 4387, Ouagadougou, Burkina Faso.

Laboratory Tests

Date tested: 1985

Reported: World Bank Applied Technology Note No. 2

Performance data (typical values) — 50mm dia. cylinder

Head (meters)	7	25	45
Stroke (mm)	310	190	140
Pumping rate (cycles/min)	50	52	50
Volume/min (liters)	30	19	11
Input (watts)	78	120	133
Mechanical efficiency (%)	40	63	60
Maximum handle force (kg-f)	10	12	18
Footvalve leakage (ml/min)	No significant leakage		

Note: Figures are for a "flying" start

Evaluation

Three versions of the Volanta have been tested at different times. This summary is based on the most recent design, incorporating stainless steel pumprods with hook-and-eye connectors in place of the previous cable connection between above and below ground parts. Details of the earlier tests are in Project Report No. 3.

Following the earlier laboratory trials, the manufacturer made a number of changes, settling for the seal-less stainless steel plunger in a fiberglass reinforced plastic cylinder as standard, relocating the taper seat at the top of the cylinder to prevent sand-locking, adding brass weights to the molded rubber valves, and substituting steel pumprods with hook-and-eye connectors for the previous cables.

Initially, pump performance did not match the manufacturer's figures and this was found to be due to excessive clearance between the plunger and the cylinder. A replacement cylinder produced improved results. Two pumprod breakages occurred during the first half of the **endurance tests**. The manufacturer supplied new rods from a different grade of stainless steel for the remainder of the endurance tests and no further failures occurred.

In the final inspection, the valves showed some signs of wear but were still serviceable and the cylinder and footvalve were in good condition. The pumpstand

gland needed repacking, but otherwise the pumpstand was in good order.

There was no evidence of **corrosion** at the end of the test.

Some **users** found the Volanta difficult to start and to maintain a steady rhythm, and the delivery is greater when the pump has a flying start, as it commonly does during daily use in the field.

After the endurance test, the work input per stroke was very much lower, with a corresponding improvement in overall pumping efficiency. There was no significant change in the plunger or cylinder dimensions, and the plunger has no seals, so the lower work input was attributed to reduced friction in the wellhead gland.

The **body impact test** was not applicable to the Volanta, which is fixed to an in-situ pedestal, but in the earlier trials tests were carried out on the spokes of the wheel, which bent at an impact of 400 Joules, though the pump remained usable.

The **overall conclusion** of the laboratory testing was that the Volanta is an innovative design, which is very simple to install and maintain. The design improvements have been successful in improving the performance, reliability, and serviceability of the pump.

Many parts are suitable for manufacture in developing countries, though rigorous quality control is needed in manufacture of the cylinder assembly.

Indicative prices - Mar 1985

Per pump US\$ 600-630

Field Trials

Test conditions

Country	Number of pumps	Head range (meters)	Data available (months)
Burkina Faso	50	16-31	36
Ghana	24	6-14	15
Kenya	9	12-45	12



The pumps initially installed in Burkina Faso were of the old design, using a cable as the connection between the plunger and the head assembly and threaded joints for the PVC rising mains. The cables frequently caused poor performance and were eventually replaced with the new arrangement of stainless steel pumprods. Cracks and joint failures occurred in the rising mains until a solvent cement jointing system was introduced.

Except for these early failures, the Volanta proved very reliable, though differing qualities of stainless steel can still lead to some rod failures (the softer steel is more satisfactory).

The Volanta's above-ground assembly is robust, and in Burkina Faso it has been found that the rotary action is well suited to mechanical operation, using a small engine. User reaction to the rotating flywheel has generally been good, and the output, averaging 0.8 to 1.5m³/h has proved adequate for the field trial users.

The apparently high number of pump-rod failures on the bar chart is largely accounted for by the early experiences with steel cables and rods. More recently, the Volantas have been averaging about

0.3 breakdowns per pump per year and a similar number of interventions to correct poor performance. Both figures are very similar to the record of the India Mark II in West Africa.

The Volanta has also been well accepted by the users in northern Ghana. None of the 24 pumps monitored there required any maintenance intervention during the first 15 months of operation. Though the pumping lift is only 6-14 meters, they are heavily used. From March to September 1986, daily outputs ranged from 2.2 to 18.7m³, with an average of 7.7m³, and in the dry season some pumps reached an output of 25m³/d.

The Volanta pumps tested in Ghana are of a later model (1984), while those in Burkina Faso are older pumps which have been modified during the field trial.

The Volanta has been designed on VLOM principles with emphasis on ease of repair. Only simple tools are needed to pull out the entire pumping element, including pumprods and footvalve. The fact that the pump is manufactured in Burkina Faso, in a workshop without any sophisticated equipment (a Catholic Mission near Ouagadougou), verifies its suitability for local manufacture.

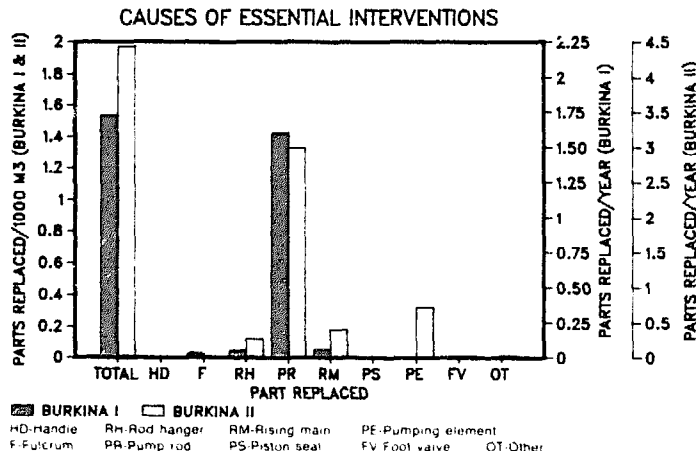

Assessment

The Volanta ratings are based on the pump's performance in both field trials and laboratory tests.

Discharge Rate

The adjustable stroke enables the pump to deliver a high discharge at all lifts, and it earns a "good" (oo) rating under this heading in all the tables.

Ease of Maintenance

Most maintenance operations on the Volanta can be readily carried out by village caretakers over the full depth range, but the need for some help from area mechanics for special repairs reduce the rating to "adequate" (o) under maintenance system A from oo under systems B and C.

Reliability

Performance in the field trials earns the Volanta a oo rating for reliability for depths down to 30 meters, but reservations about pumprod performance below that depth mean a o rating for the 45m lift.

Corrosion Resistance

The Volanta is built entirely from corrosion resistant materials below ground and earns a oo rating.

Abrasion Resistance

The pump has a seal-less piston and was unaffected by sand pumping in the field trials, earning a oo rating for abrasion resistance.

Manufacturing Needs

Most of the pump components are suitable for manufacture in developing countries with a moderate industrial base (manufacturing environments 2 and 3), though good quality control is needed in manufacture of the fiberglass reinforced plastic cylinder and stainless steel plunger. External help would be needed if attempts were made to make the Volanta in a country with only a low or moderate level of industrial development (manufacturing environments 1 and 2). The ratings under categories 1, 2 and 3 are therefore o, o and oo respectively.

United Kingdom

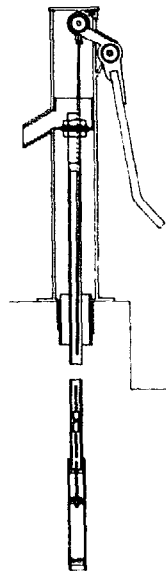

General Description

The Consallen is a deep-well, lever-arm force pump. Pumpstand and handle are fabricated from steel and hot-dip galvanized. Handle bearings are sealed ball races. The rising main is attached to a removable delivery tray, making it possible to extract the below-ground assembly without removing the pumpstand.

The rising main is ABS pipe and pumprods are stainless steel with rolled threads. The cylinder barrel is internally honed stainless steel tube. The brass plunger is fitted with a hydraulic polyurethane U-seal. The footvalve varies with different cylinders using either a molded rubber membrane or a rubber O-ring seal.

Manufacture

The pumpstand requires machining and welding of steel sheet and section. Processes are straightforward, but high standards of workmanship and quality control are necessary. Similar requirements apply to the below-ground assembly, particularly to achieve an appropriate internal finish in the cylinder bore.

Suppliers

Consallen Structures Ltd., Epping, Essex, UK.

Indicative prices - Feb 1985

Pumpstand and cylinder	US\$ 132
Stainless steel pump rod, per meter	US\$ 3
ABS rising main, per meter	US\$ 3.50

Laboratory Tests

Date tested: Full test in 1980; extra tests on modified below-ground components in 1983
Reported: ODA Report 1981 on 1980 testing.

Performance data (typical values) - 63mm cylinder, 1983

Head (meters)	7	25	45
Pumping rate (cycles/min)	40	40	40
Volume/min (liters)	14	14	14
Input (watts)	29	79	135
Mechanical efficiency (%)	54	68	72
Maximum handle force (kg-f)	4	10	18
Footvalve leakage (ml/min)	No significant leakage		

Note: These results obtained after bedding in the pump for 190 hours. Initially, the pump was stiff to operate because the piston seals were oversized.

Evaluation

The pumps tested in 1980 were packed in heavy-duty corrugated cardboard cases, locally reinforced with wood, and were received in working order. In one of the samples tested in 1983, however, the brass bush inserted in one of the handle bearings was too long, so that the handle could not be assembled into the pumpstand. The threads on the pumprods were not straight, due to a fault which the manufacturer corrected immediately.

Helpful and comprehensive **Instructions** for installation, maintenance and repair were provided, in English. Using ABS rising main, the pump is relatively easy to **install** without lifting tackle. General **maintenance** is also straightforward, though repairs to the steelwork of the pumpstand would be difficult to carry out in the field, and care is needed when the handle bearings are replaced.

In the 4000 hour **endurance test**, carried out on the 1980 version, the pump was driven at 40 cycles per minute, with a simulated head of 45 meters. No breakdowns were recorded. In the final inspection, the pump was found to be in good working order throughout, with little wear. There was no **corrosion**. The 1983

version was not endurance tested.

The 1983 version was subjected to **impact tests**. The handle was distorted, though this did not affect the operation of the pump. The baseplate was also distorted by a heavy impact on the body of the pumpstand. Although the construction of the pumpstand should prevent any loss of sanitary seal at the wellhead, such distortion would be likely to impose additional bending loads on the pumprod and rising main. The pump withstood the allotted 96,000 cycles of the handle shock test without failure. **Users** found the pump generally easy to operate.

The **overall conclusion** of the laboratory tests was that the pump has the potential to be suitable for community water supply, if adequate reliability in the field can be assured. A number of modifications have been introduced since 1980, though there remains scope for further improvement. The light weight of the below-ground assembly, using ABS pipe, assists in both installation and maintenance. However, the materials and methods of construction mean that the pump would not be easy to manufacture in most developing countries.

Field Trials

Test conditions

Country	Number of pumps	Head range (meters)	Data available (months)
Malawi	16	8-25	31



The lengthy field trial in Malawi has provided good data on the performance of the Consallen pump. Generally, the pumps have performed poorly. The most significant problem was the failure of ABS rising mains at the threaded joints. It is thought that the problem was aggravated in many cases by oversized polyurethane seals supplied with the cylinders. After the seals had been filed down by the manufacturer, fewer breakdowns occurred, though some were still recorded.

Several pumpheads suffered severe damage, with the handle fulcrum bracket shearing off the pumpstand, because of the weak nature of the flange and its connection to the square-section pumpstand.

As field trials progressed, the manufacturer was kept informed of the problems. As a consequence, stiffened pumpheads were delivered and replaced the earlier ones. The modified pumps also incorporated a delivery tray which allows removal of the downhole components through a cover plate on the pumpstand.

Most of the Malawi pumps were equipped with 2-inch cylinders, giving relatively low discharge. The combination of low discharge and frequent breakdown meant that users were not enthusiastic

about using the Consallen. Consallen pumps, which were breaking every 2-3 months were eventually replaced with either Maldev (Pump 14) or India Mark II (Pump 09) pumps, which would last for 1-2 years between repairs.

Installation of the Consallen is a fairly simple operation, helped by the light weight of the downhole components, though some skill is needed. Maintenance too is comparatively easy, unless the breakdown is major (as with the broken fulcrum brackets).

The overall conclusion of the field tests was that use of the 1983 Consallen should be restricted to lifts of 10 meters or less, when it can be expected to have reasonable reliability and be straight-forward to maintain. For greater lifts, frequent breakdowns can be expected, and the pump cannot therefore be recommended for village use (though it has been advertised as suitable for lifts down to 60 meters). Used for low lifts, the pump has the advantages of good abrasion and corrosion resistance.

Design changes have been made, but the modified pumps have not been tested.

Assessment

The Consallen ratings are based on the pump's performance in lengthy field trials in Malawi and on laboratory testing. Modifications made to the pump design as a result of early trial results have been taken into account where possible in the ratings. Because of the Project judgment that the pump cannot be recommended for deep lifts, it has been included in Pump Selection Tables for lifts up to 25 meters only, though manufacturer's literature indicates greater lifts.

Discharge Rate

With the right choice of cylinder size, the pump can achieve high discharges and earns a "good" (oo) rating for all lifts.

Ease of Maintenance

The skills and tools needed preclude village-level maintenance, but the comparative simplicity of most maintenance earn the pump a oo rating for area-mechanic or central maintenance.

Reliability

The frequency of breakdown results in the pump being rated "unsuitable" (—) for use at 25 meters lift. It is rated "adequate" (o) for daily outputs up to 4m³/d at 12m lift or 8m³/d at 7m lift, and earns a oo rating for lighter duties.

Corrosion Resistance

All components are corrosion resistant, giving a oo rating.

Abrasion Resistance

The polished cylinder and polyurethane seals earn a o rating.

Manufacturing Needs

Though the Consallen's basic assembly is not complex, it needs careful quality control in manufacture, and uses ABS rising main which may not be readily available in many developing countries. Ratings for high, moderate and low levels of industrial development are therefore oo, o, and — respectively.

CAUSES OF ESSENTIAL INTERVENTIONS

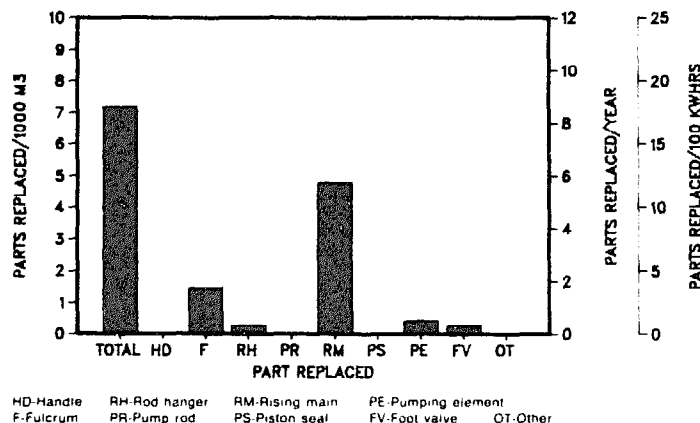

Thailand

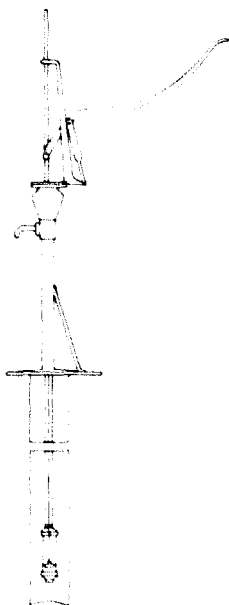

Laboratory Tests

THE DMR (DEMPSTER DERIVATIVE) HAS NOT BEEN TESTED IN THE CATR LABORATORY

General Description

The original Dempster pump was designed in the USA in the last century, as a family pump used normally in a farmyard. The DMR uses a similar design. Most parts of the pumphead and working mechanism are made from cast iron, with steel used for the top guide flat bar, connecting rod and pivot pins. The many exposed moving parts need heavy lubrication.

Below ground, the pump is of conventional reciprocating design, using galvanized steel rising main, steel pumprods and a 3-inch diameter brass cylinder with traditional leather cupseals.

Manufacture

In Thailand, fairly complicated sand casting is used to manufacture the pump. Machine finishing is necessary for some above-ground components and many below-ground ones, notably the cylinder and pumping element assembly.

Suppliers

There are several manufacturers in Thailand, including Muangthong Charkkol Co. Ltd, 363/2 Takisin Road, Bangkok 10600, Thailand.

Indicative prices - May 1985

Pumpstand and cylinder	US\$93.50
Pumprods and rising main per meter	US\$2.60

DMR (Dempster derivative)

Field Trials

Test conditions

Country	Number of pumps	Head range (meters)	Data available (months)
Thailand	35	3-21	21

The DMR Dempster derivative did not perform well in the field trials. The pump was heavy to operate with the original mechanical advantage of 5:1. Extension of the handle, to increase the mechanical advantage to 8:1 did not prove successful, as the handles were not strong enough to withstand the extra strain then imposed.

A good discharge rate can be achieved by those able to use the full stroke length (215mm), but the long pump body makes the handle too high for young children. The drive mechanism is shaky and the exposed moving parts need continual heavy lubrication to avoid rapid wear. Even with lubrication there are problems, as the grease combining with dust and sand in the air causes grinding of several moving parts.

The most common failure in the field was breakage of the fulcrum link, with other failures including wear of the flat bar to connecting rod thread, pumprod breakage at the connecting rod adaptor, broken handles and failure of the pump base flange weld.

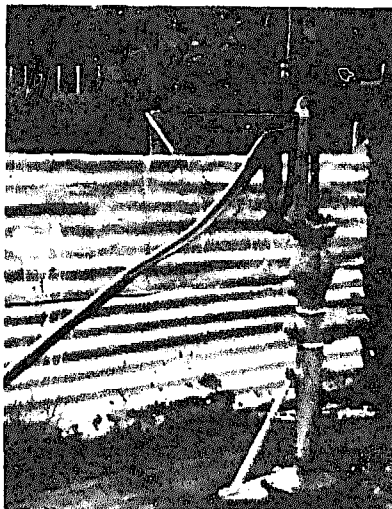

The below ground components of the DMR Dempster derivative are conventional and required the usual repairs to worn leather cupseals, footvalves and leaking joints. The threaded connection between the pump body and the 1-1/2 inch diameter galvanized steel rising main proved especially prone to fatigue failure.

As a result of the field trials, it was recommended that DMR Dempster derivative pumpheads in Thailand's rural water programme should be replaced with Korats (Pump 13), leaving the downhole components in place.

Assessment

The ratings for the DMR Dempster derivative are based on the pump's performance in field trials over a limited depth range.

Discharge Rate

Availability of a range of cylinder sizes means that the pump can achieve a "good" (oo) discharge for all heads up to 25m.

Ease of Maintenance

The pump is not suitable for village-level maintenance, but at shallow lifts can be readily maintained by area mechanics. It therefore earns a oo rating for maintenance system B at 7m and 12m, reducing to "adequate" (o) at 25m.

Reliability

Performance in the field trials showed that the DMR Dempster derivative would require an unacceptable level of repair if used for lifts in excess of 12 meters. At shallower lifts, the pump is rated oo for low daily outputs and o for moderate daily outputs (4m³/d), but unsuitable for higher outputs.

Corrosion Resistance

The pump has no special protection against corrosion and cannot be recommended for situations where groundwater is corrosive.

Abrasion Resistance

Use of leather cupseals means a — rating for abrasion resistance

Manufacturing Needs

The Dempster design has been adapted to make the pump suitable for manufacture in Thailand, and it could be readily made in a country with a moderately developed industrial base, earning a oo rating for manufacturing categories 2 and 3.

CAUSES OF ESSENTIAL INTERVENTIONS

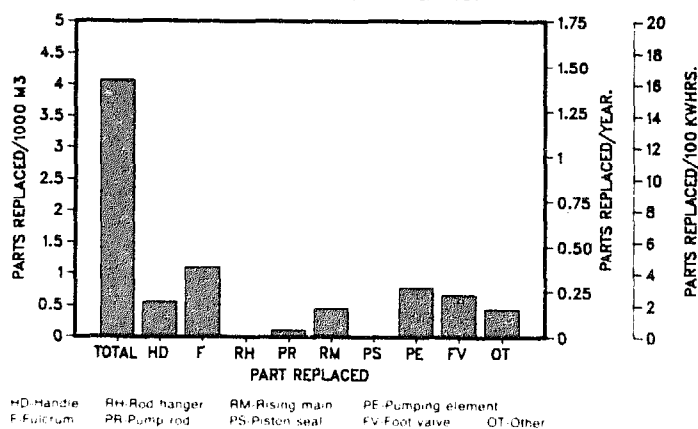

Finland

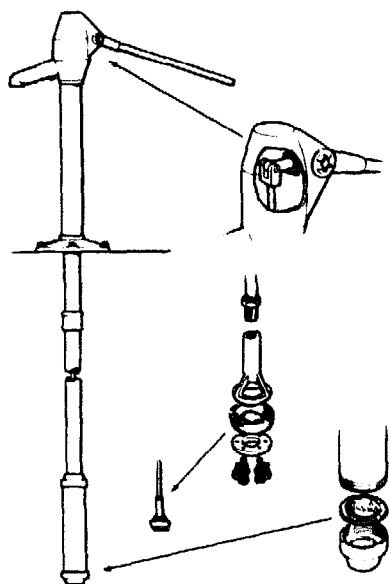

General Description

The Nira AF76 is a deep-well, lever-arm force pump. The pumpstand has a galvanized tubular steel column with a cast iron base and pumphead which is nylon coated. The seamless thin-walled brass cylinder has a gunmetal plunger and molded rubber cupseal and valve bobbins.

Cylinders are available in 50mm and 76mm diameters.

Manufacture

Foundry work and steel fabrication skills are needed, together with facilities for rubber molding.

Suppliers

Vammalan Konepaja Inc, 38200 Vammala, Finland.

Indicative prices - Feb 1985

Pumpstand and cylinder	US\$ 236
Rising main and pumprod per meter	US\$ 11

Laboratory Tests

Date tested: 1982

Reported: Handpumps Project Report No 3

Performance data (typical values) — 76mm dia cylinder

Head (meters)	7	25
Pumping rate (cycles/min)	40	40
Volume/min (liters)	25	26
Input (watts)	39	139
Mechanical efficiency (%)	71	75
Maximum handle force (kg-f)	8	34
Footvalve leakage (ml/min)	No significant leakage	

Evaluation

The two test pumps, including the pumprods and rising main, were delivered in a single wooden case. The case was large and very heavy. Both pumps were in working order, but one cylinder had been damaged causing distortion of the bore.

A leaflet was supplied with the pumps which included an annotated sketch of the components, but there were no **instructions** for installation or maintenance. **Installation** is straightforward, but the below-ground assembly is heavy, demanding lifting tackle for all but the shallowest settings. Care is needed to avoid damaging the relatively thin cylinder barrel.

Maintenance of the cylinder will also require lifting tackle, since the pumphead and entire below-ground assembly must be lifted out. To service the plunger or footvalve, manufacturer's spares are required. The pumpstand is easy to dismantle. Handle bearings would be simple to replace in a workshop; in the field, replacement of the complete fulcrum casting might be required.

For the 4000 hour **endurance test**, the pump was driven at 40 cycles per minute, at a simulated head of 36 meters. This was the maximum depth recommended by the manufacturer at the start of the test. The handle broke several times during the test, and in response the manufacturer reduced the maximum recommended depth for the 76 mm cylinder to 18 meters, and offered a 50 mm cylinder for

greater depths. At the end of the test, the handle bearings, plunger seal, cylinder and valves were in good condition.

Corrosion caused the pump to fail after 1000 hours. The setscrews used to assemble the plunger were badly corroded, and one of them broke. The plunger could not be dismantled and was therefore replaced. The setscrews in the second plunger corroded in the same way as those of the first, but less rapidly, so the second plunger completed the remainder of the test without failure. There was no corrosion elsewhere in the pump.

The pump was undamaged by **impacts** on the handle, but a heavy impact on the pumpstand body broke the cast iron baseplate. However, the cast iron baseplate has been superseded by a fabricated, all-steel version. Fitted with a handle constructed in the laboratory, the pump completed the allotted 96,000 cycles of the handle shock test without failure.

Many **users** found the high levels of effort required to operate the pump difficult to apply. Children in particular found it difficult to bring their weight to bear on the handle at the start of the downstroke.

The **overall conclusion** of the laboratory tests was that the AF76 was not a **VLOM** pump, but relatively small design changes could make it suitable for community water supply, although the range of working depths is limited.

Nira AF76

Field Trials

Test conditions

Country	Number of pumps	Head range (meters)	Data available (months)
Kenya	3	6-25	12
Tanzania	89	1-10	35

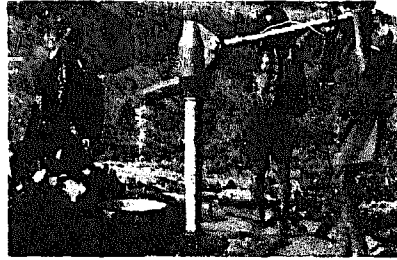

A large sample of pumps have been on test over a long period in Tanzania on a project where a total of some 2000 pumps are installed. Comparative data is therefore extensive, though average pumping heads are extremely low, so few breakdowns might be expected and few occurred.

A serious design flaw with this pump is that the single major wearing component, which is the brass fulcrum unit (referred to as "the lever") is a very expensive spare part (in the region of US\$50).

The pump proved relatively popular. It lifts substantial quantities of water with its short handle and low mechanical advantage acting on a 76mm cylinder.

Field maintenance was simple in the shallow settings used in Tanzania, because the complete pumphead, together with rising main and pumprods, could be pulled out in one piece. Nevertheless, a substantial tool kit is required, and at greater depths (beyond about 6-8 meters) the pump is more difficult to maintain.

Wear on the fulcrum "lever" can result in impact damage to the cast iron pumphead, caused by endplay in the handle.

The elastomeric seal in the brass cylinder gives good abrasion resistance, but corrosion would be a problem in aggressive groundwater, because of the use of steel rising main.

Assessment

The Nira AF76 ratings are based on monitoring of large numbers of pumps in lengthy field trials and on laboratory tests, giving a basis for confident judgments.

Discharge Rate

Cylinder options available give the pump a "good" (oo) rating for all heads (7-25 meters).

Ease of Maintenance

Though the tools and skills needed preclude village-level maintenance of the Nira AF76, the comparative ease of the operation at shallow depths earns the pump a oo rating for area-mechanic maintenance at 7m and 12m, falling to "adequate" (o) at 25m.

Reliability

Combining the anticipated breakdown frequency with the repair skills needed, the pump's reliability is less than adequate (—) at 25 meters lift, or for high daily outputs at shallower lifts. It rates o for a daily output of 4m³/d at 7 or 12m lift and oo for 1.5m³/d at the same lifts.

Corrosion Resistance

Corrosion occurred in the laboratory tests, and the pump has no special protection against corrosion. It cannot therefore be recommended where groundwater will be corrosive.

Abrasion Resistance

The pump earns a o rating for abrasion resistance, with the cautionary note that the soft brass cylinder lining does abrade slowly and may be costly to replace when the limit is reached.

Manufacturing Needs

The need for good quality casting of brass and cast iron components means that the pump is unsuitable for manufacture in countries with a low level of industrial development (Category 1). It requires no exotic materials and could be readily manufactured in developing countries with moderate industrial bases, scoring oo for Categories 2 and 3.

CAUSES OF ESSENTIAL INTERVENTIONS

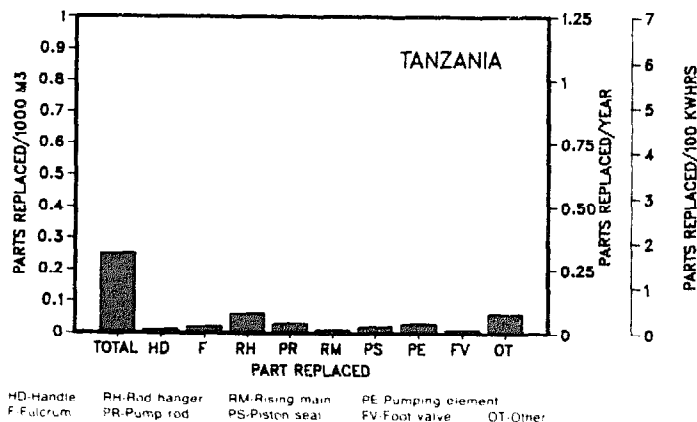

Zimbabwe, Malawi, Papua New Guinea

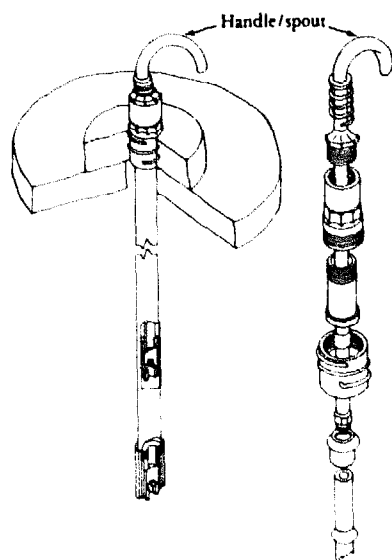

Laboratory Tests

THE BLAIR PUMP HAS NOT BEEN TESTED IN THE CATR LABORATORY

General Description

The Blair pump is an innovative direct action design developed by the Blair Research Laboratory of Zimbabwe's Ministry of Health. It is manufactured in Zimbabwe, and modified versions are being made in Malawi (known as the Madzi pump) and in Papua New Guinea. Prototypes have also been made in the Philippines.

All above ground parts are made from steel and below ground parts in plastic. The Blair is different from other direct action pumps in that the rising main also serves as the pumprod, with water discharging from the "walking stick" handle. Because the pumprod is always full of water, it returns under gravity, in contrast to the low-mass high-displacement rods used on other direct action pumps, which require a positive downstroke.

It is possible to connect rubber hosing to the outlet and thus lift water to an overhead tank.

Manufacture

As the pump consists primarily of standard pipe and fittings, it is well suited for manufacture in any country with experience in working with PVC.

Suppliers

Proderite (Pvt) Ltd, 21 Leyland Road, Ardennie Industrial Sites, PO Box 2887, Harare, Zimbabwe.
Pipe Extruders Ltd, PO Box 30041 Lilongwe 3, Malawi.

Indicative prices - Mar 1985

Pump for 7m depth	US\$ 145
Pumprod and rising main per meter	US\$ 7.60

FOB less 13% for export (Proderite)

Field Trials

Test conditions

Country	Number of pumps	Head range (meters)	Data available (months)
Malawi	10	2-10	36
Tanzania	20	1-5	6
Sudan	5	3-7	30
Philippines	5	N.A.	N.A.
Papua New Guinea	45	N.A.	20
Kenya	1	7	28



from Australian manufacturers.

Most breakdowns which have occurred have been at the connection between the plastic rising main and the steel "walking stick" handle.

The pump is very easy to install and to maintain. It is possible to remove, repair and replace the complete installation in only half an hour, with no lifting equipment and minimal tools.

The pump has not been popular with users who have experience of other handpumps, partly because of the low discharge and partly because of the difficulty of directing the flow from the moving spout into narrow-necked containers.

The innovative Blair design has many merits, notably its simplicity and corrosion resistance. The seal-less plunger also has advantages, including giving the pump a reasonable abrasion resistance.

The Blair pump obtained mixed results in the field trials, which covered a wide range of operating conditions, and, particularly, intensity of use. In heavy use in Sudan, two out of five pumps broke down during the first six months, and in Tanzania, 8 out of 11 suffered the same fate.

In Malawi, where user group sizes are smaller (about 125 users per pump), the failure rate was about one breakdown per pump per year, while in Papua New Guinea, where the pumps serve only a few people and are used for only short periods each day, no breakdowns were experienced in the first 20 months of testing. It is important to recognize that in PNG, the locally modified Blair pump is assembled from high quality PVC pipes and fittings

Assessment

The Blair pump ratings have been based on widespread and varied field trials, which provide a good level of confidence in the judgments made. The direct action operation of the pump restricts its use to lifts not exceeding 12-15 meters.

Discharge Rate

In comparison with other low-lift pumps, the Blair has a low discharge, because of the small plunger size. Its rating at 7 and 12 meters lift is "adequate" (o).

Ease of Maintenance

The pump is extremely simple to service and must be regarded as a true VLOM pump, earning a "good" (oo) rating for all possible maintenance systems.

Reliability

The ease of repair combined with breakdown frequencies under different operating conditions gives the pump a oo reliability rating for a daily output of 1.5m³/d at 7 meters lift and at 12 meters lift. The rating drops for heavier duty application, and the pump is not recommended for daily outputs as high as 8m³/d.

Corrosion Resistance

Use of PVC pipe and fittings below ground earns a oo rating for corrosion resistance.

Abrasion Resistance

The seal-less design gives adequate abrasion resistance, though sand would score the cylinder wall.

Manufacturing Needs

The Blair pump is very easy to assemble and parts are relatively simple to manufacture. The rating of oo for manufacture in countries with moderate or high levels of industrial development (Categories 2 and 3), reduces to o in those with only low industrial bases, because of the dependence on good quality PVC, to assure pump reliability.

CAUSES OF ESSENTIAL INTERVENTIONS

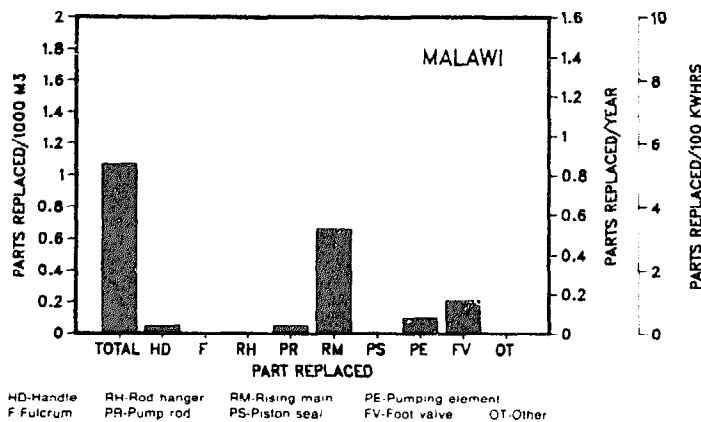

Ethiopia

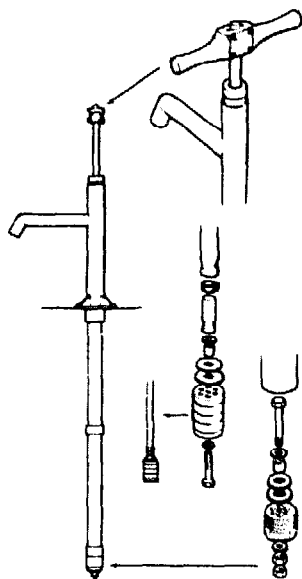

General Description

The Ethiopia BP50 is a shallow lift direct action pump. In 1981, the pump used standard uPVC pipe for rising main and pump rod, and was originally intended for lifts of up to 12 meters. The plunger had no flexible seal; it consisted of a machined block of HDPE, with circumferential grooves on the outer surface acting as simple labyrinth seals. The pump rods, though hollow, were not sealed.

Recently, it has not been possible to obtain suitable materials in Ethiopia. The current design retains uPVC pipe as the cylinder barrel, but the rising main is galvanized steel and the pumprod is solid steel. The plunger is conventional, cast in gunmetal, with a leather cup seal.

Manufacture

The Ethiopia BP50 has been designed for manufacture in a developing country. Basic facilities and skills in steel fabrication will be sufficient for the manufacture of the pumpstand. In 1981, only simple machining skills were required to manufacture the below-ground parts. In its current form, however, a foundry is required to cast the gunmetal plunger, together with basic machining skills to complete the plunger and foot valve.

Suppliers

Ethiopia Water Works Construction Authority, Addis Ababa, Ethiopia.

Prices not available

Laboratory Tests

Date tested: Full test 1983; additional tests on current design 1986.
Reported: Handpumps Project Report No.3

Performance data (typical values)

Head (meters)	7
Pumping rate (cycles/min)	40
Volume/min (liters)	28
Input (watts)	89
Mechanical efficiency (%)	35
Maximum handle force (kg-f)	40
Leakage of foot valve (ml/min)	0.8

Figures are for the 1986 version of the 50mm cylinder.

Evaluation

The pumps were supplied in a wooden case, and arrived in good working order.

A technical report and engineering drawings were provided with the pumps supplied for testing in 1983. The report, in English, was informative and the drawings were helpful for installation. However, it is not clear what information is normally provided for installations in the field.

Maintenance of the 1983 version of the pump was particularly straightforward. The plunger could be extracted by simply removing the guide bush in the pumpstand and pulling out the pump rods. In the current version, this is more difficult. Since the pump is suitable only for shallow settings, this should not prove difficult.

The 4000 hour **endurance test** was carried out in 1983 with the pump driven at 40 cycles per minute at a head of 7 meters. The pump completed the test with no failures, but wear in the plunger tended to increase the end float of the center bolt, and remedial action was taken at the 1000

hour intermediate inspections. Progressive loss of cylinder performance was observed, with the most pronounced loss in the final stage of the test, for which sand was added to the water. At the end of the endurance test, the rate of delivery was about 50% of that obtained in the original performance test.

In the final inspection, most parts of the piston and foot valve were worn, with corresponding wear on the bore of the rising main. Many particles of sand were embedded in the HDPE piston.

Corrosion was observed in ferrous parts of both the piston and foot valve.

Successfully more severe **impacts** on the body of the 1983 pumpstand produced progressive distortion of the baseplate. The pump completed the allotted 96,000 cycles of the handle shock test without failure.

Users found the pump very difficult to operate. The 1983 design used uPVC pipe for the pump rods, but these were not sealed and there was therefore no contribution from buoyancy. In the current design, the rods are solid steel, so that a lifting force of about 40kgf is required, even at only 7 meters lift. The pump is therefore much more difficult to operate than other direct action pumps which use lightweight, high displacement pump rods.

The **overall conclusion** of the laboratory tests in 1983 was that the BP50 represented a simple design with potential for **VLOM**. However, it has not been possible to develop many of the original concepts because suitable materials are not available in Ethiopia, and in its current form the BP50 has steel pump rods and a conventional, sealed plunger with a leather seal. This has further increased the required lifting force, with the effect of limiting the maximum practical lift to about 5 meters. Lightweight, high displacement pump rods could provide a more favourable distribution of the required operating effort between the upward and downward parts of the pumping cycle, and this is a development which should be encouraged.

Ethiopia BP50

Field Trials

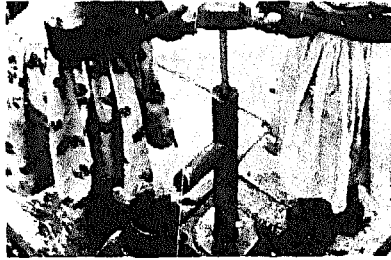

THE ETHIOPIA BP50 PUMP WAS NOT FIELD TESTED BY
THE HANDPUMPS PROJECT

Assessment

In the absence of field trials, the Ethiopia BP50 ratings are based on the pump's performance in the laboratory tests and on the judgment and experience of Project staff.

Though, as a direct action pump, the BP50 is grouped in the 0-12 meter range, the high operating force restricts its use to low lifts, and it is therefore rated only for a maximum lift of 7m.

Discharge rate

At the recommended low lifts, the pump achieves a high discharge and earns a "good" (oo) rating.

Ease of Maintenance

In the current version of the pump, the complete downhole assembly must be removed to service the plunger or footvalve. While this is relatively easy to achieve at low lifts it means that the oo rating for maintenance systems B and C reduces to "adequate" (o) for maintenance system A (village-level).

Reliability

The pump is well suited for light use, but would require relatively frequent interventions at higher discharges, and earns only a o rating for daily outputs of 4 and 9m³/d.

Corrosion Resistance

The uPVC cylinder barrel is corrosion resistant, but use of steel pumprods and galvanized steel rising main reduces the rating to o.

Abrasion Resistance

Use of leather cupseals means that the pump cannot be recommended for use in sand-laden water.

Manufacturing Needs

The need for foundry facilities and machining skills in the manufacture of the current model leads to a o rating for countries with a low-level industrial base (Category 1). For moderate and high levels of industrial development, the pump is well suited for local manufacture.

Malaysia

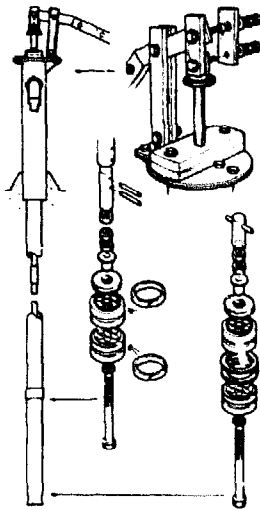

General Description

The IDRC-UM is a shallow lift lever-arm force pump designed at the University of Malaya. It is manufactured in Malaysia with support from the International Development Research Center of Canada. It is also available as a suction pump.

The pumpstand casing is steel. Internal components and the spout are uPVC. The wooden handle pivots on wooden links fitted with brass bushes.

Rising main and pumprod are standard uPVC pipe with solvent-cemented joints. Pumprods are not sealed. The cylinder is a length of thicker walled uPVC pipe and has an all-plastic plunger fitted with polyethylene ring seals. The basic components of the plunger are also used in the footvalve, which can be extracted without withdrawing the rising main, by removing the piston and attaching an extractor to the end of the pumprod.

Manufacture

Plastic molding skills and facilities are needed, along with simple uPVC and metal machining. Construction is simple.

Suppliers

Dept. of Mech. Engineering, University of Malaya, Kuala Lumpur, Malaysia.

Indicative prices - Apr 1985

Pump, per unit	US\$ 290
Pumprods, per meter	US\$ 2.00
Rising main, per meter	US\$ 5.00

FOB Port Kelang, Malaysia

Laboratory Tests

Date tested: 1986

Reported: Report not yet published

Performance data (typical values)		
Head (meters)	7	12
Pumping rate (cycles/min)	40	41
Volume/min (liters)	26	25
Input (watts)	83	144
Mechanical efficiency (%)	36	33
Maximum handle force (kg-f)	11	24
Leakage of foot valve (ml/min)	0.5	1.0

Evaluation

The two test pumps were securely packed in a wooden packing case, and arrived in good condition. However, in both samples the spout tended to leak at the joint with the rising main, and the steel tube at the top of the pumprod tended to jam in the wooden plate at the top of the pumpstand until lubricated with water. Rising main and pumprods were not supplied.

A manual was supplied with the test samples, covering both installation and maintenance, in English. The presentation was very good, with plenty of drawings in a clear, lively style. However, the instructions for installation did not make clear how the pump should be installed in relation to ground level.

The all-plastic below-ground assembly is easy to install, and the pump is designed for both the plunger and footvalve to be removed for subsequent maintenance and repair, without extracting the rising main. Installing the above ground parts requires skill to ensure that the pumpstand is correctly assembled and securely mounted at the well head. Prefabricated uPVC components will be required if the rising main breaks at the spout connection.

The 4000 hour endurance test was carried out at approximately 30 cycles per minute, with a simulated head of 12 meters. In the first few hundred hours of the test, there were repeated failures of the upper pumprod due to excessive angular movement during the pumping cycle.

In consultation with IDRC and the University of Malaysia, the components of the handle fulcrum and the upper pumprod were replaced. An additional wooden plate was fitted, thereby improving the guidance of the upper pumprod, the brass pins in the connecting rod were replaced with steel bolts, and a Tara-type (Pump 33) upper pumprod connector was fitted in place of the original joint secured by brass pins.

A crack developed in the rising main within the pumpstand, originating at the welded connection to the spout. A number of suggestions were made either to eliminate the fabricated spout connection, or to re-position the rising main support so that this part of the pipe would not be subject to tensile stress.

At the end of the test the plunger, the seals and the cylinder were badly worn, and the rate of delivery from the pump was substantially reduced as a result. There was no significant corrosion, however.

In the impact tests, the pumpstand body proved to be robust but the wooden handle links cracked. However, the pump completed the allotted 96,000 cycles of the handle shock test without failure.

Many of the younger users described the pump as awkward to use, and some found it difficult to apply the necessary force on the down-stroke. Both adults and children criticized the lack of lateral stiffness in the handle mechanism.

The overall conclusion of the laboratory tests was that the IDRC-UM is a pump designed for Malaysia and with limited scope for wider application. It is suitable only for depths of 12 meters or less, where it has to compete with inherently simpler direct-action pumps. The wooden handle links proved to be durable in normal use but susceptible to abuse. The plunger seals wore rapidly in sandy water.

It is understood that, with further field trial experience, the University of Malaya is now supplying a Mark 3 version, which is said to be more robust (the version tested was Mark 1). It has metal instead of wooden handle links; the plunger rings have been redesigned to increase durability; and the pump is now bolted to a concrete pedestal. This new version is being installed by the Ministry of Health in Malaysia and is being field tested by IDRC in several countries in Africa and Asia.

Field Trials

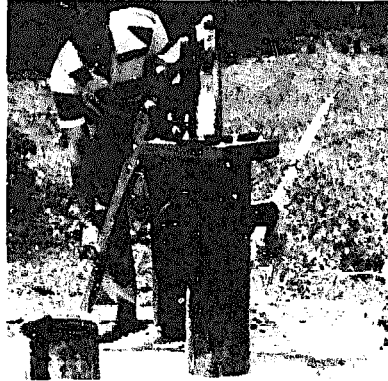

THE IDRC-UM PUMP WAS NOT FIELD TESTED BY THE HANDPUMPS PROJECT

Assessment

In the absence of field trials, the IDRC-UM ratings are based on the pump's performance in laboratory tests and on the experience and judgment of Project staff.

Discharge Rate

A relatively high discharge rate can be achieved, earning the pump a "good" (oo) rating (though the work input is comparatively high at 12 meters lift).

Ease of Maintenance

Maintenance is quite simple, but the degree of skill needed to assemble the pumpstand means that the oo rating for maintenance systems B and C reduces to "adequate" (o) for system A (village-level).

Reliability

The IDRC-UM is best suited for light use and earns a oo rating for a daily output of 1.5m³/d, reducing to o at 4m³/d. The pump is not recommended for higher daily output.

Corrosion Resistance

Use of all-plastic components earns the pump a oo rating.

Abrasion Resistance

The plunger, seals and cylinder showed considerable signs of wear after pumping sandy water, and the pump is not considered suitable where sand pumping is expected.

Manufacturing Needs

The IDRC-UM has been designed for manufacture in a developing country (Malaysia) and earns a oo rating for countries with moderate or high levels of industrial development (Categories 2 and 3). The machining and steel fabrication needed reduces the rating to o for countries with only a low level of industrial development (Category 1).

The Netherlands

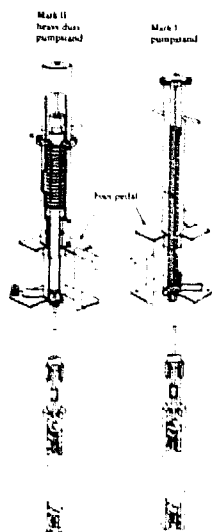

General Description

The Kangaroo is a direct action pump with a unique form of action. Foot-operated, its upstroke is provided by the relaxation of a spring compressed by the operator on the downstroke. Below-ground components are the same as those of the SWN 80 & 81 (Pump 20), consisting of a uPVC cylinder, neoprene double-acting cupseal, and plunger made from stainless steel and nylon. Pumprods and connectors are stainless steel, with each connection encased in polyethylene hose, to combat abrasion of the uPVC rising main. Valves are brass with rubber sealing faces. Different cylinder diameters are available to suit different depths. Two models are made: Mark 1, with square telescoping tubes around the spring; and the heavier duty Mark 2 with circular tubes.

Manufacture

The manufacturer supplies parts to be welded and assembled in developing countries. The spring would have to be purchased from a special manufacturer and below ground the components call for a high degree of skill and quality control.

Suppliers

Van Reekum BV, Kanaal Noord 115, Postbus 89, 7300 AB Apeldoorn, Netherlands.

Indicative prices - May 1985

Pumpstand only	US\$ 396
Riser/rod in 3m lengths	US\$ 94

Laboratory Tests

Date tested: 1980

Reported: O.D.A. Report 1981

Performance data (typical values)

Head (meters)	7	7
Pumping rate		
(cycles/min)	20	48
Volume/min (liters)	10	24
Input (watts)	Not recorded	
Mechanical efficiency (%)	15	12
Maximum footplate		
force (kg-f)	90	110
Leakage of foot		
valve (ml/min)	Not recorded	

Figures are for 2-inch cylinder

Evaluation

The two test pumps were collected from the manufacturer's factory in the Netherlands, and the normal method of packing was therefore not assessed.

No instructions for installation, maintenance or repair were provided. Because the below-ground assembly was light in weight, installation was relatively easy, with no need of lifting tackle.

Care is needed to ensure an adequate seal at the wellhead.

The most frequent maintenance requirement is likely to be to replace the spring in the pumpstand. This is a straightforward task, but requires a supply of suitable spare parts. Below-ground maintenance requires the whole assembly to be extracted, but this is also relatively easy.

For endurance testing, the pump was driven at 40 cycles per minute at a head of 7 meters. The spring broke after 250 hours and again after 400 hours, at which point the test was stopped. Corrosion was not assessed; however, all the below-ground parts are plastic, brass or stainless steel, and the spring in the pumpstand is also stainless steel.

The pump proved to be resistant to impacts.

Some users found the pump difficult to use, particularly where their body weight was insufficient to compress the spring.

The overall conclusion of the laboratory tests was that the Kangaroo is unsuitable for community water supply. It is difficult to use, the range of working depth is very limited, and the spring inside the pumpstand proved to be very unreliable.

Kangaroo

Field Trials

Test conditions

Country	Number of pumps	Head range (meters)	Data available (months)
Tanzania	10	4-7	13

The field trial was conducted on the Mtwara project in Tanzania, and the humid atmosphere was a severe test for the Kangaroo pump's steel spring. The downhole components of the pump are identical to those of the SWN80 & 81 (Pump 20), and again proved highly resistant to abrasion and corrosion.

The pumphead however did not perform well. Though the trial was limited — only ten pumps for a little over a year and shallow lifts — the measured failure rate was 1.5 breakdowns for every 1000m³ of water pumped. All the failures were associated with the pumphead, and involved broken springs and some broken footplates. Even working springs exhibited severe corrosion. Though the pump can be operated by hand when the spring is broken, it is a heavy lift, requiring two strong men.

The pump is difficult to repair, the

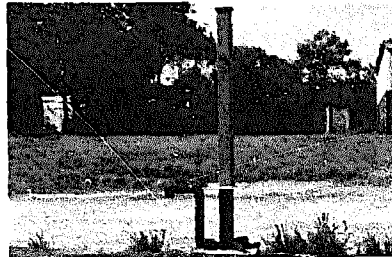

spring being hard to replace and the underground components difficult to remove.

Installation is complex, because the pump is heavy and connection of the rising main to the pumphead requires a minimum of two skilled people.

User reactions were generally favorable when the pumps were working. People liked the foot operation, and the capacity to employ full body weight in a comfortable way.

In general, the conclusion of the field trials was that the Kangaroo's innovative design is let down by major problems with the pumphead. The system is judged too complex, when compared with a conventional direct action pump using a high displacement pumprod, with which the operator can achieve the upstroke without the need for a spring.

Assessment

The Kangaroo ratings are based on limited field and laboratory trials, together giving reasonable data from which to draw conclusions about the pump's performance.

Discharge Rate

The Kangaroo is capable of relatively high discharges and earns a "good" (oo) rating for both 7 and 12 meter lifts.

Ease of Maintenance

The pump is not suitable for village-level maintenance, but is within the capacity of an area mechanic to maintain, and so rates oo for maintenance systems B and C.

Reliability

The frequency of necessary repairs combined with the need for area-mechanic maintenance, means that the pump is not reliable for high daily outputs. It is rated "adequate" (o) for 4m³/d and oo at 1.5m³/d.

Corrosion Resistance

Downhole components of the Kangaroo are highly corrosion resistant, but the susceptibility of the spring to suffer in the corrosive conditions of the field trials reduces the rating to o.

Abrasion Resistance

The downhole components of the Kangaroo proved highly resistant to abrasion, confirming the results obtained by the SWN 80 & 81, which use the same components, and earning a oo rating.

Manufacturing Needs

The complexity of the pumphead assembly makes the Kangaroo unsuitable for manufacture in developing countries with a low level of industrial development (Category 1). The degree of quality control needed means a o rating for Category 2 (moderately developed industrial base), and the pumps scores oo only for manufacture in a Category 3 environment (highly developed industry).

CAUSES OF ESSENTIAL INTERVENTIONS

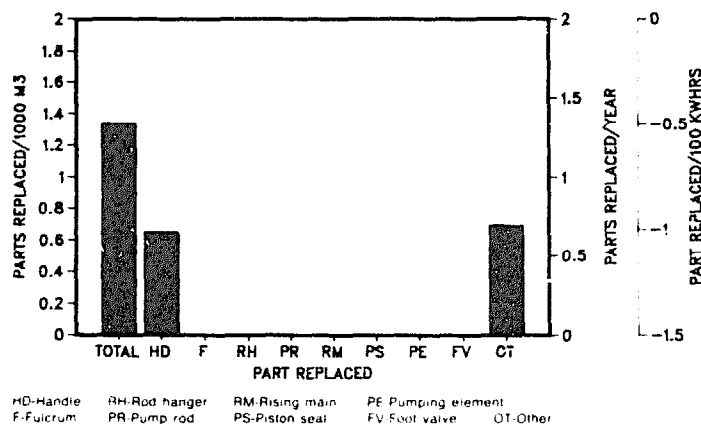

HD-Handle
F-Fulcrum
RH-Rod hanger
PR-Pump rod
RM-Rising main
PS-Piston seal
PE Pumping element
FV Foot valve
OT-Other

Laboratory Tests

THE MALAWI MARK V PUMP HAS NOT BEEN TESTED IN THE CATR LABORATORY

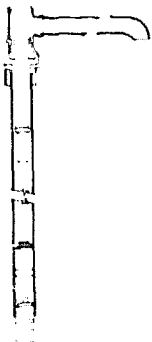

General Description

Mark V is a shallow-well direct action pump developed in Malawi and designed for local manufacture and to suit local conditions for a corrosion resistant low-lift pump.

The pump continues to undergo modifications, and this description applies only to the pumps tested in the trials. The pumpstand is made from galvanized steel pipe and standard galvanized pipe fittings, and fits into a 50mm diameter socket cast into the well cap.

The 32mm diameter PVC pumprod passes through a polypropylene bush and is connected to a hardwood T-handle via a 25mm diameter galvanized steel pipe. The uPVC pump body has a low density polyethylene fitting into a 56mm diameter PVC pump main which also forms the cylinder. A low density polyethylene disk forms the foot check valve, while the footvalve is a rubber disk in a uPVC body.

Manufacture

The pump was specifically developed for manufacture in Malawi and could be made in any developing country where the materials and quality of plastics materials are available.

Address

Secretary for Works and Supplies,
Department of Lands, Valuation and
Private Bag 390, Capital City,
Lilongwe, Malawi.

Estimated prices - Jun 1985

Complete pump, including riser pipe and rising main	US\$ 135
--	----------

Malawi Mark V

Field Trials

Test conditions

Country	Number of pumps	Head range (meters)	Data available (months)
Malawi	61	2-10	22

The Malawi Mark V was an early example of what has become an important pump group for low lifts — the direct action pumps. It makes extensive use of plastics, and has been designed for quick and simple maintenance. However, there are some serious design flaws, which have resulted in rapid breakdown in the field trials.

The types of failure which have occurred have demanded more than straightforward replacement of parts, involving skilled repair, with the need for solvent cement, etching fluid and tools which would not be available to a village caretaker.

Failure of the connection between the T-bar handle and the PVC pumprod was the commonest form of such breakdowns. This is a predictable weak point, but even when the connection has been

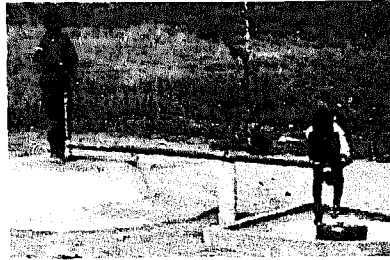

strengthened, the Mark V fails at another high stress point, where the pumprod joins the plunger.

The top guide bush wore rapidly, and there was some scoring of the plastic rising main when pumping sandy water, though the seal-less design is generally abrasion resistant.

Because of the frequent stress failures in the field trials, the Mark V cannot be recommended for lifts beyond 7 meters, and even then is only appropriate for comparatively light use.

Under those conditions, it does have the merit of complete corrosion resistance. It is also capable of delivering a high amount of water per stroke, which makes it popular with users when it is working.

Assessment

The Malawi Mark V ratings are based on monitoring of a large sample of pumps over a reasonable period of time, giving a good degree of confidence in the judgments made. As a direct action pump, it would be limited to lifts of less than 12-15 meters, and the field experience has shown that the present design is not suitable for use beyond 7 meters lift.

Discharge Rate

The pump is capable of achieving a high discharge rate and earns a "good" (oo) rating under this heading.

Ease of Maintenance

The simplicity of parts replacement on the Mark V should make it well suited to village-level maintenance. However, the common breakages of rod/handle and rod/plunger connections require skilled repair, which reduces the rating to "adequate" (o) for maintenance system A.

Reliability

The frequency of essential repairs combined with the need for skilled assistance in carrying them out restrict the Mark V's recommended application to low duties. It is rated o for a daily output of 1.5m³/d at 7 meters lift.

Corrosion Resistance

Use of all plastic parts below ground earns a oo rating.

Abrasion Resistance

The seal-less design cuts down abrasion, but scoring of the PVC cylinder wall limits the rating to o.

Manufacturing Needs

Manufacture of the Malawi Mark V is simple and could be readily accomplished in most developing countries. The demonstrated need for high quality plastics restricts the rating to o in countries with only low levels of industrial development (Category 1).

CAUSES OF ESSENTIAL INTERVENTIONS

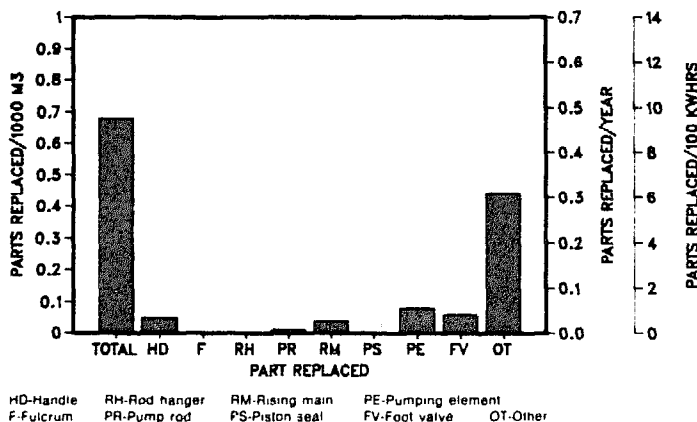

Finland

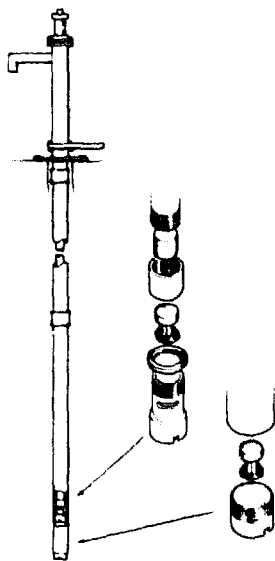

General Description

The Nira AF85 is a direct action pump developed as a result of, and with feedback from, the Project field trials. The pumpstand is made from fabricated steel and is nylon coated for corrosion protection. A stainless steel T-bar handle slides in a long guide bush made from high density polyethylene (HDPE). A footplate is bolted to the bottom of the pumpstand.

The rising main and large diameter pumprod are made from polyethylene and both originally had brass screwed couplings, but the pumprods are now connected using polyethylene couplings. Tight fitting rubber plugs prevent water ingress at the ends of pumprods. Plunger and footvalves are in HDPE with identical molded rubber bobbins. The plunger seal is also HDPE. Valves are interchangeable with those on the Nira AF84 (Pump 18).

Manufacture

Use of expensive imported materials is a constraint to manufacture in developing countries.

Suppliers

Vammalan Konepaja Inc, 38200 Vammala, Finland.

Indicative prices - Feb 1985

Pumpstand, cylinder, rods, and rising main to 10.5m	US\$ 340
--	----------

Laboratory Tests

Date tested: 1986

Reported: Not yet reported

Performance data (typical values) — 58mm dia cylinder

Head (meters)	7	10
Pumping rate (cycles/min)	30	30
Volume/min (liters)	26	24
Input (watts)	70	85
Mechanical efficiency (%)	42	45
Maximum handle force (kg-f)	18	down 24
	29	up 31
Footvalve leakage (ml/min)	No significant leakage	

Evaluation

The two test pumps were securely packed in wooden cases, and were in good condition on arrival. The manufacturer subsequently supplied new valve poppets to replace those in the original consignment.

Instructions for installation and maintenance were supplied with the test samples. They consisted mainly of drawings and photographs, augmented by a small amount of text, in English. The installation instructions were comprehensive and helpful, and a full set of tools was also provided. **Installation** was easy, with no need of lifting tackle.

In contrast with the installation literature, the instructions for **maintenance** were very brief. Nevertheless, the light weight of the below-ground assembly, and the simplicity of its design, mean that only a few tools and a modest degree of skill will be required to maintain the pump in working order. On the pumpstand, the only item likely to require attention is the pumprod guide bush, and this is easy to replace using a single hexagon key.

For the 4000 hour **endurance test**, the pump was driven at approximately 30 cycles per minute, at a simulated head of 10 meters. A device simulating the inherent buoyancy of the sealed tubular pumprods was also fitted, and the driving mechanism was so arranged to impose a lateral force on the pump handle similar to that typically applied by users.

For the first phase of the test, with clean water, the pump was fitted with molded rubber valves. The footvalve failed shortly before the end of this phase, when the rubber extruded into the valve port, causing the valve to seize shut. In consultation with the manufacturer, the

rubber valves were replaced with polyurethane moldings, for both this pump and the Nira AF84 deepwell pump (Pump18).

At the end of the test, the plunger and cylinder were badly worn, and the rate of delivery from the pump was considerably reduced. The rising main and pumprod were also locally worn as a result of contact between them. The latest valves showed few signs of wear, but were beginning to crack. The manufacturer has since made further modifications to the valves. There was no **corrosion**.

The pump proved to be robust in the **impact tests**; although heavy impacts on the pumpstand bent it a few degrees out of vertical, the pump could still be used without difficulty. The pump completed the allotted 96,000 cycles of the handle shock test without failure.

In the **user test**, the smaller children found it difficult to achieve the necessary operating force on the upstroke, but adults commented favorably on the rate of delivery from the pump. Several users found the footrests uncomfortable to use, and would have preferred to stand on the ground beside the pump.

The **overall conclusion** of the laboratory tests was that the Nira AF85 is a generally robust pump of simple design, well-suited to the requirements of **VLOM**. There was considerable wear of the plunger seal, particularly in sandy water, but the pump is easy to maintain and repair. The new valve design introduced by the manufacturer in consultation with the laboratory represents a significant improvement. The pump also has considerable potential for manufacture in developing countries, though specialist equipment for molding the polyurethane valves is unlikely to be widely available.

Nira AF85

Field Trials

Test conditions

Country	Number of pumps	Head range (meters)	Data available (months)
Tanzania	13	0-9	12
Kenya	7	2-15	9
Malawi	10	1-10	6

Though only a few Nira AF85 pumps have been monitored in the field trials, and data is therefore limited, increasing numbers of pumps have been installed during the latter stages of the Project, allowing judgments to be made beyond those reflected in the record of interventions represented below.

Overall, the pump has performed very well. It is popular with users, being very easy to operate down to heads of about 12 meters, and giving a high discharge. One significant problem has been failure of valve bobbins. This has been brought to the attention of the manufacturer as a result of which the valve has recently been substantially redesigned and further problems are not expected.

The Nira AF85 is very easy to install and to maintain, requiring only two simple bolt spanners to disconnect the rising main. Removal and replacement of the entire pump can be achieved by two people in about half an hour.

The use of plastics, stainless steel and brass for downhole components gives good corrosion resistance. The pump uses a plastic piston ring, which is



susceptible to abrasion damage, but the sealing provided by this ring is not important, because of the high plunger velocity, which means that the pump will continue to lift water if the seal is damaged (even without the seal).

The manufacturer has made several substantial modifications to the pump design during the field trials, partly in response to suggestions made by Project staff. The changes have proved generally successful. They include standardizing on one cylinder size and simplifying the connection of the top bush to the pumphead.

Overall, the judgment is that the Nira AF85 is an important pump for lifts of up to 12 meters, using the most up-to-date thinking and producing good results, though the price is high.

Assessment

The Nira AF85 ratings are based on data from comparatively short field trials involving only small numbers of pumps. However, with the laboratory test data and observations of additional pumps in other locations, there is adequate information for judgments to be made. As a direct action pump, the Nira AF85 has a practical operating limit of 12-15 meters.

Discharge Rate

A high discharge rate can be achieved comfortably, and the pump earns a "good" (oo) rating.

Ease of Maintenance

The Nira AF85 is well suited to village-level maintenance and earns a oo rating under each possible maintenance system.

Reliability

Because of the quick and simple maintenance, the pump is rated oo for reliability for all uses except a daily output of 8m³/d at 12 meters lift, which represents very heavy use for a pump of this nature. The rating then drops to "adequate" (o).

Corrosion Resistance

All downhole components are corrosion resistant, earning a oo rating.

Abrasion Resistance

Heavy sand pumping will lead to wear of the plastic piston ring, but this has a limited effect on pump performance, justifying the o rating for abrasion resistance.

Manufacturing Needs

The Nira AF85 is relatively simple to manufacture, but the need to import some materials reduces the rating to o for countries with only a low level of industrial development (Category 1). The rating is oo for Categories 2 and 3.

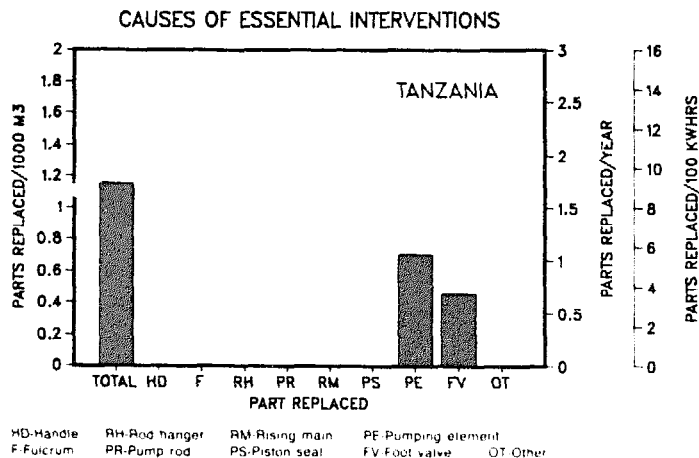

Bangladesh

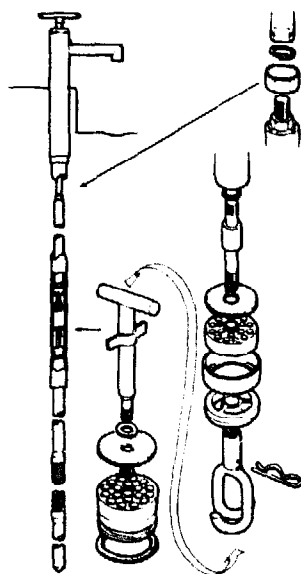

General Description

The Tara is a direct action handpump under development in Bangladesh (See Box 4.7 in Chapter 4). The pumpstand casing is fabricated from steel. Pumprod and rising main are standard uPVC pipe. The cylinder is also uPVC pipe of the same outside diameter as the rising main but greater wall thickness. When used in the small diameter tubewells constructed in Bangladesh, the rising main also serves as the well casing.

The piston is machined from aluminum and has a simple rubber flap valve. A similar rubber flap is used on the molded plastic footvalve. Fittings on the piston and footvalve enable them to be coupled together and removed for maintenance or repair without extracting the rising main.

Manufacture

The Tara has been designed for manufacture in Bangladesh, and involves simple steel fabrication, some thermal forming of uPVC pipe, machining of aluminum, and simple plastic molding. The design provides scope for use of alternative materials where appropriate.

Suppliers

Mirpur Agricultural Workshop and Training School, Pallabi, Dhaka-16, Bangladesh.

Indicative prices - Mar 1985

Per unit, including rods and rising main to 11 meters US\$ 103

Laboratory Tests

Date tested: 1985

Reported: Applied Technology Note No. 2

Performance data (typical values)

Head (meters)	7	15
Pumping rate (cycles/min)	21	20
Volume/min (liters)	24	23
Input (watts)	53	97
Mechanical efficiency (%)	51	58
Maximum handle force (kg-f)	18 down	31 up
Footvalve leakage (ml/min)	Not significant	

The volume discharged per stroke was about 1.2 liters and was not affected by pumping rate.

Performance was tested for a cylinder immersion of 5 meters.

Evaluation

The two test pumps were well packed and were received in good condition. Cylinder pipes were supplied, but uPVC pipe for the rising main and pumprod was bought locally.

Installation and maintenance instructions were included in a comprehensive album of drawings and specifications, which might be considered overwhelming at the village level. Specific installation instructions were supplied later, and included clear line drawings and guidance on site selection.

Only simple hand tools are required for installation of the Tara, and all the components are light and easy to handle. Care is needed to ensure that all the pumprod joints are watertight, as the buoyancy of the rod is critical to pump performance. It is also important that the joints on the rising main should point downwards, to enable the piston to be extracted for maintenance.

The grapple device below the plunger makes it possible to remove the footvalve for maintenance without extracting the rising main, though some care is needed to avoid damage to the pumprod as it is lifted out. All maintenance operations can be performed by a village caretaker.

The 4000 hour endurance test was

carried out at 30 cycles per minute, with a simulated head of 15 meters. Special arrangements were made to simulate the buoyancy effect of the pumprod, and the mechanical drive was set up to match the out-of-line forces typically applied by users operating direct action pumps.

There were no failures in the first 2000 hours of testing, using clear water. However, the Tara did break down repeatedly during the initial stages of the final 2000 hours of testing, when sand and Kieselguhr had been added to the water. Fragments of uPVC jammed under the leather cup seal caused the pump to seize, and the problem was repeated several times when new leather seals were fitted. It was thought that sand particles embedded in the leather seal abraded the cylinder walls. Substitution of a nitrile rubber cup seal overcame the problem.

At the end of the 4000 hours, the foot valve was leaking badly and the pattern of the valve ports was impressed in the piston valve rubber, but the valve was still in good working order. The nut on the piston spindle had rusted on tightly and the footvalve body had jammed in the taper seat, making it impossible to remove from above. Except for the piston spindle nut, corrosion was limited to surface marks on the aluminum components of the piston.

The pumpstand withstood the impact tests, suffering slight bending of the baseplate, but remaining serviceable. The handle was subjected to a shock test involving repeated banging against the lower stop. It survived the allotted 96,000 cycles without failure.

The Tara's proportions and the distribution of effort between upstroke and downstroke make the pump well-suited for direct action by most users, though at 15 meters depth and with a cylinder immersion of 5 m, the required forces are difficult for children.

The overall conclusion of the laboratory trials was that the Tara is a VLOM pump, designed to exploit the materials and manufacturing skills indigenous to Bangladesh, with potential for further improvement and wider application. Relatively easy to manufacture, operate, maintain and repair, it is seen as suitable for community water supply use for lifts of 15 meters or less, and should be fitted with a nitrile rubber seal if sand may be pumped.

Field Trials

Test conditions

	Number of pumps	Head range (meters)	Data available (months)
Sri Lanka	20	3-11	15
Bangladesh	128	3-12	11
Kenya	10	12	7
Tanzania	5	2-6	6
Malawi	6	1-3	11
Bolivia	16	4-11	14
China	44	7-14	4

This report concentrates on the results of testing in Bangladesh, where design modifications have been made as testing progressed.

The most important aspect of installation is proper jointing of the PVC pipe for pumprod and rising main, and some masonry skill is needed to embed the pumpstand lower flange in concrete. An average pump installation was completed in six hours by four workers.

An average of three essential interventions was needed for each pump in approximately two years of testing, mostly to correct poor performance. Including preventive maintenance and other non-essential interventions, each pump received some kind of maintenance attention about five times in the year, with the average intervention lasting about two hours, and involving a labor cost of US\$0.37 and a spare parts cost of US\$0.39. Since June 1985, groups of three women caretakers have been servicing ten pumps per group, with encouraging results.

Among the 128 pumps under test, there was a total of four breakdowns, two due to pumprod breakage, and two due to uncoupling of the bottom connector. Other



essential interventions were mainly to replace footvalve parts (O-rings and body) or leather cupseals. Sand entry into the well is a problem in Bangladesh, and leather cupseals are not suitable in these conditions; nitrile rubber seals have proved substantially better.

The field trials also revealed potential problems caused by abrasion of the seal on the PVC cylinder and between the pumprod and rising main. Nitrile rubber guides are being investigated (see also Box 4.7 in Chapter 4). There were no complaints from users about the mode of operation of the Tara, and the high discharge was liked. The Taras also continued to work when suction pumps failed in the dry season, as the water table dropped.

The Tara trials showed that the pump has great potential, though some problems remain to be solved. The number of interventions needed was high, but the speed and simplicity of repairs meant that few pumps were out of action at a time.

CAUSES OF ESSENTIAL INTERVENTIONS

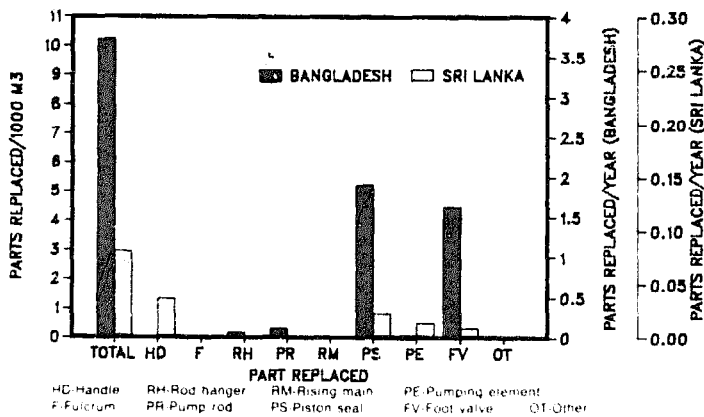

Assessment

The Tara ratings are based on the pump's performance in both field trials and laboratory tests. For a direct action pump, the practical operating limit is 15 meters, and the pump is therefore included only in Tables S.1 and S.2.

Discharge Rate

A discharge rate of more than 20 liters per minute earns the Tara a "good" (oo) rating.

Ease of Maintenance

The Tara is a true VLOM pump and earns a oo rating for maintenance under each possible maintenance system.

Reliability

Under conditions of low usage and 7m head, the ease with which maintenance can be carried out gives the pump a oo rating for reliability, but for higher daily outputs, the frequency of essential interventions to replace cup seals or footvalve components reduces the rating to "adequate" (o) at 4m³/d and to "unsuitable" (—) at 8m³/d. At 12m lift, the pump achieves a o rating for a daily output of 1.5m³, but is unsuitable at this stage of its development for higher outputs.

Corrosion Resistance

Most of the pump's components are corrosion resistant, but experiences in the laboratory and the field with the footvalve assembly mean that the appropriate rating is o.

Abrasion Resistance

Sand caused severe problems with the leather cupseals, and nitrile rubber seals are therefore essential if there is a possibility of sand entering the well.

Manufacturing Needs

The Tara has been specifically designed for manufacture in Bangladesh, and is suitable for modification (using alternative materials) to take advantage of indigenous materials and skills in any developing country. The need for some assistance with quality control reduces the rating to o for manufacturing environment 1.

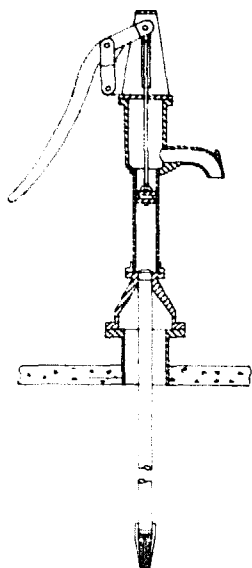

Laboratory Tests

NEITHER THIS SHALLOW-WELL VERSION NOR THE SRI LANKAN MANUFACTURED DEEPWELL AID DERIVATIVE WERE TESTED IN THE CATR LABORATORY. HOWEVER, THE LABORATORY REPORT ON TWO AID DEEPWELL DERIVATIVES WHICH WERE TESTED CONTAINS SOME RELEVANT DATA

SEE ENTRY FOR PUMP 03

General description

This is a shallow-well version of a pump derived from the basic design developed by the Battelle Institute and Georgia Institute of Technology on behalf of USAID. The pumpstand is similar to the deepwell version (Pump 03) and consists of a cast iron drive head assembly and cast iron base joined by a steel tube. The base is flanged to bolt to the platform.

In this suction version, the steel tube is lined with 75mm ID PVC pipe and a 32mm ID PVC suction pipe extends down to the desired pumping level. Two outboard cast iron cleats on the rodhanger axle slide up and down in cast iron runners. The fulcrum stand is pinned to the pumpstand below and the handle above, so that the fulcrum moves in an arc as the handle is operated. A cross head guides the pumprod.

Manufacture

Basic skills in foundry work, machining and leather crafting are needed to manufacture the pump and careful quality control is needed to ensure interchangeability of spare parts.

Suppliers

Diason Pumps Ltd, 112 Isipathana Mawatha, Colombo 5, Sri Lanka.

Indicative prices — 1982

Per unit, excluding suction pipes	US\$ 120-160
--------------------------------------	--------------

Field Trials

Test conditions

Country	Number of pumps	Head range (meters)	Data available (months)
Sri Lanka	13	2.8*-4.8	11

* Average head

There were no major failures among the 13 test pumps during the monitoring period. Three leather cupseals and one flap valve were the only parts replaced in essential interventions. The PVC cylinders showed little wear and the cross heads and guides, though worn, were still functioning satisfactorily after 11 months. On the other hand, routine maintenance demands were comparatively high. The drive head is exposed and needs frequent lubrication (at least once a month) of fulcrum, eye and pivot pins.

All moving parts are accessible above ground and maintenance tasks can be easily accomplished by a trained mechanic equipped with only pliers, a screwdriver and three spanners. A new gasket must be installed when the base flange is detached to service the footvalve.

No installation instructions were supplied with the pumps, but installation was easily accomplished by one skilled worker and one helper using basic hand tools. Pumps can be installed on a ground-level wellhead without a plinth.

Because the moving parts of the drive-head assembly are not protected from dust, heat and rain, corrosion and abrasion of these components is a danger. Complaints about the taste of the water were noted at 10 of the 13 test sites,



suggesting that corrosion products may have affected palatability.

Impact can lead to water leaks at the threaded joint between the cylinder and the base flange; otherwise the pumpstand is adequately robust. The pump's open design means that water can be contaminated through the connecting rod hole, and the spout profile is such that deliberate contamination is possible. Split pins are easily removed and there are no locking fixings, so the pump can fall victim to vandalism or abuse.

Users liked the relatively high discharge rate of the pump (about 24 liters/minute at a comfortable 30 strokes a minute). Though there were potential finger traps around the fulcrum mechanism and the sliding guide blocks, no injuries were reported.

As the bar chart shows, the parts replaced for every 1000m³ of water pumped were very low (0.3). Though the test period is short, it does seem that this pump will perform well for low lifts, provided that the drive head is lubricated regularly.

Assessment

The ratings are based on field trials in Sri Lanka. As a suction pump, this AID Derivative is appropriate only for pumping lifts of 7 meters or less. It also requires priming and is therefore at risk of contamination if polluted water is used for the purpose.

Discharge Rate

The discharge rate of 24 liters per minute at 30 strokes per minute earns a "good" (oo) rating.

Ease of Maintenance

No special tools or lifting tackle are needed, but for village-level maintenance it will be necessary to ensure that a village caretaker has access to spare cupseals and valves. Assistance from an area mechanic may be needed for special repairs, and the rating reduces from oo to o for System A maintenance.

Reliability

The reliability rating is also oo for outputs of 1.5 and 4m³/d, but drops to o for 8m³/d, when the frequency of maintenance required would be greater. It should also be noted that the pump calls for regular lubrication, and the ratings should be downgraded if such routine maintenance may not be readily achieved.

Corrosion Resistance

A galvanized steel suction pipe and exposed drive head components make the AID Suction unsuitable (—) where groundwater may be corrosive.

Abrasion Resistance

Use of leather cupseals means a o rating for abrasion resistance.

Manufacturing Needs

The pump is suitable for manufacture in countries with a moderate level industrial base, but the need for careful quality control of casting and machining operations reduces the rating from oo to — in a country with minimum manufacturing capabilities (Category 1).

CAUSES OF ESSENTIAL INTERVENTIONS

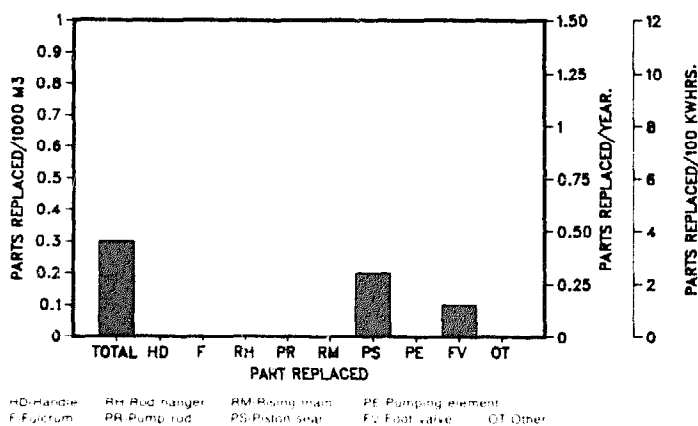

Indonesia

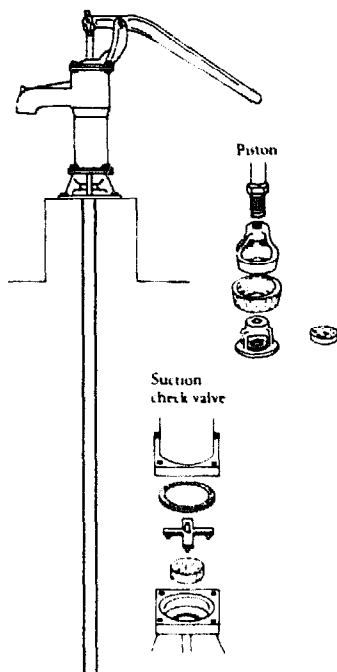

General Description

The Bandung is a suction pump with a conventional lever action. It is constructed mainly of cast iron, with an enamelled steel liner in the cylinder bore. The plunger is cast iron with a molded rubber cupseal and the check valve is a rubber disk retained by a plastic cage. There are no handle bearings; the mild steel pivot pins bear on holes drilled and reamed in the iron castings.

Manufacture

The pump can be manufactured in a country with cast iron foundry and simple machining skills together with rubber/plastic molding facilities. Quality control is necessary to ensure that the pivot holes in the handle fulcrum and fork are correctly aligned.

Suppliers

Iwaco BV, West Java Rural Water Supply Project, Jalan Banda 25, Bandung, Indonesia. The pump is manufactured by several firms in Indonesia.

Indicative prices - Mar 1985

Per unit US\$65

Laboratory Tests

Date tested: 1983

Reported: Project Report No. 3

Note: The sample tested differed slightly from the latest drawings supplied by the manufacturer. The cast iron handle has been replaced with one of galvanized iron; the webs of the top fulcrum casting have been extended to increase strength; and the connecting rod fork has been redesigned to remove the potential finger trap.

Performance data (typical values)

Head (meters)	7
Pumping rate (cycles/min)	30
Volume/minute (liters)	29
Input (watts)	47
Efficiency (%)	70
Maximum handle force (kgf)	16
Footvalve leakage (ml/min)	0.25

The volume discharged was about 1.0 liters per stroke and varied little with pumping rate.

Evaluation

The two pumps acquired for testing both arrived damaged, because of inadequate packaging. According to the supplier, the pumps left the factory packed together in a wooden crate and must have been separated by the carrier. They arrived wrapped in pieces of corrugated cardboard and plastic sacks, with the handles of both pumps and a third spare handle broken and one cylinder top casting cracked. Damaged components were replaced by the manufacturer.

Installation and maintenance is quite straightforward and requires only simple tools, though no installation or maintenance instructions were supplied with the pumps. Frequent attention is likely to be needed, particularly to replace cup washers. Three replacement cup washers were needed during the 4000 hour **endurance test** which took place at 30 strokes per minute at 7 meters head.

At the end of the endurance test, **rust** was found on the sliding plate at the pump top, in the plunger valve cage and inside the pump body above the cylinder lining, though the cylinder bore remained in good condition. Fulcrum pins and bushes were worn, and the plunger valve was noticeably worn, but still serviceable.

The top fulcrum casting and the base casting both broke during the **impact tests**, indicating a susceptibility to accidental damage, and the absence of lock washers on the fixings lowers the pump's resistance to possible abuse. The laboratory noted a potential finger trap between the connecting rod fork and the top of the pumpstand, but later designs have eliminated this danger.

User reactions were neutral: overall few users criticized the pump and few singled it out for praise. The handle movement means that many muscle groups contribute to the operating action.

The **overall conclusion** of the laboratory trials was that the Bandung is inexpensive, but could be comparatively easily damaged and is likely to need frequent maintenance. As with any suction pump, the Bandung has to be primed and is therefore susceptible to contamination if polluted water is used.

Field Trials



THE BANDUNG PUMP WAS NOT FIELD TESTED BY THE HANDPUMPS PROJECT

Assessment

In the absence of field trials, the Bandung's ratings are based on its performance in the laboratory, and on the best judgement of Project staff as to its likely performance in field conditions. As a suction pump, the Bandung is not suitable for lifts in excess of 7 meters. It also requires priming and is therefore at risk of contamination if polluted water is used for the purpose.

Discharge Rate

The measured discharge rate of 29 liters/minute earns the pump a "good" (OO) rating.

Ease of Maintenance

Maintenance is simple and requires few tools, earning the pump a OO rating for each possible maintenance system.

Reliability

The reliability rating is OO for daily outputs up to 4m³, falling to "adequate" (O), at 8m³/d, as the endurance testing suggests that more frequent repair interventions will then be needed.

Corrosion Resistance

Some corrosion was noted in the laboratory trials, which indicates that the pump cannot be recommended for use where groundwater is likely to be highly aggressive. However, rusting was mainly confined to the pumphead, so the pump is given a O rating.

Abrasion Resistance

The rubber seals failed comparatively frequently during the endurance tests, so the pump earns only a O rating for abrasion resistance.

Manufacturing Needs

The Bandung is suitable for manufacture in countries with a medium-level industrial base, but the degree of quality control needed makes it unsuitable for manufacture in a country with a low-level base (Category 1).

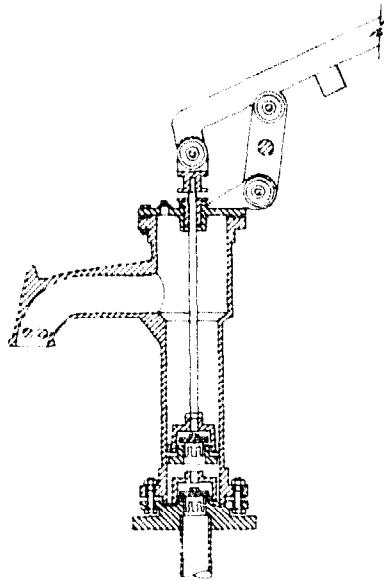

Laboratory Tests

THE INALSA SUCTION PUMP WAS NOT TESTED IN THE CATR LABORATORY

General Description

The Inalsa Suction is a shallow-well suction pump with a cast iron pumpstand and fabricated mild steel top plate assembly. The cylinder is machined in the cast iron stand. Sealed ball bearings are fitted in the linkage pivots and the pumprod passes through a brass bush in the top plate, which also has a plugged hole for priming. The risk of contamination is therefore less than for other suction pumps.

Pumprod, handle and links are galvanized steel. The plunger and valves are cast gunmetal, with a leather plunger seal and rubber valve seals.

Manufacture

The Inalsa Suction pump can be manufactured in a country with adequate skills in foundry work, simple sheet metal work, basic machining and simple leather work, but exacting quality control is needed, in particular to ensure a smooth surface on the cast iron cylinder.

Suppliers

Industrial and Allied Sales Private Ltd (INALSA), Suriya Kiram, 19 Kasturba Gandhi Marg, New Delhi 110001, India.

Indicative prices - 1983

Price per unit	US\$ 127
excluding suction pipe and footvalve	

Inalsa Suction

Field Trials

Test conditions

Country	Number of pumps	Head range (meters)	Data available (months)
India	5	1.9-3.7	13.2

* Average head

The field trial pumps had only low usage — average output for the five pumps was just 0.7 m³/d.

No literature was supplied with the pumps, but only basic tools and skills are required for installation. Average installation time was half an hour and involved three workers. The pump base should be at least 300mm above the wellhead for comfortable pumping.

No breakdowns occurred in the 18 month test period, but a total of 14 leather cupseals were changed in that time, and it seems that the cupseals will last from 4 to 6 months, depending on the intensity of use and the cylinder roughness. Frequent maintenance was also needed to adjust the alignment of the fulcrum plate and piston rod, to avoid accelerated wear on the guide bushing and the cup seal. Most maintenance tasks were found to be simple to perform, requiring only two open spanners and a 450mm pipe wrench. Care was needed to avoid overtightening of the check valve cage, which could lock open the poppet valve. The lever arrangement did not require lubrication over the test period. On average, each maintenance intervention lasted for one hour, at a cost of \$0.50.

At 30 strokes per minute, the pumps delivered 25 liters/min under the test

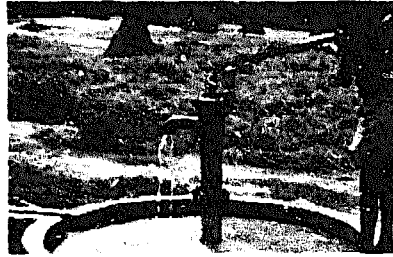

conditions (less than 5 meters head).

There were no complaints from users about operation of the pumps, but the irregular discharge pattern from the spout caused by built-in baffles was regarded as a nuisance. Complaints about the taste of the water were noted at four of the five test sites, supporting Project staff's belief that combining brass fittings with ferrous metals can lead to galvanic corrosion in aggressive waters. Slight rusting was detected on the inner portions of the pump body.

The test pumps had low-grade leather cupseals, which accounted for the majority of maintenance interventions, and which could be expected to wear even more quickly if sand was present in the water. Abrasion would also be a risk in those circumstances.

The pumpstand was found to be generally robust, and the baffles offer resistance to abuse, by preventing debris from entering the pump. Some finger traps are apparent around the handle fulcrum.

Overall, the Inalsa Suction pump compares favorably with the other two suction pumps used in the India field trials. The two major maintenance needs could be reduced by design improvements and use of better quality leather cupseals.

Assessment

The Inalsa Suction ratings are based on the pump's performance in field trials in India. As a suction pump, it is not suitable for pumping lifts in excess of 7 meters. It also requires priming, and is therefore at risk of contamination if polluted water is used for the purpose.

Discharge Rate

The discharge rate of 25 liters per minute earns the pump a "good" (oo) rating under this heading.

Ease of Maintenance

All wearing components are easily serviceable with hand tools, but there are problems in aligning the top plate. The pump therefore scores oo for maintenance System B (area mechanic), but only "adequate" (o) for System A (village-level).

Reliability

Because maintenance is comparatively quick and easy, the reliability rating is also oo where usage is low, but when the daily output rises, the anticipated frequency of seal replacement means that the downtime will be greater, and the rating drops to (o) at 4m³/d and "unsuitable" (—) at 8m³/d.

Corrosion Resistance

The present design incorporates brass and ferrous metal parts, which have been shown to lead to galvanic corrosion, and the pump cannot therefore be recommended for situations where water is corrosive.

Abrasion Resistance

The leather cup seals failed frequently in the field trials, even with low usage, and would be more susceptible to failure in sand-laden water, which is why the pump is rated — for abrasion resistance.

Manufacturing Needs

The Inalsa Suction is suitable for manufacture in countries with a medium-level industrial base, but the degree of quality control needed reduces the rating from oo to — in a country with minimum manufacturing capabilities (Category 1).

CAUSES OF ESSENTIAL INTERVENTIONS

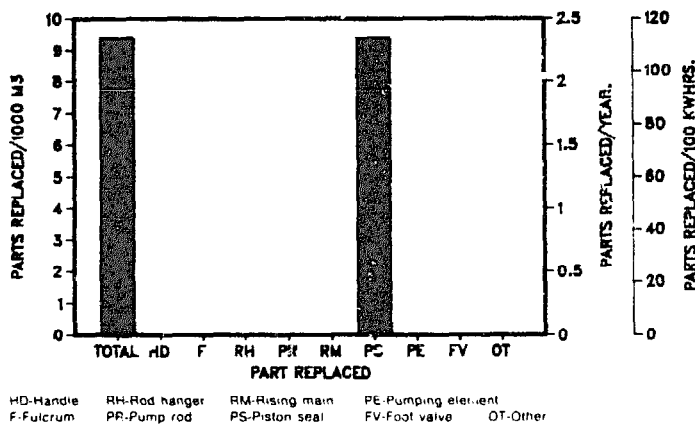

Philippines

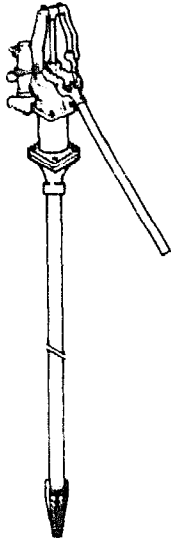

Laboratory Tests

The suction version of the Jetmatic pump was not tested in the CATR Laboratory. However, tests were carried out on the deepwell version, which has the same pumphead mechanism, and the entry for Pump 11 has some details which are also relevant to the Jetmatic Suction. In particular, the handle mechanism failed during the endurance test and the gland nut wore badly.

General Description

The Jetmatic is made in the Philippines to a design similar to that of Kawamoto Pumps of Japan. It is also available as a deepwell pump (Pump 11). The cast iron pumpstand is compact and fits on the protruding end of the suction pipe, which must protrude at least 440mm above ground to prevent the handle touching the ground and to provide clearance for the spout. A discharge valve in the spout allows either free discharge or pressure delivery through a hose or pipe.

Manufacture

Gumetal and iron foundry work and basic machining are required, with good quality control to ensure interchangeability of spare parts.

Suppliers

There are several, including Sea Commercial Co Inc, Cor. V. Cruz Street, Manila 2806, Philippines.

Indicative prices - Feb 1985

Pumpstand and cylinder	US\$35
------------------------	--------

FOB Manila

Jetmatic Suction

Field Trials

Test conditions

Country	Number of pumps	Head range (meters)	Data available (months)
Philippines	43	2-6	18

The Jetmatic pumps suffered many failures in the field trials. Production quality was generally poor, so that the low initial cost of the unit was more than compensated by the high demand for spare parts.

Failures were occurring within a few weeks of installation, and included broken handles and crossheads and worn pins. In addition, there was constant replacement of seals worn down by the rough cylinder surface.

The general conclusion was that the present design and manufacturing standard of the pump make it suitable for only light use. It might, for instance provide



water for a family unit or a group of 10-15 users for up to one year without major failure.

If production quality could be improved and controlled, and if the design was altered to include sleeved cylinders, quality seals, ball race pivots, and quality castings, it should be possible to improve durability and raise the user group to perhaps 50 beneficiaries. Some design improvements have already been made, in response to shortcomings encountered during the field trials.

Assessment

The Jetmatic Suction ratings are based on field trials and the performance of the deepwell version in the laboratory, and on the experience and judgment of Project staff. As a suction pump, it is not suitable for lifts in excess of 7 meters, and is also at risk of contamination if polluted water is used for priming.

Discharge Rate

The pump is capable of achieving a relatively high discharge and earns a "good" (oo) rating.

Ease of Maintenance

The number of wearing parts which need regular attention keeps the rating for village-level (system A) maintenance down to "adequate" (o). For maintenance systems B and C, the rating is oo.

Reliability

The field tests showed that the Jetmatic suffers rapid wear, and the oo rating for reliability at 1.5m³/d reduces to o at 4m³/d. The pump is rated "unsuitable" (—) at 8m³/d.

Corrosion Resistance

The suction version of the pump earns a o rating for corrosion resistance.

Abrasion Resistance

Regular replacement of leather cupseals in the field trials resulted from roughness of the cylinder casting. In general, the suction pump has adequate resistance to sand pumping and earns a o rating.

Manufacturing Needs

The Jetmatic Suction is not suitable for manufacture in countries with a low level of industrial development (category 1) because of the need for foundry and machining skills. For categories 2 and 3, the ratings are oo.

Thailand

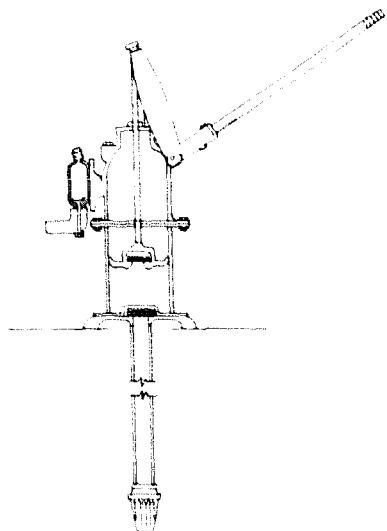

Laboratory Tests

THE LUCKY WAS NOT TESTED IN THE CATR
LABORATORY

General Description

The Lucky is a simple shallow-well suction pump constructed mainly of cast iron and supplied complete with 10 meters of 1-1/2 inch diameter galvanized steel drop pipe fitted with a footvalve. PVC drop pipes can be used as an alternative.

The plunger has a large diameter rubber seal, giving a high discharge per stroke.

Manufacture

The Lucky is widely manufactured in Thailand by small and medium foundries, but its reliability depends on good casting skills and quality control of items such as the handle, fulcrum pins, piston rod guides, etc.

Suppliers

Available from many foundries throughout Thailand.

Indicative prices - Apr 1986

Per unit, including 10m of G.I. drop pipe and footvalve	US\$ 35-40
---	------------

Field Trials

Test conditions

	Number of pumps	Head range (meters)	Data available (months)
Thailand	20	2-6	30

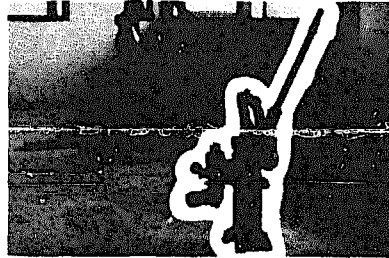

The Lucky pumps performed very poorly in the field, proving quite unsuitable for heavy duty operation at the village level.

The crosshead system has too many moving parts, which are subject to rapid wear. Though the discharge is high and the pump is therefore popular with users when it is working properly, the frequency of necessary repairs means that its use would have to be restricted to small user groups.

As a suction pump, the Lucky is inherently easy to maintain, though in

comparison with other suction pumps, it does have some disadvantages. Several spanners are needed to take the pump apart, and the need to lift out 10 meters of 1-1/2 inch diameter galvanized steel drop pipe to service the footvalve precludes maintenance by a village caretaker.

Even if higher production standards could be achieved, it is unlikely that the Lucky design would be suitable for high daily outputs.

Assessment

The Lucky ratings are based on the pump's performance in lengthy field trials in Thailand, which provided enough data for confident judgments about the pump's capabilities. As a suction pump, the Lucky is restricted to pumping lifts of 7 meters or less. It also requires priming and is therefore at risk of contamination if polluted water is used for the purpose.

Discharge Rate

The pump is capable of achieving a high discharge rate and earns a "good" (oo) rating under this heading.

Maintenance Needs

As a suction pump, the Lucky is fairly simple to maintain, but the need for several spanners to take the pumphead apart, and the difficulty in removing the footvalve for servicing make it unsuitable for village-level maintenance (System A). For area-mechanic and central maintenance (Systems B and C), the pump earns a oo rating.

Reliability

The Lucky needed frequent repairs in the field trials and cannot be recommended for high daily outputs. It is rated "adequate" (o) for 4m³/d, and oo for 1.5m³/d.

Corrosion Resistance

The pump has no special protection against corrosion and so cannot be recommended where groundwater will be corrosive.

Abrasion Resistance

The rubber seal earns a o rating for abrasion resistance.

Manufacturing Needs

The pump is widely manufactured in Thailand, though to a varying quality standard. It would not be suitable for manufacture in a country with a low level of industrial development (Category 1), but is given a oo rating for medium or high levels of industrial development (Categories 2 and 3).

CAUSES OF ESSENTIAL INTERVENTIONS

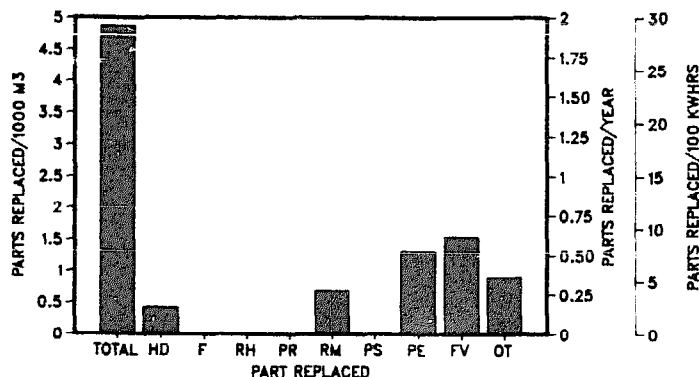

HD-Handle RH-Rod hanger RM-Rising main PE-Pumping element
 F-Fulcrum PR-Pump rod PS-Piston seal FV-Foot valve OT-Other

Bangladesh

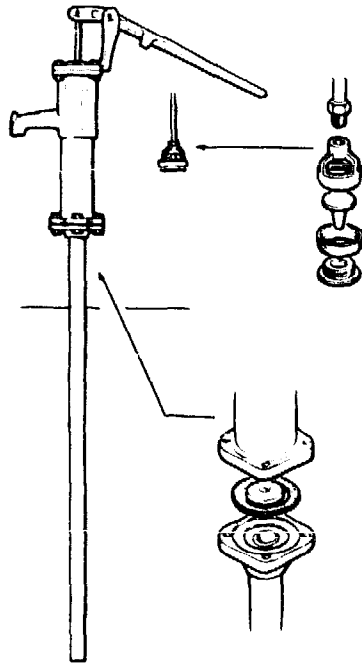

General Description

The New No. 6 is a simple and robust shallow-well suction pump constructed almost entirely of cast iron. The piston uses a molded PVC cupseal and the check valve is a weighted leather flap. The pumpstand is mounted directly on the suction pipe, which is 1.5 inch galvanized steel or PVC. More than a million units have been installed in Bangladesh.

Manufacture

The pump is manufactured widely in Bangladesh and is suitable for manufacture in any developing country with basic foundry skills. It has no fine tolerances.

Suppliers

The pump tested at CATR was supplied by Engineers Wood Steel Industries Ltd, 67 Tejgaon Industrial Area, Dhaka-8, Bangladesh. There are many more manufacturers of the New No. 6 in Bangladesh.

Indicative prices - Feb 1985

Price per unit (min. 50 units) US\$63

Laboratory Tests

Date tested: 1982

Reported: Project Report No. 3

Performance data (typical values)

Head (meters)	7
Pumping rate (cycles/min)	30
Volume/minute (liters)	36
Input (watts)	60
Efficiency (%)	67
Maximum handle force (kgf)	14
Leakage of foot valve (ml/min)	<1.0

The volume discharged per stroke was about 1.2 liters.

Evaluation

The two pumps acquired for testing were both received in working order, though pump tops were loose and in one case the halves of the plunger were not tightly screwed together.

No **installation and maintenance** instructions were supplied with the pumps, but a helpful leaflet was supplied on request. Installation is simple and requires only basic tools and skills. The assembled pump is mounted directly on the drop pipe, which must be securely fixed in position. Maintenance is simple and could be carried out by a village caretaker. Handle pivots need to be oiled twice weekly, and the manufacturer recommends that the piston seal and valve should be replaced yearly. This could be troublesome, as the test pumps suffered extensive **corrosion**.

The 4000 hour **endurance test** was conducted at 30 strokes per minute and 7 meters head. The original cupseal and plunger valve were badly worn after 1000 hours and were replaced, along with the check valve. The replacements lasted the remaining 3000 hours, though the cupseal and plunger valve were badly worn at the end. Poor **performance** in the first 1000 hours reflected an initial roughness in the

cylinder bore causing rapid wear in the cupseal.

At the end of the endurance test, the plunger could not be dismantled because of rusted threads, corrosion of the retaining screw prevented removal of the check valve weight from the leather flap, and there was considerable rust on the unprotected cast iron of the pump body. Pivot holes in the handle, pump top and connecting rod eye were all noticeably worn and the pivot axles were also worn, though still serviceable. The check valve leather flap was deeply indented.

The pump failed in one of the side **impact tests**, but proved capable of withstanding considerable shock to both the body and the handle, which indicates that it is quite robust. The simplicity of installation does mean that it has little resistance to abuse, as it is easy to remove the complete pump from the drop pipe and steal it. Pivot axles and bolts are also easy to remove.

Many **users** were pleasantly surprised by the performance of the New No.6, which contrasted with its somewhat crude appearance. It delivered well over a liter of water with each stroke, and the handle movement allowed arms, shoulders, back and legs to contribute to the operating effort. Some users disliked the roughness of the handle.

The **overall conclusion** of the laboratory trials was that the New No. 6 is a very simple, cheap and sturdy pump, but likely to wear considerably when heavily used. It is well suited to manufacture in developing countries with basic foundry skills and has no close tolerances - the holes for the handle pivot axles are deliberately drilled oversize to avoid problems of misalignment.

As with any suction pump, the New No. 6 has to be primed and is therefore susceptible to contamination if polluted water is used. A sliding plate on the connecting rod would be a simple design improvement, to combat accidental contamination.

Field trials



THE NEW NO. 6 PUMP WAS NOT FIELD TESTED BY THE HANDPUMPS PROJECT

Assessment

In the absence of field trial monitoring, the New No. 6's ratings are based on its performance in the laboratory, and on the experience and judgment of Project staff. As a suction pump, the New No. 6 is not suitable for lifts in excess of 7 meters. It also requires priming and is therefore at risk of contamination if polluted water is used for the purpose.

Discharge Rate

The high discharge rate of 36 liters per minute earns the pump a "good" (OO) rating under this heading.

Ease of Maintenance

Repairs are simple to carry out and require only basic tools, so that the pump qualifies for a OO rating under each of the maintenance headings (A, B and C).

Reliability

Under low usage conditions the pump also earns a OO rating for reliability, but for more intensive applications, more frequent repair interventions would be necessary, and the rating drops to "adequate" (O) for 4m³/d and to "unsuitable" (—) for 8m³/d.

Corrosion Resistance

The pump has no special protection against corrosion and suffered extensively from rusting in the laboratory tests. It cannot therefore be recommended for situations where groundwater is likely to be corrosive.

Abrasion Resistance

In general, the pump proved to be reasonably resistant to sand pumping in the laboratory. It earns a OO rating for abrasion resistance principally because of the tough plasticised PVC seal.

Manufacturing Needs

The New No. 6 is widely made in Bangladesh and is well suited for manufacture in a country with a moderately developed industrial base. However, its manufacture requires a basic awareness of quality control procedures, and it is therefore rated only O for countries with a low level of industrial development (Category 1).

Bangladesh

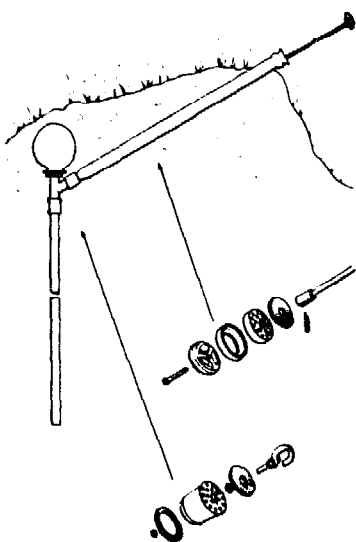

General Description

The Rower is a high-capacity low-lift pump designed primarily for irrigation. The operator pulls directly on the plunger rod by means of a T-bar handle, and the angle is convenient for operation from a sitting position using a rowing action. The cylinder is an extruded uPVC tube with heat-swaged ends and the aluminum piston is fitted with a leather cup washer and flap valves cut from tire inner tubes. Several different sizes are available.

The pump is fitted with an aluminum surge chamber, and is normally embedded in earth for support and protection, or may be supported by a smaller earth bank and protected by strips of bamboo around the cylinder.

Manufacture

The pump was designed for manufacture in a developing country and most components are easy to make. Some skill is required in heat-forming the uPVC tube and spinning the surge chamber, and care is needed in machining.

Suppliers

Mirpur Agricultural Workshop Training School, Mirpur Section 12, Dhaka, Bangladesh.

SWS Filtration in the UK have also developed versions of the Rower pump.

Indicative prices - Jun 1985

Per 2in. pump with screen and	
7.6 meters of drop pipe	US\$ 30-35
Extra drop pipe per 0.76m	US\$ 4.00

Laboratory Tests

Date tested: 1983/84

Reported: Project Report No. 3

Performance data (typical values) — 54mm cylinder

Head (meters)	7
Pumping rate (cycles/min)	15
Volume/minute (liters)	27
Input (watts)	48
Efficiency (%)	64
Maximum handle force (kgf)	20
Leakage of foot valve (ml/min)	High

The volume discharged per stroke was about 1.8 liters.

Evaluation

The sample pumps were delivered by hand, so no judgment can be made on the packaging arrangements.

Engineering drawings were supplied with the test samples, and these contained useful information but would not be suitable as an alternative to installation and maintenance instructions. However, installation of the Rower pump should be very easy, particularly if plastic pipe is used. The most important tool may well be a spade or shovel to construct the earth bank. Care is needed to achieve airtight joints in the drop pipe, as any leaks will significantly affect the efficiency of the pump.

Maintenance too is very straightforward, and requires only the simplest hand tools. The Rower is a true VLOM pump, though the need for priming introduces a pollution risk when it is used for drinking water. The pump achieves a high delivery on each stroke, and its discharge of 27 liters per minute at 15 cycles per minute is also high.

The 4000 hour endurance test was carried out at 19 cycles per minute and a head of 7 meters. No breakdowns occurred, though the check valve was replaced after 1000 hours as inspection revealed that the rubber flap valve was loose. Some joints in the drop pipe were found to be leaking during the test, and the threaded joints were replaced with cement joints. As well as reducing performance, leaking joints caused a rapid loss of prime.

Small amounts of surface rust were found on the check valve and plunger body fixings and there was slight pitting of the plunger rod, but all parts remained serviceable. The cylinder bore was worn at the end of the test, resulting in a 2mm step in the bore at the end of the swept stroke. The volume delivered per stroke was down on the original performance test, but still well over one liter.

User reaction was generally favorable, once users were instructed in the appropriate method of operation. Only small children found the pump difficult to use. Everyone liked the very high discharge, though some objected to getting wet when water spurted out of the pump at the start of the return stroke. The lack of an upper stop caused some problems, with some stronger users pulling the plunger right out of the cylinder.

The impact test was not applied, as the Rower is intended to be protected against such eventualities. The handle can be distorted quite easily, but is equally easy to straighten.

The overall conclusion of the laboratory trials was that the Rower is a commendably simple pump, easy to install, maintain and repair. Its main application is likely to be low-lift irrigation, as contamination of drinking water is almost inevitable. Performance falls off with time, because of wear, but all wearing parts are cheap and easy to replace.

Field Trials



THE ROWER HAS NOT BEEN FIELD TESTED UNDER THE HANDPUMPS PROJECT, BUT MANY ROWER PUMPS HAVE BEEN OBSERVED IN USE IN BANGLADESH.

PROJECT STAFF COMMENT THAT THE ROWER IS A TRUE VLOM PUMP, WHICH SETS A STANDARD FOR DESIGNERS IN A RANGE OF IMPORTANT PARAMETERS:

LOW COST
EASY SERVICEABILITY
HIGH CAPACITY
EASE OF MANUFACTURE

THE ROWER IS IDEAL FOR SMALL PLOT IRRIGATION UNDER LOW LIFT CONDITIONS IN MOST DEVELOPING COUNTRIES.

Assessment

The Rower pump ratings are based on performance in the laboratory tests and on experience and judgment of Project staff. The Rower was developed principally as an irrigation pump, and produces a high discharge. As a suction pump, it is not suitable for pumping lifts in excess of 7 meters. It also requires priming and is therefore at risk of contamination if polluted water is used for the purpose.

Discharge Rate

The discharge rate of 27 liters per minute at a pumping rate of 15 cycles per minute declines as wear takes place in the PVC cylinder, but remains high enough to justify the pumps "good" (OO) rating.

Ease of Maintenance

Practically no tools are needed for maintenance and the pump earns a OO rating under each maintenance system (A, B and C).

Reliability

The reliability rating is also OO, for outputs up to 4m³/d, as the repairs which are necessary can be carried out very quickly and easily. The rating drops to "adequate" (O) when daily output rises to 8m³/d.

Corrosion Resistance

Though small amounts of corrosion have been detected both in the laboratory and in the field in Bangladesh, they have not been extensive enough to impair the pump's performance, and should not be a problem unless the groundwater is highly corrosive. The Rower is therefore rated O.

Abrasion Resistance

The Rower design allows it to pump sand-laden water without difficulty, but the wear of the cylinder walls will be accelerated if sand is present regularly, and the pump is therefore given a O rating for abrasion resistance.

Manufacturing Needs

The Rower has been designed for cheap and simple manufacture in a developing country with a low industrial base. It earns a OO rating under each category of manufacturing capability.

China

Laboratory Tests

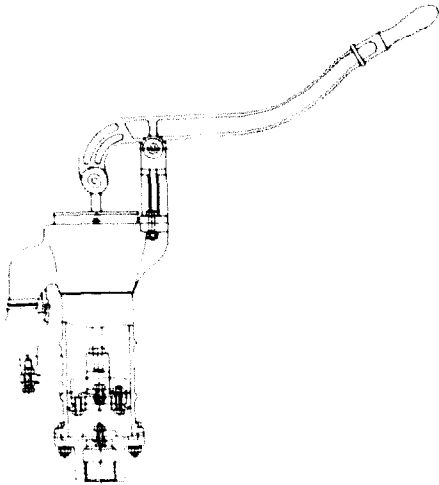

THE SYB-100 WAS NOT TESTED IN THE CATR
LABORATORY

General Description

The SYB-100 is a simple shallow-well suction pump constructed mainly of cast iron. The handle and pumprod pivots are fitted with ball races. Plunger and check valves are rubber flaps and rubber is also used for the plunger seal which moves in a honed cylinder bore.

Manufacture

The pump is manufactured to a high standard in China, under good quality control of casting and with first class machining.

Suppliers

Changsha County Light Industrial Plant,
Hunan, People's Republic of China.

Indicative prices - May 1986

Per unit	US\$ 30-40
----------	------------

SYB-100

Field Trials

Test conditions

	Number of pumps	Head range (meters)	Data available (months)
China	85*	1-6	24
Papua New Guinea	10	2-7	12

*20 of the discontinued SYB-80 were also tested.



The China field trials involved large numbers of prototype suction pumps, many of which have been discontinued as a result of their performance in the field trials. The SYB-100 is the exception, having proved both popular and reliable.

The trials were conducted in Changsha (Hunan Province) where the pump is manufactured. It must be remembered that there are many millions of suction handpumps in use in China, and they generally operate for only short periods each day, serving just one family or a small user group. The same kind of operating conditions also apply in Papua New Guinea. Nevertheless, the Project collected enough data on the pump perfor-

mance to predict that it could reliably serve up to 100 users over two years without excessive failures. The standard of village-level maintenance in China is high in comparison with most developing countries, and in China, the SYB-100 is well suited for village-level maintenance.

The quality of manufacture of the SYB-100 was high, and the pump is well designed for economic replacement of low-cost components (though this may not be readily replicable in other countries).

The pump design has been improved as a result of the Project experiences, and the SYB-100 is becoming increasingly popular in the country. Some 17,000 units were ordered for one province, with another 10,000 in preparation.

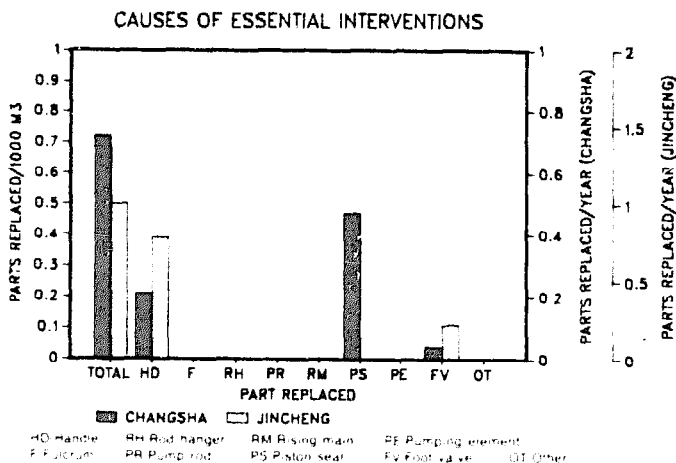

Assessment

The SYB-100 ratings are based primarily on the pump's performance in field trials in China and to a lesser extent on the limited experience in Papua New Guinea. This provided enough data for confident assessment of the pump's capabilities. As a suction pump, the SYB-100 is restricted to pumping lifts of 7 meters or less. It also requires priming and is therefore susceptible to contamination if polluted water is used for the purpose.

Discharge Rate

The pump is capable of delivering a high discharge and earns a "good" (oo) rating.

Ease of Maintenance

With the standard of village-level maintenance available in China, the pump would be readily serviced by a village caretaker. In general, however, for countries with lower skill levels available in most villages, the rating under maintenance System A is "adequate" (o).

Reliability

The SYB-100 proved highly reliable for moderate daily outputs in China and Papua New Guinea, and earns a oo rating for discharges up to 4m³/d, dropping to o for 8m³/d.

Corrosion Resistance

Though the pump has no special provision for combatting corrosion, little sign of corrosion emerged from the field trials, earning a o rating.

Abrasion Resistance

The honed cylinder bore and rubber cupseals resulted in long seal life, and justify a oo rating under this heading.

Manufacturing Needs

Manufacturing quality in China is high, and the SYB-100 design would suit manufacture in countries with moderate or highly developed industrial bases (Categories 2 and 3), for which the pump scores a oo rating. The skill levels and quality control needed to ensure reliable performance make it unsuitable for manufacture in developing countries with low levels of industrial development.

India

Laboratory Tests

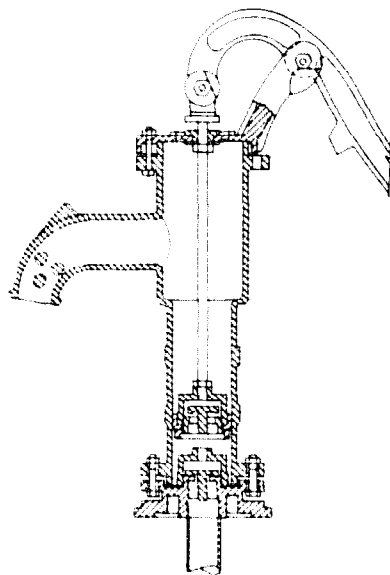

**THE WASP PUMP WAS NOT TESTED IN THE CATR
LABORATORY**

General Description

The Wasp is a conventional shallow well suction pump constructed almost entirely of cast iron. The cylinder is machined in the lower part of the pump body. The cast iron piston is fitted with a single leather cup seal and gunmetal valve.

The check valve is also of gunmetal and is held in a cast iron cage. The stainless steel pumprod passes through a sliding brass plate covering the slot in the pumpstand top-plate and so reducing the contamination risk.

Bars in the spout prevent sticks or stones from being pushed into the pump. The handle has a low starting position.

Manufacture

The Wasp can be readily manufactured in a country with basic foundry skills plus basic machining and leather crafting, though careful quality control is needed with cast iron components.

Suppliers

Shukla-Manseta Industries Private Ltd.
24B Ambalal Doshi Marg, Bombay 400023.
India.

Indicative prices - 1983

Per unit, excluding suction pipe US\$185

CIF Colombo

Field Trials

Test conditions

Country	Number of pumps	Head range (meters)	Data available (months)
Sri Lanka	25	2.8* - 5.0	20

* Average head

The Wasp is a derivative of the Maya No. 6 cast iron suction pump design common on the Indian subcontinent. Its drive mechanism is exposed to dust and weathering.

No literature was supplied with the pumps, but only basic tools and skills are required for installation. On average, three workers completed installation in half an hour on protected dug wells in Sri Lanka. The pump is attached to anchor bolts embedded in the concrete cover slab of the well and must be set at least 300mm above the well head to provide a comfortable standing position for operation. The handle can be set at a right angle to the spout to avoid the need for the operator to stand on the well cover slab.

Servicing of all parts is easy, using a single adjustable spanner and a screwdriver. All bolts are the same size, and are set in slots to prevent rotation of the bolt head. Frequent lubrication of the exposed axles and bushes was found to be essential, and even then bearing failure accounted for half of all breakdowns.

The pumps were only lightly used and an average of 2.1 interventions were needed per pump per year to repair breakdowns or correct poor performance, the main items being bearings and seals. In all, 23 leather cupseals were changed on the 25 test pumps during the first 18 months of testing, and it seems that a



cupseal can be expected to last from 8 to 10 months, depending on the usage and the roughness of the cylinder.

Plunger valves and check valves were noticeably worn after 18 months, both on their circumferences and on their faces. There was no significant wear on the cylinders. Pivot bushes generally wore out within a year and pivot pins were worn but serviceable. In all, three handles and two fulcrum plates broke during the trials.

The Wasp delivers a respectable 26.5 liters/min at 30 strokes/min, but the some users dislike the operating action because of the low starting point of the handle.

The use of brass with ferrous metals led to galvanic corrosion, and there were complaints about taste and/or color of the water at 15 of the 25 test sites.

As with any suction pump, the Wasp has to be primed, and is therefore susceptible to contamination if polluted water is used for the purpose. In the Sri Lanka trials it compared unfavorably with the Inalsa Suction pump in terms of cost, reliability, ease of maintenance, and resistance to abuse and contamination.

Assessment

The Wasp ratings are based on the pump's performance in field trials in Sri Lanka. As a suction pump, the Wasp is not suitable for lifts in excess of 7 meters. It also requires priming and is therefore at risk of contamination if polluted water is used for the purpose.

Discharge Rate

A discharge rate of 26.5 liters per minute at 30 strokes per minute gives the pump a "good" (oo) rating.

Ease of Maintenance

Maintenance is simple, requiring only a single spanner and screwdriver, but frequent lubrication of bushes is needed. The pump therefore earns a "good" (oo) rating for maintenance Systems B and C, reducing to "adequate" (o) for System A (village-level).

Reliability

The reliability rating is oo for low usage — similar to conditions in the Sri Lanka field trials — but reduces to o for 4m³/d and to "unsuitable" for 8m³/d, where the higher intensity of use would require too frequent maintenance interventions.

Corrosion Resistance

After 18 months in the field, the inner pump body, pumprod, plunger and check valve were heavily rusted, and the Wasp cannot therefore be recommended for use where water is corrosive.

Abrasion Resistance

The leather cupseals failed regularly during the field trials, and would be even more susceptible in sand-laden water. The pump is therefore given only a o rating.

Manufacturing Needs

The Wasp is made in India and is suitable for manufacture in any developing country with basic foundry, machining and leather craft skills. The degree of quality control needed results in a — rating for countries with a low-level industrial base, but a oo rating for other countries.

CAUSES OF ESSENTIAL INTERVENTIONS

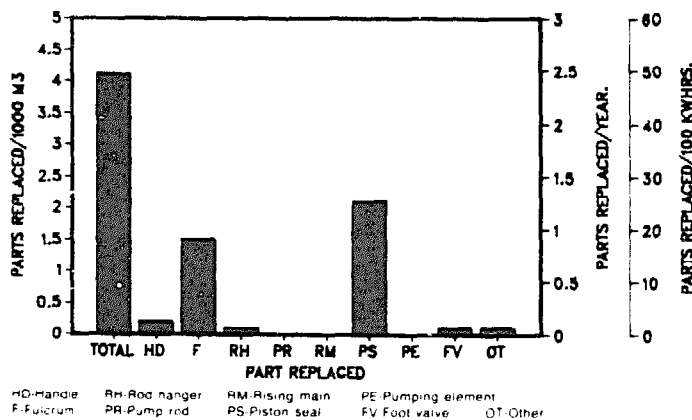

Annex 1

Interesting Pumps Not Tested by the Project

This Annex contains brief details of 17 additional pumps which have come to the attention of Project staff during the course of the field trials. They were not included in the laboratory or field trials organized by the Project (or were included too late for results to be available for this document).

The pumps may be of special interest because they involve unique features or promising design concepts, or because they have received wide publicity, or because they are known to be used by large numbers of people in particular regions. The information available is generally

restricted to manufacturers' published data and observations by Project field staff, so that it has not been possible to "rate" the pumps in the same way as those included in the Pump Selection Tables in Chapter 5.

Analysts wishing to include particular pumps from this Annex in the selection procedure described in Chapters 5 and 6 should first seek fuller details from the manufacturer, and, where possible, obtain field experience from existing users. The pumps included in the Annex are tabulated below.

<i>Pump</i>	<i>Country of manufacture</i>	<i>Known installations</i>	<i>Page</i>
Abi-MN	Cote d'Ivoire	Cote d'Ivoire	184
Aquamont	United Kingdom	Burkina Faso, Cameroon, Malawi, Zambia	184
Atlas-Copco	Sweden	Ghana	184
Bourga	Cote d'Ivoire, France, Niger	Niger	184
Bucket	Zimbabwe	Sierra Leone, Zimbabwe	185
Bush	Zimbabwe	Zimbabwe	185
Grundfos	Denmark	Sudan	186
Nsimbi	Zimbabwe	Zimbabwe	186
Pek	Canada	Bolivia, Cote d'Ivoire, Kenya, Senegal	186
Pulsa	Italy	Benin, Burkina Faso	187
Puno	Peru	Bolivia, Peru	187
Rope ("Soga")	Peru, Nicaragua	Bolivia, Nicaragua, Peru	188
Sholapur	India	India	189
Swedpump	Sweden	Central African Rep., Ghana, Sudan	189
UPM	France	Burkina Faso, Niger	189
Wavin	The Netherlands	Bolivia, India, Kenya, Malawi, Tanzania	190
Wearmaster	United Kingdom	Not known	190

Abi-MN**Cote d'Ivoire**

The Abi-MN is a conventional reciprocating piston pump with a lever handle. The cylinder is made of brass, and the standard version is equipped with galvanized rods and rising mains. Most of the above-ground components are identical to those of the Abi-ASM pump (Pump 01 in the Handpump Compendium), except for

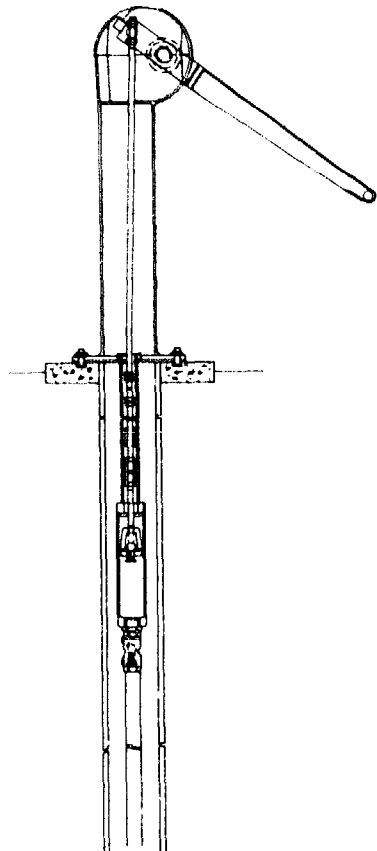

the connections to the rising main and rod, the lack of a hydraulic drive cylinder, and a slightly different handle. An earlier model with the same name (Abi-MN) had different above-ground components, and was generally liked by users because of its easy operation and reasonable discharge rate, although repairs were difficult. The most significant difference between the old and new above-ground components of the Abi-MN is the change from ball bearings to plastic bearings. The plastic bearings, which have been standardized for both the Abi-ASM and the Abi-MN pumps, have the advantage of being easily replaceable.

Manufacturer: Abidjan Industrie, 01 BP 343, Abidjan, 01 Cote d'Ivoire.

Aquamont**United Kingdom**

This pump is manufactured in the UK and marketed by E.T.C. Aquaservice of Liver-

pool. Two head assemblies are available: the MK 1 standard drive, which provides a positive pumprod return; and the MK 2, a chain drive version. Above ground, the pumpstand is galvanized or painted and sealed taper roller bearings are fitted to the fulcrum and hanger. Galvanized iron or ABS rising main is used with 10mm stainless steel pumprods incorporating PTFE centralizers. A PTFE lined glass-reinforced epoxy resin cylinder is provided, employing nitrile seals and claimed to have both low wear and friction, making pumping from lifts up to 90 metres a practical possibility. Pumps have been sent to Cameroon, Malawi, Zambia and Burkina

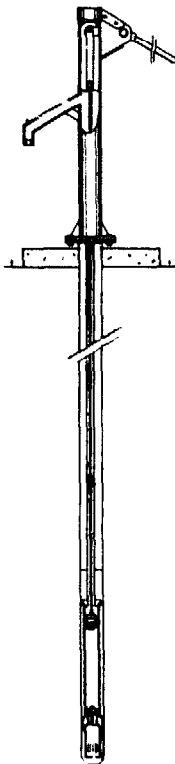

Faso for limited field trials and will be tested in the CATR Laboratory in the near future.

More information: E.T.C. Aquaservice, Cunard Building, Liverpool, L3 1HR, United Kingdom.

Atlas-Copco**Sweden**

The Atlas Copco model 111 is a Swedish-made pump with a galvanized welded pumpstand assembly. The handle fulcrum bearing has a special rubber element which purports to eliminate wear problems evident in conventional bearing systems. A connecting belt between the end of the handle and the pumprods is designed to avoid the wear which occurs with chain and quadrant operation. The SW-system of rising main and pumprod is in stainless

steel, and is attached to a wire-reinforced rubber hose pumping element. Recommended maximum installation depth is 30 meters. Samples with stainless steel

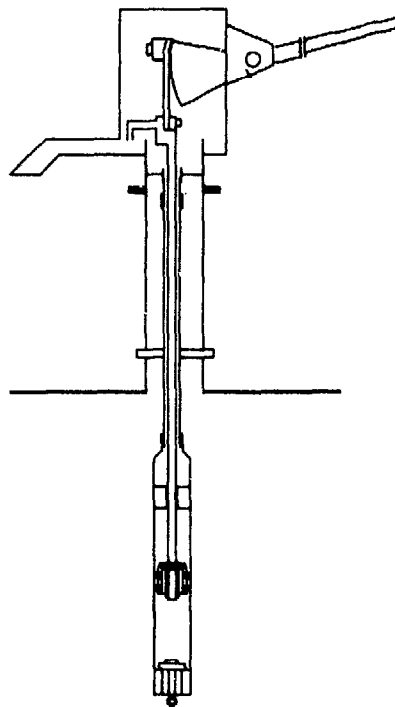

below-ground components are being sent to Ghana for field testing and CATR laboratory tests of this pump started at the end of 1986.

Model 122 uses the same above-ground pumpstand, rising main and pumprods as the 111 but uses a conventional stainless steel cylinder below ground.

Manufacturer: Atlas Copco Energy AB, S-105 23 Stockholm, Sweden.

Bourga**Cote d'Ivoire,
France, Niger**

This is a reciprocating piston pump operated with a lever handle, based on conventional handpump design concepts. The standard versions are equipped with galvanized steel rising mains and rods, and cylinders made of brass. The handles are counterbalanced to ease operation. Three models are available, which the manufacturer specifies as follows:

- the Model 1000 has a 70-mm piston, and is specified for one-person (adult) operation at lifts up to 45 meters, and two-person (two adults or 3-4 children) operation at lifts up to 90m;
- the Model 2000 has a 100-mm piston, and is specified for one-person operation at lifts up to 22.5m, and two-person operation at lifts up to 45m;

- the Model 3000 has a 120-mm piston, and is specified for one-person operation at lifts up to 15m, and two-person operation up to 30m.

The handle has a T-bar to facilitate operation by more than one person and to allow the user to apply force at the

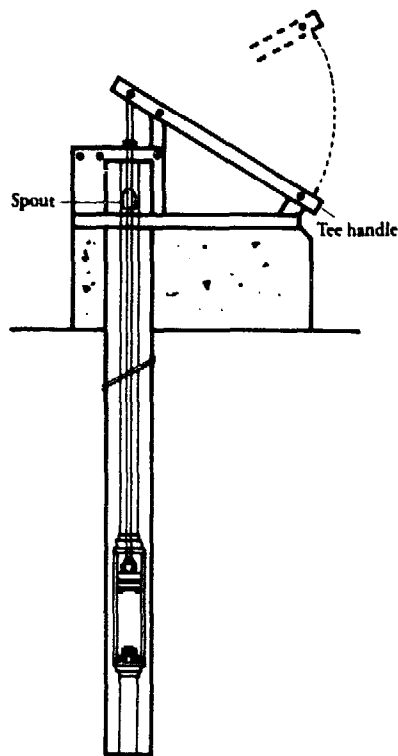

extreme end of the handle where the maximum mechanical advantage can be achieved. Also, the handle has a counter weight which can be adapted for the lift at which the pump is to be used. The pump has a high discharge rate, although this is accompanied by the need for a relatively high force to be applied to the handle. However, the facility of having multi-person operation compensates for the high force required, and users like the high discharge rate. The Project has field tested a few of these pumps in Niger — 3 of Model 2000, and 1 of Model 3000. These have been intensively used during 22 months of field data collection, and have performed well. Although the small numbers of each model that were tested limits the statistical significance of the field data, the following may nonetheless provide a rough indication of repair requirements.

The average rate of repair or maintenance interventions has been 1.2 per year for each pump. The majority of repairs were required due to defects on footvalves (27%), pumprods (18%), handles (9%), fulcrums (9%), and pumping elements (9%). The manufacturer

has responded to these reports by modifying several components.

The assessment of this pump can be summarized as follows: users like the high volume flow; it is robust; it is suitable for local manufacture in some developing countries; access to below-ground components for repair is difficult and the pump therefore cannot be classified as VLOM (Village Level Operation and Maintenance).

Manufacturers: The pump was originally manufactured in France by G. Bourrier, 5, Rue Elisee-Reclus, 93300 Aubervilliers, France. Later, production was begun by the following two manufacturers in Cote d'Ivoire and Niger (in at least some cases pumps have been assembled in Niger with components made in Cote d'Ivoire and France): Ateliers de Construction Electro-Mécanique de Côte d'Ivoire (ACEM-CI), B.P. 522, Abidjan 15, République de Côte d'Ivoire; SEEE (Société d'Etudes et Entreprise d'Equipment), BP 11.966, Niamey, Niger,

Bucket Zimbabwe

The Bucket Pump is an improved version of the traditional rope and bucket connected to a windlass. However, the Bucket Pump is suitable for installation in narrow-diameter wells, whereas the traditional arrangement requires a wide-diameter well. The Bucket Pump is essentially a long narrow bucket with a large check valve at its bottom, which allows water to enter it from below as it is submerged, but which does not allow the water to escape as the bucket is lifted up the well (this is analogous to the piston valve on a conventional handpump). Its own weight is sufficient to submerge it when lowered into the well, and, when full, it is lifted by turning the windlass, thus lifting the connecting chain and pulling the bucket up. A simple "water discharger" is attached to a post, and, when the bucket is set on it by hand, this opens the check valve and discharges into a waiting container which the user has placed below. When compared to the traditional rope and bucket, it has, in addition to the ability to be used with drilled wells, the advantage of decreasing the likelihood of contaminating the well water. This is because the bucket is not normally set on the ground where it could pick up contamination before being lowered into the well, as commonly happens when personal buckets are used with wide-diameter wells. Also, only a small lid is required to cover the well when it is not being used.

Compared with most other handpumps, the Bucket Pump has the advantages that it is extremely simple to manufacture, operate, and maintain, and is

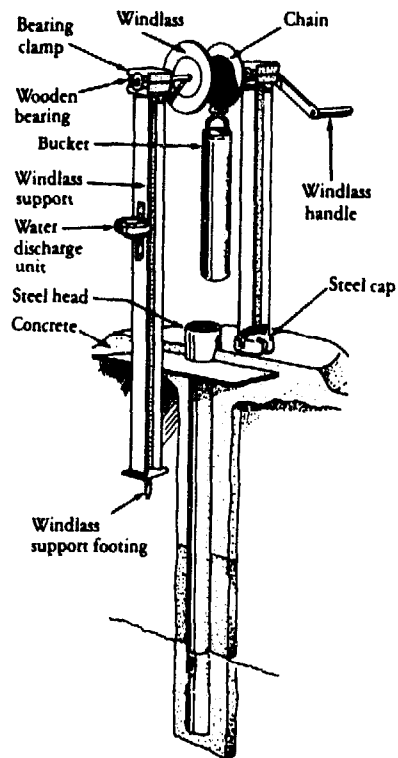

particularly well suited to VLOM (Village Level Operation and Maintenance). A major disadvantage of the Bucket Pump is the low rate at which water can be extracted from the well, making it more of a family or multi-family pump and not suitable for use by larger numbers of people. Another disadvantage is that some contamination may take place.

The Bucket Pump is made by local shops in Zimbabwe and Sierra Leone. *More information* can be found in a pamphlet describing the pump, entitled *Pump Handout No.1: The Zimbabwe Bucket Pump*, available from the Blair Research laboratory, Box 8105, Causeway, Harare, Zimbabwe.

Bush Zimbabwe

The Bush pump, a reciprocating deep-well force pump, was originally designed and installed in the early 1930's in Zimbabwe. The pump is still used extensively in the country, with one estimate placing the number of pumps installed at 10,000 units. Since then, it has appeared in various forms throughout East Africa. The pump design has no exacting tolerances and it can be erected by reasonably well trained persons using basic tools. The original pumpstand column was made of 6-inch borehole casing, while later models used 5-inch casing or black iron pipe. The pumpstand column is set in

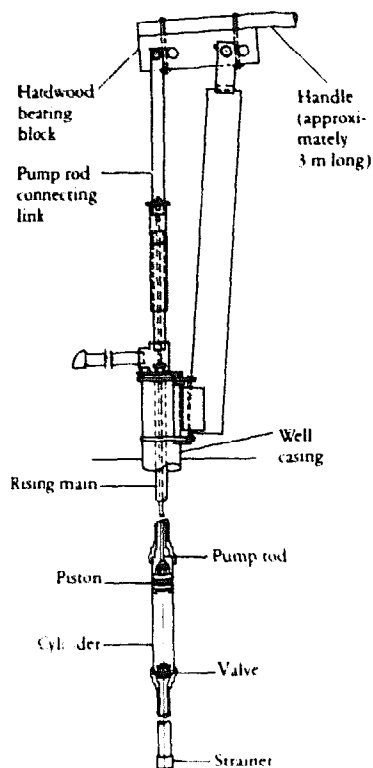

a concrete foundation block that also encompasses the borehole casing. The handle is made from 2-inch galvanized steel pipe and is typically 10 to 12 feet (3.0 to 3.7m) long with a single bend. In this way the upward travel of the piston is limited by the handle contacting the ground.

Mechanical advantages of as much as 12 to 1 allow use of a 3 inch cylinder even at high pumping lifts. An oil-soaked hardwood bearing block is used at the fulcrum and rod hanger. Four holes are drilled, two of which provide a backup pair to extend the life of the blocks. Pins are made from 1-inch pipe.

The relatively large size of the pump components serves the purpose of minimizing wear rates of the wooden bearing blocks. A 0.9m-long connecting link is used to minimize the lateral movement of the pump rod in its wooden guide bush. Also, a 3/4 inch sleeve is placed over the pumprod. Its larger diameter reduces wear on the guide bush.

The Handpumps Project has no information on water delivery rates or repair frequencies for this pump. As with other closed cylinder designs, replacement of seals and repair of other down-hole components are difficult and require lifting tackle.

A version of the Bush Pump, known as the Kenya Atlas-Copco, was tested in the CATR Laboratory in 1981, and the

results are reported in Handpumps Project Report No. 4.

Additional information: Office of the Provincial Water Engineer, Ministry of Energy, Water Resources and Development, P.O. Box 566, Bulawayo, Zimbabwe.

Grundfos Denmark

The distinguishing features of this pump are the stainless steel cylinder and piston, which are designed to provide corrosion resistance, strength, and efficient operation. These pumping elements can be connected to a wide variety of makes of above-ground components, including the Maldev type pumphead (Pump 14 in the Handpump Compendium), which can be either locally produced or purchased from Grundfos.

If total corrosion resistance is required for all below-ground elements, Grundfos can supply stainless steel rising main and pumprods, although this will increase the cost of the unit.

Aside from the use of stainless steel, with rubber seals, the pumping element is fairly conventional in design, with a 2.5 inch diameter cylinder connected to 1-1/4 inch rising main. When connected to a Maldev pumphead and subjected to an endurance test at the Consumers' Association Testing and Research (CATR) laboratory in the U.K., the pumping elements exhibited high efficiency, high discharge rates, and very little wear of the piston seal. They were tested at lifts of 25 and 45 meters.

Manufacture of the pumping elements requires stainless steel fabrication techniques and is not suitable for most developing countries. However, the Maldev pumphead, or other pumpheads to which the pumping elements can be connected, can be locally produced in many developing countries.

The first of these units were installed in the Sudan and other East African countries in early 1986, but it is still too soon to have meaningful data concerning their endurance under field conditions.

Manufacturer: Grundfos International a/s, DK-8350 Bjerringbro, Denmark.

Nsimbi Zimbabwe

This is a direct action pump manufactured and installed in Zimbabwe by the Lutheran World Federation. It uses locally manufactured PVC for the rising main and pumprod. The footvalve is a unit obtained locally. The plunger uses a simple disc valve and an imported, double-acting rubber seal. The head consists largely of standard pipe sections and fittings, the

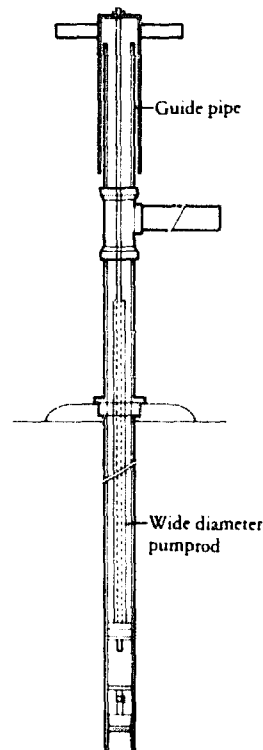

latest design featuring a plastic guide bush for the handle tube.

Additional information: Lutheran World Service, Attn. Rev. Wolfgang Lauer, P.O. Box 988, Harare, Zimbabwe.

PeK Canada

The PEK pump is a direct action hand-pump, using an innovative design and several plastic materials. It has a hollow rod, and in 1985 was offered with two different cylinder diameters: Model P rated by the manufacturer for a maximum pumping head of 25 meters; and Model G for up to 50 meters. Those tested by the Handpumps Project were all of Model P (25m).

Modifications were made by the manufacturer immediately following the laboratory test and on other occasions. Consequently, there are slight variations among PEK pumps sent to different countries for field trials. However, these modifications did not result in significant changes in performance. Further changes made in 1986 in response to reports of field problems have not been evaluated by the Project at the time of preparation of this report.

Manufacture involves casting in polyurethane and simple steel fabrication techniques. Complex molding tools are required, as well as experience in the use of polyurethane and a supply of raw material. It is therefore unlikely to be

suitable for manufacture in the majority of developing countries.

Complete for installation at 30 meters depth when 50 units are ordered, the ex-factory price in February 1985 was US\$465 each.

The CATR laboratory evaluation concluded that the PEK is simple and lightweight, and therefore very easy to install and to maintain at village level. The rate of delivery is low and likely to fall substantially. In laboratory testing the mechanical efficiency at a 25 meter pumping lift was initially measured at 60%. However, at the end of the 4000 hour endurance test it had decreased to 13% as a result of wear. The pumprods were found to be inadequately sealed, and the ingress of water will dramatically affect the operating characteristics. The pumpstand is tough and wear-resistant, but extensive use of polyurethane may make the PEK unsuitable for manufacture in developing countries.

The Project did limited field testing of 25 PEK pumps in 5 countries. Due to excessive operational problems, pumps in all countries except Bolivia were withdrawn shortly after installation, and therefore there are no statistical data for

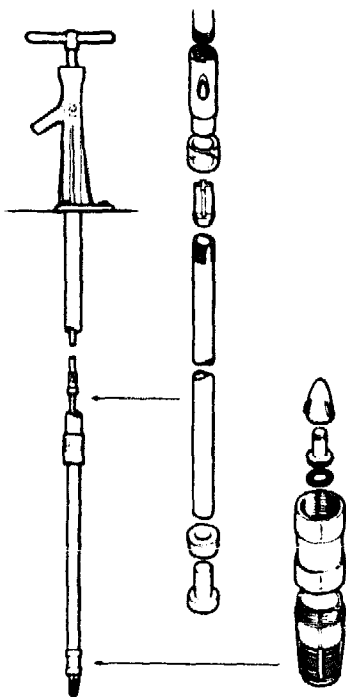

repair frequencies. The most noteworthy shortcomings of the PEK observed in the limited field testing included: A. Operation is exhausting work; B. Discharge rates are very low; C. Users dislike the pump; D. Manufacturing quality control has been inadequate; E. Installation requires excessive care to ensure proper operation;

F. The piston seal wears too rapidly.

The pump has many interesting features and is a break from traditional ideas of pump design (even of direct action pumps). However, good innovative thinking is let down by several weak points. In spite of its severe shortcomings, it is the judgment of the Project that the PEK pump has the potential to be developed into a good VLOM product, but would require some major changes. It has the basic advantages of being lightweight, having a minimum number of wearing parts, requiring a minimum number of tools for installation, and having most of its components made from long-life materials. Also, if produced in large quantities, the Project believes it could be sold for a modest price.

The manufacturer is responding to the Project's reports of shortcomings of the pump, by producing a modified version which the Project has not yet evaluated.

Manufacturer: Produits pour l'Exhaure de l'Eau Kaine Ltee, 1106 Claire Crescent, Lachine, Quebec, H8S 1A1, Canada.

Pulsa

Italy

The Pulsa 3 is a lever-operated deepwell handpump which works via a principle of oscillating water columns. The connection between the above-ground and downhole elements of the pump is via a single hose, without rods. It comprises two basic elements: an upper part made of stainless steel situated above ground, containing a plunger actioned by a lever handle; and a lower part, submerged in the water, which is an elastic element closed at the bottom by a check valve with a filter. The two are joined by a flexible hose. The cylinder at the bottom acts like a diaphragm, with the internal volume of water becoming larger when it is under increased hydraulic pressure, via the compression of flexible balls that are situated in the cylinder.

In some ways, it is analogous to the better-known Vergnet pump (Pump 21 in the Handpump Compendium), insofar as both have flexible hoses and operate via hydraulic pressure without conventional pumprods. However, efficient use of the Pulsa is very dependent on the speed and rhythm with which it is operated.

The design concept facilitates installation and access to below-ground components. Installation is unaffected by curves in the borehole because of the flexible hose used for the rising main, and the lack of conventional pumprods. The manufacturer also provides modified versions which allow installation of several pumps on the same borehole, which under certain circumstances can be very

advantageous. The Handpumps Project staff have periodically inspected three Pulsa pumps in Burkina Faso since October 1983, and also made a single limited inspection of five Pulsa pumps in Benin in 1984. However, full-scale monitoring of a large sample of Pulsa pumps

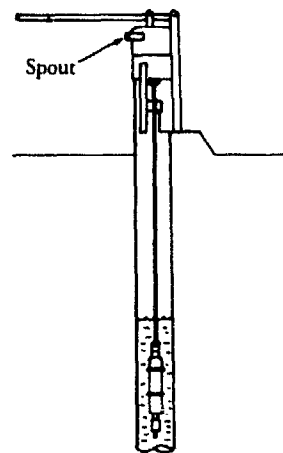

was not undertaken. Furthermore, the manufacturer has made some changes since these pumps were installed, so the observations of the Project are no more than indicative and not a final "verdict."

A major drawback of using this pump for community water supply is its low discharge rate. In Burkina Faso, it was found that when operated at 50 strokes per minute the discharge ranges from 2 to 9 liters per minute. In Benin, the discharge rate, when operated by local women and children who were experienced with it and seemed to be operating it optimally, was only about 50 to 75% of what would be expected with other pumps such as the India Mark II, which is installed in nearby communities. The pump is also difficult to operate efficiently, although as users become accustomed to the rhythmic operation required, this becomes less troublesome. Several breakdowns occurred during the first 2.5 years that the pumps in Burkina Faso were visited.

Manufacturer: Fluxinos, Via Genova 10, 58100 Grosseto, Italy.

Puno

Peru

This is a conventional reciprocating handpump with a lever handle, which was developed specifically for production in small local machine shops. The Puno handpump is produced in the Department of Puno, Peru, where it was developed under a Peruvian project with support from the Netherlands. The first prototype was installed in 1981, but most Puno pumps have been installed only in the past

couple of years. The Handpumps Project has included 15 Puno pumps in its Bolivian field trials. Testing began too recently to provide meaningful data on frequency of repairs, but some worthwhile observations have been made. These observations are presented below, and are based on both the experience in Bolivia and on short visits to Puno made in 1985 and 1986 by the Project's Bolivian Country Monitoring Engineer.

This pump was originally designed with the intention of lifting water from as much as 25 meters, but it is now recommended by its producers for a maximum lift of only 15 meters, and in practice it is used where the average lift is about 9 meters. An advantage is its suitability for local manufacture with no imported parts,

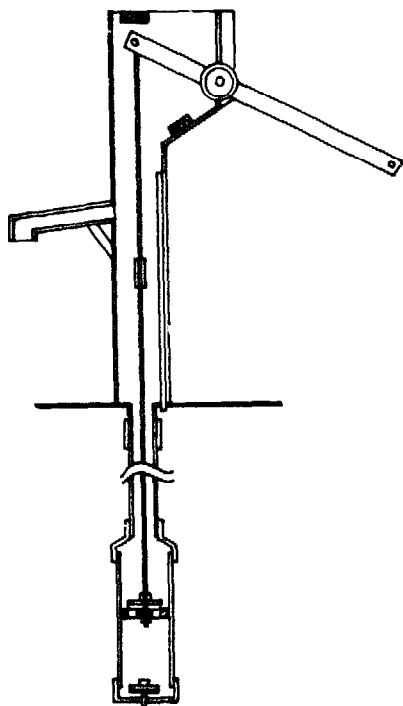

and the majority of parts are "off-the-shelf" items found in the medium-sized town of Puno. Manufacture does not require extremely precise machining or other difficult operations. Manufacture is said to be economical in quantities of as few as 25 pumps, and there are several shops in Puno which produce the pump.

Some of the materials used in its construction are highly susceptible to corrosion, such as the 3/8-inch diameter construction reinforcing steel used for the pumprod. The galvanized steel rising main is also susceptible to corrosion. However, other components were designed specifically to resist corrosion, such as the bronze piston and the cast iron cylinder with a PVC pipe lining its interior (some

models are sold without the PVC lining, and have very rough cylinder walls which will probably result in short life for the piston seals). As of 1985, quality control was assured by inspections undertaken by a local entity supported by the Puno Departmental Development Corporation (CORPUNO) and GTZ of the Federal Republic of Germany. However, some local shops in Puno were bypassing this control, and selling apparently inferior pumps to the public.

The price is modest, with single units sold in Puno quoted in mid-1985 at the equivalent of US\$142, complete for installation at a 6m cylinder setting.

The pumphead has an interesting feature shared with the Kenyan-made Afridev (Pump 02 in the Handpump Compendium): an internal overflow return pipe assures that, if a user (such as a child playing) plugs the discharge spout or if the user pumps so rapidly that not all of the water can discharge through the spout, then the excess water will flow back into the well via the overflow pipe instead of backing up into the upper part of the pumphead, where it could accelerate corrosion.

Installation is fairly simple, especially for shallow settings, where the length of rising main is short. However, maintenance is complicated by the fact that access to the piston requires that all below-ground components be lifted out of the well. This is made particularly difficult by the poor design of the flange connection between the rising main and the pumpstand, which requires awkward handling, while lifting the rising main whose weight is increased by the water.

The pumphead seems to be robust, and is ergonomically comfortable to use. One concern with the latest model of this pump relates to the bushings for the fulcrum and rodhanger, which are PVC, cut from standard pipe stock, against steel. The wide diameter should help prolong the life of this component, but local sand-storms may result in sand becoming embedded in the PVC, which would then act like sandpaper against the steel pins. This could result in accelerated wear of the pins, which are much more expensive than the plastic.

The discharge rate is good. For instance, in a location where the lift was about 13 meters, a local man was measured to pump 47 liters per minute (he filled a 20-liter bucket in 26 seconds). The high discharge rate may relate to the T-bar at the end of the handle, combined with an appropriate mechanical advantage for this lift, resulting in good ergonomics.

Supplier: Centro de Asesoría Para Bombeo de Agua, Convenio Peru-Alemania, Jiron Bolognesi 165, Puno, Peru.

Rope ("Soga")

Peru,
Nicaragua

The Rope Pump described here is manufactured in Peru, where it is known as the "Soga Handpump." A similar pump, called the "Mecate Pump", is manufactured in Nicaragua. The Rope Handpump is essentially a very low lift pump with a high discharge rate that may be suitable for small-scale irrigation. The Peruvian manufacturer states that it is adequate for pumping lifts up to 6 meters, but field observations indicate that above 4 meters pumping is difficult. In Nicaragua, there has been experimentation with a smaller diameter rising main which allows use with higher lifts, but with a lower discharge rate. The pump has a nylon cord with a series of rubber discs placed along it. As illustrated in the drawing presented here, the cord is pulled up through a PVC rising main, lifting the column of water in the rising main into a receptacle, from where it flows out of the discharge spout. The cord is installed as a long loop and continuously returns down the well and back up the rising main. The pump is operated by rotating handles on either side of the wheel. The rope and discs move through the grooved rim of the wheel as it is rotated. The rim of the wheel is made from an automobile tire turned inside out.

The Project has begun to field test the Rope Pump in Bolivia, but it is still too early to provide a complete assessment. However, it is already apparent that the discharge rate is particularly high. For instance, it was observed that when

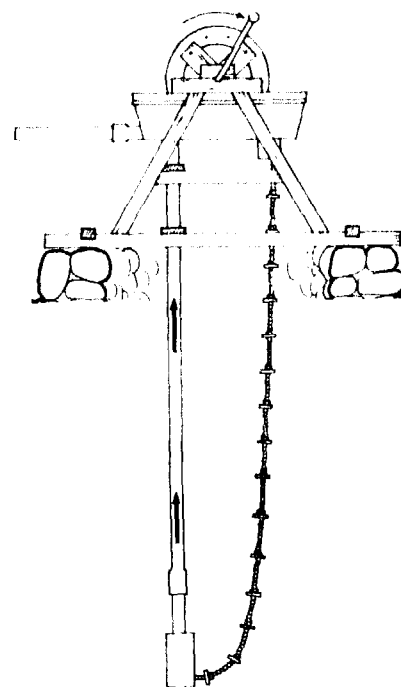

operated by a single person where the lift was 2.4 meters, a 20 liter bucket was filled in 6.5 seconds (i.e. at a rate of 180 lpm). At the same site, when it was operated by two men, 650 liters were pumped in 5 minutes (i.e. 130 lpm). Due to exhaustion of the operators, these pumping rates could not be sustained for longer periods, but, nonetheless, they indicate that the discharge rate of this pump is very high. Pending further evaluation, this pump seems to meet the criteria for village-level operation and maintenance (VLOM), including being suitable for local manufacture, and being simple to maintain. All components are easily accessible. However, it is still too soon to reach a conclusion concerning its durability when used intensively either for irrigation or community water supply. In late 1986, the ex-factory price was approximately US\$125.

The pump is designed for use in wide-diameter wells. However, it is reported that an experimental version has been developed in Nicaragua which may be suitable for use in 150mm diameter tubewells.

The Rope Handpump (known locally as the Bomba Manual de Soga) is manufactured by several small workshops in Puno, Peru, with supervision and quality control inspections provided under a joint Peru-GTZ (Federal Republic of Germany) project.

Additional information: Centro de Asesoría Para Bombeo de Agua, Jiron Bolognesi 165, Puno, Peru.

Sholapur **India**

In the mid 1960's, the first predecessor of the India Mark II was made as part of the Jalna Project in Maharashtra State, India. The pump featured all steel construction, a single pivot handle instead of the multi-pivot handle typical of earlier pumps, and a chain and quadrant. Although modified, these basic design components remain today on the India Mark II.

In the early 1970's, the Sholapur Well Service improved on the Jalna design, and accurately manufactured their pump on jigs and fixtures for uniformity. Other Maharashtra-based mission projects copied the Sholapur design. However, without standardized drawings, dimensions tended to vary and parts were not interchangeable. Manufacture was primarily done by mission projects manufacturing sufficient pumps for wells drilled by their own drilling rigs.

In the mid 1970's, both UNICEF and the Government of India became convinced of the need for a standardized pump. The Sholapur handpump was taken as a starting point for development of the

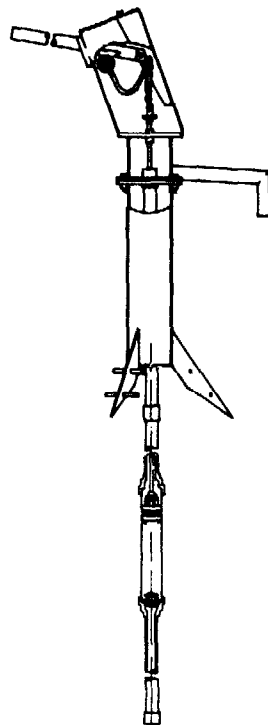

India Mark II. The Sholapur pump was strengthened and the solid bar handle for counterweighting was added. Various other design changes made it possible to mass produce the pump in simply equipped workshops, to make it easier to maintain, and to prevent tampering. At present, there are 36 manufacturers certified to make the India Mark II.

Both the India Mark II and the Sholapur pumps have continued to evolve. Changes to the standard specifications for the India Mark II are only made when their advantage outweighs difficulties of changing a standard design used by many different manufacturers and by increasing the number of spare parts that must be distributed. Thus some design features of the Sholapur pump may be more advanced than the India Mark II.

At present, the main differences between the two are that the Sholapur pump has: (1) internal handle stops with rubber cushions that reduce the chance of finger injuries and reduce shock loads on the pumphead and bearings; (2) an enlarged access cover to make it easier to work on the pumphead; and (3) cups around all pumphead nuts that make it difficult to remove them without the proper socket, and so reduce vandalism. However, the Sholapur pump does not benefit from the same quality control inspections to which certified manufacturers of the India Mark II must subject their pumps. *Manufacturer:* Sholapur Well Service, 560/59 South Sadar Bazar, Civil Lines, Sholapur 413 003, India

Swedpump **Sweden**

This is a Swedish-designed lever-arm pump from Scandinavian Clinics in Stockholm. It has a galvanized iron pumpstand and uses a spherical plain bearing on the pumprod assembly, with ball bearings either side of the handle fulcrum. Below ground it uses a stainless steel lined acetal cylinder with a plastic piston incorporating two Delrin piston rings. Delrin pumprod guides are used on stainless steel pumprods operating in stainless

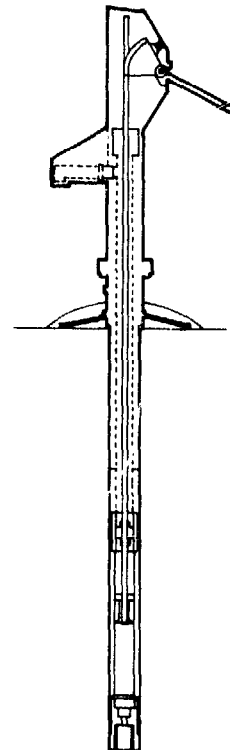

steel rising main. Samples of this pump are on field trial in the Central African Republic, the Sudan and Ghana. The pump will be tested in the CATR laboratories during 1987.

Manufacturer: Swedpump, Scandinavian Clinics, Box 511, S-101 26 Stockholm, Sweden.

UPM **France**

The UPM is a deep-well pump manufactured in France, with a number of innovative features. It is a reciprocating pump with a lever-type handle, and is not yet mass-produced. It incorporates two important departures from the mainstream of conventional reciprocating handpump design. The pumpstand is designed to act as lifting tackle for installation and maintenance of the below ground assembly. The letters UPM in the original French

stand for "Universal Multi-Pistons", which relates to the design feature of having a piston, with discharge valve, located every 3 meters along the pumprod. These pistons move within the 2-inch uPVC rising main. The multiplicity of pistons minimizes leakage of water around them, especially when operated at a high velocity, and thus allows the design to do without piston seals, leaving a clearance of 1mm over the diameter. Piston guides are provided to centralize the motion of the pistons, and thus the manufacturer claims that friction and wear between the pistons and the rising main (which doubles as an extended cylinder) is minimized.

The superstructure is made of structural steel, and includes a 3.5m high mast with a pulley at the top, and a beam with a T-

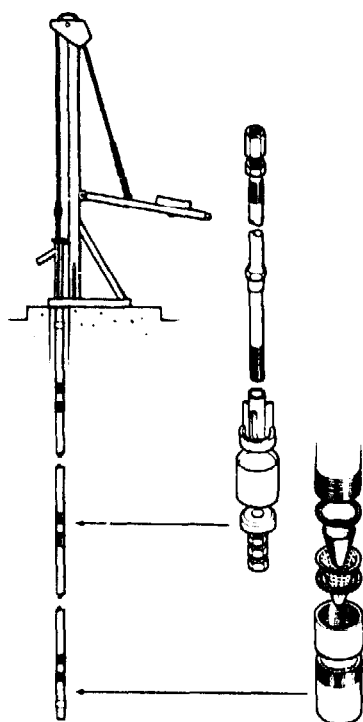

bar which serves as the handle. This T-bar handle is 1.25m wide and is convenient for operation by one to four persons. A cable passes over the mast. One end of the cable is connected to the top of the pumprod, and the other end to the beam-handle. This beam is fitted with an adjustable counter-weight. The mechanical advantage of the beam-handle may be adjusted to suit the water depth and the power available (one to four persons) by simply moving the cable connection to the appropriate hook on the beam.

For use where groundwater is aggressive, the manufacturer can supply stainless steel rods and couplings, at an additional cost. The standard pumprod is made of galvanized steel. The Project has

periodically inspected a single UPM pump in Burkina Faso, which was installed in October 1983. The depth to the water table at this installation is only 10m. This pump has performed well under conditions of heavy use, but it would be inappropriate to present conclusions on the repair frequency as data are from only a single pump, installed in low-lift conditions, although it is designed to serve both low and high-lift conditions.

In response to feedback from the laboratory and the field, the manufacturer has made some design modifications since this pump was installed in Burkina Faso. Nonetheless, it can be concluded that this pump is worthy of further evaluation because of its high discharge rate, corrosion resistance (when used with stainless steel rods), suitability for a wide range of lifts, easy access to most below-ground components for inspection or repair, and its VLOM (Village Level Operation and Maintenance) approach. *Manufacturer: Domine SA, 86530 Naintre, France.*

Wavin The Netherlands

This is a direct action low-lift handpump which is not yet being mass-produced. It has been developed by a major international plastics manufacturer with the participation of its operations in both India and the Netherlands. Prototypes of the pumps are being installed for field testing.

Conceptually, this pump has similarities with the Tara pump made in Bangladesh and the Nira AF85 made in Finland (for related information see the Handpump Compendium entries for Pumps 33 and 32) in so far as all are innovative direct action low-lift handpumps which have a predominant use of plastics for their below-ground components.

The design concept of these direct action pumps holds promise for applications where the lift is less than about 12 to 15 meters, and perhaps for even greater lifts (the Wavin is rated by its manufacturer for a lift of 25 meters, but its suitability for such a lift has yet to be proven). Such pumps are light simple and easy to install, are corrosion resistant due to their use of plastic, can be fitted into narrow wells (the outside diameter of the Wavin is only 50 mm), and, when mass-produced, they may prove to be less expensive than many other types of low-lift pumps.

The design details of this pump, at least until recently, have been undergoing changes as the manufacturer responds to initial feedback from laboratory and field tests. It is still premature to comment on repair frequency due to the short time this pump has been available and the design modifications it has undergone. Nonethe-

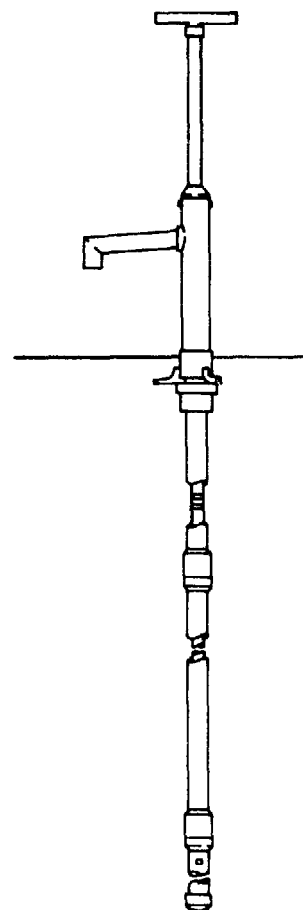

less, based on CATR laboratory tests and 1986 installation of a small number of Wavin pumps in Kenya, Tanzania, Malawi, and Bolivia, the Project has observed that: it is easy to install, operate and maintain; it is accepted by users, especially because of good volume flow and ease of operation; discharge rates are about 25 liters per minute with typical users and heads of 7.5 to 13 meters; the piston seals require a few hours of use before they are "bedded-in" and operating efficiently; some components, such as the rods, have shown an undesirable degree of wear (the manufacturer is considering design modifications to minimize these problems).

The Project encourages the further development and testing of this pump by the manufacturer, and the Project itself will monitor a small number in the field.

Manufacturer: Wavin Overseas bv, Rollepaal 19, 7701 BR, P.O. Box 158, 7700 AD Dedemsvaart, The Netherlands.

Wearmaster

U.K.

This hydraulic pump has been designed to be operated by either a conventional lever-arm pumphead, a see-saw drive or

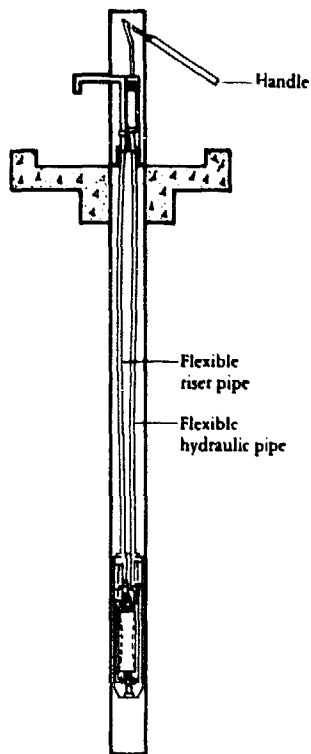

bicycle drive. The pumphead contains a hydraulic unit connected by flexible pipes to another diaphragm pumping unit below ground claimed to be capable of producing over 8 liters per minute from 80 metres. This pump is expected to be tested at CATR laboratories during 1987. *Manufacturer:* Merrill Pumps and Engineering Co. Ltd, Chapel Works, Sheffield Road, Sheepbridge, Chesterfield, S41 9EH, England.

Annex 2

Complete List of Pumps Tested

<i>Pump name</i>	<i>Country of manufacture</i>	<i>Number tested</i>	<i>Pump ref. no. in Compendium</i>
Abi-ASM	Cote d'Ivoire, France	9	1
Abi-MN	Cote d'Ivoire, France	20	Annex 1
Afridev	Kenya	37	2
Afridev	Malawi	3	2
AID Deriv. Deepwell (Funymaq)	Honduras	1	3
AID Deriv. Deepwell (Sumber Banyu)	Indonesia	1	3
AID Suction	Sri Lanka	13	34
Bandung	Indonesia	1	35
Bestobell	Zambia	1	4
Blair	Zimbabwe	31	27
Blair Derivative	Philippines	5	27
Blair Derivative	Papua New Guinea	45	27
Blair Derivative (Madzi)	Malawi	10	27
Bolivia (Ingavi)	Bolivia	2	Monitoring in progress
Bourga	Niger, Cote d'Ivoire	11	Annex 1
CIFEMA (Deriv. SIHILASE)	Bolivia	6	Monitoring in progress
Climax	United Kingdom	1	5
Consallen LD6	United Kingdom	17	24
DMR (Dempster Derivative)	Thailand	35	25
Direct Action Prototype	Kenya	5	Prototypes only
Direct Action Prototype	Tanzania	19	Prototypes only
Dragon 2	Japan	1	6
Duba Tropic 7	Belgium	32	7
Ethiopia BP-50	Ethiopia	1	28
GSW	Canada	1	8
IDRC-UM	Malaysia	1	29
Inalsa Suction	India	5	36
India Mark II (standard)	India	505	9
India Mark II (modified)	India	11	10
Inti (Tara Derivative)	Bolivia	10	Similar to Tara (No. 33)
Jetmatic Deepwell	Philippines	1	11
Jetmatic Suction	Philippines	43	37
Kangaroo	The Netherlands	11	30
Kardia	Germany, Fed. Rep.	14	12
Kenya Atlas-Copco	Kenya	1	Old model, discontinued

Annex 2

Complete List of Pumps Tested

<i>Pump name</i>	<i>Country of manufacture</i>	<i>Number tested</i>	<i>Pump ref. no. in Compendium</i>
Abi-ASM	Cote d'Ivoire, France	9	1
Abi-MN	Cote d'Ivoire, France	20	Annex 1
Afridev	Kenya	37	2
Afridev	Malawi	3	2
AID Deriv. Deepwell (Funymaq)	Honduras	1	3
AID Deriv. Deepwell (Sumber Bariyu)	Indonesia	1	3
AID Suction	Sri Lanka	13	34
Bandung	Indonesia	1	35
Bestobell	Zambia	1	4
Blair	Zimbabwe	31	27
Blair Derivative	Philippines	5	27
Blair Derivative	Papua New Guinea	45	27
Blair Derivative (Madzi)	Malawi	10	27
Bolivia (Ingavi)	Bolivia	2	Monitoring in progress
Bourga	Niger, Cote d'Ivoire	11	Annex 1
CIFEMA (Deriv. SIHILASE)	Bolivia	6	Monitoring in progress
Climax	United Kingdom	1	5
Consallen LD6	United Kingdom	17	24
DMR (Dempster Derivative)	Thailand	35	25
Direct Action Prototype	Kenya	5	Prototypes only
Direct Action Prototype	Tanzania	19	Prototypes only
Dragon 2	Japan	1	6
Duba Tropic 7	Belgium	32	7
Ethiopia BP-50	Ethiopia	1	28
GSW	Canada	1	8
IDRC-UM	Malaysia	1	29
Inalsa Suction	India	5	36
India Mark II (standard)	India	505	9
India Mark II (modified)	India	11	10
Inti (Tara Derivative)	Bolivia	10	Similar to Tara (No. 33)
Jetmatic Deepwell	Philippines	1	11
Jetmatic Suction	Philippines	43	37
Kangaroo	The Netherlands	11	30
Kardia	Germany, Fed. Rep.	14	12
Kenya Atlas-Copco	Kenya	1	Old model, discontinued

<i>Pump</i>	<i>Country of manufacture</i>	<i>Number tested</i>	<i>Pump ref. no. in Compendium</i>
Korat 608 A-1 (conventional)	Thailand	51	13
Korat 608 C (modified)	Thailand	40	13
Korat 608 CT (prototype)	Thailand	4	13
Lucky	Thailand	20	38
Maldev	Malawi	198	14
Maldev	Kenya	14	14
Mark V (Lutheran modified)	Zimbabwe	2	31
Malawi Mark V	Malawi	61	31
Monarch P3	Canada	56	15
Monitor	United States	8	Monitoring in progress
Mono Direct Drive	South Africa	1	16
Monolift	United Kingdom	30	16
Moyno	Canada	190	17
Nepta (Briau)	France	1	Old model, discontinued
New No. 6	Bangladesh	1	39
Nira AF76	Finland	93	26
Nira AF84	Finland	1	18
Nira AF85	Finland	31	32
Onga (Intersigma)	Czechoslovakia	2	Unsuccessful in field trial
Philippines Deepset, Eureka cylinder	Philippines	63	19
Philippines D'set, Takasago cylinder	Philippines	65	19
PVC Deep	Thailand	1	Unsuccessful prototype
PVC Shallow	Thailand	20	Unsuccessful prototype
Pb Mark II	Germany Fed. Rep.	1	See India Mark II (No.9)
Pek	Canada	35	Annex 1
Petro	Sweden	21	Production discontinued
Puno	Peru	15	Annex 1
Rope ("Soga")	Peru	8	Annex 1
Rotary	China	10	Unsuccessful prototype
Rower Irrigation	Bangladesh	15	40. Testing to begin soon
Rower (ATA)	Thailand	14	Limited observations
SLB-00	China	14	Unsuccessful prototype
SM-2	China	15	Unsuccessful prototype
SWN 80&81	The Netherlands	39	20
SY-81	China	15	Unsuccessful prototype
SYB-100	China	95	41
SYB-80	China	20	Unsuccessful prototype
Sarvodaya L-4	Sri Lanka	8	Unsuccessful
Sholapur	India	5	Annex 1
Sihilasa (Kandy)	Sri Lanka	11	Unsuccessful
Six types of irrigation pumps	China	18	Laboratory tested
Tara	Bangladesh	230	33
Treadle Irrigation	Bangladesh	3	Limited field observation
Turni	Germany Fed. Rep.	13	Production suspended
VEW A18	Austria	1	22
Vergnet	France	69	21
Volanta	The Netherlands	24	23
Volanta	Burkina Faso/Netherlands	60	23
Wara	Bolivia	5	Monitoring in progress
Wasp	India	25	42
Wavin (prototype)	The Netherlands	16	Annex 1
Number of pump types	87	Total number of pumps	2678

Annex 3

Comparison of Costs and Time Savings for CWS Options

This Annex outlines a method for estimating and comparing the costs and time savings of CWS options in specific situations. The method has been developed into a computerized calculation to aid in program design and decision making. When choosing an option, other important factors must also be taken into account, as discussed in Chapter 2, particularly financial, resource and organizational constraints. But, if used with caution, the method can be a useful aid in decision making, at least to show some of the implications of deciding between alternatives.

The inputs to the calculation, i.e. the cost and benefit parameters, vary considerably from one situation to another. Cost data were collected by the Project from a number of countries in Africa and Asia, and these are summarized under "low" and "high" cases in Table 2.2 of Chapter 2 (page 23). In what follows, illustrative comparisons are presented, using what may be typical input parameters in a relatively efficient CWS project in a hypothetical situation. The computer program will be made available shortly to interested readers, who are urged to explore for themselves to what extent the calculation can assist in their own particular circumstances.

In the analysis, cost of water provided by the different water supply systems is compared at the point of use (the home), by adding the costs of piping in the case of yardtap supplies, the value of time spent hauling water for handpumps, and a combination of the two for standpipes. Other costs include pumps, wells, storage tanks, piping, and operation and maintenance.

Because of the difficulties of identifying and quantifying health benefits which are likely to accrue from an improved water supply alone, the model uses only time saved as the measure of benefit. The benefit-cost analysis may therefore be useful in justifying projects only in cases where previously water had to be drawn from outside the community. When time savings are small, health implications will be important and should be brought into the analysis separately.

In the model, reductions in the time taken to collect

Table A-1. Parameters for Prototype Village

<u>Demographic characteristics</u>			
Total population			400
Persons per household			8
Total households			50
Density	— persons per hectare		200
	— households per hectare		25
<u>Economic conditions</u>			
Av. value of time (US\$/hr)			0.125
Income (US\$/capita/yr)			200
Discount rate (%)			10
Electric power cost (US\$/kW)			0.10
<u>Village water use and collection</u>			
	<i>HP</i>	<i>SP</i>	<i>YT</i>
Distance to alternative water source (meters)	500	500	500
Amount of water carried per trip (liters)	20	20	—
Walking rate (km/hr)	4	4	—
Collection time (min/trip)			
Travel time	1.5	1.5	—
Queue time	2.5	1.0	—
Fill time	1.3	1.3	—
Daily water use (lit/cap)	20	30	60
<u>Water supply system</u>			
Number of wells	2	1	1
Number of water points	2	3	50
Capital cost per well (US\$)	2000	2000	2740
Pumping lift (meters)	20	20	20
Storage vol/daily flow	—	0.30	0.30
Useful life (yrs)			
Mechanical equipment	10	10	10
Non-mechanical equipment	20	20	20
Water delivery rate (lit/min)	15	15	10
Annual O&M (% of cost)			
Mechanical equipment	10	10	10
Non-mechanical equipment	1	1	1

water represent benefits, reducing the "price" of the water, and a further benefit comes from the increased consumption induced by a reduced collection time. These two elements are shown graphically on the stylized demand curve in Figure A-1. If a water supply improvement reduces the collection time, the "price" of water falls from P1 to P2, with a corresponding increase

Figure A-1 Typical Demand Curve

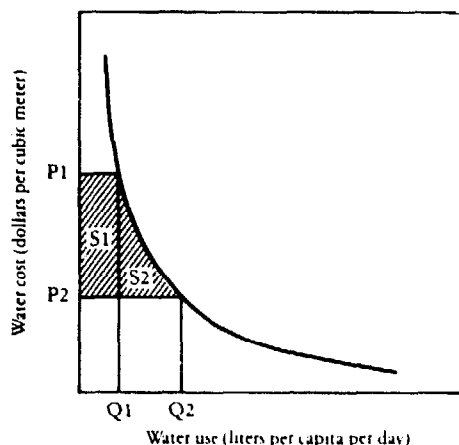

in per capita consumption from Q1 to Q2. The consumer benefits in two ways: first, the price P1 of the original Q1 liters falls to P2 (shaded area S1 represents the benefit); and second, the value placed on the extra water exceeds the price (benefit = shaded area S2).

In comparing different community water supply options, the model computes the total benefits S1 + S2, on the basis of the assumed local value of time, and subtracts the total annualized costs of constructing, operating and maintaining the improvements, to calculate a net benefit for each option.

First, the optimum handpump and standpipe systems are determined by computing costs and benefits for providing different numbers of handpumps or standpipes and noting which corresponds to the maximum net benefit. Figure A-2 illustrates the optimization process for handpumps. Only one yardtap service level is possible (one tap per household), so no

Figure A-2 Determination of the Optimum Number of Handpumps

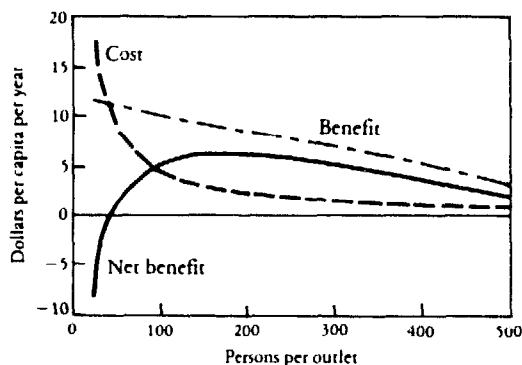

optimization is needed for that option. Once the best configuration for each type of system has been determined, handpump, standpipe and yardtap systems can be compared on the basis on net benefits.

The importance of the value of time is brought out when the model is applied to the prototype community, with diesel as the energy source for motorized pumps. The costs and benefits for the different technologies are as shown in Table A-2.

Table A-2 Costs and Benefits of Technology Options for the Prototype Village (US\$/capita/year)

Value of time =	12.5¢/hr			25¢/hr		
	HP	SP	YT	HP	SP	YT
Cost	2.1	5.5	11.7	3.2	6.5	11.7
Benefit	8.0	9.1	12.2	18.1	19.8	24.5
Net Benefit	5.9	3.6	0.5	14.9	13.3	12.8

Note: Costs in dollars per capita for handpumps (HP), standpipes (SP) and yardtaps (YT) have been calculated by adding recurrent costs to the annualized capital costs over the life of the capital equipment, at a 10% discount rate. Well cost is US\$2000 per well.

Handpumps have the lowest cost and show the greatest net benefit when the value of time is 12.5¢/h., and that situation is unchanged, when the value of time rises to 25¢/h, though standpipes and yardtaps are becoming more competitive as the value of time increases. In fact, at time values over about 35¢/h, yardtaps give the greatest net benefit. Note that at 12.5¢/h, the greatest net benefit from handpumps comes from two handpumps in the village of 400 people, while at 25¢/h, the optimum number of handpumps is three per village.

To obtain an overview of the way that community water supply choices can be expected to turn out on a global basis, the model has been applied to a wide range of different situations and general conclusions have been drawn about the sensitivity of the results to each of the important variables. By varying each of the parameters in turn, their influence on the choice of technology and service level can be evaluated.

The importance of the distance to the original source is brought out in Figure A-3, which indicates that technology selection is independent of the distance to the traditional source and that the distance to the traditional source would have to be more than 150 meters to justify a handpump-based system on the basis of time savings alone. Note that the average distance to the new source is about 50 meters when two point sources are placed in the prototype village.

The model can also be used to calculate the value of time at which the net benefits of two alternative technologies are equal to each other. The graphs in Figure A-4 illustrate typical results for a range of pumping lifts, well costs and village populations. The

Figure A-3 Influence of Distance to Traditional Source on Net Benefits

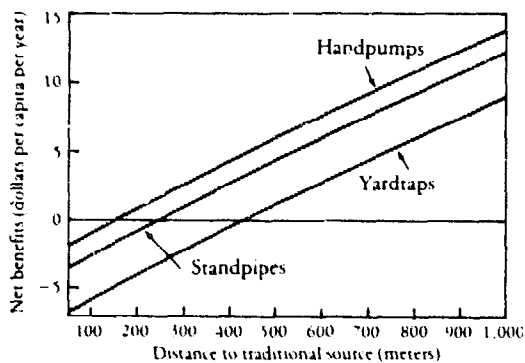

Population = 400 persons
 Housing density = 25 households per hectare
 Value of time = \$0.125 per hour

labeled areas represent the combination of conditions where that particular technology has the highest net benefit. The shaded area at the bottom indicates a negative net benefit. It is in this area that consideration of other benefits (e.g. health impact) would be necessary to justify investment in rural water supply improvements.

The general conclusions emerging from applications of the computer model to a variety of different scenarios are summarized in Table A-3.

Table A-3 Technology Selection*

	Electric pumps	Diesel pumps
Pumping lift up to 25m Well cost < US\$2000	HP/SP	HP
Pumping lift 25-45m Well cost up to US\$5000	SP	HP
Pumping lift >45 meters	SP	No good alternative

* Value of time less than 20¢/hr. If value of time is greater than 30¢/hr, yard taps are the most economic technology.

These conclusions are dependent on a number of assumptions (notably equal system reliabilities, various unit costs, and the demand curve) and it must be stressed that the model is not so much designed for

yes/no rural water supply decisions, but as an aid to technology selection. Furthermore, the model is no substitute for site-specific investigations and the preference of individual communities. In situations where the model calculates a negative net benefit (short distance to traditional source, low value of time, or high well costs), planners will need to make a careful assessment of other benefits than time savings, before going ahead with investment.

Figure A-4 Examples of Technology Selection for Varying Village Parameters

Effect of Pumping Lift

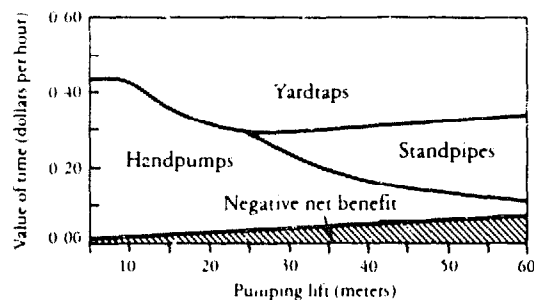

Effect of Well Cost

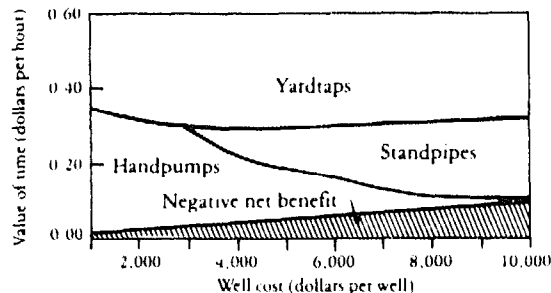

Effect of Population

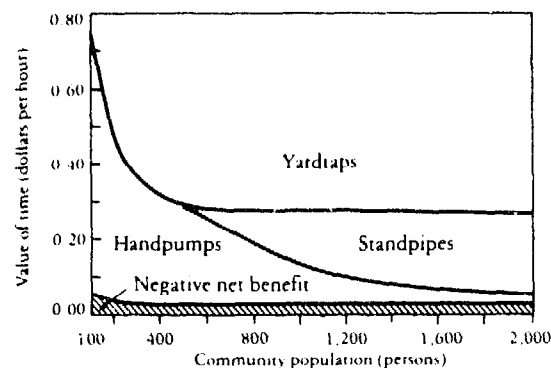

Note: These graphs apply to diesel pumps for standpipes and yardtaps. Unless otherwise specified, pumping lift = 20 meters, well cost = \$2,000 per well, population = 400 persons, and housing density = 25 households per hectare.

Bibliography

Agarwal, Anil; Kimondo, James; Moreno, Gloria; and Tinker, Jon. *Water, Sanitation, Health — For All?* London: International Institute for Environment and Development, 1981.

Anderson, Keith E. *Water Well Handbook*, 5th ed. Belle, Missouri: Missouri Water Well & Pump Contractors' Association, Inc., 1984.

Appleton, Brian. "First VLOM Prototypes Expected This Year." *World Water*, February 1983, pp. 28-34.

Arlosoroff, Saul, et al. *Handpumps Testing and Development: Progress Report on Field and Laboratory Testing*. World Bank Technical Paper No. 29. Washington, D.C.: World Bank, 1984.

Barua, D. "Diarrhea as a Global Problem and the WHO Programme for its Control." In *Acute Enteric Infections in Children — New Prospects for Treatment and Prevention*, edited by T. Holme et al. New York, Elsevier/North: Holland Biomedical Press, 1981.

Blankwaardt, Bob. "Hand Drilled Wells: A Manual on Siting, Design, Construction and Maintenance." Dar-es-Salaam: Rwegarullia Water Resources Institute, 1984.

Boland, R.G.; and Young, M.E. "The Strategy, Cost and Progress of Primary Health Care." *Bulletin of the Pan American Health Organization* (1982) 16(3):233.

Bom, Gert-Jan; and van der Mandele, Hugh. "High Quality Equipment May Mean Long-Term Rural Economies." *World Water*, June 1984, p. 37.

Bradley, D.J.; and Emurwon, P. "Predicting the Epidemiological Effect of Changing Water Sources." *East African Medical Journal* 45 (1968):284-291.

Bradley, D.J. "Water Supplies: The Consequences of Improved Water Supplies." In *Human Rights in Health*, edited by K. Elliot and J. Knight. Amsterdam: 1964.

Brush, Richard E. "Wells Construction: Hand Dug and Hand Drilled." ACTION Pamphlet 4200.35. Washington D.C.: Peace Corps Information Collection and Exchange, 1979.

Cairncross, A.M. "Village Water Supplies." Overseas

Building Notes No. 178, 1978.

Cairncross, Sandy; and Feachem, Richard. "Small Water Supplies." Ross Bulletin No. 10. London: The Ross Institute Information and Advisory Service, 1978.

Cairncross, Sandy, et al. *Evaluation for Village Water Supply Planning*. Chichester and New York: John Wiley & Sons, 1980.

Charnock, Garry. "Malawi's Livulezi Project Provides a Primer for Pump Studies." *World Water*, November 1982, pp. 22-26.

Charnock, Garry. "Committees Are Key to Kenyan Success/Women Take Lead in Kwale Handpump Development." *World Water*, August 1985, pp. 38-43.

Chinese Academy of Agricultural Mechanization Sciences, Beijing. "A Survey of the Production and Use of Handpumps in China." Washington, D.C.: World Bank, 1982.

Consumers' Association Testing & Research Laboratories (CATR, U.K.). "Hand/Foot-Operated Water Pumps for Use in Developing Countries." ODA Paper. Harpenden, Hertfordshire, U.K.: CATR, 1981.

Consumers' Association Testing & Research Laboratories. *Laboratory Testing, Field Trials and Technology Development*. Washington, D.C.: World Bank, 1982.

Consumers' Association Testing & Research Laboratories. *Laboratory Evaluation of Hand-Operated Water Pumps for Use in Developing Countries*. World Bank Technical Paper No. 6. Washington, D.C.: World Bank, 1983.

Consumers' Association Testing & Research Laboratories. *Laboratory Testing of Handpumps for Developing Countries: Final Technical Report*. World Bank Technical Paper No. 19. Washington D.C.: World Bank, 1984.

Consumers' Association Testing & Research Laboratories. "Handpump Laboratory Test Results." Applied Research and Technology Note No. 2. Washington, D.C.: World Bank, 1986.

Day, Chris. "Rural Supply Needs Integrated Approach." *World Water*, August 1985, pp. 30-31.

DHV Consulting Engineers. *Shallow Wells*, 2nd ed. The Netherlands: Development Cooperation Information Department, 1979.

Eubanks, Bernard M. *The Story of the Pump and its Relatives*. Salem, Oregon: Bernard M. Eubanks, 1971.

Evans, J.R.; Hall, K.L.; and Warford, J. "Health Care in the Developing World: Problems of Scarcity and Choice." *New England Journal of Medicine* (1981) 304 (19):1117

Farrant, Tony. "Realistic Timetable Required for Africa." *World Water*, June 1985, pp. 48-49.

Feachem, Richard. "Water Supplies for Low-Income Communities in Developing Countries." *ASCE Journal of Environmental Engineering Division* (1975), 101:687-702.

Feachem, Richard, et al. *Water, Health and Development: An Interdisciplinary Evaluation*. London: Tri-Med Books, Ltd., 1978.

Feachem, Richard; and Cairncross, A.M. *Tropical Public Health Engineering: An Introductory Text*. Chichester and New York: John Wiley and Sons, 1978.

Feachem, Richard; Mara, Duncan; and McGarry, Michael, eds. *Water, Wastes and Health in Hot Climates*. Chichester and New York: John Wiley and Sons, 1977.

Gibbs, Ken. "Billion Dollar Promise of New Bangladesh Pump." *World Water*, October 1982, pp 27-29.

Glennie, Colin. *Village Water Supply in the Decade: Lessons from Field Experience*. Chichester and New York: John Wiley and Sons, 1983.

Goh, Sing Yau. "Laboratory and Field Testing of Handpumps." IDRC-TS51e. Ottawa: International Development Research Centre, 1985.

Gordan, Raymond W. *Water Well Drilling with Cable Tools*. South Milwaukee, Wisconsin: Bucyrus-Erie Company, 1958.

Gray, Kenneth D. "Working Towards Village-Based Handpump Maintenance — UNICEF's Approach in India." *Waterlines*, July 1984, pp. 26-28.

Grey, David; and Langenegger, Otto. "The Implementation of Handpump Schemes for Rural Water Supplies in Africa." Washington, D.C.: World Bank, 1984.

Grey, David. "Meeting Notes: Handpump Design Meeting, Msambweni, Kwali District, Kenya, November 18-22 1984." Nairobi: World Bank, 1984.

Hahn, Robert. "Handpump Testing and Development. Part 3 — New Design: Particle Separator Foot Valve and Rod Guide." Lund, Sweden: University of Lund, 1983.

Hahn, Robert. "Handpump Testing and Development. Part 4 — The First Year: Results of Completed and On-going Tests." Lund, Sweden: University of Lund, 1983.

Hahn, Robert. "Lund Puts Pumps Through Long Test." *World Water*, June 1984, p. 41.

Helvetas. "Manual for Rural Water Supply" (Publication Number 8). Zurich: Swiss Association for Technical Assistance, 1980.

Hofkes, E.H., ed. *Small Community Water Supplies: Technology of Small Water Supply Systems in Developing Countries*, enlarged ed. Chichester and New York: John Wiley and Sons, 1983.

Hofkes, E.H. "Practical Handpump Maintenance Systems: Synthesis of Information and Experience from Handpump Maintenance Systems in Twelve Developing Countries." Paper for International Reference Centre for Community Water Supply and Sanitation. The Hague: IRC, 1984.

Hofkes, E.H. "Water Pumping for Rural Water Supply." Dakar: ENDA, 1983.

Institute of Public Health Engineering and Research. "Survey of Handpumps in Punjab Province." Lahore, Pakistan: Institute of Public Health Engineering and Research, 1982.

International Development Research Centre. "Rural Water Supply in Developing Countries: Proceedings of a Workshop Held in Zomba, Malawi, 5-12 August 1980." IDRC-167e. Ottawa: IDRC, 1981.

International Development Research Centre. "Rural Water Supply in China." IDRC-TS25e. Ottawa: IDRC, 1981.

International Reference Centre for Community Water Supply and Sanitation. "Small Community Water Supplies: Technology of Small Water Supply Systems in Developing Countries." Rijswijk, the Netherlands: IRC, 1981.

Johnson Division, UOP Inc. *Ground Water and Wells*. Saint Paul, Minnesota: Johnson Division, UOP Inc., 1982.

Journey, William K. "A Hand Pump for Rural Areas of Developing Countries." World Bank Utilities Department Working Paper No. RES 9(a). Washington, D.C.: The World Bank, 1978.

Krishna, Sumi. "Handpumps for Health: Water Use in Village India." New Delhi: Water and Environmental Sanitation Section, UNICEF, 1985.

McJunkin, F. Eugene. "Handpumps for Use in Drinking Water Supplies in Developing Countries." IRC Technical

- Paper No. 10. The Hague: International Reference Centre for Community Water Supply, 1977.
- McJunkin, F. Eugene. "Water for Human Health." Washington, D.C.: U.S. Agency for International Development, 1983.
- Morrison, Allen. "In Third World Villages, A Simple Hand-pump Saves Lives." *Civil Engineering Magazine*, October 1983.
- National Demonstration Water Project. *Safe Water and Waste Disposal for Rural Health: A Program Guide*. Washington, D.C.: National Demonstration Water Project, 1982.
- Norconsult A.S. "Rukwa Water Master Plan. Volume 1: Executive Summary." Oslo: Norconsult/NORAD, 1982.
- Pacey, Arnold. "Technology Is Not Enough: The Provision and Maintenance of Appropriate Water Supplies." *Aqua* 1 (1977):1-58.
- Power, Gwynne. "Bangladeshi Rower Travels to Africa." *World Water*, June 1984, p. 39.
- Roy, Sanjit. "A One-Tier System: The Tilonia Approach to Handpump Maintenance." *Waterlines*, January 1984, pp. 13-16.
- Rural Water Supply Handpumps Project Team. "Draft Sample Bidding Documents for the Procurement of Hand-pumps." Applied Research and Technology Note No. 1. Washington, D.C.: World Bank, 1986.
- Samanta, B.B.; Roy, Dipak; and Dutta, T.N. "Survey on the Performance of India Mark II Deepwell Handpumps: Maintenance, Repair Systems and Costs." Bhubaneswar, India: Operations and Research Group, 1986.
- Saunders, Robert J.; and Warford, Jeremy J. *Village Water Supply: Economics and Policy in the Developing World*. Baltimore and London: Johns Hopkins University Press, 1976.
- Sharp, Donald; and Graham, Michael, ed. "Village Hand-pump Technology." IDRC-204e. Ottawa: International Development Research Centre, 1982.
- Shiffman, M.A., et al. "Field Studies on Water Sanitation and Health Education in Relation to Health Status in Central America." *Progress in Water Technology* 11(1/2):143.
- Sternberg, Yaron M. "Testing of Wood Bearings for Hand-pumps." World Bank Public Utilities Department Working Paper No. 13. Washington, D.C.: World Bank, 1978.
- Sternberg, Yaron M.; and Knight, Robert. "Development of PVC Well Screens for Local Fabrication in Developing Countries." World Bank Public Utilities Department Working Paper No. 14. Washington, D.C.: World Bank, 1978.
- Trietsch, Robert. "Shallow Wells for Low-Cost Water Supply in Tanzania." *Waterlines*, July 1984, pp. 10-13.
- Tschannerl, Gerhard; and Bryan, Kedar. *Handpumps Testing and Development: Proceedings of a Workshop in China*. World Bank Technical Paper No. 48. Washington, D.C.: World Bank, 1985.
- United Nations Department of Technical Cooperation for Development. "Ground-Water Storage and Aquifer Recharge." Natural Resources/Water Series No. 2. New York: United Nations, 1975.
- United Nations Department of Technical Cooperation for Development. "The Use of Non-Conventional Water Resources in Developing Countries." Natural Resources/Water Series No. 14. New York: United Nations, 1985.
- United States Environmental Protection Agency. "Manual of Water Well Construction Practices." EPA - 570/9-75-001. Washington, D.C.: Office of Water Supply, Environmental Protection Agency.
- Walsh, J.A.; and Warren, K.S. "Selective Primary Health Care: An Interim Strategy." *New England Journal of Medicine* 301 (18):967.
- Water and Sanitation for Health Project (WASH). "Technical Assistance in the Manufacture and Quality Control of the AID/Battelle Handpump in the Dominican Republic." WASH Field Report No. 20. Arlington, Virginia: WASH, 1981.
- Water and Sanitation for Health Project (WASH). "Hydrogeological Reconnaissance of the Yelimane-Tambacara Area, with Reference to the Village Wells Project." WASH Field Report No. 32. Arlington: WASH, 1982.
- Water and Sanitation for Health Project. "Community Water Supply and Sanitation in Sudan." WASH Field Report No. 37. WASH, 1982.
- Water and Sanitation for Health Project. "Philippine Handpump Program (Barangay Water Program)." WASH Field Report No. 54. Arlington: WASH, 1982.
- Water and Sanitation for Health Project. "Selection of Alternatives to Gravity Flow Systems for Rural Communities: A Workshop to Train Guatemalan Engineers in Pumping Technologies." WASH Field Report No. 56. Arlington: WASH, 1982.
- Water and Sanitation for Health Project. "Comparative Costs of the AID Pump Fabricated in the Dominican Republic and the U.S. Manufactured Moyno Pump." WASH Field Report No. 80. Arlington: WASH, 1983.
- Water and Sanitation for Health Project. "USAID Hand-

pump Program in Tunisia." WASH Field Report No. 100. Arlington: WASH, 1983.

Water and Sanitation for Health Project. "Malawi Self-Help Rural Water Supply Program: A Mid-Term Evaluation of the USAID-Financed Project." WASH Field Report No. 105. Arlington: WASH, 1983.

Water and Sanitation for Health Project. "Job Aids for Quality Control in the Manufacturing of the AID Hand pump." WASH Field Report No. 124. Arlington: WASH, 1984.

Water and Sanitation for Health Project. "Job Aids for the Installation, Maintenance and Repair of the AID Hand-pump." WASH Field Report No. 25. Arlington: WASH, 1984.

Water and Sanitation for Health Project. "A Technical/ Managerial Review of AID Handpump Programs in Sri Lanka, the Philippines, Honduras, and the Dominican Republic." WASH Working Paper No. 29. Arlington: WASH, 1983.

Water and Sanitation for Health Project. "A Workshop Design for Handpump Installation and Maintenance: A Training Guide." WASH Technical Report No. 26. Arlington: WASH.

Watt, S.B.; and Wood, W.E. *Hand Dug Wells and Their Construction*. London: Intermediate Technology Publications Ltd., 1979.

WEDC, ed. *Developing World Water*. London: Grosvenor Press International Ltd.

Weiner, Aaron. *The Role of Water in Development*. New York: McGraw-Hill Book Co., 1972.

Wiseman, Robin. "Billions Will Still Lack Supply in 1990." *World Water*, June 1985, pp. 43-47.

Wiseman, Robin. "Quality Control is Culprit, says Bank." *World Water*, July 1986, pp14, 36-37.

White, Gilbert F.; Bradley, David J.; and White, Anne U. *Drawers of Water: Domestic Water Use in East Africa*. Chicago and London: University of Chicago Press, 1972.

World Bank. *Village Water Supply*. Washington, D.C.: World Bank, 1976.

World Health Organization. "Drinking Water and Sanitation, 1981-1990: A Way to Health." Geneva: WHO, 1981.

World Health Organization. "Guidelines for Drinking-Water Quality. Volume 1: Recommendations." Geneva: WHO, 1984.

World Water. "Wanted: Low-Maintenance Handpumps for Vast World Market." *World Water*, December 1981.