

AT MICROFICHE
REFERENCE
LIBRARY

A project of Volunteers in Asia

Residential Water Re-Use

California Water Resources Center Report No. 46

by: Murray Milne

Published by:

California Water Resources Center
University of California at Davis
Davis, CA 95616 USA

Paper copies are \$10.00.

Available from:

California Water Resources Center
University of California at Davis
Davis, CA 95616 USA

Reproduced by permission of the California Water Resources Center, University of California at Davis.

Reproduction of this microfiche document in any form is subject to the same restrictions as those of the original document.

RESIDENTIAL WATER RE-USE

MURRAY MILNE

School of Architecture and Urban Planning
University of California/Los Angeles
Illustrations by Chet Wing

**CALIFORNIA WATER RESOURCES CENTER
UNIVERSITY OF CALIFORNIA/DAVIS**



**REPORT NO. 46
SEPTEMBER 1979**

TECHNICAL COMPLETION REPORT

The research leading to this report was supported by the University of California Water Resources Center, as part of Water Resources Center Project UCAL-WRC-W-424.

Report No. 46 September 1979

©-1979 The Regents of the
University of California

ISSN 0575-4968

\$10.00

RESIDENTIAL WATER RE•USE

Murray Milne; Professor, University of California at Los Angeles

Why do you use drinking water to flush toilets? Wouldn't the soapy water from bathtubs or laundries do a better job? Why don't you use household wastewater with its organic nutrients to irrigate and fertilize your garden?

Why do you carefully collect rainwater only to dump it into its own special sewer system, instead of using it to recharge the water table under your houses?

Every dollarsworth of water you reuse on site represents two dollars saved: one for the water that wasn't bought, and the other for the sewage that didn't have to be treated.

Components for building residential water reuse systems are readily available nowadays from swimming pool supply houses, lawn sprinkler system installers, and plumbing hardware stores.

Greywater reuse systems, rainwater cisterns, and wells are cost effective in many parts of the country today. Dozens of small scale water reuse systems have been designed for easy installation in existing homes. The simplest cost only a few dollars and can be installed in an afternoon.

Water is continually reused. Downstream communities inevitably use water that was previously used by communities upstream. Given a chance, many different natural mechanisms can easily purify this water between uses.

Garden soil is a superb natural purification medium. Filtering greywater through about 4 feet of sandy loam renders it quite safe to reenter the water table. Gardeners and agricultural scientists have solved the problems of salt accumulation and alkalinity that earlier plagued greywater recycling.

Energy costs are the fastest growing component in your water bill. In California, more electricity is used pumping water than anything else.

State and Federal legislation following recent droughts now encourages experimentation with on-site reuse systems, and even provides grants covering up to 85 percent of the cost in some instances.

In the future it will not be necessary to build new aqueducts and dams if Americans decide to reuse the water they already have.

Report No. 46

California Water Resources Center, University of California, Davis, 95616

Illustrations by Chet Wing

CONTENTS

Abstract	iv
Acknowledgements	v
1. Why Water Reuse?	1
2. History of Water Reuse	33
3. Rainwater and Groundwater	95
4. Garden Uses	131
5. Systems	253
5.1 Proprietary Systems	255
5.2 Operating Experimental Systems	275
5.3 Home-Built Systems	309
5.4 Design Proposals	331
6. Components	359
6.1 Filters and Related Equipment	361
6.2 Backflow Prevention Devices	389
6.3 Chlorinators	405
6.4 Controls	427
6.5 Pumps	443
6.6 Piping	467
6.7 Tanks	477
6.8 Miscellaneous Components	489
Appendix: Water Reuse Terms	497
Appendix: Residential Flow Rates	499
Appendix: Index of Manufacturers	501
Appendix: Annotated Bibliography	509

ABSTRACT

Greywater, rainwater, groundwater, and surface water are sources of 'free' water already available to every homeowner on-site. This book explains the various ways to collect, store, treat, and distribute this water, and gives examples of how it has been successfully reused for toilet flushing, landscape irrigation, washing, bathing, or drinking. For many of these functions water can be reused directly without treatment.

The argument in favor of water reuse is given along with a brief history of residential water reuse, how rainwater and groundwater can be developed as an on-site supply, the uses of greywater for garden irrigation, various residential-scale systems that have been designed for on-site reuse, and an explanation of the components needed to build such systems. The appendix contains a directory of manufacturers, a glossary of specialized terms, units of measure, and an annotated bibliography containing over 500 citations.

The conclusion of this study is that residential on-site water reuse systems are already technically feasible and environmentally sound, and are becoming more economically attractive every day, due primarily to the rapidly increasing cost of energy required for pumping and treatment by centralized water and sewage systems.

This volume is a companion to Residential Water Conservation by the same author, published by the California Water Resources Center in 1977.

The objective of this book is to help homeowners, builders, developers, architects, planners, and lawmakers understand the design and installation of small on-site residential water reuse systems.

ACKNOWLEDGEMENTS

A great many people contributed to this project since it began here at UCLA in July, 1973. The first report "Residential Water Conservation", was published in 1976. Research on this, the second report, began in July, 1977.

The bulk of this effort was undertaken individually by my graduate student Research Assistants. I am extremely proud of the work each of these young men and women contributed:

Pat Ballard	M.A. Urban Planning
Carol Barkin	Master of Architecture
Mitchell Carlson	M.A. Urban Planning
Catherine Howard	M.A. English
Joel Lakin	M.A. Architecture
David Wade	M.A. Urban Planning
Chet Wing	Master of Architecture
Shin Yoshikawa	Master of Architecture

The preparation of the report was managed by Marsha Brown whose patience and competence I deeply appreciate. She was responsible for typing drafts, proofreading, and preparing camera-ready copy.

This project benefitted greatly from the suggestions and comments graciously contributed by many colleagues: Rosa Crowell, Water Resources Center; Louis De Luca, Kentucky Design Advisory Council; Max Kroschel, Farallones Institute; Suzanne Melnick, California Department of Water Resources; Fred Nelson, Sunset Magazine; Mary Ann Righetti, Water Resources Center; Olivia Robinson, California Energy Commission; John Tenero, California Department of Water Resources; Malcolm Walker, California Office of Appropriate Technology; and Beth Willard, Water Resources Center Archives.

The one person who deserves special thanks is Herb Snyder, Director of the California Water Resources Center, who initially took a chance in supporting this potentially controversial project, who kept it alive when it ran short of funds, and who patiently endured seemingly endless rewriting and editing before this report was finally published.

To the reader, I would like to address a personal comment. I believe this study shows clearly that residential water reuse is technically feasible, environmentally sound, and economically attractive. This book describes dozens of simple systems and explains how you can install them in your own home. I urge you not to be discouraged by the indifference of lawmakers and utility companies. I am convinced that the only way that residential water reuse will become a serious alternative to the construction of new centralized supply systems, is if it is proven to be viable by thousands of homeowners just like you.

Murray Milne
UCLA School of Architecture and Urban Planning
September 1979

WHY WATER REUSE ?

All water is recycled.

Water by itself is incorruptably pure. The problem, however, is the company it keeps. Because water so willingly picks up and transports almost anything, man uses it as a kind of ever-flowing garbage collection system. This is the reason we have come to distrust the purity of the water in our lakes and rivers, especially if we suspect that there are towns or farms upstream. The same apprehension carries over into our attitudes about the water we use inside our own homes. But all water once used is not necessarily contaminated for all further uses. In many cases it can be directly used for less critical applications without any treatment. In fact effluent from some residential fixtures picks up materials valuable to subsequent uses such as soap or plant nutrients. For example:

- Why can't shower water be used to irrigate our gardens?
- Why do we use pure drinking water to flush toilets?
- Wouldn't soapy water from our bathtubs or laundries be even better for toilet flushing?
- Why don't we collect rainwater to use for bathing or clothes washing?
- Why don't we pump the groundwater from underneath our houses for landscape irrigation or to use indoors?

WHY BOTHER REUSING WATER?
RESIDENTIAL WATER REUSE PATTERNS
RESIDENTIAL RECYCLING
WHO SHOULD USE THIS BOOK

WHY BOTHER REUSING WATER?

In days of virtually free and limitless supplies, there was no reason to consider using water more than once. However today, a new picture is rapidly developing:

- . Energy Costs: The price homeowners pay for water is primarily effected by energy. The fastest growing cost item is the cost of energy needed to pump water from one place to another. In Southern California, for example, the station which pumps water over the Tehachapi Mountains consumes almost one-tenth as much energy as the entire city of Los Angeles. Anything which permanently reduces the amount of imported water will continuously pay off in energy savings.
- . Oil Shortages: Some experts believe that within ten years energy shortages will force the institution of strict water conservation programs in some parts of the nation. Individual on-site water collection and reuse systems require virtually no energy input and therefore present a more reliable and cost-effective alternative for the future.
- . Environmental Impact: Voters and lawmakers are becoming so sensitive to environmental concerns that it is almost impossible to create "new" water by damming wild rivers or diverting water from one natural drainage basin to another. They claim that huge interstate and international water redistribution systems are unnecessary until all the possibilities for local water conservation and reuse have been exhausted.

Much of the material in Chapter 1 is excerpted from Residential Water Conservation, published by the author in 1976.

- . Difficulty of Developing New Water: Everywhere in the country the most easily exploited water sources have already been developed, so tapping each new source will be progressively more costly and complicated than the last one. Many consumers suspect that utility companies tend to overestimate future demand in order to justify continued growth. But even if demand does increase, developing reuse systems eliminates the need to develop new water supplies.
- . Utility System Growth Limits: In recent years the growth in the demand for water in our cities and towns is creeping dangerously close to the limits of local water companies' pumping, piping, and storage systems. New houses are hooking up to existing mains at the rate of between two and three million a year. If demand grows unchecked, major critical expenditures will be required to enlarge these existing water supply systems. However, a much more economical way to meet this growth may be to reduce per-capita demand by developing methods of water reuse.
- . Utility Company Management: Ideally a carefully managed phase-in of residential recycling systems could bring about reductions in demand which exactly balance increases in demand created by new customers hooking up to the system, thus eliminating the need either for rate increases to cover lost revenue, or for capital expenditures to expand the supply system.
- . Sewage Treatment Costs: To reduce property taxes, a number of municipalities now bill the homeowners directly for sewage treatment as a percentage of the amount of water they use, therefore it is doubly clear that on-site water reuse will reduce the cost of both these services.
- . Septic System Overloads: Homeowners with individual on-site sewage treatment systems can often postpone extensive

Enormous amounts of energy are used to bring water into our cities. For example, the station that pumps water into Los Angeles County from the San Joaquin Valley used:

1975:	1,582,460,000 kwh
1976:	1,395,490,000 kwh
1977:	364,010,000 kwh (drought)

Compare this with the fact that in 1977 the entire city of Los Angeles consumed:

Industrial:	3,968,844,000 kwh
Residential:	4,612,413,000 kwh
Other:	8,525,915,000 kwh
Total:	17,107,172,000 kwh (DWR 1978, DWP 1978)

The energy from 15 barrels of oil is needed to transport one million gallons of water from the Sacramento River to Los Angeles (New West 1977), therefore everyone who cuts their residential consumption in half by reusing greywater is saving the equivalent of about 1/2 gallon of oil per week.

replacement costs by simply reducing the amount of sewage produced in their homes by reusing greywater at least once before it enters the tank, or by diverting it to on-site irrigation.

- . Consumer Convenience: Convenience is still the primary motivation for consumer behavior, and so the most successful residential water recycling systems now in the marketplace make it just as convenient to reuse water as to let it flow down the drain into the sewer.
- . Consumer Economic Behavior: Homeowners inevitably make many non-cost-effective decisions, sometimes as a matter of principle and other times simply to satisfy preference. For instance, homeowners do not make cost-effectiveness calculations when deciding to buy Jacuzzi hot tubs, backyard swimming pools or exotic landscaping, and the same is true when they buy bottled water. This is why new recycling systems are attractive to many homeowners.
- . Drought Protection: Millions of Americans have recently suffered great inconvenience and financial loss due to drought. By and large we were caught unprepared because we relied unequivocally upon sources which were never supposed to dry up. From practical experience, many people have now learned that water collection and recycling offers protection for their life-style and their property when other systems fail.
- . Self Sufficiency: The idea that many homeowners long to be free from manipulation by big business and dependence on big government perhaps accounts for some of the current appeal of on-site recycling systems, which give a certain measure of independence in at least one of the necessities of life.

- . Cultural Attitudes About Water Recycling: Recent surveys have shown that as people learn more about water recycling their attitudes towards it change. We are willing to adopt techniques that have been tested and proven, and our illogical fears about "used" water are diminishing.
- . Recycling is Ecologically Efficient: Greywater recycling returns water to the underground water table, naturally purifying it and replenishing our water supplies while conserving energy. Recycling ultimately means that fewer dams are needed, helping to preserve our wilderness.
- . Recycling is Beneficial to Plants: Recycling water means there is more available for irrigation. Greywater can be more beneficial to plant growth than freshwater because it contains many of the nutrients found in fertilizer. Not only can more plants be grown than would be otherwise feasible, but some of these plants will grow better.
- . Wastewater Reclamation Precedents: In many parts of the country it is now economically feasible to use treated wastewater for irrigating cropland, golf courses, free-way landscaping, groundwater recharge, and for water sports facilities. In the future, water reclamation and reuse will likely be one of the fastest growing methods of meeting increased municipal demand. The precedent established by these large-scale recycling projects will encourage homeowners to try their own small-scale systems.
- . New Commercially Available Products: For the first time new components designed specifically for water recycling are being marketed at prices that are competitive with traditional plumbingware. Most of these devices are intended for new construction, although there is a huge untapped market for retro-fitting existing dwellings. If water and energy costs continue to rise, even the more expensive components will become cost-effective.

A survey in 1976 showed that 92% of people surveyed in Orange County, California supported the use of reclaimed water for irrigating greenbelts (Lee 1978).

WHEREAS...Over 2.5 million residents of the State of California are presently serviced by individual on-site wastewater disposal systems...the cost of conventional wastewater collection and treatment facilities is prohibitive for a number of unsewered communities...conventional systems may be more energy intensive than low-cost, low-technology alternatives ...THEREFORE BE IT RESOLVED that the State Water Resources Control Board does hereby announce its support and encouragement to greatly increase effort and emphasis on the use of alternative wastewater disposal systems...: RESOLUTION NO. 78-10.

- . Future Technology: The homeowner will soon be able to enjoy spinoffs from the new water recycling and treatment systems that have been developed and tested in space-craft and other new transport vehicles. Government agencies are researching many alternative systems and this will result in more new designs and new products.
- . Housing Construction Moratoriums: In some parts of the country water and sewer hookup embargos have halted construction projects and have convinced many home-builders and developers that it is in their best interest to rethink the way their new buildings use water. Water recycling gives the developer more freedom of choice in site selection because it lessens the dependency of his project on the existing utility grid. It also gives the home-builder a certain amount of standing with public decision-making agencies because it is tangible evidence of his commitment to lessen the adverse impact of his project on the community.
- . Local Government Encouragement: When confronted with the likelihood of shortfalls in future water supply, some local governments are encouraging individual homeowners to build on-site collection and recycling systems because the other alternatives are politically much less attractive: rate surcharges, penalties for excessive use, connection prohibitions, building permit moratoriums or rationing plans.
- . State Government Action: Many states have created specific agencies to develop plans for alternative technologies applicable to homeowners. For example, California's Office of Appropriate Technology has been charged with analyzing the cost-effectiveness and reliability of various on-site wastewater management and water reuse systems.

- . Federal Grants: Individual privately owned residential on-site wastewater systems are now eligible for EPA grants under recent amendments to the Federal Clean Water Act (PL 92-500). Current grants cover such things as grey-water treatment systems, innovative water supply sources, waterless toilets, and alternatives to septic tanks.

RESIDENTIAL WATER USAGE PATTERNS

Residential water usage can be broken down into two categories: indoor (drinking, laundry, bathing, toilets, etc.) and outdoor (irrigation, car washing, pools, etc.). The amount of water used indoors is fairly constant throughout the nation, but outdoor usage shows great variability, primarily influenced by the local climate.

In order to establish a base line for use in this report the data from a great many different studies were compiled and summarized into a picture of "average" residential consumption (see Flow Chart). There probably is no household in the country that exactly matches these figures, but the overall pattern is good enough for our purposes here; it allows us to compare the relative effectiveness of various approaches to water recycling. For example, there is a good reason why most of the research and development in this area has focused on designing toilets which use recycled water and on outdoor uses, especially irrigation. The flow chart shows that as a rough rule of thumb toilets use half of all indoor water, while outdoor water represents about half of all residential consumption, and so toilets plus irrigation account for about two thirds of all consumption.

Admittedly the consumption figures used in this report are somewhat arbitrary, but they are all somewhere near the middle of the many different values reported in the literature. For instance the Federal Housing Administration's 1965 Minimum Property Standards suggests that 100 gallons per capita per day (gpcpd) should be used in designing a typical

Indoor Use
Outdoor Use
On-Site Recycling

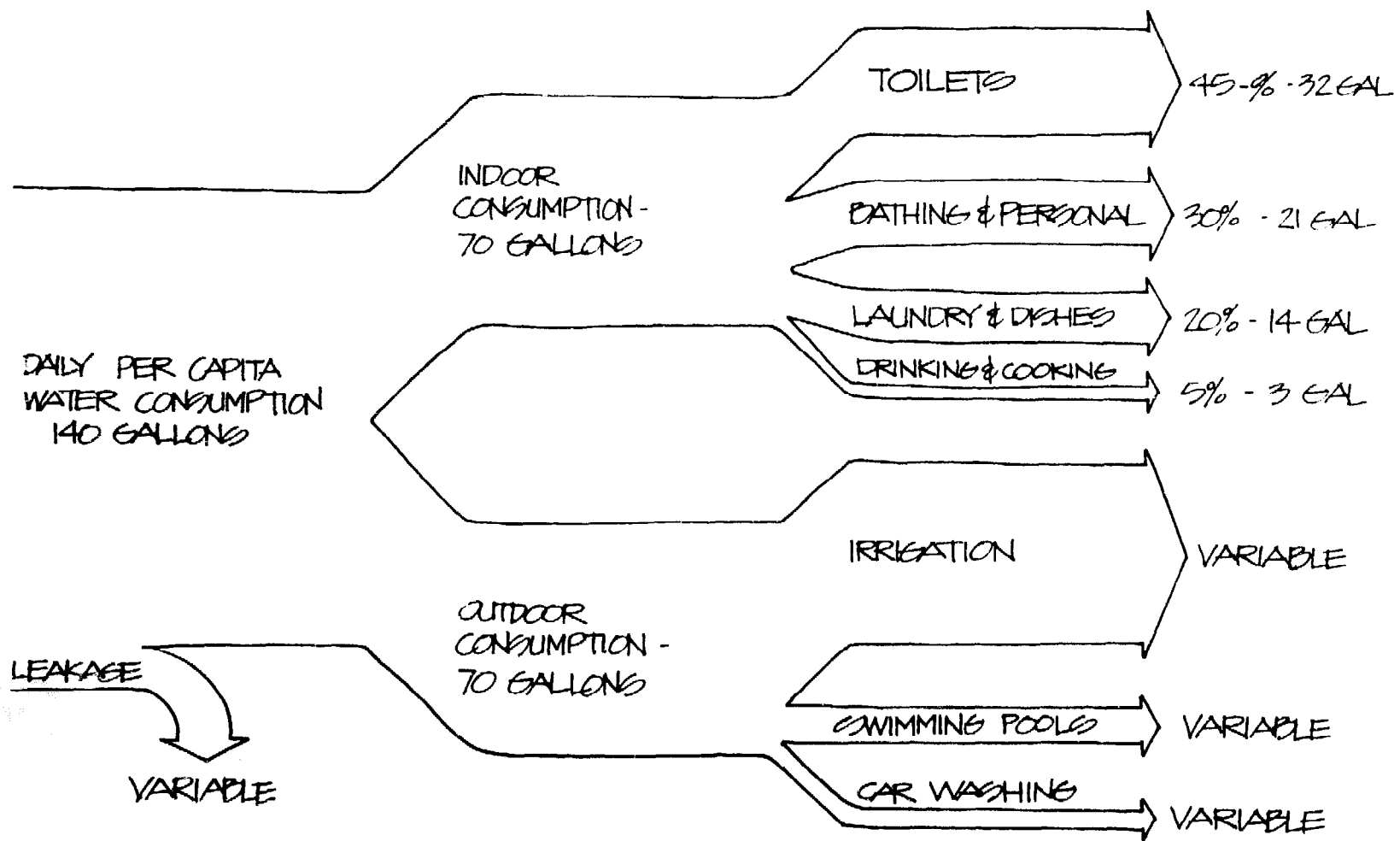

A PICTURE OF RESIDENTIAL CONSUMPTION

(MILNE, 1976)

residential unit. The differences between communities can be staggering. For instance consumption on the Northern California coast averages 153 gpcpd while in the arid southeastern part of the state it averages 410 gpcpd (California Department of Water Resources 1968). But actual residential consumption figures change from one year to the next and from one season to the next. The most dramatic changes occurred as a result of legislation passed during California's recent drought. In Marin County, California, consumption dropped from 170 to 148 gpcpd as a result of a resolution in 1975 urging voluntary water conservation, but two years later mandatory rationing brought consumption down to about 50 gpcpd.

Indoor Use

In this report we will use 70 gallons as the typical amount of water used daily by each person indoors. Approximately 45 percent (32 gpcpd) is used to flush toilets, each flush requiring 3.5 to 8 gallons of water for toilets in general use (5.25 gallons is the national average flush). Bathing and other personal uses account for about 30 percent of the indoor total (21 gpcpd), but more than half of this amount is used in showers which may easily consume 30 gallons of water for each occurrence. About two gallons of this is used for brushing teeth. Laundry and dishwashing use amounts to 20 percent of the domestic total. Finally, 5 percent of the indoor water (about 3 gpcpd) is consumed by drinking and cooking. But even this last value is far above the minimum of 2 quarts needed daily for human consumption (Milne 1965).

All of these residential water consumption figures will begin to show significant changes in the near future as a result of legislation inspired by the recent drought and by the impact of energy cost increases. For instance, the average amount

of water used in toilets will drop steadily in the future because of a recent California law limiting all new toilets to 3.5 gallons per flush. Reduced flow shower heads and faucets may soon be mandated by the California Energy Commission. Any homeowner considering water recycling should first study the opportunities for residential water conservation (Milne 1976).

Outdoor Use

It is much more difficult to establish an accurate value for outdoor use. These activities are extremely unpredictable and show great differences from one consumer to the next: lawn watering, landscape irrigation, car washing, swimming pool evaporation, and even hosing off paved areas. For this reason we have settled on 70 gpcpd as an average figure, which means that outdoor and indoor consumption are approximately equal. But there are tremendous variations in the value for outdoor use reported in the literature. Western residential living units use over twice as much water per capita for sprinkling lawns and gardens as do comparable Eastern units (Linaweaver 1966). In fact, one New Hampshire study found that in two out of three representative towns, less than 10 percent of the households watered their lawns at all (Andrews 1970). Two Los Angeles area studies, on the other hand, indicate that on an annual basis roughly 50 percent of the water consumed daily per capita, or about 70 gpcpd, was used outdoors (California Department of Water Resources 1965 and 1966). In a study of sprinkling use in 41 communities across the country, Linaweaver found average summer use was 2.49 times greater than average annual use. In the face of all these different figures, about all we can reliably conclude is that outdoor use represents a very big proportion, more often than not, annually accounting for at least half of total consumption (Milne 1976).

A PARTIAL REUSE SYSTEM

25% REDUCTION IN WATER DEMAND - 52% REDUCTION IN LOAD ON SEWAGE PLANT.

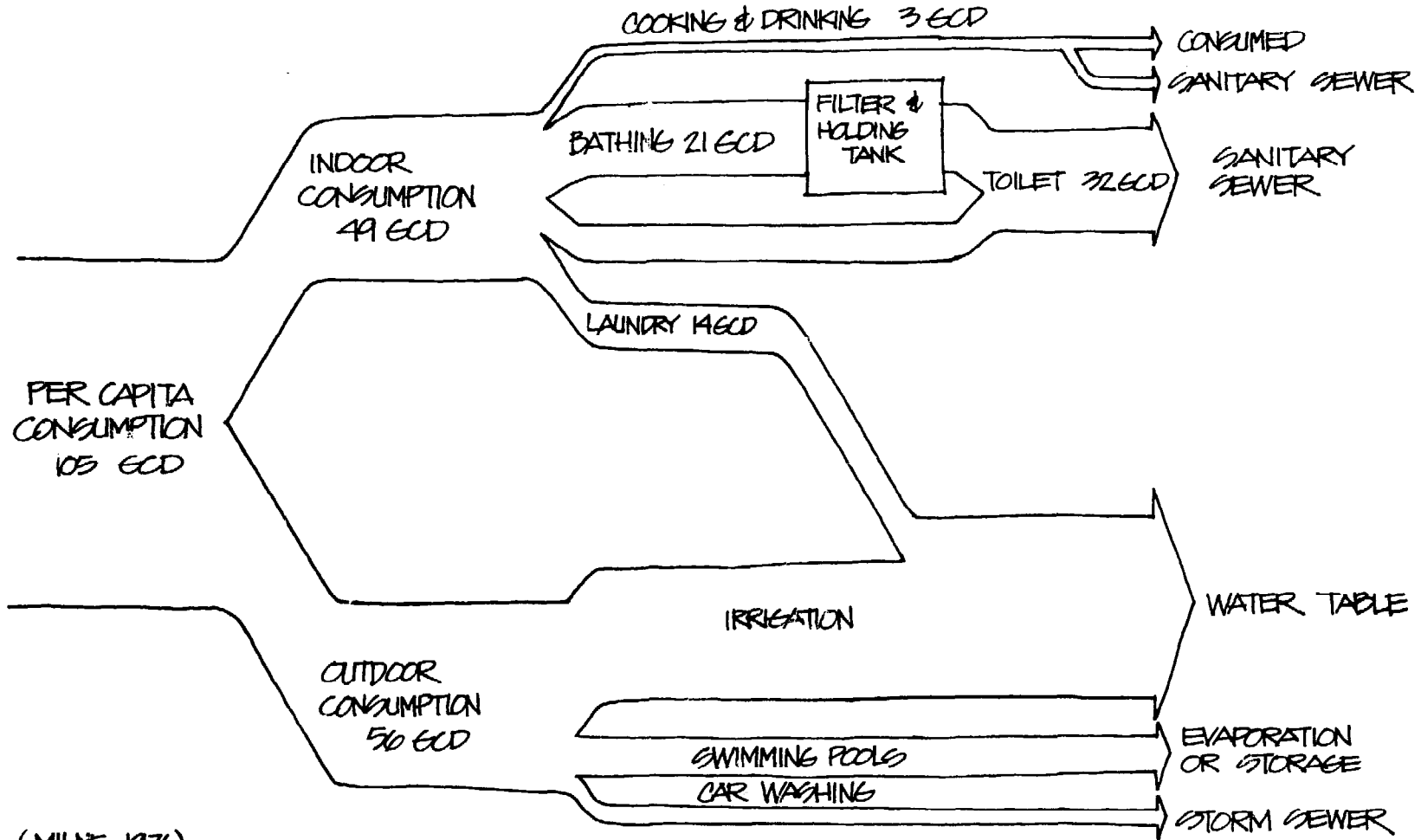

(MILNE, 1976)

(GCD = GALLONS PER CAPITA PER DAY)

On-Site Recycling

Even a simple water reuse system will have significant impact on the water supply and sewage systems. For example assume that toilets are flushed with bath water that is filtered and stored in a holding tank, along with some additional make-up water. Assume also that all laundry water is used directly for landscape irrigation. Such a cascaded recycling system is not technically complicated and in fact a number of similar systems are already in operation (see Systems chapter). Using the same average figures of residential water consumption, the net result is a 25 percent reduction in water consumption and a 52 percent reduction in load on the sewer system.

Of course, systems with almost any amount of reuse could be designed. For example, a total reuse system can be constructed from readily available components. As in the previous example bath water plus laundry water can be filtered into a holding tank and used for toilet flushing. Any overflow from the tank, plus kitchen sink wastes, and toilet blackwater all end up in the septic tank. The leach field can be designed to irrigate deep rooted plants. Some of the additional water needed for outdoor uses can provide the necessary surface irrigation. Total household consumption is reduced 50 percent even if all of this water is supplied from the municipal system. However, if collected rainwater or pumped groundwater is available, then in effect 100 percent of residential needs are supplied by on-site sources. The result is a totally self sufficient house, completely disconnected from the water supply and sewage system utility grids.

Many other recycling systems have been designed, some much more or less complicated than others, but in all cases drawing a simple flow diagram will help the homeowner clearly see the effect of each different component.

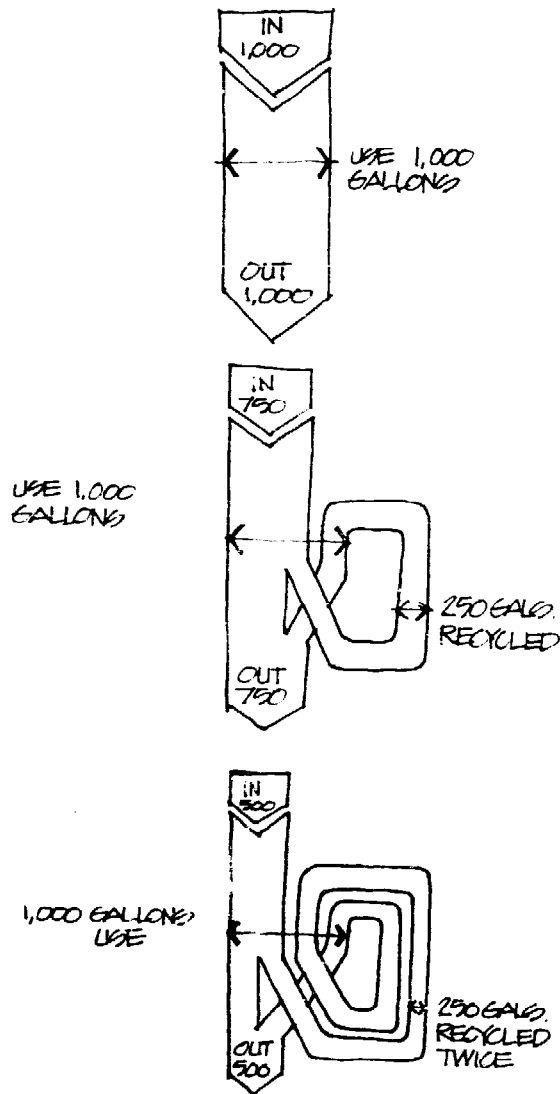

A TOTAL REUSE SYSTEM
50% REDUCTION IN WATER DEMAND

(ALL CAN BE SUPPLIED BY ON-SITE SOURCES WITH
NO LOAD ON SEWER SYSTEM)

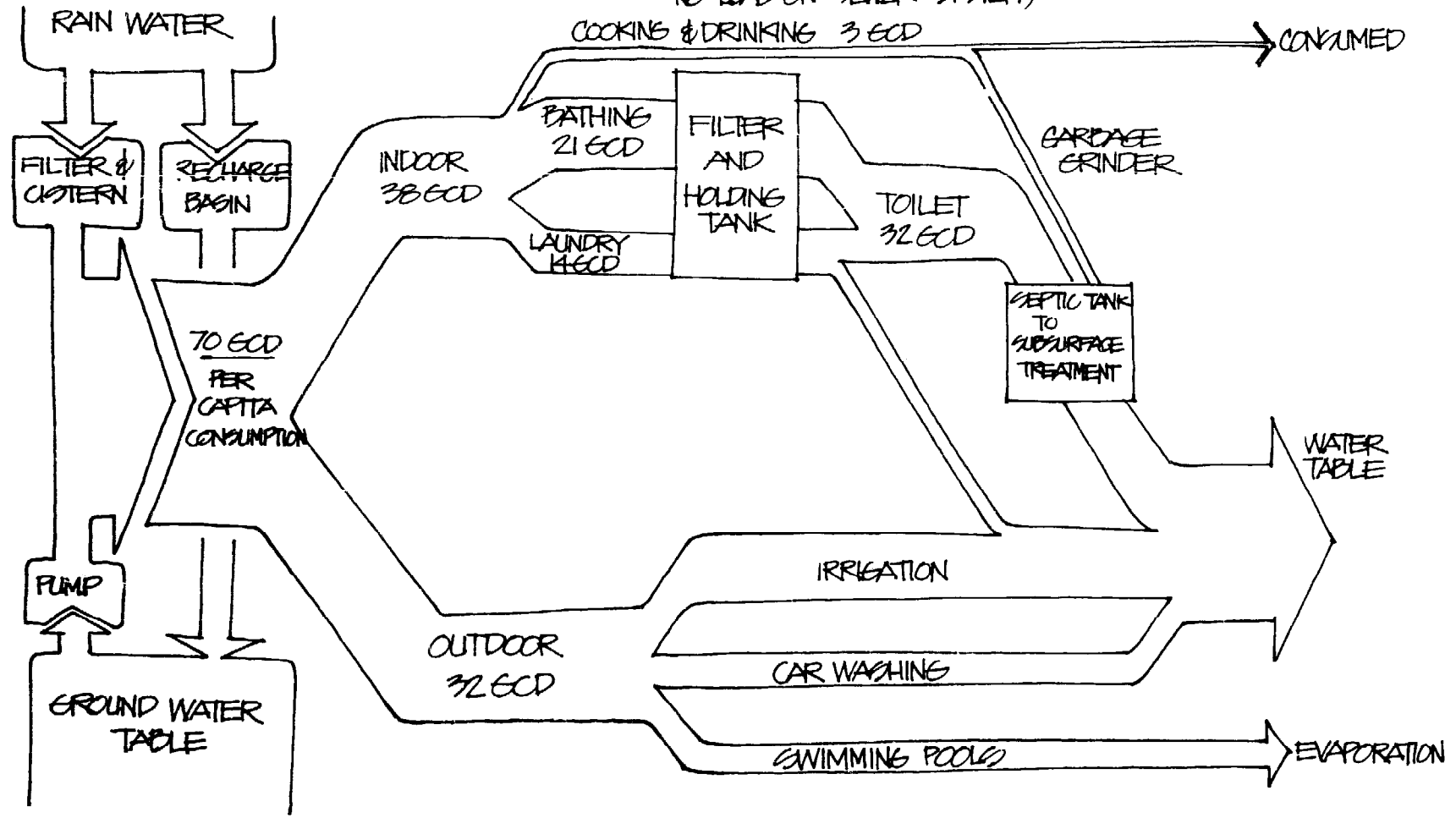

RESIDENTIAL RECYCLING

On-site recycling systems save at both ends of the system. Thus, in a sense a penny recycled is two pennies earned (if the mixed metaphor can be forgiven). For example, if household use is 1000 gallons, and if 250 gallons is recycled (i.e., using shower water to flush toilets) then fresh water supply is reduced 250 gallons and sewage water output is also reduced 250 gallons. The money the homeowner saves due to reduced supply is direct and immediate, but he will probably not realize any savings due to the reduced sewage load. This is because many communities still pay sewage treatment costs as part of property taxes. However, in California, recent revisions in municipal funding forced by proposition 13 have convinced San Francisco, Beverly Hills, and other communities to bill for sewage treatment in proportion to water consumption. This is good news for people with on-site recycling systems.

Greywater vs. Blackwater
What is Done with Greywater Now?
Cascading
Greywater Reuse without Treatment
Greywater Recycling with Primary
Treatment
Blackwater Recycling
Rainwater
Groundwater
How Recycling Effects Municipal
Sewerage Systems
Off-Site Treatment of Recycled Water
Designing a Residential System

Greywater vs. Blackwater

How the water is recycled within a home depends on whether blackwater or greywater is being recycled and on where the recycled water is used. Greywater can be defined as all the wastewater generated within a home except toilet wastewater. Blackwater is any wastewater that is contaminated by the effluent from toilets. During the construction of a residential plumbing system, it would be fairly simple to separately collect blackwater and greywater. This would allow for the subsequent reuse of the greywater.

Greywater has a relatively low biological oxygen demand (BOD) and carries almost no harmful organisms (Hypes 1974). It comes from the shower, bathtub, clothes washer, dishwasher or kitchen sink. The amount of treatment that greywater requires depends on how the water is to be reused, but in any case it will not need to be as extensive as that required for blackwater.

Wastewater from the kitchen sink is usually excluded from greywater collection systems because it contains grease and other organic matter, as well as soap, detergents, cleaning agents, and dirt. Of all this material, grease usually presents the greatest problems for on-site recycling systems because when it cools it can clog pipes, filters, etc. If the sink contains a garbage grinder the contaminant loading is much worse. Therefore, the simplest solution is to connect the kitchen drain to the blackwater line. Greywater from the bathtub, shower, and laundry will also contain soap, detergents, and other cleaning agents, as well as dirt, oil, hair, blood, and other biological contaminants, but in such low concentrations that clogging is not a problem. If diapers are to be washed in the laundry machine, its effluent should be treated like blackwater.

What is Done with Greywater Now?

In conventional residential plumbing systems no distinction is made between blackwater and greywater, and in fact both are mixed together which means that the total must be classified and treated as blackwater.

Three different levels of sewage treatment are used by cities in the United States. These are commonly referred to as primary, secondary, and tertiary treatment processes.

Primary treatment physically removes large organic and inorganic solids and smaller suspended or dissolved solids from the sewage. This is generally accomplished by straining, settling, and filtration. Gratings and screens remove the largest waterborne objects from the incoming sewage. Settling removes smaller solids by letting the heavy particles sink and light particles float while the sewage is held quiescent in a settling tank. Finally the remaining tiny suspended solids are removed by mechanical filtration usually through large sand beds. This effluent from primary treatment is by no means sanitary or safe for human contact, but most cities in the United States still only have primary treatment plants.

Secondary treatment is a biological process that is designed to reduce the biological oxygen demand (BOD) in the sewage. This is accomplished by aerobic or anaerobic processes. In an aerobic process, air is pumped through the sewage where oxygen breathing microorganisms thrive by feeding on the bacteria in the sewage. In an anaerobic process, the sewage remains in a sealed tank without air and microorganisms that grow in this condition attack and kill the bacteria. Anaerobic digestion produces methane gas and the possibility of recovering methane is a potential added benefit. Most large cities have or are in the process of building secondary treatment plants. The Federal Water Pollution Control Act of 1972 required that by 1977 all publicly owned treatment plants provide secondary treatment (McCarthy 1974). However, because of funding limitations this deadline has not been met successfully.

Tertiary treatment is a chemical process which is designed to remove phosphates, nitrates, organics, and other materials. Tertiary treatment is a relatively new process and some experts still consider it experimental. Many different methods of tertiary treatment are being developed. Water that has gone through tertiary treatment is technically safe for human use. However, to date municipal sanitation and health departments have been reluctant to approve the direct human consumption of the water from tertiary treated sewage.

Cascading

The most cost effective way to recycle water within the home is to eliminate or minimize the need for treatment between uses. This can be done by "cascading" the water in a sequence of uses which require progressively less sanitary conditions. For instance water from a shower might be reused in a washing machine, then finally in a toilet. Another way to minimize the need to treat recycled water is to reuse it in the same appliance. This method has long been used by washing machines with "suds savers", and in effect swimming pool filters do the same thing.

Greywater Reuse without Treatment

Greywater can be reused directly without treatment for irrigation (see Systems chapter). An added value is that the phosphate in some laundry detergents acts as a plant nutrient. Recently however, the phosphate content in most commercially available laundry detergents has been reduced because it was contributing to the eutrophication of our nations waterways. This means of course, that the homeowner must now be more careful to use only those cleaning products that are biodegradable and are beneficial to vegetation (see Garden Uses chapter).

The Clean Water Act (PL 92-500) emphasizes waste management alternatives that are cost-effective and which reuse and recycle wastes; in many instances land application has been found to meet these recommendations better than any other wastewater treatment method (Loehr 1979).

Another possibility is to collect and store the water that was used in such functions as laundry and personal bathing, and to reuse it directly for flushing toilets. However, since this water has a grey tint and slight "laundry" odor, wide public acceptance may require that it be made more aesthetically attractive, possibly by using one of the widely advertised blue colored deodorizing products in the toilet tank.

Of course the soap and detergent contained in some greywater could be considered beneficial to toilet flushing.

Greywater Recycling With Primary Treatment

Greywater that is reused in the toilet should not contain organic solids or food particles from the garbage disposal or kitchen sink. This problem is most easily eliminated by not connecting garbage disposals and kitchen sinks to the greywater recycling system, but if they are connected, the organic solids and food particles can be removed by any one of a number of different filters (see Components chapter). Hair, soap and dirt from personal bathing and clothes washing can most easily be separated and removed from greywater with a simple plastic strainer on the drainpipe, but the homeowner can also use more sophisticated settling or filtration processes. Once the greywater has been treated to this level, it might be used for any of a variety of functions, such as lawn sprinkling, car washing or toilet flushing.

In fact, settling will automatically occur in any greywater recycling system which contains a holding or storage tank, especially if the tank is designed to minimize turbulence.

Blackwater Recycling

Blackwater is so highly polluted and dangerous that it must be extensively treated before it can be reused for any purpose. Presently the only commercially available technology which can safely treat and reuse blackwater totally within a single family home are the self-contained recirculating toilets (described in the Systems chapter). On the other hand a home with a septic tank and leach field under the lawn or garden has, in effect, its own on-site blackwater treatment system.

By the time the effluent from a septic system has filtered through a few feet of dry ground it is safe to enter the underground water table (Warshall 1979).

Thus, treated blackwater is indirectly being reused on-site for groundwater recharge and deep subsoil irrigation (see Garden Uses chapter). If the water table is not too deep, groundwater can be pumped back up for surface irrigation or even for indoor uses.

Over one quarter of the homes in the United States have no sewer system available (Bennett 1975). The last census showed that more than 6 percent of the homes in America still do not have indoor toilets. Even today in densely settled cities such as Los Angeles, residential sewage is being safely treated and disposed of in individual on-site septic tanks and leach fields. In all types of on-site disposal, water safely reenters the hydrologic cycle by evaporating or by filtering down through the soil into the water table.

Soil, in fact, is a superb natural purification medium, with a whole variety of methods for cleansing different pollutants from water (see chapter on Garden Uses). The chief worry of health officials is that pollutants may somehow find their way into groundwater or rivers before these various natural processes have had sufficient time to act. But if a residential septic system or on-site reuse system is well designed and maintained environmental pollution need not occur. Local codes are usually very specific about the required distance between a well and a sewer line or septic tank leach field. Usually it is about 50 feet. In addition some codes require that the well head be "uphill" from the leach field, although paradoxically the bottom of the leach field will inevitably be "uphill" from the point below ground where the well enters the water table. A more relevant concern is the direction

in which groundwater migrates, although admittedly it often parallels surface topography.

Rainwater

Rain is clean pure water delivered on-site free of charge. Millions of acre-feet of water cascade off our impermeable city roofs and roads only to be drained away into its own special sewer system. Our technology has bypassed the ancient art of catching it for individual use. In times of drought, however, when giant water systems fail, all possible resources are put to use. In droughts in Great Britain in 1976, and in California in 1978, people began catching rain in buckets and barrels, off patios, and roofs. Every few gallons collected was a plant saved or a toilet flushed. Individual on-site rain collection and storage systems are often more efficient than large-scale man-made systems because they use less energy and probably lose less of the water through evaporation and leakage.

Rainfall runoff can be filtered, and then stored in tanks or cisterns. Rainwater systems can be easily retrofitted to existing structures. In fact, most homes already come equipped with some of the essential components. Rainwater is usually of higher quality than greywater and so requires virtually no treatment. It can be used for every task including irrigation, bathing, toilet flushing, and even human consumption. While rainwater systems are somewhat less reliable than greywater recycling systems (supplies are more irregular), they can be less expensive and yield more. Clearly, a rainwater collection system can complement a greywater system.

The Safe Drinking Water Act (PL 93-523) requires protection of the groundwater as future source of drinking water. However, what this implies for the installation of septic systems or for the direct land application of greywater has been interpreted differently by each state (Loehr 1979).

Groundwater

Pumping groundwater is seldom thought of as on-site recycling,

but if the homeowner is recharging the aquifer beneath the house with collected rainwater or with septic tank effluent, then it qualifies. Homeowners can tap water from the ground just as easily as from the sky. In fact groundwater sources provide a large percentage of all municipal water.

Unfortunately, using groundwater sources is often not practical, because it is too difficult to reach or legal rights to it have long since been transferred to others. But for those who see no choice but to pay dearly for trucked-in water, developing a well may prove the best alternative. If the water table is within easy reach of the surface, well development is an excellent means of providing outdoor needs, and even indoor uses. This option is often overlooked. Many people might feel well-development is too complicated, technical, or time-consuming, but in many cases it is easily within the capabilities of the homeowner. Depending upon the depth of the aquifer, developing a well may be simply a matter of driving a pipe and well-point a few dozen feet into the ground, or it may involve hiring a professional to find water if it is several hundred feet deep. With minimal guidance, the homeowner can find the appropriate well development method.

How Recycling Effects Municipal Sewage Systems

A major consequence of recycling water within a home is that the sewage leaving the home will have a higher concentration of pollutants in it. Initially it might appear that this would create problems for the municipal sewage treatment plant, especially if a large portion of the homes in the city began to recycle water. However, the exact opposite is the case. By decreasing the sewage output of the homes, the per capita costs of treating sewage for the city would be reduced. This is because treatment costs are proportional to the volume of effluent created, not the amount of pollutants removed. It also appears that with reduced flow the design life of the

treatment plant would be lengthened (Cole 1975). The only potential problems are that if there is an extreme reduction, flow rates in the sewer network might be too slow to maintain solids transport or scouring, or possibly that gasses might build up because of retention in the system. But it is extremely unlikely that the total amount of effluent could be cut back to the point where either of these situations would occur (Konen 1975).

Off-Site Treatment of Recycled Water

Although the focus of this report is on small scale residential systems in which water is reused on-site, it should be mentioned that the reuse of wastewater which is treated off-site and returned to the residence offers some very attractive alternatives.

There are more different types of innovative wastewater reclamation projects in California than anywhere else in the world (see Garden Uses chapter). Among the uses to which reclaimed water is put, are recreational boating by a Santee water district, pasture irrigation by Las Virgines Water District, groundwater recharge by Water Factory Number One, and university campus irrigation by the Irvine Ranch Water District. Reclaimed municipal sewage is also used for fire fighting, industrial cleaning, air conditioning cooling towers, freeway landscape irrigation and golf course irrigation. Treated sewage has been recycled directly into municipal drinking water systems in Chanute, Kansas, Ottumwa, Iowa, and Windhoek, South Africa (Wilkinson 1975). In 25 years Denver plans to get a quarter of its fresh water from purified wastewater, and similar projects are planned in other U.S. cities as well as in Israel, South Africa, and Britain (Drummond 1974, Wilkinson 1975).

2200 acre-ft. of reclaimed water will soon be used to irrigate landscaping on the University of California campus at Irvine at an annual saving of over \$160,000 (Lee 1978).

The biggest problem with reclaiming water is getting rid of it. During the dry season it is easy; everyone is happy to use up

cheap irrigation water. But the demand dries up as soon as the rainy season arrives. This means either that reservoirs have to be built or that some other way must be found to use up reclaimed water during the wet season. A related problem is the distribution system required, essentially a second water supply piping network. Laying such a system could be extremely expensive unless, as the Irvine Ranch requires, reclaimed water lines are installed along with potable water lines in all newly developed areas.

Dual water supply systems are already operating in cities as widely separated as Hanna, Alberta, and St. Petersburg, Florida. Because about half of all residential consumption is used outdoors, primarily for irrigation, and half of the indoor consumption is used in toilets, a dual system providing recycled water for just these two functions could represent a 75 percent reduction in potable water consumption. In systems primarily intended for lawn sprinkling, the wastewater treatment process can be designed to keep the nutrients in the effluent for fertilization (Lee 1978).

The growing number of these large-scale off-site examples only serves to demonstrate that the technical and economic problems can all be overcome. By comparison small-scale on-site reuse has the obvious advantage of eliminating the piping systems and energy costs of moving effluent back and forth to a remote treatment plant. This report will focus on the other half of this issue: the design of small scale systems which optimize the interaction between the type of on-site use and the type of treatment required, if any.

Municipal sewage can be reclaimed so that it is high in nitrogen and phosphorous which has a fertilizer value of \$30 per acre-ft. (Lee 1978).

Designing a Residential System

The potential to recycle water within single family dwellings is greatest in homes yet to be constructed. The infrastructure

EXAMPLES OF ON-SITE REUSE DISCUSSED IN THE FOLLOWING CHAPTERS

Legend

- 0 Reusable directly (without treatment)
- 1 Reusable with settling and/or filtering (primary treatment)
- 2 Reusable with settling, filtering, and chemical treatment usually chlorination (secondary treatment)

Notes

- * Very difficult to collect
- ° Special soaps required
- a Small valves & underwater moving parts may cause clogging problem
- b Large orifice: unpressurized open hose or channel
- c Small orifice: pressurized
- d Assumes no diapers with fecal matter
- e Shaving and brushing teeth
- f Septic tank and leach field

ORIGINAL SOURCE	REUSE														
	Toilet ^a	Irrigation	Sprinkler	Kitchen sink grinder	Carwash	Laundry	Pool	Shower/tub	Bathroom sink	Dishwasher	Drinking	Cooking	Fire fighting	Rainwater	Groundwater
Toilet	2	2	2												2 ^f
Irrigation* ^b		1	1										1		0
Sprinkler		1	1										1		0
Kitchen sink grinder	1	0	1												
Carwash*		0°			1										
Laundry ^d	1	0°	1°			0									
Pool							2						0		
Shower/tub	1	0°	1°			1		0							
Bathroom sink ^e	0	0°	1°												
Dishwasher	1	0°	1°	0						0					
Drinking* (spillage)	0	0	1	0					0			0			
Cooking	1	0	1	0						0	0	0			
Fire fighting														0	0
Rainwater	0	0	0	0	0	0	0	0	0	0	1	1	1		0
Groundwater	0	0	0	0	0	0	0	0	0	0	1	1	1		

(Milne, 1976)

required to recycle water, such as a separate drainage system for greywater and blackwater, is very costly to retrofit. However, if installed when the home was being built, the difference in cost between a conventional system and a recycling system would be minimal, and undoubtedly will eventually be offset by savings on water bills.

Of course from the hardware point of view the simplest systems are those which cascade, or reuse greywater directly without treatment. This reduces the need for filters, pumps, and holding tanks, and usually eliminates the requirement for biological or chemical treatment.

Today most of the components needed to build simple recycling systems using greywater, rainwater, and groundwater are available from swimming pool supply houses, the local hardware store, or even Sears catalog (see Components chapter). However, in the future as these systems become more numerous, specially designed recycling devices will appear. For instance, if a new type of non-clogging ballcock valve can be developed it will eliminate the need to filter bathing and washing water for reuse in toilets. An even better approach would be to eliminate the need for the toilet tank altogether along with all of its mechanisms. Clearly there is some duplication of function between the toilet tank and the holding tanks in the recycling system and so it is reasonable to expect that soon a clever inventor will devise a less redundant system combining these two functions.

One of the first and most extensive studies of residential water reuse was published in 1969 by Bailey. It includes a detailed analysis of water quality requirements for health, aesthetics, and engineering suitability.

Once water has been used in a residential fixture or appliance, it is no longer under pressure, therefore all systems must incorporate either a mechanical pump or a drop in elevation. If the system uses settling tanks, grease traps, or other elements with minimal pressure losses, changes in elevation alone may provide enough pressure to move water through the system. However in some situations this may prove too

awkward, for instance requiring the bathtub and shower to be on the second floor and the toilets on the first floor. If the system contains a filter, the pressure losses may be so great that a pump will be required. In such cases it is usually simpler and easier to install a pump downstream from the storage tanks. In fact similar pumps are already built into commercially available washing machines and dishwashers. Remember that even though the on-site system may use an electric pump, recycling water still consumes much less energy than using new water which must be pumped in over vast distances.

WHO SHOULD USE THIS BOOK

Residential greywater recycling and rainwater collection systems are not practical for everyone.

Residents of areas susceptible to water shortages due to drought and inadequate local water supply systems, and residents of less densely populated suburban and rural areas where utility services are expensive or needs are too great, will find the systems discussed in this handbook especially practical. Those people who live in communities where costly new water or sewage systems are being proposed will also be interested in some of the new alternatives now available.

This book is designed for the layperson who has some experience in home maintenance. Professional help may be necessary for some systems, especially where changes in plumbing are required, and for which most municipalities require permits (with subsequent inspections). Please notice that some of the alternatives described in the Systems chapter have been designed and built entirely by laypersons who were depending primarily on imagination and common sense.

Urban dwellers who already enjoy reliable water supply and sewage services will probably find the capital costs prohibitive and legal restrictions insurmountable. This is not to say, however, that city dwellers should be unconcerned with these topics, because more and more people find themselves dependent on uncertain water supplies and inadequate disposal systems.

Politicians, utility managers, architects, planners, and other

professionals will also find that this book is a useful tool to help change present water use patterns.

The do-it-yourselfer will find this topic a rich field to plumb (sic). While little of the technology presented is new, it is not widely applied in the context of water collection and reuse. Today there are few commercial enterprises which can provide the beginning-to-end guidance required.

All of the components discussed in this book have been selected on the basis of their low cost, minimal maintenance, ready availability, and applicability for residential use. Most of the components can be found in hardware stores, swimming pool supply stores, and mail-order firms, or may be ordered directly from the suppliers listed in the Appendix. Many of the systems can be easily retrofitted to existing structures. Much of the manual labor involved in the construction of these projects can usually be performed by the homeowner. In cases where more than the usual expertise is required, specific recommendations are made for additional reading or professional help. Some of the smaller systems can be installed in a few hours, and many can be completed within one or two weekends. Maintenance will be easier if the construction allows for easy access to components. Most systems will require about the same maintenance as an ordinary swimming pool.

THE FUTURE

Rural homes have always casually reused a great deal of their domestic water, sometimes by the simple expedient of connecting a garden hose to the shower and bathtub drains. But it has only been in the last 10 years that serious design proposals have been made by environmentalists, ecologists, and advocates of "low impact technology" for on-site domestic reuse systems (see Systems chapter). One could conclude that the reason for this slow start was that back-yard engineers found the costs prohibitive, plumbing manufacturers do not see a potential market, and governmental research funding agencies had other priorities.

Now however, the trend toward on-site residential recycling systems is blossoming. How long it will last will probably be determined more by public attitude and economics than by the available technology. In fact all the basic components are now readily available in hardware stores and swimming pool supply houses. The problems of irrigating the garden with domestic wastewater are also now becoming fairly well understood.

The primary objective of this report is to convince the reader that all these technical aspects of the problem have essentially already been solved. The second objective is to change public attitudes about the feasibility of on-site recycling. Presumably the best way to do this is to reveal the long and fascinating history of water recycling, and to describe the many successful systems already in operation.

An Environmental Protection Agency survey showed that wastewater was already being recycled at 358 sites in the U.S., mostly for irrigation and industrial processes (Wilkinson 1975, Schmidt 1975).

However, two other issues are in such flux that they can be only indirectly discussed in this report. The first is the problem of dealing with building and health departments, where the primary variable seems to be the attitude of the individual inspector. The large number of water reuse systems already in operation implies that almost any inspector has enough discretionary power to authorize the installation of any reasonably intelligent system. Clearly every year more and more legislation is being passed to encourage such innovative environmentally responsible systems.

The last issue, which is undoubtedly the most difficult to deal with, is the economic feasibility of these systems. During the period when this report was being written there were unbelievably rapid increases in the cost of water, sewage treatment, hardware, and of course energy. It is this latter factor which will most certainly have the greatest impact on the economics of on-site recycling. The reader should take very seriously the slogan "saving water saves energy", and this report will try to show that every increase in the cost of energy makes new on-site recycling systems increasingly cost-effective, and of course accelerates the return on investment of already operating systems.

A recent California law prohibits the use of potable water by a public agency for irrigating parks, cemeteries, golfcourses, and highway landscaping when reclaimed water is available at a suitable quality and reasonable cost (Lee 1978).

2

HISTORY OF WATER REUSE

Water has been recycled throughout human history. People who live near rivers inevitably use the river for both water supply and sewage disposal, and so the downstream communities end up using at least some of the water that was previously used by communities upstream (Milne 1976).

For a long time this was a safe practice because the rivers were capable of diluting and naturally treating the sewage. However, as population densities along rivers increased the rivers could no longer handle the increasing amounts of raw sewage and became polluted. The average river water today contains an average of 2.4 percent waste from upstream communities, and in some cases as high as 18.5 percent (Stevens 1974). To remedy this situation, the downstream communities treated their water prior to using it. This still did not solve the pollution problem because they continued to dump untreated raw sewage into the rivers at amounts greater than the rivers could assimilate. Recently state and federal legislation was passed that required all communities to at least partially treat their sewage before it is dumped into a river.

Per Capita Domestic Consumption

The amount of water used for domestic purposes for most of history has been limited to what could be carried by hand.

USING WATER MORE THAN ONCE
HISTORY OF WASTE COLLECTION AND
REUSE
HISTORY OF WATER SUPPLY AND STORAGE
BATHING
RECYCLING TOILETS
THE COST OF WATER
CULTURAL ATTITUDES ABOUT WATER
REUSE

It is estimated that before there was piped-in water in the cities, the amount of water consumed each day by one person for all purposes was only 3 gallons. In the mid 19th century when cities such as Boston and Philadelphia had installed piped-in water service, the consumption in these two cities was between 40 and 60 gallons per capita per day (Goldstein). Today, indoor consumption alone averages about 70 gallons per capita per day.

Once people could get water by simply turning a tap, they got used to the idea very quickly, abandoning other forms of supply and increasing their usage accordingly. At first, running water was a novelty and people would turn it on just to watch it flow. But soon they accepted it and expected it. In the late 1800's, Philadelphians consumed 54 gallons, New Yorkers 60, the residents of Boston 73, Chicago 102, and Washington, D.C. 143; on the average considerably more than in Europe (Shadwell 1899).

In ancient Rome, because water was piped into the homes of the wealthy and the abundant water flowed into public fountains, water consumption reached 38 gallons per capita per day. The Roman's penchant for copious consumption appears to have carried over into the last century. While other Europeans were getting along on as little as 13 gallons in Berlin and 11 in Amsterdam, Rome's per capita consumption had soared to 160 gallons per day (Shadwell 1899).

USING WATER MORE THAN ONCE

Historically, when people needed water they found ways of getting more rather than using less. They have only rarely resorted to what seems to be an obvious strategy, reusing it.

However, the Romans, those assiduous procurers of water, actually did recycle some of their seemingly abundant supply. They channeled water from the public baths and industrial establishments to be reused for flushing the public latrines.

Before piped-in water, the poor, who had to carry buckets of water themselves, frequently used water over and over until it was quite dirty. Bath water was most often reused for laundering clothes. Then the water was drained out and reused for several more loads. Finally, this wash water might even be reused again to give the wash-house a good scrubbing, and then eventually end up irrigating the garden.

In the technologically advanced cities of the 20th century there have been only a few instances of water reuse. An automatic slop-toilet, patented in England in 1913, used waste water from the kitchen sink for flushing. Many are still in use today (Milne 1976).

Early 20th century washing machines automated the reuse of wash water. Suds-saver models required a 20 gallon laundry tub with a drain next to the washer. The soapy wash water from the first wash cycle was pumped into the tub, then after

The Missions of Early California
Water Filters
Soil Applications of Greywater
Relating Water Quality to its Use
Dual Systems, Dual Quality

the first load was rinsed and removed, 17 gallons of this used wash water was pumped back into the washer for the next load. Three gallons were left to retain sediment from the first wash, and fresh hot water replaced it. Thus, 17 gallons of hot water was saved from every wash load. Unfortunately more "modern" washing machines no longer offer this option, perhaps because of the disappearance of laundry tubs from the American home.

Other countries have developed more complex recycling systems. For example, a hotel in Sri Lanka, a very water-conscious island, has been recycling greywater for years. Water from the guest bathtubs and showers is collected in a huge cistern in the cellar. This greywater is then used for water-cooled air conditioning and for landscape irrigation around the hotel (Warshall 1977). Similar systems exist in Japanese hotels.

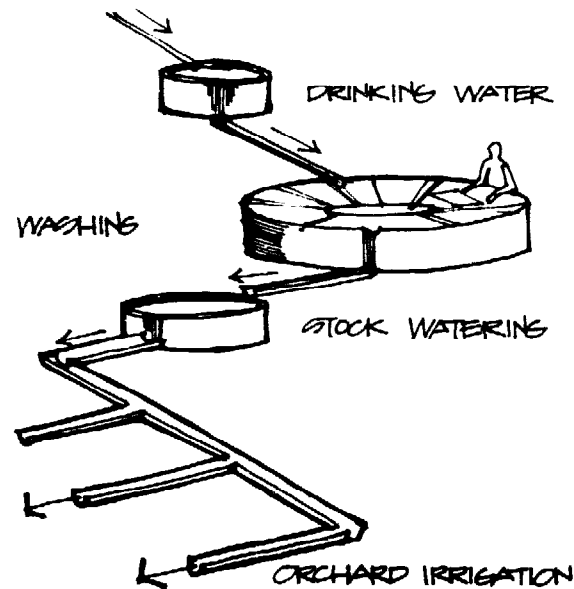

CASCADED WATER REUSE SYSTEM
PURISMA MISSION

The Missions of Early California

Each mission originated near an ample source of fresh water. But as they grew, population demands increased to the point where careful water conservation and reuse was necessary. At La Purisma Mission, north of Santa Barbara, an ingenious system of cascaded reuse is still visible as a series of elegant cisterns connected by carefully hewn trenches stepping down a gentle slope from a fresh water spring. The mission's drinking water was drawn from the first high-sided cistern. The stone trough carried the overflow into the second cistern, a low, large-diameter cylinder with a wide flat rim sloping toward the center, undoubtedly for washing clothes. Next, the water flowed under a fence into a cool deep tank for watering the stock. Finally, the stone trench divided the overflow into an irrigation network for a formally laid out garden of ornamentals and citrus

trees. All along the way paths were carefully designed with shaded benches where one imagines enjoying the moist breeze and pleasant water sounds on a summer evening.

Water Filters

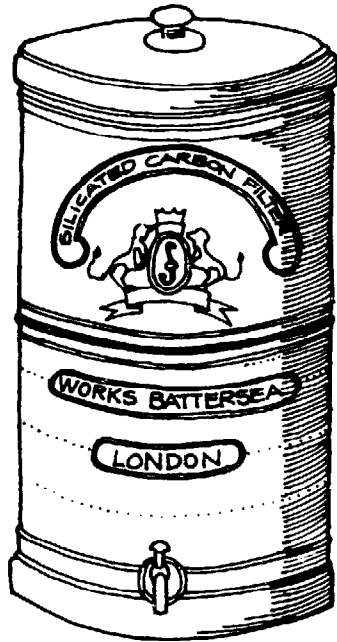

AN 1867 DOMESTIC WATER FILTER

Because water is rarely pure, over the years people who chose to drink it had to find a way to purify it. In ancient times this was done by merely exposing water to the sun and air, but more frequently by filtering it through sand, a method still used today. Water was also filtered through tufa, a porous limestone, and wool. The kings of Persia, who may have felt that filtering was not safe enough for them, had their water boiled and served in silver pitchers (Carr 1971). It was also common to purify water by adding wine to it. It may be that as the water quality declined, more wine was needed for purification until it completely displaced the water. There were probably few who complained about the transition.

In England in the 18th and 19th centuries, when water from wells and springs became so polluted that drinking it was dangerous, water filters became familiar household appliances. They were advertised to be effective in removing organic and saline impurities and minute animal matter from water. Charcoal was the common filtering medium but silicated carbon was also used. Filters could be home-made from leaky buckets with burnt wood from the fireplace serving as the filtering medium.

The filters were designed to satisfy aesthetic as well as practical needs. One company made a filter of cream colored stoneware for the kitchen and another of marbled china which was considered "chaste and elegant in appearance, and well suited for the dining room" (Hartley 1964).

The water that comes from our taps has gone through many processes of filtration. It has also been chlorinated, aerated, and sometimes flouridated. Unlike the Englishman whose water filter was a regular fixture in his house, we take it all for granted.

Soil Applications of Greywater

For centuries we have relied on rivers and oceans as the primary medium for diluting and purifying human wastes. As long as there was plenty of water, concentrations of population (hence, concentrations of pollutants) were small, and the amount of time before the next use was adequate, this arrangement was satisfactory. We could rely on the natural purification capabilities of surface waters to assimilate and reduce our wastes to stable, safe compounds.

But it has been adequately demonstrated throughout history that the assimilative capacity of water is limited. In instances where the pollutant concentration exceeded these limits there have often been serious consequences in the public health, or in destroying usefulness of the receiving water for other productive purposes. Even when the assimilative demands on receiving water is substantially reduced by pretreatment in conventional treatment processes, the quality of receiving water may still be degraded to the point where it is not suitable for many public uses.

An alternative to the disposal of waste water into water bodies, one which is becoming more common in this country, is disposal on land. This technique relies on the assimilative properties of soil organisms as a treatment process for producing a high quality effluent which can be allowed to reenter the natural water supply.

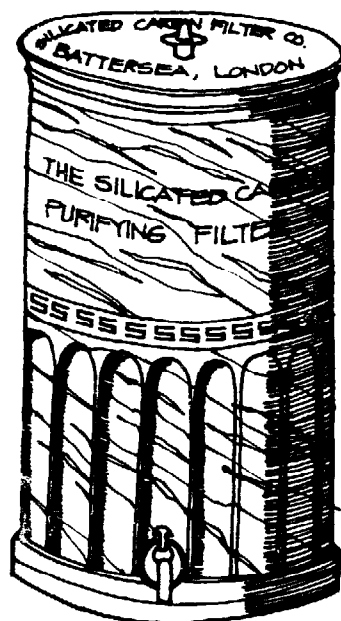

THE DINING ROOM WATER FILTER
MADE OF MARBLED CHINA

On a municipal scale operation, land disposal is used as an advanced, or tertiary, treatment for waste water which has been treated in a conventional process to at least secondary treatment quality. Application to the land has taken a variety of forms including flooding, spraying, and subsurface injection through dry-wells or leach fields. In most cases the water is used to irrigate plants of various kinds, either for food, forage, fiber, lumber, or ornamental purposes. The plants play an integral role in the purification of the waste water.

In the last half of the 19th century, major cities in Europe, notably Berlin, London, and Paris, operated large "sewage farms" as the principal means of treating waste water. The effluent from primary treatment where the solids settled out was stored in reservoirs and used to irrigate a variety of crops, including fruit and food crops, which could be sold in the city. Water passing through the soil was collected by a subsurface drainage tile field and channeled back to the river from whence it originated (Stevens 1974).

In the United States the use of land for sewage disposal and irrigation of crops has not been widely acknowledged, but it is not totally unknown. As we look back to the late 1800's there are a number of cities and public institutions that used waste water or raw sewage for crop irrigation (Stevens 1974). The 1880 Census reported that 103 of 222 cities queried applied their wastes to the land to grow crops. This practice was most common in the New England and Middle Atlantic states (Goldstein 1977). With the advent of conventional waste water treatment early in this century, the use of land disposal techniques declined. This was not because the new techniques were necessarily more effective, rather it was simply easier to get the wastes "out-of-sight, out-of-mind," and thus reduce the management burden of taking responsibility for one's own wastes.

Relating Water Quality to its Use

H₂O is water, pure water, nothing added. However, we rarely get it that way. Water travels over the earth in rivers, picking up particulate matter; it travels through the ground collecting minerals, and through the air, absorbing whatever chemicals have found their way into the atmosphere.

Some water is clean and some is dirty. Some of it smells and some of it doesn't. Some of it tastes good and some of it doesn't. And some just isn't safe to drink at all.

Some people have learned to live with this uneven quality of water and some have not. The wise (or lucky) ones can be quite specific about what water is to be used for what purposes to give the best results.

In England, 19th century household books specified that ale was to be made with well water, washing done with rainwater, and many cooking recipes insisted on freshly drawn spring water. Even after water was piped in, the big pitchers on the bedroom washstands were filled with tap water, but the crystal water bottles, with their drinking glass covers, were filled with "fresh" water that was brought in from a spring or well.

Rainwater was considered best for shaving, and no woman washed her hair or her face with anything else but "soft" rainwater. In Victorian hotels, shaving water jugs containing rainwater were delivered to the rooms separately from the usual hot water can.

Reusing greywater is another way of relating the quality of water to its use. It doesn't make sense to use expensive drinking quality water to flush toilets, unless of course you believe we have an unlimited supply of pure water.

Dual Systems, Dual Quality

The Roman aqueducts delivered water of various qualities from different sources. Some of it was considered "sweet" and was used for drinking. Other water was dirty and undrinkable and was used to supply mills and for sewer flushing. Paris, like Vienna and Munich, built a drinking water system that came entirely from springs, but water for industry and public services was supplied from the Siene and the Ourcq canal (Carr 1968).

In the 19th century, as cities and towns grew rapidly, water supplies became contaminated. The division between drinking water and washing water, that in the country had been only a matter of convenience and taste, became a necessity (Hartley 1964). Before water was piped in, houses were designed with two separate hand pumps, one for well water and one for rainwater.

Even today, separate faucets are still used in England where old water supplies are not considered safe for drinking. In the United States there are many dual water systems. For instance, in St. Petersburg, Florida, there are two lines to each house. Because the groundwater has an unpleasant smell it is used only for irrigating lawns and a second more expensive supply is used for drinking.

This may sound too complex, but in fact dual water systems currently exist in a great many homes all over the country. In addition to piped-in tap water, there is a supply of bottled water brought in by water carriers, a tacit acknowledgement that all water is not equal.

An isolated group of Indians in northern Mexico exists without any water supply at all. Their only beverage is fermented cactus juice, which also contains a rich supply of vitamin C. The Indians reportedly live both a healthy and a very happy life (Davis).

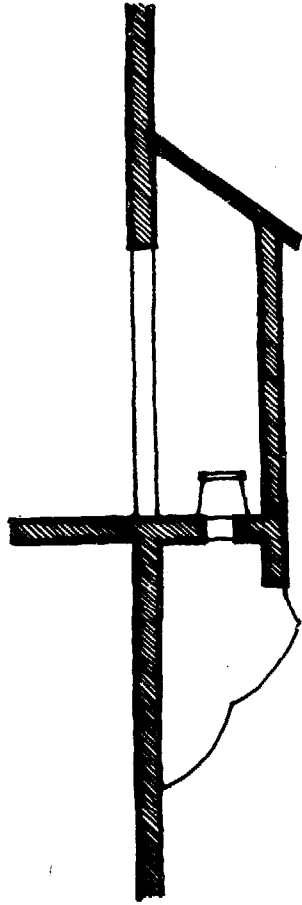

SECTION THROUGH MEDIEVAL PRIVY

HISTORY OF WASTE COLLECTION AND REUSE

Whenever people have clustered together to form a community, there has been a need to do something with their collective wastes. People have coped with this problem in various ways throughout history. Few cities have had sewage disposal systems. However, all waste did not necessarily end up in the streets and gutters. There have been times throughout history when human waste was considered too valuable a commodity to be wasted.

Waste recycling is an urban problem. Before people gathered together in dense settlements, human wastes did not accumulate in such concentrations that they could not be naturally absorbed and reused. Today each person in America produces about 70 gallons of sewage, or about 15 billion gallons per day nationwide.

Ancient Times

In the Indus capital of Mohenjo-Daro before 1700 B.C., there were buildings with brick toilet seats overhanging running water in internal conduits. This six hundred acre city which was located in what is now Pakistan, had brick-lined drainage channels throughout its streets. Although they may have been used primarily as storm sewers, these drains also formed an extensive waste collection system (Mumford 1961, Dales 1978).

On the island of Crete, around 1500 B.C., the Palace of Minos at Knossos had a more advanced waste system. Latrines inside the palace had seats built over a stone channel. This emptied into the main drainage channel which was ventilated by air shafts, and had large manholes which allowed easy access for cleaning. The main drain was also connected to drainage shafts from the roof, the central court, and a light well, collecting rainwater and using it to flush the system.

However, the enlightened city of Athens was, from the standpoint of hygiene, a deplorably backward municipality. Sanitary facilities that existed at Knossos hardly existed in fifth century Athens. Refuse, which included human excrement, accumulated at the city's outskirts. This was in spite of the fact that the early Greeks showed a great interest in curing disease and promoting good health. Hippocrates, the great physician who lived from 460 to 375 B.C., wrote a famous treatise entitled "Air, Water, and Places," which laid down the outlines of public hygiene in relation to the choice of sites and the planning of cities. In his writings Hippocrates recommended orienting buildings to avoid the summer sun and to catch the cooling winds. He stressed the necessity of obtaining pure water. Yet the medical school at Cos, where he studied and taught, left no text on public sanitation and no references to the proper disposal of human waste (Mumford 1961).

"Thou shalt have a place also without the camp, wither thou shalt go forth abroad; and thou shalt have a paddle upon thy weapon and it shall be, when thou wilt ease thyself abroad, thou shalt dig therewith and shalt turn back and cover that which cometh from thee."
(Deuteronomy 23: 12-13)

Roman Sewers

The original Roman sewer, begun in the sixth century B.C., was a ditch dug to drain the swampy land between the seven hills. It ran along an existing stream and had a stone lined channel to carry off storm waters. Over several generations this drain was continually enlarged and improved, eventually being covered over with a stone barrel vault.

The Roman sewers reportedly enjoyed the protection of Cloacina, their own private goddess (Goodman 1977).

This became the great Cloaca Maxima, the main sewer of Rome, which was large enough to row a boat through (DeCamp 1963).

The existing remnants of the Roman sewer system might suggest that the Romans took their wastes out of the city as grandly as they brought their water in. However, as impressive as the system was, and as solidly as the drains were constructed, the Romans did not utilize them to the fullest. This was partly because public health requirements were not understood and because compulsory sanitation would have been considered an invasion of the rights of the individual (Metcalf & Eddy 1972).

The sewers of Rome were essentially built as storm drains, with the removal of waste as a secondary function. The sewers did collect excreta from the public latrines and insulae (apartment houses) which stood directly along their routes. The insulae usually had latrines on the ground floor only. The majority of Romans lived in upper stories or in buildings away from the sewer lines, none of which had sewer connections. Wastes were either carried to public cesspools or, in apartment houses, deposited in covered cisterns at the bottom of stairwells. The contents of the cesspools and cisterns were periodically removed by manure merchants who acquired the right to empty them and sell the contents as fertilizer (Carcopino 1941).

Residents of the insulae could pay to use the public toilets during the day, but excrement accumulating during the night or produced by those too old or sick to use the public facilities, was sometimes illegally dumped out the window. An unlucky passerby who became the target of the contents of a chamber pot could try to collect damages. First, the culprit had to be found and then the case taken before a judge. If a free man was injured by anything thrown from a window he would be awarded medical fees and wages for time lost working due to injuries. Damages considered

appropriate to the injury would have to be paid by the guilty party. No damages were awarded for scars or disfigurement; the value of a man's body was thought to be beyond price. What happened to an injured slave is not known but he was probably not considered priceless.

The Middle Ages

The removal of household wastes was mainly a function of private enterprise during the middle ages, as it had been in Roman times. Farmers who lived near a city or town collected or bought the wastes that accumulated in cesspools and used it as manure, transporting it in "night-soil" carts to their nearby farms. In Holland barges carried it through the canals to the fields.

Urine continued to be used in the dyeing process in England. Whether cloth was woven at home or by the village weaver, dyeing it was a household task. Before wool was dyed the housewife soaked it in a mixture of potash and ammonia, called ley, an archaic form of the word lye. Urine provided the ammonia, and the resulting home brew was called chamber ley, or piss-pot ley. Many privies had a separate hole that opened into a tub instead of the cesspool so that urine could be collected. Urine was a common source of ammonia until the 1870's when it was commercially manufactured and sold in more convenient containers (Hartley 1964).

Urine was also a valued waste product and was collected in special jars. Ammonium chloride, which was used in both metalworking and cloth dyeing, was made by heating a mixture of salt and urine.

Sewage systems were practically unknown during the Middle Ages. Sanitary conditions inside the cities were deplorable. Waste was disposed of in the streets and open sewers. In some places water carts filled with carbolic acid went around to wash down the gutters and then lime was thrown down on the whole mess.

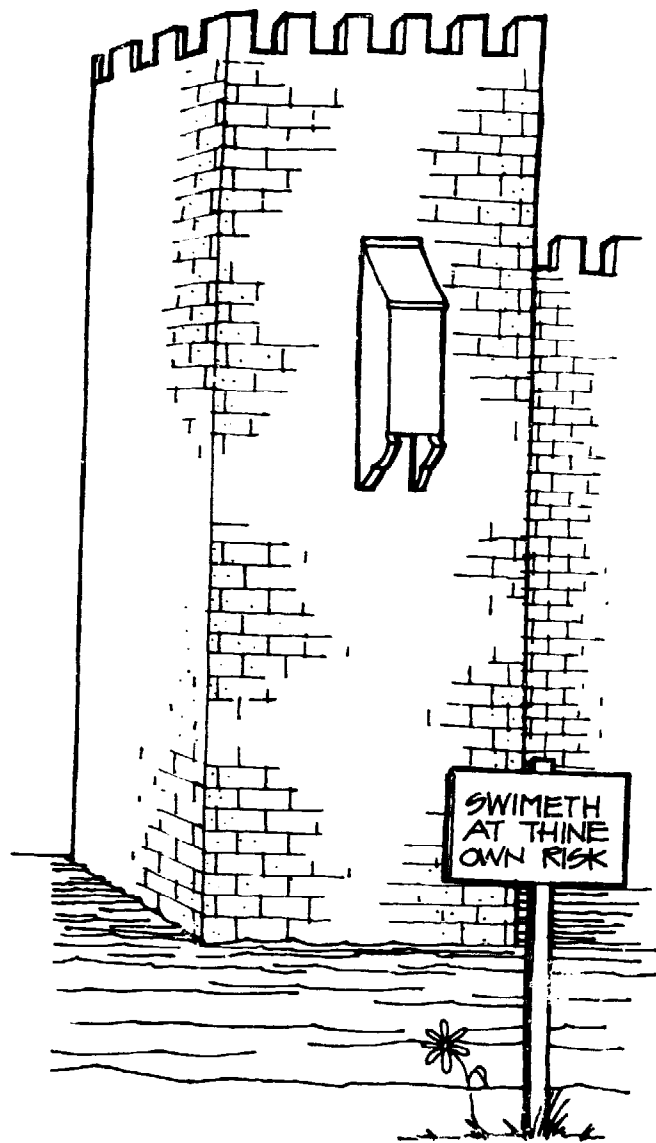

DRAIN FROM MEDIEVAL PRIVY TO MOAT

Water pollution has been a problem for a long time. Many people dumped waste into rivers and streams which became fouled by all sorts of filth including dead animals. In 1388 the English parliament passed an act that forbade the throwing of filth and garbage into ditches, rivers, and waters (Mumford 1961).

In the Norman castles of England, privies were built inside the castle, always next to an outside wall. The location was good for ventilation and also allowed the sewage to fall down a vertical stone shaft and then through an opening in the wall. It either landed on the ground outside the castle, or into a moat if there was one (Quennell 1961). Brave knights who swam moats to rescue fair damsels were a courageous lot indeed.

The Renaissance

The fifteenth century did not bring much improvement in sanitary conditions. Sienna, which had no drains, stank at all times of the day. Some towns were so dirty that "whatever filth is made during the night is placed in the morning before men's eyes to be trodden under foot...it is impossible to imagine anything fouler" (Mumford 1961).

Paris had open ditches that were intended for storm drainage only. But, although it was against the law, people dumped household wastes into them as well. Since Paris seldom received a downpour heavy enough to flush out the ditches, its aroma must have equaled that of Sienna.

The first public sewage treatment plant was built in the city of Bunzlau in the Polish province of Silesia, in 1543 (Mumford 1961). But it did not have much impact on the rest of Western civilization, and there was little

progress in waste removal for several centuries.

In general, instead of improving the technology for removing waste, cities tried to solve the problem of the increasing volume by legislation. By the sixteenth century, special provisions for sanitary control and decency had become widespread. An ordinance was passed in London which stated that "no man shall bury any dung...within the liberties of the city...nor carry any ordure till after nine o'clock at night" (Mumford 1961). But since there was little else to do with one's rubbish, it was commonly thrown into the streets, despite laws forbidding that means of disposal.

London Sewers

Eighteenth century London had no sewer system. Privies were usually in the garden in the back of the house, placed over a cesspool. When the cesspool needed cleaning the buckets often had to be carried through the house (Quennell 1961).

In 1802 a sewer system was built in the Strand section of London, probably running into the Fleet or Thames River. Additional sewers were built, but they were originally constructed as storm drains. Human excreta were excluded from London sewers until 1815.

Building Materials from Waste

In 1872 a proposal was made to turn sewage into cement. It was estimated that 10,000 persons, eating average meals, could produce a ton of cement a day. The process, as described in a science magazine, consisted of:

Today, cities in many parts of the world still have no sewers. For example, in Nepal, open gutters in back streets are crowded in the morning with school children side by side with bureaucrats in suit and tie, briefcases carefully if incongruously set off to the side. The absence of privacy here is startling to Western eyes.

"...mixing with the sewage quantities of lime and clay; the former combining with the carbonic acid of the fecal matters forms carbonate of lime, which is precipitated. The lime and clay are thrown into the main drains high up, to ensure complete incorporation and to destroy the slimy glutinous character of the 'sludge'...the success of the process depends on the fact that the precipitated matter supplies, to a considerable extent, the fuel necessary for the burning operation."

"After the water is drawn off from the settling tanks it is dried on tiles, and the heated gas that passes below the tiles is obtained from the refuse of organic matter deposited below the precipitate. The quantity of carbon is small but the hydrogen given off gives intense heat" (Hartley 1964).

The Far East

Less sophisticated methods of using wastes as building materials are still used in India, where cow dung is packed around the outside of houses to provide the inhabitants with a warm, if not fragrant, environment. In northern Canada cow manure was used in a similar manner. It was banked against the foundations of farm houses as insulation against the bitter winters.

In China and Japan night soil has been used for centuries to fertilize the fields. Carts made regular rounds through the cities emptying the cesspools and taking the contents to outlying farms. In 1911, China, Korea, and Japan applied 182 million tons of human wastes to the soil. Recent visitors to mainland China report that this custom still continues (Goldstein).

The Japanese used creativity in their pursuit of fine, fresh fertilizer. In the nineteenth century farmers provided roadside privies for travelers, hoping to be repaid with an abundant supply of manure. Competition developed, and each farmer tried to outdo the other by building the most attractive accommodations.

At the same time, in Hiroshima, living in a crowded tenement had its advantages. The more people that occupied a room the cheaper the rent, because the more waste the landlord accumulated for sale, the less he had to charge to make a profit. If it was economically advantageous then, it is worth considering why today human excrement has no monetary value whatsoever, let alone as a discernable percentage of real estate profits.

Septic Tanks

One of the most important inventions in the history of water recycling was the modern septic tank, first developed in 1896 by a Scotsman named Donal Cameron. Essentially it is a dark sealed chamber where powerful anaerobic (non-air breathing) bacteria can attack and break down pathogens in domestic blackwater. The effluent from the tank is still septic (i.e., infected), but subsequently is easily purified by exposure to the aerobic bacteria in porous soil, and so after leaching or seeping through at least 4 feet of earth it is safe to reenter the water table (Milne 1976). It uses no energy and very little maintenance, only a pumping every few years.

Today about a quarter of all homes in the nation safely use septic systems and many of these homes are in some of our most heavily populated cities. In recognition of the benefits of this type of system, California has passed legislation setting up special assessment districts to maintain private on-site sewage treatment (septic) systems.

Progress in Design

There was little progress in the design and construction of wastewater systems from Roman times until the 1840's.

In 1842 Hamburg, Germany was partly destroyed by fire. For the first time, a complete new wastewater system was designed according to the latest theories, taking into account topographic conditions and recognizing community needs. The fundamental principles used in the design of the Hamburg system are still in use today.

American Sewers

Not much is known about early wastewater systems in the United States. They were often constructed by individuals or by small communities at their own expense and with little or no public supervision.

As in other countries, there was a tendency to construct early sewers that were much larger than required. One of the oldest is in Brooklyn. It drained less than 20 acres but was four feet high and five feet wide. These sewers were often poorly designed and there was frequent accumulation of solids which decomposed in the lines creating offensive odors. In some cases the drains sloped in the wrong direction.

As in England, the first American sewers were built only as storm drains. Cesspools were used to collect human excreta. Modern septic tanks were unknown then. As the cities grew larger, the cesspools became incapable of handling the increased volume of wastes. The situation became serious in the densely populated slums and health problems increased.

In the nineteenth century the water closet was perfected and its use was spurred by the coincidental spread of piped-in water systems. The new water systems also increased water usage which in turn increased the burden on the

One individual who did something about garbage on a large scale was Benjamin Franklin. Although he did not build a sewer system, he did come up with a scheme for solving Philadelphia's refuse problem. By 1792 the city had grown to 70,000 and the garbage had grown proportionately. His solution was to have garbage hauled to the Delaware River, downstream from the city. Slaves then hefted a load of garbage, waded out into the water and deposited the city's refuse into the swift river. This is an idea for which Franklin is not well remembered.

already overloaded cesspools. The two together, along with the heightened need for improved sanitation, led to the adoption of water carriage sewer systems. First, storm drain systems were pressed into service to carry away the toilet effluents. Then separate wastewater systems were built.

But of course it meant that the volume of sewage was increased many times because of being diluted with water. No one seemed to have seriously considered treating the waste on site without water, rendering it harmless through chemical or organic methods. The choice was made instead, to flush excrement away in a river of water which then created pollution problems wherever it finally reappeared -- oceans, lakes, or rivers.

However, most of us have little complaint about our wastewater removal. A flush of the toilet, a quick grinding in the garbage disposal, and away it goes. There are, however, a couple of instances of throwbacks to medieval times. For example, any pedestrian walking the streets has to carefully make his way around excrement, although now from dogs, not humans. Despite our elaborate sewage systems, feces are still being carried away in garbage trucks, bypassing the sewers. The dog wastes from the streets, along with the contents of cat boxes and human wastes in disposable diapers, are being thrown in the garbage. In the interest of good sanitation, disposable diapers were originally designed to be flushed down the toilet. One brand was called Flush-a-Byes, but the name was changed when it was found that they did not flush-a-bye, but clogged-a-lot. Users are now instructed to separate the soiled portion from the plastic backing, but most mothers toss the whole mess into the garbage pail instead.

Recently enacted legislation means that although there are still about 750,000 dogs depositing their daily droppings on the sidewalks of New York, presumably there are now an equal number of humans picking up the droppings and disposing of them someplace else.

Human Waste Recycling in America

The U.S. Census of 1880 revealed that 103 out of 222 cities applied their wastes to the land as fertilizer. Eleven of the cities had adopted the "odorless evacuator," a vacuum pump powered by hand or by steam which destroyed objectionable gases while removing the contents of a cesspool (Goldstein).

In some cities the wastes were first mixed with earth and other materials, and this mixture was applied to the land. New York, Baltimore, Cleveland and other cities sold their wastes to processing plants where it was made into fertilizer which was marketed under the trade name of "Pouderette". Ads boasting of its ability to improve such crops as corn, potatoes, and tobacco appeared in farm journals as early as 1839.

Brooklyn supplied 20,000 cubic feet of wastes to farms and gardens outside the city. At the same time, in Philadelphia, there were 20 companies using odorless evacuators to remove 22,000 tons of human wastes to be used in nearby farms.

Baltimore did not have a sewage system until 1912 (Goldstein). Up until that year the contents of 70,000 cesspools and privy vaults were collected and sold to a contractor for 25 cents per 200 gallon load. The contractor shipped the wastes by barge to a depot 10 miles from the city and sold them to Virginia and Maryland farmers who purchased over 12 million gallons of wastes from Baltimore each year. These same farmers produced food for the city of Baltimore; the cycle was thus complete.

Human Waste Recycling in the Twentieth Century

Although the manure merchant may be a thing of the past, wastes are still in demand. Today in Southern California, 300 tons of sludge are recycled every day. The Los Angeles County Sanitation District, which is made up of 71 communities not including the city of Los Angeles, processes 385 million gallons of sewage each day. The sludge is composted by the sanitation district and sold to a private company which screens and bags it. The composted sludge is sold to home gardeners under the brand name of Nitro Humus. This marriage of private enterprise and public utility saves the county about \$3.2 million per year, which is the estimated cost of hauling away the sludge. The City of Los Angeles, on the other hand, pipes its sludge out to sea.

Garbage played an important role in a Los Angeles mayoralty campaign. Up until the early 1960's, Los Angeles residents were required to put their paper, cans, and bottles in one garbage can, and their food scraps in another. This made it possible for the sanitation department to sell the food scraps to hog farmers. The citizens were unhappy about segregating their garbage, and Sam Yorty, a candidate for mayor, made it a campaign issue. He promised that if he was elected he would put an end to the practice. He won the race and in 1963 an ordinance was passed that allowed Angelenos to dump all their garbage into one can. Sam Yorty was happy, the citizens were happy, but no one polled the hogs.

Buildings Designed for Waste Reuse

Thomas Jefferson did more than build an elegant Palladian jewel sitting atop his mountain. His attention to detail

The manure merchant plied his trade well into this century. In a recent movie, "Quackser Fortune has a Cousin in the Bronx," the hero made his living by following the horse driven delivery wagons of Dublin, shoveling up their droppings and selling them to the residents for their gardens. His career came to an abrupt end when the horses were replaced by modern trucks.

at Monticello included the necessities of life as well as the esthetics. There were outdoor privies for fair weather, which had views overlooking the valley below. There were also indoor privies on each floor. These emptied into vertical zinc-lined shafts which led down to a subterranean tunnel where the refuse emptied into zinc-lined carts. These carts sat on tracks so they could be rolled out of the tunnel and emptied each morning. The shafts had separate air vents to the roof. He also collected rainwater for washing and used well water for drinking (Fitch 1961).

Buckminster Fuller's Dymaxion house of 1928 was designed to use little water. He designed a recirculating atomizer spray shower which used one quart of water. The toilets, which required no water at all, consisted of a splashless hermetic and waterproof system which mechanically packed, stored, and cartoned wastes for eventual pickup for processing and reuse by chemical industries (Marks 1960).

Sewage Farms

Ideas about how to deal with municipal sewage seem to go through cycles. In London before the early 1800's cesspools and seepage pits were the only option for domestic sewage. But, unlike a modern septic system, they allowed raw untreated effluent which eventually contaminated the city's wells. After 50,000 people died in the cholera epidemic of 1848-49 Londoners began to believe Sir Edwin Chadwick who urged that domestic wastes be diluted and flushed down the storm sewer system.

But 20 years later Baldwin Latham was urging that sewage no longer be dumped into England's rivers; instead he advocated land disposal which he said would "swell the

wealth of the nation" (Stevens 1974).

By the end of the 19th century, sewage from many European towns was piped to nearby farms where it was used for irrigation and fertilization. In a book subtitled "How Soil and Plants can Solve our Water Crisis", Leonard Stevens describes numerous examples of the successful on-site reuse of domestic wastes in Berlin, Paris, and London. He describes the first U.S. experiment in land treatment begun in 1872 at Augusta, Maine, and the first municipal farm built nine years later to serve the model town of Pullman, Illinois.

But by the early 20th century many U.S. rivers and streams were carrying raw municipal sewage in increasing degrees of dilution to the point where in 1939 the Department of Agriculture published a bulletin entitled "Sewage Irrigation as Practiced in the Western States" in which they discussed the use of such stream water and sewage irrigation.

By the mid 50's the treated effluent from dozens of cities was irrigating cropland in many parts of the country. Among the more impressive were Fresno's 1,200 acre farm and Lubbock's 4,200 acres. Stevens also describes the 27,000 acre cattle and sheep ranch that for the last 70 years has been turning all the municipal wastes of Melbourne, Australia into cash.

Industrial Sewage Recycling

By the middle of the 20th century some of the most impressive systems for reusing wastewater to irrigate crops were operated not by municipalities but by private industry, often canneries or paper plants. The Green Giant plant spray irrigated 100 acres of asparagus in Ohio. Union

Paper Corp. spray irrigated 150 acres of corn, peanuts, and woodlands in Virginia. Stevens reports that Seabrook Farms Co. irrigates 180 acres of woodlands with overhead spray rigs in what is apparently one of the most studied irrigation projects in history. In Paris, Texas, Campbell Soups purifies plant effluent by trickling it across 500 acres of gently sloping terraces planted in reed canary grass, and in Maryland they treat chicken processing plant wastes on an 80 acre plot which functions as an unofficial wildlife sanctuary.

The Building of Golden Gate Park

In 1858 the city of San Francisco purchased 1,000 acres of windswept sand dunes for an urban park. Now it is one of the most famous examples of how the land application of sewage can produce rich soil and abundant plants. Initially horse manure from the city streets was transported to the site in a special trolley car. Later a sewer line that ran through the park was tapped and raw sewage was used for irrigation. In 1932 a chlorination plant was built and 6 years later a nearby sewage treatment plant began supplying dried sewage as a soil conditioner. Stevens describes similar irrigation and soil conditioning projects in Las Vegas, Nevada and Gainesville, Florida.

In 1920 the city of Milwaukee began selling 50 lb. bags of dried sludge as a soil conditioner. Today the dried sludge from dozens of municipal sewage treatment plants is marketed under an imaginative list of tradenames: Milorganite (Milwaukee), Nu-Earth (Chicago), Philorganic (Philadelphia), and Nitrohumus (Los Angeles). In liquid form it was dispensed from tank trucks under the name of Hydig (London, England) and Orcon (West Chester, Pennsylvania).

Municipal waste water has also been successfully reused to reclaim strip mines, worn out agricultural land, sterile urban soil, and refuse dump sites (Goldstein 1977). In another example sludge was applied to a sterile dump of grinding and polishing wastes from a glass factory, and in less than 3 months it was covered with dense vegetation (Stevens 1974).

Reclamation vs. Direct Reuse

One of the basic assumptions of modern society was that technology, not nature, must solve the 'sewage problem'. Essentially this means that all sewers are supposed to lead to sewage treatment plants, the effluent from which must be safe to reenter surface watercourses.

The opposite view is that natural processes (i.e., sewage farms, septic tanks, etc.) can treat sewage wastes and produce an effluent that is safe to reenter below ground watercourses.

Reclaimed or renovated waste water produced by tertiary treatment is a very good quality effluent that is safe for human contact. The major criticism of the high technology approach is that it is energy intensive and wastes potentially valuable nutrient material.

Reclaimed water that is used for irrigation is paradoxically less valuable than untreated waste water.

Although the land disposal of untreated waste water on forest and crop lands is thousands of years old, the public still regards use of the much safer reclaimed water as an untested innovation that may threaten their health. However, within the last 10 years there has been a flurry of demonstrations and proposals advocating the merits of this approach

(Hartigan 1975). For example, at Walt Disney World in Florida the effluent from a 1,000,000 gallon tertiary treatment plant is used to sprinkle a 100 acre experimental farm which is actually functioning as a huge "living filter". A University of Florida research team is evaluating the performance of this experimental municipal waste water recycling system.

Recreational Uses of Reclaimed Waste Water

In the late 1950's the Southern California town of Santee began an ingenious waste water reclamation project that 10 years later would result in three new beautifully landscaped lakes, a new golf course, and two municipal swimming pools, all supplied by pure safe water that earlier had been effluent from the municipal sewage plant. Percolation through shallow gravel in a dry river bed, purification time in the lagoons (lakes), plus a little chlorination was all that was needed to meet state swimming water standards (Stevens 1974). About the same time an equally successful project at South Lake Tahoe created a beautiful new man-made lake.

In Southern California the famous Whittier Narrows system percolates reclaimed sewage effluent into the groundwater table, from which it is pumped for swimming and drinking.

Drinking Reclaimed Sewage

The two classic historical examples of direct reuse are Chanute, Kansas and Windhoek, South Africa.

For five months in 1956, Chanute existed on a completely closed recycling system. In the midst of a record drought the river dried up leaving only a pool behind the local dam.

Treated effluent can have significant economic value, as was shown in California where all the capital costs of the Whittier Narrows Reclamation Plant have been paid off by the sale of water for irrigation and for groundwater recharge.

To survive they simply redirected the outfall from their sewage treatment plant into the reservoir. Water drawn from the reservoir was treated to meet state health requirements (Stevens 1974). To make up for permanent shortages Windhoek uses a tertiary treatment process to treat a portion of its sewage well enough so that it can be mixed with the drinking water supply.

HISTORY OF WATER SUPPLY AND STORAGE

Man's first response to his need for water was to settle near a river or spring where it was immediately available. But the earliest known method for obtaining water away from these primary sources was by digging wells or by catching and storing rainwater.

Both wells and cisterns allowed the reuse of what would otherwise be lost waste water. Once it has filtered down through at least 4 feet of well aerated soil, domestic waste water could be purified enough to safely enter the groundwater table.

Wells

The first wells were crude shallow cavities scooped out of the ground in damp places. But as tools became more sophisticated, wells could be dug deeper.

There are remains of wells in Egypt that were used when the pyramids were constructed. References are made to important wells in ancient Greece and there are remains in Assyria, Persia, and India. Probably the deepest ancient wells were dug by the Chinese who could go down 5,000 feet.

Joseph's Well at Cairo exhibits a high degree of skill, having been excavated out of solid rock to a depth of 297

Wells

Ancient Water Supply Systems

Ancient Cisterns

Roman Water Supply

Roman Aqueducts

The Middle Ages

Cisterns in the United States

Bathroom Design

Increased Demand for Water

Pipes

The Development of Water Works in
the U.S.

History of New York Water Works

The Los Angeles Water Supply System

feet. Water was raised in two stages by buckets on endless chains. The lower level was operated by mules in a chamber at the bottom of the upper shaft which was reached by a spiral path winding around the well (Turneure 1940).

Ancient Water Supply Systems

Eventually more advanced means were invented for obtaining and storing water. The inhabitants of Mesopotamia, beginning in isolated villages, began to build local networks of irrigation ditches and canals as early as 9000 B.C. This management of water made survival of the community possible in the face of an irregular water supply.

In the eighth century B.C., an irrigation system called a qanat was developed in Armenia and Iran. A qanat is a sloping tunnel leading from an underground water source in a hill, through the hill, and finally surfacing in the flat land at the bottom. The water is then dispersed through irrigation channels. At intervals along the tunnel, shafts were dug on a slant from the surface down to the underground conduit which allowed men to go down to make repairs and to bring out water. Qanat tunnels were commonly several miles long and many supplied more than 1,000 gallons per minute. They are still constructed and used in the Middle East.

Ancient Cisterns

A cistern with a capacity of two million gallons of water was dug 60 feet into the limestone beneath the ancient Temple in Jerusalem. It was aptly named the Great Sea and was one of 37 cisterns under the temple area which together were called the Pools of Solomon (Garnett 1922).

The city of Carthage, founded by the Phoenicians in 814 B.C. in what is now Tunisia, had 18 large storage cisterns that were still in good repair over two thousand years after they were built. Each cistern was about 100 feet long by 20 feet wide and 20 feet deep, and was originally covered with earth (Mason 1916).

Small scale water storage was also common. An Egyptian house of about four thousand years ago had roofs that sloped inward and a central tank under the courtyard to catch every drop of rainwater. Here the water stayed cool and dark, free from plant and animal growth. Traditionally a small frog or a single fish was kept in the family's cistern in order to dispatch insect visitors. Centuries later, Etruscan houses had small openings over the central atrium which allowed rainwater to fall into a storage tank. A house in the Athenian Agora, constructed in the fifth century B.C., was excavated in 1968. Two cisterns were found and it appeared that one was a replacement for the other. Both cisterns measured a little over three feet in diameter at the mouth and widened toward the bottom. One was roughly rectangular at the bottom and had a depth of twelve feet. The other was nearly circular and only about six feet deep. Both cisterns were lined with water-proof cement (Hesperia 1974).

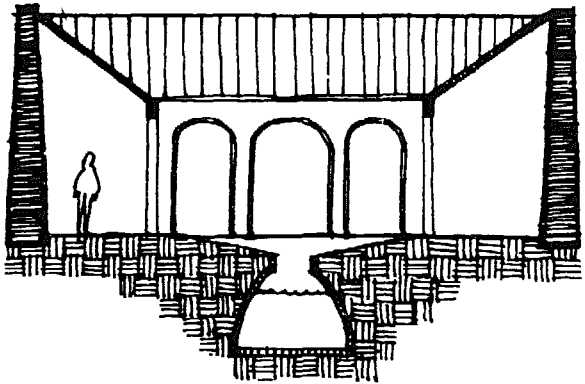

TRADITIONAL ATRIUM-TYPE HOUSE
DESIGNED TO COLLECT RAINWATER

Cisterns were common in every type of house, from humble to elegant. When the Ca'D'Oro, one of the most beautiful of the palaces flanking Venice's Grand Canal, was built in 1434, it too had a cistern for collecting rainwater (Cantacuzino 1969). The same pattern continues today on arid Greek islands such as Delos, where traditional houses are still built with their roofs and patios sloping toward a cistern under the courtyard in order to capture every precious drop of rainwater.

Roman Water Supply

The largest ancient cities seem to have sprung up in great river valleys: the Nile, the Tigris and Euphrates, the Indus, the Hwang Ho. Likewise, Rome lies on the Tiber River, which in the earliest centuries of the city's growth was the major traffic artery of central Italy. The Tiber was also the city's major source of water. For 441 years after the founding of the city the Romans obtained their water from the Tiber and from the wells in the immediate vicinity. But as the city grew, the river water became both polluted and inadequate.

The increased need for water was caused by more than simple population growth, which reached 1,200,000 in the second century A.D. (Carcapino 1941). Water escalated in importance to the Roman way of life. Communal public baths were central to the culture and the city was soon awash with public fountains from which the poor could draw water. Elegant villas were built with numerous fountains, and the well-to-do had water piped directly into their homes and apartments. By the time of Constantine there were 937 public baths, 1,212 public fountains, and 247 reservoirs (Turneure 1940).

Roman Aqueducts

To meet this demand, the Romans constructed the greatest water supply system of the ancient world. That many of its aqueducts still stand today is evidence of their engineering skill.

In order to bring water from distant sources it was necessary to build aqueducts over difficult terrain. Because the water flowed by gravity, a constant gentle down-grade had to be maintained from the point of source to destination.

The system built through the hills around Rome carried the water across valleys in arched aqueducts and through tunnels, often taking long detours to maintain the required gradient.

The first aqueduct, the Aqua Appia, was constructed in about 312 B.C. By 305 A.D. there were 14 aqueducts in Rome with an aggregate length of 359 miles, 50 miles of which were the familiar arched structures built above grade (Turneaure).

In 97 A.D., Sextus Julius Frontinus became Water Commissioner of Rome. He took it upon himself to write a detailed description of the existing system and made suggestions for improving it. The Roman water works so impressed this practical man that he was moved to write: "Will anybody compare the idle Pyramids, or those other useless though much renowned works of the Greeks with these aqueducts, with these many indispensable structures?"

Each aqueduct ended in an extensive distribution system. First the water flowed into one or more tanks to let mud and pebbles settle. Then it was piped by gravity to a tower called a castellum or "little castle." The castella allowed for additional settling and where necessary may have reduced the pressure head (Mason 1916). From the castella, leaden pipes distributed the water to fountains, baths, and private users. A few insulae (apartment houses) had running water on the ground floor only because the pressure was not great enough to supply upper stories. But more commonly, Romans carried water into their houses themselves or it was brought in by a slave or paid water bearer from the nearest fountain.

Another more devious method for obtaining water was by illegally diverting the public water, sometimes with the help of bribed waterworks laborers. A large number of landowners whose fields bordered on the aqueducts tapped the conduits, and the public water courses were sometimes brought

to a standstill by the watering of gardens (Frontinus).

After the Goths' siege of Rome in 537, the water supply system fell into disrepair, with the aqueducts being only fitfully maintained, finally failing completely around the tenth century. The people of Rome once more went to the Tiber for their water, until 1453 when one of the aqueducts was restored (DeCamp 1963).

The Middle Ages

European water supply systems during the Middle Ages were mostly on a small scale and not always adequate; a big step back from some of the grand schemes of ancient times.

Each village or town took on the responsibility of providing drinking water to its citizens. A local system would begin with the provision of a fountain in the main public square. The fountain became the social center of the community, where everyone came together at least once a day.

Large cities had a distribution system similar to that of the small towns. Paris depended entirely on the River Seine for its water supply until a small aqueduct was constructed in 1183, but as late as 1550 the city's water supply averaged only about one quart per person per day. All water was supplied to public fountains and hand carried to the house (Turneure 1940).

In London, up until the beginning of the 13th century, the Thames and the springs supplied the city with water. But an increasing population made the existing supply insufficient. So, in 1236, a patent was granted for a leaden conduit to bring water from Tybourne Brook to the city of London. Shortly thereafter eleven more conduits were built to bring in water from suburbs.

Cisterns in the United States

Surprisingly there is virtually nothing written about rainwater collection in the United States. But there must be a wealth of lost folk wisdom about the design and use of the traditional American rain barrel.

In the U.S. early in this century, cisterns were still built in country houses which did not have access to piped-in water. Soft rainwater was considered especially suitable for laundry and personal hygiene, particularly hair washing. One of the few references is contained in a household book published in 1924 which gives the following sketchy directions for collecting and storing rainwater:

Rainwater for household use is best stored in containers called cisterns dug into the earth or built in the cellar. The first fall of rain not only washes the air of its impurities but also the buildings of their dirt. To keep rainwater in good condition, first, have a cut-off in the pipe so that the first fall of rain (for half an hour) may be prevented from going into the cistern; second, as an extra precaution, the water on its journey from the roof to the cistern may be led through a filter...filled with gravel or small stones sometimes mixed with pieces of charcoal...Cisterns should be bricked or cemented on all sides so that the water in storage will be kept free from dirt and contamination (Balderston 1924).

On the streets of San Francisco, brick circles still outline the fire department's huge underground cisterns, a precaution against earthquakes which severed water mains.

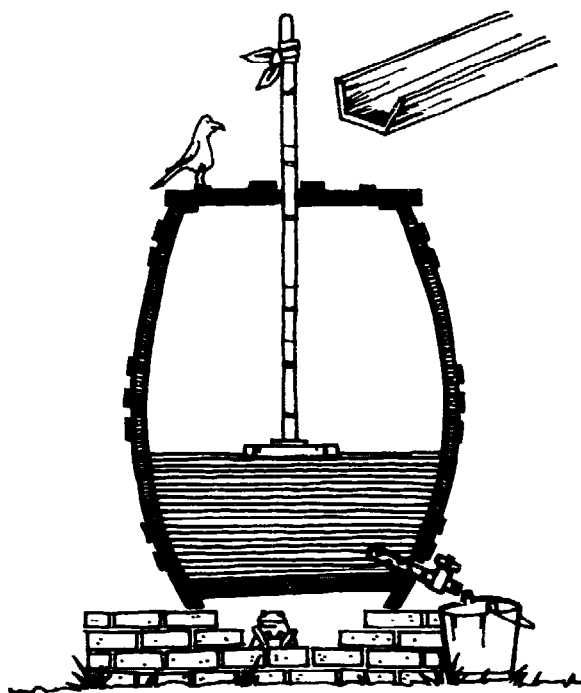

WATER BARREL

The major means of distribution was by water carriers, who were so numerous that they had their own guild. They either carried two wooden tubs hanging from a shoulder-yoke, each with about 3 gallons of water, or delivered the water in a cart (Garnett 1922).

In the English countryside, natural springs and small water courses were channeled to form private water supplies. A village or a manor would locate a water supply cistern uphill and with suitable draining tiles, pipes, or tubing, water was directed down to the village or house.



LONDON WATER CARRIER

Bathroom Design

Having water piped into the house was a mixed blessing. When running water was brought into these old buildings, the bedroom which was taken over for use as a 'bathroom' was often much too large. By today's standards this would be considered a gross waste of space compared to the ubiquitous contemporary minimum prototypical 5' x 7' bathroom plan. Tanks and cylinders were placed in unlikely places such as wine cellars or old fireplaces. They sometimes blocked off hallways. Pipes visibly made their way up the outside of walls and then disappeared suddenly through ceilings, reappearing out of holes in the floors above. In ancient castles, bathrooms were often inserted in such tight spaces that the occupant would have to stand in the tub to shut the door. Nor was the new convenience always appreciated. Families with maids still had water jugs and wash basins brought to their bedrooms because it was considered an inconvenience to walk all the way to the new bathroom to wash. Attitudes about the privacy of 'milady's toilet' were slow to change.

In 18th century London, unlike today, the availability of an adequate water supply was not a prerequisite for approval of new subdivisions.

Like 19th century London, a similar prohibition is contained in the Constitution of the State of California against "waste or unreasonable use or unreasonable method of use of water," and "the conservation of such waters is to be exercised" (Article XIV, Section 3).

Increased Demand for Water

With the rise of industry and the growth of cities, obtaining enough water became a serious problem. In the major cities no adequate provision for water was made in many of the new areas that sprung up to house the growing population. In 1809, London had one million inhabitants and water was available over the greater part of the city only in basements of houses. Also, water was not always supplied on a steady basis. In parts of London water was pumped to houses for a short time only 3 days a week. People used bribery to keep the water on long enough to fill their cisterns or they kept their taps on all the time to catch any sudden gushes of water.

To prevent excessive demand on pumps, water was turned on in only one district at a time. If a fire occurred, the firemen would frequently find that the water main was empty. A message had to be sent to headquarters to turn on the water in the main and the engines had to wait, sometimes an hour or more, until the water came.

In 1871 a government act was passed which provided that every company should give a constant supply of pure and wholesome water under specified conditions. The conditions also imposed certain obligations on consumers with a view to the prevention of waste. If a customer consumed too much water his supply would be cut off as provided for in the act:

If any person supplied with water by such company... wrongfully fails to do anything which...ought to be done for the prevention of the waste, misuse, undue consumption or contamination of the water of such company, they may cut off any of the pipes by or through which water is supplied by them to him... (Shadwell 1899).

To economize on the cost of pumping, water reservoirs and large cisterns were placed at many different levels. London was divided into districts and the reservoir was placed at the highest point of each district. The water flowed naturally through the pipes to most of the houses. The few houses on higher ground were supplied by a small main from a higher reservoir into a neighboring district or from a standpipe or water tower.

Pipes

Another major advance that aided in the expansion of water works was the invention of cast-iron pipes. These were first experimented with in the seventeenth century, but were not cheap enough for wide use until the middle of the eighteenth century. It was fifty years later that they came into general use.

Before cast-iron pipes, the material most commonly used for water mains was wood. Elm was often used because it can be exposed to water for a long time without rotting. Elm trunks were bored out to a diameter of about 7 inches. The smaller, or spig, end was sharpened to form a cone. At the other end the borehole was enlarged into a conical socket to join with the spig end. Pitch was applied outside and around the joints. Wooden pipes leaked a great deal and could not withstand much pressure.

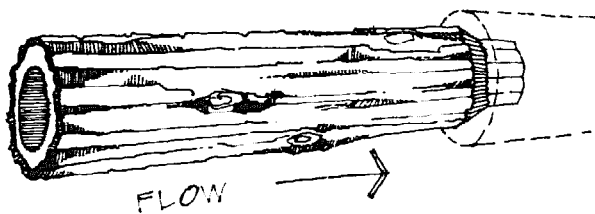

WOOD WATER PIPE

Lead was widely used for pipes carrying water from mains into houses because the metal is malleable and easily joined. On the other hand, lead has the disadvantage of being poisonous. This was known as far back as Roman times when Vitruvius warned against using lead pipes for transporting water because it could be harmful to the body. Yet lead pipes continued to be popular from that time until

the late nineteenth century, despite frequent and indisputable cases of lead poisoning. The problem was that the case against lead always ended in a hung jury. It seems that there were cities where lead pipes were used for years without any apparent harm. This inconsistency made it difficult to declare lead guilty of manslaughter beyond a reasonable doubt.

Finally, in the nineteenth century, investigators learned that the kind of water flowing through the lead pipes determined the death rate. Soft water tends to dissolve lead, forming a poisonous brew. But hard water forms a protective coating of calcium carbonate on the inside of the pipe, preventing contact between water and lead. Sometimes, however, the calcium carbonate became too much of a good thing. The coating would grow so thick it would clog the pipe completely.

The Development of Water Works in the U.S.

The first water works in America were built in Boston in 1652. Spring water was brought to the city by gravity through wood pipes. In Bethlehem, Pennsylvania in 1754, machinery was first used to supply spring water to the city. The water was forced by a wooden pump through hemlock logs into a wooden cistern. Eight years later the wooden pump was replaced by three iron ones. These water systems were followed by those built in Providence in 1772 and in Morristown, New Jersey in 1791. By 1800 there were 16 water works in the United States.

In the United States steam engines were first used to pump water in Philadelphia in 1800. These engines were constructed largely of wood. Even the boiler was partly made of wood (Turneure 1940).

History of New York Water Works

When the Dutch founded their new city on Manhattan Island, it was crossed by many streams and had a large fresh-water pond fed by numerous springs. By 1664 the population was 1,500 and water was obtained from private wells, and in 1658 a public well was dug near Bowling Green.

By 1774 the city's population was 30,000 and the water supply failed to meet the demand. To solve the problem the first water works were begun shortly before the Revolution. It was planned to pump water from wells through hollow logs to a reservoir, but construction was halted by the war.

After the Revolution the population was up to 60,000. Not only was there a need for more water, but the spread of yellow fever made a supply of clean water imperative. The Manhattan Company was chartered to supply water to the city (White, 1913). The company started operating in 1799 with a horse powered pump which was replaced by a steam pump in 1803. The water was brought up from a well in the city to a 132,600 gallon reservoir constructed of flagstone, clay, sand and tar (Blake, 1956). From the reservoir wooden pipes made from bored-out logs were laid through the lower part of the city. The water, which was supplied to 1,400 houses, was of poor quality and limited quantity.

Yet this remained the city's major source of water until the construction of the Croton water supply system, which was begun in 1837 and completed in 1842. It consisted of a dam and an aqueduct which ran from the Croton River, 30 miles north of New York, to the Central Park Reservoir, and included a section over the Harlem River built in the style of the Roman aqueducts.

The next major source of water was 100 miles north of the

city in the Catskill Mountains. The Catskill water system was built between 1906 and 1918 and furnished 660,000,000 gallons of water per day to New York City. The water was carried through the city in a pressure tunnel to all five boroughs. This system was followed by the Delaware River Supply, begun in 1936, which was planned to yield 920,000,000 gallons per day (White 1913).

The Los Angeles Water Supply System

Los Angeles, unlike most major cities in the world, did not have its beginnings near a major source of water. Because it was located in a semi-desert region it had little hope of growing into a large metropolis until a way was found to supply the city with water. Like the Roman aqueducts, the system bringing water to Southern California is an engineering marvel. The first aqueduct brought water from the Owens Valley in the southern Sierra Nevada Mountains. The Los Angeles Aqueduct, finished in 1913, was 233 miles long and had a daily capacity of 288,000,000 gallons of water. Water flows by gravity, and along the way is used to generate huge amounts of electric power, to the point where the Los Angeles Department of Water and Power makes more money from selling electricity than from water.

The construction of the Los Angeles Aqueduct was an heroic engineering feat. But only the decidedly un-heroic financial dealings that followed were depicted in the film "Chinatown." Equally fascinating but more accurately written accounts are available (c.f. "The Water Seekers").

When the Owens Valley supply failed to meet demand, the Colorado River Aqueduct was built. Completed in 1936, it ran through six mountain ranges with 38 tunnels and could supply another 677,000,000 gallons daily to the metropolitan area. In its continuing search for water, Los Angeles has gone to even greater lengths, all the way to Northern California. The California State Water Project could supply an additional 687,500,000 gallons daily to Southern California by bringing water from as far as the Feather River, 650 miles north, to the man-made oasis of Los Angeles.

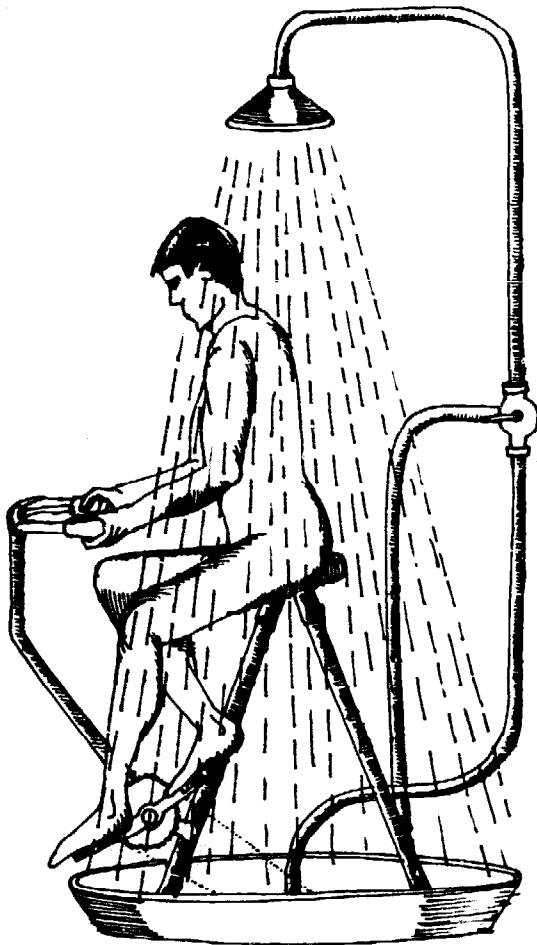

VELOCIPEDA RECYCLING SHOWER

The Japanese Bath
The Modern Bathroom
Water Consumption

BATHING

During most of the past bathing was a shared public affair. In ancient Rome the bath house was a place for social contacts, where politics were discussed and conspiracies planned. Although its popularity waned after the fall of the Roman empire, in the middle ages public bathing was again common, and bath houses were found in every northern European city (Mumford 1961).

In the more affluent pre-modern home a footman or maid brought in a big bath mat, placed a large tub on it and filled it from two cans of water, one hot and one cold. The servant left, and the bather crouched in the tub and rinsed off the soap the best he could (Quennell 1961). After the bath the servants returned to carry the water out, often to their own quarters where the rapidly cooling water was re-used by the staff, in descending order of status.

As late as the 1880's five out of six dwellers in American cities had no bathing facilities more elaborate than a pail and a sponge. Growing health problems in the cities in Europe and the U.S. led to a renewed interest in public bathing. In England where the working class family still had to carry water from pumps, it was found that one tubful of water frequently washed a whole family, plus their clothes. Still today it is not unheard of to share bath water among more than one member of the family, especially children.

The Japanese Bath

The American bathes to get clean, the Japanese gets clean to bathe (Frazier 1973). In Japan the distinction between cleansing and relaxation has been clearly defined. The ritual of bathing fulfills both requirements in a simple and efficient manner. This ritual starts by soaping and rinsing the body with a small pail of water, either in a squatting position or sitting on a wooden stool. The washing area, next to the soaking tub, is traditionally made of a removable wooden grating placed over a concrete floor which drains to the outside. After cleansing thoroughly, the bather enters the tub ready to enjoy a tranquil soak in water heated up to 115 degrees, frequently in the company of others.

The bathroom, which is separate from the toilet, consists of a washing area and a tub. The bathtub, traditionally made of wood, is deep enough to immerse a sitting bather. Some have metal bottoms, which are part of the stove underneath which heats the water. A wooden plank the same shape as the bottom of the tub is used to protect the feet from the hot metal bottom. When not in use this plank floats to the top of the water and there are holes in it so the bather can force it down with his foot as he enters the tub. A not too agile bather may tilt the plank as he steps down and a minor disaster follows.

Because of a shortage of water and the size of the tub, the same bath water is reused over a period of months. It is reheated each time it is used. Between uses it is tightly covered to reduce evaporation losses and condensation problems inside the bathroom.

Even when people have their own baths, it is common to go occasionally to public baths where the steaming water and

the relaxed atmosphere are conducive to animated conversation and the lowering of social barriers. In Japan bathing retains its best attributes: cleansing, regeneration, relaxation, and socialization, all with minimal use of water.

The Modern Bathroom

America came into existence too late to participate in the hedonistic rituals of the Roman bath. We now appear to be ready to make up for what we missed. Americans are discovering other pleasures of bathing that have either been forgotten or suppressed by puritan ethics, for example, the Greek idea of body regeneration and the Japanese emphasis on relaxation. Now, even though Americans retain their desire for privacy, the social aspect of bathing is slowly creeping in. Visitors, along with all members of the family, are sharing in the joys of the new communal home spas and hot tubs. For many people, these are just smaller and more intimate versions of the backyard swimming pool, which happily are cheaper to build and use a good deal less water (and energy). Unlike the backyard pool, however, the social conventions of communal hot tub behavior are still evolving, leaving the first-time guest a bit uncertain about the extent to which swim suits are optional.

Many whirlpool baths and hot tubs are installed in patios and outdoor decks. They can fit into small urban spaces where swimming pools could never find room. Their growing popularity suggests that even people with pools would rather soak than swim.

Water Consumption

Small bathtubs fitted with whirlpool systems are usually

filled and drained each time they are used. The smallest tubs, which are the standard five foot length, hold about 50 gallons of water. A lot of water goes down the drain after each bath. The larger communal tubs, advertised to accommodate a family of four, hold more than 100 gallons. Fortunately, even those who can afford such a luxury are not always willing to dump out 100 gallons of water after each soak in the tub. These large hot tubs, which are up to four feet deep, are installed with heater, filter, and pump, just like a swimming pool. Unlike a pool, they are easily covered to prevent evaporation.

The changing attitudes toward bathing could very well affect water use. As with the Japanese bath, soaking in a whirlpool bath or hot tub requires precleansing, because oily and soapy water can't be run through the whirlpool system, and if the water is to be reused it should be kept clean. With the prospect of a long, relaxing bath, cleansing, probably in the shower, will be quick in order to get on to the good part.

RECYCLING TOILETS

In the U.S. today, the toilet consumes more water than anything else in the home. Of the estimated 70 gallons consumed per person per day, toilet flushing uses 45 percent, or 31.5 gallons (Milne 1976). This is compared to 21 gallons for bathing, 14 gallons for laundry and dishwashing, and 3 for cooking and drinking.

The Water Closet

Water does nothing to treat or dispose of toilet wastes. It is only a transport medium for removing organic wastes from the house. But the water closet, as it is appropriately named, has only been a common household fixture in Western culture for less than a century. The first English patent for a water closet was issued in 1775, but it was almost 100 years later that Thomas Crapper patented the improved version which insured his place in history (Palmer 1973). In America, Thomas Jefferson, who himself had invented many ingenious devices, had one installed in the White House at the beginning of the 19th century. But no patents were issued for a water closet in the U.S. until 1833.

American toilets use more water than their British antecedents. Standard English toilets use less than 2-1/2 gallons, and water-saving models use only 1-1/2 gallons. Today American toilets use up to 8 gallons per flush, except in California where they are limited by law to 3-1/2 gallons (Milne 1976).

The Water Closet
The Earth Closet
Modern Recycling Toilets
Composter Toilets

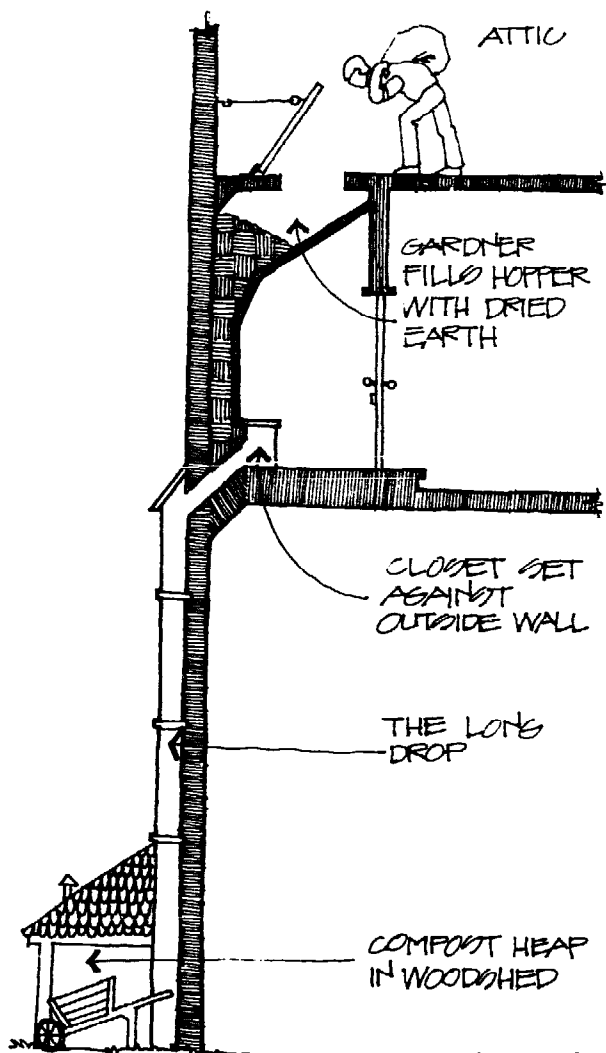

OXFORDSHIRE EARTH CLOSET

The water closet did not come into its own until the introduction of running water and the construction of sewers, around the middle of the 19th century. Noah Webster aptly stated what must have been the common response to the idea of flushing everything down the toilet: "...personal impurities of every kind may be hourly washed away. All that is troublesome and noxious, all that is hostile to delicacy, decorum and health, may be instantly swept from sight" (Blake 1956). This Victorian attitude toward the body and its unpleasant waste products undoubtedly hastened the adoption of water closets, which could make sins disappear and always look clean and smell pure.

The water closet had its critics. Although out-voted, there were sanitarians in the late 19th century who argued that the water closet wasted valuable human wastes which could be better used in gardens.

The Earth Closet

A villa at Amarna, Egypt, that was built around 1300 B.C. contained an earth closet (Cantacuzino 1969). Like the complex plumbing systems of the ancient world, the earth closet was invented and lost, only to be reinvented again. It reappeared in England in the 19th century when many people considered earth closets to be preferable to water closets.

The earth closet worked on the principle that powdered, dry earth, which contains clay and natural soil bacteria, will absorb and retain all offensive odors, fecal matter, and urine. It required a supply of dry and sifted earth, or a mixture of two parts earth and one part ashes. After the user got up from the seat a sufficient amount of dry earth was discharged to entirely cover the solid wastes and to

A portable earth closet was invented by Rev. Henry Moule of Dorsetshire, England, and manufactured in this country by the Earth Closet Company of Hartford, Connecticut in the 19th century. Its advantage was that it could be used in any room in the house.

Those who consider the earth closet a relic of the past may nonetheless have a simplified version in their house today: the cat box.

absorb the urine. The wastes and the dry earth fell into a pail that was easily removed for emptying, or into an existing holding pit. The pit did not have to be emptied for up to a year.

An example of a simple earth closet was in use in a house in Oxfordshire, England until 1936. It had a wooden shutter which dropped down when a handle was pulled. The same handle simultaneously released an avalanche of earth which fell across the shutter carrying the wastes down a chute on the outside wall of the house. It all ended up in a garden shed where it eventually became compost for the garden.

If six persons used the earth closet daily, 100 pounds of dry earth were required each week. The earth could be dried under the kitchen range. But it was also possible to recycle the earth. After a few weeks outside of the pit or pail, the combination of earth and wastes decomposed and was odor free, ready to be used again in the earth closet. In fact it could be recycled five or six times, each time becoming richer in nutrients. A variation of the earth closet was the dry ash commode which was a similar device that used fireplace ashes instead of dry earth.

Catharine Beecher and Harriet Beecher Stowe devoted a whole chapter of their 1869 household book to the earth closet. They referred to it as, "A great improvement" that "will probably take the place of water-closets to some extent... For those living in the country away from the many conveniences of city life"...it will contribute "largely to the economy of families, the health of neighborhoods, and the increasing fertility and prosperity of the country round about."

Modern Recycling Toilets

Today some people are again looking aghast at what the water closet and water carriage sewage system have wrought: the dumping of our sewage into our drinking water, which must then be purified at great expense. Alternatives are being considered, especially in light of the many nations that are not locked into an existing sewage system and can learn from the past mistakes made in the U.S. and Europe.

There now are many commercially available alternatives to the traditional water closet, such as composting toilets, vacuum-flush systems, oil flush toilets, incinerator toilets, shallow trap toilets, wastewater recycling toilets and even small scale package sewage treatment systems (Milne 1976). These give the user the choice of either reusing wastes or at least reducing the amount of water being flushed down the drain (see Components and Systems chapters).

Composter Toilets

Many people are attracted to the idea of using valuable human wastes to fertilize the land, as well as saving water. Like the earth closet, the composter toilet turns wastes into fertilizer, and uses no water. All composter toilets work on the same principle. Wastes are deposited in a well-ventilated container where bacteria and mold, in the presence of oxygen, eventually reduce the wastes to a nutrient-rich humus that can be used in the garden. They also greatly reduce the volume of waste; only a few cupfuls of humus are produced every few months. The units are designed to make removal of the humus simple, and with proper ventilation, eliminate all unpleasant odors.

Composter toilets have been in use in Sweden for years.

There are now several hundred in the U.S. and Canada. In 1974, Maine became the first state in the U.S. to permit composter toilets to be installed. There are now 200 compost toilets in Maine and there has been no evidence of health problems.

The basic problem in obtaining permission for their installation is that most sanitation codes were written before compost toilets were distributed in this country, so new codes must be written covering them (Popular Science, January 1978).

THE COST OF WATER

Most people think their water bill pays for water. That is because they take the existence of water mains for granted. But in earlier times, when people first started paying for water, it was more apparent that what they were actually paying for was the transportation of water, not the liquid itself.

Roman Times

Originally the water brought into Rome was meant for public use. It was piped to baths, fountains, and water basins to be freely used by the citizens. The first public works were financed by the chief magistrates with money amassed from the spoils of foreign wars. They expected the people to repay the favor by building statues in their honor.

When the Roman emperors appeared on the scene, they bestowed upon their favorites the right to have water piped into their houses. Notice that a water right had been thus granted was marked on the inlet pipe by the words "ex liberalitate", obviously a prime status symbol of the day. The laws forbade the general population from having water piped into their homes. Many of those who felt that they deserved the same facilities as the citizens favored by the emperor, tapped the conduits illegally.

In the first century A.D. licenses signed by Caesar were more restrictive, giving only the right to take water from

Roman Times
The Middle Ages in Europe
Private Water Companies
The United States
Paying for Water in New York
Bottled Water

delivery tanks, not from conduits. By the third century this restriction had lapsed and once again "eminent citizens" were allowed to tap the mains for water, and as in the past, did not have to pay for the privilege.

But the situation finally got out of hand. Who was an eminent citizen and who was not? The water commissioners gave up trying to decide, and made piped-in water more widely available. But now a fee was imposed, not for the water, because there was no way of metering the amount used, but for the pipes. The Romans also charged a fee for water used by business establishments that were located on or near conduits, reservoirs, or public fountains. This revenue was used to pay the salaries of the water workmen.

Those who were not privileged enough to pay for having water piped-in, paid for having it carried in. In some cases slave water carriers were considered fixtures in the buildings they served and, like the porters and sweepers, were inherited with the property. In other words, they were just part of the plumbing. They were human water pumps who got the water up to where it was needed. Supporting slave water carriers was another kind of water bill.

The Romans never took the idea of charging for water to its conclusion because it never occurred to them that a public utility could be made to support itself by offering its service to all in return for a reasonable system of payment (DeCamp 1963).

The Middle Ages in Europe

In the 14th century in Paris, lords and royal officers asked for permission to tap the public mains in order to run private pipes into their houses. By 1392, so much water was being diverted by those in favor that the public

fountains at the end of the lines barely received a trickle.

Thereupon, King Charles IV issued a proclamation: "...We recall, cancel, annul, and revoke all privileges, grants, licenses, rights, duties, permissions, or suffrages... excepting only...Us and Our uncles and brother." But as in Rome, the prominent citizens felt that they had as much right to private running water as the royal family, and got it however they could despite the king's heavy-handed decree.

A similar proclamation was passed in 1553, which again excepted the extended royal family. As before, it had little effect. In 1600, after another abortive attempt to cut off private water pipes, Henry IV agreed to leave the pipes intact. He then thought of a brilliant innovation: to charge fees large enough to support the water system (DeCamp 1963).

In London in 1237, a conduit was built from the Tybourn River to the city, and local inhabitants were taxed to pay for the working expenses. But for most citizens the price of water was the fee charged by the water bearer who brought it to the house. In 1343, some enterprising people living in the streets leading down to the Thames tried to take advantage of their location and get into the water business. They closed the streets and charged a toll for every person going to the river to get water (Garnett 1922).

Although the City of London was regarded as the authority for providing a public water supply, they must have failed to meet the public needs. Water was piped from wells, or the river, to "conduit houses", buildings that contained cisterns and taps where people or water bearers could obtain water free of charge. The piping of water and erection of conduit houses were considered to be proper objects of charity. People frequently bequeathed money for their

construction to provide a water supply to areas lacking such service (Garnett 1922).

Private Water Companies

In 1582 the first private water company was formed in London. The system of allowing private companies to supply water to the city for profit continued until 1904.

In 1899, London was about to decide whether or not to purchase the eight private companies that supplied the city's water. A book was written in the defense of the companies, a not very subtle forerunner of present day public relations writing. The book states that when the second water company was formed in London, the corporation of the City of London declined to incur the expense of bringing water from outside the city because of the financial risk. It claims that the private companies saved the day.

Nevertheless, the City of London, in what must have seemed to the water companies as a total lack of appreciation for past services, simply took over the water business.

The United States

In the United States, technical knowledge from Europe was available for constructing large scale water works. But first the decision had to be made as to whether the large investments required should be made by the cities themselves, or by private corporations.

Philadelphia, after investigating various schemes for financing and running water works, including a partnership with

a private company, finally decided to take over the water supply business itself. In 1809, the Mayor and members of a Water Committee of the City Council were vested with the power to run the water works. The city recognized its responsibility to provide an adequate water supply for its citizens. This was not the decision that most cities came to at that time.

At first, relatively few Philadelphians considered the convenience of piped-in water worth the expense, which included paying for connections plus a flat rate of \$5 per year. Business slowly built up and after ten years the water works had 2,127 customers. By that time the rate for large houses had risen to \$7.50 a year; that for small houses remained \$5.

Five dollars in the early 1800's was not the same as five dollars today. One way of ascertaining what it was worth then is by using the Consumer Price Index. The index measures the changes in the prices of goods and services purchased by average families. The consumer price index in the middle of 1977 was around 181 and in the early 1800's around 50. This means that 150 years ago \$5 worth of water would now cost \$18.10, but today a family of four pays five to ten times that amount for a year's water.

Paying for Water in New York

In the 19th century, residents of New York City still depended on water-carriers to deliver water to their houses. Water from city wells was so bad that it was said that even the horses would not drink it. People had to use water brought from a large spring outside of town by water carriers. The carriers made a tidy profit by buying 130 gallons of water for six cents and selling it for one cent a gallon.

After the American Revolution the growth in population in New York City made the need for more water urgent. New York's City Council invited submission of sealed proposals for supplying the city with water. Three bids were received, but the Council did not take immediate action. There was some opposition to having a private company manage the water works.

The problem was solved by the ambitions of Aaron Burr, who was a state assemblyman at the time. A bill was introduced to the legislature that would empower the city to build its own water works. Through Aaron Burr's manipulations the bill ended up as a charter for the privately owned Manhattan Company to establish a water works. Burr of course was soon controlling the company too.

The charter gave the company almost unlimited powers to obtain and conduct water, to enter and use any land freely, to dam any river or stream and to dig whatever canals it needed. The charter also neglected to require the company to repair the streets it tore up while laying its pipes, and also neglected to limit the rates the company could charge for water.

The Manhattan Company's water works no longer exist, but the bank that resulted from Aaron Burr's shrewdness is alive and doing very well. In 1955, the Bank of the Manhattan Company, which was still operating at its original address and under its original charter, merged with The Chase National Bank. Together they became the second biggest bank in the country, The Chase Manhattan.

The act included a clause which revealed the reason for Burr's eagerness to start a water works. It involved an interesting political ploy. At that time the Federalists controlled both the New York legislature and the only banks in New York. Burr was the leader of the Republicans and was unable to obtain a bank franchise. The obscure clause gave the Manhattan Company the right to use all surplus money to enter any lawful business. As a result, they not only got their bank, along with their water works, but were exempt from the usual restrictions included in bank charters (Blake 1956).

Burr's water company based its rates on the size of a house, as determined by the number of fireplaces. For no more than four fireplaces the charge was \$5 per year, for every additional fireplace \$1.25 was added to the bill. The maximum that could be charged for any house was \$20 per year. This was a reasonably progressive rate structure because the number of fireplaces in a home was roughly proportional to the number of occupants or the family's relative wealth. It also allowed the company's inspectors to establish the rate without the necessity of entering private property, simply by counting chimney pots.

Most private water companies did not have such devious beginnings as did the Manhattan Company. They did have some mercenary instincts, however. They laid their pipes through parts of cities that promised the greatest return, and left poorer sections of town without a water supply. Private customers were favored over public needs and frequently an inadequate number of fire hydrants were provided.

The growth of the population made expansion necessary and the capital required and the cost of maintenance did not encourage private investors. Private companies became unpopular in the early 19th century, as they had in England. High rates and inadequate service were common. The example of Philadelphia's municipally owned water works which provided more water at lower rates was an additional incentive for the cities to take over the water supply systems.

Bottled Water

Human water carriers still exist today and the home delivery of bottled water is big business. The estimated total gross revenue for sales of bottled water and attendant supplies was about \$200 million in 1977. Bottled water companies

Today bottled water delivered by "water carriers" costs at least 50 cents a gallon.

have been around since the last century, and as far back as 1787 mineral spring water was offered for sale as a cure for various diseases.

There are five major marketing areas for bottled water: Texas, Florida, New York, Chicago, and Southern California. It is estimated that one of every six families in Southern California buys bottled water. The major reason they give for buying bottled water is the taste. Although the tap water is safe, it isn't savory enough for many people. The cost for this tasty water is high: about 56 cents a gallon. On the other hand, 56 cents will buy as much as 1,200 gallons of water from the Los Angeles Department of Water and Power.

Now, a new and more costly bottled water is on the scene. Perrier, the ultimate in bottled waters, the favorite of the European elite, is being imported into the U.S. where its marketers hope to discover a whole new coterie of discerning customers. The cost is about \$5 per gallon. But it is not just the rich who drink bottled water in Europe. If you ask for water in a restaurant you are brought a bottle of mineral water, which you are charged for. This bubbly, naturally carbonated water comes complete with a label extolling its medicinal value.

CULTURAL ATTITUDES ABOUT WATER REUSE

In Medieval times there would have been no question that if you carried water from the town well you got as much use out of it as you could.

Many parts of the country have recently experienced droughts or temporary water shortages. With the increase in population, water consuming appliances, and water pollution, these shortages might well become more permanent unless long-standing attitudes and habits are changed. For this reason, experts are now studying current attitudes toward water use and the possibilities of introducing methods of modifying these attitudes in order to solve the problem.

Reusing Reclaimed Waste Water

Treated or reclaimed waste water is already being used throughout the country for public recreational facilities, irrigation, groundwater recharge, and dozens of other uses. In the early 1970's a study, conducted by William H. Bruvold of the University of California, Berkeley, surveyed five communities which already used reclaimed water in public recreational facilities and five similar communities which did not.

People were asked whether they "would oppose" or "would not oppose" a particular use of reclaimed water in their

Reusing Reclaimed Waste Water
Media Impacts on Attitudes About
Reusing Water
Changes in Attitudes about Recycled
Water

Drinking	56.4%
Preparing food in restaurants	56.0%
Preparing food in the home	54.5%
Canning vegetables	54.1%
Bathing in the home	38.7%
Swimming	23.7%
Ground water recharge	23.2%
Laundry in the home	22.8%
Laundry, commercial	21.9%
Irrigation of dairy pasture	14.1%
Irrigation of vegetable crops	14.0%
Spreading on sandy areas	13.3%
Irrigation of vineyards	12.0%
Irrigation of orchards	10.1%
Irrigation of hay or alfalfa	7.5%
Pleasure boating	7.3%
Commercial air conditioning	6.5%
Electronic plant processes	4.9%
Toilet flushing, home	3.8%
Golf course hazard lakes	3.1%
Irrigation of lawn, home	2.7%
Irrigation of recreation parks	2.6%
Irrigation of golf courses	1.6%
Irrigation of freeway green-belts	1.2%
Road construction	0.8%

Respondents Opposed to Specified Uses of Reclaimed Water (Bruvold 1976).

own community. Twenty five possible uses were included, ranging from the most intimate personal contact, to the most impersonal non-contact uses. Surprisingly, opinion in the two different sets of communities was virtually identical, never separated by more than 5 percent. The study showed more than half of the people were against using reclaimed water for drinking or cooking. However, there are many uses for reclaimed water that most people would not oppose. For example, only one person in 25 would oppose using reclaimed water to flush toilets or water lawns.

When Bruvold asked respondents to state their reasons for rejecting the water, it appeared that "psychological repugnance and concern over the purity" were most frequently mentioned as reasons for opposition. Cost of treatment did not appear as an important determinant of opposition.

Professor Bruvold is currently studying people's responses to an actual situation that is similar to the one used in his previous hypothetical study. He has found that people's reactions to the idea of using reclaimed water are much the same as they were in the conjectural situation. People still accept reclaimed water for recreational use and for irrigation. As before, they are less receptive to the idea of personal use of reclaimed water and did express concern about raw sewage going into the groundwater.

Notice that these studies do not test how people feel about reusing greywater as compared to reclaimed sewage effluent, or how they feel about bath water and clothes washing water being reused for flushing toilets or watering their gardens. But since currently proposed greywater recycling systems in the home do not include using it for any human contact, there would probably not be much difference in the small amount of negative opinion.

These results were confirmed by a University of Chicago survey in the late 1960's which interviewed people in six cities across the country. The study found that most people would accept the use of renovated waste water if properly treated. They were willing to reuse water if water shortages face their area, if their existing water quality is poor, or if they are well acquainted with how water is reclaimed. However, the most important finding was that the key public officials and water managers thought the public would not approve water reuse. Their beliefs about what consumers would accept undoubtedly influence decisions they make about waste water recycling (Stevens 1974).

A Gallop Poll in 1973 showed similar results. Of the people surveyed, 55 percent objected to drinking recycled sewage, 38 percent did not. Gallop noted that older people were more likely to object.

Media Impacts on Attitudes About Reusing Water

The media have played an important part in awakening people to the idea of reusing water as a means of reducing the amount they consume. As early as 1973, the magazine Organic Gardening and Farming published articles entitled "Recycling the Wash Water" and "In Pursuit of the Zero Discharge Household." But this magazine is aimed at readers who already believe in developing a sympathetic partnership with nature and who are prepared to spend a good deal of effort to that end.

Sunset Magazine, which has a broad readership in the West, began featuring articles on water reuse during the drought. In the April 1977 issue there was an article about a deck garden that "Makes it With Gray Water." The July issue

of the same year discussed important plant health, public health, and legal questions in using greywater, but carefully pointed out that reusing water was against most existing plumbing codes. With the drought still hanging on in September, Sunset published "Gray Water...The Hazards and the Hope", showing how five home owners had developed systems for reusing water to keep their gardens healthy and flourishing.

But the media can also contribute to the opposite opinion. In Chanute, Kansas, for four months one summer the only supply was treated sewage effluent returned to the towns reservoir. Metzler (1958) reports that "initial public acceptance was good, probably because the citizens knew that their supply normally received diluted treated sewage from seven upstream communities...Public reaction became more adverse when stories appeared in the local newspaper." Even though local doctors agreed that the water was safe, consumer acceptance deteriorated (Chan 1976).

Changes in Attitudes About Recycled Water

About the same time that Bruvold's California study was published, a nationwide survey found that four of ten Americans would have no objection to drinking recycled waste water if their community health authorities said it was safe (Wilkinson 1975). But more recently 85 percent of Denver's residents said they would drink recycled water if its quality was the same as Denver's present supply (Wilkinson 1975). Clearly these new trends are still tentative, but the results do indicate that under certain circumstances people's attitudes about recycled water can change.

Certainly it is possible to change the prevalent attitudes toward recycled water. Bruvold notes that those with more

education showed a more positive attitude. He feels that exposure both to the benefits of reclaimed water and to additional educational material will be helpful in obtaining its acceptance. Bruvold also believes that new uses of reclaimed water should start with those for whom there is the least opposition "and then move upward step by step as desirable, and as reclamation technology improves." He states that domestic use of reclaimed water should therefore start with lawn irrigation.

3

RAINWATER AND GROUNDWATER

Imagine a perpetual motion machine -- gigantic in proportions -- that pumps water out of the oceans, filters and desalinates it, lifts it above the highest mountaintops, and sends it back down filling all of our storage and collection systems. That machine, of course, is our planet's solar powered hydrologic cycle, which provides the rain that fills our rivers and groundwater aquifers.

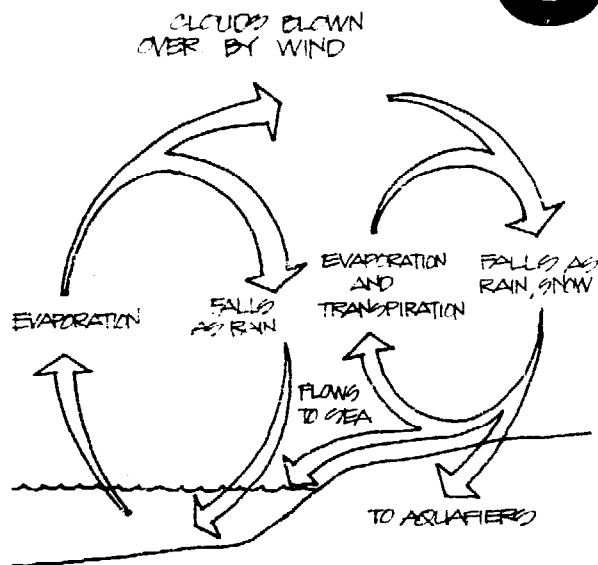

HYDROLOGIC CYCLE

RAINWATER AND GROUNDWATER
DESIGNING RAINWATER COLLECTION
SYSTEMS
WELLS
PONDS AND SPRINGS

The hydrologic cycle is a collection of all the processes involved in the exchange of water among the atmosphere, the earth, and the oceans and other bodies of water. In its most basic form, it can be described as the sequence in which water from the oceans evaporates into the atmosphere, precipitates from the atmosphere as rain or snow, and eventually returns to the sea through the drainage systems of streams and rivers. This sequence occurs within the hydrosphere, a layer surrounding the earth from about one mile below the crust to about nine miles above the surface.

As water evaporates, not only from oceans but also from soil, vegetation, and other bodies of water, it changes state from liquid to gas. Once the evaporated water has lifted into the colder upper layers, it begins to condense into very small water droplets. Concentrations of these droplets result in cloud formations. As the air becomes saturated with water and the water vapor continues to cool and condense, larger droplets form around nuclei of ice crystals or dust. Finally, when the weight of the drops becomes too great for the air to support, it falls to earth as rain, hail, or snow.

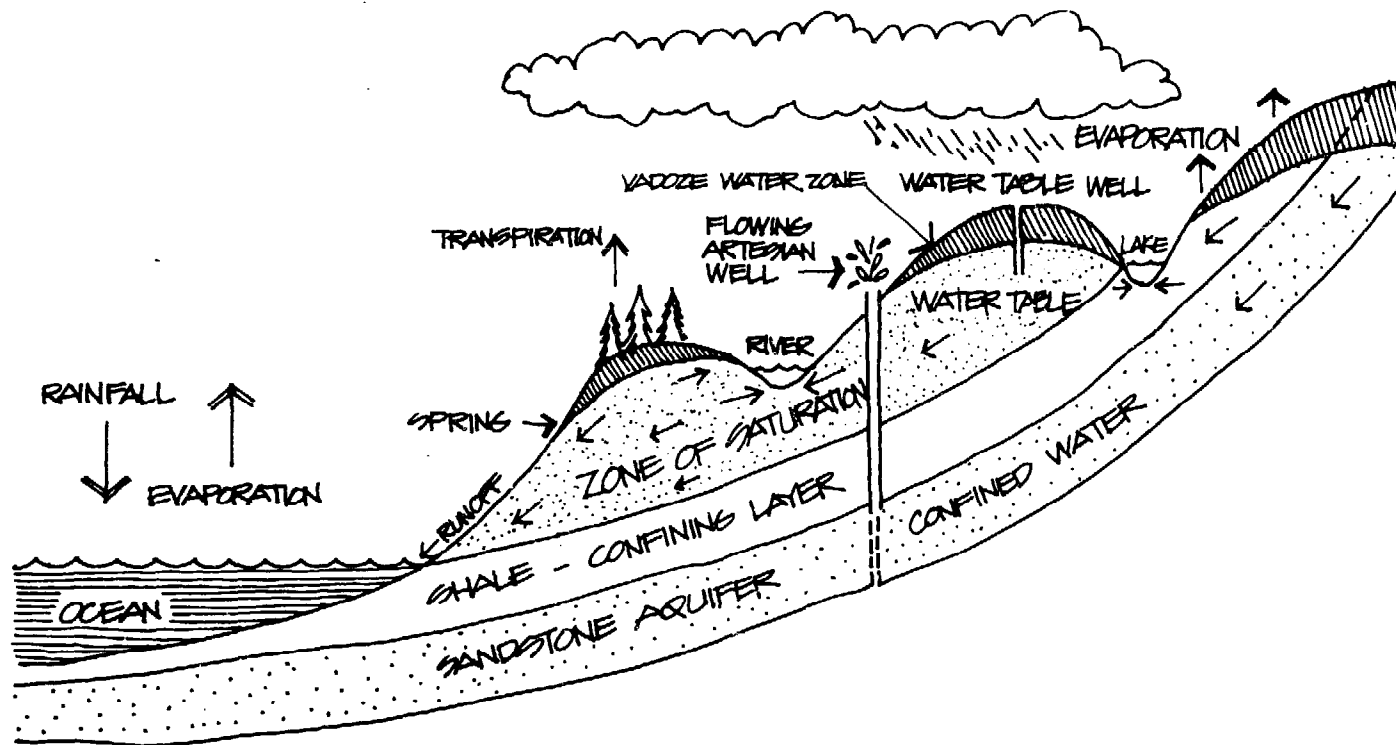

THE GROUND-WATER SYSTEM
 (WATER SUPPLY SOURCES)

MANHATTAN:

1.6 million people
22 square miles
42 inches of rain annually
Thus annual rainfall is 15.7¹⁰
billion gallons.

If indoor consumption is 70 gallons
per person per day (Milne 1977),
then annual consumption is 40.9
billion gallons.

Thus: rainfall equals 38% of
indoor needs.

LOS ANGELES:

2.5 million people
452 square miles
11.5 inches of rain annually
Thus annual rainfall is 88.5¹⁰
billion gallons

If indoor consumption is 70 gallons
per person per day (Milne 1977),
then annual consumption is 63.9
billion gallons.

Thus: rainfall equals 139% of
indoor needs.

Much of the water that hits the earth infiltrates into the ground where it is held in the shallow "root zone" for use by the plants. Water which infiltrates deeper into the ground, or "percolates", will ultimately enter underground reservoirs, the "aquifers". These aquifers may exist in large hollows below the surface or within layers of permeable rock. In either case, the water in aquifers is constantly moving toward streams, lakes, or oceans where the evaporation process occurs again (Sayre 1950).

Municipalities tap both precipitation and groundwater sources to provide water for the individual homeowner. Most often, water is collected from surface runoff, and transported great distances at great costs. What is often overlooked by homeowners is the fact that precipitation and groundwater are viable on-site sources of household water supply -- sources which only need to be recognized and developed to provide an alternative to dependence upon increasingly scarce and costly city-supplied water.

Rainwater as Residential Resource

It is ironic that homeowners do not think of rainfall as a viable source of water, when in fact it is their only source. Rainwater is considered instead a nuisance and is drained off our cities' impermeable roof and street surfaces and channeled away in special sewers before it has a chance to soak into the ground. The earth's 36 billion acres of land receive an average of 26.3 inches of rain each year. But Manhattan receives about 42 inches annually which equals about one third of the city's indoor residential consumption. Los Angeles receives only about 12 inches annually but it's larger area means that rainfall is almost 1-1/3 times residential consumption.

Rainwater, collected and used on-site, can reduce the demand on existing community water supplies by providing either an

alternative or a supplement to household water needs. For example, the earth's average annual rainfall collected from an 1800 sq.ft. roof could provide all of one person's indoor needs (only 1000 sq.ft. would be needed if toilets use recycled household greywater). In areas with greater or less precipitation, the collection or "catchment" area requirements change proportionately. An obvious advantage is that since the supply (precipitation) and demand (domestic use) for water occur on the same site, costs for transfer and delivery (including household utility hookup) are reduced.

American homeowners are becoming less confident of their water supply systems as industrial pollution, droughts, and increased demand take their toll. Yet because of their past sense of security, homeowners gave up the practice of storing water for shortages. Before city water supply systems became the rule, rainbarrels, cisterns, and wells were common sights outside American homes (as were waterless privies). In many foreign countries today, the inhabitants are still largely dependent upon rainwater collection for fresh water supplies.

In Hawaii and on other Pacific islands, rainwater collection has been in practice since long before westerners first arrived, and now rainwater cisterns are regaining attention as a "new" source of residential water (Fok 1979).

Fog is a more effective source of water in some parts of the world than rain, although specially designated 'fog catchers' are required for on-site collection (Ekern 1979).

It is ironic that while the Middle East must use revenue from oil exports to buy expensive technology to desalinate sea water, regions only slightly more abundant in rainfall enjoy free water by performing the ancient ritual of rainwater collection and storage. On Greek islands roofs and courtyards all slope to the center so rain drains into a

Example:

Earth's average rainfall = 26.3 inches

If roof area = 1800 sq.ft.

Rainfall collected = 30,000 gal.

Daily equivalent = 81 gal.

If 13% evaporates = 70 gal.

National average daily indoor consumption per person (Milne 1977) = 70 gal.

(Toilets consume about 45% of this)

The Flick-Reedy Corporation in Bensenville near Chicago needed more water. To have it piped from the mains (two miles away) would cost them \$0.75 per 1,000 gallons. So they built large rainwater lagoons into which stormwater from the whole plant was channeled. The cost came out the same, with a plus of soft water. One pool, 40 by 60 feet, served as a swimming pool and also a reservoir for fire-fighting. Two other pools were stocked with fish (Ionides 1977).

cistern buried below the house where the water stays cool and dark, free from plant and animal growth (Steadman 1975). The island of Hong Kong has an elaborate rain catching system to help serve the needs of its 4.2 million inhabitants. In times of water shortages, Hong Kong is one of many cities, including Calcutta and Mexico City, that pump water into the mains for only a few hours each day (Milne 1965). Therefore, every family has to use barrels and cisterns to store enough water until the mains are filled again. In San Francisco the brick outlines of the huge underground fire department cisterns are still visible in many streets.

Few people realize that large volumes of water are commonly stored in tanks or cisterns inside most tall buildings. Throughout the United States, virtually every building over 9 stories tall holds huge water storage tanks on the roof or in the upper level mechanical equipment rooms which pressurize the domestic plumbing system and store a 20 minute supply of water for fire-fighting standpipes and sprinkler systems. The reason is that the pressure in street level water mains averages about 50 psi, which cannot raise water much higher than 100 feet. High pressure pumps in the basements of highrise buildings maintain water level in the cisterns on the floors above.

In Adelaide, as in many Australian cities, rainwater is collected as a matter of course off the roof of virtually every house. The rain gutters run directly to a large prefabricated metal tank mounted on stilts or integrated into a porch roof or attic space. A single pipe or tube from the bottom of the tank leads to a tap at the kitchen sink, where it is used for drinking, cooking, and making tea. The piped-in city water is perfectly safe to drink, but people in Adelaide think the rainwater tastes better. Thus, Australians use rainwater in the same way as Americans use delivered bottled water, but of course the cost is much less. Maintenance on such systems is apparently quite

minimal. Silt is hosed out of the tank at the same time the gutters get their semi-annual cleaning. A little cooking oil is kept floating on the surface of the water to reduce evaporation and keep out insects.

Groundwater as a Residential Resource

Of course the most environmentally appropriate way to reuse rainwater may be simply to recharge the groundwater aquifer then pump it out later as needed. The critical issue is the nature of the underlying soil and its ability to safely receive and hold rainwater (discussed more fully in the chapter on Garden Uses).

The architectural design of the home and its surroundings can easily integrate groundwater recharge features: dry wells at the end of each downspout, lawns contoured to act as rainwater settling basins, driveways and patios designed to allow rainwater to filter into the soil slowly without causing erosion, and permeable ground coverings like gravel or wood chips used instead of concrete or asphalt.

The key is to leave intact as much of the site's natural drainage pattern as possible, and to minimize the velocity of the runoff so that surface erosion is reduced (Cahn 1976). To do this, minimize the amount of paved or impervious surfaces, keep slopes as flat and level as possible; don't funnel or collect large areas of runoff at one point. Contour drainage depressions to act as gentle natural swales and plant tough turf grass to help prevent erosion. This kind of design treatment is especially effective on the down-slope side of patios, driveways, and streets. It takes very little to make drainage swales and recharge basins a wonderful community amenity.

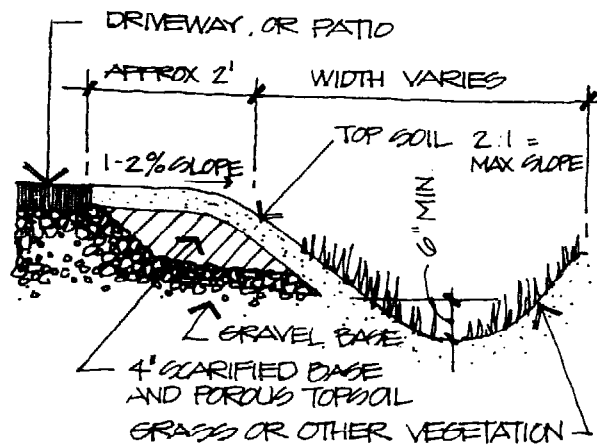

SHOULDER AND SWALE SECTION

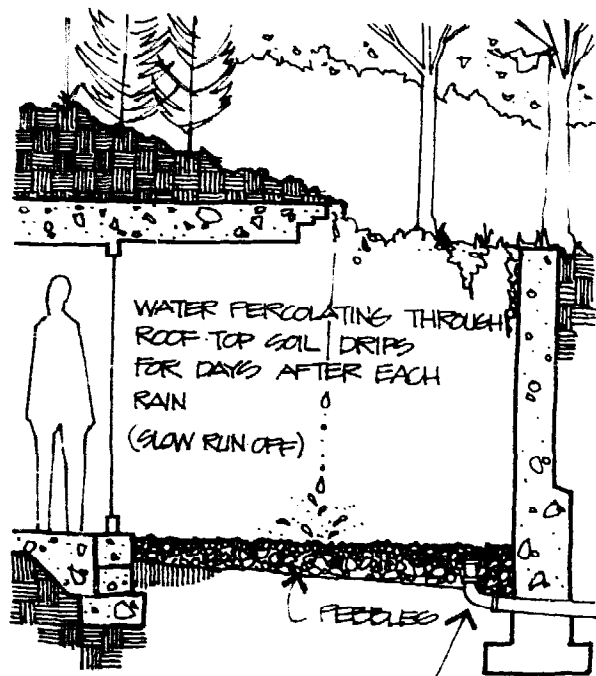

OVERFLOW DRAIN SET
JUST BELOW PEBBLE SURFACE
FORCES MAXIMUM PERCOLATION
INTO SOIL

EARTH COVERED
UNDERGROUND HOUSE

In the Village Homes project in Davis, California, the rainwater collection and recharge system which winds through the community is beautifully designed to resemble a dry stream bed using plant materials, rocks, rip-rap, and occasional dry sand 'ponds'. Of course these sandy bottom retention ponds are the kiddies most popular play areas during both dry and wet seasons. The builders calculate that it costs less to build this system than installing the pipes and pumps that would otherwise be required.

Underground buildings have potentially serious problems with rainwater percolation and high groundwater levels. Malcolm Wells, an architect who has designed many underground buildings, has developed a number of ingenious details to solve these problems. Most of the buildings he designs incorporate rainwater percolation beds and retention basins in the form of sunken gardens (Wells 1976).

DESIGNING RAINWATER COLLECTION SYSTEMS

A basic rainwater collection system built by the homeowner requires a surface which collects rainfall (catchment), channels it (gutters or downspouts), and stores it (tanks and cisterns). In addition, some form of pumping system will be necessary if water is not stored above the point of use and fed by gravity, or if it must be distributed to remote sites. If rainwater is used for human consumption, some type of treatment may be required (filtration or purification), which could range in complexity from a simple screen or sand filter to one of the modern chemical treatment systems.

Catchments

While much of the earth's surface absorbs water into the aquifer, impermeable formations such as rock and clay function as huge catchment areas. Most city surfaces are also virtually impermeable -- roofs, roads, and parking lots -- surfaces which can also perform the function of catching rainwater. Thus the homeowner can use the roof to do more than just keep the rain out, or the driveway to transport more than the family auto. The slope, permeability, and possibility for contamination of the catchment are the significant design variables of a collection system. Asphalt can be safely used as a lining for rainwater catchments, but deterioration may be a problem (Chinn 1965).

Roofs are the most common catchments. The advantage of course

Catchments
Gutters and Downspouts
Cisterns and Storage Tanks
Purification and Water Quality
Sizing Rainwater Systems
Rainwater Collection System Performance

The Systems chapter describes many projects which incorporate rainwater collection and reuse:

- Hawaiian Energy House
- Living Lightly Proposal
- Key Largo Proposal
- Malibu Self-Sufficient House Proposal
- McGill Eco House Proposal
- Cambridge Autonomous House Proposal
- Rainwater Roof
- Rainwater Room
- Patio Cistern

Each square foot of catchment area will provide:

Annual Rainfall (in inches)	Water Yield (in gallons)
10	4.7
15	7.0
20	9.4
25	11.7
30	14.1
35	16.4
40	18.7
45	21.1
50	23.4

Losses of 25% of the annual rainfall have been deducted.

is that most buildings come already equipped with a rainwater collection and delivery system. The elevation of the roof provides natural gravity flow so that water is transported into the cistern without additional energy input for pumping. In addition, water collected on the roof has less chance of being contaminated by contact with humans. However, other possible roof-top sources of contamination include air pollution, materials used in constructing the roof, debris from nearby vegetation, and bird droppings.

Flat Roofs: Flat roofs are ideal for collecting and even storing rainwater, but unless properly designed and maintained problems can occur, including leakage, overflow, collection of debris, clogging of the drainage system, and structural failure due to overload. In some areas, the collected, still body of water on rooftops is an ideal breeding ground for mosquitoes and other insects. Evaporation is also a problem where the water stands too long in the open on the roof.

Flat roofed buildings designed specifically for the collection of rainwater have fewer of these problems than if an existing building is retrofitted to hold water on the roof. Proper flashing and layering of roof materials will minimize leakage. Most areas which receive snow have sufficient structural load requirements already. Water weighs about 62.4 pounds per cubic foot, and so roofs designed with live loadings of 40 pounds per square foot would be able to safely hold about 8 inches of water. Overload problems are minimized with the installation of overflow drains and scuppers which allow for the buildup of water only to the calculated depth.

Pitched Roofs: In general, the best system for collecting rainwater is a pitched roof with a gutter leading to an enclosed cistern. The smoother, more impermeable, and cleaner the roof surface, the better the collection and quality of

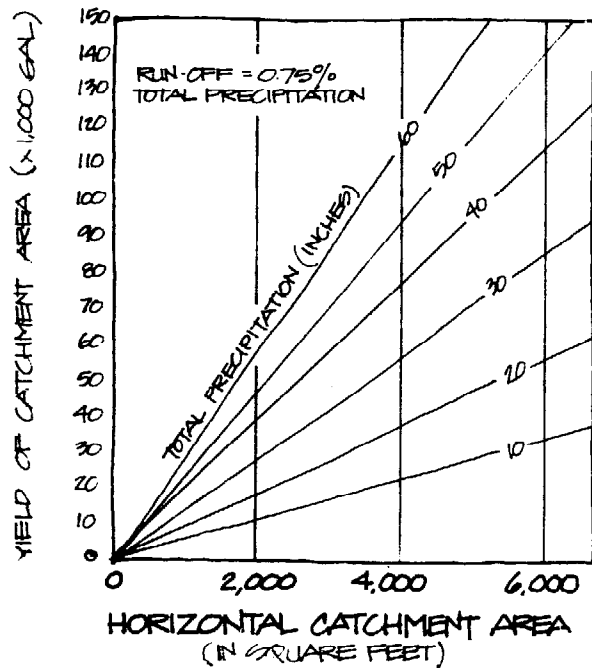

DETERMINE THE NUMBER OF INCHES OF RAINFALL PER YEAR (LOSSES HAVE ALREADY BEEN DEDUCTED) AND THE CATCHMENT AREA FOR THE TOTAL YIELD AVAILABLE. (EPA)

the water. However, certain roof surfaces can contribute to the contamination of water. Thatch or other rough surfaced roofing materials tend to collect dust and other debris; asbestos shingles, chemically treated wooden shingles, and lead roofs can release toxic substances into the collected water (Steadman 1975).

Losses: Yield will vary with the size and surface texture of the catchment area. Losses from smooth concrete or asphalt-covered ground catchments average less than 10 percent; for shingled roofs or tar and gravel surfaces losses probably will not exceed 15 percent; and for sloped sheet metal roofs the loss is negligible (EPA 1973). A reasonable rule of thumb for the design of a rainwater collection system is that 75 percent of the total annual rainfall can be recovered for storage and future use. This will allow for water loss due to evaporation and inefficiency in the collection process.

Driveways and patios are potential collection surfaces, however their adaptation for rainwater collection presents some problems. Materials used in some impermeable driveway and patio surfaces are a potential source of contamination. Concrete driveways and patios are more inert than asphalt and will reduce the problems of leachate (tar, etc.). Automobile "droppings" (dirt, grease, oil, detergents from washing, decomposition of rubber tires, etc.) also affect the quality of collectable water, as will runoff from lawn water containing chemicals or fertilizer. The seriousness of contamination from these and other sources depends upon the various ways the household uses its driveway or patio, how well an automobile is maintained, the quality of adjacent water runoff, the presence of animals, etc., and of course the use for which the water is intended.

Driveways and patios also have to be equipped with routing or delivery systems (gutters) to channel the rainwater runoff to a collection point. If the driveway or patio is sloped away from the storage point, some form of pump must be installed to bring the water back to the storage area.

Gutters and Downspouts

The size of gutters or downspouts is determined by the amount and intensity of rainfall per hour in the worst storm. An annoying task for the homeowner is cleaning the gutter of debris periodically to avoid clogging and overflow, but this must be done even if the rainwater is discarded. A slight slope of the collection troughs towards the downspout will reduce pooling.

Metal gutters may contribute to the contamination of the rainwater by supplying heavy metal ions to the runoff as it passes through. This problem can be reduced by painting the surface of the gutter with a non-toxic, waterproof paint. Lead or lead painted gutters should never be used for potable water systems.

Diameter of Downspout (inches)*	Maximum Projected Roof Area (Square Feet)
2	720
2-1/2	1300
3	2200
4	4600
5	8650
6	13500
8	29000

* The equivalent diameter of square or rectangular downspout may be taken as the diameter of that circle which may be inscribed within the cross-sectional area of the downspout (McGuinness 1971).

Cisterns and Storage Tanks

Where natural storage basins do not exist, rainwater has traditionally been collected in pots, troughs, hollow tree trunks, barrels, wooden tanks, and clay or concrete cisterns -- anything clean which will hold water for immediate or future use. A bucket or plastic waste basket can collect small quantities for drinking, hair washing, and other "soft water" uses. However, to meet long term household needs a larger tank is required (many are described in the Components Chapter). (The Systems Chapter also describes many ingenious cistern designs.)

Cistern Location: Ideally the cistern should be located as close as possible to both the supply and demand points, either inside or outside the building, above or below ground.

Cisterns placed below ground will have the advantage of insulation by the surrounding earth, with less chance of freezing and cracking in cold climates and greater chance of keeping the water cool in warm climates (an important factor in water purity). In addition, the cistern can be out of sight or easily disguised with landscaping. Subterranean cisterns should be located on the highest ground available with the surrounding earth contoured so that surface water drains away to minimize contamination. Seepage from groundwater tables may also contaminate the stored water. The cistern should be placed uphill from, and not within fifty feet of, any sewage disposal system (EPA 1973).

Construction costs are another variable in cistern location. The added structural costs of installing a cistern on the inside of a building should be weighed against locating the cistern outside, either above or below ground. The size of an indoor storage unit is limited by the amount of space which can be economically devoted to water storage, and its load on the structural system. Most residential buildings are not constructed to support several tons of water, and do not have the space required to hold an adequate supply. Exceptions are those houses which have adequate space in a basement or crawl space under the house where weight will not be a problem (some of the rainwater collection systems described in the Systems Chapter utilize such a design).

Another consideration in cistern design is how the stored water will have to be delivered to the point of use. It may be desirable to install a pump and pressure switch to automatically supply the cistern water supply to the household's pressurized system, or to adapt the cistern to supply

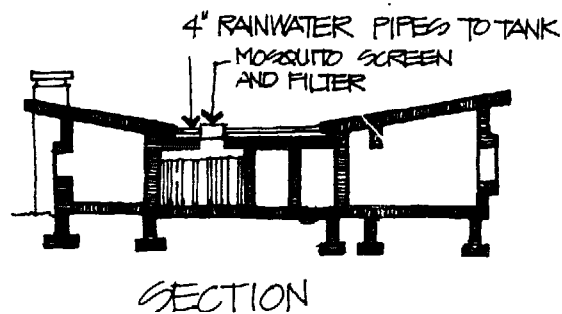
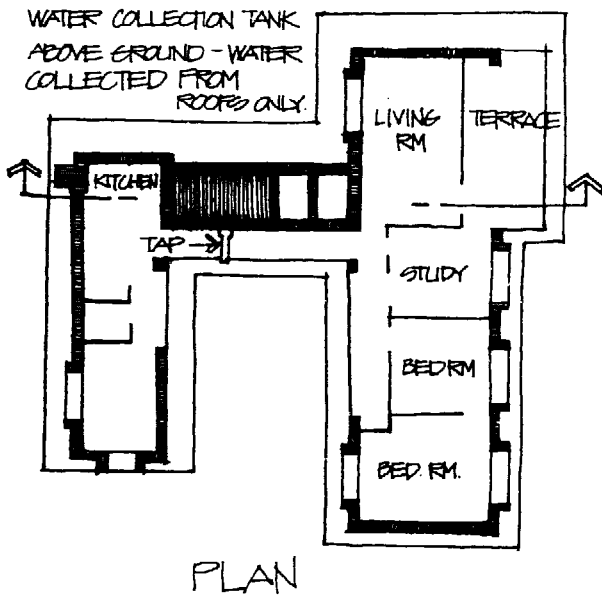

Water pressure increases about 1/2 psi per foot of head, which is the vertical height from the point of use up to the surface of water in the cistern.

Friction losses in pipes and valves will reduce this value.

supply an irrigation system through pipe connections and gravity flow (see the Components Chapter and the Systems Chapter). The gravity flow system created by an elevated cistern (either inside or outside) may not provide enough water pressure to run appliances (washers, toilets, shower heads, etc.). For example, toilet ballcock valves require at least 5 psi, which means that the bottom of the cistern must be at least 10 feet higher than the toilet tank.

Purification and Water Quality

If the rainwater is to be used indoors, some form of filtration or purification system is required to remove debris and other contaminants. Sand filters built into or adjacent to the cistern prove quite successful (see Components Chapter).

The water quality of rain will depend upon the atmospheric conditions of the area, the material found in and on the collection and delivery surfaces, and the cleanliness of the cistern.

Rainwater has virtually no bacterial content before it touches the earth's surface. In urban areas, however, rainwater can react with air pollution to form "acid rain". Acid rain is the product of sulfur dioxide (SO_2) reacting with atmospheric constituents and resulting in sulfur trioxide, sulfate and sulfuric acid, all of which can affect the color, odor, and taste of the water, as well as react unfavorably with certain crops (People and Energy). Rainwater should be tested for quality to determine the extent of purification necessary due to these pollutants if human consumption or irrigation is the end use.

Any surface runoff requires some form of filtration or purification, the degree of which will depend on the expected

use of the water. Rainwater used to flush the toilet requires only a simple screen filter, but the purification process for rainwater used for human consumption must remove biological or disease carrying contaminants, air-polluting chemicals, and suspended solids.

The purification process can be divided into four basic, usually sequential, stages. These are: screening, settling, filtration, and sterilization.

Screening: In the preliminary cleaning stage a series of screens with increasingly finer gauge can be used to remove large particles and debris found on the collection surface. The screens can be located together or placed at various points in the collection system. For example, 1/4 inch hardware cloth placed along the gutter or at the intersection of the downspout and gutter prevents large particles (or bird and squirrel nestings) from clogging the system. The next screen(s) could be placed above the settling tank or cistern. Screens will have to be periodically cleaned to ensure the efficient functioning of the collection system and prevent overflow.

Two ingenious components used to keep gutters from clogging and to filter out large debris particles are the roof washer and the Hawaiian Energy House prefilter. The roof washer, besides screening debris, also diverts initial runoff which is usually the most contaminated. It should hold about 10 gallons for each 1,000 sq.ft. of catchment area. Initial water is trapped in a small tank (i.e., trash can) and screened over a trough which filters large particles. The initial, contaminated water settles to the bottom of the tank while the less contaminated, subsequent runoff overflows at the top of the tank directly into a sand filter or cistern. (The Hawaiian Energy House prefilter is discussed in the Systems Chapter.)

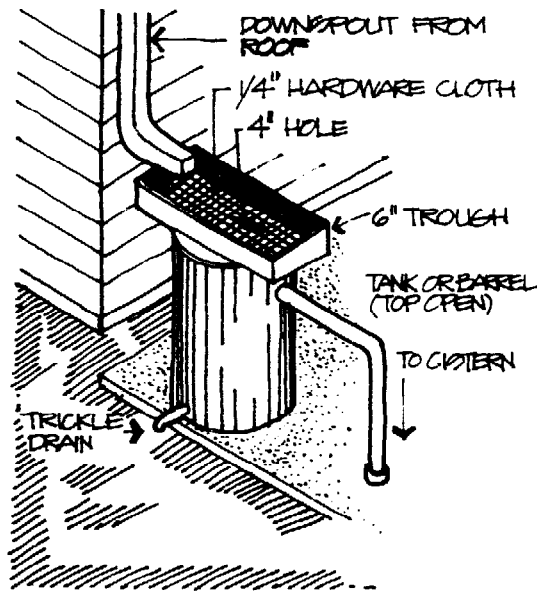

ROOFWASHER
(MIDWEST PLAN SERVICE, 1968)

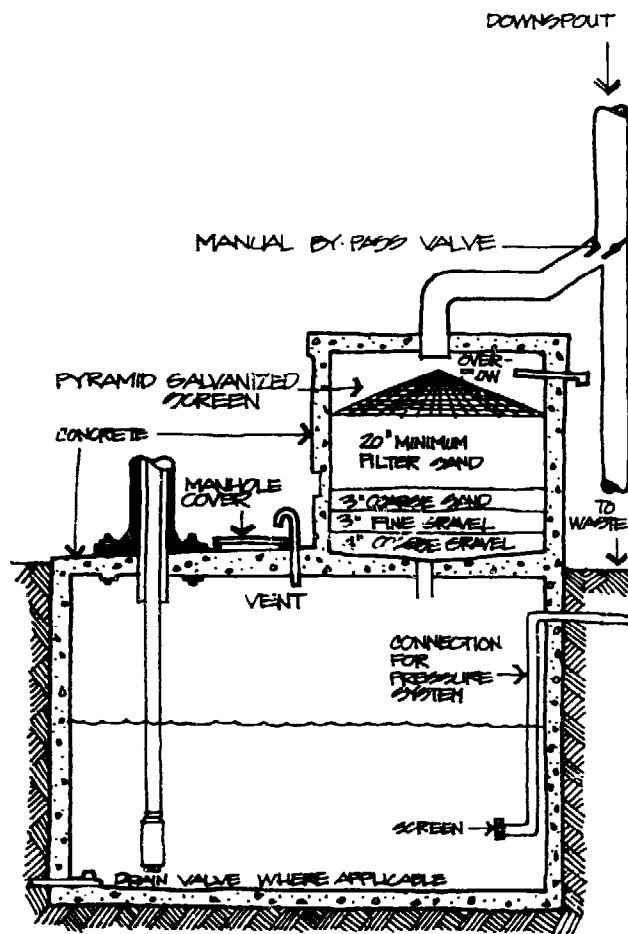

CISTERN WITH SAND FILTER

Settling: The second stage in water purification is settling or sedimentation, which removes the gross turbidity (cloudiness) of the water and aids in the reduction of bacteria. The efficiency of the sedimentation process depends upon the type and size of the materials suspended in the water, the water temperature, and the time allowed for settling.

Sedimentation can take place in a special temporary storage tank or in the cistern. Before being used water must be allowed to remain still after it has been added to the cistern. To accelerate the settling process, very small suspended particles can be coagulated by introducing small quantities of alum (aluminum sulfate). Settling tanks are used for sedimentation where water does not have time to settle before use (after a rain) or where household greywater is simultaneously introduced (see Components Chapter). The sediment must of course eventually be cleaned from all the places where water is allowed to stand.

Filtration: The third stage of purification involves filtration, the percolation of water through a filtering medium. Either gravity or pressure systems move the water through the filter. Rainwater collection systems can use a slow sand filter, mixed media sand filter, pressure vessel filter, ceramic filters, or solar still, all of which are described in the Components Chapter. The choice of filter and any additional components (i.e. overflow valve) depends upon the frequency and intensity of storms, the extent of contamination, the end use of the water, whether or not a pumping system is used, and whether or not greywater is simultaneously recycled.

One of the most economical and efficient filters for rainwater collection is the slow sand filter. On a large scale, they are used by many municipalities to filter water for

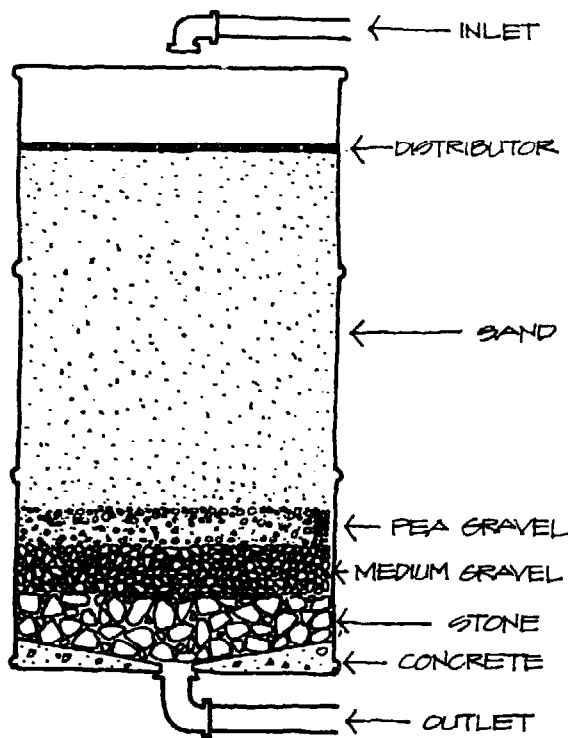

TO MAKE A DISTRIBUTOR, CUT THE TOP OF THE DRUM SO THAT IT FITS DOWN INSIDE THE DRUM. DRILL 1/2 INCH HOLES IN IT SPACED 1 INCH APART. COAT THE TOP WITH EPOXY TO PROTECT IT FROM CORROSION.

SLOW SAND FILTER
MADE FROM A 55-GALLON DRUM

general consumption, however on a small residential scale, water run through a slow sand filter, if used for human consumption, will require additional purification. Since the slow sand filter depends on the healthy growth of a layer of organic material (schmutzdecke) to break down pathogenic organisms, a regular dosing of the top layer of sand must be ensured to prevent dehydration. Since precipitation is most often sporadic, this may pose a problem.

The size of a slow sand filter will determine its ability for handling storm conditions which create a fast flow rate. To determine the size of slow sand filter needed for a storm situation, consult the Weather Bureau's rainfall records for an "average" worst storm. Calculate the number of inches of rain which fell in a representative time period (24 hours or less). Assume 6 gallons per hour per square foot of filter surface. It can be shown that 1 inch of rain over 1,000 sq.ft. of catchment equals 623 gallons. Thus, the following equation gives the size of filter needed:

$$C \times \frac{R}{T} \times \frac{1}{6} \times \frac{623}{1000} = S$$

where C = catchment area in sq.ft.
R = inches rainfall in T time
T = time lapsed in hours
S = sq.ft. filter surface area required

For example the record rainfall in Los Angeles is 6.11 inches in 24 hours which means that a 1000 sq.ft. catchment area would require about 27 sq.ft. of slow sand filter. A smaller filter would mean that in heavy rainfalls some water would overflow and be lost.

Each of the filters described in the Components Chapter has different flow rates and different abilities to purify water for human consumption.

Meteorological Data Normals, Means, And Extremes

Station: LOS ANGELES, CALIFORNIA
93134

CIVIC CENTER

Month	Precipitation in inches										
	Water equivalent						Snow, ice pellets				
	Normal	Maximum monthly	Year	Minimum monthly	Year	Maximum in 24 hrs.	Year	Maximum monthly	Year	Maximum in 24 hrs.	Year
(a)		38		38		38		38		38	
JAN	3.00	14.94	1969	0.00	1975	6.11	1956	0.3	1949	0.3	1949
FEB	2.77	12.42	1941	T	1964	4.02	1944	T	1951	T	1951
MAR	2.10	8.14	1941	0.00	1959	3.61	1943	0.0		0.0	
APR	1.27	6.02	1965	0.00	1977	2.05	1956	0.0		0.0	
MAY	0.13	3.03	1977	0.00	1978	2.41	1977	0.0		0.0	
JUN	0.03	0.32	1964	0.00	1978	0.32	1964	0.0		0.0	
JUL	0.00	0.03	1969	0.00	1978	0.03	1969	0.0		0.0	
AUG	0.04	2.25	1977	0.00	1978	2.22	1977	0.0		0.0	
SEP	0.17	2.82	1976	0.00	1977	1.83	1976	0.0		0.0	
OCT	0.27	1.83	1941	0.00	1977	0.82	1941	0.0		0.0	
NOV	0.02	6.40	1965	0.00	1979	4.07	1970	0.0		0.0	
DEC	2.16	6.57	1971	T	1963	3.92	1965	T	1947	T	1947
VR	14.05	14.94	JAN 1969	0.00	AUG 1978	6.11	JAN 1956	0.3	JAN 1949	0.3	JAN 1949

U.S. DEPARTMENT OF COMMERCE
NATIONAL CLIMATIC CENTER
FEDERAL BUILDING
ASHEVILLE, N.C. 28801

Sale Price: 20 cents per copy.

(a) Length of record, years, through the current year unless otherwise noted, based on January data.
(b) 70" and above at Alaskan stations.
° Less than one half.
T Trace.

Local Climatological Data Annual Summaries are available for 20 cents from local weather bureau or from National Climate Center, Asheville, N.C. 28801.

Sterilization: An alternative to, or an additional step in filtration is sterilization, or the disinfection of water. This process can ensure that the water is safe for human consumption. Boiling water or adding chemicals (chlorine or iodine) are two common methods of disinfecting water. Boiling water for human consumption means simply that a small amount of water will be heated to a rolling boil for five to 30 minutes (depending upon the water source and potential for disease). The process of chlorinating or iodinating water, and equipment which performs this semi-automatically are described in the Components Chapter.

Distillation can be used to purify water of contaminants that are not transportable as aerosols. Water is heated until it vaporizes into its gaseous form, then is cooled until it condenses again into its liquid form leaving behind all non-volatile components. The 'flat' taste of distilled water can be eliminated by trickling it over marble chips. Simple solar stills are an energy-efficient and inexpensive way to distill water (solar stills are described in the Components Chapter).

Sizing Rainwater Systems

Unfortunately rainfall is not distributed evenly over the earth's surface. At any location the distribution is usually uneven throughout the year; in some places the wet season occurs in the winter and in others it comes in summer. Thus the balance between rainfall (the supply) and residential usage (the demand) fluctuates from month-to-month and year-to-year. It is the points of minimum supply and maximum demand which determine the design of a rainwater collection and storage system.

To establish normal available supply for your particular area,

get a Local Climatological Data Summary sheet from your local weather bureau. It gives both average annual rainfall and monthly average rainfall (in some areas, such as desert areas, even weekly average amounts). If an exposed storage area is used (such as a pond or flat roof), annual or monthly evaporation and transpiration rates should be determined and deducted. These figures may also be obtained from the U.S. Weather Bureau, county forestry offices, or soil conservation agencies. Predictions based on recent records may vary greatly, so longer historical records are more reliable in determining means and deviations.

Regardless of the volume of storage, the average annual precipitation represents the upper limit to the long-term yield of the collection system. Generally, demand will determine the needed volume of storage: as demand increases, storage capacity must also increase. When calculating rainfall collection amounts, a good rule of thumb is that 1 inch rainfall over 1000 sq.ft. of catchment area = 623 gallons. From this figure deduct 10 percent or more for loss due to evaporation and spillage, although this figure is highly dependent upon details of the system's design.

Consult past water bills to determine your home's maximum and minimum demand in gallons per month, for the entire year. Indoor uses generally remain consistent, while outdoor uses are higher during hot dry months and lower or zero during cold wet months. Assume a maximum monthly demand will persist throughout the year for a minimum percentage yield, then assume a minimum monthly demand will persist for a maximum percentage of yield (R. L. Valentine, et.al., 1977). Other factors which should be taken into consideration when designing a system's capacity are the size of gutters and pipes carrying the rainfall runoff, the permeability of the catchment surface, and the extent of spillage from other sources (i.e., slope).

Diameter of Semi- circular Gutter*	Maximum Projected Roof Area for Gutters of Various Slopes	
	1/8 inch slope	1/4 inch slope
Inches	sq.ft.	sq.ft.
3	240	340
4	510	720
5	880	1250
6	1360	1920
7	1950	2760
8	2800	3980
10	5100	7200

* Gutters other than semicircular may be used provided they have an equivalent cross-sectional area (McGuinness 1971).

Rainwater Collection System Performance

The most straightforward way to understand the interaction of the various elements in a rainwater system is to figure out the month-by-month performance as in the worked example below.

This example assumes a climate with about 3-1/2 inches of rain per month. Daily per-capita consumption is assumed at 30 gallons, which is below the national average, but is not difficult to achieve in a household equipped with water-conserving appliances or if greywater is used for toilet flushing.

Notice that this rainwater system supplies 91 percent of total demand. On the average year the 1954 gallon deficit could be eliminated if the 2000 gallon cistern had been enlarged to at least 3954 gallons. On half of the years which are wetter than average there would be a much smaller deficit, or perhaps no deficit at all. On dry years the cistern would need to be larger still. The deficit will still remain, not because the cistern is too small, but instead because net rainfall is below total demand. From this example it can be seen that there is a good deal of art involved in the design of rainwater collection systems.

Example: Rainwater Collection System Performance

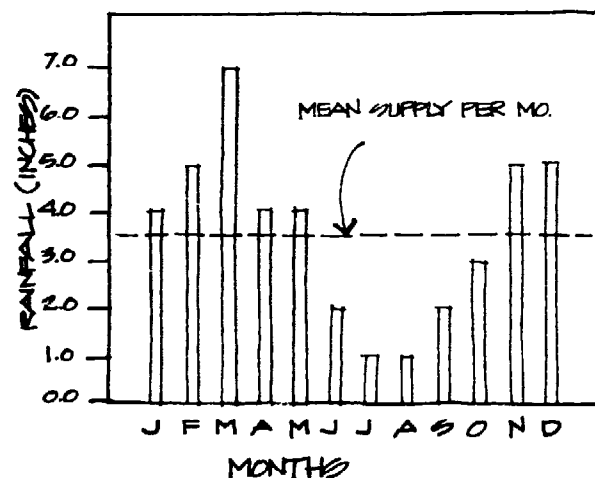

AVE. ANNUAL RAINFALL

Month	Inches of Rain	Net Rainfall in Gallons	Monthly Demand	Net Change in Storage	In Storage from Prior Month	Lost to Overflow	Deficit (from other sources)
Jan.	4.0	2243	1800	0	2000	443	0
Feb.	5.0	2804	1800	0	2000	1004	0
Mar.	7.0	3925	1800	0	2000	2125	0
April	4.0	2243	1800	0	2000	443	0
May	4.0	2243	1800	0	2000	443	0
June	2.0	1121	1800	-679	1321	0	0
July	1.0	561	1800	-1239	82	0	0
Aug.	1.0	561	1800	-82	0	0	-1157
Sept.	2.0	1121	1800	0	0	0	-679
Oct.	3.0	1682	1800	0	0	0	-118
Nov.	5.0	2804	1800	+1004	0	0	0
Dec.	5.0	2804	1800	+996	1004	+8	0
Annual	43.0	24,110	21,600			4466	1954

Assumes 2000 gallon cistern, 1000 square foot catchment, 10% evaporation loss, 30 gallons/day demand for 2 people for 30 days/month.

WELLS

The easiest way to re-use collected rainwater is to pump it from the ground. Compared to tiny man-made cisterns, catchments, and filters, nature's design is truly impressive. The entire surface of the earth acts as the catchment, the soil mantle is the best imaginable filtering matrix, and natural storage formations within the ground offer virtually limitless capacity.

Under a surprising number of homes the water table is within easy reach. While not all homeowners are legally entitled to the groundwater beneath their residences many do have water rights and are simply not aware of it.

Most rainwater which is not carried away in drainage systems is absorbed by the surface soil. Once under ground, water moves freely by gravity in the "zone of saturation" where all openings in the rock or soil are filled with water, the upper limit of which is called the "water table" or "ground water level." The zone of saturation changes with stratum contours (not always the same as surface contours). It may be close to the surface or several hundred feet underneath, and may rise or fall, depending upon precipitation. Groundwater collected in mountains and hills moves constantly to lower elevations where it may surface in springs, streams, or lakes.

Groundwater aquifers are classified as either water table or artesian aquifers. An artesian aquifer is one which is

Quality of Groundwater
Percolation Beds
Well Construction
Well Location
Well Yield
Methods of Well Construction
Sanitary Protection of Wells
Well Development
Well Pumps
Selecting a Well-Driller

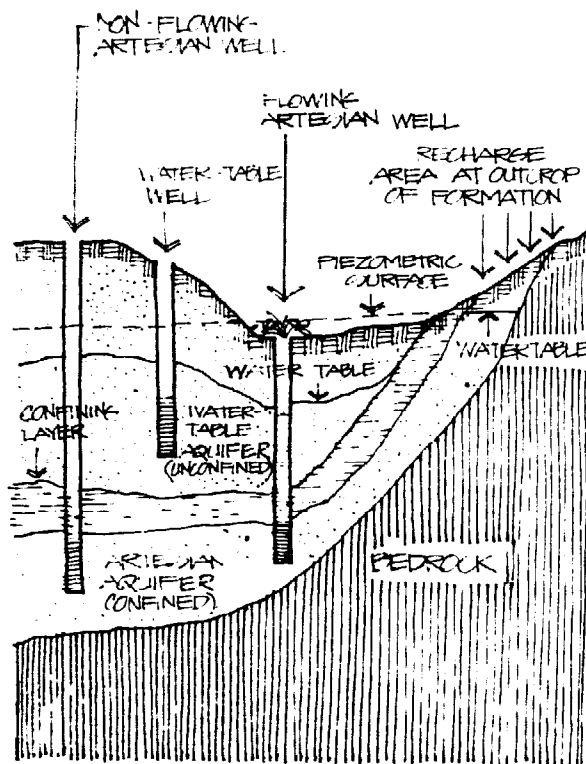

TYPES OF AQUIFERS

confined by an overlying, impermeable layer which is at an elevation lower than the piezometric surface (the imaginary surface to which water will rise in a well). Because the pressure in an artesian aquifer is greater than atmospheric pressure, a break in the earth's surface will yield flowing water at the surface, called an artesian spring or well. Where the water table aquifer is not confined by an upper impermeable layer, it is only under normal atmospheric pressure. The groundwater level represents the highest level to which water will rise in a well sunk in this type of aquifer.

In many residential areas, the water table remains untapped in spite of favorable costs and ease of access. Where ponds or springs exist, water may be diverted, collected, and purified in the same storage and purification system used for rainwater (although there are usually more impurities in pondwater than in rainwater). Where a water table is within easy access, a well may be an extremely attractive alternative to rainwater collection and above-ground storage, or to imported water.

Quality of Groundwater

The movement of water through as little as four feet of aerated ground purifies it by removing suspended particles and micro-organisms. (This process is discussed in detail in the chapter on Garden Uses.)

Groundwater may also contain high concentrations of minerals, especially in arid regions, or where the aquifer is deep beneath the earth's surface. Such substances affect the taste and odor of groundwater although some people prefer the taste of water which has higher mineral content.

A chemical analysis of groundwater should be made before and periodically during use. The two most important considerations in reducing contamination are the distance of the well from the source of contamination and the direction of groundwater movement. Many factors influence the determination of a safe distance from a source of contamination including the nature of the contaminant, the depth of disposal of contaminants, the limited filtration caused by consolidated formations, the volume of contaminants, and concentration of contamination sources. Excreta and toxic chemicals are the most potent, but water soluble chemicals may travel greater distances because they are not filtered out naturally. As a rule of thumb, 50 to 200 feet is usually recommended as an adequate distance, but the shorter separation applies only to deep wells in heavy less-porous soils.

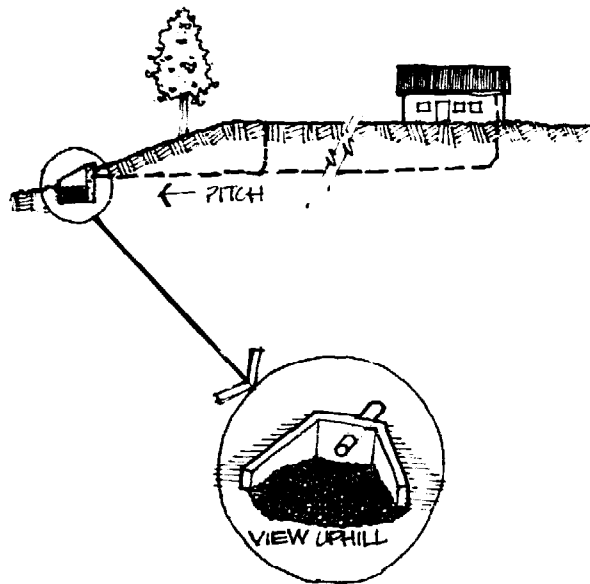

PERCOLATION BED

Proper design, construction, and installation of the well will reduce the possibility of contamination, as will adequate filtration and purification of the well water.

Percolation Beds

Rainwater from roof gutters is usually discharged into a city storm sewer. Instead much of this water can be made available for reuse by diverting it so that it percolates into the ground if the soil is sufficiently permeable and if the terrain is relatively flat. Rainwater recharge is not recommended on sloped land, or where there is any possibility of earth movement, or where there is dense, impervious, or expansive clay.

The simplest way for rainwater to recharge the aquifer without eroding the topsoil is to lead roof downspouts to a splash pan or a dry well made from a large gravel-filled

Although it rains only a few inches a year in the Negev Desert, rain-water catchments and percolation beds once made agriculture possible. Long ridges carved out in V-shaped patterns up the gently sloping desert hills made it possible to grow a single fruit tree in a shallow depression at the bottom of each catchment.

pipe (McGuinness 1974). If the ground is insufficiently permeable (i.e. clay), a percolation bed may be constructed to provide a permeable basin where water is stored until there is sufficient time for it to be naturally absorbed.

The best household percolation bed is a garden or lawn. But if the absorption rate is too slow so that surface runoff occurs, a trench or basin filled with gravel may be required. A percolation bed may be constructed almost anywhere and in any shape: for example, a horizontal trench alongside a driveway, a circular trench around an orchard, or a decorative square or round basin in the center of a yard. A layer of topsoil and landscaping may be planted on the surface, provided that the slope of the ground or intensity of rainfall will not cause erosion. Clay pipes can serve to distribute rainwater to or alongside a percolation bed, and if flow is not too great, can percolate water themselves.

Well Construction

The construction of wells is an ancient and wide-spread form of rainwater collection. Before the advent of modern drilling equipment, all wells were dug or driven by hand. Wells are the preferred water supply system for rural areas for, unlike surface rainwater cisterns, they usually provide a year-round unlimited supply of water. In many places in the country it is still feasible for a homeowner to construct a well, at a cost which is often comparable to or even less than that of city supplied water.

In the United States, in 1962, there were approximately 14,185,000 domestic water wells in use, 8,831,000, or over half of which were non-farm wells (U.S. Bureau of the Census 1976). Compared to other groundwater supply systems wells are usually less subject to contamination and provide a

generally unlimited supply of water for a constant price.

Factors which influence the type and feasibility (both physical and economical) of well development are: legal restrictions on water rights, the proximity and yield of an aquifer, and the geologic composition of the stratum in which the well is to be located.

Many cities now have restrictions on water rights which prohibit private development of what is considered to be a commonly owned natural resource. Indeed, residents of Chesapeake Bay have long been fighting legal battles for the right to continue to use their existing domestic wells. Governmental restrictions usually prohibit development of wells except in areas which have no other water supply. Before incurring cost to determine well feasibility, a thorough investigation of water rights restrictions in the proposed area should be made by consulting the local water department, local well-drilling firms, and state and local government agencies.

Well Location

Groundwater is present almost everywhere, but locating an aquifer suitable for well development is not a simple task of water witching (U.S. Department of the Interior 1966). Water must be found reasonably close to the surface, in sufficient quantity, and of good quality. While locating large-scale well development requires scientific expertise, most domestic well locations can be determined by the lay person through careful analysis and common sense.

The easiest approach is to establish the location and depth of all the neighboring wells. But the easiest method is not always the most reliable.

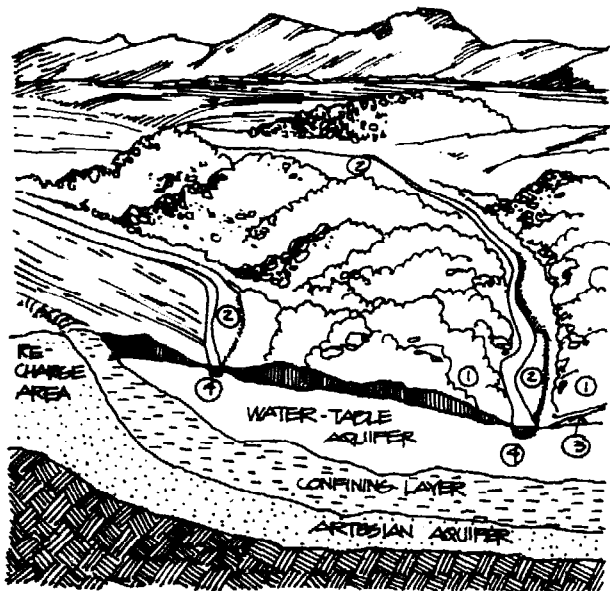

SURFACE EVIDENCE OF GROUNDWATER OCCURRENCE

- ① DENSE VEGETATION INDICATING SHALLOW WATER TABLE & PROXIMITY TO SURFACE STREAM.
- ② RIVER FLAINS: POSSIBLE SITES FOR WELLS IN WATER-TABLE AQUIFER.
- ③ FLOWING SPRING WHERE GROUNDWATER CUTCROPS. SPRINGS MAY ALSO BE FOUND AT THE FOOT OF HILLS AND RIVER BANKS.
- ④ RIVER BEDS CUT INTO WATER-BEARING SAND FORMATION. INDICATE POSSIBILITY OF RIVER BANKS AS GOOD WELL SITES. (DEPT. OF STATE)

The next step in determining well feasibility and location is to survey the available geologic data, well logs (data submitted to local government agencies on each well developed), and surface evidence of groundwater location (Department of State, Agency for International Development, 1969).

Geologic Data: Geologic data is provided by geologic maps, cross sections, and aerial photographs. Geologic maps provide information on rock formations and fault and contour lines which may indicate the location and extent of an aquifer. Geologic cross-sections show the character of underlying stratum and the depth and thickness of the aquifer if it is known. Aerial photographs display surface features such as erosion, vegetation, drainage patterns, and alluvial plains which indicate subsurface water distribution. This information may be obtained from government geologic surveys, universities, libraries, or private engineering firms.

Well Logs: Well logs are perhaps the most valuable of all geologic tools in determining location, depth, and yield of a potential well. Well logs record complete descriptions of rock formations penetrated, water level variations, yields, type of well construction, and water quality. Logs for wells located near the proposed site are most pertinent, and may be obtained from local government agencies, well owners, and well developers.

Surface Indications: Surface indications of groundwater include the presence of deep rooted water-loving vegetation, streams, springs, lake patterns, seeps and swamps. These can be determined by making a surface survey on foot. Valleys are usually sites of large quantities of groundwater, especially those filled with eroded wastes or porous alluvial material (the same is true of coastal and river plains). While the existence of any of these signs does not in itself mean an abundant supply of water, when combined with other

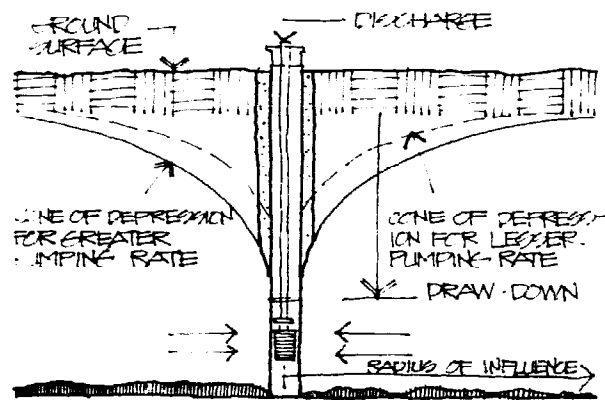

EFFECT OF PUMPING ON CONE OF DEPRESSION

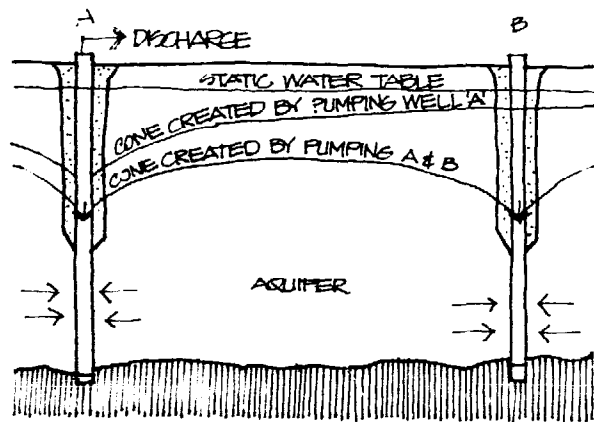

EFFECT OF OVERLAPPING FIELDS OF INFLUENCE PUMPED WELLS

geologic data and well log information, a good idea of the existence and depth of an aquifer may be obtained (Department of State, Agency for International Development, 1969).

Well Yield

The yield of a water well will depend upon the permeability and thickness of the aquifer, the number of wells using the aquifer, seasonal variations (which have more effect on water table aquifers than artesian aquifers), the depth to which a well is sunk into an aquifer, the diameter of the well, and pumping capacities.

Drawdown: When water is being pumped from the aquifer through a well, the water table level will be lowered in the vicinity of the well. If no impermeable strata exists near the well and the aquifer is of even permeability, the resulting lowering of the water (called drawdown) will result in an inverted "cone of depression". The size of the cone of depression is affected by the pumping rate, the permeability of the aquifer, and the existence of nearby wells. Where the slope of the cone of depression meets the upper limit of the water table (static water table), the radius of influence occurs. The greater the drawdown, the greater the pumping costs, for additional pumping lifts are required, so that the extent of drawdown will have a direct bearing on well yield. Well yield, therefore, is described as gallons per minute per foot of draw-down (gpm/ft) (EPA).

Size: Increasing the depth of a well (if feasible) will have more effect on its yield than will increasing the diameter of the well. Most domestic well casings are from 2 to 6 inches inside diameter with 4 inches being the average. The well casing diameter is sized according to the pumping depth and rate required. Also affecting the yield is the type of well

point inlet and size of inlet area exposed to the aquifer; slot types are cheaper with less yield than screened types, which cost more and yield more (Department of State, Agency for International Development, 1969).

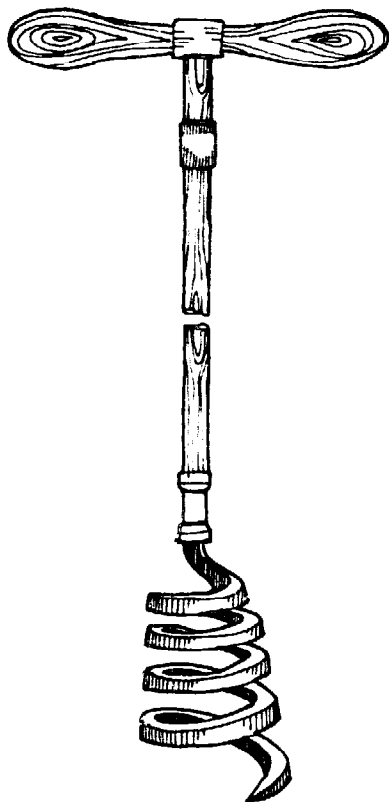

SPIRAL AUGER

Methods of Well Construction

There are five common methods of well construction: dug wells, bored wells, driven wells, jetted wells, and drilled wells. The first three can be done "by hand", if the well depth is less than 50 feet, using a minimum of materials and a lot of physical exertion. Jetted and drilled wells require more equipment, hence greater cost and expertise, although they can be developed to much greater depths (which usually requires hiring a well drilling team). The methods of developing wells "by hand" are discussed here, however, since well development requirements vary greatly with geologic conditions it is suggested that the homeowner who intends to construct any but the simplest of wells consult the manuals listed in the bibliography, any of which adequately describe all aspects of well development for the layman.

Dug Wells: Dug wells are excavated by hand and usually cannot extend more than a few feet below the static water table. Due to the dangers inherent in digging any size well, it is recommended that this type of well be developed only under the safest possible conditions under the supervision of a well expert. Dug wells are lined with concrete pipe, stone, concrete, brick, or other inert materials, either as the well is dug (if formation is unconsolidated) or after (if the well is shallow and the formation consolidated). However, some form of shoring must be used to prevent caving while digging. Power operated tools may be used to aid excavation, and dirt and rock are carried out in a bucket. Dug wells are most subject to contamination since the well will be at least 3 feet in diameter, so the surface around the well must be

adequately protected from runoff and animals, and fenced for human safety.

Bored Wells: Hand-turned earth augers can bore wells for depths of less than 100 feet (some authors say less than 50 feet). Wells deeper than 15 feet require the use of a light weight tripod or platform so that the auger shaft can be taken out, emptied, and reinserted without disconnecting all shafts. A spiral auger can be used to remove rocks. Bored wells can be developed further into the aquifer than dug wells. They may be lined with steel casing, concrete pipe, tile, or other materials (excluding lead and other contaminating materials).

Driven Wells: Driven wells are the easiest and least expensive because they are simply a special drive-well point attached to the end of a pipe section driven by hand into the ground with a heavy sledge hammer. Driven wells can only be developed in rock-free, unconsolidated formations. Hand driving is effective for wells less than 30 feet deep; machine driving is suitable for wells up to 50 feet deep (Department of State, Agency for International Development, 1969). A starting or pilot hole must be made, using an auger or excavating tool, slightly larger in diameter than the point and pipe sections (which also form the casing). If possible, this hole should extend down to the water table for easier driving. The pipe is capped and weighted, and attached to the point, which is driven into the ground with a heavy driving tool. The necessary components are readily available at all large hardware and department stores and catalog outlets. A driven well can be used to extend the depth of a bored or dug well.

Jetted Wells: Jetting uses a high velocity stream of water to break up the formation and force it to the surface. Jetted wells require the use of a pressure pump, a source of water, a small tripod, pulley, and a jet drive-well point. Water at 50 to 70 psi is pumped at 150 gallons per minute into the pipe section and through a slot in the drive-well point. The

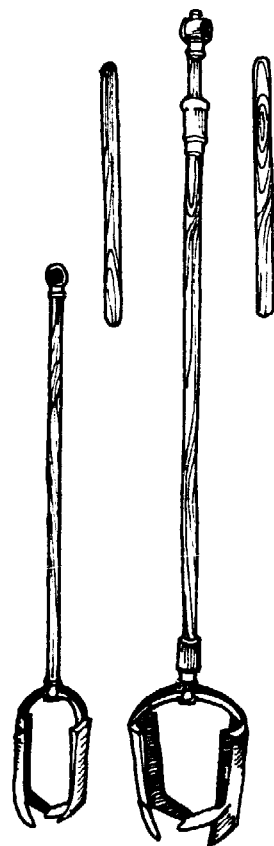

HAND AUGERS

water then emerges up from the hole and is drained into a settling pit where the pump picks it up and recirculates it (Department of State, 1969). Jetted wells can be developed to a depth of 100 feet if caving does not occur, and is suitable for unconsolidated formations.

Drilled Wells: Drilled wells are developed through either percussion or rotary drilling. Drilling a well is usually faster than other methods, which can save in manpower and cost when a well is to be developed deeper than 50 feet. If wells are to be developed in consolidated materials, the only option is to drill, although wells may be drilled in unconsolidated formations as well. Drilling a well requires a great deal of expertise - and often the use of expensive heavy equipment - so that most drilled wells are contracted out to professional well developers.

The percussion (cable-tool) drilling method involves crushing the consolidated formation by repeated impacts of a heavy drill point and stem, raised and dropped from a drilling rig. A bailer (a valved pipe) is then dropped into the hole to remove cuttings which are mixed into a water slurry at the bottom of the hole. A casing, slightly larger than the bit, is driven into the ground to prevent caving, except where consolidated material is encountered.

The rotary drilling methods use either water pressure or air pressure to remove cuttings. Rotary drilling employs a revolving table which rotates the drill stem and rotary bit, a pump, hose, and engine. A rotary drill bit (unconsolidated formations) or roller-type rotary bit (consolidated formations) breaks up the formation as it rotates, and water pumped down the piping carries slurry up and out of the hole. Casing is usually driven after the hole is completed.

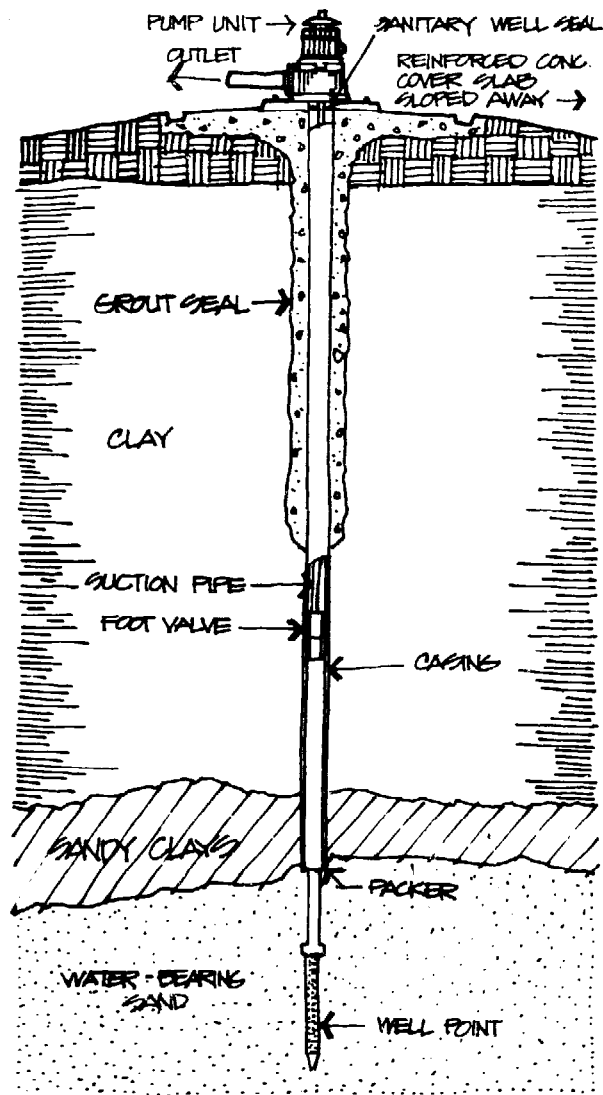

HAND-BORED WELL WITH DRIVEN WELL-POINT AND SHALLOW WELL JET PUMP

Sanitary Protection of Wells

The two most common routes by which contamination can enter a well are through the upper terminal ground level outlet of the well and the space between the pipe or casing and the borehole.

Casing Protection: The well must be protected with a sealed casing for the entire length of the borehole as it passes down through the "zone of contamination". With a well which is built in unconsolidated formations, the space between the pipe or casing and the borehole will quickly fill up with caving material, so that contaminated water will not be able to drain down around the outside of the casing. In consolidated formations, however, irregular spaces between the casing and the borehole must be filled with cement grout (Department of State, Agency for International Development, 1969).

Upper Terminal: The outlet end of the well must extend 2 feet above flood height to protect it from surface runoff contamination. The well should be closed with a water-tight seal or cap and, if possible, enclosed in a pump-house. In addition, a 4-inch thick concrete slab should slope away from the well terminal in every direction to drain water away from the well and into a ditch which discharges some distance from the well site. In regions where freezing temperatures do not permit the terminal or water-bearing point to be above the frost line, pits are often dug and a discharge pipe laid underground. Pits are very easily contaminated, however, and a pitless adaptor should be used so that casing may be terminated above ground.

Well Development

Wells built in unconsolidated formations (other than dug wells) must be "developed", which is the process of surging water through the well point or screen to remove fine particles from the water bearing material. This decreases drawdown and increases yield by increasing the permeability of the material immediately surrounding the inlet and permitting better flow, and also corrects any clogging which results from developing the borehole (U.S.D.A. #2237). The borehole should first be washed out (a hose and a pump or bucket will do the job). A plunger is then inserted into the borehole to just above the screen or well point, and moved up and down, first slowly and then more rapidly as flow becomes smoother. Periodically, the plunger is removed and the sand residue bailed out, and this process is repeated until little or no sand is removed by continued surging. Plungers are available commercially, or, for small diameter wells, may be made by wrapping cloth around the drill pipe to closely fit the borehole.

Well Pumps

Pump capacities are determined by well yield, rather than vice versa. A pump which can draw more water than the well can yield is a waste of money. A well can easily be tested to determine its yield and then the appropriate pump selected.

A deep well or submersible pump is used when the pumping water level is greater than 25 feet and the well is large enough in diameter to accomodate it, otherwise a surface pump will do. Commonly used types of well pumps are discussed in detail in the Components Chapter.

Selecting a Well-Driller

Call three or four well-drillers for estimates. Well drillers should visit the site, and if there is disagreement about where a well should be drilled, find out why. Ask the driller what type of drill rig he plans to use, and with the preceding information, see if you agree as to its appropriateness. It is best to obtain a contract, and be sure that the cost (per foot or per job) includes move-in, gravel, casing, cement seal, and cost of mud. Get a starting date and a completion date. It is good to be present during drilling to see that drilling residues indicate the type of geologic formation expected, and so that you can order a stop to the drilling anytime you feel you have enough water (drillers sometimes drill deeper than needed). Before you pay the remaining cost, test the well for four hours at the rate stated on the well log, and be sure you keep a copy of the well log (New West Magazine, April 9, 1979).

PONDS AND SPRINGS

Ponds and springs are not a common source of residential water supply except perhaps for irrigation around suburban or rural homes. Before using any surface water a sanitary survey should be made, including water quality testing.

Ponds

Other than natural ponds, two man-made types are useful for collecting surface water. An embankment pond or dam is built across a stream or other watercourse. An excavated pond is made by scraping out a pit or dugout in a nearly level area where the water table meets the earth's surface, and piling the excess dirt around the water perimeter.

Design of a pond will depend upon land costs, space availability, physical and aesthetic characteristics of the area, topography, climate, and other local factors. Design also depends upon the volume of water available and required (U.S.D.A. #387).

Water can be drawn from a pond by digging a trench at the lowest point. Perforated pipes are then laid and surrounded by two or three layers of gravel which is gradually finer in size, and the remainder of the trench is then filled with sand. A valve regulating flow can channel water into a small holding tank from which it can be pumped or drained by gravity to appropriate residential uses (Feachman 1977). All ponds should be fenced to protect children and to keep out animals.

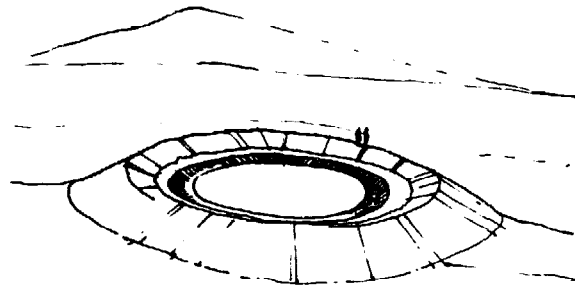

RING TANK: FLATLAND WATER STORAGE

Ponds and other surface catchments are often eligible for state or federal funding from agencies responsible for flood control, fish and game, agriculture, or irrigation. For more specific information on how to construct or use a surface water storage pond consult any of the government manuals listed in the bibliography (especially EPA 1973). (The Garden Uses chapter discusses treatment lagoons, another application of surface storage.)

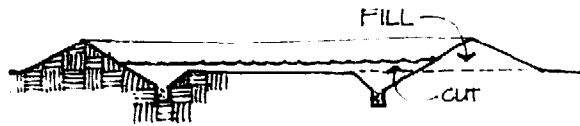

RING TANK: FLATLAND WATER STORAGE

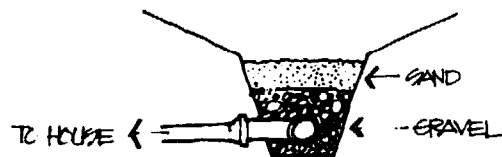

DETAIL: SAND & GRAVEL FILTER

Springs

Where groundwater is forced to the surface by pressure (artesian) or gravity, water is generally of good quality, although it is subject to contamination from polluted surface water, animals, etc. Before using a spring, dig a ditch at least 10 yards up hill from the spring to divert surface runoff, and erect a fence (animals should not be permitted within 60 feet). If frequent flooding of the area occurs, the spring's overflow should be above flood level. A cistern can be constructed on site (springs are generally inconveniently located), or water may be channeled into a surface pond. The best source of more detailed information on building spring-fed water supply systems will be found in the government manuals listed in the bibliography (especially EPA 1973).

4

GARDEN USES

CONTENTS:

PLANNING A GREYWATER GARDEN
EVALUATION OF SOILS FOR GREYWATER
USE
CLIMATIC INFLUENCES
PLANT SELECTION
DETERMINING IRRIGATION NEEDS
METHODS OF IRRIGATING WITH
GREYWATER
PLANT NUTRIENTS IN GREYWATER
SALT ACCUMULATION AND SOIL
ALKALINITY
PARTICULATE MATTER IN IRRIGATION
GREYWATER
VIRUSES AND BACTERIA
SPECIAL RECYCLING APPLICATIONS

One of the oldest and most logical ways to reuse household wastes has been to irrigate and fertilize gardens. In many rural areas dishwater is routinely thrown onto the kitchen garden. Vegetable peelings are buried or composted. Even blackwater or nightsoil is carefully collected and used by farmers in many parts of the world. However, because blackwater can pose health hazards to the average homeowner, this chapter will discuss only the use of greywater in the garden. Also if kitchen greywater is used, this chapter assumes the system contains some type of grease trap or filter.

In California greywater use in gardens apparently occurs almost everywhere. A survey in early 1977 revealed that over half the county health officials believed that homeowners' laundry and bath water commonly bypassed septic tank systems for surface discharge (OAT 1977). Only 10 percent of these officials believed that it never occurred in their counties. Typically greywater surface discharges were discovered only as a result of a complaint and the official response was to order the homeowner to replumb the system.

PLANNING A GREYWATER GARDEN

Irrigating plants with greywater offers the homeowner distinct advantages:

- . It conserves water.
- . It may save money.
- . It makes gardens possible in water-short areas.
- . It captures nutrients for plant growth that would otherwise be lost.
- . It provides water for recharging groundwater table.
- . It reduces wastewater flow to the septic tank or municipal sewage treatment system.

THE CLEANEST GARDEN IN TOWN

"I launder the clothes in a less-than-one-percent phosphate soap like Ivory Snow, then drain the wash and rinse water into a tank, then pump it into the garden."

"My vegetables and flowers thrive with the extra watering while the mild soapy mixture helps keep down insect and fungus infections. (Remember grandmother's prize roses that never saw a modern chemical fertilizer, but got dish-water thrown on them three times a day?)"(Kilbourne 1976)

Gardeners in Marin County who used soapy water for irrigation stated unanimously that it seemed to cause no damage to their plants (Sunset 1977).

The success of greywater irrigation depends on the interaction of the soil, the climate, the quality of the water, and the type of vegetation selected. In nature, each of these factors are balanced one against the other so that indigenous plants evolve which are well matched to the soil, rainfall, and temperatures in their own particular "micro environment". However, in the cultivation of non-indigenous plants, sometimes called exotics, man must adjust these factors by augmenting natural rainfall with artificial irrigation or amending soils with fertilizers and other additives.

The use of greywater for irrigation is different from any other artificial irrigation program in two important ways.

First, greywater may be produced by the household in frequency and volumes which might not match the garden's needs. Second, it contains varying amounts of materials that can be either beneficial or detrimental to the garden.

Most people would not notice anything unusual about a garden designed to be irrigated with greywater. There are in fact a few specific issues which the homeowner must consider before making such a switch. This chapter discusses these factors.

However, before launching into this topic, a note of caution must be sounded. Problems inevitably crop up initially, even for experts. For example in a greywater irrigation project at the Farallones Institute Rural Center, grease and solids clogged irrigation orifices, and the greywater equipment also developed strong anaerobic odors. They reported:

"Our preliminary assessment of greywater was somewhat naive. It was felt that eliminating toilet flushing from the waste stream would reduce the level of contamination and the remaining waste water would be easier and safer to deal with...After a year and a half of working with greywater we realize that the problem is much more complex and will require a longer term investigative effort." (OAT 1977).

But apparently most of these problems proved to be solvable because later reports from the Farallones Integral Urban House are much more optimistic (Javits 1978).

EVALUATION OF SOILS FOR GREYWATER USE

Soil is the major determinant of the frequency and amount of water required for irrigation and the type of plants that can be cultivated. Because soil is an excellent filter and treatment medium, it is also the key factor in the conversion of organic materials and disease-causing organisms to beneficial soil materials. The importance of soil in planning and practicing greywater irrigation suggests that acquiring a first hand knowledge of the available soils' characteristics would be the first order of business in designing such a garden.

The complete evaluation of soils is a very complex science and considers a variety of soil properties and characteristics depending on the intended use. The evaluation of soils for greywater use, however, is concerned with only a few key characteristics.

- . The amount of organic material present in soil affects the soil's fertility and the amount of water it can hold.
- . The soil texture or particle size is the key factor in the removal and treatment of impurities in the water.
- . Soil structure, or the way the particles stick together, affects the permeability of the soil to air and water.
- . The infiltration rate is an indication of how quickly water can be absorbed into the surface of the soil and conversely how much water will run off.

Organic Material
Soil Texture
Soil Structure
Infiltration Rate
Percolation Rate
Topography
Subsurface Geology

- . Percolation is the rate at which water can travel down through the soil, beyond the surface layer.
- . Topography effects the potential for runoff and surface erosion.
- . Subsurface geology affects the ability of water to safely enter the underground water table or to cause soil movements.

Organic Material

There are two primary components of soil, organic materials and mineral fragments. The minerals are further classified as clays, silts, and sands. The relative proportions of the mineral and organic components is the most important factor in determining the character of a soil.

Soil often includes significant amounts of organic materials such as roots, humus, and decaying matter from plants and animals. Fresh organic matter helps physically by keeping soil open and spongy which allows the free movement of water and air. The organic material also holds water in the soil so that it has more available water capacity for plant growth than would a similar soil with less organic matter.

The presence of humus can be determined by visual inspection of the soil. Organic material is usually dark in color (a very rich loam will be almost black), and bits of organic particles will be apparent.

The top 5" to 6" of soil is where most of the biological filtration processes take place (Stevens 1974). This thin layer of earth contains huge populations of microbes which do most of the work in rendering greywater safe to enter the water table.

Soil Texture

The proportion of each mineral component in a given volume of soil determines the "texture" of the soil. The mineral components are classified as sand, silt, or clay according to the diameter of the individual particle. In a formal laboratory evaluation of soil texture all organic materials are removed from the soil sample, and the remaining mineral particles are separated according to size by screening; a process called "mechanical analysis." The various size classes are called "separates" and they are distributed as follows:

<u>Soil Separate</u>	<u>Microns</u>	<u>Diameter Range (mm)</u>
Very coarse sand	2,000 - 1,000	2.0 - 1.0
Coarse sand	1,000 - 500	0.1 - 0.5
Medium sand	500 - 250	0.5 - 0.25
Fine sand	250 - 100	0.25- 0.10
Very fine sand	100 - 50	0.10- 0.05
Silt	50 - 2.0	0.05- 0.002
Clay	less than 2.0	less than 0.002

The proportion of mineral particles that fall in each size classification, or "soil separate," determines the textural name of the soil.

No two soils will have precisely the same distribution of mineral particle sizes: the possible combinations of proportions of material in each size class is virtually infinite. However, the U.S. Department of Agriculture has established a classification system based on differences in the physical properties between various combinations of

The common name for organic soil is "loam". By definition, loam includes about 40 percent sand, 40 percent silt, and 20 percent clay for the mineral component, plus some unspecified amount of humus (Donahue 1971).

1. Sand
2. Loamy sand
3. Sandy loam
4. Loam
5. Silt loam
6. Silt
7. Sandy clay loam
8. Clay loam
9. Silty clay loam
10. Sandy clay
11. Silty clay
12. Clay

**SOILS CLASSIFIED BY INCREASING
FINENESS**

particle size classes. The more common class names, in order of increasing fineness, are listed at left (Donahue 1971).

The texture class name of any soil with given proportions of sand, silt, and clay can be determined with a diagram developed by the Department of Agriculture. A percentage range of 0 to 100% is distributed along one side of the triangle for each of the three components. The percentage of each component (known from the results of the mechanical analysis process) is located along the appropriate side of the triangle. A line is then traced from each side at a 60 degree angle toward the center. The point of intersection of the three lines locates the name of the soil texture. For example, a soil that is 45% silt, 25% sand, and 30% clay will intersect in the area marked "clay loam".

Testing Soil Texture: The evaluation of available soil texture is an important step in planning for the use of greywater. A complete evaluation of soils can be obtained for a fee from a commercial soils engineering firm, or by contacting the County Farm Advisor or similar government extension service. However, there is a simple technique that provides the homeowner with a general idea of the soil characteristics, most importantly texture, without going to any trouble or expense.

This test, described by Olkowski (1975), is based on the consistency of the soil when it is moist and gauges the response of the material to simple manipulation.

1. Take a small amount of soil (about a tablespoon) and moisten it slightly.
2. Make sure that the moisture is well mixed with the soil and that any granules are broken down by kneading the

soil with your fingers. The mixture should be firm and not so moist that it is runny. Clay particles may take a little while to become saturated and break down and they will feel grainy until they do.

3. Roll this mass between your palms until a ball is formed. Then roll it into as thin a wire as possible. The sandier the soil is, the harder it will be to form a ball and any wire you can make will quickly disintegrate. As the percentage of clay increases, the more easily the wire keeps its shape and the thinner the wire can become without falling apart. With a very high percentage of clay you can roll a very thin wire that can be picked up by one end. When the amount of clay reaches 35 percent or more a wire 1/4 inch in diameter can be picked up by one end without breaking.
4. Rub the mixture out thinly against your palm. Clay gives the soil a shine when you press down firmly and spread it out, and it feels slippery. If the soil is sandy it will not shine and will feel gritty. Silt gives soil a greasy quality, yet it is not plastic the way clay is.

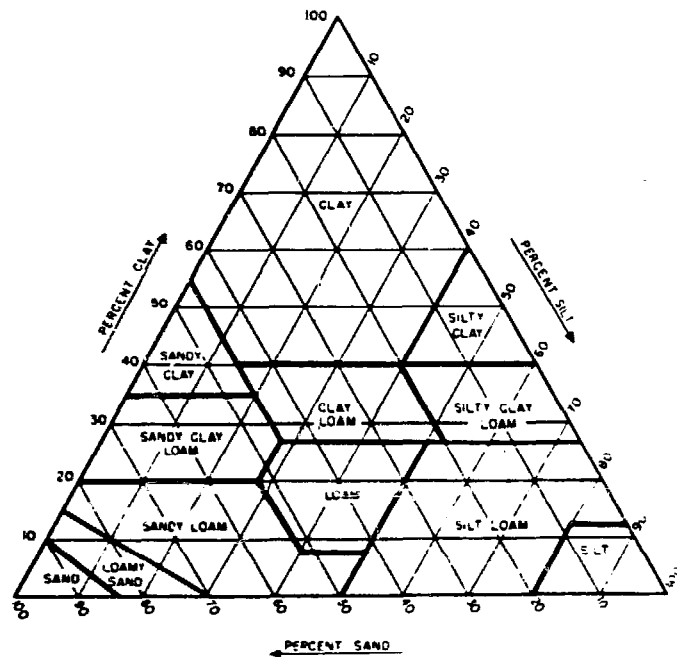

Soil Textural Classes

Accurately evaluating soil texture is a skill which is acquired with practice. It is helpful to test a number of different soils in order to become acquainted with the variety of textures one will encounter. In this way a relative scale can be established which will help to determine the character of any particular soil.

Soil Structure

Whereas soil texture is the relative proportions of individual particle sizes in a soil mass, soil "structure" is the manner in which these particles clump together into

aggregates. Soil structure is important because it influences the way water and air move through the soil. Well structured soil with large spaces between aggregates, and aggregates that keep their form when they become wet or compacted will allow air and water to circulate freely.

Soil structures are identified by shapes and arrangements, and by the size of the aggregates. The aggregates are called "peds" when they occur naturally, and "clods" when they are the result of human activity, such as plowing. There are four principal types of structures:

1. **Platy:** Peds exhibit a matted, flattened, or compressed appearance.
2. **Prismlike:** Peds exhibit a long verticle axis and are bounded by flattened sides.
3. **Blocklike:** Peds resemble imperfect cubes like baby blocks, but are usually smaller.
4. **Spheroidal:** Peds are imperfect spheres like marbles, but are usually smaller. This is also called "granular".
(Donahue 1971)

The type of structure that is present in soils can be approximately determined by examining a handful of dry soil that has been crushed between the hands to break up the mass into small crumbs or aggregates. The shape of the aggregates should be visible to the naked eye.

Granular (spheroidal) and single grain soils, (uniform, small grain aggregates with no clear structure) have rapid water infiltration rates; and platy and massive soil structures result in slow infiltration rates (Donahue 1971). A moderate to rapid infiltration of water is desirable for greywater application.

Infiltration Rate

Infiltration refers to the movement of water into the surface of the soil. By contrast, "percolation" is the movement of water through deep subsurface soil. Surface soil should provide channels down through which water may move as rapidly as it is received on the surface as rainfall or irrigation. Water that cannot enter the soil will move off over the surface, often carrying soil with it resulting in sheet erosion of the surface and loss of soil.

For the use of greywater it is essential that all of the water enter the soil and none be allowed to leave the irrigation site as surface run-off. Greywater may contain materials that are a hazard to public health, or may become a nuisance if not properly handled. Therefore it is imperative that the irrigation site be capable of receiving and infiltrating all greywater applied to its surface.

The principal factors controlling the rate of movement of water into soil are:

1. The percentage of sand, silt, and clay in the soil. Coarse sands encourage increased infiltration.
2. The structure of a soil. Soils with large, water-stable aggregates have higher infiltration rates.
3. The amount of organic matter in the soil. The more organic matter and the coarser it is, the greater the amount of water entering the soil. Organic surface mulches are especially helpful in increasing infiltration.
4. The depth of the soil to a hardpan, bedrock, or other impervious layer is a factor in infiltration. Shallow soils do not permit as much water to enter as do deep soils.

5. The amount of water in the soils. In general, wet soils do not have as high an infiltration rate as do moist or dry soils.
6. The soil temperature. Warm soils take in water faster than do cold soils. Frozen soils may or may not be capable of absorbing water, depending upon the kind of freezing that has taken place (Donahue 1971).

Infiltration rates may be classified as follows:

1. Very low: Soils with infiltration rates of less than 0.1 inch per hour are classified as very low. In this group are soils that are very high in percentage of clay.
2. Low: Infiltration rates of 0.1-0.5 inch per hour are considered low. This group includes soils high in clay, soils low in organic matter, or shallow soils.
3. Medium: Rates of infiltration 0.5-1.0 inch per hour are classified as medium. Most soils in this group are sandy loams and silt loams.
4. High: High rates include soils with greater than 1.0 inch per hour of infiltration. Deep sands, and deep, well-aggregated silt loams and some virgin black clays are in this group.

(Donahue 1971)

Infiltration Testing: The rate of infiltration can be approximated by a simple test. Remove both ends from a large coffee can or similarly large, round cylinder. Jam one end into the soil in the area to be tested remembering that the purpose is to estimate how quickly water will enter the surface of undisturbed soil. Make sure that the edge of the can is buried deep enough so that water can't simply seep under the edge and flow out over the soil surface. Fill the can with water to a level of about 6 inches and mark the level on the inside with a grease pencil

or laundry marker. At one hour, again mark the inside of the can at the water level and measure the amount of drop for comparison with the classification outlined above. Considering that the soil surface will probably be broken up and the infiltration rate changed by cultivation, the percolation rate of water below the surface is an even more important concern.

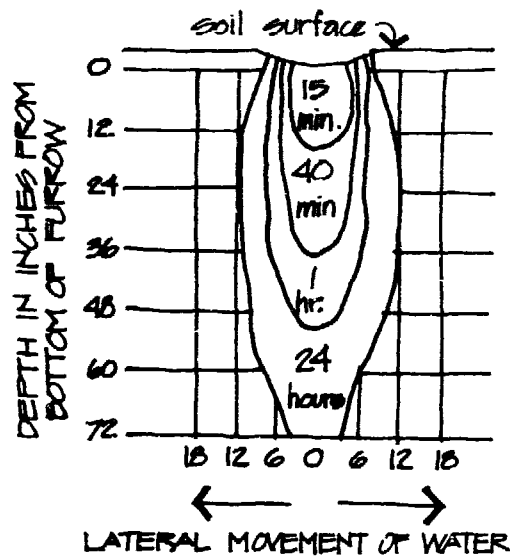

PENETRATION OF WATER THROUGH SOIL

Percolation Rate

The rate at which water percolates through the deep subsurface soil determines how quickly the greywater will be carried downward through the ground and therefore how much water can be applied before the soil becomes saturated and cannot accept more water. Permeability, the capacity to transmit water through subsurface soil, is the common measure of water percolation. Permeability is often expressed as the rate that water passes through soil in inches per hour.

For irrigation with greywater, sites with impermeable layers near the surface should be avoided. Preferable soils are deep, well drained loams. Soils of moderate permeability are better than soils with either very slow permeability, such as clays, or very rapid permeability, such as coarse sands and gravels. Soils with very low permeability are generally unsuitable because they may waterlog and create run-off problems, whereas soils with very high permeability might result in inadequate "treatment" of greywater because of the retention time required to break down pathogens before entering the water table. The optimum rate of soil permeability will vary somewhat with the application but generally the desired permeability will be moderate to rapid.

Percolation Testing: A simple test can be conducted on site to determine the permeability of the soil. This is generally referred to as a percolation (or "perc") test. Comparing the test results to the chart provides an indication of the permeability class of the soil.

1. Dig or bore a hole with hand tools either 12 inches square or 13 to 14 inches in diameter. One hole should be dug to about 12 inches deeper than the depth of the intended greywater irrigation system, (this includes surface irrigation systems). Dig a second hole in the same vicinity to a depth of about 48 inches.
2. Remove any smeared surfaces from the sides of hole to provide as natural a soil interface as practical to infiltrating waters. Remove loose material from the bottom of the hole and add an inch or two of coarse sand or fine gravel to prevent the bottom from scouring.
3. Presoak the hole carefully, never filling it deeper than about 8 inches with clean water. Do not drop the water into the hole from much distance. Ease it in gently. If it is known that the soil has low shrink-swell potential and clay content is low (perhaps less than 15%), proceed with the test. If not, let the hole rest over night.
4. Fill the empty hole with clean water to exactly 6 inches above the soil bottom of the hole (do not consider the layer of protective gravel as the bottom of the hole). The level of water can be most easily gauged with a wooden yardstick held vertically in the hole.
5. Wait one hour and measure the amount of drop in the water level in the hole. Without taking into account the gravel in the hole, you will get a faster rate of drop than actual water absorption. Out of 1 inch drop, a portion will actually be space occupied by the gravel.

<u>Permeability Classes</u>	<u>Rate In Inches Per Hour</u>
Very slow	Less than 0.20
Slow	0.20 to 0.63
Moderate	0.63 to 2.0
Rapid	2.0 to 6.3
Very rapid	More than 6.3

* Undisturbed, saturated soil cores under a constant 0.5 inch of water. (Donahue 1971)

Permeability Class of the Soil

The effect of the gravel can be determined in advance by estimating the volume of the gravel and subtracting that volume from the volume of water absorbed by the soil (Warshall 1976).

As a general rule, if the hole has 2 inches of gravel in the bottom and 6 inches of water, it is estimated that 40% of the volume of the first inch of drop in water level is actually attributable to the volume of the gravel. Thus, a 2 inch drop is actually only 1.6 inches. A number of factors, including size and shape of the gravel, and the shape of the bottom of the hole will affect the influence of the gravel on the rate of drop. Precise estimates are therefore rather complicated and application of the general rule is acceptable for most purposes.

Topography

The slope of the irrigation site (combined with the soil infiltration and percolation rates) is an important factor in controlling surface runoff and the amount of greywater that can be used for irrigation. Steep slopes and poor soil infiltration will result in surface runoff leading to surface erosion and loss of soil. In all cases, the loss of greywater from the irrigation site through surface runoff is to be avoided.

Surface irrigation is easiest with soil that is flat or gently sloping. The recommended slope for agricultural irrigation is no more than 4%; for a sodded field, including lawns and dense landscape materials (such as ivy ground-covers) no more than 8%; and for wooded areas, no more than 14% slope (Herson 1976). Where soils have a high infiltration rate these recommendations can be amended slightly upwards.

It is also important that the irrigation site be relatively smooth and free of low spots. The water will tend to drain toward these low areas resulting in a concentration of water at these points. The concentration of greywater, particularly if the subsurface drainage is poor, will hasten accumulation of salt in the soil and perhaps change the soil acidity. These changes could ultimately damage the plants in the area.

Subsurface Geology

The structure and composition of the earth below the level which can be easily explored with hand tools can pose problems for greywater use. First, the subsurface geology can affect the rate at which the greywater moves downward through the earth. Bedrock or impermeable layers near the surface can halt percolation, and therefore should be avoided. The existence of bedrock or impermeable layers close enough to the surface to cause problems should be evidenced by nearby rock outcroppings or the exposure of bedrock in percolation test holes.

Subsurface geology can also cause too rapid percolation of greywater such that it reaches the water table before the soil has completely removed all potentially harmful materials. This would occur where there are open fractures in bedrock, carbonate or glacial deposits, or where extensive cut and fill has occurred. These conditions may be very difficult to detect because there may be no manifestation at or near the surface. In order to minimize the possibility of too rapid percolation it is recommended that a soil specialist be consulted if the groundwater table is within 10 feet of the level of the irrigation system.

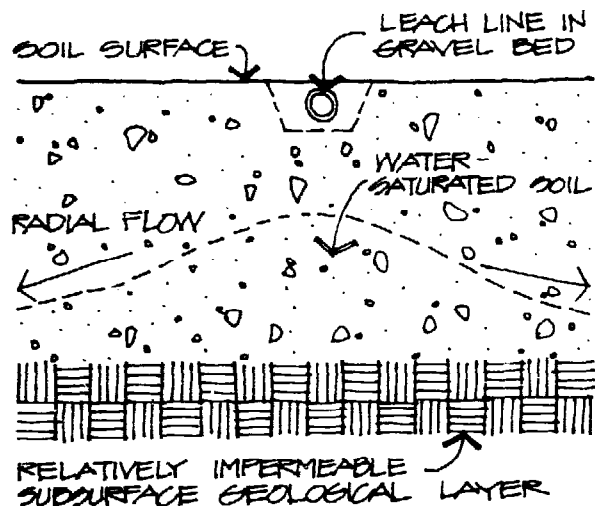

The disposal of water under ground causes the water to temporarily form "mounds" below the surface resulting in horizontal radial outflow. This radial flow can sometimes travel horizontally great distances before it can drain downward again or reach another pocket of fresh groundwater. Once the disposed water reaches a subsurface pocket of groundwater, pollutants are relatively free to move long distances, although their movement may not be uniform due to the configuration of subsurface geology (Herson 1976). Moreover, little additional removal of dissolved solids, such as pesticides, salts, and detergents takes place. Thus, once pollutants from greywater reach the water table, there is a chance of polluting other locations.

An additional problem is the effect that water can have on the stability of subsurface geology. Soil conditions that are reasonably stable when dry can become quite unstable when unusual amounts of water enter by surface irrigation, or by subsurface irrigation or disposal systems. This potential problem is not peculiar to greywater use, rather it exists whenever water in excess of natural precipitation is applied to the land for irrigation or any other purpose. Thus, if greywater irrigation will simply augment or substitute for existing irrigation practices there is no need to regard greywater as a special case.

Excess water in the soil can act in a number of ways to disrupt the existing soil stability. Water in certain clay soils (montmorillonitic clays) can cause swelling and heaving which can cause pressure against foundation walls resulting in their failure, and can cause buckling and cracking in driveways, decks, and other paved surfaces. Most building departments prohibit any type of construction on such expansive soils. Excess water can cause subsurface

erosion resulting in soil depression or sink holes as the surface collapses into the eroded void below.

The greatest potential hazard exists in hillside areas where the steep hillsides and likelihood of extensive grading (for dwelling construction) poses the hazards of soil slump, creep, or landslides. Soil creep is a very slow movement of a soil mass that is too heavy for the steepness of the hill on which it rests; trees and fences lean downhill on such slopes. Slump is a more rapid collapse of a soil mass downhill that essentially retains its shape and is displaced only a matter of inches. Landslides are much more severe in that displacements are much greater and the shape of the soil mass is completely destroyed. Obviously any of these types of soil movement can cause expensive damage to buildings and utilities.

All three hazards can occur as a result of two events. First, water enters the soil increasing the weight of the soil mass until it can no longer resist gravity, and moves downhill. Second, water lubricates the soil at the interface between the fill and the natural slope, or the "slip plane", and the soil mass begins to slide as the force of gravity overcomes the friction between the soil mass and the hillside. In some instances both the additional weight of the water and the lubrication of the interface combine to cause the earth to slide.

Although soil movements are a natural part of geologic history, they begin to occur much more frequently once man touches the land. The primary reason is that suddenly a great deal of water is flowing down into the soil from new gardens and lawns, from septic tank leach fields, from local concentrations of runoff from roofs and parking lots, and from leaking water pipes, sewers, and swimming pools. This latter factor is the most insidious not only because

it is unseen but because it can be so huge. Most utility companies can account for only 90% of the water and sewage they pump, which means that at least 10% is leaking out of their system somewhere. It is reasonable to assume that many of these leaks are in geological zones where there has already been a certain amount of soil movement, and hence the problem compounds itself.

For most homeowners this will not be a problem, simply because they live in relatively flat areas. But for those living in hillside areas it is important to irrigate with caution. Areas of obvious instability, gullying, or active landsliding should be irrigated only as necessary to allow growth of indigenous plants to hold the soil.

CLIMATIC INFLUENCES

Seasonal patterns of temperature, humidity, rainfall and wind determine the climate for an area and, to a large degree, determine how much supplemental irrigation is beneficial to a garden, especially if it contains non-native plants.

Greywater can be expected to be a fairly constant supply with only minor seasonal variations due to changes in household cooking, washing, and bathing routines. On the other hand, the irrigation needs due to annual climatic variations can be expected to vary radically. The quantity of water required by a vegetable garden in the midst of winter is substantially reduced when the temperature is too low to grow crops and the perennial plants are dormant. In fact, when the ground freezes in extremely cold winter climates, an alternative use for greywater must be found.

In parts of the country where rainfall is relatively evenly distributed throughout the year, greywater can be easily used to supplement the natural supply. Most areas, however, have unevenly distributed annual rainfall patterns with identifiable wet and dry seasons. In these cases the rate of greywater irrigation required to meet the needs of plants during dry months may become excess and may actually waterlog the soil in the wet months.

In locations where the seasonal variations in rainfall are great, the native vegetation has adapted to these alternating periods of wet and dry, and artificial irrigation is

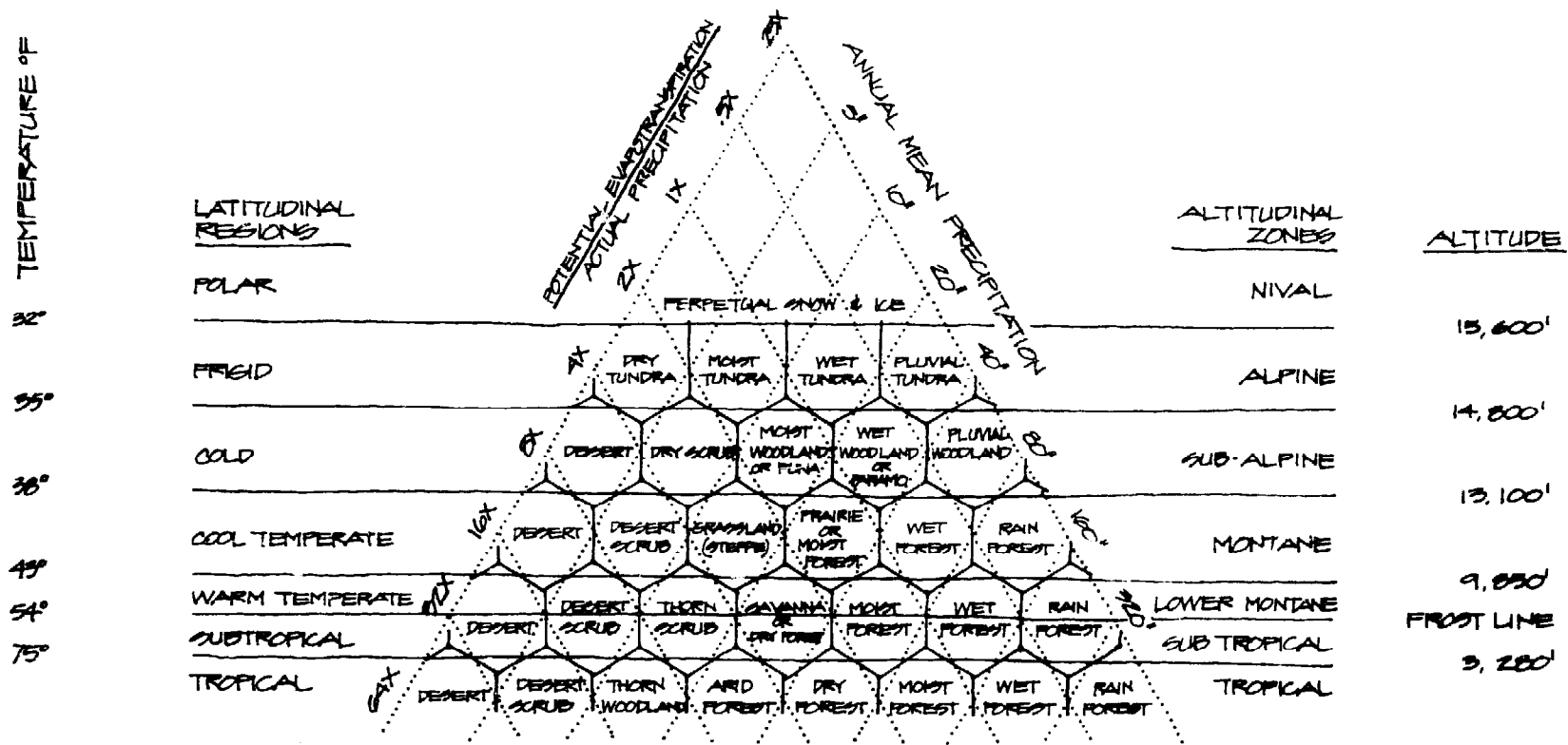

IN TROPICAL BIOMES, THE PHYSICAL ENVIRONMENT FOR LIVING THINGS CHANGES WITH THE SEASONS AND GEOGRAPHIC DIRECTIONS FAR LESS THAN IN TEMPERATE AND POLAR ZONES. AVERAGE TEMPERATURE AND EVAPORATIVE RATE VARY CHIEFLY WITH ALTITUDE, AND THE CLIMAX VEGETATION FOLLOWS A PATTERN THAT REFLECTS THE DEGREE TO WHICH PRECIPITATION EXCEEDS OR FALLS SHORT OF EVAPORATION OF WATER. (MILNE, M. & L.; 1971).

Rule of Thumb: ANNUAL RAINFALL =
ANNUAL GREYWATER

Average residential
lot size (50 x 100) = 5000 sq.ft.

Average house covers 1600 sq.ft.

Driveways, sidewalks
and other non-irri-
gated areas = 1000 sq.ft.

Irrigated landscape
areas = 2400 sq.ft.

Average family size = 4 people

Average greywater
produced per day = 35 gpcpd

Household daily
average = 140 gallons

Days per year = 365

Annual greywater
produced = 51,000 gal.

Thus,

Annual greywater = 21.3 gal/sq.ft.

or = 34.0 in./year

National average
annual rainfall = 34 inches/year

generally unnecessary and may even be harmful. Such is the case, for example, in Southern California where regular irrigation practices have actually altered the natural microclimate in many household yards and gardens to allow the habitation of many exotic species to the exclusion of native dry-summer plants. Irrigation of the yards during the winter is normally minimal, if done at all, because the winter rains are more than adequate for the survival of both native and exotic plants. If greywater is continuously applied during this period the effect is to even further modify the microclimate, perhaps making it suitable only for exotic wet-land plant species.

Applications of greywater can be quite significant. For example, the average production of greywater per person in the household is about 40 gallons per day. For a family of four this results in a total annual production of 58,400 gallons. One gallon is equivalent to 2/3 inch of water over one square foot. Assume now, that the family has 1,000 sq.ft. of garden and landscape area that must be irrigated. This means that the greywater supplies an additional 58 inches of water for irrigation each year. If the family lives in a warm temperate zone and the average annual rainfall is between 10 and 20 inches, the plants and animals native to the region would belong in the "thorn scrub" biome. The addition of 58 inches of water annually would change the microclimate in the irrigation site to a "moist forest" biome with an entirely different complement of native plant species. These effects, which are obviously quite significant, occur whenever irrigation is practiced. The primary difference with greywater is that the source is fairly constant throughout the year and cannot be readily adjusted to seasonal variations in demand for water due to the seasonal characteristics of plants or the variations in rainfall.

Greenhouses are an efficient way to use greywater in spite of seasonal variations. They allow plant cultivation of any species year round and provide an excellent opportunity to match greywater flows exactly to plant needs. An interesting demonstration of how to design a greywater irrigated greenhouse will be described later as part of the Clivus Multrum system (Stoner 1977).

Irrigation Greywater Diversion Strategies

In some cases it may not be possible to continue year round irrigation. During the wet season when the household supply of greywater exceeds the irrigation requirements, the homeowner must find a way to divert or reduce the flow of greywater. For example:

- . In-house water conservation techniques could be stepped-up to reduce the amount of greywater produced, although most families find this difficult to sustain for long.
- . Indoor uses of greywater might be increased, although normal demands such as toilet flushing are fairly unchangeable. If greywater is already in use it will be difficult to increase the demand for more.
- . Dumping the excess greywater into the sewage system is perhaps the simplest solution, but it wastes the greywater resource as well as significantly increasing the load on the sewage system at the very time when it is heavily stressed due to rainfall entering the system. (Note that both public and private systems must be sized to accommodate this peak load.)
- . Short-term storage of greywater can help alleviate the problem of peak storm loading until the ground can again absorb water. A septic tank performs the function automatically because no effluent will flow

into the leach field if the soil is already saturated.

- . Long term storage of greywater from wet season to dry season is usually impractical due to the size and cost of a storage tank, and is compounded by the organic material in greywater which may become septic over any extended period of time. However, storage is not totally unfeasible, for example, in a dark air-sealed storage tank treated with chlorine or other disinfectant.
- . Greywater which is in excess of plant requirements during wet months can recharge the groundwater table (if it is deep enough) through a deep subsurface leach field or dry well, in this way avoiding the problem of saturated or frozen surface soils. In one example, two 100 ft. leach lines were installed with a switching manifold to divert greywater from the garden (Kroschel 1977).
- . In soils where waterlogging or saturation never occurs, even during the rainy season, it may be possible to continue to use greywater for irrigation if special care is taken to prevent surface runoff.
- . In warm climates where the rainy period occurs during the growing period it may be possible to divert excess greywater from the year around garden to a seasonal vegetable or ornamental garden which is allowed to go dormant during the dry period.
- . If it is too cold for plant growth during the dry season, it may still be possible for evaporation beds to get rid of greywater. Under ideal circumstances it may be possible to evaporate one gallon for every 5 sq.ft. of evaporation bed.

- . In subfreezing temperatures it is still possible to vaporize a lesser amount of greywater that is sprayed and allowed to freeze above ground, although to date this has only been done experimentally.

PLANT SELECTION

Selection of plants to be irrigated with greywater is an important part of planning the irrigation system.

Faced with water shortages or droughts in years ahead, homeowners need no longer think only in terms of drought tolerant plants. Because the supply of household greywater is virtually constant all year long, gardeners can use almost any kind of plant material they wish, even wetland exotics, should they decide to concentrate all their available greywater on a small area.

There are two key factors to be considered: the plant's tolerance for salt and other chemicals typically found in greywater, and the degree to which the plant's water demand corresponds to the greywater supply. The questions regarding the most tolerant plants are taken up at the end of this section, but first this section discusses plant characteristics which influence water demand.

How Plants Use Water

Plants work with the soil and climate to move water up from the soil back into the atmosphere. The rate and amount of water moved in this cycle is controlled by the processes of evaporation and transpiration (shortened to evapotranspiration) determined by the plant's physical

How Plants Use Water
Evapotranspiration Characteristics
Rooting Depth
Seasonal Variations
Salt Tolerance and Alkaline Soils
Lawns

characteristics. These processes are further controlled by external effects of wind, temperature, soil type, and the surface conditions. Proper selection of plant species and management of the soil with due consideration to the climate make it possible to complement the garden irrigation demand with the amount and quality of the available greywater supply.

Water demand in the plant is primarily determined by two sets of characteristics, the root system and the leaf canopy. The characteristics of the leaf canopy are most important in the rate of evapotranspiration, that is, the total amount of water required. The root system which supplies the water from the soil reservoir determines how large the reservoir shall be and hence how often the plant needs irrigation.

In general, the larger the plant, the larger the root system to explore for water. Many common landscape plants are "water spenders" because their evapotranspiration rates are quite high. They have extensive root systems and as long as some of their roots are in moist soil they can survive drought but if irrigated still use relatively large amounts of water. Among the many examples are eucalyptus and black walnut trees. Succulents are another interesting example. During dry periods they go dormant but whenever water is available they can consume great amounts. If irrigated all year long they will exhibit amazing growth.

Try to use greywater only on well established plants; seedlings less easily tolerate the impurities in household wastewater (Javits 1977).

Evapotranspiration Characteristics

The pathway for water from the soil, through roots and stems and out of the leaves to the atmosphere is a continuous one. Leaves will develop a deficiency of water,

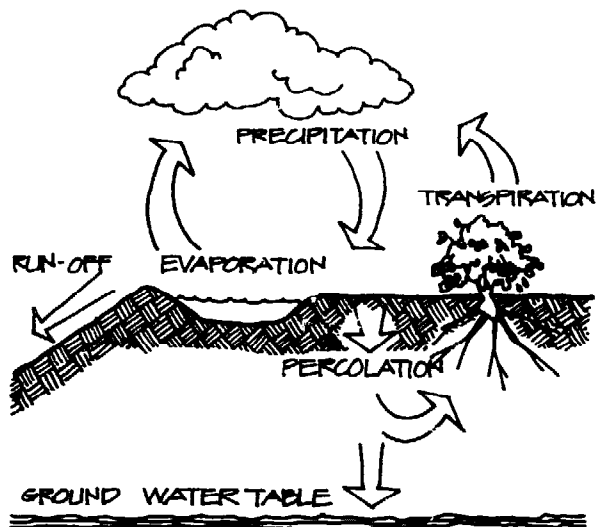

HYDROLOGIC CYCLE

called a "water deficit," if the loss of water through evapotranspiration exceeds the uptake by roots. The magnitude of the leaf water deficit depends on the rate of water loss balanced against the rate of uptake. The latter rate depends in part on the root resistance, which varies greatly among different plants. Those with dense, finely divided root systems generally have lower root resistances and can take up water much faster than those with simple elongated systems. During hot dry windy periods of high evapotranspiration, plants with high root resistances may undergo leaf water deficits even in fully wetted soil.

On a warm July day (85°F, 40% relative humidity) a single corn plant growing in a cubic yard of wet loam soil would use about 1.4 gallons of water per day. If that same plot were covered by annual herbs with their characteristically high transpiration rates, such as desert evening primrose, water use would jump to about 4.3 gallons per day. However, if the plot were filled with many stalks of corn, daily water use would increase still further to 7 gallons (Gulmon 1977).

Under these same conditions, evaporation alone from the surface of a fully saturated cubic yard of soil would be about 2.3 gallons per day. However, after 2 days, the dry surface soil would form a natural mulch and greatly reduce further evaporation (Gulmon 1977). Thus soil watered deeply and infrequently loses little water from the surface.

There are many possible characteristics which indicate how plants are adapted to certain moisture levels. The majority of common garden and landscaping plants are in the great middle grouping of plants which are adapted to neither a very moist nor a very arid climate. These plants are called "mesophytes" and are likely to exhibit

a blend of characteristics which reflect its particular native origins.

Tough, rigid leaves are an indication of drought tolerance. When leaves on any plant reach a point of water deficit there is insufficient water to maintain cell turgor and the leaf wilts resulting in a corresponding decrease in transpiration and photosynthesis in the leaf. Plants native to dry habitats can frequently sustain much greater leaf water deficits without wilting than those from moist areas. Moist area plants tend to have thin, flexible leaves.

Drought tolerant plants, xerophytes, exhibit characteristics in their leaves and canopy which act to reduce the flow of moisture from the plant to the atmosphere:

- . Leaves are often light in color or may be covered on the underside with short, lightly colored hairs to trap moisture and reduce evaporation from the leaf surface.
- . Leaves may be covered with cutin, a dense, waxy substance excreted by the plant. Cutin is effective in reducing moisture loss from the epidermal layers of the plant. Representatives include oak, sumac, madrone and most evergreens. Plants without this protective layer, such as beans and tomatoes, can experience significant water losses through the leaf surface in a single warm afternoon.
- . Leaves are often small and have a small surface area to volume ratio. The small surface area reduces the transpiration rate and water loss.
- . The stomata, or "breathing holes," of the leaves are small and sunken in pits in the leaf surface. Large numbers of wide apertures allow rapid water loss and

Normal Crop Rooting Depths

<u>Crop</u>	<u>Feet</u>
Alfalfa	5-10
Artichokes	4
Asparagus	6-10
Beans	3-4
Beets (sugar)	4-6
Beets (table)	2-3
Broccoli	2
Cabbage	2
Bush berries	4-6
Carrots	2-3
Cauliflower	2
Celery	3
Citrus	4-6
Corn (sweet)	3
Corn (field)	4-5
Deciduous orchards	6-8
Garlic	1-2
Grapes	4-6
Grain	3-4

concomitant rapid carbon dioxide entry. In addition, plants control water loss by closing the stomata in response to an increasing water deficit. When stomata are completely closed, transpiration losses are reduced and leaf water content begins to rise. Many cereals and other grasses of dry habitats rarely open their stomata at all. Still others, including the potato, cabbage and onion, do not shut their stomata until the leaves wilt. Such plants are not drought adapted, but are cool climate species which seem to have evolved in areas where water shortage seldom occurs.

- The leaf canopy is often sparse because simply having fewer leaves reduces water loss. Examples are ceanothus, manzanita and olive.
- Some plants simply drop their leaves when water is inadequate. New leaves are produced when moist conditions return. Many coastal California native plants, such as the sages and the bush sunflower, as well as the California buckeye are drought deciduous.
- Similarly, some plants will simply fold or collapse their leaves to reduce the interception of energy from the sun and consequent heat load on the leaves. Many species of the pea family with double rows of leaflets can be observed to fold the pairs together in response to water stress.

Rooting Depth

The depth from which a plant will normally extract water varies greatly with the species of plant as well as with the structure of the soil and how easily roots can penetrate it. More importantly, root depth varies with the frequency of watering. If watered weekly or less frequently, the

roots will go deeper seeking additional moisture. Conversely frequent watering will result in shallow root systems.

The depth to wet the soil for the best response of plants will vary with the normal rooting depth of the plant. Probably the best rule is to irrigate to a depth where 90 percent of the plant roots are growing (Donahue 1971). Water normally moves almost straight down in soil with very little lateral movement. Therefore, water applied outside the root zone can be expected to have little effect on the plant, and the majority of water applied over the root zone can be expected to be distributed downward.

Normal Crop Rooting Depths (Cont.)

<u>Crop</u>	<u>Feet</u>
Grass pasture	2-4
Hops	5-8
Ladino clover	2
Lettuce	1-1 1/2
Melons	6
Onions	1
Peas	3-4
Peppers	2-3
Potatoes (Irish)	3-4
Pumpkins	6
Radishes	1
Spinach	2
Squash	3
Strawberries	3-4
Tomatoes	6-10
Walnuts	12

(California Interagency Agricultural Information Task Force, 1977)

In general, the main root zone for lawn grasses and leafy vegetables is the top one foot; for corn, tomatoes, and small shrubs the top one or two feet; and for small trees and large shrubs the top two or three feet. Some large trees go down 20 or 30 feet (Olkowski 1975, Plant Science #6009).

Drought tolerant plants exhibit three specialized types of root systems: shallow, horizontally spreading roots; deep penetrating tap roots; or combinations of both. Shallow, diffuse-spreading root systems are characteristic of true desert plants which must take advantage of the sporadic and sparse precipitation in order to survive. Some plants also tend to have enlarged fleshy roots or stems in which water is stored.

Evergreen species such as California lilac, coffee berry, toyon and manzanita, plus other species from dry climates such as oleander, olive, and strawberry tree all have deep root systems which help make these plants more drought resistant. Shrubs with deeper root systems will need

less frequent water than those with surface root systems such as rhododendrons, azaleas and camellias.

Seasonal Variations

Most plants are inherently accustomed to a seasonal variation in available moisture which corresponds to the rainfall cycle in their native environment. For many plants the seasonal differences in available water are moderate, and they have grown accustomed to a relatively constant moisture level. Many other species, however, are inherently acclimated to radical seasonal moisture fluctuations which may include a period of drought during more than half the year. For these plants the continuation of irrigation through normally dry months might result in root rot, mildew, and other conditions which can be seriously damaging to the plant.

If the landscaping and garden plants are all native species, the need for greywater irrigation will be limited to unusual periods of extreme drought. During these periods it may be necessary to provide supplemental irrigation even to drought resistant plants in order to ensure their survival.

In general, drought resistant species need not be provided for in an irrigation plan, particularly where they are native species to a climate characterized by seasonal dry periods. These species can be expected to survive without supplemental water and may actually be harmed by excessive watering.

The amount of water which is required for any plant will vary from location to location and even from day to day. Rough formulations have been developed for commercial

agriculture applications where the crop is uniform, the soil conditions well managed and experience with water demand for specific crops is widely shared. The wide variety of plantings and conditions found in the home garden would render a formula approach less useful.

For established plantings the best guide is prior experience with tapwater irrigation. For selection of new plants the characteristics of the plant as a water user should be considered in light of the amount of greywater available. For new plant groupings it is recommended that high water using plants should not be mixed with drought tolerant species. The higher water demanding plants become the controlling factor and consequently the drought tolerant species are over watered and will probably die. New plantings should be small to test the effects of greywater use and to provide a number of test areas for trying various levels of irrigation (Beaty 1977).

Salt Tolerance and Alkaline Soils

Plants which grow best in acid soils, at pH below about 5.0, are likely to be quite sensitive to the alkaline character of greywater. Unless the greywater has been neutralized before being applied it would be best not to use it on these plants, especially rhododendrons, azaleas, and citrus fruits.

The Interagency Agricultural Information Task Force (1977) has studied the relative salt tolerance of many common fruits and garden vegetables. These are expressed in terms of the decrease in percent of yield for increasing levels of soil salinity. Generally grasses are the most tolerant, which points to the value of greywater for lawn irrigation. Cantalope, broccoli and tomato are quite salt tolerant, whereas fruit crops (particularly peaches and

apricots) are quite sensitive as are certain vegetables (most notably beans, perhaps the most sensitive of all common vegetables). Additional information regarding the salt tolerance of garden species can be obtained from the County Farm Advisor, the U.S. Soil Conservation Service or University Cooperative Extension Service. Advice regarding tolerance characteristics of landscape species can be obtained from a local nurseryman.

Seashore plants obviously are salt tolerant and so the homeowner might consider iceplant, sea grape, dune grass, and pampas grass. Desert plants are well adapted to alkaline soils and send down extremely deep tap roots, thus ignoring salt accumulation in the surface soil layers.

As a starting point in selecting new plant materials, species should be selected which are indigenous to climates which have fairly constant rainfall all year round, which have more rainfall than the local climate, and better yet, which have slightly higher amounts in the corresponding season as the local climates highest rain.

Lawns

Americans spend an immense amount of their money, effort and time coaxing a particular tiny plant to grow over a large percentage of their property, then regularly hacking it to within an inch of the ground. When drought occurs these brave little plants are the first to feel its effect; in fact laws have been passed preventing them from getting the water they need.

Clearly the American lawn needs help. Everyone agrees that lawns are among the thirstiest plant materials. Some experts suggest that lawns soon will disappear because

they simply do not make sense in an environment of limited resources (McAllister 1977, Beatty 1977). Ideally lawns need a year round supply of free water that hopefully also contains valuable nutrients supplied by a system that is silent, invisible, automatic, and requires no energy and very little maintenance. Happily it turns out that gravity fed underground drip or trickle greywater irrigation systems do just that (as explained in the section on irrigation methods).

The challenge is to size the lawn (or train it) to consume greywater at just about the same rate that the household produces it, year around, rain or shine. All grasses have high transpiration rates although there are differences between species. This is one of the reasons they make excellent cover for evapotranspiration beds. In dry weather the lawn can be cut shorter or more frequently to reduce the area of leaf surfaces. During the rainy season fertilizer should stimulate plant growth and increase the evapotranspiration rate somewhat.

DETERMINING IRRIGATION NEEDS

The cardinal rule of irrigation is to water thoroughly and infrequently. Water for irrigation is used most efficiently by applying just enough water to fill up the soil reservoir, and then waiting until the plants have used up at least half of the available moisture before adding more. Sufficient time between waterings is necessary because the plant must have oxygen at root level as well as water, and when the soil is saturated it in effect suffocates. An exception to this rule is the use of drip irrigation discussed in the section on Methods of Irrigation. Drip irrigation is intended to constantly maintain the proper water/air mixture.

When the volume of free water reaches the point where it totally fills the interspaces between soil particles, the supply of oxygen to roots is cut off and they begin to "drown". Root elongation stops and nutrient absorption is hindered. If soil continues low in oxygen long enough, harmful organisms thrive, producing toxic substances and beneficial aerobic bacteria are killed off. Roots become susceptible to fungus diseases. Plants vary in the length of time they can resist these conditions, but many plants continuously require air in the soil (Sunset 1976).

Available Water Holding Capacity of
Soils
Measures of Soil Moisture
Testing Soil Moisture
Estimation of Water Demand

Available Water Holding Capacity of Soils

The frequency and amount of irrigation required for a given plant is determined by the water holding capacity of the

soil and the normal root depth of the plant. Plant roots will grow toward moist soil, and will not grow into dry soil. Thus, the plant root zone is limited and defined by the extent that moisture has penetrated the soil.

Plants with a large, deep root system, corresponding to large soil water reservoir, will require less frequent but larger amounts of water with each irrigation. By the same token soils with greater holding capacity will require less frequent but greater amounts of irrigation. Thus, the total amount of water that is required for all irrigations through a season is primarily determined by the climate and the type and age of the vegetation, but the amount and frequency of individual irrigations is determined by the water holding characteristics of the soil and the normal rooting depth of the plant.

Water is held available for plants in soil against the force of gravity by the attraction of water molecules to the surfaces of soil particles. Large soil particles such as sand have rather small surface areas in relation to their volumes and therefore have relatively less surface area to attract moisture per cubic foot of soil than would an equal volume of smaller grained material such as clay. The capacity to hold water increases with the fineness of the soil and the percentage of clay present. For this reason, soil texture, and the amount of organic material present are probably the most influential factors in determining available water capacity.

The soil texture is the relative proportions of each of the mineral particle size classifications, sand, silt, and clay. Sand particles, the largest mineral particles, fit together in such a way that large pore spaces result and they have the least surface area per volume of material. Thus sandy soils drain quite rapidly and have low water

Available Water Capacity Per Foot
of Depth for Various Soil Textures

Soil Type	Available Moisture	
	Range in./ft.	Average in./ft.
Very coarse sand	0.5-1.25	0.90
Moderately coarse sandy loams and fine sandy loams	1.25-1.75	1.50
Medium texture - very fine sandy loams to silty clay loam	1.50-2.30	1.90
Fine and very fine texture silty clay to clay	1.60-2.50	2.10
Peats and mucks	2.00-3.00	2.50

(California Interagency Agricultural Information Task Force, 1977)

holding capacity. Sand holds only about 3.5 to 16 gallons of water per cubic yard of soil when at "field capacity" (Plant Science #6009, Gulmon 1977).

"Field capacity" is the amount of moisture that remains after soil has been saturated and allowed to drain for two or three days. It is the greatest amount of water that the soil can hold under conditions of free drainage.

Clay, with the smallest particle sizes, holds up to 120 gallons per cubic yard (Gulmon 1977). Due to the size of the particles, the surface area is very large. Warshall (1976) estimates that the surface area in a pound of clay can be the equivalent of 25 acres. But many of the pore spaces between clay particles are too small for roots to enter, so that over half this water is unavailable to plants.

Loams, soils that contain a substantial amount of organic material in addition to their predominantly sand texture, are the best compromise between total water storage capacity and interparticle spaces. The organic material helps physically by absorbing and holding moisture as well as by keeping soil open and spongy, which in turn allows the free movement of water and air.

A representative loam soil in a cultivated field contains approximately 50 percent solid particles of sand, silt, clay, and organic matter, 25 percent air, and 25 percent water. Only about half of the water is available to plants at any time; the other half is held in thin films and gaseous forms which plants cannot absorb (Donahue 1971). Silt loams can have an available water capacity more than twice as great as fine sand. When fully saturated, one cubic yard of loam soil contains from 60 to 90 gallons of water (9" to 14") of which as much as 55 gallons may be available to plants (Gulmon 1977).

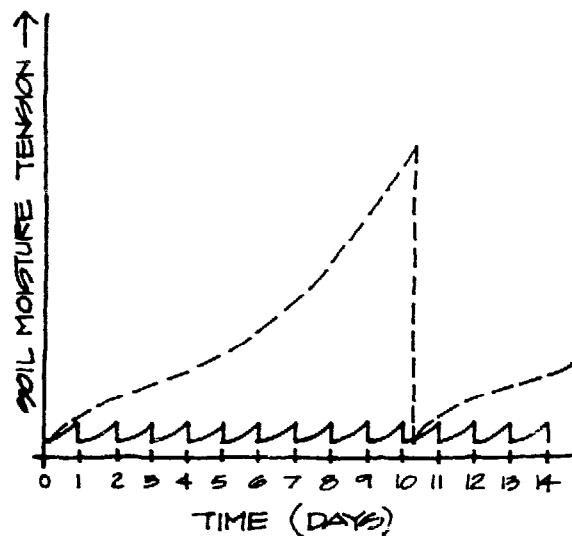

SOIL MOISTURE TENSION, A MEASURE OF THE FORCE BY WHICH WATER IS HELD IN THE SOIL (AND THUS OF THE EFFORT REQUIRED OF A PLANT TO EXTRACT WATER) IS COMPARED FOR DRIP IRRIGATION (SOLID CURVES) AND SPRINKLER OR FURROW IRRIGATION (DASHED CURVES). IN DRIP IRRIGATION, THE WATER IS APPLIED DAILY. THE SOIL MOISTURE TENSION RISES SLIGHTLY DURING THE PERIOD OF 12 TO 18 HOURS BETWEEN APPLICATIONS. WITH SPRINKLER OR FURROW IRRIGATION, THE SOIL MOISTURE TENSION BUILDS UP CONSIDERABLY BETWEEN APPLICATIONS.

Well drained soils have tremendous capacity to accept water sprayed irrigation. At Saybrook Farms Company in New Jersey, in the classic of all the early land treatment projects, a clover field could accept only 2" of water before pools formed and surface runoff occurred. But forest land in the same soil accepted 4 feet of water in 16 hours all of which vanished into the earth (Stevens 1974). Forest spraying proved to be a safe and efficient means of returning industrial wastewater to the environment, although all the native plant materials are soon replaced by moisture loving herbs and shrubs.

Measures of Soil Moisture

Soil moisture is most commonly measured by the "soil moisture tension" which is based on the amount of energy required by plant roots to absorb moisture. When the moisture content of the soil is low, the energy or tension that must be exerted by a root is high. At the point at which a plant will permanently wilt the soil moisture tension is usually about 15 atmospheres of pressure.

At field capacity the soil water tension is less than 1 atmosphere pressure (usually about 1/3 atmosphere) and so water is absorbed easily by plant roots. The best soil water conditions for plants is at, or just below, field capacity. Above field capacity the soil tends toward water saturation and the soil water becomes unavailable to most plants because of too little available oxygen.

Available water is the range of soil moisture between the wilting point and the field capacity. Soils have differing capacities to hold water, therefore the amount of water it takes to get from the wilting point to the field capacity (called the available water capacity) will

vary with the soil. Available water capacity is usually expressed as the number of inches of water it takes to bring a layer of soil one foot deep from the wilting point to the field capacity.

Testing Soil Moisture

Determining when irrigation is required can be accomplished directly in one of three ways: plant observation, tensiometers, or the soil hand-feel test.

Plant symptoms provide a guide to the moisture condition of the soil. This is particularly true in timing the first irrigation of the season, when you may not know how much moisture is in the soil reservoir or how fast it is being used. Symptoms include wilting leaves, changes in appearance of the leaves (shiny leaves become dull, bright green leaves fading or turning grey-green); and heavy leaf fall and sometimes death of young leaves.

Measuring the moisture level directly in soils is easily done with a device called a "tensiometer". This is a porous clay cup filled with water and connected to a vacuum gauge or mercury manometer. As the soil dries out it draws water from the cup creating a vacuum which is measured by the gauge; the drier the soil becomes, the higher the vacuum. Tensiometers can be used to override automatic sprinkling systems by preventing the automatic timing device from turning on the water if soil moisture content is too high (Milne 1976).

Another method is to use a shovel or soil sampling tube to collect soil samples from various depths and locations around the garden. Take a small sample of soil in your hand and try to roll or squeeze it in a ball. If the soil will not mold into a ball, it is probably too dry to supply water to plants.

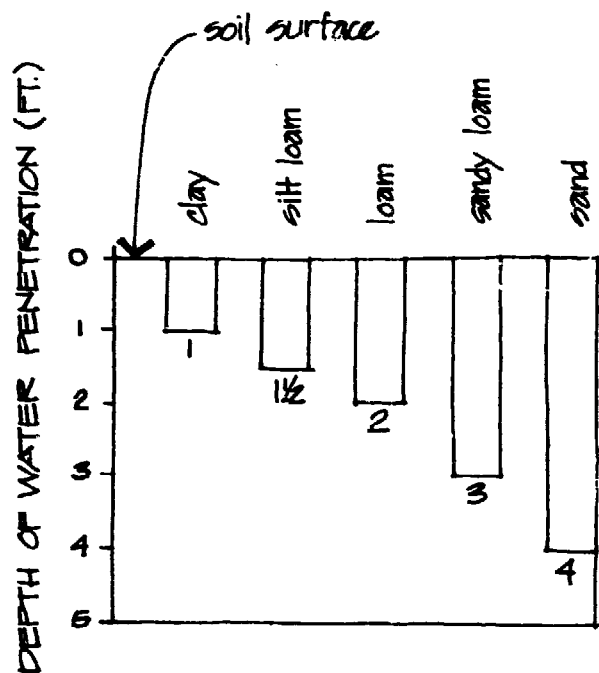

THREE INCHES OF WATER WILL WET EACH SOIL TEXTURE TO APPROXIMATELY THE DEPTH SHOWN

Rub the ball with your thumb and if it will crumble the soil moisture is probably about right. If it will not crumble it is probably too wet.

Estimation of Water Demand

Given a soil with known water penetration characteristics, and a vegetation type with known rooting depth characteristics it is possible to approximate the amount of water that is required to wet the soil to a desired depth.

Just as soil texture will determine the amount of water that a given volume of soil can hold, it also determines how deeply a given amount of water will penetrate a column of soil. Three inches of water will penetrate approximately 4 times further into a column of coarse sand than into a column of clay.

The application of one inch of water is equal to about 2/3 gallon per square foot of soil surface area. Therefore the amount of water required to soak a 100 sq.ft. garden bed of spinach, a shallow rooted vegetable, for example, to a depth of 2 feet would depend on the soil type as follows:

sandy soil would require about 125 gallons;
loamy soil would require about 190 gallons; and
clay soil would require about 330 gallons (Sunset 1976).

These figures are for bringing soil from the wilting point to the field capacity. Assuming that the soil is not allowed to reach the wilting point between irrigations, somewhat less water is required in each subsequent irrigation. A good rule of thumb is that a square foot of loamy soils, rich in organic matter, is capable of handling

PRACTICAL INTERPRETATION CHART FOR SOIL MOISTURE

	Sand (gritty when moist, almost like beach sand)	Sandy loam (gritty when moist; dirties fingers; contains some silt and clay)	Clay loam (Sticky and plas- tic when moist)	Clay (very sticky when moist; behaves like modeling clay)
Moisture available*	Feel or appearance of soils			
Close to 0% Little or no moisture available.	Dry, loose, single-grained, flows through fingers.	Dry, loose, flows through fingers.	Dry clods that break down into powdery con- dition.	Hard, baked, cracked surface. Hard clods diffi- cult to break, sometimes has loose crumbs on surface.
50% or less. Approaching time to irri- gate.	Still appears to be dry; will not form a ball with pressure.	Still appears to be dry; will not form a ball.	Somewhat crumbly, but will hold together with pressure.	Somewhat pliable, will ball under pressure.
50% to 75% Enough avail- able moisture.	Same as sand under 50%.	Tends to ball under pressure but seldom will hold together.	Forms a ball, somewhat plastic; will sometimes stick slightly with pressure.	Forms a ball; will ribbon out between thumb and forefinger.

(continued on next page)

PRACTICAL INTERPRETATION CHART FOR SOIL MOISTURE (continued)

	Sand (gritty when moist, almost like beach sand)	Sandy loam (gritty when moist; dirties fingers; contains some silt and clay)	Clay loam (sticky and plas- tic when moist)	Clay (very sticky when moist; behaves like modeling clay)
Moisture available*	Feel or appearance of soils			
75% to field capacity. Plenty of available moisture.	Tends to stick together slightly sometimes forms a very weak ball under pressure.	Forms weak ball, breaks easily, will not become slick.	Forms a ball and is very pliable; becomes slick readily if high in clay.	Easily ribbons out between fingers; feels slick.
At field capacity. Soil won't hold any more water (after draining)	Upon squeezing, no free water appears but moisture is left on hand.	Same as sand.	Same as sand.	Same as sand.
Above field capacity. Unless water drains out, soil will be waterlogged.	Free water appears when soil is bounced in hand.	Free water will be released with kneading.	Can squeeze out free water.	Puddles and free water forms on surface.

* Amount of readily available moisture remaining for plants.

(Leaflet 2976, University of California, Division of Agricultural Services, 1977)

Approximate Days Between Required Irrigations*

<u>Vegetation Type</u>	<u>Soil Type</u>		
	<u>Sandy</u>	<u>Loam</u>	<u>Clay</u>
Shallow rooted	4-6	7-10	10-12
Medium rooted	7-10	10-15	15-20
Deep rooted	15-20	20-30	30 or more

(Interagency Agricultural Information Task Force, 1966)

* The frequency of irrigations required in individual gardens will vary over the growing season and therefore it is important that irrigations be determined by actual demand rather than a predetermined schedule.

1/2 gallon (3/4 inch) of greywater per week on the average. Sandy, well drained soils will accommodate more water; clayey, poorly drained soils, less (Javits 1977).

The majority of common garden plants have root zones within the top 2 to 3 feet of soil. The diagram shows that the depth of penetration of water in loam to sandy loam is 2 to 3 feet for a 3-inch irrigation. It is reasonable to assume that the soil in a typical well maintained garden will be loam or sandy loam. The table, "Approximate Days Between Required Irrigations," indicates that loam soil with shallow to medium rooted plants will require an irrigation every 7 to 15 days. If we assume an average irrigation span of 10 days and a per person daily production of 40 gallons we can make the following calculation:

2/3 inch of water = 1 gallon over 1 sq.ft.

In 10 days at 40 gallons per capita per day a family of 4 would produce 1600 gallons of greywater. This would be adequate to irrigate 800 sq.ft. of garden or landscaping every 10 days.

This is a rough approximation but a similar calculation will serve as a starting point for a homeowner beginning to design a greywater irrigation system. Other factors act to adjust the water demand in a given situation. In addition to the soil texture and rooting depth of plants included in this calculation water demand is affected by:

- . The age of the plants; early growth generally requires more water than mature plants.
- . Evaporation from the soil surface can be substantially reduced by use of mulches.

Rules of Thumb: A square foot of loamy garden soil with good organic matter can handle 1/2 gallon of waste water per week. Sandy lighter soils can handle more; clayey heavier soils less. This rate will be greater in summer, less in winter (Javits 1974). This means that 500 sq.ft. of garden or lawn can handle all the greywater produced by an average family. This area represents only 10% of the average 50 by 100 ft. residential lot.

- . Irrigation methods which can be used vary significantly in their efficiency. Losses from evaporation in open irrigation systems, for example, can be substantial.
- . Additional water may be required in some cases simply to leach accumulated salts from the soil.

All of these factors make it difficult to estimate water demand precisely. With a little preliminary planning and gradual accumulation of experience it should be possible to approximately match the garden demand for water with the greywater supply.

METHODS OF IRRIGATING WITH GREYWATER

There are a number of ways in which greywater can be applied to the soils for irrigation. The most common irrigation methods are:

- . flooding either in furrows or basins
- . sprinkling or spraying either by hand or sprinkling heads
- . drip or trickle irrigation systems which convey water in tubes directly to the point of use at or above the plant's root zone
- . subsurface irrigation through multiwalled tubes or perforated pipes
- . underground dispersal through gravel-filled trenches
- . ponds and lagoons
- . land flooding.

Each method has characteristics which make it more or less suitable for a specific type of greywater use.

The key points to consider in selecting a method of greywater irrigation are:

- . reliability of the system and the probability of avoiding failures
- . amount of maintenance required

Furrows and Basins
Sprinklers and Sprayers
Drip Irrigation
Subsurface Irrigation
Pond, Marsh, and Lagoon Systems
Land Flooding
Pretreatment of Irrigation Greywater
Design Problems of Residential Grey-
water Irrigation Systems
Typical Systems Being Developed

- . efficiency of the method in getting the water to the plant's roots
- . control of the greywater to prevent runoff from the irrigation site, particularly in soils with low infiltration rates or on relatively steep sloping terrain
- . control of the greywater to restrict human contact when disease causing organisms are a potential constituent of the greywater supply.

Furrows and Basins

Furrow and basin irrigation are by far the simplest methods and require very little equipment. With hand tools furrows are simply dug out between row crops or basins scooped out around the root zones of individual plants. In the most rudimentary systems, the greywater can be hand carried in buckets, but far easier is transporting it with a conventional garden hose supplied either from a buffer storage tank or directly from the greywater source drain pipe.

The furrow or basin method provides great flexibility in changing the irrigation site and poses a few problems of reliability, but requires regular attention. A very simple filter for grease and particulate matter can be provided by simply tying a cotton bag or old sock over the end of the hose. This simple filter only needs to be turned inside out, washed, and left out in the sun to be renewed.

When watering trees or large plants, keep water away from the base of the tree where it can cause "crown rot"; instead put the furrow or basins out around the "drop line" of the outer branches where feeder roots are located (Ayres 1977). If possible make a watering basin only on one side of the plant. That way only a small area of soil will be affected by sodium build up.

<u>Irrigation Method</u>	<u>Approximate Range of Application Efficiencies</u>
Furrow	70-85%
Basins	75-90%
Sprinklers	70-85%
Drip (trickle)	80-90%

Irrigation Application Efficiencies Under Good Management

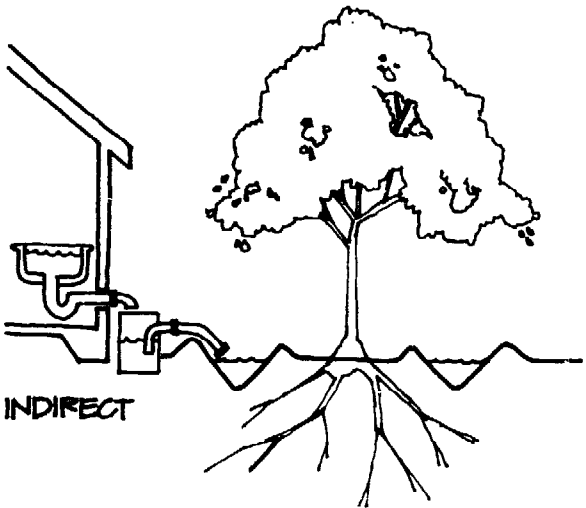
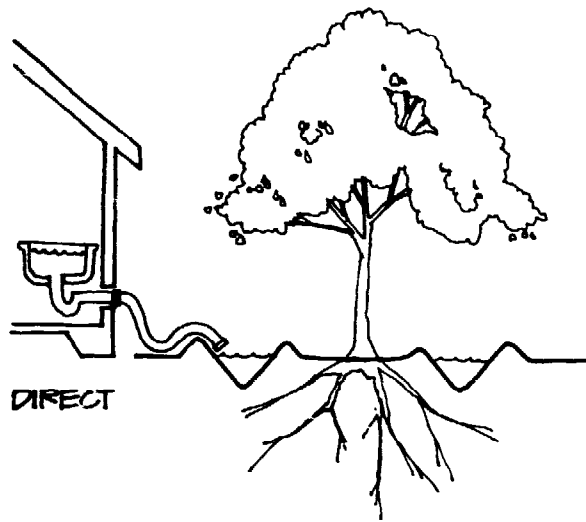

FURROW AND BASIN

The disadvantage of furrow or basin irrigation is that more water is lost due to evaporation than most other methods. There is also a potential for slop-over and surface runoff if the furrows and basins are poorly constructed or are allowed to overflow. In addition, if the presence of pathogenic materials in the greywater is a matter of concern, the open water could allow contact by small children. Therefore, furrow or basin irrigation should be restricted to areas that are not generally accessible, or unless it is reasonably certain that there are no harmful materials in the water.

Sprinklers and Sprayers

Untreated greywater is really not safe to sprinkle overhead, but if it has been treated in some way, irrigation with a sprinkler head is more efficient than furrow or basin methods to apply water evenly over a large surface such as a lawn or a firebreak. The application rate should be slow enough so that the water soaks into the soil immediately, without runoff.

The amount of water delivered by a sprinkler and the pattern of distribution can be determined by placing a row of coffee cans or similar, equally sized containers in a straight line away from the sprinkler (Sunset 1967). The sprinkler should then be run for a period of time and the amount of water in each can measured. Equal amounts of water in each can indicate that the sprinkler head is very efficient in distributing water. Sprinklers lose 3 to 15 percent of water to evaporation and this can increase the salinity of the water actually hitting the ground by 10 to 20 percent (Merriam in CDWR 1976).

For irrigating individual plants, hand held hoses are better than stationary sprinkler heads because the water can be put where needed. Also there is less tendency to overwater

using this method as contrasted with methods where water is turned on and the device is left to be repositioned at some later time. However, the hand waterer may not have the time or patience to make sure that the ground is adequately soaked.

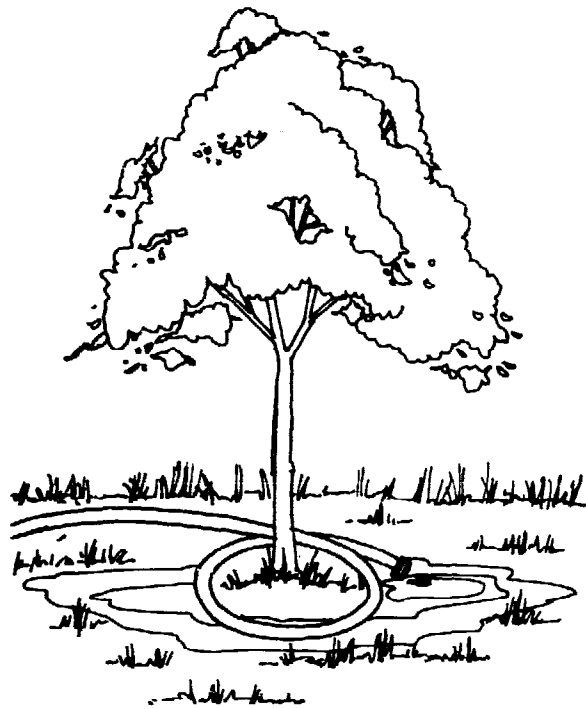

END OF DRIP TUBE TIED
LOOSELY AROUND STEM

Problems: Sprinkling, either by hand or with a sprinkler head, presents two problems for the residential greywater user. First, greywater systems are likely to be at very low pressures. This is simply because most systems operate on gravity flow from plumbing fixtures that are not much higher in elevation than the irrigation site. Without the pressure of normal household taps (anywhere from 25 to 50 psi) most sprinkler heads cannot work. This makes it almost inevitable that a pump is required, which in turn leads to problems of initial cost, periodic maintenance, energy consumption, higher pressure fittings, etc.

Second, sprinkling presents the possibility that pathogenic viruses and bacteria could be spread beyond the irrigation site in airborne droplets of water. Many authorities (e.g., California Department of Water Resources, 1977) flatly recommend against spraying greywater for this reason. The only other option is to disinfect the greywater, which is not necessarily beneficial to the garden. But, in instances where the irrigation site is isolated from potential points of human contact or the greywater is not likely to contain any pathogenic materials, sprinkling could be considered as an effective method of irrigation.

Examples: Spray irrigation with greywater is becoming more common. The first important studies of spray irrigating forests and meadowland with treated sewage effluent occurred at Penn State in the 1950's (Stevens 1974). For example, in Southern California the Las Virgenes sewage treatment plant sprays pastures as a means of disposing of tertiary treated

effluent in dry weather. More recently disposal of treated effluent by sprinkler systems in the forests of the Lake Tahoe basin was practiced until completion of a tertiary sewage treatment plant about 1970. All effluent is now pumped out of the basin where it is used for crop irrigation on the eastern slope of the Sierras.

In central Florida sewage from Disneyworld is treated by filtering it through a tract of low lying forest and crop land on the outskirts of the amusement park. Vegetation from the farm provides feed for the park's animals as well as wood pulp.

Penn State University scientists originated the term "living filter" in 1950 to characterize their precedent-setting experiments in spray irrigation of agricultural and forest land with secondary treated effluent from the university's sewage treatment plant (Stevens 1974). They were delighted to find that many plant species grew twice as fast and that the living filter successfully removed virtually all of the nutrients and pathogens from the wastewater.

Spraying greywater as a method of irrigation might be considered for fire breaks in wildland areas or for planting beds where the vegetation is so dense or thorny that people are discouraged from entering the area. Fenced in wood lots or meadows where access can be strictly controlled might also be considered. Hillside areas steep enough to discourage access present another alternative. However, steep slopes pose a potential for surface runoff, erosion, and earthslides. Use of sprinkler irrigation on a hillside requires that a solid groundcover be established, that the hillside is never irrigated to the point of soil saturation and that periodic checks are made for signs of erosion and soil slump or creep.

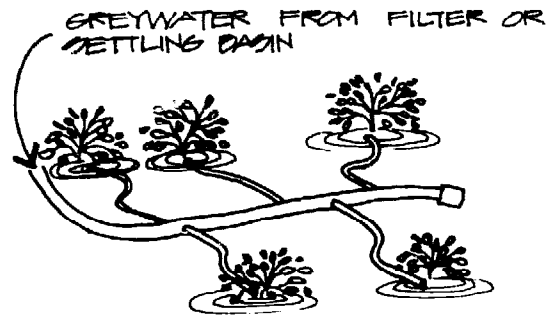

DRIP IRRIGATION

In any case where spraying or sprinkling of greywater is contemplated it is important to consider the uses adjacent to and nearby the irrigation site. Vegetable gardens or children's play areas, for example, which are close enough to be reached by airborne particles of spray, should preclude spray irrigation.

Drip Irrigation

Drip, or trickle irrigation systems can actually be categorized in two different ways. They can be located on or below the soil surface, and they can release water only at specific points along the distribution system or an entire length of distribution line can "ooze" water. In all cases the fundamental concept and objective is the same: to distribute water where it is most needed, at the plant roots, and at a slow and frequent rate which approximates the soil's loss of water through evapotranspiration.

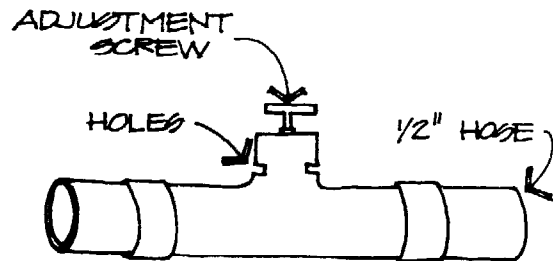

DRIP IRRIGATION EMITTER

In general a drip irrigation system includes a pipe or hose which carries the water from the source to the irrigation site. From this point smaller tubes inserted in the lateral lines discharge greywater at the base of the plants. The discharge lines may be laid directly on the surface of the soil (if ultraviolet resistant) where they can easily be moved, or they may be buried a few inches below the surface in a more permanent arrangement. The actual discharge of water may occur through holes drilled or poked into the tube, through nozzle-like fittings called emitters, spaced along the distribution lateral, through the clipped off end of 1/8 inch diameter tubes inserted in the supply tube, or the distribution tube itself may be made of a porous material, or have a continuous series of small holes every 4 to 12 inches along its entire length. The purpose of these discharge methods is to achieve an

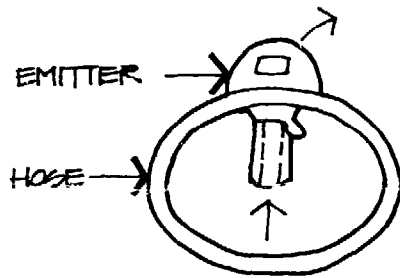

DRIP IRRIGATION DEVICES

even distribution of water around a plant and relatively constant flow.

An extremely simple trickle system was built in New England by Abby Rockefeller. She simply ran her household greywater out through 30 feet of 1 1/2 inch plastic pipe with 1/4 inch holes drilled every foot laid over a 3 foot high pile of leaves. In the winter she added another foot of leaves for insulation, although this was not really necessary because greywater leaves the house at about 60°F. It handled 60 gallons of greywater per day until it was diverted two years later into a newly constructed greenhouse (Stoner 1977).

At the other extreme are the highly sophisticated drip irrigation systems such as might be installed in a commercial greenhouse or orchard. In these systems the amount and rate of flow of the water is carefully controlled with tensiometers buried in the soil, timers, and electrically controlled flow and sequencing valves to replenish the water supply in the soil at the same rate it is lost through evapotranspiration.

In recent years a number of kits for home gardeners have appeared on the market. These kits and comparable component parts are now available from nursery supply, hardware, and farm supply stores. (Refer to the Components section of this report and to Milne, 1976, for more detailed information.)

Kits typically contain a 20 gal/hr flow control hose fitting 100 feet of quarter inch tubing, a punch and insertion tool, various lengths of smaller diameter tubing for emitters, plus end caps, plugs, and couplers as required. (See Drip Irrigation Equipment in Components chapter.)

Advantages: The use of drip irrigation methods provides some distinct advantages over some of the other methods, particularly when greywater is being used. Drip irrigation provides more efficient use of water. The distribution system is closed and therefore evaporation losses are reduced. The closed distribution system also means that it can be used in almost any situation without concern for the potential contact of people with greywater. It can easily be distributed and discharged without being openly

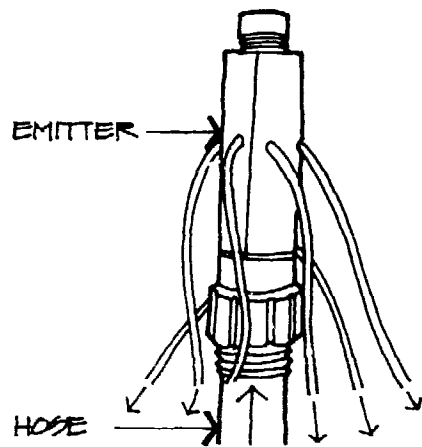

accessible on the surface.

A drip irrigation network needs only 5 to 14 pounds per square inch pressure. Greywater systems easily provide such pressures if the source of supply, the household fixtures, are from 10 to 20 feet above the point of discharge. Shorter, larger diameter systems can be designed to operate at even lower pressures. Drip irrigations need to be frequent and at low volumes. Therefore, it is well matched to the flow production characteristics of greywater. Periodic loads from the laundry or bath can be temporarily held in a small storage tank for cooling, settling, and slow discharge to the irrigation field. Other irrigation methods are effective if discharges are made infrequently and in volumes sufficient to saturate the soil root zone. Thus, when the greywater supply is available only intermittently and in small quantities it would be necessary to provide sufficient storage capacity to accumulate a suitable amount of water to operate these other methods.

The system is designed to maintain the soil above field capacity in most of the wetted area. This has the advantage of making the water available to the plants at very low stress levels.

An added benefit of drip irrigation system use with greywater is that it works well with water which initially is highly saline. Water in arid areas often is, and greywater may often be, quite high in salt concentrations. As discussed in the section on Salt Accumulation in Soils, this can be a serious detriment to plants. Because drip irrigation maintains the moisture content of the soil at field capacity in the root zone, this causes almost constant downward flow of moisture past the root zone because the soil never dries out to the point where evaporation at the surface causes a net upward flow of moisture. The constant downward flow leaches the

Gophers and other rodents reportedly nibble on drip irrigation tubes. It is not clear whether they find the plastic tasty, intriguing, or annoying. One large system suffered 13 leaks a day until embarking on a rodent eradication program (L.A. Times 6/30/78).

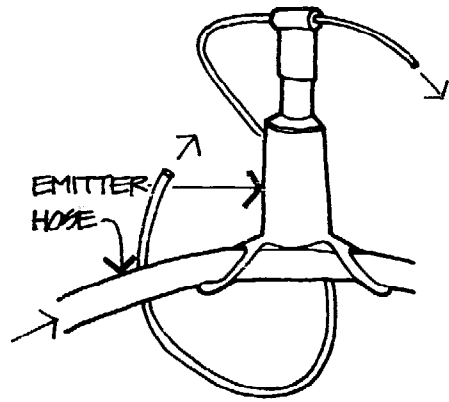

salts in the water through the soil and carries them to the outer reaches of the wet zone beyond the plant roots. Thus salts are never allowed to build up to the point that plants are affected.

Drip systems are adaptable to uneven terrain which allows greywater use on some irrigation sites where it might be infeasible with other methods.

Disadvantages: Drip irrigation poses some problems for greywater users. The system requires a higher initial investment, both in labor for installation and in purchase of materials, than any other commonly used irrigation method. These costs are partially offset by the reduced labor requirements of daily operation and the more efficient use of increasingly costly water.

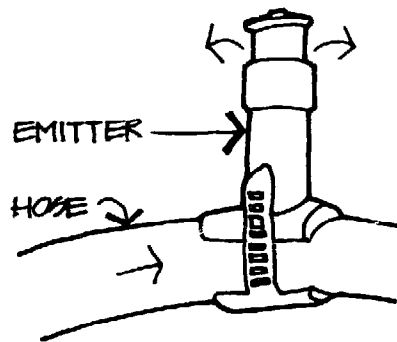

Burial of the discharge lines and emitters can sometimes result in damaging them with tools in the process of cultivating, planting, aerating lawns, or even with tent stakes or croquet wickets. In small scale operations such as a home garden this problem can be avoided by burying the lines in permanent beds below the level of normal tilling and weed control operations. A second, perhaps simpler, alternative is to lay the lines on the soil surface where they can be easily moved out of the way when necessary. This also allows for ease of inspection to observe their operation and detect failures before crop damage occurs. A third method is to staple tubes to the underside of a piece of wood (bender board) and bury both in such a way that the wood protects the tube. In any case damaged pipes and tubes are easily repaired with a new connector or repair coupling.

DRIP IRRIGATION DEVICES

The biggest problem of using drip irrigation systems with greywater is the presence of particulate matter, food

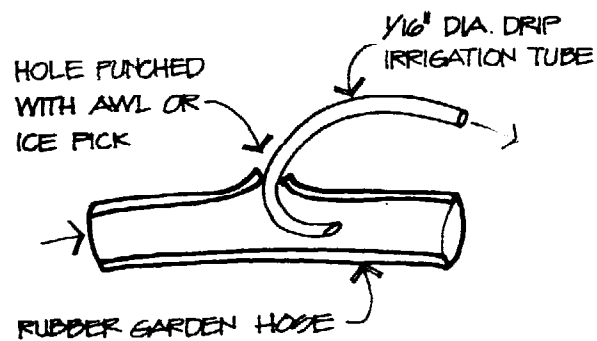

DRIP IRRIGATION

If there is no danger of freezing lay the subsurface lines as shallow as possible. This is where more plant roots plus the most active and diverse bacteria and invertebrate ecosystems help metabolize organic wastes and keep the soil open (Lindstrom 1971). Drill 1/4" holes in 1-1/2" diameter pipe and bury it 2" deep.

particles, lint and silt, which can clog the distribution lines and emitters. Grease from the kitchen can be particularly troublesome because as it cools it hardens in the tubes and can totally block them. The presence of particulate matter is especially significant with these systems because of the low pressure, small orifices and low velocity of the water flow.

The problem can be minimized by a few simple improvements to the system and by a few management practices.

- Avoid small diameter tubes and openings, especially "micro tubes".
- A simple "roughing" filter of gravel or sand will remove much of the particulate matter before it is sent into the distribution system. A description of this type of filter can be found in the Components section.
- Orient the orifices in the emitters or discharge hoses upward if possible. The orifices are small enough that particles of soil will not enter.
- Flush out blocked tubes with a surge of higher pressure water to force through any accumulation of particles in the line. But be extremely careful not to blow the system apart because the tiny plastic tubes are held in place only by friction.
- If slime begins to form inside the lines from material in greywater, treat it by mildly chlorinating the water for 20 minutes per day at a concentration of 10 ppm (Shoji 1977). Chlorine also controls the bacteria that flourish on iron and sulfur in water in certain areas but this probably will not be necessary because household greywater may already contain small concentrations of chlorine from municipal pre-treatment and from bleach used in the laundry.

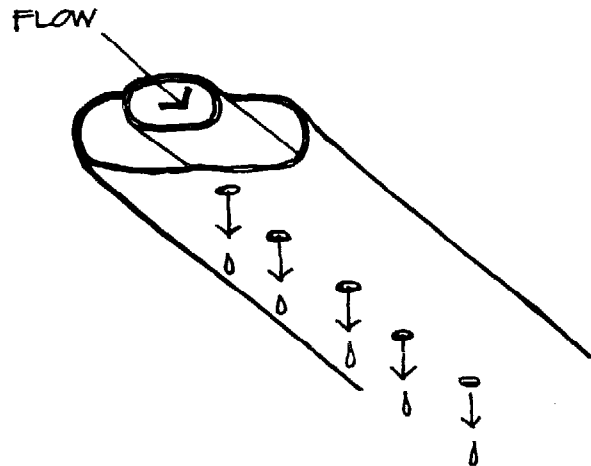

DUAL WALL TUBING, USED IN
SUBSURFACE DRIP IRRIGATION SYSTEMS,
IS BURIED WITH THE HOLES DOWN.



POROUS FOAM PVC TUBING DRIPS
WATER SLOWLY EVERYWHERE
ALONG ITS SURFACE

- Blockages will often disappear spontaneously with regular use, especially if they originally occurred after a long period of nonuse.

Subsurface Irrigation

There are at least three different strategies for irrigating with greywater below ground: perforated pipes, gravel-filled trenches, and evapotranspiration beds.

Perforated Pipes: There are at least four kinds of simple buried perforated pipe irrigation systems. The cheapest is simply an old soaker hose. Perforated dual wall tubing is essentially a tube within a tube; the inner one ensures uniform supply pressure along its full length, the outer tube is perforated every 4 to 12 inches to emit water uniformly underground. The third type is "foamed" PVC tubing, sometimes called MPT (multi-porous tube), which simply oozes water evenly all along its surface (Sunset 1977). Fourth is plastic pipe with drilled holes.

However, none of these tubes withstand very high pressures. So if using a pump be sure it has a pressure limit shut-off, and when backflushing the system be sure to uncap the plugs at the end of each line.

Underground systems apply "invisible" amounts of greywater, therefore timing the period of application is critical. Initially water every other day for 2 hours with MPT tubes or 1/2 hour with dual wall tubing. If stripes of healthy grass appear over the tubes increase the time 15 minutes, if stripes of healthy grass appear only between the tubes you are overwatering so cut back the time 15 minutes (Sunset 1977). An automatic timer is a great convenience for controlling the flow to underground irrigation systems from a storage tank. But complicated valves and timers

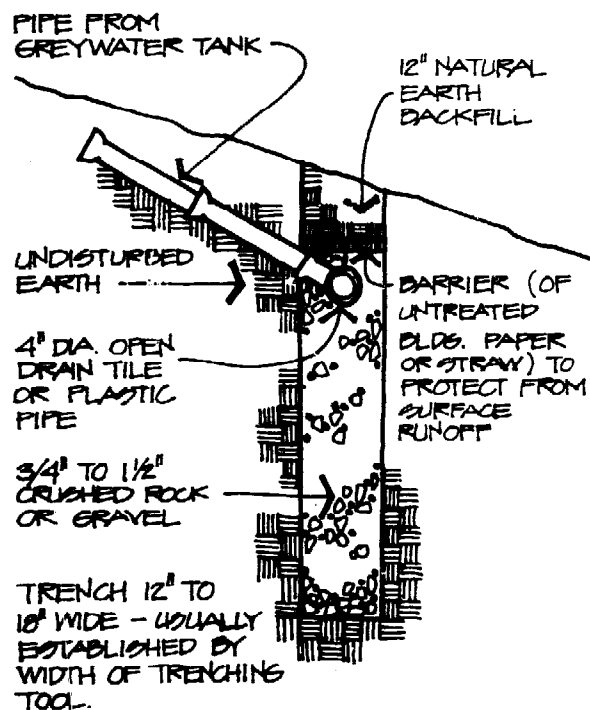

TRENCH DESIGN

can be avoided if the irrigation system is designed to use greywater at approximately the same rate as it is produced by the household. In fact a buried, gravity fed system comes closest to being a zero cost, zero energy, completely automatic, invisible, low maintenance system for watering a lawn or garden.

Gravel Filled Trenches: For greywater irrigation these may prove to be the most reliable and need the least maintenance of any of the on-site greywater irrigation methods. A possible disadvantage is that they primarily provide moisture for trees and other deep rooted plants.

Gravel trenches were originally developed as leach fields to dispose of septic tank wastes. Large diameter open tubes or perforated pipes can distribute unfiltered greywater with less likelihood of clogging than systems using smaller diameter tubes and orifices. But the most important thing is they must be laid level. If the trench has at least 12 inches of gravel or crushed rocks under the distribution pipe there should be no problems with roots (Winnenberger 1974). Larger diameter gravel works better. The trench bottom and sides should not be compacted or smeared, which reduces absorption, so do not dig when the ground is wet. An impervious barrier such as sheet plastic or tar paper should cover the gravel to discourage surface water from flooding and silting up the trench. This barrier in turn keeps the trench from "stealing" surface irrigation water from shallow rooted plants in the topsoil above.

If for any reason the trench is opened up, it is likely that at the gravel-soil interface there will be a layer of organic-microbiological slime. Depending on its thickness this slime mat probably slows down the infiltration rate, but not to worry, because it actually increases the efficiency of the filtering action by removing coliforms and other

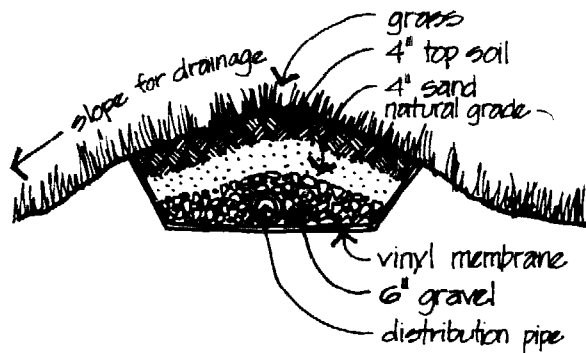

EVAPOTRANSPIRATION BED

WATER TABLE	DISTANCES BELOW SURFACES Inches	SURFACE TREATMENT	EVAPOTRANSPIRATION RATE (AEROBIC) Gallons/Sq.Ft./Day		
			Average Summer	Average Winter	Average Year
	2 to 3	Grass & shrubs	.22	.10	.16
	2 to 3	Bare	.13	.04	.08
	6 to 9	Grass & shrubs	.13	.02	.08
	6 to 9	Bare	.07	.01	.05

(This data was originally developed for use in Southern Canada: Bernhart 1972)

bacterial pathogens (DWR 1975). However, assuming that this slime might build up too much, Winnenberger (1976) suggests building two separate fields of trenches then alternating the flow from one field to the other, always allowing one of the fields to "regenerate while resting". On the other hand, Laak (1974) found that this mat will not clog to ultimate failure but reaches a long term equilibrium, and that the efficiency of the field is not increased by short resting periods, as, for example, by using 3-day dosing cycles.

Evapotranspiration (E.T.) Beds: These provide yet another simple method of subsurface irrigation. They were developed originally as an alternative method of disposing of septic tank effluent on land where the water table was too high or percolation rates were too slow. You will understand how E.T. beds work if you have ever grown a house plant in a pot without a drainage hole: The plant "pumped" all of the irrigation water you gave it into the air by the process of evapotranspiration.

E.T. beds are quite simple to construct (Stewart 1977). First excavate a flat bed 12 to 24 inches deep and line it with 10 mil polyvinyl chloride sheet, the type used for plastic above-ground swimming pools. Then fill it up to ground level with gravel topped with 4 inches of sand. Cover this with a mound of 4 to 8 inches of topsoil. The mound must be high enough to ensure good surface runoff so that the subsurface bed will not be flooded during the rainy season. Effluent is distributed evenly throughout the gravel by large diameter drain tubes. To keep the bed from becoming anaerobic, air can be introduced into the gravel through 2 inch diameter perforated pipes laid between the drain tubes just below the soil cover angled at either end to stick up above the surface of the mound.

In arid climates calculate the volume of the bed to hold at

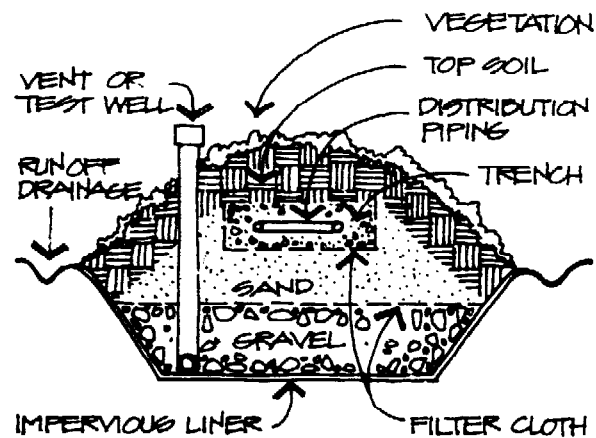

MOUNDED ET SYSTEM

least two weeks of household effluent (Mara 1976). Remember that the gravel alone takes up 70 percent of the volume. If the water table is 6 to 9 inches below the surface of the bed, the evapotranspiration rate for sandy soil cover with grass and shrubs averages .08 gallons/sq.ft./day, but can range from .02 in subfreezing weather to .13 in mid-summer (Bernhardt 1972). The E.T. rate is much less if the fluid level falls much below 12 inches. But the biggest drawback is the large amount of land required. Almost any kind of plant materials can be grown on E.T. beds, although grasses, perennials, and shallow rooted shrubs are particularly successful.

Notice that except for the vinyl waterproof membrane, an E.T. bed is similar to the leach field of a septic tank which means that many of the same problems and design solutions apply (Winneberger 1974). Certainly this raises the possibility that conventional leach fields could be converted to E.T. irrigation systems.

Root Intrusion: The biggest threat to subsurface greywater irrigation comes from active, aggressive roots, paradoxically the very thing the system is designed to encourage. A couple of strategies have been suggested:

- . Use plant materials, such as grasses, which have limited root depth, then place the irrigation tubes below that depth. However, some turf plants such as Bermuda grass have extremely deep roots, which is why they are one of the most drought tolerant lawns.
- . Use plant materials that do not like "wet feet", whose roots will not enter zones of continuous wetness but rather seek well aerated soil.
- . The subsurface distribution system sits on top of a layer of at least 12 inches of gravel with no moisture

USING SHALLOW ROOTED GRASSES
KEEPS ROOTS FROM CLOSING
SUBSURFACE IRRIGATION PIPES

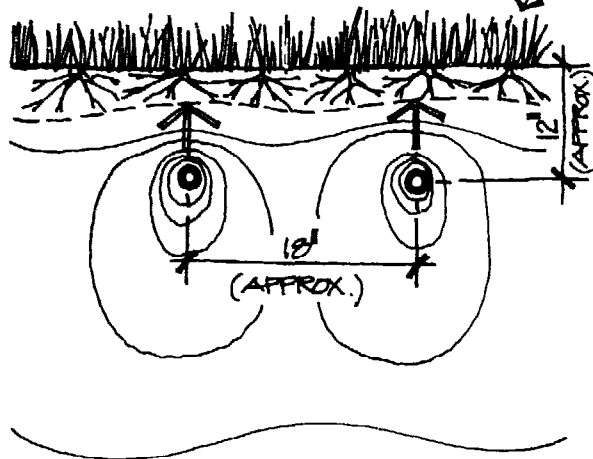

SUBSURFACE IRRIGATION WATER
"WICKS" UPWARDS THROUGH DRY SOIL
TO FEED SHALLOW-ROOTED PLANTS

holding capacity. The greywater will sink rapidly away from the distribution pipe.

- Shutting the system down for a few weeks may kill intruding roots, provided some form of surface irrigation keeps the rest of the plant roots healthy. However, root intrusion in septic tank leach fields is usually greatest when the system has been shut down for an extended period. (Apparently when deprived they progressively seek out their expected daily ration. Winnenberger 1974).
- Experiment with different length dry periods in the schedule to discourage root intrusion.
- If the situation is serious, consider using some of the root killers developed for use in sewers and septic tank leach fields (Leonard 1971).

Pond, Marsh, and Lagoon Systems

For raising plant materials (and animals) that thrive in aquatic environments, greywater ponds, marshes, and lagoons have great potential.

In Southern California a series of ponds or "aqua-cells" in a greenhouse are being tested as a means of treating sewage while at the same time producing food and fodder. In the first pond water hyacinths metabolize the nitrogen, phosphorous, and other nutrients. In the next pond water ozone is injected to kill bacteria. In other "aqua-cells" fish, freshwater shrimp, and aqueous plants thrive. The final effluent is said to be comparable to conventional secondary treatment, but longer retention times would reportedly produce even better quality effluent (Rain 1977).

If the lagoon is more than about 6 feet deep, it will separate

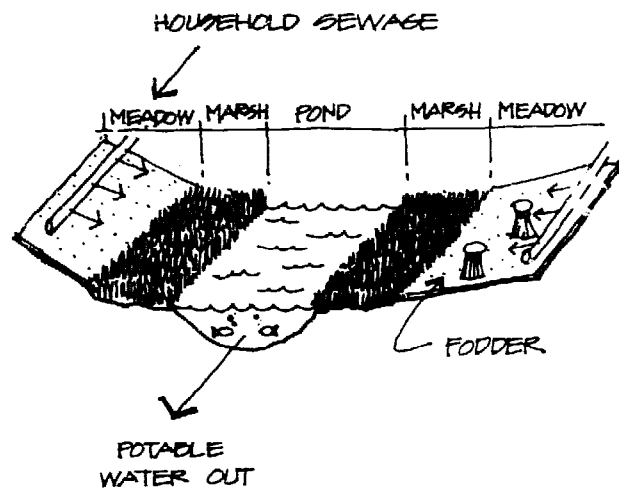

MEADOW-MARSH SYSTEM

out with a stable anaerobic layer on the bottom and an aerobic layer on top. If it is too shallow the anaerobic layer will cause odors and will not treat completely. If it is shallow enough for plants to grow, it will become anaerobic and insect problems will be much more severe. About 40 days detention time is required, so a typical household would require two 4,000 gallon ponds (OAT 1977). If necessary a wind-powered aerator can increase the oxygen content to encourage aerobic digestion.

Lagoons and waste stabilization ponds are inexpensive to build and operate, and so have great promise for food production, especially in protein-short third world countries. In addition to rice farming, ducks and algae-eating fish thrive in these maturation ponds, especially tilapia, carp, catfish, and mosquito fish (Mara 1976). The people from the New Alchemy Institute probably have the most experience using the effluent from fish tanks for garden irrigation (McCarney 1976).

Although it sounds like heresy, raw household sewage including blackwater is being sprayed and flooded on meadows and marshes in dozens of experiments and demonstration projects in many different parts of the country (Hartigan 1975). The results are extremely encouraging.

On Long Island, Brookhaven Laboratory has been experimenting since 1972 with various direct land application sewage treatment systems. Each system is designed to treat the sewage produced by 100 people. Raw sewage is pumped into a holding pond where it is continuously aerated by a floating agitator. From here it is pumped to flood a meadow which slopes down gradually to a marsh which in turn drains into a pond. The effluent from the pond "will generally be potable water without any further treatment" (Small 1975, 1977). The meadows produce fodder which is harvested and fed to

apparently contented cows. The marsh and pond also produce cash crops; the pond is stocked with native aquatic animals. The discharge from the pond is used for irrigation and ground-water recharge. A family of four people producing about 100 gpcpd total sewage, would need about 1,400 sq.ft. of land area for such a system, or about 350 sq.ft. per person.

In another experiment Brookhaven eliminated the meadows but produced approximately the same result. Thus, although the land area was cut in half (to about 175 sq.ft. per person) the cash fodder crop was eliminated and so it is not clear which approach is the most cost effective.

It must be emphasized that at Brookhaven none of the partially treated effluent in this system could enter the groundwater table because all the land was underlaid with an impervious sheet of plastic.

Pond treatment was rediscovered somewhat by accident in 1928 when the town of Fessendon, North Dakota, ran out of money and was unable to complete its new sewage collection system. As an emergency measure the town piped its sewage into a huge natural pothole. Surprisingly as the months went by and the pothole filled up, nothing happened. It did not smell, evaporation and seepage kept the level about constant, and analysis showed that the raw sewage was actually purified by the pond just as well as by the proposed primary-secondary plant. The town never did buy the plant (Stevens 1974).

It is important to realize that although ponds and lagoons might play a role in the on-site reuse of household wastewater, obviously for most urban homeowners their application is limited.

Land Flooding

Almost 500 municipalities treat their wastewater by some type of land application, often by simply flooding gently sloped grassy fields. In most cases some type of income generating crop is produced (Stevens 1974).

For example, all of the sewage from the city of Melbourne, Australia, 100,000 gallons per day, is treated by simply flooding the pastures of a huge sheep and cattle ranch at the rate of about 4 inches every 18 days.

But interestingly enough, the majority of these land application systems are now operating in California. Apparently the main reason this method is not more popular is that conventional sewage treatment plants require much less land and appear more technologically sophisticated, thus are seemingly easier to manage. The biological treatment of wastewater by land application uses more time and space but uses much less energy and at the same time produces food and reusable water.

Stevens cites dozens of cases of how plants and soil safely treat municipal wastewater, without any odor problems. All of the systems he discusses contain blackwater wastes, but hopefully if blackwater can be safely treated by land flooding, then greywater could be just as successfully handled. Unfortunately, no such greywater systems appear as yet in the literature. On the other hand it may be that a certain amount of nutrient is necessary in order to encourage microbes to digest the less appealing substances found predominantly in greywater, such as detergents and other cleaning products. Without toilet wastes or at least kitchen wastes present, some kinds of greywater may prove less susceptible to biological treatment (OAT 1977). One imagines tricking the poor little microbes into eating the

Rule of Thumb: Land area requirements for sewage farming is 1 acre per 1,000 people; aerated oxidation ponds is 1 acre per 5,000 people; trickling activated sludge is 1 acre per 50,000 people (Van der Ryn 1970).

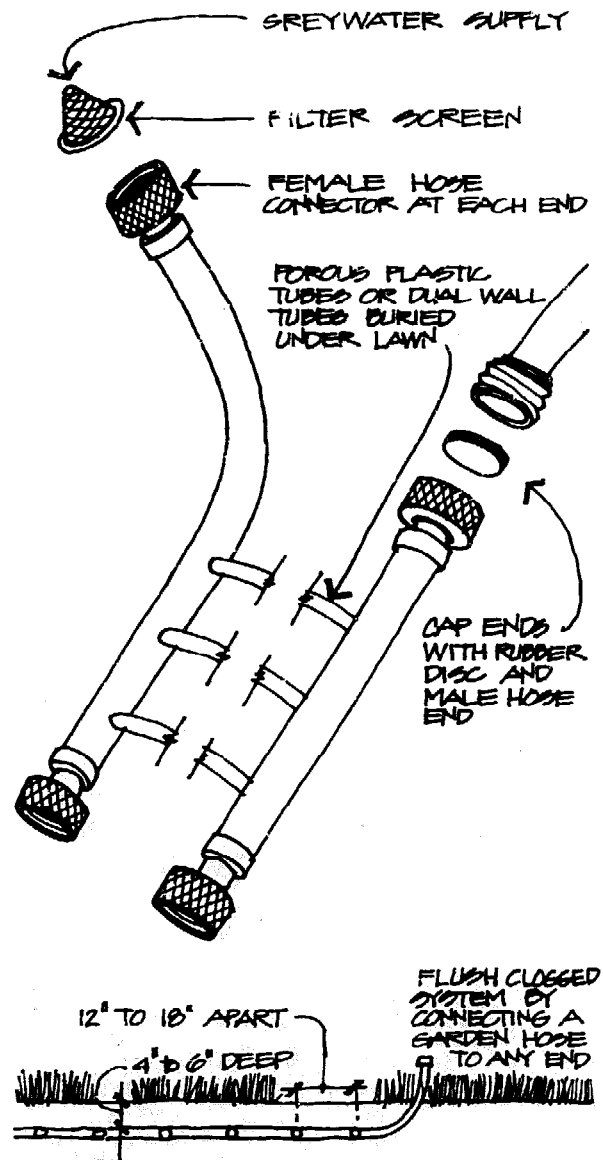

bad tasting stuff by mixing it with their favorite food.

Pretreatment of Irrigation Greywater

Ideally household greywater should be able to flow directly into the garden, without intervening hardware, but sometimes there are good reasons why that just is not possible.

Buffering and Dosing: In order to prevent the soil from being continually soaked, it may be necessary to store up a certain volume of water and then release it in one big dose. The momentum of a large dose can help distribute the greywater over a larger area. This is done easily enough with a storage tank and dosing siphon. Temporary storage also allows a certain amount of mixing, diluting, or buffering of various household effluents, and of course particulate matter will settle out, which reduces problems in the distribution system but adds problems of periodic cleaning of the tank.

Filtering: Ideally particulate matter can be passed directly into garden soil. But if for some reason removal is required, there are many types of filters available, ranging from small screw-on cartridge type, high pressure swimming pool type, and large gravel filled trickle filter tanks, to huge underground sand filter beds. If the only reason to filter greywater is the aesthetics of eliminating hair, lint, and strange objects from the garden, then use the easier strategy of buying strainers for the household fixtures or installing a cloth bag or sock on the outlets. However, if a buffering tank is used, settling will probably eliminate the need for filtering.

Aerobic Pretreatment: However, something else goes on inside a filter. It acts as a matrix in which aerobic

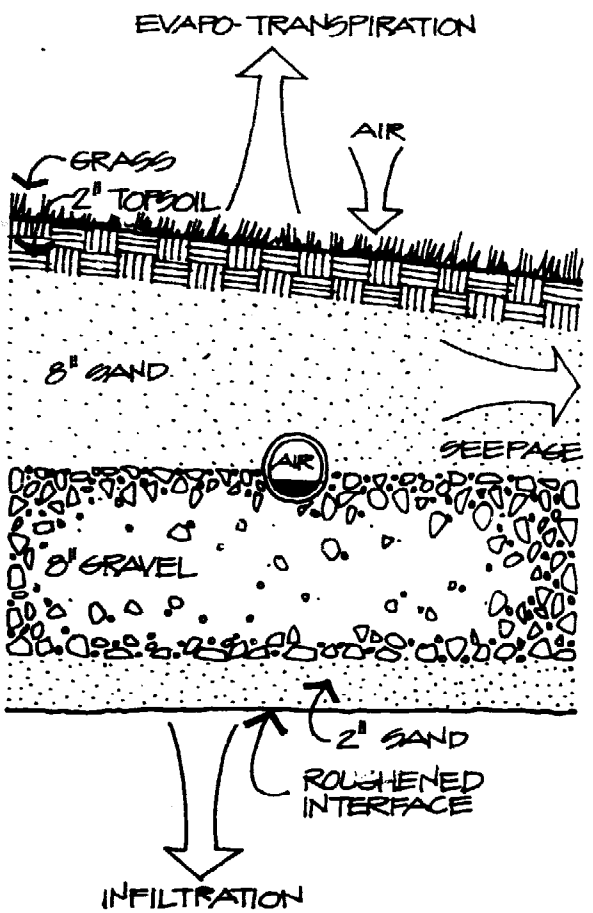

AEROBIC SEEPAGE BED OR TRENCH

bacteria can attack and break down pathogens in the greywater, and depending on public health requirements, this may be the primary reason for needing to install a filter in the first place. Of course, aerobic bacterial action occurs automatically in the upper layers of the garden soil, but then the only problem is how to get the greywater into the soil without intervening human contact which is judged to be dangerous. Here subsurface distribution systems have a big advantage.

Anaerobic Pretreatment: If anaerobic bacterial pretreatment is required before irrigation, a septic tank system is just about the only choice. The operation of underground tanks is fairly simple, although they do have initial cost and maintenance problems. However, if the tank receives only the household greywater it can be about 60 percent smaller and should require less maintenance (Winneberger 1974). A pump will probably be required to lift the treated effluent back up to the level of the garden.

Disinfection: Chlorine or other disinfectants can be injected into the greywater flow or into the storage tank. But it is hard to imagine irrigation greywater so pathogenic that it needs such complex treatment. Certainly these added chemicals cannot be particularly beneficial to the garden. It should be possible to redesign the collection or distribution system to avoid the need to disinfect the greywater.

Grease Trap: If kitchen wastes are included in the irrigation greywater, most experts believe some form of grease interceptor must be installed. Septic tanks, storage tanks, or filters all will entrap at least some of the grease which must be removed during regular maintenance. However, a grease trap installed in the system just down stream of the kitchen sink should simplify maintenance

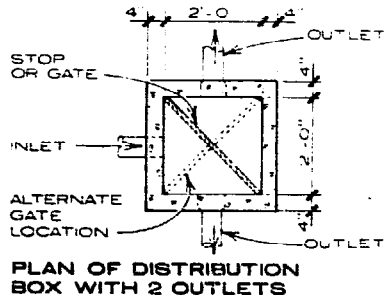
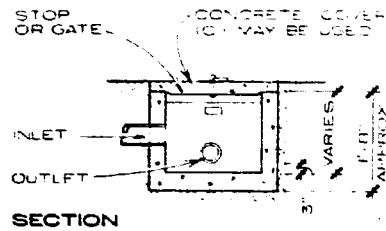

** May vary with state regulations.

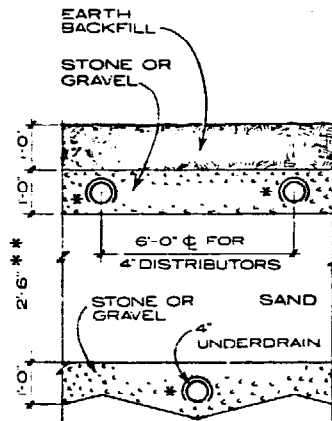

Open sand filters: 2 gallons per square foot per day.
Bed and closed filters: 1 to 1.15 gallons per square foot.

Professional reference books such as Architectural Graphic Standards contain many details which can be adapted for greywater irrigation systems.

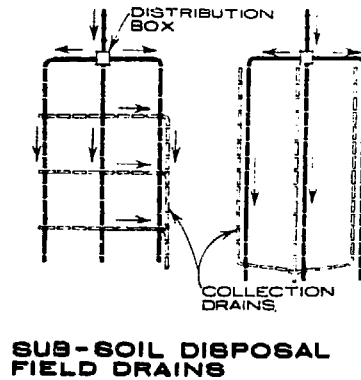
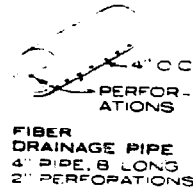

problems somewhat. The simplest solution, however, is not to use kitchen greywater in the garden. Since kitchen greywater represents a very small percentage of the total household flow, little is lost by not using it in this manner.

Design Problems of Residential Greywater Irrigation Systems

The recent severe drought conditions in the West have prompted a great deal of experimentation with different kinds of greywater irrigation systems. A few of these have been the work of established research groups with long standing interest in water conservation and/or agricultural methods. The great majority, however, have been the efforts of individual homeowners interested in utilizing a heretofore wasted resource to maintain their landscaping and gardens.

While no single best system has yet emerged, the innovations of these home experimenters have often been quite successful and much useful information is available. Prompted by the need to provide irrigation water for their plants and with due consideration to the potential hazards, many homeowners have found ways to intercept greywater before it is drained away into the main waste line.

Odor Control: When greywater is allowed to stand for long periods, odors will begin to develop, most often the smell of methane produced by the action of anaerobic bacteria. This usually occurs in the holding tank. Remember that the function of the holding tank is to allow the greywater to cool so it will not harm plants and so that any grease will harden, and to allow particulate matter to settle out. It also facilitates periodic dosing by accumulating the necessary volume of greywater.

Thus, the simplest solution to the odor problem is not to let greywater stand too long. Aerating the holding tank

with something like an aquarium pump will undoubtedly help, but it uses energy unnecessarily. Other solutions are less desirable. Eliminating organic matter from the greywater or disinfecting it would not necessarily be good for the garden.

Pumping: Moving greywater from one location to another can be a problem, particularly when the source and the irrigation site are at about the same elevation. In one example a small inexpensive submersible pump, such as that used in a landscaping fountain, is used to lift the water from the bathtub or laundry tray to storage tanks outside from which a water line leads to a soaker hose layed in the garden (Sunset, Sept. 1977). Standard sump pumps are designed for maximum reliability under adverse conditions and are capable of lifting greywater to even greater heights.

In a similar application the reversible pump inside the washing machine is able to raise laundry greywater to the height of the house eaves. There, an old sock tied over the end of the inlet hose filters the greywater as it enters the storage drums. The water then flows by gravity to the garden where it is distributed with a simple garden hose (Sunset, Sept. 1977).

Where the source of greywater is at least a few feet above the irrigation site the system can be much simpler. In such cases it is possible to divert the water from an existing plumbing fixture drain line with a simple "Y" connection into a hose and directly into the garden by gravity.

Sprinkling: It is notable that no small residential systems using spray or sprinkler irrigations have been reported in the popular literature. Although such an

approach is feasible and has been used with treated municipal sewage effluent, it seems that the higher pressures required and the potential health hazards of aerosols make it unattractive to the homeowner.

Piping: PVC components have become the standard material for landscape irrigation systems, principally because they are the least expensive and easiest to assemble. The major disadvantages are the threat of mechanical damage (from lawn mowers, shovels, croquet wickets, etc.) and the lack of durability caused by the decomposition of the material by ultraviolet radiation, although new compounds have recently been developed with increased UV resistance. Above ground systems are easiest to move and repair, but probably will last only about 5 years, about the same as a good garden hose left outdoors. But a well designed underground system eliminates most of these problems.

Filtration: To prevent clogging pipes, it may be necessary to filter the greywater, and filtration also helps to reduce bacteria. But the primary disadvantage of filtration is the need to regularly clean out the filter. It should be possible to design a greywater irrigation system that needs no filter. This usually means some type of subsurface distribution, large diameter pipes and openings, cleanouts at the end of all lines, and if necessary, a settling tank or grease trap which also requires maintenance although much less frequently. Winnenberger produces a simple inexpensive settling tank and check tank system built out of plastic garbage cans which performs this function and is very easy to maintain (OAT 1977).

However, if bacteria removal is a problem, before resorting to disinfection, consider using a sand filter or a commercial cartridge filter. They are often more effective and less expensive, and are clearly better for the garden.

See Components chapter for detailed descriptions of pumps, pipes, filters, etc.

Typical Systems Being Developed

Some of the most extensive testing of various methods of using greywater has been carried out at the Farallones Institute Rural Center in Occidental, California (Kroschel 1977). Here a series of systems was built over a period of about two years. Some were improvements on previous designs and others were designed for specific applications. One of the earliest was a simple design which carried greywater from the house to a 55 gallon storage drum via rigid plastic pipe. Water was distributed in the garden with buckets by hand. This proved too laborious and the water in the drum became septic within about a month because no means of filtering or otherwise treating the water was provided.

An improvement over the first system was distribution of the water through 3/4 inch black plastic tubing which was buried under a heavy mulch layer atop an intensively cultivated planting bed. This system developed problems of clogging from kitchen grease and accumulation of particulate material. It became necessary to periodically flush the tubing with hot water which was considered wasteful and time consuming.

A third system approached the problem of clogging by laying the perforated tubing in a trench, triangular shaped in section, and filled with gravel. This trench was built along a permanent bed of asparagus. The system is useable but the distribution of water along the trench tends to be uneven.

With a fourth system a settling tank was added ahead of the distribution tubing to remove suspended solids. The resulting greywater flow to the garden was less concentrated and allowed use of 1 inch perforated tube irrigation line

See Systems chapter for more examples of greywater irrigation systems.



DUAL WALL IRRIGATION SYSTEM
RELEASES WATER SLOWLY
RIGHT AT CORN ROOTS

laid in a 4" by 4" trench filled with pea gravel. The system is considered to be successful for crops with a high water demand such as asparagus, artichokes, raspberries and blueberries.

A fifth system was devised for intensively cultivated beds with annual vegetables such as squash and beans. Rigid 3/4 inch black plastic pipe is perforated with holes 1/8 inch in diameter spaced at 6 inch intervals along the pipe. The pipe is laid down the center of a planting bed with the holes facing up. Low pressure in the pipe is supplied by a drum set on a platform at the head of the bed and 18 inches above the level of the pipe. The tank is connected to the distribution hose with flexible hose.

A new subsurface irrigation system has been developed at the USDA's Snake River Conservation Research Center in Idaho by Robert V. Worstell, an agricultural engineer. The new method yielded 35 percent more silage than a field receiving twice as much water by conventional irrigation. The system consists of 2-inch plastic pipes buried 12 to 15 inches deep. Gravity flow of water through the pipes is controlled by low-pressure valves connected to a control system that automatically applies light, frequent irrigations to match water use of the crop being grown (Solar Energy Digest, April 1977).

PLANT NUTRIENTS IN GREYWATER

Greywater typically contains various quantities of nearly all of the 16 elements known to be essential for the growth and reproduction of higher plants.

Each of the 16 elements are equally important in contributing to plant growth; however, in terms of the amount of nutrient typically found in plant tissues, the most important nutrient elements are nitrogen (N), phosphorous (P), and potassium (K). These are called the "primary nutrients". They are classed as "macronutrients"; that is, plants typically contain them in portions greater than one part per million (ppm).

Nitrogen, Phosphorous and Potassium

Nearly all soils contain an adequate supply of all nutrient elements except the three primary nutrients, and therefore it is only necessary to add more of these by fertilizing (Sunset 1967). These elements are most often deficient in naturally occurring soils because they are taken up by plants in the greatest quantities and are not readily released by the soil to the plants. Consequently, these three elements are typically the key elements in commercially produced "complete" fertilizers.

The percentage of each is indicated by the three numbers on the label of commercial fertilizers in the order N-P-K.

Nitrogen, Phosphorous and Potassium
Composition of Greywater
Phosphorous and Nitrogen Balance
Detrimental Chemical Constituents of
Irrigation Greywater
Sewage Effluent Fertilizer

For instance:

10-8-6

means that the analysis shows this fertilizer contains 10 percent nitrogen, 8 percent phosphorous (phosphoric acid), and 6 percent potassium (water-soluble potash).

Different "recipes" of fertilizers are blended for different special purposes. For instance a check of the garden store shelf may show Citrus Food (10-12-4), Rose Food (5-10-5), Azalea Food (10-8-7). Fertilizers which have very little or no nitrogen tend to force plant bloom without stimulating further growth.

Nitrogen in the soil speeds up vegetative growth, the green tender parts of the plant such as tips of buds and opening leaves. It helps give the plant a rich green color. Phosphorous is essential for photosynthesis and is the means by which energy is transported in the plant and tends to encourage blooming. Potassium is essential to the manufacture of sugars and starches and plant growth by cell division.

Organic fertilizers such as fish emulsion, blood meal, and bone meal tend to be high in just one of the three primary elements. There is still some controversy whether these are more useful for specific purposes. Manure is a complete fertilizer with equal percentages of the three primary elements, although compared to commercial fertilizers it seems weak. Even though manure's NPK ratios are approximately 1-1-1, it has other values as a soil conditioner and mulch.

The chemistry of fertilizers and their effect on soil and plants is explained in much more detail by household garden encyclopedias such as those published by Sunset, Better Homes and Gardens, etc.

Composition of Greywater

Greywater that does not include garbage disposal solids still has picked up many of the elements essential to plant growth (Hypes 1975). Of course other elements exist in greywater in similar concentrations as in ordinary tap water.

The most significant increases in the elements found in greywater are the phosphates, sulfates, nitrate/nitrites, and ammonia, and sodium. Sodium becomes a problem for soils and plants when it reaches high concentrations, but the rest of the elements can be considered beneficial. Iron and calcium, notably, actually have lower concentrations (on the average) in greywater than they do in tap water, thus greywater's influence is negligible for these two elements.

ELEMENT	TAP-WATER (ppm)	GREYWATER (ppm)		Maximum Change
		High	Low	
Copper	.08	.16	.08	2:1
Sodium	8.0	93.0	68.0	10:1
Ammonia	.06	.80	.05	12:1
Nitrate/ Nitrite	0.2	2.1	0.1	10:1
Phos- phates	1.0	68.0	50.0	68:1
Sulfates	40.0	160.0	83.0	3:1

Nutrients Available in Greywater Without Garbage Disposal Solids (Hypes 1975)

Phosphorous and Nitrogen Balance

Nitrogen is considered most important for plant growth. In fact it is taken up at 5 times the rate of phosphorous. But phosphorous is the most plentiful nutrient element found in greywater. It is approximately 6 times the concentration found in a sampling of plain tap water, or about 60 parts per million (ppm) on the average. Greywater has little or no potassium. Nitrogen, although in 10 times greater concentration than found in tap water, represents only small amounts of nutrient. In Hypes' sampling, all forms of nitrogen combined (ammonia, nitrites, and nitrates) had an average concentration that was 4 to 5 times stronger than tap water, but this amount of additional nitrogen represents only a very tiny percentage compared to the amount of phosphorous found in the same samples. The relative amounts of each element in commercial complete

fertilizers would typically provide a much closer ratio between the elements. Greywater can be considered a source of phosphate but is not a substitute for a complete fertilizer. And so when using greywater for irrigation, the home gardener should anticipate adding high nitrogen fertilizers to restore the balance and to take full advantage of the available phosphorous. If kitchen wastes or blackwater was added to greywater the relative amount of nitrogen would sky-rocket and nitrogen buildup in groundwater becomes a serious problem requiring plants which are unusually good at nitrogen-nitrate removal such as corn, soy beans, alfalfa, red clover, and especially reed canary grass (Stevens 1974).

Recall that "high phosphate" detergents in wastewater were identified in the early 1970's as the villain causing the algae blooms or eutrophication which choked the nation's waterways. As a result manufacturers reduced the amount of phosphate in detergents significantly.

The amount of phosphorous being applied to plants in greywater can be very roughly estimated by keeping track of the amount of detergent that is being used in the laundry per week. The phosphates applied to the soil will be approximately equal to the percentage of phosphates in the detergent compound (indicated on the box side panel) times the weight used. For example, a typical "low phosphate" detergent may include 6 percent phosphates. If 2 pounds of detergent per week is used in the laundry, the phosphates applied will be approximately 0.12 pounds per week, or about 6 pounds per year.

To put these figures in perspective, we can compare them to some recommended applications for common fertilizers prepared by the University of California Division of Agricultural Sciences (1974).

Type of Manure or Fertilizer	Nitrogen (N)	Percentage*		Suggested Amounts of Material (pounds)	
		Phosphorus (P ₂ O ₅)	Potassium (K ₂ O)	Total	Phosphorus
chicken manure, dry	2 to 4.5	4.6 to 6.0	1.2 to 2.4	125	5.75 to 7.5
steer manure, dry	1 to 2.5	0.9 to 1.6	2.4 to 3.6	450	4.00 to 7.2
dairy manure, dry	0.6 to 2.1	0.7 to 1.1	2.4 to 3.6	600	4.2 to 6.6
calcium nitrate (15.5-0-0)	15.5	0	0	16 to 25	0
ammonium sulfate (21-0-0)	21	0	0	12 to 19	0
ammonium nitrate (33.5-0-0)	33.5	0	0	7 to 12	0
urea (45-0-0)	46	0	0	5 to 9	0
19-9-0	19	9	0	13 to 21	1.2 to 1.9
16-20-0	16	20	0	16 to 25	3.2 to 5.0
12-12-12	12	12	12	20 to 35	2.4 to 4.2

* P₂O₅ actually contains only 44 percent phosphorus, and K₂O contains only 83 percent potassium. The percentages for the oxide may be converted to percentages of the element by multiplication:

$$P_2O_5 \times 0.44 = P \quad K_2O \times 0.83 = K.$$

The amount of phosphorous compound that is recommended ranges from about 1.2 to 7.5 pounds per year. It was estimated above that weekly use of 2 pounds of laundry detergent will yield about 6 pounds of phosphate a year. It is apparent, allowing for these rather rough estimates, that the phosphate compound in greywater can be a significant factor in improving soil fertility.

The amount of nutrient taken up by a plant is dependent on a number of external factors affecting the availability of nutrients. Internally, the plant's requirement for nutrients is generally controlled by a set of fixed ratios between nutrient elements. For example, a plant may require 20 times more carbon than nitrogen. Nutrients in excess of these ratios are simply in excess of the plant's requirements and will not be taken up by the plant. Thus, the rate and quality of plant growth is regulated by the element present in the minimum required quantity. The relatively large amounts of phosphorous available in greywater are likely to be in excess of plant requirements unless the soil is also supplemented with the other key nutrients in the form of commercial fertilizers.

Other Nutrients Needed for Balanced Growth: The amount of other nutrients found in greywater is not great, but their presence does provide some advantages over normal fertilizer applications. First, the nutrients in greywater are applied almost continuously as opposed to normal fertilization which may be applied only once or twice a year. A small but relatively continuous flow of nutrients in the form of greywater can provide a sustained supply of nutrients when other fertilizers have been depleted. Plants use nutrients at varying rates depending on the state of growth of the plant, but most nutrients, particularly nitrogen, are needed every day. Nutrients applied only once during the year can be lost in time: nitrogen can be leached by watering and used up by soil organisms; phosphorous may have been just enough

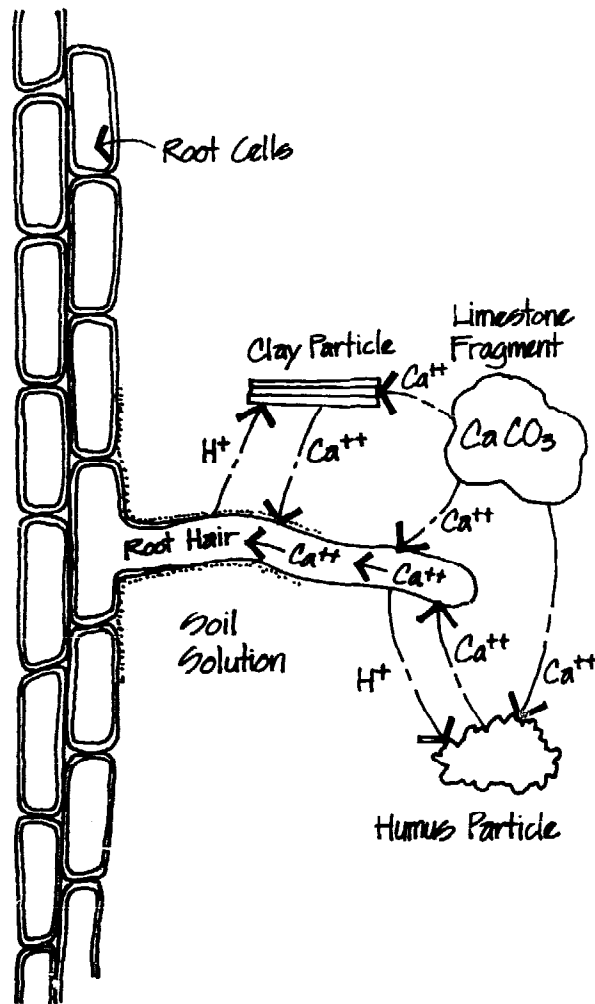

SCHEMATIC DIAGRAM OF A PLANT TAKING ON NUTRIENTS THROUGH ION EXCHANGE, IN THIS CASE - CALCIUM

to satisfy the soil minerals that "fix" it; soluble potassium may be used up quickly creating a hard pull on what exchangeable potassium exists in the soil (Sunset 1967).

Second, the nutrients in greywater are already suspended in solution and therefore may be more readily taken up by plant roots. To acquire calcium, potassium, and magnesium, plants feed through ion exchange with the particles in the soil, notably the clay and humus (organic matter). That is, they release an ion (for example, an anion such as hydrogen, H^+) and absorb a cation (such as calcium, Ca^{++}) which has been released by a nearby clay or humus particle (Donahue 1971). Soil water is the carrying medium in this exchange and therefore the presence of nutrients in greywater reduces the need for readily exchangeable nutrient ions on the soil particles.

Nitrates, sulfates, phosphates, and borates are made available to plants in a somewhat different manner. These nutrient elements are hard for the plant to acquire because they are held in minerals which are only very slowly soluble and supply too few ions for normal plant growth, thus creating the need for fertilizers which make these ions available in certain soils. Organic matter also serves as the principal storehouse for these ions, and they are made available to plants through the decomposition of organic matter by bacteria, fungi, and subsequent oxidation. Therefore, a high organic matter content is important for plant absorption of these essential nutrients.

Upon decomposing, organic material releases important plant nutrients which then become available for absorption by plant roots. Decomposition also releases carbon dioxide (CO_2) which acts as a solvent on soil minerals so that plant nutrients held by those minerals become available to plants. The process also provides carbohydrates as

food for microorganisms in the soil which are important in breaking down organic material such as beneficial viruses and bacteria. The chemical compounds found in greywater also help convert these carbonates to stable chemical compounds beneficial to the soil. The nutrients in decomposing organic matter are released in harmony with the needs of the plants, because environmental conditions favorable for rapid plant growth, also favor a rapid release of nutrients from the organic matter.

Soils that are quite alkaline, a pH value above about 7.5, may not release enough iron, zinc, or manganese for normal plant growth, and may require some form of supplement. Usually the deficiency of one or more of these trace elements is indicated by "chlorosis", a condition in which the plant leaves turn yellow. Greywater contains very little of these elements and thus correction of this condition should be handled in the normal way through application of readily available garden products such as chelated iron.

Bio-Degradable Cleaning Products: Special soaps have been developed which will not harm the microorganisms living in septic tanks, or which degrade quickly in the natural environment (Kaye 1977). However no studies have been published on the composition of greywater using these products. No information is available on their relative value as plant nutrients compared to standard detergents or soaps.

Detrimental Chemical Constituents of Irrigation Greywater

Detrimental chemicals exist in greywater in greater concentrations than typically found in tap water. These chemicals are found at all sources of greywater but the most troublesome chemicals generally originate in the laundry or wherever household cleaners are used. Many of

these chemicals can be directly harmful to plants or can cause undesirable structural and chemical reactions in soil.

Treatment of greywater to remove these chemicals before applying it to the soil is quite complex and well beyond the capability of the homeowner. Indeed, the removal of many of these chemicals can only be accomplished by costly advanced wastewater treatment, and in fact, they are usually not removed by most municipal treatment systems before the water is sent back to the natural water system. The best approach to avoiding accumulation of chemicals in plants and soils is to manage the quality of greywater that is applied to the soil; that is, to control the type and quantity of chemicals that are used in the home.

Most of the problem chemicals can be avoided through the use of comparable, safe bio-degradable substitutes. In some cases where a chemical cannot be entirely avoided it may be necessary to minimize its effect by diluting with greywater from another source, or with fresh water, or by alternating the greywater applications with irrigations of fresh water. Periodic monitoring of the effects of greywater by simply observing the condition of irrigated plants should provide adequate safeguard against sustained damage to either plants or soil.

Comparison of the greywater samples taken by Hypes (1975) with tapwater samples taken in the same experiment indicate that only about a third of the chemicals tested showed concentrations in greywater significantly higher than tapwater. (For the comparison, the highest greywater concentration values are used, rather than the average.) The chemicals found to increase significantly were copper, lead, sodium, nitrates/nitrites, ammonia, chloride, phosphate, and sulfate. The greatest potential damage to plants is likely to come from excessive amounts of chlorine and sodium.

Rule of Thumb

In General: Detergents are worse than soap; products with "softening power", boron, or "enzyme action" are the worst detergents; chlorine is worse than ammonia (Javits 1978).

	Tap- water* mg/l	Grey- water* mg/l	Irrigation Standard** mg/l
Arsenic	<0.01	<0.01	0.05
Barium	<1	<1	1.0
Cadmium	<0.01	0.01	0.01
Chloride	19	30	500.0
Chromium	<0.05	<0.05	0.05
Copper	0.08	0.16	1.0
Fluoride	0.75	0.95	6.0
Iron	0.18	0.20	1.0
Lead	<0.01	0.10	0.05
Manganese	<0.05	<0.05	0.5
Nitrate	0.2	2.1	180.0
Sulfates	40	160.0	500.0
Phosphates	1.0	68.0	N.A.
Sodium	8.0	93.0	N.A.
Boron	not measured	not measured	N.A.

* (Hypes 1975)

** (Withee 1973)

N.A. Means that water quality standards are available for drinking water but are not applicable to irrigation water.

CHEMICAL CHARACTERISTICS OF GREYWATER AND TAPWATER COMPARED TO SUGGESTED IRRIGATION WATER STANDARDS

Boron can also be toxic to some plants in concentrations found in laundry greywater. Plant damage will appear as a "burning" on the leaf edges (Ayres 1977). Many laundry products contain small amounts of boron, but the ones which have the highest amounts and are most likely to cause plant damage are those with "boron" or "boraxo" in the product name. Packaged water softeners which are added directly to the wash are also very high in boron and should be avoided.

Chlorine, the active ingredient in most household bleach, can damage plants, particularly if it comes in contact with the foliage. If an excessive amount of chlorine is taken up by the plant it will cause new or expanding leaves to appear "bleached out" (Ayres 1977). The suggested irrigation water standard is 500 mg/l of chloride (Withee 1973). The strongest concentration found by Hypes (1975) was 30 mg/l, well within the recommended standards. It is likely that this concentration was diluted by greywater from other sources and it is conceivable that an undiluted slug of wash water taken directly from the washing machine may be much closer to the maximum concentration. The presence of chlorine can be beneficial if it does not exceed about 10 mg/l. As noted in the sections on Particulate Matter, and Viruses and Bacteria, chlorine can help control pathogen growth and the buildup of slime which can clog the distribution system. Generally, however, bleach should be avoided in the wash if possible. If used, the resulting greywater should be allowed to stand for several hours to allow the chlorine to dissipate into the air. Exposure to light and moving air will speed this process (Ayres 1977). The chlorine should have the added advantage of preventing the standing water from becoming septic.

Sodium presents two problems for the greywater user. First, sodium can reach a concentration which is toxic to plants

if it cannot be leached away from the root zone. Second, sodium reacts chemically to "seal up" soil particles rather than clumping together into crumbs. The spaces between particles become smaller, and air and water cannot pass as easily, thus the soil becomes impervious (Sunset 6/1977). Soil that is sandy or low in organic matter will not have the problem because the sodium will not readily attach to the soil particles and will be more readily leached out. The effects of sodium in the soil may not be easily detected in a short period of time. Unfortunately, sodium is not easy to avoid. It is a common element in laundry detergents because when combined with phosphates it softens water so that more suds are produced. For this reason it is also found in water softener tanks and packaged washing machine additives. These sources of sodium should be restricted or avoided entirely if possible.

If water is slow to percolate through the soil the effect can be counteracted by the addition of gypsum. As explained, it can be added directly to the soil either as dry gypsum (calcium sulfate) at a rate of up to 25 pounds per 100 sq. ft. by lightly raking it in; or it can be spread as liquid gypsum (calcium polysulfide, or lime sulfur) with a sprayer or watering can. The liquid form can take several weeks to become effective (Sunset 1977, California Department of Water Resources, 1977). The addition of gypsum also supplies calcium for plant growth, but unlike other lime products, gypsum does not affect alkalinity of the soil. Therefore, gypsum is safe to use even when excessive soil alkalinity is a problem. A separate section on Salt Accumulation and Soil Alkalinity explains this problem in greater detail.

Phosphates, also a common ingredient in household cleaning products are a serious problem when dumped into water courses with the effluent from conventional primary and

secondary sewage treatment plants. As mentioned above, the fertilizing property, which is a problem in water, is a benefit when applied to soil, and the amount of phosphorous produced by the typical household consumption patterns is not a matter of concern in the land application of greywater. However, low phosphate detergents are preferable because they usually contain less sodium (Javits 1977).

Other household cleaners include a great variety of caustic and toxic compounds which could be damaging to plants, particularly if they are allowed to flow directly to the irrigation site in an undiluted slug. Generally, it is best to minimize the use of such products in the home, and when their use becomes necessary, to make sure that they are sufficiently diluted before allowing them to enter the garden, perhaps by using a holding tank.

Sewage Effluent Fertilizer

Compared to greywater, the effluent from sewage treatment plants is much richer in nutrients, especially nitrogen. It seems inevitable that soon it will be recognized as a valuable natural resource for soil reclamation (Goldstein 1977). By now everyone must know that the bags of "Mil-organite, the Natural Organic Fertilizer" which you buy at the garden supply store is dried sewage sludge from Milwaukee, and "nitrohumus" comes from the Los Angeles county. In Chicago dried sludge accumulated at the rate of 330,000 tons a year until the city hit upon the idea of delivering free "Nu-Earth" to any gardener or farmer that wanted it.

In their study of the feasibility of using secondary treatment municipal sewage effluent for maintaining plant growth in fire protection greenbelts, Youngner and Williams

The Denver suburb of Northglenn has an agreement with Farmers Reservoir and Irrigation Co. which will allow Northglenn to borrow stored irrigation water from Stanley Lake, use it for municipal purposes, treat it, add some water from other sources, and return the same amount to the company -- plus a 10% bonus. Northglenn won't have to bear full treatment costs because the farmers want some nutrients left in the water for their fertilizing effect (Conservation Foundation 1979).

(1976) cited the conclusions of a number of other researchers:

"Acting as a fertilizer, the effluent stimulates vegetative growth in most plant species. The effects can be dramatic as illustrated by Day and Tucker (1959). They found that effluent irrigation with no fertilizer additions increased barley, wheat, and oat yields from 200% to 300%. This is comparable to the results obtained following normal fertilizer practices but with one important exception, the cost of fertilizer, ..., is eliminated. Sopper (1968) showed similar growth increases for forest tree species. Kardos (1967) determined the fertilizer equivalency of normal municipal effluent. He found that a 2 inch per week application of effluent for 1 year was equal to 1 ton of 14-15-14 fertilizer per acre. The benefits derived from this application are potentially of great importance in food and pasture crop production, in that the difficult and costly problems of waste treatment and disposal are reduced while crop yields are increased."

SALT ACCUMULATION AND SOIL ALKALINITY

Greywater irrigation almost inevitably leads to two inter-related problems. Salt begins to build up in the soil and it becomes progressively more alkaline. Fortunately salt and alkalinity are less of a problem in sandy soils low in organic matter.

Greywater Effects on Soil pH

Greywater tends to be slightly alkaline with a pH range typically between 6.5 and 9.0 (Hypes 1975). Extended use of greywater for irrigation could ultimately cause soil to become progressively more alkaline.

The relative acidity, or "pH", of a soil is an important determinant of the type of plants that can be successfully grown. Plants grow best when the soil is within specific pH ranges. For example most plants tend to do well in the slightly acid range between 6 and 7, but very few do well at 8 or 9. The most common range of soil pH is between 4 and 8 (Donahue 1971).

When the soil becomes alkaline, various minerals such as iron, manganese, and copper become fixed in chemical compounds and unavailable to plants. The plants may show symptoms of manganese or iron deficiency, or chlorosis, a condition where leaves turn yellow. When these minerals are held fixed due to high alkalinity, the plants will show

Greywater Effects on Soil pH
Evaluation of Soil pH
Salt Accumulation in Soil
Greywater Compared to Tap Water
Methods of Dealing with Salt in
Garden Soil
Treatment Strategies

deficiencies even though testing the soil may indicate plenty of the mineral (Olkowski 1975).

In acid soils iron, manganese, and aluminum all become easily available, sometimes toxic to plants. Important nutrients such as phosphorous may become fixed in compounds unavailable to plants in either acid or alkaline soils. It is most available in the pH range 5.5 to 7. This slightly acid range also provides the best conditions for the bacteria that rot plant residues and those that take nitrogen out of the air, both essential processes to plant growth (Olkowski 1975).

The pH of most common household detergents is about 9.0. Since these will often be found in irrigation greywater, it is wise to monitor the soil pH and take corrective measures if the pH begins to rise above the optimum range. Naturally occurring limestone has a pH of 8.3 and any pH above that is likely to be the result of excessive sodium buildup (Donahue 1971). Sodium is a major component of many laundry detergents and, thus, a high pH may signal that greywater is adversely affecting the soil. If the soil is already alkaline the application of greywater will exacerbate the problem.

In arid regions where use of greywater is likely to be of greatest value, the likelihood of naturally occurring alkaline soils is also greatest, and extra care is required in greywater applications. The hydrogen ion (H^+) is able to displace other ions such as calcium or magnesium on the surface of clay particles. Thus in naturally occurring soils subject to significant amounts of rainfall, the soil is likely to become gradually more acid. In other words, natural forces tend to reduce soil pH because rain both supplies the hydrogen ions, and leaches away the mineral and base ions which the hydrogen displaces. In arid regions, where little water is available to wash them away, clay surfaces may be covered

The entire pH range is from 0 to 14 with the midpoint, or neutrality at 7.0. A pH below 7 indicates acid reaction, above 7 is alkaline.

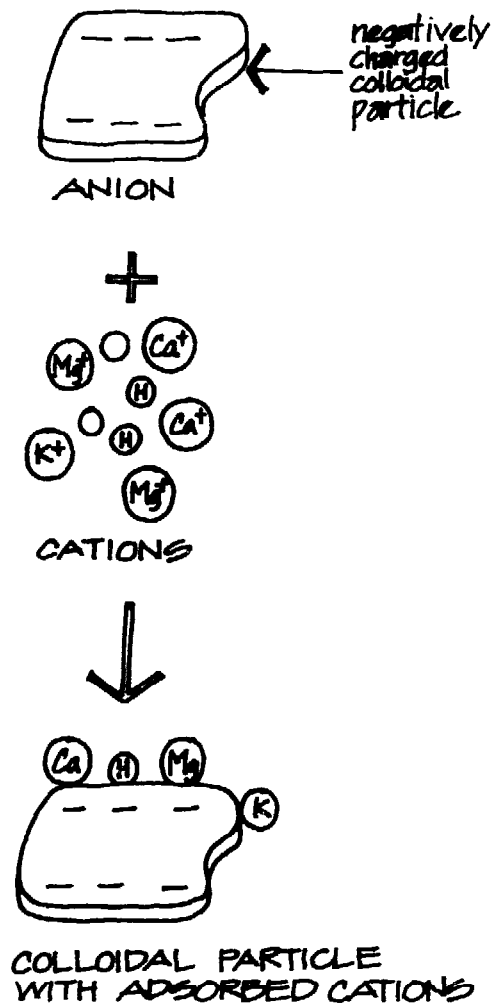

with calcium, magnesium, and sodium ions, thus creating alkaline soils (Olkowski 1975).

Evaluation of Soil pH

Determining the acidity of soil is quite simple. Rolls or strips of test paper called PHydrion are readily available from garden supply or chemical supply houses. The technique is to simply make a solution of water and soil (half and half), dip the paper in the solution and compare it to the color chart provided. A color scale is equated to the pH scale and indicates the pH of the soil solution. Generally, if the soil is outside the range of 5.5 to 7 it should be amended by addition of compounds that will have a neutralizing action.

Salt Accumulation in Soil

To the home gardener, salts are the white crusty substances that build up on the top of soil around plants and on the outside of pots.

Chemical salts are carried into the soil dissolved in irrigation water. These salts, which are typically ionized chloride, sulfate or carbonate compounds of sodium, magnesium or calcium, are present to some extent in virtually all water. The salts become dissolved in the water as it passes through soil. When water is used for irrigation the portion of water that drains away will pick up a load of salts from the soil as it passes through and will become more saline than it was. On the other hand, water that evaporates from the soil surface or is taken up by plant roots will leave a majority of its salt load in the soil. The combined flows of water down through and up from the

soil controls the movement of salts within the soil and the residual salt load after irrigation. The net effect may be an accumulation of salts within the soil well beyond that which naturally occurs.

The accumulation of salts around plant roots can be very detrimental to plants. It can inhibit germination of seed, stunt growth, and cause leaves to scorch and turn yellow or leaf margins to turn brown and wither (salt burn). These symptoms can be caused by two effects of salt. First, many salts are toxic to plants once a certain concentration is reached. Second, the dissolved salts increase the specific gravity of the water and inhibit the movement of water into the plant roots.

The excessive accumulation of salt is also indicated by the buildup of a crust of white salts on the soil surface. These crusts occur when the net movement of soil moisture is upward and the salts are left as the water evaporates from the surface.

Salt accumulation is a matter of concern to all home gardeners and landscapers regardless of the water source. The matter is of even greater importance to commercial growers who must maintain the fertility of their soil and often must use water that has already irrigated a crop upslope and consequently carries a higher than natural salt load because of evaporation losses.

The use of greywater for irrigation calls for special vigilance because it often carries a higher salt load. These salts originate primarily in laundry detergents but can also come from bathing water and kitchen cleaning compounds. If a water softener is used in the home it will be the major source of salts (primarily sodium) and it is recommended that water treated with a softener not be used for plant irrigation.

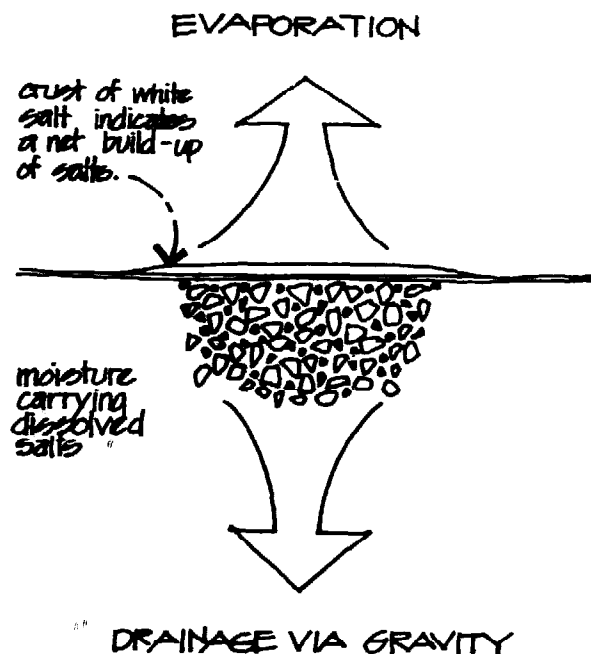

Salinity of Some Natural Waters

Source	Dissolved Solids (ppm)	Water Classification
Rio Negro	10	Fresh
Lake Tahoe	70	
Lake Michigan	170	
Yukon River	280	
Missouri River	360	
Colorado River	700	
Pecos River	3,000	Brackish
Baltic Sea	7,000	
Black Sea	20,000	Salty
Oceans	35,000	
Dead Sea	250,000	Brine
Great Salt Lake	266,000	

(Giddings 1973, p. 316)

Greywater Compared to Tap Water

The salt concentration of greywater (without softening) is generally about two to three times as high as regular tap water. Hypes (1975) found the total dissolved solids in samples of greywater averaged 358 ppm without garbage disposal solids compared to 108 ppm for sampled tap water. The inclusion of garbage disposal solids in these samplings raised the average total solids to 559 ppm. To put these figures in perspective a table of salinity of some natural waters is provided. Assuming an average salinity for greywater of 400 to 500 ppm, it is slightly more salty than the Missouri River but somewhat less than the Colorado River.

Another, more definitive, measure of salinity is the electrical conductivity of a soil sample moistened to the consistency of a fine paste. While such a measure will rarely be used by the homeowner, the results of some studies are expressed in this manner and provide a useful indication of the relative salinity of greywater. Electrical conductivity is expressed as mill reciprocal ohms per centimeter or mmhos/cm. Soils are classified as saline if they have a value of 4.0 mmhos/cm or more (Donahue 1971). Hypes (1975) reported a conductivity of 0.20 mmhos/cm for samples of plain tap water and an average value of 0.417 mmhos/cm and 0.358 mmhos/cm respectively for greywater samples with and without garbage disposal solids. Thus, greywater can be expected to accentuate the potential for salt accumulation in the soil but the salinity is not so much greater than ordinary tap water that it presents a major obstacle to its use for irrigation.

Methods of Dealing with Salt in Garden Soil

Salt accumulation has been a continuing problem for farmers throughout the history of irrigated agriculture, particularly

in arid regions. The methods for dealing with this problem can be readily applied in home gardening situations.

Leaching salts down to below the root zone is the primary method used. The idea is to keep the salts in solution and moving downward so that they do not come out of solution and accumulate in the root zone. To accomplish this, farmers rely on rainfall or supplemental irrigations to maintain a net downward flow. Deep, thorough waterings are more effective than frequent, shallow irrigations. Leaching is limited by the drainage characteristics of the soil. A slow draining soil may not allow the salts to be carried quickly or far enough away from the root zone. Excessive leaching can also be a problem because it can carry away nutrients in solution as well as the salts. Both nutrients and salts may ultimately be carried all the way down to the water table which will become contaminated. This problem can be minimized by avoiding excessive irrigation and regulating the amount of each irrigation such that the water saturates the soil to no more than a foot or two below the root zone.

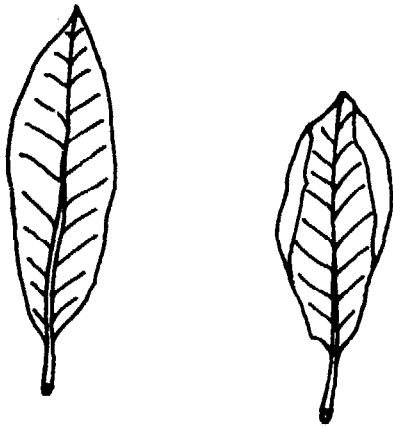

HEALTHY LEAF SALT-BURNED LEAF

BLACKENED AREAS ON OLDER LEAVES MAY MEAN SALT BURN

Dilution of saline water with less salty water is another preferred method which is accomplished by rainfall or supplemental irrigations. Dilution of greywater can be accomplished either by premixing greywater with a high quality water source (i.e., tap water or collected rainwater) or by alternating greywater irrigations with tap water irrigations. Either method should satisfactorily mitigate the higher salt content of greywater.

Selection of salt tolerant plant materials provides a third alternative for combating salt accumulation. The homeowner may choose to plant exclusively salt tolerant species and use greywater throughout the garden, or simply to use greywater first on the salt tolerant species and limit tap water use to the sensitive species. Sensitive species might be

The following appeared in Sunset Magazine, June 1977.

An antidote for gray water

One problem with gray water is that it often contains sodium, an element that may have a bad effect on soil and consequently on plants. Here is the lowdown on where sodium comes from, what it does, and how you can counteract the effects in your soil.

Sodium is an important component of most household detergents: Combined with the phosphates, it combats hard water to produce suds and work under dirt and grease. From the kitchen sink and laundry the sodium goes down the drain or, if you are using gray water, out into your garden soil.

The two sodium chasers

If you've found that water is slow to penetrate your soil (a symptom of excess sodium) you can correct the problem with either of two soil amendments. The most widely used is gypsum (calcium sulfate). In powder form, it requires light raking into the soil to provide long-

used as an early warning of salt buildup by scattering them throughout the garden. The ill effects of salt accumulation should be evident in these "sacrificial" plants long before salts reach harmful concentrations for more tolerant species and remedial action can be taken.

Treatment Strategies

If it is necessary to counteract the alkaline character of greywater there are three general approaches that can be taken: to treat the soil after the greywater is applied, to neutralize the greywater before it is applied to the soil, or to eliminate alkaline inputs to household greywater.

Treatment of the Soil: The first approach would involve application of an acid compound such as sulfur or gypsum (calcium sulfate) directly to the soil, mechanically mixing it in, and monitoring the soil pH to determine the amount and frequency of applications. This treatment should be supplemented by periodic flushing of the soil with clear water to leach out accumulated salts. Soil overloaded with sodium can be restored by spreading 2 pounds of gypsum per 100 square feet each month (Javits 1977). If the soil is really "tight" and resists soil penetration use up to 25 pounds per 100 square feet (Ayres 1977). Another choice is calcium polysulphide, sold under many different brand names. Being liquid it is easier to apply; use a watering can or sprayer (Sunset 6/1977). In some cases (e.g., lawns, and other permanent landscaping) the application and mixing of a neutralizing agent may be impractical.

Another factor to be considered in amending soil pH is the percentage of clay and organic material in the soil. These materials tend to buffer the soil, that is, they resist any change in pH regardless of whether the change is toward

lasting benefits.

The other choice is calcium polysulfide (also called lime sulfur or liquid gypsum, and sold under many brand names). Being liquid, it's easier to apply than gypsum: You simply apply it with a sprayer or watering can and water it in lightly. It may, however, take weeks or months to become effective.

The problem with sodium in the soil

In the soil, sodium—being a positively charged element—hooks onto the negatively charged soil particles. When the sodium hooks onto enough charges, it exerts a greater influence on soil structure than soil calcium.

Rather than holding soil particles in large crumbs and allowing for pore (open) spaces between them as other bonds do, the sodium bonds let the particles disperse, resulting in elimination of pore spaces. The lack of pore spaces yields an impervious condition where air and water have difficulty entering the soil.

The calcium that you add with either gypsum or calcium polysulfide provides strong bonds between soil particles, producing large crumbs and pore spaces. It displaces the sodium, which ends up in the water around the soil particles. An occasional soaking will be needed to leach the sodium beyond the root zone.

You may discover that gray water doesn't cause any problem in your soil. If so, that's because the soil is sandy or low in organic matter, and sodium will not readily attach to it. □

JUNE 1977

acidity or alkalinity. Thus, highly organic, clay soils will be most resistant to the alkaline effects of greywater, but will also be most difficult to amend the pH if that is required.

Treatment in Storage: Direct treatment to neutralize the greywater would involve adding an acid compound to the solution as it is being transported, stored, or treated for some other purpose. The simplest method would be to test the pH, using a common swimming pool testing kit, or pH test paper, while the water is in temporary storage, such as a buffer tank. The pH could then be adjusted to the acceptable range by the addition of non-harmful common pool chemicals or some other neutralizing agent. Dispensing the chemical could be accomplished automatically using a device that dispenses a given amount of neutralizing agent when the tank reaches a given level. Various devices are discussed in the chapter on Components. This assumes that for a given volume the average pH would fall within a fairly narrow range, a reasonable assumption considering the tank will contain a blend of household discharges.

In treatment of the water the reaction is instantaneous compared to the weeks or months it may take in the soil, and it provides much more control over the reaction and the ability to make necessary adjustments before the water is released.

If the greywater is not stored at any time, but is transported directly from source to application the problem is more difficult. Such a system would have to be capable of automatically monitoring the pH and volume of the flow, and dispensing the appropriate amount of neutralizing agent. The problem is somewhat compounded by the fact that the pH will fluctuate with the various loads that are placed in the system. For this reason, among others, the inclusion of a buffering tank is recommended.

The Irvine Ranch Water District sent this request to all its customers:

"PLEASE help our plants, shrubs, trees, lawns and other growing things from being 'aSALTed' by that illegal invader, the self-regenerative water softener. (The type you fill with rock salt.)"

"This villain loves salt to such an extent that one unit deposits up to 600 pounds of brine each year into the sewer system. That might not appear to be a problem unless you realize that the Irvine Ranch Water District reclaims and reuses every drop of wastewater. Those beautiful greenbelts and parks that blanket our city are kept green with this water. We can't get the salt out of our wastewater, so we ask you, PLEASE, don't put any in. With your cooperation we'll never have to see our plants withering away in salt-laden soil." (June 1977)

Eliminating Alkalies: The most straightforward approach, although not necessarily the most foolproof, is simply to eliminate the input of alkalies to the greywater that is to be used in the garden. The strategy is simply to dispose of high sodium and high boron household cleaning products. Other alternative products are readily available. Unfortunately many products are not accurately labeled. The acid/alkaline balance of household wastewater can be upset by a whole host of unexpected occurrences and so the homeowner who is counting on abstinence to control pH is advised to keep a watchful eye on the health of the most sensitive plants as an indicator that something has upset his system.

PARTICULATE MATTER IN IRRIGATION GREYWATER

The solid particulate materials in greywater pose significant problems in the day to day maintenance of a greywater system. Particulate matter includes solid particles of organic and inorganic materials from all greywater sources.

This particulate matter can cause maintenance problems in two ways. First, organic material can become septic if collected and stored for more than a few days. The septic material produces objectionable odors and provides a breeding environment for harmful bacteria and viruses. The second problem is that both organic and inorganic material can clog both the greywater system and the soils receiving the greywater. A particular problem is grease from the kitchen which becomes hard when cool and is not easily digested by the bacteria in the soil. Thus, the grease along with other materials, is capable of clogging the pipes and other apparatus of the greywater distribution system. Also, once in the soil these materials are capable of filling in the spaces between the soil particles and actually clogging the soil so that no more water can infiltrate, causing the system to backup to the greywater source.

Preventing Septic Storage

The problem of organic material becoming septic can be avoided by not storing greywater for more than about 24 hours unless it has been filtered to remove the particulate

Preventing Septic Storage
Preventing Clogging
Reopening Clogged Soil

material and has been disinfected. Disinfection typically implies the use of chemicals that will be harmful to plants, so it is not recommended for water that will be used in the garden. The length of time that water should be held is somewhat variable depending on the ambient temperature and the content of the greywater. Greywater with a high organic content (such as kitchen waste) may not be stored for as long a period in warm weather as it can be in cool weather.

The use of a "buffer" tank for short term storage is recommended. A buffer tank is simply a small tank with capacity to hold about one day's production of greywater (about 25 to 40 gallons per capita per day) so that the waters with heavy pollution loads can be diluted with less polluted waters (e.g., the bathwater), and warm water can cool before being applied to the soil.

Preventing Clogging

The second problem, clogging of the distribution system and the soil, can be avoided in a number of ways:

Reduction of Kitchen Wastes: The kitchen accounts for a fairly small percentage of the total water consumed in the household, about 9 percent, yet it produces one of the highest pollution loads (Laak 1975). Thus it may be worthwhile to avoid the problem altogether by not connecting the kitchen waste to the greywater system. However, one loses the benefit of the additional water and some useful nutrients it carries by doing so. It is possible to use the kitchen water and reduce the damaging load of particulate matter at the source. The most important step is to stop using the garbage grinder. The grinder reduces the solid material to soft chunks or a foamy substance which can easily clog the system. Instead of using the

grinder, left-over food and vegetable trimmings should be disposed of as solid waste in the garbage can, or preferably, composted for later application as organic material in the garden.

Reduction of Grease in the System: The most important factor in improving the quality of kitchen greywater is the careful handling of grease. For example, keep a small container near the sink for collecting grease drippings for later disposal as solid waste. Greasy water from washing dishes, and particularly cooking utensils, should not be allowed to enter the greywater system. Whether a dishwasher is used or dishes are done by hand in the sink or a basin, the water should be diverted to the sanitary sewer rather than the greywater system when a load of greasy utensils is being washed. This can be done by installing a diverter valve in the drainline so that the user can select whether the water produced will go to the greywater system or the sanitary sewer.

Grease Trap: An alternative for those who want to allow the kitchen waste to enter the system directly is to install a grease trap in the kitchen drain line. Grease traps are readily available products designed for commercial kitchens, or one can be fabricated by the homeowner (see Components chapter). The problem inherent in grease traps is the frequent maintenance required to keep them clean and operating. Periodically the trap must be cleaned and the accumulated grease disposed as solid waste, or the trap will clog and cease to operate. It is recommended that, rather than install a trap, the homeowner first attempt to reduce the amount of grease entering the system.

Reduction of the Laundry and Bath Waste Load: Installing simple mesh screens in the drain to capture lint, dirt, hair, and other particulate matter is effective in removing

the larger particles that would cause clogging problems further along in the system. They can be easily cleaned by removing the particles by hand and disposing of them in a wastebasket.

Dilution: Perhaps the easiest method of dealing with particulate matter once it has entered the greywater system is to dilute it. Additional water, either from other greywater sources or from freshwater supplies, if necessary, will reduce the clogging potential by reducing the concentration of the particles and increasing the velocity of the flow. Dilution can be designed into a greywater system by placing a buffer tank ahead of the distribution system.

Settling: The heavier particles will settle out if the effluent is allowed to stand quietly long enough. The buffer tank can also serve as a simple settling tank to allow the removal of the larger particles that will sink to the bottom. An automatically controlled valve mechanism can be installed to drain away these solids to the sanitary sewer on a periodic basis. The buffer tank could also be used for removal of grease and other floating materials by including a skimming device at the top of the tank. The skimming device would remove hardened grease and scum for disposal in the sanitary sewer or an aerobic compost digester.

Filter: As with the grease trap, a filter provides an alternative to reduction of the particulate matter at the source. But, also like the grease trap, there is a certain amount of periodic maintenance required to keep the filter operating efficiently (see Components chapter). A simple sand or fine gravel filter may be desirable if the greywater is to be applied to particularly tight clay soils, or if it is applied in a trickle irrigation system using small feeder tubes and small orifices. A sand or fine gravel filter should be effective in removing the particulate matter.

Furthermore, they are relatively easy to maintain with periodic flushing, or in the case of a sand filter, by periodic removal and composting of the top layer of sand.

Reopening Clogged Soil

Once greywater reaches the soil, the soil itself provides an efficient treatment of both organic and inorganic particulate material. Particulate matter which is too large to be passed between the soil particles is held for decomposition by biological microorganisms or chemical reduction by reaction with elements in the soil. As long as the biological and chemical processes can keep up with the amount of material captured in the pores, the soil will remain open and will allow water and oxygen to pass through. This is important both to sustain plants growing in the soil, and to maintain an aerobic (oxygen rich) digestion process. If the soil captures more material than can be digested readily there is a danger that the soil will become clogged with material. Oxygen will not be able to enter the soil and the aerobic digestion will become anaerobic (lacking oxygen). A layer of gelatinous slime will form from anaerobic digestion and this slime, known as the "organic mat", will substantially restrict the infiltration of water (Warshall 1976).

The biological treatment or digestion actually includes two distinct processes. The aerobic process (with oxygen) occurs in well aerated soils. The anaerobic process (without oxygen) occurs in compacted or waterlogged soils, and in slow moving water courses. Anaerobic digestion is the fundamental process in conventional sewage treatment. The two processes are quite different in their ability to break down effluent to stable chemical compounds, the speed with which the digestion occurs, and the end products of the

process. The ideal soil for removal of particulate matter will have lots of air and be moist but not waterlogged.

The "failure" of most land systems (including the common backyard septic tank and disposal field) is a result of soil clogging and concomitant reduction of both water movement through the soil and aerobic digestion activity. In most cases the failure can be remedied by reducing the pollutant load on the soil and allowing the soil pores to be reopened by the biological and chemical digestion processes.

Well aerated soils allow more oxygen to be dissolved in the soil's water. The more dissolved oxygen, the faster food and other organic wastes can be consumed by the bacteria. The consumption process releases heat which warms the soil. Water and nutrients travel up, out of the ground into the stems and leaves of higher plants. Here, part of the water is transpired through the breathing pores of the plant and a smaller part is evaporated from the leaf surface. This process of evapotranspiration accounts for up to 20 percent of the water in the soil (in humid-temperate regions) and is one of the major ways in which water is cleaned and returned to the atmosphere. Under aerobic conditions evapotranspiration is strong. The end products of aerobic digestion are all stable chemical compounds which benefit soil fertility.

In anaerobic digestion the bacteria and other soil microbes that need lots of oxygen die or go dormant. The predators (protozoa) also die or go dormant and in their place an anaerobic community of bacteria, fungi, actinomycetes and other organisms take over. Without oxygen, nutrient and water recycling by higher plants slows drastically. Some pollutants are changed to chemical compounds that can be toxic to higher plants. Nitrogen, carbohydrates, sulfur, iron, and manganese are all changed to entirely different compounds;

the carbohydrates may change to acids rather than sugars (Warshall 1976).

The end products of anaerobic digestion, ammonia, methane, and hydrogen sulfide are compounds that demand oxygen from other natural communities. The problems commonly associated with sewage treatment- methane gas, odors and the high Biological Oxygen Demand (BOD) - are the result of anaerobic digestion processes. The advantage of anaerobic digestion is that it is easily monitored and controlled in the conventional treatment facility and its by-product, methane, might be captured and used as fuel for electric generation or heat. For land irrigation uses of greywater the chief advantage of anaerobic digestion is that the bacteria are more stable and less susceptible to sudden die-off from an overload of toxic material than are aerobic bacteria.

Public Health
Indicator Organisms
Methods of Counting Coliforms
Viruses and Bacteria in Irrigation
Greywater
Standards for Environmental Health
Sources of Pathogens
How Soil Organisms Destroy Foreign
Pathogens
How Soil Itself Destroys Foreign
Pathogens
Comparative Hazards of Land Spread-
ing of Blackwater Residue
Composting Toilets
Reducing Hazards with Greywater
Irrigation
Disinfection

VIRUSES AND BACTERIA

Depending on who you talk to you will learn that the health problems of greywater irrigation are either 1) too complex and dangerous to be trusted to the layman, or 2) a matter of logic and common sense that has been intentionally complexified in order to perpetuate bureaucratic control.

The public health literature is so extensive that only a few topics can be touched on here and the reader with a specific question is urged to consult the original sources. Unfortunately the popular literature, although more accessible, contains lots of oft-told anecdotes, many generalities and a few flat out errors. There are, however, a few excellent technical yet readable sources on this topic (see especially DWR 1975 and DWR 1977).

Public Health

Greywater irrigation worries public health officials with two kinds of problems. The easiest to solve are the potential nuisance conditions of ponding and runoff which might create odors, attract flies and rodents, and create mosquito breeding grounds (DWR 1977). If unchecked, these conditions help breed and spread disease. Also, greywater storage containers become tempting hazards to small children. The argument can be made however that homeowners environmentally concerned enough to want to reuse greywater will also be sensitive enough not to allow such nuisance conditions to occur in their gardens.

The second kind of health problem focuses on the composition of greywater itself. These are the four water quality factors which must be considered in any type of water reuse (DWR 1975):

- . Microbiological (viruses, bacteria, parasites)
- . Total minerals (salts, household chemicals, etc.)
- . Heavy metal toxicants (arsenic, lead, etc.)
- . Stable organic substances (pesticides, solvents, etc.)

However, considering only domestic greywater, the latter three factors are apparently so unlikely to create health hazards in garden reuse that no standards have been published. However, the hazards of microbiological contamination are well understood and documented, except that there is very little information with regard to the fate of viruses in response to treatment and in the environment. Therefore, of necessity, the focus will be on the other microbiological pathogens.

Indicator Organisms

Not all microorganisms can be easily or reliably isolated and counted, so public health officials use "indicator" organisms whose presence is easily detected. For example, fecal coliform bacteria (*E. coli*.) commonly live in the digestive systems of humans and other warm blooded animals, and although they are not themselves pathogenic, their presence detected outside their host indicates the presence of fecal matter and therefore the presence of other potentially pathogenic microbes. However, other strains of coliform bacteria occur naturally, outside animals, and so their presence does not indicate fecal contamination. There is

Analysis	Grey-water	Black-water	Ratio of Concentration (Grey: Black)
BOD ₅ (ppm)	206	2353	1:11
Non-filterable fixed residue (ppm)	25	588	1:23
Coliforms 35°C (10 ⁶ /100 ml)	7.0*	56.5	1:8
Coliforms 44°C (10 ⁶ /100 ml)	1.4*	44.7	1:32
Plate Count 35°C (10 ⁶ /100 ml)	68.3*	732	1:11

*The average of the weighted arithmetic average values for the greywater from kitchens, bathrooms, and the combination group kitchens and bathrooms. The laundry is not included (adapted from Withee, 1973).

COMPARISON BETWEEN KITCHEN GREY WATER AND BLACK WATER POLLUTIONAL STRENGTHS

some disagreement in the literature about how to separate these two, although different strains tend to thrive at different temperatures. Every human expels about 20,000,000 E. coli. every day. However, realistically it is impossible to seek zero concentrations of all microorganisms in water. Drinking only 1 E. coli, with 100 ml of water is not considered dangerous, nor is bathing in water containing 200 or less per 100 ml (DWR 1975).

Methods of Counting Coliforms

A simple method to measure coliform counts above 1,000 involves dipping a special slide in the sample for 30 seconds, then incubating it and comparing the number of tiny dots or colony that appear. For coliform counts less than 100, membrane filtration field kits are available (Milipore 1976).

Viruses and Bacteria in Irrigation Greywater

Public health officials consider all water once used in the household to be potentially hazardous as a carrier of pathogenic material regardless of the source. They resist sanctioning the use of greywater except in emergency situations.

Admittedly pathogenic material can occur in any household function that produces greywater: bath and shower water might carry organisms from the skin, laundry water might carry pathogens from soiled underwear and diapers, and kitchen water might carry biological or chemical contaminants from the surface of vegetables, dishes and utensils, or from spoiled food. But the level of potential danger varies significantly with the source.

<u>Reclaimed Water Use</u>	<u>Health Standard</u>
Food crops: spray or surface irrigation	Median coliform count 2.2 per 100 ml
Landscape irri- gation, lawn, parks, playgrounds or dairy pastures	Median coliform count 23.0 per 100 ml
Orchards and vine- yards, fodder, fiber and seed crops, surface irrigation only	0.5 ml per liter per hour settle- able solids (i.e., primary treat- ment)
Extensively pro- cessed food crops	Exception to above may be granted by Dept. of Health
Recreational lake public contact	Median coliform count 2.2 per 100 ml
Landscape lake no public contact	Median coliform count 23.0 per 100 ml

Based on current Wastewater Reuse Standards (California Environmental Health Code, Title 22, Chapter 4, 1975)

When greywater is compared to toilet wastewater (black-water), the differences between the two sources become quite clear. The concentrations of pollutants in toilet waste range in magnitude from 6 to 144 times greater than the concentrations found in greywater (Withee 1973).

Standards for Environmental Health

The National Technical Advisory Committee recommends that bathing water contain less than 200 coliforms per 100 ml, and drinking water less than 1 coliform per 100 ml (DWR 1975). State health departments establish their own standards for various uses of reclaimed blackwater. For example, the current California Environmental Health Code standards limit bathing lakes to 2.2 coliform per 100 ml and landscape irrigation to 23 per 100 ml. Unfortunately, coliform levels in non-kitchen greywater exceed 1,000 per ml and in kitchen greywater exceed 1,000,000 per 100 ml. Thus, the State standards are not easily achievable. However, orchards, vineyards, seed and fiber crops can be irrigated with untreated greywater and still meet the State standards. But for all other uses chemical disinfection of kitchen greywater is just about the only economical way to achieve the required reduction in coliform count. Carefully maintained sand filters may be able to achieve the required coliform reductions in non-kitchen greywater. Another alternative, more expensive but requiring less maintenance, is to install a greywater septic tank (Warshall 1977).

In any case, the apparent inconsistency between the Federal and the State standards should be clarified. The current State standards effectively outlaw the reuse of greywater for above ground irrigation by the average homeowner, even though a survey of "outlaw" irrigation systems has never

found a case of illness caused by greywater (Warshall 1977). None of these codes mention subsurface distribution so apparently greywater may be legally used in this way.

Another difficulty for the conscientious homeowner trying to reuse greywater is the State Health Code requirement for automatic alarms, emergency power supplies, and emergency backup wastewater storage or disposal systems, unless alternatives are approved by the Department of Health. Samples must be collected daily and analyzed by an approved lab and a careful engineering record must be kept.

Sources of Pathogens

The potential for carrying pathogenic materials is highly dependent on the source of the wastewater. The kitchen garbage disposal stands out as the primary source of organic pollutants in greywater. Siegrist (1976) found only 2000 coliforms per 100 ml in greywater from only the bath, shower, and laundry. But notice that on a daily basis surprisingly high values for bath and laundry water are due to the proportionately higher volumes generated. Bath and laundry concentrations are not significantly different from each other. Thus, in the words of Warshall (1977), while it is not innocuous, "greywater may be no more dangerous than kissing a friend's wife." Of course if handled badly, either could be quite dangerous.

The quality of greywater is subject to the control of the homeowner. The pathogens that are allowed to enter the greywater stream and the uses that are made of the greywater from the various sources are at the discretion of the household. For example, discontinuation of the use of the garbage grinder/disposal unit or not adding its outflow to the greywater system would substantially reduce the

Analysis	Kitchen	Bath	Laundry	Toilet
BOD ₅	17	5	3	20
Non-filterable fixed residue	13	3	2	30
Non-filterable volatile residue	12	2	1	25

Wastewater Characteristics: Grams per capita per day (Withee 1973)

pathogen content in greywater. Any source which is considered a special hazard due to the lifestyle or preferences of the household can be diverted to a use which minimizes the potential for human contact, such as subsurface irrigation

How Soil Organisms Destroy Foreign Pathogens

In greywater used for irrigation, bacterial and viral pathogens must compete for survival with the multitude of "native" organisms which are so much more at home in the soil environment. Even if pathogens survive it is unlikely that they will be taken up by plant roots and then translocated to the edible portions of the plant (Javits 1977). Nonetheless, for safety, greywater irrigation should be restricted to ornamental plants. However, there is some evidence that a certain amount of the chemical and organic nutrient material should be left in the greywater in order to encourage the many different favorable soil organisms to thrive (OAT 1977.)

The majority of pathogens prefer to live in warm bodied animals and when introduced into soil do not compete well. However, some organisms can survive in soil long enough to cause public health concerns. For example, salmonella survives up to 2 1/2 months, coliforms up to 5 months, tuberculosis up to 6 months, and certain ova and cysts 5 to 7 years (DWR 1975).

Soils play host to a rich polyculture of life forms, including bacteria, invertebrates, algae, and plants, each of which does its part to eliminate some particular pathogen. This is one of the reasons why conventional sewage treatment processes, which are essentially monocultures, cannot detoxify many of the most dangerous constituents of wastewater such as pesticides, herbicides, phenol, and other complex chemicals (Van der Ryn 1978).

The ability of vegetation and soils to remove specific components of effluent irrigation has been demonstrated by numerous researchers. Kardos (1967) and Sopper (1968), among others, found that sewage effluent irrigation applied to crop and forest vegetation underwent significant renovation in the soil and presented no problems of groundwater degradation. The studies showed a stimulation of crop and forest growth and a recharge (about 80 percent of the total effluent applied) of the groundwater. While soils alone have substantial renovative abilities, the combination of vegetation, especially grasses, with soils, provide the most effective renovation system (Younger 1976).

How Soil Itself Destroys Foreign Pathogens

Once in the soil the pathogenic viruses and bacteria are not in a favorable environment and their lifespan is limited. Soils have a great capacity to assimilate them and render them harmless (Chen 1975). Two different mechanisms operate. Soil particles, particularly clay and humus in the colloidal range (between 0.5 and 1.0 millimicron in diameter), have a negative electric charge. As the viruses percolate through the soil they are electrically attracted and held to the surface of the soil particles by a process called adsorption.

In addition, a fairly common type of clay, known as montmorillonitic clay, expands when wet. As it expands spaces open within the material and the viruses can become lodged in these spaces. When the soil begins to dry, the clay particle contracts and the viruses are trapped and quickly die.

Bacteria are larger particles and not as much affected by the surface attraction phenomena as are viruses, but the

A simple way to test the biological stability of filtered effluent is to store it for a day in a tightly closed container. A foul odor means it has become septic (Lindstrom 1977).

effect is similar. The bacteria also are trapped by adsorption, but they may be able to travel a few feet further through the soil depending on the soil particle size, and velocity of water moving through the soil.

Soils with the greatest surface area per unit volume are high in both clay particles and organic matter (humus), will exhibit the highest degree of the surface attraction phenomena and are therefore more efficient in removing the pathogenic material than are sandy, inorganic soils.

Lateral movement through the soil is primarily a function of groundwater velocity, but if the soil particles are fine enough it is likely that all viruses will be absorbed within 2 or 3 feet (Winnenberger 1973). Similarly, in the famous Flushing Meadows study, secondary effluent with coliform counts of 1,000,000 per 100 ml were reduced to less than 100 per 100 ml by filtering downward through 2 feet of sandy loam and sand and gravel, while similar results were obtained in 4-5 feet of soil at Lodi and 3-7 feet at Whittier and Azusa (DWR 1975).

Comparative Hazards of Land Spreading of Blackwater Residue

Composting is one way to dispose of sewage sludge. Currently about 8 percent of the sewage from the Nation's Capitol's sludge is being turned into a rich, dark compost which is being spread on the White House grounds and at various government buildings (People and Energy 6/78).

This study of water reuse in the garden has been explicitly limited to greywater, but the reuse of blackwater residue receives much more scientific attention. One of the most recent comprehensive summaries suggests that sewage sludge is a wasted natural resource and cites dozens of cases in which the settled solids produced by municipal wastewater treatment plants were safely and beneficially used as soil amendments (Goldstein 1977). The land spreading of "septage", the residue pumped from septic tanks, also has been shown safe (Moore 1978). All of these sewage effluent reuse studies

were done by professionals under controlled conditions, and are well beyond the expertise of the average homeowner. However, because greywater poses so little health hazard compared to blackwater residues, these examples suggest that with reasonable care the homeowner can quite safely reuse greywater in his garden.

Composting Toilets

One of the primary arguments in favor of waterless toilets is that they produce a clean, odorless compost suitable as a soil amendment. Much has been written about their ecological appropriateness because of their ability to safely recycle human wastes (OAT 1977, Van der Ryn 1978, Stoner 1977). Clearly then, if composted human feces are safe for garden use, then greywater properly managed should not be considered any more hazardous.

In one of the most severe tests, Rutgers University scientists grew tomatoes, lettuce, and carrots irrigated with raw sewage "souped up" with added pathogenic organisms (Stevens 1974). They concluded that no evidence could be found that pollution penetrated the surfaces of healthy plants or caused internal contamination.

Reducing Hazards with Greywater Irrigation

A few simple guidelines can substantially reduce the potential hazard of pathogen contamination in irrigation greywater:

- The preferred use for greywater is on ornamental rather than food producing plants. Lawns and other landscaping areas should be the first choice. As noted by Youngner,

Crops for Human Consumption Irrigated with Municipal Wastewater (Usually Secondary Effluent)

<u>Crop</u>	<u>Number of Instances</u>
Asparagus	1
Avocados	1
Barley	10
Beans	2
Carrots	1
Citrus Crops	1
Corn	5
Cucumbers	11
Grapes	1
Oats	6
Olives	3
Onions	1
Potatoes	1
Rye	1
Spinach	1
Squash	1
Sugar Beets	3
Tomatoes	1
Wheat	8
Total:	<u>59</u>

(Schmidt and Clements 1975)

et.al. (1976), irrigation of perennial grasses provides one of the most effective means of renovating polluted waters.

- . Where greywater is used for food crop irrigation it should not be sprayed or allowed to come in direct contact with the edible portions of plants. It is not clear whether irrigation of root crops such as carrots and radishes poses any special hazard, but it is recommended that these be avoided if there is any reason to suspect that the greywater is carrying pathogenic materials.
- . The distribution system should be entirely closed if possible to minimize potential human contact with greywater. This can best be accomplished by using drip irrigation or subsurface distribution which makes it possible to keep greywater enclosed in either a storage tank or distribution tube for the entire journey from plumbing fixture to garden soil.
- . Greywater should not be stored any longer than necessary. In storage, the concentration of pathogens sometimes increases rapidly. Greywater should be stored only long enough to moderate the effect of surge flows, await additional input to dilute the concentrations of household cleaning chemicals, or to allow cooling or dissipation of chlorine. None of this requires longer than a few hours, or a day at the very most.

Disinfection

In some cases it may be desirable to disinfect the greywater before it is applied to the soil. For example, it may be necessary to store the greywater longer than normally advisable or some unusual circumstances may make the greywater

particularly suspect, such as a case of diarrhea in the family.

The common approach to disinfection has been to add chlorine or other chemical agents to the water. Chlorine bleach works fine. In fact virtually all municipal sewage treatment facilities disinfect the effluent by addition of chlorine. The dosage applied in conventional treatment systems ranges from 1 to 25 ppm depending on the type of process used. An activated sludge plant, for example, one of the more common treatment processes, typically uses chlorine concentrations of 2 to 8 ppm (Metcalf and Eddy 1972). Devices for injecting chlorine into the greywater storage are readily available and the various types are described in the Components chapter under the heading Chlorinators.

Chlorination must be practiced with caution. As discussed in the section Chemical Constituents in Irrigation Greywater, chlorine can be damaging to the plants and soil. Recently it has come into question as a disinfectant in sewage treatment due to undesirable side effects. However, it is likely that a certain amount of chlorine is already present in greywater from other sources, notably the laundry. Hypes (1975) found concentrations ranging from 20 to 30 ppm in his samples. Notice that this range is higher than that typically applied to treated sewage effluent just prior to discharge.

Therefore, further chlorination of greywater is not recommended unless special circumstances exist.

SPECIAL RECYCLING APPLICATIONS

There are a number of ingenious ways to use greywater for irrigation that might be of interest to the homeowner in special cases. They indicate uses which will become more common in the future when greywater is more widely recognized as a valuable resource.

Container Gardening

Growing plants in pots, tubs and other large containers is a common practice for many home gardeners, and for many people living in small quarters, such as apartment dwellers, it may provide the only way to enjoy live plants in the home. In general, the use of greywater is as suitable for potted plants as it is for plants grown in open soil.

Container gardens require a bit more care than do open ground gardens, but there are also certain advantages.

- . With a potted plant the gardener has more control over the three major determinants of the plant's successful growth: The type and character of the soil, climatic influences, and the type of plant. It is much easier to monitor the condition of the soil and the plant root system in a container than in open ground.
- . It is easier to take remedial action with a potted plant. If trouble develops, additional sunlight, humidity, or whatever is required can often be

Container Gardening
Greenhouse Greywater
Hydroponics
The French Intensive Gardening
Method
Groundwater Recharge
Irrigation with Septic Tank
Effluent
Firebreak Greenbelt Irrigation
Winter: What Happens Then

achieved by simply moving the plant. Even a complete change of soil and regeneration of the root system can be done if necessary.

- . Potted plants require frequent waterings because the root system can go no further than the boundary of the pot in search of water. In some cases even daily watering may be required. This frequent demand for water is well matched to the daily supply pattern of greywater from household activities. It is likely that only a small storage capacity would be required because the greywater could be used almost immediately on potted plants.
- . Use of greywater on potted plants would not require an elaborate distribution system. Watering cans are fine. In most homes water is always carried by hand in small containers from the source to individual container plants, so greywater is just as convenient to use as freshwater.

Greywater Still

"Another creative idea (not tested) would be to build a simple greenhouse over an evapo-bed or part of a mound on which a forage crop such as comfrey is grown. The transpired water (essentially distilled) would condense and run down the greenhouse sides where it could be collected for reuse. The crop could be harvested as animal fodder or mulch for the garden. Having the greenhouse as a lean-to scuth wall of a barn or house could make the investment pay double dividends as a solar heater." (Stoner 1977)

The primary disadvantage of irrigating potted plants with greywater comes from the fact that their roots are limited and the plant is totally dependent on water and nutrients put in the container for its survival.

- . Because the root area is small and restricted, the potential for salt accumulation and damage by toxic chemicals is greater than for plants growing in open ground. Plants in containers need to be closely watched for signs of salt, chlorine, or boron concentrations in the soil. Indicators of these conditions are traces of white powder (salts) on the surface of the soil or sides of the pot, and yellowing and wilting of leaf edges. Generally, periodic flushing of the pot with fresh water will leach out any harmful salts and minimize salt buildup. Some water-conserving

gardeners save cold water from the shower (before it warms up) for their potted plants.

A closely related problem is the potential buildup of slime and particulate matter in the soil. This condition blocks the passage of air into the soil and can suffocate the plant roots. It is caused by poor drainage and is made potentially worse by the relatively high levels of organic and particulate matter in greywater. The solution is to make sure that the pot allows adequate drainage and the soil mixture includes vermiculite or similar material which makes the soil porous to both air and water. It is a good idea to periodically use a small trowel to aerate the soil of potted plants. This will assure that the pot drains freely with each irrigation. Furthermore, irrigations should not be so frequent that the soil remains soggy from one irrigation to the next.

Rapid drainage through a small quantity of soil is not likely to change the characteristics of greywater a great deal. Most plants should not be over irrigated to the point where water drains through the bottom of the pot or overflows the sides. However this sometimes happens. Therefore, it is necessary to have some way of collecting or diverting the drainage water so that it can be put to further use and poses no potential problem of collecting in the open. For outdoor pots on balconies, consider relying on the rainwater collection system to take care of any overflows; gutters and down spouts are often connected directly into sewers, or otherwise provide safe disposal. For potted plants at ground level it may be safe to allow the excess to simply flow on into the soil to nurture other root systems below. If this isn't possible, the pots should be placed over a container to catch the water.

Plants which have some type of pan or container below

the pot to catch greywater drainage pose special problems. Whether this water can be allowed to stand and be evaporated or taken back up into the soil depends on the quality of the water. If the greywater carries a load of organic materials it may begin to sour and cause odors after a period of days. Generally it is recommended that some means of collecting the water either by removing, siphoning, or draining the container be provided. Greywater should not be allowed to simply evaporate away from a hard surface such as a patio or deck.

Greenhouse Greywater

One of the most interesting year-around uses of greywater for irrigation is in a greenhouse built in a small urban back yard by Abby Rockefeller (1977). About 80 gallons of effluent per day from the kitchen, laundry, and bathroom are first treated in a Clivus Multrum trickle filter, then pumped into perforated pipes running just below the surface of 4 foot deep planting boxes. The bottom of the boxes is filled with gravel and a second perforated pipe runs down the center. After the greywater filters down through the soil it is collected by these pipes and is discharged to a standard scaled-down leach field. Supplemental heating is provided in the winter by a set of flat plate solar collectors (Miran 1978, Stoner 1977). The soil is mostly composted leaves and Abby reports that the vegetables and earthworms are all doing fine. This home also has a Clivus Multrum composting toilet which means it does not need to be connected to a municipal sewer or a septic tank.

Hydroponics

Recall that initially the motivation for writing this

report was to examine simple residential scale systems which reused water on-site. And so, by that criterion, hydroponics is the perfect system because irrigation water is collected and reused continuously.

Hydroponic gardens have no soil. Instead, plants grow in an inert aggregate. Periodically a nutrient solution containing all essential elements is pumped through the mix and when it drains back into a sump tank the cycle is ready to repeat again (Smay 1978). In the extreme, hydroponic systems could theoretically eliminate all residential irrigation which has been estimated at about 70 gpcpd (Milne 1976). In a UCLA greenhouse, hydroponic beds are now growing vegetables in secondary treated municipal wastewater (Berry 1977). However, some feel that household greywater cannot be used for hydroponic irrigation if there is to be periodic sterilization and accurate pH control.

The French Intensive Gardening Method

The most obvious attributes of French intensive gardens are raised beds of well worked soil with dense planting. Ecology Action of the Midpeninsula, Palo Alto, California, provides a good example of water requirements for a specialized but appropriate type of agriculture for small scale greywater applications. The group is noted for its experimentation with the Biodynamic/French Intensive gardening method and claims to achieve a reduction of 1/3 to 1/7 the normal water requirement per pound produced with this technique (Jeavons 1977). Tests were conducted on a garden plot of 88 net sq.ft. (excluding pathways). Water requirements were 10 to 30 gallons per day, depending on crop maturity, type of crop, soil condition and weather conditions. The average requirement of 20 gallons per day amounted to about 1.7 inches per week. This compares to a

normal water requirement of about 1.5 inches per week. Thus, the water demand is higher for the French Intensive method, but the yield is 4 to 8 times greater than normal methods. Therefore, the water required per pound of vegetables produced is only 1/3 to 1/7 of normal.

The characteristics of the French Intensive method which make it especially attractive for greywater irrigation are:

- . The enclosed raised planting beds make management of the greywater distribution system easier.
- . This method requires a skilled gardener which reduces the likelihood that the greywater will be handled unsafely: Presumably in knowledgeable hands it would be treated like any other garden product such as fertilizer, insecticide, etc.
- . Beds are heavily composted and compost holds 6 times its weight in water. Therefore, less greywater will irrigate more plants.
- . Plants are spaced evenly and closely over the entire bed so that when mature their leaves will touch, covering the ground and keeping moisture in. This creates its own microclimate and reduces evaporation by 13 to 63 percent, depending on soil type. It also allows surface irrigation by flooding or soaking hoses.
- . The intensive method results in high soil fertility. Therefore, greywater's particular nutrient imbalances can be compensated for.
- . Water is applied two hours before sunset when it is less subject to evaporation and has 16 hours to sink down to the root zone before the afternoon sun appears. Such regular automatic dosing is quite compatible with greywater systems containing a holding tank.

An On-Site System for Disposing of Kitchen Scraps Strained from Greywater:

"It's maintenance free, odor-free, rather handsome, and extremely convenient. It's the California Blue Jay. It's only drawback is the noise factor. My wife has tried lubricating with meat grease but that had no apparent effect."
(Letter reprinted from Co-Evolution Quarterly).

The French Intensive method recommends watering with an overhead spray to simulate the effect of rainfall. The spray tends to cool and humidify the environment around the plant, and to wash down the leaves. However, because it is not a good idea to let greywater come in contact with the edible portions of plants, the intensive method would need to be modified to use surface or subsurface irrigation on everything except root crops.

Groundwater Recharge

Any discussion of outdoor uses of household greywater must acknowledge that some of this greywater will eventually trickle down into the water table. Long experience with septic tank leach fields and with wastewater recharge projects has shown that 4 or 5 feet of fine soil can remove enough contaminants so that the effluent is safe to enter the water table.

Research has shown that water reaching the groundwater table as a result of surface irrigation with secondary (sewage) effluents is adequately treated for biological pathogens, organic material, trace elements, and heavy metals. However, because of evapotranspiration losses, it actually has higher concentrations of dissolved salts and very likely still, has an unacceptably high nitrogen concentration (DWR 1975). Fortunately, when irrigating with household greywater these two problems can be eliminated. First, most of the nitrogen never enters greywater because of the elimination of toilet wastes. Second, most of the dissolved salts are attributable to sodium from water softeners, or from detergents and some soaps. Therefore, careful management of the cleaning products used in the home can eliminate the potential threat to the aquifer.

Protecting the quality of the aquifer is of crucial concern

to the millions of people in the country who rely on wells for their water supply. In California for example, 48 percent of the total municipal and industrial demand is met by groundwater. There are thousands of water utilities and countless thousands of individual household wells which rely on the quality of groundwater. Thus, over 80 percent of the state's population is exposed to groundwater (DWR 1975).

Rainwater which is not immediately channeled into storm sewers but is instead allowed to soak into the soil also eventually trickles down into the water table. Except for houses on hillsides, encouraging this type of recharge is logical and environmentally responsible.

For the homeowner who makes the effort to safely recharge the aquifer under his home, the final logical step is to sink a well and pump this safe, pure water back up for his own (re)use. This, after all, is the ultimate on-site water recycling system (see chapter on Groundwater Collection).

Irrigation with Septic Tank Effluent

Blackwater systems can produce treated effluent comparable to greywater, which can be of considerable value for on-site irrigation. A conventional septic tank with a four day detention time (800 gallons for a family producing 200 gallons of greywater per day) has low initial cost and almost no operation and maintenance costs (OAT 1977). The great advantage of a septic tank is that while it cuts BOD in half, it will not remove nitrogen and phosphorous. This is exactly what a gardener needs, since these nutrients help defray fertilizer costs. For subsurface or ridge and furrow irrigation on non-edible crops, no further treatment may be necessary. For trickling or spray irrigation, some kind of filter is necessary to prevent clogging. Such systems

are usually designed with a below ground overflow tank and sump pump to get the effluent back up to grade (Siegrist 1976).

Firebreak Greenbelt Irrigation

The great majority of home gardeners need never be concerned about providing their own greenbelt as protection against brush or forest fires. But many homeowners living in rural and suburban areas adjacent to open land may feel the need to provide a measure of protection which will substantially reduce the potential hazard of brushfires. This is important in arid areas where native grass and brush have become extremely dry and susceptible to fires.

One means of providing protection is to establish an irrigated greenbelt of fire resistant plants as a buffer between dry grass or brushland and the dwelling. Use of greywater for irrigation would help to maintain these greenbelts. In addition to maintaining the necessary moisture levels, greywater provides nutrients to the plants and some species, notably perennial grasses, which flourish with greywater irrigation, also provide the most effective firebreak.

A five year study was conducted by the University of California and the U.S. Forest Service (Youngner 1976) to determine the feasibility of using secondary treated municipal sewage effluent to maintain fire suppressive plant growth. The study was conducted in a mountainous area in San Bernardino County, California, at an elevation of about 4,700 feet. The terrain is gently sloping in the test area, averaging about 10 percent slope, and the dominant native plant life is chaparral, a low growing but highly flammable brush. Effluent irrigation was tested in three types of areas; uncleared, brush cleared, and introduced plant materials.

The practice of clearing chaparral brush and converting areas to perennial grasses for use as fuel breaks has been followed by fire officials in the belief that grasses provide less fuel and would therefore retard the spread of fire. These conversions have been successful under actual fire conditions. Theoretically, irrigation of the grasses should improve the fuel moisture content of the grasses yet maintain a low growing cover, thereby enhancing the effectiveness of the fuel break.

The chief conclusions of the study are:

- . Rates of irrigation less than 1 inch per week had little effect on native brush growth, fuel moisture or soil moisture content. At rates of 3-1/2 inches irrigation per week, brush species exhibited substantially increased growth and moisture content in direct relationship to elevated soil water levels.
- . Regrowth of vegetation on brush cleared sites was significantly altered under 3-1/2 inches of irrigation per week with mullein (*Verbascum thapsus*) proliferation and inhibition of native brush regrowth most evident. Under lesser irrigations no major alterations were apparent.
- . Perennial grasses, notably Alta tall fescue, flourished under 3-1/2 inches per week irrigation providing a relatively low growing, high moisture plant cover. Survival at rates less than 3-1/2 inches was poor.
- . Several introduced coniferous trees (Scotch, Ponderosa, Knobcone, Jeffrey, Japanese Black Pines, and Incense Cedar) survived well and exhibited increased growth over lesser irrigated trees. Sugar pine, Red, White, and Douglas Firs, Sequoia, Big Cone Spruce, and Coulter Pine exhibited very poor survival.
- . Effluent irrigation appeared to have no significant

effect on the quality of water in the surface or ground-water systems.

- . Renovation of effluent at 3-1/2 inches per week application rate appeared to occur in the following manner:
 - a) Alta fescue vegetation effectively removed large quantities of nitrogen, potassium, chloride, and sulfur, and lesser amounts of phosphorous and boron. No significant additional uptake of sodium, magnesium or calcium above levels normally present in the plants appeared to exist. No toxic effects were evident.
 - b) Chaparral soils accumulated sodium, chloride, phosphorous, boron and magnesium at significant, but not toxic, levels. Excess chloride levels occurred in late season. Nitrate nitrogen in surface soils increased due to increased organic litter. Nitrogen and potassium may have been depleted from the soil by vegetative growth. Soil pH and electrical conductivity (indicating salt accumulation) increased significantly.
- . In a greenbelt design, Alta fescue vegetation under 3-1/2 inches per week irrigation provides the best combination of fire suppression qualities (high moisture, low fuel quantity, survival) with effective effluent renovation characteristics. Additionally, the grasses provide excellent forage.
- . With adequate information on the hydrology, soil physical and chemical properties, and climatic data of the site, the disposal and renovation of sewage effluent can be carried out in chaparral areas through the establishment of a perennial grass greenbelt.

These conclusions, of course, cannot be adopted as a general statement because they reflect a particular relationship of soils, climate and vegetation type. They do provide a

guideline for establishing a fuel break greenbelt and help to set a level of expectation for its success. The application of 3-1/2 inches of water is equivalent to slightly more than 2 gallons per sq.ft. per week. Assuming that a person produces about 40 gallons of greywater per day, a family of four should be able to irrigate about 560 sq.ft. of greenbelt area. The exact amount depends on the soil physical and chemical characteristics, the vegetation type, the climate and the irrigation method used.

Winter: What Happens Then

If the ground freezes, irrigation systems must be drained and the greywater will have to go elsewhere. Returning it to the sewer or the septic tank along with the household blackwater is the easiest option. However, a study at Penn State showed that evaporation and infiltration still operate even when the landscape is covered with ice from sprinkler applied wastewater (Stevens 1974).

Of course, if all the greywater was used in a greenhouse or on protected container plants, some reduced volume of irrigation will occur, as the plants become somewhat dormant during the shorter days.

Because household greywater is initially quite warm, sub-surface irrigation may be possible year around if winters are mild enough.

5

SYSTEMS

Many on-site water recycling systems have already been designed. The collection of systems described in this chapter fall into four categories based on their stage of development. Proprietary Systems are those currently being manufactured or tested for future marketing. Operating Experimental Systems have been custom-built for one installation. Published technical data for these systems is available. Home-Built Systems are those which have been assembled by individuals and successfully installed in their own homes. Design Proposals are untested systems which are still on (or never made it past) the drawing board.

Operation of the proprietary systems is, by necessity, described only briefly; but all of the others are described in enough detail so that they could be reproduced with little difficulty. All of the items needed to assemble these systems are described in the components chapter of this report.

Installation and Service

Homeowners should be able to install and maintain most of these systems by themselves. In a few cases, however, it is specifically stated that this not be attempted. Homeowners wishing to have someone else install the system should contact either a plumbing contractor or a general plumber, as they are experienced in working with the pumps,

- 5.1 PROPRIETARY SYSTEMS
- 5.2 OPERATING EXPERIMENTAL SYSTEMS
- 5.3 HOME-BUILT SYSTEMS
- 5.4 DESIGN PROPOSALS

filters, chemical feeders and other components used in these systems. Periodic maintenance could be performed by local swimming pool service companies.

Additional technical data, an annotated bibliography, an index of manufacturers, and other references are included in the appendix.

5.1 PROPRIETARY SYSTEMS

CLIVUS MULTRUM
AQUASAVER
PURE CYCLE
GREAT CIRCLE
THETFORD CYCLE-LET
CONSERVAGATOR
HANDBASIN-TOILET
ENVIRO-PAK RECIRCULATING TOILET

Proprietary systems are those which have been developed for manufacture and sale as complete packaged units. Some of these systems are already on the market. Others are being test marketed and will become available in the near future. Still others are currently being tested and are awaiting approval by health authorities. Very little information is available for most of these systems because the manufacturers are anxious to protect their ideas from competitors.

The scale of the proprietary systems covers the entire spectrum, ranging from a simple kit for temporary operations to a large and complex system requiring maintenance operations by specially trained personnel.

CLIVUS MULTRUM SYSTEM

The Clivus Multrum System is a complete waste treatment and recycling system that is assembled in an individual household with components manufactured by Clivus Multrum, Inc., a Swedish firm with U.S. offices in Cambridge, Massachusetts. The two primary components of the system are Clivus Multrum's composting toilet (see Milne 1976) and their Washwater Roughing Filter (see Components chapter). The system specifically described below is in operation at Clivus Multrum's experimental house in Cambridge and was reported by Lindstrom and Rockefeller (1977, 1978). However, with the exception of the greywater-irrigated greenhouse, it represents a typical Clivus Multrum system which could be installed in any new house (designed to accommodate it) and in some cases, an existing house as well. The Clivus Multrum System was also an integral part of the Naturhset Stockholm (the Nature House), a proposal for a self-sufficient house by Swedish architect-philosopher Bengt Warne (1977). In addition to recycling its wastes, the Naturhset was solar heated and collected rainwater for indoor uses.

Operation

Greywater from the laundry, showers, tubs, bathroom sinks, and kitchen sink (excluding food wastes) is collected and delivered to the large sand and gravel Washwater Roughing Filter. From the filter, the greywater is pumped to a greenhouse, where it irrigates two plant beds as it drains

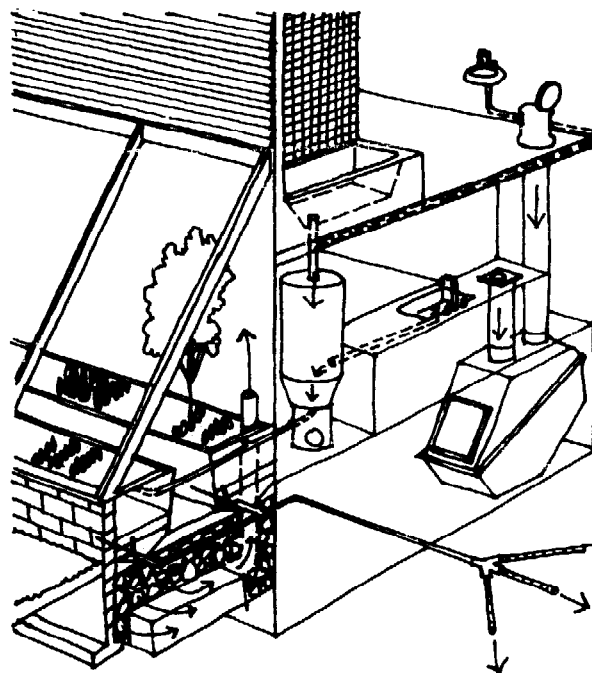

GREY WATER FROM THE BATHROOM, KITCHEN AND LAUNDRY GETS PRIMARY TREATMENT IN THE TRICKLE FILTER. IT THEN GOES INTO THE SOLAR GREENHOUSE PLANTING BEDS WHERE IT IRRIGATES AND FERTILIZES PLANTS AS IT FILTERS THROUGH THE SOIL AND DRAINAGE MATERIAL. AFTER LEAVING THE GREENHOUSE IT IS DISCHARGED INTO A SMALL LEACHFIELD.

through the soil and drainage material (see chapter on Outdoor Uses). From the greenhouse the greywater flows to a small leachfield. Theoretically, at least, this house does not need to be connected to the municipal sewer system.

The plant beds were modified in a number of ways because they were designed also to serve as leachfields. The beds, which have a total surface area of 54 sq.ft., were made 3 feet deep rather than the usual 9 inches, in order to absorb the approximately 80 gallons of greywater which is produced in the house each day. Thus, even if the beds are saturated, water introduced rapidly will drain out slowly. The soil boxes have drains at the lower end of their slightly sloping bottoms and are lined at the bottom with a 2-inch layer of crushed rock to facilitate drainage. The excess depth of the beds also eliminates plant root depth as a limiting factor in what may be planted and has a stabilizing influence on the soil environment. As a result, a much more diverse and balanced population of organisms can thrive, whereas they could not in shallow beds where moisture and temperature fluctuations are too great.

The dosing occurs as soon as any of the contributing fixtures are used because Lindstrom and Rockefeller found that the filtered greywater would turn fully septic if allowed to stand for even a day. The greywater is distributed along the entire length of the growing beds through 1-1/2 inch pipes having 1/4-inch perforations every foot.

Toilet wastes and organic wastes from the kitchen, garden, and greenhouse, are deposited in the composter which is located in the basement directly below the bathroom and kitchen. Wastes enter by gravity through sealed vertical pipes -- one beneath the toilet seat and another beneath an opening in the kitchen counter top. In the composter the organic wastes undergo aerobic decomposition and are transformed, after a couple of years, into a nutrient-rich

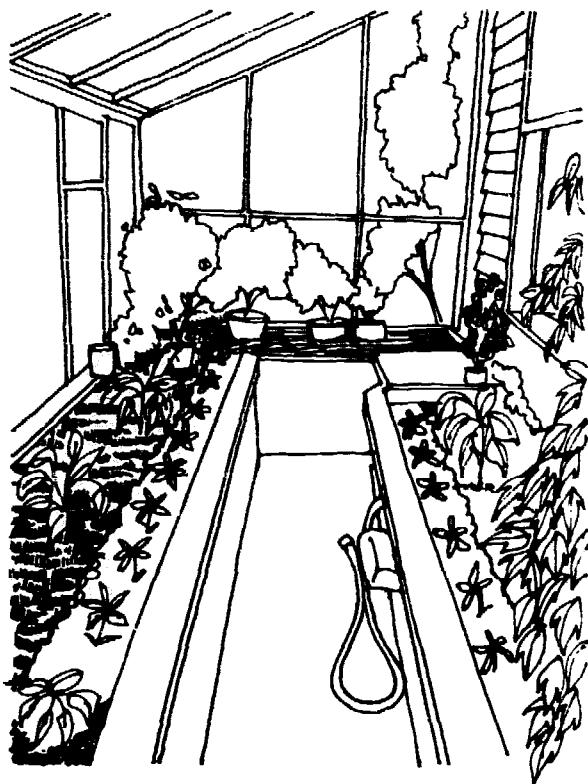

IN THE CLIVUS MULTRUM SYSTEM, THE FILTERED GREYWATER FLOWS THROUGH TWO DEEP PLANTING BEDS BEFORE GOING TO A SUBSURFACE LEACHING FIELD.

THE CLIVUS MULTRUM GREENHOUSE

soil-like humus which is used as a fertilizer in the greenhouse and garden.

The collection and treatment of combined kitchen and toilet wastes in a composter offers a number of significant advantages. The first, and most obvious, is that because the flush toilet and garbage disposal are eliminated, household water consumption is immediately reduced by about 40 percent. The second is that these wastes, which constitute the most troublesome pollution load to water leaving the house in a traditional water-borne sewage system, are instead turned into a beneficial garden product. The third is that the separated and relatively clean greywater can be passed through the roughing filter rather than a septic tank, since it is the large size and slow decomposition of fecal material which makes a septic tank necessary in the on-site treatment of combined wastes. This is important because the effluent from the roughing filter is relatively aerobic, whereas the effluent from the septic tank is anaerobic and may promote anaerobic processes in the soil which would be harmful to plant roots.

The greenhouse provides an ideal way to irrigate and feed plants through a subsurface distribution system. Because they are sheltered by the greenhouse, the plant beds provide a highly favorable environment for the further purification of the greywater in the soil: the warm and stable climate promotes the healthful activity of the decomposer microorganisms in the soil and enables the plant beds to be active year-round, even during the height of the rainy season. Because there is no danger of flooding or freezing, the perforated pipes can be located close to the surface where the greatest biological activity takes place. As a result, the soil remains aerobic even directly around the leach lines, and shallow plant roots have the opportunity to absorb the nutrients in the greywater which have been made available by the microorganisms in the soil. In addition, pipes near

the surface are easily accessible for inspection and cleaning. As Lindstrom and Rockefeller note, the greenhouse, when combined with the composter and the roughing filter, closes the cycle of waste conversion, nutrient recovery, water purification, and food production in the home.

Maintenance

The primary maintenance required by the Clivus Multrum system is the periodic cleaning of the trickle filter and the distributing of the humus produced in the composter to the plants. It should be noted, however, that if it is to function properly the composter must receive regular feedings of organic material, a nearly continuous supply of fresh air, and it must be kept under steady temperature conditions.

Cost

A Clivus Multrum composter serving the kitchen and one toilet on the first floor costs about \$2,000. A Washwater Roughing Filter costs about \$450. The total cost of the total system will vary with the lengths and type of collection and distribution pipes employed.

AQUASAVER

The Aquasaver is a commercially available greywater recycling appliance designed to be installed in new homes and, if drain pipes are accessible, in existing homes as well. The Aquasaver system processes wastewater from the washing machine, tub, shower, and bathroom sinks. It is not intended to treat wastewater from the kitchen.

Operation

The greywater is first collected into a single pipe and then delivered to the Aquasaver storage tank. As the greywater enters the tank, coarse materials are removed by a strainer located on the end of the inlet pipe. From the outlet located near the tank bottom, the greywater in the storage tank is drawn through a cartridge filter by a 1/3 HP shallow well jet pump. At the pump, a small portion of the filtered greywater is diverted through a tablet chlorinator and then returned to the storage tank. The remaining greywater in the pump is discharged to the point of reuse. The chlorinated greywater mixes with the greywater in the storage tank to provide a uniform chlorine residual in the tank of 5 parts per million (ppm). The treated greywater may be reused for toilet flushing, irrigation, or other non-drinking purposes.

In addition, the Aquasaver system has a provision for automatic freshwater supplementation should the supply of

greywater fall below a certain level. Flow of freshwater into the storage tank is controlled by a solenoid valve located in the freshwater supply line and actuated by a float switch. The float switch is mounted on the tank wall, approximately 3 inches above the outlet to the filter and pump. Thus, the level of the greywater in the storage tank may fall until the arm of the float switch drops to its lowest position. At this point, the solenoid valve opens and freshwater flows into the tank.

The storage tank is also equipped with an overflow outlet and a drain valve. The overflow outlet is located near the top of the tank, but below the level of the greywater and freshwater inlets. In this way, excess greywater is discharged to the sewer system before it can backflow into the freshwater or greywater inlet pipes.

According to the manufacturers, greywater recycled through the Aquasaver is odorless, free of discoloration, and contains no solid material greater than 25 microns in size. It reportedly has an average turbidity level of 60 ppm and contains an average of 31 ppm suspended solids.

The manufacturer recommends a storage tank capacity of 150 gallons for an average family of four, with an additional 25 gallons of capacity added for each additional person in the household. The system requires about as much space as a washer and dryer. The system has been certified by the National Sanitation Foundation (NSF) and is currently being marketed. Prospective owners should check with local authorities for acceptance of the unit in their area.

Maintenance

The principle maintenance requirements of the Aquasaver system are replenishment of the chlorine tablet supply,

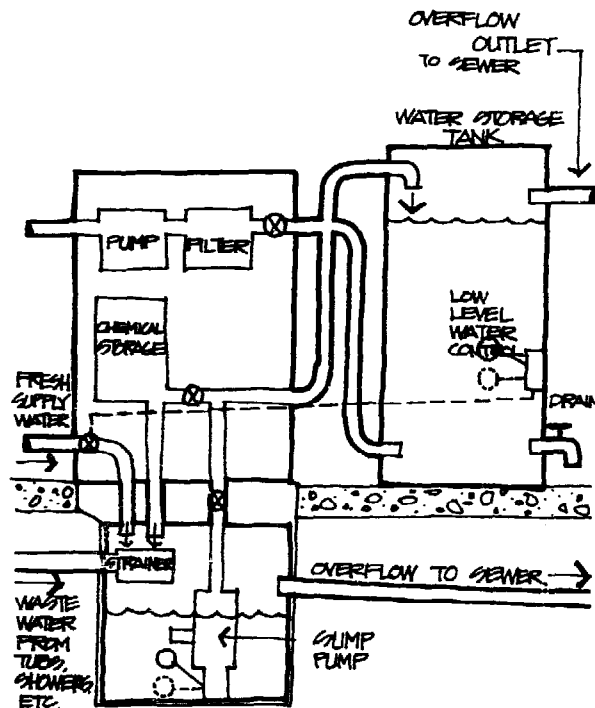

THE AQUASAVER SYSTEM

replacement of the filter cartridges, and cleaning of the storage tank. These maintenance operations should be performed approximately every 90 days.

Cost

The Aquasaver system will cost approximately \$2,500. Maintenance costs for the system result primarily from replenishing the chlorine supply and replacing the filter cartridges. Thus, annual maintenance costs will vary largely with the volume of water recycled. These maintenance costs may be expected to range from approximately \$45 to \$120, with the breakdown as follows:

Chemical replenishment	\$32
Cartridge replacement	\$12
Electrical power	\$15
<u>Total</u>	<u>\$59</u>

PURE CYCLE

Pure Cycle is a proprietary household wastewater treatment and recycling system which processes both black-water and greywater and reportedly delivers pure potable water as its end product, thus allowing 100 percent re-use.

The system is designed for installation in individual dwelling units. However, because it requires semi-annual maintenance by specially trained personnel, a service center must be established in the vicinity of the homes employing the system. As a result, the system is economically feasible from the manufacturer's point of view only when enough homes use the system to effectively utilize a service center. Thus, the system is intended for installation in groups of 200 or more homes. Currently the system has been approved for demonstration and use in two Colorado counties. In these counties, the Pure Cycle Corporation has established service centers and is marketing prototypes of their product on a limited basis.

Operation

To date, the Pure Cycle Corporation has been very vague about how their system operates. It appears that household wastewater from all sources, flows into a "biological reactor" in which organic materials are oxidized through biological digestion and inorganic solids are settled out. The digested wastewater then moves through an "ultra-

filtration stage" in which most bacteria, viruses, and remaining suspended particles are removed. From there, the water moves through an organic adsorption system which removes organic contaminants. The water then moves through a demineralization stage in which resins remove heavy metals and inorganic salts. At this point, the water contains less than 10 ppm dissolved solids and is passed through a sterilizer as the final stage in the process. The purified water is then stored in an underground storage tank and delivered to the household at standard pressure.

The system operates with the aid of a micro-processor computer which monitors and analyzes the quality of the wastewater as it moves through the various stages of treatment. The micro-processor is capable of shutting down the system if a malfunction is detected. In this event, it would then automatically inform the local service center of the problem through the dwelling's telephone system. Under normal conditions, the system requires the attention of service personnel once every six months to remove accumulated solids, replenish materials, and perform other maintenance chores.

The system costs approximately \$5,000 and requires an initial input of 1,500 gallons of water. Once the system is in operation, it reuses 100 percent of the wastewater and thus requires no additional water input except to make up for losses due to evaporation and the like. The system can be replenished with rainwater, snow-melt, sea water, or any number of other sources in addition to water from the tap.

GREAT CIRCLE

The domestic wastewater system developed by Great Circle Associates collects wastes from all sources in the household (both blackwater and greywater) and treats them in a batch-type filtration process to obtain an effluent suitable for irrigation purposes.

Two prototypes of the Great Circle system are currently in operation. However, because it is one of the most complex systems discussed in this report, this description can provide only a general idea of its operation.

Operation

Wastewater from all sources in the household flows into a single collection pipe and is delivered to the system's input pipe. When the influent reaches the bottom of the input pipe, a liquid level sensor starts the system's centrifugal pump. The pump draws wastewater processed in the previous cycle from a "power reservoir" and discharges it into a "return reservoir" located immediately above. A slime-retarding oxidant is injected into the return reservoir concurrent with pump operation. The air volume above the water in the power reservoir is connected by a pipe to the air volume above the water in a third reservoir, known as the "buffer reservoir". Through this connecting line, the suction created by drawing the filtered wastewater from the power reservoir is transferred to the buffer

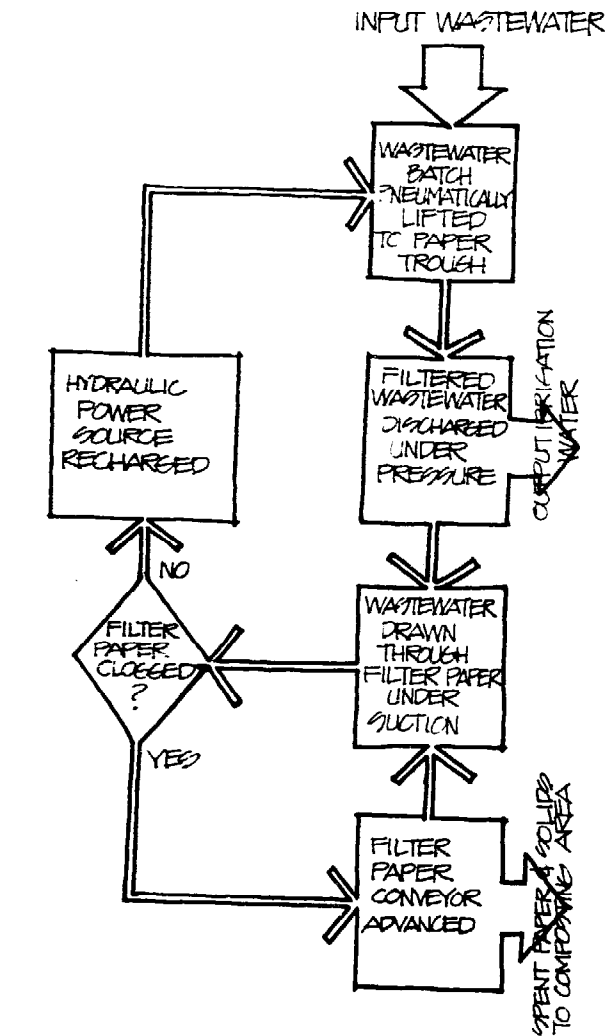

FUNCTIONAL SYSTEM DIAGRAM
GREAT CIRCLE SYSTEM

reservoir and lifts the batch of wastewater from the bottom of the input pipe to the buffer reservoir.

When the buffer reservoir becomes filled, a second liquid level sensor actuates solenoid valves which seal the power reservoir and return the buffer reservoir to atmospheric pressure. With the buffer reservoir at atmospheric pressure, the weight of the wastewater within opens the flap valve and the wastewater is dumped into the trough below. Because the power reservoir is now sealed, a suction accumulates within it as the pump continues to withdraw water from it. The pump continues to operate until a third liquid level sensor determines that the power reservoir has nearly been emptied. When this occurs, the sensor shuts off the pump and opens a solenoid valve to apply the suction in the power reservoir to the bottom of the trough. The applied suction draws the wastewater through the filter paper, conveyor net, and perforated suction plate and discharges it into the power reservoir.

The system contains a mechanism to automatically change the filter paper when clogged. The clogged filter paper and accumulated solids can be composted and later reused as humus in the garden or otherwise disposed of in a safe manner. It totals about 6 cu.ft. per household per year.

All the while the pump is in operation, it continues to discharge filtered wastewater into the return reservoir. After the return reservoir is filled, any additional filtrate flows through the overflow pipe into the irrigation system. When the filtration process is completed and the trough is empty, the filtrate in the return reservoir is dumped into the power reservoir by means of a solenoid-actuated flush valve. This recharges the power reservoir with a "fresh" supply of filtrate for use in the next treatment cycle.

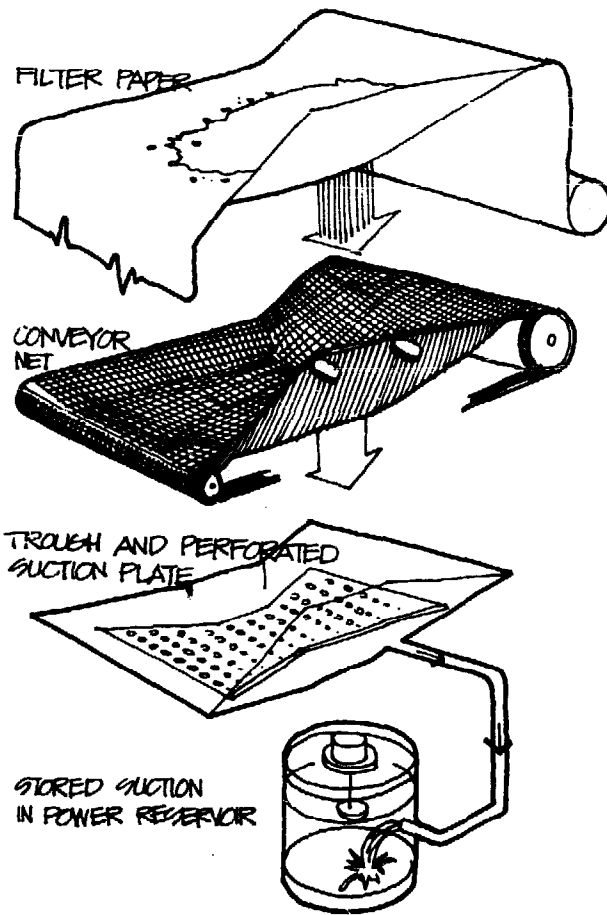

SUCTION-AIDED PAPER FILTRATION
GREAT CIRCLE SYSTEM

The Great Circle system is intended for use with a sub-surface irrigation system. The system's developers claim that the effluent is high in nutrient content, low in bacterial content, and free of heavy metals and other toxins; although at this time, no test data has been seen which would either support or refute these claims. The system is intended for both single and multiple household applications.

Maintenance

Because of its complexity, maintenance on the Great Circle system should be performed only by specially-trained personnel.

Cost

The manufacturer's initial estimates of \$700 per household plus \$26 per year operating cost, based on a 6-household installation, seem highly optimistic.

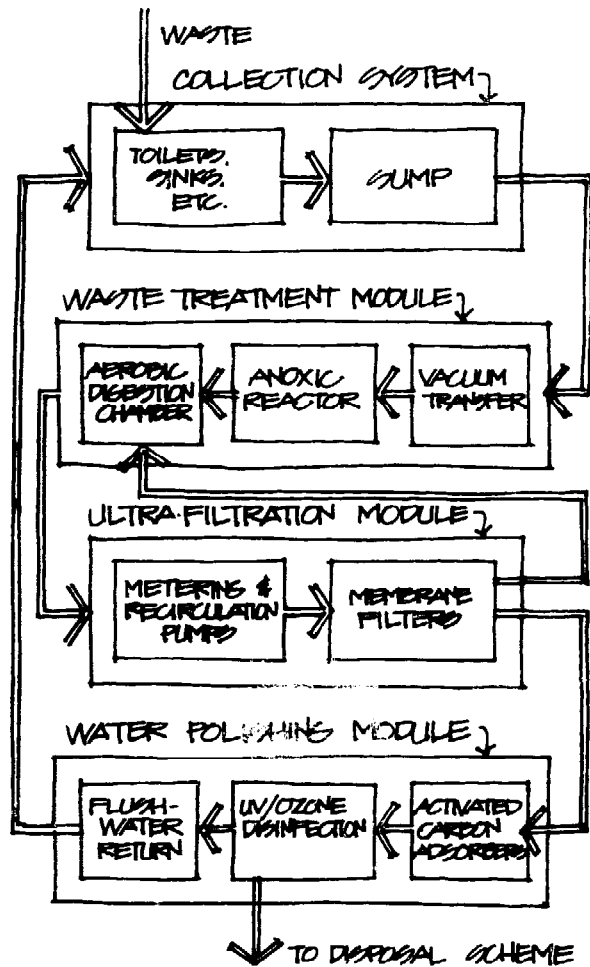

CYCLE-LET® FLOW DIAGRAM

THETFORD CYCLE-LET

The Thetford Corporation, manufacturers of a sophisticated water recycling toilet system, are currently experimenting with processing greywater as well as blackwater in their unit and discharging all recycled water that is not reused in toilet flushing to a subsurface leachfield or irrigation system.

Operation

Thetford's system, the "cycle-let", is a self-contained waste treatment system which continually recycles its own water for flushing toilets. Depending on the model selected, toilet wastes are transferred by gravity or air pressure to a sump. From the sump, wastes are transferred by vacuum to the "waste treatment system".

Within the waste treatment system, wastes progress through an anoxic reactor, an aerobic digestion chamber, and a sedimentation chamber. From the sedimentation chamber, the water enters the "water recovery system".

In the water recovery system, the effluent passes through membrane filters, activated carbon absorbers, and a disinfection unit. The disinfected water is stored in the flush water storage tank and then moves on demand to the water pressure tank. With each flush, water from this tank is piped back to the toilet, thus completing the water recycling process.

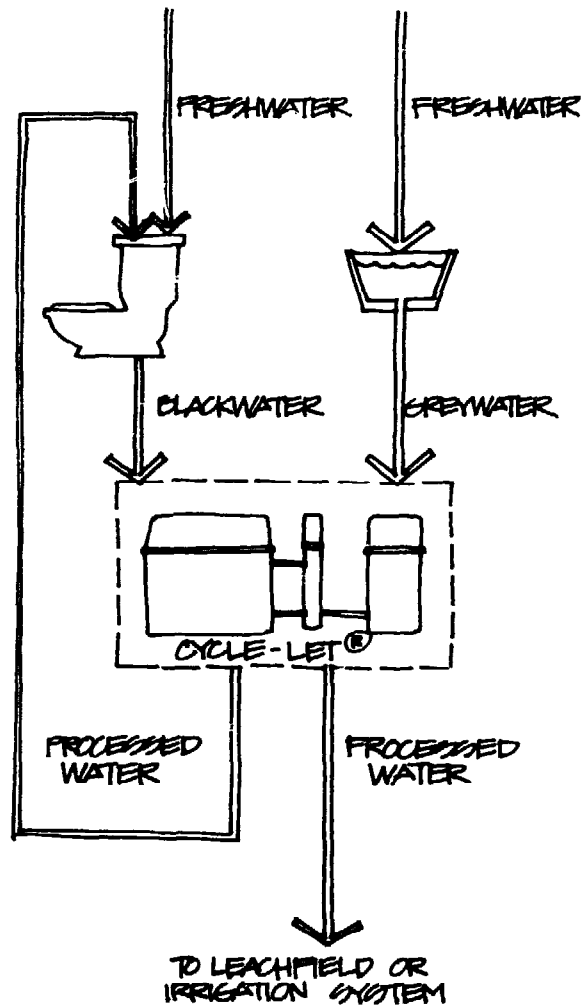

BLACKWATER AND GREYWATER IN
THE CYCLE-LET®

In their work with greywater, the Thetford Corporation is apparently experimenting with collecting blackwater and greywater together and discharging the entire volume to the Cycle-let unit. The combined wastewater goes through the same process as would the separated blackwater, and is renovated to the same level of purity, which the manufacturers claim is "crystal clear, odorless, colorless, and coliform bacteria-free."

A portion of the recycled water in these tanks is reused for toilet flushing. The remainder is discharged to a subsurface leachfield or irrigation system. One of the advantages over the completely closed blackwater recycling system is that the average pathogen level in the system is lower, and the final effluent is treated blackwater rather than untreated greywater (which the manufacturer undoubtedly believes is safer).

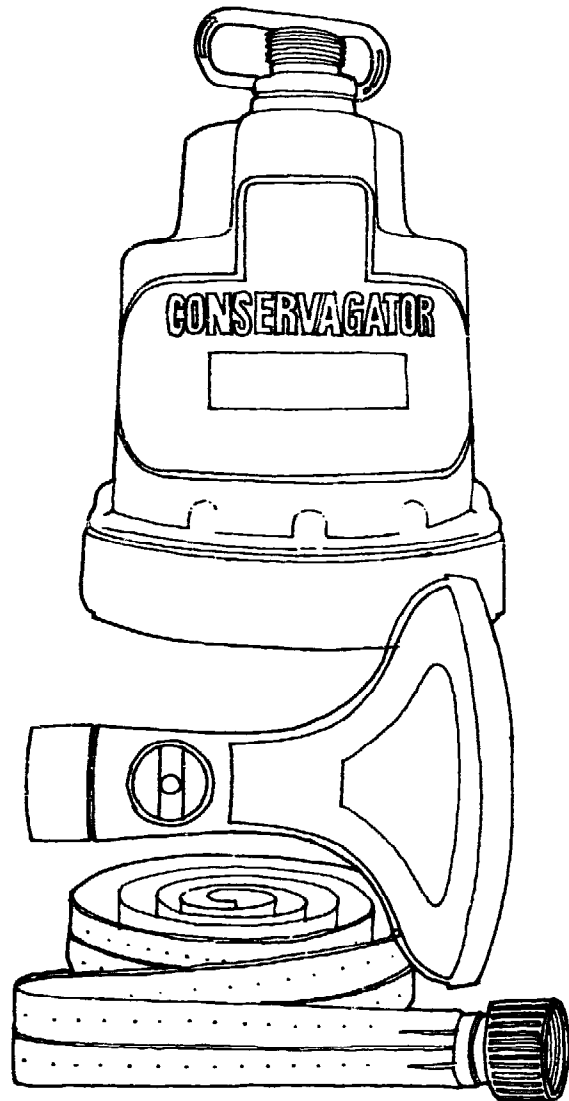

THE CONSERVAGATOR KIT

CONSERVAGATOR

The Conservagator is a simple, commercially available, portable kit designed to enable the homeowner to recycle greywater from the bathtub, laundry tub, or other basin directly into the garden or toilet bowl without altering the home's plumbing. It was initially marketed during California's recent drought as an alternative to hand-carrying buckets of household greywater.

Operation

The kit consists of a standard portable submersible sump pump, 20 feet of soaker hose, and a sprinkler nozzle with an integral shut-off valve. The portable sump pump is simply placed in the tub, basin or other volume of water that is to be reused and a standard garden hose is connected to the pump outlet. For reuses involving irrigation, the garden hose is run out through a window and connected to the soaker hose or sprinkler nozzle. The 1/6 HP centrifugal pump may be plugged into any home convenience outlet.

The Conservagator is designed to pump clean, dirty, or salt water at temperatures up to 120°F. The flow rate produced by the pump is a function of the height above the water level at which the water is discharged, plus any frictional losses in the pipe or hose. The Conservagator pump is capable of pumping 20 gpm at 3 feet of head or 5 gpm at 20 feet of head.

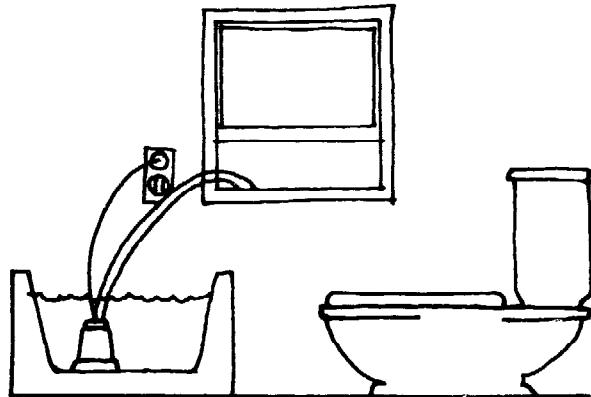

FOR RE-USE IN GARDEN IRRIGATION

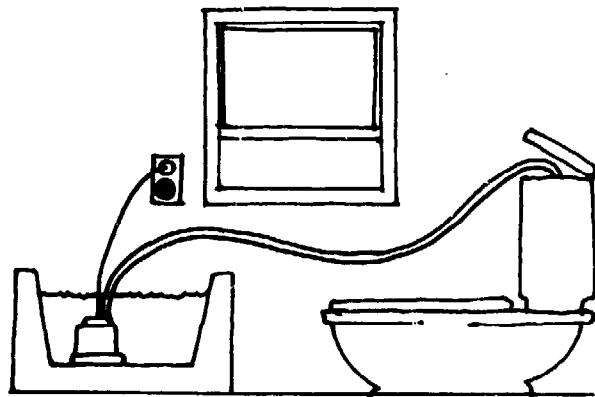

FOR RE-USE IN TOILET FLUSHING

The unit may be completely submerged, however, it requires only 1/2 inch of water to begin pumping. Once pumping has begun, the unit will continue to draw water until the depth drops to 1/8 inch, although it does not shut off automatically when no more water is left.

Maintenance

The Conservagator pump is a sealed unit. Thus, the only maintenance required is keeping the bottom screen free of debris. If the pump should become clogged with sand, it can be cleaned by backflushing the pump with a garden hose or by dipping the unit up and down in a bucket of clean water.

Cost

The Conservagator kit costs approximately \$65. Portable submersible pumps alone are available from about \$30.

HANDBASIN-TOILET

The "handbasin-toilet" is the name we have given to a disarmingly simple, commercially available device which is indeed a self-contained residential water recycling system. It is a standard flush toilet with a sink and faucet built into the top of the tank. After the toilet is flushed, the user washes his hands in the water that is refilling the tank through the basin.

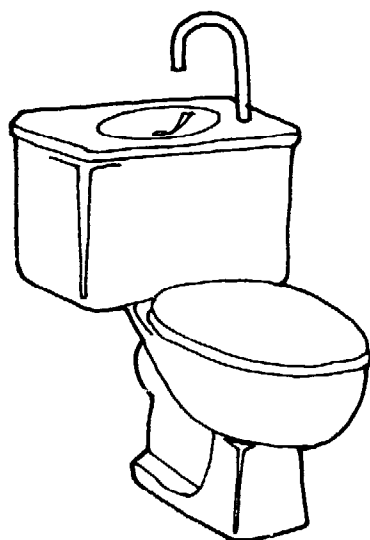

HANDBASIN TOILET

Operation

In the most basic form of this device, the water delivered to the tank after the toilet is flushed flows from the faucet, into the sink, and then drains into the tank. The faucet has no turn-off valve and the sink has no stopper. When the user washes his hands under this flow of water, the greywater that is produced also flows into the tank and is reused in the subsequent flush. This form of the device is currently in wide use in Japan.

A variation of the device has recently been developed at McGill University. In this version, the faucet contains a valve much like a typical bathroom faucet. The valve provides water upon demand, rather than only after a flush, and thus enables the tank-top sink to serve all of the functions of a bathroom sink. As a result, all of the greywater normally produced by the bathroom sink can be discharged to the tank and reused in toilet flushing.

Maintenance

As yet, no data has been published regarding the maintenance record of either the Japanese or Canadian designs. However, there remains some question of whether or not soap scum builds up in the toilet tank. If it does, one solution is simply not to use soap when rinsing the hands. Another, perhaps more desirable, solution is to find a non-scum-producing cleaning agent, possibly a mild detergent. A third possibility is that tank mechanisms have been redesigned and are indifferent to scum build-up, or automatically scour it away during the filling or flushing cycle.

ENVIRO-PAK RECIRCULATING TOILET

Enviro-Pak has developed a modular "recycled flush water treatment system" called "STP". It was specifically designed as a small mobile toiletwater water recycling system to process blackwater and greywater by a series of sub-treatments; the grinding of combined sewage, the aerobic digestion of the same, the physical separation of particulate matter, the clarification of waste, and finally, the disinfection of the effluent now processed and ready for reflush. This operates together with an evaporator for the removal of excess water.

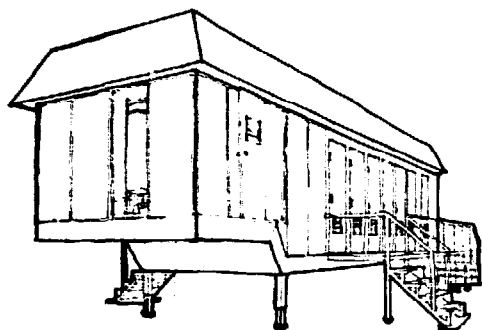

This effluent treatment plant was designed as a relocatable "comfort station and sewerage treatment plant". Mounted on a flat-bed semi-truck trailer, it was designed to accommodate twelve separate toilets and four sinks in two separate sets of restrooms.

ENVIRO - PAK

5.2

OPERATING EXPERIMENTAL SYSTEMS

MCLAUGHLIN SYSTEM
COHEN-WALLMAN SYSTEMS
FARALLONES INTEGRAL URBAN HOUSE
FARALLONES RURAL CENTER
POINT BARROW, ALASKA
HAWAIIAN ENERGY HOUSE
MIRAFLORES DEVELOPMENT

The systems described in the following sections were actually constructed and either are or have been in operation. These systems are classified as "experimental" because they were assembled not by typical homeowners, but by persons or organizations researching the feasibility of on-site water recycling. Technical data has been published on each of these systems. This classification, however, does not imply that such a system is beyond the scope of the typical homeowner.

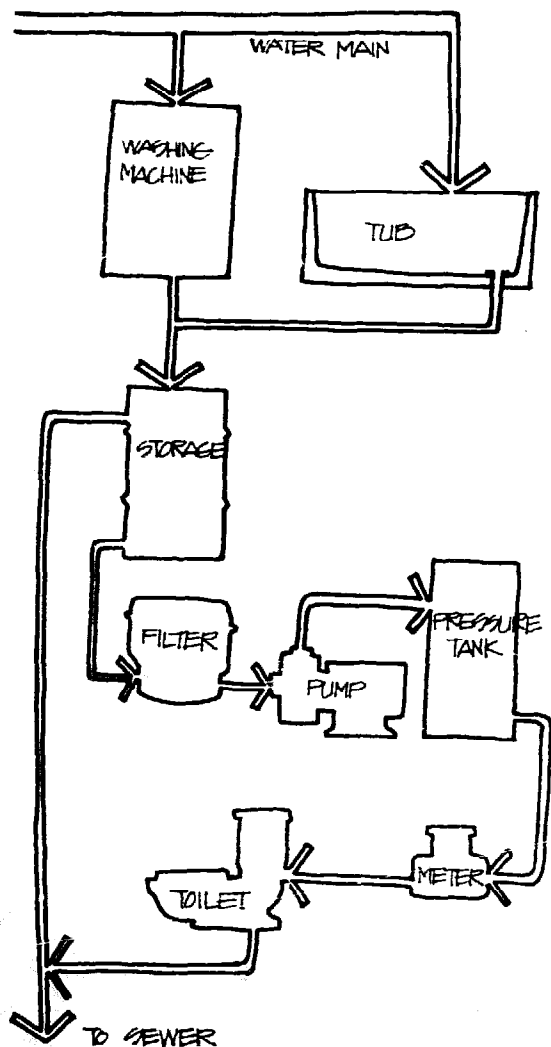

MCLAUGHLIN SYSTEM

One of the first, and still one of the best, greywater recycling systems was designed and installed in a residence by Professor Everett R. McLaughlin of Pennsylvania State University in 1967. Realizing that the various functions performed by water in a residence have different requirements for initial purity and for volume of water used, McLaughlin determined that wastewater from the laundry and tub-shower could adequately meet the average needs for toilet flushing and that recycling this amount of water could result in as much as 39 percent reduction in total consumption.

Operation

In this system, the drains from the laundry and tub-shower were disconnected from the sewer and reconnected to a storage system. The sewer connections were sealed. The storage system initially consisted of two 55-gallon drums, painted on the inside with an asphalt paint to inhibit corrosion. The useable capacity of the two drums was only about 70 gallons because the outlet to the filter was located 4 inches above the bottom of the drum and the overflow outlet 2 inches below the top. The storage tank overflow line was connected to the sewer system.

A diatomite spin filter having a surface area of 20 sq.ft. was included in the system to remove lint and other debris that might otherwise foul the pressure tank or toilet

MCLAUGHLIN SYSTEM FLOW DIAGRAM

control valves. Water from the storage tanks was drawn through the filter and discharged into a 15-gallon pressure tank by a conventional shallow well pump. The pressure tank supplied water at pressures between 10 and 40 psi, as needed by the standard flush toilet used in this system. In order to measure the volume of water being recycled, a water meter was located in the pressure tank discharge line.

After three months of operation, two additional storage drums were integrated into the system to provide a total useable storage capacity of 140 gallons. Storage is a critical factor since the laundry provides large volumes of water at relatively infrequent intervals, whereas the toilet uses small volumes of water at short, fairly regular intervals.

This system operated for one year, during which time 11,674 gallons of wastewater were recycled. The house water meter indicated that, during this year, 40,074 gallons of water had been consumed. The sum of the volumes of freshwater supplied and greywater recycled is 51,748 gallons and represents the total volume of water consumed in the house during the year. Thus, the recycled greywater represents 22.6 percent of the total consumption.

Maintenance

The system was designed to be virtually maintenance-free. After the year of operation, the system was shut down and inspected. The drum into which the laundry water was discharged had accumulated a layer of lint and soil approximately four inches thick. This material required substantial dilution before it would flow through the 1/2-inch diameter pipe to the sewer. The other storage drums showed little

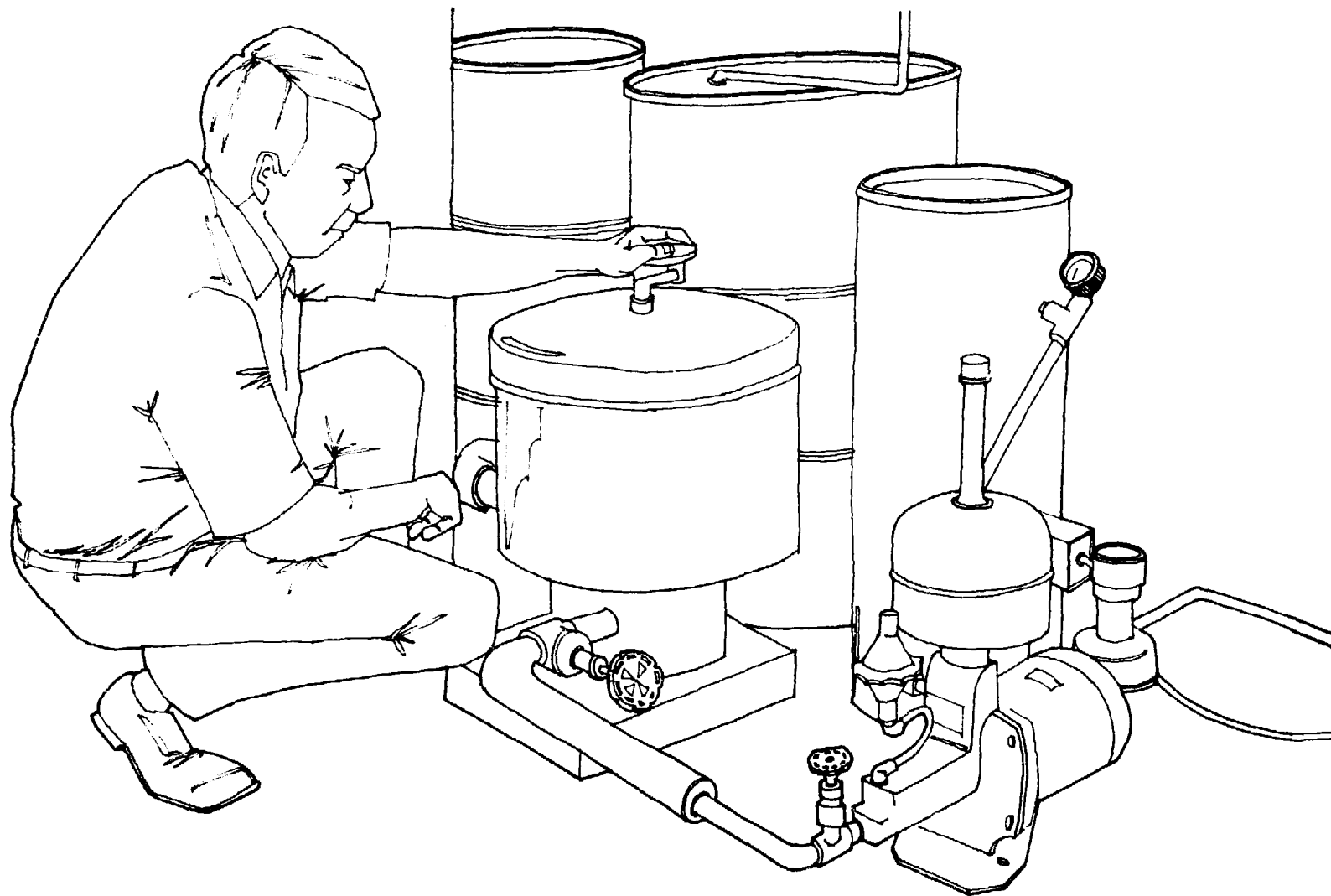

THE MCLAUGHLIN SYSTEM

sediment accumulation. If suspended material were first collected in a separate, easily flushed settling tank, much of the effort associated with cleaning out the tanks would have been eliminated. Alternatively, a drain facilitating easy sediment removal could have been installed in the bottom of the main storage tanks.

The first drum into which the wastewater was discharged also experienced peeling of large pieces of the asphalt paint which coated the interior. The exposed metal rusted severely. Peeling of the asphalt paint appears to have been induced primarily by the fluctuating water level within the tank.

McLaughlin reported that the toilet water was slightly grey in color and had a barely noticeable soapy odor but that it created no problems with the operation of the float mechanism. The filter elements showed a light grey deposit of wash water solids, but in no way appeared overloaded. This observation lead McLaughlin to feel that with adequate settling facilities, the need for a filter is questionable. It appeared, in this case, to contribute very little to the operation and was one of the most expensive components in the system. He determined that, in any event, the filter was oversized and could have been smaller, as could the pump (McLaughlin 1975).

McLaughlin concluded that the conditions in the storage tank were conducive to bacterial growth and odor production, and that a disinfecting agent should have been included in the system.

Cost

At the time of installation, the McLaughlin system cost approximately \$500.00. The breakdown of this cost is as follows:

Storage Drums	\$ 40
Filter	\$150
Pump	\$ 60
Pressure Tank	\$ 50
Piping	\$ 50
<u>Installation</u>	<u>\$150</u>
Total	\$500

The only operational cost encountered during the experiment was that of the electricity required to operate the pump. Based on a unit cost of 3.0 cents per kilowatt-hour (kwh), the pumping costs were calculated to be 14.7 cents per 1000 gallons. The pump required an average of 4.9 kwh of electricity per 1000 gallons. McLaughlin noted that this cost was higher than indicated by a single cycle of the pump and attributed the difference to pump recycling as required to maintain pressure during long periods when the check valve permitted some backflow through the pump. The unit cost of water is not known.

COHEN-WALLMAN SYSTEMS

The Cohen-Wallman systems, as they are collectively known, recycled greywater for toilet flushing and lawn watering in three Connecticut homes in the early 1970's. The three homes were part of a project conducted by Sheldon Cohen and Harold Wallman and sponsored by the U.S. Environmental Protection Agency to evaluate the effectiveness of various water conserving devices and practices. The program monitored the water consumption of eight volunteer families in whose homes various plumbing modifications were made using commercially available components. For purposes of identification, the homes with the recycling systems were given the numbers 6, 7, and 8.

Operation

The three recycling systems differed only with respect to the design of their filtration and disinfection systems. In each case, wastewater was collected from the bathtub, shower, and laundry and discharged into a storage tank. In the storage tank, the water was disinfected by the addition of chlorine on either a continuous or intermittent basis, depending on the system. From the storage tank, the wastewater was drawn through a cartridge or diatomite filter, again depending on the system, and into a pressurization tank by a shallow well jet pump. The pump, mounted atop the pressurization tank, was controlled by a pressure switch. Upon pressurization, the treated greywater became

by a specially designed and fabricated float rod assembly mounted within the tank and protruding through the top. The low level control system was, in each case, adjusted so that it would initiate freshwater input when the water level in the tank dropped to 3 inches above the top of the outlet pipe. At this point, sufficient water remained to meet the requirements of 3 to 4 toilet flushes. Freshwater input was terminated when the water level reached a height of 5 inches above the top of the outlet pipe.

Disinfection: On the basis of cost and disinfecting power, chlorination was selected as the best means of removing pathogenic and odor-causing bacteria from the greywater stored in the tank. Two different techniques of administering the required amounts of chlorine were employed in these recycling systems. Both were relatively simple and inexpensive (see section on Chlorinators).

The first of these techniques was an air lift feeder which introduced a solution of diluted laundry bleach (NaOCl) into the water on a continuous basis. The air lift feeder consisted of a bubbler immersed in the bleach solution which was contained in a plastic feeder bottle. Air forced through flexible plastic tubing by a standard aquarium air pump entered the side of a "tee" connection to lift droplets of the bleach solution through polyethylene tubing to the top of the storage tank.

The rate of chlorine administration was controlled by adjusting either the solution's concentration or feed rate. The concentration of the bleach solution was varied between .85 percent and 1.70 percent NaOCl . The feed rate averaged .85 ounces/hour and was a function of the level of the solution in the feeder bottle. The appropriate level of solution in the feeder bottle was maintained by a simple apparatus which automatically introduced additional bleach solution into the

feeder bottle when required. The supplemental bleach solution was contained in an airtight plastic aspirator bottle. Flexible plastic tubing from the aspirator bottle was inserted into the feeder bottle to the level which produced the desired flow rate. As long as the end of the tubing remained immersed in the bleach solution, no solution was transferred to the feeder bottle because of the vacuum which existed in the aspirator bottle. When the level of solution in the feeder bottle dropped so as to expose the end of the tubing, the vacuum was broken and the solution was transferred, via gravity flow, to the feeder bottle with air bubbles displacing the fluid transferred from the aspirator bottle. Flow continued until the end of the tubing was no longer exposed and the vacuum reestablished in the aspirator bottle.

The second chlorination technique employed a commercially available chlorine tablet feeder, manufactured for use with swimming pools. This mechanism was installed and tested in homes 6 and 8. The tablet feeder consisted of a plastic basket filled with chlorine tablets and a small water reservoir, into which the lower portion of the basket was immersed. Upon contact with the water circulating through the reservoir, the tablets in the bottom of the basket slowly dissolved. The resulting chlorine solution then flowed from the reservoir into the storage tank. The rate of chlorine administration was controlled by adjusting the depth to which the tablet basket was immersed and the rate at which water circulated through the reservoir.

When water circulated through the tablet feeder continuously, as in home 8, problems were encountered due to the rapid dissolution rate and incomplete solubility of the tablets. At normal circulation rates, over-chlorination resulted. At lower flow rates, initiated to prevent over-chlorination, the tablets failed to dissolve completely and, instead, tended to coalesce, preventing further dissolution. The

extent of tablet immersion was found to be critical and necessitated frequent adjustment.

In order to eliminate the problems associated with the tablet chlorinator, a solenoid valve actuated by the existing jet pump pressure switch was incorporated into the system in home 6. With this modification, filtered, pressurized greywater was delivered to the chlorinator concurrent with pump operation. Immersion depth and flow rate were adjusted to provide an average dose of 20 to 30 ppm. With intermittent operation, the tablet chlorinator performed satisfactorily, however, over-chlorination could have occurred in the event of excessively long periods of pump operation.

Filtration: From the storage tank, in each system, the chlorinated greywater was drawn through a filter. In home 7, a cartridge filter was employed, while in home 8, a diatomite filter was used. In home 6, both filter-types were examined at different times during the test period.

The cartridge filter used in the system in home 7 consisted of a stainless steel tank containing four cartridges surrounding an internal center post. This model was selected primarily on the basis of ease of maintenance, availability, corrosion resistance, and the relatively large number of cartridge types and porosities available. Two filter types were chosen for testing in this system: disposable depth-type cartridges made of wood fiber embedded in phenolic resin, and disposable surface-type cartridges made of pleated cellulose (see the section on Cartridge Filters). A 1-1/4 inch diameter bypass line with an in-line strainer was included in the system in the event of filter breakdown.

The cartridge filter used in the system in home 6 was an epoxy-coated steel filter tank designed to accept a single

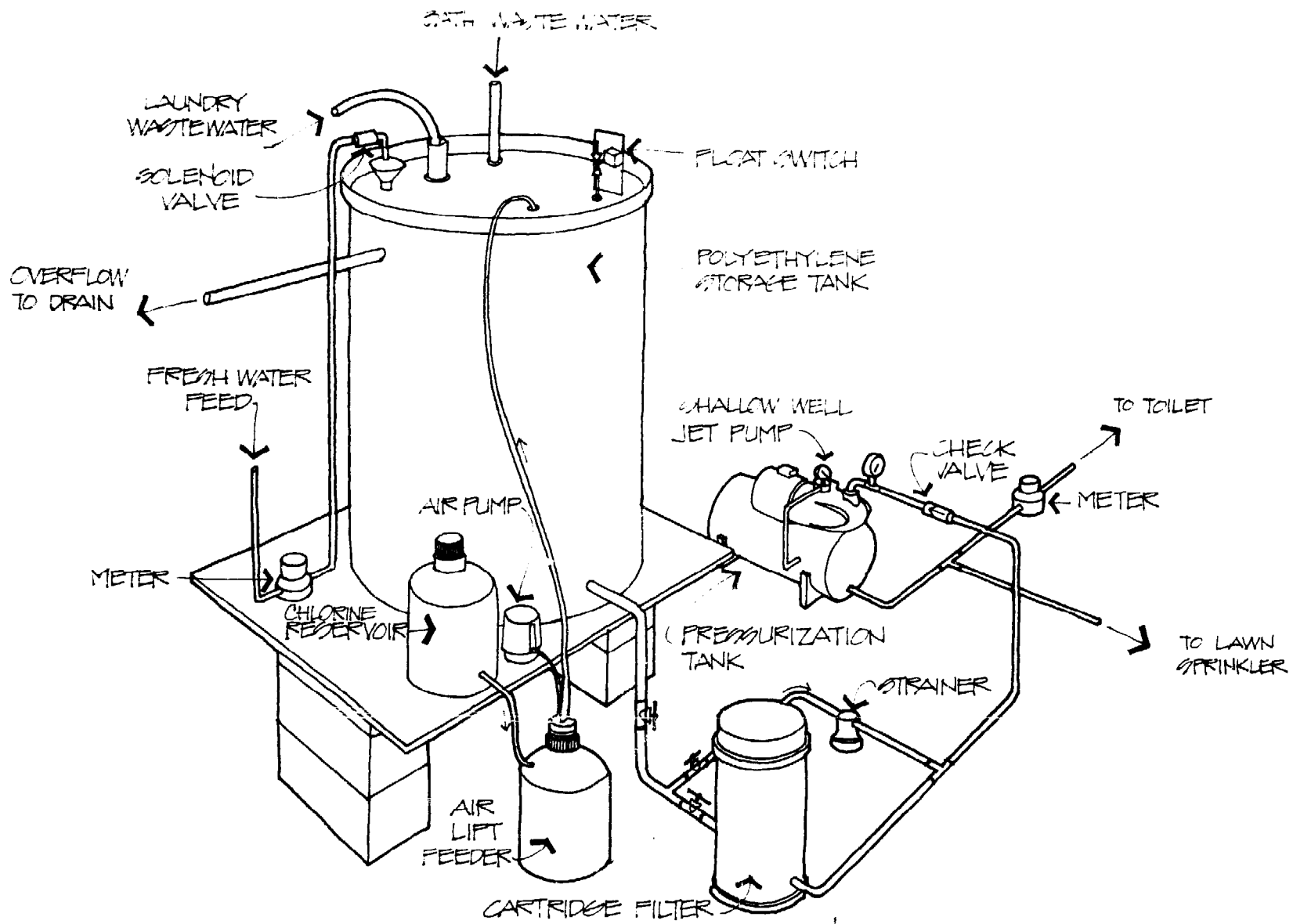

RECYCLING SYSTEM WITH CARTRIDGE FILTER

large cartridge. Again, two cartridge types were available for testing: a surface-type made of pleated cellulose, with nominal solids removal down to 5-15 microns, and a depth-type made of glass fibers, with nominal solids removal down to 10 microns. In this case, a second filter was located in the bypass line. The filters in both systems were equipped with vent and drain plugs to facilitate cleaning and re-starting.

The system installed in home 8 employed a diatomite filter which consisted of a steel tank containing a pagoda-shaped element made of woven polypropylene. The surface area of the element was 18 sq. ft. This system was necessarily somewhat more complicated than the systems involving cartridge filters because of the additional plumbing required to provide for backwashing and recirculation.

To facilitate backwashing, a PVC reciprocating slide valve was connected to the filter inlet and outlet lines. Changing the position of the slide valve reversed the direction of flow through the filter and flushed the dirty diatomite from the filter element to the drain. Each backwashing operation consumed approximately 20 to 25 gallons of wastewater. Prior to starting the filter cycle after each backwashing, the filter had to be coated with a diatomite slurry (see section on Diatomite Filters). In this system, the slurry was mixed in a bucket and then drawn to the filter through a separate, valve-controlled feed line; the end of which was simply placed in the bucket. About 1.5 pounds of diatomite were required for each pre-coating operation.

Preliminary testing of this filter yielded poor results without the condition of continuous flow which would exist with a swimming pool. In the absence of flow, the diatomite cake fell from the element to the bottom of the filter. Each time the jet pump was activated, the diatomite was reapplied

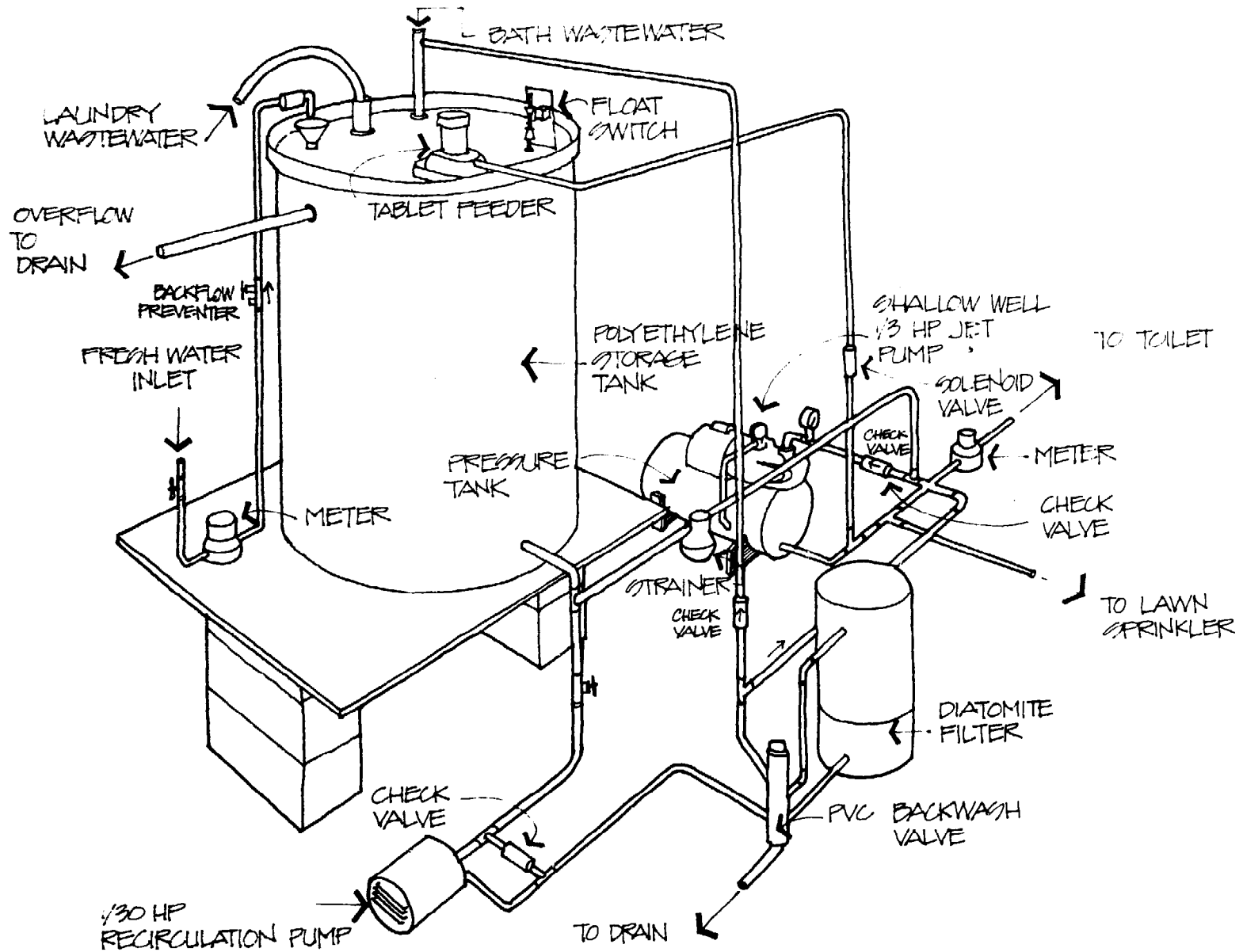

RECYCLING SYSTEM WITH DIATOMITE FILTER

to the element; however, sufficient time elapsed to permit a significant portion of the washwater to pass through unfiltered. A low rate of continuous recirculation was required to keep the filter cake intact. In order to achieve adequate recirculation rates (1 to 2 gpm/sq.ft.) with minimum operating costs and noise levels, a 1/30 HP recirculation pump was incorporated into the system. In addition to the recirculation pump, a bypass line with an inline check valve was required to prevent cavitation during pressurization of the filtered wastewater.

Fluid Transfer and Pressurization: The shallow well jet pump was included in each system to draw the greywater through the filter and to pressurize it for use in toilet flushing and lawn watering. A pressure of 20 to 40 psi was considered to be an adequate supply pressure for the intended uses. However, an additional 10 psi was required to draw the water through the filter. To meet these pressure requirements at flow rates compatible with the filters employed, a 1/3 HP model, which operated on 115 VAC, was selected. The pump was mounted on either a 12 or 30 gallon pressure tank, depending on the consumption requirements of each home. Also included in each pressurization system was an air volume control, which maintained the required volume of air within the tank. The pressure switch was set to maintain tank pressure between 20 and 40 psi.

Performance

In general, all of the recycling systems performed successfully and resulted in substantial reductions in water consumption. The maximum amount of water that could be saved was, of course, equal to the total amount normally used for toilet flushing and/or lawn watering, the two forms of reuse employed in this project. The actual amount of water saved was equal to this amount minus the amount of supple-

mental freshwater supplied to the storage tank during periods of insufficient supply, and minus the amount of surplus greywater which was lost as overflow to the septic system. In homes 6 and 7, greywater was initially reused only for toilet flushing. During this time, there was a substantial surplus of greywater, and the average household water savings was only 70 gallons per day (gpd). The incorporation of lawn watering as a supplemental form of reuse increased the average household water savings to 81 gpd, a 16 percent increase. On a per-capita basis, the average flow reduction for these homes was 12.6 gpcpd. In home 8, the volume of greywater produced by the laundry and bath was not sufficient to meet that household's water requirements for flushing conventional toilets. As a result, dual flush toilets were installed, thereby reducing demand to a level which could be satisfied by the greywater supply. The average daily per-capita flow reduction for home 8 was 11.3 gallons.

Overall, the average daily per-capita water savings for toilet flushing and/or lawn watering for the three homes was 11.6 gpcpd. This corresponds to a 26 percent decrease in water consumption. These savings were not as substantial as they could have been, however, in view of the fact that an average of 8.3 gpcpd were lost as overflow to the septic system. Although freshwater make-up averaged only 5 percent, it is clear from the amount of overflow that greater water savings could be incurred with changes in homeowner lawn watering habits -- to use the treated water as it became available.

"Continual chlorination of the stored wash water effectively inhibited bacterial growth, and no unpleasant odors were detected in any of the bathrooms during normal operation" (Cohen and Wallman 1974).

"The clarity and color of the recycled water attained by the diatomite (swimming pool) filter proved to be satisfactory

in terms of aesthetic acceptance by the homeowner and was achieved with relatively low operating costs and maintenance requirements. The residual suspended solids in the recycled wash water did produce temporary stains in the toilet bowls which resulted in increased cleaning requirements. Since dissolved soaps and detergents were not removed by the diatomaceous earth, the foaming tendency of the wash water was not significantly reduced. However, no problems due to foaming were observed at the toilet inlet valve during refill of the water closet tank" (Cohen and Wallman 1974).

Additional Benefits: The recycling and reuse of greywater for toilet flushing and/or lawn watering provided tangible benefits to two of the three homeowners in addition to the reduction in water consumption: in both homes 7 and 8, the septic systems performed poorly prior to recycle system installation. By minimizing the surges in outflow to the septic system associated with laundry and bath discharges, as well as by reducing total waste flow, the recycling systems allowed the septic tanks and soil absorption systems to operate more effectively. In home 7, the normal annual septic backup and associated odors were noticeably absent despite record rainfalls during the year. Inspection of the septic system at the end of the test period indicated that all lines were clear with no sign of clogging or back-up. In home 8, before and after installation of the recycle system, the household experienced difficulty laundering a number of wash loads in succession without causing the septic system to back-up. This difficulty was not experienced during the test program.

Maintenance

As was described above, the storage tank was designed to allow suspended solids to settle out and accumulate on the

tank bottom. This supplemental function made periodic removal of the settled sludge necessary. An alternate configuration which did not facilitate settling would reduce the frequency of required tank cleaning operations. This would increase the load placed on the filter, and thus, increase the filter cleaning requirements instead. However, it is probably a good deal easier to clean the filter than it is to clean the storage tank. In addition, Cohen and Wallman feel that this would reduce disinfection requirements because of the decreased potential for bacterial growth with the absence of the settled sludge.

Disinfection: For the airlift feeder system installed in home 7, replenishment of the bleach solution in the aspirator was required approximately once a month. This corresponds to an annual requirement of household bleach of about 11 gallons. The chlorine tablet feeder held approximately 200 tablets and required replenishment approximately once every 80 days. This corresponds to an annual requirement of approximately 8 pounds of tablets.

Filtration: The cartridge filters required disassembly and cleaning or replacing the cartridges when dirty. In home 7, cartridge life ranged from a low of 18 days to a high of 108 days. Average life for the cartridges was 71 days. In general, depth-type cartridges had longer life spans than did surface-type cartridges (see Cartridge Filters in Components section).

The filter used in home 6, which accepted a single large cartridge, experienced generally shorter life spans. Cartridge life, in this case, ranged from a low of 8 days to a high of 52 days. Average cartridge life for this filter was 48 days.

Filter System	Average Volume Gal/cycle	Equivalent Filtration Period	Annual Costs
Diatomite	4,500	86 days	\$16
Single cartridge	3,300	48 days	\$43
Four cartridge	4,000	71 days	\$40

Filter System Performance Summary

The diatomite filter achieved the best overall performance. The filter provided an average capacity of approximately 4,500 gallons per cycle and a corresponding backwashing interval which ranged from 56 to 124 days, with an average of 86 days.

In all cases, for all types of filters and cartridges, cycle life diminished more rapidly as sludge accumulated in the bottom of the storage tank.

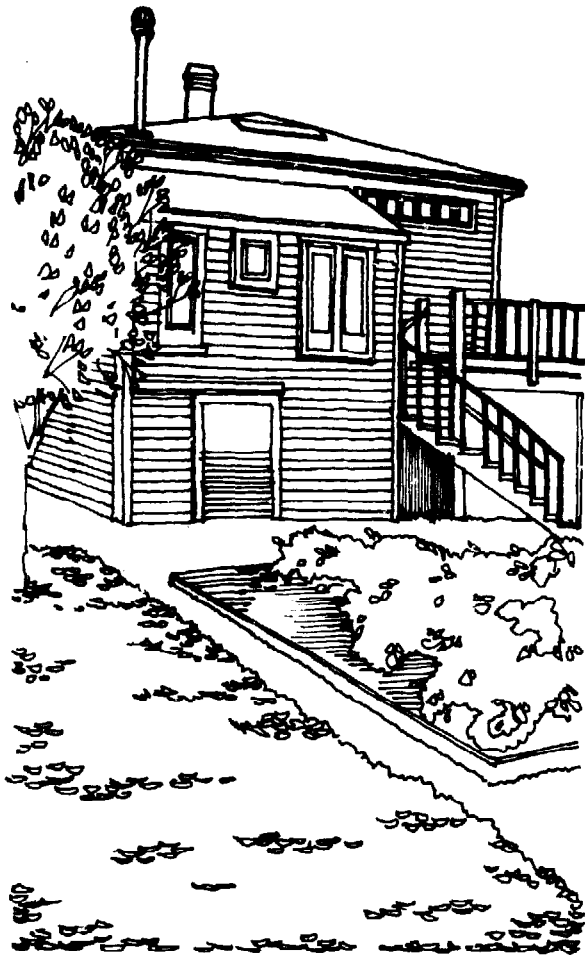

INTEGRAL URBAN HOUSE

FARALLONES INTEGRAL URBAN HOUSE

The Farallones Institute is a small, independent association of scientists, designers, horticulturalists, and technicians who are carrying out one of the country's first research and education programs in appropriate technology. The Integral Urban House is a result of the Farallones Institute's objective to produce a totally integrated illustration of environmentally sound living in an urban setting.

To achieve this objective, the Institute bought an aging Victorian house in Berkeley, California, and redesigned both the structure and the surrounding grounds to show what a motivated family of four persons could achieve in resource-efficient living under the normal urban constraints of time, space, and light. One of the many energy and resource-conserving systems in operation at the Integral Urban House is a simple gravity-fed greywater recycling system.

Operation

In order to circumvent the need for filtration, only greywater from the bathroom sink and shower is collected for reuse at the Integral Urban House. The underfloor plumbing carrying wastes from the bathroom was modified so that water from the sink and shower is diverted to a storage tank, while wastes from the toilet continue to be discharged to the municipal sewer (although at various times experimental composting and recycling toilets are also used).

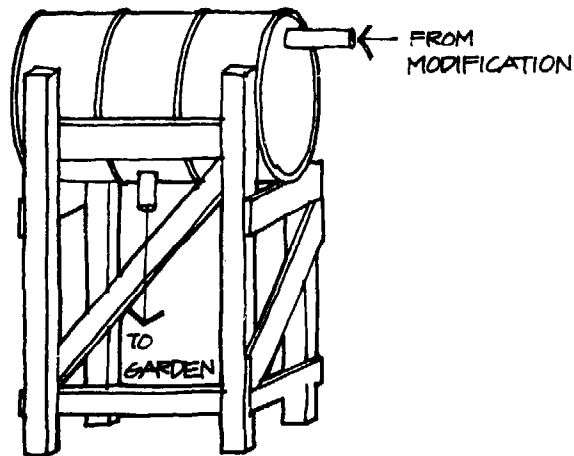

The storage tank, a 55-gallon steel drum mounted horizontally on a wooden stand, holds the greywater until a valve in the outlet pipe is opened. When this occurs, the greywater flows by gravity through a 3/4 inch hose to the garden. The end of the hose is connected to a "Y" fitting which, in turn, is connected to two more "Y" fittings. Each coupling of the two Y's is connected to a length of garden hose which has a cloth bag tied around the end. In this way, the greywater is partially filtered and evenly distributed over the soil.

The hose ends are periodically moved to distribute the greywater over a large expanse of soil and to allow irrigation of the garden plots with fresh water on a rotating basis. The greywater irrigated plots contain ornamental crops and food groups of which only the above-ground part of the plant is eaten.

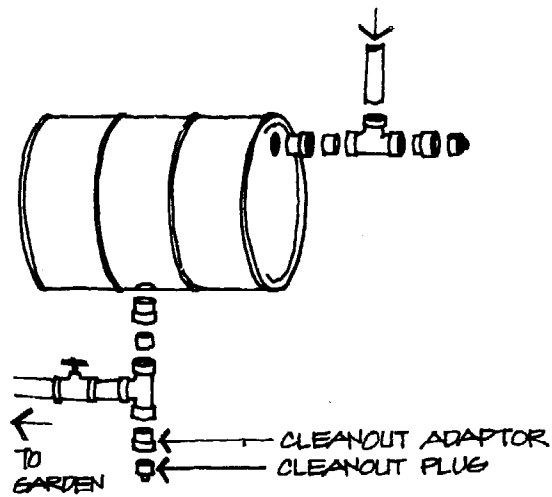

Residents of the Integral Urban House hold the greywater in the storage tank for a period of not more than 12 hours to permit warm greywater to cool and to permit relatively clean wastewater to dilute the occasional discharge which is heavily laden with contaminants.

Maintenance

The primary maintenance requirements for this system are cleaning or replacing the cloth bags tied around the ends of the four hoses, and occasionally removing settled solids from the bottom of the storage tank. To facilitate easy cleanout of the tank, both the inlet and outlet pipes are equipped with clean-out fittings.

STORAGE TANK PLUMBING

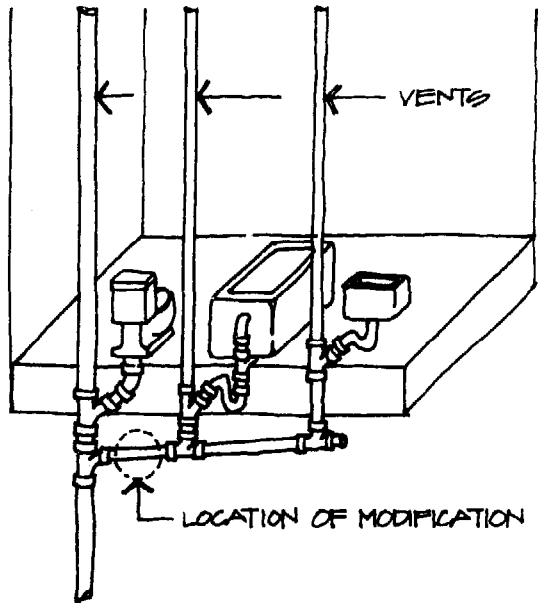

Cost

Information concerning the cost of this system was not available. The only items involved in the system are a 55-gallon drum, ABS pipe and fittings, three "Y" fittings, the hoses, and the wood making up the tank stand.

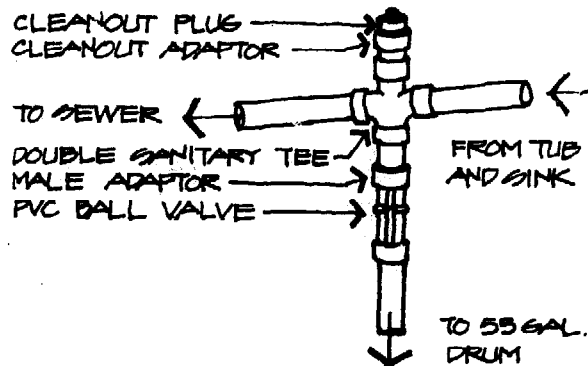

PLUMBING MODIFICATIONS

FARALLONES RURAL CENTER SYSTEMS

The Farallones Rural Center in Occidental, California, under the direction of Max Kroschel, is currently conducting three experiments involving the use of recycled greywater for irrigation.

The experiments are testing subsurface irrigation of perennial plantings using settled greywater from segregated sources, and drip irrigation of perennials and annuals (excluding root and leaf vegetables) using filtered greywater mixed from various sources. In all three systems, greywater flows by gravity only to avoid the cost and maintenance of hydraulic pumps. However, as Kroschel points out, most residences do not have the elevation changes necessary for a gravity system to function properly and there is good evidence that pump-assisted systems afford simpler and more uniform distribution. Each system was designed to minimize labor and maintenance requirements.

Operation

In the first system, greywater from the shower and bathroom sink is used to irrigate raspberries and boysenberries. The 25 people at the Rural Center produce an average of 50 gallons of greywater per day. From the showers and bathroom sinks, the greywater flows into a 40 gallon polyethylene storage tank where suspended solids settle out. From the settling tank, the greywater flows to a 50 gallon dosing siphon which gradually fills and then discharges into the subsurface distribution network. This distribution

system consists of three perforated pipes, each 20 feet in length, buried 2 inches below the surface and 8 inches from the berry plants. In winter a switching manifold diverts the greywater to a standard subsurface disposal field.

In the second subsurface irrigation system, greywater from the kitchen sink is used to irrigate forage crops. An average of 180 gallons of greywater per day is produced by the preparation of food for 25 people. From the sink, the greywater flows into a 50 gallon grease trap and then into a 1,200 gallon settling tank made from a commercial septic tank. From the settling tank, the greywater flows to a 20 gallon dosing siphon which discharges it to two irrigation fields; one consisting of four rows of corn silage and the other consisting of two rows of comfrey. The comfrey was chosen for its high tolerance of raw wastes. This system also has a switching manifold and a winter disposal field.

Without the dosing siphon Kroschel noted that gravity flow at low head is totally ineffective; the first two holes of the pipe at the lowest elevation got all the greywater.

In the third system, greywater from the dairy kitchen, a utility sink, and a bathtub and bathroom sink, is collected, filtered, and used to irrigate a number of "blocks", each of which contains a different type of plant. In the dairy kitchen, water is used for washing milk buckets and equipment. The utility sink is used for hair washing. From these sources, the greywater is collected and delivered to a storage system consisting of three 40 gallon plastic tanks. Designed for a flow of 75 gallons per day, the storage system provides 24 hour retention and 45 gallon sludge storage. From the storage system, the settled greywater flows into a 25 gallon dosing siphon made from a concrete laundry sink with a redwood lid. When filled, the

dosing siphon discharges the greywater into a homemade 5 sq.ft. slow sand filter. This occurs about three times a day.

From the filter, the greywater flows into a 75 gallon dosing siphon, which delivers a charge of water through a 1-1/2 inch polyethylene pipe to a distribution manifold made of two ABS "T" fittings. Each "T" contains a valve that connects it to a drip irrigation block. The blocks are rotated throughout the week to receive water and then rest. This system does not include a winter disposal field. Instead, the system is shut down in the fall and the filter is scraped to remove the scum mat and allowed to rest (oxidize trapped organic matter) for 5 to 7 months.

Maintenance

In the two systems involving subsurface irrigation, the primary maintenance required is keeping the distribution pipes unclogged. Kroschel points out that clogging must be anticipated and the pipes must be designed for ease of clean-out. This is accomplished by installing fittings such as "T"s and crosses with cleanout plugs. In addition, settled sludge must periodically be removed from the bottoms of the storage tanks, and grease and other floating debris must be removed from the grease trap.

Cost

The costs of these systems are not given. Pipes and storage tanks were purchased, while the filter and dosing siphons were homemade. As a do-it-yourself project, the sand filter was estimated to cost approximately \$300 in 1977 (OAT 1979).

POINT BARROW, ALASKA, PARTIAL RECYCLING SYSTEM

The system constructed at the Point Barrow, Alaska, weather station is not specifically a greywater recycling system; rather, it is a complete sewerage system which collects and treats combined wastes (both blackwater and greywater) in a commercially available aerobic unit and then recycles a portion of the treated effluent for reuse in toilet flushing. The system services a small, isolated compound of four houses and a duplex which has a total population of about 25 people.

Until the introduction of this system, the high cost of water (6 cents per gallon) precluded the use of a water-borne waste system. The "honey bucket", a primitive waste collection method, was used instead. However, when added to the isolation and bitter weather associated with the remote location, the inconvenience of using the honey bucket became the proverbial "final blow", and made staffing of the Point Barrow station with highly trained technical personnel a constant problem. As a result, the National Weather Service received, in 1970, an appropriation from Congress for a complete sewerage system for the Point Barrow Station (Buchanan 1972).

Operation

Without flush toilets, the 25 inhabitants of the Point Barrow weather station consumed a total of approximately

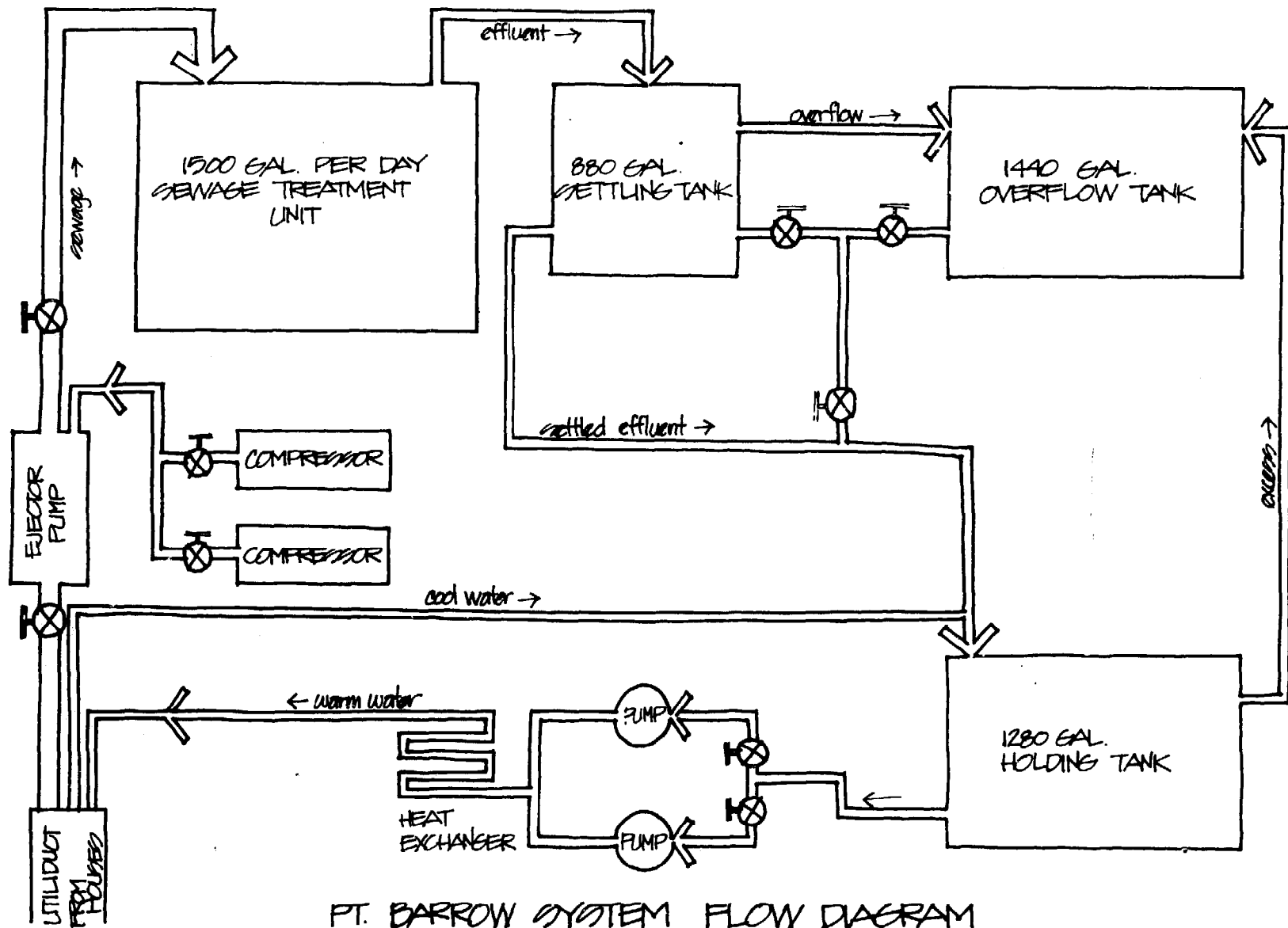

PT. BARROW SYSTEM FLOW DIAGRAM

500 gallons of water per day (gpd) or 20 gallons per capita per day (gpcpd). This figure was predicted to increase to approximately 1,200 gpd (50 gpcpd) with the implementation of a water-borne waste system. This is still less than the 70 gpcpd we use as the national average. In order to handle peak loads and account for the water returned as sewage, the new waste system was designed to collect and treat 1,500 gpd, with the capability of easy expansion to 2,000 gpd.

In the Point Barrow system, combined sewage from each of the dwellings is gravity-fed to an ejector unit to begin the treatment process. The ejector unit delivers the influent to the main sewage treatment unit, a 1,500 gpd batch-type extended aeration plant. From this unit, the effluent is discharged into an 880 gallon secondary settling tank. After additional settling, the effluent flows to a 1,280 gallon holding tank. From the holding tank, the effluent (which is now clear and odorless) is pumped through a heat exchanger and then returned to the dwellings for reuse in toilet flushing.

In addition, a 1,400 gallon overflow tank was provided as an alternative to the high cost of installing the long line which would have been required to pipe the effluent away from the weather station. Instead, approximately once a week, the overflow tank is emptied and the contents hauled to a salt water lagoon off the Arctic Ocean. A short blast on a horn, followed by a continuously burning red light, notifies the operator that the overflow tank must be emptied soon.

Utiliducts

A unique feature of the Point Barrow system is the utiliducts

WARM TREATED EFFLUENT
RECIRCULATING SYSTEM

1" SUPPLY - 1" RETURN

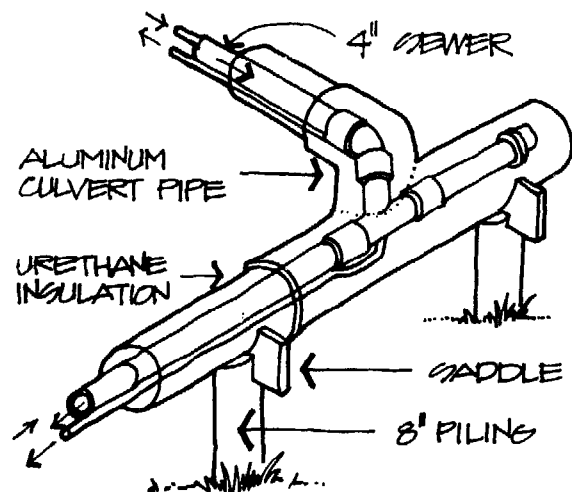

PT. BARROW UTILIDUCTS

which are used to transport the water and sewage throughout the system. Because of the permafrost which exists beneath Point Barrow, the pipes could not be buried. The heat which would be required to prevent the lines from freezing up would eventually flow through whatever insulation was employed and cause the permafrost to melt. This would result in the buried lines sinking into a trench of water.

As a result, the utiliducts employed in this system are located above ground and are supported by non-conductive wooden cradles.

The utiliducts consist of a gravity sewer line and a two-pipe recirculation system. The 4-inch sewer line and the 1-inch treated effluent supply and return lines are bound together and then surrounded by two inches of urethane foam insulation. The entire assembly is covered with a protective casing of aluminum culvert pipe.

Steel pipe was used in the three lines to provide structural support to the utiliduct assembly and to facilitate heat transfer from the recirculation pipes to the sewer line. The warm, treated effluent is circulated continuously to prevent the utiliduct from freezing up.

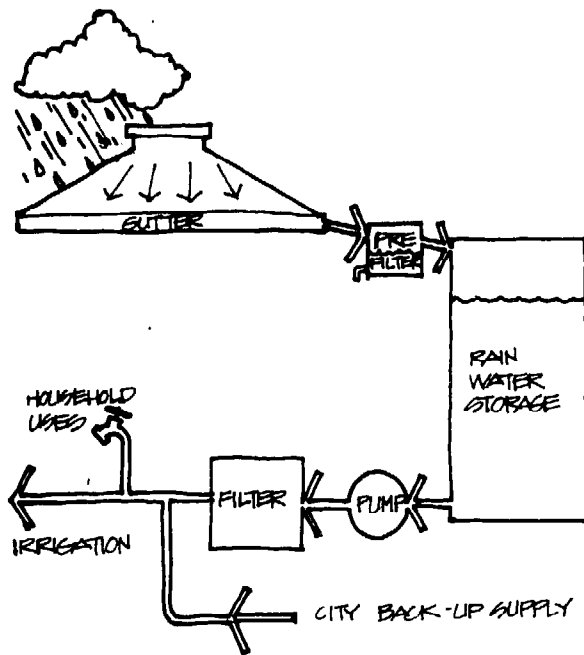

RAINWATER COLLECTION & REUSE

HAWAIIAN ENERGY HOUSE

The Hawaiian Energy House is an experimental house-laboratory on the Manoa campus of the University of Hawaii. Architect James Pearson, assisted by a team of students and professionals, designed and built the house to respond to local climatological conditions and minimize the consumption of natural resources. Of the many resource and energy conserving systems existing in the project, two are of particular interest here: a rainwater collection system and a greywater recycling system.

Operation

The city-provided household water supply is supplemented by the collection of rainwater. Rain falling on the corrugated aluminum roof flows into the continuous gutters surrounding the house and is then channeled through a small pre-filter and into a 2,800 gallon storage tank. The pre-filter is simply a plywood box suspended beneath the gutter bridging from the house over to the storage tank. Leaves, dirt, bird droppings, and other material that accumulates on the roof between rains, falls into the box through a 4-inch wide slot in the bottom of the gutter, while the water continues on to the tank.

On demand, the rainwater is pumped through a pressurized cartridge filter and delivered both indoors, where it is used for general household purposes, and outdoors, where it is used for garden irrigation. Indoor water consumption

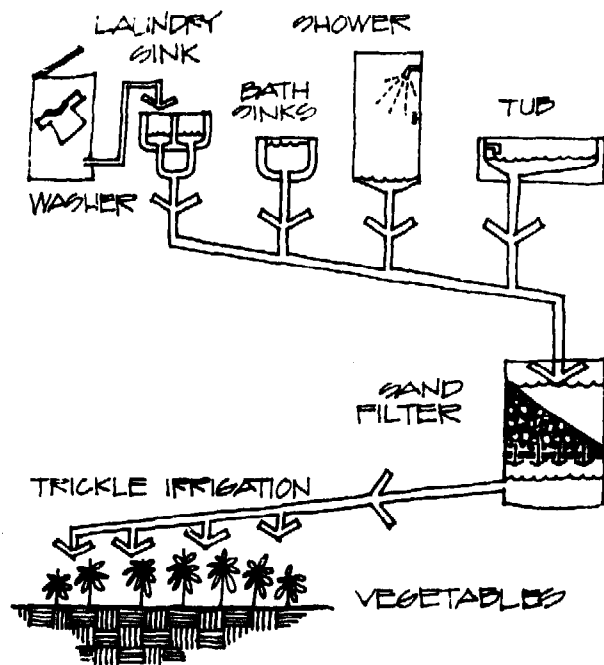

GREY WATER RECYCLING
HAWAIIAN ENERGY HOUSE

is reduced by household fixtures and appliances which were selected on the basis of low energy and water consumption.

Water consumption is further reduced by the greywater collection and recycling system which is connected to the tub, shower, and bathroom sink fixtures, as well as the laundry tubs. Greywater from these sources is directed into a 55-gallon drum which serves as both a sand filter and a storage tank. The bed of sand is suspended above the bottom of the drum by a fine grid. From the bottom of the drum, the filtered greywater is reused to irrigate the herb and vegetable garden through a trickle irrigation system.

Wastewater from the toilets, garbage disposal, and automatic dishwasher is treated in a septic tank and discharged through a leach field beneath the front yard. Septic tank overflow is discharged into the city sewer system.

Maintenance

The principle maintenance requirements of these systems are keeping the gutters free of debris and periodically cleaning the various filters.

Cost

The Energy House was constructed in 1976 and cost approximately \$52,000. This price includes the dwelling and the carport as well as the special equipment and plumbing associated with the energy conserving systems in the house. It does not, however, include the cost of the land, nor the wind-generator used in the house's electrical system.

MIRAFLORES DEVELOPMENT

Each house in a new development built in Tiburon, California, by the Miraflores Development Company, is provided with a simple system which recycles greywater for reuse in toilet flushing. Unfortunately the developers have released very little detailed information about their greywater system.

Operation

In the Miraflores system greywater from the tubs, showers, and bathroom sinks is collected and flows by gravity to a small (300-500 gallon) settling tank. The tank, which is located in the basement, is equipped with a vent and an overflow pipe which discharges excess greywater to the existing municipal sewer system. After settling, the greywater is drawn through a cartridge-type swimming pool filter by a standard swimming pool pump and delivered to the toilets. It appears that the pump is actuated by a float switch in the toilet tank, as the system does not have a pressure switch or control.

Maintenance

The Miraflores System will require periodic cleaning or replacing of the filter cartridges (depending on the type of filter) and occasional removal of accumulated solid material from the bottom of the settling tank.

TABLE

The cost of the system is approximately \$2,000 per
foot. However, this additional cost is relatively small
and it is felt that the developers will market each
unit for a profit between \$30,000 and \$40,000. The
profitability of the project will be estimated because it is not known
whether the project will utilize disposable or reusable
materials.

With the development point of view, the greywater reuse
system may be relatively attractive because the water
is not used in the process of installing more sewer hookups and
the cost of installation is low.

5.3 HOME-BUILT SYSTEMS

Many simple straightforward systems have been designed and assembled by homeowners using inexpensive and readily available parts. Each of these systems was installed in an existing house and therefore does not involve major house modifications or special features that might be designed into a new house specifically to accommodate a water recycling system.

The majority of these systems were identified by Fred Nelson of Sunset Magazine. Sunset became interested in the possibility of recycling greywater in the Spring of 1977 when, after a winter of minimal rainfall, it became apparent that California and the rest of the west would be very short on water in the months ahead.

As a result, in its March 1977 issue, Sunset invited its readers to submit descriptions of any greywater recycling activities they were already undertaking. With the exception of the Jaquette system, the Brandies Rainwater Room, and the Cistern Patio, all of the following systems are "Sunset systems".

JAQUETTE SYSTEM
ZUCK SYSTEM
SCHMIDT SYSTEM
LAJEUNESS SYSTEM
MERLONE SYSTEM
ROICE SYSTEM
STRAMBI SYSTEM
GREEN SYSTEM
MALLOW SYSTEM
PUGH SYSTEM
CLANCY SYSTEM
HANEY SYSTEM
BRANDIES SYSTEM, RAINWATER ROOM
CISTERN PATIO

JAQUETTE SYSTEM

During the height of the recent California drought David Jaquette, of Santa Monica, modified the plumbing in his house, salvaged a few items no longer being used (including an old water bed), and assembled a system which collected and reused greywater for lawn irrigation.

Operation

In the crawl space underneath his house, Jaquette first disconnected the soil pipes of the tub in the childrens' bathroom, and the tub and sink (which were connected together) in the master bathroom, from the house drain. After plugging the connections to the house drain, he connected the soil pipes to a new drain line and ran this line to the inlet port of an old water bed mattress which he located underneath a porch.

In the kitchen, Jaquette modified the drain beneath the double sink so that one basin, which he labeled "garbage", discharged its wastes to the house drain and municipal sewer, and the other, which he labeled "non-garbage", also drained into the water bed.

Jaquette also diverted the drain hose from the washing machine to a small holding tank which he installed immediately above the washer. From the holding tank the washwater drained by gravity through a small diameter pipe to the water bed. The holding tank was necessary because the

small diameter pipe could not carry the water away from the washer fast enough to allow it to drain completely between cycles. In addition, if a direct connection existed between the washing machine and the water bed, wash-water would be siphoned from the washer, even during the middle of a cycle, whenever water in the storage bag was used.

Jaquette connected the water bed drain to a pump, which he salvaged from an old washing machine. Once every four days or so Jaquette simply switched on the pump delivering the greywater to hoses serving the front and back lawns.

According to its creator, the primary problem with this system was the odors which were generated inside the water bed. Jaquette noted, however, that these odors disappeared soon after the water was applied to the lawn. In an effort to reduce this problem, Jaquette employed a small aquarium air pump to aerate the water in the bed. This action reduced the odors, but did not eliminate them entirely. As the drought waned, Jaquette disconnected the kitchen sink and later the washing machine in an effort to further reduce the odors.

Maintenance

During its operation, Jaquette's system required no maintenance. The few particles that accumulated in the water bed were pumped out by the old washing machine pump which, of course, is designed to accept small amounts of particulate matter.

Cost

Jaquette spent approximately \$40 assembling his system.

This price, however, does not include the washing machine pump or the water bed, which were salvaged. The primary expense in this system, Jaquette noted, was his own labor, which amounted to somewhere between 40 and 100 hours.

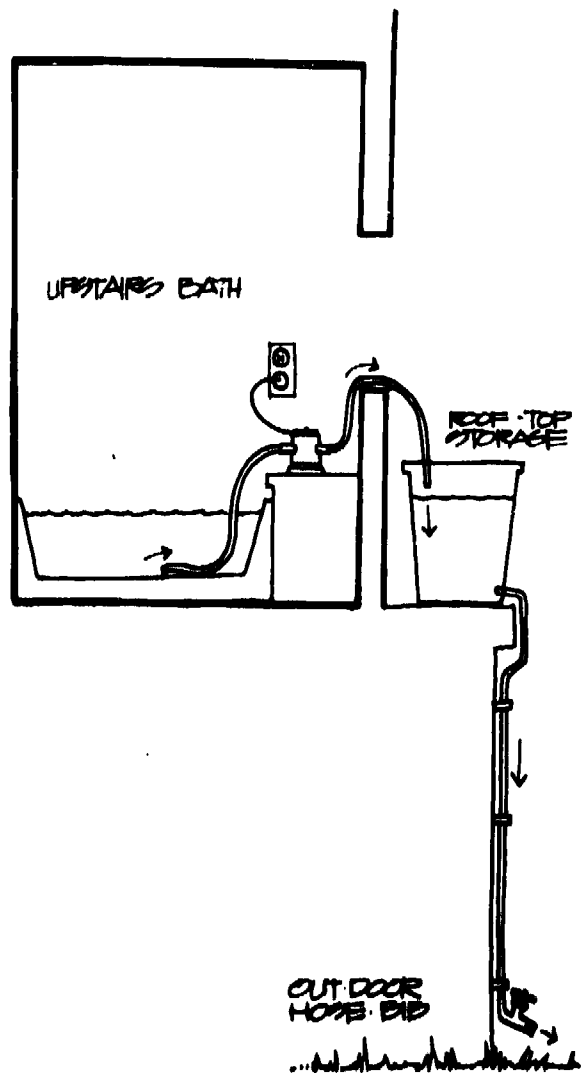

ZUCK SYSTEM

Thomas and Susan Zuck of Larkspur, California use a tiny submersible fountain pump to lift greywater from the upstairs bathtub out the bathroom window. On the roof below the window, the greywater is stored in four plastic garbage cans reinforced with strapping tape and linked together with short sections of plastic pipe. The pipes are located about 5 inches above the bottoms of the cans so that each may function as a settling tank.

From the storage system, the greywater flows by gravity down an exterior wall through a 1-inch pipe to a tap. A soaker hose is connected to the tap and the greywater is used for lawn irrigation. The storage system also contains an overflow line which discharges excess greywater to a rain gutter.

THE ZUCK SYSTEM

SCHMIDT SYSTEM

Wiley Schmidt of San Carlos, California built a simple system which collects and reuses wastewater from the washing machine for garden irrigation. Schmidt capitalized on the fact that his washing machine could pump water to a height of 7 feet and developed a system in which the vertical height of the storage system pressurizes the water for reuse.

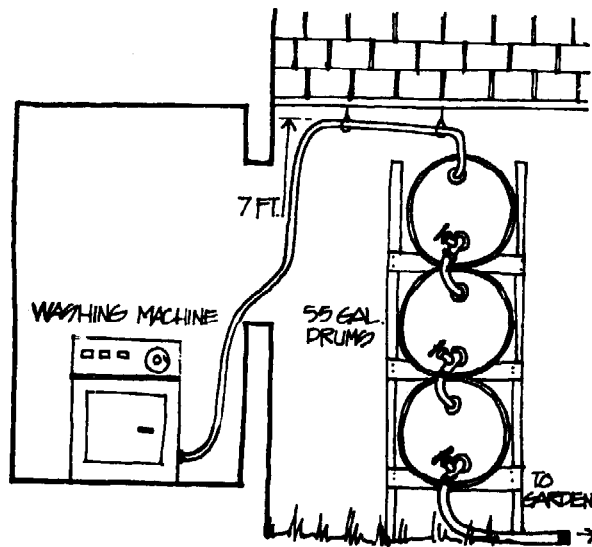

THE SCHMIDT SYSTEM

After the discharged washwater is pumped to this height it flows by gravity through a garden hose to a storage system located outside the house near the garden. The storage system consists of three horizontal 55-gallon drums stacked on top of each other in a wooden rack. A sock tied around the end of the hose filters the washwater as it enters the top drum and small tubes vent the drums, which are linked together by short sections of hose, as they fill. A second hose carries the water from the bottom drum downhill to the vegetable garden. A valve located in the outlet port of each drum enables garden irrigation to be manually controlled and also enables the upper drums to be disconnected and used separately to supply water to higher parts of the garden.

LAJOURNESS SEWER

John Lajourness of La Graciosa, California made a minor modification in the plumbing beneath his house to divert wastewater from the kitchen and bathroom directly to the outdoors.

Lajourness cut about an 8-inch section out of the 1-1/2 inch pipe in pipe which carried wastewater from his kitchen sink, tub, shower, and bathroom sink at a point just upstream of where it engaged with the line from the toilet. He replaced the cutout section of pipe with a plastic sewer "Y" and pipe secured in place with two hose clamps. In the open leg of the Y, Lajourness installed a brass gate valve and connected it to a length of plastic pipe which he led out to the back yard. At the end of the pipe, he installed a hose pipe adapter which enabled the connection and volume control of two garden hoses. The greywater flows to the garden by gravity. Lajourness estimates his modifications have made in about 1 hour and required about \$15 worth of parts.

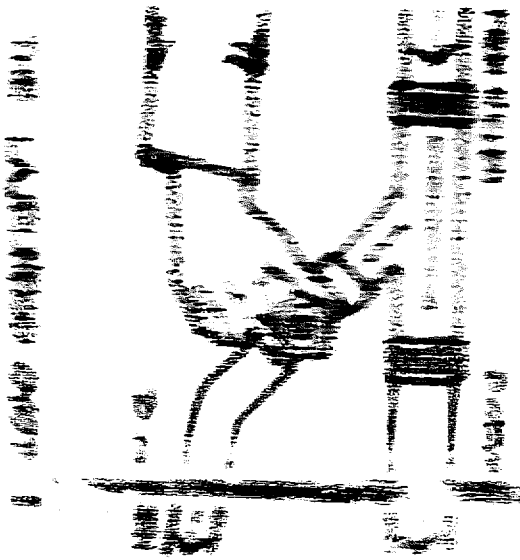

MERLONE SYSTEM (WATER ON WHEELS)

Carol Merlone of Moraga, California developed a portable storage system in which she collects rinsewater from the washing machine and then wheels out to the garden for distribution.

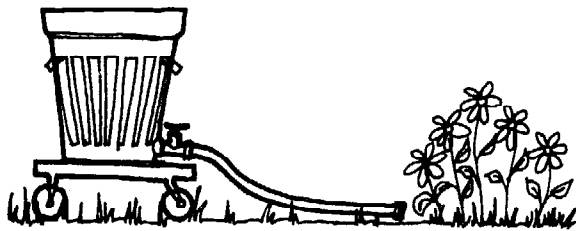
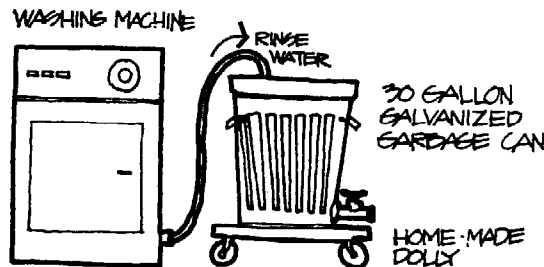

THE MERLONE SYSTEM

Merlone built a heavy-duty dolly and on it mounted a 30-gallon galvanized steel garbage can. She keeps the garbage can next to the washing machine and places the drain hose from the washer into it at the beginning of each rinse cycle. Water from the wash cycle is allowed to drain into the laundry basin and down to the sewer. When the garbage can is filled, she wheels it out to the garden, connects a hose to the drain valve (which she assembled from a cooler drain and a hose shut-off valve), and allows the water to flow by gravity onto the plants in the garden. Because the drain valve is installed near the bottom of the garbage can, the end of the hose must be kept on the ground to achieve flow. To prevent having to continuously bend over to hold and move the hose, Merlone uses a short stick with a cup hook on the end to pick up the hose and move it while standing upright.

ROICE SYSTEM

Tom Roice of Milpitas, California uses a plastic garbage can and a small fountain pump to reuse wastewater from the washing machine for irrigating thirsty trees in his backyard.

Wastewater from the washing machine is discharged into the garbage can which simply stands in the laundry room next to the washer. An outlet port installed near the bottom of the garbage can allows the water to flow through a hose to the inlet of the fountain pump and thereby automatically prime the pump as the can fills with water. The pump delivers the greywater through a standard garden hose to the backyard. At the rate of 3.3 gpm, the pump can discharge the approximately 30 gallons of water produced by each cycle in about 9 minutes, so the system can easily keep up with a normal washing cycle. Roice uses biodegradable soap so that he can reuse water from the wash cycle as well as the rinse cycle.

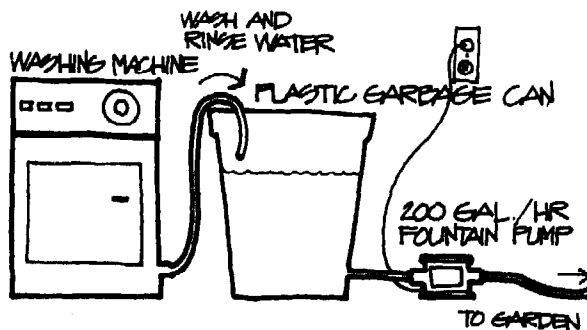

THE ROICE SYSTEM

STRAMBI SYSTEM

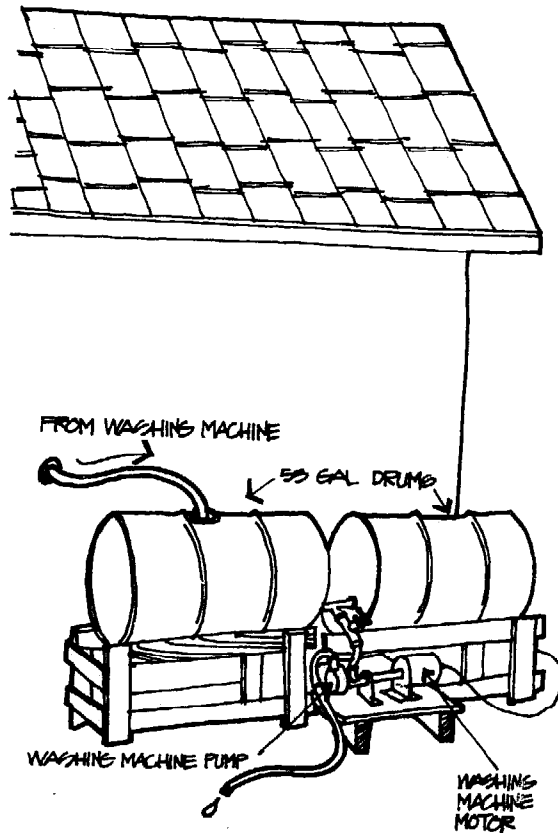

THE STRAMBI SYSTEM

William Strambi of Millbrae, California also developed a system to recycle wastewater from the washing machine for garden irrigation.

Strambi drilled a hole through the wall of his house and ran a 3/4-inch PVC pipe from his washing machine to a storage system which he made from two 55-gallon drums located immediately outside the wall, in his backyard. The two drums lie horizontally, end to end, in wooden cradles and are connected together by a short length of 3/4-inch galvanized steel pipe. Located in the middle of this connecting pipe is a "T" fitting which delivers water by gravity from the two drums to a washing machine pump, which in turn delivers the greywater to the garden through a standard garden hose. A gate valve located in the line connecting the "T" fitting to the pump, controls the flow rate of the water delivered to the garden. Strambi intends to replace the washing machine pump and motor assembly with a waterproof combined unit to reduce the possibility of electric shock.

Originally, the line running from Strambi's washing machine to the storage drums contained an in-line filter which he assembled from a 21-inch section of galvanized pipe. The pipe had 3/4-inch ports on each end and was packed with charcoal and cotton. In time, Strambi eliminated the filter and allowed the washwater to flow directly into the storage system. Apparently, it was unnecessary or required too much maintenance for the benefit it provided.

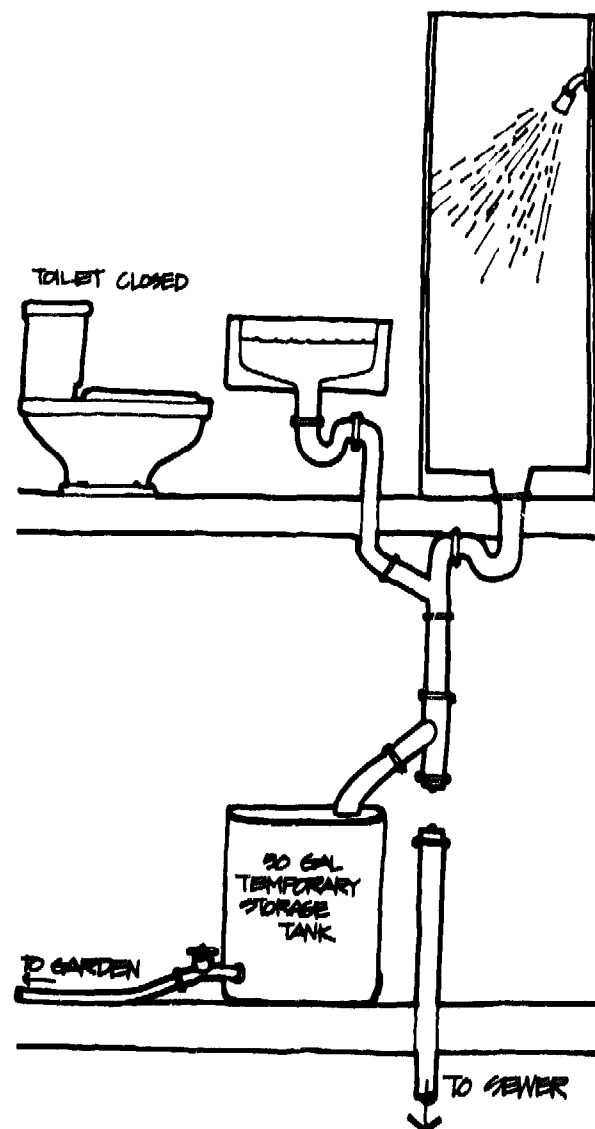

THE GREEN SYSTEM

GREEN SYSTEM

Maureen Green of Tiburon, California diverts the greywater from a bathroom shower and sink into a 50 gallon storage tank. When enough has been collected a valve is opened to allow the greywater to flow by gravity out to the garden. With a water conserving shower head it should take about 15 minutes to fill the tank, but a standard shower head will fill it in half the time. The toilet in this bathroom must be sealed closed in order to prevent blackwater from contaminating the storage tank or reaching the garden. Some sort of air tight seal is necessary to prevent water in the toilet trap from evaporating and allowing sewer gases into the bathroom (pouring vegetable oil in the toilet bowl is one option).

She also recycles greywater from the washing machine into two 32-gallon plastic garbage cans; one for washwater and one for rinsewater. Her machine does not have a Suds-Saver so she employs a small submersible pump to return the water from the garbage cans to the washing machine for reuse in the subsequent washloads. Using the old-time method of washing lightly-soiled clothes first and progressing to the more heavily-soiled clothes, Green can use the same water to do two, three, or even four washes. When all the wash is done, she carries the water by hand buckets to the garden where she dumps it on thirsty plants.

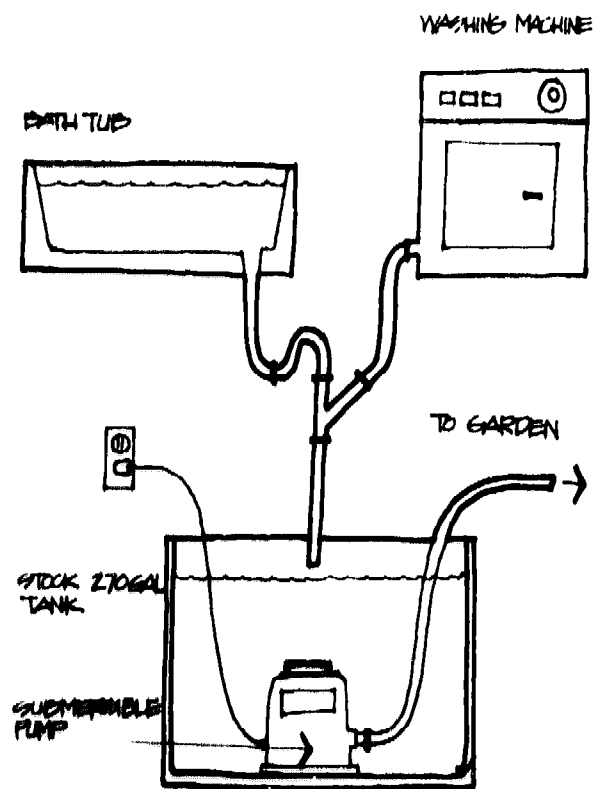

MALLOW SYSTEM

The Mallows of Evergreen, Colorado joined the drain pipes from the bathtub and washing machine underneath their house and ran the common pipe under their deck to a stock 270-gallon tank. When it is plugged in, a submersible pump at the bottom of the tank delivers the greywater to the vegetable garden. So far, they have grown peas, beans, lettuce, radishes, turnips, cabbages, and carrots, without noticeable problems.

THE MALLOW SYSTEM

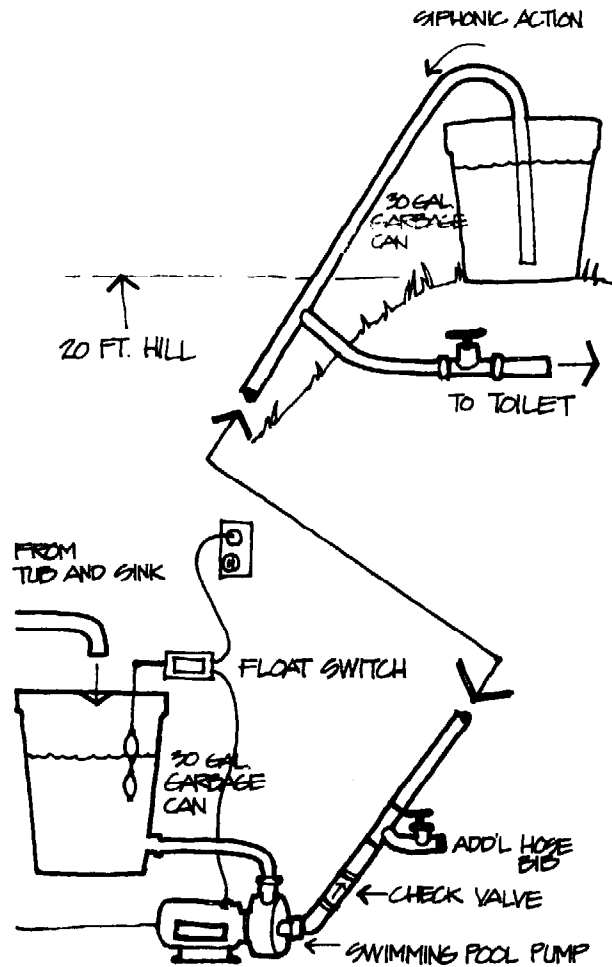

THE PUGH SYSTEM

PUGH SYSTEM

Don Pugh of Woodside, California took advantage of his hillside lot and developed a system which employs both a pump and siphonic action to recycle greywater from the tub and bathroom sink for reuse in toilet flushing and landscape irrigation.

Pugh modified the plumbing in his house so that the greywater from bathroom sink and tub is discharged into a 30-gallon garbage can. Near the bottom of the can, Pugh installed an outlet port and connected it with a short length of hose to an old swimming pool pump. When the garbage can becomes filled, a float switch turns on the pump and the greywater is pumped about 20 feet up the hill to a second garbage can. A check valve located in the line just upstream of the pump prevents the greywater from backflowing into the pump and thereby maintains pressure in the upsloping line at all times. A "T" connection coming off the line about midway between the two cans delivers the greywater to the toilet. When the valve to the toilet opens, water in the line uphill of the "T" fitting flows into the toilet and starts a siphoning action in the uphill garbage can which continues until the toilet valve is closed. A second "T" fitting downslope of the line to the toilet, delivers greywater to the garden by the same principle.

Pugh reports that his system, which cost about \$40 to construct (excluding the pump), has operated very successfully for several months.

CLAYTON'S SYSTEM

Clayton recently converted an old barn on his farm in ... into a comfortable 3-bedroom house and ... it with a complete on-site waste recycling system. ... the kitchen, among other things, the unique feature ... the greywater produced in the house through ... pipes in order to help biodegrade soaps and deter- ... to obtain a nutrient-rich liquid fertilizer.

Each hot water line connecting toilet is used in place of ... to use to fertilize fruit trees. Grey- ... the unit is used to fertilize fruit trees. Grey- ... the bathroom, laundry, and kitchen, is collected ... immediately outside. The grey- ... through a distributor which ... from the 2-inch ABS discharge ... consists simply of a T-shaped ... with 3/8-inch holes drilled ... in opposite ... As the greywater flows out the ... evenly distributing ... the compost pile. Clayton made his com- ... garden and soiled hay bedding ... but he notes that leaves, straw, and ... will drain and be well aerated.

Greywater flows through the compost pile and is collected ... through a 2-inch ABS drain

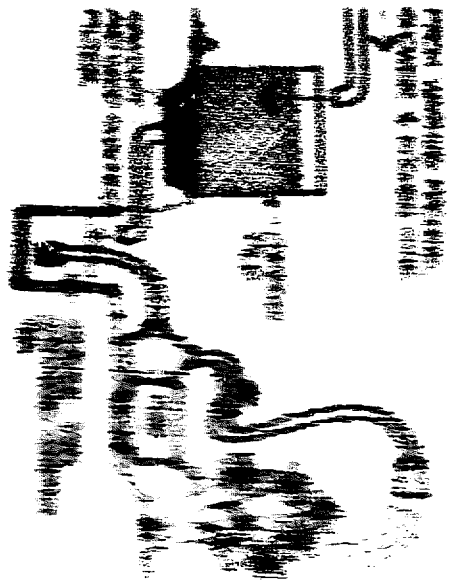

Clayton's System

pipe to a sump. In Clancy's system, the sump is made from a 4-foot diameter concrete well tile sunken into the ground and covered with a sturdy plywood lid, although a large plastic garbage can or 55-gallon drum would work equally well.

From the sump, the "compost tea" is pumped onto the vegetable garden through a hand-held garden hose. Originally Clancy used an old swimming pool pump to move the "tea" through the hose, but he recently replaced it with a "FlowJet hose pump". This little device is installed in the hose line and utilizes household water pressure and the Venturi principle to draw the "tea" from the sump. With the hose pump, 50 percent potable water and 50 percent compost tea is discharged from the hose onto the garden. It must be emphasized that this direct proximity of potable water and "compost tea" raises the potentially dangerous possibility of backflow or cross connections. The original pump was undoubtedly much less hazardous.

HANEY SYSTEM

The Haney Suds Saver System utilizes a 30 gallon holding tank to store wash water from the washing machine for reuse. A Y-valve is installed on the drain hose of the washer with one outlet leading to a storage tank mounted above the washer. The other outlet leads outdoors to the lawn, for irrigation. Haney states that he saves three ways: on fuel for hot water heating, on detergents, and on water.

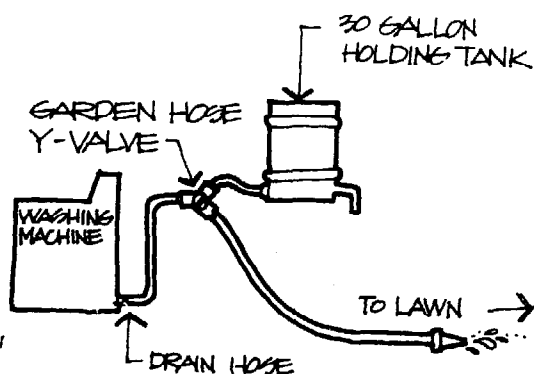

The system is operated manually (but could be automated by a signal from the washer control timer). To reuse warm suds, before the cycle begins the valve must be opened between the washer and storage tank, thus allowing the machine to fill by gravity feed. One caution is not to use undersized tubing, hosing, or valves that will cause back pressure at the washer's pump. At the minimum, this might lead to poor rinsing or washing, and at the worst, pump failure. The machine will automatically make-up for any water shortage in the system with its built-in water level sensor (Haney 1978).

HANEY SUDS-SAVER

BRANDIES SYSTEM, RAINWATER ROOM

Monica Brandies had a surprise when her family moved into an old home in Wilton, Iowa. Little did they realize when they purchased the house, they had a rainwater cistern tank in an empty room above the bathroom. They were later assured that tanks such as theirs were common occurrences in such old Victorian houses. For years in this part of Iowa no one would have considered building a house without a cistern. Such a system made much more sense than an open rain barrel at the end of a gutter because gravity alone can supply water to all the indoor fixtures.

Rather than waste the valuable rainwater resource, it was collected by roof gutters and diverted into a 3'x2'x8' cattle watering tank, a common piece of farm equipment. The water was always clean without more than a screen filter over the end of the inlet spout. The tank never overflowed during extended periods of rain because of a scupper which ran outside and emptied into a downspout which exhausted onto the lawn below.

Water flows by gravity from the cistern through a 3/4" pipe, welded to the bottom of the tank, to a valve in the basement marked "gravity feed". This valve connects the cistern to the "regular system", which is supplied by a well pump, and feeds all the faucets except the cold (drinking) water in the kitchen.

Ms. Brandies does not mention any check valves at this location, although two would probably be required; one

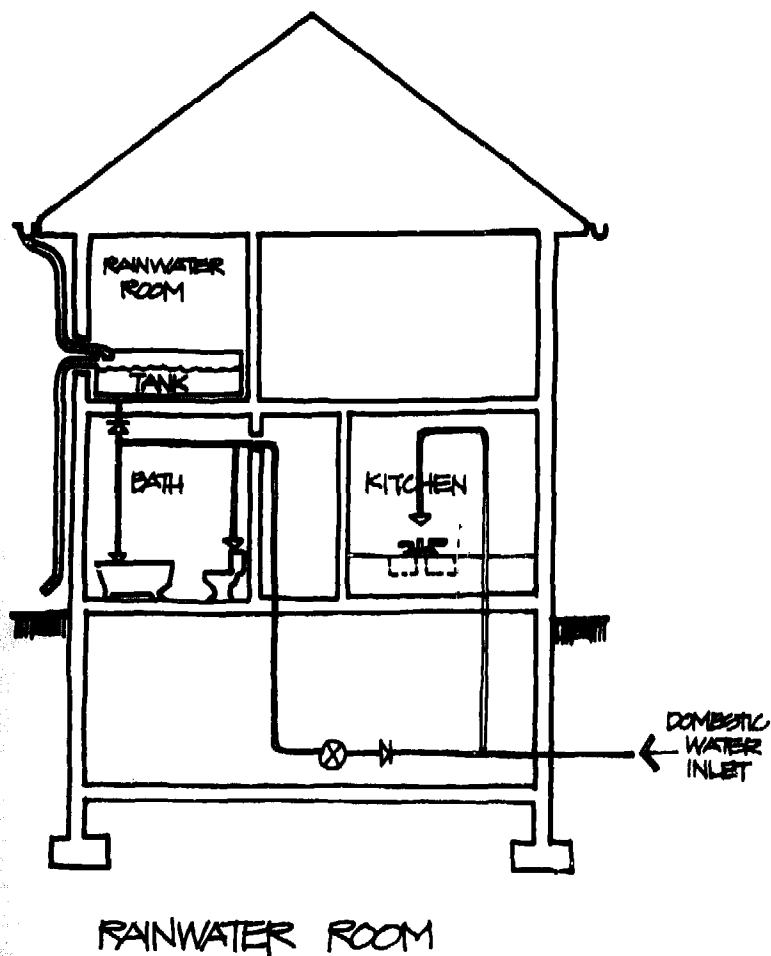

to prevent any possible backflow into the part of the system supplying the kitchen sink, and the other to prevent the well pump from forcing water back up to the rainwater room, possibly overflowing the tank. Another alternative might be to replace the "gravity feed" valve with a standard pressure reducing valve, which if carefully adjusted would automatically pass "regular" water only when the cistern was empty. A potential inconvenience will always be the low pressure in the cistern-fed system, although it can be improved by maximizing the height of the cistern above the fixtures and reducing the friction loss in the piping (by minimizing length and number of fittings or maximizing diameter and smoothness).

One drawback was the limited 360 gallon size of the tank because with six people in the house flushing toilets and taking baths, the storage capacity would only last through two dry days. The problem with simply increasing the capacity of the cistern is its weight. At 8.3 lbs./gallon, this "small" tank weighed almost 3000 pounds when full.

Brandies suggests that in planning such a system in consideration of this weight problem, the floor should be strongly reinforced. Second, in order to avoid leaks and achieve a longer tank life (the stock tank was guaranteed for 8 years), a stainless steel bulk milk tank might be used.

The Brandies' describe this old Iowa house as the place they were to first learn a degree of self-sufficiency and delighted in "the beauty of lying in bed on rainy nights and hearing water trickle musically into their cistern above" (Brandies 1976).

CISTERN PATIO

Edwin Krehbiel of Lemont, Illinois, built an 8000 gallon cistern to store rainwater that also serves as a backyard patio. The concrete box-like cistern supplies water to all sinks and wash basins in his home. A separate water line supplies cold drinking water from a drilled on-site well.

The cistern is a poured-in-place concrete tank buried behind the house at the same depth as the basement. A long concrete partition down the center provides a longer passage between the inlet and outlet to help settling which clarifies the water and to help support the concrete roof.

The interior surface of the cistern should be waterproofed with 1/2 inch to 3/4 inch of sand and cement plaster. Do not use lime or asphalt based waterproofing materials which will contaminate the water.

The drainage surface, in this case the roof of the house, must also be waterproofed with a material that will not contaminate the rainwater. Downspouts that feed the tank must be covered with a filter, strainer, or mesh to prevent contamination from leaf material.

To prevent freezing the 4 inch roof downspouts run through the foundation wall into the basement. The water is conducted under the floor joists to a 6 inch pipe that runs below ground level outdoors and empties into the upper portion of the tank. A 1-1/4 inch copper outlet pipe carries water back into the basement and to a centrifugal pump and pressure

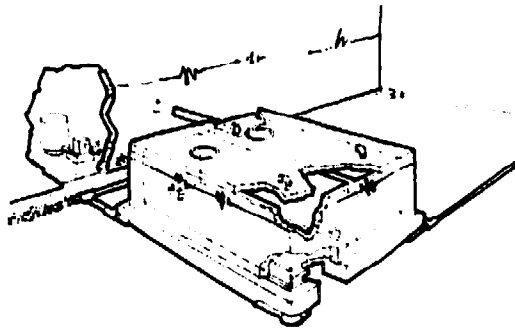

CISTERN PATIO

tank. Ideally this pipe should exit through the top of the tank not the side wall, to prevent leakage caused by the pump vibration. A 1-1/3 HP pump along with a 20 gallon pressure tank is enough to supply 40-50 pounds of water pressure.

A 40 gallon sand filter between the pressure tank and house piping removes any dirt. A Fram fiberglass filter was installed after the sand filter to remove small grains of sand. The designer believes the Fram filter alone would have been sufficient to remove any dirt, leaves, mosquito larvae, etc.

If necessary, a back-up supply valve for water during dry periods of the year can be added. A check valve at the supply inlet will prevent cistern water from backflowing into the city water supply, and a pressure relief valve at the hot water tank is needed to compensate for changes in pressure.

A pair of large overflow outlets are necessary because a heavy rain can fill the cistern and crack it if not relieved. Two manholes are required for future access, and these should be elevated slightly above the surface of the lid/patio to avoid contaminating the cistern with surface runoff.

The designer also developed a simple "gauge" to measure the water level in the cistern from inside the basement. He tapped a small valve into the outlet pipe, and connected it to a piece of clear plastic tubing which he ran up to the ceiling. To check the level he simply opens the valve and the water in the tube rises or falls to the same level as in the cistern (Krehbiel 1979).

In Bermuda similar cisterns have been in use since the 1600's, but they are raised 1 or 2 feet above grade to prevent entry of surface runoff. There, as a rule of thumb, trees are kept at least 30 feet away to prevent roots from breaking through the walls or into pipes. A consulting engineer there states that "should the water appear to be biologically

contaminated and have a bad taste, a half gallon of Clorox should solve the problem" (Watlington 1979).

Maintenance

The principal maintenance requirements are to change the 52 fiberglass filter once a year and drain and clean the tank and sully and its new coats of cement wash every 10 to 15 years.

5.4

DESIGN PROPOSALS

The systems described in this section have not been built or tested. Thus, they are classified as design proposals. Some of these systems were designed for class projects or competitions and, as a result, will never be constructed. Others, however, were designed by architects for actual residential projects and may very well be constructed in the near future.

In either case, these proposals represent a considerable amount of thought and research on the subject of rainwater collection and water recycling and, in theory at least, demonstrate the successful integration of a number of energy and resource conserving systems.

For the most part these proposals could be constructed by the homeowner, as described, with little difficulty. All of the necessary components are described in this report.

**MORRISON-JACONI PROPOSAL
ECO-UNITY PROPOSAL
LIVING LIGHTLY PROPOSAL
KEY LARGO PROPOSAL
MALIBU SELF-SUFFICIENT HOUSE
GREYWATER FLUSH PROPOSAL
RAINWATER STORAGE ROOF
AUTONOMOUS HOUSE
ECOL HOUSE**

MORRISON-JACONI PROPOSAL

The need to keep the land well irrigated because of its susceptibility to brush fires, plus a consciousness of the need for water conservation, were the primary reasons why architects King Morrison and Martin Jaconi proposed greywater recycling systems in their designs for a group of four Southern California houses whose lots were already provided with connections to the municipal sewer system.

Background

Located in the Malibu Lake area of the Santa Monica Mountains, the four adjacent lots were naturally covered with chaparral and, thus, were vulnerable to the notorious Southern California brush fires. Because the lots were large (approximately 1 acre each), the architects knew that irrigating them with city-supplied potable water in amounts sufficient to make plant materials resistant to fire would drastically increase each house's total water consumption and monthly bill as well.

In an effort to reduce this consumption, Morrison and Jaconi proposed to collect all household wastewater (both black-water and greywater), treat it in a standard septic tank, and discharge the effluent into shallow subsurface leach-fields throughout the site, to keep the chaparral green enough to reduce its volatility. However, because a basalt rock formation existed about 4 feet beneath the surface of the four lots, there was a danger that the effluent would

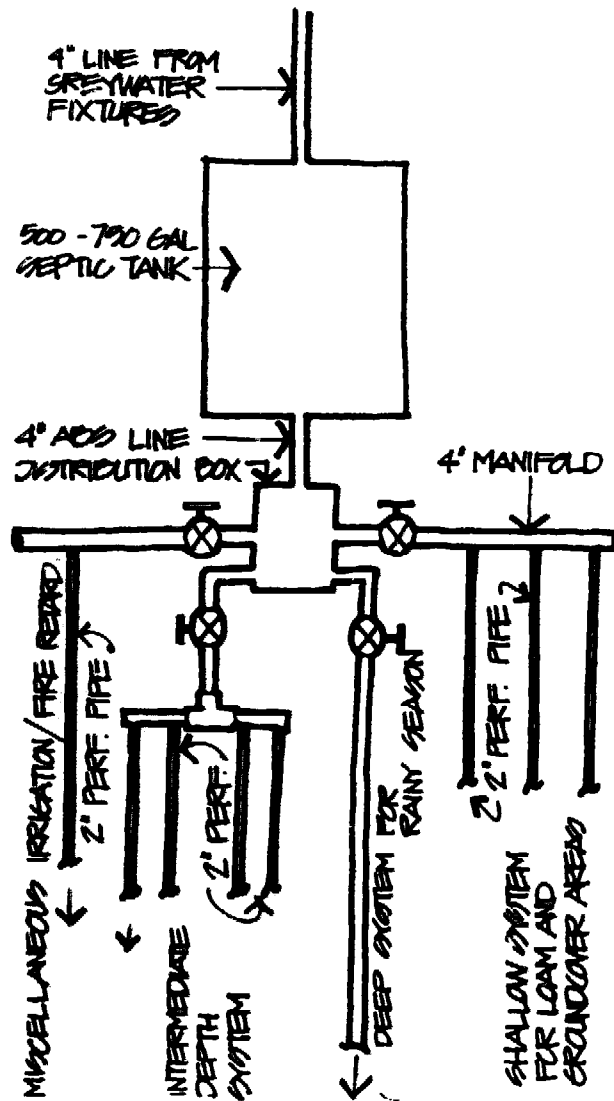

MORRISON, JACONI SYSTEM DIAGRAM

migrate downslope across the face of the subsurface formation and resurface, or "daylight", in the face of the bluff which bordered the road at the bottom of the site. Because of this potential hazard, the Las Virgines Water District (L.V.W.D.) refused to allow a septic tank system for combined wastes.

However, the Water District faced a problem of disposing all of the renovated wastewater treated in their own sewerage system and was thus anxious to reduce the amount of wastewater they collected wherever possible. As a result, the architects developed, and the Water District accepted, a proposal for a split system wherein blackwater and kitchen wastes are discharged to the municipal sewer system, and greywater is treated in a septic tank and reused for subsurface irrigation. With this system it was judged that if the greywater "daylighted" in the face of the bluff, it would not constitute a health hazard.

Operation

In each of the four houses, wastewater from the toilets, kitchen sink, and dishwasher, is discharged to the existing sewer system. Greywater from the showers, tubs, bathroom sinks and washing machine, is discharged to a standard septic tank which has a capacity of 500 to 750 gallons, depending on the size of the house. Two of the houses are approximately 3,400 sq.ft. in area, while the other two are approximately 4,000 sq.ft. All of the houses have 3-1/2 baths.

After settling, the greywater flows from the septic tank to a distribution manifold. The manifold connects the single 4-inch ABS line from the septic tank to several subsurface distribution systems, each of which supplies water to a different portion of the lot.

The first system irrigates a large area of lawn and ground cover and therefore consists of several rows of 2-inch diameter perforated pipe located 1 or 2 feet apart and buried only 2 inches below the surface. The second system irrigates a relatively small area of ornamental vegetation and therefore consists of fewer rows of pipe located slightly farther apart from each other and buried about 4 inches below the surface. The third system irrigates that portion of the lot upon which grows the highly combustible chapparal or (hopefully) its replacement, native fire-resistant vegetation. A fourth system, a conventional deep-set leachfield, is also provided to dispose of the greywater during rainy periods when the other systems could become waterlogged. Each system is connected to the distribution manifold by a valve, which may be actuated either by hand or by a solenoid valve and time clock assembly. In addition, the greywater septic tank is equipped with an inlet port through which liquid fertilizers may be added to the greywater. In this way, the greywater irrigation system can also serve as an automatic fertilizing system.

Maintenance

The system was designed to be virtually maintenance-free. It contains no filters to clean, no chemicals to replenish, and, with the exception of the valves in the distribution manifold, no moving parts to wear out. However, like any subsurface disposal system, it is probable that the leaching pipes will eventually become clogged and require cleaning. In addition, it is conceivable that after a very long period of time, settled solids could accumulate in the septic tank to the point where it would require cleaning.

Cost

The architects estimate that for each house it would cost from \$1,200 to 1,500 for the septic tank and distribution equipment, plus \$1,000 to \$1,200 for the additional plumbing required to achieve a split system.

ECO-UNITY PROPOSAL

The Eco-Unity System is a proposal for a wastewater treatment and recycling system that would service a 30-house cluster of self-sufficient homes. Designed by Peter Clegg and Ryc Loope, the Eco-Unity project was an award winning entry in the 1972 AIA/ASC competition on Energy Conservation and Building Design (Clegg 1975).

Operation

Greywater from the tubs, showers, lavatories and kitchen sinks of the 30 homes would first be collected and delivered to a scum and grease trap. Relieved of most of the material floating on its surface, the greywater would next flow into a coagulant feeder in which alum (or other metallic salts) would be added. As a coagulant, the alum would precipitate up to 95 percent of the dissolved phosphates, enabling them to be filtered out.

The greywater would next pass through a standard vertical pressure filter, containing a filter-bed of either sand or anthracite, which would remove suspended solids. The greywater would then pass through a second filter, containing activated carbon, which would oxidize organic substances and remove odors.

After passing through the filters, the greywater would be chlorinated and then lifted (by a wind-powered pump) to a

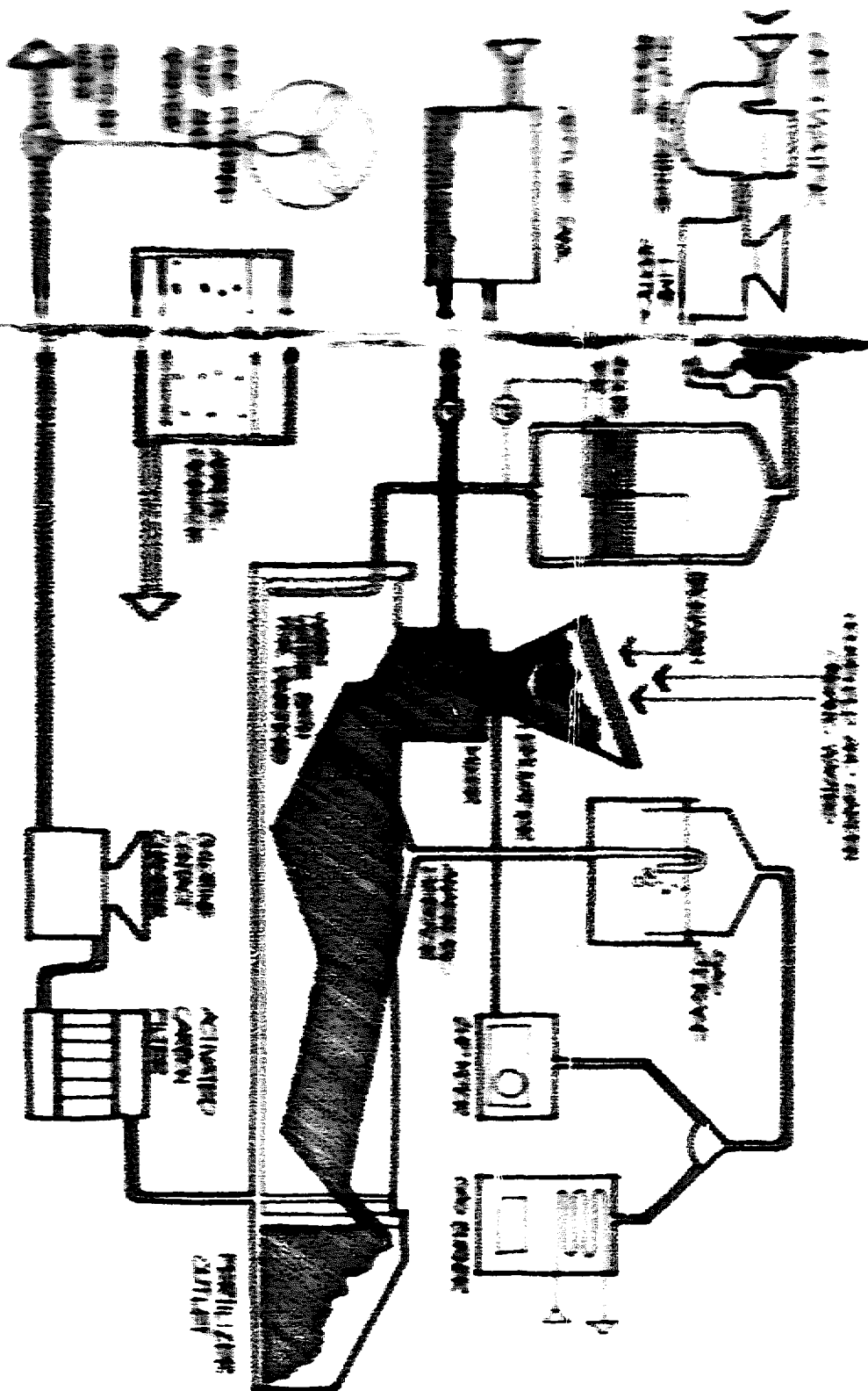

Water Treatment Plant (Schematic, 1972)

holding tank where it would be available for reuse in washing, laundering, and toilet flushing. When the demand for greywater exceeded its supply, a line from the main water supply would deliver potable water to the holding tank.

Blackwater from the toilets would flow first to a settling tank where solid material would separate out of the influent. It would then flow into an aerobic digester which would be aerated by the same windmill used in the greywater system. From the aerobic digester, the effluent would be delivered to the landscape for use as irrigation water, or simply disposed of via soakaways (seepage pits).

The settled solids at the bottom of the separation unit would follow an altogether different course. This material would be pumped from the separation unit to an anaerobic digester. The anaerobic digester would also receive organic wastes from the household and garden and, thus, would contain a shredder to grind up the cellulose and organic wastes and an agitator to keep the digestion material moving.

Heat would be provided to the digester by the warm greywater discharged from the kitchen and bathroom. The warm greywater would circulate through a bath surrounding the digester on its way from the filters to the chlorine contact chamber.

The anaerobic digester would produce two products as a result of its operation: a nutrient-rich humus and methane gas. The humus would be available for use as fertilizer in the garden. The methane gas would be collected in a chamber and employed to provide heat for the homes and to power a 2 HP motor which would drive the shredder in the digester.

In describing the proposed system, Clegg makes the point that anaerobic digestors are not very practical for single dwelling units. This is due to the fact that while an anaerobic digester requires a regular input of digestable material, the amount and content of wastes produced by an individual household may vary considerably from day to day. Primarily, the amount of toilet wastes produced will vary according to the number of occupants present, and the amount and content of the waste will vary according to the occupants' diet. The small digester, sized for an individual dwelling unit, would thus be quite likely to experience the cessation of biological action due to inconsistencies in input material.

In addition, the volume of methane that would be produced daily by a small anaerobic digester (a maximum of 12 cubic feet) would not be worth the money which would have to be invested in order to collect it. For single dwelling units, Clegg suggests the use of an aerobic digester, such as a Clivus Multrum unit, to facilitate on-site treatment of toilet and other organic wastes.

LIVING LIGHTLY PROPOSAL

"Living Lightly" is the title of a preliminary design proposal for a self-sufficient community of five families. The design was developed by the students of an Environmental Design Studio given in the School of Design at the California Institute of the Arts.

The primary goal of this project was to design a housing cluster in which the inhabitants lived solely within the means provided by the resources available on the site. With respect to water consumption, this meant developing a viable water supply and recycling system which enabled the demand for water to be met by the on-site supplies that were naturally available and renewable. The fact that the site was located in an arid region made this a particularly challenging objective.

Background

Even though their site was located in an arid region which received only 18.5 inches of rainfall per year, the students determined that rainfall was the most feasible source of replenishing water. In making their calculations, however, they assumed a more conservative figure of 15.5 inches of rainfall per year in view of the droughts which have frequently occurred during the last 20 years.

After allowing 10 percent for losses due to evaporation and

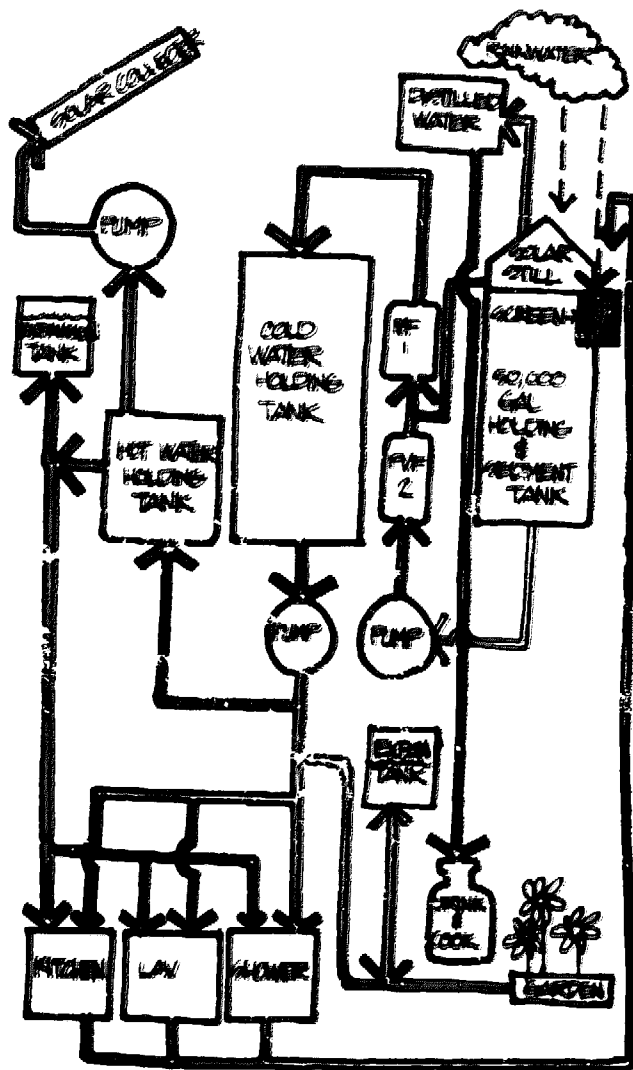

LIVING LIGHTLY SYSTEM

the inefficiencies of collection, the students found that their 15,000 square feet of roof area could collect approximately 140,000 gallons of water per year. Calculations projecting water demand, however, indicated that the 17 inhabitants of the proposed community would require more than 400,000 gallons of water per year without even including irrigation and other outdoor uses.

With annual rainfall amounting to only 35 percent of the projected annual demand, it became apparent that water conservation measures were essential. By substituting waterless toilets for flush toilets and installing flow reducing devices in all of the fixtures, projected water demand was reduced by 60 percent without significant changes in life style.

As substantial as it was, however, the 60 percent reduction still did not enable the community to exist solely on the water supplied by rainfall. As a result, the students incorporated a greywater recycling system into their design to extend the rainwater supply.

Operation

Rain falling on the rooftop catchment area would flow first through a screen and into a 50,000 gallon holding tank. The screen would remove from the water dirt, leaves, bird droppings, and other solid material that would accumulate on the roof between rains. The 50,000 gallon capacity of the holding tank is designed to store a 6-month supply of water plus a safety factor in order to ensure a constant and adequate supply through the dry season. Suspended solids not removed by the screen would settle out in the holding tank during the first 24 hours of storage.

After settling, water would be pumped from the tank through a pressure vessel filter for secondary filtration. The water would then branch and follow two separate paths. A small portion would flow into a 400 SF solar still, which would be located on top of the holding tank, where it would be sterilized for drinking and cooking. Since approximately 30 square feet of solar panel area is required to distill 1 gallon of water daily, the 400 SF still would produce approximately 40 gallons of potable water each day. From the still, the purified water would flow into a 150 gallon community holding tank and there would be bottled by the individual families and carried home for use.

The remaining portion of the water (that which is not diverted through the solar still) would flow through a second pressure vessel filter and into a 1,000 gallon cold water storage tank. Most of the water in the cold water storage tank would be pressurized by a pump and pressure tank assembly and made available for reuse in irrigation, bathing, clothes washing, and dish washing. Some of the water, however, would be pumped to a 500 gallon hot water storage tank heated by a solar collector. A second pump and tank assembly would pressurize the heated water.

The second pressure vessel filter would be employed to prevent the possibility of an inhabitant ingesting contaminated water while brushing his teeth, showering, or working in the kitchen. The designers of the system claim that the second pressure vessel filter would produce water equal in bacteriological quality to that produced by the solar still. The solar still, however, would remove lead and other heavy metals as well as all non-volatile substances and would therefore be a more desirable source of water for drinking and cooking.

All of the greywater produced in the five homes would then be collected in a main collection pipe and transferred back to the screen at the inlet of the 50,000 gallon holding tank, where it would begin the filtration and purification process again.

Like Peter Clegg's Eco-Unity system, the Living Lightly proposal has not been constructed. Nonetheless, the design represents a considerable amount of thought and research on the subject of greywater recycling and, in theory at least, demonstrates the successful integration of a number of energy and resource conserving systems.

KEY LARGO PROPOSAL

In 1975, Murray Milne was commissioned to design a home in Key Largo, Florida which presented a number of challenging problems. One such problem was the client's dislike of the taste, odor, and high cost of the water supplied by the Florida Keys Aqueduct Authority. As a result, the house was designed to be virtually independent of the local water system, depending instead on rainwater, recycled greywater, sea water, and condensate from the air conditioner.

Background

The history of water in the Florida Keys is fascinating. Although the climate is considered subtropical, annual rainfall is only 40 inches -- slightly less than the national average. The first settlers in the Keys survived entirely on rainfall. Today, evidence of this still exists in Key West, where all of the old homes still have large cisterns and elaborate gutter systems. Up until World War II, the naval base there was supplied with fresh water by ship.

Eventually, the Florida Keys Aqueduct Authority brought water down to the Keys from central Florida by laying a pipe along the Keys' bridges. Automobile accidents on the bridges, however, periodically interrupted service for days at a time so many people continued to rely on rainfall and their cisterns. In 1975 a reverse osmosis desalinization plant began operation, supplying water to Key Largo, the largest island.

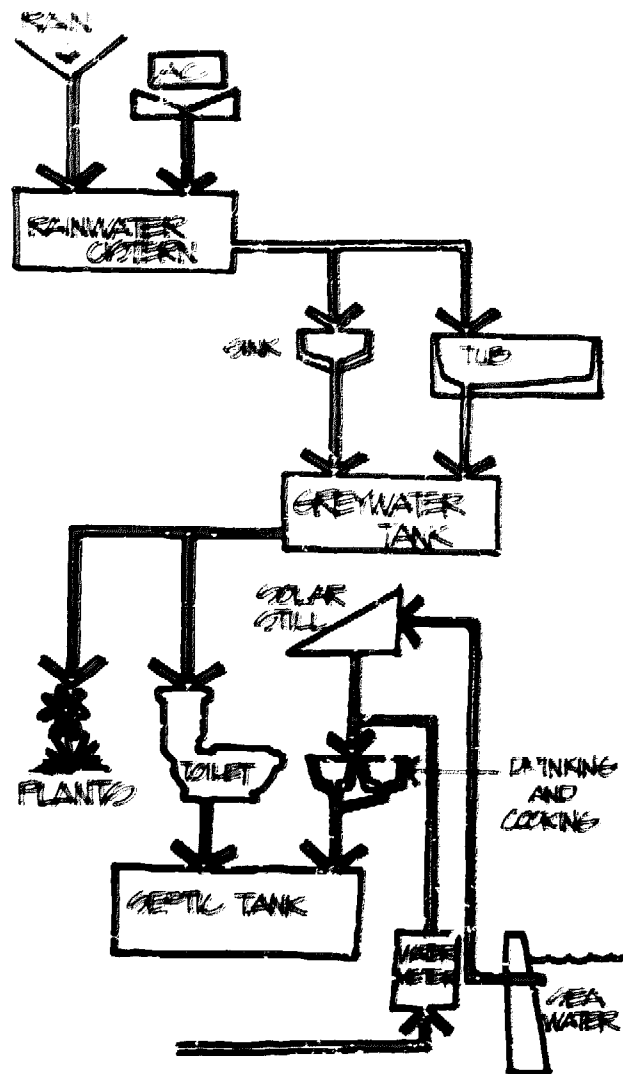

KEY LARGO HOUSE - FLOW DIAGRAM

Because of the difficulties associated with supplying water to the Keys, rates there are among the highest in the nation -- about \$4 per 1,000 gallons. As a result, many water conservation and recycling projects there are cost effective.

Operation

The basic elements of the system are as follows: Rainwater is collected and stored in a cistern. Drinking water is provided by a solar still supplied with water from the cistern. A greywater collection and reuse system extends the rainwater supply to the extent that the need for water from the Aqueduct Authority is virtually eliminated. Condensation from the coils of the heat pump provides an additional source of water for the cistern. In the humid Keys climate, this source can provide more than 24 gallons of water per day. Finally, because the clients are shell collectors, sea water is pumped from the canal to the house to circulate through their aquariums, to serve the shell cleaning sink, and possibly to provide an emergency source of water for the solar still.

Rainwater and heat pump condensation drain directly off the flat roof into a 5,000 gallon cistern built like a shallow swimming pool in the crawl space under a storage room. A small pressure tank and pressure switch controls a submersible pump in the cistern and maintains a pressure of about 30 psi at all fixtures in the house. Water from the cistern is pumped through a standard swimming pool filter, through a solar heater, and then to the washing machine, dishwasher, bathtubs, showers, sinks and the solar still. Water from the still accumulates in a storage tank at roof height and flows to the house by gravity. A special "drinking fountain" tap which delivers purified water from the still is provided at the kitchen and bathroom sinks. The still, which provides about 1/2 gallon of water per day per square

foot of collector area, flushes itself and refills with water from the cistern each day. The 20 gallons or so of flush water is discharged to the greywater storage tank.

Greywater from the tubs, showers and, if desired, from the washing machine, drains directly into a 1,000 gallon storage tank buried under the floor of another part of the house. Fine mesh strainers located at each of the fixtures and appliances minimize the amount of lint, hair and particulate matter discharged to the greywater tank. A second pressure tank and pressure switch controls a submersible pump which delivers the greywater through another swimming pool filter to the toilets and the subsurface irrigation system.

Blackwater from the toilets as well as greywater from the kitchen sink and dishwasher is discharged to a septic tank. Because the water table is high and the coral-limestone soil is nearly impermeable, the leach field is raised above grade and functions, in part, as an evapotranspiration bed.

The sea water pump is controlled by a timer as well as a pressure tank and switch. The sea water which is circulated through the aquariums is returned to the canal.

Metered water from the aquaduct is required to be provided on-site. However, it is used only to provide backup water for the rainwater cistern and distilled water storage tank.

Maintenance

Periodic cleaning of the two swimming pool filters is required but will be performed by a local pool service company. Thus, as far as the owners are concerned, this system is totally automatic.

Cost

Given the average annual rainfall of 40 inches, the 2,640 square feet of roof collection area will provide 3 occupants about 50 gallons of water per day each.

With aqueduct water at \$4 per 1,000 gallons, this system will save about \$220 per year. Assuming a mortgage rate of 9-1/2 percent, this is roughly equivalent to an added construction cost of \$2,300. Estimates of the actual construction cost of the system ranged from \$3,600 to \$5,000. The cost of the electricity required to operate the pumps is negligible -- approximately \$.05 per 1,000 gallons (300 gph @ 375 watts x \$.04/kwh = \$.05/1,000 g). Thus, the cost of pumping water from the cistern represents only about 7.25 percent of the cost of buying it from the Aqueduct. Other costs include the Aqueduct Authority's connection fee and monthly service charge plus the cost of the periodic maintenance of the two filters.

From a purely economic point of view, this system is not cost-effective. However, the system does have other, non-monetary compensations, such as not having to taste or smell the Aqueduct water, providing the pleasure of bathing in soft rainwater, not being affected by breakdowns in the Aqueduct system, and being unaffected by increases in the Aqueduct water rates.

MALIBU SELF-SUFFICIENT HOUSE PROPOSAL

The lack of water was the primary reason why a magnificent site in Malibu on the top of a hill overlooking the ocean was for sale at an extremely low price. The couple who subsequently purchased the site asked Murray Milne to design a home that could exist independently of a municipal water system. In the design that resulted, the house depends instead on rainfall and recycled greywater and even includes a Japanese hot tub.

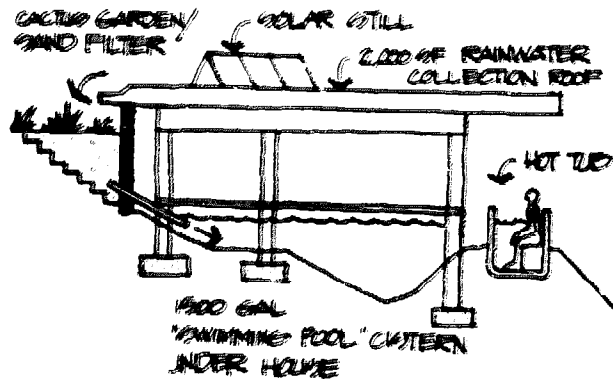

MALIBU SELF-SUFFICIENT HOUSE PROPOSAL

Background

The climate of Southern California is hot and arid. Annual rainfall seldom exceeds 15 inches and falls mostly in Winter, followed by 9 months of virtual drought. Because the site is extremely vulnerable to the infamous Southern California brush fires, the Fire Department required that 3,000 gallons of water be stored on-site at all times. Thus, a cistern was necessary regardless of the source of the water supply.

Operation

The 2,000 square foot roof collects approximately 15,000 gallons of rainwater annually. From the roof, the rainwater flows into a large, open sand filter bed which also functions as a dry landscape garden and is covered with indigenous rocks and a few native cacti. From the filter bed, the

RAINWATER COLLECTION ASSUMPTIONS:

Roof = 2000 sq.ft.
Annual rainfall = 15 inches
Evaporation losses = 20 percent
Thus, annual total = 2,000 cu.ft.
Or = 15,000 gal.
Required fire reserve = 3,000 gal.
Thus, net in cistern = 12,000 gal.
Or = 33 gal./day

HOUSEHOLD CONSUMPTION ASSUMPTIONS: (2 Adult Occupants)

Bathroom sink = 2 gpcpd x 2 = 4 gpd
Shower = 1/2 gpm x 4 min x 2 = 4 gpd
Dishwasher = 13 gal/load = 13 gpd
Clothes washer = 28 gal
twice/week = 8 gpd
Available greywater sub-
total = 29 gpd
Kitchen (cleaning vegetables) = 3 gpd
Hot tub losses (evaporation,
splashing) = 1 gpd
Total from cistern = 33 gpd

Drinking, cooking = bottled water
Optional solar still = 2 gpd drinking
water
Toilets = greywater @ 3-1/2 gal/flush
Irrigation = greywater

water drains slowly into a plastic-lined cistern built like an above-ground swimming pool between the footings and piers which support the house above the uneven terrain. The cistern's average depth is less than 2 feet and its top forms the floor of the house.

A standard shallow well pumping system delivers water from the cistern at 20 to 40 psi to the showers, bathroom sinks, washing machine and dishwasher. A portion of this water is heated for such service by a domestic solar hot water system. The resulting greywater from these fixtures flows by gravity into a holding tank where it is made available by submersible sump pumps for irrigating the landscape and flushing two 3.5 gallon toilets. The volume of greywater produced is sufficient to provide at least 8 flushes per day. Should more than a week's worth of greywater accumulate in the holding tank, water from the bottom of the tank is automatically pumped into the irrigation system. In the process, settled solids are automatically flushed from the tank.

The clients, who were familiar with Japanese bathing practices, wanted a hot tub built into a patio outside the master bedroom. As a result, the bathroom is designed with an area for Eastern bucket and sponge baths and a Western-type shower. Two types of shower heads are planned: a standard 3 gpm model and a Minuse air-assisted model which uses only 1/2 gpm (Milne 1976).

As with most houses in the vicinity, bottled water is used for drinking and cooking. However, a solar still provides a back-up source of purified water. To eliminate carrying heavy bottles of water into the house, racks are provided in a cabinet near the parking area and are connected by copper tubing to special taps at the kitchen, wet bar, and bathroom sinks.

Sand filter bed	\$1,000
Increased cistern size	\$4,000
Pump and pressure control system	\$500
Greywater collection tank	\$200
Greywater pumps	\$200
Minuse air-assisted shower	\$500
Solar still	\$400
Bottled water plumbing system	\$200
Hot tub, solar heated	<u>\$1,500</u>
TOTAL	\$8,500

Estimated savings of 600 ft. well with pump and accessories = \$13,500

Wastewater from the toilets and kitchen sink is discharged to a standard septic tank and leach field. However, provision is provided for switching the effluent to an evapotranspiration bed on the downhill side of the house in order to irrigate fire-retardant plants. The plants protect the house from slope running fires, the greatest threat to houses built on the crest of chaparral covered hills. A sprinkler system with fusible links that automatically open in the presence of fire may be installed on the roof. If this were done, the house could protect itself almost indefinitely because water from the sprinklers would drain through the sand filter and back into the cistern, where it would again be pumped onto the roof.

Maintenance

The house is designed to be essentially maintenance-free. Everything is totally automatic, including the irrigation system.

Toilets use:

3.5 gal/flush, 4 times/day
= 14 gal/day
= 100 gal/week

Showers use about:

2.5 gal/min for 5 min/day
= 12.5 gal/day
= 100 gal/week

Bathtub holds about:

50 gal/bath
twice a week
= 100 gal/week

BATHING USE = TOILET USE

GREYWATER FLUSH PROPOSAL

Toilets need not be flushed with potable water; in fact warm, soapy water should work better. Since toilet flushing consumes just about the same amount of water as bathing, why not collect bath water and reuse it for toilet flushing? The system described below is designed to be a maintenance-free, completely automatic way to collect and store bath water, and laundry water if desired, and reuse it for toilet flushing.

Background

Bath water is probably the cleanest greywater produced in the home. The major pollutant in it is soap, although it also contains small amounts of dirt, hair, lint, and possibly toothpaste. Conceivably, bath water could also contain minute particles of fecal material; but because toilet flushing is a non-contact form of reuse, this should not be a significant issue. Odors should not develop if the bath water is prevented from standing quietly in an oxygen-free environment.

Assuming that each person flushes the toilet an average of four times a day, the volume of water consumed in toilet flushing (at 3.5 gallons per flush) is approximately equal to that consumed in taking a 10 minute shower every other day or a tub bath twice a week.

Operation

Disconnect and plug the trap from the tub or shower. Connect a 1-1/2 inch pipe to the drain and lead it to a storage tank. Install a small 3 to 5 gpm submersible pump so that it draws water from the storage and discharges it, through a hose or tube, directly into the toilet tank. Epoxy an electrical float switch onto the side of the toilet tank so that when the water level falls, it turns the pump on. Finally, disconnect the potable water supply to the toilet by shutting the stopcock valve and removing the connecting tube. This eliminates the possibility of a cross-connection. Even though these modifications have been made, the toilet is basically unchanged. When the handle is depressed, it operates in the normal manner. To service a second toilet, simply add another pump-float switch and supply tube assembly.

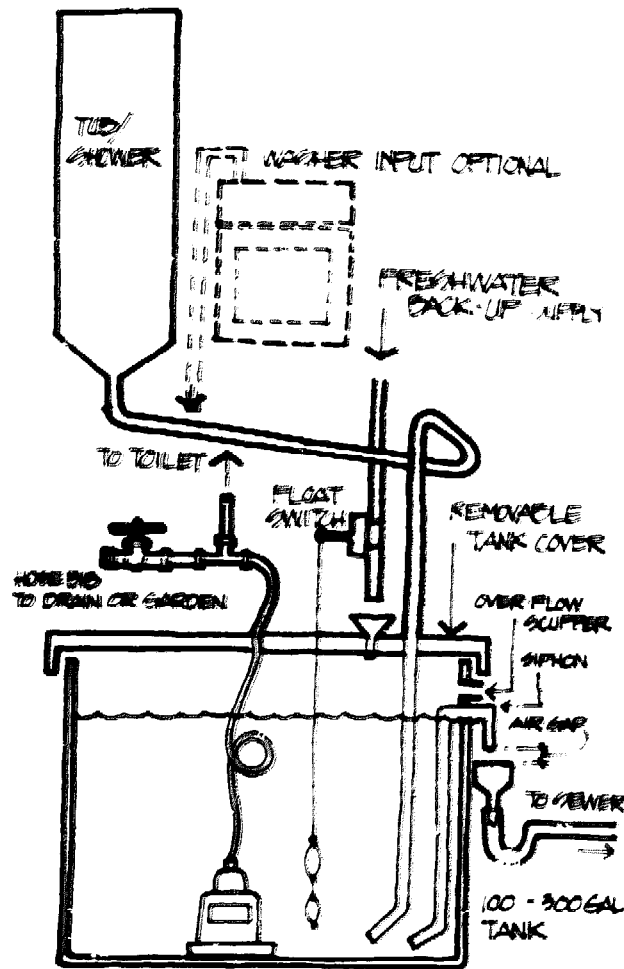

GREYWATER FLUSH PROPOSAL

The storage tank must be provided with an overflow scupper which discharges excess greywater to the sewer through a standard drain with a vented trap. A floor drain, an old laundry basin, or a new drain installed in an existing sewer will suffice. The overflow scupper must have an air gap to prevent the backflow of material from the sewer into the storage tank. If desired, an overflow tube may be installed at the lowest point in the tank so that water flowing to the sewer will siphon sediment out of the bottom of the tank.

In addition, fresh water should automatically be added to the storage tank when the water level falls too low to adequately service the toilet. This can be accomplished by means of a simple float valve. However, a 1-inch gap must be provided between anything that contains potable water and the overflow level in the storage tank. A standard toilet tank float valve could be modified to perform this function.

If the volume of bath water is insufficient to adequately supply water for toilet flushing, greywater from the bathroom sink may be added. This source, however, produces such a small volume of greywater, that its addition will probably have a negligible effect. Greywater from the washing machine, on the other hand, represents a significant additional volume. The source, however, also adds potential maintenance problems because it greatly increases the amount of lint and caustic detergents. Moreover, if diapers are washed in the washing machine, the pathogen count in the greywater could skyrocket.

For a bathroom used by only a single person, the capacity of the storage tank should be at least 100 gallons. As the number of people increases, the required per capita storage capacity need not be as great. For example, a family of four may need only a 200 or 300 gallon storage tank. These estimates assume that people tend to repeat their bathing patterns on a weekly cycle (a la the Saturday night bath). The homeowner should consider using a plastic wading pool for his storage tank as they are easy to install, relatively inexpensive, and fit nicely in crawl spaces or under porches.

Maintenance

This system is designed to be self-cleaning and should therefore require no maintenance: The submersible pump sits at the bottom of the tank and the greywater inlet pipes are located so as to scour the bottom of the tank. However, some sediment may accumulate in the farthest corners. If it begins to create odors, it should be cleaned out. This could probably be accomplished by sliding the pump around the bottom of the tank to vacuum up the sediment. Should musty odors in the toilet bowl become annoying simply pour a cup of chlorine bleach down the tub or shower drain.

Plumbing problems in the toilet should be reduced because the

mechanical ballcock and float which cause most of these problems is completely deactivated. It is not clear whether the toilet bowl will need to be cleaned more or less often, because although there is added lint and dirt, there is also added soap and detergents. Possibly a soap ring will develop at the water line, even though toilets are specifically designed to scour this location during flushing.

Submersible sump pumps are designed for trouble-free operation in water with more "junk" in it than in household greywater, however lint accumulation in the intake strainer may prove troublesome. Consider removing this strainer entirely, because lint should pass easily through the rest of the system. There probably will be no rocks or metal objects in the greywater to damage the pump blades.

RAINWATER STORAGE ROOF

The storage roof system is designed to collect and hold about 6 inches of rainwater for indoor use in bathing, toilets, etc. In the designer's opinion, it reduces the initial cost of a building (Stephens 1974).

A flat monolithic poured concrete roof and parapet wall are constructed like a shallow pan, which is lined with rigid foam insulation boards (an inch or two thick) and a butyl waterproof membrane. The top is covered with a walking surface of precast insulated concrete slabs, supported on small piers. Rainwater runs through the cracks between these slabs to fill the "pan". Overflow scuppers prevent the roof loads from exceeding design limits by limiting the maximum water level. The designer claims that the amount of rainwater collected and stored between these two concrete slabs will be sufficient for flushing the toilets. In a single family dwelling in England the Stephens system uses the city water supply as an automatic backup in order to maintain a minimum water level on the roof pond.

The assertion is that the savings in the initial cost of the building would primarily occur from the elimination of a rainwater disposal system. But the collection and use of rainwater, especially in an urban setting, has many other benefits and opportunities. It offers the potential of reducing demands on municipal water services and reduces the likelihood of overloading storm sewer drains and in some cities reduces the load on the sewage treatment plant if rainwater is dumped into the sanitary sewer system.

Flooded roofs are not a new idea. In England, industrial mills were built so as to retain rainwater on their roofs.

This system also raises very exciting possibilities for passive solar heating and cooling. The Sky Therm system uses a similar volume of water on the roof, combined with movable insulation panels to heat and cool a one-story residence (Hay 1969).

The Stephens system uses insulation at three positions in order to optimize the thermal effects of the roof pond. Rigid insulation is placed above the pond on the lower side of the precast slabs in order to insulate the water from the outdoor air temperature and solar loads. It is necessary to insulate both surfaces of the slab in humid climate zones, in order to protect the interior spaces from condensation on the bottom side of the concrete slab, due to the cool water above.

The most common reaction to the proposal is the disbelief that a roof can be made 100 percent watertight. Here, the use of a single layer butyl sheet membrane is the most workable. The material's high tensile strength gives it a good resistance to perforation. In order to prevent further leakage, a drain should be constructed in the concrete slab beneath the membrane.

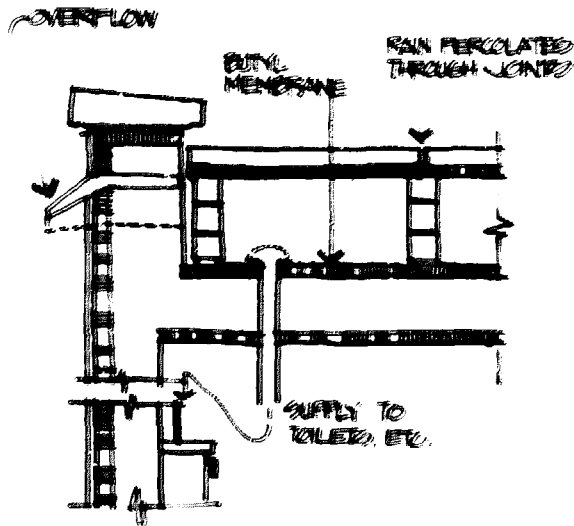

WATER STORAGE ROOF

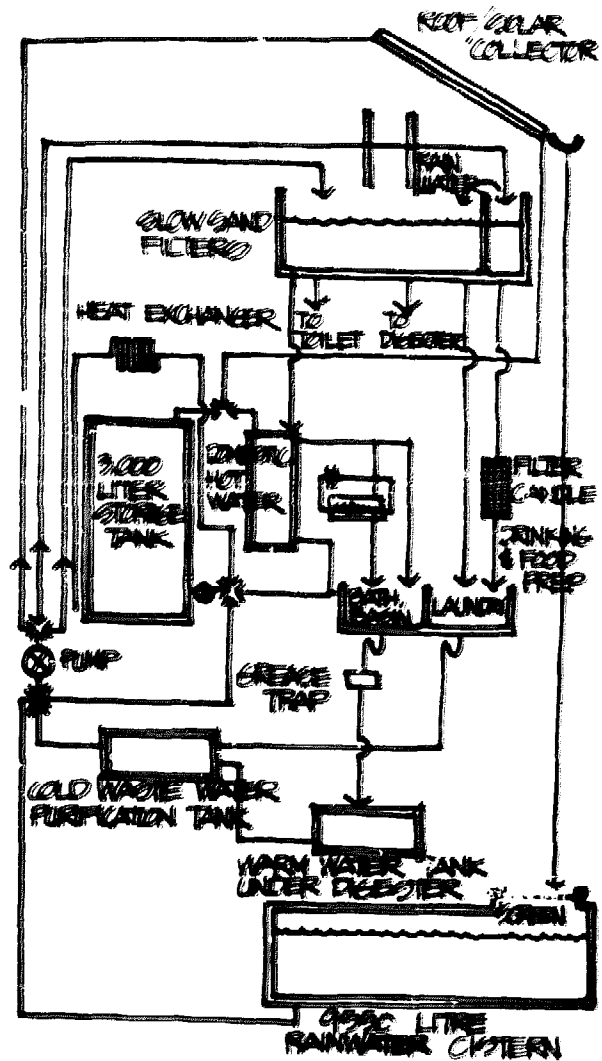

AUTONOMOUS HOUSE

At Cambridge University a water system for the "Autonomous House" project has been proposed by Brenda Vale. It utilizes rainwater for all domestic water needs. The Autonomous House collects rainwater and channels it through a screen into a 2,500 gallon cistern. From this point, upon demand, water is pumped to a slow sand filter in a cistern in the upper portion of the house. From here drinking and cooking water is passed through an additional ceramic candle filter. The rest enters the solar collector loop where it is heated for washing or for space heating. Wastewater from the laundry and bathing are cleaned of soap and other impurities by a purification process involving coagulation and precipitation with sulfuric acid and alum (Vale 1972; Steadman 1975).

AUTONOMOUS HOUSE



ECOL HOUSE

The self-contained bathroom in the Ecol House designed by the "Minimum Cost Housing Group" at McGill University, consists of an integrated water collection, treatment, and recycling system. The roof serves as both a rainwater collection basin and solar still. The rainwater drains into a ceiling mounted storage tank from which it is used untreated for showers, laundry, handwashing, and hairwashing. The greywater from the bathroom sink and shower drains into an under-floor storage tank from which it is recycled to flush the toilet, and is also cycled to the solar still to be distilled into pure water for drinking, cooking and washing dishes (Minimum Cost Housing Group 1972, 1973; Steadman 1975).

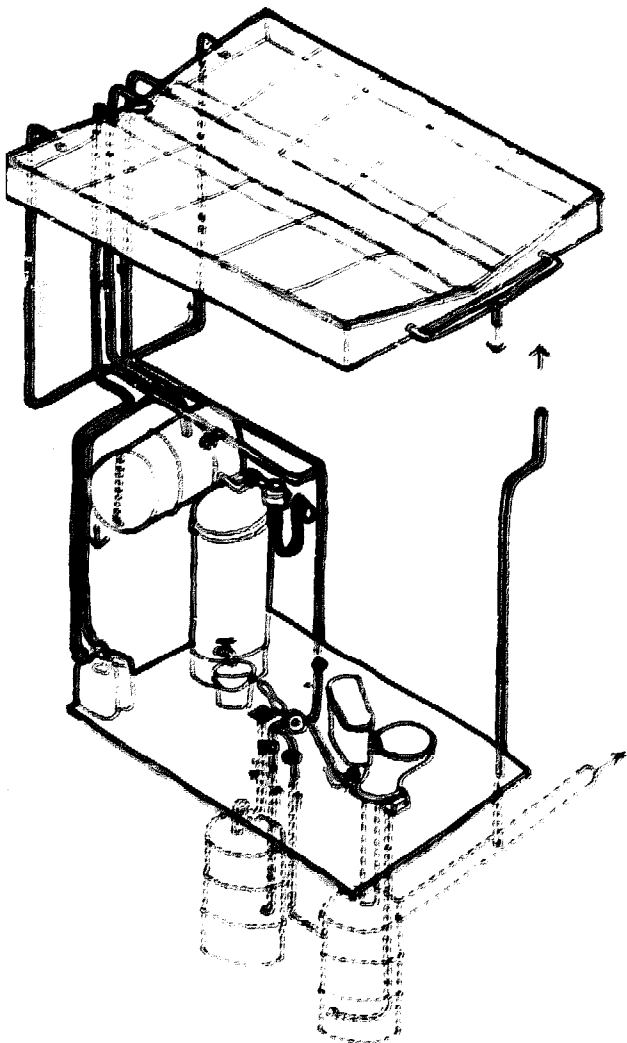

ECOL HOUSE

6

COMPONENTS

Homeowners can assemble their own water reuse systems from readily available components. Most of this "technology" was developed for swimming pools and lawn sprinkler systems and has been in use for many years. As a result, these components are now about as inexpensive, reliable and readily available as they will ever be.

Availability

There are many sources from which these components can be purchased. Hardware stores and plumbing supply houses, of course, will stock all of the common items. Sears and other large department stores sell a fascinating array of items through their special catalogs. More unusual components are easily ordered through specialty supply houses such as W. W. Grainger, who puts out a huge catalog and has stores in every state. Swimming pool supply houses should also be considered for major components such as high-volume pumps and pressure filters. The appendix contains a list of the distributors and manufacturers of all the specific products discussed herein.

Service

Homeowners who may want to have someone else design and install their water reuse system for them should talk first

- 6.1 FILTERS AND RELATED EQUIPMENT
- 6.2 BACKFLOW PREVENTION DEVICES
- 6.3 CHLORINATORS
- 6.4 CONTROLS
- 6.5 PUMPS
- 6.6 PIPING
- 6.7 TANKS
- 6.8 MISCELLANEOUS COMPONENTS

with plumbing contractors. They are generally better qualified for non-typical work of this type than are general plumbers. Of course, once the system is installed, it can be maintained and repaired by a general plumber or even a swimming pool maintenance company. Underground work can be performed by landscape contractors, irrigation sprinkler specialists or septic tank installers.

Any of these contractors can also take care of obtaining the necessary permits and deal with the health department, if necessary. The contractor should be willing to give the homeowner a fixed price bid and a firm completion date. The homeowner should try to find someone who is intrigued by the project and who is creative enough to develop a workable system.

6.1

FILTERS AND RELATED EQUIPMENT

For some applications greywater must be filtered before it is reused. The material suspended in greywater can clog pipes, valves, orifices and even porous soils. The type of filtration apparatus required depends largely on the daily volume of greywater and its intended use. Often a simple settling tank is the best solution. For situations in which 50 gallons or less is recycled each day, small low-technology arrangements are quite satisfactory. Situations in which 75 gallons or more is recycled each day require arrangements which are higher in capacity and sophistication. A higher degree of filtration will be required for uses which involve a mechanism that is particularly susceptible to clogging or fouling. For example, water used for toilet flushing must be highly filtered if a conventional ball cock valve is used in the tank. Filtration also helps disinfect greywater because the filter provides a matrix in which beneficial bacteria can thrive.

CLOTH BAG FILTER
DRAIN FILTER
IN-LINE FILTER
SLOW SAND FILTER
MIXED MEDIA FILTER
CLIVUS MULTRUM FILTER
HIGH-FLOW RATE SAND FILTER
PRESSURE VESSEL FILTER
CARTRIDGE FILTER
DIATOMITE FILTER
BACKWASH VALVE

The variety of filters suitable for household use may be roughly classified into two major categories: gravity filters and pressure filters. Generally speaking, gravity filters are appropriate for low-volume conditions such as are generated by 2 or 3 household fixtures, while pressure filters are suitable for high volume conditions in which flow rates are greater than 20 gallons per minute (gpm).

While pressure filters must operate in sealed pressure vessels, gravity filters may be open at the top and thus

allow easy visual inspection of the filter medium. However, available head for gravity flow is usually limited to 8 to 12 feet (3.5 to 5.2 psi), whereas it may be as high as 150 psi for a pump driven pressure filter.

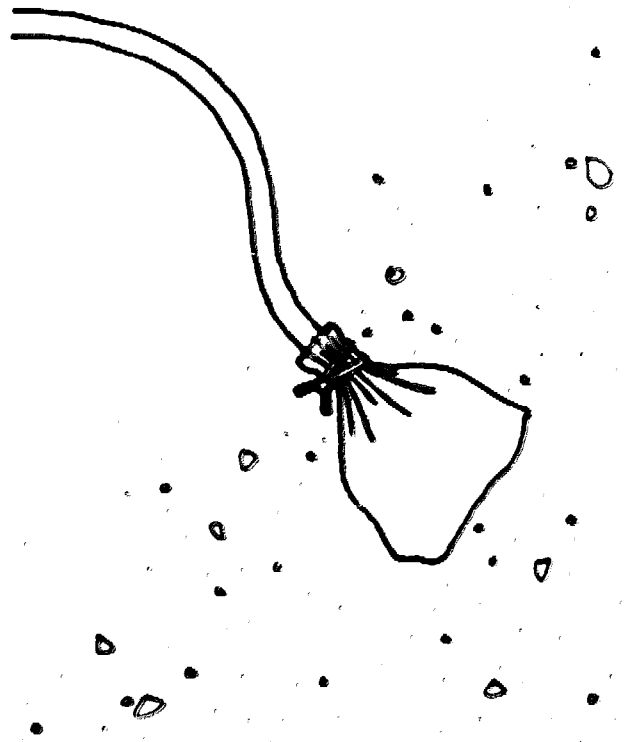

A CLOTH BAG OR OLD SOCK TIED AROUND THE END OF THE HOSE IS THE EASIEST AND CHEAPEST WAY TO REMOVE LINT, HAIR, AND LARGE PARTICLES FROM HOUSEHOLD GREYWATER.

CLOTH BAG FILTER

The cheapest and easiest way to remove large particles, lint and hair from household greywater is with a cloth bag or an old stocking tied on the end of the outlet pipe.

Operation

Nothing could be simpler; the greywater flows out of the pipe and seeps through the cloth. Everything that is left behind is gradually pushed down to the far end of the cloth bag. The bag can be held in place with a spring, wire, rubber band, or hose clamp.

Maintenance

Cleanable bags are turned inside out, hosed off, and left to dry in the sun, or perhaps even laundered. If old stockings are used they can simply be removed, discarded, and replaced with another old stocking.

DRAIN FILTER

The drain filter is simply a screen of some kind whose base nests snugly in the drain of a tub or basin.

Operation

Water entering the drain passes through the screen, by gravity, and is relieved of lint, hair and larger particles of suspended material. Wastewater from the clothes washer can be quite adequately filtered in this manner if it is discharged through a hose into a laundry tub. If water is to be reused from a shower or bathtub, a small mesh drain filter will catch hair and lint and is easy to clean.

An upstanding conical or hemispherical filter offers a greater surface area and as a result does not clog quite as rapidly as a flat screen under similar conditions. A drain filter is typically made of fine wire mesh or perforated polypropylene plastic.

The filtration capacity of a drain filter is rather limited. If left unattended for long the filter can accumulate a layer of debris to the point where it becomes impervious to the passage of water and causes the tub or basin to overflow. Nonetheless, if used regularly, it can significantly reduce the load of impurities in the water and offer a good point at which to begin a recycling system.

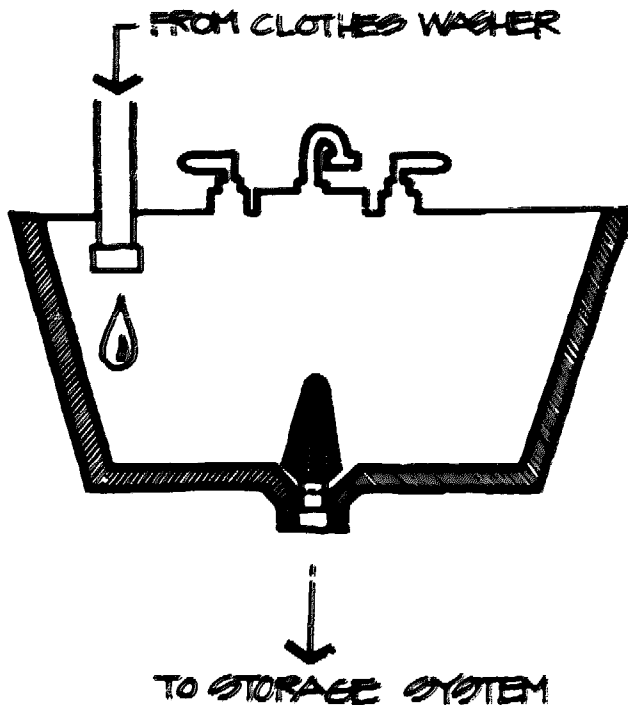

DRAIN FILTER

Maintenance

The drain filter is simply hand-cleaned when dirty. The operation is not unlike removing material from the lint screen of a clothes dryer. One must simply remember to deposit the material in the garbage and not wash it back down the drain.

Cost

The drain filter costs between \$2 and \$5. There are no maintenance costs and the filter should last indefinitely.

IN LINE FILTER

As its name implies, the in-line filter is mounted directly in the line transporting the water to be filtered.

Operation

The in-line filter basically consists of a cartridge of filter media within a steel or plastic container. The device is typically a compact cylinder, less than 14 inches high and 5 inches in diameter, and weighing 6 pounds or less. As a result, special structural arrangements are not usually required for installation. In most cases the filter is capable of operating at pressures up to at least 80 psi.

The device is installed in the line in one of two ways. In the first configuration, the inlet is on one end of the filter and the outlet is on the other. The flow proceeds straight through the body of the filter, not unlike a muffler in the exhaust pipe of an automobile. In the second configuration only the head of the canister, which contains both the inlet and the outlet ports, is installed in the line. The body of the canister, which contains the filter cartridge, is threaded to the underside of the head to facilitate easy removal and replacement of the filter cartridge, similar to the oil filter in an automobile.

An in-line filter is usually employed to further purify potable water for drinking and cooking. As a result, most

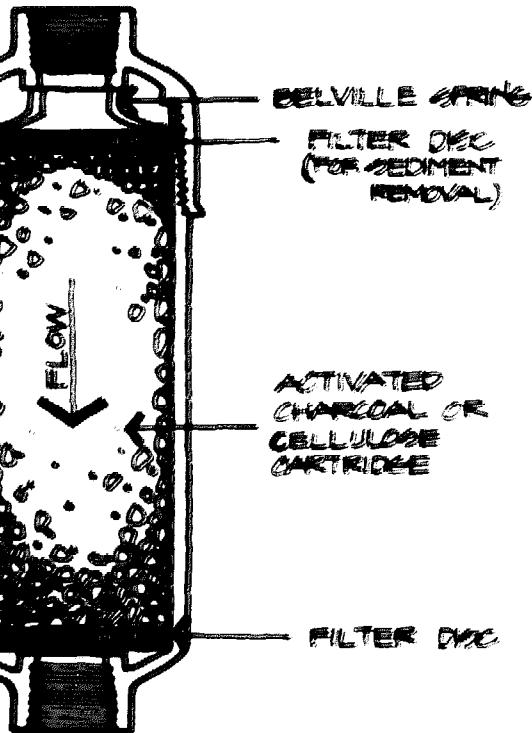

IN - LINE FILTER

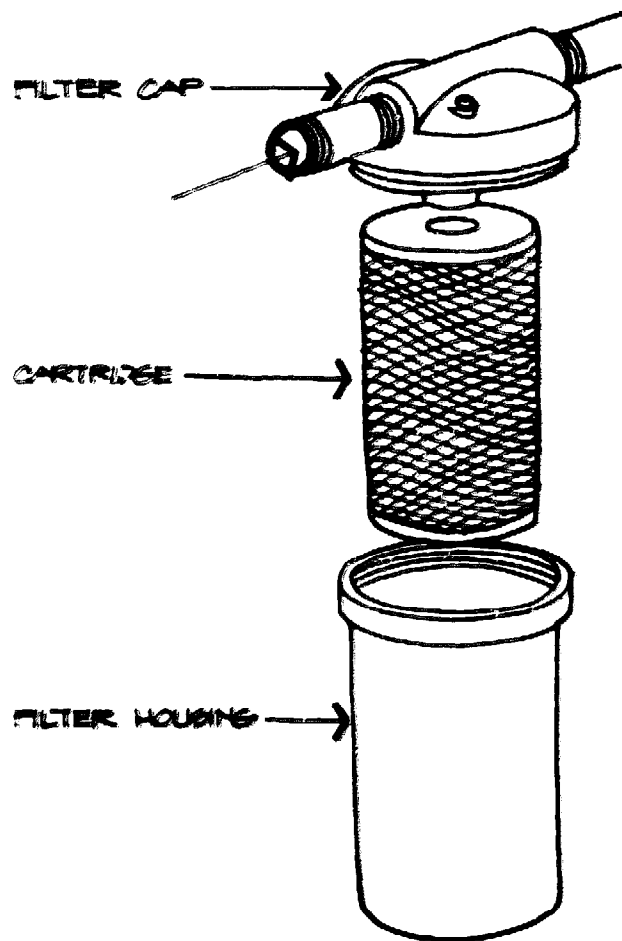

CANISTER-TYPE IN-LINE FILTER

Cartridges are designed to remove tastes and odors from the water. However, a number of manufacturers offer a line of cartridges designed to remove sediment and it is these which would be most appropriate for use in greywater recycling systems. Systems which do not have pumps will require a fairly high static pressure head to drive the water through the filter.

In-line filters are available with either disposable or reusable cartridges. Disposable cartridges are typically made of activated charcoal for taste and odor removal, or cellulose for sediment removal. Reusable cartridges are porous ceramic. Many ceramic cartridges and some activated charcoal cartridges are impregnated with silver in some form, to remove biological impurities.

The in-line filter is capable of filtering only a moderate volume of water without maintenance. Each sediment cartridge is rated by its manufacturer as being able to filter from 50 to 500 gallons, depending on the quality of the water, before needing to be cleaned or changed. Activated charcoal cartridges are frequently rated at several thousand gallons of water. However, this refers to the filtration of chlorine and other impurities which cause undesirable tastes and odors, rather than suspended particulate matter. Cellulose cartridges are capable of removing fine particles as small as 5 microns (.002 inches), while activated charcoal cartridges can typically remove solid material only down to 25 microns.

Maintenance

When the cartridge of an in-line filter becomes clogged it is removed from the canister and cleaned or replaced. Most reusable ceramic cartridges are cleaned with a small brush under running water.

Cost

The cost of an in-line filter covers a considerable range. A small filter containing an activated charcoal or cellulose cartridge is approximately \$20. A stainless steel model which contains two cartridges to accommodate high flow rates is available for about \$55. Replacement cartridges for this filter usually come in packages of two which cost between \$3.50 and \$6.00.

A cleanable silver impregnated ceramic filter system costs approximately \$250, although the ceramic cartridge should last indefinitely.

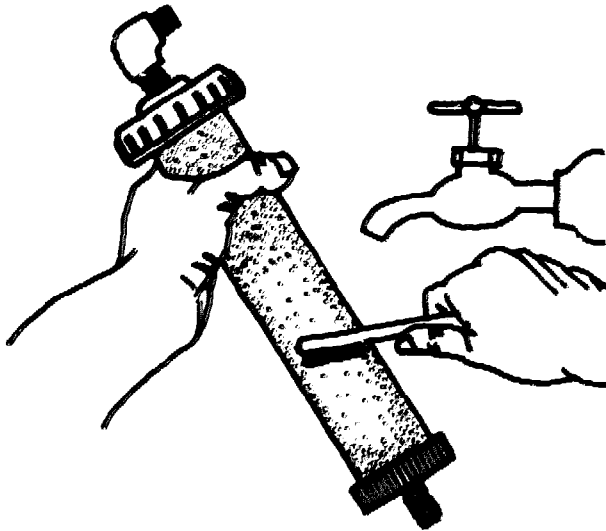
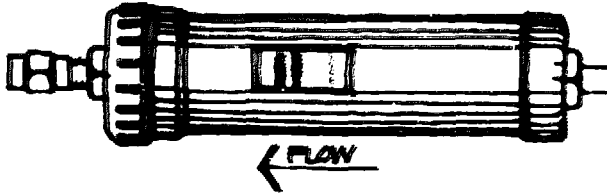

SILVER-IMPREGNATED CERAMIC FILTER

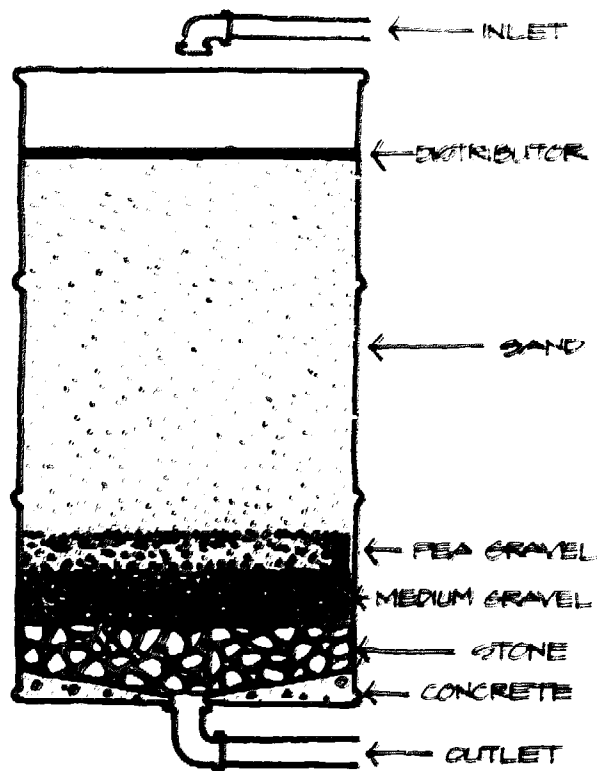

TO MAKE A DISTRIBUTOR, CUT THE TOP OF THE DRUM SO THAT IT FITS DOWN INSIDE THE DRUM. DRILL 1/2 INCH HOLES IN IT SPACED 1 INCH APART. COAT THE TOP WITH EPOXY TO PROTECT IT FROM CORROSION.

**SLOW SAND FILTER
MADE FROM A 55-GALLON DRUM**

SLOW SAND FILTER

The slow percolation of water by gravity through a bed of sand and graded gravel is the oldest and most successful method of water purification on a large scale. When used with a settling tank the slow sand filter can significantly reduce the concentration of suspended solids, BOD, and pathogenic organisms present in greywater.

Operation

A slow sand filter is generally not a commercially available product; in most cases it must be constructed by the homeowner. A filter can be constructed using a 55-gallon drum, a barrel, or a sturdy garbage can. In addition, a filter container can be constructed using stone, masonry, or concrete.

The filter is simply set up so that the water drains into the top of the filter, flows through the sand bed, and drains out of the bottom of the filter vessel. The fine grain of the sand provides an effective strainer which removes a large portion of the suspended material from the water.

Initially the sand filter is effective only as a strainer. However, as the suspended material is trapped, an active biological growth forms in the top 1/3 to 1/2 inch of sand. This organic layer, the "schmutzdecker", forms an extremely fine straining mat in which 95 percent of the suspended

material is retained and pathogenic organisms are eaten by the bacteria living within.

The water must be smoothly and evenly distributed over the top of the filter so that the entire surface area is dosed regularly. This is necessary to effectively utilize the full capacity of the filter and to keep the biological layer healthy. The filter should be screened or covered to prevent flies from entering. If covered, it should be vented to allow gas to escape.

A slow sand filter will filter greywater at a rate between about 0.05 and 0.13 gallons per minute per square foot of surface area (gpmpsf).

Maintenance

Although it is initially aerobic, the slow sand filter will eventually become anaerobic as the schmutzdecker builds up. A simple raking of the surface approximately once every four months is all that is required to restore the filter to aerobic conditions.

With continuous operation of the filter the organic layer will eventually become clogged. When this occurs the filter must be cleaned by scraping off and either cleaning or replacing the top 1/2 to 1 inch of sand.

Cost

Specific cost data on the slow sand filter cannot be provided as the cost varies depending on the container and other materials selected by the homeowner to construct the filter.

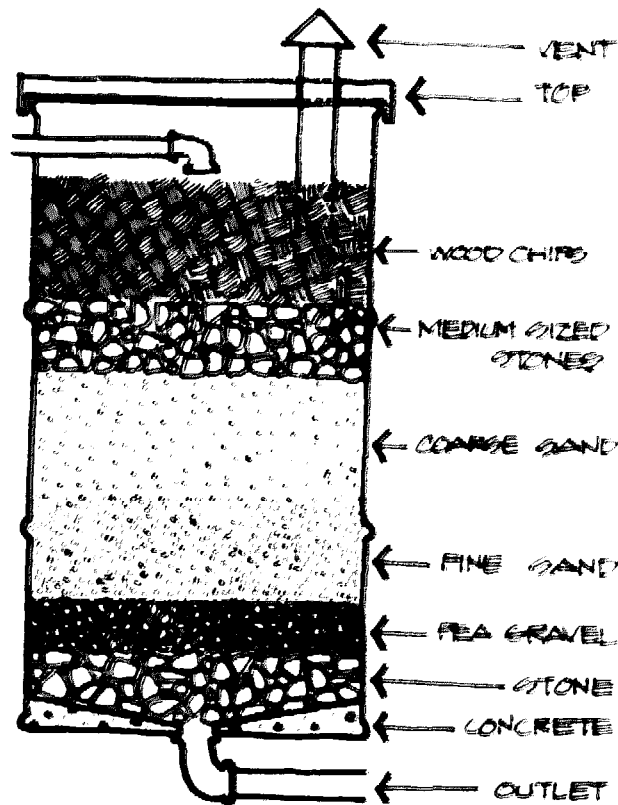

MIXED - MEDIA FILTER

MIXED-MEDIA FILTER

A number of materials other than sand can be employed in a gravity filter, either singly, in series, or in several layers within the same container. When several materials are used it is known as a mixed-media filter. The most common materials used are pea gravel, standard gravel, and crushed rock. Wood chips, sawdust, straw, grass clippings, and compost have also been tried.

Operation

Ideally, the size of the particles, and hence the size of the spaces in between, should be uniformly graded from coarse to fine in the direction of flow. In this configuration suspended particles first pass through the larger pores and encounter the coarse media. Smaller particles pass through and then reach the finer media where more opportunities for contact occur.

Maintenance

In a mixed media filter, material is removed and stored throughout the entire depth of the bed. This contrasts greatly with the slow sand filter in which material is removed and stored by only the top few inches of sand. The vast storage capacity of the mixed media filter bed greatly increases the period of time between required cleanings. However, when cleaning is required the entire depth of

the filter bed must either be cleaned or discarded and replaced.

Cost

Like slow sand filters, mixed media filters are not purchased as a single item, but are built by the homeowner, usually using very inexpensive materials.

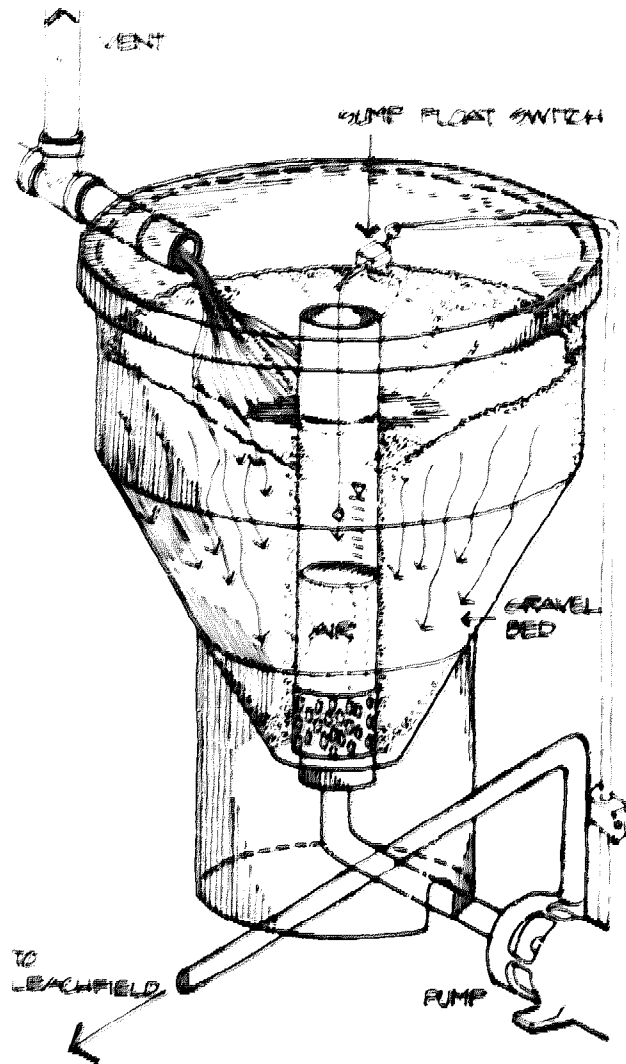

CLIVUS MULTRUM ROUGHING FILTER

CLIVUS MULTRUM FILTER

The Clivus Multrum filter, known commercially as the Clivus Multrum Washwater Roughing Filter, is a trickling filter designed specifically to pretreat household greywater for dispersal in a subsurface irrigation or disposal system. The filter is intended to perform three functions which increase the effectiveness and operational life of the subsurface dispersal system: First, to protect the leaching pipes and soil from becoming clogged with hair, lint, and food or other particles; second, to reduce the temperature of the outgoing water; and third, to act as a partial grease trap. Gravel is used as the primary filtering medium in order to absorb the maximum amount of heat from the greywater.

Operation

Greywater from the various sources within the home is collected into a single pipe and then delivered through this pipe to the top of a funnel-shaped fiberglass filter tank. The greywater inlet pipe enters the tank through a port in the side wall near the top. As the greywater flows toward the bottom of the tank, suspended material is removed and heat is absorbed by the stones in the gravel bed.

The conical shape of the tank causes the water to flow toward the center as it flows downward. When it reaches the bottom of the tank it flows through a baffle which

supports the overflow pipe, and into the tank drain. From the drain the water can be piped to the leaching field.

During periods of high water use the flow rate of greywater into the system may exceed the percolation rate of the water through the gravel bed. In this situation, the level of greywater in the filter will rise until it reaches the lower level inlet of the overflow pipe. The overflow pipe, which stands vertically in the center of the tank, conducts excess greywater directly to the tank drain, bypassing the gravel bed. The location and orientation of the lower overflow inlet allows the greywater to flow freely into the overflow pipe while retaining most of the floating grease in the tank.

In the event of extreme overflow conditions, the level of the greywater will rise to the top of the overflow pipe, whereupon the excess water will flow into the tank drain, grease and all.

According to its manufacturers, the Clivus Multrum filter is not meant to be a purification system. The bacteria count in the greywater will not be substantially reduced after it passes through this filter. Purification will take place in the soil in the leaching field. As a result, it is not recommended that water cycled through the Clivus Multrum filter be used to irrigate root crops that will be eaten raw.

Maintenance

The maintenance required for the Clivus Multrum filter is to clean or replace the stones in the filter bed. The organic particles collected will decompose slowly. The resulting silt-sized particles will make their way through the gravel bed, causing a gradual decrease in the flowrate

of the water through the gravel bed. The stones will need to be either cleaned or replaced depending on the type of waste material most prevalent.

Cost

The Clivus filter costs about \$400. For situations in which the level of the filter is below that of the leach field, a complete system including the filter tank with all internal pipes installed, a pump, and a float switch, is available for about \$460. The owner must supply the stones for the gravel bed.

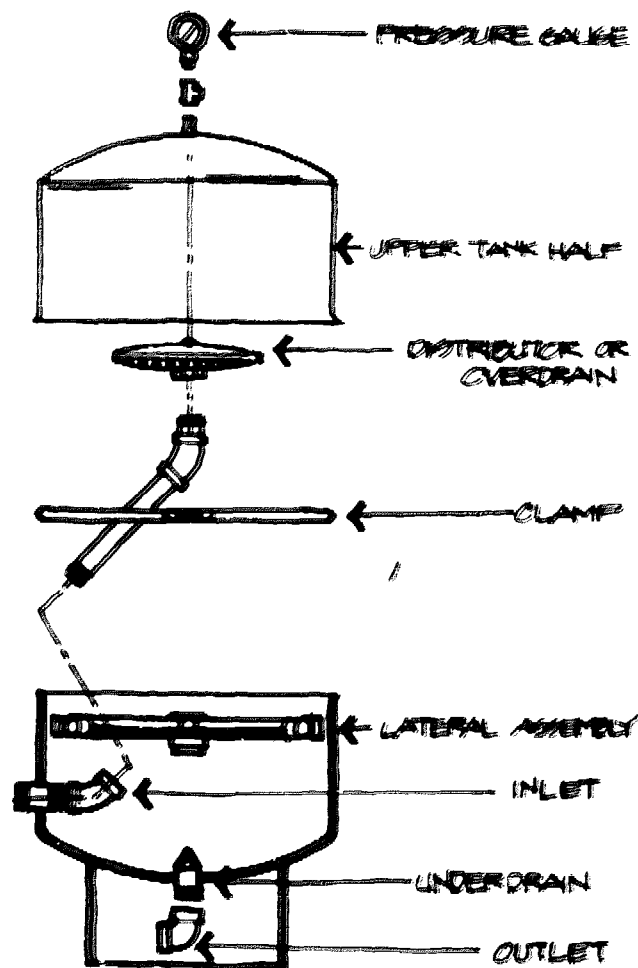

HIGH-FLOW RATE SAND FILTER

HIGH-FLOW RATE SAND FILTER

The high-flow rate sand filter is a pressure filter which employs sand as a filtration medium. It is commonly used in residential swimming pools. As is the case with all pressure filters, its use requires a pump.

Operation

A commercially available sand filter typically consists of a bed of relatively fine sand (20 grade silica) contained within a steel filter tank. Water pumped into the filter is discharged evenly over the sand bed by a special head assembly. The water flows vertically downward through the sand bed and is collected in a system of under-drains. The under-drains transport the water to the filter outlet while keeping the sand in the filter tank.

Because most of the impurities are removed from the water by the first inch or two of sand, the surface area of sand exposed to the water is of greater significance than simply the total sand volume in determining the filtration capacity of the filter. A residential scale sand filter can typically filter 15 to 20 gallons of water per minute per square foot of surface area. Sand filters are available with surface areas ranging from about 1 square foot to 5 square feet. Thus, the range of capacities is from approximately 15 to 100 gallons per minute. Utilizing the 20-grade silica, sand filters are capable of removing solid particles

as small as 15 to 9 microns. Sand filters are excellent high-flow rate filters for situations in which grease and other similar kitchen wastes may be encountered.

Maintenance

The pressure sand filter requires little in the way of maintenance. After a period of operation the sand becomes clogged with impurities and resistance to the passage of water becomes too great for efficient operation. This is typically indicated by a pressure gauge mounted on the top of the tank. When this occurs, the sand must either be removed, cleaned, and replaced, or cleaned in place, depending on the system. Cleansing the sand in place is accomplished by backwashing -- reversing the direction of flow through the filter so that impurities are lifted from the sand and transported to a drain. The process requires a flow of about 10 to 15 gpm per square foot of surface area and takes about 3 to 4 minutes to complete.

Cost

A high-quality stainless steel filter begins at approximately \$175 for a 1.5 square foot unit (22.5 to 30 gpm) and increases to about \$475 for a 5 square foot unit (75 to 100 gpm).

Many portable above ground swimming pools use a complete pre-plumbed system consisting of a 1.2 square foot galvanized steel tank, a 1/2 HP pump, and a two-position backwash valve, which may be obtained for as little as \$180.

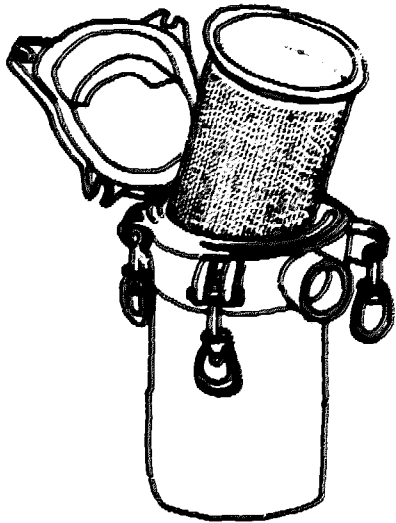

PRESSURE VESSEL FILTER

The pressure vessel filter is a compact filter which employs a porous bag to remove suspended material from the water.

Operation

Water in the system flows into the steel pressure vessel through an inlet port located near the top of the tank. The water enters the filter bag which is open at the top, flows through the bag and then exits the vessel through a port centered in the bottom of the filter vessel. Contaminants are thus collected in the filter bag, which is available in micron ratings from 1 to 800.

Maintenance

When the filter bag becomes filled, it must be changed. According to its manufacturers, the filter bag should require changing only about once every two years.

Cost

Cost data is not available for the pressure vessel filter.

PRESSURE VESSEL FILTER

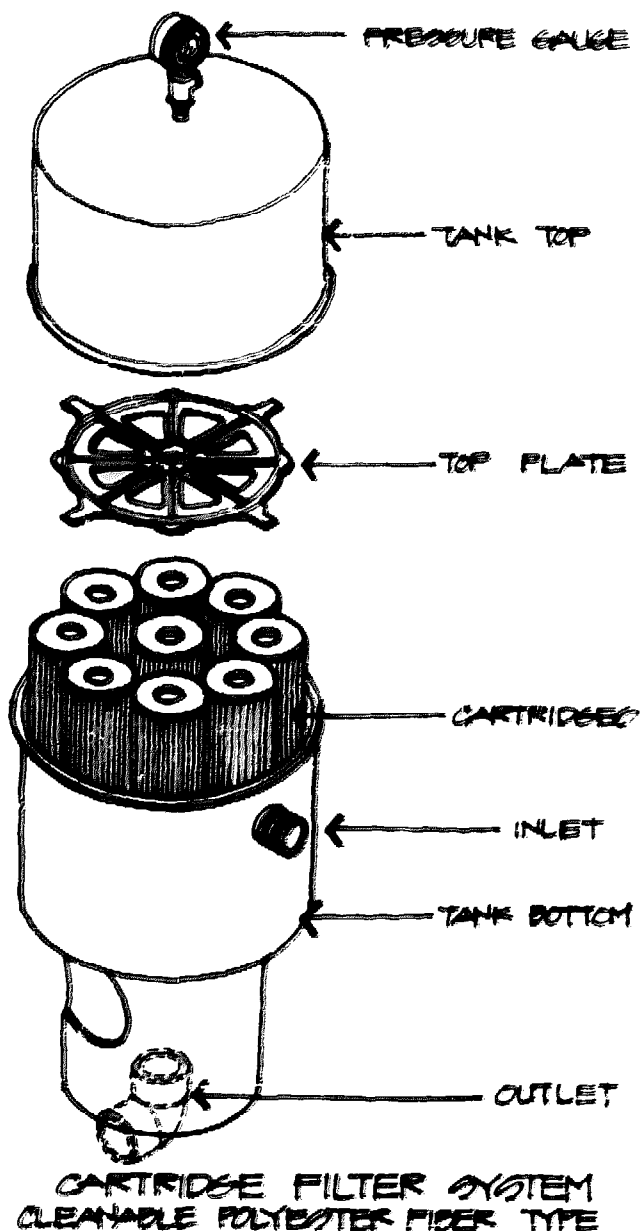

CARTRIDGE FILTER

The cartridge filter is a large-volume pressure filter which employs one or a series of cartridges as its filtration medium.

Operation

The cartridge filter basically consists of a round corrosion-resistant pressure vessel, usually stainless steel, within which the filter cartridges are mounted. As with in-line filters, the cartridges may be either disposable or reusable. There are two types of disposable cartridges. The first is made of wood fibers imbedded in phenolic resin. A network of fibers throughout its entire thickness traps and retains impurities. These filters are thus known as "depth-type" filters. The second type is made of sheet cellulose and is usually pleated to present a greater surface area. These filters employ only the surface of the filter to retain the impurities and hence are known as "surface-type" filters. Reusable cartridges are typically made of industrial type non-woven polyester fiber. Most filters, particularly those used with swimming pools, employ reusable cartridges. Cartridge filters were employed in two of the systems designed and tested by Cohen and Wallman (1974). These systems are discussed in the Systems chapter of this report.

The filtration capability of a cartridge filter varies with the total surface area of the cartridge and its

"maximum filter flow rate". Thus, a filter containing nine cartridges, each of which has a surface area of 6 square feet and a maximum filter flow rate of 1 gpm/sf, could filter a maximum of 54 gallons of water per minute. However, the actual flow rate depends on the pump which drives the water through the filter. Pump size may be varied to achieve a desired flow rate, but to prevent damage the flow rate must not exceed the maximum capacity of the filter. Cartridge filters are available with surface areas ranging from about 20 to 150 square feet. Most cartridges have maximum filter flow rates of 1 to 2 gallons per minute per square foot (gpm/sf).

Maintenance

The cartridge filter may be considered as an alternative to the diatomite filter. The cartridge filter does not employ diatomaceous earth in its operation, and this, proponents claim, is its primary advantage. Without diatomaceous earth the need for backwashing is eliminated. Hence, the need for the additional piping, special valves, and separation tank that is associated with a backwashing system, is also eliminated. The problem of disposing of the dirty diatomite filter cake is eliminated as well.

Cleaning a cartridge filter system involves shutting down the pump, relieving the pressure from the system, unclamping and removing the upper portion of the tank, and then removing and either cleaning or replacing the filter cartridges. Reusable cartridges are cleaned with a garden hose. Upon reassembly, the pump is restarted and all the air is bled from the system to reestablish pressure. A cartridge filter should not be exposed to grease and other kitchen wastes as it clogs too rapidly and is too difficult to clean.

<u>Type of Cartridge</u>	<u>Size of Particles Removed</u>
depth-type, fiber-resin (disposable)	5-10 microns
surface-type, pleated cellulose (disposable)	10 microns
polyester fiber (reusable)	5-10 microns
Nominal Solids Removal in Filter Cartridges	

Cost

Cartridge filters are available at a cost from about \$150 to \$350. A typical 36 square foot model which has a flow rate in the range of 36-72 gpm costs about \$200. These prices do not include a pump, although some manufacturers do offer complete pre-plumbed systems.

The average annual cost of replacing disposable cartridges is about \$40. Cleanable cartridges hopefully never need replacing. However, should one fail or become damaged, cost of replacement will be between \$4 and \$16 depending primarily upon whether the system uses one large cartridge or several smaller ones.

DIATOMITE FILTER

The distinguishing feature of the diatomite filter is that it employs a layer of diatomaceous earth caked onto the filter grids to remove suspended material from the water.

Operation

Diatomite is a hydrous form of silica formed from the shells of microscopic unicellular plants called diatoms. Diatomite is very light in color and weight and is found in sedimentary beds somewhat resembling chalk. The microscopic size of the diatoms gives diatomite extremely fine filtration capabilities. A diatomite filter typically can remove solid particles down to 1 micron (.001 mm) or less.

Similar to a cartridge filter, a diatomite filter consists of a cylindrical corrosion-resistant pressure vessel within which is mounted a series of filter elements. However, with diatomite filters these elements are more properly called grids since the diatomite is actually the filtering element. The grids are typically made of styrene plastic and are tightly fitted with a cover of mono-filament polypropylene or dynal. The diatomite is held against the exterior surfaces of the grids by the force of the circulating water.

When the diatomite filter cake becomes clogged it must be removed and a new layer applied. The condition of the diatomite cake is indicated by a vacuum gauge or manometer

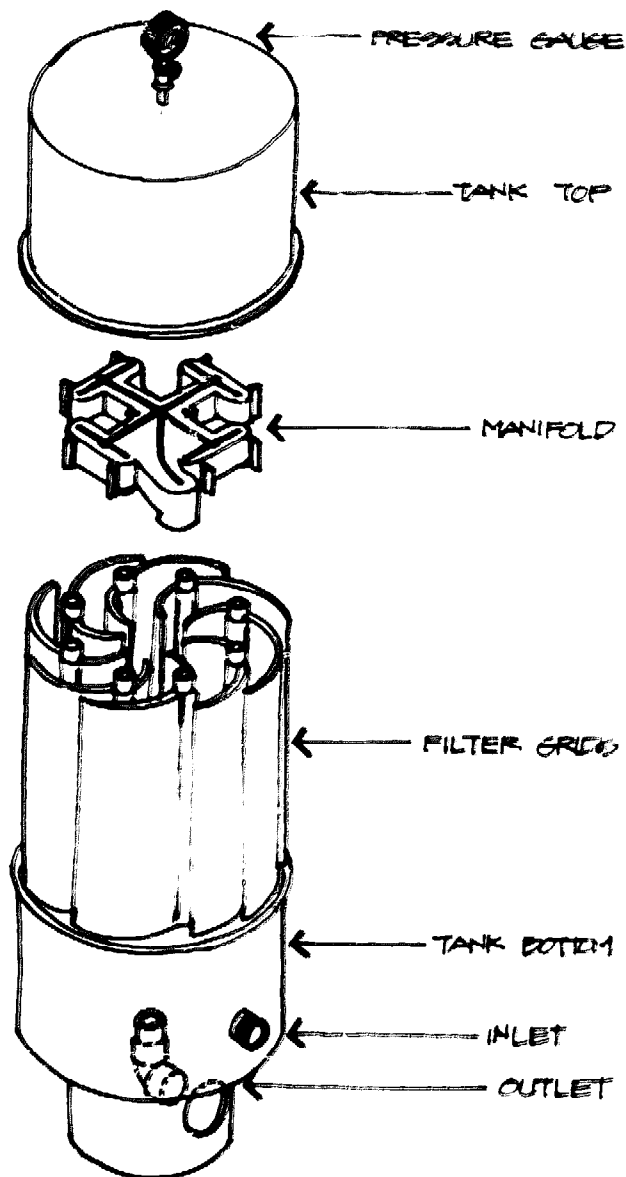

VERTICAL GRID FILTER

which measures the difference in pressure between the filter grids. When the pressure drop exceeds the value specified by the manufacturer the diatomite must be changed.

There are two generic types of diatomite filters available. Known as vertical grid filters and spin filters, they differ principally in the way the diatomite cake is applied and removed. Vertical grid filters have a slightly higher flow rate (3 gpm/sf) than spin filters (2 - 2.5 gpm/sf).

Vertical Grid Filters: The grids are semi-elliptical in shape and are arranged vertically in a spiral configuration approximately 1 inch apart. The spiral is very efficient in terms of flow distribution and enables a large area of grid to be accommodated in a relatively small volume tank. The dirty filter cake is removed by backwashing, which is accomplished by manipulating a series of valves to reverse the direction of the flow of water through the filter. The reverse flow lifts the clogged diatomite cake from the grids and transports it to a separation tank or, occasionally, to a drain. When the dirty diatomite cake is pumped to a separation tank the material is collected in a double-walled polypropylene bag which lines the tank. After the backwashing operation is completed the bag is removed, emptied into a garbage can, and reinstalled in the tank.

Spin Filters: The grids are disc shaped and are mounted 1 inch apart along a shaft which runs through the center of the tank. The circumference of each grid is sealed within the filter tank to prevent water bypass. To backwash the dirty filter cake from the grids, the valves are manipulated to direct the effluent to a separation tank or drain, the pump is started, and a hand crank which is mounted on the end of the shaft is spun vigorously. The centrifugal

force thus generated throws the diatomite from the grids. Professor McLaughlin, who built a greywater system for reuse in toilet flushing, felt that his 20 SF spin filter could have been smaller (McLaughlin 1975).

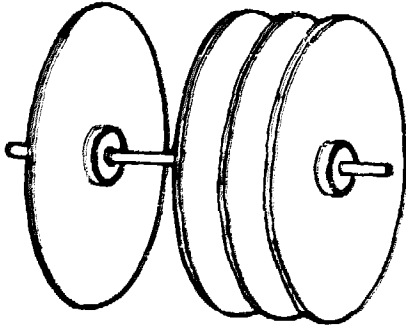

With both filter types, a sight-glass in the discharge line enables the owner to visually determine when removal of the dirty filter cake is complete. When the backwashing cycle is completed the pump is shut down, the valves are reversed, and the flow returns to its original direction. Backwashing typically takes 5 to 10 minutes.

Upon restarting the pump to begin a new filtration cycle a new layer of diatomite must be applied to the grids. In the case of a swimming pool, the diatomite is simply fed into the pool's skimmer.

Diatomite filters are not recommended for use in systems in which wastewater from the kitchen is recycled, as grease has a strong tendency to clog the diatomite.

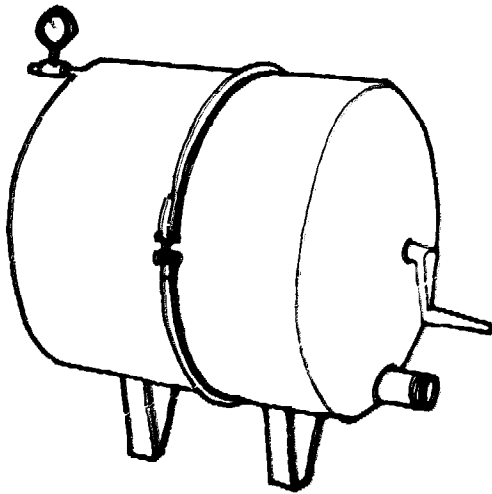

SPIN FILTER

Maintenance

The only regular maintenance required for a diatomite filter is the backwashing and diatomite cake application operation. The frequency with which this must be performed (as is the case with any filter system) is a function of the volume of water filtered and the quantity of solid material present in the water. In swimming pool applications a diatomite filter runs an average of 6 to 8 hours per day and requires backwashing only once every 2 or 3 months.

Backwashing usually requires slightly less time and is more complete with vertical grid filters. After several backwashing operations the owner will probably need to

disassemble and inspect the filter as the backwashing operation is never 100 percent effective in removing the diatomite cake from the filter grids.

Cost

The cost of a diatomite filter also varies with capacity. Typical prices for vertical grid filters are about \$300 for a 25 square foot unit (75 gpm) and about \$575 for a 72 square foot unit (215 gpm). Prices for spin filters are similar: a 15 square foot unit (30-37 gpm) is about \$250, while a 45 square foot unit (90-112 gpm) is about \$375.

Some diatomite filters do not perform well with only intermittent operation. Cohen and Wallman (1974) found that with no flow the diatomite cake fell from the element into the bottom of the filter, so when the pump was reactivated some wastewater passed through unfiltered before the diatomite was reapplied.

The filter grids for both filter types are designed to last the life of the filter. However, should a grid become damaged it may be easily replaced. Grids for spin filters typically cost about \$5 to replace, while grids for vertical grid filters cost between \$10 and \$15. A 25 pound bag of diatomite costs approximately \$5 and will last for several backwashing cycles.

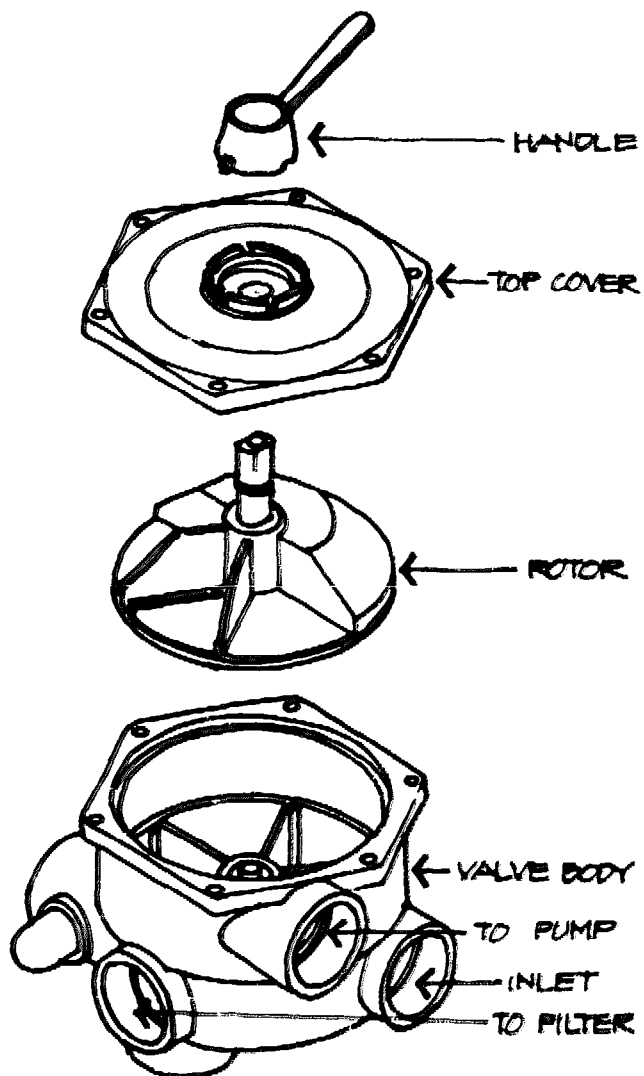

ROTARY BACKWASH VALVE

BACKWASH VALVE

The cleansing of a high-volume pressure filter by the process known as "backwashing" can be accomplished in one simple operation with the utilization of a backwash valve.

Operation

Sand filters and diatomite filters are designed to be purged of the solid material they have filtered out of the water by backwashing. This process essentially involves reversing the flow of water, which lifts the material from the filtering element and transports it to a drain or separation tank.

Prior to the introduction of backwash valves, such systems required gate valves in each plumbing line connected to the system. Flow reversal was achieved by closing all "normally open" valves and opening all "normally closed" valves. At the end of the backwashing cycle, of course, all valves had to be returned to their normal positions.

A backwash valve is designed to collect, at a single point, all of the plumbing lines associated with the filtering and backwashing operations, and thereby enable the backwashing cycle to be initiated and terminated by the actuation of a single valve.

There are two principle types of backwash valves available. They are the rotary valve and the push-pull valve.

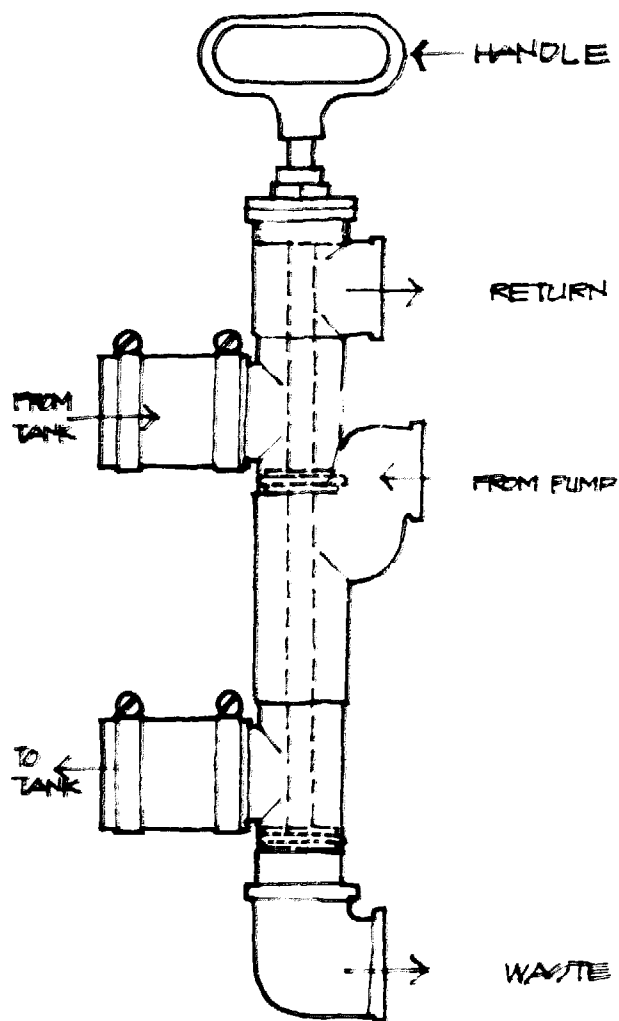

PUSH-PULL BACKWASH VALVE

Rotary Valve: A rotary valve is a six port, six position valve in which the desired flow pattern is selected by positioning the rotating valve handle into one of the six operating positions. Those ports which are not useful for the particular application are simply closed off with the plugs provided. The valve body is made of heavy duty plastic and is available with either 1 1/2 inch threaded ports or 1 1/2 inch socket ports. An optional kit is available which converts the 1 1/2 inch socket ports to 2 inch socket ports. It requires no maintenance or lubrication.

Push-Pull Valve: A push-pull valve is a five port, two position valve in which the desired flow direction is selected by positioning the sliding valve handle into either the up or down position. As in the case of the rotary valve, the push-pull valve is made of heavy duty plastic and is equipped with 1 1/2 inch ports. Different models of the push-pull valve are for the different types (sand or diatomite) of filters. This valve may require periodic lubrication or replacement of the valve-stem O-ring seals.

6.2

BACKFLOW PREVENTION DEVICES

Wherever contaminated water could conceivably reverse its direction and flow backwards into a potable water line some type of backflow prevention device is required. Backflow prevention devices are designed to prevent the unintended reversal of flow in supply lines and thereby eliminate contamination through "cross connections".

Backflow prevention devices take several forms but all may be classified as either mechanical or non-mechanical devices. Non-mechanical devices (the air gap and the barometric loop) contain no moving parts and employ natural physical phenomena to prevent backflow conditions. Mechanical devices (the check valve, the vacuum breaker and the backflow preventer) contain moving parts and thus have some possibility, however slight, of jamming or malfunctioning in some way. All of these mechanical devices are designed for a working pressure of at least 125 psi and are available for either cold or hot water service. Devices intended for cold water service will operate under temperatures ranging from 32°F to 110°F, while devices intended for hot water service may be operated at temperatures up to approximately 200°F. A final mechanical device, the surge tank, is designed specifically to eliminate the possibility of backflow occurring in a pressurized water distribution system.

All of the devices discussed herein provide protection against backflow. None, however, is foolproof. Most of the devices do not provide a positive indication of either device operation when backflow occurs, or device failure. However,

CROSS CONNECTIONS
AIR GAP
BAROMETRIC LOOP
CHECK VALVE
VACUUM BREAKERS
BACKFLOW PREVENTERS
SURGE TANK

two types of mechanical backflow preventers, the double check valve assembly and the reduced pressure principle preventer, are required to have test cocks as an integral part of their design. The test cocks, located both upstream and downstream of the check valves, enable the owner to periodically test the tightness of the check valves.

Maintenance

Although little maintenance is possible with air gaps and barometric loops, mechanical backflow prevention devices must be maintained in good operating condition in order to provide reliable protection against backflow and contamination. Primarily, the various components of the device must be kept free of particulate matter. Debris in the check valve can cause the poppet to improperly seat or be partially held open, resulting in check valve leakage. Some standards therefore recommend the use of strainers upstream of the check valve to trap the debris. Others, however, contend that this would cause too great a pressure drop in the line. Debris in the air port of the relief valve can prevent air from entering the line and displacing the vacuum during conditions of back-siphonage. Thus, most devices have separate air and water ports so that salts in the discharged water do not clog the air inlet.

CROSS CONNECTIONS

The most serious mistake which can be made in installing a greywater recycling system is to cause the contamination of the fresh water supply due to some type of cross connection. Simply defined, a cross connection is any physical connection or arrangement between the fresh water supply system and a system containing potentially contaminating material which could allow a flow to occur from one system to the other due to a pressure difference between the two systems.

Types of Cross Connections

Cross connections may be classified as direct or indirect. A direct cross connection is one in which the fresh water supply piping is mechanically joined to piping carrying potential contaminants. An example of direct cross connections are the interconnections which exist within a dual purpose water distribution system such as one which provides both potable water and service water in a laboratory. A negative pressure difference across a direct cross connection causes a "backflow" to occur.

An indirect cross connection might be thought of as a potential cross connection. In such a case the interconnection is not permanent and its completion requires at least three unexpected occurrences. For example, imagine a hose is connected to a household faucet. The

fresh water supply could become contaminated if a negative pressure occurred in the supply line at a time when the hose was submerged in dirty water. With an indirect cross connection, the negative pressure difference causes a back-siphonage to occur.

In either case, the flow results from a temporary reversal of the pressure difference. Thus, contamination of the fresh water supply will occur whenever the following conditions appear simultaneously: a cross connection; an adverse pressure differential; and the presence of a contaminant in what is normally the downstream side of the cross connection.

Unfortunately, adverse pressure differentials and the presence of contaminants in other systems cannot always be positively prevented. For example, high use demand placed on a city's distribution system in a densely populated area can cause fluctuating and sometimes negative supply pressure in a building. A fire department pumper truck can reverse the flow in nearby buildings. Draining a water supply system or hot water heater without venting air into the system can create vacuums within the system. Imperfections in workmanship at "tee" connections can produce restrictions of sufficient magnitude to cause water velocities to increase, and therefore pressures to decrease, to the point where a negative pressure is exerted on the side outlet of the "tee" connection.

Thus, many of the events which give rise to dangerous conditions occur quite unexpectedly, are not readily observable, and are sometimes beyond human control.

The EPA (1974) reports that since 1938 over 20 cases have occurred in which cross connections led to serious illness or death. One of the most famous cases took place in October

1969 when virtually the entire Temple University football team contracted infectious hepatitis. The cause was a drinking fountain on the practice field which was connected to the same supply line as the irrigation system. A heavy water demand due to a fire in the area caused surface water from around the sprinklers to be sucked into the potable water line. The remainder of the school's football games had to be cancelled that year.

One man in a California suburban community died after spraying his lawn with a weed killer containing an arsenic compound. He had been using an aspirator attached to a garden hose. At some time during the course of the application, the water pressure reversed, causing some of the weed killer to be back-siphoned into the fresh water supply line. Not having noticed the incident, he later disconnected the hose, drank from the bibb of the hose connection at the house, and thus ingested some of the arsenic-tainted water.

Codes

Plumbing codes are written to prevent installations which could result in cross connections. For example, codes now require an air gap of at least one inch between a faucet and the overflow line of the sink it serves. The same air gap is prescribed in the surge tank for "make-up" water supplied to boilers, chemical feed systems, and the like. Some codes even prohibit the use of hand-held shower hoses because of the possibility that the hose could be dropped into the dirty bath water at the moment a negative pressure condition occurred in the supply line.

Household Installations: The codes also specify the way in which household appliances must be installed, although do-it-yourselfers may not understand or even be aware of these requirements. Built-in dishwashers pose a serious

danger. If the drain hose is installed incorrectly and the check valve gets clogged, greywater from the garbage disposal can drain back into the dishwasher. Many codes require an air gap or vacuum breaker at sink level. Similarly, if the drain hose on the washing machine is installed incorrectly, by making a sealed air-tight connection at the trap, the pump could pressurize all the drains and sewers in the house causing unexpected mischief.

Whenever the household water is suddenly turned off and drained to make repairs, all sorts of negative pressures are created in the system. If the homeowner opens a trap, the "sucking" sound he hears is evidence that back-siphoning could have occurred if it had been attached to a hose submerged in dirty water.

Recycling Systems

The possibility of indirect cross connections can never be completely eliminated even in the best designed water recycling systems. Thus, the designer's objective must be to anticipate all possibilities for backflow and devise the safest possible system. A safe system is, of course, by no means an impossible technical problem, as is clearly demonstrated by the safety record of the flush toilet. In each one of the millions of flush toilets which are in existence, potable water and deadly black water are present simultaneously.

In designing systems which involve both potable and non-potable water, one should follow a few simple rules to achieve a safe level of protection:

- . Locate water supply inlets so that they cannot become submerged at any time.
- . Use an appropriate backflow prevention device to

protect receptacles which discharge into the sewer or any other system carrying material of lower quality.

- . Prevent equipment with pumps from creating back-pressure by installing an appropriate backflow prevention device.
- . Prevent closed systems from developing negative pressures by building some type of vent mechanism into the system.

For a more complete discussion of this topic see the Cross Connection Control Manual (EPA 1974).

AIR GAP

The simplest backflow prevention device is a space or "air gap" between the fresh water supply outlet and the overflow level in the volume of contaminated water. This configuration makes it impossible for water to return to the supply line once it has left the outlet.

Operation

An air gap exists in every household sink and tub. In all cases, the end of the faucet is simply located about 1 inch above the highest level to which the tub or sink can be filled.

An air gap provides positive protection against the backflow of liquid and solid contaminants. However, the effect of an air gap can be destroyed by the attachment of by-passes or any form of tubing to the end of the supply outlet such that the end of the tubing is below the overflow level of the receptacle.

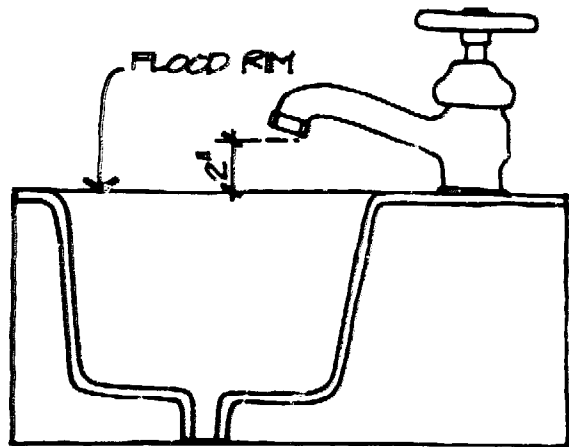

AIR GAP

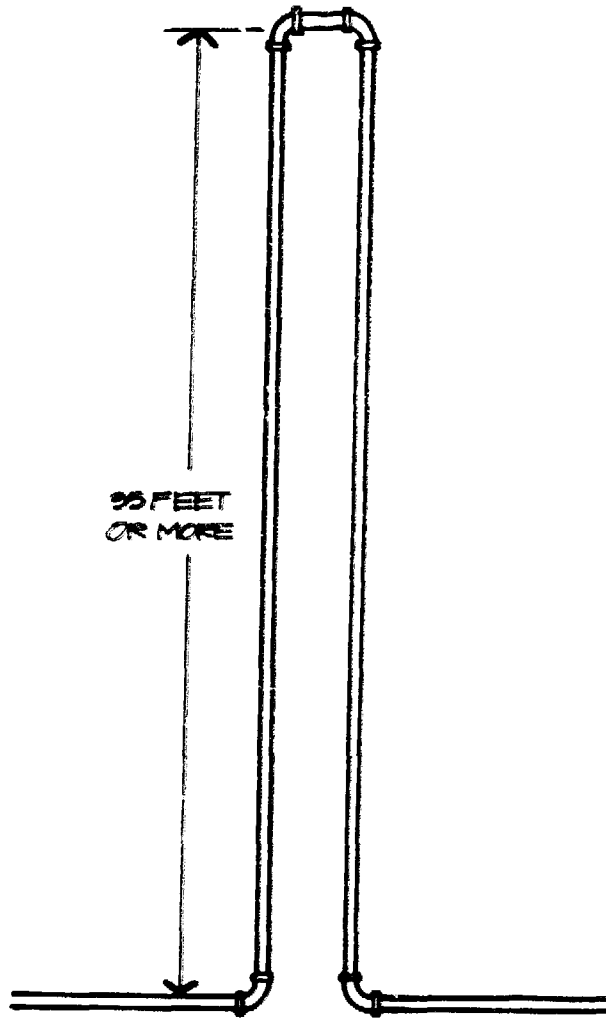

BAROMETRIC LOOP

BAROMETRIC LOOP

The barometric loop is nothing more than an elongated U-shaped bend in the supply pipe extended to a height above which siphonic action cannot occur.

Operation

Because barometric pressure is equivalent to a column of water 33.9 feet high, the top of this bend must, in practice, be approximately 35 feet above the highest opening. In view of the large height requirement, it is unlikely that a barometric loop is appropriate for anything other than systems built into new construction over 3 or 4 stories tall.

Barometric loops provide the least positive protection against contamination. It is conceivable that if air were to enter the downstream side of the loop, bubbles of sufficient size could form and rise to the top of the loop, each carrying a small quantity of contaminated water to the freshwater supply. Such an occurrence is known as the "air lift effect". Moreover, it is not known what effect temperature gradients might have on the transfer of contaminants over the loop. Finally, a barometric loop must not be used if there is any possibility of backpressure forming.

CHECK VALVE

The check valve is the heart of most mechanical backflow prevention devices. This device allows flow in one direction and prevents it in the other.

Operation

Located directly in the pipe which is to be protected, the check valve typically consists of a disc, ball, or poppet, housed in a cylindrical valve body and held in place with a light spring. Flow in the normal direction pushes against the disc, and by compressing the spring, moves the disc enough to allow water to flow past. The pressure at which the valve will open to permit flow in the normal direction is basically a function of the strength of the spring and is called the "cracking pressure".

Flow in the opposite direction, assisted by the spring, slams the poppet against its seat, thereby preventing flow from proceeding beyond the valve.

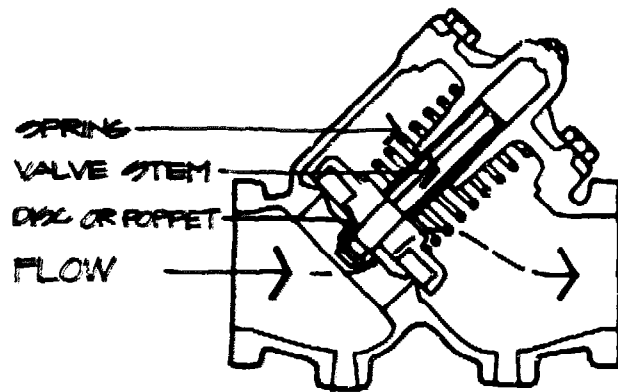

POPPET CHECK VALVE

VACUUM BREAKERS

Among the simplest of the mechanical devices are the "vacuum breakers". These devices are primarily intended to prevent back-siphonage and should not be incorporated in any system in which back-pressure could be applied to the device. Vacuum breakers are suitable for situations in which an air gap is not possible and the opening of the supply outlet may be in contact with potentially contaminating water.

Operation

All vacuum breakers are similar in their schematic configuration in that they each contain a check valve followed on what is normally the downstream side by an atmospheric relief valve. When pressure in the supply line drops so as to siphon water from the storage tank or other receptacle, the flow of greywater into the line is prevented by the check valve and the vacuum downstream is broken by air entering the line through the atmospheric relief valve. The atmospheric relief valve opens when the pressure in the line equals the atmospheric pressure. Most atmospheric relief valves will also discharge water to relieve pressure when it builds up.

Vacuum breakers are vulnerable to having the air ports of their atmospheric relief valves inadvertently blocked by rags and the like. Blockages of this nature will render these devices ineffective. It is important, therefore, that

the homeowner keep the air inlets of the vacuum breaker open.

There are three types of vacuum breakers: the "pipe applied", the "hose connection", and the "pressure type". Each of these devices is suited for a different application. Pipe applied vacuum breakers (PAVB) and hose connection vacuum breakers (HCVB) are intended for installation downstream of the supply control valve, while pressure-type vacuum breakers (PVB) may be located upstream of a supply control valve.

Pipe Applied Vacuum Breaker: This device is typically a single unit containing both the check valve and the atmospheric relief valve. It is available in sizes to fit 1/8 to 4 inch pipes and should be located at least 6 inches above the overflow line of the receptacle served.

Hose Connection Vacuum Breakers: As their name implies, these devices are used on a hose rather than on a pipe. Screwed onto the outlet end of the hose, it prevents back-siphonage from occurring due to a loss in supply line pressure in situations where the end of the hose is located at a level above the hose control valve. This device is available in sizes to fit both 1 inch and 3/4 inch hoses and must be set up such that the air vent cannot be submerged. The hose connection vacuum breaker is in its weakest mode of operation when subjected to back-pressure formed when the terminal end of the hose is elevated above the device. An HCVB will continue to provide protection in this situation as long as the check valve does not leak.

Pressure-Type Vacuum Breaker: This type of device is designed for systems using threaded pipe and is available to fit pipe sizes from 1/2 to 10 inches. PVB for pipes 2 inches or smaller consist of one check valve and an atmospheric relief valve located between two shut-off valves.

For pipes above 2 inches, the device consists of two check valves. The relief valve is located downstream of both check valves and the assembly is again located between two shut-off valves.

BACKFLOW PREVENTERS

The three devices discussed in this section are designed to prevent backflow due to conditions of back-pressure (rather than back-siphonage) and are thus appropriately called "backflow preventers".

Operation

Backflow Preventer with an Intermediate Atmospheric Vent: This device consists of two independently operating check valves separated by a chamber within which is an atmospheric relief valve to automatically vent the chamber to atmosphere. This device can prevent back-siphonage as well as back-pressure backflow, but is intended only for situations in which the contaminants are of low hazard. It may be operated under continuous or intermittent pressure conditions.

Reduced Pressure Principle Backflow Preventer: This device is similar in schematic configuration to the device described immediately above except that here the chamber is vented by a pressure differential relief valve. Thus, water generating excessive back-pressure in the chamber is vented to the atmosphere. Some models of the reduced pressure principle backflow preventer may protect somewhat against back-siphonage although, as noted, this is not its primary purpose. The reduced pressure principle backflow preventer is considered to be the best device available for situations in which the hazard is high. It is in its weakest mode of operation when subjected to the highly unlikely condition

of simultaneous back-pressure and back-siphonage. Given such a condition, the device will still provide protection if the upstream check valve does not leak. This type of backflow preventer is designed to operate under conditions of continuous pressure.

Double Check Valve Assembly: This device simply consists of two independently operating check valves. It contains neither an intermediate chamber nor any provision for automatic relief. Protection with this device depends entirely on the tightness of the check valves. As such, the double check valve assembly is appropriate only for situations in which backflow is undesirable, but does not constitute a hazard. This type of backflow preventer is available to fit threaded pipe sizes from 1/2 inch to 16 inches.

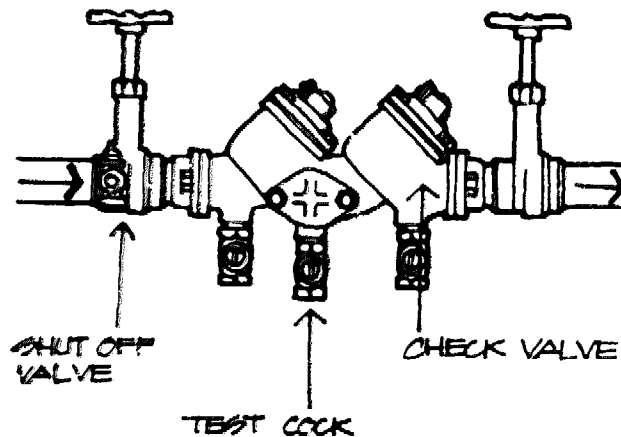

DOUBLE CHECK VALVE ASSEMBLY

SURGE TANK

A surge tank is specifically designed to prevent backflow into a water supply line from a pressurized distribution system. As such, it is composed of completely different components than the in-line mechanical devices and achieves its backflow prevention capability from the way in which these components are assembled.

Operation

A surge tank basically consists of a reservoir and pump combination with the water supply delivered to the reservoir through an air gap. The pump, which draws water directly from the reservoir, discharges the water into the distribution system under pressure. The flow of water into the reservoir is controlled by a float valve. As the water level in the reservoir falls, the float arm follows, opening the valve in the supply line. Because the supply line delivers the water through an air gap, water cannot possibly re-enter and contaminate the supply line once it has entered the reservoir. In residential systems the surge tank should be covered to prevent contamination of the water by airborne agents.

A surge tank can be used to serve single fixtures, equipment units, or entire systems. The size of the reservoir, pump, and supply line in each unit is determined by establishing the water supply demand rate of the system served.

6.3 CHLORINATORS

The term "chlorinator" is the common name given to any device which automatically feeds chlorine into a water system. Disinfection is easily achieved by continuously administering small doses of chlorine, in one of its various forms, to the water. Chlorine is the popular choice for disinfection because it kills pathogens quickly and then, in time, vaporizes from the water.

Many of the devices discussed herein were developed for residential swimming pools. The first two devices employ a liquid solution of chlorine, while the remaining three devices use a dry tablet form of chlorine from which a liquid solution is produced. The last device discussed, which goes by the trade name Iodinator, uses iodine crystals as a disinfectant.

Maintenance is generally quite simple for all of these systems. However, the most important step is too often forgotten. Testing the effectiveness of a chlorinator can be easily done with a standard swimming pool test kit. A similar test kit is available for the Iodinator. As a rough rule of thumb, if chlorine can be tasted or smelled in the water, too much is being used.

It should be noted that, of the systems surveyed in the previous chapter, few involved disinfection of the greywater. In most cases this was not included because the greywater was not permitted to stand for long periods of time and was used for non-contact purposes.

DISINFECTION
POSITIVE DISPLACEMENT FEEDER
ASPIRATOR
BASKET-TYPE TABLET FEEDER
FLOATING-TYPE TABLET FEEDER
IN-LINE TABLET FEEDER
THE IODINATOR

DISINFECTION

Theoretically all greywater could contain disease-causing organisms regardless of its source. Some argue, therefore, that all greywater should be disinfected. However, others argue that the need for disinfection should be determined according to the intended form of reuse.

Disinfection is less necessary in systems where the greywater is reused immediately and is reused for irrigation, toilet flushing, or similar non-contact purposes. However, regardless of its intended reuse, greywater must be disinfected in any system where it may be stored for more than a few days. This is a result of the fact that untreated greywater will gradually turn septic if allowed to stand quietly. The simplest way to prevent this from occurring is to agitate the greywater, aerate it, or expose it to the ultraviolet rays of the sun. Alternatively, greywater may be disinfected chemically with either chlorine or iodine.

Chlorine

Chlorine is the most common agent used for the disinfection of water because of its dependability, solubility in water, stability in storage, ready availability, relative economy of use, and high germicidal capability. If used in optimum concentrations, chlorine imparts no taste or odor to the water. Detectable concentrations of chlorine may be psychologically reassuring to the homeowner, but do not necessarily

provide any better protection from pathogens. The chlorine concentration should be great enough to satisfy the chlorine demand and provide a free chlorine residual of 0.4 ppm after a contact time of about 30 minutes (see Disinfection Terminology). Chlorine concentrations are most easily measured with an inexpensive swimming pool test kit.

Liquid chlorine occurs in the form of sodium hypochlorite. The most common form of this is household laundry bleach, which contains 5 percent available chlorine. Liquid chlorine from swimming pool supply houses contains from 10 to 20 percent available chlorine.

The most common source of dry chlorine is calcium hypochlorite. It is available in the form of granules or tablets from swimming pool supply stores and hardware stores. These compounds are classified as "high-test" hypochlorites and contain from 65 to 75 percent available chlorine by weight.

Calcium hypochlorite is fairly stable if kept dry, retaining 90 percent of its original chlorine content after one year's storage. When moist it loses its strength and becomes extremely corrosive. It should be stored under cool, dry conditions in a container that is resistant to corrosion and light.

Although it is sold in solid form, calcium hypochlorite is best applied in solution. Dry calcium hypochlorite may be added to water directly, although it is not a commonly recommended practice because it results in a less even distribution of the chlorine in the water. Dry calcium hypochlorite is best mixed with a small volume of water to form a chlorine solution of known strength and then added to the water to be disinfected. Fresh solutions should be prepared at frequent intervals because the strength of the solution deteriorates after preparation. Storage of the material in dry form is much more desirable.

Iodine

Bactericidal efficiency tests have revealed that free iodine solutions display greater antibacterial activity than chlorine at 75°F and 98.6°F, whether in the absence or presence of organic material. Iodine is chemically less reactive than chlorine in that it is less soluble in water, lower in oxidation potential, and less reactive with organic compounds. Thus, in a water supply residual iodine is more stable and persists longer in the presence of organic or any other oxidizable material. Moreover, iodine is more effective over a wider pH range. The manufacturers claim 100 percent effectiveness within the pH range of 5.0 - 9.0, which is incidentally the normal pH range of greywater.

Iodine is recommended for purifying drinking water only in situations where the consumers are of a transient nature and no person would consume iodinated water at a concentration of 1.0 mg/l for more than three weeks. However, no test performed to date has provided any good evidence that the same daily intake would be harmful on a more permanent basis.

The table of contact times shows that iodine requires two minutes or less to kill most pathogenic microorganisms.

Disinfection Terminology

The following paragraphs identify and discuss the most pertinent terms associated with the disinfection of water by chlorine.

Chlorine Demand: When chlorine is added to water for disinfection purposes, a portion of the chlorine combines with

Effectiveness of Iodine as a Disinfectant

(Time required for a 0.5 mg/l concentration of iodine
with a ph of 7.5 at 68°-80°F to kill all organisms listed)

<u>Bacteria</u>	<u>Disease Caused</u>	<u>Contact Time</u>
<i>Escherichia coli</i>	Cystitis of urinary tract	under 50 seconds
<i>Salmonella typhosa</i> P-4	Typhoid fever; gastro-enteritis	1 minute
<i>Salmonella typhosa</i> P-5	Typhoid fever; gastro-enteritis	1 minute
<i>Salmonella typhosa</i> P-10	Typhoid fever; gastro-enteritis	1 minute
<i>Salmonella paratyphi</i> P-2	Paratyphoid fever	1 minute
<i>Salmonella schottmuelerri</i> P-3	Paratyphoid fever	2 minutes
<i>Salmonella typhimurium</i> P-6	Food poisoning	5 minutes
<i>Shigella flexneri</i> P-7	Paradysentery	2 minutes
<i>Shigella dysenteriae</i> II P-8	Dysentery; intestinal ulcers	2 minutes
<i>Shigella sonneri</i> I P-9	Paradysentery	2 minutes
<i>Streptococcus fecalis</i> E-40	Can be pathogenic	2 minutes
<i>Staphylococcus aureus</i>	Septicemia, brain abcess, enteritis	50 seconds
<i>Staphylococcus epidermidis</i>	Subacute endocarditis	1 minute
<u>Virus</u>		
<i>Poliovirus</i> Type I	Polio	under 9 minutes
<u>CYSTS (@ 1 ppm iodine)</u>		
<i>Entamoeba histolytica</i>	Severe dysentery	Approx. 30 min.

Morgan, Donald P., and Raymond J. Karpen, Test of Chronic Toxicity of Iodine as Related to Purification of Water, U.S. Armed Forces Med. J. 4:725-728, 1953.

impurities in the water, such as organic materials, and is thereby rendered unavailable for disinfection action. The chlorine demand is the amount of chlorine taken up in combining with these impurities.

Contact Time: The period of time which elapses between the time when the chlorine is added to the water and the time when the water is used is known as the contact time. Contact time is required in order for the chlorine to perform its disinfecting function. The longer the contact time, the more effective the disinfection.

Chlorine Residual: In addition to the demand exerted by impurities, chlorine can also combine with ammonia nitrogen if it is present in the water, to form chlorine compounds that have some germicidal properties. These chlorine compounds are known as the combined chlorine residual. Free chlorine is a much more effective disinfecting agent than is combined chlorine.

Concentration: The amount of chlorine present in a given quantity of water is known as the chlorine concentration and is generally expressed as a percentage or in parts per million (ppm). A solution expressed as a percentage can easily be converted to parts per million and vice versa. For example, a concentration of 20,000 ppm may be rewritten as 20,000/1,000,000, which is equivalent to 0.02 or 2 percent. Less commonly, chlorine concentrations are expressed in milligrams per liter (mg/l). For water and other liquids with about the same density, milligrams per liter and parts per million are approximately equal. Generally, although not always, the higher the chlorine concentration, the more effective the disinfection and the faster the rate.

Temperature: The effectiveness of chlorine as a disinfecting agent varies with the temperature of the water. Chlorine is

more effective at higher water temperatures than lower.

pH: In simple terms, pH is a measurement of the acidity or alkalinity of the water. It is expressed in the form of a numerical value on a scale from 0 to 14, with 7 being neutral. Values less than 7 represent increasingly acid conditions, while values above 7 are increasingly alkaline. Chlorine is more effective as a disinfecting agent when the water has a lower pH value.

Determining Concentrations

The chlorine concentration which will result from adding a given amount of chlorine to a known volume of water can be simply calculated. If dry chlorine is used, the formula shown below may be employed. This formula yields results in units of mg/l which, as was noted, is equivalent to parts per million.

$$\frac{(\% \text{ available chlorine}) \times (\text{weight of chlorine added (lbs.)}) \times (453592.37 \text{ mg/lb})}{(\text{volume of water (gallons)}) \times (3.79 \text{ liters/gallon})} = \text{mg/l (or ppm)}$$

For example, a 1/2 pound of calcium hypochlorite granules containing 70 percent available chlorine would produce a concentration of 418.88 ppm when added to 100 gallons of water.

$$\frac{(.70) \times (5 \text{ lbs.}) \times (453592.37 \text{ mg/lb})}{(100 \text{ gallons}) \times (3.79 \text{ liters/gal.})} = 418.88 \text{ mg/l (ppm)}$$

This formula can be manipulated to determine the amount of chlorine required to produce a desired concentration.

$$\frac{\text{desired concentration (mg/l)} \times \text{volume of water (gallons)} \times (3.79 \text{ liters/gallon})}{(\% \text{ available chlorine}) \times (4535.92.37 \text{ mg/lb})} = \text{wt. of chlorine (lbs)}$$

For example, about 0.12 lbs of calcium hypochlorite granules would be required to produce a concentration of 100 ppm in 100 gallons of water.

$$\frac{(100 \text{ mg/l}) \times (100 \text{ gallons}) \times (3.79 \text{ liters/gallon})}{(.70) \times (453592.7 \text{ mg/lb})} = 0.119 \text{ lbs}$$

POSITIVE DISPLACEMENT FEEDER

A positive displacement feeder employs a small piston or diaphragm pump to draw a chlorine solution from a chemical reservoir (usually a small polyethylene tank) and inject it into the water system.

Operation

This type of feeder pump accurately and reliably meters the rate of chlorine solution administration and, in most cases, is equipped with controls that enable the feed rate to be adjusted while the unit is in operation. Given the operating pressure of the greywater system, the homeowner simply adjusts the flow rate and solution concentration to provide the desired chlorine concentration.

A positive displacement feeder should be equipped with a relief valve and a return line which diverts the chlorine solution back to the supply reservoir. These minor additions will prevent rupturing of the supply lines and/or burning out of the pump motor in the event that greywater system pressure exceeds the maximum operating pressure of the feeder pump. Many manufacturers include this return with their products.

In addition, if a large volume pump, such as a shallow well jet pump, is employed in the recycling system, the power wires of the feeder pump may be connected to the terminals

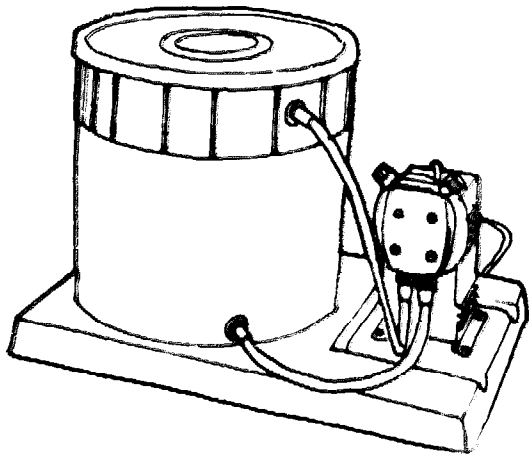

POSITIVE DISPLACEMENT FEEDER

of the circulation pump to make the feeder system operate concurrently with the pump. This type of chlorinator can be used with any water system, however it is particularly desirable in systems where water pressure is low and fluctuating.

A typical positive displacement feeder has an operating range of 0-75 psi. This feeder is available in a variety of sizes (and prices), which correspond primarily to the maximum solution feed rate which can be produced by the pump. A typical small feeder has a maximum feed rate of about 5 gallons per 24 hours at 30 psi. Large feeders have maximum feed rates many times greater. A positive displacement feeder is usually driven by a small 115 vac, 60 Hz fractional horsepower electric motor which may turn at a speed as low as 5 rpm.

Maintenance

The only regular maintenance that should be required for a positive displacement feeder is replenishing the chlorine solution in the supply reservoir. The pump and motor will, of course, experience normal wear.

Cost

The price of a positive displacement feeder varies primarily with its maximum feed rate. A small feeder costs approximately \$75, while a large model costs about \$120. Many manufacturers also offer "complete systems", which include the feeder, a polyethylene supply reservoir, a mounting base and the required hoses and fittings. A medium sized "complete system", whose feeder has a maximum feed rate of 11 gallons per 24 hours at 30 psi, costs approximately \$140.

ASPIRATOR

An aspirator is not a component in the sense that it is commercially available as a manufactured product. Rather, an aspirator can be put together by the homeowner with easily obtained parts.

Operation

An aspirator operates on the simple hydraulic principle that a vacuum is created when water flows either through a venturi tube or perpendicular to a nozzle. The vacuum draws a chlorine solution from a supply reservoir into a second reservoir where it mixes with the greywater that is passing through. The chlorinated greywater solution is then injected into the recycling system storage tank where it is diluted to the desired concentration by the rest of the greywater in the system.

Typically, the inlet line to the mixing reservoir delivers water from the discharge side of the recycling system's circulation pump. The chlorinated greywater solution is usually injected into the system on the suction side of the pump.

Because the chlorine solution is drawn from the supply reservoir by the flow of water, this type of chlorinator operates only when the system's circulation pump is operating. The flow rate of the chlorine solution is adjusted by means

of a control valve. Variations in system pressure, however, may produce changes in the chlorine solution feed rate.

Maintenance

Refilling the chlorine reservoirs and inspecting for air leaks or clogged lines is about all that is required.

Cost

The cost of an aspirator is essentially nil: all the jugs, tubes, and fittings can probably be found laying around the house or purchased at the local hardware store for a few dollars.

BASKET-TYPE TABLET FEEDER

This type of chlorinator requires that the recycling system include a pump, in order to push an adequate flow of water through the unit.

Operation

A basket-type tablet feeder basically consists of a plastic basket filled with calcium hypochlorite tablets and a shallow water reservoir into which the lower portion of the basket is immersed. During operation, a small portion of water circulating through the recycling system is diverted through the feeder inlet into the reservoir. The tablets in the bottom of the basket partially dissolve and thus form a chlorine solution in the reservoir. The solution then leaves the reservoir and flows into the storage tank, where it is diluted by the greywater to the desired level of uniform concentration.

The rate of chlorine administration is controlled by adjusting the depth to which the basket is immersed in the reservoir, and the rate at which the water is circulated through the reservoir.

Maintenance

Theoretically, the only regular maintenance required for a basket-type feeder is replenishing the supply of calcium hypochlorite tablets in the basket. Unfortunately, however, the tablets have a rapid dissolution rate and are not

completely soluble. As a result, the tablets in the basket frequently tend to coalesce which prevents further dissolution unless the flow rate and basket depth are precisely adjusted.

When this occurs, the basket must be removed from the feeder unit, cleansed of the coalesced material and refilled with fresh tablets. Caution must be exercised in handling and discarding the coalesced tablets. This type of feeder, then, necessitates frequent adjustment.

Cost

A basket chamber costs about \$40 but the cost of the tablets can vary widely.

FLOATING-TYPE TABLET FEEDER

This type of tablet feeder is designed to float on the surface of a residential-sized swimming pool and provide automatic chlorine administration on a continuous basis. However, because it does not require the integration of a pump, connection to any plumbing, or the use of electrical power, a floating-type tablet feeder could also be employed in a recycling system with the greatest of ease. The unit would simply float on the surface of the greywater collected in the recycling system storage tank.

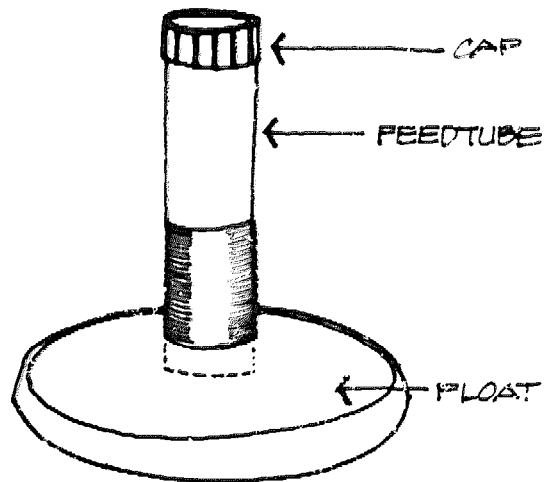

Operation

A floating-type tablet feeder consists of a feeder tube roughly the size of a tennis ball can, which is held in an upright position by a plastic floatation collar. The body of the feeder tube is perforated near the bottom with slots or holes to permit water to flow through the tube and come into contact with the calcium hypochlorite tablets.

The strength of the chlorine dosage is dependent upon the length of feeder tube suspended in the water, and is controlled by adjusting the body of the feeder tube up or down with respect to the floatation collar.

FLOATING-TYPE TABLET FEEDER

Maintenance

The only regular maintenance required with a floatation-type tablet feeder is replenishment of the calcium hypochlorite tablets. The need for tablet replenishment is determined by removing the cap and visually inspecting the contents of the feeder tube.

It should be noted however, that floatation-type tablet feeders may experience the problem of the tablets coalescing in the feeder tube, just as in basket-type tablet feeders.

Cost

A floatation-type tablet feeder costs less than \$15.

IN-LINE TABLET FEEDER

An in-line tablet feeder combines the primary features of a basket-type tablet feeder and a floatation-type tablet feeder.

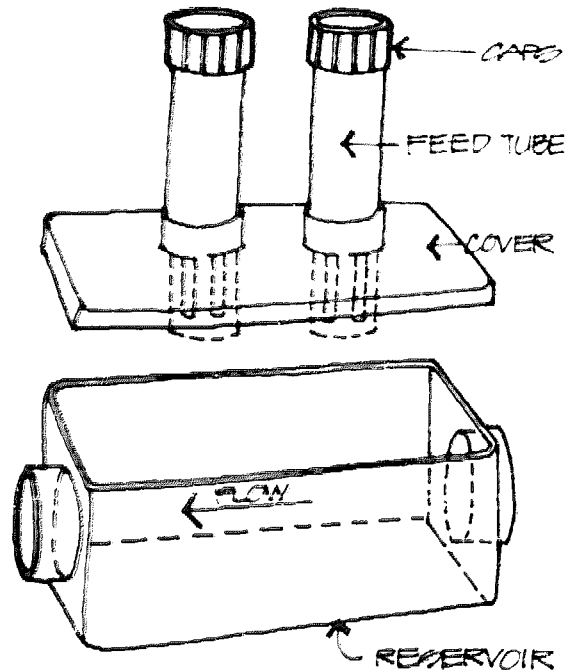

Operation

An in-line tablet feeder consists of a mixing chamber or reservoir, and two feeder tubes. The reservoir is designed to be located in one of the system's main supply lines (such as the line leading to the greywater storage tank).

The removable reservoir cover contains two specially sized apertures to accept the two feed tubes. The feed tubes contain slots or holes to allow water to pass through, and are adjusted up or down with respect to the reservoir cover to control the rate of chlorine administration.

Because the unit is an in-line apparatus, the entire volume of greywater flows through the unit, theoretically increasing the thoroughness of the disinfection. The unit does not require the use of electrical power, nor does it specifically require the integration of a pump, although effective chlorination requires adequate circulation.

IN-LINE TABLET FEEDER

Maintenance

All that is required is periodically replenishing tablets and checking for smooth flow.

Cost

An in-line tablet feeder costs less than \$15. The cost of tablets, however, may vary considerably.

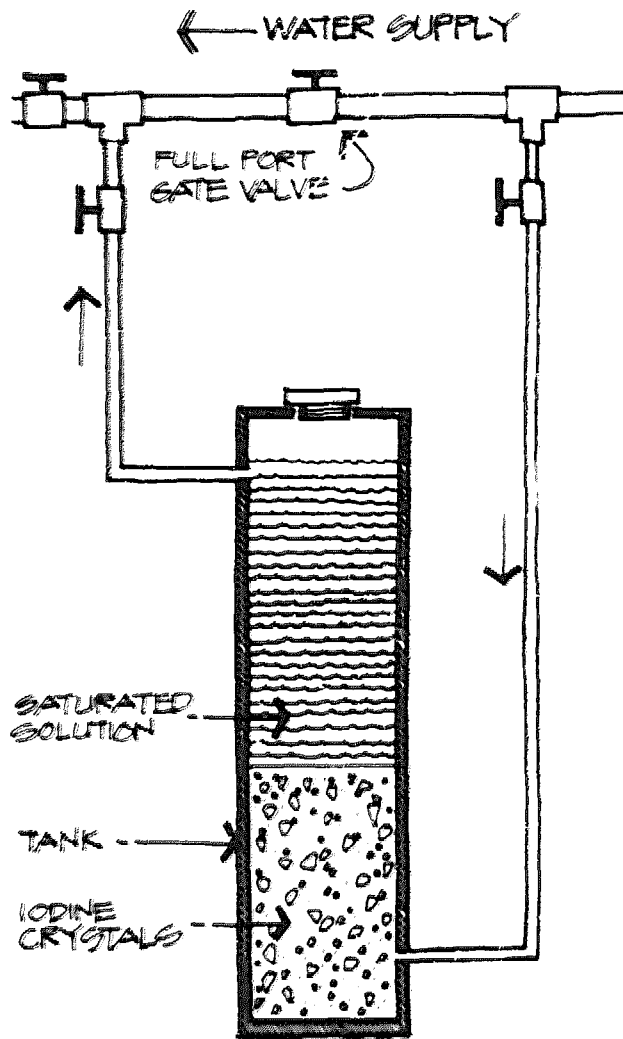

IODINATOR - FLOW DIAGRAM

THE IODINATOR

The Iodinator is the trade name for a simple system which utilizes iodine crystals instead of chlorine to disinfect household water supplies. Iodine is an effective disinfecting agent capable of killing many forms of bacteria, viruses and fungi. Iodine is also essential to plant and animal life. Lack of sufficient iodine in the diet is known to cause goitre, an enlargement of the thyroid gland. The Iodinator attempts to take advantage of this dual role played by iodine and provide a safe and reliable system which, according to its manufacturers, is more effective than systems which disinfect with chlorine.

Operation

The Iodinator is basically a tank made of PVC plastic, filled to about 1/3 of its depth with iodine crystals. The crystals are composed of elemental iodine (I_2), guaranteed by the manufacturer to be 99.5 percent pure. A full port gate valve located in the main water supply line is partially closed, creating a slight back pressure in the line. This slight back pressure causes a small fraction of the main water flow (theoretically 1/600) to be diverted through a "tee" connection located in the supply line upstream of the gate valve, and into the iodinator tank inlet. The water flows up through the bed of crystals and becomes chemically saturated with iodine (300 ppm at 68°F). The saturated water then leaves the tank and rejoins the main supply at a second tee connection slightly downstream from the gate

valve. There it is diluted to the recommended concentration of 0.5 mg/l (300 mg/l x 1/600). The dosage is controlled by adjusting the service valves located in the inlet and outlet lines.

Although not included in the package, it is strongly recommended that a holding tank be installed downstream to temporarily retain the iodinated water, thus providing the contact time required for effective disinfection. The holding tank should have a capacity of at least 15 gallons.

While designed for use in potable water supply systems, the Iodinator could also be a candidate for integration in a greywater recycling system.

It must be noted, however, that the saturation point of iodine varies with the temperature of the water. At a constant temperature only a finite amount of iodine dissolves in the water regardless of the length of the contact time. Thus, the system should be protected from temperature variation as much as possible. Once the water has become saturated and is out of contact with the iodine crystals, a temperature change has no effect on the concentration. In addition, the system should be set up so that operational pressure is maintained and flow rate remains unchanged. In field testing, the Iodinator has provided constant dosages over the pressure range of 0.5 to 40 psi.

Maintenance

The Iodinator has no moving parts and thus requires no maintenance per se. However, the residual iodine concentration in the water must be checked regularly, as with any disinfection system. The iodine crystals should be checked at least once a year and replenished when two-thirds depleted.

The only other maintenance is adjusting the Iodinator service valves, when necessary, to maintain the desired dosage.

Cost

The one pound Iodinator unit costs approximately \$160, while the five pound unit is about \$200. The package includes the container tank, flexible tubing, fittings, the two service valves, a supply of iodine crystals, and a residual iodine test kit. Replenishment crystals for the system are approximately \$12 to \$14 per pound. Each one pound of crystals is capable of treating 241,000 gallons of water at a concentration of 0.5 mg/l. This volume of water is equivalent to the average annual indoor consumption of 10 people.

6.4 CONTROLS

SOLENOID VALVE
PRESSURE REDUCING VALVE
PRESSURE RELIEF VALVE
FLOAT SWITCH
PRESSURE SWITCH
AIR VOLUME CONTROL

A number of different components are available which may be utilized by the homeowner to automate his system. These devices control the flow of water without requiring the presence or attention of the homeowner. Most of these components, such as the pressure relief valve, are simple mechanical devices. Others, however, are electrical devices which require the input of electrical power.

SOLENOID VALVE

With a solenoid valve, electricity is used to open and close the valve and thereby control the flow of liquids and gases. In homes, solenoid valves have been used for years in automatic washing machines and dishwashers, and in automatic lawn irrigation systems with electric time clocks. In greywater recycling systems, solenoid valves can be used in conjunction with electrical controls such as pressure switches, float switches and time clocks, to automatically regulate the flow of water (or air) in the system.

Operation

A solenoid is simply a spring-loaded iron plunger surrounded by an electric coil. When current flows through the coil, a magnetic field is created which pushes or pulls the plunger through the coil. The movement of the plunger compresses the spring and opens or closes the valve. The spring returns the plunger to its original position when the current is no longer applied to the coil.

As with most types of valves, the performance of a solenoid valve is rated primarily in terms of flow rates and operating pressures; both of which basically depend on the size of the valve. All valves are designed to withstand at least 200 psi, which is twice the pressure that is likely to occur in a residential plumbing system. The operating

pressure differential is the maximum pressure difference which may exist across the valve and still allow the valve to operate without leaking or jamming. Frequently the operating pressure differential is expressed as a range of pressures.

The chart presented below describes the performance of typical general purpose solenoid valves which are designed for either fluid flow or air flow.

Pipe Size (inches)	Maximum Water Flow (gpm)	Maximum Air Flow (scfm)	Operating Pressure Differential (psi)
1/8	3.8	34	0-300
1/4	4.2	28	0-150
3/8	34.4	226	5-150
1/2	44.2	292	5-150
3/4	61.5	380	5-125
1	139.5	910	5-125

Performance of Typical General-Purpose Solenoid Valves

Maintenance

There are essentially no maintenance requirements for a solenoid valve. Valve failure is usually due to dirt or corrosion on the valve seat or a short circuit in the electrical system.

Cost

The cost of a solenoid valve begins at about \$12 for a 1/8 inch valve and increases to about \$50 for a 1 inch valve.

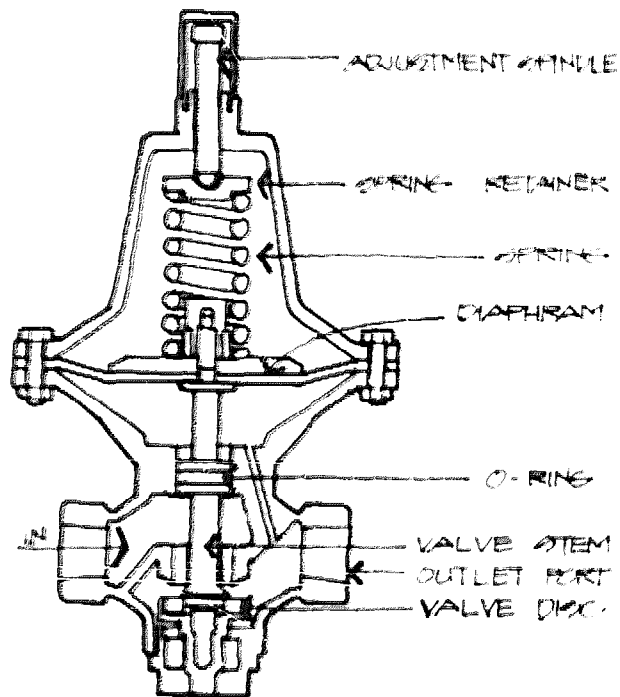

PRESSURE REDUCING VALVE

PRESSURE REDUCING VALVE

A pressure reducing valve is used to automatically regulate the pressure in the line downstream from itself. Thus, the device is appropriate for situations in which downstream equipment must be protected from excessive pressure or requires a constant pressure for optimum operation. Pressure reducing valves are also called pressure regulators.

Operation

Water from the downstream side of the pressure reducing valve enters the main valve cavity through an internal port. Increasing pressure in the downstream line, and hence the main valve cavity, causes the valve disc to move towards its seat. Flow through the valve body is thereby reduced or terminated until the downstream pressure falls to the preset level. The disc, which is balanced by an adjustable spring, moves away from its seat as downstream pressure decreases.

Selection of a particular valve is usually based on the desired system flow rate. The flow rate through a pressure reducing valve is a function of the friction losses, valve size, inlet pressure, the outlet pressure setting and the allowable outlet pressure variation (5 or 10 psi below the maximum allowable outlet pressure).

The following chart depicts the typical flow rates which occur under various conditions for 1/2 inch to 4 inch valves.

REDUCED SET PRESSURE-PSI	INLET PRESSURE-PSI	GALLONS PER MINUTE																	
		Reduced Pressure Change from Minimum to Maximum Flow																	
		1/2"		3/4"		1"		1 1/4"		1 1/2"		2"		2 1/2"		3"		4"	
		PRESSURE DROP-PSI																	
		5	10	5	10	5	10	5	10	5	10	5	10	5	10	5	10	5	10
25	50	7	13	15	26	17	28	31	60	42	81	89	123	220	395	298	530	385	685
	75	9	17	17	29	21	34	38	75	52	96	101	132	350	630	450	800	580	1020
	100	11	20	21	36	23	39	46	92	65	111	120	148	441	790	565	1000	725	1280
	150	14	25	24	48	29	48	62	115	83	142	131	155	590	1050	740	1310	940	1650
50	75	7	13	15	26	17	28	31	60	42	81	89	123	220	395	298	530	385	685
	100	9	17	17	29	21	34	38	75	52	96	101	132	350	630	450	800	580	1020
	150	12	22	22	40	25	42	51	101	71	121	124	151	550	990	645	1050	870	1530
75	100	7	13	15	26	17	28	31	60	42	81	89	123	-	-	-	-	-	-
	150	11	20	21	36	23	39	46	92	65	111	120	148	-	-	-	-	-	-

Performance of Typical Pressure Reducing Valves

Maintenance

Pressure reducing valves do not require regular maintenance. A flexible diaphragm which produces the movement of the valve disc is the only part in the valve which is really susceptible to failure and this is an uncommon event. Should it occur, however, the valve is easily disassembled and the diaphragm replaced.

Cost

The cost of a pressure reducing valve varies primarily with size. Costs begin at about \$20 for a 1/2 inch valve. A 2 inch valve is about \$120.

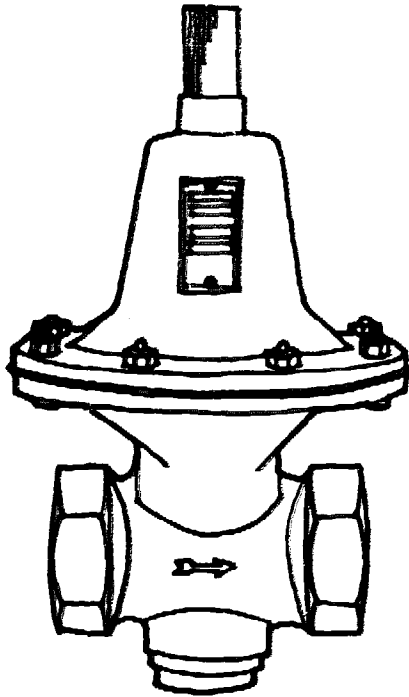

PRESSURE REDUCING VALVE

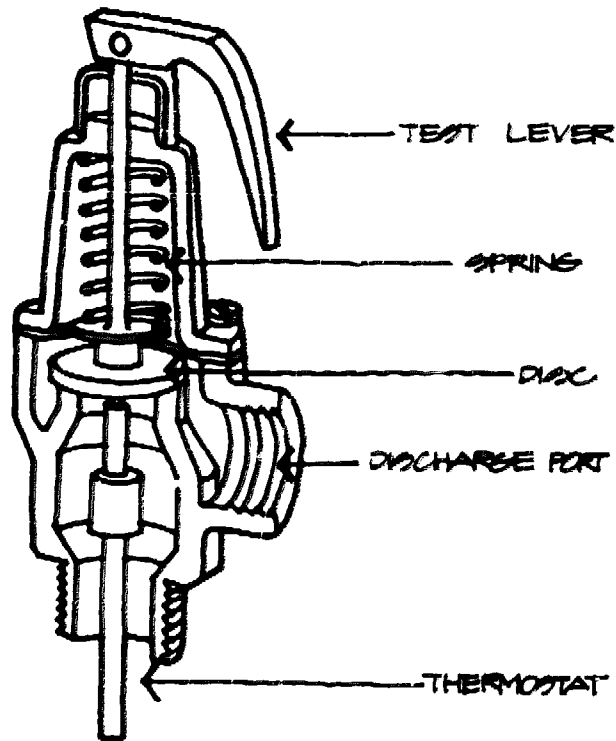

RELIEF VALVE
TEMPERATURE - PRESSURE TYPE

PRESSURE RELIEF VALVE

A pressure relief valve is a simple safety device which opens at a designated pressure and allows air or water to escape, thereby protecting components such as pipes and tanks against rupture.

Operation

A typical pressure-actuated relief valve consists simply of a spring-loaded disc seated in a cast-metal valve body. The end of the valve body is threaded into a "T" pipe connection or directly into a tank.

Under normal operating conditions, the spring holds the disc tightly against its seat, preventing any flow of air or water. As the pressure increases, it forces the disc off its seat and the air or water escapes. Most relief valves can be adjusted to open at any point within a broad range of pressures. Frequently this range is 25 to 125 psi. A valve with a 1/2 inch discharge opening may allow an escape flow rate as high as 6 gpm.

Maintenance

A relief valve requires no regular maintenance. About the only way one can fail is by the disc becoming permanently welded to its seat due to corrosion. A handle is mounted

on some models to enable the owner to periodically check the valve for proper operation by pulling up and thereby manually unseating the valve disc.

Cost

Most simple, adjustable relief valves cost less than \$7.

FLOAT SWITCH

A float switch is an electric switch which is activated by the movement of a float in response to the changing water level in a tank or other container. Thus, like a pressure switch, the float switch provides a simple means of automatically controlling pump operation.

Operation

A typical float switch consists of a small single-pole toggle switch with the on/off lever linked to an arm which has a float mounted on the end. Typically, a vertical float rod passes through a hole in the switch lever. Adjustable stops are clamped onto the rod, both above and below the switch. Thus, as the water level in the container falls, the float follows. At the designated lower limit of the water level, the upper stop on the float rod forces the switch lever down, starting the pump. A float switch can, of course, perform other functions as well, such as activating indicator lights or warning bells.

A float switch is designed to give long trouble-free service. Highly reliable designs have evolved over the years because the failure of this inexpensive little item could cause extensive and costly damage in difficult to reach and highly corrosive environments.

Maintenance

The maintenance requirements of a float switch are minimal. They need no lubrication or cleaning. Perhaps after 5 or 10 years of operation, however, the contact points in the switch itself will require replacing.

Cost

A complete float switch assembly, consisting of a switch, bracket, copper float and a 12 inch rod, costs approximately \$10. Individual replacement switches cost between \$4 and \$7.

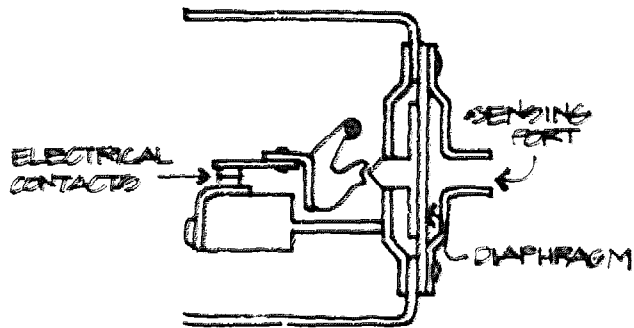

PRESSURE SWITCH - ON

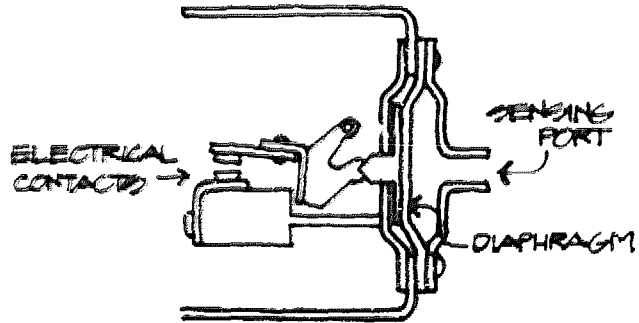

PRESSURE SWITCH - OFF

PRESSURE SWITCH

A pressure switch is an electric switch that is actuated by a change in the pressure of air or liquid. In residential plumbing systems supplied by pumped well water, pressure switches are utilized to maintain pressure in the system. In a water reuse system, a pressure switch can be similarly employed and thereby contribute to system automation.

Operation

Typically, a pressure switch is mounted on the outside of a storage tank in conjunction with a pressure gauge. Water or air from the tank reaches the switch through a tube and pushes against a water-tight diaphragm which in turn pushes against a linkage held in place by an adjustable spring. Movement of the linkage, as controlled by the diaphragm and the spring, forces the electrical contacts in the switch to open and close, thus stopping and starting a pump wired to the switch.

Pressure switches are produced in various models for different pressure ranges. The three most common ranges are 20-40 psi, 30-50 psi and 40-60 psi. In some models, the precise pressure at which the switch is turned on and off is adjustable. Preset models turn the pump on at the lower limit and turn it off at the upper limit.

Maintenance

A pressure switch should provide many years of trouble-free service. No regular maintenance is required. Occasionally, however, one may fail. The most common problem is pitting of the contact points, although pressure leaks at the connection to the tank and corrosion of the linkage may also occur.

Cost

A pressure switch costs about \$10, regardless of the pressure range selected. The difference in the price between adjustable and preset models is negligible.

AIR VOLUME CONTROL

An air volume control is a simple device used to maintain the appropriate volume of air in the pressure tank of a water pressurizing system. The function of the air volume, as well as the importance of properly maintaining it, is discussed in the section entitled Pressure Tanks, which is also located in the Components chapter of this report.

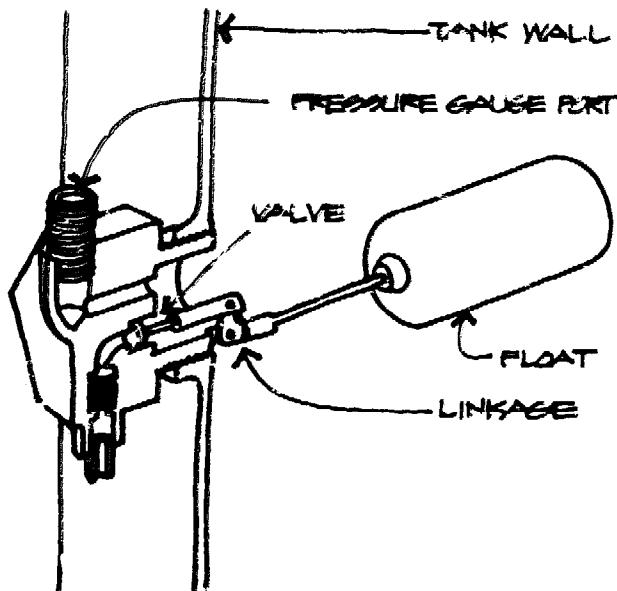

AIR VOLUME CONTROL

Operation

The most common type of air volume control is the float type, which consists basically of an air release valve connected by a simple linkage to a float arm. The valve body is mounted, via a threaded port, on the outside of the tank wall with the float arm assembly penetrating into the tank volume. As the water level in the tank falls, the float follows, activating the linkage which opens the air release valve. In most cases the valve body also contains an auxiliary valve which limits the outflow of air in the event of a pump failure, and a threaded port onto which can be mounted a pressure gauge. A float-type air volume control can, in most cases, be operated within the pressure range of 0-100 psi.

Maintenance

There are no maintenance requirements for a float-type air volume control device.

Cost

A complete float-type device, including the float arm assembly, valve body, and pressure gauge, costs approximately \$12. An air volume control alone, without the pressure gauge or other accessories, costs about \$8.

6.5 PUMPS

For residential recycling systems, excluding only those in which the water flows completely by gravity, the most important component will be a hydraulic pump. A pump can be used to circulate the water through the system's pipes, force the water through a filter, lift the water up to a holding tank or maintain static pressure in the system.

The pumps most suitable for use in residential recycling systems are all variations of the centrifugal pump. They are designed for situations requiring large flow rates under conditions of relatively low pressure.

The nine types of pumps described herein may be classified into four major categories: shallow well pumps, deep well pumps, sump pumps and utility pumps. The shallow well pumps (the standard centrifugal pump, the swimming pool pump and the shallow well jet pump) are appropriate for situations in which the water level is no more than 20-25 feet below the level of the pump. The deep well pumps (the deep well jet pump and the deep well submersible pump) are designed specifically for drawing water from a well more than 25 feet deep, and are included here because recycling could occur in the form of groundwater recharge and subsequent reuse. Sump pumps (the submersible sump pump and the upright sump pump) are designed to sit on the bottom of the water source and to pump it dry. Sump pumps are particularly suitable for recycling operations that require simplicity, low maintenance and high reliability.

STANDARD CENTRIFUGAL PUMP
SWIMMING POOL PUMP
SHALLOW WELL JET PUMP
DEEP WELL JET PUMP
DEEP WELL SUBMERSIBLE PUMP
SUBMERSIBLE SUMP PUMP
UPRIGHT SUMP PUMP
RECIRCULATING PUMPS
DRILL-DRIVEN PUMP

Utility pumps (the recirculating pump and the drill driven pump) are the least expensive pumps and are suitable for low flow rate, intermittent recycling operations.

Pump Capacities

The capacity of a pump is rated in terms of the flow rates the pump produces in gallons per minute (gpm) under various conditions of "total pumping head", which is rated in feet.

For the purposes of this discussion, the action of a pump can be simply divided into two stages. The first, assuming that the surface of the water stands at a level below that of the pump, is lifting the water from the source to the pump inlet. The second, assuming that the destination of the water is above the level of the pump, is pushing the water up to its destination.

A pump can never "suck" water higher than 33.9 feet. A pump lifts water from a lower level source by reducing the pressure in the inlet pipe below atmospheric pressure (creating a relative vacuum). As the pressure in the inlet pipe falls, the pressure exerted by the atmosphere on the surface of the water outside the pipe forces the water in the pipe to rise. If a pump could reduce the pressure in the pipe to absolute zero, the water in the pipe would only rise to a height of about 34 feet. This is a result of the fact that water weighs 62.4 lbs./cu.ft., or 0.36 lbs./cu.in. At this weight, a column of water 2.3 feet, or 27.69 inches high, will be sustained by each 1 psi of pressure. Atmospheric pressure, which is approximately 14.7 psi, will therefore lift a column of water 33.9 feet ($2.3 \text{ ft./psi} \times 14.7 \text{ psi} = 33.9 \text{ ft.}$). Conversely, every foot in height of a column of water will exert a pressure of 0.434 psi. Thus, with

Technically speaking, the "pump" consists only of the mechanism which actually moves the water. Most references, however, use the term to include the motor which drives the pump mechanism. This report does the same and uses the term "pump mechanism" or "pump head" to distinguish the pump itself from the pump motor combination when necessary.

the pressure in the inlet pipe at absolute zero, equilibrium would be reached when the column of water in the pipe exerted a downward pressure in the pipe equal to the atmospheric pressure.

In reality pumps are not that efficient, as the best pumps can only produce sufficient suction to lift the water about 25 feet. Less expensive pumps, moreover, may only lift water about 15 to 18 feet. The height to which the water can be lifted to enter the pump inlet is known as the "suction lift".

Once the water level has reached the pump head, the function of the pump is to increase the pressure on the water an amount above atmospheric pressure sufficient to lift the column of water up to its destination. The height above the pump to which the water can be lifted is known as the "delivery head".

In both stages of pumping action, the pump must also overcome the friction generated by the water moving against the interior surfaces of the pipes, around the pipe elbows, and across any sharp edges. The loss in pressure due to friction is also rated in "feet of head". This enables the "total pumping head" to be easily determined; it is the sum of the suction lift, the delivery head, and the friction head. A pump will thus produce flow in a recycling system if the pump is of sufficient capacity to overcome the pumping head inherent in the system. The work done by a pump is constant: When the total pumping head in the system is high, the flow rate for any given pump will be low, and vice versa.

Good Head:

An automobile careens out of control and shears off a fire hydrant. A 100 ft. tall geyser of water shoots straight up in the air. This oft-repeated movie stunt is a nice illustration of hydraulic head. Somewhere there is a pump capable of delivering 100 feet of head, or a storage tank or reservoir 100 feet above the hydrant. Incidentally, the static pressure in the hydrant was $100 \text{ ft.} \div 2.3 \text{ ft./psi}$ or about 43 psi, slightly less than the average residential system.

Centrifugal Pump Operation

The basic element of a centrifugal pump is a curved impeller which rotates within a spiral-shaped housing to centrifugally push water out toward a discharge outlet at the perimeter. The whirling impeller blades create a partial vacuum at the pump inlet. The water is drawn by this partial vacuum into the center of the impeller and then is thrown outwards, by the movement of the impeller blades, into the stationary housing. The spiral shape of the housing provides a volume which increases in size as the water approaches the discharge outlet. This configuration reduces the velocity and thus increases the pressure of the water as it leaves the impeller.

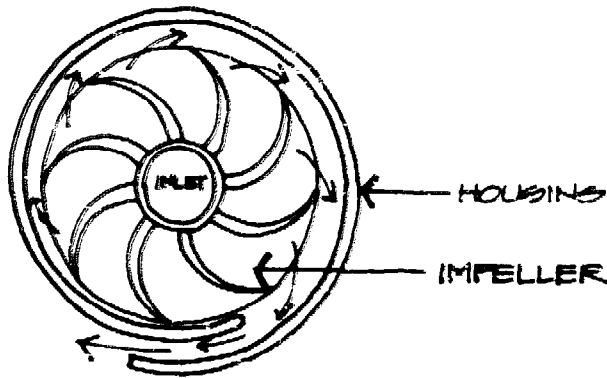

A centrifugal pump must contain a continuous body of water, devoid of any trapped air, or it will spin uselessly when the motor is started. If allowed to run in this condition, the motor will burn out after a short period of time. "Priming" is the process in which water is added to the pump to displace a volume of trapped air. Unless provided with a priming reservoir, centrifugal pumps are not usually self-priming and, thus, work best when located below the level of the water source. This configuration keeps water in the pump inlet and impeller housing at all times. A pump can, in many cases, be made self-priming if a check valve is located in the line upstream of the pump inlet.

Centrifugal pumps are usually driven by electric motors, although pumps powered by small gasoline engines are available for use in situations where electrical power is not readily available. Electric powered pumps, which are available with motors ranging from 1/200 to 2 horsepower (HP), in almost all cases run at a speed of either 1,725 or 3,450 revolutions per minute (rpm). Generally speaking, the smaller motors (1/4, 1/3 and 1/2 HP) operate on 110 volt alternating current (vac) while the larger motors operate on either 110 or 220 VAC.

Maintenance

Centrifugal pumps require very little maintenance. Because of their simple design, only two parts are subject to wear: the seal and the bearings. The seal may be of either the lip type or the mechanical type. A lip seal is a flexible ring, made of rubber or a similar material, whose inner edge is held closely against the rotating shaft by a spring. Lip seals are subject to normal wear and occasionally a spring failure. A mechanical seal has two parts, one rotating and one stationary. The surfaces of these parts are highly polished and in constant contact with each other. If it resists corrosion, a mechanical seal will have excellent sealing capacity and long life. It can, however, be damaged by dirt or grit. Thus, in recycling systems which will include a filter as well as a pump, the homeowner should try to locate the filter upstream of the pump.

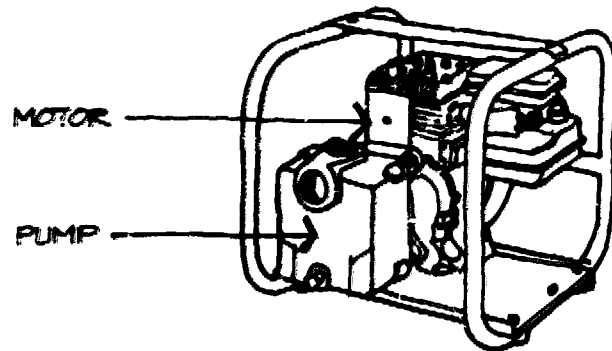

GASOLINE - POWERED CENTRIFUGAL
PUMP

Lubrication of the bearings, a pump's most common maintenance requirement, is needed approximately twice a year. Typically however, this maintenance is not performed until grinding or whining noises begin to be heard. Should the pump be located where its operation is not normally audible, bearing wear could easily go unnoticed and eventually result in freeze up and burn out of the motor. This problem can be avoided by using a pump with permanently lubricated bearings.

Submersible pumps that are designed to operate continuously under water virtually eliminate maintenance by using sealed motor housings and permanently lubricated bearings. Some have built-in water level switches, although others require remote electrical controls such as solid state water level sensing switches, mechanical float switches and the like.

STANDARD CENTRIFUGAL PUMP

The hydraulic equivalent of the Model T, the basic centrifugal pump is simple, completely reliable, and getting harder to find all the time.

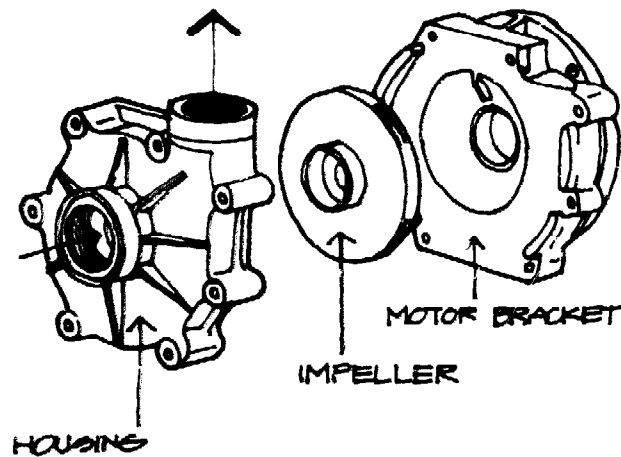

CENTRIFUGAL PUMP HEAD

Operation

The centrifugal pump head and its electric motor can each be purchased separately. In this situation, the number of motors differing with respect to horsepower, type of enclosure, type of bearings, method of mounting, and degree of thermal protection increases greatly, usually to the point of total confusion. However, commercially available pre-assembled pumps and motors should be adequate for residential recycling systems, and therefore selecting separate pump heads and motors is generally not recommended. If they are purchased separately, the homeowner must insure that the pump head is the correct size for the horsepower and rotational speed of the motor, and that the pump head will align and mate with the motor without the excessive use of adaptors and special fittings.

Gasoline powered pumps are available with 2, 3 or 5 HP, 4-cycle recoil-start engines which operate at a speed of 3600 rpm. Gas powered pumps are usually self-priming and come either secured to a mounting bracket or to a cage not unlike a portable gasoline powered electric generator.

The following chart depicts the performance of a typical

centrifugal pumps. Flow rates are given in gallons per minute (gpm).

HP	Total Pumping Head (in feet)						
	5 ft.	10 ft.	15 ft.	20 ft.	30 ft.	40 ft.	50 ft.
1/3	27	26	25	23	17	12	2
1/2	43	37	32	28	20	16	10
3/4	83	78	70	68	57	47	22
1	89	86	83	76	67	54	37
1 1/2	95	94	92	88	77	66	52

Performance of Typical Centrifugal Pumps

Cost

The cost of a simple centrifugal pump begins at about \$70 for a 1/3 HP model and increases to approximately \$170 for a 2 HP model.

SWIMMING POOL PUMP

The swimming pool pump is the most readily available type of pump suitable for use in a residential recycling system.

Operation

A swimming pool pump is simply a centrifugal pump head and electric motor assembly with a built-in lint and hair strainer pot located upstream of the pump inlet. During pump operation, hair, lint and other coarse materials are trapped in the plastic strainer basket nested in the strainer pot. When the basket becomes filled, the lid is unclamped and the basket removed, cleaned and replaced. Some models are available with transparent plastic strainer pot lids to enable the homeowner to visually inspect the basket without shutting down the system. A pressure gauge, installed in the discharge line, may also be used to indicate when the basket needs cleaning.

Cost

A swimming pool pump is considerably more expensive than a simple centrifugal pump both because of the addition of the strainer pot and because a swimming pool is a luxury commodity. It is conceivable, however, that the utilization of a strainer pot may, in some situations, make the installation of a filter unnecessary. The cost of a swimming pool pump begins at about \$150 for a 1/2 HP model and increases to about \$250 for a 2 HP model.

SHALLOW WELL JET PUMP

The shallow well jet pump is a combination of a centrifugal pump and an ejector unit. It is of interest with respect to recycling systems for two principal reasons. First, it is capable of lifting water from a deeper source than a centrifugal pump of equal size acting alone. Second, it is readily mounted atop, and integrated with, a pressure tank to maintain pressurized water for reuses such as toilet flushing and irrigation.

Operation

The additional suction lift capability of the shallow well jet pump is achieved with the ejector unit. This unit is mounted on the face of the impeller housing and consists of a tapered nozzle inserted into the end of a venturi tube. During operation, about 50 percent of the water discharged from the pump is diverted through a diffuser located at the bottom of the impeller housing and back into the ejector nozzle. The taper in the nozzle causes the water to suddenly increase in velocity as it leaves the nozzle and enters the venturi tube. The increased velocity of this water jet reduces the pressure within the venturi tube and thereby creates a partial vacuum which provides more suction lift than normally produced by the centrifugal pump alone. Water from the source is drawn through the suction pipe which joins the ejector unit at the entrance to the venturi tube. The diameter of the venturi tube then gradually increases as the water passes through it. This

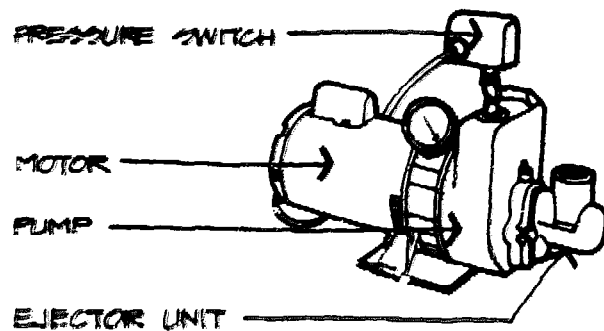

SHALLOW WELL JET PUMP

configuration slows the water velocity back down and thereby recovers almost all of the water pressure. The centrifugal pump picks up the flow at this point, discharging part of it and returning the rest to the ejector nozzle to sustain the operation. This extra lifting power is achieved at the cost of reduced total flow out of the pump.

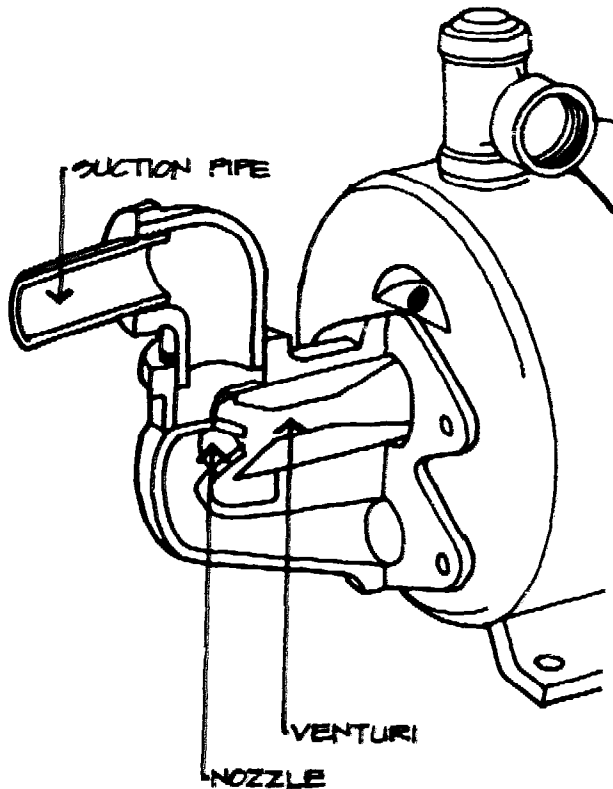

SHALLOW WELL EJECTOR UNIT

Because a shallow well jet pump is frequently used in conjunction with a pressure tank, the data presented in the chart below takes the pressure in the tank into account. The tank pressure is analogous to the delivery head pressure. Therefore, the heights listed across the top of the chart reflect only the depth to the source of water, rather than the total pumping head.

HP Horse Power	psi Delivery Pressure	Depth of Water Below Pump				
		5 ft.	10 ft.	15 ft.	20 ft.	25 ft.
1/3	20	12.0	11.0	9.7	8.3	6.2
	40	5.3	4.5	3.8	2.8	2.0
1/2	20	11.8	10.7	9.0	7.5	6.0
	40	10.2	9.7	8.3	7.0	6.0
3/4	20	8.0	7.3	6.7	5.8	4.2
	40	7.8	7.0	6.5	5.5	4.0
1	20	12.0	11.2	10.0	8.3	6.7
	40	12.0	11.2	10.0	8.3	6.7

Flow Rates (gpm) of Typical Shallow Well Jet Pumps

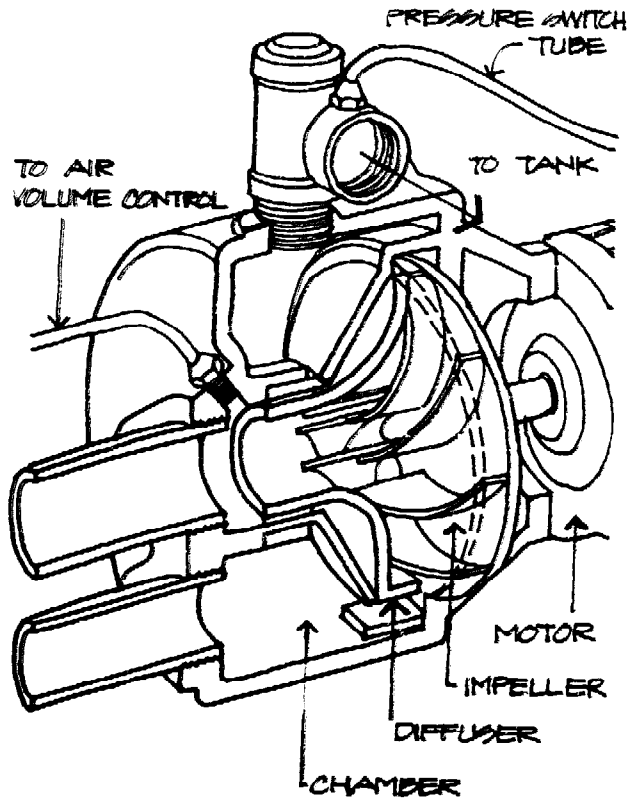

Cost

The cost of a shallow well jet pump begins at about \$85 for a 1/3 HP model and increases to approximately \$200 for a 1 HP model.

SHALLOW WELL JET PUMP

DEEP WELL JET PUMP

The deep well jet pump is mounted above ground with no moving parts submerged in the water. The ejector's reinforcing suction can lift water from a depth as great as 120 feet.

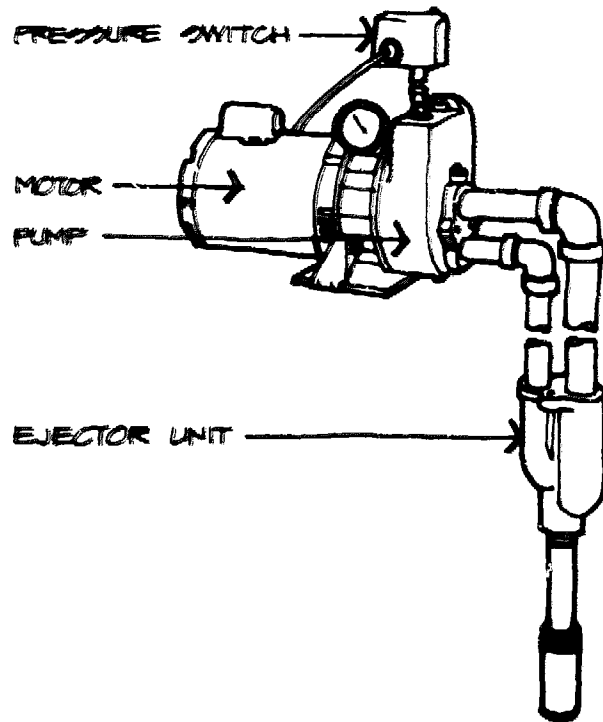

Operation

As its name suggests, the deep well jet pump is similar in operation to the shallow well jet pump, but is designed to lift water from wells 30 to 90 feet deep. This type of pump is also a combination of a centrifugal pump and an ejector unit, however, the ejector unit in this case is located down in the water source rather than on the face of the impeller housing.

With a deep well jet pump, from 50 to 75 percent of the water, depending on the depth of the source, is diverted back into the "pressure pipe" and delivered to the ejector unit below. Water from the source enters the ejector through a screened intake port which contains a foot valve that closes when pumping stops and thereby keeps the system "primed".

Because a deep well jet pump may also be used in conjunction with a pressure tank, the following performance chart also takes into account the pressure in the tank.

DEEP WELL JET PUMP

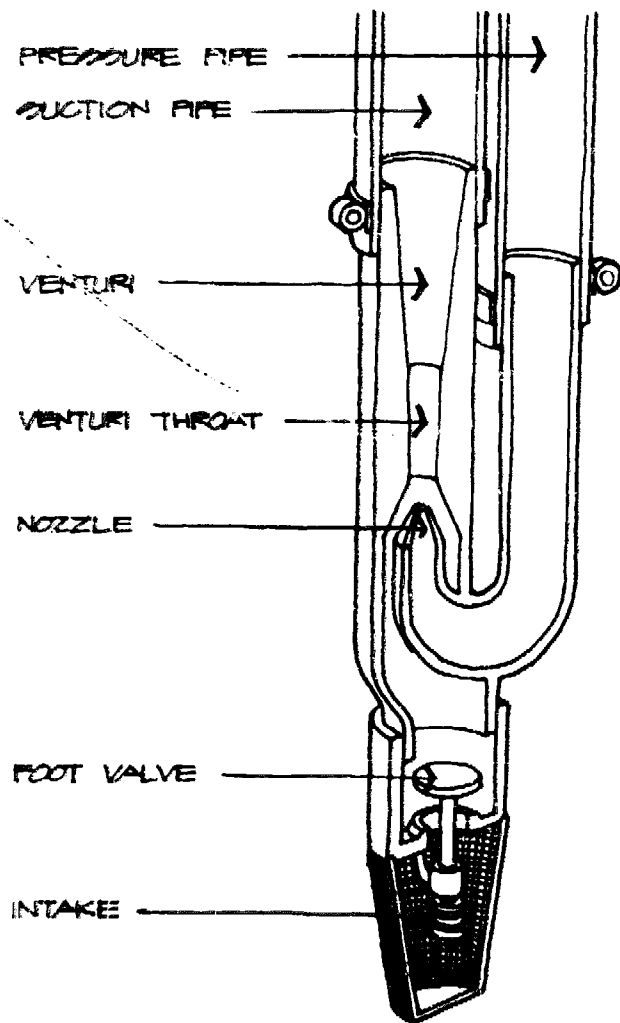

DEEP WELL EJECTOR UNIT

Horse Power	Delivery Pressure (psi)	Depth of Water Below Pump						
		30ft.	40ft.	50ft.	60ft.	70ft.	80ft.	90ft.
1/2	20	10.3	9.2	6.7	5.0	-	-	-
	40	6.4	5.5	4.0	2.7	-	-	-
3/4	20	7.2	6.5	5.8	5.0	4.2	3.3	2.2
	40	5.3	4.5	3.8	3.2	2.3	1.5	-
1	20	11.7	11.3	10.8	10.0	8.7	7.3	6.0
	40	11.7	11.3	10.8	10.0	8.7	7.3	6.0

Flow Rates (GPM) of Typical Deep Well Jet Pumps

Cost

The cost of a deep well jet pump is generally comparable to that of a shallow well jet pump. That is, about \$85 for a 1/3 HP model, increasing to approximately \$200 for a 1 HP model. This is largely because shallow and deep well jet pumps differ only in the configuration of the ejector unit which is bolted onto the face of similar impeller housings. However, deep well pumps do involve the extra cost and complexity of the return flow pipe which must be installed in the well.

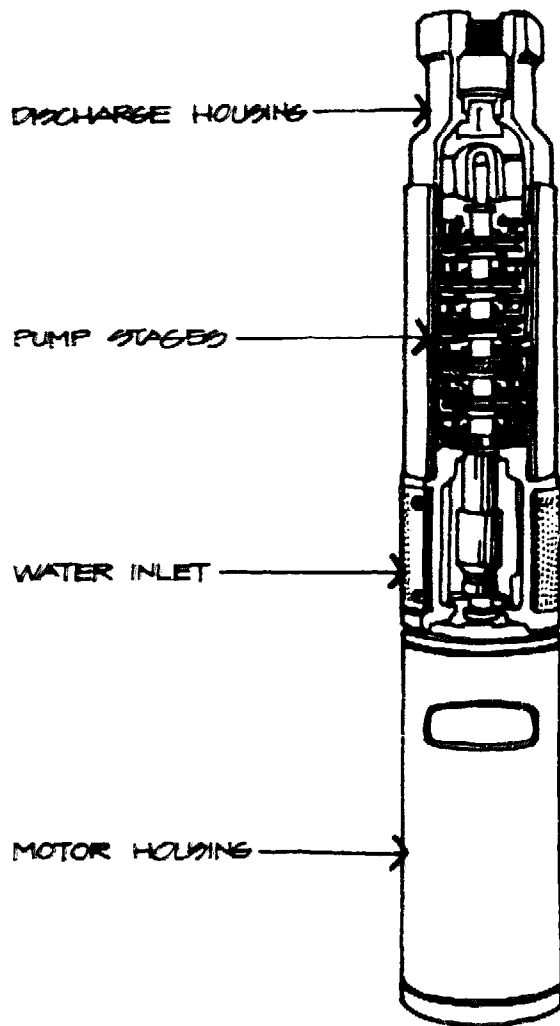

DEEP WELL SUBMERSIBLE PUMP

DEEP WELL SUBMERSIBLE PUMP

The deep well submersible pump is completely different in configuration from a deep well jet pump, being designed to operate, motor and all, at the bottom of a well. It can push water up from virtually any depth.

Operation

The deep well submersible pump sits at the bottom of the well and pushes water up to the surface rather than pulling it up as do suction pumps. The basic components, suspended within the well by the discharge pipe, are an electric motor and a series of centrifugal pump stages. Each pump stage is itself a miniature pump, consisting of an impeller rotating within a stationary diffuser housing. The water enters the pump below the lowermost stage and flows up into the center of its rapidly rotating impeller. It is then flung centrifugally outward by the impeller blades and passes into the stationary diffuser at its rim. The diffuser baffles direct the water back toward the center, increasing its pressure and converting it again to a single stream that enters the center of the next impeller. Hence the water proceeds outward, inward and upward; each stage successively increasing the pressure until it eventually passes into the supply pipe at a pressure sufficient to lift it to the surface. The volume of water discharged by a multi-stage pump is almost the same as for a single stage of that same pump. However, the pressure head developed by the pump, as

well as the horsepower required for its operation, increases in direct proportion to the number of stages in the pump. The pressure developed by each individual stage is a function of the dimensions of the impeller and the number of guide vanes it has.

It should be noted that, because of its large diameter and length, a deep well submersible pump requires much more accurate well drilling and shaft alignment than does a deep well jet pump.

Needless to say, the electrical cable, motor, and connections are carefully designed to operate safely under water. However, to be doubly careful, the homeowner should install a ground fault interrupt circuit breaker to protect submerged electrical equipment and the people who touch it.

The chart on the following page depicts the performance characteristics of typical deep well submersible pumps. The first two columns of the chart clearly demonstrate that the number of pump stages and the horsepower are interdependent and mutually responsible in determining the capability of the pump.

Cost

The cost of a deep well submersible pump depends upon the pressure the pump produces, the horsepower, and the number of stages. The cost of a low capacity, 1/2 HP pump, designed to discharge water at pressures between 20 and 40 psi begins at about \$175. A high capacity, 3 HP pump, capable of discharging water at pressures between 30 and 50 psi from wells as deep as 450 feet costs from \$500 to \$650.

HP	Horse Power	No. of Stages	PSI Delivery Pressure	Depth to Water Below Grade					
				60ft.	80ft.	140ft.	200ft.	250ft.	300ft.
1/3		6	40	8.0	5.5	-	-	-	-
			60	-	-	-	-	-	-
1/2		8	40	11.0	10.0	4.8	-	-	-
			60	8.6	6.7	-	-	-	-
3/4		12	40	13.3	12.8	11.0	8.9	6.1	-
			60	12.1	11.5	7.6	6.6	-	-
1		15	40	14.1	13.7	12.4	10.9	9.5	7.9
			60	13.2	12.7	11.2	9.7	7.8	5.0
1 1/2		20	40	14.8	14.5	13.6	12.7	11.9	11.0
			60	14.1	13.7	12.9	12.0	11.1	10.1

Flow Rate (GPM) of Typical Deep Well Submersible Pumps

SUBMERSIBLE SUMP PUMP

The submersible sump pump is a compact, portable unit typically used to transfer water from a collection point, such as a flooded basement or flat roof, to an appropriate disposal point.

Operation

Because the submersible sump pump is designed to remove as much water as possible, the impeller is horizontally mounted on the bottom of the unit with minimal clearance and is rotated on a vertical shaft by a close-coupled 1/2 or 1/3 HP electric motor. Water enters the center of the impeller on the underside of the unit and is transferred out of the housing via a hose connected to the pump's discharge outlet. Some pumps of this type are capable of pumping from within as little as 1/8 inch of the floor. Some models are automatically actuated by an integral float switch. Others require an external electrical control such as a pressure switch or timer.

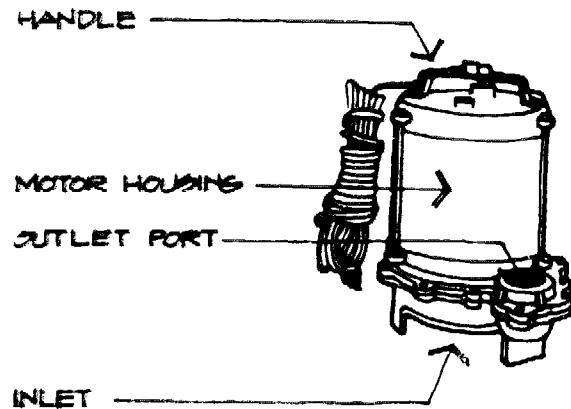

SUBMERSIBLE SUMP PUMP

Many models of the submersible sump pump, however, are not intended to operate under water on a continuous basis. Nonetheless, this type of pump is quite appropriate for use in temporary or intermittent household recycling operations. For example, greywater can be collected from the bath tub or laundry basin with a portable sump pump and, with a hose, pumped directly onto the lawn. In such a

simple system where reuse is immediate, the need for plumbing alterations and equipment installation may be avoided.

The performance of typical submersible sump pumps is represented in the chart below.

<u>HP Horse Power</u>	<u>Total Head in Feet</u>			
	<u>5 ft.</u>	<u>10 ft.</u>	<u>15 ft.</u>	<u>20 ft.</u>
1/6	18	14	10	5
1/3	75	65	53	38
1/2	90	80	67	50

Flow Rate (GPM) of Typical Submersible Sump Pumps

Cost

A light-duty 1/6 HP submersible sump pump costs about \$40. A heavy-duty 1/2 HP commercial-industrial model costs about \$100.

UPRIGHT SUMP PUMP

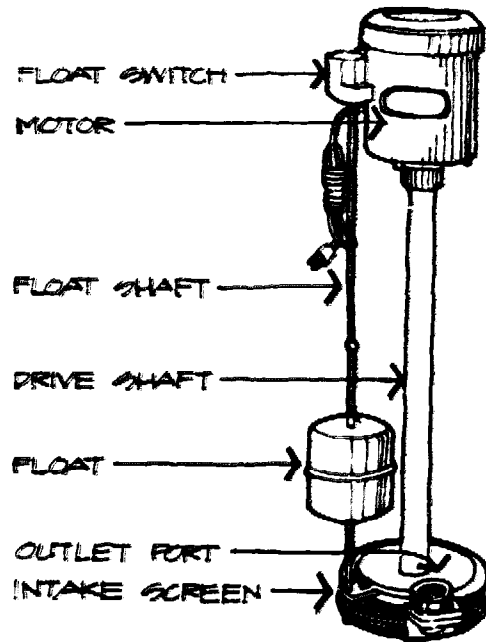

UPRIGHT SUMP PUMP

The upright sump pump is more suitable for situations requiring operation on a more continuous basis.

Operation

In an upright sump pump the impeller assembly sits below water and is connected to the electric motor by a long vertical shaft which enables the motor to remain above the level of the water. In this design, the motor and its electrical connections are not waterproof and thus may not be submerged. Operation is controlled by a float which turns a switch on top of the motor on or off.

The performance of typical heavy duty commercial upright sump pumps and lighter duty residential models are presented in the chart below.

HP Horse Power		<u>Total Head</u>			
		<u>5 ft.</u>	<u>10 ft.</u>	<u>15 ft.</u>	<u>20 ft.</u>
1/3	heavy-duty	47	40	32	15
1/2	heavy-duty	103	78	37	-
1/3	light-duty	43	37	28	11

Flow Rate (GPM) Performance of Typical Upright Sump Pumps

Cost

A 1/3 HP light-duty upright sump pump costs about \$60, while a 1/2 HP heavy-duty model costs about \$120.

RECIRCULATING PUMPS

A huge variety of inexpensive, low-flow rate, submersible pumps have been designed for continuous service in fountains, aquariums, beverage coolers, dairy machines, chemical keepers, etc.

Operation

Typically these little centrifugal pumps are hermetically sealed in plastic or aluminum. Some of the submersible models can also be run in open air. Some type of external electrical control is required, such as a float switch, pressure switch, or timer.

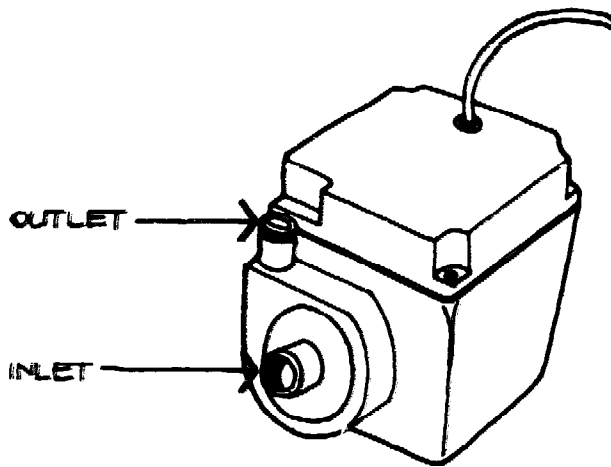

RECIRCULATING PUMP

HP Horse Power	<u>Total Feet of Head</u>			
	<u>5 ft.</u>	<u>10 ft.</u>	<u>15 ft.</u>	<u>20 ft.</u>
1/200	1	-	-	-
1/40	3	1	-	-
1/15	6	4	2	-
1/12	12	10	6	3

Flow Rates (GPM) of Typical Recirculating Pumps

Cost

Prices range from \$15 to \$50 in most hardware and garden supply stores. Many have built-in screens or strainers. Many are designed to operate with mild acids or alkalis, or with high temperature fluids.

DRILL DRIVEN PUMP

The least expensive of all the pumps is designed to be powered by an electric hand drill.

Operation

This simple plastic pump, clamped into the chuck of a 1/4 inch hand drill, can deliver 3GPM at a maximum pressure of 20 psi. Garden hoses screw on the inlet and outlet. They are not designed for continuous heavy-duty use, but for occasional jobs around the house, such as emptying a plugged washing machine, pumping out an aquarium or draining oil from an automobile.

Cost

\$5 to \$10 without the hand drill.

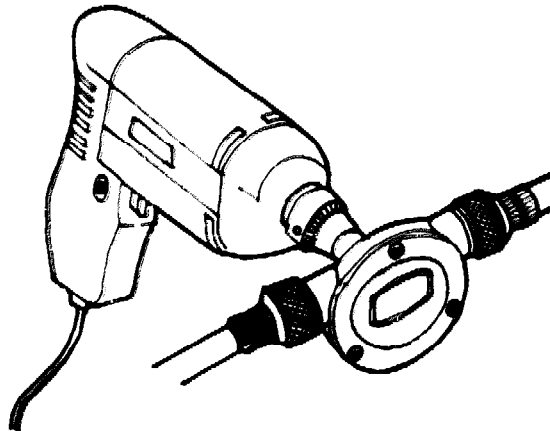

DRILL - DRIVEN PUMP

6.6 PIPING

The piping utilized in water reuse systems must meet the same performance requirements as that used in normal residential water systems except for some instances where water reuse systems are not pressurized. In all other respects the two systems require virtually identical pipe characteristics, including corrosion resistance, thermal stress, mechanical strength, sanitation, ease of assembly, cost, and the like.

The following sections discuss the three types of pipe commonly used in the United States: ferrous metal, non-ferrous metal, and plastic.

Sizing Pipe

Determining which diameter of pipe to use can be accomplished by performing calculations with engineering precision, by applying rules of thumb that have developed over the years, or by following the guidance of the local plumbing code. With respect to drainage systems, for example, codes typically require a 1 1/2 inch diameter drain pipe for most individual sinks, bathtubs and showers. They will require 2 inch diameter pipes for floor drains, dishwashers, and washing machines, and 3 inch diameter drains for toilets.

In most residential systems 3 inch diameter mains are appropriate and have the added advantage of fitting neatly inside

FERROUS METAL PIPES
NON-FERROUS METAL PIPES
PLASTIC PIPES
MECHANICAL PLUMBING VENT

a 2 x 4 stud wall. Vent lines for most plumbing systems are 1 1/2 inches in diameter or 2 inches in diameter if they serve a group of fixtures (excluding a toilet). Vent lines do not carry fluid wastes, but rather exhaust sewer gas and equalize atmospheric pressure within the system to prevent traps from siphoning.

The diameter of water supply pipes is usually much smaller than that of drain pipes because supply water is under pressure and therefore flows at higher rates. Most residential systems are designed for approximately 50 psi. At pressures less than 15 psi standard tank-type toilets misbehave, while at pressures above 100 psi noise and the possibility of leaks become concerns. Assuming average pressures, 3/4 inch diameter pipe should be appropriate for most residential supply systems, although 1/2 inch diameter pipe should be able to handle any single group of fixtures. Flexible copper or plastic tubing may be smaller in diameter because of their lower friction losses. For a short run, connecting a single fixture such as the cold water connection to a sink, 3/8 inch diameter tubing should be adequate.

In residential applications horizontal pipe runs rarely exceed 100 feet so friction losses are usually not significant. Changes in elevation of more than 2 stories, however, may cause pressure drops which reduce flow rates. As a rough rule of thumb, 5 psi is required to lift water 10 feet, excluding the friction loss due to valves, connections, etc.

<u>Drainage Pipe Diameter (inches)</u>	<u>Maximum Capacity (gpm)</u>
1 1/4	7.5
1 1/2	22.5
2	30
3	45
4	60

Drainage System Maximum Accumulated Discharge Capacity

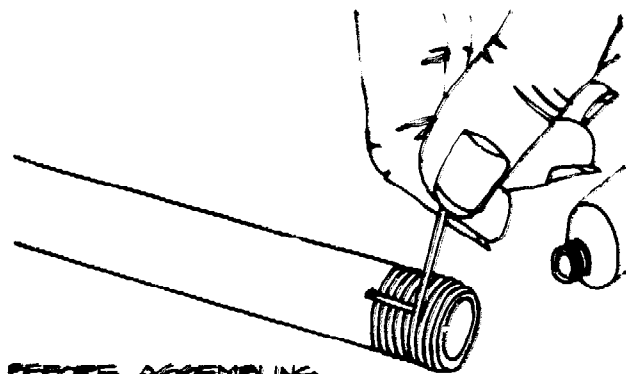

BEFORE ASSEMBLING
THREADED PIPE CONNECTIONS
COAT THREADS WITH
FINE WICKING AND
PIPE COMPOUND OR
SEALING TAPE.

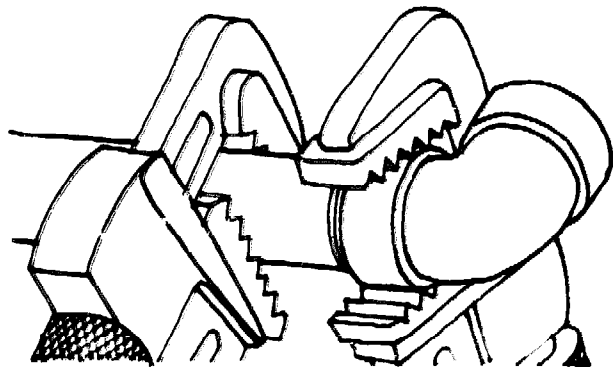
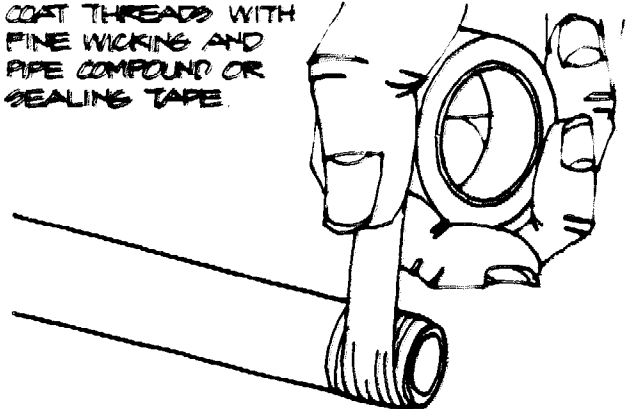

FERROUS METAL PIPES

There are four types of ferrous metal pipes: plain steel, galvanized steel, wrought iron and cast iron. The major disadvantage of plain steel, often called black iron, is that it is more susceptible to corrosion than any other type of pipe. Galvanized steel resists rusting and is therefore frequently employed. Steel pipes can handle water under any pressure and are approved for drinking water. Wrought iron and cast iron pipes also resist corrosion but are seldom used in modern systems. Cast iron is approved for drainage systems indoors. Though available in a large selection of lengths and diameters, ferrous metal pipes are steadily being replaced by the lighter, less bulky and less expensive plastic pipes.

Assembly

Ferrous metal pipes have many advantages, the most significant of which is their ease of assembly due to tapered, threaded connections. Leakage at the joints may be all but eliminated if prior to assembly the threads are covered with a pipe compound. Assembly techniques have been standardized and are in conformance with all building codes.

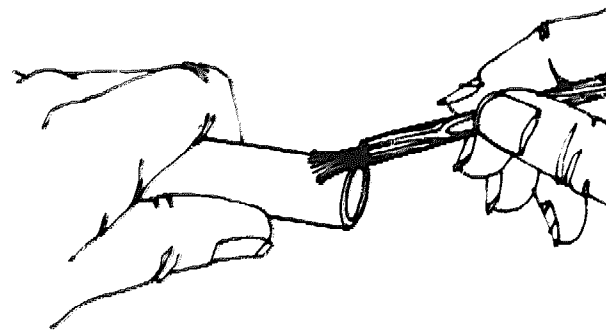
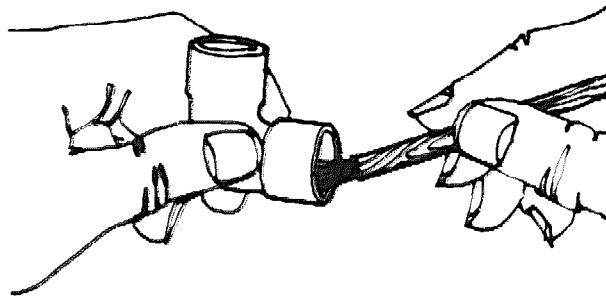
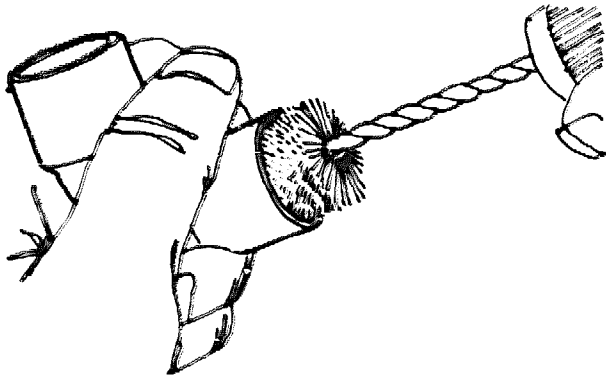

AFTER CLEANING THE SURFACES WITH A WIRE BRUSH OR EMERY CLOTH, BRUSH ON A THIN COATING OF FLUX AND ASSEMBLE

NON-FERROUS METAL PIPES

There are two types of non-ferrous metal pipes: red brass and copper. Pipes made from both metals can carry water of any temperature or pressure and both are approved for drinking water.

Red brass is composed of 85 percent copper and 15 percent zinc. While less susceptible to corrosion than ferrous pipes, red brass is subject to dezincification (the attack by acids on the zinc in the metal).

Copper tubing is also highly resistant to corrosion, and in addition, its very smooth internal surface and the absence of angular connections produce very little friction when flow occurs. Copper tubing is less expensive than red brass and lighter in weight.

Assembly

Red brass pipes employ the same threaded connections as steel pipes but are very expensive and are thus used only in specific applications.

Copper tubing is easier to assemble than red brass whether solder "sweated" connections or threaded compression fittings are used. To make a solder connection, the mating surfaces of the tube and fitting are first polished with a wire brush or emery cloth, coated with a special "fluxing" paste, and assembled into their final configuration. The assembly is

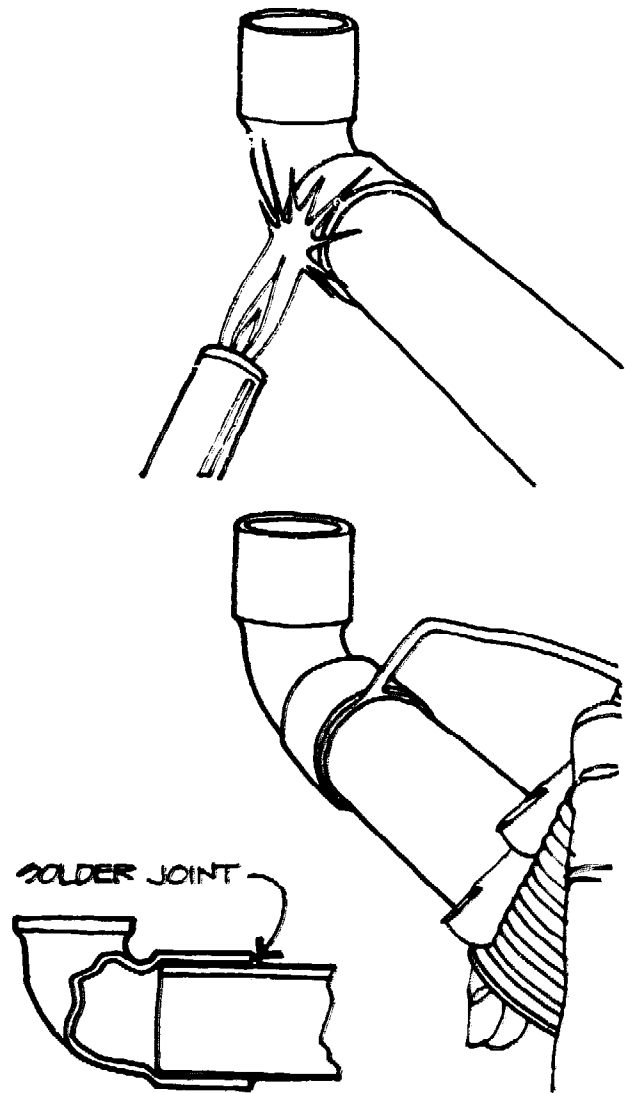

HEAT THE JOINT WITH A TORCH, BUT DO NOT BURN AWAY THE FLUX. WHEN HOT, APPLY SOLDER TO THE SPACE BETWEEN.

then heated with a blow torch or large soldering iron and solder is applied to the joint. As it melts, capillary action draws the solder into the space between the two surfaces. The solder joint system offers two significant advantages. First, it enables the entire system to be assembled before anything is made permanent by the addition of solder. Second, because there are no threads cut into the tubing, strength equal to threaded pipe can be achieved with thinner walls.

Compression fittings are more expensive, although they take less time and require no special skills to assemble. To make a watertight connection, a rubber sleeve is slipped around the end of the tube and then wedged into a tapered hole with a threaded collar. Both systems produce equally watertight connections, although the rubber in a compression fitting will deteriorate with age and thus should not be sealed inside a wall.

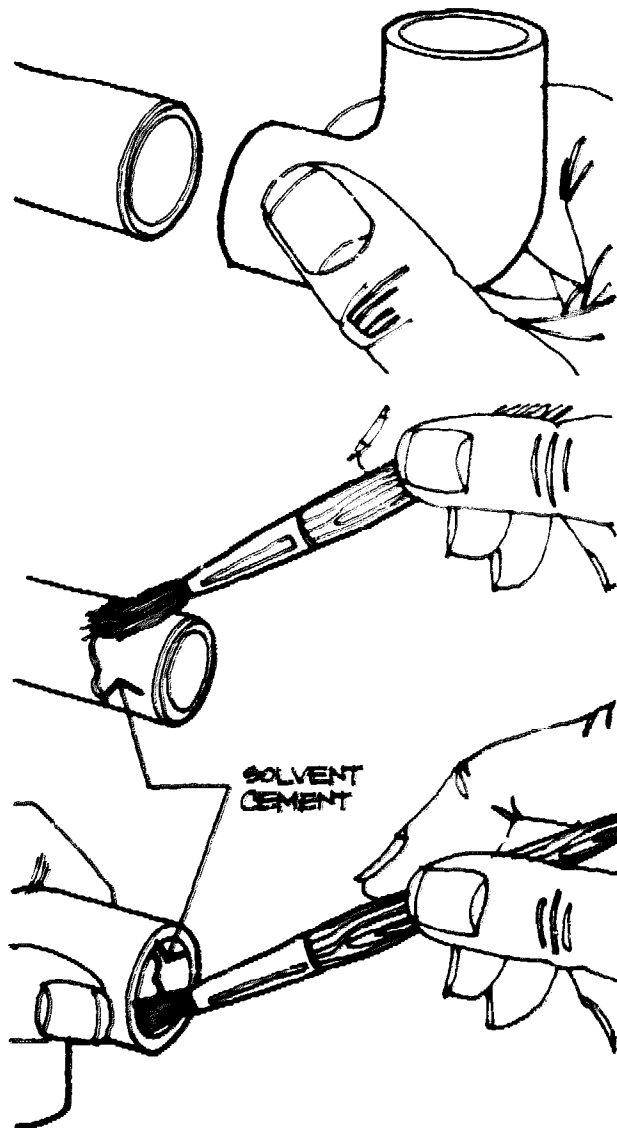

ASSEMBLING PLASTIC PIPE

PLASTIC PIPES

Four types of plastic pipe are suitable for use in residential water systems. These are Acrylonitrile-Butadiene Styrene (ABS), Polyvinyl Chloride (PVC), Chlorinated Polyvinyl Chloride (CPVC), and Polyethylene (PE). Of these, only CPVC is approved by the National Sanitation Foundation for transporting pressurized hot water indoors (NSF 1976), although other specifications or codes may apply in individual communities.

ABS is typically black and comes in 10 foot lengths. A wide variety of connections and special fittings are available for 1-1/2, 2, and 3 inch diameter drain, waste and vent systems. ABS is approved by the National Sanitation Foundation for indoor use.

PVC is usually white and comes in 10 foot lengths, 4 inches in diameter, for outdoor sewer and drainage systems. A lighter weight, less expensive collection of large diameter pipes and fittings is available for downspouts, septic tank lines and leach fields (perforated pipe). Smaller diameter pipes (1/2 to 1-1/2 inches) are available for outdoor cold water use. These pipes can withstand pressures of at least 160 psi but cannot be used for hot water service or in freezing climates (unless they are drained). The smaller diameter pipes are primarily employed in underground sprinkler systems although they are approved for drinking water.

SLIP THE PARTS TOGETHER WITHIN ONE MINUTE OF APPLYING THE SOLVENT. GIVE THE PIPE A QUARTER TURN TO SPREAD THE CEMENT EVENLY. A BEAD OF CEMENT SHOULD SHOW BETWEEN THE PIPE AND FITTING.

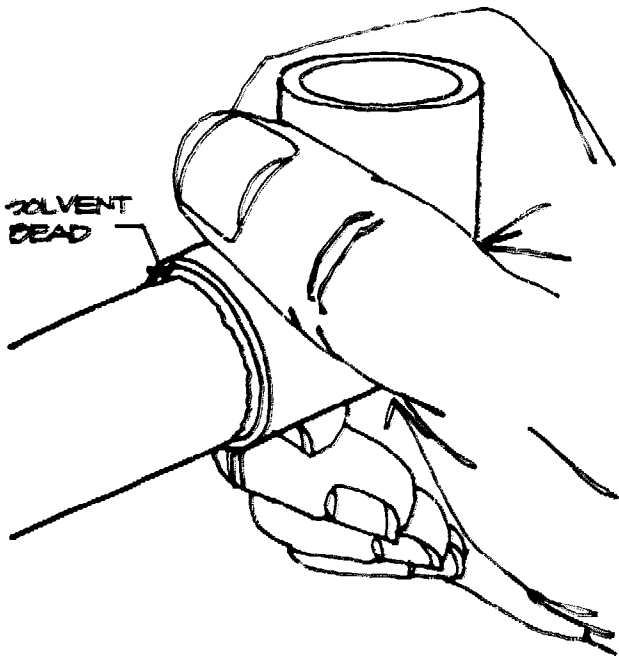

JOINING PLASTIC PIPE PARTS

CPVC can be used indoors for either cold water or hot water up to 180°F and at pressures up to 100 psi. It is approved by the National Sanitation Foundation for drinking water. CPVC comes in 10 foot lengths, 1/2 and 3/4 inches in diameter, with a wide variety of valves and fittings for connection to all types of household fixtures and appliances.

PE tubing is black and comes in 100 foot flexible coils from 1/2 to 1 1/2 inches in diameter. It is designed for outdoor cold water systems under pressures up to 160 psi and is approved for drinking water. PE tubing is primarily employed to connect with submersible pumps in domestic wells and to distribute water to outlying buildings.

Assembly

Rigid plastic pipe employs a solvent weld to make connections. Similar to copper tubing components, the mating surfaces of plastic pipe and fittings are smooth rather than threaded. To make a solvent weld connection, the mating surfaces of the pipe and fitting are first cleaned with a dry cloth and a liquid solvent is applied to the external surface of the pipe. The two components are then assembled, given a quarter-turn to spread the solvent inside the joint, and held in their final position for a few minutes in order to "set".

The solvent, as its name implies, literally dissolves the surfaces of the two pieces of plastic and thus permanently fuses them together. Once set, solvent welds cannot be disconnected. Changes require cutting off the end of the pipe containing the unwanted fitting and repeating the weld operation with a new fitting. Adaptors are available to make transitions from one piping system to another.

Flexible PE tubing is clamped to special nylon fittings with stainless steel hose clamps.

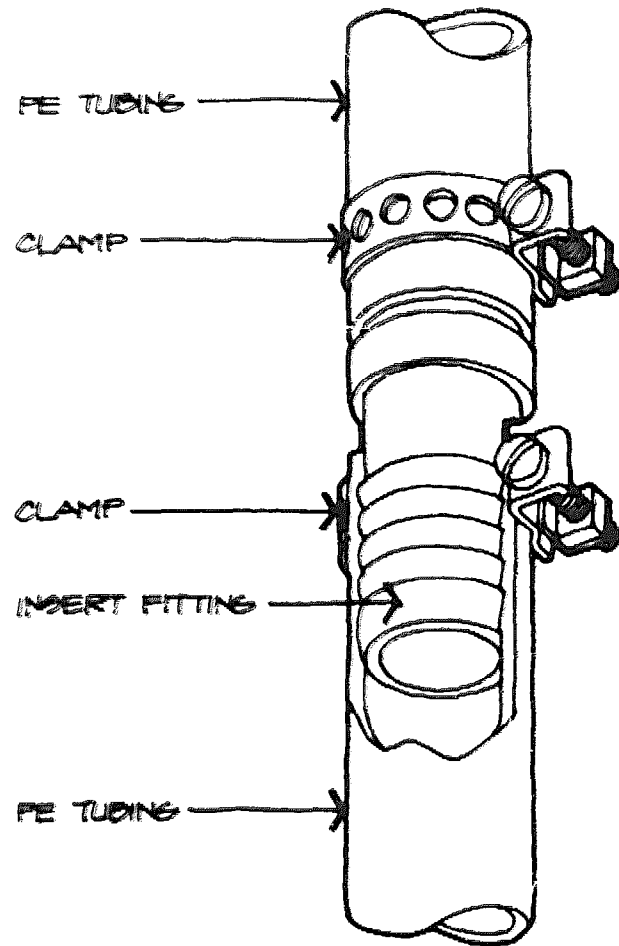

CONNECTING FLEXIBLE PE TUBING

MECHANICAL PLUMBING VENT

Rerouting vent lines poses horrendous problems when one attempts to modify or retrofit existing plumbing systems. This simple little component eliminates the need to run new vent pipes through walls and roofs when installing such fixtures as sinks, tubs, showers, and washing machines.

Operation

A plumbing vent performs two important functions: First, it prevents sewer gases from entering the house; and second it prevents the fixture trap from back-siphoning. Houses are usually provided with a main vent stack for each toilet, to which the vent pipes from other nearby fixtures are connected. The mechanical plumbing vent is simply a little one-way valve which lets air into vent the trap, but prevents sewer gas or fluid from getting out.

A mechanical plumbing vent must be installed 6 inches above the trap arm and must not be enclosed in a wall. It may, however, be installed under a counter. Typically, these devices are used to vent the traps of island sinks.

Maintenance

Mechanical or automatic vents are designed to be maintenance free. About the only conceivable problem would be if the valve were to stick in the open position. If this occurred, it could be disassembled by hand and easily cleaned or repaired.

6.7 TANKS

**STORAGE TANKS
PRESSURE TANKS
SETTLING TANK**

Greywater recycling systems use three different types of tanks: storage tanks, pressure tanks, and settling tanks. As their name implies, storage tanks collect large volumes of greywater, while the much smaller pressure tanks, used in conjunction with a pump, pressurize the greywater system. Settling tanks allow suspended solids to settle out before the greywater proceeds to the next step in the system or the point of reuse.

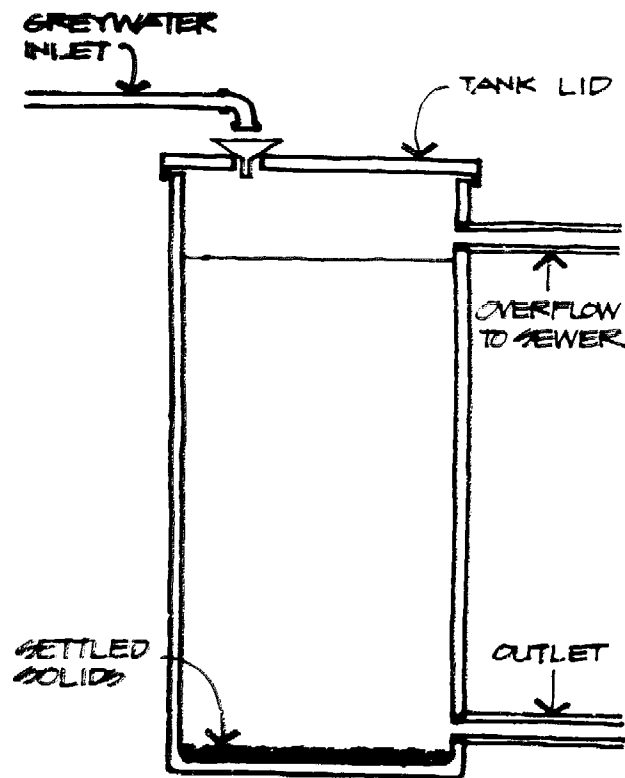

TYPICAL GREYWATER STORAGE TANK

STORAGE TANKS

A storage tank is used in a recycling system to collect and store, in a single volume, all of the greywater discharged from the various sources in the home. The primary advantages of greywater storage are threefold. First, it enables all of the greywater that is reused to be distributed from a single location rather than from the locations of each of the various sources. In addition to reducing the requirements for distribution plumbing, this enables the volume of greywater that is available for reuse at any given time to be greater than that which would be available from a single source. Second, storing greywater for a brief period of time enables suspended solids to settle to the bottom of the tank, grease particles to float to the surface, and heated greywater to cool. This buffering function sometimes eliminates the need for more expensive filtering equipment. Third, storage enables the greywater to be used when it is most needed or most convenient. One is not forced to reuse the greywater the moment after it is generated.

For safety in designing a greywater storage system, the homeowner must be certain that any storage tank has an overflow outlet to the sewer and is protected by an appropriate backflow prevention device. Backflow prevention devices, as well as the hazards of cross connections, are discussed in separate sections of this report.

The required volume of the storage tank depends primarily on the daily volume of greywater generated by the household, the daily volume of greywater that is reused, and the period

of time for which it is to be stored. For example, if one wished to have the greywater stored for two days in order to allow settling, the required storage tank volume would be approximately twice the volume which flows into the tank each day.

The storage system must be kept reliably tight in order to prevent leakage, contamination and entry of insects, children or other small inquisitive animals. However, if the tank is completely air tight, pressure fluctuation can build up and interfere with system operation. The usual causes of failure are seepage, warpage, and corrosion. The tank must not impart tastes, odors or toxins to the water and therefore must be either constructed of or coated with inert materials. In addition, there should be easy access to the container above the maximum water level in order to permit visual inspection and convenient maintenance when necessary.

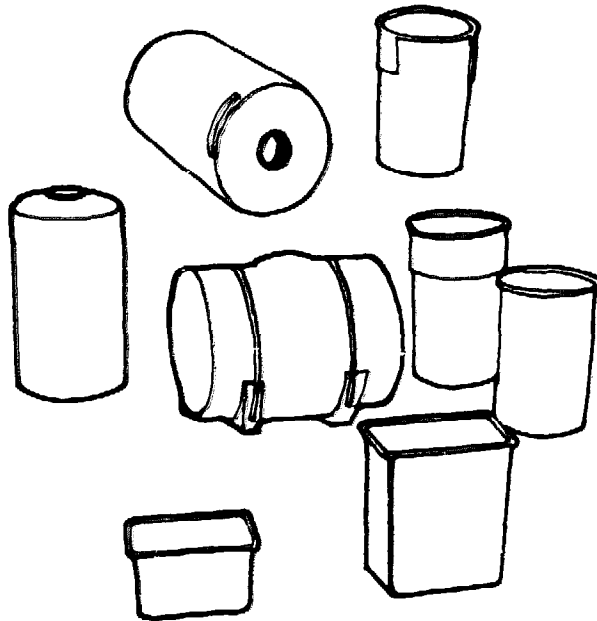

STANDARD POLYETHYLENE TANKS

The storage of household greywater produces an accumulation of scum and sludge in the tank which will eventually go septic if left to stand undisturbed for more than 3 or 4 days. The simplest solution to this problem in conditions of low-flow is to be sure that air regularly reaches everything in the tank, perhaps by using the inlet flow to gently mix the stored greywater. Another solution is to empty the remaining greywater from the storage tank at the end of every day. Under conditions of higher flow volumes, disinfection of the stored water with chlorine may be necessary. Storage which includes greywater from the kitchen sink will require much more regular maintenance to remove floating grease and sunken foodstuffs.

More than half a dozen different types of containers are suitable for use as storage tanks in greywater recycling systems: plastic garbage cans, 55-gallon drums, metal tanks, polyethylene tanks, fiberglass tanks, concrete tanks, wooden tanks and plastic pillows.

Plastic Garbage Cans: By far the least expensive and most readily available container suitable for greywater storage is the common plastic garbage can. These are available in capacities ranging from 20 to 50 gallons, which covers a price range of approximately \$10 to \$35. Garbage cans can be easily fitted with valves, drains, or other plumbing fittings. When filled with water, some models may bulge or sag alarmingly, but they can be easily reinforced with metal straps, reinforced packaging tape, or the like.

55-Gallon Drums: These ubiquitous containers are used to store and transport every imaginable liquid. As a result, 55-gallon drums are readily available from industrial suppliers and surplus dealers. Because they are made of steel, many different coatings are available on the inside to protect against corrosion. Most are already fitted with different kinds of plumbing ports. Some have easily removable clamp-on lids. Used 55-gallon drums may cost as little as \$5.

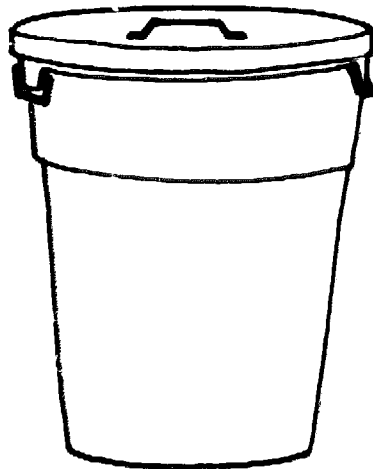

STANDARD PLASTIC GARBAGE
CAN

Steel Tanks: Most manufacturers of steel storage tanks offer a line of stock sizes, typically with capacities ranging from 50 to 1,000 gallons. These tanks generally come with several ports or outlets for making plumbing connections. The owner simply plugs or caps off those he does not wish to use. They are also provided with legs, saddles, or other flanges to facilitate mounting, and in most cases, are coated on the inside with an epoxy or asphalt emulsion to inhibit corrosion. Often they are intended for use on farms to hold well water, gasoline, or chemicals. In addition to their catalog of stock tanks, many manufacturers will custom build a tank to any specifications. Unfortunately even the stock tanks are usually too expensive for most residential recycling systems.

Polyethylene Tanks: Unlike steel, polyethylene is resistant to corrosion. As a result, inert coatings are not necessary.

Polyethylene tanks have the added attraction of being translucent, thus enabling easy visual inspection of the water level in the tank. Most manufacturers offer a broad range of standard cylindrical tanks which range in capacity from about 50 to 500 gallons, but are reluctant to build custom tanks. Most consumers could have a standard tank adapted to meet unusual circumstances, as manufacturers can easily cut and install additional ports in standard tanks. A typical 150 gallon polyethylene tank costs about \$200, with a tank stand running about \$125 and additional ports costing about \$25 each.

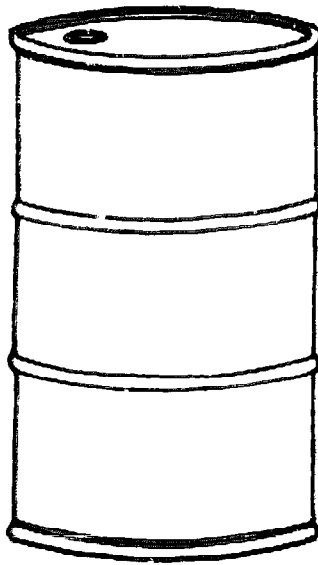

55 GALLON DRUM

Fiberglass Tanks: Tanks constructed of fiberglass are basically similar to polyethylene tanks in terms of performance. However, fiberglass tanks are generally available in a larger range of sizes and a great variety of special shapes and configurations. Typically stock tanks are available in capacities ranging from 50 to 2,000 gallons, although one Los Angeles manufacturer offers tanks up to 30,000 gallon capacity. Some are designed as septic tanks to be buried underground. Larger tanks are usually available with either an attached lid which clamps or bolts down, or an integral lid which contains a manhole. Both vertically and horizontally oriented tanks are available. The cost of the tank depends primarily on capacity, but is also affected by the configuration and the type of lid. A typical vertically oriented tank with a flat bottom and removable lid costs approximately \$120 for a 55-gallon model, \$150 for a 100-gallon model, and \$400 for a 500-gallon model. Covers are approximately \$20 to \$50. Septic tanks with capacities of 600 to 1,800 gallons cost \$600 to \$1,000.

Concrete Tanks: Designed primarily for septic systems, concrete tanks are relatively inexpensive and give long life underground. They usually range in size from 600 to 1,800 gallons. They are usually manufactured locally

and the supplier usually delivers it to the site and hoists it directly into the excavation as part of the purchase price.

Pipe Tank: Large diameter concrete or steel drainage culvert or sewer pipes can be made into inexpensive storage tanks by tipping them up on end and sealing the bottom. With concrete pipe this is simply done by setting them in a flat base of wet concrete. Steel culvert pipes require a carefully welded steel plate for a base. The top can be left open or closed with a wooden, concrete, or steel man-hole-like cover.

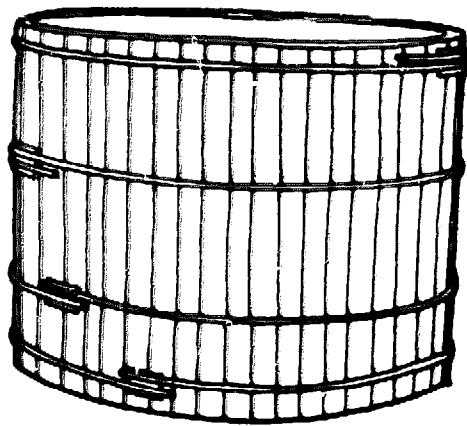

WOODEN TANK

Wooden Tanks: Barrels, drums, or tanks made of wood are non-corrosive and impart no taste or odor to the water. Thus, wood tanks require no coatings or treatment, although they must be kept from drying out for more than two months at a time as the wood may warp, resulting in leakage when the tank is refilled. If properly maintained, a wood tank should last 40 years or more. Unfortunately wood tends to be more expensive than other materials. Standard size wooden storage tanks are available in capacities ranging from 50 to 500,000 gallons, although other capacities can be built to custom specifications. Wooden tanks are typically made of redwood, although douglas fir is sometimes used. Rectangular tanks made of waterproof plywood and lined with epoxy have been built by some experimenters, although vinyl or polyethylene pool liners are probably less susceptible to leaks.

Plastic Pillows: When water beds became popular they made available yet another type of greywater storage tank which has some interesting advantages. Water bed mattresses are low and flat and will thus fit into odd spaces such as under porches, in attics, or on grade in crawlspaces. They distribute their load over a broad area and so may not need special

structural support or even flat surfaces. They can be made in virtually any shape or size and prices are highly variable, which means "negotiable". Being sealed, they keep out insects and rodents, but the lack of oxygen makes an ideal environment for anaerobic bacteria. Therefore odors and septic effluent may become major problems.

Portable Swimming Pools: Probably the least expensive way to store large volumes of water is in a portable plastic backyard swimming pool. A covered 450 gallon pool costs about \$30. A 1,000 gallon model is about \$50 and a 5,000 gallon model is about \$200. Portable swimming pools are probably the easiest to clean and repair.

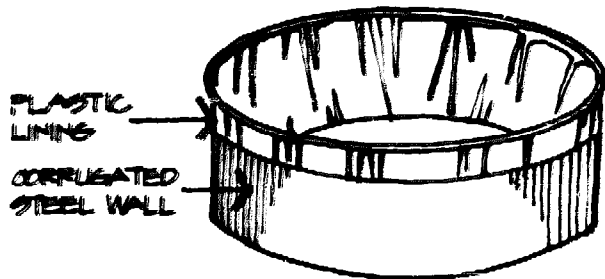

PORTABLE SWIMMING POOL

PRESSURE TANKS

A pressure tank is used with a pump to pressurize a water supply system. In a water pressurization system, a volume of air is held in the tank and is compressed as the volume of water in the tank, delivered by the pump, increases. The compressed air, in turn, exerts pressure on the water. This pressure remains fairly uniform as the water is used out of the tank.

Left on its own, this air volume will not remain in the tank indefinitely because the air in the tank is gradually absorbed by the water. The result of this phenomenon is that the air volume becomes smaller and smaller over time until it is so small that only a few pints of water are discharged from the tank before the pressure is expended and the pressure switch again starts the pump. When this condition exists, the pump starts and stops almost constantly and the tank is said to be "waterlogged".

In order to prevent waterlogging, a small air pump or other device may be added to the system to inject a small volume of air into the tank each time the pump starts. While such a configuration is usually very effective in preventing waterlogging, it can result in too large a volume of air forming in the tank. When this occurs, only a small volume of water is delivered to the tank by the pump before the pressure increases to the point where the pressure switch shuts off the pump. As a result, only a small volume of pressurized water is available for

reuse. When this condition exists, the pump again starts and stops almost constantly and the tank is said to be "air-bound".

Thus, it is important that the proper volume of air be maintained in the tank if the desired pressures are to be achieved and maintained over time.

Three types of pressure tank are discussed herein: the conventional pressure tank, the diaphragm-type tank, and the bag-type tank.

Conventional Pressure Tank: This type of tank is made of steel and is available in capacities ranging from 12 to 75 gallons. Most models are designed to sit in a horizontal orientation and thus have a pump mounting plate welded to the top of the tank. These tanks are typically designed to work at pressures up to 75 psi, and can be set to operate at any pressure up to their maximum working pressure. Their main problem is loss of air by absorption (water-logging) and they therefore require special controls to maintain the proper volume of air within them. Conventional pressure tanks cost about \$45 for a 12-gallon tank and \$60 for a 30-gallon tank. Prices do not include the pump.

Diaphragm-Type Pressure Tanks: These tanks feature a heavy-gauge flexible diaphragm which is permanently bonded to the inside of the tank shell. The diaphragm separates the air volume from the water volume and thus eliminates the possibility of waterlogging. They are usually oriented in a vertical position, with plumbing connections at the tank bottom, accessible through two holes in the tank skirt. Pressure is regulated by means of an air valve mounted on top of the tank. A diaphragm-type pressure tank costs approximately \$60 for a 20-gallon capacity model and about \$100 for a 40 gallon capacity model.

Bag-Type Pressure Tanks: Pressure tanks of this type incorporate a heavy-gauge vinyl bag to contain the volume of water in the tank. Complete containment of the water volume not only separates the water from the air volume, thus preventing waterlogging, but in addition, eliminates the possibility of corrosion because the water never touches the steel body of the tank. They are available in capacities ranging from approximately 6 to 85 gallons, and are usually mounted on legs in a vertical position to enable plumbing connections to interface with the bottom of the tank. Manufacturers of the bag-type pressure tank claim that it delivers more water between pump starts and stops than does a conventional pressure tank. A 6-gallon tank costs about \$40, while a 36-gallon tank runs about \$100. An 85-gallon tank will cost the homeowner close to \$200.

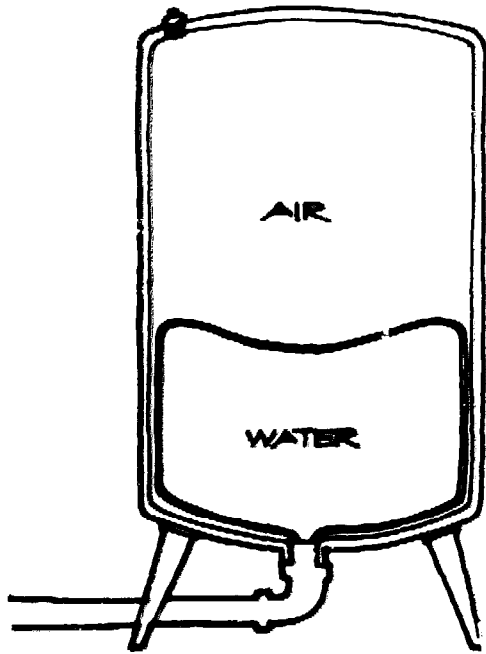

BAG-TYPE PRESSURE TANK

SETTLING TANK

Whenever water stands quietly, everything that is heavier than the water will slowly settle to the bottom by gravity. Settling occurs inadvertently in some household fixtures such as hot water tanks (which must be drained occasionally), or sink traps (which require periodic cleaning). Most systems should have some type of buffer or storage tank where settlement will undoubtedly occur.

Operation

A settling tank should be designed to keep the largest volume of water as quiet as possible. The problem is how to get water in and out of the tank without stirring things up. This is usually done with baffels, splash shields, or overflow gutters.

Maintenance

If large enough, settling tanks rarely need cleaning: perhaps every few years. Usually they have a drain valve at the bottom and a removable lid. However, sometimes the material which settles out of greywater can become somewhat solidified and may need to be removed with a high pressure hose or with a brush or scraper.

GREASE TRAP
DOSING SIPHON
SOLAR STILL

6.8 MISCELLANEOUS COMPONENTS

The components described in the following sections are simply those which do not conveniently fall into any of the previous categories. This does not imply that they are not important components. On the contrary, these components can be valuable assets to almost any water recycling system.

GREASE TRAP

A grease trap is a small skimming tank in which greasy wastewater, typically from the kitchen sink, is retained for a short period of time to solidify grease and remove other floating material. A grease trap is a particularly important component in systems where the water is reused for subsurface irrigation, as the grease will quickly clog leaching pipes and surrounding soil.

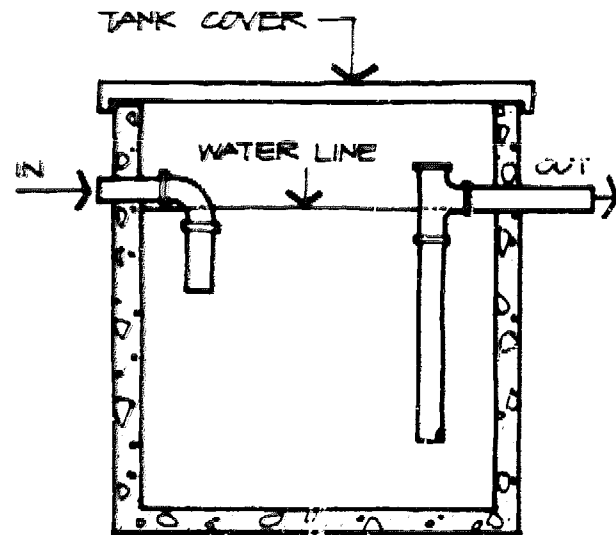

CONCRETE TANK

GREASE TRAP

Operation

A grease trap typically consists of a small tank with a removable cover. Wastewater enters the trap through the inlet pipe, which is submerged approximately 6 inches below the surface of the water in the tank. As the wastewater cools, the grease solidifies and floats to the surface.

The wastewater remains in the grease trap until additional wastewater enters the tank. The "new" water forces an equal volume of "old" water through the outlet pipe. Because the end of the outlet pipe is also submerged, the outflowing wastewater contains a minimum of grease.

Maintenance

In order to prevent the escape of accumulated grease, the trap must be cleaned regularly; generally when about 75 percent of its grease-holding capacity is filled. The

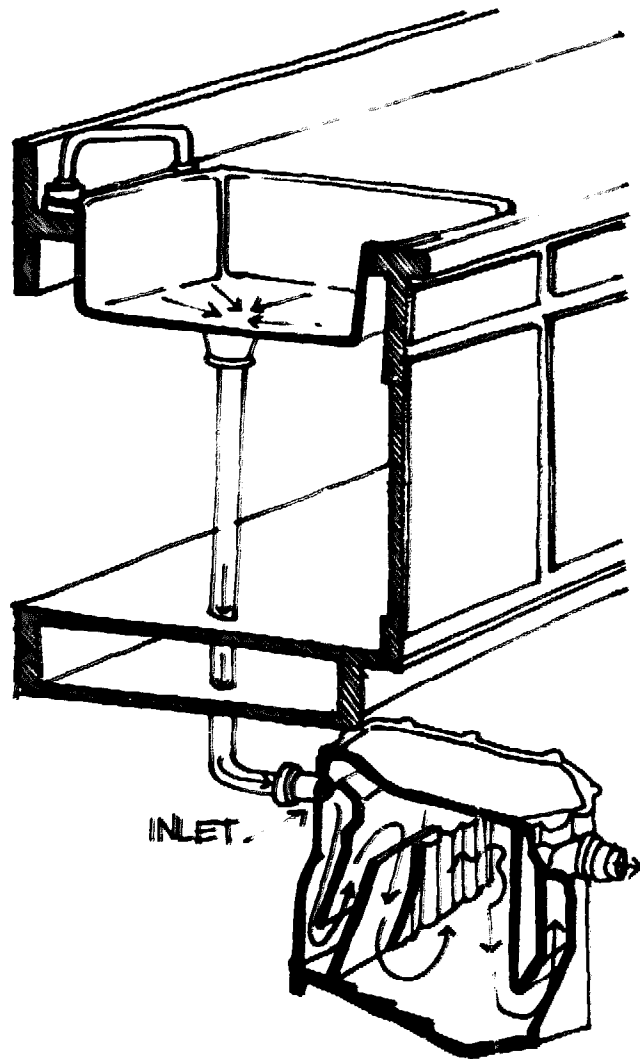

GREASE TRAP

frequency with which cleaning is required is most easily determined by experience. Wastes from the garbage grinder should not be discharged into a grease trap, as they will become septic.

The grease trap should be placed in a location that is readily accessible for cleaning and is as close as possible to the fixture discharging the greasy wastes. The smallest grease traps are only about the size of a breadbox and so can be easily placed under the kitchen sink.

Cost

The cost of a grease trap depends on the capacity of the trap and the materials of construction. The trap should have a capacity of at least 2-1/2 gallons per person per meal if the trap is to primarily receive wastewater from the kitchen. The tank is best constructed of concrete if it is to be buried in the ground, but may be of steel or aluminum if it is to be used indoors. Homemade grease traps are also successful, especially if located outdoors.

DOSING SIPHON

A dosing siphon is a simple device containing no moving parts, which employs natural hydraulic phenomena to transform a continuous low-rate flow of water into an intermittent high-rate flow. The device is typically used to more effectively utilize gravity-fed components such as subsurface irrigation systems, slow sand filters, and the like.

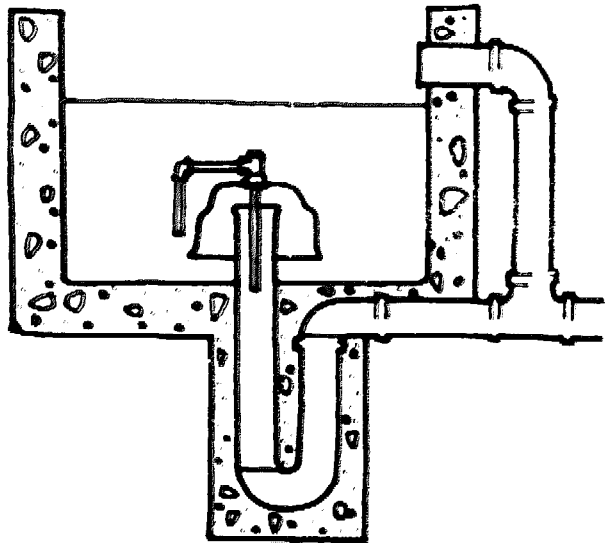

DOSING SIPHON

Operation

A dosing siphon consists basically of a small tank (20 to 50 gallons) and a J-shaped trap. The trap is mounted in the bottom of the tank, which is usually concrete, so that the long leg of the trap protrudes a short distance above the floor of the tank and the short leg remains below the tank floor. A bell-shaped cap containing an integral air vent is mounted on top of the long leg of the trap. A discharge pipe, containing a back vent and overflow pipe, is connected to the short leg of the trap.

Operation of the dosing siphon requires that the trap be initially filled with water. At the beginning of the dosing cycle the water level in the tank is at the bottom of the trap bell. This point, which is approximately 3 inches above the floor of the tank, is the lowest level the water will reach during the dosing cycle and is therefore called the "low water line". Because the trap is filled with water (both legs of the trap are filled to a level equal to the

top of the short leg), the air volume in the top of the long leg is sealed in when the water level in the tank rises above the open end of the bell vent pipe.

As the water level in the tank continues to rise, it forces the trapped air volume down the long leg of the trap to the point where the air volume is at the bend in the trap just about to escape up the short leg. At this point, the difference in the water levels in the two legs of the trap is equal to the difference in the water levels in the tank and in the bell. Thus, the column of water in the short leg of the trap is equal in height to the head of water in the tank above the level at which it stands in the bell. Hence, at this specific level of water in the tank (the high water line) the two columns of water counterbalance each other.

As soon as the water level in the tank rises any further (regardless of how little), a portion of the trapped air is forced around the bend in the trap. The air rushes up the short leg of the trap carrying some of the water with it. This action destroys the system's equilibrium and immediately causes a full siphoning action to occur. The siphoning action continues until the water in the tank is again drawn to the bottom of the bell where it is stopped by air being drawn under the bottom of the bell. The system is completely vented by air entering through the bell vent pipe and thus, the cycle begins again.

Maintenance

The dosing siphon must simply be kept free of debris and settled solids.

Cost

Dosing siphons are commercially available for 3 to 6 inch pipe sizes. A 3 inch siphon costs approximately \$175. Commercial siphons for smaller diameter pipe sizes are not available.

Although dosing siphons are expensive commercially, with a little ingenuity they can be easily assembled from readily available plastic drain pipe parts. For example, a 2 inch diameter siphon can be assembled in about 3 hours, using ABS pipe and fittings, for about \$20.

SOLAR STILLS

A solar still utilizes energy from the sun to purify water through distillation. Because distillation requires a large input of energy per unit volume of water purified, and because the supply of solar energy is endless, the solar still has become a very interesting device.

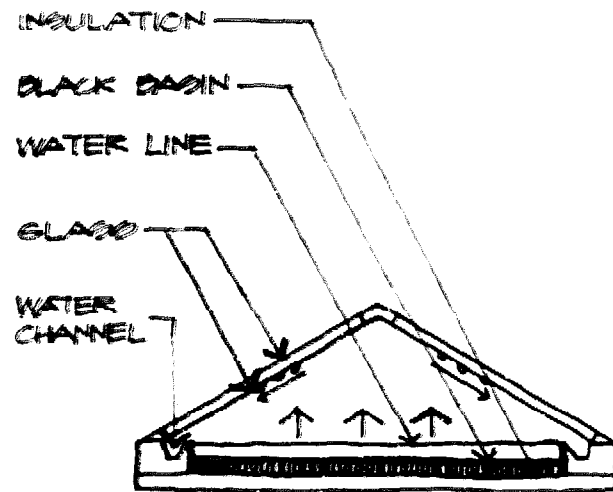

TYPICAL SOLAR STILL

Operation

Conceptually the operation of a solar still is extremely simple: Solar energy is trapped in an enclosure containing the water to be purified. The water absorbs this energy in the form of heat and evaporates, leaving impurities behind. It then recondenses at a point where it may be readily collected. Although a variety of solar stills exists, they all operate on this basic principle.

Basin Still: The most common type of solar still is the basin still. The sun's rays pass through a glass cover and are absorbed by the black-colored surface of a basin which contains the water to be purified. The water is in turn heated by the energy reradiating from the basin. As the water evaporates, the gaseous water vapor rises until it hits the underside of the glass cover where it recondenses into liquid form. The water then runs down the inclined surface of the cover to a collection trough. From the collection trough, the purified water usually flows by gravity to a storage tank. A typical basin still will

produce approximately 0.10 gallons of water per day per square foot of surface area.

Other forms of solar stills are designed to use the sun's energy more efficiently by orienting the still more directly towards the sun. These types of stills are particularly important in higher latitudes where much less solar radiation is intercepted by horizontal surfaces.

Tilted-Wick Still: This type of still employs a porous black cloth to wick water from a storage tank or other source and hold it, in a form equivalent to a thin sheet of water, on an incline oriented towards the sun. A tilted-wick still can produce approximately 0.12 gallons per day per square foot of surface area.

Focusing Still: A focusing still employs a parabolic mirror as a concentrating reflector to focus the sun's rays on the water. After evaporating, the water vapor goes from the central evaporating unit to a condenser unit for cooling. A focusing still evaporates water vapor very rapidly and therefore requires a continuous supply of water. It can typically produce 1/2 gallon of water per day per square foot of reflector area. However, a focusing still is much more expensive than the more common basin still and is more difficult to install.

Maintenance

Over time, the impurities that are left behind during evaporation accumulate on the evaporator surface. As a result, the still must periodically be emptied and flushed out to remove these accumulated impurities. If left unattended, the light color of this material will greatly reduce the efficiency of the still.

APPENDIX: WATER REUSE TERMS

GLOSSARY

Aquifer - An underground body of permeable rock, sand, or gravel capable of storing water that can be removed and used for human purposes; an underground reservoir of water.

Blackwater - The effluent from toilets or urinals.

BOD - Biochemical oxygen demand; an index of the amount of biodegradable organic material in a water sample. Water with lower BOD is thought to be less polluted.

COD - Chemical oxygen demand; an index of the total organic content of a water sample.

Greywater - The effluent from residential appliances or fixtures except toilets or urinals.

GPCPD - Gallons per capita per day.

Pathogen - A causative agent of disease.

Potable - Suitable for drinking.

Primary Treatment - The settling of raw sewage, usually accompanied by skimming of floatables and chlorination.

Secondary Treatment - The stabilization and removal of fine suspended solids, BOD, and COD from wastewater.

TDS - Total dissolved solids; a measure of the mineral content of water supplies.

Tertiary Treatment - Advanced wastewater treatment used to remove pollutants not affected by primary and secondary treatment and to produce an effluent that is suitable for reuse.

QUANTITY

Gallon	= 8.33 pounds
	= 231 cubic inches
	= .134 cubic foot
Liter	= .263 gallons
Cubic foot	= 7.48 gallons
	= 62.4 pounds
Ton	= 240 gallons
Acre-foot	= 43,560 cubic feet
	= 325,851 gallons
1 million gallons	= 3.07 acre-feet

FLCW

Gallon per minute = 1440 gallons per day
= 193 cubic feet per day
= 525,600 gallons per year
= 1.4 acre-feet per year

Cubic foot per second = 449 gallons per minute
= 646,100 gallons per day
= 1.98 acre-feet per day

Acre-foot per year = 893 gallons per day
= .62 gallons per minute
= roughly the annual consumption of a family of five

COST

\$1 per 1000 gallons = \$.75 per 100 cubic feet
= \$325.85 per acre-foot

\$1 per 100 cubic feet = \$1.34 per 1000 gallons
= \$435.60 per acre foot

APPENDIX: RESIDENTIAL FLOW RATES

When designing water supply and sewage systems, engineers use a unit of measure known as the Fixture Unit (F.U.), which is a flow rate equal to 1 cubic foot of fluid per minute, or 7.5 gallons per minute (GPM). Thus from the hydraulic engineer's point of view it does not matter how much water a fixture uses, what counts is how fast it is used. Thus a fixture which uses a moderate amount of water in a very short period of time imposes a much greater load on the system than if it used the same amount of water over a much longer period. Once the engineer has counted up all the Fixture Units in a given building, he can simply look up in a chart and find the required sizes of water supply lines and sewer pipes. However, in practice, hydraulic engineers never bother designing the plumbing systems in homes and small apartment buildings; the plumbing contractor simply installs the minimum sized pipes allowed in the plumbing code, which have been shown in practice to be more than large enough to handle the loads.

Flow Rates Assumed in Designing Residential Plumbing Systems

	<u>Water Used</u>		<u>Sewage Produced</u>	
	F.U.	GPM	F.U.	GPM
Toilet (flush tank)	3	22.5	4	30
Bathroom Sink	1	7.5	2	15
Bathtub	2	15	2	15
Shower Head	2	15	3	22.5
Kitchen Sink	2	15	3	22.5
Floor Drain	-		1	7.5

APPENDIX: INDEX OF MANUFACTURES

ADVANCED ENVIRONMENTAL CONCEPTS

Glendale, California

Amway biodegradable soap, and Wash-Line soaps for septic tank users (for dishwasher, washing machine, shampoo, etc.)

AERA-FILT SYSTEMS, INC.

P.O. Box 567

Lafayette, Indiana 47901

Sewerless toilet; diffused air, extended aeration unit

AMERICAN MACHINE & FOUNDRY COMPANY

AMF CUND Division

Meriden, Connecticut 06450

Cartridge filter housing

AMERICAN PRODUCTS COMPANY

10913 Vanowen Street

North Hollywood, California 91605

Pumps, filters, rotary backwash valves

AQUA BRAIN

18414 Eddy Street

Northridge, California 91325

Soil moisture sensors

AQUA-DATA CORPORATION

P.O. Box 901

Carpenteria, California 93013

Drip irrigation

AQUA SAVER, INC.

7902 Belair Rd.

Baltimore, Maryland 21236

Aqua saver water recycling system

BIO SYSTEM

1200 28th St., Suite 1

Boulder, Colorado 80802

Evapotranspiration home sewage treatment and disposal systems

BIO-UTILITY SYSTEMS, INCORPORATED

P.O. Box 135

Narberth, Pennsylvania 19072

Enviro-Pak water recycling toilets, Bui-Let electrical composting toilet, on-site grey-water disposal system, iodicators and chlorinators for on-site water purification

Note: The inclusion of a company's name in this list does not in any way constitute an endorsement of its products.

BRW INDUSTRIES
Box 2413
Fullerton, California 92633
Soil tensiometers

BUEHLER TANK COMPANY
321 W. Catella Ave.
Orange, California 92668
Steel tanks

CAN-TEK INDUSTRIES
Process Equipment Division
P.O. Box 340
Mineral Wells, Texas 76067
Large aerobic treatment plants

CARE-FREE IRRIGATION SUPPLIES
Box 151
San Juan Capistrano, California 92675
Irronometers and compatible time clocks

CHAPIN WATERMATICS, INC.
368 N. Colorado Ave.
Watertown, New York 13601
"Micro-Dripper". Drip irrigation emitter,
direct tap into polyethylene pipe

CHRISTOPHER ENTERPRISES, INC.
P.O. Box 352
Provo, Utah 84601
Water distiller

CHRYSLER CORPORATION
Michoud Defense - Space Division
Environmental Systems
P.O. Box 29200
New Orleans, Louisiana 70189
Aqua Sans waterless sewage treatment system

CLA-VAL CO.
P.O. Box 1390
Winter Park, Florida 32789
or
P.O. Box 1325
Newport Beach, California 92663
Clayton automatic valves, backflow preventers,
pressure reducing valves

CLIVUS MULTRUM USA, INC.
14A Eliot Street
Cambridge, Massachusetts 02138
Composter toilet

COLT INDUSTRIES
Water and Waste Management Operation
701 Lawton Avenue
Beloit, Wisconsin 53511
Envirovac system vacuum toilet; Liljendahl,
Electrolux

CONSERVAGATOR
Conserva-Products Div.
141 Pierpont Ave.
Salt Lake City, Utah 84101
Pumps

CONTAINER CORPORATION OF AMERICA
615 Hawaii Avenue
Torrance, California 90503
Polyethylene tanks

CONTROLLED WATER EMISSION SYSTEMS
585 Vernon Way
El Cajon, California 92022
Drip irrigation

CROMAGLASS CORPORATION
Box 1146
Williamsport, Pennsylvania 17701
Aerobic waste treatment tanks

DEEP SEEP CAP-TOP SOAKERS
915 E. Bethany Home Road
Phoenix, Arizona 85014
Drip irrigation

DEFECO, INC.
325 North Daloson Drive
Camarillo, California 93010
Emitters for drip irrigation

DIXEL IRRIGATION SYSTEMS
17 Briar Hollow
Houston, Texas 77027
Drip irrigation - strap on emitter

THE DRAWN COMPANY
P.O. Box 528
Manitowoc, Wisconsin 54220
Solenoid valves

DUPONT COMPANY
1007 Market Street
Wilmington, Delaware 19898
Drip irrigation

ECODYNE CORPORATION
Smith & Loveless Division
96th & Old Santa Fe Trail
Lenexa, Kansas 66215
Aerobic sewage treatment, large units

ENVIROSCOPE, INCORPORATED
P.O. Box 752
Corona Del Mar, California 92625
Composter toilet, pressurized flush toilet,
greywater recycling systems, greywater treat-
ment system

FLYGT CORPORATION
129 Glover Ave.
Norwalk, Connecticut 06856
Flygt mini plant - individual aerobic waste-
water treatment plant

G.A.F. FILTER PRODUCTS
1500 Daisy Ave.
Long Beach, California 90813
Pressure vessel filters

W.W. GRAINGER, INC. (general offices)
5959 W. Howard Street
Chicago, Illinois 60648
(Catalog sales plus 134 locations)
Pumps, plumbing fittings, chlorinators, tanks,
etc.

GREAT CIRCLE ASSOCIATES
89 Edgcroft Road
Kensington, California 94707
Domestic wastewater treatment systems

GRO-MOR
3156 E. La Paloma, Suite J
Anaheim, California 92806
Drip irrigation kits

A B GUSTAVSBERGS FABRIKER
Fleminggatan 62 B, Box 12159
10224 Stockholm 12, Sweden
Composter toilet

HANCOR, INC.
P.O. Box 1047
401 Olive Street
Findlay, Ohio 45840
Drainage & water management products including
filter wrap tubing, sump pumps, valves

HATCH CHEMICALS
Ames, Iowa 50010
B.O.D. test kit

HOME STILL, INC.
Box A
Bismarck, North Dakota 58501
Home Still water distiller

HORIZON ECOLOGY CO.
7435 North Oak Park Ave.
Chicago, Illinois 60648
Soil test kits, cartridge filters & demineral-
izers, flow meters

HUMMAT LIMITED
9403 120th Street
Delta, British Columbia
Canada V4C 2P3
Composter toilet

HYDROLON SYSTEMS, INC.
1948 Gladwick
Compton, California 90220
Water filters

HYDRO-RAIN, INC.
26031 Avenida Aeropuerto
San Jaun Capistrano, California 92675
Solenoid valves

HYDRO TERRA CORPORATION
800 North Park Avenue
Pomona, California 91768
Automatic irrigation controller tensiometers

IODINAMICS CORP.
P.O. Box 26428
El Paso, Texas 79926
Iodinator

IRROMETER
Box 2424
Riverside, California 92506
Moisture sensor watering system

ISTA
Energy Systems Corporation
29 South Union Ave.
Cranford, New Jersey 07016
Backwash water filters, chemical metering
pumps, water refining combination filter and
dosing device

ITT LAWLER
453 N. Mac Questen Parkway
Mount Vernon, New York 10552
Pressure reducing valves

KEENE CORPORATION
Water Pollution Control Division
1740 Molitor Road
Aurora, Illinois 60507
Large sewage aerobic treatment units

KENCO, INC.
Loraine, Ohio
Portable electric sump pumps

KEYSTONE, INC.
Hatfield, Pennsylvania 19440
Fitter elements

KNIGHT EQUIPMENT CORPORATION
Box 1378
Costa Mesa, California 92626
Fiberglass tanks

LEISURE TIME WATERING SYSTEMS
P.O. Box 1298
Hollister, California 95023
Drip irrigation

MARINE SWIMMING POOL EQUIPMENT CO.
North Hollywood, California 91605
Push-pull backwash valves

MARTEC INDUSTRIES
21208 Vanowen Street
Canoga Park, California 91303
Small scale drinking water filters

MILIPORE INTERTECH INC.
Bedford, Massachusetts 01730
Procedure sheets and kits for field testing
fecal coliform, suspended solids

MODULAR CONCEPTUAL SYSTEMS
Ivyland, Pennsylvania
Portable comfort station and sewage treatment
plant

MONOGRAM INDUSTRIES, INCORPORATED
100 Wilshire Blvd.
Santa Monica, California 90401
Oil flush toilet (Magic Flush), chemical
toilet, greywater treatment systems

MULTI-FLOW INCORPORATED
500 Webster Street
Dayton, Ohio 45401
Recycling extended aeration filtration unit

MULTI PURE DRINKING WATER SYSTEMS
12926 Saticoy Street
North Hollywood, California 91605
Drinking water system

MUL-TOA
Tenax Corporation
3848 Campus Drive, Suite 119
Newport Beach, California 92660
Composter toilet

NATIONAL TANK AND PIPE CO.
10037 S.E. Mather Road
Post Office Box 7
Clackamas, Oregon 97015
Wooden tanks

NEPTUNE MICROFLOC INCORPORATED
P.O. Box 612
Corvallis, Oregon 97330
Community wastewater treatment

NEW X PRODUCTS
16300 Lavender Lane
Los Gatos, California 95030
Moisture sensors

M.C. NOTTINGHAM COMPANY
P.O. Box 2107
Irwindale, California 91706
Septic systems

OGDEN FILTER COMPANY, INC.
4222 Santa Monica Blvd.
Los Angeles, California 90029
Water filters

ON-SITE SEWERAGES, INC.
P.O. Box 567
Lafayette, Indiana 47901
Wastewater treatment

PERMA-RAIN IRRIGATION
Box 880
Lindsay, California 93247
Soil tensiometers

PHILMAR, INC.
8879 W. Pico Blvd.
Los Angeles, California 90035
Water purifiers, in-line filters

POLLUTROL TECHNOLOGY, INCORPORATED
32 Kearney Road
Needham Heights, Massachusetts 02194
Aerobic waste treatment

PURCOLATOR FILTERS
9738 S. Atlantic Ave.
Southgate, California 90280
Pressure vessel filters

PURECYCLE CORPORATION
2855 Walnut Street
Boulder, Colorado 80301
Purecycle wastewater system

PUREWATER
Xonics, Inc.
6849 Havenhurst Ave.
Van Nuys, California 91406
Small scale water purification systems

RAIN BIRD
Glendora, California 91740
Drip irrigation emitters

RAVEN INDUSTRIES, INC.
Box 1007
Sioux Falls, South Dakota 57101
Polyethylene tanks

RECREATION ECOLOGY CONSERVATION OF THE UNITED STATES, INC.
9800 W. Bluemound Road
Milwaukee, Wisconsin 53226
Ecolet waterless toilet

PAUL REDFIELD
Box 50 RR#2
Madison, South Dakota 57042
"Water Wise" water reuse system

REDDI FRESH WATER COMPANY
11726 Gateway Blvd.
Los Angeles, California 90064
Reverse osmosis water systems

ROBERTS IRRIGATION PRODUCTS
700 Rancheros Drive
San Marcos, California 92065
Drip irrigation kits

SAFE WATER PRODUCTS, INC.
8337 Nieman Road
Lenexa, Kansas 66214
Cartridge type water filter

SCOTT-FETZER COMPANY
Carefree Division
2760 Industrial Lane
Denver, Colorado 80220
Carefree recycling "porta-shower"

SEARS, ROEBUCK AND COMPANY
Special Catalogs Division
Sears Towers
Chicago, Illinois 60684
Valves, pipe, pumps, plumbing supplies,
filters, chlorinators, etc.

SHAM PUMP, INC.
9660 East Rush St.
P.O. Box 3336
South El Monte, California 91733
Chemical pumps & motor units

SOILMOISTURE EQUIPMENT CORPORATION
801 S. Kellog Ave.
Goleta, California 93017
Soil tensiometers

THETFORD CORPORATION
Waste Treatment Products Division
P.O. Box 1285
Ann Arbor, Michigan 48106
Recycling toilet

TURF SERVICE LABORATORY
P.O. Box 1001
Laguna Beach, California 92651
Moisture indicators, moisturometer

TYME VALUE CORPORATION
12100 E. Park Street
Cerritos, California 90701
Sprinkler control

VITA GREEN FARMS
P.O. Box 878
Vista, California 92083
Solar water purifier

WAICO-NORTHWEST
5920 N.W. 87th Avenue
Portland, Oregon 97220
Drip irrigation

WATERMASTER MOISTURE INDICATOR
521 Hilmar
Santa Clara, California 95050
Soil tensiometers

WATTS REGULATOR COMPANY
Lawrence, Massachusetts 08142
Water pressure reducing valve house connection

**WESTERN ENVIRONMENTAL ENGINEERING
1747 Hancock Street
San Diego, California 92101
FLYGT aerobic sewage mini-plant**

APPENDIX: ANNOTATED BIBLIOGRAPHY

A.I.Ch.E. Proceedings of the Second National Conference on Complete Water Reuse. Chicago, Ill., May 4-8, 1975 (see EPA 1975).

A.I.D. Small Wells Manual. Department of State Agency for International Development, Washington D.C., September 1969.

An excellent manual for laymen on well location, design, construction and maintenance. 156 pp. with bibliography and appendices.

Alexander, G. "Water Saving, the West's New Challenge" in "Drought, Our Changing Weather." Popular Science, September 1977.

"Several recycling machines were put on the market in early '77. These devices force greywater through a series of filters that remove suspended matter, then add chlorine."

Alpert, Joel, and Harrington, Donald. Economic Evaluation of the Promulgated Interim Primary Drinking Water Regulations. Energy Resources Co., Inc., Cambridge, Mass., October 1975.

Drinking Water Regulations prescribed by the EPA indicate that water monitoring will cost from \$.25 to \$240 per capita.

Alternate Sewage Manual. Section of Plumbing and Fire Protection Systems, P.O. 309, Madison, Wisconsin, June 1975.

American Chemical Society. Cleaning Our Environment: The Chemical Basis for Action. Washington D.C., 1969.

Chapter 2 presents the technical issues in water pollution abatement and a brief examination of the state of the art of water treatment. Particularly good explanation of Biochemical Oxygen Demand (BOD), and phosphorous and nitrogen removal.

American Public Health Association. Excreta Disposal for Rural Areas and Small Communities and Water Supply for Rural Areas and Small Communities. New York.

American Public Works Association. Practices in Detention of Urban Stormwater Runoff. Special Report No. 43. American Public Works Association, Chicago, Ill., 1974.

Ames Research Center. "The Closed Life-Support System," report prepared by National Aeronautics and Space Administration, April 1966.

Anderman, W.H., Jr. "Economic Feasibility of Rural Sewage Management" a paper presented to the National Environmental Health Association, 1975 Annual Conference, Minneapolis, Minnesota, June 28 - July 3, 1975.

Angelides, Sotirios, and Bardach, Eugene. Water Banking: How to Stop Wasting Agricultural Water. Institute of Contemporary Studies, San Francisco, California, 1978.

Arizona State Department of Health Services. Guidelines for Approval of Subdivisions, Engineering Bulletin No. 19, July 1975.

Arizona State Department of Health Services. Guidelines for Installation of Septic Tank Systems, Engineering Bulletin No. 12, May 1974.

Aver, Jane. "Implementing Re-Use of Wastewater for Groundwater Re-Charge in California." State Water Resources Control Board, Sacramento, California, June 1975.

Aver, Jane. "Reclamation: Forestalling A Water Shortage Time Bomb", California Today Newsletter, 717 K St., Sacramento. Feb/Mar. 1977.

By 2000 as much as 60% of California's expected water shortage could be met by reclaimed water. In 1977 there were over 200 wastewater reuse and reclamation projects in California.

Ayres, Robert S., Branson, Roy L., and Madison, John H. Using Household Waste Water on Plants, Leaflet 2968, Division of Agricultural Sciences, University of California, 1977.

An informative little sheet explaining how to irrigate with "used" water.

Bailey, J.R., et al. A Study of Flow Reduction and Treatment of Waste Water From Households. Federal Water Quality Administration, Department of the Interior, Program # 11050FWE, December 1969.

Also referenced as: Water Pollution Control Research Series, U.S. Environmental Protection Agency, Washington, D.C., 1969; FWQA Contract Project 14-12-428, U.S. Government Printing Office, Washington, D.C., 1969; and Water Pollution Control Research Series, 11050FKE, Advanced Waste Treatment Research Laboratory,

Cincinnati, Ohio, December 1969.

This is one of the most often referenced documents in residential water conservation. It was apparently one of the first to study residential flow reduction devices and the possibility of on-site reuse. It also analyzes the possibility of household waste treatment. In addition, it provides data on current requirements of water quantity for the various uses in the home and suggests water quality standards for these uses. A small public opinion survey showed little unfavorable reaction to water conserving devices with the exception of the home urinal and the recycle toilet.

Baker, Larry K., Bailey, Harold E., and Sierka, Raymond A. "Household Water Conservation Effects on Water, Energy, and Wastewater Management." A.I.Ch.E., 1975, pp. 178-183 (also in Sharpe, 1975).

Balderston, Lydia Ray. Housewifery. J. B. Lippincott Co., Philadelphia, 1924.

A handbook of practical housekeeping designed to reduce tasks and save time, money, and energy, although the work it prescribes appears exhausting to today's reader.

Bargman, R.D., et al. "Water Reclamation in Los Angeles." Journal of the Environmental Engineering Division, ASCE, 99 (EE6), 1973.

Barnes, D., and Wilson, F. The Design and Operation of Small Sewage Works. Halsted Press, a

division of John Wiley & Sons, N.Y., 1976.

A one-volume treatment of the design, construction, and operation of small scale sewage plants, filled with how-to-do-it data. It outlines general principles of sewage treatment and sludge disposal and spotlights advantages and disadvantages of various alternatives.

Barry, Wade. "Reuse of Wastewater for Plant Growth." Laboratory for Nuclear Medicine, University of California, Los Angeles.

Bartlett, R.E.. Surface Water Sewerage. Halsted Press, 1976.

This book covers those aspects of rainfall and runoff which affect surface water sewerage design, together with the hydraulic and structural calculations of the sewers themselves. The entire range of surface water sewer design is discussed including how to reduce the cost of sewerage design without underdesigning, rainfall, and runoff calculations, hydraulic and structural design of pipelines, storm sewage overflows on combined sewers, and the provision of storage facilities (storage in the form of balancing reservoirs and water sewerage meadows).

Baylin, Frank. "Solar Sewage Treatment - Low Tech System Harnesses Natural Processes," Popular Science, May 1979.

Beatty, Russell A. "Browning of the Greensward," Pacific Horticulture, Fall 1977.

Examines the origins of our ideas about landscape design and the paradisaean fantasy that results in high water-use designs. He proposes

a revision of these ideas and their alignment with the realities of climate.

Bechtel, C.R. "Cross-Connections: 'Minor' Oversights that Become Major Disasters," Plumbing Engineering, July-August 1974.

Case studies of back-siphonage accidents.

Bedard, Roger, G. Biodegradability of Organic Compounds. Institute of Water Resources, Connecticut University, Storrs, 1976. (PB-264 707/1PSM).

Beecher, Catherine E., and Stowe, Harriet Beecher. The American Woman's Home. J.B. Ford & Co., New York, 1869.

The authors hoped to improve the status of women in society by treating housework as a profession. The book gives instructions on how to run a house, furnish it, and even includes a plan for building an efficient house.

Bemis, Albert Farwell, and Burchard, John, II. The Evolving House, Volume I. The Technology Press, Massachusetts Institute of Technology, Cambridge, 1933.

A thorough history of dwellings from prehistoric and primitive homes up to the time the book was published, including both Europe and Asia.

Benenson, Peter. A Water Conservation Scenario for the Residential and Industrial Sectors in California: Potential Savings of Water and Related Energy. U.S. Energy Research and Development Administration, Energy Analysis Program,

Lawrence Berkeley Laboratory, Berkeley, California, 1977.

Well written explanation of possible water and energy savings in California given a set of household water conservation techniques, including greywater use. It projects a saving of 38% of estimated residential and industrial water use (approximately 5% of statewide use), 2% of statewide electricity consumption and 3% of statewide natural gas consumption.

Bennett, Edwin R. "Impact of Flow Reduction on On-Lot Sewage Systems," in Sharpe, 1975.

Bernhardt, A.P. Treatment and Disposal of Waste Water From Homes by Soil Infiltration and Evapotranspiration, University of Toronto Press, 1973.

Bernhart, A.P. Small Wastewater Units for Soil Infiltration and Evapotranspiration. Hancore, Inc., Findley, Ohio, 1972.

Berry, B.J.L., and Horton, F.E. Urban Environmental Management: Planning for Pollution Control. Prentice-Hall, Inc., Englewood Cliffs, N.J., 1974.

An excellent, comprehensive discussion of the environment and the problems of environmental pollution generated by urban development. Presented in the format of an original text integrated with selected readings; the book explores in depth the issues of urban location, spatial relationships, the mutual interdependencies of man and nature, the complexities of ecological systems and the responses of nature to the products and by-products of urban systems.

Berry, W.L. "Flowers, Vegetables From Wastewater," University Bulletin, Vol. 26, No. 9, November 28, 1977. University of California.

Recycled water irrigates hydroponic greenhouse.

Bertolino, Rosaleen. Water Supply: Constraints and Opportunities. Sierra Club, San Francisco, California, 1977.

General discussion of water supply issues. Points out, through use of several examples, the lack of cost effectiveness of several federal water supply projects. Includes discussion of laws pertaining to water rights and interbasin transfers.

Betz, Jack M. Summary of Activities 1976-77. City of Los Angeles, Bureau of Sanitation, 1977. Provides data on work loads, volumes of solid waste and wastewater processed by the Bureau of Sanitation.

"Biological Treatment of Wastewater", Rain Magazine, November 1977.

A nice little summary. Describes the "aquacells" being tested by Solar Aqua Systems of Encinitas, California.

Bishop, A.B., and Hendricks, D.W. Analysis of Water Reuse Alternatives in an Integrated Urban and Agricultural Area. Utah State University, Water Research Laboratory, 1971.

Bishop, A.B., et al. Evaluating Water Reuse Alternatives in Water Resources Planning. Utah State University, Water Research Laboratory, 1974.

Bishop, A.B., et al. Social, Economic, Environmental, and Technical Factors Influencing Wastewater Reuse. Utah State University, Water Research Laboratory, 1973.

Blake, Nelson Manfred. Water for the Cities. Syracuse University Press, 1956.

A history of the urban water supply problem in the United States and how several major cities went about solving it.

Bowden, Charles. Killing the Hidden Waters. University of Texas Press, 1971.

A fascinating description of how primitive peoples lived in arid land in the south western U.S., and how overdrafting or "mining" groundwater is rapidly destroying the entire region.

Brandies, M. "The Rainwater Room", Alternate Sources of Energy, Vol. 22, September 1976.

Brown, Robena J. (Ed.). Sewage and Organic Waste Irrigation (citations from the NTIS Data Base: 1964 - July 1977). U.S. Department of Commerce, National Technical Information Service, Springfield, Va., August 1977.

Brown and Caldwell. An Evaluation of Alternatives for On-Site Sewage Treatment and Disposal. Oregon Department of Environmental Quality, April 1975.

A nice complete discussion of septic tanks and other on-site disposal methods.

Bruvold, W.H. "Affective Response Toward Uses of Reclaimed Water," Journal of Applied Psychology, V. 55, 1971.

Bruvold, W.H. Public Attitudes Toward Reuse of Reclaimed Water. University of California California Water Resources Center, Contribution No. 137, University of California, Davis, 1972.

"A discussion of a survey conducted by Bruvold examining the attitudes of the public toward the reuse of reclaimed water. An example of the actual questionnaire is included and the results are analyzed. Bruvold's study shows that people have a 'psychological repugnance' toward reused water and find it acceptable only in uses which do not involve body contact. His study also shows that people with more education are more accepting of the reclaimed water and he concludes that greater communication and attempts to educate the public will be required."

Buchanan, R.D. "Partial Recycle: A New Sewerage System," Water and Sewage Works, January 1972. The article is about the Point Barrow System.

Buie, Jonie. "Greywater Use Practical," Southern Sierran, L.A. Chapter, Sierra Club, May 1977. Urges County arboreta to test greywater with various soaps and detergents.

Burstall, Aubrey F. A History of Mechanical Engineering. The M.I.T. Press, Cambridge, Mass., 1965.

Early water projects. An easy to read, entertaining book with many illustrations.

Cahn, Joel. "Natural Drainage," House and Home, December 1976.

California Department of Health. Guidelines for the Use of Reclaimed Water for Spray Irrigation of Crops. California Department of Health, 1974.

California Department of Health. "Wastewater Reclamation Criteria," California Environmental Health Code, Title 22, Chapter 4, 1975.

On these 7 pages are all the health regulations governing the reuse of greywater. (The coliform counts and settleable solids are achievable, but other regulations such as automatic alarms, emergence storage, daily sampling, pose problems for the average homeowner.) See also Porter-Cologne Water Quality Control Act of 1974 which establishes requirements for land application.

California Department of Public Health. Water Reclamation. Bureau of Sanitary Engineering, 1972.

California, University of. "Saving Water in Landscape Irrigation," Leaflet 2976. Division of Agricultural Sciences, University of California.

A useful and comprehensive discussion.

California, University of. "Using Reclaimed Water on Farmland," Cooperative Extension Leaflet 2931. University of California, February 1977.

Salts are the problem but soils and management make the difference.

Cambridge University. See Vale 1972.

Campbell, L.A. "A Feasibility Study of a Completely Recycled Water System in an Apartment Complex with a Population of 1000 People," Report AM-6803 for Central Mortgage and Housing Corporation, March 1968.

Campbell, L.A., and Smith, D.K. "An Investigation of Individual Household Aerobic Sewage Treatment Units," Canadian Municipal Utilities, November-December 1963.

Campbell, Michael D., and Lehr, Jay J. Rural Water Systems Planning and Engineering Guide. Commission on Rural Water, Chicago, Illinois, "A manual for construction of groundwater facilities, which covers water system planning and development, construction, well pump systems, water treatment facilities, distribution and storage units, costs, and system maintenance. Selected bibliography."

Cansdale, George. "A Simple Low Maintenance Water Filter Suitable for Village Use," reprint from Appropriate Technology, P.O. Box 555, Forest Grove, Oregon 97116.

Cantacuzino, Sherban. European Domestic Architecture, Its Development From Early Times. E. P. Dutton and Co., New York, 1969.

A history of domestic architecture with an emphasis on architectural style and how society effected the design and plan of houses.

Carcopino, Jerome. Daily Life in Ancient Rome. Penguin Books, 1941.

Water supply and sewage are mentioned in the chapter "Houses and Streets."

Carr, Donald E. Death of the Sweet Waters. W. W. Norton & Co., Inc., New York, 1971.

A book about water, how it is used, how it got polluted. It includes suggestions on how to make the government aware of the seriousness of water pollution.

Cecil, L.K. "Complete Water Reuse, Technology Transfer," Environmental Protection Agency, Washington D.C., 1973.

Cecil, L.K. (Ed.). Complete Water Reuse: Industry's Opportunity. A.I.Ch.E., New York, 1973.

Cecil, L.K. (Ed.). Water Reuse, A.I.Ch.E., No. 78, Vol. 63, New York, 1967.

A collection of 39 papers on the reuse of water, mostly concerning industrial reuse and large scale urban projects.

Cedergren, Harry R. Seepage, Drainage, and Flow Nets, 2nd Ed. Wiley-Interscience, 1977.

Chan, M.L., and Heare, Steve. "The Cost Effectiveness of Pricing Schemes and Water-Saving Devices," Environmental Protection Agency, In Sharpe, 1975.

"The cost savings of various water-saving options to reduce household wastewater flow and water consumption were enumerated in this study...Two computer models were constructed. Water-saving devices were evaluated with respect to cost savings to households, water utilities, and wastewater industries. Pricing schemes were evaluated for various climatic regions and housing types with respect to consumer surplus, producer surplus, the sum of

consumer surplus and producer surplus, distributional effects across income classes, revenue adequacy, ability to conserve water, and savings to water and wastewater industries... They found that recycling for toilet flushing would save water and wastewater industries \$64 billion (1975 dollars)."

Chan, M.L., et al. Household Water Conservation and Flow Reduction. Office of Water Planning and Standards, Environmental Protection Agency, Washington D. C., July 1976. Also NTIS PB-265 578 5WB.

Studies the legal and economic aspects of devices and policies to reduce water and wastewater flows. Through use of a computer model, benefits are calculated for various replacement strategies in the adoption of water saving devices. Concludes that the recycling toilet is not cost effective unless rates greatly exceed \$7.00 per thousand gallons, but is the most cost effective if rates equal \$10.00/thousand gallons.

Chen, K.Y. "Soil Mantle as a Purification System for Greywater" in Winneberger, 1974.

Chinn, S.W. "Water Supply Potential from an Asphalt-Lined Catchment Near Holualoa, Kona, Hawaii", Water Supply Paper No. 1809-P, U.S. Geological Survey, U.S. Department of the Interior, 1965.

Churchill, James, E. The Homesteaders Handbook. Stackpole Books, 1974.

Simplistic, almost whimsical; little hard information. Devotes 200 words to rainwater collection, storage, and use.

Clark, Robert M. Renovated Wastewater as a Supplementary Source for Municipal Water Supply: An Economic Evaluation. U.S. Environmental Protection Agency, Cincinnati, Ohio, October 1976.

Clegg, Peter. New Low Cost Sources of Energy for the Home. Garden Way Publishing, Charlotte, Vermont, 1975.

The chapter on water/waste systems includes references to recycling of water plus a product catalog.

Cobb, Edwin L., and Zimmerman, Stanley. Guide for the Development of Local Water Projects. Commission on Rural Water, 221 N. La Salle Street, Chicago, Illinois 60611, 323 pages, softbound \$5.00.

"A how-to-do-it manual for project developers which covers a project from beginning to end - assessing the needs, setting up the organization, securing necessary financing, approval by governmental units, personnel training, construction and support, etc. A lengthy appendix has 'model' documents and other data."

Coe, J.L., and Laverty, F.B. "Wastewater Reclamation in Southern California," Journal of the Irrigation and Drainage Division, ASCE, 98 (IR3), 1972, pp. 419-432.

Cohen, S., and Wallman, H. "Demonstration of Waste Flow Reduction from Households", U.S. Environmental Protection Agency, Environmental Protection Technology Series, National Environmental Research Center, Cincinnati, Ohio, 1974.

A landmark study of normal household water use

patterns and testing of various water-saving systems in eight homes, including both flow-reduction devices and recycling systems, with a general discussion on homeowner acceptance of such systems and a cost analysis.

Conservation Foundation. "Is Colorado Helpless Against Land Blight?", Conservation Foundation Letter, Washington D. C., May 1979.

Conservation Foundation. "Paying for Pollution: Water Quality and Effluent Charges", Proceedings of Conservation Foundation sponsored conference, May 1977.

Proposes fees assessed by government against discharge of pollutants.

Converse, et al. "Design and Construction Procedures for Mounds in Slowly Permeable Soils with or without Seasonally High Water Tables," March 1976.

Cooper, R.C. "Public Health Aspects of Wastewater Renovation." School of Public Health, University of California, Berkeley.

Cooper, R.C. "Waste Water Management and Infectious Disease, I. Disease Agents and Indicators," Journal of Environmental Health, Vol. 37, No. 3, 1974.

Cooper, R.C. "Waste Water Management and Infectious Disease, II. Impact of Waste Water Treatment," Journal of Environmental Health, Vol. 37, No. 4, 1975.

Council for Agricultural Science and Technology. Application of Sewage Sludge to Cropland: Appraisal of Potential Hazards of the Heavy Metals to Plants and Animals. Council for Agricultural Science and Technology, Ames, Iowa, November 1976. NTIS PB-264 015/9PSM.

Council on Environmental Quality. Environmental Quality - 1977, The Eighth Annual Report of the Council on Environmental Quality. U.S. Government Printing Office, Washington D.C., December 1977.

Cowell, F.R. Everyday Life in Ancient Rome. B.T. Batsford Ltd., London, 1961.

In the section on apartments and houses there is information about water supply and sewage.

Culp, Gordon L., and Culp, Russell L. New Concepts in Water Purification. Van Nostrand Reinhold, New York, 1974.

A technical manual for water treatment practitioners; helpful discussion of potable water quality standards, and filtration and disinfection on the scale of the waterworks treatment plant; a chapter devoted to use of high-quality reclaimed wastewater including description of key examples and discussion of the primary problem areas.

Currie Engineering Company. "San Bernardino Sewerage Study," Consulting Engineers, 1968. Discussion of combined wastewater (grey and black) composition, determining quality standards, and establishing flow rates for systems design. Focuses on design of conventional treatment facilities.

Dales, George. "Strange Relics in the Crumbling, Still-Puzzling Indus Culture," Smithsonian Magazine, 1978, pp. 56-65.

4500 year old brick toilets with running water!

Darrow, Ken, and Pam, Rick. Appropriate Technology Sourcebook: A Guide to Practical Books and Plans for Village and Small Community Technology. Volunteers in Asia, Stanford, California, 1976.

Davis, Adelle. Let's Eat Right To Keep Fit. Harcourt, Brace, Jovanovich, New York, 1970.

A reference to a Mexican tribe who live without any water.

Day, A.D., and Tucker, T.C. "Production of Small Grains Pasture Forage Using Sewage Effluent as a Source of Irrigation Water and Plant Nutrients," Agronomy Journal, Vol. 51, 1959, pp. 569-572.

Deaner, D.G. Directory of Wastewater Reclamation Operations in California, Berkeley: State of California Department of Public Health, 1969.

De Camp, L. Sprague. The Ancient Engineers. Doubleday & Co. Inc., Garden City, New York, 1963.

The chapter on early Roman engineers includes information on the aqueducts and water supply system. An earlier aqueduct built in Mesopotamia is also described.

DeVries, Tom. "California's Drought Can We Change the Weather Before it's Too Late?" New West Magazine, February 28, 1977.

Disney World. "Living Farm" At Walt Disney World Experiment in Waste Water Recycling, news release (no date given).

Dixon, F.R., and McCabe, L.J. "Health Aspects of Wastewater Treatment", Journal of the Water Pollution Control Federation, Vol. 36, No. 8, August 1964, pp. 984-989.

Donahue, Roy L., et al. Soils: An Introduction to Soils and Plant Growth, 3rd Edition. Prentice Hall, Inc., 1971.

A textbook: good discussion of soil taxonomy, properties, ecology, and how to rectify poor soil conditions.

Dreyfuss, John. "Ecology May Dictate Where People Can Live," Los Angeles Times, June 25, 1972.

Drip Irrigation Magazine. Munford Publications, Incorporated, 375 N. Fulton, Fresno, California 93701.

Technical information on this new method of large scale agricultural irrigation.

Drummond, Wm. J. "Central Valley Project Losing \$70,000 a Day, Underpricing of Water and Power Blamed for Deficit of Vast System", Los Angeles Times, February 2, 1978.

Drummond, Wm. J. "Israel's Use of Water Recycled from Sewage Called 'Inevitable'," Los Angeles Times, page I-22, November 23, 1974.

Dunn, Edwin, E. The Bacterial Effect of the Halogens. A review of literature from 1936

through 1959. The Biochemical Research Laboratory, Dow Chemical Co., Michigan, 1960.

Durbin, Emily. "Water We Don't Need", editorial, Southern Sierran, May 1979.

D.W.P. "Emergency Water Conservation Plan." Los Angeles Department of Water and Power, May 1977.

D.W.P. "Statistics Card," for the fiscal year July 1977 to June 1978. Los Angeles Department of Water and Power, November 1978.

DWR. Are You Using Greywater During the Drought? Health Considerations Using Household Waste Water. California Department of Water Resources, 1977.

Here is a state agency saying (1) greywater use for irrigation is prohibited by the Uniform Plumbing Code, and (2) then explaining how to do it. A useful little 'how-to' pamphlet (supplements "Information Circular on Gray Water", Department of Health, 1977).

DWR. The California Drought - 1977 An Update. California Department of Water Resources, February 15, 1977.

DWR. The California State Water Project, Bulletins # 132-75, 132-76, 132-77 and 132-78. California Department of Water Resources.

DWR. California Water, Bulletin # 201-77. California Department of Water Resources, February, 1978.

An overview of the activities of the department. A collection of short articles addressing various projects and issues of water supply and flood

control. An interesting report on new uses for wastewater, water rights law commission, and DWR conservation materials.

DWR. A Pilot Water Conservation Program, Bulletin #191. California Department of Water Resources, October 1978.

DWR. Proceedings of the Agricultural Water Conservation Conference. California Department of Water Resources, June 1976.

Includes an interesting series of papers on irrigation methods, and papers on water quality pertaining to reuse of irrigation water and economics of water conservation. Back cover pocket contains a number of very informative water conservation "tips" for practicing agriculturalists.

DWR. Proceedings of the Governor's Drought Conference, Los Angeles, California, March 7-8, 1977. California Department of Water Resources.

Covers many aspects of drought related problems, addresses ways of preventing another crisis through conservation, both urban and rural, and mentions greywater specifically on pages 120-121.

DWR. Report of the Consulting Panel on Health Aspects of Wastewater Reclamation for Groundwater Recharge. California Department of Water Resources.

DWR. A "State of the Art" Review of Health Aspects of Wastewater Reclamation and Groundwater Recharge, prepared by the California

Department of Water Resources, the State Water Resources Control Board, and the Department of Health, November 1975 (\$5.00 copies available from DWR, Box 333, Sacramento, California).

A superb discussion of virtually all the health aspects of on-site water reuse. An absolute must for anyone seriously intending to build a water reuse system.

DWR. The 1976-77 California Drought: A Review. California Department of Water Resources, May 1978.

DWR. Waste Water Reclamation, Bulletin #187. California Department of Water Resources, March 1973.

How wastewater is reclaimed and used (mostly irrigation) and discussion of future implications.

DWR. Waste Water Reclamation, Bulletin #189. California Department of Water Resources, 1973.

DWR. Water Conservation in California, Bulletin #198. California Department of Water Resources, May 1976.

In almost 100 pages about water conservation only two brief paragraphs are devoted to the reuse of greywater. Greywater systems are perfunctorily deemed successful but explosive.

DWR. Using Household Wastewater for Plants, pamphlet. California Department of Water Resources, Resource Evaluation Office, 1977.

Helpful hints on greywater reuse, primarily focused on problems relating to laundry greywater.

Eastman. "Municipal Wastewater Reuse for Irrigation," Journal of the Irrigation and Drainage Division, Proceedings of the American Society of Civil Engineers, 93:IR3, 25, 1967.

Ebersbach, Karl F. "Heat Recovery From Waste Water in Domestic Buildings", Forschungsstelle fur Energiewirtschaft Munchen (in English), 1977. (See Smith et al.).

Eccli, Eugene (Ed.). Low Cost Energy Efficient Shelter; for the Owner and Builder. Rodale Press, Inc., 1976.

Brief treatment of Clivus Multrum, low-flush toilet and other water conservation techniques and appliances.

Edwardes, Michael. Everyday Life in Early India. G. P. Putnam's Sons, New York, 1969.
Early wells and irrigation systems.

Ekern, Paul. "Direct Interception of Cloud and Fog Water," Rainwater Cistern Symposium, Monterey, California, Proceedings to be published by the California Department of Water Resources, 1979. (See also Soil Soc. Amer. Proc., 28(3): 419-21).

Ekistics, a magazine devoted to the problems and science of human settlements, "Water for Human Use" issue, January 1977.

El-Sammani, Mohammed Osman. "Urban and Rural Water Supplies in the Sudan," Ekistics, Vol. 43, No. 254, January 1977.

About the lack of drinking water in the Sudan due to overgrazing and misuse of the land.

Endicott, William. "Success May Spoil Water Ration Efforts," Los Angeles Times, June 28, 1977; "Use More Water or Face Rate Increase, S.F. Warned," Los Angeles Times, June 30, 1977; "Criticism Rained on Call for More S.F. Water Use," Los Angeles Times, July 1, 1977.

Series of articles on the outrage and confusion caused by city officials threatening a water rate increase unless people used more water at the peak of the 1977 drought.

Engle, Henrich. The Japanese House. Charles E. Tuttle Company, Rutland, Vermont, 1964.
Descriptions of traditional Japanese baths and toilets.

English, Marshall J., and Orlob, Gerald T. Decision Theory Application and Irrigation Optimization. California Water Resources Center, Contribution No. 174, University of California, Davis, 1978.

Environmental Defense Fund. "Connecticut Watershed Protection," EDF Newsletter, Jan/Feb, 1978.

Federal court found that preserving open spaces is better and cheaper way to protect pure water supplies than removing pollutants at treatment facilities.

EPA. Cross-Connection Control Manual, Report No. EPA 430/9-73/002. Environmental Protection Agency, Washington D.C., 1974.

Documents many cases where plumbing cross-connections have been responsible for contaminated drinking water, and have resulted in

disease and deaths. This "how-to" manual has been designed as a tool for health officials, plumbers, and laymen. This manual is a revision of a 1963 report entitled Water Supply and Plumbing Cross-Connections (PHS Publication No. 957).

EPA. Directory of Federal Programs Related to Water Conservation. Environmental Protection Agency, Washington D.C., November 1978.

EPA. Environmental Pollution Control Alternatives: Municipal Wastewater. Environmental Protection Agency, Technology Transfer (no date).

EPA. Evaluation of Land Application Systems. Environmental Protection Agency, Office of Water Program Operations, Washington D.C., 1975. (EPA-430/9-75-001).

EPA. Final EIS/EIR for Joint Outfall System Facilities Plan of the Sanitation Districts of Los Angeles County, Volume II. Environmental Protection Agency and Sanitation Districts of Los Angeles County, July 1977.

Contains correspondence and comments on the draft EIS and public hearings. Provides clarification and insight to the technical analysis that made up the bulk of Volume I. Most interesting is a letter in Appendix C by the chief administrator in response to a citizen's inquiry as to why the original study did not consider waterless toilets as an alternative to the proposed centralized system.

EPA. Land Application of Sewage Effluents and Sludges: Selected Abstracts. Environmental

Protection Agency, Water Quality Control Branch, Corvallis, Oregon, 1974 (updated periodically). (EPA-660/2-74-042).

EPA. Manual of Individual Water Supply Systems. Environmental Protection Agency, Office of Water Programs, Water Supply Division, 1973, 1975, 1976. (EPA-403/9-74-007).

Development of individual water supplies, aimed at federal agencies as well as developers, contractors and laymen. Discusses sources, water treatment, pumping, health hazards, distribution, and storage of water.

EPA. National Interim Primary Drinking Water Regulations. Environmental Protection Agency, Office of Water Supply, Washington D.C., 1976. (PB-267 630/2PSN).

EPA. Preliminary Assessment of Suspected Carcinogens in Drinking Water, Report to Congress. Environmental Protection Agency, Office of Toxic Substances, Washington D.C., December 1975.

EPA. Proceedings from National Conferences on Shopping for Sewage Treatment: How to Get the Best Bargain for your Community or Home, held April 28-30, 1978, Washington D.C., and June 4-6, 1978, Denver Colorado. Environmental Protection Agency, Washington D.C.

EPA. Proceedings of the Second National Conference on Complete Water Reuse: Water's Interface with Energy, Air and Solids. Sponsors - American Institute of Chemical Engineers and the Environmental Protection Agency Technology Transfer, 1975.

Over 150 papers primarily covering industrial

problems, but also on household conservation, dual supplies, etc.

EPA. Process Design Manual for Land Treatment of Municipal Wastewater, by Metcalf and Eddy, Inc., for the Environmental Protection Agency, 1977. (EPA-625/1-77-008).

EPA. Quality Criteria for Water. Environmental Protection Agency, Washington D.C., July 1976. Provides definitive information on the effects of materials on water quality. Includes virtually all pollutants of significance in grey-water applications.

EPA. Reductions in Water Consumption and Flow of Sewage, report to the Congress. Environmental Protection Agency, Washington D. C., June 1974.

EPA. Research Needs for the Potable Reuse of Municipal Wastewater. Environmental Protection Agency, 1975. (EPA 600/9-75-007).

EPA. Survey of Facilities Using Land Applications of Waste Water. Environmental Protection Agency, Washington D.C., 1973. (EPA 4301/9-73-006).

EPA. Wastewater Use in the Production of Food and Fiber. Environmental Protection Agency, Office of Research and Development, Washington D.C., 1974. (EPA 660/2-74-041).

Evans, Sir Arthur. The Palace of Minos at Knossos, Volume II. Biblo and Tanner, New York, 1964.

Evans wrote in great detail about his excavations at Knossos which were started in 1898.

Includes plans and a description of the complex plumbing and drainage system in the palace.

Fair, G.M., Geyer, J.C., and Okun, D.A. Water and Wastewater Engineering, 2 Volumes. John Wiley, New York, 1968.

Vol. I: Water Supply and Wastewater Removal
Vol. II: Water Purification and Wastewater Treatment and Disposal.

Farallones Institute. Composting Privy, Technical Bulletin No. 1. The Farallones Institute, Occidental, California, 1975.

Feachem, R., McGarry, M., and Mara, D. (Eds.). Water, Wastes and Health in Hot Climates. Wiley, 1977.

Twenty two specialists from such fields as engineering, economics, geography and medical hygiene show you how to make the best uses of the resources at hand to deal with problems peculiar to tropical climates. Deals with three major areas: 1) health aspects of water supplies, including irrigation schemes and man-made lakes; 2) water supplies of low-income communities, including resource allocation, and planning and design for a crisis situation; and 3) sanitation, including waste collection, wastewater treatment, and solid waste disposal. Also includes details on effluent reuse and wastewater reclamation.

Feldman, Stephen L. Handbook of Water Conservation Devices (NTIS publication # PB 283018). U.S. Department of Commerce, National Technical Information Service.

Fitch, James Marston. Architecture and the Esthetics of Plenty. Columbia University Press, New York, 1961.

Fok, Yu-si, and Murabayashi, E. "Past, Present and Future of Rainwater Cistern Systems in Hawaii," Rainwater Cistern Symposium, Monterey, California, Proceedings to be published by the California Department of Water Resources, 1979.

Frankel, Richard J. "Viewing Water Renovation and Reuse in Regional Water Resources Systems," Water Resources Research, Vol. 3, No. 1, pp. 52-61, First Quarter, 1967.

Frankel investigates the possibility of turning pollution control requirements into resource generators, and considers water in particular. Using cost figures from various sources, he concludes that, except for the institutional drawback of preferential treatment for conventional procedures, water reclamation has significant potential as an extension of water pollution control programs.

Frazier, Gregory, and Frazier, Beverly. The Bath Beck. Troubador Press, San Francisco, California, 1973.

A history of bathing; suggestions for bathroom design.

Frontinus, Sextus Julius. The Water Supply of the City of Rome.

In the year A.D. 97 Frontinus was named Water Commissioner of the City of Rome and felt that "the first and most important thing to be done...is to learn thoroughly what it is that I have undertaken." And then set out

to write all about the water supply of Rome, including details of the aqueducts and water usage.

Fry, Maxwell and Drew, Jane. "Water Systems in the Tropics," Chapter 6 in Tropical Architecture in the Hot and Humid Zone. Reinhold, New York, 1964.

Gall, Graham. Water Recycling. Aquaculture Program, University of California, Davis.

Gallup Poll. "Water Quality and Public Opinion," Journal of the American Waterworks Association, August 1973.

Gannon, T.J., and Cook, J. "Explore the Health-Related Limits of Wastewater Treatment and Reuse," California Water Pollution Control Association Bulletin, Vol. 13, No. 1, July 1976.

Garnett, William. A Little Book on Water Supply. Cambridge University Press, Cambridge, 1922.

This book intends to give "general knowledge respecting the sources and mode of supply of one of the chief necessities of life."

Garrett Corporation. Project Apollo Environmental Control System: Water Subsystem, Design Certification Review Manual.

The handbook describing the Apollo potable water supply and waste handling subsystems.

Gerba, Wallis, and Melnick. "Viruses in Water: The Problem, Some Solutions," Environmental Science and Technology, December 1975.

Gerhard, Wm. Paul. Modern Baths and Bath Houses. John Wiley and Sons, 1908.

Totally irrelevant to our work but includes a great chapter extolling the virtues and recommended precautions of indulging in air and sun baths.

Gibson, U.P., and Singer, R.D. Small Wells Manual. See A.I.D., 1969.

Giddings, J. Calvin. Chemistry, Man and Environmental Change. Canfield Press, San Francisco, 1973.

Good fundamental chemistry text relating to current water quality issues.

Giedion, Siegfried. Mechanization Takes Command. Oxford University Press, New York, 1948.

A classic! He discusses the bath in the nineteenth century and the later mechanization of the bathroom.

Goldman, Michael. "Recycling Wastewater Examined," United Press International, Tallahassee, Florida, January 1967.

An article describing some of Florida's water problems and recycling possibilities.

Goldstein, J. Sensible Sludge, A New Look at a Wasted Natural Resource. Rodale Press, Emmons, Pa., 1977.

A comprehensive review of land application of solids produced by sewage treatment plants. Very convincing.

Goldstein, Steven N., and Moberg, Walter J. Wastewater Treatment Systems for Rural Communities,

Commission on Rural Water, Washington, D.C., 1973. An excellent guide to systems and components available for treating wastewaters in rural areas. It is intended to assist designers and planners of wastewater treatment facilities for rural communities in laying out preliminary system plans.

Golueke, C.G., Oswald, W.J, and Gee, H.J. Waste Water Reclamation through the Production of Algae, Technical Bulletin No. 22, University of California, Sanitary Engineering Laboratory, Berkeley, Calif., 1959. Also in Metcalf, 1979.

Goodman, Percival. The Double E. Anchor Press, 1977.

Hygeia and Cloacina chapter is a witty history of bathroom functions from the energy point of view, sort of.

Gordon, Malcolm. "Recycling of Nutrient Materials in Treated Domestic Wastewater." Department of Biology, University of California, Los Angeles.

GPO. Beneficial Use of Storm Water. United States Government Printing Office, Washington D.C., 1973.

GPO. Characterization of Taste and Odors in Water Supplies. United States Government Printing Office, Washington D.C., reprinted 1973.

GPO. Conference on Recycling Treated Municipal Wastewater Through Forest and Cropland. United States Government Printing Office, Washington D.C., 1974.

GPO. Final Report, Evaluation of Municipal Sewage

Alternatives. United States Government Printing Office, Washington D.C., 1974.

GPO. Management of Recycled Waste-Process Water Ponds. United States Government Printing Office, Washington D.C., 1973.

GPO. Manual of Individual Water Supply Systems. See EPA, 1973.

GPO. Rain: A Water Resource. United States Government Printing Office, Washington D.C., reprinted 1975.

GPO. Renovation of Secondary Effluent for Reuse as a Water Resource. United States Government Printing Office, Washington D.C., 1974.

GPO. Safe Drinking Water Act. United States Government Printing Office, Washington D.C., 1975.

To amend Public Health Service Act to assure public is provided with safe drinking water. Approved December 16, 1974.

GPO. Salvage and Recycling. Bibliography, 33 references. United States Government Printing Office, Washington D.C., February 11, 1977.

GPO. Sanitation and Sewage. Bibliography, 3 pages. United States Government Printing Office, Washington D.C., October 4, 1977.

GPO. Urban Hydrology for Small Watersheds. United States Government Printing Office, Washington D.C., 1975.

GPO. Urban Stormwater Management and Technology, An Assessment. United States Government Printing Office, Washington D.C., 1974.

GPO. Water Pollution and Water Resources, Bibliography, 31 pages. United States Government Printing Office, Washington D.C., July 7, 1977.

GPO. Water Supply Sources for the Farmstead and Rural Home. United States Government Printing Office, Washington D.C., reprinted 1976.

GPO. Wastewater Treatment and Reuse by Land Application, Vol. 1 and 2. United States Government Printing Office, Washington D.C., reprinted 1975.

Great Lakes Basin Commission. Highlights Water Conservation Conference, University of Michigan December 6-7, 1977. Public Information Office, Ann Arbor Michigan, 1978.

A new provision makes individual treatment systems for residences and small commercial establishments eligible for federal 75% grants if the individual systems can be proved more environmentally sound and economical than collection and central treatment.

Green, Dorothy. "Metropolitan Water District: Water Mover." Southern Sierran. Sierra Club of Southern California, 1978.

Greywater Use in the Home Garden. Farallones Urban House, 1516 Fifth St., Berkeley, Calif., 1977.

"A brief but concise booklet packed with

practical answers to questions about possible hazards of greywater use in gardens and best methods for its use. Expansion of material excerpted in Rain (April, 1977)."

Grievess, Robert B., Bhattacharyya, Dibakar, and Paul, J.W. "Membrane Ultrafiltration to Treat Laundry Wastes and Shower Wastes for Water Reuse," Society of Automotive Engineers, 740924, 1974.

Grima, Angelo P. Residential Water Demand. University of Toronto Press, 1972.

Investigates how water rates can be used to regulate domestic water demand.

Guarino, Victor J, and Bambenek, Robert A. Development and Testing of a Wastewater Recycler and Heater. U.S. Environmental Protection Agency, Cincinnati, Ohio, December 1976.

Gulman, S.L., and Mooney, H.A. "Water Use by Plants," Pacific Horticulture, Fall 1977.

Halacy, D.S. Earth, Water, Wind, and Sun; Our Energy Alternatives, 1978.

Some discussion of water recycling for power, etc.

Hammer, Mark J. Water and Waste-Water Technology: SI Version. Wiley, 1977.

Haney, Jim. Popular Science, December 1978, p. 136.

Hardenbergh, W.A. Sewerage and Sewage Treatment. International Textbook Co., Scranton, Pa., 1936 (2nd edition, 1942).

Harris, Ellen Stern. "Turning Down the Flow of Water," Los Angeles Times, Part V, P. 6, Sunday, March 27, 1977.

Some easy methods of recycling greywater without altering or installing any equipment, and a few simple precautions.

Harris, Ellen Stern. "Will Reuse Cure Water Blues?" Los Angeles Times, Part IV, P. 6, Sunday, March 13, 1977.

Harris, Richard. "Subsoil Irrigation Methods." Landscape Architecture Department, University of California, Davis.

Harrison, Randall. How to Cut Your Water Use in Half. Communication Press, San Francisco, Calif., 1977.

Hartigan, John P., and Willeke, Gene E. Land Disposal of Waste Water: An Annotated Bibliography. Council of Planning Librarians Exchange Bibliography, Box 229, Montebello, Illinois, July 1975.

Covers history, site selection, planning, design, etc. 837 pages, 85 references.

Hartley, Dorothy. Water in England. MacDonald & Co., London, 1964.

All anyone ever wanted to know about water in England from running water to water clocks, with information on washing, bathing, and drinking included.

Hay, H.R., and Yellott, J.I., "Natural Air Conditioning with Roof Ponds and Movable Insulation," ASHRAE Transactions, V. 75, pp. 165-171, 1969 (see also Solar Energy, V. 12, pp. 427-438, 1969).

Health and Welfare, Department of. Sanitation Manual for Isolated Regions. Department of Health and Welfare, Ottawa, Ontario, Canada.

Helliwell, P.R. (Ed.). Urban Storm Drainage. Halsted Press, 1978.

Henderson, Upton B. Economic Assessment of Wastewater Aquaculture Treatment Systems. National Technical Information Service, Springfield, Va. (EPA-600/2-76-293), 1976.

Concludes that at many water quality levels aquaculture is cheaper than conventional treatment. Gives presentations of 15 different aquaculture strategies (Rain, 1977).

Hendricks, G.F., and Rees, S.M. "Economic Residential Pressure Sewer System with No Effluent," Sieco, Inc., Columbus, Indiana, December 1975. Used home grinder-pump units; aerobic and anaerobic lagoon storage, with subsequent irrigation of effluent.

Herson, Albert. Land Based Sewage Sludge Management Alternatives for Los Angeles: Evaluation and Comparison. University of California, Los Angeles, School of Architecture and Urban Planning (NTIS PB-262 423/7ST), 1976.

Los Angeles' Hyperion treatment plant currently discharges digested sludge via a seven-mile outfall to Santa Monica Bay. This must be discontinued by the end of 1976 unless the sludge is further treated. The city has begun examining alternative means of disposing Hyperion sludge on the land.

Herson, Albert. Municipal Wastewater Recycling: A Strategy for Meeting the Zero Discharge Goal of PL 92-500. Thesis, University of California Los Angeles, School of Architecture and Urban Planning, California Water Resources Center Project (CAL-WRC-W-503), February 1976.

Reusing municipal wastewater is increasingly likely because of water shortages, particularly for irrigation, and higher efficiencies in the removal of pollutants from municipal effluent. The most important national law in the context of wastewater reuse is the Federal Water Pollution Control Act Amendments of 1972 (PL-92-500). The relationship between it and wastewater reuse projects is reviewed.

Hesperia. Journal of the American School of Classical Studies at Athens, Vol. XLII, No. 1, January-March 1974. Ancient cisterns.

HEW. Manual of Individual Water Supply Systems. U.S. Department of Health, Education and Welfare, Washington D.C.

HEW. Manual of Septic Tank Practice. U.S. Department of Health, Education and Welfare, 1967 (see Public Health Service).

Humphrey, M.F., Simmons, G.M., and Dowler, W.L. "Carbon Wastewater Treatment Process," 74-ENAs-46, The American Society of Mechanical Engineers, 1974. "Elimination of the present problems, associated with a) the disposal of biologically active sewage waste solids, and b) water reuse, is the goal of a new powdered-carbon treatment process..."

Hypes, W.D. "Characterization of Typical Household Greywater" (see Winnenberger, 1974).

Hypes, W.D., Batten, C.E., and Wilkins, J.R. The Chemical/Physical and Microbiological Characteristics of Typical Bath and Laundry Waste Waters. NASA TN D-7566, National Aeronautics and Space Administration, Washington D.C., March 1974.

Hypes, W.D., and Collins, V.G. "Reclamation and Reuse of Domestic Waste Water and the Processing of Sewage Solids to Reduce Organics," 74-ENAs-48, The American Society of Mechanical Engineers, 1974.

"Langly Research Center tested processes and hardware units originally designed for aerospace system use. An experimental facility simulating a single family household was used to produce typical household wastes for loading processing units. The program was accomplished in four steps: a) incorporation of commercially available water saving devices, b) reuse of bath and laundry wastewaters for toilet flush water, c) reclamation of household greywater for multiple purposes, and d) oxidation of garbage disposal and toilet solids to reduce organics..."

Institute for Local Self-Reliance. "Bibliography of Alternative Toilet and Sewer Systems," 2 pages. 1717 18th St., N.W., Washington D.C., 1974.

Institute for Local Self-Reliance. Sewage Treatment and Our Urban Communities. 1717 18th St., N.W., Washington D.C., 1976.

Analysis of high technology sewage treatment

technology and non-water-carrying in-house treatment systems.

Institute for Local Self-Reliance. "Economic Feasibility of Recycling", see Seldman 1979.

Institute for Rural Sanitation Services, National Demonstration Water Project, 1820 Jefferson Pl., N.W., Washington, D.C., Rain, October 1978, p. 15. "The IRSS was established in 1978 by the NDWP. It operates an extensive research program, and is designed to provide up-to-date information about rural sanitation services, policy and technology." (Rain).

Institute of Contemporary Studies. Water Banking: How to Stop Wasting Agriculture Water. Institute of Contemporary Studies, 260 California St., San Francisco.

Ingelfinger, A.L., and Murray, R.W. "Integrated Water and Waste Management System for Future Spacecraft," 74-ENAs-10, American Society of Mechanical Engineers.

"At General Electric, the feasibility of the system to recover potable water from biological wastes and to dispose of waste solids has been proven in over 200 days of continuous testing..."

Ingram, W.T., et al. "Space Capsule Waste Treatment and Potable Water Recovery," Journal Water Pollution Control Federation, p. 38, January 1964.

Ionides, Michael. "Shall We Run Short of Water?" Ekistics, Vol. 43, No. 254, January 1977.

This article discusses the advantages of small scale water systems, such as individual household water cisterns, over massive systems serving large cities, as a means of providing adequate water for everyone.

Iowa State. See Midwest Plan Service.

Jaquette, David. "Ground Water and the Role Economics Plays in Effective Management", RAND Corporation, Santa Monica, Calif.

Javits, Tom. "Greywater Re-Use in the Urban Garden", 6 pages. Farallones Institute, 1977. Later revised and expanded: see Javits, 1978.

Javits, Tom. "Greywater Use In the Home Garden", Farallones Institute (Integral Urban House), Berkeley, Calif., 22 pages, 1978.

This nifty little pamphlet contains all you need to know about modifying home plumbing to capture greywater and using it in the garden. Javits knows because he has done it.

Jeavons, John, and Leler, Robin. "Intensive Gardening - Less Water and Higher Yields", Organic Gardening and Farming, July 1977.

Bio-dynamic/French Intensive farming method may require an average of only 1/3 to 1/7 the water per pound of food produced compared to commercial agriculture production. However, typical technique involves overhead spray application of water which is not recommended with greywater. Some modification of the intensive method will be necessary for greywater applications.

Jennings, Charles. Drought Gardening. 21625 SE Hwy 212, Boring, Oregon 97009, 1977.

"We have one rain barrel placed so as to catch all the rainwater runoff...within twenty feet of our garden."

Jopling, W.F. "Alternative Grey Water Disposal System" (100675), Copy for ARSS, 1977.

Kardos, L.T. "Wastewater Renovation by the Land ...A Living Filter," Agriculture and the Quality of Our Environment, AAAS Publication No. 85, Washington D.C., 1967.

Kays, William B. Construction of Linings for Reservoirs, Tanks, and Pollution Control Facilities. Wiley, 1977.

Kelly, Katie. Garbage. Saturday Review Press, New York, 1973.

Kern, Ken. The Code, the Politics, and Building Your Home. United Stand, P.O. Box 191, Potter Valley, California.

Kerr, James. Domestic Life, Character and Customs of the Natives of India. Wm. H. Allen & Co., London, 1865.

Kilbourne, Frances. "Recycling the Wash Water" in Energy We Can Live With, edited by Daniel Wallace, Rodale Press, 1976.

She has the cleanest garden in town.

Kira, Alexander. The Bathroom. The Viking Press, New York, 1976.

A detailed study of the bathroom, its history,

what's wrong with its present design and how to design it better.

Ko, S.C., and Duckstein, L. "Cost Effectiveness Analysis of Wastewater Reuses," Journal of the Sanitary Engineering Division, ASCE, Vol. 98 (SA6), pp. 869-881, 1972.

Konen, P.E. "The Effect of Water Closet Type on Drainage System Capacity," Plumbing Engineering, July-August 1974.

Experiments comparing flush valve and flush tank toilets.

Konen, Thomas P. and De Young, Raymond. "An Investigation of the Performance and the Effects of Reduced Volume Water Closets and Sewage Treatment Plants," in Sharpe 1975.

Konen, Thomas P., et al. Water Related Energy, Report # SIT-DL-77-1969. Davidson Laboratory, Stevens Institute of Technology, Hoboken, N.J., August 1977.

Krehbiel, E.P. "Patio Cistern," Popular Science, April 1979, p. 125.

Kreisel, J.F. Rural Wastewater Research, NSF Second National Conference on Individual Onsite Wastewater Systems, National Sanitation Foundation, Ann Arbor, Michigan, 1976.

Kroschel, Max. "No Drought About It: Reusing Wastewater at Farallones," Rain, April 1977.
Describes experiments in greywater use in the garden at the Farallones Rural Center in Occidental. Covers the basic approach taken and

problems encountered with a few simple systems for irrigation, distribution, filtration, and sedimentation in small test plots. Presented in a cautious tone on the basis of 18 months experience.

Kroschel, Max. Wastewater Reclamation: Development of a Small Scale Greywater System for Agricultural Use. Farallones Institute, 15290 Coleman Valley Rd., Occidental, California 95465, January 1977.

Kugelman, I.J. "Water Reclamation and Reuse," Journal of the Water Pollution Control Federation, Vol. 46, No. 6, June 1974, pp. 1195-1199.

Laak, R. "Design Criteria and Procedure for Grey Water Subsurface System." University of Connecticut, Storrs, Conn.

Laak, R. "Influence of Domestic Wastewater Pretreatment on Soil Clogging," Journal of the Water Pollution Control Federation, Vol. 42, pp. 1495-1500, 1970.

Laak, R. "Pollution Loads from Plumbing Fixtures and Pretreatment to Control Soil Clogging," Individual Sewage Disposal System Workshop, National Association of Environmental Health. Published by Harcore Inc., Findley, Ohio, 1974.

Laak, R. "Relative Pollution Strengths of Undiluted Waste Materials Discharged in Households and the Dilution Waters used for Each," in Winnenberger, 1974.

Law, J.P. Nutrient Removal From Enriched Waste Effluent by the Hydroponic Culture of Cool Season Grasses, Federal Water Quality Administration, U.S. Government Printing Office, Washington D.C., 1969.

Lawrence, A.W. Greek Architecture. Penguin Books, Ltd., 1957.

Includes a very brief reference to the water supply system at Samos.

Lawrence, Walter B. "Reclamation and Reuse of Wastewater," Department of Hydraulic and Sanitary Engineering, University of California, Berkeley.

Leckie, Jim, et al. Other Homes and Garbage. Sierra Club Books, San Francisco, 1975.

This is a handbook of designs for self sufficient living. The section on water supply covers wells, surface water and solar distillation as sources for supply. There is no mention of greywater but there is a reference to quality and control which includes filtration methods.

Lee, Garry E. "Reclamation in a Planned City Is Easier...but Still Tricky!", Bulletin of the California Water Pollution Control Association, Vol. 15, No. 1, July 1978.

Every day the Irvine Ranch Water District reclaims 15 million gallons of municipal sewage and sells it for irrigating parks, golf courses, and orchards plus recreational lakes: A blockbuster success story.

Leich, Harold. "The Sewerless Society," Bulletin of Atomic Scientists, November 1975.

Leich, Harold. "A Sewerless Society is Starting to Take Shape," Los Angeles Times, Sunday July 22, 1973.

"We flush body wastes into public waterways, then spend billions in futile attempts to restore the water to its original quality." He urges on-site treatment using incinerator, oil-flush, or composter toilets.

Leonard, O.A., and Townley, N.R. "Control of Tree Roots in Sewers and Drains," California Agriculture, November 1971.

Two chemicals - metham (Vapam), and dichlobenil (Carsoron) - used alone, or in combination, killed roots in sewer pipes in one-hour long treatments by soaking.

Leopold, Luna B. Water, A Primer. W.H. Freeman and Co., San Francisco, 1974.

A fundamental reference on the characteristics of water with regard to land alterations, sources of water, methods of measurements.

Lingappa, B.T., and Lingappa, Yamuna. "Family Size Methane Generators," Solar Age, March 1979, pp. 16-18.

Linstedt, K.D., et al. "Quality Considerations in Successive Water Use," Journal of the Water Pollution Control Federation, Vol. 43, pp. 1681-1694, 1971.

Linstedt, K.D., and Bennett, E.R. (Eds.). Research Needs for the Potable Reuse of Municipal Wastewater, proceedings of a workshop held March 17-20, 1975, Boulder, Colorado. U.S. Environmental Protection Agency, Cincinnati, Ohio, December 1975.

Lindstrom, C., and Rockefeller, A. "Greywater for the Greenhouse," Proceedings of the Conference on Energy Conserving Solar Heated Greenhouses, Marlboro College, Marlboro, Vermont, November 19-20, 1977.

A wonderfully informative chat, with pictures of their successful experiments in greywater irrigation in Cambridge, Massachusetts; includes a detailed description of the planting beds in the greenhouse and the effect the greywater is having on them.

Loehr, Raymond C., et al. Land Application of Wastes, Vols. 1 and 2. Van Nostrand Reinhold, 1979.

Volume 1 covers soil as a treatment medium, role of vegetation, societal constraints, legal aspects, and 14 case studies drawn from more than 360 land application sites in the U.S.; Volume 2 covers more technical topics.

Loewe, Michael. Everyday Life in Early Imperial China. G.P. Putnam's Sons, New York, 1968.

Brief mention of water works.

Los Angeles County Waterworks Districts. How Saving Water Saves Energy.

A pamphlet of tips on water conservation that stresses the cost of bringing water to Los

Angeles from Northern California and the Colorado River.

Los Angeles Department of Public Works. Wastewater Facilities Plan, Summary of Final Draft, November 1977.

Los Angeles Times. "Drip Irrigation System Used in Anaheim Hills," Los Angeles Times, Part VIII, p. 21, July 30, 1978.

Loudan, Jack. In Search of Water. Wm. Mullan & Son, Belfast, 1940.

A history of the Belfast water supply.

Lvovich, M.I. The World's Water. Mir Publishers, Moscow, 1973.

Mann, H.T., and Williamson, D. Water Treatment and Sanitation, Simple Methods for Rural Areas. Intermediate Technology Publications, Ltd., London, 1976.

Mara, Duncan. Sewage Treatment in Hot Climates. John Wiley and Sons, 1976.

A nice little undergraduate text, covers essential microbiology, water reuse (aquaculture and agriculture), and nightsoil collection. Refers to "sullage" as the wastewater resulting from personal washing, laundry, food preparation and the cleaning of kitchen utensils.

Markarian, et al. Review of Current Interest and Research in Water Hyacinth-Based Wastewater Treatment, BCL-OA-TFR-77-1. Battelle Columbus Labs, Columbus, Ohio, 1977.

"Conclusions from the nine groups surveyed:
(1) hyacinth treatment can be a low-cost way to meet stringent effluent requirements and
(2) within three years systems may be available on a widescale commercial basis." (Rain 1977).

Markland, Robert E., Smith, Douglas L, and Becker, Jack. "Computerized Regional Planning for Land Disposal of Wastewater," Urban Systems, Vol. 2, pp. 1-14. Pergamon Press, 1977.

To determine which land disposal sites should serve which treatment plants.

Marks, Robert W. Dymaxion World of Buckminster Fuller. Reinhold Publishing Co. New York, 1960.

This book discusses the philosophy and work of Buckminster Fuller; includes his bathroom and kitchen designs.

Marsh, G.J.W. Water for Six, Marley Plumbing Technical Publication 5, Lenham, Kent, 1971.

Martin Maietta Corporation. Water Recovery and Solid Waste Processing for Aerospace and Domestic Applications. Final report, executive summary, NASA contract NAS9-12504, January 1973, (see also Murawczyk 1973).

Marx, Leo. "American Institutions and Ecological Ideals," Science Magazine, November 27, 1970.

Marx, an English professor at Amherst College, examines the American institutions dealing with unlimited expansion and their conflict with present ecological needs.

Mason, William P. Water Supply. John Wiley & Sons, Inc., New York, 1916.

This book is about water supply from a sanitary point of view. It covers drinking water and disease, the purity of water from various sources, and methods of purification.

McCabe, B.J., and Eckenfelder, W.W. Biological Treatment of Sewage and Industrial Wastes, Vol. 2. Reinhold, 1958.

McCaul, Julian, and Crossland, Janice. Water Pollution, edited by Barry Commoner. Harcourt, Brace, Jovanovich, Inc., 1974.

McDonnell Douglas Corporation. "Program Summary Operational 90-Day Manned Test of a Regenerative Life Support System," MDC 92282, June 1971.

Washwater and urine from a four-man crew was purified and recycled.

McGauhey, P.H., Krone, R.B., and Winneberger, J.H. Soil Mantle as a Wastewater Treatment System. University of California, Berkeley, SERL Report No. 66-7, 1966.

McGhee, Ronnie, Reardon, Mary, and Shulman, Arlene (Eds.). Readings in Water Conservation. National Association of Counties Research, Inc.

McGuinness, W.J., and Stein, B. Mechanical and Electrical Equipment for Buildings, 5th edition. John Wiley and Sons, Inc., New York, 1971.

Almost every imaginable subject regarding equipment in buildings. Not just for engineers

and architects, this would be a great reference manual for anyone interested in designing his or her own home, or parts thereof. Includes: good discussion of plumbing systems, storm-water runoff detention, and percolation beds.

McKee and Wolf. Water Quality Criteria, 2nd Edition. California State Water Quality Control Board, Publication 3-A, 1971.

McKenna, H. The Toilet Book (Knowing Your Toilet and How to Fix it -- Sometimes). A Harmless Flirtation With Wealth, San Diego, California, December 1976.

A nice little how-to booklet dedicated to women. Too cute for some tastes.

McKernan, J.M., and Morgan, D.S. Experiences with the Clivus-Multrum and Mull-Toa Toilets in Northern Manitoba. Sym/bios, 16-74 Carlton St., Winnipeg, Manitoba R3C 1N9, Canada, 1976.

McLarney, W.O. "Aquaculture: Towards an Ecological Approach," Radical Agriculture, R. Merrill (Ed.). Harper and Row, 1974.

McLarney, W.O. "Further Experiments in Irrigation of Garden Vegetables with Fertile Fish Pond Water," The Journal of the New Alchemists, Vol. 3, 1976.

McLaughlin, E.R. "A Recycle System for Conservation in Residences," in Sharpe 1975.

A greywater recycling system which collected waste water from the laundry and a tub-shower for reuse in toilet flushing. Included with the system description is a brief cost analysis,

a summary of observations made during a year of system operation, and a list of conclusions reached in performing this experiment.

Metcalf and Eddy, Inc. Land Treatment of Municipal Wastewater. See EPA 1977.

Metcalf and Eddy, Inc. Wastewater Engineering. McGraw-Hill Book Company, New York, 1972.

A textbook on wastewater engineering. It deals with the collection, treatment, and disposal of wastewater. It includes chapters on sludge disposal and advanced wastewater treatment.

Metzler, Dwight F., et al. "Emergency Use of Reclaimed Water for Potable Supply at Chanute, Kansas," Journal of the American Water Works Association, Vol. 50, pp. 1021-1060, August 1958.

Middelton, F.M. "Overview of Wastewater Reuse and EPA Research Strategy," in Linstedt, 1975.

Midwest Plan Service. Private Water Systems. Iowa State University, Publication # MWPS-14.

Miller, R.H. "The Soil as a Biological Filter", in Sopper and Kardos, 1973.

Milne, Lorus, and Milne, Margery. Arena of Life. Doubleday/Natural History Press, Garden City, New York, 1971.

Good introductory text on ecological principles.

Milne, Murray A. Residential Water Conservation. California Water Resources Center, Report No. 35,

University of California, Davis, 1976, revised and reprinted, 1977.

Minimum Cost Housing Group (A. Ortega, et al). The Ecol Operation. School of Architecture, McGill University, Montreal, Canada, 1972.

Minimum Cost Housing Group (A. Ortega, et al.) Stop the Five Gallon Flush. School of Architecture, McGill University, Montreal, Canada, 1973.

Mitchell, Suzanne, Crowell, Rosa L., and Snyder, J. Herbert. What Can We Do Before the Well Runs Dry! A Summary of WRC Report No. 35 - Residential Water Conservation by M. Milne. California Water Resources Center, University of California, Davis. April 1977.

Monogram Industries. Manual of Grey Water Treatment Practice, Part I: On Site Treatment and Sub-Surface Disposal, 1974. Reprinted from U.S. Department of Health, Education and Welfare, 1967.

Moore, J.A. "Land Spreading Impacts," Water Research in Action, Newsletter, Office of Water Research, University of Texas, Vol. 3, No. 2, 1978.

Septic tank spread on land has not resulted in contamination of shallow groundwater.

Moran, Edward. "Waterless Toilets - Modern Home Systems Turn Waste into Compost," Popular Science, January, 1978.

Contains a sketch of Abby Rockefeller's grey-water greenhouse.

Morgan, Donald P., and Karpen, Raymond J. "Test of Chronic Toxicity of Iodine as Related to Purification of Water," U.S. Armed Forces Med. Journal, Vol. 4, pp 725-728, 1953.

Mosley, J.W. "Transmission of Viral Diseases by Drinking Water," Transmission of Virus by the Water Route, E. Berg (Ed.), Wiley, 1967.

Muller, John George. "The Potential for Energy Savings Through Reductions in Hot Water Consumption," in Sharpe, 1975.

Residential water heating accounts for an energy consumption of 1.1 million BPD (barrels per day) oil equivalent today, but this energy use could be cut sharply. Potential savings exist in excess of 500,000 BPD obtainable without adverse effect upon our health, comfort, or lifestyle. The biggest savings potential is shown by the following measures:

Replacement of existing water heaters over a period of years with more efficiently fired (300,000 BPD); adoption of cold water laundering savings (100,000 BPD); use of flow restrictors in showers and basin faucets (100,000 BPD); miscellaneous other measures saving (60,000 BPD).

Mumford, Lewis. The City in History. Harcourt Brace & World, New York, 1961.

Murawczyk, C., and Ihrig, D.C. "Water Recovery and Solid Waste Processing for Aerospace and Domestic Applications," National Aeronautics and Space Administration, Manned Spacecraft Center, Houston, Texas, January, 1973.

Murphy, R.F. "Comparison of Economics of Normal Sewage Collection and Disposal vs. Ground Disposal," presented to the National Association of Environmental Health, Individual Sewage Disposal System Workshop, Cincinnati, Ohio, June 22, 1974. Reproduced in On-Site Waste Management, Volume IV, Hancor, Inc., P.O. Box 1047, Findlay, Ohio 45840.

Murray, C.R., and Reeves, E. Bodette. Estimated Use of Water in the United States in 1975, Geological Survey Circular 765.

Describes methods of estimating water use, terminology and various categories of water use. Provides tabular data on water use by category for each state.

Murray, C.S. (Ed.). "A Live in Laboratory," Home Magazine, Los Angeles Times, April 17, 1977.

Description of laboratory-house on the campus of the University of Hawaii in Honolulu which includes among its many energy and resource conserving systems, a greywater recycling system and rainwater collection system. Color photographs clearly demonstrate that the interior of an energy conserving house needn't be ugly.

Nader, Ralph, et al. Power and Land in California. Center for Study of Responsive Law, Washington, D.C.

NAS. Drinking Water and Health. National Academy of Sciences, Washington D.C., PB-269 519/5PSN, 1977.

NAS. More Water for Arid Lands. National Academy of Sciences, Washington, D.C., 1974.

Fascinating and valuable, especially good chapters on Rainwater Harvesting, reuse of water, wells (Qanats), innovative irrigation.

National Bureau of Standards. "Drainage and Water Supply for Buildings," Proceedings of CIB Commission W62 Symposium, University of Glasgow, Scotland, September 30 - October 1, 1975. National Bureau of Standards, Washington, D.C., 1975.

National Sanitation Foundation. National Sanitation Foundation Standards. NSF Building, P.O. Box 1468, Ann Arbor, Michigan 48106.

- No. 9: Diatomite Type Filters
- No. 10: Sand Type Filters
- No. 14: Thermoplastic Materials, Pipe Fittings, Valves, Traps & Joining Materials, February, 1976.
- No. 15: Thermoset Plastic Pipe, Fittings, Valves, Tanks, Potable Water Supply Systems, February, 1976.
- No. 16: Dosimetry Services, February, 1971.
- No. 17: Centrifugal Pumps.
- No. 19: Adjustable Output Rate Chemical Feeding Equipment.
- No. 24: Plumbing System Components for Mobile Homes & Recreational Vehicles, November, 1977.
- No. 28: Cartridge Type Filters.
- No. 40: Individual Aerobic Wastewater Treatment Plants, November, 1970.
- No. 42: Filtration Devices Relating to Supplementary Treatment of Potable Water, March, 1973.
- Criteria C-9: Evaluation of Special Processes or Devices Used in Treating Wastewater, November, 1970.

National Sanitation Foundation. Proceedings of the NSF/EPA National Conferences on Individual On-Site Wastewater Systems. First Conference, 1974; Second Conference, 1975; Third Conference, 1976; Fourth Conference, 1977. Ann Arbor Science Publishers, Inc., Ann Arbor, Michigan.

National Sanitation Foundation. The Well Supplied Home (How to Build Safe Wells). NSF Building, Ann Arbor, Michigan 48105.

National Science Foundation. Multiple Water Supply Approach for Urban Water Management, Annual Report. Weston Environmental Consultants-Designers, NSF, Washington D.C., March 1978.

A systems model was developed to help cities decide whether the multiple supply approach is beneficial in long-term planning of water resources. Three grades of water were considered: potable, subpotable, and nonpotable (reuse of wastewater for industrial uses and urban irrigation).

National Science Foundation. What To Do With Sewage Sludge. National Science Foundation, Washington D.C., 1976.

Nelson, John. "Change in TDS (Total Dissolved Solids) Concentration Resulting From Use of Low Flush (3-1/2 gal./fl.) Toilets in New Residential Construction," in Little Compendium of Water Saving Ideas. North Marin County Water District, Novato, California, August 1976.

Nesbitt, Patricia M. "Dealing With Greywater," in Stoner 1977.

Nesbitt and Seldman. Sewage Treatment Technology and Our Urban Communities. See Institute for Local Self Reliance, 1976.

New Alchemy Institute. "The Ark: A Solar Heated Greenhouse and Aquaculture Complex Adapted to Northern Climate," The Journal of the New Alchemists, No. 2, 1974.

O.A.T. Present Value: Constructing a Sustainable Future. Office of Appropriate Technology, Sacramento, California, 1979.

O.A.T. Rural Wastewater Disposal Alternatives, Final Report - Phase 1, A Report to the California State Water Resources Control Board. Office of Appropriate Technology, Sacramento, California, September 1977.

An excellent analysis of waterless toilets: installation, maintenance, health problems, etc. Also contains much useful information on greywater systems. This report is also referred to as "On Site Waste Management Systems Evaluation Project," A goldmine of useful information: free.

Okun, D.A. "Planning for Water Reuse," Journal of the American Water Works Association, Vol. 65, No. 10, pp. 617-622, 1973.

Ongerth, Henry J. "A Public Health Overview of Reuse," in Watercare, 1975.

California has regulations for crop and landscape irrigation and recreational use but no regulations for direct reuse or groundwater augmentation for indirect reuse for potable purposes.

Ongerth, Henry J., et al. "Public Health Aspects of Organics in Water", Journal of the American Water Works Association, Vol. 65, No. 7, pp. 495-498, July 1973.

Otis, R.J. On Site Disposal of Small Wastewater Flows. Small Scale Waste Management Project, University of Wisconsin, Madison, Wisconsin, January 1976.

Otis, R.G., and Boyle, W.C. "Performance of Single Household Treatment Units," Journal of the Environmental Engineering Division, ASCE, Vol. 102, No. EE1, Proc. Paper 11895, pp. 175-189, February 1976.

Otis, R.J., and Stewart, D.E. Alternative Wastewater Facilities for Small Unsewered Communities in Rural America. Small Scale Waste Management Project, University of Wisconsin, Madison, Wisconsin, July 1976.

Page, Albert. "Municipal Water Reuse in Agriculture." Soil and Environmental Sciences Department, University of California, Riverside.

Falmer, M.L., et al. Private Water Systems. Publication No. 14. Midwest Plan Service, Iowa State University, 1968.

Fairly detailed "how-to" information primarily directed toward rural settings. Provides some very useful tables for sizing equipment, diagrams, and conversion factors.

Palmer, Roy. The Water Closet. David & Charles: Newton Abbot, Devon, England, 1973.

An informative and well illustrated history of

the water-closet. Palmer's research indicates that Thomas Crapper's contribution to the manufacture of water-closets was minimal and that S. Stevens Hellyer and others played more important roles in the development of the modern toilet.

Parazek, Richard. Waste Water Renovation and Conservation. Pennsylvania State University, 1967. Contains a summary of the pioneering work at Penn State on using cropland and forests for sewage treatment, and nutrient recycling for plant growth.

Parkhurst, John D. Reconnaissance Study, Undeveloped Water Reuse Potential in the Joint Outfall System, 1975 (Draft). County Sanitation Districts of Los Angeles County, California, April 1976.

A study of potential for use of reclaimed wastewater from existing treatment facilities. Provides good cost estimates and identifies several potential uses for reclaimed water.

Parkhurst, John D. "Wastewater Reuse -- A Supplemental Supply," Journal of the Sanitary Engineering Division, ASCE, Vol. 96, (SA3), pp. 653-663, 1970.

Pecoraro, J.R., et al. "Contributions of a Developmental Integrated Life Support System to Aerospace Technology," paper presented at American Institute of Aeronautics and Astronautics, 4th Annual Meeting and Technical Display, Anaheim, California, October 1967.

People and Energy, "Destruction Rains from Power Plants," pp. 6-7 (pamphlet, no date).

Plews, G. "Management Guidelines for Conventional and Alternative On-Site Sewage Systems," paper presented at the Third National Conference on Individual On-Site Waste Water Systems, National Sanitation Foundation, Ann Arbor, Michigan, November 17, 1976.

Plews, G.D., and Lenning, D.A. On-Site Sewage Disposal Program, A Preliminary Status Report to the State Legislature, Publication No. 77-1, Washington State Department of Social and Health Services, February 1977.

Pryor, Larry. "Water Cleanup is Second Biggest Program in State's History," Los Angeles Times, May 26, 1974.

Public Health Service. Manual of Septic Tank Practice. U.S. Department of Health, Education and Welfare, 1967 (see HEW, 1967).

Public Law 94-580, The Resource Conservation and Recovery Act of 1976, October 21, 1976.

Deals only with solid waste and involves wastewater treatment and management only with regard to use or disposal of sludge by-products of separate greywater treatment although this would be the appropriate law if a greywater system were developed which produced significant amounts of solid waste.

Putnam, D.F., Wells, G.W., and Wong, W. Design Considerations for Space Mission Wash Water Processing by Reverse Osmosis, MDAC WD 2080, McDonnell Douglas Corporation, June 1973.
Analysis of wash water and cleansing agents

required for showering, personal hygiene, housekeeping, dishwashing, laundry, and experiment purposes.

Putnam, D.F., Thomas, E.C., and Crombo, G.V. "Water Management Results of the 90-Day Space Cabin Simulation Test," CUD 1582, McDonnell Douglas Corporation, April 1971.

All potable water was stored on-board before test was begun, body and clothes washing water was filtered and reused, urine was stored in a holding tank, and fecal matter was frozen.

Putnam, D.F., and Wells, G.W. Water Recovery for Spacecraft Application, MDAC WD 2205, McDonnell Douglas Corporation, October 1973.
Survey of spacecraft potable water purification and recycling of urine, humidity condensate, shower, and laundry water.

Quennell, Marjorie, and Quennell, C.H.B. A History of Everyday Things in England, Volume III. G.P. Putnam's Sons, New York, 1961.
The chapter on sanitation in Volume III discusses bathing, water supply, and sewage.

Rain, Journal of Appropriate Technology. 2270 N.W. Irving, Portland Oregon 97210.
Up to the minute source of latest information on recycling and reuse.

Rain. "Drying Up the Toilets," reprint from Rain Magazine, 2270 N.W. Irving, Portland, Oregon 97210, (no date given).

Rain. "Goodbye to the Flush Toilet," reprint from Rain Magazine, 2270 N.W. Irving, Portland, Oregon 97210, April 1976.

Rain. "Solid Waste Utilization," reprint from Rain Magazine, 2270 N.W. Irving, Portland, Oregon 97210 (no date given).

Rainbook, Resources for Appropriate Technology. Schocken Books, New York, 1977
Nice notes on recycling, on-site reuse (see especially "taking pipe.")

Recycling. See Office of Water Recycling.

Revelle, Roger, "Water," Scientific American, September 1963.

This article is an extensive discussion of the hydrologic cycle. It looks at where the world's water comes from and how it is used.

Reyburn, Wallace, Flushed with Pride, The Story of Thomas Crapper. London, Macdonald & Company, 1969.

A biography of one of the inventors of the modern toilet. The story is told of the man whose name was later to become associated only with the functions of the toilet he helped to design. A description of the miserable sewerage conditions which existed in London in the early 1800's as well as some of the problems found with earlier toilets was useful.

Rider, Bertha Carr. The Greek House. Cambridge University Press, 1916.

From the neolithic period to the Hellenistic age: There is a brief reference to rainwater cisterns in the courtyards of houses.

Ripton, Ray. "Study Puts Stopper on Water Losses," Los Angeles Times, West Side Section, Part IX, Sunday, October 9, 1977.

Robeck, G.G., Clarke, N.A., and Dostal, K.A. "Effectiveness of Water Treatment Processes in Virus Removal," Journal of the American Water Works Association, Vol. 54, No. 10, pp. 1275-1290, October 1962. (See also Hartung, H.O., "Discussion," Journal of the American Water Works Association, Vol. 54, No. 10, pp. 1290-1292, October 1962.)

Roberts, Edwin B., and Hagan, Robert M. Guidelines for the Estimation of Total Energy Requirements of Municipal Wastewater Treatment Alternatives. State Water Resources Control Board, Sacramento, California, August 1977.

Energy required to desalt wastewater is often too high to justify reuse, especially where increased hardness and TDS increase damage to appliances or pipes, or where salt accumulation in soil reduces plant productivity.

Rockefeller, Abby, 1977. See Lindstrom and Rockefeller, 1977. Also Moran, 1978.

Rood, W.B. "Limits to Sewage Growth Urged," Los Angeles Times, Part I, p. 3, September 31, 1975.

Rybczynski, Witold, Polprasert, Chongrak, and McGarry, Michael. Low Cost Technology Options for Sanitation: State of the Art Review and Annotated Bibliography. I.D.R.C. Publication No. 102E. International Development Research Centre, Ottawa, 1978. (Available from UNIPUB, Box 433, Murray Hill Station, New York, 10016.)

Said, Mogueed Mohamed. The Role of Water in Influencing the Form of Cities. Ph.D. Dissertation, The University of Michigan, 1967.

Saleato, J.A. "Above Ground Filters," Environmental Engineering & Sanitation. Wiley Interscience, 1972 (2nd Ed.).

Schmidt, Curtis, J., and Clements, Ernest V., III. Demonstrated Technology and Research Needs for Reuse of Municipal Wastewater, NTIS PB-249 151/2MU. National Technical Information Service, Springfield, Va., 1975.

The survey identified 358 sites at which direct reuse of municipal wastewater was being practiced. Irrigation and industrial cooling account for virtually all of this reuse. Only three sites practice reuse for recreational lakes, and one for nonpotable domestic use.

Schmitt, R.P. "Reverse Osmosis and Future Army Water Supply," 74-ENAs-6, The American Society of Mechanical Engineers, 1974.

"...The Army Mobility Equipment Research and Development Center (MERDC) is responsible for the methods and equipment to provide potable water for the soldier in the field. This paper discusses the basic guidelines for the Army's Multi-Purpose Water Purification unit and the fresh water operation."

SCS Engineers. Rural Wastewater Management, Technical Report, Vol. 1 and Guidance Manual Vol. 2. California Water Resources Control Board, Sacramento, California, 1978.

The Technical Report is an easy to understand

explanation of how to design and install septic tanks, leach fields, seepage beds, seepage pits, absorption mounds, evapotranspiration systems, sand filters, electro-osmosis units, and holding tanks. The Guidance Manual covers broader issues including permit procedures, land use control, and future developments.

Seaquist, Bob. "Aquatic Farms Clean Up Waste Water," Popular Science, September 1977.

Segall, Burton A. "The Impact of Vacation Homes on National Forest Water Resources," Eisenhower Consortium Bulletin 3, Fort Collins, Colorado, 1976.

The investigation in northern Arizona showed that sewage flow rates... fluctuate widely in comparison with suburban and urban areas. This sporadic waste discharge is deleterious to package plant type treatment systems. Dispersed, well designed and maintained soil disposal systems are preferred in a forest environment. Conventional sewerage systems and treatment plants concentrate wastewater flows, partially treat waste materials, and are less desirable."

Seldman, Neil, Economic Feasibility of Recycling. Institute for Local Self-Reliance, 1717 18th St. N.W., Washington D.C., 1979.

A 26 page report prepared for the Economic Development Administration of the U.S. Department of Commerce.

Seldman, Neil. "Flush Toilets: They Overload the Sewers, Steal our Tax Dollars, So Let's Get Rid of them," Washington Star News, Sunday,

December 22, 1975. Also from The Institute for Local Self Reliance, 1717 18th St. N.W., Washington D.C. 20009.

Seldman, Neil. "Waste Treatment in Washington D.C.: Flush Toilets," Washington Star News, Opinion Section, December 22, 1974. Also from The Institute for Local Self Reliance, 1717 18th St. N.W., Washington D.C. 20009.

Sekler, David (Ed.). California Water. University of California Press, Berkeley, Calif., 1971.

Sephton, Hugo. Reuse of Industrial Wastewater for Power Plant Cooling. Richmond Field Station, University of California, Richmond, Calif.

Sepp, E. Guidelines for Sewage Disposal by Hill-side Sprays. California Department of Public Health, Bureau of Sanitary Engineering, 1972.

"The Sewerless Society," The Bulletin of the Atomic Scientists, November 1975.

Discussion of alternatives to the conventional flush.

Shadwell, Arthur. The London Water Supply. Longmans, Green, and Co., London, 1899.

A defense of private water companies in London that is also a very good history of the water supply in that city.

Sharpe, W.E., and Fletcher, P.W. (Eds.). Conference on Water Conservation and Sewage Flow Reduction with Water Saving Devices, Proceedings. Pennsylvania State University, University Park,

Pennsylvania, April 8-10, 1975.

An excellent set of papers.

Sharpe, W.E., and Fletcher, P.W. The Impact of Water Saving Device Installation Programs on Resource Conservation. Institute for Research on Land and Water Resources, Research Publication 98, Pennsylvania State University, University Park, Pennsylvania, 1977

A report on the effectiveness of two home water conservation projects. Provides an overview of the projects which were essentially plumbing code enforcement and brick-in-the-tank flow reduction.

Sherlin, G.C., Beausoliel, R.W., and Galwin, L.S. Evaluation of Backflow Prevention Devices: A State of the Art Report. National Bureau of Standards, Washington D.C., NBSIR-76-1020, June 1976. (See also EPA PB-255 303/OWB.)

State of the art in backflow prevention devices. Provides an introduction to the hazards of cross-connections, and the various devices used to prevent backflow, as well as the elements of device evaluation procedures, conclusions and recommendations.

Shoji, Kobe. "Drip Irrigation," Scientific American, December 1977.

Discussion of the history of development, characteristics, advantages and disadvantages of modern drip irrigation systems. Also includes figures on the extent and type of applications both domestically and world wide. Good introduction to the subject.

Siegrist, Robert. Segregation and Separate Treatment of Black and Grey Household Wastewaters to Facilitate On-Site Surface Disposal. Small Scale Waste Management Project, University of Wisconsin, Madison, Wisconsin, November 1976. (See also Marshall 1977).

Small, Maxwell. Meadow/Marsh Systems as Sewage Treatment Plants. Brookhaven National Laboratory, Upton, New York, NTIS BNL-20757, 1975.

A demonstration project in which raw aerated sewage is flooded across a sloped meadow where it irrigates a fodder crop; it drains into a marsh where another harvestable crop is grown and then filters into a pond where native aquatic life grows, the discharge from which is suitable for "reuse without public health hazard" and which "will generally be potable water without any further treatment."

Small, Maxwell. Natural Sewage Recycling Systems. Brookhaven National Laboratory, Upton, New York, NTIS BNL 50630, 1977.

"This paper reviews efforts at Brookhaven to utilize natural systems (especially marsh/pond systems) to produce potable water from sewage." (Rain 1977).

Smay, V. Elaine. "How to Grow with Gardens without Soil," Popular Science, March 1978.

A nice introduction to hydroponics with a how-to list of materials and a bibliography.

Smith, G.E. "Economics of Water Collection and Waste Recycling," Working Paper 6, Technical Research Division, University of Cambridge, Department of Architecture, Cambridge, England (see

also Cambridge University), 1973.

Smith, Khervin. "The Testing of a Clivus-Multrum System in a Limited Use Campground and a Review of Evapotranspiration, Substitute for Water, Vacuum Transportation and Incineration Systems," in Sharpe 1975.

"A Clivus Multrum Sewage System was installed at Hawk Mountain Sanctuary on an experimental basis in order to gather information relating to the manufacturer's claims. The Clivus System did not function as stated in the manufacturer's literature. The Department feels additional testing is necessary to determine its suitability as a sewage disposal system."

Smokler, Paul. Unpublished, untitled draft manuscript on pricing mechanisms for Metropolitan Water District of Los Angeles. University of California, Los Angeles, School of Engineering, April 25, 1978.

Smyser, Steve. "In Pursuit of the Zero-Discharge Household," Organic Gardening and Farming, Vol. 23, No. 5, May 1976. Also in Wallace 1976.

Water conservation and private sewage systems: mentions two systems that allow for recycling water back to flush toilets.

Sofios, Mary. "Microbial Contamination of Water -- Traditional and Space-Age Problems and Approaches." 73-ENAs-33. The American Society of Mechanical Engineers, 1973.

Background information to introduce the necessity and means for control of microbial contaminants in water supplies.

Sonnen, Michael B., Roesner, Larry A., and Shubinski, Robert P. Future Direction of Urban Water Models. PB-249 049/8W. Water Resources Engineers, Inc., Walnut Creek, Calif., 1976.

Urban water subsystems addressed were: rainfall, runoff and snowmelt, waste collection, and water reuse.

Sopper, W.E. "Wastewater Renovation for Reuse: Key to Optimum Use of Water Resources," Water Research, Vol. 2, pp. 471-480, 1968.

Sopper, W.E., and Kardos, L.T. (Eds.). Conference on Recycling Treated Municipal Wastewater through Forest and Cropland. See EPA, EPA-660/2-74-003, 1974.

Southern California Association of Government. 208 Final Work Plan. Los Angeles, California, October 1976.

Southern Sierran. "Reclamation: Future Hope," Los Angeles Chapter, Sierra Club, May 1977.

Each million gallons of water reused saves 4500 kwh of electricity or 15 barrels of oil.

Springer, E.K. "Cross Connection Control," Foundation for Cross-Connection Control and Hydraulic Research, University of Southern California, Los Angeles, California.

State Department of Water Resources. See DWR.

State Water Resources Control Board. Guidance Manual of Rural Wastewater Management. Office of Water Recycling, State Water Resources Control Board, Sacramento, California, (publication

pending).

Low cost, low technology, low energy alternative treatment systems.

State Water Resources Control Board. May 1978 Action Plan: Alternative Wastewater Management Systems. State Water Resources Control Board, Sacramento, California, March 1978.

State Water Resources Control Board. Waste Discharge Requirements for Non Sewerable Waste Disposal Site Design and Operation Information. State Water Resources Control Board, Sacramento, California, 1978.

California law requires that a report be filed and a \$100 fee paid before land disposal of "domestic...sewage or mixture of predominantly sewage...from...privately owned systems (excluding individual subsurface leaching systems disposing of less than 1000 gallons per day)." However this law is primarily intended to apply to garbage dumps and land fills.

State Water Resources Control Board. Wastewater Reclamation: A Guide for Local Agencies. Office of Water Recycling, State Water Resources Control Board, Sacramento, California.

Steadman, Philip. Energy, Environment and Building. Cambridge University Press, New York, 1975.

There is a short section on rainwater collection, reuse design proposals, and local water collection with several examples and a bibliography.

Steele, Ernest W. Water Supply and Sewerage. McGraw-Hill Book Co., Inc., 1947.

A textbook for engineers that gives the essentials

of principles and present-day practice needed to solve the problems of water supply and sewerage.

Steele, J.A., et al. "A Study of Water Reclamation Systems for Space Stations," Research and Development Department, General Dynamics, Electric Boat Division, Groton, Connecticut, December 31, 1962.

Steele, J.A., et al. "Water Reclamation Sub-systems for Space Stations," Contract NAS1-2208, July 1963.

Stephens, David. "Water Storage Roof," International Symposium on Roof and Roofing, Brighton, England, September 1974. John Lang Research and Development Ltd., U.K.

Stevens, Leonard A. Clean Water, Nature's Way to Stop Pollution: How Soil and Plants Can Solve Our Water Crisis. E.P. Dutton & Co., Inc., New York, 1974.

Stewart, Arthur. "Instead of a Septic Tank, Bio System," Popular Science, pp. 78-79, March 1975.

Describes an evapotranspiration system.

Stewart, D.E. Central Management of Non-Central Systems, Special Purpose Districts and Other Entities. Small Scale Waste Management Project, University of Wisconsin, Madison, Wisconsin, May 1975.

Stewart, D.E. The Regulation of On-Site Home Sewerage in Wisconsin: A Study As It Exists

Today, An Analysis of Its Effectiveness and Proposed Changes. Small Scale Waste Management Project, University of Wisconsin, Madison, Wisconsin, May 1974.

Stewart, D.E. "Regulatory Methods to Assure the Maintenance of On-Site Sewerage Systems," paper presented to ASAE Annual Meeting, University of Nebraska, Lincoln, Nebraska, June 27-30, 1976.

Ralph Stone and Company. Wastewater Reclamation: Socio-Economic, Technology, and Public Acceptance. Office of Water Resources Research, U.S. Department of the Interior, Washington D.C., May 1974.

The social, economic, and technical practicality of wastewater reclamation was investigated for domestic, agricultural, irrigational, recreational, and industrial reuses. Attitudes of the public in ten Southern California case study communities towards wastewater reuse were obtained by a random sample of 100 households from each community, and socio-economic correlates of these attitudes were ascertained.

Stoner, Carol. Goodbye to the Flush Toilet: Water Saving Alternatives to Cesspools, Septic Tanks and Sewers. Rodale Press, 1977.

Another winner from Rodale Press.

Stroh, J. Dietrich. "Water Conservation," an address given at the Governor's Drought Conference Los Angeles, March 1977. Proceedings published by California Department of Water Resources.

Stuart, J. Arthur. "Instead of a Septic Tank, BIO-SYSTEM," Popular Science, March 1975.

With Bio-System, effluent does not pass into

the ground but evaporates from a gravel and sand field.

Sunset. Gardening in Containers. Lane Books, Menlo Park, California, 1967.

Detailed "how-to" manual of selecting, displaying and caring for plants in containers.

Sunset Magazine. "An Antidote for Greywater," p. 219, June 1977.

Recommends applications of calcium sulfate (gypsum), or calcium polysulfide (liquid gypsum) to counteract sodium buildup in soils, a common problem in greywater applications.

Sunset Magazine. "Defeat the Lawn Water Thieves? Maybe the Answer is Underground," p. 106 & 108, May 1977.

Explains how to install an underground irrigation system using dual wall tubing, or foamed (porous) PVC tubing. (See also Care Free Products, Gro-Mor, etc.)

Sunset Magazine. "Drip Irrigation," pp. 60-63, July 1975.

"It's a new system that may save you water and bother. You put in skinny tubes that water often and slowly."

Sunset Magazine. "Frugality With Garden Water ...Here is a Summing Up of Experience in Super-Dry Marin County in 1976," p. 2408, 1977.

Sunset Magazine. "Gray Water Put to Work in Your Garden?" pp. 150-151, July 1977.

Describes some of the hazards to health, soil, and garden associated with the direct reuse of

untreated greywater; discusses precautions which must be taken as well as some backyard technology devices which can be easily constructed to reduce some of the problems resulting from greywater reuse.

Sunset Western Garden Book. See Williamson 1967.

Tannahill, Reay. Food in History. Stein and Day, New York, 1973.

This book examines the influences that have shaped man's diet and how the pursuit of more and better food has influenced the course of history.

Taylor, F.B. "The Holy Cross Episode," Journal of the American Water Works Association, Vol. 64, No. 4, pp. 230-232, April 1972.

Time Life Books. How Things Work in Your Home (and what to do when they don't). Time, Inc., New York, 1975.

Todd, David Keith, and McNulty, Daniel E. Orren, . Polluted Groundwater, A Review of the Significant Literature. Water Information Center, Inc., Huntington, New York, 1976.

Tourbier, Joachim, and Pierson, Robert W., Jr. Biological Control of Water Pollution. Center for Ecological Research in Planning and Design, University of Pennsylvania, 1976.

Sourcebook includes work on drinking water quality, aquifer recharge, biological treatment methods, the legal status of natural treatment methods. Useful survey of international projects

employing diverse biological treatments -- reeds, tidal marshes, aquaculture, algae and forests to effectively treat sewage. (Rain).

Trim, Wayne. "A Composting Waste Disposal System: Aerobic, Non-Polluting," EQ News (supplement to The Conservationist), December-January, 1973-74.

Tucker, T.G. Life in Ancient Athens. MacMillan & Co., Ltd., London, 1922.
Water supply is mentioned briefly.

Turneaure, F.E., and Russell, H.L. Public Water Supplies, John Wiley & Sons, Inc., New York, 1940.
The opening chapter is a good, short history of public water supplies.

United Stand. Pit Privy and Grey Water Guidelines. United Stand, P.O. Box 191, Potter Valley, California 95469.

United Stand. United Stand Privy Booklet. United Stand, P.O. Box 191, Potter Valley, California 95469.
Construction drawings and explanation of several models of homemade composting privys for rural applications.

U.S. Bureau of the Census. Selected Data from 1973 Survey of Purchases and Ownership. U.S. Bureau of the Census.
Includes statistics on how many people own various household appliances.

U.S. Bureau of the Census. The Statistical History of the United States, with an introduction

by Ben J. Wattenberg. Basic Books, Inc., New York, 1976.

U.S.D.A. How Much Irrigation Water Are You Applying? Interagency Agricultural Information Task Force, U.S. Department of Agriculture, Washington D.C.

Pamphlet full of tables on calculating the amount of water applied through various media.

U.S.D.A. Ponds for Water Supply and Recreation, Agriculture Handbook No. 387. U.S. Department of Agriculture, Washington D.C., January 1971.

U.S.D.A. Water Supply Sources for the Farmstead and Rural Home, Farmers Bulletin No 2237. U.S. Department of Agriculture, U.S. Government Printing Office, Washington, D.C., March 1971.

U.S. Department of the Interior. Rain - A Water Resource. U.S. Department of the Interior Geological Survey, USGS: INF-74-17, 1974.
A concise informative 1-page pamphlet.

U.S. Department of the Interior. Water Witching. U.S. Department of the Interior Geological Survey, U.S. Government Printing Office 0-233-096, 1966.
A short pamphlet on the location of groundwater which discusses and criticizes water witching.

U.S. Senate. Conservation of the Land and the Use of Waste Materials for Man's Benefit. Committee on Agriculture and Forestry, March 25, 1975.

"A pretty well-known summary of the present and prolonged effects of mono crop agriculture in the midwest and lack of or failure of adequate

windbreak systems. The second half of the report is most interesting, outlining the use of sewage sludge and animal manures as fertilizers... 'Of the 7 million tons of dry sewage sludge equivalent now produced annually in the United States, it is estimated that 40% goes into landfills, 20% is applied on land, 25% is incinerated and 15% is discharged into the ocean. Because land use is the only direct beneficial use of this material, we have opportunities for a five-fold increase in such use.'"

Urban Land Institute. Residential Storm Water Management. Urban Land Institute, 1200 18th St., N.W., Washington D.C., 1976.

Vale, B. Autonomous House. Cambridge University, Department of Architecture, Cambridge, England, 1972.

Valentine, R.L., et al. Rainwater Collection System Characteristics and System Design. Sanitary Engineering Research Laboratory, College of Engineering and School of Public Health, U.C. Berkeley, UCB-SERL Report # 77-4, Berkeley, California, October 1977.

Discusses several rainwater system performance models, using case studies of 13 representative California sites. Good reference if you need precision calculations for demand/supply system performance.

van der Leeden, Frits. Ground Water, A Selected Bibliography. Water Information Center, Inc., Huntington, New York, 1974.

van der Ryn, Sim. The Toilet Papers. Capra Press, Santa Barbara, California, 1978.

Designs for composting toilets, on-site grey-water systems, and some discussion of large scale urban sewage problems, from one of the most widely acknowledged experts. New West magazine calls him Governor Brown's Privy Counselor; Rain magazine says Captain Compost has written his memoirs -- a warm addition to the pile of information.

Varshneya, J.K. and Mathur, O.N. Handbook of Rural Housing and Village Planning. National Buildings Organization, New Delhi, Government of India Press, 1968.

Discussion and how-to descriptions of conventional water supply and sanitation techniques for rural villages. No consideration given to recycling systems; straightforward supply and disposal approach.

VITA. Village Technology Handbook. Volunteers for International Technical Assistance, Mt. Rainier, Maryland, 1970.

Wade, David A. "Residential Water Conservation and Community Growth," a paper delivered at the EPA National Conference on Water Conservation and Municipal Wastewater Flow Reduction, Chicago, November 28-29, 1978.

Wagner, E., and Lanoix, J. Excreta Disposal for Rural Areas and Small Communities, Monograph #39. World Health Organization, Geneva, Switzerland, 1958 (reprinted 1971).

Wagner, E., and Lanoix, J. Water Supply for Rural Areas and Small Communities, Monograph #42. World Health Organization, Geneva, Switzerland, 1959.

Wallace, Daniel (Ed.). Energy We Can Live With. Rodale Press, Inc., Emmaus, Pa., 1976.

Wallman, H. "Should We Recycle/Conserve Household Water?", 6th International Water Quality Symposium, Washington, April 18-19, 1972.

Walker, M. Rural Wastewater Treatment Project. Office of Appropriate Technology, State of California, Sacramento, 1979.
A field study of a variety of on-site recycling systems.

Warshall, Peter. "Aboveground Uses of Greywater," Box 42, Elm Road, Bolinas, California 94924, 1977. Also revised and reprinted in OAT, 1977, pp. 35-47.

A super little "how-to" review of greywater irrigation.

Warshall, Peter. "Greywater Re-use," The Co-Evolution Quarterly, Spring 1977, p. 72.

A short article describing some ways to reuse greywater with little or no alteration of plumbing. In addition, it lists a few cautions which must be observed, and describes a number of very simple "backyard technology" greywater filters which can be built.

Warshall, Peter. Septic Tank Practices, A Guide to the Conservation and Re-Use of Household Wastewater. Anchor Books, New York, 1979.

A superb little book written with much love by a genuine expert on the on-site use of blackwater and greywater, a watershed.

Warshall, Peter. "Water Conservation," Proceedings of the Governor's Drought Conference, March 7-8, 1977, Los Angeles. California Department of Water Resources, 1977.

A talk on water conservation that strongly emphasizes water reuse. Also the importance of cooperation between urban, rural, and industrial users.

Warshall, Peter, and Ferraro, Patrick. Water Conservation in the Coastal Zone of California. Occasional Paper No. 2, California State Office of Appropriate Technology, Sacramento, June 1976.

Discusses water conservation techniques applicable to coastal environments (water conserving toilets, flow reducers, etc.), and the conformance of these items with policies of the California Coastal Plan. Also briefly describes the ponding treatment approach utilized in Bolinas. Focus is on recreational uses with their peculiar peak-loading problems and on residential uses. Notes on the impact of water conservation on wastewater treatment operational costs.

Warshall, Peter, and Matson, Steve. Drum Privy Guidelines. Box 42, Elm Rd., Bolinas, California 94924.

Pamphlet produced for the California Office of Appropriate Technology. "The 55-gallon drum privy is the best design we have seen so far. It includes some solar heating methods but emphasizes healthy habits and care during the process of turning human waste to compost."

Watercare. Proceedings of the Second Annual Conference. Water Reclamation and Domestic Water Conservation. California Association of Reclamation Entities of Water, 5750 Almaden Expressway, San Jose, California 95118, June 1975.

Water Foundation. Waterfacts Newsletter. 6255 Sunset Blvd., Los Angeles, California 90028
A P.R. effort apparently trying to increase agricultural water supply.

Water Research Foundation of Australia Limited. "Forest Management for Water Catchments," The University of Melbourne, Final Report being prepared. Listed in the Water Research Foundation of Australia Limited, Twenty-first Annual Report and Balance Sheet, 1976.

Water Research Foundation of Australia Limited. "Use of Ultrafiltration for Water Purification." Listed in the Water Research Foundation of Australia Limited, Twenty-first Annual Report and Balance Sheet, 1976.

Ultrafiltration is a relatively low cost method of effluent treatment which can be used to recover recyclable water from effluent streams.

Water Resources Control Board. See State Water Resources Control Board.

Water Resources Engineers, Inc. Future Direction of Urban Water Models. National Technical Information Service, PB-249 049, 1976.

Water Reuse Study News Bulletin. Published quarterly by Orange and Los Angeles County Water Reuse Study, 1111 Sunset Blvd. Los Angeles, California 90012, Issue 1, April 1979.

Water Treatment and Sanitation. Intermediate Technology Publications, 9 King Street, London, WC2E 8HN.

A handbook of simple methods for rural areas in developing countries.

Watlington, F.W. "Follow-Up: Installing a Cistern," Popular Science, Page 120, July 1979.

Watson, K.S., Farrell, R.P., and Anderson, J.S. "Contribution from the Individual Home to the Sewer System," Journal of Water Pollution Control Federation, Vol. 39, No. 12, pp. 2039-2054, December 1967.

Watt, S.B., and Wood, W.E. "Hand Dug Water Wells Lined with Reinforced Concrete," reprint from Appropriate Technology. International Scholarly Book Services, Inc., P.O. Box 555, Forest Grove, Oregon 97116.

Weber, Mary Louise. "Add Water and Stir," New Republic, April 14, 1979.

Urges urine be collected, diluted with water, filtered, and used for showering, claiming it is healthier.

Weibel, S.R., Straub, C.P., and Thoman, J.R. Studies of Household Sewage Disposal Systems, Part I. Federal Security Agency, Public Health Service, Environmental Health Center, Cincinnati, Ohio, 1949.

Wells, Malcolm. Underground Buildings. The Underground Press, P.O. Box 1149, Brewster, MA 12631, 1977.

Interesting designs of rainwater catchment systems and percolation beds.

Westinghouse Corporation. Homelab. Research and Development Center, Pittsburg, Pa.

Westman, W.E. "The Future for Land Disposal of Water Wastes," Operculum, pp. 75-79, May/June 1972.

Whipple, Wm., Jr., et al. Characterization of Urban Runoff. Rutgers, New Brunswick, New Jersey, for the Office of Water Research and Technology, Washington D.C., September 1976.

Study is a summary of detailed case studies done on location in five northeastern states.

White, Lazarus. The Catskill Water Supply. John Wiley & Sons, Inc., New York, 1913.

Account of the planning and building of the Catskill water works for the city of New York. The first chapter is a history of New York water works.

Whitford, P.W. "Residential Water Demand Forecasting," Water Resources Research, AGU, Vol.8, No. 4, August 1972.

Wilkinson, Joseph F. "Fresh Water From Sewage," Popular Science, August 1975.

"Unthinkable to drink purified wastewater? Most of us already do."

Wilkinson, Joseph F. "On the Way: Fresh Water From Sewage," Popular Science, p. 36+, August 1975.

Report on Denver's progress toward building a million gallon-per-day demonstration plant by 1977 to provide 'melted snow' quality water. Also mentions other 'reclamation' plants in Virginia, Washington D.C., South Lake Tahoe, Dallas, and St. Petersburg.

Williamson, J.F. (Ed.). "Watering Your Garden," Sunset Western Garden Book. Lane Publishing Company, Menlo Park, California, 1967.

Willson, John. Preventive Approaches to Storm-water Management. Water Planning Division, Environmental Protection Agency, Washington D.C., 1977.

Winneberger, John T. Greywater and the Drought. California Governor's Office of Appropriate Technology, Sacramento, California, March 1977. Pointers on greywater management and potential problems.

Winneberger, John T. (Ed.). Manual of Greywater Treatment Practice, Part I: On-Site Treatment and Sub Surface Disposal. Monogram Industries, Inc., 1974.

An especially revised version of the classic Manual of Septic Tank Practice, published by the U.S. Public Health Service. Essentially suggests using standard septic tank leach field that is 40% smaller.

Winneberger, John T. (Ed.). Manual of Greywater Treatment Practice, Ann Arbor Science Press, 1974, 1976.

A collection of classic papers: Part I is the Monogram revision of the Manual of Septic Tank Practice. Part II contains Winneberger's "Separation of Water-Born Wastes", Laak's "On the Pollution Strength of Household Effluents," Hypes' "Characterization of Typical Household Greywater," and Chen's "Soil Mantle as a Purification System for Greywater."

Winneberger, John T. "Practical Uses of New Septic Tank Technology," Journal of Environmental Health, Vol. 30, No. 3, pp. 250-262, November-December 1967.

Winneberger, John T. The Principle of Alternation of Subsurface Wastewater Disposal Fields. Hancore, Inc., Findley, Ohio, 1976.

Winneberger, John T. Setback Needed to Protect Water Supplies from Viruses, technical report distributed by Hancore Inc., Findlay, Ohio (c. 1973).

Discusses the distances viruses can travel in soil; concludes that in favorable soils only 2 to 3 feet might be adequate.

Winneberger, John T. Suitability of On-Site Wastewater Disposal Systems Along California's Coast. Occasional Paper No. 1, California State Office of Appropriate Technology, Sacramento, California, June 1976.

The paper deals with the subject of its title only tangentially; rather it is an essay on the institutional, professional and attitudinal

obstacles to maintaining on-site disposal systems. Greatest contribution is a discussion of the concept of public management of private on-site systems through establishment of local districts.

Winneberger, John T., and Anderman, W.H., Jr. "Public Management of Septic Tank Systems Is a Practical Method of Maintenance," Journal of Environmental Health, Vol. 35, No. 2, September/October 1972.

Winneberger, John T., and McGahey, P.H. A Study of Methods of Preventing Failure of Septic Tank Percolation Systems. San. Eng. Research Laboratory, University of California, October 31, 1965.

Wisconsin. "On Site Disposal of Small Wastewater Flows," Department of Civil and Environmental Engineering, University of Wisconsin, Madison.

Small scale Waste Management Project. See also Siegrist.

Withee, Craig C. Segregation and Reclamation of Household Wastewater at an Individual Residence. Department of Civil and Environmental Engineering, Colorado University, Boulder, Colorado, 1977.

Massive study dealing with on-site wastewater management in isolated rural settings. Contains extensive information on wastewater characteristics, user attitudes, and alternative means of treatment. Evaluation of various alternatives leads to description of two favored methods including cost data.

Wolf, Ray. "Greywater in the Garden," Organic Gardening and Farming, Vol. 24, No. 7, July 1977.

Gives specific instructions for setting up temporary greywater recycling systems and how to use the greywater for irrigation. Shorter version (including illustrations) of Marshall's article in Co-Evolution Quarterly, Spring 1977.

Mollman, Nathaniel, and Bonem, Gilbert W. The Outlook for Water: Quality, Quantity and National Growth. The John Hopkins Press, Baltimore and London, 1971.

"...On the basis of data findings as organized through the authors' water use model they conclude that the greatest problems relating to water are and increasingly will be those related to water quality and to the technologies affecting water quality." A valuable source. (Water Resources Library).

Wright, Lawrence. Clean and Decent. University of Toronto Press, 33 E. Tupper St., Buffalo, New York 14203, 1960.

A fascinating history of the bathroom and the water closet.

Younger, Victor. "Recycling and Conservation of Wastewater," Botany and Plant Sciences Department, University of California, Riverside.

Youngner, V.B., and Williams, T.E. Ecological and Physiological Implications of Greenbelt Irrigation. California Water Resources Center, Report No. 157, University of California, Davis, April 1976.

Used secondary treated sewage effluent as irrigation of uncleared, brush cleared, and type converted grass plots in a mountain chaparral ecosystem. No toxic build-up was evident in the grass tissue; stream monitoring within and surrounding the application site showed no indication of water quality degradation or contamination.

Zwick, David, and Benstock, Marcy. Water Wasteland, Ralph Nader's Study Group Report on Water Pollution. Grossman Publishers, New York, 1971.