

AT MICROFICHE
REFERENCE
LIBRARY

A project of Volunteers in Asia

The Planning, Installation and Maintenance of
Low-Voltage Rural Electrification Systems and
Subsystems

Published by:

Volunteers in Technical Assistance
1815 North Lynn St. Suite 200
P.O. Box 12438
Arlington, VA 22209 USA

Paper copies are \$ 5.95.

Available from:

Volunteers in Technical Assistance
1815 North Lynn St. Suite 200
P.O. Box 12438
Arlington, VA 22209 USA

Reproduced by permission of Volunteers in
Technical Assistance.

Reproduction of this microfiche document in any
form is subject to the same restrictions as those
of the original document.

Stock No. 61E
\$5.95

**The Planning, Installation and
Maintenance of Low-Voltage
Rural Electrification Systems
and Subsystems**

a VITA publication

**THE PLANNING, INSTALLATION AND MAINTENANCE OF LOW-VOLTAGE
RURAL ELECTRIFICATION SYSTEMS AND SUBSYSTEMS**

for

PEACE CORPS VOLUNTEERS

Prepared for the United States Peace Corps

by

Volunteers in Technical Assistance, Inc. (VITA)

3706 Rhode Island Avenue

Mt. Rainier, Maryland 20822 USA

In accordance with Contract PC 25-1709

April, 1969

PREFACE

THE PLANNING, INSTALLATION, AND MAINTENANCE OF LOW-VOLTAGE RURAL ELECTRIFICATION SYSTEMS AND SUBSYSTEMS is designed to aid both the technical instructor as a training manual and the Peace Corps Volunteer as a field resource reference. We hope that the manual will help to turn out Volunteers who can perform effectively in the field.

Each logical unit of instruction is sub-divided into the following categories.

OVERVIEW	A statement summarizing the general significance of the material to follow, and points requiring special emphasis.
OBJECTIVE	A definition of the goal to be achieved by the trainee for this unit of instruction.
TASKS	The steps to be followed to accomplish the objective.
FUNCTIONAL SKILLS	The knowledge and skills needed to be able to perform the tasks.
TERMINAL PERFORMANCE TESTS	The means of evaluating the ability of the trainee to perform the skills needed to complete the tasks in order to accomplish the objective.
RELATED INFORMATION	Content information describing the knowledge and skills needed to perform the tasks correctly.
LESSON PLANS	Suggested guidelines for providing instructional time for the essential areas of each unit.

Although we have followed a typical pattern of presentation, offering logical units of information, it is important to keep in mind that the manual is to be used in preparing Volunteers for a program and that no single unit can possibly stand alone. All are interrelated and need to be included in a systematic presentation. Its value as a reference tool will come after the skills have been learned and the Volunteer is overseas. Once in the field, the objectives and tasks can be used by the Volunteer as an outline description of how the project should proceed.

Throughout the project, a task force of the VITA chapter in Detroit, Michigan, spearheaded by Rod Herrick and Ted Ewald, spent many hours compiling the material from which the manual emerged.

I am deeply indebted to Robert Ellis who collected, summarized and organized the material into the manual's present format. Without his efforts, we would still be in the first draft stages.

A deep bow to Ethel Carlson, who managed to keep all the horses on the track; and Barbara Ille, who spent many hours trudging through first-draft scratchings.

Special appreciation is extended to Messrs. Richard Williams and Mike Furst, United States Peace Corps, and Ken Kalb, Executive Director, VITA. Without their vision, support and encouragement, this manual would not have been written.

Finally, errors and oversights must be credited to...

Michael J. Glowacki

Project Coordinator

Schenectady, New York
April 18, 1969

TABLE OF CONTENTS

BACKGROUND ESSENTIALS

SECTION 1	THEORY	
OVERVIEW.....		1
Matter.....		4
Atoms.....		4
Electric Charge.....		4
Proton.....		4
Electron.....		4
Current.....		5
Current Types.....		5
Electrical Circuit.....		5
Voltage.....		6
Resistance.....		6
Power.....		6
Energy.....		7
Multiple Units.....		7
Effects of Current Flow.....		7
Meters.....		9
Ohm's Law.....		11
Series Circuits.....		11
Voltage Drop.....		13
Parallel Circuits.....		13
Series-Parallel Circuits.....		15
Alternating Current Principles.....		16
The Electrical System.....		20
LESSON PLANS.....		21

SECTION 2	SAFETY	
OVERVIEW.....		30
Electric Shock.....		32
Safety Precautions.....		32
Rescue and First Aid Techniques.....		33
Grounding.....		34
LESSON PLANS.....		35

DESIGN AND INSTALLATION

SECTION 3	HOUSE WIRING	
OVERVIEW.....		37
Conductor Sizes.....		40
Conductor Insulation.....		41
Cables.....		41
Coloring of Conductors.....		42
Wire Handling Techniques.....		42
Types of Service.....		45
Service Entrance.....		46

SECTION 3 HOUSE WIRING (continued)

Switchboxes, Fuses and Circuit Breakers.....49
Electrical System Layout.....50
Installation.....51
Switches.....52
Component Location.....54
"New" and "Old" Work.....56
Motors.....57
Circuit Design.....59
Circuit Schedule.....59
Safety Considerations.....61
Total Load Requirements.....61
Nameplate Information.....62
Total Load Calculation.....63
Consumer Education.....63
LESSON PLANS.....64

SECTION 4 DISTRIBUTION WIRING

OVERVIEW.....79
Map Making.....82
Selecting the Route.....86
Clearing the Route.....86
Locating Pole Positions.....86
Choosing the Pole.....87
Pole Hauling.....88
Pole Preparation.....88
Erecting and Setting Poles.....90
Guying the Poles.....94
Joining Line Conductors.....98
Stringing the Wire.....100
Sagging Line Conductors.....101
Transformer Installation.....103
LESSON PLANS.....105

SECTION 5 POWER SOURCE

OVERVIEW.....117
Distribution System Power Source.....119
Isolated Generator Installation.....120
LESSON PLANS.....122

PLANNING REQUIREMENTS

SECTION 6 PROJECT COST ANALYSIS

OVERVIEW.....124
Material Needs.....126
Labor Needs.....126
Overhead.....126
Material Costs.....126

SECTION 6 PROJECT COST ANALYSIS (continued)

Labor Rates.....	126
Overhead Costs.....	127
Overall Project Costs.....	127
Fund Sources.....	127
Cooperative Operation.....	128
LESSON PLANS.....	129

SECTION 7 PROJECT MAINTENANCE

OVERVIEW.....	132
Trouble Shooting.....	135
Precautions.....	135
Symptoms of Electrical Trouble.....	135
Location and Type of Fault.....	136
Test Equipment.....	137
Trouble Correction.....	142
Preventive Maintenance.....	143
Manual of Standard Procedures.....	145
LESSON PLANS.....	146

BIBLIOGRAPHY.....	150
-------------------	-----

SECTION 1

THEORY

OVERVIEW:

The purpose of electrification is to provide power to do work. This work may be running a pump, lighting a house, or numerous other jobs. Controlled power is very important in all our lives. Uncontrolled power can be very dangerous.

The electrical worker must understand the basic principles of electricity, and how to control electrical power. If he does not have this knowledge he will be handling uncontrolled power, at the risk of life, property, or wasted power.

This section is planned to give the student the basic background knowledge of electrical principles so that he can work with electricity safely and efficiently. This instruction will be in a classroom or lab situation and the instruction should be mostly demonstration or student participation. The students have grown up with electricity and have assimilated much of the information. Through these discussions, demonstrations, and practice experiences, this knowledge can be supplemented, sorted out and properly ordered in the students mind.

THE PLANNING, INSTALLATION, AND MAINTENANCE OF LOW-VOLTAGE
RURAL ELECTRIFICATION SYSTEMS AND SUBSYSTEMS

BACKGROUND ESSENTIALS

SECTION 1 THEORY

OBJECTIVE: Develop a sufficient understanding of basic electricity to explain the function and operation of an electrical distribution system.

- TASKS:**
1. List and explain the fundamentals of electricity.
 2. Identify the components of an electrical distribution system.
 3. Explain the function and operation of each component.

FUNCTIONAL SKILLS:

1. Arrange components into an electrical circuit.
2. Identify the types of control elements normally found in a distribution system.
3. Identify the measuring units of electricity, and be able to measure these in a given circuit.
4. Explain Ohm's Law
5. Explain how electricity produces heat, magnetism and light.
6. Express the laws of parallel and series circuits.
7. Recognize the terms (by definition) necessary for a basic understanding of electricity.

TERMINAL PERFORMANCE TESTS:

1. Given a list of electrical terms, define each one.
2. Explain Ohm's law and the laws of series and parallel circuits. Arrange components into a series circuit, and into a parallel circuit.

THEORY (cont.)

3. Explain how electricity produces heat, light, and magnetism.
4. List the measuring units of electricity; and given a circuit, measure each of these values.
5. List the types of control elements normally found in a distribution system.

BACKGROUND ESSENTIALS

THEORY

MATTER

Anything which occupies space and has weight is called matter. All liquids, gases, and solids are examples of matter in different forms. Matter itself is made up of smaller units called atoms.

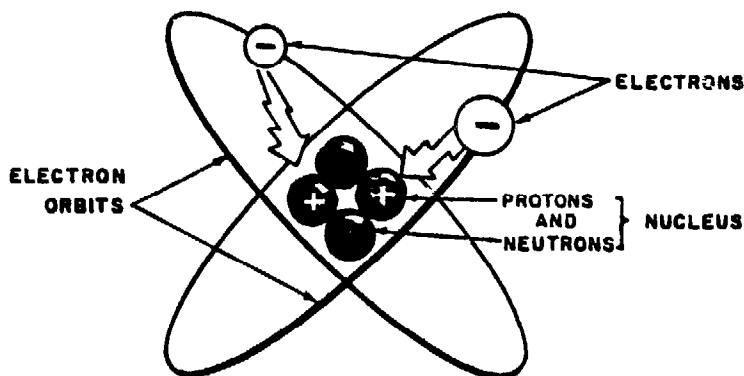

Fig. 1.1

ATOMS

An atom resembles the solar system with the sun as the center of the orbit and a series of planets revolving around it. In the atom there is a relatively large mass at the center called the nucleus.

ELECTRIC CHARGE

Any material is said to have an electric charge if it attracts or repels another material similarly charged. A material may have either a positive or a negative electrical charge. Two objects with positive charges repel each other. Two objects with negative charges also repel each other. Objects with unlike charges attract each other.

PROTON

Part of the nucleus of an atom is made up of protons with a positive electrical charge.

ELECTRON

One or more electrons revolve continuously about the nucleus. These electrons are very much lighter in weight than protons and possess a negative electric charge. All electrons are alike regardless of the atoms of which they are a part.

CURRENT

Electrons in motion constitute an electric current. Copper wire is widely used to carry electric current. Individual atoms of copper in the wire have electrons revolving about their nuclei. By applying electrical pressure from a battery or generator it is possible to force these electrons out of their circular path and cause them to pass from one atom to another, there repelling another electron to the next atom and so on along the length of the wire.

The greater the number of electrons passing a given point in a circuit, the greater the intensity of the current. An electric current is measured in amperes and the instrument used to measure current is called an ammeter. The symbol (I) is used to denote the amount of current in a circuit.

CURRENT TYPES

Direct current (DC) is the movement of electrons in one direction in a conductor.

Pulsating (DC) current is a current in one direction which varies in intensity at a regular interval of time.

An alternating current (AC) is a current which changes in direction and intensity at a regular interval of time.

A graph illustrating the types of current described above is shown in Fig. 1.2.

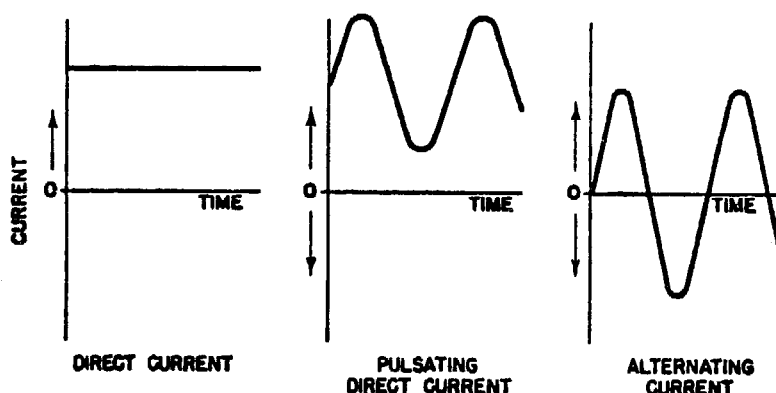

Fig. 1.2

ELECTRICAL CIRCUIT

An electrical circuit is a path or series of paths through which electric current flows. The three basic parts of a circuit are the power source, the conductors, and the load. The current flows from one terminal of the power source through the conductors to the load, through the load converting electrical energy to heat or motion, and then through another conductor back to the other connection of the power source. A switch is used to control current flow by opening a circuit or closing it.

VOLTAGE

A closed circuit and a source of electrical pressure are necessary to produce an electric current. Electrical pressure, known as voltage, or potential, is obtained from many sources. Generators are widely used for high-powered AC and DC installations. Storage batteries are extensively used for DC power in automobiles and aircraft. Photoelectric cells convert light energy into electrical energy and are used as voltage sources in light-operated devices. A thermocouple, consisting of a junction of two dissimilar metals, will generate a low voltage if heated. Electrical pressure is measured in volts and the instrument used to measure electrical pressure is a voltmeter. The symbol (E) is used to denote the electrical pressure between two points in a circuit.

RESISTANCE

The property of a material which causes it to oppose the flow of an electric current is called resistance. All materials have some resistance. Materials which offer little resistance to current are called conductors. Those which offer high resistance to current are called insulators.

Resistance is measured in ohms. The symbol (R) is widely used for resistance in formulas involving electrical calculations. The instrument used to measure resistance is an ohmmeter. The unit ohm is abbreviated, Ω , the Greek letter omega.

The most common of all conductors is copper wire. The resistance of one wire is not necessarily the same as the resistance of another. The resistance of a wire depends upon three things.

1. The material of which the wire is made.
2. The length of the wire.
3. The cross-sectional area of the wire.

The resistance is related to these factors by the following formula

$$R = \frac{k \times L}{A}$$

R = resistance
L = length of wire
A = cross-sectional area of wire
k = a specific number depending upon the material the wire is made of.

POWER

Power is the rate of doing work. An electric elevator motor does the same work speeding a car to the top of the Empire State building in two minutes as it does in crawling up in ten minutes. Although the work is the same, the motor in the first case must be five times as powerful.

The unit of electrical power is the watt. One watt is the power used when one ampere is forced through a circuit by a pressure of one volt. In DC circuits the power can always be figured with the following formula:

$$\text{Watts} = \text{Volts} \times \text{Amperes}$$

ENERGY

The energy used by a load is the power required multiplied by the time that much power was used. If one watt is used for one hour, the amount of energy consumed is one watt-hour, which is the unit of electrical energy. The consumer is charged for the amount of electrical energy that is consumed. The following formula is used to find the electrical energy consumed:

$$\text{Electrical Energy} = \text{Watts} \times \text{Hours Used}$$

MULTIPLE UNITS

In practical electrical work the units mentioned are found in much larger or smaller quantities. The Greek words below are used to indicate the corresponding multiple of the unit they are used with.

Kilo = 1,000

Mega = 1,000,000

Milli = .001 = 1/1,000

Micro = .000001 = 1/1,000,000

Examples of units using these prefixes are: kilowatts, megohms.

EFFECTS OF CURRENT FLOW

When electric current flows through a conductor there are several effects. These are the production of heat, light, and magnetism.

HEAT

When a current is passed through a wire heat is produced. The amount of heat depends upon the substance, the resistance of the wire, and the amount of current that is flowing through the wire.

A fuse is a small wire that melts at a low temperature, although the resistance is also very low. Fuses are made to melt when more than a certain amount of current is flowing through them. They protect circuits from excessive amounts of current by melting and opening the circuit, stopping current flow.

LIGHT

A hot metal will glow. A wire carrying current can heat to a high temperature and the wire will glow red hot. If the wire is in a bulb with no air it can glow white hot without burning up. This is the case with light bulbs.

ELECTROMAGNETISM

A wire carrying an electric current exhibits magnetic characteristics. If placed near iron filings this current carrying wire will attract them like a magnet as shown in Fig. 1.3.

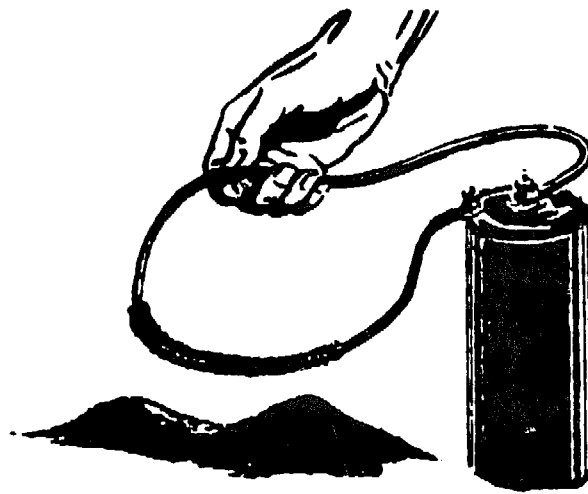

Fig. 1.3

A wire that has been coiled also acts like a magnet, and each end is like the poles of a bar magnet. Such a coil is called an electro-magnet. Fig. 1.4 shows a simple electromagnet.

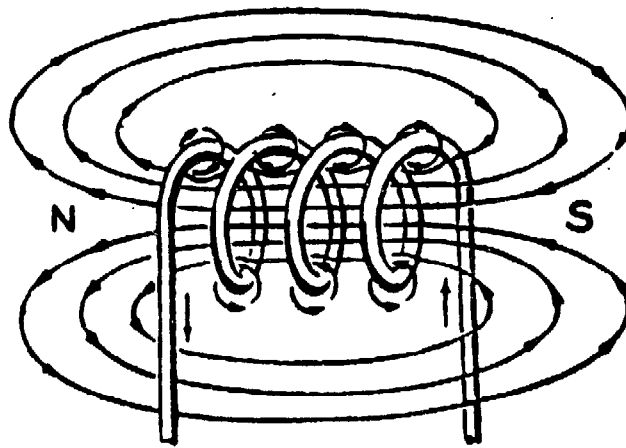

Fig. 1.4

Induced Voltage

When a wire is connected to a voltage source, a current flows. If this wire is in a magnetic field, the magnetic field induced by the current in the wire will cause the wire to be repelled out of the other magnetic field, since two magnets repel each other if two similar poles are brought close to each other. This process also works in reverse. When a wire, with its ends joined to make a complete circuit, is moved in a magnetic field, a voltage is induced which causes a current to flow. These are the principles of motor and generator operation.

METERS

Ammeters, voltmeters, wattmeters, all measure different electrical quantities, and each is connected to a circuit differently to measure a given quantity.

AMMETER

An ammeter measures the current flowing past a given point of a circuit. It is connected so that the current must flow through the meter, as illustrated below.

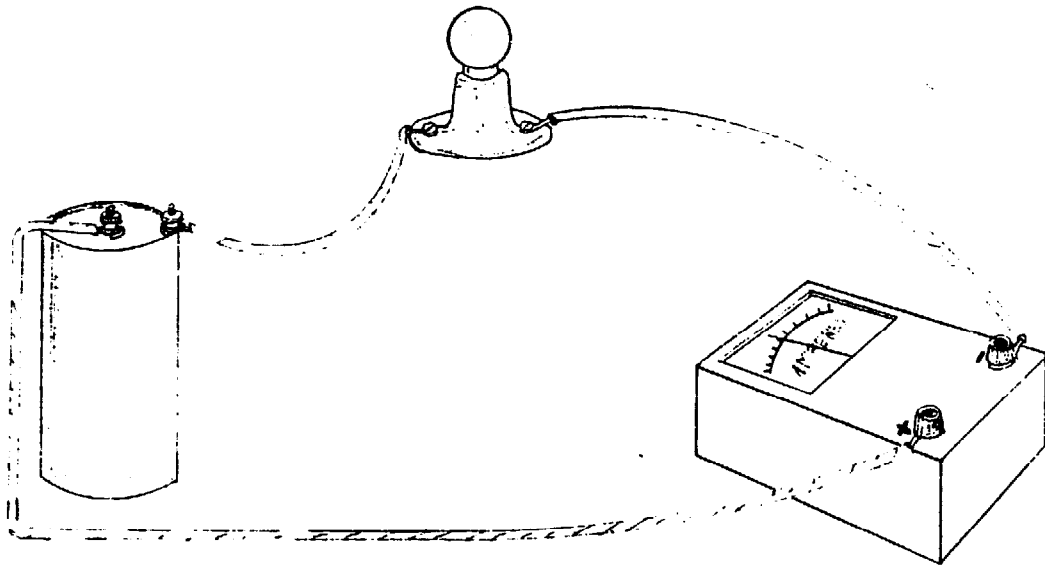

Fig. 1.5

There are some ammeters which need not be connected into the circuit. This type of meter works because of the magnetism around the wire.

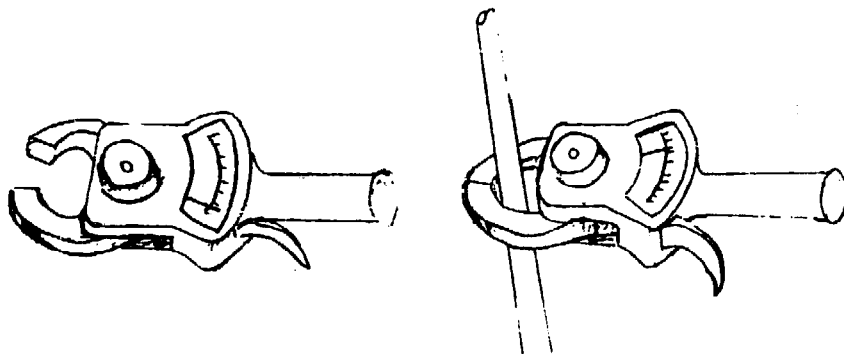

Fig. 1.6

VOLTMETER

A voltmeter measures the electrical pressure, or voltage, that exists between two points of a circuit. It is connected across the two points. In a circuit with several resistances the voltage may be different between different points.

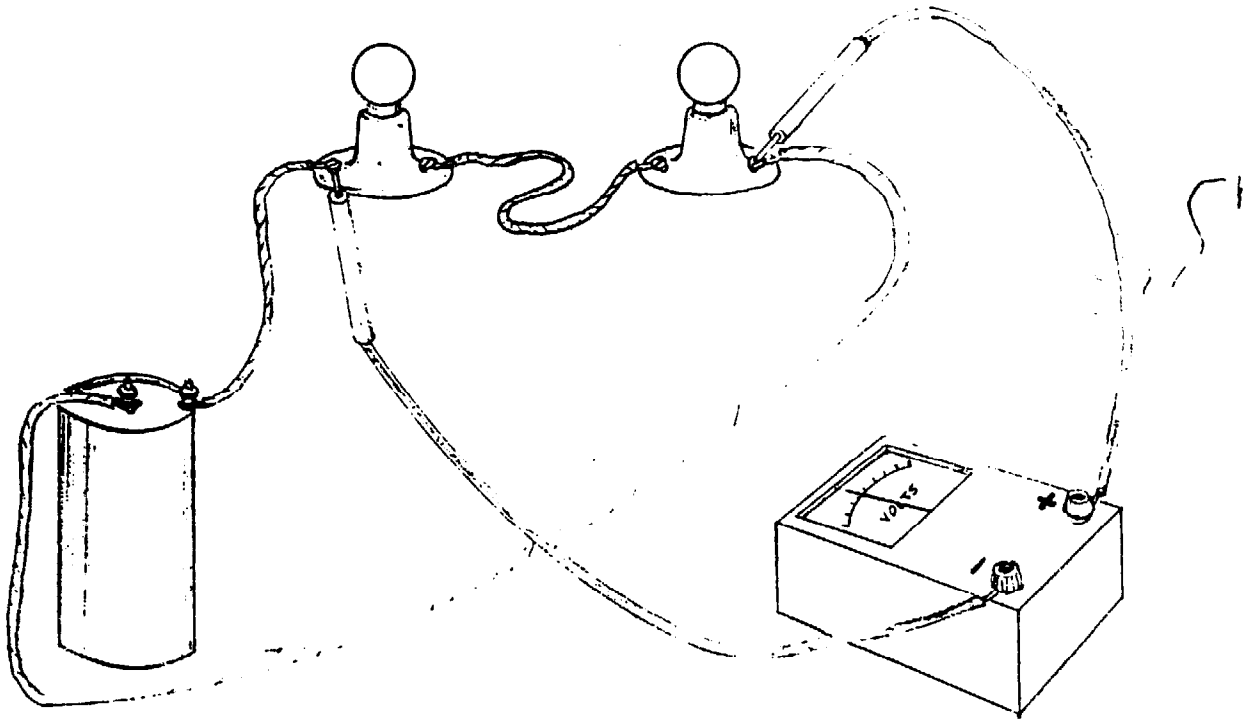

Fig. 1.7

WATTMETER

A wattmeter measures the power being consumed by a circuit. Power was defined as the product of the voltage and the current. A wattmeter measures the voltage and the current simultaneously and shows the wattage being consumed at any time. It is connected like a voltmeter and like an ammeter.

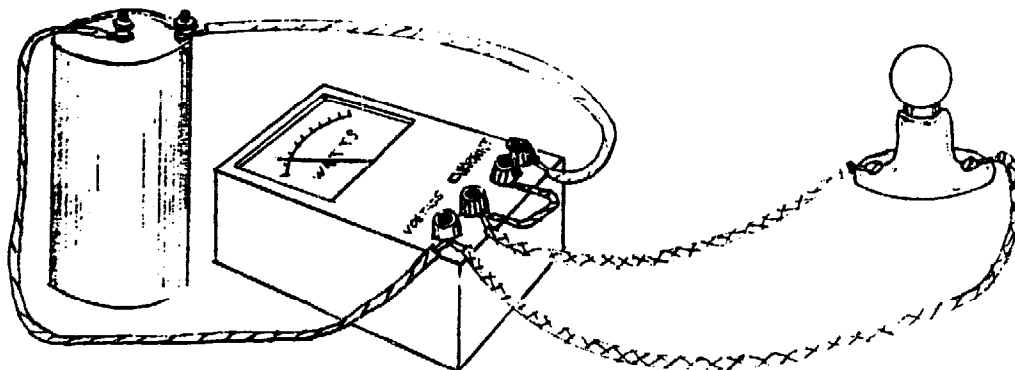

Fig. 1.8

WATTHOUR METER

The connection of a watthour meter is identical with the connection of a wattmeter. If a 100 watt lamp is being operated, the meter will record 100 WH. in one hour, and 2400 WH. in one day.

OHMMETER

An ohmmeter measures the resistance of a circuit. It is connected in place of the power source, and supplies a very small amount of power from which it determines the resistance.

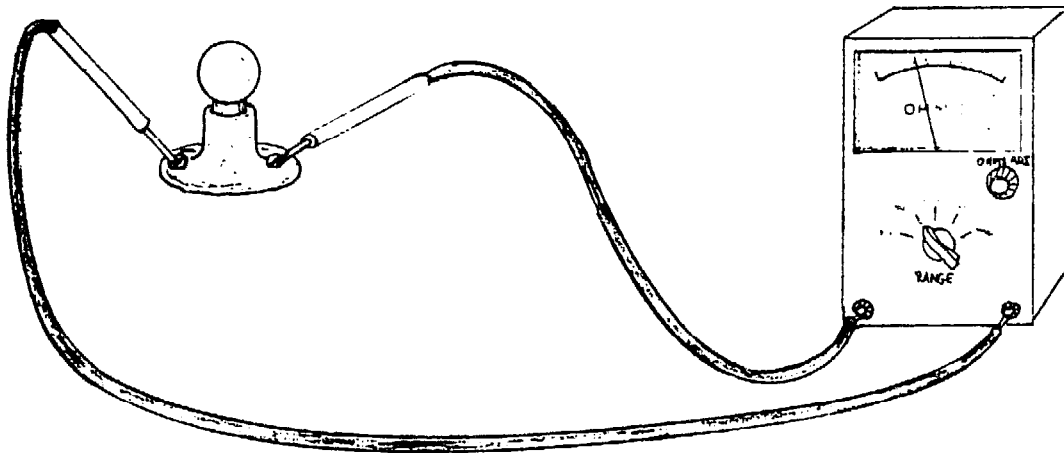

Fig. 1.9

OHM'S LAW

Experiment will show that there is a definite relationship between the voltage, current, and resistance of a circuit. This relationship is expressed by Ohm's Law. Ohm's Law is shown in the equations below, which are all equivalent.

$$E = I \times R$$

$$I = \frac{E}{R}$$

$$R = \frac{E}{I}$$

E = voltage in volts
I = current in amperes
R = resistance in ohms

SERIES CIRCUITS

In a series circuit the devices are connected so as to offer only one path for the current. Since only one path for current exists, the same current passes through all the devices, that is the current through each device is the same.

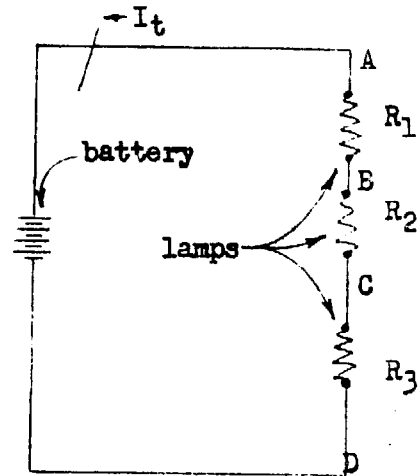
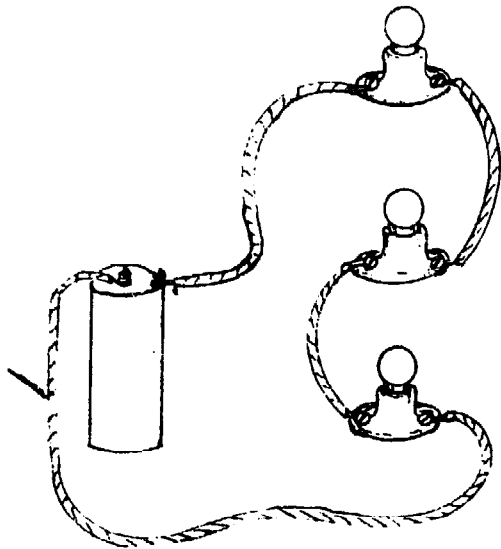

Fig. 1.10

$$I_t = I_1 = I_2 = I_3 \dots\dots\dots\text{etc.}$$

I_t = Total current

I_1 = Current through lamp #1

I_2 = Current through lamp #2

I_3 = Current through lamp #3

etc.

The total resistance of a series circuit is equal to the sum of the resistances of each part of the circuit. The total resistance in this case is the resistance from terminals A to D with the voltage source disconnected. In this case the resistance of the wire is so small we will not consider it.

In the symbol form:

$$R_t = R_1 + R_2 + R_3 \dots\dots\dots\text{etc.}$$

When R_t = Total circuit resistance

R_1 = Resistance of device #1

R_2 = Resistance of device #2

R_3 = Resistance of device #3

The total voltage applied to a series circuit is divided across the various devices of the circuit. E_1 is called the voltage drop of R_1 .

$$E_t = E_1 + E_2 + E_3$$

When E_t = The total voltage applied by the battery

E_1 = The voltage across R_1 (between points A and B)

E_2 = The voltage across R_2 (between points B and C)

E_3 = The voltage across R_3 (between points C and D)

VOLTAGE DROP

The voltage across a particular resistance is called a voltage drop. Using the above equation, the voltage available for the other resistances in the circuit is the total voltage less the voltage drop across R_1 .

Suppose a motor is connected to a generator by a long length of wire. A motor requires a high current, and this current must flow through the wire. The voltage drop across this wire is equal to the current times the resistance of the wire. If the wire is small in diameter or if it is long it will have a high resistance, and thus will have a high voltage drop across it. The motor will have less voltage and will not be able to run properly.

Voltage drop cannot be prevented, but it can be reduced. If the amperage is high the wire used should be larger in diameter or shorter in length. The increased diameter or shortened length will decrease the resistance. This will decrease the voltage drop.

PARALLEL CIRCUITS

A parallel circuit is one in which the loads are so connected as to offer a separate path for the current to each load.

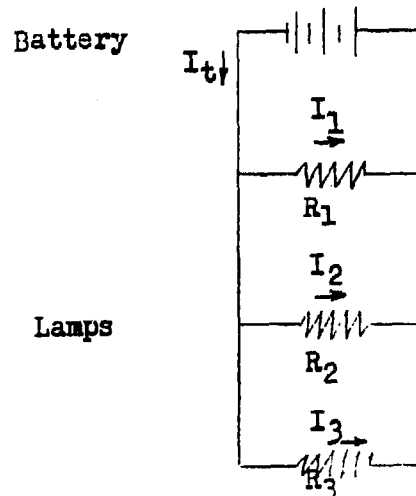
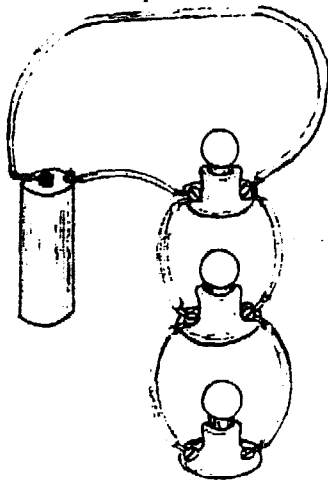

Fig. 1.11

The circuit shown in Figure 1.11 is an example of a simple parallel circuit. Note that each device is directly connected through the connecting wires to the main source of voltage. This causes each device to operate at the same voltage as the source. Thus all devices in a parallel circuit have the same voltage and must be rated at the same voltage to operate properly in parallel.

The fact that all devices in a parallel circuit operate at the same voltage is expressed mathematically in the following equation:

$$E_t = E_1 = E_2 = E_3 \dots\dots\dots\text{etc.}$$

The devices in a parallel circuit operate independently of one another. Each device takes current in accordance with its resistance. The number of separate paths for current is equal to the number of devices operated. Devices connected in parallel may have widely different ratings of current and resistance and still operate in parallel. The total current in a parallel circuit is equal to the sum of the currents in the separate devices.

$$I_t = I_1 + I_2 + I_3 \dots\dots\dots\text{etc.}$$

The total resistance of a parallel circuit decreases with an increase in the number of devices operated. This is apparent since an increase in the number of paths for current results in a decrease in total resistance. Remember: The total resistance of a parallel circuit is always smaller than the smallest resistor of that circuit.

The total resistance can be found by applying the correct voltage to the circuit and measuring the total current taken. The total resistance is then determined by applying Ohm's Law.

$$\text{Resistance of circuit} = \frac{\text{Voltage}}{\text{Total Current}}$$

The total circuit resistance can be found by an application of the following formula which applies to any parallel circuit. This formula is known as the Reciprocal Formula.

$$\frac{1}{R_t} = \frac{1}{R_1} + \frac{1}{R_2} + \frac{1}{R_3} + \dots\dots\dots\text{etc.}$$

SERIES-PARALLEL CIRCUITS

A series-parallel circuit has some loads or devices in series and others in parallel. Fig. 1.12 shows some typical series-parallel circuits.

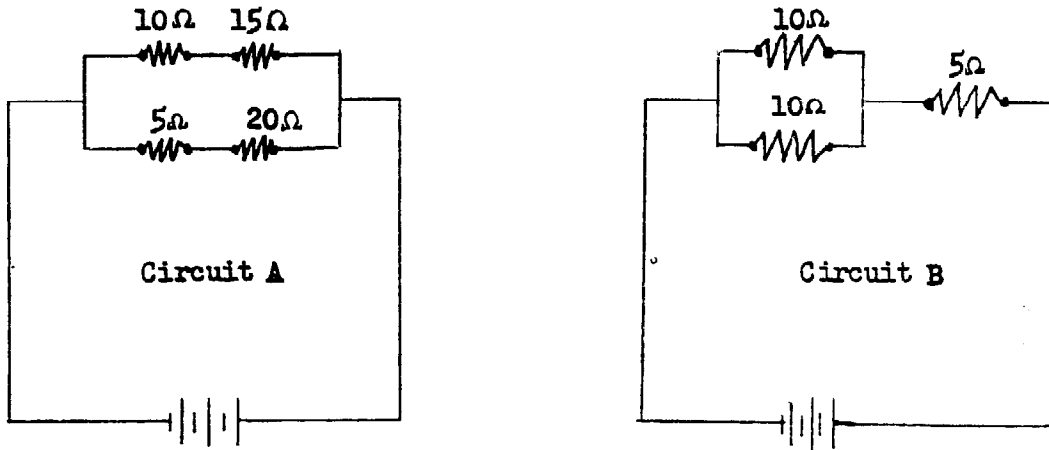

Fig. 1.12

The total resistance of Circuit A can be figured by parts. The two 10 ohm loads in parallel, considered alone have a resistance of 5 ohms. Thus circuit A is equivalent to two 5 ohm resistances in series, or a total resistance of $5 + 5 = 10$ ohms.

The total resistance of Circuit B can also be figured in parts. It is two series circuits which are in parallel to each other. It is the equivalent of two 25 ohm resistances in parallel. Thus the total resistance is:

$$\frac{25}{2} = 12.5 \text{ ohms.}$$

The most common series parallel circuit is the control of several loads by one switch.

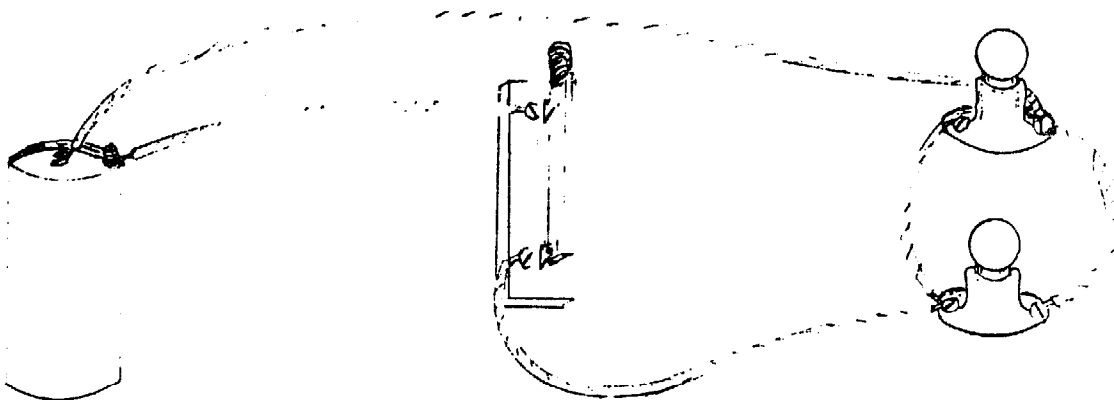

Fig. 1.13

The switch is in series with parallel loads.

ALTERNATING CURRENT PRINCIPLES

An alternating current can be generated by rotating a coil of wire in a magnetic field. The voltages induced as the coil makes one complete revolution are shown in Fig. 1.14. The part of the graph below the horizontal axis indicates voltage in the opposite direction.

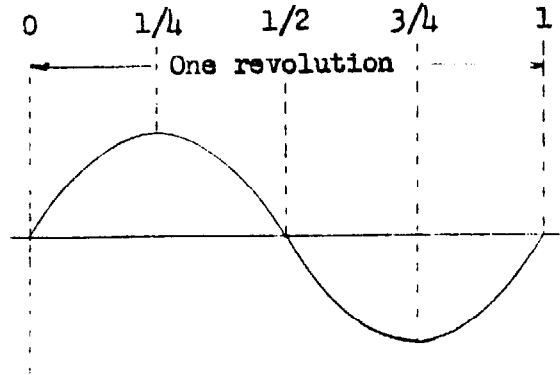

Fig. 1.14

CYCLE

A current flow that starts at zero, rises to a positive maximum, returns to zero, rises to a negative maximum, and returns to zero is on cycle of alternating current.

FREQUENCY

The frequency of an alternating current is the number of cycles of AC current in one second. If an AC current reaches its maximum voltage in the same direction, 60 times during one second, the frequency of the current is 60 cycles per second.

EFFECTIVE VALUES

The effective value of alternating current is that value which will produce the same amount of heat as the same value of direct current.

The effective voltage is that value which will force an effective current through the same resistance as a constant voltage.

$$\text{effective current} = .707 \times \text{maximum current}$$

$$\text{effective voltage} = .707 \times \text{maximum voltage}$$

The effective power is that value which will do the same work as the same value of power produced from a direct current source. AC ammeters, AC voltmeters, and AC wattmeters all measure the effective values of AC electricity.

APPARENT POWER

The product of the effective current and the effective voltage is called the apparent power, and is calculated in volt-amperes (VA), or kilovolt-amperes (KVA).

POWER FACTOR

In AC circuits, especially circuits that have large motor loads, the apparent power is not always the same as the effective power, as measured with a wattmeter. The effective power is often less than the apparent power. To measure the amount that these differ we define the term power factor:

$$\text{Power Factor} = \frac{\text{effective power}}{\text{apparent power}}$$

To measure the power factor of a circuit, measure the effective power with an AC wattmeter, measure the current with an AC ammeter, and measure the voltage with an AC voltmeter. Calculate the apparent power and use the formula.

It is desirable to have as high a power factor as possible. A low power factor means larger conductors are needed to supply the same power. Power factor can be corrected by installing capacitors into the system. They use no power but correct the power factor. Let the engineer in charge of the project decide when capacitors are needed and let him decide upon the size needed. Capacitors store power. They are dangerous even when disconnected. Handle with extreme care and always with the terminals connected together.

AC MOTORS

There are many ways to build AC motors. However, they all operate on the same principle. In all AC motors an AC voltage is applied to stationary coils, which produce a varying magnetic field that changes at a speed proportional to the frequency of the current. The rotating coil rotates in an effort to line up with this changing field.

SINGLE PHASE AC

All the material about alternating current so far has been concerned with single phase AC. The voltage reaches a maximum twice during each cycle (once in each direction). Therefore an AC motor receives two "pushes" each cycle.

THREE PHASE AC

A lawnmower engine has one cylinder. An automobile engine has six or eight. The automobile engine receives six or eight pushes per revolution compared to the single push of the lawnmower engine. It would be convenient if an electric motor could receive more pushes per revolution. This happens with three phase AC. A generator is so construc-

ted that it generates three alternating voltages, but they reach their maximum values at different times. A three phase motor has three coils which each connect to a different "phase" of the three phase generator. Thus the motor is getting six pushes (two pushes from each phase) in the same period of time that a single phase motor gets only two pushes.

The advantage of generating three phase power is single phase power can also be obtained by connecting the circuit to a single phase, rather than all three. Also, three phase motors are more efficient, simpler, less expensive to buy and run. There are two ways to connect loads to a three phase generator. In Fig. 1.15 and Fig. 1.16 the generators are the same, the diagrams show the three coils which have voltage induced in them by a rotating electromagnet. In the diagrams the arrangement of the coils is different but only for convenience in drawing. The coils each generate 120 V. The voltages obtained with each type of connection are indicated.

Delta Connection

The delta connection of a three phase generator, which resembles the Greek letter Δ (Delta), is shown in Fig. 1.15.

Wye Connection

Fig. 1.16 shows the same generator connected similar to the letter Y. This connection is sometimes referred to as a star connection.

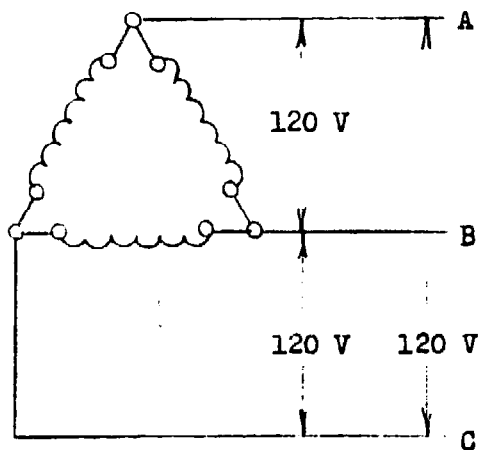

Fig. 1.15

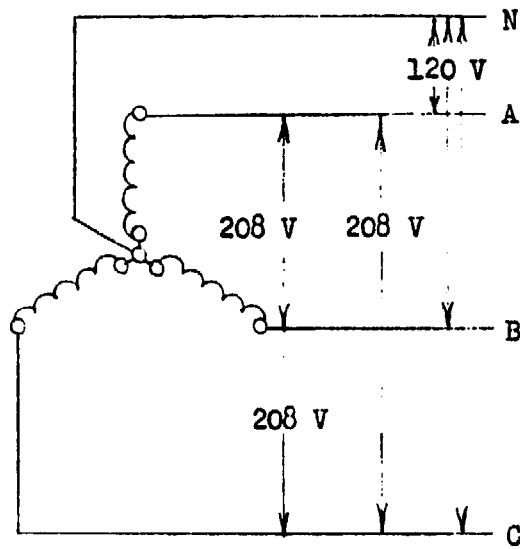

Fig. 1.16

TRANSFORMERS

A moving magnetic field generates an electric current in a conductor, and an alternating current flowing in a conductor produces an alternating magnetic field. These two effects can be combined in a circuit such as Fig. 1.17.

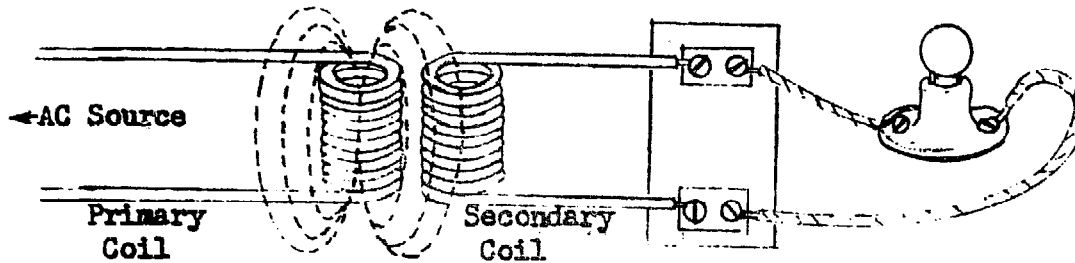

Fig. 1.17

One coil has a current flowing in it. It is an AC current that sets up an alternating magnetic field around the coil. If another coil is placed next to it, there will be an alternating current induced in it by the magnetic field. The first coil is the primary, the second coil is the secondary, and the combination is called a transformer. Most commercial transformers appear as shown in Fig. 1.18.

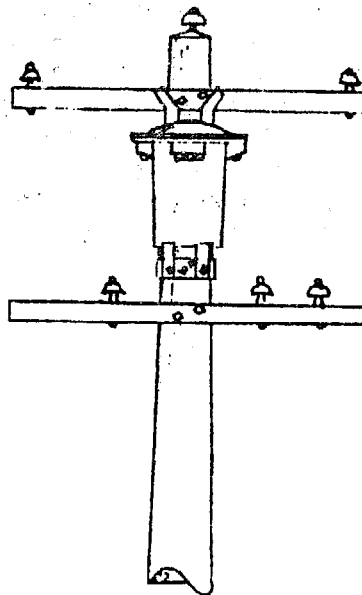

Fig. 1.18

Transformers can change voltage. If there are twice as many loops in the coil of the secondary as there are loops in the primary, the voltage in the secondary will be twice the voltage of the primary. This ratio is called the turns ratio, or voltage ratio. A transformer which will change the voltage from 1,000 V. to 100 V. is called a step down transformer. A transformer that would raise the voltage would be called a step up transformer.

THE ELECTRICAL SYSTEM

An electrical system is made up of seven major parts. These are:

1. The generator plant
2. Transmission lines
3. Substations
4. Distribution lines
5. Distribution transformers
6. Secondary lines
7. The house system

Each of these parts has components designed to protect or control the system. Throughout the system are switches to disconnect part of the system from the power, so that part of the system can be safely worked on. Each part of the system has fuses to protect that part from over-current. The transmission and distribution lines have lightning protectors to make lightning strikes harmless to the system.

The system is connected as follows. The generating plant is the source of power. If the power must be transmitted a long distance the voltage is stepped up at the generating plant by a transformer. This reduces the current flow through the transmission lines which decreases the voltage drop. At a substation this voltage is reduced by another transformer and is then distributed over the distribution lines to the area where the power is to be consumed. Near the houses a distribution transformer steps the voltage down to the supplied voltage and which is supplied to the house systems.

THEORY

LESSON NO. 1

LESSON OBJECTIVE: Describe the electrical units of measurement and the essential components of an electrical circuit.

TOPIC	INSTRUCTIONAL PROCEDURE	SUPPLEMENTAL MATERIALS / RELATED READING
Electron Theory	Define: matter, atoms, electric charge, proton, electron.	VanValkenburgh Vol. I, pp. 1-29
Current	Define current flow and the unit of current, the ampere.	VanValkenburgh Vol. I, pp. 42-50
Electrical Circuit	Define and exhibit an electrical circuit . Define the components of an electrical circuit and discuss examples of sources and loads.	VanValkenburgh Vol. II, pp. 1-6
Voltage	Define voltage and the unit of voltage, the volt. Discuss the various sources of voltage.	VanValkenburgh Vol. I, pp. 83-87
Resistance	Define resistance and the unit of resistance, the ohm. Discuss the resistance of conductors and insulators and show examples.	VanValkenburgh Vol. I, pp. 98-107
Power	Define electrical power and the unit of power, the watt. Discuss the relationship of electrical power with mechanical power.	VanValkenburgh Vol. II, pp. 42-48
Energy	Define energy and the unit of electrical energy, the watt hour. Discuss the relationship of electrical energy with mechanical energy.	Richter, pp. 20-21

THEORY
Lesson No. 1 (continued)

<p>Multiple Units</p>	<p>Define the use of the prefixes:</p> <p>kilo- mega- milli- micro-</p> <p>Discuss which units are usually considered in these multiple units.</p>	<p>Richter, p. 20</p>
<p>Effects of Current Flow</p>	<p>Discuss and demonstrate the effects of electric current flow:</p> <p>heat light electromagnetism</p>	

THEORY

LESSON NO. 2

LESSON OBJECTIVE: Demonstrate the measurement of the units of electricity.

TOPIC	INSTRUCTIONAL PROCEDURE	SUPPLEMENTAL MATERIALS / RELATED READING
Ammeter	<p>Demonstrate the use of an ammeter to measure current.</p> <p>Discuss the protection of the meter from overcurrent.</p> <p>Advise and stress safety as trainees practice the use of an ammeter.</p> <p>Demonstrate the use of a "tong type" ammeter.</p> <p>Discuss its advantages.</p>	VanValkenburgh Vol. I, pp. 60-74
Voltmeter	<p>Demonstrate the use of a voltmeter for measuring the electrical pressure between points of a circuit.</p> <p>Discuss protection of the meter and the trainee.</p> <p>Have trainees measure various voltage sources and the voltages between various parts of circuits.</p>	VanValkenburgh Vol. I, pp. 88-97
Wattmeter	<p>Demonstrate the use of a wattmeter for measuring the power consumption of a circuit and various parts of a circuit.</p> <p>Discuss safety of the trainee and meter.</p> <p>Have trainees use wattmeters to determine the power consumption of various loads.</p> <p>Discuss the difference between a wattmeter and a watthour meter.</p>	VanValkenburgh Vol. II, pp. 36-39

THEORY
Lesson No. 2 (continued)

<p>Ohmmeter</p>	<p>Demonstrate the use of an ohmmeter to measure the resistance of a circuit.</p> <p>Show how to use the range selector and the "zero adjust" to insure correct readings.</p> <p>Have trainees measure the resistance of several loads.</p>	<p>VanValkenburgh Vol. I, p. 108</p>
-----------------	---	--

THEORY

LESSON NO. 4

LESSON OBJECTIVE: Define series, parallel and series-parallel circuits.
 Develop the laws for voltage, current and resistance
 in these circuits.

TOPIC	INSTRUCTIONAL PROCEDURE	SUPPLEMENTAL MATERIALS / RELATED READING
Series Circuits	<p>Define a series circuit.</p> <p>Have trainees connect various resistances into parallel circuits with a battery.</p> <p>Have the trainees measure the voltages and currents across and through the various parts of the circuit and record this data.</p> <p>Repeat the above procedure with different resistances and voltage sources.</p> <p>Discuss the relationships observed and develop the laws for calculating the total resistance of the circuits.</p>	<p>VanValkenburgh Vol. II, pp. 7-23</p>
Parallel Circuits	<p>Define a parallel circuit.</p> <p>Have trainees connect various resistances in parallel with a battery.</p> <p>Have the trainees measure the voltages and the currents across and through different parts of the circuit and record the data.</p> <p>Repeat the above procedure with different resistances and then again with different voltage source.</p> <p>Discuss the relationships observed and develop the laws for calculating the current and resistance of the complete circuit.</p>	<p>VanValkenburgh Vol. II, pp. 55-89</p>
Series-Parallel Circuits	<p>Show examples of series parallel circuits.</p> <p>Discuss how to use the series and the parallel laws to determine the total resistance and current of the circuit and the voltage differences across different points of the circuit.</p>	<p>VanValkenburgh Vol. II, pp. 90-102</p>

THEORY

LESSON NO. 5

LESSON OBJECTIVE: Describe and demonstrate properties of AC circuits.

TOPIC	INSTRUCTIONAL PROCEDURE	SUPPLEMENTAL MATERIALS / RELATED READING
Cycles	Define one cycle of alternating current.	Richter, pp. 36-45.
Frequency	Define the frequency of an alternating current.	
Effective Values	Define the effective values of current and voltage for AC circuits.	
Power	Define effective power, apparent power and power factor.	
AC Motor Operation	Discuss briefly motor operation.	
Single Phase AC	Define single phase and three phase power.	
Three Phase AC	Describe delta connections and measure the voltages from a small three phase generator when delta connected. Describe "Y" connection and measure the voltages from the generator when "Y" connected.	

THEORY

LESSON NO. 6

LESSON OBJECTIVE: Demonstrate and describe the operation of a transformer.

TOPIC	INSTRUCTIONAL PROCEDURE	SUPPLEMENTAL MATERIALS / RELATED READING
Transformer Operation	<p>Demonstrate transformer operation using an iron rod and winding coils of wire around it.</p> <p>Use the principles of electromagnetism to explain this operation.</p> <p>Define the turns ratio and voltage ratio.</p>	VanValkenburgh Vol. IV, pp. 71-85

THEORY

LESSON NO. 7

LESSON OBJECTIVE: Describe the operation of an electrical distribution system.

TOPIC	INSTRUCTIONAL PROCEDURE	SUPPLEMENTAL MATERIALS / RELATED READING
The Electric System	<p>List the major parts of an electrical system.</p> <ol style="list-style-type: none">1. The generator plant2. Transmission lines3. Substations4. Distribution lines5. Distribution transformers6. Secondary lines7. The house system. <p>Discuss the function of each part and describe the operation of each part using the terms and concepts of this section.</p>	Kurtz, Sec. 2.

SECTION 2

SAFETY

OVERVIEW:

Safety must be stressed at all times in all electrification work, whether or not work is being done with electrical currents present. Instructors must stress safety every time they teach a skill. They must stress safety every time they describe a procedure. Every skill and procedure has a safe way of being done and many many ways that are unsafe.

This section of instruction describes how electric shock is received, why it is dangerous, and how to treat someone who has received a shock. The major protection from shock is a properly grounded system, so the theory of grounding should be taught. Exactly what to ground and how to ground it should be stressed in later sections at the time that the installation techniques are being taught.

SECTION 2: SAFETY

OBJECTIVE: Demonstrate the basic safety procedures that must always be followed when working with electricity. Demonstrate basic rescue and first aid techniques that will be needed if basic safety procedures are not followed. Explain how and why electrical systems should be grounded.

- TASKS:**
1. List the basic safety procedures that must be followed when working with electricity, and the reasons why.
 2. Demonstrate the basic safety procedures and the basic first aid and rescue techniques.
 3. Properly ground the electrical systems.
 4. Teach these safety, first-aid, and grounding techniques to the local workers.

FUNCTIONAL SKILLS:

1. Perform artificial respiration and treatment of persons for burns or shock, and recognize when such treatment is necessary.
2. Perform rescue techniques for removing a person from a live wire.
3. Demonstrate how and explain why an electrical system is grounded.
4. Instruct others in the use of required safety procedures through verbal instructions and demonstration.

TERMINAL PERFORMANCE TESTS:

1. List, and demonstrate in field exercises, the necessary safety procedures that must be followed in working on various parts of an electrical distribution system.
2. Demonstrate appropriate first aid and rescue techniques for various accidents that may occur in working on an electrical system.
3. Explain how and why electrical systems should be grounded.
4. Prepare a lesson plan to teach these procedures and techniques to local workers.

BACKGROUND ESSENTIALS

SAFETY

ELECTRIC SHOCK

An electric circuit is a path through which electric current flows. When a person's body becomes part of a circuit, current will flow through his body. This current may:

1. Knock the person unconscious.
2. Give the person a bad burn.
3. Stop the person's breathing.
4. Stop the person's heart.

SAFETY PRECAUTIONS

Electricity cannot be seen, smelled, or heard, so it is impossible to tell whether a wire has one volt running through it, 1000 volts, or no voltage at all. You should treat every electric wire as if it were dangerous. Before approaching any electric wire, first study the whole electric system to see how this particular wire is connected, and if possible, measure the voltage and current in the wire with a voltmeter and an ammeter. The following DO'S and DON'TS, if carefully observed, should prevent accidents:

1. Always disconnect the electric wire from the source of current and voltage before working on it.
2. Always use a test light, a voltmeter, or an ammeter to determine whether the line has a voltage in it and how much the voltage is.
3. Always wear dry gloves when approaching any electric wire.
4. Always pull the disconnected end of an electric wire well away from the source of current to create an air gap.
5. Never touch an electric wire when your feet are in water or on wet ground.
6. Never let one of the three wires in a three-phase circuit touch the ground or one of the other wires. This sort of contact will create an electric arc and intense heat.
7. Never work on a line which has more than 250 volts running through it from line-to-ground or from phase-to-phase.
8. Never replace a fuse without disconnecting all appliances and motors connected to the line.
9. Never use metal tools or wear metal jewelry (rings, I.D. bracelets, etc.) around electric wires. Always use tools with wooden, plastic, or insulated hand grips.

RESCUE AND FIRST AID TECHNIQUES

RESCUE

When someone touches a "live" wire, and becomes part of an electrical circuit, the victim must first be rescued, or freed from any contact with the "live wire". He must then be promptly treated with first aid. But be very careful lest you be shocked too.

Never approach or touch the victim unless you are positive he is not in contact with the electric current. Be especially careful if he is lying in a puddle of water or on wet ground.

Always pull or push the victim free of the "live wire" or wet ground with a dry, non-conductor, such as a wooden board, a rope, clothing, or lineman's rubber gloves.

Never try to pull the victim free of the "live wire" or wet ground with your bare hands, a piece of metal, or anything wet. If the victim has been suffocated by gas, smoke, or fumes, move him into fresh air before beginning first aid.

FIRST AID

Once the victim is free of the "live wire", look at his eyes to see if the pupils are dilated, and check his pulse at either wrist or neck. If the pupils are dilated or enlarged and there is no heart beat, begin closed chest heart massage immediately.

Check the victim's breathing. If the breathing has stopped, start mouth-to-mouth rescue breathing at once. Do not delay, do not stop to call for help, have someone else call a doctor.

If someone else is nearby, use him. Tell him to:

1. Call a doctor.
2. Loosen the victim's clothing.
3. Cover the victim to keep him warm and comfortable.

Continue rescue breathing until natural breathing starts again but stay with the victim. Breathing may stop again and rescue breathing should be started once more. Do not stop the rescue breathing if natural breathing does not begin again. Keep it up until the victim is pronounced dead by a doctor (and the American Red Cross recommends three checks for death by a doctor at 10-minute intervals) or until rigor mortis sets in.

Keep the victim lying down, well-covered to keep him warm and quiet until a doctor advises that he may move, sit, or stand.

GROUNDING

Grounding means connecting a wire or piece of equipment to the earth. This is done by connecting the wire, or equipment to be grounded, to a copper rod that has been driven deep into the earth. The earth is an adequate conductor and current will flow through it.

ELECTRICAL SYSTEMS ARE GROUNDED TO PREVENT THE DANGERS OF ELECTRICAL SHOCK AND FIRE.

All electrical systems should have one grounded wire.

All equipment cases and covers should be grounded.

All pipes, structural steel, and other conductive paths should be grounded.

All of these must be connected together or grounded to the same place.

When short circuits occur or when a device is connected from an energized wire to ground, the grounding wire provides a means of completing the path for the current. This completed path will allow excessive current to flow which will blow one of the fuses, thus removing the current and the danger. The grounded wire of the system must never be fused, for if this fuse should blow, the entire system would no longer be grounded, and considerable danger could be present.

Distribution systems should be grounded to a grounding electrode every 300 feet to maintain an adequate ground. Generating equipment, like all other equipment, must also be grounded.

SAFETY

LESSON NO. 1

LESSON OBJECTIVE: Discuss the danger of electric shock and demonstrate rescue and first aid for victims.

TOPIC	INSTRUCTIONAL PROCEDURE	SUPPLEMENTAL MATERIALS / RELATED READING
Electric Shock	Describe how electric shock occurs using the definition of an electric circuit. Discuss and describe situations when an electric shock hazard exists.	Richter, pp. 3-13.
Rescue	List and demonstrate the procedures for rescuing a person from a live wire.	
First Aid	Arrange for an instructor from the local Red Cross or Y.M.C.A. to instruct the trainees in the administration of artificial respiration, heart massage and treatment for: shock burns Similarly cover other areas of first aid for treatment of other accidents fractures lacerations abrasions Have trainees practice these first aid techniques on each other.	American Red Cross, <u>First Aid</u> .

SAFETY

LESSON NO. 2

LESSON OBJECTIVE: List and explain the reasons for grounding an electrical system.

TOPIC	INSTRUCTIONAL PROCEDURE	SUPPLEMENTAL MATERIALS / RELATED READING
Grounding Theory	<p>Discuss why electrical systems are grounded.</p> <p>List what should be grounded.</p> <p>Discuss why.</p> <p>Discuss the possible hazards that may occur when a system is improperly grounded or not grounded at all.</p> <p>Based on discussion, identify rules for grounding an electrical system.</p>	Richter, pp. 128-34.

SECTION 3

HOUSE WIRING

OVERVIEW:

The learning exercises of this section and the following sections, are centered around the construction of a sample electrical system by the PCTs. The PCTs will wire two sample homes (one of mud construction) with standard techniques and techniques applicable to mud construction. These will include lighting, appliance, motor and pump installations.

This installation of a sample electrical system will be the performance test. It will also be on the job training. The emphasis should be on doing, with instruction and lecture as needed to impart information, but the instructor will primarily be advising as the PCTs install the wiring of the sample houses.

DESIGN AND INSTALLATION

SECTION 3 HOUSE WIRING SYSTEM

OBJECTIVE: To plan and install a wiring system and service entrance for a house or family compound.

- TASKS:
1. Prepare a sketch of the house (or compound) layout.
 2. Determine and list the power requirements for the lighting, motor, and appliance outlets anticipated. Calculate the total power required for the house.
 3. Decide proper location for outlets, switches, and service entrance, and mark location on layout sketch.
 4. Decide which outlets should be on the same circuits and prepare a circuit schedule, listing the outlets, switches, wire size, and fuse size of each circuit.
 5. Indicate the paths the wires for each circuit will follow.
 6. Obtain necessary equipment and tools.
 7. Organize local workers into installation crews.
 8. Install the main and circuit fuse sockets.
 9. Install the wiring and outlets for each circuit, including any underground circuits for pumps.
 10. Select the proper types and sizes of components for the service entrance.
 11. Install and connect the service entrance components.
 12. Install proper ground.
 13. Inspect installations for safety and completeness, and correct any errors or omissions.

FUNCTIONAL SKILLS:

1. Recognize proper locations for switches; light, motor and appliance outlets; and service entrance components.

HOUSE WIRING SYSTEM (cont.)

2. Communicate with property owners to determine their needs, desires and restrictions.
3. Recall and perform proper techniques for installation of house wiring, service entrance, and ground.
4. Recall and perform method of installation of a motor outlet.
5. Recall and perform methods for installation of a pump.
6. Recognize best paths for wiring to follow.
7. Modify normally used procedures to fit local customs and construction techniques without sacrificing safe practices.
8. Given the load requirements, be able to specify equipment type and size.
9. Identify and correct any unsafe practices.
10. Splice and solder wires.
11. Prepare job descriptions for the local workers, and provide the necessary training and supervision.

TERMINAL PERFORMANCE TESTS:

1. For a given house, sketch a layout, and indicate suitable locations for switches, outlets, and service entrance components; prepare a circuit schedule, and a list of the types and sizes of service entrance components.
2. Given examples of typical locally constructed houses, select the necessary tools and materials, install the wiring and service entrance for each type of construction.
3. Given examples of wiring practices, identify and correct any unsafe practices.
4. Identify the jobs for which local workers may be used, and list the skills that must be taught for each job.
5. Install an electric water pump, given a water supply, a pump, and necessary tools.

DESIGN AND INSTALLATION

HOUSE WIRING

CONDUCTOR SIZES

The current that a given conductor can carry depends upon its size. The larger the diameter of a wire, the greater the current that it can carry. Wire and cable come in varying sizes, and these sizes are numbered. The higher the number, the smaller the wire and the less current it will carry without excessive voltage drop or fire hazard. The word ampacity means the maximum current a wire should carry. The following chart gives the ampacities of various sized copper conductors in normal use.

Wire Size	Ampacity in amps.
14	15
12	20
10	30
8	40
6	55
4	70
2	95
1	110
0	125
00	145
000	165
0000	195

For specific ampacity of a wire in a specific case check manufacturer specifications. Also check the local electrical code to see if it has stricter requirements. The size of a particular wire should be marked on the cable. It can be measured with a wire gauge. A wire gauge is shown in Fig. 3.1. The widths of the openings on the rim correspond to diameters of wires whose numbers are opposite the openings.

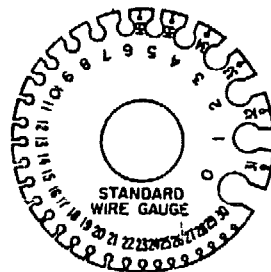

Fig. 3.1

CONDUCTOR INSULATION

All conductors used for residential wiring must be insulated. There are several types of insulation in standard use. The most common is thermoplastic insulation, which is called "Type-T". "Type-R" means a rubber or rubber compound insulation. The letters W or H following the type, indicate moisture resistant or heat resistant insulations and can be used in wet or hotter than usual locations. Thus Type-RW or Type-TW can be used in wet locations; Type-THW or Type-RHW can be used in hot and wet locations; etc.

CABLES

For many purposes it is desirable to have two or more wires grouped together in the form of a cable. This is easy to install, especially when used to wire a building that was completed before the wiring is installed, for the cable lends itself well to being fished through wall spaces.

All wires are marked with the size of the conductor and the type letters indicating its insulation. A cable made up of two size 14 conductors, is marked 14-2, or one with three size 12 conductors is marked 12-3, etc. The insulation type is marked on the conductor insulation and the cable type is marked on the cable sheath.

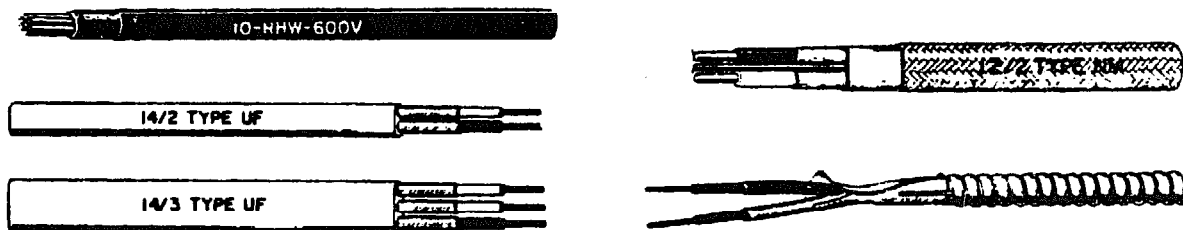

Fig. 3.2

NON-METALLIC SHEATHED CABLE

This cable consists of two or three Type-T or Type-R wires bundled together in an outer cover. It costs less than other types of cable, is light in weight and very simple to install; no special tools are needed. There are two types, they are called Type-NM and Type-NMC. The first is for use in dry locations and the second is enclosed in a plastic sheath and is suitable for use in wet locations.

ARMORED CABLE

This type of cable is commonly called BX cable. It is two or three conductors of Type-T or Type-R sheathed in a spiral galvanized armor, and called Type-ACT or Type-AC respectively. The armored cable can be used in most any location that is not considered damp. There is no armored cable for use in wet locations. In such locations the use of a lead shielded cable similar to Type-NM in construction is used.

UNDERGROUND CABLE

There are two types of underground cable, Type-UF and Type-USE. These types are for underground feeders and underground service entrances. There are Type-UF cables that also meet the requirements for Type-NMC. These will be marked UF-NMC.

There are many other types of cable, suited to specialty uses. These are described in the references.

COLORING OF CONDUCTORS

Conductors, separate and in cables, come in various colors, and there is a purpose for this. Only white wire may be used for the grounded neutral wire in wiring. White wire may be used when ungrounded only for feeding power to switches when cable is being used. Other wires may be any color except white or green. They occur in the following combinations:

2-conductor	White, Black
3-conductor	White, Black, Red
4-conductor	White, Black, Red, Blue
5-conductor	White, Black, Red, Blue, Yellow

WIRE HANDLING TECHNIQUES

INSULATION STRIPPING

To connect a cable or wire in a circuit the insulation at the ends of the wire must be removed. A hacksaw is used to cut the armor on Type-AC cable. The cut is made diagonally across the sheath, cutting just one section of the spiral. The armor is then twisted off the end. To protect the conductors from the sharp edges a fiber bushing is installed between the wires and the sheathing. Type-NM cable requires a knife to remove the sheathing. A cable should have about 8 inches of sheathing removed, but care should be taken not to hurt the conductor insulation. A knife is then used to remove the insulation from the ends of the conductors, without nicking the conductor.

SPLICING

Two wires can be connected together using a splice. The most common splice is the Western Union splice shown in Fig. 3.3. It makes a good electrical contact and is strong mechanically.



Fig. 3.3

A tap splice is used to connect one wire in the middle of another, as shown in Fig. 3.4.

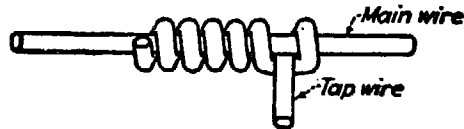

Fig. 3.4

SOLDERING

Soldering is the bonding of two conductors together with molten solder. This makes a low resistance path for current. The steps in soldering are:

1. Clean the wires to be soldered.
2. Splice the wires.
3. Clean the finished splice.
4. Heat the splice until the wires will melt the solder.
5. Apply the solder, allowing it to melt and flow through the splice.
6. Remove the heat and allow the splice to cool.

This procedure allows the solder to make a chemical bond with each of the wires. This bonding operation will be hindered if the wires or the soldering iron are not clean. Many solders contain a flux which prepares the wires for the bonding. Only the rosin flux should be used for electrical wiring, as the others tend to corrode the connection. The best solder for electrical connections is 60% tin--40% lead, rosin core solder.

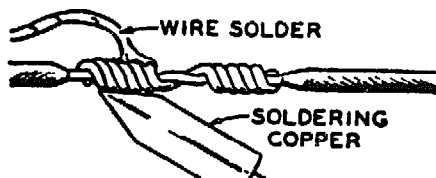

Right



Wrong

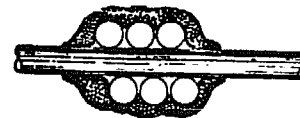

Fig. 3.5

TAPING

Splices should be taped after soldering to insulate the conductor. Plastic tapes are readily available and are the best to use for this purpose. The tape should be wound around the wire diagonally and progress down the splice. This should be repeated in the other direction, and back and forth until the taped splice is the same diameter as the wire.

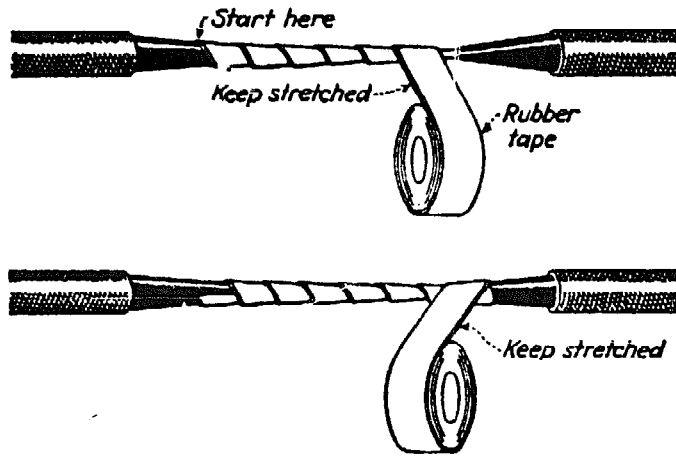

Fig. 3.6

SCREW TERMINALS

Most switches, outlets, fuse holders, circuit breakers and appliance plugs have screw terminal connections. The connection of a wire to a screw terminal is shown in Fig. 3.7. The loop should be formed in the wire before it is placed around the screw. When the loop is placed around the screw it should be placed so that the tightening of the screw tends to close the loop, rather than open it.

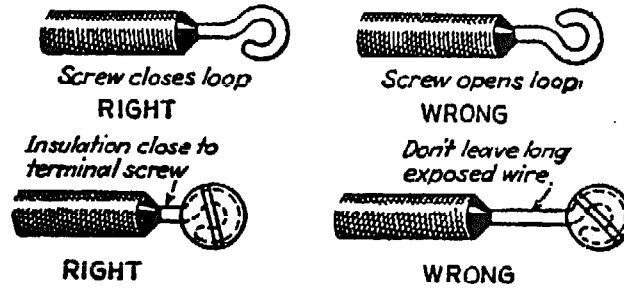

Fig. 3.7

SOLDERLESS CONNECTORS

There are many types of connectors for joining wires that do not require soldering. These all depend upon pressure between the wires to insure a good electrical contact. It is difficult to heat the larger sizes of wire, and this makes soldering difficult or entirely impossible. On larger sizes of wire solderless connectors must be used. Fig. 3.8 and Fig. 3.9 show several types of solderless connectors.

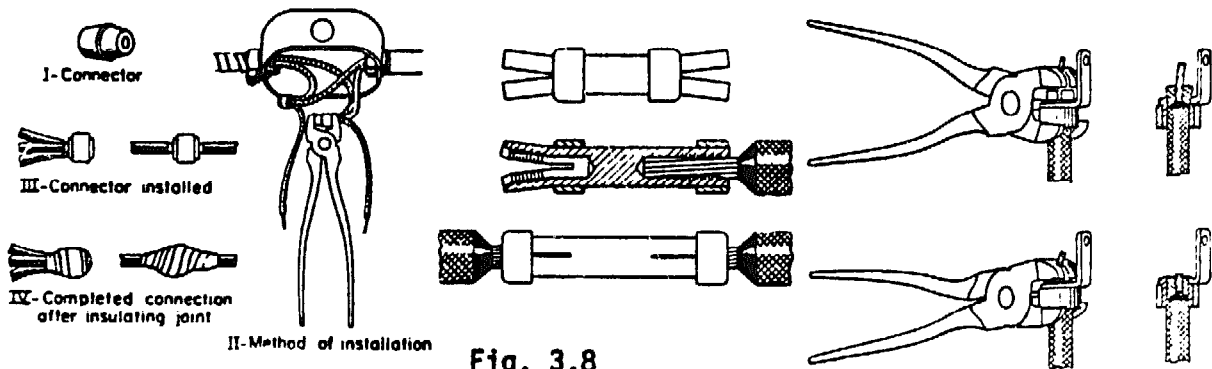

Fig. 3.8

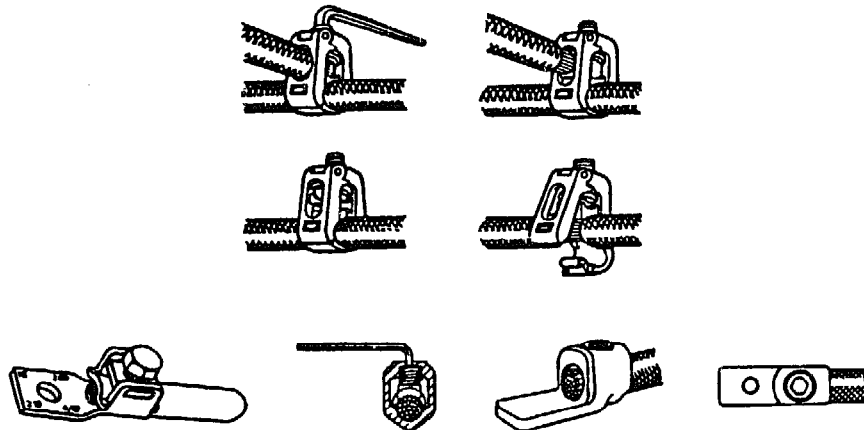

Fig. 3.9

TYPES OF SERVICE

There are several types of service that can be supplied to a consumer from the distribution or secondary lines of the system. They are:

1. 3 wire three phase (delta connection)
2. 4 wire three phase (wye connection)
3. 3 wire single phase
4. 2 wire single phase

The three wire three phase service is rarely used as it provides only one voltage. The 4 wire three phase service provides three phase power at 208V. and also provides 120 V. single phase power. When three phase power is to be provided, a 4 wire service is usually the most practical. To obtain this from the three wire distribution lines, three transformers are used. The primaries of these transformers are connected in delta, and the secondaries of the transformers are connected in wye, with the neutral wire grounded.

Three wire single phase service is the basic single phase service. It is obtained from the distribution lines using one transformer as illustrated in Fig. 3.10.

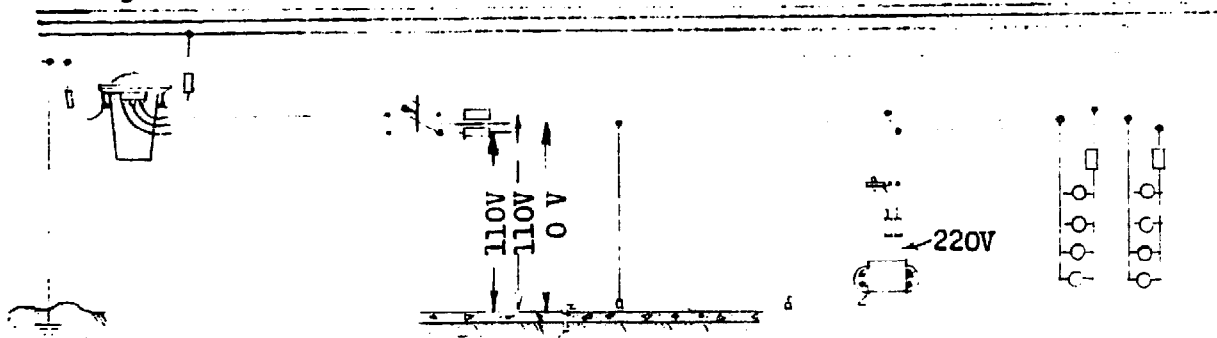

Fig 3.10

The 3 wire service provides two voltages. When a building requires only the lower voltage and no expansion of service is anticipated a 2 wire

service can be installed using just the neutral and one of the single phase lines. In any service that uses a neutral line the neutral line must be grounded for safety.

SERVICE ENTRANCE

The term service entrance describes several pieces of equipment and their interconnection. The components of a service entrance are:

1. The service drop
2. The service insulators
3. The service head
4. The service entrance conductors
5. The meter
6. The building entrance
7. The main switch
8. The main overcurrent protection
9. The service ground

THE SERVICE DROP

The service drop is the connection of the house system to the distribution system. This is done after the house installation is completed and tested, and is performed with the main switch open. The connection is made to the distribution system by removing the insulation on the secondary wires and making a tap splice, using solderless connectors. The service drop conductors are secured to an insulator rack on the pole, and strung to the service drop insulators and then connected to the conductors entering the service head. The service head should either be higher than the service drop, or there should be drip loops to prevent water from entering the service head.

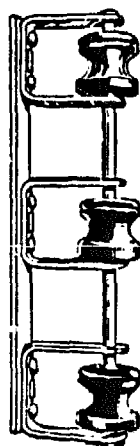

SERVICE INSULATORS
Fig. 3.11

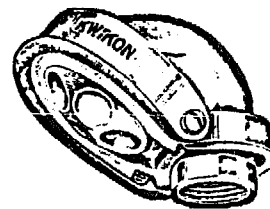

SERVICE HEAD
Fig 3.12

THE SERVICE INSULATORS

These insulators are for securing the service drop to the residence. They should be mounted high enough on the building to allow ten feet

of clearance between the service drop and the ground. They should be mounted on a secure structure of the building or on a mast or pole installed for the purpose.

THE SERVICE HEAD

This is a unit which is mounted on the top of the conduit or cable leading to the meter. Its purpose is to prevent rain from entering the conduit or cable. It should be mounted above the service insulators so that any rain will drip down the conductors and away from the service head.

THE SERVICE ENTRANCE CONDUCTORS

These include the cable from the service head, or the conductors in the conduit, to the meter and the conductors (in cable or conduit) from the meter to inside the building and to the main switch. They should be of large enough size to safely carry the current that the house system will demand. Future expansions of the house loads should be considered when sizing these conductors so that the service entrance conductors will still be adequate after expansion.

THE METER

The meter should be supplied by the co-op. The meter must match the type of service being provided. If the service is just 220 V. then a meter for 220 V. should be used. If the service is for 220/440 V. then a 440 V. meter should be used. If the service is three phase, then a three phase meter must be provided. Most meters come with the wiring done internally and for connection all that is required is to connect the ungrounded lines in series through the connections to the meter, as in Fig. 3.13.

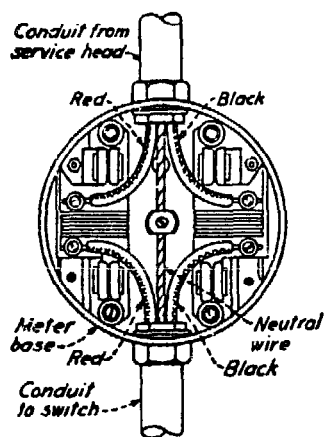

Fig. 3.13

THE BUILDING ENTRANCE

Whether cable or conduit is used for the service conductors they must be sealed from the weather while outside of the building and at the entrance to the building, so that no rain can enter, and possibly cause

shorting of the conductors at the main switch or panelbox.

MAIN SWITCH

There must be a main switch for the house system. It is necessary for disconnecting the system from the power when there is work to be done on the main fuse box or feeders of the system. This switch must be rated at the same ampacity as the service entrance conductors. If knife switches are used, they must be installed so gravity will not tend to close them.

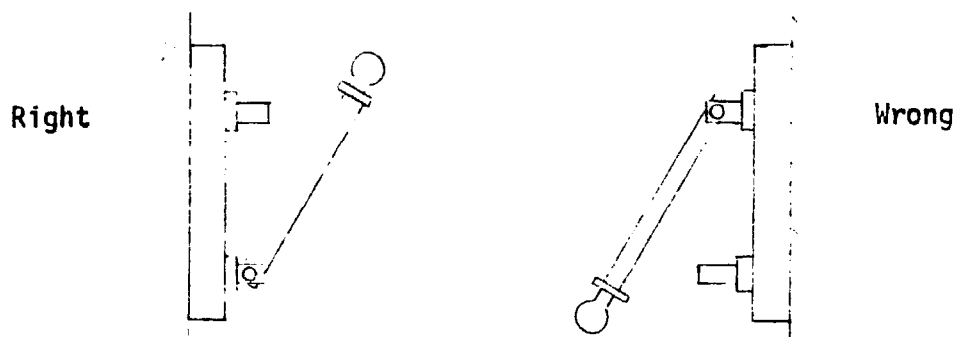

Fig. 3.14

MAIN OVERCURRENT PROTECTION

There must be fuses or circuit breakers in series with the ungrounded conductors of the service entrance, after passing through the main switch. Never fuse a grounded conductor, if that fuse should blow there would be no ground for the entire system and severe damage could result to the equipment of the house system. If circuit breakers are used for this function they may take the place of the main switch.

THE SERVICE GROUND

If there exists an underground water system, the installation of a system ground is easily accomplished. If there are pipes that extend underground for a distance greater than 10 feet, the system can be grounded by connecting the neutral wire at the main switch to this piping system. There should be jumpers over the pipe connections between where this connection is made and where the pipe enters the ground.

If there is no underground water system, then an electrode must be driven into the ground for the purpose. This electrode can be a piece of galvanized water pipe or preferably a copper rod, of 3/4 in. or 1/2 in. diameters respectively. This rod must extend at least 8 feet into the ground.

There should be no soldered joints anywhere in the service entrance or ground, because soldering of the larger conductors is a very tricky skill. Solderless pressure connections should be used instead.

EQUIPMENT SPECIFICATION

The rating of the service entrance components must be considered before installation. Determination of the total requirements of the house is covered later in this section. This determination will indicate the maximum current that will be supplied to the system. The components of the service entrance handle all of this current and must be at least large enough to handle this maximum current. The conductors, main switch, and service ground must be able to safely handle this maximum current. The main fuses should be chosen to protect the components of the service entrance which have the smallest ratings.

SWITCHBOXES, FUSES AND CIRCUIT BREAKERS

In any installation there must be a main disconnect switch. This is necessary to allow servicing of the installation without the danger of shock. A switch box will allow for the disconnection of individual circuits so that they may be worked on with safety.

Fuses or circuit breakers are required on any branch circuit. They must be of a size no larger than the ampacity of the conductors of that branch. They are needed primarily as fire protection in case of overload or short circuiting. They also protect the installation itself, by disconnecting the circuit before it can become so hot as to start a fire or the voltage drop become so great that equipment is damaged.

CONNECTION OF SWITCHBOXES AND FUSEBOXES

Switch boxes and fuse boxes are designed with a common buss for connecting all of the neutral or ground wires to. These wires must all be white. The fuse sockets, the circuit breakers, or switches must be connected in series on the "hot" lines only. NEVER fuse or switch a grounded or neutral conductor.

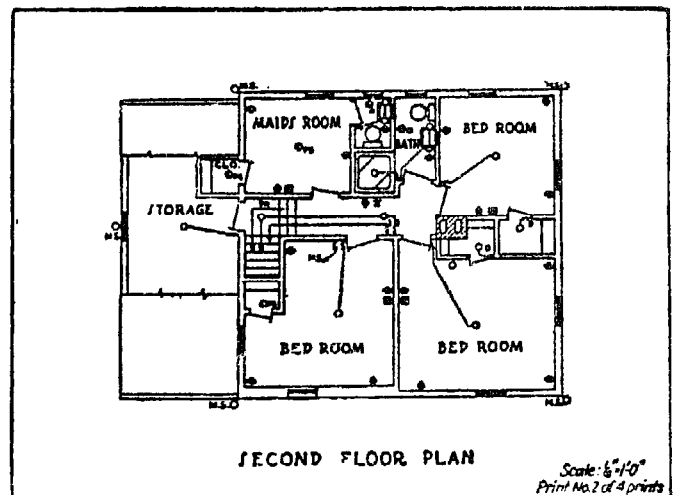
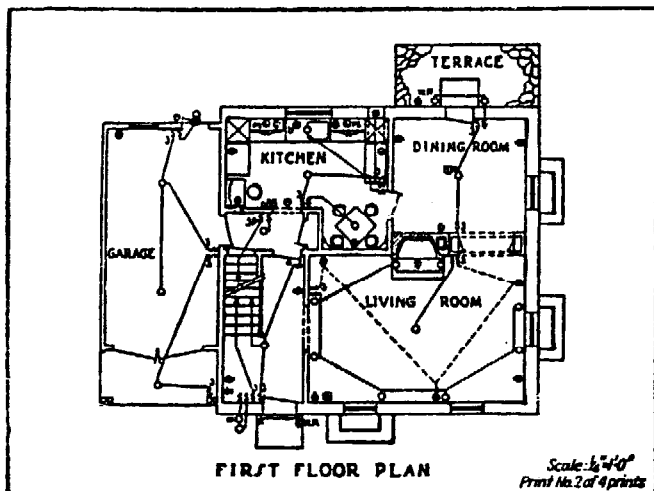

Fig. 3.15

ELECTRICAL SYSTEM LAYOUT

Fig. 3.15 shows an example of a house layout sketch with the layout of the electrical system indicated. You will note that the switch connection is indicated by solid or dotted lines, this denotes wiring through the walls and ceiling, or beneath the floor respectively. Other connections are not indicated on the layout, but are indicated on the wiring schedule. Fig. 3.16 shows the symbols used in house layout plans.

Ceiling Wall

- —○ Outlet
- Ⓟ —Ⓟ Blanked Outlet
- Ⓞ — Drop Cord
- ⓔ —ⓔ Electric Outlet; for use only when circle used alone might be confused with column, plumbing symbols, etc
- ⓕ —ⓕ Fan Outlet
- ⓙ —ⓙ Junction Box
- Ⓛ —Ⓛ Lamp Holder
- Ⓛ_{PS} —Ⓛ_{PS} Lamp Holder with Pull Switch
- Ⓢ —Ⓢ Pull Switch
- Ⓢ —Ⓢ Outlet for Vapor Discharge Lamp
- Ⓧ —Ⓧ Exit Light Outlet
- Ⓢ —Ⓢ Clock Outlet (Specify Voltage).

GENERAL OUTLETS

- Ⓢ Duplex Convenience Outlet
- Ⓢ_{1,2} Convenience Outlet other than Duplex
1=Single, 3=Triplex, etc
- Ⓢ_{WP} Weatherproof Convenience Outlet
- Ⓢ_R Range Outlet
- Ⓢ_S Switch and Convenience Outlet
- Ⓢ_R Radio and Convenience Outlet
- Ⓢ_{SP} Special Purpose Outlet (Des. in Spec.)
- Ⓢ Floor Outlet

SWITCH OUTLETS

- S Single Pole Switch
- S₂ Double Pole Switch
- S₃ Three Way Switch
- S₄ Four Way Switch
- S_D Automatic Door Switch
- S_E Electrolier Switch
- S_K Key Operated Switch
- S_P Switch and Pilot Lamp
- S_{CB} Circuit Breaker
- S_{WCB} Weatherproof Circuit Breaker
- S_{MC} Momentary Contact Switch
- S_{RC} Remote Control Switch
- S_{WP} Weatherproof Switch
- S_F Fused Switch
- S_{WF} Weatherproof Fused Switch

SPECIAL OUTLETS

- _{a,b,c,etc} Any standard symbol as given above with the addition of a lower case subscript letter may be used to designate some special variation of standard equipment of particular interest in a specific set of architectural plans.
- ⊖_{a,b,c,etc} When used they must be listed in the Key of Symbols on each drawing and if necessary further described in the specifications.
- Ⓢ_{a,b,c,etc}

PANELS, CIRCUITS, AND MISCELLANEOUS

- Lighting Panel
- ▨ Power Panel
- Branch Circuit; Concealed in Ceiling or Wall
- Branch Circuit; Concealed in Floor
- Branch Circuit; Exposed
- Home Run to Panel Board. Indicate number of circuits by number of arrows.
Note: Any circuit without further designation indicates a two-wire circuit. For a greater number of wires indicate as follows: --- (3 wires)
--- (4 wires), etc.
- Feeders. Note: Use heavy lines and designate by number corresponding to listing in Feeder Schedule.
- Ⓢ Underfloor Duct and Junction Box. Triple System.
Note: For double or single systems eliminate one or two lines. This symbol is equally adaptable to auxiliary system layouts.
- Ⓢ Generator
- Ⓢ Motor
- Ⓢ Instrument
- Ⓢ Power Transformer (Or draw to scale.)
- Ⓢ Controller
- Ⓢ Isolating Switch

Fig. 3.16

LIGHTING OUTLETS

It is difficult to specify required locations for lighting outlets. There are many ways to light a room. In general, each room or area should be given a source of general lighting. This might be a ceiling fixture, several wall fixtures, or a continuous strip. In a living room or similar area the general lighting may be provided by portable units, floor and table lamps, etc. In each room, the general lighting source should be provided with control by a wall switch at the main entrances to the room. This could be done using split outlets in a living room area, where the top of each double outlet is switched and the lower has power straight from the feeders. Common sense is the best guide for the location of lighting outlets. Consider the activities that take place in a room and decide if these require special lighting. For example, in a bedroom, light would be needed near a mirror, preferably on both sides, in a bathroom or kitchen over the sink; or in a closet where stored material must be identified. Wall light outlets are usually located 63 inches above the floor.

LOCATION OF SPECIAL PURPOSE OUTLETS

There will be areas where there is a need for a special outlet to operate a particular appliance or machine. These should be installed at the location of the machine and meet the requirements of the machine.

LOCATION OF SERVICE ENTRANCE

The ideal location for a fusebox is near the center of the house, because less wire is needed to run all the circuits. The service entrance should be located as close to this location as possible. The main switch and main fuses should be just inside of the entrance of the service conductors. If the circuit fuses are located more centrally, then wire of size equal to the service conductors should be run from the main fuses to this panelbox.

SAFETY

In planning the location of the various components and circuits, remember to avoid areas that would require installation in damp locations, or where the equipment or installation would be a hazard to the occupants.

INSTALLATION

JUNCTION BOXES

All outlets are installed in metal junction boxes. These have knock out slugs, which allow for entrance of the cable. All junction boxes must be securely fastened to the walls or ceilings. They are secured with wood screws to the studs or some other secure structural support. After the junction boxes are installed, the cable is run to the boxes,

SWITCHES

SWITCH OPERATION

A switch of any type is a device for the opening or closing of a circuit. Some switches operate between several conductors, others just two. The switching of any circuit must never allow interruption of a grounded or neutral wire (white). The white or neutral wire always runs without interruption by a switch, fuse or other device, up to each point where current is to be consumed.

SINGLE POLE SWITCHES

When it is desired to control a light or group of lights, an outlet or group of outlets, from one switching point a single pole switch is used. It is wired in series with the ungrounded (black) wire feeding the load. If there are to be several loads controlled by this one switch, the switch is in series with the parallel connected loads. (Fig. 3.17)

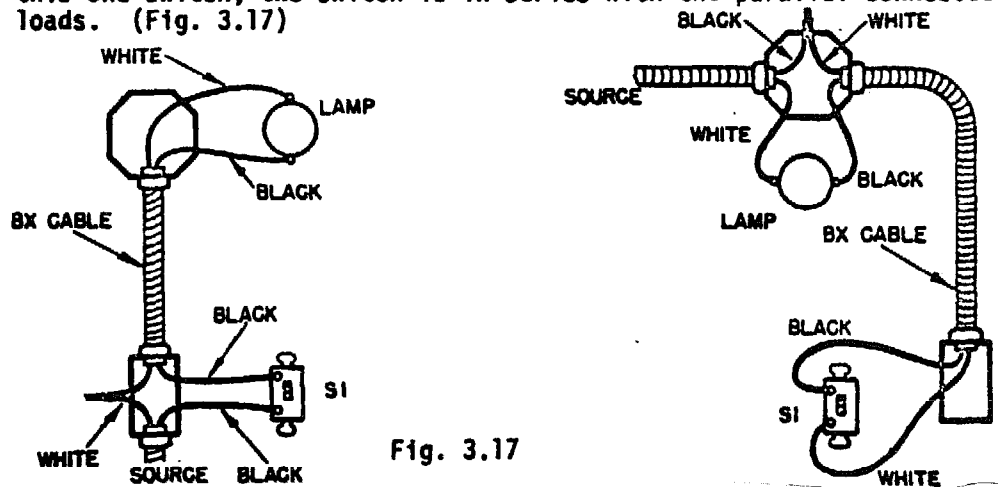

Often it is desired to operate one light from a switch but to supply continuous current to an outlet further along the same circuit. Fig. 3.18 illustrates such wiring.

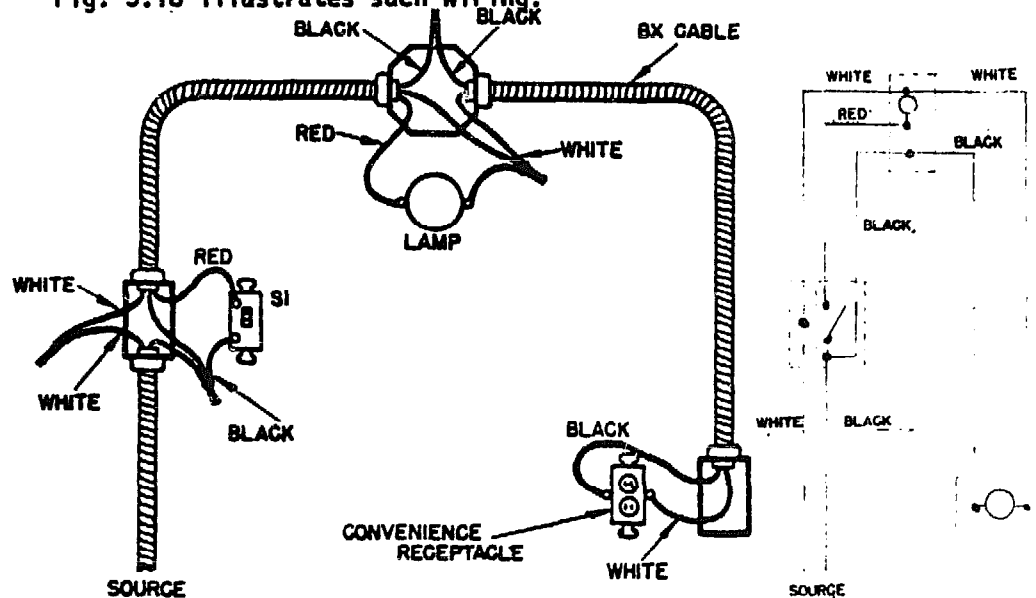

THREE-WAY SWITCHES

When it is desired to operate a load (or several in parallel) from two switch locations a three-way switch is used. The wiring is illustrated in Fig. 3.19. It must be remembered that this wiring must not interrupt the grounded or neutral (white) wire, from the source. Thus the wiring involves only the "hot" wire, (black). Note that in Figs. 3.17, 3.18, and 3.19 that although a white wire is run to the switch, it is an extension of the "hot" wire (black).

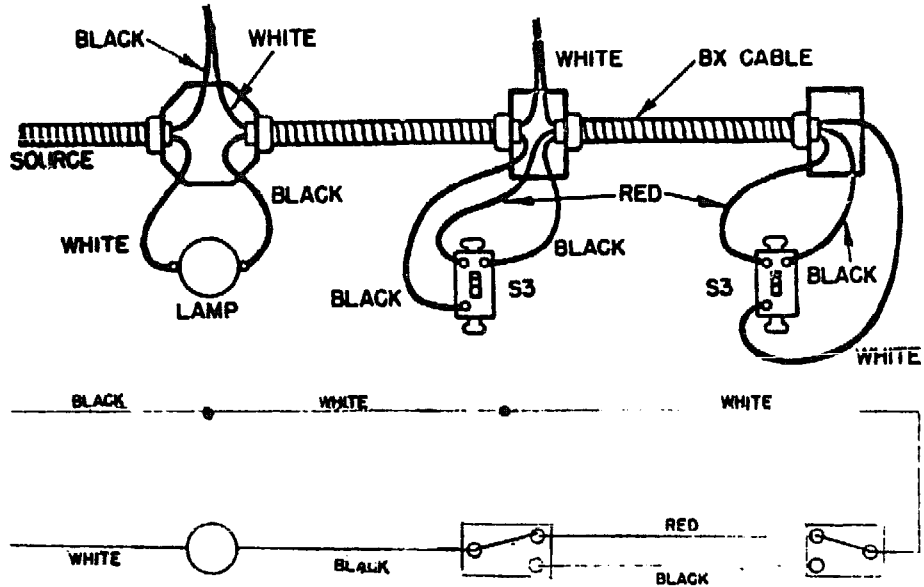

Fig. 3.19

FOUR-WAY SWITCHES

Four-way switches are used with two three-way switches to control a load (or several loads in parallel) from more than two locations. A four-way switch is pictured below:

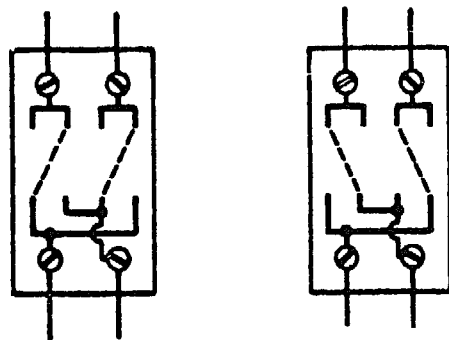

Fig. 3.20

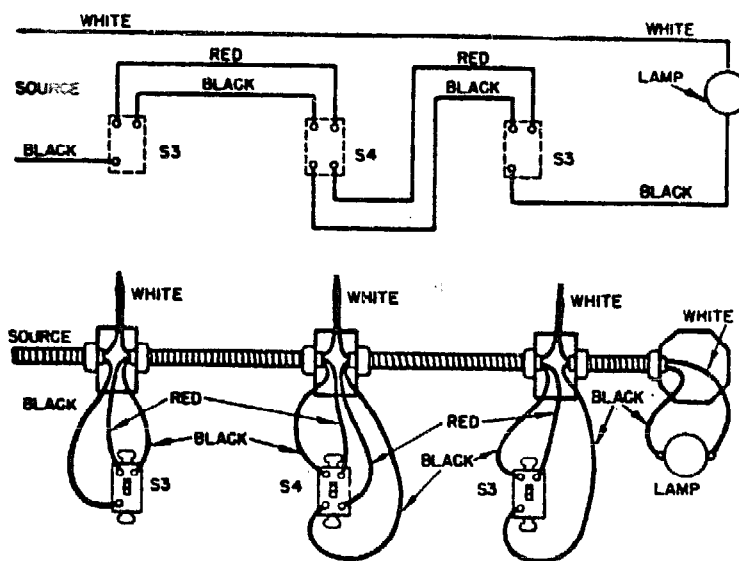

Fig. 3.21

Note that the white or grounded wire always connects directly to the load, with one exception. The exception is using cable in switch loops where cable runs to the switches. In this case the black wire must be used between the switch and the load, the white wire between the branch feeder wire and the switch.

COMPONENT LOCATION

LOCATION OF CONVENIENCE OUTLETS

Outlets are normally located about 12" above the floor level. They should be placed near (2 or 3 feet) corners of rooms rather than in the center of the wall to lessen the chance that they will be blocked by large pieces of furniture. They also should be installed at locations where there is an expected demand.

LOCATION OF WALL SWITCHES

Wall switches should be installed about 48" above the floor level on the latch side of the doorway, within the same room as the lights it controls.

MULTIPLE SWITCH CONTROL

Any room or area with more than one entry should have multiple switch control, i.e. using 3-way and possibly 4-way switches. There should be a switch at each entrance.

the fastener attached to the cable and the cable and fastener connected to the box. The cable is prepared for wiring to the outlet or switch by removing about six inches of the outer covering from the cable and removing about 3/4 in. of insulation from each conductor. Then the fastening clamp is attached at the point where the outer cover ends. If there is a grounding wire in the cable, it should always be connected to the junction box.

OUTLETS

Lighting and appliance outlets are manufactured with a color coding. There are two screw terminals for the attachment of the conductors. One screw is a whitish colored nickle, and the other is the standard brass color. The ground or neutral wire (always white) is connected to the whitish colored screw. The "hot" wire, which should usually be black, is connected to the brass screw. If there is a third, green connecting screw, this should be connected to the grounding wire of the cable, or to the junction box, which has been grounded.

SWITCHES

Switches are not color coded at the connecting terminals, because they are always connected in series with the "hot" lines. Therefore the terminals on a switch are brass. Switches and outlets are connected, installed in the box, and covered with a plate that protects the consumer from contact with any of the conductors.

SPLICES

All splices made on the cables must be placed in junction boxes. This prevents the possibility of the splice being pulled apart, since the cables are securely fastened to the box. Any connections that are not made to the terminals of a switch, outlet or lamp fixture must be taped or otherwise insulated.

DROP CORDS

When wiring a drop cord ceiling outlet, an underwriters knot should be tied in the cord to prevent pulling on the connections. This knot should also be used when wiring any plug for an appliance.

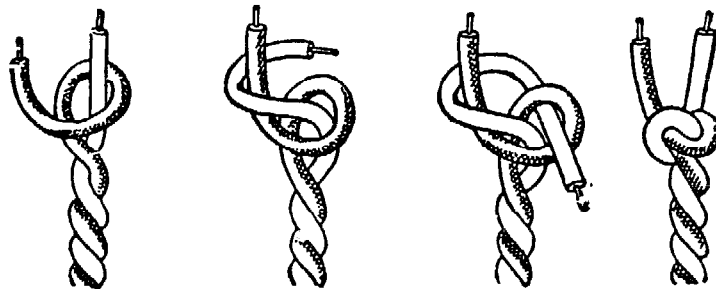

Fig. 3.22

"NEW" AND "OLD" WORK

"New" work is the installation of a system in a house while under construction. "Old" work is the installation of a system in a completed house. Most of the work that will be encountered in the electrification project will be "old" work. Any concealed wiring will have to be installed in covered over areas. If allowable, surface wiring techniques will be most economical. This requires the use of Type NM or Type NMC cables, surface raceway, surface conduit, or open knob and tube work.

NM OR NMC SURFACE WIRING

With most any wood frame, or similar construction, the installation of surface NM type cable is a matter of securing the cable to the wood supports of the house. Care must be taken in running the cable to protect it from damage, that is to keep it flush against the surface and avoid areas that will subject it to injury. This is done with straps, or staples, leaving the insulation unharmed. There should be a strap or staple every 3 feet and within 12 inches of a box.

OPEN KNOB AND TUBE WORK

Knob and tube work is very little used today. It has been almost entirely replaced by non-metallic sheathed cable. It is a wiring system using only single insulated conductors, which are run on the surface and supported by insulating knobs or cleats and when passing through holes in walls or studs, are enclosed in insulated tubes. These knobs and tubes are usually porcelain. This method is only practical when insulators and single conductors are economically available, while cable is prohibitive in price.

SURFACE RACEWAYS

Although this method is seldom seen in residences, it is a very useful method of protecting wiring done on the surface. A raceway consists of two pieces, one that is fastened securely to the wall and the other snaps on like a cover. The number of conductors that may be run through a raceway depends upon its size.

ARMORED CABLE (METAL CLAD CABLE)

Type AC or Type MC cable can also be used for surface wiring, and allows for good protection of the conductors from physical damage. It is secured by staples or straps, in such a way as to avoid damage to the sheathing. It cannot be used in damp locations. The type that is useable in damp or other destructive situations, has a lead sheathing just inside the spiral armor. It is called Type ACL.

GENERAL

For all of these wiring methods, metal boxes are required for mounting the switches, outlets, lamp sockets, etc. Any splicing of wire must

be done in a metal box and not in the raceways, conduits or in the open, except for knob and tube work where there must be support within 12" on both sides of the splice or tap, and the splice must be taped.

CONCEALED OLD WIRING

Old wiring that is concealed requires much extra effort in the installation. Holes must be carefully cut in the walls for the installation of the outlet boxes, and wires or cables must be fished through the spaces in the walls. Extra holes have to be drilled to allow for the cables to pass through hidden obstructions. The techniques required for concealed old work are described in: Richter, Chapter 22.

MOTORS

MOTOR SELECTION

Motors are not rated in watts as are other electrical loads, they are rated in horsepower. This is because motors consume electrical power in proportion to the amount of power they are delivering. The horsepower stamped on the nameplate of a motor is the power it will deliver continuously over long periods of time. A motor can deliver more than this for short periods but will burn out if overloaded continuously. For example, a 1-horsepower motor consumes 1,000 watts while delivering the horsepower for which it was designed, in this case 1-hp.

All motors consume more power while starting than while running. Starting draws considerably more current than is drawn when running at rated horsepower. A 1-hp motor requires four times the running current for starting.

The speed of most motors is not easily adjustable. A 50-cycle motor theoretically runs at 1,500 rpm, but when delivering its rated horsepower will run closer to 1,450 rpm. A belt and pulley drive, is the most practical way to obtain the desired speed.

Motors are marked with a temperature rating. This indicates the amount the motor will heat up above the room temperature, when operating at its rated horsepower. If a motor were operating in a room with the temperature 100°F and the motor had a rating of 40°C (72°F), the motor would operate at a temperature of 172°F. Although this would seem very hot to the touch it would cause no danger for the motor.

There are various motors for various applications. The following items should be considered in choosing a particular motor for a particular application.

1. The voltage rating of the motor and the voltages available (the higher the voltage, the less current is required and the smaller the conductors needed for service).
2. The horsepower needed for the machine being operated (if it continually requires 1-hp and just for brief periods requires higher, then a 1-hp motor would be appropriate. If it would continually draw 1 1/2-hp then a larger motor [1 1/2-hp, ideally] would be needed).
3. How hard the machine being operated starts. (If it starts easily a split phase motor could be used, if it is harder starting a condenser or R-I motor may be needed).
4. The starting current required. (Less required current means smaller conductors).

The most common types of single phase motors are:

Split Phase Motors

Capacitor Motors

Repulsion-start, Induction-Run Motors (R-I motors)

They are listed above in order of price, the split-phase type of motor is least expensive for a given horsepower. However, it cannot start heavy loads, and it requires the largest starting current for a given horsepower. The R-I type motor can start very heavy loads and requires less starting current than any other type of single phase motor, but it is more costly.

Three phase motors cost less to purchase and to operate than any other type. They are also much simpler in design, break down less frequently and are simpler to repair. This should be considered when deciding to supply a building, that will have motors, with single or with three phase power. Consult with the Engineer in charge of your project for advice as to which is best in a particular situation.

MOTOR INSTALLATION

There are three considerations for any motor installation.

1. There must be overcurrent protection.
2. There must be a disconnecting switch.
3. The size of the conductors supplying the motor must be large enough to handle the starting current.

Overcurrent protection is provided by units that will shut the motor off if a high current is consumed for longer than is safe. These units are placed close to the motor and usually incorporate the start

and stop controls. A separate disconnect switch must be installed to disconnect power from this equipment and the motor, so that servicing can be done without danger.

PUMP INSTALLATION

When electrical power is available pumps are conveniently operated by motors. The installation is exactly similar to the installation of a motor for other purposes. The motor may be located at a distance from the control unit. In such cases a remote control circuit may be used. It may be an automatic starting unit, which will allow for the motor operation when the water supply is low. For all these situations the basic safety procedures must still be followed. There must be a disconnect switch that disconnects the motor and its controller from the power source. There must be overcurrent protection for the motor. The conductors feeding the motor and control must be sized correctly depending upon the maximum current and the length of the conductors. As mentioned in the lesson on wire types, if a pump installation requires an underground run of cable Type UF or Type USE must be used.

CIRCUIT DESIGN

When designating which of the outlets in a plan should be connected to the same circuit there are several factors to consider. The main factor is the size of the loads connected to each outlet. Then consider the total load that is on a circuit. An attempt should be made to have the circuits share the total load of the house. There are other aspects to consider. Outlets in one area of the house will take less wire if they are all wired on the same circuit. The references offer many more considerations for specific situations. A large appliance may require a circuit of its own, with no other outlets on it. In a kitchen area there will be a larger demand from high wattage appliances, so a kitchen should have at least one circuit for appliances only, perhaps two. An electric range would be independently supplied. If the lighting is placed on the same circuit there is a ready indication when a fuse does blow due to overloading.

CIRCUIT SCHEDULE

The sample of the following page is one possible circuit schedule. The important parts of any circuit schedule are:

1. Indication of what outlets are on each circuit.
2. Indication of what circuit each outlet is on.
3. Estimated load for each circuit.
4. Total load for the house.

If the system consists of two or more buildings, all powered from the same meter, there must be separate disconnect and fusing for each building, if there is more than one circuit in each building.

CIRCUIT SCHEDULE

for

Owner's name and address

No.	Location	Type of outlet	Circuit No.
<u>Outlet Numbers</u>		<u>Est. Circuit Wattage</u>	
Circuit # 1:			
Circuit #2:			
Circuit #3:			
Circuit #4:			

SAFETY CONSIDERATIONS

Safety must be considered in the design of circuits. After completing the design, check to see that no circuit draws more current than the wire size can carry. Make sure that the fuse for each circuit is no larger in size than the rating of the circuit's wires. Check the specification of each outlet, switch, and other components to see that they are not too large or too small.

TOTAL LOAD REQUIREMENTS

The total load requirements of a house or compound system must be determined before installation. The service entrance must be sized depending on the total load requirements.

The total load of the house or compound can be divided into four areas: Lighting, Small Appliances, Heavy Appliances, Motors.

LIGHTING

To determine the total lighting requirements, a formula can be used. Allow 3 watts for each square foot of floor area, using the outside dimensions of the house. Thus a two story house which measures 25 x 30 x 2 stories x 3 watts/sq. ft. = 4,500 watts.

SMALL APPLIANCES

A small appliance is defined to be any appliance that does not have a circuit for it alone. Standard practice allows 3,000 watts for the total to be used by small appliances.

HEAVY APPLIANCES

This term includes any permanently installed equipment, water heater, dryer, farm equipment, heating, etc. The heavy appliances load is determined by adding the individual loads of each appliance.

MOTORS

For the purpose of determining the total load requirements for the motors in a home or compound, the following table should be used. This chart is designed only for determining approximate total load requirements, these figures allow for adequate service entrance ampacity. Motors run using less wattage, these figures allow for starting and overload.

<u>HP</u>	<u>EQUIVALENT LOAD</u>
1/6	450
1/4	700
1/3	850
1/2	1,000
3/4	1,350
1	1,500
1 1/2 and higher	1,200/hp

NAMEPLATE INFORMATION

All electrical devices have a nameplate. On lamps and some other devices the nameplate is printed directly on the device. Most other devices have a small metal plate mounted on it. Examples of nameplates are shown in Fig. 3.23

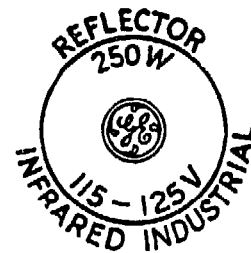
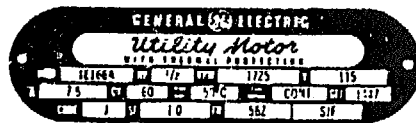
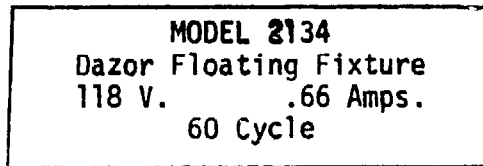
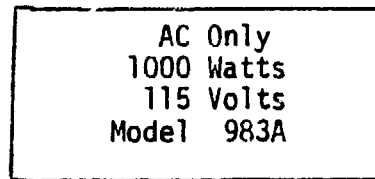
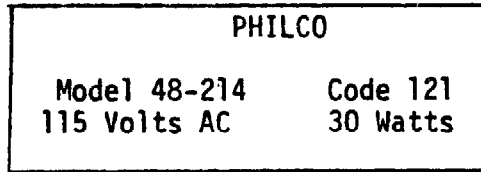

Fig. 3.23

The translation of the motor nameplate data above is as follows: A 1/2-hp motor to operate from a 115-volt 60-cycle AC single phase source, the full-load current is 7.5 amp and the full-load speed is 1,725 rpm. The model number is 1E166A and the frame number is 56Z. It is a utility motor type and is rated for continuous operation with a normal temperature rise of 50°C above room temperature. The service factor (SF) is the multiplier, indicating the amount of overload permitted for the motor (1.0 x 1/2 hp = 1/2 hp, no overload permitted).

TOTAL LOAD CALCULATION

To find the total load requirements for the home, total the figures for each of the four areas: Lighting, Small Appliances, Heavy Appliances, and Motors.

CONSUMER EDUCATION

When the project is near completion the consumers must be taught the use of electrical power. They must be educated about the nature of electricity, and the safety precautions that they must follow in their use of electricity.

When electrical power was first introduced in many parts of rural USA there were many reactions. Some people didn't know that there were switches that could turn their lights on and off. Some thought if a lamp was missing from a socket, electricity must be running out all over themselves and the floor. A simple lesson in electricity explaining what a complete circuit is, and that a break in the circuit causes no flow, but no waste would be helpful. It must be explained how to change fuses, why they blow and how to correct the situation before they are replaced. The safety that fuses provide, and the severe danger of pennies in fuse sockets must be stressed. If the co-op supplies the fuses free, their use would be encouraged rather than their disuse.

HOUSE WIRING

LESSON NO. 1

LESSON OBJECTIVE: Exhibit various types and sizes of cable.
Discuss and describe the construction, sizing, marking and applications.

TOPIC	INSTRUCTIONAL PROCEDURE	SUPPLEMENTAL MATERIALS / RELATED READING
Wire Sizes	Pass around various sizes of the same type of conductor. Discuss how the size determines the ampacity of a conductor. Demonstrate the use of a wire gauge. Have trainees practice the use of a wire gauge by measuring the various sized samples.	Richter, pp. 102-12.
Wire Types	Pass around various types of cable. Discuss the construction, type and applications of each.	Richter, pp. 87-101.
Cables	Pass around short lengths of multiconductor cable. Discuss the construction and the coloring of the individual conductors.	
Marking	Explain the markings on a cable.	

HOUSE WIRING

LESSON NO. 2

LESSON OBJECTIVE: Demonstrate methods of wire handling:
stripping, splicing and soldering.

TOPIC	INSTRUCTIONAL PROCEDURE	SUPPLEMENTAL MATERIALS / RELATED READING
Stripping	<p>Demonstrate how to saw the sheathing of armored cable, remove the cut sheathing and to insert a fiber bushing to protect the conductors.</p> <p>Have the trainees practice the removal of armored sheathing.</p> <p>Demonstrate how to cut away the sheathing of non-metallic cable without damaging the conductors.</p> <p>Demonstrate the stripping of the individual conductors with a knife.</p> <p>Have the trainees strip the sheathing and conductors of non-metallic cable.</p>	Richter, pp. 113-27
Splicing	<p>Demonstrate the Western Union splice and the tap splice, and discuss when they would be used.</p> <p>Have the trainees practice making these splices.</p> <p>Discuss how and why joints are soldered.</p> <p>Demonstrate correct soldering techniques.</p> <p>List the important steps in soldering a connection.</p> <p>Have the trainees solder the splices they have just made.</p> <p>Demonstrate how to tape the finished splices.</p> <p>Have the trainees practice taping the splices that they have just soldered.</p>	

HOUSE WIRING

LESSON NO. 3

LESSON OBJECTIVE: Demonstrate methods of wire handling: attachment to screw terminals and splicing with solderless connectors.

TOPIC	INSTRUCTIONAL PROCEDURE	SUPPLEMENTAL MATERIALS / RELATED READING
Screw Terminals	<p>Demonstrate the forming of a wire for attachment to a screw terminal.</p> <p>Have the trainees practice these techniques.</p>	Richter, pp. 113-15, 125-27.
Solderless Connectors	<p>Pass around several types of solderless connectors.</p> <p>Explain when they should be used and demonstrate how to use them.</p> <p>Have the trainees practice the application of split sleeve connectors, pressure connectors, tap connectors, etc.</p> <p>Discuss when solderless connectors need insulating tape.</p> <p>Demonstrate how to tape solderless connectors.</p> <p>Have the trainees practice the taping of the connections they have previously made.</p>	Carr, pp. 2-238-45.

HOUSE WIRING

LESSON NO. 4

LESSON OBJECTIVE: Define the components of a service entrance and demonstrate the methods for installation.

TOPIC	INSTRUCTIONAL PROCEDURE	SUPPLEMENTAL MATERIALS / RELATED READING
Types of Service	<p>Discuss the types of service that can be provided to a consumer.</p> <ol style="list-style-type: none">1. 2 wire, 1 phase2. 3 wire, 1 phase3. 3 wire, 3 phase4. 4 wire, 3 phase	
Service Entrance Components	<p>Define the components of a service entrance.</p> <p>Discuss the need for each.</p> <p>Have trainees lay out the components of a service entrance and install them in the sample house.</p> <p>Demonstrate installation as the need arises.</p>	Richter, pp. 262-86.
Specifications	<p>Discuss the choice of differently rated equipment.</p> <p>Discuss the size specifications for conductors, switches and fuses.</p>	
Grounding	<p>Review the need for grounding and list all other safety factors included in the installation of a service entrance.</p>	

HOUSE WIRING

LESSON NO. 5

LESSON OBJECTIVE: Explain how to interpret a home electrical system layout sketch.

TOPIC	INSTRUCTIONAL PROCEDURE	SUPPLEMENTAL MATERIALS. RELATED READING
Symbols	<p>Exhibit a layout sketch and a chart of symbols.</p> <p>Explain what each symbol represents.</p>	Richter, pp. 255-61.
Layout	<p>Explain how the sketch shows switch control and component locations.</p> <p>Through a series of questions, have trainees demonstrate ability to read layout sketches.</p>	

HOUSE WIRING

LESSON NO. 6

LESSON OBJECTIVE: Discuss and illustrate the connection of switches for control of various circuits.

TOPIC	INSTRUCTIONAL PROCEDURE	SUPPLEMENTAL MATERIALS RELATED READING
Switch Connections	<p>Discuss and illustrate the connection of switches for the following circuits:</p> <ol style="list-style-type: none">1. single switch control2. 2 switches to operate load3. 3 or more switches to operate load. <p>Demonstrate the connections for the above circuits.</p> <p>Discuss the connections with regard to the colors of the wires.</p> <p>Discuss the safety factors involved.</p> <p>Stress that a grounded or neutral wire should <u>never</u> be switched.</p>	Richter, pp. 287-314.

HOUSE WIRING

LESSON NO. 7

LESSON OBJECTIVE: Discuss and indicate proper locations for home electrical system components.

TOPIC	INSTRUCTIONAL PROCEDURE	SUPPLEMENTAL MATERIALS / RELATED READING
System Component Locations	<p>Tour a sample house with properly located components.</p> <p>Have the trainees observe the locations of the various components.</p> <p>Have trainees prepare a set of guide lines for locating each type of component.</p> <p>List the guide lines for correct placement of:</p> <ol style="list-style-type: none">1. switches2. light outlets3. appliance outlets4. motor outlets5. service entrance6. fuse box and distribution box <p>Discuss the reasons for such placement while comparing this list to the trainees lists.</p> <p>Discuss safety factors that must be considered in choosing component locations.</p>	

HOUSE WIRING

LESSON NO. 8

LESSON OBJECTIVE: Demonstrate installation of branch circuits:
fuse installation, cable running, box installation.

TOPIC	INSTRUCTIONAL PROCEDURE	SUPPLEMENTAL MATERIALS / RELATED READING
Cable Running	<p>Demonstrate method of securing Type-NMC cable and describe how and where to run it to protect it from harm.</p> <p>Demonstrate securing of this cable with staples or straps.</p>	Richter, pp. 356-87, pp. 157-9.
Metal Box Installation	<p>Demonstrate installation of junction boxes and outlet boxes in walls and ceilings.</p> <p>Demonstrate attachment of clamps to cables and to boxes.</p> <p>Demonstrate installation of distribution fuse box and connection of circuits to the fuses.</p> <p>Have trainees install the branch circuits indicated on a layout sketch of the house.</p> <p>Demonstrate techniques for installation of circuits in houses of mud construction.</p> <p>Have trainees install a circuit in a house of mud construction.</p>	

HOUSE WIRING

LESSON NO. 9

LESSON OBJECTIVE: Demonstrate installation of outlets:
lighting, appliance, switches and special
appliance outlets.

TOPIC	INSTRUCTIONAL PROCEDURE	SUPPLEMENTAL MATERIALS / RELATED READING
Outlet Installation	Review connection to screw terminals. Discuss the installation of plug outlets, lamp sockets, switches, into outlet boxes.	
Component Specifications	Discuss installation specifications of outlets and switches, considerations for higher voltage special appliance outlets and other safety factors. Have trainees install the switches and outlets indicated on the layout sketch.	

HOUSE WIRING

LESSON NO. 10

LESSON OBJECTIVE: Discuss installation of armored cable, conduits, raceways and open wiring on insulators.

TOPIC	INSTRUCTIONAL PROCEDURE	SUPPLEMENTAL MATERIALS / RELATED READING
Armored Cable	Compare armored cable installation to that of non-metallic cable.	Richter, pp. 159-65.
Knob and Tube	Describe and discuss the installation of open and concealed knob and tube work.	Carr, Sec. 9, pp. 9-17.
Conduit	Discuss the advantages of conduit installations. Describe the different types of conduits and discuss how they are installed. Discuss how to fish wire through conduit.	Richter, pp. 148-55.
Raceway	Describe and discuss the installation of surface metal raceways. Review the advantages and disadvantages of each wiring method.	Richter, pp. 472-74.

HOUSE WIRING

LESSON NO. 11

LESSON OBJECTIVE: Discuss the requirements of motor and pump installations.

TOPIC	INSTRUCTIONAL PROCEDURE	SUPPLEMENTAL MATERIALS / RELATED READING
Motor Installation	<p>Discuss the requirements of a motor installation.</p> <ol style="list-style-type: none">1. Motor selection2. HP rating3. Feed conductor size4. Feed conductor fuse size5. Running overcurrent protection6. Disconnection switch7. Starter8. Mounting <p>Discuss special considerations of a pump installation.</p> <ol style="list-style-type: none">1. Remote or automatic starting2. Underground wiring (perhaps)3. Motor selection <p>Have trainees install a pump and motor to be operated by remote control.</p> <p>Review the safety considerations of a motor installation.</p>	Richter, pp. 238-52, pp. 497-526.

HOUSE WIRING

LESSON NO. 12

LESSON OBJECTIVE: Discuss the design of an electrical system and provide instruction for trainees sketching layouts of a house.

TOPIC	INSTRUCTIONAL PROCEDURE	SUPPLEMENTAL MATERIALS / RELATED READING
Layout Sketching	<p>Have trainees measure and sketch the layout of a house.</p> <p>Review the proper locations for components.</p> <p>Review the symbols used in laying out an electrical system on a layout sketch.</p> <p>Discuss safety requirements that must be considered when designing a house electrical system.</p> <p>Discuss with individual trainees plans that they propose for the house that they mapped.</p>	

HOUSE WIRING

LESSON NO. 13

LESSON OBJECTIVE: Discuss circuit designation and preparation of a circuit schedule.

TOPIC	INSTRUCTIONAL PROCEDURE	SUPPLEMENTAL MATERIALS / RELATED READING
Circuit Schedule Preparation	<p>Discuss the factors that must be considered in the designation of circuits:</p> <ol style="list-style-type: none">1. conductor size2. fuse size3. economy4. convenience5. safety <p>Discuss the elements of a circuit schedule and how each is used.</p> <p>Discuss individually with each trainee the circuit schedule he has prepared from his system layout.</p>	Richter, pp. 179-203

HOUSE WIRING

LESSON NO. 14

LESSON OBJECTIVE: Discuss methods of determining the total load requirements for a house or compound.

TOPIC	INSTRUCTIONAL PROCEDURE	SUPPLEMENTAL MATERIALS / RELATED READING
Lighting Requirements	Describe method of calculating the lighting requirements from the floor area of a house.	Richter, pp. 179-203.
Appliance Requirements	Illustrate how to determine the load requirements of small and large appliances by referring to the nameplate. Discuss motor power requirements and the interpretation of motor nameplates. Discuss with individual trainees their calculation of total power requirements for the system they planned.	

HOUSE WIRING

LESSON NO. 15

LESSON OBJECTIVE: Discuss consumer education and techniques of instruction in proper usage.

TOPIC	INSTRUCTIONAL PROCEDURE	SUPPLEMENTAL MATERIALS / RELATED READING
Consumer Education	<p>Discuss common home owner safety practices and unsafe practices.</p> <p>Discuss the difficulties of introducing electricity to these local people.</p> <p>Identify instructional techniques that can be used with local villagers.</p>	

SECTION 4

DISTRIBUTION WIRING

OVERVIEW:

As in the previous section the emphasis of this section is doing. The PCTs will be digging pole holes, erecting the poles, and stringing the lines for the sample distribution system. They will also install needed equipment such as transformers, fuses, and lightning arresters.

In an effort to reduce the length of the training period it is recommended that the PCTs actually dig only one or two of the necessary holes for the poles and anchors. It is recommended that a professional crew be hired to dig the remaining holes with a truck mounted power auger. This operation would be observed by the trainees and discussion of the methods used by the professional crew encouraged. The remainder of the installation should be handled by the PCTs.

The design of the distribution system should be the responsibility of the engineer in charge of the project. This section considers briefly the design of the system, in order to give the PCTs needed background knowledge.

SECTION 4

POWER DISTRIBUTION SYSTEM

OBJECTIVE: Plan and install a power distribution system.

- TASKS:
1. Identify the organization (co-op, government agency, etc.) that is initiating the program of electrification.
 2. Determine which people in that organization will assist with the project, and what type of support each will provide.
 3. Determine the population of the community to be served and project the growth of the community.
 4. Determine the electrical usage for the immediate system, and project the usage to five years.
 5. Map the community showing the elevations and contours of the area, and indicate exact locations of the layout of the distribution system.
 6. From the map determine distance of power transmission and determine the preferred voltage of the transmission.
 7. Determine voltage ratings of available appliances, lights, etc., and the voltage ratings of power source and nearby systems. Using these facts as a guide, determine the preferred voltage to be supplied to the users.
 8. Determine transformer (perhaps none), fuse and lightning protection requirements.
 9. Determine wire type, size, and separation.
 10. Procure all necessary materials and tools.
 11. Stake out locations of poles.
 12. Erect needed poles.
 13. Mount crossarms, pins, and insulators.
 14. String, sag and secure line conductors.
 15. Install transformers, lightning arresters, and fuse protectors.
 16. Ground equipment and neutral lines.

POWER DISTRIBUTION SYSTEM (cont.)

17. String secondary lines.
18. Inspect for safety and completeness and correct any errors or omissions.

FUNCTIONAL SKILLS:

1. Recall and perform proper techniques for framing, transporting, erecting, setting and guying poles.
2. Recognize suitable existing supports for distribution lines.
3. Recall and perform proper techniques for: hoisting and installing crossarms, transformers and other pole equipment.
4. Using surveying instruments, determine exact location and measurements of points, elevations, lines and contours.
5. Identify and correct any unsafe practices.

TERMINAL PERFORMANCE TESTS:

1. List the components of a distribution system.
2. Given a map of a community, the population, the power needs and the expected growth of the community, plan a power distribution system which includes: a layout of the system on the map; a listing of voltages for the different parts of the system; a description of wire types and sizes; transformer requirements; fuse requirements; and grounding requirements.
3. In a field test, choose and prepare suitable trees for power poles.
4. Given a power distribution system, identify and correct any unsafe practices or conditions.
5. Prepare lesson plans for teaching local workers to assist with installation of distribution system.
6. Prepare a map of a small rural community, using surveying instruments.
7. Install a sample distribution system which includes all components that may be used in a system.

DESIGN AND INSTALLATION

DISTRIBUTION WIRING

MAP MAKING

The following describes the construction of serviceable maps using a plane table. Such maps are valuable for village layout plans, and planning the route of distribution lines.

The following tools and materials are needed:

- Plane table
- Paper
- Pencil
- Ruler
- Pins
- Tape measure (optional)
- Spirit level (optional)

Lay out a one hundred foot interval on level ground, an uphill, and a downhill slope. If only a foot ruler is available, this may be used to mark out three or four feet on a stick, and this stick in turn used to measure the 100 feet. Being careful to work normally, the map maker then determines the number of paces over the 100 foot interval for each slope. By division, it is then possible to find a number of feet in an average pace or uphill, level, and downhill slopes.

The next step is to decide on a scale for the map. This is determined by judging the longest distance to be mapped and the size of the map desired. It should be noted that the map does not have to be made on a single sheet of paper but can be spliced together when completed. As an example, if one wanted a map 2 1/2 feet long to portray an area whose major distance is 1/2 mile, 2640 feet, then a scale of 100 feet to the inch would be convenient.

Paper should be placed on the plane table and the plane table oriented on or near some principal feature of the map, that is, a path, road, creek, street, etc. A pin should then be placed vertically in the spot on the finished map where this location is desired. The plane table should be made level - by use of a spirit level, if available. The table should be rotated to a proper orientation, that is, so that the direction will appear on the finished map in the desired way. Now sight along the first pin to another principal feature which is visible from the table location (a bend in the road, a hill or any feature that will tie the map together), moving the second pin into the line of sight. A ruler may be used for this purpose if it has a sighting edge or even a couple of pins stuck into it. Now draw a line in the direction defined by the two pins. Measure the distance to the feature observed either by pacing or with a tape. Scale this distance along the line drawn, starting at the initial pin. Repeat this process for other principal features which may be seen from this location. When this has been done move

the table to one of the points just plotted, selecting one which will enable you to move over the territory in a convenient fashion. For example, follow a lane or creek or some feature which ties things together. Set up the plane table over this point and reorient the table. Do this by putting pins into the map at the present and previous locations. Next rotate the table so that the pins line up with the previous location. This procedure in fact locates the line joining the two locations on the map in the same direction as the line exists in nature. Again from this new location map in the desired features which can be conveniently sighted.

In this way the entire region to be mapped may be covered in a systematic way. If gaps appear or if more detail is needed, you may go back and set up over some mapped feature, reorient the map by sighting on a second feature, and proceed to map in the detail.

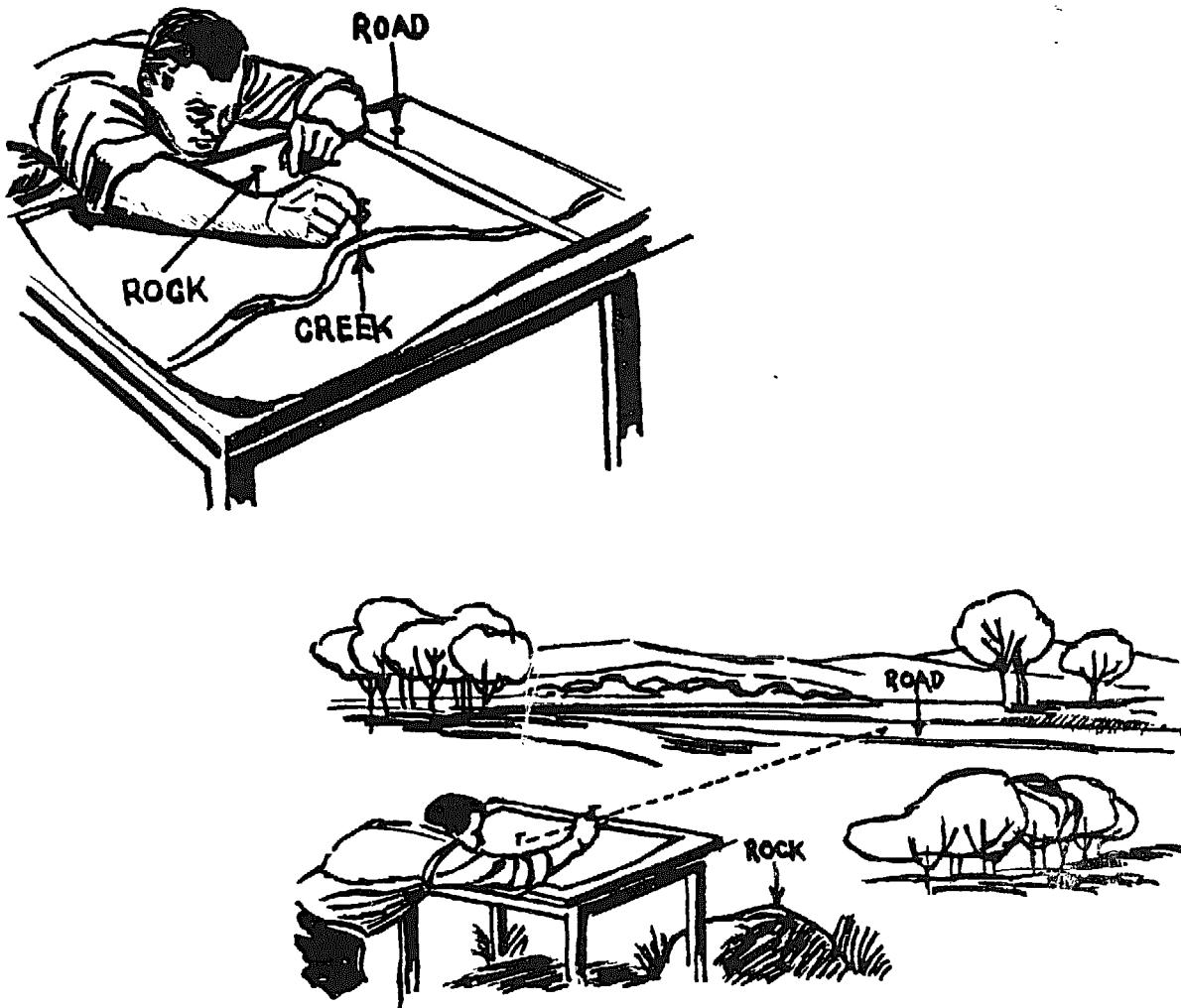

Fig. 4.1

An alternate procedure may be used in mapping features which are not going to be used as plane table locations in the mapping process. This involves drawing a line in the direction of each feature from two plane table locations. The intersection of these two lines corresponding to a single feature locates the feature on the map. As a result this avoids the necessity

for measuring distances. Note, however, that it is impossible to avoid measuring the distances between plane table locations.

If a spirit level is available, it is possible to level the plane table accurately, and using a ruler or other sighting device, relative elevations may be plotted on the map. A stick about six or eight feet long should be marked off in inches, and the person holding the stick vertically can, by moving his finger, identify to the person sighting, the distance up from the ground through which the line of sight passes.

A topographic map is a means of illustrating, through the use of contour lines, the shape of the ground surface. Many other kinds of numerical geo-physical and geological data also lend themselves to the contouring method of expression. This exercise involves the determination of ground relief (topography) from points whose elevations above sea level are known.

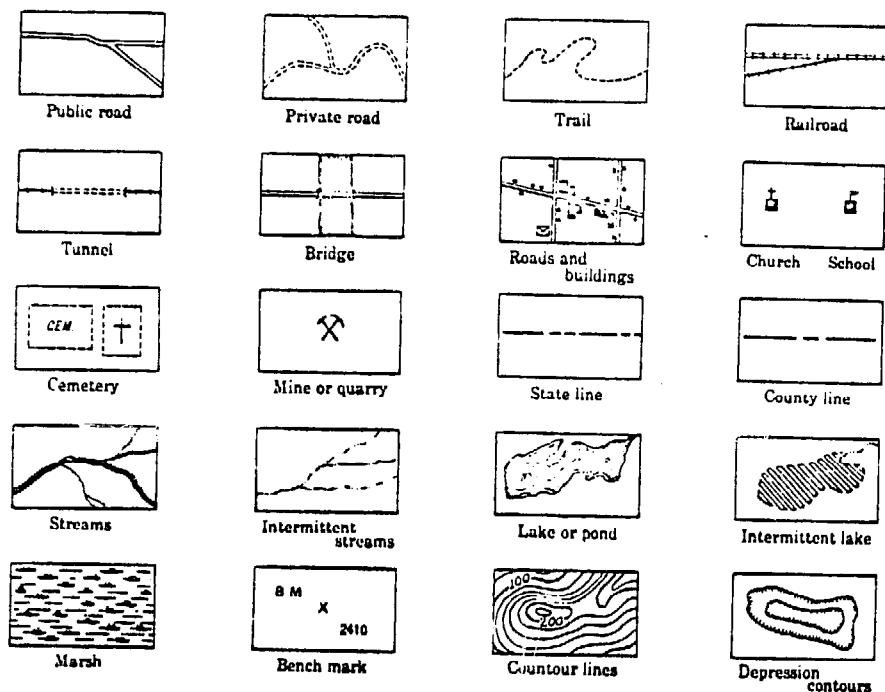

Fig. 4.2

The method is called "contouring from spot elevations". The data might have been obtained by surveying with a plane table, although modern topographic maps are made much more easily and accurately by the stereoscopic plotting of airphoto information.

A set of rules and hints in topographic contouring are:

1. All points lying on a contour are of the same elevation above (or below) mean sea level which is taken as the reference horizon. However, one contour need not satisfy all the points of equal elevation; eg. adjacent hilltops of similar relief might require separate, closed contours each showing comparable levels. Some contours may be cut by the edges of the map and appear to be discontinuous but if the map be made large enough every contour eventually closes on itself, becoming continuous.
2. With rare exceptions, the contour interval is constant for the map area and is defined as the vertical distance between successive contours. The contour interval is stated as part of the scale of the map so that the vertical dimension of the contoured surface has identity. 10-foot, 20-foot, 50-foot and 100-foot intervals are common. The interval is selected to best show the shape of the surface at the desired horizontal scale without requiring an unnecessary, unreadable number of lines. The relief of the area to be mapped also influences the choice of the contour interval.
3. Contours do not cross. Such a situation would illustrate an impossible ground surface shape. Contours are closely spaced on steep slopes, and distantly spaced on gentle slopes.
4. Closed depression contours are hachured (See Fig. 4.2) on the lower side. They are used when all points within the line are below the level of the line. Obviously they are only required to show depressions which are completely surrounded by high ground. Gullies and river valleys are not illustrated by depression contours. A depression contour takes its value from that of the lowest, topographically adjacent regular contour.
5. In contouring gullies and valleys, the contours vee in the upstream direction. Be careful to confine the stream to the lowest part of its valley by passing the stream through the notch of the vee.

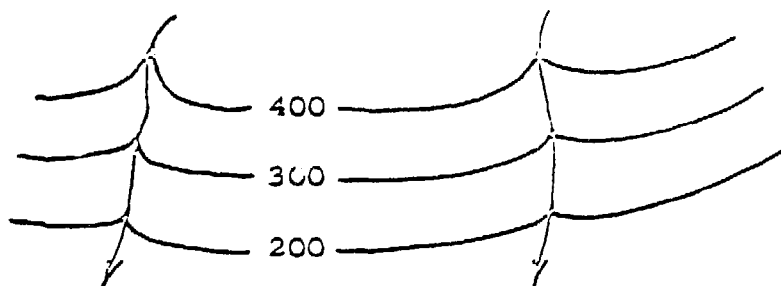

Fig. 4.3

Contours are broken where numbering is necessary, to improve readability.

6. The use of some degree of "artistic license" is recommended in contouring. Do not attempt to just satisfy the point data. Try to make the trend of a contour reflect the trend of its neighboring contours.

SELECTING THE ROUTE

The first step to be taken in the design or construction of any electric power line is to survey and map the country over which the line is to pass.

With the map completed, the following principles should be used as guides in selecting the exact route:

1. Select the Shortest Route Practicable. The shortest line naturally is the cheapest, other things being equal.
2. Parallel Highways as Much as Possible. This makes the line readily accessible both for construction and for inspection and maintenance.
3. Follow Property Lines. This causes less damage to farmers' property and crops and often prevents legal squabbles.
4. Route in Direction of Possible Future Loads. If there is possibility of adding future loads, the route selected should be as close as possible to the locations which will require electricity in the future.
5. Avoid Crossing Hills, Ridges, Swamps, and Bottom Lands. Lightning and storms are likely to hit lines on hills and ridges. Floods may affect lines in swamps and bottom lands.

CLEARING THE ROUTE OF THE LINE

Practically all lines will cross through some brush or timberlands. A line built in such terrain must have its route cleared before construction can be started. In clearing the route, all stumps should be cut low. All logs and brush should be cleared away for ten feet on either side of the pole line to make room for assembling and erecting poles and stringing wires. All dead limbs and branches near this cleared pole line should be cut down because a high wind may blow them into the line. Brush killing sprays may be sprayed on the base of shrubs and small trees to a height of 12 to 15 inches above ground.

LOCATING POLE POSITIONS

In locating poles, the following general principles should be kept in mind:

1. Select high places (avoid lowlands, swamps, etc.)
2. Keep "spans" uniform in length. ("Spans" are the distances between poles. This prevents the weight of the wire on one side from pulling the pole over).
3. Locate to give horizontal grade. (See Figure 4.4)

Locate the poles on knolls or high places, so that shorter poles can be used to maintain the proper ground clearance at the middle of the span. (The ground clearance should be at least 18 ft. at middle of span). Avoid ravines and low places where the footing is bad.

In rolling country, the location should take into account the grading of the line. A well-graded line does not have any abrupt change, either up or down. The permissible difference in level between adjacent line poles is usually limited to 5 or 10 ft. This eliminates the necessity of using guys to counteract the strain of the different levels of line conductors. A difference of 5 ft. is allowed on spans of 150 ft., and 10 ft. on spans of 250 to 300 ft.

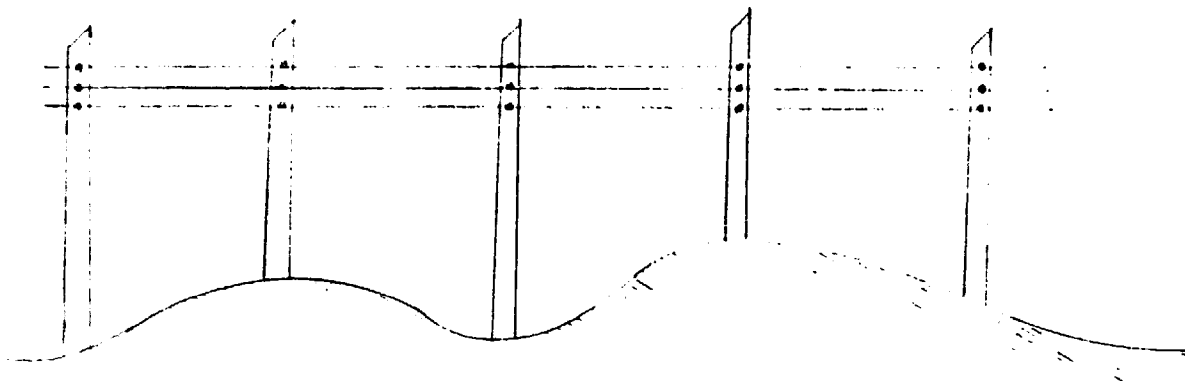

Fig. 4.4

Special attention should be given to the location of poles where the ground washes badly. Poles should not be placed along the edges of cuts or embankments or along the banks of creeks or streams. When it becomes necessary to set poles on the edge of a cut, the pole should be set deep enough to protect the line in case the bank washes or crumbles away.

After the exact pole positions have been fixed, drive a stake to indicate the center of the pole.

CHOOSING THE POLE

A pole or line support is simply a device to keep electric lines off the ground. Overhead electric lines are desirable for a number of reasons. It is safer to keep electric lines out of the hands of untrained people and roads and houses can be built beneath them. Any type of structure that keeps electric wire above ground is better than running the wire directly on the ground.

The following list gives line support materials from the most desirable to the least desirable:

1. A 20 ft. standard wood pole (treated with wood Preservative).
2. A 20 ft. length of 4" x 4" lumber.
3. The corner of a building - wire mounted 12 ft. above ground.
4. A metal pole properly grounded (steel, aluminum, etc.).
5. A living tree.

Tree limbs falling into overhead wires cause the majority of low voltage power interruptions. For this reason do not use trees as line supports. If living trees must be used, trim the tree extensively almost to the point of stripping the tree to the trunk. Do not use a dead tree because it is very likely to be weak and rotten.

POLE HAULING

Poles can be hauled in several ways. They can be supported several feet below the mid point by a trailer, then towed behind a truck or jeep by securing the top of the pole to the vehicle. For shorter hauls a "timber hitch" (Fig. 4.5) can be tied around the butt of the pole and tie the rope to the yoke of an ox team, or a jeep.

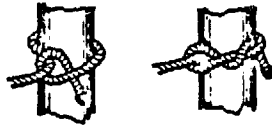

Fig. 4.5

POLE PREPARATION

The typical electric pole consists of high voltage wire supported on cross-arms and low voltage wire mounted on racks of insulators below the cross-arms. (Fig. 4.6)

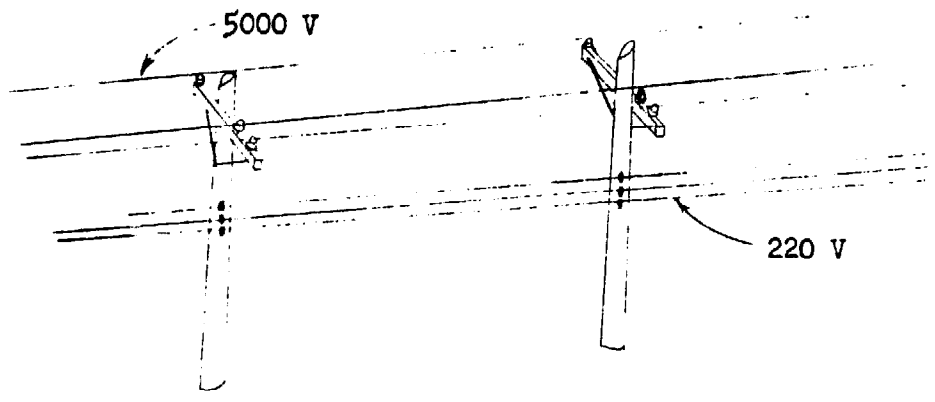

Fig. 4.6

TRIMMING

Trimming is required if the pole is in an unprepared state. Trimming is the stripping off of all the bark and knots till flush with the main body of the pole.

ROOFING

Roofing is the cutting of an angle on the top of the pole so that water, or perhaps snow or ice, will not collect on the top, thus preventing decay. In Fig. 4.7 there are several examples of roofs. Roofing is unnecessary if the entire pole is treated with wood preservative such as creosote.

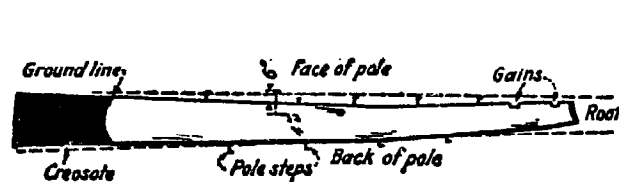

Fig. 4.7

GAINING

Gaining is the notching of a pole so that a crossarm or other piece of hardware will mount flush against the pole.

PRESERVATIVE

A pole will last much longer if it is treated with a preservative. This will protect it from rot, and termites. The section of the pole that will be under ground level must be painted with a wood preservative. Ideally the whole pole should be so painted.

Before a pole is erected as much preparation as possible should be done. The work is much much easier to do on the ground with firm footing than it is in the air, after the pole has been erected. The preparations should include:

trimming

roofing

gaining

boring of all needed holes for bolts.

painting with preservative

mounting all close fitting equipment, i.e. insulator racks, guy wire bolts, etc.

ERECTING AND SETTING POLES

DIGGING THE POLE HOLE

The diameter of the hole is determined by the size of the large end of the pole. The hole should be large enough to allow plenty of space on each side of the butt of the pole for tamping the soil back into the hole. This requires at least 3 in. all around the butt. The diameter of the hole should be fairly uniform from top to bottom. How deep the hole should be is determined by the length of the pole and by the holding power of the soil or earth. The recommended depths of setting in soil and rock are given in Table 4.1 for various pole lengths from 20 to 50 ft.

Table 4.1 Recommended Pole-Setting Depths in Soil and Rock for Various Lengths of Wood Poles

Length of Pole, ft.	Setting Depth in soil, ft.	Setting Depth in rock, ft.
20	5	3
25	5	3.5
30	5.5	3.5
35	6	4
40	6	4
45	6.5	4.5
50	7	4.5

RAISING THE POLE (Pike Method)

The piking method is the oldest method of raising poles. It gets its name from the so-called "pike pole" used by the men raising the line pole. A pike pole is a long pole with a steel spike on the end of the pole. A "jenny", a sort of heavy shaft with a U on the top end, is also used to support the pole

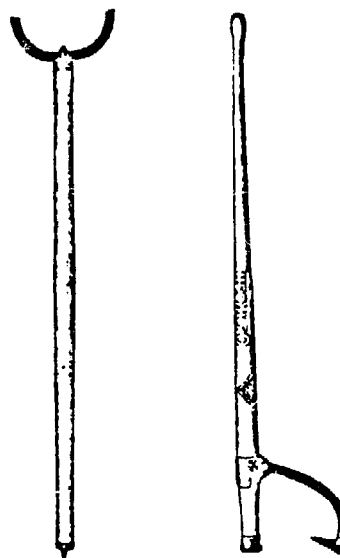

Jenny

Cant Hook

Fig. 4.8

A "piking" crew always has one man at the butt of the pole and one man at the "jenny" -- a "jennyman." The number of "pikers" depends upon the length and the weight of the line pole to be raised. Table 4.2 gives recommended crew sizes.

Table 4.2 Average Size of Crew Required to Raise Poles of Different Lengths

Pole length, \ft.	No. of Jennymen	No. of men at butt of pole	No. of Pikers	Size of Crew
25	1	1	3	5
30	1	1	4	6
35	1	1	5	7
40	1	1	6	8

The first step in raising a pole using the piking method is to lay the butt end of the pole over the hole against a bump board or bar which rests on the bottom of the hole and extends over the top, as shown in Fig. 4.9. The board or bar protects the walls of the hole and prevents them from being caved in by the butt of the pole as the pole is raised.

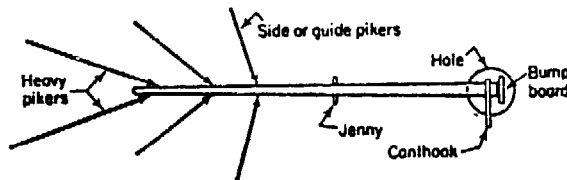

Fig. 4.9

In the second step the pole is raised by hand and placed on the pole support. The pole support, or jenny, is essentially a heavy tree limb with a fork in the small end. The main duty of the man at the butt is to keep the pole from rolling. This is done by means of a cant-hook--See Figure 4.10.

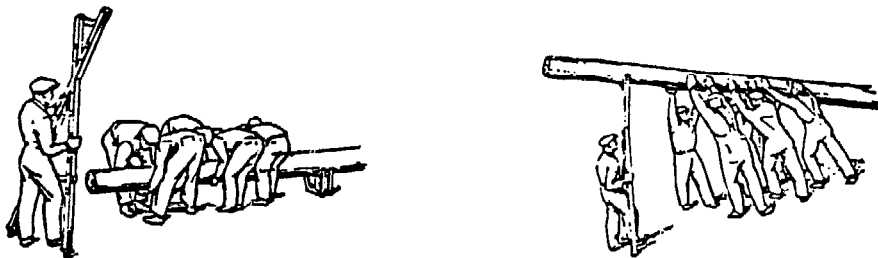

Fig. 4.10

In the third step the men stand side by side on either side of the top end of the pole. They then lift the top end of the pole as high as they can while the jennyman slides the jenny toward the butt. The jennyman supports the pole between lifts. In this manner they move along the pole until the pole is high enough to require the use of pikes.

The fourth step is to punch the pikes into the pole and prepare to raise the pole. As the pole is raised, the man carries the jenny forward always ready to support the pole if need be. The raising continues until "high pike" is called by one of the men. This means that the top of the pole is so high that he can no longer push it with his pike pole. The jennyman then sets the jenny to support the pole and while the other pike men hold it steady, first the man nearest the butt releases his pike and steps forward for a fresh lift closer to the butt. The other pike men follow in order and when all are ready they lift once again. The pole is raised in this manner until it drops into the hole.

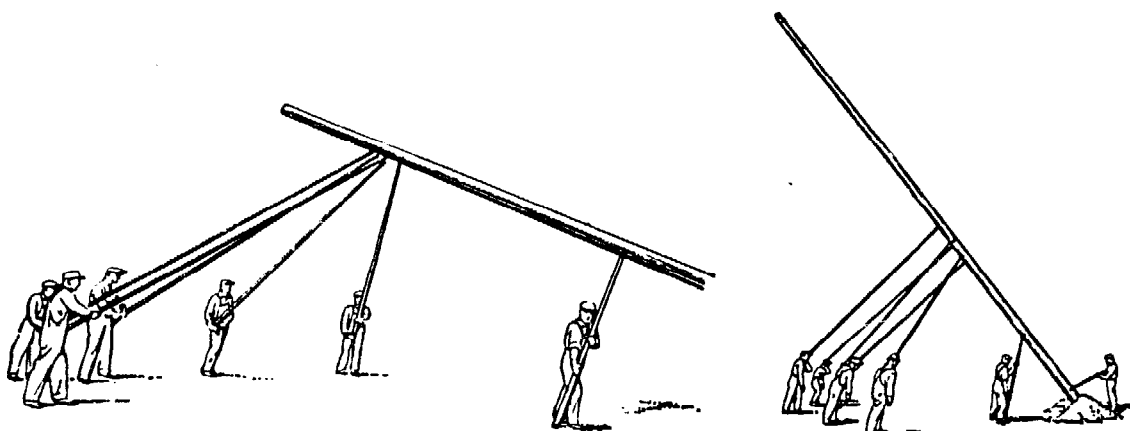

Fig. 4.11

POLE SETTING

When setting the pole after it has slid into the hole there are several things to keep in mind. First the pole should be faced. This is turning the pole with the cant hook, until the gains or the insulator racks are lined up facing the direction of the lines that will pass through them.

The pole should then be straightened, or plumb. This is to adjust the pole with the pikes until it is in a vertical position. This is done by the piking crew with a "foreman" standing away and giving directions. Once the pole is plumb the butts of the pikes should be jammed into the ground so that they support the pole without assistance.

Then the pole is ready to have the hole filled. In some soils there will be a need for cribbing as in Fig. 4.12. It cannot be stressed too much that the fill shoveled back in the hole must be well tamped. This is pounding down of the fill with rods until it is very hard packed. There should not be any soil left over if enough tamping is done.

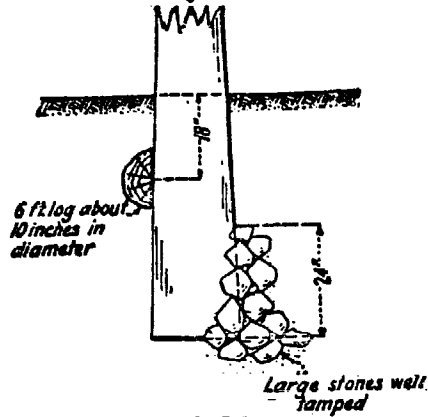

Fig. 4.12

Many utility accidents and fatalities are caused by linemen falling from line poles. With this as a preface, we can now discuss the proper way to climb a line pole. Climbing a line pole is extremely dangerous and the use of a ladder is much more desirable for the novice electric lineman. The ladder should be so placed that the distance from the base of the pole to the bottom of the ladder is $\frac{1}{3}$ the distance from the base of the pole to the top of the ladder. (See Fig. 4.13). Before working on the pole from the top of the ladder, the ladder should be tied securely to the pole.

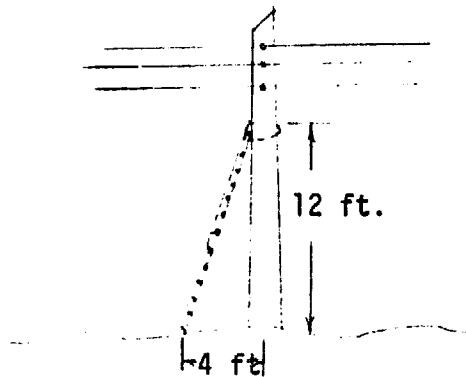

Fig. 4.13

Teaching the techniques of climbing poles with a pair of "climbers" is beyond the scope of this manual. (Instructor's Note: If these techniques are deemed necessary to the PCVs training, local utility personnel should be contacted and brought in to teach these techniques.)

GUYING THE POLE

Guys should be used whenever there is stress on a pole that tends to pull it out of line.

Dead ends or corners should be guyed as the weight of the lines will tend to pull the pole over. Guys should also be used at a road or railroad crossing. "Crossarms" may need guying if there is an unbalanced pull on them. Examples of these are shown in Figs. 4.14--4.19/

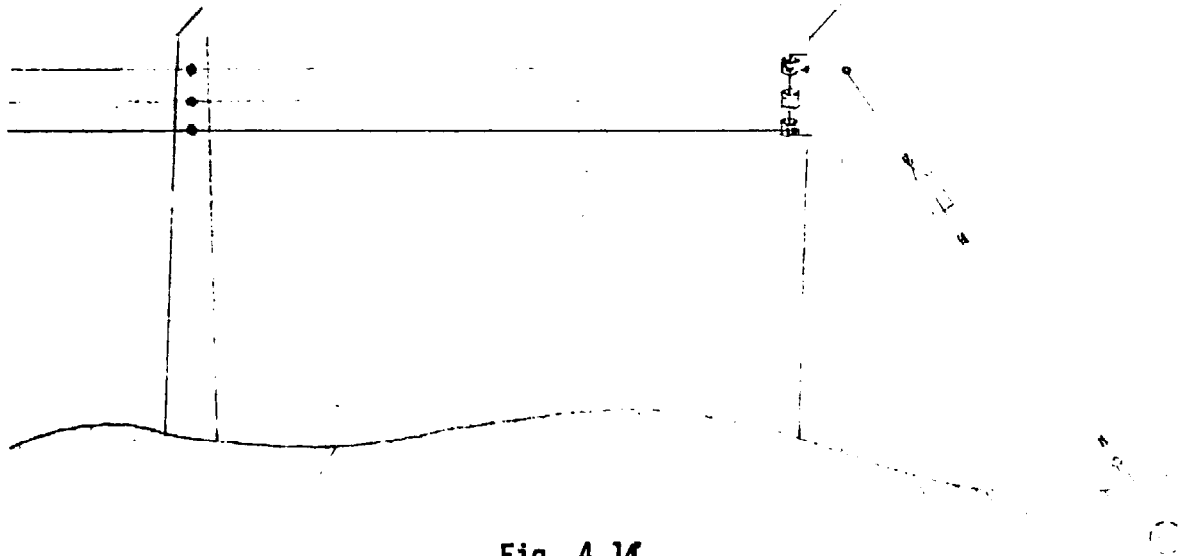

Fig. 4.14

Guy wire installed on a distribution line to counterbalance the pull of the "dead-ended" distribution wires. (Side view).



Fig. 4.15

Wire guy installed on a terminal or end pole. (Top view).

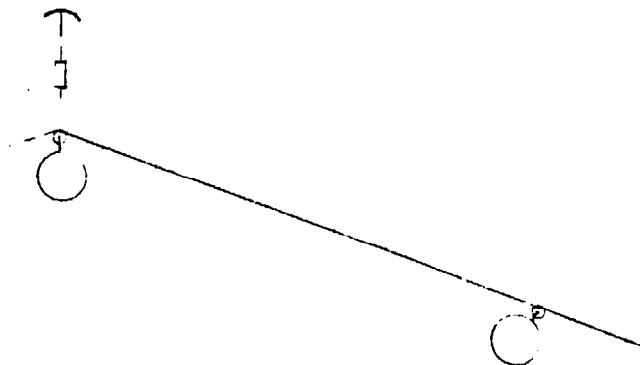

Fig. 4.16

Guy installed at angle in line.

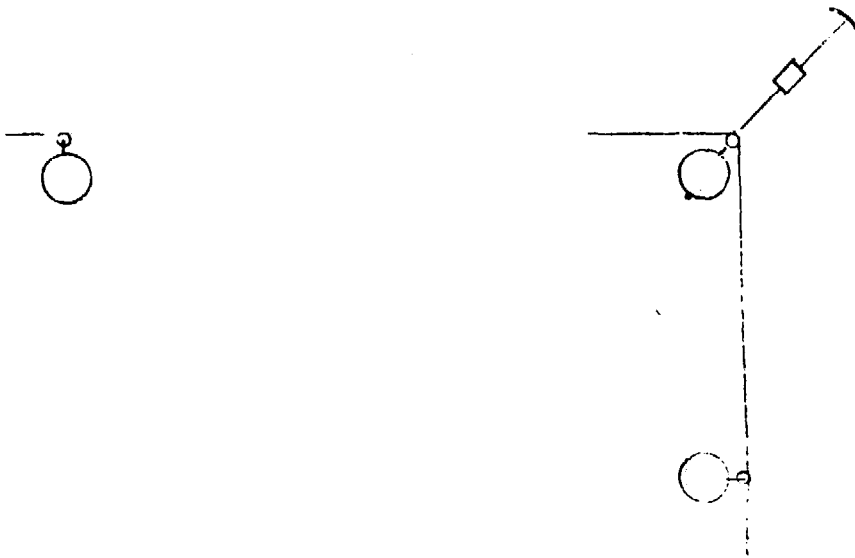

Fig. 4.17
Guying a corner pole

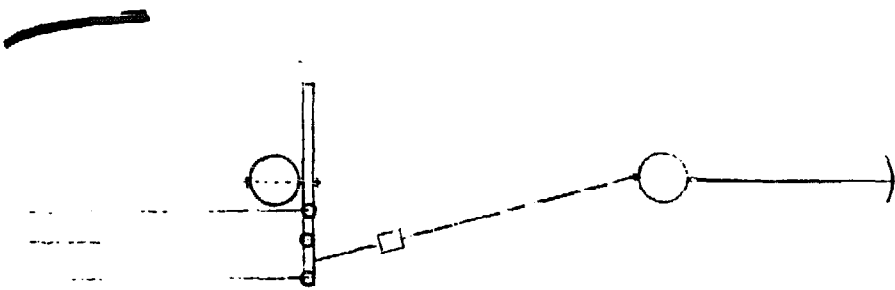

Fig. 4.18
Guy installed on crossarm.

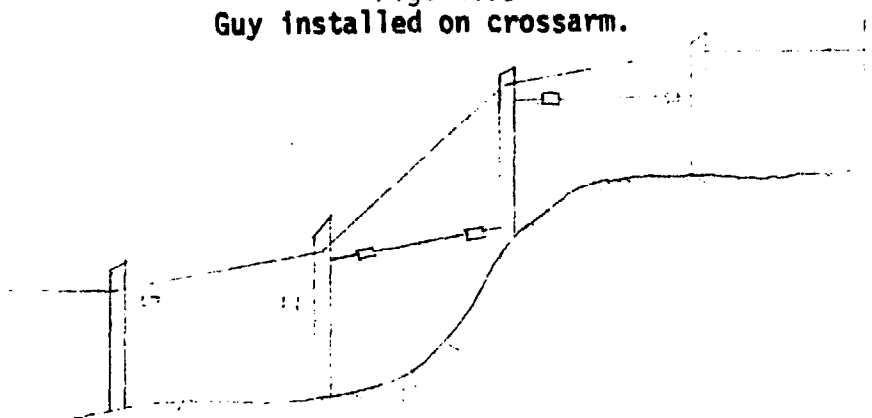

Fig. 4.19
Guying to strengthen pole line installed on steep grade.

There are four steps in the installation of a guy:

1. Digging in the anchor
2. Inserting the insulators
3. Fastening the guy to the pole
4. Tightening the guy and fastening to the anchor

DIGGING IN THE ANCHOR

There are several types of anchors, some are illustrated in Fig. 4.20.

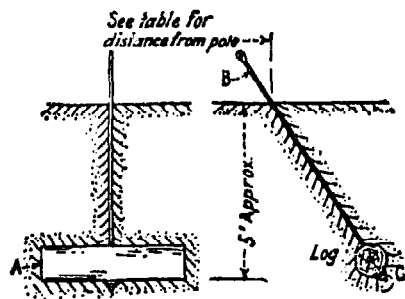
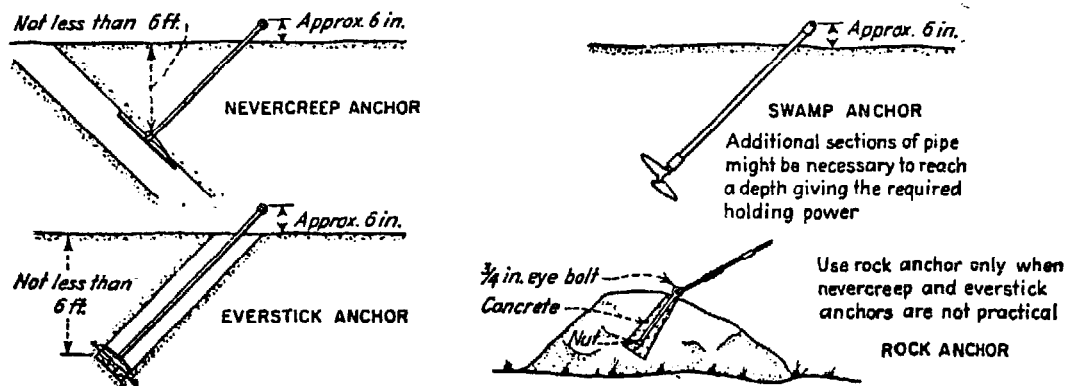

Size of pole, ft	Minimum distance from pole, ft
30 and 40	15
45 and 50	20
55 and 60	25

Material		
Loc.	No.	Description
A	1	12" x 4' - 0" log
B	1	Anchor rod
C	1	Anchor-rod washer

Fig. 4.20

The most economical anchor when labor is inexpensive is the log type anchor. It is also the most effective anchor. Its installation will be described here. The installation of the others is explained in Kurtz's Handbook.

A trench is dug a minimum of 4 feet deep. After having a hole bored in the log to pass the anchor rod through, the log is laid in the trench. The anchor rod is driven through the ground at the proper angle, and is secured through the log with a washer and nut. The trench is then filled and well tamped.

INSERTING THE INSULATORS

Insulators must be installed in a guy whenever there is the possibility of live wires falling and coming in contact with a guy. The insulator should be placed to insulate that portion of the guy from ground. The two sections of guy are looped through the separate parts of the insulator and the ends clamped to the guys.

FASTENING THE GUY TO THE POLE

The easiest method is to bore a hole for a bolt in the pole at the point the guy is to be attached. Loop the guy wire through the eye of an eye bolt and clamp the end to the guy. Then install this eye bolt through the pole. There are other pieces of hardware available for fastening a guy to a pole.

TIGHTENING THE GUY AND FASTENING TO THE ANCHOR

A wire grip is used with a block and tackle to pull the guy taut. The guy is tightened until the pole is pulled over slightly toward the guy. Then when the line conductors are strung later the pole will stand erect under the combined strain of the guy and the line. Once taut, the guy is looped through the anchor rod and clamped.

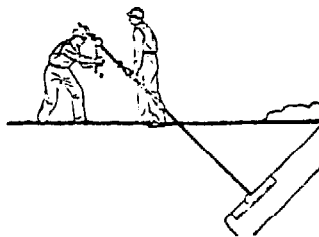

Fig. 4.21

JOINING LINE CONDUCTORS

Line joints can be divided in three classes:

- 1) Splices.
- 2) Sleeve joints.
- 3) Compression joints.

Small-sized copper wires can be spliced, but the larger sizes of copper wire are usually joined by means of splicing sleeves or compression joints.

MAKING A SPLICE JOINT

In the case of covered wires, the two ends of the wires to be spliced should be scraped perfectly clean and free from insulation. The wires should be cleaned until they are bright. After the conductors are cleaned, they should be placed together until approximately 8 to 12 in. of the ends overlap each other for the smaller sizes and 12 to 18 in. for sizes No. 4 and larger (See Fig. 4.22)

It is easier to make a good splice if a clamp is used to hold the wires in place prior to twisting.

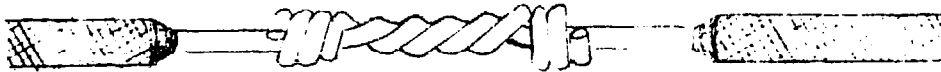

Fig. 4.22

Table 4.3

Size of Wire	Length of covering to be removed from each wire, in.
No. 8 - No. 6	8
No. 4 - No. 2	12
No. 10	18

MAKING A SLEEVE JOINT

The best way to make a joint in medium-size conductors is by means of the so-called "splicing sleeve." It is a special connection that ensures good electrical and mechanical joints. The sleeve itself is a piece of single or double tubing. (Fig. 4.23)

To make a sleeve joint, the ends of the wires should be scraped clean and bright. They are then inserted, one in each tube if a double tube is used, from opposite ends so as to lie side by side. The ends of the wires should project several inches beyond the ends of the sleeve. The ends of the sleeve are then grasped by two sleeve clamps or twisters. (See Fig. 4.24) The next operation consists in giving the conductors three and one-half or four turns. The twisting should be done from both ends. Sleeves should always be made of the same kind of material as the conductor they are to be used with. In making sleeve joints in iron wires, the sleeve should be tinned iron.

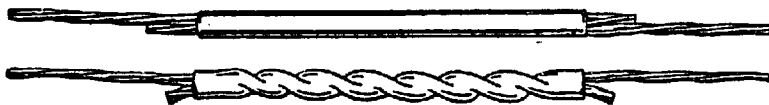

Fig. 4.23

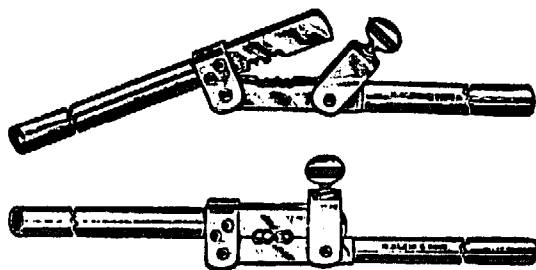

Fig. 4.24

MAKING A COMPRESSION JOINT

A compression joint also makes use of a sleeve. Instead of twisting the sleeve, however, the sleeve is compressed with great force onto the conductor. This great force is brought about by the use of a hand-operated compression tool modeled after a bolt-cutter. The use of a die in compression makes the sleeve grip the conductor firmly.

To make a compression joint:

1. Clean the conductor ends thoroughly.
2. Match the size of splicing sleeve to the size of the conductor.
3. Match the die number to the sleeve number.
4. Center the conductor ends in the sleeve.
5. The specified number of indents must be made. [Not Explained]

Although the compression joint is one of the best electrical joints, the compression tool is a rather expensive piece of equipment.

STRINGING THE WIRE

When wire is installed on electric poles, all the wire is installed at one time. That is, if 3 conductors are to be put up, all three are put up at the same time. A truck with the three spools of wire loaded on the rear end is used to pay out the distribution wires. The spools of wire are set up on the truck and unwind as the truck moves along.

In stringing wires on rack mounted insulators, the conductors are unreeled and passed through the rack. When the desired number of pole spans have been laid in place, the conductors are drawn up and tied to the insulators. As many as 10 spans can be drawn up at one time in this manner. The regular "Western Union" tie is generally used (See Fig. 4.25). If the conductors are to be tied to the outside of the insulator, the Western Union tie is also used.

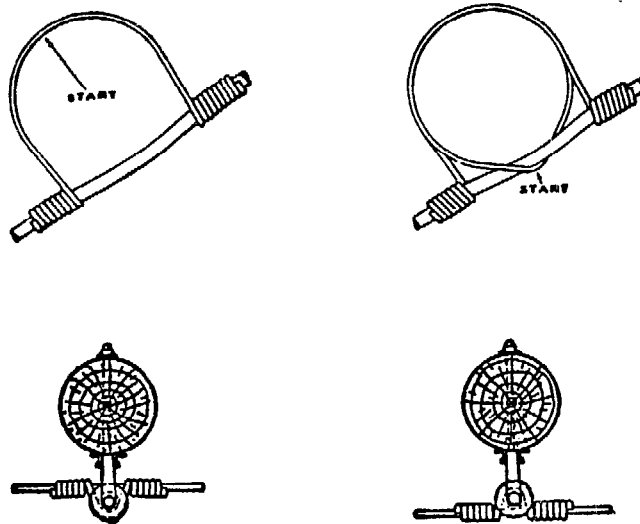

Fig. 4.25

In turning corners and at angles in the line, the position of the line wires on the insulators will be determined by the direction of the strain. They should always be so placed that the conductor is pulled against the insulator and not away from it. Fig. 4.26 illustrates the correct positions for corner and angle construction.

When a section of wire is strung to the last pole of a pole line, the section of wire is "dead-ended" on that last pole. Fig. 4.27 shows a dead-ended pole.

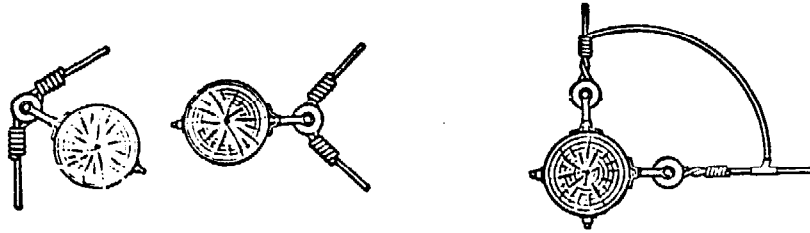

Fig. 4.26

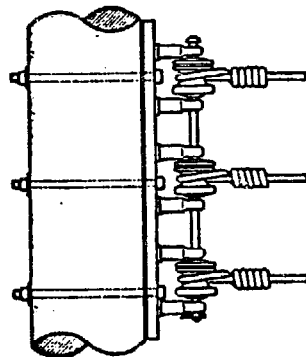

Fig. 4.27

SAGGING LINE CONDUCTORS

The line conductors expand in hot weather and contract in cold weather, so there should be some slack, or sag, between poles. The conductors should be sagged in accordance with the sag chart applying to the particular conductor used, the length of the span and the temperature prevailing. The sag should be adjusted in the middle span in short sections of line of five spans or less and at two or more spans in longer sections. Sagging is done just prior to tying the line conductors to the individual insulators or insulator bracket. Conductors can be sagged correctly only when the tension is the same in each span throughout the entire length.

A simple and accurate method of measuring the sag is by the use of targets placed on the poles below the insulators, as shown in Fig. 4.28.

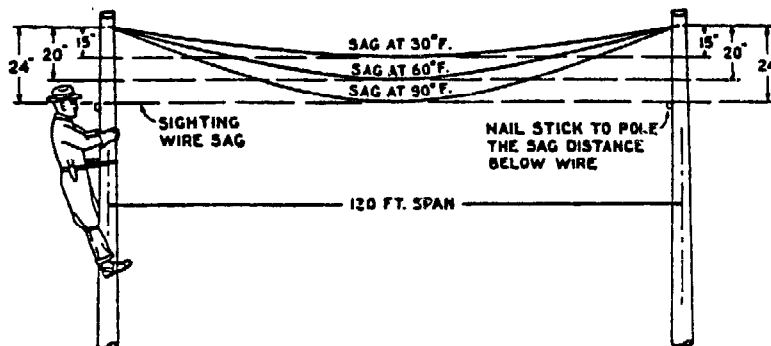

Fig. 4.28

TABLE 4.4

SAGS FOR HARD - AND MEDIUM - DRAWN COVERED
COPPER WIRE FOR DIFFERENT SPAN LENGTHS

Wire Size	Temperature °F	Span - Length in Feet							
		100	125	150	175	200	250	300	
6	30	8.5	14	22	31				
	60	12	18	27	36				
	90	15.5	22	32	41				
4	30	7	11.5	17.5	24	33			
	60	10	15	22	30	39			
	90	13.5	19.5	27	36	45			
2	30	7	11.5	17.5	22.5	26	43	68	
	60	10	15	22	27	32	50	76	
	90	13.5	19.5	27	34	38	57	83	
1	30	7	11	17	19.5	23.5	33	52	
	60	10	15	22	25	29	39	60	
	90	14	19.5	27	30	35	46	68	
0	30	7	11	17.5	19.5	21.5	30	46	
	60	10	15	22	24	27	36	54	
	90	14	19.5	27	31	33	43	62	
00	30	7	11	17	19	21	27	40	
	60	10	15	22	24	26	33	48	
	90	14	19.5	27	30	32	40	56	
0000	30	7	11	17	18	19	23.5	33	
	60	10	15	22	23	24	29	40	
	90	13.5	19.5	27	29	30	35	47	

The targets may be a light strip of wood like a lath nailed to the pole at a distance below the conductor resting on the insulator equal to the desired sag. The lineman sights from one lath to the next. The tension on the conductor is then reduced or increased until the lowest part of the conductor in the span coincides with the lineman's line of sight. The recommended sag for copper conductors is obtained from Table 4.4 for the particular span length, conductor size and temperature prevailing.

TRANSFORMER INSTALLATION

MOUNTING TRANSFORMERS ON THE POLE

Most transformers are fastened directly to the pole with bolts that run through the pole. When more than one large transformer must be used at a single location, a platform should be constructed to hold their weight. The hoisting of the transformers is done by means of block and tackle. One set of blocks is supported at the top of the pole, and the other is hitched to a rope fastened to the transformer itself. The pulling line runs through a snatch block tied to the pole near the ground. With the transformer hoisted to the proper position on the pole, it is then bolted to the pole, or a bracket is installed on the pole and the transformer is attached to the bracket. The method installation depends on the design of the transformer itself.

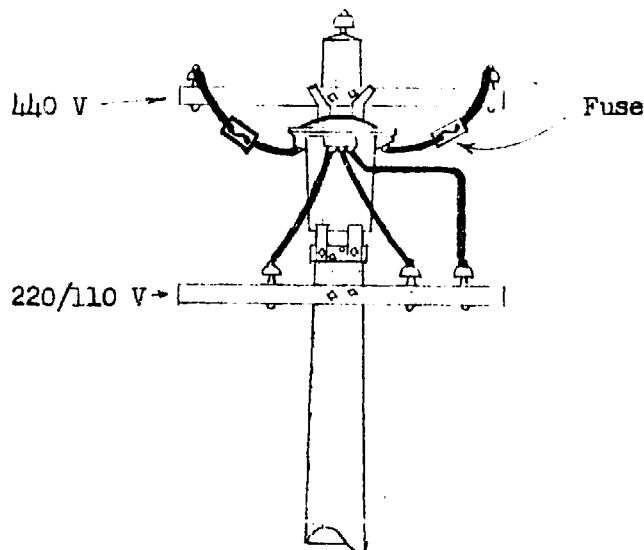

Fig. 4.29

CONNECTING THE TRANSFORMER TO THE LINE

Figure 4.29 shows how a transformer is mounted on the pole and connected to the lines.

Notice that a ground rod is driven at the base of the pole, and a ground wire is run up to the low voltage side (220 volt side) of the transformer. This is done to "ground" the transformer itself and also to provide a ground wire to run into the individual buildings. This

ground rod should be a 5/8" x 6 ft. long copper rod driven into solid ground until it is driven completely below ground level. The earth around the top of the ground rod is then removed so that six inches of rod is exposed. A wire clamp is then installed on the rod and the ground wire (running up the pole) is attached with this clamp to the ground rod. This ground wire should be no smaller than #2 wire. The rod is then recovered with earth.

Fuses should be installed in the high voltage wires (440 volts) running down to the transformer to protect the transformer and the rest of the distribution system in case of electrical trouble. Selecting the proper fuses size is covered in the preceding chapter. A type of fuse used by many electric utilities is shown in Fig. 4.30.

When the fuse link blows only the link needs to be replaced at very low cost.

From the low voltage side of the transformer, wire is run to an insulator bracket mounted on a "crossarm" below the transformer. "Service drops" are then attached to these low voltage wires near the bracket and are then run into the buildings or houses. "Service drops" consist of two insulated wires wrapped around a bare "messenger wire". This type of wire is called self-supporting service drop cable. This bare wire is used to support the two insulated wires and also serves as the ground wire to the building.

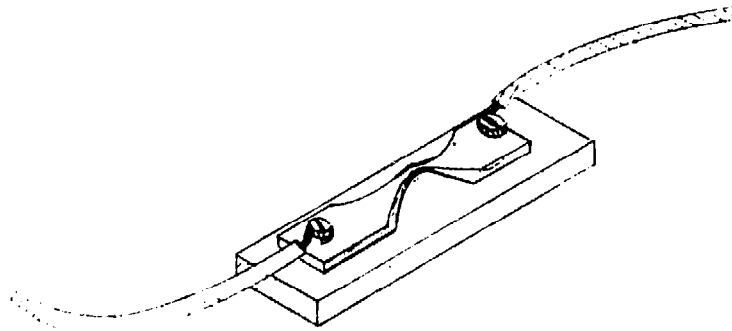

Fig. 4.30

DISTRIBUTION WIRING

LESSON NO. 1

LESSON OBJECTIVE: Exhibit maps and discuss their interpretation.
Demonstrate and assist trainees in mapmaking.
Discuss the criteria used for selecting proper routes for distribution lines.

TOPIC	INSTRUCTIONAL PROCEDURE	SUPPLEMENTAL MATERIALS / RELATED READING
Map Interpretation	<p>Exhibit topological maps and layout maps of small regions.</p> <p>Indicate the various symbols used and discuss their meaning.</p> <p>Illustrate other symbols that might be used that do not appear on these maps.</p> <p>Discuss the use of contour lines on a topographic map to indicate elevation.</p>	Davis & Kelly, <u>Elementary Plane Surveying</u> .
Map Making	<p>Demonstrate the use of a plane table to make maps.</p> <p>Have trainees use a plane table to map the area around the sample system.</p>	
Route Selection	<p>With a topographic map discuss the selection of a route for the distribution lines to follow.</p> <p>From the above discussion, list the principles of route selection.</p> <p>Mark the map of the local area with the route of the sample system to be constructed.</p>	Kurtz, Section 9, pp. 1-2.

DISTRIBUTION WIRING

LESSON NO. 2

LESSON OBJECTIVE: Discuss the need and demonstrate the techniques for clearing brush and trimming trees along the route of the distribution lines.

TOPIC	INSTRUCTIONAL PROCEDURE	SUPPLEMENTAL MATERIALS / RELATED READING
Clearance Distances	<p>List the hazards associated with improper clearance distances.</p> <p>Discuss and list the correct clearance distances around a distribution line.</p>	Kurtz, Sec. 9, pp. 2-6.
Techniques	<p>Demonstrate the techniques for trimming trees and clearing brush.</p> <p>Describe the correct shaping of trees.</p> <p>Discuss safety measures that must be followed when trimming trees.</p> <p>Have trainees clear the route for the sample system.</p>	Kurtz, Sec. 35.

DISTRIBUTION WIRING

LESSON NO. 3

LESSON OBJECTIVE: Describe and demcnstrate methods for correct staking of pole locations along the route.

TOPIC	INSTRUCTIONAL PROCEDURE	SUPPLEMENTAL MATERIALS / RELATED READING
Pole Placement	Discuss the considerations in pole placement: Grading Soil conditions Span length Ground clearance Have trainees stake out the pole positions of the sample system.	Kurtz, Sec. 9, pp. 7-10.

DISTRIBUTION WIRING

LESSON NO. 4

LESSON OBJECTIVE: Discuss selection and preparation of poles.

TOPIC	INSTRUCTIONAL PROCEDURE	SUPPLEMENTAL MATERIALS / RELATED READING
Pole Selection	Discuss criteria used in selecting poles or other supports for distribution lines.	Kurtz, Sec. 10.
Pole Transport	Demonstrate methods of hauling a pole. Have trainees select and haul poles to stake locations.	
Pole Preparation	Discuss the preparations that must be made on a pole before erection. Have trainees prepare the poles for erection.	

DISTRIBUTION WIRING

LESSON NO. 5

LESSON OBJECTIVE: Describe and demonstrate method of digging pole holes, erecting and setting of poles.

TOPIC	INSTRUCTIONAL PROCEDURE	SUPPLEMENTAL MATERIALS / RELATED READING
Hole Digging	<p>Discuss the depth that hole should be dug depending upon the pole length, soil type and pole use.</p> <p>Describe the shovel and spoon method and the hand auger method of digging pole holes.</p> <p>Have the trainees dig two holes for the sample system, using each method.</p> <p>Discuss and observe a professional crew with a power auger as they dig the additional holes needed for the sample system, including those needed to install anchors for guys.</p> <p>Discuss additional techniques which might be needed if digging were to be done in sandy soil or other bad soil conditions.</p>	Kurtz, Sec. 11, pp. 1-9.
Pole Erection	<p>Describe the piking method of pole erection. Discuss the duties of each person on the crew.</p> <p>Demonstrate how to drive a pike to insure a firm hold.</p> <p>Demonstrate the use of a cant hook and the use of a jenny.</p> <p>Point out how these methods insure the safety of the crewman.</p> <p>Have trainees erect the poles for the sample system.</p>	Kurtz, Sec. 11, pp. 9-19.
Pole Setting	<p>List and describe the steps in the setting of a pole.</p>	Kurtz, Sec. 11, pp. 19.

DISTRIBUTION WIRING
Lesson No. 5 (continued)

<p>Pole Setting (Continued)</p>	<p>Describe additional procedures needed in sandy soil or where there are lateral stresses.</p> <p>Stress the importance of correct tamping and demonstrate the correct tamping techniques.</p> <p>Describe the procedures for plumbing and lining up a pole.</p> <p>Have trainees set the poles of the sample system.</p>	
-------------------------------------	--	--

DISTRIBUTION WIRING

LESSON NO. 6

LESSON OBJECTIVE: Demonstrate correct techniques for climbing poles.

TOPIC	INSTRUCTIONAL PROCEDURE	SUPPLEMENTAL MATERIALS / RELATED READING
Pole Climbing	<p>Describe and demonstrate how to place ladders for safe pole climbing.</p> <p>Show how to tie it to the pole.</p> <p>Stress the safety requirements of the ladder (angle and the footing).</p> <p>Have trainees set, climb and secure ladders to poles, correcting any unsafe practices observed.</p>	Kurtz, Sec. 45, p. 27.
Climbers	<p>Have a representative of the local power company instruct the trainees in the safe wear, use and maintenance of climbers.</p>	Kurtz, Sec. 43.

DISTRIBUTION WIRING

LESSON NO. 7

LESSON OBJECTIVE: Demonstrate the proper methods and techniques for guying poles.

TOPIC	INSTRUCTIONAL PROCEDURE	SUPPLEMENTAL MATERIALS / RELATED READING
Pole Guying	<p>Discuss the need for guys on dead ends, turns and grades.</p> <p>Discuss the angle and orientation of the guy depending on the use of the pole.</p> <p>Describe and list the types of anchors and the installation of each.</p> <p>Have trainees dig the anchor holes, install the anchors and rods and fill and tamp the holes of the dead end of the sample system.</p> <p>Discuss the proper lengths and sizes for guy wires and demonstrate how to cut the wire.</p> <p>Have trainees cut the required guys to the proper lengths.</p> <p>Describe the installation of a guy, the connection to a thimble bolt on the pole, to the anchor rod and the need for insulators in the wire.</p> <p>Demonstrate how to apply tension to the guy and advise as the trainees finish the installation of the necessary guys for the sample system.</p>	Kurtz, Sec. 12.

DISTRIBUTION WIRING

LESSON NO. 8

LESSON OBJECTIVE: Demonstrate methods for stringing and joining line conductors.

TOPIC	INSTRUCTIONAL PROCEDURE	SUPPLEMENTAL MATERIALS / RELATED READING
Joining Line Conductors	<p>Review the Western Union splice from the house wiring section of this course.</p> <p>Demonstrate the use of tools for making a twisted sleeve joint.</p> <p>Have trainees practice making the twisted sleeve joints.</p>	Kurtz, Sec. 15.
Stringing Lines	<p>Describe the steps to be followed when stringing line conductors:</p> <ol style="list-style-type: none">1. paying out the conductors2. joining or splicing as needed3. pulling up4. sagging5. tying in. <p>Describe how to pay out the line conductors.</p> <p>Have trainees pay out the line conductors for the sample system.</p>	Kurtz, Sec. 14.

DISTRIBUTION WIRING

LESSON NO. 9

LESSON OBJECTIVE: Demonstrate the methods for sagging
line conductors.

TOPIC	INSTRUCTIONAL PROCEDURE	SUPPLEMENTAL MATERIALS / RELATED READING
Sagging	<p>Discuss the need for sagging line conductors.</p> <p>Describe the proper methods of sagging line conductors using the sighting method.</p> <p>Discuss the use of tables for determining the proper amount of sag for a particular size of conductor.</p>	Kurtz, Sec. 16.
Tying In	<p>Demonstrate the Western Union method of tying a line conductor to an insulator.</p> <p>Demonstrate method of pulling up cables, determining sag and tying in.</p> <p>Have trainees sag and tie in the conductors of the sample system.</p>	Kurtz, Sec. 16, pp. 46-58.

DISTRIBUTION WIRING

LESSON NO. 10

LESSON OBJECTIVE: Demonstrate methods of hoisting and mounting transformers.
Describe steps to follow when connecting transformers.

TOPIC	INSTRUCTIONAL PROCEDURE	SUPPLEMENTAL MATERIALS / RELATED READING
Hoisting	<p>Discuss the use of hand lines and block and tackle.</p> <p>List the duties of each man and discuss his location during hoisting.</p> <p>Stress the safety requirements.</p>	<p>Kurtz, Sec. 17.</p> <p>Kurtz, Sec. 36, p. 1.</p>
Transformer Mounting	<p>Describe how a transformer is mounted on a pole.</p> <p>Have trainees hoist and install transformer on the pole.</p>	
Connection	<p>Discuss the connection of a distribution transformer and the other equipment that must be installed:</p> <ol style="list-style-type: none">1. lightning arrester2. cutout fuses3. pole ground.	

DISTRIBUTION WIRING

LESSON NO. 11

LESSON OBJECTIVE: Demonstrate proper techniques used in the installation and connection of ground electrodes, lightning arresters and cutout fuses.

TOPIC	INSTRUCTIONAL PROCEDURE	SUPPLEMENTAL MATERIALS / RELATED READING
Ground Electrodes	<p>Review installation of a "made electrode" from the house wiring section of this course.</p> <p>Have trainees install grounding electrodes for the sample system.</p>	Kurtz, Sec. 17, pp. 15-30.
Lightning Arresters	<p>Describe the operation of a lightning arrester.</p> <p>Discuss methods of installing a lightning arrester and its connection to the distribution system.</p>	
Cutout Fuses	<p>Discuss the methods of connecting a cutout fuse in a distribution system.</p> <p>Have trainees install lightning arresters, cutout fuses and connect distribution transformers in the sample system.</p>	

SECTION 5

POWER SOURCE

OVERVIEW:

The design, installation, and operation of a generating plant is beyond the scope of this manual. This section describes briefly the connections of a distribution system to a power source. This section also covers the installation of a small power generator plant in an isolated location. The PCTs will install a low power, gasoline driven generator and connect it to power the pump previously installed.

SECTION 5 POWER SOURCE

OBJECTIVE: Arrange for connection of power distribution system to a power source and provide support for the technicians responsible for the connection. Install low power generators for isolated consumers.

- TASKS:**
1. Discuss with the technicians the connection of the distribution system to the power source. Arrange for the connection.
 2. Prepare the system for connection to the power source as recommended by the technicians.
 3. Provide any additional assistance that may be requested by the technicians making the connection.
 4. Install low power generators at isolated locations.

FUNCTIONAL SKILLS:

1. Describe the system's power requirements.
2. Discuss considerations of connection to a power source.

TERMINAL PERFORMANCE TESTS:

1. Install a low power gasoline generator to operate the pump previously installed. Indicate the essential components needed for a safe connection to the load.

DESIGN AND INSTALLATION

POWER SOURCE

DISTRIBUTION SYSTEM POWER SOURCE

There are two possible sources of power for a distribution system. The system can be powered directly from a generating plant, or the system can receive its operating voltage from a substation of a transmission system. The installation and operation of a generating plant for a distribution system is beyond the scope of this manual.

The attachment of a distribution system to a generating plant or a substation is essentially the same. The connection should be made by extensively trained personnel only.

The trainee who has constructed the distribution system needs to understand the connection. The considerations are outlined below. These are not all of the considerations, they will be left for the trained personnel responsible for the connection. These considerations will give the trainee the necessary understanding of the task.

SYSTEM POWER REQUIREMENTS

The power source must be able to supply the power demanded by the system. Therefore the demand of the system must be considered before the connection is made. If the demand is greater than the power source can supply, either an additional power source must be obtained or the loads on the system reduced until the power required is less than or equal to the power supplied.

CONNECTION

There are two considerations to be considered in the connection of the power source.

A. Disconnection

The system must be able to disconnect from the power source. The system cannot be maintained in case of failure unless the power can be positively removed from the system, by use of a switch.

B. Overcurrent Protection

There must be overcurrent protection to protect the power source from the damage that would result if more current was demanded than could be delivered. Also there must be protection of the distribution system so that it will be disconnected if it tries to carry more current than it is designed to carry.

ISOLATED GENERATOR INSTALLATION

An isolated generator is defined to be any installation where the owner generates his own electricity.

FEASIBILITY

There may be times when it is not feasible to construct the necessary distribution lines to supply power to a particular consumer. The consumer may have only modest power needs and be quite distant from other consumers. If the distribution lines were to pass a long distance through rugged country the construction and maintenance costs could be much higher than the cost of purchasing, installing and operating a low-powered generator to supply the needs of this consumer's compound.

GENERATOR SELECTION

The most common type of isolated generator produces AC power. Capacities are available from 400 to 100,000 watts.

The generator should be selected to supply the same voltage at the same frequency as the power system that someday may be extended to supply this consumer. This selection has the advantages that ordinary appliances can be used and that if the system is extended to supply this compound no rewiring will be necessary. The generator must be chosen to supply the maximum load that will be required at any given time. It is wise to consider the future; perhaps a generator with a larger capacity should be selected to allow for future growth.

INSTALLATION

The manufacturers of the generating plants supply full details for the installation.

Location of Generator

A generator must be located where the generator will be able to cool properly, so proper air circulation is a must. To avoid noise and fumes it is also convenient to locate the generator away from the living areas of a compound. However, the generator should be located close enough to the loads to keep voltage drops to a minimum, and the cost of conductors to a minimum.

Mounting of the Generator

A generator and its engine must be mounted on a solid base. Usually a concrete slab or similar base is used. This is to prevent vibrations from damaging equipment.

Grounding

It is just as important to ground an isolated system as it is to ground a larger system. The generator case should be grounded

and one of the conductors for the system, should be grounded

Metering

Since the consumer owns his own generator he does not need to measure the energy that he supplies to himself. He will need to observe the voltage, frequency and current outputs from time to time to insure that the generator is operating properly and if not to make the necessary adjustments. The needed meters will be built into the generator plant and full instructions will be found in the operating manual.

Lightning Protection

If there are any outdoor lines in the system the grounded line should be run above the others. It will still be necessary to install lightning arresters to protect the system and the generator from any lightning strikes to the wires of the system.

Overload Protection

A generator can provide only a set amount of current. If more current is demanded than the generator can produce the generator may burn out. Therefore fuses or circuit breakers must be installed to protect the generator from delivering more power than it is designed to supply. The compound system should still be installed as any other system, with its own fuses to protect the entire system and the parts of the system from overcurrent.

Disconnection

The generator will need to be shut down occasionally for routine maintenance. There must be a switch (or the circuit breakers) to disconnect the generator from the loads. This is a must, as the generator must have no load on it when it is started. It must be running properly before any load is applied. It is also best to disconnect the load before stopping the generator.

POWER SOURCE

LESSON NO. 1

LESSON OBJECTIVE: Discuss factors to be considered prior to the connection of a distribution system to a power source.

TOPIC	INSTRUCTIONAL PROCEDURE	SUPPLEMENTAL MATERIALS / RELATED READING
System Power Requirements	Discuss how to calculate the power requirements of the entire system and the methods of matching these to the power source.	

POWER SOURCE

LESSON NO. 2

LESSON OBJECTIVE: Discuss the methods of installing an isolated generator for a single consumer system.

TOPIC	INSTRUCTIONAL PROCEDURE	SUPPLEMENTAL MATERIALS / RELATED READING
Definition	Define the concept of an isolated generator.	Richter, pp. 410-415
Feasibility	Discuss the relative merits of an isolated generator versus the construction of distribution lines.	
Generator Selection	Discuss the criteria used for selecting an appropriate generator for use in an isolated location.	
Installation	Discuss and list the requirements of any generator installation. Have trainees install a 3,000 watt gasoline powered generator to supply the pump previously installed (see Section III, Lesson 11).	

SECTION 6

COST ANALYSIS

OVERVIEW:

It is beyond the scope of this manual to cover in detail the requirements of operating the financial aspects of a rural electrification program. It is assumed that there will be PCVs assigned to work with the electrification project, who have been extensively trained in Cooperative operation. They will be in charge of the financial aspects of the project. They will however need the support of the PCVs working on the installation for information relating to the cost of the materials and labor. This section briefly describes the requirements that must be considered.

PLANNING REQUIREMENTS

SECTION 6 PROJECT COST ANALYSIS

OBJECTIVE: Prepare a report for the co-op, listing the total cost of installation and operation of an electrical system, the available funds, and the benefits to be derived from the system.

- TASKS:**
1. List materials needed, obtain and list the cost of the materials.
 2. Determine the labor needed for installation and maintenance, obtain the labor rates, and list the labor costs.
 3. Determine the overhead costs (power costs, maintenance costs, repair costs, and administrative costs).
 4. Calculate the total costs.
 5. Identify sources of income and list the amounts coming from each.
 6. List the benefits to be derived from the system.
 7. Prepare a report using these lists.

FUNCTIONAL SKILLS:

1. Prepare a statement defining material needs, labor needs, and overhead factors, for installation and operation of an electrical system.
2. State economic and social improvements usually possible with the existence of a power distribution system.

TERMINAL PERFORMANCE TESTS:

1. Given the design of a rural electrification system, labor rates, and materials prices; prepare a report presenting materials, overhead, and labor costs, available funds and possible benefits to be derived by installing an electrical power distribution system.
2. List possible sources of cost information.

PLANNING REQUIREMENTS

COST ANALYSIS

MATERIAL NEEDS

The material needs of an electrification project can be divided into two categories. These are direct and indirect materials. Direct materials are those that are used directly in the system. These are the poles, the line conductors, the transformers, the meters, switches and boxes, etc. The indirect materials are those which are needed but are not a direct part of the system. These would include the tools needed to install the system, the friction tape or the solder, block and tackles, etc.

LABOR NEEDS

Labor needs are also divided into direct and indirect needs. The direct labor needs are the jobs that must be performed to build the system. These would include the erection of poles, stringing of lines, installation of house wiring. The indirect labor needs are those which do not relate to specific parts of the system. These would include the storage of materials, the procurement of poles, the training of assistants, etc.

OVERHEAD

The overhead costs of a project are those costs that are not due to a particular part of the system. These are in part the operating costs. Included in the overhead would be the labor and materials needed for maintenance of the completed system, the administrative costs of the cooperative, the cost of the right of way for the lines, etc.

MATERIAL COSTS

Material costs are readily available, once a source of materials has been selected. Simply calculate the total cost including transportation using the quoted prices and the list of material needs.

LABOR RATES

The labor rates for an electrification project depend primarily on how the project is being run. If it is a cooperative, all the partners of the co-op may pitch in to do the work and the labor rates would be zero. Perhaps the project is being sponsored by a government organization and one of the aims of the project is to employ the local people. Then the government might be subsidizing the project and the labor rates might be higher than otherwise.

To obtain the labor rates will take an investigation of the organization of the projects.

OVERHEAD COSTS

The determination of the total overhead costs will require a determination of an approximate cost for each overhead factor. Some will depend upon labor rates, others on material costs. Some on other fixed rates or costs, How to figure or obtain the cost will depend on the overhead factor.

OVERALL PROJECT COSTS

The overall project costs are calculated from the totals for each of the basic costs. It will be found that the project installation costs will generally break down as follows:

Labor	25%
Materials	70%
Transportation	5%

Major deviation from this break down should be examined and accepted only if the PCV can justify the deviations under the specific circumstances.

FUND SOURCES

There are three major areas where the funds needed for the project can be obtained. These areas are:

1. Governmental
2. Private Industry
3. Cooperative

The funding of the project will most likely be determined before your arrival on the scene. If not, it will most likely be in the hands of one or several PCV'S that have been trained in cooperative management or a similar area. Briefly, the types of funds that are available from each of these areas follow:

Governmental

This means that either the host country's government is financing the electrification program, or that aid is being received from a branch of the U.S. government. Such a branch might be U.S.A.I.D., working in cooperation with the National Rural Electric Cooperative Association.

Private Industry

This type of program would be the Peace Corps helping to set up private industry in the country and working in cooperation with a group interested in starting a private power company.

Cooperative

The people to be receiving the power would form a cooperative and funds from the membership and perhaps a governmental agency would form the needed capital.

COOPERATIVE OPERATION

A cooperative is a membership organization to provide a service to the members. An electrification cooperative would be started by the residents of an area for the purpose of supplying the members with electric power. They would pool their finances, perhaps borrow capital as a group, and actually run a small power distribution company. They might generate their own power or contract to purchase it from some company or group nearby. The primary differences between a company and a cooperative are:

To serve the members--not to provide services to others or to make a profit although both of these may happen.

Savings are distributed by the amount of use rather than by the amount invested. Voting control is based on membership.

The best sources of information on electric cooperatives would be the Rural Electrification Administration, Dept. of Agriculture; or the National Rural Electric Cooperative Association, 2000 Florida Ave. NW, Washington D.C. 20009.

COST ANALYSIS

LESSON NO. 1

LESSON OBJECTIVE: List and define the elements of a cost analysis.

TOPIC	INSTRUCTIONAL PROCEDURE	SUPPLEMENTAL MATERIALS / RELATED READING
Material Needs	Define the term: Material Needs List materials generally required for the construction of an electrification system.	
Labor Needs	Define the term: Labor Needs. Discuss typical labor needs in any electrification program.	
Overhead Factors	Define the term: Overhead Factors. Discuss typical overhead factors that might be encountered in an electrification program.	

COST ANALYSIS

LESSON NO. 2

LESSON OBJECTIVE: Identify sources of cost information.
Discuss where to find information about the costs of the project.

TOPIC	INSTRUCTIONAL PROCEDURE	SUPPLEMENTAL MATERIALS / RELATED READING
Cost Information	Discuss where to find information of materials costs. Discuss where to find information on labor rates. Discuss how to calculate overhead costs.	

COST ANALYSIS

LESSON NO. 3

LESSON OBJECTIVE: Identify the types of fund sources and discuss the preparation of a statement of economic and social improvements with the existence of a power distribution system.

TOPIC	INSTRUCTIONAL PROCEDURE	SUPPLEMENTAL MATERIALS / RELATED READING
Funding	<p>Discuss possible method of funding an electrification project.</p> <p>Describe the operation of a cooperative.</p> <p>Discuss possible economic and social improvements associated with electrification.</p>	
Cost Justification Report	<p>Discuss the preparation of a report listing these benefits and the costs of the proposed system.</p>	

SECTION 7

PREVENTATIVE MAINTENANCE

OVERVIEW:

A well installed electrical system is relatively trouble free. But troubles do arise. A sound preventative maintenance program will reduce the amount of failure. This section covers the basic elements of a preventative maintenance program. It also covers the elements of trouble shooting the problems that do occur.

As the PCVs will stay only two years, the local workers must be trained to perform the maintenance and trouble shooting operations. This section of instruction also describes the preparation of operation manuals to aid the PCVs in this instruction.

The activities of this section stress the learning of trouble shooting techniques. The PCVs cannot effectively teach the local workers if they do not have the skills themselves.

SECTION 7 PROJECT MAINTENANCE

OBJECTIVE: Train local workers to recognize, locate and correct faults, and perform necessary preventative maintenance.

- TASKS:**
1. Establish rules/procedures for locating and correcting faults in the distribution system.
 2. Prepare an operation manual for instructing workers in these procedures.
 3. Prepare a schedule of preventative maintenance procedures necessary to insure an efficient system. In the schedule, identify: procedure, frequency, tools and/or materials required, steps to follow, precautions to be taken.
 4. Identify workers to be responsible for various maintenance functions.
 5. Train workers to carry out their assigned tasks properly.
 6. Establish a facility to house maintenance tools and replacement parts.

FUNCTIONAL SKILLS:

1. Recognize when trouble exists.
2. Identify the usual trouble areas for particular faults.
3. Operate a test lamp.
4. Interpret system and house diagrams.
5. Demonstrate proper techniques for installation of house wiring and service entrances, grounding, repairing poles, stringing, splicing, securing and sagging lines, and replacing fuses.
6. Recognize safety hazards and possible fault causes.
7. Simplify procedures to a level compatible with local language and worker education levels.
8. Design and construct work benches, tool boards, and stock bins out of cheap, local materials.
9. Demonstrate the proper uses, handling, and care of tools needed to effectively maintain the distribution system.

PROJECT MAINTENANCE (cont.)

TERMINAL PERFORMANCE TESTS:

1. Given an electrical system with a fault, locate and correct the fault. Repeat for various faults.
2. Given an existing electrical system, and manuals for the equipment being used, perform routine maintenance. Identify and correct any hazards that exist.
3. Prepare an electrical system trouble-shooting and maintenance manual for use by locally trained people.

PLANNING REQUIREMENTS

PROJECT MAINTENANCE

TROUBLE SHOOTING

Things can go wrong with an electrical system just as they can with an automobile. Therefore, to keep the electrical system operating after the installation is completed, you must be able to trouble shoot. Trouble shooting has three basic parts. These are:

1. Recognize the existence of trouble.
2. Determine the type and location of the trouble.
3. Correct the trouble.

PRECAUTIONS

Always observe the safety rules. Study and memorize the nine safety rules in Section 2 before you start to trouble shoot any electrical difficulty. Also carry with you a sketch of the system with the voltages and currents in each line clearly indicated. You should always know, not guess, how much voltage and current is flowing, or should be flowing in a wire before you approach it. Get into the habit of saying to yourself, "This wire should have ___ volts running in it."

SYMPTOMS OF ELECTRICAL TROUBLE

To recognize the existence of trouble in an electrical system, you must be able to recognize the symptoms of trouble. The following are the most common types of trouble in an electrical system.

NO VOLTAGE

If the circuit is dead and no current flows there is no voltage. This is usually caused by a blown fuse, loose connection or broken wire. It might also be a failure of the generator.

FUSES KEEP BLOWING

This may be caused by an overload, that is, too many appliances are connected to the circuit, thus drawing too much current. It may be caused by a short circuit, which is a power wire touching a ground or two power wires in contact.

LIGHTS GROW DIM

When the lights grow dim and motors will not start, it usually means that the voltage is lower than it should be. A variety of troubles can cause this problem. There may be a loose connection or an arcing switch. The wiring may be undersized or too long, causing too much voltage drop.

LIGHTS BURN BRIGHTLY, BUT BURN OUT

This usually means that the voltage is too high. Either a generator is not regulated properly or a transformer is improperly connected.

LIGHTS FLICKER, MOTORS RUN UNEVENLY

This may happen when a motor is started. If so it is because the motor draws five times the current while starting than it does while running. While it is starting the voltage drop is five times as great, thus causing the flicker. If the flickering continues after the motor has started it may be that the motor is improperly grounded. Other causes might be loose connections or too small a transformer.

CONNECTIONS GET HOT

This usually means that the connection is loose and thus creating a high resistance. All electrical connections must be very tight and solid.

SHOCKS WHEN TOUCHING EQUIPMENT

This symptom indicates that the appliance or motor has not been properly grounded.

MOTORS RUN IN REVERSE OR WILL NOT START

This occurs in three phase circuits and means that one or more phases are not connected (blown fuse, loose connection, broken wire, etc.) and the motor is said to be "single phasing." Or, this symptom can mean that the connections to the motor have been reversed.

LOCATION AND TYPE OF FAULT

After realizing that the system is not operating properly you still need to determine the type of fault and where this fault is located. These two tasks are accomplished at the same time. The symptom observed gives clues to the type of trouble, but in most cases different faults could produce the same symptom. For example: what is the cause of no voltage? Is a fuse blown, is there a broken wire, is there an open connection, is there a bad switch, transformer, or other piece of equipment, or is there a generator failure? All of these faults could produce the symptom of no voltage. As you locate the fault you are simultaneously finding out what type of fault is present.

A systematic procedure must be used to find the location of the trouble. The design of an electrical system makes this fairly easy. An electrical system is like a tree. From any leaf there is only one stem, one branch, one limb, and one trunk that lead from that leaf to the roots where the energy is received from the soil. Similarly, in an electrical system there is only one branch circuit, one service entrance, one set of second ary lines, one set of distribution lines, and one set of transmission lines that lead from the load to the generator. To locate the fault start from the load that has the symptom and proceed toward the power source. At each convenient point along the system you will need to test to see if the fault exists at that point as well as at the points already checked behind it. When you find a point where the fault does not exist then work back towards the load testing each point until you find the location of the fault.

TEST EQUIPMENT

To locate the fault in a system you must test the system for the fault at the points successively closer to the power source. There are three pieces of equipment for this testing. They are:

1. Test lamp
2. Continuity tester
3. Meters

TEST LAMPS

There are several types of test lamps that can be used for testing the condition of various electrical circuits. Neon lamps are used in some test lamps and these will glow at any voltage from about 50 volts and up. Test lamps can be homemade by wiring in series 2 or more lamp sockets and inserting in each a 110 volt lamp. If 5 or 6 lamps are used, the tester can be used on circuits containing as high as 600 V.

Voltage Test

A test lamp can be used to determine if there is a voltage between two wires. If there is the lamps will light. The lower the voltage, the dimmer the lamps will be. If two lamps (in series) are placed across 110 volt lines the lamps will each be at half brightness. The same lamps placed across 220 volt lines will each be at full brightness. Similarly test lamps with 4 lamps or 5 lamps in series can be used to determine when higher voltages are present.

Determine Grounded Or Ungrounded Lines

After determining that voltage is present, it is useful to know if one of the lines is grounded. Place the test lamp(s) across one of the lines and a known ground. In a properly installed system the boxes or the fuse panel is grounded, or the lamp can be placed across the line and a radiator or other ground. If the test lamp lights the line is ungrounded. If the lamp does not light, the line is either a grounded line or the ground being used to test is not really grounded.

Determine A Blown Fuse

Fig. 7.1 shows a part of a distribution system, including the layout of a house wiring system. Suppose an appliance connected to outlet 5-A would not operate. With the test lamp touch the ends of the test lamp to the plug contacts. If it lights there is power at the outlet and the fault must be in the appliance. If it does not light then there is no power at the outlet and perhaps the fuse is blown. Go to the fuse box and make the following check. With two lamps in series test across the top of fuses A and B. (Fig. 7.2)

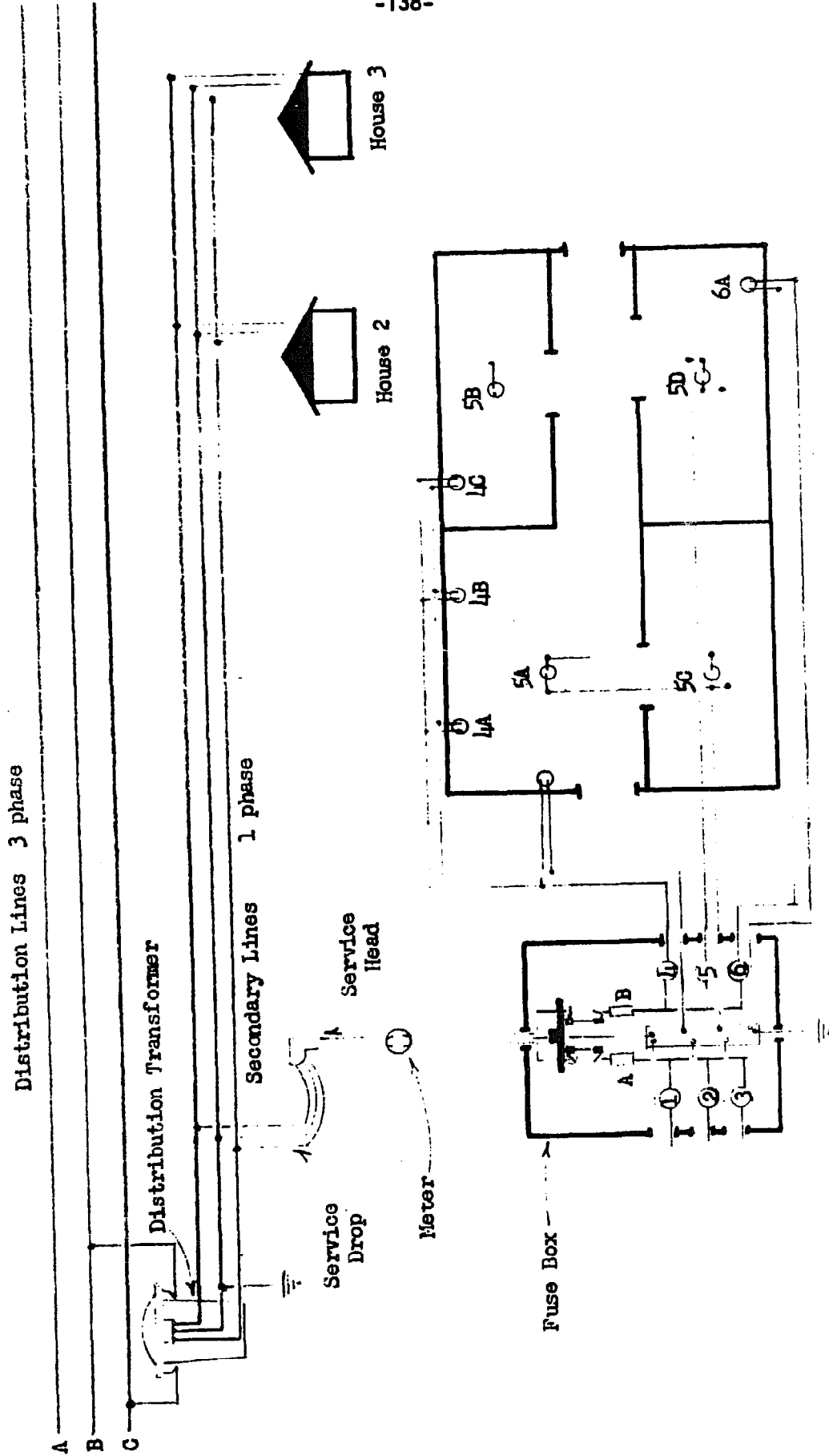

House 1

Fig. 7.1

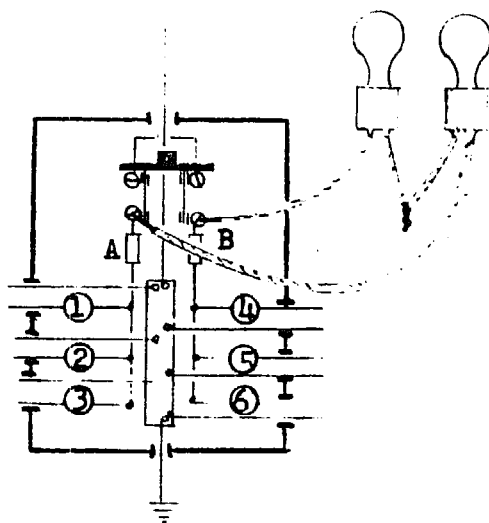

Fig. 7.2

If the lamps do not light then there is no power coming into the house. If they do light test to see if fuse A or fuse B is blown. This is done by placing the lamps across the top of one fuse and the bottom of the fuse to be tested. Fig. 7.3 shows the test for fuse B.

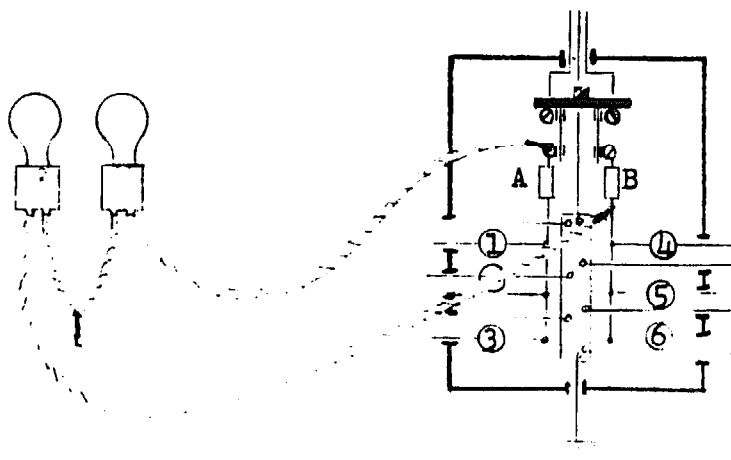

Fig. 7.3

If the lamps light, then the fuse is good. If the lamps do not light, then the fuse is bad and should be replaced. (See below the procedures to follow when changing a fuse).

If the main fuses are good, but there is no voltage at the outlet, test the circuit fuses. Fig. 7.4 shows the test for the fuse protecting circuit #5.

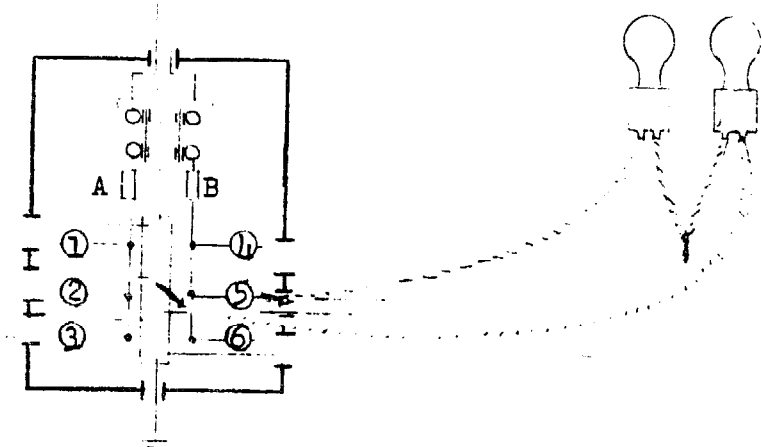

Fig. 7.4

If the lamps do not light then the fuse is blown. If they do light, they will only be at half brightness, since they are not across the full voltage (220V.) but only across one hot wire and the ground (110 V.). If they do light this indicates that the fuse is good and that there is a loose connection, a broken wire, and open switch or some other fault between the fuse panel and the outlet.

To check a fuse in a three phase circuit, shut down the motors and other loads in the circuit and then test to see that power is present at the fuses. If there is power on all three lines, then check the fuses as described for the main fuses of a house system. Place the test lamp across the top of one fuse and the bottom of another. If the lamp lights the fuse is good. Fig. 7.5 shows the test for fuse B.

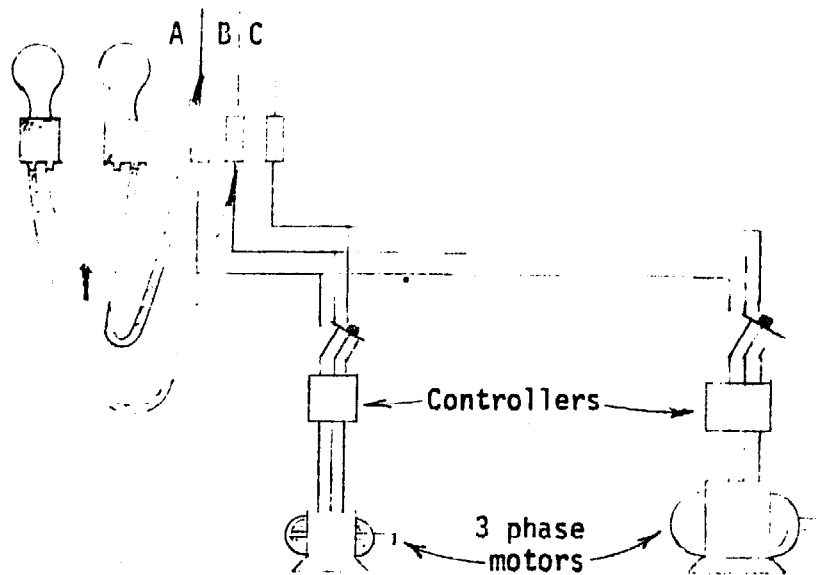

Fig. 7.5

CONTINUITY TESTER

Fig. 7.6 shows the construction of a continuity tester. It is made of a bell and batteries. When the test leads are touched together or when connected to a closed circuit the bell will ring. The continuity tester can be used for the following tests.

1. Short Circuits
2. Grounded Lines
3. Open Lines

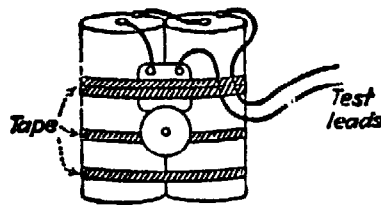

Fig. 7.6

Short Circuits

Before making any tests disconnect the power from the lines. A continuity tester must only be used on dead lines. If there is a length of cable that you suspect to be shorted between two of the conductors, follow the following steps. First, at the junction box at one end of the section of cable disconnect all the connections. Second, do the same at the other end of the section of cable. Third, connect the test leads of the tester across two wires at a time. It will ring when connected to the two shorted wires. Fig. 7.7 shows the connection of a continuity tester to find a shorted line.

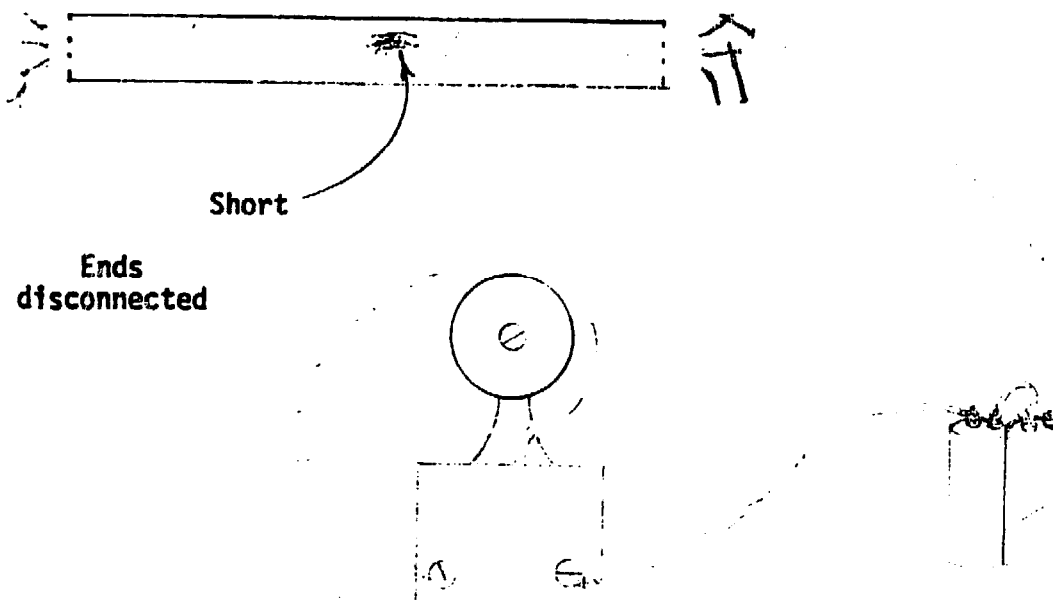

Fig. 7.7

Grounded Lines

The test for a grounded line is similar to the test for shorted lines. The only difference is the test is made between one of the open lines and a ground.

Open Lines

To test to see if a line is open, first disconnect all power from the part of the system that is being tested. Second, at one end of the cable being tested, connect all of the wires together in a firm (but temporary) splice. Third, at the other end of the section of cable connect the continuity tester across two lines at a time. It should ring each time as the circuit is closed at the other end. If it does not ring then one of the two lines is open.

METERS

A voltmeter is even better to use than a test lamp for it is able to indicate how much voltage is present rather than just that there is voltage. An ohmmeter can be used in place of a continuity tester but most ohmmeters use only a very small current and on longer lengths of line or when testing a poor ground they may not be reliable.

Whenever it is desired to know the amount of current or voltage present at a particular point in the system a meter should be used. It is always safest to disconnect the power when making the connections and then to reconnect the power to take the reading.

TROUBLE CORRECTION

When trouble shooting you are only half done when you have located the trouble. You now know why there is trouble and where this is. But you must ask, "Why?" If a fuse has blown, this is the reason that there is no power. But, you must ask, "Why did the fuse blow?" If a wire is broken you must ask, "What caused this wire to break?" Before correcting the obvious fault, these other faults must be corrected so that the same fuse won't blow again, or the wire break again because the cause was not corrected.

The specific corrections for various troubles are readily identifiable. If there is a bad connection, the connection should be opened and remade as if it were the first time it was being made. If there is a bad piece of equipment such as a switch or outlet plug, then this should be replaced. If there is a shorted cable this will need to be replaced or the circuit disconnected and not used. In most cases the skills needed to correct a trouble are the same skills needed for installation of that part of the system.

BEFORE ATTEMPTING TO WORK ON ANY PART OF THE SYSTEM, DISCONNECT THAT PART OF THE SYSTEM FROM THE POWER SOURCE.

FUSE REPLACEMENT

Suppose a fuse has blown. Before replacing it check all the outlets on that circuit to see what loads are connected. Total these loads and determine if the circuit is overloaded. If it is overloaded, disconnect some of the loads until the circuit is no longer overloaded. Now open the main switch and replace the fuse that blew with a fuse of the same rating. Close the main switch. If the problem was an overload, it has been corrected. If the fuse blows immediately, and the circuit is not overloaded there must be a short circuit either in one of the appliances or else in the wiring of the circuit. Before replacing the fuse again, disconnect all the appliances on the circuit and turn off all the lights. Now replace the fuse by again turning off the main switch, replacing the fuse and turning the main switch on. If the fuse again blows with all the loads disconnected, there is a short circuit in the wiring. Disconnect the main switch, and using the continuity tester, test to find where the short circuit is. If the fuse does not blow the short circuit is in one of the appliances. Connect the appliances one at a time. If the fuse does not blow when the appliance has been connected, that appliance is good. Disconnect it and try another appliance. Continue this process until the appliance that has the short circuit is connected and again blows the fuse. Disconnect this appliance and see that it is discarded or repaired. Now the other appliances may be reconnected and the fuse again replaced, always with a fuse of the same rating as the fuse that blew.

This is an example of how the cause was found for the blown fuse, and this cause corrected.

PREVENTATIVE MAINTENANCE

There is actually very little maintenance required by an electrical system. There are only two requirements of a maintenance program.

1. Periodically inspecting the system visually.
2. Performing the required preventative maintenance on all equipment and appliances as specified by the manufacturers.

PERIODIC VISUAL INSPECTION

It is wise to have the entire system inspected twice a year. Once in the fall and once in the spring.

Poles

Washout at ground line.

Rotting at ground line: Scrape away the earth from around the pole at the ground line to a depth of 2 or 3 inches. Use a short crowbar or hand spike to determine depth to which rot has penetrated.

Hollow rot: sound body of pole for hollow rot.

Splitting.

Effects of lightning.

Splitting or pulling of guys.

Twisting or raking.

Ground wire: See that this wire is rigidly supported and that it has not been cut or the cross section reduced to any considerable extent by linemen's spurs.

See that the connection between ground wire and ground rod has not been weakened by corrosion or mechanical injury.

Grass around base of pole: All grass, weeds, and any inflammable material should be kept cleared away from the base of the pole for a distance of 2 feet to reduce the fire hazard.

Crossarms

Rotting

Splitting and twisting (especially on double arms).

Loose, broken, or missing pins.

Loose or missing braces.

Insulators

Cracked: make close inspection for cracks.

Chipped or broken.

Unscrewed.

Wire

Broken wires.

Short circuits.

Twisted spans.

Loose connections.

See that the wire is clear of tree twigs, limbs, kite strings, hay wire, etc.

Delay necessary brush cutting until the autumn, except where there is danger of the brush fouling the lines in the interval.

Lightning Arresters (general)

Inspect pipe framework supports of arresters and paint with graphite if necessary.

Check gaps.

Check horns for loose bolts and position.

Inspect for loose ground connection.

Transformers

Inspect for Oil Leaks.

Ground

Make a mechanical inspection of all ground connections to transformer cases, transformer secondary wiring, and lightning arresters.

MAINTENANCE OF EQUIPMENT

All transformers, generators, motors, appliances, and any other equipment should be maintained according to the directions in the operation manuals provided by the manufacturers.

MANUAL OF STANDARD PROCEDURES

Once the electrification project is completed the only need for personnel will be to occasionally add a service drop, a small extension to the system, or to perform the routine maintenance and trouble shooting. It will be most helpful for the local workers that are assisting with this project if you prepare a manual that lists the particular steps to follow for a specific job. This manual should list all the installation, maintenance, and trouble shooting tasks that these workers will need to perform. With each of these tasks should be:

1. the procedures to follow
2. the tools and/or materials required
3. the safety precautions that must be observed/

PROJECT MAINTENANCE

LESSON NO. 1

LESSON OBJECTIVE: Describe and discuss trouble shooting procedures.

TOPIC	INSTRUCTIONAL PROCEDURE	SUPPLEMENTAL MATERIALS / RELATED READING
Definition of Trouble Shooting	Define the basic parts of trouble shooting. <ol style="list-style-type: none">1. Recognizing trouble2. Locating and determining type of trouble3. Correcting trouble	
Precautions	Discuss the precautions that must be observed in the correction and location of troubles. Review the safety rules of Section 2.	
Symptoms	List the symptoms of trouble in an electrical system. Discuss the causes of these symptoms.	
Locating and Classifying Faults	Describe the systematic approach to trouble shooting that must be followed to locate and determine the type of fault. <ol style="list-style-type: none">1. Test the sections of system for the trouble2. Isolate the section where the trouble is3. Isolate the location of the trouble in the section	

PROJECT MAINTENANCE

LESSON NO. 2

LESSON OBJECTIVE: Demonstrate construction techniques and use of test equipment.

TOPIC	INSTRUCTIONAL PROCEDURE	SUPPLEMENTAL MATERIALS / RELATED READING
Test Lamps	<p>Demonstrate how to make a test lamp.</p> <p>Demonstrate and discuss methods of connecting a test lamp to determine the presence of power, the identification of grounded and ungrounded lines and the presence of blown fuses.</p> <p>Have trainees practice using test lamps on various circuits.</p>	Carr, Sec. 1, pp. 56-79.
Continuity Testers	<p>Demonstrate how to make a simple continuity tester from a bell and batteries.</p> <p>Demonstrate and discuss methods of connecting a continuity tester to discover shorted lines, open lines and grounded lines.</p> <p>Have trainees practice using continuity testers on various circuits.</p>	
Meters	<p>Demonstrate and discuss methods of connecting meters to the electrical system when being used for test purposes.</p> <p>Have trainees practice connecting meters for use in trouble shooting various circuits.</p>	

PROJECT MAINTENANCE

LESSON NO. 3

LESSON OBJECTIVE: Discuss the procedures to follow when correcting the trouble just located.

TOPIC	INSTRUCTIONAL PROCEDURE	SUPPLEMENTAL MATERIALS RELATED READING
Trouble Correction	Discuss the underlying reasons for system trouble, the causes of the discovered trouble. Discuss how to locate the causes of system malfunctions.	
Correction Techniques	Review the installation techniques that will be needed for trouble correction. Have trainees locate and correct typical faults that have been purposely introduced by the instructor in the sample system.	

PROJECT MAINTENANCE

LESSON NO. 4

LESSON OBJECTIVE: Describe and discuss maintenance procedures.

TOPIC	INSTRUCTIONAL PROCEDURE	SUPPLEMENTAL MATERIALS / RELATED READING
Definition of Preventive Maintenance	<p>Define the parts of preventive maintenance.</p> <p>List the faults to look for in a visual inspection of the system.</p> <p>Show examples of each of the faults.</p> <p>Using the manufacturer's operation manual for the transformer, generator and motors installed during the training session, discuss and demonstrate the procedures for maintaining these pieces of equipment.</p>	Kurtz, Sec. 21.
System Operation Manual	<p>Discuss the need for an operator's manual for the system just installed.</p> <p>Have trainees prepare the outline of an operator's manual.</p> <p>List precautions to follow in writing the manual for use by local people.</p>	

BIBLIOGRAPHY

Alerich, Walter N.; Electric Motor Control, Albany, New York (Delmar Publishers, Inc.)

Bureau of Naval Weapons, Washington

Soldering for Electric and Electronic Application, Technical Inspection Manual Volume I, 1961

Carr, American Electrician's Handbook, New York (McGraw-Hill), Seventh Edition, 1953

Davis, J.F.; Use of Electricity on Farms, Agriculture Information Bulletin No. 161 Washington (U.S. Department of Agriculture, Agricultural Research Service), 1956

Davis and Kelly, Elementary Plane Surveying, McGraw-Hill Book Co., 1st Ed.

Department of the Air Force, Washington

Electrical Facilities, Safe Practices Handbook, Air Force Pamphlet 85.1 1967

Maintenance and Operation of Electric Power Generating Plants, Air Force Manual 85-19;;1967

Dickson, W.G., Electricity-Related Information, ed.: Albany, N.Y. (Delmar Publishers, Inc.) 1960

Electric Machinery Mfg. Co. The ABC's of Engine Driven Generators and Their Control

Frazier, Richard H.; Elementary Electric-Circuit Theory, New York (McGraw-Hill Book Company, Inc.), 1945

General Electric Company, How to Maintain Electric Equipment

Graham, Kennard C. Fundamentals of Electricity, 4th Edition, American Technical Society, Chicago

Hofmeister, Ralph H; Cost Analysis of Electricity Supply Systems for Rural Communities, General Electric Co. 1963

Instructional Materials Laboratory, 1885 Neil Avenue Columbus, Ohio

Basic Instructional Units for Electrical Trade

Electric Lineman - Learner's Manual, Series, 100,200,300 and 400

Residential Wiring - Learner's Manual

Kurtz, Lineman's and Cableman's Handbook, McGraw-Hill, 4th Edition

Lowen, Walter; Electric Vocational Training, VITA Report No. 8, Schenectady
New York (Volunteers for International Technical Assistance, Inc.) 1962

Montgomery Ward and Company

Electric Wiring

Wiring Simplified

REA Bulletins, Superintendent of Documents, U.S. Government Printing Office,
Washington, D.C. 20250

ABC's of Accounting and Interpretation of Financial Statements, No. 180-3

Application Guide for Watt-Hour Meters, No. 151-12

Engineering and Operations Manual for Rural Electric Systems, No. 160-1
1968

Guide for Establishing Continuing Property Records, No. 184-3

Safety Manual for Electric Borrowers, No. 168-7

Specifications and Drawings for 7.2/12.5 Kv Line Construction, No. 804

Transmission Line Manual, Mechanical Design, No. 62-1

Uniform System of Accounts, NO. 181-1

Richter, H.P. Wiring Simplified, Minneapolis, Minn. (Park Publishing, Inc.)
1965

Schuler, Albert; Electric Wiring, New York (McGraw-Hill), 1936

Sears, Roebuck and Company, Simplified Electric Wiring Handbook

Siskind, Charles; Electrical Principles and Practice, New York (McGraw-Hill)
1947

Siskind, Charles S. Electricity - Direct and Alternating Current, New York
(McGraw-Hill) 1955

State Education Department, Bureau of Industrial and Technical Education,
Albany, New York

Electrical Circuit Diagrams for Power, 1944

Electrical Trades for Vocational High Schools, 1958

Related Technology - Electrical Trades, Cooperative pamphlets

Stetka & Brandon, NFPA Handbook of the National Electrical Code, 1965
Edition New York, (McGraw-Hill), 1966

Stout, Melville B. Basic Electrical Measurements, New York (Prentice-Hall)
1950

Uhl, Nelson and Dunlap; Interior Wiring and Estimating, Chicago, American
Technical Society, Fourth Edition 1951

Van Valkenburg, Basic Electricity, Vol. 1-4, Nooger & Neville, Inc., New
York (John F. Rider Publisher, Inc.) 1954