

AT MICROFICHE
REFERENCE
LIBRARY

A project of Volunteers in Asia

Wind Power for Farms, Homes and Small Industry

by: Jack Park and Dick Schwind

Published by:

United States Department of Energy
Washington, DC USA

Paper copies are \$ 9.50 in the USA, \$12 outside
the USA. Ask for Document RFP 2841/1270/78/4 when
ordering.

Available from:

National Technical Information Service
Springfield, VA 22161 USA

Reproduction of this microfiche document in any
form is subject to the same restrictions as those
of the original document.

U.S. DEPARTMENT OF COMMERCE
National Technical Information Service

RFP-2841/1270/78/4

WIND POWER FOR FARMS, HOMES, AND SMALL
INDUSTRY

Jack Park, et al

Nielsen Engineering and Research, Incorporated
Mountain View, California

September 1978

RFP-2841/1270/78/4

WIND POWER FOR FARMS, HOMES, AND SMALL INDUSTRY

By
Jack Park
Dick Schwind

September 1978

Work Performed Under Contract No. EY-76-C-03-1270; EY-76-C-04-3533

Nielsen Engineering and Research, Inc.
Mountain View, California

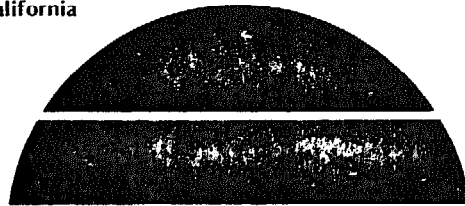

U.S. Department of Energy

REPRODUCED BY
**NATIONAL TECHNICAL
INFORMATION SERVICE**
U.S. DEPARTMENT OF COMMERCE
SPRINGFIELD, VA. 22161



Solar Energy

NOTICE

This report was prepared as an account of work sponsored by the United States Government. Neither the United States nor the United States Department of Energy, nor any of their employees, nor any of their contractors, subcontractors, or their employees, makes any warranty, express or implied, or assumes any legal liability or responsibility for the accuracy, completeness or usefulness of any information, apparatus, product or process disclosed, or represents that its use would not infringe privately owned rights.

This report has been reproduced directly from the best available copy.

Available from the National Technical Information Service, U. S. Department of Commerce, Springfield, Virginia 22161.

WIND POWER FOR FARMS, HOMES,
AND SMALL INDUSTRY

September 1978

by
Jack Park and Dick Schwind

Prepared under Contract No. E(04-3)-1270

by

NIELSEN ENGINEERING & RESEARCH, INC.
Mountain View, California

for

UNITED STATES DEPARTMENT OF ENERGY
DIVISION OF SOLAR TECHNOLOGY
FEDERAL WIND ENERGY PROGRAM
Washington, D. C.

NOTICE

THIS DOCUMENT HAS BEEN REPRODUCED FROM THE BEST COPY FURNISHED US BY THE SPONSORING AGENCY. ALTHOUGH IT IS RECOGNIZED THAT CERTAIN PORTIONS ARE ILLEGIBLE, IT IS BEING RELEASED IN THE INTEREST OF MAKING AVAILABLE AS MUCH INFORMATION AS POSSIBLE.

CONTENTS

<u>Chapter</u>	<u>Page</u>
1. INTRODUCTION - IS THE WIND A PRACTICAL SOURCE OF POWER FOR ME?	1-1
A summary of steps to assist in your decision-making process.	
2. WIND POWER - HOW IT WORKS	2-1
Basic Wind Turbine Aerodynamics	2-1
Work, Energy and Power	2-8
Wind Power	2-9
3. WIND BEHAVIOR AND SITE SELECTION	3-1
WIND POWER VARIATIONS WITH TIME	3-3
AVERAGE WIND POWER DISTRIBUTION IN THE UNITED STATES	3-11
WIND POWER VARIATIONS WITH HEIGHT AND LOCAL TERRAIN	3-14
Effect of Height on Wind Power	3-14
Effect of Regional and Local Terrain Features on Wind Power	3-17
YOUR WIND POWER	3-22
Making a Preliminary Estimate of Your Wind Power (Beaufort Scale)	3-23
Wind and Wind Power Measurement Equipment	3-28
Determining Your Wind Power	3-31
4. POWER AND ENERGY REQUIREMENTS	4-1
ELECTRIC LOAD ESTIMATION	4-1
MECHANICAL LOAD ESTIMATION	4-11
ENERGY STORAGE	4-17
Water System	4-17

CONTENTS (Continued)

<u>Chapter</u>	<u>Page</u>
5. THE COMPONENTS OF A WIND ENERGY CONVERSION SYSTEM	5-1
WIND SYSTEM PERFORMANCE	5-6
Comparing Different Types of Wind Machines	5-6
Wind System Power and Energy Calculations	5-13
WIND MACHINE ROTOR CONSTRUCTION	5-22
ELECTRIC POWER GENERATION	5-28
ENERGY STORAGE	5-34
Batteries	5-34
Pumped Water Storage	5-38
Hot Water or Hot Air Storage	5-41
Flywheels	5-43
Synchronous Inversion - Energy Storage in the Utility Company Grid	5-44
WIND SYSTEM TOWERS	5-45
OTHER EQUIPMENT	5-48
Inverters	5-48
Backup Equipment	5-49
6. SELECTING YOUR WIND ENERGY CONVERSION SYSTEM AND FIGURING THE COST OF ITS POWER	6-1
THINKING OUT YOUR MOST APPROPRIATE SYSTEM	6-1
A COMPARISON OF THE POWER COSTS USING TWO DIFFERENT WIND TURBINES	6-7
GATHERING THE FACTS FOR YOUR ECONOMIC ANALYSIS	6-8
Total Installed Cost	6-8
Expected System Life	6-10
Total Energy Yield	6-11
Annual Maintenance and Repair Costs	6-11

CONTENTS (Continued)

<u>Chapter</u>	<u>Page</u>
Expected Resale Value	6-12
Other Annual Costs and Savings	6-12
Effect of Inflation of Future Value Such as Cost of Energy	6-14
7. POSSIBLE LEGAL HURDLES	7-1
ANY RESTRICTION IN YOUR DEED?	7-1
WIND RIGHTS AND THE "NEGATIVE EASEMENT"	7-1
OBTAINING A BUILDING PERMIT	7-2
Zoning	7-2
Other Laws and Regulations Relevant to Land Use	7-4
Building Codes	7-5
SHARING, BUYING, AND SELLING POWER	7-6
Selling Power to Neighbors	7-6
Buying Power	7-7
Selling Excess Power to a Utility	7-8
WARRANTY, LIABILITY, AND INSURANCE	7-9
Liability of the Manufacturers and Installer	7-9
Liabilities of the WECS Owner	7-10
Insurance	7-10
8. THIS BOOK AND YOUR WIND SYSTEM - EXAMPLES AND OTHER WIND ENERGY INFORMATION	8-1
REFERENCES	R-1
GLOSSARY	G-1
APPENDIX 1 - WIND POWER IN THE UNITED STATES AND SOUTHERN CANADA	A1-1
APPENDIX 2 - OWNING A WIND SYSTEM	A2-1
Installing Your Wind Turbine and Tower	A2-1
Tower Raising	A2-3
Wind Turbine Raising	A2-3

CONTENTS (Continued)

<u>Chapter</u>	<u>Page</u>
Wiring	A2-8
Lightning Protection	A2-10
Installing Other Equipment	A2-10
Maintenance	A2-12
ENVIRONMENTAL IMPACT	A2-14
APPENDIX 3 - UNITED STATES - METRIC UNITS CONVERSION TABLE	A3-1

CHAPTER 1

INTRODUCTION

Is the Wind a Practical Source of Power for Me?

Wind systems have caught the public imagination. The idea of installing a machine which produces power out of thin air, allows its owner to thumb his nose at utility bills and turns a home into an energy self-sufficient castle is immensely appealing. Those who, in increasing numbers, have sought to make this idea a reality have found that harnessing the wind is usually neither as inexpensive nor as easy as it sounds. Unless you build your own, the initial cost of even a small wind turbine can be high. In most cases, utility power is still needed during windless periods and times of high power demand. And even with storage batteries, many wind system owners have found that wind power can meet only part of their energy requirement.

But despite these drawbacks and limitations, wind machine ownership can still be a satisfying experience. If your power costs are high, if you need mechanical or electrical power in a remote location away from existing utility lines, if you live in an area with documented high annual average winds, or if the use of alternate energy sources makes practical and philosophical sense to you, installing a wind turbine may offer definite economic and operational, as well as emotional, rewards.

This publication is intended to provide you with a basis for determining the practicality of wind energy for your particular situation. Whether or not it is a practical solution depends upon your specific energy needs and a variety of other considerations. If you decide that the wind is a practical energy source for you, other decisions are required, such as the type and amount of equipment you will need and whether to buy a wind energy conversion system (WECS) or build your own. This book will help you in making these decisions.

To decide if wind energy is practical for you, you will want to determine your energy requirements, your available wind energy resource and the equipment needed to convert and use the available energy. You will have to consider the cost of energy obtained from

FIGURE 1-1:

Steps for Determining the Practicality of a Wind System

- Evaluate the legal and environmental impacts (A2, Chapter 7)
- Evaluate your energy requirements (Chapter 4)
- Evaluate the wind resource at your proposed location (Chapter 3)
- Select system components (Chapter 5. 6)
- Evaluate cost of the system (Chapter 6)
- Re-evaluate energy requirements and legal and environmental impacts if necessary
- Evaluate alternatives in buying, installing, and owning a wind system

a wind system and decide if the wind is a practical source of power for you. This publication will provide you with the basic information or methods you need to make these decisions. You may already be familiar with material in some of the chapters. In that case, use this introduction as a guide to determining the chapters in which you would like to concentrate your efforts.

Figure 1-1 shows the steps necessary in your decision-making process. Each step in the table is discussed briefly in this introductory chapter; however, subsequent chapters provide more detailed information about each step. With the aid of this book, you may choose to proceed on your own through the entire decision-making process. Alternatives are to hire a consultant, or perhaps to seek advice from a manufacturer or distributor of wind machines.

The steps listed in Figure 1-1 are sequential. The results determined at any given step, however, may negate results already obtained from previous steps. You then may want to repeat an earlier step in search of a different answer that will satisfy the new information.

If your site is in a remote rural area, you may want to go directly to Step 2. But if it is in an area with strict building or zoning codes, you will want to check the applicability of these codes to a wind turbine. Examples of possible restrictions include structure height and distance from property lines and roads. There also are other considerations to keep in mind as you proceed through the decision-making steps outlined in Figure 1-1. There may be environmental issues such as visual impact and noise from your wind system. Social issues may arise such as getting along with your neighbors while your wind machine blocks their view of the sunset. You may be confronted with a "wind rights" problem (your neighbor erects a tall building upwind of your shiny new machine and renders it an idle art form in your yard). You must think each possible issue through and resolve whether or not to proceed further in your WECS plan.

Step 2 in Figure 1-1 calls for calculating your total energy requirements. One method is to look at your various monthly electric bills. These will tell how much you have used in the past. Try to relate this information to how you expect to use energy after you switch to a wind machine. Another way to assess your needs is to calculate the monthly energy demands (expressed in kilowatt-hours or kWh) by adding up the energy required to operate individual loads. Figure 4-2 shows the energy rating for most appliances and farm equipment in current use.

For pumping water, it is necessary to calculate the needed horsepower and the hours of pumping needed. This gives you horsepower-hours which, like kilowatt-hours, can be used as an energy assessment. Methods for making these calculations are given in Chapter 4. In some cases, you can simply determine gallons-per-hour of water you must pump and the total height you must raise the water (from well bottom to tank top, for example). Some water pumper manufacturers present performance data for their wind machines in terms of gallons-per-hour, height of water lift, and wind speed.

The third step calls for an evaluation of the wind resource at your proposed site. This step requires more than holding up a wet finger or seeking the advice of neighbors. Most people tend to overestimate wind speeds. The amount of time and money you spend on this task is directed by your need for accuracy and by the size and importance of your wind system (from the standpoint of safety and energy production). Your options are hiring a consultant to perform a wind site survey or doing the survey yourself.

Techniques used in a site survey have varying degrees of effectiveness. The crudest, of course, is the wet finger to intuitively find places to install a wind machine. Another approach is the use of the Beaufort Scale shown in Chapter 3. That table relates wind speed to the movement of trees and to other effects of the wind. You might contact a weather service for climatic data for your area or perhaps a local airport for its average wind speed. It is unlikely, however, that either source will have information pertinent to the exact area you have in mind. Average monthly wind power calculations for over 700 locations in the United States are included in Appendix 1. The most effective approach is using instruments--the placement of wind speed and wind direction equipment--to get actual site readings.

During your intuitive exploration and/or site instrumentation, you should have an awareness of the effects on wind speed by man-made and natural blockages. Examples are buildings, buildings, trees, and other features of the terrain. As shown in Figure 3-14, these obstructions interfere with normal wind speeds at given heights and thus will influence your eventual tower height.

In the field, you might measure a wind speed of 20 mph at about 30 meters high (98.5 feet, which is very high for a tower intended for a home or farm wind system). Back in the city, however, you may have to go as high as 200 meters to find the same wind speed as at 30 meters in the country. This is due to the interference that buildings have on air flow. It's somewhat better in the suburbs, but you can see that open country causes the least resistance to wind, and that higher towers will raise your machine up into stronger winds. Much of Chapter 3 and Reference 10 are devoted to the effects of obstructions on air flow.

Stronger winds have a critical effect on wind machines: a doubling of wind speed results in eight times more power available to your wind machine. This means that a location with an annual average wind speed of 12.6 mph offers twice the energy available compared to a site with a 10 mph average. This phenomenon is discussed more in Chapter 2.

Calculating an average wind speed per year based on limited observations can be difficult at best. Winds vary considerably during the year when viewed on a monthly basis. This variation is illustrated in Figure 3-3 for three different locations. Your site may have strong winds in winter and weak winds in summer. A nearby site may have little or no wind at all.

After analyzing available data to this point, you should know your energy requirements and energy resources (monthly and annual wind speed). Now is the time to match this information to determine the windmill size that will be needed. One means of doing this is shown in Figure 5-18B. As an example of how that illustration can be used, suppose you determine that 500 kilowatt-hours of energy will be required. By means of a few simple calcu-

lations (described in Chapter 5), it is resolved that 2000 watts of power would be required from the wind generator when the wind blows at its average speed. Suppose now that your site analysis indicated an average wind speed of 10 mph. Referring to Figure 5-18B, it is noted that no curve for windmill diameters crosses the intersection of 10 mph and 2000 watts. If another curve were to be drawn across this point, it probably would indicate a 40- or 50-foot diameter machine. If you think that this size windmill is too large for you, your budget, neighbors, or site, you have two alternatives: reduce your energy needs or find a site with a greater average windspeed.

As another example, assume that you reduced the energy needs just mentioned to 500 watts. On Figure 5-18B, a curve crosses very close to the intersection of 500 watts and 10 mph. That curve indicates a wind machine 20 feet in diameter. You might be able to better cope with a machine this size.

These are two examples, each illustrating a different type of conclusion. The ultimate conclusion, however, is based on more than the analysis just discussed. Attention also should be given to the wind system's intended application and to the importance of size, cost, and to other factors.

Selection of the type and brand of wind system, tower, and other components will require careful consideration. There are various types of wind machines to choose from. Figures 1-2 and 1-3, for example, show two different types of machines. They are similar, however, in having propeller type blades mounted on a horizontal power shaft whereas the machine in Figure 5-5 has with a vertical shaft. There are other shapes for wind machines, and there are several manufacturers for practically all of the proven types. More types and brands of machines are emerging continually.



FIGURE 1-2: American farm windmill.

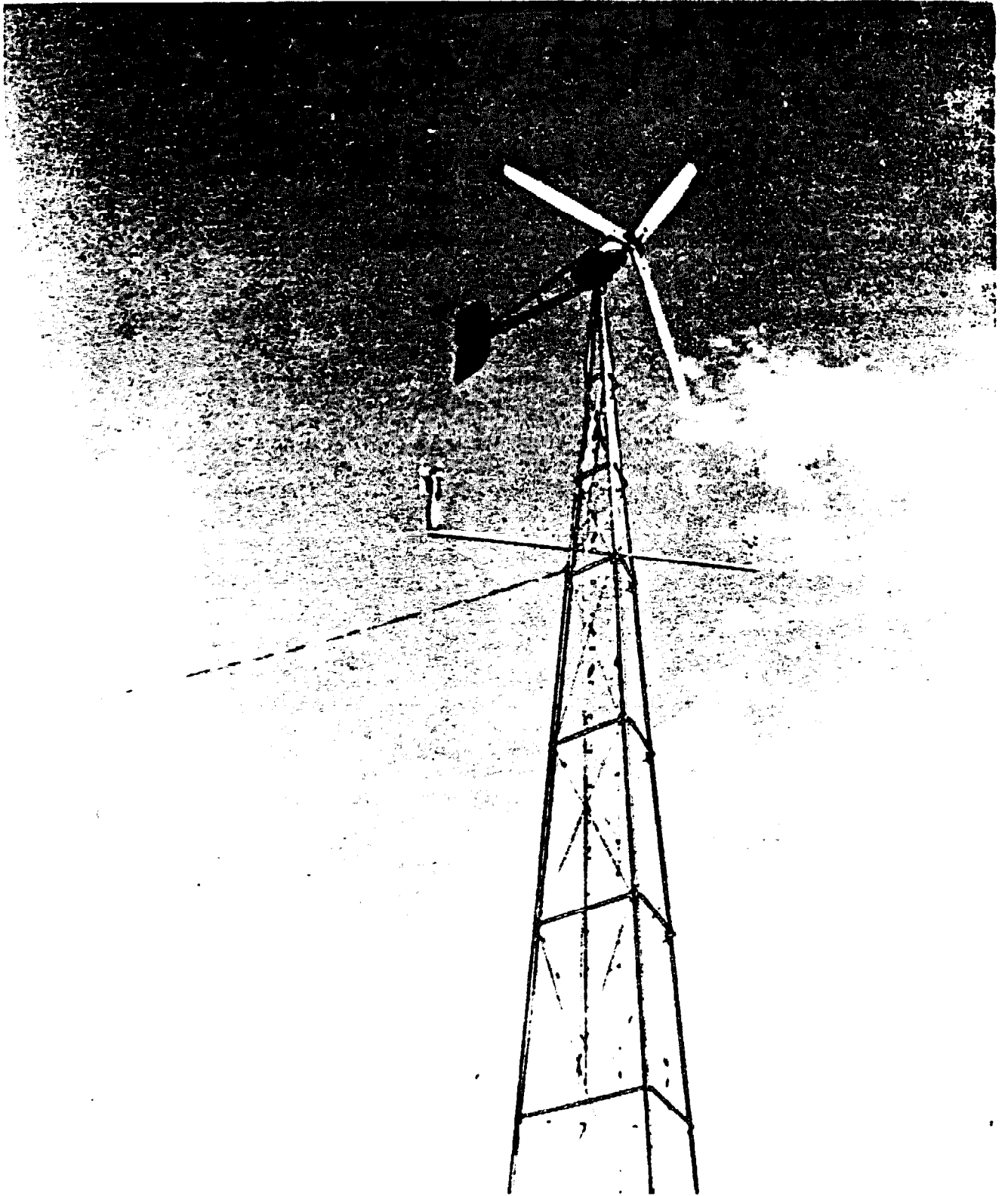

FIGURE 1-3: Pre-REA wind turbine.

The U.S. Department of Energy (headquartered in Washington, D.C.) and the American Wind Energy Association (54468 Cñ 31, Bristol, Indiana 46507) work together closely to maintain current lists of manufacturers. The Department of Energy has a Small Wind Systems Test Center located at its Rocky Flats Plant near Golden, Colorado. Many of the different brands and types of wind machines are tested at the Center in an effort to promote product improvement. Results from these tests will be available to the public.

Selection of a wind electric machine will be followed by selection of the tower, batteries, inverters, and other devices in the case of battery systems. For a non-battery electric system, a synchronous inverter or wind furnace heating element may be selected. A water pumper system requires the selection of a wind machine, tower, pumps, and plumbing.

Figure 5-33 illustrates the interrelationship of components in one wind electric system. It shows a system in which the wind generator charges a set of batteries where the energy is stored. The batteries then supply electric power to various loads such as lights, motors, refrigerators, and television sets. Included is a backup generator that charges the batteries in the event of an extended low-wind period or during a period of extra heavy energy usage.

At the same time as equipment is being selected, cost factors begin to appear. Figure 6-6 illustrates the trend usually experienced in installation planning. For small wind systems (under 30 to 40 kilowatts maximum power rating), the trend is for larger installations to be less expensive per kilowatt of rated power.

In a complete cost analysis, you might estimate such factors as initial costs, interest and insurance costs, maintenance costs, and energy yield over the life of the equipment. Dividing total estimated costs (dollars) for the life of a windmill by total energy production (kilowatt-hours) provides you with a cost estimate of energy expressed in dollars per kilowatt-hour. You then can compare this directly with other sources of energy or other potential wind system installations.

In preparing a system plan, you may discover it sometimes is more desirable to reduce your energy usage than to buy a larger wind machine. It is almost always prudent to evaluate your options in the area of conservation. It also is well to allow for future growth in energy needs, but many times you will still find that a good system plan can be vastly improved by saving more power.

After deciding what equipment is wanted, you have three options as to how the equipment will be purchased: (1) buy directly from the manufacturer, (2) buy new or used equipment from a dealer, or (3) buy used equipment from someone else. Purchasing is important enough to warrant a brief comment on at least the first two alternatives.

Buying factory-direct may seem to be a way to save time or money, and for some folks it may be; but is the factory fully equipped to come out and install your machine and maintain it? If it isn't, are you? Many wind turbine manufacturers simply do not offer such services and you should check before you buy. If you hire someone to do such work, don't overlook the liability aspects that might be involved.

Dealers are usually organized and staffed to provide all of the services you need in addition to offering the products needed to fully equip your system. Again, it is essential to ask if the dealer provides planning, installation and maintenance services. Generally they will help you perform all of the system planning tasks discussed here.

Where you go from here depends on how helpful this introductory chapter was to you. If you need more information, use Figure 1-1 and the various chapters, as identified in the table of contents, to guide you through the book. Additional data on wind machines or manufacturers can be obtained from The American Wind Energy Association.* Also, a great deal of assistance can be obtained if there is a dealer in your area.

*American Wind Energy Association
54468 CR 31
Bristol, IN 45607

The drag effect was used by early windmill builders to great advantage. A diagram of a simple panemone, like the machines they built, looks something like Figure 2-2. Notice that one vane is broadside to the wind. On this side of the machine, wind force (drag) will be strong. On the other side of the center shaft, the vane swings around edgewise to the wind and the drag is much less. Thus the machine turns, pivoting about the center shaft. This is how most drag machines work, although not all of them feature the pivot-mounted vanes. Elsewhere in this book, you will see other examples of this type of wind machine.

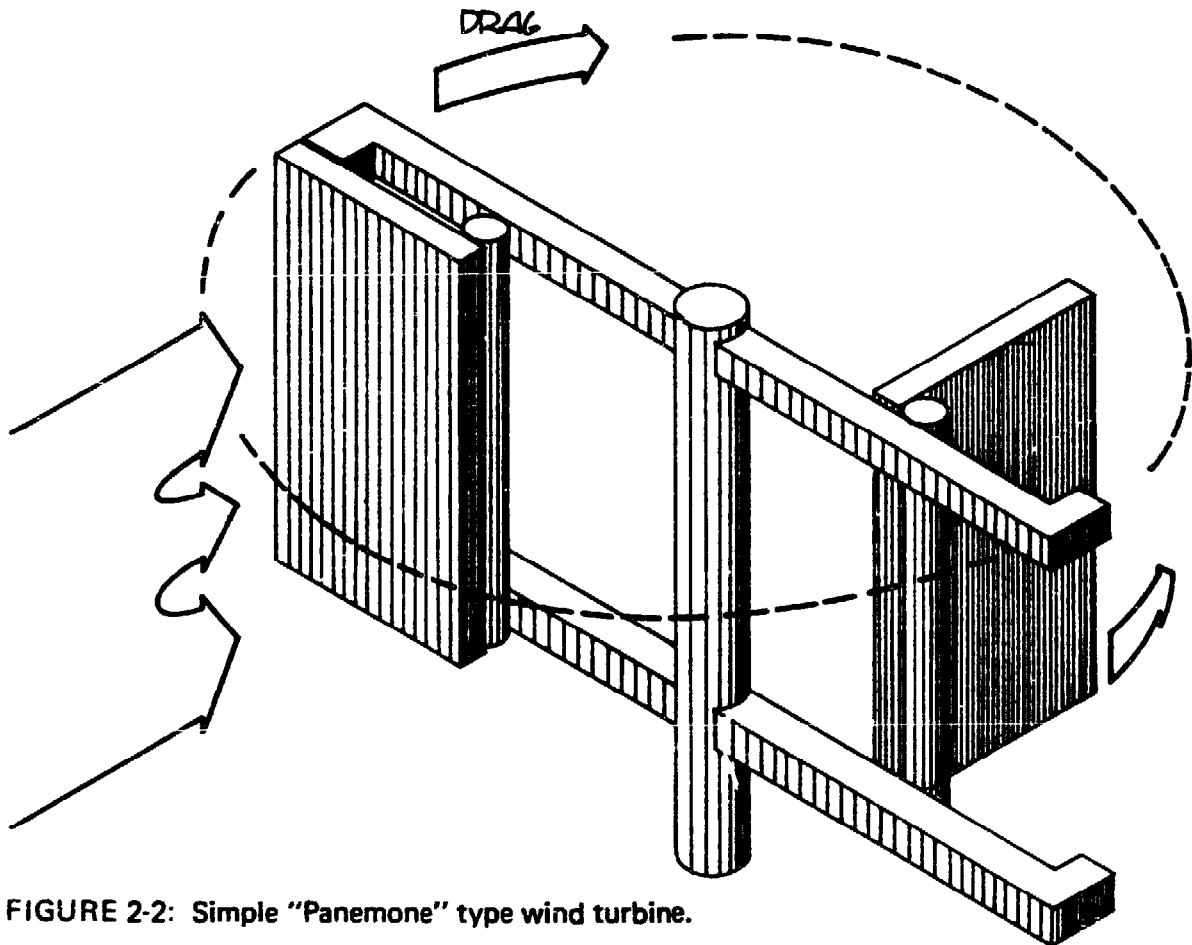

FIGURE 2-2: Simple "Panemone" type wind turbine.

The other way in which wind can exert its force on a wind machine is by the aerodynamic action called lift. Lift is a force produced on airplane wings in flight (Fig. 2-3). Notice that airflow around the airfoil-shaped blade tends to change direction slightly. A low-pressure area (like suction) forms over the curved side (topside) of the airfoil, and a high-pressure area

CHAPTER 2

WIND POWER - HOW IT WORKS

Basic Wind Turbine Aerodynamics

Basically, wind turbines extract power from the wind when the rotors are pushed around by moving air. There are two primary ways in which the wind can accomplish this. One way is illustrated in Figure 2-1. It is a diagram of a parachute that tugs on a rope that in turn lifts a bucket of water from a well. Indeed, it is a wind machine. Important here, though, is the parachute tugging. It is caused by drag, which is the same force* you experience while holding your hand in the breeze outside your car while motoring along the highway. Wind is actually pushing the parachute along.

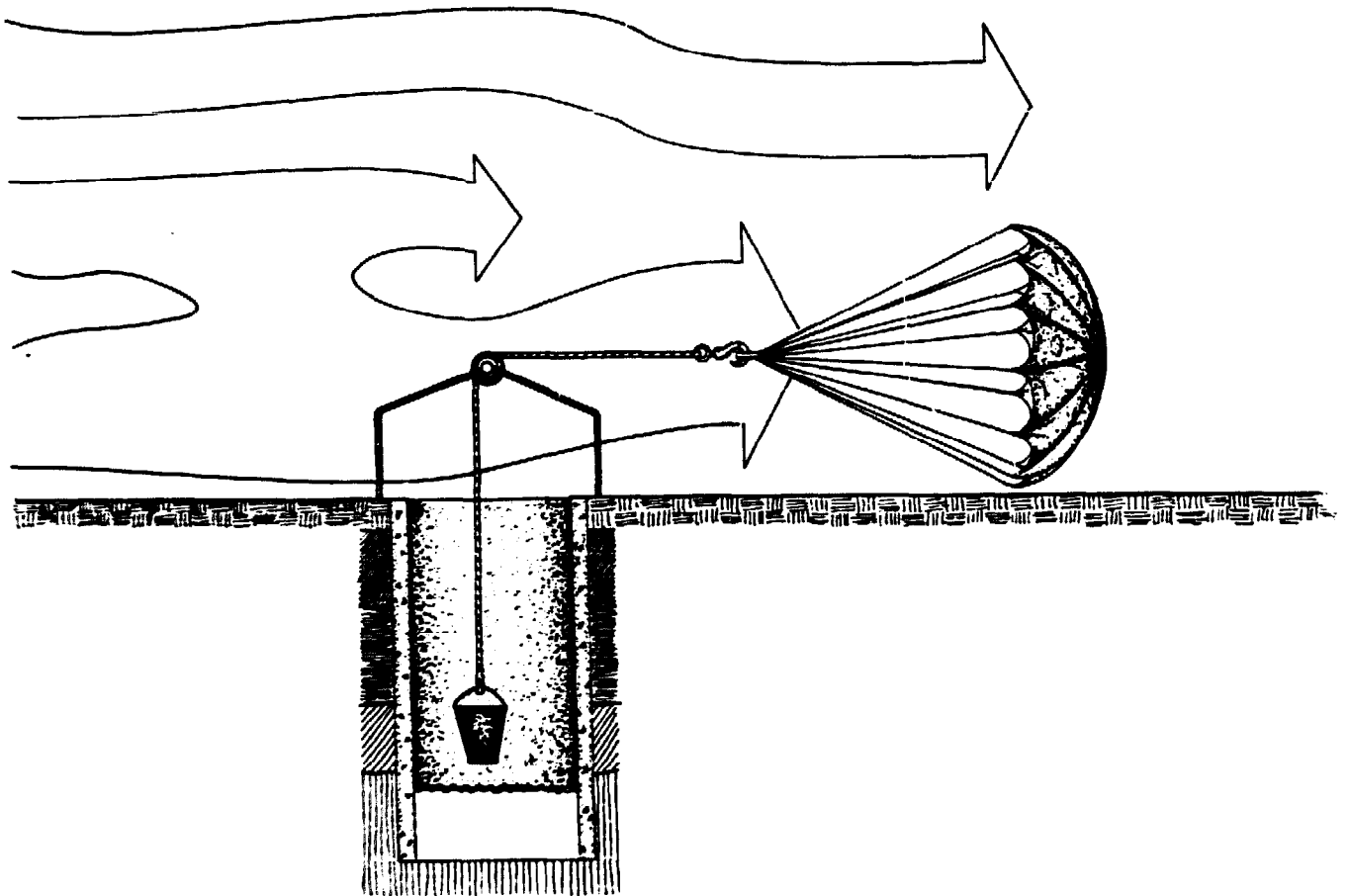

FIGURE 2-1: Simple wind-powered water pump.

*Terms like force, power, and energy are more technically discussed later. Also see the Glossary.

(pushing upward) forms on the bottom. The result is a force upward and perpendicular to the wind direction; this makes the lift arrow point slightly forward in Figure 2-3. Drag is also produced because the wind is being slowed slightly in the process of creating lift.

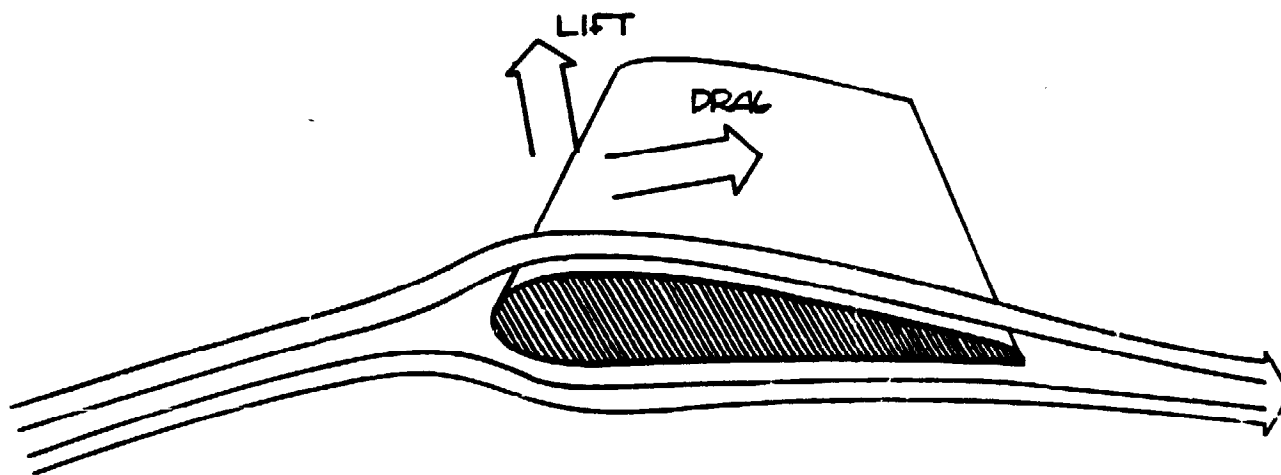

FIGURE 2-3: Forces acting on a wind turbine blade.

You can perform simple experiments to verify lift. Take a sheet of stiff cardboard or a wood slat about the size of a 3-by-5 inch filing card. During a trip in an automobile, at about 30 mph hold the sheet or slat out in the wind.

You are now ready to experience lift and drag. Gripping one end only, hold the board with its long dimension pointing outward from the car. Hold it edgewise to the wind. Let us call the edge at the front end the leading edge. Point the leading edge slightly upward; you should experience a slight upward lift. Point it slightly downward; you should now experience a slight downward force (also called lift by engineers). Somewhere between upward and downward lift is an angle that produces no lift at all. See if you can find this angle of zero lift. It may not be parallel to the ground because your car bends the airflow around the windshield, fenders, and over the hood.

At the angle of zero lift, notice that a slight amount of drag is produced. Drag will tug the board aft. Now, tilt the board about 90° , leading edge up. Notice that the drag has greatly increased. You might drop the board at this point if you are moving too fast.

Now, to discover lift and drag working together, return the leading edge to the zero-lift position. Slowly rotate the board, leading edge upward. Notice lift increasing. Notice drag also increasing. Lift will increase a little faster than drag, then suddenly drop substantially while drag continues to rise. This occurs with the leading edge somewhere near 20° above the zero-lift angle. Engineers say the wing (your board) has stalled.

During this experiment you will realize that at some particular angle, lift is much greater than drag. Lift is the force used to power wind machines designed for high efficiency, and this region of highest lift with low drag is very important to windmill designers.

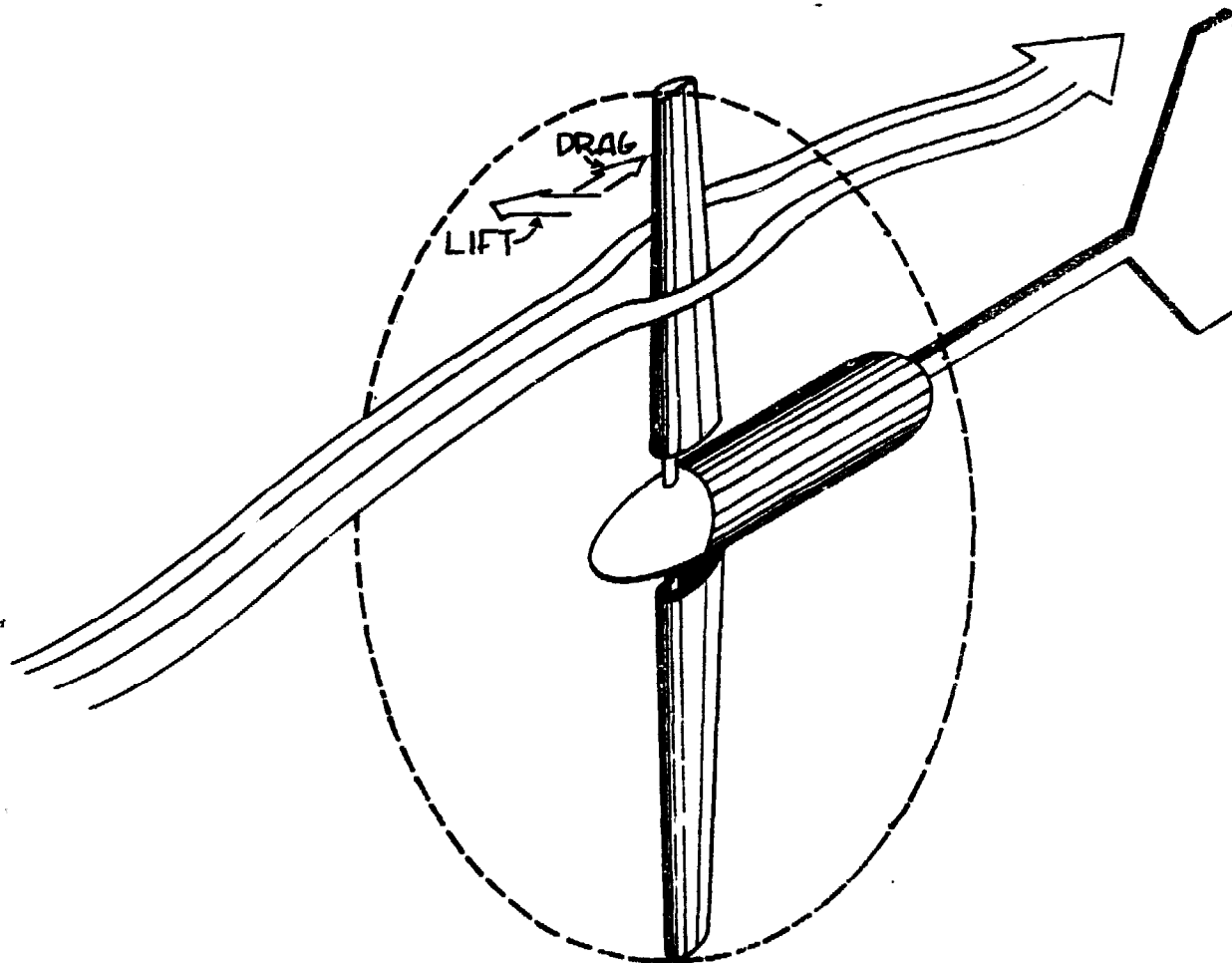

FIGURE 2-4: From lift to power – horizontal-axis wind turbine.

How does a wind machine use lift as the power-producing force? Let us look at a diagram of a familiar propeller-type wind turbine (Fig. 2-4). Notice that the blade performs its slight bending action on the windstream, with low-pressure and high-pressure sides similar to those shown in Figure 2-3. Lift is produced, as illustrated, generally in a direction that pushes the blade along its path.

Drag is also produced, as you might expect, and this force tries to bend the blades and slow them down in their travel around the center power shaft. In addition, the drag force tries to topple the tower that supports the wind turbine. Designers would like high lift at low drag for this type of wind machine. Figure 2-5 illustrates a typical wind generator designed for high-lift, low-drag operation.

Figure 2-6 shows a Darrieus wind turbine, sometimes called an "eggbeater" type of wind machine. Unlike the propeller type in Figure 2-5 with its power shaft pointing horizontally into the wind, the power shaft of the Darrieus is pointed across the wind. It could be horizontal as long as it pointed across the wind, but designers have found it to be more practical for the shaft to be vertical.

Chances are, you found it easy to see how the propeller blade of Figure 2-4 was pulled along, but the functioning of the Darrieus blade of Figure 2-6 is less obvious. You will agree, though, that sail boats can be sailed in circles. If you sit and visualize how a sailboat has wind first on one side of the sails, then on the other as it travels around, you can begin to see how the Darrieus works.

In the propeller case (Fig. 2-4), the lift force always pushes the blade along at about the same force, pivoting it about the shaft. With the Darrieus (Fig 2-6), the lift force almost always tugs the blade along its path but never with a constant force. At two areas along the path, lift is very weak. You can see that this occurs when the blade is pointed directly into the wind and directly downwind. At all other points along the blade path, lift tends to be much stronger and generally pulls the blade along its path. For this to work well, the blade must be moving along its circular path much faster than the wind is blowing. We discuss blade speed and wind speed in greater detail in Chapter 5.

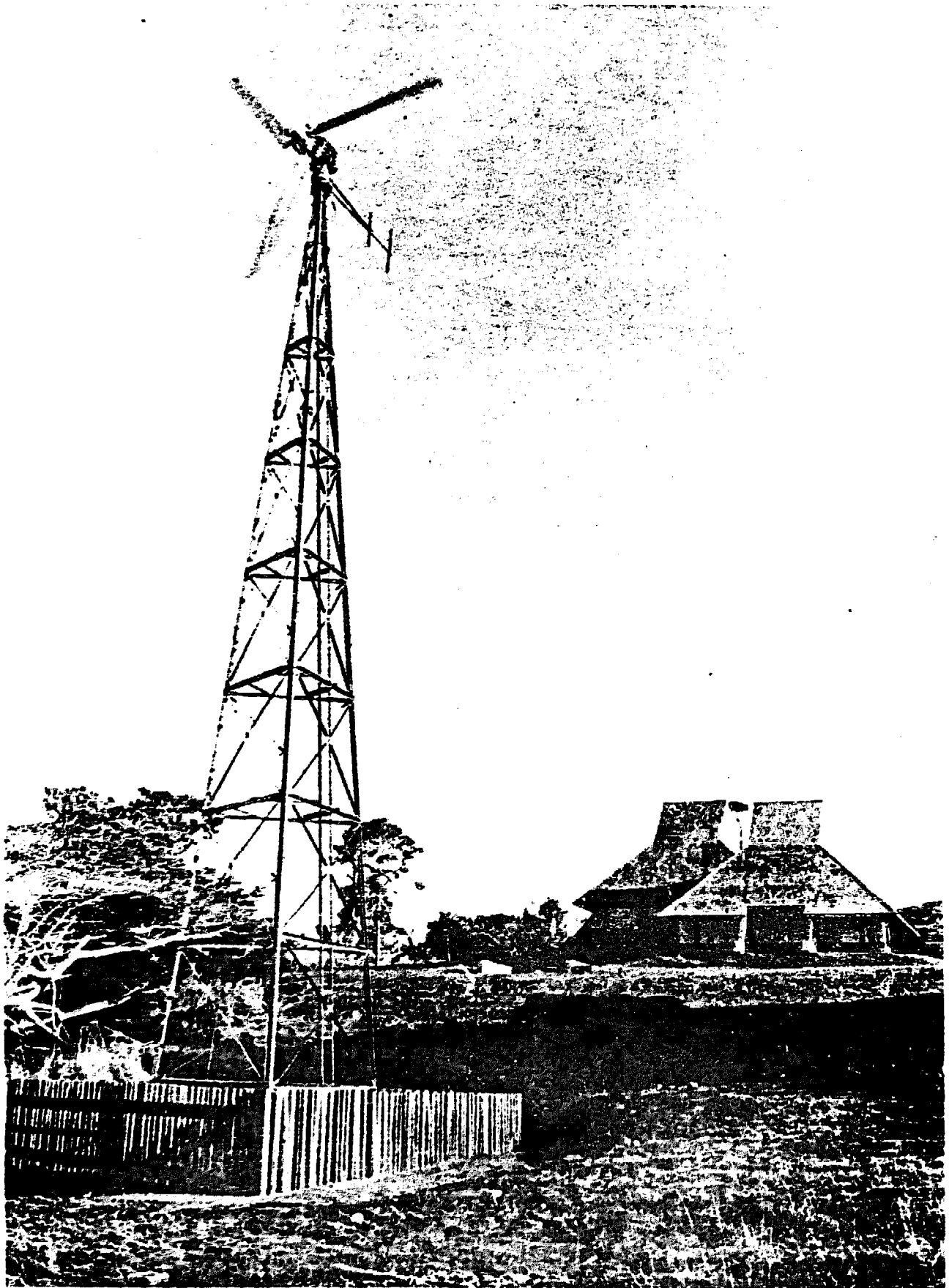

FIGURE 2-5: Propeller-type wind turbine generator.

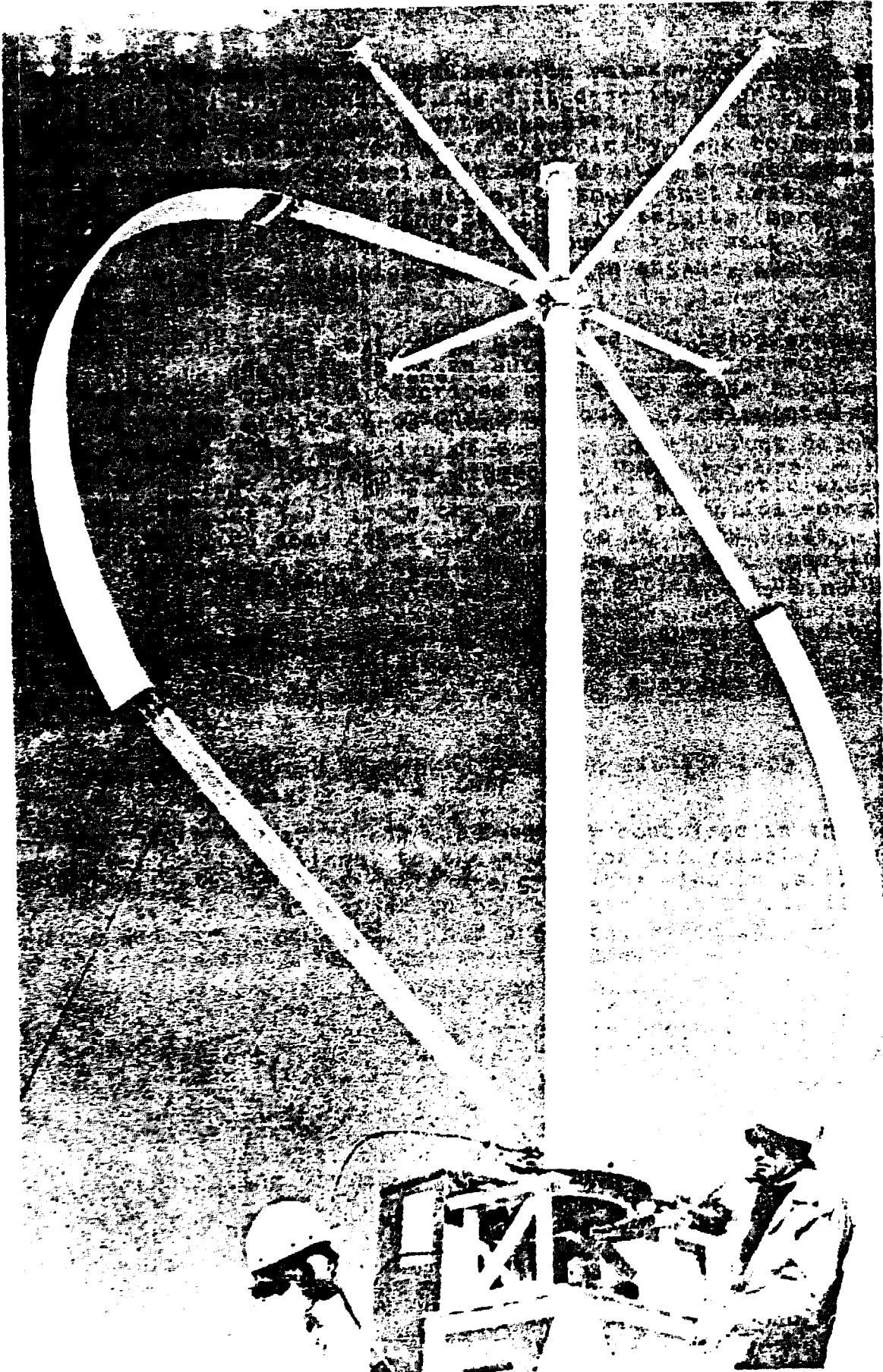

FIGURE 2-6: Darrieus Rotor.

Work, Energy and Power

A good understanding of work, energy, and power is not completely necessary for using this book, but in most situations it will be very helpful. For instance, does a 12-volt, 100-amp-hour battery store power or energy? The words power and energy, while often used interchangeably, have different and important meanings.

A length and force are needed to describe amounts of work. Work and velocity are needed to describe power, and power multiplied by time equals energy.

Work is performed when a force is used to lift, push, or pull some object through a distance. The amount of work done is determined by multiplying the force applied by the distance travelled (assuming the direction of the force is the same as the direction of travel). For instance, raising a 550-pound rock (250 kilograms*) one foot (0.305 meter) requires 550 foot-pounds of work.

Mechanical power is the rate at which that work is performed. That is, the force applied to an object times the velocity of the object (in the direction of the force), gives the power applied to it. For instance, if a windmill raises the 550 pounds of water at the rate of one foot per second, it is doing 550 foot-pounds of work per second, which is one horsepower (1 hp).

Electric power, as distinguished from the mechanical power just discussed, is measured in watts, kilowatts (1000 watts), and (by a power company) in megawatts (1000 kilowatts). One horsepower equals 746 watts of electric power.

If we operate a 1 hp motor for ten hours at full capacity, 10 horsepower-hours of energy will have been consumed, assuming that the motor is 100 percent efficient. Similarly, since 1 hp equals 746 watts, then $746 \times 10 = 7,460$ watt-hours, or 7.46 kilowatt-hours (kWh) of electric energy will have been used, again assuming 100 percent efficiency.

More realistically, let us assume the electric energy is consumed at 50 percent efficiency. This means that half the power going into the motor is wasted. Then, to get 1 hp-hour out (7.46 kWh), we need to put twice this amount in (2 hp-hour, or 14.92 kWh).

Power is usually measured in hp (mechanical) and watts (electric), while energy is usually measured in hp-hour (mechanical) and kWh (electric). Electric energy consumption at constant power is simply power (kW) multiplied by the length of time involved (hours).

*Common English-metric conversions of these and other measurement units that may be of use to you in your future energy considerations are given in Appendix 1.

For our purposes, we can conveniently categorize energy and power as electrical or mechanical, as just described, or thermal (heat). Mechanical power is converted to electricity by a generator. A motor, for instance, converts electricity back to mechanical power. Because inefficiencies in both devices produce some heating, they usually need ventilation to remove that heat. An electric heater, of course, converts the electricity (more accurately electric power) that passes through it to heat. Heat energy is converted to mechanical energy by an engine, such as an internal combustion engine.

Mechanical power is most often generated and transferred through a rotating shaft (such as an auto drive shaft or motor shaft). Mechanical power is described as a force times a velocity. For rotating machinery, mechanical power is calculated from shaft torque times rpm.*

Mechanical energy can be either potential or kinetic energy. A weight held in your hand above the ground has potential energy. It can potentially do some damage if you drop it because the potential energy, due to its height above the ground, is continually transformed to kinetic energy as the weight speeds up. This kinetic energy is the result of speed and weight. In fact, kinetic energy increases with the square of the speed (speed times speed) while the weight is falling. That means that if the speed doubles while a weight is falling, the weight then has four times the kinetic energy.

Wind Power

The kinetic energy in the wind (energy contained in the speeding air) is proportional to the square of its velocity (just as for a falling weight). Kinetic energy in the wind is partially transformed to pressure against an object when that object is approached and air slows down. This pressure, added up over the entire object, is the total force on that object.

Power, we noted earlier, is force times velocity. This also applies to wind power. Since wind forces are proportional to the square of the velocity, wind power is proportional to wind speed cubed (multiplied by itself three times). If the wind speed doubles, wind power goes up by a factor of eight. This is an extremely important concept in wind power generation. To demonstrate this, consider that the blades of a conventional type of electricity-generating windmill function much like an airplane propeller (the blade shapes, however, are much different). In Figure 2-7, three propeller-driven airplanes are used to demonstrate this velocity-cubed effect.

* A useful expression relating torque and rpm to horsepower is:

$$\text{horsepower} = 0.190 \times \text{torque} \times \text{rpm} \div 1000$$
 where the torque is in foot-pounds.

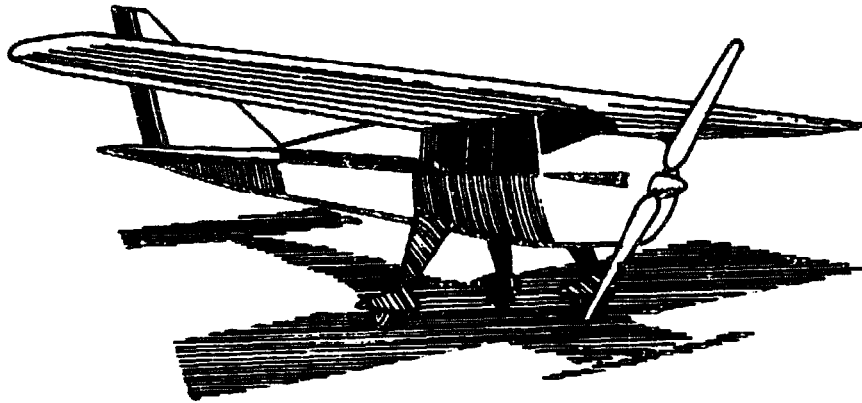

A. 100 mph from 100 hp.

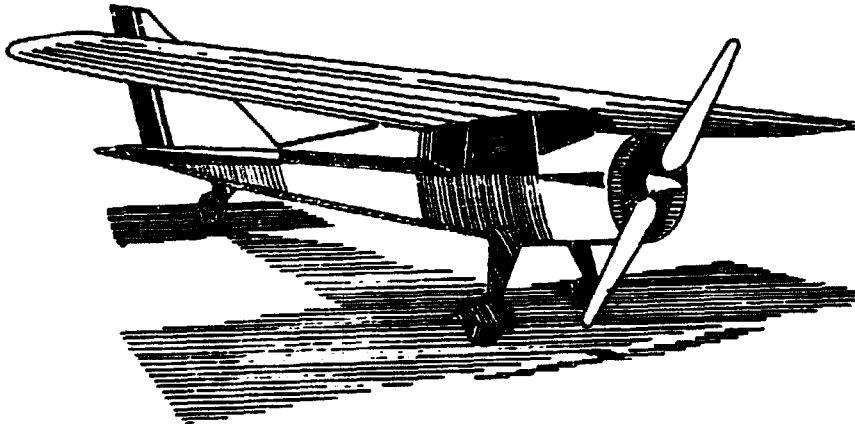

B. 200 mph from 800 hp.

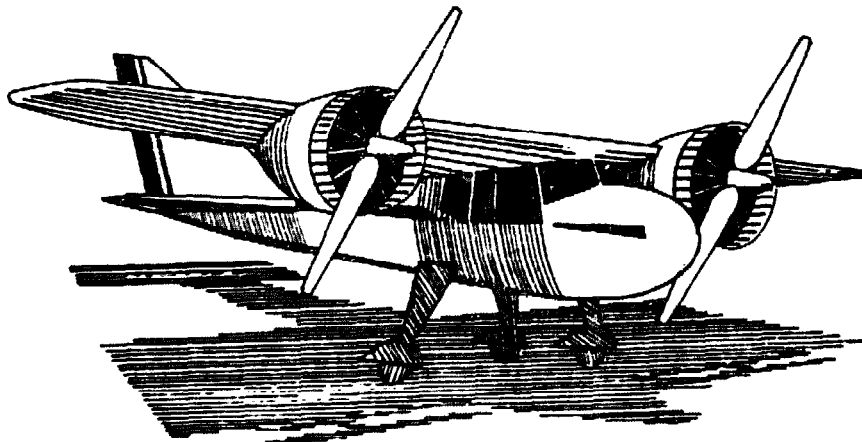

C. 300 mph from 2700 hp.

FIGURE 2-7: Power requirement increases with the cube of velocity.

Here, as air speed increases from 100 to 200 to 300 miles per hour (44.7, 89.4, 134.1 meters per second), the power required increases from 100 to 800 to 2700 horsepower (74.6 to 597 to 2013 kilowatts).

As you can see, increasing the speed capability of the 100 mph airplane to 200 mph means an engine change from 100 hp to 800 hp (double the speed, eight times the power). Also, to get 300 mph, we need 27 times the power, $3 \times 3 \times 3 = 27$. As shown in Figure 2-7, we have gone from a slow, good little plane to something that is bound to have to be rocket-launched, at extreme risk to the pilot and the reputation of the structural engineers required to keep the thing together.

Incidentally, perhaps a word can be said here, drawing from the above example, about the idea of scaling up a 10-foot diameter wind turbine to, say, 100 feet in diameter. New structural problems must be considered.

Wind turbine blades take energy from the air rather than put energy in like a propeller, so when wind speed doubles, the power that can be extracted is eight times as great. When the wind speed triples, the power that can be extracted is 27 times greater. This tremendous effect of cubing the velocity can place great importance on the process of determining the best wind turbine location and emphasize the selection of the correct machine for your wind speeds.

The power that wind turbine blades can extract from the wind is given by the expression:

$$\text{Power} = \frac{1}{2} e \times k \times A \times \rho \times V^3$$

where:

x = indicates multiplication (see Appendix 3)

e = efficiency of the blades

k = conversion factor for units (e.g., if units on the right side are feet, pound, and seconds, and results are desired in kilowatts)

A = area swept out by the blades ($\pi \times \text{blade radius}^2$ for conventional wind turbines)

V = wind velocity, far enough upstream so as not to be affected by the wind turbine

ρ = Greek letter rho; equals the density of air.

The terms e , k , and ρ need describing.

The efficiency of the blades in converting the kinetic energy in the wind to rotational power in the shaft needs some careful consideration. If all the kinetic energy in the air approaching a wind turbine were extracted by the spinning blades, the air would stop, like a car losing all its kinetic energy when it crashes into a wall. However, the air cannot stop, otherwise all the rest of the air behind it would have to spill around the rotor. Nature does not work that way. The air senses any solid object that it is approaching and moves around it, like the airflow around your automobile. When air approaches a partially solid object, such as the disc created by a spinning rotor, some of the air moves around it. The rest slows down as power is extracted by the windwheel. Figure 2-8 illustrates how air, starting far upstream of a conventional windmill rotor, travels past the rotor. This airstream starts out being somewhat smaller than the windwheel but gradually expands to the windmill rotor size as it passes through. At this point, some of the power is taken from the wind. The power extracted by the windwheel, divided by the power in the undisturbed wind passing through a hoop the same size as the rotor, is called the rotor power coefficient, or more commonly, the rotor efficiency. Because some of the wind passes around, rather than through, the windwheel, the efficiency must be less than 100 percent.

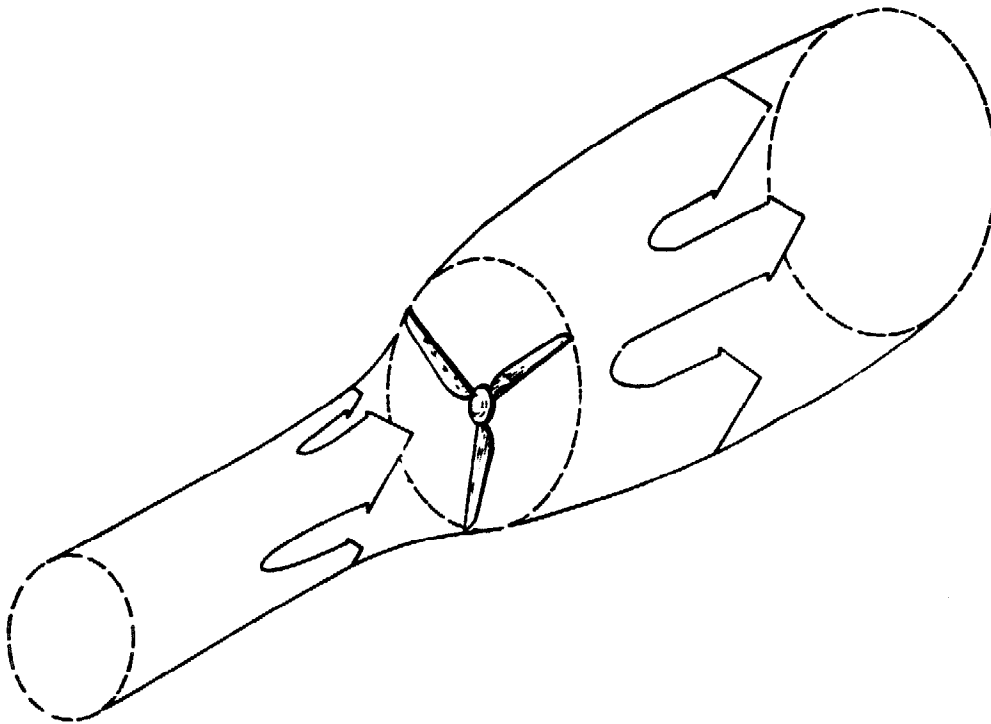

FIGURE 2-8: Airstream expansion through a rotor.

Using laws of physics, engineers have shown that the maximum efficiency of a conventional wind system cannot exceed 59.3 percent. The same laws of nature that have been harnessed to produce our present industrialized world and send men to the moon dictate this limit. Wind system efficiencies that are claimed to be greater than this are suspect.* We have been discussing, however, horizontal-axis machines without a tip vane or surrounded with sheet metal to direct the flow. More power can be extracted from the blades if a duct is placed around the rotor, but then, if the maximum duct cross-sectional area is used in the equation, rather than the blade rotor area, the maximum efficiency possible is still about 59.3 percent.

Well-designed blades operating at ideal conditions can extract most but not all of the 59.3 percent maximum power available. About 70 percent of this 59.3 percent is typical. Thus, a wind turbine rotor might have an advertised power coefficient, or efficiency, of $0.7 \times 0.593 = 41.5$ percent. Also, gear box, chain drive, or pulley losses, plus generator or pump losses (Chapt. 5) could decrease overall wind turbine efficiency to about 30 percent. This is about the maximum coefficient possible from a conventional, well-designed wind turbine, operating at its best condition. It can be much less (see Chapt. 5 for typical wind turbine component efficiencies).

The density of air at 60°F at sea level is 0.0763 pounds per cubic foot (1.22 kilogram per cubic meter). The densities at various altitudes divided by the sea level density (we will use the symbol DRA for density ratio at altitude) are:

Altitude, feet	0	2,500	5,000	7,500	10,000'
DRA (at 60°F)	1	0.912	0.832	0.756	0.687

The densities at various temperatures divided by the density at 60° (we use the symbol DRT for density ratio at temperature) are:

Temperature °F	0	20	40	60	80	100	120
DRT	1.130	1.083	1.040	1	.963	.929	.897

* There presently are no manufacturer's standards established for rating wind turbines. Usually, wind turbines are described in terms of power, not efficiency. Occasionally, an efficiency may be stated in terms of percentage of this 59.3 percent of theoretical maximum power available. Thus, a 70 percent efficiency would mean 41.5 percent true efficiency.

To determine the true density at some particular altitude and temperature, we multiply together the appropriate DRA, DRT, and standard density of 0.0763. For example, at 100°F and 5000 feet elevation, the density $\rho = 0.832 \times 0.929 \times 0.0763 = 0.0590 \text{ lb/ft}^3$

The symbol k is simply a number depending on the units used for density, velocity, and area. To simplify the above equation $1/2 k \times (\text{standard density})$ are grouped together and labeled K, so:

$$\text{Power} = K \times e \times \text{DRA} \times \text{DRT} \times A \times V^3$$

The most common units for K are:

<u>Power</u>	<u>Area</u>	<u>Velocity</u>	<u>Value for k</u>
watts	square feet	miles per hour	0.00508
watts	square feet	meters per second	0.00569
watts	square meter	miles per hour	0.0547
watts	square meter	meters per second	0.6125
watts	square feet	knots	0.00776
horsepower	square feet	miles per hour	0.00000681
horsepower	square feet	meters per second	0.0000763

The above equation has been used to calculate the curves in Figure 5-18A for DRA and DRT equal 1.0, and $e = 30$ percent.

As an example, a 15-foot diameter rotor is operating in a 20 mile-per-hour wind at an altitude of 5000 feet and at 80°F. The windmill efficiency (including generator and transmission losses) is 30 percent. What is the power?

$$\begin{aligned} \text{Area} &= 3.14 \times 15^2 \div 4 = 176.6 \text{ square feet} \\ \text{DRA} &= 0.832, \text{ DRT} = 0.963 \\ \text{Power} &= 0.00508 \times 0.30 \times 0.832 \times 0.963 \times 176.6 \times 20^3 \\ &= 1725 \text{ watts} \\ &= 1.725 \text{ kilowatts} \end{aligned}$$

Notice that Figure 5-18B shows a power of 2.2 kilowatts for this rotor at sea level and 60°F.

Finally, you want to buy power, not efficiency. If two wind turbines have the same power output in the same wind conditions, and cost and reliability are the same, it is relatively unimportant that one may be more efficient than the other.* Placing the wind turbine in the best wind location available to you and matching the power-producing velocity range of the wind turbine to your wind conditions and load is most important. This is covered in subsequent chapters.

*Everything else being the same, the more efficient wind turbine will have a smaller rotor diameter. This could reduce its weight and cost.

CHAPTER 3

WIND BEHAVIOR AND SITE SELECTION

Two percent of all solar energy reaching the earth is converted to wind energy. Surface winds over the United States available for conversion are sufficient to supply about 30 times the total energy consumption of the U.S. That is a huge amount of power. To reduce the scale of our thinking and to understand how winds are generated, let us first look at a few generalities about winds.

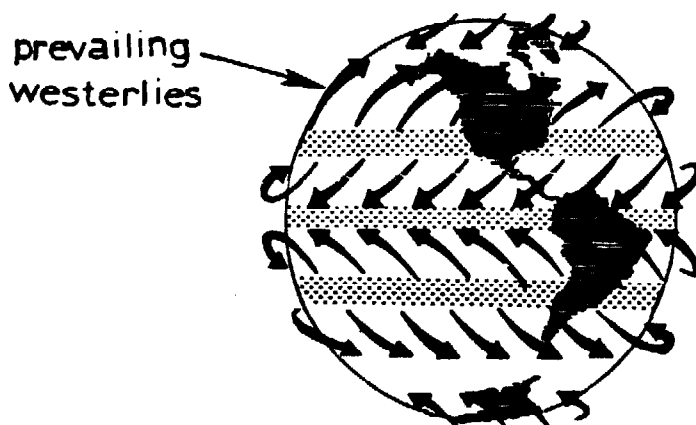
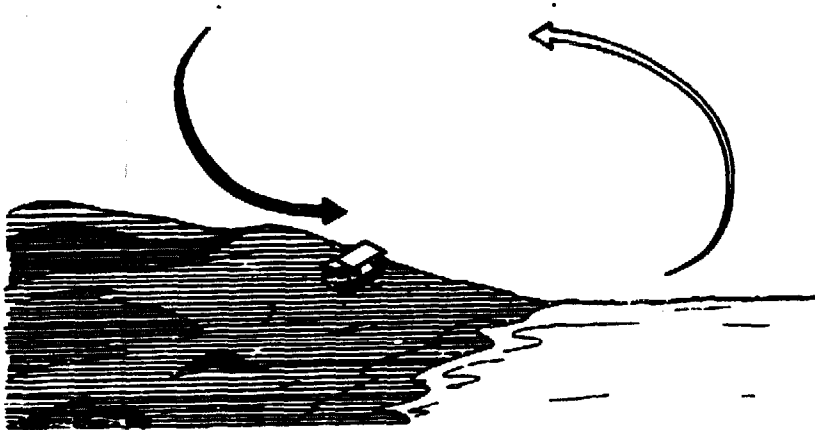

FIGURE 3-1: Worldwide wind circulation.

The United States and other parts of the north and south temperate zones experience a general westerly wind (Fig. 3-1). Changes occur in the weather with the alternate passage of high and low pressure systems. These cause barometer readings to fluctuate. The various pressure systems tend to migrate from west to east and bring about wind shifts, temperature changes, rain, and other weather features.

Along with this general trend are the regional and local weather effects that are often strongly influenced by temperature differences between the air, land, and water. For example, in an area of mountains and valleys, daytime sunshine heats the mountain air, which rises and is then replaced by cooler air from the valley. This creates valley winds moving uphill. At night, the air cools by radiation to the night sky and moves downhill, creating a mountain breeze.



land breeze
(Night)

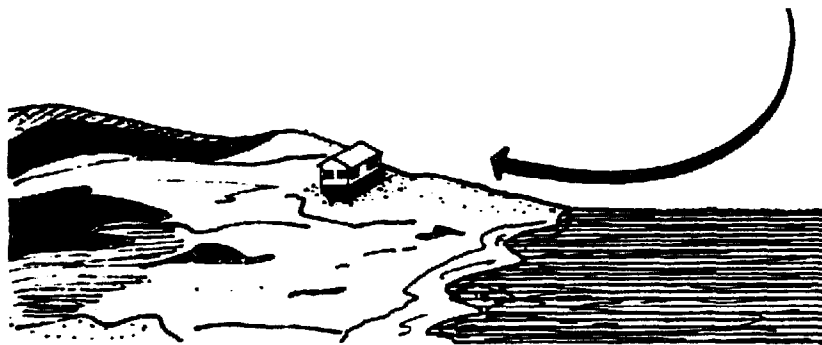

sea breeze
(Day)

FIGURE 3-2: Local wind circulation example.

Another example of regional or local wind occurs along coastal areas. Daily temperature differences between the surfaces of the sea and land cause alternate sea and land breezes (Fig. 3-2). Sea-land and valley-mountain winds are described in more detail later in this chapter. We can see that wind available for conversion is a result of both the motion in the atmosphere over a huge area and the local effects of terrain and temperature.

Understanding the characteristics of wind power variations with time is most important and is described in the first section of this chapter. The average winds in the United States are des-

cribed in the second section. Local wind effects are presented in the third section. In the final section equipment and techniques for determining your best sites and their wind power potential are discussed.

Appendix 1 contains wind speed and power information for 750 stations in the United States and Southern Canada, plus other tables showing wind characteristics. Reference 10 contains additional detailed information on the behavior of the wind and on how to perform a wind survey.

WIND POWER VARIATIONS WITH TIME

A 16-foot-diameter wind turbine might produce one kilowatt of power in a steady 15-mph wind, depending on the design. One kilowatt of power produced continuously for 30 days amounts to 720 kilowatt-hours. This amount of energy is about that used in the typical American home. The wind, however, is not constant. It is even more erratic than the average person would expect. The "speed-cubed" effect described in the previous chapter magnifies the effect of the fluctuating wind. For instance, a 20-mph wind has 2.37 times more power available than a 15-mph wind:

$$\left(\frac{20 \times 20 \times 20}{15 \times 15 \times 15} = 2.37\right).$$

A 10-mph wind only has .30 times as much power as the wind blowing at 15-mph:

$$\left(\frac{10 \times 10 \times 10}{15 \times 15 \times 15} = 0.30\right).$$

What if, instead of a 15-mph wind blowing continuously, half the time the wind blew at 20-mph and the other half of the time, at 10-mph? The average wind speed would be 15 mph, and the average wind power would be half of the two above numbers added together,

$$\frac{2.37}{2} + \frac{.30}{2} = 1.33.$$

So, in this simple example we find that 33 percent more power is available when the wind speed varies than when the wind is steady and has the same average wind speed.

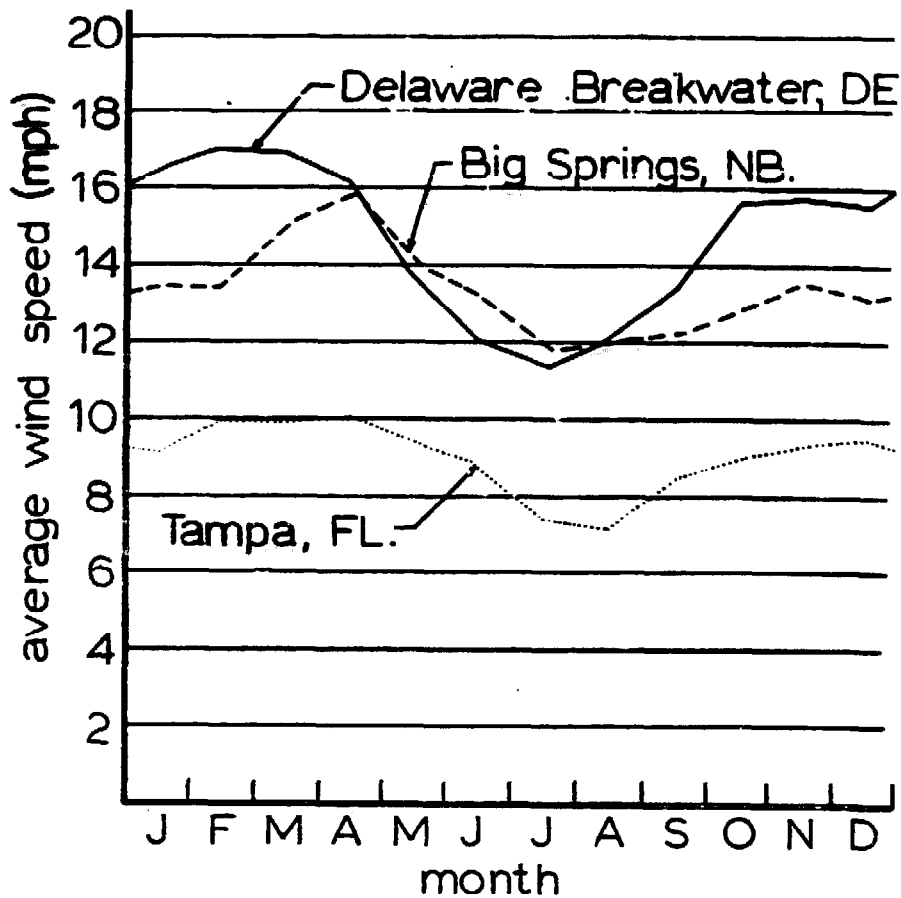

FIGURE 3-3: Average monthly wind speeds.

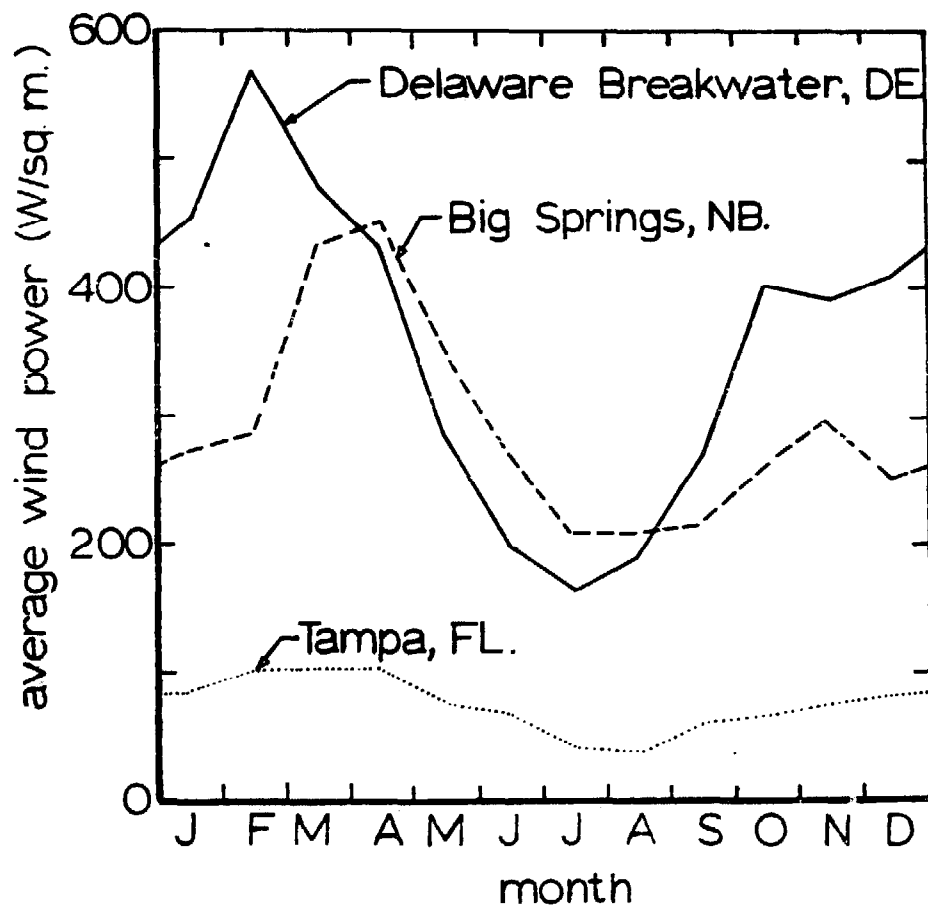

FIGURE 3-4: Average monthly wind powers.

Wind speed increases considerably with height. This is discussed in detail later in the chapter. To allow comparison of wind data, many of the recorded wind measurements in the world are taken at the standard height of 10 meters (32.8 ft).

Figure 3-3 shows average wind speed for each month at three locations in the United States.* Each monthly value is an average of records from many years. The resulting average monthly wind powers are shown in Figure 3-4. These are determined by averaging the cube of each hourly wind speed reading (i.e. $15 \times 15 \times 15$) for each month. By comparing with Figure 3-3, the speed-cubed effect is, once again, very striking. For example, Big Springs, Nebraska, usually has its windiest month in April, with an average wind speed of 15.8 mph, and its least windy months in July and August, when the average wind speed is 12.0 mph. The average wind powers for these two cases are 451 watts per square meter** for April, and 10 for July and August.

The wind turbine owner who lives in an area with a high annual wind speed certainly has a great advantage. However, if his demand peaks in the season when the wind is at its minimum, the power requirement for a satisfactory wind system could be considerably higher than it would be if the annual average wind speed were less, but the seasonal wind speeds followed his demand. How to determine your power and energy needs is described in Chapter 4.

Storage battery costs are high enough that no one attempts to even out wind energy cycles from month to month with batteries. They are useful for making up hourly, daily, or weekly differences between supply and demand. Deficits over a month's time would have to be made up by alternative energy sources, such as an engine-driven generator, a wood stove, solar heating panels, or a connection to a utility power line.

A wind rose plot is shown in Figure 3-5 for a weather station along the east side of Lake Michigan for one year. The length of each bar in these diagrams shows the percentage of time that the wind blows from that direction (toward the center of the circle). Each circle, or circular arc, represents 5 percent of the total time. The number at the end of each bar is the average wind speed for that direction. As an example, 11 percent of the time the wind blew from the northwest at the average wind speed of 18.5 mph (6.7 m/s), and 15 percent of the time from the south at 15.8 mph. The total length of all the bars adds up to 100 percent.

*We use data from several examples in this chapter to show how to use similar data for understanding your own site and estimating your wind energy potential.

**This refers to watts per square meter of rotor swept area of the wind machine. Refer to Chapter 5 for methods of calculating rotor swept area.

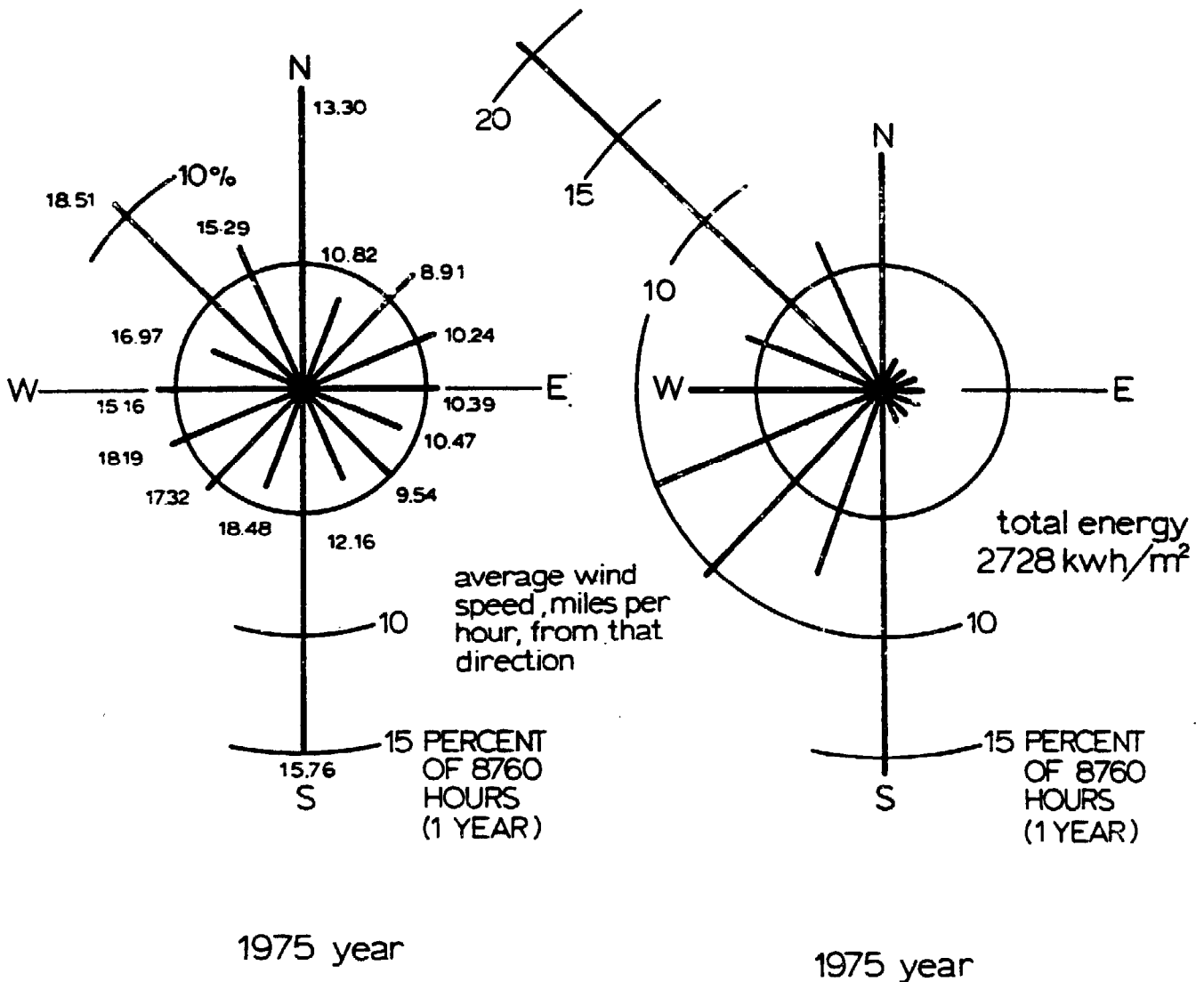

FIGURE 3-5: Wind rose for Muskegon Coast Guard Station, Michigan, at 30 meters.

FIGURE 3-6: Energy rose for Muskegon Coast Guard Station, Michigan

An energy rose is obtained by separately averaging the cubes of all the wind speed readings from each of the sixteen directions. In Figure 3-6 is the energy rose for the same case as the previous wind rose. The length of each bar gives the percent of wind energy from each direction. Again the total length of the bars is 100 percent. Notice the differences between the wind and energy roses. While the wind blows from the northwest 11 percent of the time, it is responsible for 21 percent of the annual available wind energy.

The battery capacity (or size of any other type of energy storage device) in a wind energy conversion system will depend partly on the typical length of time the wind speed remains too low to generate an adequate amount of power. This waiting time for the wind to return is called the return time. The following table gives an example of four cities in Kansas, where a calm day is one when a speed of 10 mph is not reached. As an example, ten times a year at Concordia, the return time is two days, and once a year, on an average, it is six days.

<u>Location</u>	Avg. monthly wind power*	Total calm days/yr.	Occurences of return times of:				
			2	3	4	5	6 days
Concordia	140	68	10	3	1	1	1
Topeka	157	52	8	2	1	0	0
Wichita	253	16	1	0	0	0	0
Dodge City	336	7	0	0	0	0	0

Notice that the number of consecutive calm days (wind speed does not reach 10 mph) increases rapidly as the average wind power decreases. The number of batteries required in a wind electric system will depend upon more weather factors than the return time. For instance, if the wind exceeds the cut-in speed for only a fraction of a day and only partially recharges the batteries, the next return time must be very short or the batteries will be completely discharged.

Regular daily fluctuations in wind speed can be large or small. Figure 3-7 shows the typical daily fluctuations of hourly readings of wind speeds at three locations. Oak Ridge, TN (5 year average record) is a southeastern U.S. interior location. Most of that area has a low average annual wind speed. The winds at the Muskegon Coast Guard Station, MI (1 year record) are considerably enhanced by a clear sweep from Lake Michigan and by strong lake breezes. The Livermore, CA (1 month record) location is in a mountain pass into the great Sacramento-San Joaquin Valley, so a daily mountain-valley wind cycle occurs.

*Watts per square meter.

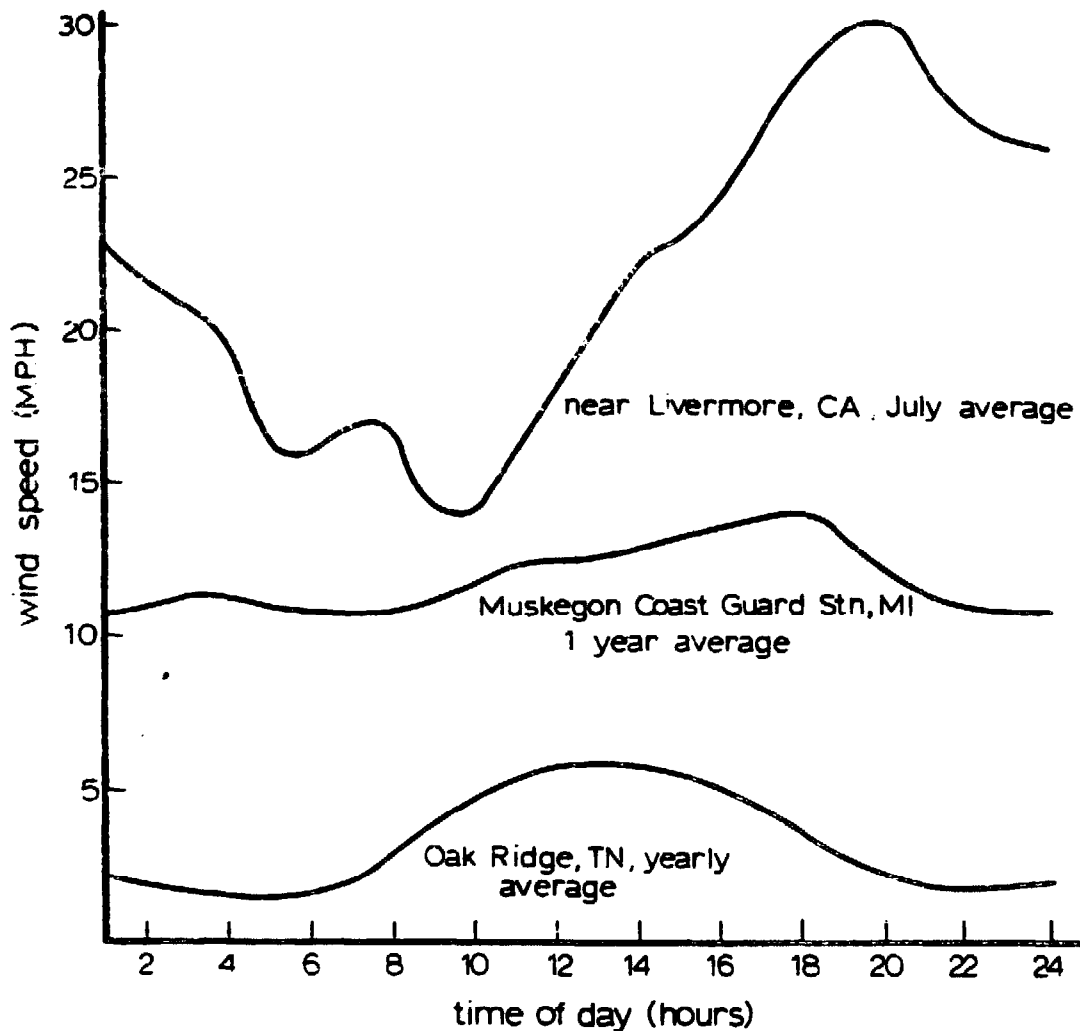

FIGURE 3-7: Sample daily wind variations.

Everyone is aware of good and bad years for rain. Wind power also varies from year to year. Dodge City, Kansas has an average wind speed of 15.5 mph and an average wind power of 336 watts per square meter - about the highest for any city in the United States. In the ten year period from 1955 to 1964, the yearly deviations from the average power were: +5, -9, +5, -22, +26, +3, -13, -15, +18.5, and +33.5 percent.

How are monthly and annual wind powers determined from wind speed readings? The sophisticated way that has been used by meteorologists to produce power curves and energy rose has involved the use of computers to take the cube of regularly sampled wind speeds, usually hourly or every third hour, and then average the thousands of values to obtain these monthly or annual averages. Many of the hourly wind readings are available from the National Weather Service in a form ready to be processed by a computer.

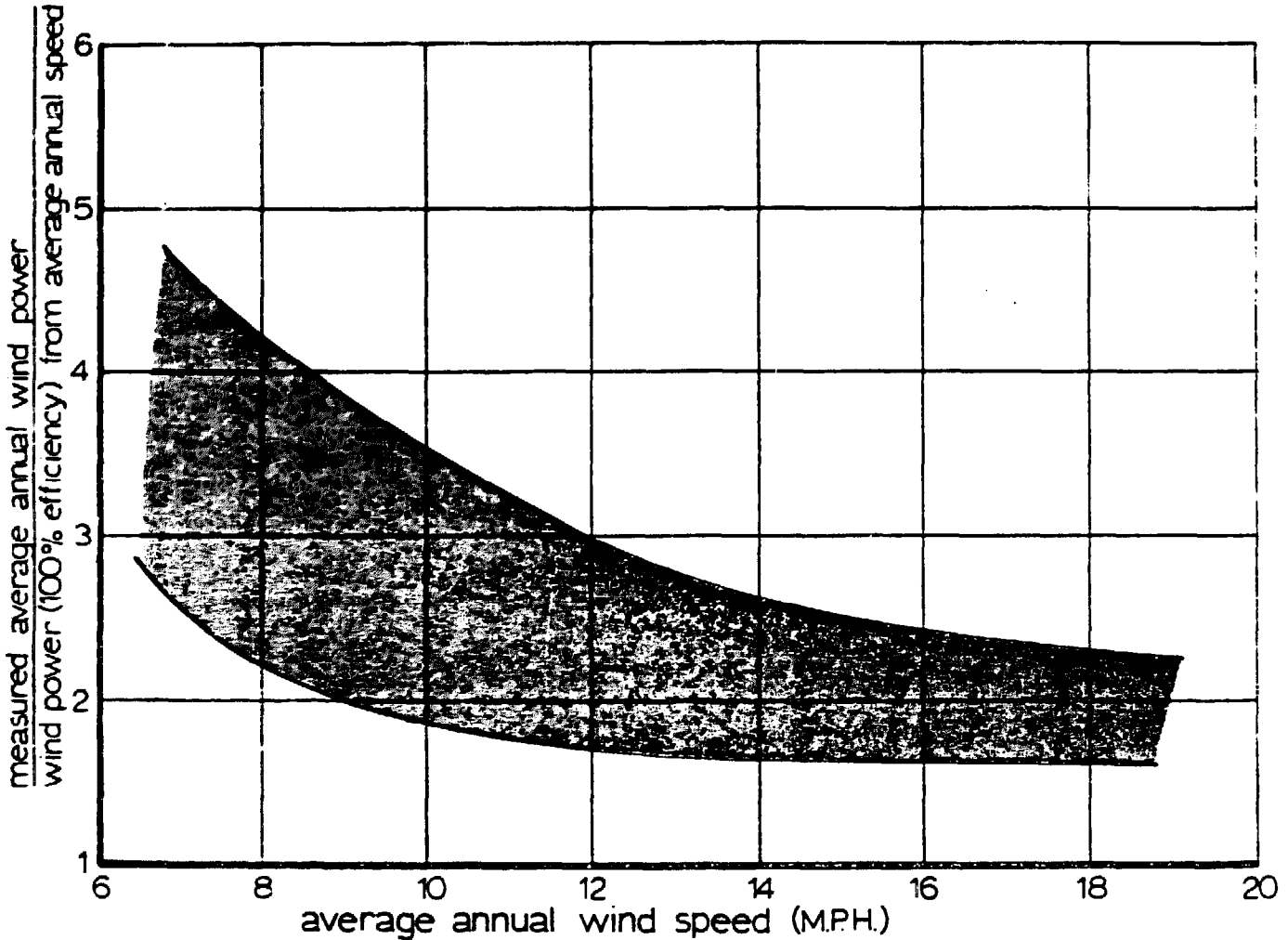

FIGURE 3-6: Average annual wind speed, mph.

There are several approximate methods that can be used to determine average wind power. First, the average speed can be used in the power equation given in Chapter 2. However, Figure 3-8 shows the large error that can occur if this is done. The shaded band in this figure represents the actual wind power divided by the power calculated from taking the cube of the average wind speed for 90 percent of the U.S. weather stations listed in Appendix 1. Like the example on page 3-3, the average of the cube

of each of many fluctuating readings is considerably greater than the cube of the simple average wind speed. The effect is largest at low annual wind speeds. The band in this figure contains 90 percent of the values, so you have a 90 percent chance of being within this band. Taken from this figure, the average values are listed here.

Average annual wind speed, mph	8	10	12	14	16	18
Correction Factor*	3.2	2.7	2.4	2.1	2.0	2.0

A simple way to calculate the average annual energy for each square meter or square foot of rotor swept area is to use your average annual wind speed (the way to determine this is described in the last section of this chapter) in the power equation on page 2-13 along with the above factor, times the number of hours (8760 in one year). Thus, the annual average energy generated, in kWh (kilowatt-hours), is approximately:

$$\begin{aligned} \text{annual kWh} &= 8760 \times \frac{\text{watts}}{1000} \\ &= \frac{8760}{1000} \times K \times e \times A \times V^3 \times \text{DRA} \times \text{DRT} \times (\text{above correction factor}) \end{aligned}$$

For instance, if the two density ratio correction factors (DRT and DRA) are assumed to be 1.0, the average annual wind speed is 10 mph (so the correction factor from the above table is 2.7), the windmill diameter is 15 feet (so the area $A = 3.14 \times \frac{15^2}{2} = 177$ square feet), and the average efficiency is 20 percent, then the approximate annual average energy generated is:

$$\text{annual kWh} = 0.876 \times .00508 \times .20 \times 177 \times 10^3 \times 2.7 = 4,253 \text{ kWh}$$

This is a simple way to obtain a value for your annual energy generation. It is, however, quite approximate, since the shaded band in the above figure indicates there is a 90% chance your value will be somewhere within 30 percent of this calculated value (above 16 mph the uncertainty drops from 30 to 20 percent). The data in Appendix 1 can be used to reduce this uncertainty.

A better way to determine the expected wind power from a specific wind turbine being considered is described in Chapter 5. The method uses a wind duration plot. Some typical wind duration curves are shown in Figure 3-9. Each point on these curves shows the number of hours in the year which the speed equals or exceeds the hours indicated directly below. For instance, a 10 mph wind speed is exceeded 3500 hours a year at Plum Brook, Ohio (where a large DOE-NASA wind turbine is being tested) and is exceeded 6950 hours a year at Amarillo.

$$\begin{aligned} \text{*Correction factor} &= \frac{(\text{Average annual wind power})}{(\text{Fictitious power calculated from average annual wind speed})} \end{aligned}$$

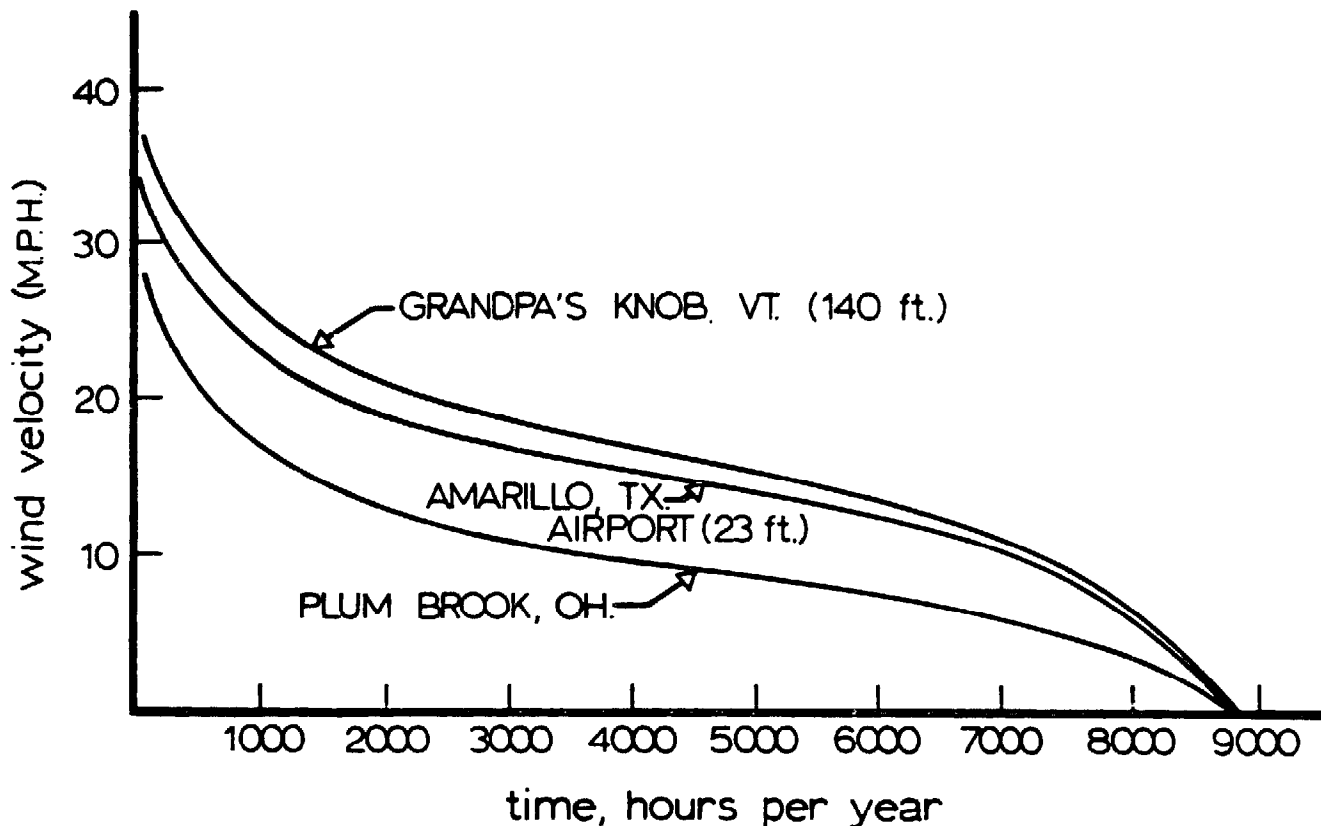

FIGURE 3-9: Wind duration curves.

AVERAGE WIND POWER DISTRIBUTION IN THE UNITED STATES

At over one thousand locations in the United States, a daily log sheet is filled out with hourly weather observations of the one-minute average wind speed and direction. These records are sent to the National Climatic Center in Asheville, North Carolina, where these one-minute averages for every third hour are entered onto computer magnetic tape. Various monthly and yearly summaries are prepared, and all the original data are stored in archives. Each station receives summaries of its data and these are usually available for inspection (this is described in more detail later in this chapter).

The data from 750 wind recording stations in the United States and southern areas of bordering Canadian provinces have been processed to determine monthly averages of available wind power. The results are included in this report in Appendix I. The stations are arranged with the states in alphabetical order and by region within the state. These data have not been corrected for varying heights of the wind anemometer* (the instrument that is used to measure wind speed). Also, distortions in the wind pattern by natural terrain features, trees, and buildings affect most of these locations. Most stations are at civilian or military airports. Very often, the anemometer location has been changed at least once over the years, new buildings erected, or even a highway overpass added nearby. No particular set of data can be blindly accepted as unaffected by obstructions. As an example, the energy rose for Moffett Field, California, one of the stations listed, shows 45 percent of the average annual wind power coming from the north-northwest. However, directly upwind of the anemometer and not very far away, stands one of the world's largest dirigible hangars! The wind and wind power measured from that direction would most certainly be considerably different if they were measured upwind of the hangar.

Figure 3-10 shows very generally the wind power patterns for the continental United States. Typical open locations in the Pacific Northwest, southern Wyoming, Oklahoma-Texas Panhandle, and Cape Cod all average at least 200 watts per square meter at a height of 10 meters (32.8 feet). Two locations where data were previously presented, the east shore of Lake Michigan (Muskegon Coast Guard Station, Figs. 3-5,6,7) and 50 miles east of San Francisco (Livermore, Fig. 3-7) both have a high annual wind power -- over 200 watts per square meter. These locations show here as areas of only medium and low wind power, respectively. This plot may be reasonably accurate for large open areas in the Great Plains but actually has little value in mountainous regions, as far as application to any specific site.

Alaska and Hawaii are not shown, the latter having too few stations to allow this sort of plot to be developed. An example is made of Oahu later in this chapter. In Alaska, there are generally high wind areas along much of the coastline, but in general, the wind diminishes rapidly inland from the coast.

While Figure 3-10 gives a general impression of wind power available over the United States, the large table in Appendix I is much more useful.

*As you will shortly read, wind speed varies with height above ground. Anemometers mounted higher above ground will measure more wind.

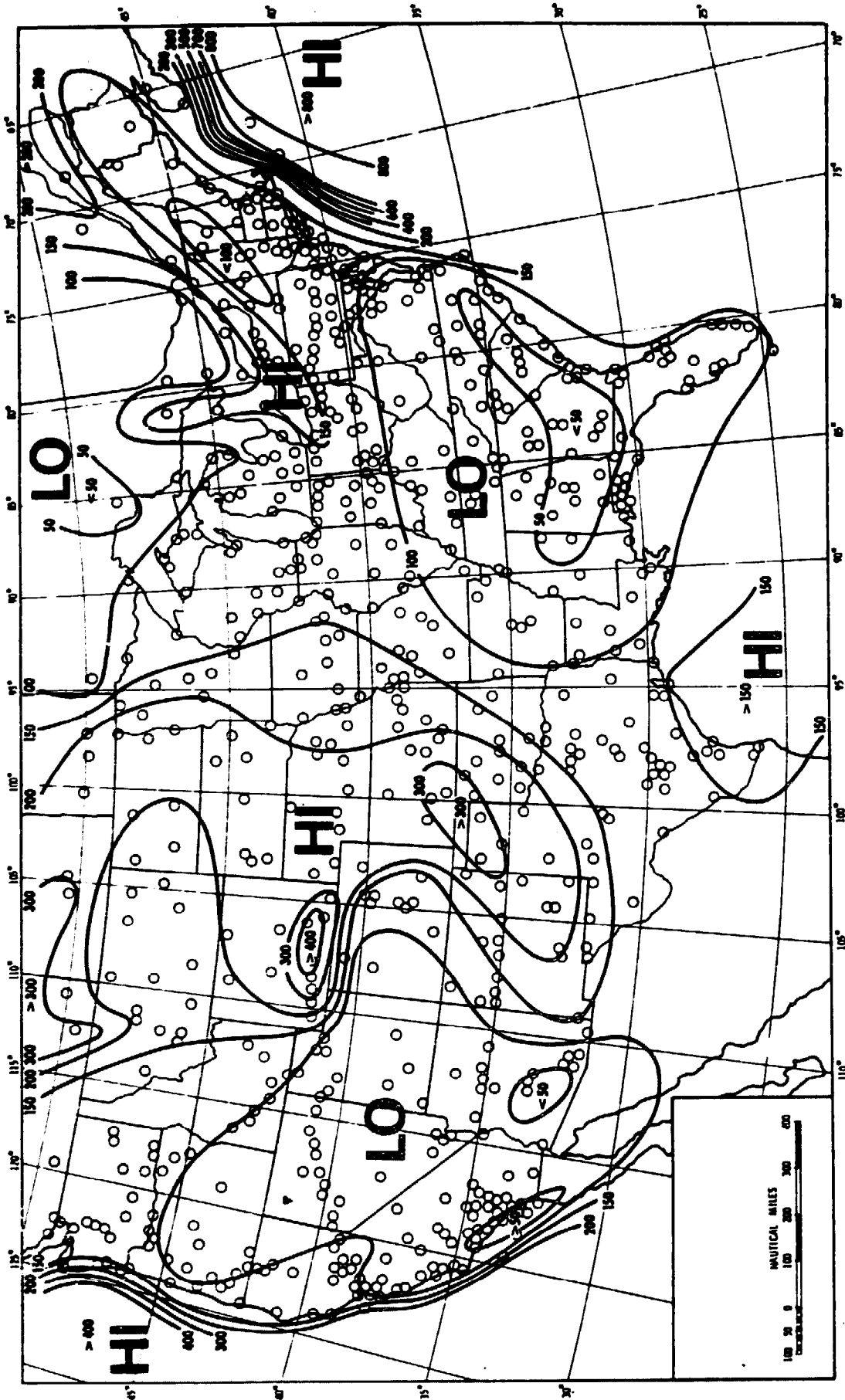

FIGURE 3-10: Available wind power – annual average.

Jack Reed, Sandia

WIND POWER VARIATIONS WITH HEIGHT AND LOCAL TERRAIN

From Figure 3-10 and the wind power records in Appendix 1, you can obtain a general idea whether your part of the country has good wind power. If you live in an area with apparently low wind power, certain types of hill terrain can double the local wind speed, and this will create an eightfold increase in available wind power. If, on the other hand, you are in a generally good wind area, your local winds may be disappointingly poor due to mountains, ridges, trees, or buildings. Generally, if you live in flat country with a meteorological station in the region, probably a fairly good estimate of your available wind power can be made before any wind survey is performed. However, if you live in hilly or mountainous country, or even in flat country with a considerable number of local obstructions, it is nearly impossible to estimate in advance the available wind energy. Experience has shown that the typical person will greatly overestimate the local average annual wind speed.

Effect of Height on Wind Power

We describe here how the wind power changes with height over reasonably flat country. Examples of changes with height in hilly country or near different types of obstructions were being prepared in handbook form as this guide went to press. (Reference 10). The wind speed gradually increases with increasing height up to roughly 500 to 2000 feet above the earth's surface. Meteorologists call this region the atmospheric boundary layer. We will call how the wind changes with height the wind speed profile. Above it, the winds are more regular and only influenced by the largest geological features, such as mountains. Figure 3-11 shows typical winds over flat country at heights of 15, 30, and 100 feet near Sunnyvale, California.

Figure 3-11 shows how irregular the winds are over a short time. It is not unusual for the instantaneous wind speed at a lower elevation to occasionally be greater than the wind speed at a higher elevation.

Figure 3-12 shows the average wind speed for each time of the day or night at 10 heights up to nearly a mile high above Oak Ridge, Tennessee. The data for all but the bottom two curves were obtained from balloon measurements. Five years of daily data were averaged to obtain these curves. While there are large changes in the average wind speed during the day at each height (except 160 meters), at any time during the daily cycle the average speeds increase with height. Taking the average of each curve in the above figure and plotting that versus height we have in Figure 3-13 the average wind speed profile at Oak Ridge. This is an important type of curve, so let us practice reading it. What are the wind speeds at the 600 and 1100 meter heights above

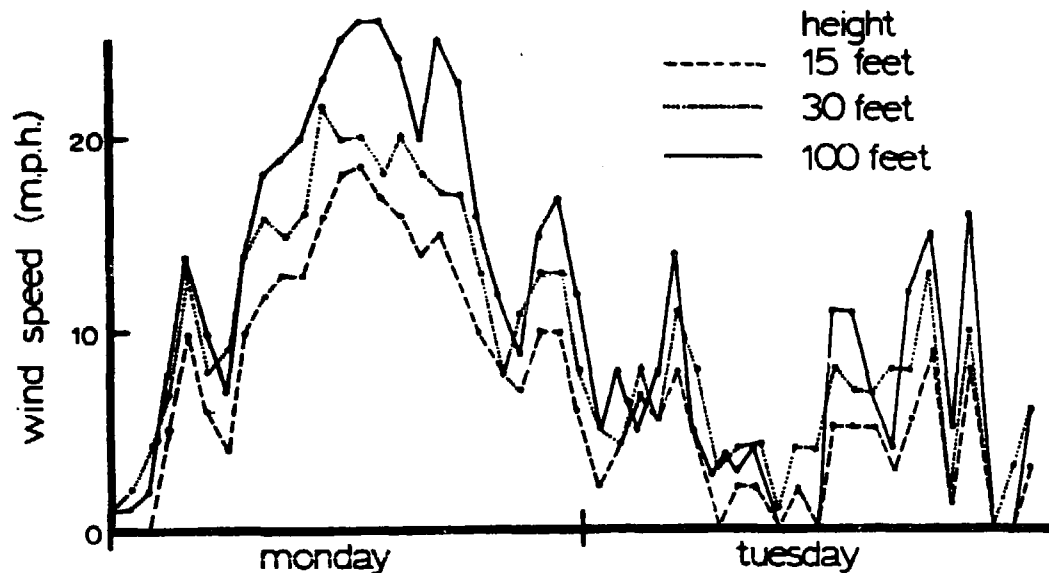

FIGURE 3-11: Hourly wind speeds at 3 heights.

the ground? Arrows have been drawn at these two heights. We move straight down from the tip of the arrows to the horizontal axis and read about 7 and 8 meters per second wind speed. Knowing the shape of your wind profile will help you select the best height for your wind turbine.

The location on top of the wind speed profile and the shape of the profile depends on (a) how flat the surface of the earth is, (b) the friction of the air trying to move across the surface of the earth, and (c) temperature differences along its path and up through the atmosphere. Figure 3-14 shows three wind speed profiles over flat terrain. Notice how the profile thickness increases with surface roughness. These profiles are really only correct when the wind is blowing strong enough to produce an appreciable amount of power from a wind turbine. If you live in flat country, you can estimate your wind speed profile shape by following the detailed explanation given in Reference 10.

FIGURE 3-12: Daily curves of wind speed for for several heights above the ground at Oak Ridge, Tennessee (5 year averages).

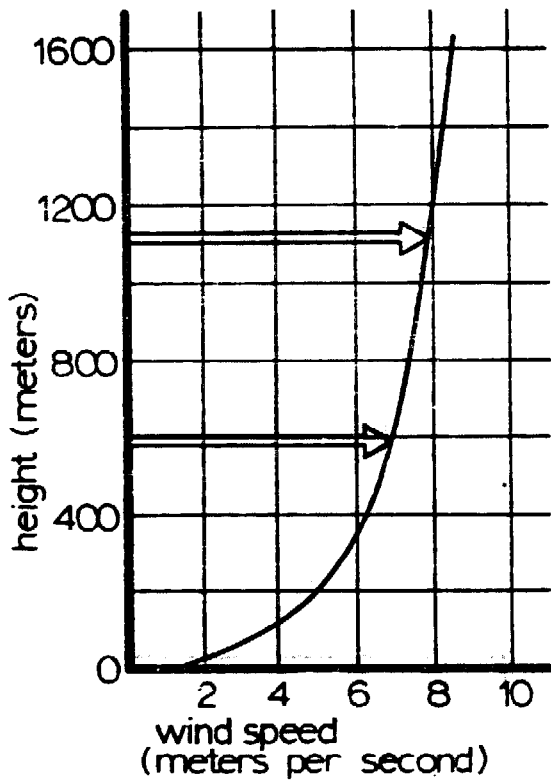
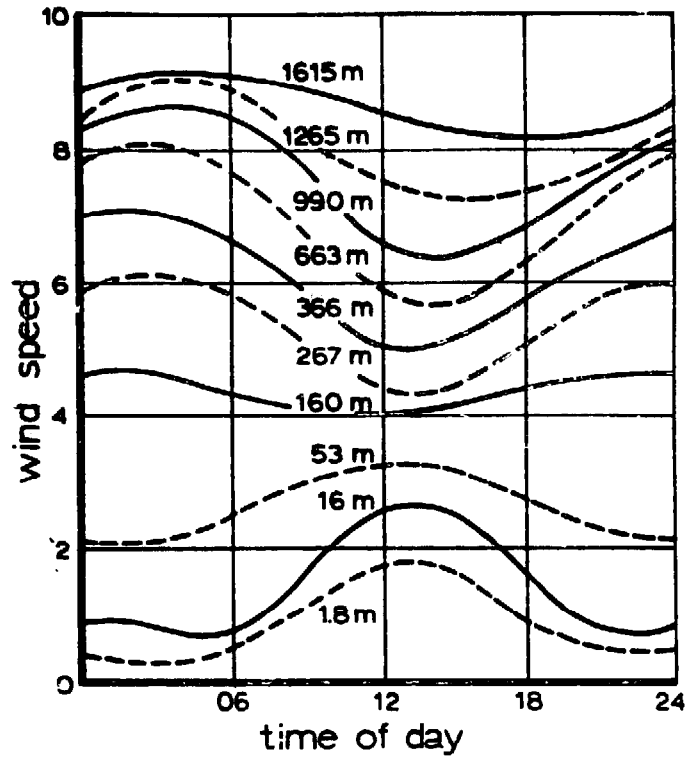

FIGURE 3-13: Average wind speed profile at Oak Ridge, Tennessee.

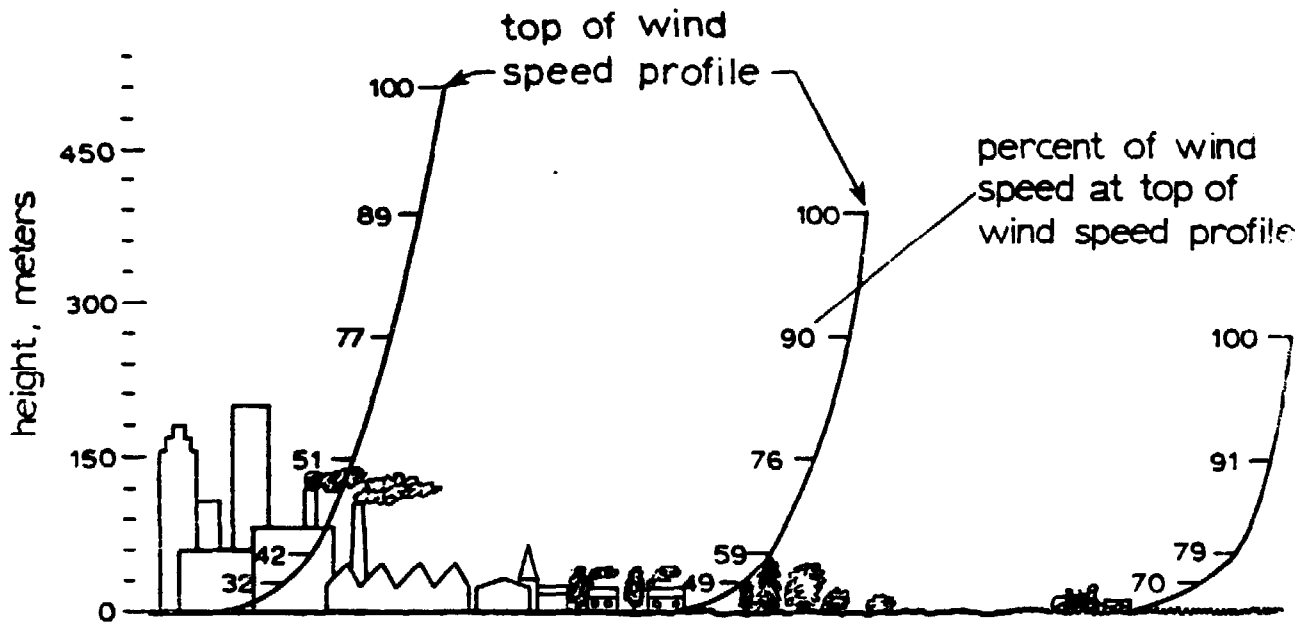

FIGURE 3-14: Atmospheric wind speed profiles change shape and height with surface features.

Effect of Regional and Local Terrain Features on Wind Power

Before delving into local terrain effects upon the winds, we should distinguish between two kinds of wind. The large weather features which cover the country at any time contain large scale patterns of winds. We experience this wind from above, or the wind aloft, after it is considerably diminished by the wind speed profile. Local winds are created from the ground up, so to speak, any time adjacent surfaces warm up at different rates and the winds aloft are not overpowering the local effects. Thus a sea breeze is created since land heats up much faster than the sea. A hillside receiving the morning sun warms up rapidly, while the valley below receives little direct sun and remains cold. This creates a wind. These local winds are in effect created by nature to reduce local air temperature differences; they do not have any appreciable effect on the winds aloft.

Local winds can only be described in general terms. If you live in an area with significant local winds, your awareness of these special situations will help you to capitalize on their wind enhancement effects.

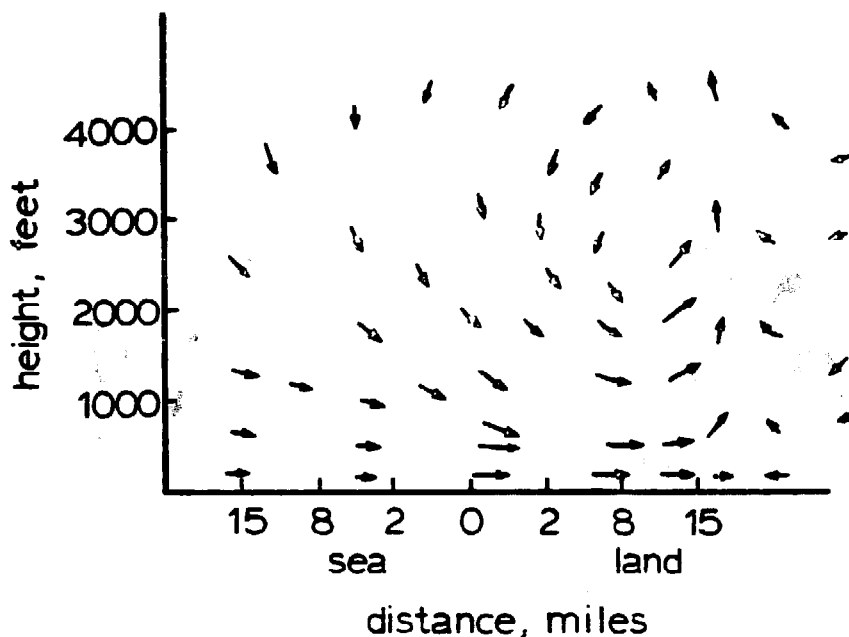

FIGURE 3-15: Example sea breeze winds, late afternoon, with no winds aloft.

During periods of light winds aloft in spring and summer, surface winds blow from ocean to land during the day (sea breeze) and in the reverse direction at night (land breeze). These breezes, as anyone near a large body of water knows, can be substantial winds. In winter, the land breeze may occur in the daytime as well as at night. Figure 3-2 roughly illustrates sea and land breezes. During a 24-hour period, the cycles of wind and temperature are much smaller over water than over land.

The development of a sea breeze is roughly as follows. Assuming there is no wind aloft, the sky is clear, the daytime has arrived, the sun will start heating the water and land. This heat is absorbed into several feet of water, but only into a fraction of an inch of earth, so the latter warms up much faster. The land heats the air at ground level, but this air gradually rises many hundreds of feet. The warmer air is lighter than the air over the sea so, as in the case of an open refrigerator door, the cold air rushes from the sea onto the land while the partially heated air far above the land moves out to sea to replace the incoming cold air. The circulation pattern has been completed; a sea breeze has been created. Starting as a local disturbance, this circulation pattern will extend many miles landward and seaward during each day.

A feeling for possible wind speeds in a sea breeze can be obtained from Figure 3-15. This shows the wind speed at 5 P.M. with no winds aloft in an area extending about 1 mile high by 20 miles out to the sea and 50 miles inland. In this example, winds from shoreline to about 11 miles inland are about 10 mph. Wind speeds of 15 mph caused by these sea breezes are common, even when winds aloft are still. Thus, a wind turbine at a seaside location can gain a great amount of power from this sealand breeze phenomenon and not rely solely on high winds aloft to be transmitted to the ground. Large lakes also create similar but smaller breezes.

The complex nature of winds in valleys is briefly described here. When a strong wind aloft is blowing in a direction more or less parallel to a valley, there is a funneling effect. Winds are often stronger in the valley than over level country at these times, particularly where the valley narrows or its sides steepen. When the wind blows perpendicular to the valley, very complex flow patterns develop and often large areas in the valley will experience a great commotion in the air called turbulence.

Next, we consider what happens if the wind aloft is light. At night the air on the sloping sides of the valley will cool near the ground and, being heavier, will flow to the valley floor. When the slopes of the valley are warmed during the day, the wind will reverse direction. Complex combinations of these flows will occur as shown in Figure 3-16. The above effects cause most of the wind energy available in a valley to be aligned with the direction of the valley. Therefore, when siting a wind turbine, care should be taken to obtain the best location for capturing these winds.

If a valley narrows at its lower end, the cold air may drain out of the upper, broader end of the valley. A study of night wind profiles in a number of Vermont valleys indicated that maximum winds on most nights were found at heights of 100 to 1000 feet above the ground, often about two-thirds the height of the surrounding hills. The intensity of the wind gradually increases with increasing distance from the head of the valley.

In spite of the frequent valley winds, if prevailing wind directions are roughly at right angles to the valley, chances are that there is more wind energy available on the plateaus above the valley. The valley wind patterns sketched in Figure 3-16 may not contain a significant amount of recoverable wind energy.

It is easy to see that wind records from a meteorological station at another part of a valley from your location (or at a different distance from a coastline) may give little indication of your own winds.

The flow over a long isolated mountain ridge that faces the wind (and tends to block it) is another interesting case. Near the ground (at wind turbine height) the wind speed decreases as the toe of the ridge is approached, then speeds up to greater than

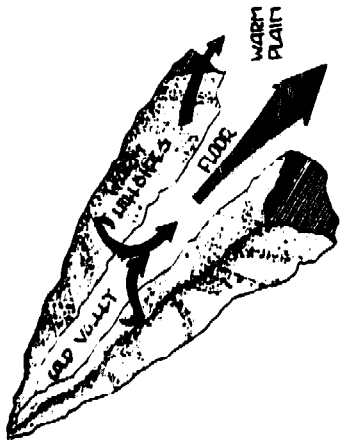

4 SUNRISE WARMER AIR ON HILLSIDES RISES, CIRCULATES OVER AND DOWN INTO VALLEY.



5 FORENOON SLOPE WINDS ONLY.

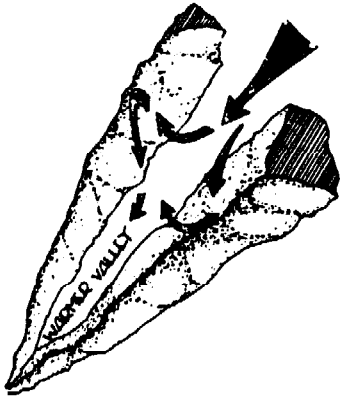

6 EARLY AFTERNOON BREEZE INTO VALLEY AND UP HILLSIDES.

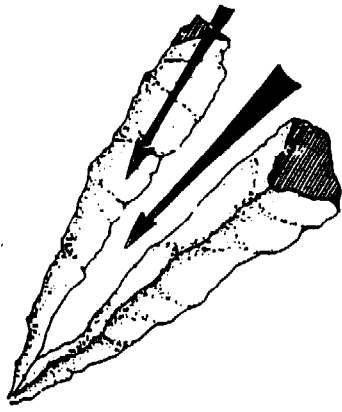

7 LATE AFTERNOON VALLEY WIND

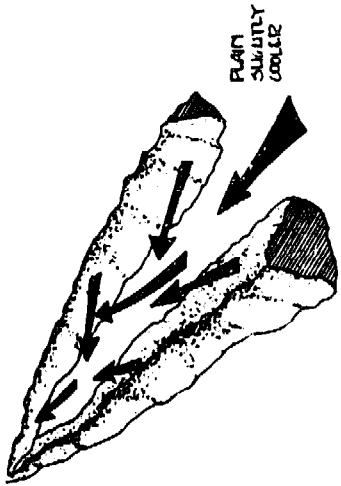

8 MORNING HILLSIDE CIRCULATION STARTING TO REVERSE.

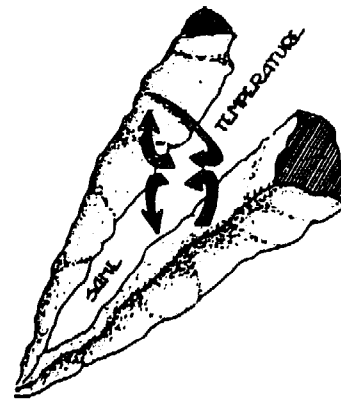

9 EARLY NIGHT SLOPE WINDS ONLY.

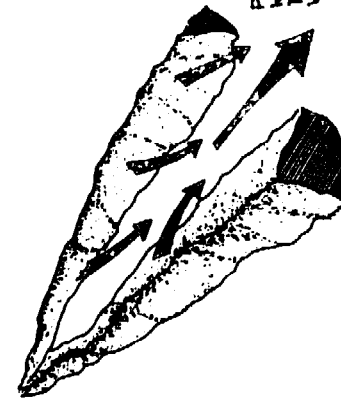

10 MIDDLE OF NIGHT WIND DOWN HILLSIDES OUT ONTO PLAIN.

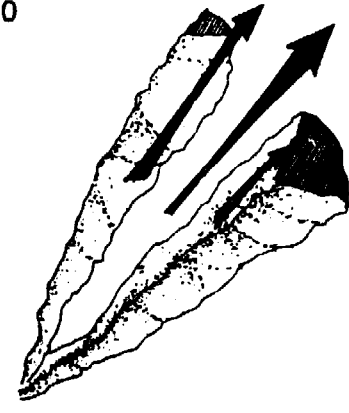

11 LATE NIGHT MOUNTAIN WIND.

FIGURE 3-16: Daily wind cycle in a valley facing a plain. No wind aloft.

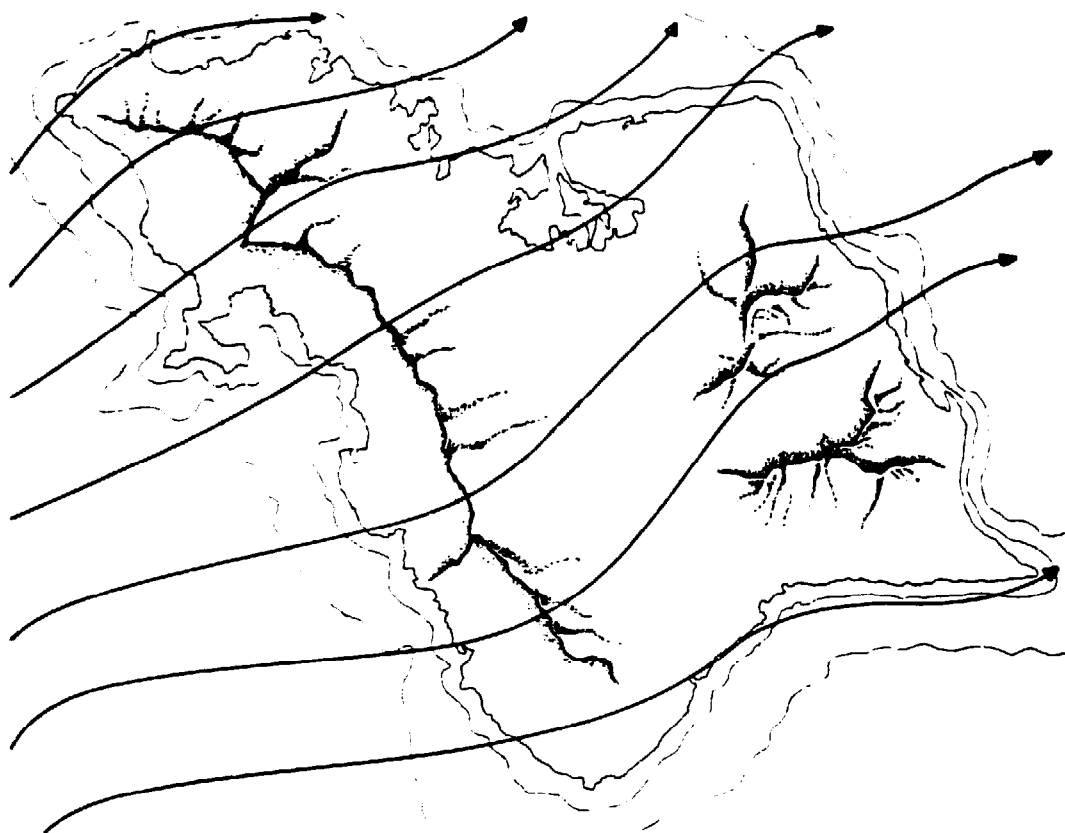

FIGURE 3-17: How the mountains of Oahu affect the wind.

the average in the region of the ridge line. If the sides of the ridge are very steep the increase in wind speed at the top will not be as great as for a ridge of moderate steepness. Also, the wind on the back side may be very turbulent and unsuitable for wind turbines. Near the toe of the hill on the upwind side the wind power may be reduced to 50 percent, and near the top it can be double the average wind speed depending on the slope of the sides. Some specific cases will be described in Reference 10.

What happens to the wind near the ends of a ridge that faces the prevailing winds? The Hawaiian island of Oahu provides an excellent example of this. Recently, a large computer was used to predict the flow over and around this island. For much of the year, such a strong wind blows across the island that the sea breeze influence is not particularly significant. This wind is confronted by a range of mountains 30 miles long (Fig. 3-17) that can be described as a ridge about 2500 feet high, with occasional peaks several hundred feet higher. The ridge line is oriented only about 13° counter-clockwise from a right angle to the prevailing wind direction. At each end, the ridge slopes down to sea level within a space of 5 to 10 miles.

The wind path lines at 500 feet above the surface of Oahu and the surrounding ocean are indicated in Figure 3-17. This ridge is very long - about 60 times as long as it is high - but even so, the wind path lines indicate that about one-third of the air approaching the island at the 500 foot height is deflected around the ends of the ridge. There are some good wind turbine sites along the top of the ridge line where the wind speed is about twice that of the approaching wind. The north and south ends of the ridge are particularly attractive sites, however, as the airflow that is deflected around the ends of the ridge speeds up to approximately twice the approaching wind speed for large regions at each end of the ridge. Thus, if your location is near the end of a ridge that tends to block prevailing winds, you may have considerably more wind power than your neighbors out on the flat land.

The wind near the top of an isolated hill is quite different than the wind over a long ridge. There is a strong tendency for the lower layers of the wind speed profile to split and go around the hill, particularly during the night and early morning when the ground has cooled off. For a wind turbine near the top, the hill acts quite a bit like a giant tower.

There is another characteristic of the wind that is helpful for increasing the wind power available on high hills. Reexamining Figure 3-12, the average daily wind curves above Oak Ridge, Tennessee, notice how the wind above 200 meters is greater at night than during the day while the reverse is true below 100 meters. This is a very general condition around much of the country. A wind turbine on a hilltop may produce power all night while below in the flat country the air will be nearly calm.

Structures and trees are likely to be in the vicinity of a wind turbine. How close can a wind turbine be placed to these, and how much penalty is paid if these obstacles cannot be avoided? Both loss of wind speed and the wind turbulence downwind of these obstructions are important. Wind turbine generators spin at high speeds and tend to have long, thin blades. This makes them much more susceptible to damage from wind turbulence than water-pumping windmills. Older water-pumping windmills are often found very close to trees and apparently are able to withstand the resulting turbulence. A rule of thumb generally used for wind turbine generator placement is: if the location is not well above all surrounding obstacles, the wind turbine should be placed at least 10 obstacle heights or widths away from the obstacles. This is a reasonable rule. The results of some available wind measurements will be presented in Reference 10 to give a better feeling for how the wind is disrupted when it passes over and around obstacles.

YOUR WIND POWER

You are indeed fortunate if you live in flat, open terrain and happen to have a neighbor with a wind turbine. You are doubly fortunate if he happens to be performing the same tasks with his machine that you wish to perform, such as pumping water or pro-

ducing electricity. In effect, he has been measuring his wind power for a long time. The questions that you should consider are, how adequate is the wind for him, how does your demand compare with his, and how likely are you to have an appreciably lower (or higher) wind power per square foot (or square meter) than he has?

More likely, there is no wind turbine close enough to provide any useful experience for you. You will have to make a decision about how much time, effort, and money it is appropriate to invest to increase your knowledge of your wind. There are three parts to this process:

1. Making a preliminary estimate of your wind power.
2. Measuring your winds, or wind power.
3. Comparing your measurements with nearby meteorological stations to determine your long-term average from your short-term data.

Before describing each of these, we will make a few observations. Step 1 is the very least you must do. That rough estimate of your wind power can be combined with results from a preliminary load survey (Chap. 4), equipment selection (Chap. 5) and a preliminary cost analysis (Chap. 6). You may find that you probably have only a fraction of the necessary wind available to make your investment a sound one and that only a minimal effort should be made to determine whether your wind power is much greater than your initial estimate.

Making a Preliminary Estimate of Your Wind Power

As a first step in making an estimate of your wind power, you should check for tall, unavoidable obstructions, particularly trees. Typical tower heights for wind generators in the one-to-ten-kilowatt class (the range you are most likely going to be interested in) are up to 100 feet. Two simple methods for measuring tree height, if the top is visible, are illustrated in Figure 3-18. For the first method, find a time in the morning or afternoon when the tree shadow falls across flat ground. Set up a vertical stick of known height and compare the length of the shadow from the stick to that from the tree. The equation for determining the tree height is:

$$\text{Tree height} = (\text{tree shadow}) \times (\text{stick height}) \div (\text{stick shadow})$$

The second method for measuring tree height involves attaching a yardstick to a small pole or to the edge of some other fixed object so that you can simultaneously sight both the bottom and top of the tree without moving your head. The yardstick should be vertical. Note the distance along the yardstick between the lower and upper lines of sight; we call this distance h ; the distance from your eye to the yardstick, distance d ; and finally the distance from your eye to the tree, distance D . The equation for determining the height is then: $H = h \times D \div d$. This method can be used on rough terrain with changing slope, as long as the measurements are accurately made.

$$\text{TREE HEIGHT} = (\text{TREE SHADOW}) \times \frac{\text{STICK HEIGHT}}{\text{STICK SHADOW}}$$

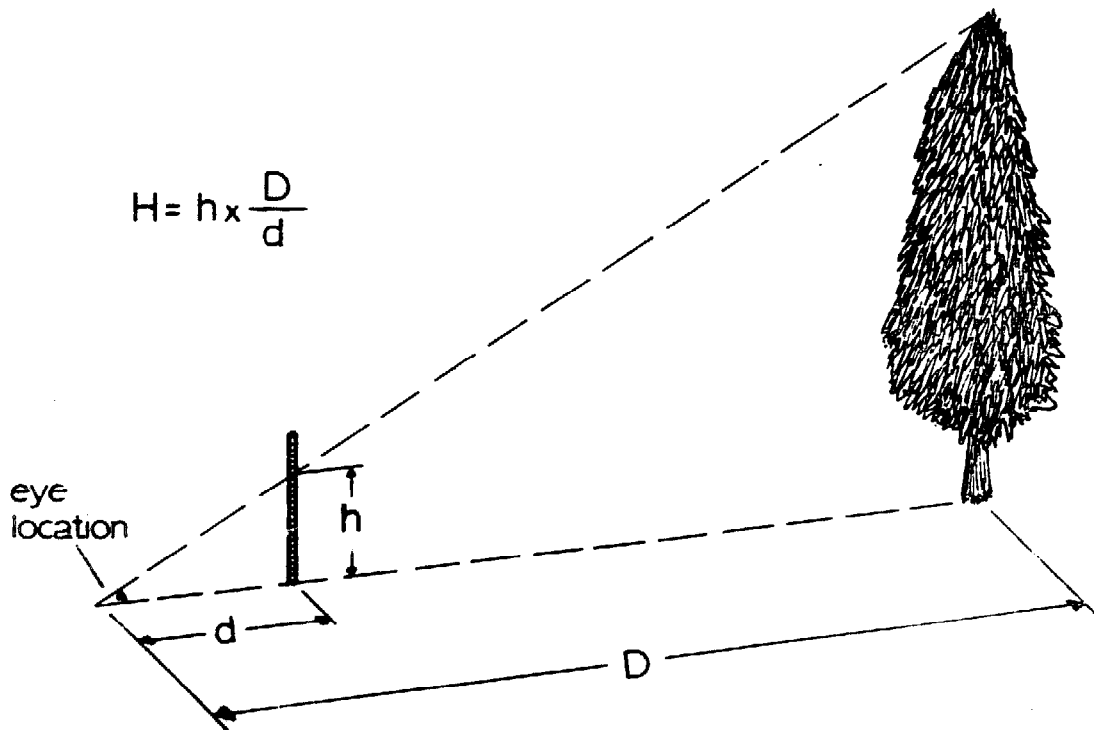
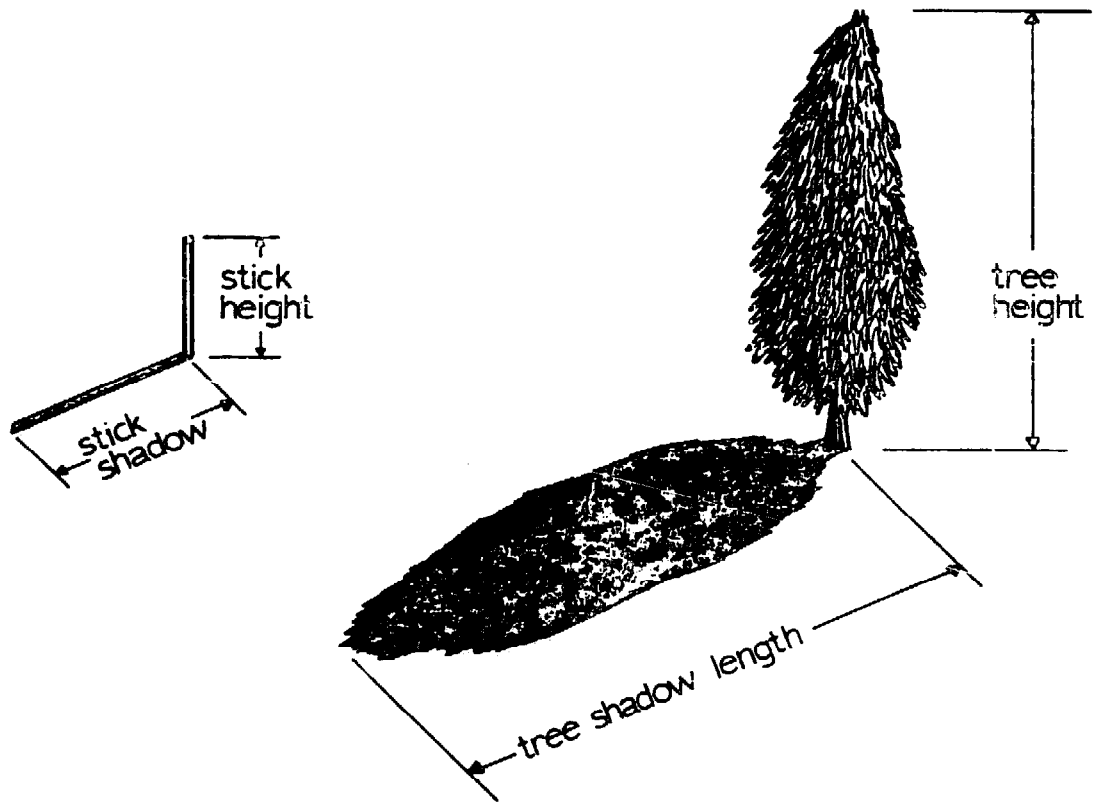

FIGURE 3-18: Two methods for estimating the height of a tree.

The second step in estimating your wind power involves finding the closest meteorological stations that are listed in Appendix 1. Compare their annual wind power averages. If they are at all close and there are no reasons (see previous discussion of terrain and obstruction effects on wind) why your value would not be about the same, you can take an average or place more weight on some of the readings than the others, according to your circumstances, to get a first estimate of your wind power. For open plains areas, this will work well, while in hilly or mountainous terrain, the results will most likely be poor. As an example, from Appendix 1, four meteorological stations in central Oklahoma (a typical plains area) within about 60 miles of a certain location have average annual wind powers of 263, 264, 174, and 167 watts per square meter. The average value is about 220, a very high value. On the other hand, an extreme case that can be taken from the tables in Appendix 1 and results in no useful data is the following: two meteorological stations are each 40 miles away from a fairly mountainous location. These two stations have average annual wind powers of 420 and 45 watts per square meter!*

The third step in obtaining a preliminary estimate of wind power is to simply start developing a better awareness of the wind and to make comparisons of the wind at your location with that where there are wind-measuring stations. The following table, the Beaufort Scale, relates wind speeds to easily recognizable phenomena.

Hand-held wind anemometers, such as shown in Figure 3-19, are available at many boating, outdoors, and aircraft supply stores. These are the least expensive of all wind-measuring devices. One of these can be used to help calibrate your sense of the wind. Where around you do you find it to be especially windy or especially quiet?

Do you occasionally or even regularly pass by one of the listed stations in Appendix 1? Arrange to stop and look for the anemometer. Is it in a sheltered location or out in the open? Stay and eat your sandwich for lunch there. Get a feeling for their winds versus yours. At the very least, call them and ask about their anemometer location. Look for other anemometer stations that are not listed in Appendix 1, such as at small airports, forest fire and lookout stations, and colleges. Ask around.

*Point Arena and Santa Rosa, California, which are located in a mountainous, coastal region.

BEAUFORT SCALE

	<u>Observations</u>	<u>Speed mph</u>
Calm	Calm. Smoke rises vertically.	0-1
Light air	Direction of wind shown by smoke drift but not by wind vanes	1-3
Light breeze	Wind felt on face. Leaves rustle. Ordinary vane moved on wind.	4-7
Gentle breeze	Leaves and small twigs in constant motion. Wind extends light flags	8-12
Moderate breeze	Raises dust and loose paper. Small branches are moved	13-18
Fresh breeze	Small trees in leaf begin to sway. Crested wavelets form on inland waters	18-24
Strong breeze	Large branches in motion. Whistling in telegraph wires. Umbrellas used with difficulty	25-31
Near gale	Whole trees in motion. Inconvenience is felt when walking against the wind	32-38
Gale	Breaks twigs off trees. Generally impedes progress	39-46
Strong gale	Slight structural damage occurs (chimneys & roofs)	47-54
Storm	Seldom experienced inland. Trees uprooted. Considerable structural damage occurs	59-63

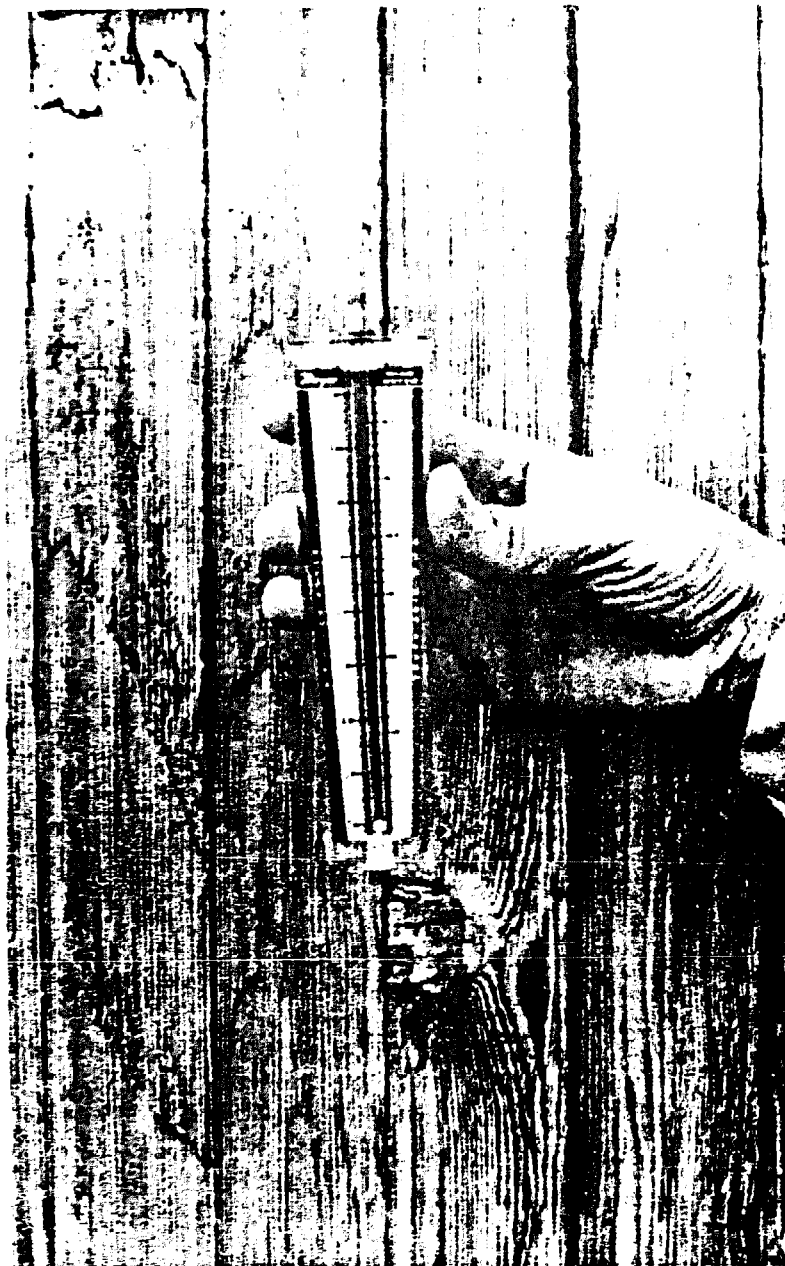

FIGURE 3-19: Handheld wind anemometer.

Nearly all libraries will carry the government publication titled Climatological Data* for your state. It contains some wind data, and it lists all the local weather observers for the National Weather Service. Most of these observers record only rainfall data, but they all receive this monthly publication.

*Available from National Climatic Center, Federal Building, Asheville, NC 28801. Available on a subscription or single-copy basis. Subscription costs about \$5/year. Order by the state you want.

The team that designed and built the Smith-Putnam wind turbine (see Reference 6) studied many promising wind sites in New England. They were mostly frustrated in their efforts to develop general rules for predicting the best wind sites. One powerful indicator that they did discover was that trees and plants can be greatly deformed in a consistent way by the wind. This is called flagging. They concluded:

1. Occasional very severe storms do not deform trees.
2. Tree deformation is a poor yardstick of maximum icing, although absence of breakage by ice may be significant.
3. Balsam trees are the best indicators of the mean wind speed in mountainous New England. Deformation begins when the mean velocity at a tree height of 30 to 50 feet reaches 17 mph. The other end of the scale is reached when balsam is forced to grow like a carpet, at a height of one foot, which indicates a mean wind speed of about 27 mph.
4. In this range between 17 and 27 mph, there are five easily recognized types of progressive deformation, brushing, flagging, throwing, clipping, and carpet.
5. Tree deformation is a sensitive indicator of the unpredictable wind flows through and over mountains. Local transitions from prevailing very high winds (which hold balsams to a carpet), to prevailing winds so moderate that the balsams reach normal growth without deformation, occur within a matter of yards of one another! Many a gardener knows that even moderate winds can have a strong effect on most vegetable plants. A government sponsored study is under way for determining wind effects on vegetation in the northeastern section of the United States.

Finally, combine all your information to make the best estimate of your wind power. Use this value for the first cut at sizing your wind system and estimating its costs.

Wind and Wind Power Measurement Equipment

To really measure your wind, you must mount a sensor on a pole high enough and far enough from buildings and trees to have a clear sweep of the wind. Ten feet is an absolute minimum height. Considering the time and money that will be invested in the survey, 25 to 50 feet is probably easily justifiable. Television antenna towers provide a good method to obtain these heights and can be as inexpensive as \$1.50 to \$2.00 per foot.

Most standard meteorological equipment for commercial use will appear to be quite expensive to the individual homeowner. However, new, relatively inexpensive items are rapidly being developed by manufacturers involved in the wind turbine market. Many of these items can also be rented from the manufacturer or distributor. For discussion purposes, this equipment can be divided into: 1) sensors for actually measuring the wind

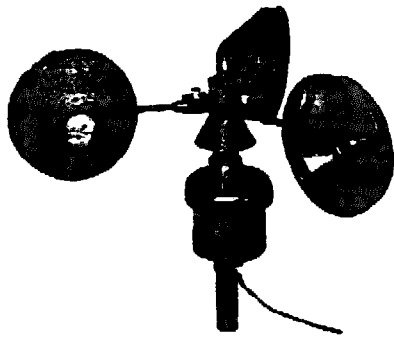

Wind Cup Anemometer

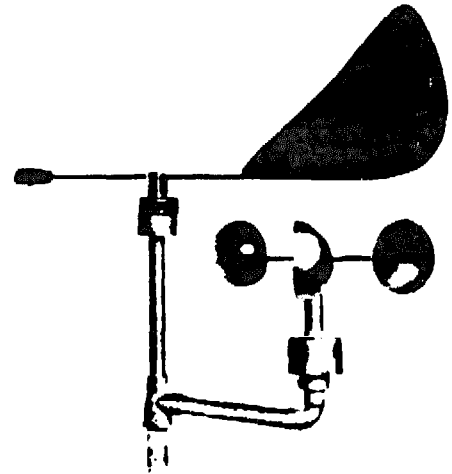

Wind Cup Anemometer with Wind Vane

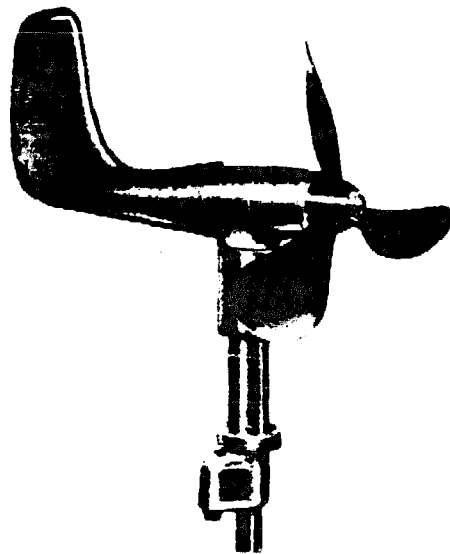

Propeller-Type Wind Anemometer

FIGURE 3-20: Wind Speed and Direction Sensors.

velocity, 2) meters for indicating the speed and/or direction, and 3) recording equipment that processes the data in one of several different possible ways and records the results.

Three kinds of sensors of particular interest here are shown in Figure 3-20. The wind-cup anemometer is the most popular type for surveys. It measures wind velocity but not direction. To measure the direction, a wind vane is required. Both pieces of data can be obtained with the third type, the propeller-type device attached to a tail vane. If you expect that the direction of the wind will be important to the placement of your wind turbine, then more than the wind-cup anemometer is advisable.

A note of caution must be made here. It is not unusual for an anemometer to give readings that are considerably in error, particularly after extended use. A ten percent wind speed error will produce about a 30 percent error in expected wind power, so some care is appropriate in selecting and maintaining the anemometer.

The simplest way of displaying the wind speed and direction is on meters. You must, however, read and log the values on a regular basis, preferably hourly during your hours awake. These sensors can generate either a direct current signal, pulses, or an alternating current signal. If a dc signal is used by the sensor, the wire length will probably be important, while the pulse type is unaffected by wire length as long as the signal received has adequate strength.

The simplest recorder is a counter that displays the run-of-the-wind. It totals up the miles of wind that blow past the anemometer. Thus, if it records 240 miles in a 24-hour period, the average wind velocity is 10 mph. You only need to read it once a day, but it would be better to read it more frequently to establish daily wind patterns. A homemade wind vane can be used to advantage for estimating the wind direction.

Long-term recording devices need no attention on a daily basis. One type prints the wind speed and/or direction on a paper chart. Such continuous recordings as obtained at meteorological stations require expensive apparatus and are not necessary here. At a fraction of the cost is a small, adequate recorder that prints a dot onto a slowly advancing paper chart recorder indicating velocity every few seconds. A roll of paper will usually last a month or more. To use the data, one can eyeball an average for each time period, such as quarter, half, or one-hour intervals, and then record and process the data by hand. Owner's manuals and equipment manufacturer's publications detail simple methods for data reduction and use.

Several recorders are available that divide wind speeds into ranges (i.e. 0-3, 4-7, 8-11, etc.) and have counter displays for each range. For each time interval, such as one minute, one count is added to the counter for the average speed experienced during that period. The total counts in one month, for example, can be plotted as a wind duration curve (see Fig. 3-9).

At least one manufacturer of WECS equipment presently sells a device that collects data essentially the same way as the previous recorders but then calculates the power that would result if some specific wind turbine were located there. There is just one display: total wind energy generated! The manufacturer will help you select a suitable wind turbine and use its characteristics in this recording device to perform the calculation. It can predict results for other windmills with a similarly rated wind speed. While this device is simple and direct, it is difficult to make correlations between its results and data from nearby meteorological stations.

Determining Your Wind Power

If you asked, "how long do I need to take wind data?" a meteorologist might tell you, "if you really want to know your wind, about five years is required!" He would be right and wrong. His answer could be right for some utility company which is considering the investment of millions of dollars in a group of wind-turbines and there is no long-term wind data for that region. His answer would not be appropriate if you are considering installing a \$5,000 wind system.

Better questions are, "how much will I gain by taking data an extra week, an extra month, or an extra six months, and how much will I gain by using wind survey equipment with more capability?" Measuring your wind for one month and claiming you have determined your average wind power is as absurd as measuring your rainfall for one month, multiplying by 12, and claiming you now know your average annual rainfall. However, by comparison with local weather station records, a few months worth of rainfall records can often provide you with a good indication of your annual average rainfall. Likewise, your average annual wind power is best estimated by comparing your data with weather station records.

You might ask, "where is the trade-off between time and money invested in a wind survey and the time and money invested in the windmill? What is the value of a wind survey to me? How much should I be willing to pay?" Let us look at three examples to get a feeling for what is involved.

For the first example, we assumed you live in flat country, about 20 or 30 miles from the nearest meteorological station. You have done a preliminary wind survey and you think you have a good site. The wind power at the nearest meteorological station is within ± 40 percent of other stations within 100 miles. You feel that your wind power is probably within ± 50 percent of that at this local station. We will assume that you have looked ahead at the next chapter and have evaluated your energy needs. You have tentatively selected several wind systems, the smallest one if your wind power is 50 percent greater than your estimate, and the largest windmill if your wind power is 50 percent less than the

estimated. The largest unit has $(100 + 50) \div (100 - 50) = 3$ times the capacity of the smallest unit. They range in price from \$3000 to \$7000.

From your study of the economics involved (Chapter 6), you have decided that \$7000 is your break-even point compared to extending the power lines and using public utility power. You feel that spending \$700 for a survey would be well worthwhile. Say that the survey shows you have 25 percent more power available than your original estimate with a ± 15 percent uncertainty. You would simply buy a \$4000 system and be done with it. The \$700 survey cost has in effect bought you assurance (in a sense, insurance) that you need not spend \$7000. You have saved \$2300 [$7000 - (4000 + 700)$].

As another example, suppose you have a summer cabin off in the woods and you use it approximately one month in a year. You are tired of hauling bottled gas and know that your tired, noisy, smelly, gummed-up engine-driven generator needs replacing. You have estimated the available power to ± 40 percent. Since your entire need for electrical energy is only for recreation, when you hit an unusually calm spell of weather you could simply not go to the cabin. Using the high (140 percent) and low (60 percent) wind power and your estimated need, you come up with two systems, mostly composed of used equipment, with price tags of \$1200 and \$1600. The summer season is coming up and you are not there to take a survey and would have to contract it out. You decide to simply go ahead with a larger system since you feel you cannot get enough useful wind survey information for the few hundred dollars difference and the time allowed.

As a final example, consider a farmer or rancher who needs a lot of power. He has made a preliminary survey and selected two systems based on his estimate of maximum and minimum wind power that will cost \$10,000 and \$25,000. Obviously, spending several thousands of dollars for a good wind survey will be a worthwhile investment.

The important features of all three of these examples are: 1) a preliminary estimate of wind power with an estimate of your accuracy; 2) an estimate of energy requirements (at least a preliminary estimate); 3) an estimate of your wind energy system low and high wind power cost, and 4) the maximum sum to place on the site survey. These four common features of the above examples are the first four steps shown in Figure 3-21, a logic diagram showing the steps to be taken in accomplishing a wind power survey.

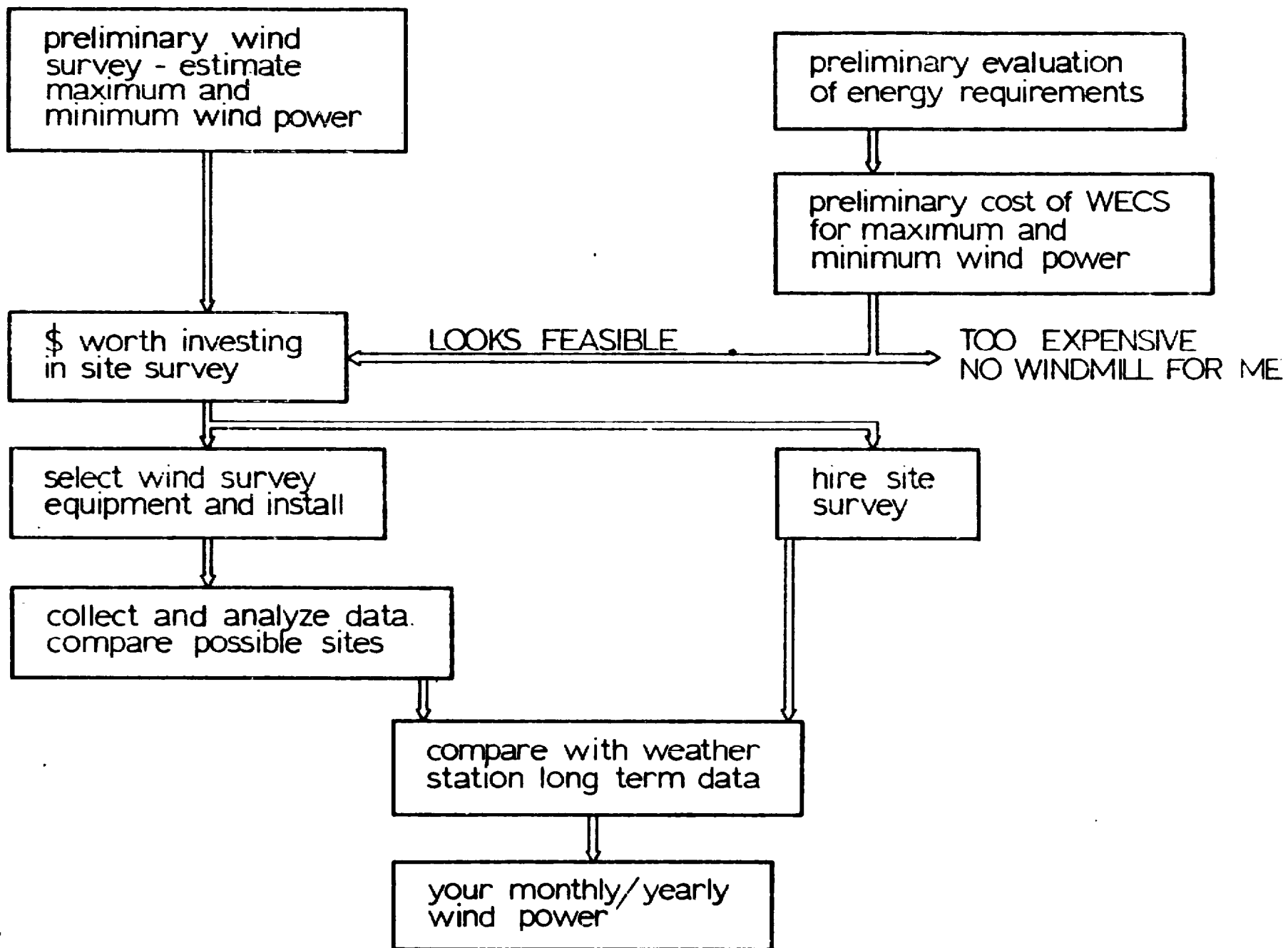

FIGURE 3-21 Determining your wind power.

Concerning the decision on the value of the wind survey, we return to the questions posed at the beginning of this section. "How much will I gain by taking data an extra week, month, or six months, and how much will I gain by using wind survey equipment with more capability?" These questions probably don't have any definite answers, but if you are interested in a small system, live in flat country near a weather station with wind records, and your preliminary survey shows your estimated average annual wind speed is quite high, two or three months of data with one wind-cup anemometer will probably produce adequate results. For the potentially larger, more expensive system, more sophisticated wind survey equipment and longer data collection times are appropriate. Also, where the estimated average annual wind speed is less, there is a greater need for more than just run-of-the-wind readings. This is due to the larger scatter in wind power at the lower annual wind speeds shown in Figure 3-8, as described earlier in this chapter.

Equipment alternatives include renting or purchasing of the wind sensor equipment. Some wind turbine manufacturers/distributors will rent anemometer equipment. If you buy equipment, you can expect to recover some of your costs by selling it when you have finished your site survey. Also, you may wish to have a professional meteorologist, meteorology firm, or a knowledgeable distributor install the wind measuring equipment and perform the wind survey for you.

The next step in the process of determining your wind power (see Figure 3-21) is to compare your wind recordings with the readings that have been obtained simultaneously at nearby meteorological stations. You will then be able to estimate your long-term average wind power by using their summaries of years of data.

At each of the stations listed in Appendix 1, an hourly record of weather conditions is written out on form WBAN 10A, one sheet for each day. This sheet includes hourly observations of wind direction and speed. These are made by estimating on the hour the average wind speed for a one minute period by observing a dial or strip chart recording. Visit or write your nearby station(s) to obtain copies of the records for the days of interest to you for comparison with your data. The WBAN 10A sheets (and the strip chart recordings) are sent to the National Climatic Center, and copies can also be ordered from them.*

Much of the data since the mid-1940's has been prepared for and processed by computers to obtain various long-term wind averages. Each station has a set of average monthly and yearly wind speeds for their location. These sheets are titled Percentage Frequency of Wind Direction and Speed. A sample from an exceptionally windy site is shown in Figure 3-22. It shows the percentage of the hourly readings in each of 11 different speed

*Federal Building, Asheville, North Carolina 28801

ranges (in knots) and 16 directions. In the right column is the mean wind speed (same as average wind speed) for each wind direction (remember that is the direction the wind blows from). Along the bottom are summations for each column and the average wind speed for the entire period. This last value will be essentially the same as listed in that station in Appendix 1.* You will at least want a copy of the annual summary and the sheets for your critical months when your expected demand is greatest compared to the available wind power. All the information you need for making up a wind rose (Fig. 3-5) or a wind duration curve (Fig. 3-9) is on this form. How to use this information to produce the wind duration curve is presented in Chapter 5.

The method for using the data you collect from a wind-cup anemometer registering just the run-of-the-wind is quite simple. Read your meter at the beginning of each month. Follow the manufacturer's procedure for determining the miles of wind passing the meter during the previous month. Divide this number by the hours that have elapsed (for a 30 day month, $24 \times 30 = 720$) and you have your average wind speed for that month. Now, add up all the hourly wind speeds recorded at your nearest meteorological station for the month and divide that by the same number of hours. You have the average wind speed for the meteorological station for the same period. For instance, if your reading at the end of the first month is 5760, divided by 720 gives 8.0 miles per hour. If the sum of the weather station speed values for the same month were 6261, then the average wind speed would be:

$$6261 \times 1.15 \div 720 = 10.0 \text{ mph}$$

The 1.15 factor converts knots to miles per hour (all weather station readings are in knots). Your wind speed was 80 percent of that measured by the weather station, and your wind power is $(.8 \times .8 \times .8 \times 100) = 51$ percent of that at the station. Now, look in Appendix 1 at the average annual wind power for that station. Let us say for example, that this value is 200 watts per square meter. Your expected average annual wind power based on your single reading for one month would be $0.51 \times 200 = 102$ watts per square meter. This might be a quite satisfactory estimate, or it may be a very poor value depending on the terrain factors. If subsequent monthly comparisons show large differences in your wind power compared to the weather station wind power, the single month value was, of course, not good. However, if the values for the next couple of months are close to the first value, the average wind power based on these three months could be quite good.

*Small changes in the average monthly and yearly wind speeds can be caused by including more recent years of wind records than used for the results in Appendix 1. Any large change should be investigated. Have they relocated the anemometer or built new buildings nearby?

DATA PROCESSING DIVISION
 ETAC, USAF
 ASHEVILLE, N. C. 28801

SURFACE WINDS

PERCENTAGE FREQUENCY OF WIND DIRECTION AND SPEED (FROM HOURLY OBSERVATIONS)

45702 AMCHITKA ISLAND ALEUTIAN IS 44-50 JAN
STATION STATION NAME YEARS MONTH

ALL WEATHER
CLASS

CONDITION

ALL
HOURS (EST)

SPEED (KNTS) DIR.	1 - 3	4 - 6	7 - 10	11 - 16	17 - 21	22 - 27	28 - 33	34 - 40	41 - 47	48 - 55	≥56	%	MEAN WIND SPEED
N	.1	.3	1.3	1.1	1.0	.5	.2	.1	.0	.0	.1	4.8	15.8
NNE	.2	.1	.5	.7	.9	.8	.6	.1		.0	.0	3.8	19.8
NE	.2	.1	.6	.8	1.2	.8	.7	.1	.0	.1		4.5	19.4
ENE	.1	.1	.3	.8	1.3	1.5	1.2	1.0	.3	.2	.9	7.7	30.0
E	.2	.4	1.1	1.9	1.5	1.0	.9	1.0	1.0	.9	.2	9.5	23.7
ESE	.1	.1	.5	1.0	1.3	1.3	1.1	.8	.8	.7	.1	7.9	27.4
SE	.1	.3	.6	.7	1.1	1.6	1.3	.9	.4	.3	.1	7.6	25.1
SSE	.0	.2	.3	.2	.3	.4	.4	.7	.5	.8	.3	3.9	32.1
S	.3	.3	.6	.9	1.0	.7	.7	.8	.5	.4	.2	6.4	24.9
SSW	.1	.1	.5	.6	.4	.7	.7	.3	.0	.2	.2	3.7	24.9
SW	.1	.2	.6	1.2	.9	1.1	.9	.5	.3	.2	.2	6.3	23.9
WSW	.0	.2	.8	.9	1.1	1.1	.9	.6	.3	.2	.0	6.1	23.0
W	.2	.3	.7	.9	1.3	1.4	.9	.4	.1	.1		6.3	20.7
WNW	.2	.3	.5	1.1	1.0	1.1	.7	.6	.2	.1		6.0	21.3
NW	.3	.4	1.7	1.9	1.4	1.4	.7	.6	.2	.0		8.7	18.1
NNW	.0	.2	.8	1.7	1.5	1.1	.4	.2	.0	.1		6.0	18.6
VARBL													
CALM	X	X	X	X	X	X	X	X	X	X	X	.9	
	2.3	3.7	11.4	16.4	17.3	16.6	12.2	8.7	4.8	3.7	2.1	100.0	22.9

TOTAL NUMBER OF OBSERVATIONS 5146

FIGURE 3-22: Sample of average wind data from an extremely windy location.

3-36

CHAPTER 4

POWER AND ENERGY REQUIREMENTS

In Chapter 2 we described the difference between work, energy, and power. This chapter will deal with two of these quantities: how much power is needed, and how long is this power required. This is the same as asking how much energy is needed.

As we stated in Chapter 1, the entire process of selecting a suitable wind system involves determining what power is available from the wind at your site, knowing what you need in the way of energy and power, and then matching these to arrive at a wind system that will do the job. We will break this discussion of power and energy requirements into two separate parts. The first will discuss electric load estimation, and the second will discuss mechanical load estimation, particularly for water pumping.

Before the discussion of power requirements, let us keep in mind that while it is well to calculate how much power you need, some consideration must be given to losses, or inefficiency. That is, if you figure how much electric power you need to run a light bulb, it will take a little extra, over and above the amount needed by the light bulb alone. The wires running from the generator to the light will waste some power because of electrical resistance. Friction is another example of inefficiency. This waste ends up as a power loss in the form of heat. Estimation of losses is an important part of your calculation of your power and energy needs.

A pictorial view of energy and losses is shown in Figure 4-1. The smaller the pie slice representing loss, the more energy available to the user.

ELECTRIC LOAD ESTIMATION

Two different numbers will result from performing the simple calculations here - first, the power load, which is expressed as the number of watts, or kilo (thousand) watts, and second, the energy requirement, which is expressed in kilowatt-hours (kWh).

Electric power is a product of electric pressure, called volts, and current flow, called amperes (amps). Just as force times rate of motion equals power, usually expressed as horsepower, volts times amps equals power, expressed in watts. For example, a 12-volt battery that pushes 10 amps through a light uses electric power equal to $12 \times 10 = 120$ watts. Now suppose that the 120-watt light is left on for 10 hours. Then, the electric energy consumed will equal 120 watts times 10 hours, which equals 1200 watt-hours, or 1.2 kilowatt-hours.



entire circle represents
total energy.
net energy available is
total less losses.

FIGURE 4-1: Some energy is always lost.

If a battery could store 2400 watt-hours of energy, then it would have a capacity to produce 120 watts of power for 20 hours. That is, 2400 watt-hours divided by 120 watts equals 20 hours. We will see more of these simple calculations as this chapter progresses.

In order to arrive at these types of numbers, it is necessary for you to determine two types of information:

- * Which electrical devices you will use and how much power, in watts, they will draw.
- * How long these devices will operate, say, in hours per month.

Later, we shall add a third item of information: at what time of the day the devices operate.

If it turns out that your wind system will provide power to electrical devices that you already use, and perhaps have used for some time, then load analysis becomes a simple task of checking all your electric bills for the last dozen or so months. It is a good idea to know how your electric bill changes with each month of the year to see what seasonal changes look like. In many cases, changes in the weather affect your energy use patterns. Here, you are not concerned with the dollar figure of the bill, but instead the actual demand figure expressed as kWh. Make sure that your utility company meter-reader has really read your meter, as occasionally utilities will estimate your use if the meter reader is behind schedule or is afraid of your "Beware of Dogs" sign! Estimated kWh figures will not help you at all.

If you have not saved enough bills to check the demand, you can usually obtain a summary from your electric utility company. In either case, the utility bill will give you the monthly energy demand. It will not, however, give you the power demand in watts or kilowatts. For that, you will have to list the devices you use and determine the power requirement of each. Figure 4-2 will assist you. This figure will also serve to assist in estimation of energy demand if you do not have your utility bills.

Name	W-110	Hrs/Mo	KWHRS/Mo	Name	Capacity	HP or watts	Est. KWHR
Air conditioner, central			620*	Lawnmower	1000	8	8**
Air conditioner, window	1566	74	116*	Lighting	5-300		10-40
Battery charger				lights, 6 room house			60
Blanket		80	15	in winter			9
Blender	350	3	1	Light bulb, 75	75	120	4.8
Bottle sterilizer	500	6	3	Light bulb, 40	40	120	4.8
Bottle warmer	500	6	3	Mixer	125	8	1
Broiler	1436	6	8.5	Mixer, food	50-200		1
Clock	1.10		1.4*	Movie projector	300-1000		
Clothes drier	4800	20	92**	Oil burner	500	100	50*
Clothes drier, electric heat	4856	18	86**	Oil burner			50*
Clothes drier, gas heat	325	18	6**	Oil burner, 1/8 HP	250	64	16*
Clothes washer			8.5*	Pasteurizer, 1/2 gal.	1500		10-40
Clothes washer, automatic	250	12	3*	Polisher	350	6	2
Clothes washer, conventional	200	12	2**	Post light, dusk to dawn			26
Clothes washer, automatic	512	17.3	9*	Power tools			3
Clothes washer, ringier	275	15	4**	Projector	500	4	2*
Cloppers	40-60		%	Pump, water	450	44	20**
Coffee maker	800	15	12	Pump, well			20**
Coffee maker, twice a day			8	Radio			8
Coffee percolator	300-600		3-10	Radio, console	100-300		5-15*
Coffee pot	894	10	9	Radio, table	40-100		5-10*
Cooking attic fan	1/6-3/4HP		60-90**	Range	8500-1600		100-150
Cooling, refrigeration	3/4-1 1/2 ton		200-500*	Range, 4 person family			100
Corn popper	460-650		1	Record player	75-100		1.5
Curling iron	10-20		%	Record player, transistor	60	50	3*
Dehumidifier	300-500		50*	Record player, tube	150	50	7.5*
Dishwasher	1200	30	36*	Recorder, tape	100	10	1*
Dishwasher	1200	25	30*	Refrigerator	200-300		25-30*
Disposal	375	2	1*	Refrigerator, conventional			83*
Disposal	445	6	3*	Refrigerator-freezer	200	150	30*
Drill, electric, 1/2"	250	2	5	Refrigerator-freezer			
Electric baseboard heat	10-1000	160	1600	14 cu.ft.	326	290	95*
Electric shaver	5-250		1*	Refrigerator-freezer,			
Electronic oven	3000-7000		100*	frost free	380	500	180*
Fan, attic	370	65	24**	Roaster	1320	30	40
Fan, kitchen	250	30	8**	Rotisserie	1400	30	42*
Fan, 8" 15"	35-210		4-10**	Sauce pan	300-1400		2-10
Food blender	200-300		%	Sewing machine	30-100		1/2-2
Food warming tray	350	20	7	Sewing machine	100	10	1
Footwarmer	50-100		1	Shaver	12		1/10
Floor polisher	200-400		1	Skillet	1000-1350		5-20
Freezer, food, 5-30 cu.ft.	300-900		30-125*	Ski Saw	1000	6	6
Freezer, ice cream	50-300		%	Sunlamp	400	10	4
Freezer	350	90	32*	Sunlamp	279	5.4	1.5
Freezer, 15 cu.ft.	440	330	145*	Television	200-315		15-30*
Freezer, 14 cu.ft.			140*	TV, BW	200	120	24*
Freezer, frost free	440	180	57*	TV, BW	237	110	25*
Fryer, cooker	1000-1500		5	TV, color	350	120	42*
Fryer, deep fat	1500	4	6	TV, color			100*
Frying pan	1195	12	15	Toaster	1150	4	5
Furnace, electric control	10-30		10*	Typewriter	30	15	5*
Furnace, oil burner	100-300		25-40*	Vacuum cleaner	600	10	6
Furnace, blower	500-700		25-100**	Vacuum cleaner, 1 hr/wk			4
Furnace, stoker	250-600		3-60**	Vaporizer	200-500		2.5
Furnace, fan			32**	Waffle iron	550-1300		1-2
Garbage disposal equipment	1/4-1/3 HP		%*	Washing machine, 12 hrs/mo			9*
Griddle	450-1000		5	Washer, automatic	300-700		3-8*
Grill	650-1300		5	Washer, conventional	100-400		2-4*
Hair drier	200-1200		1/2-2*	Water heater	4474	69	400
Heat lamp	125-250		2	Water heater	1200-7000		200-300
Heater, base	1320	30	40	Water pump (shallow)	1/4HP		5-20**
Heater, portable	660-2000		15-30	Water pump (deep)	1/3-1 HP		10-60**
Heating pad	25-150		1				
Heating pad	95	10	1				
Heat lamp	250	10	3				
H. F. Stereo			9*				
Hot plate	500-1650		7-30				
House heating	8000-15,000		1000-2500				
Humidifier	500		5-15*				
Iron	1100	12	13				
Iron			12				
Iron, 16 hrs/month			13				
Ironer	1500	12	18				
Knife sharpener	125		1/2*				

AT THE BARN

Name	Capacity	HP or watts	Est. KWHR
Barn cleaner	2.5 HP		120/yr.*
Cipping	fractional		1/10 per hr.
Corn, ear crushing	1.5 HP		5 per ton*
Corn, ear shelling	1/2-2		1 per ton**
Electric fence	7-10 watts		7 per mo.**
Ensilage blowing	3-5		1/2 per ton
Feed grinding	1-7 1/2		1/2-1 1/2 per 100 lbs **
Feed mixing	1/2-1		1 per ton**
Grain cleaning	1/2-1		1 per 100 bu**
Grain drying	1-7 1/2		5-7 per ton**
Grain elevating	1/2-5		4 per 1000 bu**
Hay curing	3-7 1/2		60 per ton*
Hay hoisting	1/2-1		1/3 per ton**
Milking, portable	1/2-1		1 1/2 per cow/mo.**
Milking, pipeline	1/2-3		2 1/2 per cow/mo **

Sheep shearing	fractional		1 1/2 per 100 sheep
Silo unloader	2.5 HP		4-8 per ton*
Silage conveyor	1-3 HP		1-4 per ton*
Stock tank heater	200-1500 watts		varies widely
Yard lights	100-500 watts		10 per mo.
Ventilation	1/8-1/3 HP		2-6 per day** per 20 cows
IN THE MILKHOUSE			
Milk cooling	1/2-5 HP		1 per 100 lbs. milk*
Space heater	1000-3000		800 per year
Ventilating fan	fractional		10-25 per mo.**
Water heater	1000-5000		1 per 4 gal
FOR POULTRY			
Automatic feeder	1/2-1 HP		10-30 KWHR/mo**
Brooder	200-1000 watts		1/2-1 1/2 per chick per season
Burglar alarm	10-60 watts		2 per mo.*
Debeaker	200-500 watts		1 per 3 hrs.
Egg cleaning or washing	fractional HP		1 per 2000 eggs**
Egg cooling	1/8-1HP		1/4 per case*
Night lighting	40-60 watts		10 per mo. per 100 birds
Ventilating fan	50-300 watts		1-1 1/2 per day** per 1000 birds
Water warming	50-700 watts		varies widely
FOR HOGS			
Brooding	100-300 watts		35 per brooding period/litter
Ventilating fan	50-300 watts		1/2-1 1/2 per day**
Water warming	50-1000 watts		30 per brooding period/litter
FARM SHOP			
Air compressor	1/2-1 HP		1 per 3 hr.*
Arc welding	37 1/2 amp		100 per year*
Battery charging	600-750 watts		2 per battery charge*
Concrete mixing	1/2-2 HP		1 per cu. yd.**
Drill press	1/8-1 HP		1/2 per hr.**
Fan, 10"	35-55 watts		1 per 20 hr.**
Grinding, emery wheel	1/4-1/3 HP		1 per 3 hr.**
Heater, portable	1000-3000 watts		10 per mo.
Heater, engine	100-300 watts		1 per 5 hr.
Lighting	50-250 watts		4 per mo.
Lathe, metal	1/2-1 HP		1 per 3 hr.
Lathe, wood	1/2-1 HP		1 per 3 hr.
Sawing, circular 8"-10"	1/3-1/2 HP		1/2 per hr.
Sawing, jig	1/4-1/3 HP		1 per 3 hr.
Soldering, iron	60-500 watts		1 per 5 hr.
MISCELLANEOUS			
Farm chore motors	1/2-5		1 per HP per hr.
Insect trap	25-40 watt		1/3 per night
Irrigating	1 HP up		1 per HP per hr.
Snow melting, sidewalk and steps, heating-cable imbedded in concrete	25 watts per sq. ft.		2.5 per 100 sq. ft. per hr.
Soil heating, hotbed	400 watts		1 per day per season
Wood sawing	1-5 HP		2 per cord

Symbol Explanation

*AC power required
 †Normally AC, but convertible to DC
 Notes: Lighting in this table is assumed to be incandescent—if fluorescent, the wattage bulbs consume the same power but deliver 3 times as much light—fluorescent bulbs also require AC, but can be converted to DC.
 These figures can be cut by 50% with conservation of electricity.

FIGURE 4-2: Power and energy requirements of appliances and farm equipment.

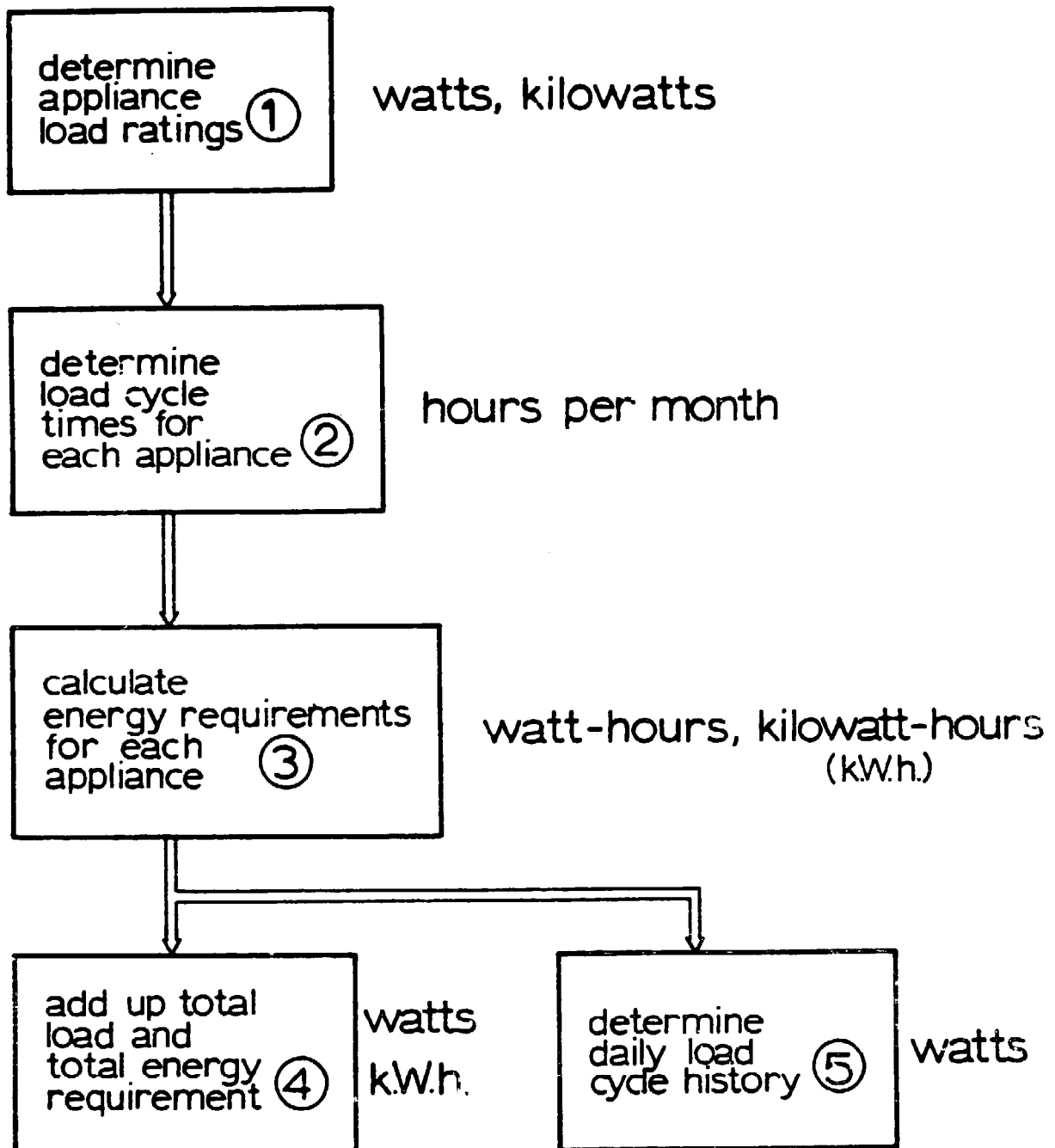

FIGURE 4-3: Estimating your energy requirements.

We will follow the blocks in Figure 4-3 to apply a logical sequence to the following discussion.

Block 1. Determine the appliance load rating, expressed in watts, or kilowatts.

Example: Brand C electric motor is a one-horsepower motor. Its electrical load when operating is 860 watts, and when starting, 1400 watts for one second. These data are found: on the appliance data plate, by writing to the manufacturer, by testing an appliance yourself, or from Figure 4-2 of this book. You can easily test the appliance if you presently have electric service. Watch your electric utility meter, which measures energy usage. Usually it contains a slowly spinning disc, and some number of revolutions of it indicates that one kWh has been consumed. Ask your power company what each revolution means. Turn off all other appliances so the meter stops. Then turn on the appliance you wish to rate and time the spinning disc.*

Block 2. Determine the load cycle time and the number of hours the load will operate on a monthly basis.

Example: Brand D refrigerator will operate an average of 15 hours per month. Note that this information depends on how well insulated the refrigerator is, the number of times the door is opened, how much bulk will be stored, and the room temperature.

Block 3. Determine the appliance's monthly energy requirement. This is calculated by multiplying together the data from blocks 1 and 2 above. The result is in watt-hours, or kilowatt-hours.

Example: A color television is determined in step 1 to require 350 watts. You know that it will be used for 150 hours per month, so:
 350 watts times 150 hours equals 52,500 watt-hours.
 To get kilowatt-hours: $52,500 \div 1000 = 52.5$
 kilowatt-hours (kWh).

Block 4. Determine maximum load. This calculation will result in your maximum power demand, expressed as kilowatts (kW), which would occur if all of your appliances were operating at the same time.

Example:

<u>Item</u>	<u>Power (watts)</u>
TV	200
Coffee pot	894
Dishwasher	1200
Refrigerator	300
Water heater	6000
Maximum Load:	8594 watts = 8.59 kW

* This will not be adequate for obtaining the starting load, but that is not necessary for these load calculations.

Block 5. Determine your total monthly energy requirement. Total energy is expressed in kilowatt-hours (kWh). This is the energy you must supply each month, or pay for when supplied by your utility company.

Example:

<u>Item</u>	<u>Energy requirement (kWh)</u>
TV	24
Coffee Pot	9
Dishwasher	36
Refrigerator	30
Water heater	300
Total Energy Requirement	399 kWh per month

(Note: The above examples are selected at random from Figure 4-2 and do not necessarily represent a typical household load.)

We shall return to monthly energy requirements shortly, but first let us look more closely at a daily breakdown of your electrical load.

Block 6. Determine your daily load cycle history. This calculation will give you a much better estimate of your actual electric load demand. Simply adding up all of the loads, as in the above example, assumes that all appliances will be on at the same time and gives a worst case figure, but does not reflect a real case. To arrive at a load cycle history, you must make estimates of the time of day your devices will be on and for how long. This estimate may be as accurate or as rough as necessary. How accurate you decide to be in making estimates will depend entirely on your assessment of the importance of this calculation. For an accurate estimation, it will be necessary to actually monitor any items that operate on a cyclic basis, such as refrigerators. For less accuracy, it may be reasonable to assume such loads "on" continuously. As a first example (not representative, but illustrative of the thinking here), we shall separate items by their nature: those which you control, and those which operate automatically. For this example, items that operate automatically shall be assumed to operate continuously. The other loads will require estimation of operating cycles, as listed below.

<u>Automatic Items</u>	<u>Load (watts)</u>	<u>Time</u>
Refrigerator	300	Continuous
Water heater	6000	Continuous

User-controlled Items

TV	200	4 hours per day as follows: 1 hour: 8 am - 9 am 3 hours: 6 pm - 9 pm
Coffee pot	894	20 minutes per day 7:30 - 7:50 am
Dishwasher	1200	1 hour per day: 5 pm - 6 pm

From this table, we can see a base load, that is, a continuous load equal to 6300 watts, with peak loads going as much as 1200 watts higher. Again, this is not a representative example, but compare it with the following example.

If we made a simple graph of this load, it would look something like Figure 4-4.

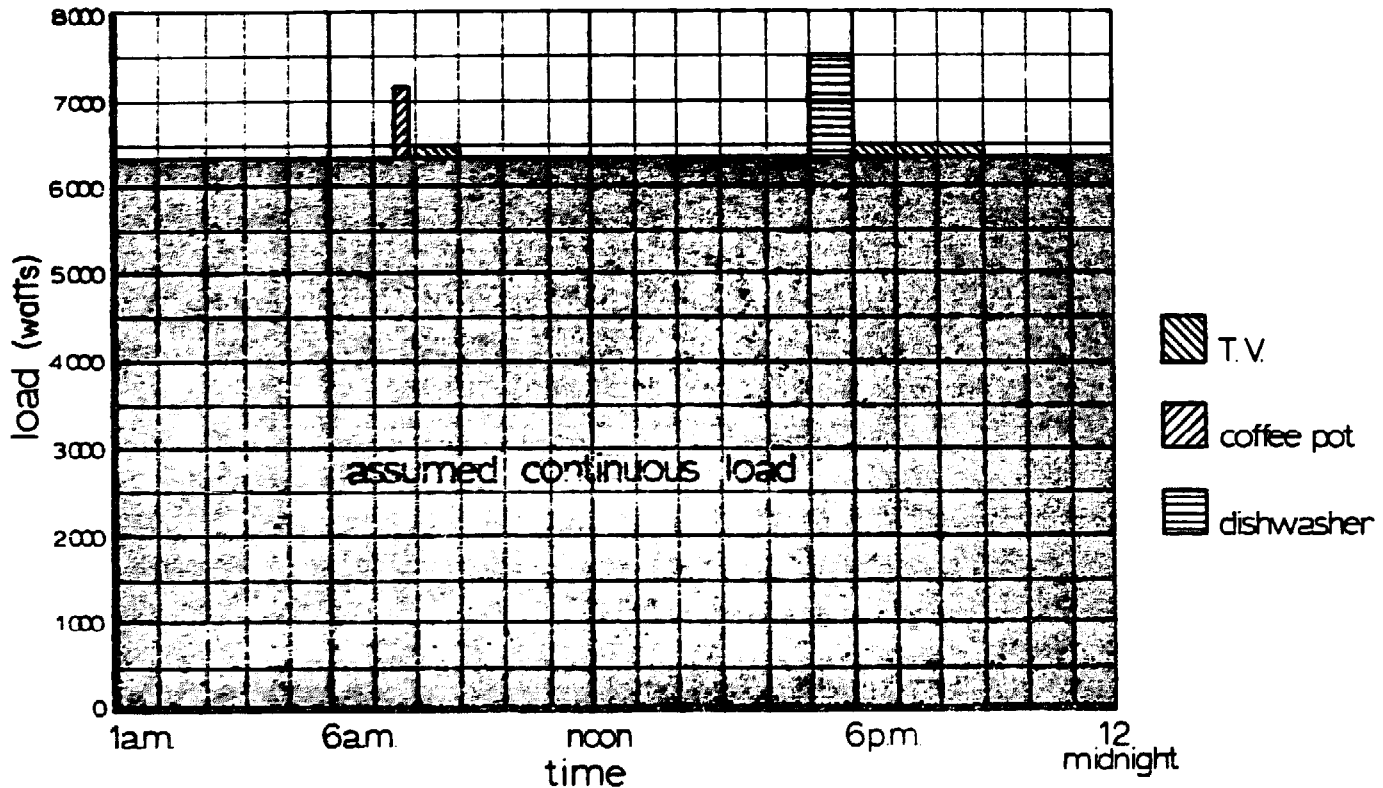

FIGURE 4-4: Graph of example load history.

For a second example, let us be more realistic. The assumption that all automatic items are continuous loads should be adjusted. Since the data were originally extracted from Figure 4-2, let us look at that chart again.

Notice that the refrigerator is listed as 200-300 watts for 25 to 30 kWh per month. Using 300 watts and 30 kWh (or 30,000 watt-hours) per month, we can calculate the hours per month this device operates:

$30,000 \text{ watt-hours per month} \div 300 \text{ watts} = 100 \text{ hours per month.}$

Now, assuming a 30-day month, $100 \text{ hours per month} \div 30 \text{ days} = 3.3 \text{ hours per day.}$ This is the estimated number of hours per day this refrigerator will operate. Now we must guess when, and for how long during each cycle it operates. A safe guess is that it cycles most during mealtimes.

For the water heater, a similar calculation should be made: $300,000 \text{ watt-hours per month} \div 6000 \text{ watts} \div 30 \text{ days} = 1.6 \text{ hours per day.}$

<u>Automatic Items</u>	<u>Load</u>	<u>Time</u>
Refrigerator	300	3.3 hours per day: 1.1 hours each 7 am, noon, 5 pm.
Water heater	6000	1.6 hours per day: 0.8 hours each 8 am, 6 pm.

With use-controlled items similar to the first example, results from the new graph (Fig. 4-5) will be somewhat closer to reality.

Performing the type of analysis in Figure 4-5 may not actually be necessary for your energy requirement estimates, but it is a good way to understand the nature and characteristics of the electric load you expect.

Block 7. Determine your monthly energy requirements. A previous example illustrated how a monthly energy requirement of 399 kWh was established. This could have been any month. For some months, a heavy demand for heating may raise electrical consumption, while in others, air conditioning will prevail. Thus, you must complete a demand analysis for each month of the year. A graph plotted from your totals would look like Figure 4-6.

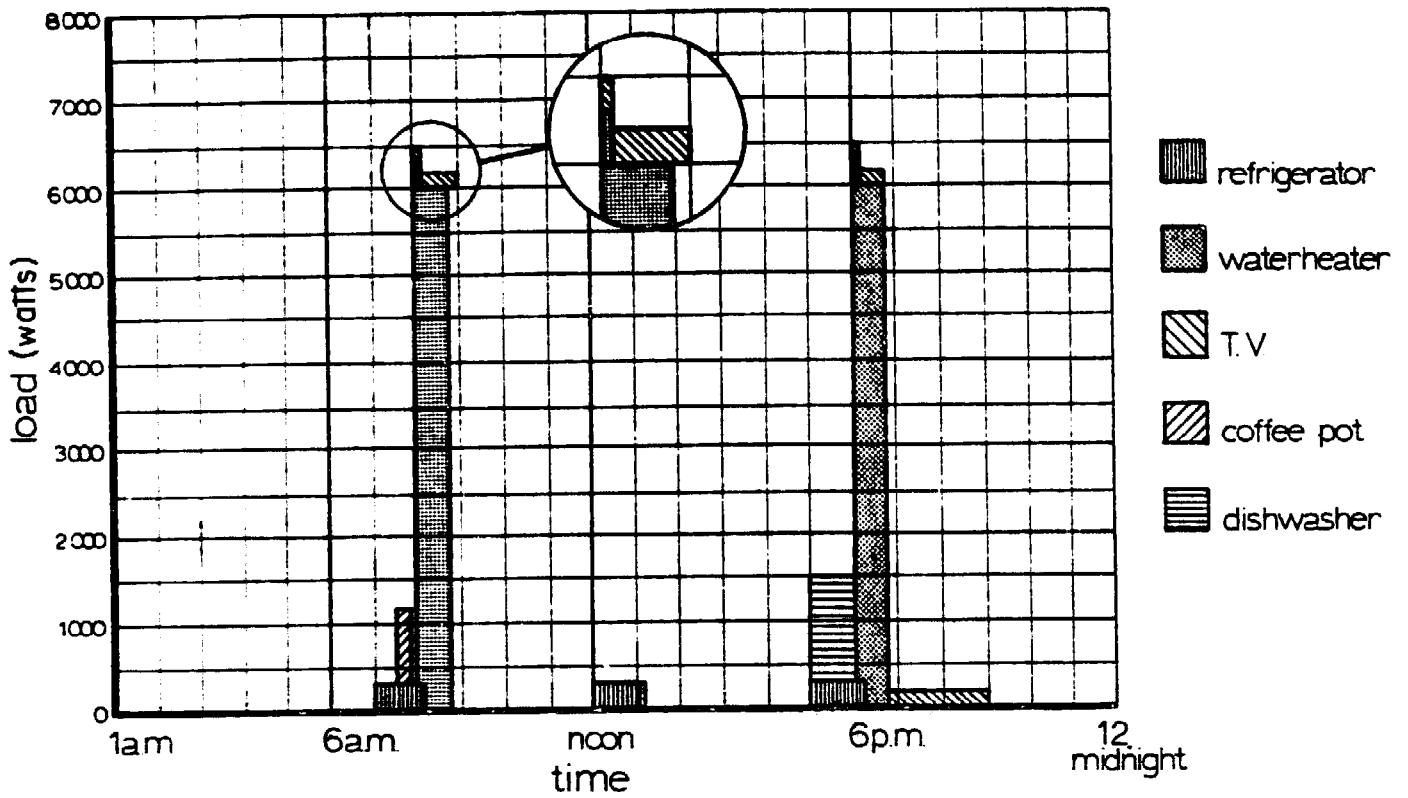

FIGURE 4-5: Graph of example load history.

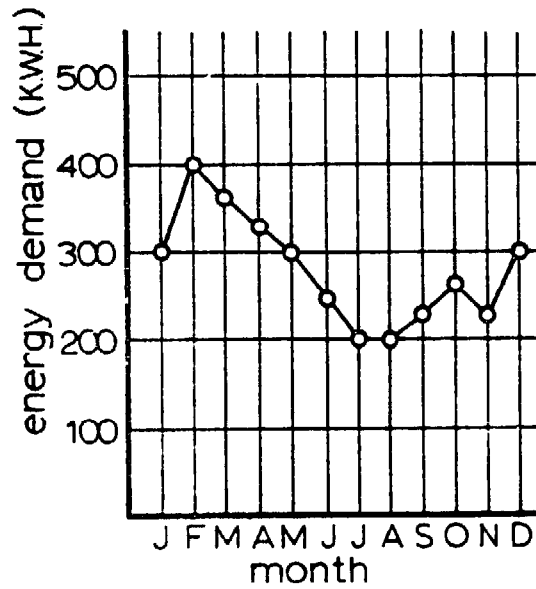

FIGURE 4-6: Typical monthly energy demand.

MECHANICAL LOAD ESTIMATION

Estimation of mechanical load may be as simple as reading the data plate on a device you expect to drive mechanically by wind power, and can be as complex as calculating the horsepower required to pump water through some pipes. This section will deal primarily with estimation of power required to pump water.

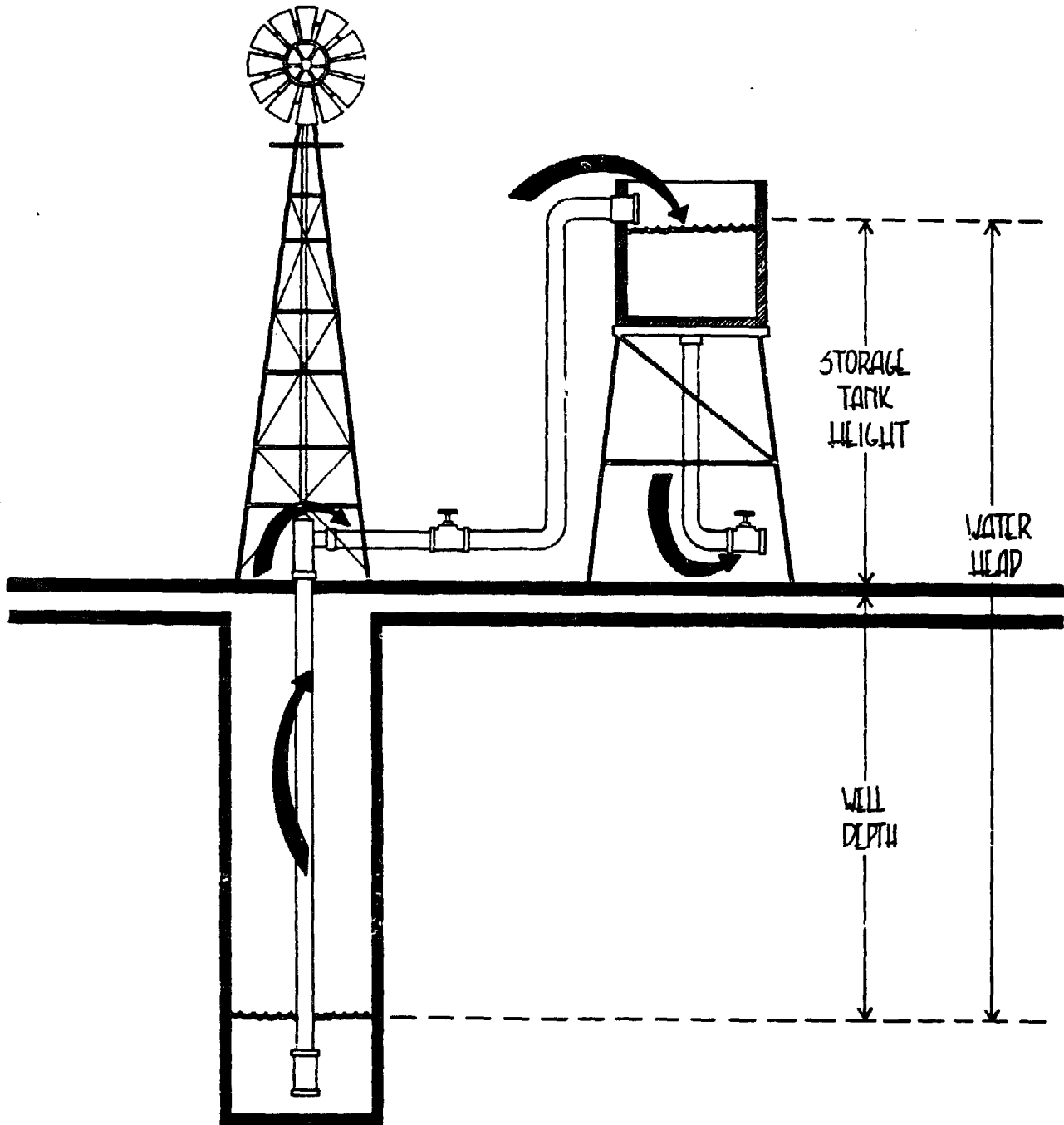

FIGURE 4-7: Water pump system diagram.

Figure 4-7 illustrates a complete water pump and storage system. In any system such as this one, you are expected to know the pump depth and tank height. Add these two together and you get water head - the maximum height to which the pump must lift water (we assume the tank is not pressurized).*

$$\text{WATER HEAD} = \text{PUMP DEPTH} + \text{STORAGE TANK HEIGHT}$$

(Where water head is measured in feet, pump depth is measured in feet from ground surface [minimum allowable water height] and tank height is measured from ground surface to top of water outlet at tank.)

Example:

Pump depth	200 feet
Tank height	70 feet
Water head	$= 200 + 70 = 270$ feet

Notice that while the water is being lifted to the total height of 270 feet as in the example, it must pass through pipes that are considerably longer, unless the tank is directly on top of the well. The loss of pressure (head loss) from water flowing through the pipes will increase the amount of load on the pump. We calculate the head loss using the head loss factor from the graph on Figure 4-8. This factor is the feet of head loss per hundred feet of pipe run. Thus, you need to measure total length of pipe run and know flow rate measured in gallons per minute and the pipe diameter.**

* For a pressurized tank add 2.31 feet of water head for each psi.

**Figure 4-8 assumes standard ("schedule 40") steel pipe. For other diameters than those listed, the head loss at the same flow rate is proportional to the fifth power of the ratio of the pipe diameters. Pipe diameter is approximately the internal diameter. The outside diameter will be 1/4 - 1/2 inch larger.

d = pipe diameter (inches)

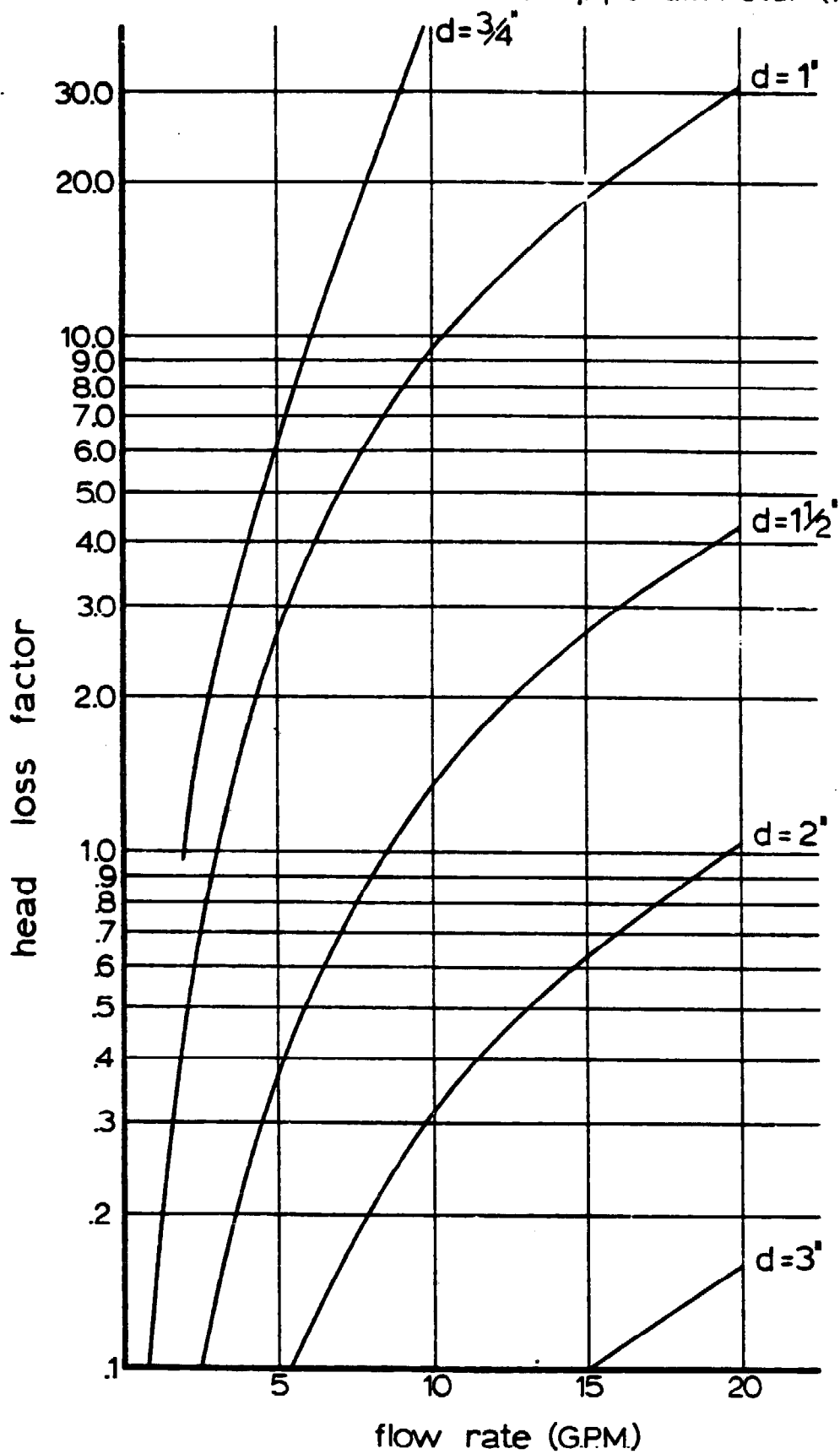

FIGURE 4-8: Head loss factor.

From Figure 4-8 a value of head loss factor can be determined that, when you have measured pipe run, can be converted to head loss.

$$\text{Head loss} = \text{head loss factor} \times \text{pipe run} \div 100$$

(When pipe run measured in feet.)

(Note: This value is for steel pipe and does not include valve and fitting losses. If several hundred feet of pipe length is involved, fitting losses can be neglected. To include them in an approximate way, count up the number of tees and elbows. For 1-inch pipe add 3 feet of pipe length for each fitting, and for fully open valves, add none for a gate, 12 feet for an angle, and 30 feet for a globe valve (the usual spigot-type valve). This is then the total equivalent pipe length. For other pipe sizes, proportion these lengths to the pipe size (i.e., twice these values for 2-inch pipe). For smooth plastic pipe reduce the head loss factor by 40 percent.)

Example: Maximum pump capacity - 5 gpm
 Pipe run - 250 feet
 Water head - 250 feet
 Pipe diameter - 3/4 inch
 Two 90° elbow fittings installed

From Figure 4-8, find 5-gpm flow rate on the horizontal (bottom) line. From this point, go straight up to the 3/4-inch pipe curve line. From there, look straight to the left to read head loss factor = 6.0 on the vertical scale. This is 6 feet per 100 feet of pipe run. Then total head loss factor = $6 \times 250 \div 100 = 15$ feet. For the two elbow fittings add 2.3 feet each. Then head loss = $15 + 4.6 = 19.6$ feet. From here, we calculate TOTAL HEAD, which is the actual load presented to the pump!

$$\text{TOTAL HEAD} = \text{WATER HEAD} + \text{HEAD LOSS}$$

(Where all factors are measured in feet.)

Continuing the example, total head loss = $250 + 19.6 = 269.6$ feet, or 270 feet.

Because of head loss, the pump is loaded as if it has to pump water 19.6 feet higher than it really does.

Now we can calculate horsepower required by the pump and supplied by the wind turbine. From Figure 4-9, you can read the theoretical horsepower (no losses) knowing the total head and flow rate. Continuing our example, for total head = 270 feet, and 5 gpm, the theoretical horsepower = 0.3. This is the horsepower supplied by the pump. Now you must calculate horsepower supplied to the pump by the wind turbine. For most well-maintained or new piston pumps installed on wind turbines, assume a pump efficiency of 70 percent.

Then:

$$\text{wind turbine horsepower} = \text{pump horsepower} \div 0.7$$

Q = flow rate in gallons per minute (g.p.m.)

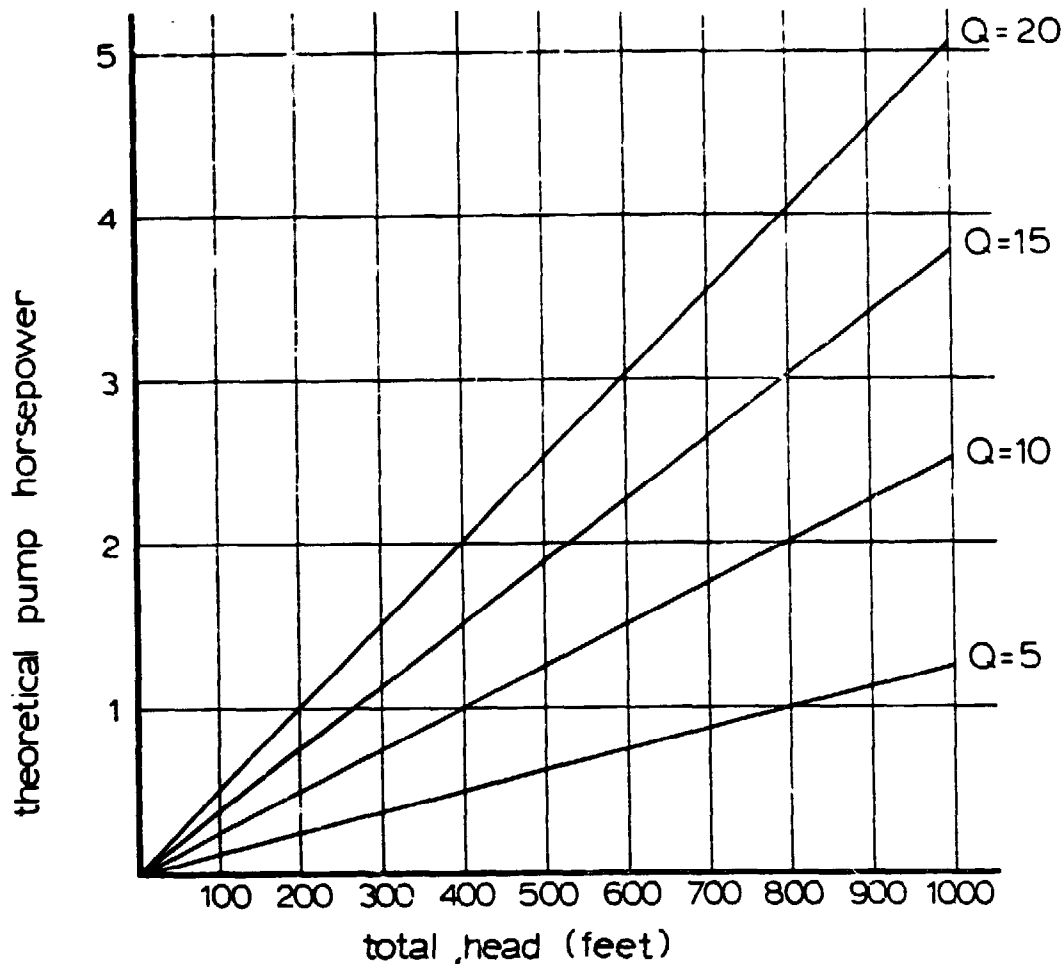

FIGURE 4-9: Theoretical pump horsepower.

Example:

Pump horsepower calculated in previous example = 0.3. Then wind turbine horsepower = $0.3 \div 0.7 = 0.43$. Thus, a 1/2-horsepower wind turbine can pump water at a little more than 5 gpm up a total height of 250 feet, through 250 feet of 3/4-inch iron pipe with two elbow fittings installed.

At this point in our calculations, we have developed a method to predict how much horsepower is needed. This is a power requirement, but, as with electrical systems, we need to know horsepower-hours (hp-hr), the energy requirement.

For this, you must estimate your daily (or monthly) water requirements in gallons just as you would estimate electrical requirements.

Use Figure 4-10 to add up the gallons of water you need daily (adjust these according to your experience). Multiply values by 30 for monthly calculations.

Effect of External Temperature on Water Consumption

Water Consumption Pounds Per Hog Per Hour

Hogs	Water Consumption Pounds Per Hog Per Hour		
	75-125 lb. hogs	275-380 lb. hogs	Pregnant Sows
Temperature (°F.)			
50.....	0.2	0.5	0.95
60.....	.25	.5	.85
70.....	.30	.65	.80
80.....	.30	.85	.95
90.....	.35	.65	.90
100.....	.60	.85	.80

Gallons Per Day Per Cow

Dairy Cows	Gallons Per Day Per Cow		
	Lactating Jerseys	Lactating Holsteins	Dry Holsteins
Temperature			
50.....	11.4	18.7	10.4
50-70.....	12.8	21.7	11.5
75-85.....	14.7	21.2	12.3
90-100.....	20.1	19.9	10.7

Milliter Per Bird Per Day

Temperature	White Leghorn		Rhode Island Red	
70.....	286	294	294	294
80.....	272	321	321	321
90.....	350	408	408	408
100.....	392	371	371	371
70.....	222	216	216	216
70.....	246	286	286	286

Water Consumption of Sheep (Pounds of Water per Day)

On range or dry pasture.....	5-13
On range (salty feeds).....	17
On rations of hay and grain or hay, roots and grain.....	0.3-6
On good pasture.....	Very little (if any)

In these experiments water was available for consumption.

Water Consumption of Cattle

Class of Cattle	Conditions	Water Consumption (Pounds per Day)
Holstein calves (liquid milk or dried milk and water supplied)	4 weeks of age.....	10-12
	8 weeks of age.....	13
	12 weeks of age.....	18-20
	16 weeks of age.....	25-28
	20 weeks of age.....	32-36
	26 weeks of age.....	33-48
	Pregnant.....	60-70
Dairy Heifers.....	Maintenance ration.....	35
	Fattening ration.....	70
Range Cattle.....	Maintenance ration.....	35-70
	Fattening ration.....	70
Jersey Cows.....	Milk Production 5-30 lbs/day.....	60-102
	Milk Production 20-50 lbs/day.....	65-182
Holstein Cows.....	Milk Production 80 lbs/day.....	190
	Dry.....	90

From: Water, Yearbook of Agriculture, 1955
U. S. Department of Agriculture

Water Consumption of Pigs

(Pounds of Water per Day)

Conditions

Body Weight=30 lbs.....	5-10
Body Weight=60-80 lbs.....	7
Body Weight=75-125 lbs.....	16
Body Weight=200-380 lbs.....	12-30
Pregnant Sows.....	30-38
Lactating Sows.....	40-50

Water Consumption of Chickens

(Gallons per 100 Birds per Day)

Conditions

1-3 weeks of age.....	0.4-2.0
3-6 weeks of age.....	1.4-3.0
6-10 weeks of age.....	3.0-4.0
9-13 weeks of age.....	4.0-5.0
Pullets.....	3.0-4.0
Nonlaying Hens.....	5.0
Laying Hens (moderate temperatures).....	5.0-7.5
Laying Hens (temperature 90°F).....	9.0

Water Consumption of Growing Turkeys

(Gallons per 100 Birds per Week)

Conditions

1-3 weeks of age.....	8-18
4-7 weeks of age.....	26-59
9-13 weeks of age.....	62-100
15-19 weeks of age.....	117-118
21-26 weeks of age.....	95-105

Water Consumption of People

Average Person: 75 gallons per day

Lawn: 0-200 gallons per 1000 square feet, every other day.

FIGURE 4-10: Water requirements.

Hypothetical example:

2 persons:	75 gal/day x 30 =	2250 gal/mo
1 beef cow:	12 gal/day x 30 =	360 gal/mo
20 chickens: (4 gal/day ÷ 100) x 20 ÷ 100 x 30	=	24 gal/mo
lawn (1000 ft ²):	160 x 15 =	<u>2400 gal/mo</u>
	TOTAL	5034 gal/mo

Using the water requirement data, you can calculate hp-hr.

Example: Assume the 1/2-horsepower pump of previous examples pumps at an average rate of 5 gpm (this rate varies with the changing wind speed).

Calculate hp-hr per month: 5034 gallons per month ÷ 5 gallons per minute = 1007 min/mo, or 1007 ÷ 60 = 16.8 hours per month required at an average flow rate of 5 gpm. Then energy required (monthly hp-hr) = 16.8 x 1/2 = 8.4 hp-hr.

ENERGY STORAGE**Water System**

The water pump system of the previous example was required to produce 8.4 hp-hr per month at an average flow rate of 5 gpm. Since wind speed varies with the time, you can expect that, at certain times of the day (or month) wind will blow strong enough to pump water faster than 5 gpm, while at other times flow rate will be less or no water will flow at all. The user may wish to use water at times when no wind is blowing, while at other times the wind turbine tries to pump water that is not being used.

To make up the difference in various conditions, a storage tank is used. Water pumped up to that tank represents energy stored.

To calculate energy storage requirements for a water system such as illustrated in Figure 4-7, you need to know the maximum number of days for which you must store water. These data come from your wind site survey (Chapt. 3), where data such as maximum number of windless days become available.

Example: From the previous example, let us total the water demands on a daily basis:

2 persons	-	75 gal/day	
1 beef cow	-	12 gal/day	
20 chickens	-	1 gal/day	
lawn	-	160 gal	-- every other day

TOTAL: Low daily (without watering the lawn) 08
 High daily = 248
 Average daily = 168

Hypothetical site data: maximum = 6 windless days.

If this occurs in January, when no lawn water is required, use the low daily value -

$$88 \times 6 = 528 \text{ gallons storage requirement}$$

If the windless day (month) occurs in July, use the high value -

$$248 \times 6 = 1,488 \text{ gallons storage requirement}$$

Depending on the relative importance of lawn water and cost of water storage, you might be inclined to weigh the two against each other in the selection of a water tank size.

Figure 4-6 illustrates a month-by-month electric energy demand curve. Figure 4-11 is a slightly more complex presentation of another energy demand curve for a hypothetical wind turbine installation. On the same graph is plotted the energy supplied to the user by his wind turbine generator.

Notice (Fig. 4-11) that from January through March, demand is higher than supply. From April to September, supply is greater than demand, and then from September to January, demand is greater again. Demand, on an annual basis, is 110 kWh greater than supply. Either demand must be reduced by 110 kWh/year, or supply increased by that amount, which is only a $(110 \div 2990) \times 100 = 3.7$ percent increase. Increasing supply can come from a larger wind turbine, a backup energy source, such as a gasoline-powered generator, or more wind. Using the wind profile information in Chapter 3, we could determine how much to increase the height of the wind turbine tower to obtain the needed additional wind (about 5 feet).

Would it be possible to store excess energy from April through August, and use this from September in to the following February when it would be exhausted? We will assume each year is the same. We calculate the actual storage requirement by adding up all of the monthly surpluses in Figure 4-11:

April	30 kWh
May	50
June	80
July	80
August	50

TOTAL 290 kWh

In Chapter 5, you will learn how many batteries would be required to hold this much energy. For now, it is sufficient to say that for a 290-kWh battery bank, using 6-volt golf cart batteries rated at 200 amp-hours each, we would need 242 batteries. At a cost of, say, \$30 each, this energy storage system would cost \$7260. Obviously, this amount would buy a much larger wind turbine and nearly eliminate the requirement for batteries. You may also choose to use an auxiliary generator during periods of insufficient wind to minimize the storage requirement.

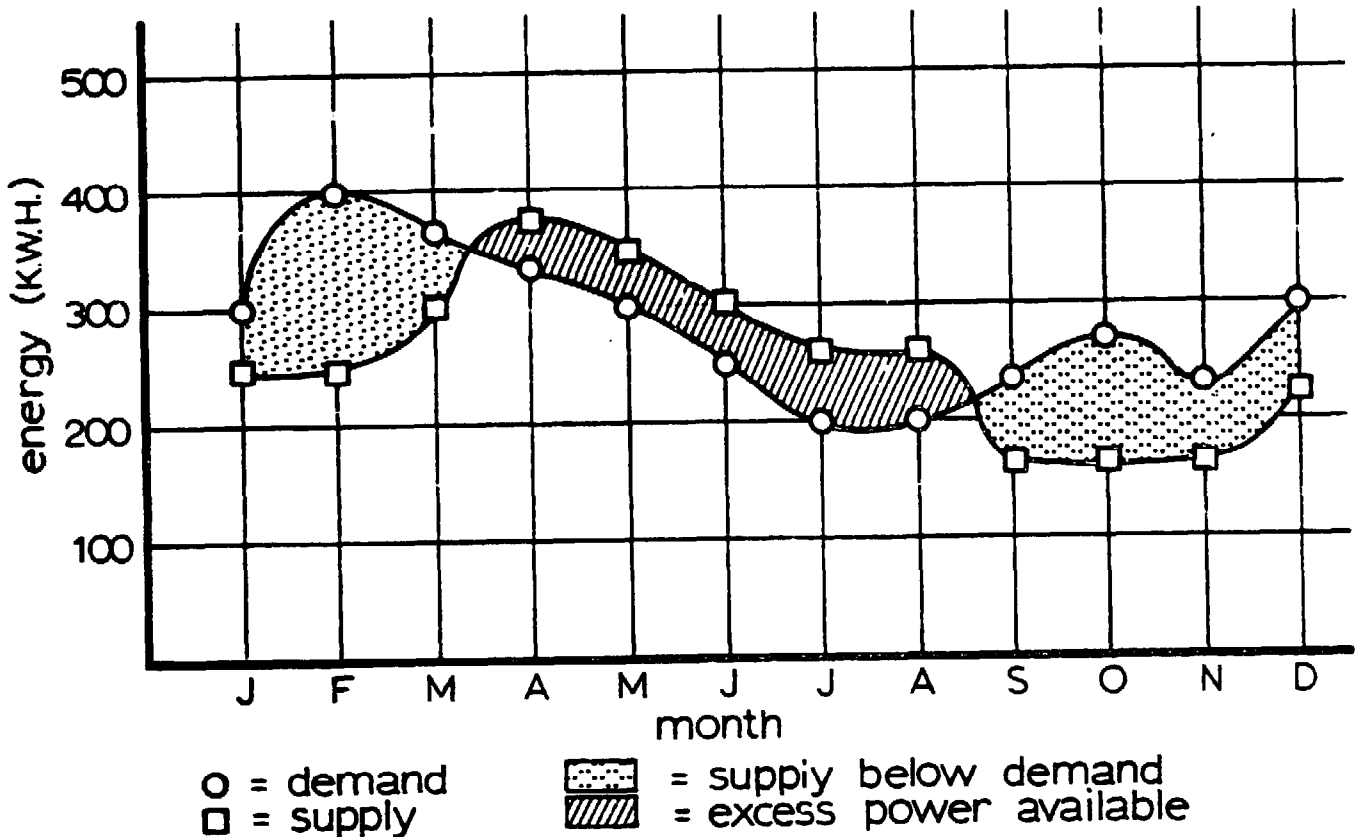

FIGURE 4-10: Water requirements.

Month	Supply KWH	Demand KWH	Difference KWH
J	250	300	50 needed
F	250	400	150 needed
M	300	350	50 needed
A	330	300	30 extra
M	300	250	50 extra
J	280	200	80 extra
J	280	200	80 extra
A	250	200	50 extra
S	180	200	20 needed
O	180	250	70 needed
N	180	200	20 needed
D	210	250	40 needed
Totals	2,990	3,100	

FIGURE 4-11: Comparing monthly energy supply and demand.

These options are described in Chapter 5

As with the water storage example it is important to know the maximum number of windless days. You also need to know that a suitable surplus of energy will be generated prior to these windless days. or you will start the windless cycle with dead batteries.

Example: Average daily energy usage - 5 kWh
 Maximum number of windless days - 5
 Energy storage requirement = 5 kWh per day
 x 5 days = 25 kWh

Again, using 6-volt, 200 amp-hour batteries, 21 batteries would be required at a cost of about \$630, if the \$30 per battery assumption is correct.

CHAPTER 5
THE COMPONENTS OF A WIND ENERGY
CONVERSION SYSTEM

A wind turbine dealer should be able to advise you on the components for your wind energy system. This chapter will provide you with the basics on each component you purchase. It will help you ask the right questions and better understand any WECS brochures you receive. The wind turbine is considered first. Why do some wind turbines only have two or three narrow blades while others have many wide blades? What are the basic choices in types of wind turbine rotors? These items are discussed, and a method is presented for comparing wind turbines by calculating the wind energy each will generate. For wind electric system owners the two sections that follow on generators and energy storage devices will be useful. Finally, towers, inverters, backup equipment, and the typical efficiencies of the various components are described.



FIGURE 5-1: Simple wind system.

In Figure 5-1, the windwheel (or rotor) is the device that actually processes the wind and converts it to mechanical power. To visualize how these blocks and arrows translate to actual hardware look at Figure 5-2.

Here, the "windwheel" is a parachute that uses a drag force caused by the wind to tug on a rope, which drapes over a pulley and is connected to a bucket (pump). Let us analyze the advantages and disadvantages of this wind system. The advantages are:

- Simple and easy to understand, low initial cost.
- Can be easily folded and stored during times of poor wind condition.
- Favorable starting torque for lifting water from the well.
- Easily repaired.
- Does not require tall towers.

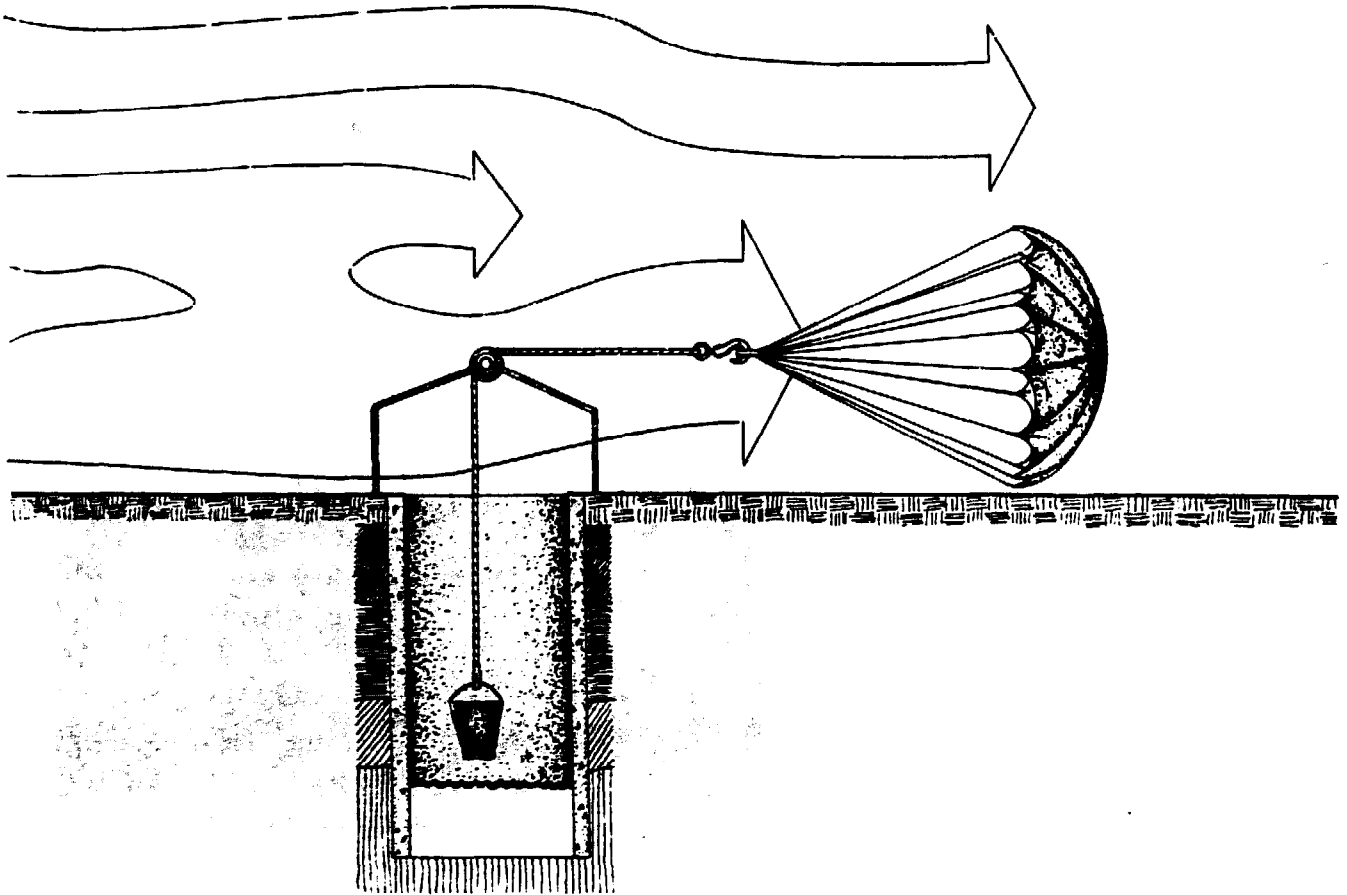

FIGURE 5-2: A simple wind-powered water pump.

The disadvantages are:

- Requires constant attention to operate.
- Operates on a cyclic basis requiring an operator to return the parachute to the starting point.
- Requires tremendous amount of land in relation to the amount of work it performs.
- Does not easily adjust to changes in wind direction while operating.
- Does not operate high above ground where stronger winds will produce more power.
- Not well suited to residential applications or generation of electricity.

This analysis is representative of the type of thinking required prior to purchase of a WECS . Oddly enough, the particular illustration used here could be appropriate technology in communities where oxen are used in a similar fashion. Replacement of the oxen with a simple wind device, such as the parachute, would release the animal for other chores.

A more familiar illustration is shown in Figure 5-3. A conventional farm windmill supported by a tower drives a piston well pump by means of a vertical power shaft. The pump is mounted at ground level. This system is used to supply domestic, stock, and irrigation water. Other wind machines are illustrated in Figures 5-4, 5-5, and 5-6.

How can wind machines be so different, yet one type can be best for some uses, and another type best for other uses? To answer this, we must examine their differences in some detail and develop ways of comparing different wind machines. This is done in the next section.

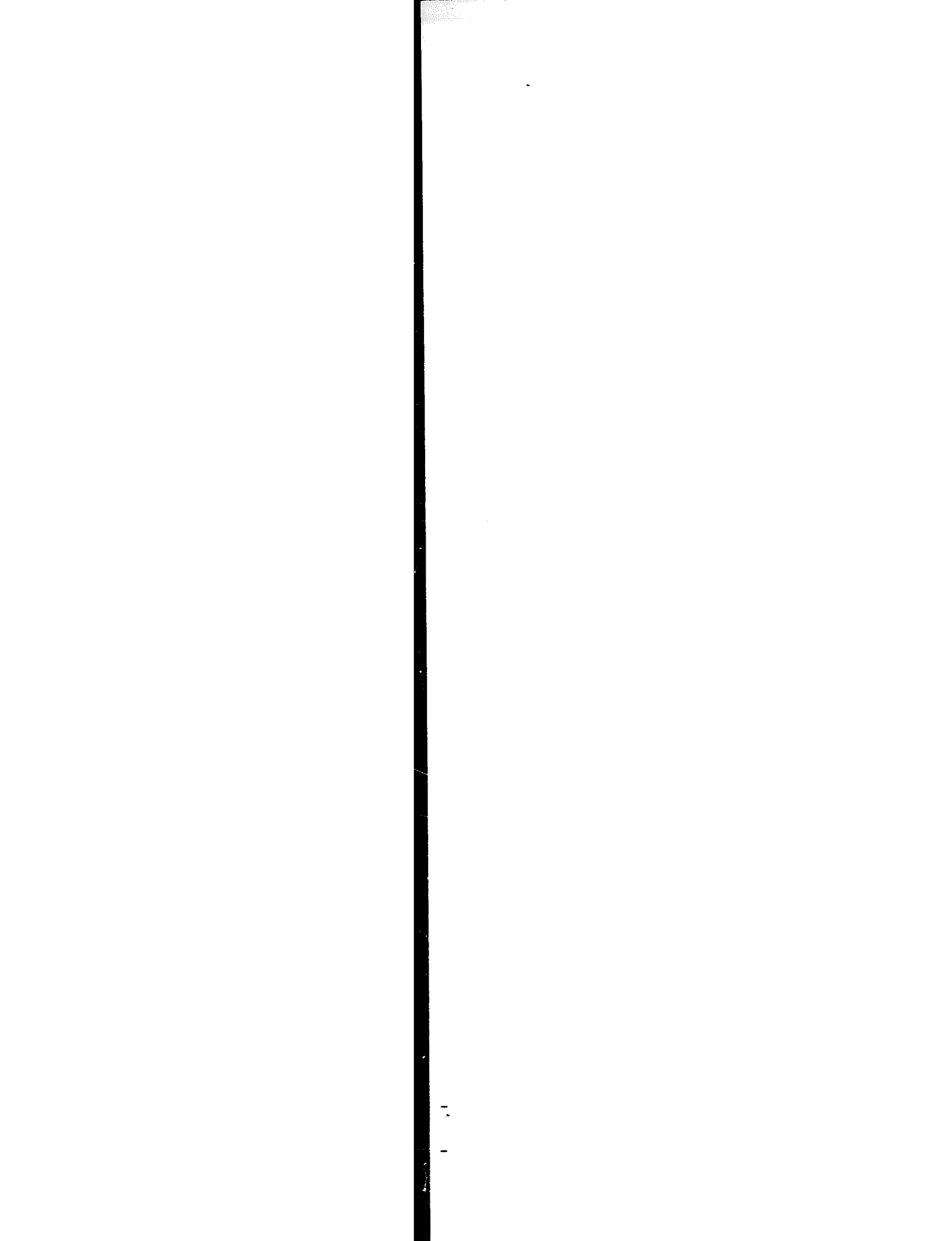

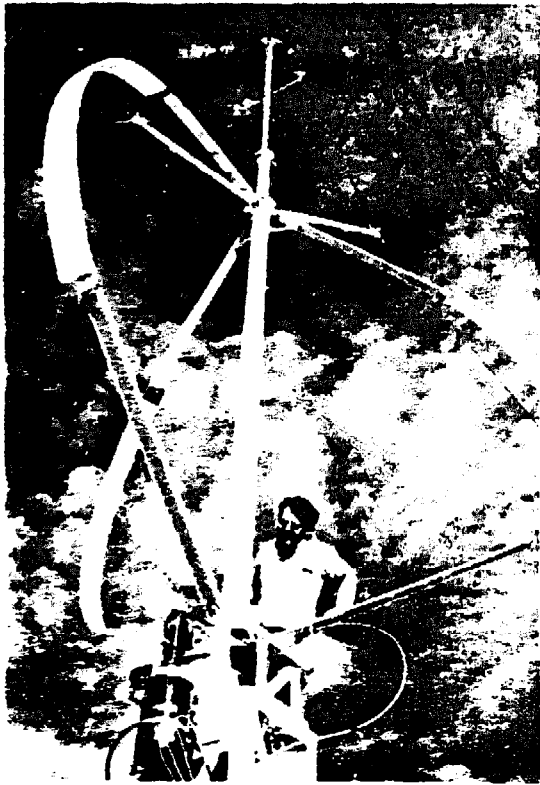

FIGURE 5-5: Darrieus "Egg-beater" rotor.

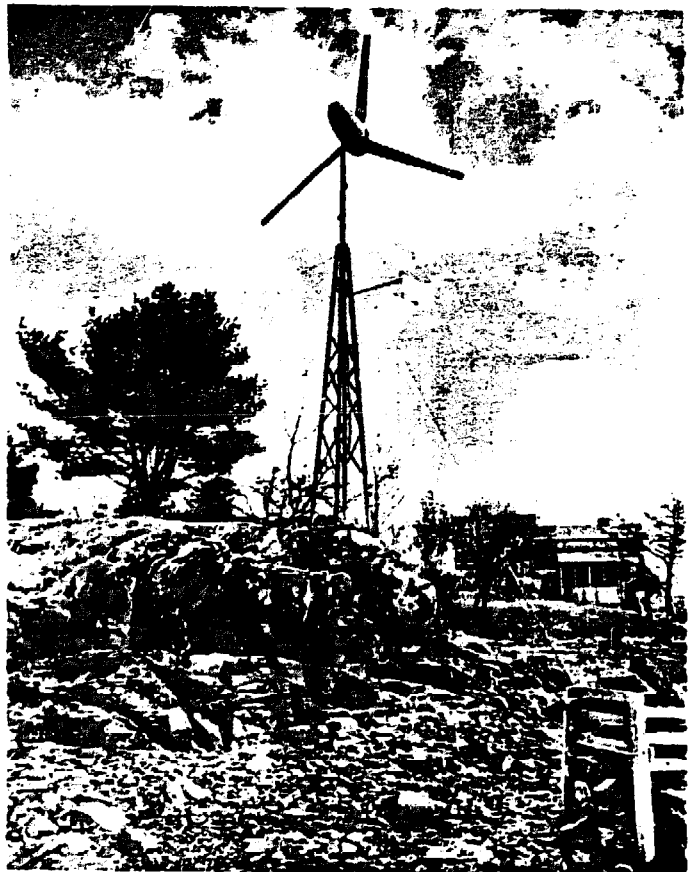

FIGURE 5-6: Propeller-type wind turbine generator.

WIND SYSTEM PERFORMANCE

Comparing Different Types of Wind Machines

Figure 5-3 shows a farm windmill, and Figure 5-4, a Savonious rotor. While these two types of wind systems are very different, both windwheels present a large surface area to the wind in relation to the width and height on the machine. Notice that almost the entire disk area of the farm windmill is covered by blade surface; this presents a solid appearance to the wind. The appropriate term for this is solidity, which is the ratio of blade or windwheel surface area to rotor swept area, the area inside the perimeter of the spinning blades. Thus, solidity for the two machines illustrated in Figures 5-3 and 5-4 is nearly 1.0.

Solidity = blade surface area ÷ windwheel swept area.

To calculate windwheel swept area, look at Figures 5-7 and 5-8. Swept area for a vertical-axis machine like the Savonious rotor is simply height times width. Swept area for disk-shaped windwheels is calculated from:

$$A = \pi \times D^2 \div 4, \quad \pi = 3.14$$

A = swept area, in square feet or square meters, and
D = diameter in feet or meters

For example, the swept area of a 16-foot diameter windwheel is calculated as follows:

$$A = 3.14 \times 16 \times 16 \div 4 = 200.9 \text{ square feet.}$$

Mechanical drive applications, such as pumping water, demand very high starting torque* from the windwheel. The pump may have a load of water it is trying to lift from a deep well at the same time the windwheel is starting to turn. Further, high rpm operation (high revolution rates from the windwheel) is not required because it is generally better to pump a large quantity of water slowly than it is to pump a small quantity rapidly. This reduces resistance to water flow in the pipes. Larger-diameter, slower-moving pumps require slow-turning, high-torque windwheels, such as shown in Figure 5-3.

Electric generators operate by moving magnets past coils of wire. Two methods are available to get the required power from a generator:

- * Large coils and strong magnets
- * High-speed motion of magnet past coil

Most generators are actually a balance of these two design methods. However, to get, say, 2 kW out of a generator that turns at 200 rpm, the large magnets and coils might weigh as much as 300 pounds (135

* See discussion on torque in Chapter 2.

5-7

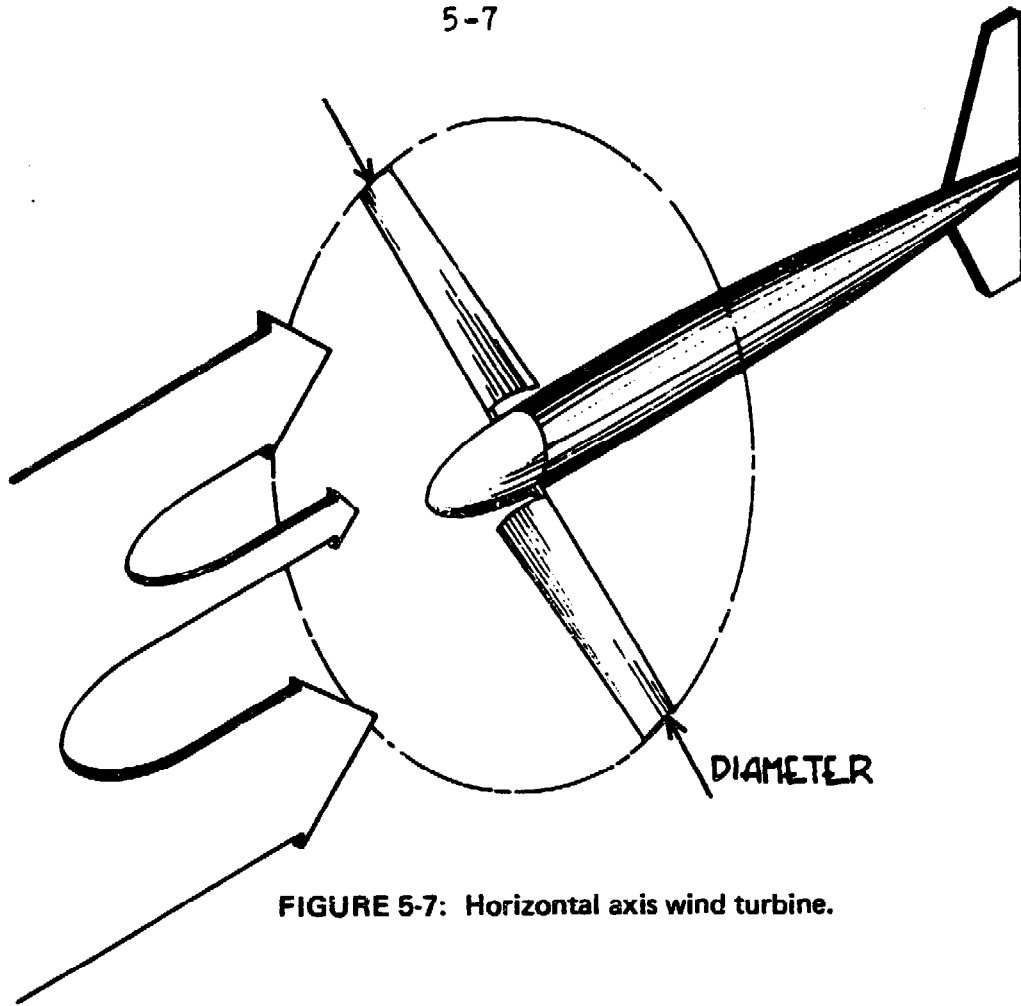

FIGURE 5-7: Horizontal axis wind turbine.

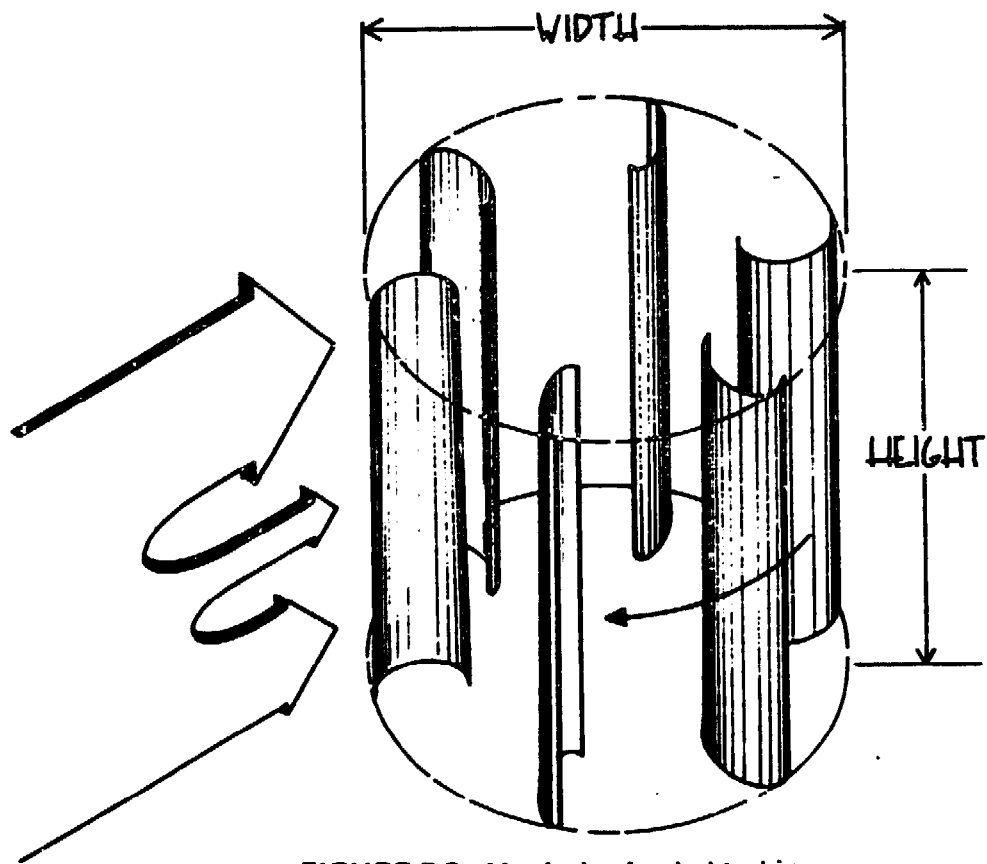

FIGURE 5-8: Vertical axis wind turbine.

kg). The same 2 kW can be generated by a smaller generator, which weighs about 50 pounds (22.5 kg), by spinning that generator at about 2000 rpm.

From this, we can see that a lightweight, low-cost wind turbine requires a fast-turning windwheel with much lower solidity, as shown in Figure 5-6.

One further relationship is needed to complete the discussion of solidity: tip speed ratio, the speed at which the windwheel perimeter is moving divided by the wind speed. If the wind is blowing at, say, 20 mph (9 m/s), and a windwheel is turning so that the outer tip of the blade is also moving at 20 mph around its circular path, tip speed ratio equals 1. Windwheels such as that in Figure 5-3 operate at tip speed ratios of about 1.

Suppose the tip were moving at 200 mph. With a wind speed of 20 mph the tip speed ratio would equal 10. Low-solidity windwheels operate at tip speed ratios much greater than 1, usually between 5 and 10. We can now see a relationship between tip speed ratio, which is a measure of rpm, and solidity. High solidity windwheels spin slowly compared to low solidity windwheels.

Figure 5-9 shows how the relative torque of various wind turbines decreases with increasing tip speed ratio. As we noted previously, high torque requires a high solidity, and that type of wind turbine works best at low tip speed ratios. Figure 5-10 shows how the best operating tip speed ratio changes with solidity.

A wide variety of wind machines are sketched in Figures 5-11 and 5-12. Lest you get the immediate impression that there are more types of wind systems available than you might care to choose from, be assured that many of the types shown are only interesting historically. Some of the others are presently the subject of advanced concept studies.

The relative efficiencies of the types of wind turbines in which you might have an interest are illustrated in Figure 5-13. Notice that the efficiency is also related to tip speed ratio, as is starting torque. As stated in Chapter 2, the maximum amount of power a simple windwheel (without a shroud or tip vanes) can extract from the wind is 59.3 percent of the wind power that would pass through that windwheel. From Figure 5-13, you can see that no windwheel actually extracts 59.3 percent.

Solidity affects design appearance in its relation to the number of blades a machine has. High solidity wind turbines have many blades; low solidity machines have few, usually four or less. Figure 5-14 illustrates a wind turbine of intermediate solidity used for electric power generation.

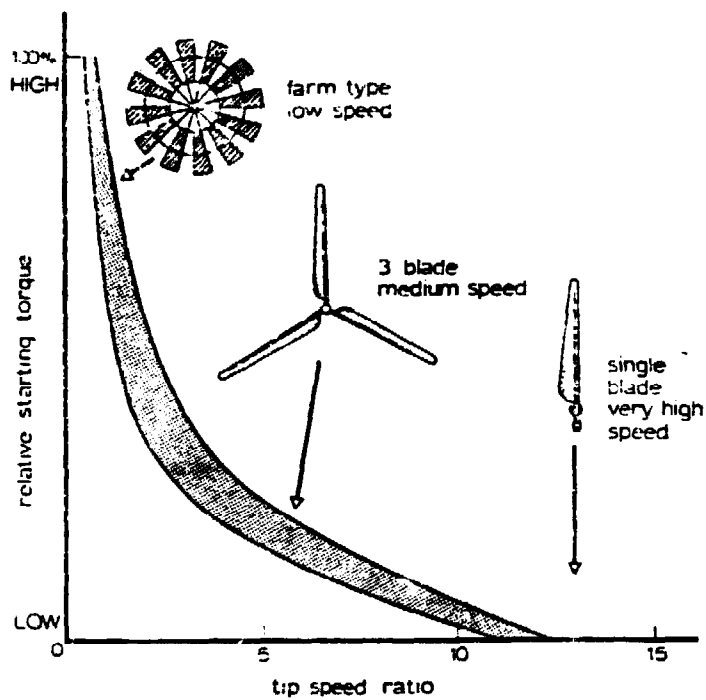

FIGURE 5-9: Relative starting torque.

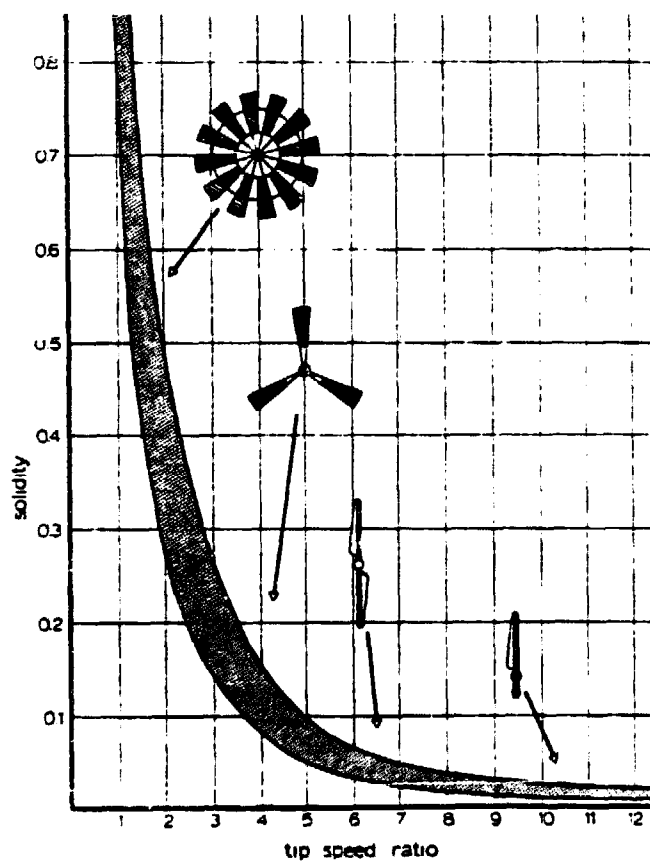
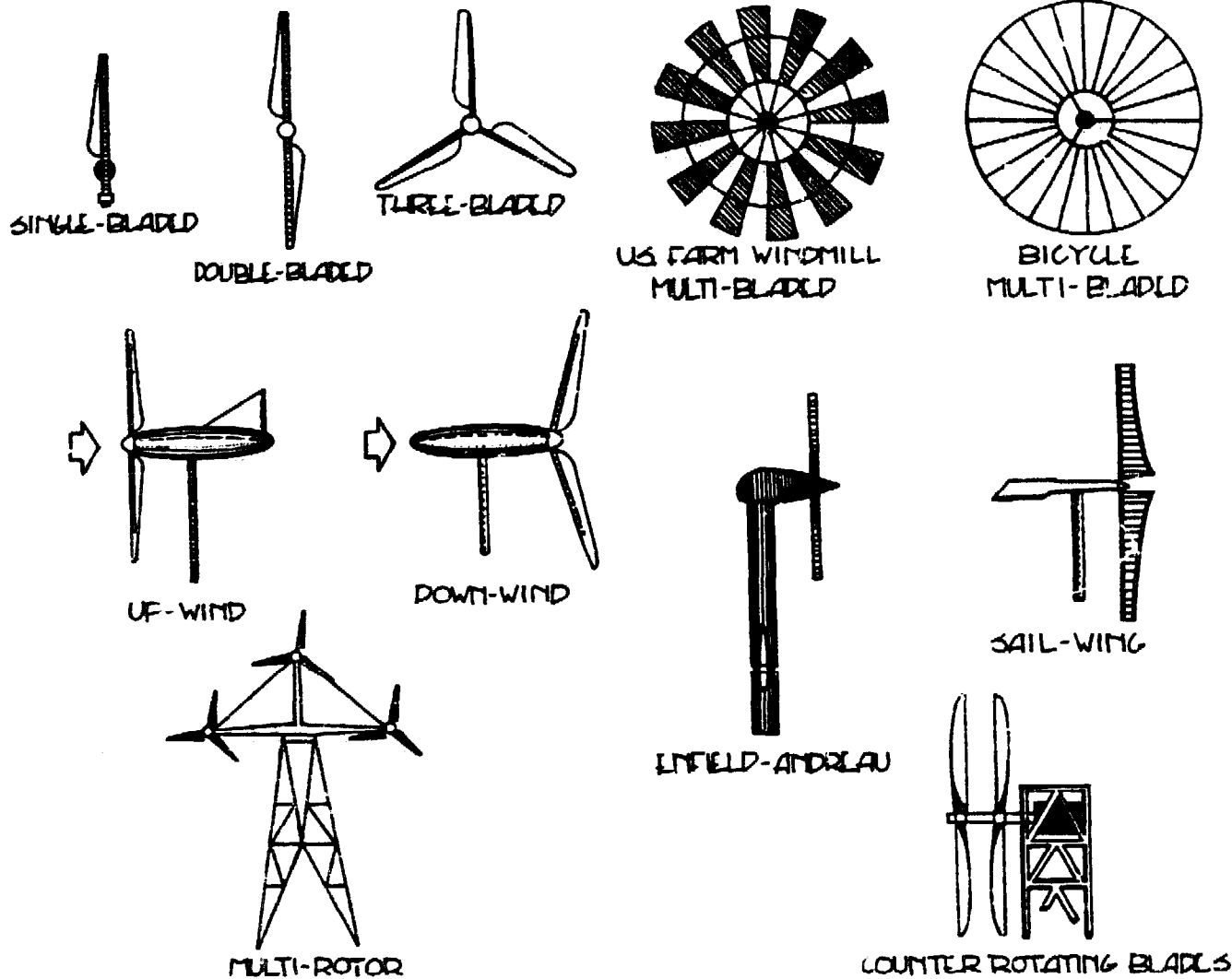

FIGURE 5-10: Solidity of several wind machines.

HORIZONTAL AXIS

LIFT TYPE



DRAG TYPE

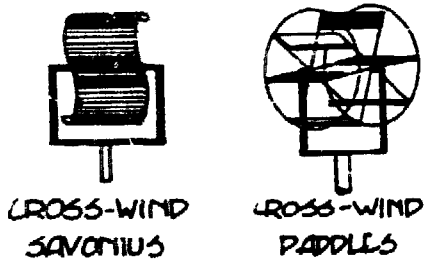

AUGMENTED

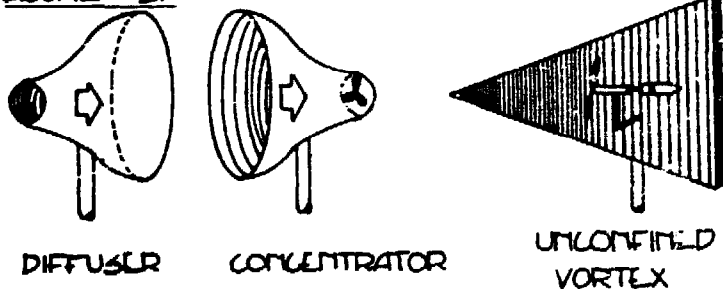

FIGURE 5-11: Horizontal axis wind machines.

VERTICAL AXIS

PRIMARILY DRAG TYPE



SAVONIUS



MULTI-BLADED
SAVONIUS

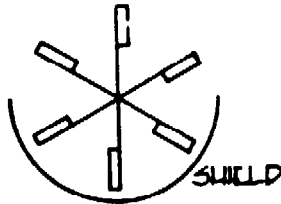

PLATES

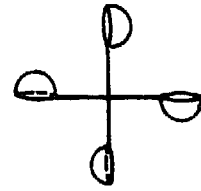

CUPPED

LIFT TYPE

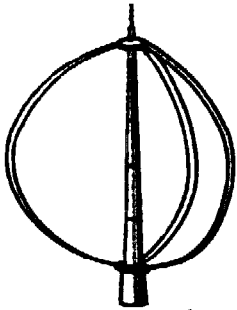

DARRICUS
(EGG BLATER)

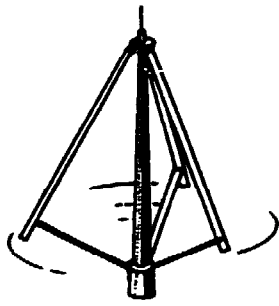

DARRICUS

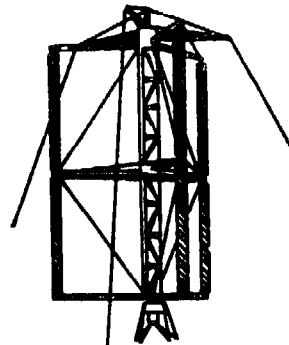

GIROMILL

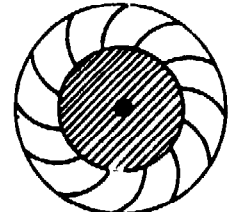

TURBINE

COMBINATIONS

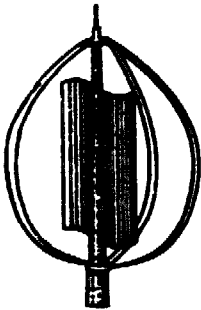

SAVONIUS-DARRICUS



SAVONIUS

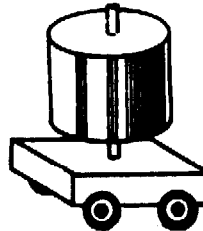

MAGNUS

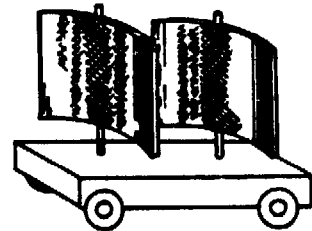

AIRFOIL

AUGMENTED

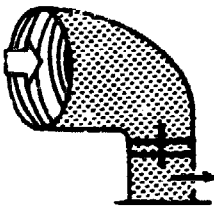

DEFLECTOR

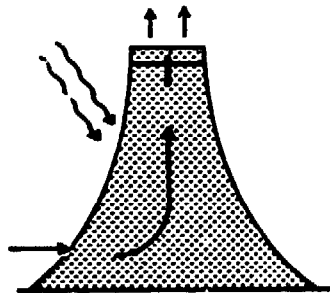

SUNLIGHT

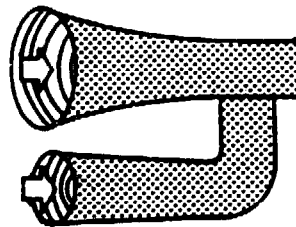

VENTURI

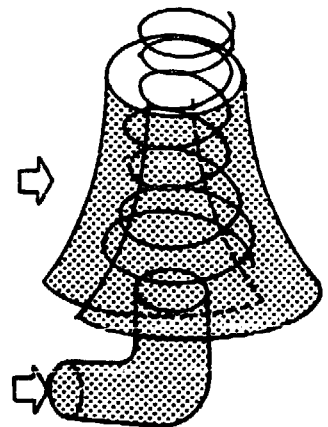

CONFINED VORTEX

FIGURE 5-12: Vertical axis wind machines

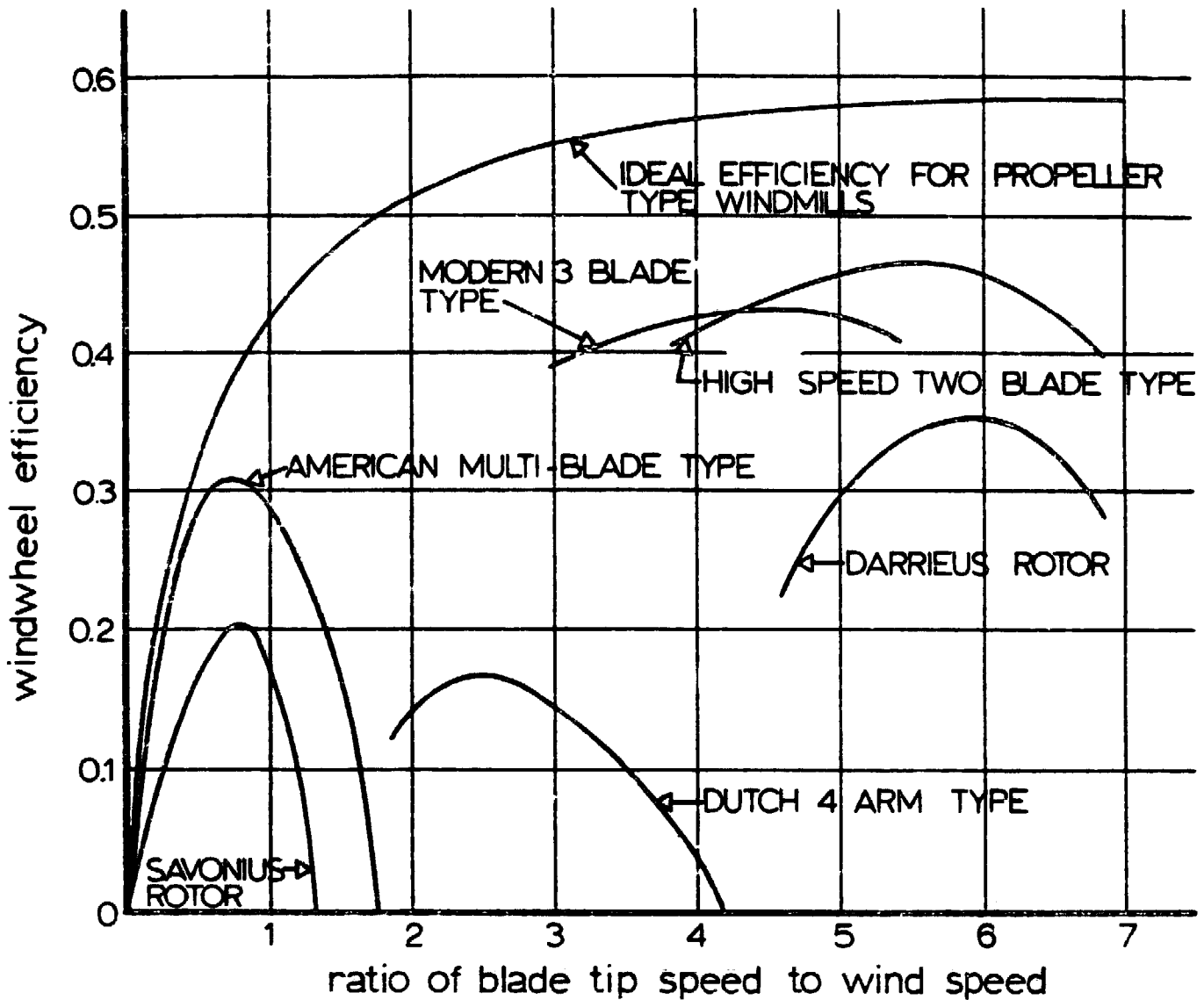

FIGURE 5-13: Typical performance of several wind machines.

There is more to a wind turbine than the solidity of the blades, the torque, the efficiency, or the load the windwheel drives. By looking at Figures 5-14 and 5-15 you can see two distinct methods for controlling the direction of the propeller-type machine: 1) upwind blades with a tail fin and 2) downwind blades that use the drag effect of the windwheel to keep the machine aimed directly into the wind. A third method, which works on either upwind or downwind-mounted blades, is shown in Figure 5-16. The small wind turbine on the side of this downwind-blade machine (called a fan tail) senses changing wind direction and

drives the larger turbine around until it is aimed directly into the wind. As you might guess, the vertical-shaft machines like the Savonius rotor are always aimed into any wind direction.

Many of the wind turbines we have illustrated are designed with three or more blades. Two blades are occasionally used, but small two-bladed wind turbines usually need a larger tail fin than an equivalent three-bladed machine, or special weights to make the windwheel behave as a four-bladed unit. Small two-bladed machines exhibit a choppy motion in yaw (aiming into the wind). This is due to the natural resistance of spinning blades to changes in direction - something like a wobbling gyroscope.

Figure 5-17 illustrates a small, two-bladed machine that has governor-control mechanism weights in a position where another set of blades would otherwise be installed. For small machines, this approach is practical. For larger two-bladed machines, yaw (aiming) controls such as seen in Figure 5-16 are more appropriate.

Wind System Power and Energy Calculations

As a first estimate, Figures 5-18A or 5-18B can be used to estimate the power output of any wind turbine in any wind. These curves use an overall efficiency for the rotor, transmission, and generator of 30 percent, which is a typical value for wind turbine generators. For example, let's assume the blade diameter is 20 feet (6 m) and the wind speed is 10 mph (4.5 m/s). From Figure 5-18B, this results in approximately 500 watts for a typical wind turbine. To convert watts to horsepower, divide by 746; so $hp = 0.67$.

Manufacturers of wind turbine generators will supply sales literature containing power curves similar to Figure 5-19, with which you can make a more accurate determination of power and energy. To evaluate any wind turbine for its power and energy yields, it is important to consider the rated wind speed of the machine. This is the wind speed at which rated power is achieved. Also, you should know the cut-in speed, which is the wind speed at which the generator begins to produce power.

Figure 5-19 illustrates the characteristics and power curves of two hypothetical wind turbine generators of the 1000 watt size. Notice that unit A is rated at 32 mph, while unit B is rated at 20 mph. You can expect that wind turbine B is considerably larger in diameter than unit A.

As an example of the comparison of energy yields, Figure 5-20 is a hypothetical wind duration curve for one month. By dividing the 720 hours of that month into 20-hour segments and finding (on the graph) the average wind speed for each 20-hour segment, we can estimate the energy yield of each of the two wind turbines, using Figure 5-21. Note that we are showing this calculation as an example of energy estimation. You may not have to perform this calculation because consultants and dealers in wind machines would supply the information.

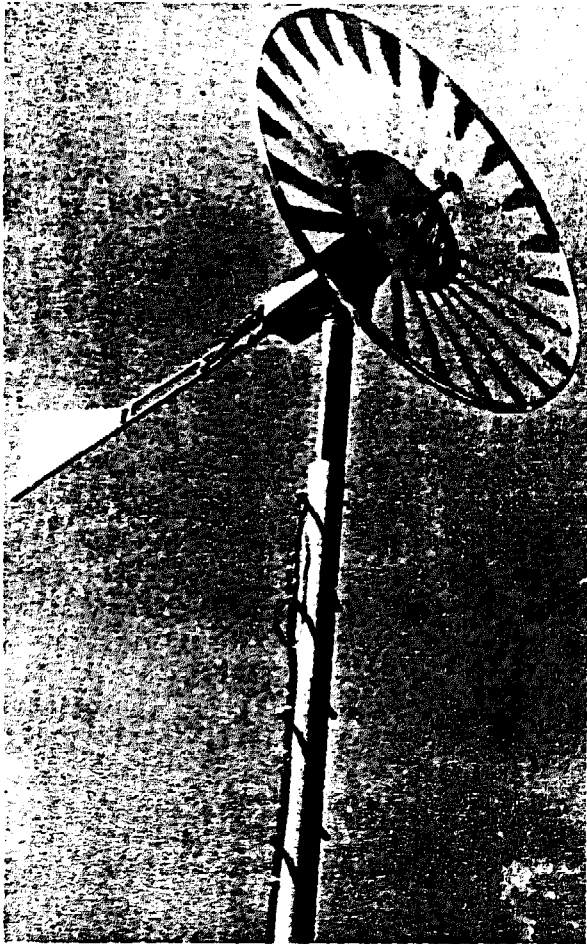

FIGURE 5-14: Upwind rotor of intermediate solidity with tail fin control.

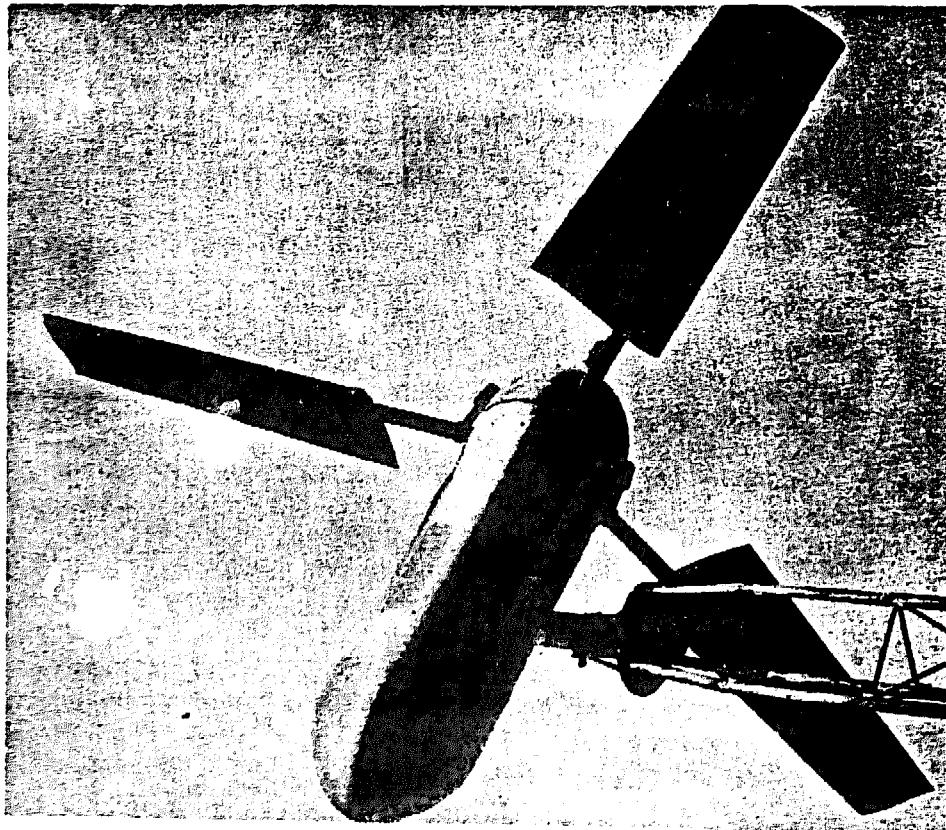

FIGURE 5-15: Downwind rotor.

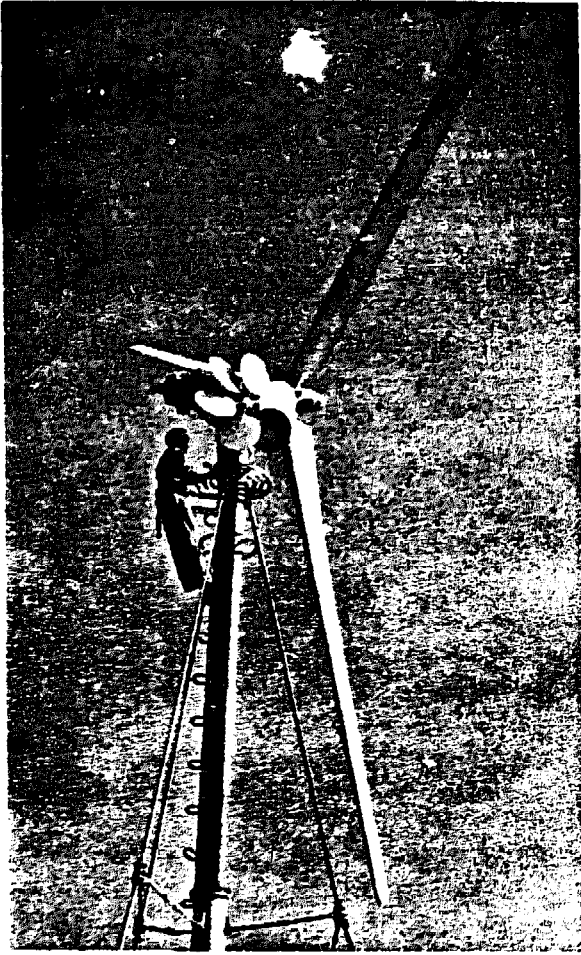

FIGURE 5-16: Downwind rotor with fan tail control.

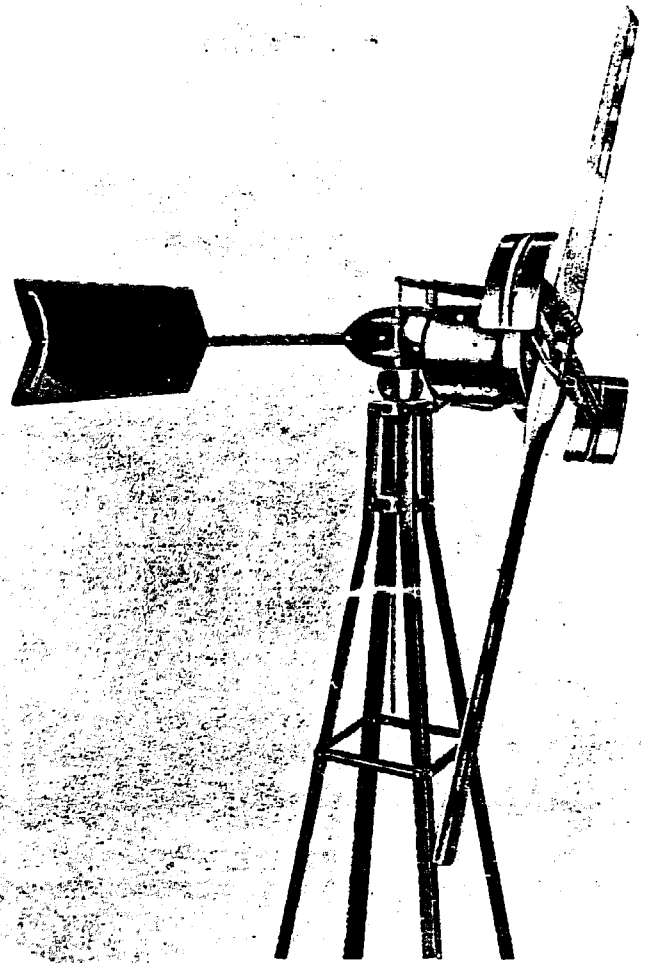

FIGURE 5-17: Small wind turbine generator with two upwind blades.

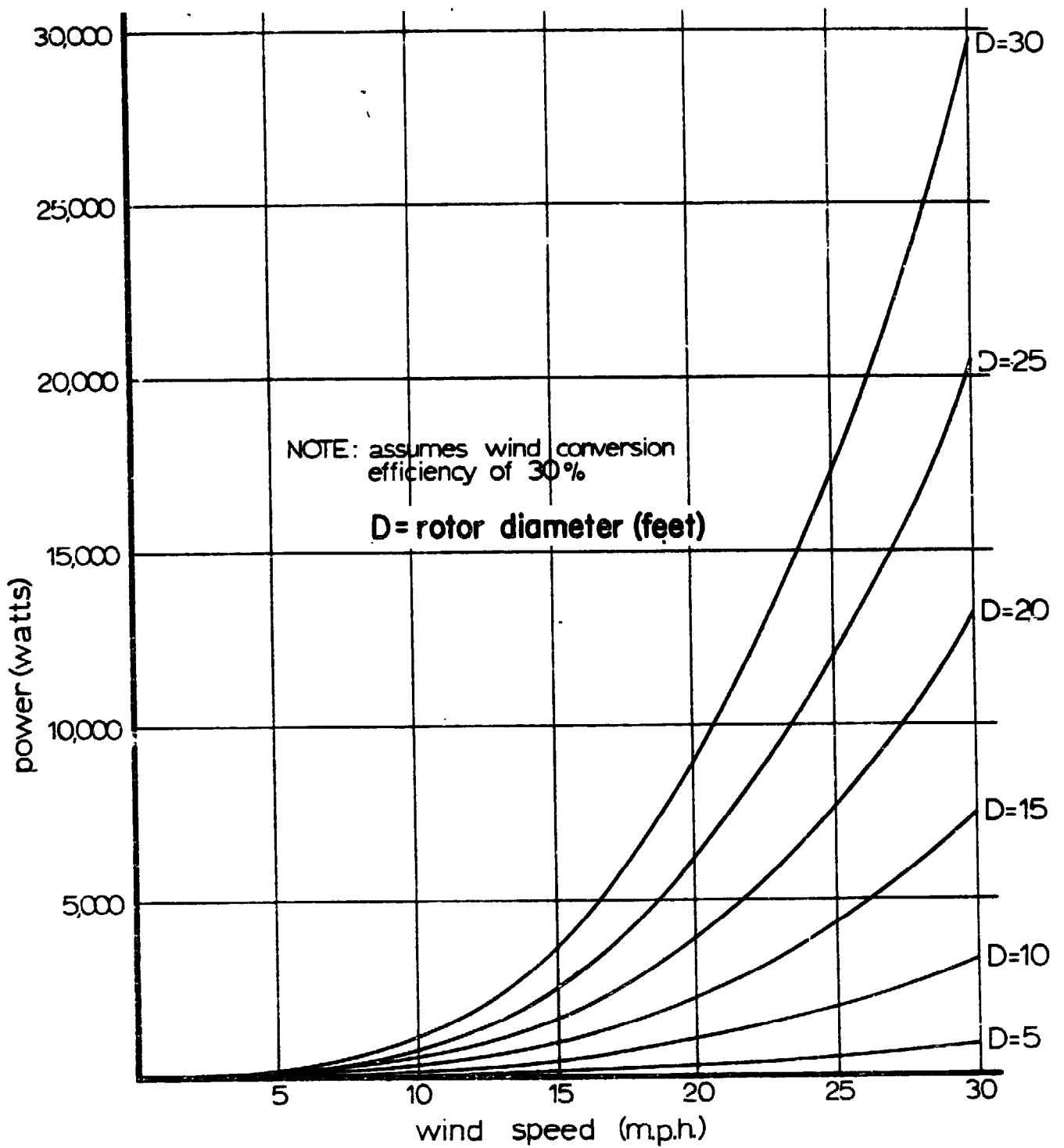

FIGURE 5-18A: Typical wind power curves.

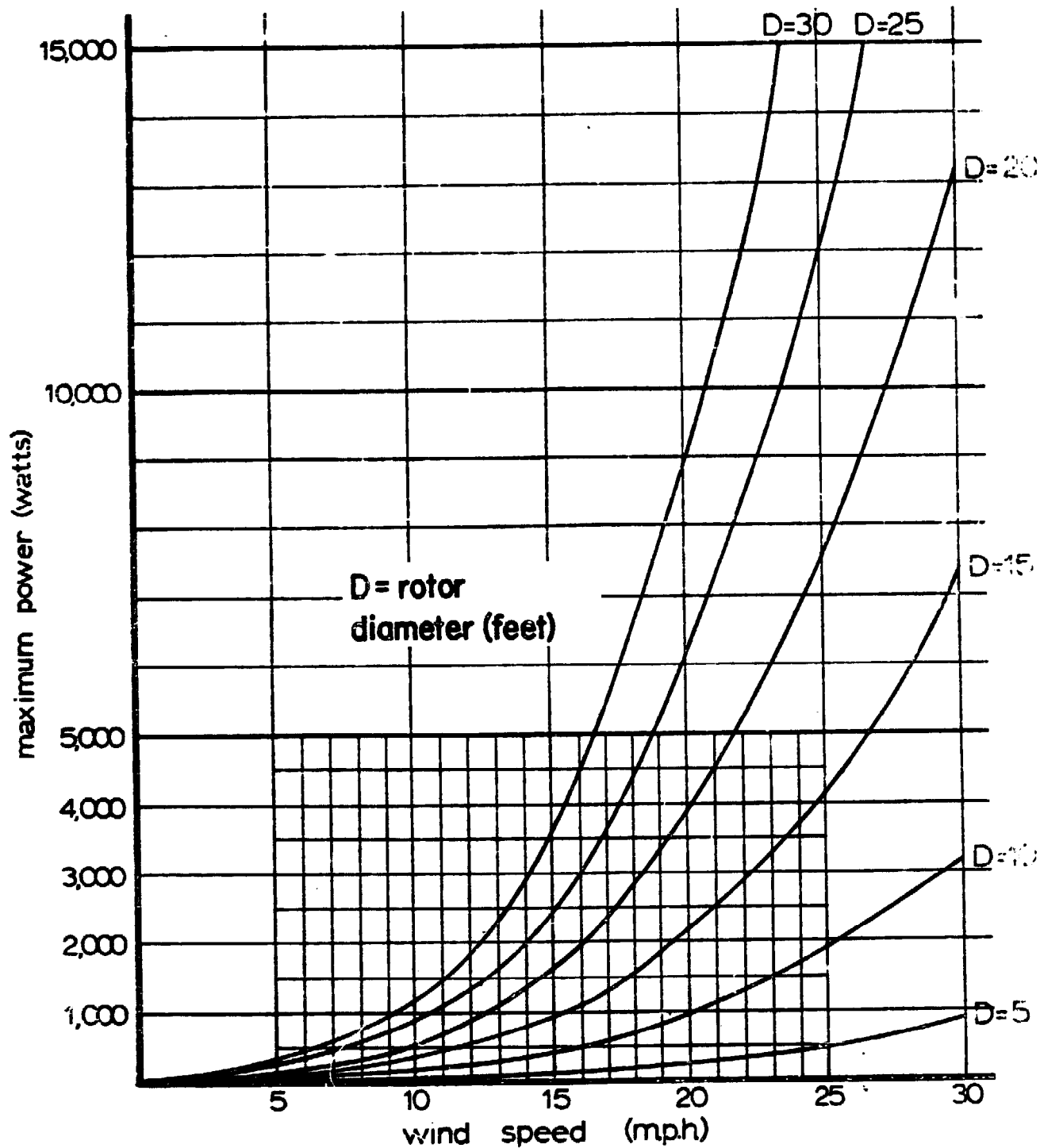

FIGURE 5-18B: Typical wind power curves.

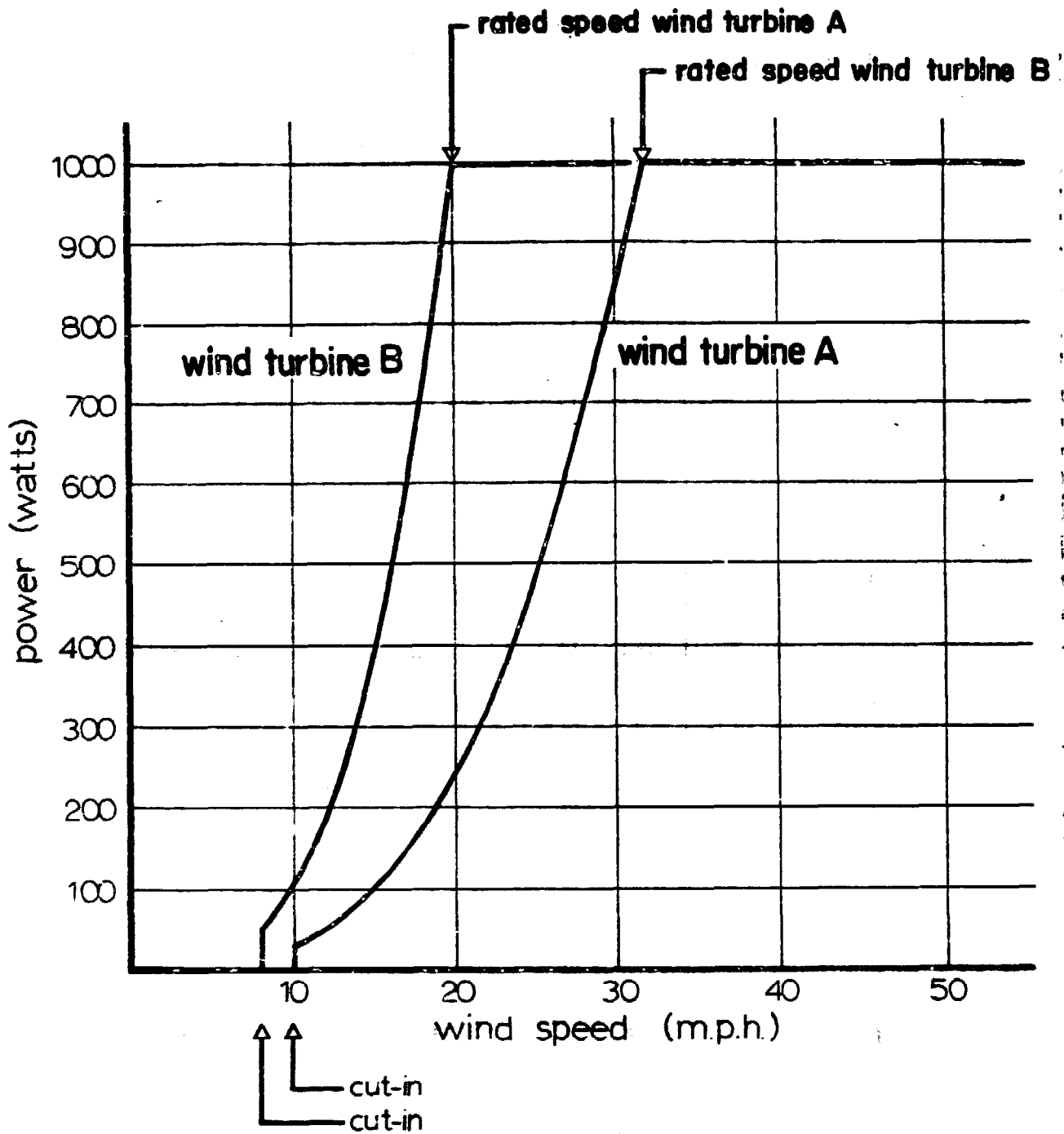

FIGURE 5-19: Power curves for two example wind turbine generators.

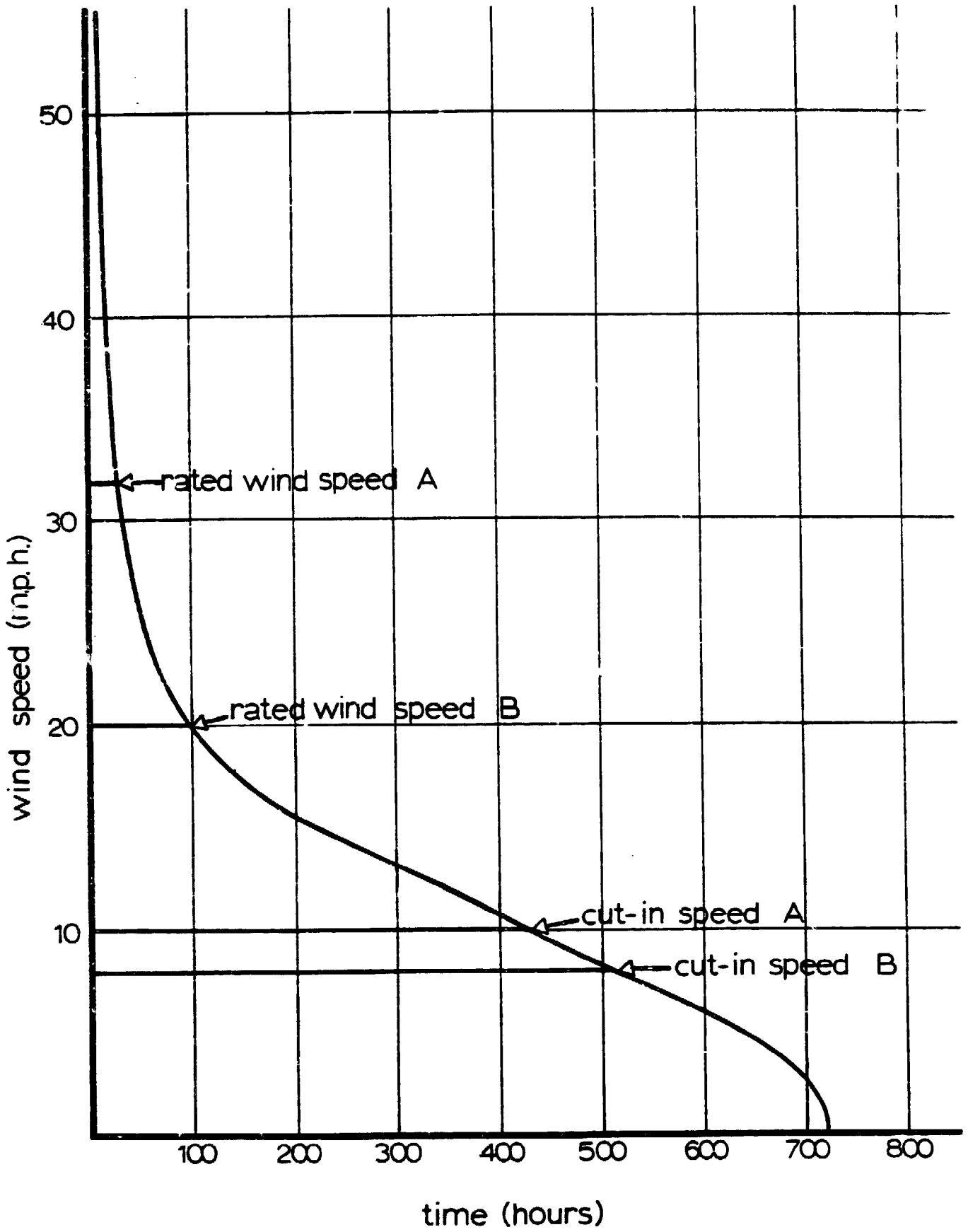

FIGURE 5-20: Example wind duration curve.

No.	V mph	WIND TURBINE A		WIND TURBINE B	
		Power watts	Watts × 20 Hrs.	Power	Watts × 20 Hrs.
1	>40	1000	20,000	1000	20,000
2	35	1000	20,000	1000	20,000
3	26	650	13,000	1000	20,000
4	22	320	6,400	1000	20,000
5	20	250	5,000	1000	20,000
6	19	238	4,760	950	19,000
7	17.5	162	3,240	650	13,000
8	17	150	3,000	600	12,000
9	16.5	138	2,760	550	11,000
10	16	125	2,500	500	10,000
11	15.5	113	2,260	450	9,000
12	15	100	2,000	400	8,000
13	14.5	90	1,800	360	7,200
14	14	80	1,600	320	6,400
15	13.5	70	1,400	280	5,600
16	13	60	1,200	240	4,800
17	12.5	50	1,000	200	4,000
18	12	45	900	180	3,600
19	11.5	40	800	160	3,200
20	11	35	700	140	2,800
21	10.5	30	600	120	2,400
22	10	25	500	100	2,000
23	9.5	0	0	95	1,800
24	9	0	0	87	1,740
25	8.5	0		70	1,400
26	8			50	1,000
27	7.5			0	0
28	7				
29	6.5				
30	6				
31	5.5				
32	5				
33	4.5				
34	4				
35	3.5				
36	2				

Total watt
hours

95,420
= 95.4 kwh

229,940
= 229.9 kwh

FIGURE 5-21: Monthly energy from wind turbines A and B for previous wind-distribution curve.

All that is required to make such a chart is to write down for each 20-hour section of the curve the average wind speed and the watts of power at that speed for each wind turbine (from Figures 5-20 and 5-19; you can use time intervals other than 20 hours if you wish). Then, multiply each power value times the 20-hour duration. This yields watt-hours. Add up all the watt-hours produced by each machine. Convert to kWh by dividing by 1000. In this example, wind turbine B yields roughly 230 kWh to wind turbine A's 95 kWh.*

As indicated, a lower-rated speed implies a higher energy yield. If, for example, in the case just illustrated, all characteristics were the same, and wind turbine C is added to the comparison with a rated wind speed equal to the average wind velocity, which in this case is about 13 mph (value at 360 hours), the yield would be considerably greater. Wind turbine A is about 6 feet in diameter, wind turbine B is about 12 feet in diameter, while wind turbine C is about 20 feet in diameter.

You can expect the initial cost per kilowatt of rated power to increase with decreasing rated wind speed; at the same time yield (kWh) will increase, unless your wind distribution shows a considerable number of hours with wind speeds greater than 20 mph. For this reason, you need to know more than price and power rating. As you can see, rated wind speed is a valuable tool in wind turbine comparison.

*You can plot a wind duration curve from the average wind records of a nearby weather station and apply this technique for calculating wind energy if you desire. As an example the "Percentage Frequency of Wind" table for Amchitka Island, Figure 3-22 can be used. Along the top line are wind speed categories, and along the bottom line, the percentage time the wind was blowing in each of these categories. Also, the percentage of time there was no wind, 0.9%, is listed in the second line from the bottom. January, the month for this record has 30 days, or 744 hours. Starting with the fastest speed category ≥ 56 , the number of accumulated hours is simply:

≥ 56	$744 \times 2.1 \div 100$	$= 15.6$
48-55	$744 \times 3.7 \div 100 + 15.6$	$= 43.1$
41-47	$744 \times 4.8 \div 100 + 43.1$	$= 78.9$
	etc.	

The numbers in the right column are then plotted to make a curve similar to that in Figure 5-20.

WIND MACHINE ROTOR CONSTRUCTION

The major construction variations you find when selecting a wind turbine generally will involve the blades. The diagrams and discussion that follow are suited to propeller as well as Darrieus machines. One popular blade material is wood, either laminated or solid, with or without fiberglass coatings (Fig. 5-22). Uncoated wooden blades usually have a copper or other metal leading edge cover for protection against erosion by sand, rain, and other environmental factors.

The extruded hollow aluminum blade first was installed on a WECS in the early 1950's. This blade construction is being used again, especially for the "eggbeater" Darrieus machines (Fig. 5-5).

Built-up fiberglass blades with honeycomb or foam cores, or hollow cores except for a tubular structural spar, are also being used, as are built-up sheet aluminum blades. All these methods of construction have a history of service life in WECS applications as well as in many aerospace applications.

It is important to understand the various methods of rotor speed control. Blades are designed to withstand a certain centrifugal force and a certain wind load. The centrifugal force tends to exert a pull on the blades, whereas wind loads tend to bend the blades (Fig. 5-23). A control is needed to prevent over-stressing the machine in high winds. Obviously, one could design a wind turbine strong enough to withstand the highest possible wind, but this would be an expensive installation compared to a more fragile unit having a good control system.

Two primary methods exist for controlling a wind turbine: 1) tilting the windwheel out of excessive winds and 2) changing the blade angles (feathering) to lower their loads.

Figure 5-24 illustrates these two methods commonly used for shut-off control. Figure 5-3 shows a farm windmill in the shut-off position.

A method of control that was used extensively in Nebraska* is illustrated in Figure 5-25. Here, a wind fence is raised to block wind from flowing through the rotor. Appropriate for the type of windmill illustrated, this method has fallen into disuse with the invention of more sophisticated mechanisms. The Greeks, long before folks moved to Nebraska, controlled their sail windmills by taking in or letting out sail cloth. They knew when to take in sail because a whistle, mounted at the tip of one blade, would emit a loud noise whenever the machine was turning too fast.

*Barbour, Erwin Hinckley: The Homemade Windmills of Nebraska, 1899. Reprinted by Farallones Institute, 15290 Coleman Valley Road, Occidental, CA 95465.

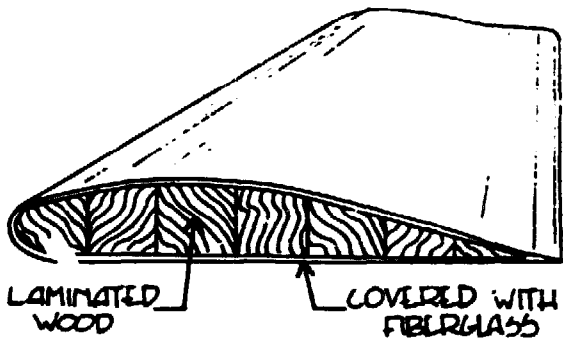

SOLID WOOD BLADE

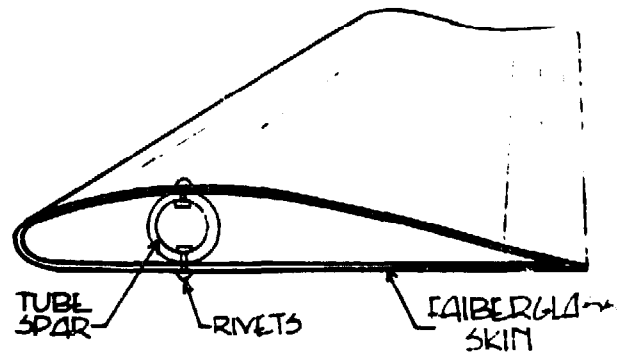

TUBULAR SPAR,
WITH MOLDED FIBERGLASS SKIN

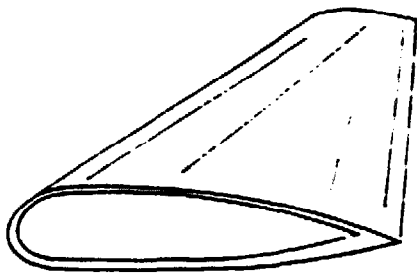

EXTRUDED HOLLOW
METAL BLADES

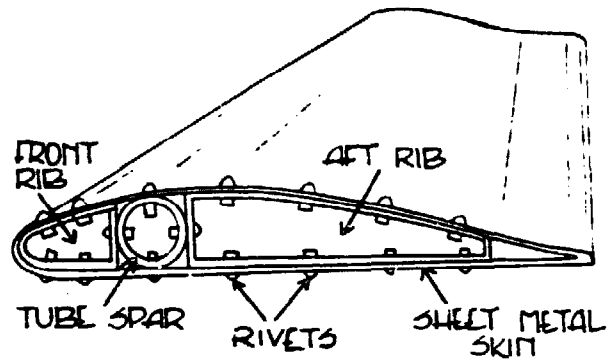

TUBULAR SPAR,
WITH METAL RIBS AND SKIN

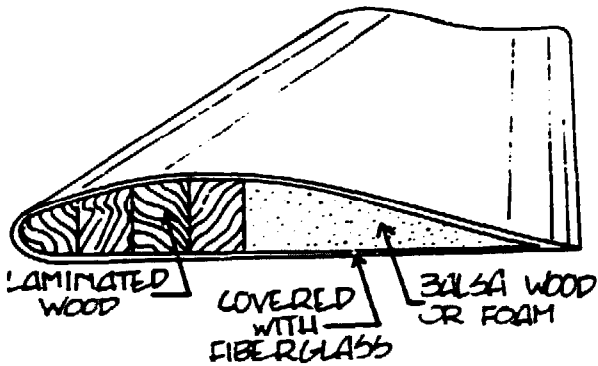

PARTIALLY SOLID BLADE

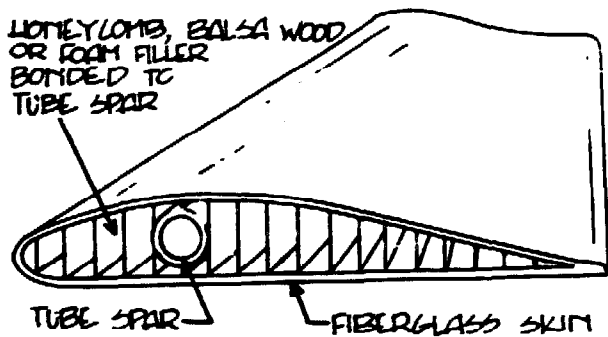

COMPOSITE BLADE
CONSTRUCTION

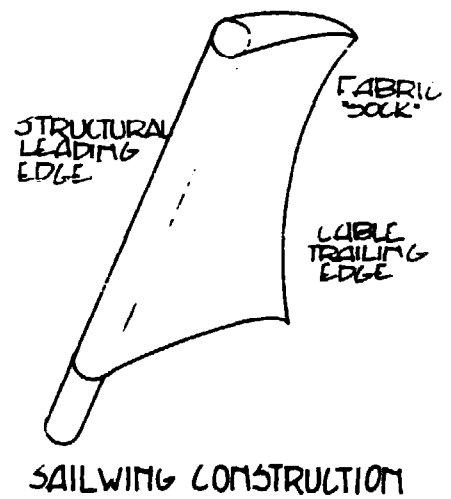

SAILWING CONSTRUCTION

FIGURE 5-22: Different blade construction methods.

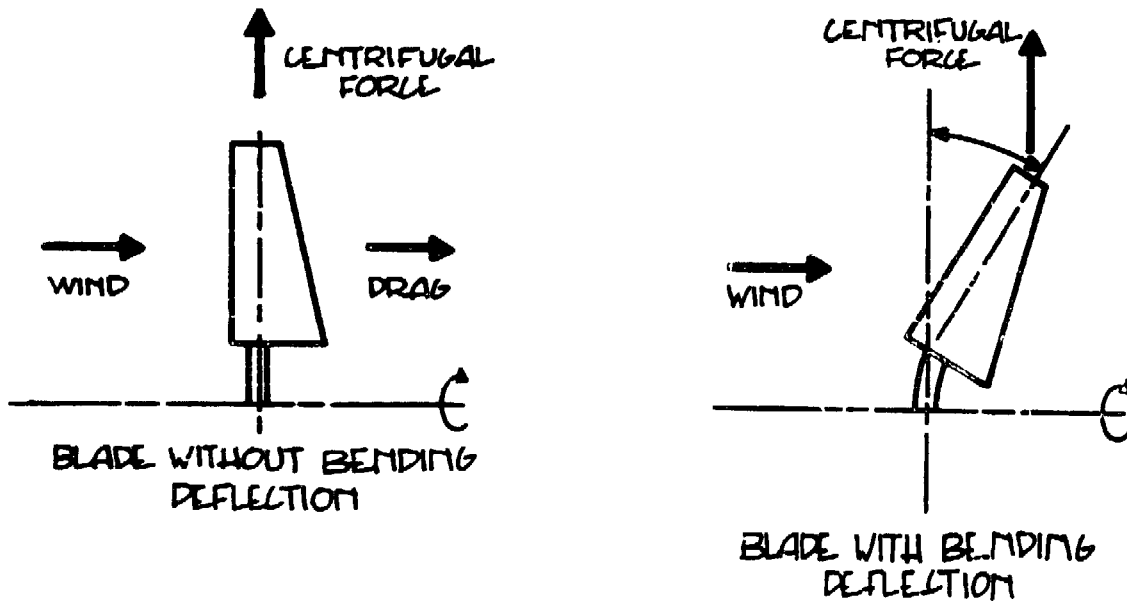

FIGURE 5-23: Loads on a wind turbine blade.

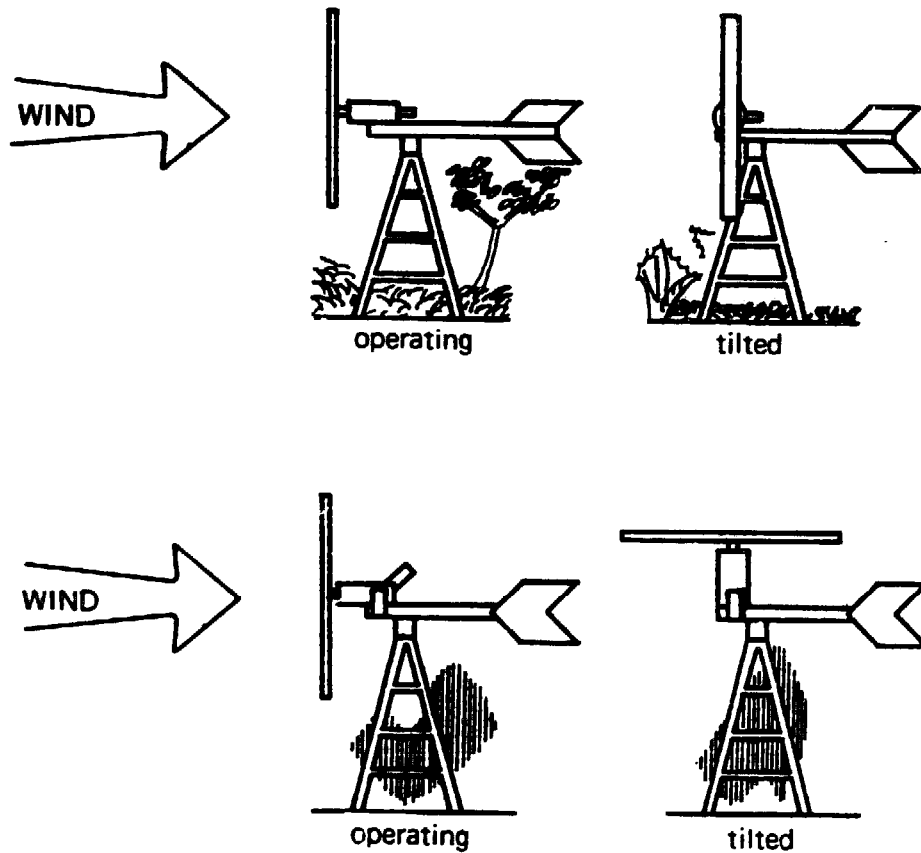

FIGURE 5-24: Two methods of wind turbine control by tilting the rotor.

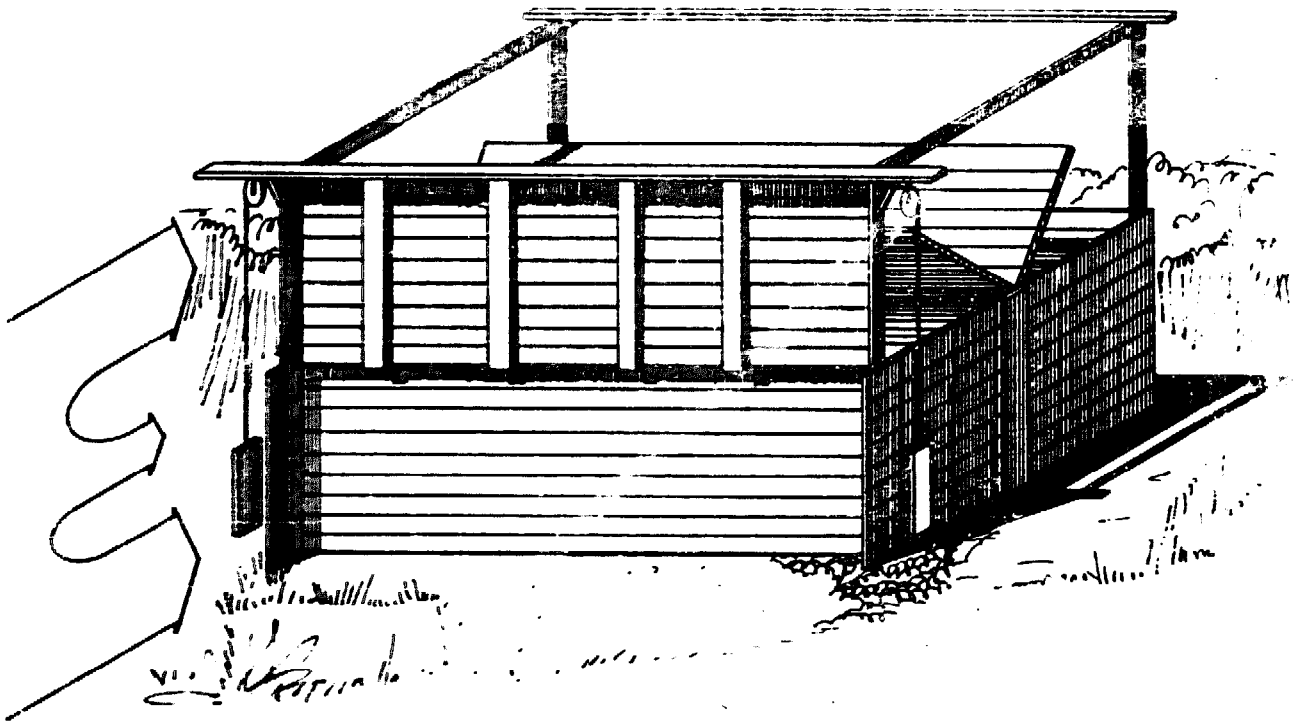
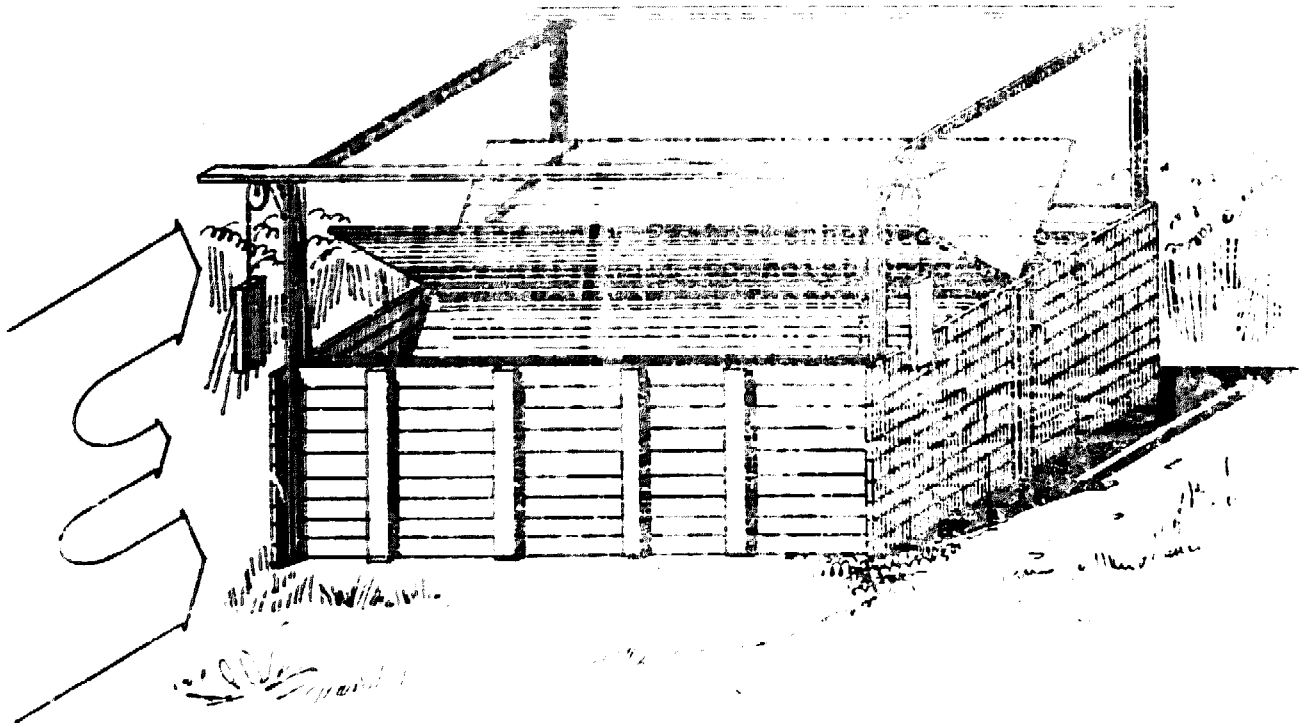

FIGURE 5-25: Control by wind blocking.

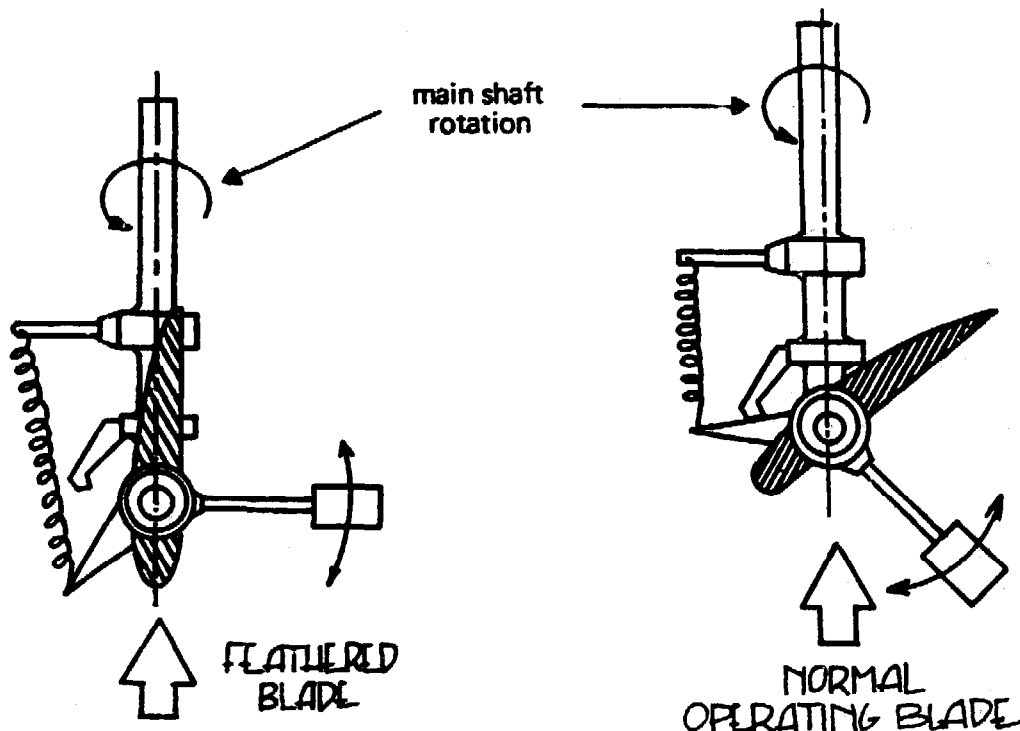
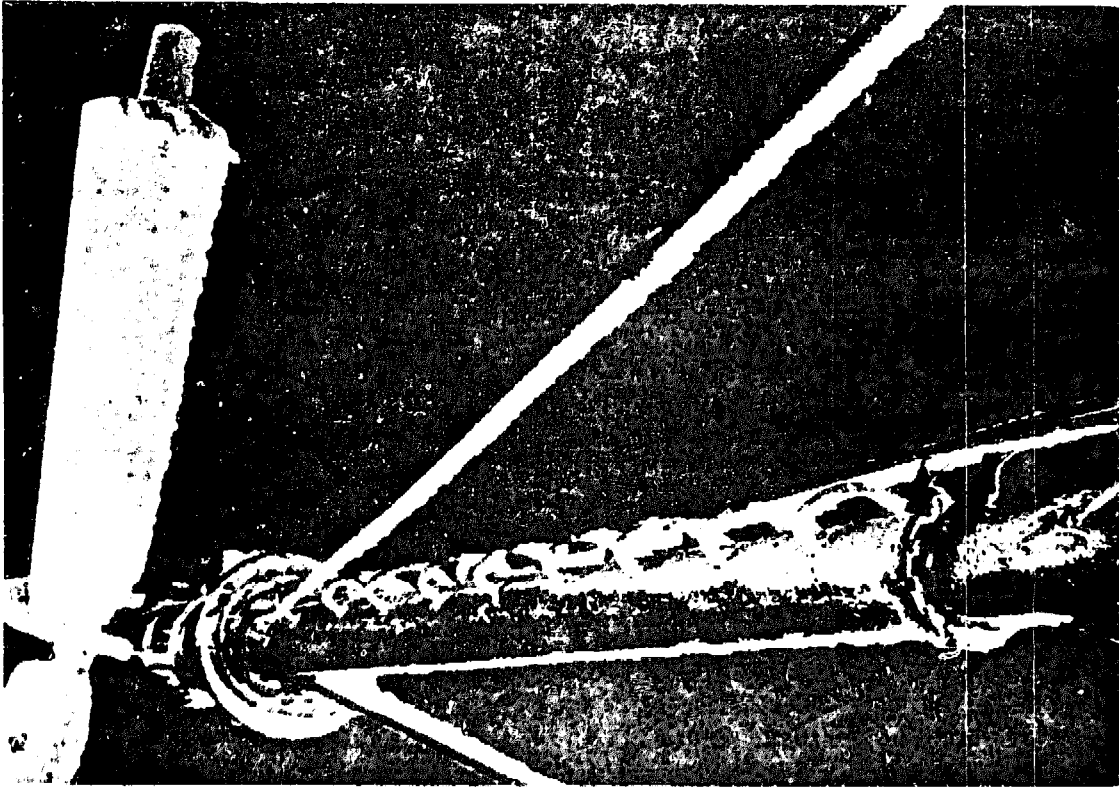

FIGURE 5-26: Blade feathering control.

Figure 5-26 illustrates a simple mechanical mechanism used to control blade angle (sometimes called blade pitch angle) for feathering the blades. Notice that the leading edge of the blade in its normal position is at an angle suitable to cause blade motion in the direction indicated. As blade rpm increases, centrifugal forces on the flyweight cause the weight, which is connected to the blade, to move around the blade center pivot shaft and cause the blade to pitch toward the feathered position. The feathered position pulls the leading edge of the blade into the wind to reduce or eliminate its driving force.

Ground control for shut-off or reset function can be combined with any of the design types to provide manual shut down of the windmill if required, such as during icing conditions, as illustrated in Figure 5-27. Other methods of blade control, such as automatic drag spoilers and hydraulic brakes, can also be used.

Ground control for the vertical-axis machines (such as Savonius type, Fig. 5-4) can be accomplished by methods such as blocking the machine from the wind as was used on old machines (Fig. 2-25), by venting the S-shaped vanes, or by changing the S-shape to reduce torque.



FIGURES 5-27: Icing on feathered blades.

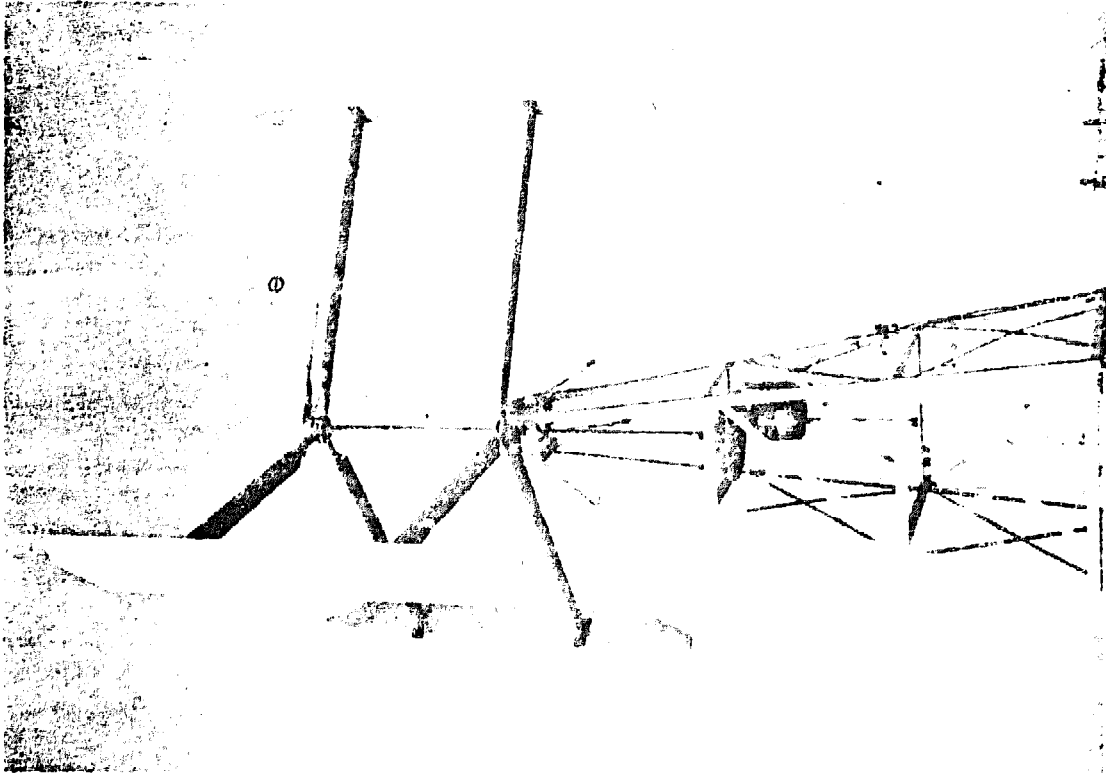

FIGURE 5-28: Darrieus rotor with straight blades.

The Darrieus rotor (Fig. 5-5), which is commercially available in the "hoop" (turning rope) shape*, can be controlled using any one of two main methods:

1. A unique aerodynamic characteristic of the Darrieus rotor permits the blades to stall; that is, quit lifting or pulling, which slows it down. Stall is caused by overloading the blades with the generator, which requires an electronic control system.
2. Drag spoilers mounted either on the blades or the support structure can be mechanically or electronically actuated to slow the speed.

Darrieus rotors designed with straight blades (see Figure 5-28) are able to use the blade pitch control in addition to these methods. The particular Darrieus machine illustrated uses variable blade pitch to control the rotational speed.

Another wind turbine characteristic you should consider is its furling speed** - the wind speed at which the wind turbine is automatically or manually shut off. First, not all wind turbines have or need a furling speed. These machines are designed to survive while operating in even the most severe winds. For these machines, the manufacturer's specifications should state the highest speed for which their product is designed or has been tested.

Machines that must be furled will do so by automatic mechanical or electronic control, or you will be required to operate a ground shut-off control when high winds are anticipated. On modern machines, the tail vane may be locked sideways to turn the machine out of the wind, a brake is locked, or blades are locked in the feathered position.

Thus, the type of control system used in a particular wind turbine will play an important part in the furling operation.

ELECTRIC POWER GENERATION

As stated before, wind turbine generators tend toward low-solidity designs that have high tip speed ratios for high rpm operation. Before rural electrification, some of the early wind turbines used direct-drive generators. This means that the windwheel directly turned the generator, which was a heavy, low-speed unit. Many of the newer machines have transmissions mounted between the windwheel and the generator to increase the windwheel rpm by a factor called gear ratio - typically 4, 5, or more.

*This shape has been given the name troposkein.

**Sometimes referred to as cut-out speed.

Thus, for example, a windwheel speed of 100 rpm is increased by the transmission to 400 rpm or more. This allows for a lighter, lower-cost generator but requires the additional weight, cost, and maintenance of a transmission.

Lower cost is not the only factor enhanced by low weight. Heavier units can be more difficult to hoist onto the tower than equivalent lighter units. However, a factor in favor of direct drive is the lower maintenance required by elimination of the transmission. You can see that the choice between direct drive or a transmission drive involves many trade-offs.

Wind turbines have been built most often with the generator and blades mounted at the top of the tower. It is possible that machines will eventually have drive shafts at the bottom of the tower where the generator will be mounted. Another possibility is to mount a hydraulic pump at the windwheel and use hydraulic pressure to cause fluid flow through tubes down the tower to a hydraulic motor. With this concept, it becomes possible to have several windwheels powering one central generator.

Generators installed in WECS can be of the direct current (dc) type or alternating current (ac) type. Many good books about generators are available in libraries, so a detailed discussion of the inner complexities of each type of generator is not presented here. However, it is useful to understand the basics.

Alternating current is generated in an ac generator (or alternator) by passing coils near alternate poles of magnets. The ac current generated is fed directly to the wires outside the unit. Here, you should understand that the frequency of the ac current is governed by the rpm of the generator (utility power is 60 Hz [cycles per second] throughout the United States). The faster the coils of wire pass the magnet poles, the higher the frequency. To establish a fixed or constant frequency, the windwheel rpm must be held constant, regardless of wind speed. For small WECS, as considered here, the blade control device required to hold a constant rpm can be an expensive mechanism.

Generators used to produce ac power (which can be electrically fed direct into your load at the same time the utility ac power is wired in) are called synchronous generators. A wind turbine generator operating in a synchronous mode would be generating ac power at exactly the same frequency and voltage as the utility mains, or other source of ac power. This type of operation, as mentioned, increases the complexity of blade control systems and therefore increases the cost of the wind machine. On large wind turbines, synchronous generation is often practical.

Special generators are being developed that produce a constant frequency but allow for variable rpm by electronic compensation. These generators are being tested by several organizations, and the results of these projects might possibly allow turbine synchronous operation without the limitation of constant rpm (expensive) blade control systems. This type of generator is

called a field modulated generator. Another method for generating fixed-frequency ac is to generate dc, and change the dc into ac by means of an inverter. Some inverters are designed to permit synchronous operation; others are not. We shall discuss inverters shortly.

Generation of dc usually involves generation of ac inside the generator, then conversion of the ac to dc by means of brushes and a commutator. This has been the common design for dc generators until recently. A method more commonly used now, because of improvements in diode technology, is to rectify the ac output of the alternator to dc. This technique eliminates the need for brushes and a commutator and takes advantage of the superior low speed characteristics of the alternator over those of the dc generator. Virtually all new automobiles use the diode-alternator combination in their electrical systems. Thus, the ac power generated internally is fed to the battery and other loads as dc. Direct current is the only type of current that can be stored in a battery. Variable-frequency ac, as generated with a small wind generator, can be used without diode rectification to dc for many applications such as electric resistance heating. The current flow for each of these three generators is diagrammed in Figure 5-29.

Some experimenters have used the current before it is rectified to dc. Alternating current can be fed to a transformer, which steps up the voltage while lowering the current (amps). This reduces line loss (which we will discuss later) that can occur on long wire runs from a wind turbine to a load. Thus, a 12-volt alternator is stepped up to, say, 100 volts. At the other end of the long run, another transformer (Fig. 5-30) steps down the high voltage to an appropriate value, where the ac is rectified to dc. This method of transmission is subject to losses (about 5 percent) from the transformers. Transformers are designed for best operation at one frequency, while small WECS alternators generate variable frequency ac according to the rpm of the windwheel. Some transformers are designed for one frequency (60 hz or 400 hz), while others are designed to operate over a 50-400 hz range.

Direct current generators have brushes made with carbon, graphite, or other materials to transfer electric power from rotating windings to the stationary case of the unit. These brushes transfer the full electric power of the generator. Some alternators have brushes also. In contrast to dc generators, however, these brushes transfer only the field current, a small percentage of the total alternator output. Alternators are also available without brushes (brushless units) at a somewhat higher cost than equivalent brush-type units.

Some generators (or alternators) are available with permanent magnets. These magnets cause the electric current to flow as they spin past the coil windings. Other generators are available field wound, which means that electromagnetic coils requiring energizing current are installed in place of permanent magnets.

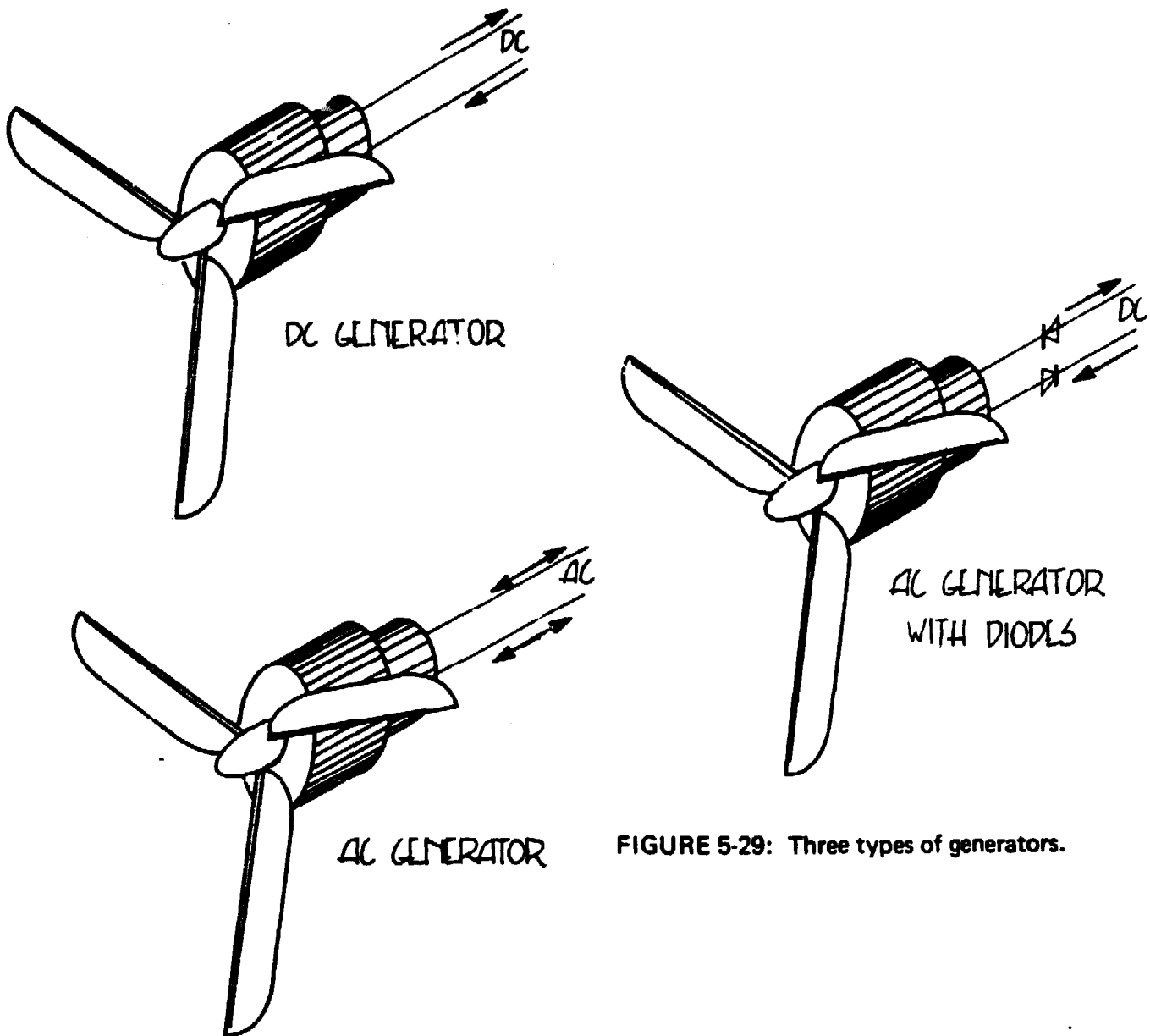

FIGURE 5-29: Three types of generators.

Three methods are used for regulating or controlling the electric output of the generator:

1. Voltage regulators are used on field wound units to control the strength of the field coils, which in turn controls the output voltage.
2. Voltage controllers may be used on permanent magnet units to adjust voltage levels according to the output of the generator and the needs of the system.
3. No regulation at all. The output of the permanent magnet generator is used as is, while that of the wound field is fed back to the field either directly, or through a resistor to give a variable-strength field according to the strength of the generator output.

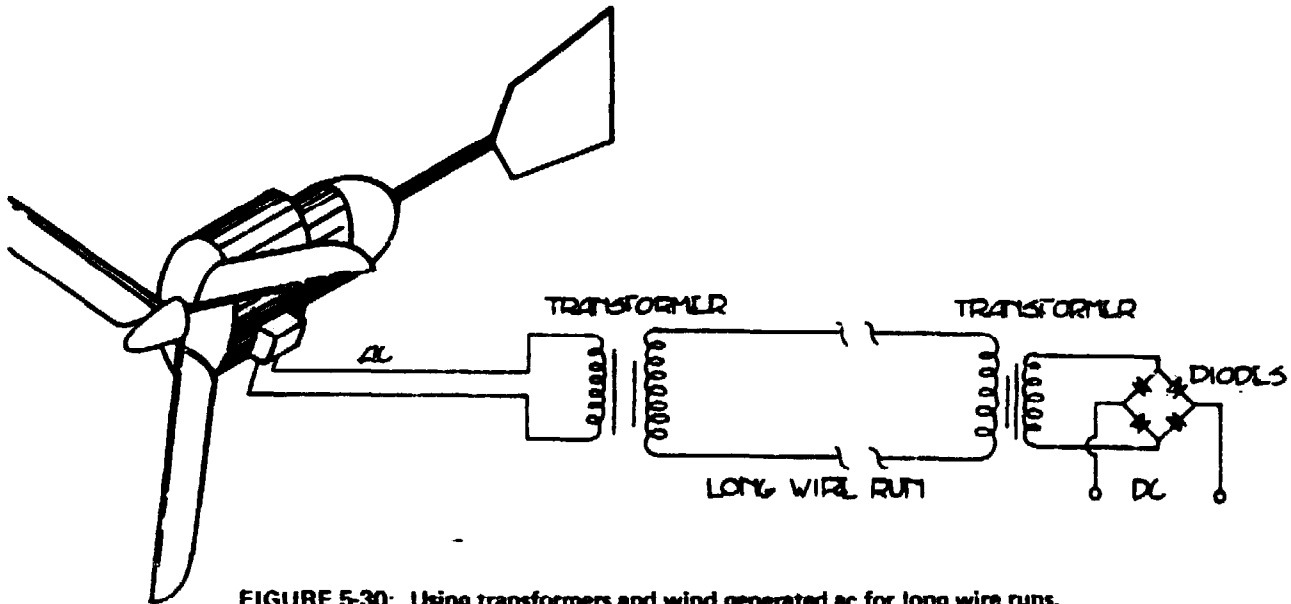

FIGURE 5-30: Using transformers and wind generated ac for long wire runs.

Generators and alternators are selected or designed by WECS manufacturers according to their own criteria, which includes cost, weight, performance, and availability. Thus, in your own selection of a suitable wind turbine, you will find units with specially made generators, as well as units with truck, automotive, and industrial alternators. You can make your own observations regarding availability of spare parts for custom, as well as industrial equipment. In some cases, the WECS manufacturer designs his own generator as a means of improving the overall system performance.

Figure 5-31 is a wiring diagram for a simple wind electric system. The wind turbine generator will charge the batteries which, in turn, will supply power to the two loads illustrated. Battery storage would be sized to store as much energy as is needed to make up for periods when the wind is lower than required or the power demand exceeds the wind generator capacity. The wind turbine would be sized to supply at least enough kilowatt-hours of energy as needed for the loads.

Suppose that the wind turbine generator supplies more kilowatt-hours than are needed. The batteries would be overcharged. Energy would be wasted. To preclude this situation, a

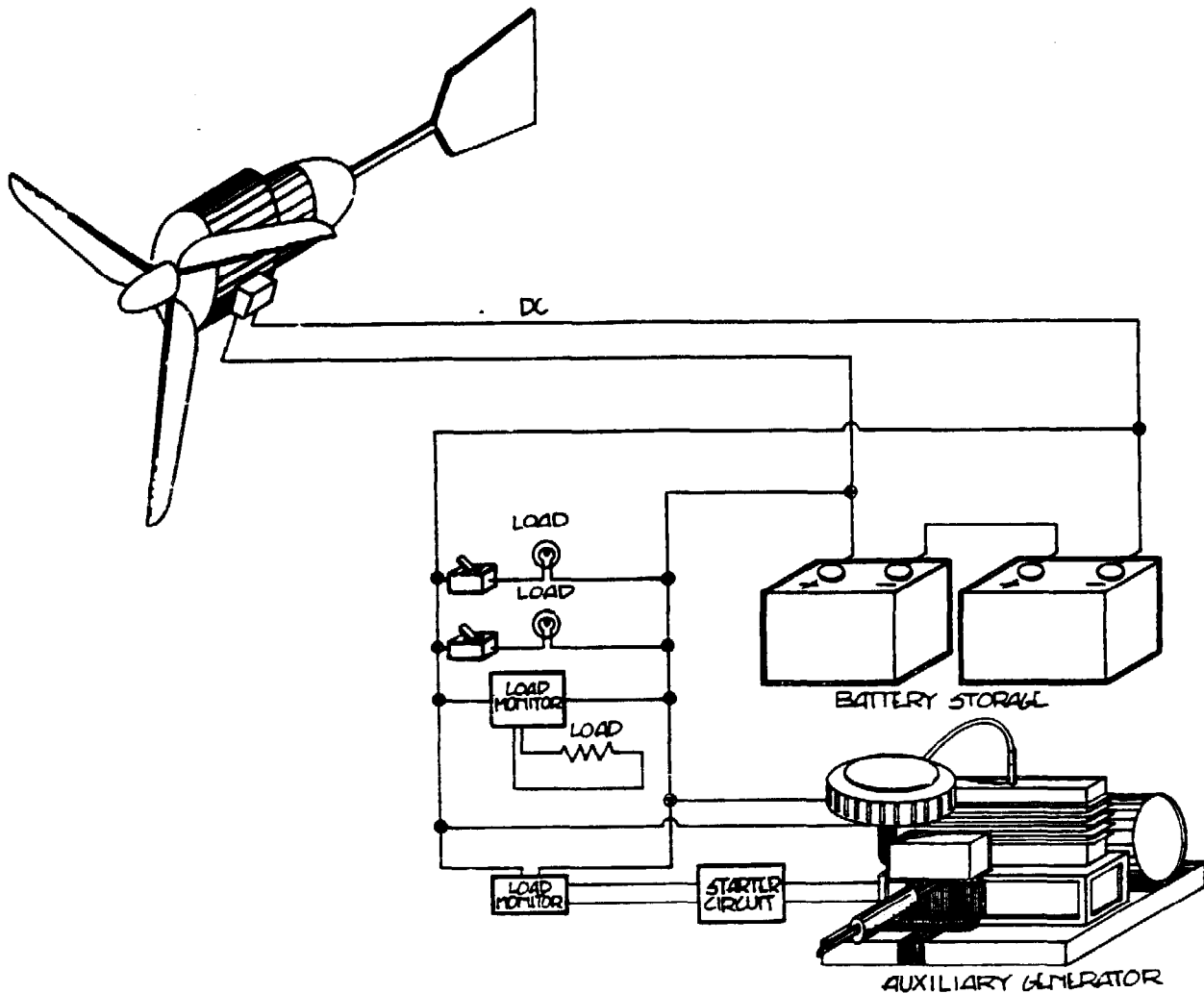

FIGURE 5-31: Simple wind electric wiring diagram.

load monitor is used (see Figure 5-32). The load monitor senses situations when the wind generator creates more power than the electric system needs, and reacts by switching on load C. Load C might be a resistance electric heater immersed in a water heater tank. It may be another battery bank, or any other load that will use the excess power. The load monitor thus prevents energy waste, and in so doing improves the energy utilization of the simple battery system.

Load monitors can be used another way. Suppose that the wind turbine generator does not supply the required energy. Perhaps a week of no wind occurs, and the batteries are nearly discharged. A load monitor can be used to sense this condition and activate a backup system.

The backup system could be a gasoline powered generator, another set of batteries, or an extension cord to your neighbor's house. In any case, the load monitor can control the source. In the case of the gasoline powered generator, the load monitor can flash a light, ring a bell, or otherwise warn you of the situation, or it can energize the starter circuit on the auxiliary generator to bring it on-line. Schematically, this could be done as shown in Figure 5-33.

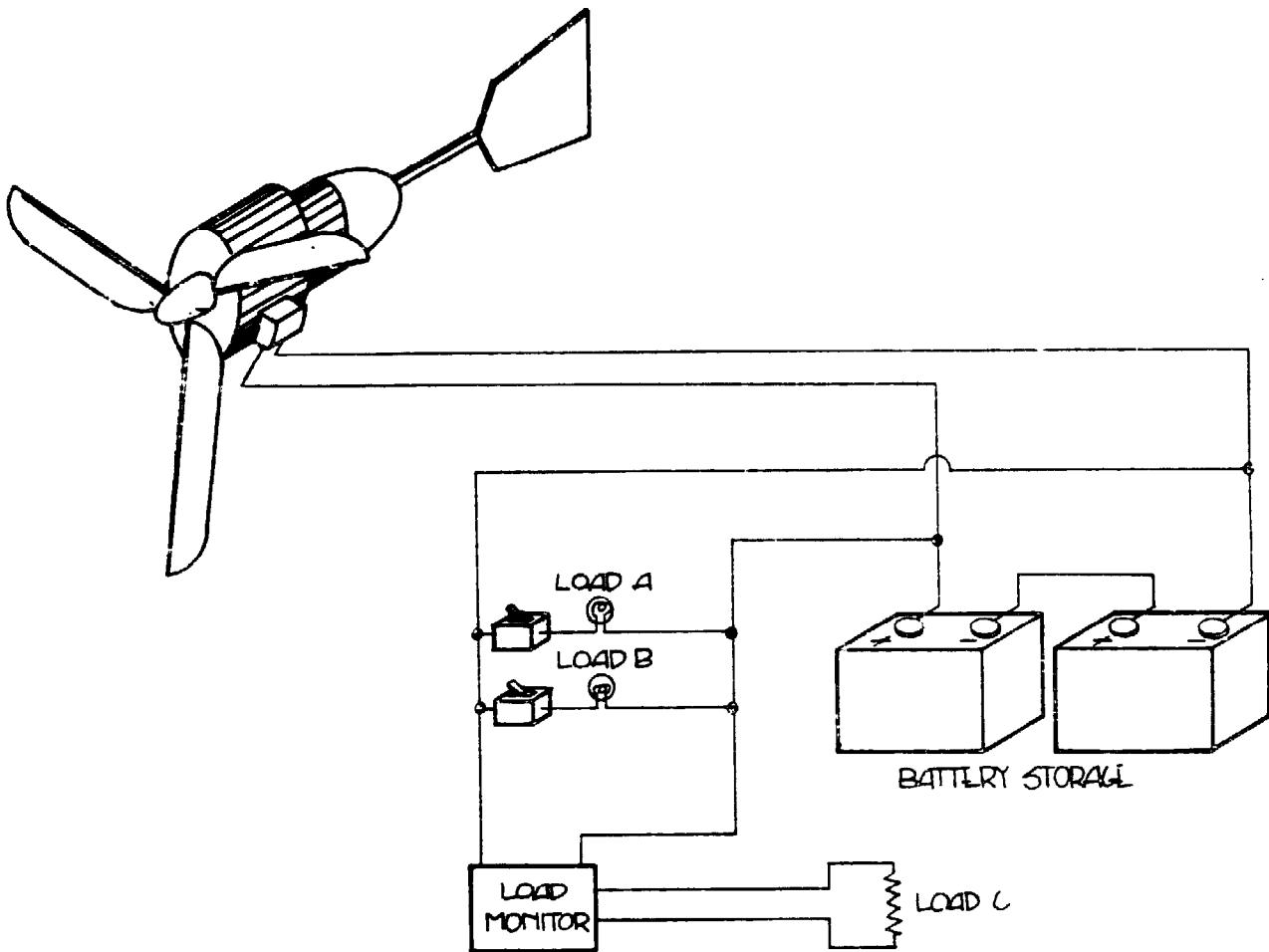

FIGURE 5-32: Wind electrical system with load monitor.

ENERGY STORAGE

Batteries

The key to a viable wind electric system using battery storage is a low-cost, high-storage-efficiency battery. Figure 5-34 presents many of the important characteristics of three prominent types of batteries.

Lead-acid batteries of the automotive type are among the lowest-efficiency storage batteries available. Auto batteries usually retain about 40-50 percent of the energy your wind turbine generator will charge them with. Since it is energy storage you are buying, and dollars per kilowatt-hour of storage is the deciding factor, you should assume a low storage efficiency for such batteries when evaluating their usefulness.

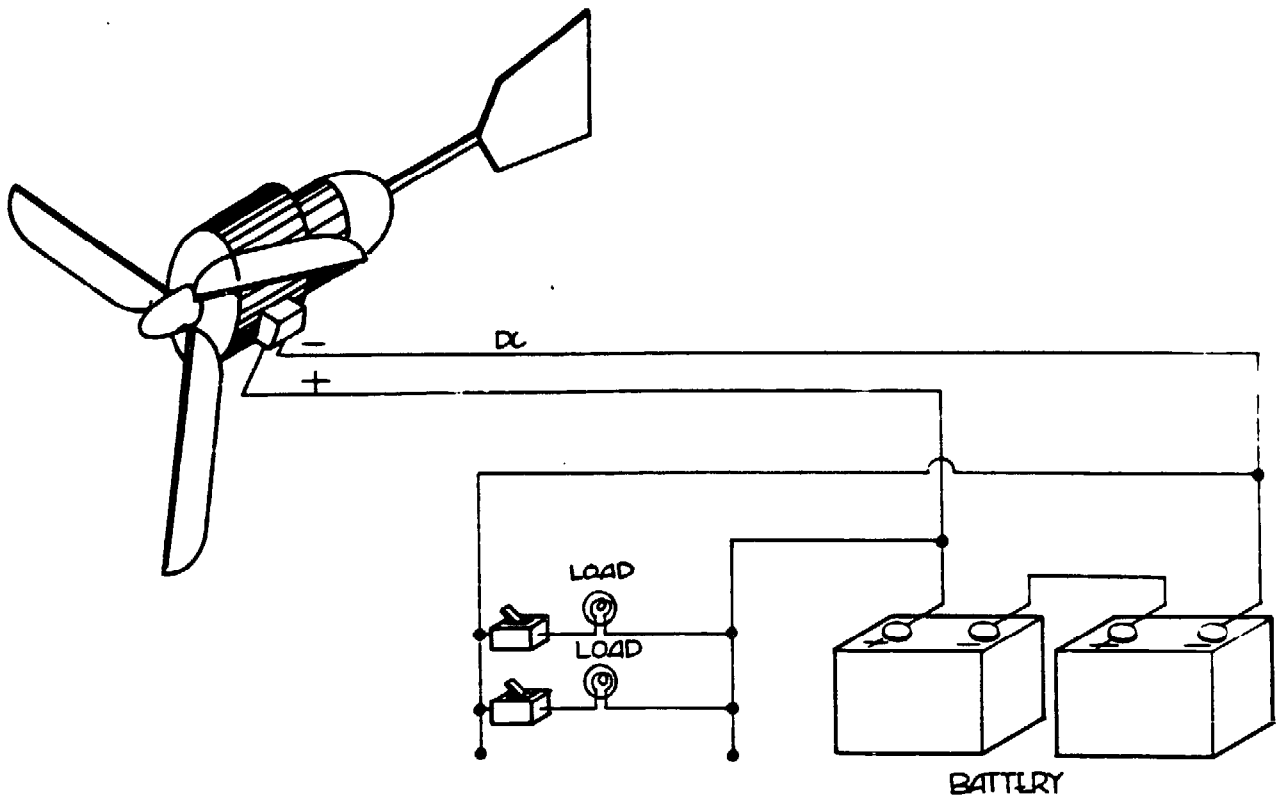

FIGURE 5-33: Complete wind-electrical system with backup generator.

Battery	Voltage Per Cell	Density Watt-hrs/lb	Cycle Life	Storage Efficiency
Lead-Acid	2.0	10-20	200-2000	50-80 %
Nickel-Iron (Edison Cell)	1.3-1.5	10-25	2000	60-80
Nickel-Cadium	1.2-1.5	10-20	2000	80

FIGURE 5-34: Characteristics of different types of batteries.

Golf cart batteries are one of the most suitable type available today, as are industrial batteries used for electric forklifts and units for standby power for computers, telephones, and electronic instrumentation. Standby batteries cost much more than golf cart batteries, but are designed for higher reliability and longer life. Golf cart and standby batteries are designed to be deep-cycled (discharged to very low charge levels) while auto batteries are not.

Batteries are rated by their voltage and by their storage capacity (amp-hours). For example, a typical golf-cart battery might be a 6-volt unit, rated at 200 amp-hours. It is important to know that the amp-hour rating is based on a certain discharge rate. The typical rating is 20 hours for golf cart batteries. If 200 amp-hours were discharged over a period of 20 hours, the discharge rate would be 10 amps/hour ($200 \div 20 = 10$ amps). Greater discharge rates will result in a slightly reduced amp-hour capacity. You can get performance curves from battery manufacturers that illustrate this fact. You can convert the amp-hour and voltage ratings into watt-hours by simply multiplying the two. For example, 6 volts x 200 amp-hours = 1200 watt hours, or 1.2 kWh. With this, you can easily determine the number of batteries you will need.

Example 1: Storage capacity needed is 30 kWh. If we use 6-volt batteries rated at 200 amp-hours, $30,000$ watt-hours \div 6 volts = $30,000 \div 6 = 5000$ amp-hours. With these 200 amp-hour batteries, we need $5000 \div 200 = 25$ batteries connected in parallel. These batteries would be wired as shown in Figure 5-35.

Notice that connecting batteries in parallel increases the amp-hour rating of the entire battery bank (simply add up the total amp-hours available from each battery), while the output voltage remains the same as that of an individual battery. All batteries in a system must have the same voltage rating. An advantage to this arrangement is that any number of batteries can be taken away or added at any time to adjust your storage capacity to your needs.

Example 2: Storage capacity needed is 10 kWh. For a 100-volt system which uses 2-volt batteries, it would require $100 \div 2 = 50$ batteries wired in series to make 100 volts out of 2-volt cells. Each battery must have an amp-hour rating of $10,000$ watt-hours \div 100 volts = 100 amp-hours. Thus, 50 2-volt, 100 amp-hour batteries satisfy the 10-kWh storage capacity requirement. These batteries would be wired in series as shown in Figure 5-36.

Notice that connecting batteries in series increases the voltage of the battery bank while the amp-hour rating of the bank remains the same as that of the smallest amp-hour rated battery in the bank. To increase the storage capacity of, say, a 100-volt battery bank, either increase the size of individual batteries or wire another 100-volt bank in parallel.

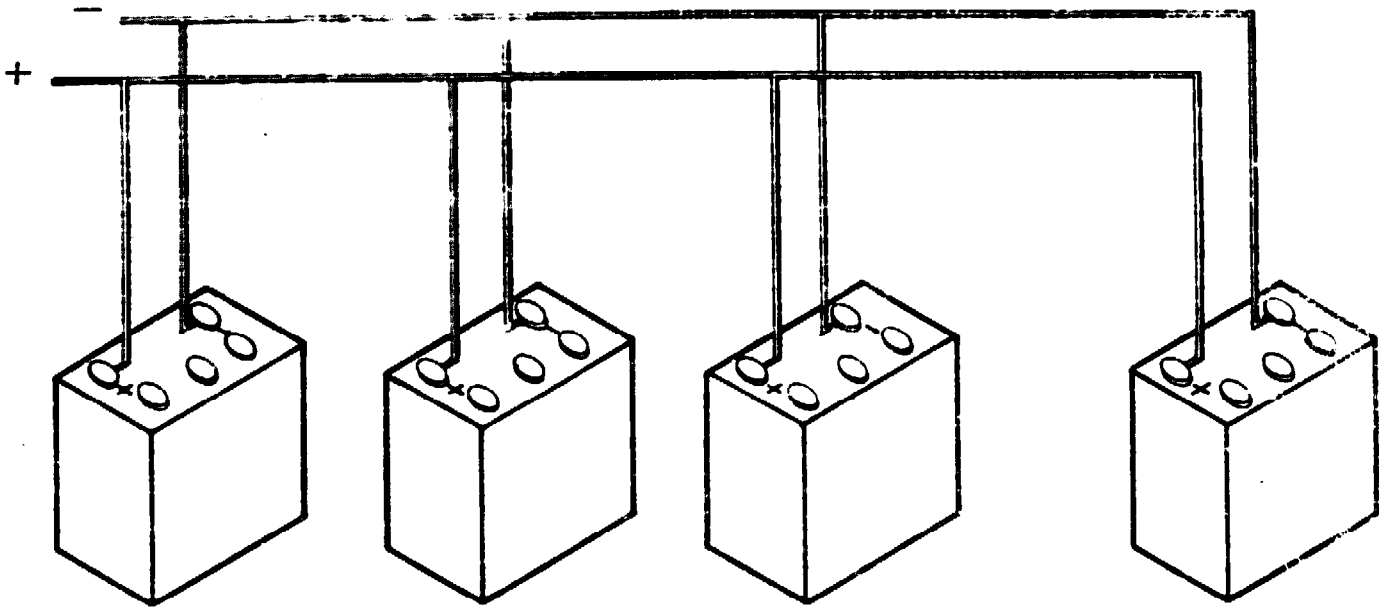

FIGURE 5-35: Battery storage bank – parallel wiring.

The cost of battery storage system is relatively high. As a result of an increasing demand for electric personal transportation vehicles, a large amount of battery research has begun to reduce these costs. Research supported both by private and government funds is rapidly closing the gap between the batteries available on the market and potentially lower-cost, higher efficiency units.

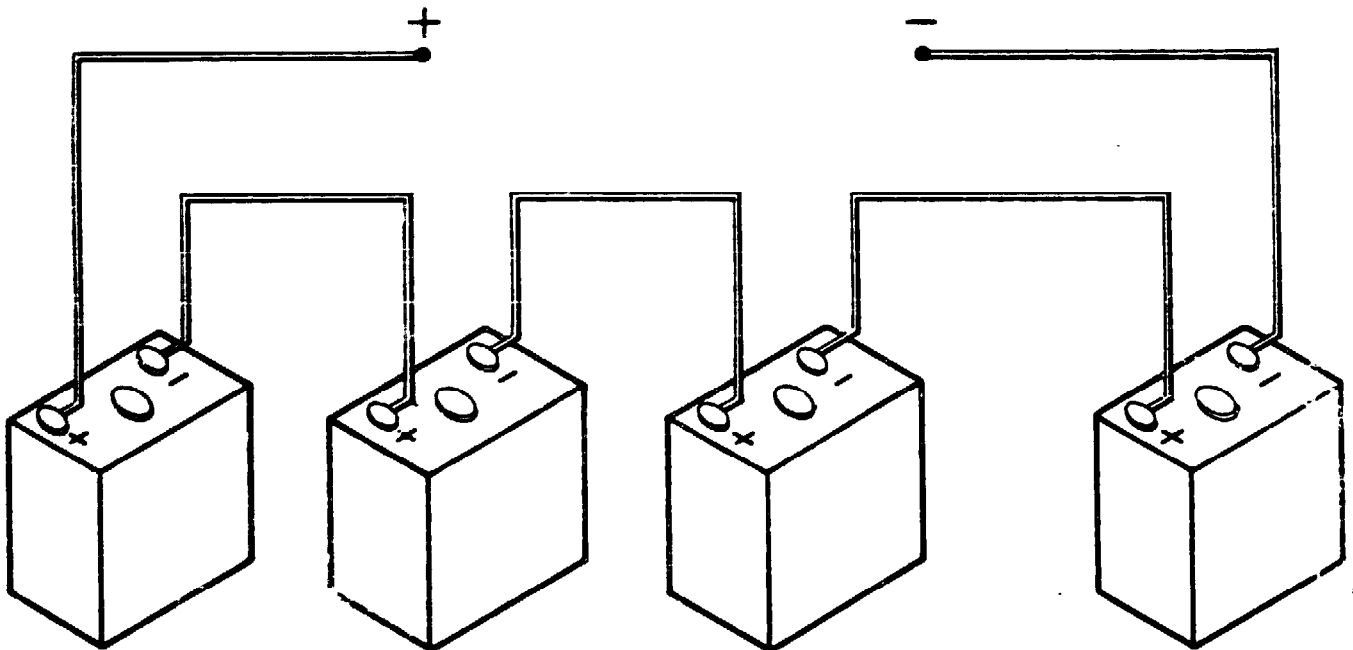

FIGURE 5-36: Battery storage bank – series wiring.

Figures like double and triple the energy density* are often quoted. Batteries made with materials like nickel-zinc and exotic metals are being tested and developed to increase electric car performance. Wind electric system energy storage per dollar invested is also expected to improve.

Pumped Water Storage

It may be that you wish to simply store enough water for domestic uses, as discussed in Chapter 4. On the other hand, it may be that you prefer an electric system where wind power pumps water up a hill to a lake. The lake then supplies water stored with enough potential energy to operate a small hydroelectric system to recover the energy, as illustrated in Figure 5-37.

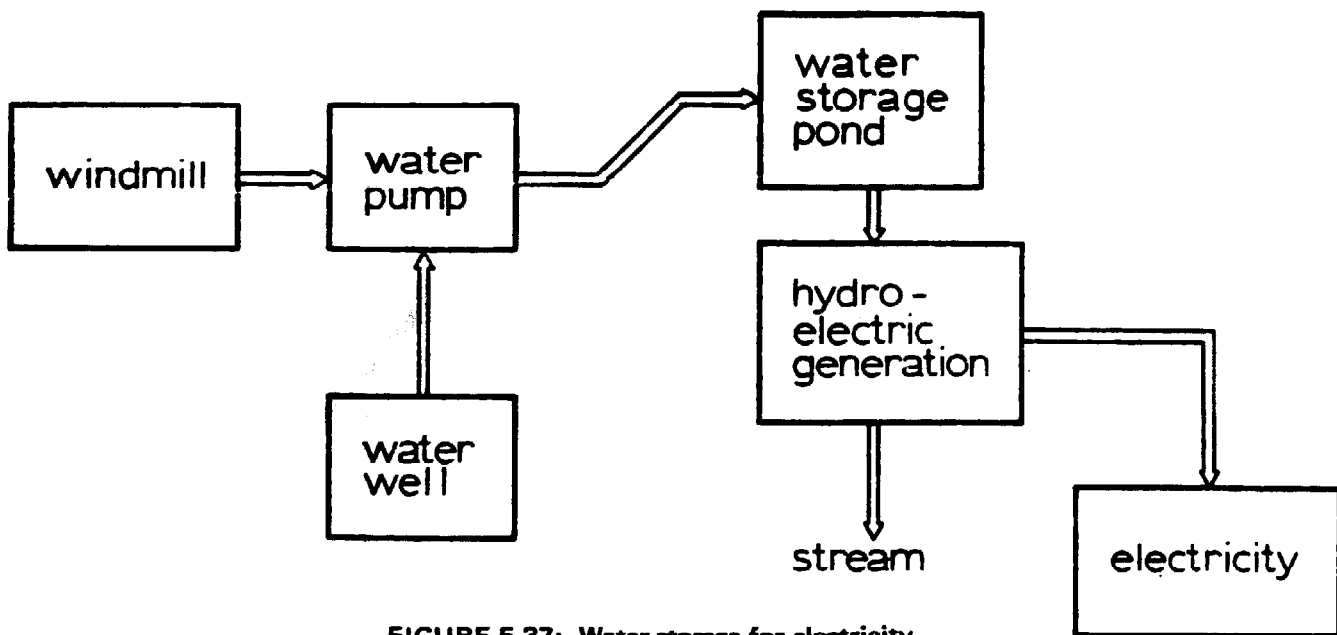

FIGURE 5-37: Water storage for electricity.

Figure 5-38 is a graph for determining the size of a pond or lake required to store a given amount of energy. Notice the large values. We sometimes hear of the idea that a few 55-gallon drums up in the attic ought to hold enough water to keep the lights burning all night, while the water trickles out of the drums turning a water turbine along its path. Unfortunately, this would not produce much power. For example, if you substitute a 1956

*Energy density is a measure of the amount of energy (kWh) per pound of battery. Since cost of items relates to weight of materials in them, higher energy density tends to enhance lower energy cost.

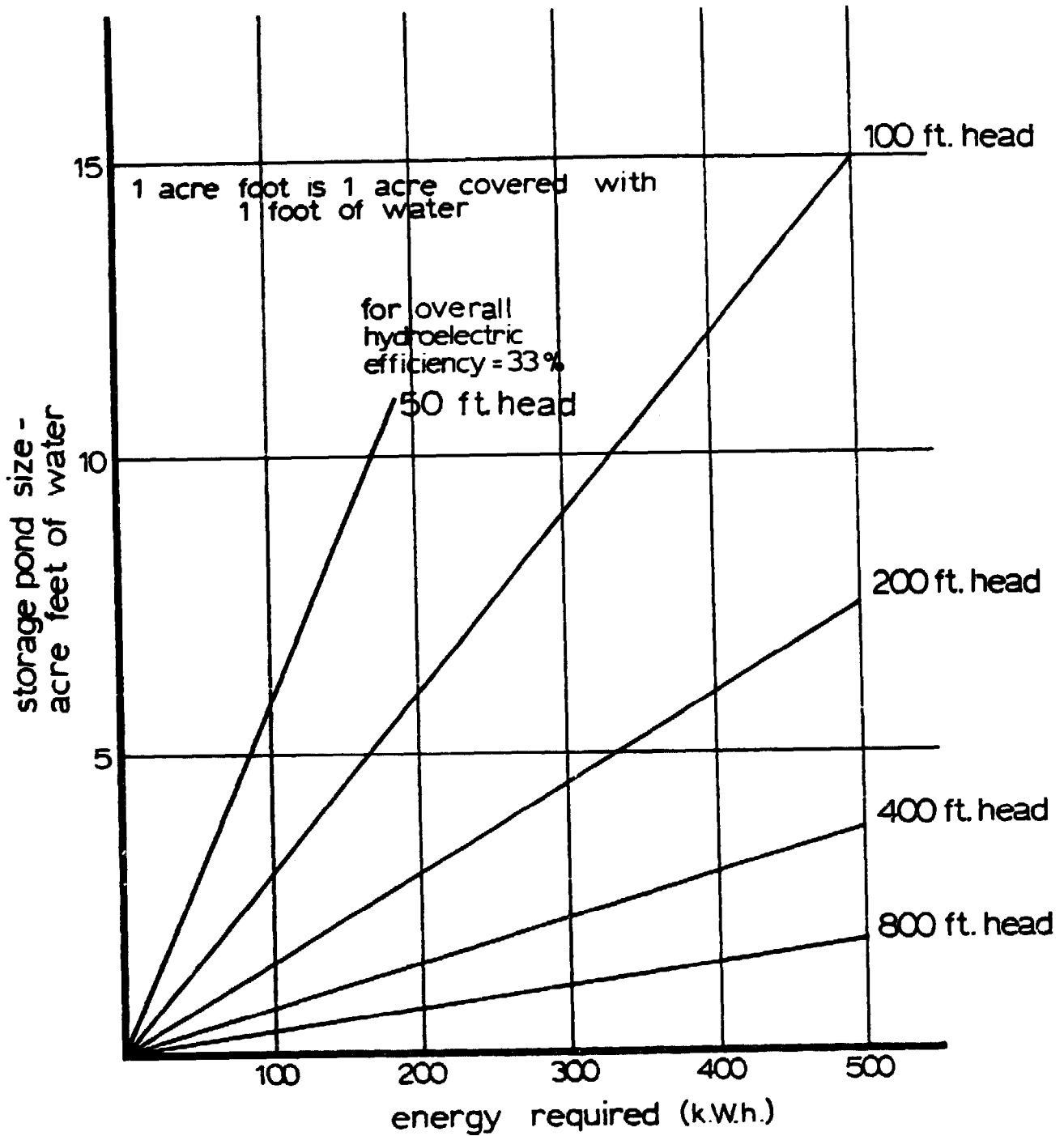
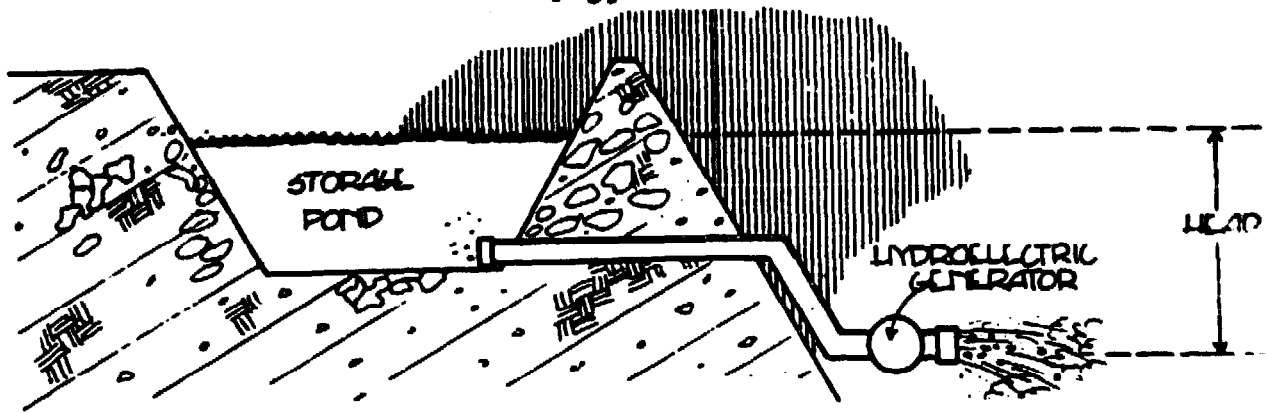

FIGURE 5-38: Pond size for energy storage.

Oldsmobile for water and hoist the car 100 feet into the air (presumably between telephone poles, with an electric motor/generator winch driven as a motor for hoisting), you ought to get back only about 800 watts for ten minutes while you let the car fall under the control of the winch-turned generator.

The decision to use pumped water storage must be based on availability of land and such factors as: would the required amount of land be better used for something else, cost (bulldozing a lake can be expensive), and the end use of the pumped water. Electricity generation is just one use; irrigation, fire prevention, stock watering, fish farm, and recreation are others.

In the case of electric energy storage, a small hydroelectric system will probably exceed the cost of an equivalent battery system.

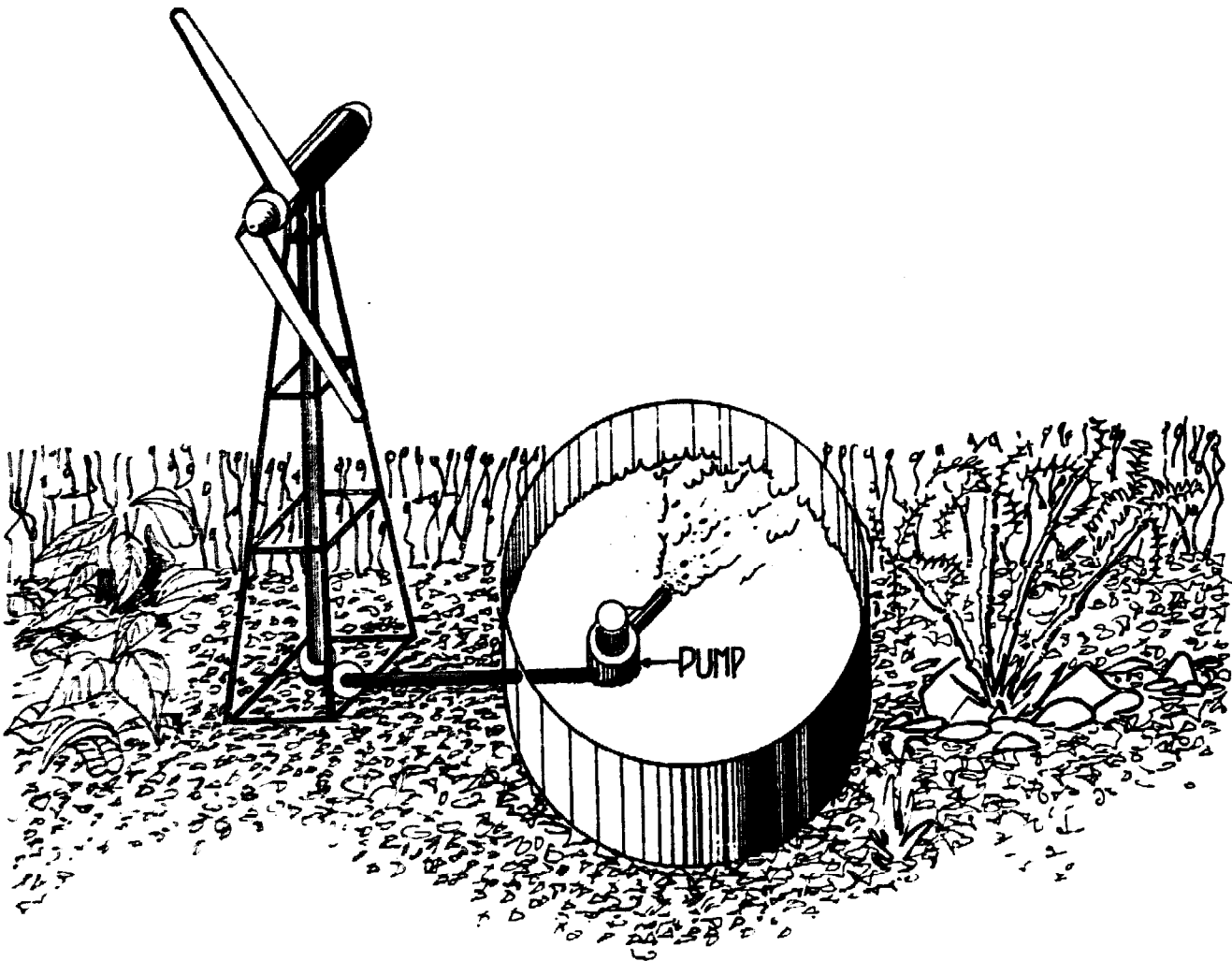

FIGURE 5-39: Water splash heating system.

Hot Water or Hot Air Storage

Wind power can be used to heat water for energy storage by splashing. Figure 5-39 schematically illustrates this method. Friction of water being pumped and splashed introduces all the energy as heat without the losses of a generator. As with any other heating system, heat loss can be kept to a minimum by insulating the tank. Splashing paddles can substitute for pumps. The cost-effectiveness of this method has yet to be determined.

Water may easily be heated by wind electricity as diagrammed in Figures 5-40 and 5-41. In fact, this is perhaps the most efficient means of storing energy once the electricity has been generated. Where batteries are 60 to 80 percent efficient, electric heaters approach 100 percent. The only losses are those through poor insulation of the storage tank and electrical line losses.

Conversion factors of interest are: 1 kWh = 3414 Btu (British thermal unit); one Btu will increase the temperature of one pound of water by one degree Fahrenheit; water weighs 62.4 lb/ft³, or 8.4 lb/gallon.

Example: By neglecting heat loss through insulation, calculate the temperature rise in 30 gallons of water caused by 1 kWh of wind generated electricity.

$$30 \text{ gallons} \times 8.4 \text{ lb/gal} = 252 \text{ lbs.}$$

$$3414 \text{ Btu} \div 252 \text{ lb} = 13/5^{\circ}\text{F heat rise.}$$

A wind-powered heating system is called a wind furnace. The heat supplied is best used for domestic or agricultural heating, as well as lower-temperature industrial applications. As illustrated in Figure 5-40, the wind-powered generator can be either ac or dc; regulated or unregulated. This provides some latitude in selection of wind turbine generator for a wind furnace, although manufacturers of the wind turbine, for many reasons, may not supply all of the options. For them, it is more efficient to manufacture just one or a few types of machines that will serve the greatest number of applications.

The resistance electrical heater unit can be the air type, as with baseboard electric home heaters, or the water (or other liquid) immersion type. By using the immersion type, energy storage is provided by the thermal mass of the liquid, while thermal mass of the room (concrete floors, tile or brick walls, etc.) provides energy storage for the air heater.

If a regulated dc generator is used, then the wind furnace could look something like Figure 5-40, or Figure 5-41. A temperature monitor (thermostat) provides a control input to a load controller, which provides priority power to the heater, and secondarily, after the heater is warm enough, power to other loads.

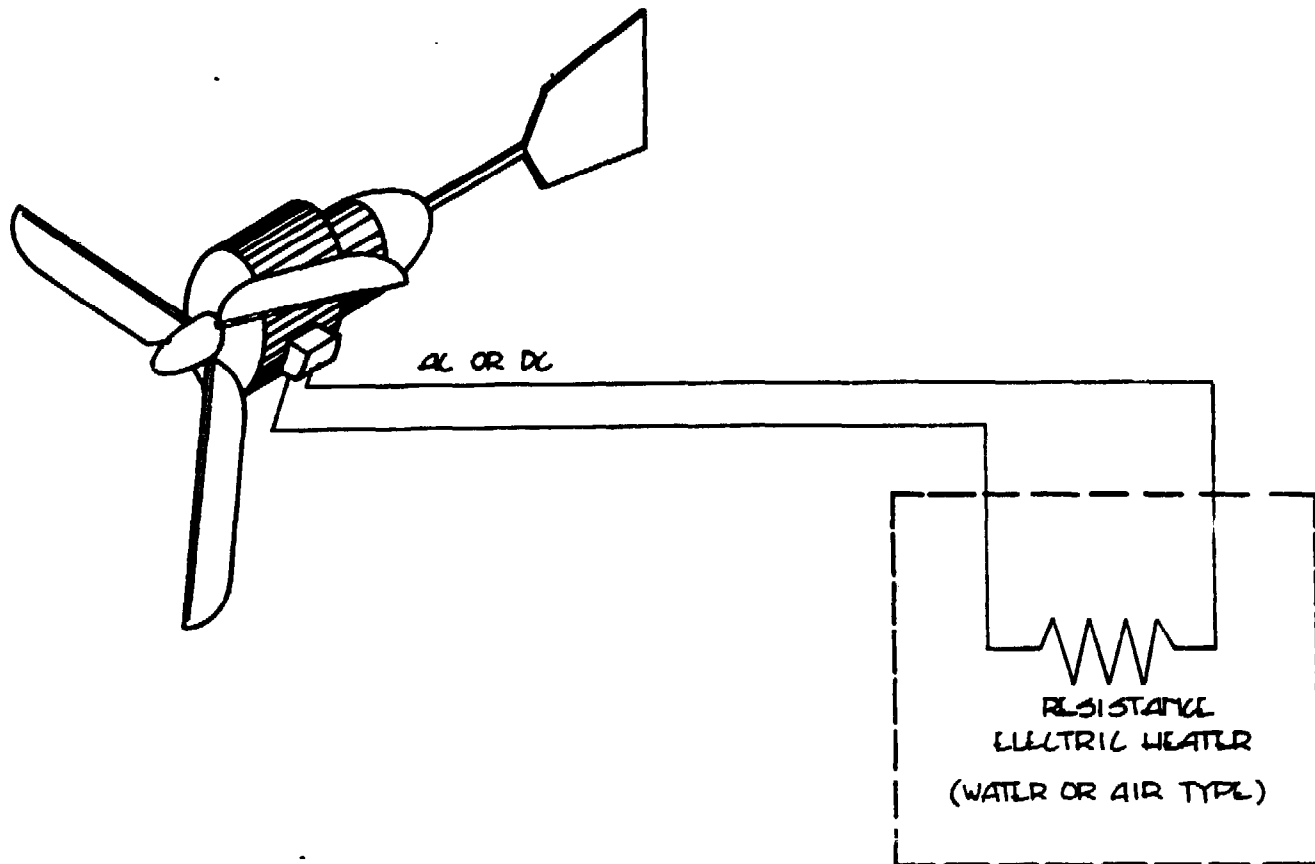

FIGURE 5-40: Simple electrical heating system.

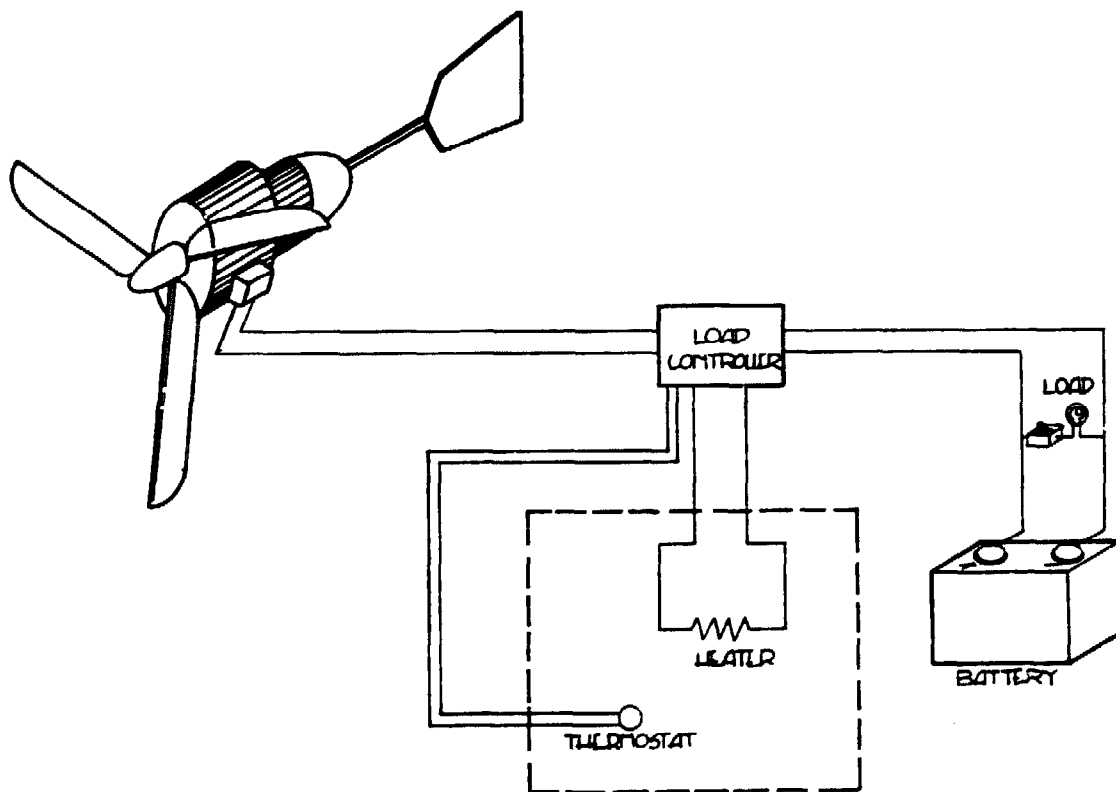

FIGURE 5-41: Complete electrical system with wind furnace.

Flywheels

Between 1951 and 1969, the Oerlikon Electrogyro bus was operated in Switzerland and the Belgian Congo. This was a flywheel-powered bus experiment in which a large flywheel was recharged at each bus stop.

Recent literature (Scientific American, December 1973) discusses an improved flywheel energy storage device, the super flywheel. The super flywheel is different from the traditional spoked-rim flywheel, which propelled mine cars and elevators. The older gyros were large, heavy-rimmed wheels, like a tractor tire filled with water, while super flywheels are thin and tapered and spin at a high rpm. See Figure 5-42.

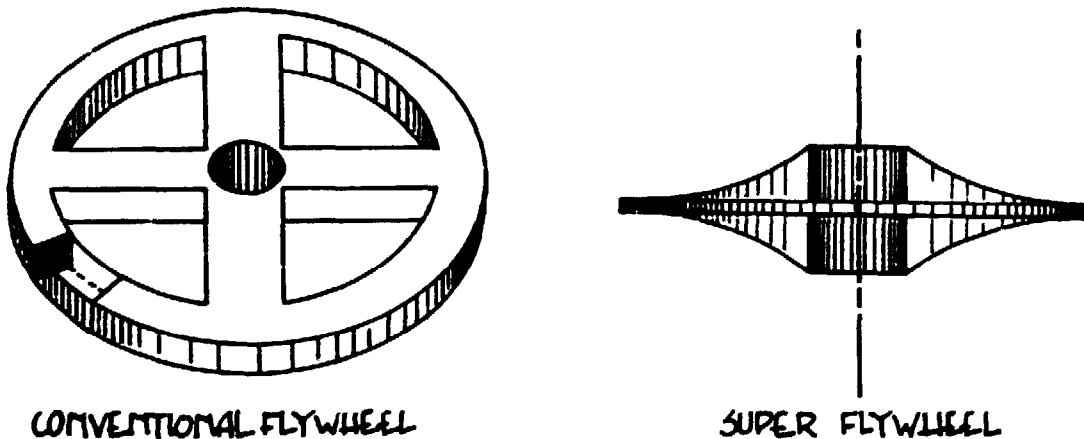

FIGURE 5-42: Flywheel diagrams.

To reduce losses in a super flywheel, the high-speed disc spins in a vacuum chamber, and precision ball bearings, magnetic bearings, or air bearings are used. These measures also enhance the safety of the flywheel by providing a housing that prevents damage, should the wheel fracture or fail.

Various design studies illustrate that a small super flywheel energy storage unit should be cost-competitive with an equivalent battery system and will most probably weigh less. Thus, this storage unit should see great potential in the commuter car applications, as well as small WECS. As this is written, no small super flywheel is commercially available, and few are being tested. Research is expanding in this area, however, and a super flywheel energy storage package could become available.

**Synchronous Inversion -
Energy Storage in the Utility Company Grid**

Synchronous inversion allows power generation in phase with a utility network. Using a device called a synchronous inverter, wind-generated dc current is charged into ac current which has the same frequency as utility power and is fed directly into your house along with the current from the power company. As we discussed earlier in this chapter, another way to feed wind power into a utility system is with a synchronous generator.

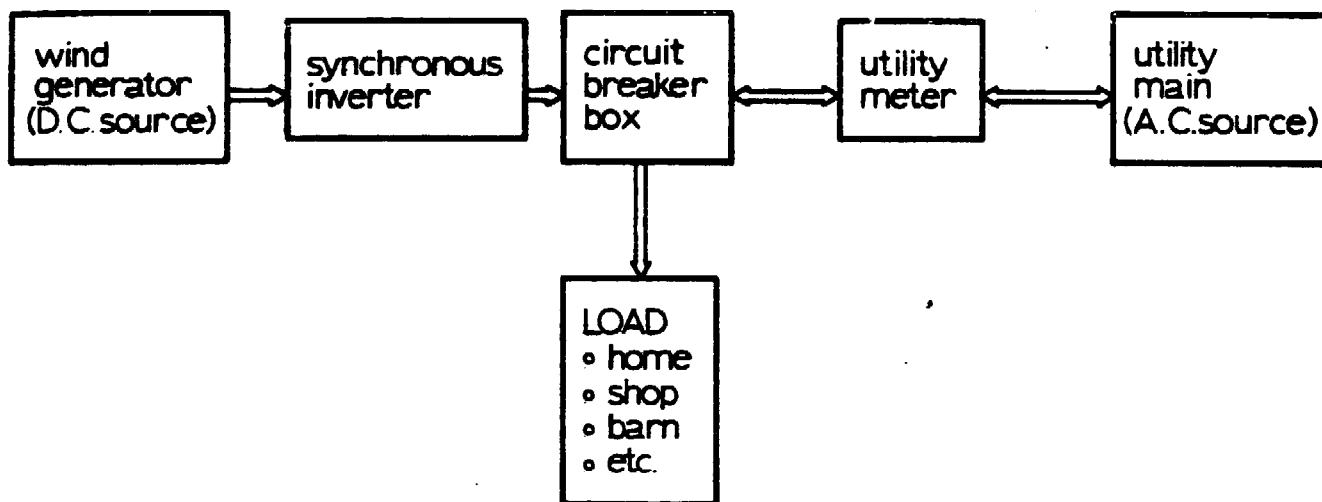

FIGURE 5-43: Synchronous inverter electrical system.

Synchronous inverters have been used for years in applications such as regenerative drives for elevators. Here, the elevator is powered by the utility lines during its upward travel. During the downward travel, the motor becomes a generator that returns a portion of the upward power to the utility grid through a synchronous inverter while the elevator descends.

The immediate reaction to this idea is, "The electric meter would run backwards!" It would. In Figure 5-44 there are three cases to note:

1. Wind generator not operating or not producing sufficient power for the load. Utility meter runs forward - its normal direction.
2. Wind generator supplying just enough power for the load. Utility meter stops.

3. Wind generator supplying surplus of power. Extra power will be fed to the grid. This will cause the meter to run backward.

The next response is usually, "But will my utility company allow this?" The answer to this question varies from state to state, and from utility company to utility company, and is rapidly changing. The key question is development of a fair billing procedure for a complex problem (Chap. 7). Other questions have been or are being resolved, like safety, power quality and power factors. Regenerative drives such as electric elevators have been used for years, and the addition of WECS applications should not pose insurmountable technical problems.

Of great importance to some WECS installations is the fact that utility mains can be replaced in the diagram (Figure 5-43) by an ac generator powered by gasoline or diesel fuel. Certain technical details must be observed (the generator must have a higher power capacity than the wind generator), but the synchronous inverter will run well with an ac generator as the source of frequency and voltage. This is because the synchronous inverter uses the mains, or ac generator, as a reference for conversion of dc to ac.

Synchronous inverters are discussed here under energy storage because, in effect, you are using the utility grid as a storage cell for your excess energy. With the gasoline or diesel ac generator instead of the grid, energy "storage" results in effect from less fuel burned by the generator.

WIND SYSTEM TOWERS

As discussed in Chapters 2 and 3, it is often best to support your windsystem, be it vertical-axis or horizontal-axis, to capture the higher winds above the ground and to be well above the nearest trees. Supporting a wind turbine that weighs several hundred pounds is no simple task and requires a rigid structure of some sort. Towers are subjected to two types of loads, as illustrated in Figure 5-44: weight, which compresses the tower downward, and drag, which tries to bend the tower downwind.

Towers are made in two basic configurations: guy-wire supported, and cantilever or unsupported (sometimes called freestanding) (Fig. 5-45). Also, given these two basic structural support configurations, towers are made with telephone poles, pipes (Fig. 5-46), or other single column structures, as well as lattice frameworks of pipe (Fig. 5-47), or wooden boards.

Regardless of which tower design you select, the overriding consideration is the selection of a tower that can support the wind turbine you select in the highest wind possible at your site. Of course, cost must also be considered. The load that causes many

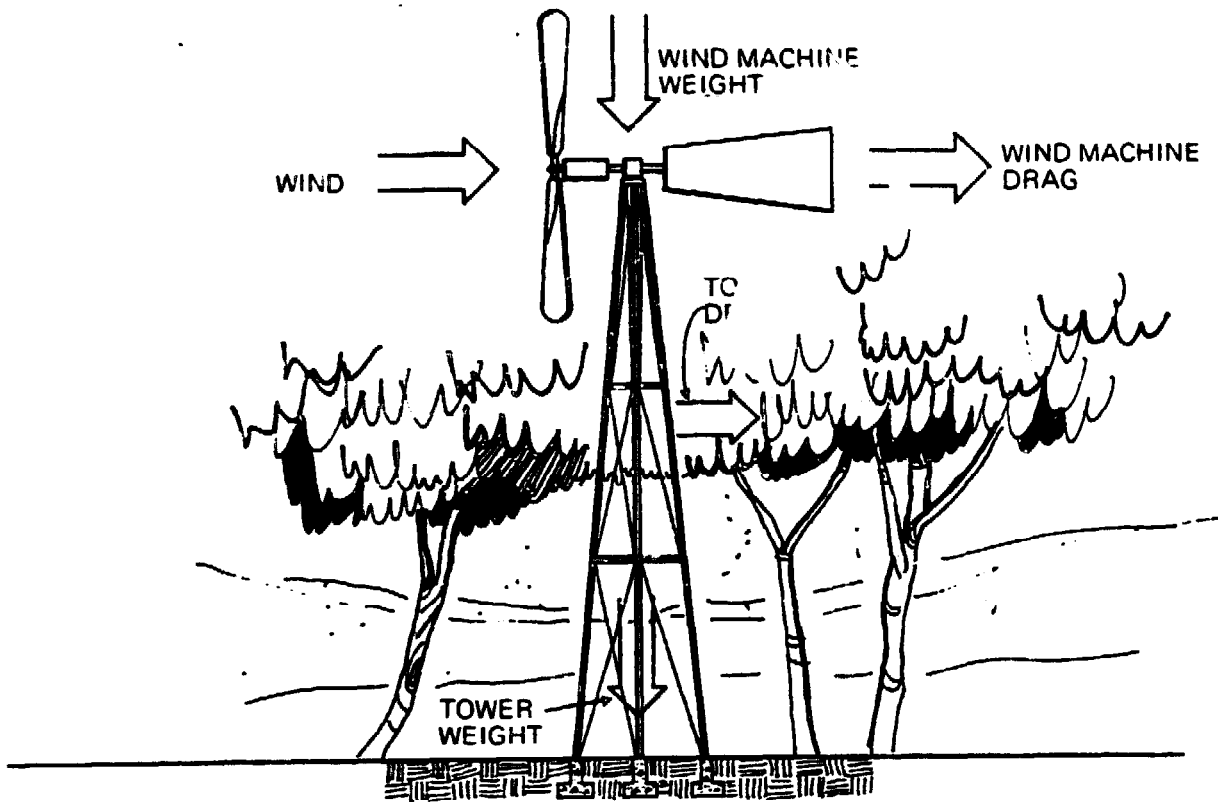

FIGURE 5-44: Tower loads.

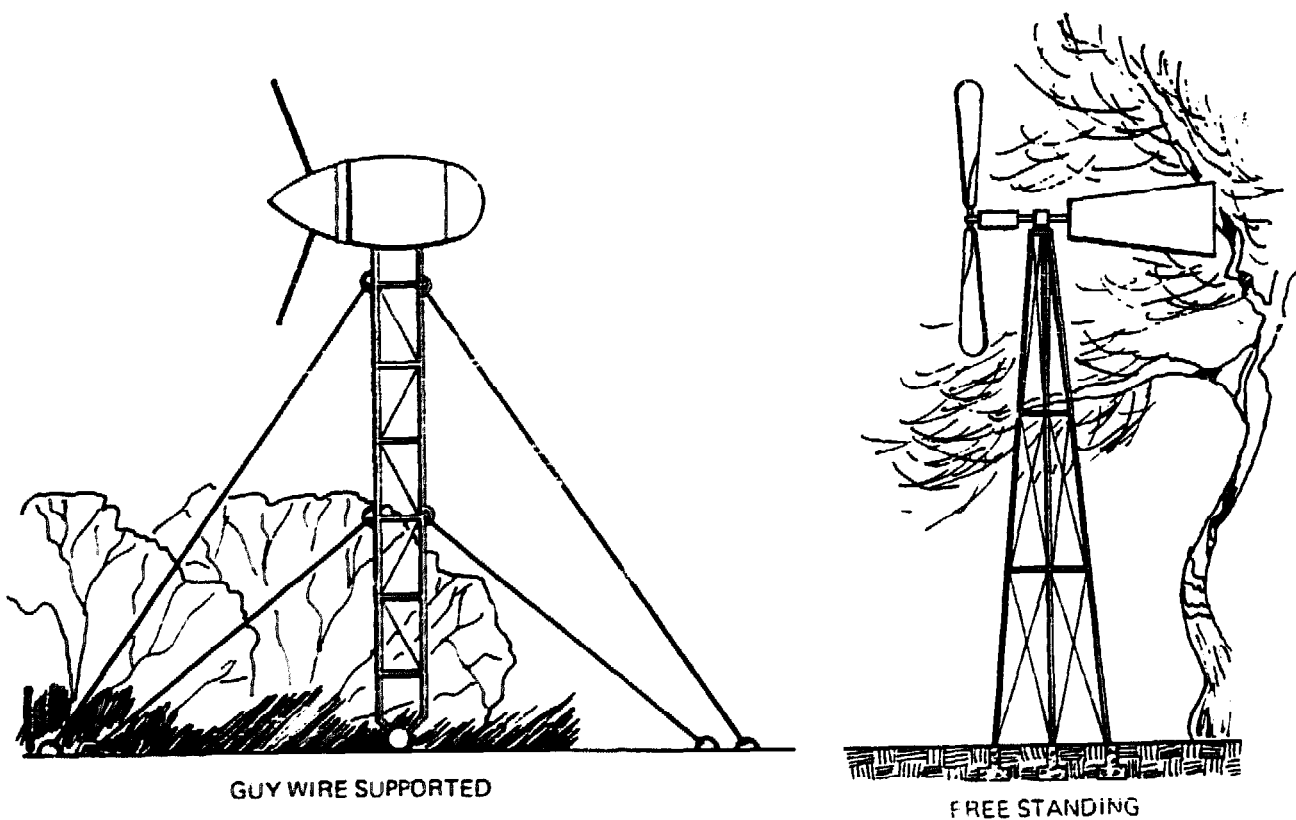

FIGURE 5-45: Two types of towers.

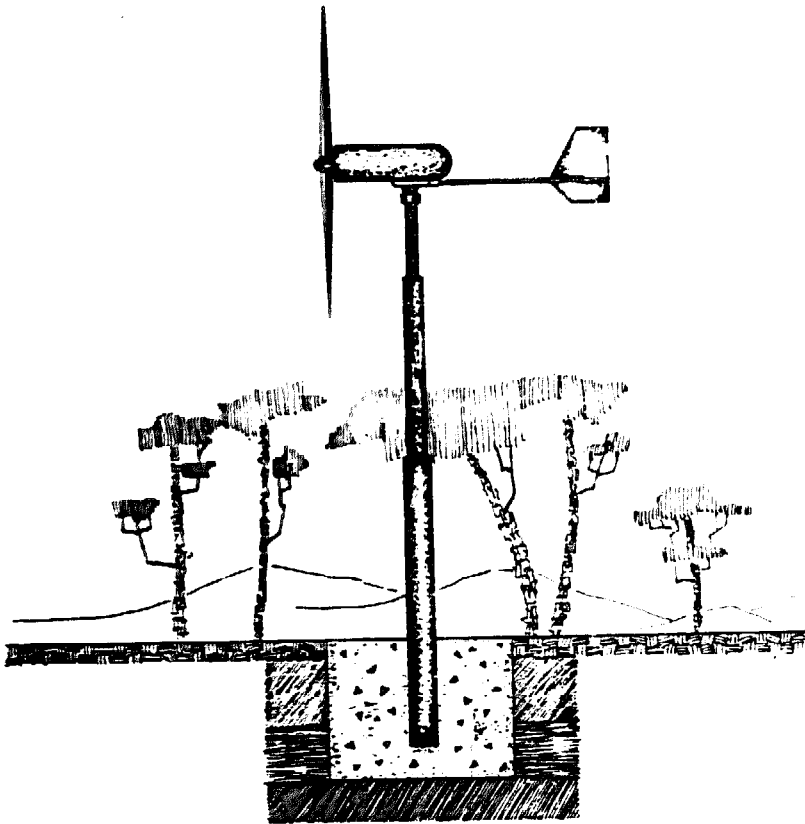

FIGURE 5-46: Free standing pipe tower.

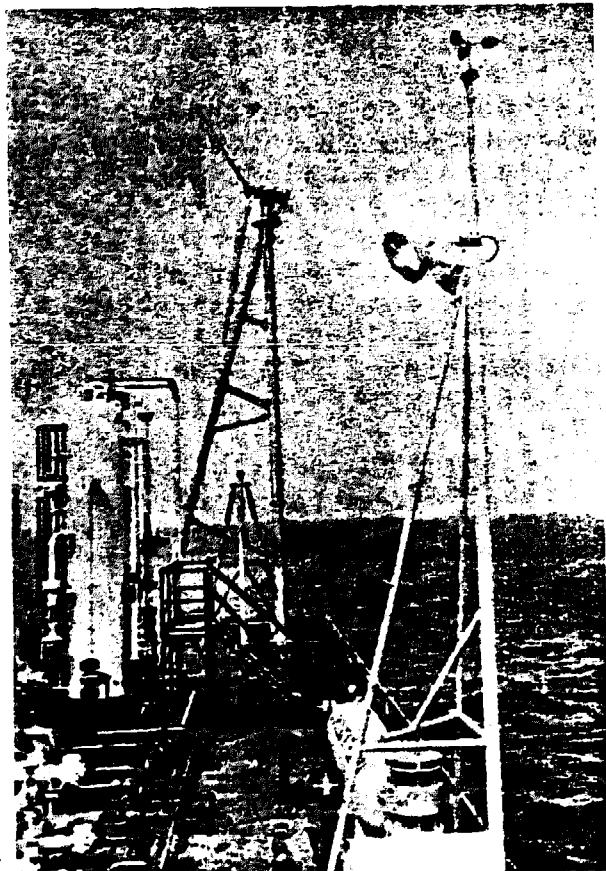

FIGURE 5-47: Pipe tower windmill support.

towers to fail is a combination of wind turbine and tower drag. A pair of skinny windmill blades may not look like they could cause much drag, but when extracting full power at rated speed they create nearly the drag of a solid disk the diameter of the rotor.

The ways in which towers typically fail are:

- 1) Freestanding towers buckle due to higher-than-design wind drag load from the windwheel
- 2) A footing that anchors the tower to the ground becomes uprooted
- 3) A bolt somewhere along the tower fails due to improper tightening (or falls out because not tightened at all), resulting in a tower weak point that eventually fails
- 4) Guy-wire-braced towers buckle from improper spacing of the wires up the tower. Here, a tower that requires, say, three sets of cables spaced evenly along the length of the tower, gets only two sets, resulting in intercable spans greater than design specifications
- 5) Guy wires fail from improper wire size, improper tension fasteners, or damage
- 6) Guy-wire anchors uproot from the ground or come away from the structure to which they are attached.

When selecting a tower, consider the difference between guy-wire braced and freestanding. Here, you must know something about the structure and about the soil supporting the tower. A wise decision would be to consult your county agent concerning the type of soil you have and its ability to act as a foundation.

Building codes for your area will detail the basis for foundation design, and the wind turbine dealer or manufacturer should have drag data for the product you select. A registered professional structural engineer can perform any calculations necessary to ensure that a particular tower installation will support your windmill. The cost of professional services in the area of tower selection and design should be considered cheap insurance for a sound installation. Vibratory loads induced by the wind or wind machine also should be considered and professional advice may be required.

One other point to consider is the potential hazard of guy wires, particularly to playing children.

OTHER EQUIPMENT

Inverters

Inverters are devices which convert the dc voltage (power) to ac power. It is an age-old question whether dc or ac electricity is better. We do not propose an answer but suggest that

many appliances are not designed to run on dc. Most motors, some stereos, TV sets, and certain other devices usually require 110 volts ac. Many wind turbine generators are rated at 12, 24, 32, or maybe 110 volts dc. To change dc to ac requires an inverter.

Some inverters use a dc electric motor to drive an ac generator. By driving the generator at constant rpm, a constant frequency, usually 60 hertz (cycles per second) is generated. These units are called rotary inverters. Other inverters, called static inverters, are solid state, using transistors to switch dc into ac. Some units, the lower-cost variety, generate a square wave output, while more expensive units and rotary inverters generate sine wave outputs. The most desirable output is sine wave, especially if a stereo or TV set is to be operated. Square waves powering a stereo sometimes distort the sound.

Inverters are rated by their maximum continuous capacity in watts. A small surge capability is possible for most models. Thus, a typical 500-watt continuous transistor inverter might be rated to 700 watts for ten seconds or even one minute, depending on the unit. Surge capability is needed, especially for inverters operating motorized appliances like refrigerators, because electric motors require considerable extra power for starting.

Selection of a suitable inverter involves another important factor, the efficiency of the inverter and, in more expensive models, automatic power adjustment. With a low-cost inverter, as would be available in most recreation vehicle supply stores, the inverter will draw (from the battery) almost the maximum rated power, regardless of the load the inverter is driving. Thus, a typical 500-watt inverter may draw 400 or more watts from the storage system, while only powering one 100-watt light bulb. Higher-cost inverters offer the important option of a load monitor, which automatically adjusts the current draw by the inverter, according to the load.

A typical efficiency curve for a static inverter looks like Figure 5-48. From this, you can see that wherever possible it is best to select inverters that will operate near their maximum rated capacity. This could mean using several small inverters for various loads or one large automatic inverter for the entire system. In any case, cost of such inverters may dictate which inverter is selected. Ultimately, the cost of energy supplied is the primary consideration. Costs are discussed in Chapter 6.

Backup Equipment

We have already mentioned backup options during previous discussions. The concept of backup implies that wind is the primary energy source and that something else is the backup. That something else could be the utility lines (switched off until the wind dies down), solar heat, a gasoline- or diesel-

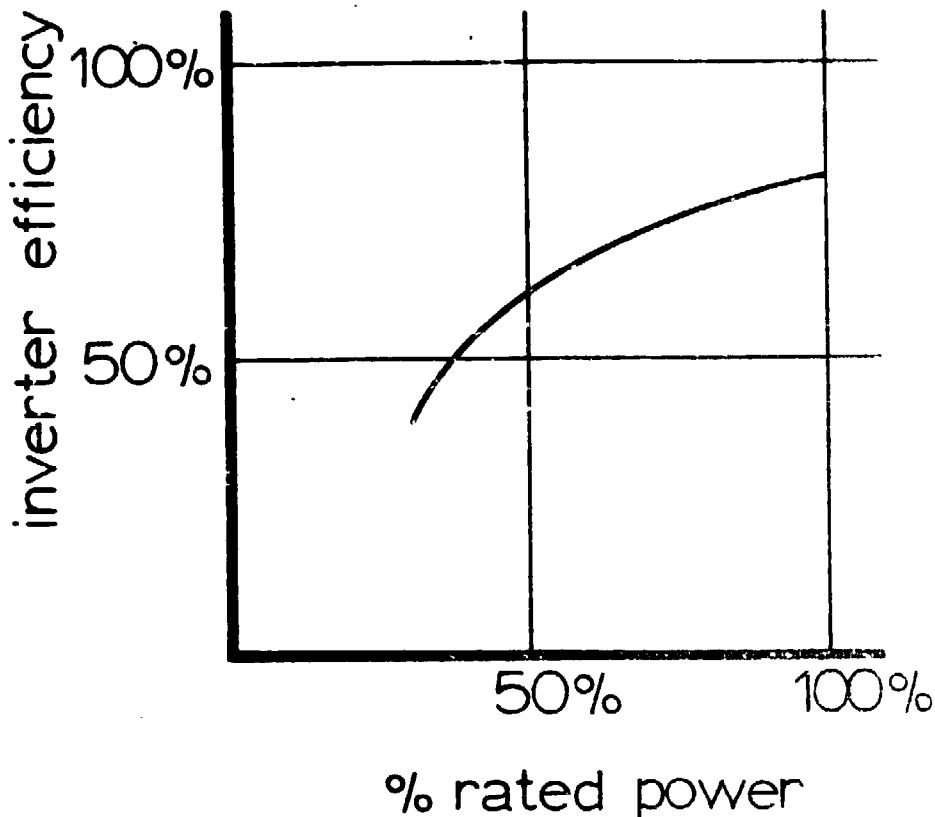

FIGURE 5-48: Typical static inverter efficiency.

generator, solar cells, or an extension cord to your neighbor's house.

Auxiliary engine-generator sets that burn gasoline, propane, or diesel oil are readily available from equipment supply houses, catalog sales stores, and dealers of wind equipment. You might consider recharging your wind system batteries by jumper-cabing your automotive electrical system to your batteries. As you warm up the car in the morning before driving to work, charge your battery bank. This is not a suggested practical alternative to a more conventional approach to backup power, but in a pinch it will work. Power take-off (PTO) generators are available for tractors. These units will recharge batteries or otherwise provide backup power. Selection criteria for any backup equipment would include maximum power requirements, cost, reliability and maintenance, and environmental factors such as noise and exhaust. Auxiliary equipment can be purchased with automatic controls or can be installed with the requirement of user control. It is a good idea to exercise your auxiliary equipment on a regular basis (even when not needed), to ensure it remains in proper operational condition.

CHAPTER 6

SELECTING YOUR WIND ENERGY CONVERSION SYSTEM AND FIGURING THE COST OF ITS POWER

THINKING OUT YOUR MOST APPROPRIATE SYSTEM

It is surprising how many WECS installations have been bought only on the basis of "first cost" rather than satisfaction of energy requirements. Often a WECS owner will choose a system on a basis such as: "This system will supply about 60 percent of my energy needs and only costs 3400 dollars." The information in this chapter should help guide you in determining the best system for your needs, the resulting actual cost of power, and the likely cost of power from the utility company in the future.

"First cost" and emotional factors such as habits and desires often have a strong effect on one's estimate of energy requirements. "First cost" of a wind system has more than once convinced a family moving to a remote location that two television sets operating off a wind-charged battery bank is an unacceptably high level of luxury.

Figure 6-1 can focus your thinking on the steps required to accomplish a rational selection of the most appropriate WECS.

Your demands will establish whether the windwheel will drive mechanical devices, such as pumps, compressors, or grinding wheels; or electrical devices, such as generators or alternators. Mechanical devices demand a windwheel design of relatively high-solidity (Fig. 5-3), whereas electric generators, for reasons mentioned earlier, tend to be equipped with relatively low-solidity windwheels.

Once established, the type of windwheel work performed enables you to evaluate the devices on which the work is performed; such as pumps and generators.

To visualize some of the many practical ways a windmill can be used as part of a complete system, study Figure 6-2. You can follow any path on this diagram that leads from top to bottom, from wind turbine to user. You will note most of the practical energy devices and processes along each path. The diagram illustrates the most common system, as well as some systems being developed. A bold line connects the components in a common wind energy system.

A basic system consists of the energy source (wind) a conversion device (wind turbine), energy storage (batteries, pumped water, etc.) energy use (such as heaters, motors, TV set), and a backup source of energy (such as gasoline generators or solar cells).

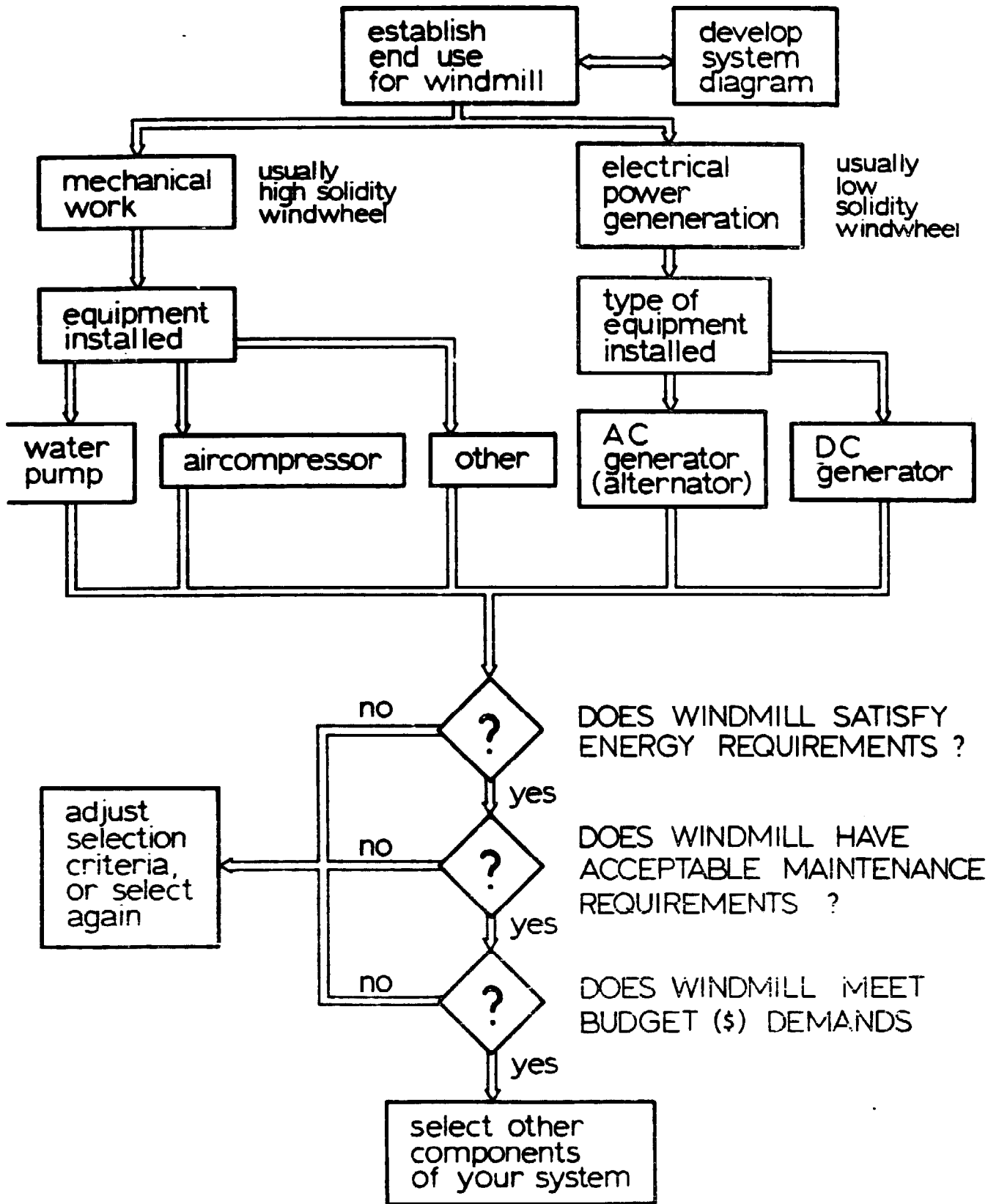

FIGURE 6-1: System design steps.

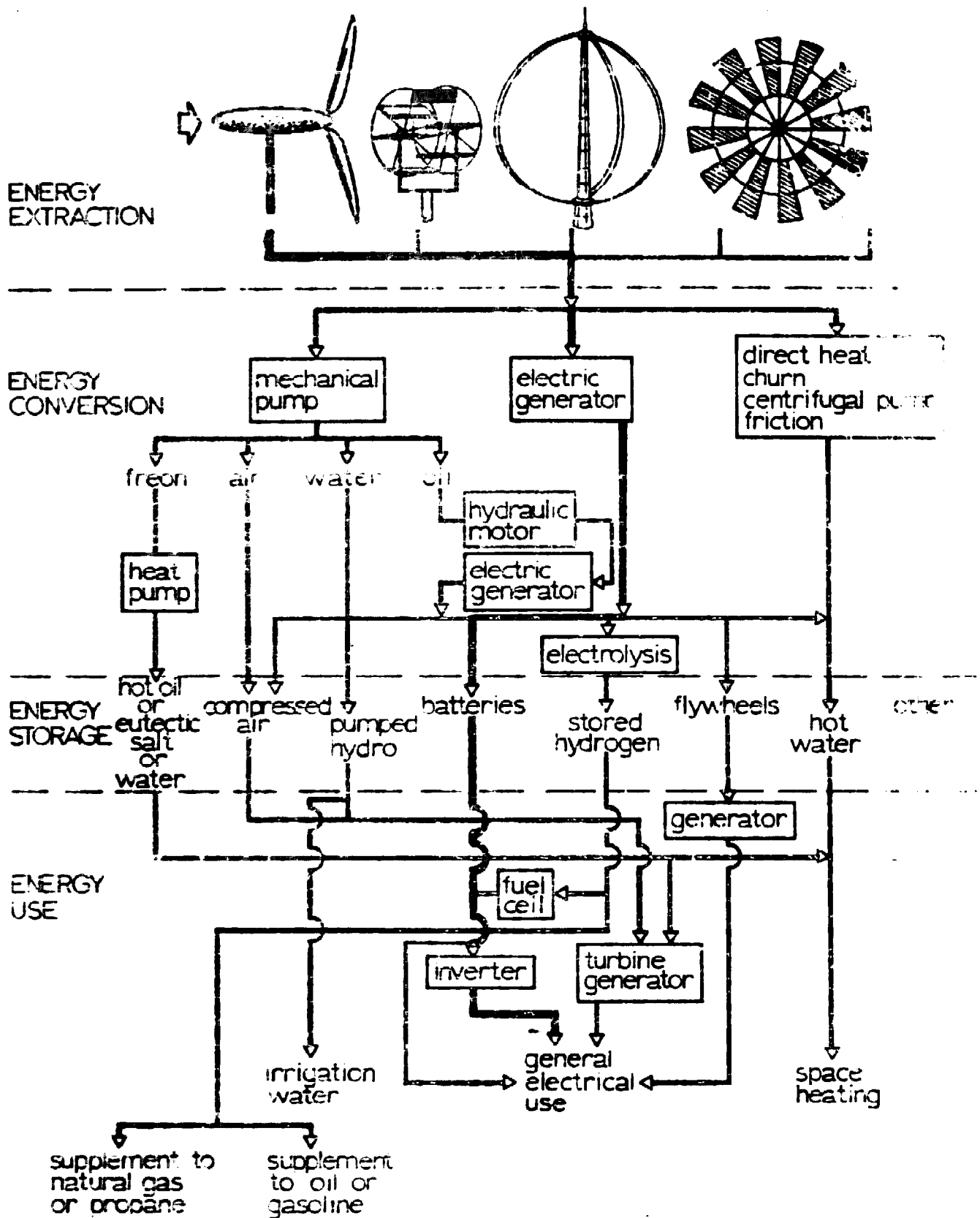

FIGURE 6-2: WECS choices.

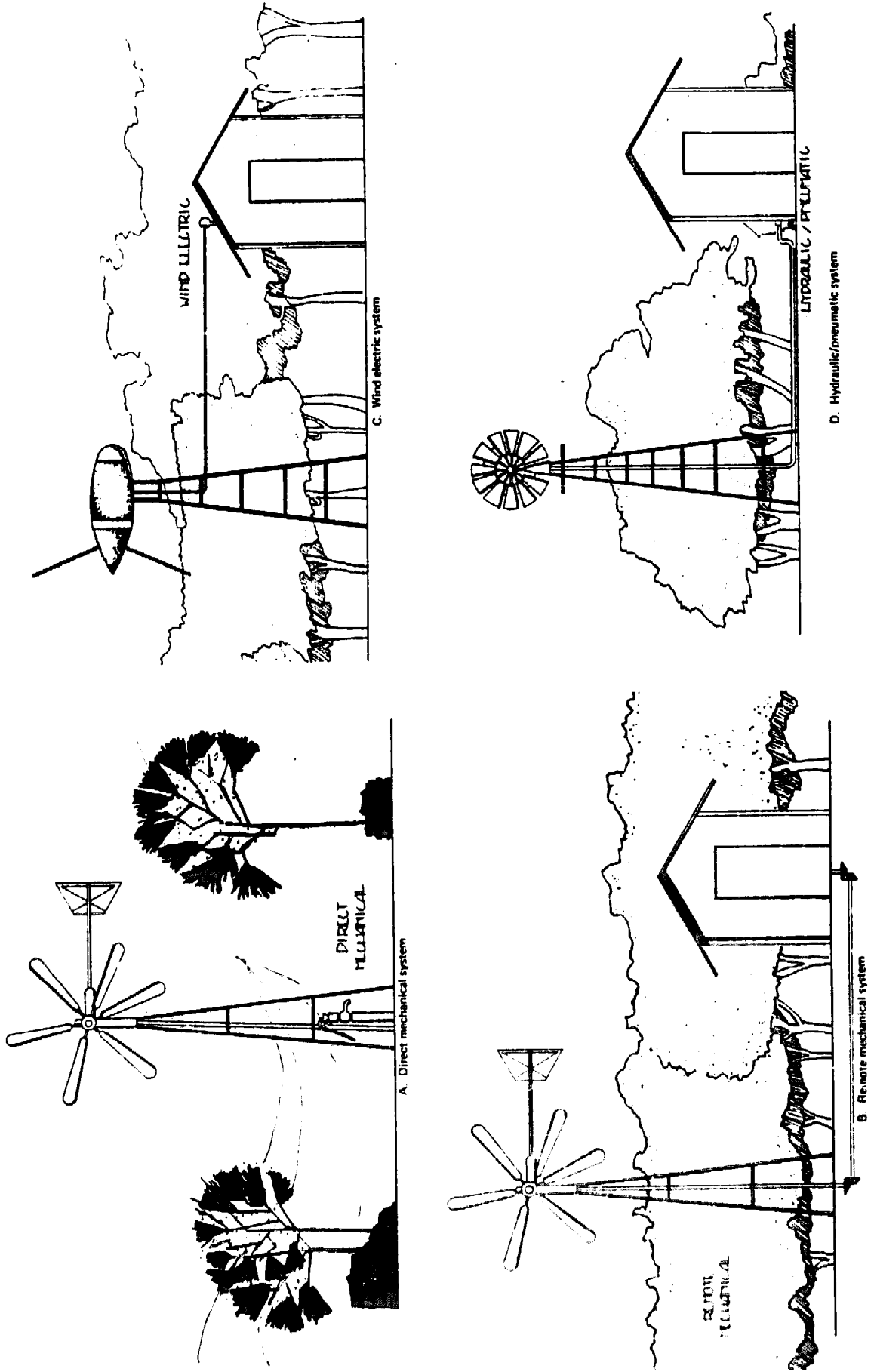

FIGURE 6-3: Water pumping options.

	METHOD	ADVANTAGES	DISADVANTAGES
A	Windmill direct over well driving pump at well with drive shaft or push rod	Simple. Possibly relatively low cost. Equipment has long history of availability	Well site may not be a good wind site.
B	Drive shaft to remote well site	Allows some flexibility in WECS siting. Allows power take off for other requirements.	Safety hazard of drive shaft. Relatively high cost of drive components.
C	Wind generator electric pump	Allows energy storage (in batteries, etc.) Electricity for other requirements. Relatively high efficiency. Equipment has long history of availability. Allows best flexibility in WECS siting.	Energy loss in long wire runs. Relatively high cost. Safety requirements of electric wire runs.
D	Windmill - hydraulic/pneumatic system. Water can be pumped directly by bubbled air, or by pneumatic pump.	Allows greater flexibility of WECS siting than B. Hydraulic power or compressed air available for other requirements.	Energy loss in long fluid pipes. Safety considerations of compressed fluids or air. Relatively high cost.
E	Jet pump geared directly to windmill. Two or three pipes come down the tower from the pump.	Allows greater flexibility of WECS siting than B. Common, relatively inexpensive pump, which is relatively efficient. Avoids generator and motor losses of the electrical system.	Minimum wind speed for developing minimum head for pumping may be quite high. Must prime the pump at the top of the tower.

FIGURE 6-4: Different possible ways to pump water with a wind system.

Some of the options you have in selecting the best system to pump water are: a wind turbine mounted directly over the pump using a push rod, a drive shaft to a remotely located pump, an electric pump system, a hydraulic or pneumatic system (Fig. 6-3) or a jet pump geared directly to the wind turbine rotor (not illustrated).

Figure 6-4 is a chart that presents many of the factors you would consider in the selection of the best water pumping system for your needs. You would normally evaluate each option by following the blocks of Figure 6-1. It may be that the question block regarding cost and your budget will eliminate several of the options from your list.

Another example of widely different choices available for accomplishing a specific task is depicted in Figure 6-5. Two methods are illustrated for preventing the freezing of a stock water pond and reducing fish kill caused by ice blocking the absorption of oxygen into the water. Either method works, and there are many other possibilities. One method uses a small Savonius rotor, which is mounted above the pond and drives a propeller that churns the water. This circulates warmer water to the surface, preventing ice formation and adding oxygen to the water. The air pump method bubbles air into the water and also causes the warmer water to rise to the surface.

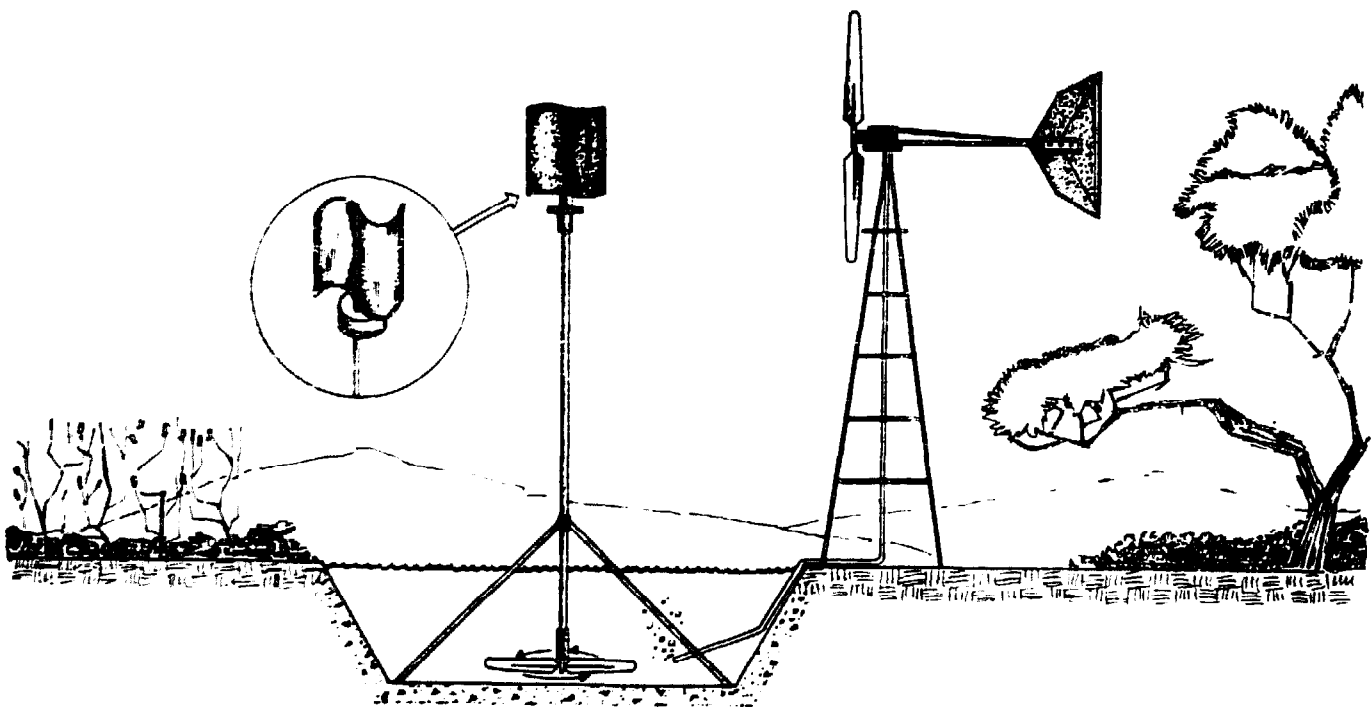

FIGURE 6-5: Two methods for wind-powered pond aeration.

A COMPARISON OF POWER COSTS USING TWO DIFFERENT WIND TURBINES

All too often a WECS installation is purchased according to first cost rather than performance. Since "the cheapest windmill will do!" is never really an appropriate criterion, you should understand what "the cheapest windmill" really is.

Analyze, as an example, a simple wind electric system that is used only for heating water (Fig. 5-40). Compare the two hypothetical wind turbines that were described in Chapter 5 (Windmill Power and Energy Calculations). Both are rated at 1000 watts of power, and their power curves are shown in Figure 5-19. The wind duration curve is shown in Figure 5-20. Unit A is about 5 feet in diameter and has a rated wind speed of 32 mph. It produces 95 kilowatt-hours in the month illustrated in Figure 5-21. Unit B is about 12 feet in diameter, has a 20 mph rated wind speed, and yields 230 kWh in the same month. For simplicity, assume you already have the necessary wire and electric water heater. Therefore, just consider the wind turbine and tower costs, plus installation. The following table shows these hypothetical cases.

Hypothetical Initial Costs of Two Wind Turbines

	WIND TURBINE A	WIND TURBINE B
Wind machine	\$1,500	\$2,000
Tower	\$ 500	\$ 600
Installation	\$ 500	\$ 600
TOTAL	<u>\$2,500</u>	<u>\$3,200</u>
Yield/year, kWh	1,140	2,760

Notice the difference in costs. Wind Turbine B requires a stronger tower and a somewhat higher installation cost.

If you selected solely by first cost, Wind Turbine A would be the obvious choice. However, Wind Turbine A will yield 1140 kWh/year at your site, while the more expensive Wind Turbine B will yield 2760 kWh/year. Two more factors will be considered: maintenance cost and depreciation. Assume both machines depreciate fully to no resale value in 20 years. Also, assume that Wind Turbine A, the smaller of the two, costs \$100 per year for maintenance, while Wind Turbine B costs \$150. per year. Without considering any interest costs (covered later in this chapter), calculate the total cost of ownership over the whole 20-year life span:

	WIND TURBINE A	WIND TURBINE B
First Cost	\$2,500	\$3,200
Maintenance 20 yrs. x \$100 =	\$2,000	20 yrs. x \$150 = \$3,000
TOTAL COST	<u>\$4,500</u>	<u>\$6,200</u>

Total yield in 20 years and resulting cost per kilowatt-hour are:

WIND TURBINE A	WIND TURBINE B
1140 kWh/year x 20 years = 22,800 kWh	2760 kWh/year x 20 years = 55,200 kWh
Cost = \$4,500 ÷ 22,800 = 19.7¢/kWh	Cost = \$6,200 ÷ 55,200 = 11.2¢/kWh

Wind Turbine A costs 19.7¢/kWh, while Wind Turbine B costs 11.2¢/kWh. However, Wind Turbine A costs only \$2500 to purchase and install, compared to \$3200 for Wind Turbine B. If you ask which one is really cheaper, you must consider other factors. Wind Turbine B has roughly twice the energy yield of Wind Turbine A, but, from your calculation of energy requirement in Chapter 4, do you really need twice the yield? Will the extra yield allow future growth that you forgot to allow for in your energy requirement calculations? What about bank interest on the money you must borrow, or lost interest on the funds you take from savings to purchase your WECS? Do wind turbines really depreciate fully to no resale value?

Before continuing, note here that if you are presently paying 6¢/kWh from a utility company and this cost increases at 7 percent per year, at the end of 20 years you will be paying 22¢/kWh, and your average cost per kWh would have been 12.3¢ during that period (the way these numbers are calculated will be described later).

GATHERING THE FACTS FOR YOUR ECONOMIC ANALYSIS

The analysis of economic factors can be as complex or as simple as you wish to make it. As in the above example, for a simple analysis you need to know the following:

1. Total installed cost (dollars)
2. Expected system life (years)
3. Total energy yield over the entire system life (kWh, hp-hr, etc.)
4. Annual maintenance and repair costs (dollars)
5. Other annual costs and savings (dollars)
6. Expected resale value at end of service life (dollars)
7. Other factors

Total Installed Cost

Generally, the bigger a WECS system is, the less it will cost per unit of rated output. The installed costs of WECS, measured in dollars per kilowatt rated power, tend to decrease with increasing rated power (Fig. 6-6).

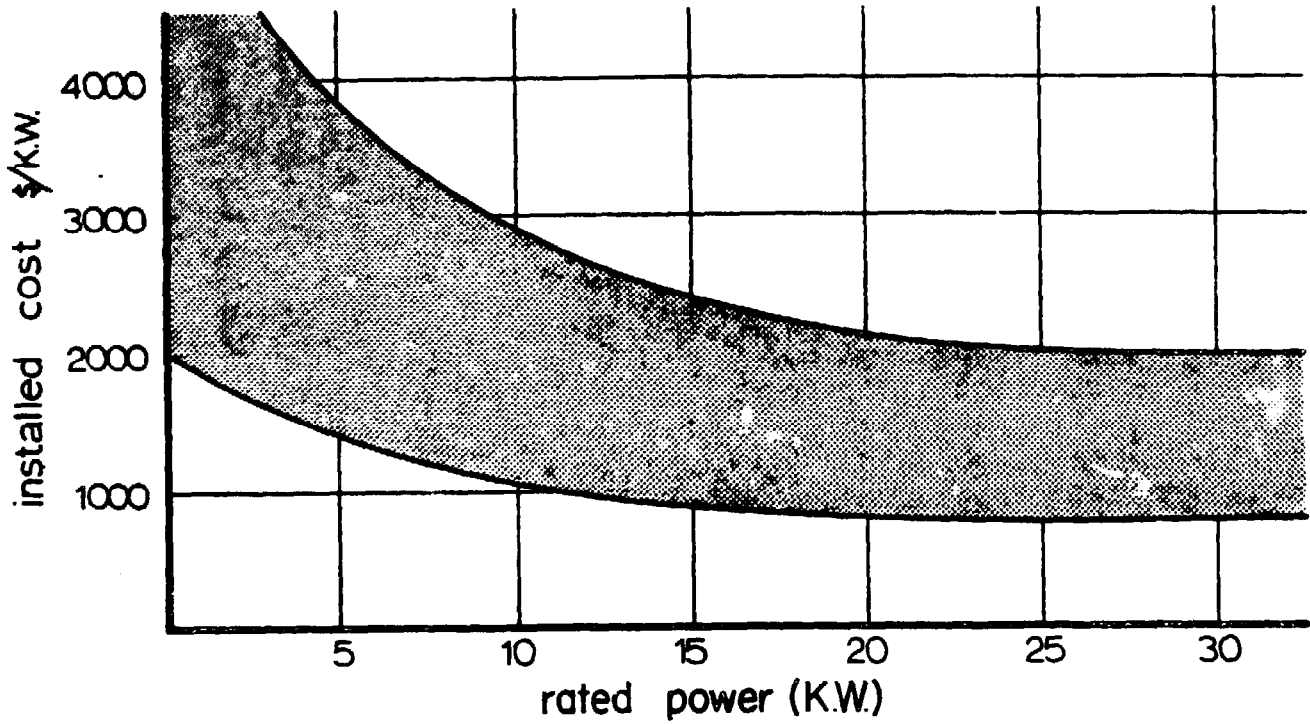

FIGURE 6-6: Costs of complete wind electric systems in the 1970's.

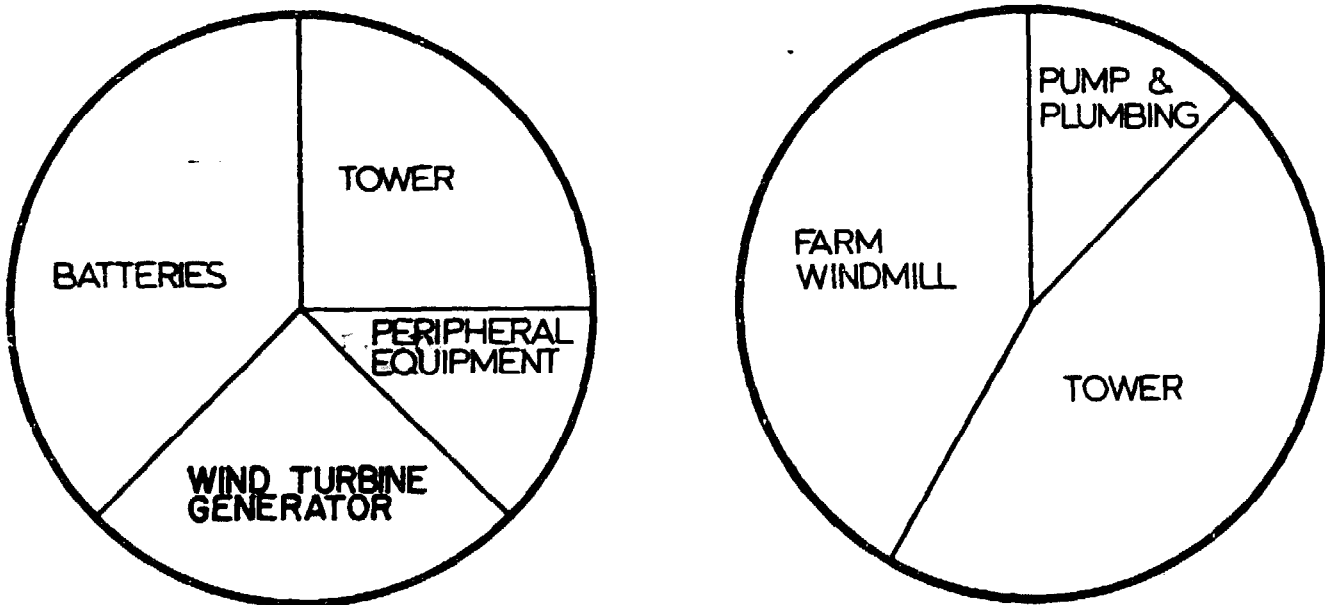

FIGURE 6-7: Typical relative costs for small WECS.

This total cost is broken down into component costs (Fig. 6-7). These pie charts show the relative costs by the size of the pie slice. For the wind electric system, batteries may cost as much as the wind turbine, as illustrated. The pie slices may not actually reflect the system you are planning, but it is a good idea to look at the relative costs.

Costs normally include everything you must purchase and install to provide normal or desired operation of the system. This would include:

1. Wind turbine
2. Tower, footing, guy wires, etc.
3. Batteries
4. Pumps
5. Storage sheds for batteries or other equipment
6. Storage tanks
7. Wires
8. Plumbing
9. All installation costs such as delivery, plumbing, electrical, and building permits.

You may wish to read Appendix 2 to decide if you want to try to do your own installation or have it done for you.

When simply comparing system costs, as we did in the first example, some costs are often omitted, like the wiring and water heater unit. These were assumed to be already available. Such omissions are not always valid, though, as in a case where the wind-electric water heater is being compared with a propane gas or solar-powered water heater. Here, water heater costs may be very different.

Expected System Life

Wind turbines have been installed at the South Pole and performed for more than 20 years. Wind turbines have been installed in the Rocky Mountains and have been destroyed, or damaged, in just a few months. Both locations are windy and both are subject to severe weather conditions. In trying to analyze the expected life of your system, you are confronted with several problems. No 20-year rating of wind turbines from a consumer-oriented organization is available. It would be wise to simply assume that the manufacturer's or dealer's statements (if any) concerning expected life are valid for your site. To do so will require intuition and an unemotional, scientific guess of the relative credibility of such statements. Most manufacturers tend to shy away from making claims on the life of their units.

Wind system designers, however, tend to plan their equipment for useful lifetimes of much longer than 20 years. Bearings, belts, and some parts may have to be replaced during such a time span, but the basic machinery--if well designed--should last.

The DOE (U.S. Department of Energy) Small Wind Systems Test Center at Rocky Flats near Golden, Colorado is testing designs and will publish results that will help answer this question. Eventually, dealers and manufacturers may publish such test data in their product literature.

The logical first estimate in any case comes from:

- Your wishes or needs
- Dealer's estimate
- Interviews and opinions of other WECS owners

Perhaps you intend to own a WECS for a limited time; use this time value in your cost study. Maybe a nearby WECS owner has had good service for ten years; see if you can find out his expectations for continued service life (and his technique for getting such good service). Start with these and the dealer's comments. Probably you will not be far off.

Total Energy Yield

This value, expressed in kWh, or horsepower-hour (hp-hr) is the result of the energy resource study and site analysis you perform using the methods in Chapter 3. Chapter 8 illustrates how to match energy needs with energy availability. Total energy yield represents the work of your entire system planning process.

You will likely estimate or calculate energy requirements on a monthly basis. Simply add these together for all the months of a year, and multiply the annual total by the expected life. This results in the total energy yield you expect from your system.

Annual Maintenance and Repair Costs

It is possible to purchase a maintenance contract from some WECS dealers. Depending on the terms of such a contract it might be possible to use the cost of the contract, plus a small contingency cost for replacement of broken parts, as the annual maintenance cost.

Another approach is the "other owner interview." Find out what everybody else is paying to keep their machine operating. At the same time, try to evaluate the maintenance practices of the owner relative to manufacturer's recommendations. Some owners of water pumpers will report 20 or more years of good service and that the only maintenance performed was an occasional topping of transmission oil. One such performance was obtained from a machine whose manufacturer recommended an annual oil change! From these interviews and discussions with the dealers, form an estimate of the annual maintenance costs.

Expected Resale Value

Some farmers who bought wind electric systems prior to the advent of the Rural Electrification Act are reselling their old machines for prices varying from scrap iron rates to the original price. Allowing for inflation, this would indicate that these WECS owners are enjoying as little as 50 percent depreciation in value over a 40-year life span.

Other folks sometimes purchase these machines, rebuild them, and resell them at prices reflecting inflation. An old Jacobs may have been purchased for \$900, sold 25 years later for between \$100 and \$1000, repaired and restored to its original condition, and resold for \$2000 to \$3000. History shows that wind turbines, if properly maintained, can sell for their original cost plus an addition for inflation.

The resale price of old machines has risen rapidly in recent years. Greatly increased demand, coupled with the availability of old machines at reasonable cost has contributed to the resale value trend. Introduction of new wind turbines from more manufacturers could soften the resale price structure, but this depends upon the ability of the WECS industry to satisfy the demand. It seems reasonable to expect some resale value.

Other Annual Costs and Savings

Added to the list of costs are: the bank interest you pay for money you borrow to purchase a WECS (or money you do not earn if you withdraw from savings); insurance; and taxes.

Taxes, as inevitable as the wind, work both ways. First, the bad news--your tax assessor may be delighted to see you erect that permanent looking structure! Rather than bothering to figure the property tax rate, percentage of assessed value, homeowner's tax rebate, and all the other present-day gimmicks, you can calculate your tax rate by dividing your total annual real estate taxes by the true estimated value of your property. For instance, if your "spread" is worth \$50,000 and you pay \$500 in taxes, your tax rate is really $\$500 \div \$50,000 = 0.01 = 1$ percent. So, you would expect to pay about 30 dollars tax on a 3000 dollar wind system.

Next think about some income tax angles. If your wind system is used for your farm or business, you can depreciate it a certain amount each year; that is, you include in your cost of doing business part of the original purchase price until it has been charged off to a preset salvage value. A reasonable lifetime for a wind turbine for tax purposes is expected to be 10 years for wind-electric types and 15 years for water pumpers. The salvage value at that time may be 10 percent of the original cost. Such values are always conservative--less than the actual life if the device receives reasonable maintenance and less than actual resale value.

If only part of the energy or water produced is used for the farm or business and the rest is for personal use, depreciation may be applied only to the farm and business portions. If you sell the wind turbine for more than its depreciated value, the excess is taxed as capital gains. Note that the cost of utility power that is no longer needed for the farm or business is a lost expense item of your tax form. Finally, if you borrow money for your wind turbine, the interest is tax deductible.

As this is being written, new tax laws are being drawn up in various states and at the federal level that promise tax relief and may provide incentives which would reduce the total cost of WECS ownership. Your local congressperson can give you the details of any such legislation.

Additional homeowner's insurance will be another added cost. You may not feel a need for fire insurance, but liability insurance is a must. The last section of Chapter 7 discusses some insurance problems. Depending on the cost, local windstorm conditions, and dealer's warranties, wind damage insurance, if offered, may be desirable.

The cost of your investment is a very important item to consider. If you plan to have a long-term loan on the wind turbine and may select the lifetime of your wind turbine, for analysis purposes, to be the same as the bank loan (this does not have to be the ten years used for tax purposes). The annual cost of your investment is then the same as your annual payments. This number leads to a more accurate way of calculating your costs than that used in the example at the beginning of the chapter. There, total maintenance costs, which are spread out over the life of the machine, were added to installation costs. This is like adding apples and oranges.

If you take money from your savings account to buy a wind turbine, you could just take the interest you lose on that money, minus the income tax you would have paid on the interest, as the cost of your investment. This is not the true rate, since you cannot count on anyone returning your investment to you at the end of the life of the wind turbine. Rates set up just like loan payments are the desired ones for a correct analysis--equal, regular payments that include both capital payback and interest. The following table gives these annual payback rates for various interest rates and lifetimes:

Interest Rate	Loan Period, years					
	5	10	15	20	25	30
4%	\$0.225	0.123	0.090	0.074	0.064	0.058
6%	0.237	0.140	0.103	0.087	0.078	0.073
8%	0.251	0.149	0.117	0.102	0.094	0.089
10%	0.264	0.163	0.132	0.118	0.110	0.106
12%	0.277	0.177	0.147	0.134	0.128	0.124

Annual loan payment per dollar borrowed

The most appropriate value for you to use is the one you have obtained on your invested money in the past, minus taxes. For example, using the Wind Turbine B described earlier with a 6 percent interest rate on your money for a 20-year life would mean a pay-back on the \$3200 invested (no salvage value) of \$279 per year ($\3200×0.0872). Adding on the estimated annual maintenance charge of \$150 gives an annual cost of \$429 for 2760 kWh, so the new estimate for the cost of power is (without considering the tax angles) 15.5¢/kWh ($\$429 \div 2760$).

Other factors deserve consideration. Your estimation of inflation rates for utility power and wind systems can greatly influence your final decision on wind power. A 9-percent long-term rate increase for utility power is one estimate at this time. How your electrical bill could increase (for the same power consumption) is indicated in the following table for several rates of inflation. This table can be used for the price change of any other service or product, or annual interest on money.

Rate of Inflation	Value or Cost At:						
	1	5	10	15	20	25	30 years
3%	1.00	1.13	1.30	1.51	1.75	2.03	2.36
5%	1.00	1.22	1.55	1.98	2.53	3.23	4.12
7%	1.00	1.31	1.84	2.58	3.62	5.07	7.11
9%	1.00	1.41	2.17	3.34	5.14	7.91	12.17
11%	1.00	1.52	2.56	4.31	7.26	12.24	20.62

Effect of Inflation of Future Value, Such as Cost of Energy

This table shows, for instance, that a 9 percent annual inflation rate leads to a new value 5.14 times as much in 20 years. If your present electrical rate is 5 cents per kWh, it would then be $5 \times 5.14 = 25.7$ cents. If propane or heating oil costs 40 cents per gallon now, it would be \$2.06 per gallon in 20 years.

The average cost of these items over the years, (instead of the final value) is shown in the following chart.

Rate of Inflation	Average Value or Cost Over:					
	5	10	15	20	25	30 years
5%	1.11	1.27	1.46	1.76	1.91	2.21
7%	1.15	1.42	1.79	2.31	2.53	3.15
9%	1.20	1.58	2.17	3.07	3.39	4.54

The average costs over 20 years for the electricity and propane in the above example would be 12.8 cents and \$1.02.

If occasional utility power outages require you to have an alternative energy supply, you may wish to compare the relative costs of a gasoline-driven portable or stationary power unit and a wind turbine generator. The initial cost of the wind turbine and storage system is probably considerably greater than the cost of the power unit, but the wind turbine might more than make up for this difference by producing usable power much of the time.

CHAPTER 7

POSSIBLE LEGAL HURDLES

This chapter deals with possible legal problems caused by purchasing, installing, and operating a wind energy conversion system (WECS). If you install a wind turbine within a few hundred feet of your property line, and your neighbor plants a row of fast-growing trees along that line, your wind energy could, in a few years, be greatly reduced. Protecting yourself from this occurrence is described in this chapter under "Wind Rights". A height limitation on structures in your local zoning ordinance is one of a number of possible problems that may affect your wind turbine construction plans. The section "Obtaining a Building Permit" explains your courses of action. Your optimized wind electric system may mean interconnection with the local utility company or sharing with your neighbors. Either can have economic or legal implications. (See section on "Sharing, Buying, and Selling Power"). Finally, before something goes wrong, warranty, liability, and insurance matters deserve your consideration.

Nearly all the material in this chapter has been taken from a comprehensive report compiled by George Washington University (see Reference 11). You and your attorney should refer to that report for more detailed information. The material presented here is for general information only. You should contact appropriate local and other governmental authorities if special permit problems are anticipated, or your attorney if easement or liability problems arise.

ANY RESTRICTIONS IN YOUR DEED?

Sometimes agreements have been made by the present or prior property owners of a potential wind turbine site not to conduct certain activities or erect buildings greater than certain heights on the property. These private agreements are commonly known as restrictions or restrictive covenants, some of which are said to "run with the land". Owners succeeding the person who entered into such an agreement are bound to comply with the restrictions. A title search of the deed should reveal any such agreement. However, these agreements must fulfill various legal requirements before a person can be bound by them. Therefore, their mere existence may not necessarily mean that a WECS owner is legally bound to follow them.

WIND RIGHTS AND THE "NEGATIVE EASEMENT"

There are no laws that describe your right to the wind that blows across your land. If wind turbines come into widespread use and conflicts arise, such laws might be enacted. The problem will be very real to you if your wind turbine is within a few hundred feet of an upwind neighbor who plants trees or builds a tall structure

so that the smooth flow of your wind is interrupted, causing a reduction in the output of your wind turbine. Worse yet, if his structure is upwind during your strongest gale winds, the added turbulence might just be enough to destroy your blades.

The document that can provide the WECS user with the greatest protection is a negative easement. Easements are interests in another person's property that give the easement holder a limited right to use the property for a specific purpose, for example, a right-of-way. A negative easement gives the easement owner the power to prevent certain acts of an upwind landowner. Short of buying the property, this is the best way of protecting your wind source.

Consider trading partial negative wind easements with your neighbor. These easements would allow each of you to block each other's wind only by your own wind turbines, possibly specifying their diameter and minimum distance to the common property line. The natural growth of existing trees should probably be excluded. Obviously an attorney should be consulted.

OBTAINING A BUILDING PERMIT

After determining that you have a satisfactory site for a wind turbine and deciding that you want to erect one, you should investigate any possible laws or local ordinances that may affect the erection of your tower and wind machine. A call to your local building inspector may be all that is required.

The categories of controls that affect the wind system owner are: (1) local zoning ordinances, (2) federal, state, and local laws, and (3) building codes. Each of these types of controls are discussed below.

Zoning

Zoning regulations are based on the state's jurisdictional powers, under which the state may regulate private activity for the purpose of enhancing or protecting the "public health, safety, and welfare." Zoning laws, usually called ordinances, are, with a few exceptions, enacted and enforced by municipal and county governments. Where zoning is in force, the WECS owner must show that his proposed activity and structure conform to the restrictions applied to the site by zoning ordinances before obtaining a building permit.

The majority of municipalities and counties use the same basic process to enforce zoning ordinances. The prospective wind turbine owner, or his contractor, starts the process with an application for a building permit, filed with the planning department, zoning enforcement office, building inspector, etc., who will issue such a permit if the provisions of the applicable

zoning ordinance are met. Construction may be checked periodically to insure that the materials and workmanship meet the building codes.

The typical lattice-type windmill tower is generally termed an accessory building since it is a separate structure and cannot be lived in. If it is part of a residence or other building, the zoning restrictions are applied to the whole structure.

Zoning ordinances typically regulate uses or activities that may occur on the land; population density; and such building requirements as height, number of stories, size of building percentage of the lot that may be occupied, and setback. Aesthetic considerations, not typically treated as a separate concern, are, however, a factor in writing and administering zoning ordinances. So-called architectural review is not standard practice, but some municipalities have enacted legislation designed specifically to regulate building appearance and compatibility with neighboring structures.

Conceivably, the proposed WECS may violate restrictions, particularly in a residential area. Resolution of this problem may depend on the wording of the ordinance and its interpretation. Also, the WECS may be permitted as an accessory use; one related to a permitted use of the land. Under this theory, for instance, ham radio towers have been permitted on residential property.

There are various options available to the WECS owner who is restricted by a zoning ordinance. He can appeal the interpretation and application of the ordinance to the board of zoning appeals or board of zoning adjustment, a local body that exists to oversee the zoning process. He may be able to utilize the so-called special exception or conditional use; a permitted use is explicitly mentioned in the ordinance but whose application to a particular area is allowed only after approval by the board of zoning adjustment. He may also be able to get a variance; a permitted variation from the ordinance. The granting of variances is governed by broad considerations of the purposes to be served by the zoning scheme, and the board of zoning appeals is often the name of the body with this power. Next, the WECS owner might attempt an amendment to the ordinance prohibiting his operations. In most states, the procedure for amending ordinances is the same as that for enacting them in the first place. This usually involves action by the city council or board of supervisors of the municipality. Also, the WECS owner might attempt to get a change ordered by the courts. This, of course, involves a court action, which might proceed under a variety of special procedures. Such an action is likely to be expensive and time consuming and may succeed only in extreme circumstances.

Other Laws and Regulations Relevant to Land Use

Federal, state, and local regulations and laws, or statutes other than the zoning ordinance, conceivably may affect the WECS owner. These include statutes that regulate the selection of sites for electric generating plants; laws designed to protect the environment; and legislation regulating the use of particular geographic areas, such as coastal lands, wildlife reserves, historic sites, or navigable waters. It is very difficult to generalize about the impact of these provisions, but their overall effect on small WECS should be minimal. Which laws affect the WECS owner will depend on the wind system's location and size and possibly who wants to erect it: an individual, a cooperative, or a company. If a permit from the federal, state, or local government is required before construction can begin, other laws may become involved in the permit process. For example, if the tower were located within the high-water mark of a river and a permit from the Corps of Engineers was required, federal laws require the Corps to consult other governmental agencies before issuing a permit.

In addition, legislation designed to protect the environment exists at both the federal and state levels. Most of these acts become relevant to the WECS owner only when a government permit-granting agency is involved. Generally, compliance with the law is the direct responsibility of that organization, not of the developer. This involves the satisfaction of various paperwork requirements and the submission of such reports to a variety of interested agencies. Overall, because of the likely low environmental impact of small WECS, such procedures will probably be time-consuming at worst. Further, the small WECS owner is not likely to be affected by a state's power plant site selection statute, since these typically apply to a minimum rated capacity of about 50 megawatts, or to those utilizing a certain fuel source.

Federal Aviation Administration (FAA) regulations require that the owner of any structure higher than 200 feet give notice to the FAA on forms provided for that purpose. While few small WECS towers are that tall, lower height limitations apply within the vicinity of an airport. For example, a wind turbine up to 100 feet high (to the top of the blade path) might be allowed at 5,000 feet from a runway. As soon as notice (if necessary) is received, the FAA applies different height standards to determine whether the tower is an obstruction. These standards are generally less stringent than those governing notice. If the WECS was found to be an obstruction, the most likely requirement would be the placing of warning lights on it. Applications for building permits for structures in the vicinity of airports are usually forwarded to the FAA by municipalities.

Building Codes

Like zoning matters, the state's jurisdictional power is the basic authority under which building codes are enacted. Some state legislatures enact statewide building codes while others delegate the authority to the local governments. One or a combination of the four model building codes has been adopted by most states or municipalities. These codes (and the geographic area) dominated by their association/author are: (1) the Uniform Building Code written by the International Conference of Building Officials (adopted primarily in the West); (2) the Basic Building Code compiled by the Building Officials and Code Administrators, International, Inc. (found in the Northeast and North Central areas); (3) the Southern Standard Building Code enacted by the Southern Building Code Conference (adopted in the South); and (4) the National Building Code, developed by the National Board of Fire Underwriters. Local variations exist despite the model codes. Some municipalities have adopted selected provisions rather than the entire code. Interpretations of the same code differ from city to city.

Unlike zoning ordinances, most building codes apply retroactively. Three types of information are provided in most codes: definition of terms; licensing requirements; and standards. Taken together, the definitions and licensing requirements have the effect of prescribing who is authorized to conduct particular sorts of construction activity. For example, unless you are doing the work on your own system, the International Association of Plumbing and Mechanical Officials Code states that only licensed plumbers may do work defined as plumbing. Many codes require that structural design plans be prepared by a state certified engineer.

Two types of code standards exist: technical specifications, and performance standards. Codes prescribing technical specifications set out how, and with what materials, a building is to be constructed. Performance standards represent a more progressive and technically more flexible approach. Codes based on these standards state product requirements that do not prescribe designs and materials. For example, "the structural frame of all buildings, signs, tanks and other exposed structures shall be designed to resist the horizontal pressures due to wind in any direction..." Typical construction components specified in codes are structural and foundation loads and stresses, construction material, fireproofing, building height (this represents a common duplication of the zoning ordinance), and electrical installation. The WECS developer is likely to be required to comply with the standards for structural and foundation loads and stresses, as well as the electrical installation code. The structural design standards set out the minimum force measure in pounds-per-square-inch that the WECS must bear under certain circumstances, e.g., wind or snow. The electrical code regulates the use of a generator and the electrical wiring when voltage levels are above 36 volts.

Administration of the building codes is delegated to a board of review in some states, and to the building official in others. No building may be erected, constructed, altered, repaired, moved, converted, or demolished without a building permit, and this can be obtained only after the building official is satisfied that the plans satisfy all applicable building codes. A trend is developing toward combining the administration of building codes and zoning ordinances in one municipal department.

Dissatisfaction with the building inspector's denial of a permit may result in an appeal before the local board of building appeals. The common bases of appeal provided by the codes are: an incorrect interpretation of the code by the building official; the availability of an equally good or better form of construction not specified in the code; and the existence of practical difficulties in carrying out the requirements of the code. The local board members are usually appointed experts in the field of construction. The local board may uphold, modify, or reverse the building official's decision. Further appeals to the state board of building appeals or to the courts are also available.

SHARING, BUYING, AND SELLING POWER

You may be considering a wind system where you: share excess power or sell it to neighbors; buy makeup power; or sell excess power to a utility. Unfortunately, the state utility regulatory structure may cause you some unwanted problems.

The first of these possible problems has to do with the regulated monopoly structure of the public utility industry. This structure operates by the assignment (based on what is often called the certificate of public convenience and necessity) of a geographical area to a particular electrical supplier. In order to operate within an area occupied by an existing utility all entities defined as public utilities typically must obtain this certificate, and to do this they usually must demonstrate a compelling need, such as the inadequacy of existing service. The result of this is often to prevent new electrical suppliers from operating within such a protected domain. Their status as a public utility is the crucial point here.

Selling Power to Neighbors

The small wind turbine owner who generates power for only personal use or shares it with neighbors at no charge is not defined as a public utility and thus will not be hindered by the regulated monopoly structure. Sales of electricity to others, however, may cause problems. Some state statutes limit the exact number of people (i.e., 10 or 25) to whom sales can be made before public utility status exists. More commonly, the statements in the law will contain language making it appear that any sale to any part of the public will result in public utility status and the need for a certificate, effectively prohibiting such sales.

However, the courts of such states often interpret this language to require a "dedication to the public use;" that is, an offering of service to the general public coupled with a willingness to serve those who apply. Under such a standard, the small WECS owner-operator selling to a few friends would probably escape. Sales of electricity by a landlord to his tenants may cause similar problems, and the states have taken a variety of approaches here. For instance, if each tenant is metered and billed apart from the rent charged, public utility status may be hard to avoid. Finally, it should be noted that if the WECS owner obtains supplemental power from the existing utility grid (see below), the service contract with the utility will almost certainly contain terms prohibiting such sales.

One possible way for small WECS owners to avoid these problems is for them to start a cooperative. Basically, co-ops are nonprofit, membership corporations, the members being both the owners of the corporation and the consumers of the electricity produced by it. Most co-ops are fairly large, located in rural areas, and funded by the Rural Electrification Administration. However, most states have special statutory schemes for the incorporation of co-ops, and these often allow incorporation by as few as three to five individuals. The various requirements, of course, must be complied with by the WECS owners.

The point of utilizing the cooperative form in this context is that cooperatives are not defined as public utilities in some states, although the number of states which make this exception is decreasing. In states which do make this exception, the WECS owners could generate power for themselves within the domain of a regulated utility without being checked by the certification requirement. However, in such a case they would not be granted protection from competition with existing or future utilities.

Generally, this problem of restriction of WECS operations due to collisions with the existing regulated utility structure may be more hypothetical than real, at least for sales to a very few people. However, given the diversity of laws and practices in the fifty states, this may not always be true. Experts in the field, or perhaps the state Public Utility Commission, should be contacted before such sales are attempted. It should be remembered that the more substantial the sales to others, the greater the likelihood of problems.

Buying Power

At present, utilities generally do not object to user-owned power generation systems that provide the user's power needs part of the time while the utility provides the power when the system is turned off. However, increased use of solar and wind power generating systems may bring about a change in attitude of the utilities toward these systems due to the fact that heavy demands could be placed on the utility during windless or sunless periods.

The need for the utilities to maintain peak load capacity, even though it would generally be selling less electricity, would result in a loss of revenues. Conceivably, this objection could be overcome through the adoption of special rate structures--not unlike existing standby rates. In general, it can be said that utilities and state power commissions will need data on the power requirements of wind generator owners before adequate rate schedules can be set.

Selling Excess Power to a Utility

If a wind turbine generator owner requires the connection of his facilities with that of a utility so that he may produce some of his needed power while simultaneously buying the remainder of his needed power, or if he wishes to sell excess power, a proper interconnection between the two generating systems will have to be made. The utility will want to ensure that the connection is safe and will not jeopardize its own facilities or men working on the line. The state commission will oversee this process to its own satisfaction. The utility will require the right to inspect the connection at any subsequent time and make any necessary modifications to ensure safety and proper operation.

Power fed back into the utility's lines will have to be at the correct voltage and be synchronized in frequency and phase. A synchronous inverter is one device available to ensure these conditions. When such an interconnection is made, two meters will probably be used: one to measure the electricity bought from the utility and the other to measure the electricity fed back to the utility's lines. This would enable the utility to charge a particular price for the power it sells and buy the wind turbine generator owner's excess power at a wholesale rate (if reimbursed at all) to make up for its capital and distribution costs.

With this general description in mind, we will turn to the many legal aspects of this situation. First, it is likely that the WECS owner will have to bear (through the rate structure or otherwise) much of the cost of effecting the interconnection (e.g., the extra meter). Second, it is conceivable (though fairly unlikely) that the utility's general duty to serve all comers may not extend to this situation. Third, a "demand charge" might be applied here (which could involve a higher cents per kilowatt-hour rate and an additional charge based on the extra capacity required by the utility) and service might also be interruptible (i.e., capable of being shut off at the utility's option). Fourth, at least some utilities now prohibit a reverse flow of electricity back into the grid when they provide supplementary electricity to a self-supplying customer. Whether this will continue to be the case if the price of conventional fuel increases and wind/solar devices become more numerous is uncertain. Finally, there is a question as to the amount of the credit to be given the WECS owner's bill, assuming that the utility does permit such a sale to

it. State utility commissions will probably be required to decide on all of these questions.

WARRANTY, LIABILITY, AND INSURANCE

Liability of the Manufacturers and Installer

Usually one who is injured (financially or physically) by a product can receive money to cover damages on the basis of negligence, warranty, or strict liability. The injured person must show that the product was defective, that the defect caused the injury, and that the defendant being sued is responsible for the defect. The term defect has come to mean anything initially wrong with the product that can occur during the process of manufacture and sale. To recover on a claim, an injured person must prove that the defendant should have taken reasonable care to take precautions against creating foreseeable and unreasonable risks of injury to others, and that his not doing so was the cause of the injury (either financial or physical).

In circumstances where there may be a dangerous nature to a product (i.e., blade and tower failure consequences), the seller may have an obligation to give adequate warning of unreasonable dangers of which the seller knows or should know. This obligation to warn the potential buyer extends to all advertising.

An express warranty is a claim, promise, description, or sample made by the seller, which is made part of the bargain with the buyer. The injured person must have knowledge of this claim or promise, and only be injured as a result of reasonable reliance on it. Liability is established when the product is demonstrated to be not as good as was claimed. Potential sources of express warranties include: the name of the product; descriptions of the product found in advertising brochures, catalogs, or packaging; drawings or other pictorial representations accompanying the product; and all representations made by the seller or his agent to the buyer. However, not all claims about a particular product are treated as express warranties giving rise to liability. Mere sales talk and opinion have been distinguished as representations which are not meant to be relied upon by the buyer.

An action for breach of warranty proceeds on a contract theory, as distinguished from the laws governing negligence. As such, it focuses upon the express or implied promises made by the defendant to the injured person and not on the defendant's fault. In such an action a consumer need only prove that the product was defective when sold, did not conform to the defendant's representation about the product, and that he was injured as a result of that defect. The advantage of a warranty action over a negligence claim is the absence of the need to prove that the seller failed to use reasonable care. The rules of warranty have been codified

by the Uniform Commercial Code, which has been adopted by all states with the exception of Louisiana.

Whom to sue in a product liability case is a question whose answer depends upon the parties connected with the particular product, as well as plaintiff's evaluation of the economic worth of each potential defendant. In most cases, the defendant will be the manufacturer, distributor, wholesaler, retailer, or other supplier in the direct chain of distribution. Anyone in the chain of distribution who represents a product as his own is subject to the same measure of liability as that of the manufacturer. Liability will depend on whether anyone in the chain of control has the duty to discover defects in the product.

Liabilities of the WECS Owner

Each owner/occupier of land enjoys the privilege of using land for his own benefit. A standard of reasonable care qualifies that privilege by imposing the duty to make a reasonable use of property, which causes no unreasonable harm to others in the vicinity. The duty of reasonable care is affected by the location since the hazards to be anticipated in crowded, commercial areas are not the same as those involved in rural areas. Reasonable care, on the other hand, does not require such precautions as will absolutely prevent injury or render accidents impossible.

Owners of property are under no legal obligation to trespassers other than to do such persons no willful harm. The status of trespasser has been held to include those who enter upon the premises unintentionally, such as persons who wander too far from the highway. The standards applicable in the case of trespassing children, however, are not the same as those for adults. A number of states follow the "attractive nuisance" doctrine, which imposes liability for the creation of conditions that are so alluring to children (despite the danger apparent to those possessing greater discretion) that they are induced to approach and be exposed to the possibility of injury. Liability has been held not to exist in more isolated places where the owner had no reason to anticipate the presence of children.

Insurance

The standard homeowner's insurance package usually covers liability connected with an accessory building with the following conditions attached:

- * the installation is not to be used for commercial purposes
- * the structure is not highly susceptible to fire (for example, a woodwork shop or a storage area for flammable materials)

It is not certain if a WECS would be considered to be engaged in commercial activity if excess power is sold to a utility and credit obtained against the cost of power that is bought. Written clarification of this point in such circumstances would assure the owner of necessary coverage. Antennas and masts are not covered against damage from wind, rain, hail, and snow. However, it is possible that a WECS will not be included in the category of antennas and, therefore, will be covered fully against fire and acts of nature that are covered by the policy.

Some insurance underwriters will not want to accept the added risk of a wind turbine and may simply force you to find another insurance company. Those companies that have a sizable business in rural areas with a good wind potential will most likely be prepared to offer coverage for your WECS. The insurance company, of course, will require that the structure conform to all applicable local, state, and federal ordinances and regulations.

Typically, a homeowner's insurance policy provides coverage only for outsiders performing minor amounts of yard work and not jobs that would be covered by workmen's compensation. In this case, help used for the erection of a tower and installation of the wind turbine will not be covered by the homeowner's policy. A contractor will have his own insurance. If other help is used for these tricky and potentially very dangerous jobs, special attention must be paid to insurance coverage.

CHAPTER 8

THIS BOOK AND YOUR WIND SYSTEM - EXAMPLES

This chapter provides examples of how wind systems should be selected using the information in this book. Each example focuses on some aspect of the decision-making process, while illustrating the types of calculations you will probably make as a result of asking the questions presented at the beginning of this book. The block diagram of Figure 1-1 will help organize your thinking.

No attempt is made here to reach conclusions with each example; we merely illustrate the steps needed to arrive at the eventual conclusions. Such conclusions will be yours. They will be based on your needs, your wants, your site, and all of the other considerations we have presented. No single hypothetical illustration would do justice to the process of making realistic decisions about your energy source.

EXAMPLE 1: The plan is to replace utility company power, if economical, with a wind-powered electric system for pumping water from deep wells on an alfalfa ranch. The preliminary data gathered by onsite analysis and research are:

- * Water depth - 600 feet
- * Water requirement - 7 acre-feet of water per acre per growing season
- * Growing season - April 1 to October 1
- * Energy requirement for pumps already installed - 700 kWh per acre-foot of water

(Note that these data are related directly to the discussion of energy requirements in Chapter 4.)

All preliminary data were supplied by a county agricultural extension agent in the area of the alfalfa ranch. It so happens that this ranch is located very near Palmdale, California - a flat, desert region. Data for Palmdale suitable for a preliminary analysis were presented in Appendix 1. Monthly wind powers are:

April - 268 W/m²
May - 315 W/m²
June - 328 W/m²
July - 254 W/m²
August - 200 W/m²
September - 165 W/m²

This data represents two of the planning chart evaluation steps (Fig. 1-1): determining the nature of the site wind resource and estimation of energy needs. At this point, the planning chart advises evaluating the social, legal, and environmental impacts of the proposed system, as well as calculating wind turbine sizes and selecting other equipment. Next, refer to Figure 6-1 for system design, where it can be seen that, because

of the initial plan, the WECS' end use as an electric power generator has already been established. At this point, the ac versus dc question might be pondered, but first, return to the environmental concerns.

Suppose, for this example, the following facts are determined by checking at the County Planning Office and the Department of Building and Safety:

- * Proposed site not affected by airport air traffic considerations
- * Wind systems (water pumpers) are common in the area and thus have legal precedence
- * Building codes cover tower installations and appear to be easily satisfied by proper engineering of the tower foundation and selection of a tower if the manufacturer can substantiate the tower design loads by submitting an engineering report to the building department.

A check with the neighbors reveals that no social concern is placed on the proposed installation. This is a farm community and the nearest neighbor is half a mile away. Now, just what does the proposed installation require?

Figure 1-1 instructs us to calculate wind turbine size next (select system components). There are two options in this regard. Existing wind data are in watts per square meter. It could have been in raw windspeed (miles per hour, etc.), which would require the calculations of Chapter 3, but with data in watts per square meter, it is possible to simply calculate the square meters of wind turbine frontal area required to produce the needed watts of power. Here is where the options come in: The wind turbine can be sized to the average of the data, or it can be sized to the minimum wind available.

If the wind turbine is sized to the average month, there will be some months with not enough water and some months with too much water. If, on the other hand, the wind turbine is sized using minimum power available (165 W/m^2), then for all the rest of the months there will be a water surplus. Indeed, the wind turbine would be larger than is actually necessary.

Another check with the county agent reveals that water requirements will increase through June, then begin to decrease through September, correlating with the wind curve of Figure 3-3. This indicates that, at least as a preliminary estimate the average wind power available can be used to size the wind turbine.

The simple average of the wind data can be calculated by adding up the power available each month and dividing by the total number of months - for an average of 255 watts per square meter. At this point two facts should be realized and appropriate action taken:

- * Energy requirements were expressed in kWh, not watts or kilowatts
- * The wind power numbers are based on 100 percent efficiency conversion, not 59.3 percent - the theoretical maximum wind power available.

With regard to the energy source, since power coefficients or efficiency of complete systems (values like 25 to 40 percent include the 59.3 percent theoretical maximum (re-read Chapter 2, if necessary), it is possible to merely multiply the system efficiency by the average wind power (255 W/m² in this case) to get the actual potential wind which will be harnessed. We only need to estimate a power coefficient for our wind electric system.

Looking at the table of component efficiencies at the end of Chapter 5, one could guess that the best wind turbine generator will be in the 10-kW size range. If 30 percent is selected as an estimated efficiency value, actual wind power available would be 76.5 W/m² (0.30 x 255).

To convert the energy requirement from kWh into kW, the number of hours involved must be calculated. Let us assume, for simplicity, that the growing season equals six thirty-day months. Then, total hours would be 4320 (24 hours per day x 30 days per month x 6 months).

Further, we need seven acre-feet of water per acre per growing season at 700 kWh per acre-foot. Total energy required would be 4900 kWh per acre per season (700 kWh x 7 acre-feet).

From this, energy demand (4900 kWh) can be converted into an average power demand (kW): $4900 \text{ kWh} \div 4320 \text{ hours} = 1.13 \text{ kW}$. (Remember, this value is kW per acre.) If it is planned to harvest five acres of alfalfa, 5.65 kW (5 acres x 1.13 kW) total average power capability would be needed from the wind generator. At 76.5 watts per square meter, the wind turbine's size can be calculated as follows:

$$5650 \div 76.5 = 73.9 \text{ square meters frontal area}$$

This could translate to a Darrieus rotor (similar to Figure 5-28) of dimensions 8.5 meters (28 feet) in diameter by 8.5 meters tall, or a propeller-type machine (similar to Figure 5-6) about 9.6 meters (31.9 feet) in diameter. Review the formulas shown in Chapter 5, (Wind Turbine Performance) to calculate the areas and dimensions.

The required size of the wind machine has been calculated based on the average wind power condition. We now need to calculate such a machine's maximum power generation capability in order to move into the next block of Figure 1-1 ("Select system components") which leads to cost analysis.

Checking our wind data, maximum power available will be 98.4 W/m^2 ($328 \text{ W/m}^2 \times 30$ percent efficiency). Then $98.4 \text{ W/m}^2 \times 73.9 \text{ m}^2 = 7272$ watts (just over 7 kW). Recall that our first estimate was for a 10 kW (or possibly larger) machine.

By checking the literature from wind turbine manufacturers, we discover a 10-meter-diameter, 8-kW machine manufactured by Brand X to be the nearest to our requirement. It sells for \$12,000, including a 90-foot tower.

A preliminary economic evaluation can be made at this point if it is remembered that the raw price of \$12,000 does not include installation, batteries, etc. The cost will only increase, but let us see.

A total of 24,500 kWh (4900 kWh per acre x 5 acres) are required per season to grow alfalfa. If the utility presently sells this amount of electricity for 5 cents per kWh, the total seasonal cost would be \$1225 ($0.05 \times 24,500 \text{ kWh}$). We expect to spend \$12,000 (or more) on the wind system. We would also like to see a return on our investment of, say, 8 percent per year (\$960). On the condition that the wind system will supply all pumping energy needs, it will actually return \$1225 by offsetting the cost of power from the utility. This is \$265 more than the minimum required \$960 return on the investment per year and indicates that the wind system may be economically worthwhile.

The investment return surplus allows leeway for other system costs, including installation, maintenance and storage. We can set up an arbitrary monitor that will serve as a cutoff dollar value of our wind system, above which we will not be willing to spend any more money for the complete system; that is, 8 percent of whose total value will equal \$1225. This would be \$15,312.

If planning a professional wind system were as simple as this illustration indicates, one would be tempted to take the \$15,312 figure to the manufacturers of candidate machines and offer it to them for a completely installed, tested, and guaranteed system. It is not usually that easy, however.

One is also inclined to notice that, if the cost of utility power rises (which it certainly will), the return on already invested money will also rise. This is because the wind turbine is now returning more dollars worth of energy on the same investment. Historically, folks who buy wind systems with no regard for return on invested dollars do not make such an observation. But those individuals and organizations who do expect returns do not observe this fact either. That is, the relationship between bank interest rates (return on investment or cost of money, depending on the situation) and cost of energy is vastly more complex than would allow the simple observation we have offered. All this points to the fact that a business that buys a wind system as a capital item will use an accountant to assess the

economic factors involved in the purchase. Our economic analysis of this example system need go no further.

To complete the planning of this system, one would follow the blocks of Figure 1-1, until either the cost of the system rises beyond a limit or the system is completed and its overall economic performance is evaluated as detailed in Appendix 2.

EXAMPLE 2: We very often hear the question "Which should I do - buy a water pumper windmill or an electric machine? I want to pump my well on wind power!" By now, you probably realize that there is no easy answer. Actually, there are three possible choices: water pumper, wind generator, or none of the above. It makes no sense to consider any of the choices if there isn't enough wind. How much wind do you need? We will discuss that problem shortly. Let's use this present example to look at the trade-offs between electric and mechanical pumping; perhaps more closely than we did in Chapter 5.

A valid conclusion can sometimes be drawn from the results of a complete site analysis. Put another way: "Where is the water well?" and "Where is the best windsite?" Answer these two questions and you may have your overall answer. It may be, for example, that the well is located in a sheltered spot, while a great increase in wind energy (an increase, that is, over what is available at the well) is available by locating the wind machine some distance away. Almost any distance, in the case of the classic farm-type water pumper, means that extra mechanical linkages, push rods, and such will have to be installed to transmit power from the wind machine to pump. Here the trade-off starts with mechanical versus electric power transmission. Trade-offs do not stop there, though.

If, on the other hand, the water site and the wind site are one and the same location, the trade-offs may start with cost, aesthetics, or some other consideration. System simplicity will favor the mechanical system. System versatility will favor the electrical system; you can always use the electricity for other things besides pumping water.

Suppose you have a situation where the best water (closest to the surface, hence, easiest to pump) is located at one site where a fair wind speed average has been recorded, whereas a better wind speed average is recorded elsewhere, at a site where water is known to be somewhat deeper. In such a situation an intelligent assessment cannot be made without some numbers and a list of objectives and requirements. Here's a sample of such a list.

- * Established purpose - water pumping to fill stock ponds for 720 head of range cattle
- * Water requirement - estimated daily consumption per head, 10 gallons (estimated from Figure 4-10)
- * Total requirement - $10 \times 720 = 7200$ gallons per day

- * Site A {good water, less wind}: windspeed average = 7 mph, well depth = 60 feet
- * Site B {good wind, less water}: windspeed average = 11 mph, well depth = 400 feet

From these numbers, we need to pump 7200 gallons per 24-hour day which is 300 gallons per hour, or five gallons per minute (gpm). Our well pipe is two inches in diameter, so, checking Figure 4-8, we find we do not need to consider head loss (friction loss from pushing water through a pipe). By checking Figure 4-9, it can be seen that a five gallon per minute flow at 60 foot depth requires 0.1 hp output from a pump. At 400 foot depth, 0.5 hp output is required. These horsepower requirements are pump output. Assuming the pump to be 70 percent efficient, the following pump power input requirements can be derived:

$$\begin{aligned} \text{Site A: } & 0.1 \text{ hp} \div 0.7 = 0.14 \text{ hp} \\ \text{Site B: } & 0.5 \text{ hp} \div 0.7 = 0.71 \text{ hp} \end{aligned}$$

Put another way, these new values are the output requirements for our wind machines. These horsepower values can be converted to watts of electric power as follows:

$$\begin{aligned} \text{Site A: } & 0.14 \text{ hp} \times 746 \text{ watts per hp} = 104.4 \text{ watts} \\ \text{Site B: } & 0.71 \text{ hp} \times 746 \text{ watts per hp} = 529.7 \text{ watts} \end{aligned}$$

The wind turbine size required at sites A and B can now be calculated using the equation from Chapter 2:

$$\text{Power} = K \times e \times \text{DRA} \times \text{DRT} \times A \times V^3$$

You may want to review Chapter 2 at this point to refresh your memory concerning this formula. In order to simplify the comparison, we shall assume that our sites are at sea level and the temperature is 60°F. Thus, DRA and DRT both equal 1. The real numbers for your own site can be inserted as indicated in Chapter 2. For this calculation power is measured in horsepower, wind turbine size is measured in square feet of frontal area, and wind speed is measured in miles per hour. For these units we obtain a value for "K" of .00000681.

From the efficiency estimator table near the end of Chapter 5 we can estimate "e", the wind turbine efficiency, as 25 percent. For a comparison, just about any assumption will do. To actually calculate system performance, you will need a less casual estimate, but for any small wind system of professional design and manufacture, 0.25 is a safe overall power coefficient estimate.

The resulting calculations are:

Site A: power at the pump = 0.14 hp:

$$0.14 = 0.00000681 \times 0.25 \times A \times 7 \times 7 \times 7, \text{ so}$$

A = 239.7 square feet, which equals a windwheel of 17.7 feet diameter

Site B: power at the pump = 0.71 hp:

$$0.71 = 0.00000681 \times 0.25 \times A \times 11 \times 11 \times 11, \text{ so}$$

A = 313.3 square feet, which equals a windwheel of 20 feet diameter

You might be inclined to think that an 18 or 20-foot diameter, high-solidity water pump windmill will be a bit on the expensive side. If one could find a used machine of the size needed (in good operating condition at a bargain price), system design would, at least for the trade-off study, end here. But one must also consider the cost evaluation.

There might be a case for setting up a wind machine at Site B, which powers a pump at Site A. This, of course, depends on a parameter not yet introduced into our comparison: distance between sites. If the two sites are not far apart, the analysis could end here. But suppose Site A and Site B are a quarter-mile apart (1320 feet).

Reviewing Chapter 5, we see that candidate methods for transferring power from Site B to Site A include: a mechanical power shaft, hydraulic fluid flow, compressed air, and hydrogen gas (although you would have to pump water to Site B, convert it to hydrogen at Site B to be used at site A to power a pump by fuel cell electricity). Hydraulic fluid pumping and compressed air look very promising since fluid pumps are well matched to windwheels, and aerospace applications are constantly improving hydraulic and pneumatic systems. For this example, let us assume that a manufacturer of a wind turbine generator has offered a system of high-voltage (low line loss) transmission similar to Figure 5-30. If the long wire run is conducted at 400 volts, and we assume a peak power transmission of 500 watts, then our peak amperage is 1.3 amps (500 watts \div 400 volts).

Looking at Figure A2-7 and the formula for line loss and wire size, we decide that a two-percent line loss (8 volts) is acceptable. To calculate wire size, the following calculation must be made:

$$\text{Circular area size} = 35 \times 1.3 \text{ amps} \times 1320 \text{ ft.} \\ \text{(aluminum wire)}$$

$$\approx 8 \text{ volts} = 7507 \text{ circular mills}$$

Looking at the chart in Appendix 2 (Wiring section), we see that this falls between number 12 and number 10 size. This, we decide, is acceptable.

While it is beyond the scope of data in this book, we can expect another five percent loss from the transformers. To be safe, let us assume a total of ten percent line loss. Then, to calculate total average power required:

$$104.4 \text{ watts} \times 1.10 = 114.8 \text{ watts}$$

Now we calculate wind turbine size as before but with different units in the equation:

$$114.8 \text{ watts} = 0.00508 \times 0.25 \times A \times 11 \times 11 \times 11$$

so:

$$A = 67.9 \text{ ft.}^2$$

This equals a wind turbine just under 10 feet in diameter. A machine with a ten-foot diameter rotor, in this example, mounted on Site B can replace a 20-foot machine at Site B or an 18-foot machine at Site A (if the water is being pumped at Site A).

If you perform a trade-off analysis like this, you will follow the above conclusions with a more detailed study, which will determine whether the added complexity and cost of the long electrical transmission lines is offset by the reduced complexity and cost of the remote-site wind machine. This would be the remaining question, and it requires a survey of specific, on-the-market equipment. Elsewhere in this book we provide you with the addresses of organizations that keep up-to-date lists of sources of equipment you will need.

ADDITIONAL REFERENCES ON WIND ENERGY

PERIODICALS

1. Wind Power Digest, \$6/yr. for 4 issues, Jester Press, 54468 CR 31, Bristol, IN 46507
2. AWEA Newsletter, \$25/yr. (includes membership) American Wind Energy Association, c/o Secretary, AWEA, 54468 CR 31, Bristol, IN 46507
3. Windustries, \$10/yr. for 4 issues (\$15 institutions), Great Plains Windustries, Inc., P.O. Box 126, Lawrence, KS 66044
4. RAIN: Journal of Appropriate Technology, \$10/yr for 10 issues, RAIN, 2270 N.W. Irving, Portland, OR 97210
5. Alternative Sources of Energy, \$6/yr for 4 issues, A.S.E., Rt. 2, P.O. Box 90-A, Milaca, MN 56353

BOOKS

6. Power from the Wind, by Palmer C. Putnam (\$9.95) Van Nostrand - Reinhold Co., 300 Pike St., Cincinnati, OH 45202; Historical study of the largest wind generator built to date - built in Vermont by Smith-Putnam in the 1940's. Discussion of institutional and technical problems, and solutions for that wind machine.
7. Electric Power From the Wind, by Henry Clews (\$2) Solar Wind Co., P.O. Box 7, East Holden, ME 04429; A brief overview of requirements for a complete wind system.
8. Simplified Wind Power Systems for Experimenters, by Jack Park (\$6) Helion, Inc., P.O. Box 445, Brownsville, CA 95919; Written for designers and do-it-yourselfers. (For technically oriented readers.)
9. Wind Machines, by Frank Eldridge, MITRE Corp., Well illustrated historical and technical background document. For sale by the Superintendent of Documents, U.S. Government Printing Office, Washington, D.C. 20402. (Stock No. 038-000-00272-4.)
10. A Siting Handbook for Small Wind Energy Conversion Systems, by H.L. Wegley, Battelle Pacific Northwest Laboratories, Richland, WA. Will be available from the National Technical Information Service.
11. Legal-Institutional Implications of Wind Energy Conversion Systems, George Washington University, Washington, D.C., September, 1977. Available from the National Technical Information Service. (Report No. NSF/RA-770203.)

GLOSSARY

- ac** alternating electric current (Chap. 5)
- airfoil** a curved surface designed to create lift as flows over its surface (Chap. 2)
- amp-hours** see amps, calculated by multiplying current flow by number of hours it flows (Chap. 5)
- amperes
or amps** a measure of electric current flow (Chap. 5)
- anemometer** an instrument for measuring wind speed (Chap. 5)
- asynchronous
generator** an electric generator designed to produce an alternating current that matches an existing power source (e.g., utility mains) so the two sources can be combined to power one load (e.g., your home). The generator does not have to turn at a precise rpm to remain at correct frequency or phase; see also synchronous generator (Chap. 5)
- current** flow of electricity through wires (Chap. 5)
- cut-in speed** wind speed at which wind turbine begins to produce power (Chap. 3,5)
- cut-out speed** wind speed at which wind turbine is shut down to prevent high wind damage (Chap. 5). Also furling speed.
- dc** direct electric current; does not alternate direction of electric flow as does ac (Chap. 5)
- diode** see also rectify, an electric device which changes ac to dc (Chap. 5)
- drag** a force which "slows down" the motion of wind turbine blades, or actually causes motion and power to be produced by drag type wind machines (Chap. 2,5)
- efficiency (e)** a number arrived at by dividing the power output of a device by the power input to that device (usually the larger of the two numbers); usually expressed as a percentage value; see also power coefficient; (Chap. 2,5)
- energy** a measure of the amount of work that can be, or has been done; expressed in kilowatt-hours (kWh) or horsepower-hours (hphr) (Chap. 2,3,4,5)

GLOSSARY (Continued)

energy density	a ratio of energy per pound; a rating usually used to compare different batteries (Chap. 5)
energy rose	see also <u>wind rose</u> , a diagram which presents wind energy measurements from a site analysis in relation to the direction from which the wind occurs at the site (Chap. 3 and example in Fig. 3-6)
fantail	a propeller-type wind turbine mounted sideways on a larger wind machine (horizontal-axis type) to keep that machine aimed into the wind (Chap. 1, 5)
furling speed	the wind speed at which the wind machine must be shut down to prevent high wind damage (Chap. 5). Also cut-out speed.
gear ratio	a ratio of speeds (rpm) between the rotor power shaft and the pump, generator, or other device power shaft; applies both to speed-increasing and speed-decreasing transmissions (Chap. 5)
gin pole	a pipe, board, or tower used to improve leverage while raising a tower (Chap. 6)
head	a measure of height a pump must lift water (Chap. 4)
head loss	a measure of friction loss caused from water flow through pipes (Chap. 4)
horsepower (hp)	a measure of power; 550 pounds raised one foot per one second (Chap. 2,5)
horsepower-hour (hphr)	a measure of energy, see also <u>energy</u> (Chap. 2,3, 4,5)
inverter	a device which converts dc to ac; generates its own frequency and voltage references; see also <u>synchronous inverter</u> (Chap. 5)
kilowatt (kW)	a measure of power; one horsepower equals 776 watts, or 0.776 kilowatts (Chap. 4,5)
kilowatt-hour (kWh)	a measure of electric energy, (1000 watt-hours), see also <u>kilowatt</u> , <u>horsepower</u> , and <u>horsepower-hour</u> (Chap. 4,5)
lift	the force which "pulls" a wind turbine blade along, as opposed to drag (Chap. 2,5)

GLOSSARY (Continued)

megawatt	one million watts
meteorological station	location where the weather is recorded (Chap. 3)
panemone	a name for drag-type vertical axis wind machines; coming from <u>pan</u> (all directions) and <u>anemone</u> (wind), it could describe Darrieus type machines also, but is not generally used except for drag machines (Chap. 1,5)
power	the rate work is performed - mechanical power is force times velocity (see <u>horsepower</u>); electric power is volt times amps
power coefficient	ratio of power output to power input; often referred to as efficiency (Chap. 5)
rated power	the power output (watts or horsepower) of a wind machine; can be its maximum power, or a power output at some wind speed less than the maximum speed before governing controls reduce the power (Chap. 5)
rated speed	wind speed at which rated power occurs; can be speed at which a governor takes over, or can be a wind speed lower than this; an industry standard for rated speed does not exist at this time (Chap. 5)
rectify	convert ac to dc, see also <u>diodes</u> (Chap. 5)
resistor	an electric device which "resists" electric current flow, used to control current (e.g., field-current in a generator) (Chap. 5)
return time	time before the wind returns to a higher, specified value, such as the cut-in speed of a windmill (Chap. 3)
rotor	the power producing structure of a wind turbine (e.g., the blades) (Chap. 5)
rotor efficiency	the efficiency of the rotor only; does not include transmissions, pumps, generators, or line or head loss (Chap. 5)
rotor power coefficient	same as rotor efficiency
run of the wind	the distance the wind travels during a specific time period; this usually refers to the dial reading from a wind anemometer (Chap. 3)

GLOSSARY (Continued)

shelter belt	a tree row planted in windy country to shelter crops and soil (Chap. 3)
sine wave	the type of ac generated by utility companies, rotary inverters, sophisticated solid-state inverters, and ac generators (Chap. 5)
solidity	ratio of rotor blade surface area to frontal (or swept) area of the entire windwheel (Chap. 5)
square wave	type of ac output from low-cost solid-state inverters; usable for many appliances, but may affect stereos and TV sets (Chap. 5)
synchronous generator	an ac generator which operates together with ac power source (similar to <u>asynchronous generator</u>) must turn at a precise rpm to hold frequency and phase relationship to the ac source (Chap. 5)
synchronous inverter	also called "line commutated inverter" inverts dc to ac (see <u>inverter</u>) but must have another ac source (e.g., utility mains, or ac gas generator) for voltage and frequency reference; ac is created synchronously, that is, in phase and at same frequency as outside ac source (Chap. 5)
torque	a measure of force from windwheel causing rotary motion of power shaft (Chap. 2,5)
turbulence	rapid wind speed fluctuations; gusts are maximum values of wind turbulence; randomness in the wind (Chap. 3)
voltage	the electrical pressure which causes current flow (amps) (Chap. 5)
watt	unit of electric power, see also <u>horsepower</u> (Chap. 2,4,5)
watt-hour	unit of electric energy, see also <u>kilowatt-hour</u>
watt per square meter	a measure of the energy in the wind passing through a square meter of area (Chap. 3)
WECS	wind energy conversion system
windmill	archaic term for wind system; still used to refer to high solidity rotor water pumpers and older mechanical output machines
wind power	power in the wind, part of which can be extracted by a wind turbine; see <u>power</u> (Chap. 3,5)

GLOSSARY (Continued)

- wind power profile** how the wind power changes with height above the surface of the ground or water (Chap. 3). Typical plots of wind power profiles for flat terrain with different types of plant and tree cover are presented in Figure 3-14; the wind power profile is proportional to the cube of the wind speed profile (see wind speed profile)
- wind rose** a plot showing the average (usually a monthly or yearly average) wind speed from each direction (usually 16 directions are used) and percent of time the wind blows from each direction (Chap. 3, see Figure 3-5)
- wind speed profile** how the wind speed changes with height above the surface of the ground or water (Chap. 3); typical plots of wind speed profiles for flat terrain with different types of plant and tree cover are presented in Reference 10, as well as sample wind speed profiles over ridges
- wind turbine, wind system or wind machine** accepted modern terms for devices which extract power from the wind; can refer to devices which produce mechanical or electrical output
- wind turbine generator** a wind system which produces electrical power; abbreviated WTG
- windwheel** same as rotor
- work** force lined up with the direction of movement times the distance moved; for example, by lifting a 1-pound weight up 1 foot, 1 foot-pound of work is performed. A 2-pound weight lifted up 3 feet requires $2 \times 3 = 6$ foot-pounds of work

APPENDIX 1

WIND POWER IN THE UNITED STATES AND SOUTHERN CANADA

The following table lists the wind power at 750 stations in the United States and Southern Canada. The data in the table have been extracted from the report Wind Power Climatology in the United States by Jack Reed of Sandia Laboratories, Albuquerque, New Mexico (June 1975). This report (SAND 74-0348) can be ordered from the National Technical Information Service, U.S. Department of Commerce, 5285 Port Royal Road, Springfield, VA 22151. A printed copy costs \$7.60 and a microfiche copy costs \$2.25 (see if your local library has a microfiche reader). Besides the data in this table, the report contains average monthly results for each station of the percentage of time the velocity was in each of about eight speed ranges, i.e.:

	0-3	4-7	8-12	13-18	19-24	25-31	32-38	39-46	mph
January:	27.6	26.1	23.5	18.6	3.5	0.6	0.2	0	

The data have not been corrected for varying heights of the wind anemometer. Also, possible distortions in the wind pattern by natural terrain features, trees, and buildings are not accounted for. Because of this, no particular set of these data can be blindly accepted as representative of a particular region (see discussion in Chapter 3).

The stations are listed by region within each state. The states are listed first, alphabetically, then the Southern Canadian provinces. Listed on each line are the following:

1. State - U.S. Postal abbreviation (obvious abbreviations of Canadian provinces).
2. Location - the most common abbreviations are APT (airport), AFB (Air Force Base), AFS (Air Field Station), IAP (International Airport), IS (island), NAF (Naval Air Field), PT (point), WBO (Weather Bureau Office).
3. International station number
4. Latitude in degrees and minutes (3439 = 34° 39' N)
5. Longitude in degrees and minutes (8646 = 86° 46' W)
6. Average wind speed in knots (multiply by 1.15 to convert to mph, V_{ave})
- 7- Twelve average monthly wind power values in watts per
8. square meter (multiply by 0.0929 to convert to watts per square foot)
9. Average of the previous twelve monthly power values.

MONTHLY AVERAGE WIND POWER IN THE UNITED STATES AND SOUTHERN CANADA*

State	Location	Sta. No.	Lat	Long	Ave. Speed knots	Wind Power, Watts per Square Meter													Ave.
						J	F	M	A	M	J	J	A	S	O	N	D		
AL	Huntsville	3856	3439	8646	6.6	80	109	118	87	48	37	29	31	56	50	78	87	66	
AL	Foley	93826	3358	8605	8.0	133	182	153	174	142	106	73	66	109	96	116	115	122	
AL	Gadsden	75258	3358	8605	5.8	84	104	114	99	43	34	25	21	40	45	63	53	61	
AL	Birmingham APT	13876	3334	8645	7.3	127	157	156	137	80	64	49	44	68	68	108	106	97	
AL	Tuscaloosa, Vn D Graf APT	93806	3314	8737	5.1	79	79	93	69	33	21	15	21	28	36	55	69	49	
AL	Selma, Craig AFB	13850	3221	8659	5.7	74	86	91	68	42	34	29	26	37	31	48	54	51	
AL	Montgomery	13895	3218	8624	6.1	74	90	85	68	39	35	34	26	39	36	51	62	53	
AL	Montgomery, Maxwell AFB	13821	3223	8621	4.8	58	67	69	51	28	25	20	19	27	26	39	45	39	
AL	Ft. Rucker, Cairns AAF	3850	3116	8543	4.7	40	50	55	41	23	18	12	12	19	19	29	35	30	
AL	Evergreen	13885	3125	8702	5.3	66	69	78	57	29	18	17	17	21	24	38	51	40	
AL	Mobile, Brookley AFB	13838	3038	8804	7.3	105	104	128	119	94	58	43	41	69	51	72	89	80	
AK	Annette IS	25308	5502	13134	9.5	320	264	216	199	110	97	71	77	128	297	324	119	199	
AK	Ketchikan	952	5521	13139	5.8	59	53	42	52	47	37	38	44	43	67	75	75	57	
AK	Craig	25317	5529	13309	7.9	185	159	167	132	82	95	71	55	113	186	174	165	128	
AK	Petersburg	960	5649	13257	3.7	26	40	37	41	32	23	22	22	24	29	22	21	33	
AK	Sitka	961	5703	13520	3.5	109	26	34	42	27	23	22	14	34	44	46	93	37	
AK	Juneau APT	25309	5822	13435	7.5	119	134	123	127	95	70	60	67	108	170	157	159	115	
AK	Haines	955	5910	13526	8.0	218	202	203	148	74	61	94	54	72	160	238	159	146	

* See previous page for an explanation of column headings.

MONTHLY AVERAGE WIND POWER IN THE UNITED STATES AND SOUTHERN CANADA (Continued)

State	Location	Sta. No.	Lat	Long	Ave. Speed knots	Wind Power, Watts per Square Meter												Ave.
						J	F	M	A	M	J	J	A	S	O	N	D	
AK	Yakutat APT	25339	5931	13940	7.0	177	144	114	100	90	71	56	64	96	181	183	169	114
AK	Middleton IS AFS	25403	5927	14619	11.9	625	597	468	355	238	141	96	134	243	519	582	608	376
AK	Cordova, Mile 13 APT	26410	6430	14530	4.4	46	48	42	41	37	23	18	17	32	53	47	48	36
AK	Valdez	26442	6107	14616	4.3	72	28	75	41	36	16	13	7	7	45	100	72	53
AK	Anchorage IAP	26451	6110	15001	3.9	61	95	48	61	108	76	61	52	46	38	38	50	61
AK	Anchorage, Merrill Fld	26409	6113	14950	4.9	57	66	29	27	41	40	23	22	30	30	59	23	37
AK	Anchorage, Elmendorf AFB	26401	6115	14948	4.4	46	60	50	41	40	34	24	22	26	30	46	33	36
AK	Kenai APT	26523	6034	15115	6.6	96	109	94	66	61	63	56	54	53	83	85	80	74
AK	Northway APT	26412	6257	14156	3.9	16	21	30	44	40	42	33	32	27	22	18	16	28
AK	Gulkana	26425	6209	14527	5.8	45	88	85	105	111	98	83	100	95	76	48	40	81
AK	Big Delta	26415	6400	14544	8.2	447	322	239	147	148	85	68	102	163	209	300	333	215
AK	Fairbanks IAP	26411	6449	14752	4.0	10	16	25	37	50	44	33	29	18	23	13	10	27
AK	Fairbanks, Ladd AFB	26403	6451	14735	3.5	10	17	24	28	36	35	23	29	23	24	12	9	23
AK	Ft. Yukon APT	26413	6634	14516	5.7	30	41	64	81	91	84	86	81	74	52	51	31	64
AK	Benana APT	26435	6433	14905	5.1	60	44	43	45	46	34	27	26	33	42	45	44	42
AK	Hanley Hot Springs	567	6500	15039	4.0	76	54	84	109	93	89	53	42	62	104	62	52	62
AK	Tanana	976	6510	15206	6.8	22	85	89	83	56	53	47	29	50	64	56	80	73
AK	Ruby	508	6444	15526	6.5	58	133	119	84	40	51	46	42	64	76	119	54	78
AK	Galena APT	26501	6444	15656	5.4	56	69	66	77	51	53	48	61	63	59	59	49	59
AK	Katag	449	6430	14948	6.7	22	182	24	81	39	21	49	22	42	106	40	51	56

5-7

MONTHLY AVERAGE WIND POWER IN THE UNITED STATES AND SOUTHERN CANADA (Continued)

State	Location	Sta. No.	Lat	Long	Ave. Speed knots	Wind Power, Watts per Square Meter												Avg
						J	F	M	A	M	J	J	A	S	O	N	D	
AK	Unalakleet APT	26627	6353	16048	10.5	520	502	336	191	112	96	116	146	175	234	395	376	265
AK	Moses Point APT	26620	6412	16203	10.6	329	363	275	279	149	129	181	233	217	222	246	263	241
AK	Golovin	502	6433	16302	9.6	188	229	246	250	142	117	178	264	271	258	369	256	236
AK	Nome APT	26617	6430	16526	9.7	328	308	228	225	153	119	117	162	189	230	263	238	217
AK	Northeast Cape AFS	26632	6319	16858	11.0	468	263	246	347	239	137	218	240	288	462	632	387	328
AK	Tin City AFS	26634	6534	16755	15.0	763	919	811	658	427	271	260	334	352	522	722	728	549
AK	Kotzebue	26616	6652	16238	11.2	455	418	310	294	161	187	212	234	228	270	397	366	291
AK	Cape Lisburne AFS	26631	6853	16608	10.5	432	268	335	266	227	210	303	216	266	432	444	333	314
AK	Indian Mountain AFS	26535	6600	15342	5.4	115	113	88	58	57	37	36	36	52	86	95	104	70
AK	Bettles APT	26533	6655	15131	6.3	28	44	57	62	66	62	44	38	43	43	43	47	48
AK	Wiseman	979	6726	15013	3.1	28	26	16	15	24	15	23	14	12	12	26	16	23
AK	Umiat	26537	6922	15208	6.0	113	121	43	77	80	93	62	53	57	51	121	78	76
AK	Point Barrow	27502	7118	15647	10.5	215	194	162	167	169	143	145	208	211	258	286	183	197
AK	Barrier IS	26401	7008	14338	11.3	512	468	379	279	216	145	123	208	287	470	486	425	341
AK	Sparrevohn AFS	26534	6106	15534	4.7	69	73	108	76	47	35	36	41	54	63	74	82	63
AK	McGrath	26510	6258	15537	4.2	13	27	29	37	39	35	34	35	32	24	15	12	27
AK	Tataline AFS	26536	6253	15557	4.4	25	37	36	37	38	27	27	29	33	35	24	21	31
AK	Flat	16	6229	15805	8.1	206	266	205	150	116	100	81	108	143	168	185	184	177
AK	Aniak	26516	6135	15932	5.6	51	59	63	59	49	37	27	34	41	47	47	42	46
AK	Bethel APT	26615	6047	16148	9.8	229	258	224	166	125	108	110	137	140	158	185	211	17

MONTHLY AVERAGE WIND POWER IN THE UNITED STATES AND SOUTHERN CANADA (Continued)

State	Location	Sta. No.	Lat	Long	Ave. Speed knots	Wind Power, Watts Per Square Meter												Ave.
						J	F	M	A	M	J	J	A	S	O	N	D	
AK	Cape Romanzof AFS	26633	6147	16602	11.7	692	699	493	476	246	124	110	154	234	305	520	654	380
AK	Cape Newenham AFS	25623	5839	16204	9.8	400	371	330	288	168	119	101	142	165	212	300	315	241
AK	Kodiak FWC	25501	5744	15231	8.8	328	271	258	198	124	87	52	77	120	210	294	329	189
AK	King Salmon APT	25503	5841	15639	9.2	250	260	235	180	182	138	92	139	156	180	230	206	191
AK	Port Heiden APT	25508	5657	15837	12.9	576	564	493	361	289	273	225	381	466	551	439	565	429
AK	Port Moller	25625	5600	16031	8.8	158	168	171	195	135	81	108	144	164	222	260	219	172
AK	Cold Bay APT	25624	5512	16243	14.6	736	731	699	580	506	465	428	507	462	606	652	631	573
AK	Dutch Harbor NS	25611	5353	16632	9.6	355	376	295	223	135	125	69	105	169	390	419	266	233
AK	Driftwood Bay	25515	5358	16651	8.0	204	203	154	148	115	72	88	77	71	120	161	182	131
AK	Unak IS, Cape NFB	25602	5323	16754	13.5	651	688	577	514	454	251	163	249	466	603	606	723	497
AK	Nikolski	25626	5255	16847	14.0	538	560	532	566	437	321	239	283	361	634	732	662	482
AK	Adak	25704	5153	17638	12.2	426	467	528	453	366	223	218	258	331	502	481	525	404
AK	Amchitka IS	45702	5123	17915	18.0	1764	1517	1418	1062	653	448	405	457	740	1053	1155	1569	1025
AK	Attu IS	45709	5250	17311	11.2	553	582	508	403	235	162	135	129	360	366	414	554	368
AK	Shemya APT	45715	5243	17406	15.7	887	932	878	641	483	266	235	285	432	301	977	870	633
AK	St. Paul IS	25713	5707	17016	15.0	758	867	684	518	355	207	175	282	399	693	691	791	547
AZ	Grand Canyon	378	3557	11209	6.2	38	43	49	71	66	55	35	31	57	58	44	28	49
AZ	Winslow APT	23194	3501	11044	7.3	104	104	232	169	161	141	93	77	63	73	63	78	111
AZ	Flagstaff, Pulliam APT	3103	3508	11140	6.4	71	70	96	95	93	86	40	33	52	56	69	63	69
AZ	Maine	178	3509	11157	8.9	132	186	218	253	240	224	111	68	116	178	139	158	151

A-5

MONTHLY AVERAGE WIND POWER IN THE UNITED STATES AND SOUTHERN CANADA (Continued)

State	Location	Sta. No.	Lat	Long	Ave. Speed knots	Wind Power, Watts Per Square Meter												Ave.
						J	F	M	A	M	J	J	A	S	O	N	D	
AZ	Ashfork	171	3514	11233	7.5	111	116	154	201	142	126	82	68	86	100	103	82	114
AZ	Kingman	381	3516	11357	8.9	126	156	172	203	153	166	126	99	102	124	115	107	138
AZ	Prescott	23184	3439	11226	7.5	54	95	117	144	138	124	75	56	67	57	59	44	85
AZ	Yuma APT	23195	3240	11436	6.8	55	62	68	77	71	69	93	77	45	40	55	51	62
AZ	Phoenix	23183	3326	11201	4.8	16	28	34	39	37	35	43	31	28	24	22	17	29
AZ	Phoenix, Luke AFB	23111	3332	11223	4.6	21	31	41	52	49	43	49	39	25	21	20	18	34
AZ	Chandler, Williams AFB	23104	3318	11140	4.1	17	21	28	35	34	33	41	33	26	22	18	16	26
AZ	Tucson APT	23160	3207	11056	7.3	71	59	69	90	87	73	75	54	62	78	82	72	74
AZ	Tucson	23160	3207	11056	7.1	71	59	69	90	87	73	75	54	62	78	82	72	74
AZ	Tucson, Davis-Monthan AFB	23109	3210	11053	5.7	48	48	57	63	56	60	51	35	42	40	43	45	49
AZ	Ft. Huachuca	3124	3134	11020	5.7	49	58	84	96	80	66	39	27	30	30	34	41	53
AZ	Douglas	93026	3128	10937	6.4	84	94	166	143	128	86	61	46	47	63	62	75	87
AR	Walnut Ridge APT	93991	3608	9056	6.0	93	81	103	104	58	27	32	28	43	64	75	62	
AR	Blytheville AFB	13814	3558	8957	6.4	85	106	108	111	66	25	36	39	67	71	65		
AR	Ft. Smith APT	13964	3520	9422	7.4	76	86	116	104	81	67	51	45	50	66	75	73	
AR	Little Rock	13963	3444	9214	7.6	82	91	105	96	70	58	46	46	48	50	73	71	70
AR	Jacksonville, Lt1. Rk. AFB	3930	3455	9209	5.8	61	67	85	70	47	34	28	24	28	29	45	49	48
AR	Pine Bluff, Grider Fld	93988	3710	9156	6.5	102	89	102	87	51	39	31	29	25	45	71	81	64
AR	Texarkana, Webb Fld	13977	3327	9400	7.7	92	108	128	115	77	69	48	49	62	61	74	87	80
CA	Needles APT	23179	3446	11437	6.7	108	125	128	112	108	98	67	67	58	78	113	124	97

A-6

MONTHLY AVERAGE WIND POWER IN THE UNITED STATES AND SOUTHERN CANADA (Continued)

State	Location	Sta. No.	Lat	Long	Ave. Speed knots	Wind Power, Watts Per Square Meter												Ave.
						J	F	M	A	M	J	J	A	S	O	N	D	
CA	El Centro NAAS	23199	3249	11541	7.7	98	126	171	208	225	189	80	73	79	86	98	76	127
CA	Thermal	3104	3338	11610	9.1	66	79	103	149	191	153	125	114	119	92	76	63	111
CA	Imperial Bch., Ream Fld	93115	3234	11707	5.9	48	51	54	54	52	45	35	32	30	31	43	42	43
CA	San Diego, North IS	93112	3243	11712	5.3	32	41	56	56	49	41	33	32	35	31	30	32	39
CA	San Diego	23188	3244	11710	5.4	30	33	40	47	47	40	30	29	27	25	22	21	31
CA	Miramar NAS	93107	3252	11707	4.4	23	24	28	30	26	19	16	17	18	19	20	24	22
CA	San Clemente IS NAS	93117	3301	11835	6.3	53	72	89	97	67	48	33	32	33	32	54	69	55
CA	San Nicholas IS	93116	3315	11948	9.9	152	199	295	306	348	244	161	166	164	140	180	159	209
CA	Camp Pendleton	3154	3313	11724	5.2	30	35	45	61	53	43	43	44	36	24	28	29	38
CA	Oceanside	189	3318	11721	8.0	129	122	108	82	67	59	49	49	64	66	96	116	87
CA	Laguna Beach	195	3332	11747	5.0	35	38	44	37	30	30	27	26	25	25	22	32	34
CA	El Toro MCAS	93101	3340	11744	4.8	45	38	33	30	26	22	19	19	19	23	36	43	28
CA	Santa Ana MCAF	93114	3342	11750	4.6	43	43	47	46	37	31	30	25	25	26	36	43	37
CA	Los Alamitos NAS	93106	3348	11807	4.8	36	39	47	44	41	37	28	25	22	23	36	37	34
CA	Long Beach AFB	23129	3349	11809	4.9	27	40	45	48	43	35	34	32	31	27	29	26	35
CA	Los Angeles IAP	23174	3356	11824	5.9	40	57	69	70	63	49	43	41	39	36	38	35	46
CA	Ontario	93180	3404	11737	7.7	36	117	109	118	148	124	135	135	92	71	46	127	103
CA	Riverside, March AFB	23119	3353	11715	4.4	35	43	40	44	49	51	52	49	37	28	29	32	41
CA	San Bernardino, Norton AFB	23122	3406	11715	3.5	43	43	33	27	25	22	22	20	19	17	28	29	28
CA	Victorville, George AFB	23131	3435	11723	7.7	89	134	170	183	163	138	89	75	64	70	87	80	118

MONTHLY AVERAGE WIND POWER IN THE UNITED STATES AND SOUTHERN CANADA (Continued)

State	Location	Sta. No.	Lat	Long	Ave. Speed knots	Wind Power, Watts Per Square Meter												Ave.
						J	F	M	A	M	J	J	A	S	O	N	D	
CA	Daggett	23161	3452	11647	9.6	94	173	315	290	355	236	177	159	145	121	107	74	187
CA	China Lake, Inyokern NAP	93104	3541	11741	7.1	121	156	238	249	225	186	124	126	113	124	103	93	155
CA	Muroc, Edwards AFB	23114	3455	11754	7.9	90	118	187	206	236	230	155	131	99	87	82	83	141
CA	Palmdale	81	3438	11806	10.2	163	205	226	267	315	328	254	200	165	158	130	109	225
CA	Palmdale APT	23182	3438	11805	8.8	121	146	233	234	234	229	173	141	107	104	113	132	163
CA	Saugus	83	3423	11832	6.3	105	128	88	96	96	108	101	88	67	76	105	90	89
CA	Van Nuys	23130	3413	11830	4.6	105	82	66	50	43	21	22	19	18	22	90	69	49
CA	Oxnard AFB	23136	3413	11905	4.4	63	56	49	46	43	26	20	15	19	31	50	76	41
CA	Point Mugu NAS	93111	3407	11907	5.6	100	79	71	78	51	33	28	26	28	35	76	82	55
CA	Santa Maria	23273	3454	12027	6.5	75	80	114	94	93	93	63	57	56	66	79	91	82
CA	Vandenberg, Cooke AFB	93214	3444	12034	6.1	62	67	99	97	115	67	34	33	41	51	58	58	65
CA	Pt. Arguello	93215	3440	12035	7.2	72	105	138	135	133	79	58	54	51	74	76	66	85
CA	San Louis Obispo	93206	3514	12039	6.9	60	69	134	127	146	173	105	120	131	129	89	73	115
CA	Estero	395	3526	12052	4.3	83	66	69	76	60	50	22	31	42	47	44	77	53
CA	Paso Robles, Sn La Obispo	93209	3540	12038	5.5	34	39	57	76	105	127	106	83	59	42	32	30	64
CA	Jolon	93218	3600	12114	2.8	9	6	10	6	11	11	8	8	6	4	6	6	7
CA	Monterey JAF	23245	3635	12152	5.0	30	33	45	48	51	45	35	32	23	21	20	30	35
CA	Ft. Ord, Fritzsche AAF	93217	3641	12146	5.7	30	31	46	61	67	63	66	59	41	34	25	24	47
CA	Taft, Gardner Fld.	23126	3507	11918	4.4	20	18	20	29	45	46	31	22	18	16	18	17	26
CA	Bakersfield, Meadows Fld.	23155	3525	11903	5.4	27	33	46	55	69	65	47	43	34	25	24	28	41

MONTHLY AVERAGE WIND POWER IN THE UNITED STATES AND SOUTHERN CANADA (Continued)

State	Location	Sta. No.	Lat	Long	Ave. Speed Knots	Wind Power, Watts Per Square Meter												Ave.
						J	F	M	A	M	J	J	A	S	O	N	D	
CA	Bakersfield, Minter Fld.	23102	3530	11911	5.0	26	31	38	49	61	73	38	25	22	21	19	25	34
CA	Lemoore NAS	23110	3620	11957	4.8	21	30	38	40	45	47	35	29	25	27	18	19	30
CA	Fresno, Hammer Fld.	93193	3646	11943	5.5	24	28	42	48	60	62	42	33	25	23	17	20	35
CA	Bishop APT	23157	3722	11822	7.5	74	106	161	145	129	100	80	81	85	101	88	80	103
CA	Merced, Castle AFB	23203	3722	12004	6.0	56	66	72	74	69	78	59	52	44	44	34	42	59
CA	Livermore	196	3742	12147	7.9	109	108	115	124	158	180	173	143	107	85	64	71	122
CA	San Jose APT	23293	3722	12155	6.4	51	47	61	61	86	84	52	43	46	34	45	47	54
CA	Sunnyvale, Moffett Fld.	23244	3725	12204	5.4	47	50	54	59	65	73	62	54	41	35	32	56	51
CA	San Francisco IAP	23234	3737	12223	9.5	96	129	183	228	268	280	236	211	171	141	80	91	176
CA	Farallon Is	495	3740	12300	9.6	61	406	287	193	188	208	100	91	83	106	204	275	212
CA	Alameda FWC	23239	3748	12210	7.4	92	94	122	125	129	124	99	87	65	65	69	81	93
CA	Oakland	23230	3744	12212	6.8	52	75	77	92	101	98	74	69	57	50	40	51	71
CA	San Rafael, Hamilton AFB	23211	3804	12231	4.8	51	52	54	52	50	50	39	39	30	34	32	51	45
CA	Fairfield, Travis AFB	23202	3816	12156	10.7	114	153	176	232	347	486	577	481	332	182	106	91	270
CA	Point Arena	499	3855	12342	13.0	401	398	361	488	500	614	388	513	321	368	320	467	421
CA	Sacramento	23232	3831	12130	7.8	145	145	126	118	116	128	92	83	64	70	61	123	95
CA	Sacramento, Mather AFB	23206	3834	12110	6.0	117	108	89	69	63	69	56	45	38	46	59	88	72
CA	Sacramento, McClellan AFB	23208	3840	12124	6.5	107	102	98	73	83	90	62	56	49	67	75	84	79
CA	Auburn	190	3857	12104	8.4	106	148	109	76	77	64	65	65	64	57	69	67	83
CA	Blue Canyon APT	23225	3917	12042	8.4	237	212	168	106	92	75	57	64	65	110	130	188	122
CA	Donner Summit	23226	3920	12022	12.1	1100	619	729	269	266	226	173	168	154	439	579	645	463

MONTHLY AVERAGE WIND POWER IN THE UNITED STATES AND SOUTHERN CANADA (Continued)

State	Location	Sta. No.	Lat	Long	Ave. Speed Knots	Wind Power, Watts Per Square Meter												Ave.
						J	F	M	A	M	J	J	A	S	O	N	D	
CA	Beale AFB	93216	3908	12126	5.1	75	59	64	56	49	52	31	29	34	39	43	62	50
CA	Williams	498	3906	12209	8.2	163	172	179	112	126	120	78	64	78	105	112	116	111
CA	Ft. Bragg	590	3927	12349	5.9	75	88	82	96	46	44	25	26	25	33	50	52	51
CA	Eureka, Arkata APT	24283	4059	12406	6.0	93	93	109	102	115	87	56	42	35	50	61	75	75
CA	Mt. Shasta	595	4116	12216	11.9	456	535	349	309	343	297	177	163	182	214	295	262	309
CA	Redding	592	4034	12224	7.9	71	86	94	81	88	89	69	62	68	68	72	70	74
CA	Montague	197	4144	12231	5.8	65	130	120	122	130	131	125	106	76	75	71	57	98
CA	Montague, Siskiyou Co APT	24259	4146	12228	5.3	106	108	123	115	78	63	59	50	45	64	82	89	80
CO	La Junta	23067	3803	10331	8.3	115	136	222	204	168	164	94	84	85	78	139	115	134
CO	Alamosa APT	23061	3727	10552	7.4	92	110	195	254	214	167	84	70	85	91	77	74	127
CO	Pueblo, Memorial APT	93058	3817	10431	7.7	101	122	180	231	168	129	105	84	82	81	93	104	121
CO	Colo Springs, Peterson Fld	93037	3849	10443	9.0	142	163	217	212	189	163	99	86	105	106	138	128	142
CO	Ft. Carson, Butts AAF	94015	3841	10446	7.3	85	93	145	218	127	131	63	71	68	112	74	87	107
CO	Denver	23062	3945	10452	8.8	117	139	182	183	132	126	94	83	85	88	118	136	126
CO	Denver, Lowry AFB	23012	3943	10454	8.1	115	94	131	163	112	100	95	87	102	88	126	121	109
CO	Aurora Co, Buckley Fld.	23036	3942	10445	6.7	60	60	79	121	79	67	54	52	51	51	57	59	66
CO	Akron, Washington Co APT	24015	4010	10313	11.7	216	313	383	359	276	239	226	184	243	212	252	280	242
CO	Rifle Co, Garfield Co. APT	23069	3932	10744	4.1	17	32	37	69	51	39	26	23	31	25	23	15	31
CO	Craig	24046	4031	10733	7.7	57	63	70	97	80	58	50	32	54	61	56	51	62
CT	Hartford, Bradley Fld.	14740	4156	7241	7.7	115	127	142	129	96	75	54	53	61	74	93	100	93

A-10

MONTHLY AVERAGE WIND POWER IN THE UNITED STATES AND SOUTHERN CANADA (Continued)

State	Location	Sta. No.	Lat	Long	Ave. Speed knots	Wind Power, Watts Per Square Meter													Ave.
						J	F	M	A	M	J	J	A	S	O	N	D		
CT	New Haven, Tweed APT	14758	4116	7253	8.7	117	122	142	120	83	55	52	60	78	89	114	106	98	
CT	Bridgeport APT	94702	4110	7308	10.4	244	274	256	219	158	114	96	101	139	192	214	251	186	
DE	Dover AFB	13707	3908	7528	7.7	135	152	148	125	85	69	49	49	73	78	99	104	96	
DE	Delaware Breakwater	404	3848	7506	12.7	449	570	477	430	283	196	163	190	270	403	391	410	343	
DE	Wilmington, New Castle APT	13781	3940	7536	8.1	127	149	175	147	105	85	66	59	61	84	118	126	109	
DC	Washington, Andrews AFB	13705	3848	7653	7.2	130	156	161	126	77	51	39	36	45	62	101	109	90	
DC	Washington, Bolling AFB	13710	3850	7701	7.5	125	173	171	140	84	58	45	40	51	72	119	112	101	
DC	Washington National	13743	3851	7702	8.6	142	151	163	134	95	82	62	44	67	85	103	107	105	
DC	Washington, Dulles IAP	93738	3857	7727	6.7	104	115	118	111	66	42	37	41	40	42	66	78	68	
FL	Key West NAS	12850	2435	8147	9.5	158	172	172	176	122	98	78	71	133	133	139	147	131	
FL	Homestead AFB	12826	2529	8023	6.4	61	74	90	89	72	51	31	35	66	59	60	56	60	
FL	Miami	12839	2548	8016	7.8	87	98	111	116	80	59	58	54	90	88	78	79	80	
FL	Boca Raton	12803	2622	8006	8.2	80	108	125	135	109	72	51	55	109	140	108	106	99	
FL	West Palm Beach	12865	2643	8003	8.3	123	129	151	145	106	79	70	67	80	105	126	102	108	
FL	Ft. Myers	12835	2635	8152	7.0	93	111	153	156	104	79	58	70	99	96	90	101	101	
FL	Ft. Myers, Hendricks Fld.	12802	2638	8142	7.1	59	68	98	91	74	51	38	47	76	85	58	60	69	
FL	Tampa	12842	2758	8232	7.5	85	100	100	101	75	57	40	30	51	65	75	80	68	
FL	Tampa, Macdill AFB	12810	2751	8230	6.9	73	95	98	83	59	51	35	40	67	73	62	57	67	
FL	Avon Park Range AAF	12804	2738	8120	5.4	50	51	55	64	45	30	18	24	51	73	43	48	45	
FL	Orlando, Herndon APT	12841	2833	8120	8.2	86	110	131	120	99	83	69	65	41	107	89	99	97	

11-4

MONTHLY AVERAGE WIND POWER IN THE UNITED STATES AND SOUTHERN CANADA (Continued)

State	Location	Sta. No.	Lat	Long	Ave. Speed knots	Wind Power, Watts Per Square Meter												Ave
						J	F	M	A	M	J	J	A	S	O	N	D	
FL	Orlando, McCoy AFB	12815	2827	8118	5.9	61	76	71	67	46	41	29	24	43	48	46	51	49
FL	Titusville	109	2831	8047	6.7	57	72	72	58	44	42	43	32	47	56	50	56	49
FL	Cocoa Beach, Patrick AFB	12867	2814	8036	8.8	127	149	144	134	115	80	52	62	130	191	143	127	119
FL	Cape Kennedy AFS	12868	2829	8033	7.4	82	107	103	90	71	55	41	37	82	94	75	76	72
FL	Daytona Beach APT	12834	2911	8103	8.9	112	141	146	142	125	94	91	95	113	161	108	116	120
FL	Jacksonville, Cecil FLD NAS93832	93832	3013	8157	5.2	43	65	56	50	35	31	21	19	39	39	37	39	39
FL	Jacksonville NAS	93837	3014	8141	6.9	61	80	81	70	58	60	40	38	76	77	62	64	62
FL	Mayport NAAS	3853	3023	8125	7.2	82	105	92	90	67	67	40	39	110	90	74	68	76
FL	Tallahassee	93805	3023	8422	5.8	51	59	76	66	41	28	24	28	39	43	51	51	49
FL	Marianna	13851	3050	8511	6.9	92	104	115	86	65	48	43	36	55	61	71	84	72
FL	Panama City, Tynwall AFB	13846	3004	8535	6.7	79	101	120	97	62	47	42	37	65	55	64	75	71
FL	Crestview	13884	3047	8631	5.6	68	77	85	57	31	22	16	16	35	38	60	65	47
FL	Valparaiso, Eglin AFB	13850	3029	8631	6.2	66	74	78	71	56	48	40	37	55	46	55	59	56
FL	Valparaiso, Duke Fld	3844	3039	8632	7.0	104	123	105	115	78	46	33	38	40	48	84	88	72
FL	Valparaiso, Hurlburt Fld	3852	3025	8641	5.5	55	62	55	51	36	31	23	21	34	33	39	45	40
FL	Milton, Whiting Fld NAAS	93841	3042	8701	7.1	107	114	125	93	62	44	36	32	65	57	84	92	77
FL	Pensacola, Saufley Fld NAS	3815	3026	8711	6.8	98	109	110	94	57	42	37	35	79	63	31	99	74
FL	Pensacola, Ellyson Fld	3840	3032	8712	7.8	87	104	116	112	86	62	48	44	65	57	74	81	77
FL	Pensacola, Forest Sherman Fld3855	3021	8719	8.0	110	119	113	106	79	75	56	57	73	71	86	99	81	
GA	Valdosta, Moody AFB	13857	3058	8312	4.8	40	51	54	43	29	28	21	19	33	32	29	35	33

MONTHLY AVERAGE WIND POWER IN THE UNITED STATES AND SOUTHERN CANADA (Continued)

State	Location	Sta. No.	Lat	Long	Ave. Speed knots	Wind Power, Watts Per Square Meter												Ave.
						J	F	M	A	M	J	J	A	S	O	N	D	
GA	Moultrie	13835	3108	8342	6.6	73	89	84	79	45	32	34	30	47	50	59	75	58
GA	Albany, Turner AFB	13815	3135	8407	5.3	50	68	73	55	33	27	23	19	33	27	36	41	41
GA	Brunswick, Glynco NAS	93836	3115	8128	5.5	39	54	53	52	40	36	28	25	38	39	35	37	40
GA	Ft. Stewart, Wright AAF	3875	3153	8134	3.7	20	30	32	23	22	14	12	10	14	16	15	23	20
GA	Savannah	3822	3208	8112	7.5	88	108	98	87	56	49	46	45	61	62	63	72	69
GA	Savannah, Hunter AFB	13824	3201	8108	5.8	59	76	86	70	44	40	34	31	36	43	48	47	51
GA	Macon	13836	3242	8339	8.0	92	112	103	117	69	59	56	44	61	56	68	73	75
GA	Warner Robbins AFB	13860	3238	8336	4.9	54	76	75	59	35	26	22	18	27	31	42	44	41
GA	Ft. Benning	13829	3221	8500	3.9	45	64	71	51	28	21	13	13	21	22	32	36	33
GA	Winder	12	3400	8342	7.6	99	113	93	91	57	50	51	44	43	79	92	92	78
GA	Adairsville	110	3455	8456	6.2	87	95	109	74	56	42	36	33	33	49	100	71	64
GA	Augusta, Bush Fld	3820	3322	8158	5.9	68	83	87	83	43	41	36	32	43	39	45	49	53
GA	Atlanta	13874	3339	8426	8.5	170	169	165	151	84	67	56	46	73	80	109	127	106
GA	Marietta, Dobbins AFB	13864	3355	8432	5.8	89	99	105	96	52	38	34	30	40	50	66	72	66
HI	Honolulu IAP	22521	2120	15055	9.8	118	131	164	163	155	172	189	194	141	128	133	144	153
HI	Barbers Point NAS	22514	2119	15804	8.3	106	99	104	102	93	97	100	102	77	76	95	104	95
HI	Wahiawa, Wheeler AFB	22508	2129	15802	5.9	48	49	61	59	60	70	72	65	43	40	39	49	54
HI	Waiialua, Mokoleis Fld	22507	2135	15812	7.7	59	52	97	141	115	136	151	158	113	84	89	108	109
HI	Kaneohe Bay MCAS	22519	2127	15747	10.0	131	144	157	156	140	137	143	143	116	113	135	168	141
HI	Barking Sands AAF	22501	2203	15947	5.6	112	62	42	40	33	24	20	22	21	38	43	69	44

CI-13

MONTHLY AVERAGE WIND POWER IN THE UNITED STATES AND SOUTHERN CANADA (Continued)

State	Location	Sta. No.	Lat	Long	Ave. Speed knots	Wind Power, Watts Per Square Meter												Ave.
						J	F	M	A	M	J	J	A	S	O	N	D	
HI	Molokai, Homestead Fld	22502	2109	15706	12.3	110	195	249	291	250	312	361	342	266	260	233	238	266
HI	Kahului NAS	22516	2054	15626	11.1	203	204	240	276	335	366	375	377	283	219	247	200	276
HI	Hilo	21504	1943	15504	7.7	82	86	77	71	65	67	63	67	59	56	52	74	67
HI	Hilo, Lyman Fld	21504	1943	15504	7.8	82	86	77	71	65	67	63	67	59	56	52	74	67
ID	Strevell	179	4201	11313	9.7	275	255	189	175	161	148	127	120	127	128	188	209	168
ID	Pocatello	24156	4255	11236	8.6	211	224	230	209	163	159	113	87	102	103	148	176	160
ID	Idaho Falls	671	4331	11204	9.7	226	185	321	295	241	214	132	139	166	184	178	172	200
ID	Burley APT	24133	4232	11346	8.0	185	162	246	199	156	116	73	58	72	89	114	150	133
ID	Twin Falls	15634	4228	11429	8.7	168	181	232	237	155	139	85	74	86	114	131	172	147
ID	King Hill	185	4259	11513	8.8	220	222	357	363	330	216	169	147	212	158	165	185	221
ID	Mountain Home AFB	24106	4303	11552	7.3	94	136	154	172	144	121	92	76	80	105	89	81	110
ID	Boise APT	24131	4334	11613	7.8	103	112	127	119	95	79	64	56	60	76	84	95	91
IL	Chicago Midway	14819	4147	8745	9.0	129	145	151	144	115	70	53	52	74	95	149	134	112
IL	Glenview NAS	14855	4205	8750	8.4	164	164	203	206	137	83	56	52	72	105	143	137	128
IL	Chicago, Ohare	14810	4159	8754	9.7	220	242	268	272	197	140	99	89	140	162	258	213	193
IL	Chicago, Ohare IAP	94846	4159	8754	9.5	189	199	227	229	174	118	83	71	113	129	227	176	162
IL	Waterman	139	4146	8845	9.1	236	269	222	269	134	100	50	60	77	99	210	175	166
IL	Rockford	94822	4212	8906	8.8	112	107	135	164	126	85	61	70	82	92	126	121	107
IL	Moline	14923	4127	9031	8.9	121	151	215	200	155	93	63	54	91	113	185	141	130
IL	Bradford	146	4113	8937	10.2	210	271	284	290	203	129	68	88	96	123	237	183	196

A-14

MONTHLY AVERAGE WIND POWER IN THE UNITED STATES AND SOUTHERN CANADA (Continued)

State	Location	Sta. No.	Lat	Long	Ave. Speed knots	Wind Power, Watts Per Square Meter												Ave.
						J	F	M	A	M	J	J	A	S	O	N	D	
IL	Rantoul, Chanute AFB	14806	4018	8809	8.5	158	164	193	210	143	91	50	47	66	87	145	127	121
IL	Effingham	436	3909	8832	9.3	170	210	251	217	116	95	73	68	89	95	217	144	136
IL	Springfield, Capitol APT	93822	3950	8940	10.6	215	253	308	295	212	131	92	82	119	152	263	242	198
IL	Quincy, Baldwin Fld	93989	3956	9112	9.9	209	229	275	220	137	98	71	61	95	136	211	194	161
IL	Belleville, Scott AFB	13802	3833	8951	7.2	129	140	162	143	85	61	36	33	46	76	109	96	90
IL	Marion, Williamson Co APT	3865	3745	8901	7.6	159	186	230	243	136	88	59	45	88	93	187	28	139
IN	Evansville	93817	3808	8732	8.1	129	139	165	154	98	69	46	38	60	71	118	117	100
IN	Terre Haute, Holman Fld	3868	3927	8717	8.2	160	151	203	182	105	74	43	33	60	79	130	134	115
IN	Indianapolis	93819	3944	8617	7.1	174	198	247	205	147	96	68	59	81	108	176	161	143
IN	Columbus, Bakalar AFB	13803	3916	8554	7.0	97	106	128	117	71	50	36	32	44	58	91	88	74
IN	Milroy	125	3928	8522	9.5	243	270	230	209	116	115	73	67	94	101	189	163	148
IN	Centerville	130	3949	8458	9.0	196	237	209	182	101	87	64	57	79	93	176	136	134
IN	Marion APT	94852	4029	8541	8.4	211	254	279	255	160	116	64	50	79	95	253	186	170
IN	Peru, Grissom AFB	94833	4039	8609	7.7	123	137	158	165	109	65	40	36	53	69	131	133	100
IN	Lafayette	530	4025	8656	10.3	290	317	290	316	175	142	91	98	112	126	296	222	215
IN	Fort Wayne	14827	4100	8512	9.5	149	167	230	205	154	103	73	66	95	116	214	171	146
IN	Helmer	535	4133	8512	9.6	256	243	263	242	141	100	79	78	133	153	242	215	161
IN	Goshen	132	4132	8548	8.9	229	209	208	221	124	104	75	73	99	103	182	148	146
IN	South Bend	738	4142	8619	9.8	243	243	283	256	155	128	92	92	107	127	229	156	188
IN	MCCool	136	4133	8710	10.7	284	297	311	290	183	149	82	96	130	157	311	231	223

A-15

MONTHLY AVERAGE WIND POWER IN THE UNITED STATES AND SOUTHERN CANADA (Continued)

Wind Power, Watts Per Square Meter

State	Location	Sta. No.	Lat	Long	Ave. Speed knots	Wind Power, Watts Per Square Meter												Ave
						J	F	M	A	M	J	J	A	S	O	N	D	
IA	Dubuque APT	94908	4224	9042	9.4	208	209	239	317	241	150	112	135	170	198	312	231	210
IA	Burlington	14931	4046	9107	9.5	147	160	257	164	94	85	52	44	72	97	200	144	120
IA	Iowa City APT	14937	4138	9133	8.6	175	195	231	229	118	82	71	61	81	100	205	159	140
IA	Cedar Rapids	14990	4153	9142	9.2	160	171	23	249	157	97	53	49	59	102	138	131	130
IA	Ottumwa	14948	4106	9226	9.1	209	243	257	239	169	140	118	112	156	169	174	168	170
IA	Montezuma	145	4135	9228	11.0	270	330	330	390	256	203	103	117	150	158	271	223	237
IA	Des Moines	14933	4132	9339	9.9	192	193	251	289	180	126	91	81	109	142	219	178	160
IA	Ft. Dodge APT	94933	4233	9411	10.3	253	260	331	334	258	140	77	74	104	181	185	188	199
IA	Atlantic	140	4122	9503	11.3	296	350	363	457	295	256	136	123	155	190	264	270	256
IA	Sioux City	14943	4224	9623	9.7	180	172	247	283	206	143	89	82	114	155	212	170	169
KS	Ft. Leavenworth	13921	3922	9455	6.3	73	84	116	111	73	57	31	33	50	52	78	66	69
KS	Olathe NAS	13909	3850	9453	9.2	143	157	211	187	139	117	69	69	91	102	152	136	135
KS	Topeka	13996	3904	9538	9.8	138	147	237	229	170	159	107	112	136	137	159	163	157
KS	Topeka, Forbes AFB	13920	3857	9540	8.6	117	134	186	185	132	115	69	79	88	95	125	104	120
KS	Ft. Riley	13947	3903	9646	8.0	112	122	224	233	171	130	86	102	139	138	125	106	139
KS	Cassoday	152	3802	9638	13.0	370	436	550	550	350	310	231	257	283	284	371	311	377
KS	Wichita	3928	3739	9725	12.0	243	273	344	337	262	276	168	177	203	221	249	237	253
KS	Wichita, McConnell AFB	3923	3737	9716	10.9	222	234	336	317	252	237	151	136	176	188	200	207	222
KS	Hutchinson	93905	3756	9754	10.7	287	335	372	375	330	351	215	195	309	280	308	269	305
KS	Salina, Schilling AFB	13922	3848	9738	9.1	134	168	230	221	176	150	100	112	148	135	147	111	155

91-16

MONTHLY AVERAGE WIND POWER IN THE UNITED STATES AND SOUTHERN CANADA (Continued)

State	Location	Sta. No.	Lat	Long	Ave. Speed knots	Wind Power, Watts Per Square Meter												Ave
						J	F	M	A	M	J	J	A	S	O	N	D	
KS	Hill City APT	93990	3923	9950	9.7	122	199	337	262	210	226	152	125	153	140	153	131	184
KS	Dodge City APT	13985	3746	9958	13.5	281	360	441	458	360	368	259	245	296	296	334	318	336
KS	Garden City APT	23064	3756	10043	12.4	227	326	451	450	415	456	277	272	309	259	216	204	295
KY	Corbin	3814	3658	8408	4.4	71	54	65	58	26	15	16	12	16	18	47	44	36
KY	Lexington	93820	3802	8436	8.9	161	158	156	169	103	75	61	47	72	73	148	146	113
KY	Warsaw	23	3846	8454	6.8	123	132	137	123	65	57	49	39	40	54	106	101	85
KY	Louisville, Standiford Fld	93821	3811	8544	6.5	75	34	104	96	53	32	26	27	29	36	56	66	56
KY	Ft. Knox	13807	3754	8558	6.6	108	121	126	111	64	46	30	25	39	47	98	96	76
KY	Bowling Green, City Co APT	93808	3658	8626	6.6	131	115	136	113	65	39	38	32	46	57	89	93	79
KY	Ft. Campbell	13806	3640	8730	5.8	78	88	107	89	51	32	27	25	29	39	60	69	56
KY	Paducah	3816	3704	8846	6.7	109	106	122	106	59	44	35	33	40	48	90	93	74
LA	New Orleans	12916	2959	9015	8.0	129	137	144	114	76	52	44	43	81	91	128	109	97
LA	New Orleans, Callender NAS	12958	2949	9001	4.6	47	55	50	35	26	14	10	10	26	24	31	40	37
LA	Baton Rouge	13970	3032	9109	7.4	105	106	102	95	72	52	40	36	50	53	79	92	77
LA	Lake Charles, Chenault AFB	13941	3013	9310	8.3	184	156	204	176	125	91	58	57	67	67	133	140	122
LA	Polk AAF	3931	3103	9311	5.7	51	69	78	68	47	37	23	15	21	29	55	51	47
LA	Alexandria, England AFB	13934	3119	9233	4.6	45	57	64	52	37	20	15	13	17	21	39	41	37
LA	Monroe, Selman Fld	13942	3231	9203	7.0	88	104	108	90	61	46	36	36	46	51	73	79	67
LA	Shreveport	13957	3228	9349	8.4	128	138	145	131	92	71	57	55	58	69	105	111	97
LA	Shreveport, Barksdale AFB	13944	3230	9340	6.0	69	74	83	72	48	36	27	27	35	34	53	59	57

A-17

MONTHLY AVERAGE WIND POWER IN THE UNITED STATES AND SOUTHERN CANADA (Continued)

State	Location	Sta. No.	Lat	Long	Ave. Speed knots	Wind Power, Watts Per Square Meter												Ave.
						J	F	M	A	M	J	J	A	S	O	N	D	
ME	Portland	14764	4339	7019	8.4	127	145	158	140	103	80	197	61	83	101	112	120	107
ME	Brunswick, NAS	14611	4353	6956	6.8	109	116	106	107	87	64	55	48	58	69	80	97	82
ME	Bangor, Dow AFB	14601	4448	6841	7.1	132	138	136	113	83	70	54	59	63	82	100	110	93
ME	Presque Isle AFB	14604	4641	6803	7.8	151	167	151	161	123	88	77	69	97	115	110	134	120
ME	Limestone, Loring AFB	14623	4657	6753	6.9	97	107	110	88	69	55	48	45	60	68	73	78	74
MD	Patuxent River NAS	13721	3817	7625	8.1	159	177	186	148	97	76	59	59	83	102	138	139	119
MD	Baltimore, Martin Fld	93744	3920	7625	6.9	107	111	119	95	53	44	37	39	34	46	57	64	61
MD	Baltimore, Friendship APT	93721	3911	7640	9.6	206	253	265	209	152	117	96	79	110	117	179	188	164
MD	Ft. Mead, Tipton AAF	93733	3905	7646	4.4	57	58	69	65	37	19	14	14	14	23	42	41	38
MD	Aberdeen, Phillips AAF	13701	3928	7610	7.9	126	170	173	157	95	66	52	55	69	95	121	118	109
MD	Camp Detrick, Fredrick	13749	3926	7727	5.4	101	122	144	110	51	33	25	22	30	47	96	75	72
MD	Ft. Ritchie	93745	3944	7724	4.6	38	34	33	37	21	16	14	23	18	27	27	52	28
MA	Chicopee Falls, Westover AAF	14703	4212	7232	7.1	122	143	131	133	96	70	52	48	60	81	104	114	96
MA	Ft. Devons AAF	4779	4234	7136	5.4	45	40	66	84	44	31	29	32	33	39	48	53	45
MA	Bedford, Hanscom Fld	14702	4228	7117	6.1	109	120	117	94	70	48	39	36	44	65	80	92	76
MA	Boston, Logan IAP	14739	4222	7102	11.8	314	321	314	268	195	150	128	108	131	131	230	277	227
MA	Boston	14739	4222	7102	11.7	314	321	314	268	195	150	128	108	131	131	230	277	227
MA	South Weymouth NAS	14790	4209	7056	7.6	125	125	146	136	84	58	43	56	53	71	92	102	90
MA	Falmouth, Otis AFB	14704	4139	7031	9.2	188	199	198	193	147	110	87	90	112	139	148	185	149
MA	Nantucket	14756	4116	7003	11.6	304	346	298	277	190	140	104	113	169	214	261	298	223
MA	Nantucket Shoals	14658	4101	6930	16.7	1024	1025	977	838	632	551	592	544	482	769	856	927	757

MONTHLY AVERAGE WIND POWER IN THE UNITED STATES AND SOUTHERN CANADA (Continued)

State	Location	Sta. No.	Lat	Long	Ave. Speed knots	Wind Power, Watts Per Square Meter												Ave.
						J	F	M	A	M	J	J	A	S	O	N	D	
MA	Georges Shoals	14657	4141	6747	17.1	1168	1175	1058	891	619	575	519	378	473	739	891	1156	783
MI	Mt. Clemens, Selfridge AFB	14804	4236	8249	8.2	157	151	160	145	96	71	56	53	71	84	156	144	115
MI	Ypsilanti, Willow Run	14853	4214	8332	9.5	169	169	244	194	139	101	85	77	104	113	108	173	147
MI	Jackson	133	4216	8428	8.8	196	149	182	215	106	92	57	69	77	99	175	147	127
MI	Battle Creek, Kellogg APT	14815	4218	8514	8.9	161	189	205	179	124	99	76	63	106	99	152	180	137
MI	Grand Rapids	94860	4253	8531	8.7	120	134	180	158	112	77	62	54	83	87	162	135	113
MI	Lansing	14836	4247	8436	10.8	273	298	356	287	178	112	69	74	123	146	251	269	203
MI	Flint, Bishop APT	14826	4258	8344	9.6	233	206	246	195	140	109	85	71	129	140	210	223	167
MI	Saginaw, Tri City APT	14845	4326	8352	9.7	218	196	223	196	152	111	92	74	121	128	199	189	158
MI	Muskegon Co APT	14840	4310	8614	9.4	156	164	140	171	121	96	68	70	80	155	177	166	129
MI	Gladwin	14828	4359	8429	5.9	67	71	92	76	63	40	31	24	34	39	61	53	53
MI	Cadillac APT	14817	4415	8528	9.4	210	204	239	193	172	151	104	89	139	161	208	203	171
MI	Traverse City	14850	4444	8535	9.5	229	206	249	207	147	132	100	91	160	187	250	225	178
MI	Oscoda, Wurtsmith AFB	14808	4427	8322	7.6	117	123	121	116	91	76	55	58	71	94	109	108	94
MI	Alpena, Collins Fld	94849	4504	8334	7.3	76	76	92	108	88	59	49	46	52	62	67	58	70
MI	Pellston, Emmett Co APT	14841	4534	8448	8.9	183	159	192	165	154	115	105	81	115	144	175	185	147
MI	Sault Ste Marie	14847	4628	8422	8.3	114	105	119	125	113	77	62	57	79	93	115	108	98
MI	Kinross, Kincheloe AFB	94824	4615	8428	7.6	98	105	106	120	106	69	53	56	68	81	109	93	89
MI	Esconaba APT	94853	4544	8705	7.8	126	164	148	186	191	150	116	93	135	163	232	143	154
MI	Owinn, Sawyer AFB	94836	4621	8723	7.5	94	116	109	116	100	72	52	57	65	92	102	105	90

61-4

MONTHLY AVERAGE WIND POWER IN THE UNITED STATES AND SOUTHERN CANADA (Continued)

State	Location	Sta. No.	Lat	Long	Ave. Speed knots	Wind Power, Watts Per Square Meter												Av
						J	F	M	A	M	J	J	A	S	O	N	D	
MI	Marquette	14838	4634	8724	7.6	78	84	118	125	117	96	73	70	89	85	88	66	
MI	Calumet	14858	4710	8830	8.5	116	126	136	139	106	90	78	66	97	108	116	112	1
MI	Houghton Co APT	14858	4710	8830	8.5	116	126	136	139	106	90	78	66	97	108	116	112	1
MI	Ironwood, Gogebic Co APT	94926	4632	9008	8.5	164	198	167	290	280	174	130	139	200	213	270	203	2
MX	Minneapolis, St. Paul IAP	14922	4453	9315	9.4	127	142	152	211	186	133	88	86	112	130	167	123	1
MN	St. Cloud, Whitney APT	14926	4535	9411	6.9	70	70	102	129	99	71	44	38	55	66	84	58	
MN	Alexandria	751	4553	9524	10.7	221	215	262	290	249	202	128	161	182	263	263	196	2
MN	Brainerd	94938	4624	9408	6.9	90	92	111	167	134	98	62	58	107	87	123	89	1
MN	Duluth IAP	14913	4650	9211	10.7	219	229	249	299	233	147	125	111	154	196	254	206	1
MN	Bemidji APT	14958	4730	9456	7.2	104	120	111	244	201	155	117	120	133	141	162	122	1
MN	International Falls IAP	14918	4834	9323	8.4	95	103	110	175	155	103	82	88	119	122	163	117	1
MN	Roseau	14955	4851	9545	6.5	33	31	50	58	51	35	16	20	27	34	49	41	
MN	Thief River Falls	8243	4803	9611	8.7	215	207	194	305	279	199	135	157	189	221	309	219	2
MS	Biloxi; Keesler AFB	13820	3024	8855	6.8	82	79	83	81	64	49	38	35	58	55	66	68	
MS	Jackson	13927	3220	9014	6.2	85	92	88	78	46	31	26	25	31	39	63	77	
MS	Greenville APT	13939	3329	9059	6.6	89	100	104	90	66	48	32	34	49	50	65	77	
MS	Meridian NAAS	3866	3323	8833	3.5	29	40	37	25	12	8	9	5	8	10	17	21	
MS	Columbus AFB	13825	3338	8827	4.7	52	60	61	48	25	17	15	13	23	21	31	40	
MO	Malden	13848	3636	8959	8.3	151	117	162	152	109	75	57	53	62	74	124	118	1
MO	St. Louis, Lambert Fld	13994	3845	9023	7.9	95	116	143	138	94	60	41	36	55	60	92	96	

MONTHLY AVERAGE WIND POWER IN THE UNITED STATES AND SOUTHERN CANADA (Continued)

State	Location	Sta. No.	Lat	Long	Ave. Speed knots	Wind Power, Watts Per Square Meter												Ave.
						J	F	M	A	M	J	J	A	S	O	N	D	
MO	New Florence	147	3853	9126	10.1	198	231	238	231	138	105	85	85	111	112	199	165	158
MO	Kirkville	540	4006	9232	10.5	250	271	297	310	191	137	111	103	118	158	231	191	184
MO	Vichy, Rolla APT	13997	3808	9146	8.6	153	158	211	170	92	72	54	45	68	76	142	156	117
MO	Ft. Leonard Wood, Forney AF	3938	3743	9208	6.0	67	65	81	88	50	37	22	21	26	50	62	67	52
MO	Springfield	440	3714	9315	9.7	183	243	230	263	123	96	70	77	97	110	183	170	150
MO	Butler	93995	3818	9420	9.3	212	208	266	226	123	124	74	65	81	131	156	160	152
MO	Knobnoster, Whiteman AFB	13930	3844	9334	7.4	96	109	146	151	94	65	40	45	61	70	94	81	87
MO	Marshall	144	3906	9312	9.5	203	223	263	250	115	109	82	90	89	95	156	136	143
MO	Grandview, Rchds-Gebaur AFB	3929	3851	9435	8.1	105	101	156	173	113	76	55	59	74	91	110	110	100
MO	Kansas City APT	13988	3907	9436	9.4	115	126	165	182	145	129	105	99	113	112	143	122	132
MO	Knoxville	142	3925	9400	10.1	210	211	284	278	144	124	84	91	98	125	171	151	158
MO	Tarkio	14945	4027	9522	8.2	121	137	258	225	192	150	87	71	85	113	135	94	135
MT	Glendive	24087	4708	10448	7.7	131	141	145	222	217	146	125	137	139	144	111	122	149
MT	Miles City APT	24037	4626	10552	8.6	123	137	120	161	134	102	87	98	104	109	93	116	115
MT	Wolf Point	94017	4806	10535	8.1	117	112	143	326	248	139	126	171	245	223	183	124	179
MT	Glasgow AFB	94010	4824	10631	8.6	133	131	125	178	198	130	102	101	138	126	119	125	133
MT	Billings, Logan Fld	24033	4548	10832	10.0	230	210	185	202	165	137	110	99	128	152	218	237	173
MT	Livingston	678	4540	11032	13.5	778	819	574	415	327	239	233	253	321	500	713	1058	500
MT	Leviston APT	24036	4703	10927	8.6	198	185	141	163	135	108	82	95	114	125	189	153	140
MT	Havre	777	4834	10940	8.7	148	106	155	141	123	115	75	74	86	120	132	127	114

A-21

MONTHLY AVERAGE WIND POWER IN THE UNITED STATES AND SOUTHERN CANADA (Continued)

State	Location	Sta. No.	Lat	Long	Ave. Speed knots	Wind Power, Watts Per Square Meter												Ave.
						J	F	M	A	M	J	J	A	S	O	N	D	
MT	Great Falls IAP	24143	4729	11122	11.6	444	439	300	281	194	193	136	143	197	300	456	509	304
MT	Great Falls, Mahstrom AFB	24112	4731	11110	8.9	253	240	181	176	120	112	80	80	115	178	215	263	164
MT	Helena APT	24144	4636	11200	7.3	145	95	142	134	63	113	85	44	111	34	61	65	90
MT	Whitehall	24161	4552	11158	11.4	710	543	352	274	221	245	195	167	174	260	410	602	344
MT	Butte, Silver Bow Co APT	24135	4557	11230	6.9	98	101	116	158	141	120	86	85	93	93	86	76	104
MT	Missoula	24153	4655	11405	5.0	49	36	64	75	72	70	64	41	57	23	19	26	50
NB	Omaha	14942	4118	9554	10.0	191	186	264	280	186	148	104	104	122	158	217	191	177
NB	Omaha, Offutt AFB	14949	4107	9555	7.6	118	123	189	198	138	98	67	58	68	93	112	112	115
NB	Grand Island APT	14935	4058	9819	11.1	177	195	270	312	251	217	161	158	179	180	232	200	211
NB	Overton	154	4044	9927	10.5	209	195	323	389	276	243	155	149	162	202	299	182	222
NB	North Platte	562	4108	11042	10.5	193	233	374	435	321	208	153	153	206	246	234	166	254
NB	Lincoln AFB	14904	4051	9646	9.4	163	173	258	251	193	143	97	102	102	119	173	146	162
NB	Columbus	73084	4126	9720	10.0	184	192	316	301	246	172	113	111	120	184	150	143	186
NB	Norfolk, Stefan APT	14941	4159	9726	9.7	236	235	308	387	275	215	142	173	204	281	361	255	256
NB	Big Springs	161	4105	10207	11.7	270	284	430	450	349	270	210	210	217	254	297	251	290
NB	Sidney	563	4108	10302	10.5	275	267	369	395	294	227	193	160	680	227	241	188	248
NB	Scottsbluff APT	24028	4152	10336	9.8	147	225	271	254	189	180	119	124	122	166	254	199	165
NB	Alliance	24044	4203	10248	10.6	203	209	274	358	289	233	189	204	233	228	238	210	238
NB	Valentine, Miller Fld	24032	4252	10033	10.0	181	237	267	323	286	242	199	226	230	271	338	242	253
NV	Boulder City	382	3558	11450	7.6	109	162	185	230	247	293	186	197	137	95	155	81	173

MONTHLY AVERAGE WIND POWER IN THE UNITED STATES AND SOUTHERN CANADA (Continued)

State	Location	Sta. No.	Lat	Long	Ave. Speed knots	Wind Power, Watts Per Square Meter												Ave.
						J	F	M	A	M	J	J	A	S	O	N	D	
NV	Las Vegas	23169	3605	11510	8.7	105	142	186	229	225	209	166	141	111	122	67	92	150
NV	Las Vegas, Nellis AFB	23112	3615	11502	5.7	73	89	137	138	125	123	77	75	61	63	66	57	88
NV	Indian Springs AFB	23141	3635	11541	5.3	38	75	141	196	154	109	64	46	54	28	63	54	80
NV	Tonopah APT	23153	3804	11708	8.7	99	150	196	196	174	142	98	94	104	113	109	101	133
NV	Fallon NAAS	93102	3925	11843	4.7	48	50	74	72	60	49	29	23	25	30	27	36	44
NV	Reno	23185	3930	11947	5.2	77	108	123	99	93	81	56	54	52	52	45	44	74
NV	Reno, Stead AFB	23118	3940	11952	5.9	79	105	125	132	110	91	72	72	56	64	51	69	85
NV	Humboldt	580	4005	11809	6.7	61	76	140	102	103	118	88	83	66	57	47	48	79
NV	Lovelock	24172	4004	11833	6.4	109	91	121	99	98	113	80	72	56	67	43	47	83
NV	Winnemucca APT	24128	4054	11748	7.2	79	91	117	115	105	97	80	81	73	80	55	60	86
NV	Buffalo Valley	24181	4020	11721	6.4	66	97	94	94	102	97	77	62	57	59	53	52	76
NV	Battle Mountain	24119	4037	11652	7.3	148	80	147	113	132	113	85	70	61	102	64	66	98
NV	Beowawe	181	4036	11631	6.2	57	98	112	106	99	86	79	68	63	62	45	51	76
NV	Elko	582	4050	11548	6.2	68	76	100	92	99	98	77	76	75	75	52	60	76
NV	Ventosa	70	4052	11448	6.8	139	160	178	179	166	112	101	97	96	88	93	99	109
NH	Portsmouth, Pease AFB	4743	4305	7049	6.6	90	112	99	82	73	50	39	37	42	54	63	90	68
NH	Manchester, Grenier Pld	14710	4256	7126	6.7	105	150	134	137	83	68	50	37	51	72	95	127	86
NH	Keene	94721	4254	7216	4.8	63	86	69	74	67	48	30	37	34	42	48	50	53
NJ	Atlantic City	93730	3927	7435	9.1	185	207	207	166	109	81	60	61	81	107	144	164	129
NJ	Camden	103	3955	7504	8.0	132	131	167	100	86	73	51	50	62	82	110	111	100

MONTHLY AVERAGE WIND POWER IN THE UNITED STATES AND SOUTHERN CANADA (Continued)

state	Location	Sta. No.	Lat	Long	Ave. Speed knots	Wind Power, Watts Per Square Meter												Ave.
						J	F	M	A	M	J	J	A	S	O	N	D	
NJ	Wrightstown, McGuire AFB	14706	4000	7436	6.6	100	114	114	101	48	42	30	28	40	52	73	89	.69
NJ	Lakehurst NAS	14780	4002	7420	7.4	133	158	166	131	94	62	49	41	48	60	99	109	93
NJ	Belmar	4739	4011	7404	6.1	80	82	83	57	37	31	23	23	30	50	56	55	50
NJ	Trenton	501	4017	7450	8.1	125	146	146	194	85	71	47	55	70	92	140	120	105
NJ	Newark	14734	4042	7410	8.7	145	145	157	126	107	80	73	68	71	96	100	110	109
NM	Clayton	23051	3627	10309	13.0	447	397	519	483	427	360	230	207	255	279	350	395	354
NM	Tucumcari	364	3511	10336	10.6	273	321	359	365	293	227	167	154	166	207	206	206	260
NM	Anton Chico	160	3508	10505	8.9	204	257	306	227	130	132	78	67	74	101	145	140	155
NM	Clovis, Cannon AFB	23008	3423	10319	9.9	171	215	320	279	228	204	126	93	111	122	160	180	186
NM	Hobbs, Lea Co APT	93034	3241	10312	10.4	195	234	353	276	250	215	138	109	118	109	166	188	190
NM	Roswell APT	23043	3324	10432	8.5	148	191	273	260	216	172	101	82	84	102	126	172	163
NM	Roswell, Walker AFB	23009	3318	10432	7.3	79	102	145	145	129	135	93	71	65	72	82	86	98
NM	Rodeo	272	3156	10859	9.4	195	216	250	325	259	191	166	131	129	155	210	173	203
NM	Las Cruces, White Sands	23039	3222	10629	6.1	100	106	169	149	123	88	50	43	41	42	82	99	89
NM	Alamogordo, Holloman AFB	23002	3251	10605	5.6	45	59	92	101	85	72	54	43	38	35	41	40	57
NM	Albuquerque, Kirtland AFB	23050	3503	10637	7.6	83	115	154	190	160	134	101	72	88	97	80	74	112
NM	Otto	166	3505	10600	9.6	248	311	491	372	271	264	116	102	94	176	234	228	243
NM	Santa Fe APT	23049	3537	10605	10.3	218	200	308	308	248	217	138	113	135	154	184	194	201
NM	Farmington APT	23090	3645	10814	7.1	53	74	136	151	106	101	78	55	50	71	81	42	83
NM	Gallup	23081	3531	10847	6.2	92	133	237	293	248	217	92	82	75	114	84	54	143

MONTHLY AVERAGE WIND POWER IN THE UNITED STATES AND SOUTHERN CANADA (Continued)

State	Location	Sta. No.	Lat	Long	Ava. Speed knots	Wind Power, Watts Per Square Meter												Ave.
						J	F	M	A	M	J	J	A	S	O	N	D	
NM	Zuni	93044	3506	10848	8.4	127	109	234	220	183	138	58	54	80	104	97	126	127
NM	El Morro	573	3501	10826	7.4	76	113	229	210	185	136	95	66	66	92	91	83	107
NM	Acomita	170	3503	10743	9.6	150	169	283	223	156	143	96	82	75	109	143	136	169
NY	Westhampton, Suffolk Co	AFB14719	4051	7238	8.1	146	145	154	133	100	82	69	67	87	110	120	118	110
NY	Hempstead, Mitchell AFB	14708	4044	7336	9.2	194	221	211	189	134	115	99	88	100	129	185	194	155
NY	New York, Kennedy IAP	94789	4039	7347	10.3	242	259	260	204	151	139	122	106	120	140	173	180	168
NY	New York, La Guardia	14732	4046	7354	10.9	300	282	283	211	160	123	105	110	135	174	217	278	197
NY	New York, Central Park	94728	4047	7358	8.1	114	108	117	99	57	43	38	37	61	63	83	95	76
NY	New York WBO	94706	4043	7400	11.6	436	428	384	259	211	173	146	107	143	209	329	336	261
NY	Bear Mountain	100	4114	7400	12.5	476	463	550	444	311	183	171	163	271	289	396	523	350
NY	Newburgh, Stewart AFB	14714	4130	7406	7.8	164	206	193	176	108	76	61	52	64	101	136	163	124
NY	New Hackensack	106	4138	7353	6.0	83	91	93	87	50	42	34	32	40	63	93	84	63
NY	Poughkeepsie, Dutchess Co	APT14757	4138	7353	6.1	68	90	106	90	52	43	33	28	36	46	66	74	60
NY	Columbiaville	115	4220	7345	8.7	185	220	226	173	131	104	69	69	97	138	164	172	138
NY	Albany Co APT	14735	4245	7348	7.9	148	163	173	138	95	80	68	63	81	96	103	111	108
NY	Schoenectady	4782	4251	7357	7.4	156	116	160	155	123	81	82	67	84	68	112	114	112
NY	Plattsburg AFB	4742	4439	7327	6.0	63	78	76	82	70	52	42	36	41	54	66	60	60
NY	Mansena, Richards APT	94725	4456	7451	9.5	176	192	217	193	150	129	108	101	111	154	170	193	158
NY	Watertown APT	94790	4400	7601	10.0	409	312	373	298	153	134	119	99	171	197	278	350	236
NY	Rome, Griffiss AFB	14717	4314	7525	5.7	91	108	109	94	66	44	30	26	36	50	71	82	65

MONTHLY AVERAGE WIND POWER IN THE UNITED STATES AND SOUTHERN CANADA (Continued)

State	Location	Sta. No.	Lat	Long	Ave. Speed knots	Wind Power, Watts Per Square Meter												Ave.
						J	F	M	A	M	J	J	A	S	O	N	D	
NY	Utica, Oneida Co APT	94794	4309	7523	8.2	117	130	113	100	74	81	43	49	59	67	106	111	87
NY	Syracuse, Hancock APT	14771	4307	7607	8.4	158	174	166	162	108	80	66	61	76	91	129	138	115
NY	Binghamton, Bloome Co APT	4725	4213	7559	9.0	157	183	194	191	138	77	73	70	77	104	155	160	132
NY	Elmira, Chemung Co APT	14748	4210	7654	5.6	73	78	91	80	50	45	29	25	34	57	79	69	59
NY	Rochester	14768	4307	7740	9.8	205	229	240	201	138	123	98	82	102	123	197	194	153
NY	Buffalo	528	4256	7843	11.5	468	430	417	411	422	281	278	383	377	334	354	306	382
NY	Buffalo	14733	4256	7849	10.9	254	258	272	239	160	151	132	118	145	160	227	251	205
NY	Niagara Falls	4724	4306	7857	8.3	193	175	147	130	106	82	72	67	82	105	134	176	126
NY	Dunkirk	127	4230	7916	11.2	488	349	368	302	173	154	121	127	174	269	396	361	281
NC	Wilmington	13748	3416	7755	8.1	118	151	163	169	102	87	77	80	98	97	101	97	108
NC	Jacksonville, New Rvr. NCAP93727	3443	7726		6.0	59	72	84	79	53	44	32	31	43	40	49	46	51
NC	Cherry Point NAS	13754	3454	7653	7.0	92	105	124	125	84	68	57	57	84	66	67	74	83
NC	Cape Hatteras	93729	3516	7533	10.6	195	229	209	202	144	138	117	135	180	169	166	168	169
NC	Goldboro, Symr-Jhnsn AFB	13713	3520	7758	5.4	55	71	80	72	45	32	30	23	30	29	42	46	45
NC	Ft. Bragg, Simmons AAP	93737	3508	7856	5.8	63	82	76	70	46	32	27	24	27	33	53	48	46
NC	Fayetteville, Pope AFB	13714	3512	7901	4.3	43	54	60	55	34	25	24	21	21	23	29	30	33
NC	Charlotte, Douglas APT	13881	3513	8056	7.4	101	101	120	118	69	57	50	53	70	76	78	82	82
NC	Asheville	13872	3536	8232	5.5	77	77	110	90	41	24	17	16	18	33	76	74	54
NC	Hickory APT	3810	3545	8123	7.2	69	69	89	79	57	50	50	49	49	54	63	61	62
NC	Winston Salem	93807	3608	8014	8.1	141	166	149	169	88	68	66	54	97	106	98	117	111

MONTHLY AVERAGE WIND POWER IN THE UNITED STATES AND SOUTHERN CANADA (Continued)

State	Location	Sta. No.	Lat	Long	Ave. Speed knots	Wind Power, Watts Per Square Meter												Ave.
						J	F	M	A	M	J	J	A	S	O	N	D	
NC	Greensboro	13723	3605	7957	6.7	67	90	94	94	47	37	34	29	35	43	69	57	58
NC	Raleigh	13722	3552	7847	6.7	89	81	106	113	53	51	49	37	45	41	64	61	64
NC	Rocky Mount APT	13746	3558	7748	4.2	72	74	97	86	49	62	51	43	45	50	57	60	52
NC	Elizabeth City	13766	3616	7611	7.4	81	89	95	98	76	65	50	58	67	71	63	63	74
ND	Fargo, Hector APT	14914	4654	9648	11.7	280	264	293	389	286	215	144	160	225	280	337	279	263
ND	Grand Forks AFB	94925	4758	9724	8.9	167	182	183	197	166	103	71	89	123	147	147	172	146
ND	Pembina	758	4857	9715	11.7	308	381	321	341	335	261	187	241	261	329	403	409	308
ND	Bismarck APT	24011	4646	10045	9.5	147	149	186	250	217	174	118	119	157	167	186	143	170
ND	Minot AFB	94011	4825	10121	9.1	191	192	166	199	185	117	95	98	127	164	163	181	157
ND	Williston, Soudin Fld	94014	4811	10338	8.2	80	86	109	143	141	104	76	83	191	98	88	78	98
ND	Dickinson	24012	4647	10248	13.0	402	365	462	486	401	402	246	208	309	332	426	334	362
OH	Youngstown APT	14852	4116	8040	9.2	187	177	218	178	115	84	66	57	81	95	180	188	133
OH	Warren	21	4117	8048	9.3	195	183	197	197	115	95	67	59	82	122	164	149	136
OH	Akron	14895	4055	8126	9.1	163	184	192	151	101	75	55	55	70	86	156	147	118
OH	Perry	128	4141	8107	10.7	296	296	290	277	136	115	82	90	106	108	111	170	223
OH	Cleveland	14820	4124	8151	10.1	189	237	244	211	147	111	80	72	104	122	230	202	152
OH	Vickery	30	4125	8255	10.7	284	310	303	284	150	136	89	88	130	157	184	217	217
OH	Toledo	94830	4136	8348	7.7	109	114	138	108	76	51	39	37	49	60	99	93	80
OH	Archbold	120	4134	8419	8.8	182	176	182	189	99	86	57	62	84	98	182	135	127
OH	Columbus	14821	4090	8253	7.2	109	118	136	116	74	52	37	35	44	55	100	91	82

MONTHLY AVERAGE WIND POWER IN THE UNITED STATES AND SOUTHERN CANADA (Continued)

State	Location	Sta. No.	Lat	Long	Ave. Speed Knots	Wind Power, Watts Per Square Meter												Ave.
						J	F	M	A	M	J	J	A	S	O	N	D	
OH	Columbus, Lockbourne AFB	13812	3949	8256	6.8	109	127	135	120	77	53	36	33	43	58	93	94	80
OH	Hayesville	124	4047	8218	10.0	257	257	236	204	123	124	76	76	104	151	258	204	163
OH	Cambridge	122	4004	8135	6.2	110	103	110	94	54	50	40	32	40	59	30	73	71
OH	Zanesville, Cambridge	93824	3957	8154	7.7	160	142	188	158	87	67	46	32	56	63	136	130	105
OH	Wilmington, Clinton Co AFB	13841	3926	8348	7.8	133	148	166	157	94	60	44	37	48	63	117	119	93
OH	Cincinnati	93814	3904	8440	8.4	133	135	150	144	90	63	51	42	61	77	126	112	99
OH	Dayton	93815	3954	8413	9.0	179	192	207	173	108	73	59	46	69	84	170	160	125
OH	Dayton, Wright AFB	13813	3947	8406	7.6	161	188	226	182	122	83	58	50	71	86	162	157	128
OH	Dayton, Patterson Fld	13840	3949	8403	7.4	171	186	202	176	108	73	47	43	61	79	160	145	120
OK	Muskogee	13916	3540	9522	8.5	149	189	230	210	132	94	53	71	80	108	114	99	130
OK	Tulsa IAP	13968	3612	9554	9.5	157	178	196	185	155	116	94	85	110	118	145	149	141
OK	Oklahoma City	13967	3524	9736	12.2	306	333	376	386	274	250	165	153	182	216	248	265	263
OK	Oklahoma City, Tinker AFB	13919	3525	9723	11.4	263	277	370	412	319	318	176	153	197	230	243	248	264
OK	Ardmore AFB, Autrey Fld	13903	3418	9701	8.7	140	165	204	203	123	113	71	72	86	98	132	114	127
OK	Ft. Sill	13945	3439	9824	9.2	174	215	272	247	193	182	104	91	125	140	164	165	173
OK	Altus AFB	13902	3439	9916	8.0	99	134	198	180	140	126	71	64	79	92	91	92	113
OK	Clinton-Sherman AFB	3932	3520	9912	9.6	184	202	283	262	224	158	84	77	108	113	139	161	166
OK	Enid, Vance AFB	13909	3620	9754	9.0	162	173	229	188	138	138	88	81	100	107	136	142	139
OK	Waynoka	358	3638	9850	12.4	295	416	562	556	389	310	290	250	275	309	308	261	356
OK	Gage	13975	3618	9946	10.5	203	207	281	323	257	321	168	132	173	161	167	188	221
OR	Ontario	983	4401	11701	6.2	52	70	96	143	139	107	115	122	75	69	49	41	81

MONTHLY AVERAGE WIND POWER IN THE UNITED STATES AND SOUTHERN CANADA (Continued)

State	Location	Sta. No.	Lat	Long	Ave. Speed knots	Wind Power, Watts Per Square Meter												Ave.
						J	F	M	A	M	J	J	A	S	O	N	D	
OR	Baker	685	4450	11749	7.0	44	52	47	54	47	40	40	40	39	45	38	43	46
OR	La Grande	24148	4517	11801	8.1	328	261	173	131	93	66	55	54	60	82	201	312	152
OR	Pendleton Fld	24155	4541	11851	8.7	96	164	196	188	174	180	134	124	134	98	127	134	145
OR	Burns	24134	4335	11903	5.9	46	46	68	69	57	60	49	44	46	50	43	40	51
OR	Klamath Falls, Kingsley Fld	94236	4209	12144	4.8	84	77	99	86	62	44	33	30	36	53	66	76	60
OR	Redmond, Roberts Fld	24230	4416	12109	5.6	56	76	63	61	46	36	29	30	38	36	58	45	47
OR	Cascade Locks	192	4539	12150	13.1	651	718	330	331	365	351	387	353	344	451	645	750	465
OR	Crown Point	194	4533	12214	9.6	746	765	209	148	107	50	36	50	113	304	712	650	308
OR	Portland IAP	24229	4536	12236	6.8	139	104	91	61	44	39	45	38	38	51	91	131	75
OR	Eugene, Mahlon Sweet Fld	24221	4407	12313	7.6	83	86	110	94	79	74	89	74	79	58	73	77	81
OR	North Bend	691	4325	12413	8.4	76	128	108	107	88	185	192	149	88	52	80	94	113
OR	Roseburg	690	4314	12321	4.2	22	23	32	26	27	28	29	26	22	16	18	19	23
OR	Astoria, Clatsop Co APT	94224	4609	12353	7.2	125	109	95	82	69	66	71	61	54	70	105	111	84
OR	Salem, McHary Fld	24232	4455	12301	7.1	160	122	100	72	56	47	52	44	47	59	104	137	85
OR	Newport	695	4438	12404	8.5	110	109	107	95	127	145	159	111	69	72	95	129	113
OR	Wolf Creek	87	4241	12323	2.5	10	11	15	16	19	19	22	18	11	9	8	8	14
OR	Sexton Summit	90	4236	12322	11.6	323	283	243	196	236	243	255	269	248	223	316	310	276
OR	Brookings	598	4203	12418	6.4	91	131	96	68	58	55	35	26	37	43	72	92	63
OR	Medford	597	4221	12251	4.9	33	44	53	50	57	51	50	49	39	28	24	40	46
OR	Siskiyou Summit	91	4205	12234	8.8	96	115	102	82	129	150	170	123	102	68	89	82	109

MONTHLY AVERAGE WIND POWER IN THE UNITED STATES AND SOUTHERN CANADA (Continued)

State	Location	Sta. No.	Lat	Long	Ave. Speed knots	Wind Power, Watts Per Square Meter												Ave.
						J	F	M	A	M	J	J	A	S	O	N	D	
PA	Philadelphia	13739	3953	7515	8.5	131	139	170	133	99	78	62	52	61	84	95	109	103
PA	Willow Grove NAS	14793	4012	7508	6.8	111	136	148	114	74	46	35	30	43	54	88	90	81
PA	Allentown	14737	4039	7526	7.3	157	141	227	124	77	73	38	35	55	61	108	151	104
PA	Scranton	14777	4120	7544	7.7	87	107	94	95	80	62	47	37	50	64	85	84	74
PA	Middletown, Olmstead AFB	14711	4012	7646	5.5	97	124	113	96	53	37	31	26	28	41	75	82	66
PA	Harrisburg	14751	4013	7651	6.4	96	120	125	88	53	41	27	24	31	42	69	68	66
PA	Parkplace	10	4051	7606	12.9	464	477	451	411	251	198	132	137	211	318	411	424	345
PA	Sunbury, Selinsgrove	14770	4053	7646	5.4	72	85	115	73	38	29	19	18	22	32	56	58	50
PA	Woodward	13	4055	7719	13.4	630	564	596	550	330	257	157	163	257	403	551	590	417
PA	Bellefonte	113	4053	7743	6.8	133	139	139	169	83	68	44	46	60	96	128	126	103
PA	Buckstown	114	4004	7850	9.4	261	308	321	241	131	83	73	62	83	179	235	247	192
PA	McConnellsburg	119	3950	7801	7.2	168	148	183	150	92	72	49	42	63	97	174	120	106
PA	Altoona, Blair Co APT	14736	4018	7819	7.9	155	180	241	164	95	79	53	46	56	82	124	143	118
PA	Kylertown	512	4100	7811	9.8	268	241	302	262	147	98	85	77	98	146	202	247	200
PA	Dubois	4787	4111	7854	7.5	118	89	127	118	79	34	36	35	41	49	77	109	78
PA	Bradford	4751	4148	7838	6.1	81	69	76	70	49	30	21	20	25	34	54	68	49
PA	Erie IAP	14860	4205	8011	9.1	234	191	208	147	92	77	67	62	94	111	176	216	139
PA	Mercer	525	4118	8012	9.0	189	169	190	176	109	80	65	58	80	107	170	163	128
PA	Brookville	121	4109	7906	7.4	146	119	119	132	75	60	42	45	46	75	112	104	89
PA	Pittsburg APT	94823	4630	8013	8.5	166	170	187	162	105	75	59	50	67	82	146	150	120

MONTHLY AVERAGE WIND POWER IN THE UNITED STATES AND SOUTHERN CANADA (Continued)

State	Location	Sta. No.	Lat	Long	Ave. Speed knots	Wind Power, Watts Per Square Meter													Ave.
						J	F	M	A	M	J	J	A	S	O	N	D		
PA	Greensburg	4718	4016	7933	9.1	239	226	207	160	94	75	72	61	80	117	186	174	141	
RI	Quonset Point NAS	14788	4135	7125	8.4	164	164	163	156	121	84	61	70	83	115	135	141	123	
RI	Providence	14765	4144	7126	9.5	173	189	129	180	140	117	98	88	100	177	150	163	144	
RI	Providence, Green APT	14765	4144	7126	9.6	173	189	192	180	140	117	98	88	100	117	150	163	144	
SC	Beaufort MCAAS	93831	3229	8044	5.7	44	70	62	61	43	35	28	23	35	35	42	43	43	
SC	Charleston	13880	3254	8002	7.5	93	124	130	117	69	64	54	52	63	59	71	81	81	
SC	Myrtle Beach AFB	13717	3341	7856	6.1	49	65	70	78	54	51	49	44	44	40	39	40	52	
SC	Florence	300	3411	7943	7.6	95	99	114	93	74	67	52	43	50	74	73	78	72	
SC	Sumter, Shaw AFB	13849	3358	8029	5.4	49	57	64	62	40	31	26	24	34	36	38	41	41	
SC	Eastover, McIntire ANG	3858	3355	8048	4.9	37	68	54	52	33	24	26	14	32	27	31	28	34	
SC	Columbia	13883	3357	8107	6.2	65	74	90	96	52	42	42	34	41	38	44	50	55	
SC	Anderson	112	3430	8243	7.7	99	107	99	113	80	60	51	51	52	73	85	98	79	
SC	Greenville, Donaldson AFB	13822	3446	8223	6.3	67	70	80	79	44	38	32	27	36	37	39	50	49	
SC	Spartanburg	313	3455	8157	8.2	121	122	156	129	95	66	65	52	60	61	208	100	94	
SD	Sioux Falls, Foss Fld	14944	4334	9644	9.5	158	156	215	266	190	129	94	91	121	144	212	147	161	
SD	Watertown	14946	4455	9709	10.1	189	224	284	332	251	233	129	123	185	210	240	151	212	
SD	Aberdeen APT	14929	4527	9826	11.2	215	234	341	413	290	244	173	177	240	249	295	202	258	
SD	Huron	14936	4423	9813	10.2	164	169	229	285	214	165	131	131	163	197	153	174	187	
SD	Pierre APT	24025	4423	10017	9.8	216	205	255	294	202	141	124	129	149	168	230	207	191	
SD	Rapid City	24090	4403	10304	9.6	176	173	239	234	178	144	123	139	168	193	285	205	191	

A-31

MONTHLY AVERAGE WIND POWER IN THE UNITED STATES AND SOUTHERN CANADA (Continued)

State	Location	Sta. No.	Lat	Long	Ave. Speed knots	Wind Power, Watts Per Square Meter												Ave
						J	F	M	A	M	J	J	A	S	O	N	D	
SD	Rapid City, Ellsworth AFB	24006	4409	10306	9.9	306	256	382	354	245	191	164	172	196	233	320	294	26
SD	Hot Springs	94013	4322	10323	8.2	90	117	155	297	219	163	94	128	126	136	179	125	15
TN	Bristol	318	3630	8221	5.9	76	105	93	85	53	40	30	30	22	37	51	59	6
TN	Knoxville APT	13891	3549	8359	7.0	133	135	156	161	85	66	53	42	47	54	99	100	9
TN	Chattanooga	13882	3502	8512	5.6	64	70	76	83	42	31	26	20	26	31	49	52	4
TN	Chattanooga	324	3503	8512	5.4	70	86	106	83	46	44	37	29	35	42	67	60	6
TN	Monteagle	126	3515	8550	5.4	77	84	84	63	32	19	18	16	19	33	60	70	4
TN	Smyrna, Sewart AFB	13827	3600	8632	5.2	76	83	87	82	42	29	22	20	22	31	58	62	5
TN	Nashville, Berry Fld	13897	3607	8641	7.4	116	114	132	117	70	67	41	33	44	57	87	80	8
TN	Memphis NAS	93839	3521	8952	6.2	84	85	93	84	54	37	25	24	29	36	67	73	5
TN	Memphis IAP	13893	3503	8959	7.9	130	137	148	125	89	57	45	42	54	61	102	110	9
TX	Brownsville, Rio Grande IAP	12919	2554	9726	10.7	231	229	281	292	277	211	185	141	102	104	150	186	19
TX	Harlington AFB	12904	2614	9740	8.8	124	175	212	207	172	160	132	129	82	75	101	109	13
TX	Kingsville NAS	12928	2731	9749	8.5	111	130	162	183	171	157	142	115	107	77	104	98	12
TX	Corpus Christi	12924	2746	9730	10.4	189	229	260	252	199	177	158	150	107	114	157	154	17
TX	Corpus Christi NAS	12926	2742	9716	11.3	209	232	272	286	263	225	189	153	150	144	206	172	21
TX	Laredo AFB	12907	2732	9928	10.0	30	122	153	185	206	223	216	174	122	101	93	82	14
TX	Beeville NAS	12925	2823	9740	7.3	81	101	124	129	111	85	71	61	60	52	76	72	8
TX	Victoria, Foster AFB	12912	2851	9655	7.9	134	173	198	138	112	97	67	71	53	58	103	124	10
TX	Houston	12918	2939	9517	10.1	191	216	240	258	186	139	85	74	101	117	185	159	15

MONTHLY AVERAGE WIND POWER IN THE UNITED STATES AND SOUTHERN CANADA (Continued)

State	Location	Sta. No.	Lat	Long	Ave. Speed knots	Wind Power, Watts Per Square Meter												Ave.
						J	F	M	A	M	J	J	A	S	O	N	D	
TX	Houston, Ellington AFB	12906	2937	9510	6.8	86	96	114	104	81	56	38	41	56	54	82	75	72
TX	Galveston AAF	12905	2916	9451	11.0	262	261	298	257	227	200	149	144	147	148	239	217	210
TX	Pt. Arthur, Jefferson Co APT	12917	2957	9401	9.3	153	186	184	190	156	95	64	54	115	85	121	134	128
TX	Lufkin, Angelina Co APT	93987	3114	9445	6.1	65	72	76	70	45	30	27	22	26	38	56	62	49
TX	Saltillo	249	3312	9519	8.7	131	172	171	185	100	86	72	58	71	84	102	104	112
TX	San Antonio	12921	2932	9028	8.1	99	113	114	123	104	104	83	62	65	71	94	87	98
TX	San Antonio, Randolph AFB	12911	2932	9817	7.3	94	105	115	109	94	82	64	58	61	56	90	82	84
TX	San Antonio, Kelly AFB	12909	2923	9835	6.9	84	85	105	109	96	83	63	53	52	53	72	63	77
TX	San Antonio, Brooks AFB	12931	2921	9827	8.9	141	144	185	189	187	166	136	108	95	107	135	103	142
TX	Hondo AAF	12903	2920	9910	6.7	59	82	88	94	99	96	51	45	42	32	50	49	64
TX	Kerrville	12961	2959	9905	7.1	86	95	134	129	117	92	97	48	52	63	74	54	86
TX	San Marcos	12910	2953	9752	7.2	115	121	142	115	127	102	64	65	56	78	108	105	98
TX	Austin, Bergstrom AFB	13904	3012	9740	7.8	145	140	167	145	118	119	88	73	58	74	117	116	115
TX	Bryan	13905	3038	9628	7.0	85	104	108	103	89	74	49	48	38	47	73	89	76
TX	Killeen, Fort Hood AAF	3933	3108	9743	8.1	123	138	151	155	130	109	81	59	60	75	96	114	106
TX	Ft Hood, Gray AAF	3902	3104	9750	9.2	163	179	198	208	162	153	121	87	72	102	147	158	146
TX	Waco, Connally AFB	13928	3138	9704	7.7	117	111	135	128	101	90	72	61	56	68	104	101	95
TX	Dallas NAS	93901	3244	9658	9.1	155	166	210	199	154	144	97	82	85	99	133	131	137
TX	Ft. Worth, Carswell AFB	13911	3246	9725	8.2	138	154	216	194	141	133	71	60	72	89	129	121	124
TX	Mineral Wells APT	93985	3247	9804	9.2	120	146	203	201	162	154	103	79	78	88	111	110	122

A-33

MONTHLY AVERAGE WIND POWER IN THE UNITED STATES AND SOUTHERN CANADA (Continued)

Wind Power, Watts Per Square Meter

State	Location	Sta. No.	Lat	Long	Ave. Speed knots	Wind Power, Watts Per Square Meter												Ave
						J	F	M	A	M	J	J	A	S	O	N	D	
TX	Mineral Wells, Ft Walters AAF	3943	3250	9803	8.7	117	135	192	184	149	136	92	71	71	82	99	103	11
TX	Santo	155	3237	9814	7.1	92	136	157	163	87	83	55	55	60	55	112	77	9
TX	Sherman, Perrin AFB	13923	3343	9640	9.1	172	164	217	213	142	121	79	73	81	106	153	153	13
TX	Gainsville	153	3340	9708	11.1	244	303	338	357	226	184	141	134	155	163	222	188	22
TX	Wichita Falls	13966	3358	9829	9.9	160	178	244	222	176	158	110	95	107	114	168	154	15
TX	Abilene, Dyers AFB	13910	3226	9951	7.7	91	104	145	147	124	102	61	51	58	66	87	87	9
TX	San Angelo, Mathis Fld	23034	3122	10030	8.9	117	154	195	184	170	147	96	86	90	90	113	108	12
TX	San Angelo, Goodfellow AFB	23017	3124	10024	8.7	108	152	191	179	169	157	85	61	91	88	114	102	12
TX	Del Rio, Laughlin AFB	22001	2922	10045	7.6	71	107	114	120	118	117	91	68	59	57	56	60	8
TX	Canadian	162	3500	10022	13.0	390	416	570	596	430	344	263	231	310	337	370	290	37
TX	Dalhart APT	93042	3601	10233	12.9	370	371	476	477	477	559	334	278	280	228	266	305	35
TX	Amarillo, English Fld	23047	3514	10142	11.7	229	279	359	329	290	240	166	135	180	200	221	222	24
TX	Childress	23007	3426	10017	10.2	152	194	272	269	221	204	118	93	117	126	128	147	17
TX	Lubbock, Reese AFB	23021	3336	10203	9.4	155	211	291	268	204	188	89	67	88	99	140	169	16
TX	Big Spring, Webb AFB	23005	3213	10131	10.1	155	197	264	256	226	216	128	101	112	124	135	139	17
TX	Midland	23023	3156	10212	8.9	91	143	146	155	133	123	94	76	85	84	89	102	10
TX	Wink, Winkler Co APT	23040	3147	10312	8.5	95	148	204	181	181	193	119	78	72	75	81	128	11
TX	Marfa APT	23022	3016	10401	7.9	128	182	165	192	146	117	84	65	85	84	88	119	12
TX	Guadalupe Pass	163	3150	10448	15.8	887	892	999	932	868	603	422	342	401	555	760	827	71
TX	El Paso	23044	3148	10629	9.8	176	257	296	299	222	173	131	111	102	128	153	163	11

MONTHLY AVERAGE WIND POWER IN THE UNITED STATES AND SOUTHERN CANADA (Continued)

Wind Power, Watts Per Square Meter

State	Location	Sta. No.	Lat	Long	Ave. Speed knots	Wind Power, Watts Per Square Meter													Ave
						J	F	M	A	M	J	J	A	S	O	N	D		
TX	El Paso, Biggs AFB	23019	3150	10624	5.0	68	99	144	144	96	74	47	38	32	33	49	59	72	
UT	St George	93198	3703	11331	5.1	26	39	73	67	72	74	53	62	40	25	34	23	49	
UT	Milford	475	3826	11300	10.2	179	241	228	275	302	241	220	175	167	173	172	152	214	
UT	Bryce Canyon APT	23159	3742	11209	6.4	69	65	93	79	94	90	40	47	53	48	53	49	66	
UT	Hanksville	23170	3822	11043	4.6	43	41	115	84	102	108	35	38	43	40	36	25	57	
UT	Tooele, Dugway-PG	24103	4011	11256	4.8	38	48	69	81	71	69	52	57	46	41	31	28	53	
UT	Darby, Wendover AFB	24111	4043	11402	5.3	59	62	90	90	71	82	62	61	49	50	58	36	62	
UT	Wendover	24193	4044	11402	5.4	48	55	91	103	84	80	57	57	43	43	47	40	62	
UT	Locomotive Springs	187	4143	11255	9.3	113	129	205	193	221	215	195	202	167	125	115	93	185	
UT	Ogden, Hill AFB	24101	4107	11158	8.0	102	118	127	126	130	124	124	130	122	123	99	92	119	
UT	Salt Lake City	24127	4046	11158	7.7	77	84	100	100	96	96	82	106	73	68	66	71	85	
UT	Coalville	174	4054	11125	3.9	25	35	39	32	30	28	17	18	37	24	17	24	28	
VT	Montpelier, Barre APT	94705	4412	7234	7.2	162	167	152	118	99	97	69	60	94	103	102	125	111	
VT	Burlington, Ethan Allen AB	14742	4428	7309	7.7	114	111	103	100	85	70	55	52	70	81	100	114	90	
VA	Norfolk NAS	13750	3656	7618	8.8	154	182	171	139	103	84	75	80	111	127	153	128	121	
VA	Oceana NAS	13769	3650	7601	7.6	135	136	150	126	84	52	52	52	83	93	97	107	90	
VA	Hampton, Langley AFB	13702	3705	7622	8.5	156	187	193	166	122	85	75	81	117	137	135	146	136	
VA	Ft. Eustis, Felker AAF	93735	3708	7636	6.5	79	90	89	74	51	42	37	32	43	45	51	64	58	
VA	South Boston	108	3641	7855	5.0	49	49	65	65	34	35	32	29	28	38	40	38	40	
VA	Danville APT	13720	3634	7920	6.1	69	63	84	78	43	36	32	31	33	35	41	39	41	

A-35

MONTHLY AVERAGE WIND POWER IN THE UNITED STATES AND SOUTHERN CANADA (Continued)

State	Location	Sta. No.	Lat	Long	Ave. Speed knots	Wind Power, Watts Per Square Meter												Ave
						J	F	M	A	M	J	J	A	S	O	N	D	
VA	Roanoke	13741	3719	7958	7.1	152	207	171	144	75	55	51	46	46	53	98	132	10
VA	Richmond	13740	3730	7720	6.7	59	68	79	74	49	40	34	32	39	40	47	47	5
VA	Quantico MCAS	13773	3830	7719	6.0	55	63	75	67	45	35	29	29	35	35	46	45	4
VA	Ft. Belvoir, Davison AAF	93728	3843	7711	3.8	42	60	60	42	24	15	12	12	13	19	34	44	2
WA	Spokane IAP	24157	4738	11732	7.2	92	111	106	102	73	68	55	53	58	63	80	95	7
WA	Spokane, Fairchild AFB	24114	4738	11739	7.2	118	138	134	121	92	87	67	62	74	84	92	123	10
WA	Moses Lake, Larson AFB	24110	4711	11919	6.2	68	62	98	101	79	80	56	45	61	55	53	55	6
WA	Walla Walla	24160	4606	11817	6.7	87	100	114	93	68	65	56	55	51	47	86	89	7
WA	Pasco, Tri City APT	24163	4616	11907	6.8	342	331	346	372	243	212	190	224	229	186	247	164	25
WA	North Dalles	188	4537	12109	8.0	65	72	171	189	264	279	334	284	166	93	63	64	15
WA	Yakima	24243	4634	12032	6.4	60	53	89	115	78	71	54	48	52	48	41	40	6
WA	Chehalis	792	4640	12205	6.4	109	86	82	59	53	44	45	44	43	57	80	110	6
WA	Kelso, Castle Rock	24223	4608	12254	6.9	128	107	87	65	65	46	46	39	52	66	119	133	8
WA	North Head	791	4616	12404	13.0	547	521	495	369	430	357	330	275	215	366	460	773	42
WA	Hoquium, Bowerman APT	94225	4658	12356	8.2	141	112	108	88	86	66	59	56	53	91	94	103	8
WA	Moclips	794	4715	12412	7.6	82	82	75	81	68	38	37	36	41	65	69	102	6
WA	Tatoosh IS	798	4823	12444	12.3	753	603	443	269	276	117	130	109	195	422	569	735	38
WA	Tacoma, McChord AFB	24207	4709	12229	4.6	50	48	53	49	38	30	25	23	25	31	41	41	3
WA	Ft. Lewis, Gray AAF	24201	4705	12235	3.9	36	28	30	30	23	19	17	18	17	21	23	27	2
WA	Seattle Tacoma	24233	4727	12218	9.5	194	210	211	173	130	120	94	84	104	135	147	195	14
WA	Seattle FWC	24244	4741	12216	5.6	69	61	58	48	32	28	25	24	28	44	53	69	4

MONTHLY AVERAGE WIND POWER IN THE UNITED STATES AND SOUTHERN CANADA (Continued)

State	Location	Sta. No.	Lat	Long	Ave. Speed Knots	Wind Power, Watts Per Square Meter													Ave.
						J	F	M	A	M	J	J	A	S	O	N	D		
WA	Everett, Paine AFB	24203	4755	12217	6.3	70	67	66	57	44	40	38	34	39	43	60	65	51	
WA	Whidbey IS NAS	24255	4821	12240	7.1	185	158	148	124	75	54	43	33	50	104	160	188	108	
WA	Bellingham APT	24217	4848	12232	6.3	131	132	92	66	42	43	43	35	26	56	89	119	71	
WV	Charleston	13866	3822	8136	5.6	46	61	62	53	37	28	24	15	22	21	45	45	38	
WV	Elkins, Randolph Co APT	13729	3853	7951	5.8	80	90	101	92	57	32	24	22	25	39	71	68	58	
WV	Morgantown APT	13736	3939	7955	5.8	73	73	86	67	37	26	18	16	22	34	64	81	48	
WI	Green Bay	14898	4429	8808	5.6	174	150	212	197	173	129	89	72	122	131	192	151	149	
WI	Green Bay, Straubel APT	14898	4429	8808	9.3	174	150	212	197	173	129	89	72	122	131	192	151	149	
WI	Milwaukee, Mitchell Fld	14839	4257	8754	10.2	198	212	246	238	195	120	95	91	129	159	229	200	175	
WI	Madison, Traux Fld	14837	4308	8920	8.8	139	148	199	197	153	97	72	62	93	112	170	136	130	
WI	Janesville, Rock Co APT	94854	4237	8902	7.6	158	170	203	271	234	138	108	90	112	137	212	170	167	
WI	Lone Rock	143	4312	9011	7.8	117	118	125	166	116	82	60	60	75	96	133	97	103	
WI	Camp Douglas, Volk Fld	94930	4356	9016	6.3	62	76	79	77	64	33	28	26	34	64	76	56	54	
WI	La Crosse APT	14920	4352	9115	8.8	120	116	145	201	171	100	70	69	100	128	179	134	127	
WI	Eau Claire	14991	4452	9129	8.3	96	113	102	168	155	90	83	85	100	109	134	106	112	
WI	Hager City	141	4436	9232	8.4	151	132	179	221	125	98	57	77	83	125	126	119	119	
WY	Cheyenne APT	24018	4109	10449	11.9	433	453	434	399	242	176	125	132	157	220	402	463	302	
WY	Laramie	164	4118	10540	11.5	498	506	520	339	313	300	152	173	212	259	338	379	312	
WY	Medicine Bow	165	4153	10611	12.7	773	758	825	518	343	296	250	223	328	423	544	726	490	
WY	Cherokee	173	4143	10740	14.0	662	703	610	463	350	337	257	277	283	364	510	577	430	

MONTHLY AVERAGE WIND POWER IN THE UNITED STATES AND SOUTHERN CANADA (Continued)

Wind Power, Watts Per Square Meter

State	Location	Sta. No.	Lat	Long	Ave. Speed knots	Wind Power, Watts Per Square Meter												Ave
						J	F	M	A	M	J	J	A	S	O	N	D	
WY	Bitter Creek	172	4140	10833	12.7	477	550	623	397	297	230	150	223	210	284	370	477	36
WY	Rock Springs	574	4138	10915	10.6	503	476	551	357	311	264	216	189	236	250	320	394	37
WY	Granger	177	4136	10958	9.6	309	283	410	296	244	257	157	191	170	176	254	252	24
WY	Knight	573	4124	11050	10.5	278	385	375	301	261	241	175	187	276	208	233	265	21
WY	Casper AAP	24005	4255	10827	11.4	445	417	359	266	201	222	145	150	219	208	362	473	24
WY	Riverton APT	24061	4303	10827	5.4	54	52	79	75	54	49	37	31	47	38	30	40	4
WY	Sheridan	24029	4446	10658	6.6	71	71	80	94	88	73	60	56	62	65	76	64	7
WY	Cody APT	24045	4431	10901	9.3	292	303	274	342	238	189	155	176	183	218	288	303	24
NS	Yarmouth	14647	4350	6605	9.0	230	173	190	153	109	84	63	67	84	123	162	196	1
NS	Greenwood	14636	4459	6455	8.8	278	240	276	207	148	120	87	98	102	167	206	243	1
NB	Frederickton	14648	4552	6632	7.7	153	124	148	116	99	86	69	64	70	94	98	127	1
QU	Mont Jolt	14639	4836	6812	11.2	356	358	310	220	197	157	134	152	188	245	297	381	2
QU	Bagotville	94795	4820	7100	9.3	206	180	202	166	164	141	95	97	128	147	181	148	1
QU	St. Hubert	4712	4531	7325	9.3	224	213	163	153	145	138	100	83	110	136	203	177	1
ON	Ottawa	4706	4519	7540	8.2	123	120	125	111	99	79	58	53	70	88	117	100	1
ON	Trenton	4715	4407	7732	8.9	203	176	166	148	125	103	94	80	100	122	181	151	1
ON	Muskoka	4704	4458	7918	7.0	52	63	68	75	61	44	41	37	44	54	69	55	1
ON	Toronto	94791	4341	7938	8.6	198	177	157	150	110	87	69	68	85	105	177	152	1
ON	London	94805	4302	8109	9.2	239	229	233	214	139	85	66	65	82	107	173	176	1
ON	Wharfedale	94809	4445	8106	9.5	234	173	164	165	127	92	72	85	113	148	222	209	1

MONTHLY AVERAGE WIND POWER IN THE UNITED STATES AND SOUTHERN CANADA (Continued)

State	Location	Sta. No.	Lat	Long	Ave. Speed knots	Wind Power, Watts Per Square Meter												Ave.
						J	F	M	A	M	J	J	A	S	O	N	D	
ON	North Bay	4705	4622	7925	8.5	108	121	122	121	98	85	68	67	84	90	126	104	100
ON	Sudbury	94828	4637	8048	12.2	318	392	330	324	328	290	218	195	252	294	355	312	301
ON	White River	94808	4836	8517	4.3	19	26	28	32	37	33	24	21	24	28	30	24	27
ON	Lakehead	94804	4822	8919	7.5	117	97	104	135	132	77	65	59	80	104	155	119	104
ON	Kenora	14999	4948	9422	8.6	91	95	91	111	104	74	63	70	88	96	112	86	90
MN	Winnipeg	14996	4954	9714	10.7	206	218	227	293	266	177	116	138	174	209	239	210	206
MN	Portage La Prairie	94912	4954	9816	9.5	164	162	183	217	207	122	91	107	135	169	157	157	156
MN	Rivers	25014	5001	10019	10.5	216	171	187	266	276	194	137	149	200	235	218	200	204
SA	Regina	25005	5026	10440	11.9	327	286	315	350	368	243	162	186	286	232	279	300	278
SA	Moose Jaw	25011	5023	10534	12.3	399	343	314	344	390	299	197	214	340	319	340	367	322
AL	Medicine Hat	25118	5001	11043	8.9	164	159	146	215	176	138	96	110	159	168	187	177	158
AL	Lethbridge	94108	4938	11248	12.5	625	563	356	450	370	319	202	246	279	510	546	567	419
BC	Penticton	94116	4928	11936	7.5	265	187	141	104	76	64	52	49	64	132	233	274	137
BC	Abbotsford	24288	4901	12222	5.8	135	108	89	72	46	38	32	25	20	57	86	93	67
BC	Vancouver	24287	4911	12310	6.5	72	75	85	83	53	48	52	39	48	62	80	75	64
BC	Victoria	24297	4839	12326	6.5	84	80	74	75	50	51	34	36	36	47	66	79	60

OWNING A WIND SYSTEM

Installing Your Wind Turbine and Tower

You should seriously consider having your dealer install your entire WECS, or at least the tower and wind turbine. First, you will get his guarantee that the job is done right. Obviously, raising the tower and wind turbine can be very dangerous if not done properly. If you are planning to have some friends help, or are hiring help, check on your insurance situation. You will most likely find that your homeowner's policy will not cover this type of activity (Chap. 7). This appendix is included to help you understand the installation and maintenance of WECS.

The most important aspects of WECS installation that you should consider are the design of the wind turbine and tower, the two items subjected to wind loads. Good design, however, is not enough. These units must be properly installed. This includes appropriate grounding for lightning strike protection. After installation, maintenance must be performed as required to assure continued reliable service. Each of these items, if performed properly, will contribute to the ultimate safety and efficiency of your wind system.

Figure A2-1 diagrams the step-by-step sequence of WECS ownership. If any block in this diagram is omitted, a potential ownership problem is created. Consider the neighborhood resident who hoists aloft a wind turbine without considering his neighbors' feelings; something like the problems which arose early in the history of television antennas. This situation is a little like "I don't have one, so why should you?", or "that's an ugly machine, can't you hide it over behind that tree?", or "that's a very noisy propeller, isn't it?" We have heard these comments before; some are legitimate, others are not.

In at least one U.S. protectorate, it would be illegal to have any form of auxiliary power source, wind included, if the utility mains exist at the edge of your property. This is not the case in the U.S., but local building ordinances and codes may prohibit installation of towers tall enough to make wind power practical, or they may require a tower designed to withstand loads so high that the tower cost makes the entire system economically impractical.

Another possibility is that the entire proposed system meets all requirements but cannot be installed for lack of space to install the equipment. For example, perhaps the tower cannot be raised within the confines of the area, or there are too many tall trees. We mention these aspects of system planning even though they only rarely apply to specific installations.

Again we must emphasize the possible dangers involved in raising a tower and a wind turbine. If you haven't had experience

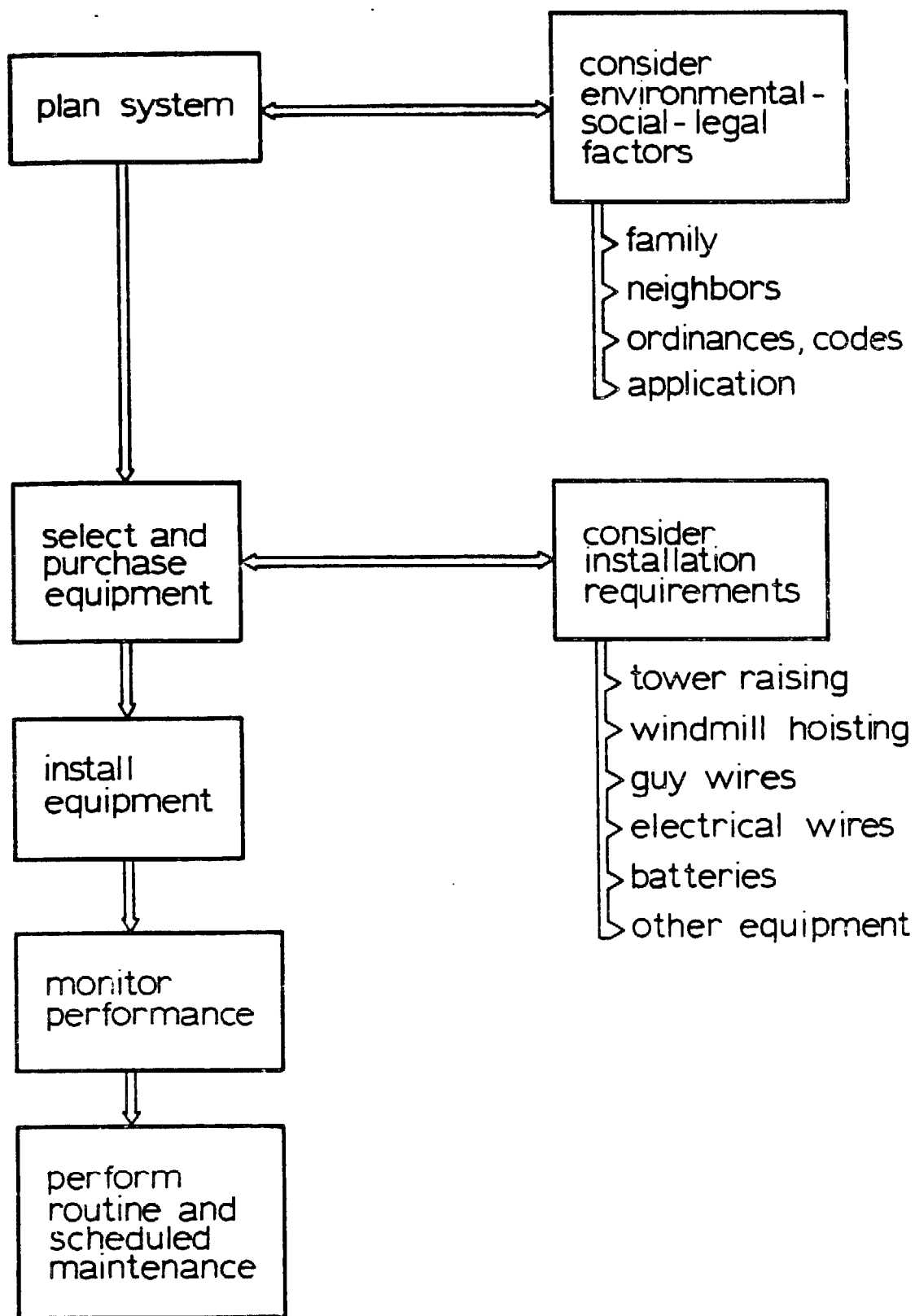

FIGURE A2-1: Planning a wecs installation.

with this sort of thing and insist on doing your own, get a knowledgeable friend whose advice you trust to go over your plan and be there when doing the most critical jobs.

Tower Raising

To raise a tower, you can either assemble it on the ground and tilt it up (Fig. A2-2) or assemble it standing up (Fig. A2-3). The first method requires assembly of all components, guy wires, and as much of the wind turbine equipment as possible on the ground. The base of the tower is then fixed to a pivot to prevent the tower from sliding along the ground and a rope is tied from the tower, over a gin pole (Fig. A2-2) to a car or winch. Moving the car pulls the tower up. The gin pole serves in the initial stages to improve the angle at which the rope pulls on the tower.

In the case of the tower being pulled up by a rope tied to a car bumper, it might be well to pull with the car backing up so the driver maintains a clear view of the action. Also, an effective, foolproof communications link must be established and maintained between the driver and the person who is directing the operation. If not, towers pulled over center, bent, broken cables, and a host of other crises are likely to beset the tower crew.

Tower-raising techniques such as this are usually described in the owner's manual or installation instructions that come with the tower. Since each tower has a different load rating and different installation requirements, it is not possible to discuss the details of tower raising.

Many towers, such as the freestanding octahedron module tower (Fig A2-3), can be erected in place. This is usually done by assembling the first few bays on the ground, standing these up, then assembling the remaining bays while standing on each successive lower bay.

Wind Turbine Raising

To raise a wind turbine, you can: hoist a completely assembled machine up an already erected tower (Fig. A2-4); hoist a partially assembled machine up an already erected tower (Fig. A2-5), completing the assembly aloft; or tilt the tower up with the wind turbine already installed (Fig. A2-6). The first two methods rate the title "traditional"; the last, in many cases, is not possible or safe.

Personal experience will tell, but generally the amount of enthusiasm one has for doing anything atop a tower decreases rapidly with increasing tower height. This serves as a token justification for ground level assembly of the tower and wind turbine, but you should consider the hazards.

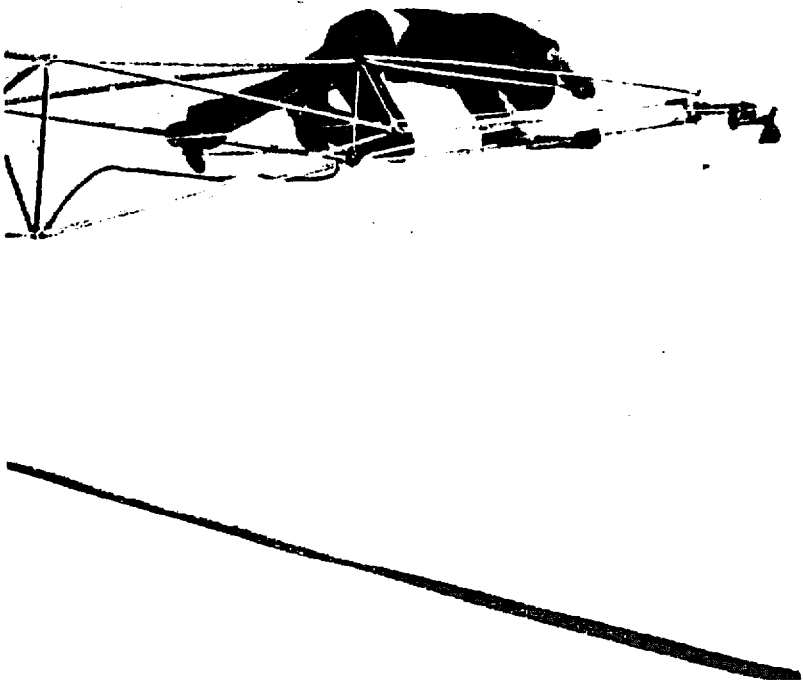

FIGURE A2-2: Tower raising with a "Gin Pole".

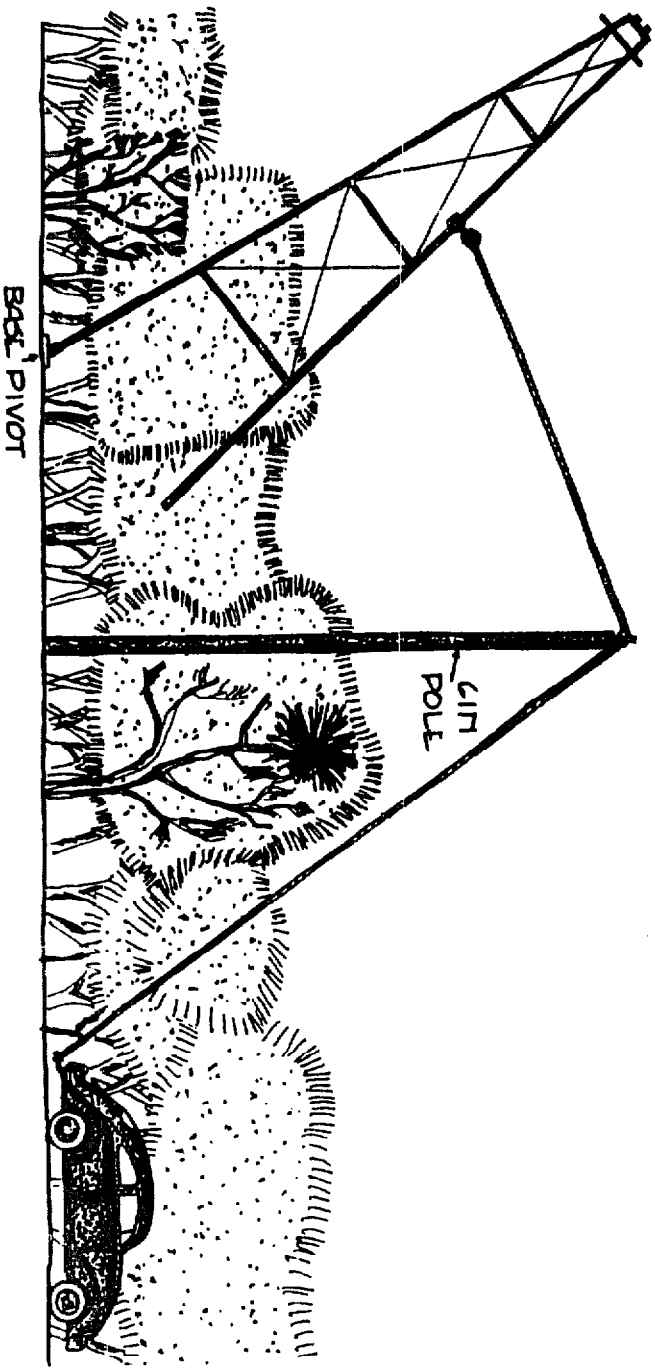

FIGURE A2-3: Assembling a free standing octahedron tower.

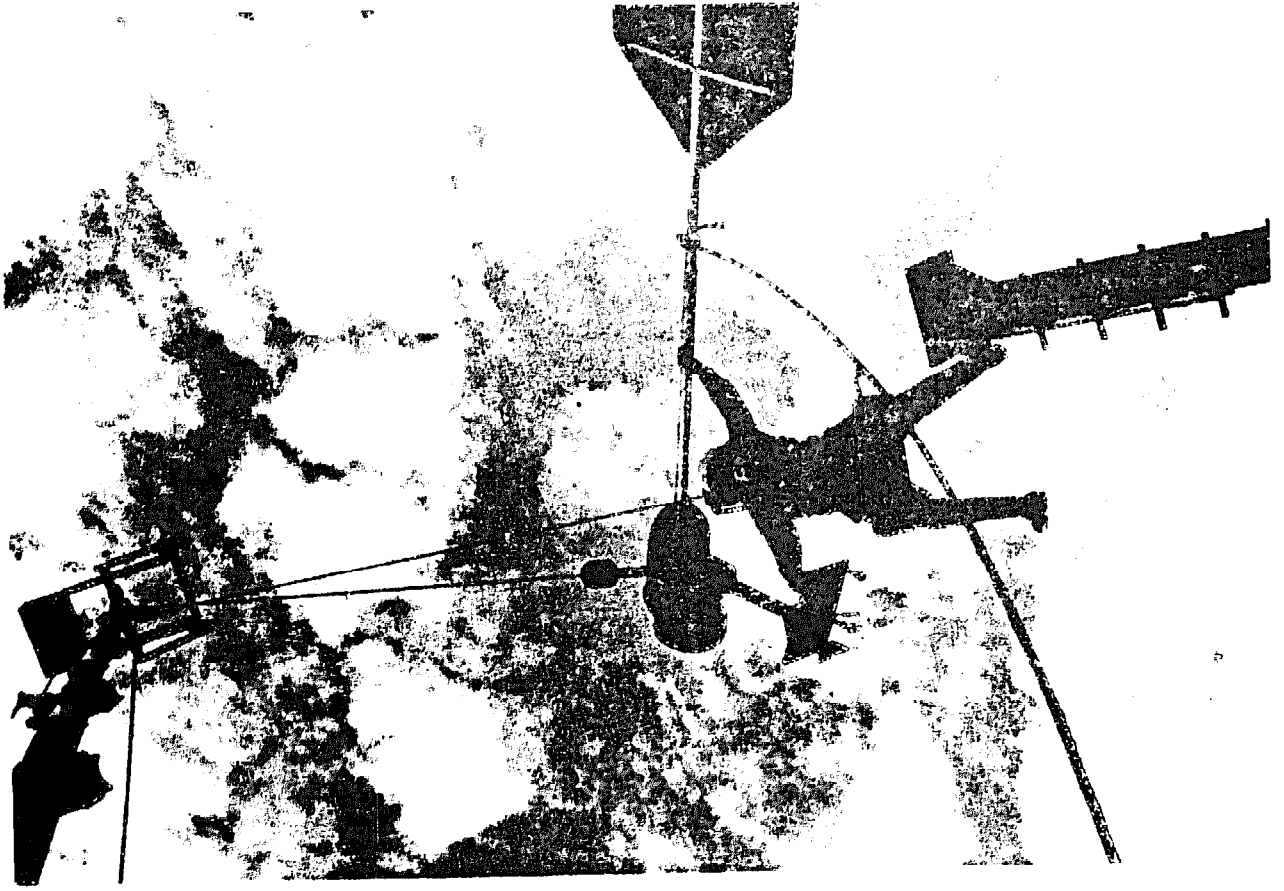

FIGURE A2-5: Hoisting a wind machine up the tower.

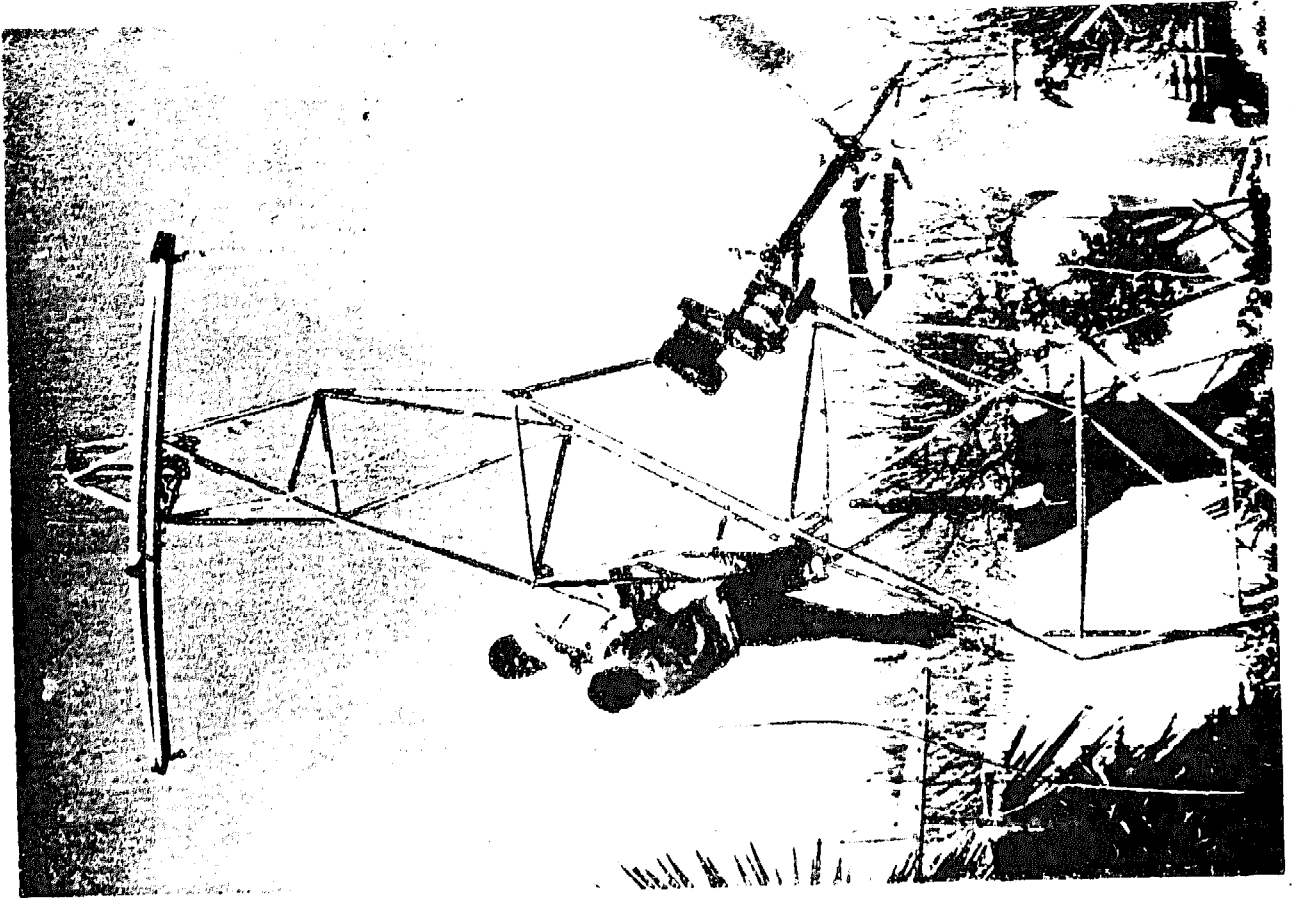
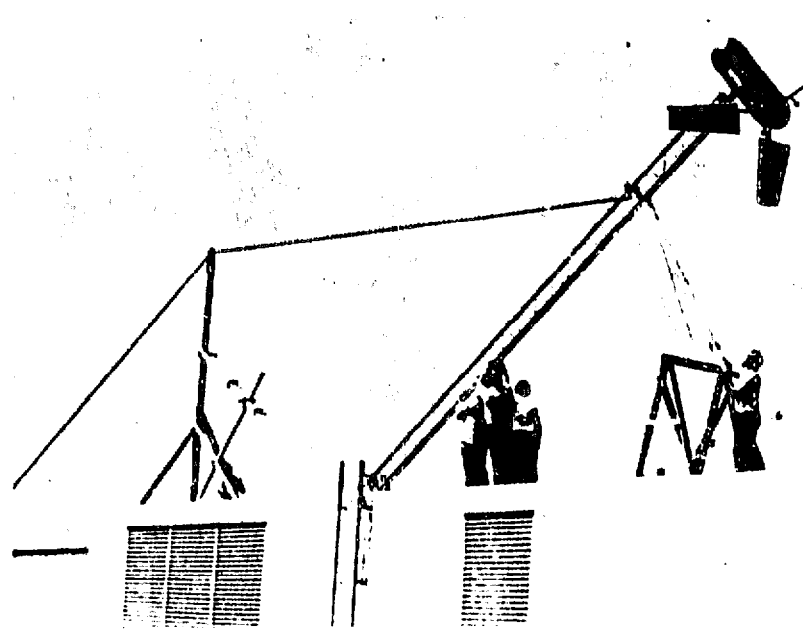
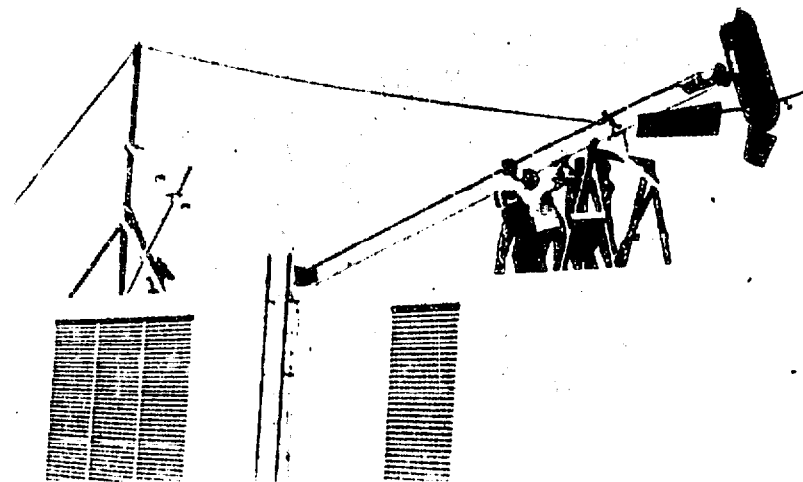

FIGURE A2-4: Sometimes, things don't go exactly as you plan.



A



B

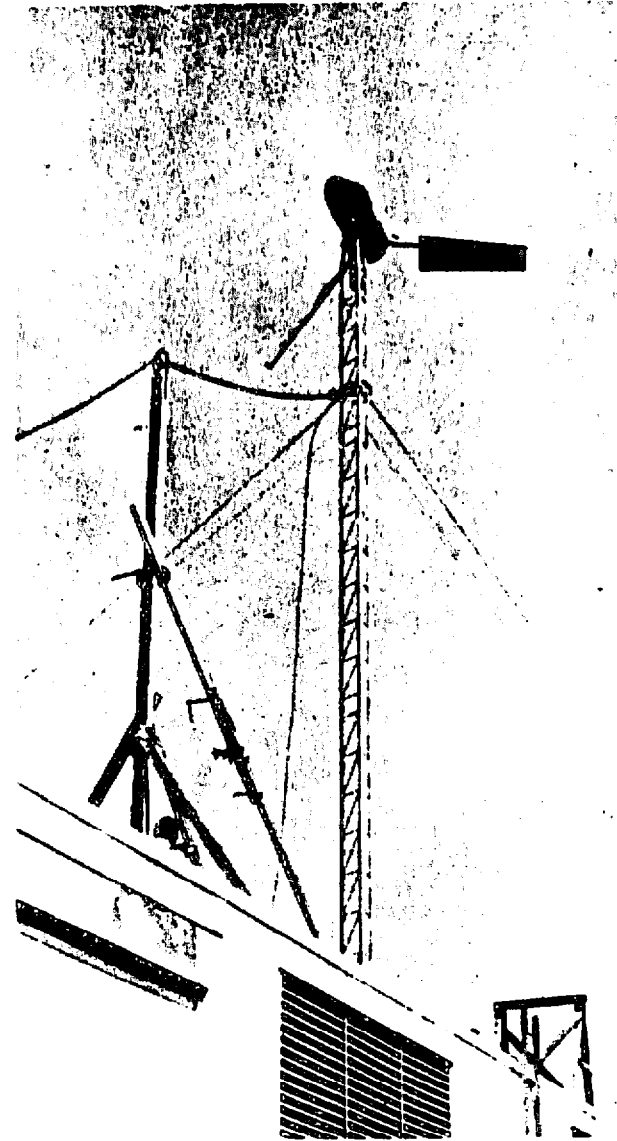

C

FIGURE A2-8: Tilting up wind system and tower using a Gin Pole.

Tilting up a tower with the wind machine already installed (Fig. A2-6), imposes additional loads on the tower. The compressive load at the base pivot and the bending loads where the rope is attached will be much greater. Most likely, you will have to provide extra bracing, but in any case you should consult the manufacturer about these loads or rely on a competent installation crew.

Consider also that if anything goes wrong, you stand to lose the entire tower and wind machine. Risks go up rapidly as tower height and wind machine weight increase. This is not to say, however, that this method will not work; it does, but the individual installation will dictate the method. For sturdy towers of 20 to 40 feet, experience has shown that tilting the whole works aloft can work.

For taller towers, you can expect to hoist the wind turbine up an already erected tower. This will require a block-and-tackle supported aloft and an extra rope to the wind machine. The block-and-tackle is used to lift, while the rope is tugged at from the ground to keep the wind machine from banging into the tower as it journeys upward.

Consider that with a hand-operated block-and-tackle, you can feel what is happening. Tail vanes snagged on a guy wire may not be detected until damage has occurred if you use a winch or auto-pulled hoist. The support structure that holds the block-and-tackle to the tower top must not bend or otherwise yield to the loads of the wind turbine. You can test it by hoisting up the wind machine with a volunteer adding extra weight. Remember that you or another person must depend on this hoist to suspend the machine over its mount while you bolt it down, maybe 60 or 80 feet in the air. This is something like changing engines in a Volkswagen that is hanging much higher than you would care to fall.

Points to remember while doing any wind turbine installation:

1. Hard hats are required, as tools, bolts, and other objects seem to be routinely dropped from aloft.
2. Climbing safety belts must always be used.
3. Make provision for preventing the wind turbine from operating until it is fully installed. Feather the blades, tie them with a rope, or otherwise lock them. One of Murphy's laws says that whatever can go wrong, will. While you may not detect a breeze on the ground, there may be enough wind aloft to create an unpleasant surprise about halfway into the installation process.
4. Perform installations when no wind is expected, and start early. Installations always take longer than expected; bolting a wind turbine aloft after dark is to be avoided.
5. Plan and practice the entire installation process very carefully. The process should cover such details as who has which bolt in which pocket, when said bolt is to be installed with what tool, and by whom.

6. Create an alternative plan. This plan is designed to be used as a contingency if something goes wrong (e.g., the main bolt gets dropped and the wind is coming up).

7. Tools and parts can best be carried aloft in a carpenter's tool belt, available at most hardware stores.

8. Gloves and a warm jacket with lots of pockets will be useful in keeping you warm and able to work and finish the installation, even if a wind starts to come up; the pockets will save tiring trips up and down the tower.

9. Pay close attention to the strength of ropes, pulleys, or other auxiliary equipment you may use in hoisting equipment aloft. For example, if you use standard 7/16-inch climbing rope for hoisting, a nylon rope will withstand about 3900 pounds (wet strength), while a manilla rope is rated at 2600 pounds. If you tie a knot in the rope, you will reduce its strength to about 60 percent of the original, and if you pull it around a tight radius - like a bolt - you reduce the strength of the rope to 80 percent of its rating. Naturally, smaller ropes have lower load ratings. If you are hoisting aloft a 400-pound machine, and you want a factor of safety of about 4 (a minimum you should plan for), you are going to need a rope and other equipment capable of hoisting $4 \times 400 = 1600$ pounds. If you have a manila rope rated at 2600 pounds and you tie a knot at its attachment, the rope is really good for $0.6 \times 2600 = 1560$ pounds. This rope is the minimum strength to consider for the job.

Wiring

Wire size, wire routing, and lightning protection are important considerations. Wire size is determined by the current (amps) that will flow and the length of wire. In general, you select wire sizes to limit the line voltage loss to a small percentage (Fig. A2-7). Using Figure A2-7 and the following simple equation, you can calculate the wire size you need.

For aluminum wire: Circular area size = $35 \times \text{amps} \times \text{feet of length} / \text{volts line loss}$
 For copper wire: Circular area size = $22 \times \text{amps} \times \text{feet of length} / \text{volts line loss}$

Circular area size is converted to wire gage size from the following table:

Wire Gage (AWG)	Circular Area Size	(Circular Mills)
14	4,017	
12	6,530	
10	10,380	
8	16,510	
6	26,250	
4	41,740	
3	52,640	
2	66,370	
1	83,690	
1/0	105,500	
2/0	133,100	
3/0	167,800	

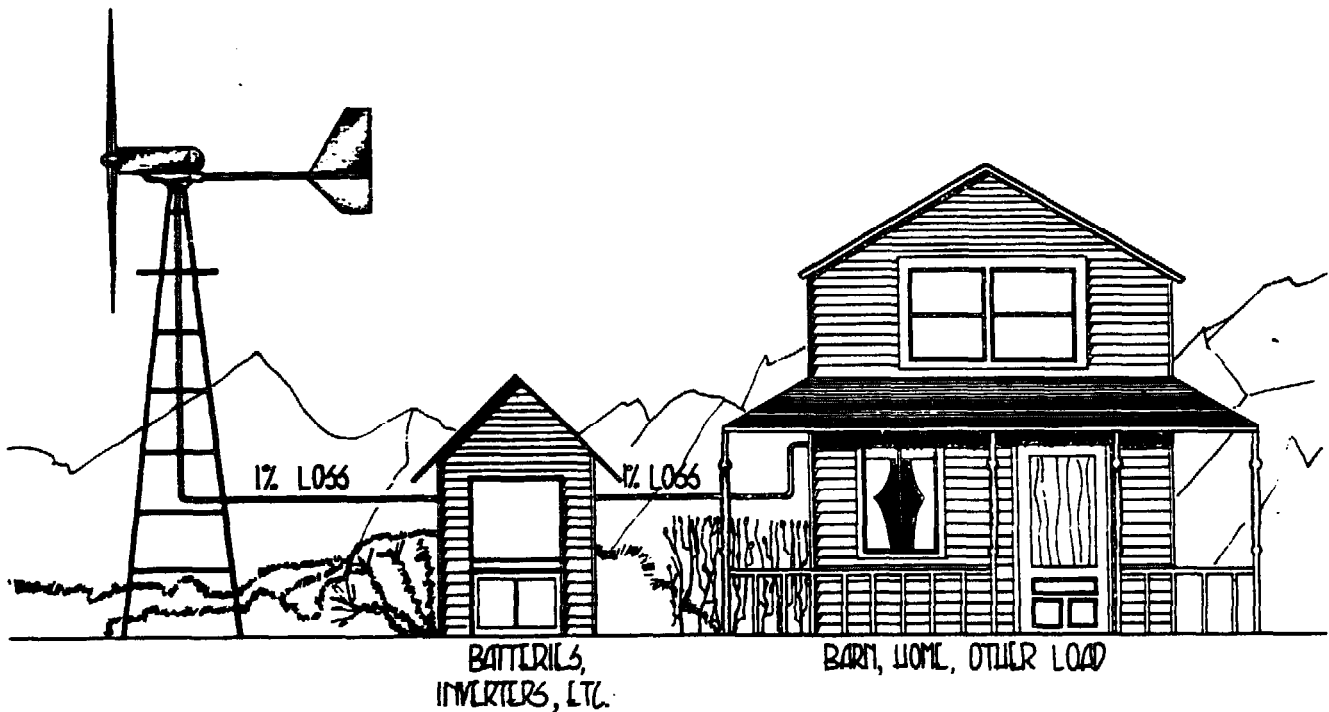

FIGURE A2-7: Typical line voltage loss allowance.

For example, calculate the wire size required for a copper wire run of 25 feet, carrying 25 amps at 24 volts, with a 1-percent line voltage drop.

Solution: from Figure A2-7, 1% = 0.24 volt

then,

$$\text{Circular area size} = 22 \times 25 \times 25 / 0.24 = 57,291$$

From the table, 57,291 is between wire gage 2 and 3. Select wire gage 2 for conservative selection.

Wire routing, except for any deviations necessary for lightning protection, is a matter of direct routing, adequate support to prevent wind or mechanical damage to the wind turbine or wire insulator and adequate separation for prevention of electrical short circuits. Wires that are routed down the tower should be tied to the tower every few feet or fed through a conduit to preclude wind damage.

Lightning Protection

The secret of protecting wind power equipment is to install a good ground wire. This means that you must electrically tie the tower if it is metal, or the wind turbine itself (if it is mounted on a wooden tower) to the earth. All tower guy wires must be grounded by the methods discussed here, and electrically connected to each other as well as the tower.

The National Electrical Code (available at libraries) specifies ways in which various towers and antennas are to be grounded, and the information is useful for WECS. In general, an underground metal water pipe is desirable to use as the ground. In its absence, one or several (use several in dry ground) heavily galvanized pipes (1-1/2 inch diameter is adequate, 1-1/4 inch minimum), or a 1/2-inch copper rod, are driven into the ground to a minimum depth of 8 to 10 feet. Instead of rods, sheets of copper-clad steel or galvanized iron about 3 by 3-feet in dimension can be buried about 8 feet deep horizontally and connected to each other as well as to the tower. This forms an electrical "ground plane." When more than one rod is used, all should be electrically connected to each other as well as to the tower. Wire size for grounding should not be smaller than number 10 copper wire (usually number 6 or bigger), and it is usually a bare wire.

Electrical wires can be protected by a spark arrester (Figure A2-8). These are available at electrical supply houses. In the case of a ground wire on a wooden tower, this wire will protect both the wind turbine and the electrical wires. You should consider adding a ground wire up the entire height of a metal tower as corrosion eventually weakens the ground connection of these towers. This ground wire should have a cross-sectional area at least as great as the total of the two wires it is protecting.

Installing Other Equipment

A wind system that generates electricity to be stored in batteries is a good deal more complex in its installation requirements than, say, a farm-type water pumper. Provision must be made to install batteries, inverters, controls, wires, and perhaps other equipment. In all cases, follow the manufacturer's recommendations, but here are a few items to consider: It is generally desirable to install batteries near the wind generator, especially if lower voltage is to be inverted up to higher voltage. Higher voltage means lower current for any given load. This means wires can be smaller in size, and line loss is reduced.

Batteries should be installed in a cool (but not cold), dry, well-ventilated space and should be well insulated to prevent large temperature changes (Fig. A2-9). Some installations have the batteries in a small lean-to built alongside a home or barn;

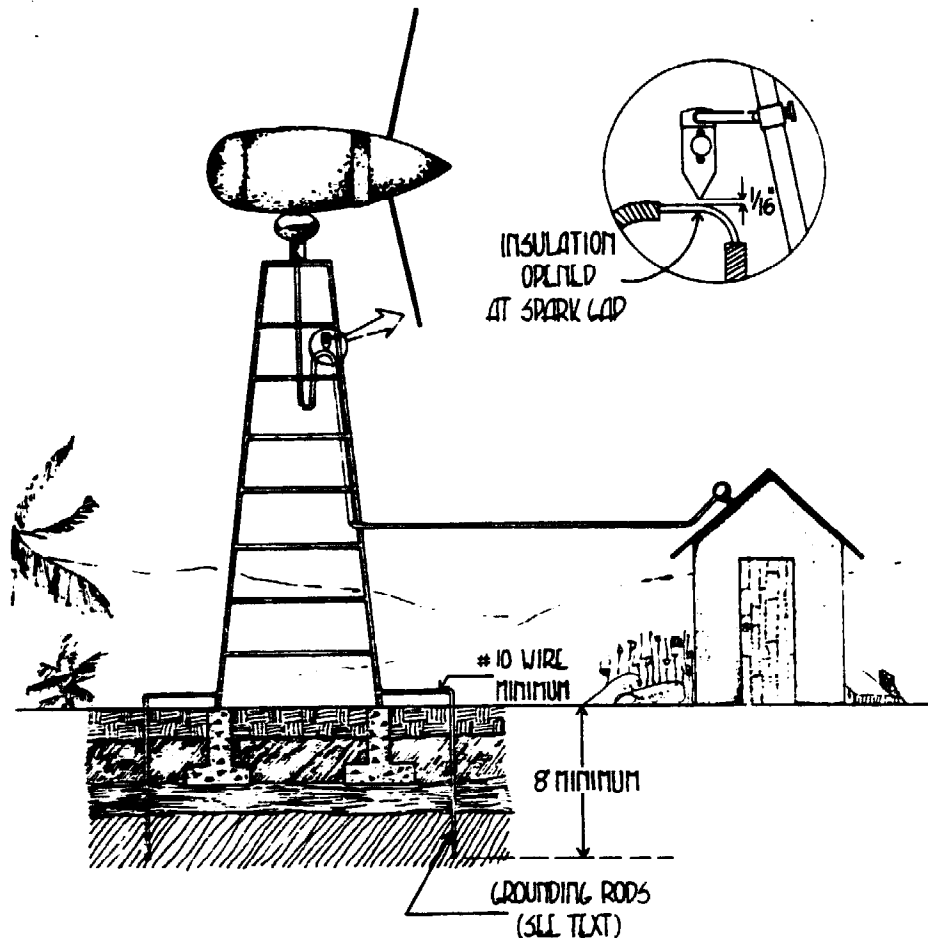

FIGURE A2-8: Lightning protection.

others have the batteries in a basement.* Basement installation is reasonable, but gas formed by the batteries produces an explosion hazard if there are open flames or sparks in the same area. Special caps can be purchased for lead-acid batteries that reduce gassing by catalytic conversion of the hydrogen gas back into water. Some batteries are even offered without vents. You must know the gassing characteristic of your battery before selecting an installation site. Inverters of the motor-generator type should be bolted to a bench or mounting pad. These units don't vibrate much, but their bearings last longer with a solid installation. Static (electronic) inverters generate heat, which means ventilation is the prime installation requirement, as is a dry space free from heavy dust exposure. Most electrical controls and load monitor equipment may be installed in the same space as inverters and batteries.

*Electrical equipment, and especially large battery banks, should be protected by a locked door from vandals and small children. A large wrench dropped across large battery terminals could result in an explosion or a fire.



FIGURE A2-9: Battery bank installation.

Maintenance

From a historical standpoint, you might purchase a good automobile and drive it an average of 50 mph for 100,000 miles. This translates to 2000 hours of operation. You likely would have the car serviced every 5000 miles, or 100 hours. Sales brochures for small WECS, on the other hand, sometimes speak of 20 years of trouble-free operation. Factory representatives talk of customers asking how long their wind turbine will last before it needs fixing.

There are 8760 hours in a year. If your wind turbine operates just one-fourth of the hours in one year - a reasonable number - it will have as many hours on it in one year as your automobile does when you trade it in. It is also reasonable to expect to change the oil, grease a bearing, or change the brushes

just once a year to get long-life performance out of a machine. Here are some of the factors you should consider before making the final selection of your system:

- * Maintenance history of WECS components
- * Can routine maintenance be easily performed up on a tower, or must the machine be lowered?
- * Frequency of expected routine maintenance
- * Nature of monthly, or yearly, expected routine maintenance: lubrication, component replacement, and inspection
- * Number of different tools required to perform maintenance tasks
- * Availability and cost of spare parts
- * Completeness of owner's manual/maintenance documentation
- * Relative safety: can machine be shut off, is there sufficient blade clearance from maintenance personnel, and are there exposed shafts, wires, and potential hazards?
- * Is a factory-trained, experienced installation/maintenance organization available?

Answers to many of these questions are available directly from dealers and other users. Some questions will never have answers but are subject to your best estimate during product evaluation.

The air mass flowing past your wind machine is full of dust and grit, which, over a long period of time, gets into the various components, including bearings, transmissions, and generators. Changing the oil, greasing the bearings, inspecting generators or pumps is the way in which you or your mechanic can monitor the system and prevent rapid wear from such environmental conditions. Evidence of rust, loose wires, worn bushings, and so on should be on an inspection list, which is used each time the wind turbine is inspected.

Blades or vanes which are exposed to the wind are subject to impact from hail, rain, ice, and rocks. Any inspection should include examination of these blades. Wooden blades might need fresh paint; fiberglass and metal blades might also need similar service.

Vibrations in the wind turbine can cause bolts and nuts to loosen and parts to fatigue and fail, wires to break, and so on. This is another area for thorough examination. Properly bolted joints will not fatigue. These are items that should be inspected as a routine, preventative procedure. Once a year is a usual interval for performing this type of maintenance. You or your mechanic would normally schedule this work for a nonwindy day. Most of the items listed above rarely, if ever, require any maintenance action but should be inspected anyway. Some owners climb their tower once a month, just to see that everything is in order. In any event, manufacturers usually have a recommended inspection routine.

Maintenance should be scheduled following any extreme wind or hailstorm. These conditions warrant a brief inspection.

Electrical equipment such as batteries and inverters require cleaning, water checks, and terminal inspection. Water pumps need to be checked for leaks. The list seems endless, but each check is necessary. Time spent in inspection, cleaning, and lubricating will be returned in extended service life.

ENVIRONMENTAL IMPACT

Along with all other factors, planning a WECS installation involves consideration of its impact on the environment.

Small systems are not suspected of producing harmful effects, based on almost a century of experience with hundreds of thousands of wind machines.

Studies are also being conducted to test the impact of wind turbine rotors on TV reception. Again, small systems are not really suspect here, unless one installs a dozen or so of them, in which case all of these units collectively might affect electromagnetic waves. These effects would be highly local in nature.

Typically, wind turbines are installed far enough from dwellings that ambient wind noise is higher than machine or rotor noise. You should keep this characteristic in mind and determine for yourself the noise characteristics of the wind machine you plan to use. Noise comes from blade tips, transmissions, bearings, and generators. Some machines are noisy; others are not.

Towers with guy wires usually require care to preclude guy wires from encroaching upon existing or planned easements. Tower footings may extend deep into the ground. It is usually unacceptable to install a tower directly over a septic tank or water main, but it has been done.

The visual impact of a wind system is an area for personal taste - not just your taste but that of your neighbors. No words of caution written here will substitute for your own investigation into the potential reaction to your planned wind system.

All of the notes in this Appendix have been derived from the collective experience of the authors and from interviews with respected wind energy technicians and consultants. While many of the points raised here were written as warnings, the frequency of occurrence is low for any problem area mentioned. We feel that such occurrences will remain low and owners of small WECS will enjoy years of satisfactory service from their machines if careful consideration is given to these and other factors related to WECS ownership.