

AT MICROFICHE
REFERENCE
LIBRARY

A project of Volunteers in Asia

Small Scale Hydropower Technologies

by J.J. Tiemersma and N.A. Heeren

Published by:

Stichting TOOL
Entrepotdok 68A/69A
1018 AD Amsterdam
THE NETHERLANDS

Available from:

same as above

Reproduced by permission.

Reproduction of this microfiche document in any form is subject to the same restrictions as those of the original document.

tool
CAT

TECHNICAL DEVELOPMENT WITH DEVELOPING COUNTRIES

CENTER FOR APPROPRIATE TECHNOLOGY

SMALL SCALE HYDROPOWER TECHNOLOGIES

J.J. TIEMERSMA
N.A. HEEREN

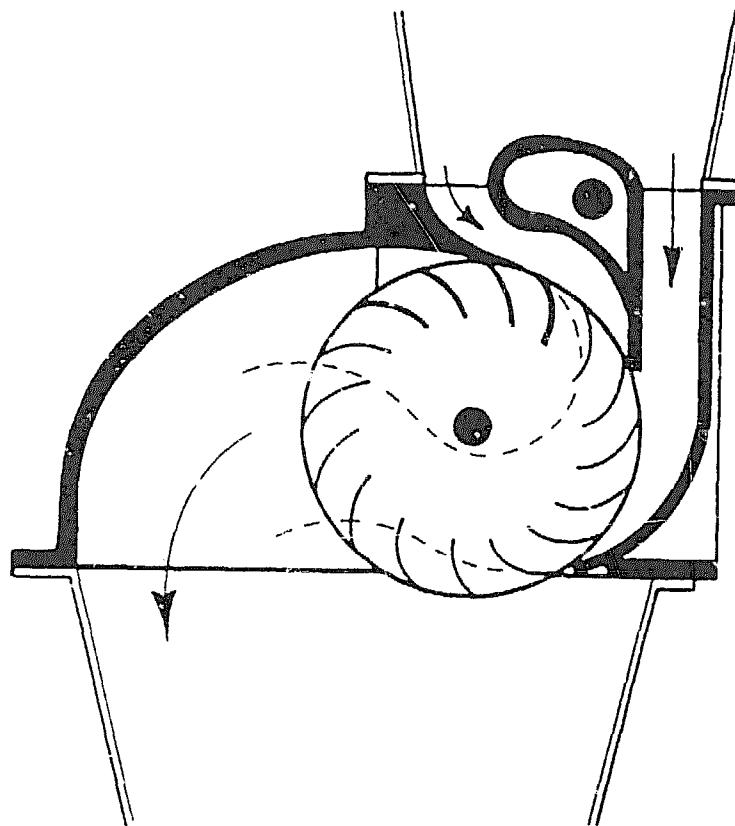

Published and compiled by:

TOOL Foundation
Technical Development with Developing Countries

Entrepotdok 68A/69A
1018 AD Amsterdam
The Netherlands

C A T
Center for Appropriate Technology

Stevinweg 1
2628 CN Delft
The Netherlands

Typists: Petra Dorsman and Martin Rijn.
Lay-out: Martin Rijn and Niq. Heeren.

*The use of data, methods and/or results, given in this publication,
is at your own risk.*

*The Delft University of Technology declares herself (through CAT)
not responsible for any damage arising from the use of these.*

Frontcover shows a cross-flow turbine.

SMALL SCALE HYDROPOWER TECHNOLOGIES

AN OVERALL VIEW OF HYDROPOWER TECHNOLOGIES FOR SMALL SCALE APPLIANCES

J.J.Tiemersma
N.A.Heeren

Commissioned by:
the Directory General for
environmental Hygienics of
the Dutch Ministry of Housing,
Physical Planning and
Environment



*Cease your work, ye maidens, ye who laboured at the mill,
sleep now and let the birds sing to the ruddy morning;
for Ceres has commended the waternymphs to perform your task;
and these, obedient to her call, throw themselves upon the
wheel, force round the axle tree and so the heavy mill.*

This is, in a lyrical way, the first known reference to a watermill, in the form of an epigram by Antipater of Thessalonica, written about 85 BC.

TABLE OF CONTENTS

INTRODUCTIONAL SECTION

- 1. PREFACE page 3
- 2. SCOPE OF THIS PUBLICATION page 5

GENERAL SECTION

- 3. MEANINGS OF SMALL SCALE HYDROPOWER page 8
- 4. BASICS OF HYDROPOWER page 12
- 5. CONVENTIONAL HYDROPOWER TECHNOLOGIES page 17
- 6. SMALL SCALE HYDROPOWER TECHNOLOGIES page 22
- 7. TURBINE TYPES page 30

PRACTICABILITY SECTION

- 8. WATERWHEEL DEVELOPMENT AND USE page 42
- 9. PRACTICE EXAMPLES page 63
 - I. GENERATING ELECTRICITY page 63
 - II. MOTIVE POWER page 70
 - III. WATER PUMPING page 73
- 10. APPLICABILITY LIST page 83
- 11. COSTS OF SMALL SCALE HYDROPOWER page 84

APPENDIX

- 12. DESIRED FURTHER STUDIES page 88
- 13. LITERATURE AND MANUFACTURERS page 91

INTRODUCTI ONAL SECTION

1. PREFACE

The use of waterpower for industrial and domestic purposes has generated interest since Grecian culture. In the last decades, interest has even increased, as this power source has the appraisable qualities of being renewable and non-polluting and giving more oil- and import independence. Especially these qualities make waterpower an excellent option both in developing countries as in economies like Europe and Northern America.

Import independence is most attractive for developing countries. In the Western World the non-polluting aspects suits to attemptions made to reduce disturbance of the environment caused by exhausts from thermal electricity generation.

In the past most of the most suitable sites for hydropower stations are being used on a large scale. Technologies on this scale have proven well and are being employed and published worldwide.

Now that energy has become a topical issue, also locations with a smaller waterpower source become interesting in the Western World. These locations and the respective lower outputs need their own techniques. This is why the numbers of producers of smaller waterpower installations as well as the number of field tests and publications hereabout increase.

Alike in the Western World in medieval times and thereafter, power needs in countries with a developing economy are of a smaller amount. Also these needs are to be fulfilled locally, caused by greater distances and lack of good (power)infra-structure. This is why, apart from national supply schemes, the small scale schemes are of importance also.

However, in both areas, waterpower has the constraint of needing relative high capital investments. This counts also for small scale schemes, especially when techniques are copied from those for big scale applications.

Fortunately researchers and even product makers have started to develop an own approach to small scale waterpower technology. Aspects herewith are to try to lower the capital costs by minimizing civil constructions and by designs or mechanical installations which can be made easy and locally with local materials.

Close attention should be paid to these new developments as they might provide the utilization of formerly ignored sources of hydropower. More in general, small scale waterpower forms the greater part of the yet unused hydropower resources in the world, much of these in developing countries. As energy is an important factor in human activity and development, emphasis should be laid on making this power source work.

The authors of this publication are Niq. Heeren, working at TOOL Foundation, Amsterdam and Jan Jaap Tiemersma, scientific officer at Delft University of Technology, Department of civil engineering, group of hydraulic engineering, and contributor to feasibility studies of hydropower projects in the Netherlands and in developing countries.

This study has been commissioned by the Directory General for environmental Hygienics of the Dutch Ministry of Housing, Physical Planning and Environment. On assignment of this Ministry the following gives an overall view of, and information about the possible techniques and devices on small scale hydropower, and is meant to stimulate the spreading of the knowledge.

It is hoped that anyone thinking of small scale and non-polluting power generation can extend insight in available hydropower techniques.

2. SCOPE OF THIS PUBLICATION

The purpose of this study is to give a survey of present technologies to use hydropower on a small scale. As a limitation a net output of 300 to 500 kiloWatts could be adopted, which range can be divided into micro hydro (up to 100 kiloWatts) and mini hydro (100 to 500 kW). Special remark is given to those configurations that need little civil constructions and investments, and are easy to build.

The applicability and feasibility of these techniques are discussed and indications are given on some aspects which need further investigations. Most subjects appear as examples of practice, manufactured items and laboratory studies.

While reading, one should keep in mind to compare small scale hydropower with other alternatives like biogas, solar energy and windpower. Always diesel generation and electricity grid connection should be compared in economical, environmental and social studies.

In the following the present technologies on small scale hydropower will be discussed in a general section and illustrated in a practicability section.

In the general section first some definitions are given together with some remarks on small scale hydropower (Chapter 3). For a good understanding Chapter 4 describes the theoretical basics of hydropower. In Chapter 5 implementation technologies are dealt with, as is done in Chapter 6 on small scale implementation in special. To give an overall view of the types of the most important component of a hydropower unit, the turbine, Chapter 7 will give some details.

The practicability section starts with Chapter 8, where the development and use of hydropower in former days are surveyed. These technologies can improve understanding or even can give ideas for today's implementations. In Chapter 9 some practice examples of present small scale implementations are given. A summary of applicabilities of small scale hydropower devices is listed in Chapter 10, while in Chapter 11 some remarks are made about the costs of small scale hydropower.

In appendical section at last blanks in small scale hydropower technologies are summarized in Chapter 12 and a Chapter 13 lists referring and further literature and addresses of manufacturers of small scale hydropower units.

GENERAL SECTION

3. MEANINGS OF SMALL SCALE HYDROPOWER

DEFINITION OF THE TERM

The word "hydropower" is to be understood as any capability of water to do a kind of labour, to produce power that may be useful to men and men's activities.

For the scale of hydropower utility both costs, head and output are determining. Although several different ranges can be found in literature, the border line between big hydro and small hydro at 1000 kW seems appropriate.

	Power range (kW)	Head (m)		
		Low less than	Medium	High more than
Big hydro	more than 1000	25	25-150	150
Small hydro	500-1000	25	25-125	125
Mini hydro	100-500	20	20-100	100
Micro hydro	less than 100	10	10-50	50

The term small hydro often stands also for mini and micro sizes and is often confused with small scale hydro.

A definition of small scale hydropower can be given as any mini or micro hydro implemented with little investments, little impact on the surrounding area by its small installation size and serving a limited number of demands.

POTENTIAL

The power of water depends on the amount of water per time unit (discharge) and the vertical height that water can be made to fall (head). A site with a great amount of water flow and a big head will make a big scale hydro-power plant. On earth however such places are scarce in comparison with those where either head or flow are not exorbitant or where both are relatively small.

WEIGHING CONSIDERATIONS

Compared with big scale implementation advantages of small-scale hydropower are :

- Solution to problems of growing supply and of difficulties in supply of fuel , particularly in rural, isolated areas.
- Help to promote socio-economic and cultural development of consumers and owners.
- Technologies available that only require adaptations to specific conditions.
- Low operating costs.
- Cheap and simple maintenance due to simple technologies.
- Little or no environmental impact.
- Compatible with use of water for other purposes.

Disadvantages and limitations are :

- High unit investments costs per installed kW.
- High costs of preliminary and design studies in relation to total investments.
- Utilization dependent upon the availability of resources near the point of demand.
- Low head projects are vulnerable to fluctuations in stream flows , falling even to (nearly) zero.
- Each plant requires separate installation of transmission facilities and eventual connection to electricity grid , and possibly as many people to operate as it does to operate a big scale plant.

INVESTMENTS

Investments per installed kW raise as installed power lowers. Also investments are higher for low head implementing than for high head units.

For mini hydro sets the installation costs lay between 1000 and 2000 US\$ per kW. Prices per unit of delivered energy depend also on installation size, but also on using rate and river flow characteristics.

For micro hydro, if implemented with simple design and little and cheap materials (artisan made turbines for example), investments per kW of around 700 US\$ can be achievable.

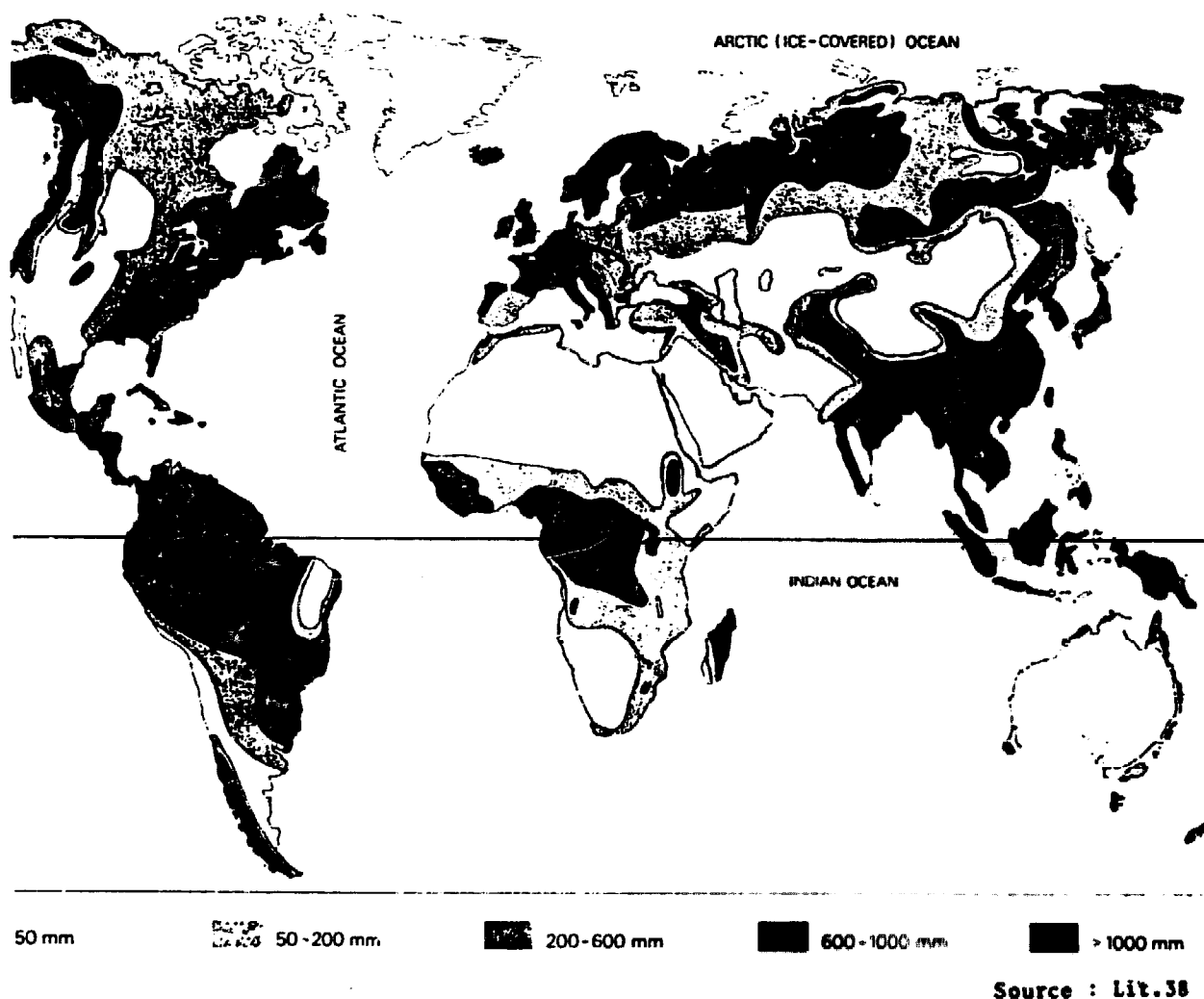

fig. 1 : World distribution of river runoff in mm/year.

In literature the total hydropower potential worldwide (exclusive of tidal- and wavepower) is estimated at 1.2 to 1.7 x 10¹⁶ Watt-hours each year. This is about 15 to 25% of the total world consumption today. The hydropower production developed so far is around 10% of this figure. The remaining capability is available mainly in small quantities and mainly in developing countries.

4. BASICS OF HYDROPOWER

As most of the energy sources, hydropower originates from the sun's energy radiated on earth. By processes of evaporation, (wind)transport and precipitation on an elevated area, water in this area has obtained potential energy. This potential energy accounts $E_{\text{pot}} = mgh$, where h is the height difference compared to sea level (other symbols see end of section).

NORMAL RIVERFLOW

While streaming downward (runoff), this potential energy, converts gradually to pressure energy (water submerged under the water surface) and velocity energy ($E = mgh + mp/\rho + \frac{1}{2}mv^2$). In a river the pressure energy (mp/ρ) remains quite constant like the water depth does, except when, for example, a reservoir or lake is concerned. Also the velocity energy ($\frac{1}{2}mv^2$) remains nearly constant.

While the water streams down the release of energy by the decrease of potential energy (mgh by lowering h) is completely absorbed by friction between water particles and between water and riverbed, producing heat. This hardly measurable increase of temperature then is transmitted to the surrounding, and, is lost.

ENERGY OUT OF HEADS

To adapt energy from water either potential, pressure, velocity or combined energy may be drawn on. In the process of adapting, however, also energy conversions from one feature to another may occur. To visualize the type of energy, the presented formula can be divided by mg : $e = h + p/\rho g + v^2/2g$, where e is now the energy of water per unit of weight, and is expressed in meters, while the right hand terms are head, pressure head and velocity head respectively.

As an example of adapting primarily potential energy the overshoot wheel is wellknown :

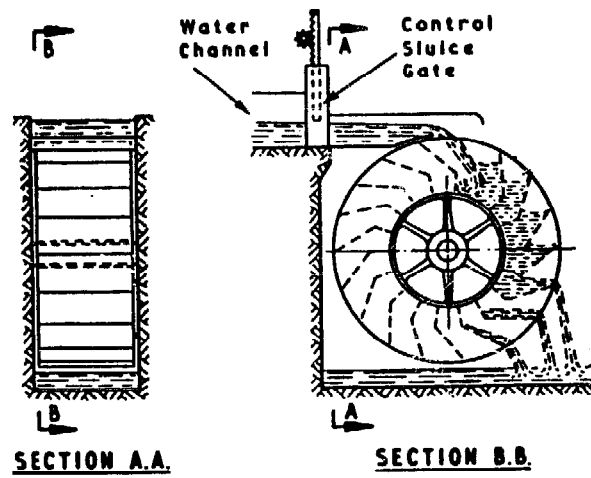

fig. 2 : Overshot wheel.

A good example of using primarily velocity energy is the undershot wheel :

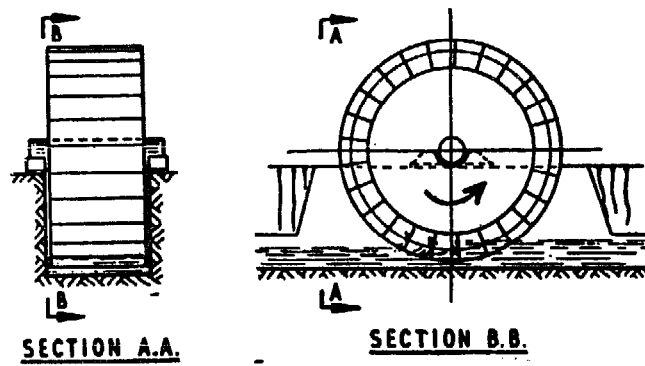

fig. 3 : Undershot wheel.

An example of adapting primarily pressure energy is given by the Pelton wheel. Also an energy conversion within the unit is clear : when leaving the nozzle the water pressure is converted completely to velocity energy :

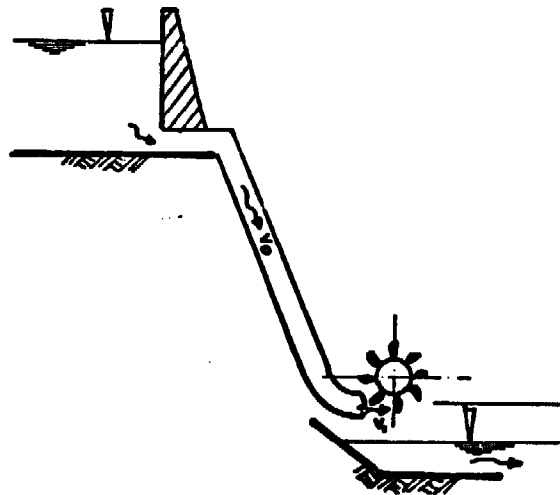

fig. 4 : Pelton wheel

Other turbine types like Francis and Kaplan are more complex in the mixture of energy adapted and occurring. All techniques have in common however that the normal local river flow is changed. Instead of initial energy getting lost by friction, the potential energy is converted to useful energy.

ENERGY CALCULATIONS

To calculate the amount of energy that can be diverted by a hydropower installation, the total height of water just before and just after the installation has to be compared, which difference is the usable head H .

As in all cases waterpower is potential energy $E = mgh$ at first, the theoretically to be adapted energy is $E_t = mgH$, or, as $m = \rho V$, $E_t = \rho gHV$ in joules.

The theoretical power to be generated is E_t per unit of time or $P_t = \rho ghQ$.

By friction in or by the installation also a part of the energy will be lost to heat, so that about 40 to 90 % of the theoretical energy becomes available on the axis.

When the properties of water are filled in, together with an output of 70 %, handy formulas then are :

$E = 2HV$ in Watthours and $P = 7HQ$ in kiloWatts. These estimating formulas are valid for any type of waterpower installation, as long as for the usable head H , local head h , pressure head $p/\rho g$ as well as velocity head $v^2/2g$ before and after the installation are taken into account.

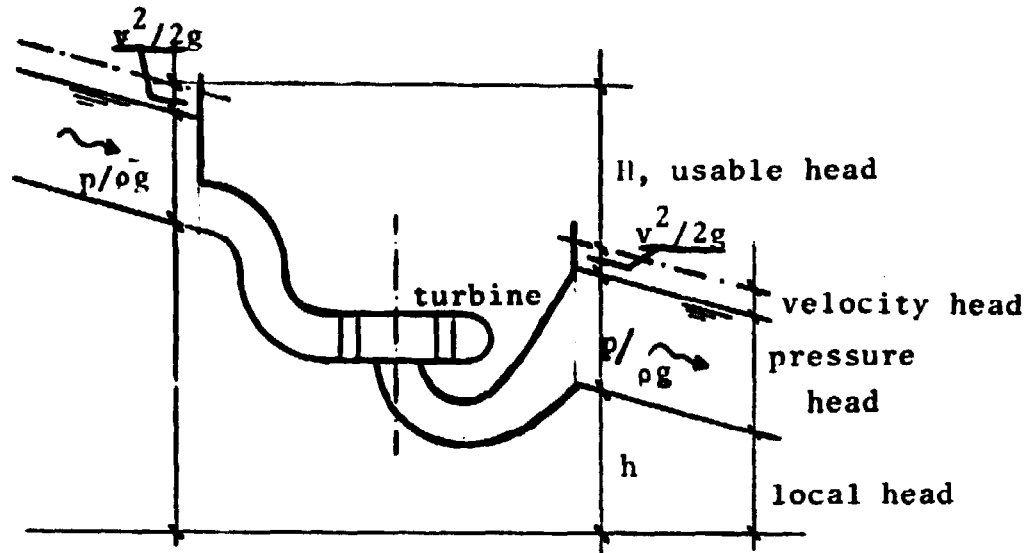

fig. 5 : Usable head.

Velocity head is not visible in nature. As for freestream turbines that use primarily velocity energy, this feature can be written as : (filling in $m = vAt$) $E_t = \frac{1}{2}\rho v^3 At$, and power as : $P_t = \frac{1}{2}\rho v^3 A$, where A is the rotor-swept area.

Here a strong dependence of the occurring stream velocity is obvious. Both for undershot wheels and Savonius-rotors as for hydrofoiled rotors¹ a theoretical optimum can be reached of 1/3 of this energy, adapted to the axis. Practically only 25% is reached, so that for first investigations one can handle the formulas $E = .035v^3 At$ in Watthours and $P = .125v^3 A$ in kiloWatts.

1 : See also Chapter 7.

USED SYMBOLS

- A Cross section of the stream that is swept by the rotor in m^2 .
- E Energy in Joules or Watthours (1 Wh = 3600 J)
- e Energy per Newton of weight in meters.
- g Acceleration of gravity in $m.s^{-2}$.
- h Local head or height in m.
- H Gross usable head in m.
- m Mass in kilograms.
- p Pressure in Newton per square meter.
- Q Discharge in $m^3.s^{-1}$.
- t Time in seconds.
- v Water velocity in $m.s^{-1}$.
- V Water volume in m^3 .
- ρ Specific mass in $kg.m^{-2}$.

5. CONVENTIONAL HYDROPOWER TECHNOLOGIES

Hydropower installations can be divided into three main groups :

- reservoir installations
- diversion installations
- run off river installations

RESERVOIR INSTALLATIONS

Main element in reservoir installations is a dam that heightens the water level of a river to make a usable head. Through this dam water is tapped and lead into turbines placed directly behind the dam or at lower locations. An other purpose of the dam is to create a reservoir to conserve water for times in which the river flow is less than needed by the turbines.

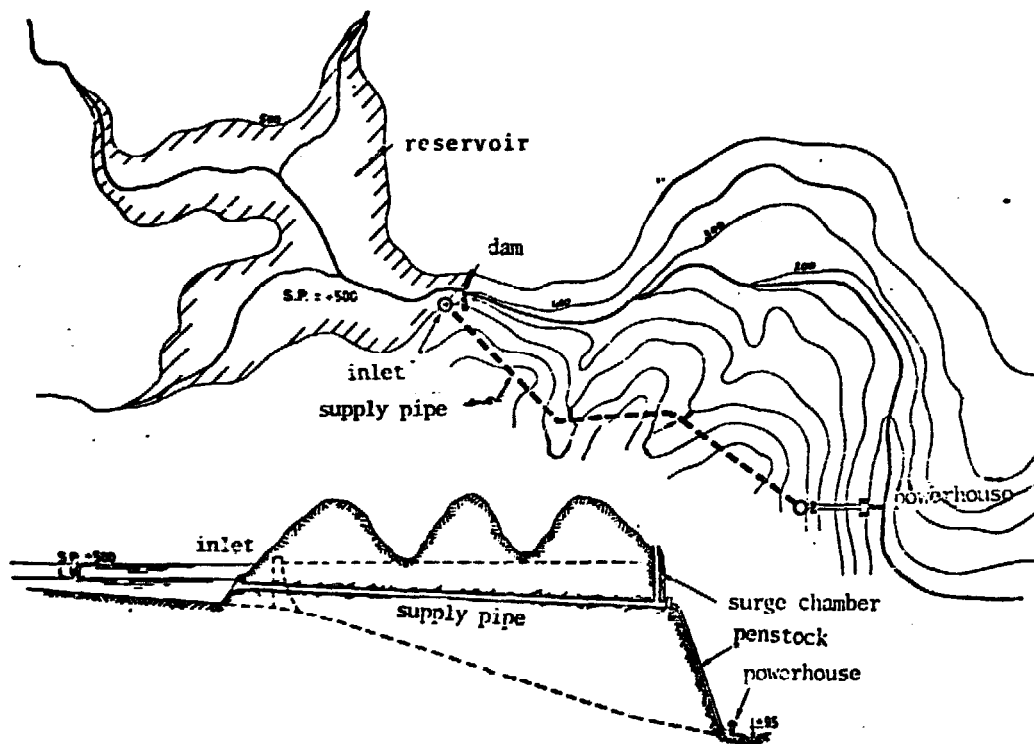

fig. 6 : Reservoir installation.

DIVERSION INSTALLATIONS

The main element of a diversion installation is a canal, parallel to the river, with a smaller slope. At the inlet of this diversion canal a small barrage may be built in the river, to force the water into the canal and to control flow and entrance of sediments.

After the height difference between river and canal has reached a usable head, a pressure pipe is used to lead the water down to the turbines placed at the border of the river.

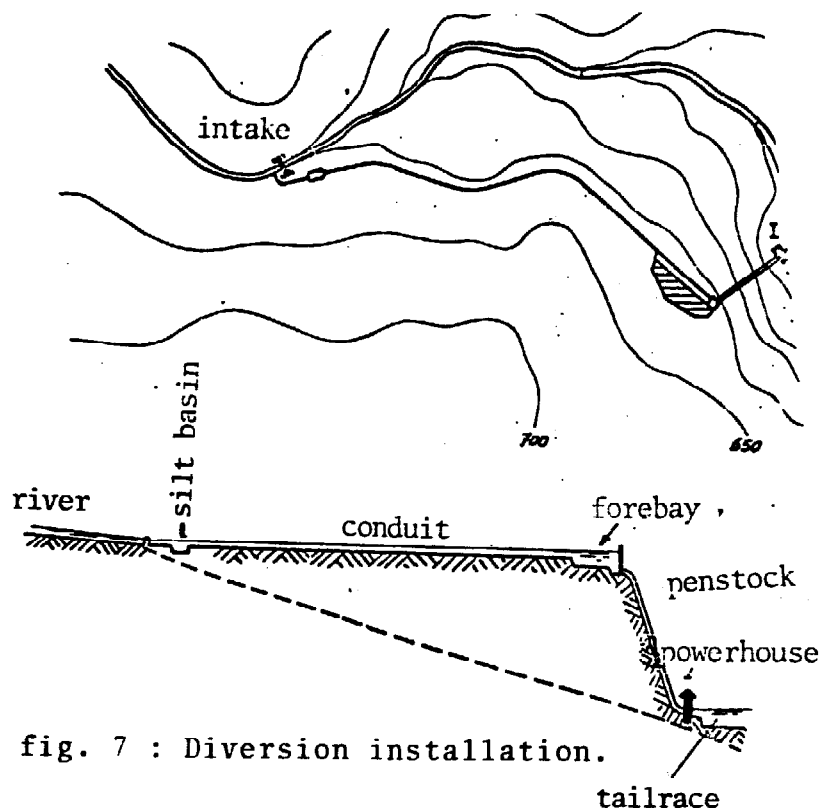

fig. 7 : Diversion installation.

RUN OFF RIVER INSTALLATIONS

Typically for run off river installations is the absence of a dam, a penstock and a diversion canal. The installation is built in the middle of or aside the river, or floats on it. If this structure forms a barrage from one river border to the other, an artificial local head may be provoked. No reservoir is been formed however.

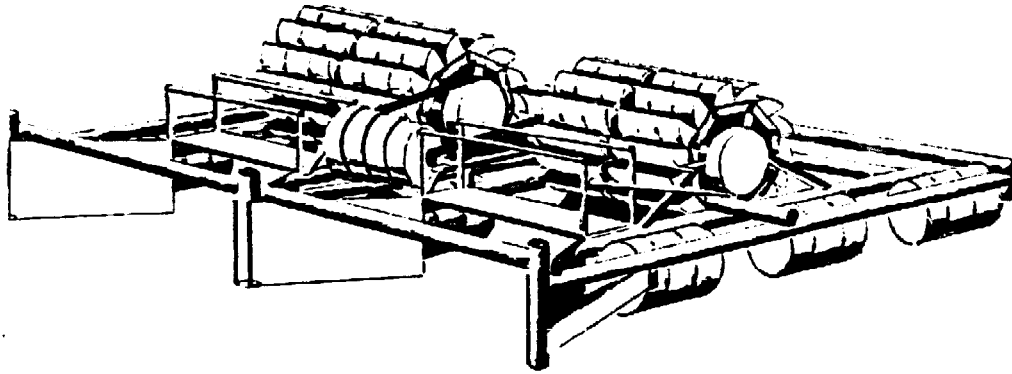

fig. 8 : Run off river installation.

INSTALLATION ELEMENTS

The main components of a hydropower installation are:

Dam

A structure built across the main watercourse in order to store and raise the level of the water. Materials: concrete, earth clay, rock, wood, plastic etc. or combinations.

Intake

A structure to facilitate the entry of water to the conduit system. May or may not be submerged. Materials: concrete, masonry, rock etc.

Conduit

A canal or tunnel with free water surface leading the water from the intake to the forebay. For micro hydro irrigation canals or wooden aquaducts can be used. Materials: unlined or lined with concrete, rock, masonry, or wood.

Silt basin

A system for preventing solid particles from entering the penstock or conduit, to protect the turbines for wear.

Forebay

Structure that facilitates the entry of water to the penstock.

Materials : concrete, masonry, lined rock etc.

Penstock

Pressure pipe leading the water with big slope to the turbines.

Materials : steel, concrete or wood wrapped round with steel cable, plastics.

Surge chamber

A tank or tower for compensating over- and underpressures in penstocks, which occur by opening and closing of valves.

For most micro hydrosystems not necessary, if automatic load control is provided.

Power house

Structure in which the turbines, generator and other (elektro-) mechanical equipment are housed.

Valve

Tap to shut off all input of water to the turbine.

Draught tube

Tube that discharges water from a reaction turbine to the tailrace.

Tailrace

Structure that returns the water from the power house to downstream of the river.

Turbine

A hydraulic motor that converts energy of water into mechanical rotational energy.

If energy from the shaft of the turbine has to be transformed to electrical energy, the following components are important :

Generator

An electric machine that converts mechanical energy at its rotor into electrical energy in its stator. Choices between synchronous and asynchronous and of different phases and voltages.

Transformer

High voltage cables to transmit the electrical energy from the power house to the consumers. At the power house a step-up transformer is used, as a step-down transformer is placed at the other end, nearby the point of consumption.

6. SMALL SCALE HYDROPOWER TECHNOLOGIES

LOWER COMPLEXITY

If not a copy of big hydropower technology, small scale hydropower technology should have :

- easy or standard manufacturing
- cheap and simple installation lay outs.

Easy or standard manufacturing of mechanical and other apparatus can be achieved by adapting those techniques that permit fabrication and assembly with little special knowledge and equipment, or permit standard production suitable to standard application on different sites.

Cheap and simple lay out of small scale waterpower demands a minimum of civil construction works, e.g. by looking away from reservoirs.

To applicate these conditions one must accept a lower efficiency of the achieved output, compared with technologies copied from the big scale. However, to reduce investment costs the design for a particular site should not take too much time and funds nor should too sophisticated technologies be adapted that have relatively high costs in compare with their little raise of plant efficiency. This is a way to reduce the investment costs per kW to a standard compatible with those of big hydro and alternative (small scale) technologies. One must keep in mind that hydro investments are the bigger part of the hydro energy price.

RELIABILITY

For the same reason investment savings possibly can be gained by regarding the reliability of delivered power not that important as is common with big hydro. Depending of nature of demand a water shortage on a few days a year might be acceptable. This can save on civil works e.g. inlet structures.

If future demand is not to be predicted with certainty care should be taken not to over-estimate this figure. Many small hydropower sources never came to be harnessed by choosing too high a future demand and according power to be installed, in feasibility studies.

Also to avoid too big dimensions of civil constructions and power sets a (predicted) peak demand should be regarded in a different way as is done with big hydro.

Again depending on nature of demand the peaking demand may not be accepted and postulated to a period of lower demand. This also lowers the system reliability, but brings continuing pleasure of lower energy prices.

Never investments savings should be adhibited that result in lower safety, more maintenance needed and shorter lifetime. Failures like absence of good desiltation basins where needed and generators having too low capacity are disastrous but not seldom happening.

For reason of the lower outputs involved some new or complementing technologies are possible in small scale applications.

MOTIVE POWER GENERATION

As an alternative of generating electricity the power on the axis of a turbine can be made useful as a motor to drive apparatus directly. These can be food processing equipment, like rice hullers, grain mills, oil presses and wood saws, water pumps etc. This makes electrical equipment redundant and herewith rotation speed more flexible and energy conversion and transport losses smaller.

A restriction is given by having to use the generated power at the hydropower site itself.

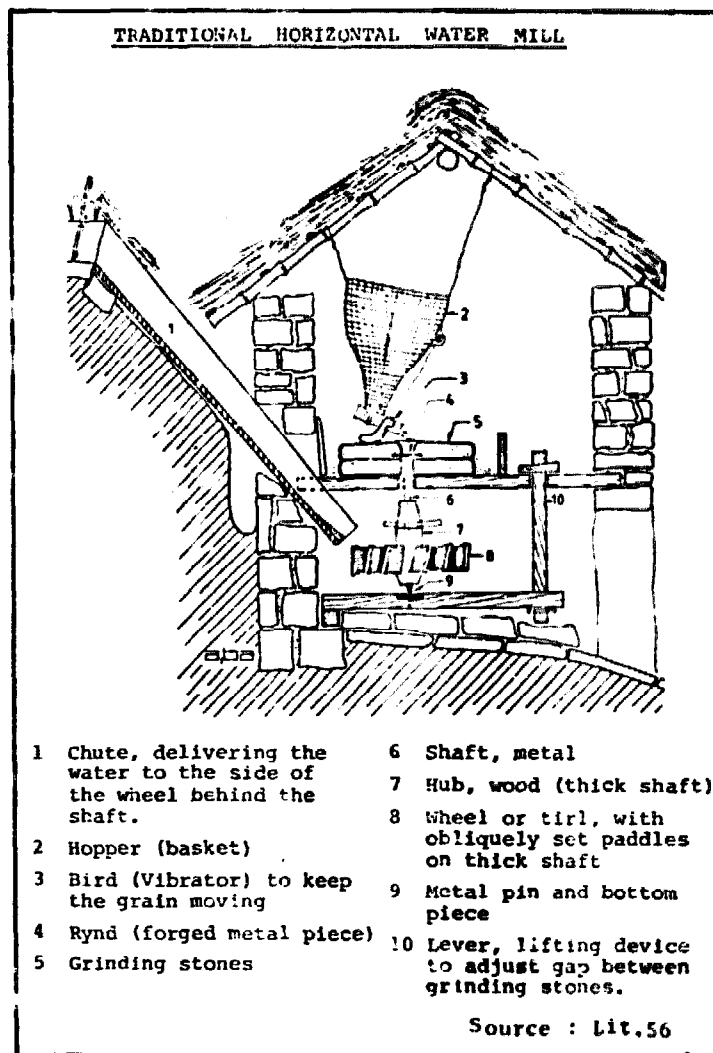

fig. 9 : Motive power from impeller wheel.

USING FREESTREAM TURBINES

To avoid tubes and housings that are needed with normal (restricted flow) applications, some technologies are available that permit to place a naked turbine in a stream flow.

These turbines use velocity energy available in flowing water without building up significant head (pressure energy).

A special group of freestream turbines is formed by installations for converting wave power. A more common example is the undershot wheel, placed in a river.

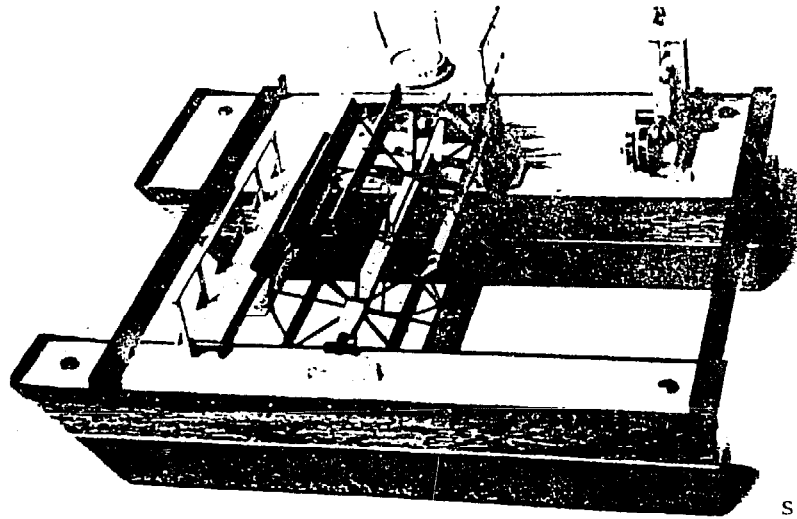

Source : Lit.98

fig. 10 : Model of a floating mill.

Only since recent times a new group of freestream turbines is added, that is based on technologies similar to windpower techniques. By giving the runner blades a cross-section like aircraft wings, underpressure will appear at one side of the blades, giving the lift force to turn round the runner. As water is a different medium, underpressure can be dangerous to the runner blades by cavitation. This effect limits the application of this group of freestream turbines, the submarine windmills, to small scales, as does the little energy flux in water of $.02$ to $.4 \text{ kW.m}^{-2}$ in river currents of $.5$ to 1.5 m.s^{-1} at 25% efficiency. Even with installations of big size still moderate power can be distracted. (This does not count for tidal currents with high stream velocities). In favour of freestream turbines counts that efficiency is not affected by changing water levels, if the device is mounted on a float. Thus adaption to varying river flows is made automatically, as a float always keeps the same distance to the water level.

Where head is only available at high prices or when only little energy is needed, freestream turbines are a simple and cheap alternative.

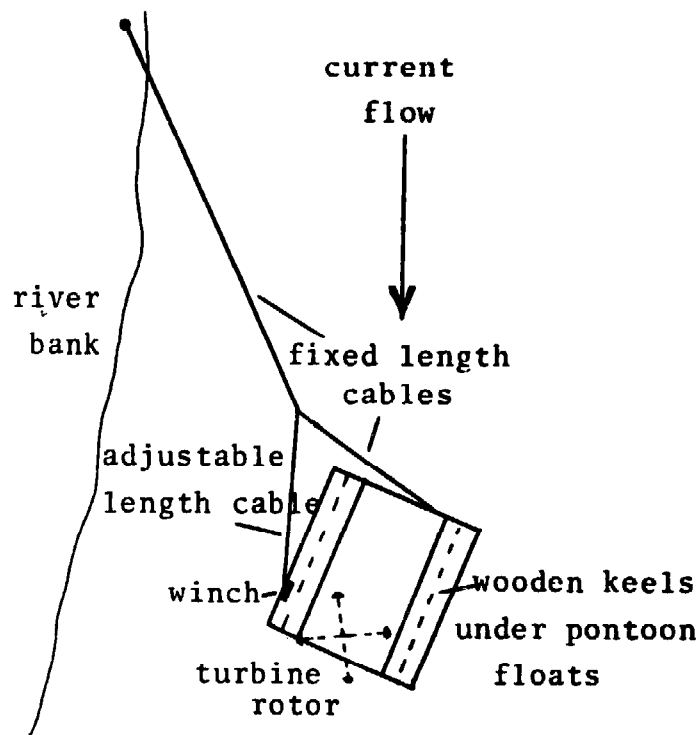

fig. 11 : Floating hydrofoiled turbine moored to a river bank.

STORAGE OF ENERGY

The small output of a micro hydro set enables the storage of energy to moments of high demand. For up to 24 Volts depending currency generation a number of batteries may be used, for example to run a heavy motor a few hours per day. During day and night driving energy may be collected herefore. Other storage means are compressed air for motive power or elevated storage tanks for drinking or irrigation water.

AUTOMATIC LOAD CONTROL

Production and demand have to be equal at any time, if no storage is provided. In normal applications the demand is regarded as a given value. Then production is regulated as a function of the demand by closing or opening the inlet

valves or adjusting the regulating vanes of a turbine. This needs reliable and expensive valves and control, and, in the case of pressure pipes, surge chambers.

By turning from regulating production to regulating demand, cheaper and more reliable load control can be achieved. When generating electricity, the demand is divided into classes of different importance. Also not primarily necessary demands can be added to the lowest demand class as can any dummy loads (resistors). An electronic load governor then switches production to these demand classes, dependent on demand priorities.

The lowest demand classes are only provided with energy if no more important apparatus is using all the power available, or energy production is abundant enough to provide all demands.

Moreover such a load governor can prevent overloading and overspeeding by simply switching off some demands instead of a mechanical device having to close down the turbine.

These electronic load controllers are for sale at low prices today. Different makes for ready installation already are available.

MAKING USE OF EXISTING WATER DROPS

In many canals water droppings are artificially made to keep up water levels or to destroy water energy. Especially in irrigation canals structures like sluices, shutes and turbulence evoking irrigation canals are used to adapt the level of the canal to the height of the surrounding agricultural land.

Making advantage of these available heads saves a hydro installation much civil construction. In China this implementation is quite common. Power use does not have to be in conflict with other uses. Instead, as for irrigation

systems, generated power could be used to pump water to remote or higher lands.

USING PUMPS IN REVERSE

Pumps and turbines differ in the direction of water flow, and, if coupled to an electric motor/generator, also the direction of electric current is opposite. The difference in flow direction can result in a slightly different design of the rotor and housing. The electrical part mostly is the same or is adapted also on little aspects.

This makes pumps usable as a turbine, while only little electrical changes might be needed. One just does not feed the pump with electrical energy but with a water flow in opposite direction, and now energy is delivered.

Use of a second hand pump is possible as is the use of a complete unit consisting of pump, motor and piping.

If wanted a double function is possible, e.g. in irrigation systems, where at some time a (waste) flow can drive the runner and at another time this runner can pump water up to the system.

In this alternation the runner just is forced in opposite rotation, by the falling water in turbine mode or by (electric) energy, the wires connected interchanged, in the pumping mode.

Where pumps are widely available and many sizes are stock items, pumps are several generations ahead of conventional turbines in cost reduction. They are less sophisticated, easier to install and to maintain and more simple to operate.

For instance each centrifugal pump appears to functionate in reverse. The efficiency of an inverted pump can be nearly the same as in pumping mode, while revclution speed and design head and flow are only slightly different.

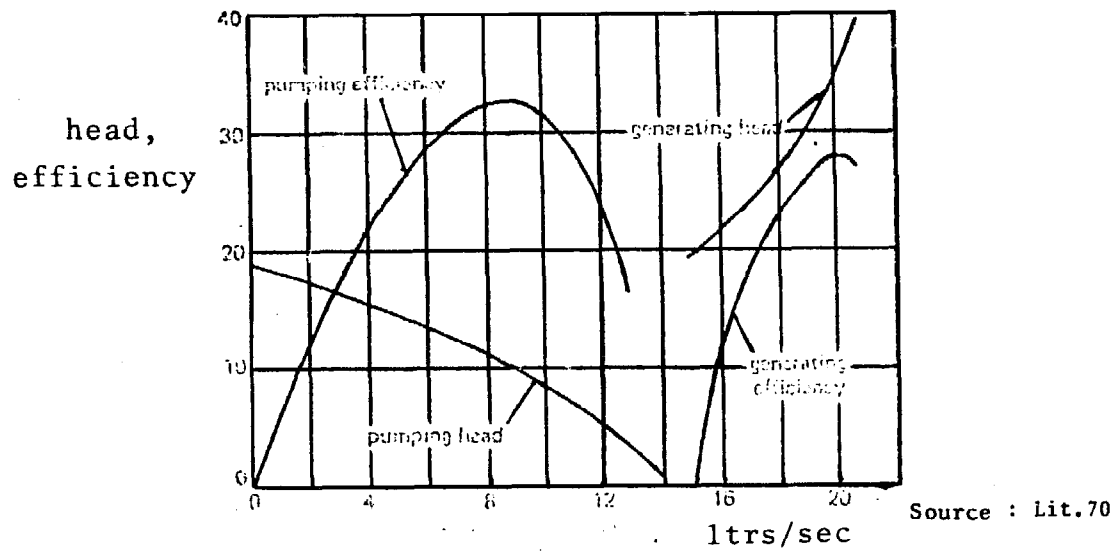

fig. 12 : Comparison of pumping and generating mode of one type reversible pump.

7. TURBINE TYPES

TYPES OF FREESTREAM TURBINES

WATERWHEEL

The waterwheel can be mounted on a float or placed on the border of a stream. More common than such a run off river configuration is a setting in a short diversion canal. Sizes from .4 to 12 meters in currents up to 5 m.s^{-1} , using $.05$ to $5 \text{ m}^3.\text{s}^{-1}$ of flow. Rotation rates of 2 to 15 RPM. Low cost and low efficiency : up to 60% if some head is created. Else efficiency can come to 30% as is the case with normal undershot wheels. Poncelet types, That have a special blade design, however do better. Artisan construction is easy. They are not sensative for silted water, if no bearings are under water surface. Depending on point of water supply types are called overshot, breast or undershot wheels. High torques appear in the axis. A Savonius rotor, copied from windpower technology, can be seen as a waterwheel with two blades, although also lift forces behind the blades occur like with hydrofoiled turbines. Efficiency of these rotors seems to be very low.

HYDROFOILED TURBINES

When an airplane wing formed blade is moving through flowing water a lifting force can be generated that drives this blade. The foil makes a slight angle with its moving direction : the pitch. The motion of the foil evokes a resistant stream, which together with the inclined stream velocity makes a virtual relative velocity of water flowing to this foil. Straight to this direction acts the lift, caused by underpressure behind the foil. This lift has a component that drives the foil in the moving direction. Attention has to be given to the fact that the local stream velocity is smaller than elsewhere, because of the resistance of the turbine.

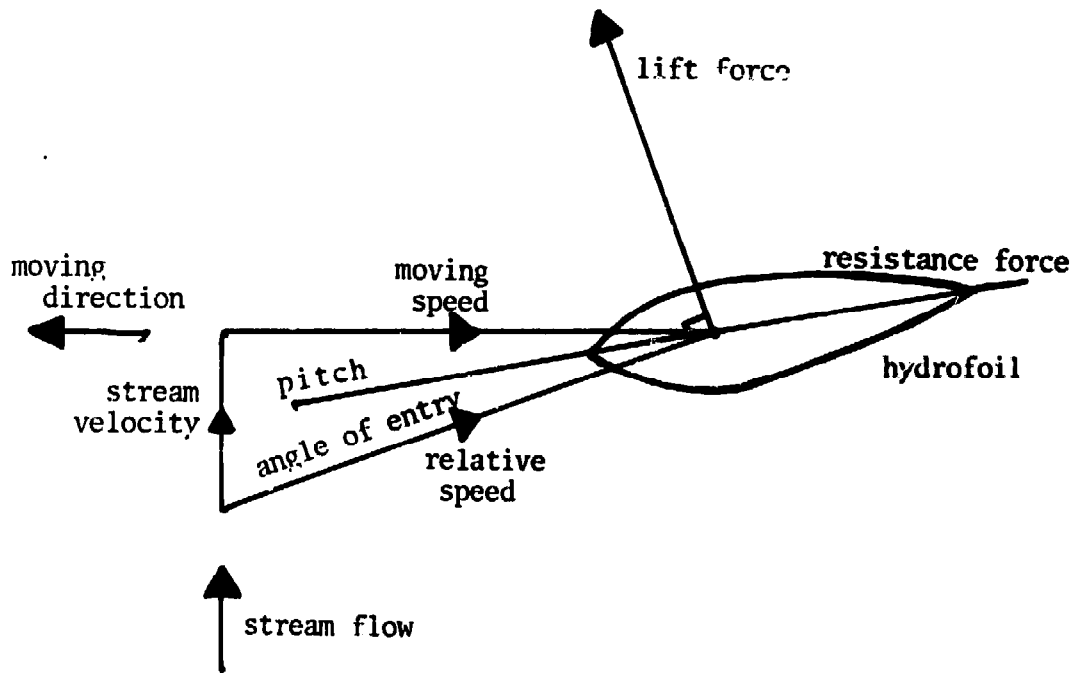

fig. 13: Forces working on a moving hydrofoil!

The foils can be mounted parallel to the axis (Darrieus rotor) or radial (Propeller type). The shaft of those types can be vertical or horizontal. Vertical implementation has the advantage of the shaft coming out of the water, which enables dry shaft power conversion, as well as the advantage of stream direction independence.

For Darrieus-type turbines horizontal axis implementation has the advantage of being able to construct in wide, shallow waters.

In this position the turbine may also be only partly submerged. Feasibility for shallow rivers also counts for propeller-type hydrofoiled turbines, but here in vertical axis implementation. In this position however, the area swept by the rotor is prohibitive small. In completion also implements with a to water surface inclined axis are possible. In this position also propeller-type rotors may only partly be submerged.

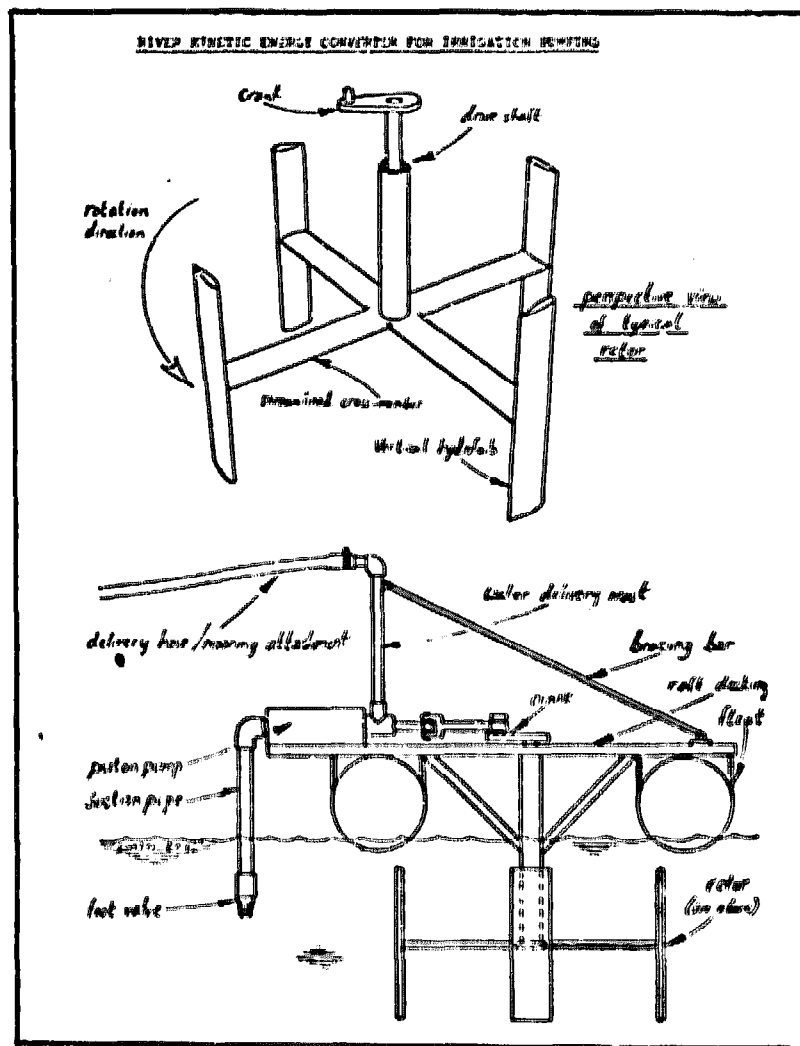

fig. 14 : Vertical axis Darrieus-rotor.

The use of hydrofoiled turbines can be a good option if no head can easily be created, or where high stream velocities are available. Efficiency comes to 25%. Sizes from 1 to 6 m² swept area. Rotation rates up to 30 RPM. Artisan manufacture is easy when wooden foils are used.

By lack of inlet structures these turbines are sensitive for debris.

TYPES OF RESTRICTED FLOW TURBINES

PELTON TURBINES

The Pelton turbine is the most suitable turbine type for high heads and small water discharge.

Pelton turbines are of a very simple design and therefore economic. They are made of cast steel, suitable to make in a moderate equipped workshop. Also more simple impellers are possible e.g. made of wood. No axial bearing loads are apparent. These turbines run no risk of cavitation as they are positioned above tailrace level.

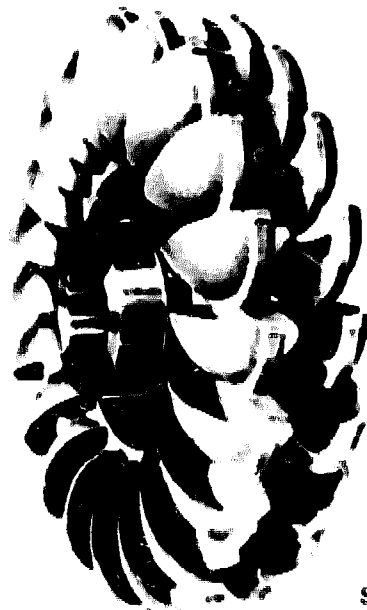

Source : Lit.38

fig. 15 : Pelton runner

Water under pressure in a penstock is forced through a nozzle, thus converting pressure energy into velocity energy. The outcoming jet is directed onto the buckets of the wheel, that diverts the water sideways.

Flow and efficiency regulation can take place deflecting the jet, or by using a suitable number of jets. In larger installations also a notch within the nozzle is used to adjust the flow. In the 20 kW range efficiencies of 80 to 85% are normal, while on larger installations this figure can reach 95%.

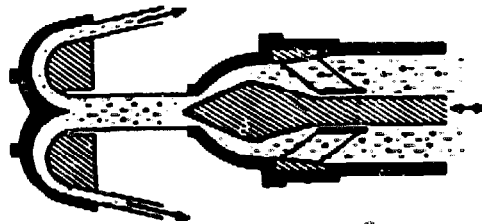

Source : Lit.38

fig. 16: Jet impinging
on Pelton-bucket.

Both horizontal and vertical axis implementation is possible. Diameters vary from .4 to 8 meters. Limitations in application can arise by their low rotation speeds up to 600 RPM.

A familiar type is the Turgo wheel, not carrying a number of buckets, but having water deflecting tracks on one or both runner sides.

Both types are placed in free air above tailwater level. This means a head loss of about .2 to 1 meter. For using no pressure energy the types belong to the group of impulse turbines, in contrast to most other turbines, where a mixture of velocity and pressure is converted.

FRANCIS TURBINE

The use of this turbine is limited to medium specific speeds, medium heads and moderate flows.



Source : Lit.38

fig. 17: Francis runner.

The water enters from a spiral casing surrounding the wheel tangentially, thus reaching the runner blades radially. The special formed blades take over energy by deflecting the water to axial flow, in which direction the water leaves the wheel from its centre. This process takes place in a completely filled space. Not only velocity energy is converted, but also pressure and underpressure have their role. Therefore Francis turbines belong to the group of the reaction turbines. The special curving of blades and the danger of too much underpressure (cavitation) makes this type of turbine not suitable for artisan construction. For this second reason only vertical axis implementation is possible in larger scale installations.

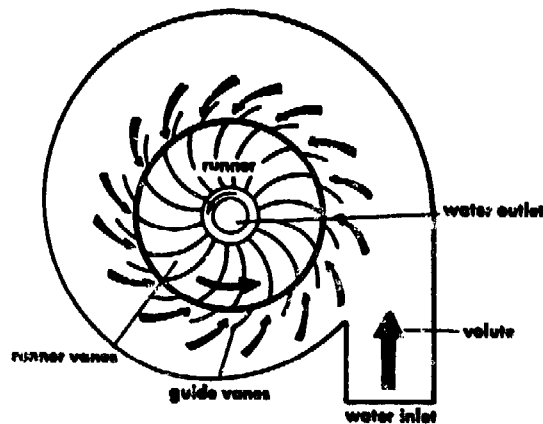

Source : Lit.38

fig. 18: Water flow in a Francis runner.

Flow control takes place by adjusting guide vanes, fitted circlewise around the runner. Also these vanes give the water the optimal direction of flow to the runner blades.

Efficiencies lie between 83 and 90%. Part-load efficiencies are poor.

Rotation rates vary from 200 to 1600 RPM, and runner diameters from .5 to 8 meters.

AXIAL TURBINES

In a process of taking over pressure energy turbines like Propeller and Kaplan form a different group of reaction trubines. Water both enters and leaves the runner axially. In this respect they are inverted ship propellers. Kaplan turbines differ from normal Propeller turbines by having the possibility to adjust the pitch of the blades suitable to head and flow. Thanks to this control, efficiencies of 90% are achievable for a wide range of circumstances.

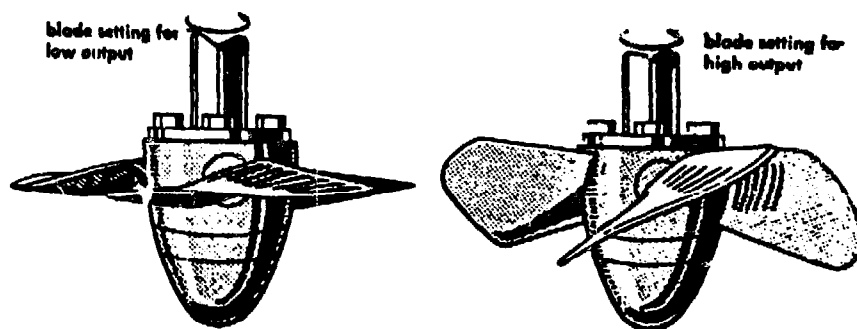

Source : Lit.38

fig. 19: Kaplan runner.

Implementations are horizontally, inclined or vertically shafted. Special lay-outs are possible with bulb turbines (horizontal axis) where gearing and generator are positioned in the same casing, also axially passed by the water.

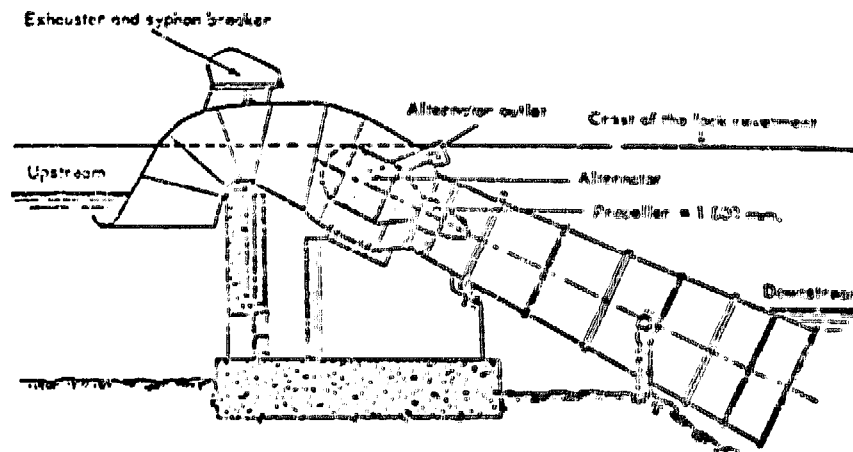

Source : lit.18

fig. 20: Siphon arrangement of a bulb turbine.

Rim generators are a special type of propeller turbines that have the generator rotor mounted in the outer circle of the wheel and the generator stator in the circumference of the tube. For having this great rotor diameter no gearing is necessary. These clever turbines however are not commercially available under 100 kW yet.

Tube-type turbines are horizontal or inclined shafted, while the turbine's axis is lead out of the tube in a curve of this tube.

In accordance with the head three to seven casted or welded blades can be used. Its manufacture requires a medium equipped workshop.

Axial turbines are suitable for low heads (1 to 30 meters) and large flows (1 to $100 \text{ m}^3 \cdot \text{s}^{-1}$) only. Rotation speeds have values up to 1000 RPM.

CROSS-FLOW TURBINES

This impulse turbine has a cylindrical runner. Water enters radially between parallel blades to the centre of the runner and leaves this centre also radially, thus impelling the runner twice. The runner width can be screened partially, thus making efficiencies in the order of 80% for a wide range of flow rates.

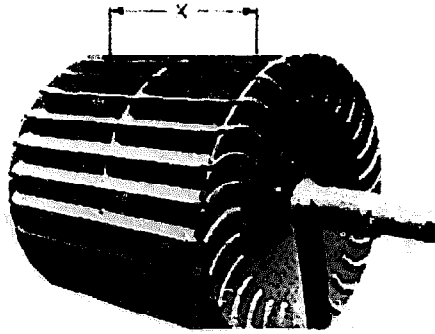

Source : Lit.38

fig. 21 : Cross-flow runner

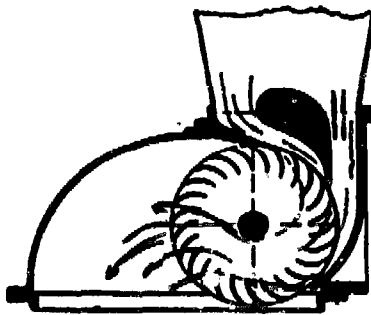

Source : Lit.38

fig. 22 : Water flow in a Cross-flow turbine.

The parallel blades are curved circular, which makes artisan construction easy. The runner always is mounted in horizontal axis position.

The cross-flow turbine is also called Mitchell or Banki turbine, after two designers, or Ossberger turbine, after a manufacturer.

The application is suitable for heads from 1 to 100 meters, with flow rates from $.25 \text{ m}^3 \cdot \text{s}^{-1}$ upwards. Rotation speeds vary from 100 to 1800 RPM.

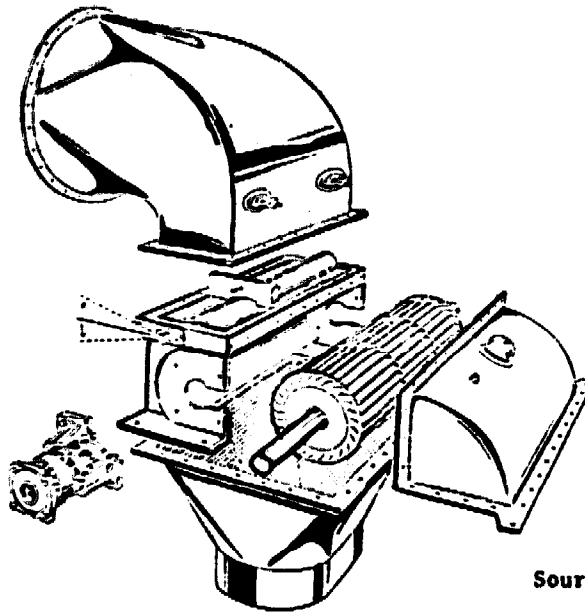

Source : Lit.59

fig. 23: Ossberger Cross-flow device.

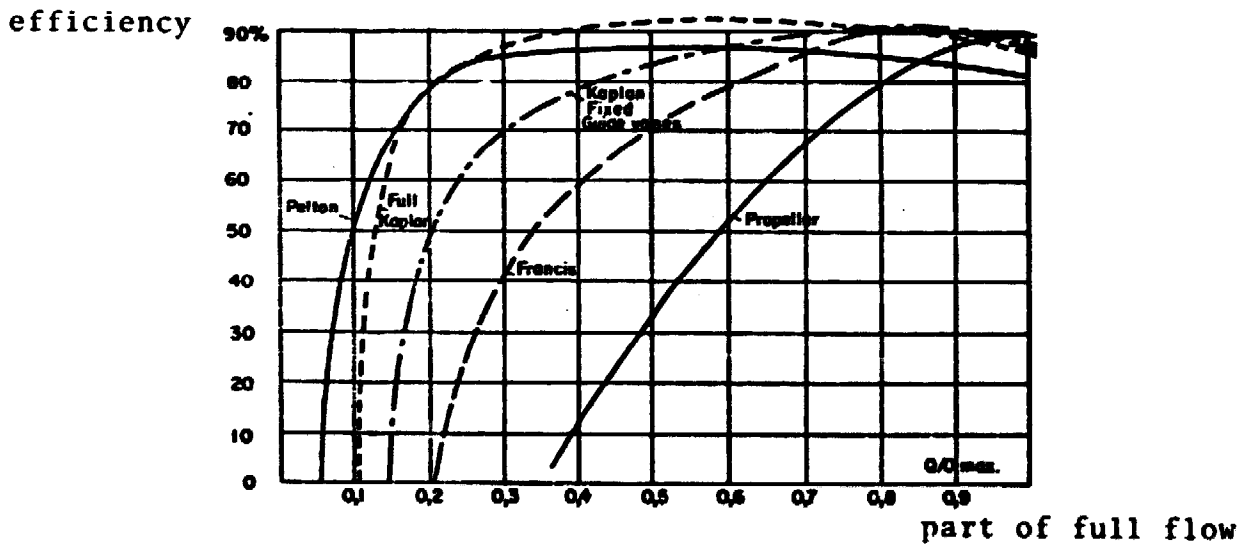

fig. 24: Efficiency curves of some turbine types.

Source : Lit.100

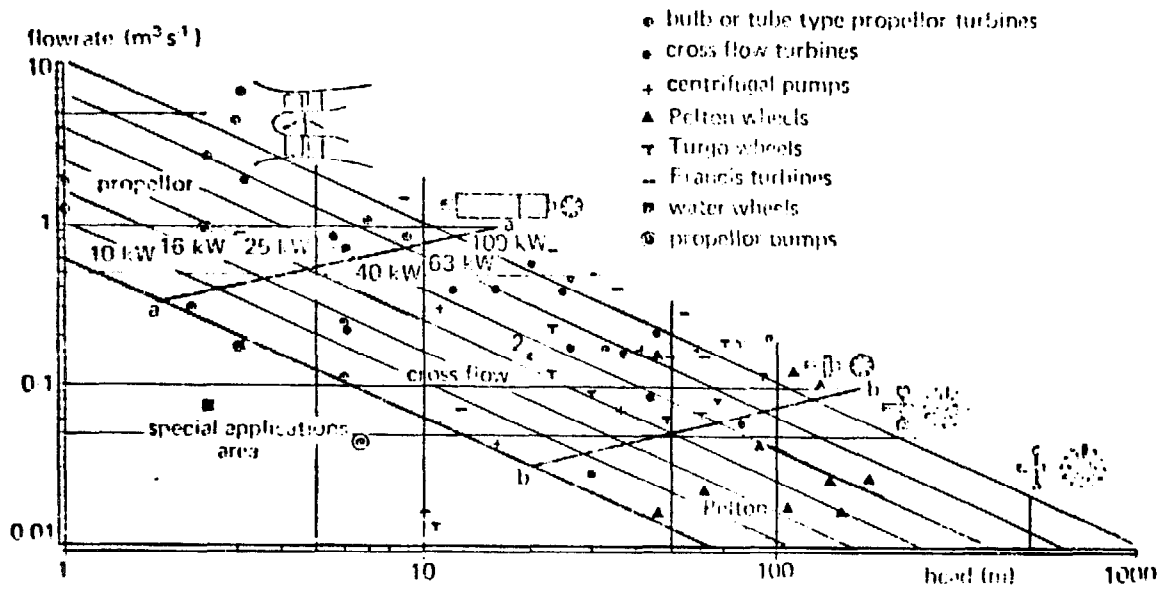

fig. 25 : Selection of restricted -
flow turbine types.

PRACTICABILITY SECTION

8. WATERWHEEL DEVELOPMENT AND USE

INTRODUCTION

The following is mainly based on the very thorough and attractive book "Windmills and Watermills" by John Reynolds. Other data, reproductions and designs are added and obtained from various resources in order to achieve a brief but still an as complete as possible survey of applications and developments. The survey concentrates on the technical part of the matter. The purpose of this survey is to describe the background and origin as well as present possible utilizations of waterwheels as a source of hydropower. New ideas, with a special reference to developing countries, can be developed on the basis of the applications which have been widely known in former days. No mentioning has been made of the social impact of the different developments, although they may be well worthwhile to investigate. Further material on waterwheels may be obtained from the works mentioned in the bibliography at the end of this paper.

THE VERTICAL WATERWHEEL

The origin of waterpower may be found in the irrigation works in the valleys of the Nile and the Euphrates. Various means were employed to raise water from the river to a higher level on the bank. One of these was the "Persian wheel" (or "Saquia" or "Noria"). In principle the Noria consisted of a wheel or chain of bailers, revolving on a horizontal axle, and set upon the bank of a stream. It existed in several different forms. Normally the Noria was driven by an external driving force, for instance a treadmill or domestic animals.

One particular type however was automotive. In this case the wheel was hollow with internal divisions forming a series of watertight compartments. When paddles were mounted around the rim of the wheel, it would revolve by itself, forced by the current. No external moving power was necessary.

The automotive Noria-type is an elegant example of the application of the power of the water, although the ultimate purpose was the elevating of water.

It may be looked upon as the first 'waterwheel' using the rivercurrent as a source of power.

From a technical point of view, these wheels are named "vertical waterwheels", because of its vertical position on a horizontal placed axle. An other type is the "horizontal waterwheel", which will be discussed further on.

From this original the modern vertical waterwheel developed.

Waterwheels by itself, however, can also be applied as a direct source of energy, transforming the motion of the watercurrent into the revolving motion of the wheel's axle. The use of waterwheels as a hydraulic engine or prime mover.

TYPES OF VERTICAL WATERWHEELS

Waterwheels are of three main types: overshot, breast and undershot. The first two use the weight of the water falling into the buckets, while the third is driven by the force of the current. The amount of power delivered by each type can be increased by raising the level of water in the mill-pond, thus creating the 'head'. By this means additional energy from the falling water can be brought to bear on the buckets of the wheel, or additional velocity imparted to the stream that impinges upon them. 'Head' is, in this case, the vertical difference in level between the water above the wheel and that immediately below it or downstream; that is the so-called 'tailrace'.

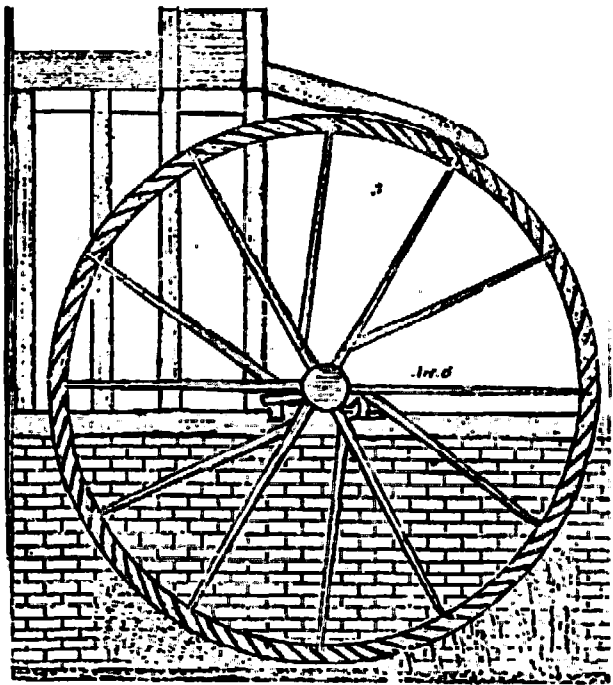
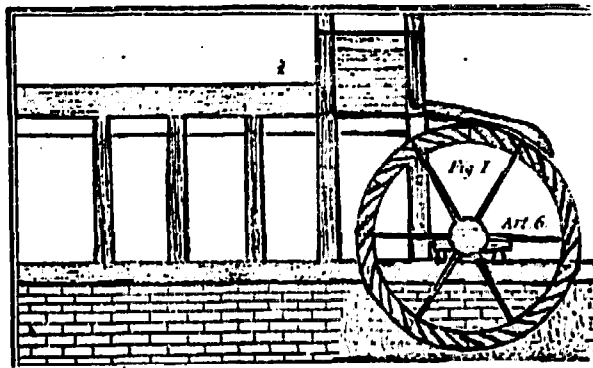

fig. 26:

Source : Lit.27

a : Low overshot
wheel, diameter-12 ft.
Breadth-same as diameter
of millstone

b : Very high overshot wheel,
diameter 30 ft.
Breadth-3½ in. for each ft.
diameter of millstone.

Wheel and the mill machinery were made of several kinds of wood (oak, holly, applewood, elm). The construction of the wooden machinery was an accurate work which had to be done by skilled millwrights.

From the middle of the eighteenth century onwards, cast iron was employed to an increasing degree in millwork. At first, because of casting difficulties, only iron parts were made. By the end of the century, however, complete frames of iron were being produced, only the floats still being made of timber.

At this period the principles of waterpower were being investigated in an increasingly scientific manner, and advantages were made in the design of the three basic wheel types.

An improvement in the efficiency of the breast-shot wheel was achieved by the introduction of a close fitting, curved to the weir. The primitive undershot wheel was improved by the French engineer J. Poncelet. In 1824 he introduced the design of an undershot wheel of increased potential, capable of extracting the maximum amount of energy from a fluctuating millstream. The velocity of the water striking the wheel is increased by channeling it below an inclined sluice, the curvature of the buckets being calculated to allow water to enter and leave the wheel without shock. Thus undershot wheels are able to compete in terms of power-output with rival types. Large numbers of Poncelet wheels were installed during the nineteenth century. They were constructed entirely of iron, sheet metal being particularly suitable for the shaping of the buckets. Both breast-shot and overshot wheels benefited from the introduction of the "ventilating buckets", while the problem "back-watering", which could reduce the power of the conventional overshot wheel, was countered by the introduction of the "pitch-back" type.

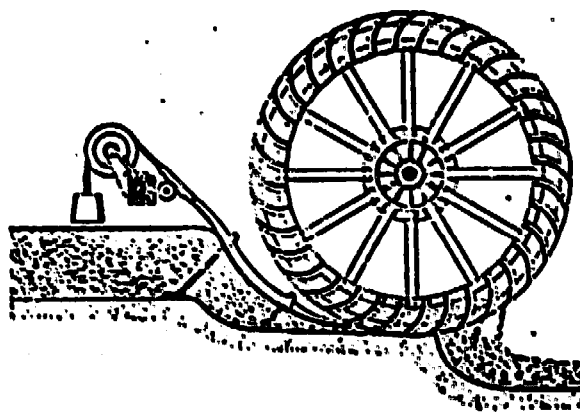

Source : Lit.96

fig. 27: Poncelet's wheel.

Cast iron came into general use for other components of the mill-machinery as well, especially the gearing. The remaining machinery of the mill remained timber, for example the shaft. At present vertical waterwheels are made of modern materials such as fibreglass. The units can be overshot or breastshot wheels with diameters up to 20 ft. Some manufacturers produce wheels which can be transported in separate sections and can be erected on site.

THE HORIZONTAL WATERWHEEL

The horizontal waterwheel originated somewhere in the south and east of India and was originally used in cornmills to drive the millstone. For motive power it requires fast falling mountain streams. This restricts the application of horizontal mills to more or less mountainous areas. The stream current is directed against the blades of the rotor, which are mounted on the axle and drive the upper millstone.

The millstream is channeled into an inclined trough or 'lade'. To increase the velocity of the stream, the trough is enclosed, thus forming a pipe in which pressure can be built up by a head of water. In the Near East the enclosed lade developed into the 'Aruba penstock'. This consisted of a vertical shaft containing a column of water and fed from above by a head.

Aqueducts brought the water to the top of the penstock.

The form of the blades of the rotor are another part of the horizontal mill which developed and improved through the centuries. The simplest form of the rotor was a set of wooden paddles mounted on the axle making a slight angle with the vertical. Sometimes they were shrouded by a vertical rim of sheet iron. In places where water resources were abundant, this type performed satisfactory. A more sophisticated design is found in the Alps, where the paddles are spoon-shaped.

In the nineteenth century great improvements were made. In France experiments were performed using two types of horizontal wheels, called whirl wheel (rouets volents) and bucket wheel (roue à cuve), placed on the river or canal. The water to drive the bucket wheel was discharged through a sluice and passing through a channel of stonework and thrown obliquely on the wheel. The other kind, the whirl wheel, received the water directly upon it through an inclined trunk of wood upon one side of the wheel.

The water was regulated by the sluice against which a head of water of several feet was built up.

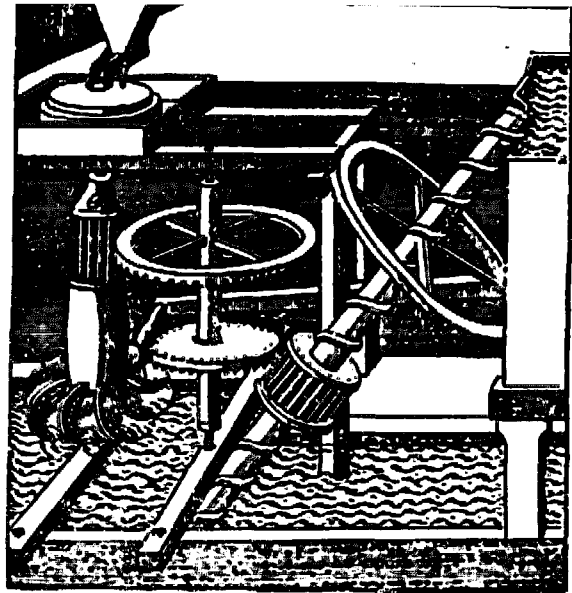

Source : Lit.96

fig. 28: Spoon-shaped paddles
of a horizontal wheel.

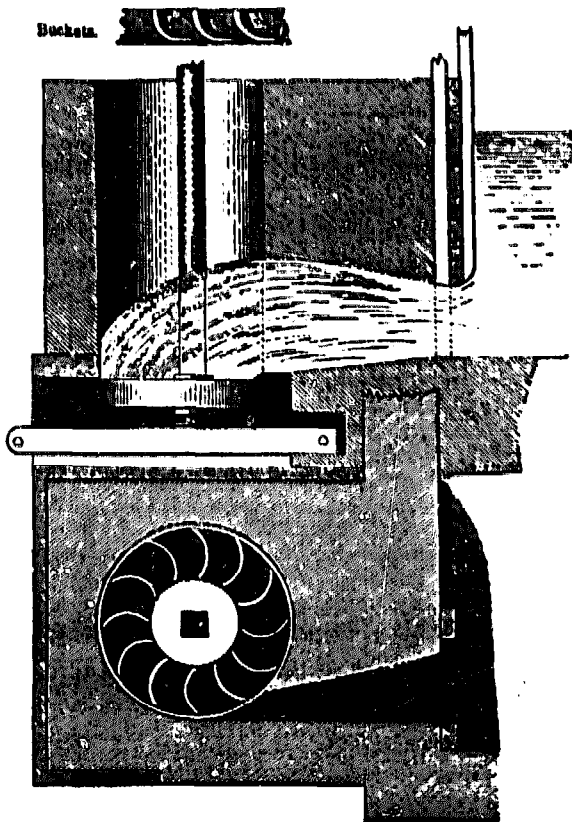

Source : Lit.73

fig. 29: Rouets à cuve.

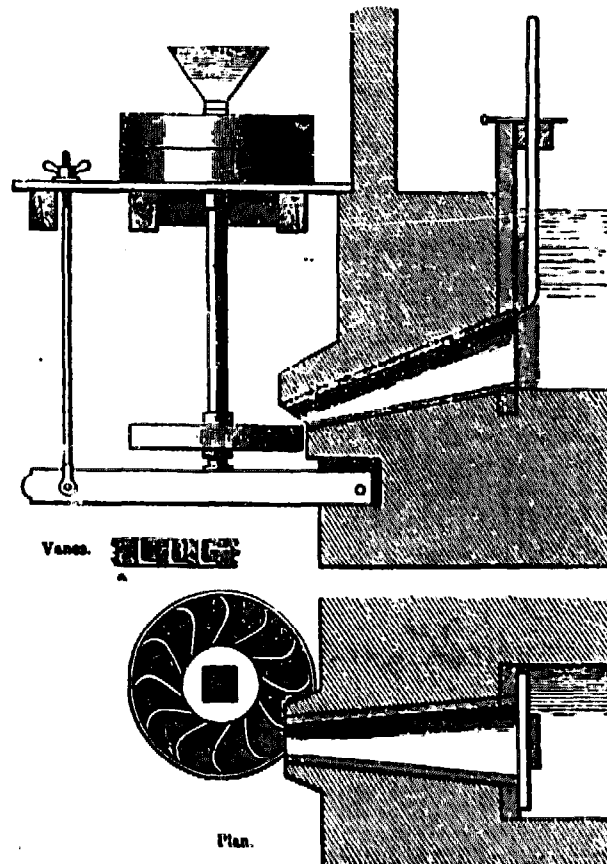

Source : Lit.73

fig. 30: Roue .olant.

The wheels were acted upon by the weight and impulse of the water. Certain requirements were necessary, for instance large quantities of water had to be available. The wheels were made of cast iron.

Other wheels, making use of the velocity of the water rather than its impulse, were developed and consisted of a fixed part with guide curves and a revolving part with its buckets. This model was even further improved by applying moving sluices in the guide curves to regulate the speed of the machine. The regulation was effected by conical pendulum governor similar to that of the steam engine.



Source : Lit.73

fig. 31: Double horizontal wheel.

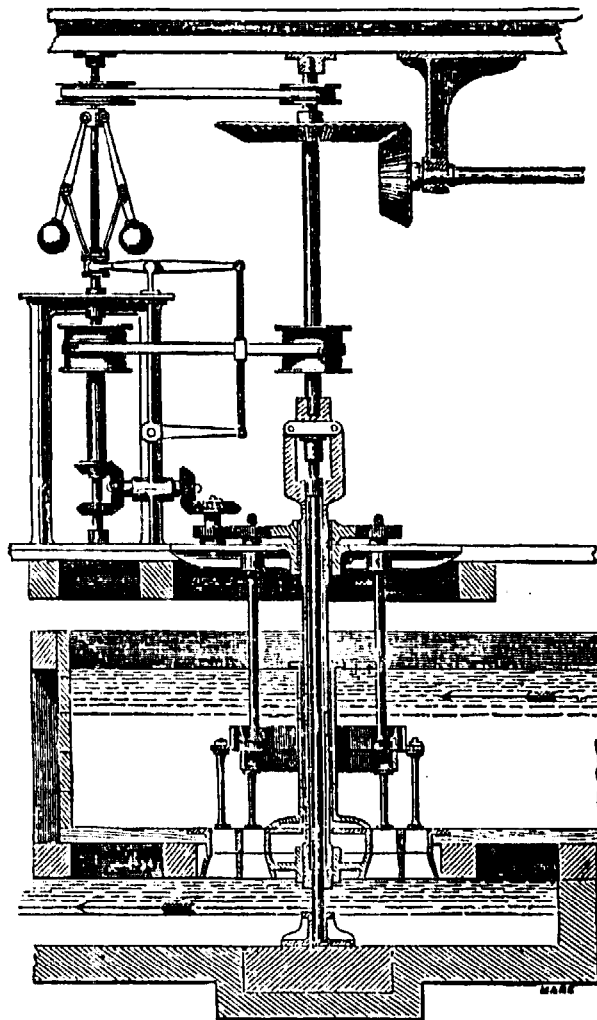
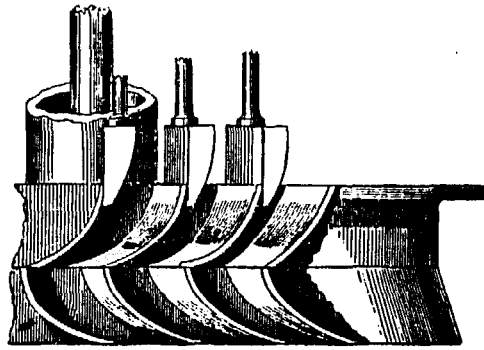

fig. 32: Speed controlled turbine.



Source : Lit.73

fig. 33: Guide curve with
three sluices.

These and other developments and improvements lead to the modern turbine applied in hydro-electricity works.

APPLICATIONS OF WATERPOWER

In the following a number of applications of waterpower using vertical or horizontal waterwheels are described. Though they may find their origin in former days, the usefulness and applicability in situations where modern forms of energy are not available, is obvious.

THE CORNMILL

Grinding methods offer illustrative examples of the useful application of waterpower with a waterwheel as prime mover. Introduction of waterwheels has replaced the use of the manually operated simple handquerns by cornmills which use horizontal waterwheel to drive the upper millstone. The axle passes through the centre of the lower one and turns the upper millstone by means of a crossbar fixed in the eye or centre of the stone.

On the lower end of the axle a horizontal wheel is mounted. There is no gearing, both rotor and runnerstone revolve at the same speed. They are still in use in regions in Nepal.

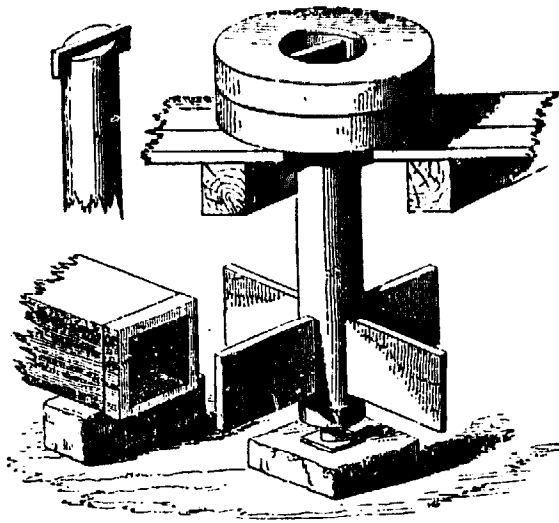

fig. 34: Primitive horizontal cornmill.

Another type of cornmill used a vertical wheel to drive the millstone. The essential components of this type are : the vertical waterwheel fitted with blades or paddles, a toothed pinion keyed to the same horizontal axle and a larger toothed gear wheel mounted on the vertical spindle of the millstone.

Mechanically, the introduction of gearing marks an advance over the horizontal direct-drive mill, allowing power to be transmitted from one place to another, from a vertical waterwheel to the horizontal runnerstone. This innovation also permits the future use of different speeds.

Tide and waterlevel problems were the reason for the installing of floating mills and these ark-like vessels were well-known in the cities of medieval Europe. Floating mills are powered by simple undershot wheels, which are mounted on a barge floating in the river. Because the barge follows the level of the water, the wheels remain at a fixed height above the water and can thus operate in the most efficient manner possible. The millstones are set on a timber frame, driven by conventional gearing and protected from the weather by a pitched roof.

In cities, floating mills were most commonly moored beneath the arches of bridges. The roadway afforded a convenient means of access, while the piers created an increase in speed of the current, thus providing the miller with a ready made race.

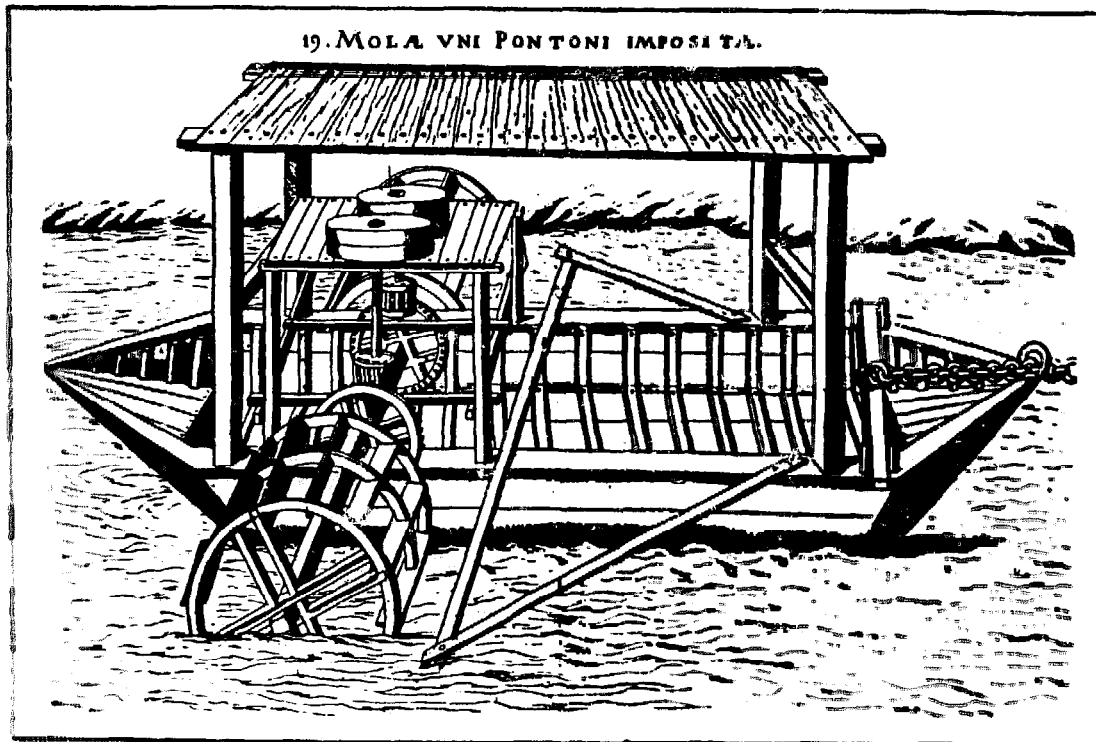

fig. 35: Floating cornmill.

WATER LIFTING

Wherever climate conditions make irrigation necessary, and streams are available to provide motive power, the primitive wheel of pots might be found. The tall lightly built undershot wheel of timber with jars of earthenware lashed around its rim. Its function is to elevate water from the river and discharge it into a trough projecting from the bank above. They still exist in Portugal and Syria. In China, one makes use of hollow bamboo tubes mounted on bamboo frames instead of clay pots. Considerable elevations can be obtained with this type of wheel, while the operation is automotive and needs almost no attendance.

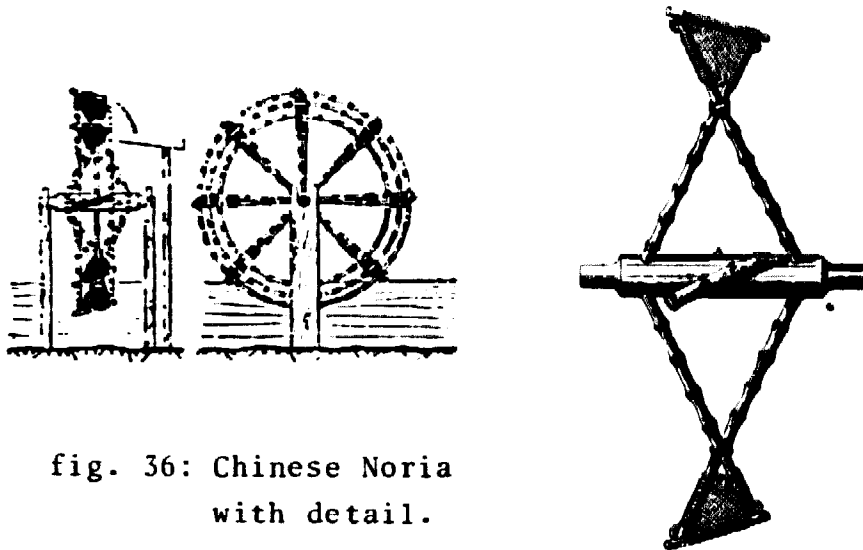

fig. 36: Chinese Noria
with detail.

In the areas with swift running rivers in West Sumatra and West Java (Indonesia), waterlifting and irrigation wheels are found, able to lift water 1 to 8 meters, depending on the height and the strenght of the current. These wheels can lift between 10 and 30 liters per minute. They range from 2 to 10 meters in diameter and are made from bamboo with some wooden parts.

Bamboo tubes are mounted to the wheel and dip into the stream, fill with water as the undershot waterwheel revolves due to the current which pushes the paddles attached to the rim of the wheel.

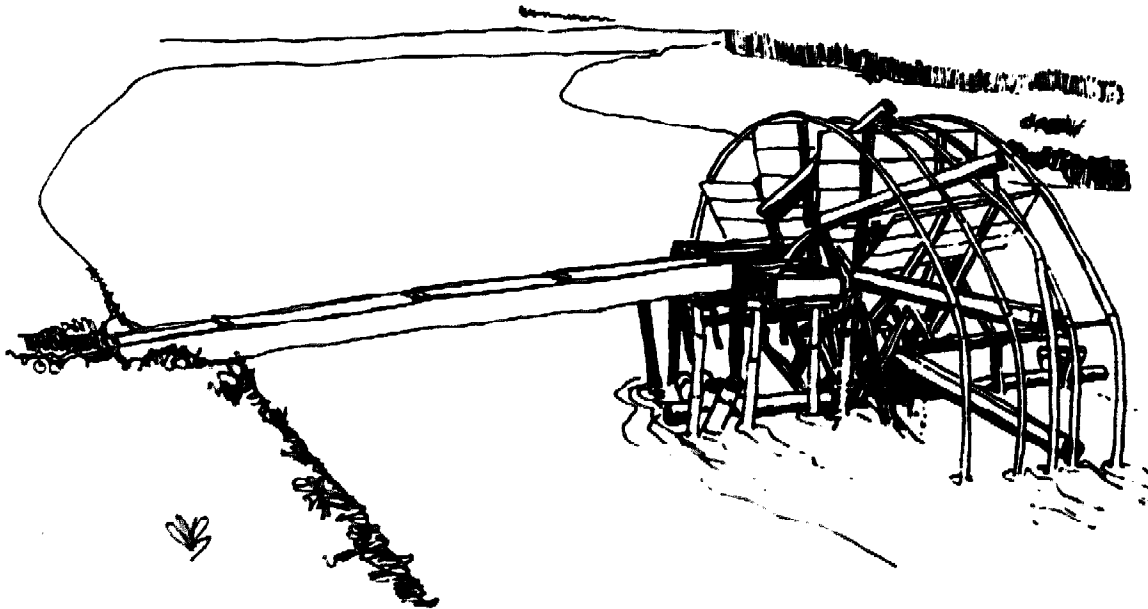

fig. 37: Indonesian waterwheel.

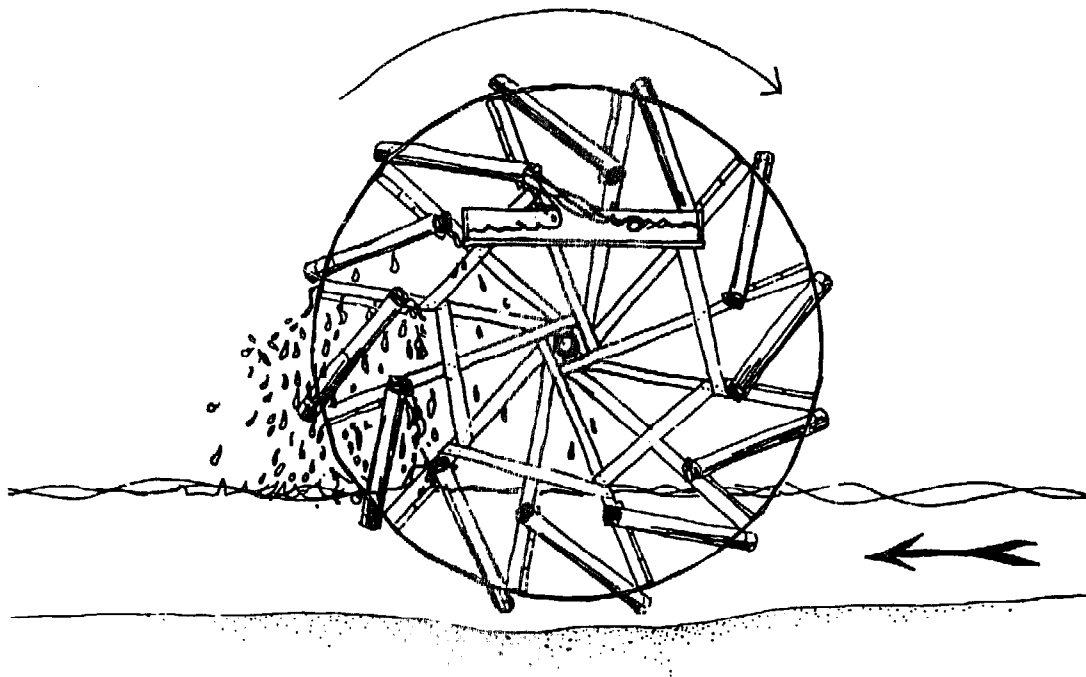

fig. 38: The wheel with bamboo tubes.

In Northern Europe the waterwheel was brought into service for mine drainage. Water was raised by various methods, the simplest of which employed the axle of the wheel as a winding drum.

Other machines were of more advanced design. For instance those transforming the revolving motion of the waterwheel into an up-and-down motion for the driving of the pump shafts. Ingenious designs are to be found in "De Rei Metallica" by Georgius Agricola written in 1556. Illustrations of suction pumps and chain pumps are given in the figures.

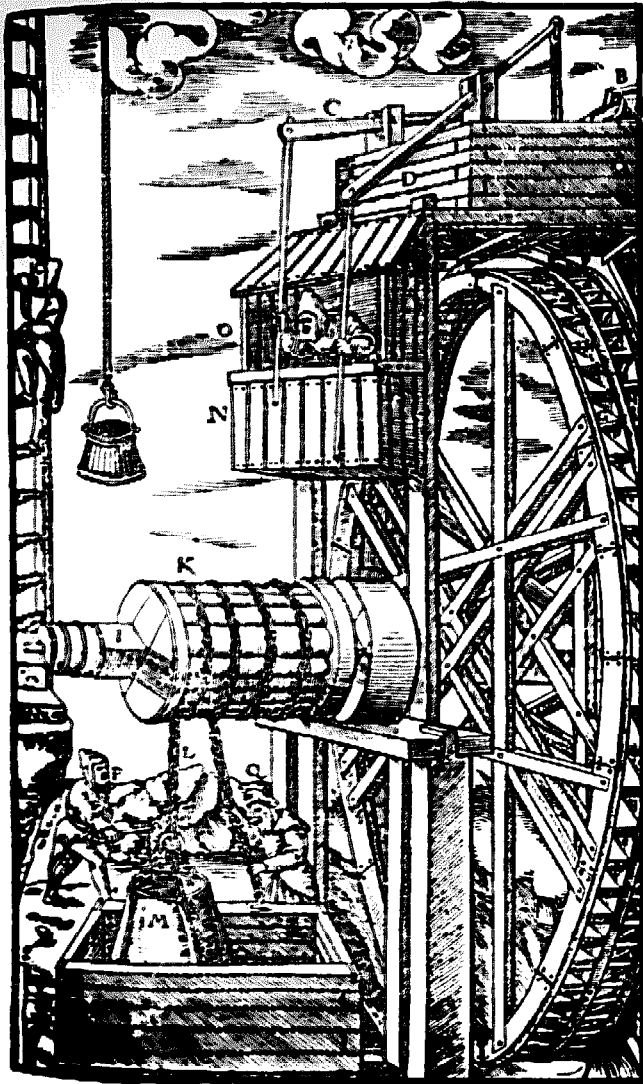

fig. 39: Axle used as a winding drum.
 A: Reservoir
 E: Race
 C, D: Levers
 F, F: Troughs under the water gates
 G, H: Double rows of buckets
 I: Axle
 K: Larger drum
 L: Drawing-chain
 M: Bag
 N: Hanging cage

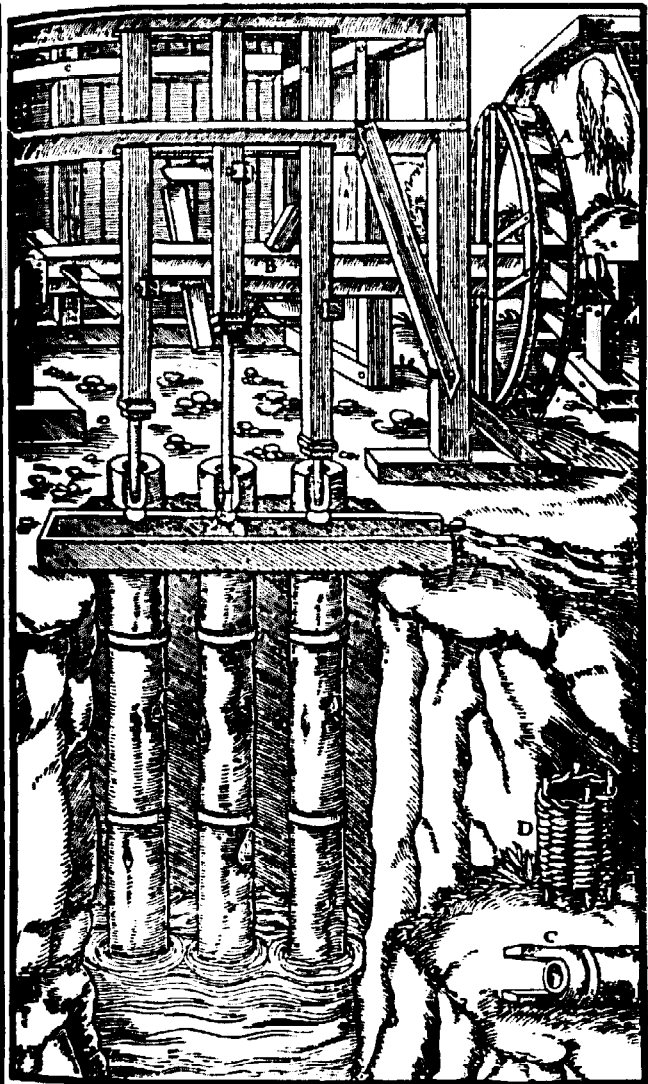

fig. 40: Suction pump.
 A: Waterwheel
 B: Axle
 C: Trunk on which the lowest pipe stands
 D: Basket surrounding trunk
 O: Operator
 P, Q: Men emptying bags

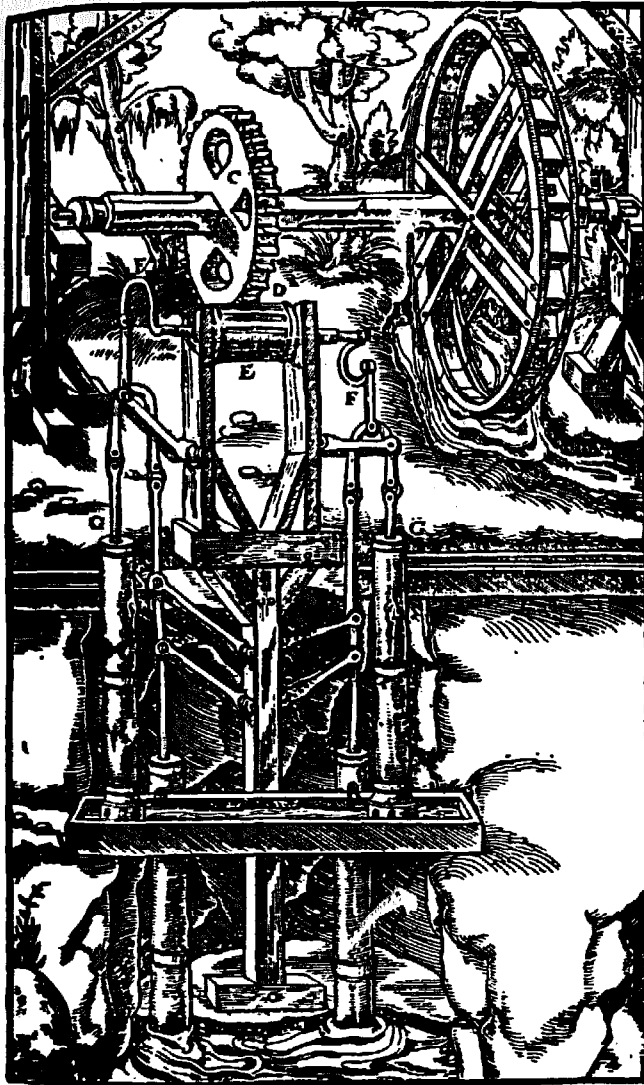

fig. 41: Suction pump.

- A: Upper axle
- B: Wheel whose buckets the force of the stream strikes
- C: Toothed drum
- D: Second axle
- E: Drum composed of rundles
- F: Curved round irons
- G: Rows of pumps

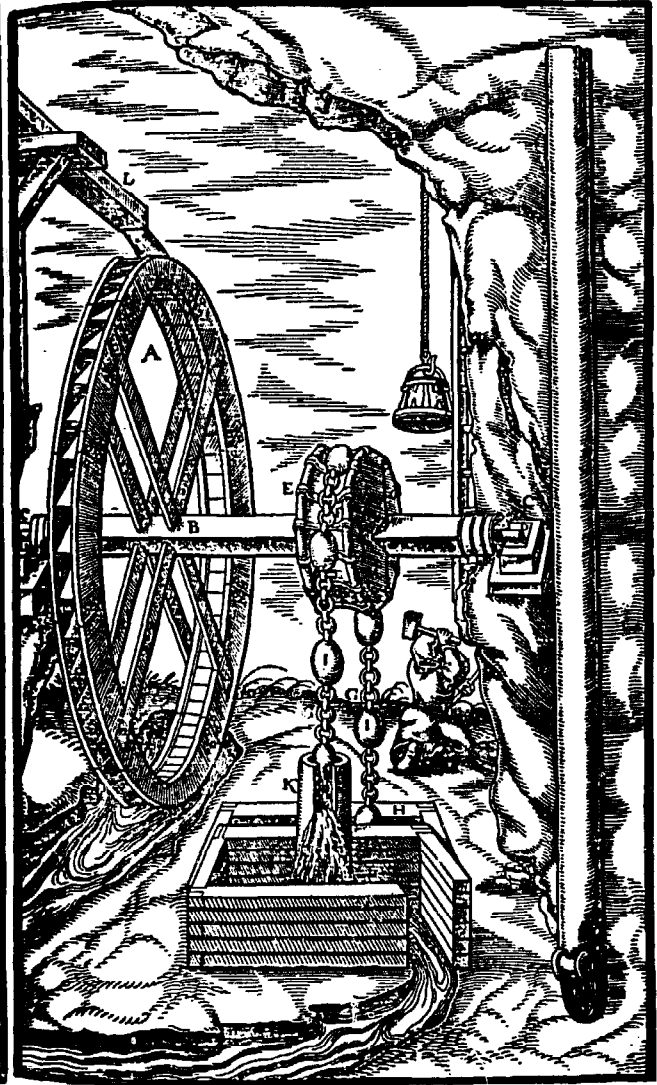

fig. 42: Chain pump.

- A: Wheel
- B: Axle
- C: Journals
- D: Pillows
- E: Drum
- F: Clamps
- G: Drawing chain
- H: Timbers
- I: Balls
- K: Pipe
- L: Race of stream



fig. 43: Ventilating air pump.

- A: Hollow drum
- B: Its blow-hole
- C: Axle with fans
- D: Drum made of rundles
- E: Lower axle
- F: Its toothed wheel
- G: Waterwheel

As the great cities of Europe grew in size, for example London, large pumps were installed in rivers to provide the cities' demand of water. The pumps were driven by an undershot wheel and raised into a 'turret' or watertower and then distributed by gravity. At the end of the seventeenth century some very large pumping installations had been constructed, The undershot wheel drove, through cranks and rods, 16 pumps.

During the eighteenth century, improvements in the design and construction of pumping machinery were of importance for the general progress of mechanical engineering. Smaller, and more efficient pumps were developed and by the end of the nineteenth century, small pumps for domestic use driven by waterwheels were available.

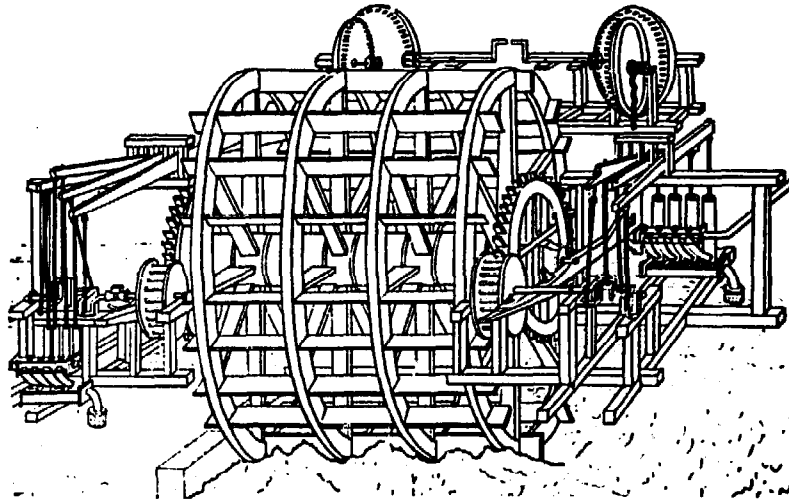

fig. 44: Pumping machine
in the river Thames.

THE TEXTILE INDUSTRY

The production of woollen cloth involves at least six basic operations, some of which lend themselves more readily than others to the use of machinery. One of these processes is fulling. Freshly woven cloth is subjected to a pummeling action, which permanently alters its texture by thickening and felting the fibres of the wool. Originally this was achieved by "walking". In the mill the beating process is performed mechanically in fulling stocks.

Power for the mill comes from an undershot wheel and drives the stocks. For many years, fulling was the only mechanized process in the production of woollen cloth. Only in the latter part of the eighteenth century and the beginning of the nineteenth century progress was made towards the general mechanization of the textile industry. Their machines led to the adaption of the factory system, and revolutionized the whole process of manufacture. But they were not designed specifically for the waterwheel.

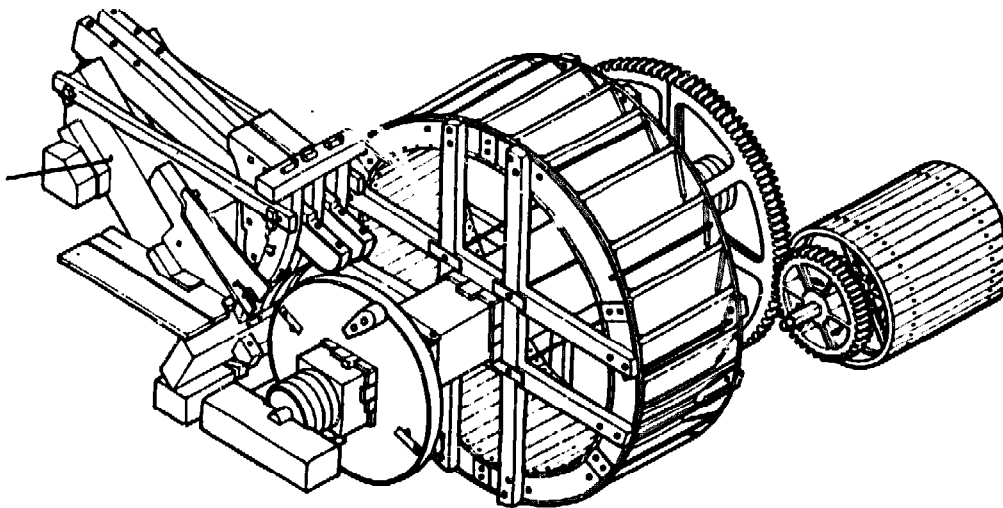

fig. 45: Fulling stocks.

THE IRON INDUSTRY

Another application of the power of water which developed during the past centuries, was the use in the iron industry.

Chinese sources record that bellows were used to produce draught required for the smelting of iron, were driven by a wooden waterwheel using a crank to obtain the necessary eccentric motion.

In the early Middle Ages, tilt hammers driven by waterwheels came into practice. The punding action of the smith was reproduced mechanically by the use of a heavy pivoting hammer, its haft depressed and released by crams projecting from the axle of a waterwheel.

With the introduction of the blast furnace in the fifteenth century, served by waterpowered bellows, it became possible to reduce large quantities of iron to the molten state, for the casting of objects. Other sources give applications like wire drawing and mechanical scissors.

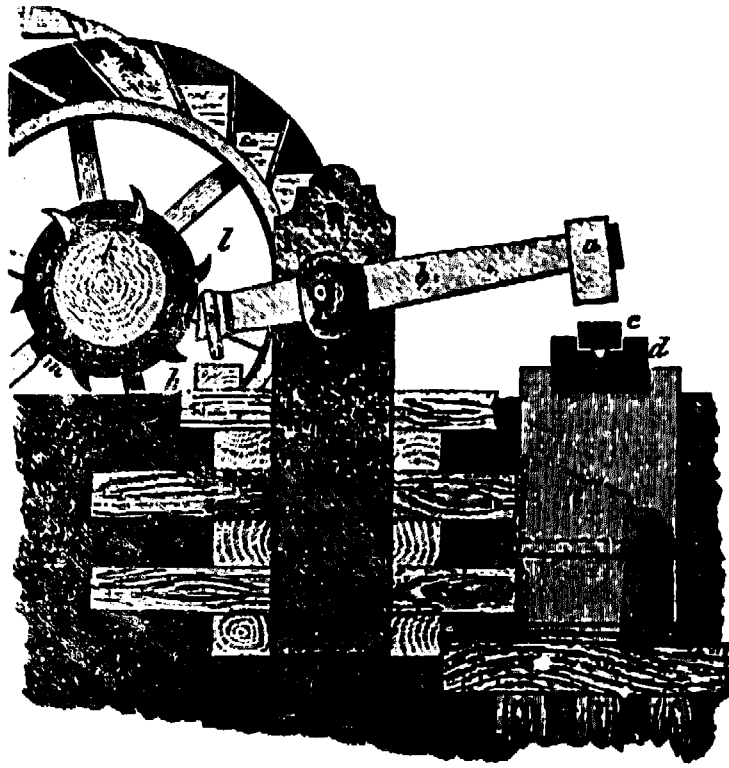

fig. 46: Tilt hammer.

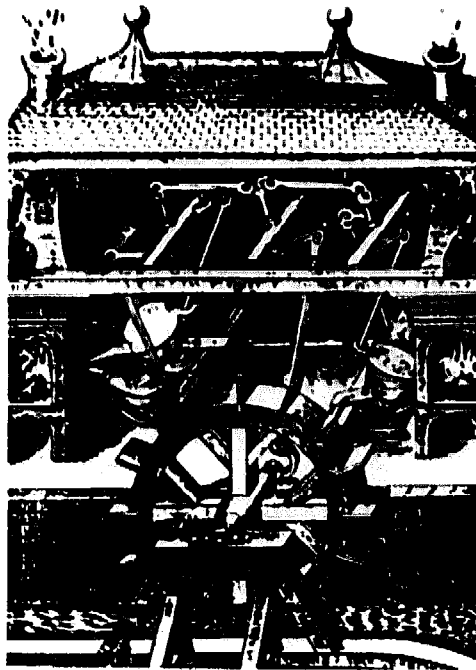

fig. 47: Bellows.

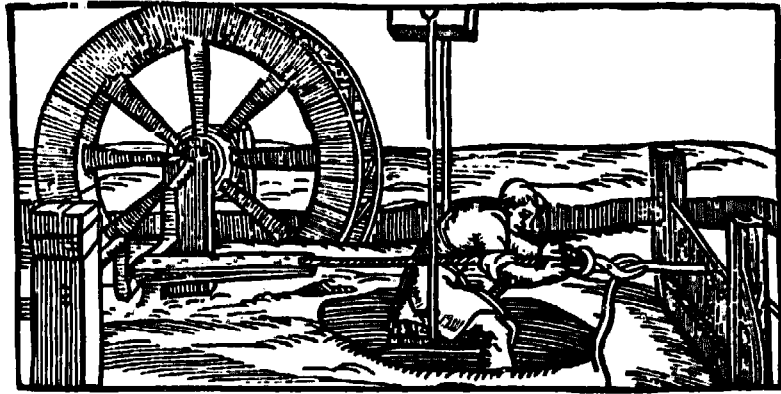
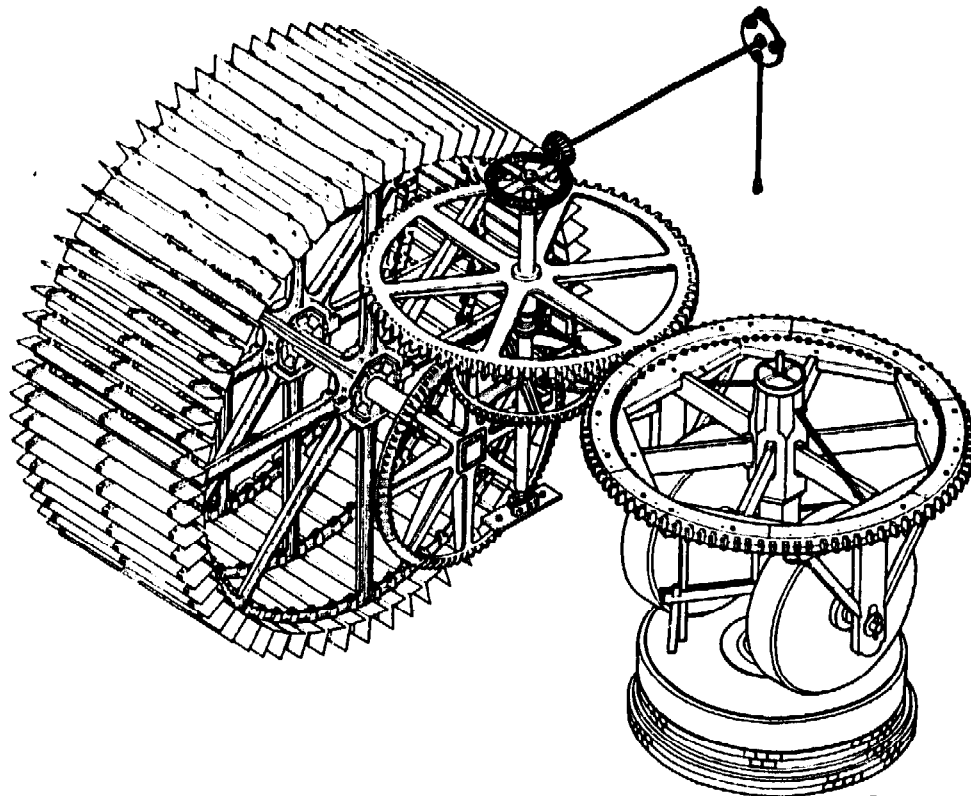

fig. 48: Wire drawing.

CRUSHING MILL

A number of industrial processes made use of the edge runner mill, a device suited to crushing rather than grinding. The edge runner mill can be used in the preparation of raw materials for a very wide variety of products including spice, pipe clay, cement, oil and even gunpowder.



Source : Lit.93

fig. 49: Edge runner mill.

SAW MILL

Waterpower was used in North America and in some parts of Europe for the driving of machines. Waterwheels by means of a cranked arm give the required power and up-and-down motion of the saw, while an ingenious mechanism takes care of the constant movement of the log towards the saw. The watercurrent discharged in the trough is controlled by a sluice and thus regulates the operation.

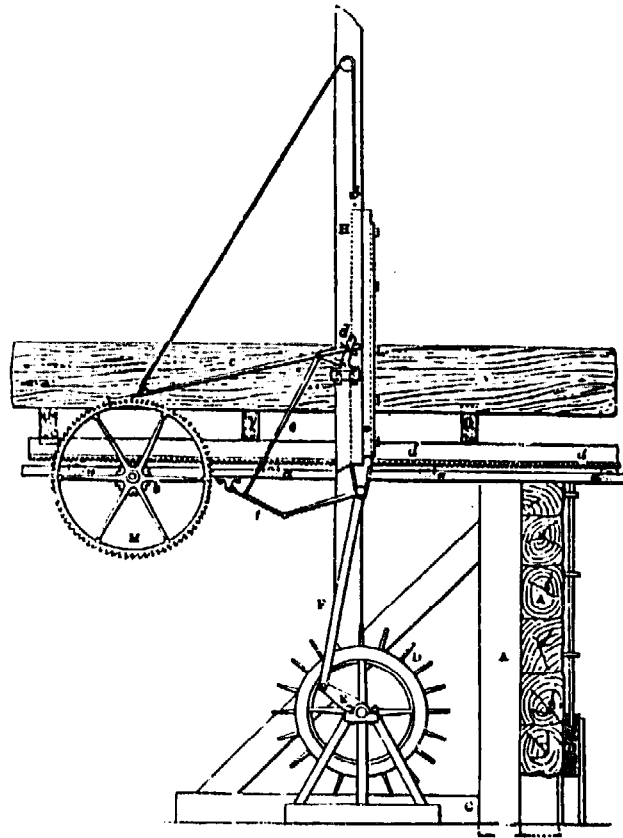

fig. 50: Saw mill.

9. PRACTICE EXAMPLES

I. GENERATING ELECTRICITY

The use of generators to convert axial power from a turbine into electrical power has its advantages of energy being transportable and applicable for various purposes.

A choice has to be made between depending and alternating current, three or single phase alternating current, voltage level and type of generator.

Depending current is only suitable for low voltages and low power outputs. It has the advantage of independence of generator rotating speed and it can be stored in batteries. The distance to point of demand has to be short to prevent high energy losses.

For longer distances and higher power outputs alternating current should be chosen. To reduce transmission losses, voltage from the generator should be stepped up.

A single phase generator will do at medium outputs if at present or in future no three-phase frequency is needed. A three-phase system is necessary when powerful electric motors are to be installed or large outputs are involved.

If the hydropower unit is to be linked to a utility grid an asynchronous generator is the best option. As however in uncoupled situations the choice of generator type is more complex. Issue in the case of generating alternating current delivery is the frequency of the current, that is to be held constant around 50 or 60 cycles per second. Various generator types and clever tricks are possible, such as DC-AC converters, inverters, generating dependent current to drive a DC-motor which is coupled to an AC-generator.

For micro and mini hydro problems can be overcome by keeping the demand at constant level by load governors that switch off and on demands of a lower class depending of actual first class demand and production. Now the rotation rate of the turbine is held constant, for which case a synchronous generator is a very cheap solution.

RESTRICTED FLOW TURBINES

Pelton turbines

Direct coupling to a generator sometimes is possible. Various lay-outs of turbine, gearing and generator are practised.

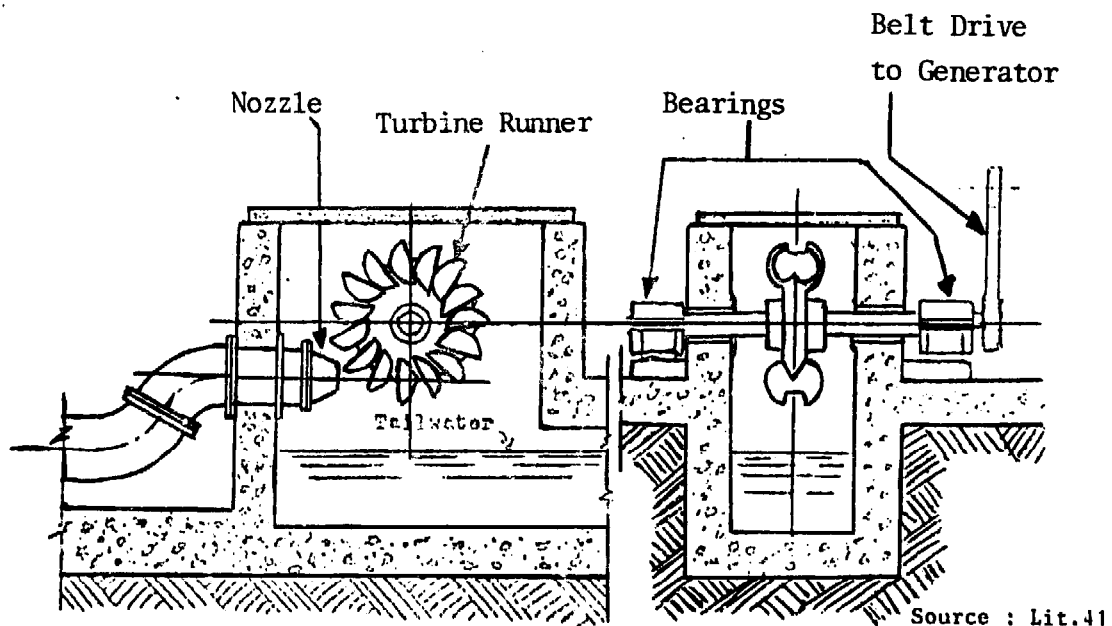
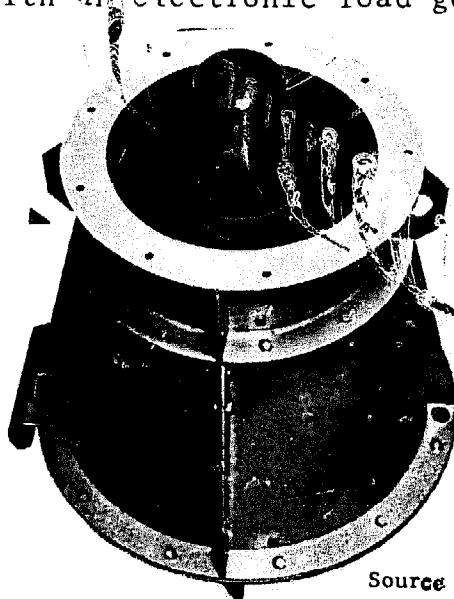

fig. 51: Pelton generating set.

Axial turbines

An example of a readily available assembly is the Hydrolec Unit. This Kaplan bulb turbine is fitted in a tube which can be mounted at the end of a supply pipe. Also this tube can be placed just below water surface, when a special suction cap is provided. Overspeed control here acts automatically by an air valve that stops the suction.

In the bulb a gearing unit and an asynchronous generator are fitted. Minimum head is 1 meter, and the assembly can be delivered together with an electronic load governor.



Source : Lit.22

fig. 52: Hydrolec generating unit.

Being principally an impulse turbine like a Pelton wheel, also reaction forces can be generated by closing an air inlet. If overspeed or overpressure occurs this air valve is automatically opened.

Delivery assemblies contain turbine housing with draft tube and guide vanes, generating sets including governor, speed increaser and generator.

Cross-flow turbines

The main advantage of a cross-flow turbine is a high efficiency (80-85%) over a wide range of flow variations. This is possible by manipulating guide vanes automatically to admiss water to a desirable section of the runner.

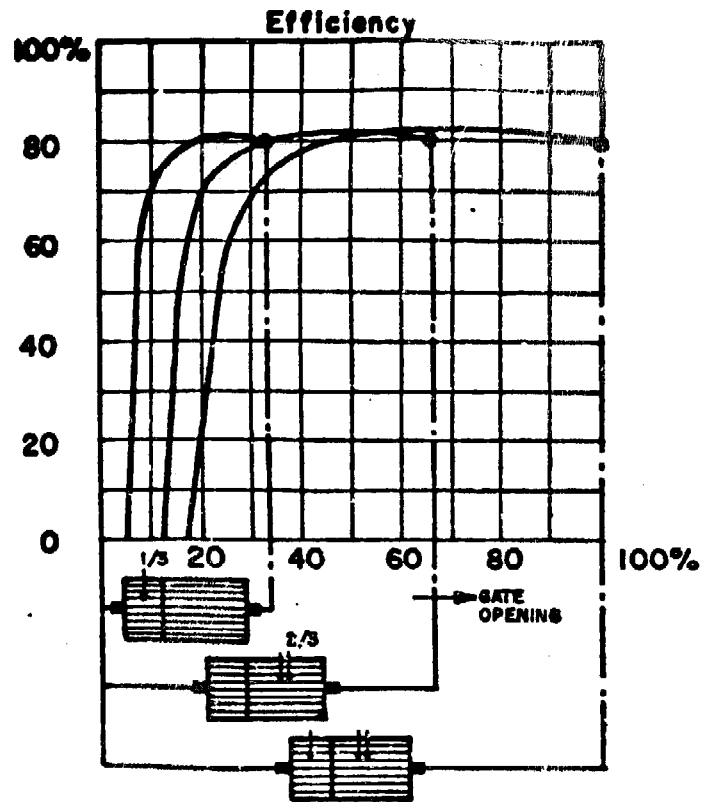

Source : Lit.80

fig. 53: Cross-flow turbine flow adjustment.

FREESTREAM TURBINES

As rotation rate varies with river current and also rotation speed c.q. alternate current frequency varies with demand, some control device should be used to keep frequency at constant level. All devices have a relatively low efficiency that drops the total freestream generating efficiency, being low itself, to very low values. Freestream generators therefore should only be used to produce dependent currency, or they should be accompanied by load governors dispatching load over various (dummy) demands.

One mechanical control device as referred to, is adjusting the angle between rotor axis and water surface with inclined axis hydrofoiled turbines. This varies the rotor-swept area

and herewith energy adaption, to be equalled to demand. Indeed this device uses much energy if automatic control is needed.

Hydrofoiled turbines

The low output up to 2 kW for a very large 5 square meter submerged part of a rotor merits a choice of a 12 to 24 Volt dependent current system. More in general, electricity generating from a freestream device should come to question if there is too little electricity demand (such as limited bulb lightning) to justify any restricted flow option. A freestream generating set also can be an option if no head can be made.

Maintenance (e.g. water hyacinth removal) is intensive compared to restricted flow installations with well designed inlet structures.

The Appropriate Technology institute of Belgium, ATOL, came to the conclusion after tests made in a small stream, that a 100 Watt out of a prototype was not worthwhile to make electricity of. They recommended direct drive water pumping.

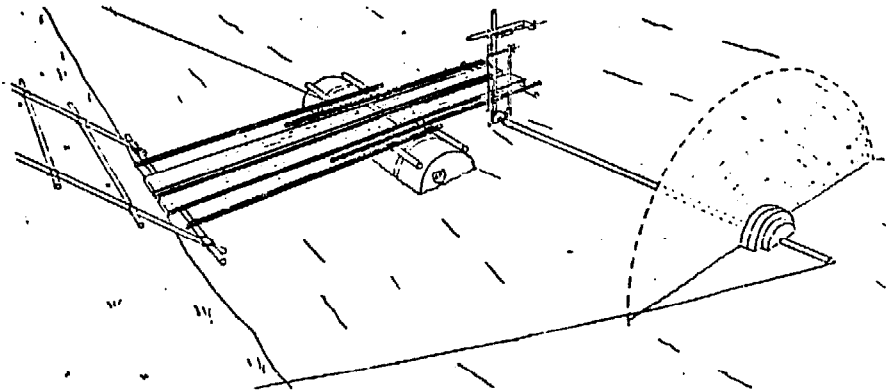

Source : Lit.8

fig. 54: ATOL hydrofoiled propeller with horizontal axis.

However in tidal currents much faster water flow speeds can occur. A make of Nova Energy Ltd., placed in the St. Lawrence river, produces 6kW electricity, linked to the Canadian grid. This company is now building a 100kW unit to be floated in the tidal currents of the Bay of Fundy, which have velocities of 3 to 5 m.s⁻¹. These locations are very scarce spread over the world, however.

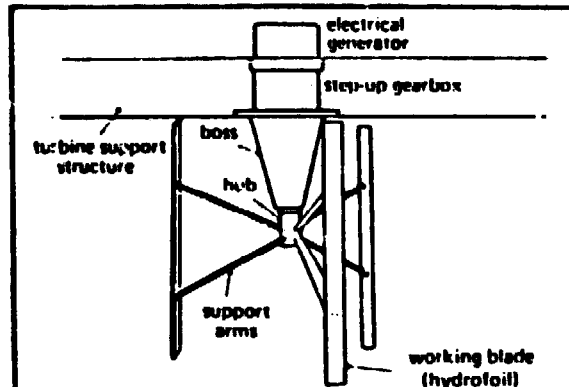

Source : Lit.99

fig. 55: 6 kW vertical axis hydrofoiled turbine.

Waterwheels

Waterwheels run relatively slowly : 2 to 15 RPM or in extreme designs to 100 RPM. For this reason waterwheels are hardly suitable for use with standard electricity generators that require rotational speeds of 1500 RPM or more. Gearing can be used by belts or chains to step up the speed. But the very high torque in the low speed end requires large and extensive gearing designs. Also the waterwheel itself is very heavy and material-intensive in terms of its output.

Electricity generation will operate at an efficiency that is lower than 40%. In advantage of the waterwheel option the little complexity of supply works is remarkable. Yet only if no other device is possible, e.g. dictated by local manufacture possibilities, waterwheels should be used for electricity generation.

Freestream propellers

Frequently used on river cargo vessels this is a simple unit acting in reverse of a ship propeller, to charge ship batteries.

It could easily be immersed in the current of a river or stream.

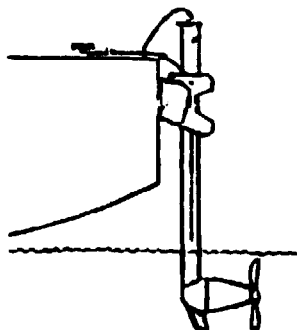
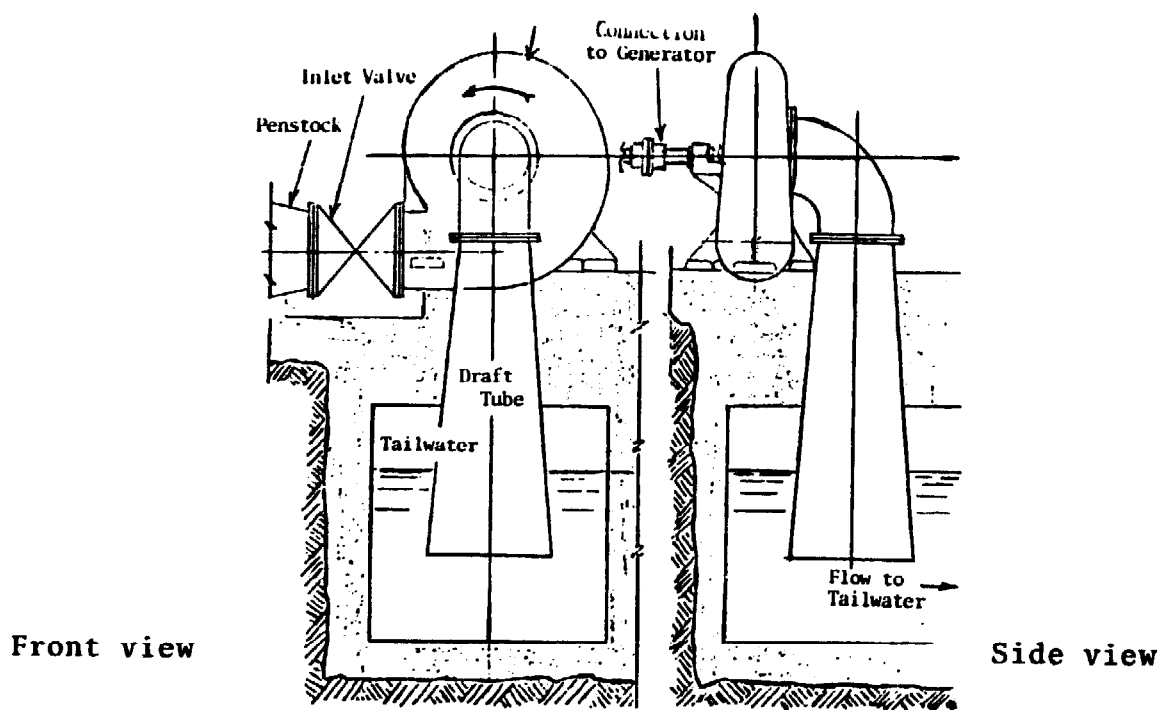

fig. 56: Freestream propeller.

Pumps used as a turbine

In designs analogic to pumping configurations, pumps can be used as turbines. If a synchronous or dependent currency motor is part of the pump unit, this motor can functionate as a generator without adaptations.



Source : Lit.41

fig. 57: Centrifugal pump in reversed rotation.

II. MOTIVE POWER

RESTRICTED FLOW TURBINES

To make electric apparatus redundant, both as not to be constrained with energy conversion losses, a direct use of turbine shaft power is a simple and reliable way to harness small scale waterpower.

Pelton turbines

At El Dormilon in Columbia the British Technology Development Institute, ITDG, helped to install a Pelton wheel powered sawmill of 20 kW, that drives a 30 inch saw blade and also supplies electricity for household lightning and cooking.

The sawmill can generate sufficient income to repay investments quickly. Also other direct drive uses are possible.

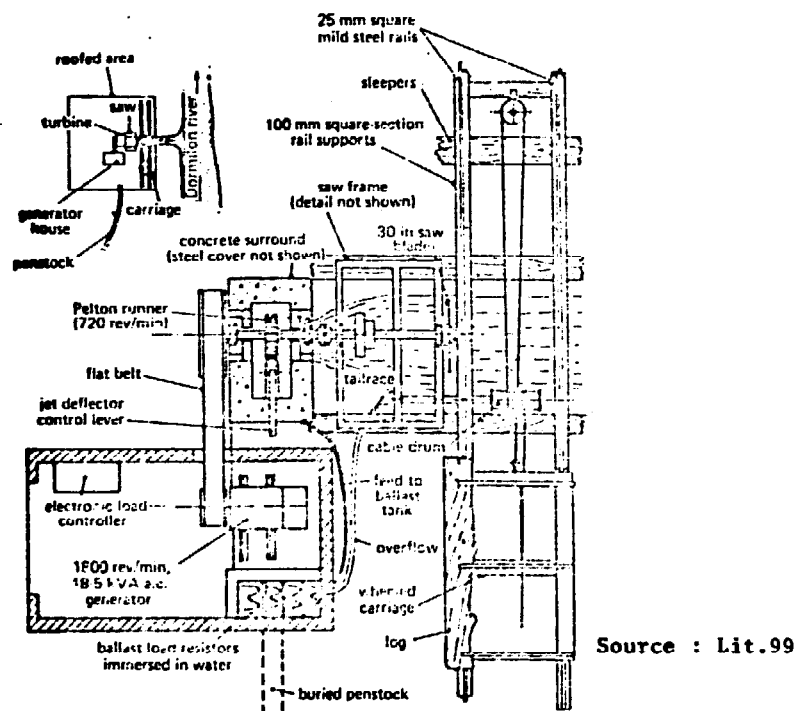

fig. 58: Saw mill powered by a Pelton wheel, ITDG.

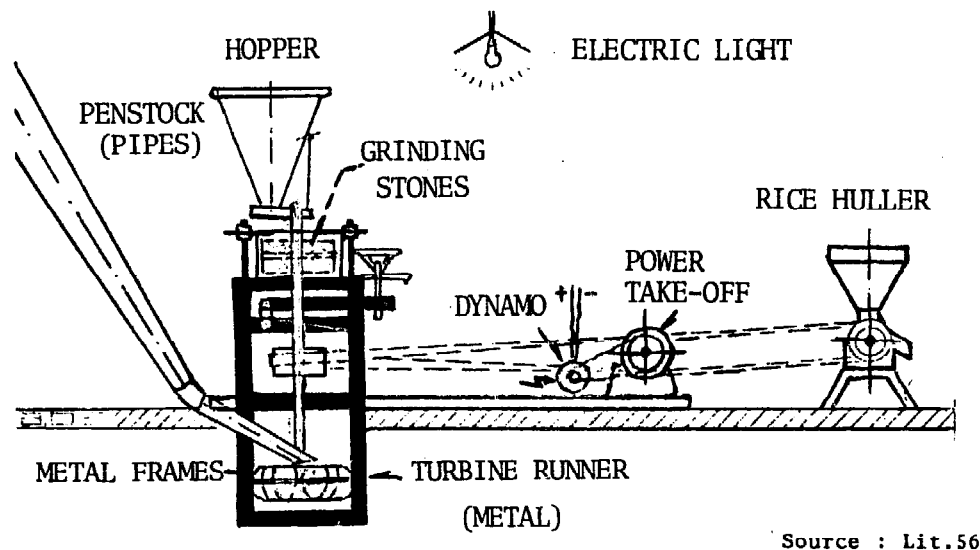

fig. 59: Multi-purpose unit.

Impeller turbine

Another Pelton-like turbine device is supported by the Research Centre for Applied Science and Technology in Nepal. A vertical axis impeller (circular or rectangular flat blades) directly drives a grain mill. Belts can drive other equipment, like a small generator (car dynamo), if wanted. Head should be around 4 meters, combined with a flow of $.1 \text{ m}^3$ per second. Rotation rate of the runner axis of this multiple purpose unit is around 300 RPM.

Propeller turbines

Working at heads as low as 15 cm an example of a motive power turbine is given by the Jansen Venneboer assembly.

Also to be delivered with an electricity generator, one type converts axial shaft power from a small propeller turbine into an oil-hydraulic pump within the bulb. This bulb unit is mounted in a tube. The hydraulic pressure can be applied for several functions e.g. closing and opening hydraulical governed valves and gates, as used in irrigation systems.

FREESTREAM TURBINES

Waterwheels

One of the oldest devices for using waterpower is the undershot wheel, driving directly a rotational operated processor. Well-known is an undershot wheel aside a driver, mounted on the wall of a housing in which the processing takes place. Also possible is a configuration with horizontal axis on a float, anchored in the river. For direct drive use the processing must take place on the float also. This float saves housing construction and civil structures like supply canals.

Hydrofoiled turbines

Because of very low output a motive power generation from these turbines is less suitable. Moreover hydrofoiled turbines should be floated in the middle of a river to reach the optimal river current where motive power use is difficult.

OTHER NON-TURBINE DEVICES

Hydraulic air compressor

In medieval Europe this machine with no moving parts was known as the "trompe" and supplied compressed air to Catalan iron furnaces. Basically the hydraulic air compressor is the inversion of the air-lift pump. A head of water is used to flow through a circumferential Venturi entrance of a vertical tube. In this Venturi openings are provided so that the water flowing past these openings will induce air to be sucked into the water stream downward. The water velocity out of the water now takes along this air to the bottom of the tube where air is trapped in a chamber. This air has pressure energy according with the height difference with the tailwater level.

An implementation is known that delivered air compression of 8 Atmospheres with 750kW of power, at Victoria Mine, Michigan.

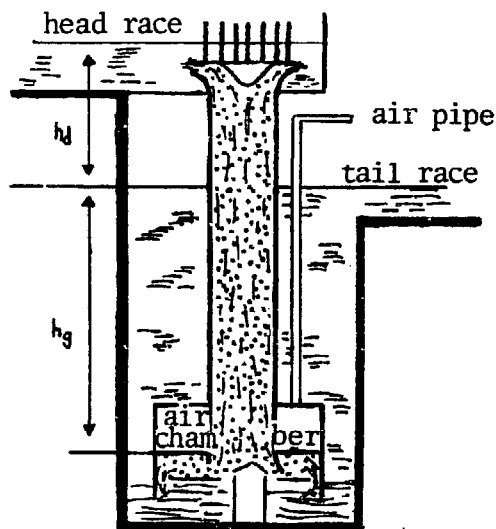

Source : Lit.18

fig. 60: Hydraulic air-compression arrangement.

However this technology seems to have been forgotten for almost 70 years, despite the possibility of compressed air to be stored easily for motoring use.

Small scale implementation depends on availability of tailrace water depth, if expensive cavern building has to be avoided.

III. WATER PUMPING

Independence of rotation rate makes water pumping a very suitable option for harnessing small scale hydropower. Especially when power figures are low, no frequency or rotation control is needed. For agriculture and drinking water supply this energy is of great importance in developing countries.

A second advantage is independence of demand. Lifted water can be stored in tanks to moments of demand.

No load governors are needed and all running energy production can directly be converted into raised water.

RESTRICTED FLOW TURBINES

Propeller turbines

One example of a readily available unit for pumping water with hydropower by use of a propeller type is the Nel-Plata pump. It consists of a tube placed in an angle over a small weir in the stream, of .25 to 1 meter of height.

Water levels on both sides should remain quite constant as to permit water to flow through the tube with a free surface. This mostly is the case with irrigation canals. In rivers however water levels can vary too much.

Inside the tube two or more propeller runners, partly submerged in the passing water, abstract velocity energy and drive two reciprocating piston pumps. These pistons pump water from a separate flexible supply pipe into a delivery pipe.

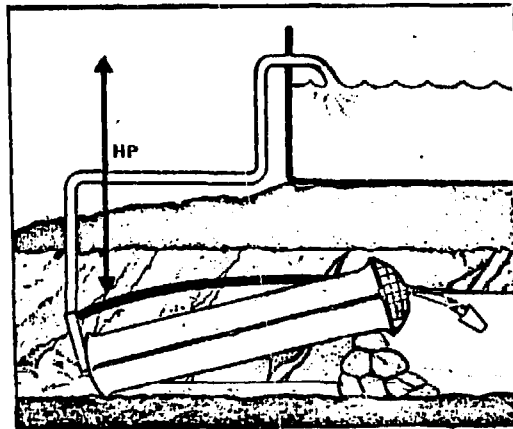

fig. 61: Nel Plata pumping unit.

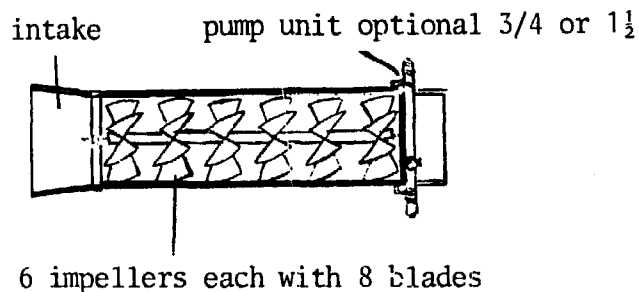

fig. 62: Internal propeller blades of Nel Plata device.

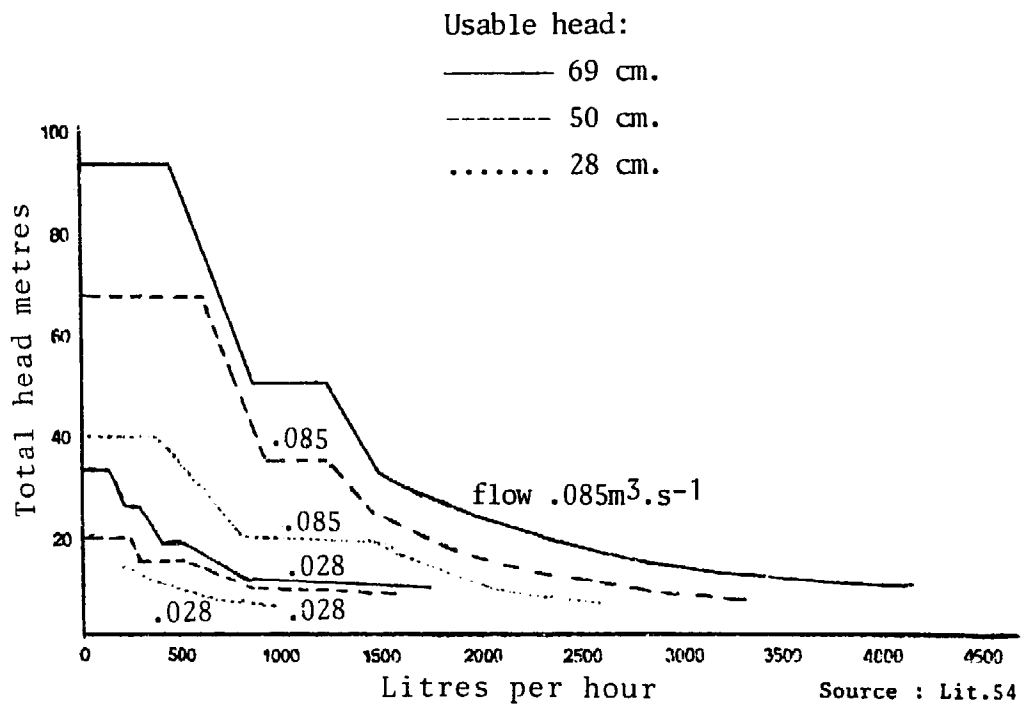

fig. 63: Nel Plata Unit performance.

FREESTREM TURBINES

Hydrofoiled turbines

Two types are in prototype stage: with Darrieus-rotor or with propeller-rotor. Both possibly with vertical, inclined or horizontal shaft are suitable for water pumping. Best applicable are centrifugal or piston pumps.

Intermediate Technology Development Group, ITDG, has undertaken tests on a vertical shaft submarine windmill, showing a maximum efficiency of 25% on the rotor shaft. On test location one turbine delivered enough water to supply a moderate vegetable garden.

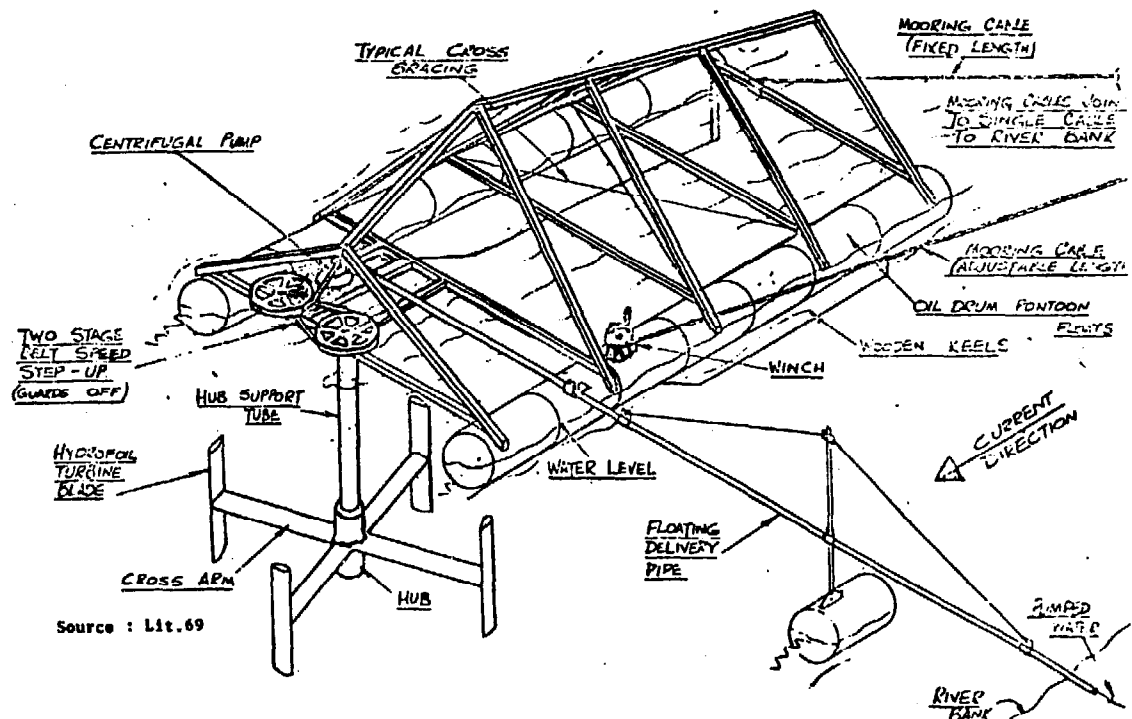

fig. 64: ITDG vertical axis hydrofoiled rotor test arrangement.

Waterwheel bucket pump

When buckets are mounted at the outer circle of a waterwheel these buckets will raise filled out of the stream that also drives the wheel. Coming at a certain point a bucket will pour over. This overflowing water is caught in a trough mounted aside the wheel or traverse, parallel to axis. Lifting head can be half to 70% of the wheel diameter.

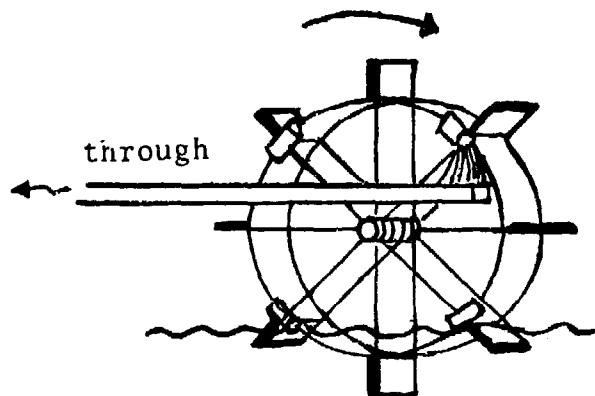

fig. 65: Water wheel bucket pump.

Waterwheel chain pump

The chain pump (Pater Noster) consists of a tube made of wood, iron, bamboo etc., which is placed with one open end in the water source, while the other open end leads to a delivery through. Through this tube runs a continuous chain fitted with a series of washers, made of wood or rubber (car tires). The chain is hung over a waterwheel, that uses the velocity of the supply water to drive the chain. This chain, turned by the wheel, comes up the tube, into which water is forced by the washers, while water is released at the top of the tube. The pump works very efficiently at slow rotation rates. This also is needed to prevent too much wear of the washers and the tube.

Spiral pump

The moving part of this manometric pump consists of a coiled tube, forced round by stream flow. The axis of this rotation is horizontal and is also axis of the spiral tube. Instead of a spiral of one tube, also more tubes may be coiled together. While turning the open end the spiral wined tube partly submerges into the stream. Part of a rotation further, this open end moves through the atmosphere.

Alternate packages of water and air will pass through the tube to a rotary connection from which they pass into a delivery pipe.

The lift (or pressure) in this delivery pipe is provided by the successive loops of the coil, acting as a series of manometers.

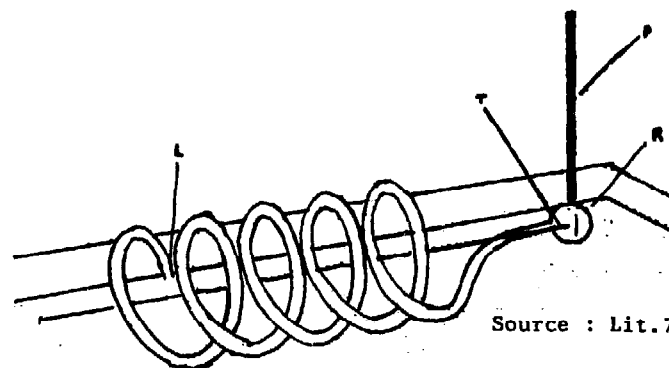
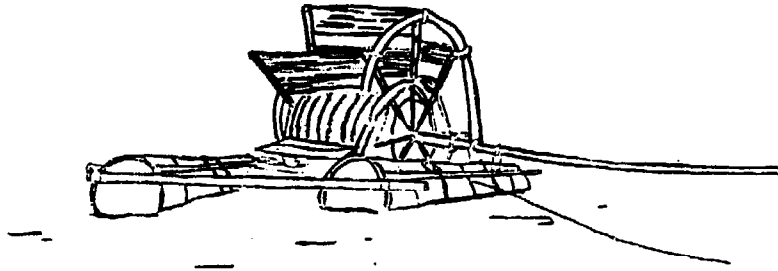

fig. 66: Schematic view of a spiral pump.

Although the idea of this hydrostatic coil pump alters from the eighteenth century, the pump is now in laboratorial stage. Here results were in the order of 3 litres per minute against a head of 4.2 meters, the powering water-wheel being placed in a stream velocity of 0.3 m.s^{-1} . A spiral pump is operational at the Rejaf-project near Juba, Sudan. Here it is mounted on a float in the White Nile.



Source : Lit.91

fig. 67: Floating spiral pump device with water wheel.

Hydropneumatic pump

This is a device that carries over pressure energy ($p/\rho g$) out of a head (H) onto a higher level, by means of a compressed air pipe. From this high level, the ejection tank, water can be lifted to almost $p/\rho g$ higher than the level of the origin water source level. In short, water can be lifted from a source level almost as high as water can be made to fall from this level: the usable head H .

The falling water flows into the bifurcation tank. As this tank fills, as does the communicating ejection tank, it reaches a level (lower than the source level) from which the water flows over into a conduit, which leads to the compression tank. While the compression tank is filling, the air above the level herein is compressed. This compressed air now carries over its pressure to the water level in the ejection tank by the compressed air pipe. By means of two backflow valves this pressure energy lifts the water out of the ejection tank into the delivery pipe, as it is obstructed to flow back to the bifurcation tank.

Before the ejection tank is emptied, the compression in the compression tank has become so high that a siphon starts working (or pressure valve opens), thus emptying the compression tank.

The air pressure in the ejection tank now suddenly lowers until a backflow valve opens and starts to flow from the bifurcation tank to the ejection tank again. The level in this bifurcation tank lowers as happens in the compression tank by siphoning, until air is able to entry through the conduit. The siphon now stops working and pressure in the compressed air pipe is zero (atmospheric pressure). Now the process starts all over. Thus alternatively delivery flow and siphon spilling flow will occur.

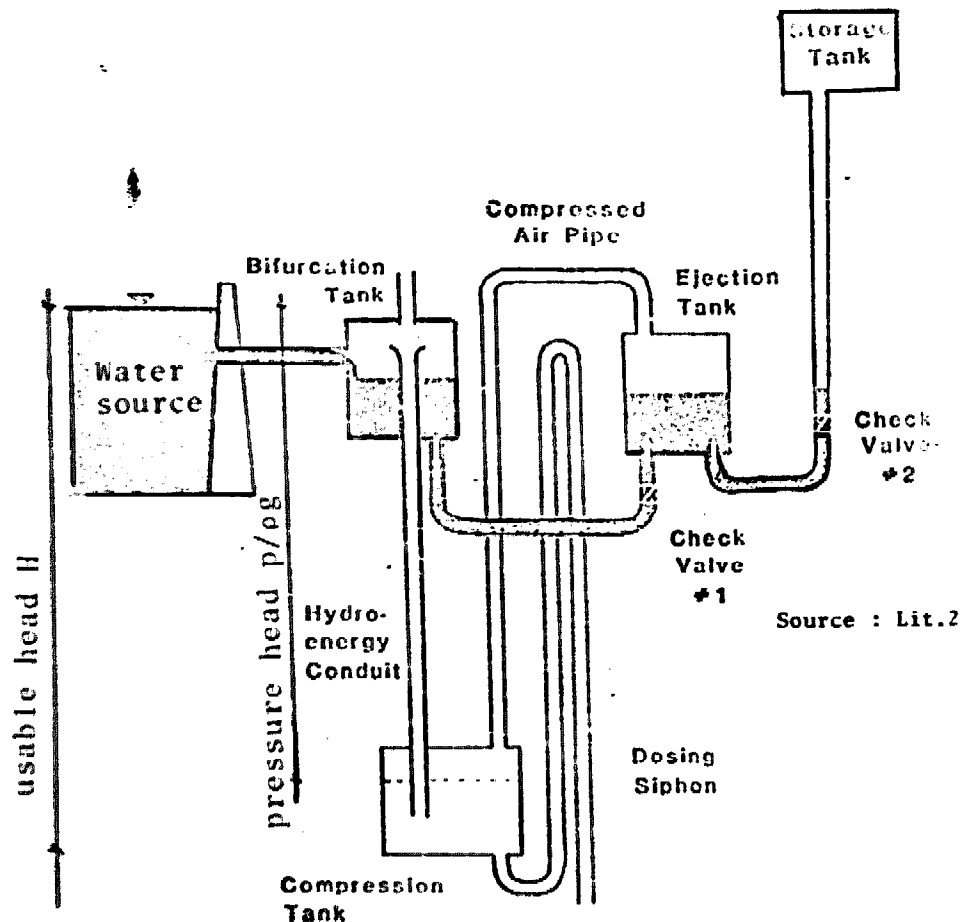

fig. 72: Siphon activated hydropneumatic pump.

For lifts up to about 8 meters a siphon is convenient. For higher lifts instead a pressure-activated dump valve on the compression tank is needed.

The part of the flow from the source that is delivered accounts to about $10/(H + 10)$, where H is the usable head. The complementing part is spilled on a level lower than the compression tank. Depending of tank and piping design (still to be determined by experiments), delivery flow can reach about 30 litres per minute, while efficiency varies from 15 to 70%.

OTHER NON-TURBINE DEVICES

Water ram

The hydraulic ram converts a big flow with low head into a small head with a considerable head. The installation consists of a supply pressure pipe, an impulse-activated waste valve, an air and a delivery valve, an air chamber and a delivery pipe.

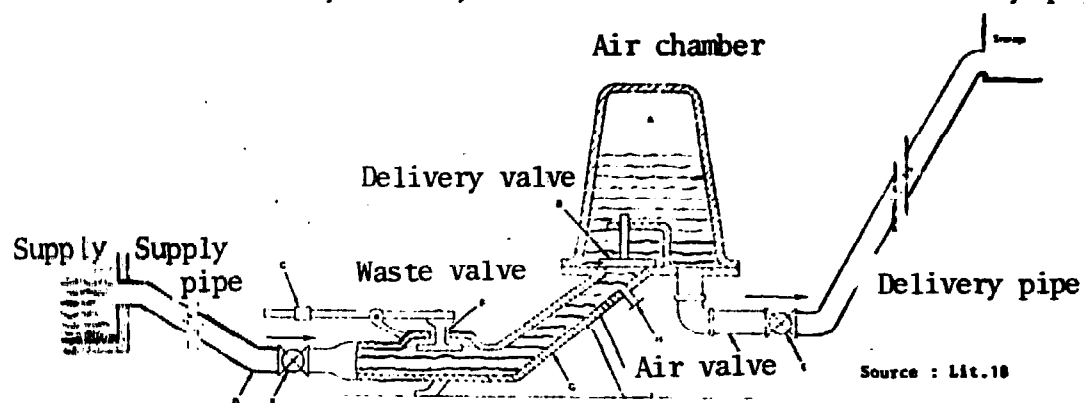

fig. 69: Water ram pumping device.

The waste valve is in initial stage in opened position, by its weight or forced by spring tension, in downward direction. Water from the supply pipe escapes through this valve with increasing speed. When this flow has become fast enough, the upward force on the valve will exceed its weight and this waste valve will suddenly close.

The flow through this valve is stopped at once. However the momentum of the fast flowing water column in the supply pipe, trying to continue, forces a pressure rise on the delivery valve. This pressure overcomes the pressure in the airchamber and the delivery valve (a backflow valve) will open, allowing a small flow continuing into the air chamber. The air cushion permits water to be stored temporarily, thus preventing the occurrence of water hammer (pressure waves) into the delivery pipe.

When the velocity energy of the driving water is exhausted, the delivery valve will shut by backflow into the supply pipe. This flow causes an underpressure near the waste valve, causing it to reopen. In the meantime the water stored in the airchamber is driven into the delivery pipe by the temporary overpressure of the air.

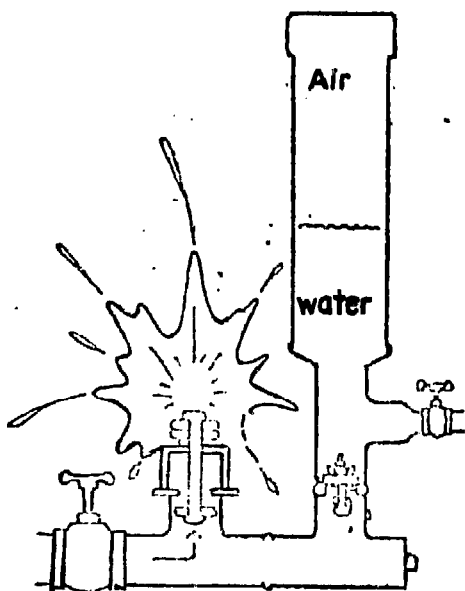

fig. 70: Wasting part
of a ram cycle.

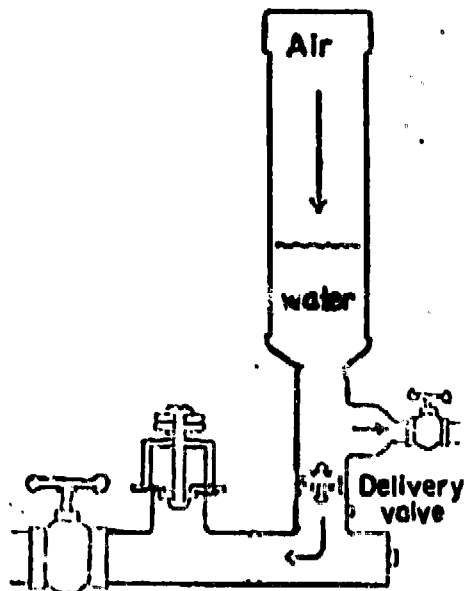

fig. 71: Backflow and
delivery part
of a ram cycle.

In addition an air valve is mounted just in front of the delivery valve. During the short backflow part of the ram cycle, air is entering by local underpressure.

This air is carried along with the next surge of water into the air chamber, thus replenishing air that is lost, being mixed with delivery water. Also this air valve prevents water hammer and too big underpressure in the supply pipe.

The reopened waste valve starts a new operating cycle. Depending of designs this cycle is repeated with a frequency of about 30 to 100 times each minute. Delivery head can be about 40 times the supply head and can exceed 100 meters, which makes this device incomparable with other direct drive hydropowered pumps.

Investment costs of these rams are low and they need little attention. Normal construction is of cast iron, while studies try out designs of plastic to lower the price and allow for local manufacture.

Supply head (m)	Delivery head (m)																			
	5	7.5	10	15	20	30	40	50	60	80	100	125								
1.0	144	77	65	35	59	19.5	12.5													
1.5		135	96	70	54	36	19	15												
2.0			220	156	105	79	53	33	25	19.5	12.5									
2.5				280	200	125	100	66	40.5	32.5	24	15.5	12							
3.0					260	180	130	87	65	51	40	27	17.5	12						
3.5						215	150	100	75	60	46	31.5	20	14						
4.0							255	173	115	86	69	53	36	23	16					
5.0								310	236	155	118	94	71.5	50	36	23				
6.0									282	185	140	112	93.5	64.5	47.5	34				
7.0										216	163	130	109	82	60	48				
8.0											187	149	125	94	69	55				
9.0												212	168	140	105	84	62			
10.0													245	187	156	117	93	69		
12.0														295	225	187	140	113	83	
14.0															265	218	167	132	97	
16.0																250	187	150	110	
18.0																	280	210	169	124

Source : Lit.31

fig. 72: Waterram performance example.

Litres pumped in 24 hours
per 1/min. of drive water

10. APPLICABILITY LIST

OVERALL VIEW OF SMALL SCALE APPLICABILITY OF WATERPOWER DEVICES

For all purposes

				See page
All heads	Cross-flow turbine	A		37, 65
	Inverse pumps		T	28, 69
High heads	Pelton turbines			33, 64, 70
	Impeller turbines			71
Low heads	Overshot waterwheels	A		L 13
	Axial turbines			36, 64, 71
"No" heads	Waterwheels	A	T	C L 30, 68, 72
	Hydrofoiled turbines	A		C L 30, 67, 72, 75

For water pumping only

Medium and High heads	Hydropneumatic pumps	A		C	78
	Waterrams	A		T	80
Low and "No" heads	Waterwheel bucket or chain pumps	A	T	C L	76
"No" heads	Spiral pumps	A	T	C L	77

For motive power only

Medium heads	Hydraulic air compressors	A		T	72
--------------	---------------------------	---	--	---	----

A = easy artisan made

T = little complexity, easy technology

C = little civil constructions needed

L = only suitable for low power outputs (up to about 2kW)

11. COSTS OF SMALL SCALE HYDROPOWER

Estimates of investment costs of small scale hydropower are hardly to be given. Every site has its own favours and difficulties. Also much depends on the type of device that is used and the part of the installation that can be made by future users themselves.

On this dangerous subject I.L. Gordon tried to extract formulae out of eight projects, published in "Waterpower and Dam Constructions", November 1983. He estimates small scale powerhouse costs (excluding civil constructions like a dam, inlet, tailrace etc.) as : $53,000 \text{ (kW)} \cdot H^{-.35}$, and overall costs as :

$10.7 \times 10^6 ((\text{MW})/H \cdot 3) \cdot 82$, both in US \$, where (kW) is installed power in kW, (MW) the same in MW and H is developed head.

Other sources give similar formulae, presented in graphs. These also are based on data of implemented projects.

Cost calculations become even more hazardous when no insight is available how much labour is done at an installation by users or owners without account or how much alternative materials are used. For implements in developing countries this may be an important factor. Especially in these areas imports and design studies made abroad can become a substantial part of the investment costs.

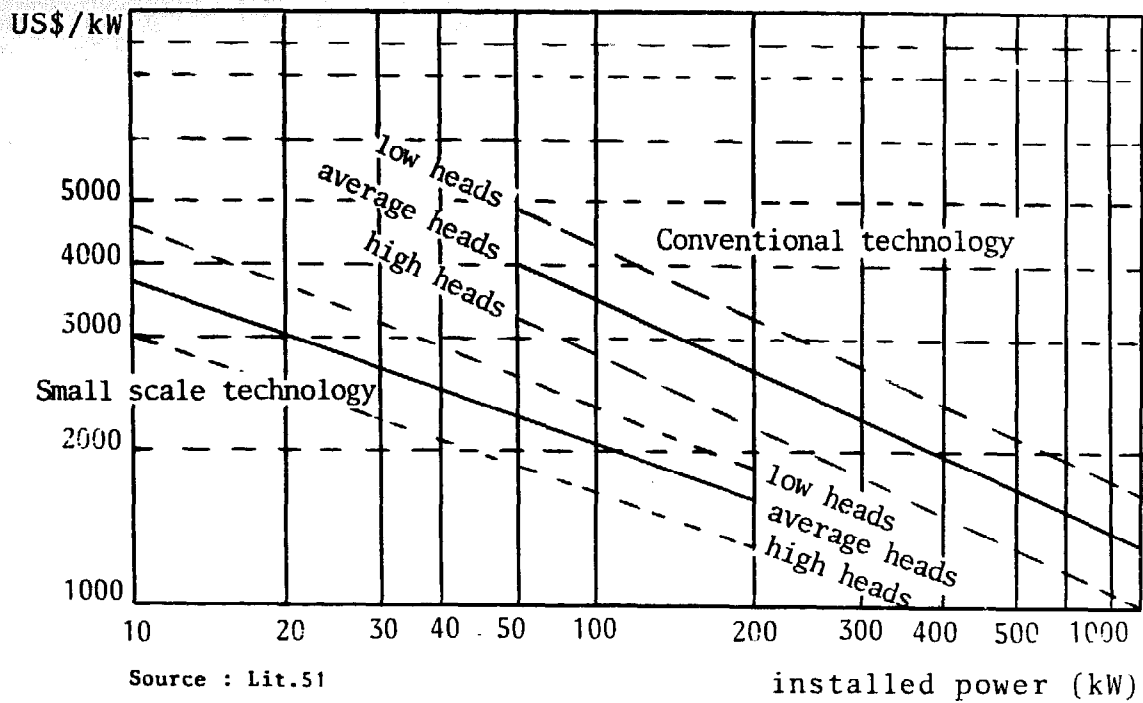

fig. 73: Reference indicators of small scale hydropower investment costs.

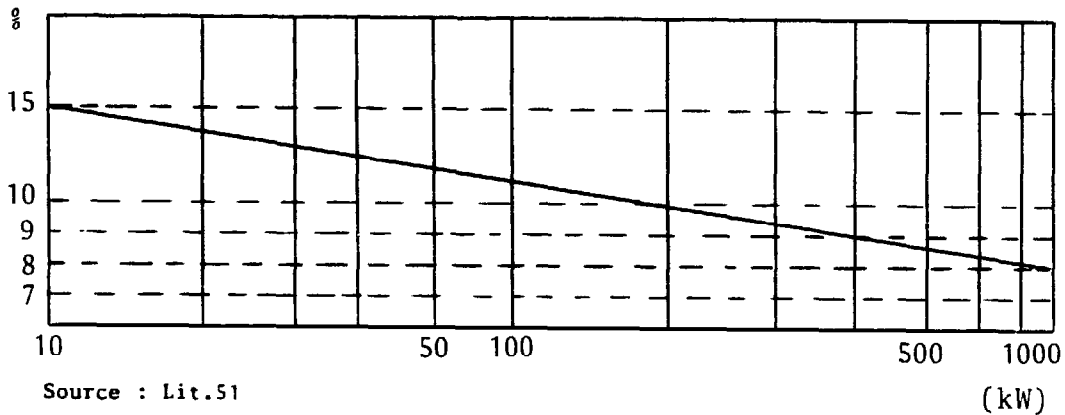

fig. 74: Study and design costs as a maximum recommended percentage of total project costs, as a function of project output in kilowatts.

In general, one should choose a device that suits his needs, and that fits to his skills and the availability of knowledge and construction materials. In addition one should be aware that investment costs per installed kilowatt rise with lowering installed power and lowering usable head.

Any simple cost estimation ignores explicit local factors and also ignores the worth of social improvement. Under these conditions the following cost estimates can be used with caution for first studies.

Costs in US\$ (1984) per kW of installed power.		
	High cost: buying standard equipment	Low cost: own labour, reuse of materials
Restricted flow turbines		
high head	2,000	1,000
low head	4,700	2,000
Other devices		
medium head	1,700	700
"no" head	1,300	500

The operating costs of small scale hydropower vary even more than investment costs.

Investment costs are the biggest part of the running costs per unit of energy. The most important factor is the lifetime the installation is estimated to last. For restricted flow devices and excellent civil lay-out, this may be 40 to 50 years, while simple freestream devices, installed without care, may be destroyed within a month by debris.

In this matter a balance has to be chosen between low investment costs and long lifetime, while naturally a suitable device and civil lay-out must be chosen. In addition, operating costs can vary much, depending of the quality of the installation, repairs, maintenance, lifetime, and most of all of qualities of river flow, varying from time to time and also influencing the available head.

Utility implements score operating prices lower than 3 US\$ cents per kWh, while in remote areas complex hydropower solutions may cause prices over 10 cents per kWh.

APPENDIX

12. DESIRED FURTHER STUDIES

Investigations on special devices

In hydropower technology all restricted flow turbine devices are developed to a high standard already. On this subject one can only remark a lack of good manuals for artisan manufacture.

Also waterwheel technologies are proven. Various manufacture manuals are published.

For being a quite new technology or a technology gaining renewed interest, many uncertainties in designs and economies are present with :

- hydrofoiled turbines
- spiral pumps
- water rams
- hydraulic air compressors
- hydropneumatic pumps
- pumps used in reverse

Hydrofoiled turbines

Only a few of these turbines are in operation at this moment. All are prototypes as to obtain data on production. Design measurements still are not optimized, not to mention manufacture manuals still to be published. No manufacturer of standard turbines is known yet. The possibilities of implementing hydrofoiled turbines in areas where nearly no heads are available are unknown. Also it is still unknown if these turbines form a barrier in small rivers, thus changing river qualities like fall, velocity and sand transportation (and erosion and sedimentation).

Spiral pumps

The uncertainties mentioned above also count for spiral pumps. The little prototypes tested leave much design data unknown yet.

Water rams

Though several makes are commercially available, a try should be made to make this device of merely plastics, as to lower investment costs.

Hydraulic air compressors

No study or design production publishing is known of. The possibility of transporting the compressed air, and the absence of any moving part make investigations much desired.

Hydropneumatic pumps

Again no test results are published yet. A design manual would improve implementation of this device.

Pumps used in reverse

A manual describing which types of pumps are usable and which adaptations are to be made could take away many obscurities with decision makers having to choose a hydropower device.

General investigations

One subject of small scale hydropower implementation in most countries is the limits laid down by legislation or hydrologic management. As small scale use of water-power mostly will not be exerted by power utilities, implementing will be done by private companies and users. As is the case with windpower, this can lead to various difficulties.

To make use of existing civil structures more data should be obtained about designs and costs. Designs could be bypassing or adapting existing constructions. Waterpower and other use may compete with each other. Further, possible cost savings are unknown in preliminary studies.

Hydraulic air compressors

No study or design and production publishing is known of. The possibility of transporting the compressed air, and the absence of any moving part make investigations much desired.

Hydropneumatic pumps

Again no test results are published yet. A design manual would improve implementation of this device.

Pumps used in reverse

A manual describing which types of pumps are usable and which adaptations are to be made could take away many obscurities with decision makers having to choose a hydropower device.

General investigations

One subject of small scale hydropower implementation in most countries is the limits laid down by legislation or hydrologic management. As small scale use of waterpower mostly will not be exerted by power utilities, implementing will be done by private companies and users. As is the case with windpower, this can lead to various difficulties.

To make use of existing civil structures more data should be obtained about designs and costs. Designs could be bypassing or adapting existing constructions. Waterpower and other use may compete with each other. Further, possible cost savings are unknown in preliminary studies.

3. LITERATURE+MANUFACTURERS

Literature that is used in this study is listed below on alfabetic order. An indication of the contents of the literature is given as follows :

- A = General technologies.
- D = Design manual.
- F = Freestream turbines study or description.
- G = General work on small scale hydropower.
- H = Historical description.
- L = (Listing of) manufacturers or organizations.
- M = Motive power applications.
- P = Inversed pumps or special pump devices.
- T = Restricted flow turbines study or description.
- W = Waterwheel study or description.

- 1 : The advent and triumph of the water mill in Land and work in medieval Europe, selected papers, Bloch M. H
- 2 : Alternative energy sources for drinking water supply; IRC, 1983.
- 3 : Ancient and modern water wheels; Eng. Magazine, Vol.1, Webber S., 1891 H
- 4 : The application of the vertical axis water turbine in developing countries; Garma F., Reading 1983. F
- 5 : Appropriate Technology; Vol.8, No.2
- 6 : Appropriate Technology for turbines of small scale hydropower stations; Strohmer F.,Walch E. G D

- 7 : Appropriate technology in civil engineering;
1981, 135-138.
- 8 : Het ATOL onderzoeksproject; Vraagbaak, Vol.10, F
no.2; TOOL, Amsterdam, 1982
- 9 : Autografieën waterkracht, dictaat F20, Delft G
- 10 : Berechnung und Ausführung Wasserräder, W D
Beyrich F.
- 11 : Country Assesments for Mini Hydro potential : C
A methodology; NRECA, Washington, 1983
- 12 : De Rei Metallica; Agricola G.;translation of A
the 1556 original in 1950 by Hoover H.C.,
Hoover L.H., New York, 1950.
- 13 : The development of a turbine for tapping river F
current energy; Appropriate Technology, Vol.8,
No.2; ITDG, London, 1981.
- 14 : Directory of sources of small hydro-electric T L
turbines and packages; Inversin A.R.;NRECA,
Washington, 1981.
- 15 : Drijvende waterkrachtcentrale; Hattem J.v., W D
Vijfhuizen W.J.; CAT, Delft, 1980.
- 16 : Early western travels, 32 vols.;Thwaites R.G. H
(ed.), Cleveland, 1904-1907.
- 17 : Electricity for the farm: Light, heat and power W
by inexpensive methods from the water wheel or
farm engine; Anderson F,; McMillan Co.,1915.
- 18 : Energy for rural development, Holland R., G
Waterpower and Dam Construction, dec. 1982,
pp 29-32, Sutton, 1982.

- 19 : Energy primer, Portola institute (USA); Prism Press, 1976.
- 20 : Energie waterbouwkunde, dictaat F20a, Delft, 1982. G
- 21 : Environmental Methodologies for small hydro-power projects; NRECA, Washington, 1982. G
- 22 : Erbe von gestern, Techniek von heute, Energie von morgen, Hydrolec. T L
- 23 : The evolution of the American type of water wheel; Jour. West. Soc. eng., Vol.3, Tyler W.W.; 1983. H
- 24 : Floating hydro-electric generators for underdeveloped regions; Ames (USA); Jolly F.H., 1970. F
- 25 : Harnessing waterpower for home energy; Garden Way Publishing Co., Charlotte, Moguegan D.; 1978. G
- 26 : Himalayan waterwheels improving performance; Waterpower and Dam Construction, Jan.1981, pp 70-71, Sutton, 1981. W
- 27 : A history of industrial power in the United States, 1780-1930, Vol. I: Water power, University Press of Virginia, Hunter L.C., Charlottesville, 1979. H
- 28 : La Houille blanche; Mondragon D. G
- 29 : La houille blanche; Ferrendier M., 1949. H
- 30 : Hydraulic handbook; Leager W.P. A
- 31 : Hydraulic rams, Tacke J., TH-Delft, 1984. P

- 32 : Hydraulic motors; turbines and pressure engines; T
Bodmer G.R., London, 1889.
- 33 : Hydro electric engineering; Gerard G. G
- 34 : Hydrologic estimates for small hydro-electric D
projects; Crawford W.H.; NRECA, Washington, 1981
- 35 : Hydro pneumatic pump in Alternative energy P
sources for drinking water supply in developing
countries, IRC, 1983.
- 36 : Hydropower, The use of water as an alternative G
energy; Simeons C., Oxford, 1980.
- 37 : International News, Water Power and Dam Construc- G
tion, May 1983, pp 5, Sutton, 1983.
- 38 : Local Experience with micro-hydro technology; G
SKAT, Meier U.; St. Gallen, 1982.
- 39 : Low head hydro : an examination of an alter- G
native energy; Gladwell J.S.
- 40 : Low head prototype water mill linked to F
Canadian grid, Water Power and Dam Construction,
Dec. 1982, pp 76, Sutton, 1982.
- 41 : Low cost development of small water power sites, G D
Hamm H.W., Mt. Rainier, 1977.
- 42 : Manual of machinery and mill work; London, 1869. H
- 43 : Mechanics for the millwright, machinist, engineer, H
civil engineer, architect and student; Overmann F.,
Philadelphia, 1858.

- 44 : Microhydropower as an energy source for rural Colombia; Burton J., Holland R., *Appropriate Technology*, Vol. 10, no. 3 pp 25-27, London, 1983. G
- 45 : Micro hydro research and development at the civil engineering department, University of Canterbury, Christchurch, New Zealand, *Reric News*, Dec. 1983, pp 15 -16, Bangkok, 1983. G
- 46 : Micro hydro : turbine selection criteria; Hothersall R.J., *Water Power and Dam Construction*, Feb. 1984, pp 26-29, Sutton, 1984. T D
- 47 : Midget power plants, Vol. II, section A, Mosonyi E. G
- 48 : Mill and mill work, Part I; Longman, Fairbairn W., Green & Co., London, 1871. D H
W M
- 49 : Mill wright and mill furnisher; Lockwood H., Grimshaw R., New York, 1882. W M
T
- 50 : Mini hydro, energy for rural development, Mt. Rainier. G D
- 51 : Mini hydro power stations. A manual for decision makers. Prepared by Olade (Latin American energy organization), UNIDO/IS. 225; April 1981. G D
- 52 : Multi purpose power unit with horizontal water turbine; Vol. 1 : Basic information; Nakarmi A.M., Katmandu, 1982. M
- 53 : The natural energy centre, Kingston upon Thames; river turbine pump. F P
- 54 : Nel Plata Co.

- 55 : Nel Plata pump; H.J. Godwin Ltd., Quenington. L
- 56 : New Himalayan water wheels; Bachman A.,
Nakarmi A.M., Katmandu, 1983. W
- 57 : Observations of Mr. Ellwood Morris' remarks
on water wheels; Journ. Franklin Institute,
Whitelan J., 3rd series, Vol. 8, 1844 H
- 58 : The old-time water wheels of America, Frizell;
in Trans. Am. Soc. Civ. Eng. 28 (1893). H
- 59 : Ossberger turbinenfabrik, Weissenburg, BRD.
- 60 : Perspectieven voor waterstromingsenergie in
ontwikkelingslanden, Deel A : algemene gezichts-
punten; Deel B : uitwerking Darrieus; Braam F.J.,
Vlissingen, 1982. F
- 61 : Plata power Ltd.; Dunedin; river turbine pump. T L
- 62 : Power from water; Leonard Hill Ltd.; Paton
T.A.L., London, 1961. G
- 63 : Power Guide. ITP, Fraenkel P.; London, 1979. T W
F L
- 64 : Prefeasibility studies of candidate mini hydro
sites; A Methodology. NRECA, Washington, 1982. G D
- 65 : Nepal, Private sector approach to implementing
micro-hydropower schemes. A case study;
Inversin A.R.; NRECA, Washington, 1982. M
- 66 : Rain, pp 28-29, Irving, 1983.
- 67 : Renewable sources of energy and alternative
technologies for developing countries, Energy for
rural development; National Academy of Sciences,
Washington. G

- 68 : Report and directory on organizations in developing countries working on renewable energy, UN Environmental Program, May 1981, pp 20-25 L
- 69 : Report to the Netherlands Government on the design, construction and testing of low cost river powered water pumping turbines in Southern Sudan; Garman P., London, 1983. F D
- 70 : Reric News; March 1983, Renewable Energy Information Centre, Bangkok.
- 71 : 1 kW River generator; Vita, Boissevan M.G.; Mt. Rainier, 1978. F
- 72 : Roovings through Southern China; Franck H.A.; New York, 1925. F
- 73 : Rudimentary treatise on the power of water. As applied to drive flour mills, etc.; Glynn J. M
- 74 : Science of mechanics; Allen. A
- 75 : De slangepomp, Vraagbaak, Vol. 10, no. 1, pp 52-59, Wageningen 1982. P
- 76 : Small hydro; Gladwell J.S., Moscow, 1980. G
- 77 : Small hydro case studies; O'Brien E., TAMS, New York. G
- 78 : Small hydro electric plants; Noyes R. (ed.). G
- 79 : Small hydro electric projects for rural development; Goodman L.J. G
- 80 : Small hydro for industry; Proceedings Vancouver, November 1980.

- 81 : Small hydro from a submersible pump; Giddens P
E.P., Spittal W., Watson D.B., Water Power and
Dam Construction, Dec.1982, pp 33-34
- 82 : Small hydro needs its own experts; Water Power G
and Dam Construction, Dec. 1982, pp 69-71,
Sutton, 1982.
- 83 : Small hydro power, Reric News, Aug. 1982, pp G
16-17, Bangkok, 1982.
- 84 : Small hydro : some practical planning and D
design considerations; Gladwell J.S.
- 85 : Some old-time water wheels; Eng. News, Vol. 42; H
Christie W.W.; 1899
- 86 : Spiralpump, operational at the REJAF-project P
near Juba, Sudan, 1983.
- 87 : Spon's Dictionary of engineering; Float water A
wheels, pp 1511-1524.
- 88 : The streampowered manometric pump; Stuckey A.T., P
Wilson E.M. in Appropriate Technology in
Civil Engineering, pp135-138, London, 1981.
- 89 : Theatrum Machinarum Molarum, oder Schau-Platz W
der Mühlen-Bau-Kunst; Leupoid J.; Dresden, 1767.
- 90 : Treatise on hydraulics; Glynn J. A
- 91 : Vraagbaak; No. 2, June 1982.
- 92 : A vertical axis river turbine; Appropriate F
Technology, Vol. 4, no. 2; ITDG, London, 1977.

- 93 : Windmills and Watermills; Preager Pubs.; H D
Reynolds J.; New York, 1970.
- 94 : Wasserräder : Berechnung und Ausführung; W D
Beyrich F.
- 95 : Water power development, Vol. II : High-head G
power plants, section A : Midget power plants
with water wheels pp 821-827; Mosonyi E.; Aka-
demia Kiadó, Budapest, 1965.
- 96 : Water power engineering; Mead D.W.; McGraw-Hill, G H
New York, 1915.
- 97 : Water or hydraulic motors; Björling P.R.; G H
Spon and Chamberlain, New York, 1903.
- 98 : Waterpower and dam construction; Jan. 1981.
- 99 : Waterpower and dam construction; Dec. 1982.
- 100 : Waterpower and dam construction; Feb. 1984.
- 101 : Water power. An outline of the development F
and application of the energy of flowing water;
Frizell J.P.; New York, 1900.
- 102 : Water Power, Hydraulic engineering 1899; D W
reprinted in Alternative Sources of Energy,
no. 14, Milaca.
- 103 : Waterturbine voor stuwbediening, Wijhe, T L
Jansen Venneboer, 1983.
- 104 : The young mill wright and miller' guide; H
Evans O., 1975.

After a period of lower demand, now the number of manufacturers of small scale hydropower turbines and units is increasing. Below the addresses of producers of turbines from below 50kW output are listed alphabetically. In the margin the type of product is given by symbols as follows:

C = Cross-flow turbine

F = Francis turbine

H = Hydraulic ram

K = Kaplan turbine

L = Pelton and/or Impulse turbine

P = Propeller turbine

R = Inversed pump

W = Waterwheel

All including electrical generator if applicable

E = including electrical equipment like control panel and over-load control

G = including mechanical governing equipment

T = turbine only.

Aebi Tavelweg, 4914 Roggwil, Switzerland	K L	
Alaska Wind & Water Power Box G, Chigiat, Alaska 99567, USA	L	T
Allis Chalmers Corporation Box 712, York, PA17405, USA	F K L	
Armfield Engineering Crow Arch Lane, Ringwood, BH241PE, UK	F P C	E G
Balaju Yantra Shala Box 209, Kathmandu, Nepal	C	E G
Bamford & Co. Ltd. Ajax Works, Whitehill, Stockport, Cheshire, UK	P	E G

Barata Indonesia 31 Kaptan P, Tendean 12-14a, Jakarta, Indonesia	K	T
Barber Hydraulic Turbines Ltd. Barber Point, Box 340, Port Colborne, Ontario L3k5W1, Canada	F P	
Beli Maschinenfabrik AG 6010 Kriens-Lucerne, Switzerland	P	
Blake Ltd., John Box 43, Accrington, Lancashire BB55LP, UK	H	
Briau SA Box 0903, 37009 Tours Cedex, France	W F P	E
Brown Boveri Hydro Power		E G
Bruzaholms Ltd. AB 57034 Bruzaholm, Sweden	H	
Butwal Engineering Works Box 1, Butwal, Lumbini Zone, Nepal	C	F G
Byron Jackson, Borg Warner Corporation 200 Oceangate Boulevard, Suite 800, Long Beach, California 90802, USA	K	
Campbell Waterwheel Company 420 South 42nd Str., Philadelphia 19104, USA	W	
Canyon Industries Inc. 5346 Mosquito Lake Road, Deming, Washington 98244, USA	F L C	E G
CeCoCo Chuo Boeki Goshi Kaisha Box 8, Ibaraki City, Osaka 567, Japan	H	
Chappalaz 1445 Voiteboeuf, Switzerland	L C	E

China National Machinery Imp.&Exp. Company 12 Fu Xing Men Wai Street, Beijing, PR China	F L K E G
Cornell Pump Co. 2323 SE Harvester Drive, Portland, Oregon 97222, USA	I E G
Dependable Turbines Ltd. 7-3005 Murray Street, Port Moody B.C., Canada V3H1X3	F L P K
Desclaud Rue Bertrand de Goth 57, 33800 Bordeaux, France	H
Disag Dieselmotoren AG 7320 Sargans, Switzerland	C L T
Drees GmbH Box 43, 4760 Werl, Fed.Rep. of Germany	L F T
Dravske Elektrarne Maribor Debro 13, Lasko, Yugoslavia	F L C E
Elektro GmbH St.Gallerstrasse 27, 8400 Winterthur, Switzerland	L
Energy Research & Applications Inc. 1820 Fourteenth Street, Santa Monica, California 90404, USA	K E G
Essex Turbine Company Inc. Kettle Cove, Magnolia, Massachusetts, USA	K P E G
Evans Engineering & Power Co. Priory Lane, St.Thomas, Launceston, PL158DQ, UK	L C K P E G
Flygt AB Box 1309, S-17125, Solna, Sweden	K E G
Gaviotas Pasea Bolivar 20-90, Bogotá, Columbia	H

GEC Machines Ltd. Mill Road, Rugby, Warwickshire, CV211BD, UK		E G
Gilbert Gilkes & Gordon Ltd. Kendal, Cumbria, LA97BZ, UK	F L	E
Green & Carter Ltd. Old Rectory, Ashbrittle, Wellington, Somerset, UK Vulcan Iron Works, Kingsworthy, Hants, SO237QF, UK	H	
GSA International Corporation Box 536, Croton Falls, New York 10519, USA	L F K	
Hugentobler Maschinenbau Rüteli, 9249, Algertshausen, Switzerland	L C	E
Hydro-Energy Systems Two World Trade Centre, New York, NY10048, USA	P	E G
Hydro Systems Pty Ltd. 445 Macquarie Street, Mobart, Tasmania, Australia	C L K	E G
Hydro-Watt Systems 146 Siglun Road, Coos Bay, Oregon 97420, USA	L F C K	
Independent Power Developers Inc. Box 1467, Noxon Montana, 59853, USA	P L	E G
Irem SpA Vaie 42, 10050, S.Antonio, Torino, Italy	P	E
Jandu Plumbers Ltd. Box 409, Uhuru Road, Arusha, Tanzania	H	
Jansen Venneboer BV Box 12, 8130 AA, Wijhe, The Netherlands	P	

Jyoti Ltd. R.C. Dutt Road, Baroda, 390005, India	F L	E C
Karlstads Mekanisk Verksted Fack, S-68101, Kristinehamn, Sweden	P	
Kössler GmbH A 3151, St.Pölten Strasse, Georgen, Austria	F K L	
Larsen & Toubro Ltd. 3B Shakespeare Sarani, Box 619, Calcutta, India	F L	E G
Leffel & Co., James 426 East Street, Springfield, Ohio, 45501, USA	L K F	
Leroy Somer Pte Ltd. 197A Goldhill Center, Singapore 1024	K L	E
Leroy Somer Boulevard Marcellin Leroy, 16015, Angouleine Cedex, France	K L	E
Leroy Somer Box 64, 3769 ZH, Soesterberg, The Netherlands	K L	E
Lips BV Lipsstraat 52, Drunen, The Netherlands	P	T
Little Spokane Hydroelectric Box 82, Chattaroy, Washington 99003, USA	P K L	E G
Litostroj Tz. Djakoviceva 36, 61000 Ljubljana, Yugoslavia	F K L C	E
MacKellar Engineering Ltd. Strathspey, Granton-on-Spey, Morayshire, UK	P	
Mckay Water Power Inc. Box 221, West Lebanon, New Hampshire 03784, USA	F	

Mitsubishi Electric Corporation Nagasaki, Japan	P	
Natural Energy Centre 161 Clarence Street, Kingston, Surrey KT11QT, UK	P	
New Found Power Co. Inc. Box 576, Hope Valley, Rhode Island, USA	C	E G
Neyrpic SA Rue Général Mangin, 38100, Grenoble, France	K P	E G
Niagara Waterwheels Ltd. 706 East Main Street, Welland, Ontario, L3B3Y4, Canada	P	
Nikki Corporation 2940 Shin Yoshidamachi, Koohoku, Yokohama, Japan	C	
Northern Waterpower Inc. Box 49, Harrisville, New Hampshire 03450, USA	P	
Obermeier Hydraulic Turbines Ltd. 10 Front Street, Collinsville, CT 06022, USA	F K L P	E G
Officine Buehler Taverne, Ticino, Switzerland	L F	E
Ossberger Turbinenfabrik GmbH Box 425, D-8852, Weissenburg, Fed.Rep. of Germany	C	E G
Pfister & Langhanns Box 3555, 8500 Nürnberg 1, Fed.Rep. of Germany	H	
Plata Power Ltd. Box 221, Dunedin, New Zealand	P	T
Portmore Products Portmore Road, Lower Ballinderry, Lisburn, UK	C	E G

Pumps, Pipe & Power

Kingston Village, Austin, Nevada 89310, USA

Rife Hydraulic Engine Corporation 132 Main Street, Box 415, Andover, New Jersey 07821, USA	H	
Schlumpf AG CH 6312 Steinhausen, Switzerland	H	
Small Hydro East Star Route 240, Bethel, Maine, USA	L	E G
Small Hydroelectric Systems & Equipment Co. Inc. 5141 Wickersham Acme, Washington 98220, USA	L F P	E G
Sukaradja CV Jalan Kom. Ud., Supadio 98, Bandung, Indonesia	C	E G
Sørumsand Verksted A/s 1920 Sørumsand, Norway	K P L	E G
Tamar Designs Ptv. Ltd. Deviot, Tasmania 7521, Australia	F L	
Turbosun AB Box 71, S-66900, Deje, Sweden	P K F L	
Voest Alpine AG Postfach 2, A 4010 Linz, Austria	F K L	E
Voith GmbH St.Pölthener Strasse 43, Box 1940, D-7920 Heidenheim, Fed.Rep. of Germany	L F K	T
Wama Maschinenbau Bergstrasse 3, 8018 Grating, München, Fed.Rep. of Germany	H	

Westward Mouldings Ltd.

W

Greenhill Works, Delaware Road, Gunnislake, Cornwall, UK

Würsch Apparate

Caubgasse 57, 8500, Frauenfeld, Switzerland

C

T

T O O L

TOOL is the abbreviation of the Dutch words Technische Ontwikkeling Ontwikkelingslanden, meaning technical development with developing countries. Numerous people in developing countries find themselves in a very difficult economic and social predicament. Appropriate Technology (AT) can, in many cases, solve their problems. By placing at their disposal knowledge and technology, appropriate to the local circumstances, TOOL wishes to help improve the position of the less fortunate in society.

TOOL receives more than 600 technical enquiries each year. If you have one, you should give as much information as possible on the circumstances and the possibilities in your particular case and area, so that we can try to provide information suited to the given local situation. Please send us a short description of your project and the organisation you work for, as well as your name and postal address. This should give us a clear picture of the general situation and the problems involved. Our address: TOOL Foundation

Entrepotdok 68A/69A

1018 AD Amsterdam

The Netherlands

C A T

The Center for Appropriate Technology (CAT) wants to stimulate Appropriate Technology (AT), especially in developing countries. That implies a constant looking for solutions and answers that are reliable, simple, cheap, at a human scale and ecologically sound.

Questions for technical research support are coming in from all over the world. It is financed from many different sources and in many different ways.

- + For long-term projects (macro-projects) CAT cooperates with counterpart organizations in the countries concerned.
- + Small problems (micro-projects) are solved within weeks by officials or students at Delft University of Technology.
- + Simple information questions can be answered by CAT-staff people themselves.

You are welcome with your technical problems and questions. Or maybe you want to subscribe free of charge to our quarterly newsletter "AT-news". Then please write to: THD/CAT

tool

Stichting TOOL

Entrepôt dok 68a/69a

1018 AD Amsterdam

The Netherlands

Stevinweg 1, kab.4.91

2628 CN Delft

The Netherlands