

AT MICROFICHE
REFERENCE
LIBRARY
A project of Volunteers in Asia

Micro-Hydropower Sourcebook: A Practical Guide to
Design and Implementation in Developing Countries

By: Allen R. Inversin

Published by: NRECA International Foundation
1800 Massachusetts Ave., NW
Washington, DC 20036

Available from: NRECA International Foundation
1800 Massachusetts Ave., NW
Washington, DC 20036
Tel: (202) 857-9696

Reproduced with permission.

Reproduction of this microfiche document in any form is subject to the same restrictions as those of the original document.

MICRO-HYDROPOWER SOURCEBOOK



**A Practical Guide to
Design and Implementation
in Developing Countries**

MICRO-HYDROPOWER SOURCEBOOK

**A Practical Guide to
Design and Implementation
in Developing Countries**

by Allen R. Inversin

NRECA International Foundation
Washington, D.C.

MICRO-HYDROPOWER SOURCEBOOK

Copyright © 1986

by

**NRECA International Foundation
1800 Massachusetts Avenue, N.W.
Washington, DC 20036**

202-857-9696

All rights reserved. No part of this book may be reproduced or distributed in any form or by any means without the prior written permission of the publisher, excepting brief quotes used in connection with reviews written specifically for inclusion in a magazine or newspaper.

Library of Congress Catalog Card Number: 86-61178

First printing, June 1986
Second printing, June 1990

Printed in the United States of America

Cover design by Gail L. Thompson

Additional copies of this book can be ordered from the NRECA International Foundation. Order forms, with publication and shipping costs, can be found at the back of this book.

PREFACE

Although worldwide interest in harnessing small-hydropower resources by means of micro-hydropower plants (less than about 100 kW) is increasing, few published guides exist for those implementing such projects. Some publications deal primarily with larger small-hydropower plants, leaving developers of micro-hydropower sites with few options but to reduce the scale of designs and approaches to implementation that are more appropriate for large plants. Consequently, such publications unconsciously promote the development of micro-hydropower schemes that do not take advantage of the unique factors encountered in implementing plants at the "micro" end of the small-hydropower range—factors which must be considered if this resource is to be harnessed cost-effectively. Other publications cover micro-hydropower technology but are incomplete, for example, making only cursory mention of power canals, even though a survey of micro-hydropower plants around the world would indicate that power canals are used at most sites. And finally, most publications are written primarily for a western audience and address western needs within the context of western standards and realities.

Although those implementing micro-hydropower plants have gained a wealth of experience during the last several decades, few have documented their efforts. Therefore, beginning with my personal efforts at implementing a micro-hydropower project in Papua New Guinea 10 years ago and continuing with numerous overseas consultancies with NRECA the last 5 years, I have gathered technical information and practical experiences that address the needs of those interested in implementing micro-hydropower schemes in developing countries. In this Sourcebook, I present detailed descriptions of many aspects of planning and implementing such schemes and document experiences from around the world.

Small hydropower can make a substantial impact in developing countries where significant waterpower resources exist and where economically viable alternatives are few. This publication focuses on these countries' needs and meeting those needs within the particular constraints found there. Although the theory of micro-hydropower applies universally, conditions found in developing countries make certain designs and approaches used in industrialized nations less applicable there. The reader must keep this in mind. For example, where water resources are abundant and energy needs are modest, less emphasis needs to be placed on maximizing turbine efficiency (especially because greater

efficiency implies greater cost and therefore less accessibility to the technology). Turbines can then be fabricated locally rather than be imported. Where labor costs are low and labor abundant, there is no need for expensive, capital-intensive designs, which would again restrict accessibility to this technology. And where power requirements are simple, there is no need to incur the costs of the sophisticated hardware necessary to meet exacting western standards.

The technology associated with micro-hydropower plants in developing countries spans a much broader range of options than that for large-hydropower plants. Penstocks, for example, can range from 25 mm plastic pipe snaking downhill to a 1000 mm steel penstock with massive concrete anchor blocks designed to maintain stability on whatever foundation they may rest. Electrical frequency may be controlled by sophisticated governors or plants may be operated with no governing whatsoever. In addition to generating ac power, micro-hydropower plants can generate dc power or even mechanical power. The Sourcebook is therefore faced with the challenging task of covering each of these options. The reader must also realize that even though an option may not be appropriate for a larger hydropower scheme, it may still represent a valid approach under a new set of circumstances. It is only by challenging conventional approaches that viable micro-hydropower schemes can be developed.

In some countries, local technical expertise has been developed, often by trial and error. For these persons, the Sourcebook can provide a reference and guide to help them build on their experiences. In other countries, local expertise is not readily available and consultants may be employed. However, few consultants have experience either in implementing cost-effective micro-hydropower schemes or in the conditions encountered in rural areas of developing countries. Also, the high costs of consultants can significantly increase the cost of implementing a scheme. For these reasons, resorting to consultants is often not a viable option. In such cases, the Sourcebook can serve as a detailed primer for persons with basic technical aptitude, covering many aspects of planning for, designing, and implementing micro-hydropower schemes.

The Sourcebook is a preliminary effort to prepare a reference book which covers many of the aspects of planning and implementing micro-hydropower schemes in developing countries. Although many more useful experiences and additional information might be added

to those already included in this publication, it seems appropriate to make available the material already gathered. In so doing, I hope that in addition to providing useful information, the Sourcebook encourages readers to submit information based on their experiences for future editions and that it provides a foundation on which to build a more comprehensive reference. I also hope that future editions can cover other areas of interest, such as mechanical and electrical end uses and their implications on system design and plant operation, approaches for managing micro-hydropower plants and programs, options for tariff structures and their social and financial implications, and operation and maintenance of small plants.

Anyone implementing micro-hydropower schemes is invited to suggest which topics already included in the Micro-Hydropower Sourcebook should be expanded upon and what new topics should profitably be included in a

subsequent edition. And anyone who has already implemented micro-hydropower schemes is invited to submit written descriptions accompanied by drawings and photographs (preferably black and white) of his efforts which might be of value to others undertaking similar projects. Any comments or general suggestions would also be welcomed.

Allen R. Inversin
Micro-Hydropower Engineer
International Programs Division
National Rural Electric Cooperative Association
1800 Massachusetts Avenue N.W.
Washington, D.C. 20036

Phone: (202) 857-9615
Telex: 64260
Cable: NATRECA

ACKNOWLEDGMENT

The Micro-Hydropower Sourcebook was initiated in 1981 under a Cooperative Agreement between the National Rural Electric Cooperative Association (NRECA) and the Office of Energy of the U.S. Agency for International Development (USAID) as part of a broader USAID effort to assist developing countries in their efforts to harness indigenous renewable energy resources. The Sourcebook has been completed with the support of the NRECA International Foundation, a newly formed non-profit organization.

The idea of a publication to address the needs of those implementing micro-hydropower schemes in developing countries had its roots in my initial work in Papua New Guinea (PNG), where Professor Jack Woodward first introduced me to this field. During his last year as head of the Department of Electrical and Communication Engineering at the PNG University of Technology, he initiated the implementation of a micro-hydropower scheme requested by the villagers of Baindoang. When he returned to the University of Auckland in 1977 to head the Department of Electrical Engineering, I found myself in the driver's seat and had my first hands-on experience implementing a micro-hydropower project. At the same time, Ian Bean, an agricultural development officer stationed at the remote government outpost of Pindiu, began implementing very small micro-hydropower plants of rudimentary design in four isolated mountain communities in PNG. While learning from his experiences, I found his enthusiasm at meeting the challenge of adapting a sophisticated technology for use in a setting where modern technology is largely unknown contagious. The desire to assist others in meeting this challenge has been an instrumental factor in deciding to write this book.

During the past 5 years while I have been working part time on the Sourcebook, numerous people around the world have contributed in one way or another. I am particularly indebted to the following individuals who have generously shared their time and experiences with me: Dr. M. Abdullah, Dean, Faculty of Engineering of the North-West Frontier Province (NWFP) University of Science and Technology in Peshawar, Pakistan, who accompanied me on several occasions on site visits to the NWFP where he had implemented several dozen schemes and patiently answered my innumerable questions; Andreas Bachmann, who, while with the Swiss Association for Technical Assistance (SATA) and later with UNICEF, was involved in a variety of renewable energy projects and shared with me numerous publications he had prepared on his activities as well as time to

visit projects in the field; Chartdanai Chartpolrak with the National Energy Administration (NEA), who accompanied me on visits to micro-hydropower schemes in Thailand for which he was responsible; Rupert Armstrong Evans from Cornwall, England, who has a vast body of experiences from his full-time involvement in the manufacture of hydropower equipment and the implementation of micro- and mini-hydropower schemes in the United Kingdom and overseas; Jaime Lobo Guerrero of the Universidad de los Andes in Bogotá, who is committed to designing technologies to make them more accessible to those in rural areas and eagerly shared the results of his work with me; Rik Hothersall, who also became involved in the field of micro-hydropower while teaching in PNG and kept me informed of his efforts; Dale Nafziger, who shared his photographs and experiences gained while working with the United Mission to Nepal (UMN); Domingo Wong, who accompanied me on visits to sites that the Instituto de Recursos Hidráulicos y Electrificación (IRHE) had implemented in Panama and freely shared with me project successes as well as shortcomings; and Robert Yoder, an engineer sensitive to the needs and problems found in rural areas, with 8 years of experience with the UMN, who was my guide and translator on a 2-week trek through the hill region of Nepal to visit schemes implemented by the UMN, contributed to the case study on Nepal, and showed by example that micro-hydropower technology can indeed be viable in rural areas of developing countries.

Others have shared their experiences from implementing or managing their own schemes: staff of the Alternate Hydro Energy Centre in Roorkee, India, implementing schemes and undertaking research in hydropower generation and productive end uses; Geoff Bishop, a mining engineer who was implementing a 220 kW scheme to provide power to the mission station of the Eglise Episcopale du Burundi in Buhiga and to an administrative center and agricultural school in Karuzi; Githuki Chege, a simple farmer in Kenya with several water-powered mills and an eagerness to try something new; Brot Coburn, who was involved in several renewable energy technologies in Nepal and implemented a micro-hydropower scheme near the base of Mt. Everest; Bernard Crétinon, a French coopérant, who managed the implementation of several schemes for the Ministry of Rural Development in Burundi; Martin Dietz, who was involved in a cooperatively administered micro-hydropower scheme with the UMN in Nepal; Gary Duncan and Mike Smith, two Peace Corps volunteers who were undertaking an ambitious micro-hydropower project in a

remote part of Liberia; Peter Garman, who researched water-current turbines on the Nile in the Sudan; Harry Langhorne, a private individual who built his own plant from scratch, which is still providing the base power to his home in the Appalachian Mountains in Virginia, before it became in vogue; Père Landolt and Père Pristt, who managed micro-hydropower plants supplying power to their mission stations in Musongati and Gihéta, Burundi, respectively; Graham Leschke, who managed a scheme in PNG and accompanied me on visits to other plants in the area managed by missions; Soheyl Mottahedah, an Iranian-born Canadian committed to development of the rural areas in eastern Zaire and founder of the Société de Développement Rural du Zaire (SODERZA), who built his first turbine with no prior experience and implemented a complete project in the space of only a couple of months; Harald Mucker, a German engineer directing a program for implementing micro-hydropower plants in the Department of Cusco, Peru, for the Proyecto Minicentrales Hidroeléctricas (PROMIHDEC), using locally fabricated turbines; the staff of the Small Hydel Development Board (SHDB) of Nepal involved in the implementation of a number of small-hydropower plants around the country; Bruno Vögtli, an enterprising Swiss who was singlehandedly constructing a road across a portion of PNG and accompanied me on an exhausting, all-day trek to visit a micro-hydropower plant in Bundi; John Wood, who designed and built an ingenious automatic rack-raking device for his plant in Ireland; and Gary and Connie Young, who rehabilitated and managed a plant that provided power to the school and hospital complex of the Mission Evangélique des Amis at Kibimba, Burundi.

In addition, a number of individuals have assisted with this effort by reviewing, or in some cases contributing substantively to, portions of the Sourcebook. These include Dr. Maurice Albertson, Professor in the Civil Engineering Department of Colorado State University; Dr. Roger Arndt, Director, and Dr. John Gulliver, Associate Professor, from St. Anthony Falls Hydraulic Laboratory at the University of Minnesota; Bard Jackson, Principal Engineer with NRECA's International Programs Division; Martin Johnson, President of The Johnson Company in Montpelier, Vermont; Mike Johnson, President of Hydro-Tech Systems Inc. of Chattaroy, Washington; Ed Kramer, former General Manager of Himel Hydro and General Construction Pvt. Ltd. of Nepal; Dr. Pedro Restrepo, Systems Analyst with Dynamics Research Corp.; and Dr. Calvin Warnick, Professor Emeritus at the University of Idaho.

Finally, preparing the Micro-Hydropower Sourcebook would have been a significantly more difficult and time-consuming undertaking had it not been for the assistance of a number of individuals: Elizabeth Graham, who not only edited portions of this publication but also made innumerable contributions throughout which shaped the final form of this publication; Darrell McIntire, who stuck with it over several years to carefully prepare most of the illustrations in their final form; Barbara Shapiro, who conscientiously and carefully edited the entire publication; Kitty Anderson, who inputted innumerable drafts and revisions on the word processor, never knowing when they would end; and Carol King, who patiently took all the pieces and laid them out in their final format.

TABLE OF CONTENTS

Preface	v	
Acknowledgment	vii	
Table of contents	ix	
I. INTRODUCTION		1
Need for energy for rural development	1	
Micro-hydropower: An appropriate energy source	1	
Perceived obstacles to viable micro-hydropower schemes	4	
Overview of the <i>Micro-Hydropower Sourcebook</i>	5	
II. MEASURING HEAD AND DISCHARGE		9
Introduction	9	
Measurement of discharge	9	
Bucket method	10	
Velocity-area method	11	
Determining the area	12	
Determining the stream velocity	12	
Float method	13	
Velocity-head rod	13	
Current meter	14	
Determining discharge	15	
Weir method	16	
Salt-dilution method	19	
Slope-area method	19	
Stage-discharge method	20	
Measurement of head	21	
Using a level	22	
Using a clinometer	23	
Using a pressure gage	24	
Using an altimeter	24	
III. STREAMFLOW CHARACTERISTICS AND DESIGN FLOW		27
Introduction	27	
Schemes using less than annual minimum streamflow	27	
Schemes using greater than annual minimum streamflow	28	
Gaged sites	28	
Data collection	28	
Data processing	29	
Ungaged sites	32	
Estimating mean annual flow	33	
Using runoff data	33	
Using ratio of areas	36	
Correlating flows	36	

Estimating minimum flow	37	
Estimating a flow-duration curve	38	
Determining power and energy potential from a flow-duration curve	38	
Alternative turbine configurations	42	
IV. SITE SELECTION AND BASIC LAYOUT		47
Introduction	47	
Is the topography suitable for hydropower generation?	48	
Developing the basic layout	49	
Locating the intake	52	
Nature of the streambed	52	
Bends along the stream	52	
Natural features along the stream	53	
Competing uses for water	53	
Ease of accessibility	55	
Locating the powerhouse	56	
Case examples	57	
Salleri/Chialsa (Nepal)	57	
Musongati (Burundi)	58	
Buhiga (Burundi)	58	
Giheta (Burundi)	59	
Bishalalo (Zaire)	61	
Ruyigi (Burundi)	61	
Mardan (Pakistan)	61	
V. CIVIL WORKS		63
Introduction	63	
Qualitative overview	64	
Dam or weir	64	
Increasing head	65	
Providing storage	65	
Diverting flow	67	
Intake	67	
Power conduit	68	
Forebay	72	
Penstock	74	
Powerhouse	77	
Tailrace	78	
Design and construction details	78	
Dams and weirs	78	
Intakes	84	
Power conduits	96	
Determining canal dimensions and slope	96	
Velocity in a canal	96	
Roughness coefficient	98	
Cross-sectional profile	98	
Procedure	99	
Excavation	104	
Canal lining	104	
Brick or stone-masonry	106	
Concrete	107	
Soil-cement	108	
Drainage	108	
Freeboard and spillways	109	
Drop structures	110	
Circumventing obstacles	112	
Flumes	112	
Inverted siphons	115	
Culverts	116	
Sizing low-pressure conduits	118	

Forebays	118
Penstocks	124
Materials	124
Sizing penstock pipes	125
Selecting pipe diameter	125
Selecting wall thickness	133
Expansion joints	136
Support piers, anchors, and thrustblocks	138
Support piers	138
Anchors	140
Thrustblocks	144
Reducing the forces acting on a structure	145
Conditions for stability	146
Air valves	147
Powerhouses	150
Other components	154
Gates and valves	154
Stoplogs	154
Sliding gates	155
Gate valves	158
Butterfly valves	159
Spillways	159
Overflow spillways	160
Shaft spillways	160
Siphon spillways	161
Trashracks and skimmers	162
Trashracks	162
Skimmers	165
Settling basins	166

VI. TURBINES

171

Introduction	171
Basic theory	171
Turbine types	173
Pelton turbines	173
Basic relationships	174
Fabrication	175
Cost-reduction approaches	176
Turgo turbines	177
Basic relationships	177
Fabrication	177
Cost-reduction approaches	178
Crossflow turbines	178
Basic relationships	180
Fabrication	180
Cost-reduction approaches	182
Francis turbines	182
Propeller turbines	182
Fabrication	184
Cost-reduction approaches	185
Waterwheels	185
Pumps as turbines	185
Basic relationships	187
Miscellaneous	187
Water-current or in-stream turbine	187
Schneider engine	189
Segner turbine	189
Marine thrusters	189
Turbine specifications	189
Turbine performance under new site conditions	191
Options for coupling	192
Direct coupling	192

Belt drives	193	
Flat belts	193	
V-belts	193	
Timing belts	194	
Chain drives	194	
Gear boxes	194	
VII. HYDROPOWER: ELECTRICAL VS. MECHANICAL		195
Introduction	195	
Points of comparison	195	
Impact on plant's financial viability	195	
Cost and sophistication	196	
Energy conversion losses	197	
Restrictions on the size of motor loads	197	
Versatility	198	
Transmission of power	198	
VIII. GOVERNING		199
Introduction	199	
Purpose of governing	199	
Why consider various governing options?	200	
Extent of governing required	200	
Heating loads	201	
Lighting loads	201	
Transformers	201	
Motor loads	201	
Approaches to governing	201	
Conventional approaches	202	
Oil-pressure governor	203	
Mechanical governor	203	
Load controller	204	
Phase control	205	
Step ballasts	205	
Nonconventional approaches	205	
Constant loads	207	
Manual control	207	
Flow modification	208	
Load modification	209	
Large base load	209	
Operation on the backside of power curve	210	
Operation in parallel with dissipative load	211	
Turbine flow modification	213	
IX. ELECTRICAL ASPECTS		217
Introduction	217	
AC vs. dc	217	
Magnitude of power generated	217	
Storage of energy	217	
Cost and complexity of system	217	
Convenience	218	
Transmission of power	218	
Inverters	218	
Single- vs. three-phase	219	
Electrical equipment	219	
Generator	220	
Type of generator	220	
Voltage	220	
Frequency	220	
Power rating	220	
Speed	222	
Physical characteristics	222	
Monitoring and protection equipment and switchgear	223	

Monitoring equipment	223
Switchgear	223
Protection equipment	223

X. CASE STUDIES **225**

Introduction	225
Private-sector approach to implementing micro-hydropower schemes in Nepal	226
Introduction	226
Background	226
Butwal	226
Program history	227
Technical designs	229
Selection of turbine type	229
Turbine design	230
Design of a typical mill installation	231
Installation teams	233
Installation of a mill	234
Site selection	234
Site layout	235
Quote for the installation	236
Design, fabrication, and delivery	237
Installation	238
Design modifications	240
Costs	240
Other developments	241
Hardware	241
Mechanical heat generator	241
Heat storage cooker	242
Mill lighting	243
Cooperative approach to implementation	245
Observations	246
End uses and viability of micro-hydropower plants	246
Appropriateness of micro-hydropower technology	247
Villager-implemented micro-hydropower schemes in Pakistan	248
Introduction	248
Background	248
Implementation and operation	249
Technical designs	252
Civil works	253
Intake area	253
Power canal	253
Forebay	254
Penstock	254
Powerhouse	255
Turbo-generating equipment	256
Turbine	256
Generator	257
Governing	257
Distribution	258
Costs	258
Observations	259
Expanding the scale of the program	259
Increasing the capacity of the plants	260
Benefits to the rural sector	261
Replication in other countries	261
Implications of design on long-term costs	262
Other project descriptions	263

APPENDICES **265**

A. Conversion factors and constants	265
B. Significant figures	267
C. Guide to field determination of soil type	269

D. Preparing concrete	270
E. Masonry	272
F. Water hammer	274

REFERENCES	277
-------------------	------------

INDEX	283
--------------	------------

I. INTRODUCTION

NEED FOR ENERGY FOR RURAL DEVELOPMENT

In many developing countries, development activities have been concentrated primarily in the urban or more accessible areas, where the greatest number of people can be served with the minimum effort and expense. However, by far the largest percentage of the population lives in rural areas. Because these people are more thinly dispersed, frequently live in areas more difficult to reach, are less vocal than their urban counterparts, and have less disposable income, they have been deprived of the benefits available to those in the urban areas that result from these development activities:

- extension and improvement of transportation and communications networks;
- provision of electricity and water and their associated benefits;
- construction of schools, hospitals, and clinics;
- increased employment opportunities; and
- access to agricultural and health extension services.

From an individual's point of view, the easiest means of acquiring these amenities is to migrate to the towns and cities, where he then also contributes to both mounting urban problems and a dwindling agricultural base. Addressing these issues places an additional demand on limited resources, which often represents a net loss to the nation and a reduced quality of life for its population as a whole.

An energy source that can be viably implemented in a rural setting would contribute to the attractiveness of the rural areas. Electric power would encourage the establishment of government offices and associated services; provide an incentive for better trained persons to serve in the more remote areas; improve the quality of educational, health, and other services; and enable individual rural households to have access to amenities which were formerly restricted to urban areas. An affordable source of electrical as well as mechanical and thermal energy could encourage the establishment of agro-processing and cottage industries, which would contribute to employment opportunities in rural areas, increased disposable income, and a decreased drain on a nation's foreign exchange spent or importing agricultural products.

Significant water resources are found in many developing countries. In areas where adequate water resources are present, harnessing the power of falling water by means of micro-hydropower plants is one way of providing affordable energy for the development of rural areas.

MICRO-HYDROPOWER: AN APPROPRIATE ENERGY SOURCE

Micro-hydropower has several advantages in common with large-hydropower schemes:

- It relies on a renewable, nonpolluting, indigenous resource that can displace petroleum-based fuels that are frequently imported at considerable expense and effort (Fig 1.1).

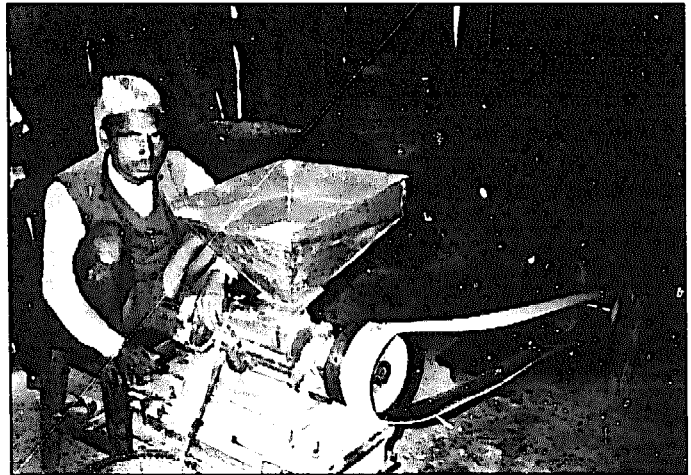
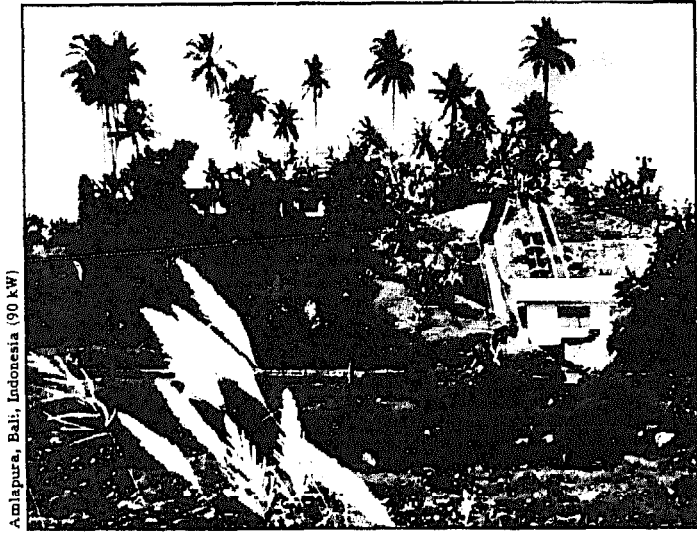

Fig. 1.1. Despite the expense and difficulty of transporting fuel to remote areas, the availability and knowledge of internal combustion engines frequently lead to their use even though hydropower can be harnessed nearby.

- As a component of a water development scheme, it can be integrated with irrigation and water-supply projects to maximize the benefits while sharing the cost among several sectors (Fig. 1.2).
- It is a well-proven technology, generally well beyond the research and development stage. In addition, hydropower resources have already been harnessed for years by rural entrepreneurs and farmers in numerous Asian, African, and Latin American countries (Fig. 1.3).

Micro-hydropower technology also has a number of positive attributes not usually associated with large-hydropower plants. One is that, because of their size, micro-hydropower schemes permit local villager involvement in the full range of activities, from initiation and implementation to operation, maintenance, and management (Fig. 1.4). When villagers contribute labor and local materials, the costs incurred are lower, and when villagers are committed to a properly planned and exe-



Amlapura, Bali, Indonesia (90 kW)

Fig. 1.2. This micro-hydropower plant is integrated with an irrigation scheme, using excess water to generate power for a nearby town, thereby displacing the diesel fuel that would otherwise be used.

cutted project, the possibility of its long-term success increases significantly.

In addition to generating electricity, micro-hydropower plants permit the generation of mechanical energy, which can be used to power agro-processing machinery or cottage industries directly (Fig. 1.5). This permits the use of a less complex technology, which in turn is both less expensive and more easily understood. The increased efficiency of direct conversion to mechanical power, rather than using a generator and then motors to provide it, means that up to twice the useful power is available from a given turbine, depending on the size of the plant.

Another attribute is that the small size of individual

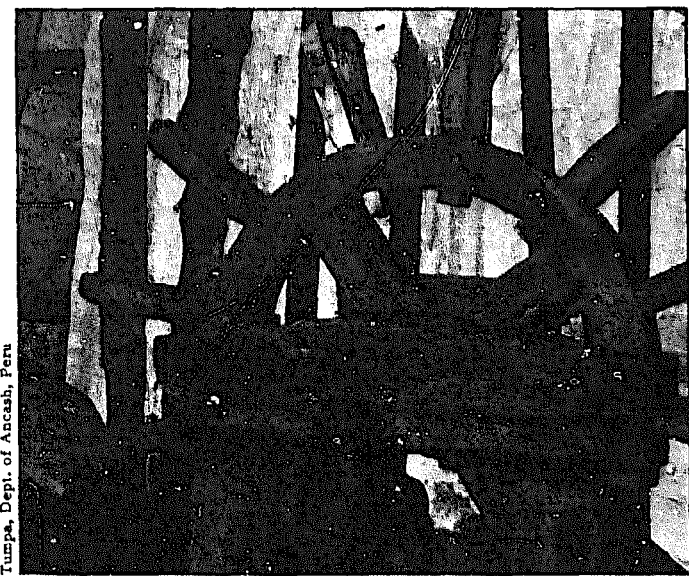

Tumpang, Dept. of Anasah, Peru

Fig. 1.3. Water falling about 5 m through an open flume to a Pelton turbine built of wood provides sufficient power to saw timber. Examples of such locally designed, built, and

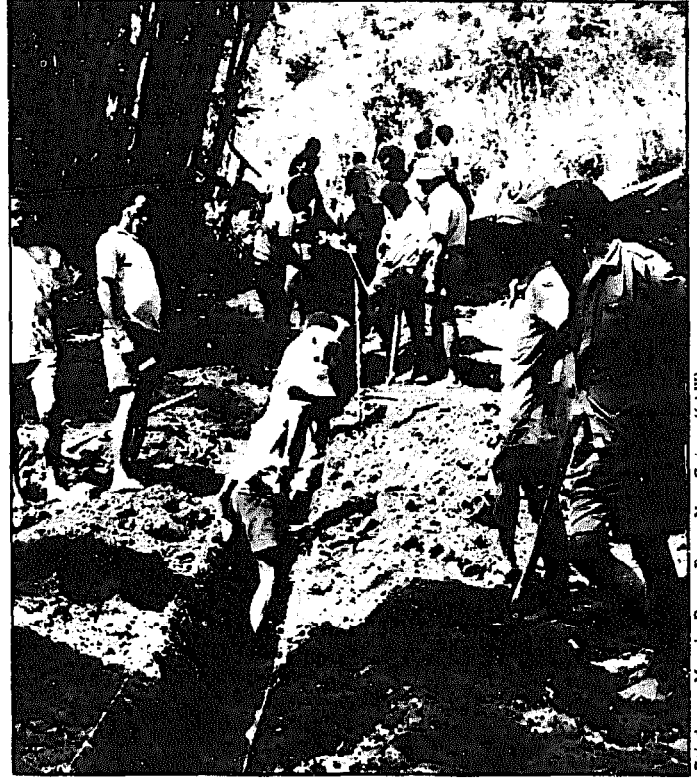

Baindoangi, Morobe Prov., Papua New Guinea (6 kW)

Fig. 1.4. Micro-hydropower projects permit significant villager involvement in all phases of the work.

plants creates widespread potential for micro-hydropower schemes in terms of the number of sites which can be exploited. Sites for large schemes are relatively few, and the energy generated has to be transmitted over larger distances to serve the end users. The economics of power transmission implies that the large quantities of power generated by large plants must be restricted to the few load centers that can most readily use it—cities and larger towns. The decentralized

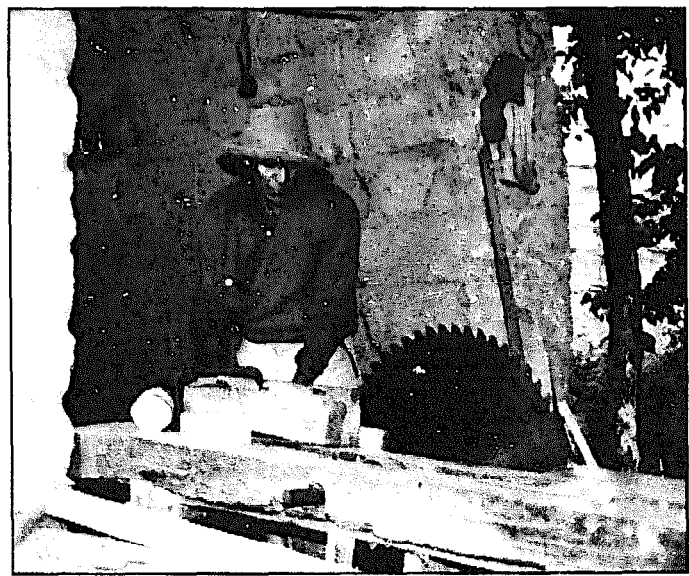

operated micro-hydropower plants are found in a number of countries throughout the world and have often been in use for generations.

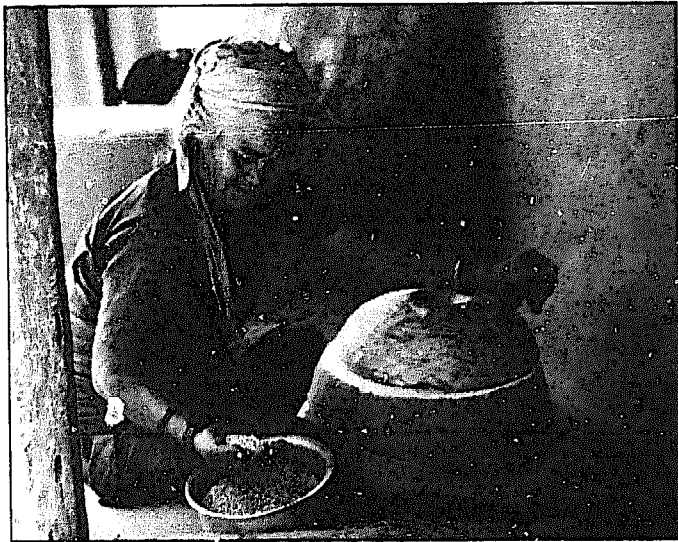
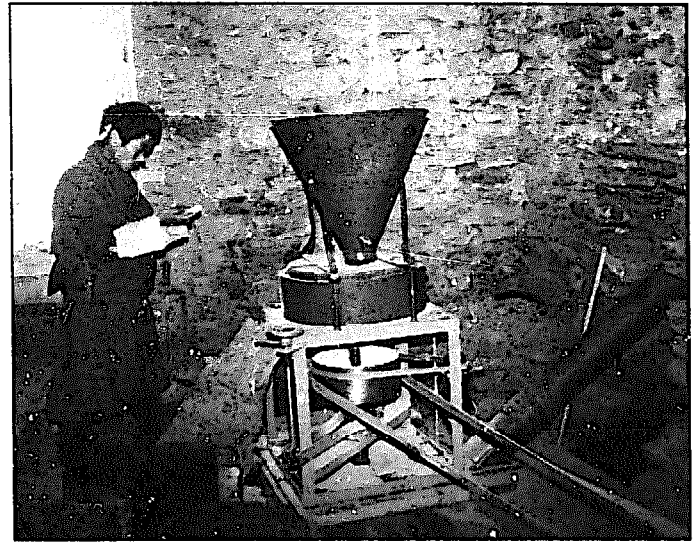

Fig. 1.5. Women in rural areas spend numerous hours performing tedious, strenuous, and energy-demanding tasks such as milling grain for domestic consumption. Such areas need mechanical more than electrical energy. The



Namelling, Bhutan

MPPU manufactured in Nepal (p. 178), here shown performing the same task performed by the woman at the left, primarily addresses these needs, although electricity can also be generated if desired (see Fig. 7.3).

nature of micro-hydropower resources coincides more closely with the dispersed nature of rural populations; it permits energy to be generated near where it is to be used, leading to reduced transmission costs (Fig. 1.6).

Several types of turbines commonly used with micro-hydropower schemes lend themselves to simple designs and fabrication techniques, which in turn encourage their local manufacture (Fig. 1.7). Because the turbine can be one of the more expensive components of a micro-hydropower scheme, considerable savings are possible if locally fabricated equipment is used. Efficiency is not necessarily a major consideration if adequate water resources are available which they often are; neither is the need for high-quality and long-lasting turbines if turbines can easily be repaired locally. In addition, designs for turbo-generating units vary widely

depending on their end use, from systems incorporating only a generator with no governing or speed control devices to stand-alone, fully automated systems generating utility-grade power.

Whereas large-hydropower schemes incorporate massive dams and major civil works, relying heavily on steel and concrete, a wide range of designs and materials for the civil works components is possible for micro-hydropower schemes (Fig. 1.8). Dams are rarely used, and the civil works for numerous schemes have been built with several bags of cement as the only material imported into the area.

Finally, large-hydropower schemes, primarily because they impound a large body of water behind a dam, can have a variety of adverse impacts on the surrounding

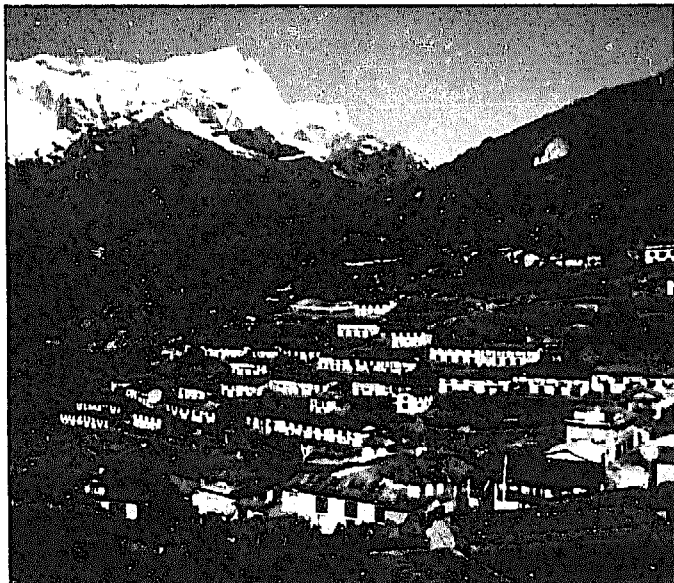

Fig. 1.6. Micro-hydropower is one of the few means of providing useful amounts of energy to remote communities.



Nanche Bazar, Nepal (25 kW)

area: flooding of arable land; social dislocation; increased incidence of certain diseases; and decreased fish populations. Because micro-hydropower schemes involve more modest undertakings and seldom require dams, social and environmental concerns are rarely raised.

PERCEIVED OBSTACLES TO VIABLE MICRO-HYDRO-POWER SCHEMES

With all the apparent advantages of micro-hydropower technology, one may question why it has not found more widespread acceptance. There are several reasons. Over the years, engineering firms and implementing agencies have gained considerable experience in designing and constructing large-hydropower projects. As interest in harnessing small-hydropower resources has grown, some of these groups have been employed to implement smaller schemes. Rather than considering the unique aspects of small hydropower and their implication on plant design and construction, these groups often have simply scaled down their more conventional designs and construction techniques. The increased cost of smaller project which results from economies of scale and the lack of cost savings otherwise possible through the use of nonconventional materials, designs, and construction techniques for small schemes are factors which have given micro-hydropower plants the reputation of being excessively expensive. Fortunately, a growing awareness of this problem and of more cost-effective designs and approaches to construction make micro-hydropower developments a more attractive alternative.

Three other factors have reduced the attractiveness of micro-hydropower:

- The significant cost and sophistication of the turbo-generating equipment have been a barrier. Until

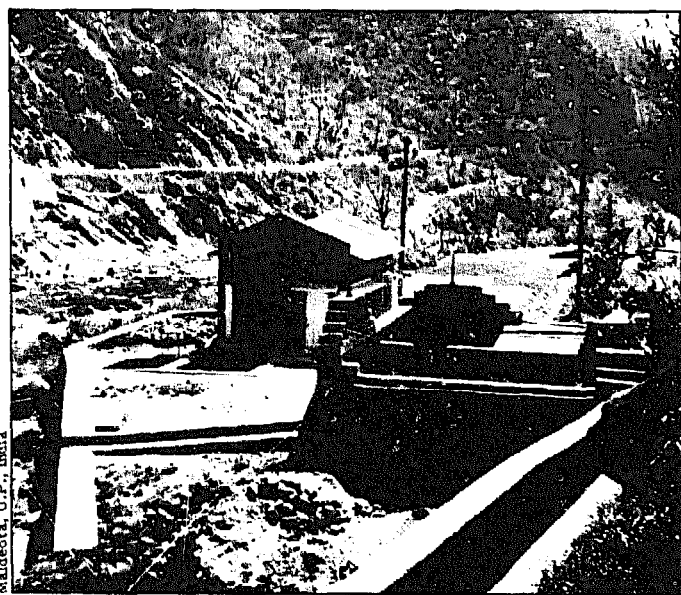

Maddeota, U.P., India

Fig. 1.8. These two schemes, which each generate 5-10 kW, illustrate the range of design options possible to those implementing micro-hydropower projects. A portion



National Structure Engineering Co., Kathmandu, Nepal

Fig. 1.7. Simple turbine designs encourage local fabrication and repair of equipment.

recently, only firms primarily involved in manufacturing equipment for large-hydropower plants have produced such equipment. High overhead costs, the conventional approach to equipment design, and economies of scale have resulted in relatively high costs for micro-hydropower equipment. However, the number of small entrepreneurs specializing in the manufacture of small turbo-generating equipment in both industrialized and developing countries has grown, leading to significant cost reductions.

- Government agencies now implementing small-hydropower schemes have been responsible for the generation, transmission, and distribution of electricity on a national scale. To these agencies, constructing small-hydropower plants drain large resources for a relatively small contribution to the national electricity supply. Their lack of motivation



Katreoti, Nepal

of the power canal, forebay, and powerhouse are visible in both schemes. The penstock to the plant at the left is buried.

for implementing such schemes has increased their inefficiency, resulting in further increases in the effort and cost of installing small plants.

- The high costs and difficulties of central government agencies operating and maintaining plants in remote areas further discourage the development of these plants. Reducing the staff for a 30 kW plant in Nepal to 14 may be a step in the right direction but one person selected from the village who would be backed up by technical assistance from a regional or central agency when needed would be a more appropriate staff for such a plant. Although high staffing costs is another factor which contributes to the impression that micro-hydropower plants are inappropriate, the problem is with conventional government approaches to implementation and operation of small-hydropower plants and is not intrinsic in the technology. In Papua New Guinea, for example, several private plants with capacities of up to 100 kW are run with the part-time inputs of a single person.

It is increasingly recognized that the development of micro-hydropower schemes holds out more promise for contributing to rural development than for significantly increasing a nation's indigenous energy-generating capacity. If the government is to implement such schemes, their effective implementation requires that the government agency involved in rural development, cooperatives, small industries, or possibly agriculture, rather than that involved in the power sector should take on the responsibility. The government of Burundi, for example, has placed the development of small-hydropower plants under the Ministry of Rural Development. Governments might also find it beneficial to encourage active private-sector involvement in this sector. For example, whereas the government of Nepal has encountered high costs for implementing and operating micro-hydropower schemes, a number of private companies have demonstrated their ability to cost-effectively implement micro-hydropower plants to directly drive agro-processing equipment and generate small quantities of electrical power. Because of these experiences, His Majesty's Government recently ruled that private individuals are now free to generate and sell electric power generated by their micro-hydropower plants. The United States, where the national grid is well established, provides another example of where legislation mandating that utilities purchase any power offered to them has significantly encouraged the cost-effective development of small-hydropower resources by the private sector.

There are numerous examples from around the world which illustrate where the apparent obstacles to effectively implementing micro-hydropower schemes have been overcome. These highlight the fact that this is possible and that there is a need to consider alternative approaches to implementing and managing such schemes in order that indigenous waterpower resources can be harnessed to contribute most beneficially to the development of the rural areas.

OVERVIEW OF THE MICRO-HYDROPOWER SOURCEBOOK

Although micro-hydropower technology has the potential to make a significant contribution at an acceptable cost, the factors summarized above have discouraged the widespread development of this technology. The purpose of the Micro-Hydropower Sourcebook is to address primarily the technical issues encountered in the planning, design, implementation, and operation of micro-hydropower plants. However, numerous other factors, some mentioned above, must be considered carefully if a successful micro-hydropower plant or program is to be implemented.

An essential requirement for hydropower generation is a stream with a combination of adequate head—the drop in elevation—over a reasonable reach of the stream and adequate flow to meet the expected demand for the power to be generated. The Sourcebook therefore begins with the chapter, MEASURING HEAD AND DISCHARGE, which describes a range of methods for measuring these two parameters which is sufficiently broad to address most situations.

Although the head between any two points at a specific site remains unchanged over time, the same cannot be said of flow, the other critical parameter. Flow is affected by several factors, primarily precipitation, but also geological features, the nature of the soil, vegetation cover, agriculture practices, temperature, and land-use patterns in the catchment basin. Measuring flow at one point in time is of little use in planning for a hydropower plant because that flow may not be representative of the flow available most of the time. The chapter, STREAMFLOW CHARACTERISTICS AND DESIGN FLOW, reviews methods of reducing flow data gathered over a period of time to forms which can be used to size turbines and predict the effect of flow variations on the power and energy generated over the year. Because few streamgaging data are available at most micro-hydropower sites, several methods for predicting flow characteristics at an ungaged site are also described.

Now that the reader has been introduced to techniques for measuring both head and flow, the next task is to prospect for a potential site. This means selecting a site with sufficient head so that the available flow can meet projected power needs. Although a plant might be located at the base of a waterfall, it is more likely to be found along a stream such as that shown in Fig. 1.9. In selecting a site, it is essential to understand the options for laying out a hydropower scheme and the features to look for in locating the intake and powerhouse along the stream. These are described in the next chapter, SITE SELECTION AND BASIC LAYOUT. At the end of this chapter, examples are presented which illustrate how and why some existing hydropower plants were laid out as they were.

Once the site has been selected and the basic layout prepared as described in the previous chapter, it is

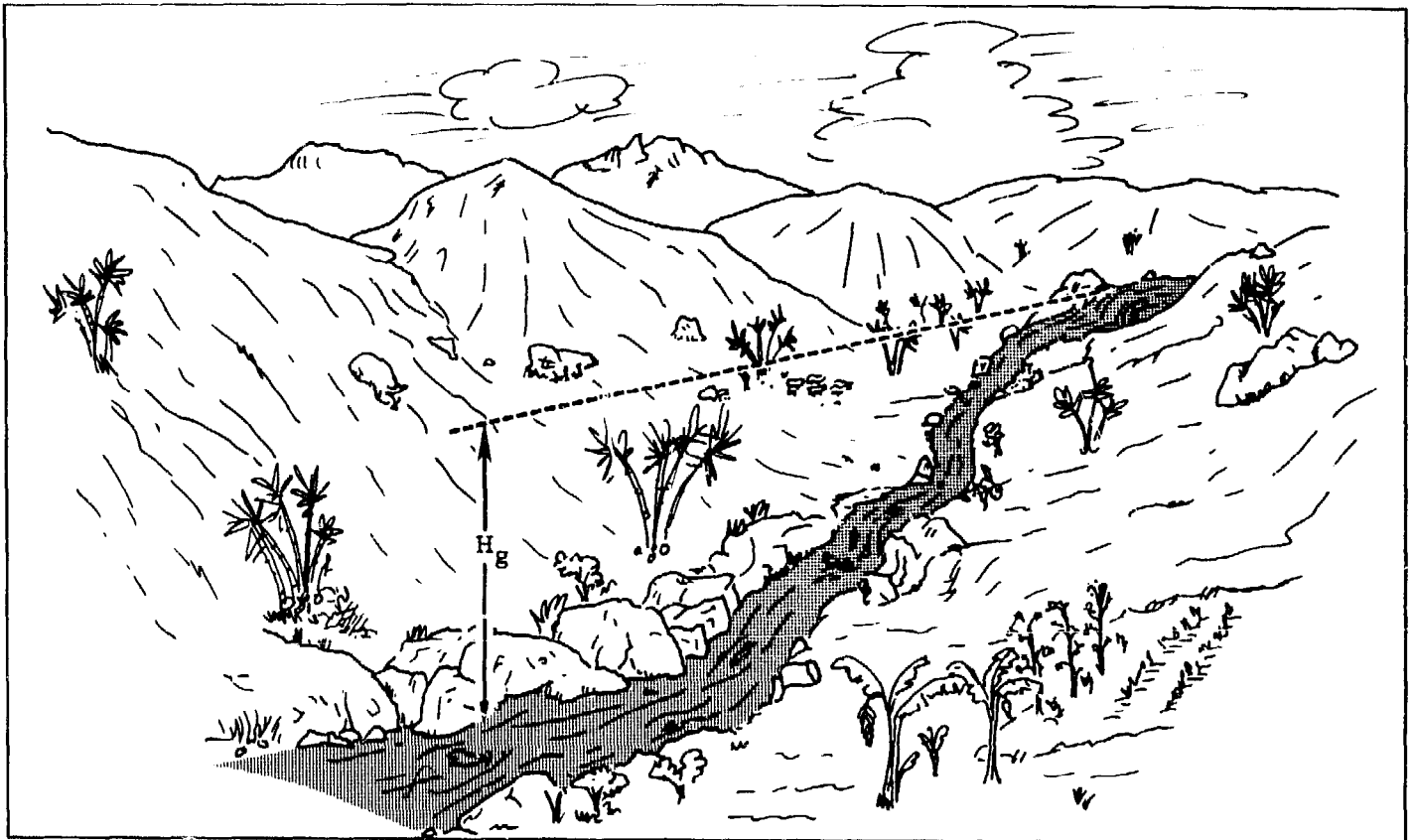

Fig. 1.9. A typical countryside where a small-hydropower plant might be located to exploit a drop in elevation " H_g ".

necessary to develop the scheme in detail. The **CIVIL WORKS** chapter first describes the function of all the possible basic components—dam or weir, intake, power conduit, forebay, penstock, powerhouse, and tailrace—which might be included in a micro-hydropower scheme to help identify which of these components are necessary and which should be excluded. The chapter then analyzes the design of each component, including basic dimensions, alternative materials, and design configurations that have been used at existing sites. Other components—spillways, settling basins, trashracks and skimmers, and gates and valves—are included in the design of several basic components. Spillways, for example, can be included in a dam, intake area, or forebay. These components are therefore described separately toward the end of this chapter.

The civil structures convey water to the turbine in the powerhouse where the power carried by the water is harnessed. For the generation of electricity in the micro-hydropower range, this equipment—turbines, generators, governing devices, and associated electrical equipment—is often purchased as a packaged unit. This unit can be considered a "black box"—a box containing an assortment of electrical, mechanical, and hydraulic devices into which water is fed and out of which electrical power is drawn (Fig. 1.10).

From a technical point of view, someone purchasing a packaged unit does not need to know what components are included within this black box or to understand how each functions; the purchaser simply specifies the head

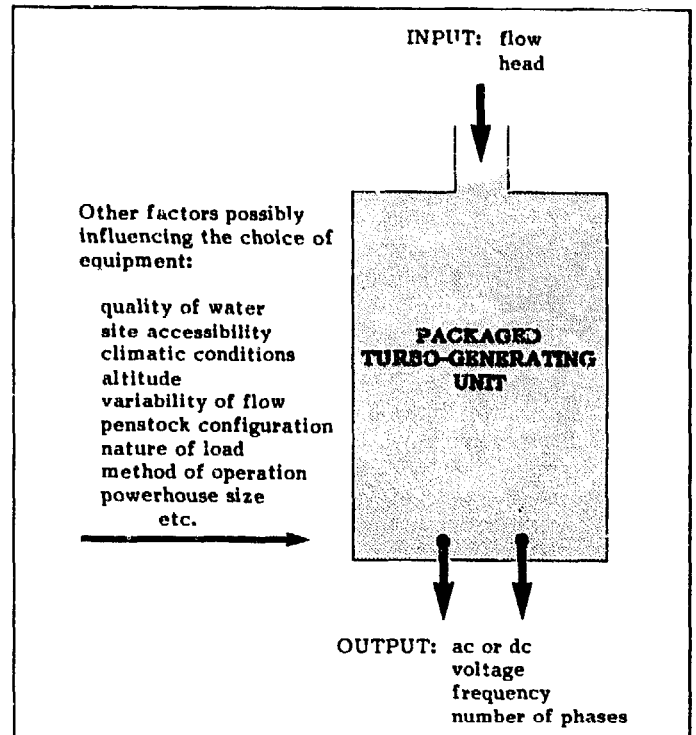

Fig. 1.10. A packaged turbo-generating unit can be considered a "black box." The site developer specifies the desired input and output values and other constraints, and the equipment supplier selects the appropriate "box" to satisfy those criteria.

and flow input and the nature of the electrical output (or mechanical output, if no electricity is to be generated). The equipment supplier will then include the necessary components within the black box to comply with the site conditions and the customer's needs. To ensure that a unit meets the needs of the customer as closely as possible, however, the supplier should also be given a more thorough description of site conditions and end uses.

From the point of view of someone wishing to implement a plant that can be easily operated, maintained, and repaired, some knowledge of the function and operation of each component is critical. The chapters on turbo-generating equipment provide the reader with some of the basic information necessary to understand the purpose and function of each component and thus to design an appropriate scheme with the greatest possibility of success.

Although a thorough knowledge of the theory of hydraulic turbines is not essential, an understanding of the basic characteristics of various turbine types will aid in ensuring a better designed system. The chapter, **TURBINES**, reviews the design and operation of the basic turbine types and outlines the data which must be furnished to a supplier to ensure that the correct turbine is supplied. For those interested in fabricating their own turbine, several publications are already available, and designs are not repeated here. This chapter contains general information on adaptability of various turbines to fabrication and references to publications that provide further details.

Generation and direct use of mechanical power presents several advantages over the generation of electrical power (Fig. 1.11). The chapter, **HYDROPOWER: ELECTRICAL VS. MECHANICAL**, compares the advantages and disadvantages of electrical and mechanical power generation.

In generating electrical or mechanical power, it is frequently necessary to control the speed of the turbine. Several devices are conventionally used for this purpose, but they are generally costly and sophisticated. The chapter, **GOVERNING**, reviews the purpose of governing and the extent of control required for various types of end uses, permitting the site developer to choose the level of governing required to meet specific site conditions and consumer needs. It also describes several conventional as well as nonconventional approaches to governing.

The chapter, **ELECTRICAL ASPECTS**, discusses the basic decisions which must be made before the electrical design is initiated and the generating equipment is specified: whether ac or dc power is better suited and, if ac, whether single- or three-phase power should be generated. It then reviews the function of the generator and other electrical components and the information necessary to specify these properly.

The final chapter, **CASE STUDIES**, presents descriptions of micro-hydropower programs in several countries, both to illustrate how technical issues were addressed and to discuss other issues which are encountered in mounting such a program.

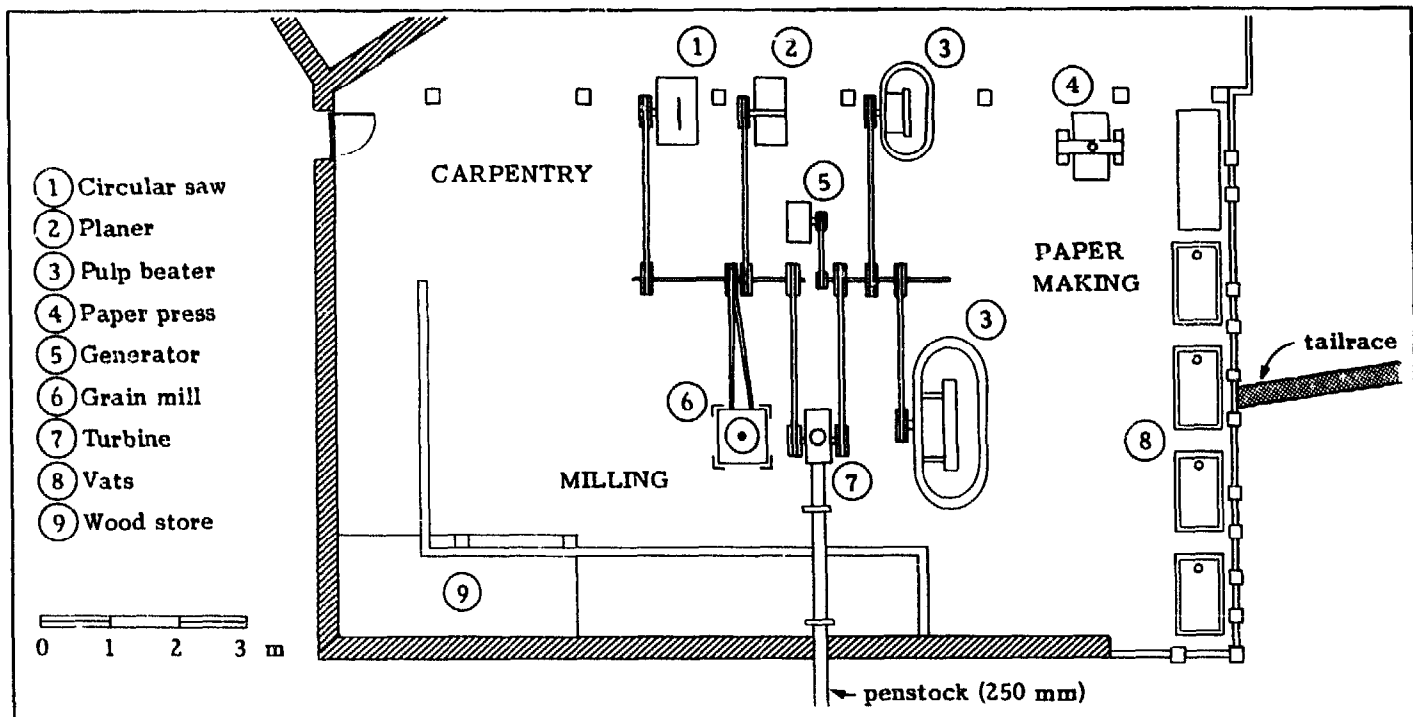

Fig. 1.11. The 13 kW turbine at a mill in Phaplu, Nepal, directly drives a variety of machinery; the generation of electricity provides a secondary benefit. Work is presently

under way to install a mechanical heat generator to boil paper pulp and dry the finished paper, saving the fuelwood which is traditionally used.

II. MEASURING HEAD AND DISCHARGE

INTRODUCTION

The purpose of this chapter is to describe various techniques which can be used to determine the discharge or flow carried in a stream and the head available at a site. Though a wide range of techniques of varying sophistication are available, one should not be overly obsessed with precision when selecting a specific technique. Measurements with two significant figures are generally more than adequate for planning and designing micro-hydropower schemes. Nothing is gained by attempting to obtain more accurate results. Knowing that the average discharge is 367 l/s rather than 360 l/s or that the head is actually 43.81 m rather than 44 m or 45 m will not lead to a more effective design for a micro-hydropower plant. A brief discussion of the accepted approach to properly recording numbers and measurements can be found in APPENDIX B (p. 267).

MEASUREMENT OF DISCHARGE (p. 9) covers a range of methods which can be used to determine the flow or discharge of a stream or canal. The discharge in a stream can vary considerably during a year and, although results can be obtained to any accuracy desired, a precise determination of discharge at one point in time is of little use. A single measurement of instantaneous flow in a stream is not normally used in estimating the installed capacity of a plant or the energy potential of a stream. For micro-hydropower schemes which will use a significant portion of the available streamflow, it is more important to take measurements regularly over at least one year than to concentrate on the accuracy of individual measurements. The manipulation of streamflow data is discussed in the chapter, STREAMFLOW CHARACTERISTICS AND DESIGN FLOW.

MEASUREMENT OF HEAD (p. 21) describes methods for determining the available head at a particular site. Though a variety of methods is available, there is no need to strive for extreme precision when making head measurements for the reasons mentioned earlier. Even results obtained by using a simple level are often adequate.

MEASUREMENT OF DISCHARGE

There are several basic methods for measuring the quantity of water flowing in a stream or canal. The bucket method (p. 10), whereby discharge is directly determined by measuring the time required to fill a con-

tainer of predetermined size, is one of the easiest and most accurate methods. However, it is generally suitable only for low discharges (less than about 50 l/s) where an adequate drop exists along the stream to accommodate the "bucket." It cannot easily be used to measure discharge of streams with small, regular gradients.

The velocity-area method (p. 11) requires the determination of stream velocity and stream cross-sectional area at a point along the stream where the flow is representative of that to be used by the hydropower plant. The velocity-area method is almost universally used because of its essential reliability and applicability to a wide range of sites and discharges. It can be used to gage streams of all sizes, especially larger streams where the other methods prove inappropriate. However, it is difficult to use with very shallow streams where velocities are hard to gage or streams with irregular cross-sections, such as those strewn with rocks and boulders. Unlike the weir method, periodic streamgagings using the velocity-area method would be tedious because new velocity and depth measurements would have to be undertaken each time. Consequently, when streamflow has to be gaged on a regular basis, the velocity-area method is only used to calibrate a staff gage, which is then used to perform these periodic streamgagings (see Stage-discharge method, p. 20). With a little experience, the velocity-area method is still a useful approach for determining the order of magnitude of the streamflow at diverse sites with minimum effort.

The weir method (p. 16) requires the construction of a weir, which incorporates an opening with any one of several standard profiles, across a stream (Fig. 2.1).

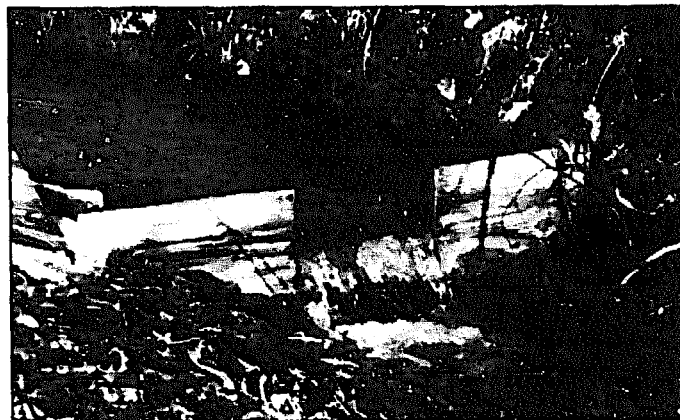

Fig. 2.1. A temporary weir set up to measure streamflow.

Conveniently, this method requires only a single linear measurement—the height of water behind the weir—in order to determine streamflow. The discharge is directly determined from this height measurement through the use of formulas or associated tables. This method is especially useful in very shallow streams where there are difficulties determining flow velocity or stream profile. In either of these cases, the velocity-area method would not be easily applicable.

Although this method is simple and can be used to gage the entire range of streamflows, it can be relatively costly if a weir has to be built only for the purpose of streamgaging. As is portrayed in many reference books, a temporary wooden weir can be built, but this is not always as easy as it appears. If not properly constructed, inaccuracies can be introduced. Also, if such a weir is constructed in an area of gravel, stone, or bed-rock, difficulty in sealing the weir can cause unmeasured discharge to pass under the weir. The weir method is most cost-effective if daily measurements need to be undertaken as part of a streamgaging program and if the nature of the streambed prevents the use of a simple staff gage calibrated by some other method.

The salt-dilution method (p. 19) is particularly useful on rough mountain streams where constructing a weir is difficult and where the velocity-area method cannot be readily used. Because it requires the use of a conductivity probe with a range of $0-1 \cdot 10^{-3} \text{ ohm}^{-1}$, which may cost \$100-\$300, this method is more appropriate when site prospecting is part of a larger program for implementing small-hydropower schemes. The accuracy is generally within $\pm 7\%$, but this degree of accuracy requires considerable turbulence to ensure good mixing in the stream.

A "spot" of concentrated salt solution could be released into a stream and a conductivity probe used to locate that spot at some point downstream. The stream velocity could then be determined as described in Float method (p. 13). However, the salt-dilution method permits a direct determination of discharge, not just velocity. There is no need to measure velocity, depth, head, cross-sectional area, or any other hydraulic factors usually considered in discharge measurements. Two approaches will be discussed.

The slope-area method (p. 19) indirectly estimates the streamflow by using an open channel flow equation such as Manning's equation and measurements of the cross-sectional dimensions of the wetted portion of the streambed, its gradient, and its roughness.

This method is rarely used to measure normal discharge in a stream, because errors can easily attain 25% or more. It is most useful in estimating flood discharge, usually after the flood crest has passed and when the slope of the streambed, the cross-sectional area of the flow during flood crest (determined from marks made along the banks), and a knowledge of general streambed conditions during the flood are available.

The stage-discharge method (p. 20) relies on the meas-

urement of stream depth (stage) to obtain the corresponding discharge by means of a rating curve—a graph of stage versus discharge. Although this method is used to measure discharge, it cannot be used alone, as can the other methods described. A staff or other means of measuring stage has to be calibrated, which in turn requires the use of one of the other methods.

Discharge measurement using the stage-discharge method is similar to that using the weir method. With a weir, any of several standard weir designs are used and correlations of streamflow with depth have been determined empirically in a laboratory setting and need not be derived in the field. With the stage-discharge method, the natural shape of the streambed serves as the "weir." But since this shape varies from site to site, the stage-discharge relationship must be re-established at each site.

The advantage of this method is that, once a staff has been calibrated by a stage-discharge curve, a single reading off the staff determines discharge. This is the method generally used for regular streamgagings at a specific site. Stage measurements can also be automated to provide readings on a continuous basis.

The following sections describe each of these methods. The Water Measurement Manual (24) describes many of these techniques in much greater detail.

Bucket method

This method simply involves recording the amount of time required for the discharge in the stream to fill a bucket (for discharges of less than about 4 l/s), oil drum (for discharges of less than about 50 l/s), or other suitably shaped and sized container. A clean drum should be used to prevent contaminating the stream being gaged. For this method, one must be able to divert the entire stream discharge into the container.

To apply this method, first measure the volume of the container " V_c " by making a few length measurements and using the appropriate volume formula or by counting the number of known volumes (from a bottle, graduated cylinder, or tin can) required to fill it. Then record the time " t " required for the stream to fill the container. The discharge in the stream is then

$$Q = \frac{V_c}{t} \quad (2.1)$$

However, if the discharge is fairly large compared to the container used, the filling is often so turbulent that it may be difficult to note at what time the container is actually full. In this case, it is more accurate to record the time required to almost fill the container and then to measure the actual volume captured " V ", which would be somewhat less than the full container volume. In this case, the container should first be calibrated by either method mentioned previously so that the volume of the water it contains is known as a function of depth.

EXAMPLE 2.1

An empty 200-liter oil drum ($H = 82$ cm) is used to measure the discharge in a creek. A trough is crudely constructed to channel all the flow (Fig. 2.2). A stopwatch is started the instant the drum begins to fill. When the drum is nearly full, the trough is promptly removed and the time recorded. In $t = 3.6$ s, the drum has filled to a depth of $h = 71$ cm. Because the full volume is known (200 l) and the cross-sectional area of the drum is constant, the volume of water in the drum is proportional to the depth of the water.

$$V = \left(\frac{h}{H}\right) 200 \text{ l} = \left(\frac{71}{82}\right) 200 \text{ l} = 170 \text{ l}$$

For an explanation of why the volume is expressed as 170 l and not 173 l or 173.170173 l, see **APPENDIX B** (p. 267).

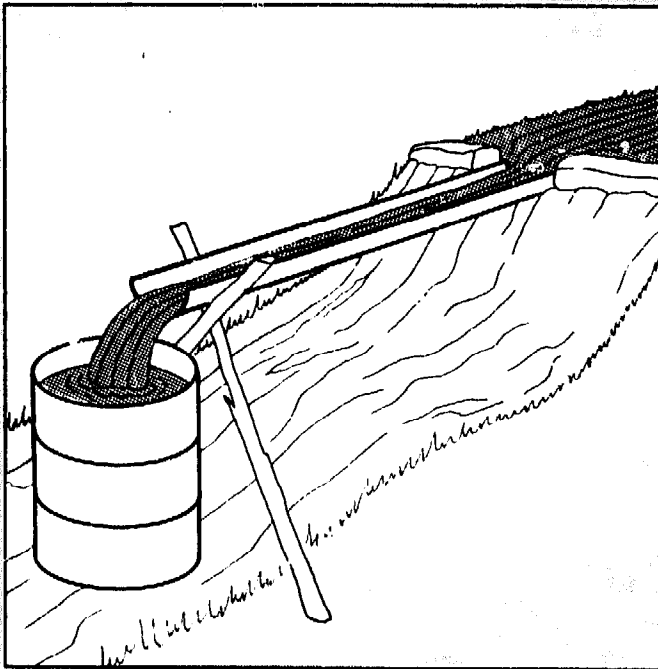

Fig. 2.2. An improvised trough is used to channel water into a drum to measure stream discharge.

Because this volume entered the drum in 3.6 s, the discharge is

$$Q = \frac{170 \text{ l}}{3.6 \text{ s}} = 47 \text{ l/s}$$

If a bucket is used, the cross-sectional area usually is not constant. In this case, it would always be possible to calibrate a bucket or prepare a conversion table (Fig. 2.3) by pouring known volumes "V" into the bucket and then measuring the depth "h" of the water. In this case, it can be seen that the volume of water is also nearly proportional to its depth. When this bucket is used in the field, measuring the depth of water captured in a given time will give the volume that this depth represents. If, for example, a depth $h = 21$ cm is captured in 2.4 s, this represents a volume of 8.2 l and a discharge of

$$Q = \frac{V}{t} = \frac{8.1 \text{ l}}{2.4 \text{ s}} = 3.4 \text{ l/s}$$

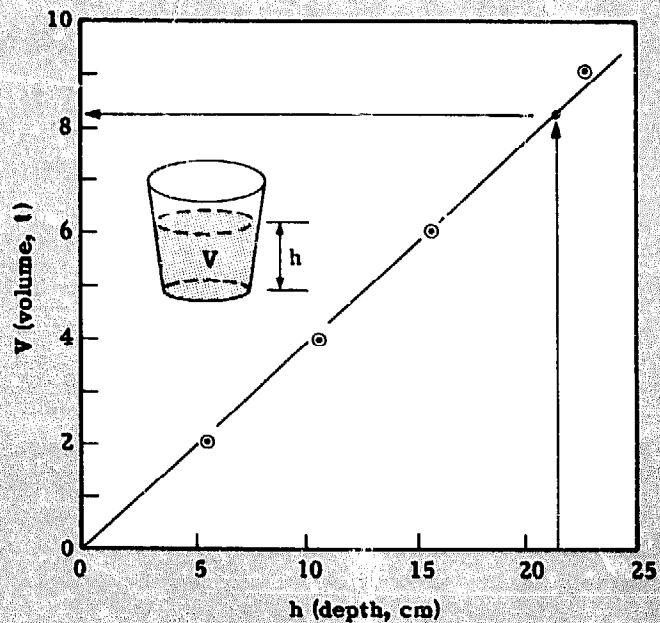

Fig. 2.3. A bucket can be calibrated by filling it with known volumes "V" and measuring and plotting the corresponding depths of water "h".

Then, by measuring the depth of water captured in time "t", the volume "V" of that water can be determined and used to determine the discharge:

$$Q = \frac{V}{t} \tag{2.2}$$

Velocity-area method

For this method, an appropriate point is selected along the stream to be gaged. This point should be along a

relatively straight, smooth-flowing portion of the stream of generally uniform width. The streambed in this area should be well-defined and not covered with boulders, tree trunks, or thick grasses.

This method looks at the volume of water flowing across a cross-section of the stream every second (Fig. 2.4). The discharge or flow "Q" (m^3/s) is then derived using the following equation:

$$Q = A \bar{V} \tag{2.3}$$

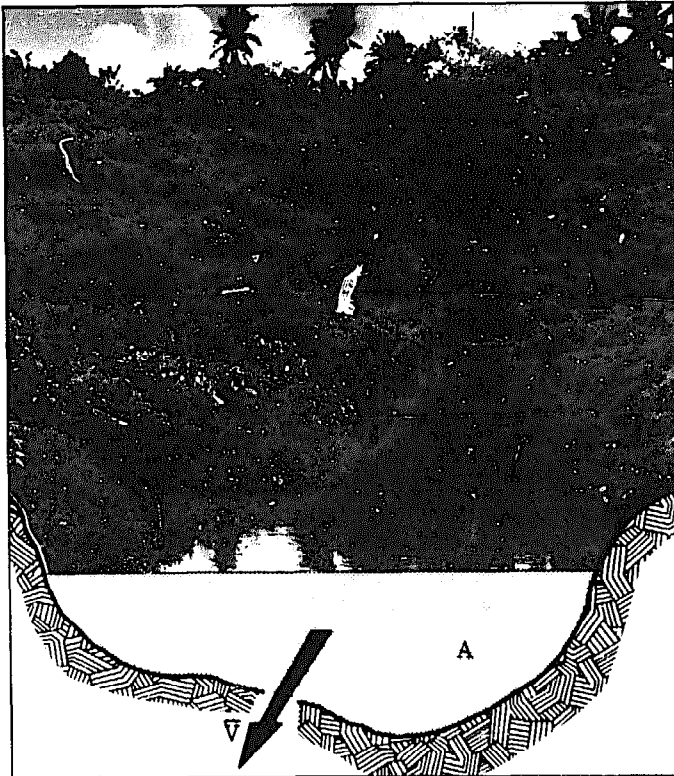

Fig. 2.4. The flow in a stream equals the product of its cross-sectional area and the average velocity through that area ($Q = A \bar{V}$).

where

A = stream cross-sectional area (m^2)
 \bar{V} = average stream velocity through area "A" (m/s)

The area used in this expression is the cross-sectional area of the water flowing downstream. In portions of some streams, the flow may be diagonal, stagnant, or even eddying back upstream. These sections should be avoided when attempting to measure discharge.

To derive the discharge, two sets of measurements must therefore be undertaken: (1) those to determine the cross-sectional area "A" of the stream and (2) those to determine the average velocity " \bar{V} " at that point along the stream. The sections which follow describe techniques for determining area and stream velocity.

Determining area

Often--especially in prospecting for potential sites--it is necessary only to obtain an approximate value of the cross-sectional area of the stream. This is easily done by measuring both the width " W " of the stream and what to the eye appears to be the average depth " \bar{d} " of the stream (Fig. 2.5a). The cross-sectional area of the stream at this point is then approximated by the area of a rectangle.

The accuracy of the above approach depends on the accuracy with which the average depth can be deter-

mined. Where greater accuracy is required, the shape of the stream's cross-section is approximated by a series of parabolas (Fig. 2.5b). The stream's cross-sectional area is then found by summing the partial areas between arcs of the parabolas and the surface of the stream. To use this method, the stream width must be divided by an odd number of equally spaced points, that is, " n " is odd. The spacing of the points " w " depends on the width " W " of the stream, the smoothness of the streambed, and the accuracy desired. If the cross-sectional profile of the stream is uniform, fewer points are required. The depth of the stream at each point is then measured. Summing the individual partial areas, the total stream cross-sectional area can be shown to equal the following expression:

$$A = (4 d_1 + 2 d_2 + 4 d_3 + \dots + 4 d_n) \frac{w}{3} \quad (2.4)$$

In the field, a surveying tape can be stretched across the stream and a ruler or calibrated stick can be used to measure the depth of the water at appropriate points along the tape. If a long tape is not available, a string with equally spaced knots or a low bridge or tree trunk across a stream, marked off in equal intervals, can serve the same purpose. (See EXAMPLE 2.2.)

Determining stream velocity

In this section, which describes methods for determining stream velocity, the following notation will be used:

v_s = surface velocity of the stream
 \bar{v} = average velocity through a partial area
 \bar{V} = average velocity of the stream

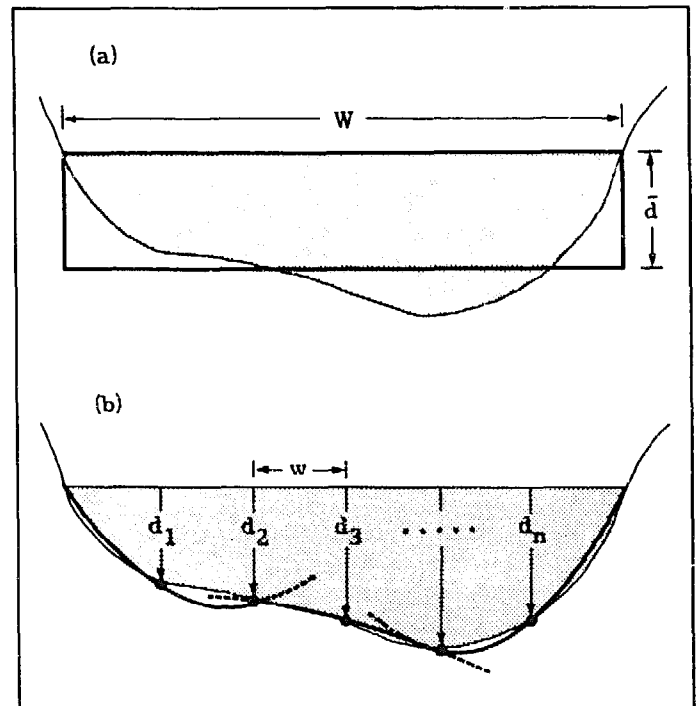

Fig. 2.5. Actual stream cross-sectional area can be approximated by (a) that of a rectangle or (b) that bounded by a series of parabolic curves.

EXAMPLE 2.2

The cross-sectional area of the stream shown in Fig. 2.6a is to be determined.

To obtain an approximate value for the area, the width of the stream was measured and its average depth estimated (Fig. 2.6b). Then

$$A = W\bar{d} = (2.2 \text{ m})(0.3 \text{ m}) = 0.7 \text{ m}^2$$

To make a more precise determination, the stream was divided by three points into partial areas of equal width. A tape was then stretched across the stream and the depth of water measured and recorded each 55 cm as shown in Fig. 2.6c. Then

$$A = [4(0.38) + 2(0.51) + 4(0.21)] \frac{0.55}{3} = 0.62 \text{ m}^2$$

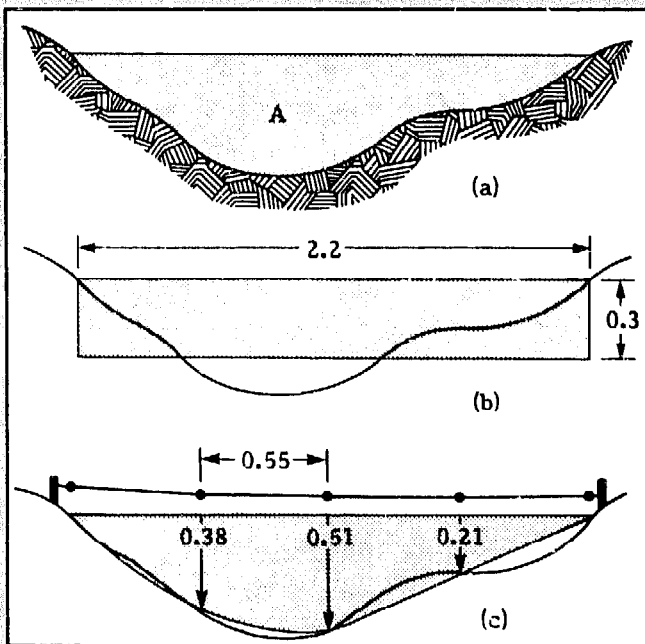

Fig. 2.6. The cross-sectional area "A" of a stream (a) can be approximated by that of a rectangle (b). A more precise method is to subdivide the area into portions bounded by parabolas (c). All three shaded areas are approximately equal.

Float method. This is the easiest method for determining velocities in a stream. It has the advantage of requiring no special equipment. However, it cannot be used accurately where the streambed is irregular in profile or width or where the stream is shallow, and thus it cannot accurately measure velocity along many streams which are suitable for micro-hydropower generation.

For this method, a length of the stream which is relatively straight and uniform is selected. A floating object is placed at the point in the stream where the velocity is required (at the stream's center if the aver-

age stream velocity is required or at the center of the partial area of interest if the average velocity across that area is required). The time "t" it takes to cover a distance "D" is recorded. A floating object which is largely submerged, such as a piece of wood or partially filled bottle, should be used; a leaf or similar object may be too easily affected by a breeze to give accurate results. The velocity of the float, and therefore the surface velocity " v_s " of the water, is

$$v_s = \frac{D}{t} \quad (2.5)$$

However, the velocity of the water at the surface " v_s " neither represents the average velocity of the stream " \bar{v} " nor the average velocity through the partial area of interest " \bar{v} " (Fig. 2.7). Water at the edges and near the bottom of the stream moves slower than water at the surface and center of the stream because of the roughness of the bed and viscosity of the water. An approximate value for the average velocity of the stream " \bar{v} " can be obtained by multiplying the surface velocity near the center of the stream by a correction factor "C":

$$\bar{v} = C v_s \quad (2.6)$$

where "C" varies from 0.60 for streams with a rocky bed to 0.85 for those with a smooth bed.

The average velocity through any partial area " \bar{v} " is less than the surface velocity over that area because of the effect of the streambed on the velocity profile. An approximate value for the average velocity through any partial area can be obtained by multiplying the surface velocity over that area by a correction factor "c":

$$\bar{v} = c v_s \quad (2.7)$$

where "c" varies between 0.75 for shallow streams to 0.95 for deep streams.

Velocity-head rod. The velocity-head rod can be used to determine the surface velocity of a stream (109). This device can easily determine the surface velocity at any

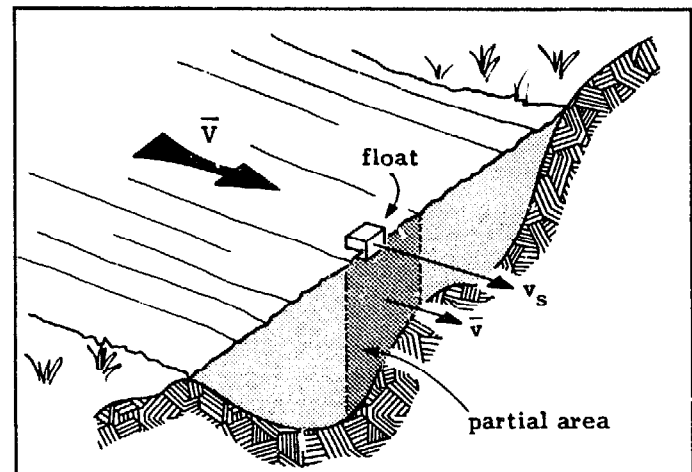

Fig. 2.7. Both the average stream velocity and the average velocity through any partial area are generally less than the surface velocity over that area.

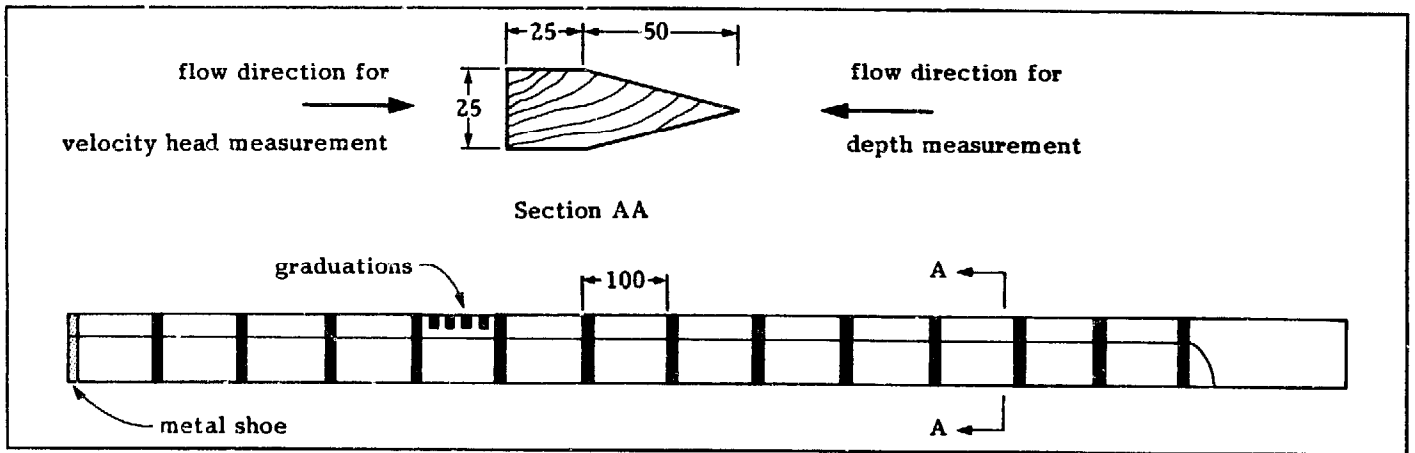

Fig. 2.8. A velocity-head rod with dimensions shown in millimeters.

point on the cross-section of the stream. If it is used to measure the surface velocity " v_s " at the middle of the stream, the average stream velocity can be derived using Eq. (2.6).

In smooth flow, the rod can easily be read and the accuracy of the velocity measured should be within 3%. In turbulent flow, the reading might fluctuate by several centimeters, but the accuracy of the measured velocity should still be within 10%.

The velocity-head rod is particularly useful in flows containing debris and bed load, which could adversely affect more convenient and accurate devices such as a current meter. It is inaccurate for velocities much below 0.3 m/s, because the head would be too small to measure, and for streams with a soft, unstable bed. It also cannot be handled well in streams moving faster than about 3 m/s.

The velocity-head rod is constructed with a cross-section shown in Fig. 2.8 and calibrated in centimeters. In use, the rod is placed on the streambed with the stream-lined edge upstream and the depth of the water is recorded. Without changing the vertical placement of the rod, it is turned around so that the streamlined edge is downstream. The rise of the stream " h " above the original level of the stream, as shown in Fig. 2.9, is equal to the velocity head— $v_s^2/2g$. The operation of a velocity-head rod is analogous to that of a pitot tube. Therefore, the surface velocity of the stream at the location of the rod is

$$v_s = \sqrt{2gh} \quad (2.8)$$

A graph of surface velocity versus the rise of water against the rod is shown in Fig 2.10. If, for example, the water rises 17 cm, the surface velocity at that point is about 1.8 m/s.

Current meter. This is the most common method for measuring velocities at any depth in larger streams and rivers which are not turbulent. It requires special equipment and is necessary only where accuracy is required. This is generally not the case with micro-hydropower installations.

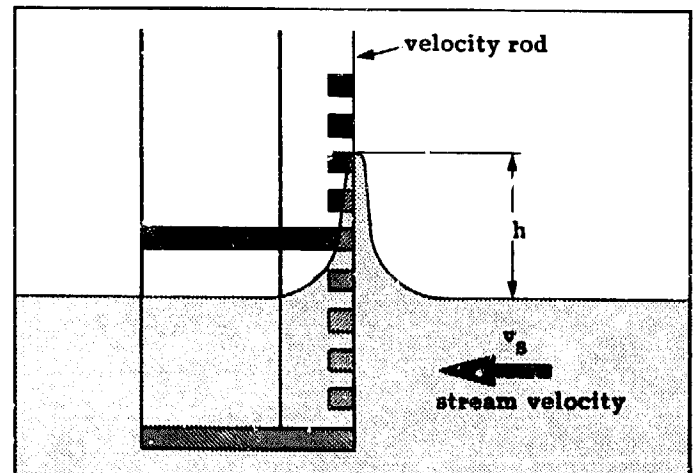

Fig. 2.9. The height of the water "piling up" on the back of the velocity rod is a measure of the velocity of the oncoming water.

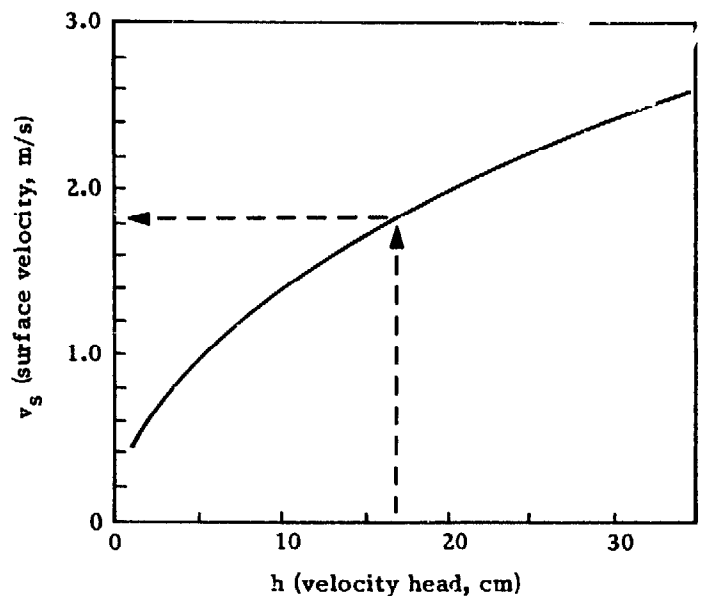

Fig. 2.10. A graph of surface velocity vs. velocity head measured with a velocity rod.

Basically, a current meter is a device with a propeller or a series of cups mounted on a shaft that is free to rotate, the speed of rotation being a function of the velocity of the water in which it is placed. It is placed in the flow at the desired depth. The current meter is equipped with a device for indicating the revolutions of the shaft, such as a simple mechanical counter. More conveniently, an electrical pulse generated each time the propeller has turned a given number of revolutions can be fed electrically through a cable placed along the lines supporting the current meter (Fig. 2.11). The manufacturer of the unit should give the correlation between the number of turns per second and the speed of the water. Even then, if accurate results are required, the current meter should be recalibrated periodically. Current meters are generally used to measure velocities in the range of 0.2-5 m/s, with a probable error of 2%.



Fig. 2.11. To facilitate placing the current meter at the appropriate depth, the meter is lowered until the preset movable pointer mounted on the handle is located at the surface of the water.

Determining discharge

There are several approaches to using velocity and area measurements to determine discharge. The simplest approach is to use the average velocity of the stream and Eq. (2.3). Although either of the two approaches described earlier can determine the value for the area used in the equation, the accuracy with which the average stream velocity was determined should be kept in mind. The accuracy of the area measurement need not

exceed this; any additional effort expended to obtain greater accuracy is of little use.

The approach described above is adequate for gaging most streams to be harnessed for micro-hydropower generation. The exception is where the velocity varies significantly across a stream. In this case, more accurate results may be obtained by determining the discharge through partial areas (Fig. 2.12) and then summing these. The discharge through each area " a_n " is equal to that area times the average velocity " \bar{v}_n " through that area. Therefore, the total stream discharge is

$$Q = a_1\bar{v}_1 + a_2\bar{v}_2 + a_3\bar{v}_3 + \dots + a_n\bar{v}_n \quad (2.9)$$

Each partial area may be found by determining the area of the trapezoid which approximates it. For example, the third partial area in the stream in Fig. 2.12 would equal

$$a_3 = \left(\frac{d_2 + d_3}{2} \right) w \quad (2.10)$$

Partial areas may also be approximated by sections bound by parabolas; however, for applications considered in this publication, little would be gained for the extra effort required.

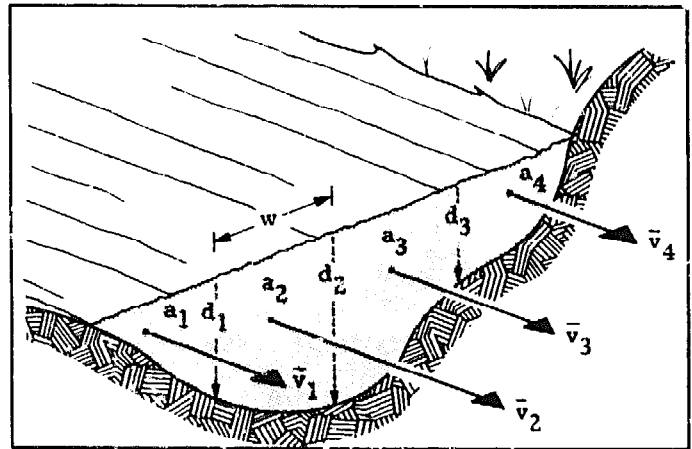

Fig. 2.12. The discharge in a stream equals the sum of the discharge through each partial area.

EXAMPLE 2.3

The discharge in a stream with a smooth bed and the profile shown in Fig. 2.6 is to be determined. A float placed near the center of the stream takes 8.4 s to cover 10.0 m. The surface velocity along the center of the stream is then

$$v_s = \frac{D}{t} = \frac{10.0 \text{ m}}{8.4 \text{ s}} = 1.2 \text{ m/s}$$

The average stream velocity is

$$\bar{V} = C v_s = (0.85)(1.2 \text{ m/s}) = 1.0 \text{ m/s}$$

To estimate the streamflow, it is frequently sufficient to estimate the cross-sectional area. In EXAMPLE 2.2, this was found to be 0.7 m^2 . An estimate for the streamflow is

$$Q = A\bar{v} = (0.7 \text{ m}^2)(1.0 \text{ m/s}) = 0.7 \text{ m}^3/\text{s} = 700 \text{ l/s}$$

If the more accurate value of area of 0.62 m^2 found in EXAMPLE 2.2 were used, then a more accurate estimate of discharge would be

$$Q = A\bar{v} = (0.62 \text{ m}^2)(1.0 \text{ m/s}) = 0.62 \text{ m}^3/\text{s} \approx 620 \text{ l/s}$$

Another approach for deriving an accurate estimate of streamflow is to sum the discharge through each partial area approximated by a trapezoid. Assume that the surface velocity at the approximate center of each trapezoidal partial area were determined as shown in Fig. 2.13. The actual average velocity across each area is somewhat less for reasons previously explained. Let us assume a value of $c = 0.9$. The average velocities in each partial area would then be 1.0, 1.2, 0.8, and 0.6 m/s, respectively. Using Eqs. (2.9) and (2.10), the discharge would be

$$\begin{aligned} Q &= 0.55\left(\frac{0.38}{2}\right)(1.0) + \left(\frac{0.38 + 0.51}{2}\right)(1.2) + \\ &\quad \left(\frac{0.51 + 0.21}{2}\right) + \left(\frac{0.21}{2}\right)(0.6) \\ &= 0.59 \text{ m}^3/\text{s} = 590 \text{ l/s} \end{aligned}$$

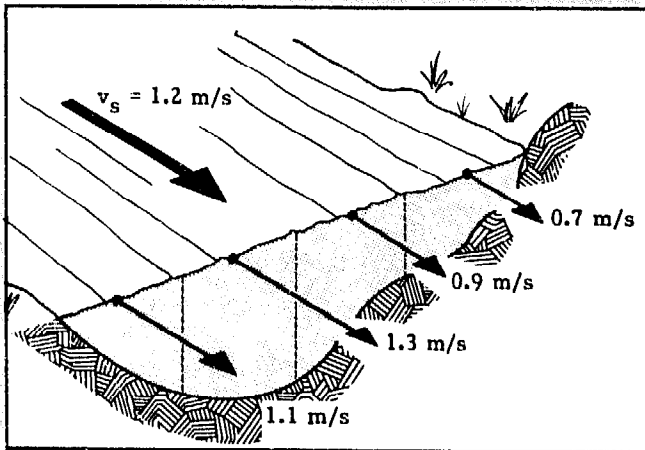

Fig. 2.13. Surface velocities shown above each partial area are those used in this example.

Weir method

This method requires construction of a low wall or weir across the stream to be gaged (Fig. 2.1), with a notch through which all the water in the stream flows. The term "weir" is also applied to the notch itself. Over the years, numerous laboratory investigations have been conducted to calibrate notches of several standard designs so that discharge "Q" through these can be determined from a single linear measurement—the difference in elevation "h" between the water surface

upstream of the weir and the bottom of the notch (Fig. 2.14). The accuracy of this method depends on the faithful reproduction in the field of conditions that existed in the lab where the calibration was performed. Under ideal conditions, this method will be accurate to within 2%–3%. Improper setting and operation may result in large errors in discharge measurement. If a weir is to continue to give reliable results, these conditions must be preserved—the crest must be kept sharp and sediment settling behind the weir must be removed.

To measure discharge in a small stream or channel, a sharp-crested weir is usually used. The sharp edge causes the water to clear the crest. This is important, because more water would emerge with the same head "h" if the emerging stream clung to the weir, and the calibrations described below would no longer be valid. Under usual circumstances, the crest need not be razor-sharp—a flat portion a couple millimeters wide is sharp enough. The notch can be cut in a wooden weir with a bevel toward the downstream side. A more durable notch can be constructed by cutting a rough opening in a wood weir and affixing over this opening a notch of proper shape and size cut from thin sheet metal.

Although several types of sharp-crested weirs can be used, rectangular and triangular (or V-notch) weirs are most common (Fig. 2.14). A triangular weir can measure small discharges more accurately than a rectangular weir. On the other hand, a rectangular weir permits a significantly larger discharge to be measured, because the width of the notch can be selected at will.

At times, a special form of trapezoidal notch, called a Cipolletti weir, is also used. Its sides are inclined outwardly at a slope of 4 to 1 (vertical to horizontal). The advantage of this weir is that it can compensate for the reduced discharge resulting from end contractions associated with rectangular notches by providing extra discharge over the sloping sides. This, in turn, simplifies the formula for discharge by eliminating the need for a correction factor to account for end contractions, as is necessary with a rectangular weir.

In its simplest form, a weir consists of a wall of timber, possibly with a notched sheet metal plate affixed to it. A concrete or metal wall is sometimes used. It should be vertical and oriented at right angles to the stream at a point where the channel is straight and free from eddies. The crest of the weir should be placed high enough so that water will fall freely below the weir, leaving an air space under the overflowing sheet of water. Upstream of the weir, the distance between the bed of the stream and the crest of the weir should be at least twice the maximum head to be encountered during its use. There should be no obstructions—sand bars, boulders, or weeds—in the vicinity of the notch, because these may cause an asymmetrical approach flow. The weir must be properly sealed, because any water leaking under or through it is not gaged. The crest of both the rectangular and trapezoidal weirs must be exactly level. With a triangular weir, a range of angles can be used, but the formula presented in Fig. 2.14 assumes a 90° notch, with both sides inclined at 45° to the vertical.

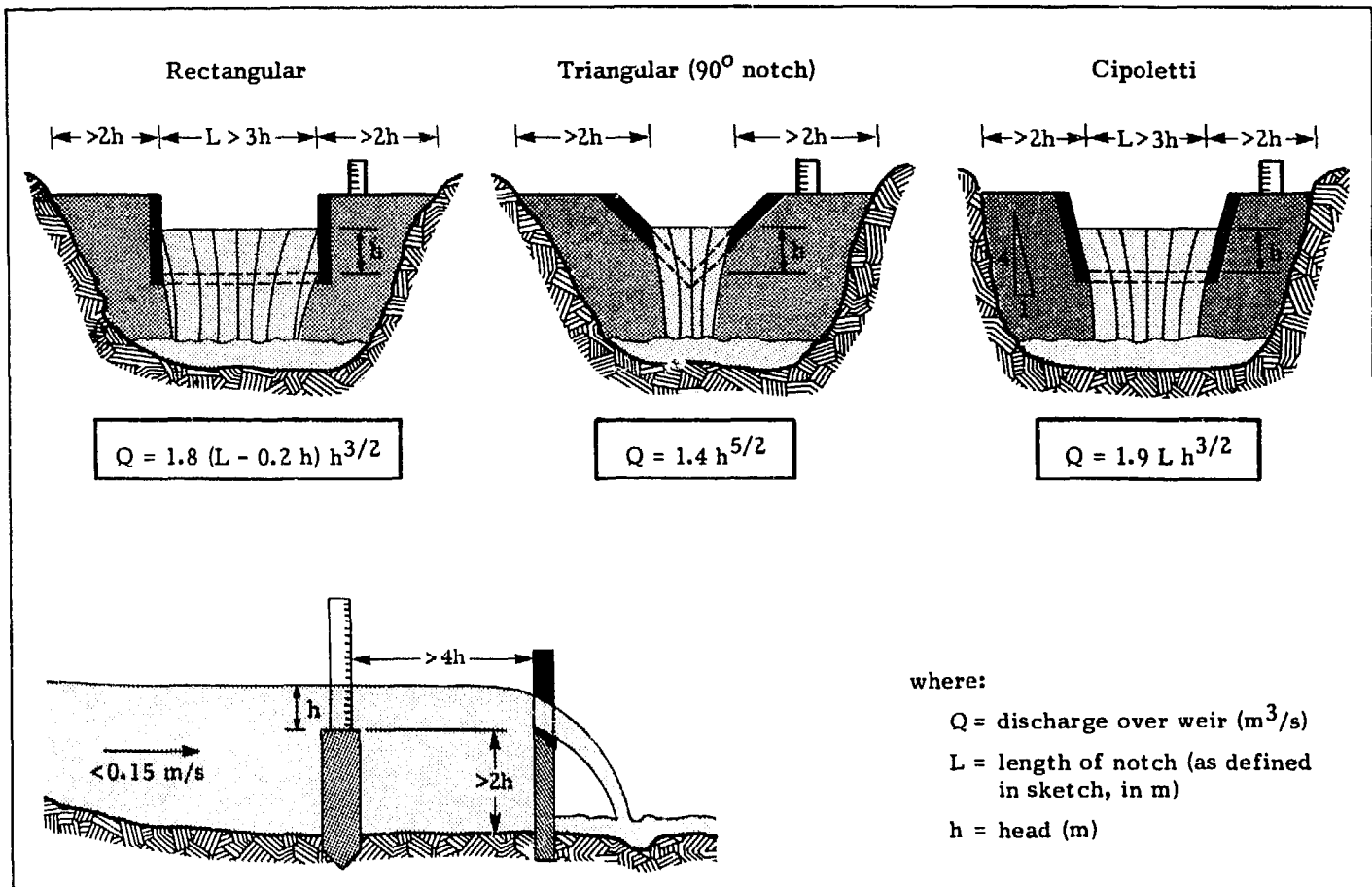

Fig. 2.14. Design criteria for weirs used for streamgaging.

Most equations for the discharge through sharp-crested weirs are not accurate for heads less than about 5 cm. On the other hand, few discharge measurements have been made on sharp-crested weirs for heads greater than about 0.5 m. Therefore, if a sharp-crested weir is to be used, it might be suggested that the weir be selected so that "h" will be in the range of 0.05–0.50 m (32). A triangular weir could consequently be used to measure discharges in the range of 3.0–300 l/s. This is a significant variation which can be measured with a single weir. The rectangular weir described in Fig. 2.14 can be used to measure discharges greater than about 5 l/s. However, a triangular weir can gage a greater range of discharges than can any single rectangular weir. With the head increasing from 0.05 m to 0.55 m, the flow through a triangular weir would increase about 100 times (from 3.0 to 300 l/s), whereas flow through a rectangular weir would increase only about 40 times.

If a weir has been properly constructed, the principal errors arise from measurement of head. For a rectangular or Cipoletti weir, the percentage error in discharge is 1.5 times the percentage error in head measurement. Therefore, if a head measurement of 6.0 cm is in error by 0.5 cm, or $0.5/6.0 = 8\%$, the error in discharge would be about 12%. For a triangular weir, the percentage error in discharge is 2.5 times the percentage error in head measurement. For the same 8% error

in head measurement noted above, the error in discharge would be 20%.

If a single weir is to be used, the notch must be wide enough to convey the largest expected discharge without exceeding the maximum head "h" for which the weir is designed. It is therefore necessary to have some feel for the range of discharges found in a stream before constructing a weir.

The weir should be set at the lower end of a pool sufficiently long and deep to give a smooth flow toward the notch, preferably with a velocity less than 0.15 m/s. If this is not possible, the formula for discharge would have to be corrected for the effect of the stream's velocity of approach.

After the weir is constructed, a method for measuring the head "h" should be included. This measurement should be made far enough upstream of the weir to prevent the reading from being affected by the downward curve of the water heading through the notch. A distance at least four times the head is usually recommended. One method for determining "h" is to drive a stake into the streambed until it is precisely level with the lower edge of the notch, as shown in Fig. 2.14. It should be far enough to one side of the notch to be in comparatively still water. To measure head "h", a scale

is placed vertically on top of the stake and the level of the stream is read directly off the scale. Numerous variations of this method can be used.

Although specific details in the construction of a weir can vary, it is important that the critical features described above be incorporated. When constructing a temporary weir, the task of sealing around the weir can be simplified by laying a sheet of plastic on the upstream side of the weir and using sand, gravel, or rocks to hold it in place (Fig. 2.15).

The formulas shown in Fig. 2.14 or the curves shown in Fig. 2.16 yield the discharge through each of the three types of notches described. Note that for rectangular and Cipoletti weirs, the discharge is given per unit effective weir length. Actual discharge is obtained by multiplying this discharge by the effective weir length—by " $L - 0.2 h$ " for the rectangular weir or by " L " for the Cipoletti weir.

In reality, a much wider range of designs for sharp-crested weirs is available, but then the formulas for expressing discharge must include the effects of decreasing end contractions, velocity of approach, and submergence. In this section, the simple forms of the formulas are presented. For these to be valid, it is necessary to adhere to the limitations noted in Fig. 2.14. If the notch is too wide or deep, contractions become suppressed and the formulas which are given



Fig. 2.15 Three separate rectangular boards are used to improvise a temporary gaging weir. Without readily available soil in the vicinity, preventing leakage around such a weir on bedrock would be difficult, but a sheet of plastic facilitates that task.

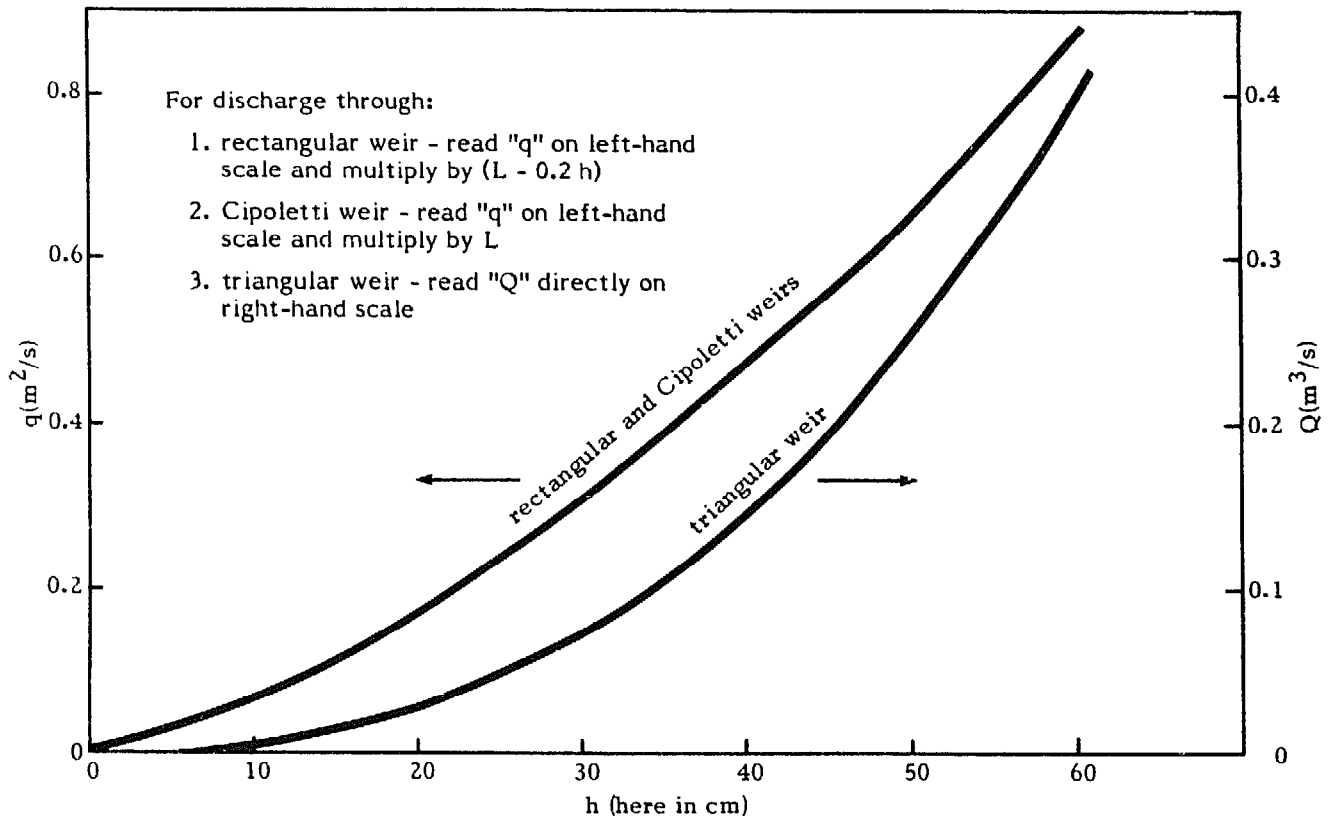

Fig. 2.16. Curves for determining flow through a weir.

underestimate the discharge. If the velocity of approach is too high, the formulas again underestimate the discharge. And if there is insufficient room for the water to fall freely downstream of the weir, the weir becomes submerged and the formulas presented overestimate the discharge.

Salt-dilution method

There are two approaches to determining discharge by measuring the dilution of a salt released into a stream. With the first approach, a concentrated salt solution is released into a stream all at once and the change in concentration in the stream is measured over time as the water flows past a point downstream. With the second approach, a salt solution is released into the stream at a known rate and the salt concentration is measured downstream.

The first approach requires that a known mass "M" of salt—about 0.3 kg for each 0.1 m³/s of streamflow—which has been completely dissolved in a bucket of water be quickly dumped into the stream to be gaged. At a point 50 m or more downstream—far enough for the salt to be uniformly dispersed throughout the stream cross-section—electrical conductivity readings are made. This may cover a period of several minutes. A curve of conductivity (ohm⁻¹) vs. time (s) is then plotted (Fig. 2.17). The shaded area under the curve is calculated (ohm⁻¹ s). Using a conversion factor "k" (kg/m³ per ohm⁻¹) between concentration and conductivity, the discharge in the stream is then found using the following equation:

$$Q(\text{m}^3/\text{s}) = \frac{M(\text{kg})}{\text{area}(\text{ohm}^{-1}\text{s}) \times k(\text{kg}/\text{m}^3/\text{ohm}^{-1})} \quad (2.11)$$

A brief derivation of this equation is as follows: At any point downstream, the volume of water passing through the stream cross-section during an increment of time " Δt " simply equals $Q \Delta t$ (m³). If, from the conductivity measurement " μ " and the conversion factor "k", the salt concentration in that volume of water is determined to be C (kg/m³) = μk , the mass of salt passing this point during this increment of time is $CQ \Delta t$ (kg). The total salt in the stream, which is already known, is then the sum of the mass of salt passing during each increment of time or $M = \Sigma CQ \Delta t$. Since the discharge "Q" is assumed to be constant during the sampling period (which it essentially always is), then $M = Q \Sigma C \Delta t$, or

$$Q = \frac{M}{\Sigma C \Delta t} = \frac{M}{\int C dt} \quad (2.12)$$

Because the factor $\Sigma C \Delta t$ equals $k \Sigma \mu \Delta t$, the denominator in this expression is simply the product of the conversion factor and the shaded area under the conductivity curve (Fig. 2.17).

A more detailed description of this method based on work by Andrew Brown, ITIS Micro-Hydro Engineer, is found in "Stream Flow Measurement by Salt Dilution

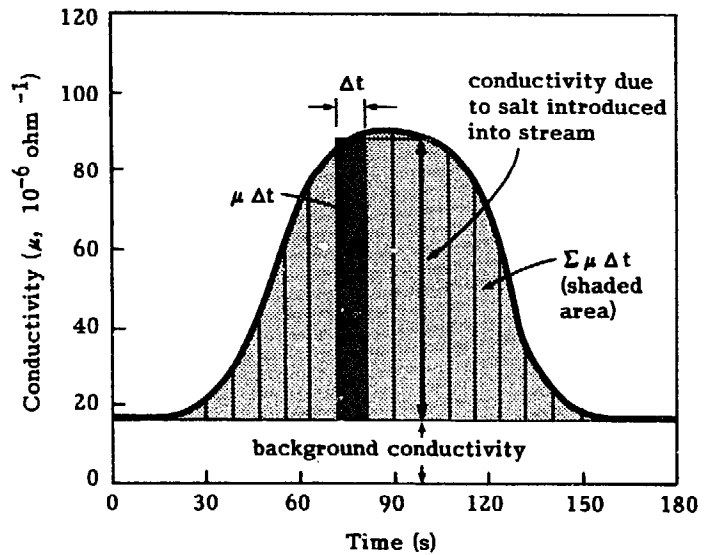

Fig. 2.17. A typical curve of conductivity vs. time at a point downstream from where a known quantity of salt has been released.

Gauging" (33). This reference also includes a discussion of meter calibration and temperature correction.

The second approach requires that a salt solution with a high concentration " C_1 " (kg/m³) be gradually discharged into a stream at a known rate " q ". This disperses transversely throughout the stream as the water continues downstream. At a point downstream where mixing is complete, the salt concentration " C_2 " is measured by measuring conductivity. The discharge in the stream is then

$$Q = q(C_1/C_2) \quad (2.13)$$

This assumes that the natural salt concentration in the stream has been subtracted to get " C_2 " and that " Q " is much larger than " q ". If either of these assumptions is incorrect, the more precise form of this equation must be used (24).

Slope-area method

This method uses an open channel flow equation, such as Manning's equation which is frequently used to determine discharges in power canals (see **Determining canal dimensions and slope**, p. 96). In metric units, this equation is expressed as:

$$v = \frac{r^{2/3} s^{1/2}}{n} \quad (2.14)$$

where

- v = average flow velocity in channel (m/s)
- r = hydraulic radius = A/P
- A = cross-sectional area of flow (m²)

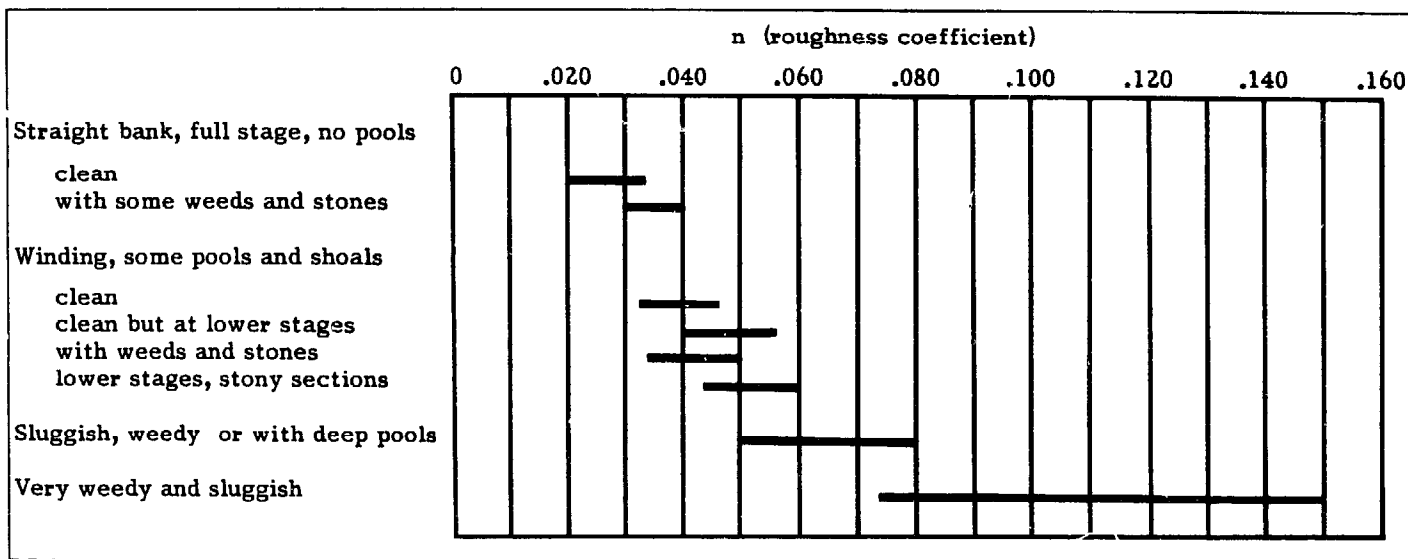

Fig. 2.18. Roughness coefficient for natural channels.

- P = wetted perimeter of this area (m)
 s = slope of the stream's surface
 n = roughness coefficient (see Fig. 2.18)

To use this method, a straight channel 50-300 m long with reasonably uniform slope and cross-section should be selected. Its bed and banks should be permanent and the slope should be steep enough to be measured without a large percentage error. To derive the hydraulic radius, the mean cross-sectional area and wetted perimeter must be determined. With irregular channels, this may have to be done at several points and the mean value used to determine hydraulic radius. The slope of the stream's surface should be measured by dividing the difference in the water surface elevation at the two ends of the channel section being considered by its length. The roughness of the bed and banks must also be estimated (Fig. 2.18). Manning's equation gives the average flow velocity associated with that cross-section. Discharge is then simply the product of this velocity with the mean cross-sectional area. Because correct determination selection of the roughness coefficient is difficult, the value derived for discharge by using this equation is only approximate.

Stage-discharge method

As mentioned in **Weir method** (p. 16), one method of measuring discharge is to construct a notched weir and measure the depth of water, or stage, behind the weir. The stage-discharge method is similar to the weir method except that, rather than a notch, some physical feature of the stream downstream of the gage controls the relation between stage and discharge. When this controlling feature is situated in a short reach of the stream, a "control section" is said to exist. This might be a stretch of rapids where there is at least a moderate fall or a culvert with a cascading discharge. If the stage-discharge relationship is governed by the slope,

roughness, and size of the streambed over a significant distance, the channel of the stream itself serves as the control. In any case, the stage measurement site should be selected so that, for a given change in discharge, as large a change in stage will result. A broad control section should be avoided, because a large change in discharge will cause only a small fluctuation in stage.

The validity of the stage-discharge method rests on the axiom that the discharge for any given stage or depth of water will remain unchanged (a) as long as the streamflow is steady and (b) there is an effective control section below the stage-gaging site where the streambed and banks are permanent. Because the control section is equivalent to a notch in a weir used with the weir method, this is analogous to saying that the stage-discharge relation for a weir will remain unchanged as long as the notch in the weir remains unchanged. Even if there are changes in the bed or banks near where head is measured, this will have no effect on the relation between head and discharge through the notch as long as the changes do not extend to the control section (the notch). For example, if debris is lodged at the control section (or around the notch of a weir), sediment or boulders are deposited there, or erosion causes the control section to change in shape, then readings will no longer remain valid because performance of the control section (or notch) will have changed.

The gage itself must be placed so that it is accessible at all stages and its datum remains constant. It should be referred to bench marks entirely removed from the gage so that, if disturbed, it may be replaced to the same datum. The gage should not be situated where it is exposed to possible damage from debris nor where silt deposited by the normal current can cut off the connection between it and the free water level of the flowing water. It is not necessary, however, that the site also be suitable for measuring discharge in order to calibrate the gage. This can be done upstream or downstream from the gaging site, if the flow is steady and no water

enters or leaves the stream in the reach between where the discharge is measured to calibrate the gage and where the gage itself is located.

The most common and least expensive gage is a staff gage, a vertical or inclined scale rigidly and permanently secured in a stream, either attached to solid rock, a bridge pier, or other structure built at the river's edge. If no suitable site is available, it may be attached to a masonry pier built for that purpose (Fig. 2.19). Water-stage recorders which operate continually are also available but involve substantially increased cost (Fig. 2.20).

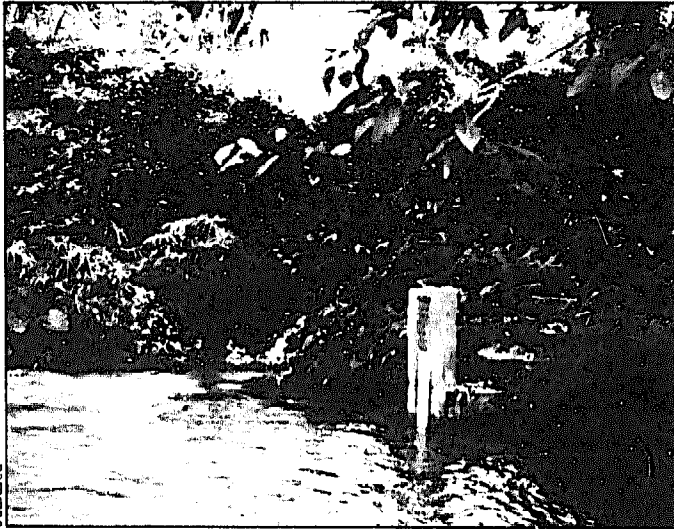

Jamaica

Fig. 2.19. A staff gage mounted on a masonry pier.

To calibrate a staff or other type of gage, both the stage and corresponding discharge must be measured for each of several stages spanning the range of stages that will to be encountered during the life of the gaging station. The velocity-area method is commonly used to measure discharge. This is done over several months, because the discharge at any stage can be determined accurately only when the stream itself attains that stage. A rating curve—a graph of stage vs. discharge—can then be prepared to determine the discharge corresponding to any stage read off the gage (Fig. 2.21). A complete rating curve requires that both minimum and maximum stream discharges be gaged, as well as several discharges in between.

A permanent control section is essential to obtain valid results using this method. Therefore, it may be necessary to verify the stage-discharge relationship periodically, after a monsoon season for example, to determine whether erosion or sediment deposits have changed the control section since the last calibration.

MEASUREMENT OF HEAD

Measuring the available head is often seen as a task for a surveyor, but for all schemes, much quicker and less costly methods can be used for the preliminary determination of head. For micro-hydropower schemes,

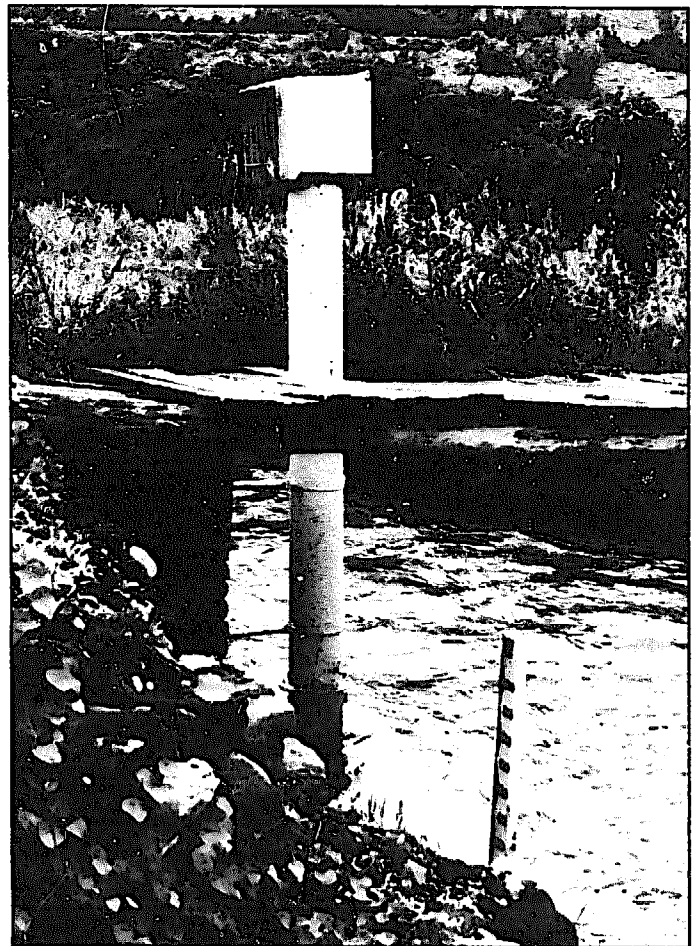

Fig. 2.20. A staff gage and a water-stage recorder on the Ruvyironza River near Kibimba, Burundi.

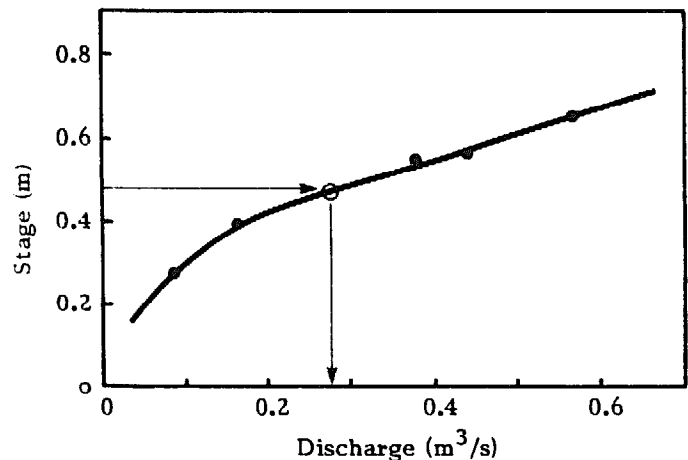

Fig. 2.21. A stage-discharge rating curve.

these methods often can also be used for final determination of gross head, although the appropriate method must then be selected, especially for sites with very low heads or small penstock gradients. Because the power available from a given turbine is proportional to $H^{3/2}$, the percentage error in the power output due to incor-

rect head measurement is about 1.5 times the percentage error in this measurement.

Of the methods described below, using a level is the most straightforward and requires the minimum investment. A carpenter's level can be used, although a less expensive line level or a more expensive Locke hand level can also be used. For a typical micro-hydropower site, accuracy is generally within $\pm 5\%$; accuracy is usually better than this figure in steeper terrain and poorer in gradually sloping terrain. One person can use this method with a carpenter's or Locke level, but two are preferable if a line level is used.

Using a clinometer or Abney level (Fig. 2.22) also requires a measuring tape, unless the clinometer is simply used as a level as in the first method described. Two persons are usually required and accuracy is of the same order as with a level. It involves making, recording, and manipulating both linear and angular measurements. However, rather than moving laboriously in 2-20 m increments up a slope, the length of the increments is limited only by the length of the tape and the nature of the terrain. If a rangefinder is used with a clinometer, greater increments are possible. With a rangefinder and clinometer, it may even be possible to measure gross head in a single step, provided the site for the intake to the penstock is visible from the powerhouse site. However, in this case, error will probably be greater.

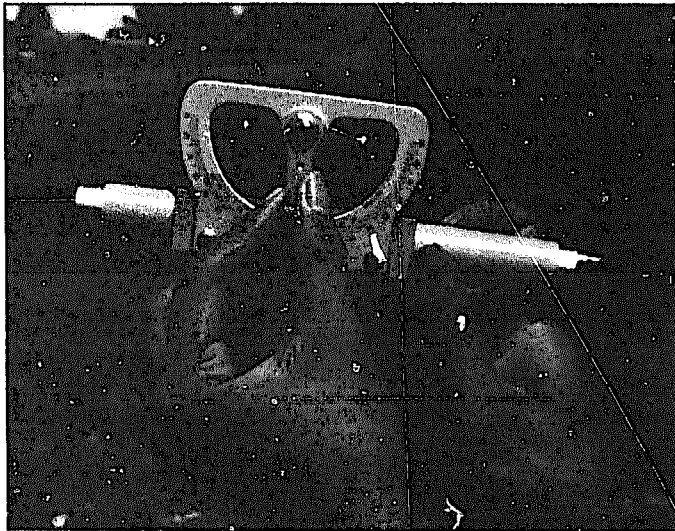

Fig. 2.22. A clinometer or Abney level used to measure angles of elevation.

Using water pressure to determine head is not generally used, primarily because it has not been considered by most and because it requires a pressure gage, which is usually not found around the home. This method requires at least a 10 m length of preferably clear plastic tubing and a pressure gage. The error associated with this method depends on the accuracy of the gage used. A single person can use this method, although two would save time.

Using an altimeter is probably the most expensive, although one of the easiest, methods of measuring head.

However, the user must be aware of how to handle this device properly and of what factors, beyond change in elevation, can affect the readings (temperature, changes in atmospheric conditions, and, to a lesser extent, relative humidity). Accuracy obtainable depends on whether a pocket or surveying altimeter (Fig. 2.23) is used. When care is used with a surveying altimeter, maximum errors can be as small as 1.0 m.

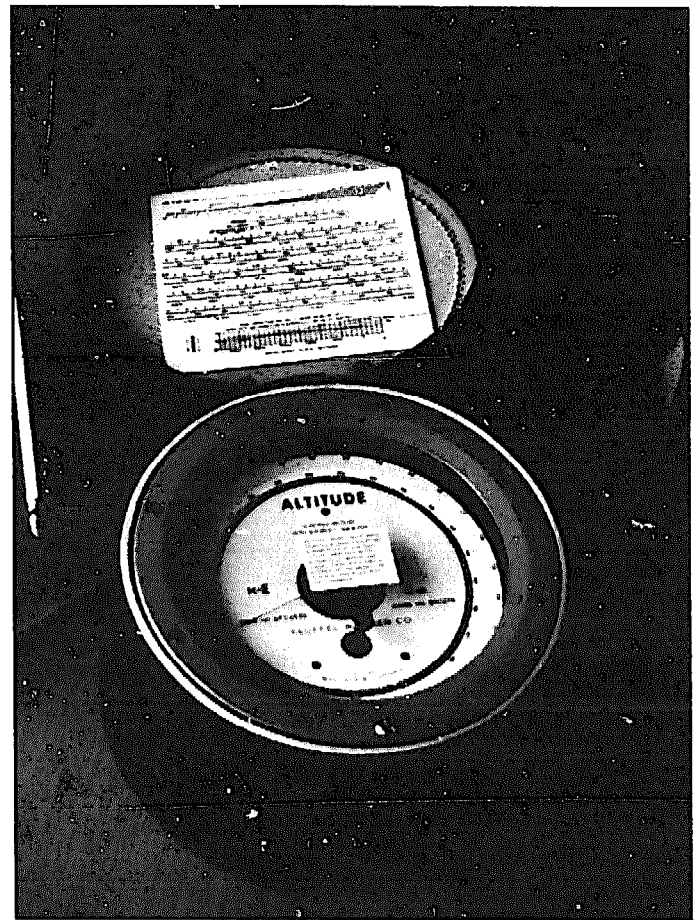

Fig. 2.23. A surveying altimeter.

Using a level

Although there are several variations for using a level to measure head, all are based on the same principle. The approach described below is probably the most straightforward and quickest, involves the fewest manipulations of numbers, and requires only a carpenter's level.

Basically, one begins at a point at the bottom of the hill, at point X in Fig. 2.24 which represents the proposed powerhouse location. A carpenter's level is set on a stake of known length which rests on this point. A horizontal line is sighted along the upper edge of a level to a point X_1 on the ground. Therefore, the difference in elevation or head from X to X_1 is "h", equal to the length of the stake plus the width of the level. The stake and level are then placed at X_1 to sight to the next point, X_2 . This procedure is continued until point Y, the level of the water at the location for the pro-

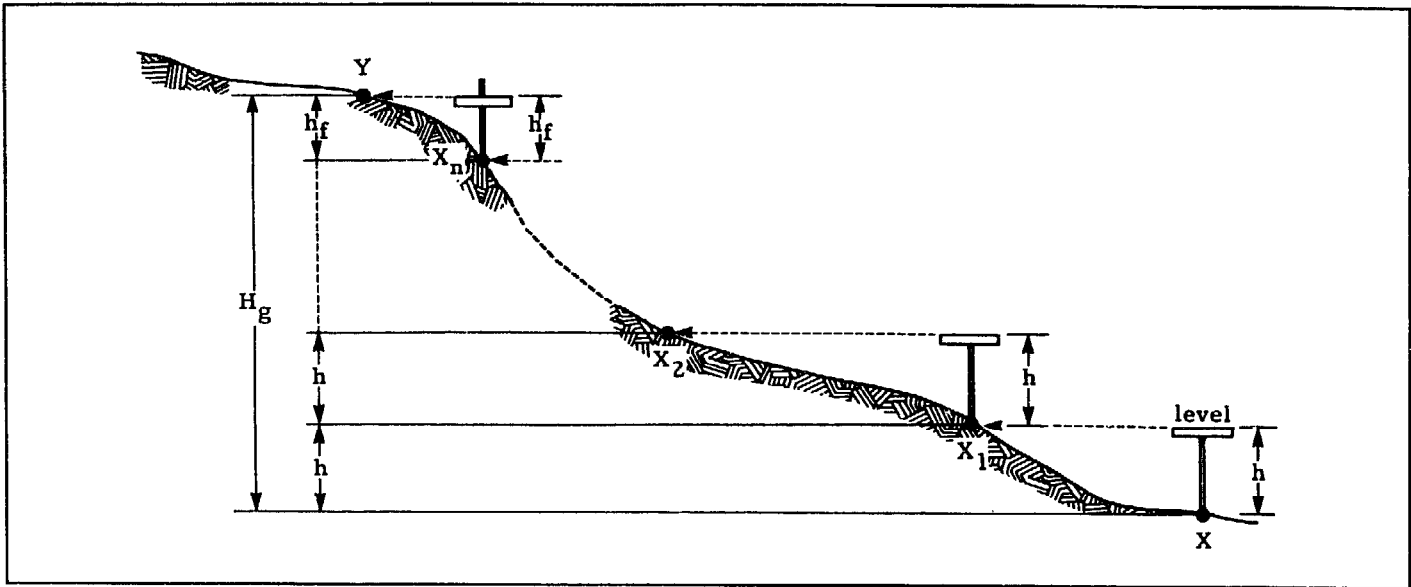

Fig. 2.24. Using a carpenter's level for determining gross head " H_g " between two points, X and Y.

posed intake to the penstock. The final reading " h_f " might be less than the full distance "h". The total head is then

$$H_g = nh + h_f \quad (2.15)$$

where n is the number of intermediary points between X and Y. In preparing the stake, the distance "h" selected should enable convenient sighting along the level from a standing position slightly below the stake.

This method requires that head be measured from the point of lowest elevation and that measurement progress upward along the slope. Surveyors with transits can progress downhill but then a longer stadia or leveling rod would be required. If going from the powerhouse to intake locations requires going downhill for a portion of the distance (Fig. 2.25), the method described requires that segments be measured separately from the lowest to highest points. The corresponding changes in elevation are then added or subtracted as appropriate to derive the gross head " H_g ".

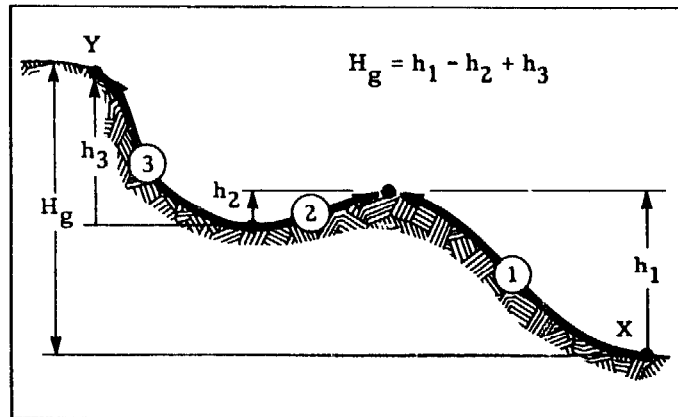

Fig. 2.25. Determining the gross head over undulating terrain.

It should be noted that, using this method, two tasks have to be performed simultaneously—viewing along the level to some point X_i while at the same time viewing the bubble to ensure that the carpenter's level is exactly horizontal. Clearly this can be performed by two persons. If only one person is available, he can perform both tasks using a small mirror oriented at 45° to the axis of the level; this permits the bubble to be viewed from the same position from which the sighting to the next point X_i is made. If a tripod is available to which the level can be secured, the level can be mounted horizontally first and then the sightings can be made.

The error in measurement of gross head using this method depends on the average gradient of the slope. The error is positioning the level horizontally may average itself out over the entire distance. The error in sighting along the level might not, depending on the user. With a little care, on a fairly steep slope of 1:2 (vertical to horizontal) or about 30° , error should be less than 2%–4%. For a fairly level grade of 1:10, error increases considerably, to possibly 10%–20%.

Note that for the determination of head, horizontal distances are of no concern. In addition, the distance along the ground from X to Y is of importance only later, when the length and diameter of the penstock pipe to be used need to be specified.

Using a clinometer

This method requires a clinometer or Abney level to measure vertical angles. The view through the eyepiece of this device is split so that while the instrument can be aimed at the next station up (or down) the hill, an attached graduated arc can be oriented horizontally by means of a spirit level which is also visible through the eyepiece. The angle of elevation " θ " in the direction being sighted can then be determined. Though clinom-

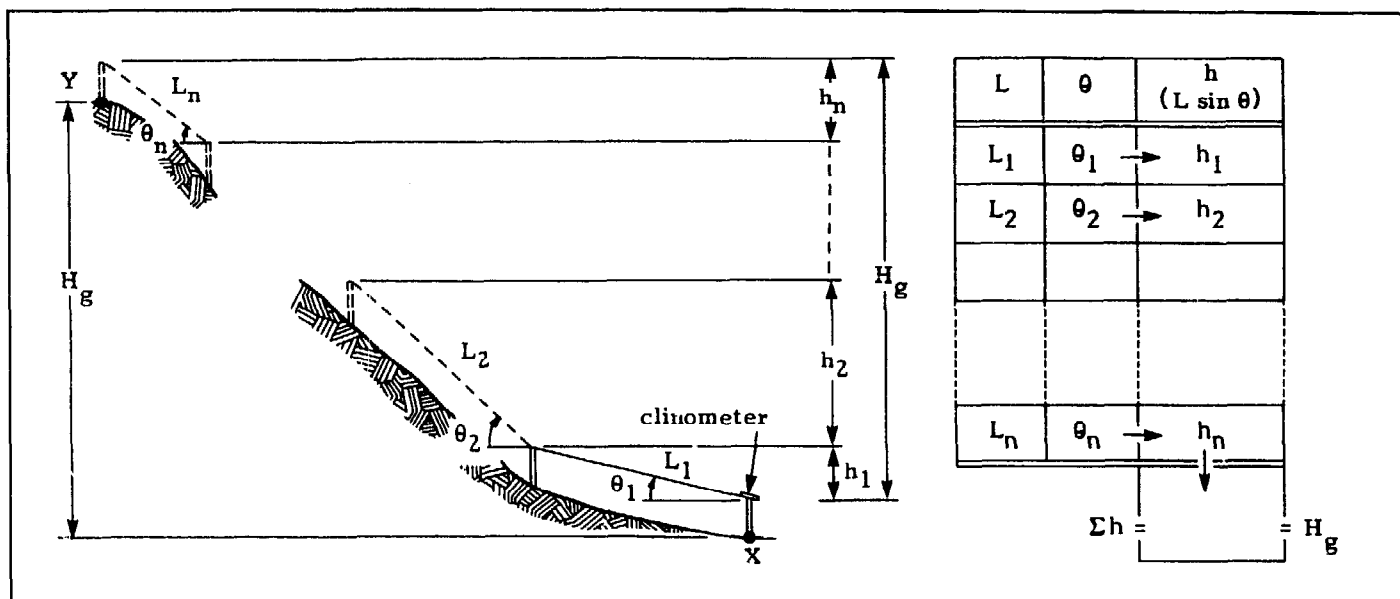

Fig. 2.26. Using a clinometer to determine gross head between two points, X and Y.

eters are available with or without magnification, sighting is often easier through one without.

In using a clinometer, a measuring tape is stretched between two stakes of equal length to determine the distance "L" between the two stakes (Fig. 2.26). A clinometer resting on one stake is used to measure the angle of elevation (or depression) " θ " to the top of the next stake. A trigonometric function, sine, is then used to convert these two readings to the difference in elevation of the two points "h". The gross head at the site is then determined by completing a table such as that shown in Fig. 2.26.

Using a pressure gage

This method for measuring head relies on the fact that for every meter vertically below the free surface of water, water pressure increases by 9.84 kPa (1.43 psi), independent of the shape of whatever is confining the water. Consequently, the distance in elevation "h" (m) between the free water surface and the pressure gage can be expressed as

$$h = \frac{p}{9.8} \quad (2.16)$$

where "p" is the pressure reading (kPa). On the other hand, a pressure gage directly calibrated in meters could be used.

A device to measure head in this fashion requires a long length of flexible tubing, one end of which is connected to an appropriately sized and correctly calibrated pressure gage. The tubing is then filled with water. The tubing must be large enough to allow all air bubbles to be expelled easily, because they could introduce errors. To help verify that no air remains in the tubing, the tubing should be made of clear plastic.

To apply this method, the distance between the proposed penstock inlet and powerhouse is measured in increments approximately equal to the length of the tubing (Fig. 2.27). The pressure reading is noted for each increment. The sum of all these readings, converted to meters, will equal the gross head.

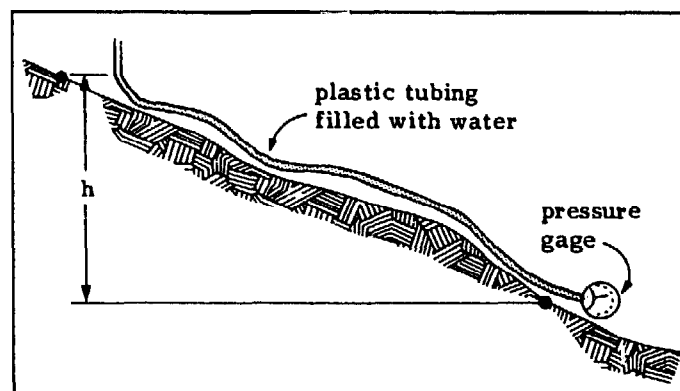

Fig. 2.27 A pressure gage can be used to measure the head between two points.

Although this method has been used in the field, it is not always practical. If the area to be measured is wooded or covered with brush, maneuvering a long length of tubing is difficult. In addition, gages with different full-scale readings are required to measure slopes with small and large gradients. It is also more difficult to verify the calibration of pressure gages.

Using an altimeter

For an increase in elevation of 100 m, atmospheric pressure decreases by approximately 9 mm of mercury. Therefore, if one were to measure the pressure at each of two locations with a barometer, the difference in pressure could then be used to derive the difference in

elevation between those two points. An altimeter used to measure changes in elevation is essentially a barometer calibrated in meters.

Although an altimeter carries a scale indicating elevation, this scale, unfortunately, is not absolute. If periodic elevation readings are taken during the day from an altimeter whose position remained unchanged, the readings will change because of changing weather, temperature, and humidity.

Ambient temperature is a major factor affecting altimeter readings. If the temperature increases at the location of the altimeter, atmospheric pressure also increases. Because of this increase in pressure, the altimeter indicates an elevation less than the actual value. Altimeter manufacturers provide simple tables or graphs for determining temperature corrections which must be applied to altimeter readings. A rule of thumb is that a 10°C increase in temperature results in a 4% apparent decrease in elevation. Therefore, in this case, the actual elevation is obtained by increasing the elevation obtained from the altimeter by 4% (102).

In certain parts of the tropics, the variations in pressure and, therefore, in altimeter readings during the day are very regular and remain nearly the same day after day over fairly long periods. A typical daily variation is shown in Fig. 2.28. In this case, altimeter readings change as much as 7 m/hr, and this may introduce a major error in head measurements if not accounted for.

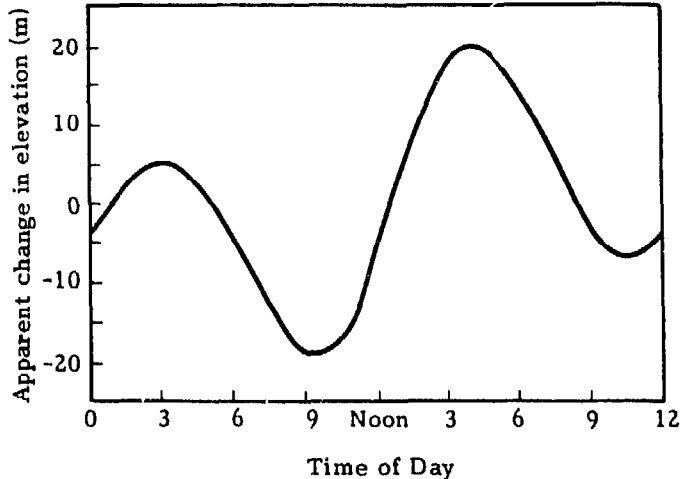

Fig. 2.28. The daily variation in pressure recorded at a meteorological office in Kakete, Kenya (30).

Another factor affecting altimeter readings is the change in pressure accompanying a change in weather. These changes can be gradual or sudden. Tropical storms and depressions can cause variations of 15 m or more within half an hour. These storms can also be very local, with considerable variation in pressure over several kilometers (30).

When high humidity accompanies high temperature, relative humidity also affects altimeter readings. The

altimeter manufacturer specifies corrections for this as well.

If only a single altimeter is used, the difference in elevation between two points can be determined by reading the altimeter and thermometer first at one point and then the other. The true difference in elevation is obtained by applying a temperature correction to each elevation reading and then subtracting the two corrected altimeter readings. If the temperature remains the same, the temperature correction can be applied directly to the observed difference in elevation to obtain the actual difference. Because changing atmospheric conditions affect altimeter readings, it is possible to determine whether a significant change in these conditions has occurred during the measurement period by taking a reading back at the first point and comparing that with the original reading.

Because changing atmospheric conditions do affect altimeter readings, delay between readings at different points should be minimal. Readings during windy or inclement weather should be avoided, because these are indications that atmospheric conditions vary rapidly and widely. The best results are obtained two to four hours after sunrise or before sunset.

If daily pressure variations are regular and therefore fairly predictable, this fact can be used to improve the accuracy of elevation measurements made using a single altimeter. These variations can be determined by a series of observations taken over the course of a day at some point in the center of the area to be studied and plotted against time. If the time when altimeter readings are made in the field is noted, these readings can be corrected by removing the effects of the regular daily changes in pressure (or elevation) during the day.

If two altimeters are available, keeping one in a fixed location or "base" permits changes in pressure caused by changing atmospheric conditions to be recorded independently from those caused by changes in elevation. Altimeter and thermometer readings are made at 5-10 minute intervals at the base. A "roving" altimeter, previously compared with the base instrument, is taken to other points to determine the difference in elevation between these locations and the base station. When the roving altimeter is read, time, temperature, and altimeter readings are recorded simultaneously. Elevation readings from the roving altimeter are then corrected for changes in temperature and atmospheric conditions.

If a single altimeter is used without correction, errors can amount to 3-30 m or more. With corrections made for regular daily pressure variations, this error can be reduced considerably. If two altimeters are used, errors can be reduced to about ± 1 m per measurement.

Instrument temperature can also affect the altitude reading, but altimeters are often compensated for this effect and corrections need not be applied unless the temperature changes by more than about 10°C .

III. STREAMFLOW CHARACTERISTICS AND DESIGN FLOW

INTRODUCTION

In planning a micro-hydropower scheme, the total flow required to generate the desired power with the head available at a specific site can be derived easily using the power equation [Eq. (4.2)]. One or more turbines then convert the power available in this flow into mechanical power. In preparing turbine specifications, it is necessary to know the flow each turbine will accommodate during normal operation. This figure is known as the "design flow" for that turbine.

If the flow required for power generation is always less than the annual minimum flow in the stream to be tapped, determining the design flow for the turbine(s) is straightforward. This is briefly covered in **SCHEMES USING LESS THAN ANNUAL MINIMUM STREAMFLOW** (p. 27).

However, power generation at some sites may sometimes require flows greater than the minimum flows found in the stream. In these cases, it is necessary to know actual streamflows over the year, especially during periods of low flows. The larger part of this chapter, **SCHEMES USING GREATER THAN ANNUAL MINIMUM STREAMFLOW** (p. 28), addresses this issue. This section begins by describing procedures for gathering streamflow data at a gaged site and processing it into a hydrograph and flow-duration curve. This discussion is included to familiarize the reader with some of the basic concepts involved.

Unfortunately, regular gagings have been carried out at very few potential micro-hydropower sites, and even in these cases, data is sparse. Furthermore, there may not be sufficient time and manpower to gather the additional data before implementing a micro-hydropower scheme. Therefore this section also explains several approaches for estimating the mean annual flow, minimum flow, and flow-duration curve for an ungaged site. These assume that streamflows originate from rainfall and not from melting snows. Depending on the quality of the data available, these estimates may be very rough, but they still provide a basis for decision-making.

This section continues by describing how the power and annual energy potential for a run-of-river scheme can be determined from a flow-duration curve. It concludes by presenting several simple turbine configurations intended to reduce equipment cost and sophistication and by reviewing the implications of these approaches

on the power and energy potential of a run-of-river plant.

SCHEMES USING LESS THAN ANNUAL MINIMUM STREAMFLOW

The simplest micro-hydropower scheme is a run-of-river installation requiring a flow that is always available from the stream. In this case, a dam would be included only to increase available head, if necessary; it would not be needed to create a reservoir for storing water. If a single turbine were used, its design flow would simply equal the required flow. Because a precise knowledge of the streamflow variation is unnecessary, there is no need to collect data over an extended period. However, an estimate of flood flows might be useful in order (a) to design an adequate dam, weir, or intake structure that can withstand these flows and (b) to place the powerhouse floor sufficiently above flood stage.

On occasion, the possibility of using two turbines rather than one might be considered, for example, when a plant serves a remote hospital and some power must be assured all the times. Using two turbines increases the probability that some power will always be available, because if one turbine breaks down, the other will still be available to run essential services.

When two turbines are used for this purpose, the design flow for the first turbine would be selected to enable it to generate at least the minimum power necessary to meet the end users' critical needs. The design flow for the second would then be selected so that the sum of the two design flows equals the full design flow—the amount required to generate the maximum power desired. With two small turbines, using turbines of equal capacity has several advantages: cost can probably be reduced, one set of spare parts can be used to service either unit, or if parts are temporarily lacking, one unit can be cannibalized to service the other.

Although using more than one turbine has advantages, doing so would generally be more expensive—two 40 kW turbines, for example, would usually cost more than a single 80 kW turbine. In addition, if each turbine drives its own generator, appropriate governing devices must be incorporated to ensure that the two units can be, and remain, synchronized; otherwise, two separate power distribution networks must be used.

SCHEMES USING GREATER THAN ANNUAL MINIMUM STREAMFLOW

If the peak power output of a powerplant requires a flow greater than the minimum streamflow, more detailed streamflow information may be needed to specify design flows. This information is usually reduced to graphical forms known as hydrographs and flow-duration curves, which can then be used:

- to ascertain the percentage of the year a particular level of power cannot be generated because of insufficient flow and during which months this occurs;
- to determine the required storage capacity of a reservoir, if one is needed to meet expected power and energy demands;
- to select the turbine configuration that will generate power of minimum cost; and
- to predict the average annual energy that can be generated.

Generally, the larger and costlier the scheme, the more critical is a full knowledge of the flow patterns of the stream to be used.

Gaged sites

Data collection

A gaged site here refers to one where streamflow data have been gathered regularly over a period of time. The frequency of these gagings represents a trade-off between the accuracy of the conclusions drawn from this data and the cost and effort involved in gathering it. Decreasing this frequency saves time but also tends to decrease the accuracy with which recorded flows represent actual flows. For example, peaks in streamflow caused by heavy downpours are relatively brief and likely to be overlooked; therefore, large flows tend to be underestimated, and this can have a disastrous impact on civil structures which have not been properly sited or designed. On the other hand, low flows vary much less in magnitude and are of longer duration than peak flows; therefore, they are more likely to be recorded. However, if there is too much time between gagings, low flows may also pass unnoticed, and there may be unexpectedly insufficient streamflow during the dry season to generate the power which is expected by, and possibly essential to, the end user.

Although measurements taken at six-hour intervals give a more precise picture of the actual flow than daily or weekly gagings, there is a point beyond which the increased accuracy of the data does not warrant the increased effort required to gather and process it. To determine a gaging frequency which yields adequate data with the minimum effort, it is necessary to have a general knowledge of the flow characteristics of the area's streams. If streamflow variations are gradual, weekly gagings may be adequate. However, for small catchment areas, which are common to micro-hydro-power schemes, flow variations are often more pronounced. Because of the time it takes for flows from various points within a large catchment to reach the

gaging site and because of the variation of rainfall over the catchment, flow variations tend to average out over larger catchments (Fig. 3.1). Streams with small drainage areas may therefore require more frequent gagings.

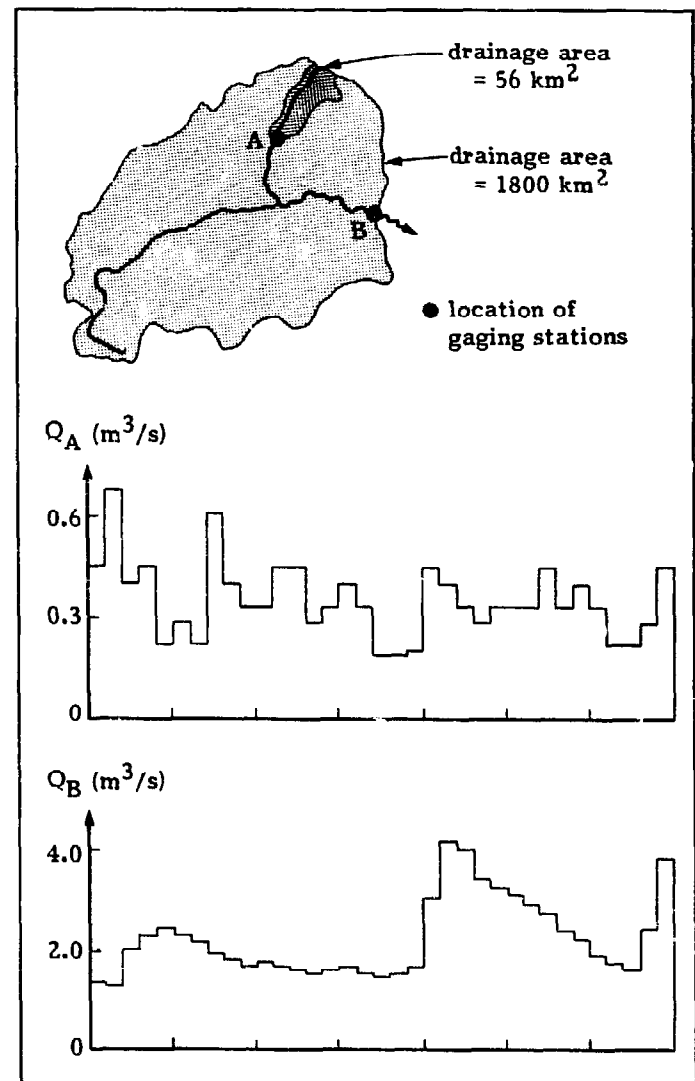

Fig. 3.1. Comparison of daily flow variations of streams with small and large catchments in the same geographical region during the dry season. The gaging stations are about 20 km apart (15).

The regularity of gaging is as important as its frequency. This may be daily, every other day, or every Monday, for example, but not at times which bias particular flows, such as only when the weather is nice, the sun is shining, and readings can be taken in comfort.

Rainfall, and thus streamflow patterns, occur on a yearly cycle. Therefore, it is also necessary that data gathered cover yearly increments of time—one, two, or five years, for example—and not two months or half a year.

If data can be gathered only for one year, it would be advisable to have a longer-term record of rainfall over or near the catchment area to help ascertain whether that year was significantly wetter or drier than the

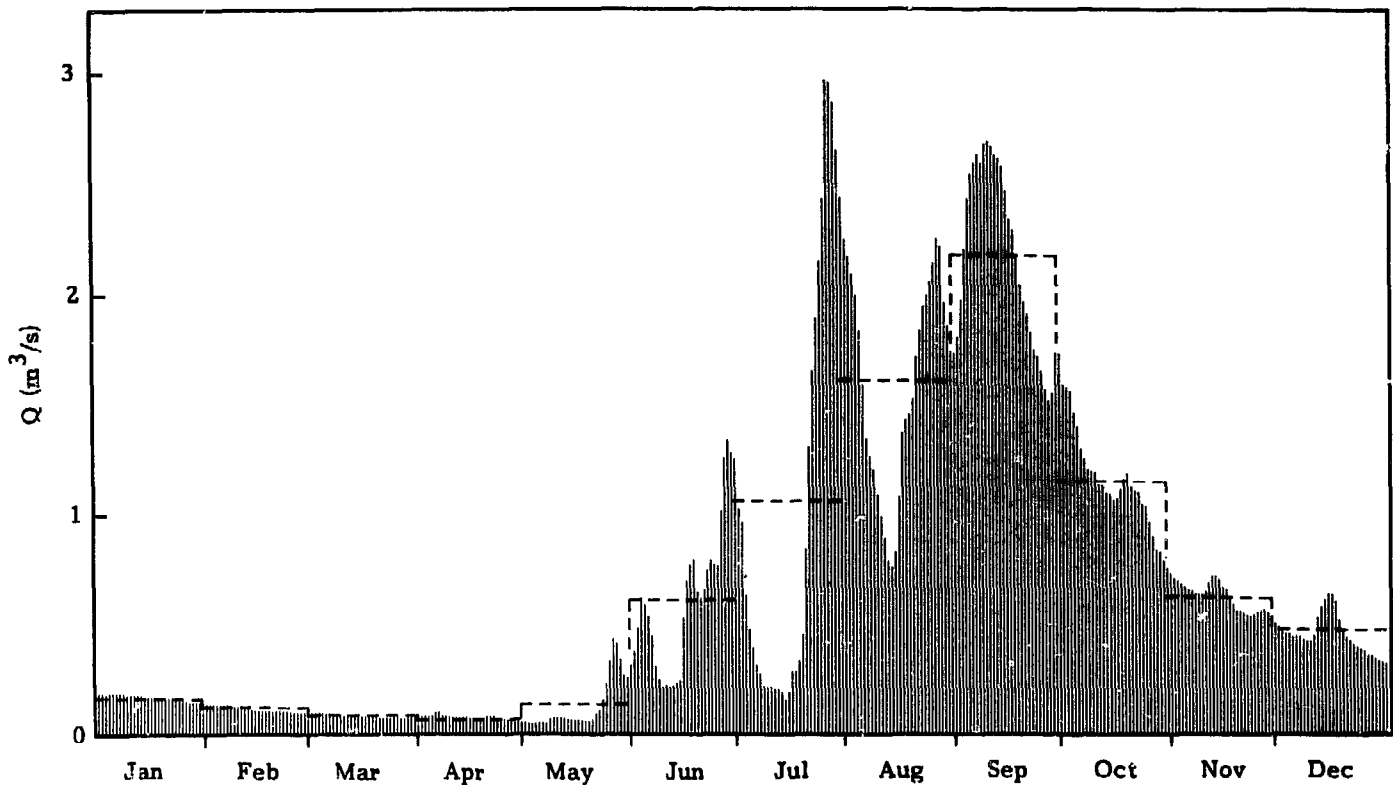

Fig. 3.2. A typical flow hydrograph. The dashed lines indicate average monthly flows.

average. The flow data should be interpreted accordingly. To ensure that a suitable turbine is selected for a particular site, its design flow should not be based solely on streamflow data from an usually wet or dry year.

Finally, in any gaging program, the gagings should be carefully performed. This requires that the gage be well calibrated, that the calibration be cross-checked periodically, and that the readings be taken and recorded properly by a reliable person. Incorrect data are misleading and are better left unrecorded.

Data processing

A streamgaging program will yield a table of carefully measured streamflow values for a particular site taken on a regular basis over an integral number of years. The next step is to organize these data in some usable form. One way is to prepare a hydrograph, a plot of flow versus time. Figure 3.2 shows a typical flow hydrograph covering one year of data.

Superimposing the flow requirements for power generation (a demand hydrograph) on the flow hydrograph gives a visual display of periods of excess flows and those when insufficient flow is available to meet the anticipated power demands (Fig. 3.3). If it is already known that excess flow is always available, an extensive gaging program, hydrographs, and flow-duration curves are unnecessary. However, in the example shown in Fig. 3.3, additional water for power generation would be

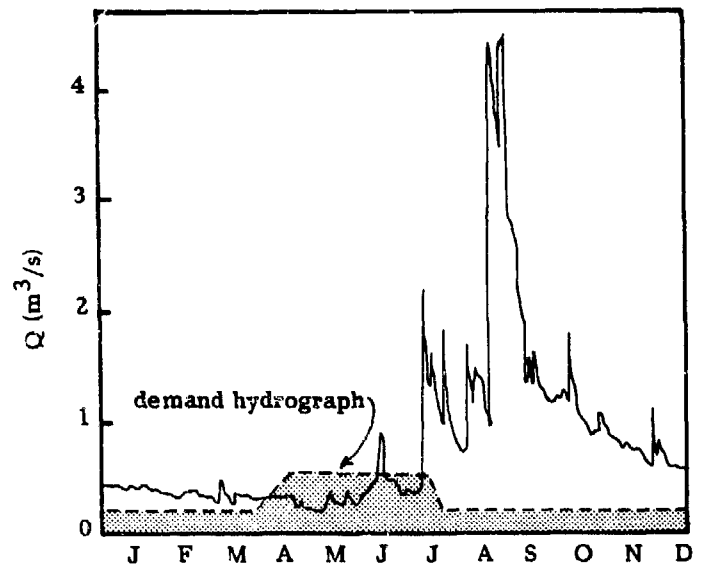

Fig. 3.3. Demand hydrograph imposed on a flow hydrograph.

required in the latter half of the dry season, possibly to process grain. If this flow hydrograph is representative of available streamflows, then for about three months of the year, flows would be insufficient to generate the required power.

There are several means of addressing this problem:

- The first is to provide for the storage of water so that excess water available during one part of the year or day can be stored for periods of insufficient flow the remainder of the year or day, respectively (see Dam or weir, p. 64). This involves constructing a dam, a task which becomes increasingly involved as the required storage volume increases. It is an approach usually not adopted in the design of micro-hydropower schemes.
- A second approach is to analyze the load to determine whether the power can be used more efficiently, for example, by staggering loads over the entire day to reduce peak loads. This would effectively lower the demand hydrograph.
- A third approach is to locate another site along the same stream where more head would be available and therefore less water would be required to generate the same amount of power. This approach would also lower the demand hydrograph. Regardless of available flow, however, a site with a higher head is generally preferable because it would mean reduced dimensions and cost for the turbine.

If none of these alternatives can provide adequate power when it is required, using diesel or other energy source as a supplement or alternative should be considered.

While a hydrograph is being prepared, the mean annual flow at the site can be determined by adding the streamflow readings taken at regular intervals and dividing by the total number of readings. Although this number is not used directly in equipment selection or energy production calculations, it does give an idea of

the magnitude of the flows found in that stream. The mean annual flow and the flow-duration curve (see below) for a gaged site can also be used in conjunction with the estimated mean annual flow at an ungaged site to estimate the flow-duration curve at that ungaged site (see Ungaged sites, p. 32).

Another way of organizing data is to prepare a flow-duration curve. This curve is useful for sizing a turbine and predicting a site's annual energy potential. It is obtained from a hydrograph by organizing each flow measurement by size, from the largest measurement to the smallest, rather than in chronological order. If, for the sake of simplicity, a stream with constant monthly flows as shown in Fig. 3.4a is assumed, the corresponding flow-duration curve would be as shown in Fig. 3.4b. Note that the flows which are organized by calendar month on a hydrograph are reorganized and sequenced on the flow-duration curve by the relative magnitude of each month's flow. Also note that the scale on the abscissa (horizontal axis) of the flow-duration curve is the number of months that the corresponding flow is equalled or exceeded during that year. For example, a flow of $0.35 \text{ m}^3/\text{s}$ is equalled or exceeded for four months of the year (which the hydrograph shows to be May, June, July, and October).

In reality, streamflows vary continually, and the associated hydrograph would be more like that shown in Fig. 3.5a. This hydrograph might be considered as essentially a bar graph as in Fig. 3.4a, but with bars a "day" wide rather than a "month" wide. To prepare a flow-duration curve, these day-wide bars would be sequenced not by date but by relative magnitude, as in Fig. 3.4b. These day-wide bars are so narrow, however, that the result would essentially be a smooth curve

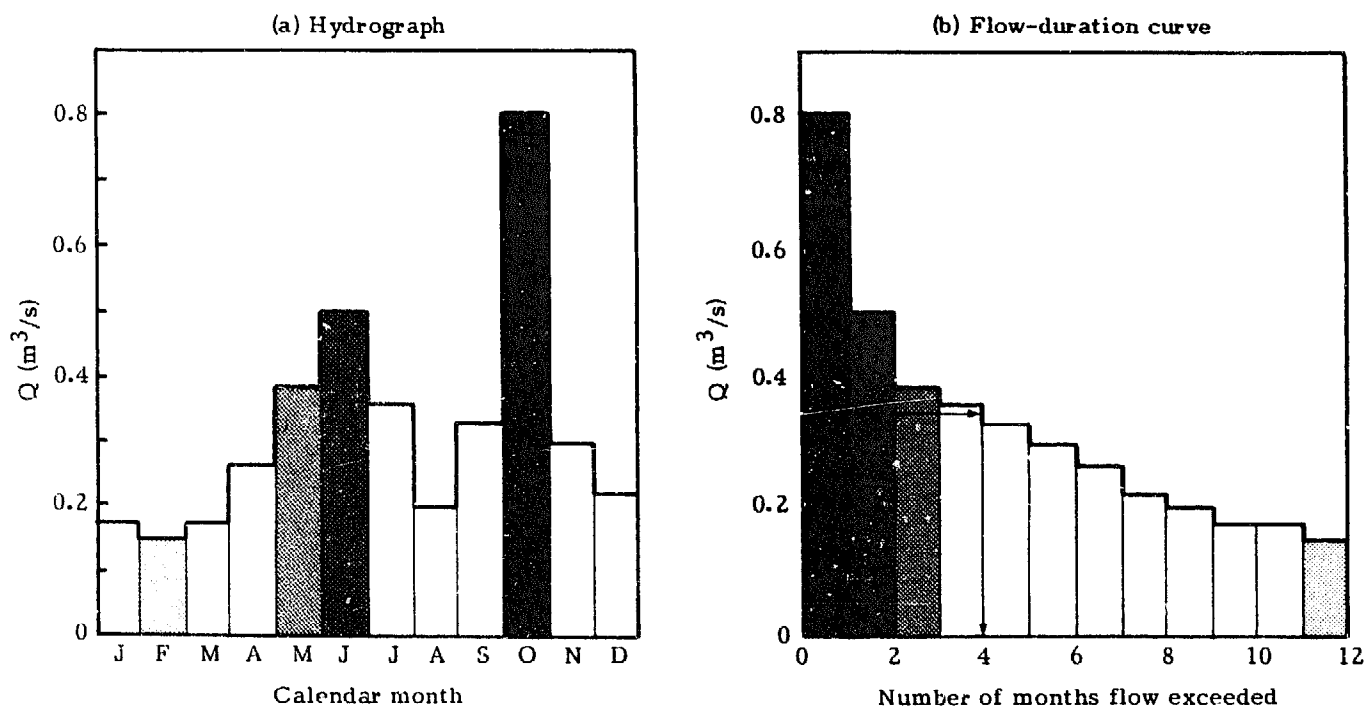

Fig. 3.4. The relationship of an average monthly flow hydrograph with the corresponding flow-duration curve.

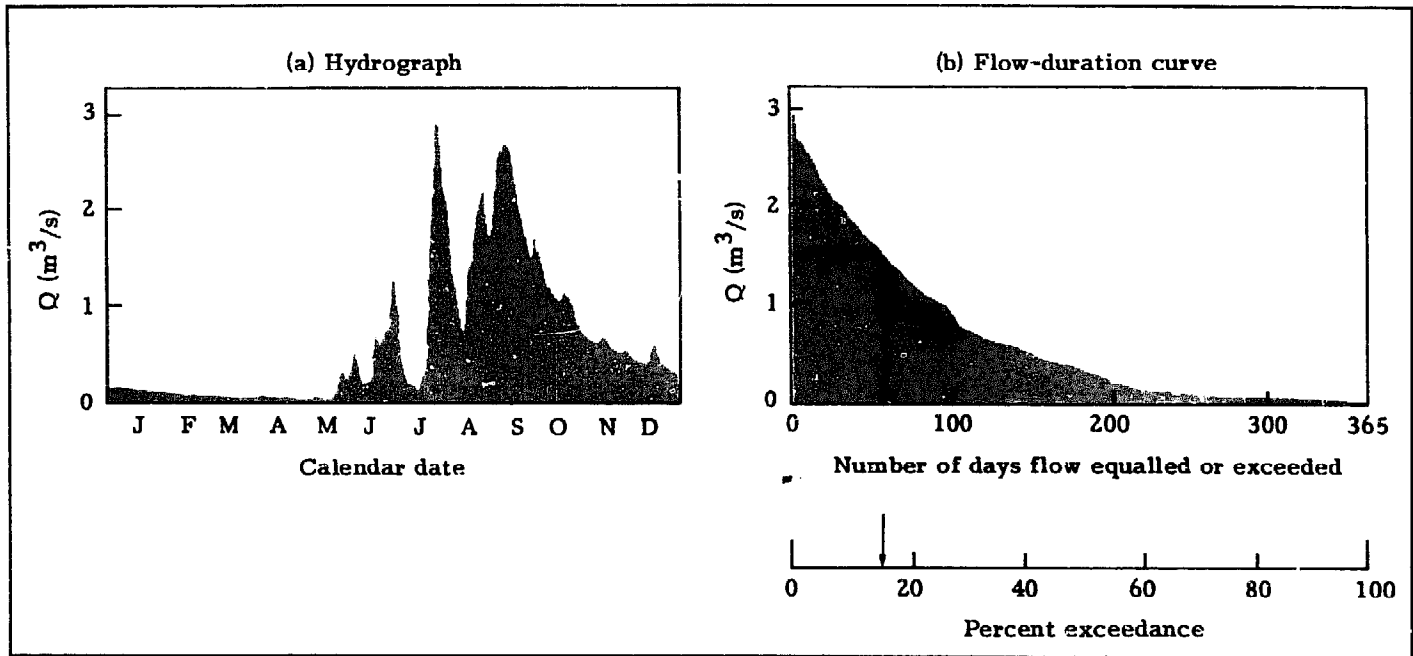

Fig. 3.5. A typical flow hydrograph and the associated flow-duration curve.

(Fig. 3.5b). Also, rather than calibrating the abscissa as the number of days per year that a flow is equalled or exceeded, a more common and useful scale is calibrated in terms of the percentage of the year that a flow is equalled or exceeded during the year, often shortened to "percent of time" or "percent exceedance." For example, from Fig. 3.5b, the percent exceedance for a flow of $1.5 \text{ m}^3/\text{s}$ is 16% (or, equivalently, $(0.16)(365) = 58$ days each year).

Presenting flow data in the form shown in Fig. 3.5b offers several advantages over presenting them as a hydrograph. It permits incorporating any number of years of data on one curve, with the additional years providing more information about the flows. Incorporating several of years of data on a hydrograph spanning one year would average the flows. Information on low and high flows would be lost, and this information is critical in the design of hydropower schemes: information on high flows is necessary to ensure designs that can accommodate flood flows, and information on low flows is necessary to design storage capacity and/or select appropriate turbines.

A flow-duration curve also provides information in a better digested and more directly useful form. Calculating a plant's energy output or the percentage of time that a specific power output can be generated can be made directly from a flow-duration curve (see Determining power and energy potential from a flow-duration curve, p. 38). Using a flow hydrograph for this purpose would require much more effort, and the results would be valid only for the year for which the hydrograph was prepared.

Although a flow-duration curve indicates the percentage of the year the streamflow is below a particular level, it does not indicate when these lower flows occur. If this

information is required, a hydrograph can be prepared.

However, a developer of a micro-hydropower scheme who needs to know when there most likely will be inadequate water for power generation usually knows when the driest period is apt to occur and does not need a hydrograph. For the few schemes that incorporate a dam or forebay to store water, their storage capacity is usually designed to meet the energy demand on a day-to-day basis. To size the storage volume in these cases, it is more important to know the magnitude of the minimum flow than to know when it occurs; consequently, a flow-duration curve is adequate for most planning purposes.

The actual procedure for preparing a flow-duration curve from daily streamflow data uses a tabulation such as that shown in Fig. 3.6. The range of streamflows covered by the data is first subdivided into suitable class intervals, such as those in the left-most column in Fig. 3.6. The intervals should be selected to provide for well-distributed points along the flow-duration curve to be plotted. The number of intervals shown in the figure is more than adequate for preparing a flow-duration curve for most micro-hydropower sites. A tick is then entered in the appropriate block for each day's flow. Upon completion, the entries in each horizontal row are totalled at the right, and the percentage exceedance is computed and plotted to prepare a flow-duration curve from the data (Fig. 3.7). The same approach would be used to prepare a curve from data gathered on a weekly or other basis. An annual flow-duration curve is usually developed from several years of daily flow data, because it more accurately represents a stream's typical flow regime. Monthly flow-duration curves for specialized applications, such as estimating energy potential on a month-by-month basis, are sometimes prepared as well (107).

Stream discharge (m ³ /s)	Number of days that discharge is in increment beginning with value at left													Period during which discharged at left is equalled or exceeded	
	Oct	Nov	Dec	Jan	Feb	Mar	Apr	May	June	July	Aug	Sept	Total	Days	%
10.0						/							1	1	0.3
7.00						/							1	2	0.5
5.00					/								1	3	0.8
4.00					/	//	/						4	7	1.9
3.00			/										1	8	2.2
2.00	/		//			///	/						8	16	4.4
1.40	/		/	/	//	//	//					/	10	26	7.1
1.00	/		///	/	/	///	///				/	//	17	43	12
0.70	//	/	/	////	/	//	///				//	///	21	64	18
0.50	/	/	////	///	/	///	///	/				//	22	86	24
0.40		//	///	///	//	///	///	/			///	/	32	118	32
0.30	/	///	//	///	///	///	///	///				/	38	156	43
0.20	/	///	///	///	///	/	///	///	///	///	/	///	79	235	64
0.14	///	///	///					///	///	///	///	///	125	360	99
0.10	///												5	365	100
	31	30	31	31	28	31	30	31	30	31	31	30	365		

Fig. 3.6. Sample worksheet for calculating an annual flow duration curve for a single year.

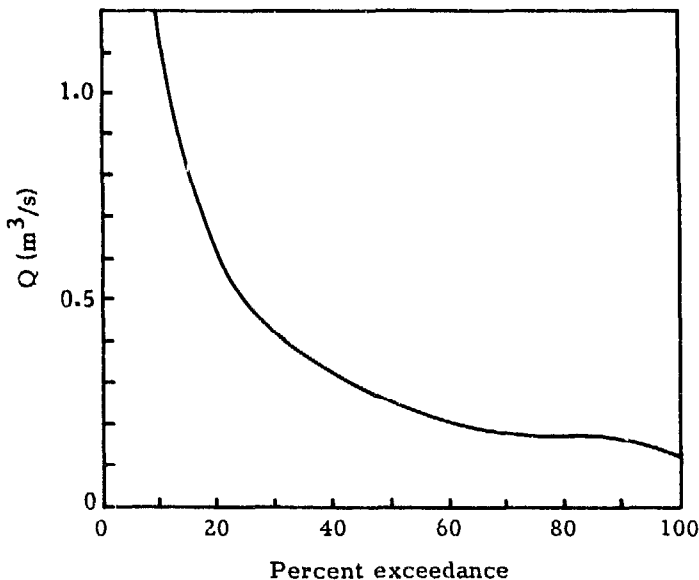

Fig. 3.7. A flow-duration curve representing the data in the sample worksheet (Figure 3.6).

Ungaged sites

Most potential micro-hydropower sites are ungaged, and any gagings necessary to prepare an annual hydrograph or flow-duration curve would require at least one year. For larger hydropower projects, where designs are optimized to maximize return on investment, at least five to ten years of gaging are required before a project is undertaken. If meteorological data suggest that the period of record is drier than usual, additional years of gaging may be required. Fortunately, for micro-hydropower plants which are not designed to maximize power potential, some knowledge of streamflow patterns may be useful, but exhaustive study and high accuracy are unnecessary.

In the first section below, **Estimating mean annual flow** (p. 33), three approaches to estimating the mean annual flow at a site—the numerical average of flows throughout a year—will be described. The estimates derived can give an indication whether the flow at the proposed site seems adequate for hydropower generation. Under some circumstances, this may be the only flow param-

ter that can be approximated with any accuracy; without a gaging station in the vicinity, no simple technique exists for accurately estimating the flow-duration curve for an ungaged stream.

For the larger part of the year, the flow in any stream will be less than the mean annual flow, because high flows—one component in calculating the average—are more above the average than low flows are below it. Although the mean annual flow gives an idea of a stream's power potential, the streamflow is usually less than this for 50%-70% of the year (60%-70% for areas with pronounced wet and dry seasons). Therefore, if design power is to be available for a significant portion of the year, the flow diverted for hydropower generation should be somewhat less than mean annual flow. How much less can be determined only with a firmer knowledge of the stream's flow regime, as obtained from a flow-duration curve.

If the flow required for power generation is on the order of the mean annual flow in the stream or greater, it is also necessary to estimate the magnitude of the minimum flow. As briefly described in the second section below, **Estimating minimum flow** (p. 37), this is one of the most difficult estimates to make. However, this information is needed to determine the maximum power that a run-of-river plant can generate during the peak of the dry season or the capacity of a storage reservoir if more power than this is periodically required.

The third section, **Estimating a flow-duration curve** (p. 38), describes a simple approach for approximating a flow-duration curve for an ungaged stream. This approach uses an estimate of the mean annual flow of that stream and a flow-duration curve developed for a gaged site in the vicinity. It also presents a method for deriving a flow-duration curve even if the stream is only partially gaged and no data on its drainage area, mean annual flow, or runoff are available.

The estimates of flow made by the simple approaches discussed in the following sections are approximate and valid only insofar as the assumptions hold for a particular situation. More involved methods, such as that described by Crawford and Thurin in Hydrologic Estimates for Small Hydroelectric Projects (37), use data on monthly rainfall on the watershed and monthly potential evapotranspiration, as well as watershed characteristics—soil-moisture storage level, fraction of runoff that flows along subsurface paths, and an index of the time for this flow to enter the stream. The calculations for these methods can be programmed on a hand calculator; however, these data often are not available, and if estimates have to be made, the results of a rather time-consuming effort may be no more accurate than results obtained by the much simpler approaches discussed in **Estimating a flow-duration curve** (p. 38). However, these approaches assume the availability of a flow-duration curve for a nearby gaged site. If none is available, the flow-duration curve for an ungaged site would have to be synthesized using a more involved method such as the one just described, and the data not readily available would have to be estimated as carefully as possible.

Estimating mean annual flow

Several approaches for estimating the mean annual flow at an ungaged site are described in the following paragraphs:

- The first approach assumes that there are no gaged sites in the vicinity and uses runoff information from maps for the region, country, or continent and the size of the drainage area associated with the ungaged site.
- The second approach assumes that a gaged site exists relatively near the ungaged site, either on the same stream or in a neighboring catchment, and that a map is available to determine the drainage area of each catchment.
- For cases where no information—runoff, drainage area, rainfall, etc.—is available at the ungaged site but a gaged site exists not too far away, a third approach requires a series of on-site visits to gather some flow data.

Although the first two approaches do not require site visits, such visits to investigate the characteristics of both the gaged and the proposed catchment are extremely useful in refining conclusions on the characteristics of streamflows in the ungaged basin. If more than one approach can be used to determine the mean annual flow at an ungaged site, each should be used. Comparing the results will give an indication of the consistency of the estimates.

Even though the approaches for estimating mean annual flow may not be precise, the values obtained can still help identify which streams to consider when prospecting for an appropriate site to develop. By knowing how much flow each square kilometer of catchment contributes to mean annual flow—the specific mean annual flow—it is possible to estimate the size of a catchment necessary for a given flow. For example, assume that each square kilometer of catchment contributes $0.050 \text{ m}^3/\text{s}$ to the mean annual flow and that typical heads in the area are about 20 m. To generate 40 kW, the power equation [Eq.(4.3)] indicates that a flow of about $0.4 \text{ m}^3/\text{s}$ would be required. Consequently, any stream to be tapped should have a drainage area of about $0.4/0.050$ or 8 km^2 to permit 40 kW to be generated from the mean annual flow. To generate this power year-round, an area several times larger would probably be necessary to ensure adequate flow during the dry season. Trying to implement such a scheme on a stream with a drainage area of 5 km^2 , for example, should not even be considered unless significantly more head can be found in the vicinity.

Using runoff data. This approach does not require that a gaged site be located in the vicinity of a site for which a micro-hydropower plant is being proposed. It goes back to basic principles and uses generalized information on streamflow which is available on a countrywide or continentwide basis.

Because the flow in a stream originates in rainfall, rainfall data provide a good indication of streamflow. For example, if an average of 1000 mm or 1.0 m of rain falls over a specific area each year, then over each square kilometer of that area, the total volume of water intercepted each year would be

$$(1.0 \text{ m/yr})(1.0 \text{ km}^2) = (1.0 \text{ m/yr})(10^6 \text{ m}^2) \\ = 10^6 \text{ m}^3/\text{yr}.$$

If all this rainwater ran off into a stream, this one square kilometer would contribute 10^6 m^3 to the streamflow each year. To convert this to a more meaningful figure, this square kilometer would contribute an average of

$$10^6 \frac{\text{m}^3}{\text{yr}} \left(\frac{1 \text{ yr}}{8760 \text{ h}} \right) \left(\frac{1 \text{ hr}}{3600 \text{ s}} \right) = 0.032 \text{ m}^3/\text{s}$$

or 32 ℓ/s to the streamflow over the year.

However, not all rainfall finds its way into a stream. Some returns directly to the atmosphere through evaporation; some might filter into the ground, where part of it may eventually flow elsewhere. The rainfall which actually does enter the stream as either surface or sub-surface flow is called runoff. Maps of mean annual runoff can facilitate the task of estimating how much rainfall contributes to the streamflow (Fig. 3.8). Like mean annual rainfall, mean annual runoff is measured in millimeters. If, for the previous example, a map of the area shows a mean annual runoff of 400 mm, only 40% of the 1000 mm annual rainfall ends up in streams and rivers. Therefore, the contribution of rainfall to streamflow actually averages about: $(0.4)(32 \ell/\text{s})$ or 13 ℓ/s over the year for each square kilometer of drainage area. Multiplying this value by the actual drainage area at the site, obtained from a contour map, gives that site's mean annual flow.

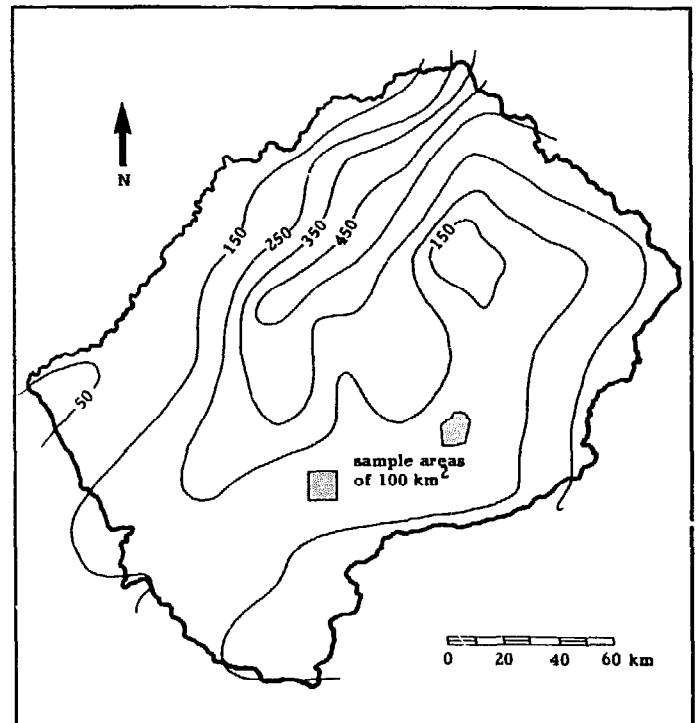

Fig. 3.8. A map of mean annual runoff (in mm) for the country of Lesotho.

The ratio of mean annual runoff to mean annual rainfall, 0.40 in the above example, is called the runoff coefficient. This coefficient ranges from 0.0 (implying that all rainfall on an area infiltrates the soil and/or evaporates into the atmosphere, leaving no contribution to streamflow) to a theoretical maximum of 1.0 (indicating that all rainfall finds its way into streams and rivers). Maps of runoff coefficients are also available but are of little use for determining streamflows without accompanying rainfall maps.

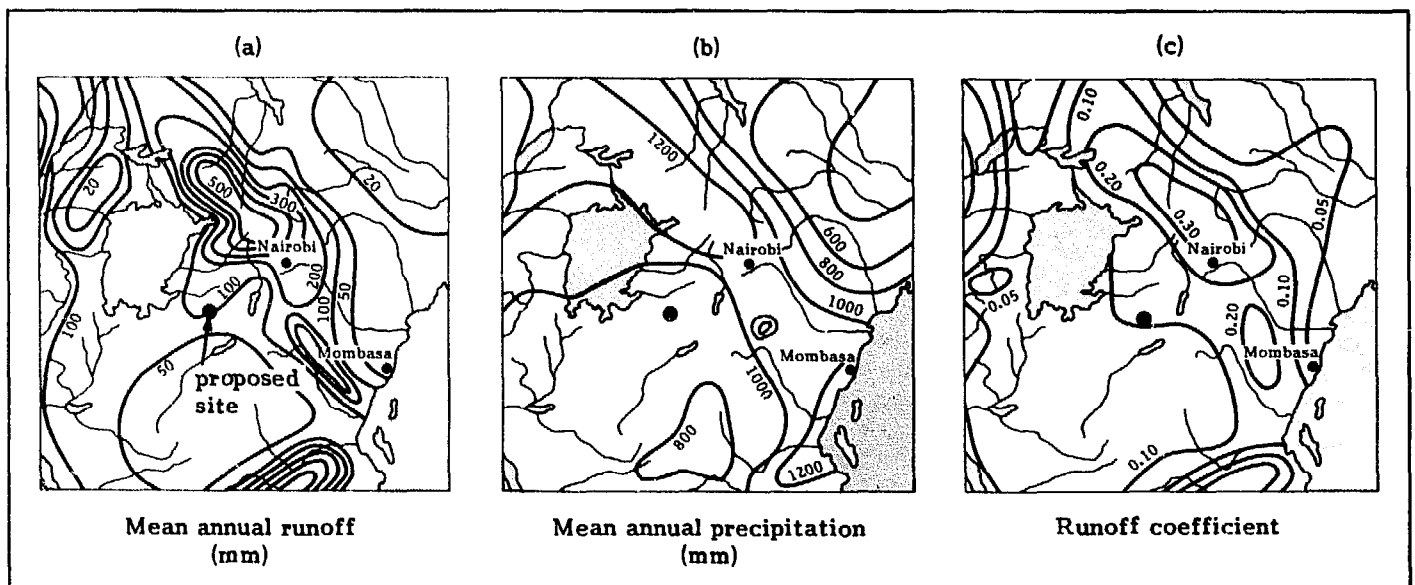

Fig. 3.9. A runoff map (a) permits estimating the mean annual flow if the drainage area is known. A knowledge of

mean annual rainfall (b) and runoff coefficient (c) can also be used to determine runoff.

As the preceding discussion shows, one method of estimating mean annual flow requires a contour map and a mean annual runoff map of the area. Instead of a mean annual runoff map, a map of mean annual rainfall together with a map of runoff coefficients can be used. In this case, the mean annual runoff for the area would be estimated by multiplying its mean annual rainfall by the appropriate runoff coefficient. For example, if a site is proposed in the location shown in Fig. 3.9a, then the mean annual runoff averaged over the basin would be about 100 mm/yr. If the drainage area has been measured from a contour map to be 42 km², then the mean annual flow at this site would be

$$(100 \text{ mm/yr}) \left(\frac{0.032 \text{ m}^3/\text{s}/\text{km}^2}{1000 \text{ mm/yr}} \right) (42 \text{ km}^2) = 0.13 \text{ m}^3/\text{s}$$

↑ ↑ ↑ ↑
 mean conversion drainage mean
 annual factor area annual
 runoff flow

If only information on rainfall (Fig. 3.9b) and runoff coefficient (Fig. 3.9c) is known, the mean annual runoff can still be determined as

$$(920 \text{ mm/yr}) (0.11) = 100 \text{ mm/yr.}$$

↑ ↑ ↑
 mean runoff mean
 annual coefficient annual
 rainfall runoff

This value would then be used to determine mean annual flow as just shown. The two values of mean annual runoff cannot be expected to agree precisely because errors are incurred in both plotting these maps and interpolating between lines.

Fig. 3.10 makes several points about the use of runoff maps or data from nearby catchment basins to calculate a site's mean annual flow. In this figure, lines of constant mean annual runoff in northwestern Thailand

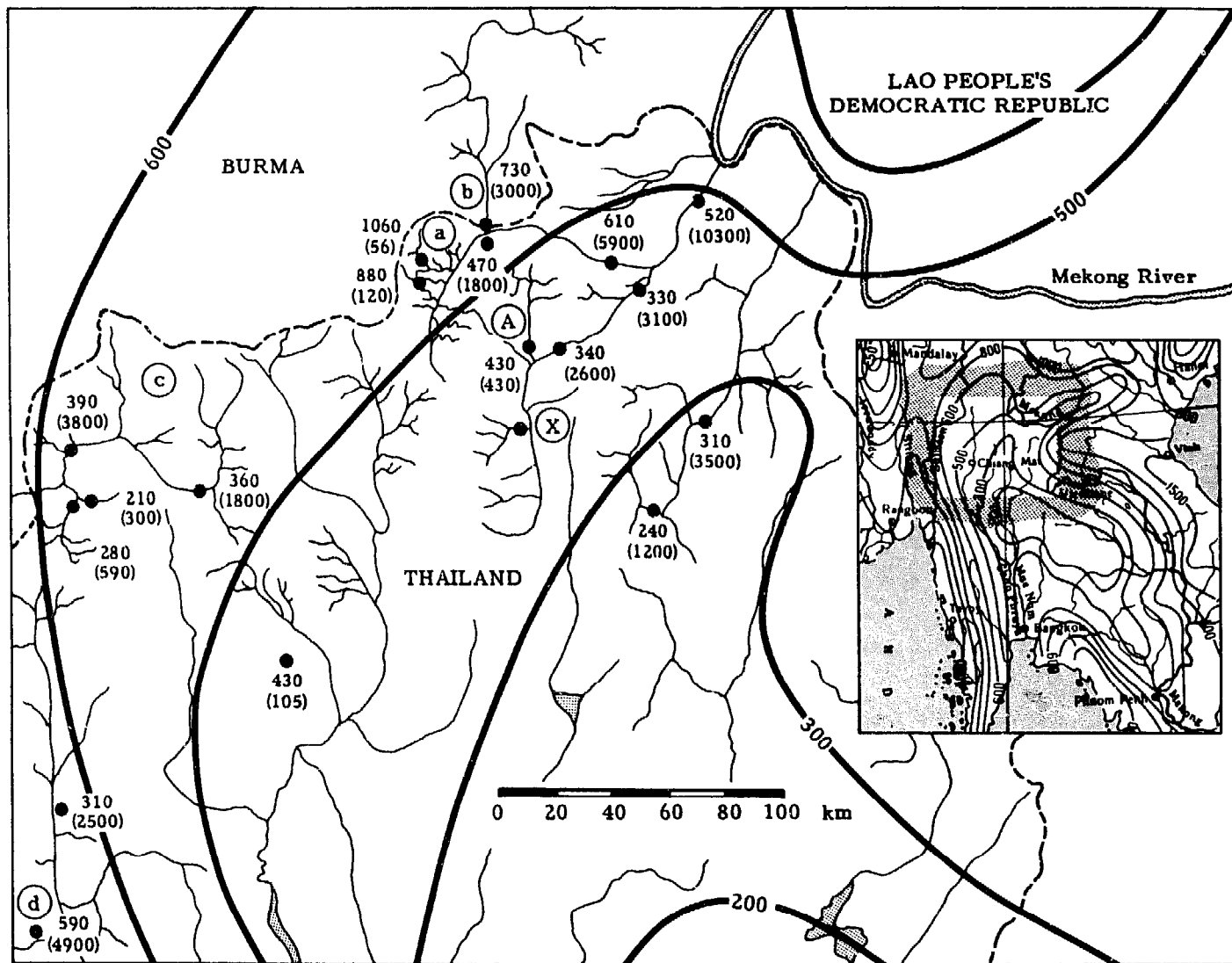

Fig. 3.10. A comparison of runoff curves (in mm) from the Atlas of World Water Balance (1) with values of runoff for the period of record derived from actual field data found

in 1980 Hydrology Data (15). The number in parentheses represents the drainage area (km²) associated with each gaging station.

found on a small-scale runoff map of Asia (1) (see insert in Fig. 3.10) were carefully transposed onto a larger scale map of the area. Also superimposed in Fig. 3.10 are values of mean annual runoff for the period of record calculated at gaging stations in the region—mean annual flow at each gaging station divided by the associated drainage area—to permit crosschecking values of runoff that can be estimated by using the runoff contours. Several conclusions can be drawn in this case:

- Mean annual runoff for small basins, such as basin (a) with a runoff of 1060 mm and an area of only 56 km², may vary significantly from that which might be estimated using either runoff contours or data from nearby sites with large catchments.
- The river runoff at a site along a river is determined by the areal average of runoff over its associated drainage area, not by the value of runoff at that site itself. The value of runoff which makes its way down to site (b), for example, is significantly larger than the runoff at that point—about 500 mm—because the large catchment stretches a considerable distance to the north into a region of larger runoff.
- In the region at the left (c), actual values of runoff are consistently about half of what the runoff map would predict. The runoff contours in this region appear to have been incorrectly drawn if the gaged values are assumed correct. When sites in that area are developed, the gaged values rather than those from the runoff map should probably be used as a guide. However, the actual runoffs in the area (d) and farther south agree fairly closely with the values from the map.

Fig. 3.10 illustrates the degree of agreement, or disagreement, between the values of runoff taken from a small-scale runoff map and the actual values derived from gagings. A value of mean annual flow derived using only contours from that map clearly is only an estimate. In scaling up a runoff map about 20-fold, as was done for Fig. 3.10, errors may be introduced. In addition, the scale of the map may not permit local variations to be taken into consideration. Furthermore, in preparing the runoff maps appearing in the *Atlas of World Water Balance* (1), various "indirect" methods were used to determine runoff for insufficiently gaged regions, and further errors may have been introduced at that level. National maps of runoff, such as that shown in Fig. 3.8, can provide more accurate results and, if not available, should be prepared, especially if a broader small-hydropower program is to be undertaken in a country.

As an example of how to predict the mean annual flow from the runoff data shown in Fig. 3.10, assume that the mean annual flow for the stream at an ungaged site X in that figure in northwestern Thailand has to be estimated. From a contour map, the catchment area associated with this site is measured to be 260 km². To determine runoff, either a mean annual runoff map or countrywide data can be used. If only a runoff map is

available, the runoff would be estimated at about 400 mm or 0.013 m³/s/km². Since its area was determined to be 260 km², the mean annual flow at site X would be 3.4 m³/s. On the other hand, assuming that a runoff map had been prepared for the region based on local data, the runoff from the proposed catchment would have been estimated as closer to 340 mm or 0.011 m³/s/km². This would correspond to a mean annual flow of 2.9 m³/s. The precision with which runoff data can be predicted at the ungaged site can be seen to significantly influence the accuracy of the final estimate.

Using ratio of areas. This approach assumes that, although a runoff map of the area is not available, a gaged site does exist in the vicinity. It further assumes that the catchment basin for a proposed micro-hydropower site displays characteristics—topography, land use, geomorphology, lithology, etc.—similar to those of a gaged site in the vicinity, on either the same stream or one in a neighboring catchment.

If, in addition to the above, the precipitation over the basins is similar, the runoff for both catchments would be of the same magnitude, and the mean annual flow would then be approximately proportional to drainage area. The mean annual flow at the proposed site can then be estimated by simply multiplying the mean annual flow at the gaged site by the ratio of the drainage area at the ungaged to that at the gaged site.

Returning to the previous example, assume that there is a gaged site A in the vicinity of site X. With the assumptions made, the mean annual flow at the proposed site will average $(260 \text{ km}^2)/(430 \text{ km}^2) = 0.60$ or 60% of the corresponding flow at the gaged site. Since a mean annual flow for the gaged site A of 5.7 m³/s can be calculated from records over the period 1974–82, the mean annual flow at the ungaged site can be predicted as

$$(0.60)(5.7) = 3.4 \text{ m}^3/\text{s}$$

If more than two gaged sites are located in the vicinity, the validity of the initial assumption—that mean annual flow is well correlated with drainage area—can be determined.

If the two catchment basins display similar characteristics as described above but rainfall differs, this factor can be taken into consideration. This can be accomplished by multiplying the mean annual flow estimated by the approach described above by the ratio of the mean annual precipitation over the ungaged basin to that over the gaged basin. An areal average of precipitation over each basin should be used if the necessary information is available.

Correlating flows. If the drainage area at the ungaged site is unknown and cannot be determined by using available maps, the previous approaches cannot be used. The approach described in this section requires a gaged site not too distant from the ungaged site. Although no knowledge of the size of the drainage area is required,

this approach requires a series of site visits to make occasional streamflow measurements. These visits need not be made on a regular basis, but they should be spread out over a year so that high, average, and low flows can be measured. If time is critical, a short-term correlation can be used; for example, the site could be gaged every few days for a month. Such short-term correlations are best made when flows are close to mean annual flow; extremely wet or dry periods should be avoided. Each day that a flow measurement is made, the flow at the gaged site should also be obtained. Each set of flow readings is plotted on log-log paper, with scales chosen to accommodate all the data (Fig. 3.11). A straight line which best fits these points is then drawn, by regression analysis or by eye.

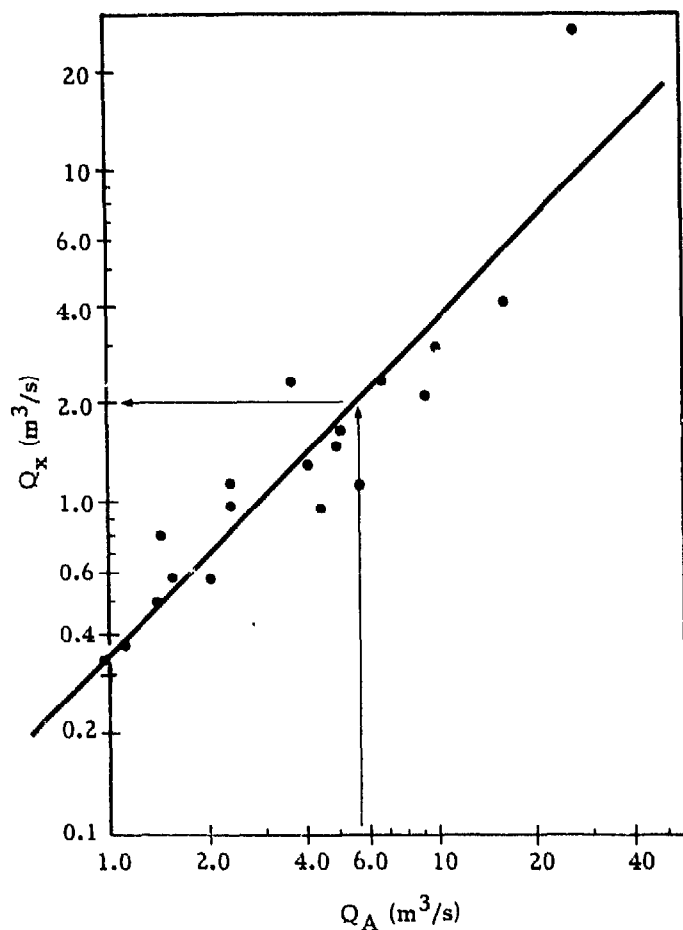

Fig. 3.11. Flows in one irregularly gaged stream are plotted on log-log paper against simultaneous flows in a gaged stream in the same region. The 19 readings used were taken at about equal intervals during 1980 (15).

The line in the graph in Fig. 3.11 represents the best fit of the points representing flow measurements at the ungaged site X and the gaged site A on corresponding days. If this line has a slope of 1.0 (or, equivalently, lies at 45°) as it is in this case, the flows are proportional to each other. Therefore, because the mean annual flow at site A was calculated earlier to be 5.7 m³/s, the corresponding mean annual flow for site X can be found from Fig. 3.11 to be 2.0 m³/s.

If the slope of the line is not equal to 1.0, the flows are not proportional to each other. Although the mean annual flow for the ungaged site can no longer be found as easily as described in the previous paragraph, this approach can still be used to estimate the flow-duration curve at the ungaged site as will be described later.

This approach also permits the validity of the initial assumption—that runoff patterns from the two catchments are similar—to be verified. The closer the slope of the line is to 1.0 and the closer the points are concentrated along the line, the better is the assumption. If the two catchment basins are near each other, are subject to the same precipitation pattern, and do not differ significantly in area, geomorphology, vegetation, and lithology, the points would tend to be concentrated along the line with a 45° slope.

Estimating minimum flow

For a micro-hydropower scheme in a remote area, some amount of firm or year-round power is usually preferred or even required. The minimum usable flow in a stream determines the value of this reliable power. A knowledge of minimum streamflow is therefore essential in the planning of many micro-hydropower schemes. Unfortunately, the minimum flow in a stream is one of the most difficult parameters to predict. Whereas large flows are immediately and directly affected by precipitation, minimum flows are fed by groundwater and springs that may be affected by precipitation occurring much earlier or by precipitation over other basins.

It might be assumed that the specific minimum flow—the minimum flow for each square kilometer of drainage area—for any one year for a particular catchment is similar to the specific minimum flow for nearby catchments for that year. This is not necessarily so. For example, Fig. 3.12 shows that even within a 100 km square, minimum specific flows for the same year vary by more than one order of magnitude.

Characteristics unique to a specific catchment can significantly affect minimum flow. For example, extraction of water for irrigation upstream of a proposed site can significantly affect minimum flows, especially because irrigation is used during the dry or low-flow season. Because minimum flows are relatively small, the nature of the riverbed can also have a significant impact on the available flow. In some cases, either part or all of the stream may flow within the streambed's coarse alluvium while the bed itself appears dry.

The most reliable way of ascertaining minimum flow is to visit the stream toward the end of the dry season, gage it, and ask the people nearby to compare the relative magnitude of that flow with past minimum flows. Many people living by a stream rely on it for agriculture, bathing, washing, and/or drinking and are well aware of its characteristics through the years. It is essential that the questions asked of villagers not be biased, that they draw as objective a response as possible—not the answer they assume the questioner would

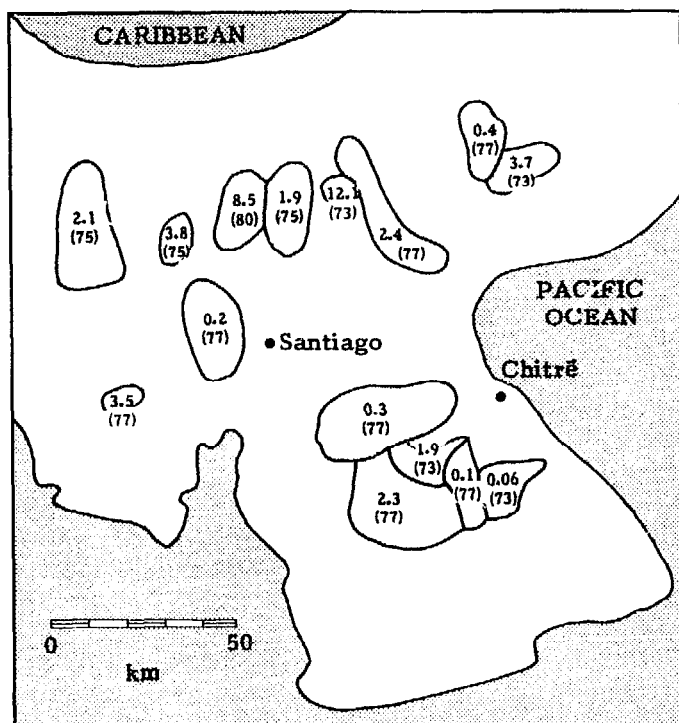

Fig. 3.12. The specific minimum flow ($l/s/km^2$) for the period 1971-80 for various catchments in central Panama, delineated by the shaded areas, varies considerably. The actual year of minimum flow is indicated in parentheses.

like to hear. Several villagers should be questioned independently.

Estimating a flow-duration curve

This section describes an approach for estimating a flow-duration curve for an ungaged site by using a curve derived for a gaged site along the same stream or in a neighboring catchment basin. Since this approach assumes that the general pattern of flows at the gaged and ungaged sites is similar, the shapes of the flow-duration curves for the two sites also must be similar. Therefore, multiplying the ordinates—the vertical scale representing flow—of the flow-duration curve for the gaged site by the ratio of the mean annual flow at the ungaged site (obtained using one of the approaches described in *Estimating mean annual flow*, p. 33) to that at the gaged site (obtained using streamgaging records) will yield the flow-duration curve for the ungaged site.

Figure 3.13 illustrates how this approach is applied in the case of the ungaged site X referred to earlier, once the flow-duration curve for the gaged site A has been prepared (Fig. 3.13b). Using runoff data as described in the first of the three approaches described earlier (p. 33), a mean annual flow of $2.9 m^3/s$ was estimated for site X. Applying this estimate of the mean annual flow, flows on the flow-duration curve for site A should be reduced to $(2.9)/(5.7)$ or 51% to get the corresponding

flows on the flow-duration curve for site X. A flow of $6.0 m^3/s$ at site A occurring at least 33% of the time, for example, would correspond to a flow of

$$Q_x = (0.51)(6.0) = 3.0 m^3/s$$

as shown in Fig. 3.13c.

From the second approach described, the ratio of areas (p. 36), it was found that the mean annual flow for site X was 60% of that for site A. Consequently, each flow on the flow-duration curve for site A must be reduced to 60% to obtain the corresponding flow on the flow-duration curve for site X (Fig. 3.13d).

Finally, the mean annual flow at site X was also estimated by correlating flows (p. 36) to be $2.0 m^3/s$ or 35% of the mean annual flow at site A. Since the slope of the line fitted to the pair of points representing the mean annual flow of the ungaged and gaged sites has a slope of 1.0 (Fig. 3.11), these flows are proportional, and the flow-duration curve for site X can be obtained by simply reducing the corresponding flows to 35% (Fig. 3.13e).

If the line has some other slope, flows at the two sites are not proportional. In this case, the values of flow for several exceedance values are taken from the flow-duration for the gaged site (Fig. 3.13b), and each flow is converted to the corresponding flow at the ungaged site using the line on the log-log plot (Fig. 3.11). The latter flows are then plotted against the original exceedance values to obtain the desired curve (Fig. 3.13e).

For the example used in Fig. 3.13, it is possible to compare the estimates of the flow-duration curves for the ungaged basin with the correct "answer," because the "ungaged" basin is actually gaged and the correct flow-duration curve is available (represented by the dotted lines in Fig. 3.13). Two points should be made:

- Although the flow-duration curves derived are only approximations, all three approximations are very close in view of the fact that virtually nothing was initially known about the flow in the "ungaged" basin.
- Although using the runoff data gave the most accurate prediction of the flow-duration curve for the "ungaged" site, this is not always the case.

Determining power and energy potential from a flow-duration curve

If a run-of-river hydropower scheme requires flows greater than the minimum streamflow for power generation, it is useful to know the variation of flow over the year to select the most appropriate turbine configuration. For this purpose, information presented in the form of a flow-duration curve is most useful.

In the following discussion, it is assumed that a flow-duration curve has been derived for the site under consideration, possibly using the methods described in **Data processing** (p. 39) or **Estimating a flow-duration curve** (p. 38). For the purpose of discussion, it is also assumed that the flow-duration curve shown in Fig. 3.14 is that curve and that the gross head at the site is about 50 m.

To begin, assume that only 15 kW will ever have to be generated at the site and that the conversion efficiency from waterpower to electrical power is 60%. Since the gross head is 50 m, the power equation [Eq.(4.2)] indicates that a flow of about $15 / (6.0)(50) = 0.05 \text{ m}^3/\text{s}$ would

be required. This would be the design flow of the turbine. Because the stream always has more flow than this, the turbine could operate at this point throughout the year (Fig. 3.15). With the required water available 100% of the time (8760 h), the energy potentially available from the turbine would be $(15 \text{ kW})(8760 \text{ h})$ or about 130,000 kWh per year. This example shows that the shape of the flow-duration curve has no effect on the power potential of a site if a hydropower scheme uses less than the minimum streamflow; there is therefore no need to prepare a flow-duration curve.

Since a constant power output is generated in this case,

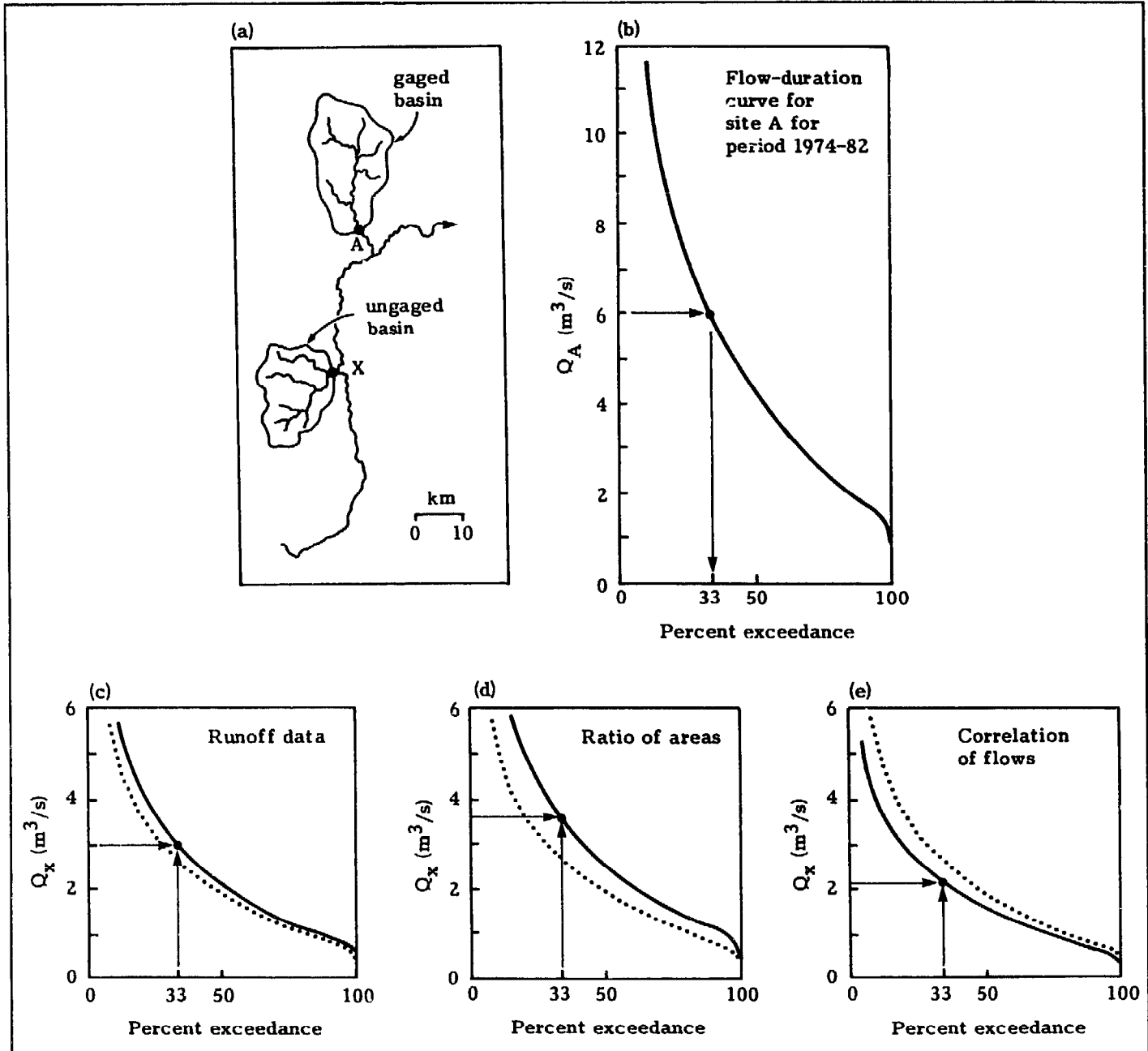

Fig. 3.13. An approximation for a flow-duration curve at an ungaged site (a) can be obtained from a flow-duration curve at a gaged site (b), modified by regional runoff data (c), the ratio of drainage areas (d), or by correlation bet-

ween flows (e). In this example, the flow-duration curve for the "ungaged" site is actually known and is represented by the dotted lines for the sake of comparison.

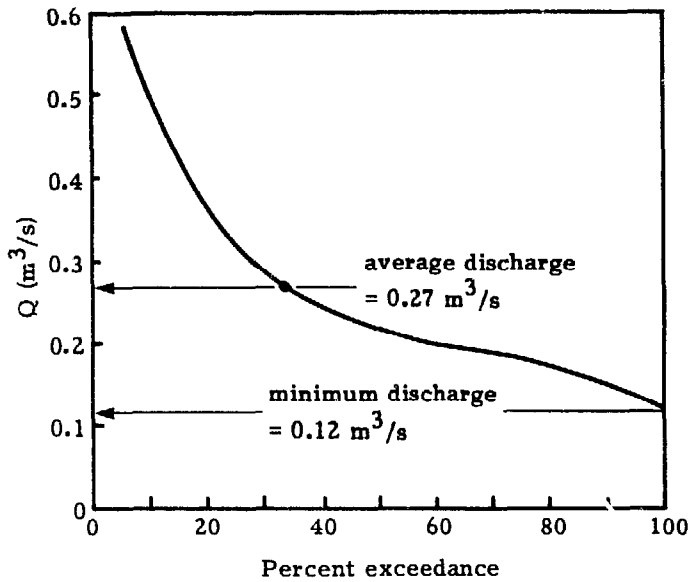

Fig. 3.14. The flow-duration curve for a stream at a micro-hydropower site used in the following discussions.

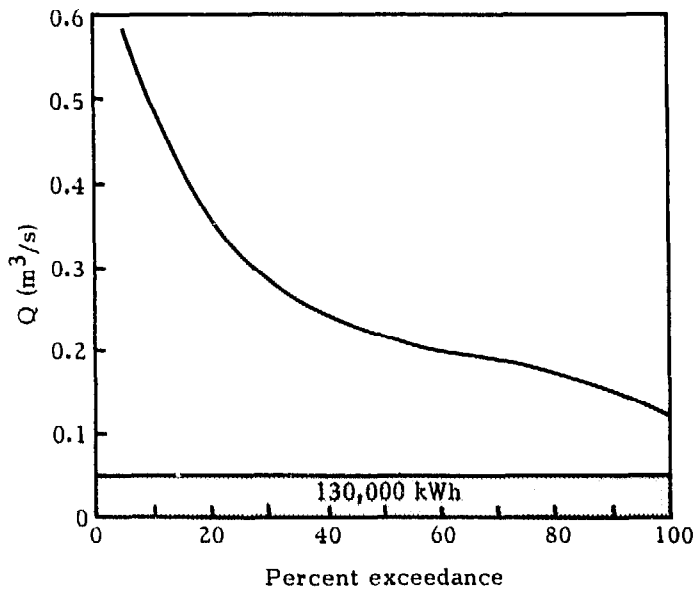

Fig. 3.15. Using $0.05 \text{ m}^3/\text{s}$, a hydropower plant could generate 15 kW year-round, providing 130,000 kWh annually.

the annual energy potential of a site is easy to calculate mathematically. This is not the case when varying flows are used. In this case, a graphical approach is used. For this simple example, the basis for this approach is as follows. The power "P" available from the turbine is proportional to the flow "Q" used (because, in this case, the power equation leads to $P = 300 Q$), which is graphically represented by the height of the shaded portion. Doubling the height of the shaded area, for example, would mean that double the flow is used and that double the power would be generated. Because power is proportional to flow (on the vertical

axis) and time is proportional to the percent of the year (on the horizontal axis), the product of power and time (or energy) is proportional to the product of the vertical and horizontal dimensions or, equivalently, the shaded area.

Now consider the case where a run-of-river plant requires flows larger than annual minimum flows for power generation. To get a feel for how a flow-duration curve affects the power and energy potential of such a plant, assume that a peak power of 90 kW is required at the previous site. The flow through the turbine must now be

$$Q = \frac{P}{6.0 H} = \frac{90}{(6.0)(50)} = 0.30 \text{ m}^3/\text{s}$$

This would be the design flow of the turbine. The flow-duration curve (Fig. 3.16) shows that peak power would be available 28% of the year. The curve also shows that, for example, 50 kW which requires

$$Q = \frac{50}{(6.0)(50)} = 0.17 \text{ m}^3/\text{s}$$

would be available 80% of the time (or 42 weeks of the year) and that there would always be available at least $0.12 \text{ m}^3/\text{s}$ or

$$P = (6.0)(0.12)(50) = 36 \text{ kW}$$

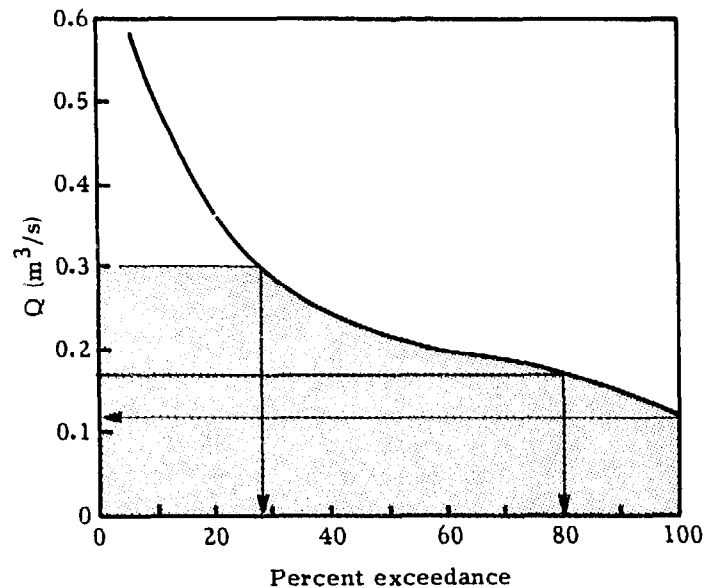

Fig. 3.16. The shaded area represents all the flow that would be available for the generation of power if the maximum capacity of the turbine were $0.30 \text{ m}^3/\text{s}$.

If it is assumed that conversion efficiency from water-power to electricity remains constant over the entire range of flows (at 60% in this case), the total energy available would be equal to the area under the curve when the appropriate scales are used (Fig. 3.17). That area (or energy potential) can be estimated by adding the areas of rectangles and/or trapezoids, for example. The energy potential "E₁" of this site would then be:

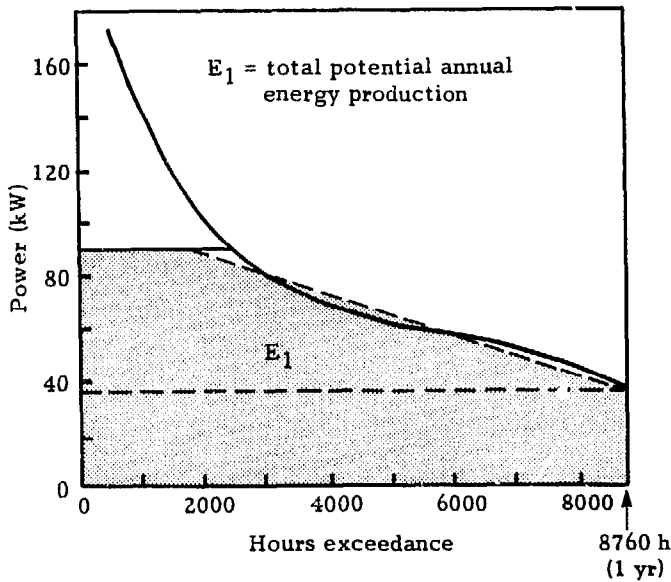

Fig. 3.17. Same curve as in the previous figure with scales changed to illustrate that the energy potential is simply equal to the shaded area.

$$\begin{aligned}
 E_1 &= \text{area of trapezoid} + \text{area of rectangle} \\
 &= \frac{(1,800 \text{ h} + 8,800 \text{ h})}{2} (54 \text{ kW}) + (8,800 \text{ h})(36 \text{ kW}) \\
 &= 290,000 \text{ kWh} + 320,000 \text{ kWh} = 610,000 \text{ kWh}
 \end{aligned}$$

This value represents the annual energy that is potentially available. Although it is imperative financially to make productive use of all energy that can be generated, this is rarely done at isolated plants. Rather, the load is often at a maximum during early evening hours, with little or no use for the power during the day. In these cases, knowing a site's power potential may be more useful than knowing its annual energy potential. For example, it is more important to know that, in spite of the fact that the turbine can generate 90 kW, the power output may not exceed 40 kW for several weeks each year. When a plant is interconnected to a grid, all the excess energy can usually be used. In this latter case, a knowledge of the annual energy potential has a direct impact of the financial viability of the plant.

Whether a plant is isolated or grid-connected, several factors reduce the power and annual energy potential available at that site. These factors relate to environmental considerations and turbine operating characteristics.

Unless the stream being tapped dries out each year, some forms of aquatic life are present, and a minimum flow should be maintained in the stream between the location of the intake to the power scheme and the tail-race where the flow is returned to the stream. Diversion of water that reduces streamflow to below this minimum flow should not be undertaken. Countries concerned with environmental issues frequently specify minimum streamflow by law. In instances where the

local population uses water for irrigation or fishing or where a waterfall serves as a tourist attraction, the need for some continued flow in a stream is more apparent.

In the previous example, assume that at least $0.05 \text{ m}^3/\text{s}$ must be maintained in the stream to avoid disrupting aquatic life. If the desired peak power output is still to be 90 kW, a streamflow of $0.30 \text{ m}^3/\text{s}$ (the design flow) plus $0.05 \text{ m}^3/\text{s}$ (which is left in the stream) or $0.35 \text{ m}^3/\text{s}$ would be now required (Fig. 3.18).

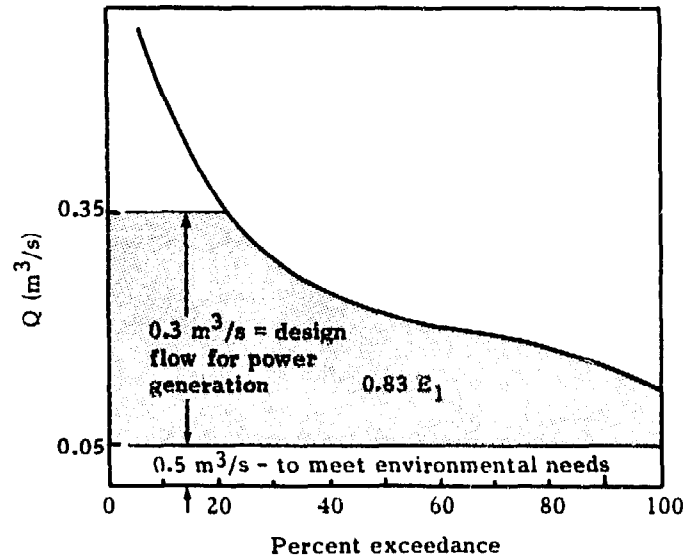

Fig. 3.18. The shaded area represents the flow that would be available for power generation if the maximum output of the turbo-generating unit were 90 kW (requiring $0.30 \text{ m}^3/\text{s}$) and $0.50 \text{ m}^3/\text{s}$ were left in the stream to meet environmental needs.

Although the peak power is not affected, the length of time for which it is available is reduced from 28% of the year to only 21%. Because a small but year-round portion of the flow is now no longer available for power generation, the total energy capacity of the site is also reduced. Now only about 510,000 kWh/year is available. A comparison of areas under the respective curves (Figs. 3.16 and 3.18) shows that, although the same turbine is used, only 83% of the energy originally available from the powerplant is now available. In addition, the flow which must be left in the stream has its largest impact during low-flow periods when, in this case, a maximum power output is as low as 21 kW, or about half of what would be possible if all the available water had been used.

A second factor which reduces the usable power and energy available from a turbine is its operating characteristics. Turbines are designed to operate most efficiently at their design flow. How a specific turbine selected for a site operates at a lower than design flow depends on the type and configuration of the turbine. For example, fixed-blade propeller turbines function well over only a limited range of flows; Pelton turbines operate efficiently over a wide range of flows. (See

TURBINES, p. 171, for a more detailed discussion.) In any case, no turbine operates efficiently from zero through to design flow. Generator efficiency also decreases with decreasing output. These factors further affect the output of a hydropower plant.

The overall efficiency is a function of factors such as head losses in the penstock, power output, and type, design, and condition of the turbine, generator, and coupling between the two. To continue with the previous example, assume a more realistic variation of overall conversion efficiency with flow as illustrated in Fig. 3.19 and not fixed at 60% as was assumed earlier. Under specific circumstances, efficiency may be better or worse than that shown in this figure; however, the effect of a varying efficiency on the annual energy and power potential of a turbine, illustrated in the example below, remains unchanged.

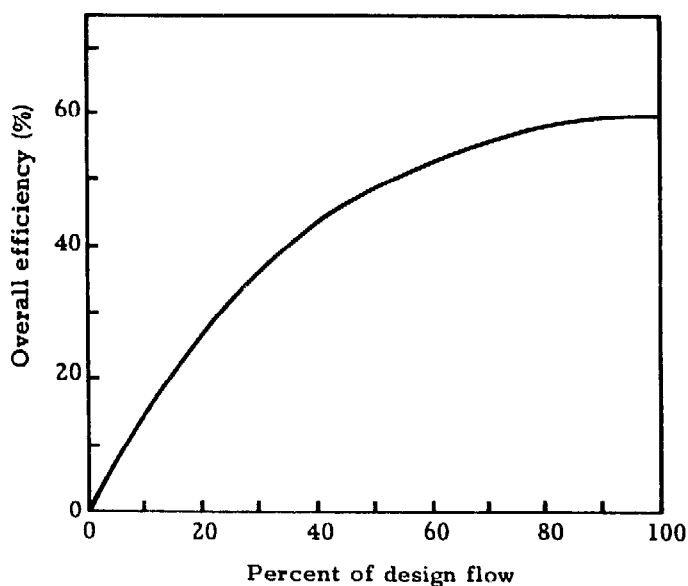

Fig. 3.19. The efficiency curve for the micro-hydropower scheme considered in the example.

To determine this effect, it is necessary to use the original form of the power equation [Eq. (4.2)]. The actual procedure for doing this is illustrated in Fig. 3.20. The energy potential at the proposed plant is equal to the shaded area under the curve in Fig. 3.20c. Therefore, by considering the actual operating characteristics of the turbo-generating equipment, the total annual energy available is further reduced to 88% of the previous case (Fig. 3.18, assuming constant efficiency) or, equivalently, 73% of the energy that would have been available if no flow had been kept in the stream and if overall efficiency had been constant (Fig. 3.17). Furthermore, there are times each year when only about 10 kW would be available, significantly less than the 36 kW which would have been available had environmental considerations and turbine characteristics not been considered.

It should be clear from the preceding discussion that only the lower portion of the flow-duration curve, from about 20%-100% exceedance, is generally of importance

for sizing a turbine for an isolated scheme. A knowledge of the shape of the upper end of the curve is not required for this purpose; its precise shape is therefore of no concern. However, the peak value is of importance in laying out the scheme and sizing spillways so that flood flows can be accommodated and do not adversely affect the operation and integrity of the scheme.

The criteria used to select the design flow for the turbine(s) at a micro-hydropower plant are determined largely by how the plant will be used. In the industrialized countries where hydropower plants are frequently interconnected to the national grid, a common criterion is to maximize the revenues generated by energy sales to the utility over the costs incurred in implementing and operating the plant. If a low value of flow is selected for power generation (Fig. 3.21a), the full capacity of the turbine may be used but the high cost per kilowatt of a small plant would make it difficult to recoup the investment from the revenues generated. If a large design flow is selected to take advantage of the economies of scale (Fig. 3.21b), the plant will not be used to full capacity and costly generating capacity will remain idle most of the year. In addition, because of the operating characteristics of turbo-generating equipment, flows below a certain percent of design flow could not be used. An optimum design flow exists somewhere in between (Fig. 3.21c) where economies of scale keep costs reasonable but where the plant's capacity will be used more effectively. If the cost of the equipment and the revenues generated for various design flows can be calculated, the actual value of the design flow can be obtained. This is not complicated and should be done if the economics of a specific project is important. Warnick provides a more indepth discussion of the issues in *Hydropower Engineering* (106).

In developing countries, power is commonly generated at isolated locations. In this case, rather than most efficiently exploiting the flow available in a stream, the objective is to use only that flow which is required to meet the specific needs of the consumers. It is usually more important to have power year-round, and needs are probably more limited. Therefore, although Fig. 3.21c may represent the optimum design flow for a grid-connected scheme where the power and energy demands are virtually unlimited, the design flow shown in Fig. 3.21a might represent the optimum for an isolated scheme.

Alternative turbine configurations

Whether the plant is grid-connected or isolated, if conventional turbine designs are used—turbines which permit flow regulation—valves and actuating mechanisms, automatic or manual, add to the cost and complexity of micro-hydropower schemes. In cases where this is of concern, alternative turbine configurations are possible. This is especially the case when simple, locally fabricated turbines are being considered and the local capacity to fabricate complicated valves and actuating mechanisms has not yet been developed.

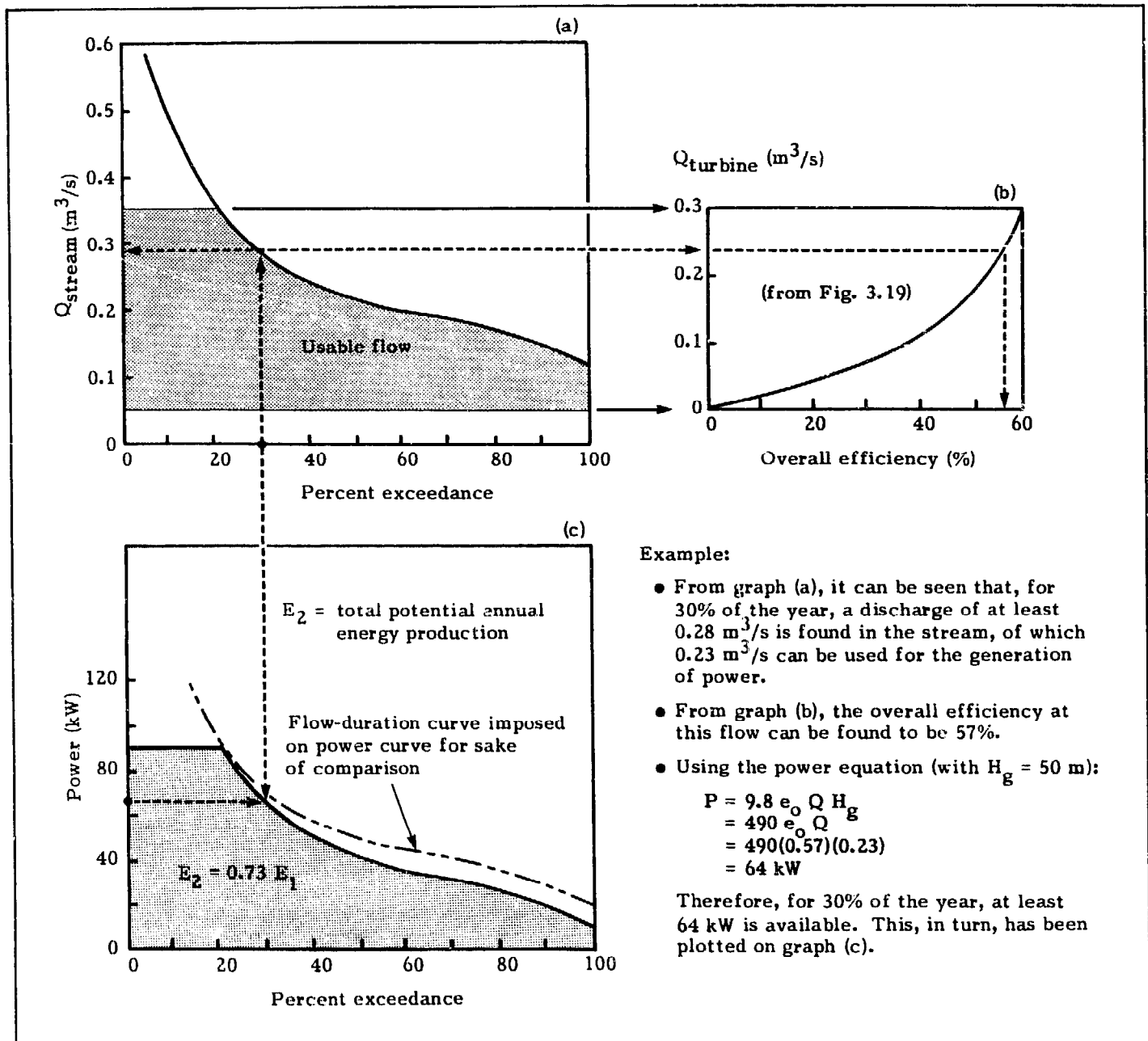

Example:

- From graph (a), it can be seen that, for 30% of the year, a discharge of at least 0.28 m^3/s is found in the stream, of which 0.23 m^3/s can be used for the generation of power.
- From graph (b), the overall efficiency at this flow can be found to be 57%.
- Using the power equation (with $H_g = 50$ m):

$$\begin{aligned}
 P &= 9.8 e_o Q H_g \\
 &= 490 e_o Q \\
 &= 490(0.57)(0.23) \\
 &= 64 \text{ kW}
 \end{aligned}$$

Therefore, for 30% of the year, at least 64 kW is available. This, in turn, has been plotted on graph (c).

Fig. 3.20. An illustration of how the flow duration and efficiency curves are used to derive the potential power

and energy available from a hydropower plant.

Flow-regulation for the purpose of governing the turbo-generating unit—keeping the speed constant by matching power available from the turbine with the power demand of the consumer—can be eliminated by use of a load controller or by proper design of the entire system (see **APPROACHES TO GOVERNING**, p. 201). Flow-regulation for the purpose of making better use of the varying streamflow can also be addressed without resorting to costly and relatively sophisticated valves or gates and actuating mechanisms.

An obvious simplification to reduce cost is to eliminate all the valves and actuating mechanisms which permit the turbine to use a wide range of flows. Of course, if a single turbine were used, only a single flow could be

accommodated. The turbine would operate at its highest efficiency (its design flow). If a peak power of 90 kW were required from the plant described in the previous example, the power and energy potential shown in Fig. 3.22 would be attainable. Although savings in cost and complexity have been gained through this choice, the energy potential of this site would be reduced to only 38% of what would be available if flow-regulating devices had been used with the turbine (Fig. 3.20). The considerably reduced quantity of energy available would generally be of importance only if the plant were grid-connected. In this case, available streamflow which is not harnessed would represent a loss of potential revenue from the sale of electricity. Extra costs of sensors, valves, and activating mecha-

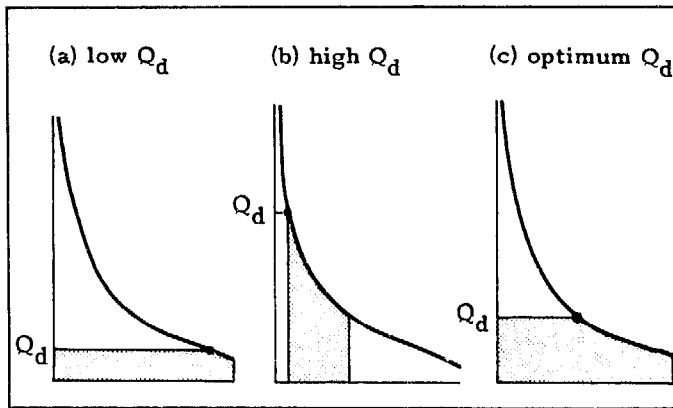

Fig. 3.21. The design flow " Q_d " selected at a site affects both the revenue generated and the costs incurred for implementing and operating the plant.

nisms might be recouped easily from the extra revenue which could be generated if these devices had been included in the system. However, if the plant is isolated, more important than reduced energy is the fact that power would be available for only 21% of the year. For the remainder of the year, no power could be generated because the turbine could not operate at lower flows without valves.

For an isolated plant, if some power is required on a regular basis, the option suggested in **SCHEMES USING LESS THAN ANNUAL MINIMUM STREAMFLOW** (p. 27) could be used. This would require a turbine whose design flow is equal to or less than the minimum streamflow and therefore can be operated year-round. But then minimum flow in the stream would set the maximum power which could be generated at the site.

On the other hand, if demand at times requires the larger power potential associated with larger streamflows yet requires some firm power year-round, the

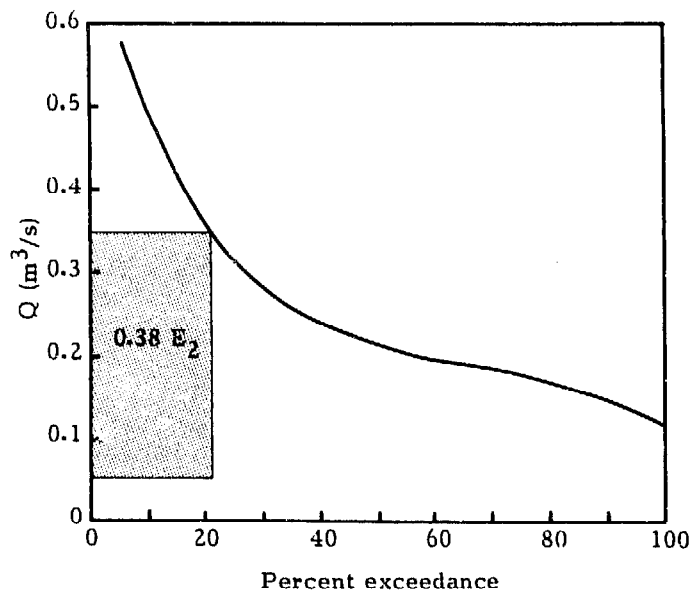

Fig. 3.22. Power and energy potential from a single turbine without flow-regulating devices.

plant could be designed to accommodate two levels of streamflows. There are several ways of accomplishing this with a hydropower plant that has no provision for continuously regulating the flow through the turbine:

- o For low-head sites that use reaction turbines (propeller or Francis), the only approach is to use two separate turbines, one which can operate year-round. Using more than one turbine at a site has the advantage of backup generation capability if needed but also the disadvantage of higher cost.
- o For high-head sites that can accommodate an impulse turbine (Pelton, Turgo, or crossflow), simpler, less costly options exist.

With a Pelton or Turgo turbine, one turbine with two or more nozzles can be used. Manually operated on-off valves would be required at the inlets to the nozzles. During the year, one nozzle could operate continually. When streamflows are adequate, additional valves would be opened fully so that the other nozzles can accommodate some of the additional flow.

A crossflow turbine has only a single, rectangular nozzle but it is possible to seal off a portion of the nozzle to reduce the consumption of water without affecting efficiency. Commercially, a guide vane is used within the nozzle to regulate or completely shut off the flow. This vane can be split so that the two portions of the nozzle can be regulated or shut off independently. Commonly, one segment of the vane covers one-third of the nozzle width and the other, the remaining two-thirds. (The reason for this unequal division is explained below.) To reduce costs, some locally fabricated turbines have replaced the guide vanes by a gate of any one of several designs which can be moved across the nozzle opening to control the emerging flow. This gate is not generally adjusted on a continuous basis.

Two turbines could also be used, as with reaction turbines. However, because modifying the nozzle configuration with impulse turbines can result in savings in cost and complexity, use of two turbines should be considered a last resort (unless redundancy is the primary objective).

- For both high- and low-head sites, one cost-reduction approach increasing in popularity is the use of pumps as turbines. Flow-regulating devices are not incorporated in pumps as they conventionally are in turbines. Consequently, to accommodate two flow levels at a micro-hydropower installation, two pumps are required. Although pumps as turbines are less expensive than turbines, they may be somewhat less efficient.

When incorporating two turbines (or two nozzles with a single turbine) which each use a constant flow, more energy can be generated if these two constant flows are unequal than if they are equal. In addition, power would be available for a greater part of the year. To illustrate this point, assume that a peak power of 90 kW is

required and that two turbines (or nozzles) which can accommodate only constant flows are to be used.

If two turbines (or two nozzles) which accommodate equal design flows of $0.15 \text{ m}^3/\text{s}$ are used (each with a capacity of 45 kW), the water that would be available for power generation is shown in Fig. 3.23. With this flow-duration curve and peak design flow, the annual energy available would be 82% greater than that from the single 90 kW turbine using a constant flow. More important, some power would be available 57% of the time rather than 21%, as was the case with a single turbine. On the other hand, the annual energy available would be 31% less than that obtained using a single turbine with streamflow sensing devices, flow-regulating valves, and associated activating mechanisms. Although the cost of the turbo-generating equipment might be reduced, so is the annual energy potential, and therefore potential revenue from the sale of electricity.

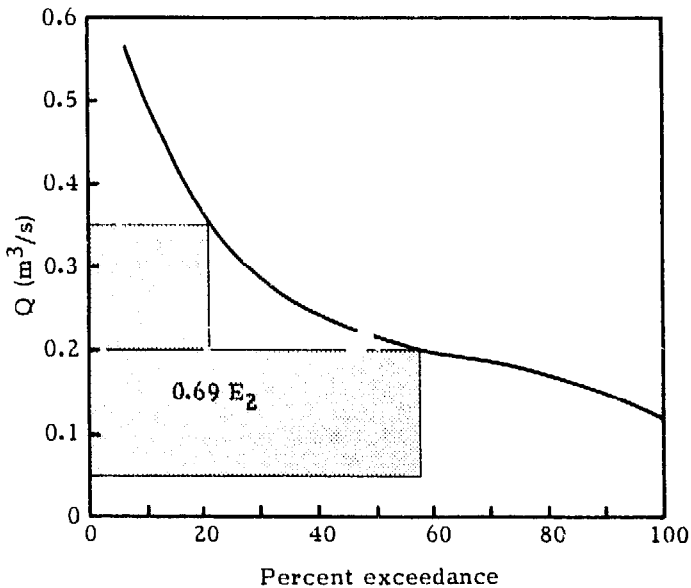

Fig. 3.23. Flow-duration curve with shaded area representing flows used by two fixed-flow turbines (or nozzles) of equal size.

A more versatile approach is to use turbines (or nozzles) which can accommodate different design flows. Cost might increase, but so would the annual energy generated. In Fig. 3.24, it is assumed that the design flow of the larger turbine (or nozzle) is twice that of the smaller, with the total equal to the peak desired flow. The small, 30 kW turbine (or nozzle) requiring $0.10 \text{ m}^3/\text{s}$ would be used during periods of low flow. As flow increases to $0.20 \text{ m}^3/\text{s}$, the 60 kW turbine (or nozzle) would replace the first. When the flow increases further, to at least $0.30 \text{ m}^3/\text{s}$, both turbines (or nozzles) would come on-line. This permits more power to be generated from the available streamflow. In this case, although the maximum flow is the same as that in Fig. 3.23, where turbines (or nozzles) of equal size are used, 26% more energy can be generated by using these two turbines (or nozzles) of different size. More impor-

tant for an isolated plant, power would be available for about 90% of the year.

A complication is encountered when electrical power is generated using two turbines at an isolated site, with each turbine coupled to a generator. In this case, governors would be needed to keep the generators synchronized. But this would add considerably to the cost of the equipment. Another option would be for both turbines to drive the same generator, but the generator would operate less efficiently when driven by the smaller turbine. With a grid-connected unit, the grid itself would govern the generators, and no governor would be needed.

It is also interesting to compare water usage in this last case, where turbines (or nozzles) of two different sizes are used, to that in the previously described case, where a single turbine with sensors and flow-regulating valves is used (Fig. 3.20). Although the more sophisticated, single turbine generates 15% more energy than the two constant-flow turbines (or nozzles), it consumes 30% more water. This is because the two turbines (or two nozzles) each always operate at peak efficiency (because they each operate only at their design flow), whereas the single turbine uses smaller-than-design flows less efficiently and therefore requires more.

For an isolated plant where some firm power is required year-round, one turbine would have to be operated at minimum usable flow or about $0.07 \text{ m}^3/\text{s}$. If a maximum of 90 kW is still desired, the design flow for the second turbine would be $0.23 \text{ m}^3/\text{s}$. In this case, although 76% of the annual energy generated by a turbine equipped with flow-regulating devices would be available with this turbine arrangement, at least 21 kW would be available year-round.

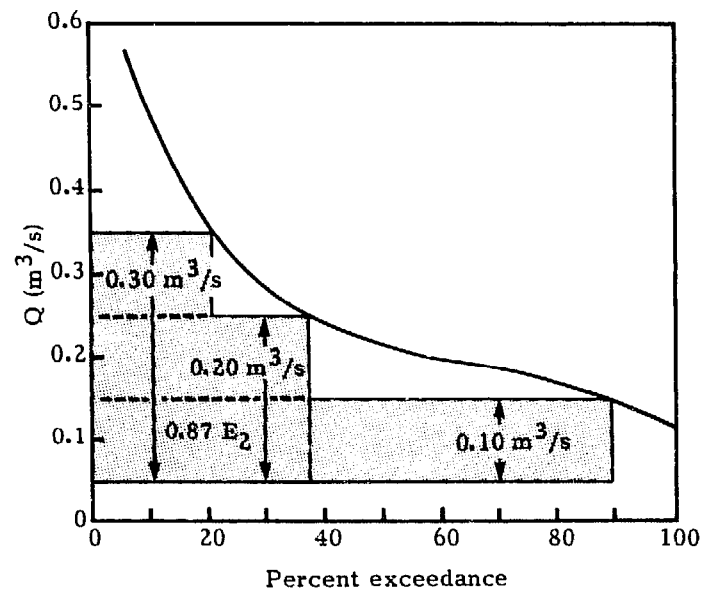

Fig. 3.24. Flow-duration curve with shaded area representing flows used when one of two fixed-flow turbines (or nozzle) can accommodate twice the flow of the other.

IV. SITE SELECTION AND BASIC LAYOUT

INTRODUCTION

Because water falling through a drop in elevation is generally a necessary condition for the generation of hydropower, the most obvious site for a micro-hydropower scheme might appear to be at a waterfall. However, waterfalls are relatively few and often are not near population centers. In addition, implementing a micro-hydropower scheme at such a site could pose construction difficulties.

A fall of water can also be created artificially by the construction of a dam. This is often the approach taken with large hydroelectric projects. Siting a micro-hydropower plant at the base of a dam might also prove appropriate in industrialized countries, because dams often already exist and the financial capital is available for the large turbo-generating equipment which would be necessary at such low-head sites. For schemes in developing countries, this approach is not generally used. Dams are expensive, require proper design and construction, and are prone to siltation and other maintenance problems.

Most micro-hydropower installations around the world are found in the vicinity of more gradually falling streams and rivers (see Fig. 1.9). Here, the water drops in elevation over a relatively long distance. Because of the larger physical extent of power schemes at such sites as opposed to sites at waterfalls or dams, more extensive civil works are necessary to convey the water from the river to the powerhouse. Associated costs can therefore be substantial if inadequate attention is given to design.

Of the numerous factors which affect this cost, site selection and basic layout are among the first which must be considered if operational and maintenance problems encountered during the life of a hydropower scheme are to be minimized. Such problems contribute to recurring costs of a scheme and could discourage future developments.

The two previous chapters presented guidelines and details for determining the usable flow which can be obtained from a stream. This chapter provides a guide for selecting a site to generate power from that flow and for developing a basic layout at that site. Since the factors presented in this and the following chapter are all interrelated, it is difficult to give a concise, step-by-

step procedure for selecting and developing that site. Site selection is somewhat of an art and is developed as experience is gained. The following chapter, **CIVIL WORKS**, covers the design of the various components which contribute to the complete scheme and potential problems associated with their construction, operation, and maintenance. That chapter might provide additional insights into difficulties presented by the site initially selected which are not covered in this chapter. If so, a new site on that stream might have to be selected. Site selection is an iterative process with numerous factors to be considered. After some experience has been gained in the field, this process becomes second nature.

This chapter reviews only the basic technical factors which affect the location and layout of a micro-hydropower scheme; other technical factors are covered in subsequent chapters. In addition, there are nontechnical factors that must be considered in selecting a site for a micro-hydropower scheme, but these are not covered here in any detail. These may include factors such as remoteness of the powerplant from the consumer, availability of land from the owners for the civil works, and potential environmental impacts.

Once a stream has been located, it is necessary to select a place where the drop in the terrain is sufficient to produce the required power with the available flow. This is briefly covered in **IS THE TOPOGRAPHY SUITABLE FOR HYDROPOWER GENERATION?** (p. 48).

Occasionally, steep drops of water are found and the layout of the power scheme is straightforward. More frequently, drops are gradual and water must be conveyed some distance in order to gain a drop sufficient to produce the desired power. When the topography of the area seems suitable for hydropower generation, the next task is to determine the basic layout that will bring this water to the turbine for power generation at minimum cost. This is covered in **DEVELOPING THE BASIC LAYOUT** (p. 49).

Additional factors that should be considered when selecting the precise location for both ends of a hydropower scheme are described in **LOCATING THE INTAKE** (p. 52) and **LOCATING THE POWERHOUSE** (p. 56). These factors may have little impact on the original cost of the scheme, but if not considered, they can lead to unexpected difficulties with, and increased recurring cost for, its operation and maintenance.

IS THE TOPOGRAPHY SUITABLE FOR HYDROPOWER GENERATION?

In the previous chapter, the usable flow available from a stream for power generation was determined. It then becomes necessary to determine whether the layout of the land in the stream's vicinity makes hydropower generation technically feasible. If it is not, considering that site any further would be of little use. This section reviews the theory which forms the basis of hydropower generation.

In Fig. 4.1, if water flows from point A down to point B along any path by any means—along the riverbed or an open canal or through a pipe—it loses energy at a rate equal to

$$P = 9.8 Q H_g \quad (4.1)$$

where

- P = power lost by the water (kW)
- Q = flow (m^3/s)
- H_g = rate at which water descends from A to B
- H_g = gross head (m)
- H_g = drop in elevation from A to B

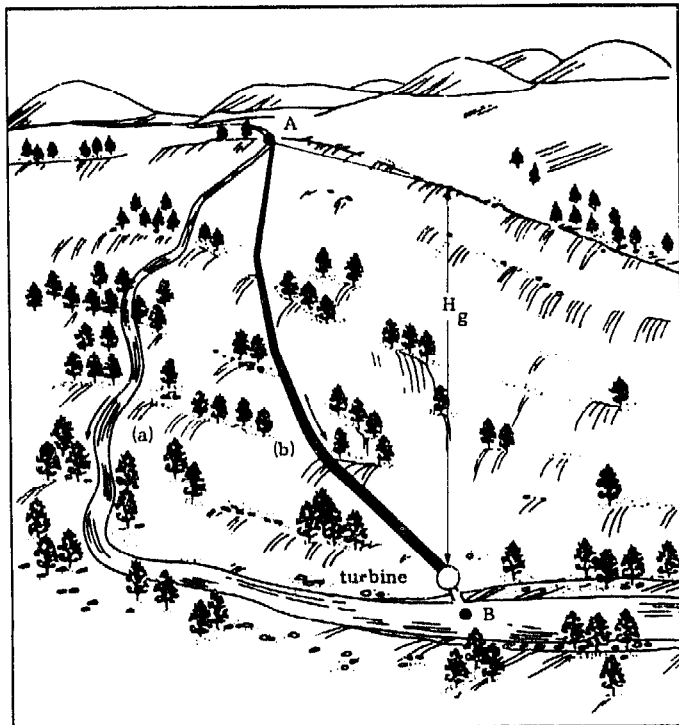

Fig. 4.1. Water loses the same energy no matter which path it follows from point A to point B.

The water might, for example, follow the riverbed from A to B along path (a). In this case, the water loses this power through friction and through turbulence. The power dissipates itself through erosion in the riverbed, heating of the water*, producing spray and air currents, etc.

Or the water might flow from A to B along path (b) through a pipe which includes a turbine. The water

would then lose this same quantity of power in pipe friction, turbulence at the inlet, outlet, and bends of the pipe, and in pushing its way through the turbine. It is that portion of the power lost by the water in moving through the turbine which is converted by the turbine and is then available at the turbine shaft to power machinery. The principal objective in planning a micro-hydropower scheme is to use proper designs to minimize miscellaneous losses in power as water is conveyed from A to B so that as much power as possible remains in the water to be extracted by the turbine.

It is also possible to generate power with water falling from point A (at the water's surface) through the turbine to point B at the base of the dam (Fig. 4.2). Such micro-hydropower schemes are less common but the general relationship given by the power equation in Eq. (4.1) is still valid and can be used to determine the theoretical power potential from such a site. However, it can be seen from the power equation that, with the low head available at a micro-hydropower dam site, a relatively larger flow would be required to generate the same power. This would require a larger, and costlier, turbine.

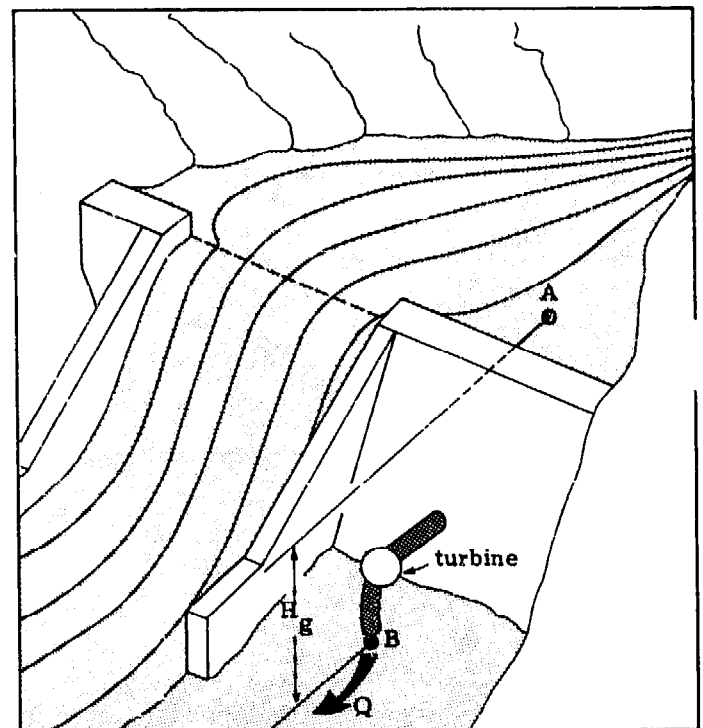

Fig. 4.2. Using a dam to develop head.

The expression for power noted previously assumes that no power losses are incurred in conveying the water to the turbine. In reality, some power is lost in the conveyance structures—intake, canals, pipes and/or penstock—as well as within the turbine and generator.

* Because of water's high heat capacity, its resulting temperature rise is not noticeable. In theory, assuming all the power lost by the water goes toward heating that water, the temperature rise would amount to only $0.024^\circ C$ for a 10 m drop.

The useful power which is generated at a site is a product of the theoretical power and overall efficiency " e_o ". Therefore, the power equation becomes

$$P = 9.8 e_o Q H_g \quad (4.2)$$

As an initial estimate, assuming that electricity is being generated at an overall efficiency of 50%, the power available can then be obtained by the equation

$$P = 5 Q H_g \quad (4.3)$$

Now to return to the original question: Does the topography in the vicinity of the stream being tapped lend itself to the generation of the required power? This is analogous to asking whether sufficient head can be exploited along the stream to generate the power "P" which is required from the available streamflow "Q". From the previous expression, the gross head " H_g " which would be necessary is

$$H_g = \frac{P}{5Q} \quad (4.4)$$

This will give an idea of the drop which must be found along a suitable reach of the stream to generate the required power. EXAMPLE 4.1 illustrates how this equation is applied in a specific situation.

Going through this exercise with the stream under consideration will give an indication of whether the topography of the region near that stream lends itself to the generation of the desired power. This will lead to one of the three following conclusions:

- (1) Sufficient head is available, in which case it is possible to lay out the basic scheme as described in the following sections.
- (2) More than sufficient head is available. In this case, there are several reasons why it might be advisable to make use of the higher head available in the area:
 - Because less flow would be required, most of the civil works as well as the turbine itself might be reduced in size, with an accompanying decrease in cost.
 - The additional unused flow still available from the stream could be used at the same site for expansion of the power plant in the future should the demand for power increase.
- (3) Insufficient head is available within a reasonable area to produce the required power with the flow found in the stream. In this case, either a reduced power level must be acceptable, with storage incorporated as part of the scheme to permit generation of peak power when required, or an alternative stream with more flow must be found. If neither option is possible, then hydropower potential in the area is inadequate to meet all the needs, and alternative energy options must be considered.

EXAMPLE 4.1

Assume that 50 kW of power is required to provide for the electric power needs of a village in a level coastal area for the present and foreseeable future and that the usable flow of the only nearby stream in the vicinity is rarely less than $1.0 \text{ m}^3/\text{s}$. What is the feasibility of tapping the hydropower potential of the stream for this purpose?

From Eq. (4.4), the required gross head is found to be about 10 m. Although such a drop probably could not be found in a "level coastal area," this does not remove hydropower generation from consideration. Several options are possible:

- (1) If 50 kW will be required on a continuous basis, the only option is to look farther from the town toward the foothills, if they exist, where greater drops in elevation might be available.
- (2) If the load can be managed so that, for example, 25 kW is adequate to serve the intended uses, correspondingly less head will be required, and this might be found in the area.
- (3) If the peak demand of 50 kW is required for only part of each day, a portion of the streamflow which would otherwise be unused the remainder of the day could be stored behind a dam for use when needed. Incorporating a storage dam effectively increases available flow for that part of the day that increased power is necessary so that less head is needed to generate that power.

If neither of these options is possible or acceptable, a micro-hydropower plant would seem an inappropriate energy option for the area.

DEVELOPING THE BASIC LAYOUT

Now assume that between points A and B along the stream in Fig. 4.1, a drop has been found which is adequate for the generation of the desired level of power. Under these circumstances, it is always technically possible to exploit that hydropower potential, but the major question of economic feasibility yet remains.

Because economic arguments are instrumental in supporting or opposing the implementation of micro-hydropower schemes, the economic aspects require careful consideration. Whereas a specific costing is not possible at this point, economic implications of certain technical choices will be noted.

Several approaches for developing the basic layout are briefly explained below:

- (1) One obvious route for a pressure pipe—the penstock—to follow in conveying water to the turbine is

one which parallels the stream (Fig. 4.3). If it is properly designed, the losses along the penstock pipe, which are proportional to penstock length and the square of the flow velocity in the pipe, will be relatively small and the power not lost through friction and turbulence is then available at the turbine. This approach is adopted when the terrain on both sides of the stream is steep, with the stream possibly in a gorge, and when none of the preferred alternatives suggested below are possible. However, for losses within the penstock to remain small, it is necessary to increase its diameter as its length increases. Therefore, if this approach is adopted, the penstock can contribute markedly to the cost of the scheme because of the long length of pipe and the relatively large diameter required.

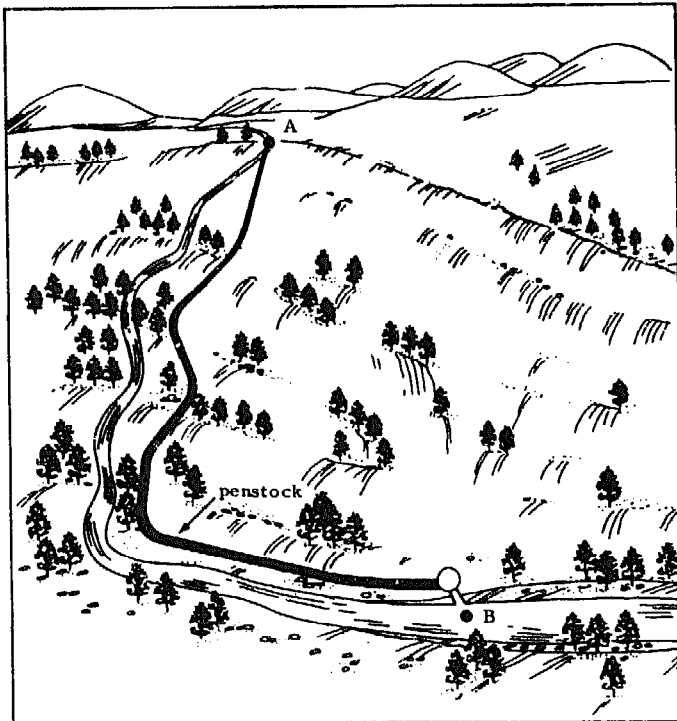
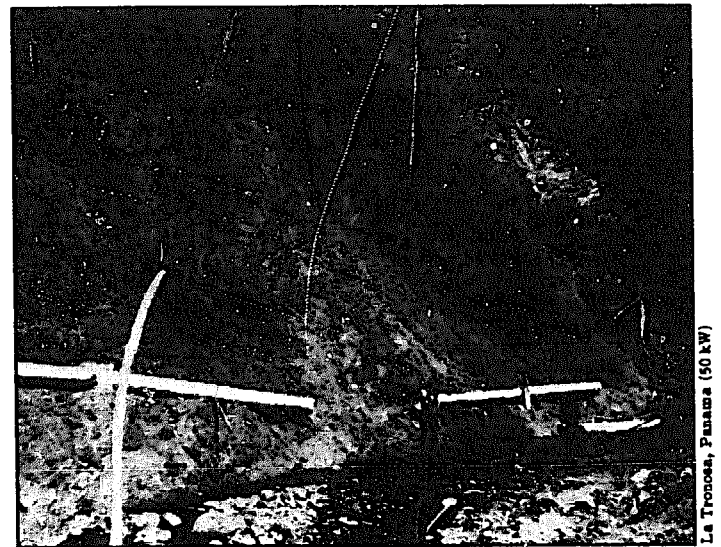

Fig. 4.3. A penstock pipe paralleling the stream can lead to unnecessary length and cost.

Two examples of penstock alignments paralleling a stream are illustrated in Fig. 4.4. Locating the penstock along a stream with steep walls (a) makes it more susceptible to damage from landslides and flood flows. Constructing the penstock to avoid these problems can be difficult. If the valley is more open (b), the penstock can be placed away from the stream and is then exposed to fewer potential problems.

- (2) If a penstock is necessary to convey the water the entire distance from A to B, then it is advisable, if the terrain permits it, to minimize its length and allow a penstock pipe of smaller diameter and cost to be used (Fig. 4.5). The pipe need not follow the contour of the land as does an open canal but can assume a positive or negative slope of any size if this is required to negotiate difficult terrain. But it is preferable to maintain a downward slope continu-



La Troncosa, Panama (50 kW)

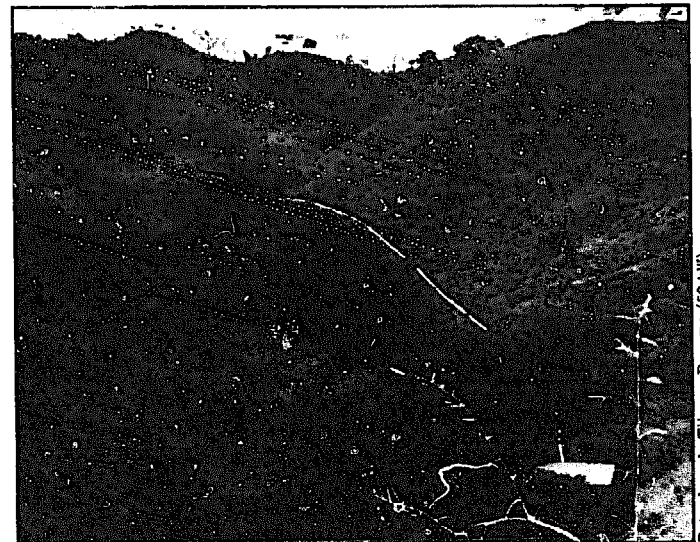
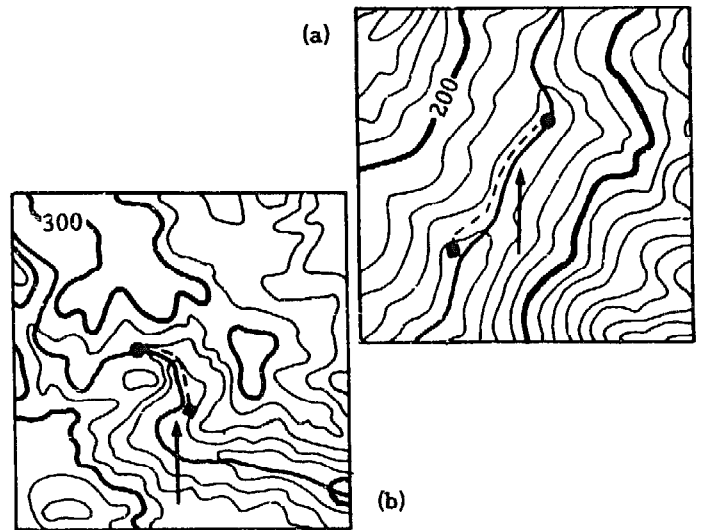

Entradero de Tijera, Panama (50 kW)

Fig. 4.4. The ease of constructing the penstock can be determined, in part, from contour maps. On these maps (1:25,000 with 20 m contours), contours remaining close to the stream (a) portend steep banks and difficult conditions. More open contour lines (b) generally indicate more favorable conditions for construction.

ally; otherwise, any air carried by the water will accumulate at the peaks and restrict the flow. Air release valves will then have to be installed at these peaks. Also, any sediment carried into the penstock might accumulate at low points along its length, and provision would have to be made for its periodic removal. It is also advisable to align the penstock so that the pressure (net head) at any point along it always remains greater than atmospheric during the operation of the plant. Unless a power conduit can be used as described below (3), this second approach may be the best alternative.

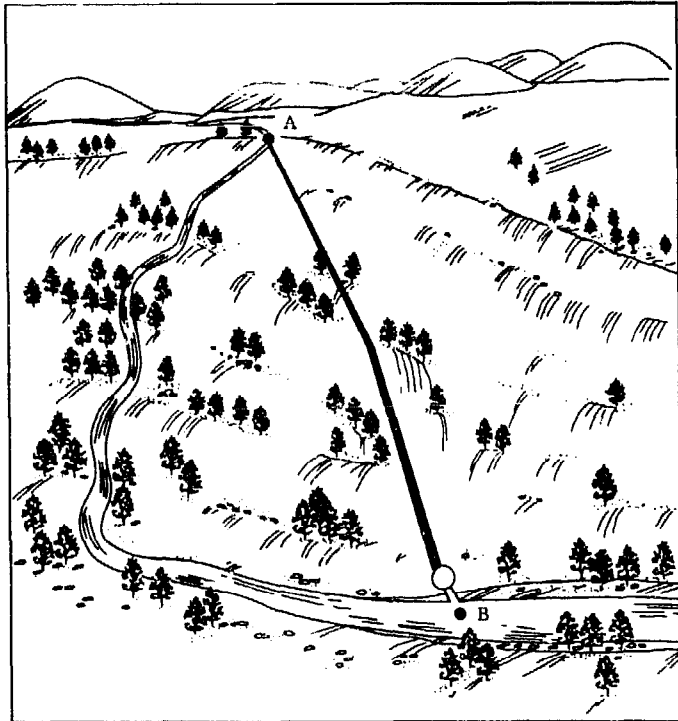

Fig. 4.5. Selecting the most direct penstock route from intake to turbine can reduce costs.

(3) Depending on the terrain, the distance from A to B might still be so large as to require a penstock pipe of inconveniently large diameter to reduce flow velocity and associated losses in head. This pipe would be costly to purchase, transport, and install. In Nepal, for example, it is not unusual to find 10 kW powerplants, operating under heads of about 10 m, where the total distance (A to B) from intake to powerhouse is on the order of 1 km. One thousand meters of at least 500 mm diameter pipe, costing \$50,000-\$100,000, would be required to keep losses down to within acceptable limits. A lower-cost alternative is clearly necessary.

If, for most of the terrain traversed, a significant portion of the available drop in elevation between A and B can be found over a relatively short distance (A'-B), a power conduit—commonly an open canal or low-pressure pipe—can be used to convey water to the top of the penstock at A' (Fig. 4.6). This is the approach commonly pursued in Nepal and elsewhere. For the typical 10 kW site referred to previously, the required penstock diameter is about 300 mm and its

length closer to 20 m than to 1000 m. Enormous cost savings can result.

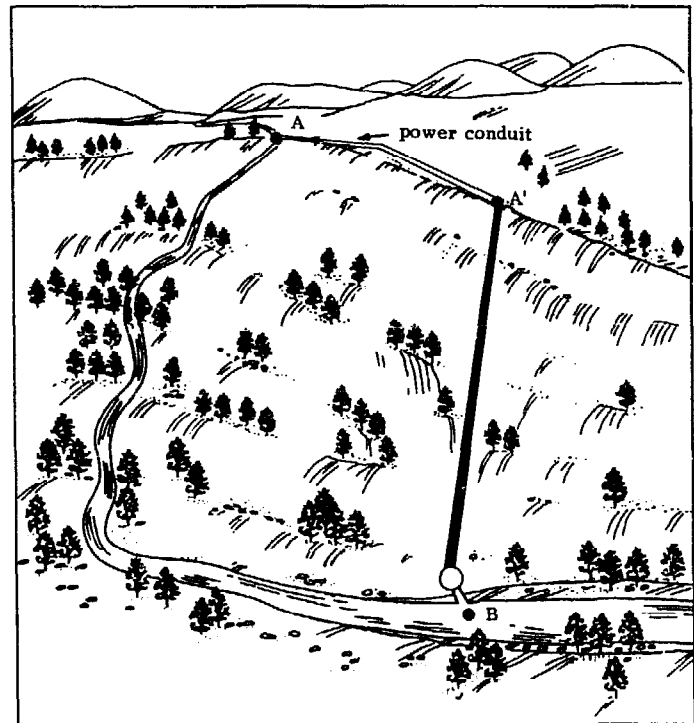

Fig. 4.6. The most popular means of developing a microhydropower site is using a power conduit—commonly a canal or low-pressure pipe—to convey the water to a point as close to above the powerhouse as possible.

This approach is the most widely used for microhydropower schemes found in developing countries where minimizing costs is a major consideration. Actually, in selecting an appropriate site, the approach is generally to keep this layout in mind. A steep drop A'-B is first located and then a contour is followed from A' back to the stream. The point where the stream is encountered, or slightly upstream of this point if more appropriate, becomes point A (see the following section, **LOCATING THE INTAKE**).

An open canal is one form for a power conduit. Because losses between A and B have to be kept to a minimum, any canal must be as smooth as possible and have as small a slope as possible, only steep enough to keep sufficient water running down from the intake on the stream toward the inlet of the penstock. Compared to the total head " H_g " available from A to B, the drop in elevation along the length of a properly constructed power canal and the associated loss in power are generally very small. A power canal has the advantage over the other conduits in that it can often be constructed using local resources, both labor and materials, and is therefore less costly than the other alternatives. If the soil is too porous, an inexpensive unlined earth canal may not be possible and lining it may introduce unacceptable costs. If the hillside to be traversed is too steep or unstable, however, a canal may be inappropriate. In both of these cases, a low-pressure pipe or

a penstock may be more suitable. However, if there are only a few stretches along the canal alignment which appear troublesome, alternative design options are available to address this problem and are described in **Circumventing obstacles** (p. 112).

Another form of power conduit is a low-pressure pipe which, although generally more costly, presents a number of advantages over the use of an open canal (see **Power conduit**, p. 68). Although using a low-pressure pipe might at first appear no different from using a penstock for the entire distance—approach (1) or (2)—a cost savings can be obtained. By trying to maintain, on the average, a low gradient between the intake and the beginning of the steep drop down to the powerhouse, a low-pressure pipe can be used. Such a pipe is usually thinner and less costly than penstock pipe. An exception is when steel pipe is used for low-head applications. In this case, low-pressure steel pipe and steel penstock pipe would have the same thickness. This thickness does not decrease with pressure as it does with plastic pipe, for example, because the thickness of steel pipe used for low-pressure applications must be sized to provide sufficient allowance for corrosion. Consequently, low-pressure steel pipe may be somewhat thicker than it would have to be merely to resist pressure and may have the same thickness as a penstock used for low-head applications.

Now that the basic layouts for micro-hydropower schemes have been roughly portrayed, it is necessary to focus on each end of the scheme, because the topography of the terrain at these points can also influence the site finally selected.

LOCATING THE INTAKE

In this section, run-of-river schemes that do not require the construction of a dam are considered. However, these may require the construction of a diversion structure or weir across a portion, or the entire width, of the river. In these cases, although a stream can be tapped virtually anywhere along its length, careful siting of the intake is necessary to avoid future problems. The natural alignment of the stream, its gradients, and the nature of the streambed must first be studied.

When locating the intake, the following factors should be considered:

- the nature of the streambed;
- bends along the stream;
- natural features along the stream;
- competing uses for water; and
- ease of accessibility.

These will be discussed in the following paragraphs.

Nature of the streambed

The elevation of the intake to a hydropower scheme is established at the time of construction. Without a per-

manent dam or weir across a stream, erosion might eventually lower the level of the streambed so that eventually it may be significantly below the intake and prevent water from entering. To avoid this problem, the intake should be situated at a point along the stream where the level of its bed seems relatively permanent, for example:

- where a stream has a relatively constant year-round flow, such as one which originates as a spring with little additional catchment area so that heavy rains have little impact on the flow;
- where the stream flows over bedrock; or
- where the river has a small gradient.

If erosion of the streambed is a possibility, a permanent weir might be constructed to maintain the level of the riverbed in the vicinity of the intake (Fig. 5.29). If a small dam or permanent weir is to be built, selecting a site so as to minimize its height, length, and associated construction costs should also be considered.

Bends along the stream

One of the more common problems affecting micro-hydropower schemes is damage to the intake caused by flood waters. This often occurs where the intake is placed at the outside of a bend in the stream or is oriented upstream.

To prevent this problem, the intake structure should be located along a relatively straight section of the stream, such as point (a) in Fig. 4.7. Water, like any object, prefers to travel along straight lines. This is especially noticeable at bends along a river, where the river tends to go straight unless forcibly constrained by its banks. The area on the outside of the bend (b) is subject to erosion, and stones and other waterborne debris can impair the operation of the intake and damage or destroy it during floods. Therefore, if at all possible, the intake should not be located at the outside of a bend in a river. It might, however, be placed on the inside of a bend of some rivers (c). This location offers the added advantage that the conduit which conveys the water

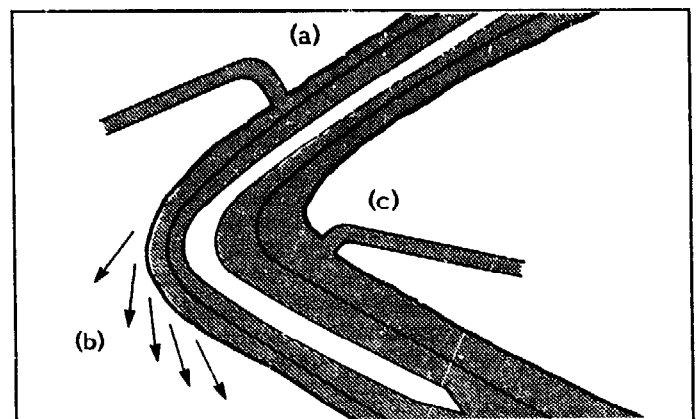

Fig. 4.7. The best location for an intake is generally along a straight stretch of a stream (a). Location (b) is susceptible to more severe damage from high flows, and sediment tends to accumulate in front of location (c).

from the intake onward is shielded from flood flows (Fig. 10.47). However, this location might not be advisable on some streams with suspended sand and silt, because these tend to accumulate on the inside of the bend and block or enter the intake.

A 90 kW Francis turbine, installed near the end of the 1960s near Kudjib in the highlands of Papua New Guinea to provide power to the Nazarene Mission hospital complex, required a fairly large flow of about $1 \text{ m}^3/\text{s}$. The intake to the headrace was unfortunately located on a bend in the stream (Fig. 4.8). Each year, flood waters carried stones and gravel and deposited these in front of the intake. Had it not been possible to use a front-end loader to remove this debris periodically, this task would have been very time-consuming and labor-intensive. As it was, this problem caused by a poor location for the intake was one factor among several which led to the decision to shut down the plant in 1981, when grid power became available from the country's large Ramu hydroelectric scheme, and not even keep it as a backup.

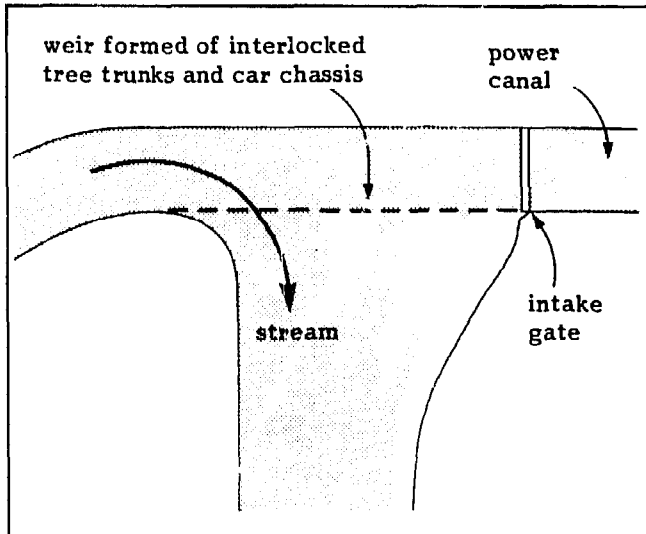

Fig. 4.8. A poor choice for the location of the intake has meant significant work in clearing stones and sediment accumulating in front of the intake.

Natural features along the stream

It is sometimes possible to protect the intake from flood waters by the natural features found along a stream such as, for example, by locating the intake under or behind large boulders at the edge of the stream (Fig. 4.9). The boulders thus limit the water which might enter the intake during high flows and also keep out larger debris which might otherwise damage the intake. The boulders might also provide some protection to the power canal that conveys water from the intake toward the penstock. It is necessary to be alert to other similar uses of the natural features along a stream.

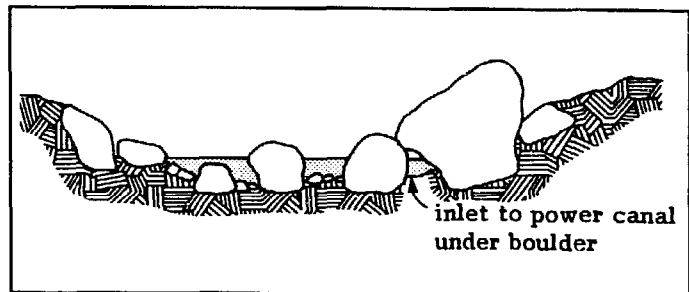

Fig. 4.9. A cross-sectional view of a streambed illustrates how a natural feature can be used to protect the inlet from water and waterborne debris during flood flows.

At a 25 kW micro-hydropower installation near Rugli in Papua New Guinea, very little maintenance work is ever necessary at the intake end of the power canal even though water from a large river is used. This is possible through a judicious choice for the intake location (Fig. 4.10). Although substantial flows can be found in the principal stream, a small portion of that stream breaks away to form a small island before rejoining the main stream. Not only is the inlet to that small stream oriented perpendicular to the main stream, but it is protected by several large boulders which were placed there by the river itself. A portion of the water from the principal stream flows under these boulders and a portion of the small, quietly flowing stream which results is then diverted into the power canal.

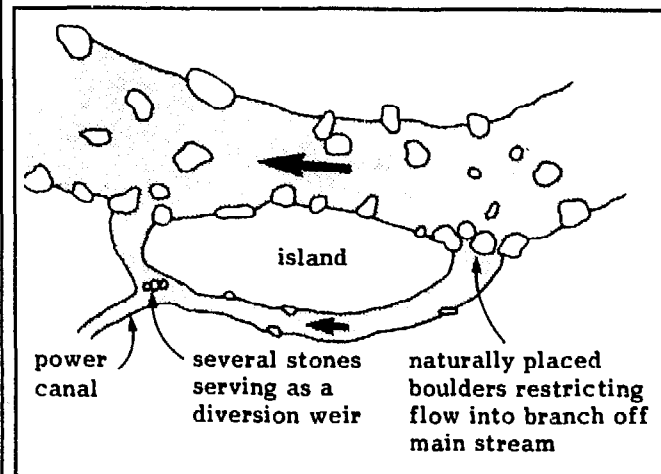

Fig. 4.10. An example of a well-located intake to a micro-hydropower scheme.

Competing uses for water

Other existing or envisioned uses for the water in the stream must be considered in siting the intake to a hydropower scheme, especially if these uses require a sizable portion of the available water. In a number of countries, water is used primarily for irrigation and

power generation must take a subordinate position. If the flow required for power generation might affect irrigation, several options are available to accommodate both uses:

- If irrigation and the proposed hydropower plant would each require a major portion of the flow, it might be possible to operate both in parallel and then to generate power when water is not used for irrigation or when the flow is in excess of that required for irrigation. In either case, periods set aside for power generation would have to be carefully planned and integrated with the irrigation needs. In areas where irrigation is practiced only to supplement rainfall during the wet season, irrigation needs may actually be nonexistent during the dry season. And when it is practiced during the wet season, more than sufficient flows should be available. But in any case, though no conflicts may arise depending on the nature of the irrigation practiced, it is important that existing irrigation patterns and needs be fully understood before embarking on the implementation of any hydropower project.

Although sharing water among several uses is possible, this approach should be used only if no better option exists; the great importance of irrigation in most areas where it is practiced can lead to misunderstandings and conflicts when a multi-use approach is used. In countries where a hydropower plant may power grain-processing mills, the period of peak water demand for irrigation—the dry season—may coincide with the period of peak water demand for power generation as well as the period of lower-than-average flows and may therefore complicate the problem.

- Any water in excess to that used for irrigation could be stored for power generation when it is required. This is a more practical approach for high-head sites that require small flows; constructing a storage volume of sufficient capacity, either behind a dam or as a separate basin, is generally costly and may require considerable effort.
- It may be possible to avoid any interference with the irrigation canals of an area by siting a hydropower scheme between two consecutive irrigation intakes along a river (Fig. 4.11). This approach permits water for the hydropower plant to be taken from that remaining in the stream below the upper irrigation intake (X) and returned to the stream below the powerhouse but above the lower irrigation intake (Y). If this approach is taken, it is necessary to foresee any future increase in irrigation that might occur in the area as a result of increasing pressure to develop new agricultural land.
- Rather than altogether avoiding areas which are irrigated, it is at times possible to incorporate a power scheme in series with an irrigation system so that power can be generated without having an adverse impact on irrigation. However, careful planning must be exercised if the power potential of an irrigation scheme is to be maximized because,

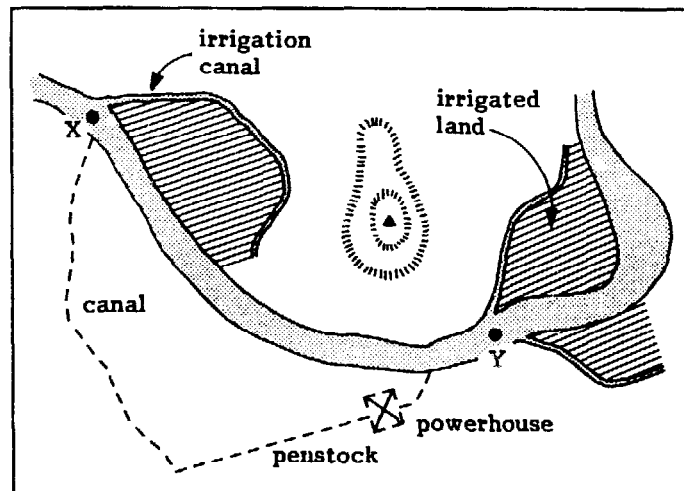

Fig. 4.11. A site selected to avoid conflict with the existing demand for irrigation water.

unlike power canals, small irrigation canals are not generally designed to minimize head and associated power losses. As is shown in Fig. 4.12, an irrigation canal (c) is designed so that the elevation of its intake on the stream is somewhat higher in elevation than the highest point to be irrigated. With a higher intake, the cross-sectional area of the canal to convey the required flow of water can be decreased, as can the amount of excavation which would then be required. However, for a smaller canal, the larger gradient implies a larger loss in head. In constructing an irrigation canal, it is also frequently easier to drop the water around an obstacle rather than to circumvent it. Irrigation drops are then necessary along the canal (b) and an even higher intake is required; additional losses in head are therefore incurred. To permit the use of the same water for both irrigation and power generation, a canal with a more gradual slope, one which more closely follows a contour, could be excavated. The extra head gained between the end of the canal and the irrigated area could then be used to generate power. All the water leaving the turbine could then be used for irrigation. If the gradient of the stream above this intake is adequate, the intake could be located still further upstream to gain extra head and power (c). A valve would be included in the powerhouse to bypass the turbine when irrigation water is required and, for one reason or other, the turbine is not functioning.

If a power scheme is incorporated into a irrigation scheme in this manner, there would be no need to construct a separate irrigation canal. However, given the principal difference between irrigation and power canals mentioned above, it should be clear that implementing a scheme for both power generation and irrigation usually must be considered in the initial planning stages of such a project if this is to be done most cost-effectively. Otherwise, after a long irrigation canal had been excavated, another long power canal would have to be excavated, resulting in a duplication of effort. Fig. 4.13 illustrates a case where a power scheme was retrofitted into an

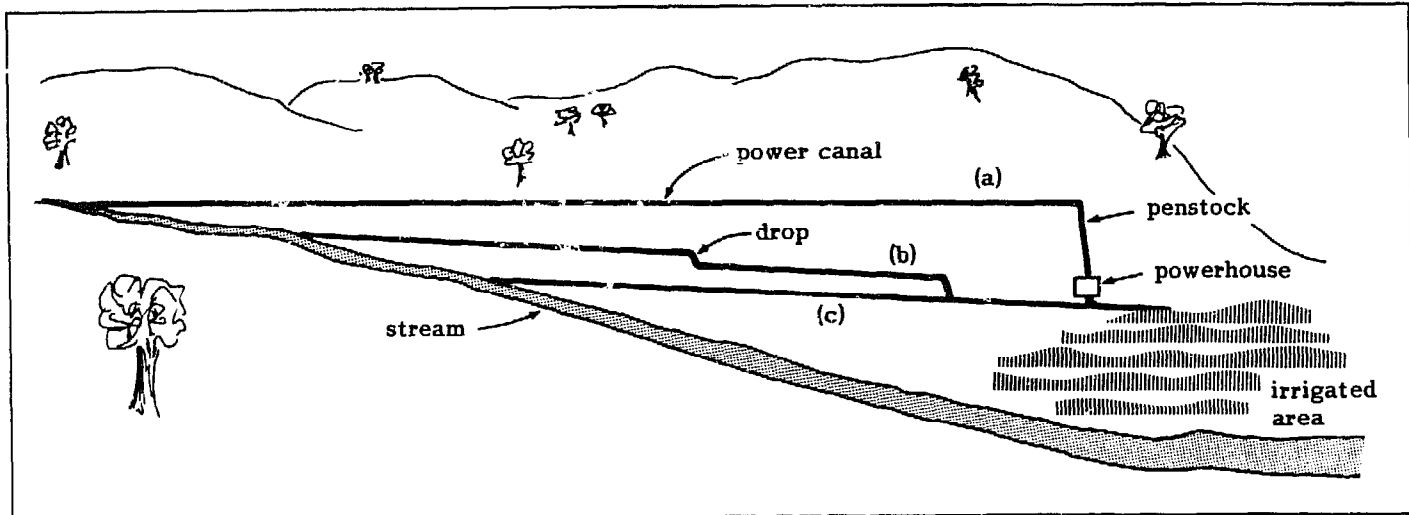

Fig. 4.12. By proper design, the same power canal (a) can provide for both power generation and irrigation, replacing

irrigation canals (b) and (c) which are not designed to minimize head losses.

irrigation scheme by extracting water from higher up into a narrow valley unsuitable for agriculture. In this case, the original length of the irrigation canal was very short, so no significant effort was wasted in excavating another canal.

tion of a scheme is access to the intake throughout the year. Easy access is needed during the construction phase of a project to facilitate the movement of supplies. But it also may be needed on a regular basis for cleaning out the area behind a dam or weir, removing debris which has accumulated on the intake trashrack, and removing sediment from the settling basin. Access may be occasionally needed to undertake repairs to the intake structure or to seal the intake prior to repairing the penstock. Though an intake should be properly designed to function during times of heavy flows, these are the times when trouble is most likely to occur and when the intake should be accessible in safety.

In addition to irrigation, all other potential uses of the water in the area, such as for fisheries development and potable water supplies, must be considered.

Ease of accessibility

Though each of the preceding factors may affect the final location of the intake from a technical point of view, one factor which is critical for the proper opera-

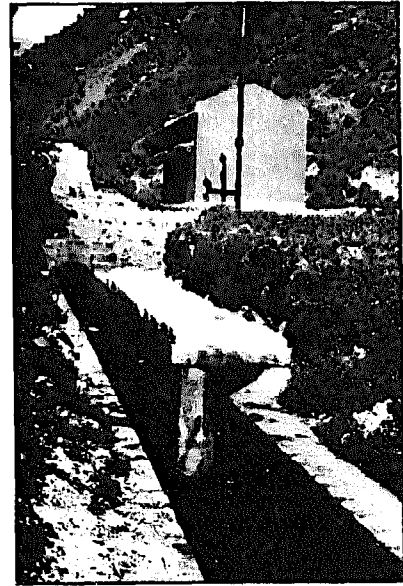

Maldeota, U.P., India (10 kW)

Fig. 4.13. At this site, irrigation water was initially diverted through an intake at the center of the left photograph. The powerhouse visible on the left was later constructed, and water for power generation is diverted into a power canal from the same stream somewhat upstream of

the old intake to increase available head. After water leaves the turbine, a covered tailrace leads it into the old irrigation canal (right photograph). With this approach, the hydropower plant has no adverse impact on irrigation practiced in the area.

LOCATING THE POWERHOUSE

The last basic question to be considered in developing a layout for a micro-hydropower scheme is the location of the powerhouse at the lower end of the scheme. What factors must be considered in selecting a suitable location for this powerhouse? And how do these factors reflect on the appropriateness of the site initially selected for the micro-hydropower scheme?

Power potentially available at a site depends on the drop or head. For the site shown in the Fig. 4.14a,

$$P = 9.8 Q (H_g - h) \quad (4.5)$$

is potentially available. If a criterion for site design is solely maximizing the power potential of a site, it would be necessary to minimize "h" by placing the turbine as close to the level of the stream (B) as possible.

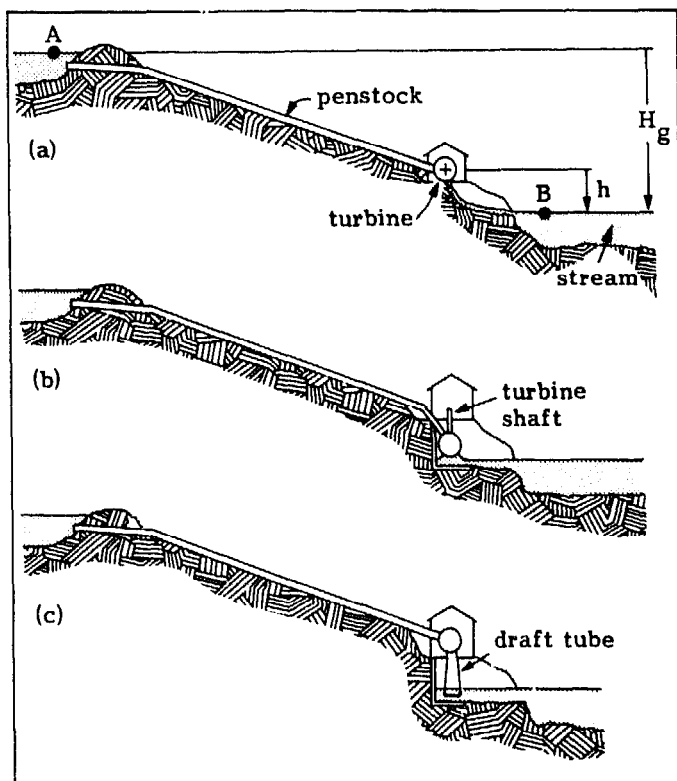

Fig. 4.14. Head and power lost because the powerhouse is set above tailwater level (a) can be reduced by setting the turbine below the floor of the powerhouse (b) or by using a draft tube (c).

The minimum distance "h" is determined by a very basic consideration. For structural and safety reasons, as well as for reasons of accessibility for equipment operation and maintenance, the floor of the powerhouse should be kept above water level at all times. Therefore, the maximum flood stage—the highest river level expected over the operating life of the plant—usually sets the minimum distance of the powerhouse above the river. Lack of recorded data might make it difficult to determine precisely the flood stage of the river. However, this information might be obtained by interviewing

people who have lived near the river or by seeking high-water marks on the riverbanks. Maximum expected flood stage may also be predicted by using the rainfall characteristics of the region and information on the nature of the catchment area above point B, but this approach may be more difficult to do properly. It is essential that, whatever method is used, the information gathered is reliable; the ravages of floods, whether caused by flood waters or their waterborne debris, can wreak havoc along the river, especially in areas of tropical rain and even more so in regions where slopes have been cleared of trees and other vegetation for firewood and gardening.

Not only must a site be selected so that the powerhouse can be constructed above flood stage, but it should be placed so that the tailrace—the canal leading the water emerging from the turbine back into the stream—is protected from the stream itself by the natural terrain. The tailrace should be oriented downstream to prevent flood water, debris, and bed load from being funneled into it toward the powerhouse. To avoid the destructive impact of flood flows, the end of the tailrace should preferably not be placed on the outside of a bend in the stream. Although extra labor would be required, the powerhouse can be placed in the most appropriate location from the point of view of power potential, access, and protection from flood flows and a long tailrace can then be constructed to lead the water to a suitable point downstream.

For low-head schemes, the powerhouse's location above maximum flood stage might significantly reduce the potential power available at a site. However, for turbines which operate under low heads (Francis, propeller, or crossflow turbines), this reduction might be minimized by either of two approaches:

- The turbine might be located below the powerhouse floor with the power drawn off by belts or from a vertical shaft extending above the floor of the powerhouse (Fig. 4.14b). The approach is commonly used with micro-hydropower schemes in Pakistan (see Figs. 10.43 and 10.59). Reaction turbines such as Francis or propeller turbines can even operate below tailwater level; however, crossflow turbines cannot operate when submerged.
- A draft tube can be used below the turbine to return the water to the tailrace (Fig. 4.14c). Using a draft tube, it is possible to regain most of the distance "h". Almost the entire drop from A to B is then available, even though the turbine itself may be located considerably above point B. (A discussion of the operation of a draft tube can be found in Cross-flow turbines, p. 178.)

There is, however, still a limit to how high above tailwater level a turbine using a draft tube can be set. If it is set too high, cavitation can occur which can damage the runner (see Propeller turbines, p. 182). The maximum elevation of the runner above tailwater depends on altitude, water temperature, and turbine characteristics. The turbine manufac-

On the slopes above a tributary of the Bari Ghat near the village of Kaireni in Nepal, a micro-hydropower mill was constructed, and the site around it was gradually built up to include a tea shop, pigsty, chicken coop, and gardens. As the owner of the mill was returning home from the mill one day, a neighbor called out that his mill had just disappeared (Fig. 4.15). Apparently, some distance upstream, the river had been sealed off by a landslide, forming a temporary lake behind it. Unannounced, the barrier broke and the ensuing wall of water, sand, gravel, and

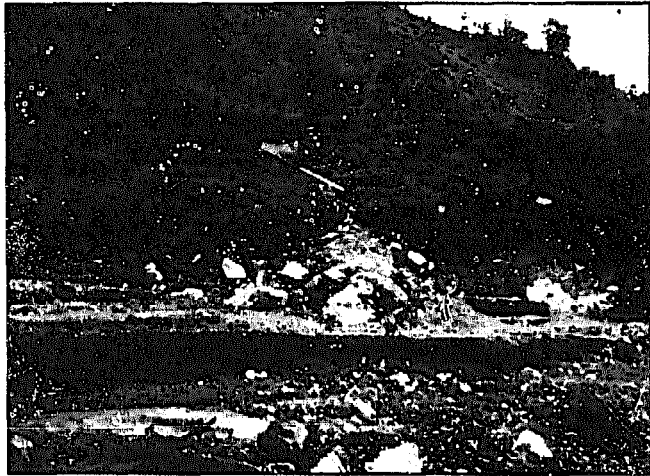

Fig 4.15 A forebay and a portion of the penstock are all that remain after flood waters washed away a micro-hydropower plant.

riverborne debris, including boulders up to 3 m on a side, surged downstream, wiping out everything in its way. Eight men lost their lives at the mill and neither their remains nor any piece of the turbine, equipment, or powerhouse has been found. Having learned his lesson, the owner is now building his mill at another site, virtually across the stream but on the inside of the bend of the river and behind a massive boulder outcrop, making most use of the natural features in the terrain (Fig. 4.16).

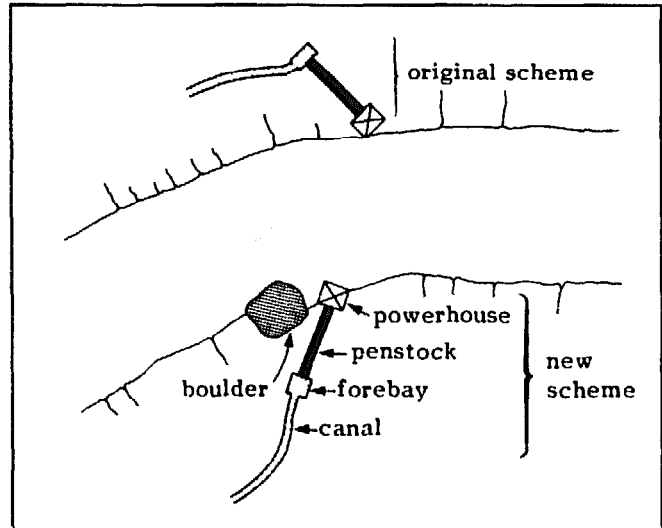

Fig. 4.16. Location of the new site in comparison to that of the original site that was washed away.

turer can specify the maximum head that can be recovered by using a draft tube.

Although it is possible to include a draft tube with a Pelton or Turgo impulse turbine for high-head sites, as is done with the crossflow impulse turbine, it is virtually never done. Because of the large head under which these turbines operate, any distance of the turbine above tailwater produces a loss of power of only several percent at most.

CASE EXAMPLES

Salleri/Chialsa (Nepal)

A contour map of the region of the Salleri/Chialsa small hydel (hydroelectric) project is shown in Fig. 4.17. Typical of many sites, the river to be tapped has a gradual fall (in this case, a gradient of about 5%). This map shows an area (circled) where a relatively steep drop is available and a penstock could be located. To minimize

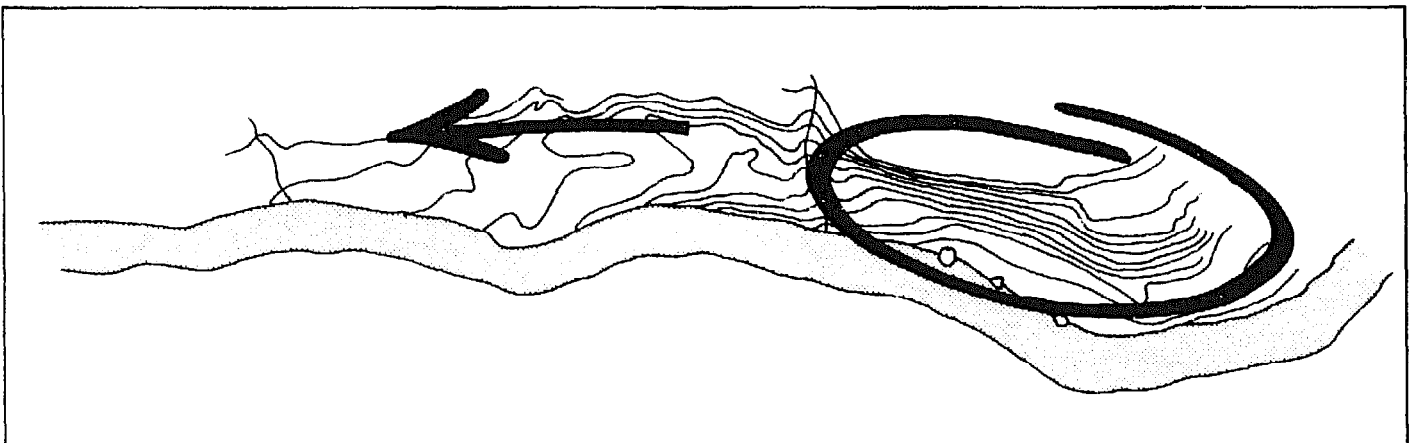

Fig. 4.17. Contour map of the proposed Salleri/Chialsa (Nepal) site. A sharp drop can be found in the circled area;

this would require water to be brought from some distance upstream.

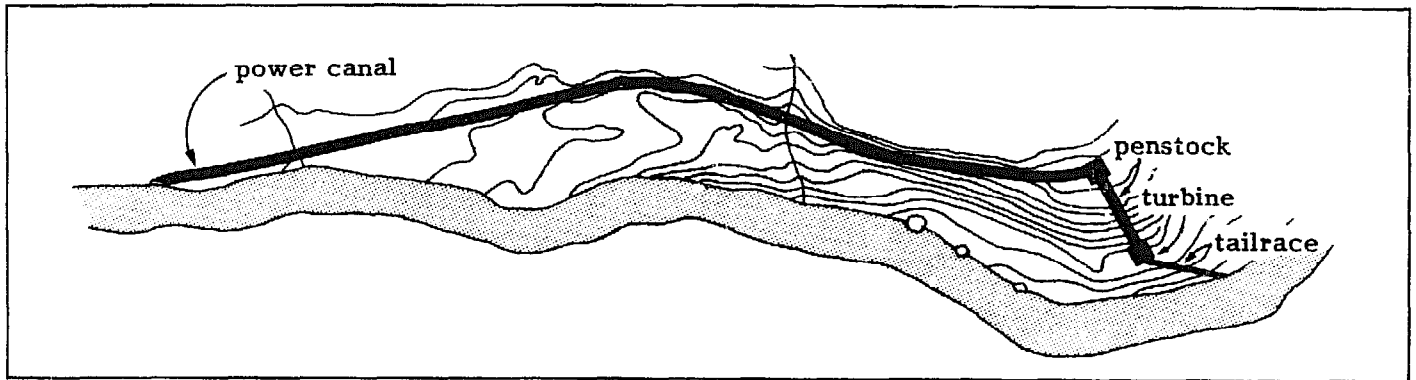

Fig. 4.18. The actual layout of the Salleri/Chialsa site.

penstock length, a power canal would be required to convey the water from an appropriate point upstream (in direction of the arrow).

Although prospective sites can be located with the aid of a contour map of the proper scale, a site visit is still necessary. This is to learn more of the nature of the terrain, soil conditions, and geological formations as well as to gather more information on streamflow throughout the year. In this case, the basic layout finally selected (Fig. 4.18) brought the power canal to a flatter region where sufficient space existed to construct the necessary structures at the inlet to the penstock. Also, the powerhouse was located on a flatter area before a short but steeper drop to the river, and the tailrace was oriented downstream to preclude any river water from entering. The map also shows that the second half of the power canal traverses a steep slope which might be a source of problems. In fact, considerable damage from landslides occurred in this area even before the scheme was put into operation. An attempt is now being made to stabilize the slope by planting trees.

Musongati (Burundi)

At this site, the minimum flow in a little rivulet amounts to about 3 l/s and the available head at the top of a gorge is about 40 m (Fig. 4.19). Electricity was needed for lighting and a few electric appliances; therefore, it was necessary to generate a few kilowatts of power for several hours each evening. A flow several times the existing flow would be required for this purpose. Because of the low flow at the site, a dam was necessary to store water when no power was being generated. Because the dam is located at the top of a steep drop, a penstock is used to convey the water the entire distance to the powerhouse.

After the plant had been operational for some time, it was decided that more power would be required. This was accomplished by extending the penstock farther down the gorge to gain an additional 20 m of head, increasing the power potential by about 50% if the same flow were used. At this site, the additional power which could have been gained by extending the penstock even farther downstream would have been offset by the increasing cost for the penstock pipe.

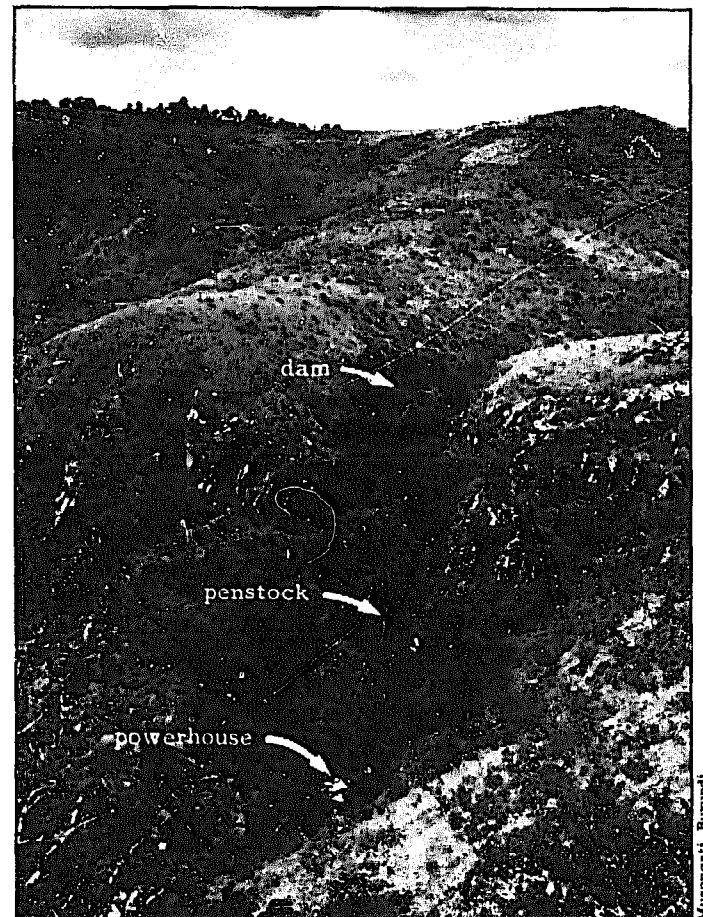

Fig. 4.19. A micro-hydropower scheme requiring a small dam for the storage of water.

Buhiga (Burundi)

To provide power to the mission facilities and staff at the Eglise Episcopale de Burundi at Buhiga and to serve several loads at the administrative center of the commune at Karuzi 10 km away, a 220 kW plant is being installed at the site shown in Fig. 4.20. It is a fairly typical site for Burundi--two flat, swampy areas joined by a short stretch of rapids with a gradient of about 5%. To maximize power available from the site, as much of the drop between these two areas as possible was to be

used. A low dam was built on a foundation of rock outcropping at the beginning of the rapids. A penstock could then have been laid along the streambed, but that would have increased its length about fivefold over that of the final design. To reduce costs and the difficulties of obtaining penstock pipe in a remote part of this landlocked country, a canal is being constructed which closely follows the contour of the land from the intake to a point above the powerhouse (Fig. 4.21). Because cement was expensive, imported, and in short supply, costs were reduced further by building the dam and canal of stone and concrete masonry rather than reinforced concrete (Figs. 4.22, 5.41, and 5.203). Skilled masons were also found locally.

A scheme could have been laid out on either bank. However, a scheme on the right bank would have several disadvantages: a longer penstock would have been required because of the more gradual slope on that side and, because of the location of the load centers, it would have necessitated slightly longer power lines and access road.

To maximize head with minimum penstock length, the powerhouse was initially to be located near the point the spillway joins the stream, with the penstock paralleling the spillway. Although slightly less head is available at the present site shown on the map, it is also at the beginning of an open area. The powerhouse is more accessible and is better protected from any flood flows which may occur.

From the spacing of the contour lines, it can also be seen that the original penstock routing would have involved two slopes; the final routing has essentially a single slope along the entire distance. This eliminates the need for a bend or considerable excavation around the central portion of the penstock. In both cases, a bend in a vertical plane is required at the powerhouse.

Gihéta (Burundi)

In the area around Gihéta, a series of rapids connects two stretches of Ruvyironza River, each with a small gradient. This is clearly the optimum location for max-

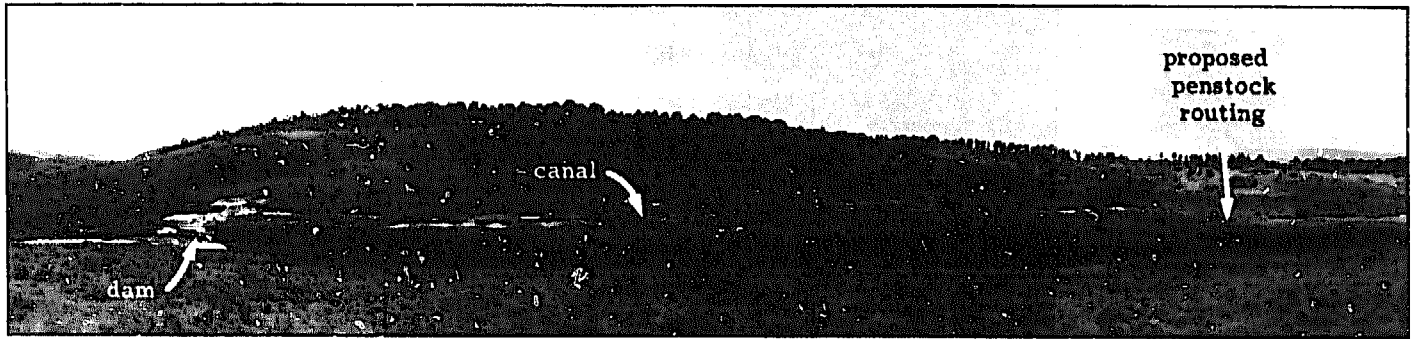

Fig. 4.20. A composite photograph of the Buhiga site drawn in Fig. 4.21.

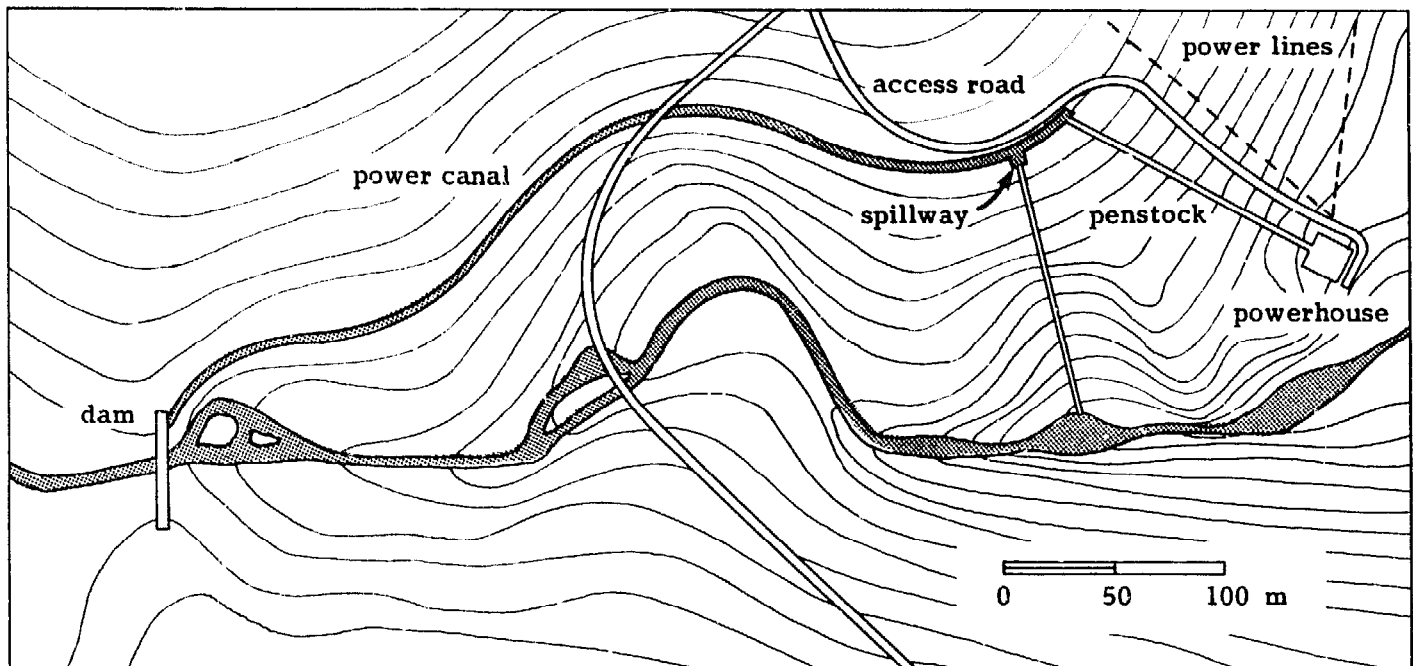

Fig. 4.21. Contour map (with 2 m contours) showing the layout of the major components at the Buhiga site.



Buhiga, Burundi (220 kW)

Fig. 4.22. With the canal walls largely completed, stone masonry is being laid for the base of the canal. Before the wall and canal bottom in the foreground can be completed, a small drainage ditch will be placed underneath.

imizing available head with the minimum length of conveyance structures. Because considerable flow is required to generate the approximately 90 kW which may eventually might be needed and because stone-masonry skills were available locally, it was decided that a canal rather than imported penstock pipe would be used to convey the water to the powerhouse area (Fig. 4.23).

The location of the intake was straightforward to determine, but the construction of a stone-masonry weir



Fig. 4.23. This low-head installation at Giheta, Burundi, designed to accommodate three 30 kW turbines, illustrates

from the actual intake across the river to a sandy oxbow, rather than orienting it perpendicular to this alignment, has caused problems. Plans had been to begin construction of the weir on the right bank, at the intake, while directing the flow toward the left bank. Then, as the left bank was approached, the dry-season flow would be bypassed through both the intake and openings in the base of the completed portion of the weir. However, the sandy left bank gradually eroded and it became apparent that this bank would not be reached. Work then proceeded on extending the weir at right angles, toward a rocky bank. When the photograph in Fig. 4.24 was taken, cofferdams had breached due to the early start of the rainy season, and work on the remaining several meters of weir had to await the next dry season. (Also see Dams and weirs, p. 78).

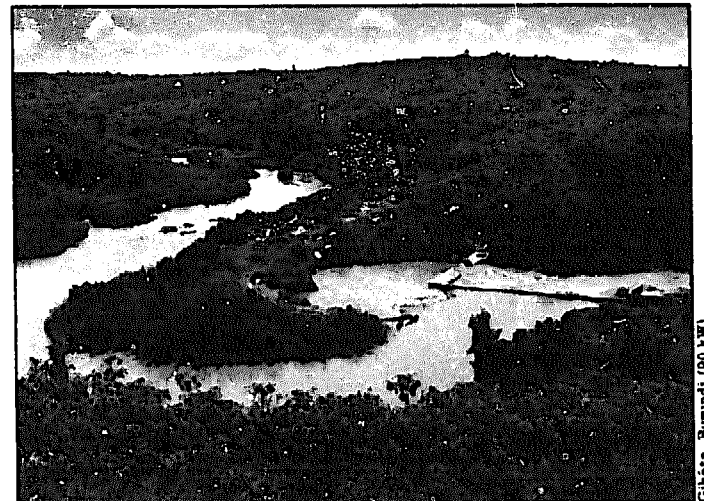

Giheta, Burundi (90 kW)

Fig. 4.24. Problems due initially to inadequate investigation into the nature of the foundation material at the oxbow on left bank was later compounded by the early arrival of the rainy season.

At this installation, an initial 30 kW unit comprising a manually-adjustable propeller turbine directly driving a submerged generator will be placed in a short length of penstock at the end of the canal. There is no need to construct a powerhouse, because the generator will be underwater and sealed. The civil works have been designed to accommodate two more similar units as the electrical load increases in the future.

the use of a power canal to reduce penstock length and maximize local inputs.



Fig. 4.25. From the head of a waterfall near Bishalalo (center of photograph), water is conveyed along a short

power canal and through a penstock to the powerhouse (lower left of center).

Bishalalo (Zaire)

The layout at this site was straightforward to develop. A steep series of cascades falling 10-15 m is located by the roadside (Fig. 4.25). A power canal is used to convey water from the head of the fall a short distance away from the steep section adjacent to the fall to facilitate construction of the penstock and powerhouse. A penstock then conveys water to the turbine, after which the water is diverted back to the stream below the fall.

Ruyigi (Burundi)

Gently rolling terrain is found in the vicinity of the Ruyigi micro-hydropower scheme. Along the Sanzu River, a small stone-masonry dam is used to create several meters of head and an additional 5-6 m is gained by means of a 800 m canal which carries water to the forebay. But from this point, there is a considerable

distance back to the stream. With a low head, a significant flow is required to generate 80 kW, and it would have been necessary to import a long, costly length of steel penstock pipe. By excavating for the powerhouse (Fig. 4.26), it could be located near the forebay, reducing significantly the length of penstock pipe required (Fig. 4.27). This also required the excavation for a tailrace in rock to return the water emerging from the turbine back to the stream. Though all the excavation was done manually, this approach proved more appropriate in this situation.

Mardan (Pakistan)

One case in which laying out a hydropower scheme becomes trivial is along irrigation canals. The designers of these canals have already addressed the problem of

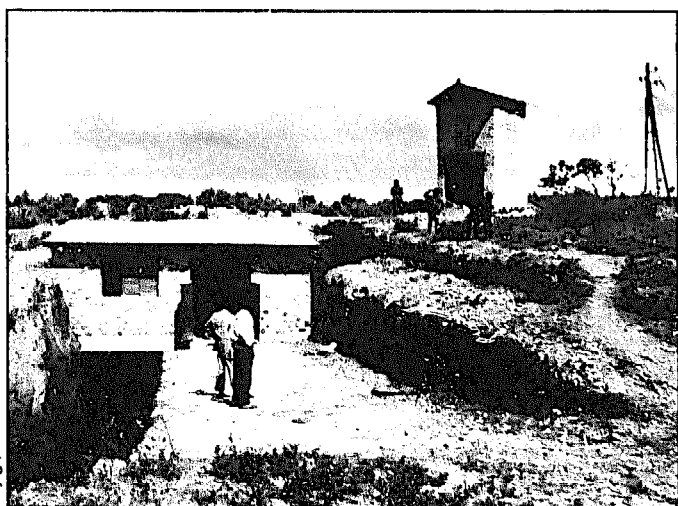

Fig. 4.26. To minimize penstock length, the powerhouse was built in rock below ground level. The forebay is located 10-20 m behind the powerhouse but is not visible. The structure to the right houses an 11 kV transformer.

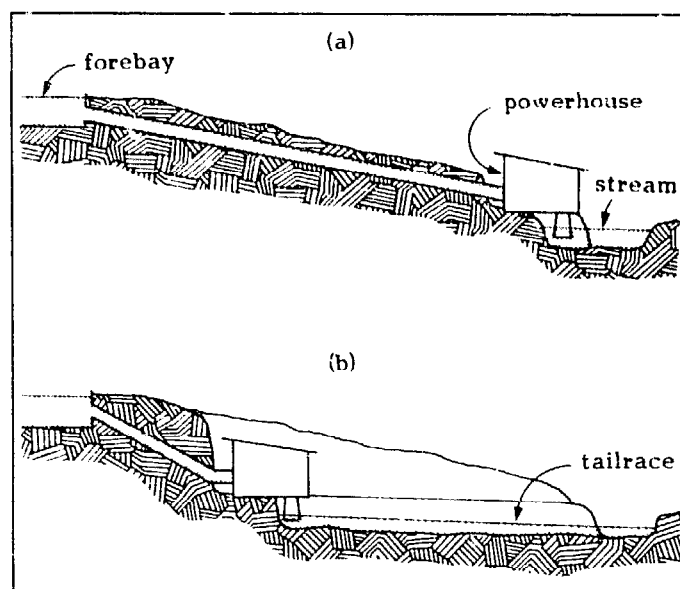

Fig. 4.27. Two possible options for developing the same site at Ruyigi: (a) using a long penstock and (b) using a short penstock but with considerable extra excavation required for the powerhouse and tailrace.

tapping a stream or river, and the quality and quantity of the flow in a canal should therefore already be controlled.

Where the terrain drops off more rapidly than is necessary for the water in the canal to attain the required velocity, drops frequently several meters high are included (see **Drop structures**, p. 110). These are

obvious sites for hydropower schemes, although the low heads available restrict the power potential of these sites. Fig. 4.28 illustrates a micro-hydropower plant which straddles a drop along a small feeder canal. The water that would otherwise tumble over the drop and dissipate its energy through turbulence is conveyed to the turbine by means of a very short flume.

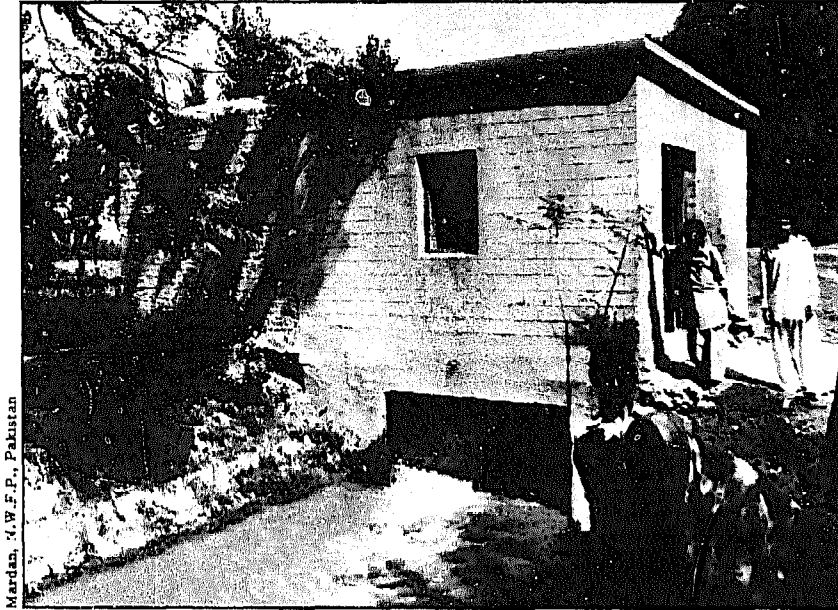
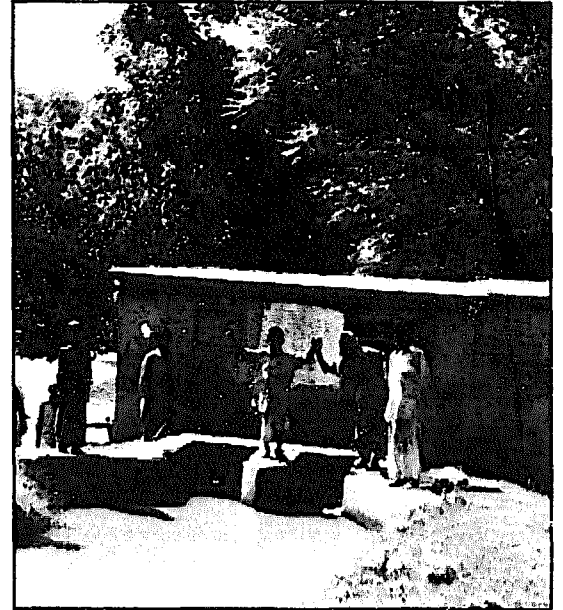

Fig. 4.28. At this mill, a traditional wooden vertical-axis turbine harnesses the energy available at a drop along an



irrigation canal to mill grain. The intake to the drop is shown at the right, with mill behind.

V. CIVIL WORKS

INTRODUCTION

The civil works for a hydropower scheme can be assembled from the principal components shown in Fig. 5.1. In addition, other components, such as spillways, gates, trashracks and skimmers, and settling basins, may be incorporated at one or more locations. Each of these components serves specific purposes. If commonly heard arguments against micro-hydropower schemes--their high cost and the relatively large efforts required to implement them--are to be countered so that micro-hydropower will be more widely accepted as an appropriate technology, it is important to incorporate only those components which are necessary at a specific site. If unnecessary components are included, overall costs are unnecessarily increased and new problems in imple-

menting and operating the scheme might be incurred. On the other hand, if necessary components are not included, the problems which these components were meant to address will remain, and these may also lead to increased cost of, and frustration with, implementing, operating, and maintaining a micro-hydropower scheme.

The first section of this chapter, **QUALITATIVE OVERVIEW**, provides the information a designer of a micro-hydropower scheme needs to decide which components are necessary for the most efficient design of the specific project under consideration. To attain this objective, this section will:

- describe briefly each component and subcomponent;

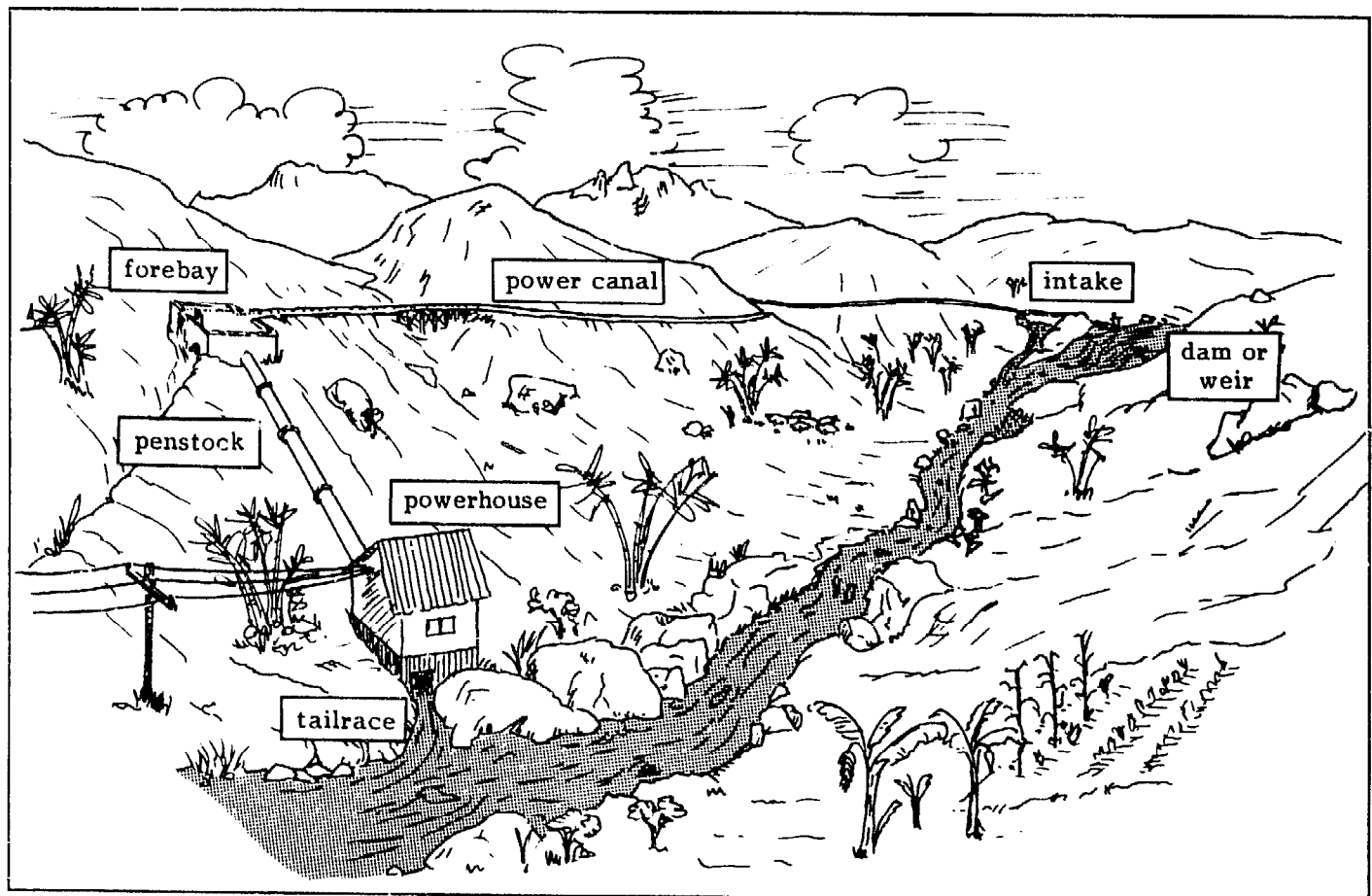

Fig. 5.1. An illustration of all principal components which might be included at a micro-hydropower site. This

scheme has been laid out at the site shown in Fig. 1.9.

- explain the function(s) each serves, how it serves the purpose, and its relationship to other components; and
- identify the factors which determine when each component should be included as part of the overall scheme.

In addition to incorporating only components necessary for cost-effective implementation of a scheme, it is also necessary to be careful in the design of each component used. Although designs of individual components might be standardized, there is still no single standard design to suit all sites. The second major section of this chapter, **DESIGN AND CONSTRUCTION DETAILS**, covers the design of individual components. Its objectives are:

- to provide a more detailed look at each component;
- to raise awareness of the range of potential problems which might be encountered in the installation, operation, and maintenance of that component;
- to identify factors which must be considered in designing and sizing each component and explain how these actually affect designs and dimensions;
- to present alternative materials that might be used to reduce cost of construction; and
- to document some design options for each component, which might be adapted as presented or serve as a catalyst for new designs.

This chapter deals primarily with projects in the micro-hydropower range (less than 100 kW). As projects increase in size, however, the same factors must be considered, although their impact of the final designs may differ as project size increases. In addition, only components relevant to micro-hydropower schemes are described; surge tanks, arch dams, and power tunnels, which are rarely used with micro-hydropower schemes, are not covered.

QUALITATIVE OVERVIEW

Dam or weir

A dam is generally thought to be an intrinsic part of any hydropower scheme, and this is frequently the case with large hydroelectric projects. However, a dam, like any component of a hydropower scheme, serves specific functions, and it is necessary to become familiar with these functions to determine whether a dam is actually required. Because of the number of disciplines—such as soil mechanics, geology, and structures—which must be considered, an experienced civil engineer is frequently required to design and supervise construction of a dam. Including a dam when it is not essential will:

- require that technical expertise be found;
- incur the expense of building the structure;
- lengthen the time before the scheme is operational; and

- possibly increase problems with maintenance.

On the other hand, excluding a dam when it should be included may result in inadequate potential for meeting present and future power generation needs. Rather than a dam, a weir is sometimes used. Although the terms "dam" and "weir" are commonly used interchangeably, they are not regarded as synonymous terms in this publication; they are each defined by the functions they serve. As used in this text, a **dam** is a structure that can fulfill either or both of two basic functions:

- A dam can be used to increase available head. Where the terrain is relatively flat, there may be a need to create head so that the required power can be generated from the available streamflow. A dam serves this function by raising the level of water behind it, thereby increasing the difference between the elevation of the water upstream and downstream of the dam.
- A dam can also be used to create a reservoir to store water. At micro-hydropower sites, the streamflow may be insufficient to meet the peak power demand with the available head, and a dam cannot add significantly to that head. In these cases, a dam might be included to store excess water in times of high flow or low power demand to make it available at times of low flow or increased demand. Except at very-low-head sites, most dams are used only to store water; they do not significantly increase the available head.

When adequate head and flow are both available, no dam is required. Water is essentially used at a rate no greater than that with which it "runs" down the river. Such a scheme is called a "run-of-river" scheme. A portion of the flow in the stream is simply directed toward the powerhouse and then rejoins the original stream. The vast majority of micro-hydropower schemes are run-of-river.

A run-of-river installation is sometimes misunderstood to be one in which the turbine is placed directly in the river. However, this is more properly referred to as an installation using an in-stream or water-current turbine (p. 187). As can be seen from the preceding definition, although an in-stream turbine installation is also run-of-river, the term "run-of-river" is much broader.

As noted in **LOCATING THE INTAKE** (p. 52), the intake to a hydropower scheme should be situated to prevent riverborne debris and unusually large flows from being funneled into the intake, especially during heavy rains. At the same time, there is a need to ensure that an adequate flow of water is diverted toward the intake to generate power during times of low flows. To accomplish this, a low diversion structure of temporary or permanent construction, commonly called a **weir**, is often constructed across a part or all of the stream. As used in this publication, a weir is a structure specifically designed to divert the required flow into the intake, not to store water. It might either channel the flow toward the intake or simply provide the required depth of water at the intake for flow to enter of its own

accord. Where the streambed is susceptible to erosion, a weir also maintains the level of the streambed constant near the intake; otherwise, the streambed might erode so badly that the stream eventually will be too low for water to enter the intake.

The following discussion describes the circumstances under which a dam or weir would be incorporated in a hydropower scheme to fulfill each of these three functions.

Increasing head

If the terrain in the vicinity of a site is relatively flat, the head available for power generation can be increased by conveying the water over a considerable distance by means of a pressure pipe or penstock (Fig. 5.2a). However, in areas with little slope, the increased length and diameter of a penstock necessary to obtain the required head and power would make this option costly. This may be true even in fairly hilly terrain if the gradient or slope of the stream itself is small. For a stream with a very small gradient or slope, incorporating a dam (Fig. 5.2b) may be the only viable option for increasing head. All the head would then be concentrated near the dam and powerhouse, markedly reducing the dimensions and cost of the penstock. If a dam is to be constructed, the topography of the area must be suitable, most probably a section of a stream with relatively steep banks. However, even at microhydropower sites with very low head, a dam is rarely built to increase head because of significant cost and

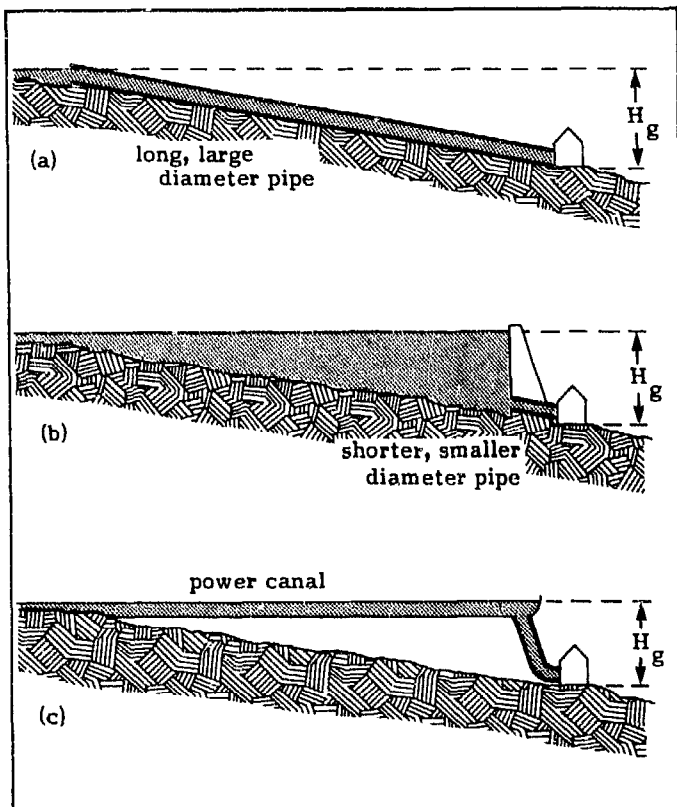

Fig. 5.2. Three approaches to obtaining the same head and power potential.

effort required for its construction. It should be noted here that, regardless of the head, a power conduit—frequently an open canal—is a most common means of increasing head (Fig. 5.2c). If the terrain is suitable, this is often more cost-effective than either a dam or a long penstock.

A dam incorporated at a low-head site can significantly increase the head and therefore the power potential at that site. At higher-head sites, dams are generally not incorporated to increase head because the increase due to the added height of water behind the dam does not justify the additional construction effort required (Fig. 5.3).

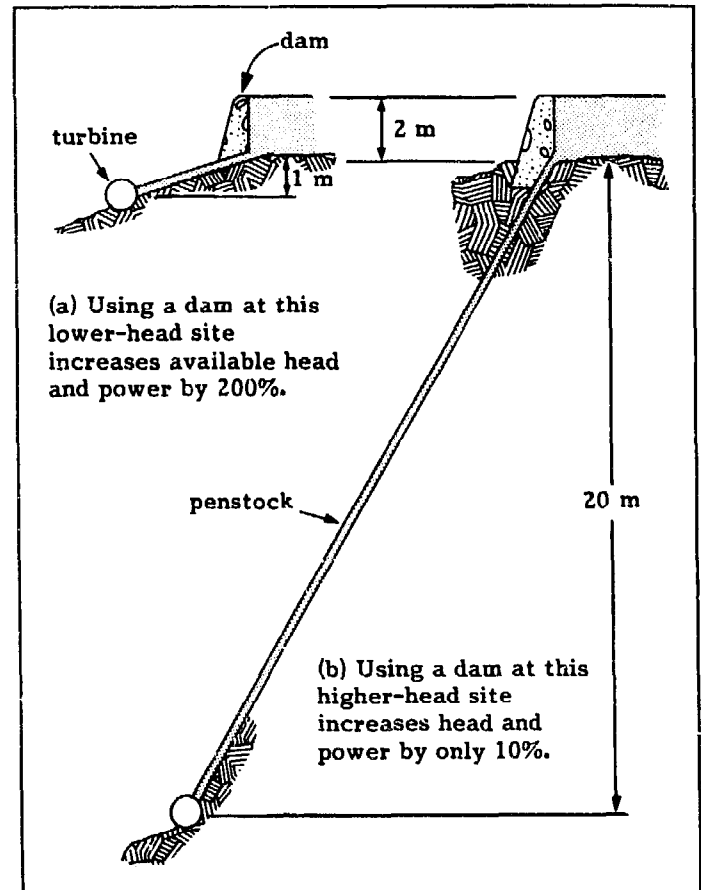

Fig. 5.3. Comparison of the relative increases in power obtained by incorporating a 2 m dam at a very-low-head and at a higher-head site.

Providing storage

Incorporating a dam to store water and make it available when water demand for power generation outstrips available streamflow requires careful forethought. There are at least two occasions when such an approach would be considered:

- Storage would be considered when streamflow is inadequate to meet the peak demand which occurs during part of each day—for example, for lighting and cooking during early evening hours. In this case, the streamflow should be adequate to provide excess water for storage during off-peak times, and the

impoundment behind the dam should have the capacity to store this excess to meet peak power demands on a daily basis.

- Storage would also be considered when there are distinct dry seasons. In this case, the volume of the impoundment must be adequate to generate power not only for several hours a day, but for weeks or possibly months. Because this would require a dam and storage reservoir of significant dimensions, storage for more than several days is rarely considered with micro-hydropower schemes.

In both cases, the required storage capacity and the associated dam height can be derived simply from the projected load patterns and streamflow data. Whether a dam of reasonable size can provide sufficient storage to meet present and future needs can then be determined. In so doing, it must be remembered that only the volume of water located above the outlet to the power scheme is available for power generation. This is called the active storage. The dead storage, or the volume of water located below the outlet, is clearly of no use for power generation.

Even if a dam can provide adequate storage, its cost might provide an incentive to look for a higher-head site so that the same energy and power could be generated from a smaller volume of water. If a dam of reasonable size and cost cannot meet the expected needs and no higher-head site can be found, two options remain:

- to consider a load pattern which makes more efficient use of the power that can be generated without an inordinately large dam, or
- to conclude that hydropower alone is not an option at this site.

It should be noted that when a dam is used to create pondage, the dam obstructs the normal flow of the stream and the water is stored in the riverbed itself. In countries with a pronounced difference between wet and dry season flows, flood flows can be significant and have a devastating effect on any structure in the stream. In addition, sediment and bed load would be deposited behind the dam, reducing its effectiveness in storing water. Under these circumstances, it might be advisable to store water off the stream. A forebay can then serve this function (Fig. 5.4).

In considering the construction of a dam for storage, several factors must be kept in mind:

- Because the power which can be generated is proportional to the product of net head and flow, the higher the available head, the lower the flow required to generate a given power. Lower required flows reduce the required storage volume and therefore the dam's size and cost. In effect, the higher the head, the more effective a given storage volume. In addition, the smaller storage volume required for a higher-head scheme implies potentially fewer adverse environmental impacts.
- If a dam is to be a major component of a micro-hydropower scheme, its inclusion must be determined by calculations based on realistic streamflow information. If streamflow information is not available but flow seems to be sufficient for most of the year, a scheme might initially incorporate a simple weir across the stream to bring the powerplant on line with minimum delay. Then, after more data are obtained, a decision can be made on the advisability of replacing the weir with a dam.



Fig. 5.4. An enlarged forebay stores water for peak evening loads when streamflows alone are inadequate.

Dhading, Nepal (30 kW)

A micro-hydropower project with a capacity of 30 kW under a head of 60 m is being implemented near the village of Yandohun in the fairly remote northern corner of Liberia. Based on occasional observations of the stream to be used and comments by the villagers, the streamflow was thought to be above the 80 t/s required to generate full power for all but two months of the year. The only existing streamflow data were gathered during a week at the end of the dry season when the low flow was measured as 7 t/s. Initial plans were to build a sizable stone-masonry gravity dam about 40 m long and 2 m high. This was intended to retain sufficient water to run the plant at half power for a 12-hour period for several days at the minimum observed flow or, equivalently, for shorter periods over correspondingly more days. Because of its design, the turbine could not operate at less than half power without modification.

When the plant was visited, work on the dam had been underway for some time but with little progress (Fig. 5.5). Construction proved time-consuming. The volume of the dam was large, and the stone was obtained by building fires on bedrock to crack it. The stone was then broken with hammers to obtain aggregate.

It was recommended that the dam not be completed but built only high enough to serve as a weir. The weir could be built up at some later date if desirable. This recommendation had the following advantages:

- The plant could be operational with minimum delay. The project was ambitious even without the dam, and the villagers needed to begin realizing some of the benefits of their efforts as soon as possible.
- Streamflow observations showed that without a dam, flow was adequate 85% of the time (10 months) to generate full power and that, for another 5%-10% of the time, the flow would probably be sufficient to operate at half power all day. Construction of the dam would only permit

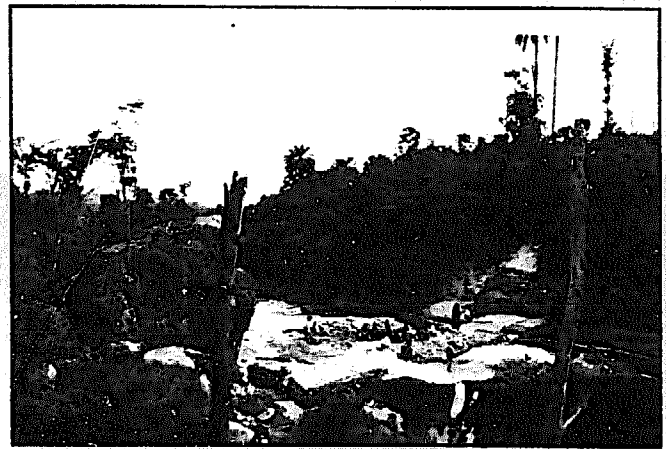

Fig. 5.5. A composite view of the dam site for a 30 kW hydropower scheme in Yandohun, Liberia.

half power to be generated part of each day for the remaining 5%-10% of the year. Because the impoundment was too small to permit storage of water from the earlier rainy season, it would still be impossible to guarantee water for power generation at all times. Therefore, not much would be gained by constructing a dam. In this case, an effort to modify one of the two fixed nozzles by reducing its size would be more appropriate than to construct a dam because it would permit at least some power to be generated at all times with no storage.

- A delay in building the dam to full height would permit the operators of the plant to determine whether the silt and bed loads carried downstream and caught behind the weir would present problems should a dam be built later. After the plant begins operation, more flow data during the dry season—information needed for proper dam sizing—could be gathered. At the same time, the villagers could decide whether having electricity for part of the day during the remainder of the dry season would be worth the additional time and expense required to complete the dam.

Diverting flow

With micro-hydropower schemes, a dam is rarely required to increase head or store water; however, a weir might be required to divert adequate flow into the intake for power generation. At some locations, the lay of the land and natural formations within the stream may direct sufficient water into the intake without a weir. Simply placing a few stones across the streambed also could achieve this purpose (Fig. 5.6).

Where the streambed is likely to erode, a weir can be included to maintain its level near the intake. If the streambed is composed of bedrock or streamflows are not large enough to erode the bed, a weir for this purpose may be unnecessary.

A weir is also useful where streamflows normally fill only a portion of a wide streambed, at least during the drier seasons, and the low flows may never reach the intake (see Fig. 5.48). In this case, a weir should be designed to deflect low flows toward the intake yet permit high flows and waterborne debris to proceed downstream unhindered. Such a design will prevent silt, bed load, or other debris from having the adverse impact on the life of a weir that they do on the life of a storage reservoir formed by a dam.

Intake

An intake permits a controlled flow of water from a river or stream into a conduit which eventually conveys

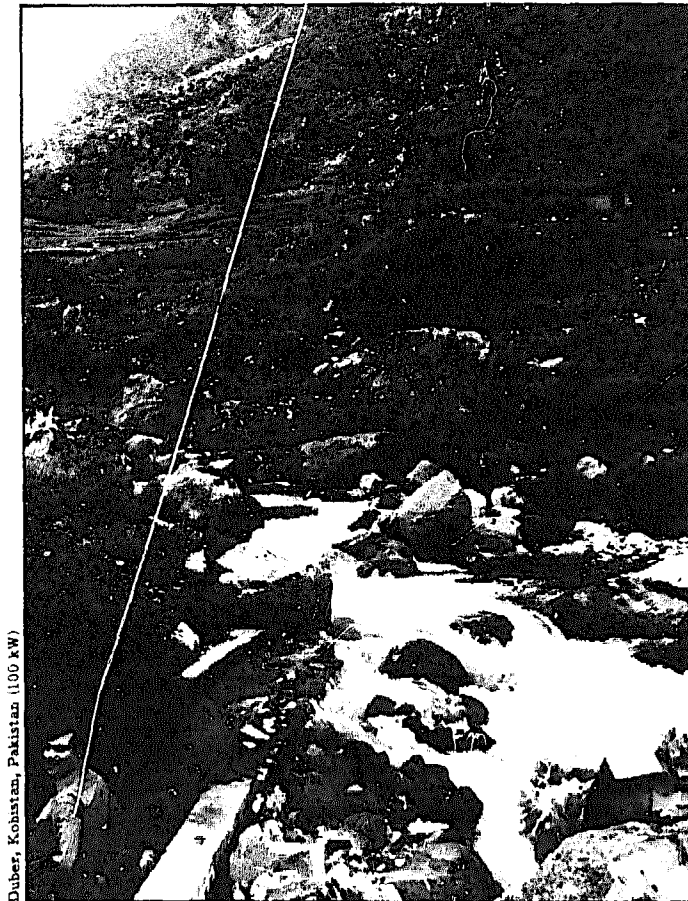

Duber, Kohistan, Pakistan (100 kW)

Fig. 5.6. No permanent weir has been included at this site. A few boulders placed across the stream will permit additional flow to enter the intake when required for power generation.

it to the turbine to generate power. An intake is a component of virtually every hydropower scheme. The intake serves as a transition area between a stream which can become a raging torrent and a flow of water which must be controlled in both quality and quantity; therefore, its design requires careful consideration. An improperly designed intake may become a source of continuing and frustrating maintenance and repair problems, not only with the intake but with all other major components of a scheme. For this reason, the long-term success of a hydropower scheme depends largely on the design of the intake.

The selection of a design is complicated by the variety of possible intake configurations ranging from simple, excavated canals opening onto a stream to large, reinforced-concrete structures. They can be either separated from, or an integral part of, a weir or dam. The most appropriate design for a specific site is determined by a number of factors, including:

- the quality and quantity of water required;
- the extremes in the stage of the stream;
- the topography and soil conditions of the site;
- the nature of the catchment area;
- whether a dam or weir is to be constructed at that site;

- the financial capital available for its construction; and
- the relative capital vs. labor resources available for construction, operation, and maintenance of the structure.

One of the major functions of the intake is to minimize the amount of debris and sediment carried by the incoming water. Trashracks (p. 162) are often placed at the entrance to the intake to prevent the entrance of floating debris and larger stones. Skimmers (p. 165) are sometimes used to prevent floating debris from entering the intake. Depending on the water quality, a settling basin (p. 166) might also be incorporated to remove some of the more troublesome waterborne sediment. Without these features, the sediment and debris could settle along the power canal, eventually obstructing the flow, or they could pass through the turbine, damaging it or reducing its effective life. If a spring or other source of clean water is used, trashracks, skimmers, or settling basins may not be needed.

The intake also controls the flow of water which is admitted under all streamflow conditions. Several types of gates (p. 154) can be used to control this flow. Spillways (p. 159) also serve as a backup to the gates by permitting excess water which has entered the intake gate to overflow back into the stream. If the waterflow is not controlled at the intake, excess water may cause the power canal or forebay to overflow unexpectedly, leading to serious erosion which can undermine the canal, forebay, penstock, or powerhouse. Although the canal and forebay should be designed to prevent damage from flows larger than those expected, it is still best to minimize this possibility by incorporating spillways in the intake structure.

Proper design of the intake is essential for trouble-free operation of the civil works; however, proper location of the intake along the stream reduces the burden placed on the intake itself (see **LOCATING THE INTAKE**, p. 52). Adequate initial planning is necessary to place the intake where it will be protected from excess water and debris which might otherwise be funneled into it during flood stage.

Power conduit

As used in this book, the term "power conduit" signifies the component of a hydropower scheme used to convey water a relatively large distance from the stream to the inlet of the penstock, with minimum loss of head and at minimum cost.

A power conduit is most frequently a canal excavated in soil, because this approach reduces cost (Fig. 5.7). Such canals are sometimes lined or constructed with concrete or other impervious material to reduce seepage of water which might eventually undermine the canal or to permit increased velocity and flow along the canal. They may also be built of concrete or stone masonry (Fig. 5.8) or of half-round wood, sheet-metal, or concrete sections supported above the ground. Because an open canal needs to have only enough slope to produce the required



Fig. 5.7. An unlined power canal cut into a steep hillside.

flow, its alignment should nearly coincide with a contour line. Depending on the topography of the area, portions of this conduit may be supported above the ground (such as when it crosses ravines) or placed underground in a pipe (such as when it crosses a road).

A pipe can serve as a low-pressure power conduit to convey water from the intake to the beginning of the penstock. The pipe has an advantage over the canal in that it eliminates components such as spillways, drop structures, and drainage which are usually incorporated in the design of power canals. It also does not need to remain level but can follow the rise and fall of the terrain it traverses. On the other hand, a pipe often must be imported and generally costs more than a canal, especially a simple canal excavated in earth. However, lengths of pipe are sometimes included along sections of the power conduit where a canal is not possible (Fig. 5.9).

With larger schemes, power conduits may take the form of tunnels; over rocky terrain, few other alternatives may exist. Among the several advantages they possess, tunnels can:

- make a more direct route possible;
- protect the conduit from landslides, heavy runoff, and debris; and
- avoid interference with surface features such as roads, gardens, or houses.

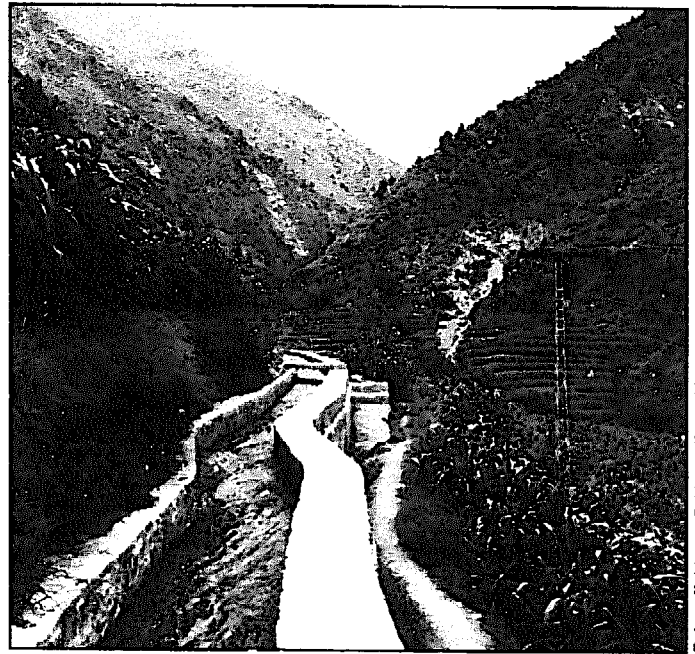

Fig. 5.8. A stone-masonry power canal.

However, tunnels must usually be large enough to accommodate men and equipment necessary for the tunneling operations and therefore are too large for the flows used by most micro-hydropower schemes. With tunnel boring machines, it is impractical to drill a tunnel much smaller than 2.5 m in diameter. In Nepal, a local company uses compressors and jackhammers to construct tunnels as small as 1.50 x 1.75 m.

Although tunnels are rarely included within micro-hydropower schemes to convey water a significant distance, short tunnels may prove useful along power canals where a rock outcropping must be crossed. These can be seen along traditional irrigation canals in countries such as Nepal.



Fig. 5.9. Pipes are used to connect two sections of a canal where a steep, unstable section had to be traversed. Three lengths were used because a single pipe of the necessary diameter was not available.

Unlike most of the other components, the power conduit is not an essential part of every hydropower scheme. Where the drop in elevation is concentrated near the powerhouse and there is a significant horizontal distance between the intake on the stream and this drop, a power conduit is used to reduce the cost of the civil works. Rather than using a costly penstock pipe for the entire distance, a power conduit conveys the water from the intake to a point as close to above the powerhouse as possible. The design objective is to make the penstock as steep as possible to reduce the diameter and length—and therefore the cost—of the required penstock pipe. The cost of the conduit itself must then be added, but the conduit frequently can be constructed at a fraction of the cost of a penstock, especially if local materials rather than imported steel, concrete, or plastic pipe can be used.

To illustrate this point, consider a scheme that extends approximately 1 km, a distance not uncommon for a micro-hydropower scheme. Assume that this site, with a gross head of 30 m, requires about 300 t/s to generate 50 kW (Fig. 5.10). One option is to convey the water through a penstock from the intake to the turbine. This would require 1000 m of 600 mm-diameter pipe. However, if there were a rapid drop near the powerhouse which would require only 100 m of pipe to obtain approximately the same head, a second option would be to convey the water 1 km from the stream to the inlet of that penstock pipe with as small a head loss as possible.

This is where a power conduit, perhaps in the form of a canal, can play a role. With a drop of only 1 m over its 1 km length from the intake to the penstock, the required flow can be conveyed with a canal cross-section of about 0.2 m². Then, only a 100 m length of 400 mm penstock pipe would be required to convey this flow from the end of the canal to the turbine.

In summary, the first option requires 1000 m of 600 mm penstock, whereas the second option requires 100 m of 400 mm penstock and the excavation of 1000 m of canal. For a clearer impression of the cost implications, assume that 400 mm steel pipe costs \$60/m and 600 mm pipe costs \$140/m. The costs for each option would be:

- first option—\$140,000 for the penstock plus the cost of excavating a trench for the 1000 m penstock if required;
- second option—\$6000 for the penstock plus the cost of excavating a 1000 m canal and a trench for the 100 m penstock if required.

Assume further that the cost of the turbo-generating equipment for this 50 kW plant is \$800/kW or a total of \$40,000. The long penstock in the first option would add \$140,000, making it the major cost component of the project. The price of the penstock proposed in the second option, however, would contribute only marginally to the cost of the project.

In the second option, the cost of the canal itself must be considered. If the canal is constructed as a self-help project, only the cost of materials for any lining deemed necessary or for a section of the canal which requires special attention, such as a supported section, would be incurred. If canal construction requires contract labor or heavy equipment or if the terrain is difficult, larger costs could result, perhaps making the first option more appropriate.

Although a power canal can considerably reduce costs, the existence of a significant horizontal distance between an intake on the stream and the powerhouse is not sufficient reason to include a power canal or other form of power conduit in the design of a hydropower scheme. It is always necessary to compare the costs of these two options—a long penstock vs. a conduit and short penstock—and to consider the nature of the terrain and the potential construction and maintenance problems associated with each option.

The principal disadvantage of incorporating a power canal when the topography is suitable is that, unlike a penstock, a canal is usually open. Because it is more exposed to the elements, it requires more upkeep. Falling trees or landslides might obstruct the flow, excessive runoff uphill of the canal might cause sections to wash away, or sediment in the incoming water might settle out along the canal. Although properly designing a scheme can prevent many such problems, a penstock pipe is less susceptible than a canal to these problems.

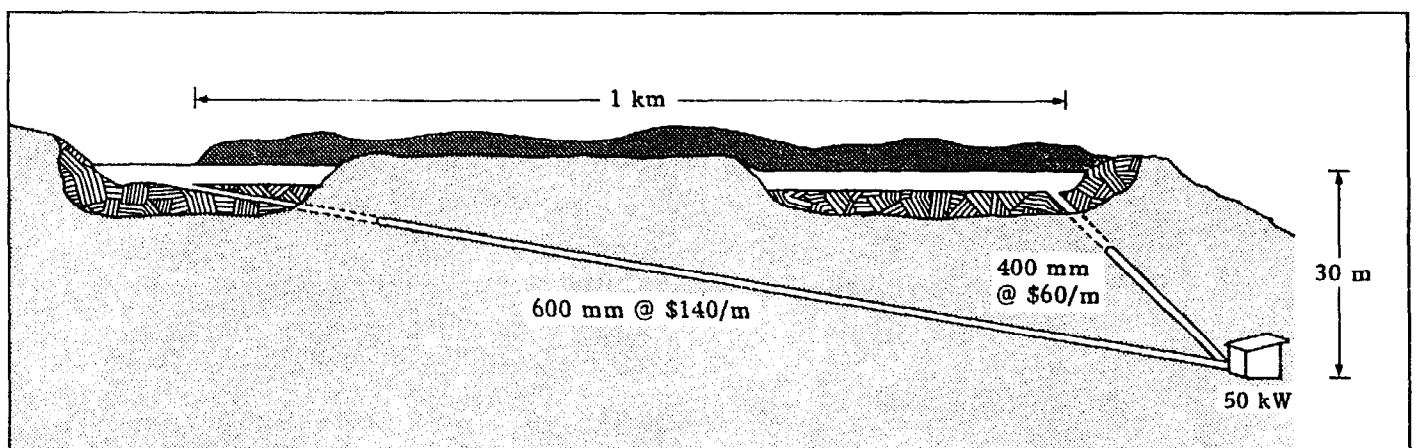

Fig. 5.10. These two approaches to developing the same site can lead to considerable differences in cost.

As mentioned, a low-pressure pipe can also serve as a power conduit. This avoids some of the disadvantages of using an open canal. By using a low-pressure conduit, especially at medium- and high-head sites, a less costly pipe can be used because a pipe wall thinner than that used for the pressure penstock is necessary. A low-pressure conduit generally will cost more than an earth canal.

Because power canals are the most commonly used form of power conduit, **Power conduits** (p. 96) deals primarily with their design and construction; however, some information on the use of pipes as power conduits is also included.

Depending on the length, slope, and dimensions of the power canal, **spillways** (p. 159) might be incorporated at appropriate intervals. When they are used, provisions must be made to ensure that any overflow leaving via the spillways will not undermine the canal or other components. Spillways are necessary if there is any chance that a canal might overflow if excess water enters the canal, although proper design of the intake should minimize this possibility. Spillways are also necessary if dirt from landslides or other debris entering a canal could restrict the flow, causing water to back up until the canal overflows.

If a canal is built on a hillside where runoff along with debris and sediment can enter the canal, provision may have to be made for proper **drainage** (p. 108) around the canal. If significant runoff can still enter a canal, a

forebay of sufficient size will be needed to serve as a settling area before the water enters the penstock.

When the power canal must cross difficult terrain or an obstruction such as a ravine, streambed, topographical depression, or road, any one of several approaches might be adopted:

- The slope of the canal can be maintained and the canal supported above this obstruction in a **flume** (p. 112) constructed of wood, steel, or concrete (Fig. 5.11).
- The slope of the canal can be maintained, with a structure to reroute that obstruction over the canal (Fig. 5.12) which would then flow in a **culvert** (p. 116).

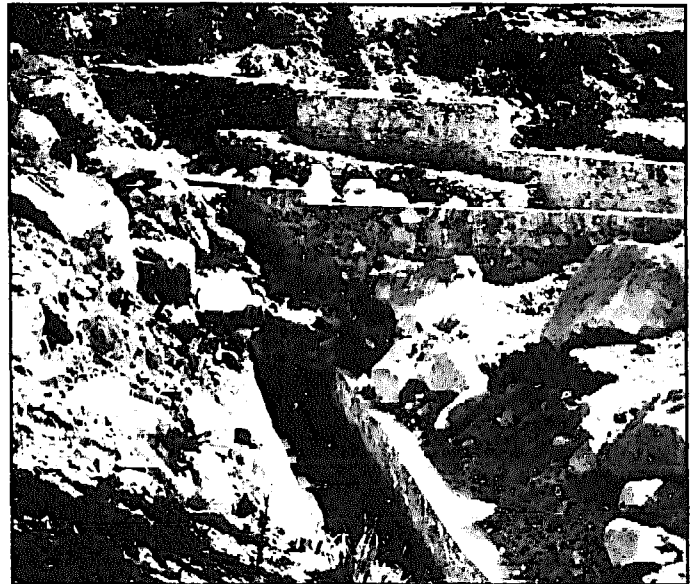

Syangha, Nepal (80 kW)

Fig. 5.12. A power canal passes through a culvert under a ravine which collects considerable runoff during the monsoon. Two walls visible above the culvert keep this flow within its banks.

- An **inverted siphon** (p. 115) can be used to lead the flow under the obstruction (Fig. 5.13). This is a closed conduit which permits the water in the canal to drop in elevation until it passes the obstruction and then to rise again on the other side. Under certain circumstances, this might be the only option. If so, it must be designed carefully because sediment can accumulate in the siphon and obstruct the flow. Adequate provision should be made at the design stage to permit removal of this sediment.

Although a power canal is usually designed to minimize head loss, drops along its length might sometimes be necessary to avoid obstacles in the terrain. The energy gained by the falling water must be dissipated in a controlled manner; otherwise, it might erode part of the canal. Properly designed **drop structures** (p. 110) are used for this purpose (Fig. 5.14).

When a power conduit runs near a stream, it is neces-

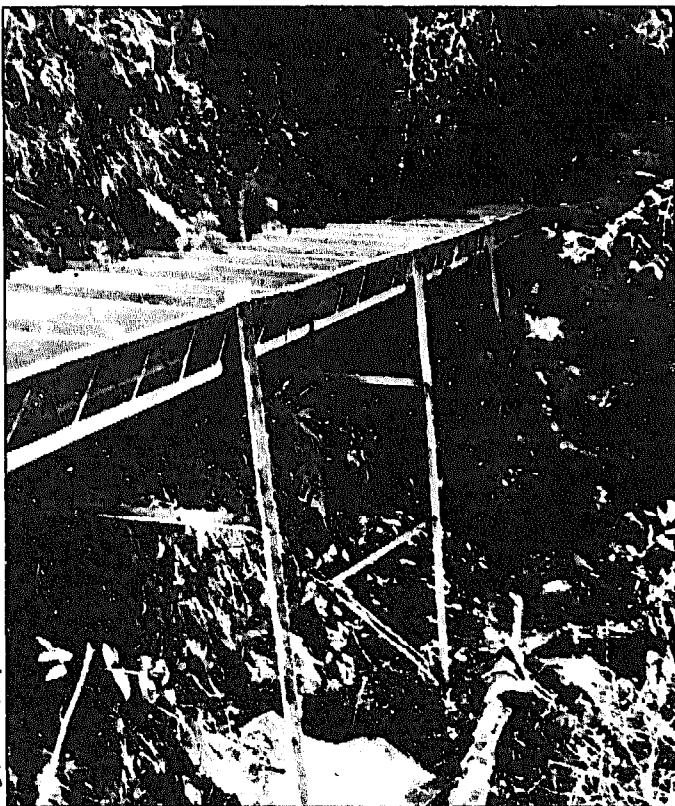

Rugit, W.H.P., Papua New Guinea (25 kW)

Fig. 5.11. A sheet-metal flume supported by a trestle constructed of angle iron.



Fig. 5.13. An inverted siphon conveys water across the main Kathmandu-Pokhara road in Nepal to irrigate fields and power a traditional water mill.

sary to ensure that the stream cannot undermine this conduit (Figs. 5.15 and 5.200). It is also important to be aware of springs which may either undermine power conduits or cause landslides above them (see Fig. 5.30).

Forebay

The forebay is a basin located just before the entrance to the penstock. Possible designs range from a simple excavated area or pond to a structure of reinforced concrete. Its size may vary depending on the quality of the water being conveyed to the penstock and whether



Fig. 5.14. Two stone-masonry drops along a power canal.

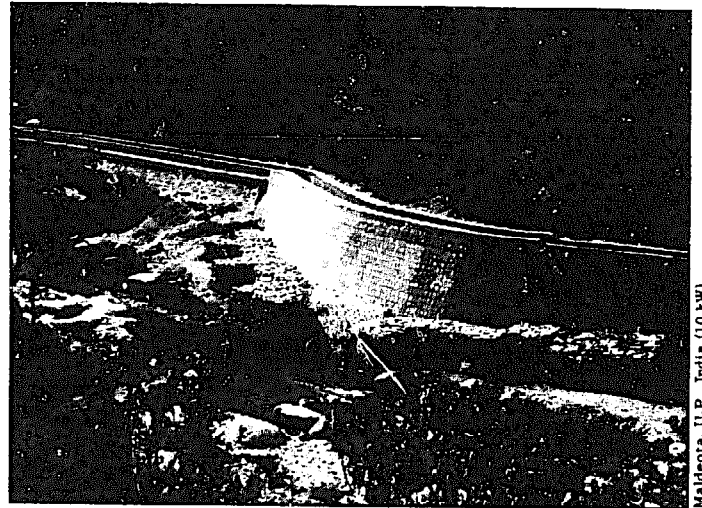

Fig. 5.15. Gabions are used to protect the foundation of a canal conveying water for power generation and irrigation.

it is to serve for storage. In some cases, it is virtually nonexistent. To be most cost-effective, the forebay must be of a size adequate to fulfill its function, neither significantly larger nor smaller.

The forebay can serve several purposes:

- It can serve as a final settling basin where any waterborne debris which either passed through the intake or was swept into the canal can be removed before the water passes on to the turbine. In this case, the forebay must be large enough to reduce flow velocities sufficiently for settling to occur (see **Settling basins**, p. 166) and to accommodate the sediment which accumulates between cleanings.
- The forebay can also provide storage. Because a significant volume of stored water would be required to supply a turbine for several hours each day, water is more frequently stored behind a dam in the streambed itself. However, if the topography, geology, or land-use in an area makes storage within the streambed difficult, a forebay might have to serve that purpose. Storage in the streambed requires a dam of sufficient height. On the other hand, forebay storage usually requires excavation of a significant volume of ground which then has to be sealed to prevent water seepage which can undermine the structure. A forebay serving as storage contains a large volume of water and is usually located just above the powerhouse, at the top of a steep drop; therefore, it must be carefully designed and constructed.

However, a forebay generally provides only enough storage to cope with water demands created by a sudden increase in loading on the turbine. This is a transient condition because, after flow in the power canal has re-established itself, it should convey the increased flow necessary to continue meeting the turbine's increased demand. Where streamflow is sufficient, it might be more appropriate to permit the maximum flow that might be required by the turbine into the forebay and to allow flows not

Yaibos, Enga Prov., Papua New Guinea (90 kW)

Maldeota, U.P., India (10 kW)

required by the turbine at times of reduced load to leave by the spillway. Where a load-controlling device is used with the turbine (see **Load controller**, p. 204), penstock flow remains constant, thus eliminating the need for storage to compensate for transient flow variations.

Several important components are usually included in the forebay. These include a spillway, a scouring gate, a gate to the penstock, a trashrack, and possibly a vent.

On occasion, the flow entering the forebay may exceed the flow leaving via the penstock, such as when a gate at the intake has been set improperly, when the valve to the turbine has been closed, or during heavy rains when excess flows enter the canal from the stream or from runoff uphill of the canal. For this reason, it is advisable to include a spillway (p. 159) in one wall of the forebay. The water passing over the spillway must be diverted properly to prevent erosion that might undermine the forebay, penstock, or powerhouse (Fig. 5.16). The dimensions and slope of a spillway canal must be adequate to convey safely the maximum flow which might ever enter the forebay. A natural rock ravine might serve that purpose. If a gate is located at the entrance to the forebay to prevent water from entering during its repair or cleaning out, the canal wall just before this gate must also incorporate a spillway large enough to permit any water descending the canal to be diverted safely.

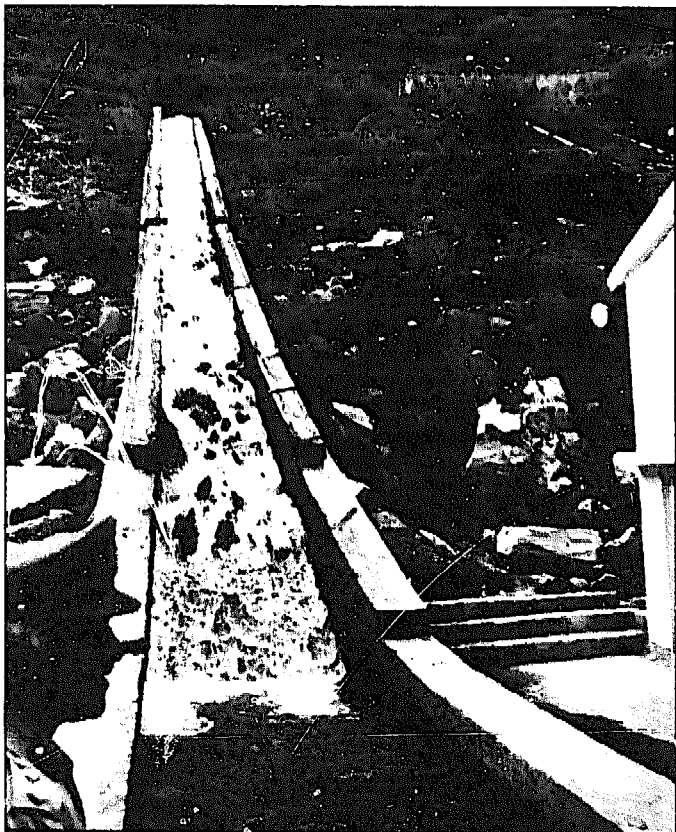

Duber, Kohistan, Pakistan (100 kW)

Fig. 5.16. Excess water is led around the powerhouse back into the tailrace canal. Stones embedded in the concrete chute dissipate the energy of the descending water.

Incoming water can carry sizable quantities of floating debris. A trashrack (p. 162) is often included at the inlet to the penstock to prevent this debris from entering the penstock and turbine. Skimmers (p. 165) are also used occasionally (Fig. 5.17). If excess water is sufficient, the spillway can be located to remove most of the floating debris automatically.

A gate or valve (p. 154) should be incorporated to drain the forebay so that any sediment which has entered and settled can be removed easily. Draining is also required when the forebay is being repaired. The flow through the drain can be led away in the same canal that removes the overflow from the spillway(s) at the forebay. When the penstock must be emptied for repairs, a valve might be incorporated at the beginning of the penstock. However, because such a valve would be the same size as the penstock, it can be costly. In addition, it would only be used infrequently. A less costly approach is to ensure no water enters the forebay, by closing a gate either at the intake to the scheme or just before the forebay (if a spillway is located just upstream of that gate). To ensure that water which might unexpectedly enter the forebay does not cause erosion along the penstock under repair or flood the powerhouse, a gate is often placed just before the inlet to the penstock. This gate is usually a stoplog because it is used infrequently and is inexpensive.

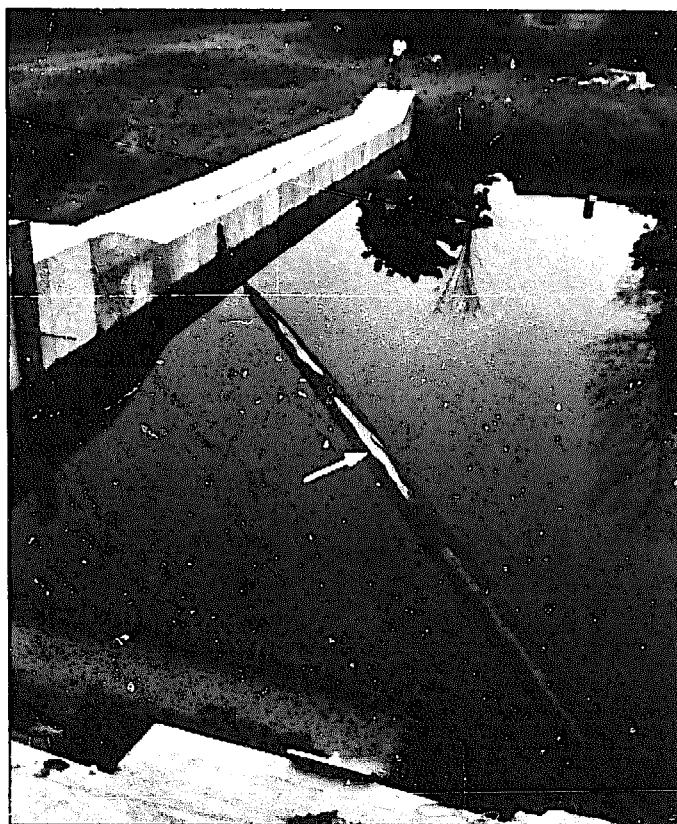

North Montpelier, VT, U.S.A. (220 kW)

Fig. 5.17. Although the trashrack is oriented upstream, a wooden pole secured to the walls serves as a skimmer. It prevents some of the floating debris from getting caught up in the trashrack and, being inclined to the flow, encourages the stream gradually to sweep this debris downstream.

As is described in Penstock, an air vent (p. 76) is often used as a safety precaution against collapse of the penstock pipe. One design option would be to incorporate this pipe in the wall of the forebay just below the inlet to the penstock (see Fig. 5.109).

If a second penstock and turbine may be added at some later date, its installation would be facilitated by incorporating a wooden plug in the concrete forebay wall, possibly with a steel plate on the inside to give the required strength. When the second penstock is to be installed, piercing the forebay wall will prove much easier.

Penstock

The penstock is a pipe that conveys water, under pressure, to the turbine. Except for some schemes with very low head—such as open-flume Francis and propeller turbines, in-stream turbines, and traditional water-wheels—it is an essential part of any micro-hydropower plant.

A penstock pipe can be installed either above or below ground. Flexible, small-diameter penstocks used for plants with very low outputs are sometimes draped over the terrain down the hillside; however, larger-diameter penstocks installed above the ground must be secured properly to prevent movement which could damage the pipe. Although this increases the cost of penstock construction and maintenance, the alternative—excavation for a buried pipe—might be no less costly. The installation of a penstock above ground increases its exposure to the elements, but its accessibility also facilitates inspection, maintenance, or repairs. Burying a penstock may involve considerable time and expense, but it protects the pipe from the elements and from landslides, falling rocks, brush fires, and tampering. In addition, the compacted soil firmly secures the penstock, providing adequate anchorage for most small-diameter pipes.

A penstock above ground is subject to greater temperature variations. If the turbine is not functioning continuously, these temperature variations can be pronounced, because the moderating effect of flowing water with fairly constant temperature is not felt. Variations in temperature result in thermal expansion, which in turn causes stresses in the pipe. Thermal expansion and contraction are greatest for a penstock which is likely to remain empty during construction or repair, and provision must be made to accommodate these; either the pipe must be designed to have sufficient structural rigidity with the help of anchors and supports or expansion joints (p. 136) should be incorporated. These joints also help protect the pipe against earth tremors and are sometimes used to accommodate a slight misalignment of two pipe sections.

For above-ground steel penstocks, a common type of expansion joint consists of two concentric portions of the penstock which permit relative motion with respect to each other, with a gland to prevent leakage between them (Fig. 5.18). Polyvinyl chloride (PVC) pipe is commonly buried, eliminating the need for expansion joints.

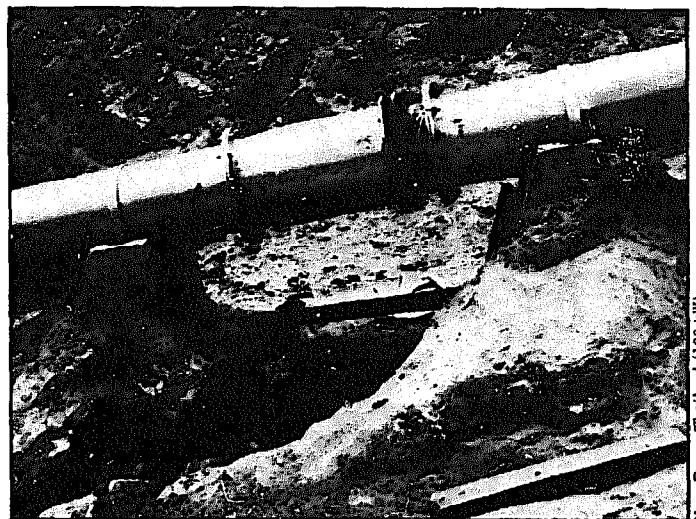

Fig. 5.18. An expansion joint along a penstock. Although this plant was not yet operational, leaking had already caused potentially troublesome erosion.

However, joints for PVC pressure pipe are often fitted with gaskets which permit some relative motion between adjacent sections. Although thermal expansion might be insignificant for buried pipe, the joints protect the pipe from vibration and earth movement and permit it to settle somewhat under loads. Cement pipes are also available with such joints. Long lengths of polyethylene pipe coupled by rigid joints are sometimes laid above ground, but this pipe is flexible and can accommodate changes in length caused by thermal expansion.

Rigid penstock pipes frequently require support piers, anchors, or thrustblocks to resist forces which can displace the pipe. Supports piers (p. 138) are used along straight runs of exposed pipe, primarily to prevent the pipe from sagging and becoming overstressed. They might also have to resist the longitudinal forces resulting from temperature-induced movement of the pipe over the support. The pipe usually lies in a saddle on a reinforced-concrete support pier and should be free to move longitudinally, to accommodate small pipe movements without abrading or cutting the pipe material (Fig. 5.19). The spacing of the support piers is determined by the maximum unsupported span associated with the specific penstock pipe material and size. For buried pipe, the bed of soil on which it lies supports it, and separate supports are not generally required.

Significant forces can be concentrated at bends along a rigid, exposed penstock. These bends can be in a vertical or horizontal plane or a combination of both. The largest force is usually caused by the hydrostatic pressure within the pipe—the pressure of water which tends to cause the penstock to crawl or the joints to separate. Depending on the alignment and design of the penstock, other forces also contribute to a varying extent, such as those caused by thermal expansion of the pipe, the weight of the upstream portion of pipe pushing downhill against the bend, and reductions in pipe diameter. Anchors (p. 140) are incorporated at bends in the penstock either to provide the weight necessary to counteract the resultant of all these forces or simply to trans-

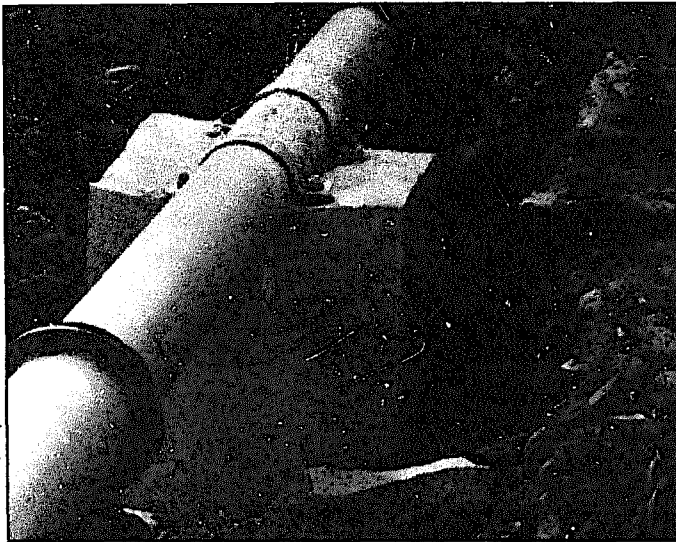

Fig. 5.19. Metal straps are used to secure the penstock to a support.

mit it safely to the ground (Fig. 5.20). Even along a straight section of pipe down a steep slope, anchors may be required at intervals to prevent the pipe from sliding downhill because of its weight. Unlike support piers, the anchor holds the pipe securely. An anchor block is usually constructed of concrete and held together and around the pipe with hoop reinforcement. A collar is sometimes affixed to the pipe to allow it to be keyed firmly into the mass of concrete.

When the pipe is buried, properly compacted backfill generally serves the same function as anchors and support piers used with exposed pipe. Unless the penstock descends a steep slope, friction between the pipe and soil provides sufficient force to counteract the weight of the pipe pulling it downhill. Also, forces caused by thermally induced stresses are small because the pipe is shielded from large temperature variations. The one



Fig. 5.20. An anchor at a bend and bifurcation at the base of the penstock.

force which may have to be held in check arises from hydrostatic pressures acting at bends along the penstock; with an exposed pipe, this is also one of the principal forces an anchor must resist. For pipes with welded or mechanically joined sections, soil reaction forces may be adequate to prevent movement of the pipe. For loosely coupled pipe, such as PVC pipe with push-together joints where an elastomeric ring that fits in a groove of a pipe section's bell end provides a watertight seal, anchoring may be necessary. If a bend is concave downward so that the thrust acting at the bend acts upward, an anchor is used to counter this force by means of its weight. Where the pipe is laid in a trench and bends are either in a horizontal plane or concave upward, thrustblocks (p. 144) are used to transfer the thrust to the undisturbed soil. These do not rely on their mass to provide the necessary restraining force.

Gates or valves (p. 154) can be incorporated at either end of the penstock to control the flow of water. A turbine isolation valve is often included at the bottom of the penstock. It is used to turn the flow to the turbine on or off and is generally not used to regulate it. A valve supplied as part of the turbine generally provides this regulation, if required. Even though this latter valve can also turn the flow to the turbine on or off, a shutoff valve is often included to perform this function if the turbine or the flow-regulating valve needs repair. A lower-cost, although possibly less convenient, option to stop the flow of water down the penstock is to avoid this shutoff valve and simply to open a gate at the forebay to drain it and prevent water from entering the penstock. The water remaining in the penstock can be drained through the turbine before repairs are undertaken. Another option would be to close a stoplog gate located at the inlet to the penstock as part of the forebay (see Forebay, p. 72). Rather than a stoplog gate, a butterfly or gate valve is sometimes incorporated at the beginning of the penstock pipe itself. In this case, an air vent (p. 76) must be incorporated to permit the water in the penstock to drain without potential damage to the pipe. However, since the pipe diameter is probably reduced just before entering the turbine, a valve at the beginning of a penstock would probably be larger and costlier than one located just before the turbine. Therefore, if a valve rather than a gate is used, it is usually placed just before the turbine.

In the operation of a hydropower plant, the flow velocity in a penstock can change suddenly when the plant operator or mechanical governor rapidly closes the shutoff or flow-regulation valve located just before the turbine. This sudden closure can create momentary pressure peaks or water hammer in the penstock which could damage the pipe. This pressure rise is determined by the rate of valve closure, the initial velocity of flow in the penstock, and the elastic properties and physical dimensions of the pipe (see APPENDIX F, p. 274).

One way of protecting against damage caused by water hammer is to ensure that the penstock is thick enough to accommodate these higher transient pressures. This is the common approach used in the design micro-hydro-power schemes. Water hammer pressures can also be reduced by increasing the area of the penstock, which

decreases the velocity of the water descending the pipe. If the penstock is unusually long, however, either of these approaches may increase the cost of the penstock pipe considerably. To reduce cost, a design for a hydro-power scheme which minimizes penstock length—possibly using a power canal to convey the water most of the horizontal distance from the intake to the powerhouse—should be sought. Pressures can also be reduced by designing the system to prevent rapid closure of any valves preceding the turbine.

With large hydropower schemes, long power tunnels or penstocks are often necessary and the preceding options are not practical. In these cases, a surge tank can be used to protect the low-pressure conduit section above the tank from high internal pressures caused by rapid valve closure. This tank is a storage reservoir placed along the pipeline as close to the powerhouse as possible to relieve the pressure peaks rising up the penstock before they continue through the upper portion of the conduit. The surge tank therefore reduces upstream pressure fluctuations and permits the use of lower-cost, low-pressure conduit. Nevertheless, the penstock section between the surge tank and turbine still has to be designed to resist high transient pressures. Because surge tanks are rarely used at micro-hydropower installations, this publication does not cover their theory and design.

When the pipe section between the surge tank or inlet to the penstock and the turbine is long and pressure rise caused by rapid closure of the shutoff valve can be too large, a pressure relief valve can be installed immediately above the shutoff valve. With micro-hydropower schemes, the relief valve is often activated by the high pressure peak and permits the water in the penstock to continue flowing by bypassing the turbine and shutoff valve, usually discharging it into the air.

At times, air has to be permitted to enter or leave the penstock at specific points along its length. This might be necessary at three points along a penstock: near the inlet, at intermediate high points along a penstock, and between a gently sloping section and a steep drop to the powerhouse.

- If a trash pile-up or a valve closure can significantly restrict or seal the inlet to the penstock, a means of letting air into the penstock just below the inlet must be included; otherwise, as the penstock empties, the pressure within will fall below atmospheric and the pipe may collapse. To prevent this possibility, a simple air vent—a pipe section open to the atmosphere (Fig. 5.21)—is located at the upper end of the penstock, possibly in the forebay wall itself. If a scheme has been designed with no valve or gate at the inlet, as small schemes often are, and so that a clogged trashrack cannot completely seal the inlet, inlet, no air vent is needed.

Including a valve at the inlet does not necessarily require a vent, because proper plant operation can avoid low penstock pressures. However, a novice operator may think that closing such a valve (possibly in an emergency) can shut down the plant safely;

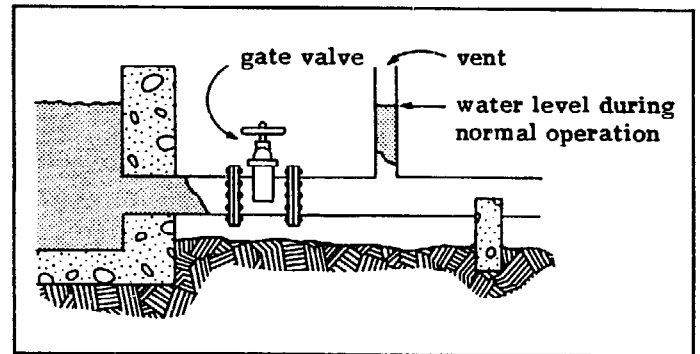

Fig. 5.21. An air vent is incorporated at the upper end of the penstock to prevent possible collapse of the pipe if the intake valve is closed during the plant's operation.

with anything but low-head schemes, this is not the case unless the penstock includes an air vent. Or the operator simply may forget that the inlet valve has been closed and open the turbine isolation valve at the lower end of the penstock to start the turbine. This could also cause the pipe to collapse if the penstock is full. For these reasons, if a valve has been included at the inlet to the penstock, it is advisable to incorporate an air vent just downstream.

If a valve is included at the inlet to the penstock, it may be necessary to fill the penstock to equalize pressures across this valve before it physically can be opened. This is done by allowing flow into the penstock through a small bypass valve. An air vent is then necessary just downstream of the valve to permit air trapped there to escape during the filling operation.

- If the penstock has intermediate high points along its length, any air inside accumulates at these points, restricting flow through the penstock. An air-release valve must therefore be included at each peak to remove this air. Even if no air enters the penstock during normal operation, such a valve is required at these points to release air while the penstock is being filled. This may be an intricate valve, shown figuratively in Fig. 5.22. As air which gathers at the peak of the pipe enters the valve chamber, the float descends, opening the valve and automatically releasing the air. The ensuing rise in water level closes the valve again. A small, manually operated gate valve or faucet also can be used. Although it is more costly, a proper air-release valve can also serve as an air vent or air-inlet valve to admit air into the penstock automatically when it is being emptied.
- If a gently sloping portion of the penstock is followed by a steep drop to the powerhouse, an air-inlet or air-admission valve may be required at the bend. If the flow into the turbine increases rapidly, water in the steeper portion of the penstock may accelerate faster than water in the upper part. This can cause the column of water in the penstock to separate at the change in grade, subjecting this part of the pipe to a pressure low enough to collapse it. An air-inlet valve allows air in to relieve this transient

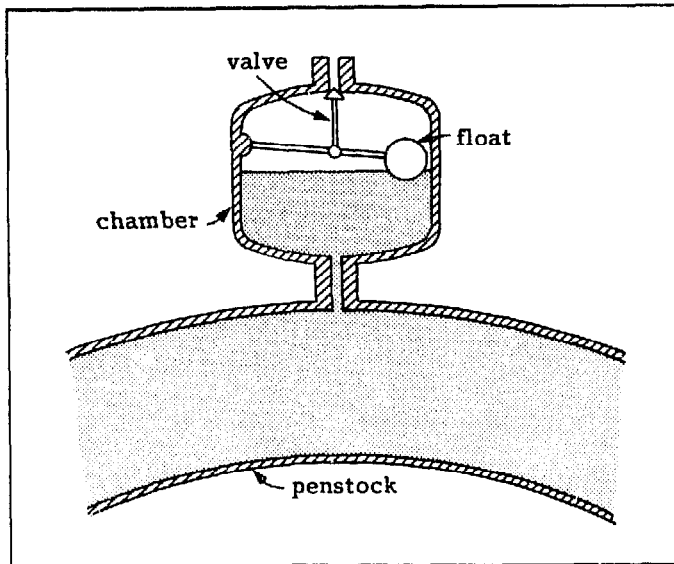

Fig. 5.22. A figurative depiction of an air-release valve at a high point along a penstock.

effect but prevents water from escaping. It is simply a check valve set on top of the pipe, normally held shut by the penstock pressure aided by a light spring. Even when a penstock includes a gradually sloping section followed by a steep drop, this valve can be omitted provided the system design prevents turbine flow from increasing suddenly.

To function properly, an air-inlet valve or vent must be adequately sized. If the opening is too small, air will enter too slowly and decreasing pressure within the penstock may still cause the pipe to collapse. (See **Air valves**, p. 147, to determine the appropriate size for this opening.)

If a penstock crosses undulating terrain, a **blowoff** should be installed at each low point along its length to drain the penstock or to remove any sediment which has accumulated at these depressions. A blowoff usually consists of a short pipe connected beneath the penstock at these low points. This pipe is generally fitted with a gate valve and is long enough to lead the water away from the penstock. Sometimes a valve is also placed just uphill of the turbine isolation valve for the same purpose.

Access ports also may be incorporated at the end of a penstock so that any large objects which have unexpectedly entered the penstock can be removed by hand without removing the turbine or nozzle. At times, a bifurcation or "Y" is placed just before the turbine, with an access port at the end of the lower branch of the "Y".

Powerhouse

The powerhouse protects the turbine, generator, and other electrical and mechanical equipment. Its size and configuration depend on the functions it serves. Conventionally, it is large enough to include not only this equipment but also a workshop, office, and sanitary

facilities. This is not generally the case for micro-hydroelectric schemes, except for those built by institutions in the habit of designing and implementing larger schemes (Fig. 5.23). If project size and cost are to be minimized, a powerhouse should be sized to house only the turbo-generating equipment, with sufficient space on all sides to permit easy access for installation, operation, maintenance, and repair. The only exception is a plant designed to accommodate mechanically driven agro-processing equipment or other machinery. In this case, additional space is required for the equipment operators and customers bringing their crops to be processed.

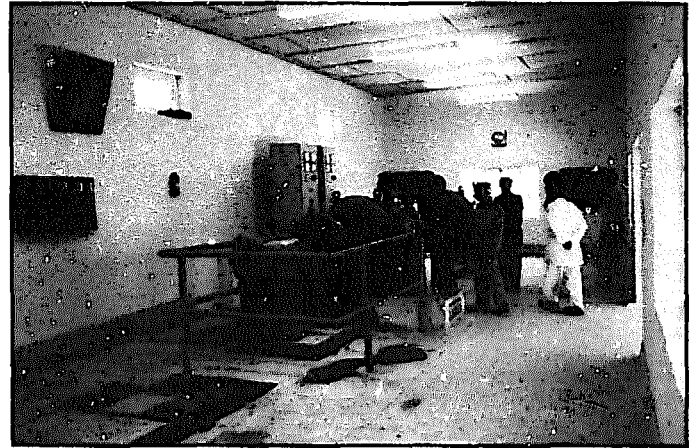

Fig. 5.23. This powerhouse, which is expected to include a second 50 kW turbo-generating unit in the left foreground, is significantly oversized for the function it serves.

With small micro-hydroelectric powerplants, it is also possible simply to cover the generator and other components sensitive to the elements (Fig. 5.24). Although this "powerhouse" costs virtually nothing, this design makes it difficult to repair the equipment during inclement weather. If a unit is properly designed, however,

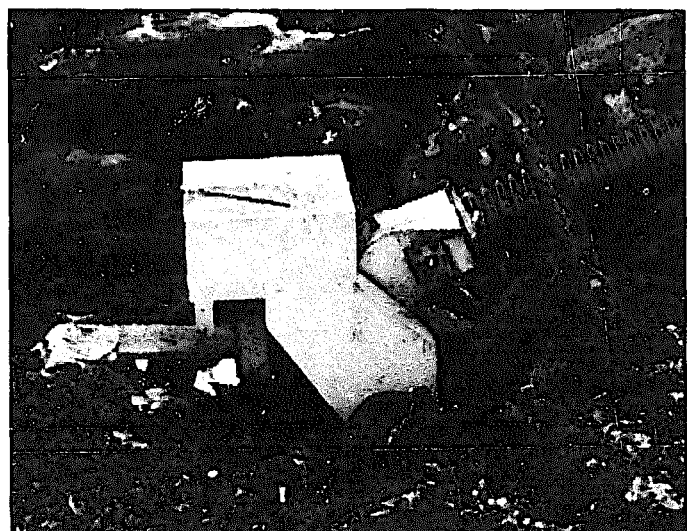

Fig. 5.24. At this site which has been in operation since 1975, a simple metal box hinged on one side and a belt guard protect the turbo-generating equipment from the elements. See Fig. 6.9 for a view of the unit with the cover removed.

Duber, Kohistan, Pakistan (100 kW)

Lovesville, VA, U.S.A. (6 kW)

access to the turbo-generating equipment is not frequently required.

With some low-head axial-flow turbines in the bulb configuration, both the turbine and generator are located in the water passageway (see Fig. 6.12b); only cables carrying the power emerge. In this case, neither powerhouse nor simple cover is required. Any switchgear near the turbo-generating equipment can be placed in a small weatherproof enclosure.

The location of the powerhouse is as important as is its design. For a discussion of this subject, see **LOCATING THE POWERHOUSE** (p. 56).

Tailrace

The tailrace is usually a short, open canal which leads the water from the powerhouse back into a stream—generally the stream from which the water came (Fig. 5.25). It is a component of every scheme except low-head plants where the water emerges from a draft tube directly into the stream.

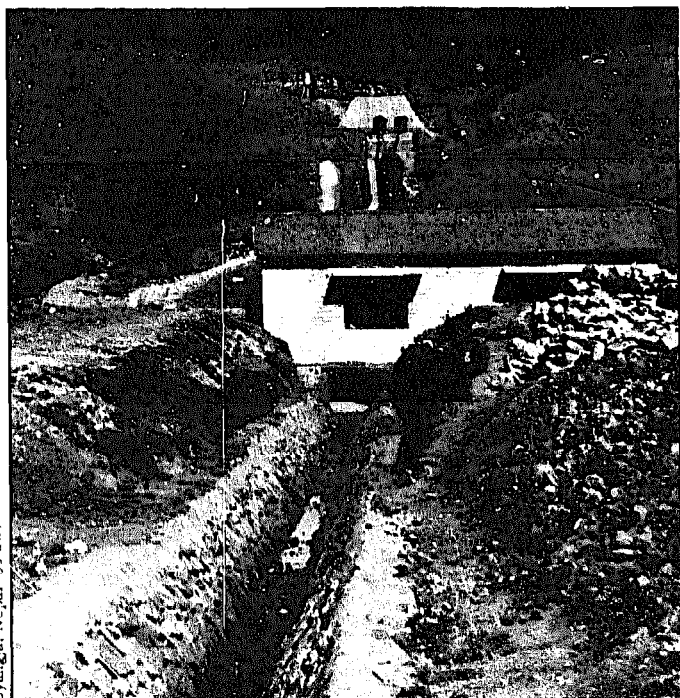

Fig. 5.25. This tailrace will carry water from the powerhouse back to the stream. The short penstock can be seen behind the powerhouse (also see Fig. 5.121).

Like a power canal, a tailrace is also a canal, but much more effort is spent on the design and construction of the former. Power canals are usually long and must traverse sloping hillsides and ravines while keeping head losses to a minimum, maintaining water quality, and guarding against excess water. A tailrace, on the other hand, is usually very short and located near a stream. Often it is simply a ditch which is designed to ensure that erosion will not undermine the powerhouse. If a tailrace is long and/or a plant is operating under a low

head, more care is necessary because head losses can be more significant. Flow in a tailrace canal is governed by the same law governing flow in power canals (see **Determining canal dimensions and slope**, p. 96).

DESIGN AND CONSTRUCTION DETAILS

Dams and weirs

This section emphasizes weirs, because a majority of micro-hydropower schemes in developing countries only need water to be diverted into the intake. However, because there is sometimes also a need for water storage or for increasing head, several types of dams are also reviewed.

Where water resources are adequate, the simplest and least costly diversion structure is a weir of loose boulders extending across part or all of the stream (Fig. 5.26). This is clearly a temporary structure, but that is one of its virtues. Large flows, common in the tropics, sweep the structure away, permitting boulders, tree trunks and branches, sediment, and other debris to pass the intake unhindered. There is no structure in the stream which restrains debris and sediment and has to be cleared out manually after the flows have subsided. And a weir is not needed during periods of high flows, because the level of the stream is already sufficient for adequate water to enter the intake. The only disadvantage of this approach is that it requires a manual effort to rebuild the weir when flows recede. This is a minor effort, however, and many developing countries have no shortage of labor. Such temporary weirs are found in all countries where irrigation has been practiced traditionally and are used at virtually all of the hundreds of modern micro-hydropower plants in Nepal and Pakistan.

It is interesting to note that conventional designs for small-hydropower plants often include a "permanent" weir across a stream. Not infrequently, however, these are eventually damaged or destroyed and, in the end, a temporary weir of loose boulders is still commonly adopted as a permanent solution (Fig. 5.27). Use of a temporary diversion weir is not limited to small



Fig. 5.26. A simple weir of loose stones diverts water to a small turbine-driven mill.

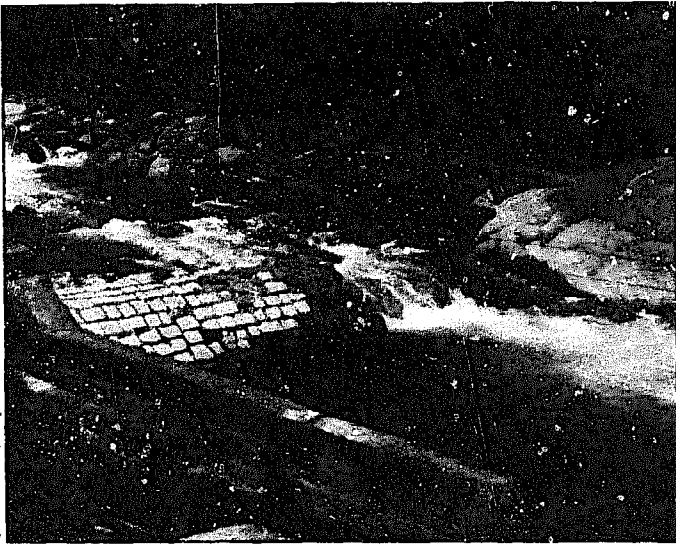

Fig. 5.27. Though the weir was ruptured by flood flows and has never been rebuilt, the plant run by Electroperu continues to operate using flows diverted into the intake by means of a temporary weir of boulders slightly upstream.

schemes; Fig. 5.28 illustrates its use at a 1000 kW plant to divert dry-season flows toward a side intake. The dam was incorporated solely to increase available head by several meters. It neither permits storage of water nor ensures that adequate water is diverted for power generation. A temporary weir serves this latter purpose.

Where a streambed is likely to lower over time, leaving the intake high and dry, the previous approach has been modified to include a permanent sill across the streambed (Fig. 5.29). At some sites (Fig. 5.30), a sill constructed of box gabions and mattresses—stone-filled, wire baskets—is used to stabilize the area around the intake. At others, gabions are keyed into the streambed and overlaid with reinforced concrete (Fig. 5.31). In addition to these permanent sills, a simple weir of loose

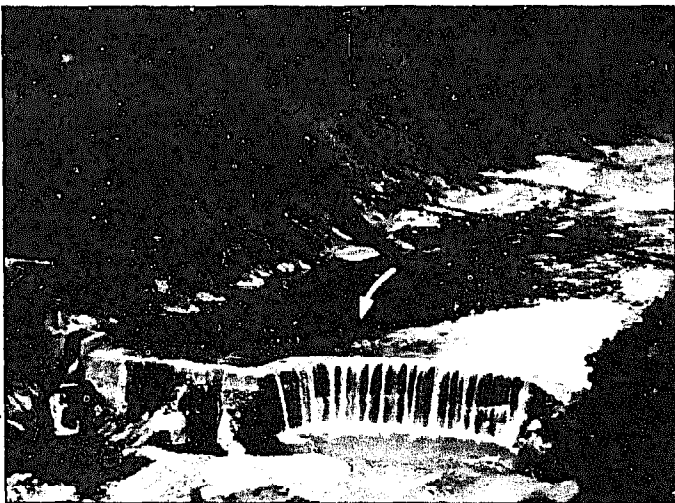

Fig. 5.28. A temporary diversion weir across the stream is used to divert water toward an underground intake at the left. This dam is used only to increase head; it does not form a reservoir to store water.

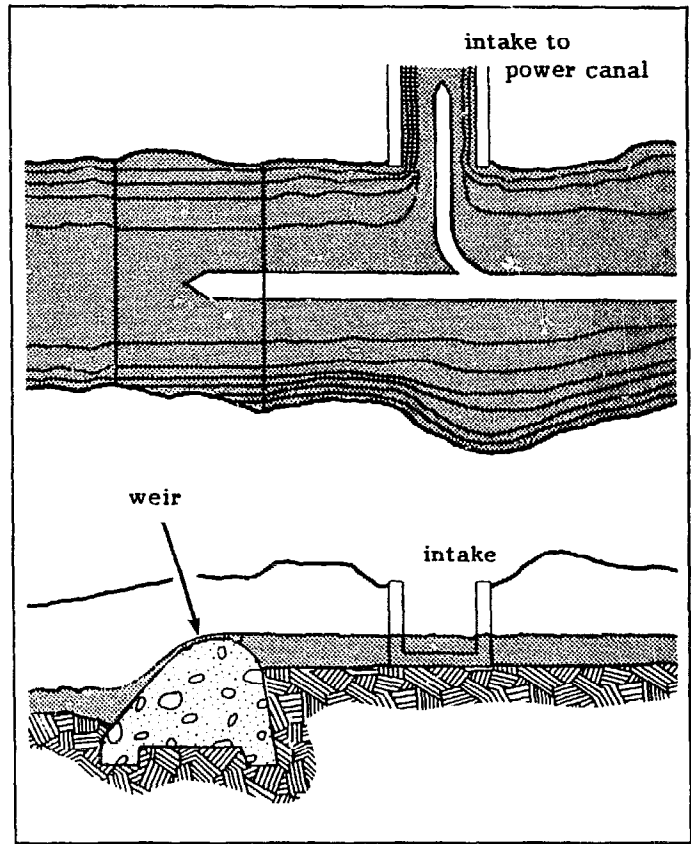

Fig. 5.29. A weir used for diversion purposes.

stones is frequently constructed across the stream near the crest of the sill to divert flow toward the intake during low flows.

The sill in Fig. 5.32 is a variation of the concrete sill just mentioned and was designed to overcome the need to build a temporary stone weir during low-flow periods.

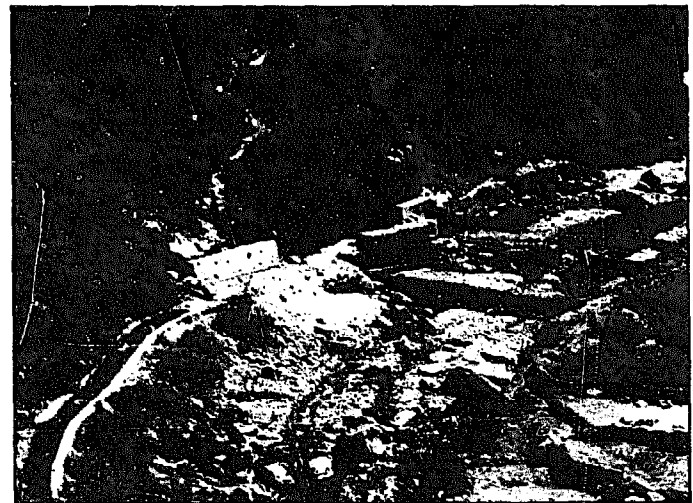
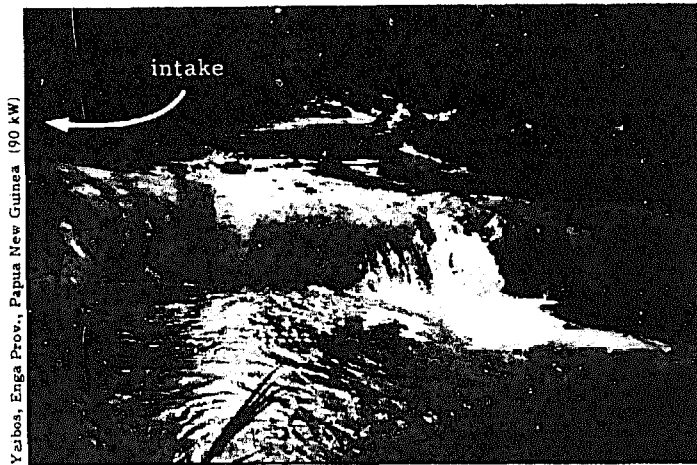

Fig. 5.30. Box gabions and mattresses serve as a sill across the stream. A small wall of stones near the crest diverts the low flows found in the dry season. The covered portion of canal and masonry retaining wall were built as an afterthought, after a spring just uphill of this area caused a small landslide over the canal.



Yabos, Enga Prov., Papua New Guinea (90 kW)

Fig. 5.31. At this site, gabions covered with a layer of concrete reinforced with a layer of heavy-duty mesh generally used for fencing stabilize the streambed near the intake located off to the left (see Fig. 5.47).

At this site, the portion of the concrete sill away from the intake is slightly raised to divert low flows toward the intake. During the rainy season, large streamflows overflow the entire width of the sill, permitting debris to pass unhindered. The raised portion is low enough to have minimal restraining effect on flood flows.

Unlike the previously described weirs, conventionally implemented diversion weirs are often designed as permanent structures, usually of concrete or stone masonry (Fig. 5.33), with a crest a meter or more above the riverbed. Even though the water surface is higher behind this structure, there is negligible storage. Its primary function is to create an adequate depth of water at the intake to ensure adequate submergence of the penstock pipe or adequate depth in the canal so that it can carry its design flow. Such structures are considerably more costly than the weirs described previously.

To achieve its purpose, a permanent weir generally does not need to be placed exactly at the intake location as is shown in Fig. 5.34. In this case, a weir slightly down-

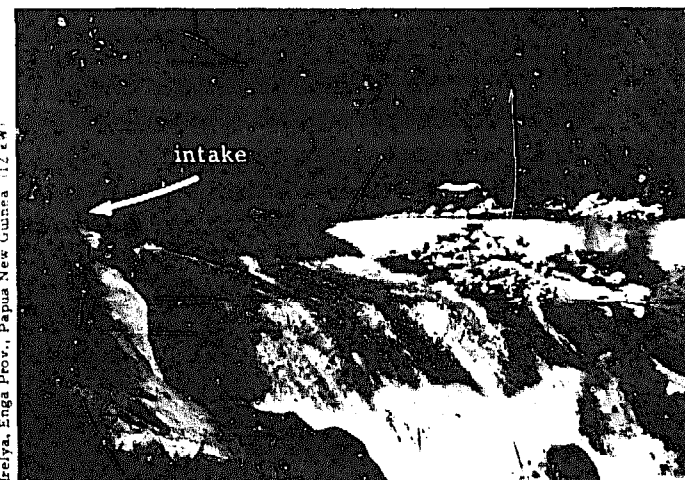

Irelya, Enga Prov., Papua New Guinea (12 kW)

Fig. 5.32. The bedrock portion of this stream was covered with a concrete sill slightly raised at the right to divert low flows toward the intake at the left (see Fig. 5.47).

stream, perpendicular to its present orientation but still at the head of the rapids, would have required a much shorter weir, avoided a major problem which was encountered, and functioned as well (see Giheta (Burundi), p. 59).

There is usually no need to construct a weir obliquely across the stream (Fig. 5.35). This merely increases the structure's length and cost and is likely to funnel bed load directly in front of, or into, the intake.

If a weir is constructed to raise water level slightly, it will also collect bed load and other debris carried downstream. Some means must be incorporated to remove the sediment, bed load, and debris which accumulate in front of the intake. For this purpose, a sliding gate (see Gates and valves, p. 154) is usually located at the end of the weir near the intake (see Figs. 5.57b and 5.59). Opening the gate should permit sufficiently high velocities near the intake to sweep away most of the unwanted debris. Unless manually removed, sediment behind the rest of the weir will remain because velocities there are too low to scour it out. However, this has no adverse impact on the operation of a weir, as it would on a dam used for storage.



Giheta, Burundi (90 kW)

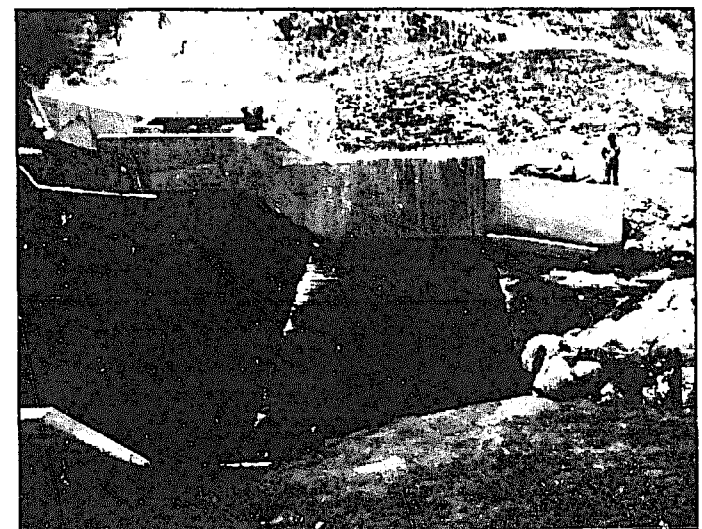

Nam Dang, Thailand (100 kW)

Fig. 5.33. Examples of concrete and stone-masonry weirs.



Gihita, Burundi (90 kW)

Fig. 5.34. After construction of the weir was started from the right bank, streamflow began eroding the left bank at the oxbow. As a result, a right angle bend in the weir was subsequently incorporated to reach the firmer rock foundation on the left bank slightly downstream (also see Fig. 4.24).

To ensure that velocities are high enough for effective scouring in front of the intake area, frequently a wall is constructed perpendicular to the weir near the intake end, with a sliding gate located between this wall and the intake area as is shown in Fig. 5.56. This is also illustrated in Fig. 5.51 where it can be seen that, even with this design, only the accumulated sediment in the immediate vicinity of the intake has been removed. Fig. 5.28 is a broader view of this same area.

At times, the crest of the weir is constructed lower near the intake end of the weir (Fig. 5.59). If the intake trashrack were located partially above water level, any excess water overflowing the weir would carry away



Boone, NC, U.S.A. (17 kW)

Fig. 5.35. Although this scheme had been shut down for repairs on the penstock, it is apparent that, by crossing the stream obliquely, the weir has caused the stream to transport and drop bed load and sediment directly in front of the intake.

debris which would otherwise accumulate in front of this trashrack. If the trashrack were exposed and the crest were lower at the end away from the intake, debris would tend to accumulate in front of the intake trashrack, requiring more frequent cleaning. This is not critical in the case illustrated, because the entire trashrack is below water level.

Another approach which permits slightly raising the water level behind a weir, for storage or to ensure adequate depth of water at the intake, is to incorporate flashboards along the crest (Fig. 5.36). In their simplest form, these consist of one or more tiers of boards sup-

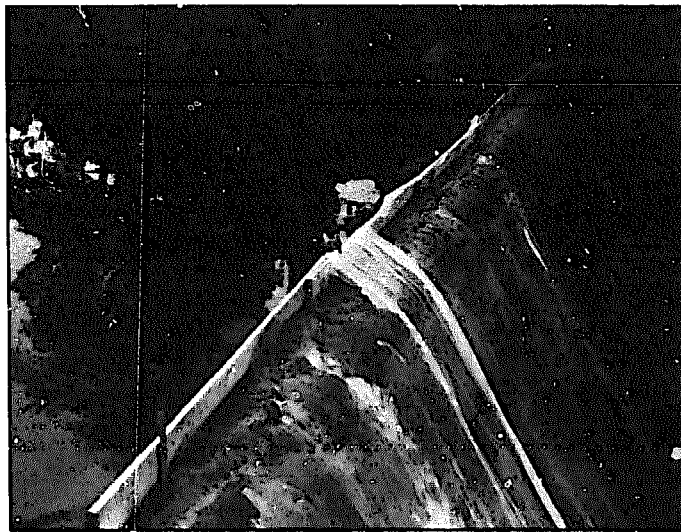

North Montpelier, VT, U.S.A. (220 kW)

Fig. 5.36. Flashboards used along the crest of a concrete dam.

ported by vertical pins embedded in sockets in the spillway crest (Fig. 5.37). To prevent the boards from falling over if the water level behind them drops too low, they are loosely fastened to the pins by wire. Commonly, solid steel rods or pipes are used as pins. Sockets are usually pipe sections set vertically in the con-

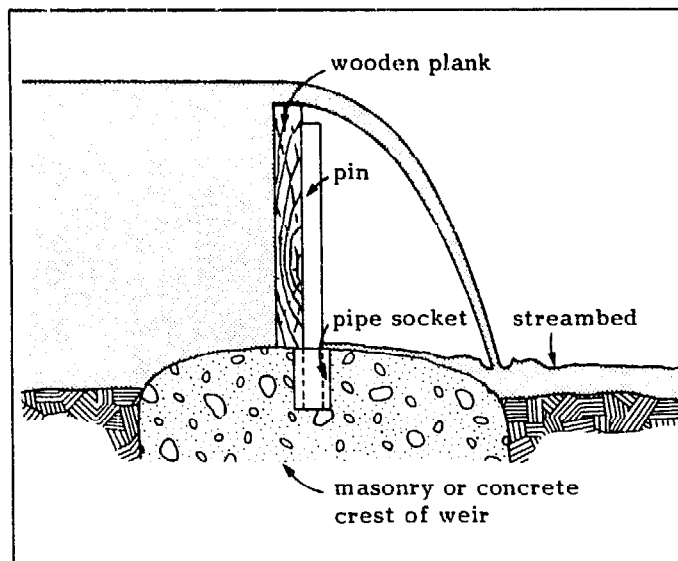

Fig. 5.37. Cross-sectional view of a weir with flashboards.

crete crest of the weir (or spillway) and sized so that the pins fit in loosely. Occasionally sprinkling ashes behind the flashboards can prevent leakage around them. If the boards are removed before times of high flows, any accumulated sediment can be swept downstream.

If flashboards are located where they have to be removed during flood flows so that high water levels do not cause damage at the intake or elsewhere, either they must be manually removed at the onset of heavy rains or the pins must be sized to bend over when the river stage exceeds a preset value and the pins can no longer support the load. In the latter case, the boards are then swept downstream and lost. Although solid steel rods or pipes are conventionally used because these can be smaller and have more clearly defined strength characteristics, wooden pins also could be used (38,112).

Any permanent structure in a river that carries boulders during flood flows must be protected. Buoyancy causes heavy boulders to lose a significant portion of their weight in water, making it easier for torrents to carry them downstream. Their mass remains unchanged, however, and because of their momentum, they can destructively impact any obstacle they encounter. Protecting exposed surfaces of concrete structures with pieces of timber is a common approach (see Figs. 5.49 and 5.51). A timber protecting layer along one portion of the crest of a dam shown in Fig. 5.38 was not maintained and the degradation of the crest is evident. At this installation, wooden cores left over from plywood manufacture at a nearby factory were split in half and secured by bolts in the dam crest. The pounding this facing receives eventually bends the bolts and ruins their threads. When the timber facing has to be replaced, holes are drilled into the crest during the dry season and new threaded rods are grouted in.

If there is a significant fall below the crest of the weir or dam, erosion can take place just downstream and undermine the structure (Figs. 5.27 and 5.39). If this area is not bedrock, a zone of riprap can be laid downstream of the structure. The riprap should be placed on a blanket of gravel or rock spalls to prevent streambed material from being drawn up through its interstices. A cutoff wall is usually provided at the downstream end of the structure to protect it from being undermined. To help dissipate the energy gained by the water as it moves over the crest, a stilling basin can be incorporated in the design (see Fig. 5.59).

Permanent weirs are usually constructed across the entire width of the stream. If a design partially restricts the width of the stream (Fig. 5.40), the water overflowing the crest will be deeper during flood flows than it would be otherwise. This factor should be considered at the design stage to ensure that it has no adverse impact on the intake or water conveyance structure, erosion at the downstream edge of the weir, etc.

If storage or increased head is needed, a dam is required. For micro-hydropower schemes, gravity dams

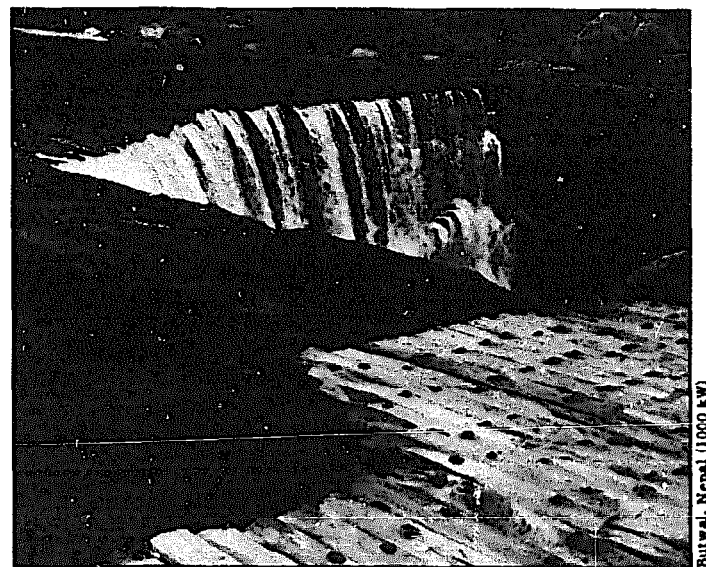

Fig. 5.38. Degradation of the dam crest is evident where the timber facing has not been replaced.

are used most frequently. These are commonly of concrete or stone masonry, although timber dams are used occasionally.

Dams are more than large weirs. Although dams and weirs may have similar features—sluice gate near the intake, erosion protection at the toe, protection against boulders, etc.—there are significant differences:

- A dam must withstand significant water pressure, which tends to push it downstream and lift it up. The design must ensure that the dam is safe from overturning along its downstream edge, that it is safe from sliding, and that no part of it is under tension.



Fig. 5.39. Even before an opening for the penstock pipe could be made through the concrete intake structure to the left of the weir, flows had already seriously undermined the structure and completely backfilled the intake and area behind the weir. The design did not include an opening behind the weir for sluicing out the accumulated sediment behind it.

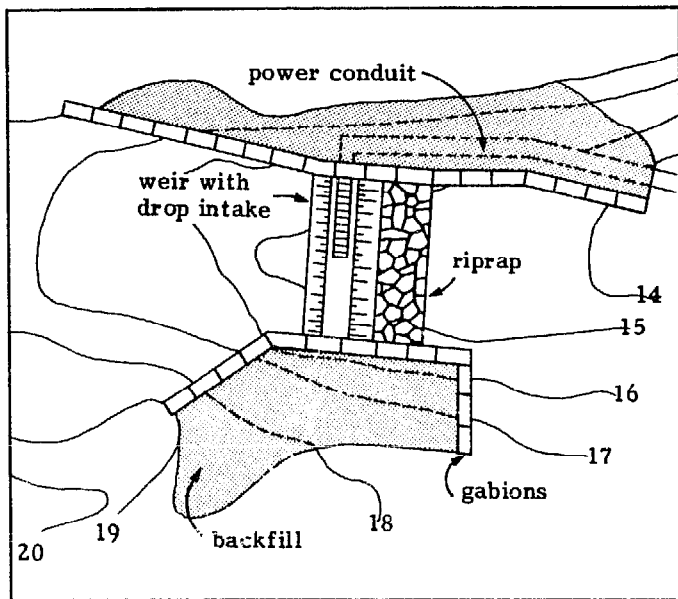

Fig. 5.40. This design of a weir with drop intake and wingwalls, proposed for use at a site in Nepal, reduces the width of the stream at this point. To preclude any adverse impact on this structure during flood flows, the increase in stage upstream of the weir caused by constriction of the flow must be considered during the design phase. (One-meter contours are shown.)

- Piping—the carrying away of finer foundation material when water seeps beneath the dam under sufficient pressure and velocity—can be a significant problem and undermine the structure, unless the dam is built on bedrock.
- The bearing strength of the dam's foundation must be sufficient to support the weight of the structure.

Most of these factors are not critical in the design of weirs because their size is small and minimal water pressures are encountered.

When small dams are constructed in developing countries, stone masonry is used more often than concrete (Fig. 5.41). Cement can be difficult to obtain, costly, and heavy to transport, especially into remote areas. Stone-masonry structures require less concrete. On the other hand, stone-masonry work requires special skills and a larger labor input, but this poses no major constraints in most developing countries.

A timber dam which has been popular for generations is the crib dam. It is built of green logs or heavy timbers stacked perpendicular to each other and spiked together. The spaces in between are filled with rocks and gravel. This structure often requires no cofferdam, because the cribwork offers little resistance to flow during construction. The upstream side is covered with planks and then clay and earth to minimize leakage. Cutoff walls are incorporated at the toe and heel of the dam to increase the length of the path of percolation beneath the dam and thereby reduce piping. This type of dam can be attractive in remote areas because it requires very few materials from outside the region.

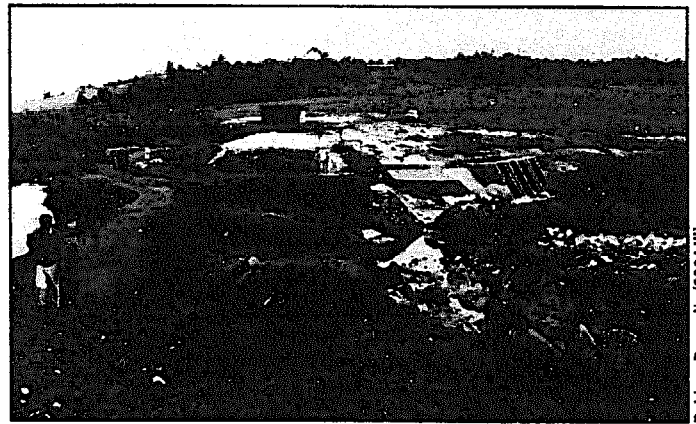

Buhiga, Burundi (220 kW)

Fig. 5.41. The portion of a stone-masonry dam on the left bank has been completed. Laborers are excavating for the remaining portion while an earth cofferdam visible at the left keeps water outside the work area. Buttresses support the outside walls of the settling basin at the far right.

Another timber dam is a wooden frame and deck dam (Fig. 5.42), which can be built on either earth or rock foundation. It is composed of a timber deck supported by a timber frame. This is not a gravity dam; the weight of water is the principal force holding the dam in place. Wooden dams deteriorate rapidly if not continuously wet.

Although earth dams can be built on almost any foundation, as can earth weirs (Fig. 5.43), they are rarely used.

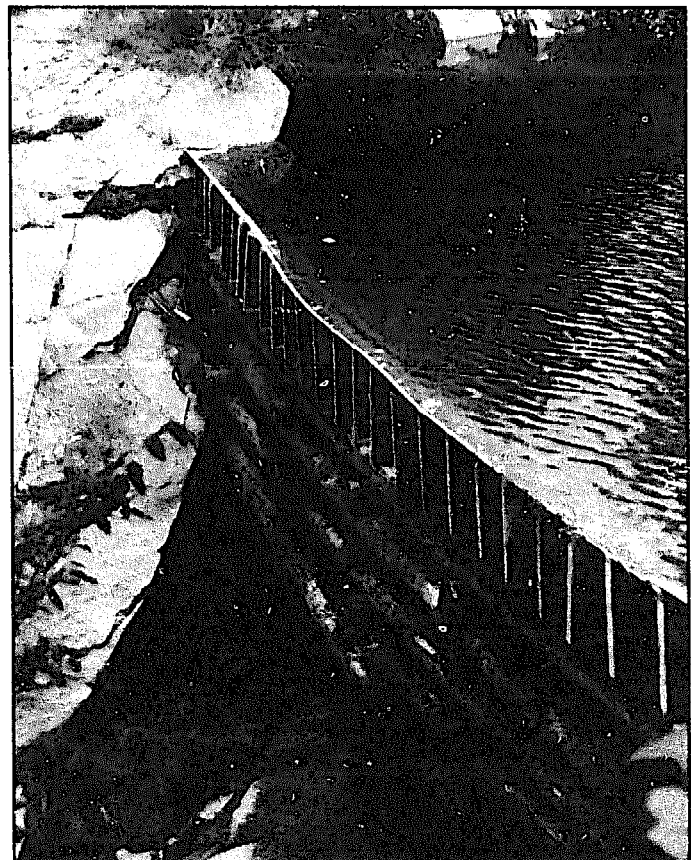

Warren, VT, U.S.A. (75 kW)

Fig. 5.42. A wooden frame and deck dam.

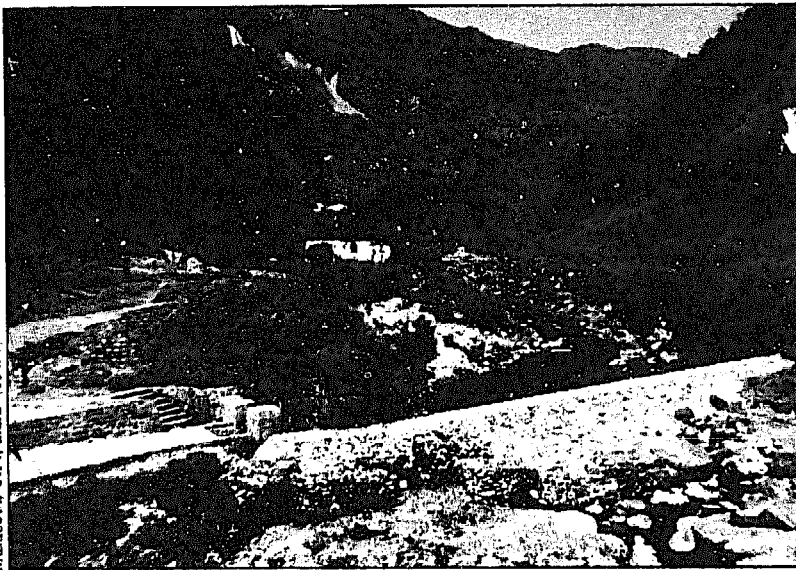

Fig. 5.43. The purpose of this permanent earth weir, covered with hand-placed riprap, is to divert water into the intake for irrigation and power generation. Because this stream carries little bed load, no sluicing gate has

been incorporated in the design. With the considerable seepage which can be seen emerging from the toe of the dam (photo on right), such a structure could not be used for storage.

in micro-hydropower schemes. Earth dams have been built safely to immense dimensions; however, small dams fail far more often, probably because inadequate attention is given to studying the foundation conditions and to properly designing and constructing the structure. Failure of a dam is most commonly caused either by seepage through or under the dam or by overtopping of the structure during periods of high flows.

To keep seepage to a minimum, an earth dam consists of an impervious core which extends well into the impervious foundation and is located in the central or upstream portion of the dam. Generally, this core is constructed of properly compacted clayey material. Cost is reduced if this material can be found near the site. If not, a concrete wall or steel sheet piling can be used instead. It is then covered with an upstream and downstream shell or embankments of well-compacted soil which provide structural support for the core. The slope of these embankments is commonly 1:2 to 1:3, but the actual value depends on the stability of the material used. The upstream surface is sometimes covered with riprap to prevent wave action from eroding it. If a pipe is placed through an earth dam, antiseep collars should be used around the pipe. These retard seepage along the outside of the pipe by increasing the length of the seepage path. As a general rule, collars should increase the length of the seepage path by 25% (71).

If no impervious foundation can be economically reached or if the foundation consists of plastic clay, the site will require more careful investigation. An earth dam on a bedrock foundation should present no problem, unless the rock contains seams or crevices through which water may escape too rapidly.

To ensure that the dam is not overtopped, the design must incorporate a spillway sized to discharge safely the maximum expected flow. This spillway is often

lined with concrete to protect against erosion and should lead well below the toe of the dam.

To build a durable structure, it is necessary to analyze the condition of the foundation and core and embankment materials. This, in turn, requires a working knowledge of soil mechanics. A simple introduction to these various considerations in the construction of earth dams can be found in "Ponds--Planning, Design, Construction" (20).

Intakes

An intake must be designed to address the conditions encountered at a specific site. There is no standard design. Even a person who has been involved in the design of several schemes and has used the same basis design must modify it to satisfy site-specific conditions. As discussed in the overview of intakes (p. 67), four basic components are usually incorporated in any intake--trashracks, gates, spillways, and a settling basin. The gates (p. 154) and spillways (p. 159) are incorporated into the design of an intake primarily to control the quantity of water entering. To control the quality of that water, trashracks and skimmers (p. 162) and settling basins (p. 166) are used. For each site, it must be decided whether each component is necessary and, if so, what size and design are appropriate. All four components might be incorporated in the intake at some sites, whereas few, if any, might be used at others, depending on site conditions. In addition to these components, the orientation of the intake with respect to the stream is another important factor which can be used to control, to some degree, both the quality and quantity of water entering an intake.

Because all components of an intake structure, which are noted above, are also commonly found at other

points in a hydropower scheme, specific design considerations for each of these are discussed in **Other components** (p. 154). This section presents a variety of designs which are currently in use and illustrates how each of these components might be incorporated in the design of an intake.

Regardless of the design finally adopted, it is necessary to consider the need to protect the intake from flood flows when planning its placement and design. If this is not done, excess water might enter and introduce waterborne debris over the trashrack. Excess sediment might also be deposited and interfere with the proper operation of the intake structure. Water in the canal and forebay may rise, overflowing these structures and undermining their foundation if spillways are inadequately sized.

One approach which addresses this problem in part is to consider natural features in locating the intake, as discussed in **LOCATING THE INTAKE** (p. 52). Another approach is to ensure that the wall separating the stream from the intake is high enough to deflect flood flows. In this case, high streamflows will still force larger flows through the intake opening, and spillways along the conveyance structure from the intake to forebay must be adequately sized to accommodate these.

If the intake leads directly to a closed conduit—a pipe rather than an open canal—another approach can be used. The intake structure can be covered entirely, permitting flood waters to submerge it, yet preventing water from entering it except through the designated opening. In this case, the structure should be designed to withstand uplift pressures (buoyancy), forces which arise when pressure forces water to infiltrate under the structure. If the intake structure is not built on rock, care must be taken to prevent scouring around the structure, which might undermine it.

The most rudimentary design for an intake is simply a opening on the stream being tapped. To keep out excess flows and debris, especially during flood flows when stream velocities are high, the intake should be oriented approximately perpendicular to the stream. If the intake's opening is directed upstream, high streamflows and accompanying sediment, debris, and bed load will tend to be channeled directly into the intake.

The intake to traditional irrigation canals frequently violate this rule by facing almost directly upstream, often as an extension of a stone weir diagonally across the stream (Fig. 5.44). In these cases, the intake is frequently situated so as to use natural features in the terrain to help shield it from high flows. For example, it might be located behind or under large and permanently placed boulders (see **LOCATING THE INTAKE**, p. 52). Traditional irrigation canals require so small a flow, however, that the dimensions of the intake are insignificant compared to those of the stream, leaving flood flows largely unaffected and not diverting them away from the stream. This is often encouraged by the construction of a low, temporary weir which washes out during high flows to let the water continue downstream unimpeded.



Bouthagar, Ouassazath Prov., Morocco

Fig. 5.44. Intake to a traditional irrigation canal. Despite the fact that the beginning of the canal is oriented nearly parallel to the stream, a rock outcropping deflects water toward the right bank during the river's high stage. The temporary weir would also wash away.

When it is physically impossible to orient the intake approximately perpendicular to the stream or when added protection of the intake is desired, a wall can be constructed across part of the stream slightly upstream of the intake on the intake side (Fig. 5.45).

Another rudimentary intake for micro-hydropower schemes requiring relatively small flows is a pipe section extended into the stream. A screen over the intake can be used to keep out debris. The mesh should be large enough to prevent rapid blockage by fine debris. It is also possible to begin the pipe with a slotted or perforated section (see Fig. 5.194). In every case, the total area of the openings must be sufficient to permit water to pass through even if they are partially obstructed by debris (see **Trashracks and skimmers**, p. 162). This pipe can lead to an open settling area or directly toward the turbine. If the pipe drops more than several meters, a vent should be included at the upper end (see discussion of air vents, p. 76, in **Penstock**).



Kibimba, Burundi (80 kW)

Fig. 5.45. Because of the solid rock on which the intake is located, it would have been difficult to orient the intake perpendicular to the stream. A stone-masonry wall was constructed slightly upstream of the intake to deflect any flood waters and debris from it.

Because this simple pipe intake requires that all points along the pipe be below water level, some excavation will be necessary. If this is not possible because the stream flows over bedrock or because the water is to be taken over an existing dam or weir, a siphon intake can be used. In this case, the outlet of the pipe must be lower in elevation than the inlet for the siphon to function. A siphon intake generally leads directly into the penstock; therefore, debris and sediment must be removed before they enter the siphon. A trashrack or screen should be provided at the inlet to the siphon to remove floating debris. The pond or body of water behind a dam or weir in which the inlet to the siphon is placed serves as a settling basin to remove the sediment carried by the incoming stream. Because an air vent is not possible with a siphon intake, it is essential that the inlet never be obstructed during operation of the siphon. In addition, the lift through a siphon is limited to several meters because greater heads can lead to collapse of the pipe. **Air valves** (p. 76) describes the maximum safe head which can be accommodated by unreinforced pipe.

A major disadvantage of a siphon intake is that some means must be found to evacuate air in the siphon to initiate and maintain its operation. For larger schemes, a vacuum pump connected to the high point of the siphon performs this function. Flow to the turbine is then cut simply by permitting air to re-enter the siphon through a valve at this point. For small schemes where a vacuum pump would be too costly, both ends of the pipe can be closed temporarily while water is poured in through an opening at the peak of the siphon. When the pipe has been filled completely, the opening at the peak is closed and the inlet to the pipe reopened. The siphon

is then primed and ready for operation as soon as the lower end of the pipe is opened.

One component which is frequently included even with a rudimentary intake to a canal is a gate (p. 154) to control or stop the flow of water (Fig. 5.46). The flow into a canal might have to be stopped when the turbine is not



Korup, Irian Jaya, Indonesia (10 kW)

Fig. 5.46. Only a simple gate is incorporated at this intake to a canal.

in use, when the intake, canal, forebay, or penstock is being cleaned or repaired, or during flood flows to prevent potential damage if the scheme has not been designed to withstand them. The intakes shown in

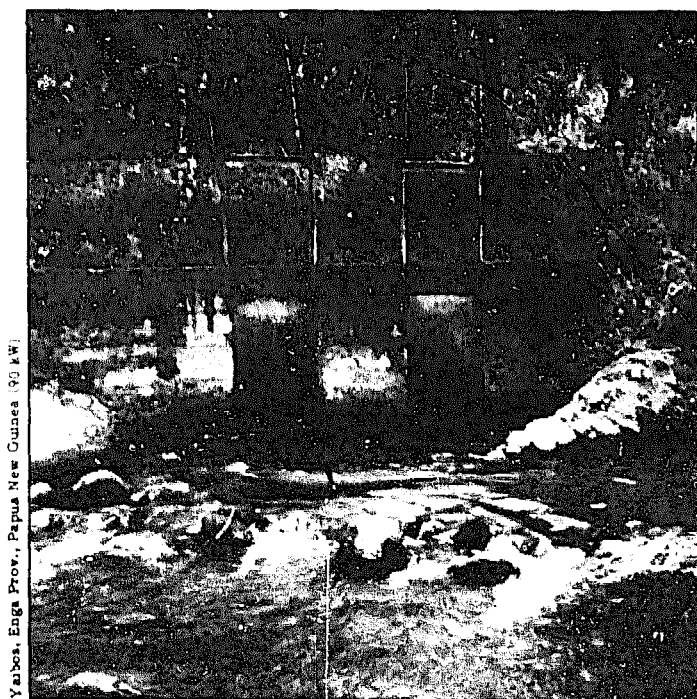

Yabos, Enga Prov., Papua New Guinea (90 kW)

Fig. 5.47. These intakes to two hydropower schemes in Papua New Guinea incorporate only gates. In the illustration at the left, the small dry-season flow flowing at the right is diverted toward a well-shielded intake by a tempo-

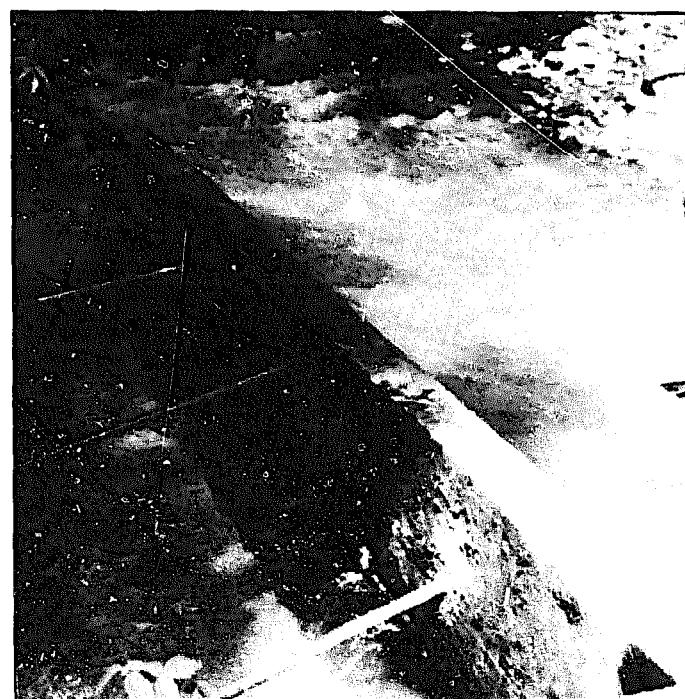

Ireija, Enga Prov., Papua New Guinea (12 kW)

rary stone weir (also see Fig. 5.31). In the illustration at the right, small gates pivoted along their lower edge control water admitted at right angle to the streamflow (also see Fig. 5.32).

Fig. 5.47 are oriented perpendicular to the stream and each incorporates only a gate to control flow into unlined earth canal. No settling area, trashrack, or spillways are used at these intakes.

A side intake, used with a simple temporary weir across the stream when necessary, is one of the better ways to avoid the brunt of torrential flood flows. In Fig. 5.48, such an intake has been placed at a narrower portion of the stream to facilitate the diversion of water toward it during the dry season. No permanent structure is placed within the stream. This intake is composed of a trash-rack oriented parallel to the stream (Fig. 5.49). The only other component incorporated at this intake is a gate (Fig. 5.50). Figure 5.51 illustrates a side intake incorporated as part of a large permanent dam.

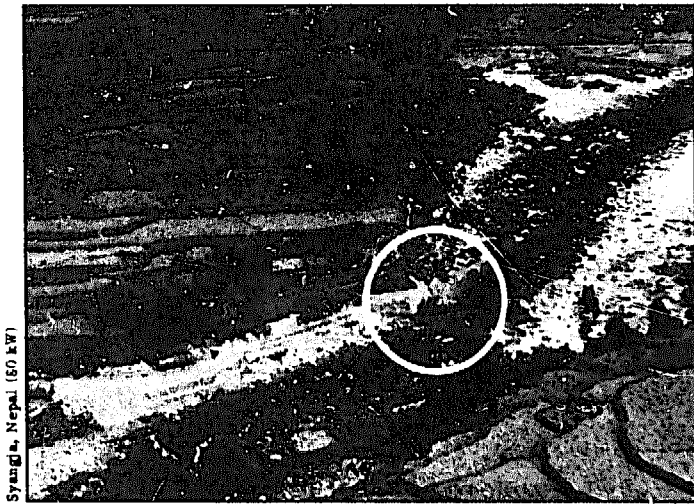

Syangla, Nepal (60 kW)

Fig. 5.48. A side intake places no obstruction in the stream which can be adversely affected by flood flows. A temporary stone weir deflects flow into the intake.

If flows larger than those required by the turbine might enter the intake and overflow the sides of the canal at any time, spillways (p. 159) are incorporated before or after the gate (Fig. 5.52). Because excess water overflows the spillway, the effect of high water levels at the intake is moderated in the canal downstream. The

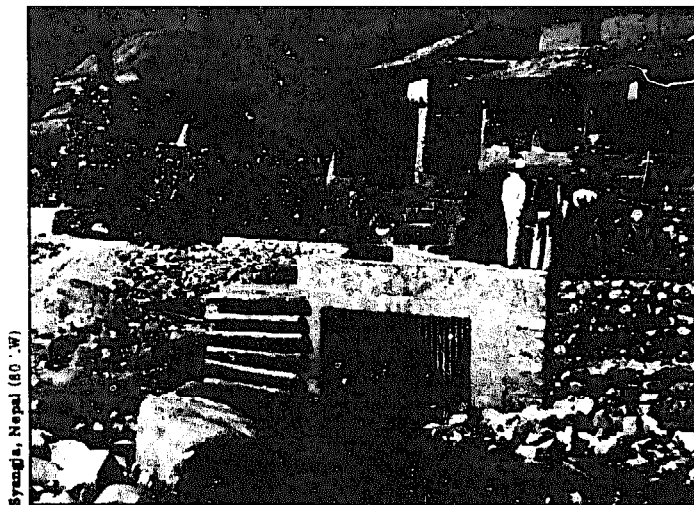

Syangla, Nepal (60 kW)

Fig. 5.49. A side intake.

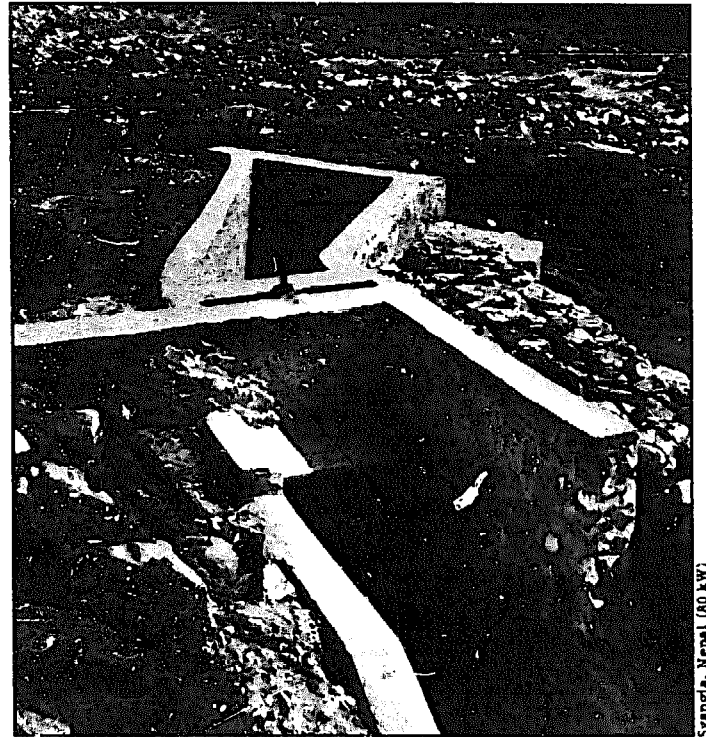

Syangla, Nepal (80 kW)

Fig. 5.50. Another view of the side intake shown in Fig. 5.49, with a platform from which the gate can be operated to control flow into the power canal.

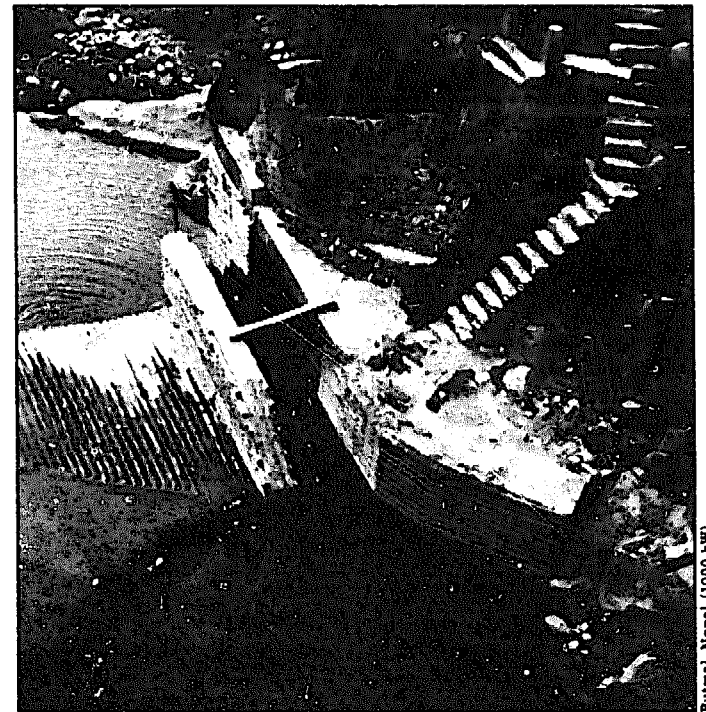

Butwal, Nepal (1000 kW)

Fig. 5.51. Timbers bolted to the concrete side intake protect it from pounding by boulders carried during flood flows. When the photograph was taken, the powerplant was operating but sediment and riverborne debris which had accumulated behind the sliding gate just downstream of the trashrack had caused it to jam. Water taken in through the trashrack at this installation is conveyed underground in tunnels to the powerhouse.

spillway should be wide enough to accommodate most of the excess flow before it enters the canal (see **Spillways**, p. 159). A spillway that is too narrow can cause the water in the canal to exceed a safe level. If a closed power conduit is used rather than a canal, a spillway may not be necessary.

With a low-cost scheme using a simple unlined canal, a masonry wall is sometimes placed over the canal inlet to help deflect flood waters and avert or reduce potential damage (Fig. 5.53). With traditional irrigation canals, the same objective is accomplished by placing the intake under large boulders found along the stream (see Fig. 4.9).

A settling basin (p. 166) permits matter suspended in the incoming water to settle out to prevent it from settling in the power conduit (and eventually impeding flow) or from being carried through the turbine (and causing abrasion which will decrease the turbine's life and efficiency).

If the water is always free of suspended matter, as it is with a scheme that uses the flow from a spring, a settling basin is unnecessary. A settling basin at the intake is often omitted with small micro-hydropower schemes that use power canals. In this case, it is necessary to clean out the sediment along the entire length of canal periodically. In Nepal and Pakistan, for example, farmers have been removing sediment from small irrigation canals for centuries. They do the same for power canals. Generally, these are cleaned out once before the rice-growing season each year and then after each flood during the monsoon. On the other hand, with a closed power conduit—a pipe or tunnel—removing sediment is virtually impossible. If a settling basin is not used before this conduit, the conduit must have sufficient slope to maintain the high velocities required to keep the sediment in suspension. In this case, a forebay at the end of the power conduit can serve as a settling basin to prevent sediment from continuing into the penstock and damaging the turbine.

When a dam is placed in the stream to provide water storage, no settling basin is required at the intake

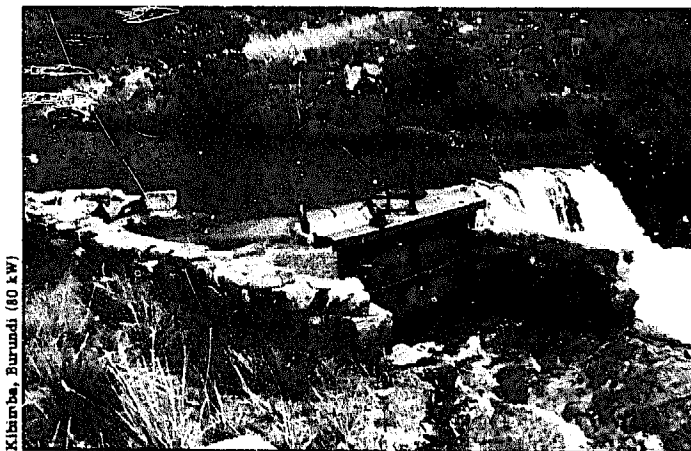

Kibamba, Burundi (80 kW)

Fig. 5.52. Only a gate followed by a spillway is used at the intake at this site.

because the reservoir itself serves this function. Although this might simplify the design of the intake structure, sediment will gradually fill the reservoir, preventing it from fulfilling its original function—the storage of water. In addition, whereas a properly designed settling basin is relatively easy to clean, there is no easy way to remove sediment which has accumulated in a reservoir.

If a scheme's layout is very compact, a separate settling basin is unnecessary. In this case, the intake, power canal, and forebay virtually coincide. The short canal itself then also serves as the settling basin.

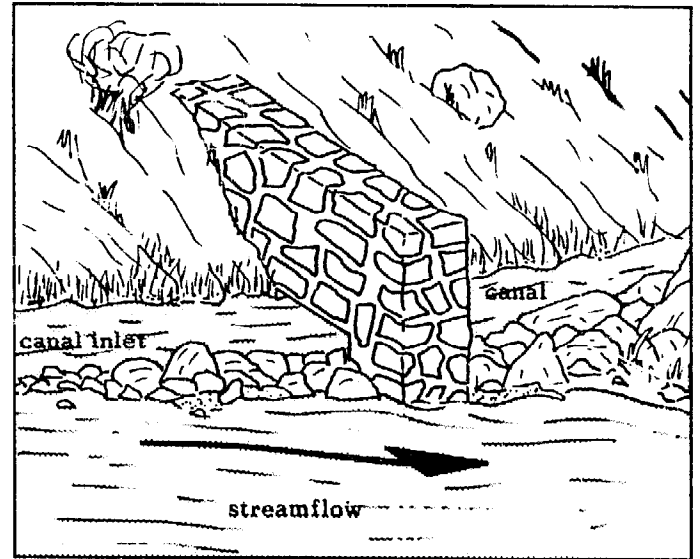

Fig. 5.53. A wall used to restrict flow into a power canal during flood flows.

Where a settling basin is used, it can be placed before the gate to the intake (Fig. 5.54). Where stream velocities are always low, a section of the streambed itself sometimes can serve as a settling area; however, the accumulated sediment then may have to be removed periodically. More frequently, the settling basin is placed after the gate, but close enough to the stream so that the accumulated sediment can be flushed back into it (see Fig. 5.56). The settling basin should always be protected from flood flows to keep out excess debris and sediment.

Trashracks (p. 162) are used to prevent larger objects and floating debris. They are not always used at an intake leading to a power canal. Trashracks at the intake to larger schemes are used primarily on streams that at certain times carry large debris—tree trunks, sizable branches, and boulders. Proper placement of the intake along a stream may make a trashrack at the intake less essential. But at virtually all schemes, a trashrack is at least included at the inlet to the penstock.

A trashrack should not extend down to the streambed, but should rest on a step or ledge rising above the streambed, as shown in Figs. 5.56–5.60. Otherwise, bed load might be drawn through it or might stop in front of the trashrack and restrict the flow through it. Any bed

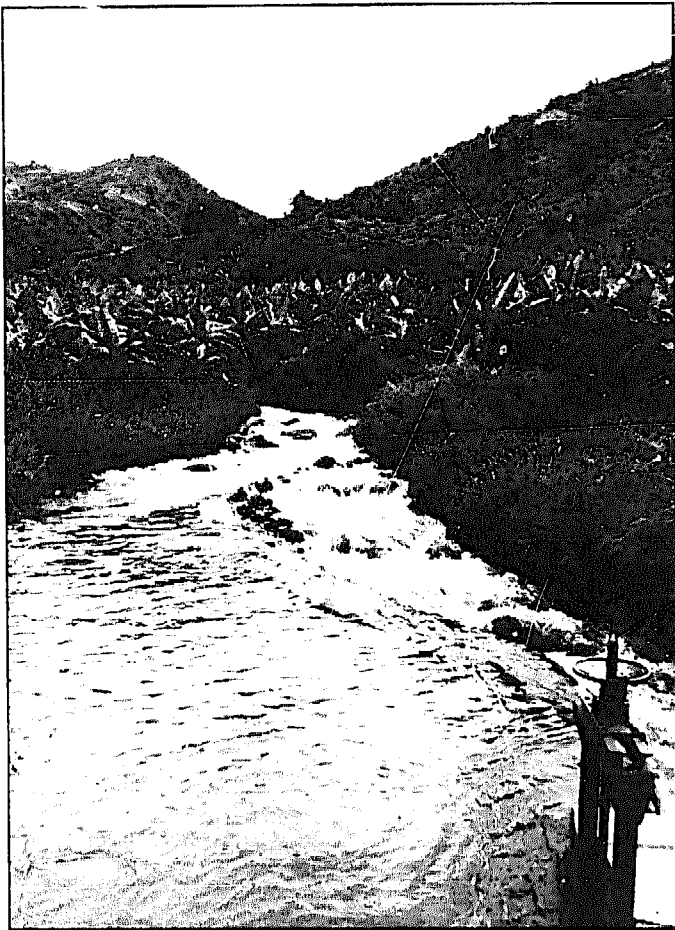
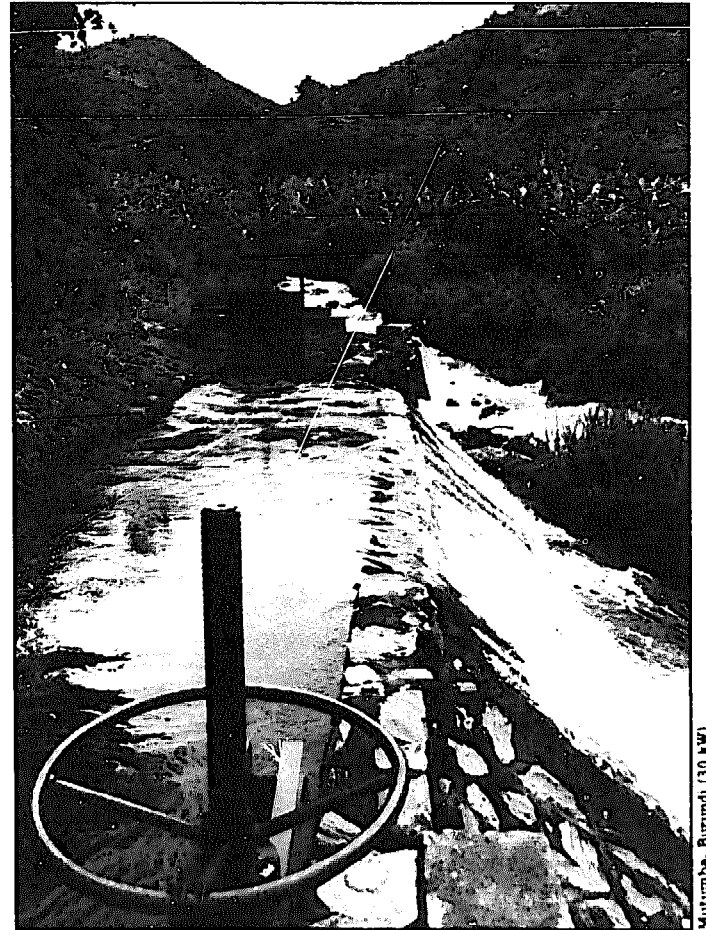

Fig. 5.54. The photograph on the left shows the primary settling area which is located before the intake gate. The scour gate visible at the right is used when cleaning out



this area. Long spillways before and after the intake gate seen in the photograph on the right ensure a fairly constant level in the canal.

Mutumba, Burundi (30 kW)

load restrained by this step will not affect flow through the trashrack if it is periodically removed.

Skimmers (p. 165), which generally prevent the passage of floating debris, are rarely found with small-hydro-power schemes, probably because this option is not considered. When debris must be strained out, the first option generally considered is a sieve-like device or trashrack that intercepts the entire flow entering the pipe or canal. Skimmers are useful because, by restraining much of the floating debris without obstructing flow below the water's surface, they reduce the frequency with which the trashracks farther downstream have to be cleaned.

Figure 5.55 illustrates the design of a simple intake on a small stream which incorporates some of the basic components described above. A temporary stone weir keeps the water level sufficient for an adequate flow to enter the intake. A spillway is unnecessary because the intake leads to a pipe. Sediment in the settling basin has to be shoveled out periodically. A second trashrack may be incorporated before the pipe to remove small floating debris that may have passed through the first trashrack. The entire area can be covered to prevent debris from falling in and to discourage tampering.

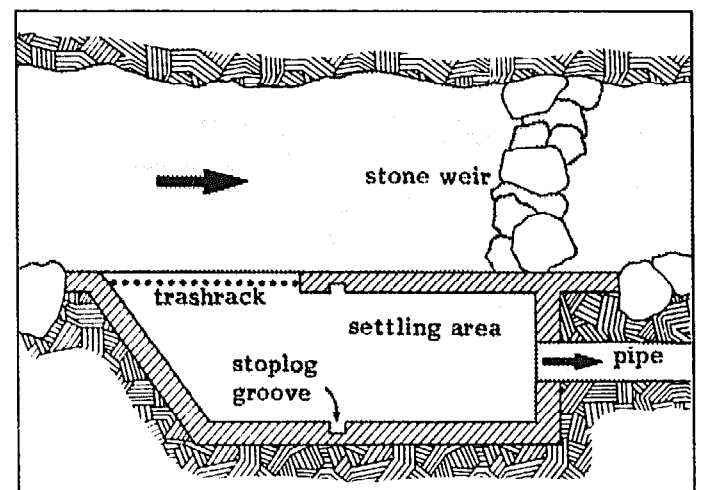

Fig. 5.55. A section view of a simple intake.

Figure 5.56 illustrates a more sophisticated, reinforced-concrete intake design which incorporates all four components. This is an example of a more conventional and expensive design developed for a site in Peru. Although this intake could not easily be placed at right angle to the stream because it is located in a narrow gorge, an

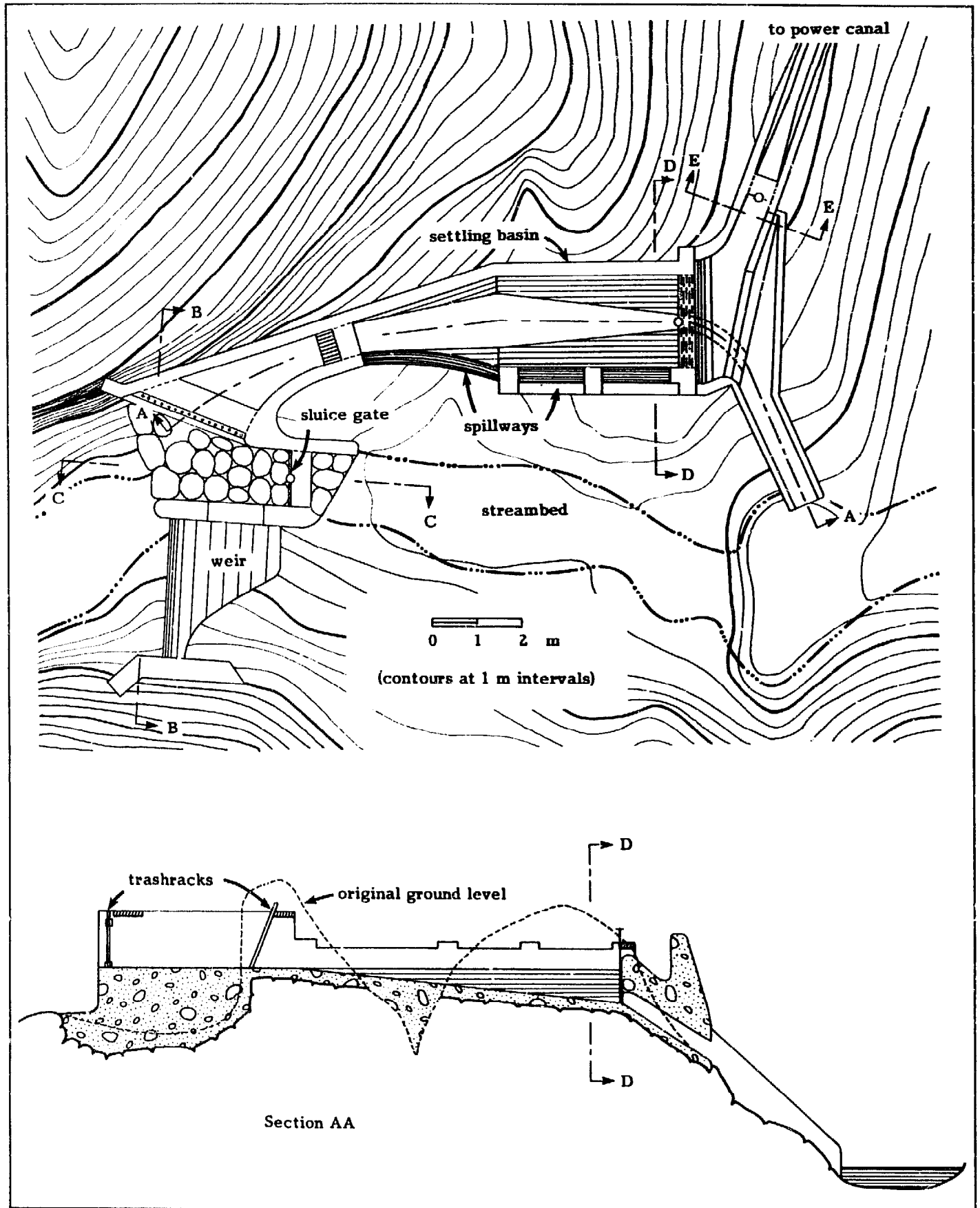

Fig. 5.56a. Views of the weir and intake for a small-hydropower project in Tabalosos, Peru (from Electroperu drawings).

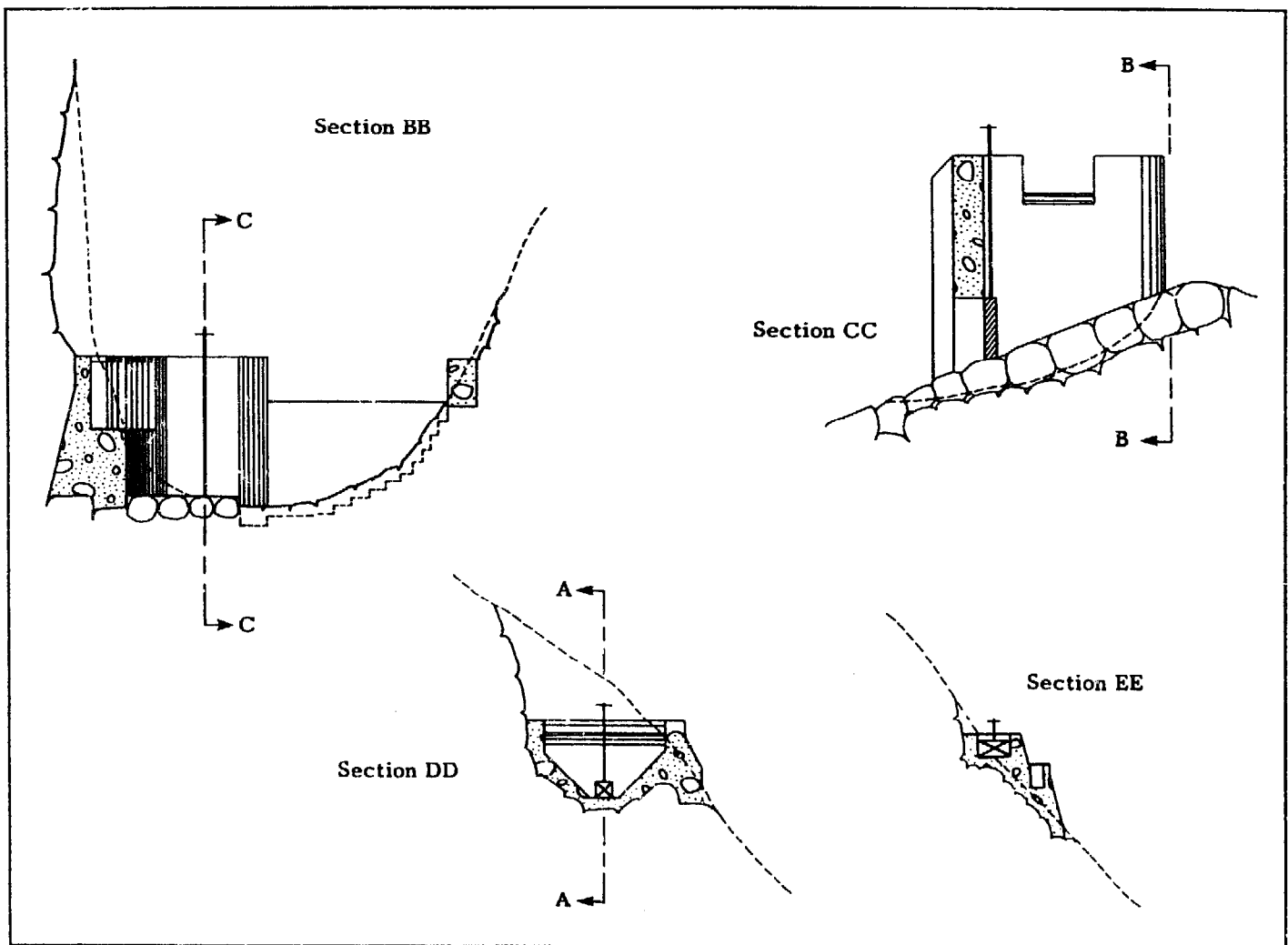

Fig. 5.56b. Additional views of the weir and intake.

attempt was made to approach this optimum as closely as possible. To prevent large debris from entering, a trashrack is placed on the stream, followed by a second trashrack to remove small debris. A settling basin after the trashracks permits removal of sediment. To help prevent large debris from interfering with the flow of water through the intake, two features are incorporated: a step in front of the trashrack prevents rolling bed load from obstructing flow through the trashrack, and a sliding gate just downstream of this area permits any accumulated debris to be flushed out periodically.

Extending the wall located between the weir and scouring area to a position in front of the trashrack ensures that scouring velocities in front of the trashrack are high enough to remove this debris. A steep gradient in this area also facilitates this task. However, if scouring is delayed, accumulated debris resting against the gate can interfere with its operation. This problem was encountered at a larger plant in Nepal (see Fig. 5.51) where the sliding gate could not even be forced open. The proposed solution at this site was to shut down the plant, divert all the flow over the weir during the dry season, and drain the water remaining in the gate area through the underground intake. Debris which has

accumulated in this area would then be manually removed to free the gate. Regular operation of the gate to clean out this area probably would have avoided this problem.

In the design in Fig. 5.56, only a single gate has been incorporated at the beginning of the power canal to control flow through the intake area. Spillways along the settling basin regulate the volume of water directed toward this gate. Because there is no gate at the entrance to the intake area, it cannot be drained if repair work is necessary. Including slots for a stop-log in front of the initial trashrack might have been advisable.

Another conventional design incorporating the four basic components is illustrated in Fig. 5.57. The area in front of the intake (a) is paved to facilitate cleaning sediment when the sliding gate (b) in the weir is opened. A stoplog (c) can be closed to permit cleaning of the settling area (d) or repair of components downstream. Accumulated sediment can be removed through the sliding gate (e). A trashrack (f) removes any floating debris from the water before it passes a gate (g) which regulates the flow into the canal (93).

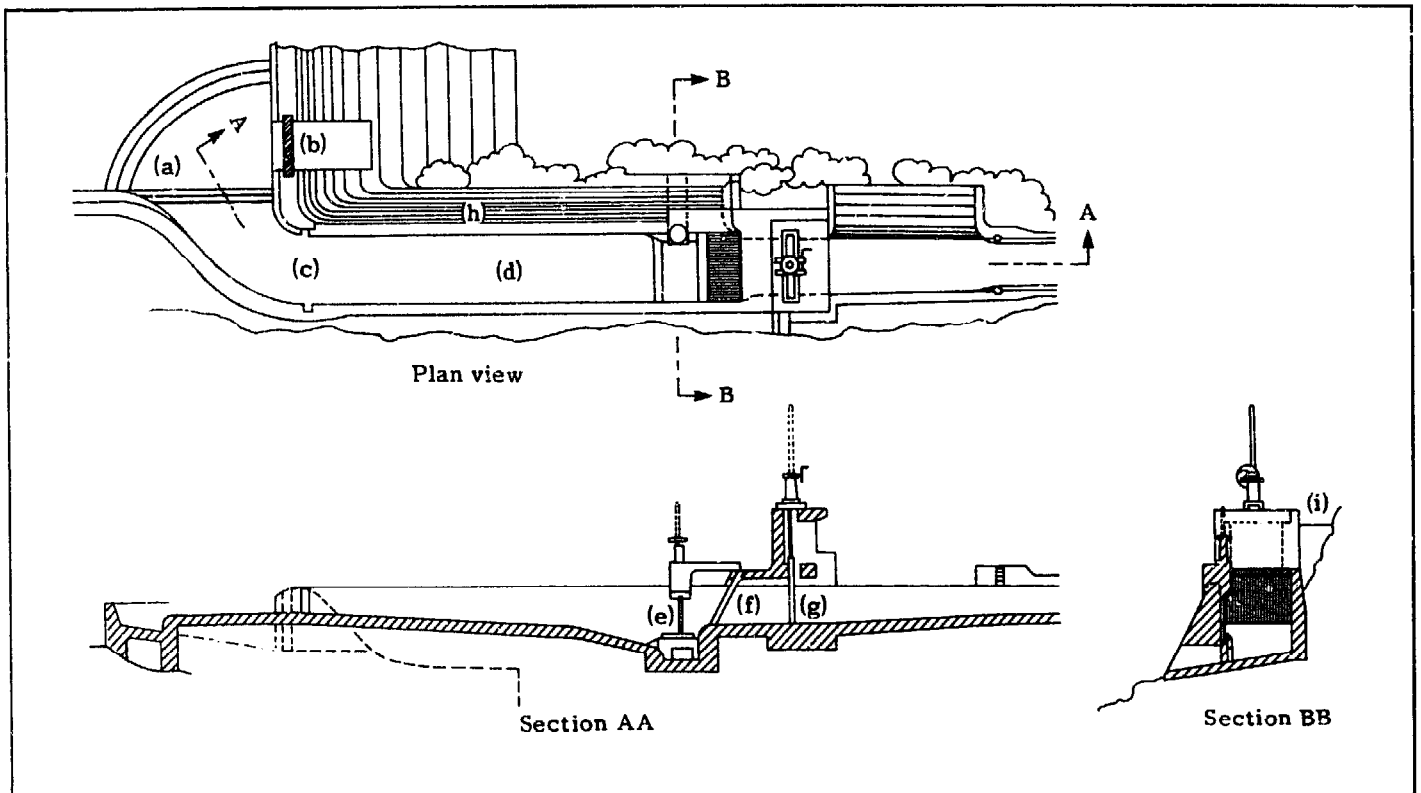

Fig. 5.57. A standardized intake design (90).

The long spillway (h) permits most of the excess water during times of heavy rains, as well as some floating debris, to return to the stream. A shorter spillway located after the regulating gate ensures that excess water which might pass the gate does not greatly increase the depth of water in the power canal. Without it, if streamflow rises significantly, the extra head across the gate might cause a larger flow and therefore a greater depth of water in the canal. Use of a closed power conduit rather than a canal would make a spillway unnecessary, because a closed power conduit cannot overflow. A small wingwall (i) prevents flood flows from overflowing the intake area into the canal.

Placing the trashrack after the spillway rather than at the entrance to the intake means that much less debris will be held back because some of it will overflow the spillway. Also, a smaller, less costly trashrack is required.

The small size of the settling area shown in Fig. 5.57 makes it suitable only for preliminary settling. Depending on the quality of the water, more complete settling might be required. If velocities in the power conduit are sufficiently high to prevent settling, the forebay can serve as a settling basin.

Because engineering costs associated with the design of intakes and other components can be significant, some implementing organizations have begun standardizing designs. But there are problems in blindly adopting this approach. The intake structure shown in Fig. 5.57 represents one of three standardized designs proposed for flows ranging from 0.1 to 10 m³/s. The first prob-

lem with this design is its complexity; fairly intricate formwork is required. Second, with this type of standardized design, the configuration is fixed; only dimensions are changed depending on the design flow it is to handle. Because there can be a large difference in cost and sophistication between a plant that consumes 0.1 m³/s and one that consumes 10 m³/s, this approach does not encourage a simple, more appropriate design

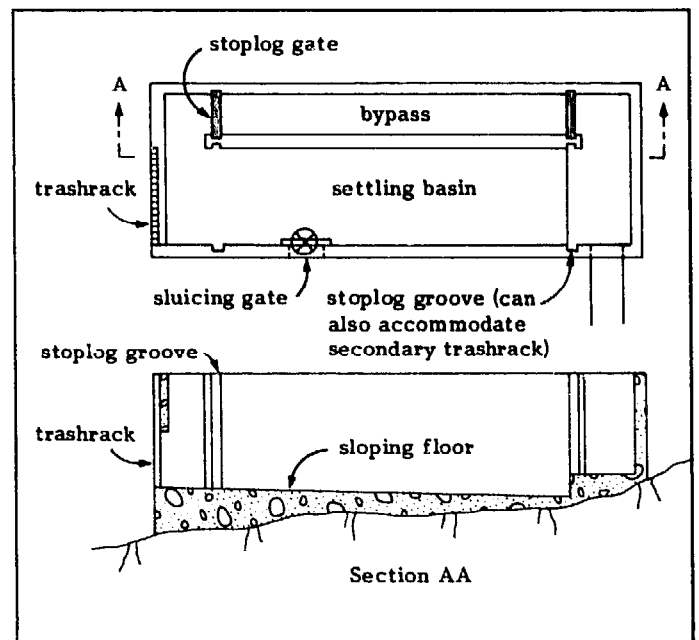

Fig. 5.58. A bypass permits the plant to continue operation while the settling area is being cleared.

for schemes requiring less water. Such standardized designs inevitably imply that there are economies of scale—that larger designs are more economical—and therefore discourage the implementation of cost-effective micro-hydropower schemes.

The basic configuration for another type of standardized design is illustrated in Fig. 5.58. Not only is the design simpler, but both the shape and size can be changed to meet specific site conditions and flow requirements. The principal component of this intake structure is a settling area. Also incorporated in the design is a

bypass—either an open channel, as shown, or a pipe—which permits flow to continue while the settling basin is closed for cleaning. Simple stoplogs direct the water through the desired area. Platforms can be incorporated across the top of the structure behind each trash-rack to permit access to the racks to facilitate clearing.

A design resulting from work by the Swiss in the Cameroons is shown in Fig. 5.59. Although designed as an intake for a potable water system, it exhibits several interesting features which should be considered at intakes to hydropower schemes:

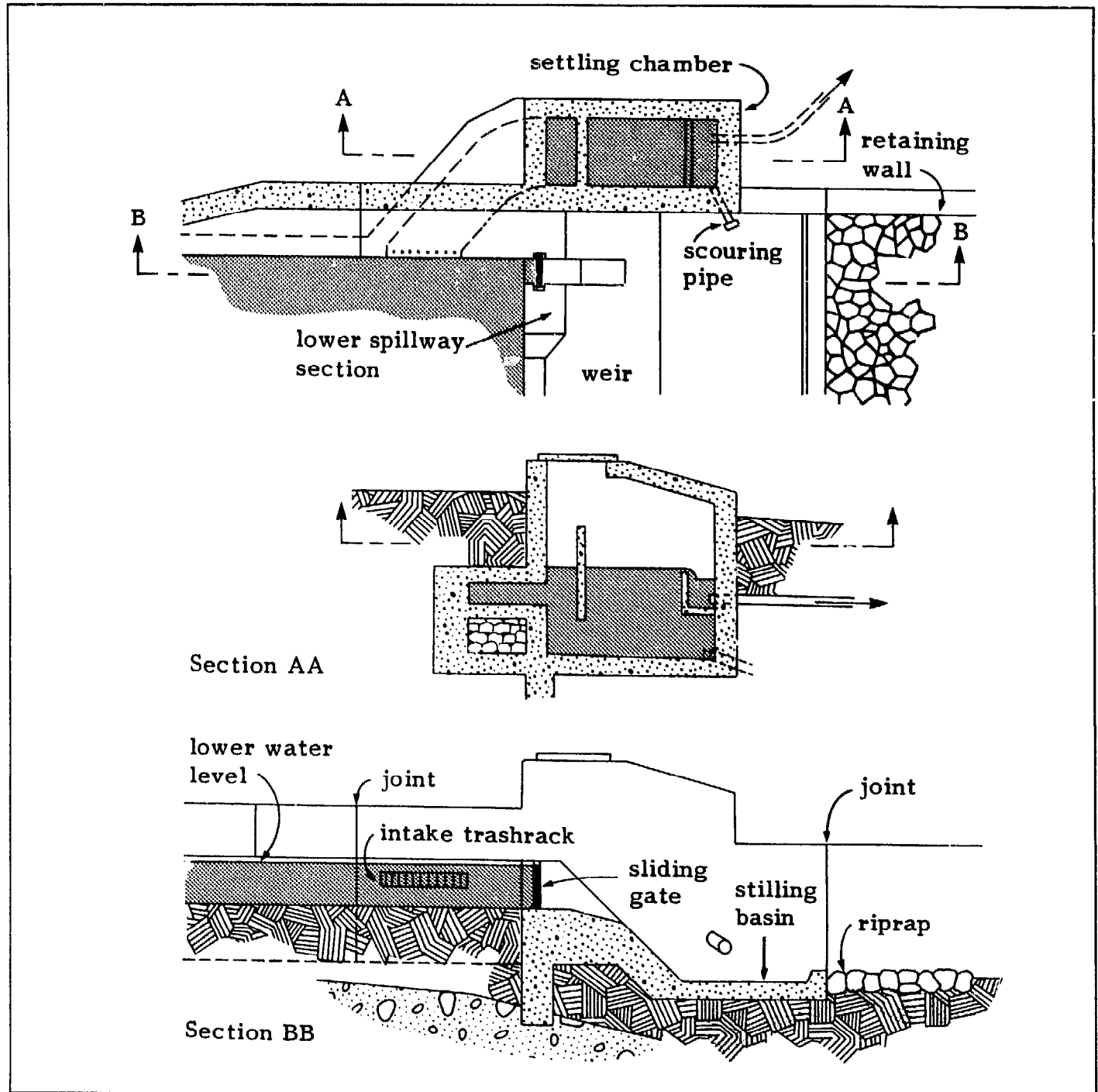

Fig. 5.59. An intake to a potable water supply system (12).

- The intake is located perpendicular to the stream, thereby encouraging any debris suspended in the water to be swept by and carried downstream.
- The opening of the intake is located below low water level, thereby reducing the possibility that floating debris will become lodged in the trashrack. At the same time, it is above the floor of the streambed so that bed load carried along the bottom is not swept in.
- A sliding gate is placed in the diversion dam just downstream of the intake, thereby permitting any bed load or sediment which has accumulated in front of the intake to be scoured away by opening this gate.

Because a closed pressure conduit is used downstream from the intake rather than an open canal, no spillways are incorporated in the design.

The area behind a dam or weir, where flow velocities are low, is often used as a settling area to remove the bed load and some sediment from the water before it enters the intake. However, this area must be cleaned out periodically if it is to continue to serve this function. This can be done manually. It can also be facilitated somewhat by use of a gate to scour out the area in front of the intake. A self-scouring intake is shown in Fig. 5.60. During normal flows, gravel transported by the stream is trapped in the bowl, and the downstream lip keeps the trashracks over the side slots submerged. During flood flows, water passes through the bowl under conditions of shooting flow, and any debris already present or in the flow is swept out. During these flows, the water level is below the side slots, and no water or debris is carried into the main conduit. The intake must be designed so that shooting flows occur only as often as is necessary to keep the bowl free of gravel or debris.

The operation of a drop intake (Fig. 5.61), also known as a bottom or a Tirolian intake, differs significantly from those previously described. It is essentially a canal built in the streambed, stretching across at least a portion of the stream and covered with a trashrack (Fig. 5.62). The trashrack bars are oriented in the direction of the streamflow. To minimize the debris which might be caught in the intake, the trashrack should have a slope about 1 in 10 greater than the slope of the streambed (104). By nature of its construction, this type of intake tends to trap sediment and can cause serious maintenance problems; therefore, a sluicing pipe should be included to remove the sediment periodically and discharge it back to the stream below the intake. The slope within the intake must be sufficient to facilitate scouring out the sediment (13,104).

In Bundi, Papua New Guinea, a less sophisticated version of this design is in use. Rather than excavating into the streambed, a concrete weir was built across a narrow stream and a drop intake incorporated in it (Fig. 5.63). The area behind the weir eventually filled with sediment and other debris, but this was unimportant because it was not designed for water storage. A sheet of steel,

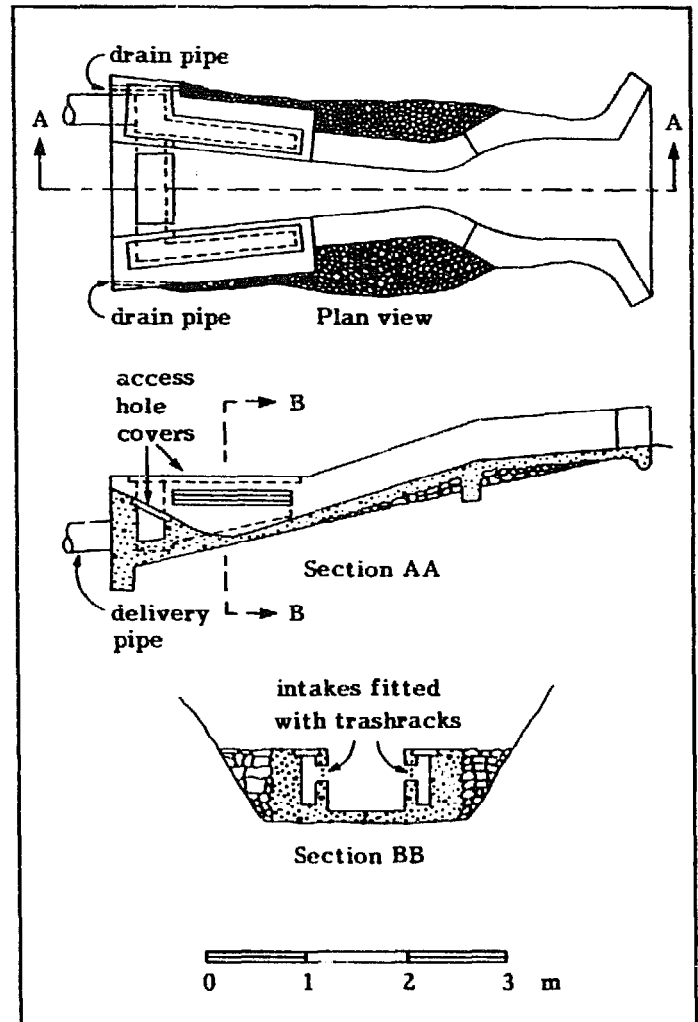

Fig. 5.60. A scoop intake (87).

perforated with closely spaced 1 cm-diameter holes and placed on the upper portion of the downstream face of the weir, serves as the trashrack (Fig. 5.64). Sections of iron pipe are welded to the upper surface of the sheet

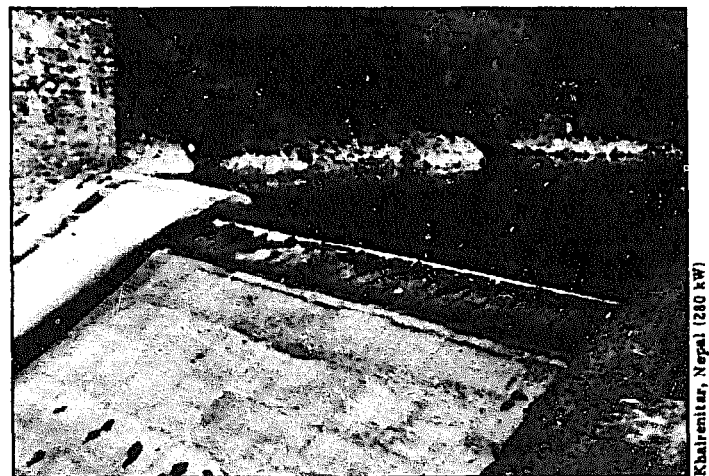

Fig. 5.61. A drop intake located at the crest of a dam. Inadequate flows when the photograph was taken had forced the powerplant to shut down.

Khalrenitar, Nepal (280 kW)

both to reinforce it and to prevent large boulders carried downstream during the rainy season from damaging it. Apparently, water falling through the trashrack only carries with it fine sand; anything larger is swept downstream.

Figure 5.65 illustrates an intake and weir configuration which contributes to larger maintenance requirements than should be acceptable. During operation, the intake

structure is submerged, and the area behind the weir quickly fills with sediment up to the inlet to the penstock, which is nearly level with the bottom of the weir. During the rainy season, students from a vocational school more than 2 km away have to come to clean out the structure about three times per week, sometimes working by flashlight. A sandbag plug at the base of the weir is removed to drain the area. One improvement would have been to raise the inlet to the penstock to

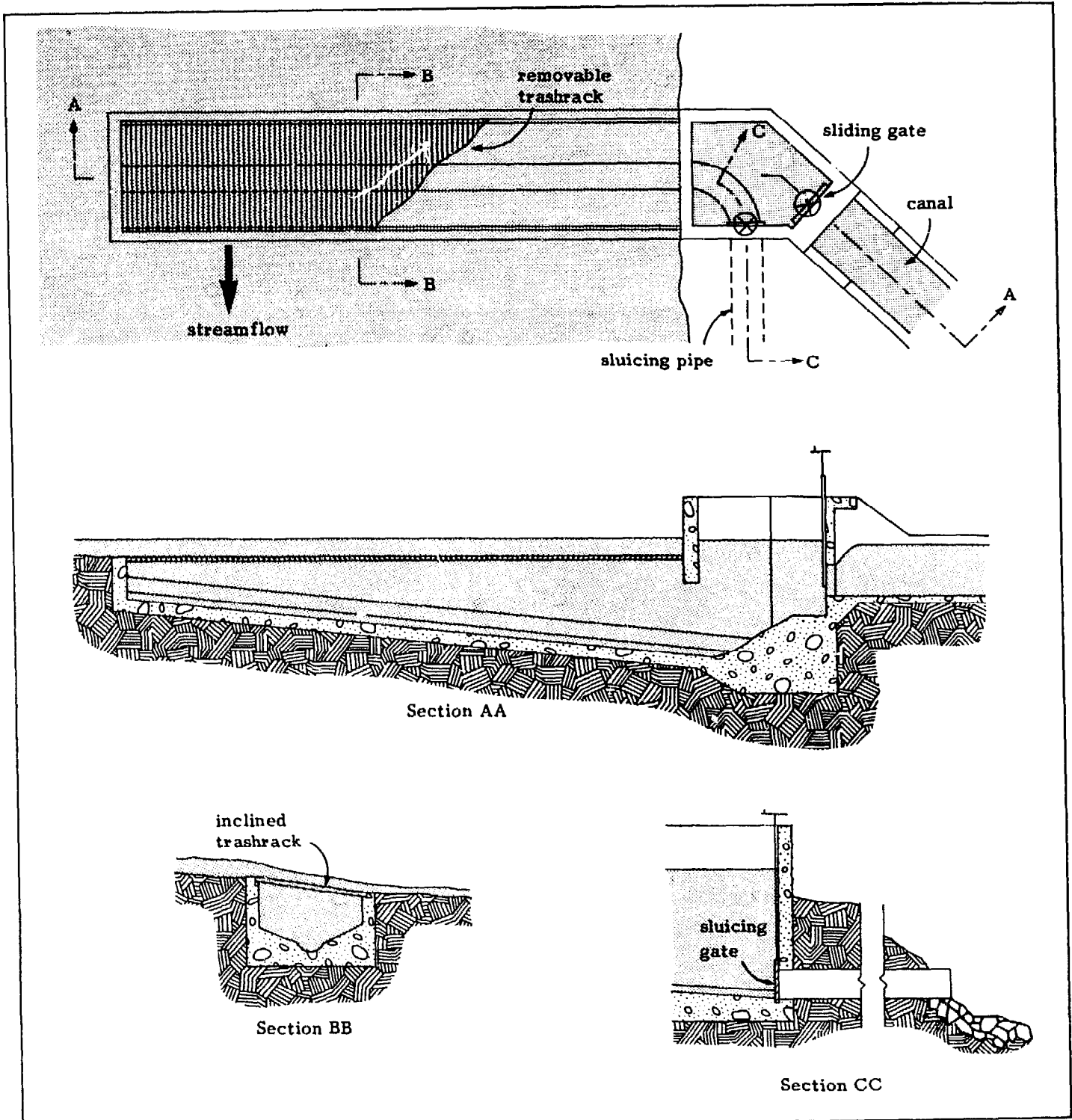

Fig. 5.62. Views of a drop intake.

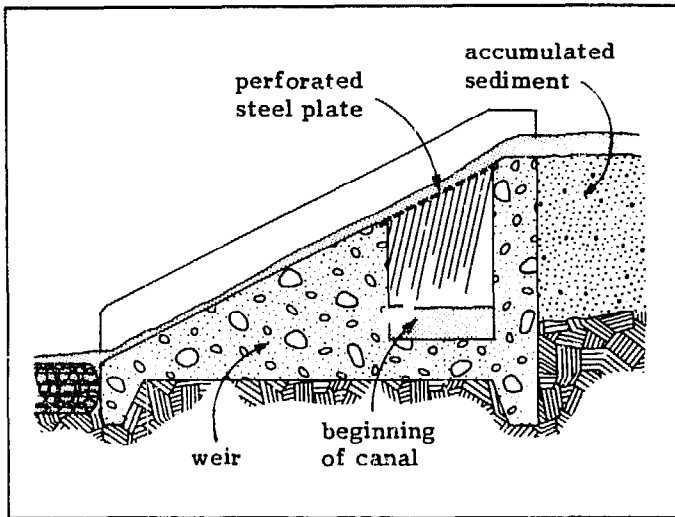

Fig. 5.63. Cross-sectional view of a drop intake. In this view, the canal carries water out perpendicular to the stream before turning in the downstream direction toward the settling basin. (Source: B. Vogtli)



Bundi, Madang Prov., Papua New Guinea (10 kW)

Fig. 5.64. A view of the drop intake shown in Fig. 5.63. Water falling through the trashrack at the upper left can be seen entering the canal at lower right.

reduce the time between sediment removal. This would leave the gross head unchanged. Another would have been to include a simple sliding gate to drain the water

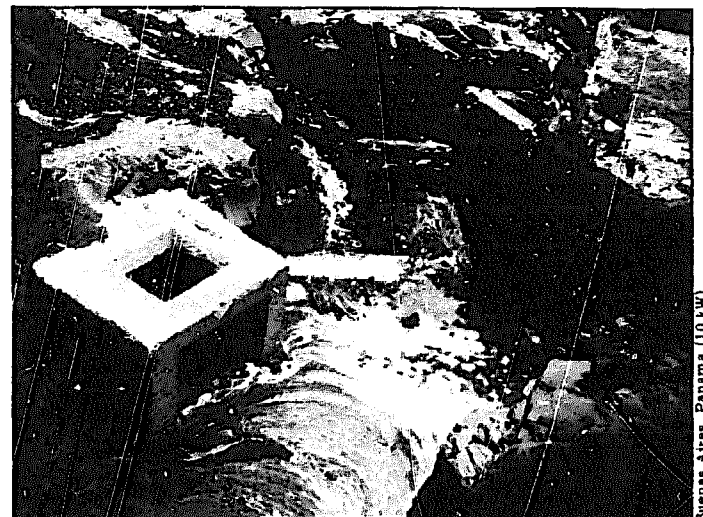

Buenos Aires, Panama (10 kW)

Fig. 5.65. A concrete box behind the small weir serves as the intake. The opening on top of the intake structure is usually closed with a removable concrete plug. A portion of the penstock pipe can be seen between the box and the base of the weir. Several features of this design could have been improved to facilitate maintenance.

and sediment from behind the weir. The design also could have been improved by providing easier access to the intake box for the removal of sediment or by redesigning it altogether. Finally, the penstock goes through the left side of the weir and passes through the nappe of water overflowing the weir crest before it continues down the right bank to the powerhouse. Consequently, a section of the penstock pipe is subjected to considerable abrasion from sediment in the water. The penstock should have been placed through the right side of the weir to avoid crossing the nappe.

Power conduits

Determining canal dimensions and slope

To determine the cross-sectional dimensions and slope of a canal required to convey a given flow, the value of each of the following parameters is required:

- velocity of water in the canal " v ",
- roughness coefficient of the canal " n ", and
- cross-sectional profile.

The paragraphs below first discuss how to determine the value of each of these parameters for a specific site and then continue with an explanation of how to use these values to determine the dimensions and slope of the canal at that site.

Velocity in a canal. The velocity of water within a canal generally must be within a narrow range. This velocity must be high enough to prevent sedimentation yet low enough to prevent erosion of the canal if it is unlined and to keep the head loss over the length of the canal within acceptable limits.

If a scheme is properly constructed, any riverborne debris which is fine enough to be readily deposited will

have settled either in the reservoir or pond before the intake or in a settling basin just before the beginning of the canal. The velocity in the canal should be high enough so that any suspended material which has not settled out in the settling area will not do so in the canal. To keep any silt still in suspension from settling out, the average minimum flow velocity in a canal should be (39):

$$v_{\min} = 0.3 \text{ m/s for silty water}$$

$$= 0.3-0.5 \text{ m/s for water carrying fine sand}$$

Apart from this consideration, the growth of aquatic plants in earth canals can seriously affect their capacity in some climates. This is rarely serious if water temperature is below 20 °C or the water is turbid or deep. A mean velocity of greater than 0.7 m/s will generally prevent growth that can seriously affect the flow in a canal (38).

To minimize the cost and labor necessary to construct a canal, the velocity in the canal must be maximized. The greater the velocity, the smaller the required cross-

Nature of canal surface and finish

	Earth	Masonry and Brickwork	Metal	Wood
0.05	<ul style="list-style-type: none"> partially obstructed with debris and weeds 			
0.04	<ul style="list-style-type: none"> rock cuts, jagged and irregular stony bed and weeds on bank 			
0.03	<ul style="list-style-type: none"> rock cuts, smooth and uniform dry-rubble surface ordinary conditions 		<ul style="list-style-type: none"> corrugated semicircular 	
0.02	<ul style="list-style-type: none"> regular surface, good condition, or well-packed gravel uniform, very good conditions 	<ul style="list-style-type: none"> masonry in bad condition or inferior brick or stone rough-face brickwork concrete, wood troweled sand and cement plaster neat cement plaster 	<ul style="list-style-type: none"> slightly tuberculated riveted cast or wrought iron glazed 	<ul style="list-style-type: none"> unplaned, badly fitted or aged well laid, unplaned well planed and fitted
0.01				

Fig. 5.66. Values of roughness coefficient "n" for canals constructed with different materials and finishes (32,40,83).

sectional area of the canal and the smaller the volume to be excavated. Canals for micro-hydropower schemes are often unlined because of the cost savings this implies. However, there is a maximum permissible velocity above which the banks and bottom of an unlined canal will start eroding. The magnitude of this velocity depends on the nature of the soil. For bare canals, approximate values of this maximum velocity are shown in Table 5.1. **APPENDIX C** (p. 269) explains how to ascertain the nature of the soil at a specific site.

TABLE 5.1. Maximum permissible velocities to avoid erosion in an earth canal (38,40,83)

Type of soil	Velocity (m/s)
Fine sand	0.3-0.4
Sandy loam	0.4-0.6
Clayey loam	0.6-0.8
Clay	0.8-2.0

If the canal is lined, wear by abrasion sets the upper limit on velocity. For clear water in concrete canals, velocities above 10 m/s have been found to do no harm. However, if the water contains sand, gravel, or stones, damage may occur at much lower velocities. Unless the abrasive material is particularly bad, velocities up to 4 m/s should not injure wood or quality concrete. Thin metal flumes may be damaged by coarse sand or gravel at 2-3 m/s, and the galvanizing that might cover the sheet metal may be injured at even lower velocities (40).

Roughness coefficient. The roughness coefficient "n", also called Manning's coefficient, is an empirical measure of the roughness of a surface. Its value for canals ranges from 0.010 and more for those with the smoothest finish to about 0.050 and more for earth canals in very poor condition and obstructed with weeds and debris. The value of "n" for an average canal ranges from 0.012 to 0.023. Values of "n" for various materials and finishes are shown in Fig. 5.66. Although a specific value of "n" has been assigned for each canal surface described, the actual value of "n" may vary by ± 0.005 or even more. For this reason, the figure has been prepared to give the reader a feel for the sensitivity of "n" to the actual surface roughness.

Cross-sectional profile. The material in which the canal is excavated or of which it is constructed generally dictates its cross-sectional profile. The following paragraphs describe the common profiles used for canals and when each is used.

A **semicircular** cross-section is the most efficient profile because, for a given canal slope and cross-sectional area, it passes the maximum flow or discharge. However, this form is impractical to excavate. It

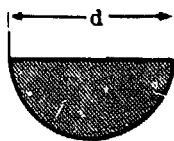

is therefore used primarily with materials which lend themselves to this shape. Examples are prefabricated concrete, sheet-metal, and wood-stave sections. Illustrations of these can be found in **Flumes** (p. 112).

A **trapezoidal** cross-section is the most common profile for both lined and unlined canals excavated in earth. If the canal is unlined, the maximum side slope is set by that slope at which the material will permanently stand under water. The nature of the soil in which the canal is excavated is the major determining factor. Clay soils, for example, can have steep slopes (see Fig. 5.7) whereas sandy soils have flatter slopes. Some soils can stand fairly steep slopes when dry but disintegrate into a fluid mass and assume a flatter slope when wet. Also, original ground which has been cut into may safely be steeper than slopes made of the same material but filled in (Fig. 5.67). However, it is always safer to excavate the portion of the canal carrying the water in original earth. The level of the water table will also affect the stability of the slope, because incoming ground water can cause the walls of the canal to slough (38). Table 5.2 presents suggested slopes for the banks of unlined canals. (See **APPENDIX C**, p. 269, for guidelines for determining the type of soil in which a canal is being excavated.)

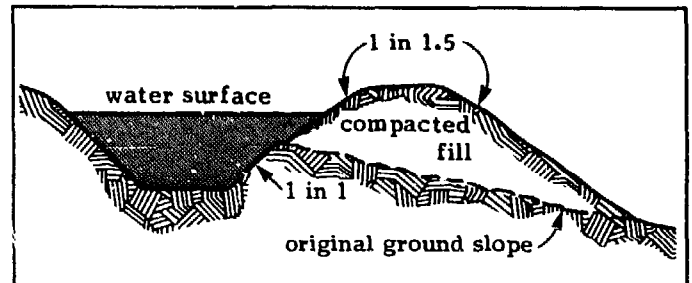
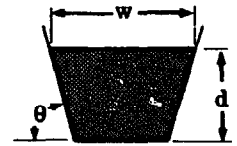

Fig. 5.67. Comparison of a canal section with slopes both cut in original ground and made of the same material but filled in.

The magnitude of the slope of a lined banks depends on the nature of the material on which the lining will rest. The banks of a canal made of almost any free-draining material can be lined if the slope is not steeper than 1 in 1. Clayey material, on the other hand, which is apt to become saturated with water, requires a lining with a flatter slope. Any lining on slopes steeper than 1 in 3/4 must be built to act as a retaining wall (40).

One disadvantage of a trapezoidal cross-section is that, if a canal is built across a hillside which has a significant slope, excavation on the uphill side of the canal may be significant (see Fig. 5.77).

For a trapezoidal canal with a given slope for its banks, the most efficient trapezoidal cross-section is one in which a semicircle can be inscribed in the wetted area (Fig. 5.68). For this section, it can be shown that the

TABLE 5.2. Suggested slopes for the banks of unlined canals (40)

Type of Soil	Slope*
For cuts in fissured rock, more or less disintegrated rock, or tough hardpan	1 in 1/2
For cuts in cemented gravel, stiff clay soils, or ordinary hardpan	1 in 3/4
For cuts in firm, gravelly, clay soil, or for side-hill cross-section in average loam	1 in 1
For cuts or fills in average loam or gravelly loam	1 in 3/2
For cuts or fills in loose sandy loam	1 in 2
For cuts or fills in very sandy soil	1 in 3

* Vertical to horizontal

length of either sloping side of the wetted area is half its top width.

A **rectangular** cross-section is often most appropriate when excavation is undertaken in firm rock. It is also commonly used when the canal incorporates properly constructed stone- or brick-masonry walls. Use of a rectangular canal reduces the excavation required (see Fig. 5.77). For the most efficient rectangular cross-section, the width of the canal is twice the depth of the wetted area and, like a trapezoidal section, is a cross-section in which a semi-circle can be inscribed.

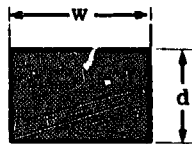

Although a **triangular** cross-section is seldom encountered, this profile would be of use, for example, when a flume is constructed of two slabs of timber or the equivalent or when a canal excavated in earth is lined with concrete slabs. The most efficient triangular cross-section is one where the side slopes are 1 in 1.

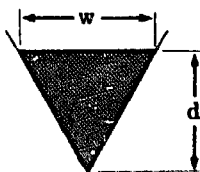

Procedure. In the following approach for determining the canal dimensions and slope, it is assumed that the most efficient cross-section for the cross-sectional profile adopted is to be used. This is the cross-section which will result in the greatest discharge for a given cross-sectional area and profile. Mathematically, this permits a more direct solution to the problem. In the actual construction, however, there is no need to adhere precisely to these "optimum" dimensions as long as the required cross-sectional area and slope are maintained. It is possible to deviate considerably from these values without markedly affecting the flow conveyed by the canal, as seen in Fig. 5.68. In that figure, all trapezoidal sections have the same area. Although section (c) is the most efficient—it conveys maximum flow and would be the section obtained by the procedure described below—there is little difference in the capacity of the canal in spite of significant changes in the ratio of depth to width.

Fig. 5.69 summarizes the procedure necessary to determine the cross-sectional dimensions of a canal and its slope. Each circled number in this figure refers to the correspondingly numbered paragraph below which explains how to derive the desired quantity following that circle. Before embarking on this procedure, it is

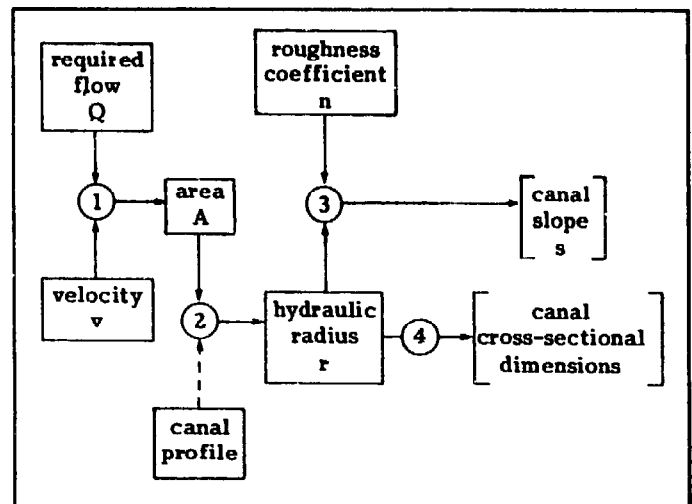

Fig. 5.69. Flow diagram of procedure for determining canal dimensions and slope described in the text.

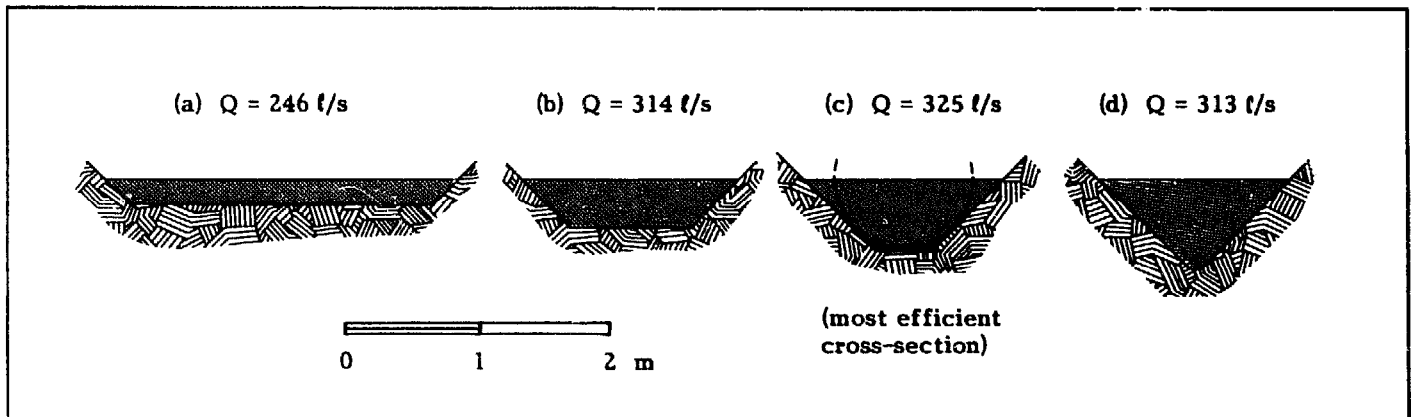

Fig. 5.68. Comparison of discharge in trapezoidal canals identical in all aspects except for the proportions of their

depth to width. In this example, $A = 0.5 \text{ m}^2$, $S = 0.001$, $n = 0.02$, and slope of banks = 1:1.

necessary to have determined the desired velocity "v" of the water in the canal, the desired profile of the canal, and its roughness coefficient "n". (Guides to selecting these were covered in the preceding sections.) It is also necessary to establish the flow "Q" required for the generation of power before a canal can be sized. These four elements permit the dimensions and slope of the canal to be determined by following the four steps below. EXAMPLE 5.1 (p. 103) and the dashed lines on the accompanying graphs illustrate the procedure.

In the following procedure, a parameter "r" called the hydraulic radius is used. This is simply defined as

$$r = \frac{A}{p} \quad (5.1)$$

where

A = cross-sectional area of the water in the pipe or canal
 p = the wetted perimeter of the pipe or canal

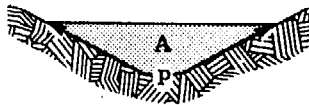

Although the hydraulic radius does not refer to any specific physical dimension, it is related to the efficiency of a pipe or canal—the larger the hydraulic radius for a given cross-sectional area of water, the smaller the area of contact between the water and conveyance structure and the smaller the friction between the two. Therefore, for a given flow, a canal with a larger hydraulic radius requires a smaller slope "S" to convey this flow, independent of profile (Fig. 5.70).

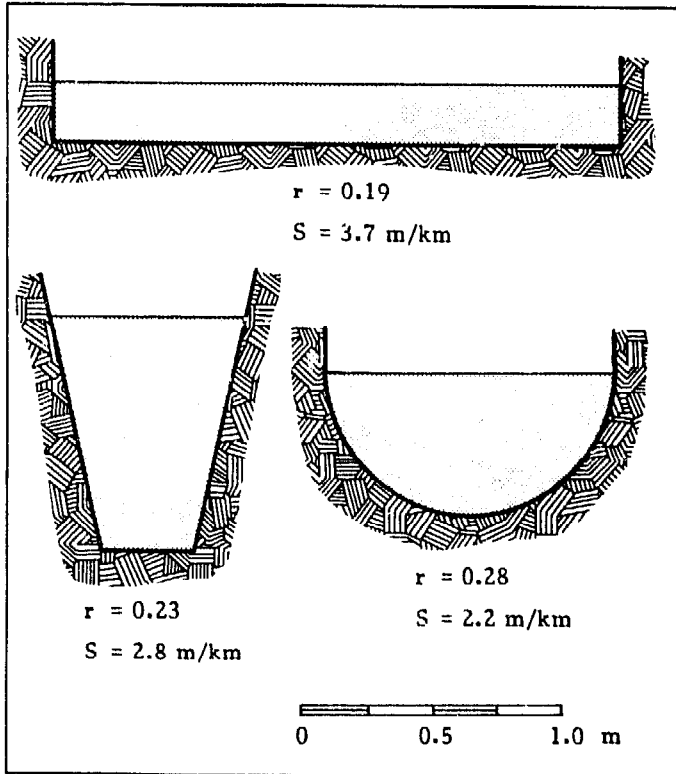

Fig. 5.70. The larger the hydraulic radius, the smaller the required slope to convey the same flow of water. Here, $Q = 0.50 \text{ m}^3/\text{s}$, $v = 1.0 \text{ m/s}$, $A = 0.5 \text{ m}^2$, and $n = 0.02$.

- ① The cross-sectional area "A" (m^3/s) of the water in the canal is determined from the basic relation

$$A = \frac{Q}{v} \quad (5.2)$$

where

Q = flow to be conveyed by the canal (m^3/s)
 v = design velocity in the canal (m/s)

A graphical solution to this equation can be found in Fig. 5.71.

- ② For the most efficient canal section, the hydraulic radius depends only on the profile selected and the cross-sectional area of water it contains. To determine the value of "r", substitute the value of "A" obtained above in the expression in Table 5.3 for the profile selected. If a trapezoidal section has been selected, the slope of its sides must be chosen based on the nature of the material in which the canal is built (Table 5.2). The angle "θ" is the angle of the banks of the canal above horizontal.

TABLE 5.3. Expressions for hydraulic radius "r" for the most efficient canal section for common profiles

Profile	Hydraulic radius, r (m)
Semicircular	$0.40 \sqrt{A}$
Trapezoidal	$0.50 \sqrt{\frac{\sin \theta}{2 - \cos \theta}} \sqrt{A}$
Rectangular or Triangular	$0.35 \sqrt{A}$

An approximate value for the hydraulic radius is independent of the profile and can be found below the appropriate value of "A" in Fig. 5.72. Note that this is only the case when the most efficient cross-sections are being considered.

- ③ Once the hydraulic radius has been determined, the canal slope "S"—the ratio of its vertical drop to its length—can be found using Manning's equation:

$$S = \left(\frac{nv}{r^{2/3}} \right)^2 \quad (5.3)$$

A graphical solution to this equation can be found in Fig. 5.73.

- ④ After determining the hydraulic radius, the cross-sectional dimensions of the wetted area can be derived using the expression in Table 5.4 for the profile selected. The variables "d" and "w" are defined under the relevant profiles in Cross-sectional profile (p. 98).

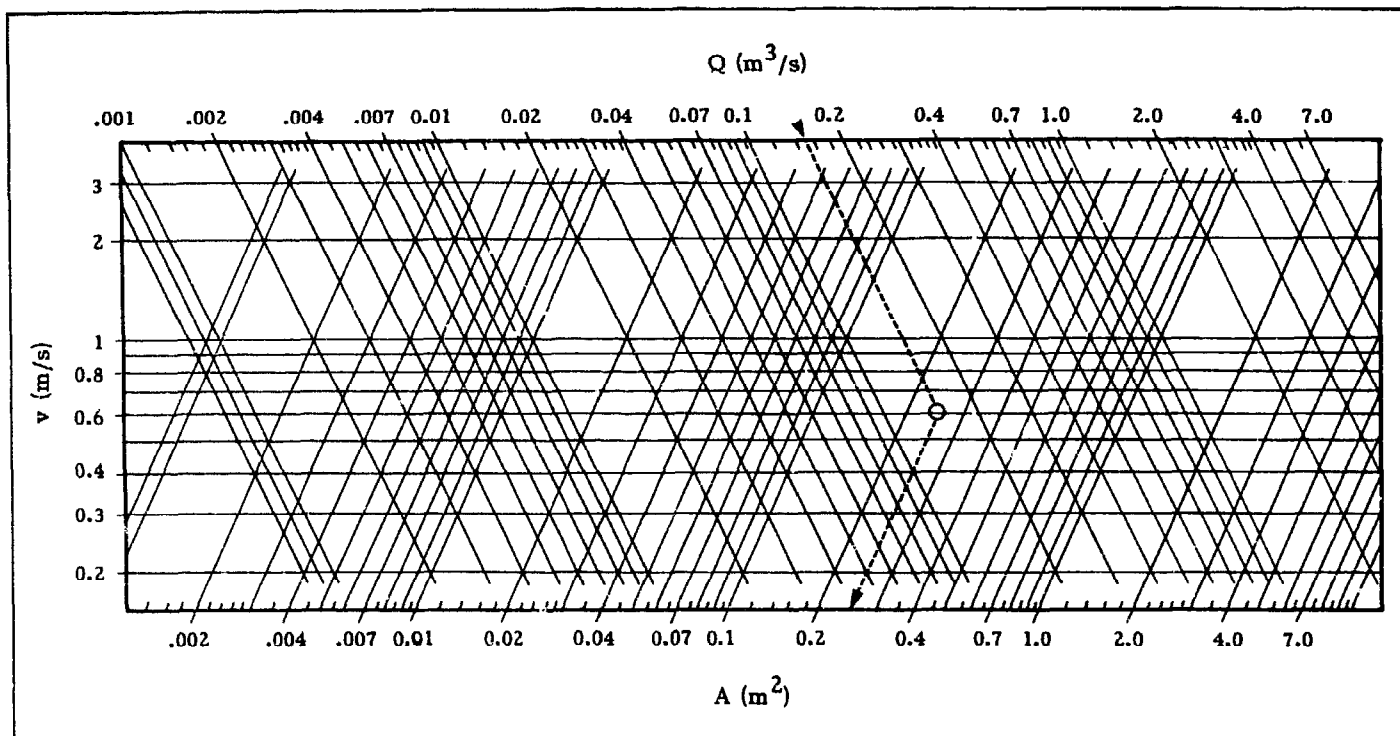

Fig. 5.71. A graph for determining required cross-sectional area of flow for a given flow and velocity.

In designing an earth canal for a micro-hydropower scheme, there is a rather narrow range within which the velocity of the flow should lie, and this velocity largely determines the slope of the canal. The procedure described above approaches the sizing of a power canal in this manner. Given certain flow requirements at a specific site, the slope is determined, and the canal is laid out accordingly.

However, at certain sites, the topography may require that a different slope be used. If the topography from the area of the proposed intake on the stream to the proposed forebay location indicates that a canal with a smaller slope is necessary, a graphical approach can be used to determine its dimensions. In this case, the procedure is to select a smaller velocity than originally chosen and find the canal slope associated with that velocity (using the first three steps in the general procedure described above). By going through this process several times, it is possible to narrow in on the velocity

associated with the desired slope. This is illustrated in EXAMPLE 5.2. Then the canal dimensions can be obtained from the corresponding hydraulic radius by following the fourth and final step of the general procedure. Because a lower velocity will result from the smaller slope, more of the suspended silt and fine sand may settle in the canal itself (unless the water is always clear or a sufficiently large settling area is located upstream of the canal).

Using Eqs. (5.2) and (5.3) and the appropriate expression for the hydraulic radius from Table 5.3, it is also possible to derive a mathematical expression for the hydraulic radius of the canal required to convey the desired

TABLE 5.4. Expression for cross-sectional dimensions of most efficient cross-sections for common profiles

Profile	Dimensions
Semicircular	diameter, $d = 4 r$
Rectangular	depth, $d = 2 r$ width, $w = 4 r$
Triangular	depth, $d = 2.8 r$ width, $w = 5.7 r$
Trapezoidal	depth, $d = 2 r$ width, $w = \left(\frac{4 r}{\sin \theta}\right)$

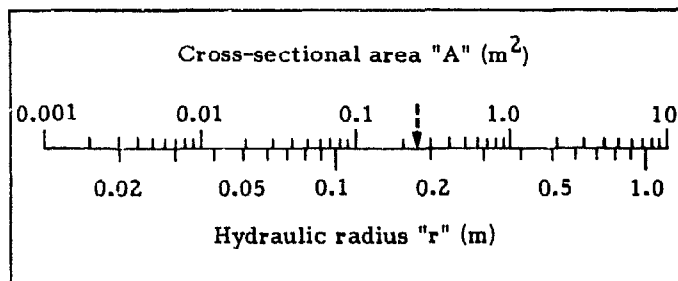

Fig. 5.72. Approximate values for hydraulic radii of the most efficient cross-sections obtained using this conversion scale are within $\pm 10\%$. This scale is based on the relationship $r = 0.36 \sqrt{A}$. The expressions in Table 5.3 should be used if more accurate values are required.

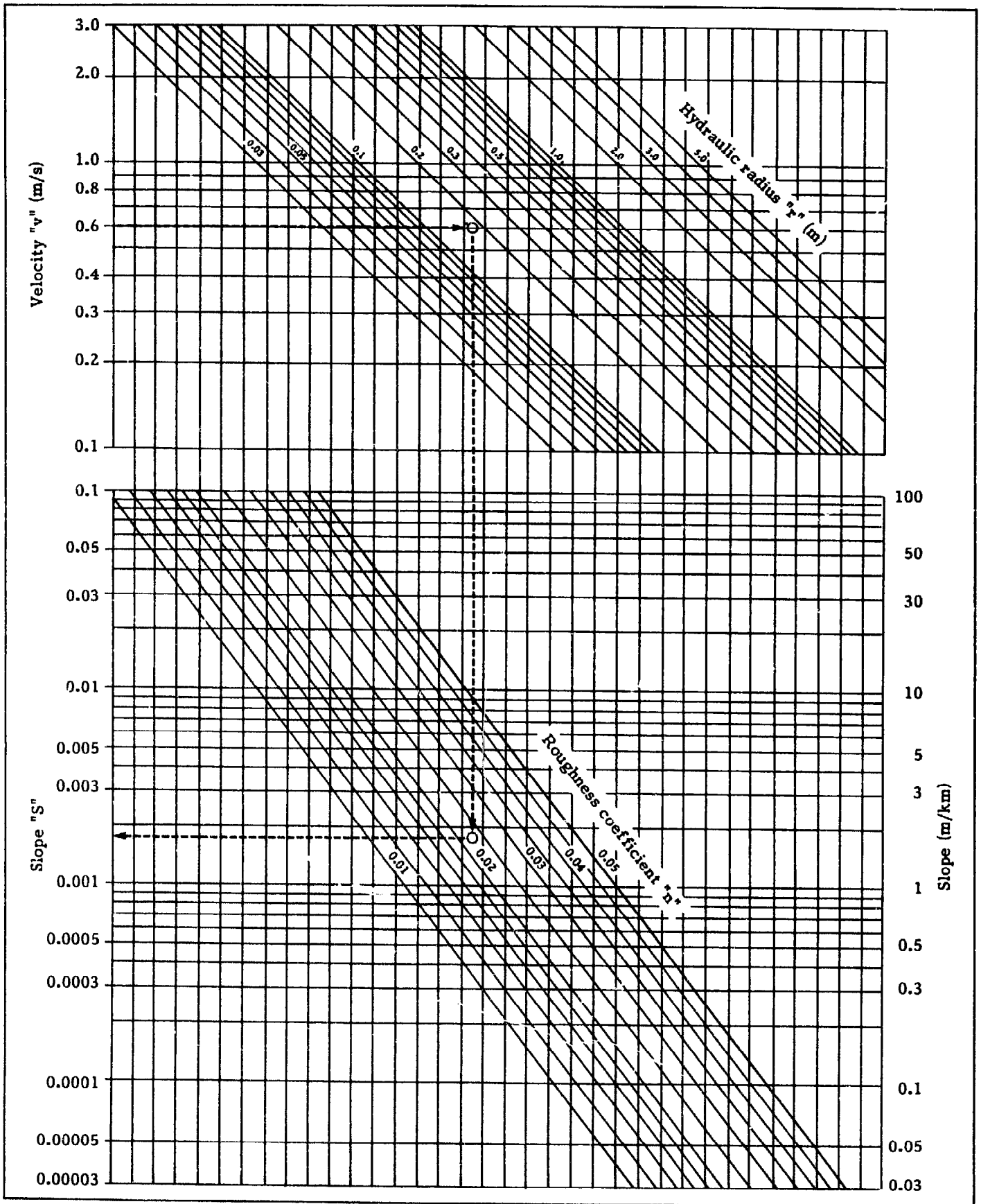

Fig. 5.73. Graphical solution to Manning's equation [Eq.(5.3)].

EXAMPLE 5.1

The flow of 150 l/s or, equivalently, 0.15 m³/s is to be conveyed in an unlined earth canal. The soil is clayey loam. What are the required canal slope and cross-sectional dimensions?

Before this problem can be solved, it is necessary to decide on the appropriate profile and to determine the values of "n" and "v".

Because an earth canal is desired, the most appropriate profile is trapezoidal. Excavation of the canal in clayey loam implies that a suitable slope for the sides is 1 in 1. The flow velocity must be at least 0.3 m/s so that silt does not settle, but it should not exceed about 0.8 m/s to prevent erosion. Let us select $v = 0.6$ m/s. For an earth canal with clean banks, Fig. 5.66 suggests that a roughness coefficient should be $n = 0.023$.

To obtain the slope and canal dimensions, it is necessary to follow the four steps described previously, using either the equations or graphs.

If the equations are used, the sequence of steps shown below are followed:

- ① Using Eq. (5.2), the area is found to be

$$A = \frac{Q}{v} = \frac{0.15}{0.6} = 0.25 \text{ m}^2$$

- ② If the slope of the canal sides of 1 in 1 is selected for the soil conditions found, then this implies a slope of $\theta = 45^\circ$. From the appropriate expression in Table 5.3, the hydraulic radius

$$r = 0.50 \sqrt{\frac{\sin 45^\circ}{2 - \cos 45^\circ}} \sqrt{0.25} = 0.18 \text{ m}$$

- ③ The required canal slope can be determined using Eq. (5.3) to be

$$S = \left[\frac{(0.022)(0.6)}{(0.18)^{2/3}} \right]^2 = 0.0017$$

or a 17 cm drop for every 100 m of canal.

- ④ From Table 5.4, the basic canal dimensions can be found to be

$$d = 2 (0.18) = 0.36 \text{ m}$$

$$w = \frac{4 (0.18)}{\sin 45^\circ} = 1.0 \text{ m}$$

If the graphs rather than equations are used for this example, the dashed lines shown in the respective graphs illustrate how these are used to solve the first three portions of this problem.

EXAMPLE 5.2

For the site considered in EXAMPLE 5.1, assume that the area between the intake on the stream and the forebay is fairly level and that a canal cannot easily have a slope of greater than 0.0010. What are the required canal dimensions for a canal with this slope?

For the originally selected velocity of 0.6 m/s, the first three steps of the general procedure indicated that a slope of 0.0017 was required. Because only a smaller slope can be accommodated, lower values of velocity must be chosen until one whose slope matches that required is found. For example,

- With $v = 0.6$ m/s, the slope was found to be $S = 0.0017$.
- Because a smaller slope is available, the velocity associated with that slope must also be smaller. If $v = 0.4$ m/s is selected, the slope which would

give rise to this velocity would be found (by following the first three steps in the general procedure) to be $S = 0.00056$.

- Because the slope is now too small, $v = 0.5$ m/s is selected. The required slope would then be $S = 0.0010$.
- Because this is equal to the available slope, $v = 0.5$ m/s must be the velocity which is required to convey 150 l/s down the canal. The associated hydraulic radius is found to be $r = 0.20$. Using Table 5.4, the actual canal dimensions necessary to convey 150 l/s can be determined.

Equivalently, Eq. (5.4) can be used to approximate the hydraulic radius directly. Using this equation, $r = 0.19$. Table 5.4 can then be used to determine canal dimensions.

flow when a specific slope is available. The exact relationship depends on the canal profile used, but an approximate formula is

$$r = \frac{0.46 (Q n)^{0.38}}{S^{0.19}} \quad (5.4)$$

If the area's topography indicates a larger average slope between the intake on the stream and the forebay than that required, a similar procedure can be followed. In this case, the larger slope implies that a smaller and therefore less expensive canal would be necessary but that the velocity would be greater. This may make it necessary to line the canal, which would increase its cost. Another approach is to maintain the original slope and use canal drops where appropriate (see **Drop structures**, p. 110).

Excavation

Before work can proceed, it is necessary to lay out the alignment or route of the canal. After the canal centerline and right-of-way limits have been staked, all vegetation along the canal alignment or route should then be stripped from the surface and removed. Stripping should be deep enough to remove all roots and organic matter, because they prevent proper compaction of the soil and can introduce earthworm and rodent activity.

The canal should be excavated in original subsoil. To avoid future settling, it should not be built over filled-in areas. Settling can cause cracks in any lining; with an unlined canal, it can change the canal gradient and thereby cause overspilling of the banks. Inadequate of compaction of the soil may also increase the water's rate infiltration into the ground, which in turn may adversely affect the integrity of an unlined canal or a canal with cracked lining. It is often preferable to use a properly supported flume (p. 112) over a dip in the terrain rather than to build over a filled-in area.

Excavation should be neat and as close to the desired profile as possible (Fig. 5.74). Wooden templates can facilitate the task for larger canals. For grade and alignment between grade stakes, a string line should be used. Over-cutting during excavation should be avoided, because it requires extra time and effort to backfill and properly compact this fill, or if the canal is to be lined, extra material would be required for the lining.

The subsoil excavated from the canal can be used to build up the bank. The top of the bank should be wide enough to ensure stability, prevent excessive seepage, and facilitate maintenance. It should equal or exceed the design flow depth in the canal but not be less than about 30 cm.

If it is necessary to fill in a slight dip and the original subsoil is dry, the surface should be scarified (loosened) to a depth of about 5 cm and moistened to ensure that it bonds with the fill material. Fill should be added in approximately 7 cm layers over the area to be filled and then compacted manually or mechanically.



Fig. 5.74. Excavation should be carefully undertaken to the desired profile. At this site, concrete sills rather than grade stakes have been placed at 4 m intervals. A 4 m length of square steel channeling spanning these sills will be used as a reference for placing a stone-masonry lining at the base of the canal.

Soil material used for fill should be selected from outside the canal right-of-way. It should be moist and uniform, have as many fine particles as possible (silt or clay), and be free of stones, roots, sticks, and organic matter. Moisture in soil is necessary for proper compaction. It acts as a lubricant to allow soil particles to slide closer together when tamped. The proper amount of water can be judged by taking a handful of soil, balling it up in the hand with a good grip like a firm handshake, and releasing the pressure. The soil must remain in a ball. Optimum compaction is obtained with 12%-15% moisture by weight, depending on soil type. Compaction is adequate when a heel print with a person's full weight upon it will not indent the fill over 0.3 mm (17).

Canal lining

For centuries, numerous countries have used unlined earth canals for conveying water for irrigation. These are also frequently used with micro-hydropower schemes because:

- they are easily built and maintained by unskilled personnel,
- they require no special equipment or material, and
- their initial cost is low.

Occasionally, it may be necessary to line a canal with

an impervious material such as clay, concrete, or stone masonry (Fig. 5.75). This might be done to reduce seepage losses, prevent the growth of weeds, or reduce damage caused by rodents, livestock, and erosion. A canal should not be lined without reason, because the lining increases the cost of construction considerably. Lining a canal with simple stone paving limits erosion but does not help reduce seepage losses (Fig. 5.76).

Seepage can have two adverse affects:

- On hillsides, it can saturate the soil below the canal and eventually cause a landslide which can carry away part of the canal.
- It can also cause loss of water. Although this generally has little impact on the water available for power generation, it can be a serious problem in irrigation canals, where water is usually a more valuable commodity. For ordinary soils with negligible sand, losses because of seepage amount to approximately $2 \cdot 10^{-6} \text{ m}^3/\text{s}/\text{m}^2$ of wetted area (or, equivalently, $2 \cdot 10^{-6} \text{ m/s}$). It can vary from $1 \cdot 10^{-6} \text{ m/s}$ for impervious clay loam to $20 \cdot 10^{-6} \text{ m/s}$ for gravelly soils (5,38,40,46). EXAMPLE 5.3 illustrates how seepage in a canal can be estimated.

The actual loss of water from seepage is determined by a number of factors in addition to the nature and porosity of the soil. These include the turbidity of the water, the age and shape of the canal section, the compaction of the soil, and groundwater level. Seepage loss in a canal usually decreases with age, particularly if the water carries silt. The addition of clay or other fine material to the water initially can significantly improve porous formations.

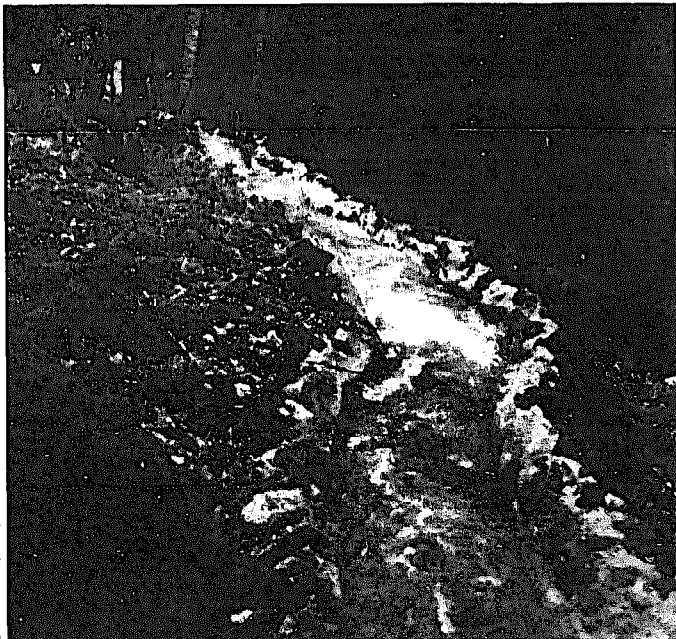

Lovessville, VA, U.S.A. (6 kW)

Fig. 5.75. The stones and cement lining this power canal were necessary to limit erosion. Although more care in the alignment of the canal would have reduced the slope of the canal and losses, the terrain made it difficult to cost-effectively use the greater head that is available.

EXAMPLE 5.3

In ordinary silt soil with little sand, a canal 500 m long is to be excavated to convey $0.10 \text{ m}^3/\text{s}$ to the forebay. The wetted perimeter of the canal is 1.3 m. What percentage of the canal flow is lost through seepage?

$$Q_t = (500 \text{ m})(1.3 \text{ m})(2 \cdot 10^{-6} \text{ m/s}) \\ = .001 \text{ m}^3/\text{s}$$

so that

$$\frac{Q_t}{Q} = \frac{.001}{0.10} = .01 = 1\%$$

Lining a canal also reduces surface roughness and permits larger velocities in the canal, because erosion is no longer a limiting factor. This, in turn, allows the cross-sectional area of a canal to be reduced. For a canal excavated in soil, lining also permits use of a rectangular profile where only a trapezoidal profile would otherwise be possible. All these factors can considerably reduce the required volume of excavation (Fig. 5.77).

Brick or stone masonry are commonly used to line power canals. Bituminous mixtures, soil-cement (Fig. 5.78), chemical sealants, clays, wood (Fig. 5.79), and impermeable membranes are also used, but not frequently.

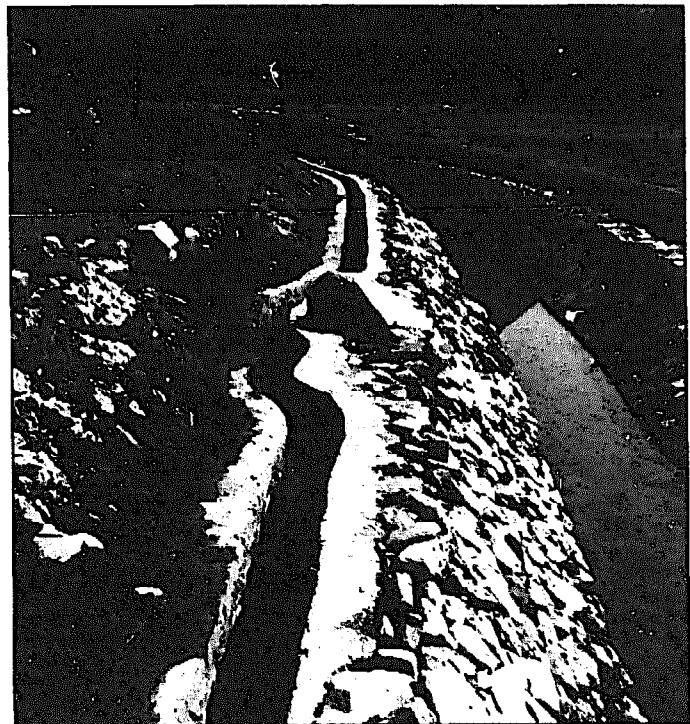

Syangla, Nepal (80 kW)

Fig. 5.76. The portion of this canal where soil is not very porous is lined with stones. The small uphill canal serves as a settling area for uphill runoff and is paved to facilitate cleaning. No drainage around the canal has been incorporated.

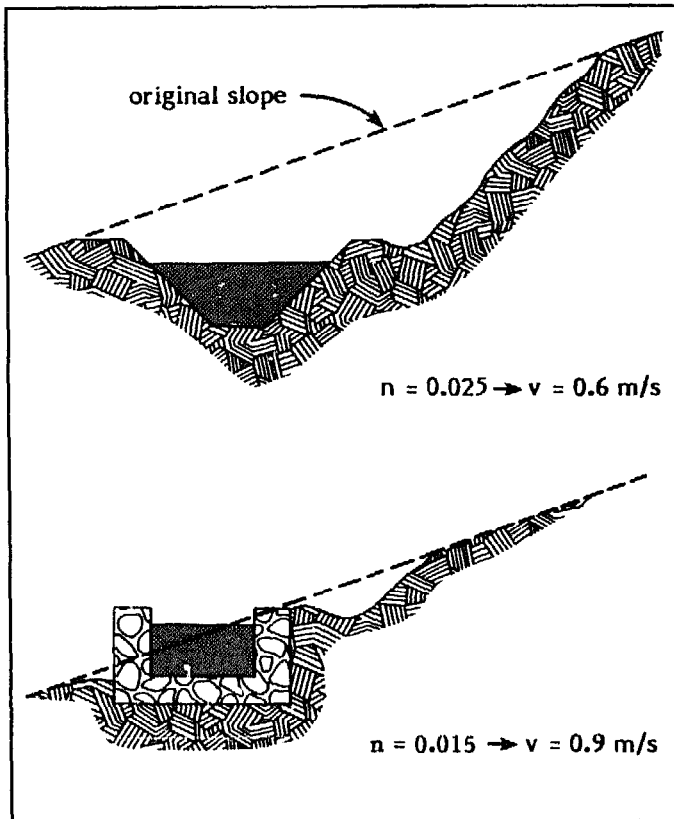

Fig. 5.77. Two canals conveying the same flow along identical alignments ($S = 0.002$, $Q = 0.2 \text{ m}^3/\text{s}$). Although material costs are greater, a properly constructed rectangular, lined canal reduces canal dimensions and the volume of excavation.

Table 5.2 (p. 99) shows permissible side slopes for unlined canals. The same side slopes should also be used if the lining is thin (not designed as a retaining wall). The canal embankment is prepared for lining like that of an unlined earth canal (see **Excavation**, p. 104). If the lining is built as a retaining wall, such as when a rectangular canal is constructed of stone masonry (Fig. 5.80), the side slope is unimportant.

Brick or stone-masonry. This is the most frequent type of lining encountered in micro-hydropower installations. The principal reasons for this in many developing countries are probably the difficulty of obtaining sufficient cement for a concrete lining and the high cost of this cement, which often has to be imported. Use of stone masonry permits savings by reducing the quantity of cement required (see **APPENDIX E**, p. 272). Whether brick or stone is used depends on their relative availability and cost.

With a brick- or stone-masonry lining, a rectangular canal section is often used. In this case, the sides of the canals are constructed as retaining walls to counteract the lateral forces of either the earth backfill or the water within the canal. Commonly, the walls are built first, sometimes on concrete footings, and then the base of the canal is laid between the completed walls (see Figs. 4.22 and 5.80).



Fig. 5.78. A canal lined with a thin soil-cement mortar.

A canal to be lined with brick or stone masonry is laid out like an earth canal. In the design of such a canal, the excavation must allow for the thickness of the lining. If a canal has to be lined, it is even more critical that the canal bottom (and sides also, if a trapezoidal profile is used) is properly compacted to avoid any



Fig. 5.79. Along a swiftly flowing section of a canal, a lining of planks is used to prevent erosion.

Yanahuara, Dept. of Cuzco, Peru (5 kW)

Katana, Kivu Prov., Zaïre



Fig. 5.80. The uphill stone-masonry wall of the canal is largely completed. A portion of a concrete footing for the downhill wall can also be seen. The base of the canal will be placed when the walls have been completed.

future settling and cracking of the lining. If the original soil has not been disturbed, that soil is already sufficiently compact.

Grade stakes should be set level with what will be the top of the finished floor of the canal (Fig. 5.81). Then a string line between grade stakes can be used to establish the grade of the finished canal floor. Fig. 5.74 illustrates another approach.

Before the bricks or stones are laid on the compacted earth foundation, it should be wetted slightly and time given for the water to penetrate the soil to prevent the mortar from drying too fast. However, the foundation should not be wet enough to cause tracking and disturbance by the workmen. **APPENDIX E** (p. 272) contains a description of the procedure for constructing brick or stone masonry.

To reduce resistance to flow and possible seepage through poor-quality brick or a poor joint, the masonry surface can be hand-plastered. This requires an extra level of work and is rarely done for micro-hydropower canals.

Concrete. Because a concrete lining requires more cement than a brick- or stone-masonry lining, it is generally more costly and found less frequently in micro-hydropower schemes.

The excavation of a canal with a thin, unreinforced concrete lining is similar to that of an earth canal. It should be done carefully to ensure that the lining conforms closely to the desired profile when it is completed; otherwise, the lining will require more material

than expected. For example, an extra centimeter of excavation below the design grade for a 5 cm lining would require that 20% more material (cement, sand, and gravel). The foundation should be adequately compacted and moistened before the concrete is placed, as explained previously.

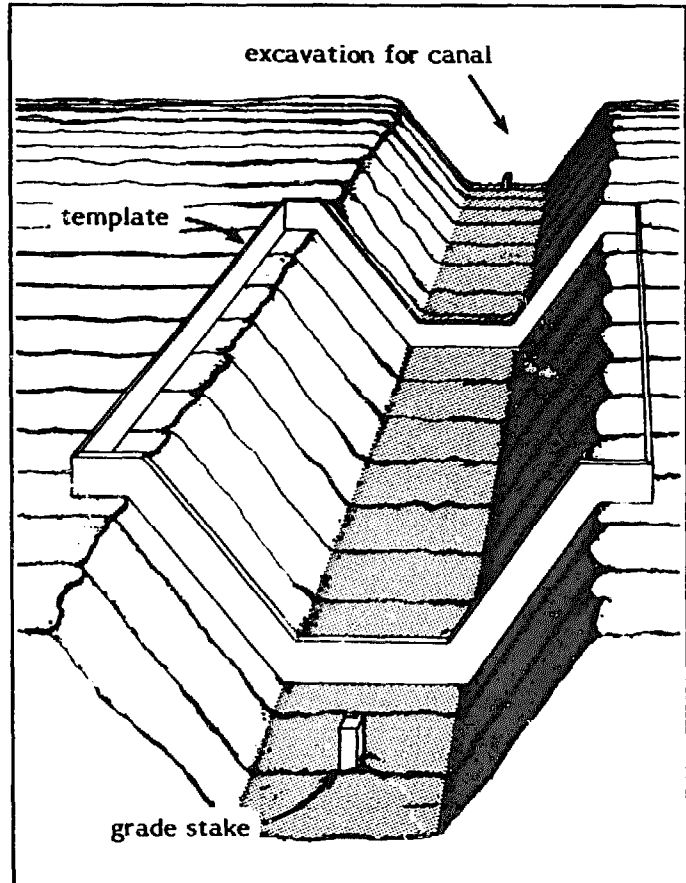

Fig. 5.81. A template which can be used for laying sections of concrete lining.

Concrete sections of a lining can be hand-formed. If the side slopes exceed 1 in 1, forms may be necessary to hold the concrete in place until it sets. In placing concrete by hand, some form of template is usually used. It might be fabricated of steel in the form shown in Fig. 5.81.

In preparing concrete for lining a canal, it is important to use the minimum amount of water needed for workability. Excess water will cause the concrete to slump and not stay on the canal slopes. A mixture of a 1:3:4-5 volume proportion (cement, sand, gravel) is adequate for lining a canal (17). Further guidance is found in **APPENDIX D** (p. 270).

When a template is used, concrete is placed at the bottom of the slope between the template sides. A straight piece of lumber serves as a screed which is worked back and forth, starting at the bottom of the slope and slowly moving up. After both sides are finished, concrete is placed at the bottom of the canal and leveled with the screed. All that is needed to finish the concrete surface

is a light troweling with a wood trowel. The concrete is then cured as explained in **APPENDIX D** (p. 270).

Soil-cement. Although there is little documentation on the use of soil-cement in the lining of power canals, the following excerpt describes one use of this material in Colombia (49):

A long thin-walled polyethylene bag is filled with water to form a flexible sausage which serves as a form. This is placed over a bed made of a very lean cement and soil with stone mixture (in the proportion 1:6) and then covered with the same. Once the mixture has cured and the water withdrawn from the plastic bag, a large diameter pipe, cast in place, remains. Every 15-20 m, an inspection shaft is built to avoid pressure build-ups in case the level is incorrect. This type of power conduit is necessary because of cattle, leaves, and plants, all of which could ruin the operation of an open canal.

Drainage

Some form of cross-drainage must be considered if the canal follows a slope where, during heavy rains, runoff from the uphill side of the canal can enter the canal and interfere with its proper operation.

If the runoff is concentrated in gullies and ravines, it may be possible to pass above or below the ravine by means of a flume (p. 112) or inverted siphon (p. 115), respectively. A less complicated approach might be to let the canal flow through a culvert (p. 116) and ensure that all the runoff in the ravine is constrained and diverted over this culvert (Fig. 5.82).

Where the runoff is more uniformly distributed along the canal and might introduce debris and sediment into it, a small drainage ditch may be placed on the canal's

uphill side (Fig. 5.83). This would gather the runoff, and, at appropriate intervals, this flow would then be diverted below the canal (see Figs. 4.22 and 5.84). Drainage ditches must be sized adequately to handle the expected runoff and may have to be cleared of sediment



Fig. 5.83. A drainage ditch to the right of the power canal collects runoff and diverts it under the canal at several points along its length. The power canal here has not yet been put into operation.

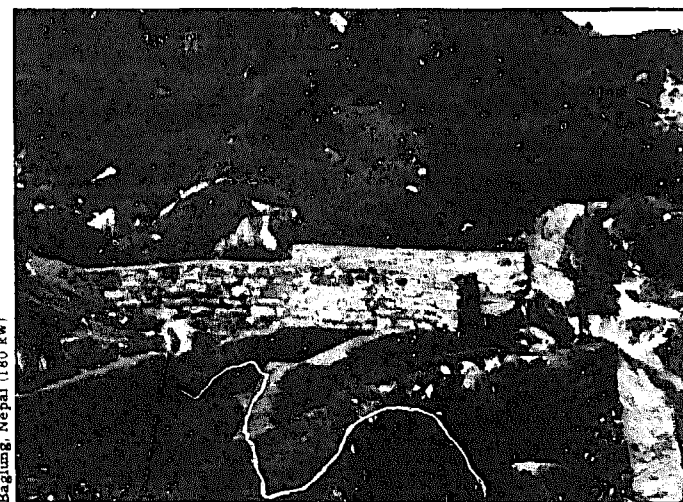

Fig. 5.82. Any runoff which gathers within the ravine is conveyed over the power canal by a stone-masonry structure. The power canal here is temporarily not in operation.



Fig. 5.84. A drainage ditch will eventually pass under the bottom of the power canal. At this site, the portions of the canal incorporating the drainage ditches are completed last.

Baglung, Nepal (180 kW)

Buhiga, Burundi (220 kW)

and debris periodically. If the runoff is small and does not carry debris, directing it into the canal will obviate the need for cross-drainage; however, spillways (see below) must then be incorporated at strategic locations along the canal to prevent excess flows diverted into it from overflowing unexpectedly.

Freeboard and spillways

The final cross-sectional dimensions of a canal are not those derived in **Determining canal dimensions and slope** (p. 96); those are the dimensions of the wetted area only.

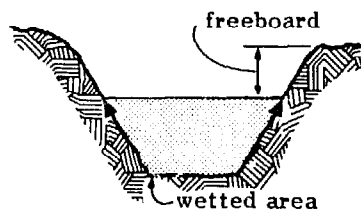

The actual dimensions have to include sufficient freeboard—the height of the bank above the water level in the canal—to prevent excess water which might enter the canal from overspilling its banks. Unless the canal is built on or over rock, overspilling may cause erosion and breach the canal (Fig. 5.85). Minimum freeboard requirements for unlined earth canals are about one-third of design flow depth or 0.15 m, whichever is greater. For lined canals, these requirements are about 0.10 m (16). More freeboard may be provided if required for bank settlement, siltation, or expected poor maintenance.

The water level in the canal may rise for several reasons:

- There may be a problem at the intake, caused by the control gates or flood flows, and excess water may enter the canal.
- Rainwater may run off the slopes uphill of the canal and, if drainage is insufficient, may enter the canal.



Nyakabongola, Kivu Prov., Zaïre

Fig. 5.85. A canal with inadequate freeboard can overflow and start eroding the downhill slope. This problem is frequently aggravated by people who use the banks of canals as footpaths.

- The water may rise because the canal flow is obstructed, possibly by a landslide or by closure of a gate located at the forebay, penstock, or turbine.

One obvious way to prevent overflow of the canal is to include a large freeboard. However, this increases cost and labor for excavation. The usual method is to include spillways at appropriate intervals. Spillways are designed to permit controlled overflow at specific points along the canal; this excess water is carefully led away in an existing streambed, ravine, or otherwise, so that it does not undermine the canal or other structures downhill of the canal.

The slope of the canal and the amount of freeboard determine whether spillways are required and, if so, the distance between them. Fig. 5.86 shows a canal section

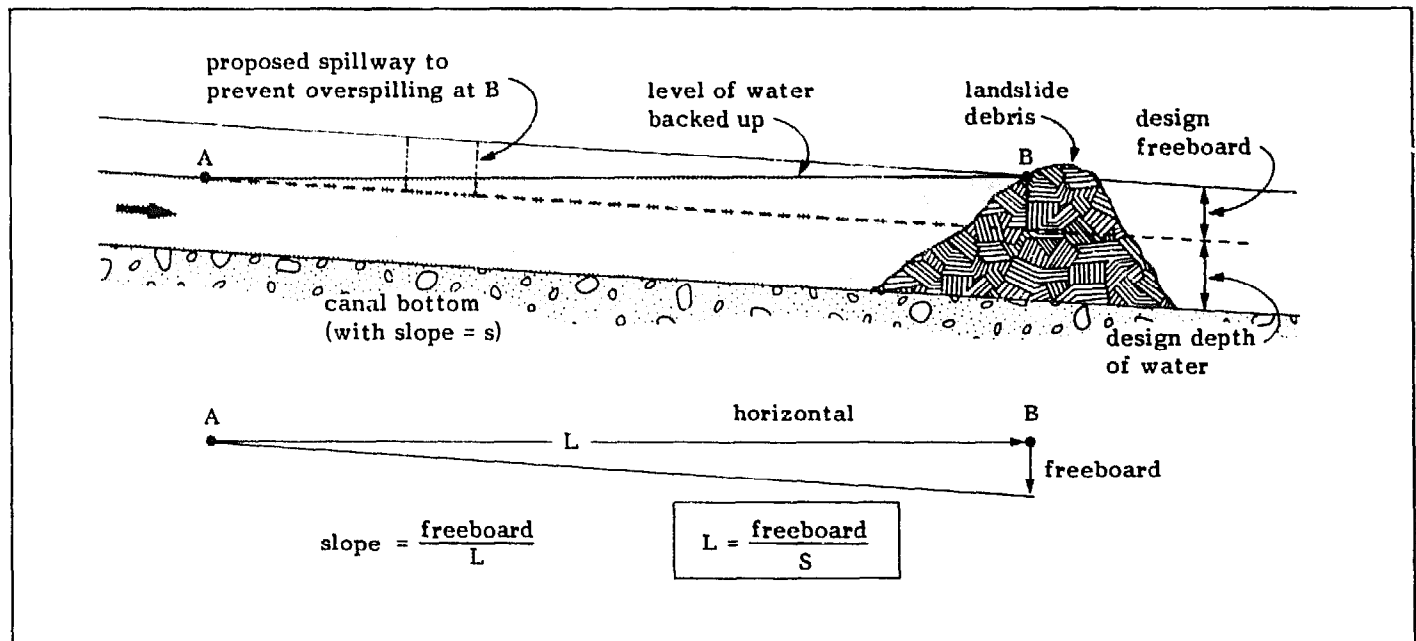

Fig. 5.86. Water, backed up behind an obstruction in a canal, is shown about to start uncontrolled overspilling of the bank.

where the bottom and the banks both have the same slope, as is usually the case. Assuming an obstruction along a canal as shown, the water will start backing up and rising, until it reaches point B. Water will then start overspilling the banks of the canal unless a spillway has been located somewhere between points A and B. Over each distance "L" which can be found from the formula shown, there must therefore be at least one spillway to avert uncontrolled overspilling. If the canal is short or has a very small slope, "L" will be greater than the canal length and spillways may not be necessary.

The value of "L" derived above is only approximate and serves as a maximum limit. All the excess water in a canal will pass over the spillway only if the water level in the canal is high enough above the level of the spillway (Fig. 5.87). By lengthening the spillway sufficiently, it is possible to reduce this extra head needed to permit all the excess water to leave. If the spillway is not wide enough, it may not prevent the canal banks from overflowing. (See *Spillways*, p. 159, for descriptions and sizing of various types of spillways.)

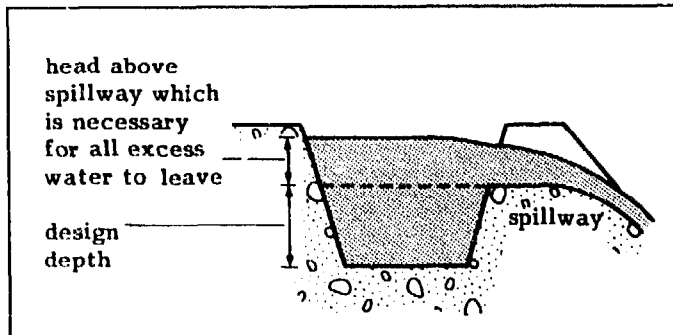

Fig. 5.87. Water level may have to rise significantly above the spillway crest to permit all excess flow to leave.

Unless a canal is very level or short, the magnitude of the waterflow entering the canal will not be affected by obstructions to the flow downstream. In this case, the dimensions of a spillway must be adequate to permit the entire flow which might enter the canal to overspill.

If a canal is short or its slope is very small, its banks can be constructed horizontally from intake to forebay (Fig. 5.88). The banks will not overspill unless a major flood submerges the intake. As that figure shows, this approach cannot be adopted for long canals or for those with large slopes, because the canal would become too deep at its lower reaches. In this case, the banks should be built parallel to the canal bottom, and spillways should be incorporated at appropriate intervals.

Drop structures

For some canals, the drop in elevation between the proposed intake on a stream and the proposed forebay location is more than that necessary to provide the required flow. One solution is to use a steeper canal with smaller cross-sectional area; however, this would increase velocities, and the canal may then have to be lined. Another alternative is to use segments of canal with the original slope and to connect these by one or more drops (Fig. 5.89). Appropriate design velocities are thereby maintained along the entire length of the canal except at the drops. At these points, properly designed drop structures should be included to ensure that the energy gained by the falling water dissipates without undermining the canal. If the drop is not over natural rock, it is usually necessary to construct a drop structure of concrete, brick, stone masonry, or timber. Timber is usually not chosen because of its relatively short life. Low-cost drop structures can also be built of discarded oil drums or the equivalent.

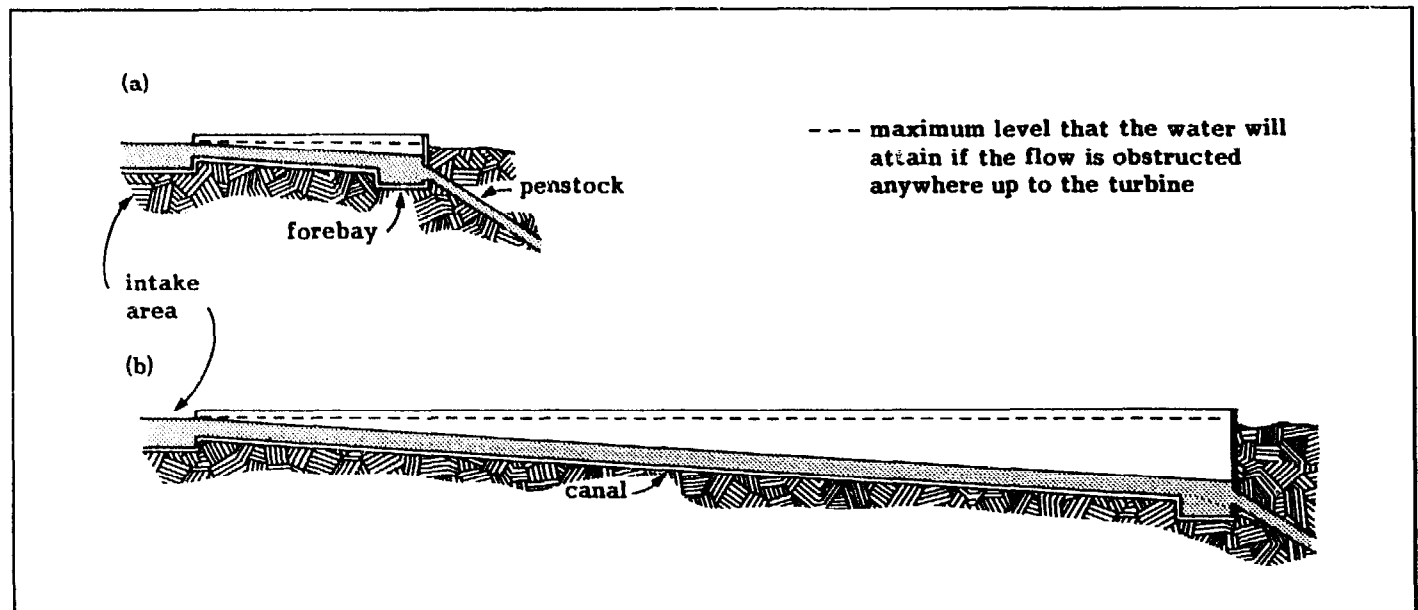

Fig 5.88. Comparison of canal depth for a short (a) and long (b) canal where the banks are constructed horizontally

to prevent overspilling if flow is obstructed.

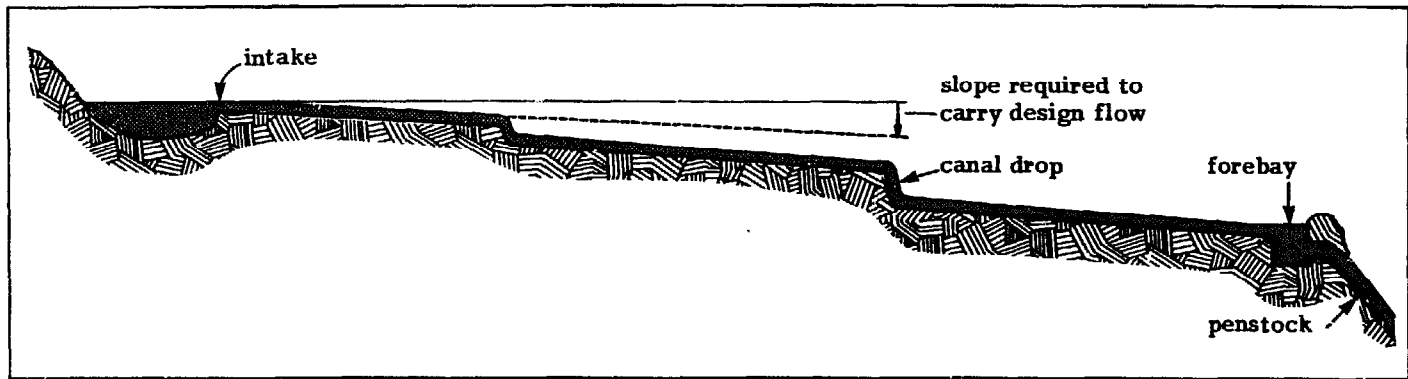

Fig. 5.89. Canal drops permit small slopes and velocities to be maintained even where a large average slope is required.

Strictly speaking, a drop is used only when the difference in elevation from one section of the canal to the next is small and can be effected over a relatively short distance, often by a vertical fall. Fig. 5.90 illustrates the basic configuration of one design for a drop. In this case, the drop is approximately 1 m. Drops usually include a section along which the drop in elevation takes place and a stilling basin in which the excess energy gained by the falling water is dissipated. They can also include an inlet structure with a weir or gate designed to control the level of water in the upstream stretch of the canal. The water leaving a drop is often turbulent, and this can cause erosion in the section of canal imme-

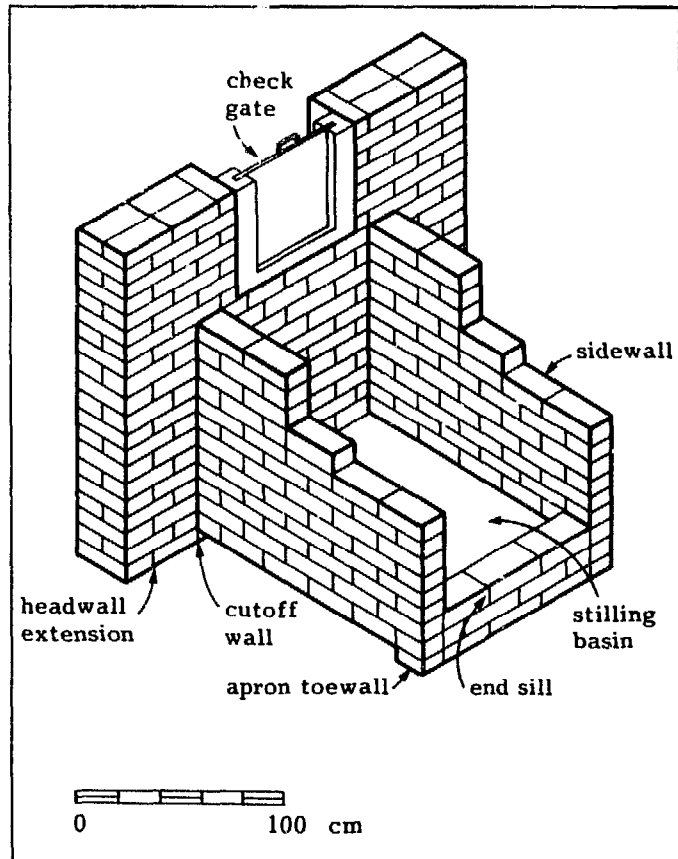

Fig. 5.90. Isometric view of a typical brick-masonry drop structure used along irrigation canals in India. (83)

diately downstream of the structure. If the canal is not lined, it is necessary to place riprap over a length of several meters. Also, sufficient freeboard must be provided around the stilling basin because of the splashing which occurs there.

Another design for a drop is a pipe drop structure (Fig. 5.91). A stilling basin, suitably lined, is still needed to dissipate the energy of the incoming water. To prevent seepage along the outside of the pipe, a concrete apron around the inlet or collars along its length are often used. A lid on the inlet to the pipe can function as a check valve. The required pipe diameter for a specific flow is found in the same manner as that for an inverted siphon (see Inverted siphons, p. 115).

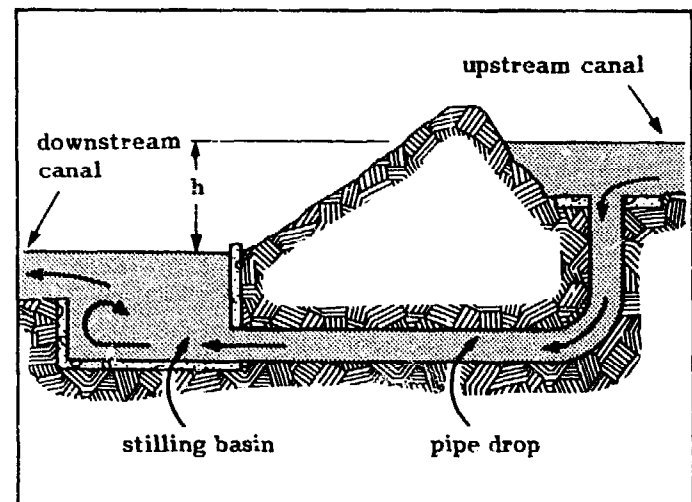

Fig. 5.91. A sectional view of a pipe drop.

With conventional projects in some areas, there has been a tendency to abandon vertical drops in favor of short, inclined, concrete drop structures. The one shown in Fig. 5.92 is designed for a flow of $0.15\text{--}2.0\text{ m}^3/\text{s}$ and a maximum fall of about 5 m. These often have a rectangular cross-section, but trapezoidal or semicircular cross-sections have also been used. Engineering Field Manual for Conservation Practices (9) includes a detailed design for an inclined concrete drop which can be made without formwork and can convey up to $1.0\text{ m}^3/\text{s}$ through a maximum drop of 1.5 m.

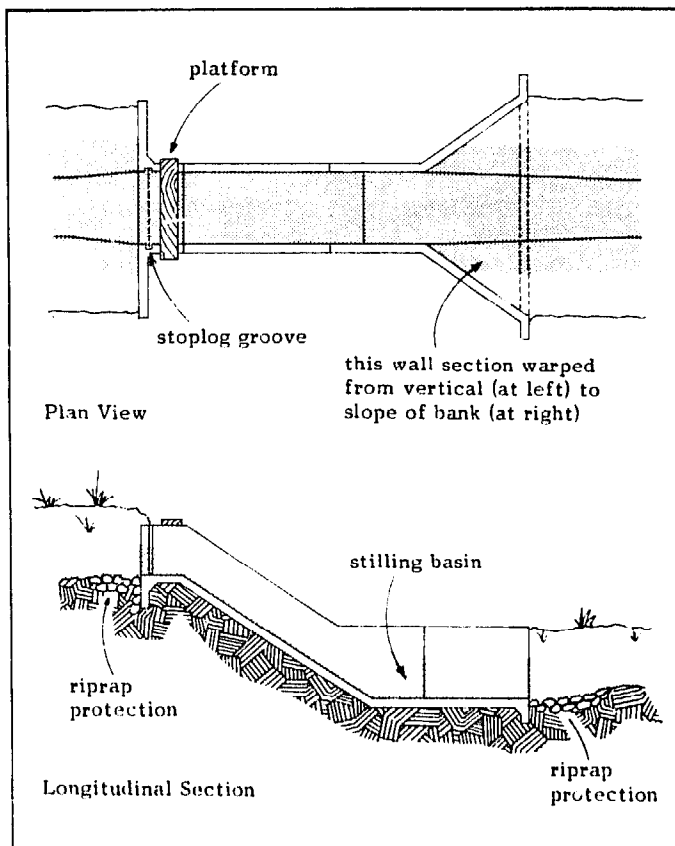

Fig. 5.92. A view of a rectangular inclined drop (40).

Where larger drops are required and a series of drop structures might be used, an inclined lined channel called a chute may be more economical (Fig. 5.93). It has essentially the same design as an inclined drop (Fig. 5.92) and generally contains the same features. Detailed descriptions of larger drop structures can be found in Design Standards No. 3, Canals and Related Structures (5).

Circumventing obstacles

Obstacles may be encountered along the alignment of a canal. It may be necessary for a canal to be supported above or to go around or below these obstacles. A flume, inverted siphon, or culvert can be used for this purpose.

Flumes. A flume is often used when it is necessary to traverse a stream, ravine, gulley, or other depression, to detour around an obstacle such as a large boulder or part of a cliff face (see Fig. 5.11), or when the ground is too rough or too steep to permit excavation for a canal. The flume is simply an extension of the canal, often continuing with the canal's slope but generally supported on concrete, steel, or wooden piles, piers, or trusses above the ground. A flume may be an open channel made of timber with a rectangular or sometimes a triangular cross-section or of wood staves, sheet metal, or reinforced concrete, frequently with a semicircular cross-section.

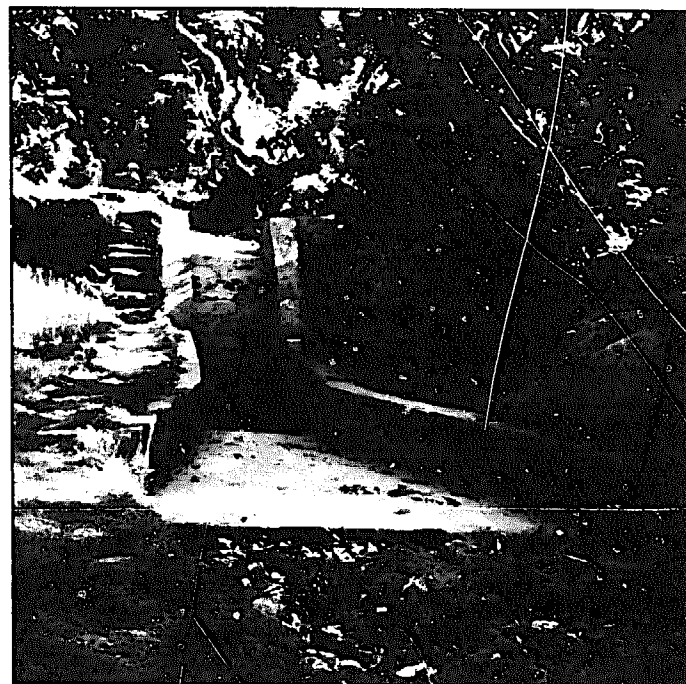

Fig. 5.93. A chute permits controlled dissipation of energy along a power canal.

A flume may also be a pipe of reinforced concrete, steel, or other material. Although a pipe seems the optimum choice to minimize labor requirements, pipes are expensive in rural areas of developing countries and often must be imported. Also, it can be very difficult to remove sediment and debris deposited within the pipe during operation of the scheme, especially if the pipe is more than several meters long. Removing settled silt or clay is not simply a matter of re-establishing the design velocity through the pipe by putting the plant back in operation, because the velocity at which the deposited clay or silt is eroded, picked up, and carried back in suspension is considerably greater than the velocity at which it was deposited.

In sizing a flume constructed of any material, the same principles apply as those for canals. Even if the slope of the flume and canal are equal, the difference in the roughness coefficients "n" of the two sections may imply that different cross-sectional dimensions can be used.

The joint between the canal excavated in the ground and the inlet and outlet of the flume should be built carefully to prevent leakage that might undermine the canal at that point. To minimize losses as well as turbulence, any transition between the canal and flume cross-sections should be gradual. Depending on the velocities encountered and the nature of the canal bed, riprap or other protection against scour may be needed for a short distance beyond the outlet.

Ample freeboard also must be provided, especially if overtopping of the flume can erode the ground below and undermine the supports. If the flume is long, it may be necessary to include spillways at appropriate points

to safely convey any unexpected excess water away from the flume. Freeboard for a flume is usually less than that for a canal. A common rule is a freeboard of about one-tenth the width of the flume, with a minimum of about 5-7 cm (40). Curved flumes require greater freeboard, especially along the outside edge.

In areas with a ready supply of sawn timber, wood is a cheap and convenient material with which to construct a flume. Small wooden flumes are made of plain boards nailed together with a triangular or rectangular cross-section, reinforced with timber collars at 1-2 m intervals, and supported on the ground or on timber posts (Fig. 5.94). The walls of large flumes are built of multi-

ple boards with a rectangular (Fig. 5.95) or semicircular cross-section, and collars become more important.

Semicircular wood-stave flumes are similar to wood-stave pipe and generally require staves that have been specially milled. Timbers for rectangular flumes are easier to prepare and, because wider planks can be used, there are fewer joints through which water might leak. To make the joints more watertight, various types of joints can be used (Fig. 5.96). Good-quality timber, free of warps and knots and at least 3 cm thick, is often recommended even for small flumes, because thinner

Cherokee, N.C., U.S.A.

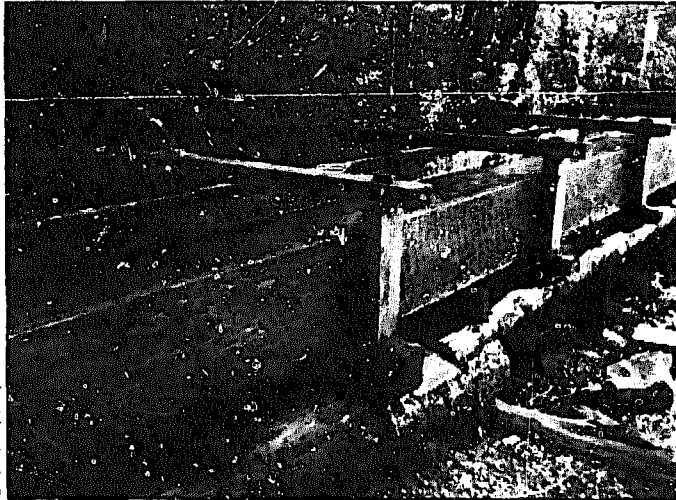

Fig. 5.94. A common design for wooden flumes used to convey water to mills.

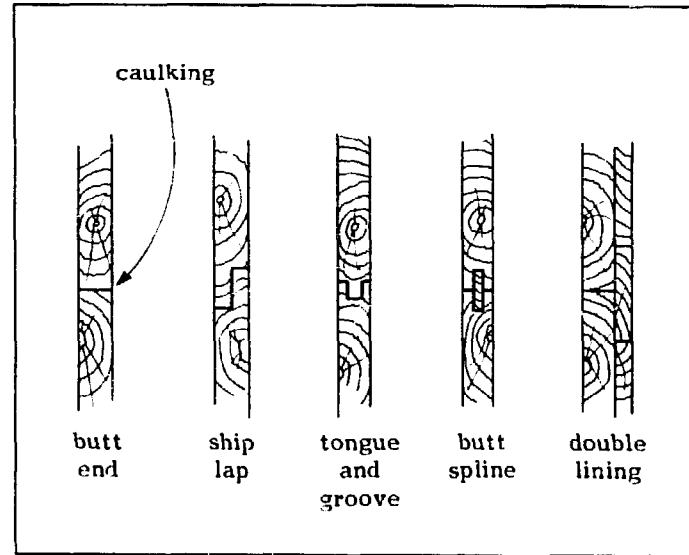

Fig. 5.96. Various joints that can be used between the wallboards or floorboards of a wooden flume.

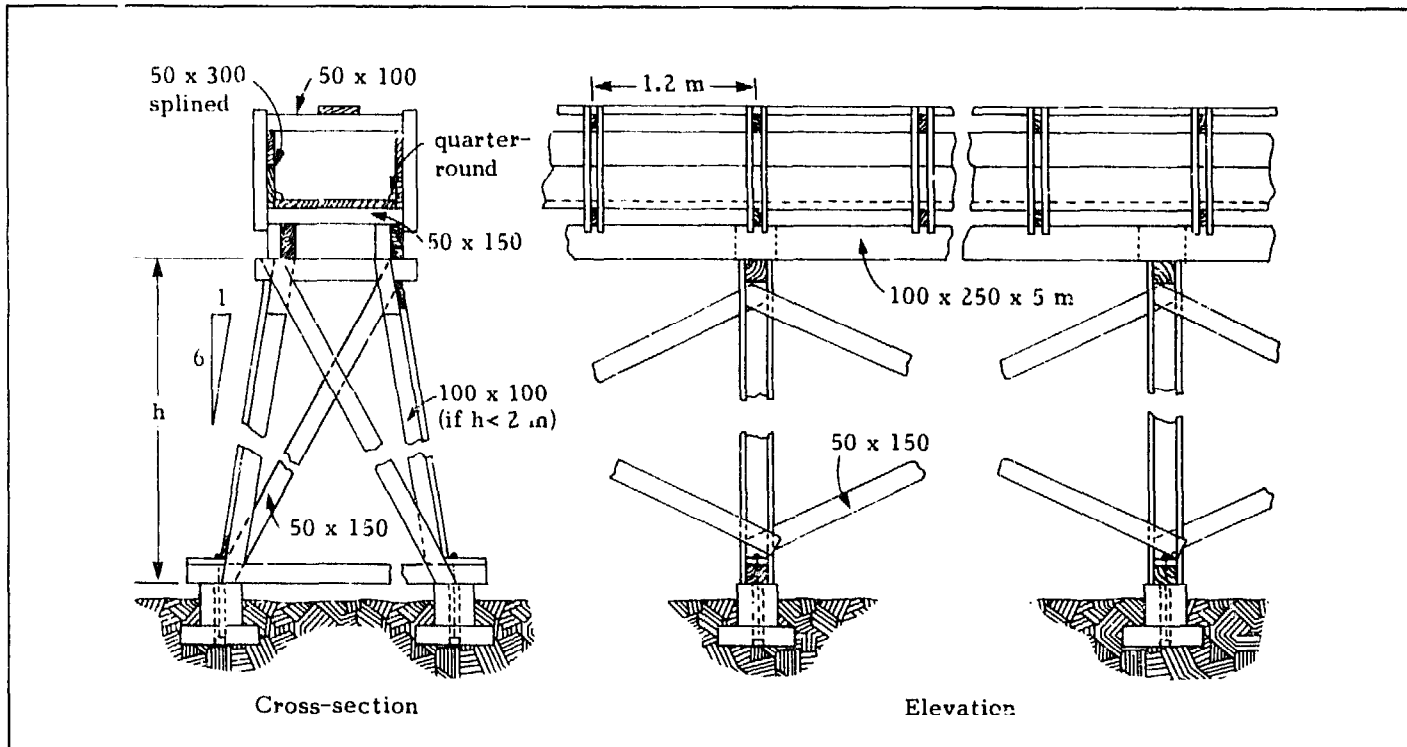

Fig. 5.95. A wooden flume on a supporting trestle. Nominal timber sizes are given in millimeters unless otherwise noted (40).

boards tend to warp or crack. Boards properly seasoned before use will swell and tighten when wet.

The life of a timber flume depends on the type of timber and the treatment it was given. An untreated timber flume may last 10-50 years, and creosoting may extend its life 50%-100% (40). Intermittent service shortens its life.

Collars for the rectangular flumes usually consist of a rectangular frame around the three sides of the flume tied across the top. If floating debris may pass along a flume, there must be sufficient freeboard to permit this debris to continue unhindered. Steel bands with wooden crossties are used as collars for semicircular timber flumes.

Support trestles can be pairs of posts for smaller flumes; multi-column trestles can be used for larger flumes. The posts should be inclined slightly and anchored to supports—concrete or masonry piers—to increase stability. The structure should be secure enough to resist overturning by strong winds and earthquake loads when either full or empty. All frame joints should be connected by bolts, except for very light construction; side and floor boards can be nailed in place.

If the flume is placed on a bench cut into a hillside, the sills can rest on the ground or on blocking. Broken stones or gravel under the sill facilitates draining and prolongs its life. If the flume is on trestles, the sills are supported by longitudinal stringers; with small flumes, the flume itself acts as a girder between supports.

A flume can also be built of sheet metal. Generally, such flumes consist of thin steel sheets curved to semicircular form and suspended from wooden or steel stringers or crossties (Fig. 5.97). The design of trestles is similar to that for wooden flumes described above.

Overlapping edges of the sheets forming the flume barrel are generally pressed together between an outside rod or hanger and an inside compression member. The rod is supported by a crosstie and the inside compression member reacts against the underside of the crosstie as shown in Fig. 5.98. Various types of joints have been used. The Newcomb and American types are simple to manufacture and install, particularly on curves. These

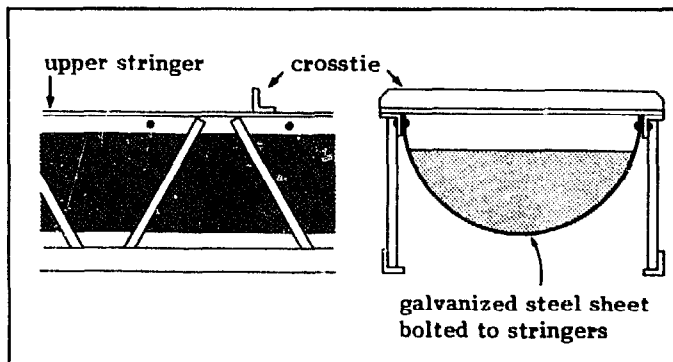

Fig. 5.97. Elevation and sectional views of the flume shown in Fig. 5.11.

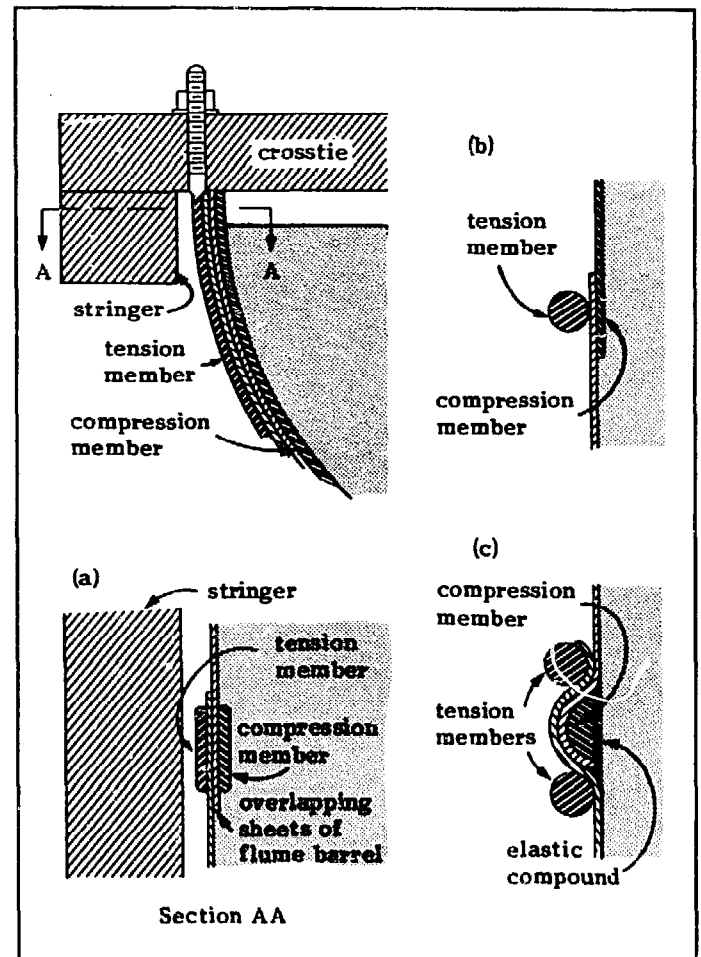

Fig. 5.98. Some examples of metal flume joints including (a) the Newcomb type, (b) the American type, and (c) the Lennon type (40).

joints can accommodate moderate curvature without specially mitered sheets. Tightening the outside (tension) member of an American-type joint forces the outside sheet against the inner sheet which serves as the compression member. More sophisticated designs such as the Lennon type have also been used. These provide greater structural security and watertightness while minimizing resistance to flow, but they require specially formed beads or grooves at the ends of the metal sheets, and mitered joints have to be custom-made for a specific curvature (40).

The metal sheets and all metal parts that come in contact with them should be galvanized. When the galvanizing wears away, the interior surface should be treated periodically with coal-tar paint or enamel. Considerable other details concerning sheet metal flumes can be found in "Design, Construction and Use of Metal Flumes" (57).

At the Christian Radio Missionary Fellowship station at Rugli in Papua New Guinea, sheet-metal flumes are used both to cross depressions in the terrain and to traverse steep areas. In this case, stringers are reinforced by welding steel rods as shown in Fig. 5.97 and crossties are constructed of angle iron. Bolts along the edges of

the galvanized metal sheets secure them to the angle-iron stringers. Consecutive sheets of metal simply overlap, with no attempt to seal these areas, but leaking has not been a major problem. During several decades of operation, these sheets have had to be replaced about every 10 years. Rusting through the galvanized surface seemed to be most severe at areas of overlap. The number of overlapping joints can be reduced by using long rolls of galvanized steel sheet rather than small rectangular sheets.

As part of one shorter sheet-metal flume at Rugli which traverses a stream, a simple gate was fabricated by not bolting one edge of a short section of sheet metal to the stringers. When the canal has to be emptied or the flow has to be prevented from flowing beyond a specific point, this edge is lifted, permitting the water in the canal to drain into the stream beneath (Fig. 5.99).



Rugli, W.H.P., Papua New Guinea (2.5 kW)

Fig. 5.99. A simple but effective gate in a sheet-metal flume.

Reinforced concrete flumes can also be built but are rarely used for micro-hydropower schemes. They are the most permanent type, but also the heaviest and most expensive. It is also difficult to make concrete products of reliable quality in thin sections, and heavy sections pose handling problems if they are precast. If they are cast at the site, appropriate skills are required and formwork costs may be excessive. Although they can be supported above ground level, concrete flumes are generally built as bench flumes, resting directly on the ground.

Flumes made of other materials or designs are possible. One example proposed in "Micro-Hydro: Civil Engineering Aspects" (72) has a basic appearance that resembles a sheet-metal flume; however, rather than sheet metal, a steel mesh covered with a sheet of rubber or other suitable material is hung from the stringers (Fig. 5.100).

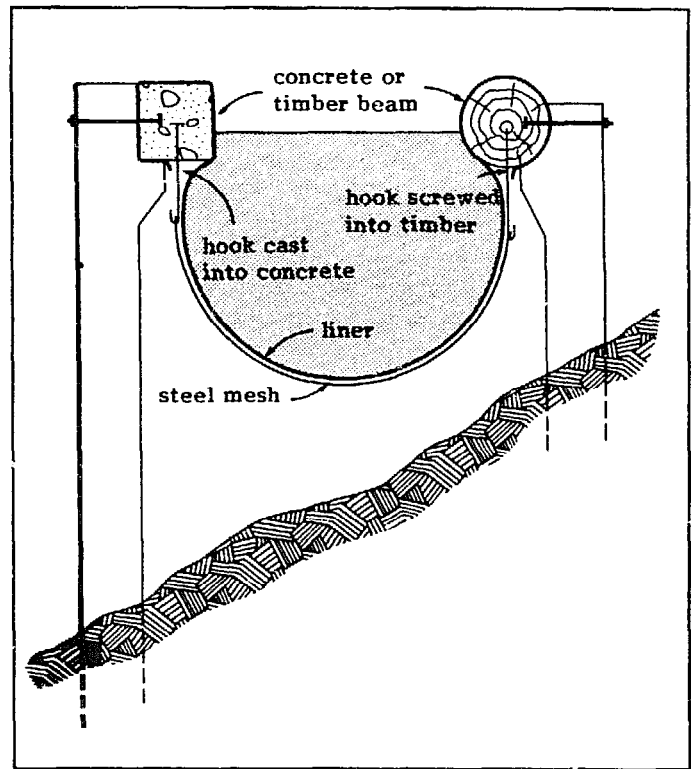

Fig. 5.100. A flume design proposed as appropriate for remote areas where the quantity of materials to be transported should be minimized (72).

Inverted siphons. At times, an obstacle such as a road or streambed may lie just below the elevation of the canal. A flume might not permit sufficient clearance underneath or it might be difficult to support adequately. At other times, the canal may have to traverse a long and deep depression, and a flume might be too expensive or objectionable for some other reason. In these cases, the canal discharge could be carried in an inverted siphon (Fig. 5.101).

An inverted siphon consists of an inlet and outlet structure connected by a pipe. If the canal is unlined, including inlet and outlet tanks may be advisable to facilitate removal of debris or sediment which accumulates in the siphon (Fig 5.101a). These should be adequately sized to permit access. If possible, a valve should be included at the low point along a longer siphon (Fig. 5.101b) so that the siphon can be drained.

The size of a pipe used in an inverted siphon is governed by the same principle that governs flow in a penstock pipe. (See **Selecting pipe diameter**, p. 125, for more information). Assuming that the velocity of water in the canal is the same at the inlet and outlet, Bernoulli's equation gives the following relationship between the head loss through the siphon " h_f "--the difference between elevation of the water at the inlet and at the outlet--and the velocity through it:

$$h_f = \frac{120 n^2}{D^{4/3}} L \frac{v^2}{2g} + (K_e + K_b + 1) \frac{v^2}{2g} \quad (5.5)$$

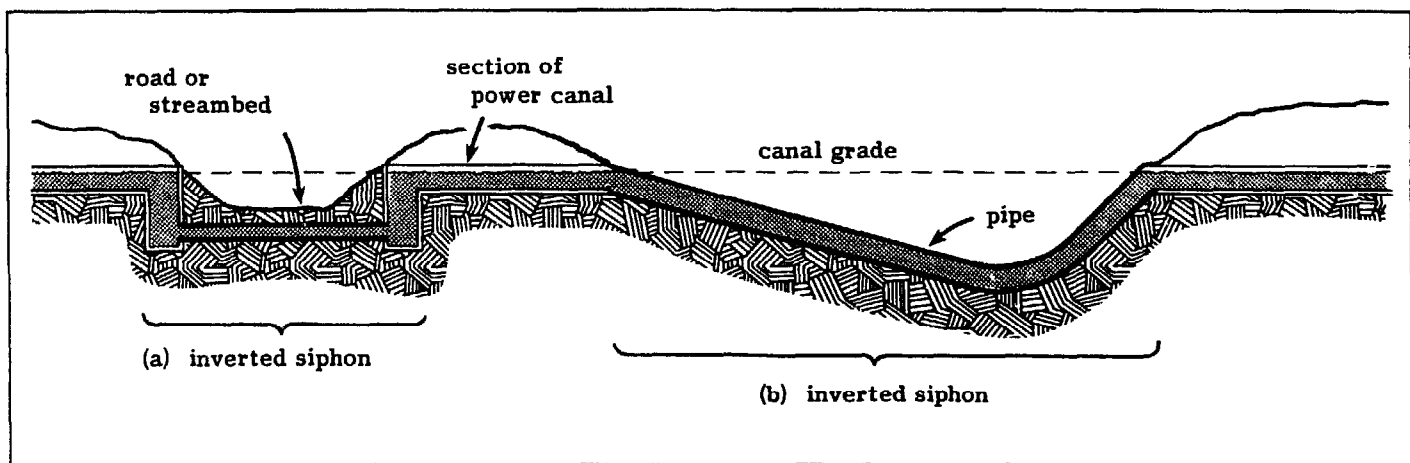

Fig. 5.101. Two examples illustrating how an inverted siphon may be used along a canal alignment to circumvent obstacles.

where

- h_f = head loss through inverted siphon (m)
- n = roughness coefficient (see Fig. 5.126)
- D = diameter of siphon (m)
- L = length of siphon (m)
- v = velocity in siphon (m/s)
- g = gravitational constant (9.8 m/s^2)
- K_e = coefficient of losses at entrance (see Fig. 5.128)
- K_b = coefficient of losses at bends (see Fig. 5.128)

The first term represents friction losses along the siphon [see Eq. (5.13)]; the other terms represent entrance and exit losses caused by turbulence and losses at any bends included along the siphon.

If a coefficient of friction losses is defined as

$$K_p = \frac{120 n^2}{D^{4/3}} \quad (5.6)$$

Eq. (5.5) can be solved for the velocity in the siphon:

$$v = \sqrt{\frac{2gh_f}{K_p L + K_e + K_b + 1}} \quad (5.7)$$

Using Eq. (5.7) and the relationship

$$Q = \frac{\pi D^2}{4} v \quad (5.8)$$

it is possible to derive the equation

$$Q = \frac{\pi D^2}{4} \sqrt{\frac{2gh_f}{K_p L + K_e + K_b + 1}}$$

or

$$Q = 3.5 D^2 \sqrt{\frac{h_f}{K_p L + K_e + K_b + 1}} \quad (5.9)$$

which must be solved for the required diameter of the siphon. However, because K_p depends on pipe diameter as is apparent in Eq. (5.6), it is not possible to solve

Eq. (5.9) to obtain a simple expression for the required diameter for a given flow and head loss. Rather, a trial diameter should be selected and the flow derived from Eq. (5.9) should be compared with the desired flow. Repeating this process several times will quickly lead to the required diameter.

If the water contains silt or other sediment, velocities in an inverted siphon should be maintained at levels high enough to prevent it from settling. Minimum velocity should range from 0.3 to 0.5 m/s. To determine the maximum siphon diameter required to maintain this velocity, the design flow and minimum velocity can be introduced into Eq. (5.8). This value of diameter can then be substituted into Eq. (5.9) to determine the head loss across the siphon required to obtain this velocity. A smaller diameter pipe would lead to increased velocity but also to an increased head loss.

Fig. 5.102 shows the typical design and dimensions of an inverted siphon used along irrigation canals in India. The inlet and outlet tanks act as settling basins because of the increased area of flow and lower velocities through them. Any silt carried by the water is likely to be deposited in these tanks; therefore, their interior dimensions are commonly 0.6 m square to permit access for cleaning out the accumulated sediment. The bottom of the tank is at least 0.15 m below the invert (bottom) of the pipe to prevent this sediment from interfering with the operation of the siphon. The pipeline should be buried deep enough to protect it from any traffic over it.

Culverts. When a canal has to avoid an obstacle such as a road or streambed which is just slightly higher in elevation, a common culvert can be used (see Fig. 5.12). This is simply a pipe which flows partially full. To prevent piping—the flow of water along the outside of the pipe—which may lead to collapse of the ground above, masonry headwalls should be constructed at the ends of the culvert or buried pipe; alternatively, collars could be included along the pipe.

On steep slopes, where providing for drainage around a canal can prove difficult because it would require too

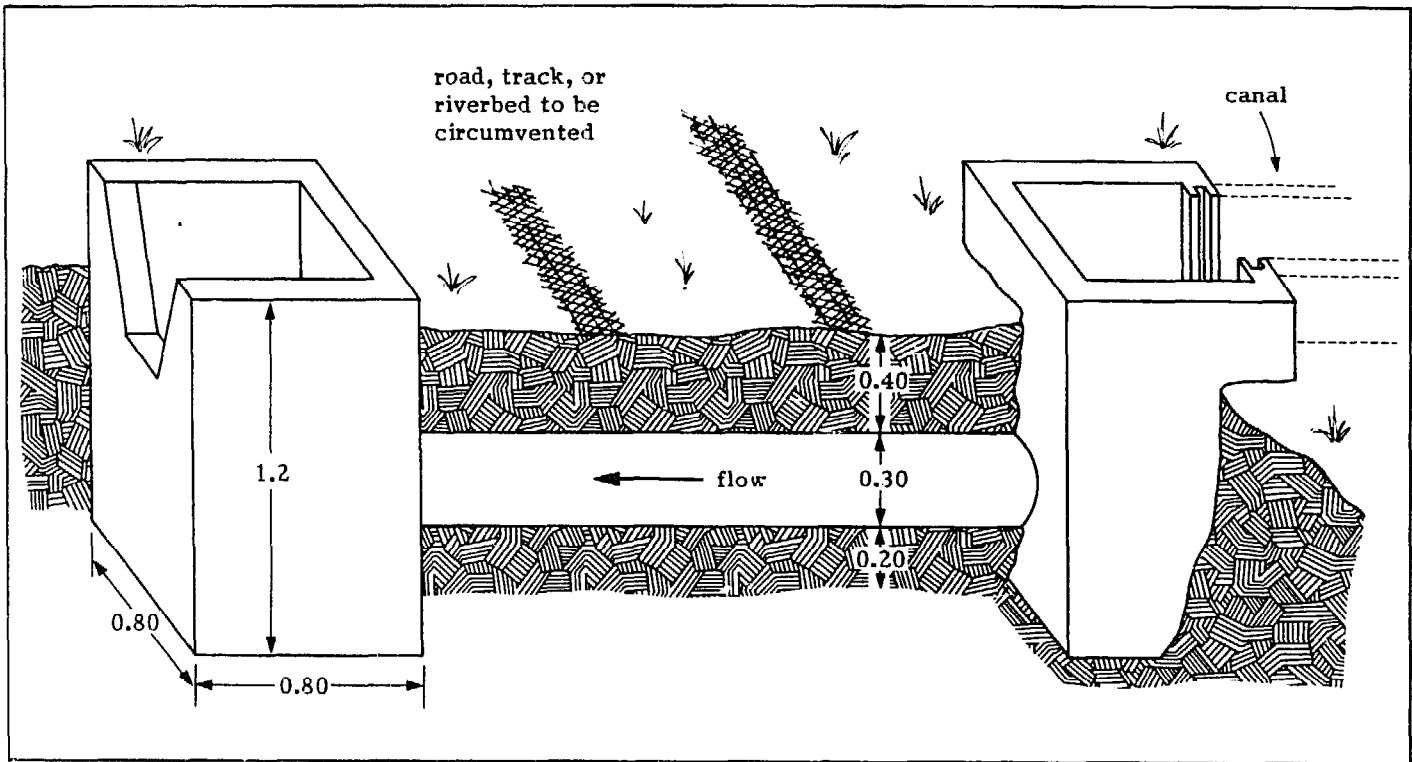

Fig. 5.102. Typical dimensions (m) of an inverted siphon used in India to carry irrigation water below obstacles (83).



Kalam, N.W.F.P., Pakistan (100 kW)

Fig 5.103. The steep, rocky soil slope at this site makes it difficult to provide drainage. In this case, flat concrete covers will eventually be placed along the length of the canal to prevent debris from entering.

much excavation (Fig. 5.103), one approach is to cover the canal and construct a culvert. Flat covers made of timber or reinforced concrete can be placed over the canal (Fig. 5.104). These covers can be removed to permit access to the canal for repair or cleaning. Any debris coming off the hillside would either settle on these covers or be carried over. Because some rain-water and sediment may still enter the canal, some settling at the forebay may be necessary.

At a site at Bundi, Papua New Guinea, where it seemed better to backfill over the canal, a rectangular canal with a width slightly larger than the diameter of a 200 l

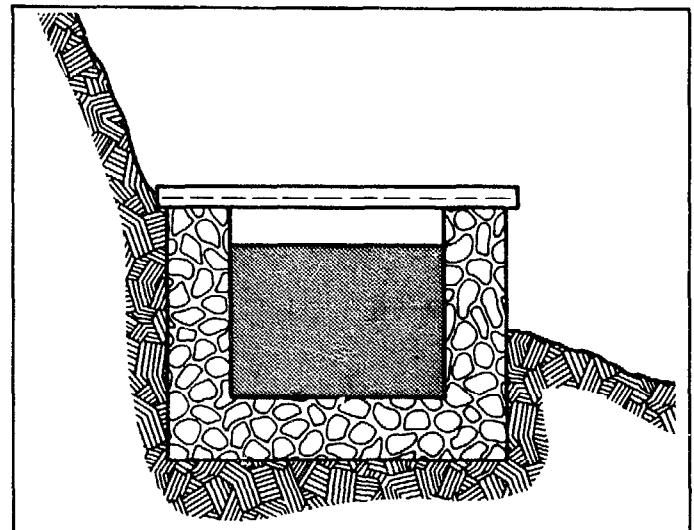

Fig. 5.104. A canal section showing flat covers to prevent entry of debris.

oil drum was built. When it was completed, a half-drum was used as formwork and placed over the canal on timber supports, and concrete was laid over it (Fig. 5.105). When the concrete had set, the timber supports were removed. The oil-drum forms dropped down and were removed for use farther down the canal. The outside surface of the drum was oiled before use to facilitate its removal. Soil was backfilled over this "culvert." Occasional access holes along the canal (Fig. 5.106) permitted a workman to enter and crawl along the canal to remove sediment carried from the intake area.

At Kagua, Papua New Guinea, a culvert was cast in place (Fig. 5.107). Automobile tires were placed side by side along their common axis, and planks were then laid around this core of tires, also parallel to this axis. This served as cylindrical formwork around which concrete was poured. When the concrete had set, the tires were pulled out and the planks were removed, leaving a concrete culvert.

For large canals, brick arches over the canal have been built (Fig. 5.108). However, this is generally costlier and requires brick-masonry skills.

Sizing low-pressure conduits

Although canals are the most common type of power conduit used with micro-hydropower schemes, low-pressure pipes are also used for the reasons mentioned in **Power conduit** (p. 68). The appropriate pipe diameter can be determined from Figs. 5.125 and 5.129, the same figures used to determine losses in a penstock pipe.

Forebays

A forebay is basically a basin with dimensions that need be no larger than those required for it to perform either of the functions mentioned earlier. Any of several components—settling basins, spillway, gates, and trash-rack—may be incorporated within this basin as described in **Forebay** (p. 72). This section describes various forebay designs to illustrate how these components have



Fig. 5.106. An access hole permits access to the covered canal.

been incorporated. (For information on design and sizing of these components, see **Other components**, p. 154). It also discusses design considerations for the shape and location of the inlet to the penstock to minimize losses and the chance for air entrainment into the penstock.

One version of a forebay design frequently recommended by the Ossberger Turbinenfabrik of Germany at installations using its turbines illustrates how all the basic components are incorporated into the forebay (Fig. 5.109). The initial portion of the forebay can be sized as a secondary settling basin if necessary. A stop-

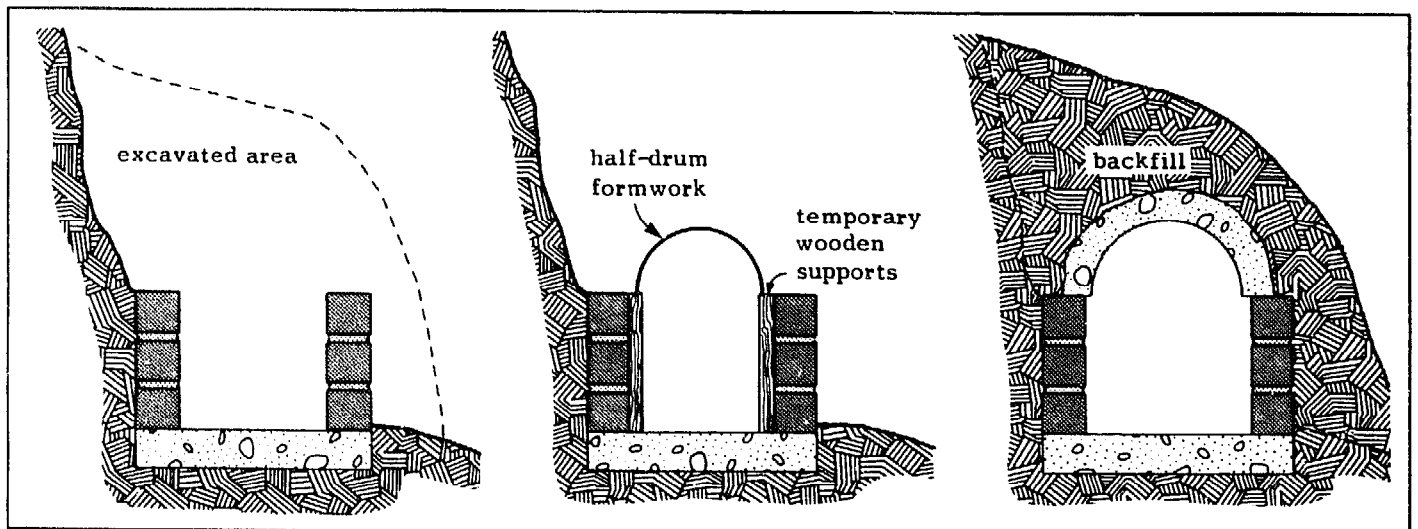

Fig. 5.105. Steps in the construction of a covered stretch of canal at Bundi, Papua New Guinea (Source: B. Vögtli).

Kagua, S.H.P., Papua New Guinea

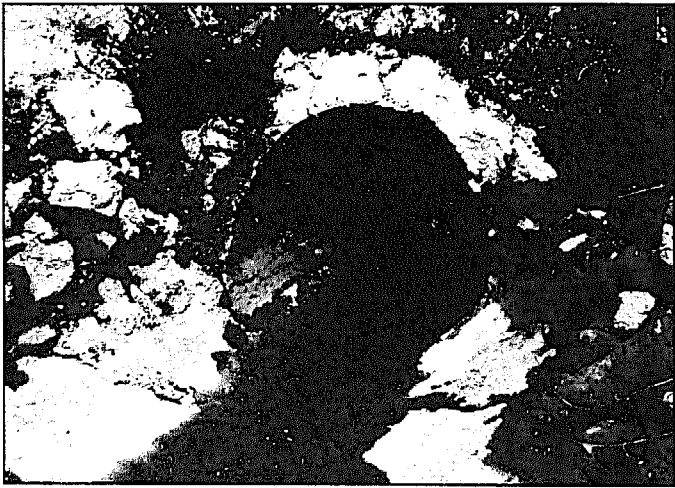

Fig. 5.107. This culvert was cast in place using tires and sawn timber as formwork.



Dehradun, U.P., India

Fig. 5.108. An irrigation canal is covered with a brick arch to prevent slides from obstructing the flow of water.

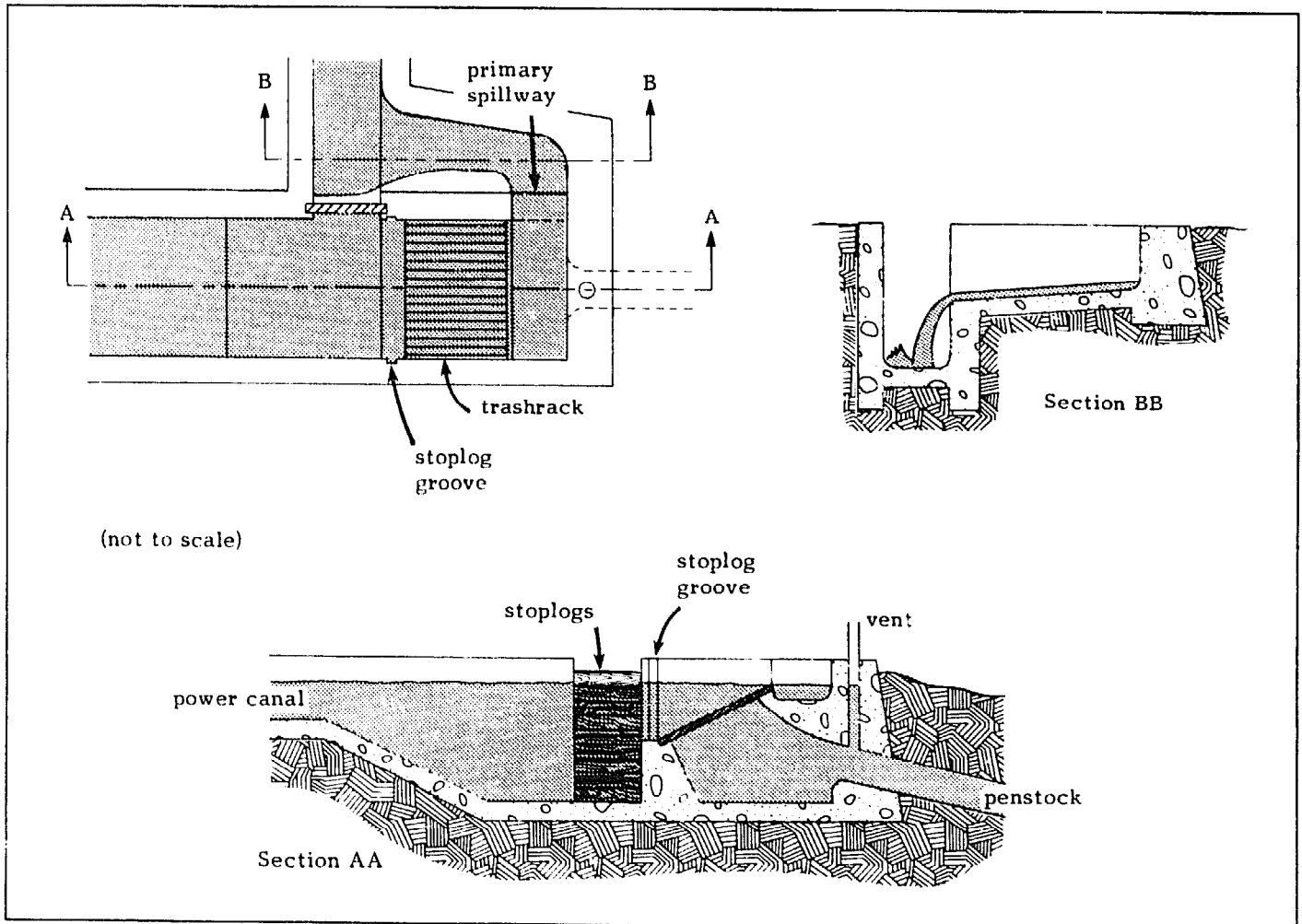

Fig. 5.109. Basic features of a forebay.

log gate permits the forebay to be drained so that sediment can be cleared or repairs made. Because the trashrack is located below the surface of the water, much of the surface debris is not caught. The spillway is strategically placed so that excess, overflowing water continuously sweeps floating debris out of the forebay. Less frequent cleaning of the trashrack is therefore necessary. Just before the trashrack, stoplogs can be inserted to prevent flow into the penstock when this is necessary. The design shows a vent incorporated in the wall of the forebay; however, this vent is frequently installed at the upper end of the penstock pipe itself (see Fig. 5.21).

To reduce turbulence and losses, the penstock inlet of large hydropower schemes is generally bell-shaped. However, for many micro-hydropower plants, the penstock inlet is simply a portion of the pipe extending through, or flush with, the forebay wall. Even for these configurations, the losses incurred are usually minimal.

The head loss coefficient " K_e " associated with various pipe entrances is illustrated in Fig. 5.128. The actual head loss is found by using the following equation:

$$h_e = K_e \frac{v^2}{2g} \quad (5.10)$$

where " v " is the velocity in the penstock. By incorporating a proper bell-shaped rather than a square-edged entry, head losses at the inlet are significantly reduced. But for penstock velocities even as high as 2 m/s, these losses amount to only 0.1 m. Consequently, these losses are generally insignificant, and only for very low-head sites should an effort be made to incorporate a proper bell-shaped entry. Even slightly rounding the entrance reduces head loss by at least 50%. Although a hooded inlet increases losses slightly, it makes it more difficult for passersby to drop small stones into the penstock.

A vortex which forms at the inlet to the penstock occasionally can cause troubles. It can induce loss of turbine efficiency, possible cavitation, surging caused by the formation and dissipation of vortices, and flow reduction as air replaces part of the water through the inlet. It can also draw floating debris into the penstock. Most research on the formation of vortices has involved hydraulic model studies of specific sites. These are appropriate for large hydropower schemes, but those implementing micro-hydropower plants cannot afford the cost and delays associated with such studies. Design criteria to prevent vortex formation are needed, but little has been done in this area.

Designing for a low velocity into the penstock and increasing submergence of the inlet can help prevent the formation of vortices. Also, a vertical inlet has a greater tendency for vortex formation than a horizontal one. Whereas these parameters are easy to quantify, vortex formation also seems to depend considerably on the circulation (swirl) in the water as it approaches the inlet. This circulation is primarily a function of the configuration of the area just upstream of the intake and can be caused by canal irregularities or separation of flow at the edge of a canal or forebay wall. Flow

approaching the intake asymmetrically is more prone to vortex formation than symmetrical flow (Fig. 5.110). It is therefore important that flows upstream of the inlet area be as straight and uniform as possible.

Several studies have attempted to use empirical data from both actual sites and model studies to derive guidelines for minimum inlet submergence. Although these efforts are not conclusive, they do indicate design parameters for which vortices are less likely to form. From data from 29 sites, one study derived the two curves drawn in Fig. 5.111 (48). Regimes which are presumed free of vortices are found above each of these curves. Also included in this figure are data points obtained in a more recent study undertaken at the St. Anthony Falls Hydraulic Laboratory (53). Based on this more comprehensive study, the two previously derived curves, which are still used for inlet design, are clearly not adequate to specify vortex-free regimes. Had it been possible to quantify approach conditions, more accurate curves presumably could have been derived. Although there is no area where vortices are certain not to occur, the area bounded by the dashed lines indicates an area where they are less likely to occur. Even in this area, however, vortices may form if approach conditions are poor.

Even if factors discouraging vortex formation are considered during the design stage, vortex flow can still occur during operation of the plant. By then, it may not be economically feasible to increase the submergence of the inlet, increase its diameter, or alter approach conditions to discourage vortex formation. In this case, several remedial actions to suppress these vortices are possible (94).

One of the simplest and least costly remedies is a floating raft which disrupts the angular momentum of the water near the surface (Fig. 5.112). It can be a square grid built of strips of lumber. On one occasion, a floating piece of plywood has also been used. However, if this latter approach is taken, the piece of wood should be large enough not to be sucked underwater and seal the inlet to the penstock, especially if the penstock does not include a vent pipe. In tests, a better location for a raft was found to be slightly below the surface of the water, where it is more effective in removing swirling

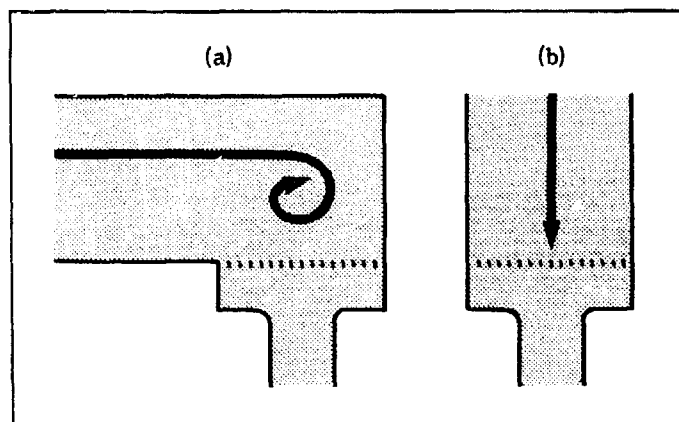

Fig. 5.110. Asymmetrical (a) and symmetrical (b) flow approaching an intake.

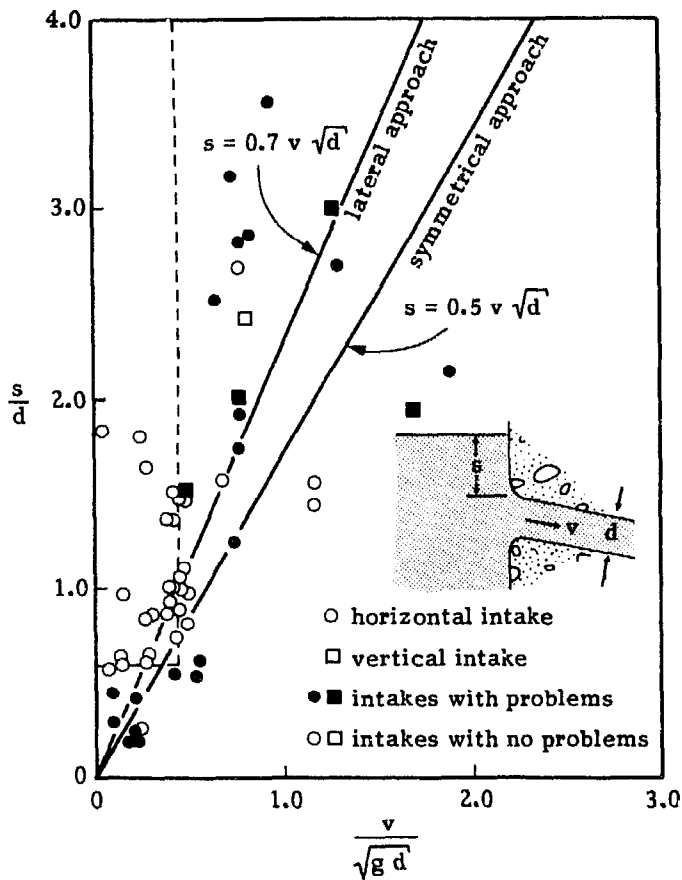

Fig. 5.111. This dimensionless plot of data obtained from intakes at existing installations and from model studies identifies intakes with and without vortex problems (53).

motion below the raft. If the raft is submerged too deeply, it will not be able to provide resistance to the swirl above it.

A hooded inlet with baffle is another vortex suppressor common to small intakes such as culverts. Figure 5.113 illustrates one such design used with culverts 150 mm or greater in diameter (94). With the penstock velocities commonly encountered in micro-hydropower installations, the pipe will then flow full even if submergence is somewhat less than equal to pipe diameter, although the

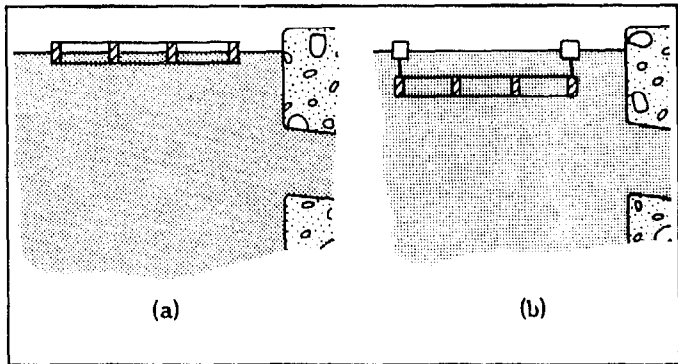

Fig. 5.112. Section view of floating (a) and submerged (b) raft vortex suppressors.

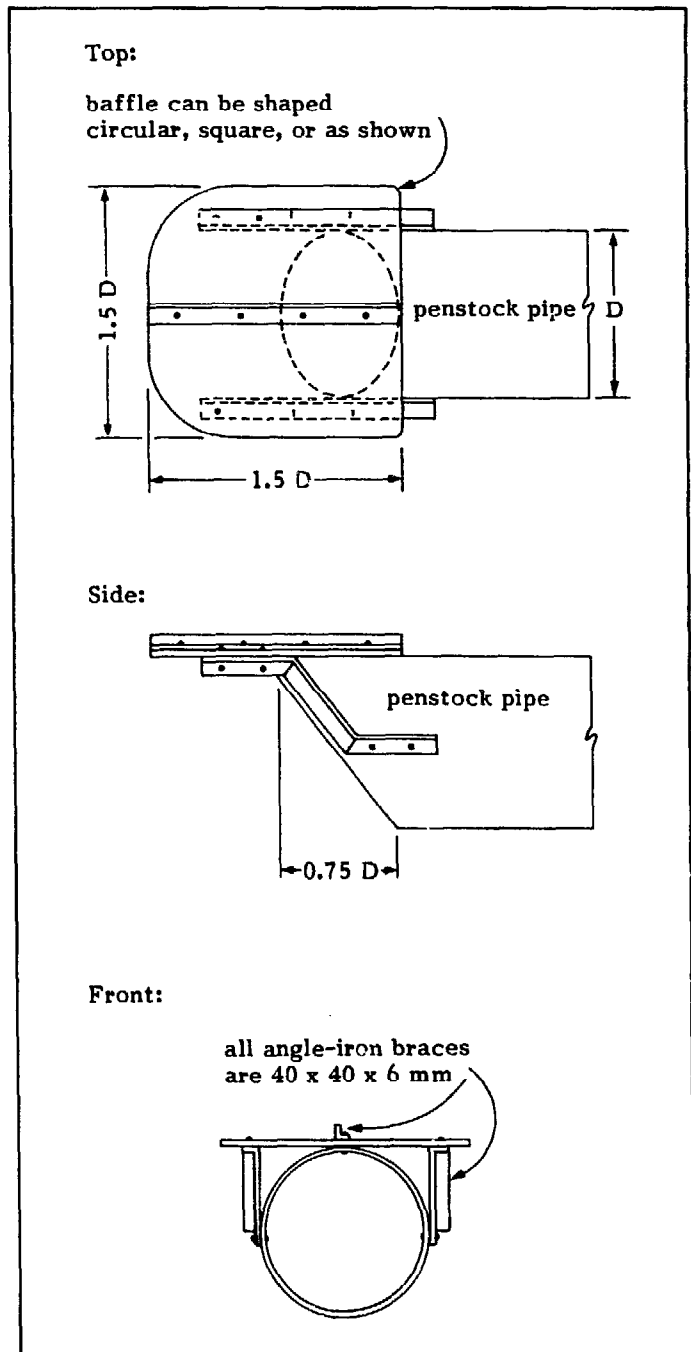

Fig. 5.113. Three views of a baffle on a hooded inlet used to suppress vortex formation (9).

flow may still have some swirl. If a metal baffle is used on a metal pipe, the same coating should be used on each component to avoid cathodic corrosion.

Trashracks fabricated of bars of rectangular cross-section can also disrupt the angular momentum of flow, and suppress vortex formation. A variation of this is a perforated plate (52). Laboratory tests have shown that the head loss across a plate pierced with holes through 50% of its area suppressed vortex formation (Fig. 5.114). With low-head schemes where head losses should be minimized, a perforated plate would not be an appropriate method of vortex suppression.

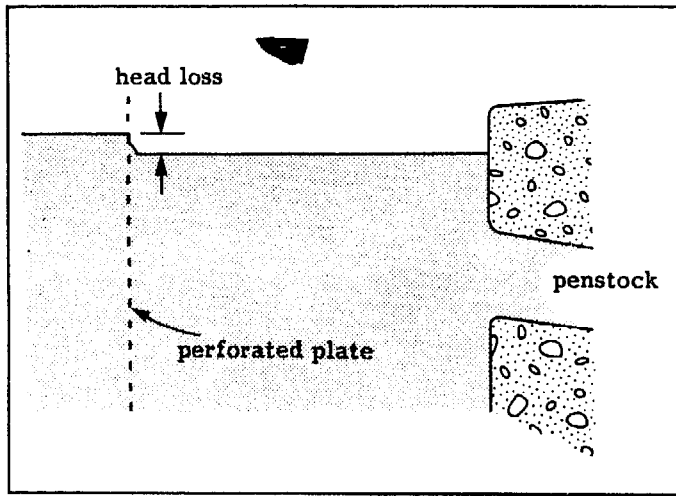

Fig. 5.114. A perforated plate can also be used to suppress vortex formation.

Although micro-hydropower schemes generally require a flow of less than $1.0 \text{ m}^3/\text{s}$, the design shown in Fig. 5.115 is proposed as a standardized design for flows from 0.1 to $10 \text{ m}^3/\text{s}$. Accompanying the original figure is a table which assigns values to the variables represented by letters. The magnitude of these values depends on the design flow the forebay is to accommodate. This is an example of a more sophisticated and costly design that is simply reduced in size to accommodate the smaller flows used by micro-hydropower plants. The previous design (see Fig. 5.109) has the same basic features but is simpler and less costly. The principal differences are the use of screw hoists on the two gates and more intricate concrete work with the standardized design.

In Fig. 5.116, a simple design for a small scheme incorporates the basic features required of a forebay. In lieu of a gate valve, a loosely fitting PVC (polyvinyl chloride) elbow is inserted between the penstock inlet and the main penstock pipe. Flow to the turbine is cut off

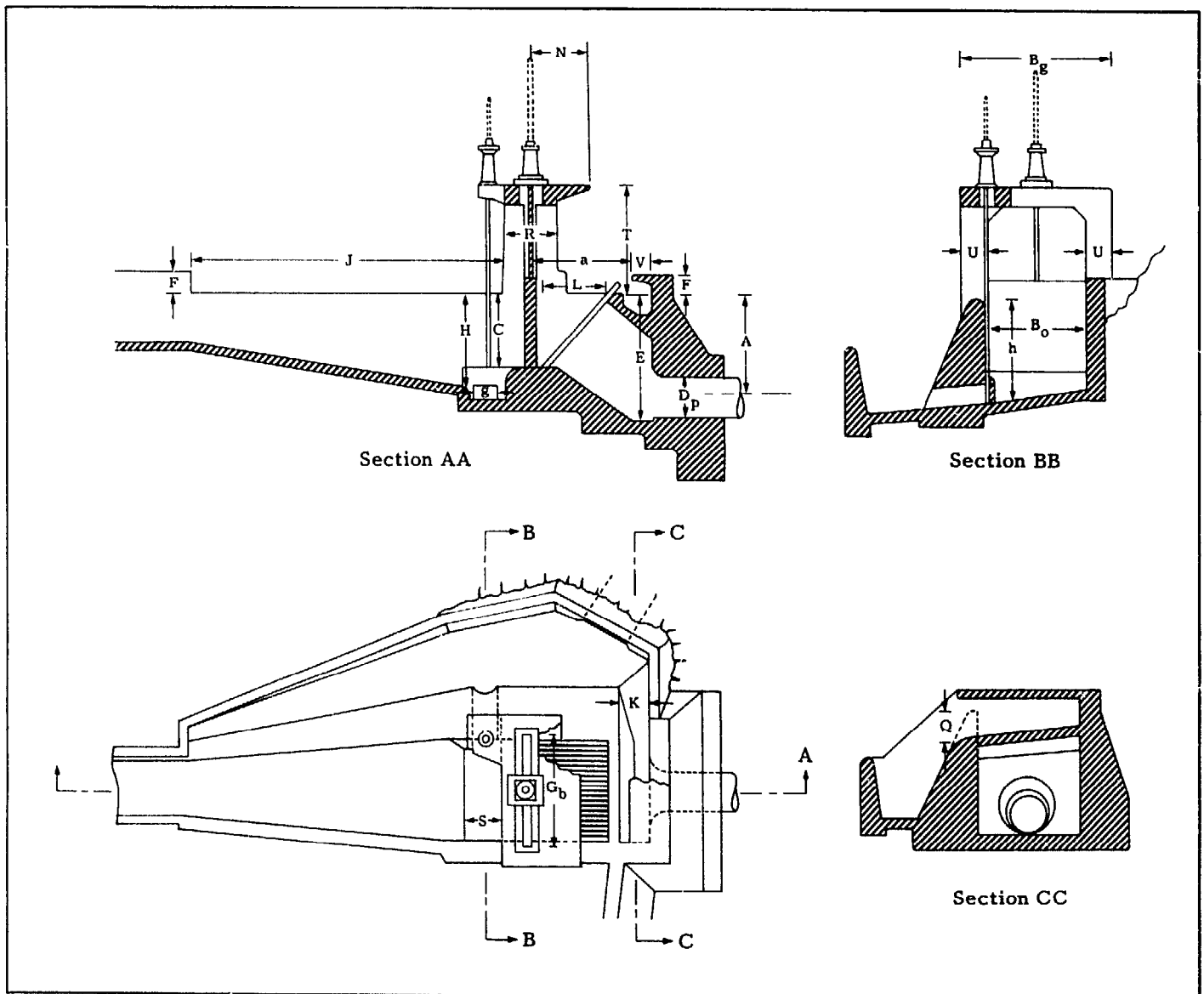

Fig. 5.115. A standardized forebay design (90).

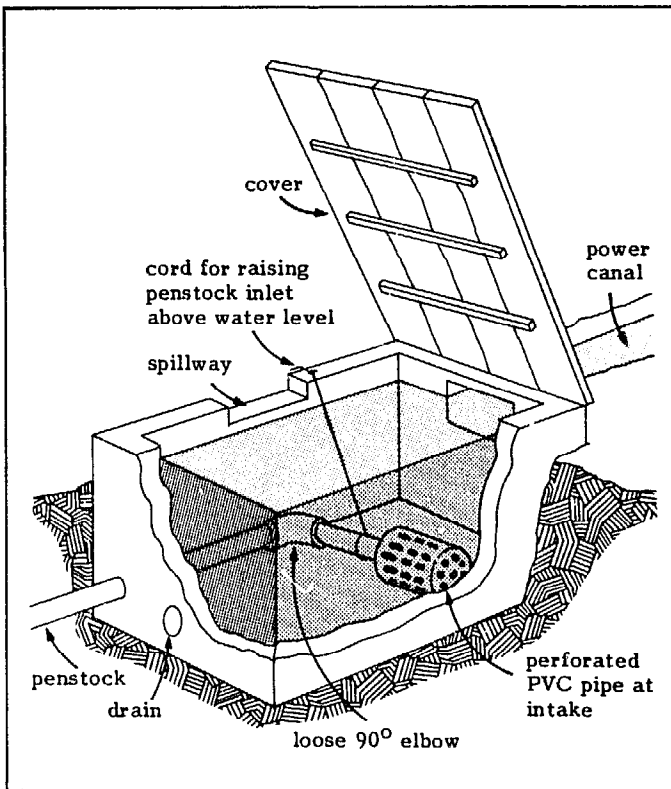

Fig. 5.116. A forebay for a small plant in Colombia (49).

simply by pivoting the inlet end of the penstock out of the water. As shown, the drain is used primarily to drain the forebay and, depending on its size and location, may permit scouring out any sediment; otherwise, this sediment will have to be shoveled out. In addition, the forebay can be covered because it is small. This prevents debris from falling in and, possibly more important, reduces chances of tampering by curious on-lookers. In this design, a length of perforated PVC pipe has replaced the conventional trashrack. In this case, it is necessary to ensure that the total area through which the flow enters is large enough to keep the pressure drop across this inlet within acceptable limits, even if it is partially obstructed (see **Trashracks and skimmers**, p. 162).

Another proposed forebay design is illustrated in Fig. 5.117. In this design, a pipe section serves as a cylinder gate through which the forebay can be drained and debris and sediment removed. (See the end of **Sliding gates**, p. 155, for a discussion of cylinder gates.) The pipe section can also serve as a shaft spillway if it has been adequately sized (see **Spillways**, p. 159). The operation of the circular trashrack is described in **Trashracks and skimmers** (p. 162). If this forebay is also to serve as a primary settling basin, it would have to be adequately sized (see **Settling basins**, p. 166).

At times, no true forebay is included before the penstock. The installations shown on Figs. 5.118 and 5.119 are both low-head sites and use considerable flow. The trashrack is placed at the end of the power canal. In the first case, excess flow passes over a sliding gate; in the second, part of this flow passes over the trashrack,

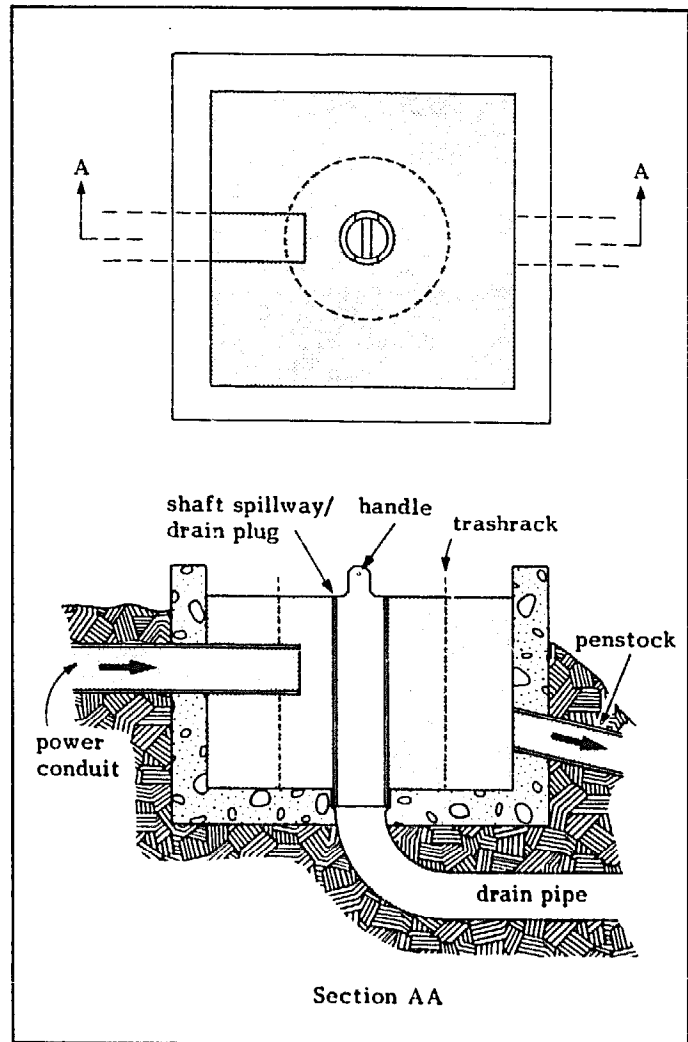

Fig. 5.117. Plan and section views of a forebay design proposed by Rupert Armstrong Evans which features a cylindrical trashrack.

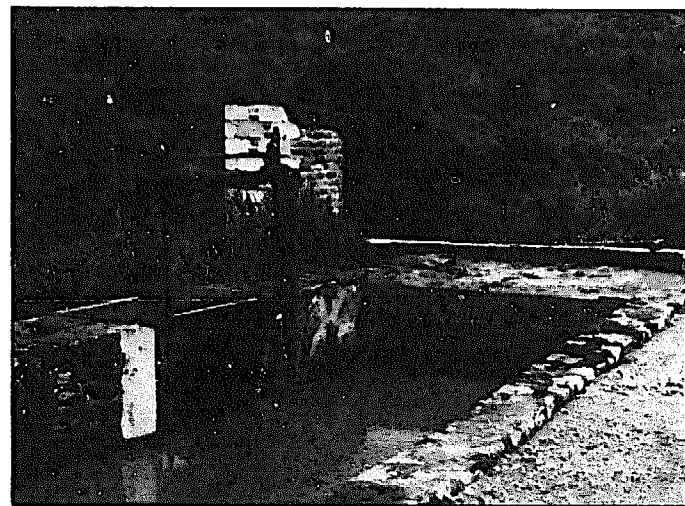
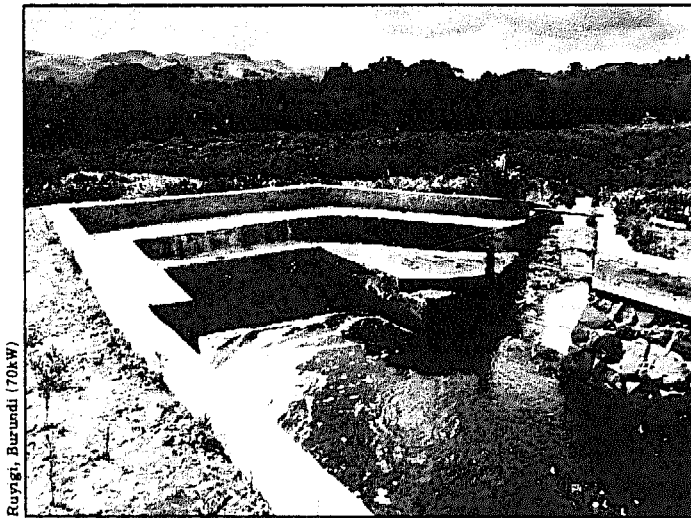

Fig. 5.118. At this site, the top edge of the sliding gate serves as the spillway. Trash is raked off the trashrack and pushed off the edge into the spillway canal.



Ruyigi, Burundi (70kW)

Fig. 5.119. The basic design is similar to that in Fig. 5.118, but the trashrack has been lowered so that it is submerged in normal operation. The gate is shown in its open position because the plant was not yet operational.

carrying away some of the debris which might otherwise become lodged in the trashrack. In this regard, Fig. 5.119 is similar to the design recommended by Ossberger (see Fig. 5.109), except that the latter is better designed--all excess flow passes over the trashrack.

At other times, the forebay can be a substantial structure used to store water for peak generation purposes (Fig. 5.120). Because a forebay used for this function can be large, concrete is used only for the area around the intake to the penstock. If the soil is pervious, the entire forebay must be lined with concrete or other impervious material. Fig. 5.121 shows a view of another scheme which incorporates a forebay with significant storage capacity. A close-up of the forebay (Fig. 5.122) shows that concrete is only used around the inlet to the penstock (at the left). The remainder of the forebay has been carefully excavated and lined with a 10 cm-thick layer of clay to seal it (Fig. 5.123). Hand-placed riprap protects this clay lining (Fig. 5.124).

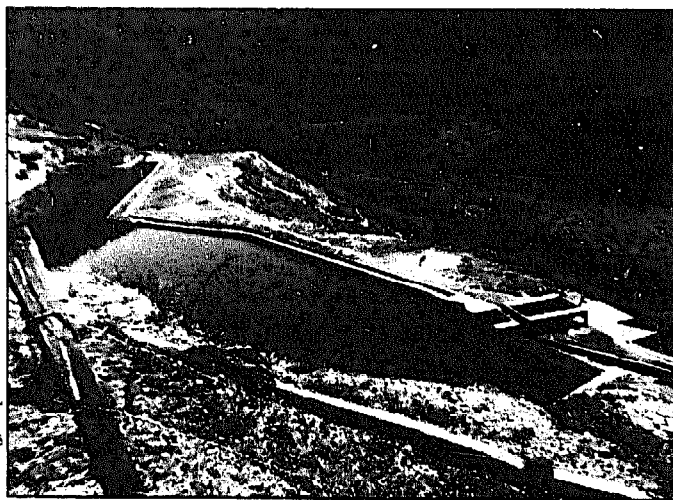

Dhading, Nepal (30 kW)

Fig 5.120. A forebay used to store water for power generation during peak demand periods.



Fig. 5.121. A view of the forebay (with 4000 m³ capacity), penstock, and powerhouse at an 80 kW scheme to provide power to Syangja, Nepal.

Penstocks

Materials

Steel is the most frequently used penstock material, but various types of concrete are also used. Wood-stave penstocks with steel reinforcing rings, used extensively in large, old plants, were entirely satisfactory. However, wood-stave pipe is now rarely used, probably because of increased familiarity with steel penstocks. For small schemes, the low cost, low weight, and ease of installation of plastic pipe has made plastic an attractive material. For very small self-help schemes, pipes have also been constructed of other materials, such as oil drums (see Fig. 10.53) and ordinary timber (see Fig. 10.54). Properties of materials used for penstock pipes are shown in Table 5.5 and will be referred to in subsequent sections.

In selecting the type of penstock pipe for a specific site, the following factors should be considered:

- required operating pressure and diameter;
- method of coupling;
- weight and ease in handling and accessibility of site;
- local availability of pipe;
- maintenance requirements and expected life;
- nature of terrain to be traversed; and
- effect on pipe of water quality, climate, soil, and possible tampering.

Although polyvinyl chloride (PVC) pipe has become more popular, a source of concern with this material is its degradation from exposure to ultraviolet radiation, primarily from sunlight. This exposure can occur when a portion of the pipe is installed above ground or during shipment or storage at the job site.

Degradation occurs on the exposed surface of PVC pipe where the sun's radiation breaks the chemical bonds within the polymer chains. The structure of the plastic is permanently altered in the affected area, which often



Fig. 5.122. Close-up of the forebay under construction. Concrete is used only in the vicinity of the inlet to the penstock.

turns the surface a light yellow. But penetration depth of this altered area rarely exceeds 0.003 mm. Degradation ceases when exposure ends.

Tests were performed across the United States to gage the effect of ultraviolet radiation on PVC pipe. During the two years that the pipe samples were placed outdoors with maximum exposure to sunlight, both tensile strength (which is directly related to pressure rating) and modulus of elasticity (which is related to the pipe's ability to resist external loads) remained virtually unchanged. Impact strength was somewhat reduced but still within acceptable limits (7).

Because long-term trends may be less clear, pipe installed above ground should be protected from sunlight by an opaque shield of any thickness. The pipe can be painted, coated, or wrapped. Because some paints and cements contain solvents which can be detrimental to PVC, it is advisable to apply the proposed paint or coating to a sample length of pipe to ensure compatibility and adhesion. Generally, water-based latex paints formulated for outdoor use work well.

Sizing penstock pipes

When sizing a penstock pipe, two parameters must be specified:

- its diameter, which should be selected to reduce frictional and therefore energy losses within the penstock to an acceptable level, and
- the thickness of its walls, which should be selected to accommodate the pressures encountered during plant operation.

Selecting pipe diameter. A more widely used form of the power equation is not Eq. (4.2) but

$$P = 9.8 e_t Q H \quad (5.11)$$

where, in addition to the variables defined earlier,

- e_t = efficiency of the turbine (or turbo-generating equipment if electricity is to be generated)
- H = net head acting on the turbine (m)
= $H_g - h_t$

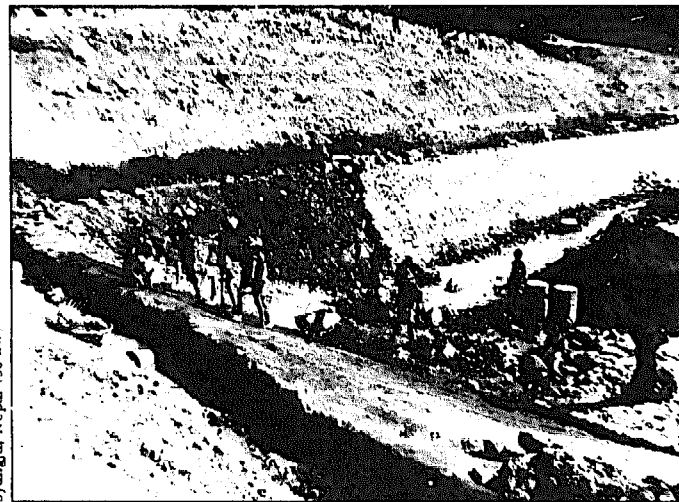

Fig. 5.123. A layer of clay (seen stacked on the right) is being tamped on the floor of the forebay.



Fig. 5.124. The clay lining of the forebay is covered with hand-placed riprap.

TABLE 5.5. Properties of materials used in the manufacture of penstock pipe

Material	Young's modulus of elasticity E (kgf/cm ²)	Coefficient of linear expansion a (m/m °C)	Ultimate tensile strength (kgf/cm ²)	Density (kgf/m ³)
Steel	21·10 ⁵	12·10 ⁻⁶	3500	7900
Polyvinyl chloride (PVC)	0.28·10 ⁵	54·10 ⁻⁶	280 *	1400
Polyethylene	0.02-0.08·10 ⁵	140·10 ⁻⁶	60-90 *	940
Concrete	2·10 ⁵	10·10 ⁻⁶		1800-2500
Asbestos cement		8.1·10 ⁻⁶		1600-2100
Cast iron	8·10 ⁵	10·10 ⁻⁶	1400	7200
Ductile iron	17·10 ⁵	11·10 ⁻⁶	3500	7300

* Hydrostatic design basis

As the value admitting water to the turbine is just beginning to open, the net head acting on the turbine is equal to the gross head across the penstock, the difference in elevation between the penstock inlet and the turbine. But as soon as the water in the penstock starts to descend, fluid friction and turbulence result in losses in head "h_f" which reduce the actual head acting on the turbine. The magnitude of these losses is approximately proportional to the square of the velocity of the water in the pipe. Consequently, if a less costly, small-diameter pipe is used to convey the same flow as a larger-diameter pipe, the velocity and therefore the losses are greater in the former. Greater losses decrease a site's net head and therefore its power potential. Thus, selecting a penstock diameter is a trade-off between cost and power losses: selecting as small a diameter as possible to minimize cost and selecting as large a diameter as necessary to minimize losses.

As discussed in Selecting wall thickness (p. 133), the pipe diameter also affects the required pressure rating and therefore the wall thickness of the penstock. A smaller-diameter pipe would be less costly, but the resulting higher velocity would cause pressure surges, such as those caused by rapid gate closure, to be higher. A more costly pipe with a higher pressure rating might therefore be required. In selecting pipe diameter, it is best not to consider the effect of diameter on pipe thickness until an initial choice of pipe diameter is made based solely on keeping head losses within acceptable limits. The choice can always be changed if it is later found to imply unacceptable surge pressures.

Pressure or head losses are comprised of losses caused by friction between the water and the pipe "h_f" and losses caused by turbulence created by changes in velocity or direction of flow which occur at the inlet, bends, valves, and enlargements or constrictions along a pipe "h_t". Losses caused by turbulence are commonly referred to as minor losses and are small in the case of micro-hydropower schemes with relatively long penstocks. However, if a short penstock is used, these

"minor losses" may be greater than friction losses. The total head loss is simply equal to the sum of these two losses:

$$h_t = h_f + h_t \tag{5.12}$$

One means of approximating these losses is described below. The equations used to estimate these losses are based on tests in both laboratories and full-scale installations.

The graph in Fig. 5.125 can be used to determine losses caused by friction in a penstock pipe. It is based on the following equation, which is derived from Manning's equation:

$$\frac{h_f}{L} = 6.3 \frac{(nv)^2}{D^{4/3}} \tag{5.13}$$

where

- h_f = head loss due to friction (m)
- L = penstock length (m)
- n = roughness coefficient (see Fig. 5.126)
- v = mean velocity (m/s)
- D = internal pipe diameter (m)

The use of this graph is illustrated in EXAMPLE 5.4.

A more convenient form of this equation expresses the losses in terms of the flow through the pipe "Q" (m³/s):

$$\frac{h_f}{L} = 10 \frac{n^2 Q^2}{D^{5.3}} \tag{5.14}$$

The very strong dependence of friction losses on pipe diameter is more clearly seen in this form of the equation. Just halving the pipe diameter for a given flow, for example, increases friction losses by a factor of 40! The equation also shows that, for a given flow and pipe diameter, losses are proportional to penstock length.

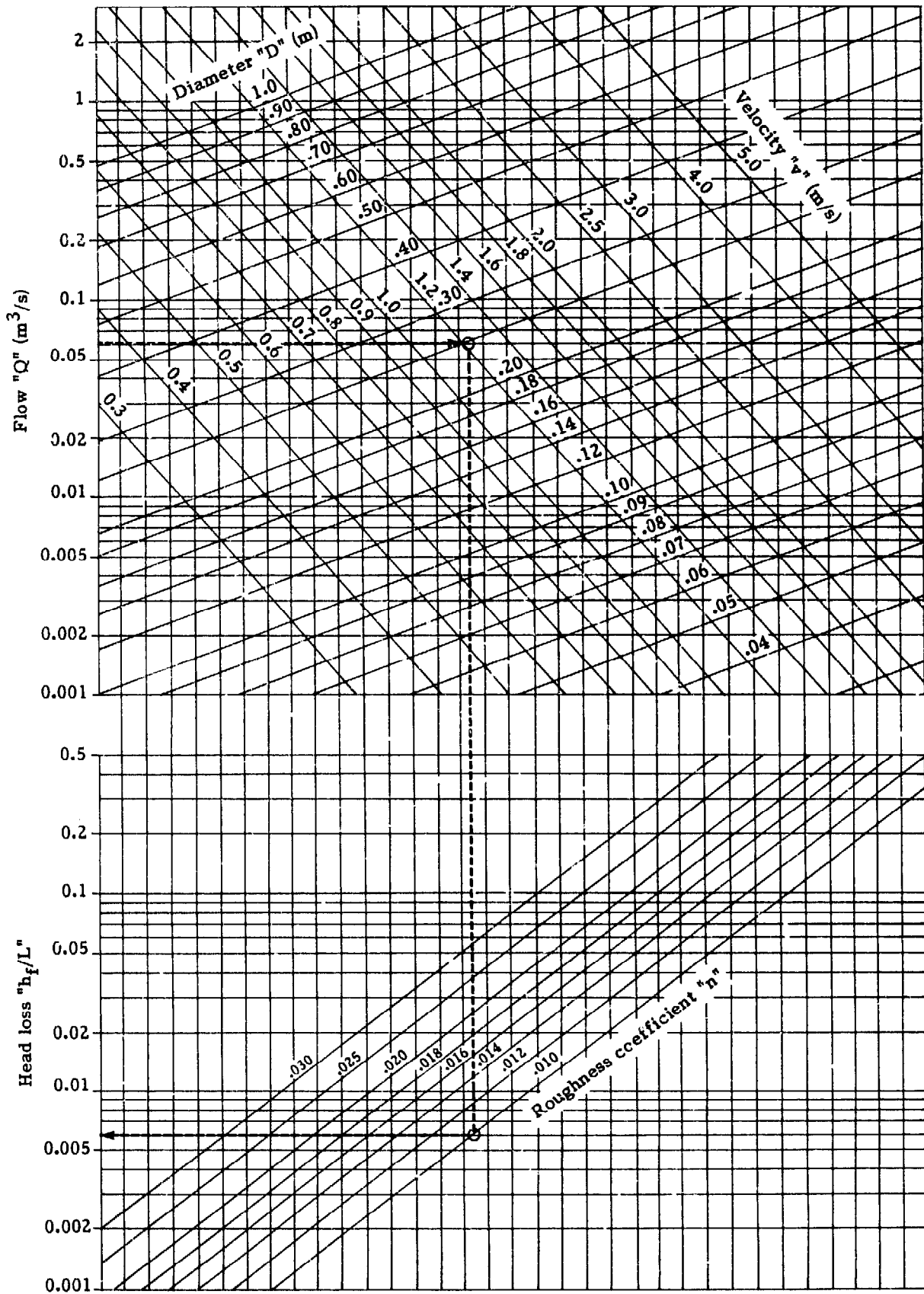

Fig. 5.125. Graph used to determine head losses caused by friction within a pipe.

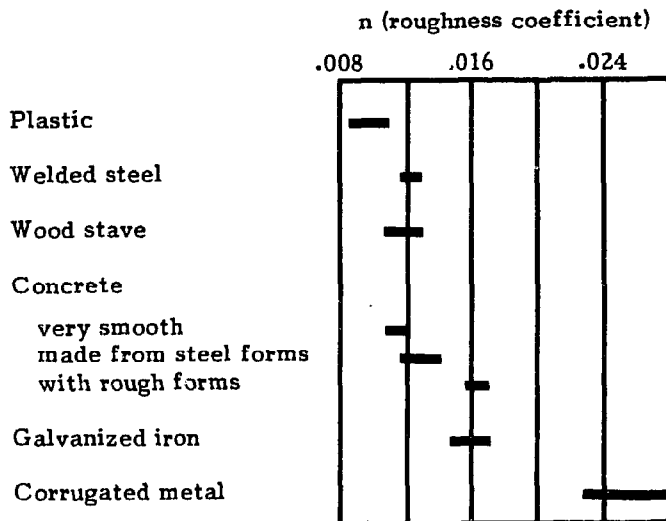

Fig. 5.126. The roughness coefficients for Manning's formula used in determining head loss caused by friction in a pipe of good condition conveying water.

This is one reason that hydropower schemes are laid out to minimize penstock length for a given gross head (see **DEVELOPING THE BASIC LAYOUT**, p. 49).

Whereas Manning's equation is used here, other empirically derived formulas also can be used, such as those of Darcy-Weisbach, Hazen-Williams, and Scobey. Information on these can be found in texts on hydraulics. Manning's formula is widely used and can be applied to conduits of any shape, including canals (see **Determining canal dimensions and slope**, p. 96). Although it can be used only for water at normal temperatures, this restriction has no impact on its use for hydropower applications.

The 4% loss in power caused by friction losses in EXAMPLE 5.4 is usually acceptable. One factor which determines acceptability is an economic one—whether the extra cost involved in installing a larger penstock to reduce the energy losses can be recouped by the additional revenue generated by selling this additional energy. This might be the case if all excess energy can be sold or, equivalently, if it replaces diesel fuel at an isolated site. In the United States, small suppliers of power are guaranteed a market in the local utility for their excess power; however, at most isolated microhydropower installations in developing countries, few arguments can be made for reducing such small power losses. At these sites, short-term peaks are usually better addressed by better load management—spreading the load more uniformly during the day—than by increasing the initial capital outlay for larger-diameter pipe.

Clearly, each situation must be considered on its own merits. EXAMPLE 5.5 presents a simple analysis of whether an increased diameter pipe is warranted in the case of a grid-connected scheme.

EXAMPLE 5.4

Assume that a PVC pipe with an internal diameter of 250 mm is to convey a flow of 60 l/s for a distance of 500 m at a site with a gross head of 80.0 m. What will be the head loss due to friction, and what percentage loss in power does this head loss represent?

From Fig. 5.126, PVC pipe is found to have a roughness coefficient of $n = 0.010$. Following the dashed line in Fig. 5.125 from the flow which the pipe is to accommodate on the upper left-hand scale, a head loss is found to be 0.0060 m/m of pipe. The actual head loss is then

$$h_f = 0.0060 L = 3.0 \text{ m}$$

and the net head is

$$H = H_g - h_f = 80.0 - 3.0 = 77.0 \text{ m}$$

if only friction losses are considered.

Because the power available from a turbine with a given flow is proportional to net head, this loss of head represents a loss of power through pipe friction of 3/80 or about 4%.

EXAMPLE 5.5

Assume that in the case presented in EXAMPLE 5.4, the owner of the power scheme can sell power for US\$ 0.05/kWh to the grid. Would it be advantageous for him to spend more for a larger-diameter pipe (300 mm at \$30/m) which would reduce head losses to about 1.0 m than to use the 250 mm pipe originally planned (at \$20/m)?

Increasing the diameter of the pipe would mean that approximately an additional

$$P = 10 e Q \Delta H \\ = 10 (0.70)(0.06)(2.0) = 0.8 \text{ kW}$$

will be generated. Assuming a plant factor of 0.9, this represents an annual revenue of

$$(0.8 \text{ kW})(0.9)(8760 \text{ h})(\$0.05/\text{kWh}) = \$310$$

The increased price of the pipe alone would amount to

$$(\$10/\text{m})(500 \text{ m}) = \$5000$$

The owner will then have to decide whether an additional investment of at least \$5000 is worth an annual return of \$310.

A more rigorous approach to selecting the optimum pipe diameter—that diameter resulting in the least cost over the life of the plant—is to select several possible pipe diameters. First, for each diameter, power and annual energy losses are computed as illustrated in EXAMPLE 5.5. Losses caused by turbulence (discussed below) should also be included in this calculation. The present value of this energy loss over the life of the plant is then calculated and plotted for each diameter (Fig. 5.127). Second, the cost of the pipe for each diameter is computed and plotted. These computations should include all factors which might significantly influence its cost. For example, decreasing the penstock diameter for a given flow may appear to reduce the price of the pipe; however, decreasing the diameter also increases the velocity and potential surge pressures, which may mean that a thicker, more expensive pipe is required. Once both curves are plotted, they are added graphically. The optimum diameter is the one associated with the minimum cost. If standard, commercial pipe is to be used, the optimum diameter would be that diameter closest to the theoretical optimum. Commercial pipe in non-standard sizes is either not available or may cost significantly more to fabricate.

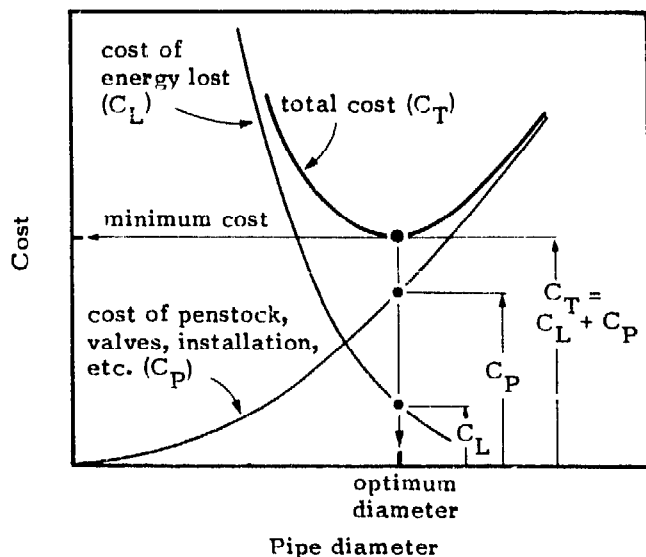

Fig. 5.127. Graphical method for finding optimum penstock diameter.

If the internal diameter of the pipe changes along the length of the penstock, the approach to determining head losses described above can be applied to each constant-diameter section. Because head losses are additive, total head loss caused by friction is simply the sum of friction losses in the individual sections of pipe.

When pipe has to be shipped a considerable distance, using pipe of two different diameters may save on project costs. For a plant in Kosrae in the Federated States of Micronesia, shipping costs for PVC pipe were approximately halved because the 15" pipe sections could be telescoped into the 18" pipe sections, reducing the bulk to be shipped by half. Volume, not weight, determines the cost of shipping the pipe in containers. When the

penstock was assembled, all the pipe sections of one diameter were secured together and laid, followed by those of the second diameter. A reducer was used to couple the two lengths of different diameter.

Losses caused by turbulence are generally expressed as a product of a loss coefficient and velocity head:

$$h_t = K \frac{v^2}{2g} \quad (5.15)$$

where

- h_t = head loss due to turbulence (m)
- K = head loss coefficient (see below)
- v = velocity where the loss is taking place (or the higher of the two velocities if a contraction or expansion occurs).

The coefficients for losses at entrances, valves, bends, and contractions along a pipe are presented in Fig. 5.128. Different sources show considerably different values for these coefficients, and they should be used only to obtain approximations of expected losses. The loss coefficient for a 90° bend with a radius equal to one pipe diameter, for example, is given in various sources as 0.21 (26), 0.35 (32), 0.4 (47), 0.50 (73), and 1.0 (40). Clearly, the losses derived using these coefficients should not be considered correct to more than a single significant figure. For example, for a 90° bend with a radius of three pipe diameters and a velocity of 2.0 m/s, the loss found using Eq. (5.15) should properly be written as 0.8 m and not 0.0816 m. Because of the meaning of "significant figures," the loss could actually be 0.5 or 1.0 (see APPENDIX B, p. 267).

Using Eq. (5.15), losses at points along a pipeline where turbulence occurs can be calculated and added together to determine the total loss resulting from turbulence. The graph in Fig 5.129 permits approximating these losses along a length of pipe of constant diameter. The total loss coefficient, K_T , is simply the sum of all the individual loss coefficients along the pipe.

If a smaller-diameter pipe is used for one portion of the penstock, Figs. 5.125 and 5.129 can be used for each constant-diameter portion. In this case, the contraction loss caused by the change in diameter between the two portions of pipe should be included only when deriving losses for the smaller-diameter portion. This is illustrated by means of EXAMPLE 5.6.

When a penstock configuration and the flow to be conveyed are given, the head loss can be determined using the graphs in Figs. 5.125 and 5.129. However, as was mentioned previously and as can be seen from EXAMPLE 5.6, friction losses are usually significantly greater than turbulence losses. In this case, turbulence losses can be neglected and Fig. 5.125 alone can also be used to approximate head losses with a given flow and penstock configuration (Fig. 5.130a). Or when the pipe diameter is unknown, as is more frequently the case, an approximate value can be obtained from Fig. 5.125 if flow and maximum acceptable head loss (perhaps 5% of gross head) are known (Fig. 5.130b) or if flow and

(a) Losses at entrance

Type	hooded inlet	inward projecting pipe	sharp-cornered	slightly rounded	bell mouth
K_e	1.00	0.8	0.5	0.2	0.04

(b) Losses through fully opened valves

Type	K_v
spherical	0
gate	0.1
butterfly ($t/D = 0.2$)	0.3

(c) Losses at bends

For 90° bends:

r/D	1	2	3	5
K_b	0.6	0.5	0.4	0.3

where r/D = ratio of radius of bend to pipe diameter

For 45° bends: Use 3/4 of above values

For 20° bends: Use 1/2 of above values

(d) Losses caused by sudden contractions

D_1/D_2	1.0	1.5	2.0	2.5	5.0
K_c	0	0.25	0.35	0.40	0.50

where D_1/D_2 = ratio of large to small pipe diameter

maximum acceptable flow velocity are specified (Fig. 5.130c). To maintain head losses and surge pressures within acceptable limits, the maximum flow velocities are usually restricted to 1-3 m/s for micro-hydro-power schemes. After a tentative value for pipe diameter has been determined, total head loss from both friction and turbulence can be determined as is illustrated in EXAMPLE 5.6 to ensure that it is within acceptable limits.

EXAMPLE 5.7 illustrates an approach for determining the pipe diameter and the flow and net head under which a turbine is to operate where only the site's gross head and the power required are known. This example goes into more detail than is necessary only to give a clearer idea of how all the variables are interrelated.

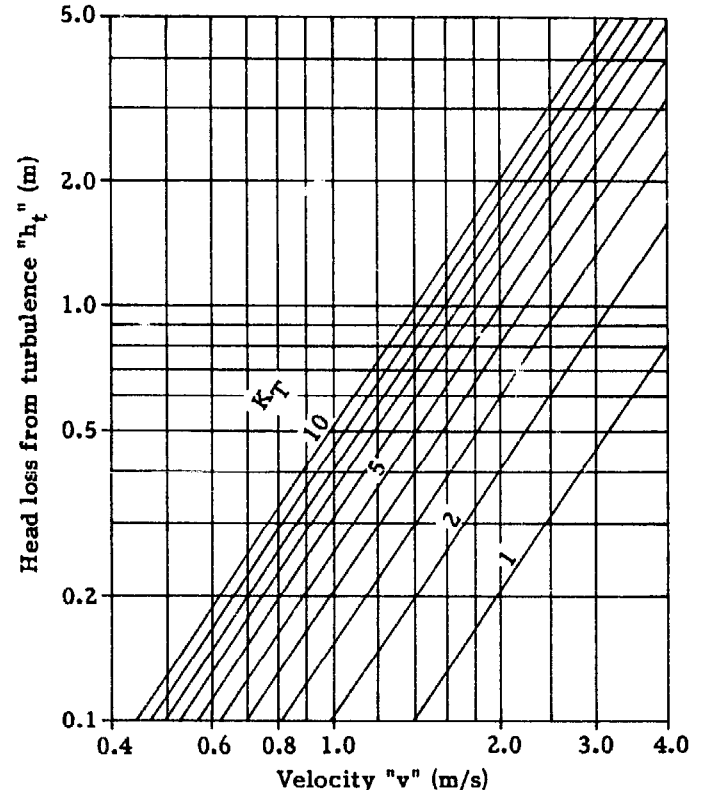
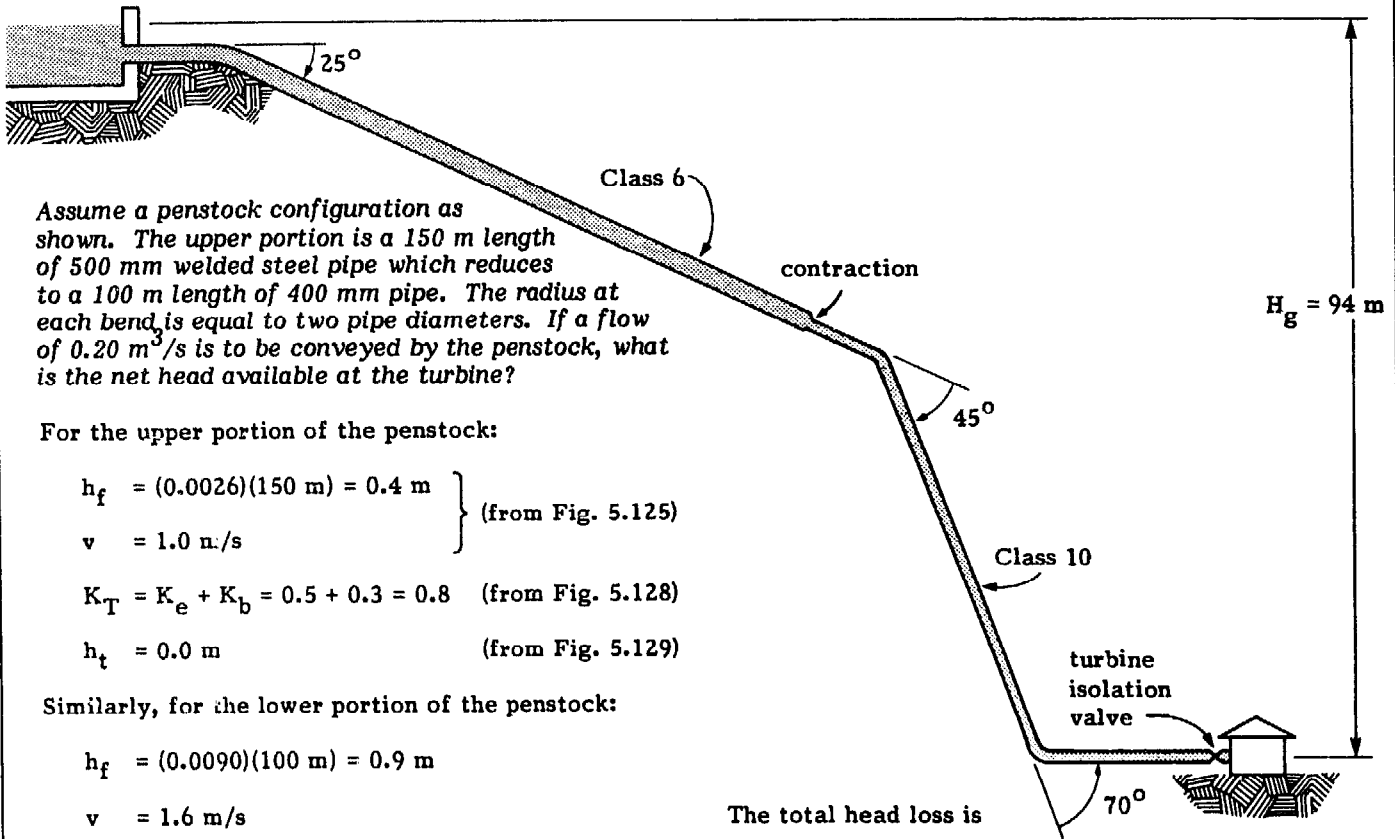

Fig. 5.128. Coefficients used to determine losses resulting from turbulence.

Fig. 5.129. Graph used to determine head losses caused by turbulence within a pipe.

EXAMPLE 5.6



Assume a penstock configuration as shown. The upper portion is a 150 m length of 500 mm welded steel pipe which reduces to a 100 m length of 400 mm pipe. The radius at each bend is equal to two pipe diameters. If a flow of $0.20 \text{ m}^3/\text{s}$ is to be conveyed by the penstock, what is the net head available at the turbine?

For the upper portion of the penstock:

$$\left. \begin{aligned} h_f &= (0.0026)(150 \text{ m}) = 0.4 \text{ m} \\ v &= 1.0 \text{ m/s} \end{aligned} \right\} \text{ (from Fig. 5.125)}$$

$$K_T = K_e + K_b = 0.5 + 0.3 = 0.8 \quad \text{(from Fig. 5.128)}$$

$$h_t = 0.0 \text{ m} \quad \text{(from Fig. 5.129)}$$

Similarly, for the lower portion of the penstock:

$$h_f = (0.0090)(100 \text{ m}) = 0.9 \text{ m}$$

$$v = 1.6 \text{ m/s}$$

$$\begin{aligned} K_T &= K_c + K_{b1} + K_{b2} + K_v \\ &= 0.1 + 0.4 + 0.5 + 0.2 = 1.2 \end{aligned}$$

$$h_t = 0.2 \text{ m}$$

The total head loss is

$$h_f = 0.4 + 0.0 + 0.9 + 0.2 \text{ m} = 1.5 \text{ m}$$

and the net head is therefore

$$H = H_g - h = 94 - 1.5 = 92 \text{ m}$$

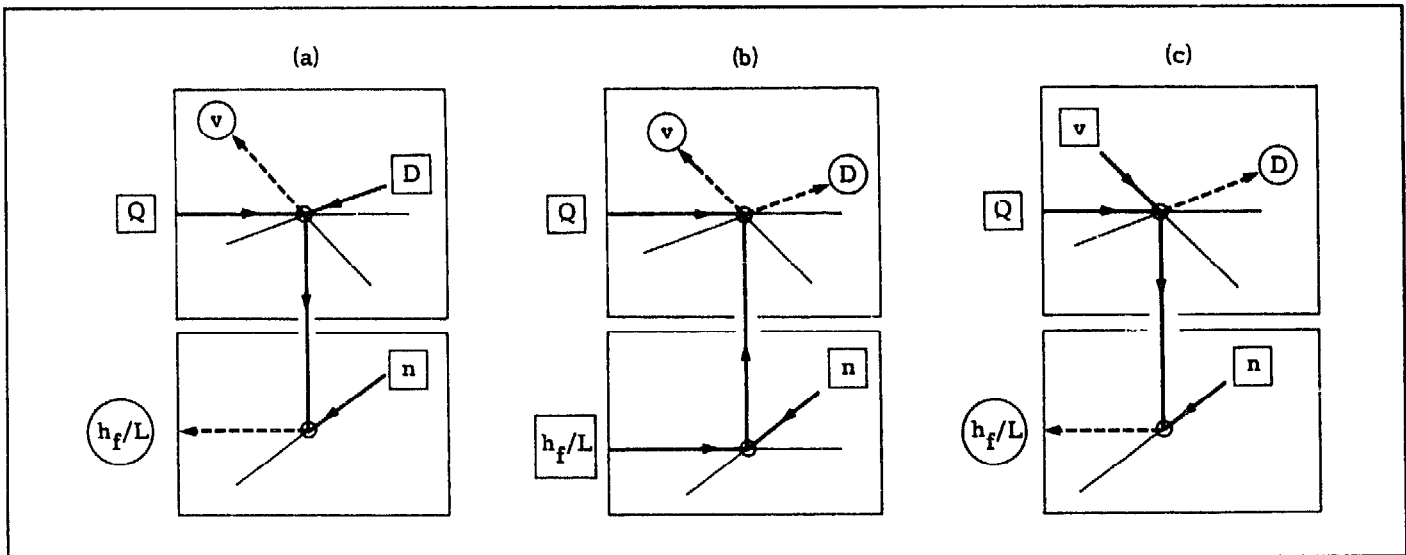

Fig. 5.130. Knowing design flow "Q", Fig. 5.125 can be used to determine (a) head loss and pipe velocity if pipe is specified, (b) required pipe diameter and associated pipe velocity if acceptable head loss is known, or (c) head loss

and required pipe diameter if maximum pipe velocity is specified. Known variables are placed within squares and derived variables are circled.

EXAMPLE 5.7

An 85 m-long steel penstock is to have a sharp-cornered inlet at the forebay, two 45° bends of moderate radius, and a gate valve located in the powerhouse. The turbine, which operates under a gross head of 35.0 m, has an efficiency of 70%, and is to generate 18 kW. Assume that standard pipe is available in diameters which are multiples of 50 mm.

- What diameter pipe would be required if head loss is to remain within 5% of gross head?
- With the pipe diameter which has been selected, what would be the net head under which the turbine will operate if both friction and turbulence losses are considered?
- If 250 mm steel pipe is difficult to procure, can a 200 mm PVC pipe be used?

(a) A number of approaches can be used to solve this problem. Initially assume that turbulence losses are negligible and that only friction losses " h_f " are to be considered. As shown in Fig. 5.130b, Fig. 5.125 can then be used to estimate the required penstock pipe diameter if flow is known.

The flow required by the turbine to generate 18 kW depends on the net head under which it operates and can be determined by the power equation [Eq. (5.11)]. For an initial estimate, assume that the net head will be the gross head less 5% or about 33 m. From the power equation, the required flow then would be

$$Q = \frac{P}{9.8 e_t H_g} = 0.080 \text{ m}^3/\text{s}$$

Restricting the head loss to 5% implies that

$$\frac{h_f}{L} = \frac{h_f}{H_g} \frac{H_g}{L} = (0.05) \left(\frac{35}{85} \right) = 0.021$$

From Fig. 5.126, the roughness of a welded steel pipe is about 0.012. From Fig. 5.125, a steel pipe to convey the required 0.080 m³/s at the site with a head loss " h_f/L " of 0.021 would require a diameter of about 230 mm. To keep losses within 5%, a standard 250 mm steel pipe would be required.

(b) If a flow of 0.080 m³/s descends a 250 mm-diameter penstock, the loss in head caused by friction can be calculated to be about 1.2 m using Eq. (5.14) or the graph in Fig. 5.125. Continuing to assume that turbulence losses are negligible, the net head actually

will then be 33.8 m. Because the net head is greater than initially assumed, the turbine will require slightly less flow to generate the required power. Using the power equation as was done in (a), the required flow under this revised head is found to be 0.078 m³/s. With this more precise value for flow, the penstock friction losses are still found to be about 1.2 m. When analyzing any site, this process of iteration can be continued in order to approach the exact value of head loss, but one or two iterations generally suffice to obtain the necessary accuracy.

Now that the penstock friction losses have been determined, the actual losses caused by turbulence can be determined from Eq. (5.15) or Fig. 5.129 if penstock velocity is known. With a flow of 0.078 m³/s descending a 250 mm-diameter penstock, the velocity can be determined to be

$$v = \frac{Q}{A} = \frac{Q}{\pi D^2/4} = 1.6 \text{ m/s}$$

The coefficient of losses from turbulence is the sum of the coefficient of losses of each point where losses are incurred—the inlet, bends, and gate valve. Therefore, from Fig. 5.128,

$$K_T = 0.5 + 2(0.3) + 0.1 = 1.2$$

and the losses can be derived from Eq. (5.15) or Fig. 5.129 to be about 0.2 m. The actual head is therefore closer to 33.6 m if losses from both friction and turbulence are included.

Because the net head has now been determined to be slightly less than the 33.8 m calculated considering only friction losses, a flow slightly greater than 0.078 m³/s would now be required to generate 18 kW. The steps performed above can be repeated assuming a net head of 33.6 m rather than 33.8 m to obtain a more precise value for the losses caused by friction and turbulence. However, changes in the values of flow and net head will be negligible.

(c) To determine whether a 200 mm-diameter PVC pipe can be used, the above procedure is repeated. In this case, the net head is found to be 32.2 m. Whereas a penstock of reduced diameter can be used, the reduced operating head means that the flow required to generate 18 kW has increased very slightly, requiring a slightly larger turbine to generate the same power. Although penstock velocity is now larger, the surge pressures are not necessarily higher because of the lower elasticity of PVC. (This will be discussed in **Selecting wall thickness**, p. 133.)

If a mathematical rather than graphical solution is desired, it is possible to incorporate both friction and turbulence losses in a single equation for the case of a penstock with a constant diameter:

$$h_t = h_t + h_f = Q^2 \left(10 \frac{L n^2}{D^{5.3}} + \frac{.083 K_T}{D^4} \right) \quad (5.16)$$

Although it is straightforward to determine either " h_t " or " Q " if the other is known and the pipe diameter is given, this equation cannot be solved in closed form for pipe diameter. If friction is indeed the major source of the losses, the second term can be neglected and the resulting equation can then be solved for pipe diameter for a given head loss and flow:

$$D = \left[\frac{10 (Q n)^2}{(h_f / L)} \right]^{0.19} \quad (5.17)$$

Commercial pipe of standard diameters is often used for micro-hydropower schemes. Because available pipe diameters probably bracket the desired diameter derived above, selecting the larger of the two diameters will keep losses and velocities within desirable limits. Once pipe diameter has been established, actual head losses in the pipe, including those caused by turbulence, can be determined with the original, longer equation, Eq. (5.16), to ensure that total head loss is acceptable. Equivalently, the graphs may be used.

If the diameters of available pipe are less than that required, two or more pipes can be laid in parallel and joined together before entering the turbine (Fig. 5.131). If pipes of equal diameter are used, both the flow and head loss in each are equal. Any of the previous approaches can then be used to find losses. With more than one penstock pipe of equal diameter, total head loss is equal to the loss for any one pipe, not the sum of individual pipe losses. If pipes of unequal diameters are used, any of the previous approaches can also be used to determine the flow in each pipe. However, in this case, although the head loss in each pipe must still be the same, flows in each will be different.

Selecting wall thickness. The approximate wall thickness selected for a penstock pipe is generally a function of the material selected (its tensile strength), the diameter of the pipe, and the operating pressures it will experience during use. The operating pressure at any point along a penstock results not only from the head of water above that point but also from surge pressures which arise from rapid changes of flow in the penstock. Although transitory in nature, surge pressures can be large and must be considered in selecting the wall thickness of a penstock pipe.

When a hydropower plant is operated, gradual changes in flow cannot be guaranteed. Sudden changes in flow can occur when the plant operator or governing apparatus rapidly opens or closes the inlet gate or valve or when debris enters the penstock and lodges itself in the nozzle. With this sudden change in flow velocity, the corresponding change in kinetic energy of the water gives rise to pressure surges in the penstock, commonly referred to as "water hammer." The size of these momentary pressure surges can be significant. They can exceed the static pressure and can cause the pipe to burst or they can reduce pressures to below ambient pressures and cause the pipe to collapse. A qualitative description of the water hammer phenomenon is found in **APPENDIX F** (p. 274).

A parameter used to indicate under what circumstances water hammer pressures should be considered is called the critical time (s) and is defined as

$$T_c = \frac{2L}{a} \quad (5.18)$$

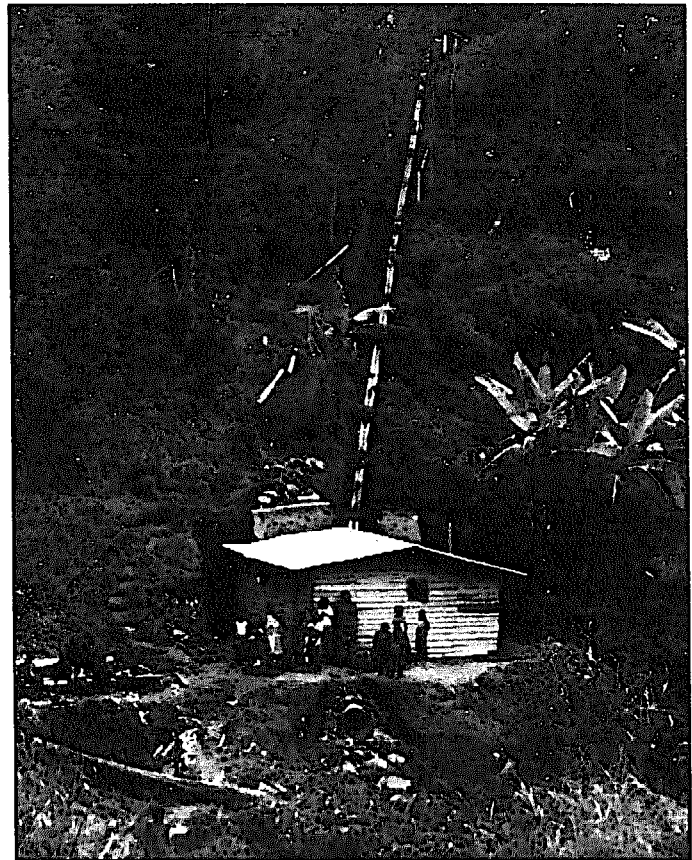

Nyakabonga, Kivu Prov., Zaire (10 kW)

Fig. 5.131. Because the diameter of a single length of asbestos-cement pipe available at the time of construction would have been too small for the flow which was required, two parallel lengths were used.

where

$$\begin{aligned} L &= \text{penstock length (m)} \\ a &= \text{wave velocity (m/s) [Eq. 5.19]} \end{aligned}$$

The wave velocity used in this equation can be expressed as

$$a = \frac{1420}{\sqrt{1 + \frac{1000 K D}{E t}}} \quad (5.19)$$

where

$$\begin{aligned} a &= \text{wave velocity (m/s)} \\ K &= \text{fluid bulk modulus} = 2.1 \cdot 10^6 \text{ kPa or } 2.1 \cdot 10^4 \text{ kgf/cm}^2 \text{ for water} \\ D &= \text{internal pipe diameter (m)} \\ E &= \text{modulus of elasticity of pipe (use same units as K above) (see Table 5.5)} \\ t &= \text{wall thickness (mm)} \end{aligned}$$

The effect of critical time on the magnitude of surge pressure is described below. It is assumed that the penstock pipe has a uniform diameter and thickness along its entire length, as is usually the case. (If not, the conclusions would have to be modified to take this factor into account. This case will not be addressed here.)

The magnitude of the surge pressures which will be encountered in the operation of a plant depends on how quickly flow velocity changes in the penstock. If this change occurs in less than critical time, maximum surge pressures will be experienced. If the valve is closed instantaneously, the entire length of penstock will experience this pressure peak. As more time is taken to close the valve, a decreasing length of pipe from the valve up is subjected to this peak. When the time of closure equals the critical time, the peak pressure is felt only by the valve at the end of the penstock. Joukovsky's equation expresses the value of this peak pressure as:

$$P_s = \frac{a \Delta v}{g} \quad (5.20)$$

where

- P_s = maximum surge pressure (in m of water)
- a = wave velocity (m/s), see Eq. (5.19)
- Δv = change in flow velocity in pipe (m/s)
- g = acceleration due to gravity = 9.81 m/s²

EXAMPLE 5.8 illustrates how peak surge pressures at a specific site can be determined.

If uniform valve closure is relatively slow, maximum pressures will be experienced at the valve, with the pressure rise decreasing to zero uniformly along the length of the penstock. If hydraulic losses in the penstock are assumed to be insignificant, an approximate expression for the maximum pressure " p_s " is given by

$$P_s = \frac{K}{2} \pm \sqrt{K + \frac{K^2}{4}} \quad (5.21)$$

EXAMPLE 5.8

Assume that, for a site with a gross head of 29 m, either of two penstock options is being considered:

- 300 mm PVC pressure pipe (with 14 mm wall thickness)
- 300 mm welded steel pipe (with 3 mm wall thickness)

(a) If the flow velocity in the PVC penstock is 1.2 m/s, what is the surge pressure if the flow suddenly stops?

(b) How much greater would the surge pressure be if the steel penstock were used?

(a) To derive the surge pressure requires knowing the velocity " a " of a pressure wave within the penstock. From Eq. (5.19),

$$a = \frac{1420}{\sqrt{1 + \frac{(10^3)(2.1 \cdot 10^4)(0.30)}{(2.8 \cdot 10^4)(14)}}} = 340 \text{ m/s}$$

where

$$K = \left[\frac{L \Delta v}{g H_g T} \right]^2$$

T = time for valve closure (s)

This expression gives a good approximation if valve closure times are greater than about twice critical time (39). The positive sign is the pressure rise caused by a closing valve; the negative sign is for an opening valve. Fig. 5.132 provides a quick solution to Eq. (5.21).

If closing time is long enough and the value of " K " is significantly less than 1.0, Eq. (5.21) can be reduced to the form

$$P_s = H \sqrt{K} = \frac{L \Delta v}{g T} \quad (5.22)$$

Even if the closing time for a valve is greater than the critical time, a sudden velocity change can still occur unexpectedly, such as when a large nut or other fruit is swept in by the water or an improperly secured spear valve suddenly becomes lodged in the nozzle opening. If there is any possibility that the flow velocity will change rapidly during the plant's operation, the surge pressure caused by this sudden change can be derived using Eq. (5.20) and will set the upper limit of its value.

To determine the minimum pipe thickness required at any point along the penstock, it is necessary first to find the maximum pressure which can act there. This pressure is the sum of two pressures--the net head at that point (gross head to that point minus friction losses) plus the surge pressure. The contribution from pressure

Using Eq. (5.20), the surge pressure can then be calculated to be

$$P_s = \frac{(340)(1.2)}{9.8} = 42 \text{ m}$$

At the instant the flow stops, the total pressure at the base of the PVC penstock pipe would reach a pressure approximately equal to a head of 70 m or, equivalently, 7.0 kgf/cm².

(b) For a given change in velocity, Eq. (5.20) shows that surge pressure is proportional to the wave velocity in the pipe, which Eq. (5.19) shows depends on penstock cross-sectional dimensions and the material used in its construction. Therefore,

$$\frac{(P_s)_{\text{steel}}}{(P_s)_{\text{PVC}}} = \frac{a_{\text{steel}}}{a_{\text{PVC}}} = \frac{1000 \text{ m/s}}{340 \text{ m/s}} = 2.9$$

Because steel pipe is stiffer, surge pressures in this case are approximately three times greater than those associated with the PVC penstock.

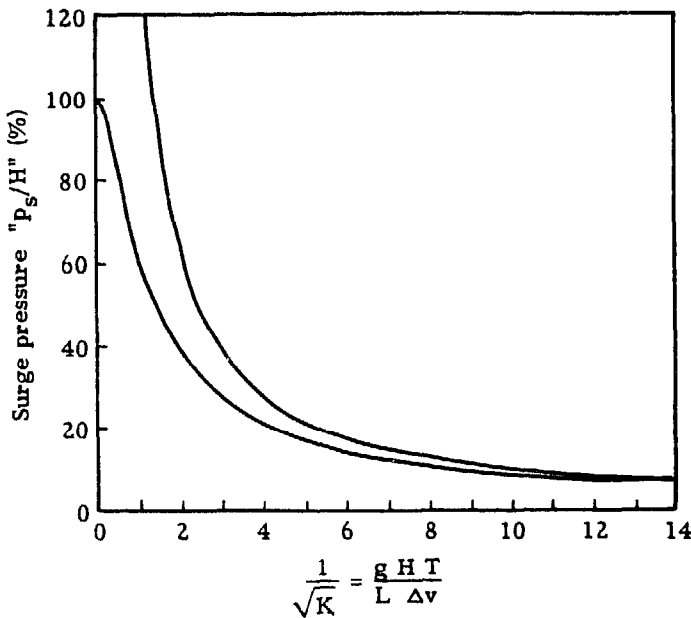

Fig. 5.132. Graphical solution to Eq.(5.21) for determining peak pressure surge caused by a slowly closing valve.

surges is only transitory but it should be included unless the hydropower scheme has been designed to preclude the possibility of surge pressures. An approximation for the absolute maximum pressure can be obtained by adding the gross head at that point to the surge pressure, assuming instantaneous gate closure at the base of the penstock. This is illustrated in Fig. 5.133. Friction and turbulence losses are usually negligible. The gross head at each point is simply the difference in elevation between the forebay water level and that point. The maximum surge pressure is that found by using Eq. (5.20).

If commercial pipe is used, it is often rated by pressure class, which is related to the maximum working pressure under which it is designed to operate. For such pipe, there is no need to derive the thickness required under specific operating conditions. Rather than being specified by its thickness, this pipe is simply specified by its maximum working pressure. The pressure rating of a pipe already includes a safety factor, the magnitude of which depends on the standard used, and sometimes may include an allowance for surge pressures.

When pressure ratings are used, they must be understood if the most appropriate pipe is to be selected. For example, AWWA (American Water Works Association) C900 is one standard specification among several for PVC pressure pipe used in the United States. This one is based on a design safety factor of 2.5 and includes an allowance for surge pressures based on an instantaneous velocity change of 2 ft/s. For example, pipe rated as Pressure Class 150 under this standard can accommodate pressures up to 150 psi plus a surge pressure of 35 psi. This pipe can be used for working pressures somewhat above its rated pressure and still operate with the same safety factor, but then the allowance for surge pressures is reduced correspondingly. With no allowance for surge pressures, a working pressure can attain

150 + 35 = 185 psi. If a safety factor of 2 rather than 2.5 is deemed adequate, the maximum working pressure for this pipe can attain 185 (2.5/2.0) = 230 psi. Consequently, although it may appear that AWWA C900 Pressure Class 150 PVC pipe can accommodate only a maximum working pressure of 150 psi, a knowledge of standards shows that this pipe can accommodate a working pressure of up to 230 psi with a fully acceptable safety factor, if surge pressures can be avoided in the design of a hydropower scheme.

If pipe is to be fabricated, the minimum pipe thickness required to safely accommodate a given pressure has to be determined. This can be expressed as

$$t = 50 \frac{p D}{s} \quad (5.23)$$

where

- t = pipe thickness (mm)
- p = pressure (m of water)
- D = pipe internal diameter (m)
- s = design stress of pipe material (kgf/cm²)
= ultimate tensile strength/safety factor (see Table 5.5)

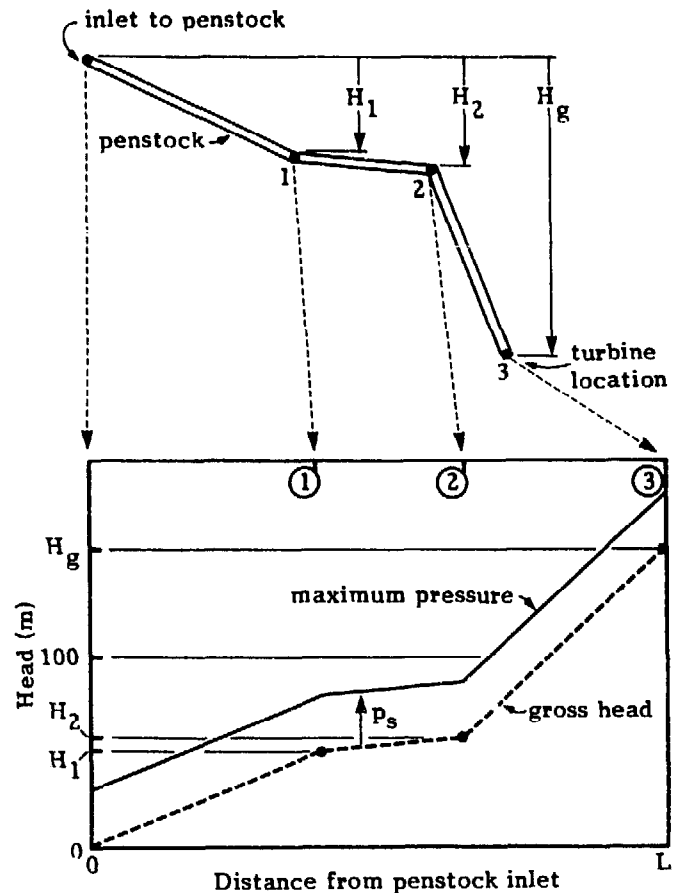

Fig. 5.133. Example of the maximum pressure along a penstock pipe at design flow. The net head at each point is approximately equal to the sum of the gross head and surge pressure.

Because the maximum pressure changes with the distance along the penstock, the minimum required thickness would change accordingly. However, commercial pipe is available in standard wall thicknesses. Even if steel pipe is fabricated, steel sheet is also available in standard thicknesses. It is therefore necessary to find the pipe or pipe material with the standard thickness closest to that derived using the previous equation. If pipe with a common single thickness is used for the entire penstock, the maximum pressure at the lower end of the turbine would set the thickness of the pipe. However, cost creates an incentive to use the thinnest pipe available for the job. This may mean that pipes with similar diameters but different thicknesses could be used along a penstock. If pipes are available for working pressures of 100 m and 200 m for the case illustrated in Fig. 5.133, for example, the thinner and less costly pipe (designed for working pressures up to 100 m) could be used to approximately point 2. At this point, the thicker pipe would be used to accommodate the higher pressures found at the lower end of the penstock.

Equation (5.23) considers only the wall thickness necessary to accommodate working pressures. Accordingly, thin-walled pipes can be used with low-head schemes. However, these would be difficult to handle and install and, with uncoated steel pipes, may be underrated quickly as they rust. Minimum thickness for low-pressure applications is therefore determined by the need for stiffness, corrosion protection, and strength. The American Society of Mechanical Engineers (ASME) code for the desired minimum thickness (26) can be expressed as

$$t_{\min} = 2.5 D + 1.2 \quad (5.24)$$

where

t = minimum wall thickness (mm)
 D = pipe diameter (m)

Expansion joints

If an unrestricted pipe of length "L" changes in temperature, there will be a change in its length equal to

$$\Delta L = L a \Delta T \quad (5.25)$$

where

ΔT = change in temperature ($^{\circ}\text{C}$)
 a = coefficient of linear expansion ($^{\circ}\text{C}^{-1}$)
 (see Table 5.5)

In this expression, " ΔL " and "L" are expressed in the same units.

This expansion and contraction can be accommodated in three ways:

- (1) If the pipe is flexible, with bends between any anchors or supports, the bends can take up any expansion or contraction.

- (2) If the pipe is rigid and composed of straight lengths, with bends only at anchor blocks, any movement of the pipeline is completely in check. Rather than causing movement of the pipe [Eq. (5.25)], temperature changes cause stresses within the pipe equal to

$$s = E a \Delta T \quad (5.26)$$

where

s = stress due to thermal expansion (kgf/cm^2)
 E = Young's modulus of elasticity (kgf/cm^2)
 (see Table 5.5)

This stress exerts a force " F_e " (kgf) on the anchors which is a product of the stress and the cross-sectional area of the material of which the pipe is composed:

$$F_e = 31 s D t \quad (5.27)$$

where

s = stress, see Eq. (5.26)
 D = pipe diameter (m)
 t = wall thickness (mm)

EXAMPLE 5.9. illustrates use of this equation.

Because the thickness of pressure pipe is proportional to pipe diameter for a specific head, Eq. (5.27) shows that the force caused by thermal expansion is proportional to the square of diameter. These forces can be counteracted easily for the small penstock diameters commonly used with small micro-hydro-power plants; however, they can be considerable for larger diameter penstocks and must be accounted for when designing anchors (see **Support piers, anchors, and thrust blocks**, p. 138).

- (3) Expansion joints can be used to reduce the size of the anchors required to counteract forces that arise from thermal expansion.

As an analogy, rails used as railroad tracks experience the same phenomenon of thermal expansion. The first option noted for accommodating expansion is not possible because the rails must remain straight and parallel. However, the third option was often used. The several millimeters left between adjoining lengths of rail were able to accommodate any foreseeable expansion and serve as an "expansion joint." Nowadays, continuous rails are popular. In this case, rails are locked onto railroad ties so that they cannot buckle or move sideways when temperature changes induce stress. This is analogous to the second option, where support piers restrain the penstock pipe and prevent it from buckling.

There are two basic designs for expansion joints: a sleeve-type expansion joint and a bellow or diaphragm type. The sleeve-type expansion joint is shown in Figs. 5.18, 5.134, and 5.135. This assembly can be incorporated at the end of one length of pipe, with the next length of pipe fitting into it, or can be a separate

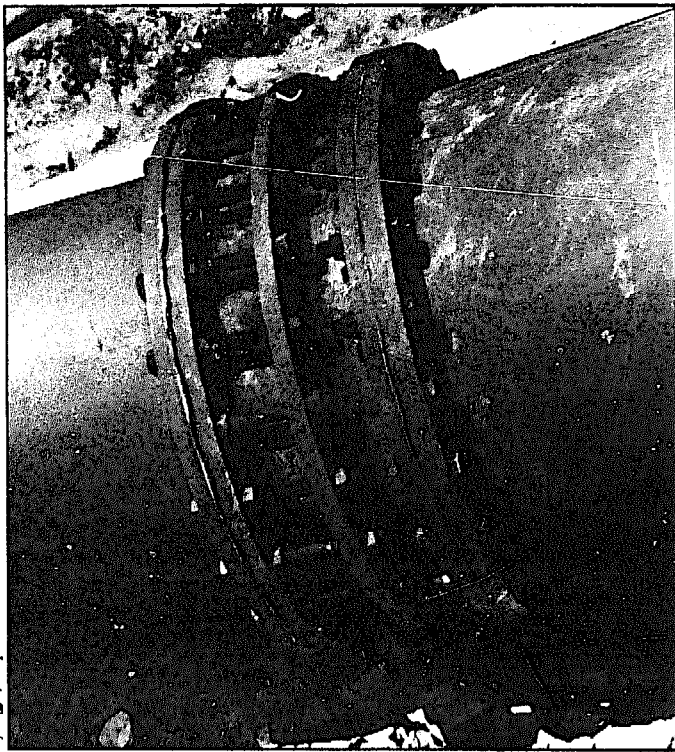

Fig. 5.134. A sliding-type expansion joint.

flanged section which can be dropped between two consecutive pipe sections and bolted to them. After the assembly has been put in place, braided hemp or flax impregnated with graphite (to reduce longitudinal forces arising from friction between concentric pipe sections) is used as packing and the stay ring bolts are tightened to compress the packing sufficiently to prevent leaking. This type of joint not only permits relative movement between adjoining pipe sections; it facilitates assembly of the penstock because it is collapsible and can be the last section placed in a length of penstock pipe between anchors. This type of expansion joint is often fabricated to accommodate several centimeters of relative movement.

In the bellows or diaphragm type design (Figs. 5.136 and 5.137), the flexibility of the bellows joint accommodates the movement of the pipe. This design is used more frequently with larger-diameter penstocks.

The change in length of a pipe section between consecutive anchors can be determined from Eq. (5.25). If a

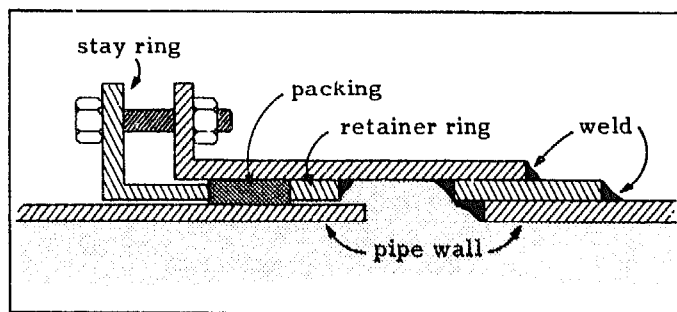

Fig. 5.135. Details of an expansion joint for steel penstock.

single expansion joint cannot accommodate this length, two joints can be used. To ensure that pipe contraction is accommodated by both joints and that the contraction is not concentrated at only one of them until it separates, joints are available with limiting rods. Alternatively, the two joints can be separated by an intermediate anchor to reduce the length of penstock acting on each joint.

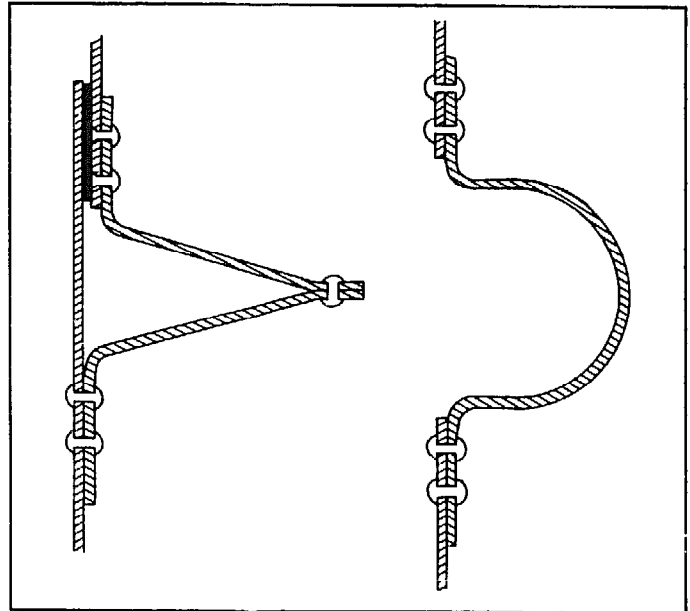

Fig. 5.136. Bellows-type expansion joints (38,41).

EXAMPLE 5.9

A 30 m length of 400 mm steel pipe with a wall thickness of 4.5 mm undergoes a temperature rise of 20 °C after it is emptied for repairs.

- (a) If an expansion joint is used, what expansion will it experience?
- (b) If this pipe were rigidly held, what force resulting from this temperature change would have to be counteracted by the anchors?

(a) The pipe would experience the following expansion:

$$\Delta L = (30)(12 \cdot 10^{-6})(20) = 0.007 \text{ m} = 7 \text{ mm}$$

(b) If it were rigidly held, the stress from thermal effects which would build up in the pipe wall would be

$$s = (2.1 \cdot 10^6)(12 \cdot 10^{-6})(20) = 500 \text{ kgf/cm}^2$$

The penstock would then push against the anchor block with the following force:

$$F_e = (31)(500)(0.4)(4.5) = 28,000 \text{ kgf}$$

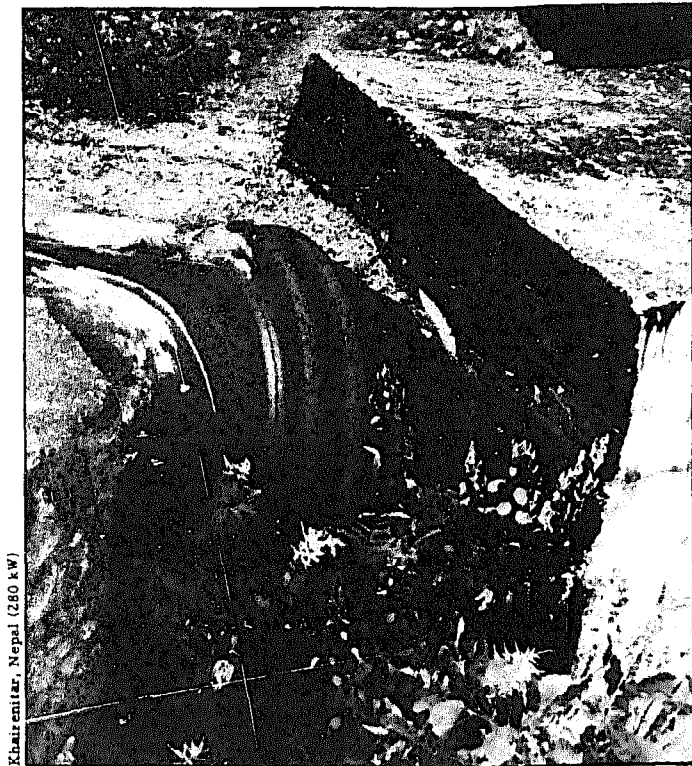

Khairemir, Nepal (280 kW)

Fig. 5.137. Two diaphragm-type expansion joints.

If the pipeline is flat, expansion joints are usually located midway between anchors to minimize movement of the pipe over the piers. On steep slopes, expansion joints for steel penstocks are generally located just below the uphill anchor. Because pipe tends to slide downhill, the pipe laying can be facilitated by working uphill and then inserting the expansion joint to finish the length. The anchor at the base of a steep drop rather than the upper anchor then resists the weight of the pipe and water; this lower anchor is usually easier to construct. Where supports are included between consecutive anchors, locating the expansion joint just below the uphill anchor means that the force caused by friction from the movement of the pipe on each intervening support is also transferred to the downhill anchor.

Support piers, anchors, and thrustblocks

Support piers, anchors, and thrustblocks all serve the same basic function--to provide the necessary forces on a rigid pipe to check undesired movement. Different terms are used with these structures simply to indicate which specific function they serve: support piers primarily support or carry the weight of the pipe and enclosed water; anchors, largely by virtue of their size, anchor or prevent the pipe from moving in response to a number of forces; and thrustblocks prevent the buried pipe from moving by transmitting the force or thrust to the surrounding soil.

Support piers. The weight of the portion of pipe and enclosed water which is supported by the pier creates a force which can be divided into two components: one

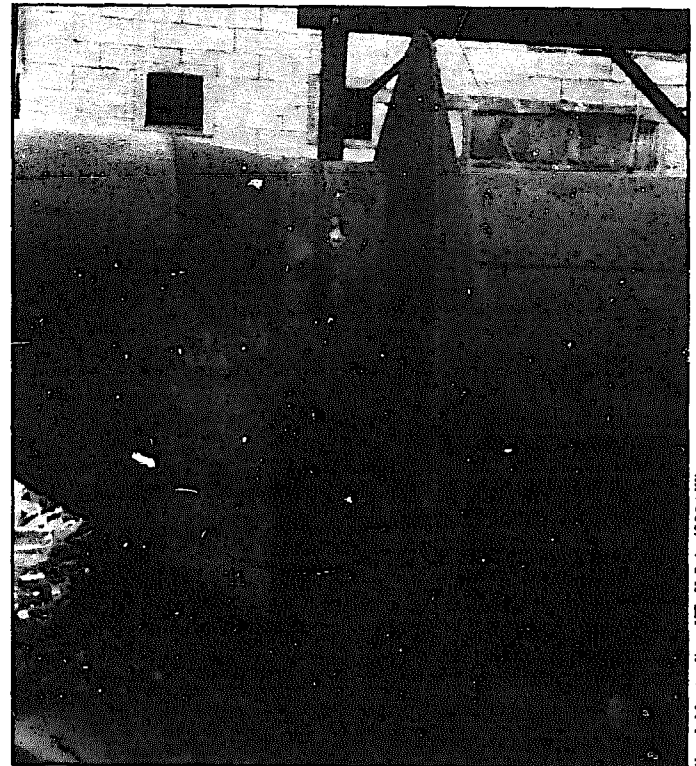

North Montpelier, VT, U.S.A. (220 kW)

parallel to the pipe and one perpendicular to it (see insert in Fig. 5.138). A support pier is not designed to resist significant longitudinal forces and is therefore unaffected by the component of this weight parallel to

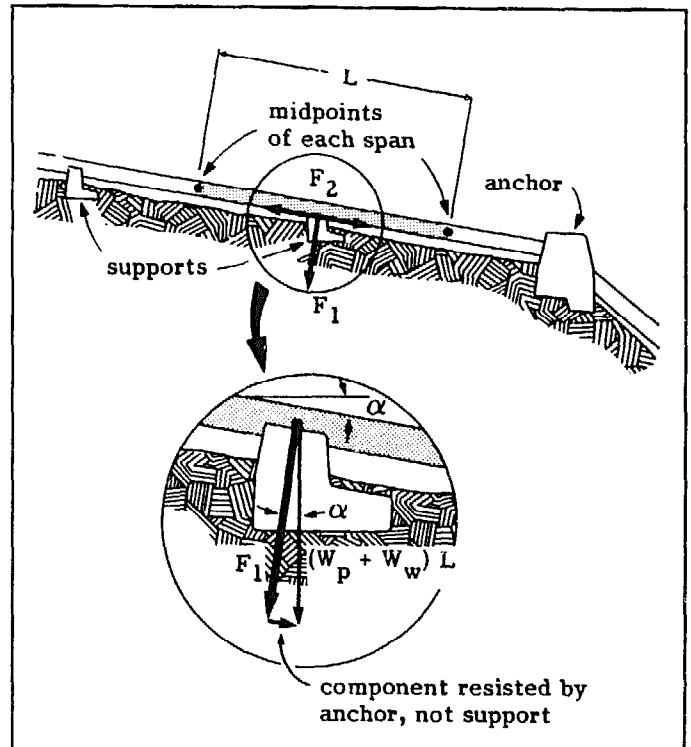

Fig. 5.138. Two principal forces exerted on a support pier by the penstock.

the pipe; an anchor is designed to resist this component. The other component can give rise to two forces:

- (1) Component of the weight of pipe and enclosed water perpendicular to pipe. This is the component of the weight which has to be transmitted to, and resisted by, the ground. This force " F_1 " (kgf) has a value of

$$F_1 = (W_p + W_w) L \cos \alpha \quad (5.28)$$

where

- W_p = weight of pipe per unit length (kgf/m)
 W_w = weight of water per unit length of pipe (kgf/m)
 L = length of pipe supported by pier (m), as defined in Fig. 5.138
 α = angle of pipe with the horizontal

- (2) Friction of pipe on supports. If the design of a penstock permits longitudinal movement as it would for a pipe that includes an expansion joint, this movement across the top of a support generates a friction force " F_2 " (kgf) which acts in the direction of this movement. This force has a magnitude

$$F_2 = f F_1 = f (W_p + W_w) L \cos \alpha \quad (5.29)$$

where

- f = coefficient of friction of the pipe against the support pier
 = 0.60 steel on concrete (cradle supports, Fig. 5.139)
 0.50 steel on steel (rusty plates)
 0.25 steel on steel (greased plates)
 0.15 deteriorated rocker supports (26)

Longitudinal forces on a support can be reduced significantly by using roller (Fig. 5.140) or rocker supports (Figs. 5.144 and 5.145).

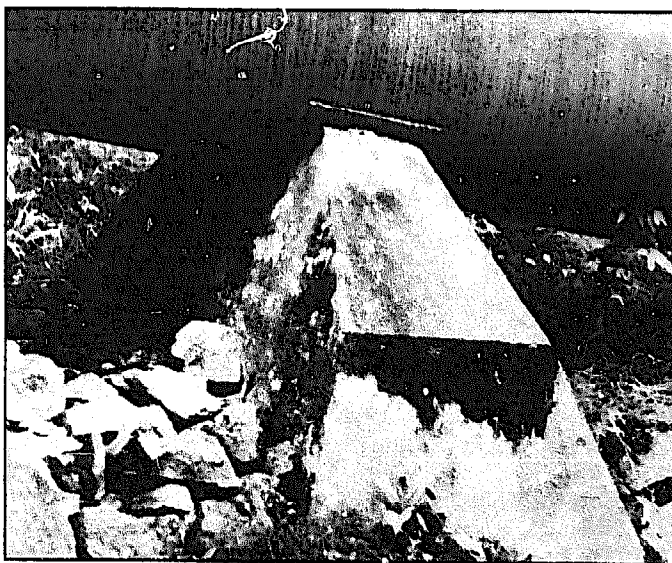

Fig. 5.139. The portion of pipe in contact with the concrete cradle is reinforced with an additional thickness of steel.

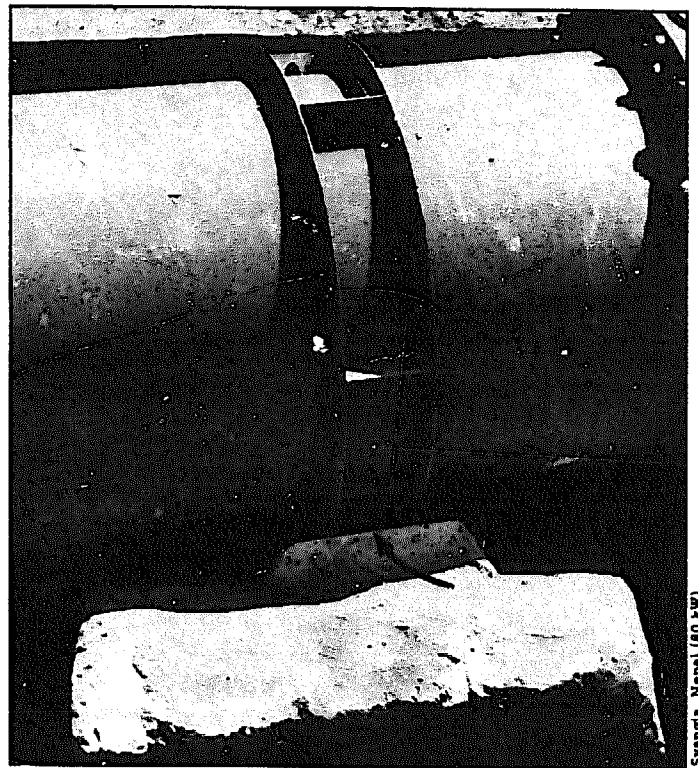

Fig. 5.140. This 800 mm penstock rests on two cylindrical rollers to reduce friction forces between it and the support.

The direction of this force is the same as the direction of pipe's movement. For example, if the pipe temperature rises, the pipe will expand and the portion of the pipe uphill of an anchor will move uphill, giving rise to a force F_2 on the pier in that direction.

All the forces acting on a support pier, except for the reaction force from the ground (caused by friction and foundation pressure), can be diagrammed as shown in Fig. 5.141. In designing a support pier, these forces will be resolved in horizontal and vertical components in a coordinate system with its origin at the corner of the pier as shown (see Reducing the forces acting on a structure, p. 145). The force W represents the weight of the support pier.

To minimize wear on the pipe from its movement over the supports, a layer or two of asphalt or tar paper is frequently placed between the pipe and support.

Support piers should be spaced to prevent excessive bending stress in the pipe and limit the sag between supports to acceptable limits. The recommended span for PVC pipe varies from 1.5 m for 80 mm pipe to 2.0 m for 150 mm pipe to 2.5 m for 300 mm pipe (10). For steel pipe, maximum spans should be limited to 5 m for smaller diameters to 8 m for diameters over 350 mm (76).

As with any of these structures, the support piers should be placed on original soil and not on fill. The bearing area should be able to support the forces on the pier

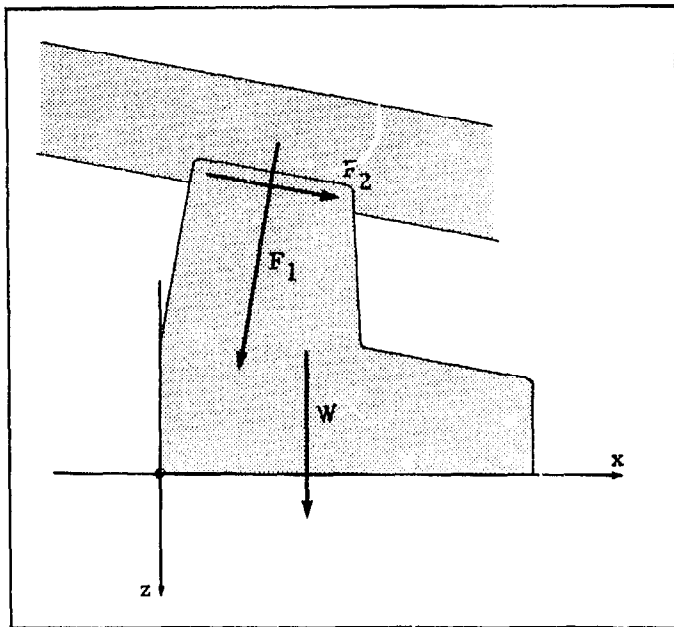

Fig. 5.141. The three forces originating from the interaction of a penstock pipe and support pier which must be counteracted through ground forces.

without exceeding the safe bearing capacity of the soil (see **Conditions for stability**, p. 146). The soil beneath the pipe should be bermed and necessary drainage should be provided to prevent erosion of the support foundation.

Unless they are founded on bedrock, supports should not be located within a streambed. Although excavating into gravel and stone deposits in the riverbed during the dry season may seem to yield a firm foundation, the high velocities of water flowing around a support during the rainy season can easily undermine it (Fig. 5.142).

For rock surfaces, piers can merely be a coating of concrete to smooth up the rock. If a concrete block for a support pier is on hard, durable rock, at least some of

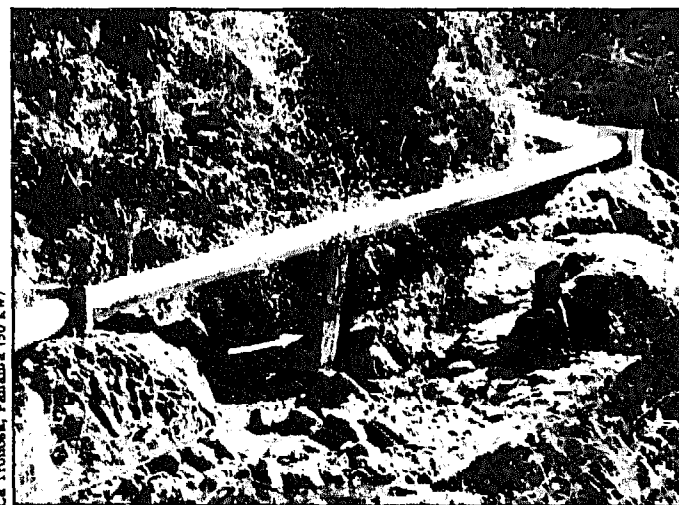

Fig. 5.142. Even before the plant is operational, a concrete support at the edge of the stream (at the center of the photograph) has already been undermined.

the force that the pipe imposes on the pier can be resisted by anchoring steel rods into rock, if they are designed to be tightened.

For large penstocks, concrete supports are cast in place. If a pipe is long, this becomes inconvenient because it requires the construction of numerous concrete structures, often on rugged terrain. One alternative is to precast concrete cradles, transport them to the site, hang them from the penstock, which is temporarily blocked up, and then pour footings in place to complete the support (Fig. 5.143). This approach has the added advantage of eliminating the need to properly align the supports before installing the penstock (44).

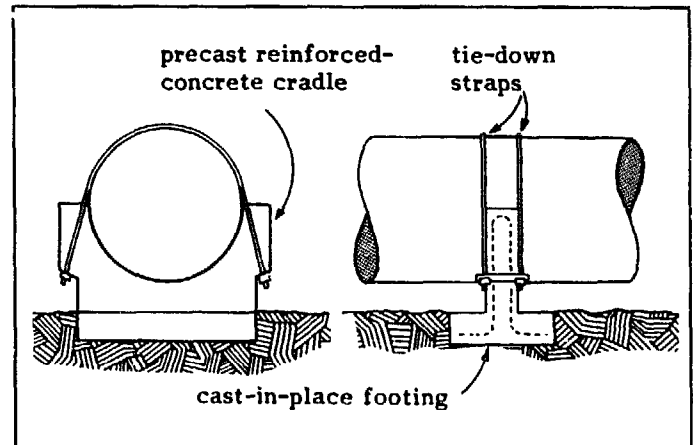

Fig. 5.143. Precast penstock support (44).

To traverse a ravine or other dip in the terrain, a short penstock span can be supported by steel or wooden stringers resting on each side of the ravine. For longer spans, the penstock can be supported on trusses, constructed of angle iron or timber, resting on a concrete foundation block within the dip or ravine (Fig. 5.144). Supports should not be located in a stream or at the bottom of a ravine, because erosion might undermine them. For large penstocks, ring girders or stiffeners are welded around the pipe at support points to prevent deformities of the pipe shell at these points and to provide a places to attach the pipe to the support piers or trusses (Fig. 5.145). When small-diameter pipe is used, it will probably be stiff enough to prevent deformity, and simple tabs welded to the pipe may be adequate to achieve the second function.

Anchors. An anchor generally consists of a mass of reinforced concrete surrounding the penstock. By virtue of its weight and bearing area, it is designed to withstand any load the penstock may exert on it and anchor it securely to the ground. Anchors are often used at horizontal and vertical bends and also at regular intervals along long straight sections of penstock. Because an anchor is keyed to the penstock pipe and is also frequently located at a bend in the pipe, more forces act on an anchor than on a support pier. These forces are described below, and mathematical expressions for their magnitude are presented in Table 5.6. Use of the formulas in this table for a specific installation will permit the relative importance of each force described below to be determined. Frequently, several of the forces

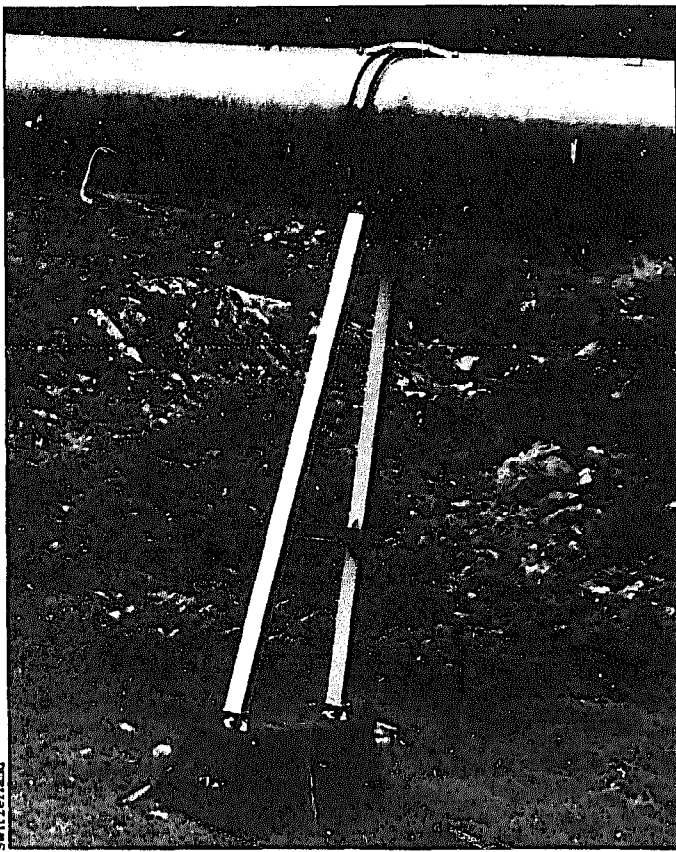

Fig. 5.144. This support, which has the same characteristics as a rocker support, permits the penstock to traverse irregular terrain while avoiding bends in the pipe.

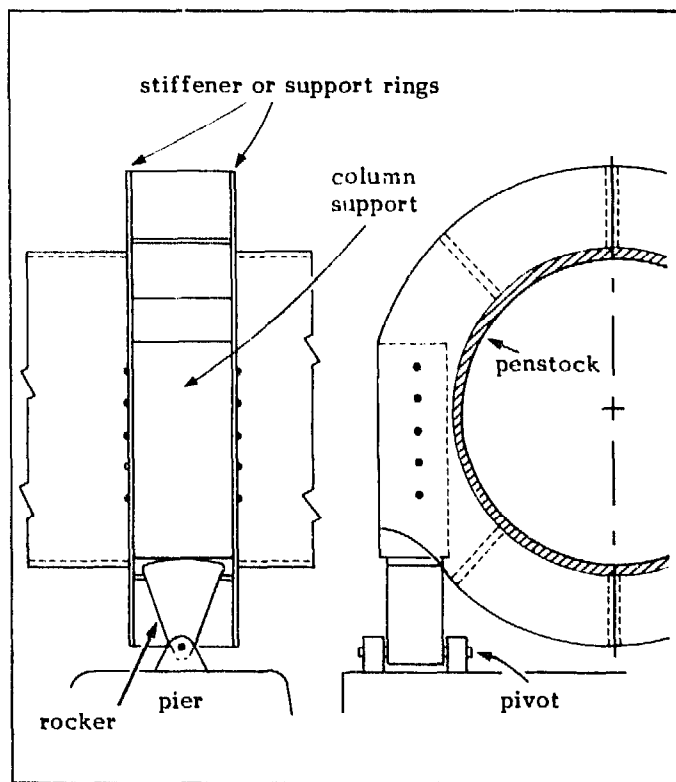

Fig. 5.145. A simplified representation of a typical rocker support.

described below can be disregarded because they are insignificant or nonexistent.

- (1) Component of the weight of pipe and enclosed water perpendicular to pipe. This force is analogous to force " F_1 " acting on supports. Because there may be a bend at the anchor, however, both the upstream and downstream lengths of pipe contribute separately, each force perpendicular to the centerline of the pipe segment which contributes to it. Figure 5.146 illustrates only the contribution from the upstream length. It should be noted that the force that results from the parallel component of the weight of these lengths of pipe is included in force " F_4 ".
- (2) Friction of pipe on supports. If the penstock moves longitudinally over support piers, a friction force on the pipe is created at each support as described in **Support piers** (p. 138). A force " F_2 ", equal to the sum of all these forces but opposite in direction, acts on the anchor (Fig. 5.147). This force exists only where one or more support piers are located between the anchor and an expansion joint. For example, if an expansion joint is located just downhill of the anchor, friction forces on the downhill length of pipe will not be transmitted to the anchor from that side.
- (3) Hydrostatic pressure within a bend. The hydrostatic pressure within the water in a bend creates a force " F_3 " which acts outward as shown in Fig. 5.148 (or inward if the bend is concave upward). This is a major force which must be considered in designing anchors or thrustblocks for medium- and high-head schemes, but it can be minimized by avoiding significant, discrete bends along the penstock alignment, such as by using gradual curves along a plastic penstock.

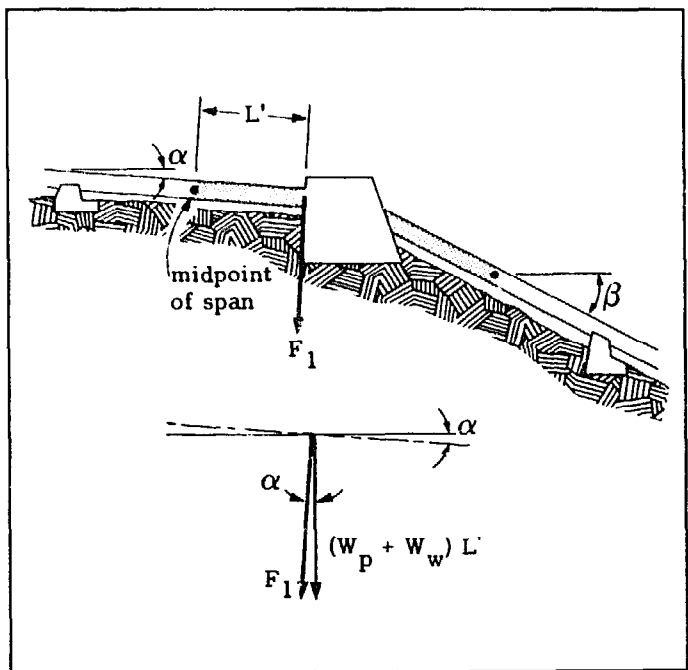

Fig. 5.146. The uphill portion of the pipe span is shown contributing a force normal to its centerline.

TABLE 5.6. The magnitude of the forces which may be encountered in designing an anchor

Source	Magnitude (kgf)	Direction
(1) Component of weight of pipe and water perpendicular to pipe	$F_1 = (W_p + W_w) L' \cos \alpha$ **	
(2) Friction of pipe on supports	$F_2 = f (W_p + W_w) L'' \cos \alpha$ **	
(3) Hydrostatic pressure of bend	$F_3 = 1.6 \cdot 10^3 p D^2 \sin(\frac{\beta - \alpha}{2})$	
(4) Component of weight of pipe parallel to pipe	$F_4 = W_p L \sin \alpha$ **	
(5) Thermally induced stresses (if no expansion joints included)	$F_5 = 31 D t E a \Delta T$	
(6) Friction within expansion joint	$F_6 = 3.1 D C$	
(7) Hydrostatic pressure on exposed end of pipe in expansion joint	$F_7 = 3.1 p D t$	
(8) Dynamic pressure at bends	$F_8 = 250 (Q/D)^2 \sin(\frac{\beta - \alpha}{2})$	
(9) Reduction in pipe diameter	$F_9 = 1.0 \cdot 10^3 p A''$	

* Direction of forces shown for expanding pipe; reverse directions if pipe is contracting.

** Replace α by β for contribution to force from downstream penstock section.

a = coefficient of linear expansion of pipe ($^{\circ}\text{C}^{-1}$)
(see Table 5.5)

A'' = reduction of pipe area at pipe reduction (m^2)
= upstream pipe area - downstream pipe area

C = friction in expansion joint per unit length of circumference (kgf/m)

D = pipe diameter (m)

E = (Young's) modulus of elasticity (kgf/cm²)
(see Table 5.5)

f = coefficient of friction between pipe and support piers (see **Support piers**, p. 138)

L = length defined in Fig. 5.149 (m)

L' = length defined in Fig. 5.146 (m)

L'' = length defined in Fig. 5.147 (m)

p = hydrostatic pressure (including surge pressure) at point of interest (m)

Q = flow (m^3/s)

t = penstock wall thickness (mm)

ΔT = maximum temperature change pipe will experience ($^{\circ}\text{C}$)

W_p = weight of pipe per unit length (kgf/m)

W_w = weight of water per unit pipe length (kgf/m)

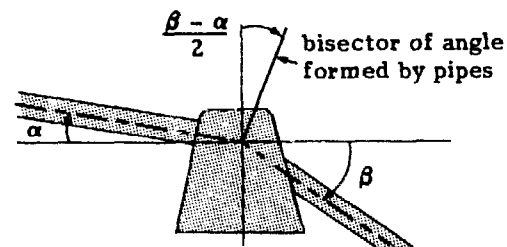

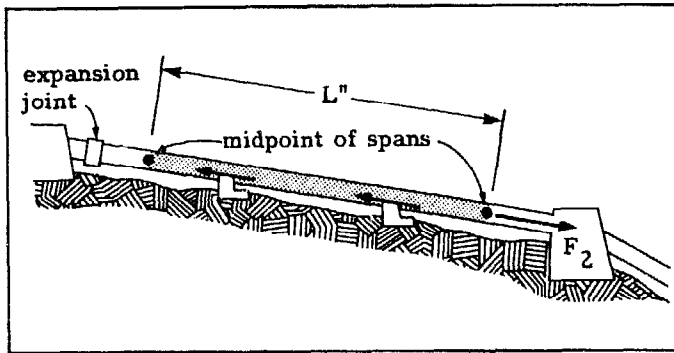

Fig. 5.147. A force in reaction to the sum of the friction forces caused by the pipe's movement over the supports acts on the anchor.

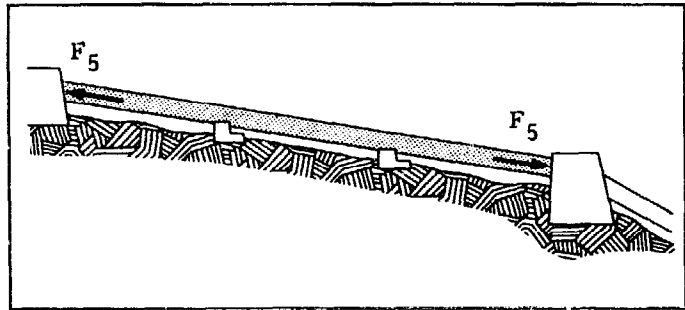

Fig. 5.150. Increase in temperature causes the pipe to expand, creating a force that pushes against the anchors.

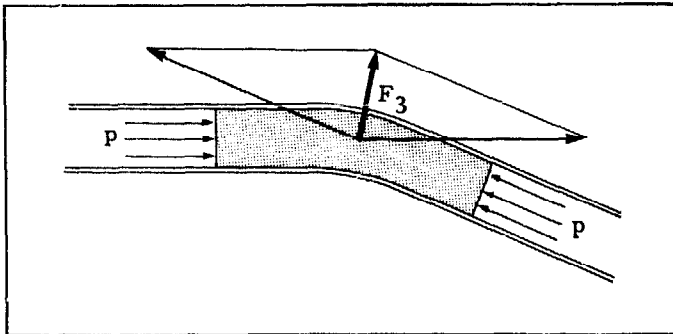

Fig. 5.148. The resultant of the hydrostatic forces at a bend.

- (4) Component of the weight of pipe parallel to pipe. On a slope, the component of the weight of the pipe which is parallel to the pipe tends to pull it downhill and exerts a force on an anchor (Fig. 5.149). The sections of pipe both upstream and downstream of an anchor may have to be considered. The length "L" in the equation for the force "F₄" acting on an anchor is the length of the upstream or downstream section of the penstock which is actually to be held in check by that anchor. The upstream section may begin at the forebay or, more usually, at an expansion joint. The downstream section usually ends at an expansion

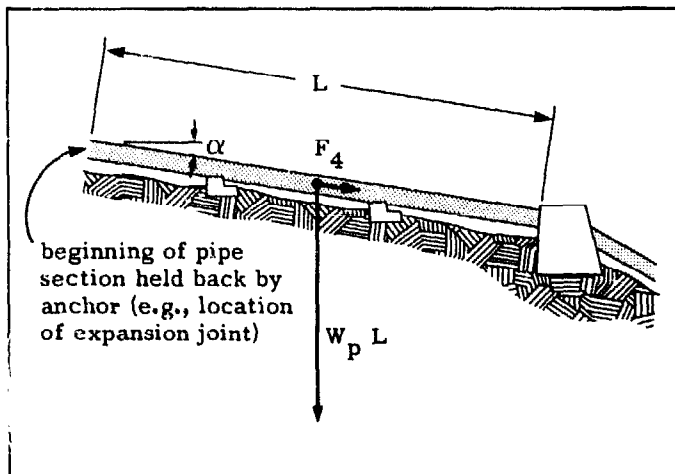

Fig. 5.149. Force on an anchor caused by the weight of the uphill segment of penstock pipe.

joint. If the expansion joint downstream of an anchor block is located near the anchor, as it usually is, the force arising from the weight of the downhill section of pipe between the anchor and the joint is insignificant and usually neglected.

- (5) Thermally induced stresses. If an exposed section of rigid pipe does not incorporate an expansion joint, thermally induced stresses build up in the pipe and act on an anchor. The associated force "F₅" may push against the anchor (with increasing temperature, Fig. 5.150) or pull the anchor (with decreasing temperature).
- (6) Friction within expansion joint. To prevent leaking, the packing within an expansion joint must be tightened sufficiently. However, this tightening also makes it more difficult for the joint to accept any longitudinal movement of the pipe. Friction between the packing and the concentric sleeves in the expansion joint creates a force "F₆" which opposes any expansion or contraction of the pipe (Fig. 5.151). This force is dependent on pipe diameter and tightness of the packing gland. An approximate value is 10 kgf times the nominal pipe diameter in millimeters (3).
- (7) Hydrostatic pressure on exposed end of pipe in expansion joint. The two sections of penstock pipe entering an expansion joint terminate inside the joint; therefore, their ends are exposed to hydrostatic pressure, resulting in a force "F₇" which pushes against the anchors upstream and downstream of the joint (Fig. 5.152). This force usually contributes minimally to the total forces on an anchor.

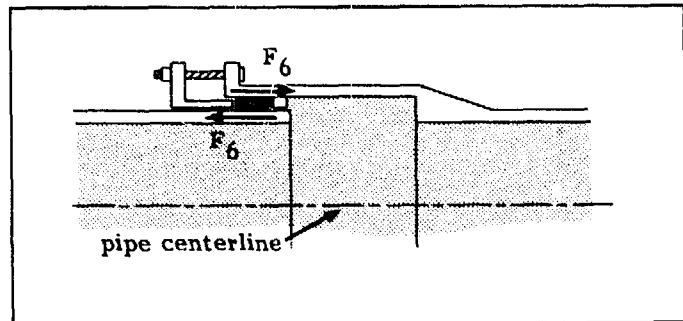

Fig. 5.151. Movement of the pipe within an expansion joint results in a friction force which is transmitted to the anchor. Here, the pipe is shown expanding.

- (8) Dynamic pressure at bend. At the bend, the water changes the direction of its velocity and therefore the direction of its momentum (Fig. 5.153). This requires that the bend exert a force on the water. Consequently, an equal but opposite reaction force "F₈" acts on the bend; it acts in the direction which bisects the exterior angle of the bend. Because velocities in penstocks are relatively low, the magnitude of this force is usually insignificant.
- (9) Reduction of pipe diameter. If there is a change in the diameter of the penstock, the hydrostatic pressure acting on the exposed area creates a force "F₉" which acts in the direction of the smaller-diameter pipe (Fig. 5.154).

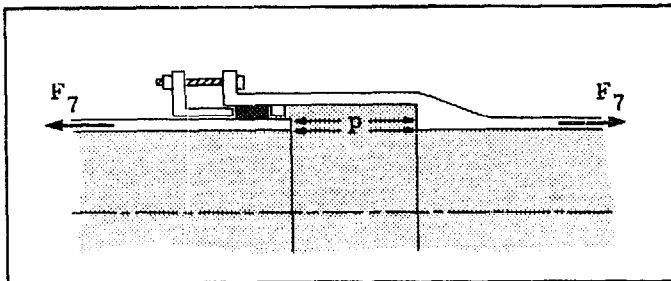

Fig. 5.152. Hydrostatic pressure acting on the exposed end of an expansion joint results in a force which is usually insignificant.

If a section of a penstock is located near a stream and might be submerged during a flood, another force must be considered: the force that arises from buoyancy if the penstock becomes empty during a flood. This force could be counteracted by encasing that penstock section with concrete. This also protects the penstock from boulders and other riverborne debris. Although gabion or timber shields also can be used to protect the pipe, they may not provide the force necessary to counteract buoyancy.

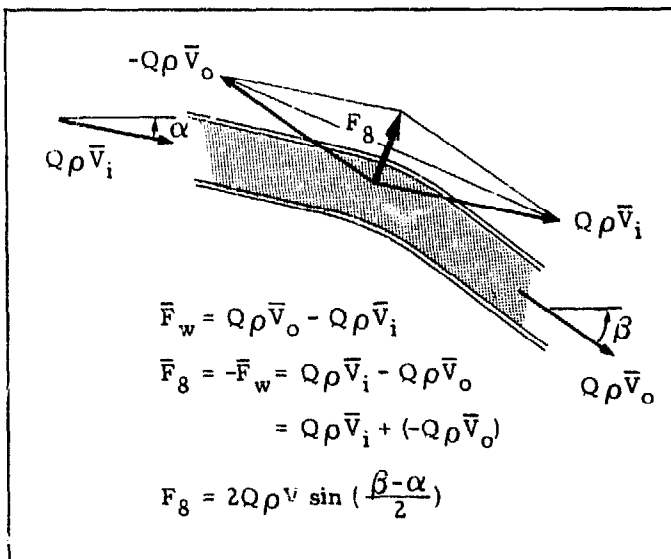

Fig. 5.153. Force caused by dynamic pressure is the vector difference between the momentum of the water into and out of the pipe.

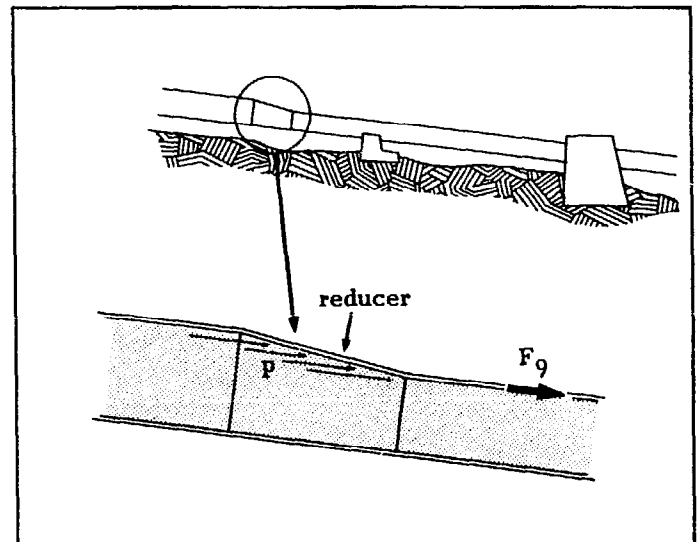

Fig. 5.154. Hydrostatic pressure acting on the walls of the pipe reducer results in a force on the anchor.

To ensure a proper key with the foundation, the foundation for the anchor block should be a serrated rock or soil surface (Fig. 5.155). To ensure a proper key between a steel penstock and concrete anchor, steel tabs can be welded or riveted to the pipe at this point (Fig. 5.156).

Although an anchor is usually designed so that its weight is used to counteract the numerous forces imposed on it by the penstock, steel rods anchored into hard rock can also contribute to this task. If the rods can be tightly secured to the rock, they can keep these forces in check, and the weight and therefore the size of the anchor can be reduced.

Thrustblocks. These are a specialized form of anchor whose sole purpose is to transmit forces primarily caused by hydrostatic pressures "F₃", which are concentrated at distinct bends along a buried penstock, to undisturbed soil which provides the reaction force. But if the force "F₃" is vertically upward, an anchor is still

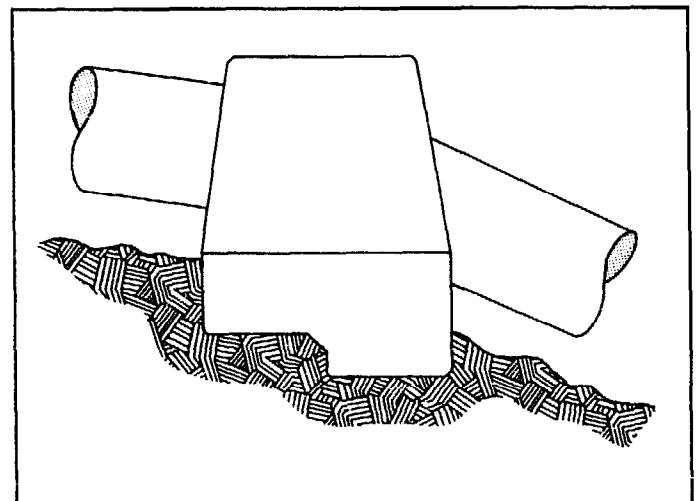

Fig. 5.155. A serrated surface ensures proper key between anchor and foundation.

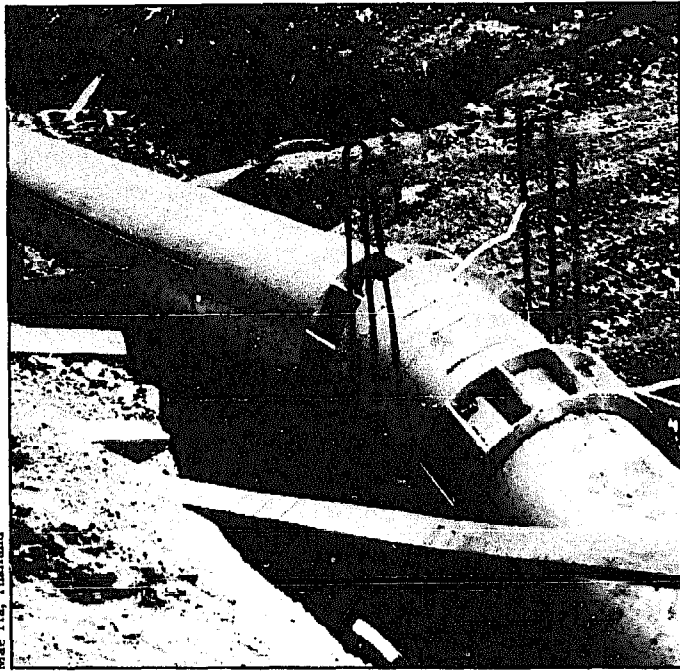

Fig. 5.156. Flanges are welded to the penstock bend to key it to the reinforced-concrete anchor located at the top of the final drop to the powerhouse.

used if the soil above a thrustblock is not able to resist this force. At gradual bends, these forces are uniformly distributed along the pipe, and soil which has been properly backfilled can easily resist the low foundation pressures which result. If there is a sudden reduction of pipe area, a thrustblock would also be required to transmit the associated force "F₉".

The magnitude and direction of the principal force acting on a thrustblock are defined by force "F₃" in Table 5.6. Because buried pipe is not subject to large temperature changes, expansion joints are not used and forces "F₂", "F₅", "F₆", and "F₇" do not arise. Because of low velocities in a penstock, the force "F₈" caused by dynamic pressure at a bend is negligible. The forces "F₁" and "F₄" resulting from the weight of the pipe are distributed along the entire length of penstock and resisted by the soil.

A thrustblock is commonly a block of concrete poured after the pipe is in place. It is placed in a position to transmit the force acting on it to the ground. The thrustblock should be no higher than half the distance from the ground surface to its base (Fig 5.157); otherwise, the soil may not offer sufficient resistance to properly restrain the thrustblock (10). The face of the thrustblock must be approximately perpendicular to the force it is to transmit.

Reducing the forces acting on a structure. In a previous section, a number of forces which a penstock pipe can exert on a support pier, anchor, or thrustblock were discussed. The next step is to design each of these structures to resist these forces. It is first necessary to simplify the problem by reducing all the forces that act on the structure to a single force that acts at a specific

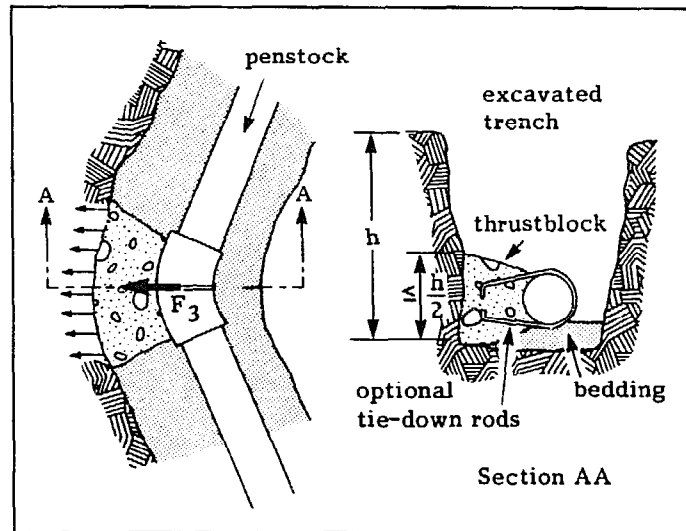

Fig. 5.157. Proper placement of a thrustblock at a bend in a penstock.

point. When this has been done, the stability of a given design can be determined.

In order to explain the procedure to be used as simply as possible, assume that the only bend at an anchor is in a vertical plane. If this were not the case, forces would need to be resolved in two perpendicular vertical planes, one plane usually including the pipe which enters the anchor. Each force would have to be resolved carefully along three perpendicular directions. In this case, the reduction of forces and conditions for stability discussed below would still be valid, but application of these ideas becomes more involved.

Assume that a structure is being acted upon by the forces shown in Fig. 5.158(a). In addition to the forces described previously, the combined weight "W" of the concrete mass plus pipe and water within the mass which acts at the center of gravity of the anchor is also included.

In reaction to all these forces, the foundation exerts an initially unknown foundation pressure and friction force over the base of the anchor. The net effect of the friction and foundation pressure is identical to, and can be replaced mathematically with, a reaction force "R" acting at an undetermined point on the anchor with a direction and magnitude yet to be determined (Fig. 5.158b).

A first step in reducing the penstock forces and weight of an anchor to a single force is to resolve each force into components parallel to the x and z axes. The original forces are then equivalent to the sum of all the horizontal components " ΣH " and the sum of all the vertical components " ΣV " acting along the x and z axes, respectively, plus a moment " ΣM " resulting from all the forces around the origin (Fig. 5.158c).

By translating the net vertical force " ΣV " a distance "d" to the right such that $\Sigma M = d \Sigma V$, the force " ΣV " acting at a new point (Fig. 5.158d) is equivalent to the same force acting at the origin plus the moment.

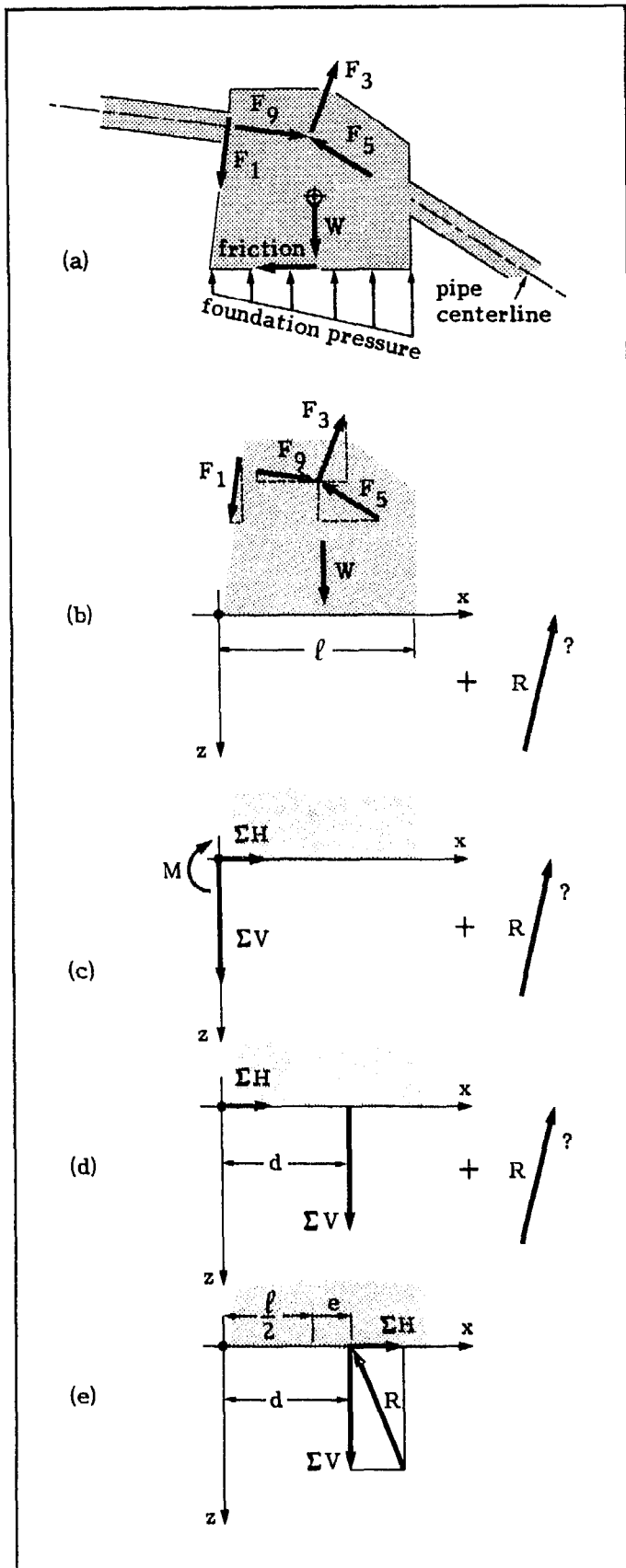

Fig. 5.158. Reducing a number of forces acting on a structure to a single force and a reaction force. The forces in all five diagrams above are equivalent.

The force " ΣH " can be moved along its line of action without contributing any moment. The vector sum of " ΣV " and " ΣH " is the sum of all the forces created by the penstock and anchor mass, and the reaction force " R " is equal in magnitude but opposite in direction (Fig. 5.158e). The reaction force therefore acts at a distance " d " from the origin of the coordinate system. A more useful way of expressing the location of the point at which the reaction force acts is to specify its distance " e " to the right of the center of the structure's base. Therefore, $e = d - l/2$, where " l " is the length of the structure's base. This is referred to as the eccentricity of loading. A negative value of " e " implies a reaction force acting at the left of the base's center.

The steps described above are illustrated by applying them to a specific problem in EXAMPLE 5.10 (p. 148).

Conditions for stability. For a support pier or anchor to be stable and fulfill its intended purpose, several conditions must be met:

- The structure should not slide over its foundation. If " μ " is the coefficient of friction between the pier or anchor and the ground, the following relationship must be met for sliding not to occur:

$$\Sigma H \leq \mu \Sigma V \quad (5.30)$$

A value of $\mu = 0.5$ is often assumed initially.

- The forces acting on the structure should not tend to tip or overturn it. If the base of the structure is rectangular, this condition is met if the resultant acts within the middle third of the base.

- The load transmitted to the foundation must be within the safe bearing capacity limit of the foundation material. Because both the structure and foundation are elastic, the foundation pressure usually is not uniform over the base of the structure. Although the exact distribution of this pressure is not known, it is assumed to be a linear distribution as is indicated in Fig. 5.158a. If the base is rectangular, the maximum and minimum foundation pressures which act at opposite ends of the base, are then

$$p_f = \frac{\Sigma V}{A} \left(1 \pm \frac{6e}{l} \right) \quad (5.31)$$

where

- A = base area of support pier or anchor (m^2)
- l = length of base (m)
- e = eccentricity of loading (m) (see above)

The maximum value of " p_f " should be below the safe bearing capacity limit of the foundation on which the structure rests. Limits for various soils are shown in Table 5.7.

Parenthetically, this equation also shows that if the reaction force on the structure acts outside the middle third, that is, $e > l/6$ or $e < -l/6$, the minimum

TABLE 5.7. Allowable bearing capacity commonly used by design engineers for different soils (22)

	Maximum allowable bearing pressure (kgf/m ²)		
	0	50,000	100,000
Alluvial soil	[Bar chart showing a small range from 0 to ~10,000 kgf/m ²]		
Soft clay	[Bar chart showing a range from 0 to ~20,000 kgf/m ²]		
Sand	[Bar chart showing a range from 0 to ~30,000 kgf/m ²]		
Sand and gravel	[Bar chart showing a range from 0 to ~40,000 kgf/m ²]		
Sand and gravel with clay	[Bar chart showing a range from 0 to ~60,000 kgf/m ²]		
Shale	[Bar chart showing a range from 0 to ~80,000 kgf/m ²]		
Rock	[Bar chart showing a range from 0 to ~100,000 kgf/m ²]		

foundation pressure " p_f " would be negative or under tension. Clearly, this is not possible, and the structure would overturn.

In determining the stability of a structure, the most adverse cases must be considered, cases in which the summation of forces or moments is a maximum. The procedure for assessing the stability of the support pier analyzed in EXAMPLE 5.10 (p. 148) is illustrated in EXAMPLE 5.11.

EXAMPLE 5.11

Assess the stability of the pier described in EXAMPLE 5.10.

For assessing stability, the two extreme conditions to consider are those which occur when the penstock is expanding or contracting. The stability of the structure in each case should be considered. Assessing its stability during expansion of the penstock is described below:

- During the expansion of the penstock, it was found in EXAMPLE 5.10 that the magnitude of the forces acting on the foundation are

$$\begin{aligned} EV &= 1700 \text{ kgf} \\ \Sigma H &= 780 \text{ kgf} \end{aligned}$$

Therefore, the structure is safe against sliding, because

$$\Sigma H = 780 \text{ kgf} \leq (0.5)(1700 \text{ kgf}) = 850 \text{ kgf}$$

- Because the resultant force acts at 0.12 m or

Because thrustblocks are acted upon primarily by hydrostatic pressure, their stability is ascertained simply by ensuring that the foundation pressure is within the safe bearing capacity limit of the soil.

Air valves

To serve their intended purpose, air valves must permit an adequate flow of air into the penstock to prevent its collapse. The smaller the valve opening, the greater must be the difference between pressure within the penstock and atmospheric pressure in order to pass a given air flow. If this difference is too great, the vent cannot fulfill its purpose and the pipe will still collapse.

The maximum pressure difference which any pipe can safely accommodate is a function of its thickness-to-diameter ratio and the material from which it has been constructed, represented by the following expression:

$$p = \frac{2E}{f} \left(\frac{t}{D} \right)^3 \quad (5.32)$$

where

- p = maximum allowable pressure difference (kgf/cm²)
- E = Young's modulus of elasticity (kgf/cm²) (see Table 5.5)
- D = penstock diameter at its upper end (any unit of measure)
- t = wall thickness at its upper end (with same units as D)
- f = safety factor = 5 for buried pipe
= 10 for exposed pipe (38)

within $t/6 = 0.2$ m from the center of the pier, the pier is safe from overturning.

- The maximum foundation pressure is

$$\begin{aligned} (p_f)_{\max} &= \frac{1700 \text{ kgf}}{0.96 \text{ m}^2} \left[1 + \frac{6(0.12)}{1.2} \right] \\ &= 2800 \text{ kgf/m}^2 \end{aligned}$$

Table 5.7 shows that this foundation pressure is within the safe bearing capacity limit of all but the poorest soil.

A similar procedure would be used to assess whether the structure is stable during contraction of the penstock.

The reaction force in this example is well within the middle third of the pier's base under all conditions. This indicates that the pier could be reduced somewhat in size and still be stable. Depending on the quantity of cement required, its cost, and the difficulty of finding adequate quantities and transporting it to the site, this might be advisable.

EXAMPLE 5.10

A concrete support pier 0.80 m wide shaped as shown supports a 400 mm steel penstock with a 3 mm wall. Supports are placed at 6 m intervals down the 30° slope. Expansion joints are used as needed. Reduce the forces acting on the pier to a single force under two conditions: (a) the penstock is expanding because of a temperature increase, and (b) the penstock is contracting because of a temperature decrease.

A penstock exerts forces "F₁" and "F₂" on the pier. From Eqs. (5.28) and (5.29), their magnitude is

$$F_1 = (W_p + W_w) L \cos \alpha$$

$$F_2 = f F_1$$

where

$$W_p = \pi D t$$

$$= (3.1)(0.4)(0.003)(7900 \text{ kgf/m}^3) = 30 \text{ kgf/m}$$

$$W_w = \rho \pi D^2/4$$

$$= (1000 \text{ kgf/m}^3)(3.1)(0.4)^2/4 = 130 \text{ kgf/m}$$

$$f = 0.5$$

Therefore,

$$F_1 = (30 + 130)(6) \cos 30^\circ = 830 \text{ kgf}$$

$$F_2 = 0.5 (830) = 420 \text{ kgf}$$

In addition to these two forces, the foundation also reacts to the pier's weight "W". Because the pier is of uniform width, its weight is proportional to the area of its side shown in the figure. The area can be determined by summing the areas of right triangles (not resting on their hypotenuse) and rectangles. The weight of the pier is then obtained by multiplying the total area of its side by its width and density. The density of concrete is about 2300 kgf/m³.

It is also necessary to locate the pier's center of gravity where its entire weight appears concentrated. This is determined by summing the moments of the weight of each increment of area around any point. In this case, the point selected is the origin of a coordinate system centered at the left end of the pier's base. To determine the moment of a rectangular area, its weight is considered to act at its geometrical center; for a triangular area resting on one of its two legs, its weight is considered to act at a distance of one-third the length of its horizontal leg from the right angle. The distance "b" to the pier's center of gravity is then found by dividing this sum by the pier's total area.

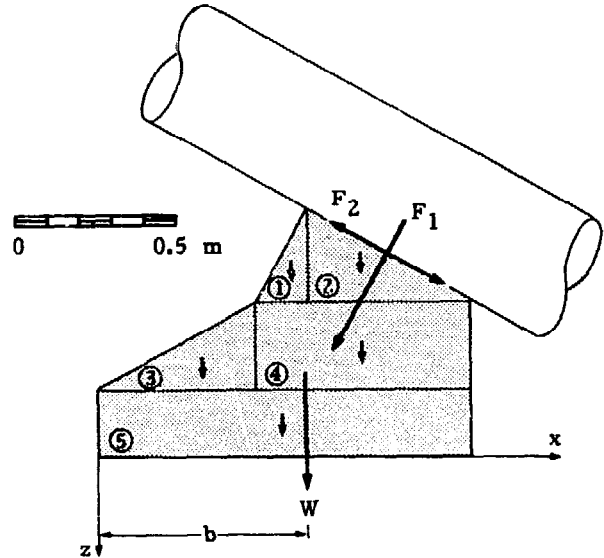
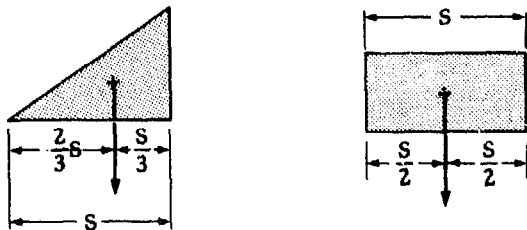

For this example, if

- a = partial areas of the pier (m²)
- r = horizontal distance between origin and center of gravity of partial area (m)
- M = moment of partial area around origin (kgf·m)

then

Partial area	a	r	M = ar
①	$\frac{(.17)(.30)}{2} = .03$.68	.02
②	$\frac{(.50)(.30)}{2} = .08$.85	.07
③	$\frac{(.51)(.30)}{2} = .07$.34	.02
④	$(.69)(.30) = .21$.86	.18
⑤	$(1.2)(.20) = .24$.60	.14
	$\Sigma a = 0.63 \text{ m}^2$		$\Sigma M = 0.43 \text{ m}^3$

As noted previously, the total weight of the pier is

$$W = (0.63 \text{ m}^2)(0.80 \text{ m})(2300 \text{ kgf/m}^3) = 1200 \text{ kgf}$$

and the distance this force acts from the origin is

$$b = \Sigma M / \Sigma a = (0.43 \text{ m}^3) / (0.63 \text{ m}) = 0.68 \text{ m}$$

The illustration above shows the forces acting on the pier which the foundation must support: the weight of the support pier itself acting at 0.68 m from the origin and the two forces arising from the penstock.

The forces can now be reduced by first resolving them into x and z components using trigonometric functions. The algebraic sign is determined by whether the component is directed in the positive or negative axis direction.

(a) In the first case, the penstock is expanding and moving uphill over the support pier. The direction of force "F₂" is therefore also uphill. These forces are resolved as shown below:

Force (kgf)	x component (kgf)	z component (kgf)
F ₁ = 830	-830(.50) = -420	830(.87) = +720
F ₂ = 420	-420(.87) = -360	-420(.50) = -210
W = 1200	0	1200
	ΣH = -780 kgf	ΣV = 1700 kgf

Each of these forces also results in a moment "M" around the origin. These can be determined mathematically by using trigonometric functions or, just as accurately, graphically off a scale drawing by measuring the moment arm of each force around the origin. Positive and negative signs are assigned, depending on whether the moment around the origin is clockwise or counterclockwise, respectively.

Force (kgf)	Arm (m)	M (kgf·m)
F ₁ = 830	0.50	+420
F ₂ = 420	1.0	-420
W = 1200	0.68	+810
		ΣM = 810 kgf·m

The initial three forces acting on the pier are therefore equivalent to two forces acting at the origin and a moment around the origin as derived above:

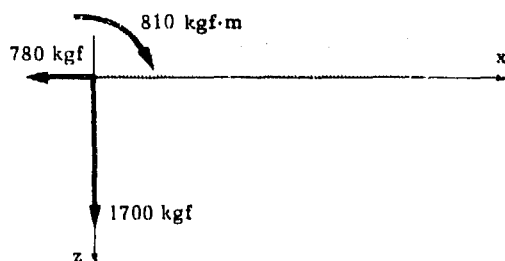

For the vertical force to replace the moment equal to 810 kgf·m around the origin, it must be translated $810 \text{ kgf}\cdot\text{m} / 1700 \text{ kgf} = 0.48 \text{ m}$ to the right:

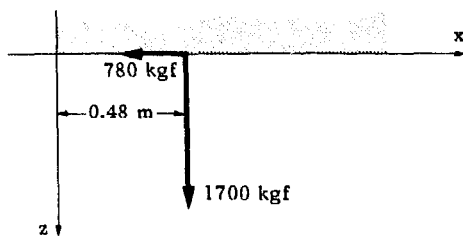

The net force of the pier on the foundation is the sum of these two components. The reaction force of the foundation is equal and opposite to this force:

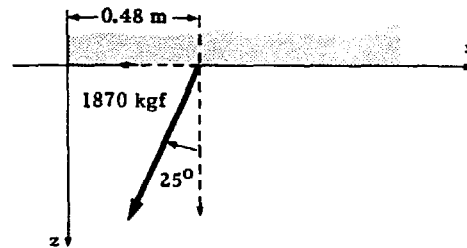

(b) When the penstock is contracting, this case is similar to the previous one except that the direction of "F₂" is reversed and its components are both positive. The same steps as before are used in finding the net vertical and horizontal forces and moment. Then

$$\begin{aligned}\Sigma H &= +410 \text{ kgf} \\ \Sigma V &= +2100 \text{ kgf} \\ \Sigma M &= +1600 \text{ kgf}\cdot\text{m}\end{aligned}$$

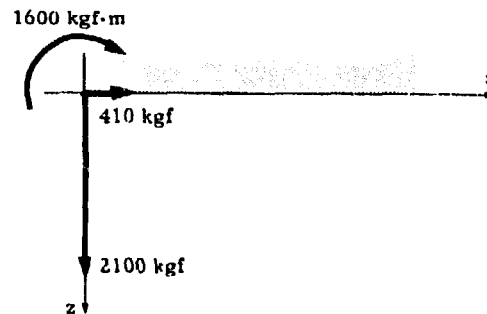

Moving "ΣV" by $1600 \text{ kgf}\cdot\text{m} / 2100 \text{ kgf} = 0.76 \text{ m}$ means that the moment caused by "ΣV" can now replace the pure moment "ΣM" around the origin:

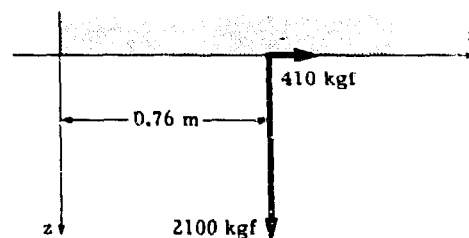

The net force on the foundation is the sum of these two components. The reaction force is equal and opposite:

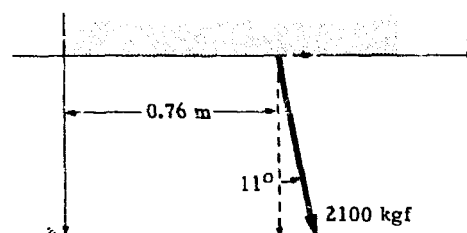

In order not to exceed this pressure, the minimum area "A" (m²) of the vent inlet is given by the following equation:

$$A = \frac{Q}{400 C \sqrt{p}} \quad (5.33)$$

where

- Q = flow of air through inlet (m³/s) (see below)
- C = coefficient of discharge through inlet
 - = 0.5 for ordinary air-inlet valves
 - 0.7 for short air-inlet pipes (38)

To cover the worse possible case, the maximum air flow "Q" through a vent should equal the maximum flow of water the turbine can accommodate. EXAMPLE 5.12 illustrates use of these equations. .

The vent pipe should be long enough so that its opening to the atmosphere is above the high-water level in the forebay (see Fig. 5.21); otherwise, a high-water level in the forebay will cause water to flow out the vent, possibly inundating the area and undermining the forebay or penstock.

Powerhouses

In the first part of this chapter, it was noted that a powerhouse is constructed to enclose and protect the turbo-generating and associated equipment. This section briefly reviews some factors which should be considered in designing such a structure.

A powerhouse needs a floor area only sufficient to accommodate the equipment and permit easy access on all sides for installation, maintenance, and repair. The door to the powerhouse should be large enough to permit passage of the largest piece of equipment. When large and heavy turbo-generating machinery is to be used, the building should be high enough to accommodate a hoist or other equipment which is used to assemble or disassemble the machinery.

To handle heavy equipment at large plants, cranes which travel on overhead rails supported by the powerhouse superstructure are often used. For micro-hydropower schemes, a hoist or block and tackle, temporarily supported from a beam, is more commonly used for heavy equipment. In these cases, the loads to be supported govern the structural design of the powerhouse walls. Rather than a beam, a temporary "A" frame can be used. At a 100 kW scheme using two 50 kW turbo-generating units in Kalam in Pakistan, rather than over-designing the roof truss to support the occasional heavy loads encountered when the equipment is moved, a horizontal slot is incorporated in opposing stone-masonry walls (Fig. 5.159). When equipment has to be lifted, one or more beams are supported within these slots and shifted to the most appropriate position. The lower surface of the slot is lined with a steel bar to distribute the force of the beam over the wall.

Numerous materials have been used in the construction

EXAMPLE 5.12

A 50 kW plant under a net head of 60 m is supplied by a 300 m exposed penstock with a 3 mm wall thickness. What should be the vent pipe diameter to protect the penstock from collapsing?

Assuming a conversion efficiency of 70%, the power equation gives the maximum flow of water down the penstock as

$$Q = \frac{P}{\eta H} = 0.12 \text{ m}^3/\text{s}$$

The maximum negative pressure difference that the pipe can accommodate is

$$p = \frac{2E}{t} \left(\frac{t}{D} \right)^3 = \frac{4.2 \cdot 10^6}{10} \left(\frac{3}{300} \right)^3 = 0.42 \text{ kgf/cm}^2$$

Assuming further that the air through the vent is to replace the water descending the penstock at its maximum rate, the area of the inlet is

$$A = \frac{Q}{400 c \sqrt{p}} = \frac{.12}{(400)(0.7)\sqrt{0.42}} \\ = 0.00066 \text{ m}^2 = 6.6 \text{ cm}^2$$

The required vent diameter is then

$$d = 2 \sqrt{\frac{A}{\pi}} = 2.9 \text{ cm}$$

A short length of pipe with at least a 30 mm internal diameter should therefore be used for the vent.

of powerhouses. With larger schemes, steel and concrete are common because their cost is insignificant compared to other costs of a hydropower project. However, with small schemes in developing countries, not only may the cost of cement and steel become more significant, but they are often more difficult to obtain, and additional cost and effort are required to transport them to remote sites.

Where cement is available, stone masonry (see Fig. 4.26) provides a durable structure with less cement. So does a powerhouse of concrete cinder blocks (Fig. 5.160). Where appropriate skills exist, dry-rubble masonry—stones without cement—can be used to make a fairly robust structure requiring only local materials (Fig. 5.161) as can stone using mud mortar (Fig. 5.162). Rather than stone, timber can be used to make the entire superstructure (Fig. 5.163) or to make a frame which is covered by sheet metal (Fig. 5.164). Where mud bricks are used in local construction, these skills and materials can be capitalized on to construct a powerhouse. Even bush materials have been used

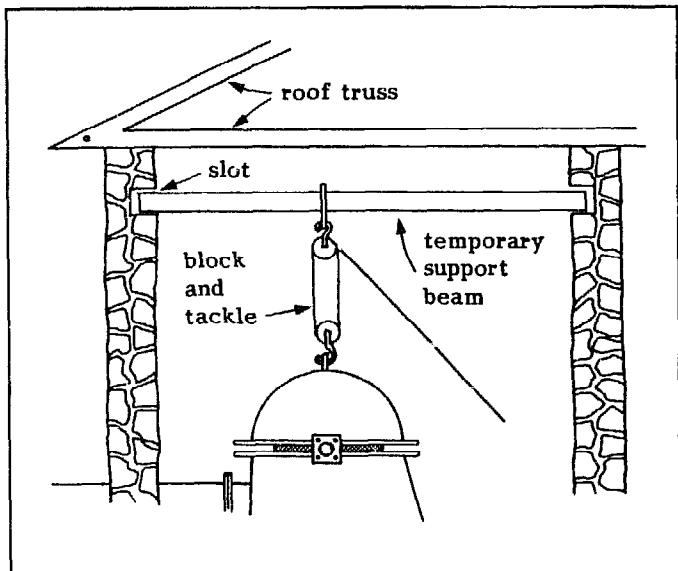
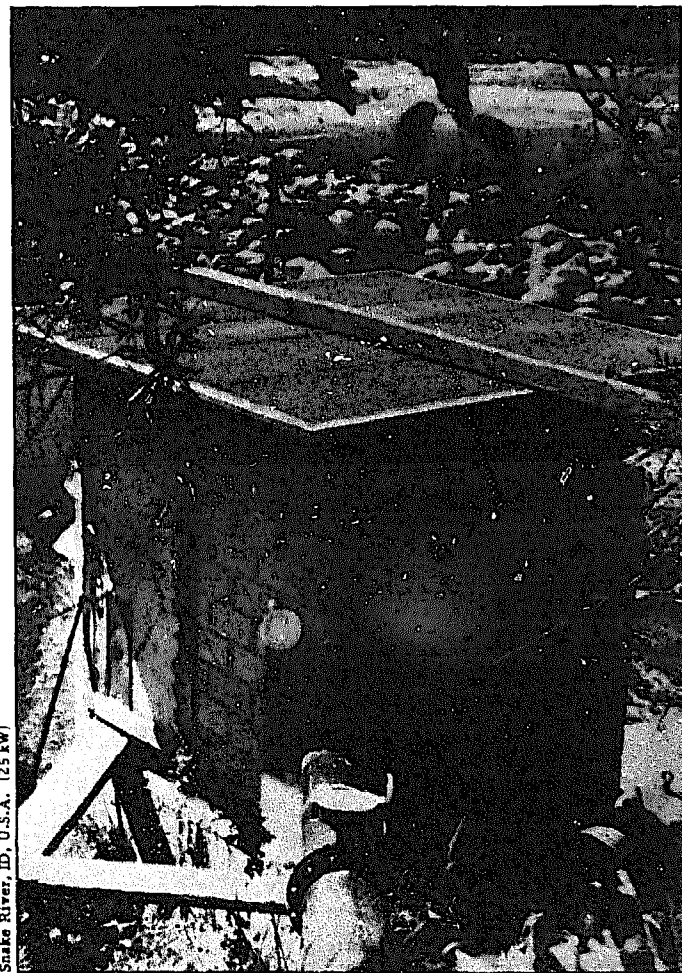
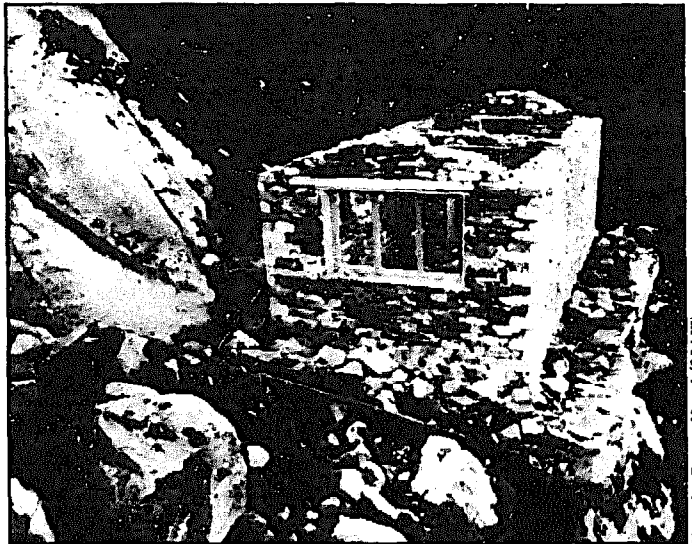

Fig. 5.159. Slots in opposing walls of a powerhouse support a beam used to support heavy machinery during its assembly or disassembly.



Snake River, ID, U.S.A. (25 kW)

Fig. 5.160. A small powerhouse constructed of cinder blocks.



Nariche Bazar, Nepal (25 kW)

Fig. 5.161. A powerhouse constructed of dry-rubble masonry.

(Fig. 5.165). Although such a structure may protect the equipment from inclement weather, it does not protect it from possible tampering and should be used only in areas where this does not pose a problem.

Locally available roofing materials can be used. Corrugated galvanized sheets are commonly used as roofing

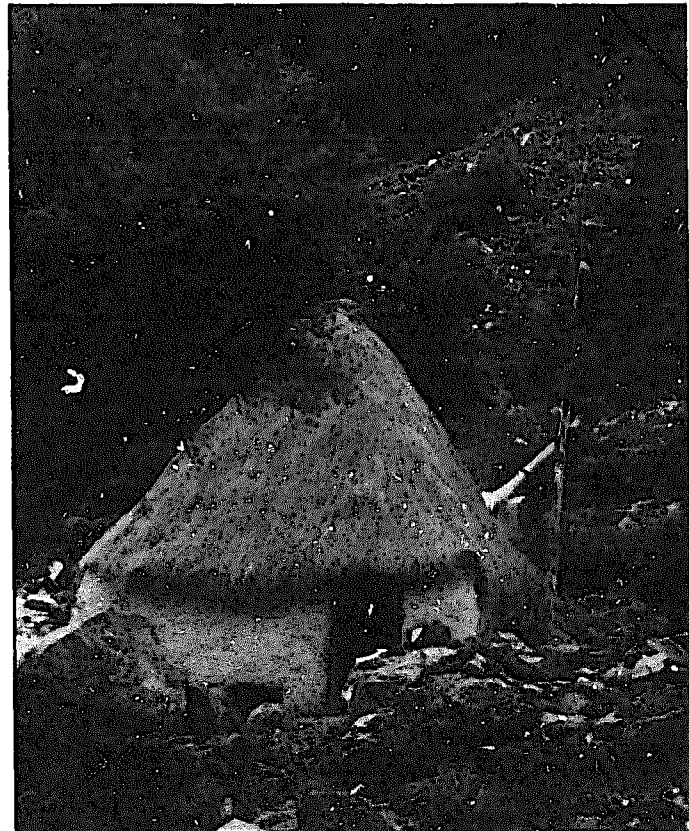

Yanahuara, Dept. of Cusco, Peru (5 kW)

Fig. 5.162. A powerhouse built of stones and earth, with a thatch roof.

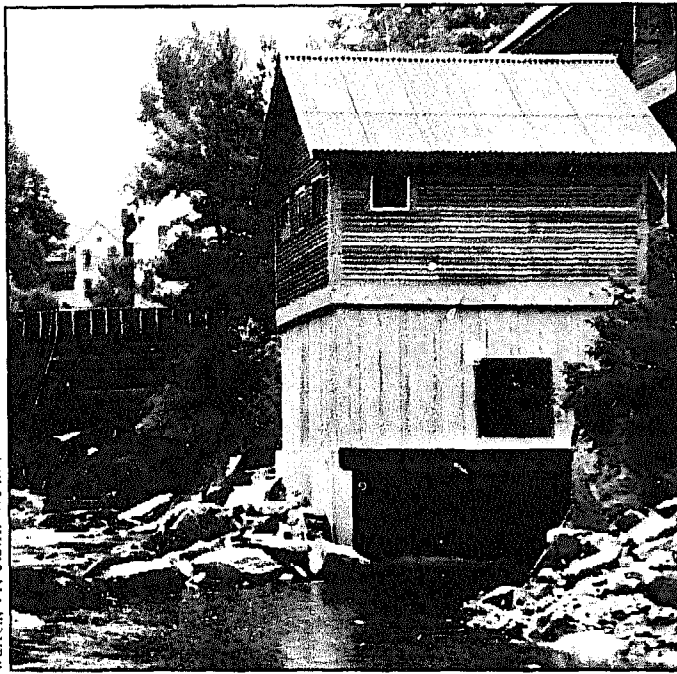

Warren, VT., U.S.A. (75 kW)

Fig. 5.163. This powerhouse has a wooden superstructure and a reinforced-concrete machine room. A wooden frame and deck dam in the background creates the head for power generation.

material because of their low weight, ease of transport, and durability. However, such a roof provides a tempting target for stones thrown by children and others intrigued by the noises produced. The number of stones on several powerhouse roofs in Burundi bears witness to this fact (Fig. 5.166). Unfortunately, much of the available roofing is thin and easily pierced. If corrugated galvanized roofing is used, it might be advisable to suspend a second ceiling below the first, at least over the area where the generator and other electrical equip-



Bandaong, Morobe Prov., Papua New Guinea (1 kW)

Fig. 5.164. This powerhouse is constructed of flat galvanized steel sheets over a timber frame. Although no permanent windows have been incorporated, shutters constructed in the same manner as the walls can be opened to provide for light and ventilation during visits to the powerhouse.

ment are located, to prevent rain leaking in from falling on this equipment.

Whereas the powerhouse floor may be of dirt or other material, the foundation for the turbo-generating equipment is generally made from a good-quality concrete mix. This serves as a slab (Fig. 5.167) for mounting the equipment as well as a mass to dampen any vibrations during operation of machinery. The concrete slab should be poured on rock, original subsoil—soil with the upper layer of topsoil and organic matter removed—or well-compacted fill. (See **Excavation**, p. 104, for more detail on how a well-compacted foundation is prepared.) If concrete is also used for the powerhouse floor, the equipment foundation is sometimes poured separately; expansion joints between the powerhouse floor and equipment-mounting slab are used to reduce vibrations transmitted to the remainder of the building.

Reinforcing steel is often used to maintain the integrity of the concrete base. If the slab is not reinforced adequately, it may crack from differential settling and cause misalignment of the turbo-generating equipment. Using a packaged turbo-generating unit, with all components mounted on a single rigid steel frame, has two advantages:

- the frame spreads the weight of the turbo-generating equipment more uniformly over the concrete slab, somewhat reducing the possibility of cracking, and
- this frame can be embedded in a stone-masonry rather than in a reinforced-concrete pad, reducing

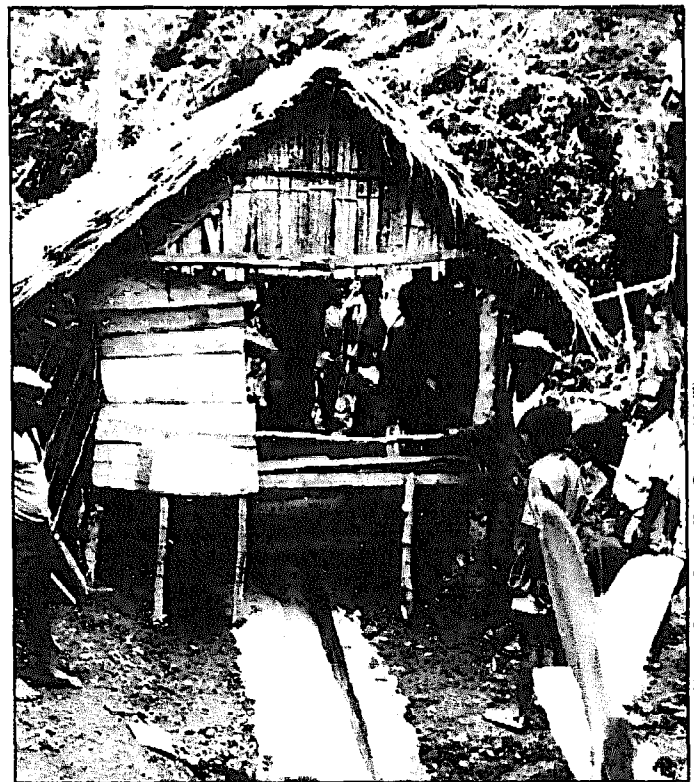

Gemaheng, Morobe Prov., Papua New Guinea (1 kW)

Fig. 5.165. This powerhouse design permits use of indigenous skills and materials—bamboo and thatch.

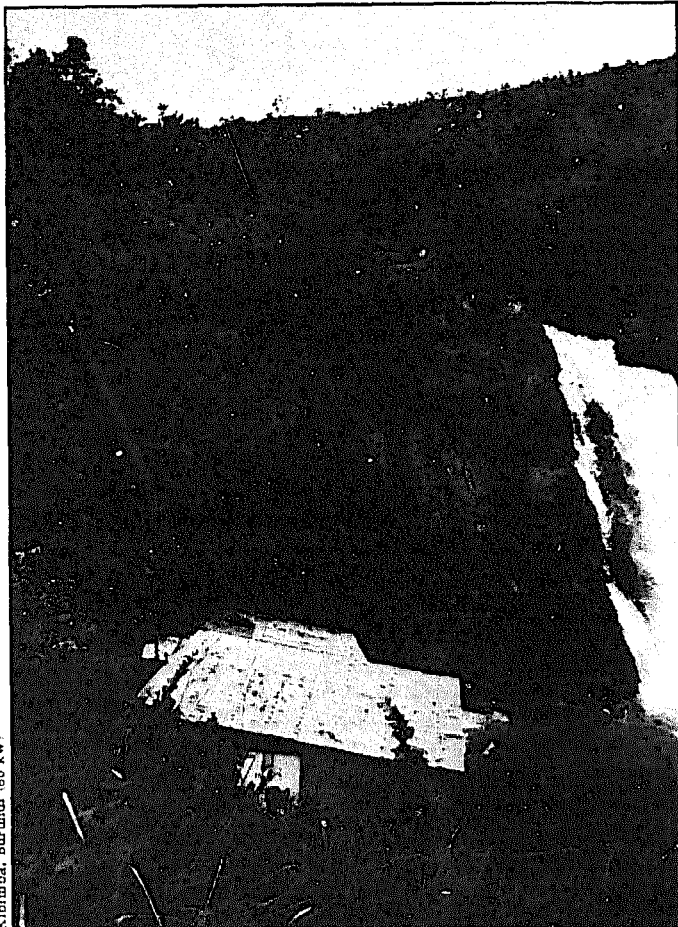

Kinmba, Burundi (50 kW)

Fig. 5.166. Stones thrown on galvanized sheet roofing can pierce it. At this site, rainwater leaking through such a hole fell on the generator, causing a short and putting the plant out of commission until five years later when the rising price of diesel fuel forced the site owners to overhaul the generator.

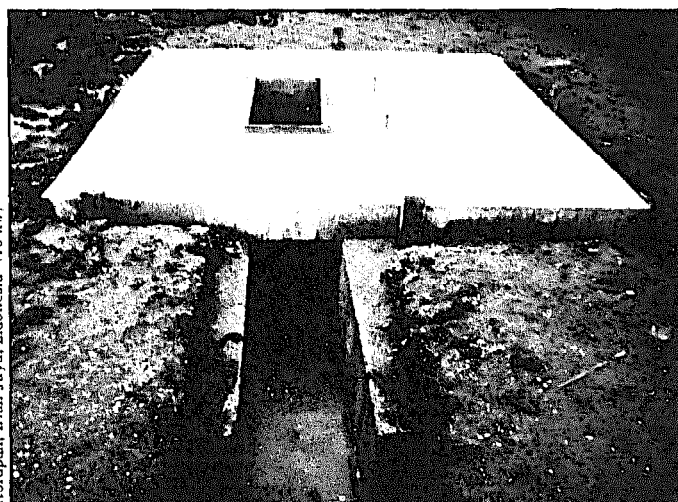

Korupun, Irian Jaya, Indonesia (10 kW)

Fig. 5.167. A concrete slab serves as the powerhouse floor on which a packaged turbo-generating unit will be mounted. The spent water from the Pelton turbine will drop into the discharge pit, or afterbay, and be channeled into the tailrace.

the quantity of cement which may have to be transported to the site.

Below the powerhouse is located a structure—sometimes referred to as the afterbay—which conveys the water emerging from the turbine to the tailrace (Fig. 5.168). With smaller schemes, this could simply be a pipe; for larger micro-hydropower schemes, it is an opening under the powerhouse usually built of concrete or stone masonry. Although the afterbay for the turbine with a draft tube can be large if it is a chamber located directly below the powerhouse, as shown in this Fig. 5.168, Figs. 10.25-10.27 illustrate an approach to reducing the amount of concrete required in the case. To guarantee proper operation, the exit from a draft tube must be submerged. A properly designed tailrace can ensure this; for a flow equal to or greater than minimum usable flow, the tailrace is sized so that the water backs up and submerges the opening of the draft tube. A more common approach is simply to incorporate a weir at the end of the afterbay just high enough to raise the water level for proper submergence (Fig. 5.168a).

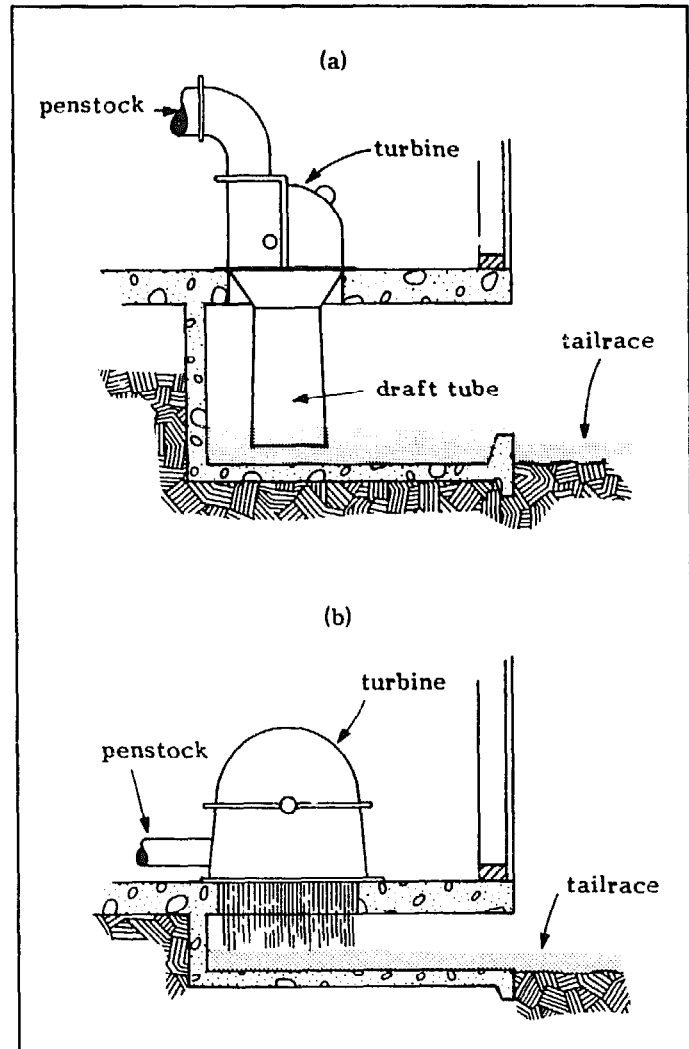

Fig. 5.168. Water emerging from a turbine (a) with a draft tube and (b) without a draft tube enters the afterbay before flowing into the tailrace.

Several other features should be considered in the design of a powerhouse:

- High ambient temperatures are found in many countries. In addition, the heat produced by losses in a generator also increases the temperature in a powerhouse. Because high temperatures reduce generator life, adequate ventilation is required. For micro-hydropower plants, louvers and roof vents provide adequate ventilation.
- For reasons of safety, the powerhouse floor should be kept dry. Adequate floor drainage should be incorporated to remove any water resulting from leaks, condensation, rain, etc.
- To minimize overhead obstructions, power and control cables should be placed in conduits in floor trenches.
- Before the power leaves the powerhouse, a tap should be included to provide power for lighting—indoors as well as possibly outdoors—and electric outlets or power points.

Other components

Gates and valves

Gates and valves control the flow through water conveyance structures. Numerous types are in use. For micro-hydropower schemes, this discussion is limited to stoplogs and sliding gates and butterfly and gate valves.

Gates are generally used for control of flow through open passageways or for other low-pressure applications. Sliding gates—also referred to as vertical lift gates or sluice gates—are used where there is a need to adjust fairly frequently the flow through an opening. Stoplogs are not usually used to adjust the flow, but to stop it completely from time to time, such as when maintenance or repair work is needed downstream.

Valves are used to control the flow through a pipe. For micro-hydropower applications, they control flow through the penstock, usually at the base of the penstock—as a turbine isolation valve to permit uncoupling of the turbine and the penstock—and occasionally at the inlet to the penstock. Gate valves are often more readily available, but butterfly valves are increasing in popularity.

Stoplogs. The simplest type of gate is a stoplog, a vertical wall of loose, horizontally placed timbers spanning an opening and supported at each end in grooves usually set in a concrete or stone-masonry structure (Fig. 5.169). These timbers are usually manipulated manually. To facilitate installing and removing stoplogs, a narrow platform spanning the opening is usually included just downstream of the grooves. For larger gates, the timbers can be difficult to remove and install, either because of unbalanced head—water on only one side—forcing the timber against the opposite

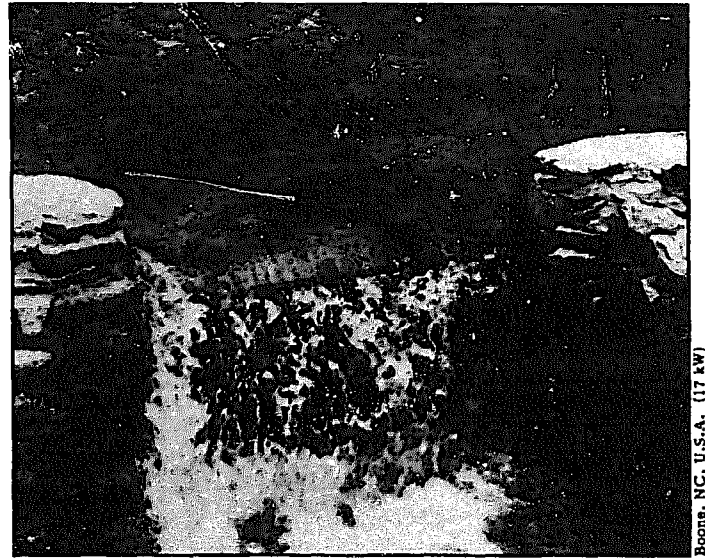

Fig. 5.169. The stoplog at this site regulates the height of water behind a stone-masonry weir.

side of the groove or because of their buoyancy. Sometimes steel or steel and timber "logs" are used. Stoplogs have another problem. Because they are used infrequently, logs stored near the opening can be appropriated for other uses and therefore not be available when they are needed.

In their simplest form, the stoplog grooves are vertical rectangular notches formed in concrete (Fig. 5.170a). To reinforce their edge, they can be lined with angle iron or steel channel (Figs. 5.170b and 5.170c, respectively). Using a steel guide also facilitates insertion and removal of the timbers by reducing friction and permits a more watertight seal than concrete.

To stop flow through a stoplog gate completely, such as when repairs are needed downstream, inserting the timbers is rarely sufficient. Rather, to accomplish this, two parallel stoplogs separated by 10-20 cm could be included in a design, so that clay can be temporarily packed between the two to provide a seal when needed.

It may also be possible to simplify construction slightly by designing trashrack grooves to accept stoplog timbers. When flow has to be stopped, the trashrack can be withdrawn and replaced by these timbers.

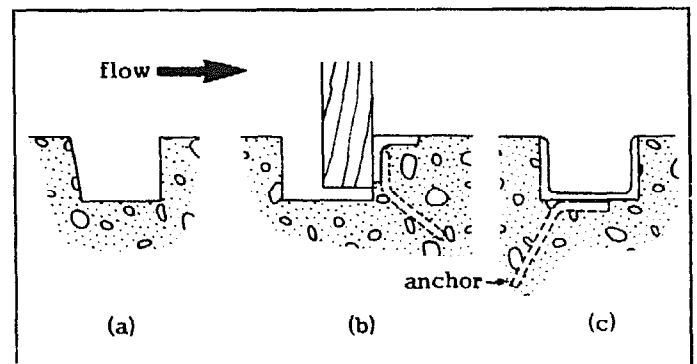

Fig. 5.170. Stoplog grooves.

Another related, but not common, means of flow control is the use of needles. These are vertical or slightly inclined timbers, supported on top by a beam and on the bottom by a sill on the passageway floor (Fig. 5.171). The needles are placed one by one. Each is extended horizontally upstream of the platform, letting the water current pull one end down until it strikes the floor of the channel near the sill. It is then slightly withdrawn until the end is in contact with the sill, and rolled sideways against the needles already installed. When required, the needles are removed one by one. Each needle should have a hole at its top to accommodate a rope, which can then hold the needle if it gets away during handling.

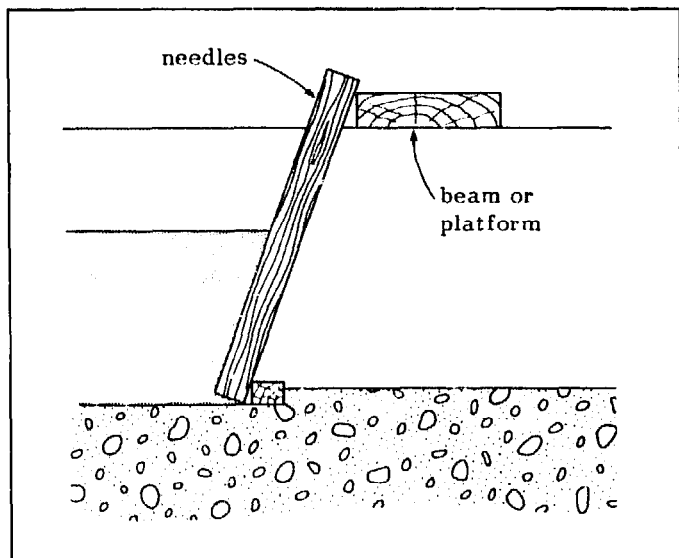
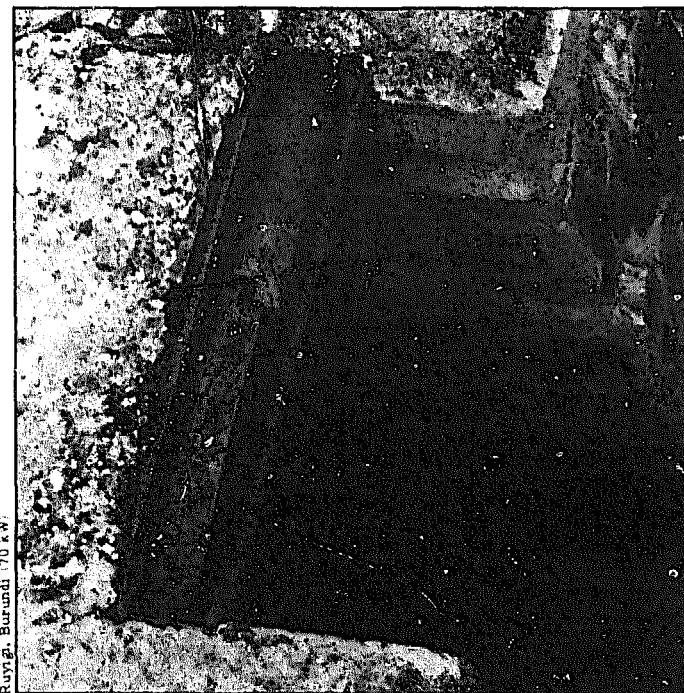

Fig. 5.171. Needles are occasionally used as a gate.



Ruyig, Burundi (70 x W)

Fig. 5.172. This gate has features common to both needles and a stoplog gate. Ship-lap joints (see Fig. 5.96) are used between adjacent timbers.

Figure 5.172 has features common to both needles and stoplog gates; vertical timbers are used, but so are stoplog grooves on the sides of the opening. In addition, horizontal steel rods span the opening to restrain the timbers. This design makes the timbers more accessible than stoplogs, because one end is always above water. Figure 5.119 shows one such gate on the same canal, with the timbers removed. Because the opening at this site is too deep, it would not have been feasible to insert horizontal stoplogs manually. Another alternative would have been to use a sliding gate, at the expense of simplicity.

Sliding gates. Unlike the stoplog gate, the sliding gate is composed of a single sliding member which, except for simple designs, cannot be completely withdrawn and misplaced easily. There are numerous design options. Figure 5.173 shows a small gate formed of unreinforced steel plate which includes a handle to lift it. It rides



Maldeora, U.P., India (10 x W)

Fig. 5.173. A small sliding gate.

within steel grooves set in concrete. Inserting an object, even a twig or small stone, in any one of several slots holds the gate in an open position. Another simple gate is shown in Fig. 5.174.

Figure 5.175 shows a larger gate built from a reinforced steel plate. Because substantially larger forces are required to raise this gate, a handwheel-activated hoist is used. Constructing a sliding gate of wooden timbers can reduce its cost and weight (Fig. 5.176).

Nyangezi, Kivu Prov., Zaire



Fig. 5.174. This simple sliding gate is used when the settling basin is to be drained.

Some form of simple machine is used to lift larger gates. One is the screw, as illustrated in the previous figures. If a handwheel is not readily available, a substitute can be improvised by welding a length of steel bar to an appropriate nut (Fig. 5.177). Figure 5.178 illustrates how a car jack was used for the same purpose.

Maddeota, U.P., India (10 kW)

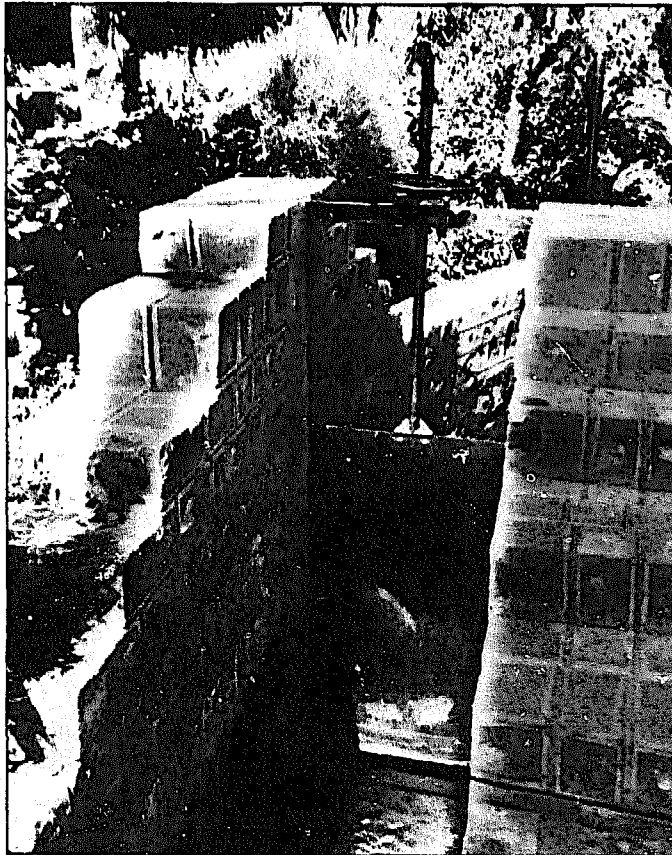

Fig. 5.175. Steel sliding gate operated by a handwheel.

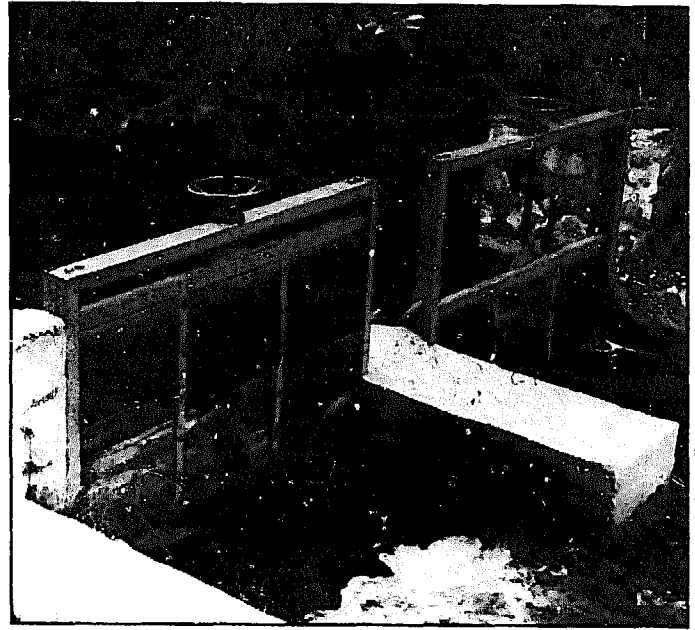

Fig. 5.176. Sliding gates formed of timbers.

Euyigt, Burundi (70 kW)

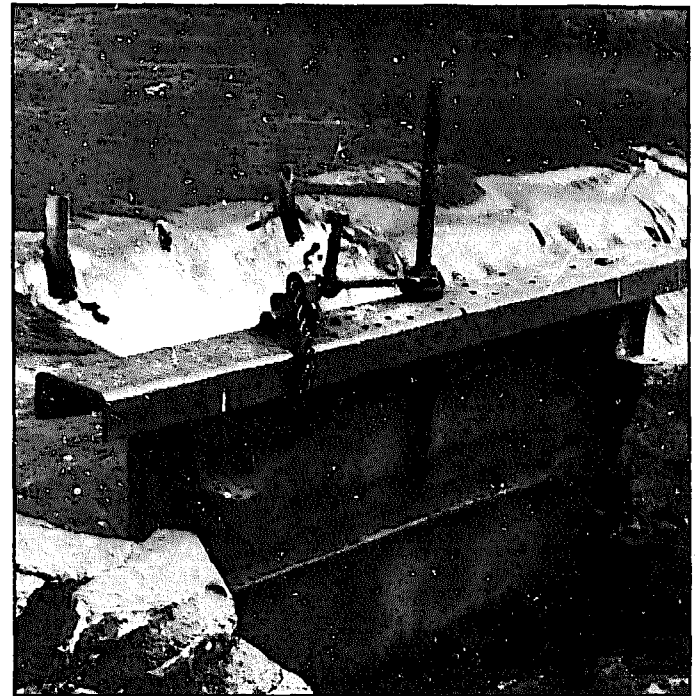

Fig. 5.177. An improvised "handwheel" on a sliding gate at the intake is locked to prevent tampering. The gate is closed by gravity.

Kibimba, Burundi (50 kW)

Another simple machine is the lever. Figure 5.179 illustrates two applications of the lever principle for activating sliding gates. Option (a) is a triangular member pivoting about one of its vertices. The travel is relatively small; therefore, use of this option is limited to small gates, such as those controlling flow through a scouring outlet. Option (b) is a rudimentary design. The stem extending above the gate is perforated and a pole or length of steel pipe, pivoting off a timber spanning the outlet channel, is used to jack up the gate. A pin



Bishalalo, Kivu Prov., Zaire (15 kW)

Fig. 5.178. A hoist to raise the gate which controls flow at the intake to the power canal has been fabricated from a car jack.

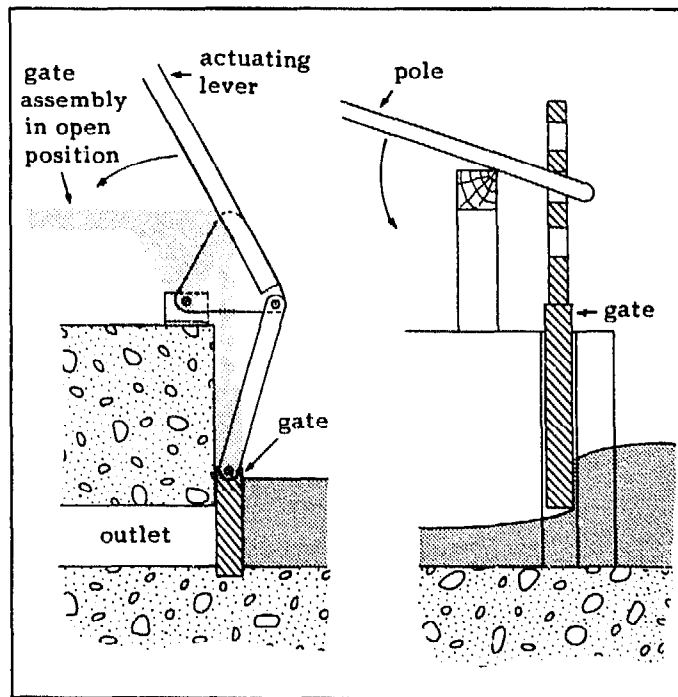

Fig. 5.179. Two applications of the lever principle for raising a gate.

inserted into the gate prevents it from falling as the pole is removed from one hole and placed in the next. If the gate is partially submerged, forces caused by friction of the gate against the grooves may be sufficient to prevent the gate from dropping while the pole is withdrawn.

The wheel and axle is another simple machine which can be used to raise a gate (Fig. 5.180). This design relies on the weight of the gate to lower itself. The gate can be kept in a raised position by a ratchet on the shaft or simply by a pin through the vertical steel channel which prevents the handle from turning.

When designing a gate-hoisting mechanism, the force to operate the gate must first be determined. In addition to the weight of the gate itself, the friction force between the gate and the channel in which it rides must be overcome. This can be a significant force. Its magnitude, which depends on the materials in contact and the condition of their surfaces, can be approximated by the following equation:

$$F = 1000 \mu Ah \quad (5.34)$$

where

F = force required to overcome friction (kgf)

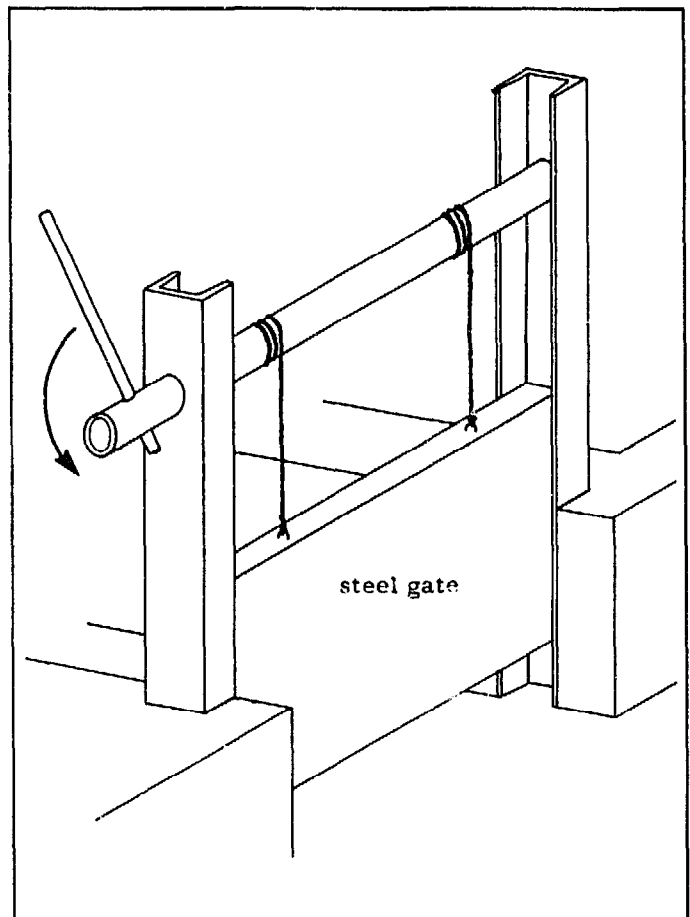

Fig. 5.180. The wheel-and-axle principle used to raise a gate.

μ = coefficient of static friction (see Table 5.8)
 A = submerged area of gate (m^2)
 h = distance from water surface to center of A (m)

The valves of " μ " given in Table 5.8 are for smooth-finished surfaces. Ferrous materials subject to rusting may develop excessive friction from pitting and the accumulation of rust when they are exposed to successive wetting and drying. If a gate is closed for long periods of time, the valves of " μ " for metal on metal should be increased by 50% (38). Even though steel on steel should not be used for normally closed gates, because they are likely to rust closed, steel is still widely used at micro-hydropower sites because of its strength, availability, and low cost. Using wood for at least one of the surfaces avoids these problems.

TABLE 5.8. Coefficient of static friction " μ " for smooth-finished dry surfaces

Surface	Coefficient of friction
Steel on bronze	0.45
Steel on steel	0.60
Wood on metal	1.0
Wood on wood	1.1
Rubber on wood	1.1

The actual force encountered in raising a gate is the sum of the friction force described above and the weight of the submerged gate. If a timber gate is used, the buoyancy of the submerged timbers will offset the weight of the gate to some degree.

A sliding gate used with micro-hydropower schemes usually does not have to be watertight. It can simply rest directly against the sides of the groove and channel bottom. Provision to drain away any leakage flow usually can be made if necessary; however, a number of approaches for providing a good seal around a sliding gate exist. The simplest bottom seal is rigid—metal on metal or on wood (Figs. 5.181a and 5.181b). Metal on metal seals usually require more accurate workmanship. Wood provides a good contact surface if it is not

allowed to dry out. Flexible seals provide greater watertightness and can be used as both bottom seals (Figs. 5.181c-5.181e) and side seals (Figs. 5.181f-5.181g).

An effective seal can be constructed of ordinary 25 mm garden hose (Fig. 5.181e) (38). To hold it in place, holes are cut at about 15 cm intervals along the upper part of the hose to accept the eyes of the eyebolts placed along the recess. Once the hose has been placed over the eyebolts, a 6 mm rod is run through the hose and eyebolts, and the eyebolts are tightened to draw the upper part of the hose tightly against the top of the recess.

A cylinder gate is a special type of sliding gate which overcomes one of the major problems of such a gate—the significant force required to lift it. A cylinder gate is basically a section of pipe which fits into a vertical outlet hole (Fig. 5.182). Because horizontal forces acting on the pipe from opposing directions cancel each other out and because no vertical forces caused by water pressure act on the pipe, the only force which the gate operator must overcome is the weight of the pipe itself. Because of the low pressures encountered, non-pressure-rated, thin-walled pipe can be used. To support it in a vertical position, the pipe passes through a loosely-fitting ring anchored to the walls of the water conveyance structure. To hold open the gate, its handles can temporarily rest on boards spanning the opposing walls (see Fig. 5.202). It is also possible in some cases to eliminate the supporting ring and instead to insert the end of the cylinder gate a short distance into the outlet opening. In this case, a close fit should be avoided as the gate may jam and be difficult to lift.

Gate valves. The gate valve is basically a circular sliding gate across a pipeline, surrounded with a body to contain the gate when the valve is open and the pipe is under pressure (Fig. 5.183). When the valve is closed, water pressure forces the gate against the seat. At high operating pressures or with large-diameter valves, a significant force is required to overcome the resulting friction forces. For this reason, when a large gate valve is placed at the high-pressure end of a penstock, a small bypass gate valve is placed in parallel to bleed water from the high- to low-pressure end. If the low-pressure end is not open to atmospheric pressure, pressure there

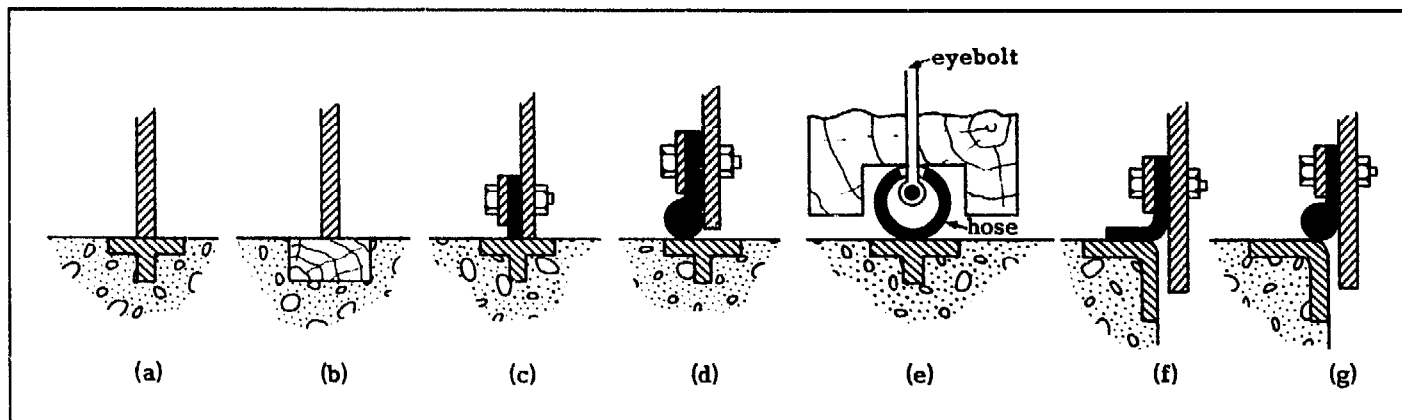

Fig. 5.181. Types of seals for sliding gates.

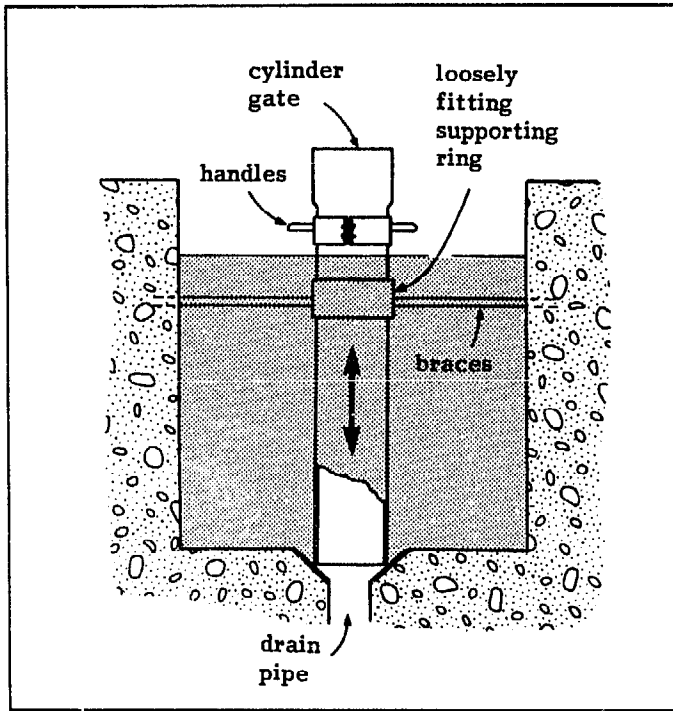

Fig. 5.182. A cylinder gate permits quick and easy operation.

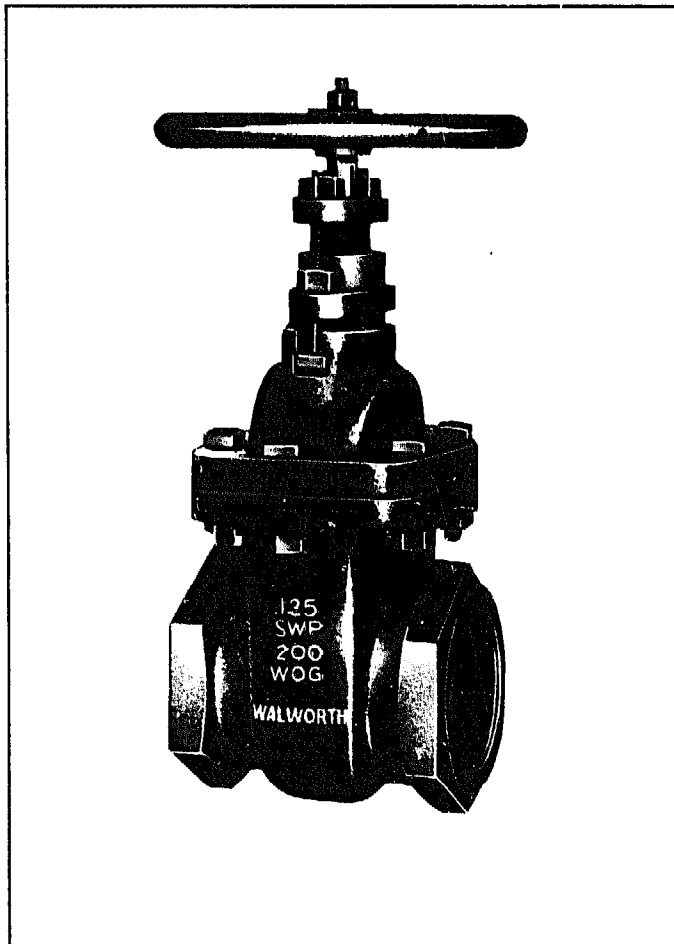

Fig. 5.183. A gate valve.

will build up, eventually equaling the high pressure. Then, when there is little or no pressure differential across the main valve, it can be opened easily.

Butterfly valves. The butterfly valve is essentially an extension of the pipe within which a lens-shaped disk, mounted on a shaft, is placed (Fig. 5.184). This type of valve can be operated with little force, because the upstream pressure on each half of the disk is essentially balanced. Because of its design, a butterfly valve can be closed quickly. Although this may be useful if the valve is used to shut down the turbine when turbine run-away conditions exist, it must not be closed so fast that an unacceptable pressure rise or water hammer in the penstock is created.

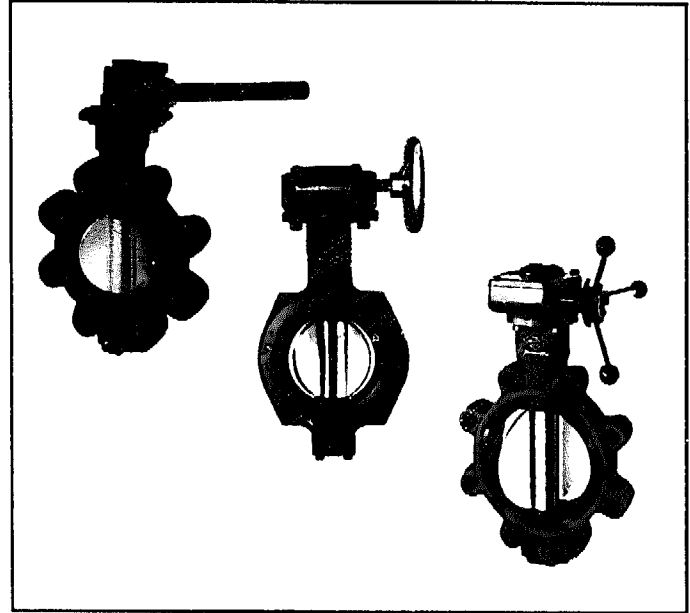

Fig. 5.184. Lever- and gear-operated butterfly valves.

Spillways

There are several points in a hydropower scheme where spillways might be incorporated: in a dam, intake area, or forebay, or along a power canal.

If a dam is included in a scheme, the spillway portion along its crest must be designed to permit the maximum flood flow expected in the river to overflow safely. Clearly, the shorter the spillway, the higher the water level behind the dam will rise. A higher water level behind the dam means that the portion of the dam's crest not used as a spillway must be higher to avoid uncontrolled overflow (and the dam must therefore be larger and costlier).

The intake structure must also be protected from high flows while it continues normal operation. If the intake is an open structure and too much water enters, either its walls must be high enough to prevent them from overflowing unexpectedly, or one or more spillways of adequate length must be incorporated in the intake area through which this water can flow back into the river downstream of the dam or diversion structure. If the intake leads into a power canal, spillways are essential

to regulate water level in the intake and canal. Even if there is a gate between the intake structure and canal, an operator will not be stationed there continuously. Then, if the water level in the intake structure increases suddenly, significantly more water will flow through the same gate opening, possibly causing the banks of the canal to overflow, erode the ground downhill, and undermine the canal.

If the canal depth may increase unexpectedly, the placement of spillways at suitable points along a canal must also be considered. This increase may result from excess water entering the canal from the intake, from runoff which enters the canal, or because of obstructions (such as landslides) which prevent normal flow along the canal (see **Freeboard and spillways**, p. 109).

A spillway should also be incorporated in the design of a forebay to prevent unexpected overflowing. This will happen when water enters the forebay faster than it is taken up by the penstock, either because the canal is conveying excess flow or because the flow into the penstock has been reduced or stopped.

In all cases, the length of the spillway and the elevation of its crest must be selected to permit all excess water to overflow through it before it occurs elsewhere (Fig. 5.185). The dimensions of the spillway required to pass the expected flows can be calculated as described in the following paragraphs. And wherever a spillway is used, the water which overflows must be led away to avoid erosion.

Overflow spillways. Of the several types of basic spillway designs, the most common is the overflow spillway where water overflows the structure itself--the crest of a dam, the wall of the intake or forebay, or the side of a canal. If the spillway is not submerged, that is, if the downstream water level is below the crest of the spillway, the discharge over such a spillway can be determined by the following equation:

$$Q = C L h^{3/2} \quad (5.35)$$

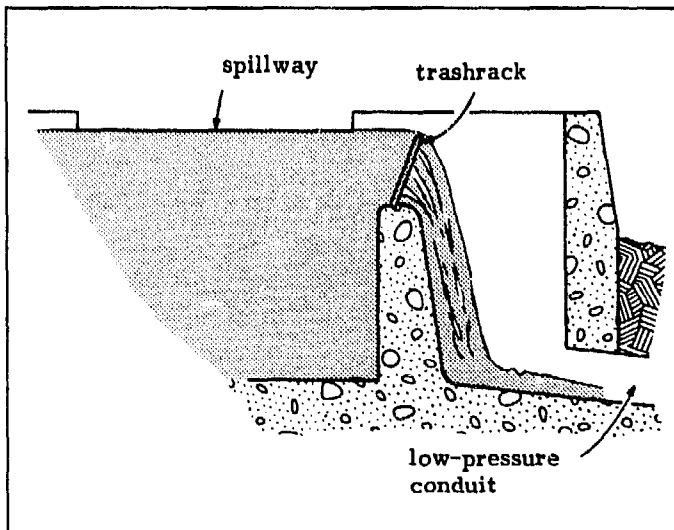

Fig. 5.185. The intake at this site has several features which were poorly designed--the area of the trashrack is

where

- Q = discharge (m^3/s)
- L = length of spillway (m)
- h = head above crest (m)
- C = coefficient of discharge
= 1.4 - 2.3 (see Fig. 5.186)

Figure 5.186 illustrates the variation of the discharge coefficient with spillway profile. For broad-crested spillways, the coefficient of discharge increases as head is increased or crest width is decreased. Rounding the upstream corner of a broad-crested spillway also slightly increases the discharge for a given head.

The spillway profile which passes the largest flow per unit length is a rounded crest shaped like the underside of the nappe of water passing over a sharp-crested weir. This is often designated as a "standard crest." Although equations for the shape of this profile are available, an extra level of effort would be required in both the design and construction of such a spillway; therefore, this profile is not generally used for micro-hydropower schemes. Most frequently, a portion of ordinary masonry wall is used as a spillway section. Because it has a lower coefficient of discharge, the length of such a spillway section compared to that of a rounded crest would have to be correspondingly greater.

Shaft spillways. Another type of spillway is the shaft or "glory-hole" spillway more commonly found behind dams associated with large hydropower plants. This spillway usually incorporates a funnel-shaped inlet to increase the length of the crest and therefore the flow which it can accommodate. Some micro-hydropower schemes using unlined earth canals have applied a variation of this type of spillway to prevent any excess water from overflowing the bank of the canal and causing a major breach (Fig. 5.187). The spillway illustrated in Fig. 5.188 has been made by using an oil drum as the inlet section. A smaller-diameter pipe can lead the overflowing water away from the canal. The flow into a pipe used as a shaft spillway can be approximated using

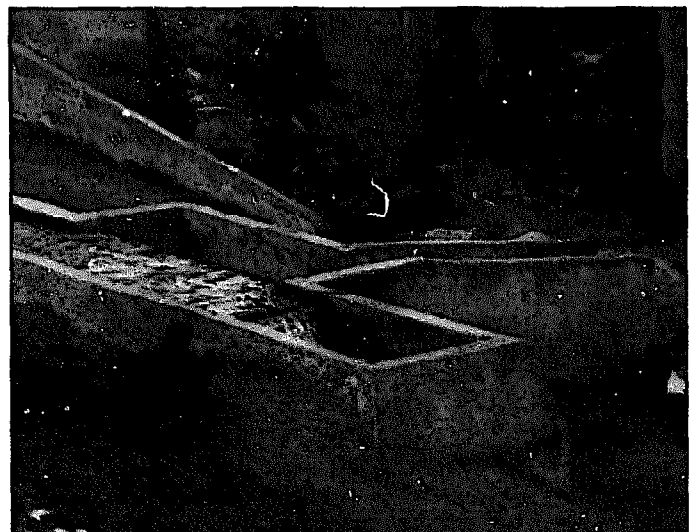

too small and quickly fills with debris and the spillway does not overflow until the trashrack itself overflows.

Chacas, Dept. of Ancash, Peru (100 kW)

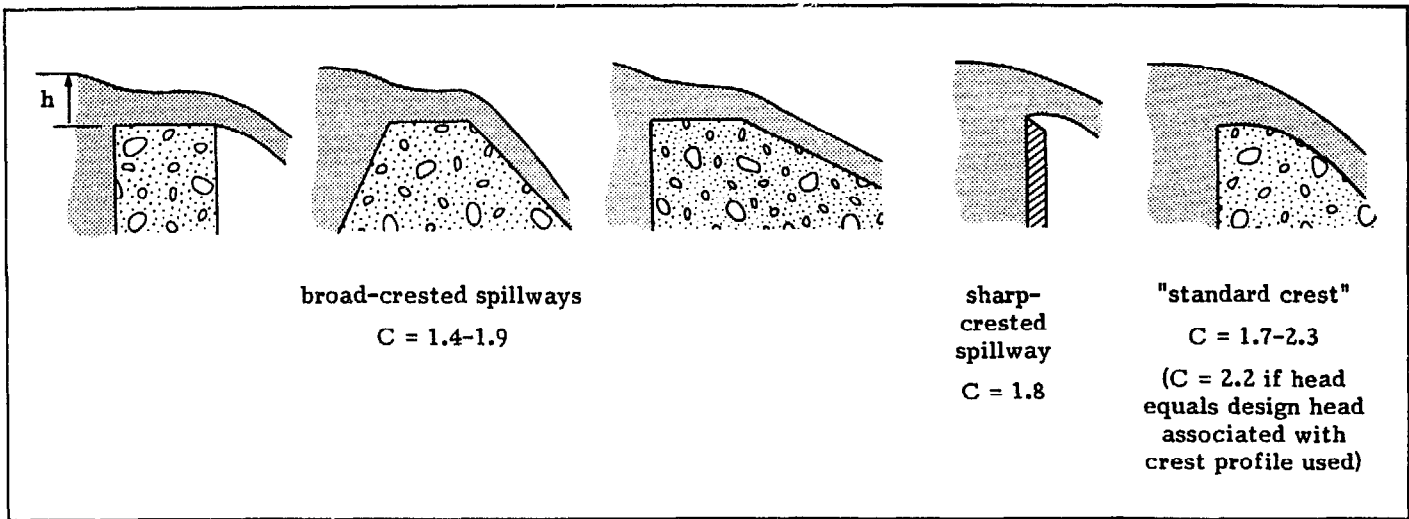

Fig. 5.186. Discharge coefficients for spillways of different profiles. For broad-crested profiles, a head and crest width each less than 300 mm is assumed.

the same equation as for flow over an overflow spillway [Eq. (5.35)], but "L" now represents the circumference of the spillway. If the pipe flows full, then it acts as a siphon and passes increased flow. This flow can be approximated by using Eq. (5.9). In this case, " h_t " represents the head across the portion of pipe flowing full.

Siphon spillways. A siphon spillway represents a third type. At large powerplants, this spillway is of major dimensions and is often incorporated in the dam itself. Although it has rarely been used with micro-hydropower plants, its principle of operation is described here because it might find some application. Because it uses the potentially large head across a siphon, it produces a significantly larger flow velocity than would be attained with an overflow weir. It is therefore useful where space available for another form of spillway is limited and where the water level must be kept within narrow limits. This is frequently the case at a forebay, for example.

The basic operation of a siphon spillway is illustrated in Fig. 5.189. When the water level rises above the elbow of the siphon, water begins to flow down the pipe. The siphon will only operate properly when all the air within has been removed, but this might not happen until the water level is considerably above the maximum level indicated in the figure. To prime the siphon sooner,

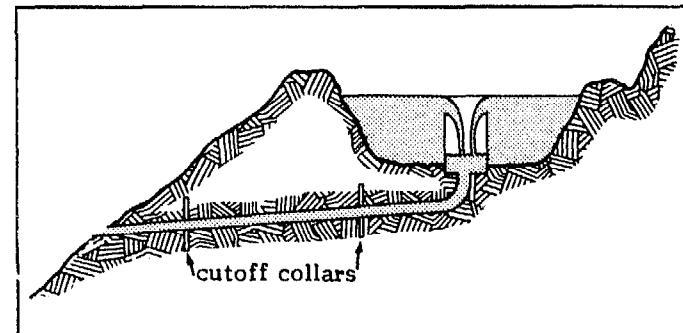

Fig. 5.187. An improvised shaft spillway used to remove excess flow in an earth canal.

bends are incorporated in the downstream leg. Water flowing down the pipe is deflected across at the second bend and seals off this leg. Water which continues to flow down the pipe entrains the entrapped air, gradually reducing the pressure until all the air is removed and the siphon is primed. The larger the gross head across the siphon—the vertical distance between the water level in the basin and the outlet of the siphon—the greater will be the flow which is then conveyed. With the rapid outflow of water, the water level in the basin will lower until the air vent hole is uncovered. Air which is then drawn into the siphon breaks the prime and the siphon stops operating. The air vent is simply a small hole drilled into the wall of the pipe. Alternatively, the air vent can be eliminated, in which case the water level would descend until the inlet to the siphon is exposed.



Fig. 5.188. A shaft spillway improvised from an oil drum.

Kudjib, W.H.P., Papua New Guinea (90 kW)

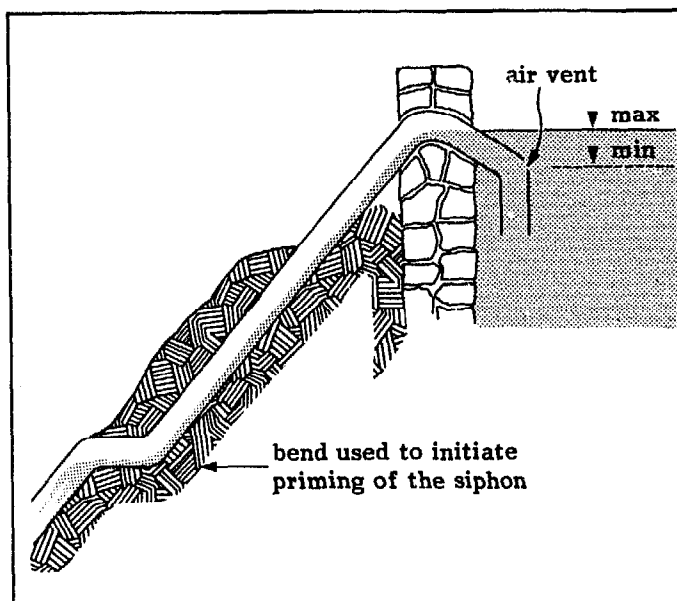

Fig. 5.189. Proposed variation of a siphon spillway for use at a micro-hydropower installation.

It is not possible to accurately predict the water level required to initiate the siphon, because that depends on the siphon's size and configuration. However, when the siphon is primed, the flow through a siphon spillway is governed by the same equation that governs the flow through an inverted siphon [Eq. (5.9)]. In this case, " h_f " is the gross head across the siphon.

Trashracks and skimmers

Any debris carried in the incoming water can have adverse impacts on a hydropower scheme:

- It can obstruct flow along the conveyance structures, interrupting power generation or causing the water to overflow and possibly undermine the structures.
- It can cause rapid deterioration of the penstock or turbine or cause a catastrophic failure, such as rupture of the penstock through a sudden blockage of flow through the nozzle or fracture of the runner blades.

It is therefore essential that the quantity of debris which enters a hydropower scheme be minimized.

A trashrack intercepts the entire flow and removes any large debris, whether it is floating, suspended, or swept along the bottom. Frequently, one is located in the intake structure to prevent debris from entering, and another is placed just before the inlet to the penstock to remove smaller debris as well as other debris which may have entered the water downstream of the intake. Sometimes a trashrack is also located at the entrance to a power conduit or along a lengthy canal. A skimmer is used only to hold back debris floating on the water surface.

In certain geographic areas or during specific seasons, the large quantity of floating debris can wreak havoc with the operation of a hydropower scheme. Trashracks might seem to compound the problem, because debris accumulates at these points and rapidly obstructs the flow. During these times, operators at some sites have been stationed around the clock to remove this debris. The proper placement of skimmers and the proper location and design of the intake and weir or dam can significantly reduce the problem of debris. This is where initial efforts should be focused.

Trashracks. A trashrack is made up of one or more panels, each generally fabricated of a series of evenly spaced parallel metal bars. The bars are parallel and evenly spaced because a rake is commonly used to clear the debris off the rack (Fig. 5.190). In this case, it is essential that the teeth of the rake mesh into the parallel bars without binding so that the rake can be pulled along the bars easily to scrape off accumulated debris. If a rake is used, trashracks made of expanded metal or screen mesh should be avoided because they would be difficult to clean. With small schemes where the trashrack is small and easy to manipulate, the rack can be withdrawn and cleared simply by inverting and striking it on the ground. A mesh can be used although removing grasses and debris intertwined with the mesh can be difficult. In all cases, trashracks should be removable and not permanently set in concrete.



Fig. 5.190. A trashrack bar spacing equal to the teeth spacing of a rake facilitates removal of debris.

Trashracks can be installed by sliding them into grooves in the concrete walls of the intake, canal, or forebay structure. When closure for maintenance or repair is desired, the trashracks can be removed and replaced by stoplogs. A platform on which the plant operator can stand while removing the debris is usually erected just downstream of the rack.

Lowesville, VA, U.S.A. (6 kW)

Trashracks fabricated of steel can be unexpectedly heavy. Therefore, they should be assembled in panels small enough to be handled easily for repair or replacement.

Bars with a rectangular cross-section set on edge are used at large hydropower schemes and are structurally superior in resisting water pressure to those with a circular cross-section. However, shape may be critical for very low-head sites. At such sites, the head loss (Fig. 5.191) through the trashrack may represent a larger portion of the gross head. If the trashrack is located in front of the inlet to the penstock, head loss through the trashrack will reduce the submergence of the inlet that is necessary to prevent vortex formation. If the trashrack is located at the beginning of a canal, the loss in head will reduce the depth of water in the canal and therefore the flow it can convey. Fortunately, head loss across a trashrack rarely is more than a couple of centimeters, and including a trashrack in a water conveyance structure generally has no major impact on the plant's operation even if this head loss is not accounted for.

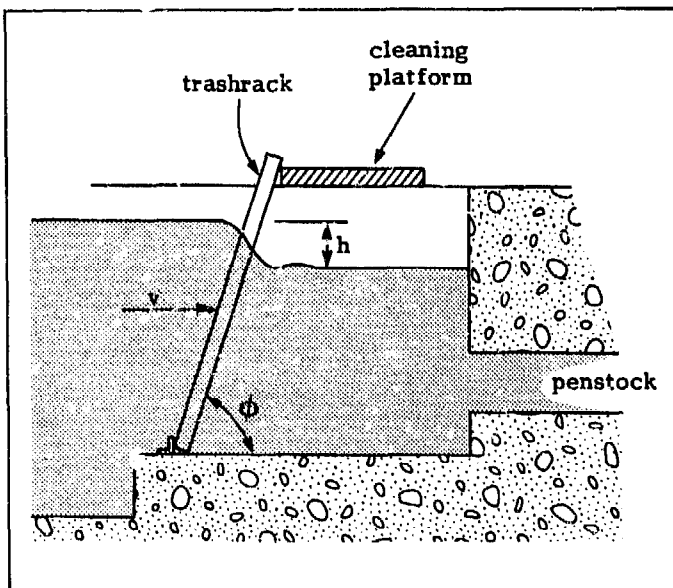

Fig. 5.191. The head loss "h" across a trashrack located at the inlet to a penstock.

The gross wetted area of a trashrack—the area of the rack below minimum water surface—is selected to limit the velocity through the rack. This facilitates the removal of debris and minimizes head losses. A design approach velocity of 0.5 m/s permits some trash to cover the rack between cleanings. If a trashrack is located immediately in front of the inlet to a penstock and the penstock velocities are significantly higher than 0.5 m/s, the trashrack can be built in a circular arc or some other configuration (Fig. 5.192). This approach increases the area of the trashrack and correspondingly decreases velocity through it.

Bars on a trashrack before the inlet to the penstock should be spaced no closer than is necessary to remove debris which might be detrimental to the turbine's operation. Otherwise, head losses may be high and the rack

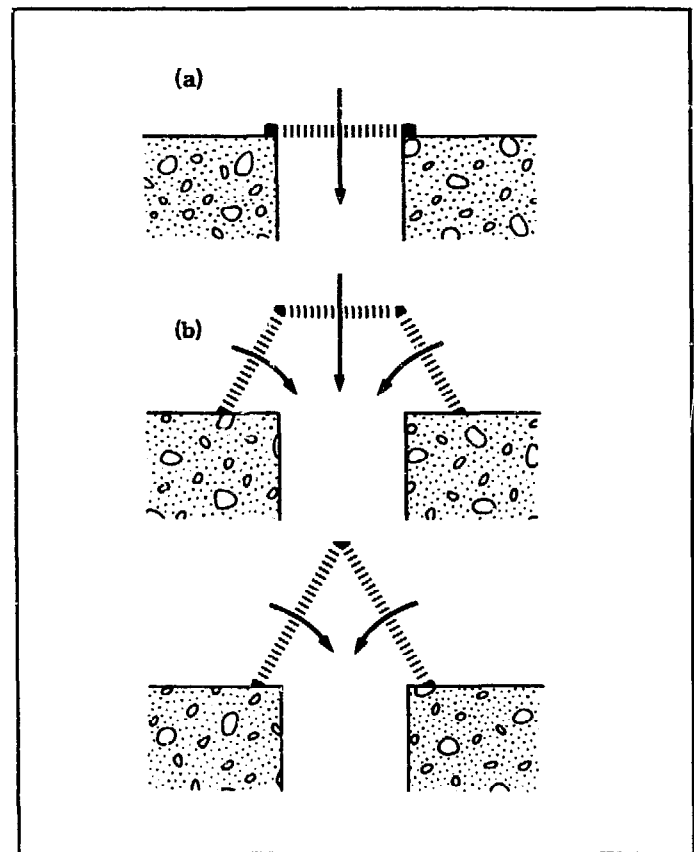

Fig. 5.192. If a small area would result in too high a velocity through a trashrack (a), other configurations can reduce this velocity (b).

may fill up quickly with debris. Letting small floating debris through a turbine will have no adverse impact. With a Pelton turbine, the space between bars usually is not more than half the nozzle diameter (or a quarter, if a spear value is used) to prevent the nozzle from choking. A similar criterion can be set for crossflow turbines. For Francis turbines, the space between bars should not exceed the distance between runner vanes.

Numerous expressions for predicting head loss across trashracks are available. One such expression is (39)

$$h = K_t \left(\frac{t}{b}\right)^{4/3} \frac{v^2}{2g} \sin \phi \quad (5.36)$$

where

- h = head loss across trashrack (m) (see Fig. 5.191)
- K_t = trashrack loss coefficient (Fig. 5.193)
- t/b = ratio of maximum bar thickness to space between bars
- v = approach velocity
= (design flow)/(cross-sectional area of water just upstream of rack)
- g = gravitational constant (9.8 m/s²)
- ϕ = angle of bars with the horizontal

The trashrack's angle of inclination is largely one of personal preference. An inclined rack facilitates the

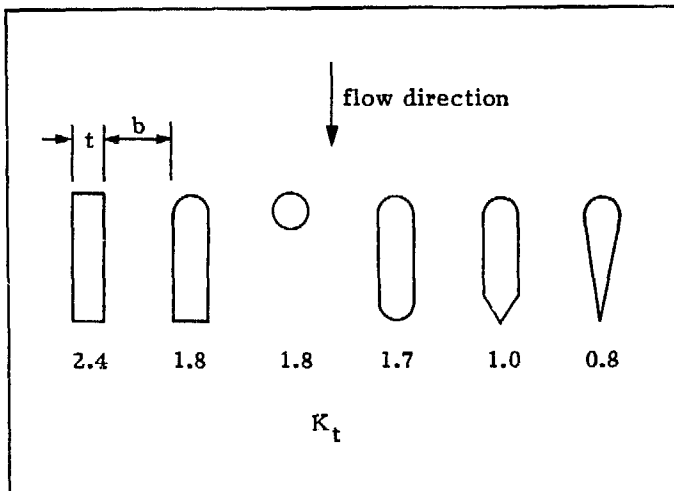

Fig. 5.193. Trashrack loss coefficients for various bar sections (41).

manual removal of debris when a rake is used and gives less resistance to flow.

A well screen also can be used as a trashrack. This is usually a plastic or metal pipe perforated with a series of slots which is used in tube wells to restrain the granular material whose pores contain the water. An improvised trashrack of this type is shown in Fig. 5.194.

In using a well screen as a trashrack, an adequate length is extended into the stream, settling basin, or forebay, with a cap over the end. The length "L" (m) of well screen required is

$$L = \frac{Q}{A_o v} \quad (5.37)$$

where

- Q = maximum expected flow through the screen (m³/s)
- A_o = effective open area per meter length of screen (m²/m or m)
- v = entrance velocity at screen

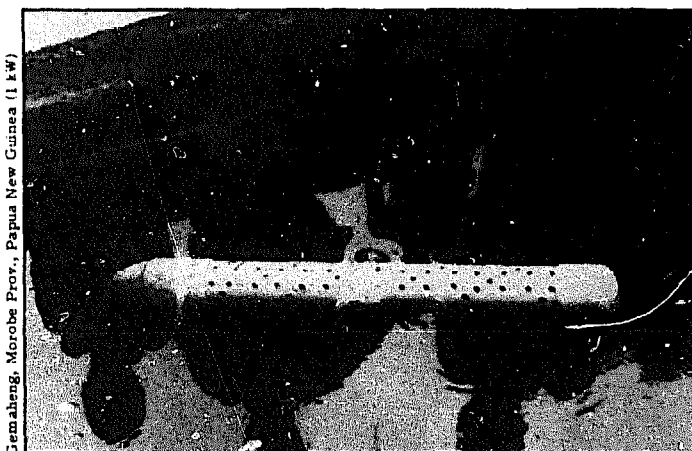

Fig. 5.194. A segment of drilled PVC pipe, installed in the forebay as an extension of the penstock, serves the function of a trashrack.

To minimize head losses, the entrance velocity "v" should be in the range of 0.05-0.10 m/s (83). The effective open area per unit pipe length, which can be increased by increasing the density of the slots or using larger-diameter well screen pipe, is specified by the manufacturer.

As mentioned, a rake can facilitate the removal of debris from the trashrack. In this case, its teeth should fit easily between the bars of the rack. To facilitate cleaning, the design illustrated in Fig. 5.109 places an inclined trashrack below water level. Floating debris is carried away by excess water. Any debris which does accumulate on the trashrack can be raked up and into the downstream trough, where it is carried away.

With a continuously operating hydropower plant, the task which requires the most frequent attention is removing debris from the trashrack. Large hydropower schemes have automatic rack-raking machines to perform this chore. These are rarely used with micro-hydropower schemes. But rather than performing this task manually, other approaches have been attempted or are being used.

One design for a self-cleaning trashrack is incorporated in the forebay described in **Settling basins** (p. 166) and shown in Figs. 5.204 and 5.205. This design incorporates a horizontal trashrack which is cleared periodically by briefly reversing the flow through it. This design is probably more effective where most of the floating debris is leaves rather than grass which can get intertwined in the trashrack.

The design shown in Fig. 5.117 also uses reverse flow to clean the trashrack. In this case, a cylindrical trashrack is used. Flow is introduced from inside and moves outward. As debris is caught in the trashrack, the trashrack is placed under tension and will not collapse as it would if the water flowed inward. The trashrack is cleaned by raising the cylinder gate to open the drain in the center. Water which has already passed through the trashrack will flow back in and, in so doing, wash off and carry away through the drain most of the debris restrained by the trashrack.

Some creative powerplant operators have replaced the electric motor incorporated in automatic rack-raking machines with other sources of motive power. Most of these devices, such as the one illustrated in Fig. 5.195, use a drum filled with water to provide the motive power (110). Water, under pressure from the higher level of water in the forebay, is fed continuously into an oil drum which is normally held in a raised position by a counterweight. When the weight of the water in the drum is sufficient, the drum lowers, pulling up the scraper to rake debris off the trashrack. Then when sufficient additional water has entered the drum and the water level reaches the bend in the siphon, the siphon is automatically primed, empties the drum, and permits the counterweight to raise the drum and lower the scraper to their original positions to repeat the cycle.

Several problems were encountered initially in the operation of this device:

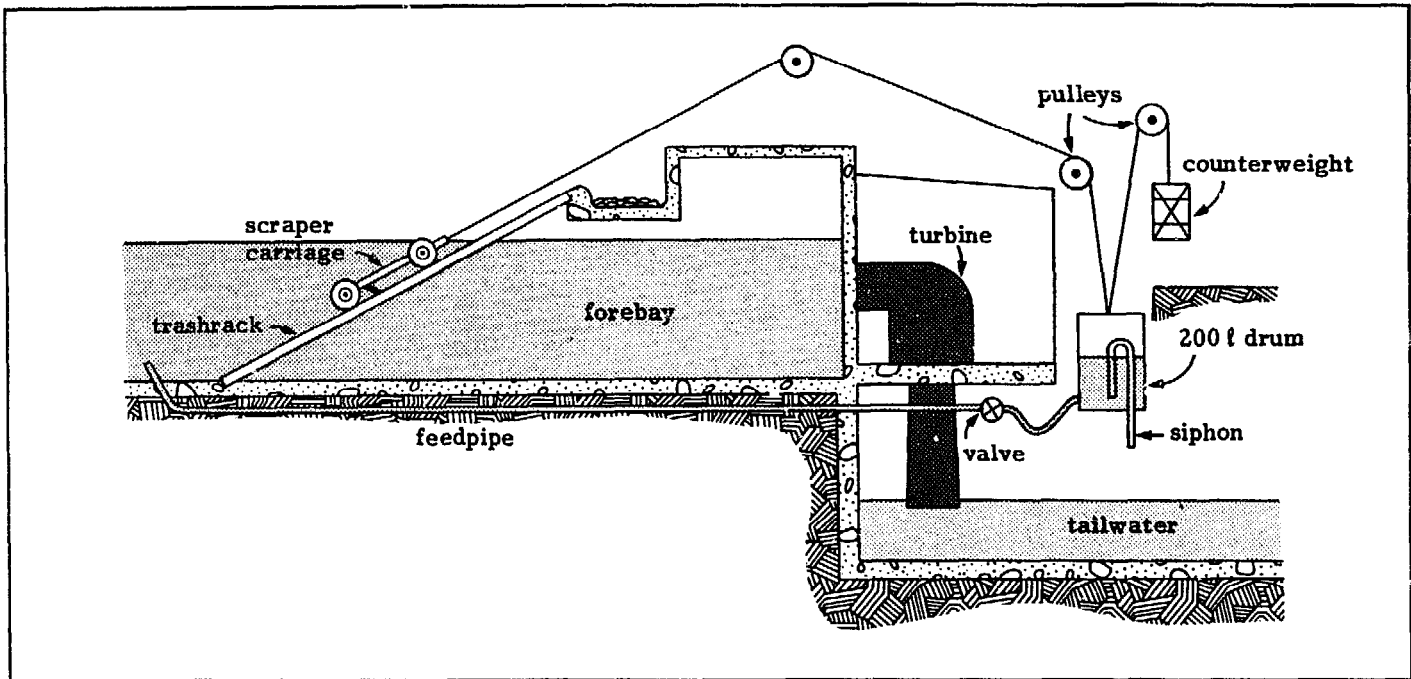

Fig. 5.195. A diagrammatic representation of a mechanical rake driven by a water-filled oil drum (110). This rake

was designed by John Wood and is in operation in Ennistymon, Ireland.

- Initially, the scraper carriage carried the counterweight, but the sizable force against the trashrack and the increased drag on the carriage as it moved up led to unreliable operation. The drum was then counterbalanced as shown in Fig. 5.195.
- The cycling period depends on the size of the feedpipe and siphon, and the resulting 14 minute cycle was too long for the increased volume of leaves the device had to handle in the autumn. Consequently, the feedpipe diameter was increased from 20 mm to 50 mm, and a valve was placed along the feedpipe to control the filling time and therefore the cycling period. In addition, the siphon diameter was increased to 80 mm.
- Feedwater was originally drawn from the forebay. Consequently, just when sufficient pressure was needed to clear a clogged trashrack, water level behind the trashrack was lowering, reducing the pressure head and flow in the feedpipe and increasing the cycling period. The simple solution to this problem was to locate the inlet to the feedpipe ahead of the trashrack. The intake to the feedpipe then had to be designed to ensure that it could not itself become clogged easily.

Skimmers. A skimmer is an obstruction placed at the water's surface, usually at an angle to streamflow, which skims floating debris from the passing water. If the water level changes markedly as, for example, at the intake off a stream, the skimmer can be a floating piece of timber secured at both ends (see Fig. 5.17). Because some debris usually passes under the skimmer, a trashrack is still necessary. However, a skimmer reduces the frequency with which the trashrack has to be cleaned.

If changes in water level are small, a fixed skimmer can be used. Figure. 5.196 illustrates such a skimmer installed in a forebay. A trashrack is still included over the inlet to the turbine. Another approach is simply to place the trashrack under the minimum water level, as shown in Fig. 5.59. In this case, floating debris is deflected by the wall of the intake and carried downstream by the excess streamflow.

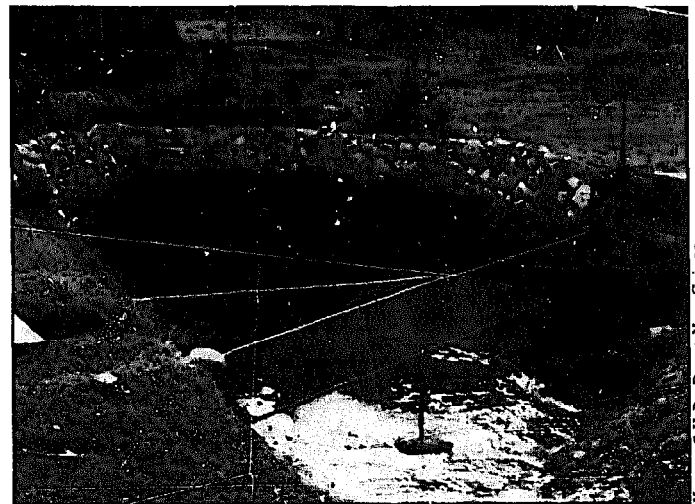

Fig. 5.196. Water is being drained out through the sluice gate at the right to facilitate cleaning out the forebay. A skimmer in the form of a screen can be seen extending across the forebay. A wall behind the skimmer prevents sediment from entering the penstock through the trashrack. The powerhouse at this very-low-head site is at the left.

Kagua, S.H.P., Papua New Guinea

Settling basins

A settling basin can serve two functions:

- When located at the intake, it removes any sediment from the incoming water which might otherwise settle in the intake or power conduit. A large accumulation of sediment there can reduce the flow available for power generation, cause an intake or canal to overflow, and require a sizable effort to clear.
- When located before or at the inlet to the penstock, it removes sediment which might cause rapid wear and reduce the operating life of the turbine.

Proper placement and design of the intake structure and the weir or dam are important factors in reducing the sediment and bed load admitted in the first place and in facilitating the maintenance of settling basins. If a scheme includes a power canal, proper design of the canal can minimize the additional debris which can enter along its length and simplify the job of a settling basin at the inlet to the penstock.

A settling basin works on the theory that if flow is not turbulent, particles denser than water will gradually settle out. When such a particle moves without interference through a fluid because of the difference between its density and that of the fluid, its settling velocity with respect to the fluid quickly becomes constant, the drag on the particle equalling its weight in the fluid.

Usually, settling basins are roughly rectangular in shape. Of the particles entering such a basin (Fig. 5.197), the last particle to settle out before the water leaves the basin would be one located approximately at point (a). To settle out, the slowest settling velocity this particle may possess is " v_o ". Any particle at point (a) with a settling velocity less than this value would not settle to the bottom. The physical characteristics of the settling basin would therefore imply that

$$\frac{60 v}{v_o} = \frac{L}{D} \quad (5.38)$$

where

v = average water velocity through the basin (m/s)

$$= \frac{Q}{D W}$$

v_o = particle settling velocity (m/min)

It is assumed that the velocity is uniform across the basin cross-section.

If this value is substituted into Eq. (5.38), then

$$v_o = \frac{60 Q}{A_s} \quad (5.39)$$

where

$$A_s = L W = \text{surface area of basin}$$

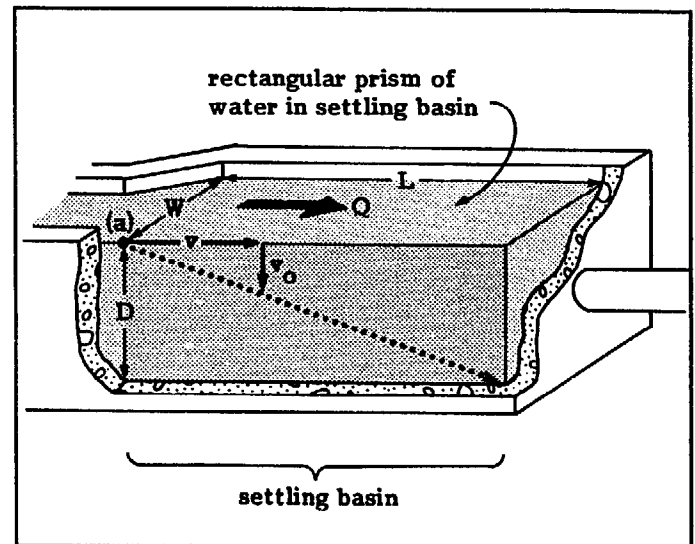

Fig. 5.197. A rectangular settling basin sized to settle out all particles with settling velocities greater than " v_o ".

Therefore, with the assumptions made above, the smallest particle size which can settle out from a given flow is solely a function of the surface area of the basin and not its depth.

Rather than constructing a settling basin approximately the same depth as the inlet canal (Fig. 5.198a), it could be significantly deeper than the inlet or outlet conduit (Fig. 5.198b). This increase in cross-sectional area would appear to decrease the velocity of water " v " through the basin and permit a basin of smaller surface area to remove particles above a given size. However,

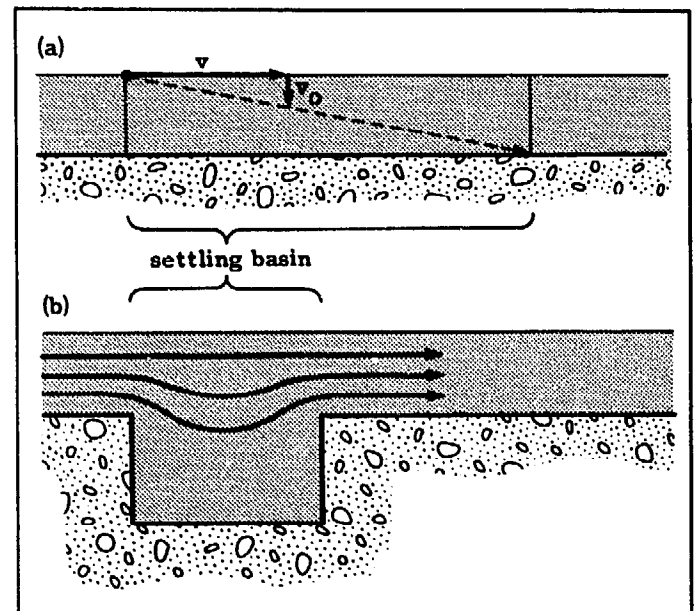

Fig. 5.198. Although the velocity through a deeper basin (b) is generally lower, flow largely short-circuits the basin in this case if special baffles are not used. The velocity, therefore, may closely resemble that of the velocity of a shallow basin (a).

the velocity would not be uniform over its cross-section, and most of the flow would short-circuit the basin—it would flow directly from inlet to outlet by the shortest route. The judicious use of baffles could increase the effectiveness of a deeper basin but would result in a more complicated and expensive design. Moreover, it would require additional excavation, and if the settling area were close to the intake, flushing of a deeper basin back into the main stream might not be possible because of the relative elevation of the stream level and basin floor.

Equation (5.39) implies that a long, narrow basin would be as effective as a short, narrow one. However, the flow velocity in the former would be greater and because of turbulence, sediment may get stirred back into suspension. To prevent this, the velocity of the flow through the basin generally should not exceed 0.3–0.5 m/s (see *Velocity in a canal*, p. 96). If the approximate depth of the basin is set equal to the depth of water in a canal, the width of the basin "W" (m) is found to be

$$W = \frac{Q}{v D} \quad (5.40)$$

where

- Q = flow (m³/s)
- v = desired velocity through the basin (m/s)
- D = basin depth (m) = canal depth in this case

When the basin width has been determined, Eq. (5.39) can be solved for the basin's length:

$$L = 60 \frac{Q}{v_o W} \quad (5.41)$$

where:

- L = basin length (m)
- v_o = settling velocity of smallest particle to be removed (m/min)

For sand (quartz) particles, the settling velocity "v_o" ranges from 1 m/min for 0.1 mm particles to 5 m/min for 0.8 mm particles. A basin for micro-hydropower schemes is often designed to remove particles with diameters greater than 0.3 mm and a corresponding settling velocity of about 2 m/min.

Although a rectangular basin was considered when deriving the previous expressions for its dimensions, a more widely used configuration includes a base sloping toward the gate through which the basin is drained and cleaned out. A base with a slope ranging from 3% to 10% is often used. In addition, the side walls sometimes have a significant lateral slope to facilitate removing the sediment (see Fig. 5.56a). Because the dimensions derived above are only approximate, incorporating a sloping base does not change the previous conclusions.

If a canal opens up into a wider settling basin, the accompanying decrease in flow velocity will cause sediment and bed load to start settling out as soon as

they enter. The upper portion of the basin will contain the coarser sediment; the finer sediment will be deposited at the downstream end of the basin. Therefore, although settling basins conventionally slope downstream toward a sluicing gate so that water entering the basin can scour its entire length, most of the sediment which will have to be removed may be at the other end.

If it is essential that water for power generation flow through the canal at all times, parallel settling basins may be incorporated (Figs. 5.199 and 5.200). One basin

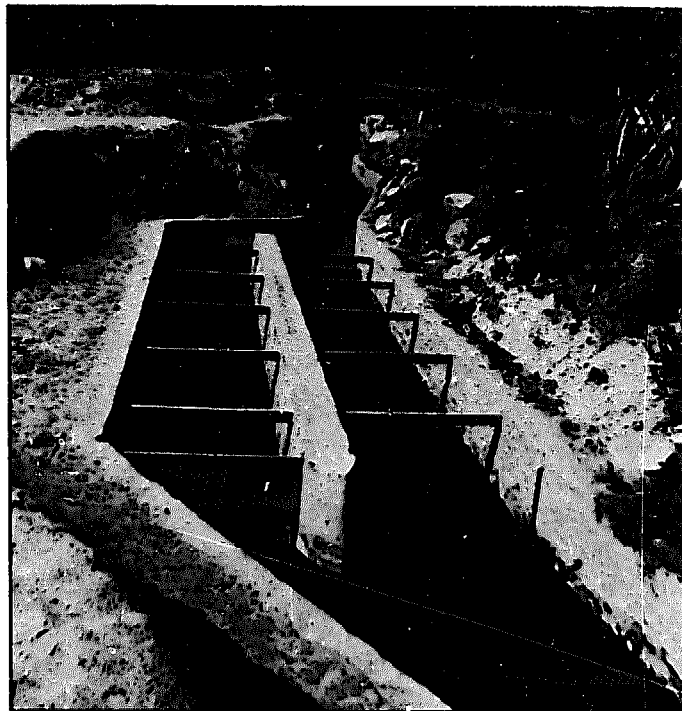

Syangja, Nepal (60 kW)

Fig. 5.199. This settling basin just after the intake incorporates two sections—one can be cleaned out while the other remains in use. No scouring outlet has been incorporated, and sediment has to be shoveled out.



Dhading, Nepal (30 kW)

Fig. 5.200. Parallel settling basins permit use of one while the other is being cleaned. Gabions were placed downhill of a portion of the canal to protect this area at a bend in the stream from being undermined by the stream.

can then be cleaned while the other is in use. Because each basin has to be adequately sized, this approach requires doubling the size of this structure, which doubles its cost and requires that a location with double the area be found along the canal route. Another approach would be to bypass the flow around the settling basin temporarily, because an insignificant amount of sediment would pass through the turbine during the brief time that the settling basin is being cleared (see Fig. 5.58). Because a well-designed settling basin should not require much time to clean, it would be simpler to incorporate only a single, well-designed basin and to shut down the turbine briefly during a low-demand period while the basin is cleared of sediment.

During site layout, in the initial stages of planning for a hydropower scheme, the settling basin should be located so that the suction head—the difference in elevation between the settling basin and the outlet of the scouring or drain pipe (Fig. 5.201)—permits adequate scouring velocities in the vicinity of the inlet to the drain pipe when the gate is opened. Insufficient scouring velocities make it more difficult for the water to draw out the sediment and more shoveling would be required. Even though a high velocity may exist through the scouring pipe, the flow velocity quickly diminishes as the area of flow increases, i.e., as one moves farther back from the inlet of the pipe. Therefore, opening the scouring gate will not necessarily result in velocities throughout the basin that are sufficient to pick up and carry away all the sediment. Some shoveling will still be necessary. The objective is to design the settling basin to minimize manual inputs, even if they cannot be eliminated completely.

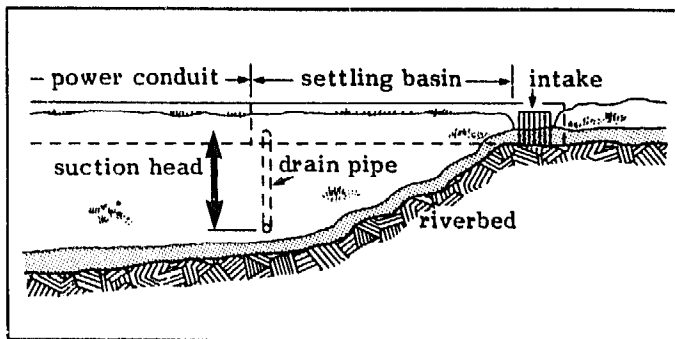
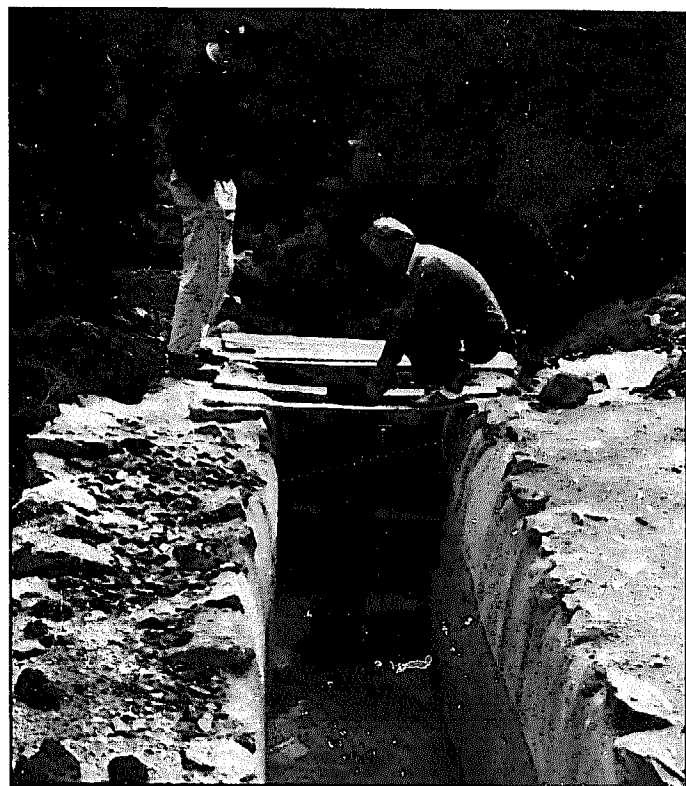

Fig. 5.201. If a settling basin is incorporated in the intake structure, selecting a site with adequate suction head will facilitate the scouring of sediment from the basin.

To facilitate scouring, it may be advantageous to open the drain pipe as quickly as possible; otherwise, the settling basin may be empty of water before the pipe is fully open, and optimum use therefore cannot be made of the scouring effect of rapidly flowing water. This is especially a problem with sliding gates raised by screw hoists. A cylinder gate (see end of **Sliding gates**, p. 155) overcomes this problem since it can be raised quickly with little effort (Fig. 5.202).

To reduce the effort required to clean out the settling basin, the floor of each basin shown in Fig. 5.203 is unusually steep, closely resembling a funnel, with a sliding gate located at the bottom. It is envisioned that the



Yanahuara, Dept. of Cusco, Peru (S.L.W.)

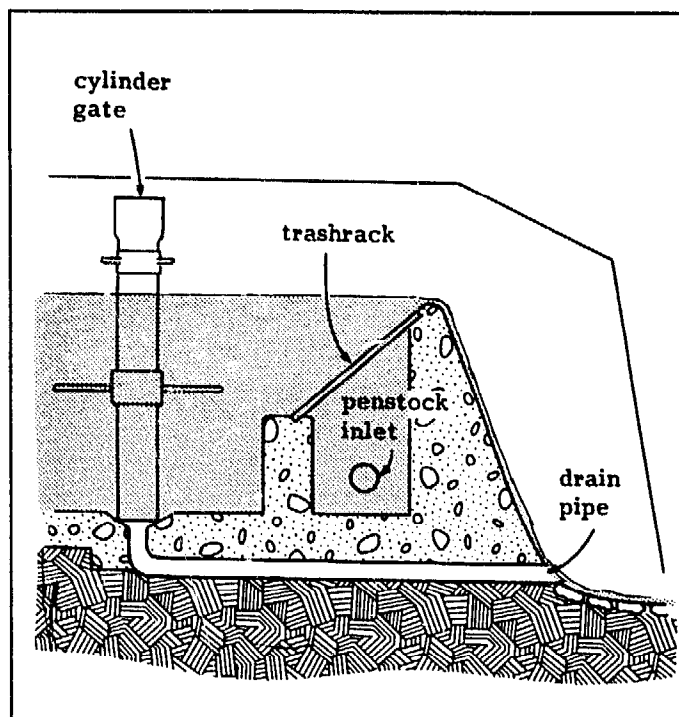

Fig. 5.202. A long, narrow forebay serves as a settling basin which is conveniently flushed out using a cylinder gate. Excess water overflows the trashrack, taking with it some of the floating debris.

sediment will be directed toward the bottom as it accumulates. With an excess of water in the stream, the gates will always be slightly open to remove the sediment on a continuous basis. (There are two settling basins in series here because the instructions for design

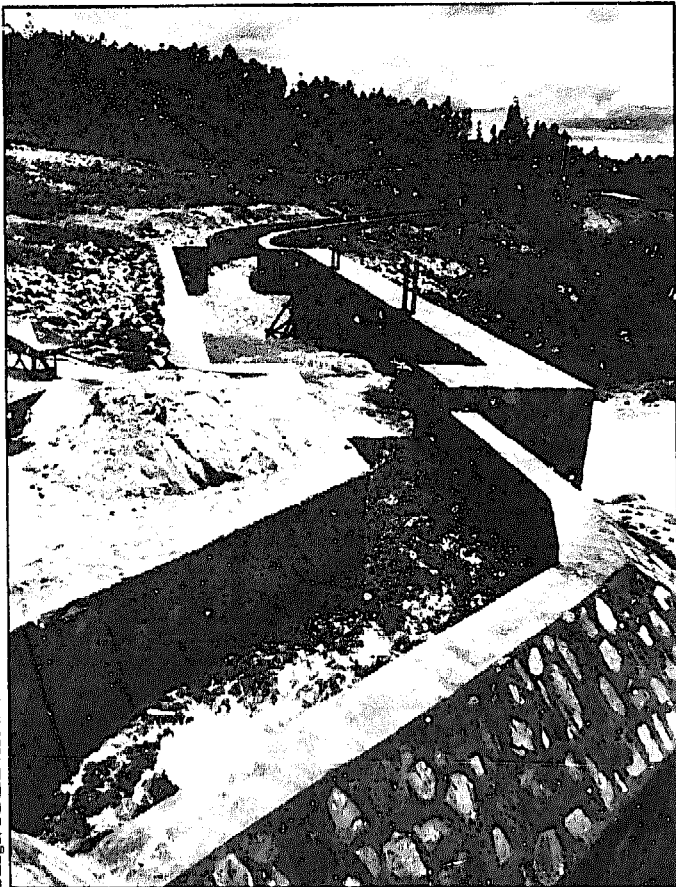

Fig. 5.203. A view of the settling area taken from the dam crest at a site under construction. Two sluice gates permit this area to be scoured out. The sediment returns to the stream at the right.

were interpreted incorrectly; two parallel basins had been envisioned.) Such deep settling basins are rarely considered for several reasons:

- additional excavation usually would be necessary,
- flushing out the sediment would be difficult unless the streambed elevation dropped significantly just after the intake, and
- additional construction materials would be required.

Fig. 5.204 shows a self-cleaning settling basin in operation. At this site, the forebay serves as a primary settling area. Its design is shown schematically in Fig. 5.205. Water is taken from below the stream's surface, permitting debris floating on the surface to continue unaffected. After entering the structure, water passes upward through a trashrack before proceeding into the penstock. The trashrack restrains debris in suspension and any sediment drops to the floor.

A scouring outlet is controlled by a radial gate which is an integral part of a pivoted container. When in operation, water fed to the container from the penstock through a length of tubing gradually fills it. When this container/gate unit is nearly full, the weight of the

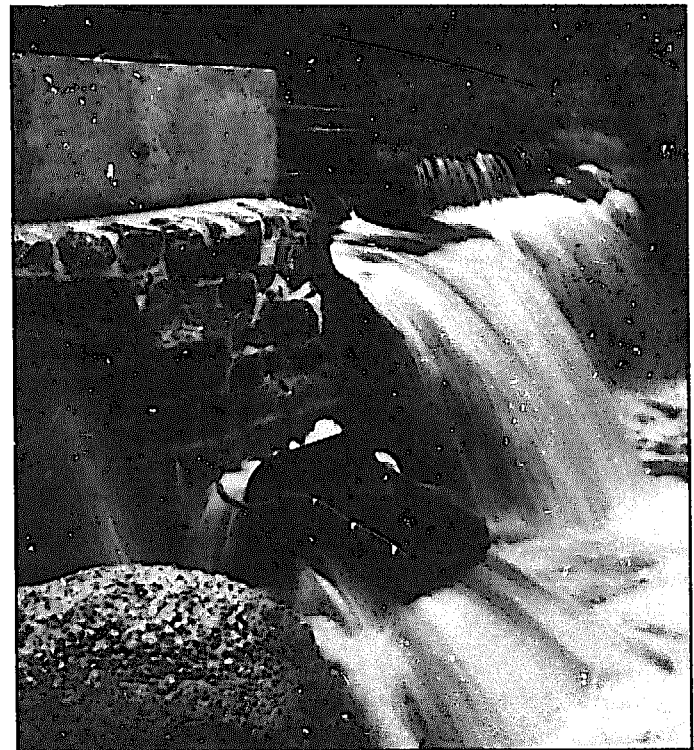
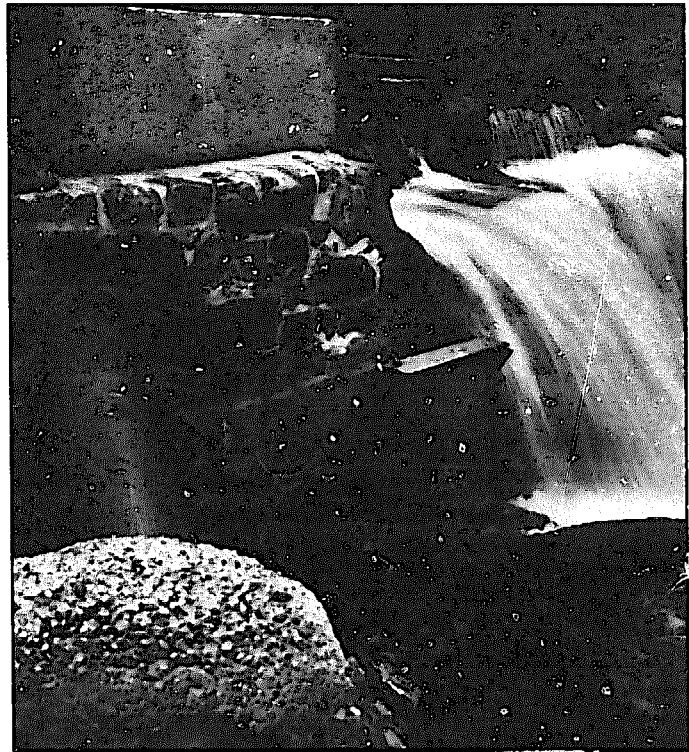

Fig. 5.204. A self-cleaning forebay designed by Rupert Armstrong Evans: (a) sluicing gate in the normally closed position and (b) gate open to permit scouring.

water contained inside forces it to tip. Several events then occur:

- The scouring outlet is opened, permitting a large velocity within the settling area to wash out any sediment.

- Water in the forebay descends, pushing debris off the trashrack and out the scouring outlet.
- The water within the container itself gradually empties. After a short period of time, determined by the emptying time of the container (which is set by the size of the opening at the top), the container then flips back, closing the scouring outlet and completing one cycle.

Although operation of this design is straightforward, it is necessary to size all the components properly. If, for example, the scouring time is too long and the inlet pipe into the settling area is too small in diameter, the water level in the forebay may drop so much that the penstock flows only partially full. If the scouring time is too short, the sediment and other debris may not be removed completely.

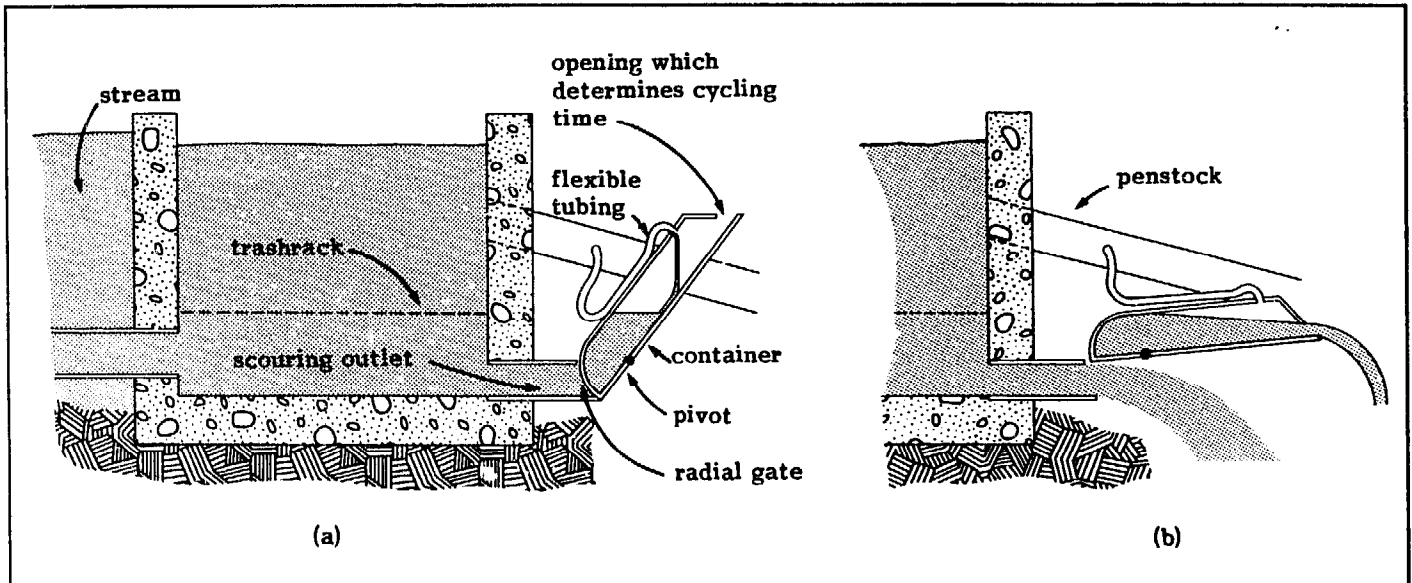

Fig. 5.205. A schematic representation of the self-cleaning forebay shown in Fig. 5.199. Two positions during a cycling period are illustrated: (a) for the larger part of the

cycle, the container is slowly filling with water, then (b) the container drops, opening the gate to permit scouring of the forebay. (Not to scale)

VI. TURBINES

INTRODUCTION

The principal motivation for developing a hydropower site is to generate power. Previous discussions have focused on selecting an appropriate site and designing the civil works necessary to convey water to the powerhouse. This chapter covers turbines, the machines which actually convert the energy of water into mechanical energy.

A variety of types of, and designs for, hydraulic turbines have been developed to accomplish the task of extracting power from water under a range of site conditions. However, most site developers need not be concerned with the theory of turbine operation and the complexities of turbine design. They must be aware of those factors necessary for power generation--sufficient water under pressure to meet their expected load--and have quantified these parameters. Competent and experienced firms are then usually relied on to select the most appropriate turbine to meet the developers' needs. After the developers have provided the necessary specifications, these firms should be able to select the appropriate components and ensure their compatibility as part of a complete turbine-generator package. Occasionally, some manufacturers that specialize in one type of turbine will specify that their turbine be used at a site for which it is not really suited (Fig. 6.1). A knowledge of the basic equations which describe the

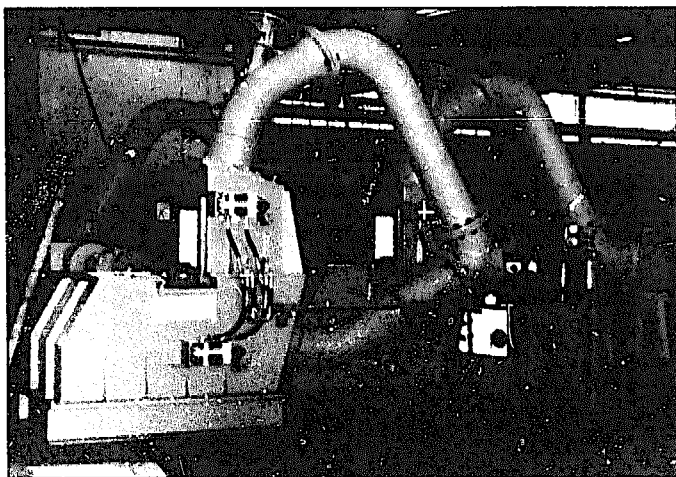

Fig. 6.1. By force-fitting Pelton turbines for sites with heads of only 20-30 m and power outputs of 30-60 kW, a manufacturer ended up with unwieldy and inefficient turbines.

operation of each turbine can be useful in identifying some of these cases.

Some site developers may wish to fabricate their own turbines. They need access to sufficient information to decide which turbine is most appropriate for their site, followed by specific design information.

And finally, some developers may have an old turbine that they would like to use at a new site. They need to be able to predict how it will operate under a new set of conditions.

To address these subjects, this chapter reviews the general applicability of the principal turbine types, their operation and basic characteristics, and some design modifications that can reduce their cost. It reviews the suitability of each for local fabrication and describes reference materials on their design and fabrication which are available. This chapter also reviews the specifications that site developers interested in purchasing equipment must provide a manufacturer or supplier. Relationships to predict the operation of an old turbine under new site conditions are presented. And for site developers interested in purchasing or fabricating turbines and end-use equipment separately and assembling a packaged unit themselves, this chapter describes various options for coupling the two.

BASIC THEORY

Water under pressure contains energy--the ability to do work. This pressure energy can be harnessed by a turbine runner* in two basic ways:

- The pressure can exert a force directly on the surface of the runner, which imparts energy to the runner and causes a corresponding energy or pressure drop in the water as it goes through the runner. Turbines which operate in this fashion are called reaction turbines and include the propeller and Francis turbines.

* In this publication, "runner" refers to the hydraulic device which actually converts waterpower to mechanical power. In most cases, it is shaped like a wheel. The term "turbine" refers to the entire unit--the runner, casing, valves, vanes, etc.

- The pressure can be first converted into kinetic energy in the form of a high-speed jet of water emerging from a nozzle. In this case, the pressure drop occurs across the nozzle. The water in the jet strikes the runner, imparting its momentum to the surface it strikes, and then drops into the tailwater with little remaining energy. Turbines operating in this manner are called impulse turbines and include the Pelton, Turgo, and crossflow turbines.

Because the runner of a reaction turbine is fully immersed, the casing around the turbine must be strong enough to withstand the operating pressures. With an impulse turbine, the casing serves only to prevent splashing, to lead the water to the tailrace, and to safeguard against accidents.

Careful fabrication is more critical for a reaction turbine, because the pressure drop takes place across its runner. The clearance between the runner and casing has to be as small as possible, because any leakage through this clearance represents a loss of energy. Because these clearances are small, a reaction turbine is less tolerant of sediment carried by the water.

Although advantages or disadvantages associated with a specific turbine type may influence the final choice, several specific site parameters may still suggest that it be used:

- The net head under which a turbine will operate is a major factor governing the selection of a turbine type. For example, Pelton turbines cannot be used effectively at low heads, and propeller turbines do not operate effectively under high heads.
- The relationship of the required power to the head available at a site also influences the choice of turbine. A Pelton turbine under a head of 30 m could generate 5 kW, but another turbine type would usually be selected if 100 kW were required.
- If the turbine is to operate at a certain speed for coupling to a generator or other machine, this factor also affects the choice of turbine. For example, for directly coupling a generator with a turbine operating under a low head, a reaction turbine would be required; a Pelton or Turgo runner would turn too slowly.

All three of these variables are incorporated in an expression called the specific speed " N_s ", which is defined as follows:

$$N_s = \frac{N\sqrt{P}}{H^{5/4}} \quad (6.1)$$

where

- N = working speed of turbine (rev/min)
- P = maximum turbine output (hp) = 1.4 x maximum turbine output (kW)
- H = net head (m)

TABLE 6.1. Specific speeds for various types of turbines

Type of runner	N_s
Pelton	12-30
Turgo	20-70
Crossflow	20-80
Francis	80-400
Propeller and Kaplan	340-1000

It should be noted that the metric specific speed expressed in Eq. (6.1) is 4.45 times the specific speed in the English system of measurement.

To ascertain which type of runner is conventionally used under conditions found at a proposed site, the appropriate plant parameters are substituted into Eq. (6.1) to determine its specific speed. Then Table 6.1 is used to identify which type of runner operates most efficiently at that specific speed. The values in this table are based on experience gained over the years.

For a Pelton or Turgo runner with multiple jets, "P" in Eq. (6.1) represents the power output with one jet in use. Therefore, it is possible to extend the range of efficient operation of both Pelton and Turgo turbines by equipping them with two or more nozzles. For example, a Pelton turbine with two nozzles and a runner having a specific speed of 12 would generate twice the power at the same speed and head as an identical runner with a single nozzle. From Eq. (6.1), it can be seen that this 2-jet Pelton turbine would be equivalent to a turbine with a specific speed of $12\sqrt{2}$, or 17, because specific speed is proportional to \sqrt{P} . Pelton turbines equipped with two nozzles would therefore operate most efficiently within the range of specific speeds similar to that for a single-jet Pelton multiplied by $\sqrt{2}$, or 17-40. Even in this case, however, the runner itself is still said to have a specific speed of 12.

For large hydropower plants, runners are always directly coupled to the generator and must therefore be designed to run at the speed of the generator. Consequently, the specific speed of the turbine which is required at a specific site is set by the generator's speed. This is often not the case with micro-hydropower installations. Because it is frequently more important to use less costly, standardized runners rather than custom-designed runners, gearing between the turbine and generator is often required. For a site with a given head and power output potential, turbines that operate at speeds other than those required for direct coupling can then be used. A single site may therefore accommodate turbines within a broader range of specific speeds than is implied in Table 6.1, including several turbine types.

For example, if a turbine that is to generate 90 kW under a head of 55 m to drive a 1500 rev/min generator is conventionally selected, it would need a runner with a specific speed

$$N_s = \frac{1500 \sqrt{90 \cdot 1.4}}{55^{5/4}} = 110$$

and a Francis turbine would probably be selected. However, if gearing is acceptable, with a gearing ratio of up to 3:1, for example, the turbine speed required to drive the generator could range from 500 to 4500 rev/min, with an associated specific speed in the range of 37-330. Therefore, in addition to a Francis turbine, a Turgo, crossflow, or two-jet Pelton turbine could also be used in this situation.

To return to the example quoted earlier in this section, it can now be seen that a turbine generating 5 kW under a head of 30 m to drive a 1500 rev/min generator would require a runner with a specific speed of 57 and single-jet Pelton with a specific speed of 19, and a gearing ratio of 1:3 could be used. However, to generate 100 kW at the same site would require a turbine with a specific speed of 250, and a single Pelton runner even with multiple jets and appropriate gearing would rarely if ever be used.

In addition to its value in selecting the most appropriate turbine types, the specific speed of a runner has several other useful properties:

- This number is entirely a function of the geometrical shape and design of a runner. Each turbine therefore has a unique value of "N_s" independent of the head under which it operates.
- This number is not a function of turbine size. Geometrically similar turbines—one turbine which is simply an enlarged or reduced replica of another—have identical values of "N_s".

Although plant operating parameters can be used to determine specific speed, which can then be used to select the turbine that would function most efficiently, this procedure cannot carelessly be reversed. For a turbine with a known specific speed, either "N", "P", or "H" cannot be determined by selecting any values for two of the remaining parameters, because these parameters are not independent of each other. The speed and power output of a specific turbine both depend on head. For example, a runner with a specific speed of 18 will not necessarily generate 9 kW when run at 160 rev/min under a head of 16 m, even though the equality expressed in Eq. (6.1) holds true. This is because the power will probably be other than 9 kW under a head of 16 m, and the optimum operating speed may not be 160 rev/min under this head. However, if the functional relationships of speed and power to head for the turbine type under consideration are substituted into the expression for specific speed, Eq. (6.1) can be used for this purpose.

TURBINE TYPES

Pelton turbines

A Pelton turbine has one or more free jets discharging

from nozzles and striking a series of buckets mounted on the periphery of a disk (Fig. 6.2). Although this turbine is usually not used under a head of less than about 150 m at large hydropower installations, it has been used down to heads of several meters at micro-hydro-power installations. The principal reason for not using this type of turbine at lower heads is that its operating speed becomes low and the runner becomes unwieldy for the quantity of power generated. If runner size or speed poses no obstacle, then a Pelton turbine can be used under fairly low heads.

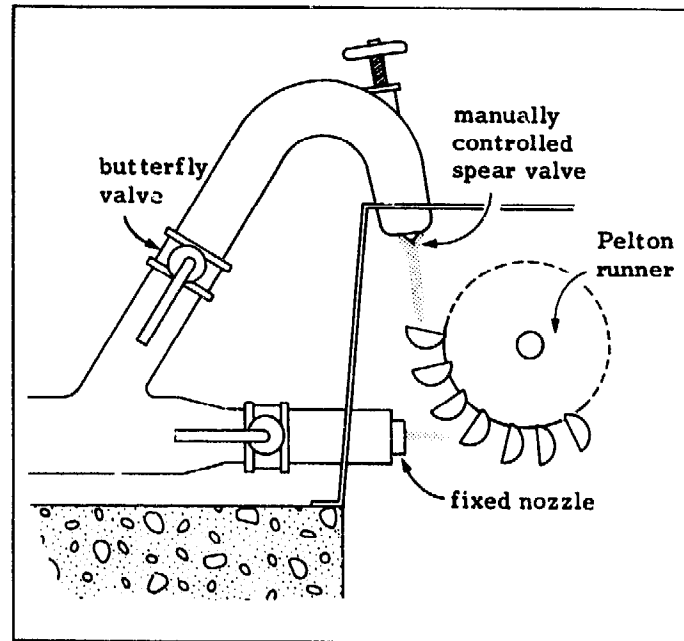

Fig. 6.2. A Pelton turbine incorporating both a needle valve to regulate one jet and a fixed second jet. The butterfly valves are used only to turn the flow on or off.

The head under which a Pelton turbine operates has the following implications for the turbine's design. At high heads, enough water emerges from a single jet to generate the desired power, and the runner revolves at a speed high enough for direct coupling to a generator or other end-use equipment.

Assume that identical power is to be generated by the same runner but that a lower head is available. On the one hand, a decrease in head leads to a decrease in the jet velocity and therefore a decrease in runner speed. On the other hand, because reduced head implies less water through the nozzle as well as less power associated with that water, a nozzle with a larger area is required to pass the increased flow necessary to generate the same power. However, increasing the jet diameter is feasible only up to a point. There is a maximum jet diameter, which is set by the size of a bucket on the runner being used. Empirical data show that the maximum jet diameter is about one-third the width of the bucket.

If the Pelton turbine is used under a still lower head and the area of a single nozzle can no longer be increased to maintain the same power output, the next approach is to increase the effective nozzle area by increasing the

number of jets. The power output from a turbine is roughly proportional to the number of jets. Two equally sized jets will make approximately twice the power available than that from the turbine using a single jet. In practice, interference between the water and runner within the casing reduces this value somewhat. When two jets are used, they usually strike the runner at points a little less than 90° apart.

As head is decreased further, three or more jets can be used. The runner is then set on a vertical rather than horizontal shaft. Rather than using more than two jets, another approach is to use two runners side by side on the same shaft or to place a runner at each end of the generator shaft.

Pelton runners for micro-hydropower plants usually have efficiencies of 70%-85%. They have the advantage of being able to accommodate a wide range of flows with nearly constant efficiency. For this to be possible, a turbine must be equipped either with a needle or spear valve or with nozzles of different sizes which can be turned on or off as required.

The runaway speed for a Pelton turbine—the speed of the runner when, under design conditions, all external loads are removed—is about 1.8 times its normal operating speed. Under these conditions, bucket speed nearly equals jet velocity.

In preparing the powerhouse foundation to accept a Pelton turbine, only a hole in the powerhouse floor is required. It is usually rectangular and is about the size of the outlet of the turbine casing through which the water leaving the turbine drops into the tailrace (see Fig. 5.167). If a pipe section conveys the water from under the turbine to the tailrace, it must be large enough so that the water does not back up and submerge the runner.

Basic relationships

With an impulse turbine such as the Pelton turbine, the pressure at the bottom of the penstock creates a jet of water with a velocity

$$v_j = \sqrt{2gH} \quad (6.2)$$

where

- v_j = jet velocity (m/s)
- H = net head (m)
- g = gravitational constant (9.8 m/s²)

From Eq. (6.2) and the fact that the flow through the turbine equals the product of jet area and velocity, it is possible to determine the jet diameter required as a function of "H", which depends on site conditions, and "Q", which is determined from the power equation Eq. (5.11) :

$$d = \frac{54}{H^{1/4}} \sqrt{\frac{Q}{n_j}} \quad (6.3)$$

where

- d = jet diameter (cm)
- Q = total flow through turbine (m³/s)
- H = net head (m)
- n_j = number of nozzles

It should be noted that the diameter "d" does not refer to the diameter of the nozzle opening but to the jet diameter, which is equal to or, more frequently, somewhat smaller than, this opening. With a needle valve, the jet diameter is usually 10%-20% less than the nozzle diameter, depending on the design (38). With a simple cylindrical nozzle with rounded entry and slight taper, jet and nozzle diameters are nearly equal.

Solving Eq. (6.3) for "n_j" will give the minimum number of equally sized jets that would be required to develop the design power under a given net head and flow when using jets of diameter "d":

$$n_j = \frac{2900 Q}{\sqrt{H} d^2} \quad (6.4)$$

For horizontal-axis Pelton turbines, a maximum of two nozzles is commonly used. The maximum number of nozzles for a Pelton turbine used in micro-hydropower plants is commonly four, arranged around the runner on a vertical shaft. Up to six are used in large hydropower plants.

The linear velocity of the bucket for most efficient operation of the runner will equal 0.43-0.47, or about half, of the jet velocity. Using Eq. (6.2), runner speed can therefore be expressed as

$$N = 38 \frac{\sqrt{H}}{D} \quad (6.5)$$

where

- N = runner speed (rev/min)
- H = net head (m)
- D = runner pitch circle diameter (m)
= diameter of circle centered on runner shaft and tangent to centerline of jet

These equations indicate that, for a given Pelton runner, its speed depends on the net head acting on the turbine and is not directly affected by nozzle area or number of nozzles. Changing nozzle area affects the speed only insofar as a change in flow affects penstock losses. Increasing nozzle area, for example, increases the flow in the penstock, which increases friction loss in the penstock, slightly decreases net head, and slightly decreases optimum runner speed. From Eq. (6.5) it is clear that, at a given site, runner speed can be changed significantly only by changing runner diameter.

For the generation of electricity and some other uses, high runner speeds are preferred because they permit reduced gearing or, possibly, direct coupling (see **OPTIONS FOR COUPLING**, p. 192). Equation (6.5) implies that a smaller runner diameter would be preferred in this case. However, the minimum permissible

bucket size and the minimum number of buckets for efficient operation set a limit for the minimum size of a runner:

- The buckets must be large enough to accommodate the jet(s).
- The runner must be large enough to accommodate the required number of buckets to ensure efficient operation.

To establish minimum bucket size, years of accumulated experience indicate that bucket width is rarely less than three times the jet diameter. This is necessary to ensure that the water entering the bucket does not interfere with the water leaving it.

The number of buckets " n_b " to ensure efficient operation can be estimated by the following equation:

$$n_b = \frac{m}{2} + 15 \quad (6.6)$$

This equation is expressed in terms of a parameter called the jet or diameter ratio "m". This is defined as

$$m = \frac{D}{d} \quad (6.7)$$

where the jet diameter "d" and the runner diameter "D" are both expressed in the same units. If too few buckets are used, a portion of the jet passes through the runner without striking the buckets. Using too many buckets leads to their interference with the water leaving the runner.

To ensure that a runner is large enough to accommodate the optimum number of buckets, the diameter ratio can be used. The minimum value of this ratio has been found from experience to be about 6. This implies that the runner diameter cannot be smaller than six times the jet diameter. The minimum value of the diameter ratio is the lowest value for which the water in the jet is still used effectively. Conventionally, this ratio is usually in the range of 10-20.

Since minimum runner size depends on jet diameter, the only way of further increasing runner speed is by decreasing jet diameter. This can be achieved by increasing the number of jets, as is shown by Eq. (6.3).

Fabrication

Although Pelton runners have been fabricated of sheet metal and pipe sections (Fig. 6.3), this requires considerable effort. More frequently, a Pelton runner is cast—either the buckets are cast individually and bolted or welded to a central disk, or the runner is cast integrally (Fig. 6.4). Consequently, Pelton turbines generally require casting facilities, and this may limit their appeal among those interested in constructing a Pelton runner for a single site.

EXAMPLE 6.1

As part of a micro-hydropower project to serve a remote school in Buenas Aires, Panama, a small-hydropower equipment manufacturer supplied a four-jet Pelton runner with a pitch circle diameter of 150 mm. The turbine was to generate 10 kW under a head of about 20 m. Determine (a) what jet diameter would be required to generate the desired power and (b) whether this jet size reasonable.

(a) For a 10 kW turbo-generating package using a Pelton runner, assume a turbine efficiency of about 75%, a generator efficiency of 80%, and a coupling efficiency of 90%, resulting in an overall efficiency of about 50%. Therefore, Eq. (5.11) specifies that the flow required to generate this power is $0.10 \text{ m}^3/\text{s}$. Equation (6.3) then indicates that the required jet diameter be about 4 cm.

(b) Equation (6.7) indicates that the diameter ratio for this runner is 3.8. This is much too small, implying a nozzle which is too large.

In fact, the unit was provided with 2.5 cm-diameter nozzles (corresponding to a diameter ratio of about 5), which are still too small and would have generated 10 kW only at 100% efficiency. Because of the incorrect turbine design, efficiency was much lower than expected and the maximum output from this plant never exceeded about 2 kW. This example illustrates how the application of a few simple mathematical relationships can warn of a potential problem. This was not done, and the vocational school now serving more than 200 students, including interns, is deprived of critically needed power because no technical expertise nor funds have been made available to resolve the problem.

A wide variety of bucket shapes has been used. Each manufacturer of Pelton turbines has its own designs, but these are proprietary and often difficult to obtain. In *Hydraulic Machines* (69), Lal summarizes empirical relations for basic bucket dimensions and presents typical plan and section views. In *A Pelton Micro-Hydro Prototype Design* (63), Inversin provides various profiles for a bucket shape that was synthesized from several sources (the efficiency of that runner is approximately 75%). He describes the design of a two-jet Pelton turbo-generating unit with a 200 mm-diameter runner and nozzles made from orifice plates and provides a summary of test results for several different design configurations. Another approach has been to use a bucket from a commercial turbine to prepare a pattern.

Sometimes profiles are selected simply on the basis of ease of construction. As described in "A Working Pelton Wheel," Meinikheim circumvented the need for casting facilities and machined his buckets out of steel (80). The bucket profile was determined by the shape of the

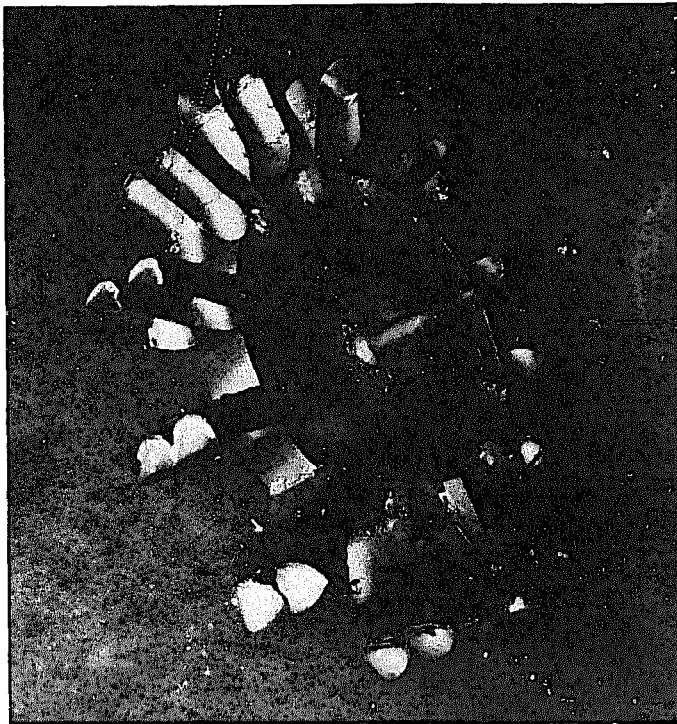

Fig. 6.3. Pelton runner fabricated of sheet metal and pipe sections. The first set of buckets fractured after running several months.

tool used. More complex profiles could be machined, but a much more sophisticated set-up would be required.

Cost-reduction approaches

One of the more expensive components of a commercial Pelton unit is the needle or spear valve that regulates

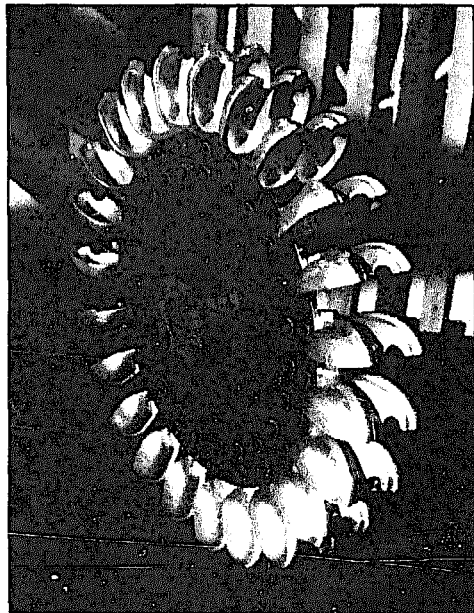
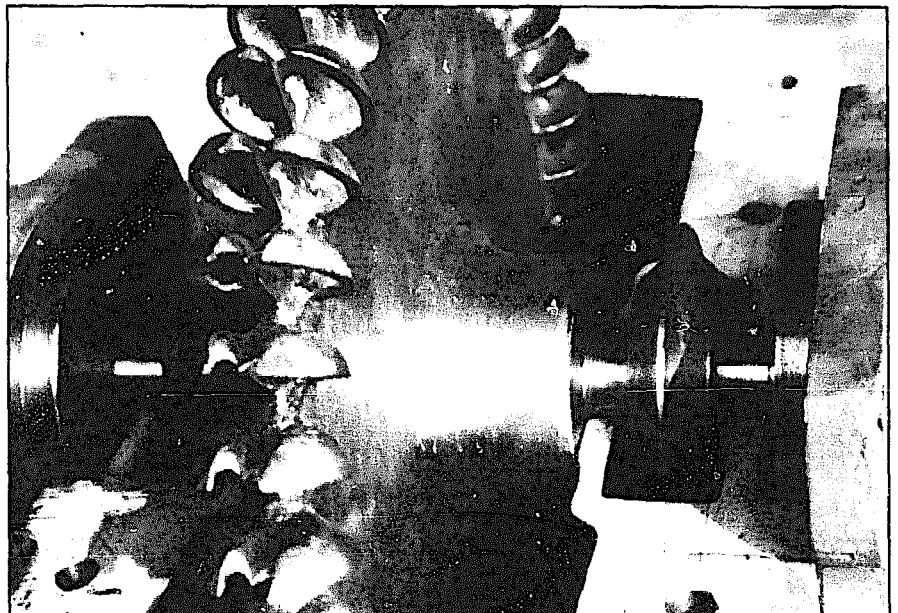

Fig. 6.4. On the left is a Pelton runner with cast buckets bolted to a steel disk (see *A Pelton Micro-Hydro Prototype Design* (63) for design details). On the right, an integral casting from Gilbert Gilkes and Gordon used at a 6 kW



the flow through each nozzle. If the design of the system incorporates a governor, there must be a valve with which the governor can regulate the flow. A needle valve is commonly used for this purpose. It permits only that flow through the penstock that is necessary to satisfy the load imposed on the turbine by the user. Any excess streamflow can be stored if a reservoir has been incorporated in the scheme's design. A needle valve can be replaced by a much simpler and less costly deflector placed between a fixed nozzle and the runner. This device deflects water that is not required for power generation away from the runner. In this case, the water that is deflected is wasted; therefore, this option would be suitable only where the water supply is always adequate and no storage is necessary.

If a governor is not incorporated in the overall design, there are several options for reducing cost. The extreme option would be to eliminate the needle valve or deflector altogether and use a nozzle of fixed size. This is a viable option if streamflow always exceeds the required flow and if either the load is constant—an electronic load controller or end-use machinery that requires a fixed power input is used—or the load can accept speed changes of up to about $\pm 30\%$ (see **Operation on the backside of power curve**, p. 210, and Fig. 8.11c).

With a turbine incorporating only a single nozzle, a needle valve does give the flexibility to use less than design flow if desired. A cheaper, although less convenient, approach is to incorporate two nozzles in the design of a turbine. One nozzle could be used during the dry season when little streamflow is available for power generation, and both could be used during the rainy season. Using two nozzles of different size further increases the energy that can be extracted from available streamflows when nozzles of fixed size are used

installation at Baidoang in Papua New Guinea. The disk between the runner and the bearings is a slinger, designed to sling off any water making its way along the shaft so that it does not reach the bearings.

(see the end of **Alternative turbine configurations**, p. 42). If a single-jet turbine is used, it could be designed with interchangeable nozzles of different sizes. This approach requires that the plant be shut down to permit changing the nozzles. The cost-reduction advantage gained may be offset by the increased bother associated with performing this task.

The profile of conventional nozzles is a continuous curve that requires careful machining. A more basic nozzle is simply a metal cylinder with a slightly tapered bore and rounded leading edge so that the flow does not separate on entering.

A very rudimentary but often adequate nozzle is simply a sharp-edged orifice—a hole drilled through a sheet of metal. The flow separates from the inside edge of the plate and emerges as a well-defined jet. Pressure losses through an orifice plate are insignificant. After leaving this type of nozzle, the jet may diverge slightly faster than one emerging from a well-designed nozzle, but this has no major effect if the nozzle is close to the runner. This nozzle can be made at almost no cost. A series of plates with orifices of different diameters can be used to vary the flow through a turbine. In sizing an orifice, it is necessary to keep in mind that the flow contracts on flowing through the orifice and that the jet diameter is about 0.8 times the diameter of the orifice. The jet can be expected to increase somewhat as the inside edge of the orifice wears with use. This type of nozzle has already been used in several cases (59,63).

Turgo turbines

Gilbert Gilkes and Gordon Limited of the United Kingdom developed and manufactures the Turgo turbine which can operate under a head in the range of 30-300 m. Like a Pelton turbine, it is an impulse turbine; however, its buckets are shaped differently and the jet of water strikes the plane of its runner at an angle of about 20° rather than remaining within this plane (Fig. 6.5). Whereas the volume of water which a Pelton runner can accept is limited because the water which emerges from each bucket interferes with the incoming jet as well as with adjacent buckets, the Turgo runner does not present this problem. Water enters the runner through one side of the runner disk and emerges from the other. Consequently, for the same jet diameter (and power output) as a Pelton turbine, a smaller-diameter runner can be used with the Turgo turbine. The resulting higher runner speeds imply a better chance for direct coupling of turbine and generator. This is the principal advantage of the Turgo runner.

A Turgo runner may prove appropriate at lower heads where a Francis runner might otherwise have been used. In this case, a Turgo turbine has advantages similar to those of a Pelton turbine:

- it requires no seals with glands around the shaft,
- it is more tolerant of sand and other particles in the water,
- working parts are more easily accessible,

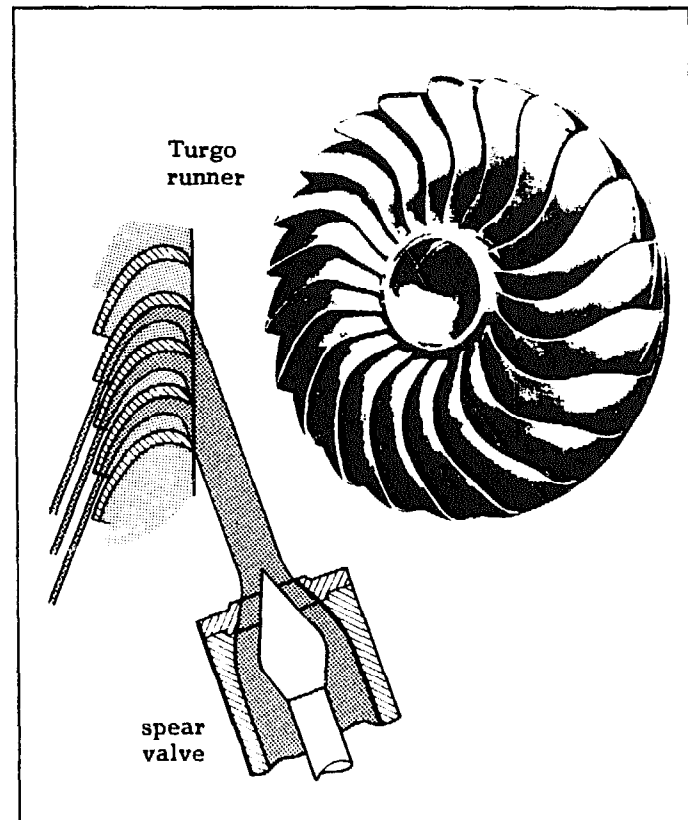

Fig. 6.5. Water enters a Turgo runner from the side.

- its efficiency curve is nearly flat, and
- there is no danger of cavitation.

However, unlike a horizontal-axis Pelton turbine, the water flowing through the Turgo runner produces an axial force and requires thrust bearings on the runner shaft.

Basic relationships

Turgo and Pelton runners have a similar theory of operation. Therefore, the expressions for runner speed "N" and jet diameter "d" are approximately equal to those derived previously [Eqs. (6.2) through (6.5)]. The maximum number of jets for a Turgo turbine conventionally mounted on a horizontal shaft is two. Some small-hydropower equipment manufacturers have fabricated small vertical-axis units with more than two nozzles.

Fabrication

In addition to Gilbert Gilkes and Gordon, the People's Republic of China has also been manufacturing its version of a Turgo runner for micro-hydropower applications, as have several small U.S. companies. The complex curves used in the design of the bucket for a "proper" Turgo runner may discourage its construction. However, there have been several attempts to fabricate a Turgo runner. Some involved making buckets of short sections cut from steel pipe. These were welded bet-

ween two concentric steel bands. The inner band was welded around the circumference of a steel disk that served as the hub.

The Nepalese "ghatta" (see Fig. 10.7) is a runner whose operation roughly approximates that of a Turgo runner. Thousands of ghattas have been in operation in Nepal and elsewhere for centuries, providing mechanical power for milling (see **PRIVATE-SECTOR APPROACH TO IMPLEMENTING MICRO-HYDROPOWER SCHEMES IN NEPAL**, p. 226). They are built primarily of wood. Activating Traditional Indigenous Techniques: Development and Improvement of the Nepalese Watermill 'Ghatta' (98) describes traditional designs and changes proposed to improve their efficiency.

A recent successful undertaking in Nepal has been the design and manufacture in Kathmandu of the Multi-Purpose Power Unit or, more commonly, the MPPU. This turbine evolved as an improvement on the traditional ghatta but closely resembles the Turgo runner. Individual hemispherical buckets are forged from steel disks and welded to a hub to approximate a Pelton runner with a small diameter ratio. Then, to reinforce the runner, a steel band is placed around the circumference of the runner and welded to the buckets (Fig. 6.6). New Himalayan Water Wheels (28) includes numerous photographs, mechanical drawings, and descriptions of the MPPU in addition to reviewing traditional waterwheels and end uses for hydropower. Further information is provided in the two-volume series, MPPU, Multi-Purpose Power-Unit With Horizontal Water Turbine (89).

Cost-reduction approaches

The same approaches discussed previously for Pelton turbines are applicable to Turgo turbines.

Crossflow turbines

The development of the crossflow turbine has been credited to both Banki and Michell, and it has been manufactured commercially for over half a century by the Ossberger Turbinenfabrik in Germany. It therefore commonly goes by the names of the Banki, Michell, or Ossberger turbine.

The drum-shaped runner of a crossflow turbine is built of two parallel disks connected near the rim by a series of curved blades (Fig. 6.7). The individual blades have simple, cylindrical symmetry, and homemade blades are frequently made by cutting sections of pipe lengthwise. This turbine is always installed with the shaft horizontal. The jet of water emerges through a rectangular nozzle the width of the runner and enters the runner through the rectangular openings between the blades, imparting most of its energy. It then passes through the center of the runner and strikes the buckets a second time as it leaves, imparting a smaller amount of energy before dropping into the tailwaters.

The crossflow turbine is considered an impulse turbine, with all the pressure in the nozzle converted to velocity of the jet. However, if the runner is placed very close

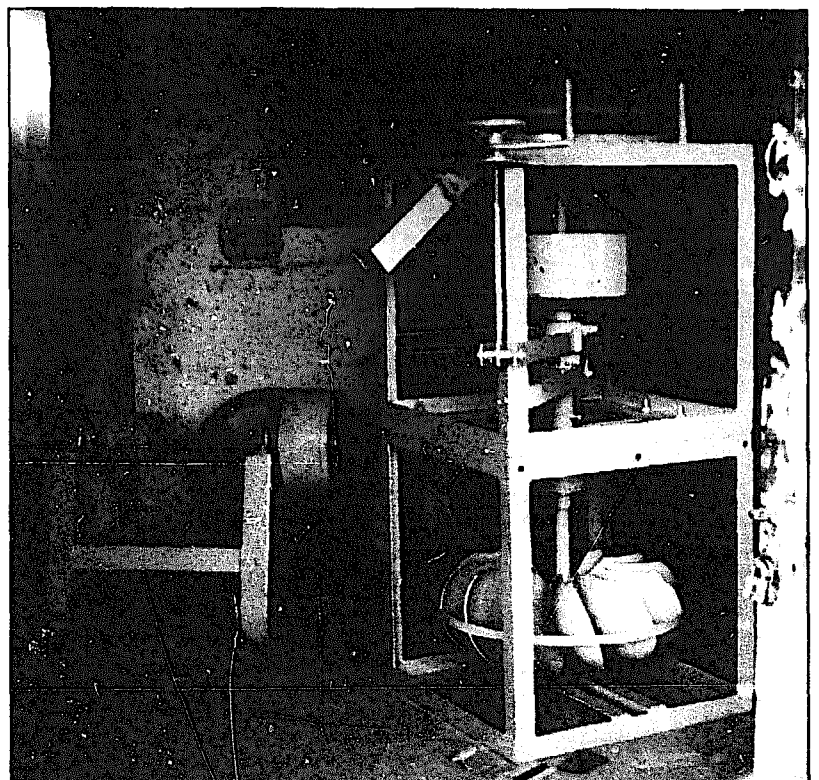

Fig. 6.6. At the left, a MPPU runner is being fabricated. At right, an MPPU unit is shown ready for delivery.

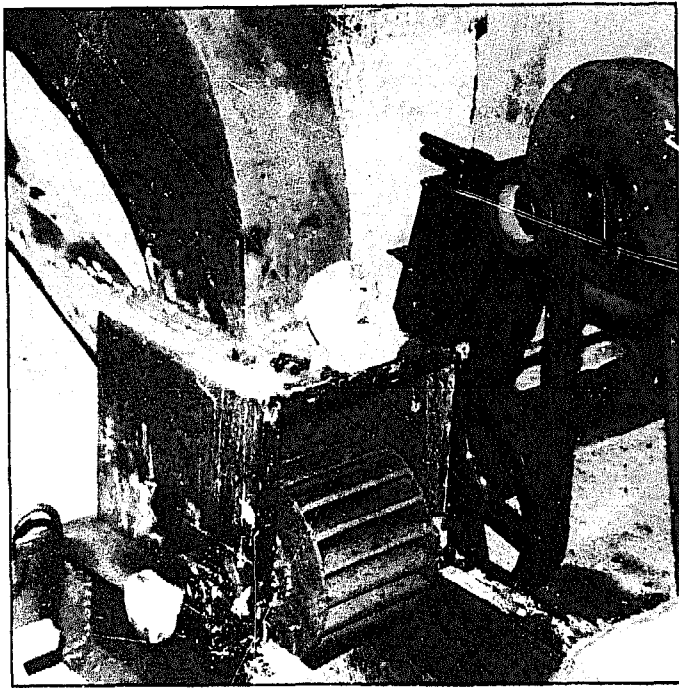

Fig. 6.7. A 5 kW crossflow turbine fabricated locally in Panama.

to the nozzle, the pressure in the jet is still higher than atmospheric pressure—sometimes water is forced laterally through the slight clearance between the nozzle and runner. In this case, there is a small reaction component to the operation of the turbine.

A principal advantage of the crossflow turbine is that, because of the symmetry of its blades, the runner width theoretically can be increased to any value without changing the hydraulic characteristics of the turbine. Doubling the runner width, for example, merely doubles the power output at the same speed, because the diameter remains unchanged. The constraints are structural in nature—flexing of long blades and shaft can lead to fracture from metal fatigue. Fracture of the blades at their extremities has been a common mode of failure (see Fig. 10.64).

Efficiencies of commercial units are said to approach 85%, although peak efficiencies of 60%–80% are more often the case. Efficiencies can be considerably less for locally fabricated units depending on the care taken in their design and manufacture. By having two guide vanes in the rectangular nozzle, one covering one-third of the nozzle width and the other covering the remaining two-thirds, it is possible to maintain fairly constant efficiency down to about 20% of design flow. For example, when only one-third of the design flow is available for power generation, the wider vane can completely cut off flow through two-thirds of the runner width, and the shorter vane can control the remaining flow. The turbine then simply acts as if a shorter runner were being used.

Because the maximum size of the nozzle is not limited by the runner diameter as it is for a Pelton turbine, lower heads do not restrict the power output of a cross-

flow turbine as severely. Crossflow turbines can therefore operate under lower heads and still generate considerable power at a reasonable speed. When they are used at lower heads, the drop in elevation from the turbine to the tailwater may be a more significant percentage of the total head between headwater and tailwater levels. For example, for a given design flow at a site with a total head from headwater to tailwater of 20 m, a turbine located about 2 m above the tailwater level to keep it above the flood plain would lose 10% of potential head and, therefore, power.

A portion of the head below the turbine that would otherwise be lost can be regained by the use of a draft tube, a tube full of water extending from below the turbine to below the minimum tailwater level (Fig. 6.8). The weight of water in the tube creates a negative pressure in the turbine casing, which places an additional pressure head across the nozzle, "sucking" more water through the nozzle than would otherwise be possible as well as imparting more energy to that water. A 1 m-high column of water in the draft tube in the previous example would add another 1 m to the gross head available for power generation, placing a pressure differential across the nozzle equivalent to a 19 m head and increasing power output by about 8%. Actually, slightly

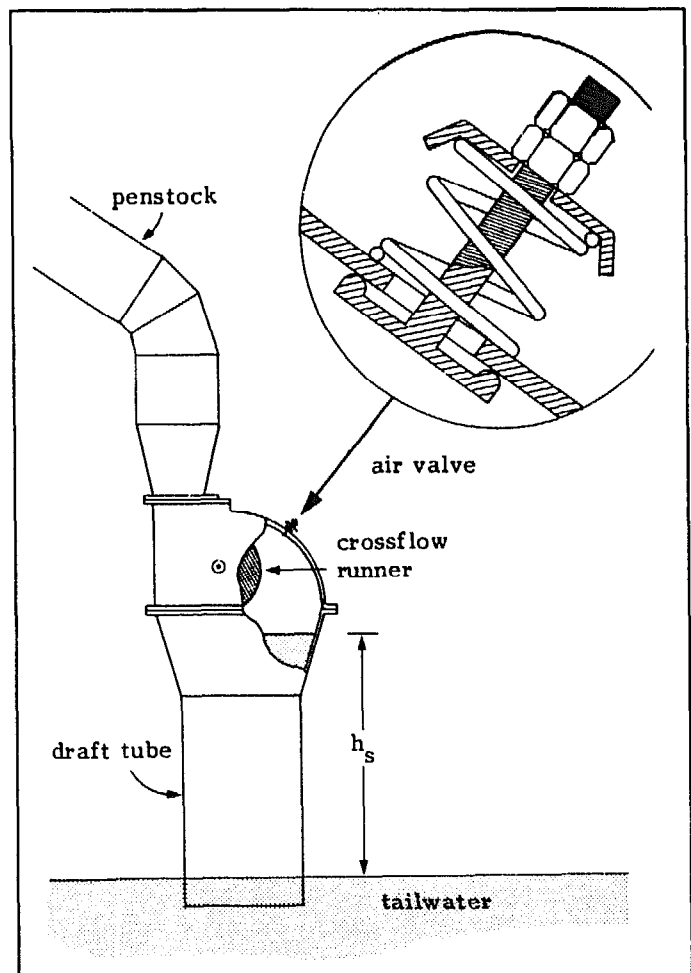

Fig. 6.8. A common design for an air valve, which is necessary to keep water in the draft tube from submerging the runner.

less head than " h_s " can be recovered, because the flow in the draft tube is aerated, reducing somewhat the weight of the column of water inside. There are also losses caused by friction and turbulence within the draft tube. It is not possible to recover the entire head represented by the distance from nozzle to tailwater level; that would imply a submerged runner. Unlike reaction turbines, a crossflow runner has to operate in air.

Pelton and Turgo runners can also operate with draft tubes. However, these turbines are generally used at high-head sites, and the distance between the turbine and tailwater is therefore insignificant compared to the head above the turbine.

One difficulty in using a draft tube with a runner that operates in air is that air within the casing will gradually be entrained or dissolved in the water. The water level in the draft tube will then rise, gradually submerging the runner and significantly reducing its efficiency. Consequently, an air valve is incorporated in the turbine casing (Fig. 6.8). It is adjusted so that when the water in the draft tube is higher than the permissible suction head " h_s " (set by the turbine's need to operate in air), the negative pressure in the casing pulls in additional outside air, permitting the water column to drop slightly.

Although a draft tube permits additional power to be generated at a specific site, stuffing boxes must be located where the shaft enters the casing and the casing must be fairly airtight. Significant leaks in the casing or draft tube will make the draft tube totally ineffective. Therefore, extra care and expense in the design and fabrication of the turbine is required to gain extra head, and therefore power, through the use of a draft tube.

For micro-hydropower turbines, a draft tube used to recover a major portion of the potential energy or head between the turbine and tailwater is often cylindrical in shape—simply a length of pipe with its outlet end always submerged below tailwater level. However, the water descending a draft tube still has velocity and therefore kinetic energy, which represents a loss in head equivalent to $v^2/2g$, where " v " is the water velocity in the draft tube. If this is significant, as is more often the case with reaction turbines, a portion of this head can be recovered by gradually increasing the cross-sectional area of the draft tube. This causes the velocity in the draft tube to decrease as it descends; the decrease in kinetic energy is converted to an increase in potential energy manifested in the increase in negative pressure or suction in the turbine casing.

A draft tube used with a small turbine to recover some of this kinetic energy is generally conical in shape. Although a quickly diverging draft tube would seem preferable to reduce the velocity as much as possible with the shortest possible draft tube, the maximum cone angle is about 8° . With greater angles, the flow detaches from the walls, creating turbulence and an accompanying loss of energy and head.

Basic relationships

"The Banki Water Turbine" (85) probably contains one of the first descriptions in English of the design and operation of a crossflow turbine, along with test results of a prototype. The initial portion of this publication is a loose translation of the original paper by Donati Banki, "Neue Wasserturbine."

For preliminary design purposes, equations and other common relationships that can be useful in approximating overall runner dimensions and speed are as follows:

$$A = \frac{0.23 Q}{\sqrt{H}} \quad (6.8)$$

where

$$\begin{aligned} A &= \text{cross-sectional area of jet (m}^2\text{)} \\ &\doteq (\text{jet thickness, m}) \times (\text{runner length, m}) \\ Q &= \text{flow (m}^3\text{/s)} \\ H &= \text{net head (m)} \end{aligned}$$

Making a first guess for a runner length and using the definition for "A" above will permit the jet thickness to be determined. The cross-sectional width of the rectangular nozzle of a crossflow turbine is approximately equal to the jet thickness. The runner diameter is usually about 10 times the jet thickness. If the runner dimensions seem unreasonable, another estimate for runner length should be tried. Then, when the runner diameter is found, its speed can be found as follows:

$$N = \frac{40 \sqrt{H}}{D} \quad (6.9)$$

where

$$\begin{aligned} N &= \text{runner speed (rev/min)} \\ D &= \text{runner diameter (m)} \end{aligned}$$

Fabrication

Because of the simplicity of its design and the fact that the construction of the runner requires only cutting, welding, and grinding (or machining, if available), the crossflow turbine is the most popular turbine for local fabrication. In addition, numerous publications describing the construction of crossflow turbines are available.

The first popular publication describing the design and construction of a crossflow turbine was VITA's Low Cost Development of Small Water Power Sites (56). In addition to providing summary information on developing a hydropower site, it presents some details for constructing a turbine. The vanes for this design are cut from sections of steel pipe and are inserted in grooves cut into the two circular end-plates. This design is also summarized in the Energy Primer (8). Because of the effort required to cut these grooves, many have omitted this step and simply arc-welded the vanes to the end-plates. Langhorne has documented his experience in

constructing a crossflow turbine after the VITA design and implementing a hydropower scheme (Fig. 6.9) in his article, "Hand-Made Hydro Power" (70).

In addition to reviewing one of several Nepalese efforts to design turbines and implement small-hydropower schemes, *Small Water Turbines* (97) presents detailed machine drawings of all the components of the standardized designs manufactured by Butwal Engineering Works. It also describes and illustrates jigs used to facilitate fabrication. This publication is presently being updated.

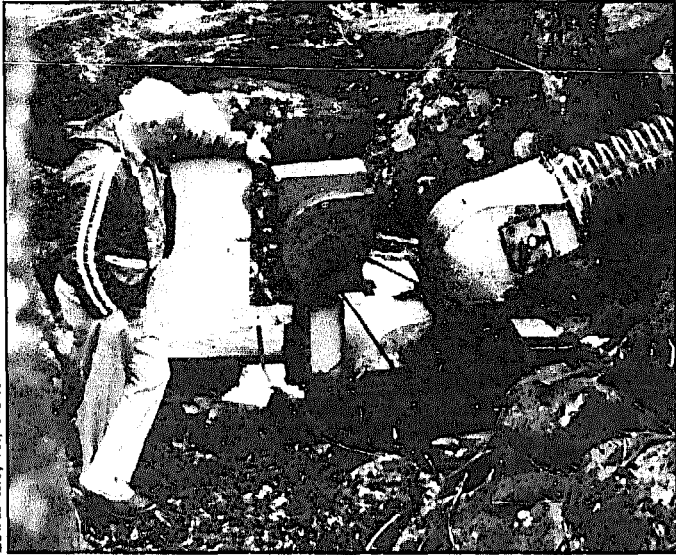

Lowesville, VA, U.S.A.

Fig. 6.9. This 6 kW scheme, using a homemade crossflow turbine, reduces demand placed by a private residence on utility power.

A complete set of detailed designs for a turbine with a runner diameter of 200 mm (Fig. 6.10), manufactured by the Nepalese company Balaju Yantra Shala, is found in *Crossflow Turbine, Type: BYS/T3* (4). Arter also contributed to this design; details of his work and extensive test results can be found in two theses in German, *Durchströmturbine* (27) and *Experimentelle Untersuchung einer Durchströmturbine des Typs Banki* (34).

In addition to the previous publications, there has been other university-based research on the crossflow turbine. *Design of Small Water Turbines for Farms and Small Communities* (43), prepared at the Massachusetts Institute of Technology, quantitatively reviews the design of a crossflow turbine. Although the objective of this study was to develop a design that could be fabricated in a simple workshop in a developing country, with facilities to weld, drill, and cut steel parts, no prototype was built or tested. Consequently, although this publication may give some insight into the design of a crossflow turbine, the preliminary design which it presents lacks design improvements that would have been apparent if prototypes had been built and field-tested. Hothersall's thesis, *Micro-hydro Development for P.N.G.* (60), describes another effort to design and fabricate a crossflow turbine. In "A Review of the Cross-Flow Turbine," Hothersall provides a technical

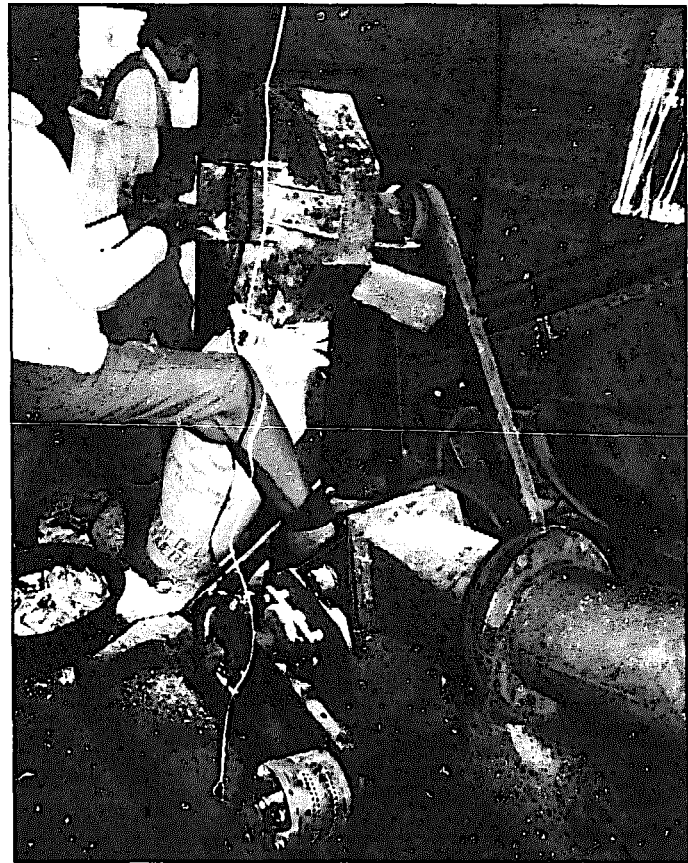

Nyatabongola, Kivu Prov., Zaire

Fig. 6.10. In a few weeks, SODERZA, a small rural development organization in Zaire with no previous experience in hydropower, built this turbine, relying solely on the publication *Crossflow Turbine, Type: BYS/T3* (4); constructed civil works (see Fig. 5.131); and installed a hammer mill and alternator. A small-diameter runner and a single-stage, flat-belt speed increaser developed the 3000-4000 rev/min required to operate the mill.

review of this turbine's operation and performance (61). Research with crossflow turbines is also being undertaken at Colorado State University.

A major problem with locally fabricated crossflow runners has been the eventual fracture of the blades through metal fatigue where they are attached to the end-plates. In "Blade Calculations for Water Turbines of the Banki Type" (105), Verhaart addresses this problem. This report presents equations to determine the maximum blade length for a given head or the maximum head for a given turbine configuration to avoid blade fracture. It also presents a computer program for performing these calculations. Balaju Yantra Shala in Nepal, which manufactures crossflow turbines in quantity, adds intermediate supporting disks to reduce the effective length of each blade. *Crossflow Turbine, Type: BYS/T3* (4) has a graph for determining the number of intermediate disks as a function of turbine width and operating head. The author tested the theory behind this graph by applying it to 80 operating turbines and correctly predicting the 20 turbines that had experienced blade failure.

Cost-reduction approaches

Among the lowest-cost crossflow turbines in use today are those in northern Pakistan (see **VILLAGER-IMPLEMENTED MICRO-HYDROPOWER SCHEMES IN PAKISTAN**, p. 248). In a number of these installations, the cost of the casing has been eliminated; pillow blocks mounted on timber or concrete support the turbine bearings (see Fig. 10.55). The runner is simply covered with wooden slats or a sheet of galvanized roofing to prevent the spray from reaching the bearings, belts, and generator. A draft tube cannot be used at such an installation, but additional head is often gained by locating the runner about 2 m below the floor of the powerhouse, with belts to transmit the power upward (see Fig. 10.43). Placing a turbine below floor level also keeps leaking water off the powerhouse floor.

Designs for crossflow turbines usually include a nozzle made of sheet metal bent to a prescribed shape and positioned to minimize clearance between the nozzle and runner. In addition, a short section of pipe is commonly used to make a smooth transition from a cylindrical penstock to a rectangular nozzle. This is another piece which has to be fabricated and which slightly increases cost. Nozzles of simpler designs include one made of flat metal sheets (see Fig. 10.55), one made by forming a rectangular opening in one end of an oil drum (see Fig. 10.56), and one made by using rectangular steel channel (Fig. 6.11). With these simple designs, proper transition pieces are sometimes omitted, and there is often considerable clearance between nozzle and runner; the crossflow runner functions entirely as an impulse unit. Fabrication has been simplified, but sometimes at the expense of slightly increased losses in head.

With these simple nozzle designs, no valves are used to regulate the flow. The frequency of the ac voltage generated is left to fluctuate somewhat. Flow into the penstock is sometimes adjusted, with the penstock flowing partially full during periods of part-load. If a generator is driven by a turbine using such simple nozzle designs with no flow control, use of a load controller can still permit close frequency control (see **Load controller**, p. 204).

Francis turbines

The Francis turbine is generally a medium-head reaction turbine, although it has been used under heads of 1-500 m. Its runner is composed of buckets formed of complex curves and is more difficult to fabricate than other turbines. In addition, a Francis turbine usually includes a scroll casing that distributes water around the entire perimeter of the runner and several series of vanes to guide and regulate the water into the runner. If a turbine for a specific site is to be built in a local workshop, most site developers prefer to use a turbine that can be made more easily. Even commercial Francis turbines are rarely used at the lower end of the "micro" range. For these reasons, the operation and

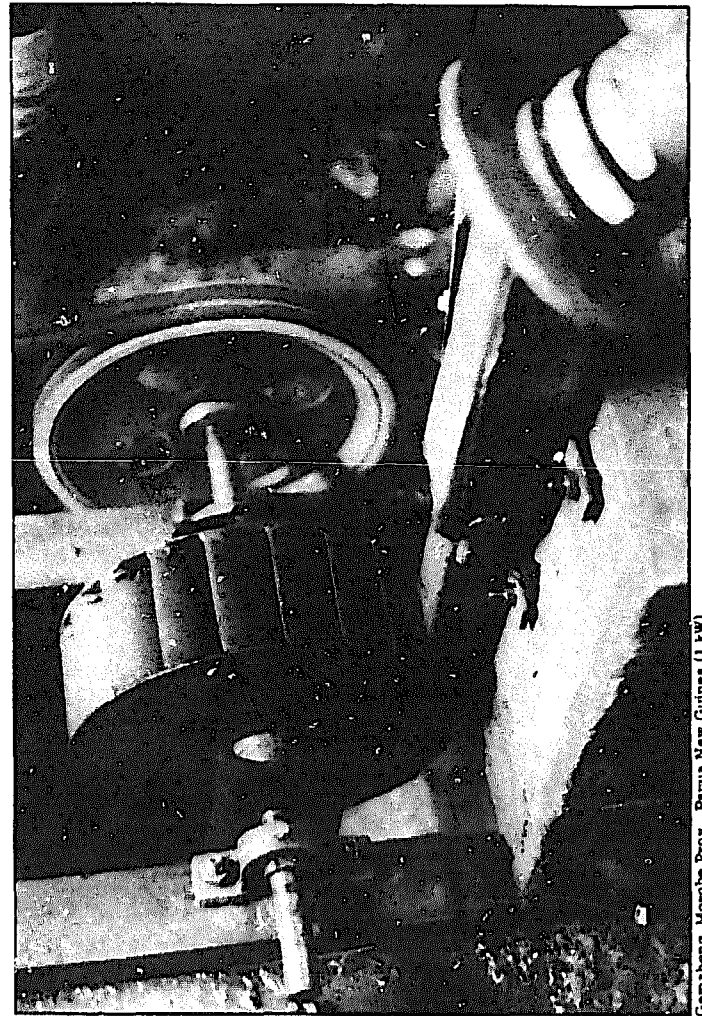

Fig. 6.11. This runner, fabricated in a rural workshop, is covered with a wooden box during operation. Runner and nozzle are independently mounted on a concrete foundation.

fabrication of the Francis turbine will not be covered here.

Propeller turbines

A propeller turbine is a reaction turbine commonly used at low-head sites. It resembles a marine propeller that intercepts all the water descending the penstock. With large conventional units, the propeller turbine has a configuration similar to that of a Francis turbine. It is a vertical-axis machine surrounded by a scroll case. The flow enters the case radially inward before being deflected axially and passing through the runner. Because flow is parallel to the shaft, this turbine is also referred to as an axial-flow turbine. The blades of the propeller can be either fixed or adjustable. In the latter case, it is referred to as a Kaplan turbine. In addition, a Kaplan turbine has variable wicket gates, regulating flow to the runner, which are mechanically coupled to the movable blades. Because this design is more com-

Genabeng, Marobe Prov., Papua New Guinea (1 kW)

plex than others, this configuration is not often used with micro-hydropower schemes.

There are several other configurations for this type of turbine, all of which permit the flow to enter or leave with less significant changes in direction. Micro-hydropower turbines are commercially available in all three basic configurations described below:

- The runner of a tubular turbine (Fig. 6.12a) is placed in a bend or kink in the water passageway so that the shaft can go through the wall, either upstream or downstream of the runner, to an externally mounted generator.

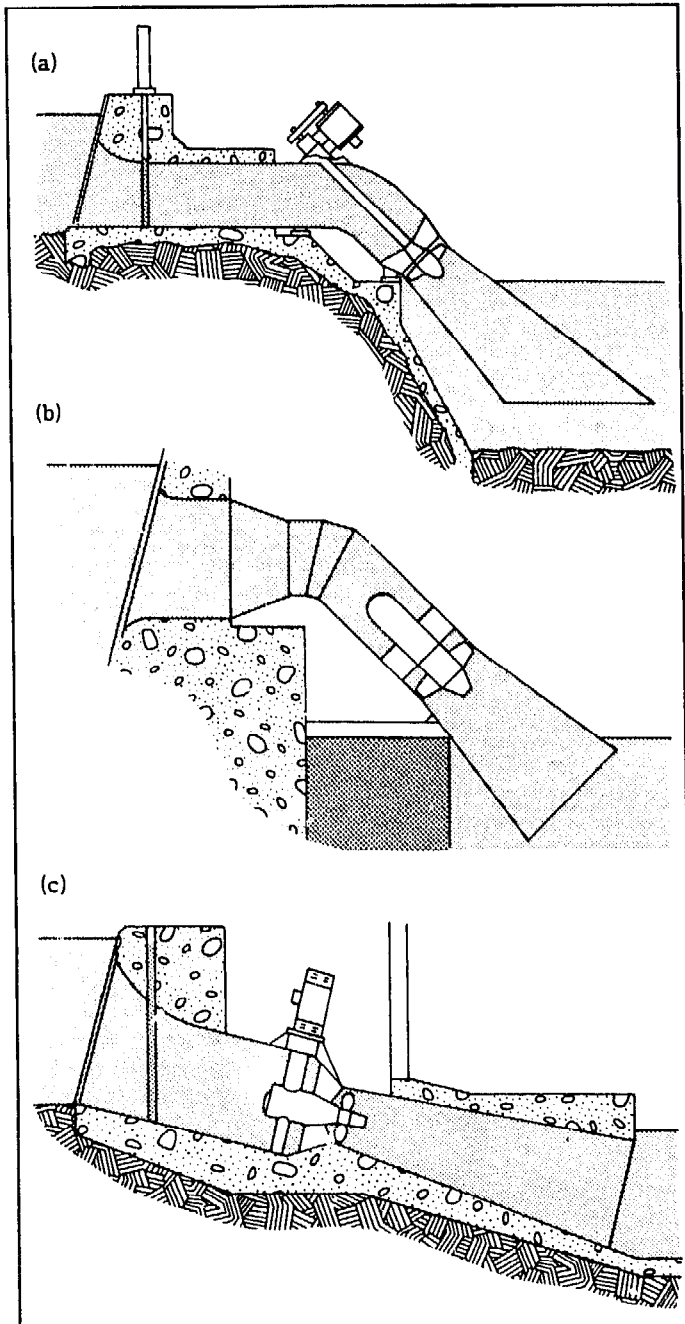

Fig. 6.12. Three configurations using a propeller or Kaplan turbine: (a) tubular, (b) bulb, and (c) right-angle drive.

- To eliminate bends in the passageway, the bulb turbine (Fig. 6.12b) includes the generator in a bulb, which is an extension of the propeller hub, either upstream or downstream of the runner, and this eliminates the need for the shaft to go through the walls of the passageway. This turbine also reduces the excavation requirements at very low-head sites.
- A cross between the bulb and tubular turbine that permits straight-through flow and an externally mounted generator for easier access is a right-angle drive unit (Fig. 6.12c). Because only the right-angle drive is located within the bulb, the size of both the bulb and the passageway is reduced.

The runner of a propeller turbine usually has from three blades (for low-head units) to six. The water under pressure enters the turbine through a series of angled guide vanes designed to induce a tangential or whirl component of velocity. On passing through the runner, water pressure is reduced as energy is imparted to the runner. The water then passes on to the tailrace through a draft tube, which recovers some of the remaining head. This head arises from both the pressure energy caused by the difference in elevation between the turbine and the tailwater level and from the velocity energy remaining in the exiting flow (see discussion of draft tubes in Crossflow turbines, p. 178).

With its high specific speed, the propeller turbine permits reasonable speeds in spite of low operating head. Runner diameter is one factor affecting runner speed. With large runners, some form of speed increase is required to attain speeds of commonly used generators. However, the speed of small-capacity, small-diameter propeller runners associated with some micro-hydropower units may permit direct coupling to four- or six-pole generators.

In large hydropower plants, flow through propeller turbines is regulated by varying the pitch of the runner blades and wicket gates while the turbine is in operation.* A hollow turbine shaft accommodates a regulating rod whose movement, controlled by a governor, is transmitted to the runner blades through a suitable link mechanism. This involves a level of sophistication and cost usually unacceptable for developers of micro-hydropower sites. To reduce the complexity of the flow-regulating mechanism, some commercial units vary only the wicket gates.

Micro-hydropower plants using propeller turbines generally do not have tightly closing wicket gates to regulate flow. To start, stop, and dewater the runner, butterfly valves are often used at the inlet to the turbine. They are not usually used to regulate flow, because they can introduce significant losses. A butterfly valve included in the draft tube (Fig. 6.13) can be used to start and stop a runner and also to regulate flow if good part-load efficiencies are not necessary.

* A wicket gate is composed of angularly adjustable blades, usually just upstream of the runner, which control the flow through the turbine.

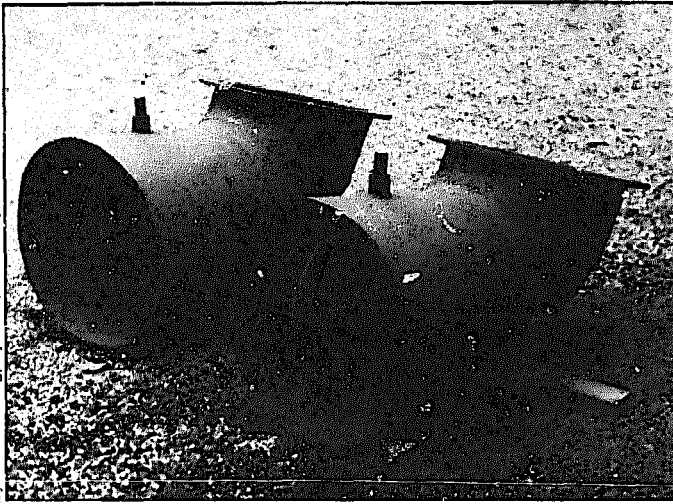

Fig. 6.13. Butterfly valves have been incorporated in these draft tubes to start and stop 20-inch propeller runners installed in an open-flume configuration.

To reduce equipment cost further, several approaches may be taken:

- If adequate flow is always available and the plant is connected to the grid or a load controller is used with an isolated plant, no flow regulation is necessary and a fixed-blade propeller can be used.
- If flow adjustment is not required often—perhaps several times a year, possibly to accommodate reduced streamflow during the dry season—a runner with manually adjustable blades can be used. A manually adjustable propeller runner consists of a central hub to which the blades are bolted in a manner that allows the blade angle to be adjusted. The adjustment can be made through a "window" in the turbine throat after the turbine has been shut down and dewatered.
- If flow varies significantly, an installation can use multiple fixed-blade propeller turbines, usually of different size, with units switched on or off depending on the flow available (see Alternative turbine configurations, p. 42).

The efficiency of well-designed propeller turbines attains 90%; with adjustable blades and wicket gates, a high efficiency can be maintained down to 30% of design flow. However, efficiency quickly drops when a fixed-blade propeller turbine is operated at part-load.

Runaway speeds of a propeller turbine are a higher percentage of nominal operating speed than those associated with impulse turbines. Runaway speeds are commonly 2.5-3 times design operating speed. Flow through the turbine must be stopped or diverted to protect the turbine and generator from overspeed during loss of load. With small turbines, a butterfly valve closed either by water pressure or a counter-balance weight can be used. During operation, the valve is held open by a solenoid energized directly from the generator output or through a sensing relay. Any design should

keep in mind the rapid closure possible with a butterfly valve (see Butterfly valves, p. 159) and its impact on surge pressures in the penstock (see discussion of surge pressures in Selecting wall thickness, p. 133).

As with all reaction turbines, propeller runners face a problem with cavitation. As water passes over the runner, the pressure may decrease to the point that water vaporizes, forming bubbles. When these bubbles are carried downstream to areas of greater pressure, they collapse violently, producing very large instantaneous pressures that fatigue and erode any nearby surface. Cavitation leads to pitting of the runner, which can eventually eat away entire portions of the blades, thereby reducing turbine efficiency. It is accompanied by vibration and a noise similar to that of gravel in a rotating vessel.

Although proper design of the runner can decrease the likelihood of cavitation, the principal factor affecting its occurrence is the turbine setting—the distance of the turbine above the tailwater. If it is set too high above the tailwater, the reduced (suction) pressure in the turbine will cause even a well-designed runner to cavitate. The tendency for cavitation also increases when a runner operates at high speeds. Therefore, for a given head, a small and consequently lower-cost, high-speed runner must be set lower than a large, low-speed runner. Using a lower-cost runner therefore implies a turbine more accessible to flood waters and possibly more excavation to accommodate the necessary draft tube.

Proper turbine setting to avoid cavitation can be determined through the use of a parameter called Thoma sigma (for a description of this parameter, see TURBINE PERFORMANCE UNDER NEW SITE CONDITIONS, p. 191). Either model or full-size testing determines the value of this parameter for a specific runner. For preliminary planning purposes, experience curves—curves based on a compilation of experience to date—can be used.

When the propeller turbine is used at a very-low-head site, small reductions in net head can have a significant impact on power output. Consequently, unlike the setting of impulse and most Francis turbines, the setting and design of the powerhouse and tailrace for a scheme using a propeller turbine are intricately tied to the physical configuration and the cavitation characteristics of this turbine and the design of the draft tube to be used.

In addition, even with propeller turbines used at low-head micro-hydropower installations, large volumes of water are used. This requires a penstock of more generous proportions. Because a large penstock is considerably more rigid than small-diameter plastic pipe commonly used for high-head installations, alignment of the penstock with the turbine becomes more critical.

Fabrication

Although propeller turbines are appropriate at low-head sites because of their relatively high speed, they are not

widely used with micro-hydropower schemes, largely because of their more complex design. For low-head sites, crossflow turbines are frequently selected. Extra gearing is then required, but this is seen as a small price to pay for a turbine that is otherwise seen as easy to design and build.

Proper design of a propeller turbine is essential to obtain a runner that is efficient and free of cavitation. Numerous parameters—number of blades and their profile, width, and pitch, runner hub diameter and overall diameter—must be determined and the guide vanes and draft tube correctly designed. Simplifications are possible, but they require a good understanding of the theory of propeller turbine design.

Two popular approaches to local fabrication of propeller turbines are to form runner blades from steel plate or to modify a marine propeller. Blades are also cast, either separately from or integrally with the hub, but this requires additional facilities and skills. The turbine casing, guide-vane assembly, butterfly valve, and draft tube can be fabricated of steel sheet.

Few references present designs for propeller turbines. In Design of Small Water Turbines for Farms and Small Communities (43), Durali presents a complete set of working drawings for a propeller turbine designed to generate 5 kW under a head of 10 m. Whereas he never actually fabricated the turbine, Ho did this later for a Master's thesis (58). For this effort, the major components of the turbine—the blades, hub, and housing—were made of fiberglass-reinforced plastic. The thesis contains details on the technique used in its manufacture.

Cost-reduction approaches

Several approaches to reducing cost and sophistication of propeller turbines have already been mentioned. These include the use of fixed-blade runners (Fig. 6.14) and a tubular configuration (Fig. 6.15).

Another approach to reducing overall cost is to eliminate the powerhouse entirely. A bulb turbine, with the generator located with the turbine within the water passageway, eliminates the need for a powerhouse. Even if an externally mounted generator is used—for example, with a tubular or right-angle drive unit—only the generator itself needs to be covered, weatherproofed, and located above flood stage. A small structure can enclose and protect the associated controls and switch-gear.

Waterwheels

Chronologically, waterwheels represent an initial step in the evolution of machines to harness the energy of falling water (Fig. 6.16). They are large, bulky, relatively slow-turning machines that are better suited to generate mechanical power to drive pumps or small grain mills and sawmills than to drive high-speed electric generators. However, with appropriate gearing, high



Fig. 6.14. A fixed-blade 20-inch propeller runner, with guide-vane assembly and turbine throat, fabricated by a small U.S. company. The lower bearing that is visible is water-lubricated.

speed can be obtained (Fig. 6.17). With the need to generate large quantities of electric power, waterwheels have been replaced by modern, smaller, high-speed turbines.

The Energy Primer (8) briefly describes the basic types of waterwheels. A detailed description of sizing of an overshot waterwheel is found in "A Design Manual for Water Wheels" (92); however, this publication does not cover its actual construction. For those interested in using a waterwheel to drive a piston pump for pumping water, it does provide information on pump selection, methods of driving pumps, and a simple pump design.

Pumps as turbines

One method for reducing the cost of a hydropower installation that is gaining popularity is to use pumps in reverse as turbines (Fig. 6.18). Pumps, of generally small capacity, have been used for years in industrial applications to recover energy otherwise wasted in

Hydro-Technology Systems, Chantarray, WA

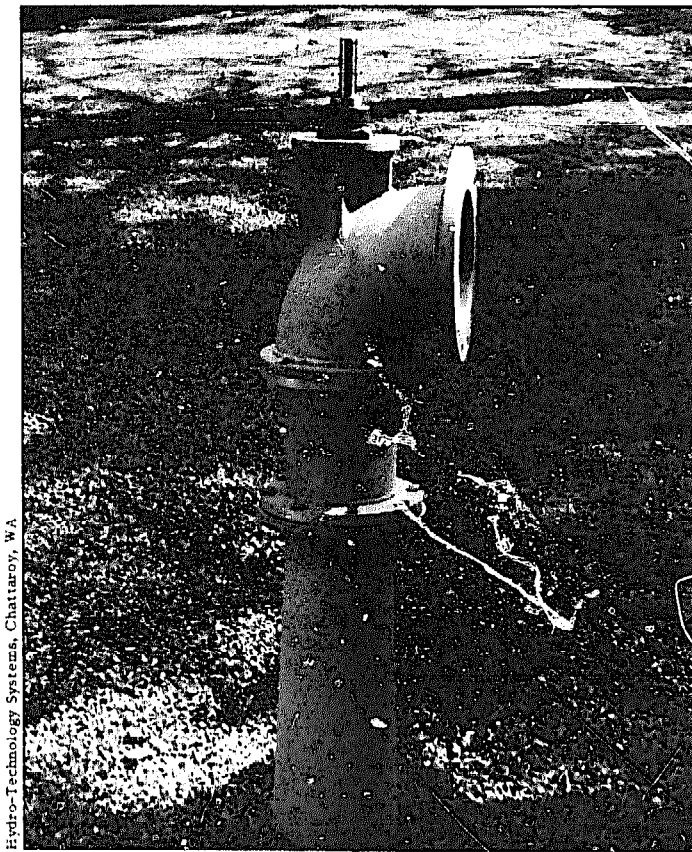

Hydro-Technology Systems, Chattahoochee, WA

Fig. 6.15. A completed 8-inch, fixed-blade propeller turbine, with draft tube, which generates 1-10 kW under a head of 2-8 m.

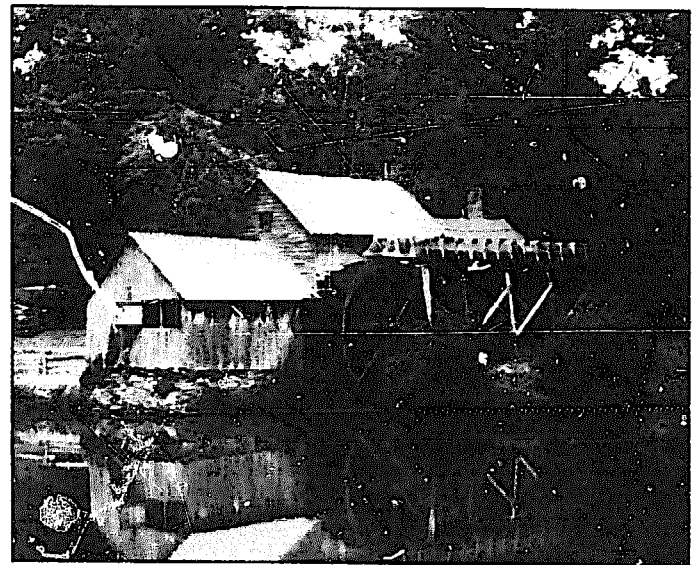
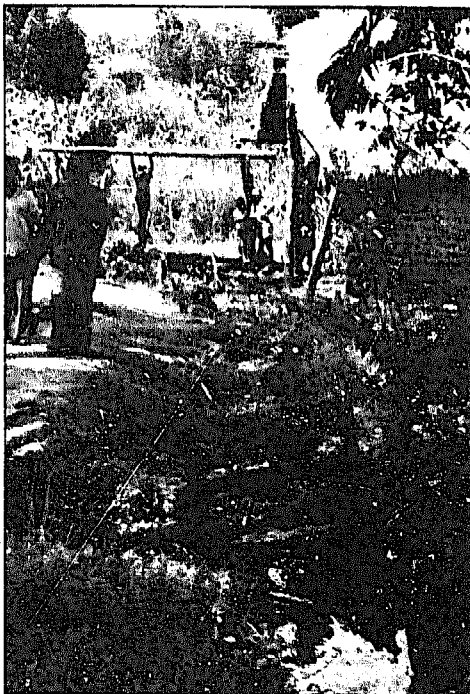

Fig. 6.16. This overshoot waterwheel was one of many that were widely used in the United States to provide mechanical power for a variety of industries.

industrial applications. On the large scale, pump/turbines have been used around the world with pumped-storage hydropower schemes.

Pumps provide several advantages:

- Because they are mass-produced by numerous manufacturers, they cost less than turbines.
- Because they are standard and available off the shelf, delivery times are minimized.



Katana, Kivu Prov., Zaire

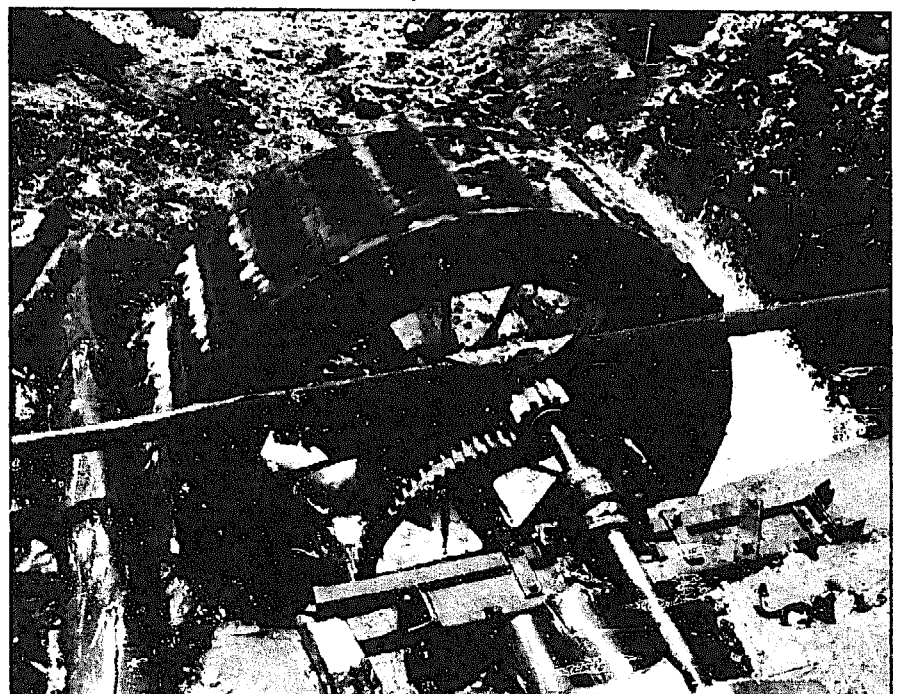

Fig. 6.17. A wood-lined canal (see Fig. 5.79) descends about 5 m, passing underground (left photograph, foreground) to strike an undershot waterwheel (right photograph and left photograph, center). Spur gears are used for the first

stage of gearing and a flat belt in the mill house adds a second stage to raise the speed to the 4000 rev/min needed to operate the hammer mill.

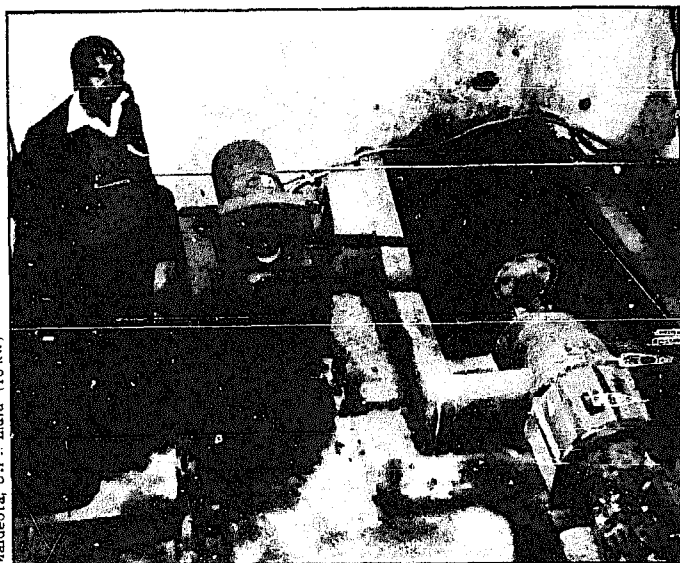

Fig. 6.18. An axial-flow pump manufactured in-country is used as a turbine.

There is no question that pumps can be used as turbines. Rather, the concern is with their efficiency, cavitation characteristics, and operating range.

One major difference between turbines and pumps used as turbines is that flow through the latter is determined by the head under which they operate; there is no efficient way of controlling flow through a pump. On the other hand, hydraulic turbines have efficient flow controls, but this is one reason they cost more.

Using pumps where constant head and flow conditions are available presents no difficulties. This is the reason they are used in industrial applications where process energy has to be dissipated. This is also the case at hydropower sites where adequate water is available to operate a unit at design flow whenever it is in use. Under these circumstances, a constant flow passes through the turbine. A constant power is generated that can either be fed into a grid or, in an isolated application, be controlled by a load controller. Pumps as turbines are less frequently used if a hydropower plant has to harness a range of flows. However, by using at least two pumps at a site, preferably of different capacities, it is possible to harness a significant portion of the energy available from varying streamflows (see Alternative turbine configurations, p. 42).

Basic relationships

Performance characteristics of a pump operating in the pumping mode and generation mode differ; the pumps cannot be assumed to have the same characteristics in both modes. Numerous articles describe methods for estimating the performance of a pump serving as a turbine. A technical description is found in the article "Centrifugal Pumps Used as Hydraulic Turbines" (66). A more qualitative comparison of performance characteristics is found in "Centrifugal Pumps as Hydraulic Turbines for the Small Hydropower Market" (101), a paper

prepared by a pump manufacturer that markets pumps as turbines. In addition, the Micro-hydropower Handbook (76) summarizes a simple technique for converting the required turbine performance characteristics, based on site conditions, to the necessary pump characteristics. The method gives only a rough approximation. If the use of a pump as a turbine is being considered seriously, the manufacturer should be contacted. Actual tests are recommended to verify a pump's performance as a turbine, especially for larger, more costly units.

Miscellaneous

In addition to the major turbine types described previously, other designs are being developed. Among these are the in-stream or water-current turbine, the Schneider engine, the Segner turbine, and marine thrusters.

In-stream or water-current turbine

Several organizations around the world are currently involved in research and development related to the in-stream or water-current turbine. For example, experimental work is being undertaken by Nova Energy Systems on the St. Lawrence River and by the Intermediate Technology Development Group (ITDG) on the Nile (Fig. 6.19). The objective of these turbines is to harness the energy of water flowing down a gradual gradient without the need for civil works such as dams or penstocks. They extract some of the kinetic energy of a large river rather than harnessing the potential energy of a smaller stream. The operation of some of the in-stream turbines tested is analogous to that of a Darrius wind turbine. This type of turbine is composed of vertical airfoils that are submerged in a stream and rotate about a central vertical shaft which extends above the water level to provide a power take-off (Fig. 6.20). The turbine can be operated below a barge or floating pontoon moored to the shore. ITDG has also successfully tested turbines with rotors similar to a conventional horizontal-axis windmill but arranged on an inclined axis so that the power take-off is above water level. ITDG's work has concentrated on the development of water-pumping turbines with shaft power up to 1 kW, but electricity generation has also been demonstrated. Further details can be found in Water Current Turbines: An Appraisal Handbook (23).

Harnessing the power in large flowing rivers is an attractive idea, but its appeal may be somewhat mitigated with the realization that the power density in a flowing stream is low. The power density in a river flowing at 1.0 m/s is 500 W/m² of cross-sectional area. As with a wind turbine, a theoretical maximum of only about 60% of this energy can be recovered. Furthermore, machines designed for low-cost manufacture in developing countries typically are 50% efficient, so that 150 W/m² of intercepted area would be available at the shaft. The power available from water current is proportional to the cube of its velocity, so that 600 W/m² would be available from a stream flowing at 2.0 m/s;

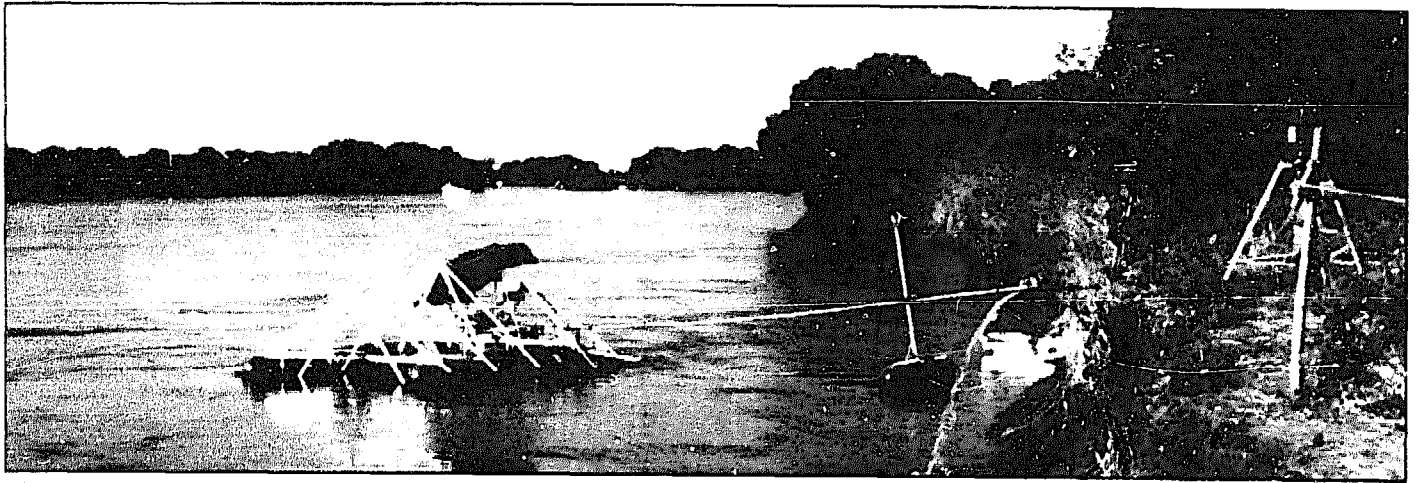

Fig. 6.19. A prototype ITDG in-stream turbine being tested on the Nile in the Sudan. The turbine is immersed in the stream moving at 1.3 m/s and provides 1 kW of shaft

power to pump water. The two mooring cables are joined to a single cable to the bank of the river.

however, such velocities are not often found in a river in which such a turbine could be used.

Although the output from a turbine intercepting an area of even several square meters is modest, and even more

so if used to generate electricity, it is available on a 24-hour basis and could irrigate a significant area if used for pumping. Even with a streamflow velocity of 1 m/s, water-pumping water-current turbines are economically competitive with diesel pumps where fuel is expensive.

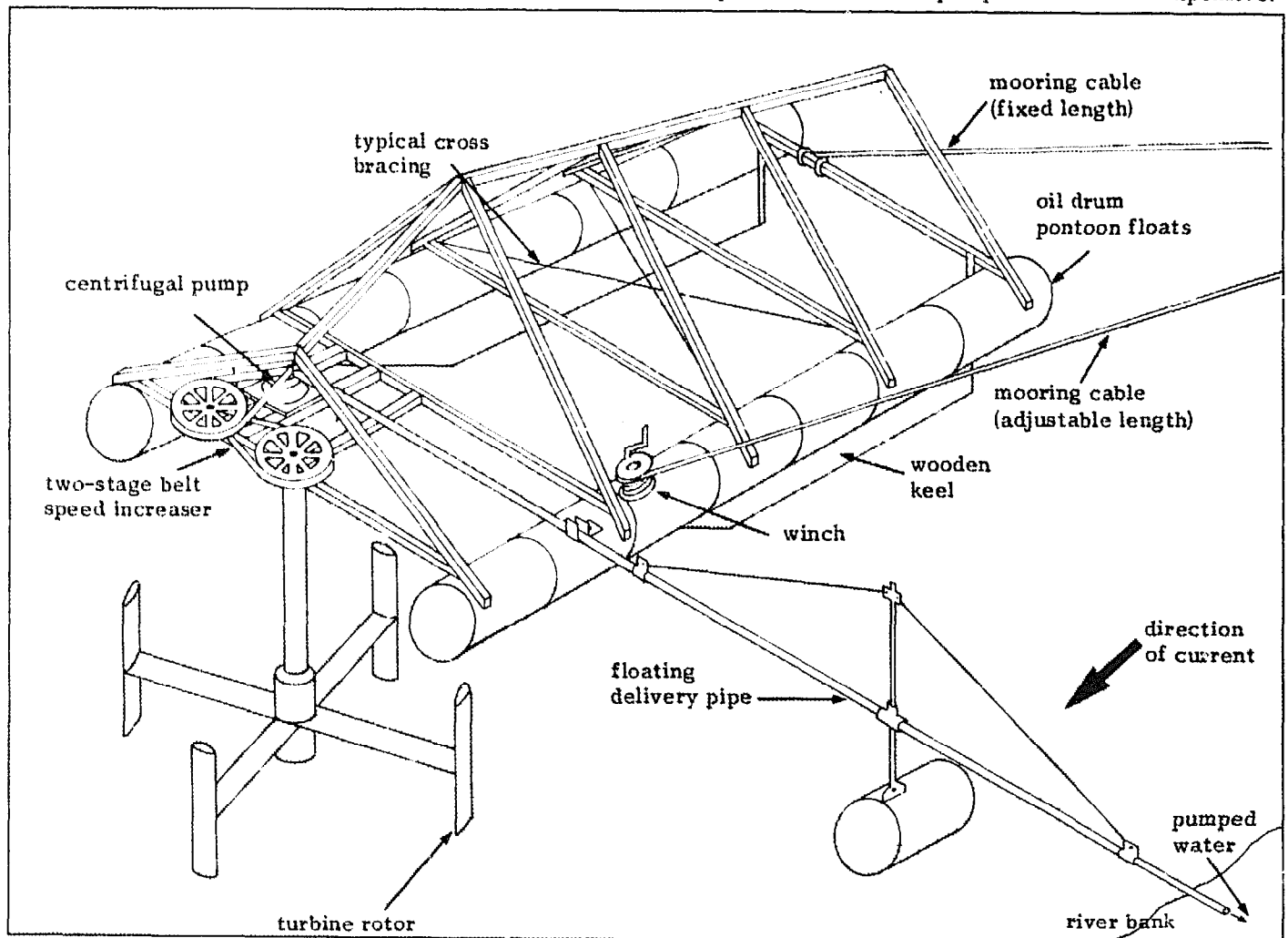

Fig. 6.20. Details of the in-stream turbine shown in Fig. 6.19.

At a test site on the Nile, a prototype "low-cost" turbine had a payback period of less than two dry seasons when used for irrigating a 0.4 ha riverside plot for vegetable cultivation.

To increase the power density through the turbine, Nova Energy Systems has experimented with incorporating surfaces upstream of the turbine to increase the effective velocity of the flow through the rotor. This increases the cost and complexity of the turbine and is unlikely to be worthwhile for small machines using only a small fraction of the available streamflow.

Schneider engine

The Schneider engine is another type of turbine, primarily for lower-head application. This turbine incorporates a series of straight lifting foils mounted between two continuous chains, similar to a continuous belt of venetian blinds running over a pair of parallel axles. The large number of moving parts is a concern with this design.

The U.S. Department of Energy (DOE) has partially funded the development of a hydropower plant at a canal drop in the Turlock Irrigation District in California to evaluate the performance of this type of turbine. After a short time of continuous running, the 140 kW unit jammed. A preliminary examination revealed the failure of water seals and a main roller bearing and cracks in the blade assembly and moving blades. These failures occurred before the viability of the basic concept was proven (95).

Segner turbine

A few years ago, in looking for an approach to generating large quantities of power than possible by using traditional mills, yet at a lower cost than using its crossflow turbines, Balaju Yantra Shala, a Nepali engineering firm and mechanical workshop, resurrected the Segner turbine, first developed in the mid-1700s (79). The turbine is comprised of a vertical pipe with nozzles mounted at the end of radial arms at the bottom. Water is fed by a flume into the upper end of the pipe and released tangentially through the nozzles, as is the case with a popular design for lawn sprinklers. The pipe, generally 1 to 5 m long, essentially serves as a penstock but is free to rotate and is supported by a thrust bearing at its base. Lower-than-design flows can be accommodated simply by reducing or stopping flow through any of the nozzles. This type of turbine can handle up to 300 l/s to generate power in the 2-10 kW range. Power is tapped off the upper end of this rotating pipe section. Probably the principal difficulty with the Segner turbine is that it requires a site with a vertical drop.

Marine thrusters

Marine thrusters are propellers used for the propulsion of ships or the maneuvering of oil rig supports. They

are also being used for low-head applications and have the advantage of being commercial "off-the-shelf" equipment, which can reduce plant costs. The DOE funded the installation and testing of a prototype 240 kW unit in the Modesto (California) Irrigation District. The maximum turbine efficiency was about 60%, possibly caused by mismatching of the turbine with the site conditions, and some cavitation was also experienced (95).

TURBINE SPECIFICATIONS

In requesting price quotations from suppliers of hydraulic turbines and packaged units (Fig. 6.21), it is important that as much of the information listed below as possible accompany each inquiry. Not knowing all this information may imply that the details of the project have not been worked out in sufficient detail and that further work is necessary before firm bids can be solicited. Because a supplier of equipment can spend considerable time preparing a tender, it is best to specify a single configuration or to minimize the number of alternative configurations and extras. An advantage of doing so is that it is much easier to compare tenders from the various suppliers.

It is also advisable to avoid unnecessarily overspecifying the equipment for a site, because this may prevent the supplier from proposing equipment that may actually be better suited to the needs of the developer.

The following is a checklist to help ensure that a site developer submits the necessary specifications to suppliers of equipment so that they have adequate information to prepare tenders:

- Customer's name, address, and telephone number or cable address.
- An indication of whether only an estimate is desired or whether a full detailed proposal or bid is required.
- If possible, a map or sketch showing the layout of the proposed site; drawings and photographs of existing structures and foundations are particularly important and useful.

For quotes on hydraulic turbines, the following information also should be submitted to suppliers:

- Average net head available. For low-head sites, if the head varies noticeably with the flow, also include the minimum and maximum heads. Penstock profile and specifications (see below) must also be described if only the gross head is provided.
- Flow available for power generation. If virtually the entire stream is to be used, include a flow-duration curve based on as many years of data as possible (see *Data processing*, p. 29) or, if unavailable, provide some indication of flow variation during a typical year. Is there provision for storage? If so, how much?

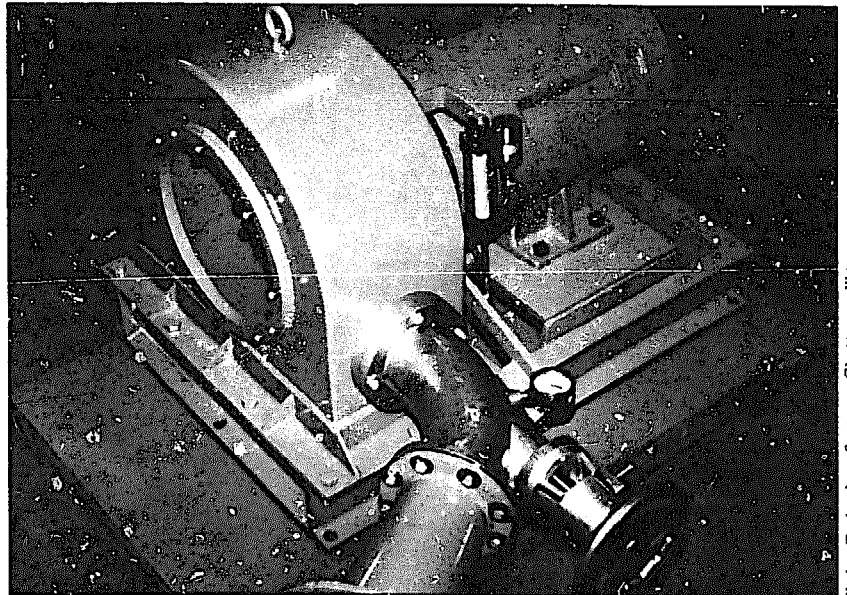
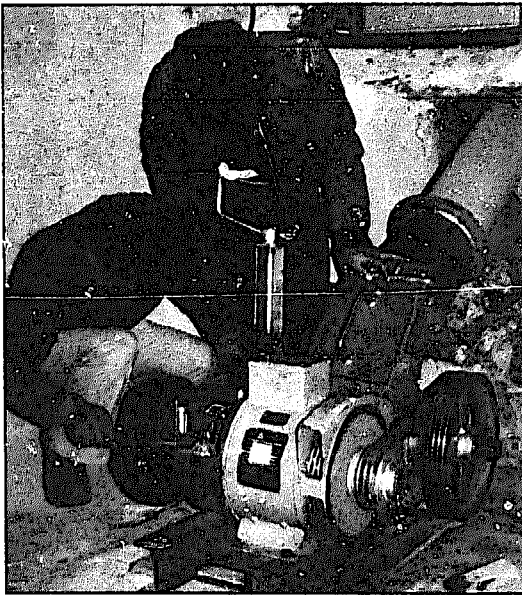

Fig. 6.21. Commercial micro-hydroelectric turbines and generators are available as complete "water-to-wire" packages, significantly simplifying their installation. A

packaged crossflow unit fabricated in Cusco, Peru, is shown at the left, a Pelton unit fabricated in the United States at the right.

- Water quality should be described. If abrasive silt is carried in suspension, provide as much information on this as possible. What is the average water temperature?
- Maximum output power desired or needed. Indicate whether this value represents generator or turbine output. How many units are contemplated to produce this power? The site developer must be sure that the flow and head are adequate for the power desired (see **SITE SELECTION AND BASIC LAYOUT**, p. 47). If the site potential is inadequate, preparing specifications for submission to an equipment manufacturer is of no use.
- An isolation valve (see **Penstock**, p. 74) normally is fitted between the end of the penstock and the turbine inlet. If the turbine supplier is to provide this, the specifications for the turbine-generator package must indicate this. The diameter of the penstock pipe then should be included also. Is the valve to be operated manually?
- Specify the type of governing device required.
- Identify the type of machine(s) to be driven. Is there a required speed (rev/min)?
- Give the altitude of the powerhouse site.
- If a penstock is to supply water to the turbine, state its diameter (and, as noted above, its length, configuration, and material used in its construction if only gross head at the site has been specified).
- If the powerhouse is already built, include the distance from tailwater to the powerhouse floor (mini-

mum, maximum, and the average) and powerhouse and afterbay configuration and dimensions.

- Accessibility to the site by rail, truck, boat, air, or foot is important. What constraints might this place on the size of the equipment that can be transported to the site?

For quotes on packaged units for electricity generation, the following information would also be necessary:

- Generator type (dc, synchronous, or induction).
- Electrical output (ac or dc, voltage, number of phases, frequency).
- Climate (maximum ambient temperature and relative humidity). "Tropical" is usually sufficient for areas with high humidity.
- Mode of operation envisioned (manual, semi-automatic, automatic, or remote control). Is the plant to operate separately or in conjunction with an existing power system? If the latter, give approximate installed capacity of this system.
- What additional equipment (control panel and protective equipment including switchgear and metering cubicle) is to be included? If so, their design requires a definition of transmission and distribution system. Unless specified, suppliers usually provide a standard equipment package to comply with minimum standards.

The electrical factors to be considered in specifying a packaged turbo-generating unit are discussed in **ELECTRICAL ASPECTS** (p. 217).

TURBINE PERFORMANCE UNDER NEW SITE CONDITIONS

There may be an occasion when a turbine at a site is no longer in operation but is still largely in working order. It may be possible to reduce costs considerably by using a secondhand turbine.

However, the flow, speed, and power output for any turbine are site-specific; these are functions of the net head under which the turbine operates. Often, the rated performance of a turbine is noted on its nameplate.

With impulse turbines, the pressure drop occurs across the nozzle; with reaction turbines, it occurs across the runner. However, any turbine can be viewed as an orifice—a constriction in a section of pipe through which a drop in pressure and energy occurs. The flow "Q" or velocity through a turbine, like the flow or velocity through an orifice, is proportional to \sqrt{H} . Consequently, if the subscripts "1" refer to the design conditions under which a turbine was originally manufactured to operate and the subscripts "2" refer to new site conditions, then

$$\frac{Q_2}{Q_1} = \sqrt{\frac{H_2}{H_1}} \quad \text{or} \quad Q_2 = Q_1 \sqrt{\frac{H_2}{H_1}}$$

where

Q = design flow through turbine
H = net head

The speed "N" of a turbine is proportional to the flow velocity within the turbine which, as noted before, is proportional to \sqrt{H} . Therefore,

$$\frac{N_2}{N_1} = \sqrt{\frac{H_2}{H_1}} \quad \text{or} \quad N_2 = N_1 \sqrt{\frac{H_2}{H_1}} \quad (6.11)$$

If the turbine installed at the new site is run at the speed specified by Eq. (6.11), the power output "P" of the turbine is proportional to the product of the head and flow. Therefore,

$$\frac{P_2}{P_1} = \frac{Q_2}{Q_1} \frac{H_2}{H_1} = \sqrt{\frac{H_2}{H_1}} \frac{H_2}{H_1} \quad \text{or} \quad P_2 = P_1 \left[\frac{H_2}{H_1} \right]^{3/2} \quad (6.12)$$

Using these three equations, it is possible to determine the flow consumed, the speed, and the power generated by a turbine operating under a different head. Two factors must still be kept in mind—the capacity of the shaft to transmit the design power and, if a reaction turbine is being considered, the effect of turbine setting on cavitation at the new site.

The shaft on which a turbine is mounted is designed to transmit a given torque; too high a torque risks shearing of the shaft. Because the power transmitted by a shaft is proportional to the product of shaft speed and torque,

$$P \propto T N \quad (6.13)$$

then

$$\frac{T_2}{T_1} = \frac{P_2}{P_1} \frac{N_1}{N_2} = \left[\frac{H_2}{H_1} \right]^{3/2} \left[\frac{H_1}{H_2} \right]^{1/2} = \frac{H_2}{H_1} \quad (6.14)$$

Because the maximum torque "T" a shaft can transmit is proportional to the cube of the shaft diameter "d_s",

$$T \propto d_s^3 \quad (6.15)$$

then

$$\frac{T_2}{T_1} = \frac{H_2}{H_1} = \left[\frac{d_{s2}}{d_{s1}} \right]^3 \quad (6.16)$$

or

$$d_{s2} = d_{s1} \left[\frac{H_2}{H_1} \right]^{1/3} \quad (6.17)$$

If the original diameter of the runner shaft "d_{s1}" is assumed to be properly sized with an adequate factor of safety, "d_{s2}" is the required diameter of the runner shaft for the new site conditions. Clearly, the same shaft can be used if the new site has a lower head. If the new site has a significantly higher head, the runner may have to be refitted with a large shaft if this is feasible. If the new head is not significantly greater than the original, the turbine might still be run, but with a lower safety factor. Because the original safety factor probably is not known, this approach has an element of risk. Other mechanical factors, such as stress on blades, seals, etc., must also be considered, and using a turbine under a higher head than that for which it was originally designed should be done with caution.

If belts, chains, or gears are used to transmit power from the turbine to the end-use machinery, these will also have to be resized. This requires knowing their speed (found using the pulley or gear diameter and turbine speed) and the power to be transmitted.

If a complete turbo-generating unit will be used at a second site, care must be taken to ensure that it operates properly under the new conditions. If the net head at a new site is not much different from its rated head—no more than perhaps $\pm 20\%$ —the runner can still be operated at the original speed "N₁" without a significant decrease in efficiency. Therefore, the power "P₂" will still be essentially equal to that found using Eq. (6.12). Because the runner can be operated at its original speed, the original gearing ratio can still be used. If the new head is slightly lower than the original, the original coupling and generator can also be used. However, if the new head is slightly higher, both the coupling and generator must be checked to verify that they can handle the increased power. If the net head at the new site is significantly different from the original head, both the coupling and the generator would need to be replaced.

In all cases, operating under a higher head implies larger turbine speeds and stresses. However, the end-use

machinery would have no such problem, because appropriate gearing would be used to ensure that it runs at the proper speed.

If a reaction turbine is to be used at a new site, the proper setting will be necessary to avoid cavitation (see discussion of cavitation under **Propeller turbines**, p. 182). A site-specific parameter called Thoma sigma " σ_T " is used to determine the proper turbine setting to avoid cavitation. This is defined as

$$\sigma_T = \frac{H_a - H_v - z}{H} \quad (6.18)$$

where

- H_a = atmospheric pressure
= 10.3 m minus 1.1 m for every 1000 m above sea level
- H_v = vapor pressure of water
= 0.24 m for water at 20 °C
- H = net head (m)
- z = elevation above tailwater elevation of that part of the turbine where cavitation would first occur (m)

Furthermore, each runner, in addition to having a unique specific speed, also has a critical value of Thoma sigma " σ_{TC} ". If Thoma sigma associated with a site is greater than the critical value of Thoma sigma for a specific runner, cavitation can be avoided. This means that

$$\sigma_T > \sigma_{TC} \quad (6.19)$$

or equivalently,

$$z_{\max} = H_a - H_v - \sigma_{TC} H \quad (2) \quad (6.20)$$

where

- z_{\max} = maximum allowable distance (m) of turbine above tailwater elevation (negative z_{\max} implies a turbine setting below tailwater elevation)

If σ_{TC} for the runner can be obtained from the manufacturer of the turbine, use of Eq. (6.20) will give its maximum elevation above tailwater elevation to avoid cavitation.

If this value cannot be obtained, another approach might be used. The Thoma sigma for the original site can be calculated using Eq. (6.18). If the turbine has no signs of cavitation from its use at the original site, it can be assumed that no cavitation will occur at the new site if the Thoma sigma associated with the new turbine setting equals or exceeds the value at its former site. The new setting, found from Eq. (6.20) by replacing " σ_{TC} " with the Thoma sigma for the former site, will be conservative if the turbine was originally set lower than it needed to have been. However, without getting data from the manufacturer or performing tests on the turbine, this is the best that can be achieved.

OPTIONS FOR COUPLING

Each piece of end-use machinery is designed to perform best at a certain speed; however, a turbine to drive that machinery runs most efficiently at a speed determined by the head set by site conditions. In the optimum case, the turbine is selected to rotate at the same speed as the generator or other piece of machinery to which it is coupled. Losses, complexity, and the number of parts requiring maintenance or periodic replacement are reduced if gearing can be avoided. For these reasons, it is best to select a turbine that will run at the speed set by the machinery it is to drive. For example, if a 1500 rev/min generator will be used, a turbine that preferably runs at 1500 rev/min under the available head should be selected; then the generator can be coupled directly to it.

With large hydropower schemes, where all turbines are custom-designed, generators are always coupled directly to the turbine. For micro-hydropower installations, however, this may be difficult to do. If turbines are available in standardized sizes, none of these may run at the necessary speed. If the turbine was selected simply because of ease of fabrication, it may be impossible to get the desired speed from that turbine for the power which is required under the available head.

Whatever the reason for using a turbine that operates with a speed " N_t " different from that required by the end-use machinery " N_m ", it is possible to size the turbine to generate the required power and then use a coupling to convert to the required speed. The coupling would then require a gearing ratio, $r = N_m/N_t$.

For most efficient operation, the gearing ratio for each type of coupling has an upper limit. If the speed has to be geared up considerably and a high gearing ratio is required, several stages of gearing may be needed (Fig. 6.22). In this case, the overall gearing ratio is equal to the product of the gearing ratios of the individual stages; however, the overall coupling efficiency is also equal to the product of efficiencies of each stage. Using two stages of gearing, each with an efficiency of 95%, for example, will result in a overall coupling efficiency of $(.95)^2$ or 90%. Ten percent of the energy generated by the turbine would therefore be lost.

There are several options for a coupling that permits an increase or decrease in speed: belts, chains, and gears. Each has its advantages and disadvantages, some of which are discussed below.

Direct coupling

When the turbine and the generator or other machinery to be driven operate at the same speed and these can be laid out so that their shafts are colinear, a direct coupling can be used. This is the optimal case—virtually no power losses are incurred, maintenance is minimal, and the system is compact. An obvious example of direct coupling is a turbine runner directly mounted on the

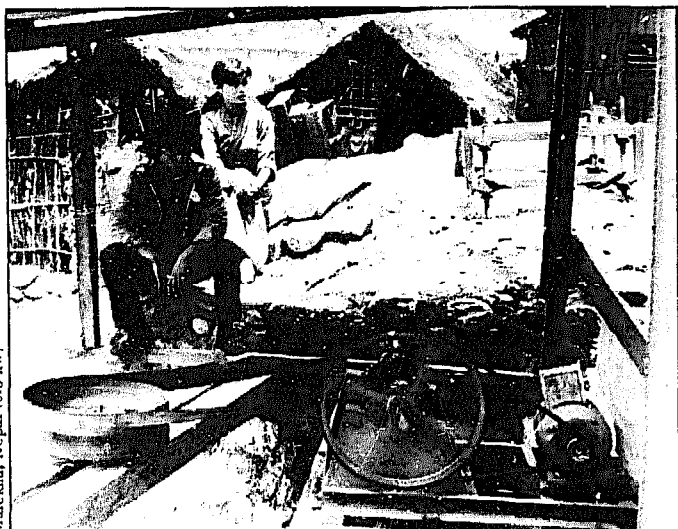

Fig. 6.22. To attain sufficiently high speeds to drive a generator, the slow speed of a vertical MPPU (p. 178) is geared up through two stages--the first using a flat belt, the second, a V-belt[†].

shaft of the equipment to be driven. Generally, the turbine and machinery to be driven are two separate components.

Although a rigid coupling is possible, extreme care must be taken in aligning both shafts and in keeping them aligned; otherwise, the coupling bolts may fracture, the mounting holes may enlarge through wear, or bearings may fail prematurely. In addition, if the load changes suddenly or some other factor leads to a sudden change in speed of either the runner--perhaps from debris lodged in the turbine--or the generator--perhaps from an electrical short across the system--the inertia of the other rotating component may cause the shaft (or other component) to shear. More frequently, a flexible coupling--constructed so that rubber or other elastic material transmits the force across the coupling--is employed. A flexible coupling tolerates some slight misalignment--either parallel but not exactly colinear shafts or shafts that are not exactly parallel--but care should still be exercised in aligning the equipment.

Belt drives

Belt drives are most often used for micro-hydropower application because the use of either standardized turbines or different types of machines driven from a single turbine usually prevents direct coupling. Belts are also readily available and inexpensive. Several types of belts are used for this purpose--flat belts, V-belts, and, to a lesser extent, timing belts.

Being made of more elastic material than chain drives or gears, belt drives can more readily absorb shock caused by sudden changes in loads or other factors. A measure of the magnitude of this effect is called a service factor, which is multiplied to the turbine power to determine the design power of the belt. For hydropower applications, a service factor of 1.5 is adequate. Should

one component suddenly seize up, slippage of flat or V-belts also protects the equipment from damage. Because belts are elastic, the distance between pulley centers must be adjustable to maintain appropriate tension.

Further details on various drives are available in mechanical engineering texts such as Mark's Handbook (73).

Flat belts

Because of the simplicity of their designs, flat belts were chronologically the first type of belt drive used. They can be made of cotton or canvas. If a belt breaks, it is simple to repair or improvise another until it can be replaced. Pulleys are easier to fabricate; rudimentary pulleys made from wooden blocks or tree trunks are in use at several plants in Pakistan (see Fig. 10.63).

Modern flat belts are made of synthetic fibers with special facing, with an efficiency that typically exceeds 97%. After initial tensioning, these newer belts do not stretch.

One disadvantage of a flat belt is that it must operate under relatively high tension to prevent slippage. This places an additional load on the bearings, shaft, and mounting. Pulleys also must be aligned carefully to ensure that the belt does not work itself off when it is used. In rural areas of Nepal, where mechanical power is used to drive agro-processing equipment, a post stuck in the ground, pushing on the belt to prevent it from running off, is not uncommon, but this approach causes rapid wear of the belt (see Fig. 10.19).

V-belts

V-belts are often made of rubber compounds, cotton cords, and fabric. They are quiet, able to absorb shock, capable of operating even if the pulleys or sheaves are misaligned, and readily available in a number of sizes. Efficiencies range from 95% to 97%. Low belt tension can cause losses of as much as 10% (76).

V-belts are available with different cross-sectional areas to transmit a range of power. Belts for a particular application are selected based on the power to be transmitted and the linear speed of the belt (m/s). Increasing belt speed permits increasing the power that can be transmitted with a particular belt, up to a limit. The diameter of the pulley or sheave should be as large as possible without exceeding about 1500 m/s belt speed. There is a minimum sheave diameter with which each type of belt should be used. Using a smaller diameter sheave increases fatigue of the belt and reduces its operating life.

When the power to be transmitted exceeds the rating of a single belt, several belts can be used. Belts that are essentially two or more V-belts vulcanized together are also available under various trade names.

When a V-belt is used, the recommended center distance—the distance between centers of the sheaves—is not less than the large sheave diameter and not more than the sum of the two sheave diameters. A properly installed belt should ride with its top surface approximately flush with the top of the sheave groove. The groove should be deep enough so that the belt does not ride on the base of the groove; the clearance should be about 3 mm.

Unlike flat belts, V-belts do not require alignment to so close a tolerance. However, unless the belts enter and leave the sheaves in the same plane as the sheaves, wear is accelerated and black dust which covers the equipment is produced.

If some machinery coupled to a turbine must be stopped while the turbine continues to drive other machinery, a V-belt can be used between a grooved small sheave and a large flat-belt pulley. This permits easy removal of the belt when the machinery has to be disengaged. This is done in many of the micro-hydropower mills in Nepal (see Fig. 10.18).

Manufacturers can provide details on the selection of V-belts. Additional material can be found in mechanical engineering handbooks as well as in the Microhydropower Handbook (76).

Timing belts

Flat belts have to operate under considerable tension to generate sufficient friction between the belt and pulleys to transmit the power. V-belts require less tension, because the friction needed to keep the belt moving is generated as the belt wedges itself between the sides of the pulley grooves. A timing belt, also known as a positive-drive or gear belt, is toothed and requires negligible tension because it relies on a mechanical coupling rather than on friction to transmit the force and power. Its efficiency is therefore higher than a V-belt's. However, it is generally costlier than other types of belt drives, is more difficult to find in rural areas, and therefore is rarely used for coupling turbines to the end-use machinery. It also generates considerably more noise during operation.

Chain drives

Chains used in conjunction with sprocket wheels have the advantage of high efficiency (98%-99%), no slip-

page, no initial tension required, and a short center distance. They have the disadvantage of requiring proper lubrication and generally being costlier than belts. Like direct coupling, a disadvantage of chain drives is that, if either the turbine or generator suddenly stops, the continued rotation of the other because of its inertia can damage it or the coupling. Chains can transmit a wide range of power; multiple chains—essentially parallel single chains assembled on pins common to all strands—can be used if the capacity of a single strand is exceeded. The power rating of multiple-strand chains is proportional to the number of strands. Single-stage chain drives can accommodate gearing ratios up to about 8.

The arc of contact on a power sprocket should have at least 120° of wrap; therefore, the center distance should not be less than the difference between the pitch diameters of the two sprockets. This implies that when the speed is multiplied by 0.33 or more, which is usually the case, any center distance can be used.

The power ratings of chain drives are based on the number of teeth and the speed (rev/min) of the smaller sprocket.

Gear boxes

Because of their cost, gear boxes are rarely used with micro-hydropower plants. They are used with standardized turbines in the small-hydropower range where gearing is required but where other drives lack the capacity to handle the power and their cost becomes an insignificant component of total plant cost. They are vulnerable if they have been installed incorrectly or if maintenance is poor. Bevel gears can be used for to increase speed as well as to connect two intersecting shafts, such as a vertical turbine shaft with a horizontal generator shaft. Spur gears are used with parallel shafts and helical gears are used with nonintersecting shafts, parallel or otherwise. Efficiencies are approximately 98%.

Although gear boxes are rarely used, secondhand car differentials and gear boxes have been used at sites where waterwheels are also used. These are bulky and not designed for this specific task, but site developers with the necessary skills have successfully adapted these devices for this purpose. The gearing ratio of such devices can be obtained by turning one shaft one revolution and counting the resulting turns of the other.

VII. HYDROPOWER: ELECTRICAL VS. MECHANICAL

INTRODUCTION

In considering harnessing the energy available from falling water, the generation of electricity immediately comes to mind; indeed, for many, hydropower is synonymous with hydroelectric power. This is clearly the case with large hydropower plants. However, an intermediate step in the generation of hydroelectric power is the generation of mechanical power, and for micro-hydropower plants in rural areas, this form of energy has several advantages over electrical energy. Before making a commitment to the implementation of a single installation or to a more extensive program, it is advisable to weigh the advantages of each option in light of local needs. At some installations, one form of energy will clearly be preferable; at others, it may prove advantageous to make both forms of energy available.

POINTS OF COMPARISON

Table 7.1 provides a summary comparison of the advantages and disadvantages of electrical and mechanical forms of energy. These are described in further detail in the following paragraphs.

Impact on plant's financial viability

Many persons working in rural villages find that electricity, especially for lighting, is a sought-after amenity. However, unless the villagers are using kerosene or some other fuel which they purchase for lighting, the financial resources to pay for this amenity may not be available. Generating hydromechanical power forces a focus on mechanical uses of power that probably already

TABLE 7.1. Summary comparison of electrical vs. mechanical energy options

Criteria	Electrical energy	Mechanical energy
Impact on plant's financial viability	Availability of electricity frequently encourages use of nonproductive lighting	Forces a focus on income-generating mechanical end uses
Cost of powerplant	Higher costs because additional equipment is required	Minimal costs beyond those of the turbine
Sophistication	Relatively sophisticated equipment for rural areas which cannot generally be repaired locally	Easily understood technology which is frequently an extension of an indigenous technology; skills necessary for repair are more widespread
Energy conversion losses	If mechanical power is a primary function of the plant, 30%-60% of the available shaft power is lost	No losses other than minor coupling losses if mechanical power is used directly
Starting large loads	Minimum size of generator, and possibly turbine, must be significantly above that of the largest single motor load	Turbine sized by maximum load demand
Versatility	Can be converted readily to other forms of energy	Other than directly driving machinery, can only be converted to thermal energy at the powerhouse
Transmission	Can be transmitted any distance	Use of power generally restricted to powerhouse location

exist in a rural community and that normally generate income. Such activities include milling grain, hulling rice, expelling oil from seed, sawmilling, ginning cotton, pulping coffee berries, crushing sugar cane, and beating pulp for paper-making (Fig. 7.1). A plant generating mechanical power to drive agro-processing or workshop equipment directly therefore has a better chance of being viable as well as of being replicable elsewhere in the region. Viability and replicability of a design are of critical importance to those planning a region- or country-wide micro-hydropower program.

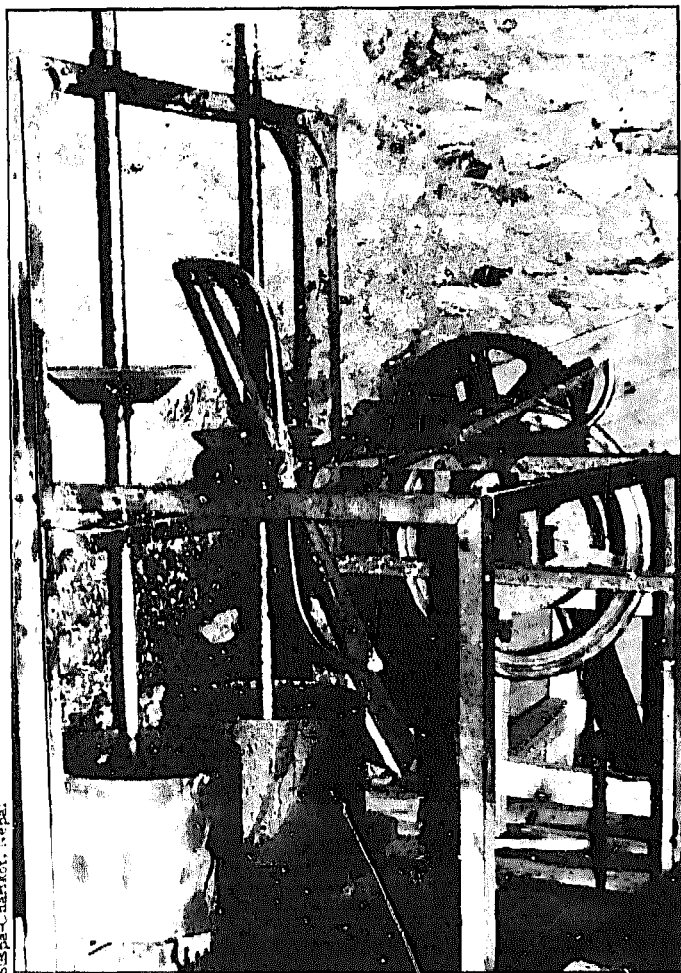

Fig 7.1. A simple waterwheel drives two paper-pulp beaters, a step in the processing of handmade paper.

An approach that has evolved in Nepal (see **PRIVATE-SECTOR APPROACH TO IMPLEMENTING MICRO-HYDROPOWER SCHEMES IN NEPAL**, p. 226) is to focus on implementing plants to drive milling and other equipment mechanically. These plants require an investment approaching \$10,000, but their owners pay back their loans in about seven years. By that time, each owner is very familiar with the operation of his plant and it provides a continuing source of income. If a small dc or ac generator is later added as another piece of belt-driven equipment in the powerhouse, lighting is an essentially free benefit; the mechanical, income-generating equipment continues to cover costs incurred in operating and maintaining the plant. Because of increasing requests by mill owners to incorporate a dc

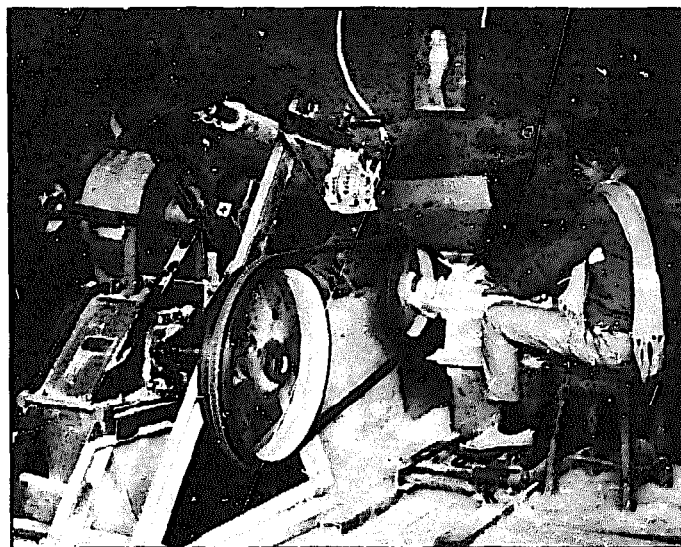

Fig. 7.2. Generating dc power is becoming another attractive end use for small-hydropower mills that previously generated only mechanical power for agro-processing. The dc generator is mounted on a counterweighted arm just above the flat belt.

generator at their existing plant, the new design for the locally fabricated turbine-equipment package includes a provision for mounting such a generator at some later date (Fig. 7.2).

Cost and sophistication

Each of the tasks mentioned previously could be performed using electric-motor-driven equipment; generating electricity for these purposes would provide power for lighting as an additional benefit. However, the generation of electricity, which requires the use of additional equipment—generator, a governing device, and monitoring, control, and protection equipment—involves added cost as well as increased sophistication. Although an understanding of the operation, maintenance, and repair of mechanical devices already exists in many rural areas, a similar understanding of electrical generators, motors, and associated electrical equipment would require a significant training effort. In addition, when an electrical device fails to function properly, there is no service center around the corner. A plant may fail because of the breakdown of an inexpensive diode, but no matter the cause, plant failure can put a major investment in jeopardy.

Motors and most other electrical devices require closely regulated frequency and voltage for proper operation; otherwise, their operating life can be reduced or they can fail entirely. For this reason, some means of regulating the speed of the turbine and therefore the generator is required when electricity is generated. Conventionally, this means costly and sophisticated governing devices (see **Conventional approaches**, p. 202).

This is generally not the case if shaft power is used to drive mechanical equipment directly. Although each mechanical device has an optimum speed at which it

should operate, the range of acceptable speeds is much broader. Consequently, often no form of speed control is necessary beyond that intrinsic in the operation of the turbine and machinery it drives. This machinery may be permitted to operate for short periods at speeds that are higher than usual; as a load is applied, its speed decreases to its normal operating value.

Even when electricity is required for specific tasks, such as for lighting or freezers, there are still advantages to using mechanical power for direct drive of equipment that may be located at the powerhouse. This has been done at a number of the schemes the ATDO has implemented in Pakistan (see **VILLAGER-IMPLEMENTED MICRO-HYDROPOWER SCHEMES IN PAKISTAN**, p. 248) and has the following advantages:

- Because less electrical power is required, a smaller, less costly generator can be used, and a less sophisticated electrical design is necessary.
- If the electrical system fails, the plant can continue to be used to drive equipment mechanically and generate income (Fig. 7.3). If only electricity were generated, a failure of any component would render the entire installation useless until it could be repaired.

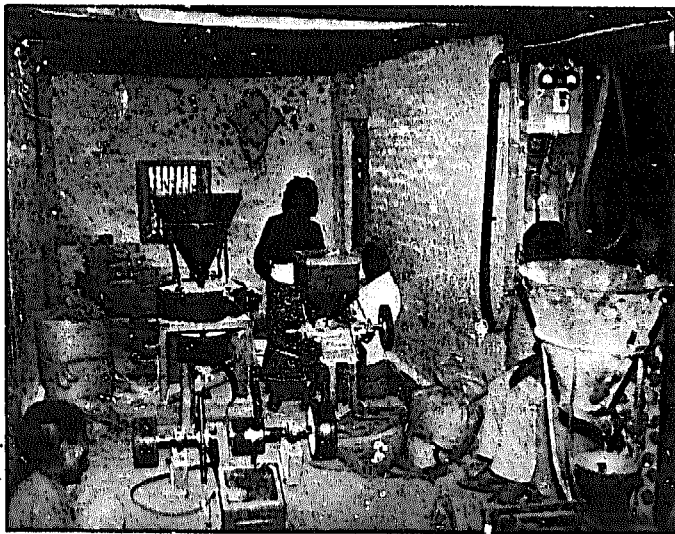

Fig. 7.3. Although a typical MPPU turbine is used to directly drive agro-processing equipment, a flat-belt-driven generator at this site (in foreground) also permits electricity generation primarily for evening lighting. The turbine (see Fig. 6.6) is located below floor level in the left-center of this figure.

Energy conversion losses

If the purpose of a hydropower scheme is primarily to drive machinery, the increased efficiency when shaft power is used directly is another factor which should be considered.

Converting to electricity can introduce considerable losses. For the range of power being considered, the

efficiency of generators varies from about 60% for a very small ac generator to 80% for one in the 5-10 kW range to approximately 90% for one greater than about 50 kW. If the generator speed is higher than the turbine speed, gearing is required. Gearing efficiency ranges from 90% to 98%, depending on the type of coupling and the number of stages (see **OPTIONS FOR COUPLING**, p. 192). Converting electricity back to mechanical power introduces further losses. The efficiency of small ac motors varies from 60% to 80%. For example, 2 kW or more is required to run a motor rated at 2 hp (equivalent to 1.5 kW).

Consequently, if turbine shaft power converted to electricity is used for mechanical purposes, total conversion efficiency can range from 40% to 70%. In other words, if electricity is to be generated for mechanical end uses, the capacity of a hydropower scheme (turbine, penstock, power conduit, etc.) should be 1.5-2.5 times the size of a scheme that provides mechanical power directly. Equivalently, for a given flow and head, an additional 50%-150% of the turbine shaft power would be available if mechanical power were used directly rather than if it were first converted to electricity and then back into mechanical power.

These figures show clearly that generating electricity at a site where mechanical power is the primary end use would increase the cost of the plant considerably. This does not even consider the increased cost resulting from the need to include a generator, load controller or governor, motors, protection and control equipment, and other miscellaneous electrical components that would be required. Generating electricity at a site where mechanical uses are envisioned is therefore an easy way to double the cost per kilowatt of a hydropower scheme.

Restrictions on the size of motor loads

Although electricity can be used to power motor-driven machinery, problems are encountered when the rated power input for one such piece of machinery represents a significant portion of the generator's capacity. The current required to start an electric motor is several times its rated current requirement. For example, although running a 5 hp motor (providing an equivalent of about 3.7 kW of mechanical power) may require about 4.5 kW of electrical power, starting such a motor may require 15-20 kW (75). In addition to the need for excess generator capacity, the turbine must have excess capacity to meet the high starting load, or a flywheel of sufficient inertia would be needed. The turbo-generating equipment therefore should have enough excess generating capacity to meet the large starting requirements of motors. Any power already being consumed by other appliances while the motor is starting is not available for this purpose; therefore, other loads on the system must be considered when the generator is being sized. If the turbine were to drive machinery directly, the turbine could be selected simply to match the load. In this case, high turbine torque at low speeds would facilitate starting any machinery, even when it is fully loaded.

Versatility

If forms of energy other than electricity are required, an advantage of generating electrical power is that devices are readily available to convert it to these other forms. It can be converted to mechanical energy for driving machinery, to radiant energy for lighting, or to thermal energy for generating process heat, cooking, or space heating.

Generally, mechanical energy is regarded as suitable only for driving machinery. However, process heat can also be generated mechanically. A device to achieve this is described briefly in Mechanical heat generator (p. 241). Recent developments have led to a design in which air can be heated to 250 °C. In addition to providing lower-temperature air (less than about 80 °C) for drying agricultural products, the equipment can therefore be designed to incorporate a kettle in which liquids can be boiled, distilled, or concentrated. Process steam also can be generated (81). An Assessment of SWECS/-Mechanical Heating Systems (99) reviews the theory and state of the art of mechanical heating systems in greater detail. The authors are primarily concerned

with coupling these systems to small wind energy conversion systems (SWECS), a more complicated task than harnessing hydropower for this purpose.

Transmission of power

One of the principal advantages of electricity generation is the ability to transmit power a significant distance from a powerhouse located near a river to a load situated elsewhere. For micro-hydropower plants, this distance is frequently up to 10 km. The maximum distance depends on the economics in each situation and is a function of the magnitude of the power to be transmitted, the cost of the transmission, and the value of the energy to the consumer.

The transmission of mechanical energy is usually by means of belts, pulleys, and shafts and is restricted to the immediate area of the powerhouse. On occasion, power available as low-speed cyclical motion, such as from a waterwheel to a piston pump, has been transmitted hundreds of meters by means of a reciprocating wire (21).

VIII. GOVERNING

INTRODUCTION

Some governing or control of the turbine speed is often required to ensure proper operation of end-use appliances or machinery, whether the power generated is mechanical or electrical (Fig. 8.1).

Hydropower schemes that include reservoirs usually require conventional governors that control the flow of water to the turbine. In addition to governing the speed of the turbine and other machinery in the powerhouse, they also permit water not used for power generation to be stored for future use. However, most micro-hydropower schemes are run-of-river, and for these, a number of approaches can be used. For isolated plants, they range from using complex electro-mechanic-hydraulic devices to relying on manual regulation (see **APPROACHES TO GOVERNING**, p. 201). The large differences in the cost and complexity of these approaches make it necessary to determine the extent to which governing is required for specific end uses. If the end uses are few and unsophisticated, as is usually the case when a micro-hydropower scheme is first introduced into rural areas, simple and low-cost nonconventional approaches can be used.

PURPOSE OF GOVERNING

When electricity is generated by a synchronous generator at an isolated powerplant, its frequency is determined by the speed of the generator and the number of poles. A four-pole generator, for example, generates two cycles per revolution (rev) of its shaft. To generate 50 cycles/s (or 50 Hz), it must run at 25 rev/s, or 1500 rev/min. If this speed increases or decreases, the frequency generated increases or decreases proportionately.

In addition, if a generator has a field of constant strength, the voltage it produces is proportional to its speed. An increase in generator speed of 10% will increase the output voltage by approximately 10%. Most generators have some form of voltage regulation that varies the strength of the field in an attempt to cancel out the effects of changes in generator speed and load; however, sufficient change in generator speed can still affect output voltage.

All electric appliances are designed to operate at a specific voltage and frequency. Operating at some other frequency or voltage can adversely affect their life or

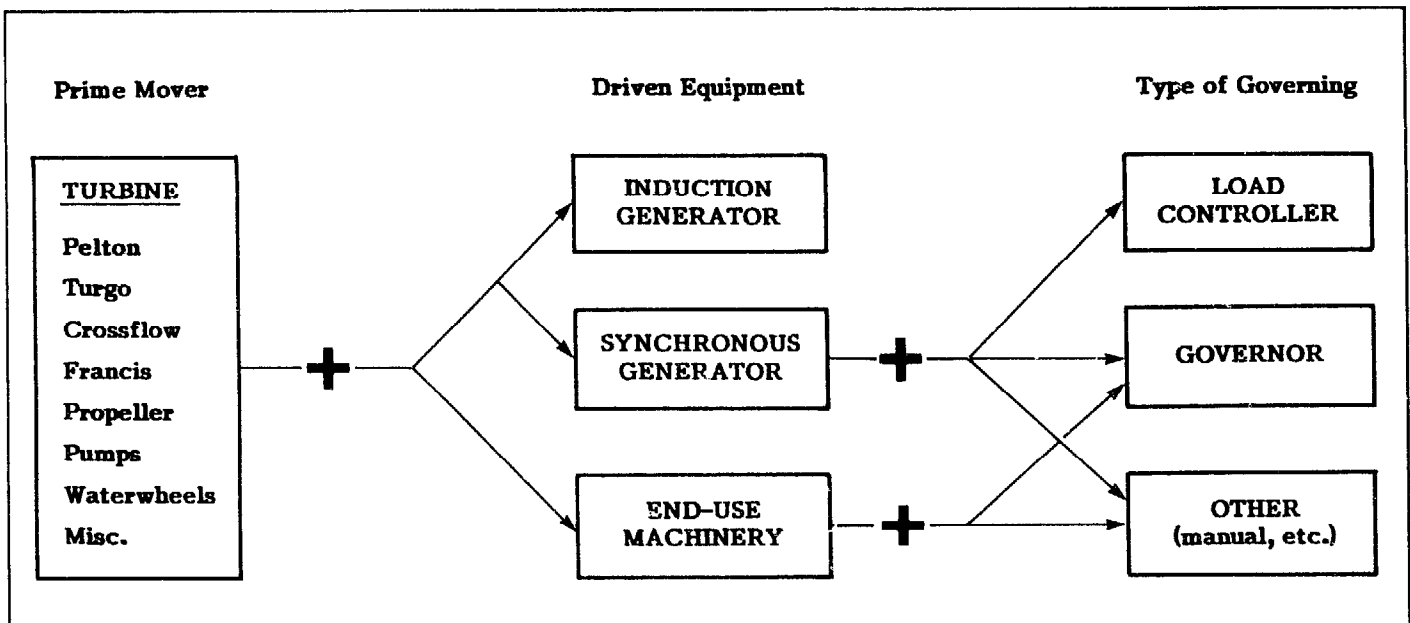

Fig. 8.1. This diagram illustrates the different approaches to governing which may be utilized at a micro-hydropower

installation to control the speed of various kinds of equipment that are driven by a turbine.

result in improper operation. An electric clock will run too fast if the frequency is too high. A motor will run hot and its life will be reduced if the frequency is too low. The life of an electric bulb is reduced significantly if the voltage is increased only slightly. On the other hand, a motor under load may not start and may burn out if the voltage is much lower than that required.

For these reasons, some control over the speed of a generator is necessary. Because a turbine drives the generator, the speed of the turbine must be regulated. This is the purpose of a governing device—to govern or control the speed of the turbo-generating equipment in the face of changing external electrical loads placed on the generator.

Where waterpower is converted into mechanical power to drive mechanical equipment directly, a governor is also needed if the speed at which this equipment is driven is critical. For most mechanical uses, this is not the case.

WHY CONSIDER VARIOUS GOVERNING OPTIONS?

It is easy to plunge into manufacturers' catalogs and select a governor based on impressive performance characteristics such as a frequency variation of ± 0.5 Hz from zero to full load. This device performs well and operates unattended but at a cost.

One of the costs incurred in using a governor is the sophistication intrinsic to this technology and the implication this has on the long-term viability of a plant. A warning included in the publication of Gilbert Gilkes & Gordon, a major turbine manufacturer, effectively makes the point:

We urge engineers who are specifying hydro-electric plant and particularly governors to beware of buying equipment which cannot reasonably be maintained by the staff available in the power stations in which they will be installed. A governor is a good servant but can be a bad master. A governor which operates with a number of sensitive relays and fine orifices may work beautifully in the temperate climate of south Germany where a skilled instrument engineer can be sent for at 2 a.m. to check a defective relay, but if the same governor is controlling a turbine in tropical Africa, the leg of a dead locust can play hell with a fine orifice or high humidity cause a breakdown in a relay which has " . . . been tested for many months in the manufacturer's research laboratory" under the eagle eye of young engineers in spotless white coats who know exactly what to do if anything goes wrong. We can only utter a warning: "It may look beautiful in colour in the manufacturer's catalogue, but can it be guaranteed to work beautifully in this particular power station?" (25)

These devices also have a considerable financial cost. For a very small hydropower plants, a governor can

equal the price of a commercial turbine and generator; if the turbine is fabricated locally, the cost of the governor can exceed considerably the cost of the turbo-generating unit. However, it is these small plants that can benefit isolated communities the most.

The cost and sophistication of components such as governors are two reasons that hydropower plants are sometimes considered inappropriate for rural areas in developing countries. But rather than depriving rural populations of the benefits that derive from the availability of energy because they can neither afford nor maintain it, this technology must be made more appropriate. Simplifying and reducing the cost of governing is one step toward achieving this. For example, were it not for this approach, the ATDO in Pakistan could not have implemented dozens of 5-15 kW hydropower plants, many supplying power to entire villages (see **VILLAGER-IMPLEMENTED MICRO-HYDROPOWER SCHEMES IN PAKISTAN**, p. 248).

Simplifications in the design of governing systems are not restricted to schemes that serve "simple" needs. A micro-hydropower plant has been operating for several years at the Mission Evangelique des Amis in Kibimba, Burundi, run by the American Friends. There, no conventional governing device has been used; during the daylight and late evening hours when the load is low, one family simply switches on a water heater to place additional load on the turbine to reduce its speed closer to its nominal value. During the early evening hours when lights are on in the homes as well as in the dormitories, the water heater is switched off. In this remote setting, a range of appliances found in a typical western home—incandescent and fluorescent lamps, washing machines, blender, hi-fi equipment, microwave oven, and refrigerator—have been operating much as they would in New York or Paris. The approach to governing used at Kibimba is one of several described in this chapter.

EXTENT OF GOVERNING REQUIRED

Before deciding which approaches are appropriate in a given circumstance—how simple or sophisticated a governing device must be—it is necessary to know what variations in frequency and voltage, or what variations in speed for mechanically driven equipment, are permissible for the different loads planned. For example, if the load can function properly with large fluctuations of turbine speed, a sophisticated and costly governing device to maintain accurate speed control is superfluous, and a much simpler approach could be appropriate. On the other hand, if end uses require precise regulation, a more sophisticated means of governing must be considered.

For electrical loads, most devices can operate with ac voltage fluctuations of up to $\pm 10\%$; even in the West, voltages in this range are found in the typical home. Because clocks and timing mechanisms in many appliances are intrinsically tied to frequency, however, it is precisely regulated, with peak short-term divergences usually kept to within $\pm 0.5\%$. Although these are the

voltage and frequency variations common in the West, they do not represent the maximum variations that most electrical appliances can tolerate. The acceptable variation usually is significantly more, especially for frequency, and depends on the category into which the specific electrical load falls--heating, lighting, transformer, or motor.

Precise limits on permissible variations of operating voltage and frequency are difficult to obtain. Manufacturers design electrical equipment and appliances to operate at some nominal value; they have few data on their operation at significantly different values. To consider less costly and less precise approaches to governing, more detailed descriptions of the range of voltage and frequency that can be tolerated by various loads are needed. Knowing the effects of non-nominal operating conditions on the operating characteristics and long-term performance of these loads would also be useful. The following only begin to address this subject.

Heating loads

Of all potential loads, resistive heating loads which include hot plates and other similar devices for cooking, water heating elements, irons, and space heaters are most tolerant of frequency and voltage variations. Frequency variations do not affect these loads. Although undervoltage does not affect the life of these devices, generating a given quantity of heat requires more time because the power consumed or rate at which heat is generated varies as the square of the applied voltage. For example, if voltage is reduced by 20%, the rate at which heat is generated is reduced by about 40%, and 60% more time would be required to generate the same quantity of heat. The heating elements would also run somewhat cooler.

Overvoltage would generate excess heat and too high a voltage would burn out the heating elements. Heating elements operating in water or other liquid are less sensitive than those operating in air, such as irons, hot plates, and space heaters, because excess heat is more easily conducted away from the element, reducing the temperature at which they operate.

Some heating devices incorporate electric motors, and the effect of frequency and voltage variations on these should be considered separately (see Motor Loads, p. 201).

Lighting loads

The two most popular sources of lighting are incandescent bulbs and fluorescent lamps. Variations in voltage and frequency affect each differently.

Incandescent bulbs are not affected by frequency. However, undervoltage increases their life significantly but decreases their light output. On the other hand, overvoltage significantly reduces their life. An overvoltage of only 5%, for example, will reduce the life of an incandescent bulb by about 50%.

Fluorescent lamps are affected by both voltage and frequency. With a voltage decrease in the range of 10%-15%, it becomes difficult to start a lamp. Somewhat below this voltage, the lamp will not ignite. If the lamp is already operating, it will flicker more as voltage decreases. If voltage drops more than 25%, the lamp may go out (47).

Transformers

Transformer losses from resistive heating in the windings and from eddy currents and hysteresis in the core manifest themselves as heat. As losses increase, so does the heat generated within the transformer and, consequently, its temperature.

At fixed frequency, all these losses vary approximately as the square of the voltage. Overvoltage therefore can pose a problem, and voltage is usually allowed to increase about 5% at rated load. However, undervoltage does not pose a problem.

At fixed voltage, decreases in frequency lead to increased magnetic flux in the core and increased losses and heat generation. The obverse is also true.

Motor loads

Motors and transformers are affected in similar ways. Manufacturers often specify that motors can operate satisfactorily at voltages within 10% of their rated value. However, motors in rural workshops are operated with completely ungrounded turbines; voltage momentarily drops significantly when a motor is switched on. During start-up, minimal loads are imposed on these motors so they come up to speed rapidly. If a motor is started under a large load, such as a motor driving a compressor in a refrigerator, the longer period of low speed and high current may cause the windings of the motor to overheat and fail. Major fluctuations in voltage and frequency can have detrimental effects on motors, but it is difficult to specify quantitatively how the nature of a load affects the life of a motor.

APPROACHES TO GOVERNING

In this sourcebook, the approaches to governing are classed in either of two categories, conventional and nonconventional.

The conventional approaches (p. 202) can be used with plants of all sizes, perform to high standards, but are generally more complex and costly. These approaches require sophisticated components available from industrialized nations and have been designed to meet the standards imposed by the needs found in these nations. This hardware is difficult to manufacture in developing countries without importing some components. Such a system is most convenient where the power generated will be put to a variety of uses, where the capital exists to cover the costs of a conventional governing system,

and where the necessary skill to operate and maintain it can be found.

The one exception to the rule that the conventional approach requires sophisticated components is when electric power is generated using an induction generator connected to a large grid. In this case, the grid itself serves as the governor, regulating both the frequency and the voltage of the generator output. The responsibility for governing and regulation therefore falls on the principal generator of power into the grid, not on the micro-hydropower plant operator.

Nonconventional approaches (p. 205) are generally used only with plants in the micro-hydropower range, where costs must be kept down but where usable power is still required. These approaches rely more on proper design and manipulation of the turbine and/or load than on the use of additional equipment. Therefore, they may require more manpower to operate than do automated, conventional approaches. Although their output is of lower quality (characterized by larger speed, frequency, and voltage variations), it can still be adequate to satisfy the expected end use.

Where mechanical or electrical power will be introduced in rural areas, these nonconventional approaches may be more appropriate. They allow micro-hydropower plant to be installed at reduced cost. They also increase chances for long-term viability by eliminating the need for more sophisticated equipment, and they permit increased use of local manpower for operation and maintenance.

If a plant demonstrates its value and income-generating uses for the power evolve, more sophisticated equipment might be warranted later. At that time, income-generating end uses for the power probably will be able to generate the capital necessary to cover the costs of a more sophisticated and expensive plant. Also, the basic operating and maintenance skills probably will have been mastered.

Conventional approaches

The conventional approaches to governing originated in the middle of the 18th century with the advent of the Industrial Revolution. Over time, these have evolved in quality and sophistication to the point where the technology is well known and can meet exacting standards. The technology was first based on mechanical and, later, hydraulic principles. With the growth of electronics, however, an increasing number of mechanical and hydraulic components are being replaced by electronic components. Some governing, notably that performed by load controllers, is now entirely electronic.

Figure 8.2 outlines the basic approaches to governing the speed of a turbo-generating unit. Until recently, all governing devices for hydropower plants—governors and associated actuating mechanisms—adjusted the flow of water through the turbine so that the waterpower input into a turbo-generating plant matched the load imposed on the plant. In this case, as more electrical power is required of the plant, the load on the generator and turbine increases, resulting in a decrease in turbine and generator speed. Through either mechanical means (e.g., using flyballs) or electrical means (e.g., by measuring frequency), the governor senses this speed reduction. Through actuators, it then opens the appropriate valves to admit more water, and therefore more waterpower, through the turbine to satisfy the increased demand. Similarly, if less power is required, the governor senses an increase in speed resulting from the excess power available and causes the valve to reduce the waterflow through the turbine. In hydropower schemes that include a reservoir, unused water can be stored for times when demand for electrical power, and therefore water, increases.

Although electronic components now replace certain portions of governors, they also permit a new approach to governing. This approach, developed to meet needs specific to micro-hydropower, uses an electronic device called a load controller to maintain turbine speed and

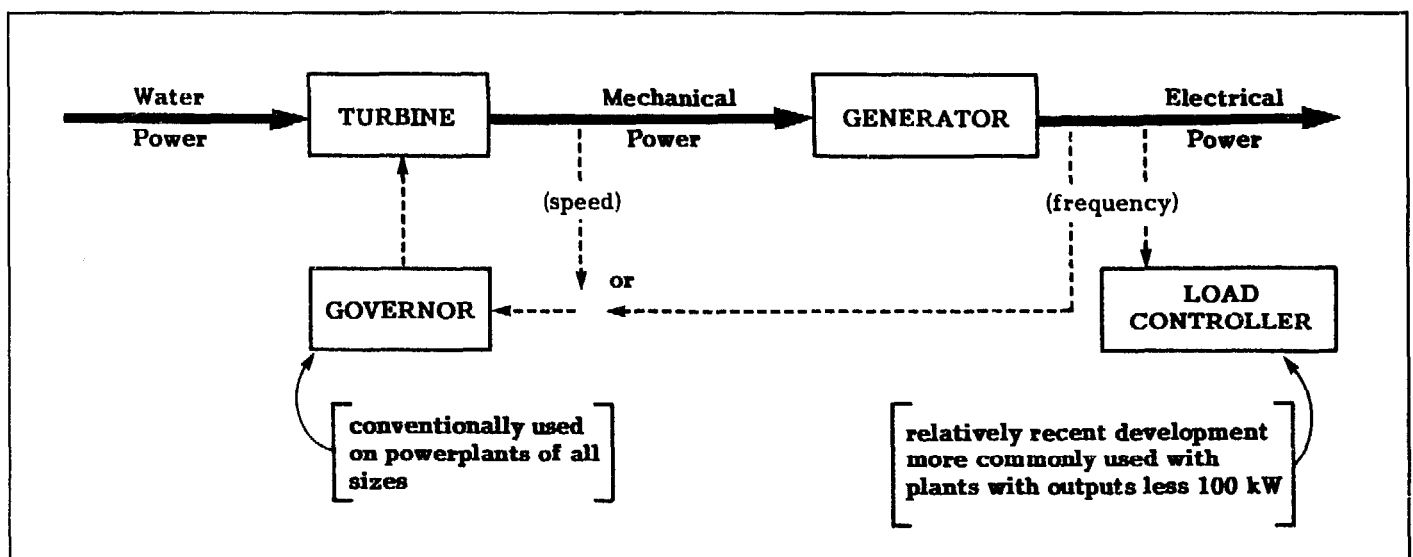

Fig. 8.2. This block diagram illustrates how conventional approaches to governing are integrated with the basic

components used to convert waterpower to mechanical and electrical power.

system frequency. Flow into the turbine is maintained at some constant value, and constant electrical power is generated. If the consumer requires less electrical power than that being generated, this is sensed electronically and the excess electrical power is dissipated, usually in a ballast resistor.

Commercial load controllers are available for plants with outputs of less than about 100 kW. However, when plant size increases, a governor generally is used because its cost becomes small compared with other costs incurred, trained operating staff and backup maintenance services are available, and water not used for power generation usually can be stored for future use.

"Advances in Controls to Govern Mini and Micro Hydro-power Systems" (55) contains a summary of the state of the art of micro-computers and electronic controls, with an extensive list of references.

Oil-pressure governor

Oil-pressure governors are so named because oil, kept under pressure by a pump, is used to drive a piston, which in turn moves the flow-control mechanisms. They are used with large turbines because they can generate the large forces necessary to control the flow of water into a turbine. They have also been incorporated in commercially available micro-hydropower plants, although load controllers are now preferred for run-of-river schemes (see **Load controller**, p. 204).

A simplified diagram of an oil-pressure governor presented in Fig. 8.3 illustrates its operation. For example, when an increased load is placed on the turbine, the resulting reduction in speed of the flyball assembly causes the flyballs to drop. This forces the floating lever to raise the sleeve in the pilot valve, opening the upper port and allowing oil under pressure into the upper chamber of the servomotor. The resulting motion of the piston opens the turbine gate, permitting an increase in the flow needed by the turbine to generate the extra power required to meet the original load increase. A compensating device consisting of a dashpot and spring is necessary to prevent overtravel of the gate and the instability that would otherwise occur because of the system's inertia. The manual control is used to set the operating speed or to start or shut down the system.

Figure 8.3 illustrates the operation of a mechanical-hydraulic governor where turbine speed is mechanically sensed by means of a flyball mechanism. Also in use are electrohydraulic governors that sense turbine speed by measuring frequency or, occasionally, voltage electronically. These values are compared electronically to a standard, and the difference results in electronic commands that are then transmitted to the hydraulic part of the governor by electromagnetic devices.

Although oil-pressure governors meet standards established in industrialized nations, they are sophisticated devices whose cost does not decrease in proportion to

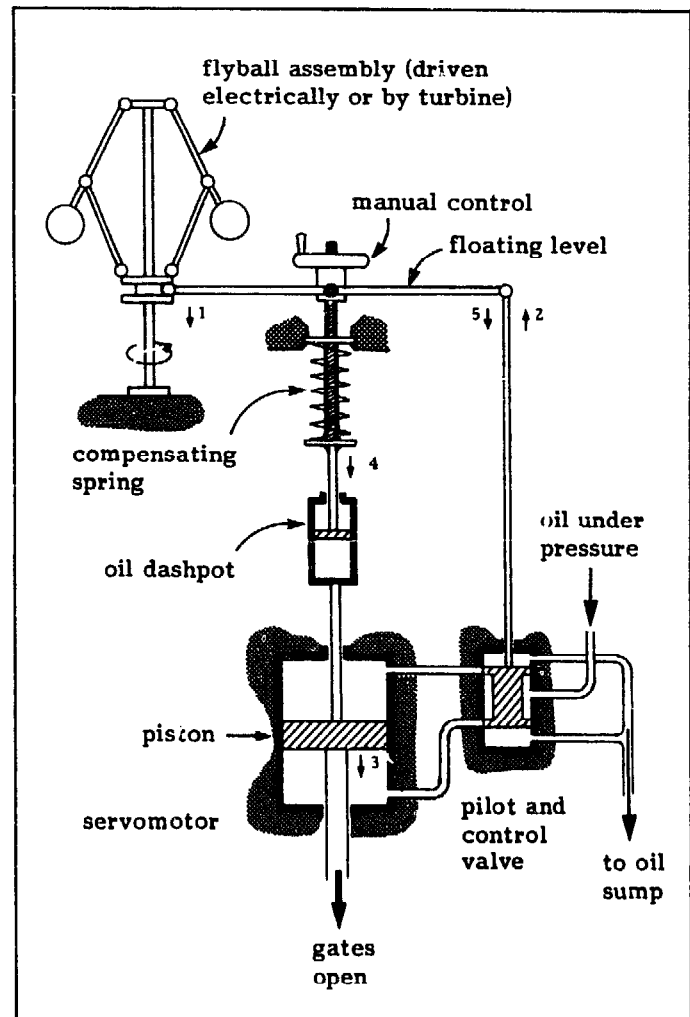

Fig. 8.3. Diagrammatic sketch showing the operation of an oil-pressure governor. Arrows indicate motion of various components in response to increased load on the turbine. Numbers next to the arrows indicate the sequence of events.

the size of the turbine they govern. They also require regular maintenance:

- Leaking seals and worn pins and bushings must be replaced.
- All bolts and connections should be checked regularly for looseness.
- All levers must be checked for friction or binding.
- All pivots, cam surfaces, and linkage rod ends should be oiled frequently and any accumulated grit, rust, or dust removed.
- Just, which serves as an insulator on electrical parts, must be guarded against.
- Governor characteristics, such as servomotor timing, should be checked periodically and appropriate adjustments made.

The cost and sophistication of oil-pressure governors detract from their appropriateness in rural areas. They should be considered only where streamflow is relatively small and provisions for the storage of water not used immediately for power generation are made.

In Nepal, where water resources are sometimes limited and a governor was required to make more efficient use of the available water, Balaju Yantra Shala, with Swiss assistance, developed an alternative governor design which, unlike conventional designs, could be fabricated largely in-country. To keep the device simple, a proportional-type governor, where the position of the turbine valve is determined by turbine speed, was designed. It uses water under forebay pressure, rather than oil under pressure generated by a separate pump, as the working fluid. Because of the lower working pressure, the servocylinder that activates the turbine valve has to be relatively larger in size. As with conventional governors, a flyball assembly senses turbine speed. As the speed changes with changes in load, a pilot valve connected to the flyball assembly controls the portion of the forebay pressure that actually acts on the servocylinder, which in turn opens and closes the turbine valve to compensate for the changes in load.

For the 30 kW plant at Dhading, Nepal, the speed deviation from its nominal value varies from +10% under no-load conditions to -6% at rated load to -20% under full load. However, it remains within a range of $\pm 4\%$ for the output range from about 10-25 kW and is therefore adequate under normal loads. Because of voltage regulation of the generator output, voltage remains constant over the entire range of loads. The Swiss Center for Appropriate technology (SKAT) is preparing Design Manual for a Simple Mechanical Governor and has already prepared a summary report (2). A brief description of the governor and its operation can also be found in Local Experience with Micro-Hydro Technology (78). Details of the operation of the governor installed at Dhading can be found in the report, The Dhading Micro-Hydropower Plant (77). This publication also discusses the procedure for tuning the governor, which is critical to avoid erratic operation.

Mechanical governor

For micro-hydropower plants, turbines can be fairly small, and reduced forces are required to manipulate turbine valves. In these cases, mechanical governors have sometimes been used. Typically, these incorporate a flyball arrangement driven by the turbine shaft. The output from this assembly is used directly to drive a valve on the turbine rather than to drive small intermediary valves controlling the flow of oil. The flyballs associated with a mechanical governor are much more massive, because a significantly larger force is required to drive the valve controlling waterflow to the turbine than to drive a pilot valve of an oil-pressure governor.

Load controller

The load controller is an electronic device that maintains a constant electrical load on a generator in spite

of changing user loads, thereby permitting the use of a turbine with no flow-regulating devices. It replaces the governor that adjusts the flow through a turbine to keep up with the fluctuating electrical or mechanical loads and that requires speed-sensing devices, actuating mechanisms, and valves, gates, or adjustable blades, depending on the type of turbine used.

The flow through the turbine is set at some value and a constant quantity of electrical power is generated. Assume that the consumer initially uses all this power. Because the waterpower into the plants is matched to the electrical load, the generator operates as it should and generates power at the required frequency of, for example, 50 Hz. If the consumer switches off some appliances or other loads that have been in use, the electrical power used becomes less than the waterpower available to the plant, and the turbine and generator speed, and frequency generated, begin to increase. This change is sensed electronically by the load controller, which then adds a ballast load of sufficient size at the generator output to dissipate power equivalent to that which was switched off. Therefore, in spite of a change in consumer load, the total load on the generator remains constant.

When a turbine is used to drive mechanical equipment in addition to a generator, a load controller can maintain the system speed and frequency at its design value regardless of fluctuating mechanical and electrical loads. In "Energy for Rural Development" (59), Holland describes a sawmill where a 25 hp turbine mechanically drives the principal load, a saw and cable drum drive for a carriage to carry the logs, and, in addition, is permanently coupled to an ac generator that provides power for cooking with storage cookers (see Heat storage cooker, p. 242) and for lighting. As soon as the saw starts to operate, a load controller automatically shifts power from the ballast load to the saw so that as much power as necessary is available for cutting.

If a load controller is located within the powerhouse, a controller that senses current, voltage, or shaft speed can be used. However, it might prove more advantageous to locate the controller away from the powerhouse to use the excess power more effectively. In this case, only frequency or voltage can be used to determine the state of the system. Use of voltage may be unsatisfactory because it is affected by factors other than the total load imposed on the system: voltage losses in the distribution line, power factor, and the action of the voltage regulator incorporated in the generator. Determining the state of the system by sensing frequency is therefore the most widely used approach.

The principal advantage of a load controller is that the overall system becomes simpler and less costly. It not only eliminates the need for an intricate governor and actuating mechanism, but it allows the design of the turbine to be simplified. A less sophisticated system increases the chances for long-term viability and reduces equipment cost considerably for plants in the micro-hydropower range. For example, rather than a cost of \$10,000 for an oil-pressure governor for an 8 kW

plant, materials for a single-phase controller (excluding ballast loads) for the same plant could cost less than \$100 (31). If electronic components fail in the field, they probably cannot be repaired on the spot; however, a well-designed unit is composed of separate printed circuit boards that can be replaced easily with spare boards kept for that purpose.

A load controller also permits maximum use of the energy generated. If properly planned, these uses can generate income and, by increasing the load factor on the plant, can significantly reduce the cost of the energy generated.

When a load controller is used, flow through the turbine is set at some constant level (but not necessarily fully open) and all the water is used for power generation. The water used to generate power that is not used productively by the consumer is wasted. For run-of-river schemes, this is irrelevant because they have no provision for the storage of unused water for later productive use. However, load controllers alone cannot be used with schemes that have to use a limited quantity of water efficiently and therefore include a reservoir to store excess water during periods of low power demand. In this case, a governor or other device that regulates the flow of water—that decreases the volume of water used by the turbine during periods of low demand and leaves it to be stored in a reservoir—must be used.

Generally, commercially available load controllers are electronic devices that electronically sense changes in generator frequency and switch excess power to ballast loads. Other designs and variations are also possible. Rather than sensing generator frequency, they can sense voltage and switch ballast loads on or off accordingly. They can also use rotating flyballs to sense speed and use them to switch power to dissipative ballast loads.

Phase control. Although numerous variations of this approach to load controlling exist, only a single ballast load per phase need be used. Under a full load, no power is diverted to the ballast. As the consumer load decreases, the accompanying increase in generator frequency is sensed electronically and the controller diverts excess power to the fixed ballast. For a single ballast to dissipate a continuous range of power for zero to maximum turbine capacity, a electronic solid-state switch diverts full generator power to the ballast for a portion of each half cycle. For the remainder of each half cycle, power is diverted back to the principal consumer load. As more power must be dissipated, generator output is switched across the ballast load for an increasing portion of each cycle until, with no consumer load, the entire portion of each cycle, and therefore all the power, is diverted to the ballast.

Step ballasts. This approach to load controlling requires several discrete loads that are switched across the generator either singly or in combination to dissipate the excess power generated. To keep frequency fluctuations to an acceptable value with the minimum number of ballast loads, these should all be different by a factor of two. Ballast loads would therefore have resis-

tance ratios of 1:2:4:8. By electronically switching these loads in various combinations to four such ballasts, for example, the total ballast load can be varied in 15 discrete steps and the frequency kept to under $\pm 1.5\%$ as consumer load varies from zero to full load. However, if the use of any ballast resistor is lost, some control over speed may also be lost. In "Electronic Load Governors for Small Hydro Plants" (31), Boys et al. provide further details of this design.

A rudimentary load controller of this type is illustrated in Fig. 8.4, which was designed and built a decade ago and is still in operation (62,70). Although it is similar to the controller just described, there is one major difference. Rather than solid-state circuitry to sense frequency, it uses voltage-sensitive power relays, electro-mechanical devices designed to energize and de-energize (and thereby make or break an external circuit) at predetermined voltage levels that can be set manually. Because generator voltage is related to generator speed, sensing voltage gives an indication of frequency. The relays then add or remove load, depending on whether the voltage (and therefore speed) is above or below preset values.

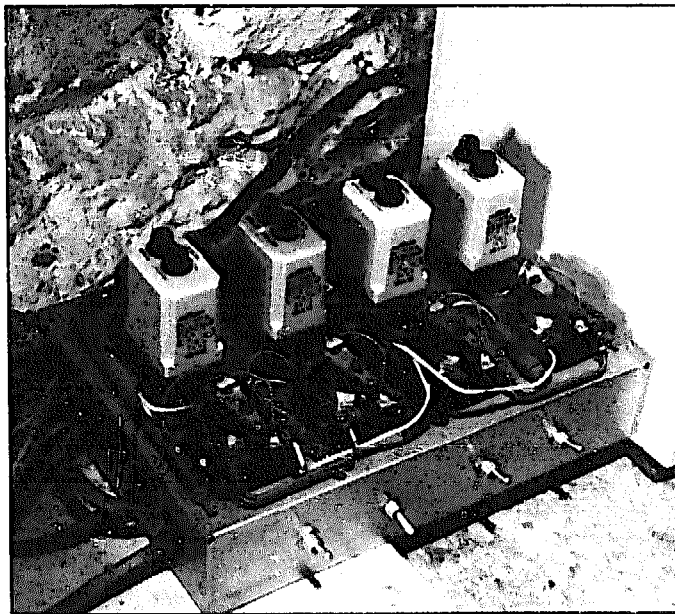

Lowville, VA, U.S.A. (6 kW)

Fig. 8.4. Load controller using four voltage-sensitive power relays. Knobs on top of each relay are used to adjust pickup and dropout voltage. At this installation, a slave relay used to actually control power to each ballast load is activated by the voltage-sensitive relay behind it.

Nonconventional approaches

If the planned end uses are sufficiently voltage- or frequency-sensitive, the conventional approaches to governing just described are usually required. Furthermore, if it is necessary to automatically make optimum use of the water available for power generation, a governor or governing device that regulates the flow through the turbine must be used. However, if these circumstances do not apply, lower-cost and more tech-

nically straightforward approaches to controlling speed are possible.

It must be kept in mind that use of nonconventional approaches usually implies less control over speed. However, this is generally not a valid argument against such approaches, especially in the initial years of a project. In rural areas, electricity is a new commodity and load builds up gradually. Nonconventional approaches to governing permit access to electricity at reduced cost and with minimum sophistication. If demand grows and the sophistication of end uses increases, a load controller can later be included with virtually no modification on the existing system. By that time, both users and plant operators will have gained some familiarity with the hydropower plant, and more sophisticated devices will have a better chance of being operated and maintained successfully.

Another advantage of several of these approaches to controlling speed is that they are failsafe. Some approaches described (**Operation on the backside of power curve**, p. 210; **Operation in parallel with dissipative load**, p. 211; and **Turbine flow modification**, p. 213) can protect against runaway with no additional protective devices required.

In addition to replacing conventional governing systems, some nonconventional approaches can also serve as a backup to these systems. Although conventional governing systems are impressive in performing their task under varying load conditions, a single component can fail and, depending on the available expertise, cause the system to be shut down. Some approaches (**Constant loads**, p. 207; **Manual control**, p. 207; and **Large base load**, p. 209) provide alternative options for making use of an otherwise nonfunctional plant until repairs can be made.

Like the load controller, the approaches described in this section are generally used where there is constant flow through the turbine. They do not guarantee the most efficient use of the water available for power generation; however, this is not important at run-of-river micro-hydropower sites, because storage of excess water is not provided for.

Several nonconventional approaches and their theory of operation are described below. For illustrative purposes, a parabolic power curve is assumed (see EXAMPLE 8.1). This pattern fits the actual situation fairly closely; nevertheless, the following descriptions are valid, regardless of the precise power curve for the turbine used. In addition, although incorporating a proper flow-regulating valve with a turbine permits more flexibility, the approaches discussed in this section can be used with rudimentary turbines which include no such valves and which therefore accept only a constant flow.

Often, two or more of these approaches can be combined to create a more effective system at minimum cost and complexity. For example, an approach to steepening the power vs. speed curve to reduce runaway speed is described in **Turbine flow modification** (p. 213).

EXAMPLE 8.1

The description of each of the nonconventional approaches to governing described in this chapter will include an example based on the following situation.

A 25 kW turbine driving a generator with a V-belt has been installed to provide electrical power to a nearby village. The turbine is equipped with a proper flow-regulating valve, not simply a gate or butterfly valve. Based either on turbine and site characteristics or on actual trial runs after the installation has been completed, a power vs. speed curve can be obtained.

Assume that at its design speed of 600 rev/min, an installed turbine with valve fully opened has an output of 25 kW. If the load is removed (runaway conditions), the speed attains 1200 rev/min. Power output readings at intermediate speeds can be obtained by use of a tachometer and makeshift prony brake. Fitting a solid curve to the data would yield the power characteristics shown in Fig. 8.5. If the turbine has a flow regulating valve, it is possible to obtain a curve similar to that represented by the dashed line for each valve opening.

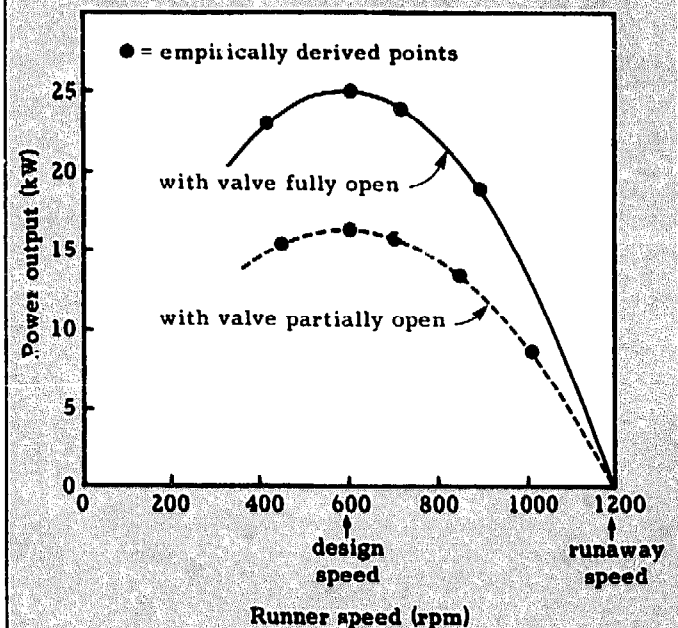

Fig. 8.5. Turbine output power characteristics vs. speed for the example used in this section. Maximum turbine output is 25 kW.

Assume also that the generator that is coupled to the turbine is designed to run at 1500 rev/min to produce 50 Hz. If the turbine is to perform optimally, it must operate at 600 rev/min. For proper operation of both turbine and generator, it is therefore necessary to gear up the runner speed (600 rev/min) to that of the generator (1,500 rev/min). For this purpose, a gearing ratio of $1,500/600 = 2.5$ is required (i.e., the diameter of the pulley on the turbine must be 2.5 times that of the generator pulley).

This approach can be used in parallel with the approaches described in **Operation on the backside of power curve** (p. 210) and **Operation in parallel with dissipative load** (p. 211) to attain even better control over speed.

Constant loads

Constraints: This approach permits only the use of fixed loads, such as village lighting. However, it allows for a bit more flexibility than may first be apparent (see last paragraph of **Large base load**, p. 209).

Although it is the most restrictive approach, maintaining a constant load is the simplest method of ensuring constant frequency and voltage. In this form, no switches are included in the circuit; power is switched on by opening the valve to the turbine wide enough to attain the nominal frequency and/or voltage. Closing the valve when power is no longer required switches off the electricity. In this approach, neither switches nor power outlets should be included in the system.

One variation of this approach permits more than one constant load to be used. A two-way switch can be used so that switching off one load (e.g., lighting) when it is no longer needed switches on a second load of similar magnitude (e.g., a water heater). In this manner, a constant load is maintained on the generator despite the use of several loads. There are numerous variations of this approach. (See **EXAMPLE 8.2**.)

A locally fabricated crossflow turbine capable of generating about 1 kW was installed about 400 m from the village of Gemaheng, in the rugged Saruwaged Range in Papua New Guinea (see Figs. 5.165). Power is supplied

to several homes in the village where it is used for both incandescent and fluorescent lighting. As evening approaches, a villager switches on the lights by opening the gate valve to the turbine in the powerhouse. The valve is then shut the following morning when the lights are no longer needed. The principal complaint was that the lights were on all night. Although they could have been turned off by shutting the water at the powerhouse, that involved a long, often slippery trek in the dark through the bush to the powerhouse, a trip that no one wanted to undertake. A solution to that problem would have been to install a two-way switch at the village, with a water heater for villager use as the alternate load.

Manual control

Constraints: For proper operation of the system, an operator must be available whenever needed to correct for changing loads. This approach can be used with a turbine that may not have any means of flow regulation. Some of the options described permit governing either from the powerhouse or from anywhere along the distribution system.

With this approach, an operator is required to maintain a relatively constant frequency manually. This can be done in either of two ways—by adjusting the flow of water to the turbine or by adjusting the total load imposed on the generator.

It is not necessary for the operator to make the adjustments continually during the operation of the plant. Small deviations from nominal frequency would have no adverse effect on the plant or the load. (See last paragraph of **Large base load**, p. 209.)

EXAMPLE 8.2

For the sample installation described in **EXAMPLE 8.1**, assume that the village has a total incandescent lighting load of 11 kW. With the onset of evening, the valve to the turbine would be opened until the frequency and/or voltage (whichever is being monitored) reaches its nominal value; the valve would then be left at that setting until the plant is shut down later in the evening or at dawn.

If no flow-regulating valve has been incorporated, the generator will have to generate the entire 25 kW. In this case, if 16 kW is used for lighting, the other 9 kW will also have to be dissipated somehow, possibly through a resistive water-heating element.

If an additional 5 kW is added to the lighting load at some later date, the same procedure would be followed. However, in this case, the valve will end up in a more open position to make more water available to the turbine to provide for the additional power (Fig. 8.6). Because the optimum runner speed depends only on the head under which the turbine operates, the speed remains essentially unchanged, as

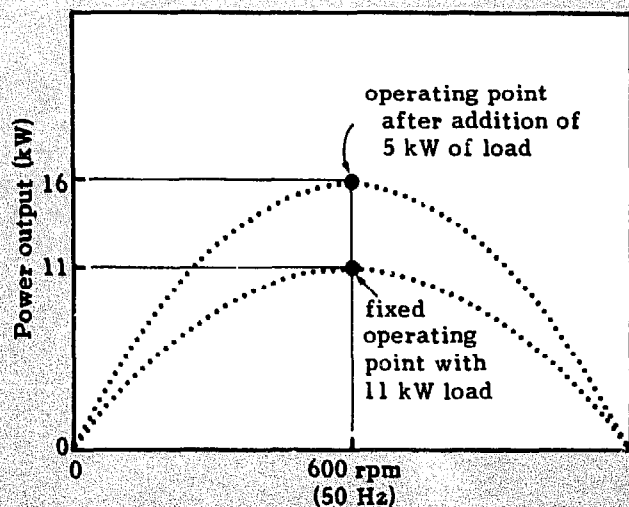

Fig. 8.6. Operating points when constant loads are imposed on the turbine.

does the gearing ratio that is required to drive the generator.

Flow modification. To keep the frequency constant as the load imposed on the generator varies, the water-power to the turbine must be varied accordingly. This approach requires a turbine that includes a flow-regulating valve. Load variations can be noted by observing voltage or frequency readings on a meter. However, it is not necessary to observe the meters continually, because changes in load will result in observable changes in light intensity. This warns the operator that the flow to the turbine should be increased or decreased. Reference to an electrical meter may be necessary when flow is readjusted in order to return to nominal operating frequency. (See EXAMPLE 8.3.)

EXAMPLE 8.3

For the sample installation described, assume that the village has a load that varies from a minimum of 16 kW to 25 kW in the evening. In this case, the turbine valve would be opened until nominal voltage or frequency is reached. From that point on, the operator would continue to open or close the inlet valve as needed to maintain these conditions. When operating properly, the operating point would remain on the heavy solid line shown in Fig. 8.7 and the frequency would remain at a nominal 50 Hz.

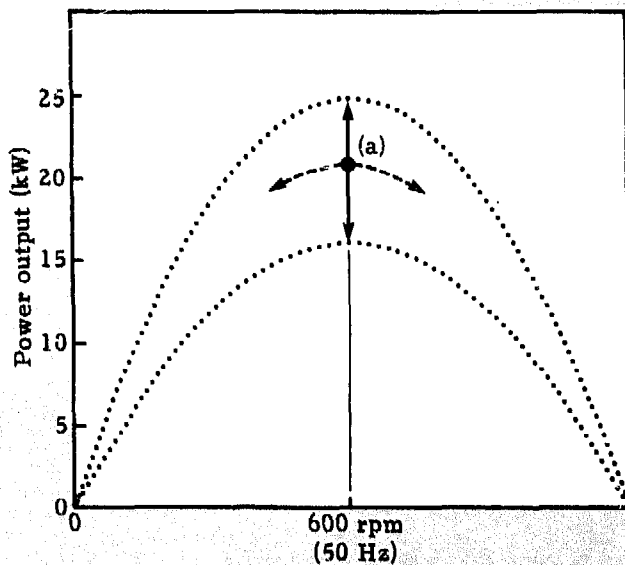

Fig. 8.7. The solid line represents the operating curve when frequency is kept constant through flow modification. If, after adjusting the flow to operate at point (a), the operator is not alert, further load variations will move the operating point along the dashed line.

However, if the operator has adjusted the valve to provide for a 21 kW load, for example, and then leaves the plant, the operating point would follow the dashed line, and the speed (and frequency) would increase or decrease as electrical devices are removed or placed on-line. If such deviations are small, they will have no adverse impact on either the turbo-generating unit or the loads.

The ATDO in Pakistan (see **VILLAGE-IMPLEMENTED MICRO-HYDROPOWER SCHEMES IN PAKISTAN**, p. 248) is implementing a growing number of micro-hydropower plants in the northern part of the country. These are all used to generate electricity, and a number are also used as a source of direct motive power to drive small cottage industries. These plants, averaging about 10 kW in size, provide electricity primarily for lighting in the villages and occasionally provide power for small electric motors and, in one case, for an arc welder. A plant operator is responsible for maintaining the desired turbine speed by adjusting flow. Plants with steel penstocks have gate valves that are used to regulate flow. Losses in efficiency when using a gate valve are of no major concern as adequate water is usually available. More commonly, flow regulation is achieved by using a wooden gate at the inlet to the penstock. This approach to flow control implies that the penstock may at times function only partially full. However, the accompanying reduction in efficiency at part-load is again of no consequence at these plants.

EXAMPLE 8.4

At the sample installation where the maximum consumer load is 16 kW, the valve on the turbine is opened until nominal frequency and/or voltage is reached with this maximum load on-line. The valve is then maintained at that setting. As the user load decreases, the operator would switch on additional loads to maintain the total load at 16 kW. Because resistive loads are usually available in discrete sizes, the actual operating point might not remain fixed but would be somewhere along the dashed line in Fig. 8.8, with slight accompanying changes in frequency.

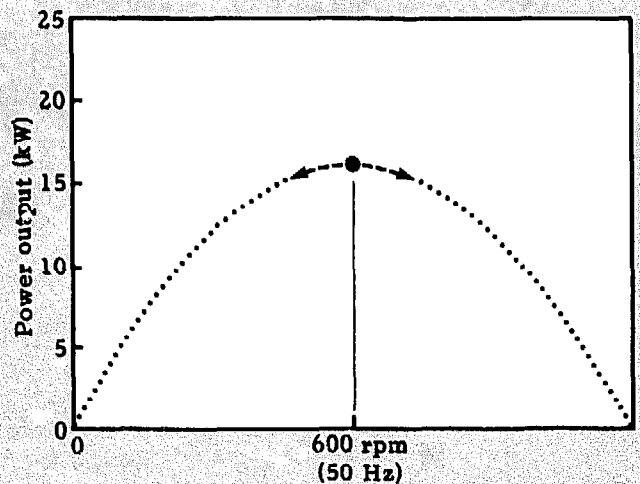

Fig. 8.8. The operating point when load modification is used. The dashed line represents excursions that would occur if the turbine output power is not exactly matched by the total load imposed on the system.

Load modification. Similar in approach to that using a load controller, this method can be used with a turbine that has no flow-regulating valves. Because the flow into the turbine remains constant, the load imposed on the generator must also remain fairly constant to prevent the frequency from varying significantly. This requires a ballast load, also connected across the generator, to be increased or decreased manually as the user load varies. The ballast loads might be a series of light bulbs or perhaps heating elements in either air or water. A voltmeter or frequency meter can be used to monitor the generator speed so that the ballast loads can be added or removed when necessary. (See EXAMPLE 8.4.)

A 20 kW Pelton unit has been providing electricity for refrigeration at a farm and for domestic uses in the home near Zenag, Papua New Guinea, since the early 1950s. A voltmeter is located in the kitchen. As user load changes over the day, anyone passing through the kitchen would switch on or off one or more ranges in the electric stove/oven to return the voltage, and therefore frequency, approximately to its nominal value.

Large base load

Constraints: This approach requires the major load on the turbo-generating unit to be constant and the variable load to be no more than about 30% of the constant load to keep frequency variations within generally accepted limits.

When the turbine is started up, the flow through it is adjusted so that the generator provides a slightly higher than nominal frequency with only the base load imposed (Fig. 8.9). The voltage may also be slightly higher than its nominal value, depending on the design or adjustment of the voltage regulator. As the variable user load is increased from zero, the operating point, originally at

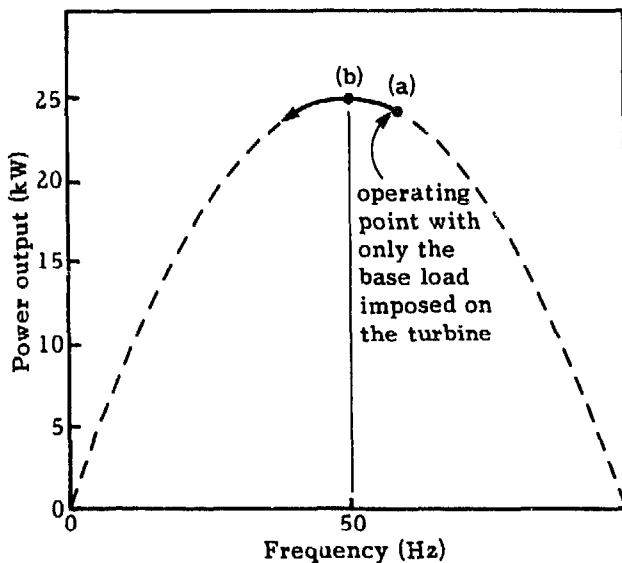

Fig. 8.9. Operating near peak power with a large base load and a small variable user load. The solid line represents the operating curve as increasing consumer load is imposed on the system.

point (a), travels down the curve, with an accompanying decrease in turbine speed and generator frequency. At point (b), the load is such that a frequency of 50 Hz is reached. As additional appliances are switched on, the load imposed on the system apparently increases. However, as the operating point continues to move to the left and the turbine speed continues to decrease, less real power is actually available. What actually occurs is that, as additional end uses are switched on and the apparent load increases, the power actually available (which may decrease slightly, depending on the location of the operating point) is redistributed among the entire connected load. The decreased voltage available at the generator terminals as the turbine frequency decreases causes this to happen automatically. For example, as additional 60 W bulbs are switched on, every 60 W bulb connected to the generator will actually consume decreasing amounts of power because the voltage across each bulb will be decreasing. (See EXAMPLE 8.5.)

With the assistance of the Papua New Guinea University of Technology, the villagers around the remote village of Bandoang installed a Gilkes 6 kW Pelton turbo-generating set to provide electricity to a small area that included a primary school, staff and some villager housing, and a few trade stores along a small mountain airstrip. A manually operated spear valve controlled flow through the single nozzle, and there was no other provision for speed control.

Because no load controller was available for installation when the plant became operational, a 3.6 kW water heater was permanently connected to the generator, providing hot water to a community washing facility. The spear valve was opened until the frequency of about 53 Hz was attained. Then additional variable load totaling less than 1 kW (composed of incandescent bulbs and an occasional small power tool) could be switched on. With this load, the frequency decreased to about 47 Hz. In the evenings, voltage fluctuations accompanied the frequency variations as lights were switched on and off, but the changes in light intensity were hardly noticeable. The only times that fluctuations in intensity were clearly visible were when the headmaster of the school plugged a 1.8 kW hot water jug into a power outlet at the school. The system continued operating, at a reduced voltage, and the headmaster eventually got his cup of tea.

With a large base load, the variable portion of the user load must amount to no more than about a quarter of the output of a turbo-generating unit to keep frequency and voltage variation within generally accepted limits. If a generator is belt-driven, other approaches described below provide more flexibility. On the other hand, if the generator is driven directly by the turbine to operate at the point of peak turbine efficiency, the options available for an alternative approach to speed control are restricted. In this case, using a large base load is

one of the few approaches that can be applied without resorting to more conventional approaches.

EXAMPLE 8.5

For the sample installation, assume that the village has a variable load totaling a maximum of 4 kW and that about 15 kW excess capacity is used on a continual basis to heat water in vats for a village dyeing operation. The gearing ratio between turbine and generator continues to be 2.5, as in the previous examples. In this case, with only the water heating elements on-line, the turbine inlet valve is adjusted so that the output frequency is about 52 Hz. As the variable load increases from zero to the maximum of 4 kW during the day, the output frequency would decrease to about 46 Hz. Consequently, the operating point would remain along the solid line on the curve in Fig. 8.10 during the plant's operation.

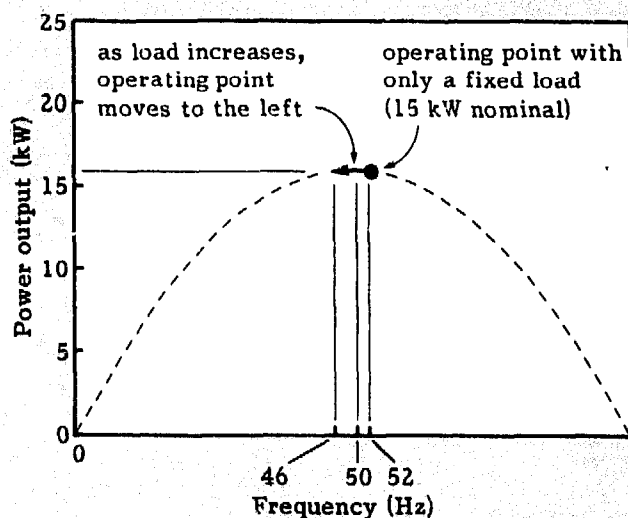

Fig. 8.10. The operating curve assuming a fixed base load of 15 kW (nominal) and a 4 kW variable user load.

In this case, assume that the voltage is proportional to generator speed and that the voltage at the generator terminals at 52 Hz is thus correspondingly larger than nominal. Therefore, although a 15 kW heating element is used, the actual power consumed by the elements is slightly higher, approximately 15 kW times $(52/50)^2$ or 16 kW. After an additional load with a nominal power rating of 1 kW has been placed on the system, frequency decreases to 50 Hz and the 16 kW actually available is dissipated in both the heater (15 kW) and the additional load (1 kW). As an additional 3 kW of nominal load is imposed on the system, the same 16 kW (or now slightly less, because the operating point has moved to the left, off the peak) is distributed to all 19 kW of nominal load. Each device then actually receives slightly less than its designed rated power, because the voltage is decreased to $(46/50)^2$ or 92% of its nominal value.

As noted in **Constant loads** (p. 207) and **Manual control** (p. 207), these two approaches described in those sections have more flexibility than is first apparent, because the turbine output need not be matched exactly to the load. Although the systems in these cases are designed to operate at the normal frequency—at the peak of the power curve—they would still operate satisfactorily if either the total load were somewhat below (e.g., because some lights have burned out) or above (e.g., because several bulbs are replaced with some of higher capacity) its normal value.

Operation on the backside of power curve

Constraints: This approach requires a plant with an impulse turbine large enough to generate more power than is to be consumed. In addition, the flow must be available to generate maximum power, even though this power will not be generated or consumed. If a reaction turbine were used with this approach, it would be adversely affected by cavitation. This approach can only be used where the turbine and generator are coupled by a belt that permits a choice of gearing ratio between the two. If a turbine is directly coupled to a generator, it is conventionally designed to operate at the point of peak turbine efficiency and this approach cannot be used. In addition, the turbine, but not the generator, must be capable of operating continually near its runaway speed.

Although good speed regulation can be obtained using this approach, it will usually lead to less than optimum use of the installed capacity of the turbine. However, plants implemented in rural areas often are oversized in anticipation of a gradual increase in size and types of load. By the time demand grows, the villagers should have more familiarity with the plant and with electricity and be able to use more sophisticated approaches to governing to make better use of the plant's capacity. This approach is a simple and cost-free way of providing effective control over speed, and requires no overspeed protection.

A turbine with a parabolic power output vs. speed curve shown in Fig. 8.11a is again assumed, but the following description is valid for any curve; only the actual values may change. Whatever the curve, there are a number of possible operating points along it.

Conventionally, a generator is coupled to the turbine so that it generates the standard frequency of, for example, 50 Hz at the turbine speed corresponding to peak efficiency and power (Fig. 8.11b). If the electrical load is removed, however, a turbine with no governor would reach runaway and the generator would be driven at approximately twice nominal speed. The generator and voltage regulator would no longer function properly at these high speeds.

If the gearing ratio between the generator and turbine is changed so that the nominal operating frequency is generated when turbine speed is halfway between nominal and runaway speed as shown in (Fig. 8.11c), then from zero to full load, speed variation would amount to

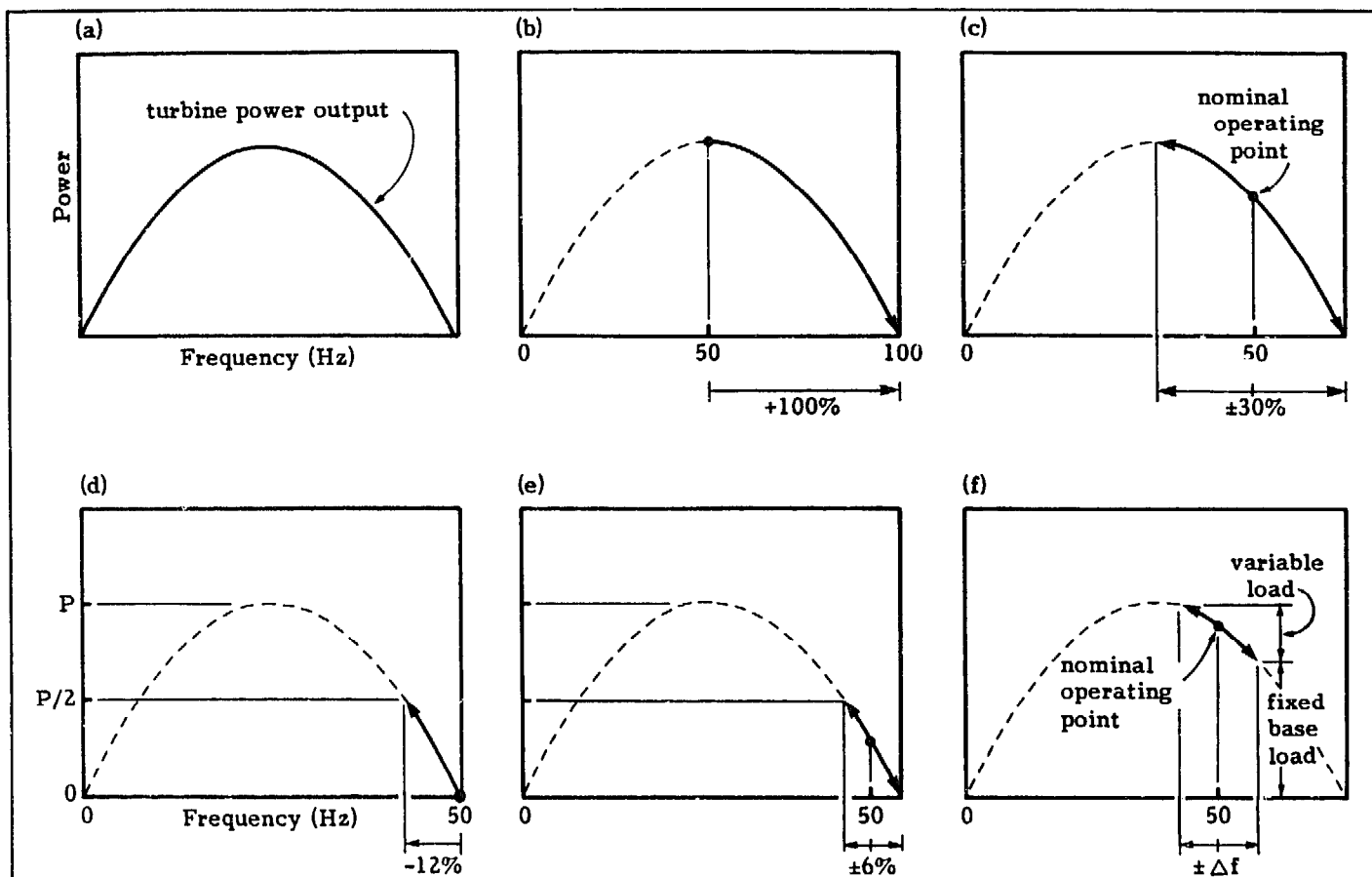

Fig. 8.11. Operating on the backside of the power curve: (a) the assumed turbine power output vs. speed curve, (b) conventional operating point, with large frequency increase at runaway, (c) decreasing the gearing ratio between the turbine and generator so as to operate on the

back of the power curve, (d) a gearing ratio designed to generate 50 Hz at turbine runaway, (e) a gearing ratio designed to generate 50 Hz at slightly below runaway, and (f) system with a fixed base load and additional variable user load operating farther up the curve.

about $\pm 30\%$ of the nominal speed. This might still be too large a speed (and frequency) variation, but it still permits full use of plant capacity.

If the variations in the user load are less than the power potential of the plant, it is possible to operate at any of a number of points:

- With no constant base load and only a variable user load imposed on the system, the generator could be coupled to the turbine so that the nominal frequency would be generated at either the turbine runaway speed (Fig. 8.11d) or somewhat below that speed (Fig. 8.11e). The actual frequency variation depends on what percentage of peak capacity the actual variation in load represents; the percentage frequency variation is about one-quarter this percentage. If the electrical load varies from zero to half or 50% of turbine capacity, as shown in the figure, the frequency variation will be about -12% or $\pm 6\%$ (or ± 3 Hz).

One drawback of this approach is that the bearings supporting the turbine shaft turn at about twice the usual speed and that their life is therefore reduced by an average of 50%.

- With a constant base load less than the peak power available from the turbine and an additional variable user load superimposed on this, the generator could be coupled to the turbine to generate 50 Hz at some lower speed (Fig. 8.11f). Because the turbine's power curve flattens as its peak is approached, a given change in load will result in a somewhat higher frequency variation than when no base load is imposed.

The hydropower plant at Kibimba, Burundi, operates in this fashion (see **WHY CONSIDER VARIOUS GOVERNING OPTIONS?**, p. 200). Because no governor was available, the plant was operated near the end of the power curve, with the turbine operating near runaway speed. In addition, during periods when the large lighting load was off, switching on the water heater base load brought the frequency to its nominal value during the day when other uses were minimal.

Operation in parallel with dissipative load

Constraints: This approach requires a second load, preferably a mechanical load serving a productive purpose, in addition to a primary variable load. This load

must be able to accommodate a range of speeds. This approach is also applicable when the turbine is directly coupled to the generator so that it operates at its most efficient point. To the author's knowledge, this approach has not yet been tried.

Although operating on the backside of the turbine's power curve (p. 210) permits some control over speed over a range of loads, it results in an inefficient use of the power potentially available. The approach described in this section permits productive use of this otherwise wasted power.

Let the dotted line in Fig. 8.12a represent the total power available from the turbine at different speeds. From an engineer's point of view, a curve illustrated by the solid line has preferred characteristics—maximum power at nominal speed, with a very small change in frequency or speed as the load varies from full load to zero. This can be accomplished by connecting a dissipative load to the turbine, which dissipates the power between the two curves as indicated. It would require a load that consumes no power at the nominal operating speed—at the peak of the turbine's power curve—but quickly consumes a large amount of power as the speed is increased slightly above this nominal operating speed (Fig. 8.12b).

Finding a simple device with such a loading characteristic is difficult. One device that only approximates this desired characteristic is a mechanically driven heat generator, basically a fan that generates heat by friction through agitation of a fluid (gas or liquid) (see **Mechanical heat generator**, p. 241). The power characteristic of this device is indicated by the dashed lines in Fig. 8.12c; the magnitude of the power dissipated varies approximately with the cube of the speed. The precise curve depends on the gearing ratio between the turbine and this device.

If both this dissipative load and the generator are coupled to a turbine, as shown in Fig. 8.13, the dotted line

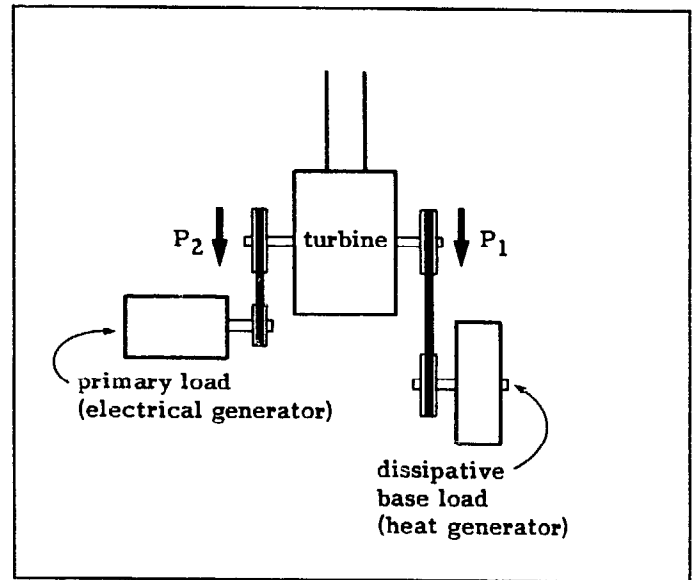

Fig. 8.13. One layout for turbo-generating equipment when a dissipative load as well as an electric generator are coupled to a single turbine.

in Fig. 8.14 again represents the power available from the turbine, and the dashed line represents the portion of that power consumed by the heat generator, the dissipative load. The solid curve—obtained by graphically subtracting the dashed from the dotted curve—represents the power remaining to drive the electrical generator. In this example, most of the power available from the turbine is converted to electrical power (P_2) under normal operating conditions. A small remaining portion (P_1) is converted to heat, which can be used for some productive purpose. As the electrical load decreases, the speed increases and the dissipative load converts an increasing amount of power into heat. When the entire electrical load is withdrawn, the turbine attains its highest speed. This value depends on how the dissipative load is incorporated in the overall system. (See EXAMPLE 8.6.)

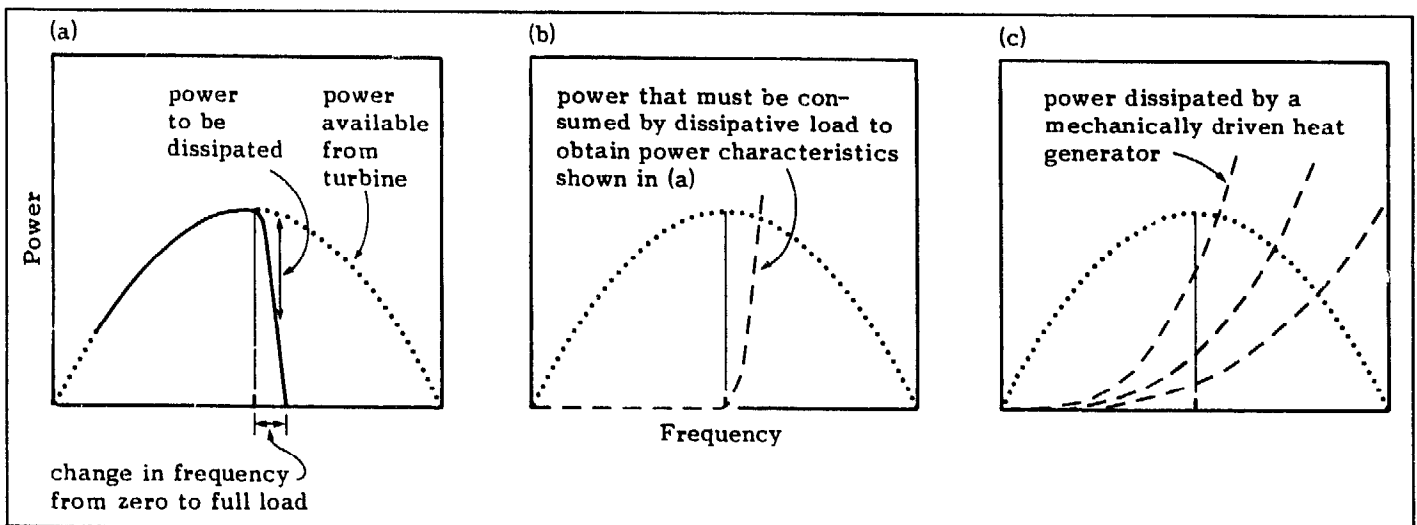

Fig. 8.12. Operating in parallel with a dissipative load: (a) desirable turbine power characteristics are shown by the solid line, (b) the desired characteristics of the parallel

dissipative load to achieve the preferred net power characteristics shown in (a), and (c) the actual power dissipation characteristics of a mechanically driven heat generator.

If coupling between the turbine and generator is changed, this approach can be used, with the approach described in **Operation on the backside of power curve** (p. 210), for speed control. (See end of EXAMPLE 8.6.)

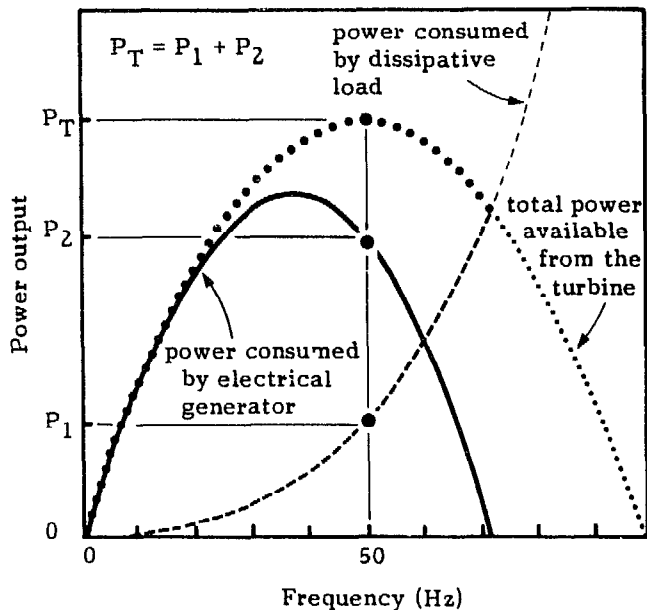

Fig. 8.14 Power available for electric power generation when the excess power available from the turbine is consumed by a heat generator.

Turbine flow modification

Constraints: Unlike other approaches discussed in this chapter, this approach cannot simply be added onto an existing system, because it involves phenomena that occur within the turbine. In addition, although this approach has been used to exercise some control over the speed of Pelton turbines, some research and development work would be required before this approach could be used with other types of turbines. Finally, this approach is better suited to persons who fabricate their own turbines, because the flow modification devices can then be integrated within the turbine during its fabrication.

To control speed by turbine flow modification, a device must be placed in the vicinity of the turbine runner. As the imposed load on the system decreases and speed increases above nominal speed, this device rechannels the flow within the turbine to introduce disturbances that effectively reduce the system efficiency. This reduces the power available from the turbine to match the reduced user load. A system developed in Colombia best illustrates such a design and its operation.

In field installations, Jaime Lobo Guerrero of the Universidad de los Andes (Bogotá) has been using a device he developed to control the speed of a Pelton runner. Although the initial studies were theoretical, the actual device grew out of numerous laboratory trials using a variety of designs and variations on those designs that were more a result of hunches based on experiment and experience than of theoretical calculations.

EXAMPLE 8.6

Assume that maximum use is to be made of output from the 25 kW turbine. Only a maximum of 5 kW of this capacity will be used to generate electricity; the remaining 20 kW will be used for driving a mechanical heat generator. Under these conditions, point Q on curve A and point S on curve B in Fig. 8.15 would represent the operating points of the electrical generator and dissipating load, respectively. As electrical load is removed from the generator, the operating point for the electrical generator descends curve A to point R. The frequency increases to a limit of about 54 Hz, at which point all the energy is consumed by the dissipating load (point T).

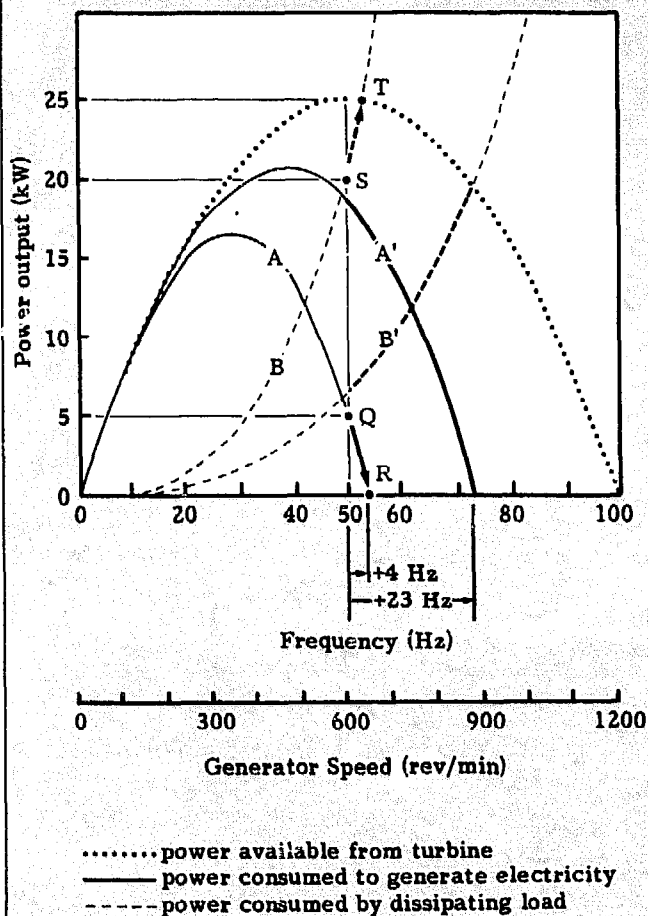

Fig. 8.15. The effect of changing the gearing ratio between turbine and heat generator on the power available for electricity generation.

Now consider changing the power dissipation characteristics of the dissipative load. With a heat generator, this can be done by changing the gearing ratio between the turbine and the heat generator. If this is reduced, this load will turn slower at the same nominal turbine speed, dissipating less energy. If the

(Continued on p. 214)

(Continued from p. 213)

gearing ratio is decreased so that the heat generator consumes only 25% of the power available, 75% will be available for electricity generation. The gearing ratio between the turbine and electrical generator is left unchanged.

The operating point for the electrical generator will now be at the upper end of curve A' rather than curve A. Although substantially more electrical energy will now be available than before, frequency increases substantially, beyond its nominal value as the electrical load is decreased (and one moves down curve A'). In this case, the frequency will be nearly 75 Hz, an increase of approximately 50%, and the turbine will be running at 880 rather than 600 rev/min. This frequency (and associated higher-than-nominal voltage) will be too high for general use. However, by adjusting the quantity of power nominally consumed by the dissipative load—in this case, by changing the gearing ratio of a mechanically driven heat generator—it is possible to set the upper limit on the frequency to whatever is desired. If both electrical and mechanical loads are on the turbine, whatever electrical power is needed (within limits set by design) will be available at an acceptable frequency and voltage.

Figure 8.16 illustrates the effect of changing the gearing ratio between the turbine and electrical generator. Assume that a maximum of 75% of the total power available from the turbine is required for electricity generation (curve A' in Fig. 8.15). Rather than generating 50 Hz at 600 rev/min, however, the gearing is changed so that 50 Hz is generated when the turbine speed is $(880 + 600)/2$ or 740 rev/min. For a 1500 rev/min generator, this requires a gearing

ratio of $1500/740 = 2$. By operating at this point, the peak frequency change is not +23 Hz, but ± 10 Hz.

Similarly, if the electrical power demand on the turbine will not exceed 5 kW (curve A in Fig. 8.15), then generating 50 Hz at the middle of that range means that frequency change from zero to full design load (5kW) will be only ± 2 Hz. In this case, all the power generated can be used productively and no governor or load controller is required, yet frequency fluctuations are well within acceptable limits for virtually all purposes.

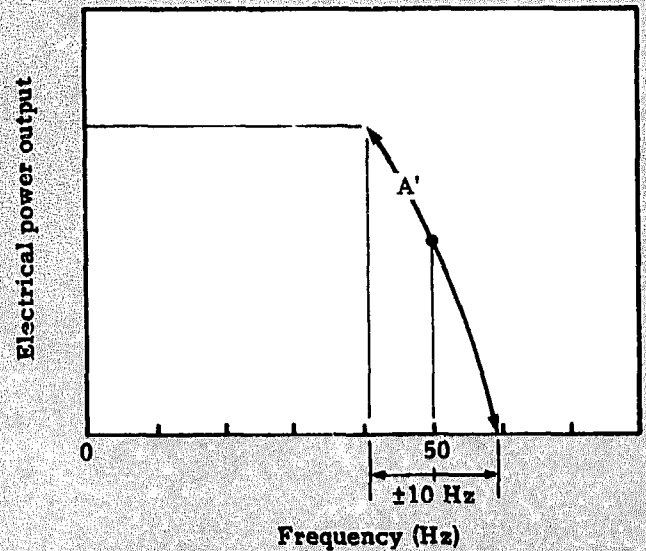

Fig. 8.16. Changing the gearing ratio between turbine and electricity generator so that nominal frequency is generated at about half the peak electrical load leads to smaller frequency perturbations from zero to full load.

To develop such a device requires a familiarity with the flow pattern within a turbine under normal operating conditions and with changes in that pattern as runner

speed increases. For example, Fig. 8.17 depicts in a highly simplified manner the flow pattern emerging from a Pelton runner rotating at different speeds.

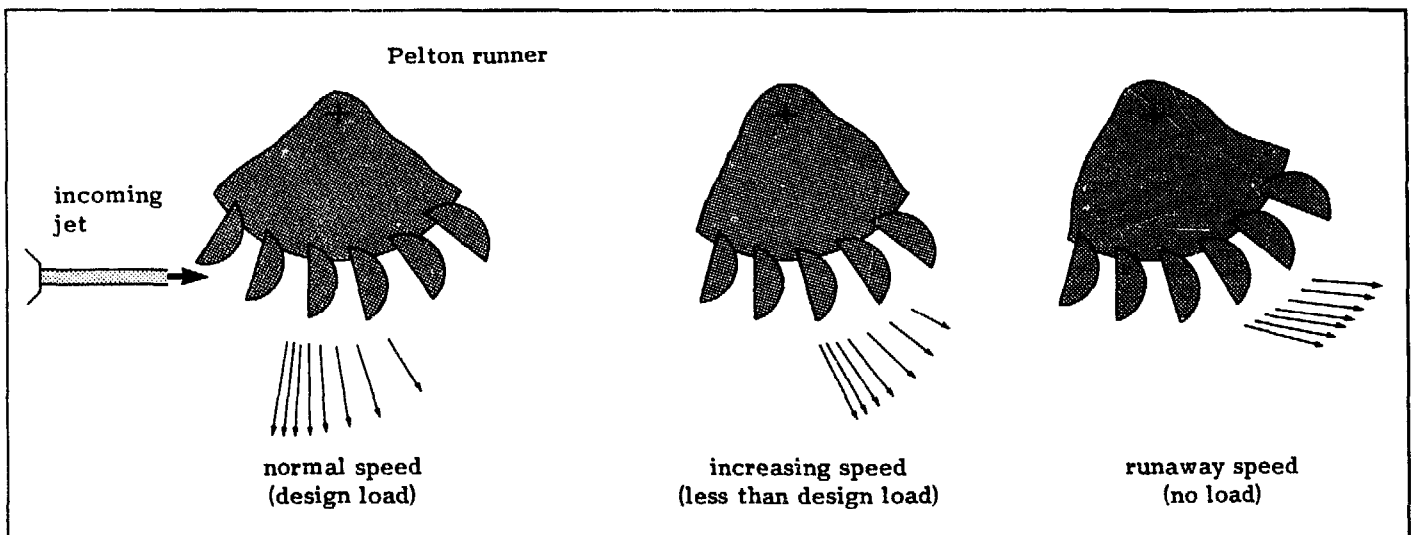

Fig. 8.17. The changing pattern of flow exiting a Pelton runner as load is removed.

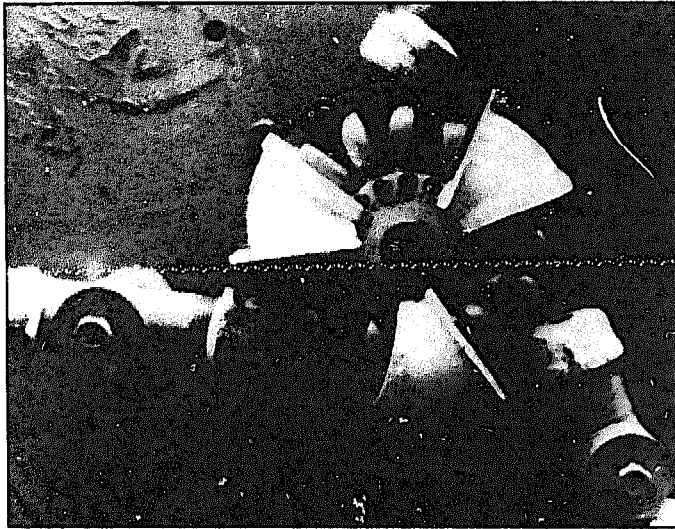

Fig. 8.18. A three-jet Pelton runner fitted with speed control sleeves. With this unit, orifice plates are used as nozzles (50).

The speed control device is designed to leave the flow largely unaffected at the normal runner speed, but at higher than normal speeds, it gathers a portion of that flow and uses it to reduce the net efficiency and power output to the runner. It thereby reduces the increase in speed to below that which would have occurred without the device.

The Colombian design that has proved to be the most effective to date is illustrated in Fig. 8.18. Short sec-

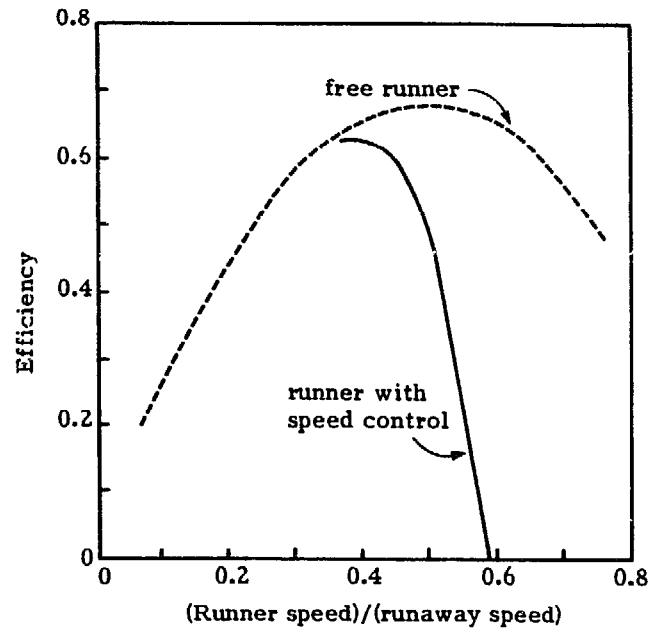

Fig. 8.19. Speed characteristics of the speed control device shown in Fig. 8.18 (50).

tions of PVC pipe were curved to form casings or sleeves through which the buckets of the Pelton runner pass. A gate that leaves just enough clearance for the buckets to escape is placed at the exit of each casing. As the load on the turbine decreases and the runner increases in speed, the flow leaving the buckets becomes caught up within this casing and, in trying to

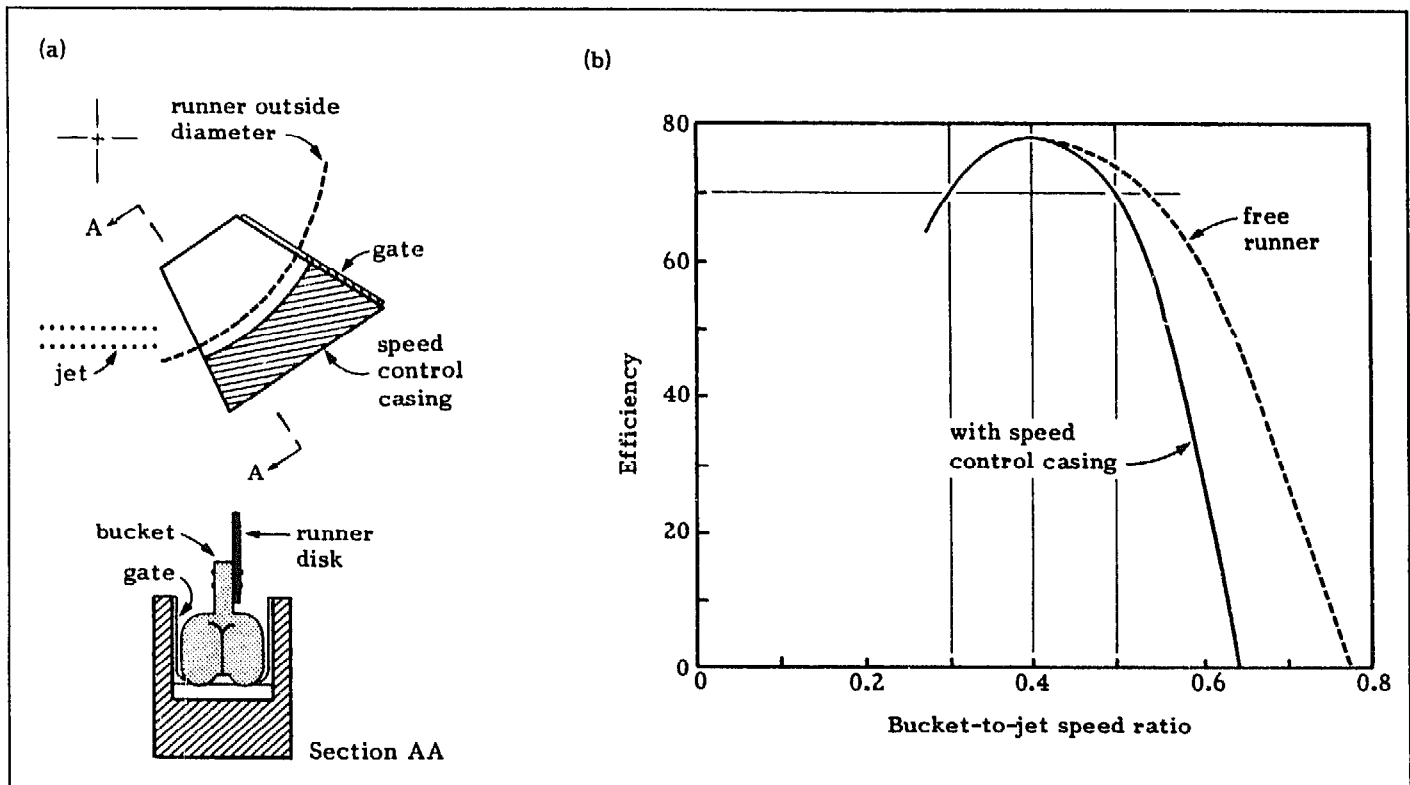

Fig. 8.20. Another attempt at speed control by modifying flow exiting a single-jet Pelton runner: a control casing

with the shape and position shown in (a) results in reduced overspeed (b) (63).

escape, applies a back pressure on the Pelton buckets. In addition, when three jets are used, as shown in Fig. 8.18, the water leaving one casing tends to spoil the jet immediately behind it, further increasing the effectiveness of this method of speed control. The speed characteristics of a Pelton runner fitted with these devices are shown in Fig. 8.19.

Because of the placement of the casings with this design, some water is caught up even at normal speed, resulting in a small drop in the peak power available. Based on an awareness of how the pattern of the water emerging from a Pelton runner changes with speed, shifting the casings back slightly would gather less water under normal operating conditions and should improve the peak power. Tests undertaken at the ATDI in Lae, Papua New Guinea, support this hypothesis (63). Figure 8.20a shows the position of an improvised casing, and Fig. 8.20b presents the associated power curve. With this design, however, although peak power remains unchanged with the addition of the casing, the speed variation from full to zero load conditions is greater than with the previous design. Tests with other designs might identify one that leaves peak power unaffected and, at the same time, decreases further the speed increase on loss of load.

To illustrate some available design options, Fig. 8.21 presents the basic configuration of a number of designs tested in the development of the Colombian design, as well as curves representing the effect of each design on the power output of a Pelton turbine.

One advantage of using flow modifications is that protection against runaway is intrinsic; no additional protective device is required. When the entire turbine load is removed, the power is dissipated within the turbine and the usual runaway speeds are not attained.

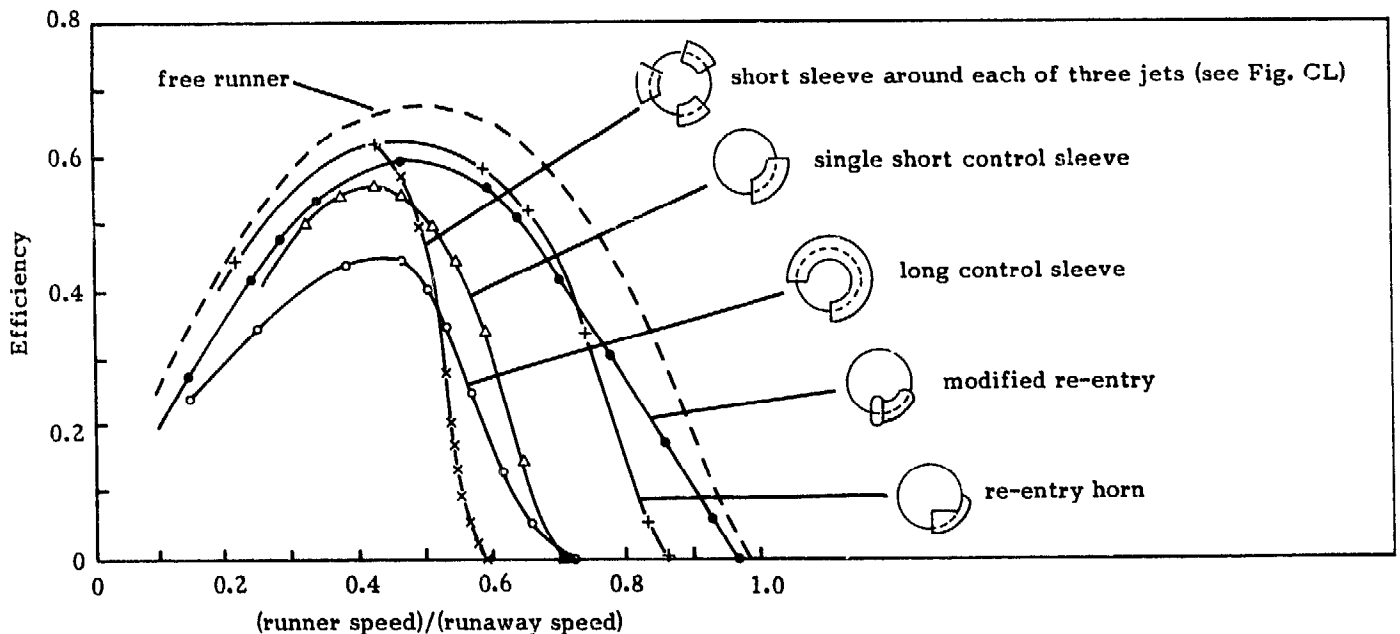

Fig. 8.21. Test results using casings of various shapes placed around a Pelton runner (51).

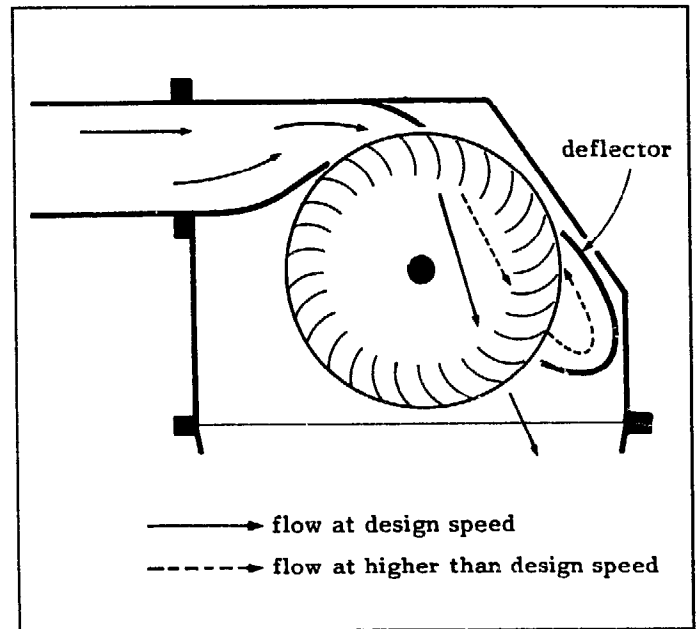

Fig. 8.22. Will the addition of the deflector affect the power characteristics of a crossflow turbine and reduce the speed increase when load on the turbine is decreased?

It may also be possible to use a similar approach with other types of turbines. For example, it might be possible to control the speed of a crossflow turbine by incorporating a flow deflector, as illustrated in Fig. 8.22. Although the flow at normal operating speed (solid line) would leave the turbine largely unaffected, perhaps the flow at greater speeds (dotted line) can be caught and redirected against the runner and used to have some effect on controlling speed. There may be other approaches to redirecting flow to control overspeeding, but these need further research and development.

IX. ELECTRICAL ASPECTS

INTRODUCTION

In this chapter, it is assumed that at least a portion of the power available from the turbine will be converted to electricity. It is also assumed that the turbine speed is adequately governed to meet the needs of the consumer (see **GOVERNING**, p. 199). Now it is necessary to specify the generator that will generate the electrical power and the monitoring, control, and protection equipment that will ensure protection of both the equipment and the user.

This chapter first reviews several decisions which will have to be made—whether alternating current (ac) or direct current (dc) is to be generated and whether single- or three-phase power most appropriately meets the consumers' needs. The following discussion assumes that the hydropower plant will provide power to isolated consumers and will not supplement power into an already energized grid.

This chapter then describes the parameters required to specify the generator and briefly describes the function of the switchgear and the various monitoring and protection devices. It is assumed that the reader is familiar with basic electrical terminology.

The design of the distribution, secondary service, and housewiring for a system served by a micro-hydropower plant does not differ from one served by any other type of electric power generator. Because this task is best addressed by an experienced electric power engineer and electricians (except for very small schemes), this publication does not discuss these areas in detail.

AC VS. DC

If a micro-hydropower installation is to generate electrical energy, a basic decision to be made is whether ac or dc generation is more appropriate in a specific situation. Selecting one or the other involves a trade-off between the advantages of dc—storage of electrical energy and a less sophisticated and costly overall system—and those of ac—transmission over greater distances, ready availability of end-use appliances, and convenience.

Magnitude of power generated

AC generators are available to generate power over the

entire power range, from the bottom of the micro-hydropower range to the level of massive hydroelectric powerplants. For a large hydropower plant that serves a wide service area, ac generation is preferred; transmitting a significant amount of low-voltage dc some distance would require heavy and costly cables to minimize losses. With ac, relatively inexpensive transformers can be used to step up transmission voltage and reduce losses, even when small cable is used.

DC generators are available up through several kilowatts. They are frequently used at the very low end—up to several hundred watts—where battery storage of dc is required to make such an installation worthwhile or where the costs for governing an ac generator would contribute significantly to the total cost of the plant.

Between this very low end and several kilowatts, either ac or dc generation can be used, depending on the specific circumstances—whether electrical storage is required, the distance from the powerhouse to the consumer, and the uses to which the power will be put. Usually ac is generated.

Storage of energy

If the energy (kWh) available from a well-situated, isolated installation is adequate on a daily basis but its power (kW) potential is less than the peak electrical power demand, energy available during low demand periods must be stored to meet needs during peak demand periods. This can be done two ways: by storing water behind a dam or in a forebay during times of low demand or by generating power and storing the excess in batteries if small quantities of electrical energy are envisioned. When the only option is the second one, dc is often generated. However, if ac is generated and a load controller is used to govern turbine speed, excess power could be rectified and stored in batteries at the powerhouse or anywhere along the ac system. In this case, an inverter (see p. 218) would be needed to convert dc back to ac if ac equipment is used by the consumer. Though batteries provide a means of storing power, they are heavy, relatively costly, and require care for their proper operation and eventual disposal.

Cost and complexity of system

With ac systems, there is generally a need to maintain frequency and therefore the speed of the turbo-generat-

ing unit within fixed limits. A governor or load controller often is used for this purpose. These are sophisticated and sometimes costly devices which, if well designed and maintained, work effortlessly. However, if a part fails, the plant may have to be shut down, possibly for months, until the needed part and/or expertise is obtained.

Because dc is obtained by rectifying ac generated at any frequency, the precise speed of the turbine and generator is not critical. Thus, there is no need for sophisticated equipment to control speed, and with less sophistication, fewer problems can occur. Providing for the storage of electrical power in the overall dc system design does not so much increase system complexity as it does the need for proper maintenance and use of batteries.

If only small quantities of power are required, dc generation may be more accessible, because a dc generator or alternator is a component found in all automobiles and trucks and is therefore available worldwide. Discarded cars often contain alternators in good working condition.

Convenience

Appliances, lights, and motors operating off either ac or dc are available commercially. Because national power systems around the world generate ac, however, ac devices are much more common, generally less costly, and available in a much wider variety. Most dc appliances are relatively difficult to locate and are usually available from suppliers that furnish equipment to owners of trailers or caravans (where power comes from automobile batteries), pleasure boats, and windmills (which often generate dc to permit energy storage to compensate for the variability of the wind).

Transmission of power

In transmitting power over any distance, losses inversely proportional to the square of transmission voltage are incurred. Minimizing the losses therefore requires maximizing, within economic limits, the voltage at which the power is transmitted.

For the range of power being considered, ac generated at the standard user voltage, such as 240 V, is rarely transmitted more than a couple of kilometers. If power is to be transmitted farther, a transformer can be used to increase the voltage. With dc, there is no easy means of changing voltage; therefore, dc losses can be kept low either by ensuring that the load is near the powerhouse or by generating at a higher dc voltage and ensuring that the consumer can use this higher voltage. Appliances that operate off this higher voltage must then be found or a sufficient number of storage batteries must be connected in series. The individual batteries in the series can power low-voltage appliances. If storage batteries are used, proper management of the system is essential to ensure that the appropriate bat-

teries are being charged by the generator or discharged by the consumer.

In rural areas, where small quantities of power would be used by a dispersed population primarily for lighting, another way of transmitting power might be considered—carrying energy not by power lines, but in a "box." The powerhouse can serve as a small, battery-charging enterprise where persons who desire power can have their batteries recharged. This method has several advantages:

- a dc generating system at reduced cost and complexity can be used,
- distribution costs are avoided, and
- a resident can discontinue service or relocate without leaving behind costly power poles and power lines that may no longer serve any consumer.

However, if automotive storage batteries are used, they are not very portable, can be damaged easily, and their contents can spill.

The load factor—the ratio of energy actually consumed to the energy potential if power were consumed continually at peak levels—in rural areas, especially in developing countries, tends to be very low; there is a large demand for power several hours each night, primarily for lighting, and little demand the rest of the day. This demand profile requires a larger and costlier hydro-power installation than is really necessary, and with a low load factor, energy cost is high and usually has to be subsidized. Another advantage of generating dc and storing excess power in batteries is that a smaller and less costly installation can meet peak lighting loads, because energy generated during nonpeak times can be stored and used to supply peak power. The cost of energy is therefore reduced.

Another approach to reduce transmission costs while keeping the turbo-generating system simple was proposed in Indonesia (103). In homes off the grid, families commonly use motorcycle or automobile batteries to power lights, radios, televisions, and small electrical appliances. These are charged periodically at small shops in electrified villages. Because the use of batteries is well established, it was proposed that power from a micro-hydropower plant, generating unregulated ac, would be transmitted to central locations in several unelectrified villages. There, it would be rectified for charging the batteries brought from homes in the vicinity. This system would permit ac to be generated at a higher voltage, such as 240 V, to minimize transmission losses, yet would require no expensive governing because power would be rectified. The turbine would be operated under some load all the times and, with an automatic voltage regulator incorporated in the generator, there would be no large voltage variations.

Inverters

It is possible to generate dc and still be able to use lower-cost and readily available ac appliances and to

transmit power farther with reduced losses. This requires using an inverter, an electronic device that converts dc into ac. DC can be generated and stored at the powerhouse; on demand, an inverter can convert dc to ac, which is then transmitted to the user to power conventional appliances. Unfortunately, although this approach is possible, the advantages of transmitting and using ac that are gained may be offset by the cost and sophistication of the inverter that would be required. However, it can still prove effective if storage is essential to a system's operation. If flow is sufficient and storage is not required, using a load controller to control frequency with an ac system can prove more cost-effective.

SINGLE- VS. THREE-PHASE

If an ac generating system is found to be more appropriate for an installation, as is usually the case, there is still a need to determine whether single- or three-phase power will be generated. The availability of equipment and the type and size of the loads affect this choice.

Single-phase generators are available to cover the entire micro-hydropower range, and three-phase generators cover the range down to about 2-3 kW. Below this rating, individual loads would probably be a more significant percentage of the total generator capacity, and balancing the phases would be more difficult. This is one reason that single-phase generation is commonly used with schemes less than 10-15 kW. Although both single- and three-phase generators cover the entire power range of concern here, local availability of generating equipment may also affect the final choice.

For small units, the costs for single- and three-phase generators are similar; however, a three-phase system requires costlier switchgear and monitoring and control equipment. A single-phase generating system can be less costly because it requires switchgear and monitoring, control, and protection equipment for only one rather than three phases.

The size of the larger anticipated system loads may determine which of these options is most appropriate. Single-phase motors are available for applications that require no more than several horsepower. For larger loads, three-phase motors are generally used.

The circuit for each phase of a three-phase generator is designed to accommodate one-third of the generator's rated power output. Consequently, as this output is approached, it becomes increasingly important that the power in each phase be balanced; otherwise, excess power may flow through one or two of the other circuits, overheating the generator windings and eventually causing the insulation to break down and the generator to fail. For example, a balanced 30 kVA generator operating at full capacity would generate 10 kVA in each phase. If the flow through the turbine remains unchanged but the load through one phase drops significantly, the two other phases would have to accommodate more than 10 kVA each. Adequate protection equipment can avoid this potential problem, which is not

encountered when a single-phase, two-wire generator is used. Thus, one advantage of a single-phase, two-wire system is that no balancing of loads is necessary.

Whether single- or three-phase power is transmitted more cost-effectively depends on the configuration selected. Table 9.1 compares the quantity of conductor material required for different configurations for lines of equal length, with equal balanced electrical loads.

ELECTRICAL EQUIPMENT

In the following discussion, it is assumed that a micro-hydropower plant will generate ac rather than dc—which is generally the case in all but some very small systems—and will operate in isolation of any other power source, such as a diesel generating set or a national or regional grid.

For micro-hydropower plants, a generator coupled to a turbine and associated electrical equipment are often furnished as part of a pre-engineered package. For a supplier to assemble the most appropriate unit for a specific site, he must have the necessary specifications.

TABLE 9.1. Comparison of the relative total conductor material required for various power transmission configurations with balanced electrical loads

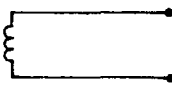
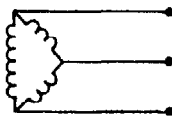
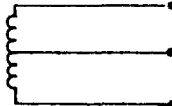
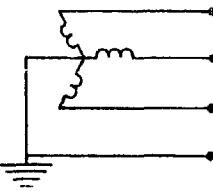
System		Comparative total conductor material	
		Short line*	Long line*
single-phase, two-wire, 240 v		100	100
three-phase, three-wire, 240 v (delta system)		87	75
single-phase, three-wire, 480/240 v		62	31
three-phase, four-wire, 415/240 v (Y system)		58	29

*For a short line, the conductor size is based on keeping heating of the conductor within acceptable limits. For a long line, maintaining voltage drop within acceptable limits determines conductor size.

This section describes the types of generator and equipment that might be incorporated in an electricity-generating system for a micro-hydropower plant and how each is specified.

Generator

Whether a generator is incorporated as a component of a packaged unit or is purchased individually, certain of its operating as well as physical characteristics must be specified to ensure that the equipment furnished meets the users' needs. Some of these characteristics must be specified only if a generator is purchased separately, not if it is part of a packaged unit, because they concern the internal workings of the overall unit. For example, if a generator is purchased separately, it is necessary to specify both the speed at which it will operate, or the number of poles, and its output frequency. If a packaged unit is purchased, however, it is necessary to specify only the output frequency. The supplier selects whatever speed he thinks is required to design a package that best meets the needs of the site developer.

Type of generator

Although there are two basic types of generators--synchronous and induction--the former is used almost universally for isolated operation, which is being considered here.

An induction generator requires some form of external excitation to operate. Most often, this is achieved by interconnecting the generator to an energized grid but this is not possible for an isolated powerplant. Induction generators are essentially induction motors run at faster than usual (i.e., near-synchronous) speeds and are simpler in construction and less costly than synchronous generators. For these reasons, several efforts have been made to design electronic devices for the excitation and control of induction generators at isolated sites (31,45). However, such devices have only begun to find their way to the marketplace. Until now, synchronous generators have almost always been used at isolated locations.

Voltage

The availability of equipment limits the options for generator output voltage. For micro-hydropower plants, single-phase generators are available with output voltages of 120 V and/or 240 V, depending on internal connections. Three-phase generators are available for voltages about 240/415 V or, in the United States, 120/208 V or 277/480 V.

If transformation of voltage is not being considered, the voltage generated should match that of the appliances and equipment that will be plugged into the system. If power will be transmitted some distance to the consumer, a higher generator voltage would reduce losses

without requiring a transformer at the powerhouse end. If both step-up and step-down transformers are being considered because of the magnitude of the power to be transmitted and the distance to be covered, either generation voltage could be used.

It is advisable to select a voltage that is accepted in the country in which the project is being implemented. In developing countries, an overseas organization funding a project such as a training center or mission hospital may sometimes find it more convenient to generate power according to its own country's standards, because appliances for staff housing and electrical equipment for the classrooms, laboratories, or workshops can then be purchased easily at home. However, this approach is short-sighted when the two countries use different standards, because it complicates transferring maintenance of the physical infrastructure to local entities, as will eventually happen. Even simple items such as light bulbs or fluorescent tubes may have to be imported specially.

Frequency

The generator output frequency is usually set by the national standard, which is either 50 Hz or 60 Hz. Because end-use appliances available on the local market operate at the national standard frequency, it is usually best to select this frequency for any power scheme implemented in that country.

Power rating

If a commercial packaged unit is purchased and the net head and flow available to a turbine have been determined, the output power is simply a function of the unit's overall efficiency. When purchasing a packaged unit, the site developer therefore has to specify only two of these three parameters, usually net head and either flow or power. Although he would have estimated the value of the third parameter from the power equation [Eq. (5.11)], only the equipment supplier, with his knowledge of the characteristics of the equipment he is recommending, can state the actual value of the third parameter. If power output must be maximized, then one factor in equipment selection might be a comparison of the usually small differences in output power for a specific flow through the turbine operating under a given head or, equivalently, a comparison of overall efficiency of the units proposed in the submitted bids.

The net head under which a turbine operates determines the flow through a particular turbine and its power output. When the gross head at a site is known, **Sizing penstock pipes** (p. 125) describes how the net head can be determined if the penstock configuration is also known. Incorrectly implying that the net head is equivalent to the gross head can lead to the selection of inappropriate equipment, especially if penstock losses are significant. For example, if a turbine is selected for a specific site but the net head is 90% of that stated in the turbine specifications, the design power output would be reduced by about 15%.

If a generator is purchased separately, the power input to the generator—the turbine output power—must be specified. For planning purposes, the site developer, knowing the approximate efficiencies of generators of various sizes (see Energy conversion losses, p. 197), can predict the approximate electrical power output from the generator. However, the supplier should specify either the efficiency or the power output of the generator he is proposing. This may be one criterion by which bids are evaluated. Because generator size is generally quoted in kilovolt-amperes (kVA) rather than in kilowatts (kW), it is appropriate to review the difference between these two terms.

The output of an ac generator is a current and voltage that both change in magnitude with time. If the exter-

nal circuit is purely resistive, the current and voltage are in phase—at each point in time, the value of one is directly proportional to that of the other (Fig. 9.1a). The average power output of the generator—equal to the power consumed by the load—is then

$$P_o = E_o I_o \quad (9.1)$$

where

P_o = effective power (VA or W)

E_o = effective voltage (V)

I_o = effective current (A)

Because the voltage, current, and power vary with time, the term "effective" signifies an average value, which is

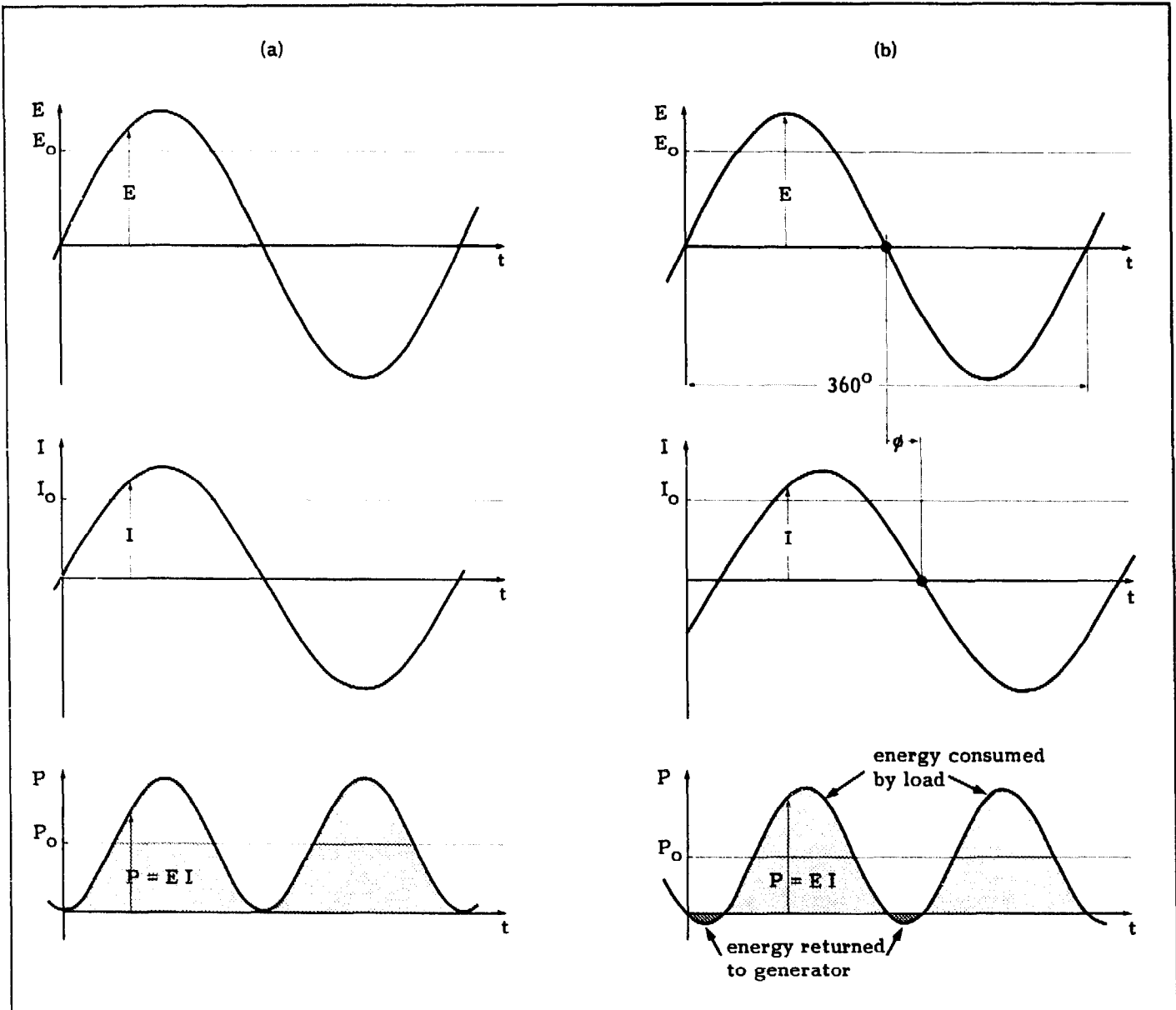

Fig. 9.1. The relationship between voltage, current, and power consumed by a purely resistive circuit (a) and one with inductive and capacitive elements (b). Here, the voltage is leading the current by 30° which results in a power

factor equal to $\cos 30^\circ = 0.87$. In either case, the power at any instant of time is equal to the product of voltage and current at that time.

that measured by a voltmeter, ammeter, or power meter. For a purely resistive load, the value of power expressed in watts is numerically equal to that expressed in volt-amperes. For example, a 220 V generator generating 30 A would generate power equivalent to 6.6 kVA or 6.6 kW.

If the external circuit also includes inductive or capacitive elements, such as motors, transformers, or fluorescent lamps, the voltage and current may not be in phase (Fig. 9.1b). Although both voltage and current still have the same frequency and same peak values, each point on the voltage curve is then reached before or after the corresponding point is reached on the current curve. The power generated, or that consumed by the load, at any instant of time is still the product of the voltage and current at that instant. However, if the real power generated or consumed is derived or measured, it is now found to be

$$P_o = E_o I_o \text{ pf} \quad (9.2)$$

where

$$\text{pf} = \text{power factor} = \cos \phi$$

The angle " ϕ " is a measure of how much the voltage leads the current. The actual value of the power factor depends on the type and size of the various loads imposed on the system. For a purely resistive load discussed earlier, it equals 1.0. From the example presented in Fig. 9.1b where the current and voltage are not in phase, the real power output is less than the product of effective voltage and current, even though the peak output voltage and current are the same. This is because some of the energy introduced into a circuit containing inductive or capacitive elements is not actually consumed but merely stored in the load and sent back to the generator twice during each cycle.

Equivalently, if the real power consumed by a purely resistive load is the same as that consumed by a load also containing inductive or capacitive elements, the current is greater in the latter case. For example, with a generator voltage of 240 V, a 10 kW resistive load would draw 42 A. A more commonly found load with a power factor of 0.8, for example, would draw 52 A or 25% more current, even though it still consumes 10 kW of real power.

The actual current drawn is critical in the design of a generator, because this affects the size of the wire used in the windings. From these discussions, it can be seen that the real power generated does not truly indicate the current and therefore the size of the generator. Rather than being specified by its real power output (W or kW), a generator thus is specified by the apparent power—the simple product of current and voltage (VA or kVA).

The relationship between the real power and apparent power " P_a " is

$$P_o \text{ (in kW)} = \text{pf} \times P_a \text{ (in kVA)} \quad (9.3)$$

The kilowatt rating of motors, lamps, and other electrical appliances usually reflects the real power consumption " P_o ". With this value, Eq. (9.3) should be used to determine the capacity of the generator " P_a " required to generate adequate power to drive these loads. If the actual value of the power factor is unknown, a value of 0.8 is assumed as the value for a typical system load.

The horsepower rating of a motor reflects the actual power that the motor can produce on a continuous basis. Because of inefficiencies introduced in converting from electrical to mechanical energy, the actual power consumed is more than this, and the apparent power consumed, which determines the generator size, is even greater.

Speed

When a packaged unit is purchased, there is no need to specify the generator speed, because the supplier will ensure the compatibility of all components incorporated in a packaged turbo-generating unit. The generator speed must be specified only if the generator is purchased separately.

The generator speed is related to the number of generator poles and the desired output frequency in the following manner:

$$N = \frac{120 f}{n} \quad (9.4)$$

where

$$\begin{aligned} N &= \text{generator speed (rev/min)} \\ f &= \text{output frequency (Hz), see Frequency (p. 220)} \\ n &= \text{number of poles} \end{aligned}$$

For micro-hydropower plants, generators usually have two, four, or sometimes six poles. Because generators with four poles run at a lower speed than those with two, they are used more often. Less gearing up is required and bearing life is extended. If some problem leads to turbine runaway, a two-pole generator would reach speeds of about 6000 rev/min with possibly disastrous consequences. Four-pole generators are available that can operate for extended periods at a runaway speed which would be about half this value. Although six-pole generators have an even lower design speed, their cost is somewhat higher. They are more commonly used for plants in the mini-hydropower range (100–1000 kW) where, because physically larger generators are required, rotor speeds must be reduced in order to reduce the otherwise increased centrifugal forces acting on the rotor.

Physical characteristics

Other specifications might be made when a generator is specified, either as part of a packaged unit or as a separate purchase.

Small generators can either have brushes or be brushless. In brushless generators, an electromagnetic field transmits excitation current from the stationary to the rotating elements. Formerly, brushes rubbing against slip rings located on the shaft served this purpose, but these wear out and have to be replaced periodically. Brushless generators have increased in popularity because, aside from bearings, they involve no physical contact between stationary and moving parts.

Although it is not an integral part of a generator, the type of coupling between turbine and generator should be specified if there is a preference. Direct coupling is preferred because it permits a more compact layout and less maintenance; however, it is often impossible for small standardized units. Although any one of several other types of coupling can transfer power from the turbine to the generator, one particular type might be most suitable. For example, flat belts may be used in a packaged unit, because very efficient types are now available. However, if such a unit will be used in a country with foreign exchange restrictions or an unreliable postal system but where V-belts can be acquired locally, it would be advantageous to specify a V-belt coupling. **OPTIONS FOR COUPLING** (p. 192) describes of the various types of coupling.

Because the ambient powerhouse temperature and humidity can affect the insulation of generator windings, it is also necessary to specify the climatic conditions under which the equipment will operate. The word "tropical" is usually sufficient to describe operating conditions where high humidity prevails.

If the generator experiences a loss of load or excitation, both the turbine and generator will attain runaway speed. A supplier of a packaged unit should consider this in the unit's overall design. If a generator is purchased separately, some means of averting runaway speeds must be incorporated in the powerplant's design. However, it would still be advisable to specify that the generator be capable of operating at runaway speed for at least a limited period of time. This speed depends on turbine type and design. Approximate values are noted in the descriptions of specific turbines in **TURBINE TYPES** (p. 173).

Monitoring and protection equipment and switchgear

Between the generator terminals and the powerlines to the end-user loads, there is need for devices to monitor the operation of the equipment, to protect the turbo-generating machinery, and to permit the generator to be isolated from the load either automatically, if a fault condition occurs, or manually.

Monitoring equipment

Voltage, current, and frequency are monitored to assess the state of an operating system. Other parameters—power, energy, power factor, forebay water level, etc.—can also be monitored but are not usually of concern for micro-hydropower plants.

Virtually all micro-hydropower plants monitor current and voltage with an ammeter and voltmeter, respectively. For a single-phase generator, a single ammeter and voltmeter is commonly used. A frequency meter, on the other hand, is relatively costly and is not used in small micro-hydropower plants if cost is a major consideration. Maintaining close frequency control is not essential for many types of end uses. Because voltage is related to generator speed and therefore frequency, frequency can usually be kept within required limits by ensuring that the voltage is maintained at its proper level.

For a three-phase system, the voltage and current on each of the three phases are usually monitored. Six meters can be used for this purpose, as shown in Figs. 10.59 and 10.60. Costs can be reduced somewhat by using one rather than three voltmeters and a selector switch to measure the voltage of each phase.

Switchgear

The switchgear is commonly composed of one or more circuit breakers, a switch designed to open even when a heavy current is flowing. Its contacts are closed mechanically against the action of a spring and held closed by a latch. When a protection device senses a fault condition, it sends a signal to the circuit breaker to release the latch and open the breaker. Some small circuit breakers open by themselves when they are forced to handle excess current. Breakers can also be opened manually.

If a current is flowing when the breaker opens, an arc is drawn between the contacts. A breaker is designed to extinguish this arc as quickly as possible. This usually takes from three to eight cycles, depending on the design, the size of the current, and the extinguishing medium. Small breakers commonly use air as the extinguishing medium and are referred to as air circuit breakers.

Protection equipment

Protection devices are incorporated in a powerplant primarily to ensure that the generator is isolated from the external load when a fault condition that could damage the turbo-generating equipment occurs. These are devices that sense anomalous conditions and trigger an appropriate response, such as signaling a circuit breaker to open.

For the simplest system, protection is at least needed to guard against overcurrent. This occurs when an electric short or excessive load causes a sustained current larger than the current rating of the generator to be drawn from it. The simplest overcurrent protection is a fuse. A more expensive but more versatile and convenient device is a circuit breaker, one tripped either by excess current that flows through it or by a protective device that senses overcurrent. Some fuses and circuit breakers are designed to prevent nuisance tripping when surge currents are needed, such as for starting motors.

Small generators may be unable to furnish adequate current into a fault long enough to trip a circuit breaker before the generator is damaged. In this case, a relay may be the most effective way to detect a fault and protect the generator. Branch circuit breakers can be used to protect individual system loads.

Overspeed protection is generally required in conjunction with overcurrent protection. If an overcurrent device is activated, the external electrical load would be removed. The turbine and generator would then accelerate to runaway speeds because the water descending the penstock would continue to impart power to the runner. Many generators are not designed to operate at runaway speeds, especially for any length of time, and some means of stopping or deflecting the flow of water--and therefore power--entering the turbine must be incorporated. This usually takes the form of a shutoff valve or deflector activated by a device that senses speed or loss of load. For example, equipping a Pelton turbine with a deflector permits the use of a simple overspeed protection device. In this case, a counterweighted lever would control the deflector. When load is lost, the solenoid holding the counterweight is deactivated and the deflector is placed across the jet, diverting the flow of water away from the runner. The solenoid can be deactivated by a loss of generator output voltage or by a relay. An advantage of using a relay is that turbine flow can be cut off when any one of several adverse conditions, such as bearing overheating or overvoltage, occurs.

Over/under voltage devices are used to shut down a system when changes in voltage exceed a preset limit, possibly caused by overspeed or underspeed, failure of the voltage regulator, or loss of excitation. Such devices, which protect end-use equipment as well as the turbo-generating equipment, are not often used with very small schemes.

Three-phase systems need protection against phase imbalance. With a properly designed system, the current in each phase is balanced. If, for some reason, this is no longer the case, the total current may be distributed so unevenly among the three circuits that the current in one or two of the circuits exceeds its design value. To prevent overheating and subsequent damage to the generator, the problem must then be remedied immediately or the system must be shut down until it is. Phase imbalance devices initiate this action.

As the size of a plant increases, abnormal operating conditions can lead to more costly problems and an increasing number of such conditions must be guarded against. These include excessive winding and bearing temperatures and overfrequency and underfrequency. For most small micro-hydropower plants, however, protecting against such conditions would not prove cost-effective.

X. CASE STUDIES

INTRODUCTION

A large number of micro-hydropower plants have been installed worldwide, often providing the only source of power in remote regions. The wealth of experience gathered by those who implemented these schemes has rarely been documented. One purpose of this publication is to enable persons implementing their own micro-hydropower schemes to benefit from the experiences of others by recording some of these experiences.

This chapter takes a broader view than the previous chapters. In addition to reviewing the designs that have evolved through field experiences, it describes overall approaches to implementing large-scale micro-hydropower programs developed by several organizations.

The first study, prepared in 1982 with contributions from Robert Yoder who was personally involved in the project, describes the efforts of the United Mission to Nepal in Butwal to implement its Small Turbine and Mill Project. This organization and Balaju Yantra Shala in Kathmandu have been involved in relevant research and development, the local manufacture of turbines, the packaging of turbines and end-use equipment, and programs to implement micro-hydropower mills in rural areas. These two groups made the first efforts to develop a broad-based micro-hydropower program in a developing country. Considerable resources and expertise were brought from overseas, and to date, each of the two companies has implemented well over 100 modern turbine-driven mills (Fig. 10.1) and has docu-

mented some of its experiences for the benefit of others. More important, their approach has been replicable—more than half a dozen other Nepalese companies have begun fabricating turbines and installing plants to perform a variety of tasks, such as flour milling, oil expelling, rice hulling, paper-making, sawmilling, wood-working, and electricity generation. In addition, one of these companies has embarked on the design and fabrication of its own turbine design and, after only four years, has built approximately 100 units.

The second study, prepared in 1983, reviews the efforts of a few dedicated persons from the University of Science and Technology in Peshawar, working with the Appropriate Technology Development Organization in Pakistan, to implement a program of micro-hydropower plants to generate electricity for remote villages. Unlike the Nepalese efforts, almost no outside resources were employed in Pakistan, yet the results illustrate what is possible with rudimentary designs and limited financial resources (Fig. 10.2).

In addition to descriptions of the Nepalese and Pakistani efforts, this chapter notes other publications that each present a more complete view of the implementation of a specific micro-hydropower scheme or programs.



Fig. 10.1. A two-story mill house with the turbine and milling equipment on ground level and living quarters above is visible on the right. The penstock is seen emerging from the forebay in the upper center of the figure.

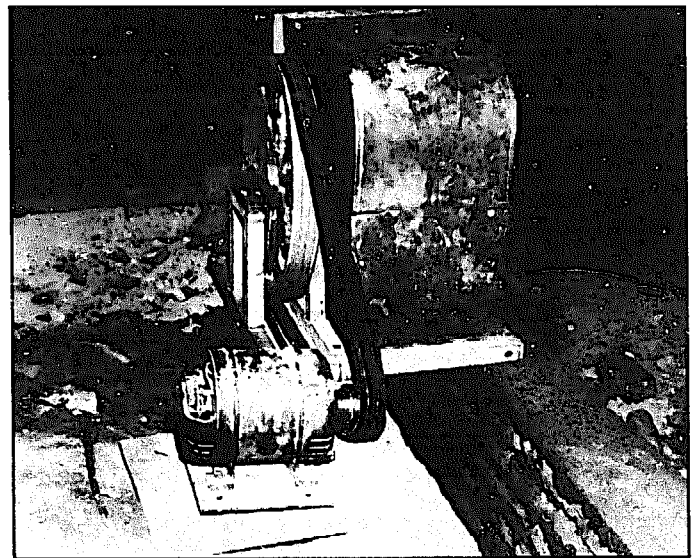

Fig. 10.2. A locally fabricated turbine has been incorporated as part of a very basic turbo-generating unit. Significant speed increase is necessary to drive the generator at this site because of the relatively low head available.

PRIVATE-SECTOR APPROACH TO IMPLEMENTING MICRO-HYDROPOWER SCHEMES IN NEPAL

Introduction

Since the turn of the century, numerous small decentralized hydropower plants have been installed in the more remote areas of developing countries, often on an individual basis to provide power to mission hospitals, government outposts, mining operations, plantations, and others with a specific need for power. The turbo-generating equipment was expensive and usually required the skills of expatriates to install, maintain, and operate.

Recently, governments of some developing countries have attempted to install small hydropower schemes on a larger scale, as part of an overall energy supply program. China, India, Indonesia, Pakistan, Papua New Guinea, and Peru are among these countries. In the 1970s, the increasing cost of oil gave such programs added impetus. Many of the efforts pursued by nations other than China proved costly, and this often discouraged further undertakings. (The extensive implementation of small-hydropower schemes in China occurred under unique circumstances.)

Nepal is another country whose government has undertaken a small-hydropower program. Faced with a difficult situation—few roads, a scattered but dense population in certain parts of the country, rugged terrain, major deforestation, and no indigenous oil reserves—the Nepalese see decentralized hydropower as a promising option. The government approach to installing small-hydropower plants in Nepal manifests some of the characteristics encountered by other nations that discourage replication on a broad scale. These include:

- lack of staff motivation,
- bureaucratic delays that result in long gestation periods before a plant is operational,
- the high cost of schemes, and
- a dependence on external financing to cover these costs.

In the 1960s, Balaju Yantra Shala (BYS), a private machine shop in Kathmandu established under a Swiss aid program, undertook to design, fabricate, and install several propeller turbines to drive grain-milling machines. This effort provided a catalyst for another group, the United Mission to Nepal, to examine micro-hydropower. Through its Butwal Engineering Works Private Limited and Development and Consulting Services, the United Mission to Nepal became involved not only in designing, fabricating, and testing turbines and associated hardware but in developing a viable, nonsubsidized approach to field implementation of small water-powered mill installations. This private-sector approach to the implementation of a micro-hydropower program illustrates an encouraging alternative to the more costly, bureaucratic governmental approach. It is an approach which lends itself to replication in other countries that have sufficient interest and motivation and appropriate end uses to take advantage of the power generated.*

The effectiveness of this approach to implementing micro-hydropower installations is apparent in the fact that, through the early 1980s, more than 60 mills had been installed, most in remote areas. As existing hydropower mills prove their usefulness, viability, and profitability to residents of these rural areas, the pace of implementation has been increasing. To assist those interested in initiating a micro-hydropower program on a broad scale and to provide a possible framework within which such a program could evolve, this case study documents the evolution and characteristics of the approach adopted by Butwal Engineering Works and Development and Consulting Services.

BYS is also involved in a similar program in Nepal but its experiences are not described here. Some of its experiences have been documented by Meier in Local Experience with Micro-Hydro Technology (78).

Background

Butwal

Behind these developments is the United Mission to Nepal (UMN), a private voluntary organization composed of nearly 40 Protestant mission groups and church-related aid agencies. In addition to work in the health and education fields, rural and industrial development is carried out under its Economic Development Board. The Butwal Technical Institute (BTI), begun in 1963, was the first such undertaking. As this project grew beyond apprenticeship training with its machine shops, new organizations were created. BTI was subsequently redefined as the holding organization for the various workshops, which were formed into private limited companies. Among these were the Butwal Plywood Factory, the Butwal Power Company, the Gobar Gas and Agricultural Equipment Company, the Butwal Wood Industries, and the Himal Hydro Construction Company. The mechanical workshop became the Butwal Engineering Works Private Limited (BEW). Another organizational structure, Development and Consulting Services (DCS), now carries out most of the non-workshop-oriented consulting and field work. The private limited companies and DCS are located in Butwal, a small Nepalese town on the northern edge of the flat rice-growing plains spreading up from India, at the base of the Himalayan foothills. Butwal is on the road from Gorakpur, India, to Pokhara, Nepal.

The term "Butwal" as used in this study indicates the overall grouping of persons and organizations involved in designing, fabricating, and installing micro-hydropower plants.

* Another perspective on the implications of government vs. private-sector implementation of micro- and small-hydropower plants, based on personal experiences in Nepal, is given by Kramer (67).

Program history

Harnessing their country's water resources is not new to the Nepalese. For centuries, they have tapped its streams and rivers for irrigation, and canals, often kilometers long, crisscross the hills and valleys, perched on steep mountain slopes and occasionally tunneled



Fig. 10.3. The *janto* is a stone mill used by each household for grinding corn, wheat, and millet.



Fig. 10.4. The *dhiki*, a foot-powered mortar and pestle, has traditionally been used by women to hull paddy (rice).

through rock. Rice, corn, wheat, and other crops are grown on irrigated plots. Traditionally, the processing of some of the produce—the hulling of rice, milling of grain, and the expelling of oil from seed—has been performed largely by hand with rudimentary tools (Figs. 10.3-10.5). One of these tasks was mechanized centuries ago with the development of the vertical-axis waterwheel to drive millstones for milling grain (Figs. 10.6-10.9). Thousands of these water-powered mills dot the countryside.

More recently, diesel-powered mills that perform all three of these processing tasks were introduced in the mountains (Fig. 10.10). These mills have proved popu-

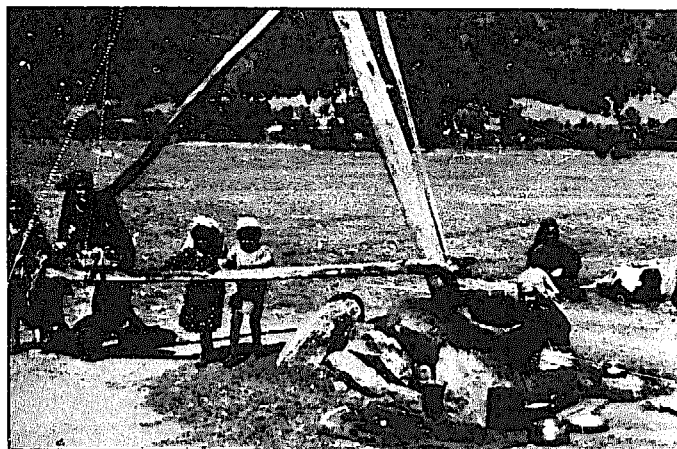

Fig. 10.5. The *kol* is used for extracting oil from seed. A heavy timber is rotated within a hollowed out boulder containing the seed. The process is arduous and time-consuming and the yield is relatively low.



Fig. 10.6. One of the thousands of traditional water powered mills found in Nepal.

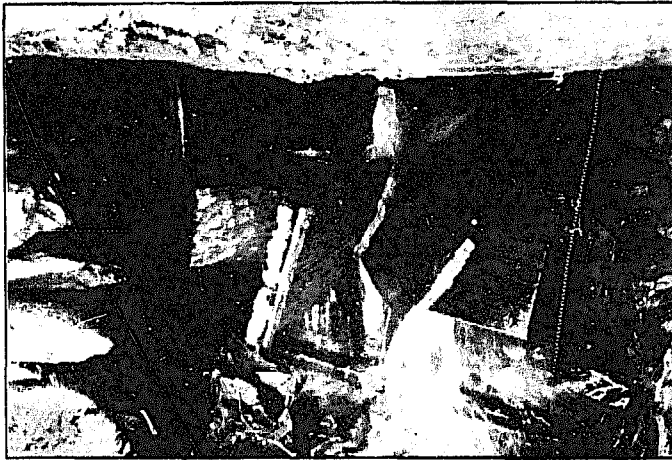

Fig. 10.7. Water falling several meters through an open wooden channel (seen emerging to the right of the shaft) provides power to drive the grindstones.

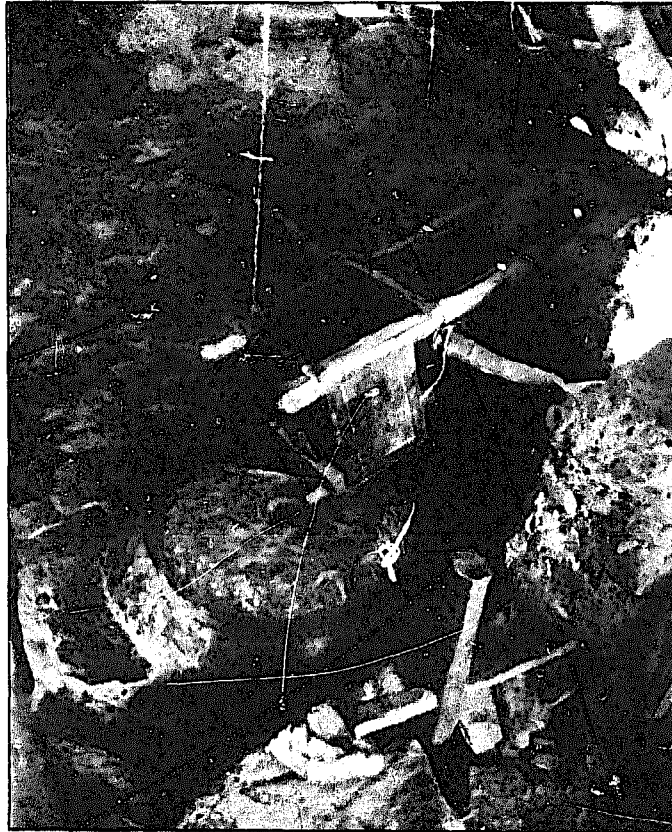

Fig. 10.8. Inside a traditional mill, grain is placed in the rectangular tin and automatically fed through the center of the grindstone, which is rotated by the waterwheel underneath the building. The wooden pole through the floor in the foreground is used to adjust the clearance between the stones.

lar, despite the higher cost for processing grain and oil seed because of the capital cost of diesel-powered mills and the high cost of diesel fuel carried on the backs of porters into the remote areas. They can be found throughout the country, far from the main roads and population centers. It was to provide an alternative

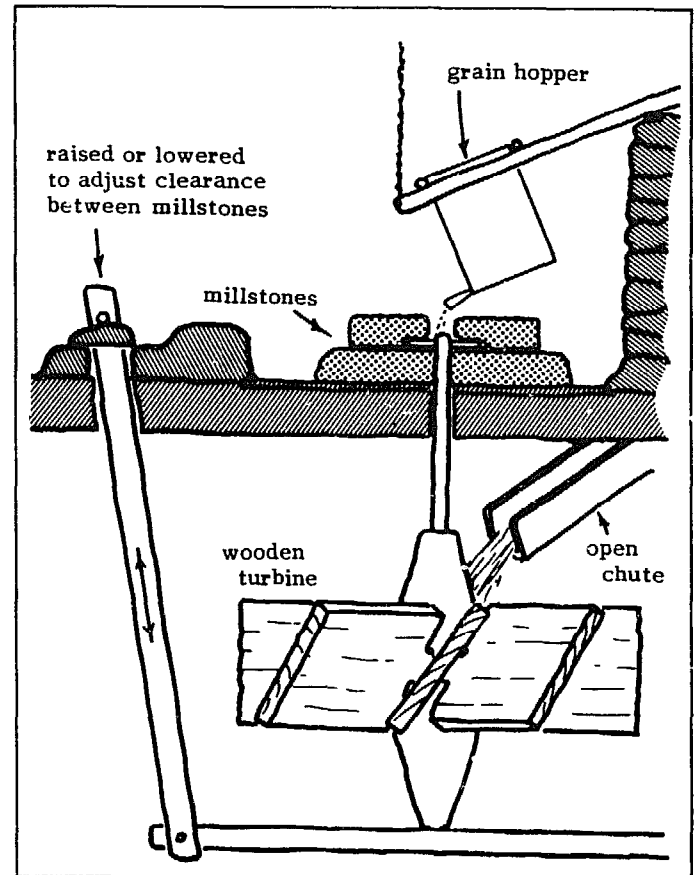

Fig. 10.9. Cross-sectional view of a traditional mill.

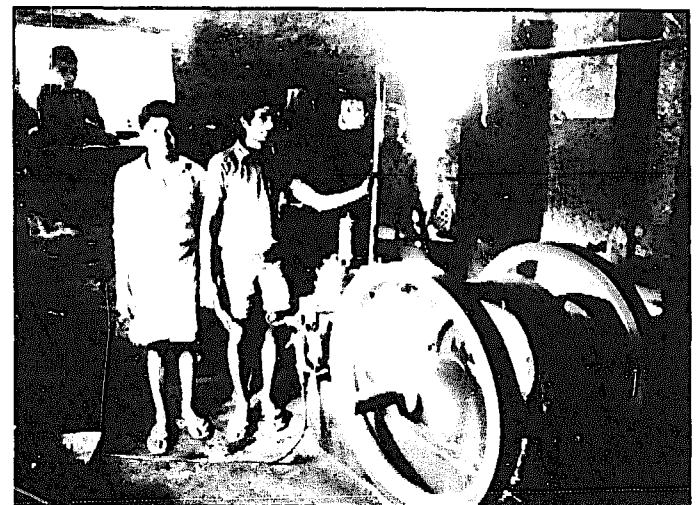

Fig. 10.10. Diesel engines used to drive milling and oil-exPELLING equipment are found scattered throughout Nepal.

source of motive power for these mills that BYS first fabricated and installed propeller, and later crossflow, turbines.

Over the years, BTI has been involved in a range of activities, including fabrication of foot suspension bridges, ropeways, tanks for bio-gas plants, and the construction of the Tinau Hydro Project, which eventually supplied 1 MW of electrical power to Butwal and the

surrounding area. In addition, BTI occasionally repaired BYS turbines in its workshop facilities. An increasing number of people who had seen these few turbines operating successfully in the hills went to Butwal to request assistance in installing similar plants in their villages. Initially, these potential customers went elsewhere because of BTI's limited capacity, its involvement with other work, and its inability to dedicate sufficient time and staff to the design of turbines. As BTI's workshop capacity increased, however, there was increasing pressure to look for new manufacturing ventures. After discussions with potential customers, local staff, and employees about existing needs that the workshop might meet, the board of directors of both BTI and DCS approved a proposal for a pilot hydropower project.

Although both villagers and the government often seek electricity for lighting, this is not a primary need. Some kerosene is used for lighting, but, aside from firewood used primarily for cooking, diesel fuel for milling is more essential to the rural population. The proposed pilot project therefore focused on providing energy for milling. Because of the emphasis on this need, it was possible to develop and perfect designs for a turbine and associated hardware for driving agro-processing machinery directly, without relying on expensive and technologically complex electrical components.

From BTI's experience with the BYS turbines and observations of existing hydropower installations, the need for a broad, well-coordinated program was apparent. This program needed to include both the design and fabrication of reliable, low-cost turbines and field teams with a broad range of expertise to:

- evaluate sites,
- discuss options for technical designs and financing with prospective customers,
- design the necessary civil and mechanical works,
- install machinery, and
- undertake the necessary followup maintenance work.

In 1975, the UMN received a grant for \$24,000 to establish such a program. In addition, BTI funded the cost of turbine development and part of the test site facility. Two full-time and several part-time expatriate engineers and staff members were fully supported by their sponsoring organizations. Because the program was planned to be financially self-supporting, with income from sales covering overhead and development costs, the grant reflected only working capital and start-up costs.

DCS took primary responsibility for field work. This included customer contact, site survey, plant layout, ordering and assembling of all machinery and materials for delivery, installation, and followup repairs. BTI (and later BEW) became the contractor for the fabricated parts. In addition, BTI retained responsibility for turbine research, development, and testing, because these contributed to its manufacturing and marketing activities.

Organizationally, it might have seemed more straightforward to keep the entire program within BTI. How-

ever, its previous experience with a footbridge program indicated that sending workshop personnel into the field disrupted installation work, workshop planning, and production. In addition, salaries for workers in the field were also higher than those for workshop staff, creating conflict between workers. Because this program had growth potential, it was made a separate program within the DCS framework from the beginning.

During the initial phases of the project, progress was slow. The self-imposed limitation of using only materials available in Nepal and the Indian subcontinent required that many items be designed and manufactured in Nepal, when importing them would have been far easier. In 1977, the first three water turbine-powered mills were installed in the hills of Nepal. This was followed by 11 installations in 1978 and increasing numbers in subsequent years. By 1982, a total of 65 mills had been installed.

Technical designs

Selection of turbine type

Innumerable small streams with steep gradients are located in the central hill region of Nepal, which supports most of that country's population. Peaks rise to a height of 3000 m. Unlike the Himalayas to the north, with their perennial snow-fed streams, streams in the central region are entirely rain- and spring-fed. Although monsoon rains lead to heavy floods, streamflows are extremely low by the end of the dry season in April and May. These conditions are not uncommon to many tropical countries with hydropower potential. Under those circumstances, a Pelton turbine, which operates under a high head and requires relatively low flows, appeared to be most appropriate. However, even the single Pelton turbine fabricated by Butwal is still in the workshop; it has never been installed.

Turbines operating under high heads have proved less appropriate in Nepal than those operating under low heads for several reasons:

- conflict with irrigation--In the hills terraced for growing rice and other crops, use of water for irrigation assumes primary importance. Water rights are carefully protected. If water in the streams were used for hydropower generation, it would bypass all the land between the elevation of the intake to a hydropower scheme and the elevation of the powerhouse and would no longer be available for irrigation. For high-head units, this land may be extensive. The owner of a water-powered mill could never deprive farmers of their water. Even where excess water for power generation would have been available, the farmers anticipated eventual loss of control and blocked further developments. It became apparent that the best sites to develop were those where the potential mill owner controlled or could purchase the land between the intake and powerhouse. This implied that, to minimize conflict, low-head sites would have to be developed. Another alternative might have been to exploit high-head sites as a

cooperative venture among all the affected farmers. However, given the social setting, it proved easier to deal with individual entrepreneurs than to initiate such ventures.

- inappropriate location of potential sites--The numerous, high-head sites were usually at impractical locations--either on steep slopes prone to landslides or too far from a village to be convenient. Observation and understanding of traditional mill locations and water control rights would have revealed this problem earlier.
- cost of penstock--High-head sites generally require a longer and therefore usually costlier penstock pipe. In several locations where a higher-head site was technically and socially acceptable, the penstock alone cost twice as much as the turbine.

After a review of these and other factors, it was decided to develop low-head sites. In the mid-1960s, BYS had begun its hydropower work with the design, fabrication, and installation of propeller turbines. Because of the complexity of the design and the manufacturing requirements, however, neither BYS or Butwal pursued this work. Both BYS and Butwal decided that their work would center on the fabrication and use of the crossflow turbine. This type of turbine seemed more appropriate because it is easier to fabricate. It could also accommodate a wide range of flows and heads with only minor design modifications; the same jigs could be used in fabricating turbines of different capacity.

Turbine design

Focusing their efforts on turbines for low-head sites with nearly identical operating conditions enabled BYS and Butwal to develop one basic design and then to improve subsequent units on the basis of experience. Most mills operate under heads of 5-15 m. Experience gained in the fabrication and installation of numerous



Fig. 10.11. A 200 mm-diameter crossflow turbine, with a length of 560 mm, fabricated by BEW. When the turbine is installed, its draft tube is connected to the rectangular flange shown.

turbines has been incorporated in what is now a well-engineered turbine design.

The design that evolved uses a crossflow runner either 200 mm or 400 mm in diameter and is manufactured in 10 standard widths to suit a range of flows (Fig. 10.11). A single guide vane as wide as the runner is used to manually control the flow. The runner, housing, transition piece between the penstock and turbine, and draft tube are fabricated of steel sheet (Fig. 10.12). A

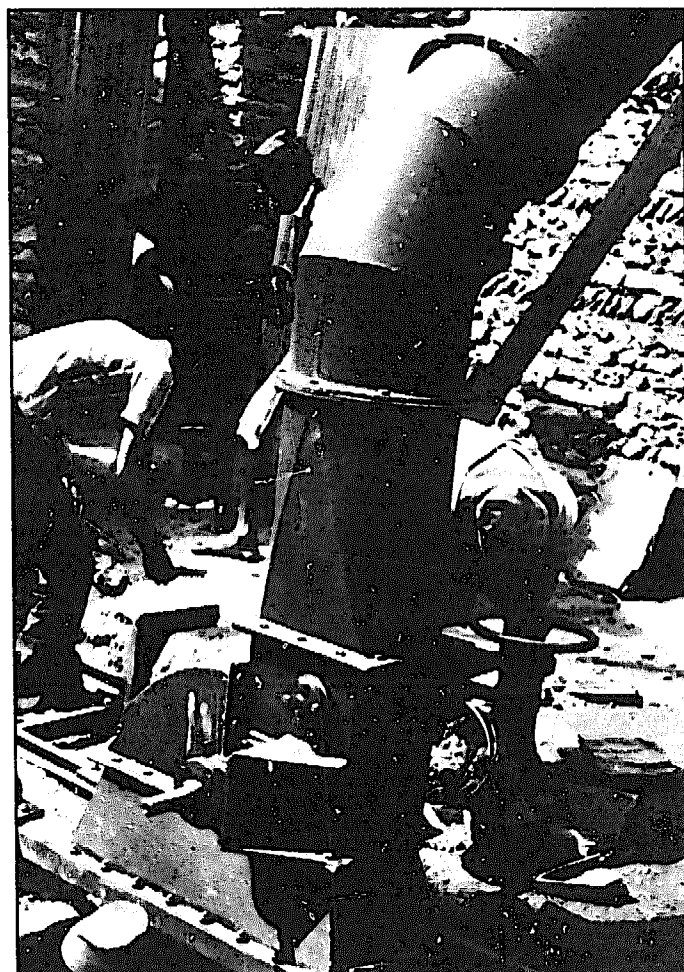

Fig. 10.12. One of the first turbines fabricated by BEW being installed at Dobilla.

hydraulic press is used to form the runner blades, guide vanes, flanges of the housing, and other components formed by bending. Initially, difficulty was encountered in locating bearings suitable to support the shaft of the runner. The limited life of imported bearings bought in India caused problems until it was discovered that these were actually old imported bearings, reconditioned and sometimes resold as originals. A source of new, sealed, self-aligning bearings made in Japan was later located in India.

A complete set of mechanical drawings, a list of required materials, a description of the technical aspects of the design, and a description of the jigs and techniques used in the fabrication of the crossflow turbine are included in Small Water Turbine (97). Because

that publication clearly documents the design, technical details will not be repeated here. Complete machine drawings for a similar design developed by BYS are found in *Crossflow Turbine, Type: BYS/T3* (4).

After fabrication, the turbine and all sections of the penstock are tested at the test site adjoining BEW (Fig. 10.13). Any misalignment, poor threads, or leaks then can be repaired easily in the workshop. After the unit is sent to the field, only hand-crafted repairs can be made.

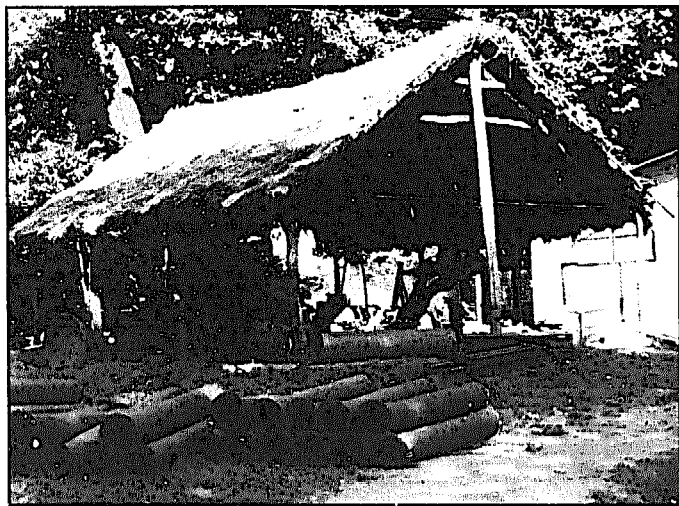

Fig. 10.13. The test site located at the workshop of BEW. Sections of penstock pipe in the foreground are ready for pressure testing.

Design of a typical mill installation

The civil works necessary to convey water from a stream to the powerhouse are identical to the those used with irrigation schemes throughout Nepal. A row of stones, sometimes interwoven with branches, forms a temporary diversion structure across part or all of the stream, and an unlined earth canal conveys water to the intake of the penstock. Sometimes, water from an existing irrigation canal itself is used, although this canal might have to be widened to ensure an adequate flow of water. Irrigation canals are cleaned once before the rice planting season each year and then after each flood during the monsoon season (115).

Generally, water from the canal enters the penstock directly. A trashrack in front of the penstock inlet retains the larger floating debris. The forebay is often simply a transition structure between the canal and penstock and does not serve as a significant settling area (Fig. 10.14). Most of the waterborne sediment that might injure the turbine settles in the canal before it enters the penstock. When a large forebay is unnecessary, incorporating one results in additional costs because of the concrete and labor it requires.

Butwal makes the penstock pipe of 2.5 mm mild steel sheet in 2 m lengths. Flanges are made by hand-forging strips of flat iron, and a groove for an O-ring is machined in one of the two flanges welded to each pen-



Fig. 10.14. A mason completing work on a forebay. The trashrack is located behind him.

stock segment. O-rings have proven much better than flat gaskets in providing leak-proof seals. The company has not provided for thermal expansion of the penstock used with its low-head installations. Leakage between the upper end of the penstock and the forebay structure, although expected, has never been a problem. Butwal tries to select a penstock alignment that avoids any deviations from a straight line, except for the portion immediately in front of the turbine (Fig. 10.15). If bends are required, their size is determined by using rudimentary field measurements.

In existing mills, all the machinery was mounted independently on the mill floor. Careless installation of the machinery frequently caused misalignment of shafts and pulleys. To minimize this problem, Butwal developed a single frame on which all the machinery required in an average mill—a turbine, rice huller, flour mill, and oil expeller—could be attached. In this way, the machinery could be fitted and aligned in the workshop under proper supervision. Machinery could also be secured onsite with a minimum of concrete. Unless a customer owned processing machinery in an earlier mill (diesel- or water-powered), machinery for a new mill had to be purchased through Butwal. This helped to ensure that all the processing machinery would be properly integrated into the overall mill design.

Initially, the turbine with a 400 mm-diameter runner was placed in a recess below floor level to gain additional head with minimum additional excavation

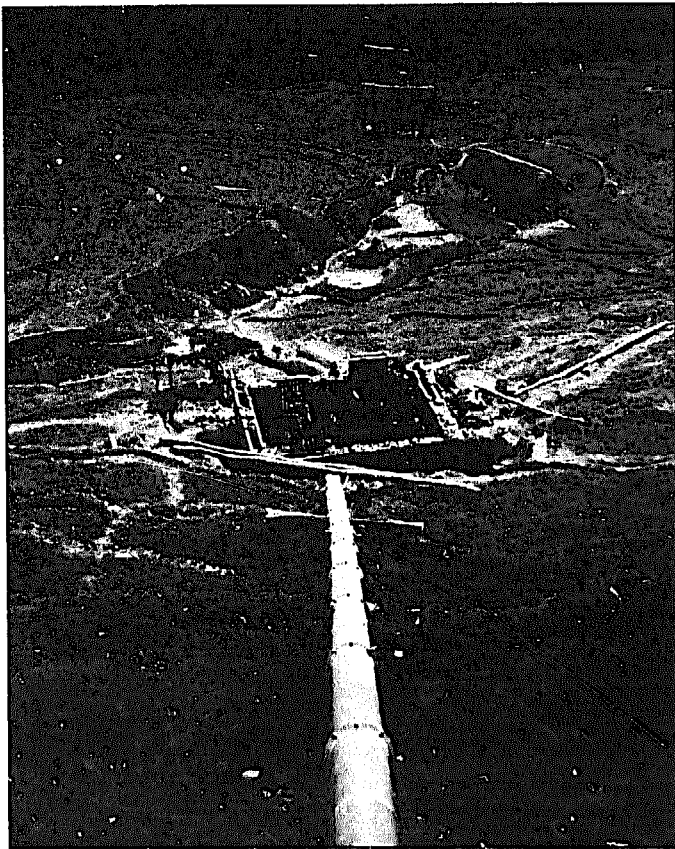

Fig. 10.15. The penstock descends from the forebay to a mill under construction.



Fig. 10.16. At Ampchaur, the turbine is placed below floor level.

(Fig. 10.16). The resulting higher level of the mill house floor also reduced the possibility of flood waters reaching the floor. In addition, lowering the turbine eliminated the wetting of the mill floor caused by water dripping from the seals. On the other hand, it made the turbine somewhat less accessible. The newer, higher-speed turbine with the smaller, 200 mm-diameter runner is now more popular and is mounted half a meter above



Fig. 10.17. A mill layout using one of the new turbines mounted on a common frame with the processing equipment. An intermediate drive shaft is not a usual component of the new layout. It has been included in this installation because the mill owner is considering adding other machinery later.

the mill floor on a four-legged stand (Figs. 10.17 and 10.29).

Butwal also changed the layout of the machinery in the mill. A problem at the first water-powered mills installed by BYS was that the turbine simply replaced the diesel engine in the typical installation but left the basic layout of the mill, with its long intermediate drive shaft, unchanged (Fig. 10.18). Three or four bearings supported these drive shafts (Fig. 10.19). These shafts, up to 6 m long, were rarely straight, and the bearings failed sooner than expected. An initial solution was to introduce a new layout for the machinery. It permitted the low-speed oil expeller to be driven directly off one side of the turbine and the two smaller machines to be driven off a short intermediate drive shaft off the other side of the turbine (Figs. 10.17 and 10.28). At present, by using a 200 mm-diameter runner at most sites, the speed is high enough for all machines to be driven directly off the turbine shaft. Use of the intermediate drive shaft has largely been discontinued, and the turbine shaft has been extended to accept two pulleys on one side. A third bearing is necessary along the turbine shaft to support the pulley load. This results in an even more compact layout (Fig. 10.20). However, misalignment of the third bearing may account for some of the subsequent problems with fracture of the runner shaft.

Another problem in existing mills involved the use of flat belts. The shafts and pulleys were rarely aligned, and poles implanted in the floor or otherwise secured often were used to prevent the belts from running off the pulleys (Fig. 10.19). This resulted in loss of power and rapid wear of the belts. To overcome this problem, Butwal turned to the use of V-belts throughout its mills. These belts transmit power more efficiently than flat belts; require no connectors, which are necessary with flat belts; and reduce the distance required between

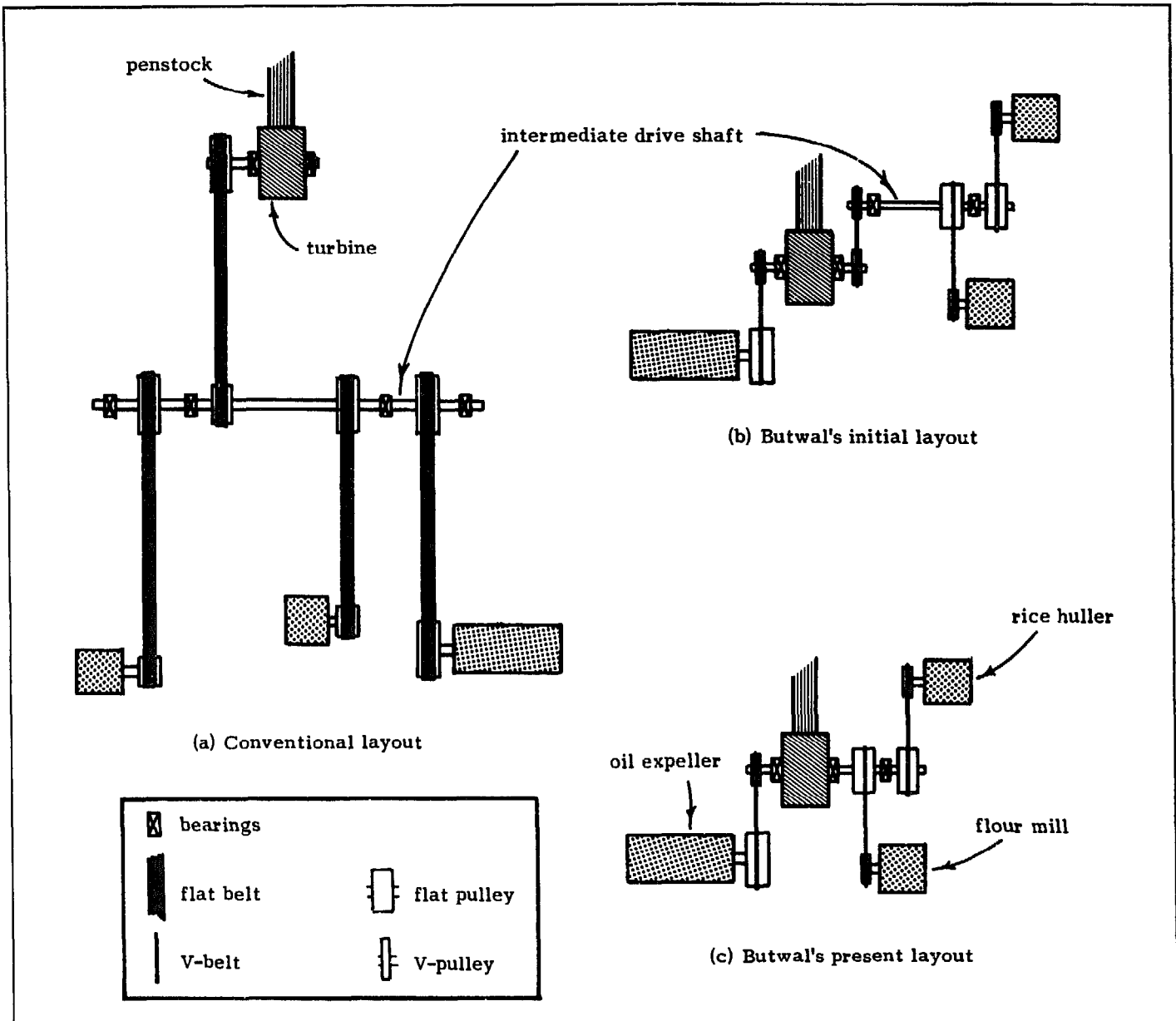

Fig. 10.18. These drawings illustrate the evolution of the standard equipment layout in a mill. Note that the floor

pulleys. From the drive shaft, a flat pulley to V-pulley permits easy removal of the belt; individual machines can then be disengaged while the turbine is running. To facilitate the replacement of belts, D-section V-belts with a common length are used throughout the mill.

Installation teams

An expatriate DCS director serves as project leader for the Small Turbine and Mill Project, but the business chief is responsible for the day-to-day running of the project. A technical supervisor, accountant, and store-keeper complete the permanent office staff.

The heart of the installation program consists of three or four teams that undertake work in the field. Ori-

ginally, each team comprised a team leader who was a skilled mechanical tradesman (each has had BTI apprenticeship training), a mason, and a helper. More recently, most teams consist of only two people; this reduces the cost of the installation to the customer. The only time a third person accompanies the team is when a new employee is being trained.

If it is possible, the team leader is present during initial discussions with a new customer who wants to install a water-powered mill. When the team later goes to the field, it acts independently. It is responsible for the survey, site selection with the customer, and price quotation. When the team returns from its first field visit, the leader prepares the layout design and order list for the sites surveyed. He also supervises his team in the workshop assembly and in checking and packing all the

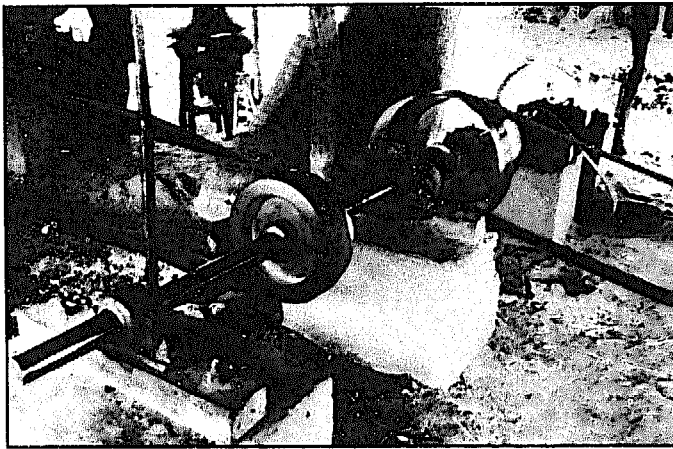

Fig. 10.19. A common sight in mills using flat belts—a metal or wooden stake is used to prevent the flat belt from slipping off misaligned pulleys. This mill has a conventional layout with a long intermediate drive shaft. The shaft was also bent, forcing the removal of the fourth bearing.

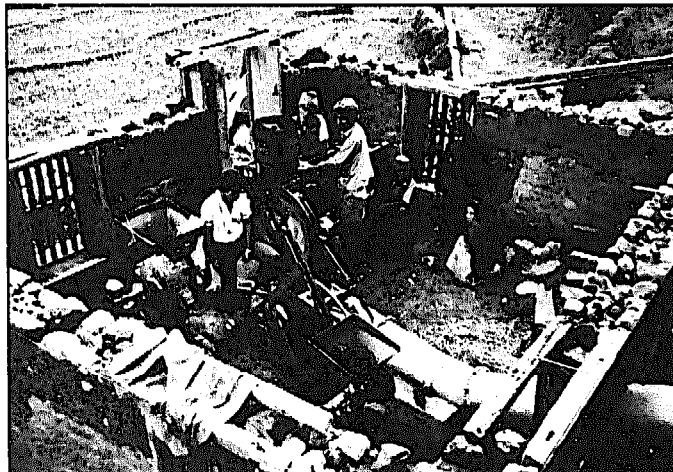

Fig. 10.20. At this new mill, no intermediate drive shaft is used between the turbine and agro-processing equipment.

machinery for an installation before delivering it to the customer for transport. The team is responsible for installing the machinery and for any necessary followup repair work. To minimize confusion, it is best if one team deals with a customer from first contact to final installation; however, practicalities make this impossible. By an insistence on uniform information-recording procedures, it has been possible for one team to survey and a second team to complete the installation. Participation in decision-making has prepared each team to set up its own independent installation operation if DCS should decide to discontinue its operation.

Installation of a mill

Site selection

With the growing reputation of an increasing number of successful water-powered mills, there is no need now to promote small turbines to get business. Ever since BYS

installed the first modern water-powered mills in the 1960s, they have promoted themselves. Villagers familiar with traditional water-powered mills and, more recently, diesel mills are quick to see the merits of this compact, trouble-free source of power with low recurring costs. After learning of the mills and their potential, persons with likely sites express their interest by visiting the office in Butwal, contacting one of the DCS teams installing a new water-powered mill in the area, or notifying an officer of the Agricultural Development Bank of Nepal (ADB-N), which has branches throughout the country.

In the dry season, after Butwal has gathered as many requests as possible from one geographical area or when a team has reason to go near that area for installation or repair work, the team takes the information needed to contact the potential customers. The loan officer from the nearest ADB-N office is also notified and invited to join in the survey. The team travels by public transport as near to the site as possible and then continues on foot, for up to a week in some cases. The team restricts its surveying equipment to the minimum required for the task—a hand-held sighting level or a clinometer, a vinyl ribbon staff, a 30 m fiberglass measuring tape, and several square meters of plastic sheet to assist in making flow measurements. These can determine the parameters necessary for layout and design with adequate accuracy.

The customer is presently charged a nominal fee of Rs 200* for each site survey to ensure more commitment on his part to following through with the project. As the number of small local workshops beginning to fabricate crossflow turbines increases, there is also an increasing risk that perspective mill owners will take the survey results to another workshop to have the machinery fabricated. This initial nominal charge therefore also covers part of the cost of the initial survey. If a site is found feasible, an additional Rs 1600 is charged as part of the final quote for the installation. This covers expenses incurred during preliminary surveys of both feasible and infeasible sites.

In every case, the potential customer must find a location where he either owns or can purchase land for the mill and obtain rights to the required water. For this reason, it is extremely important that the customer understand the requirements of head and flow, so that he can choose likely spots before the survey team arrives. Ideally, a new customer should visit an operating water-powered mill to understand the principles involved. From their experience with irrigation, Nepalese farmers have a good eye for assessing a prospective location and for sizing the canal needed to carry adequate water from the stream to the area selected for the forebay. This usually enables them to select a site with adequate water, if one exists. However, the concept that the head is the elevation difference and not the slope distance has often been difficult to explain. Because they are interested in installing a mill, they

* Rs 12 = US \$1.00

also frequently overestimate the streamflows available to be harnessed.

If streamflows are small, even careful flow measurements made at one point in time are of little use. Because irrigation often is practiced in the same area, however, the local population usually has a very good idea of how small the streamflow becomes in an average dry season and what happens during drought years. During its site visit, the team therefore measures the streamflow and, from interviewing the local farmers, determines what proportion of the average- and drought-year flows this represents. Flow measurements are made using a temporary wooden weir sealed with a plastic sheet; the float method is virtually never used. Frequently, there will not be enough water to run even one machine for at least several months, but two can be operated simultaneously for most of the year. This is carefully explained to the customer. Sometimes a second, more suitable, stream can be found in the area. At other times, the solution has been to look for a site with a higher head, but in such cases, Butwal often recommends that the site be rejected. Misunderstandings have been avoided by gathering all available information to estimate flows and clearly explaining to the customer the implications of less-than-expected flows.

With the experience gained in selecting dozens of sites, the field team can usually tell at a glance if the site is feasible. Because each typical milling machine requires approximately 3 kW of mechanical power, and three machines are customary in every mill, 3 kW is the minimum desirable power and 9 kW is the maximum operating power that would be necessary. The customer must decide if he will be satisfied with the output that can be expected from the available sites.

Site layout

After the customer selects his preferred site, the exact location of the mill is determined by establishing the maximum flood level of the nearby stream and checking the stability of the ground above the mill site to ensure safety from landslides. It is desirable to minimize the length of the penstock by selecting a point where the slope is steep or where the mill house can be dug back into the ground; however, this must be balanced against the stability of the ground and the difficulty of digging a canal to the desired point. In many cases, an existing irrigation canal can be used. Although this simplifies site development and reduces the cost of an installation, it also reduces the options for site location. It may also limit the power potential at the site because the available head might be lower than the head that could have been developed by digging a new canal with a more gradual slope.

At most sites, a spillway is included in the forebay wall to lead away in a controlled manner any excess water. In choosing a site for a mill, the location of the spillway and the course followed by the excess water as it returns to the stream must be considered. Otherwise, this water might cause erosion and undermine the penstock or mill.

The next step is to establish the canal alignment. If an existing irrigation canal cannot be used and a new canal must be dug, a hand-held sighting level is used to run a level from the proposed penstock inlet to the stream. The actual intake to the power canal would then be slightly upstream of this point; the exact location is a function of both the length of the canal and the nature of the terrain. Digging the canal is entirely the customer's responsibility. The villagers' experience with irrigation qualifies them more than outsiders to determine the cost and feasibility of the alignment. The customer also consults with villagers who specialize in canal digging and frequently hires them to excavate sections requiring rock-cutting. In almost every case, the customer can determine the necessary dimensions and slope of the canal when given the fraction of the streamflow it must convey.

After the site has been selected and the canal elevation determined, the elevation needed to keep the mill floor safe from flooding must be established. This choice is best left up to the customer, because he has the best knowledge of the site and must live with the consequences of the choice. The area to be excavated for the mill floor and tailrace canal can then be marked out.

The head and other information required to design the penstock is obtained by making a series of measurements, generally using the hand-held sighting level and the ribbon tape that is supported on a bamboo or other



Fig. 10.21. The team surveys using a hand-held level and a vinyl surveying tape suspended from a pole.

suitable pole (Fig. 10.21). An elevation profile is then run along the expected penstock alignment from the proposed turbine location to the end of the proposed or existing canal elevation. All the information is recorded on a sketch of the site in the field notebook. For future reference, a permanent mark on the root of a tree or large stone is also made and its position recorded in the field notes. Although direct measurements of the length and profile of the penstock can seldom be made without excavation, they can be calculated by making several simple linear and angular measurements.

It is important to examine and note the soil and rock formations for possible problems in excavating for the mill house, draft tube, tailrace canal, or penstock pipe. A bend in the penstock pipe can usually be avoided by shifting the site slightly; however, if a bend is required, more careful measurements must be made.

If the streamflow is large enough that only part of it will need to be diverted for the mill's use, the design flow will depend on the head available and the power required. The maximum flow easily conveyed in a traditional unlined irrigation canal is about 200 l/s. The flow for the most convenient canal design is 80-120 l/s.

Quote for the installation

After all the information has been recorded in the field notes, the technical supervisor completes a price quotation based on the survey. Except for the penstock pipe which varies considerably in price, most items cost roughly the same from site to site. The cost of an installation also depends on the types of processing machinery to be included, but most customers want all three—a flour mill, rice huller, and oil expeller. The quotations are valid for only three months, after which a new quote must be obtained for the loan procedure. If the customer does not take delivery of the machinery

within a certain period after he has been told it is ready, Butwal may sell it to another customer. In such cases, Butwal is no longer bound by the quotation given the original customer. BEW gives a six-month guarantee on its machinery and DCS gives a one-year guarantee against errors in installation, provided the work was done according to instructions from the leader of the Butwal installation team. For the Indian processing machinery, no guarantee is given.

The terms of the quotation and the details of the guarantee are explained to the customer. He must understand exactly what DCS will provide and undertake. He must also understand precisely what are his responsibilities (Table 10.1). He must beware that he must receive from the Department of Cottage Industries one license to build and then another to operate the mill. He must place a firm order with the required advance before DCS can take any further action.

Formerly, customers had to include an advance of Rs 2500 in "earnest money" with their orders before DCS would take any action; however, customers often waited until the last minute to arrange for a loan and this led to cashflow problems on the part of DCS. Since mid-1981, an advance of 50% of the DCS quotation along with a letter of guarantee from the ADB-N has been required. This procedure places more pressure on the customer to expedite the process.

Most customers turn to the ADB-N for financing. With an interest rate of 11% and a loan repayment period of seven years, it offers better financial terms than commercial banks. This loan also requires physical property as collateral. A typical loan covers all the machinery and installation costs, 85% of the land purchase, and 65% of the cost of the labor necessary to undertake the excavation and to install the machinery. A typical ADB-N loan covers about 80% of the entire project cost. Of the first 65 mills, only four have been paid for without loans. The ADB-N has officers and personnel at

TABLE 10.1. *Division of responsibilities for the installation of a water-powered mill*

Tasks undertaken by Butwal	Responsibilities of the mill owner
<ul style="list-style-type: none"> ● perform initial survey 	<ul style="list-style-type: none"> ● obtain the necessary license to build and operate a mill
<ul style="list-style-type: none"> ● design and fabricate turbine, penstock, and other required hardware 	<ul style="list-style-type: none"> ● purchase the land and right-of-way for the power canal and tailrace (as needed)
<ul style="list-style-type: none"> ● purchase, inspect, and pack the milling, hulling, and oil expelling machinery for transport as needed 	<ul style="list-style-type: none"> ● arrange for water rights
<ul style="list-style-type: none"> ● provide technical guidance and assistance in installing and commissioning of the plant 	<ul style="list-style-type: none"> ● locate sufficient cash to cover at least a portion of total cost of the installation and apply for a loan for the balance necessary
<ul style="list-style-type: none"> ● train one of the local persons designated as mill operator how to operate and maintain the machinery 	<ul style="list-style-type: none"> ● organize local labor to undertake the necessary work
	<ul style="list-style-type: none"> ● undertake the necessary excavation and collection of locally available materials (sand, stone, gravel)
	<ul style="list-style-type: none"> ● transport all the hardware and materials from Butwal to the site

every level who actively promote a loan program for water-powered mill development, having withdrawn a similar program for diesel mills. When an application has been received, a loan officer gathers information about the economic feasibility of the project before approving the loan. A customer who secures a loan from the ADB-N receives a coupon, which he then submits to DCS. With this guarantee of payment, DCS will deliver and install the mill, collecting payment directly from the ADB-N upon submission of the bill signed by the customer.

responsible for preparing the site. The canal must be built if an existing canal will not be used, the site for the powerhouse has to be excavated, and all the necessary materials that are available locally—stones, sand, and aggregate—must be gathered in preparation for the final construction effort (Fig. 10.23).



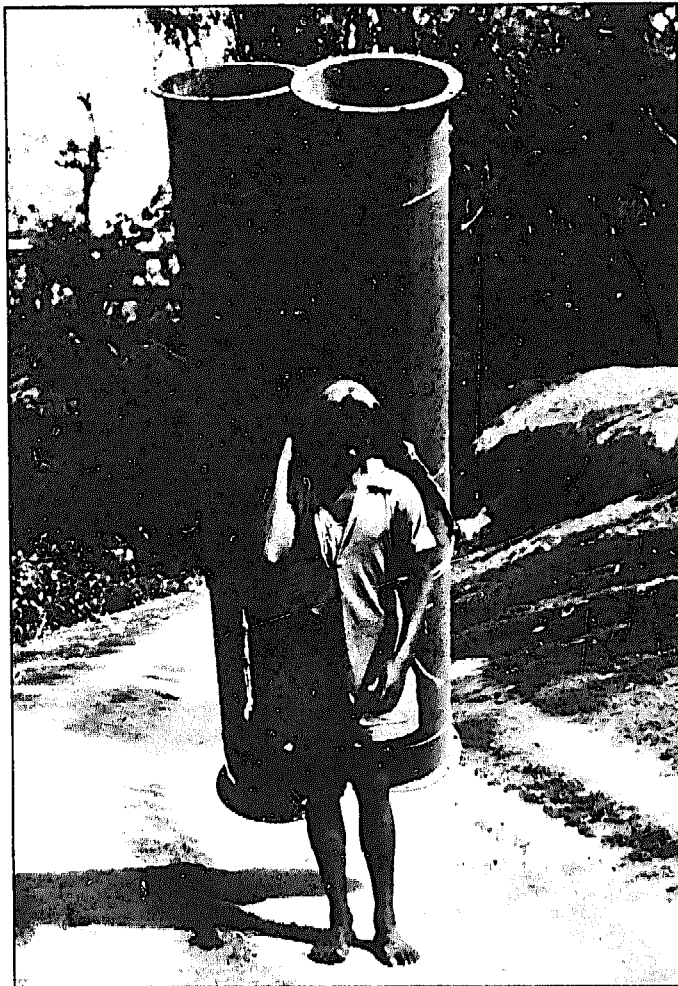

Fig. 10.24. After the site excavation has been completed and the equipment fabricated at Butwal, porters carry the necessary materials to the site. The two sections of penstock shown weigh about 100 kg.

required in advance. This sum is based on an installation time estimated at 30 days; if it is less, any overpayment is refunded after completion of the work.

Installation

The customer notifies the installation team from Butwal to come after he has ensured that all the machinery is at the site, that all materials noted on the project cost form have been stockpiled near the site, and that all necessary excavation work has been completed (Fig. 10.25). The owner usually underestimates the difficulty of transporting several tons of machinery and materials and the seasonal difficulty of locating porters. Weighing 110 kg, the gear box for the oil expeller is the single heaviest part and requires an exceptionally strong porter. If the load can be supported on a sling, two porters can carry it. Because the trails are narrow and steep, however, a load that must be carried by more than one person is often passed up in favor of more convenient weights and sizes. The team takes any special equipment needed for the installation, such as ropes,



Fig. 10.25 Before the installation team arrives from Butwal, all the necessary materials have been transported to the site.

mason's tools, and a level. All of this fits easily into their backpacks.

A per-day installation fee of Rs 180 is charged for the work performed by the installation team. This rate, which is considered extremely high for these remote areas, encourages the customer to do as much of the work as possible in advance and to supply labor to reduce the installation time. Because the masonry requires curing time, it takes priority over other jobs. The tailrace canal is prepared first, using stone masonry for the floor and dry stone for the sidewalls and top.

To install the penstock, turbine, and draft tube, Butwal uses a unique approach that eliminates the need for detailed and costly site surveys. These components are first assembled and bolted together near their final location and then temporarily braced by wooden cross-frames or piles of stones (Fig. 10.26). The empty pipe is strong enough to be self-supporting. The entire assembly is then maneuvered around slightly until a suitable alignment is found. Although this may be the most difficult part of the installation, this approach makes it possible to circumvent boulders or other obstacles that might have been encountered during the excavation. It also makes it possible to compensate for small discrepancies between the configuration of the penstock-turbine-draft tube assembly designed according to data gathered during the initial survey and the layout of the area actually excavated. To facilitate this task further when penstock bends are used, the bolt holes in one flange of the bend are slotted to permit another degree of freedom. In addition, an extra 1 m length of penstock is supplied if needed. Any excess length can be cut off with a hacksaw blade. This method allows any minor deviations to be accommodated easily, thereby eliminating the need to interrupt work for several weeks for a return to the Butwal workshop to fabricate or modify the penstock bends. After the turbine shaft has been leveled, to reduce bearing loads and to simplify alignment of the other machines, the turbine and draft tube are secured in a foundation and the penstock supports are built up.

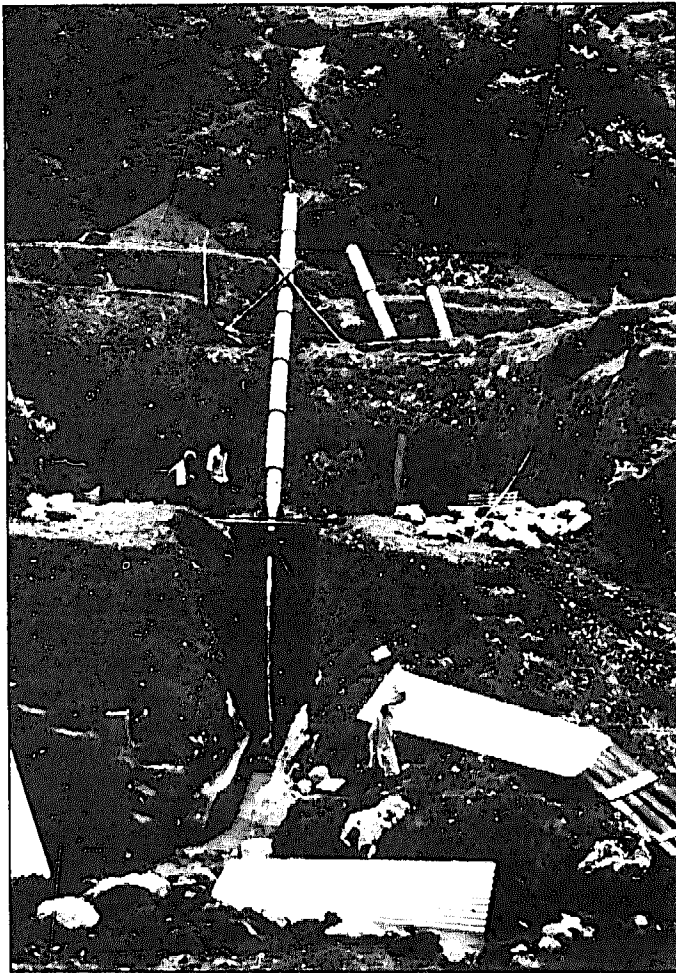

Fig. 10.26. The penstock, turbine, and draft tube are all assembled and properly aligned before they are set in concrete. A portion of the tailrace canal has already been completed.

The machines are all assembled on a mounting frame and set in place (Figs. 10.27 and 10.28). Correct spacing is assured by placing the belts on the pulleys. To ensure that the shafts are parallel and the pulleys in line, alignments must be done carefully using a string and level. The string is stretched parallel to the turbine shaft and the line shaft is adjusted parallel to it. The string is also used to line up the V-belt pulleys from their machined outer surface (Fig. 10.29). The mounting frame is supported on rocks, allowing sufficient space around the anchor bolts to place the concrete without disturbing the frame.

The mill owner and whoever he has designated to help operate the mill are encouraged to participate in fitting and mounting the milling machines and transmission system to understand how the parts fit together. The team leader uses this opportunity to explain the need for proper belt tension, adjustment of the machines, and clean and adequate lubrication.

The team usually spends from three to four weeks at a site to complete the installation. Because a few days must be allowed for the masonry to cure before testing,

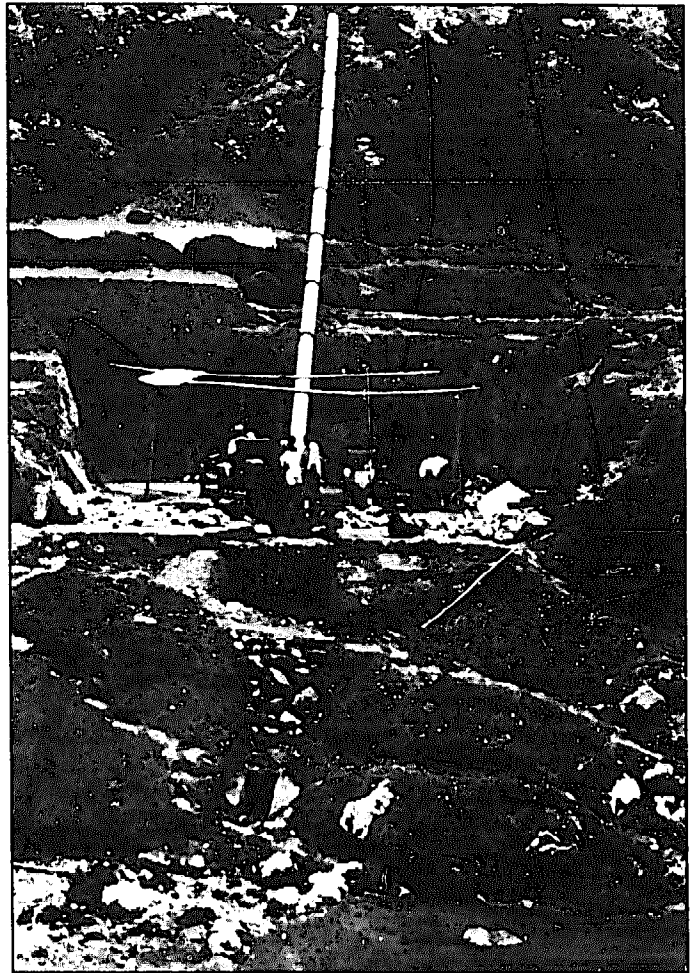

Fig. 10.27. The tailrace and forebay have been completed and the processing equipment is being installed.

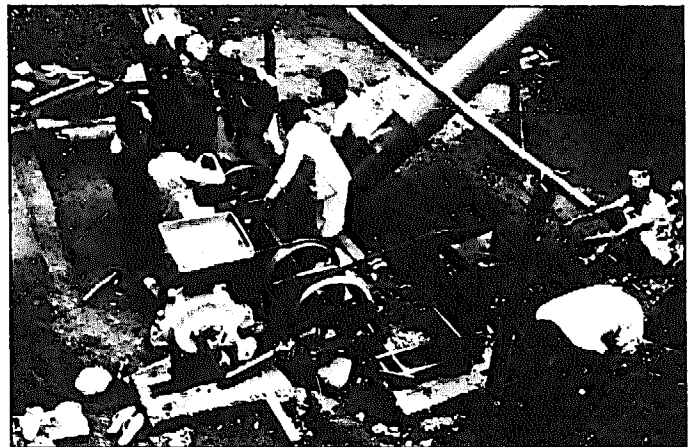

Fig. 10.28. All the equipment has been aligned and set in concrete.

there are often a few free days between completion of the installation and testing. This time is used to undertake surveys of new sites nearby or to followup on mills that may be already operating in the area.

After completing the installation, the team makes all

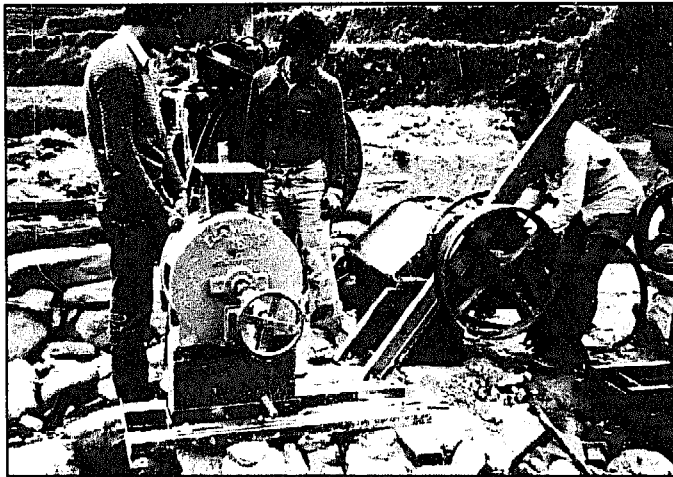

Fig. 10.29. The new turbines are mounted above the mill floor on a common mounting frame, which is eventually set in concrete. Here the installation team is shown using a string to align the pulleys.

final adjustments and operates each of the machines under full load for several hours. The owner or operator is also required to run the mill under the supervision of the team until it is satisfied that he understands the operating procedures and safety requirements.

Design modifications

To obtain continuing feedback from the field in order to improve its designs, DCS initiated a policy of team members visiting mills, free of charge, for followup adjustments, repair, possible replacement of bearings, and observation of operating problems, whenever they are near a mill they have installed. Even though this policy sometimes has required an extra day of walking, valuable information that has led to design improvements has been gathered.

For example, one of the earliest turbine designs developed a problem with the operation of the turbine inlet valve. Careful examination determined that the valve shaft had been twisted, preventing the valve from closing completely. From observing the operator in action, it became clear that when the valve was closed, he forgot the direction in which to turn the spindle to open it again and applied a substantial force in the wrong direction. The initial solution was to paint arrows indicating the directions for opening and closing. The final solution, however, was to provide blocks limiting the travel of the valve arm, thus reducing all possibility of damage caused by operator error.

The clean-out opening above the turbine runner was another design improvement that resulted from a service call. A stick that a boy had floated down the canal had lodged in the runner. Without this opening, the complete turbine had to be disassembled to gain access to the runner.

Although the forebay is small, sediment eventually accumulates on the bottom. With no sluice gate, its

removal proved a problem. Incorporating a removable standpipe in the floor of the forebay area resolved the problem (Fig. 10.30). When the forebay is to be cleaned, the pipe is removed and the sediment is flushed out. During normal operation, this standpipe serves as a shaft spillway.

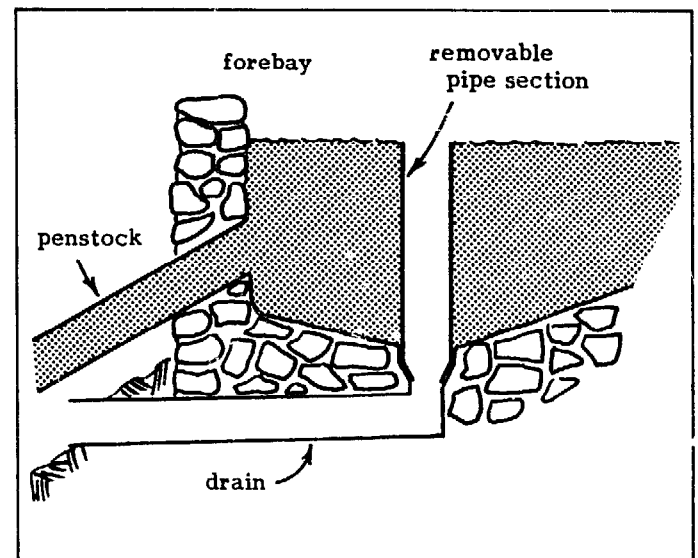

Fig. 10.30. A removable standpipe incorporated in the forebay design facilitates removal of the sediment. It also serves as an overflow.

Observing mills in operation has also resulted in the relocation of the turbine valve control handle, changes in the machine disengagement mechanisms, and other changes for the convenience and safety of the operators.

Costs

The cost of implementing a water-powered mill is clearly site-specific. Table 10.2 presents the costs of a typical mill installed with Butwal's assistance. The breakdown is graphically depicted in Fig. 10.31. Although the total cost may seem high, the owner of a water-powered mill generally charges only slightly less than the diesel mill owner. With his low recurring operating costs, he can repay his loan in four to seven years, depending on the terms of his contract.

Most mills installed by Butwal range from 8 to 12 kW. The total cost of the entire water-powered mill installation, including the agro-processing machinery, is about US\$ 9000 or about US\$ 1000/kW. The actual cost is influenced by the length of the canal required, the length and size of the penstock, the capacity of the turbine, and the size of the agro-processing machinery used. If the mills had been built to generate electrical power, the costs per installed kilowatt would be approximately the same, with the cost of the generator replacing the cost of the agro-processing machinery. This assumes that no governor is necessary, either because direct current is generated or because the plant is manually controlled, as with the Pakistani schemes implemented by the ATDO (see VILLAGER-IMPLEMENTED

TABLE 10.2. Cost breakdown for a typical water-powered mill (presented in 1981 U.S. dollars)

Machinery and services provided by Butwal		Additional costs incurred by mill owner	
Survey and design	200	Land and canal right-of-way	400
Turbine	1,100	License	40
Mounting frame, pulleys, belts, and misc. hardware	800	Transportation of machinery and materials	600
Agro-processing machinery (flour mill, rice huller, and oil expeller)	1,700	Canal excavation	700
Penstock	1,000	Mill house	700
Installation (est. 30 days)	500	Workers (fitters, masons, etc.)	500
		Cement (\$14/bag)	400
		Sand, stones, and other materials	100
SUB-TOTAL	\$5,300	SUB-TOTAL	\$3,440

MICRO-HYDROPOWER SCHEMES IN PAKISTAN,
p. 248).

Other developments

Hardware

The introduction of modern water-powered mills in the mountains of Nepal has permitted more efficient exploitation of an indigenous resource to process grains and oil seed on a village scale. This has led to a decreased reliance on expensive diesel fuel, which has to be carried by porters long distances over mountain trails. Although this is a positive development, a more pressing problem for Nepal is not the increasing cost of diesel fuel but the depletion of its forests. Food requirements for Nepal's expanding population have forced farmers to clear forests and cultivate even marginal land areas. When deforestation reaches a critical point, extraction of fuelwood becomes an additional factor in deforestation. Fuelwood is used for cooking food and for a number of village industries including drying ginger, tea, and tobacco; making paper, soap, and cheese; alcohol production; and dyeing yarn.

Current and former Butwal employees have been undertaking research to find means of using hydropower to reduce firewood consumption. Two areas of research are the development of a mechanical heat generator for village industries and a heat storage cooker for household cooking. These are examples of new approaches to addressing an increasingly pressing problem. The technical feasibility of these approaches has been demonstrated, but a critical question remains: Will villagers adopt them, and will they meet the need they intend to address? Numerous cultural, social, and economic factors are involved, and the answer is, as yet, unknown.

Mechanical heat generator. One obvious approach to drying agricultural produce using hydropower would be first to generate electricity and then to use it to operate a fan to force air past electrical resistance heaters. However, this approach has two disadvantages:

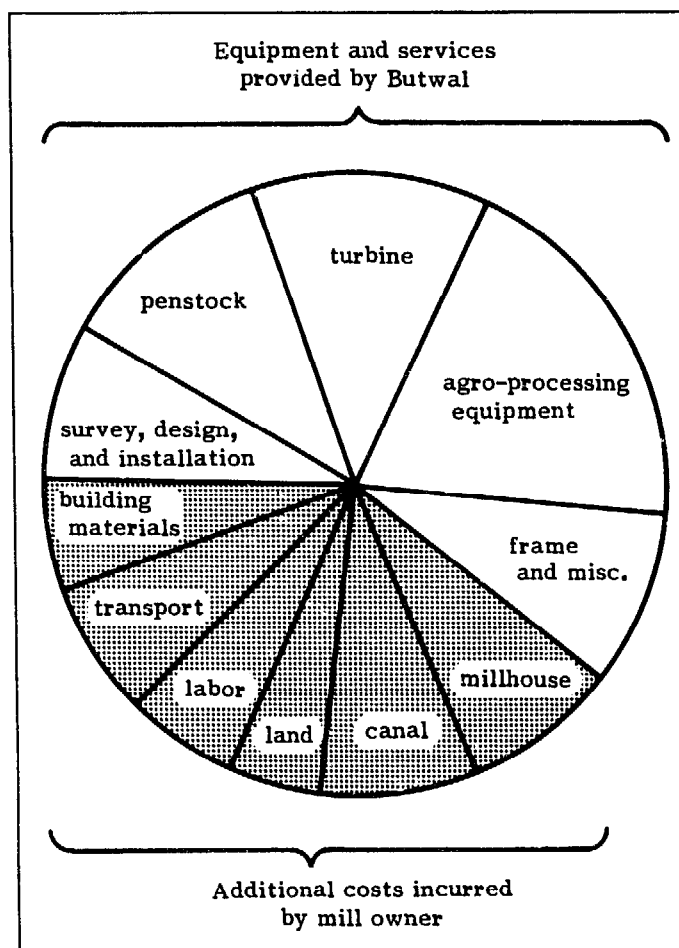

Fig. 10.31. A graphic representation of the breakdown of the total cost.

- The generator and associated electrical hardware may be more costly and complex in a situation where simplicity has distinct virtues.
- Converting mechanical into electrical energy introduces inefficiencies and, at most, only 70%-80% of

the power available at the turbine shaft can be converted into high-grade heat.

An alternative, which converts virtually 100% of the available shaft power into heat, is based on original research work on the equivalence of mechanical and thermal energy undertaken by James Joule in the mid-19th century. Although several persons have undertaken further research on various aspects of this effect, interest in the practical application of this process for generating usable heat has increased only recently (99).

At Butwal, work has centered on a heat generator that can be coupled to a turbine to heat air through viscous friction. Figure 10.32 presents the layout of this design. Air is drawn through the inlet by the fan, and part of it leaves through the outlet into the drying racks. The

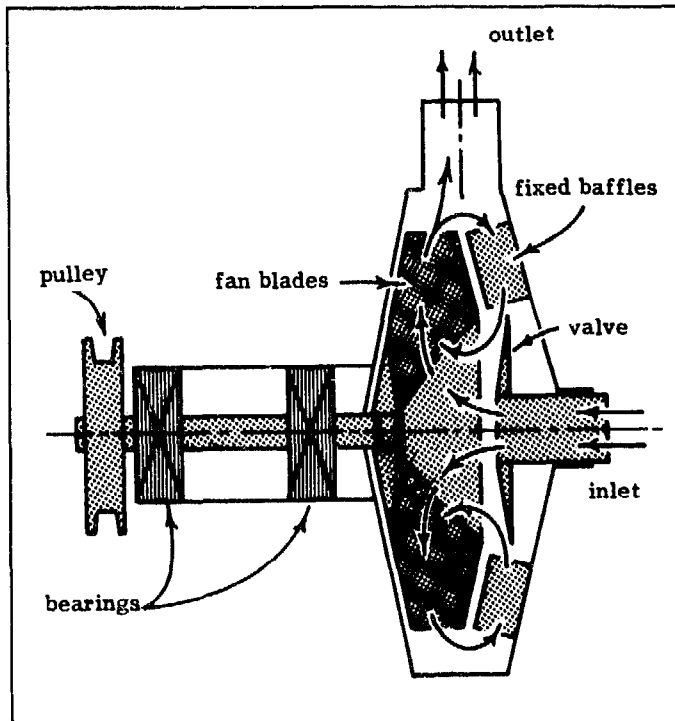

Fig. 10.32. Schematic of the heat generator developed at Butwal.

other portion flows back over the baffles, which are arranged radially. The kinetic energy imparted to the air is changed into heat by the creation of eddies. This hot air passes the valve, mixes with the incoming cooler air, and is drawn in again by the fan. The amount of air leaving the generator and its temperature depend mainly on the position of the valve. When it is closed, the generator is simply a fan blowing air at near-ambient temperature through the generator. If the valve is fully opened, nearly all the air leaving the fan is drawn back through the baffles, thereby heating it to the maximum temperature. By varying the opening of the valve, any temperature between these two limits can be obtained.

The generator is driven at about 2000 rev/min and temperatures above 100 °C have been attained. However, for crop-drying purposes, temperatures in the 60-80 °C

range are sufficient. Tests have shown that the temperature stays constant after an initial heating up period, provided that the ambient temperature does not change.

After successful test runs, Butwal has fabricated two generators. A 10 kW unit has been installed at a trade school in Jumla, in the far western region of Nepal. The school plans to use this unit to dry apples and vegetables, seasonally available in this area, to cover its annual needs. Another unit has been installed at a cooperatively run mill in Arkhala in the midwestern region of Nepal (see *Cooperative approach to implementation*, p. 245). It has already been used to dry a large quantity of ginger, and it will be used to determine the influence of drying crops artificially on post-harvest losses during storage.

Because both projects are still under UMN management, tests and modifications can be made without putting the farmers at risk. Such a risk arose from the drying of 600 kg of ginger. Although the drying was successful, the final product did not have the appearance of ginger that traditionally is dried over a fire. As a result, the product fared poorly on the market.

While field work continues in Nepal, Reinhold Metzler, former product development engineer in Butwal, is continuing research work at Furtwangen Technical University, Federal Republic of Germany, in several areas:

- testing the present design to gather reliable data on its performance;
- improving the design view to make it simpler and more efficient;
- developing a system to provide heat for boiling for rural industries; temperatures up to 200 °C are required. The first unit is intended for a small soap factory in Nepal and is undergoing tests in Furtwangen. Although the unit operates satisfactorily, it requires improvements to reduce heat losses. Field tests of the unit are expected in January 1983;* and
- designing and testing methods of storing heat produced by the heat generator when the mill is not otherwise in use.

Heat storage cooker. Small-hydropower plants in deforested rural areas are often considered as an alternative source of energy for household cooking. However, this poses several problems:

- Because the power requirements of conventional hot plates range from 750 to 1500 W, micro-hydropower

* In *The Heat Generator* (81), which has been published since the completion of this case study, Metzler reviews the design and construction of a heat generator capable of generating temperatures above 200 °C, its performance, and applications for this technology. Units are presently being constructed and field-tested in Nepal and Peru.

plants can provide electric power to only a very limited number of homes.

- The cooking of evening meals coincides with the peak lighting load, which contributes to the twin problems of low load factor and high peak loads that characterize small decentralized electricity schemes.
- Additional costs are incurred in purchasing cooking pots and kettles with flat bottoms, which would be required for cooking on hot plates, and in purchasing and repairing or replacing the hot plates.

To be a technically and economically viable source of energy for cooking, micro-hydroelectric power requires a storage device that will allow the energy that is generated between the normal cooking times to be used during these times. The full capacity of the generating equipment could then be used by delivering energy to this storage system continuously. This approach would result in a higher load factor as well as in a reduced peak load requirement. As the use of hydroelectric power expanded in the United States and Europe during the first half of this century, commercial heat storage cookers that met this requirement were developed and marketed (108). These were essentially electrical elements embedded in well-insulated cast iron blocks that stored heat until it was needed. They became popular because of a tariff structure that encouraged the consumer to use, at a fixed tariff, all the power to a maximum limit. The last company known to have manufactured heat storage cookers discontinued marketing in Norway in the early 1950s.

Robert Yoder recently completed research on heat storage cookers at Cornell University (113,114). Before this work, he was involved for eight years in a number of activities with DCS, ranging from project engineer on Butwal's 1000 kW Tinau Hydroelectric Power Project to project leader for its water-powered mill projects. The research at Cornell University focused on a design incorporating stones to store heat, rather than an expensive, heavy cast iron mass. Because heat conduction is low both within a bed of stones and between the stones and the cooking vessel, heat is transferred from the stones to the cooking vessel by dripping water into the hot stone bed to generate steam at atmospheric pressure. The steam then conveys heat to the cooking vessel, where it condenses, drops back into the stone bed, and is recycled.

The laboratory unit, with a power input of 275 W, was used for eight consecutive days to cook a typical Nepalese meal on a twice-daily basis, as is done in Nepal. These trials confirmed that heat storage in a bed of stones would work for water-based cooking.

The viability and social acceptability of a locally built unit must now be determined. Figure 10.33 illustrates a possible storage cooker design built of local materials. Although the current prices of electricity and fuelwood in urban areas make building and operating such a design competitive with using fuelwood, its acceptance by villagers is not assured. One of the problems is that, to

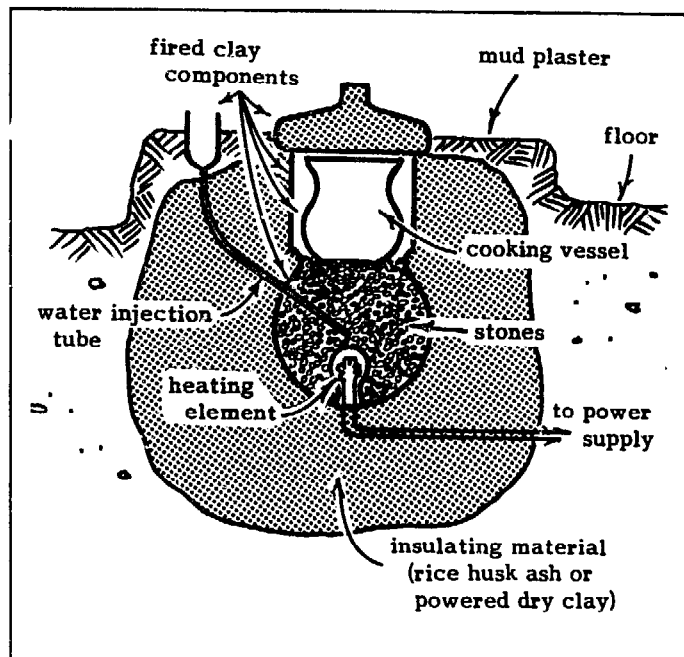

Fig. 10.33. Schematic of the heat storage cooker based on research undertaken at Cornell University (113,114).

conserve heat, the villagers would not be able to observe or stir the food while it is cooking. Perhaps of greater significance would be the loss of space heating and social value traditionally associated with an open fireplace. It is interesting to note that, even among those who can easily afford it in Kathmandu, electricity is used rarely for cooking. It is possible that cooking habits will not change until firewood becomes essentially unavailable. DCS is continuing its experiments, but there is a need to gather hard field data on the appropriateness and acceptability of this device under differing conditions.*

Mill lighting. Although most work to date has involved hydropower plants used to power food-processing machinery, mill owners have remained interested in generating electricity for lighting, in part because it facilitates milling during evening hours (Fig. 10.34). As a result, a direct-current mill-lighting system has been developed.

Most mill installations in the hills of Nepal are several days' walk from the road, and an understanding of electricity is rare. For these reasons, several basic design criteria were established. These included:

- a system with sufficient power to light a minimum of six bulbs;

* With the support of the Intermediate Technology Development Group (ITDG), conventionally designed storage cookers have since been installed at the El Dormilon (Colombia) micro-hydropower scheme to determine the social acceptability of this type of cooking (59).

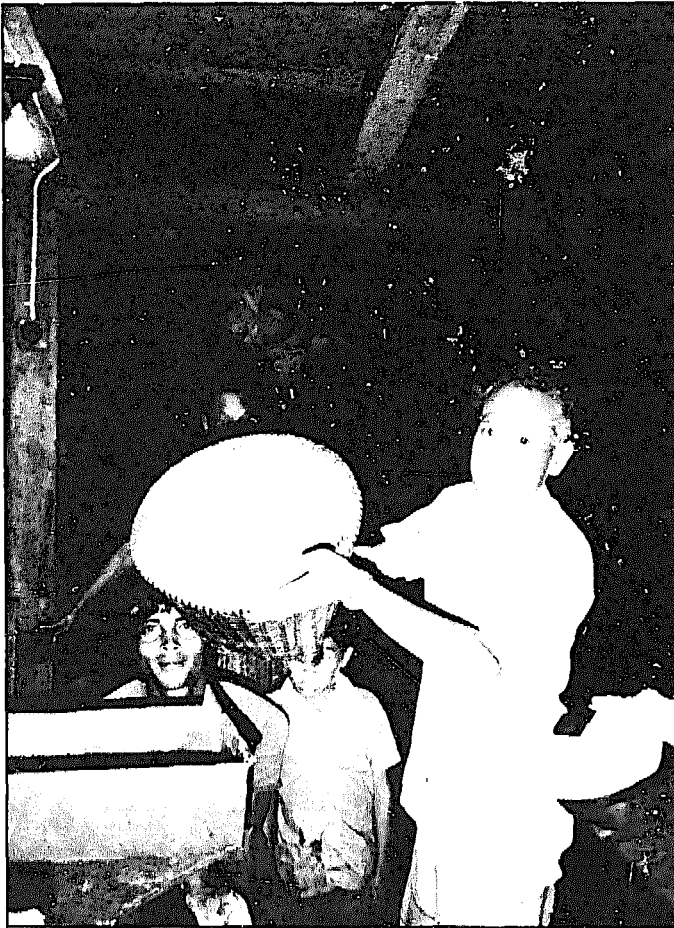

Fig. 10.34. Mill lighting permits 24-hour operation of the mill during the busy season.

- a system that did not use a lead-acid battery, which is both heavy and needs to be used and handled properly;
- a system where the voltage output of the alternator remained constant over the wide range of speeds at which the turbine actually runs; and
- a system that is designed for reliable operation.

The system that evolved uses an automobile alternator and a DCS-designed voltage regulator. An alternator manufactured in Bombay at a cost of about US\$ 100 was used initially, but a source of US\$ 40 alternators from the United States has since been found. This 12 V alternator is connected in a way that allows it to generate 24 V, thereby permitting twice the power from the same unit. Incandescent bulbs running at 24 V are widely used on the Indian railway system and are easily available.

The voltage regulator was designed to maintain the voltage output at a nearly constant level over the wide range of speeds to which it is exposed. Most of the components are mounted on a laminated printed circuit board designed by DCS and manufactured in India. The present design incorporates a plug-in circuit board rather than the permanent circuit board that was used in earlier versions. The difficulty of performing high-

quality soldering in the hills of Nepal, away from any source of electricity, necessitated this change.

The alternator is mounted on a balance arm, and the counterbalance regulates the tension of the driving belt. It is driven off the same pulley that powers the rice huller (Fig. 10.35). The alternator pulley is selected to drive the alternator at 3000 rev/min when the turbine is running at design speed.

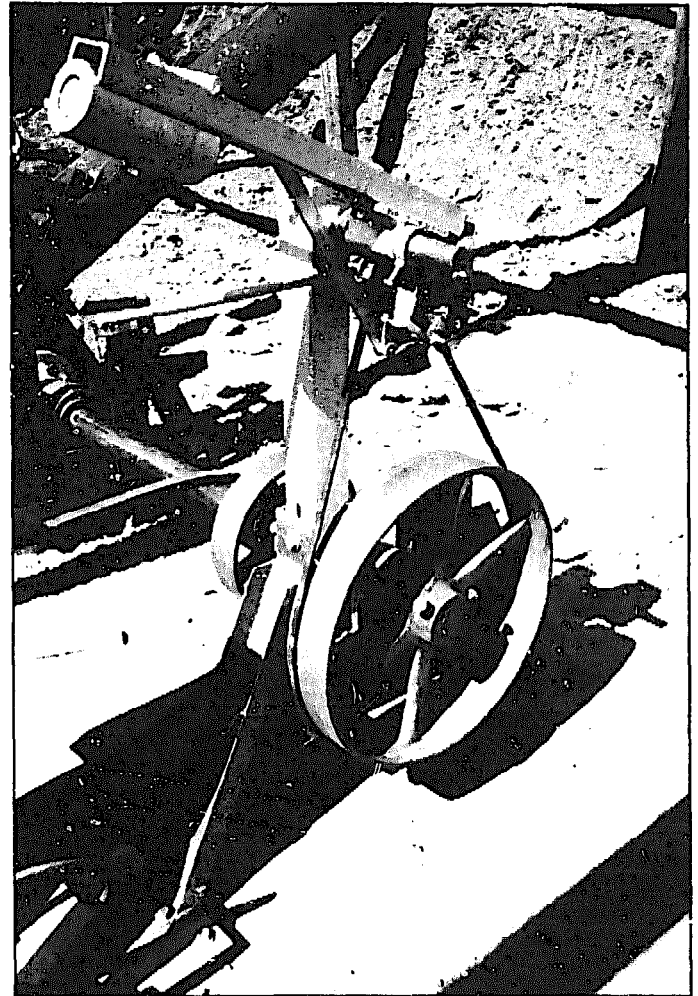

Fig. 10.35. An alternator, mounted at one end of a balance beam, will provide light for milling during evening hours.

As of the beginning of 1982, seven mill-lighting units had been installed. A standard installation with a total of eight incandescent lights costs about US\$ 420, broken down as shown in Fig. 10.36. In addition to the basic installation, optional items are also available now. These include the wiring of additional areas (with a maximum total of 12 bulbs), electric fans, fluorescent tube lighting, and an electric horn. This horn notifies the villagers in the area that the mill is open for business. An advantage of the diesel mills is that a small container could be partially inverted over the outlet of the exhaust pipe to create short intermittent toots and alert villagers, often several kilometers away, when the mill was in service. This approach was not available to owners of turbine-powered mills.

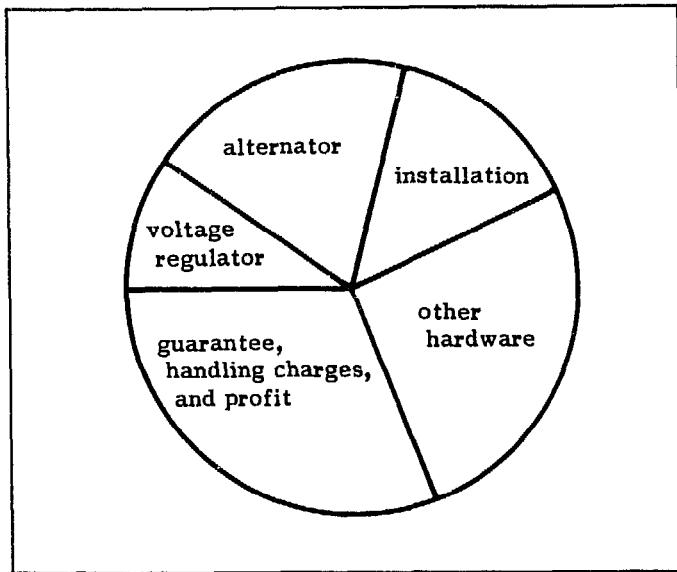

Fig. 10.36. Breakdown of the cost for a standard lighting installation.

Cooperative approach to implementation

Those who have inquired about developing a modern water-powered mill represent a cross-section of the social and ethnic groups in the hills. Some who have completed their installation have turned to milling as a business venture, either because of a lack of other options for a livelihood or because they saw this as an attractive investment. However, the majority have a high social, economic, or political standing in their community. The local entrepreneur who owns and operates his water-powered mill is the primary beneficiary of this technology. He charges approximately the same rate as that charged by diesel mill owners, has fewer recurring costs, and can repay his ADB-N loan in four to seven years. After that time, all income beyond that required to cover operating and maintenance expenses represents a net profit. Consequently, the question of whether these water-powered mills are merely enriching the already wealthy has been raised.

To increase the benefits of water-powered mills to the users rather than to a few entrepreneurs, UMN embarked on an experiment to establish cooperative mills. The first project was undertaken in Buling Arkhala, Nawal Parasi District in the Lumbini Zone (42). In the late 1960s, UMN had established a dispensary in the area; more recently, it has been involved in a Food for Work Programme. Therefore, a good relationship already existed between UMN and the people of the area. From discussions with the villagers about improving their economic standing, it was apparent that they saw the biggest potential in developing their ginger industry and improving its marketing. With Butwal's work on a mechanically driven crop drier, the idea of installing a water-powered mill evolved. In addition to drying ginger, it could also be used to process their grain and seed, a task that otherwise required a day's walk to the nearest (diesel) mill.

UMN advanced a loan for the cooperative mill and later trained the local people in operating and maintaining the mill as well as in accounting and management. Representatives from each of the wards in the area formed a building committee.

The canal to the mill was built during a Food for Work Programme. The remaining work was undertaken by the villagers, who were paid either in cash or in coupons they could use later to buy shares in the cooperative or services at the mill. Initial work was slow because of weak leadership in certain villages, the villagers' preoccupation with other tasks in their fields, and the low wages agreed upon by the committee. To expedite progress, contracts were let for specific tasks, as is the tradition in the area.

The small oil expeller that had been installed produced low yields. Consequently, in spite of the low promotional rates set when the mill became operational, villagers preferred walking to the nearest diesel mill, where they could obtain higher yields. After the installation of a standard-size oil expeller, a rice huller, and a heat generator, the mill became so popular that the villagers often had to wait several days to get their mustard seed processed. A shop that sold basic necessities to villagers waiting to process their grain and oil seed was also built as part of the cooperative.

As the mill became operational, the villagers and UMN discussed how to set up a cooperative. With assistance from the ADB-N, it was decided that minimum shares would be available at Rs 20 each but that each shareholder should strive to purchase Rs 200 worth of shares eventually. This maximum value of shares that a single person could hold was set to avoid large differences among shareholders. A management committee was formed composed of one or two members from each ward, depending on the number of shareholders in that ward. This committee meets on a monthly basis.

The advantages of a cooperative approach are apparent:

- It relieves the villagers of the work of processing their crops by hand or carrying it long distances to have it processed; this can be done locally and at an affordable cost.
- The money is kept within the community.
- Jobs are created where many men otherwise would be forced to go to the southern plains or to India.
- Any cash surplus is reinvested in projects that benefit the entire community.
- The mill area becomes a center for market activities and for exchanging views and information.
- Possibly most important, such an undertaking can be an incentive for active community involvement in other projects. This can reinforce among the villagers the idea that they can help bring about change

largely through their own efforts, without relying on substantial assistance from outside.

This has been a learning experience for both the villagers and UMN. The low initial motivation might have been reversed if the villagers and their leaders had been better informed about the organization, objectives, and operation of a cooperative and the role of the committee and the members, especially in light of the past failure of several government-initiated cooperatives. Involving villagers in the decisions made by the committee would have avoided such problems as implementing the project at the wrong time of the year. Also, the role played by the "agent of change" (UMN) should have been clarified.

Despite problems in implementing the cooperative water-powered mill project, it is now operating successfully and has recently expanded into other types of work. Agricultural supplies such as insecticide and seed dressing (for storage) are now available at the mill. The cooperative is paying the salaries of two part-time local health workers, has established a health subcenter, and is building a nursery. UMN provides the training and a loan or grant if needed, but the cooperative is responsible for setting up the organization and management structure for these new undertakings.

A second cooperative mill project in Bangbari has since been undertaken. That project was less rushed, and more villager participation was demanded. UMN paid only for the milling machinery; all other costs were borne by the community. Initially nine villages were interested in participating, but because of the demand it placed on the villagers, only four undertook the project. It, too, is now well managed and running smoothly. Registering these cooperatives in order to give their members legal protection is the only remaining problem. The government is reluctant to register new groups because of its experience with many cooperatives that have failed in the past.

Observations

Micro-hydropower projects, like related development projects in remote rural areas of Nepal and around the world, frequently have trouble making a positive impact on the rural sector and then maintaining it without some form of significant continuing external support. Butwal's Small Turbine and Mill Project presents one exception to this pattern. Those concerned with increasing the effectiveness of micro-hydropower projects should analyze the factors that have contributed to Butwal's success.

End uses and viability of micro-hydropower plants

Installing micro-hydropower plants can be costly. Their high cost is compounded if imported machinery is used and if the plants are located in remote areas. Consequently, subsidies are often necessary in order to install and operate these plants, especially if revenues rely primarily on domestic consumer uses of the power. To

place the plants on a more sound financial footing, it is important to introduce and encourage income-generating or productive end uses.

Although persons installing plants in rural areas around the world might expect that numerous rural industries will automatically be established to take advantage of electrical power when it is available, experience has shown that this rarely happens. If specific income-generating end uses are not incorporated in a project's design, the power often is used almost exclusively for lighting. This is probably inevitable, because lighting is the end use most apparent to villagers from rural areas who visit towns and cities. In addition, this use requires minimum additional capital investment on the part of the user, and it often meets an existing need. Lighting generally does not generate income, although it can result in cash savings when electricity replaces kerosene and can also enhance income-generating activities. However, continued operation of installations that provide electricity primarily for lighting usually will continue to require a sizable subsidy.

Butwal's approach to implementing micro-hydropower mills directly addresses this income-generating aspect. Butwal decided to work with a technology that would improve the profitability of an existing income-generating end use in rural areas while introducing the minimum departure from existing technologies that the people of the area had already mastered. With these goals, economically viable end uses were automatically an integral component of the project, not something to be added at a later date. In addition to generating income, Butwal's micro-hydropower plants are also less costly to operate and maintain than the diesel plants they often replace. While electricity could have been generated and used to drive motors to power the same processing machinery, Butwal elected to use mechanical power directly, because this technology was already understood. A mechanical system was also cheaper to install and maintain than the alternator, motor(s), and other electrical components that would have been required to perform the same task. Micro-hydropower plants implemented by Butwal have not had to rely on any subsidies for their success. Rather, their viability is a consequence of an active policy of incorporating productive end uses to generate revenues and an approach to meeting needs in a cost-effective manner suited to the conditions found in Nepal.

While Butwal focused on the direct use of mechanical energy in the design for a viable system, the potential usefulness of electricity cannot be discounted. Several owners of mills that have been in operation for some time have expressed an interest in adding an electricity-generating capacity to their plants. Of course, most of these mills have now paid for themselves, and an electricity-generating capacity could be added at minimum cost. To address a growing number of requests in a natural, evolutionary manner, Butwal now fabricates a frame for its new machinery that has a provision for mounting a car alternator (see Fig. 7.2). In this manner, a small quantity of "safe" (24 V) electricity can be made available to light the mill, permitting work in the evening (Fig. 10.37), and possibly for a few homes near the

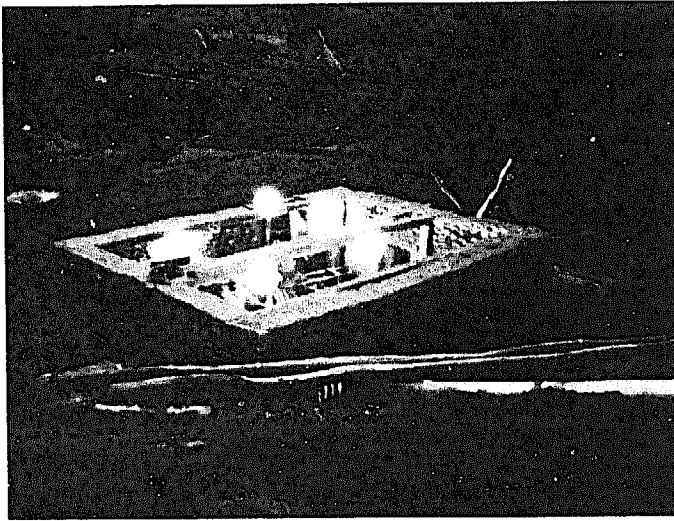

Fig. 10.37. As evening approaches, the lights at a mill under construction are already working.

mill. Owners of several mills near villages have expressed interest in including a 240 V ac alternator in their mill of sufficient capacity to provide power to the villagers, primarily for lighting. Although this is technically feasible, legal questions regarding generation and supply of electricity still have to be resolved.*

Appropriateness of micro-hydropower technology

A number of governments and aid organizations around the world have been or are now involved in small hydropower projects in developing countries. The avowed purpose of many of these projects has been to evaluate the appropriateness of this technology. Although the results of Butwal's applications of micro-hydropower technology definitely have been favorable, the same cannot be said of many results elsewhere. Can a conclusion regarding the appropriateness or inappropriateness of micro-hydropower technology be drawn from all these experiences, or do the results reflect more on the approach to the implementation of such projects than on the technology itself?

Butwal's efforts have resulted in numerous achievements. The UMN began establishing workshops and technical training in the early 1960s. Only in 1975 did it begin seriously to consider fabricating turbines and installing micro-hydropower mills. By 1982, Butwal had installed 65 nonsubsidized mills around the country. The skills in Nepal and its level of economic development are no different from those found in many developing countries. Yet the turbines are designed and fabricated in-country; the mills are installed, maintained, and operated largely by the Nepalese; and virtually all continue to operate successfully. As the pace of implementation picks up, other small workshops in the area are becoming aware of the technology and its implications and, completely on their own, are fabricating machinery. In summary, the experience of Butwal leads to the conclusion that micro-hydropower technology is indeed appropriate. But then, why do the results of projects elsewhere often seem to lead to opposite conclusions?

Like numerous development projects, Butwal's micro-hydropower program was not an indigenous effort. Outside expertise and financial assistance were essential; however, differences from conventional aid projects are numerous. As with other foreign aid projects, expatriate engineers and staff are involved in the Butwal project, but they are there primarily because of a genuine personal commitment to the work (Fig. 10.38). Unlike many consultants, they are involved in this work, not for

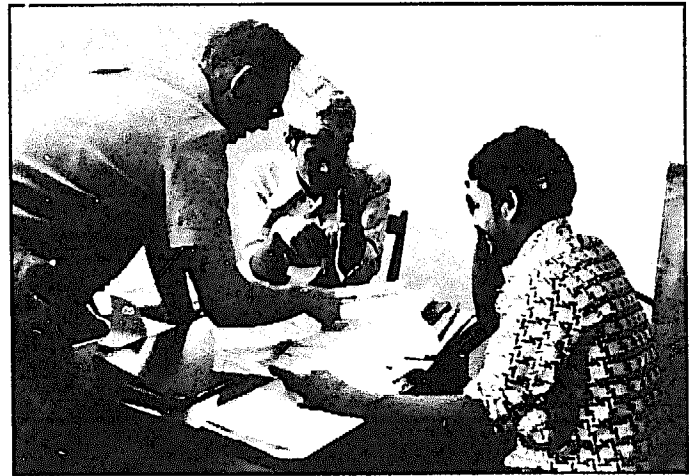

Fig. 10.38. An expatriate staff contributes to an exchange between DCS staff and a customer.

weeks, but often for years. They have time to learn first-hand about conditions in the countries in which they are working. Rather than simply talking about the rural areas in the abstract, they spend days traveling on foot to those areas, staying long enough to understand the people's way of life, their hopes, aspirations, and frustrations. Many speak Nepali, and this prevents the loss of information which often occurs when communications are filtered through an interpreter.

While development is regarded as a long-term, ongoing process, most aid projects demand short-term results. Progress is measured by reaching physical milestones, whereas the real problems are often with intangible aspects—cultural, social, environmental, economic, psychological, and others—that influence or are influenced by the technology. Butwal has the time and experience to deal with many of these problems, whereas most aid projects, faced with largely inflexible deadlines, do not.

This gulf between Butwal's approach and those adopted by more conventional aid projects in implementing micro-hydropower projects may well explain the difference in the conclusions drawn about the appropriateness of this technology. If so, the approach to implementation and not the technology itself should be examined and improved if micro-hydropower technology is to become a viable technology in the rural setting of developing countries.

* Beginning with the 1984-85 fiscal year, His Majesty's Government of Nepal has lifted all restrictions on electricity generation, distribution, and sales of up to 100 kW by the private sector.

VILLAGER-IMPLEMENTED MICRO-HYDROPOWER SCHEMES IN PAKISTAN

Introduction

In the mid-1970s, the Appropriate Technology Development Organization (ATDO), with the technical consulting services and support of Dr. M. Abdullah of the North-West Frontier Province (NWFP) University of Engineering and Technology, Peshawar, launched a program to disseminate micro-hydropower technology and install micro-hydropower plants in remote rural villages in northern Pakistan. Their objective has been to create appropriate designs whose technology and cost can be absorbed by the local population. Ranging from about 5 to 15 kW, nearly 40 plants have been installed to date, at a pace quickening with time as news of these installations spreads. A number of plants ranging in size up to 50 kW are also under construction. Shaft power is used to generate electrical power primarily at night to replace wood or expensive fossil fuels used for lighting. At about a quarter of the sites, it is also used to drive a variety of tools and agro-processing equipment during the day.

Beyond the accomplishment of implementing viable hydropower schemes in remote rural villages, this undertaking features the unusually low cost of US\$ 350 to 500/kW (in 1981 dollars) including distribution. This low cost is attributable primarily to three factors:

- nonconventional use of readily available materials;
- designs suited to local conditions; and
- community involvement in the initiation, implementation, management, operation, and maintenance of the hydropower schemes.

At a time when the high cost generally associated with micro-hydropower schemes is often used as an argument against their appropriateness, especially in a rural setting, the Pakistani exception to the rule prompts a more detailed description of their experience.

Background

In stark contrast to the flat plains that extend over a large portion of Pakistan, the northern part of the country presents physical as well as demographic obstacles to extending roads and the electricity grid and developing the infrastructure necessary to serve its people. The steep, rugged, stone-studded mountains, rendered even more austere by the dearth of trees, discourage inroads. Among these mountains, villagers in scattered and isolated communities eke out a living off the inhospitable terrain (Fig. 10.39). Greener irrigated plots of land are generally restricted to narrow strips on the slopes bordering perennial streams in the valleys. The areas farther removed, if cultivated at all, must make the most of the low rainfall in the region.

Dr. Abdullah's involvement in micro-hydropower projects was triggered by the 1973 oil crisis. After the first OPEC oil embargo, an increasing number of organiza-

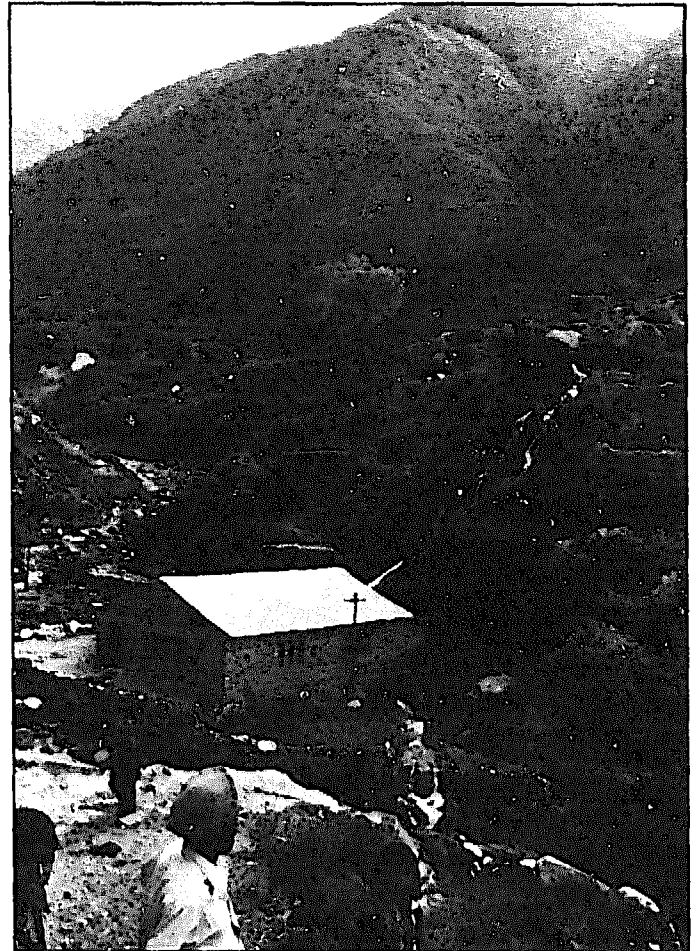

Fig. 10.39. The unusually large and well-built powerhouse at Shang. The virtually treeless terrain is typical of the area. A series of three traditional water-powered mills can be seen behind the powerhouse, each mill using the water leaving from the previous mill.

tions and programs worldwide began to address the problems caused by a dependence on imported oil. Because of the enormity of the problem, however, governments in numerous countries showed little concern or capacity for meeting the relatively insignificant energy needs of those in the rural areas. These include replacing costly fuels, especially kerosene and diesel already in use, and providing these people with some of the basic amenities available to those in the urban areas.

In Pakistan, two alternatives for providing electrical energy to the remote areas without relying on imported fossil fuels were apparent. To the extent that the national grid relied on large-hydropower generation of electricity, grid extension to these areas provided one such alternative. However, the annual development plan of the Water and Power Development Authority (WAPDA), the agency responsible for electricity generation, transmission, and distribution in Pakistan, envisions rural electrification proceeding at the rate of about 1000 villages annually. With three-quarters of the country's 43,000 villages still not electrified, it may take decades to provide electricity to most of them.

The remoteness of the villages, their small population, and the lack of income-generating enterprises combine to making rural electrification by grid extension uneconomical. Under the present system, the average cost of electrifying a village, even one only several kilometers from the main grid, approaches Rs 500,000.* This figure covers only the cost of distribution, not transmission.

Another alternative for providing electricity to the rural areas was onsite autogeneration of power. In the early 1970s, the Ministry of Water and Power installed several small-hydropower plants along conventional lines but, at US\$ 5000-6000/kW, this alternative proved equally uneconomical.

Both the high costs implicit in pursuing either grid extension or autogeneration and the logistical and organizational difficulties involved seemed to preclude the possibility of electrifying the rural areas. If this end was to be achieved, it appeared necessary to develop a new approach, one designed to address the specific conditions encountered in electrification of remote rural areas more appropriately.

The ATDO, under the Ministry of Science and Technology, initiated a program to develop a more viable approach. Although many villages in the mountainous regions had hydropower resources, a reliance on commercial equipment and conventional designs contributed to the high cost of autogeneration. This approach also required skilled expertise to install and to maintain systems on a continuing basis. Consequently, the ATDO focused on developing equipment designs suitable for local manufacture from the perspectives of fabrication, installation, maintenance, operation, and cost. After several attempts, the ATDO adopted the crossflow turbine design made of steel as the one most suited to local conditions. Its design provided ease of fabrication, useful efficiencies, and seemed suited to the head and flow conditions most frequently found in the area. Because new generators were unavailable in Pakistan, the ATDO also attempted to couple reconditioned generators to the turbine. At that time, generators were being imported only as part of a generating set—a complete package of generator and diesel prime mover—and not separately. These attempts to recondition generators were not successful; however, suitable Chinese generators later appeared on the local market.

The ATDO also developed new designs for the civil works and a new approach to implementation. It adopted designs that emphasized the use of local rather than imported materials and the use of locally available manual labor rather than machinery.

Finally, the ATDO sought to devise an administrative and management structure less costly to maintain and more responsive to the needs of small scattered communities. A structure evolved that minimized the need to rely on a central and remote administration. Each community is responsible for all aspects of its own scheme. Decisions on such questions as tariffs, hours of operation, and distribution of power are all made locally, as the need arises.

To bring the technology to the field, several persons supported by the ATDO held discussions in villages where some waterpower potential was apparent. They informed the villagers of the possibilities for tapping this power and gaged their interest in undertaking such a project. Some villages dismissed the idea; others accepted it and made a nominal contribution of labor and cash. These latter villages eventually served as demonstration sites, as examples to other villages of what they could accomplish if they had the interest and resolve.

The idea caught on. Initially, the ATDO envisioned that a team it organized and supported would have to install each scheme. However, the enthusiasm of the villagers and their ability to learn the skills necessary to install these schemes made it possible to share this responsibility with them. The ATDO has also been able to decrease its financial contribution to these schemes in line with its mandate of providing financial support only for the initial development and dissemination of appropriate technologies. Interest is snowballing—about three dozen schemes have been installed, and several dozen new sites are being considered or are under construction. Lillonai, the village where the first scheme was installed, now has four micro-hydropower schemes; in the area around Bishband, there are three schemes in the same small valley. All the plants installed to date continue to operate properly, proving the effectiveness of the ATDO's approach to implementing these micro-hydropower schemes.

The team that coordinates the implementation of these schemes includes a full-time technician and a field officer, who serves as an administrative assistant and maintains contact with the villagers. The ATDO assigns both of these team members to work under Dr. Abdullah's direction. In addition, two colleagues from the university, one civil and one electrical engineer, assist with site inspections and implementation. Personnel from the university workshop or a private workshop fabricate the turbine according to Dr. Abdullah's specifications.

Despite its very limited staffing and resources, the ATDO has installed hydropower schemes in villages in a fairly large geographical area in the mountainous regions of northern Pakistan, in the Swat, Dir, and Kaghan districts in the North-West Frontier Province, and in Gilgit in the Northern Areas. These villages, which generally house several hundred inhabitants, are far from the electrical grid. Some may be situated by a dirt road; others may be half a day's walk away from a road. Agriculture on irrigated or rainfed terraces provides employment and a meager cash income for most.

Implementation and operation

The ATDO adheres to no rigid strategy in implementing its rural micro-hydropower schemes. Its approach can

*Rs 1 = US\$ 0.10

be considered unique only in that it is flexible. Just as a turbine is designed for specific site conditions, so the approach taken in implementing these schemes caters to the social and economic circumstances existing at each site.

In considering the possibility of a micro-hydropower project that could affect an entire village, it is important to consider the intricate interrelationships and constraints to action inherent in a traditional village setting; it cannot be assumed that the "village" will request assistance in exploiting its hydropower resources. The issue is complicated further by the fact that implementing such a project requires access and rights to water, to a suitable site for the powerhouse, and to land through which water is to be conveyed from the river to the powerhouse, usually in an open canal. Consequently, it is an individual or a small group who takes the initiative, persons who retain the respect and trust of the villagers because of their economic and/or social position. They may be traditional village leaders, local entrepreneurs, managers of local cooperatives, or resident landlords. If the group also includes the owner of the land on which the hydropower plant will be built, this simplifies the implementation of a potential scheme. Generally this venture is not formal, although the villagers are encouraged to register with the cooperatives department of the provincial government to avoid future problems and to have access to benefits available through this department, especially loans.

Already operating schemes demonstrate the benefits that result from developing a village's hydropower potential and are responsible for subsequent requests to the ATDO for assistance. After villagers have made a specific request for assistance, the ATDO ascertains whether the national grid will be extended into the area in the foreseeable future. If no extension is planned, then one or more members of the ATDO team visits the village to assess its potential for hydropower development, to investigate the villagers' objectives, and to advise them about possible implications of their decisions and of costs, monetary and otherwise, that would be involved. All stages of the work, from the construction of the civil works to housewiring, are explained. The ATDO approves the project only if it is satisfied that the entire community will share in the accrued benefits. If this point is in question, the ATDO delays or withholds any potential assistance. This practice indirectly nudges the community into fruitful cooperation.

If villager interest appears well founded and genuine, the ATDO discusses the roles of each of the parties concerned. The civil works that will have to be built are also discussed with the villagers, who will undertake the construction by purchasing the necessary materials (possibly cement, timber, and/or wire) and providing the necessary labor. Designs for the civil works are discussed. The ATDO does not prepare engineering drawings because villagers cannot understand them. Instead, it may use small wooden models to convey the design of some of the components of the civil works. For example, a model of a forebay, might be presented, because this is a component unfamiliar to most villagers. On the

other hand, weirs and canals are well understood, having been components of their irrigation systems for centuries.

Because the civil works are rudimentary and their design and construction are well understood by the villagers, they undertake this work themselves under the direction of the scheme's initiators. Although masons and carpenters are often found in the villages, an electrician to wire the households might be found only in a larger town. The villagers are responsible for locating an electrician, who might pass the necessary skills on to resident villagers. The villagers themselves install the distribution lines. Depending on the circumstances, if the initiators of the scheme have more immediate access to cash, they might provide the necessary materials and the other villagers might provide the labor. The ATDO determines the portion of the total cash outlay to be covered by the villagers based on their financial resources. To avoid any misunderstandings, the ATDO has a policy of not handling any cash contributions made by the villagers. With the monies they have collected, the villagers themselves purchase whatever materials are necessary.

During the site work, the ATDO provides the villagers with technical guidance when necessary. Concurrently, the university workshop or a private workshop in Peshawar fabricates the turbine. Because of its simple design, a village-level technician with experience in sheet metal work and welding could build the turbine in several days. With limited staff, however, no effort has yet been made to train local technicians. Generators are purchased and stocked in sufficient numbers so that they are available when required. When the villagers complete the site works, the ATDO team provides guidance in installing the turbo-generating equipment. The entire project can be completed in 3-4 months from the time that a framework for the implementation of the project has been worked out and any disputes, such as those concerning land or water rights or access to future electrical power, have been resolved.

A villager designated by the community operates and maintains the plant. For a few days after completion of the installation, the local operator runs the plant with assistance from the ATDO staff, learning the various tasks necessary for proper operation. Because the system does not incorporate a governor, a principal task of the operator is manually regulating the equipment through the night. Although the lights around the village are generally provided with a switch, this lighting load, which provides the principal load on the generator, does not vary markedly. The operator therefore is not required to adjust the water into the turbine continually to keep pace with changes in electrical load. After early evening, when most of the lights are on, the only major change occurs several hours later as the villagers prepare to retire for the night. Thereafter, the load is maintained at a fairly constant low level, and the plant is shut down at or before daybreak.

The initiators of the project often also manage the system, undertaking operational decisions, including setting a tariff, with the affected villagers, although this is

generally not a formal process. Equitable operation under these circumstances depends on a mutual trust that has evolved over the years. Where the same canal serves for both irrigation and power generation (Fig. 10.40), power generation is relegated to a subordinate position; during the irrigation periods, the plant is either shut down during critical hours or days or operated at reduced power. Whenever required, the villagers contribute their services and perform the necessary maintenance on the civil works without waiting for external assistance. The ATDO maintains a strong link with the local communities through its staff, which makes occasional visits and shares experiences.



Fig. 10.40. The Barkalay powerhouse uses excess water available from an irrigation canal that cuts across the slopes a short distance uphill. Two other hydropower schemes are located farther up this same valley (see Figs. 10.51 and 10.58).

A tariff for the consumption of electricity by the villagers, which is amenable to all, is generally established to cover some of the recurring costs. In one instance, the landlord who initiated the scheme provides free power to those who provided labor toward its construction. Commonly, however, a fixed monthly rate per bulb (generally Rs 4) is set and villagers are asked to use bulbs in the range of 40–60 W. Most homes have three or four incandescent bulbs. No current-limiting devices are used. The villagers involved in the first project implemented with ATDO assistance, a unit at Lillonai generating approximately 10 kW, decided to install individual energy meters (at a cost of Rs 180 to each of the

80 consumers) simply because that was the conventional approach used in urban areas. In this case, the tariff is set at Rs 1/kWh, and the total monthly revenue collected from the villagers is about Rs 900. With initial guidance from the ATDO staff, the manager of each scheme maintains an up-to-date register of all accounts. Nonpayment of the tariff can result in disconnection of power. Government agencies do not collect revenue or levy taxes on these installations.

Lighting is the principal end use of the electrical power generated, although some appliances, such as fans, irons, arc-welders, drills, and televisions, are used occasionally (Fig. 10.41). At one site, an electrically driven wheat thresher/corn sheller is operated in the field (Fig. 10.42). It is moved to convenient locations around the

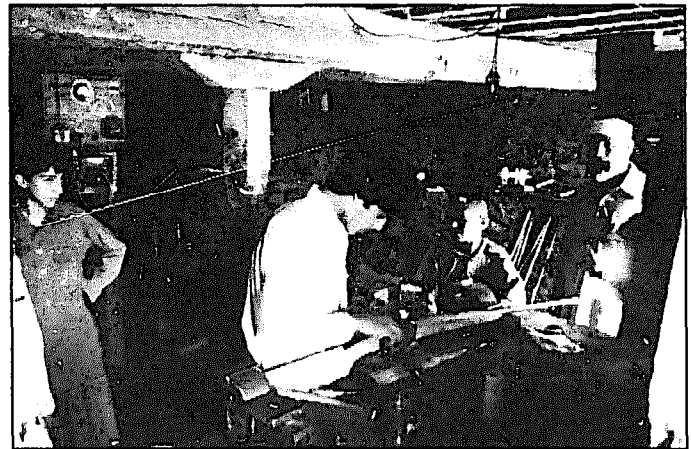

Fig. 10.41. This remote workshop uses electrical power generated at the Barkalay powerhouse.

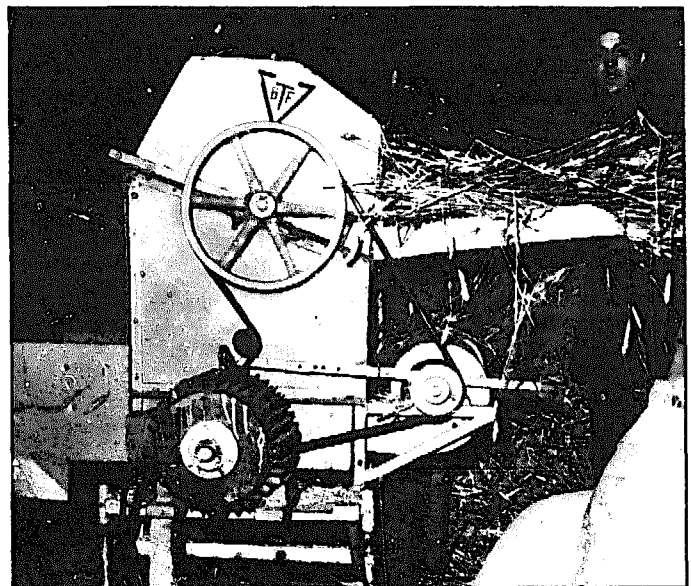

Fig. 10.42. This electric motor-driven wheat thresher draws its power from the Barkana hydropower scheme.

village, and electricity is tapped from a nearby distribution pole. The ATDO encourages other income-generating end uses and provides information on availability and cost of industrial and processing equipment of suitable capacity.

At a number of sites, cottage industries have been established that use direct mechanical power from the turbine to drive a variety of tools (Fig. 10.43). These include flour mills, rice hullers/polishers, band saws, rock-salt grinders, wood lathes, cotton gins, and workshop grinders (Figs. 10.44 through 10.46) and are generally used during the day when electricity is not generated. At some sites, the owner of the powerhouse site purchases his own equipment. Where a cooperative undertakes a micro-hydropower scheme, the provincial Department of Agriculture and Cooperatives provides

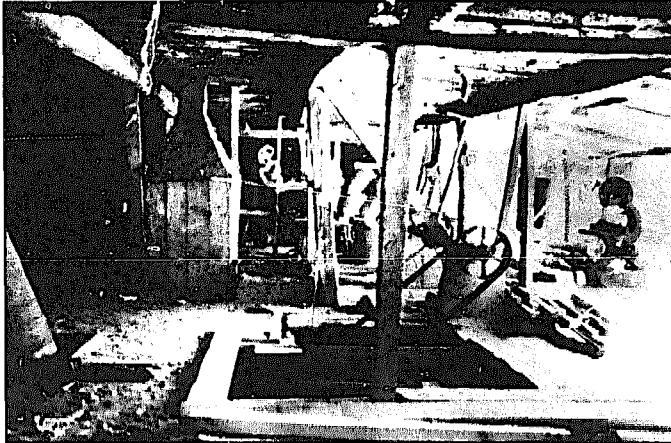

Fig. 10.43. In addition to generating electricity, a belt drive from the turbine (below floor level) drives numerous tools at one of the powerhouses at Lillonal.

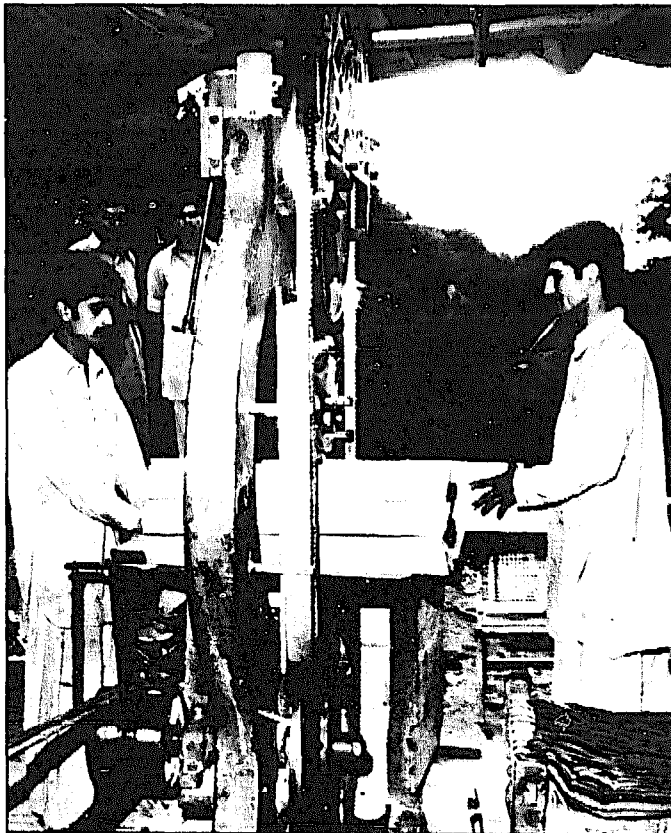

Fig. 10.44. At a number of remote powerplants, flat belts directly couple the turbine to a variety of equipment.

loans for end-use equipment. Numerous banks in Pakistan have introduced programs to make loans to farmers for agro-processing equipment powered by micro-hydropower plants.

Technical designs

Appropriate designs of the components and the entire system account for the very low costs incurred in

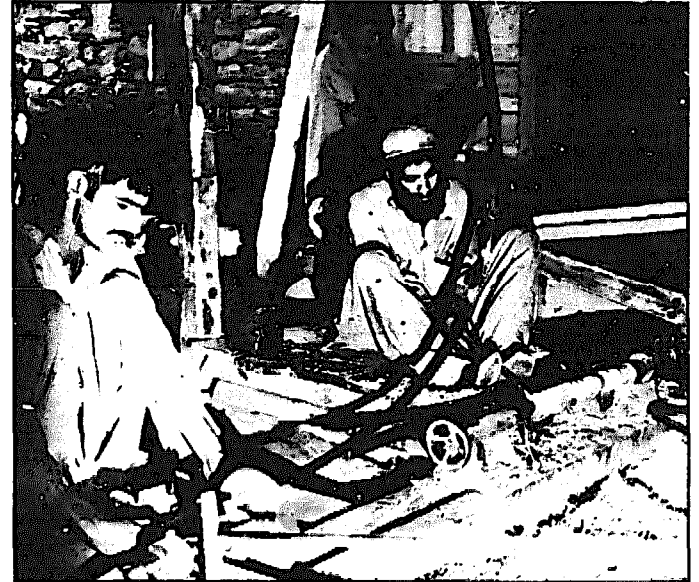

Fig. 10.45. Direct belt drives power a grinding wheel (being used to sharpen a band saw blade), wood lathe (turning a leg for a bed), and grain milling machine in background.

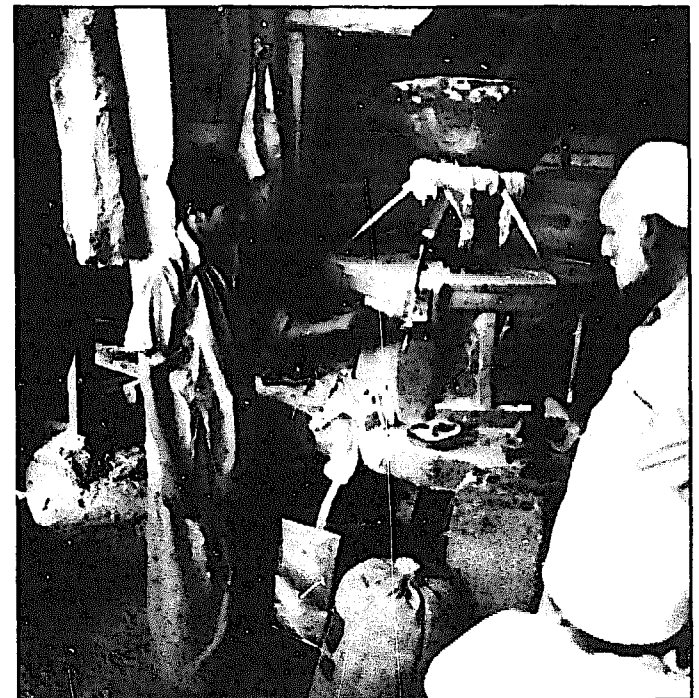

Fig. 10.46. Turbines at a number of powerhouses are directly coupled to flour milling equipment.

implementing the ATDO micro-hydropower schemes. They also permit possible use of the villagers themselves to install, operate, and maintain the schemes with little outside assistance.

Civil works

The construction of the civil works maximizes the use of local materials. Not only does this reduce costs, but it permits the use of materials and construction techniques with which the villagers are familiar. Once involved in the construction, the villagers then understand the operation of the system's various components and are better able to maintain the civil works on a continuing basis.

Intake area. A temporary diversion structure—a low wall of stones across the stream—directs part of the flow into the intake. A major advantage of this temporary diversion is that it easily washes away during periods of heavy rains and flooding, no longer restricting the streamflow or funneling it into the intake. The flood waters continue downstream unhindered, carrying potentially destructive boulders and debris down the river. The villagers can then rebuild the diversion after the flood waters have subsided. If possible, the actual intake is placed so that the natural contour of the land, rock outcroppings, or large boulders protect it from flood waters and waterborne debris. In this manner, an intake for a micro-hydropower plant is similar to the innumerable intakes to irrigation canals that have dotted the local streams for generations (Fig. 10.47). No

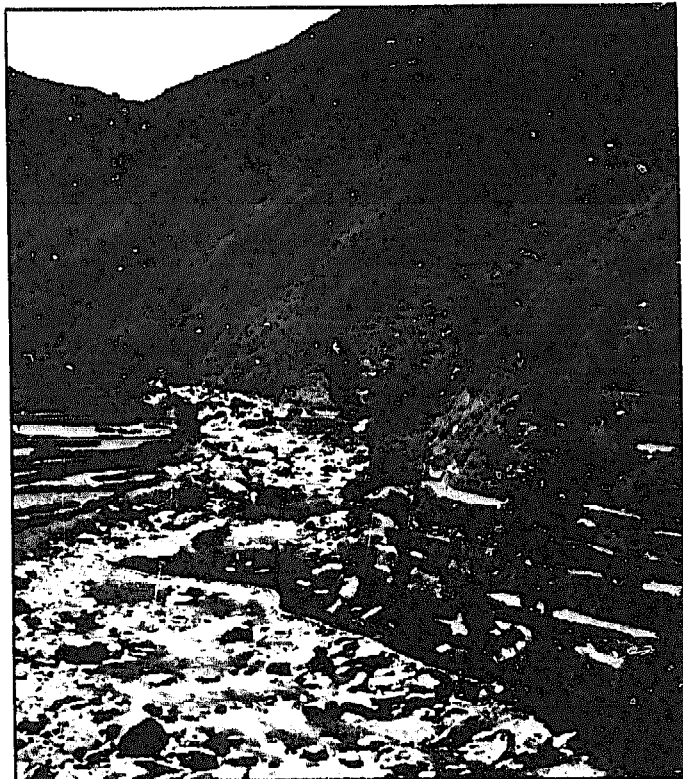

Fig. 10.47. A temporary structure across the river diverts a portion of the water into an irrigation canal at the right. Similar structures are used with hydropower schemes.

new skills have to be brought in from outside the community. Permanent dams or diversion structures used elsewhere require high-cost materials (concrete and steel) that must be purchased elsewhere, appropriately trained and experienced individuals usually from outside the community, and adequate engineering studies.

Power canal. At most sites, the power canal closely parallels the river (Fig. 10.48). It is similar to the traditional irrigation canals used in the region, except that it may be of slightly larger cross-sectional dimensions to convey the larger flow that is usually required for power generation at low head. It is typically an unlined earth canal. When part of the canal is built above the original terrain or passes through porous soils, that portion may be lined with concrete or constructed of masonry (Fig. 10.49). There are no settling ponds; instead, any



Fig. 10.48. An earthen power canal conveys water to the Alpuri powerhouse.

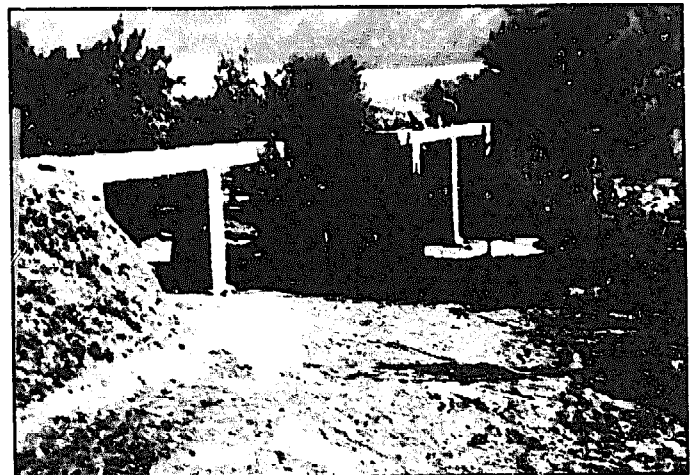

Fig. 10.49. A flume constructed of concrete and supported by masonry pillars conveys water from the canal to the powerhouse (behind the trees) at Bunji.

settling occurs in the canal itself. Depending on the site, a power canal therefore may have to be cleaned out monthly using village labor, and this may take a few days. The only kind of settling area that might be included in the scheme to save on labor would be a properly designed concrete-lined structure, but this would involve increased cost. In selecting an appropriate design, the trade-off between cost and labor must be considered. The approach actually adopted in Pakistan suits local conditions well. Labor is more readily available than capital, and the geography often precludes finding sufficient land for a settling area.

Forebay. The power canal terminates in a forebay, which is one of the few areas where concrete is used. Even so, the portion of the forebay that actually conveys the water is small, often having approximately the same cross-section as the canal itself (Fig. 10.50), and it is only on this immediate portion that concrete is used.

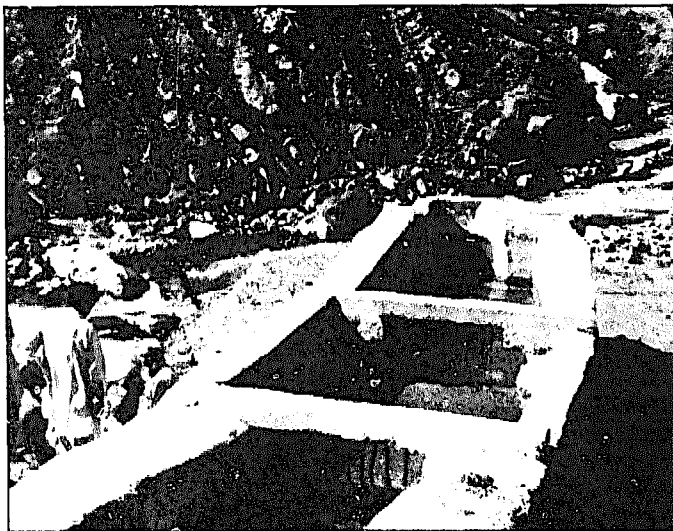

Fig. 10.50. Trashracks located just before the intake to the oil-drum penstock at Alpuri.

The forebay serves neither to store water nor to permit substantial settling to occur. A spillway is provided either before the water actually enters the forebay or as part of the forebay. A wooden sluice gate that is used either to shut off the flow into the penstock completely or to control the waterflow is included in the forebay. To eliminate bends in the penstock and to minimize its length, the forebay is placed as nearly above the powerhouse as practical (Fig. 10.51). Accordingly, the forebay is often built up above the natural terrain. To minimize use of concrete, it is often constructed of dry-rubble masonry (Fig. 10.52). Generally, concrete is used only on the upper portion of the forebay, that portion that actually contains the water.

Penstock. A range of materials can be used in the construction of the penstock. Sites with heads greater than about 6 m use conventional, relatively costly, steel pipes that are made in town. The flanged pipe sections are then transported to the site, where they are bolted together. A gate valve is included just before the nozzle, eliminating the need to run up to the inlet of the

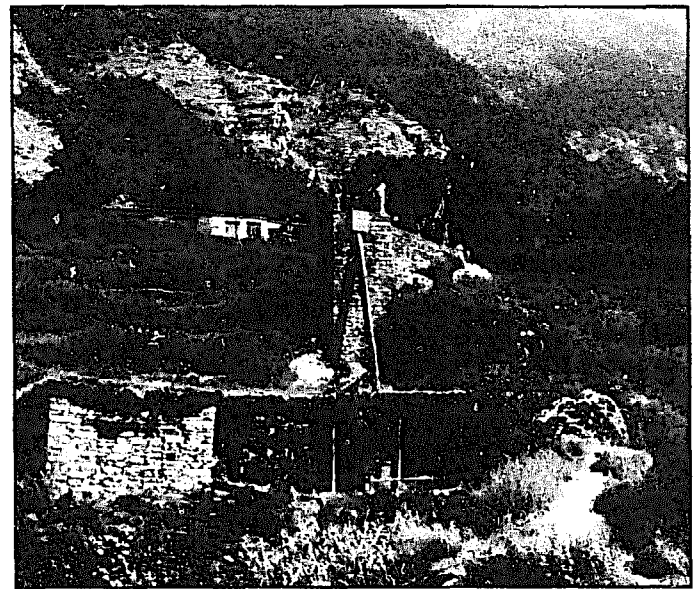

Fig. 10.51. A nearly vertical steel penstock leads to the turbine in the Bishband powerhouse.

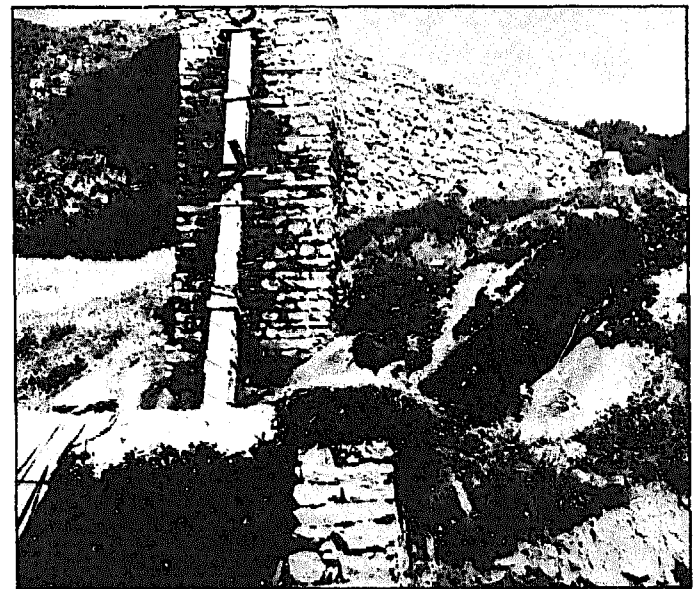

Fig. 10.52. A close-up view of the dry-rubble masonry forebay structure at Bishband. The wooden penstock was later replaced by a steel pipe (see Fig. 10.51).

penstock each time the flow must be adjusted to match the load. At lower-head sites, 200 l oil drums are sometimes used (Fig. 10.53). These are generally welded in pairs, bottom to bottom, and then transported to the site, where they are secured together with clamps. At the lower end of the cost spectrum, wood, which is sometimes available in abundance locally, is also used (Fig. 10.54). These penstocks of rectangular cross-section are fabricated of heavy, longitudinal planks, secured by large nails where appropriate and reinforced by occasional wood and steel clamps. The inner surface and joints are painted with coal tar to seal any small openings. If the penstock is built of either oil drums or wood, no gate valve is used. Instead, the flow is con-



Fig. 10.53. An oil-drum penstock passes through the ceiling to the turbine, which is placed below floor level at a powerhouse at Llllonai (Fig. 10.56).

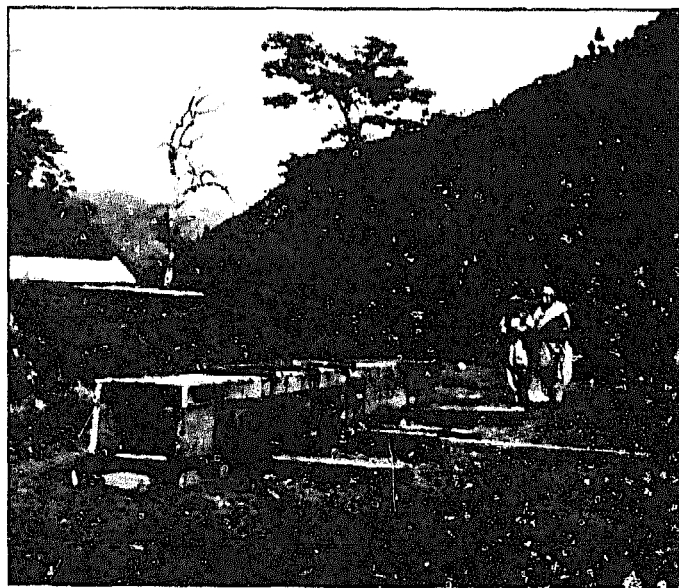

Fig. 10.54. The wooden penstock for use at the micro-hydropower scheme at Mandal.

trolled by placing a board across the inlet to the penstock.

The respective positions of the forebay and powerhouse are selected to maximize slope—to minimize penstock length for the available head—and to avoid the need for any bends along the penstock. Consequently, the penstock is steep and usually 5-15 m long. The upper end of the straight penstock is incorporated in the wall of the forebay. The lower portion ends with a rectangular nozzle made from sheet steel (Fig. 10.55) or from an oil drum (Fig. 10.56). At some sites, the forebay completely supports the longitudinal thrust of the penstock caused by its weight. At others, this is achieved by concrete or stone-masonry anchors in the powerhouse (Figs. 10.53 and 10.57). In both cases, lateral thrust is supported by the forebay and the stone wall of the powerhouse. Because the penstock is short, straight, and steep, anchors along its length are not often used.

Powerhouse. The powerhouse is generally built of dry-rubble masonry with a timber roof (Fig. 10.58). The turbine is often set 1-2 m below the level of the powerhouse floor to maximize the available head without expending a lot of additional effort excavating for the entire powerhouse.

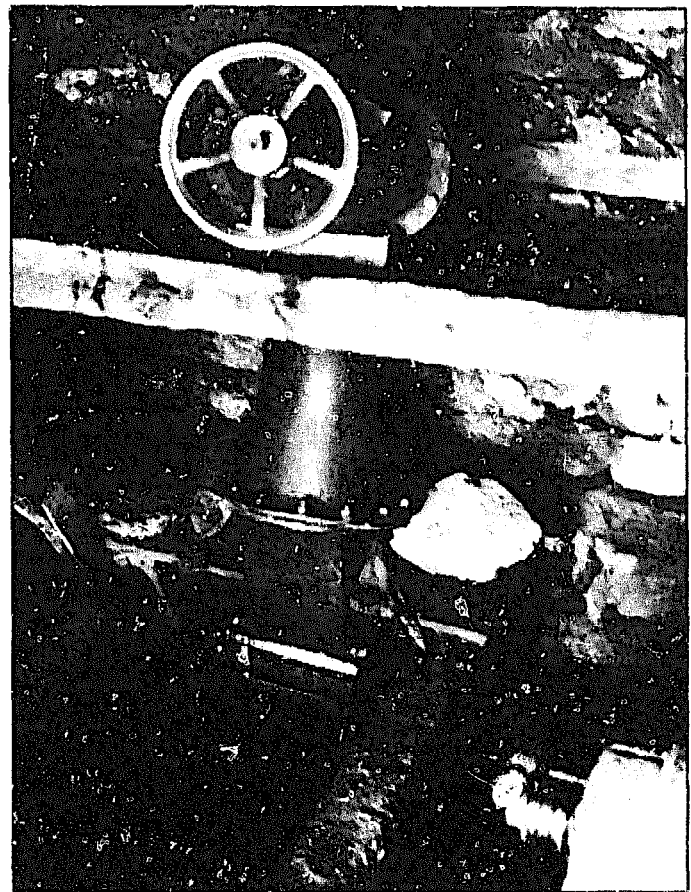

Fig. 10.55. An example of the simple design used by the ATDO. The steel penstock into the Bishband powerhouse terminates with a rectangular nozzle. The shaft with crossflow turbine is supported by bearings on a small concrete base, and wooden slats and cover prevent water from spraying out. A gate valve is not used at most sites.

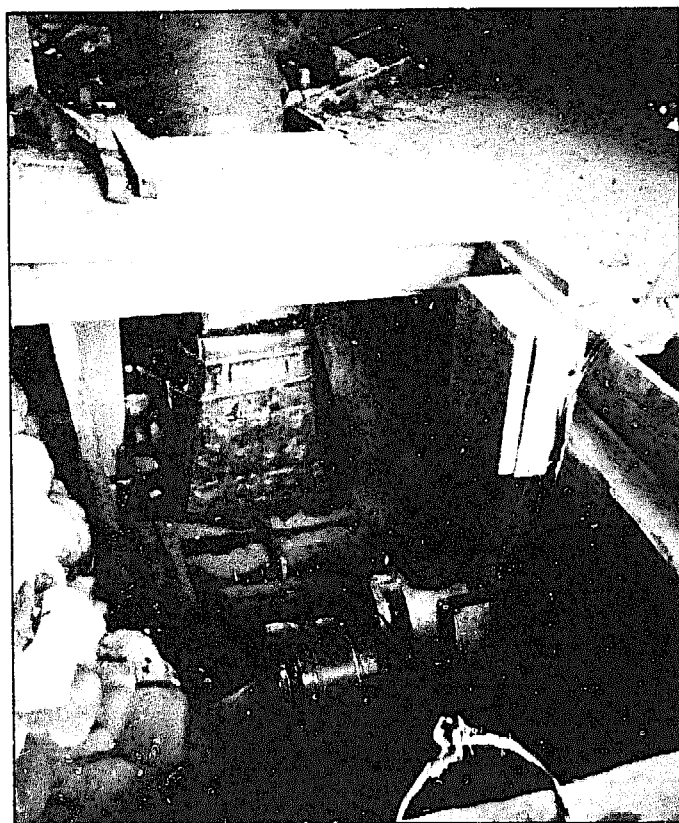

Fig. 10.56. A view of the turbo-generating area below floor level at one of the Lillonai powerhouses. The last oil drum used in the penstock is tapered to form a rectangular nozzle leading to the turbine (under the wooden cover). Also visible is the generator and separate exciter.

A single-stage, multiple V-belt drive couples the runner to the generator, which is usually somewhat above the turbine, closer to, or at, floor level (Fig. 10.59). In addition to housing the electrical equipment needed to generate electricity, the powerhouse may also serve as a workshop and contain a variety of agro-processing equipment and other machinery. These are driven by flat belts off a long intermediate drive shaft, which itself is belt-driven by the turbine. Belts are simply thrown over appropriate pulleys as the various tools are needed.

Turbo-generating equipment

Turbine. The ATDO selected a crossflow turbine because it is suited to the low heads found at most sites and is easy to fabricate, requiring no precision machining or close fits. The end-plates of suitable diameter are cut from 6 mm mild steel plate, and the blades of sufficient length are shaped by hammering strips of 3 mm mild steel sheet to the proper curvature. With some units, blades are cut from steel pipe of appropriate diameter. The end-plates are marked to indicate the position of the blades. The components are arc-welded together and onto the steel shaft. To date, no jigs have been used in the fabrication of the units, and there has been no attempt at standardization. Both lab



Fig. 10.57. The oil-drum penstock at the Alpuri powerhouse. The operator's bed is in the foreground.

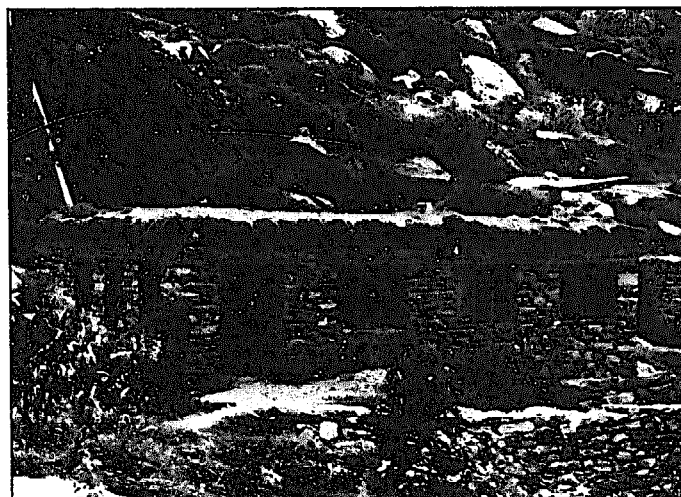

Fig. 10.58. The powerhouse at Jabakhaho.

and field measurements indicate a turbine efficiency of 50%-60%.

Two bearings support the turbine runner shaft and are secured to a small concrete foundation. The nozzle is fixed independently of the runner, with a clearance of

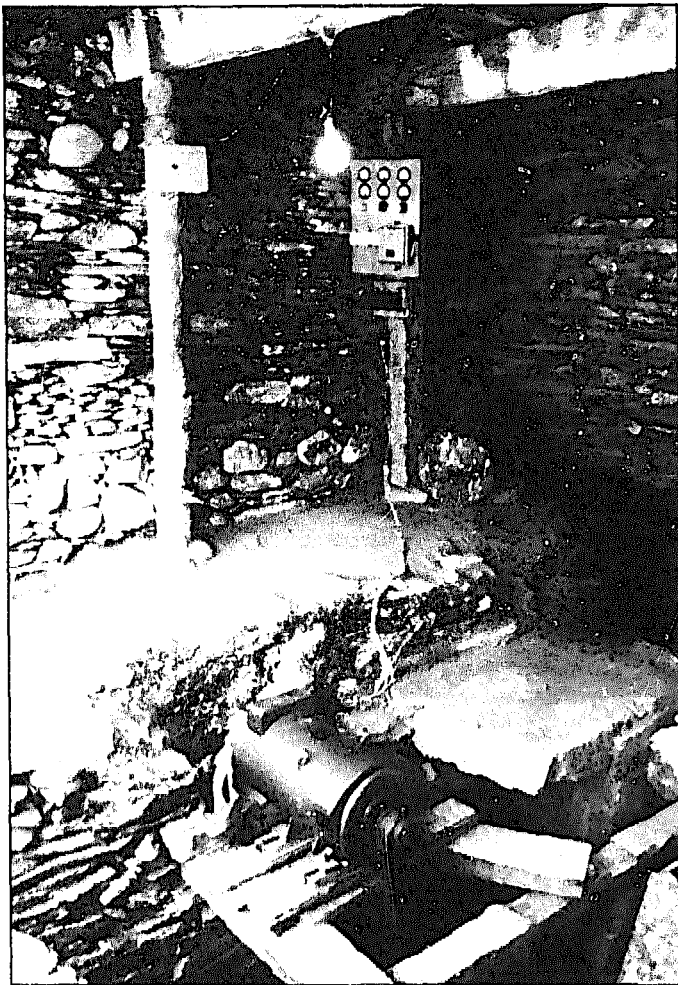

Fig. 10.59. The generator and control panel at the Alpuri powerhouse. An old crossflow turbine is visible in the background.

up to about 0.02 m between them. A simple galvanized iron sheet or wooden cover is used over the runner to shield the bearings, pulleys, belts, and generator from the spray of water emerging from the turbine.

Generator. The generators are made in the People's Republic of China and operate at 1500 rev/min, usually generating three-phase power at 220/380 V. They have a static excitation system and a manually operated voltage regulator. No effort is made to ground the system. A panel board often carries an ammeter for each phase, one or more voltmeters, and possibly a frequency meter. A main thermal circuit breaker box and switch fuse units are also included (Fig.10.60).

Now that the ATDO has reduced the cost of many components of its micro-hydropower schemes, the generator is the single largest component of the total cost (see Table 10.3). To reduce these costs, work toward local fabrication of generators is being organized by the ATDO and undertaken at the University of Engineering and Technology, Lahore, with a grant from the ATDO. Several 1000 rev/min generators, with efficiencies of

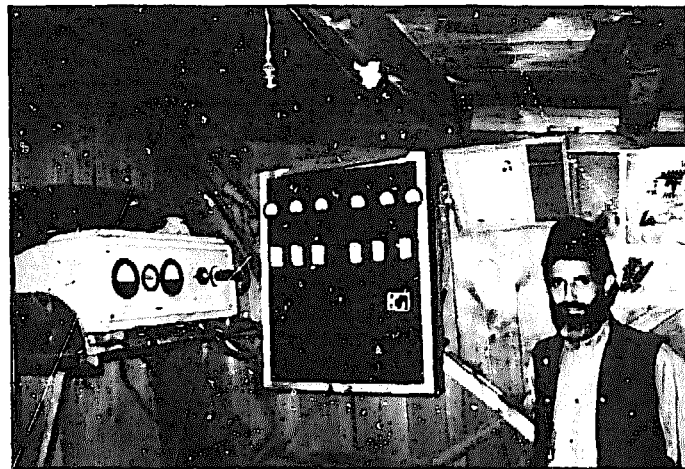

Fig. 10.60. The control panel at Lillonal I, ATDO's first micro-hydropower plant. Several other plants have since been installed in that village.

about 60%, have been built of locally available components and imported sheet steel laminations. Several units are about to be field-tested. However, with a cost reduction of only 25% compared to the price for the imported Chinese generators, the ATDO is examining whether large-scale local fabrication would ultimately prove cost-advantageous.

Governing. No governor or load controller is used with the turbo-generating equipment to maintain a match between the available waterpower and the imposed electrical or mechanical load; therefore, equipment costs are considerably reduced. At lower-head sites, where no valves are included along the penstock, the operator maintains the runner speed within acceptable limits by regulating the flow into the penstock with a wooden sluice gate included in the forebay. The penstock might then operate partially full, resulting in reduced head and jet velocity. Because the turbine must continue to drive a generator at 1500 rev/min and therefore rotate at its normal speed, it will run at reduced efficiency at this reduced head. This is of no concern because of the adequate streamflows that are generally available. At higher-head sites, a gate valve at the base of the penstock controls the flow to the turbine. At reduced load, use of the valve introduces turbulence into the jet, reducing efficiency, but again, this is generally of little concern.

In actual operation, the operator does not need to monitor the net load or, more precisely, the frequency or voltage continually. The risk is actually greater that the operator will fall asleep because adjustments to the flow are required so infrequently during the night. The operator remains near the unit all night. At one site, an alarm has been installed to alert the operator of over-voltage conditions. It also includes an overvoltage trip, which then removes the excitation from the generator if the operator has not taken the necessary corrective measures. For short durations, the generators can accommodate the turbine runaway speed encountered when the excitation is removed.

Distribution

The powerhouse is located close to the village, and no transmission system is necessary. A simple distribution line of suitably sized, bare copper wire carries the power to the consumers. A maximum voltage drop is set at about 10%. Wooden poles support the lines. The underground sections of these poles are painted with coal tar. No lightning arrestors are included, because lightning storms pose little threat in the area. Often each phase is distributed to a different part of the village, and occasionally, one phase is kept at the powerhouse, which also serves as a workshop. Although an attempt is made in the design of the scheme to balance the average expected load on each phase, no attempt is made to balance loads continually during the system's operation.

The wiring standard used varies from nationally recognized standards in the well-finished homes to rudimentary wiring in most of the stone, brick, and mud-wall homes. In spite of this, no accidents have occurred. With some schemes, fuses are mounted on the power poles in addition to being installed in each home (Fig. 10.61). Incandescent lamps are used for lighting, although the use of fluorescent lamps is encouraged where the consumer can afford the initial cost.

Costs

Around 1978, the ATDO prepared tables of the capital costs (Table 10.3) and recurring costs (Table 10.4) for the range of its micro-hydropower schemes then installed. This costing information is presented in Pakistani rupees (Rs 1 = US\$ 0.10). The unusually low cost per kilowatt for the ATDO's micro-hydropower schemes—US\$ 250–400/kW (in 1978 dollars)—results from several factors:

- low administrative costs;
- the villagers' contribution of all the labor;
- maximum use of local materials;

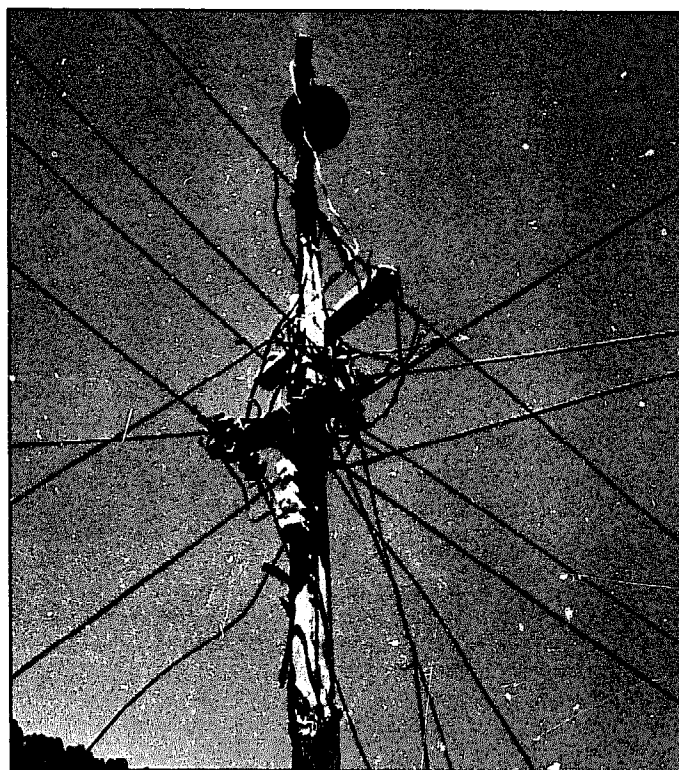

Fig. 10.61. A power pole, with street light and fuses, in the village of Alpuri. Power from a 10 kW micro-hydropower plant provides power to about 100 families in the village.

- local fabrication of some of the equipment;
- appropriate system design (e.g., no attempt to maximize system efficiency, no governor, no full-time staff);
- no provision for a profit margin included in most costings for micro-hydropower installations; and
- minimal use of costly technical expertise and supervision.

The ATDO initially financed most of the machinery and

TABLE 10.3. A breakdown of fixed costs for ATDO micro-hydropower plants (in Rs) (14)

Plant capacity (kW)	Generator	Turbine and accessories	Civil works	Technical assistance	Total installed cost	Distribution cost	Total cost delivered	Total installed cost/kW	Total cost delivered/kW
5.	9,350	1,500	5,000	3,520	19,370	4,000	23,370	3,874	4,674
7.5	12,950	1,500	6,000	3,520	23,970	6,000	29,970	3,196	3,996
10.	14,250	2,000	7,000	3,520	26,770	8,000	34,770	2,677	3,477
12.	16,780	2,000	8,500	3,520	30,300	9,600	39,900	2,525	3,325
15.	20,800	2,500	10,000	3,520	36,820	12,000	48,820	2,455	3,255

TABLE 10.4. A breakdown of annual operation and maintenance costs for ATDO micro-hydropower plants (in rupees) (R14)

Plant capacity (kW)	Labor	Belt	Miscellaneous repairs	Total operation and maintenance costs
5.	1,800	200	150	2,150
7.5	1,800	250	200	2,250
10.	1,800	300	250	2,350
12.	1,800	375	350	2,525
15.	1,800	450	450	2,700

materials required in the installation of the micro-hydropower schemes. This was partly for promotional reasons—people needed to be aware of what the "product" was, as well as its usefulness, before they would consider buying it. In addition, capital is generally in short supply in rural villages. As the technology is becoming established and its potential use is becoming visible, the ATDO contribution is being phased out. Its role of designing and disseminating this technology largely has been completed. The local population and provincial authorities are carrying an increasing portion of the capital costs. At present, the ATDO covers the cost of its technical services and half of the generator cost; the provincial government bears the other half of the generator cost, and the villagers cover the cost of the civil works. The three parties split the cost of the

turbine and materials necessary for the distribution and housewiring.

The ATDO has also performed a cost analysis for plants of the same size as those noted previously. For this analysis, the ATDO assumed a plant life of 25 years, a 13% interest rate, a 30% plant factor, and distribution losses of 5%. Its findings are noted in Table 10.5. For the range of power outputs covered by the ATDO micro-hydropower schemes, costs generated are in the US\$ 0.02-0.04/kWh range (in 1978 dollars).

Observations

Continuing progress in implementing micro-hydropower schemes in the rural areas of Pakistan and growing awareness of their potential is leading to an increased demand for assistance. This raises several questions, which are addressed below.

Expanding the scale of the program

Is it possible to maintain the effectiveness of the present program, yet to continue to implement projects to keep pace with increasing demand for assistance? What constraints hinder achieving this goal?

At present, responsibility for all design work and other technical assistance, arrangements for financial support, administration, and coordinating activities with interested villagers falls upon the very limited staff of three supported by the ATDO. Much time and effort are expended in addressing these functions; however, equally demanding are the time and effort required to visit the widely separated villages in remote areas of the country.

TABLE 10.5. A cost analysis for ATDO micro-hydropower plants (in Rs) (14)

Plant capacity (kW)	Annual energy generated @ 30% plant factor (kWh)	Annual energy delivered @ 5% distribution losses (kWh)	Total installed cost (Table 10.3)	Annual equivalent installed cost @ $i = 13\%$, $n = 25$ yrs	Annual operation and maintenance costs (Table 10.4)	Total annual cost, without distribution	Total cost/kWh, without distribution	Total cost delivered, i.e., including distribution (Table 10.3)	Annual equivalent cost delivered @ $i = 13\%$, $n = 25$ yrs	Total annual cost, with distribution	Total cost delivered/kWh
5.	13,140	12,483	19,370	2,643	2,150	4,793	0.36	23,370	3,188	5,338	0.44
7.5	19,710	18,725	23,970	3,270	2,250	5,520	0.28	29,970	4,089	6,339	0.34
10.	26,280	24,966	26,770	3,652	2,350	6,002	0.23	34,770	4,744	7,094	0.28
12.	31,536	29,959	30,300	4,134	2,525	6,659	0.21	39,900	5,443	7,968	0.27
15.	39,420	37,449	36,820	5,023	2,700	7,723	0.20	48,820	6,660	9,360	0.25

To expand the present program, a larger staff is required for implementing projects. This, in turn, leads to several other questions, the answers to which are still unknown:

- What would be the source of financial support for this enlarged staff? Could the provincial government provide such support? If so, would the program's present effectiveness be impaired by accompanying political constraints, bureaucratic inefficiencies and delays, and lack of staff motivation? On the other hand, by redesigning its implementation strategy and passing on its costs to its customers, could such an organization be self-supporting? Could the ensuing financial burden on the villagers be minimized by making loans available, loans which could then be repaid by collecting monthly fees without increasing the fees from those presently charged? Or would this place an unacceptable burden on residents of the rural areas?
- Assuming that the financial problems can be resolved, can persons with the same dedication to the job that is apparent among the present staff be recruited? This latter problem may well prove to be more difficult to resolve than financial problems. Although work in rural areas can be personally rewarding, it is very demanding. That may be one reason why the rural sector is generally largely neglected, while resources continue to pour into urban areas. Dr. Abdullah has already attempted recruiting, but his experience thus far confirms the difficulty that can be expected. Not only must the candidates be willing to undertake the work, but other factors, such as their age, motivation, and sensitivity to local conditions, must also be considered.

Increasing the capacity of the plants

The hydropower plants already implemented by the ATDO have had capacities ranging up to 15 kW. Economically, its approach appears very attractive, especially in view of general experience with small-hydropower projects undertaken by the public and private sectors around the world (Fig. 10.62). Can the ATDO approach be applied to the implementation of larger schemes? How does increasing size change the overall design? What new problems might be encountered?

One factor that cannot be avoided in generating increased power is the requirement for an increased flow of water and/or an increased head. This introduces several possible problems with the implementation of larger projects:

- Sites near adequate load centers where these physical conditions are met must first be found.
- Where water is adequate but limited at times because of other end uses, especially for irrigation, conflicts might arise. Any water used by a hydropower plant is lost to productive land between the elevations of the intake and the tailrace, although it

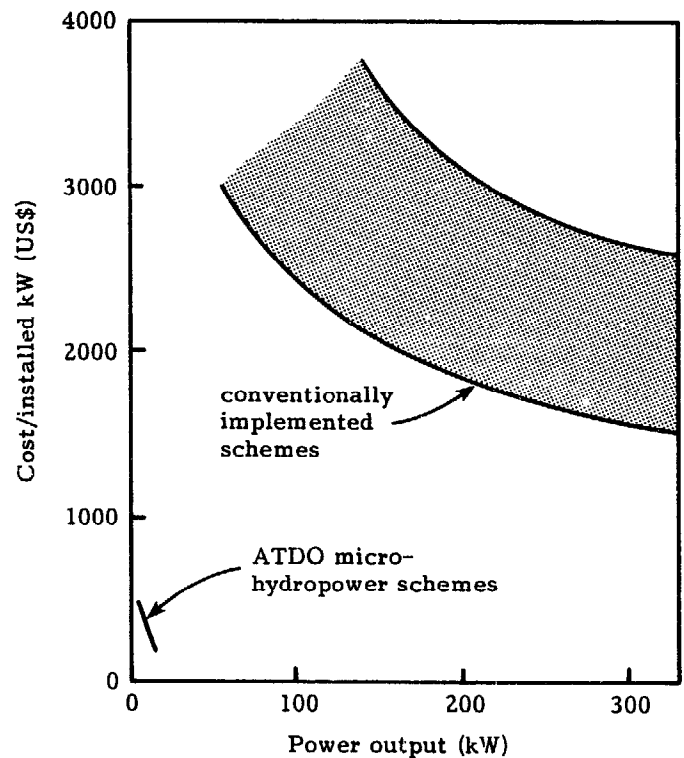

Fig. 10.62. A comparison of the costs of ATDO-sponsored schemes with those of conventionally implemented small-hydropower projects.

is available again at or below the elevation of the tailrace.

- A larger scheme might involve more extensive civil works, which could occupy or interfere with presently productive lands, causing further conflicts. The small ATDO schemes already implemented are either well integrated within the existing irrigation systems or occupy short strips of land along the river that are unsuitable for agriculture.

The low capital outlay required to implement the ATDO's micro-hydropower schemes is a direct consequence of its approach to implementation. Some of the technical aspects of this approach are applicable to larger schemes. Appropriate designs of the individual components, as well as of the overall system, can continue to reflect the realities found in remote rural areas. However, the use of increased flow and head with larger projects will affect their design: increased flow implies civil works and turbines of larger dimensions; increased head implies a greater working pressure imposed on the turbine and penstock. The construction materials and designs must both reflect these changes. Although micro-hydropower schemes should avoid the approach of simply scaling down designs used for larger hydroelectric projects, the materials and designs used with small projects will tend toward those used by these larger projects as plant capacity increases. This may well imply higher-cost materials; it may also put locally fabricated turbines to the test.

As a plant's capacity increases, the accompanying larger and more varied electrical end uses may require more sophisticated and costly governing and protective devices. Transmission might have to be considered, depending on the size and the layout of the villages that will be supplied by these plants. To date, low costs have been maintained because only rudimentary protective devices have been used and no governing devices or transmission has been necessary.

How nontechnical aspects will affect the implementation of larger schemes is uncertain. Village leaders established in the community have been instrumental in initiating and managing the small ATDO schemes. Additionally, these schemes have been implemented with substantial input and commitments from the local community, whose bond to these leaders often has been based on a time-proven trust. These factors have reduced cost markedly and increased the viability of the projects. But for larger schemes, this raises several questions:

- Is this possible for larger schemes which will cover a broader geographical area and probably include several villages? Is it possible to find a homogeneity of interest and willingness to work together as a larger group?
- How large, and increasingly complex, a system can an untrained person manage and still operate effectively?
- Would this require additional financial, managerial, and technical assistance, which would not be as readily available at the village level?

Near Gilgit in the Northern Areas, the ATDO is implementing a 50 kW hydropower scheme, a size significantly larger than those previously installed. Its experiences with this scheme should provide insights into the problems that might be encountered in implementing and managing larger schemes and the costs incurred.

Benefit to the rural sector

A basic question is whether micro-hydropower plants really improve the lives of the rural poor: Are the "rich" the real beneficiaries? Is electricity a luxury, a projection of the needs of urban-based planners on the rural population? Does it make the poor more dependent on forces largely outside their control for access to the necessary end-use appliances and expertise to maintain both the system and the appliances?

The ATDO method of implementing schemes relies on a few persons to initiate, coordinate, and manage the entire undertaking. However, these persons, by virtue of their economic or other standing, are apt to benefit more from the villager contributions to the scheme, both financial and labor. Are the villagers assisting the "rich in getting richer" at their expense, or are they reaping actual benefits in proportion to their inputs? Can a villager withdraw from the system, if he so

decides, without any net loss to himself? Over time, might the manager gradually manage the scheme to his own end on the pretext that the villagers have already reaped benefits commensurate with their original contributions, both physical and monetary? Although these are possibilities, there is no indication that these concerns are warranted for the ATDO-implemented micro-hydropower schemes.

Because the poor often live just beyond a subsistence level, they may be conservative, hesitant to accept new ideas that might compromise their already precarious economic position. But the villagers do tap onto the electricity system at the ATDO sites and seem willing to continue paying the monthly tariff, a fact which presumably indicates that they believe it is to their advantage.

Assuming the schemes continue to be managed equitably, are the stated villager benefits, primarily electricity for lighting, actually net benefits? If electricity replaces kerosene or wood previously used for the same purpose, any net benefit can be determined fairly easily, because a cash value can be assigned to it. If newly introduced lighting contributes to increased income-generating productivity, then net benefits can be determined fairly easily. But if electricity is used because it is now available, whereas nothing was used previously, the conclusion is not clear-cut. The villager will incur a new expense and will require additional income to cover it.

Social and other benefits derived from electrification that have no direct cash value may be sufficient rationale for implementing a subsidized scheme. However, this is a luxury not afforded self-supporting schemes, which must cover the costs they incur.

Replication in other countries

The approach undertaken by the ATDO in Pakistan provides an attractive alternative, given the prevailing trend of high cost per installed kilowatt for small-hydropower schemes around the world. However, two points must be stressed:

- The low costs described in this case study are for micro-hydropower plants with an output of 5-15 kW. Until plants with higher capacities are operational, it would be unwise to extrapolate from the experiences gained to date and to assume that the costs of hydropower schemes would remain low for plants of greater capacity—that may or may not be the case. Further work in the field is necessary before this assumption can be substantiated.
- Before it is assumed that such an approach and its low costs can be replicated elsewhere, even for installations of small capacity, the factors that have been instrumental in reducing the costs of the ATDO-assisted schemes should be considered. Some of these aspects are more easily replicated outside Pakistan than others.

Local materials have been used in hydropower installations of all sizes throughout the world, despite a frequent bias toward expensive, often imported, "better" materials. Although locally available materials can be incorporated in the design of hydropower schemes to reduce costs in other countries, care must be exercised. For example, the low-cost earth canals used in Pakistan may not be appropriate at other sites or in other regions. Although an attempt to maximize the use of local materials can be made, the extent to which this can be accomplished is site-specific.

Not every developing nation has the experience in and capability for fabricating a range of turbines and associated hardware such as that found in Indonesia and India. In the low power range being considered here, however, most countries have the skills necessary to undertake at least some local fabrication. Outside assistance may be necessary initially in designing appropriate equipment and in training the staffs of local workshops. On the other hand, the necessary expertise may be found in the country, possibly in a university or government ministry or department. Local fabrication of turbines can reduce cost, and any decrease in the equipment's efficiency usually can be offset by increasing the capacity of the turbine slightly. Local capacity for fabrication can also mean that turbines and related equipment can be repaired or replaced more easily when necessary.

ATDO's involvement of villagers in the implementation of its schemes reduced the labor and administrative costs substantially. Such an approach may be possible elsewhere, depending on the villagers' motivation and their commitment to the project, as well as on numerous social and cultural factors. Active involvement of villagers in a rural development project rarely occurs on its own; it may be difficult to initiate even with external assistance.

Approaches to system design similar to those used in Pakistan are possible, but they require the aid of persons with practical experience and a good command of basic engineering skills, who are sensitive to the needs and conditions of rural communities. Devising appropriate designs within a new context requires creativity and flexibility, and often a break from conventional approaches (Fig. 10.63). Finding qualified persons to address this task may be difficult.

One essential requirement for implementing micro-hydropower schemes on a regional basis is a genuine and long-term commitment on the part of the organizations and individuals concerned with following through on such a project. This requirement may be the most difficult to fulfill. The approach taken by the ATDO is not the conventional one, and therein lies the major obstacle. It requires organizations and individuals who can address a wide range of new needs, including:

- an integrated approach to implementation where technical aspects are only one small part of the overall work;

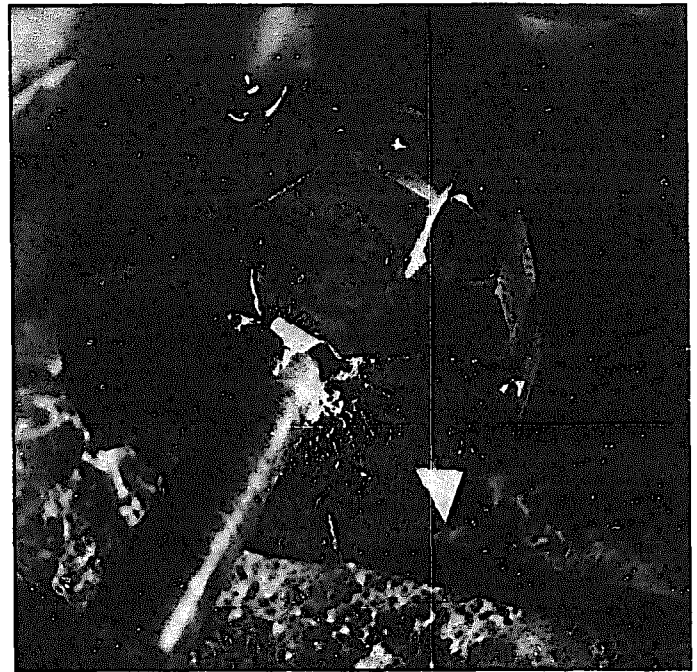

Fig. 10.63. The ATDO approach encourages self-reliance. Rather than relying entirely on store-bought steel pulleys, villagers sometimes construct their own pulleys of wooden half-sections bolted together around the shaft.

- new designs incorporating approaches and materials that may be nonconventional;
- new approaches to funding;
- new organizations at the local level or at least a new scope of work for existing institutions;
- training of a new type of project implementer; and
- conscientious end-use planning and implementation.

It requires persons who are willing to work for extended periods of time in, and are committed to, remote rural areas. It requires a changed emphasis in the objectives of hydropower programs from substituting for imported fuel to rural development.

Unless a long-term commitment can be made to such a project, micro-hydropower schemes elsewhere may not be as low-cost or viable as those in Pakistan. Careful planning for an effective project is essential; otherwise, the attempt may prove expensive and discouraging and may fail to achieve its objectives.

Implications of design on long-term costs

To achieve the low cost per kilowatt for its micro-hydropower schemes, the ATDO has adopted nonconventional approaches to design and implementation. Consequently, each of the various components has a more limited life than is generally associated with hydro-

power projects. For example, temporary weirs will have to be rebuilt after large streamflows, and a canal that has been breached will need to be repaired. Turbine runners will have to be repaired or replaced more frequently, and oil-drum penstock pipe will fail sooner because of corrosion through its relatively thin wall.

The increased attention required to maintain these schemes does not increase their long-term cost as significantly as it may first appear. Repair of the civil structures will require only minor occasional labor from a villager, and this will have little real impact on cost. Patching up weirs and irrigation canals is a task which the region's farmers already know well. The penstock may need to be replaced from time to time, but oil drums are locally available, and arc-welding skills are found in nearby towns. Runner blades of the first turbines often failed (Fig. 10.64) but they could be rewelded or a new runner could be made locally. Unlike most micro-hydropower schemes, the cost of the turbines used at the ATDO sites is insignificant compared to other costs incurred (see Table 10.3).

If the micro-hydropower schemes had been designed more conventionally and if all turbo-generating equipment had been imported, costs resulting from any failure, however infrequent, would have been significant in terms of both money and time lost. In Pakistan, the significant decrease in cost of the ATDO schemes has made micro-hydropower more accessible to remote villagers and permitted them to remain in firmer control over their own situations. There is always a trade-off between cost and quality, but in the remoter areas of Pakistan, an appropriate trade-off seems to have been made.

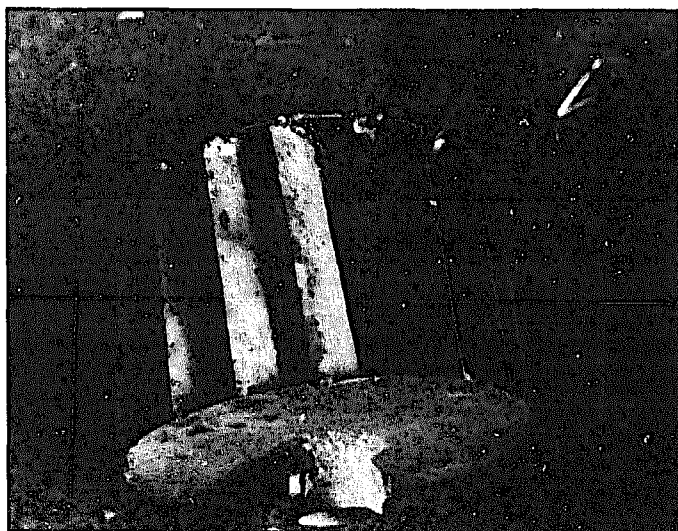

Fig. 10.64. A common problem with the crossflow runner has been the fracture of its blades. Newer blades are now fabricated of thicker steel.

OTHER PROJECT DESCRIPTIONS

Beginning in October 1983, a locally fabricated 25 kW plant began providing power to Namche Bazar, a remote village lying at an altitude of 3400 m, close to the southern entrance of Sagarmatha (Mt. Everest) National Park. Harnessing the power of a small spring emerging below the village, it is providing power to the village through two independent underground distribution systems: one for domestic lighting in the evening and the other for electrical cooking and space heating at tourist lodges at other times. As a UNESCO consultant in charge of the project, Coburn has documented his experiences in The Development of Alternate Energy Sources and the Implementation of a Micro-Hydroelectric Facility in Sagarmatha National Park, Nepal (35). A slide show with taped narration describing the implementation of the project is also available (36). The Nepalese manufacturing company that fabricated the turbine, assembled the turbo-generating package, and assisted with the implementation of the plant has also prepared the report, Namche Bazar Micro Hydropower Plant (91), covering the more technical aspects of system implementation, management, and operation. Projected and actual project budgets and a timetable for implementation also provide useful data.

The experiences encountered in implementing a 6 kW plant in the mountains of Papua New Guinea for electrification of the school complex and staff housing have been documented in Technical Notes on the Baidoang Micro-Hydro and Water Supply Scheme (64).

The National Energy Administration of Thailand has undertaken another well-documented effort. After describing general design considerations, the well-illustrated report, Development of Kam Pong, Mae Ton Luang, Huai Pui, and Bo Kaeo Micro-Hydropower Projects (6), describes the technical, social, and financial aspects of four schemes ranging in size from 35 to 200 kW. These schemes use fairly substantial civil works but locally fabricated turbines.

The photographs in this sourcebook also document efforts to implement micro-hydropower schemes. Several photographs of a single site often provide a better impression of how it has been laid out and developed than a single one. Therefore, sites illustrated by photographs in this sourcebook are listed below by their country and name of the closest village or town. The list does not include the sites described in the detailed case studies in this chapter. The numbers following each entry refer to the numbers of the figures containing the photographs. The power rating listed after the location of each scheme denotes the approximate rated capacity of the plant, if it is known.

Ehutan

Namseling: 1.5

Burundi

Buhiga (220 kW): 4.20, 4.22, 5.41, 5.84, 5.203
Gihéta (90 kW): 4.24, 5.33, 5.34
Kibimba (80 kW): 5.45, 5.52, 5.166, 5.177
Mugere (50 kW): 5.118
Musongati: 4.19
Mutumba (30 kW): 5.54
Nyabikere (110 kW): 5.74
Ruyigi (70 kW): 4.26, 5.119, 5.172, 5.176

India

Maldeota, U.P. (10 kW): 1.7, 4.13, 5.15, 5.43, 5.173,
5.175, 6.18

Indonesia

Amlapura, Bali (90 kW): 1.2
Korupun, Irian Jaya (10 kW): 5.46, 5.167

Kenya

Gatundu: 5.26

Liberia

Yandohun (30 kW): 5.5

Nepal

Baglung (180 kW): 5.82, 5.93
Butwal (1000 kW): 5.28, 5.38, 5.51
Dhading (30 kW): 5.4, 5.30, 5.120, 5.200
Kaireni: 1.7
Khairenitar (280 kW): 5.61, 5.137
Malekhu (0.8 kW): 6.22
Namche Bazar (25 kW): 1.4, 5.161
Thaibo: 7.3
Suspa-Charikot: 7.1
Syangja (80 kW): 5.12, 5.20, 5.25, 5.48, 5.49, 5.50,
5.76, 5.121, 5.122, 5.123, 5.124, 5.134, 5.140, 5.199

Pakistan

Duber, Kohistan (100 kW): 5.6, 5.8, 5.16, 5.23
Kalam, NWFP (100 kW): 5.80, 5.103

Mardan, NWFP: 4.28

Panama

Buenas Aires (10 kW): 5.65
Entradero de Tijeras (50 kW): 4.4
La Tronosa (50 kW): 4.4, 5.39, 5.142

Papua New Guinea

Baindoang, Morobe Prov. (6 kW): 1.8, 5.164
Bundi, Madang Prov. (70 kW): 5.64, 5.106
Gemaheng, Morobe Prov. (1 kW): 5.7, 5.165, 5.194,
6.11
Irelya, Enga Prov. (12 kW): 5.32, 5.47
Kagua, S.H.P.: 5.107, 5.196
Kudjib, W.H.P. (90 kW): 5.188
Rugli, W.H.P. (25 kW): 5.11, 5.99
Yaibos, Enga Prov. (90 kW): 5.14, 5.31, 5.47

Peru

Chacas, Dept. of Ancash (100 kW): 5.185
Quillabamba, Dept. of Cusco (320 kW): 5.27
Tumpa, Dept. of Ancash: 1.3
Yanahuara, Dept. of Cusco (5 kW): 5.19, 5.78, 5.162,
5.202, 6.21

Thailand

Mae Tia: 5.156
Nam Dang (100 kW): 5.18, 5.33, 5.83

United States

Boone, NC (17 kW): 5.35, 5.169
Cherokee, NC: 5.94
Lowesville, VA (6 kW): 5.24, 5.75, 5.190, 6.9, 8.4
North Montpelier, VT (220 kW): 5.17, 5.36, 5.137
Snake River, ID (25 kW): 5.160
Warren, VT (75 kW): 5.42, 5.163

Zaire

Bishalalo, Kivu Prov.: 4.25, 5.178
Katama, Kivu Prov.: 5.79, 6.17
Nyakabongola, Kivu Prov.: 5.9, 5.85, 5.131, 6.10
Nyangezi, Kivu Prov.: 5.174

APPENDIX A

CONVERSION FACTORS AND CONSTANTS

This sourcebook uses metric units, which are in common use in most of the world. Because a significant volume of literature still uses the English system, the equiva-

lents of terms commonly used in hydropower work are given below. All values are given to three significant figures.

Conversion factors

Length

1 cm	= 0.394 in	1 in	= 2.54 cm
1 m	= 3.28 ft	1 ft	= 0.305 m
1 km	= 0.621 mi	1 mi	= 1.61 km

m = meter
in = inch
ft = feet = 12 in
mi = mile = 5280 ft

Area

1 cm ²	= 0.155 in ²	1 in ²	= 6.45 cm ²
1 m ²	= 10.8 ft ²	1 ft ²	= 0.0929 m ²
1 km ²	= 0.386 mi ²	1 mi ²	= 2.59 km ²
1 ha	= 2.47 acre	1 acre	= 0.405 ha

ha = hectare = 10⁴ m²
acre = 43,600 ft²

Volume

1 m ³	= 35.3 ft ³	1 ft ³	= 0.0283 m ³
1 l	= 0.264 U.S. gal	1 U.S. gal	= 3.79 l

l = liter = 10⁻³ m³
U.S. gal = U.S. gallon = 0.134 ft³
(ft³ = 7.48 U.S. gal)
imp gal = imperial gallon = 1.20 U.S. gal

Force

1 N	= 0.225 lb	1 lb	= 0.454 kgf
1 kgf	= 2.20 lb	1 lb	= 4.45 N

N = newton = kg·m/s²
lb = pound
kgf = kilogram force (weight of a 1 kg mass)
= 9.81 N

Pressure

1 kPa	= 0.145 psi	1 psi	= 6.89 kPa
1 kgf/m ²	= 0.00142 psi	1 psi	= 703 kgf/m ²

psi = lb/in² = 2.31 ft (water)
atm = atmosphere
= 14.7 psi = 101 kPa = 1.03 kgf/cm²
= 10.3 m (water) = 33.9 ft (water)
1 m (water) = 0.100 kgf/cm²
Pa = pascal = N/m²

Energy or work

1 J	= 0.738 ft-lb	1 ft-lb	= 1.36 J
1 kcal	= 3.97 BTU	1 BTU	= 0.252 kcal
1 kWh	= 3410 BTU		

J = joule = N·m
cal = calorie = 4.19 J
kcal = kilocalorie = 10³ cal
= energy required to raise 1 kg of water 1 °C
BTU = British thermal unit = 778 ft-lb
= energy required to raise 1 lb of water 1 °F

Power

1 kW	= 1.34 hp	1 hp	= 746 W
------	-----------	------	---------

W = watt = J/s
hp = horsepower = 550 ft-lbs/s
hp (metric) = 75.0 kgf·m/s
= 735 W

Constants

$g = 9.81 \text{ m/s}^2 = 32.2 \text{ ft/s}^2$ (gravitational constant)
 $\nu = 1.00 \cdot 10^{-6} \text{ m}^2/\text{s}$ or $10^{-5} \text{ ft}^2/\text{s}$ @ about 20 °C (70 °F) (kinetic viscosity of water)

Useful equivalents

mean annual runoff: 100 mm/yr = 3.2 t/s/km² of catchment area
1.0 ft³/s/mi² = 11 t/s/km²

APPENDIX B

SIGNIFICANT FIGURES

Many individuals who deal with numbers, including engineers, do not seem to understand how to properly express measurements or the results of the mathematical manipulations of such measurements properly. The advent of the hand-held calculators and personal computers that spew forth solutions to eight figures or more compound this problem.

In determining surface velocity of a stream, for example, if the time taken for a float to cover a distance of 7.75 m were measured as 9.42 s using a hand-held stopwatch, how many would correctly record this as 9.4 s? And how many would realize that the float velocity should be expressed as 0.82 m/s, not 0.824 m/s or 0.8244681 m/s, and that rather than being more precise than 0.82 m/s, the latter two expressions are actually incorrect and misleading because they imply an accuracy that is not warranted?

This problem is encountered during two activities: when measurements are being made and when they are being manipulated mathematically.

When measurements are being made, the results cannot be more accurate than the instruments used to make the measurements. When recorded, the figures included are all the precisely known digits read off the measuring device and one digit, which becomes the right-most, which is estimated (Fig. B.1). The precisely known digits plus the one estimated digit are called "significant figures."

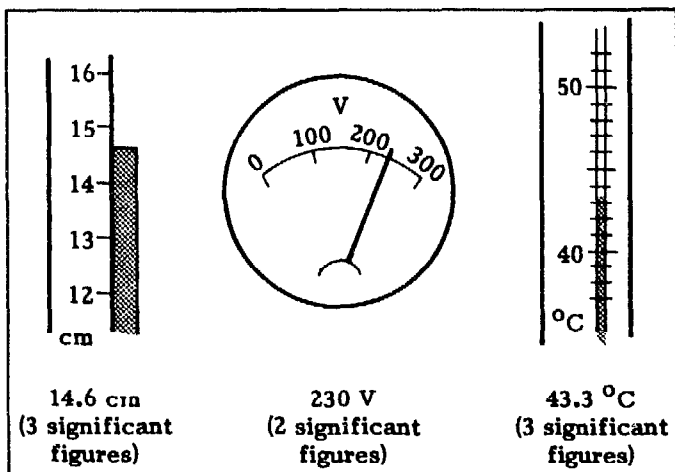

Fig. B.1. Examples of the correct way to record measurements.

This rule is generally true; however, it should not be applied blindly. For example, although hand-held stopwatches can often be read to the nearest hundredth of a second, it can take up to several tenths of a second for a person to react and stop the watch. Consequently, it is fair to say that in the previous example, if the time had been recorded by someone else, it might have been 9.60 s or 9.29 s, rather than 9.42 s. The tenths digits is clearly uncertain but can be estimated; the hundredths digit can be anything from 0 to 9, and recording it is meaningless. This measurement therefore has only two significant figures.

When measurements are being manipulated using multiplication, division, or related operations (such as raising a measurement to a power), the number of significant figures in the result is no larger than the number of significant figures in the least accurate measurement.

For example, because the smallest number of significant figures of the two measurements used to determine the velocity of the float referred to earlier is equal to two (in that case, the number of significant figures in the time measurement, 9.4 s), the velocity derived cannot have more than two significant figures. This can be illustrated as follows. Because there is some uncertainty about the exact value of the tenths digit of the time measurement in this example, the time might be expressed as 9.5, 9.6, or possibly 9.2. If the actual time were 9.2, the velocity measurement could be calculated to be 0.84 m/s rather than the 0.82 calculated earlier. In reality, there is also some error in the measurement of distance, which might change this value further. Consequently, the second digit of the result is uncertain, and it would be meaningless to add a third or fourth digit when recording the result. With the two measurements indicated, the velocity can have no more than two significant figures, one certain and one estimated, no matter how accurate the distance measurement. The least accurate measurement determines the accuracy of the result. In the above example, it can be seen that it is useless to measure any variable more accurately than the least accurate measurement used in a calculation.

As an example of another application of this rule, in calculating the circumference of a wheel measured as 25 cm in diameter (i.e., with two significant figures), it is not necessary to use π to any more than two figures—3.1 will give as accurate an answer as will 3.141592653. This is why "slide-rule accuracy" is more than adequate

for most computations, and a calculator may contribute only speed to the effort, not additional accuracy.

The rule for the addition and subtraction of measurements should be more obvious. If, for example, the gross head at a site were correctly measured and recorded as 143 m and the loss from turbulence and friction within the penstock were correctly calculated as 2.3 m, the net head would be the difference, or 41 m, not 40.8 m. As recorded, the units digit of the head measurement is an estimate; the tenths digit is unknown. Therefore, no matter how accurate the loss calculation, the tenths digits in the difference must also be completely unknown and therefore should not be included.

Another error of addition is one frequently found in budget estimates. Suppose, for example, that the cost of penstock pipe for a proposed micro-hydropower scheme is estimated at \$6300 and that about 25 bags of cement at \$9.25/bag (or \$231.25) will be required. The sum of these two components would often be expressed as \$6531.25, but this is incorrect for several reasons:

- The quantity of cement required is probably an estimate, with probably two significant figures--it might

be 23 bags or possibly 26 bags--therefore, the price should be expressed correctly as \$230 (with two significant figures, for the reasons mentioned previously). It is not known more accurately.

- The pipe estimate is also expressed to two significant figures. Although the price for the pipe eventually may be \$6086 or possibly \$6422, the current estimate is known to only two significant figures. The hundreds digit is unknown and is estimated; therefore, adding the two costs cannot lead to an estimate more accurate than \$6500, because the tens digit for the pipe costs is completely unknown. In reports and proposals, however, such a cost would frequently and incorrectly be expressed to four or six decimal places, even in estimates prepared by engineers who should know better.

In using this publication, it must be kept in mind that, although the conversion factors and constants found in APPENDIX A (p. 265) are expressed to three significant figures, all computations in the body of the text are expressed to two significant figures.

APPENDIX C

GUIDE TO FIELD DETERMINATION OF SOIL TYPE*

Clay

A clay is a fine-textured soil that usually forms very hard lumps or clods when dry and is quite plastic and usually sticky when wet. When the moist soil is pinched between the thumb and fingers it will form a long, flexible "ribbon". Some fine clays, very high in colloids, are friable and lack plasticity in all conditions of moisture.

Clay loam

A clay loam is a fine-textured soil which usually breaks into clods or lumps that are hard when dry. When the moist soil is pinched between the thumb and finger, it will form a thin "ribbon" which will break readily, barely sustaining its own weight. The moist soil is plastic and will form a cast that will bear much handling. When kneaded in the hand, it does not crumble readily but tends to work into a heavy compact mass.

Silt loam

A silt loam is a soil having a moderate amount of the fine grades of sand and only a small amount of clay, over half of the particles being of the size called "silt". When dry, it may appear cloddy, but the lumps can be readily broken, and when pulverized, it feels soft and floury. When wet, the soil readily runs together and puddles. Either dry or moist, it will form casts that can be freely handled without breaking, but when moistened

and squeezed between thumb and finger, it will not "ribbon" but will give a broken appearance.

Loam

A loam is a soil having a relatively even mixture of different grades of sand, silt, and clay. It is mellow, with a somewhat gritty feel, yet fairly smooth and slightly plastic. Squeezed when dry, it will form a cast that will bear careful handling, while the cast formed by squeezing the moist soil can be handled quite freely without breaking.

Sandy loam

A sandy loam is a soil containing much sand, but which has enough silt and clay to make it somewhat coherent. The individual sand grains can readily be seen and felt. Squeezed when dry, it will form a cast which will readily fall apart, but, if squeezed when moist, a cast can be formed that will bear careful handling without breaking.

Sand

Sand is loose and single-grained. The individual grains can readily be seen or felt. Squeezed in the hand when dry, it will fall apart when the pressure is realized. Squeezed when moist, it will form a cast, but will crumble when touched.

* This section was extracted from the On-Farm Water Management Field Manual, Vol. I, Irrigation Water Management (54).

APPENDIX D

PREPARING CONCRETE*

Concrete is composed of cement, sand, gravel, and water. To obtain workability, strength, durability, and impermeability, the above ingredients must be mixed thoroughly. Good-quality concrete should weigh from about 2300 to 2350 kgf/m³.

Cement

Cements are classified by their properties and chemical composition. Normal setting Portland cement (Type I) should be used for concrete structures and concrete watercourse linings when the concrete is not subject to sulfate attacks from the soil or water.

Sand and gravel

Sand and gravel used in quality concrete must be clean and free of clay, silt, and organic matter. The presence of these foreign materials will prevent the cement from binding the sand and gravel together and result in a weak and porous concrete.

Sand particles for concrete should be clean and hard and range in size from very fine to those that will just pass a No. 4 sieve (4.75 mm).

Gravel must be hard and durable and reasonably well graded and range in size from 1 to 4 cm. Maximum size shall not exceed one-third of the thickness of nonreinforced concrete or three-fourths of the clear space in reinforced concrete.

Water

Water must be clean and free from silt, oil, salt, alkali, and acid. Generally speaking, water that is fit to drink is suitable for mixing concrete.

Proportions

The proportion of gravel, sand, cement, and water must be measured and controlled accurately. This requires the use of scales or calibrated measuring containers. A minimum of six bags (50 kg/bag) of cement and 1.2 m³ of well-proportioned sand and gravel that has been screened or tested will yield approximately 1.0 m³ of quality concrete. The 1.2 m³ of sand and gravel should

have a ratio of 65% gravel and 35% sand. This is about a 1:2:4 (cement, sand, gravel) volume proportion.

A minimum of seven bags (50 kg/bag) of cement with 1.2 m³ of fair to poor sand and gravel (all pit run) will yield approximately 1.0 m³ of quality concrete. The 1.2 m³ of sand and gravel should have a ratio of 40%-50% maximum of sand and 50%-60% minimum of gravel. This is about a 1:2:3 (cement, sand, gravel) volume proportion.

The water/cement ratio is a critical factor in quality concrete. Lowering the water content will result in stronger concrete, but the amount of water must be enough to produce a workable mix. Excessive water will cause shrinkage cracks and a weak porous concrete. The water/cement ratio is the ratio of the weight of water in a mix (including the water in the sand and gravel) to the weight of cement in the mix. The water/cement ratio for quality concrete should be 0.45. To maintain this ratio, limit water to 20-25 l/bag of cement for dry sand and gravel and 15-20 l of water when wet sand and gravel are used. Using a volume proportioning, the proportion of water is about two-thirds the proportion of cement.

Mixing

Concrete should be mixed thoroughly but not overmixed. Cement must come in contact with and surround all surfaces of the sand and gravel. The cement must fill the spaces (voids) between the sand and gravel particles.

Machine-mixing is preferable and will give the best distribution of ingredients and a uniform appearance to the concrete. To maintain quality concrete, the mixer should not be loaded above its capacity and should be operated at the recommended drum speed. The gravel should be placed in the drum first, followed by sand and then cement. The drum should be revolving when it is charged. A small quantity of the water should be placed in the drum before the dry materials are placed in the drum. This will prevent the accumulation of cement around the blades. The rest of the water may be added

* The source of most of the material on preparing concrete is the On-Farm Water Management Field Manual, Vol. V, National Standards for Practices, Materials and Structures (17).

simultaneously with the dry materials. There is no need for any dry mixing before the water is added. The minimum time of mixing should be two minutes.

Hand-mixing concrete must be done on a clean water-tight platform or wheelbarrow. The amount of sand and gravel should be limited to approximately 0.1 m^3 . The concrete mixing and its placement should be completed within 10 minutes. Cement and sand should first be mixed while dry until the mixture is thoroughly blended and uniform in color. The gravel should then be added to the mixture of sand and cement and mixed by turning the ingredients a minimum of three times before adding water. The measured amount of water then is added and the ingredients turned a minimum of five times. Mixing should continue until the concrete is of a uniform color.

Placing the concrete

Preparation before placement of concrete includes compacting and moistening the soil and erecting the forms. If concrete is placed against dry soil and forms, excessive water will be extracted from the concrete. To maintain quality concrete, be sure the soil and forms are moist. Forms should be clean, tight, and adequately braced; sawdust, nails, and other debris should be removed before concrete is placed. Forms treated with motor oil will facilitate removal from concrete that has set.

Place the concrete immediately after mixing. Place in a position and manner to limit flow and subsequent segregation of the gravel and sand particles.

Thoroughly tamp and compact the concrete as it is

being placed to eliminate voids or honey combing.

Screed to the grade of the forms or templates and finish by troweling. Do not overtrowel, because this will result in flaking and a porous surface of the finishing concrete.

Curing

Excessive or rapid evaporation of water from freshly placed concrete will cause cracking, shrinkage, and low-quality concrete.

Protect concrete from rapid drying or curing for five days after placement. This may be accomplished by submerging in water, applying membrane curing, or covering with continuously moist burlap, canvas, straw, plastic, or soil.

Do not place concrete when there is danger of frost, unless provision has been made to protect the concrete from freezing.

Removal of forms

Forms may be removed when the concrete attains sufficient strength to support the dead loads and live loads imposed upon it. Generally speaking, good-quality concrete under ideal conditions will attain a strength of approximately 35 kgf/cm^2 /day in the first three or four days; thereafter, the curing process slows down considerably. Table D.1 can be used as a guide for removing forms and placing concrete structures in moderate service.

TABLE D.1. Curing time required before forms are removed and concrete structures are placed in moderate service

Description of concrete structure	Minimum strength requirements	Minimum curing time required (hrs)
Concrete not subject to appreciable bending or direct stress, not reliant on forms for vertical support, not liable to injury by removal of forms or other construction activity.	35 kgf/cm^2 (500 psi)	24
Concrete subject to appreciable bending or direct stress and partially reliant on forms for vertical support.		
Subject to dead load only.	50 kgf/cm^2 (750 psi)	36
Subject to dead load and live load.	110 kgf/cm^2 (1500 psi)	72
Concrete subject to high bending stress and wholly or almost wholly reliant on forms for vertical support.	140 kgf/cm^2 (2000 psi)	108

APPENDIX E

MASONRY*

Brick or stone masonry is frequently used in the construction of portions of the civil works for small hydro-power projects, for the diversion structure, intake, and forebay, and sometimes for the powerhouse and lining of the power canal. The principal reasons for this are the difficulty of obtaining cement in sufficient quantity for concrete structures in many developing countries, its high cost, and difficulties in transporting it to remote, rural areas. Brick or stone masonry permits use of local materials to replace some of the volume for which concrete would otherwise be necessary. Because a significant portion of the volume of quality concrete uses locally available sand and aggregate, the savings of concrete may not be as great as they might initially appear, but they are still significant.

For a typical wall of brick masonry, about 20% of the volume is joint mortar. If the surface of the structure is plastered, an additional 5% of the volume of brick masonry is plaster mortar. Although 1 m^3 of quality concrete requires 0.2 m^3 of cement (six 50 kg bags), 1 m^3 of plastered brick masonry requires about 25% or 0.25 m^3 of mortar or about 0.07 m^3 of cement (two 50 kg bags). Consequently, if plastered brick masonry is used, only about one-third of the amount of cement as that required for poured concrete would be needed. If the structure is not plastered, only about 25% of the amount of cement required for poured concrete would be needed. Further savings in concrete can be obtained by using stones larger than bricks in the masonry.

Brick and stone masonry requires a mix of cement and sand to join the bricks into an impervious stable mass. Portland cement is used; the sand should be well graded, clean, and free from harmful substances; and the water should be free from undesirable impurities (see APPENDIX D, p. 270).

The mortar for the joints should be prepared with a cement/sand ratio of 1:4 by volume to obtain a workable mix; about 23 l of water per 50 kg sack of cement should be added with a fine spray. This assumes that the sand is dry. Because any mortar not used after 30 minutes should be discarded, the quantity mixed each time should be determined accordingly.

If bricks are to be used, only the best should be selected. They should be soaked in a tank for at least 24 hours before they are used. They are then laid with fresh, well-mixed mortar. The horizontal joints should be parallel. The vertical joints on alternate courses

should be directly over one another. The thickness of the joints should be about 1.0 cm, and these should be properly filled with mortar. To achieve this, mortar is applied to the sides of the bricks already laid. The next (wet) brick is laid 3–5 cm away and then pressed toward the first brick, squeezing out the mortar indicating that the joint has been filled. The joints on the surfaces to be plastered or pointed (Fig. E.1) should be raked out to a depth of 1 cm before the mortar sets. The other joints should be filled and struck smooth before the mortar sets. Curing is done by keeping the masonry wet a minimum of five days by covering with wet burlap or other saturated material or by sprinkling with water.

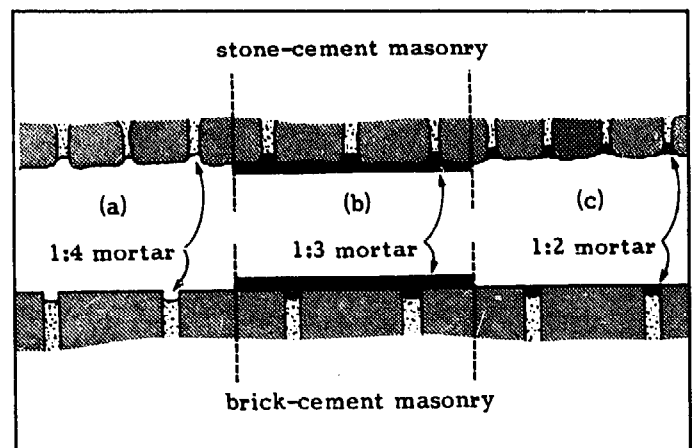

Fig. E.1. Section views of stone- and brick- masonry work with (a) joints raked in preparation for (b) plastering or (c) pointing.

Plastering

If the surface is to be plastered, a 1:3 cement/sand ratio should be used. A good key must be provided in the masonry work for the plaster to hold on firmly to prevent its crazing or cracking off. For this purpose, all joints in the masonry should be raked to a depth of 1 cm before the mortar has set. Before plaster is applied, the masonry should be brushed to remove all loose dust, thoroughly washed with water, and watered for

* A significant portion of this material is from On-Farm Water Management Field Manual, Vol. V. National Standards For Practices, Materials and Structures. (17).

24 hours. A 1 cm-thick layer of plaster is then laid on the masonry. Vertical screeds or wooden strips can be placed temporarily at regular intervals along the surface. A straight-edge then worked sideways and upward along the screeds ensures sufficient thickness of the plaster and a flat surface. The surface is then finished with a wooden float.

smooth and watertight. A 1:2 cement/sand mortar is then necessary, with only enough water to make a workable mix. The surface of the masonry work is prepared in a manner similar to that required for plastering. The joints are then filled in with the mortar and compacted using a pointing trowel.

Pointing

Rather than plastering, pointing can be used to fill in the joints in brick- or stone-masonry work to make it

APPENDIX F

WATER HAMMER

Description of phenomenon

Water hammer is a term which refers to the transient pressure peaks which occur in a pipe when there is a rapid change in the flow velocity within it. Figure F.1 illustrates how a velocity change caused by an instantaneous closure of a gate at the end of a pipe creates pressure waves traveling within the pipe.

Initially, water flows at some velocity " v_0 " as shown in (a). When the gate is closed, the water flowing within the pipe has a tendency to continue flowing because of its momentum. Because it is physically prevented from so doing, it "piles up" behind the gate; the kinetic energy of the element of water nearest the gate is converted to pressure energy, which slightly compresses the water and expands the circumference of the pipe at this point (b). This action is repeated by the following elements of water (c), and the wave front of increased pressure travels the length of the pipe until the velocity of the water " v_0 " is destroyed, the water is compressed, and the pipe is expanded its entire length (d). At this point, the water's kinetic energy has all been converted to strain energy of the water (under increased compression) and strain energy of the pipe (under increased tension).

Because the water in the reservoir remains under normal static pressure but the water in the pipe is now under a higher pressure, the flow reverses and is forced back into the reservoir again with velocity " v_0 " (e). As the water under compression starts flowing back, the pressure in the pipe is reduced to normal static pressure. A pressure "unloading" wave then travels down the pipe toward the gate (f) until all the strain energy is converted back into kinetic energy (g). However, unlike case (a), the water is now flowing in the opposite direction and because of its momentum, the water again tries to maintain this velocity. In so doing, it stretches the element of water nearest the gate, reducing the pressure there and contracting the pipe (h). This happens with successive elements of water and a negative pressure wave propagates back to the reservoir (i) until the entire pipe is under compression and water under reduced pressure (j). This negative pressure wave would have the same absolute magnitude as the initial positive pressure wave if it is assumed that friction losses do not exist. The velocity then returns to zero but the lower pressure in the pipe compared to that in the reservoir forces water to flow back into the pipe (k). The pressure surge travels back toward the gate (e) until the

entire cycle is complete and a second cycle commences (b). The velocity with which the pressure front moves is a function of the speed of sound in water modified by the elastic characteristics of the pipe material.

In reality, the penstock pipe is usually inclined but the effect remains the same, with the surge pressure at each point along the pipe adding to or subtracting from the static pressure at that point. Also, the damping effect of friction within the pipe causes the kinetic energy of the flow to dissipate gradually and the amplitude of the pressure oscillations to decrease with time.

Critical time

Although some valves close almost instantaneously, closure usually takes at least several seconds. Still, if the valve is closed before the initial pressure surge returns to the gate end of the pipeline (g), the pressure peak will remain unchanged—all the kinetic energy contained in the water near the gate will eventually be converted to strain energy and result in the same peak pressure as if the gate were closed instantaneously. However, if the gate has been closed only partially by the time the initial pressure surge returns to the gate (g), not all the kinetic energy will have been converted to strain energy and the pressure peak will be lower. If the gate then continues closing, the positive pressure surge which it would then create will be reduced somewhat by the negative pressure (h) surge which originated when the gate originally began closing. Consequently, if the gate opens or closes in more time than that required for the pressure surge to travel to the reservoir and back to the gate, peak surge pressures are reduced. This time is called the critical time " T_c " and is equal to:

$$T_c = \frac{2L}{a} \quad (5.18)$$

The wave velocity, or speed of sound, in water is approximately 1420 m/s. However, the wave velocity in a pipe—the speed with which the pressure surge travels along the pipe—is a function of both the elastic characteristics of water and the pipe material. An expression for the wave velocity is:

$$a = \frac{1420}{\sqrt{1 + \frac{1000 K D}{E t}}} \quad (5.19)$$

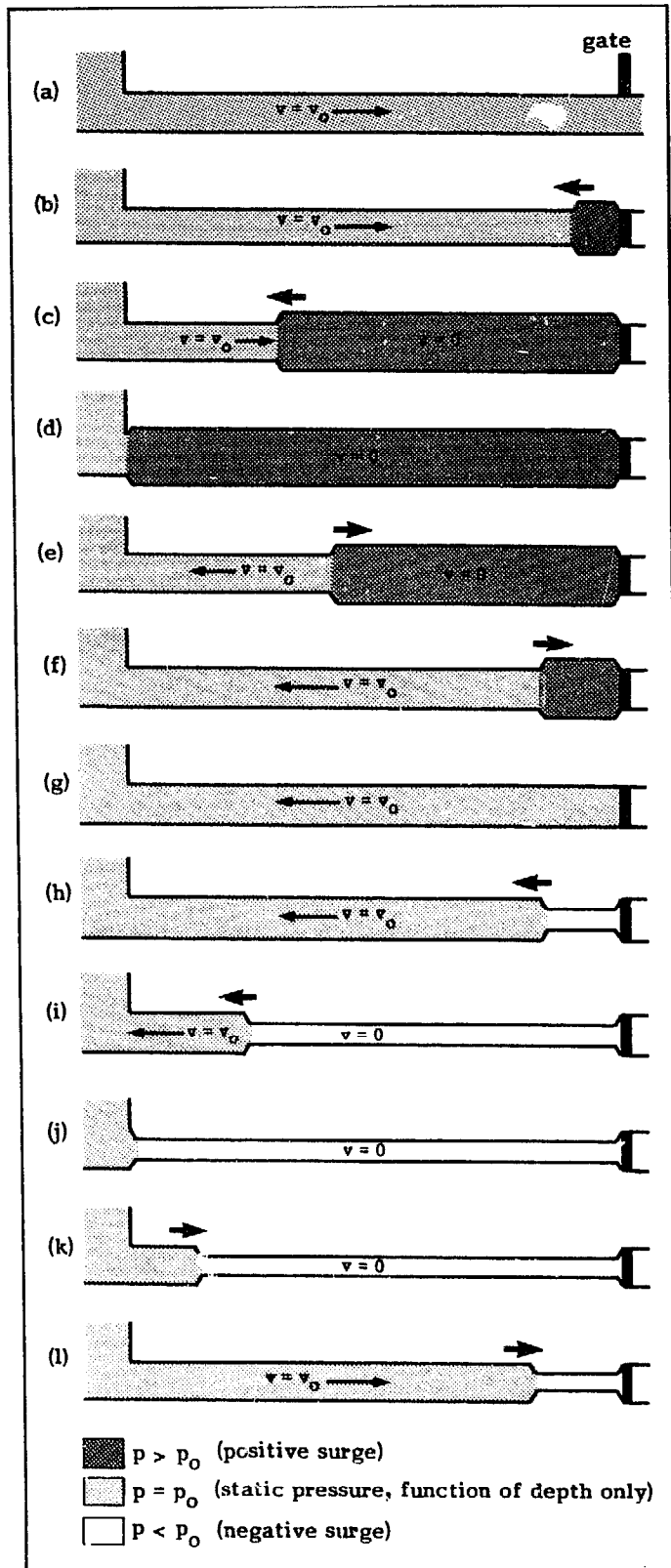

Fig. F.1. Movement along a pipe of a pressure surge caused by a sudden gate closure (shown exaggerated).

REFERENCES

The commonly used acronyms included within some of the following references are described under **ACRONYMS AND ADDRESSES** (p. 282). Other publications

not referred to in the Sourcebook but of possible interest to readers are included in **OTHER REFERENCES** (p. 281).

1. ———, Atlas of World Water Balance, prepared by the USSR National Committee for the International Hydrological Decade, The UNESCO Press, Paris, 1977.
2. ———, Brief Information on The Forthcoming SKAT Publication, Design Manual for a Simple Mechanical Governor, SKAT, 1982.
3. ———, "Clamp and Coupling Products, Expansion Joints," Rockwell International Corp. (400 North Lexington Ave., Pittsburg, PA 15208), 1985.
4. ———, Crossflow Turbine, Type: BYS/T3, SKAT.
5. ———, Design Standards No. 3, Canals and Related Structures, U.S. Dept. of the Interior, Bureau of Reclamation, Denver, 1967 (available from Burec; \$15.25 plus \$1.30 foreign handling).
6. ———, Development of Kam Pong, Mae Ton Luang, Huai Pui, and Bo Kaeo Micro-Hydropower Projects, USAID/Bangkok (Department of State, Washington, DC 20523), Bangkok, 1984.
7. ———, "The Effects of Ultraviolet Aging on PVC Pipe," Uni-Bell Plastic Pipe Association (2655 Villa Creek Dr., Suite 150, Dallas, TX 75234), 1981.
8. ———, Energy Primer, Portola Institute (558 Santa Cruz Ave., Menlo Park, CA 94025), 1974.
9. ———, Engineering Field Manual for Conservation Practices, U.S. Dept. of Agriculture, Soil Conservation Service, Washington, DC, June 1979 (available from NTIS; accession number PB244668/AS).
10. ———, Handbook of PVC Pipe, Design and Construction, The Uni-Bell Plastic Pipe Association (2655 Villa Creek Dr., Suite 150, Dallas, TX 75234), 1980 (\$25.00).
11. ———, Hydraulic Turbines, Catalog 307, Christiana Machine Co. (now available from MacLeod & Co., P.O. Box 286, Glenmoore, PA 19343).
12. ———, Manual for Rural Water Supply, SKAT, 1980 (SFr. 34). (This publication is also available in French for SFr. 39 and Spanish for SFr. 30.)
13. ———, Manual Para la Planificacion y el Dimensionamiento de Obras Hidraulicas de una Mini-central Hidroelectrica, prepared by Projekt-Planung-Lauterjung for GTZ.
14. ———, Mini & Micro Hydel Plants, Appropriate Technology Development Organization (1-B 47th Street, F-7/1, P.O. Box 1306, Islamabad, Pakistan).
15. ———, 1980 Hydrology Data, Vol. I, National Energy Administration, Bangkok, Thailand.
16. ———, On-Farm Water Management Field Manual, Vol. III, Watercourse Improvement, Water Management Wing, Ministry of Food, Agriculture and Cooperatives, Government of Pakistan, Islamabad, December, 1980.
17. ———, On-Farm Water Management Field Manual, Vol. V, National Standards for Practices, Materials and Structures, Water Management Wing, Ministry of Food, Agriculture and Cooperatives, Government of Pakistan, Islamabad, December, 1980.
18. ———, Ossberger Turbinenfabrik, personal correspondence, October 28, 1981.
19. ———, The Planning, Installation and Maintenance of Low-Voltage Rural Electrification Systems and Subsystems, VITA, April 1969 (\$5.95).
20. ———, "Ponds--Planning, Design, Construction," Agriculture Handbook No. 590, Soil Conservation Service, U.S. Department of Agriculture, June 1982.
21. ———, "Reciprocating Wire Power Transmission for Water Wheels," Village Technology Handbook, VITA, 1975.

22. ———, Steel Plate Engineering Data, Welded Steel Pipe, Vol. 3, American Iron and Steel Institute (1000 16th Street, NW, Washington, DC 20036), 1980.
23. ———, Water Current Turbines, A Field Worker's Guide, ITDG, 1986 (£10.00).
24. ———, Water Measurement Manual, U.S. Department of Interior, Bureau of Reclamation, Denver, 1967 (available from GPO; stock number 024-003-00098-1).
25. ———, Water Turbines, Gilbert Gilkes and Gordon Ltd. (Kendal, Cumbria, England LA9 7BZ), 1974 (available at £ 2.50 plus postage or from Gilkes Inc., P.O. Box 628, Seabrook, TX 77586).
26. ———, "Welded Steel Penstocks," Water Resources Technical Publication, Engineering Monograph No. 3, U.S. Department of the Interior, Bureau of Reclamation, 1966 (available from Burec; \$0.40).
27. Alex Arter, Durchströmturbine, Diplomarbeit, Abend-Technikum Zürich, Switzerland, February 1980 (xerox copies available from SKAT).
28. A. Bachmann and A.M. Nakarmi, New Himalayan Water Wheels, Sahayogi Press, Tripureshwar, Kathmandu, Nepal, November 1983.
29. H.K. Barrows, Water Power Engineering, Tata McGraw-Hill Publishing Co. Ltd., New Delhi, 1972.
30. Harold Frank Birchal, Modern Surveying for Civil Engineers, Philosophical Library, Inc., New York, 1956.
31. J.T. Boys, J.L. Woodward, et al., "A Low-Cost AC Generating System, Suitable for Use With Small Hydro Plants," Department of Electrical Engineering, University of Auckland, New Zealand (1981).
32. Ernest F. Brater and Horace W. King, Handbook of Hydraulics, McGraw-Hill Book Co., New York, 1976.
33. Andrew Brown, "Stream Flow Measurement by Salt Dilution Gauging," ITIS, November 1983.
34. Gautschi Christoph, Gloor Wilhelm, and Wong Thin Mun, Experimentelle Unterschung einer Durchströmturbine des Typs Banki, Diplomarbeit, Höhere Technische Lehranstalt Brugg, Windisch, Switzerland, 1980 (xerox copies available from SKAT).
35. Broughton Coburn, The Development of Alternate Energy Sources and the Implementation of a Micro Hydro-electric Facility in Sagarmatha National Park, Nepal, UNESCO (Division of Ecological Sciences, 7 Place de Fontenoy, 75700 Paris, France), January 1984.
36. Broughton Coburn, "Namche 27 kW Micro Hydro Project," (a narrated slide tape presentation), 1984. (Further information can be obtained from NRECA.)
37. Norman H. Crawford and Steven Thurin, Hydrologic Estimates for Small Hydroelectric Projects, NRECA, Washington, DC, 1981.
38. William Creager and Joel Justin, Hydroelectric Handbook, John Wiley & Sons, New York, 1950.
39. M.M. Dandekar and K.N. Sharma, Water Power Engineering, Vikas Publishing House Pvt. Ltd., New Delhi, 1979.
40. Calvin Victor Davis (ed.), Handbook of Applied Hydraulics, McGraw-Hill Book Co., Inc., New York, 1942.
41. M.M. Desmukh, Water Power Engineering, Dhanpat Rai & Sons (1682 Nai Sarak, Delhi 110006, India), 1978.
42. Martin Dietz, "Report About the Co-operatively Run Water-mill in Upallo Arkhala Panchayat," unpublished Butwal report, August 1981.
43. Mohammad Durali, Design of Small Water Turbines for Farms and Small Communities, TAP Report 76-1, Technology Adaptation Program (Massachusetts Institute of Technology, Cambridge, MA 02139), Spring 1976.
44. Andrew Eberhardt, "An Assessment of Penstock Design," Water Power and Dam Construction, pp. 249-253, June/July 1975.
45. Elder, Boys, and Woodward, "Self-excited induction machine as a small low-cost generator," IEEE Proceedings, Vol. 131, Pt. C, pp. 33-41, 1984.
46. Etcheverry and Harding, Irrigation Practice and Engineering, McGraw-Hill Book Co., 2nd ed., Vol. II, 1933.
47. Jack Fritz (ed.), Small and Mini Hydropower Systems; Resource Assessment and Project Feasibility, McGraw-Hill Book Co., New York, 1984.
48. J.L. Gordon, "Vortices at Intakes," Water Power, April 1970.
49. Jaime Lobo Guerrero, personal correspondence, Bogotá, Colombia, August 24, 1977.
50. Jaime Lobo Guerrero and John D. Burton, "Hydraulic Governor for Small Pelton Turbines," Appropriate Technology, ITDG, Vol. 6, No. 4, pp. 17-18.

51. Jaime Lobo Guerrero and José Rafael Toro, "Development of a Re-entry Cup Governor for Pelton Wheels," (unpublished), Dept. of Mechanical Engineering, Université de los Andes, Bogotá.
52. John S. Gulliver, et al., "Intake Design to Avoid Free-Surface Vortices" (submitted to International Water Power and Dam Construction).
53. J.S. Gulliver and A.J. Rindels, "Guidelines for Hydroplant Intake Design Without Free Surface Vortices," paper presented at Waterpower '83, Knoxville, TN, September 1983.
54. Carroll A. Hackbart (ed.), On-Farm Water Management Field Manual, Vol. IV, Irrigation Water Management, Water Management Wing, Ministry of Food, Agriculture and Cooperatives, Government of Pakistan, Islamabad, December, 1980.
55. David L. Hagen, "Advances in Controls to Govern Mini and Micro Hydropower Systems," Waterpower '85 Conference Proceedings, ASCE, 1985.
56. Hans W. Hamm, Low Cost Development of Small Water Sites, VITA, 1967.
57. Julian Hinds, "Design, Construction and Use of Metal Flumes," Engineering News-Record, Vol. 88, No. 21, May 25, 1922.
58. Lee Wing Ho, Manufacture and Evaluation of a Five-Kilowatt Axial-Flow Water Turbine, Master of Science in Mechanical Engineering thesis (Massachusetts Institute of Technology, Cambridge, MA 02139), 1976.
59. R. Holland, "Energy for Rural Development," International Water Power and Dam Construction, Vol. 34, No. 12, December 1982, pp. 29-32.
60. Rik Hothersall, Micro-hydro Development for P.N.G. (thesis), Dept. of Mechanical Engineering, UNITECH, 1984.
61. R. Hothersall, "A Review of the Cross-Flow Turbine," Waterpower '85 Conference Proceedings, ASME (345 East 47th Street., New York, NY 10017-2398), 1985.
62. John Ingersoll, "Now, Energy by the Bucket From Back-Yard Powerplants," Popular Mechanics, February 1981, pp. 122 ff.
63. Allen R. Inversin, A Pelton Micro-Hydro Prototype Design, Research Series #1, Appropriate Technology Development Institute, UNITECH, June 1980.
64. Allen R. Inversin, Technical Notes on the Baindoang Micro-Hydro and Water Supply Scheme, Research Series #2, Appropriate Technology Development Institute, UNITECH, May 1981.
65. Charles A. Keith, "Civil Works and Structures," Proceedings of the Microhydro Seminar, The University of Auckland, New Zealand, 23-24 November 1981.
66. C.P. Kittredge, "Centrifugal Pumps Used as Hydraulic Turbines," Transactions of the ASME, Journal of Engineering for Power, January 1961.
67. Ed Kramer, "Small Hydropower: Which Approach is Appropriate?," Small Hydropower in Africa, NRECA, 1983.
68. Edwin B. Kurtz and Thomas M. Shoemaker, The Linesman's and Cableman's Handbook, Fifth Edition, McGraw-Hill Book Co., New York, 1976.
69. Jagdish Lal, Hydraulic Machines, Including Fluidics, 6th edition, Metropolitan Book Co. Pvt. Ltd. (1 Netaji Subhash Marg, New Delhi, India 110002), 1977.
70. Harry F. Langhorne, "Hand-Made Hydro Power," Alternative Sources of Energy, October 1977, pp. 7-11.
71. Ray K. Linsley and Joseph B. Franzini, Water-Resources Engineering, 3rd Edition, McGraw-Hill Book Co., New York, 1979.
72. D.S. Mansell, et al., "Micro-Hydro: Civil Engineering Aspects," Dept. of Civil Engineering, UNITECH, Papua New Guinea.
73. Lionel S. Marks (ed.), Mechanical Engineers' Handbook, McGraw-Hill Book Co., New York.
74. Juan Mata, "Design Criteria of Typical Civil Works for Minihydropower Plant Projects," Small Hydroelectric Powerplants, NRECA, 1980.
75. Joseph A. McCurdy, Standby Equipment for Electric Power Interruptions, The Pennsylvania State University.
76. J.D. McKinney, et al., Microhydropower Handbook, EG&G Idaho, Inc., Idaho Falls, 1983 (available from NTIS).
77. Ueli Meier, The Dhading Micro-Hydropower Plant, Working Paper WP 6/83, SKAT, 1983 (SFr. 8).
78. Ueli Meier, et al., Local Experience with Micro-Hydro Technology, SKAT (SFr 32), 169 pp, 1983. (This publication is also available in Spanish for SFr 30.)
79. Ueli Meier, Markus Eisenring, and Alex Arter, "The Segner Turbine," SKAT, March 1983 (\$2.00).
80. B. Felix Meinikheim, "A Working Pelton Wheel," Alternative Sources of Energy, ASE, October 1977.

81. Reinhold Metzler, The Heat Generator, A Device to Convert Mechanical Power Directly into Process Heat, SKAT (1984) (SFr.22).
82. Reinhold Metzler, "Problems Encountered in Designing and Producing Small Scale Water Turbines in Nepal," ID/WG.305/26 (UNIDO), September 1979.
83. A.M. Michaeli, Irrigation, Theory and Practice, Vikas Publishing House Pvt. Ltd., New Delhi, 1978.
84. Dennis A. Minott, "Mini-Hydroelectric Generation-Local Manufacture," First Caribbean Conference on Mini-Hydropower Generation, March 9-14, 1981, Rouseau, Dominica.
85. C.A. Mockmore and Fred Merryfield, "The Banki Water Turbine," Bulletin Series No. 25, Oregon State University (Engineering Experimental Station, Corvallis, OR 97331), February 1949.
86. Peter Molinari, "The Need for an Integrated Approach in Rural Electrification in Nepal," ID/WG.305/41(UNIDO), September 1979.
87. Horace Denton Morgan and Donald David Reid Thomas, "Maintenance of Hydro-electric Schemes and the Development of Sidestream Intakes," Institute of Civil Engineering: Proceeding, Vol. 20, pp. 345-370, November 1961.
88. Dale L. Nafziger, "A Mill Lighting System in Nepal," DCS report, January 13, 1982.
89. A.-M. Nakarmi and A. Bachmann, MPPU, Multi-Purpose Power-Unit With Horizontal Water Turbine, Vol. I (Basic Information) and Vol. II (Operation and Maintenance Manual), Sahayogi Press, Kathmandu, March 1983 and February 1984, respectively (available from UNICEF, P.O. Box 1187, Kathmandu, Nepal).
90. Tsuguo Nozaki, Guia para la Elaboracion de Proyectos de Pequeñas Centrales Hidroelectricas Destinadas a la Electrificacion Rural de Peru, Japan International Cooperation Agency, June 1980.
91. B. Oettli, Namche Bazar Micro Hydropower Plant, The Supplier's Final Report, Balaju Yantra Shala (P.) Ltd. (P.O. Box 209, Balaju, Kathmandu, Nepal), January 1984.
92. William G. Ovens, "A Design Manual for Water Wheels," VITA, 1975.
93. Bennett D. Reischauer, "Design of Civil Works for Small-Hydropower Facilities," Small Hydropower in Africa, NRECA, 1983.
94. Alan J. Rindels and John S. Gulliver, An Experimental Study of Critical Submergence to Avoid Free-Surface Vortices of Vertical Intakes, Project Report No. 224, St. Anthony Falls Hydraulic Laboratory (University of Minnesota, St. Paul, MN 55414), June 1983.
95. Bennie N. Rinehart, et al., DOE Small-Scale Hydropower Program, Annual Status Report 1984, EG&G Idaho, Inc. (P.O. Box 1625, Idaho Falls, ID 83415), September 1984 (available from NTIS, printed copy A03, microfiche A01).
96. Helmut Scheuer and Bob Yoder, "A Report on the Inspection of Existing Small Turbine-run Mills in the Kaski, Parbat, Baglung and Gulmi Districts," unpublished DCS-BTI report, February 1976.
97. Helmut Scheurer, Reinhold Metzler, and Robert Yoder, Small Water Turbines, GATE, September 1980.
98. Valentine Schnitzer, et al., Activating Traditional Indigenous Techniques: Development and Improvement of the Nepalese Watermill 'Ghatta', GATE (1983).
99. Martin P. Schroeder and P.K.C. Tu, An assessment of SWECS/Mechanical Heating Systems, RFP-3261, UC-60, Rockwell International Corp., Golden, CO, July 1981 (available from NTIS; printed copy \$8.00).
100. James K. Searcy, Flow-Duration Curves, Geological Survey Water-Supply Paper 1542-A, U.S. Department of the Interior, 1959 (available from GPO).
101. L. Shafer and A. Agostinelli, "Centrifugal Pumps as Hydraulic Turbines for the Small Hydropower Market," Worthington Group (McGraw-Edison Co., Taneytown, MD 21787).
102. H.O. Sharp and R.K. Palmer, "Faster and Cheaper Field Surveys," Engineering News-Record, September 30, 1948, pp. 75-78.
103. Djoko Susanto, "Micro-Hydro Axial Flow Turbine for a Battery Charging System in Remote Areas," Small Hydropower for Asian Rural Development, NRECA, 1983.
104. Vito A. Vanoni (ed.), Sedimentation Engineering, ASCE, New York, 1977.
105. P. Verhaart, "Blade Calculations for Water Turbines of the Banki Type," Report WP3-83.03.R351, Eindhoven University of Technology, Eindhoven, Netherlands, March 1982.
106. C.C. Warnick, Hydropower Engineering, Prentice-Hall, Inc. (Englewood Cliffs, NJ 07632), 1984.

107. C.C. Warnick, "Ungaged Streams: Estimating Hydrologic Flow," Hydro Review (Hydro Consultants, Inc., 755 Bolyston St., Suite 707, Boston, MA 02116), Vol. IV, No. 1, Spring 1985.
108. Garry Whitby, "Heat Storage Cookers, The Norwegian Experience and Indications for Implementation in Developing Countries," ITIS, September 1981.
109. H.G. Wilm and H.C. Storey, "Velocity-head Rod Calibrated for Measuring Stream Flow," Civil Engineering, Vol. 14, pp. 475-476, 1944.
110. John F. Wood, personal correspondence, Ennistymann, Ireland, May 5, 1981.
111. J.L. Woodward and J.T. Boys, "Electronic Load Governor for Small Hydro Plants," Water Power and Dam Construction, July 1980, pp. 37-39.
112. Chilton A. Wright and Clifford A. Betts, "Flash-Board Pins," Transactions of the American Society of Civil Engineers, Vol. 105, pp. 1412-1444, ASCE, 1940.
113. Robert D. Yoder, Energy Storage for Domestic Cooking in Nepal (thesis), Cornell University (Ithaca, NY 14853), 1981.
114. Robert D. Yoder and G.E. Rehkugler, "Energy Storage for Domestic Cooking in Nepal," (1981 Annual Meeting, North Atlantic Region, of the American Society of Agricultural Engineers, Brock University, St. Catherines, Ontario, Canada), 1981.
115. Robert Yoder, personal correspondence, Argali, Nepal.

OTHER REFERENCES

- , Design of Small Dams, U.S. Dept. of the Interior, Bureau of Reclamation, Washington, D.C. 1974 (available from Burec for \$14.25, stock number 2403-00089; or from GPO).
- , Handbook of Steel Drainage and Highway Construction Products, American Iron and Steel Institute (1000 16th Street, NW, Washington, DC 20036), 1971.
- , "PCA Soil Primer," Engineering Bulletin, PCA, 1973.
- , "Small Concrete Gravity Retaining Walls," PCA, 1983.
- , Small Hydropower in Africa, Proceedings of a workshop held in Mbabane, Swaziland, June 20-24, 1983, NRECA.
- , Small-Scale Hydropower in Africa, Proceedings of a workshop held in Abidjan, Ivory Coast, March 1-5, 1982, NRECA (also available in French).
- , "Soil-Cement Construction Handbook," Engineering Bulletin, PCA, 1979.
- , "Soil-Cement for Facing Slopes and Lining Channels, Reservoirs, and Lagoons," PCA, 1984.
- , Steel Pipe Design and Installation, AWWA Manual M11, American Water Works Association (6666 West Quincy Avenue, Denver, CO 80235), 1964.
- J. George Butler, How to Build and Operate Your Own Small Hydroelectric Plant, Tab Books Inc. (Blue Ridge Summit, PA 17214), 1982.
- Colin R. Elliot (ed.), Small Hydropower for Asian Rural Development, Proceedings of a workshop held in Bangkok, Thailand, June 8-12, 1981, NRECA, 1983.
- K.C. Ford (ed.), Plastics Piping Manual, Plastics Pipe Institute (355 Lexington Ave., New York, NY 10017), 1976.
- P. Greenwood and P. Robinson, Small Scale Hydropower in Papua New Guinea, Dept. of Electrical and Communication Engineering, UNITECH, Papua New Guinea, 1982.
- Drummond Hislop, Upgrading Micro Hydro in Sri Lanka, Case Study 2, ITDG, 1986.
- L. Jajing and J. Arneaud Clarke, Survey of Microhydro Schemes in Pindiu Area, November 1981, Departmental Report No. 1/82, Dept. of Electrical and Communication Engineering, UNITECH, 1981.
- Jagdish Lal, Hydraulic and Fluid Mechanics, Metropolitan Book Co. Pvt. Ltd. (1 Netaji Subhas Marg, Delhi 110006, India), 1984.
- Walter D. Lawrence, "Karawa Integrated Rural Development Project, Evaluation of OPG Project Proposal for USAID/Kinshasa," March 21, 1978.
- Dermot McGuigan, Harnessing Water Power for Home Energy, Garden Way Publishing Co. (Charlotte, VT 05445), 1978.
- Bernard Miller, Manual for Calculation of Check Dams, Swiss Association for Technical Assistance (P.O. Box 113, Kathmandu, Nepal), September 1979.

ACRONYMS AND ADDRESSES

ASCE	American Society of Civil Engineers 345 East 47th Street New York, NY 10017-2398	NRECA	National Rural Electric Cooperative Association International Programs Division 1800 Massachusetts Avenue, NW Washington, DC 20036
ASE	Alternative Sources of Energy, Inc. 107 S. Central Avenue Milaca, MN 56353	NTIS	National Technical Information Service U.S. Department of Commerce 5285 Port Royal Road Springfield, VA 22151
Burec	Bureau of Reclamation Attn: D-922 P.O. Box 25007 Denver, CO 80225-0007	PCA	Portland Cement Association 5420 Old Orchard Road Skokie, Illinois 60077
GATE	German Appropriate Technology Exchange Postfach 5180 D-6236 Eschborn 1, Fed. Rep. of Germany	SKAT	Swiss Center for Appropriate Technology Varnbuelstrasse 14 CH-9000 St. Gallen, Switzerland
GPO	U.S. Government Printing Office Washington, DC 20402	UNITECH	The PNG University of Technology Private Mail Bag Lae, Papua New Guinea
ITDG	Intermediate Technology Development Group 9 King Street London WC2E 8HN England, U.K.	VITA	Volunteers in Technical Assistance 1815 N. Lynn Street Arlington, VA 22209
ITIS	Intermediate Technology Industrial Services Myson House Railway Terrace Rugby CV21 3HT England, U.K.		

INDEX

A page number in bold-face type next to a listing indicates the page on which the definition of that term can be found. An index to locations of specific micro-

hydropower installations by country can be found in **OTHER PROJECT DESCRIPTIONS** (p. 263).

- Abney level (see Clinometer)
- Access ports, 77
- Afterbay, 153
- Air inlet valve, 76-77 (see also Air valves)
- Air-release valve, 76 (see also Air valves)
- Air valves, 77, 86, 147, 150
- Air vent, 74, 75, 76, 85-86 (see also Air valves)
- Altimeter, 22, 24-25
- Anchors, 74-75, 140-144

- Battery storage, 217-219
- Belt drives, 193-194
- Blowoff, 77
- Brushless generator, 223
- Bucket method, 9, 10-11
- Bulb turbines, 183, 184
- Butterfly valves, 159

- Canals (see Power)
- Cavitation, 56-57, 182, 192
- Chain drives, 194
- Chute, 112
- Clinometer, 22, 23-24
- Collars, 84
- Concrete,
 - preparation of, 270-271
 - use for lining, 107-108
- Conduits
 - low pressure, 71, 118
- Conversion tables, 265-266
- Couplings, 192-194, 223
- Crib dams, 83
- Critical time, 133-134, 274
- Crossflow turbines, 44, 178-182
 - setting, 56
- Culvert, 71
 - designs, 116-118
- Current meter, 14-15
- Cylinder gates, 158, 168

- Dams and weirs
 - dams, 48, 64
 - designs, 78-84
 - functions served, 64-67
 - weirs, 64

- Diameter ratio, 175
- Direct coupling, 192
- Direct current, 217-219, 243-244
- Discharge
 - measurement of, 9-21
- Draft tube, 56-57, 179-180
- Drop intake, 94
- Drop structures, 71
 - designs, 110-111

- Earth dams, 83-84
- Efficiencies, 197 (see also specific turbine types)
- Expansion joints, 74
 - Bellows-type, 137
 - Sleeve-type, 136-137

- Flashboards, 81
- Flat belts, 193
- Float method, 13
- Flow
 - measurement of, 9-21
- Flow-duration curve
 - definition, 30-31
 - determining energy and power potential, 38-42
 - estimating for ungaged basins, 38
 - implication for turbine selection, 42-45
- Flume, 71
 - designs, 112-115
- Forces on supports, anchors, and thrustblocks, 138-145
 - conditions for stability, 146-147, 150
 - reducing forces, 145-146, 148-149
- Forebays
 - description, 72-74
 - designs, 118-124
- Frame and deck dams, 83
- Francis turbines, 44, 182
 - setting, 56
- Freeboard, 109, 112-113
- Frequency, 199, 220
- Friction, 157, 158

- Gabions, 79
- Gate valves, 158-159
- Gates and valves, 68, 73, 75, 86
 - designs, 154-159

- Gear boxes, 194
- Gearing ratio, 192, 206
- Generators
 - electrical, 220-223
 - mechanical heat, 198, 241-242
- Glory-hole spillway (see Shaft spillway)
- Governing devices
 - load controller, 204-205
 - mechanical, 204
 - oil-pressure governor, 203-204
 - purpose, 199-200

- Head
 - measurement of, 21-25
- Headrace (see Power canal)
- Heat generator (see Generators, mechanical heat)
- Heat storage cooker, 242-243
- Hoists, 156-157
- Hydraulic radius, 19-20, 100-104
- Hydrograph, 29-30

- Impulse turbine, 171
- In-stream turbines (see Water-current turbines)
- Intakes
 - description, 67-68
 - designs, 84-96
 - location along stream, 52-55
- Inverted siphons, 71
 - designs, 115-116
- Inverter, 218-291
- Irrigation
 - integrating with, 53-55
- Isolation valve, 75, 190

- Jet ratio, 175
- Joints
 - in timber, 113-114
- Joukovsky's equation, 134

- kVA, 220-221

- Level, 22-23
- Lining of canals, 104-108
- Load controllers, 202-203
- Load factor, 218
- Low-pressure conduits, 71, 118

- Manning's equation
 - for canal flow, 19-20
 - for pipe flow, 100, 102, 126
- Marine thrusters, 189
- Masonry, 106-107, 272-273
- Mean annual flow
 - estimating for ungaged basins, 33-37
- Minimum flow
 - estimating, 37-38
- MPPU, 178

- Needles, 155

- Oil-pressure governor, 203
- Overflow spillway, 160
- Overspeed, 224 (see also Runaway speed)

- Pelton turbines, 44, 173-177
 - with draft tube, 57
- Penstocks
 - basic layouts, 49-51, 65
 - description, 74-77
 - materials, 124-125
 - pipe diameter, 125-133
 - wall thickness, 133-136
- Phase imbalance, 219, 224
- Pipe
 - diameter, 125-133
 - thickness, 133-136
- Pipe drop, 111
- Piping, 83
- Pitch circle diameter, 174
- Power
 - electrical, 220-222
- Power canals
 - basic layout, 51-52
 - construction, 104-108
 - design, 96-104
 - drainage, 71, 108-109
 - freeboard and spillways, 71, 109-110
 - profiles, 98-99
 - roughness coefficient, 97-98
 - sizing, 99-104
 - velocity in, 96-98
- Power conduits (see also Power canals, Low-pressure conduits)
 - component of site layout, 51-52
 - description, 68-72
- Power equation, 48-49, 56
- Power factor, 222
- Powerhouses
 - description, 77-78
 - designs, 147, 150-154
 - location of, 56-57
- Pressure losses
 - pipe friction, 126-129
 - pipe turbulence, 129
- Pressure relief valve, 76
- Propeller turbines, 44, 182-185
 - setting, 57
- Pumps as turbines, 44, 185-187

- Rating curve, 21
- Reaction turbine, 171
- Reducing forces, 145-146
 - conditions for stability, 146-147
- Right-angle drive turbine, 183, 184
- Roughness coefficient
 - for canals, 97-98
 - for pipes, 126-127
- Runaway speed, 174, 206, 223

Runner, 171
 Runoff, 34
 "Run-of-river" schemes, 64

 Salt-dilution method, 10, 19
 Schneider engine, 189
 Seepage, 84, 105
 Segner turbine, 189
 Service factor, 193
 Settling basins, 68, 72, 88
 designs, 166-170
 Shaft spillway, 160-161
 Sharp-crested weir, 16
 Side intake, 87
 Significant figures
 meaning, 267-268
 use in text, 9, 268
 Single phase, 219
 Siphon (see also Inverted siphons)
 intake, 86
 spillway, 161-162
 Skimmers (see Trashrack and skimmers)
 Sliding gates
 designs, 155-158
 Slope-area method, 10, 19-20
 Soil
 types, 269
 compaction of, 104
 Specific mean annual flow, 33
 Specific minimum flow, 37
 Specific speed, 172-173
 Speed
 generator, 222
 Spillways, 68, 71, 73, 87-88, 109-110
 designs, 159-162
 Stability, conditions for, 146-147, 150
 Stage-discharge method, 10, 20-21
 Standardized designs, 92-93
 Stilling basin, 82
 Stoplogs, 73
 designs, 154-155
 Storage cookers (see Heat storage cooker)
 Support piers, 74, 138-140
 Surge pressure (see Water hammer)
 Surge tank, 76
 Switchgear, 223

Tailrace, 56, 78
 Thermal expansion, 74, 136-137
 Thoma sigma, 184, 192
 Three phase, 219
 Thrustblocks, 75, 144-145
 Timing belts, 194
 Tirolian intake (see Drop intake)
 Trashracks and skimmers, 68, 73, 88-91
 Skimmers, 89, 165
 Trashracks, 85, 88-89, 162-165
 Tubular turbines, 183, 185
 Tunnels, 69
 Turbines (see also specific turbine type)
 impulse and reaction, 171-172
 miscellaneous, 187-189
 operation under new conditions, 191-192
 setting, 56-57, 184, 192
 specifications, 189-190
 Turgo turbine, 44, 177-178
 with draft tube, 57

Units of measure, 265-266

Valves (see Gates and valves)

V-belts, 193

Velocity

 in a canal, 96-98

 scouring, 98

Velocity-area method, 9, 11-16

Velocity-head rod, 13-14

Voltage, 199, 220

Vortices, 120-121, 163

Water-current turbines, 64, 187-189

Water hammer, 75, 133-136, 274-275

Waterwheels, 185

Wave velocity, 133, 274

Weir method, 9, 16-19

Weirs (see Dams and weir)

Well screen, 164

Wetted area, 109

Wetted perimeter, 100

Wicket gate, 183

PHOTO CREDITS

Dr. M. Abdullah: 10.2, 10.42, 10.44, 10.45, 10.49, 10.52, 10.53, 10.54

Broughton Coburn: 1.4, 5.161

Andreas Bachmann: 1.5, 1.6, 6.6, 6.22, 7.1, 7.2, 7.3

Peter Garman: 6.19

Arturo Garrido: 6.1

Mike Johnson: 5.46, 5.167, 6.13, 6.14, 6.15, 6.21

Dale Nafziger: 10.1, 10.11, 10.13, 10.14, 10.15, 10.17, 10.20, 10.21, 10.29, 10.34, 10.35, 10.37, 10.38

Robert Yoder: 10.3, 10.4, 10.5, 10.12, 10.23-10.28,