

**AT** MICROFICHE  
REFERENCE  
LIBRARY

A project of Volunteers in Asia

Evaluation of Solar Cookers

Published by:

Volunteers in Technical Assistance  
1815 North Lynn St. Suite 200  
P.O. Box 12438  
Arlington, VA 22209 USA

Paper copies are \$ 5.95.

Available from:

Volunteers in Technical Assistance  
1815 North Lynn St. Suite 200  
P.O. Box 12438  
Arlington, VA 22209 USA

Reproduced by permission of Volunteers in  
Technical Assistance.

Reproduction of this microfiche document in any  
form is subject to the same restrictions as those  
of the original document.

# **Evaluation of Solar Cookers**

a **VITA** publication



EVALUATION OF SOLAR COOKERS

Prepared under contract  
with the

UNITED STATES DEPARTMENT OF COMMERCE  
OFFICE OF TECHNICAL SERVICES

VOLUNTEERS IN TECHNICAL ASSISTANCE  
3706 Rhode Island Avenue  
Mt. Rainier, Maryland  
U.S.A.

## ABSTRACT

This report was prepared in 1962 under contract with the Office of Technical Services, U.S. Department of Commerce. It is a compilation of the results of tests performed on various solar cookers to determine their potential usefulness in countries served by the U.S. Agency for International Development (then known as the International Cooperation Administration).

The solar cookers selected were evaluated for:

- cooking performance and efficiency
- durability
- cost
- shipping weight
- portability
- ease of operation
- ease of manufacture in countries involved
- adaptability to local techniques and mores.

Of all models tested, a Fresnel-type cooker developed by VITA showed the greatest promise, due particularly to its efficiency, low cost, and ease of construction with universally available tools and materials. Plans for constructing this solar cooker are available from VITA.

## ACKNOWLEDGMENTS

This report expands a previous VITA report and represents the contributions in varying degrees of a large number of people. The major technical contributors were:

Dr. Edith B. Fehr  
Dr. William E. Glenn  
Dr. William B. Hillig  
Dr. Walter W. Goodwin  
Prof. W. C. Aubrey

In addition the following people gave generously of their time to consult with us:

Mrs. Mary D. Bliss, Solar Energy Laboratory, University of Arizona  
Dr. R. W. Bliss, Solar Energy Laboratory, University of Arizona  
Dr. J. A. Duffie, Director, Solar Energy Laboratory, University of Wisconsin  
Dr. G. O. G. Lof, President, Umbroiler Company, Denver Colorado  
Dr. Milton D. Lowenstein, Technical Director, Association for Applied Solar Energy, Tempe, Arizona  
Mr. R. Thew, Garrett Thew Studios, Westport, Connecticut  
Mr. John I. Yellott, President, Yellott Engineering Associates, Phoenix, Arizona

## TABLE OF CONTENTS

	<u>Page</u>
1.0 INTRODUCTION . . . . .	1
2.0 DESCRIPTION OF COOKERS . . . . .	3
2.1 Rigid Reflector Types . . . . .	4
2.1.1 Wisconsin Cooker . . . . .	4
2.1.2 Spun Aluminum Parabolic Reflector . . . . .	6
2.1.3 Other Simple Metal or Plastic Reflectors . . . . .	8
2.1.4 Fresnel-Type Reflector . . . . .	8
2.1.5 Fixed Soil-Cement Spheroidal Reflectors . . . . .	10
2.1.6 Lightweight Molded Aggregate Reflectors . . . . .	11
2.1.7 Lightweight Plastic Reflectors . . . . .	13
2.1.8 Spun Liquid Plastic Reflector . . . . .	14
2.2 Direct Cooking Types with Collapsible Reflectors . . . . .	15
2.2.1 Solar Chef . . . . .	16
2.2.2 Umbroiler . . . . .	16
2.2.3 Solnar . . . . .	17
2.2.4 Inflatable Plastic Reflectors . . . . .	18
2.3 Oven-Type Cookers . . . . .	19
2.3.1 Reflector Oven (Telkes) . . . . .	20
2.3.2 Reflector Oven (Gosh) . . . . .	21
2.3.3 Folding Paper Conical Reflector . . . . .	22
2.3.4 Cylindro-Parabolic Solar Cooker . . . . .	22
3.0 SUMMARY . . . . .	24
TABLE I - COMPARATIVE DATA ON 12 SOLAR COOKERS . . . . .	26
REFERENCES . . . . .	27
ILLUSTRATIONS . . . . .	29
RECOMMENDATIONS FOR FURTHER STUDY . . . . .	31
APPENDIX A - Construction Methods for Inflatable Cooker . . . . .	32
APPENDIX B - Test Methods . . . . .	35
APPENDIX C - Heat Loss from Cooking Pots . . . . .	40
APPENDIX D - Sun Availability and Radiation Angle . . . . .	42

## INTRODUCTION

The study reported here, undertaken by Volunteers in Technical Assistance (VITA) for the United States Department of Commerce, Office of Technical Services, was to test various solar cookers for potential usefulness in countries served by the Agency for International Development. Specific points to be evaluated were performance and efficiency in cooking, durability, cost, shipping weight, portability, ease of operation, ease of manufacture in the countries involved and adaptability to local cooking techniques and dietary mores. Information was collected on satisfactory designs to adapt manufacturing methods and materials to the technology of the countries involved. VITA also contracted to submit suggestions for the improvement of existing models if no fully satisfactory design could be found.

An evaluation of cooking performance requires actual food preparation and is necessarily a subjective criterion. The efficiency of the cooker and the heat output to the cooking pot were measured in ways chosen to eliminate the effect of the cooking pot itself on performance. The experimental technique used was to measure the heat output when the pot was at ambient temperature. In winter, this was accomplished by observing the time to melt a known quantity of snow. In warm weather, a flow calorimeter was used; i.e., the temperature rise of water flowing through the cooking vessel at a known rate was measured. Durability was estimated from a knowledge of the materials and designs used, although in some cases, field test data were available. Costs were based either on published analyses by the various manufacturers, or on purchase prices, or on estimates. The shipping weight was defined as the weight of a single, finished item plus whatever packaging material was required for safe shipment to VITA. In the case of multiple shipments, the unit weight



might be substantially reduced. Portability and ease of use again required somewhat subjective evaluations. Although a reasonable estimate can be made regarding adaptability to local manufacture and adaptability to local cooking techniques and mores, a final appraisal depends on actual field experience.

In the study to date, models of six commercially available cookers were purchased and three others were built from descriptions in the literature. Two original VITA designs were also built and tested. In addition, such information is included as is available for those designs which have come to VITA's attention, but which were not included in the present test program because of lack of availability or other difficulties in obtaining test models.

## 2.0 DESCRIPTION OF COOKERS

The solar cookers described in this report are either the direct or indirect type, corresponding roughly to surface burners and ovens in modern kitchen stoves. The direct type permits frying, broiling and boiling to be done. The relatively large heat requirement is provided by intercepting a large amount of sunlight by a reflecting solar concentrator and focusing this onto the cooking vessel as illustrated in Fig. 1. These concentrators may be either rigid or collapsible. The direct cookers utilize direct sunshine only, and hence are relatively sensitive to short term variations in solar intensity due to cloud movement and haze. Refocusing is required at 15 to 30 minute intervals.

In the indirect type, shown in Fig. 2, a smaller amount of heat is directed into a thermally insulated box containing the cooking vessel. The indirect type is adaptable to slower cooking techniques and it is sufficient to use simple, flat reflectors to provide the necessary heat. Because these cookers utilize scattered as well as direct sunlight, and by virtue of their insulation as well as their solar capacity, they are less sensitive to variations in solar intensity and to shifts in the sun's position.

The performance of both types is influenced by ambient conditions. In addition, cooking performance depends on such design factors as the total heat available for cooking, distribution of the heat over the cooking surface, the ability of the cooker to compensate for the apparent motion of the sun, and the nature of the cooking vessels used.

For purposes of this report, the cookers are divided into three groups: (1) direct cooking types with rigid reflectors, (2) direct cooking types with collapsible reflectors, and (3) indirect cooking types with either rigid or

collapsible reflectors. Comparative data on the cookers described will be found in Section 3.0, Table 1. Most of the descriptions that follow are based on tests carried out by VITA. The descriptions marked with an asterisk (\*) are of those models which, for various reasons, VITA did not test independently.

## 2.1 RIGID REFLECTOR TYPES

Most rigid focusing reflectors devised for solar cookers are more or less saucer-shaped. Such spheroidal or paraboloidal reflectors are commonly used in automobile headlamps. In addition, other designs of rigid reflectors are possible. Rigid reflectors can be made to close tolerances and, with ingenuity, can be constructed cheaply. However, the rigidity and frequently the weight work against convenient portability of the finished product.

### 2.1.1 Wisconsin Cooker\*

Probably the best known direct cooker, and the one which is the standard against which all other cookers must be compared, is the molded plastic reflector developed at the Solar Laboratory of the University of Wisconsin (1, 2). The most recent model uses a drape-formed, high-impact polystyrene shell of 48 inches diameter and 0.060 inch thickness, stiffened at the rim with a ring of 0.5 inch diameter, thin-wall aluminum tubing. The cooker, which has an effective area of about 11.5 square feet, delivers about 40 to 55 percent of incident beam radiation to a cooking vessel seven inches in diameter; e.g., maximum delivery rate of 400-500 watts at an incident beam total energy of 1.0 kilowatt on the unshaded reflector. A reflective lining of Aluminized Mylar polyester film is applied to the shell. This polyester film is supplied with an adhesive coating applied to the aluminized side. The clear film forms a

protective covering over the specular surface. The new-condition specular reflectivity of this material is in the range of 75-80 percent. However, the reflective material cannot be expected to last more than two years with regular use. The metal parts of the cooker should have a lifetime of five to ten years with reasonable care. Although the lifetime of the reflective material is dependent upon the ambient conditions and the severity of usage, the chemical stability of the adhesive under field conditions is probably a significant factor. This is a troublesome aspect of plastic-coated reflectors, and may necessitate replacement of the aluminized plastic from time to time.

The units are light: the reflector weighs 5.2 pounds and the frame 15.6 pounds. The frame permits horizontal and vertical angular adjustment. Horizontal adjustment is provided by a rotating disc at the base. Solar altitude adjustment is provided by a locking device on a sector attached to the reflector. The grill is supported from each side for additional stability. The frame members are thin-wall steel tubing and 19-gauge sheet metal formed by stamping or spinning. The published (3) estimated individual cost for these cookers in lots of 10,000 and 1,000,000 is:

	<u>10,000</u>	<u>1,000,000</u>
Materials (including packaging)	\$ 7.70	\$6.33
Labor (\$2.00 per hour) and overhead	7.00	.48
Freight, selling expenses, etc.		1.26
Return on investment	<u>1.47</u>	<u>.59</u>
TOTAL	\$16.17	\$8.66

The latter total probably represents a lower limit on the cost of the unit.

These costs are based upon manufacture in a developed economy with subsequent transport to the country or area of ultimate usage.

A cooker used intermittently in the laboratory for several years gave the following performance. At an average beam radiation of 1.35 cal/ cm<sup>2</sup> / min (vertical sun corresponds to about 2.00 cal/ cm<sup>2</sup> / min), this cooker brought

two pounds of water from 90° F to boiling in 13 minutes; four pounds took 28 minutes and eight pounds, 62 minutes. In independent tests (4) performed by the FAO in Rome, Italy, roughly 50 percent longer heating times were required under local conditions.

Altogether, some 200 models of this cooker have been built as the designs evolved. Some 200 cookers of an earlier configuration were field-tested over a period of four years in northern Mexico. Anthropologists living in the village where the studies were made observed reactions to the cookers and also studied a variety of economic and cultural aspects of village life which affected the reactions of people to the innovation. Frequent (usually daily) visits were made to families using the cookers, and the anthropologists helped them by providing techniques of use and making any necessary repairs.

In the winter of 1961, five cookers of the advanced type shown in Fig. 1 were given to families in villages of this region. All five were used constantly for cooking meals and heating water and irons. Four of them were used on almost all possible days and the fifth on about 75 percent of the possible days. The inherent limitations of the design were appreciated by the villages, and it was accepted as a supplemental rather than a substitute cooking method.

The earlier types had essentially the same reflector, but the cooker stand was insufficiently rugged for long-term use. The cooker also had a tendency to blow over in a stiff wind. These defects were eliminated at a substantial increase in cost, but with a substantial increase in local acceptance.

#### 2.1.2 Spun Aluminum Parabolic Reflector

The best commercially available cooker that VITA studied is produced by Garrett Thew Studios of Westport, Connecticut and is shown in Fig. 3. The reflector is 39 centimeters in diameter and is made of spinning a sheet of aluminum 1/32 inch thick against a paraboloidal form built up out of several layers

of thick plywood. This requires the use of relatively heavy machinery, such as a heavy duty lathe. The edges are then rolled back to improve stiffness. A simple, inexpensive support of bent iron rods is used. This requires some blocking by stones or stakes driven into the ground, particularly when the sun is high. The wing nut which controls the reflector tilt is also difficult to use at high solar altitudes. The pot must be removed from its support for adjustment for either altitude or azimuth. The weight is moderate—about 3.5 kilograms for the complete assembly. However, the reflector area is only 0.64 square meters. A one-square-meter reflector would weigh about 5 kilograms. The retail price of the unit is \$29.50; estimated small-lot manufacturing cost is approximately \$20.

Heating performance measurements were made after six months of intermittent use. It delivered a measured 250 watts on a clear day, as determined by the flow calorimeter technique (Appendix B). This corresponds to 400 watts per square meter of reflector surface. A photograph of the focal spot, made at the same time, is shown in Fig. 4. It is not possible to make a comparison with the Wisconsin cooker since we were unable to procure a model of the latter cooker. New reflectors which have recently been received are noticeably more reflective and have a better defined focal spot. The inhomogeneity of the focal spot leads to local overheating and occasional cracking of ceramic pots and makes frying inconvenient. However, the cooker performs well in preparing small quantities (about 1 pint) of rice or stew. It heats one liter of water at a rate of 2° to 3° C per minute and is quite suitable for pan-broiling individual portions of meat. For family size cooking it would have to be scaled up to a surface area of at least a square meter. Such a construction would require even heavier machinery for construction.

### 2.1.3 Other Simple Metal or Plastic Reflectors

In a somewhat different approach, Stam (5) suggests using reflectors similar to the Wisconsin or the Thew reflectors. However, he proposes simplifying the design to its most primitive aspects. By placing the reflector shell over a depression in the ground, the stand for the cooker can be eliminated. The sun's rays are focused onto the pot by rocking the reflector-pot-holder assembly. This scheme requires an assymmetrically shaped reflector. It has not been tested experimentally.

A number of cookers described in the literature use strips of polished metal, riveted together, to form a more or less adequate approximation of a spherical parabola. One of these, developed in Burma (6), has been reproduced by us from blue prints obtained through the designer, Dr. Freddy Ba Wli. Reflectivity and mechanical rigidity of this reflector (Fig. 5) is poor and the focal spot is very large and diffuse. It is impossible to center a pot properly and the heat is inadequate to bring a quart of water to boiling in spite of the large reflector size. This may be due in part to the lack of availability of truly specular sheet aluminum. Furthermore, the equipment is hard to stabilize on a windy day, although it is very heavy (13 kg.). Tests on this model have been abandoned in favor of more promising designs.

Other metal reflector designs are supposedly in commercial production in Japan (7-9) and India (10-12). These sources have been contacted, but in spite of considerable effort, VITA has been unable to obtain models or accurate design details of these cookers.

### 2.1.4 Fresnel-Type Reflector

Of the models actually tested by VITA to date, this cooker (Fig. 6) has given the best results. Construction details for this cooker are available from VITA.

The reflector uses only simple, curved surfaces and is constructed of 1/8-inch Masonite to which aluminized Mylar has been cemented. By cutting a series of rings out of such a flat sheet of material, removing sectors and re-joining, a series of nesting collars that focus light are formed. These collars are supported in a simple wooden frame. The design is simple enough to permit construction with the tools, skills and materials (except for the aluminized Mylar) that are locally available throughout most of the world.

The reflector is 46 inches in diameter and has a focal length of 30 inches. On a clear day, it delivers in excess of 500 watts to a focal spot of about 6 inches in diameter. The focal spot is quite uniformly illuminated, as shown in Fig. 7. A square, black, aluminum pan (7x7x2 inches) with a fitted, sliding lid (Fig. 8), obtained from the Piolyte Plastics Company, Salem, Mass. as part of the "Solar Chef" equipment, makes a very convenient cooking pot. Two tripod-type support stand designs have been used. In one, the reflector is supported on the ground at one point, and two legs, in the form of a U-shaped, bent iron rod bracket completed the support. This design, which is similar to that used in the Thew cooker, is relatively easy to orient, but is not as stable in the wind as the second design. In this, the reflector is supported at two places on the ground, and a single pivoting wooden leg supports the cooker at the desired angle. Although even this mounting of the reflector may not be adequate to hold it securely in very heavy wind, the wind resistance appears to be intrinsically less than in reflector cookers having one-piece construction. The pot holder consists of a rod to which a grill is attached which holds the pot at the proper focal distance, and which permits the pot to be held horizontally, independent of the reflector position.

In the empirical cooking tests, six portions (4 cups) of rice were



prepared in 30 minutes and a small chicken was browned in an open pan and completed in a closed pan in 30 minutes total cooking time. No adjustment of the cooker was necessary during the cooking, although it was slightly defocused at the end of the cooking period. Large (6-inch) pancakes were prepared with very uniform browning in a small enamel frying pan with a black bottom. A simple type of bread (English muffin) was also quite successfully prepared using the black aluminum pan. Four muffins were baked at once, requiring about 20 minutes (10 minutes on each side). In general, cooking time and performance were comparable to that of a small surface burner on an electric range or a small electric frying pan or casserole.

In addition to the features already discussed, this cooker is sufficiently simple that if the necessary materials are available, anyone skilled in the use of simple hand tools, such as a hammer, a saw, and a screw-driver, cannot only construct it, but also repair it if and when necessary. Furthermore, it is believed that local construction of this cooker would facilitate its introduction into a developing area from a psychological and sociological point of view. Finally, the performance of the cooker is the equal of almost any cooker of comparable size, and there is reason to believe that its performance can be improved upon still more.

The most serious drawback of this cooker is that which plagues other designs as well--the deterioration of the aluminum reflecting surface of the cooker due to weathering. Even bulk aluminum loses its high reflectivity on exposure to the elements. On the other hand, this design allows convenient replacement of the reflective material whenever dictated by a loss in performance.

#### 2.1.5 Fixed Soil-Cement Spheroidal Reflectors

In one such reflector (13), a spheroidal depression in the ground is lined

first with a mixture of soil and cement to stabilize the shape and then with aluminized plastic. The symmetrical depression is formed by swinging a pendulum, or blade, fastened to a wire which is secured at a fixed point above the ground on a tripod. After the rough shape is hollowed out, a shallow layer of a soil and cement mixture is placed in the depression, smoothed with the blade and wetted. When this has set, and after some further work on the surface, a reflective lining of aluminized Mylar pressure-sensitive tape is applied. The cooking pot support is built so that the pot follows the shift in the focal spot due to the daily motion of the sun.

The advantages of this cooker are its simplicity and ease of construction in the field and the large sizes possible. No reflector mounting is necessary, and the cooking pot support is simple to fabricate. The orientation can be fixed during construction so as to make the reflector usable during the desired time of day. The cost of material for the laboratory models, exclusive of the reflective lining, was less than a dollar.

The disadvantages of this cooker are its lack of mobility, which might result in physical damage due to weather conditions, and the limited period of time during which it can be used (estimated at 4 hours a day).

Stam (5) suggests a variation of this design in which he proposes integrating a large reflector, capable of delivering 2000 watts or more, into the design of a desert home. Such a device constitutes the nucleus of a solar kitchen. Stam has worked out a whole system of cooking and utilizing the solar energy in such a design. The reflectors would be made out of adobe, or some such material, and lined with a reflective material such as aluminum foil. Only a scale model has been constructed to date.

#### 2.1.6 Lightweight Molded Aggregate Reflectors

Reflector shells have been made of lightweight, concrete aggregate of

sawdust and vermiculite, which are formed over molds and lined with aluminized plastic and plastic tape.

The most successful of this type of cooker (13) is a reflector 42 inches in diameter with a focal length of 18 inches, made of a vermiculite aggregate and reinforced with wire and a rim of thin-wall tubing. The total weight is about 50 pounds. The reflector mount is a wooden post in the ground, arranged to pivot about its axis. Holes are drilled through it to hold a rod from which hangs a pan-support basket. The top edge of the reflector leans against the post and its lower edge is supported at variable distances from the post on an arm secured to the post.

The advantages of this type of cooker are the simplicity of the mounting device and its component parts and the possibility of using locally available materials and labor for its construction. Major disadvantages are the weight of the reflector, which makes it cumbersome to handle, and the fact that the reflective lining is difficult to apply.

Another inexpensive method of fabricating this type of reflector has been suggested by J. R. Jenness (14). A convex, wire-reinforced, plaster paraboloid die is first cast from a centrifugally formed concave paraboloid mold. The cost of this is stated to be \$10. This figure presumably represents only the cost of materials in the United States. The surface of the die is coated with wax, then a layer of wood pulp, papier-mache or laminated newspaper is spread over it. After a few layers are built up, they are pressed to squeeze out excess liquid. The process is repeated until the compressed laminate is 1/8 to 1/4 inch thick. Then the rim of a wooden "wagon wheel", reinforcing framework is glued in place. Woven basketry is suggested as an alternative method of reinforcement. After removal from the die, strips of aluminum foil are pasted on the surface. Finally, a stiff hoop is clamped to the front surface. Jenness

states that the process would require 6 to 8 hours of labor and a material cost of 25¢. He gives no test results and does not state whether any such reflectors are actually produced.

#### 2.1.7 Lightweight Plastic Reflectors

A different fabrication technique has been developed by the Boeing Aircraft Company (12) primarily for space applications. The high cost of this reflector and the thinness of its coating make it unsuitable for our purposes. It was included in our study, however, because of its light weight and high rigidity and also because it provided an opportunity to test the cooking performance of a nearly perfect parabolic reflector.

We are indebted to K. G. Wood, Manager of Manufacturing Engineering of Boeing's Seattle Office, for making two reflectors available to VITA on a loan basis. The first of these had a diameter of 53.5 centimeters with a focal length of approximately 30 centimeters and a weight of 450 grams. A rough test of its efficiency made by the snow melting technique (Appendix 1), gave a value of 437 watts per square meter. The spun aluminum cooker (see Section 2.1.6), which served as the standard at the time of these tests, gave a value of 300 watts per square meter under identical conditions.

Navy searchlight mirrors serve as the blank for the reflector. A convex tool is first made from the original concave mirror using Simonize auto wax as the parting agent. The convex tool is then Simonized and rubbed to a high gloss. A film of epoxy resin is spread on and the wet resin-coated tool is enclosed in a transparent vacuum bag and smoothed until it is uniformly covered with resin. After the resin has cured, a 2-mil fiberglass cloth is impregnated with epoxy and placed on the cured film. Aluminum honeycomb of .0005 inch web thickness is laid on this wet fiberglass cloth. Three-dimensional flexibility is achieved by slitting the honeycomb cell walls. The slitting operation is

performed with the cell walls in a collapsed condition. A second layer of impregnated fiberglass cloth is placed on top of the honeycomb to form a sandwich. A bag is placed over the assembly and a 3-psi effective pressure applied by partially evacuating the bag. The entire mirror assembly is then cured at 250° F. The paraboloid is given a reflective first surface by applying a coat of aluminum in a vacuum chamber. A silicon-oxide coating is deposited on the aluminum to protect the reflective surface. Reflectivity of the coated surface is about 90 percent. The weight of the completed paraboloid is 0.2 to 0.4 pounds per square foot. Maximum efficiency of energy collection as measured with a flow calorimeter is 72 percent.

The main disadvantage of these reflectors is their high cost and the very advanced technology required for their manufacture. Unit costs have been estimated at \$18 for a collector of 36-inch diameter in lots of 1000. This includes 1-1/2 hours of labor and overhead at \$8.25 per hour.

In addition to the above, the Goodyear Tire & Rubber Company (16) has introduced the technique of making rigid reflectors out of a rigidized, foamed plastic. Although this technique is primarily intended for fabricating reflectors for space technological purposes, this technique may be used to produce reflectors for cooking devices as well. The mold-shape is produced by simply inflating an aluminized plastic balloon. This then becomes the reflecting wall of the finished reflector after being backed up by a rigid foamed plastic. The cost of materials for such a reflector is probably less than \$2 for a 48-inch reflector.

#### 2.1.8 Spun Liquid Plastic Reflector

An interesting method for producing parabolic mirrors is described by P. B. Archibald (17). A liquid in a revolving horizontal pan takes the shape of a paraboloid, and a liquid resin suitably catalyzed to harden after this

form is taken will retain this shape. With the development of the epoxy resins, satisfactory material has become available. Epon 828, catalyzed with 5 percent piperidine and cured at 80° to 90° C has been found to give satisfactory results.

The focal length of the finished reflector is controlled by the speed of rotation of the pan. The formula for the focal length may be simplified to  $\sqrt{f} = 38.4/\text{rpm}$ , where f is the focal length in feet. A 36-inch focal length requires a speed of only 22/7 rpm. Additional resin may be poured onto the first surface after it has set. In general, superior surfaces are obtained on the second or third pour. Reinforcing material such as fiberglass can be placed on the surface before the second surface is poured.

The quality of the reflectors produced to date is better than anything that can presently be made without the use of grinding and polishing techniques. This is, however, not a significant factor in cooker considerations. However, the estimated weight of such a 36-inch diameter reflector is about 30 pounds for a 1/2-inch thickness. The cost of this much epoxy resin is estimated at \$25-\$35. Hence, although this technique could perhaps be used for making a master mold, it does not appear that this offers a practical solution for low cost solar cookers.

## 2.2 DIRECT COOKING TYPES WITH COLLAPSIBLE REFLECTORS

There are at least four designs of collapsible reflectors commercially available. Most are designed for occasional use by campers or sportsmen. Since the emphasis is on easy portability, the weight is kept low and the structure simple. Thus, all models tested were inadequate from the point of view of stability on windy days. Several reflectors might possibly be modified by designing a heavier and more durable support structure, preferably one that can be built from local materials. Collapsible designs are cheap and

easy to ship and also easy to move indoors for protection against weather. In certain nomadic societies, the easy portability might be especially desirable.

### 2.2.1 Solar Chef

This design (Figs. 9a and 9b) is an intermediate between the rigid and collapsible types. The reflector consists of two thin plastic sections about 60 x 40 centimeters, which form a sort of cylindrical parabola. The plastic is vapor coated with aluminum and the two sections can be stacked. The support structure consists of a pointed rod to be stuck into the ground and four other support pieces. Altitude and azimuth adjustments require removal of the pot. The evaporated aluminum coating on our purchased cooker was very thin and transparent. The focal spot was diffuse and matched the pot poorly. We did not succeed in bringing water to a boil with our model and therefore abandoned further tests. This weak performance must be attributed in part to the inadequate collector area.

The pot, however, which is furnished as part of the assembly, is very suitable for use on other cookers. We obtained four additional ones at a price of \$1 each.

### 2.2.2 Umbroiler

This reflector (Figs. 10a and 10b) is constructed like an umbrella (13). It is made with a light aluminum frame, has 16 ribs, and is covered with aluminized Mylar-rayon laminated cloth. It is 46 inches in diameter and has a focal length of about 24 inches. The reflecting material between adjacent ribs forms a wedge-like segment which has a base length of 9 inches between rib tips. Hence, any pot that is less than 9 inches across will not receive all the light that is reflected back. For a 6-inch pot, about 1/3 of the light gathered near the periphery is lost. Increased efficiency would result from introducing more ribs. Our studies show that the focal point is quite diffuse

(Fig. 11), due partly to the folds in the cloth, and partly to fluttering of the cloth in a stiff wind.

The reflector is supported by a tripod frame which incorporates an adjustable swivel joint for proper alignment of the cooker with respect to the sun. Adjustment of the altitude angle requires removing the cooking vessel. Considerable difficulty was encountered on windy days because this cooker tended to blow over.

The designer and manufacturer of this cooker, G. O. G. Lof, has suggested a number of modifications to make this design more rugged and suitable for continuous use. These include heavier fabric, larger tube diameter for the umbrella shaft, heavier grill and more rugged support joint for the entire unit.

The present wholesale price in small lots is \$18 and the manufacturer estimates a possible wholesale price of \$10 in large lots. The retail price is about \$30. However, Lof suggests that a cost reduction of 50-68% is possible based on manufacture in areas in which they are to be used.

Cooking performance was adequate, but the 400 watts reported could not be obtained. It is interesting to note that one unit has tested to 60° N Latitude in Sweden and cooked satisfactorily.

### 2.2.3 Solnar

This elegant cooker (Figs. 12a and 12b) is manufactured in France from designs by A. Tarcici. The design is covered by a number of French and U.S. patents (19, 20, 21).

The reflector consists of two sets of 18 reflecting blades forming a fan-like array. The curvatures are such that the assembly approximates a paraboloid of revolution. The tripod frame and metal carrying case are ingeniously combined to form a one-piece assembly, including a grill. Adjustment of cooker orientation without removing the pot, although possible, is difficult. The



focal spot is very diffuse (Fig. 13), consisting of somewhat overlapping areas. In our model, the grill was poorly centered on the spot. Thus, the pot had to be put near the edge of the grill, causing instability and occasional spilling. Maximum output was only about 200 watts per square meter. The retail price of the cooker in New York City was \$37.50. We have been unsuccessful in obtaining additional cost and manufacturing information from the designer or the importer. The fan-like reflector is inherently cheap and easy to manufacture with simple tools. A reflector made on this principle but with a different support may merit consideration.

#### 2.2.4 Inflatable Plastic Reflectors

Reflectors of this type were first reported by the workers at the University of Wisconsin Solar Energy Laboratory. The reflector they described (B) is a parabola of revolution constructed of aluminized plastic, supported on a stiff outer ring of thin-wall tubing and having an air-tight cover of clear plastic. The aperture is 42 inches and the focal length 18 inches. Mylar has been used as the plastic. The reflector weighs about 5 pounds. It is believed that this type of reflector could also be used with the mounting for the plastic shell cookers described in section 2.1.1.

VITA has also considered such a design (Fig. 14) with the view that the reflector element, independent of the supporting frame, potholder, etc. can be produced at a low cost and can be folded into a small lightweight package for easy shipment to remote areas. The cost of such a reflector unit is estimated to be 75¢ and the weight less than a pound. The supporting frame, orientation and the like could be constructed locally.

In the 48-inch diameter prototypes that VITA constructed, there was no difficulty in concentrating sunlight sufficiently to ignite paper. However, several difficulties arose. One was the problem of maintaining air within the

reflector. An appreciable rate of reflector deflation occurred, either because of pin-hole leaks or because of permeation itself. Furthermore, the reflector surface fluttered in the wind, causing defocusing. Another mild disadvantage of this design is that there are two extra interfaces between the vessel and the reflector, with the radiation passing twice through each. The direct radiation from the sun to the reflector is normal to the interfaces; the reflected radiation from the parabola passes through the interfaces at angles of incidence which become progressively less favorable from the center to the rim. Each passage of the radiation through an interface results in reflection loss. However, this is simple to remedy by increasing the reflector size. Another problem is that these reflectors can be damaged if handled very roughly. Finally, the lightweight and high surface area tended to make this cooker unstable in a strong wind.

Another large, inflatable solar collector made of Mylar, developed by G. T. Schjeldahl Company of Northfield, Minnesota has been briefly described in a magazine article (22). We were unable to obtain further details of this structure.

### 2.3 OVEN-TYPE COOKERS

Two oven-type cookers were manufactured for VITA from descriptions in the literature by Yellott Engineering Associates, Phoenix, Arizona. One of these designs, described by Gosh (23), did not perform well in our latitudes; however, it may be quite suitable for use in the tropics. The other one was based on a design by M. Telkes (24, 25, 26), except that no heat storage chemicals were included. It performed very well.

The ovens are essentially plywood boxes with sheet metal lining. Both are sturdy and adaptable to simple manufacturing methods. The box could be made of any of a wide variety of woods. The sheet metal liner could be made with hand

tools. Material costs for the ovens would range from \$4 to \$7 and labor costs would vary widely according to the methods used and number produced. Dr. Telkes (27) has suggested even simpler construction, making use of locally available basket crafts. The reflectors for these ovens, on the other hand, are relatively fragile, but are also simple to manufacture. They require only tin snips and a punch or drill, provided polished aluminum is available. It should be possible to make the reflectors more rugged by adding wooden or metal frames. Dr. Telkes has designed various modifications of the design that VITA tested. In addition, a somewhat similar design has been tested (4) by F.A.O.

Two designs, intermediate between the direct and indirect, have come to VITA's attention. One of these, employing simple, folding, aluminized cardboard reflector, was included in our tests. The information on the other was taken from the literature.

#### 2.3.1 Reflector Oven (Telkes)

The oven (Fig. 15) is a box of plywood approximately 48 x 48 centimeters at the base and 41 centimeters high. One side is cut off at a 45° angle and the opening is covered with a double glass window. Surrounding the window are four polished, flat aluminum sheets hinged to the outside of the box. Each sheet is 34 x 34 centimeters. Triangular pieces of polished aluminum are fitted between the larger sheets to complete the reflector. One side of the box has a hinged door. The interior is lined with sheet metal, painted black. A 3-quart casserole fits easily in the oven.

Assembly is simple, requiring the equivalent of a screwdriver to assemble the reflector and about 15 minutes. The oven, which weighs about 13.6 kilograms, can be lifted by two handles. The reflector, while flimsy, is sufficiently rigid to stand up in a strong wind. It maintained its setting and required little adjustment during cooking tests.

Although the temperatures reached were low (315° F on a day when outdoor temperature was 46° F), the oven could be used to cook simple dishes with such foods as meat, rice and potatoes by increasing the ordinary cooking time. The Food and Agriculture Organization of the United Nations carried out a series of tests in Rome during the summer of 1959 on a solar oven of almost identical design. They report (4) that this cooker required an average of 112 minutes to heat 2 liters of water from tap temperature (15°-20° C) to boiling. Although the latter cooker did possess a container of a heat storage chemical, the heating time was increased by the time of any cloud cover during the test.

Telkes and Andrassy (27) have carried out extensive cooking tests on a modification of the same basic cooker. They report being able to achieve temperatures as high as 460° F near New York City on a clear day. They were able to prepare the following foods successfully in the oven: rice (1 lb. + 1 lb. of water) in 45 minutes; lentils (1 lb. + 4 lbs. water) in 2 hours; dry peas and black beans (1 lb. + 4 lbs. of water) in 3-4 hours; meat roasts (8 lbs. beef) in 3 hours; stew (meat and vegetables) in 2 hours; bread, rolls and cake (2 lbs. of bread) required 45 minutes; fruit preserves (2 lbs. fruit + 1 lb. sugar and 0.5 lbs. water) in about 3 hours. The foods cooked as they would in a standard oven.

### 2.3.2 Reflector Oven (Gosh)

The oven (Fig. 1b) was a plywood box, 45 x 56 centimeters on the base and 32 centimeters high. The top, hinged, double glass window, served as the oven door. The reflector was one flat sheet of polished aluminum supported by a system of light bars and flat sheet metal strips which could not hold the reflector in any breeze. The interior was a sheet metal, painted black. No assembling was required. The weight was about 18.2 kilograms. The maximum temperature reached with this model was 238° F at an ambient temperature of 45° F.

The reflector would stay in position only in calm weather and frequent adjustments were needed. This design should perform much better at high solar altitudes, as in the tropics. The tests made in Schenectady at solar altitudes between 30° and 40° are probably not indicative of its performance under optimum conditions.

### 2.3.3 Folding Paper Conical Reflector

This design (Figs. 17a and 17b), marketed by Honor House Products, Lynbrook, N.Y., is midway between the folding reflectors and the oven types. At a retail price of \$3.98 it has the distinction of being the only cooker of this type with a cost well within the \$5 limit generally accepted as maximum price for wide distribution in fuel-poor countries. The price includes a cardboard packing box, which also serves as a support for both cooker and reflector, and a cooking pot with a blackened lid. The reflector is made of thin, aluminized cardboard. All of the other parts except the pot are also cardboard. The reflector folds and rolls in an ingenious fashion to fit inside the pot. At our geographical latitude, it is not possible to cook liquids, since the pot must be tilted to intercept solar radiation. However, in the tropics, wet cooking may be possible. The cooker performed quite well with some foods, heating frankfurters or cooking thin steaks or hamburgers in about 20 minutes. Durability is necessarily poor. We estimate that this cooker would last for about 20 or 30 cooking sessions, or less if the cooker were subjected to moisture. If it were necessary to fold the reflector after each use, durability would be impaired, as it is difficult to avoid damaging the reflector when opening and closing it.

### 2.3.4 Cylindro-Parabolic Solar Cooker

This cooker was designed by A. S. Prata (26) in Portugal, to combine the best features of the previously discussed direct cookers and the oven types.

It is shown in Fig. 18. In this design, the oven consists of a 10-inch ID x 24-inch insulated metal drum with doors in the ends for inserting the cooking vessels. A strip of metal is removed along the length of the drum, and is replaced with a plate of glass which permits light to be concentrated by a cylindrical reflector made by bending a sheet of highly reflective metal. Instead of a focal spot, this produces a line of concentrated sunlight. The oven is supported by a wooden frame, which holds it in the right position with respect to the reflector, so that the focused light enters the oven through the glass window. In this way, considerably more heat can be directed into the oven than was possible with the cookers described in 2.3.1 and 2.3.2. Accordingly, some improvement in cooking time was found in the cooking tests.

The cooker cannot be considered simple. The designer estimates that the cost of the materials is \$18, plus 8 hours of labor. Although the apparatus weighs only 18 kilograms, it is a relatively bulky design. It may be advantageous in an area where it must compete with conventional electric, gas or wood-burning ovens.

### 3.0 SUMMARY

TABLE 1 gives comparative data on the properties of the cookers and reflectors which were tested.

No commercially available unit tested thus far has met the criteria of low cost, efficient operation and ready transportability. Furthermore, the majority of the effort has not gone into developing designs suitable for local manufacture. In particular, none of the commercially available cookers appear to be well adapted to such manufacture. It is felt, however, that a Fresnel-type solar cooker would meet these criteria. The Fresnel-type cooker performed acceptably in cooking tests and standard tests. It can be produced using about \$5 worth of materials plus about one day of locally available labor and simple tools.

We have been unable to make direct comparison between the Fresnel cooker and the more widely known Wisconsin cooker. Although the material costs in the United States are comparable, the Fresnel cooker involves simpler construction techniques and is more adaptable to the use of indigenous materials and skills.

Comparative merits of the oven-type and the direct-cooking type have not been quantitatively established. Some tests were noted in the literature (4), but these results were inconclusive. VITA studies indicate that the direct-cooking devices have the advantage of greater speed. On the other hand, the oven-type cooker will retain heat for a much longer period of time after the sun has set or cloud cover has formed, and the food is also protected from contamination and damage by animals and insects. There appears to be no inherent reason why a low-cost oven-type cooker cannot be made locally.

It is felt that a choice between the two depends on local dietary mores

and local meteorological conditions. Indeed, it may be desirable to utilize both types, just as we utilize both surface units and ovens in a modern electric or gas stove.

There appear to be important gains in heat utilization possible with simple pot shielding.



TABLE 1

## Comparative Data on 12 Solar Cookers

Cooker †	Type ††	Reflector Area (m <sup>2</sup> )	Focal Length (cm)	Weight (kg)		Approx. Size (Packaged) (Inches)	Performance	Retail Cost (Dollars)	Estimated Manufacturing Cost (Dollars)
				Net	Packaged				
Misconsin Design (2.1.1)	D-R	1.2		9-10			***		8.66-16.17
Bosung Reflector <sup>1</sup> (2.1.7)	D-R	.21	36	0.45		22 x 22 x 4	***		18.00
Thew Cooker (2.1.2)	D-R	.64	45	3.5	6.2	42 x 42 x 8	**	29.50	20.00
Burmese Design (2.1.3)	D-R	2.5	~ 60	13.2	20.	52 x 52 x 10	--	12.00	
Fresnel Type <sup>2</sup> (2.1.4)	D-R	1.	~ 60	5.3 .10.	7.	50 x 50 x 10	***		< 5.00
Solar Chef <sup>3</sup> (2.2.1)	D-F	0.5		1.3	2.5	25 x 16 x 6-1/2	--	19.95	12.00
Umbroiler <sup>4</sup> (2.2.2)	D-F	1.2	45	1.4	2.4	29 x 10 x 4	*	29.50	15.00
Solnar (2.2.3)	D-F	Ellipsoid ~ 1.	45	3.7	4.2	22 x 10 x 3	*	37.50	10.00-12.00
Inflatable Type <sup>5</sup> (2.2.4)	D-F	1.3	~ 50	0.2	.25	5 x 5 x 1	**		< 5.00
Oven Design, Felkes (2.3.1)	I-F	0.46		13.6			***		
Oven Design, Gosh (2.3.2)	I-R	~ 0.2		18.2			#		
Conical Paper Ref. (2.3.3)	I-R	0.59		0.72	1.07	11 x 11 x 6	*	3.98	2.00

† Numbers in this column refer to corresponding sections in text.

†† D = Direct; R = Rigid; I = Indirect; F = Folding or Collapsible.

1 Reflector only. Manufacturing cost is based on a 36-inch reflector.

2 Not optimized for weight.

3 Our model may not have been optimum.

4 Performance tests hindered by wind; better support possible.

5 Data refer to reflector without frame.

\*\*\* = Very Good

\*\* = Good

\* = Fair

-- = Unacceptable

## REFERENCES

1. Duffie, J. A., Lappala, R. P., and Lof, G. O. G. "Plastics for focusing collectors." Journal of Solar Energy Science and Engineering 1 (No. 4): 9-13, 1957.
2. Duffie, J. A., Lappala, R. P., and Lof, G. O. G. "Plastics in Solar Stoves." Modern Plastics 35 (No. 3): 124-125, 260-262, 1957.
3. Duffie, J. A., Lof, G. O. G., and Beck, B. "Laboratory and Field Studies of Plastic Reflector Solar Cookers." U.N. Conf. on New Sources of Energy, Rome, 1961, paper 35/S/87.
4. "Report on Tests Conducted Using Telkes Solar Oven and the Wisconsin Solar Stove over the period July to September, 1959." Ibid., 35/S/116.
5. Stam, H. "Cheap but Practical Solar Kitchens." Ibid., 35/S/24.
6. Ba Hli, F. "A New Solar Cooker for the Utilization of Solar Energy in Burma." Journal of the Burma Research Society 38: 107-111, 1955.
7. Goto, S. Cooking Apparatus by Sun Heat. Japanese patent 179,653. 1949.
8. Goto, S. Cooking Apparatus by Sun Heat. Japanese patent 179,644. 1949.
9. Goto, S. Cooking Apparatus by Sun Heat. Japanese patent 378,475. 1950.
10. Ghai, M. L. Solar Cooker. Indian patent 46,981. Sept. 15, 1952.
11. Ghai, M. L. "Solar Heat for Cooking." Journal of Scientific and Industrial Research 12A (No. 3): 117-124, 1953.
12. Ghai, M. L., Bansal, T. D., and Kaul, B. N. "Design of Reflector-type Direct Solar Cookers." Journal of Scientific and Industrial Research 12A (No. 4): 165-175, 1953.
13. Duffie, J. A. "Reflective Solar Cooker Designs." In: Transactions of the Conference on the Use of Solar Energy--the Scientific Basis, Vol. 3, Part 2, pp. 79-86. Tucson, Arizona, Association for Applied Solar Energy, 1955. (Sections 2.11 and 2.12 and parts of Section 2.24 of this report are abstracted from this reference.)
14. Jenness, J. R., Jr. "Recommendations and Suggested Techniques for the Manufacture of Inexpensive Solar Cookers." Solar Energy 4 (No. 3): 22-24, 1950.
15. Gillette, R., Snyder, H. E., and Timar, T. "Lightweight Solar Concentrator Development." Paper No. 60-WA-90, presented at the Winter Meeting of the American Society of Mechanical Engineers, 1960.

16. Private Communication.
17. Archibald, P. B. "A Method for Manufacturing Parabolic Mirrors." Journal of Solar Energy Science and Engineering 1 (Nos. 2 and 3): 102-103, 1957.
18. Lof, G. O. G., and Fester, Dale A. "Design and Performance of Folding Umbrella-type Solar Cooker." U.N. Conf. on New Sources of Solar Energy, Rome, 1961, paper 35/S/100.
19. Tarcici, A. Solar Heating Apparatus. U.S. Patent 2,770,229. Nov. 13, 1956.
20. Tarcici, A. Solar Heating Apparatus. U.S. Patent 2,770,230. Nov. 13, 1956.
21. Tarcici, A. Sun-Operated Heating Devices. U.S. Patent 2,760,482. Aug. 28, 1956.
22. Stone, I. "Surveyor Lunar Spacecraft Has Varied Approaches." Aviation Week 74 (No. 5): 50-56, 1961.
23. Gosh, N. K. "Utilization of Solar Energy." Science and Culture 22: 304-312, 1956.
24. Telkes, M. "Solar Stoves." In: Transactions of the Conference on the Use of Solar Energy--the Scientific Basis, Vol. 3, Part 2, pp. 87-98. Tucson, Arizona, Association for Applied Solar Energy, 1955.
25. Telkes, M. "Solar Cooking Ovens." Solar Energy 3 (No. 1): 1-11, 1959.
26. Telkes, M. "The Solar Cooking Oven." Report to the Ford Foundation from the Research Division, College of Engineering, New York University, N.Y.; Ford Foundation, 1958.
27. Telkes, M., and Andrassy, S. "Practical Solar Cooking Ovens." U.N. Conf. on New Sources of Solar Energy, Rome, 1961, paper 35/S/101.
28. Prata, A. S. "A Cylindro-Parabolic Solar Cooker." Ibid., paper 35/S/110.
29. Hillig, W. B. "Solar Cookers." VITA Report No. 1, Schenectady, N.Y., Volunteers for International Technical Assistance, 1960.

## ILLUSTRATIONS

	<u>Page</u>
Fig. 1. Wisconsin Cooker . . . . .	45
Fig. 2. Telkes Solar Cooking Oven with Tubular Stand . . . . .	46
Fig. 3. Thew Cooker . . . . .	47
Fig. 4. Focal Spot Shape of the Thew Cooker . . . . .	48
Fig. 5. Burmese Cooker . . . . .	49
Fig. 6. Fresnel Hillig Cooker . . . . .	50
Fig. 7. Focal Spot Shape of Fresnel Hillig Cooker . . . . .	51
Fig. 8. Cooking Pan . . . . .	52
Fig. 9A. Solar Chef . . . . .	53
Fig. 9B. Solar Chef, Disassembled . . . . .	54
Fig. 10A. Umbroiler . . . . .	55
Fig. 10B. Umbroiler Folded . . . . .	56
Fig. 11. Focal Spot Shape of Umbroiler . . . . .	57
Fig. 12A. Solnar Cooker . . . . .	58
Fig. 12B. Solnar Cooker Folded . . . . .	59
Fig. 13. Focal Spot Shape of Solnar Cooker . . . . .	60
Fig. 14. VITA Inflatable Cooker . . . . .	61
Fig. 15. Telkes Type Cooker Tested . . . . .	62
Fig. 16. Gosh Type Cooker Tested . . . . .	63
Fig. 17A. Demountable Cardboard Cooker . . . . .	64
Fig. 17B. Collapsed Demountable Cardboard Cooker . . . . .	65
Fig. 18. Cylindro-Parabolic Solar Cooker Viewed From the Side of the Slip Rings . . . . .	66

	<u>Page</u>
Fig. 19. Calorimeter Test Arrangement . . . . .	67
Fig. 20. Crude Pyrheliometer . . . . .	68
Fig. 21. Arrangement for Incident Light Measurements . . . . .	69
Fig. 22. Arrangement of Heat Loss Experiment . . . . .	70
Fig. 23. Results of Heat Loss Tests . . . . .	71

## RECOMMENDATIONS FOR FURTHER STUDY

- A.
  - 1. Better cementing techniques
  - 2. Test merits of different pot supports
  - 3. Improve reflector material
    - a. Evaporate protection layer over aluminum
    - b. Other evaporated materials such as chromium
    - c. Try burnished aluminum
    - d. Some sort of satisfactory spray paint
- B. Construction of very cheap oven type
- C. Try marrying an oven to a Fresnel cooker
- D. Develop cooking pots with lower convection losses

## APPENDIX A

### CONSTRUCTION METHODS FOR INFLATABLE COOKER

A particular advantage of the inflatable type is that the small reflector weight of only a few ounces makes shipment cheap. This is important because the reflector would have to be produced in a relatively developed country since its manufacture must be carefully controlled in order to attain the proper shape. The frame of the cooker could be constructed in the country where it is to be used from local materials of wood or metal.

The intrinsic cost of both these cookers is well below \$5. Materials for the reflective element of the inflatable cooker cost about 50 cents and although manufacturing techniques have not yet been worked out, it is believed that the manufacturing costs could be quite minimal, perhaps \$1 per reflector. The frame cost would be largely dependent on local material cost but in general should be low (about \$1.50 in U.S.). The pot cost would be similar to that for other cookers.

The inflatable cooker consists, in essence, of a circular air pillow constructed of two sheets of thin Mylar plastic having a diameter of about 4'. One sheet is 1/2-mil aluminized Mylar; the second is 1-1/2-mil clear Mylar. The two are cemented together around the edges and holes, reinforced with 20-mil vinyl plastic tabs at the rim so that the plastic can be lashed or fastened by bands to a suitable frame. The fastenings are used to hold the reflector taut so that when the space between the two sheets of plastic is filled with air, the reflector will form a pillow-like shape. The frame may be made of wood, bamboo, pipe or some other locally available material. The frame of the

prototype was made of eight pieces of 1" x 3" lumber fastened together at the ends to form an octagon. The reflector is inflated through an air tube formed at the edge of the plastic.

Light from the sun passes through the clear plastic, is reflected off the aluminized inside surface of the reflector, again passes through the clear plastic and is focused upon a spot which can be used for cooking. The amount of air that is blown into the reflector determines the focal length. Focal lengths of about 30" have been obtained in practice.

Mylar was selected as the plastic because of its strength and light weight. The Mylar is quite resistant to abuse and can be repaired, in case of punctures, with a plastic tape. However, Mylar is not very elastic and this causes wrinkles to form around the edge of the reflector when it is inflated, resulting in some astigmatism of the focal spot and waste of energy.

It is believed that this problem can be eliminated either by shaping the plastic through the addition of seams or, most probably, by softening it with heat so the wrinkles can be annealed out. A technique must be developed in the latter case that will avoid introducing other irregularities and which will produce a final shape approaching the ideal spherical section.

It is believed that these reflectors could be mass produced once the proper technique for shaping them is developed. The finished reflector can be easily shipped to any place where it may be needed. There a new frame can be provided and the reflector fastened to it and inflated. Hence, this type would be particularly suitable for areas where transportation is a problem.

The rest of this cooking device consists of a pot holder, which would probably be independent of the reflector frame, and of supports for the frame. Such an arrangement could consist simply of some legs fastened to the frame and a pole or tripod which might support the cooking pot.



## APPENDIX B

### TEST METHODS

Performance of any solar device can be described by a heat balance for the solar energy absorbing surface expressed by the following formula:

$$H_{\odot} A_{\text{r}} r Y_{\text{oc}} = q_{\text{u}} + q_{\text{th}}$$

Here  $H_{\odot}$  is the intensity of beam radiation, fixed by weather and time of day;  $A_{\text{r}}$  is the unshaded area of the reflector; and  $r$  is the specular reflectivity of the reflector.  $Y$  is an intercept factor which denotes the fraction of the specularly reflected radiation which is intercepted by the cooking vessel. It is a function of the accuracy of the reflector shape, the precision of orientation of the system and the size of the vessel, and in a good system properly used is near unity. The absorptivity of the vessel for solar radiation is  $\alpha_{\text{c}}$ . Useful heat delivered to the contents of the vessel is  $q_{\text{u}}$ , and thermal losses from the vessel by convection, radiation and evaporation are denoted by  $q_{\text{th}}$ .

A complete performance analysis of a solar cooker would require measurements of all these quantities. However, for a comparison of cookers from a practical point of view a complete analysis is not necessary. Our measurements were therefore limited to the determination of  $q_{\text{u}}$  (the useful heat developed in the cooking pot) as a function of  $H_{\odot}$  (the solar radiation). Heat losses ( $q_{\text{th}}$ ) are discussed in Appendix C.

#### A. Measurement of Useful Heat

Three methods were used: empirical cooking tests, measurements of rate of temperature increase, and calorimeter tests.

1. Empirical cooking tests. Typical methods of food preparation--such as moist cooking (rice, vegetables, stew), frying (meat, pancakes) and baking (bread, cake)--were tried for each cooker and required cooking time for various quantities was observed. This method is, of course, of prime interest in a practical evaluation, but it is not very accurate for comparison of different cooker designs, since it does not permit quantitative correction for differences in solar radiation, ambient temperature and wind conditions from day to day.

2. Measurements of rate of temperature increase. A better method for comparison of heat production for the cookers is determination of the heating rate of a given quantity of water. This simple method was used during the earlier tests (see graphs in reference 29) and permitted a rough comparison of the various designs. A variation of this method (used during the winter when dry snow was available and when the heat losses at the low ambient temperatures were too large to bring water to a boil) consists in melting a known quantity of snow. The heat needed for melting (79.2 cal./g.) is roughly equivalent to the heat required to bring an equivalent amount of water from ambient temperature to boiling. This method has the advantage of being nearly independent of heat losses due to convection and of the heat capacity of the container, since the container temperature is nearly constant at about  $0^{\circ}\text{C}$  and not much higher than the ambient temperature.

3. Calorimeter Tests. In our later tests a more accurate and convenient method was used. A simple flow calorimeter was constructed as shown in Fig. 19. A 1-gallon insulated thermos jug with a bottom spout was used as a reservoir of cold water. A 3-quart Pyrex flask, painted dull black, served as heat absorber. This was sufficiently large to absorb all heat that could be focused onto a 2- or 3-quart cooking pot. By measuring the flow rate (e.g.,

the time required to collect one liter of water in the discharge vessel) and the difference in temperature between the inlet water and the outlet water, the heat absorption rate in K-Cal/hour could easily be computed. This, in turn, was converted into watts by the conversion:

$$1 \text{ kw. hr.} = 860 \text{ kcal; or } 1 \text{ kcal./hr.} = 1.163 \text{ watts.}$$

#### B. Measurement of Incident Solar Energy

A conventional method of measurement of incident solar energy is by means of a Pyrheliometer calibrated in Langley:

$$1 \text{ Langley} = 1 \text{ cal./sq/cm/} = 69.7 \text{ milliwatts.}$$

The so-called solar constant equals about 2 Langley/min. This represents the amount of energy received outside the earth's atmosphere and corresponds to a probable radiation of less than 1400 watts per square meter on a surface normal to the incident rays. On the surface of the earth this is reduced to between 800 and 1000 watts per square meter on a clear day. We did not have a Pyrheliometer available, but constructed a simple instrument for comparative measurements, using a photographic light meter (General Electric type 58). Fig. 20 illustrates this device. The light meter is mounted with its slotted cover (filter factor = 10) at the end of a cardboard tube 62 cm. long and blackened on the inside. An additional filter with a factor of 19.3 is mounted at the other end. An aperture with a 1/4" hole (made of a slice of cork) is mounted on the outside near the top of the tube. When the image of this aperture is focused on a target plate at the bottom of the tube the device is pointing at the sun and maximum brightness readings are obtained. A transport is mounted parallel to the axis of the tube and a string and weight permit an approximate reading of the solar angle. We plan to calibrate this device against the Pyrheliometer at the U.S. Weather Bureau Station in Ithaca, New

York. As our tests are primarily comparative this absolute calibration is not imperative.

Two types of measurement were used to determine the effectiveness of the reflectors: (A) the concentration ratio (the ratio of energy in the spot to the incident solar energy) and (B) the uniformity and size of the focal spot. For cooking purposes the concentration ratio need not be very high. It is more important to have a uniformly heated area matching the size of the cooking pot --approximately 6 inches in diameter. A focal area or spot which is much smaller than the bottom of the pot is acceptable for wet cooking, but not suitable for frying or baking. An area larger than the pot leads, of course, to a waste of energy.

A photographic method was used to record the size and uniformity of the focal spot. A dull finish (sand blasted) plate with a 5 x 5 cam. grid inscribed was placed at right angles to the incident light. The camera was placed behind the reflector with the lens parallel to the interceptor plate to avoid parallel distortion. Figs. 7 and 11 show some typical photographs of focal spots.

A relative measurement of the incident amount of light to a 5" area was obtained, again using the General Electric photographic light meter. Fig. 21 shows the simple arrangement used. The light is reduced to suitable values by a 5" mechanical filter plus a glass filter (1.93 percent transmission) placed in front of the photo cell. The mechanical filter consists of a perforated brass plate backed up by a plate of opaque diffusing glass. Transmission of this combination is about 15 percent. Readings were taken both in a plane normal to the incident light and in a horizontal plane. The latter values are important when flat-bottomed cooking utensils are used and vary, of course, as a function of the solar angle. At low solar angles it is desirable to use a

globular pot, which can absorb heat on the side as well as the bottom, or at least utilize light falling on the side wall of the pot facing the reflector. One is thus limited to wet cooking methods at the higher geographic latitudes, particularly during the early and late hours of the day.

The test methods used at present give relative values only, since the combination of photographic light meters and filters does not furnish values directly convertible into heat energy units; however, we believe that the relative values are accurate within 10 percent. We are considering the possibility of making more accurate measurements using a silicon photocell.

## APPENDIX C

### HEAT LOSS FROM COOKING POTS

Since experiments with solar cookers have shown that a slight wind greatly affects the heat loss from pots, tests were carried out (A) to obtain data so that heat loss and incident solar energy magnitude could be compared and (B) to determine simple methods for minimizing the effect of the wind.

#### A. Methods

The data were obtained by heating water in 2,000 ml. flasks, 6" in diameter by an electric resistance heater made of nichrome wire. Fig. 22 is a schematic sketch of the test arrangement. The electric power was obtained from a DC supply with measurement of volts and amps. The water temperature was measured by a thermocouple immersed in the water. The air temperature, which varied between 82 and 88° F, was measured by a mercury thermometer. The air velocity was measured by probing with a velometer at various points in a plane upstream of the flask.

The heat losses were determined at equilibrium conditions, equilibrium being determined by comparison of successive water temperature readings taken at approximately 5-minute intervals. At equilibrium, the electrical power input was equal to the heat loss from the flask. The water temperature was held at approximately 205° F, rather than at boiling (212° F), to simplify detection of equilibrium conditions.

#### B. Results

The test conditions and test results are summarized in Fig. 23. Results are preliminary.

The paper towel shield was wrapped around the flask to form a crude cone extending below the bottom of the flask. Care was taken to use one thickness of paper only. A test using flannel cloth as a shield yielded results similar to the results with one sheet of paper towel.

### C. Conclusions

1. The preliminary tests indicate that simple shielding can considerably reduce the heat loss in a 5-m.p.h. wind for a 2,000-mil spherical flask. Similar trends would be expected for pots having other shapes but tests have not yet been performed to check this.

2. The greater heat loss for the long neck flask compared to the short neck flask loss is attributed to the condensation of vapor on the "cool" neck which acts as a condenser. Additional surface also accounts for some of the additional loss.

## APPENDIX D

### SUN AVAILABILITY AND RADIATION ANGLE

The problem of the usefulness of the solar cooker depends on many variables besides the question of need. These include such factors as the availability of sunlight, angle of solar radiation, atmospheric dust and moisture and actual number of days of sunshine.

Atmospheric dust and moisture are too variable to be considered on more than a local level. In extremely arid regions or near cities dust can be a serious factor. Moisture in valleys or near a coastal area may reduce energy received at the cooker. Yet these factors may become negligible in areas nearby which have some elevation. For example, the quantity of received solar energy would be higher in elevated areas of Mexico than along coastal zones where moisture is of importance. Furthermore, valleys will be poor areas whereas the adjacent hills may be excellent for the use of the cookers. The amount of sunshine may also be affected by obstructions. A valley often will have less sun than surrounding areas and in some cases may be in direct sunlight only for very short periods each day. Obviously these factors are better left to the consideration of the inhabitants of the local areas themselves.

Determination of the number of days of sunshine for a given area involves a detailed study of weather conditions over a period of at least 10 years. Such data are available for the United States and for much of the world but it is too voluminous to digest in this report and is better handled locally.

A world map of the annual total hours of sunshine is attached at the end of this report. The reverse side of the map provides a series of references



for weather data in various parts of the world. Simply stated, the map is similar to a topographic map using contour lines. In this case, however, the lines connect points of equal number of sunshine hours per year. All the lines are of equal value whether solid, heavy solid or dashed. The number of hours of sunshine (in hundreds of hours) per year are indicated by a number on that line, e.g., a line numbered 18 indicates that 1800 hours of sunshine can be expected each year in that area. Where several lines converge to become a heavy solid line an abrupt change in the available sunshine hours per year can be expected across that line. For example, in central Mexico about 2400 hours of sunshine may be expected each year. However, along the east coast and southwest along the Yucatan Peninsula the changes are abrupt from the coastal areas toward the interior.

The angle of solar radiation for a given area may be determined by reference to Table 170 (Solar altitude and azimuth) of the Smithsonian Meteorological Tables, Sixth Revised Edition, 1951, published by the Smithsonian Institute, Washington, D. C. The azimuth portion on the tables will provide data on the daylight hours at various latitudes during the various months of the year. It is merely necessary to determine the latitude of the area under consideration, locate that position on the diagrams for that latitude and by reference to the various dates determine the extremes of that angle of solar radiation based on solar time. Where these tables are unavailable, a general rule may be followed: north of latitude  $40^{\circ}$  north and south of latitude  $40^{\circ}$  south the angle of solar radiation (altitude) is less than  $25^{\circ}$  during half the year. This general rule is useful since it is based on a 50 percent cut-off as a basis of evaluating the minimum utility of the solar cooker. Also, the efficiency of the cooker is apparently low when the angle of solar radiation is below  $25^{\circ}$  from the horizon. If the angle of radiation is less than  $25^{\circ}$  for half

the year the solar cooker appears to be of marginal usefulness. The 40° north and south latitude figures are, of course, not precise but are reasonable approximations. Virtually all developing countries where the cooker might be useful fall between these parallels.

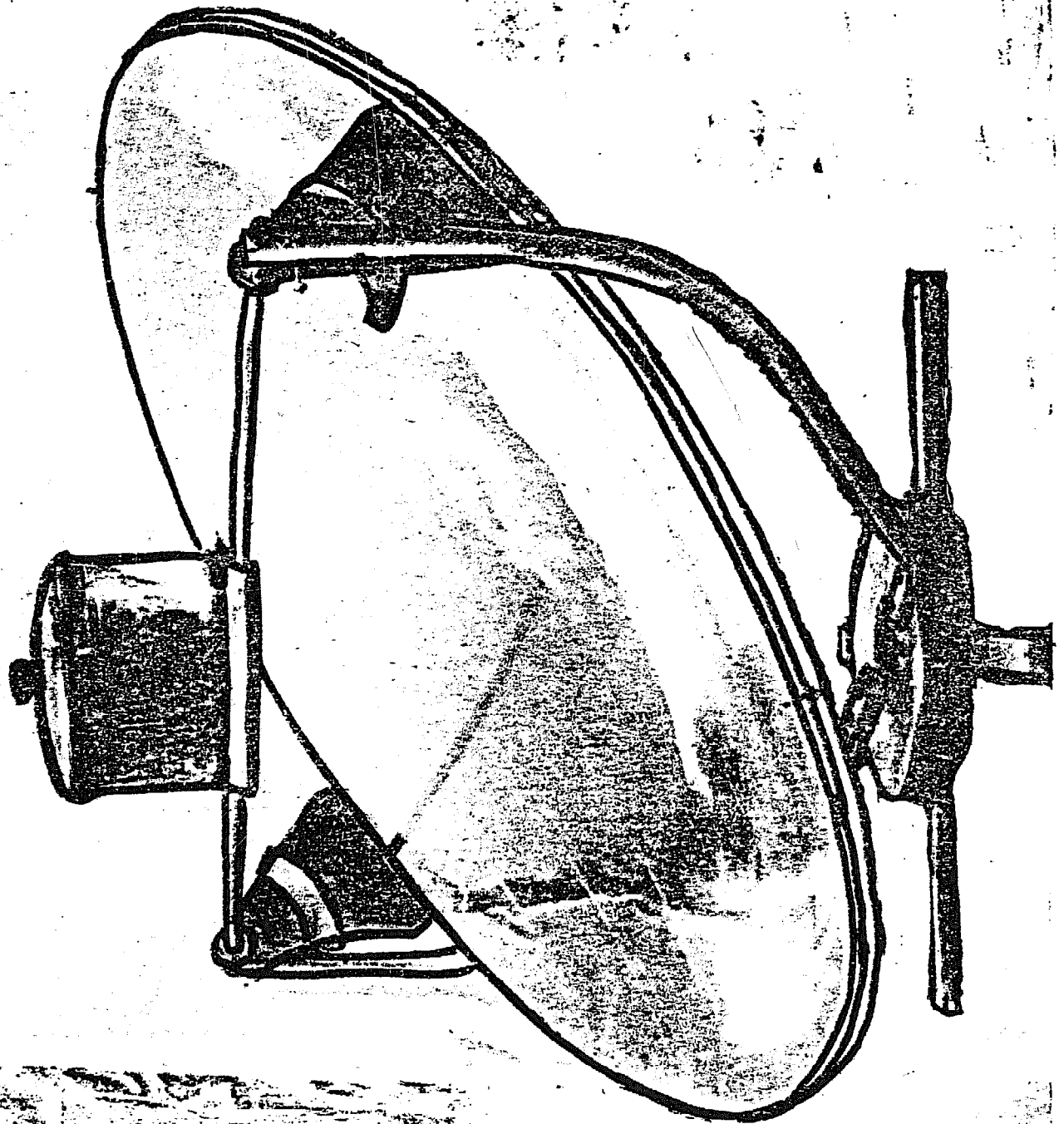

FIGURE 1.

Wisconsin Cooker (Model 3)

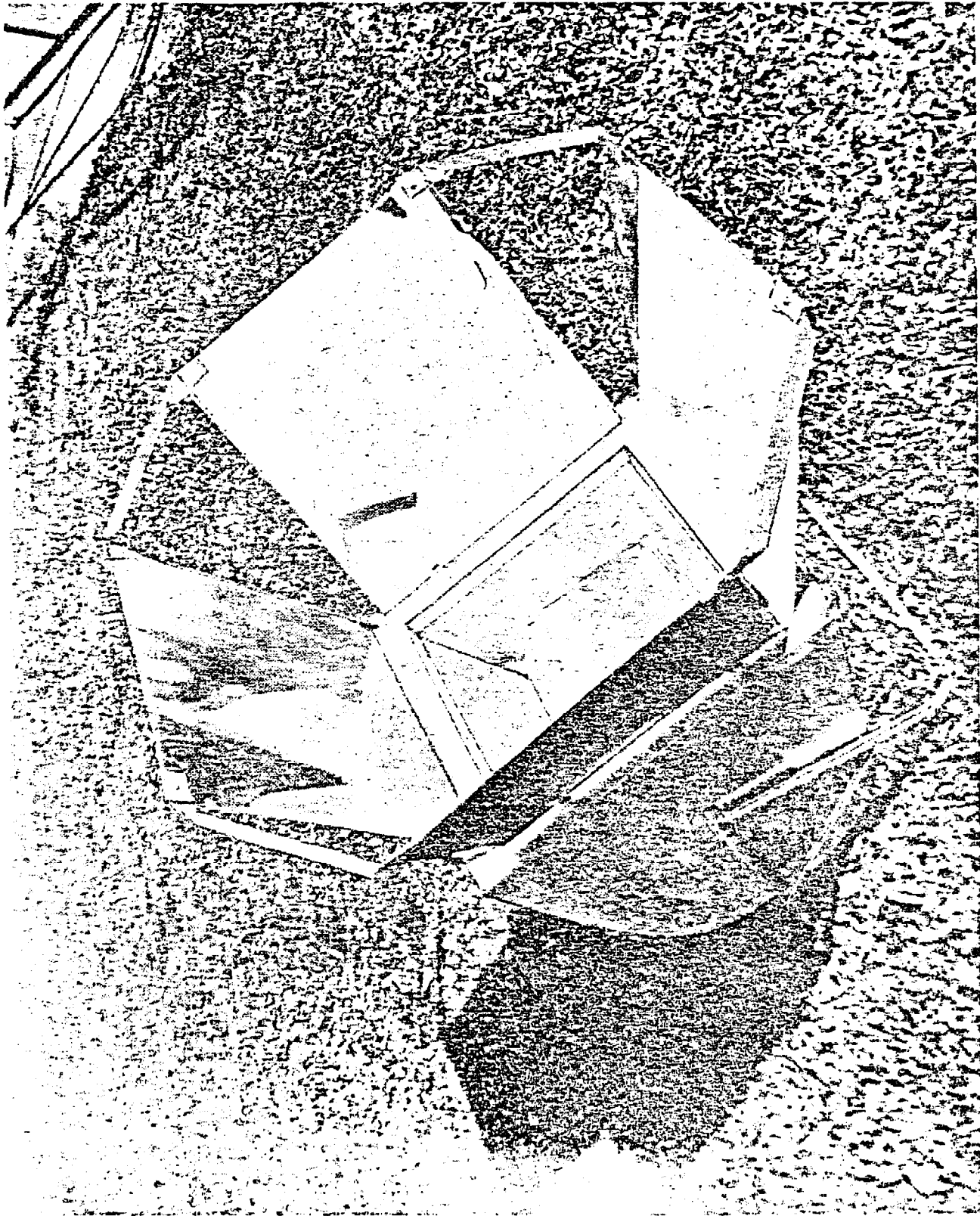

FIGURE 2

Telkes Solar Cooking Oven with Tubular Stand

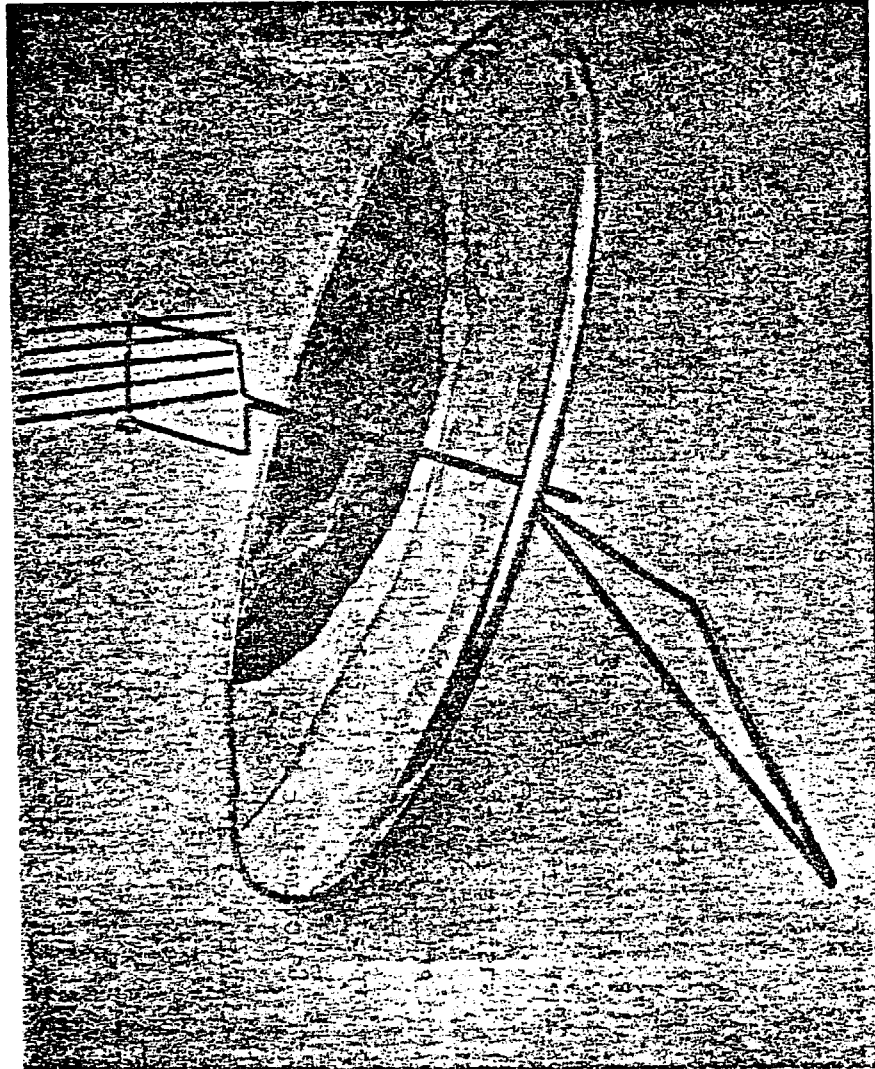

FIGURE 3

Thew Cocker



FIGURE 4

Focal Spot Shape of Thew Cooker

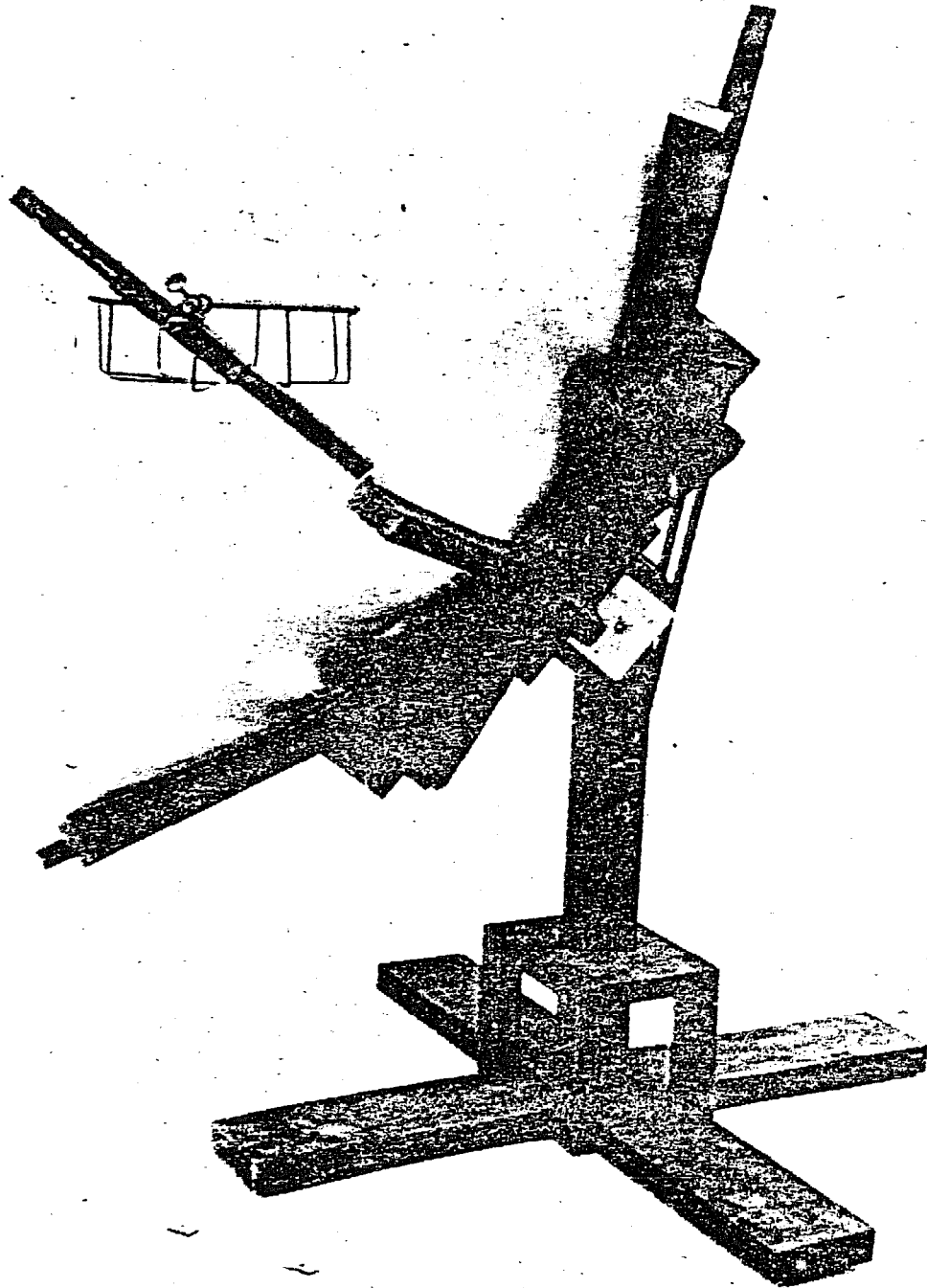

Burmese Cooker



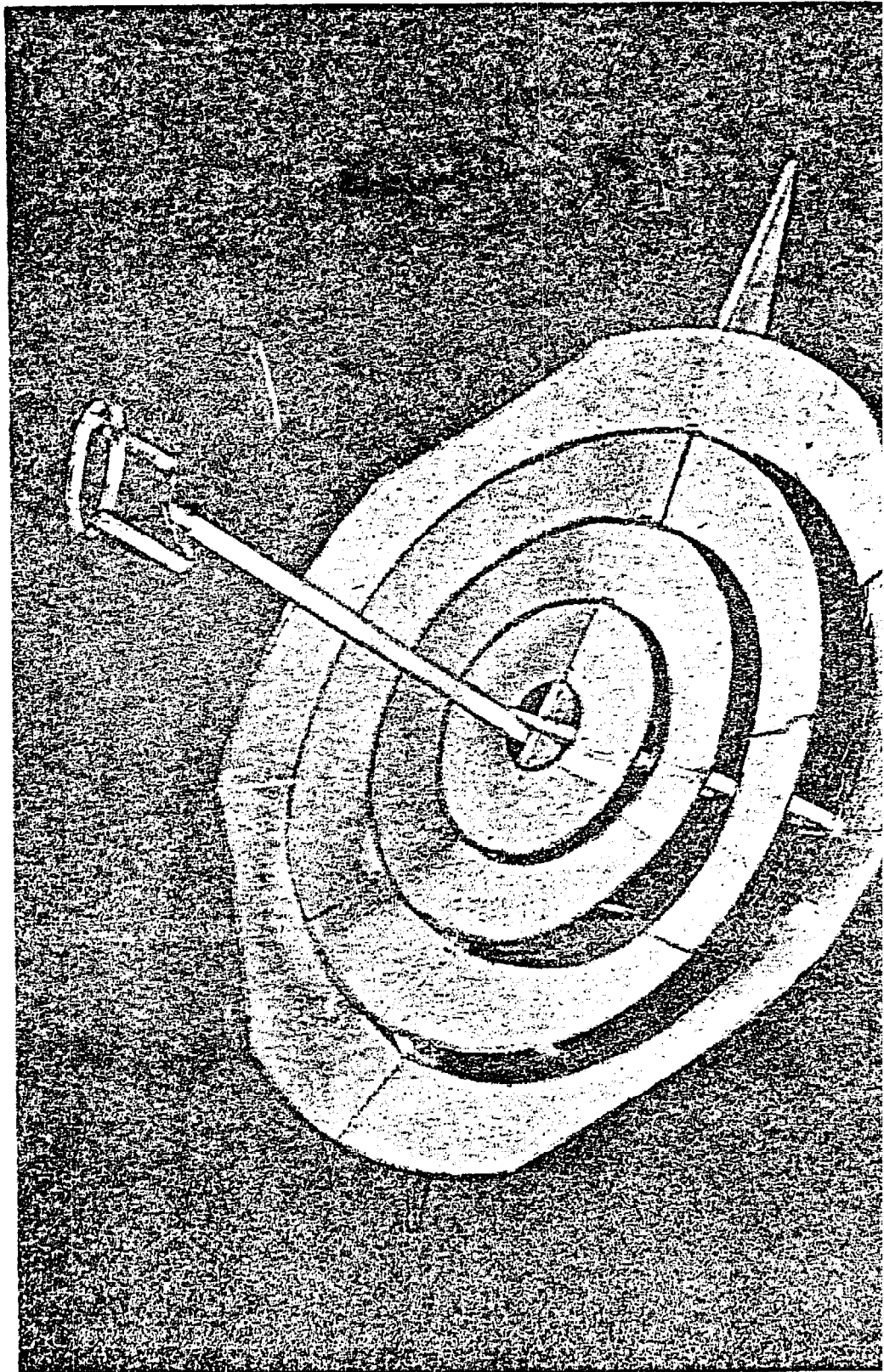



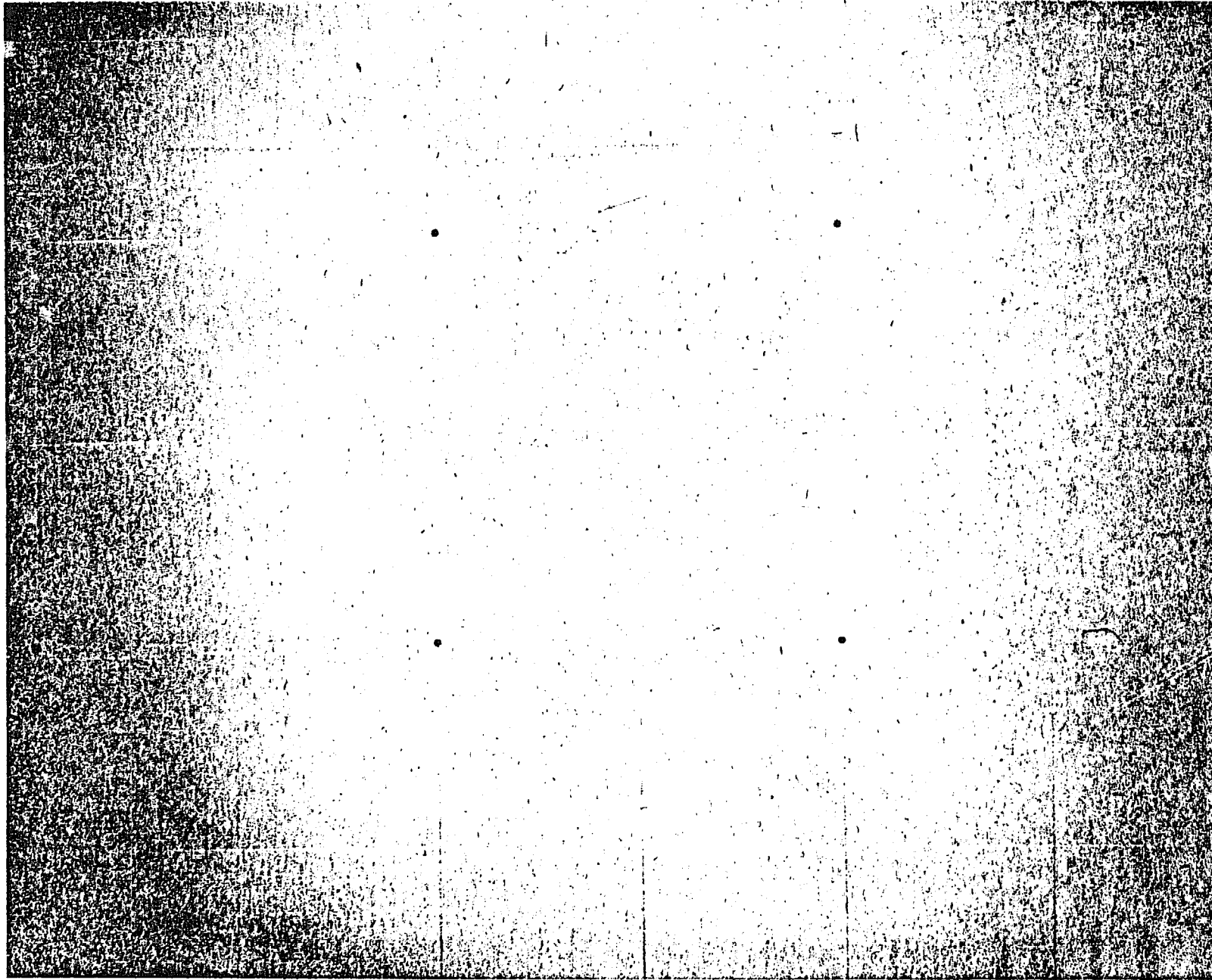

FIGURE 7

Focal Spot Shape of Fresnel Hillig Cooker

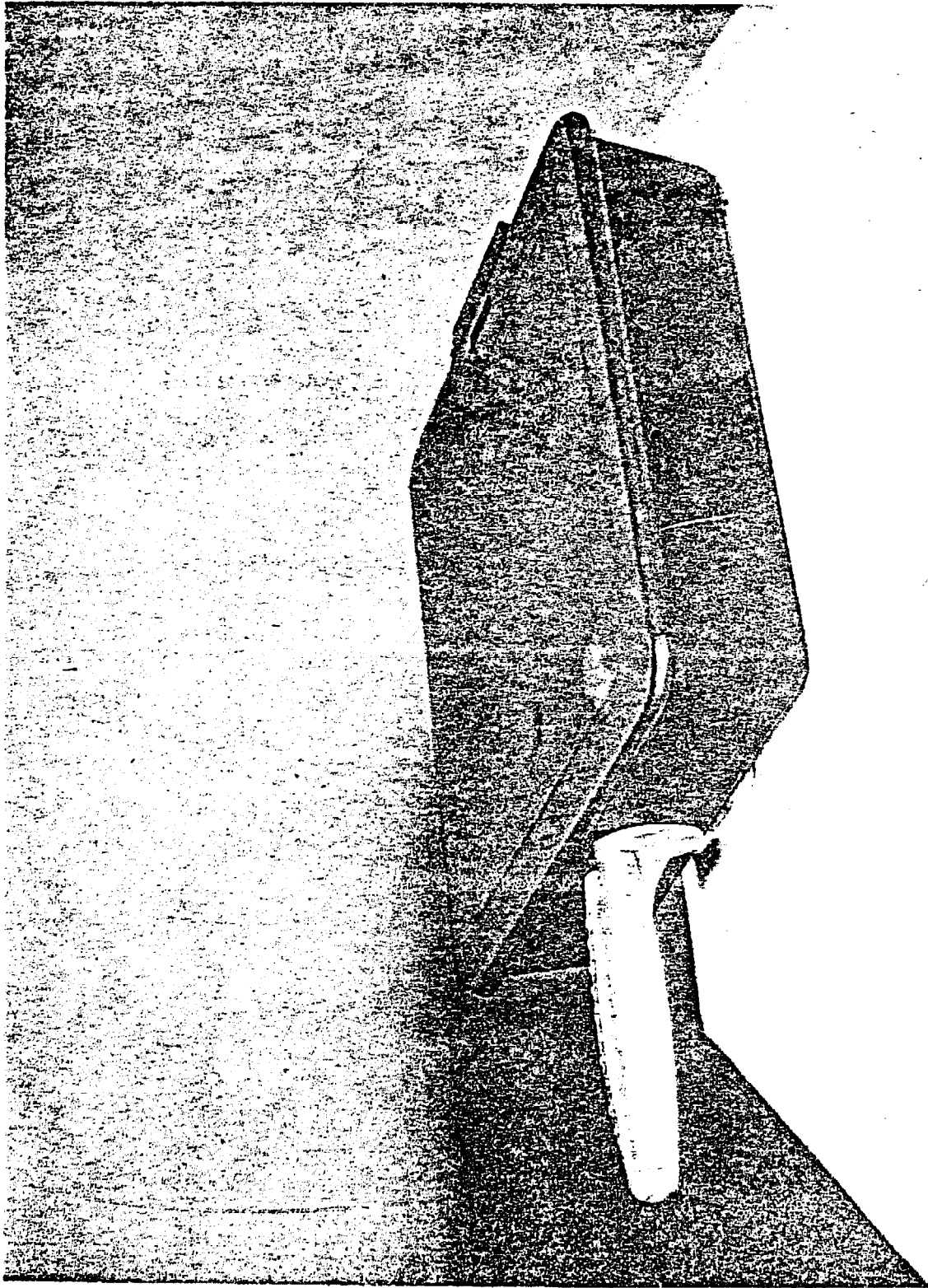

FIGURE 8  
Cooking Pan

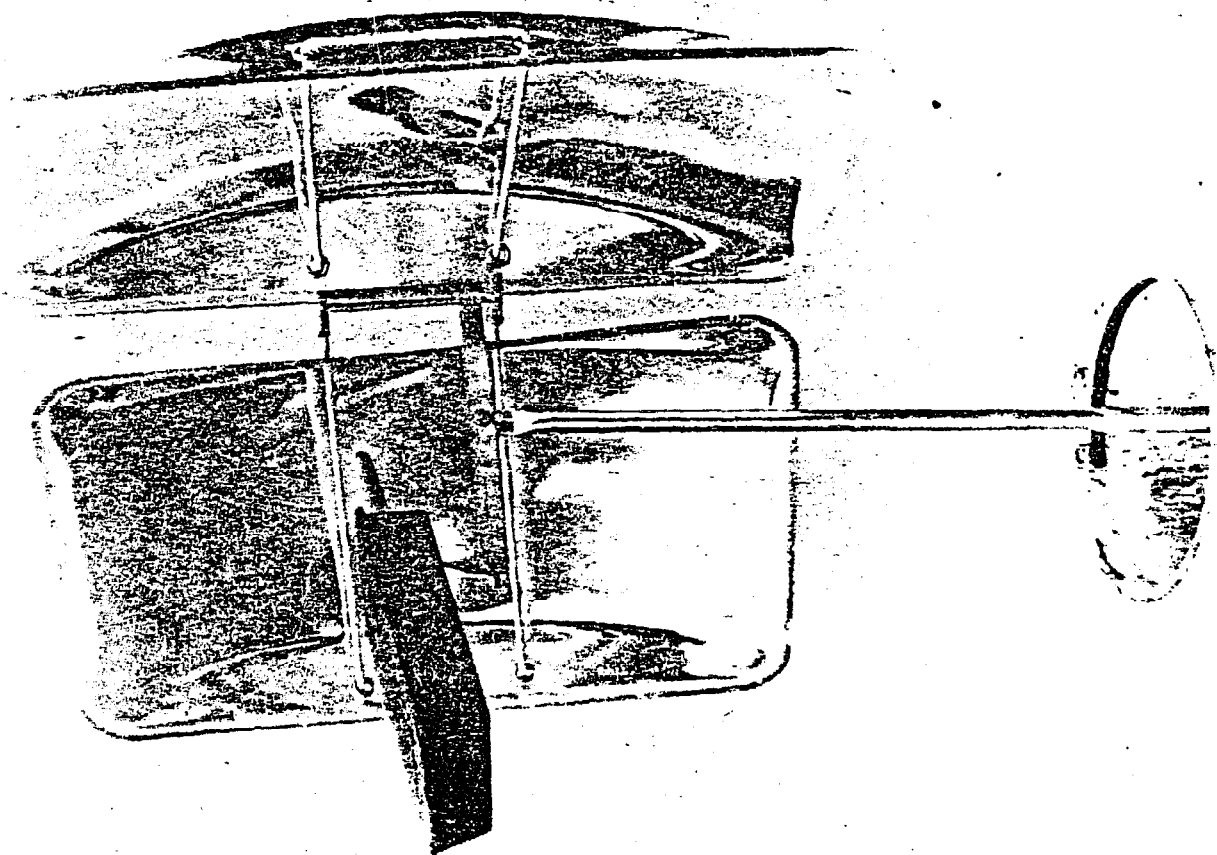

FIGURE 9A

Solar Chef

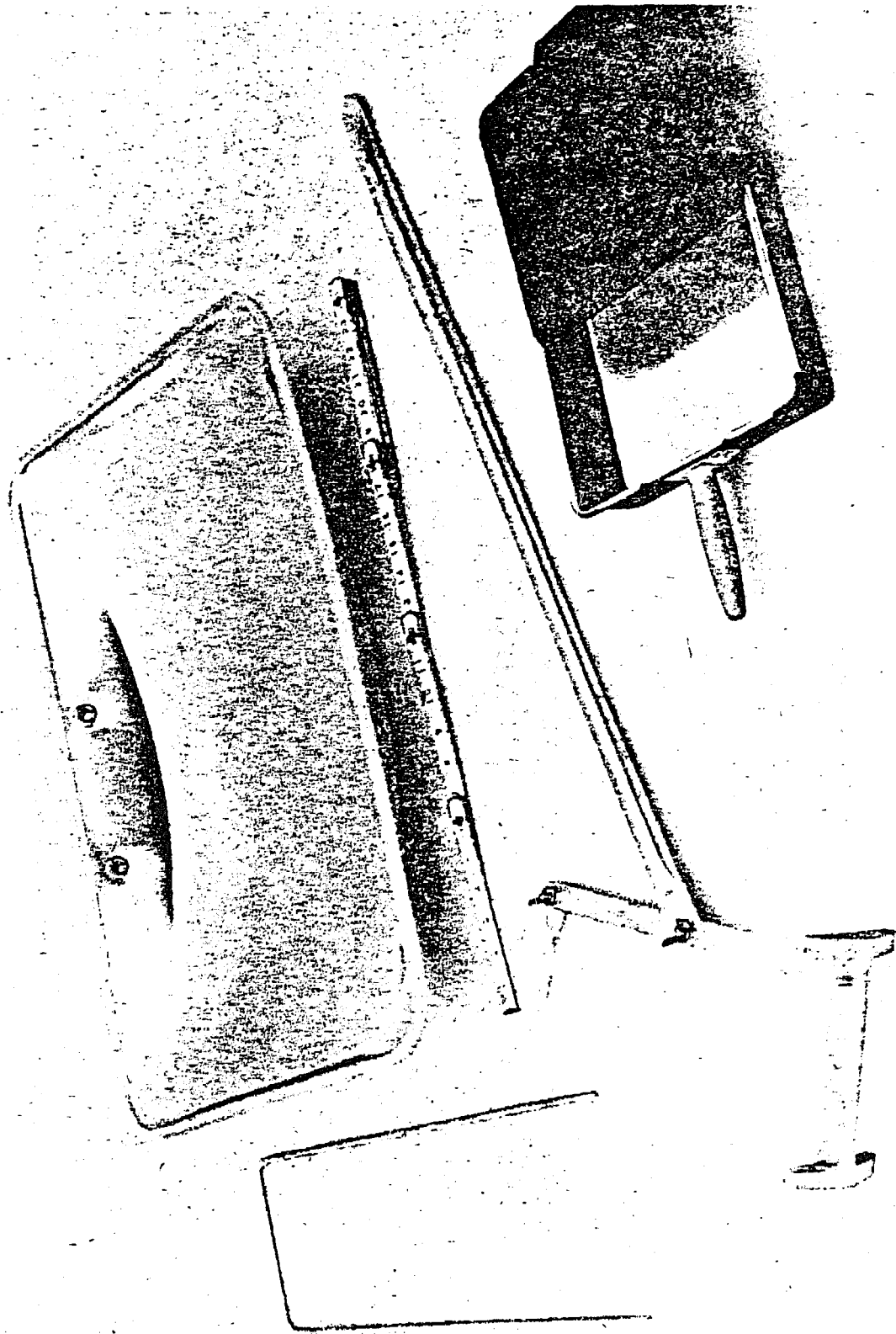

FIGURE 9B

Solar Chef, Disassembled

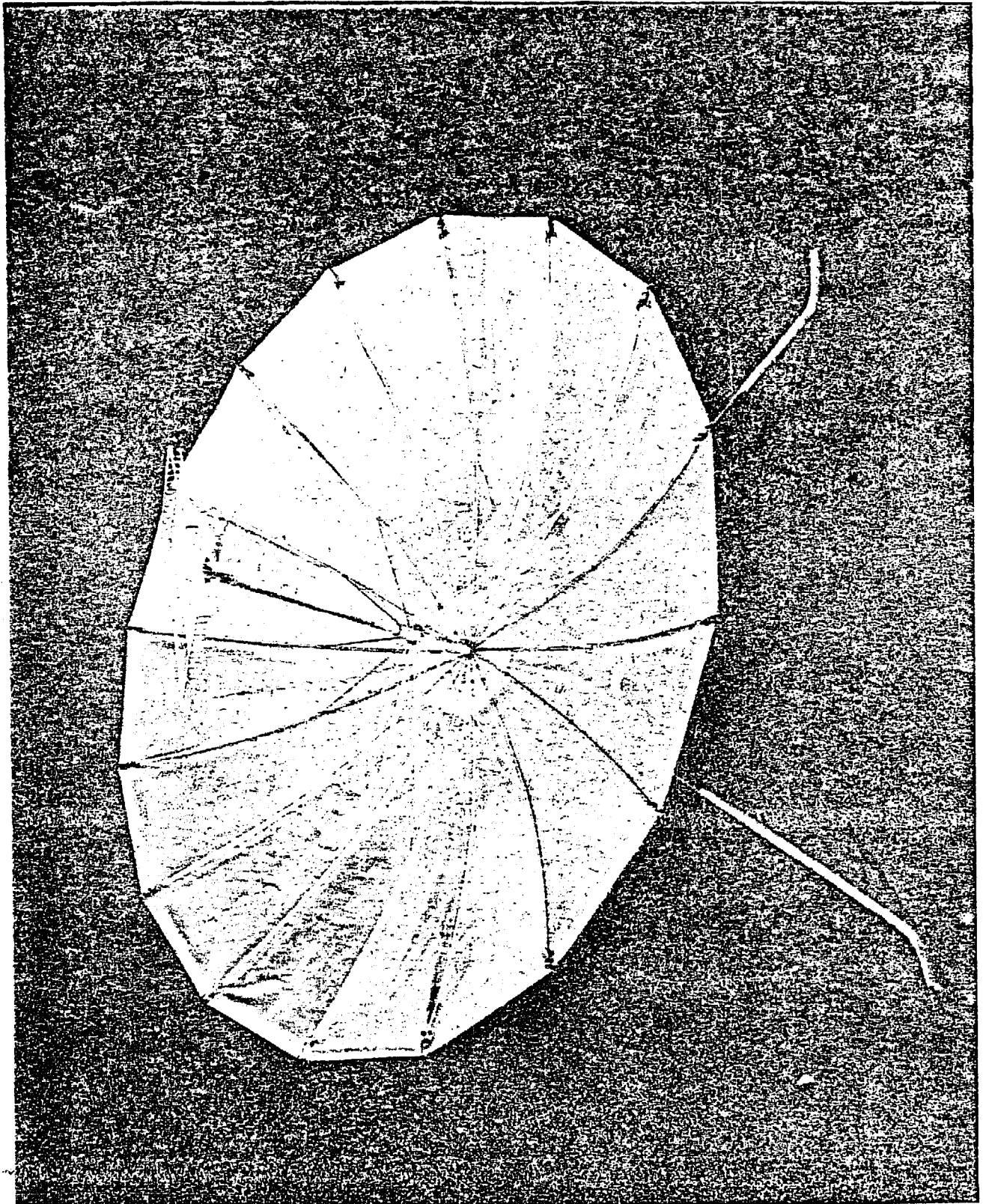

FIGURE 10A

Umbroiler

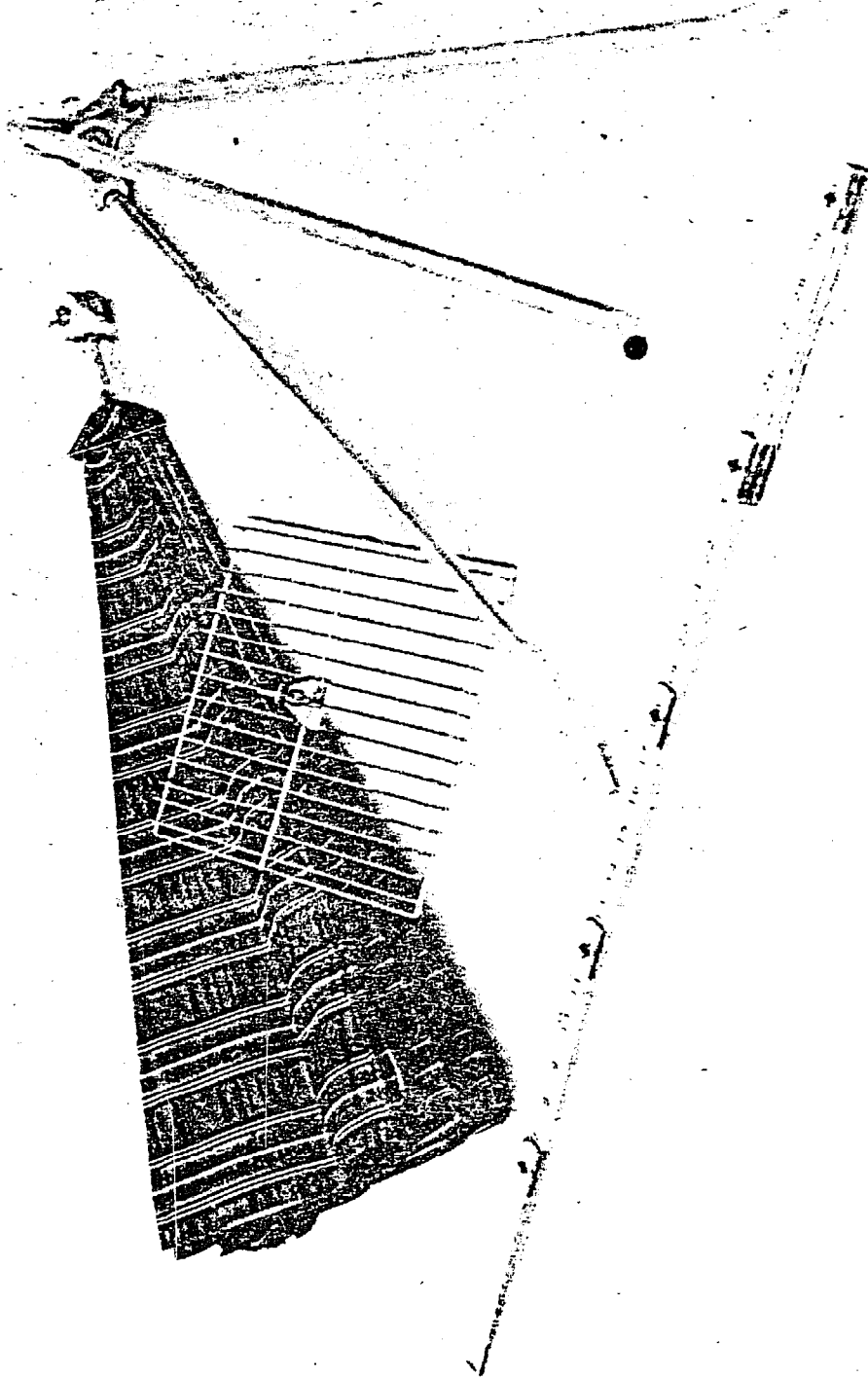

FIGURE 10B

Umbroiler Folded

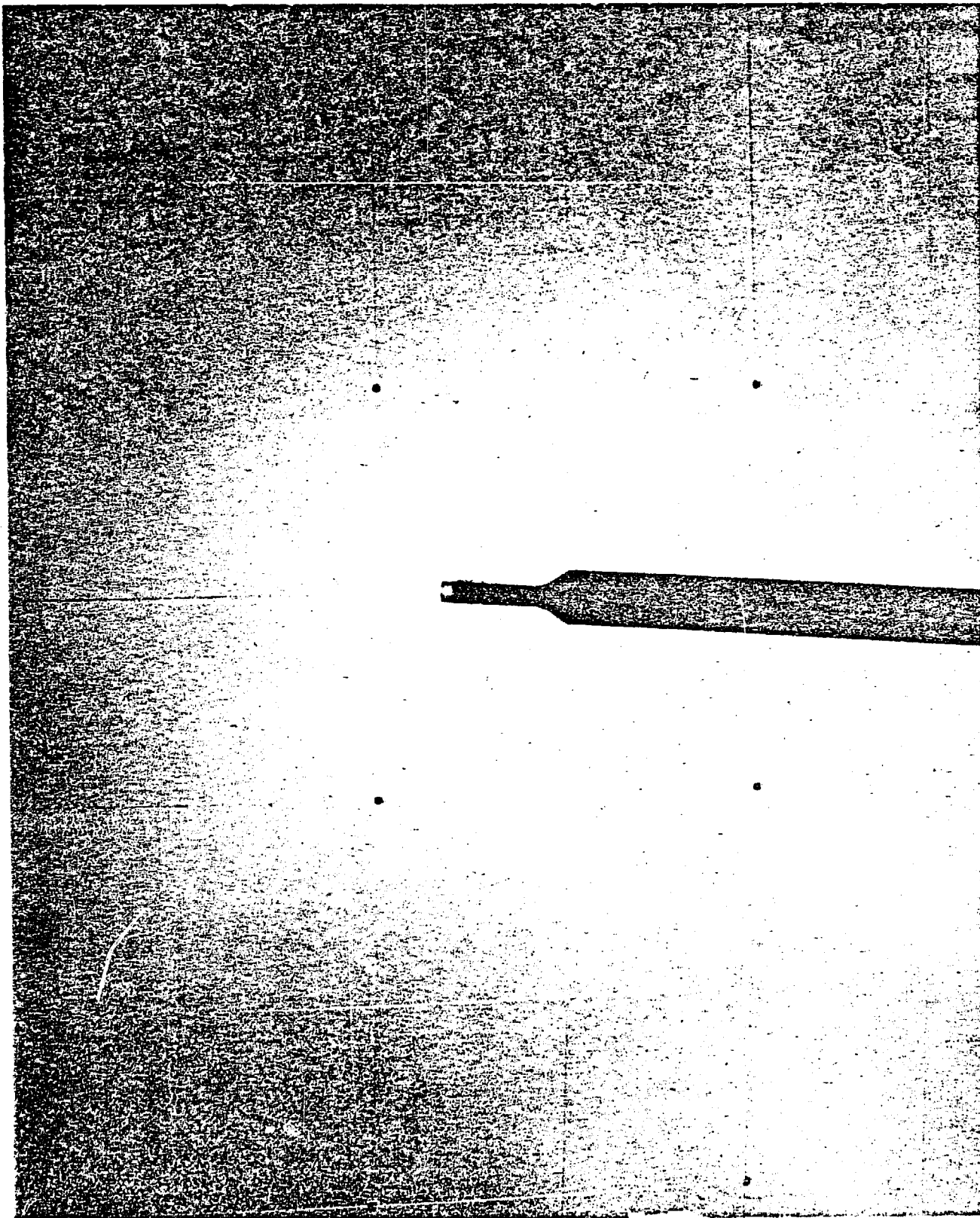

FIGURE 11

Focal Spot Shape of Umbroiler



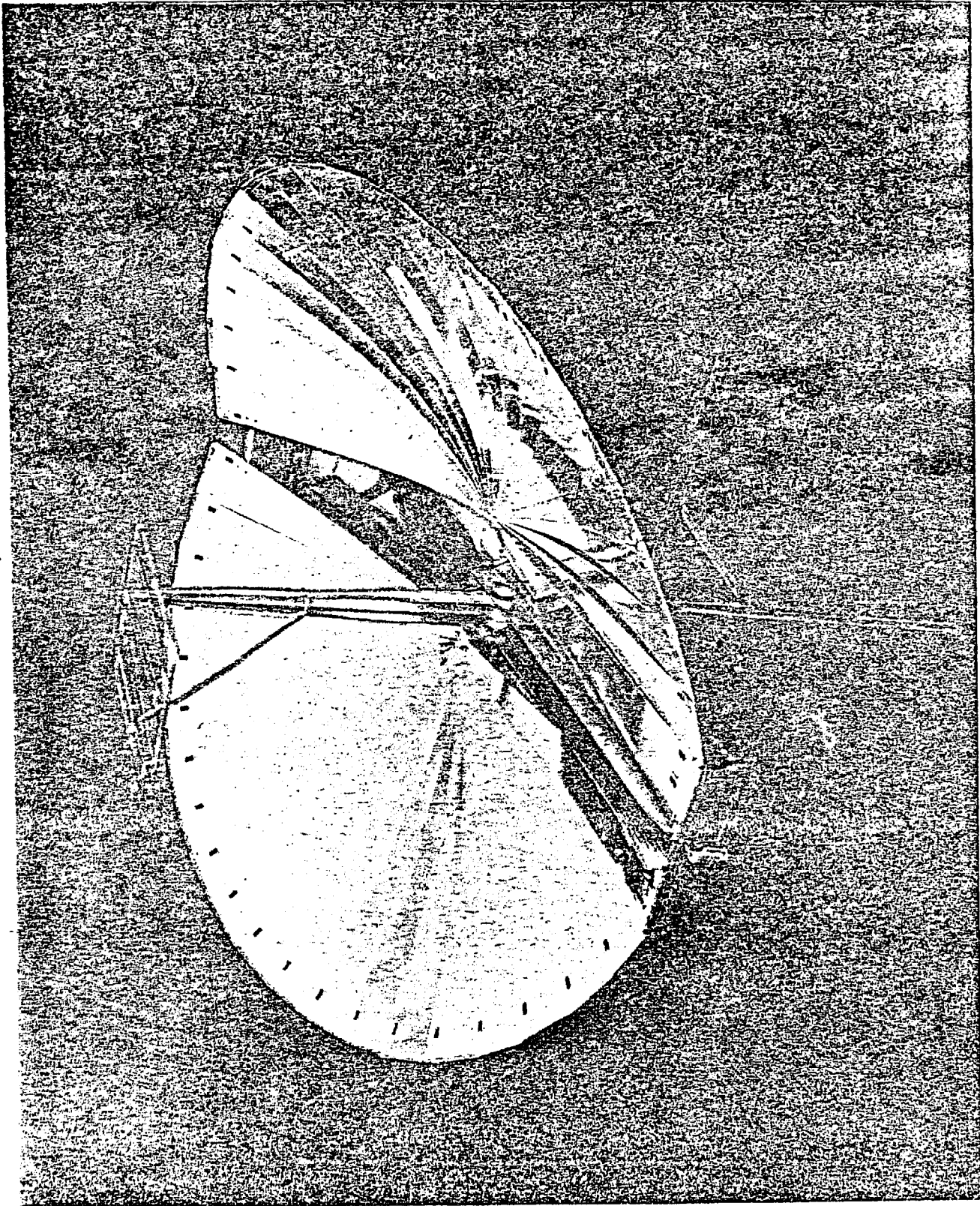

FIGURE 12A

Solnar Cooker



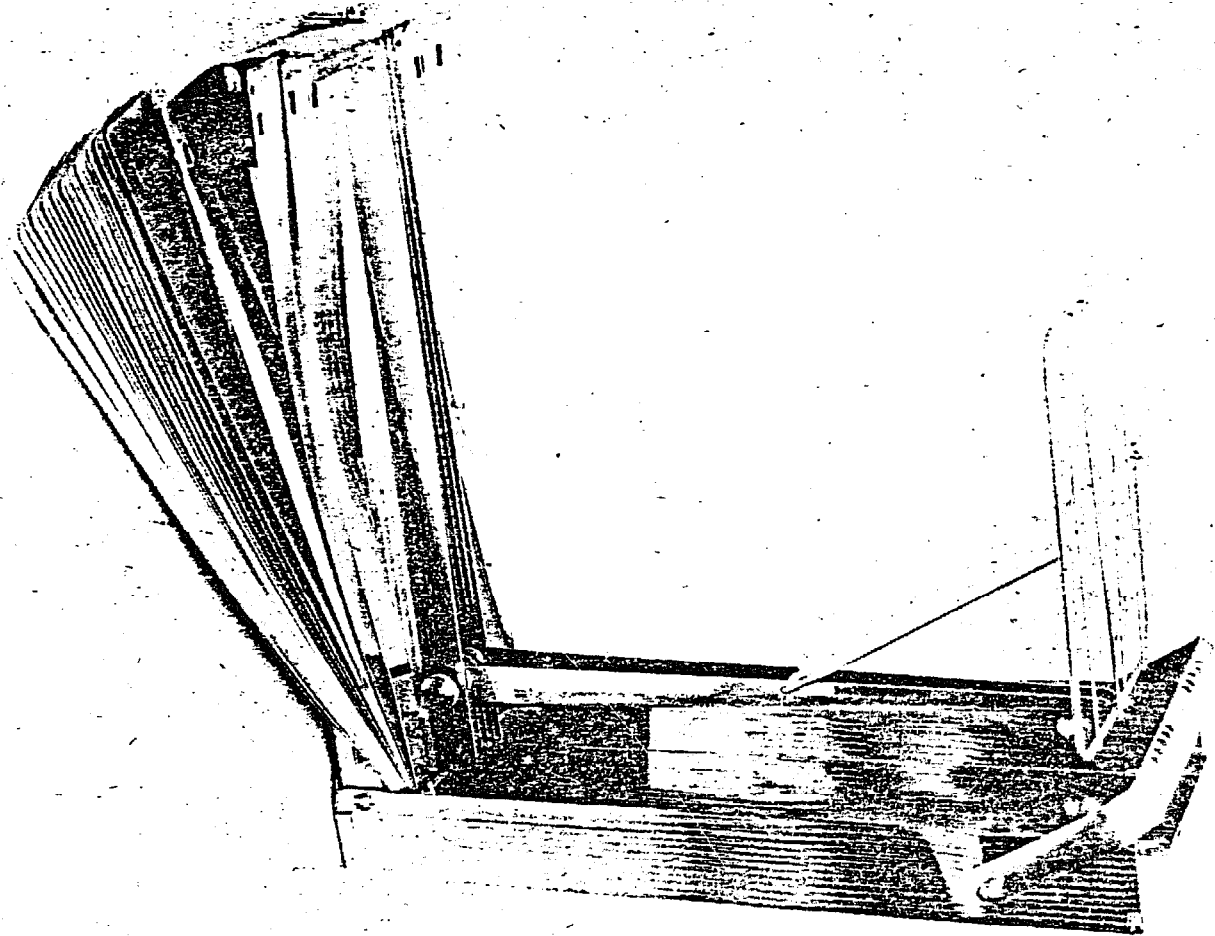

FIGURE 12B

Solnar Cooker Folded

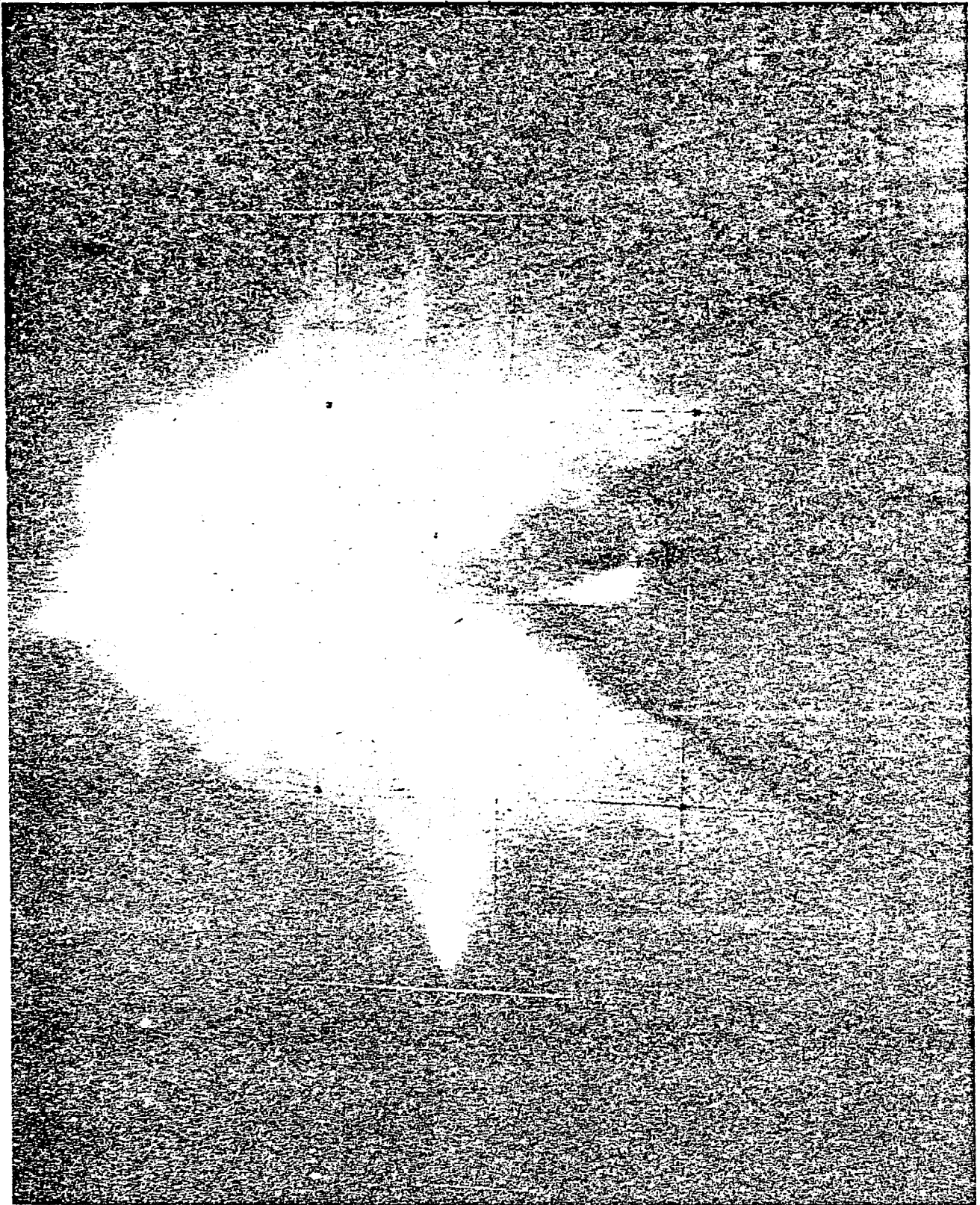

FIGURE 13

Focal Spot Shape of Solar Cooker

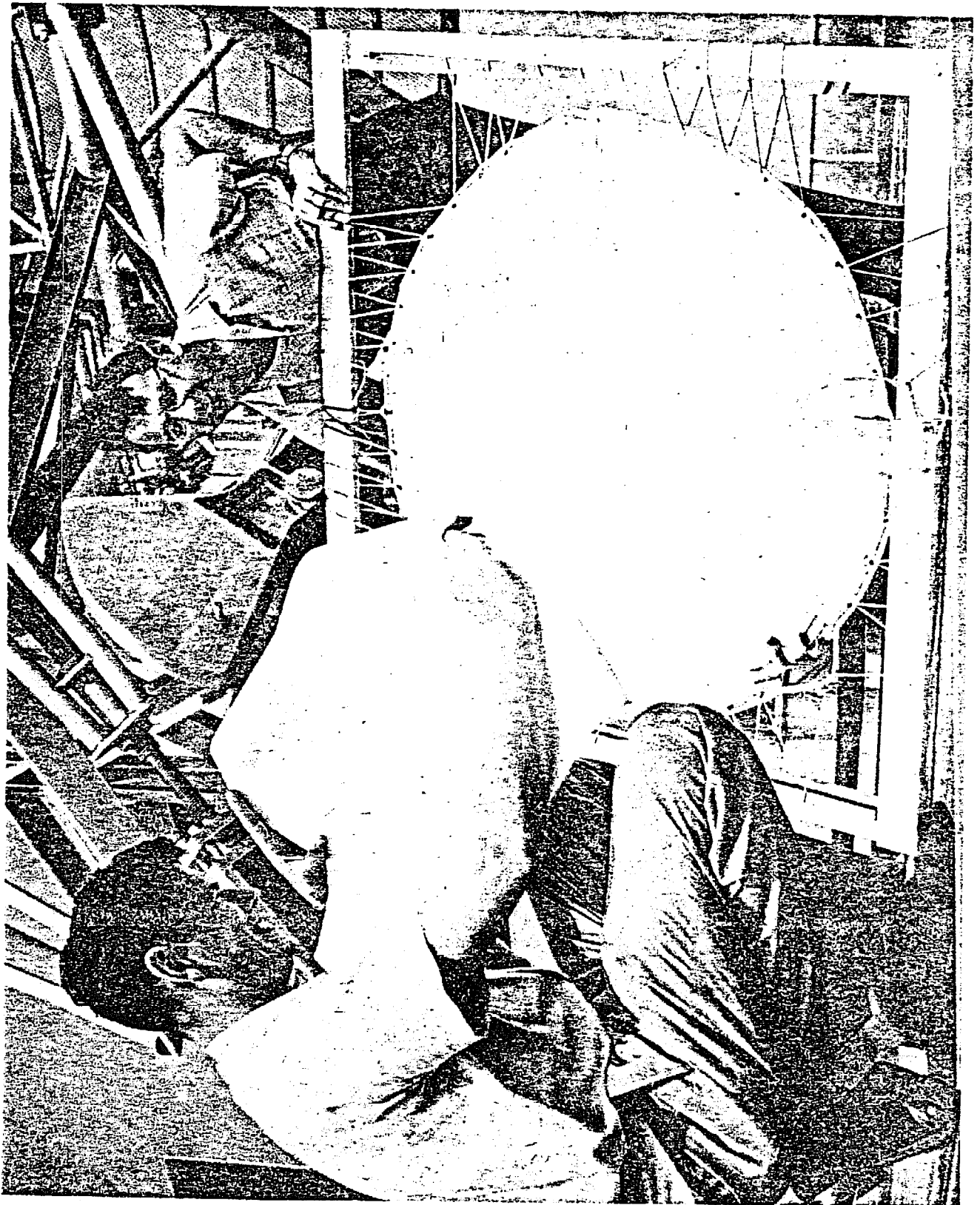

FIGURE 14

VITA Inflatable Cooker

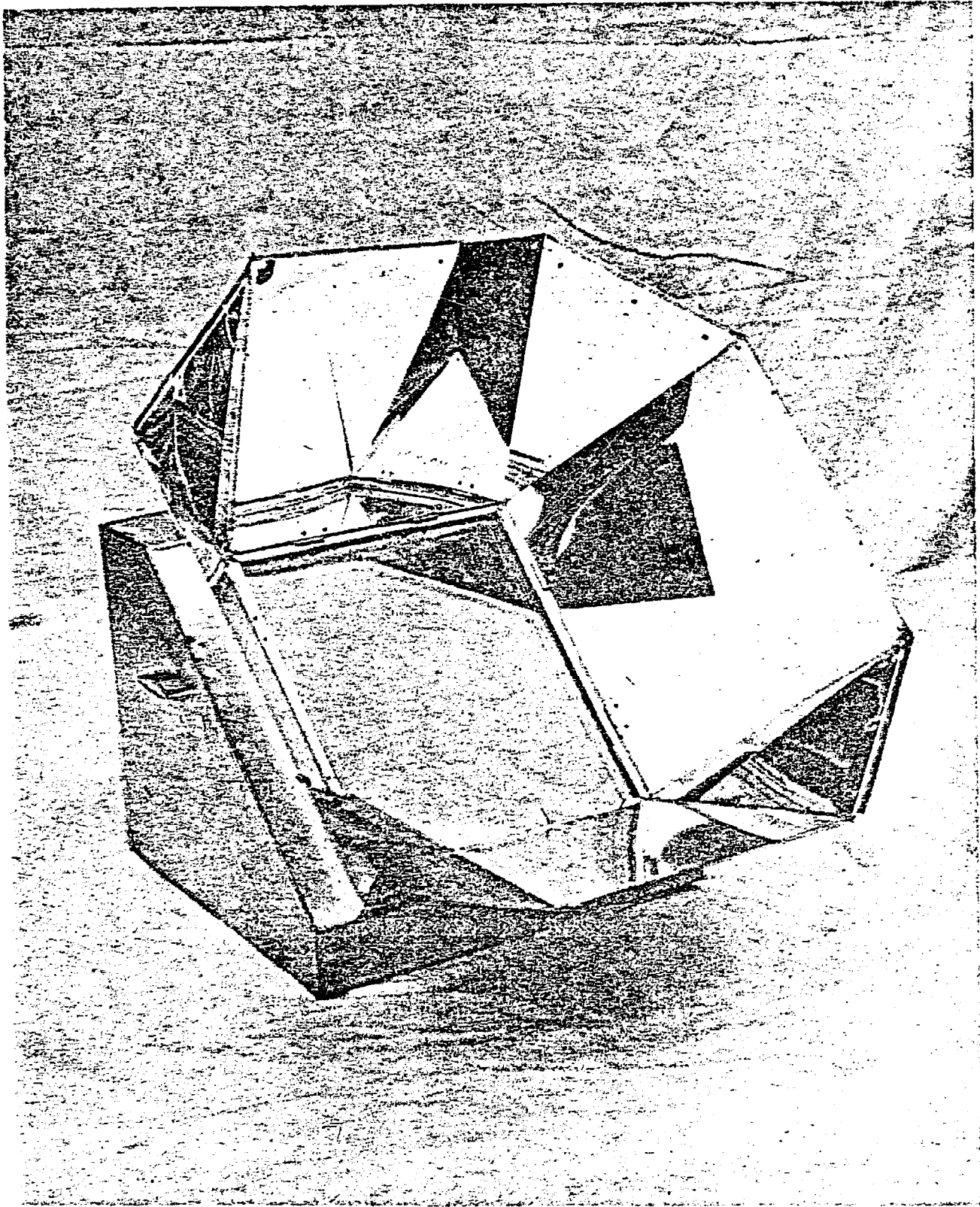

FIGURE 15

Telkes Type Coker Tested

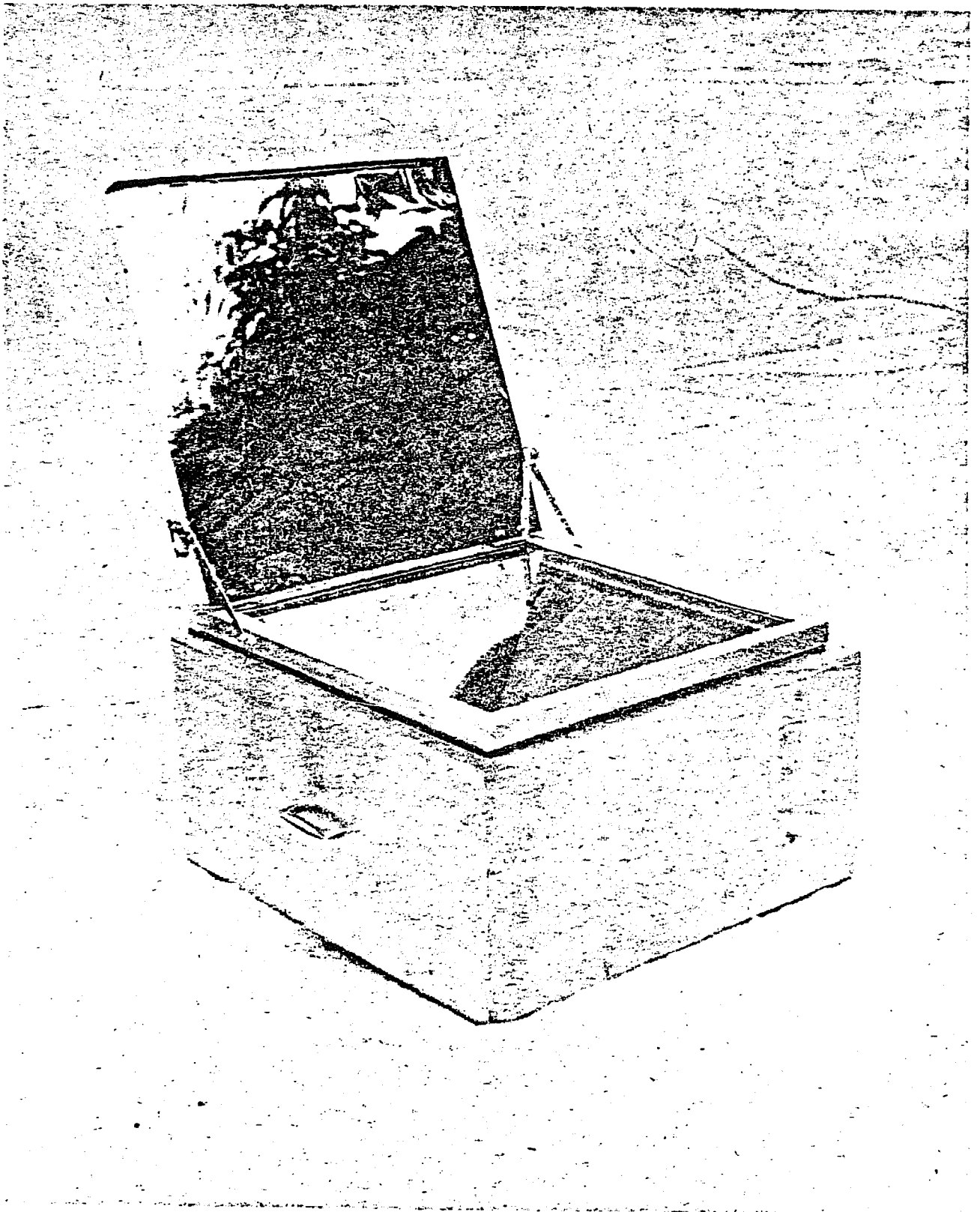

FIGURE 16

Gosh Type Cooker Tested

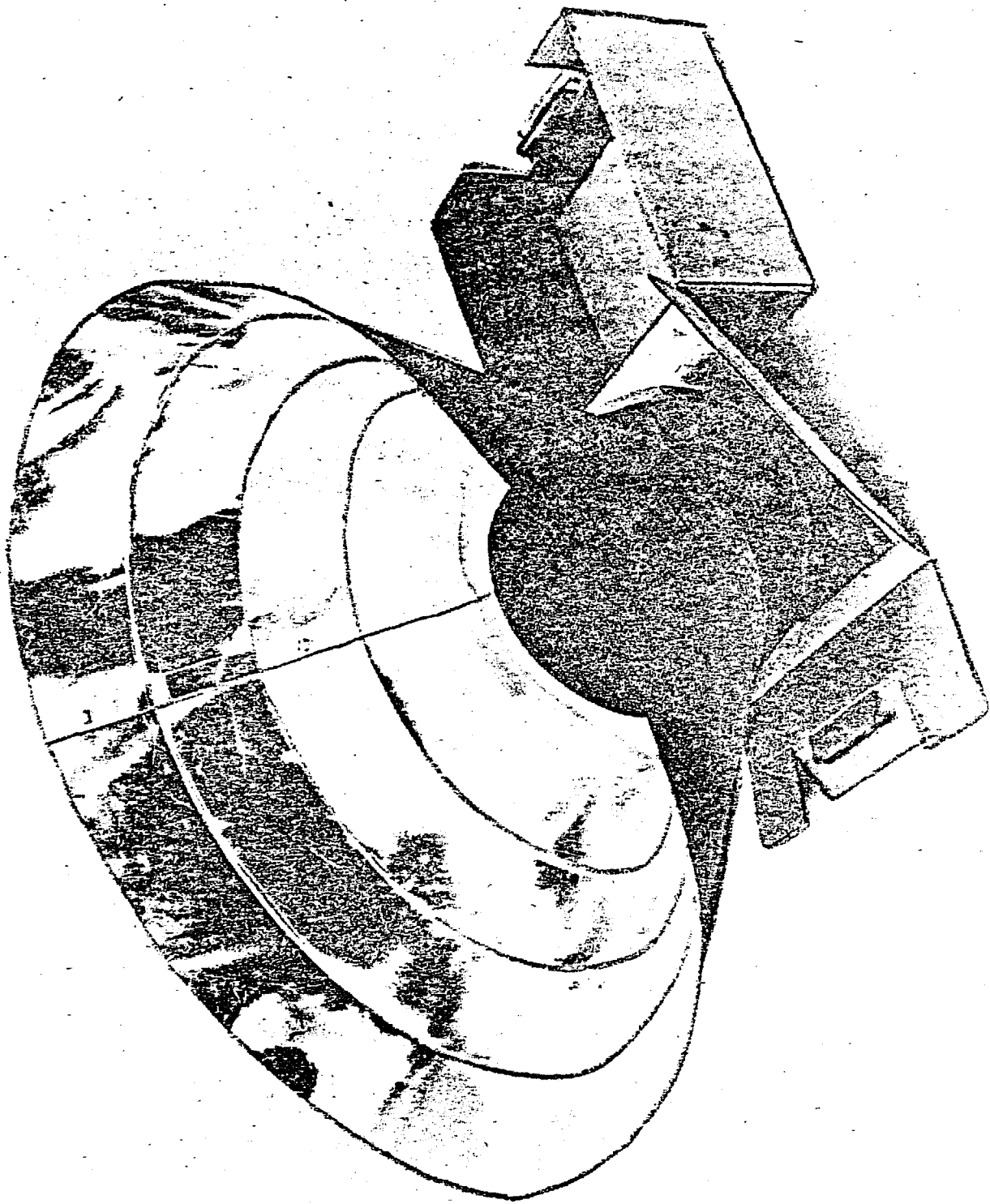

FIGURE 17A

Demountable Cardboard Cooker



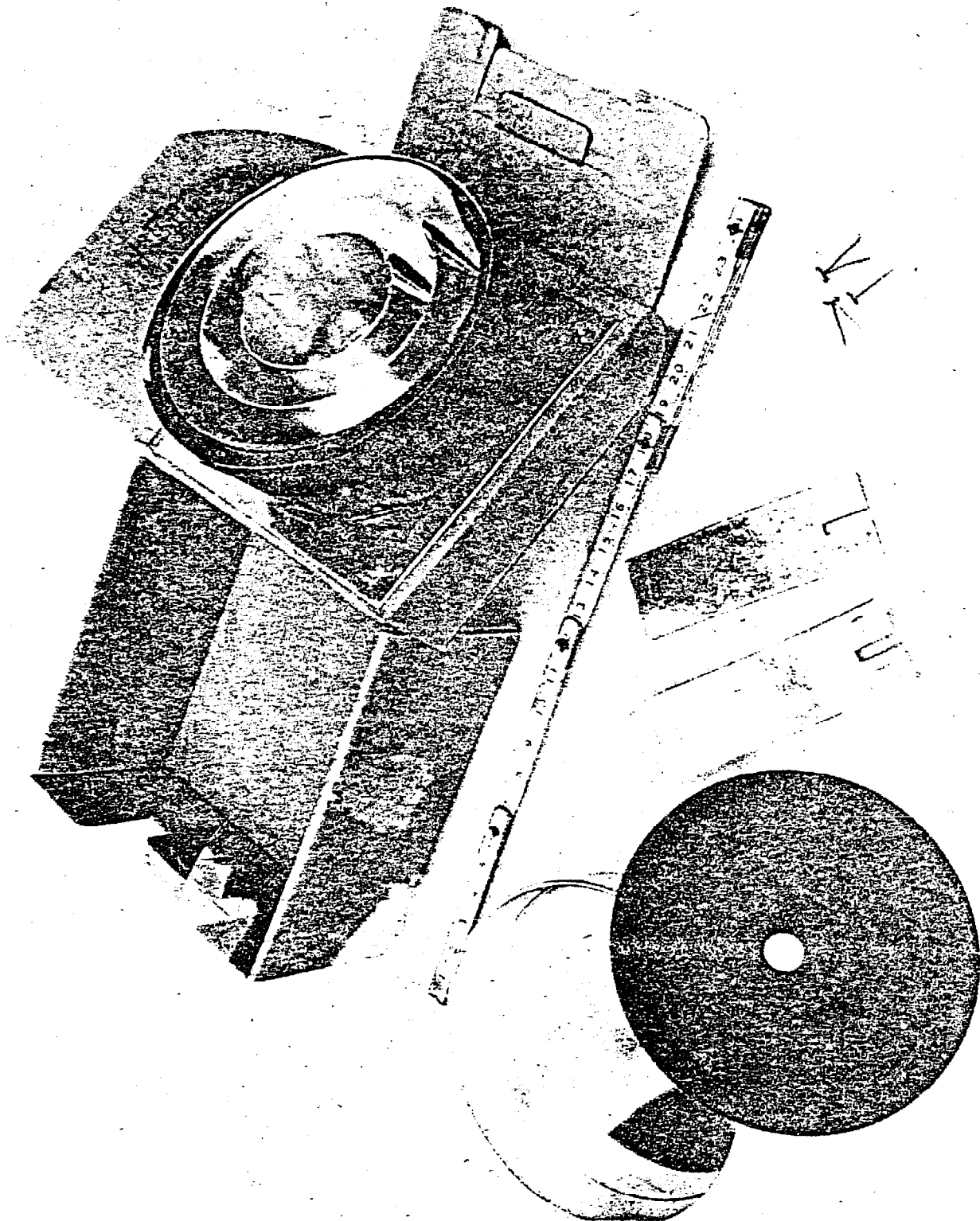

FIGURE 17B

Collapsed Demountable Cardboard Cooker

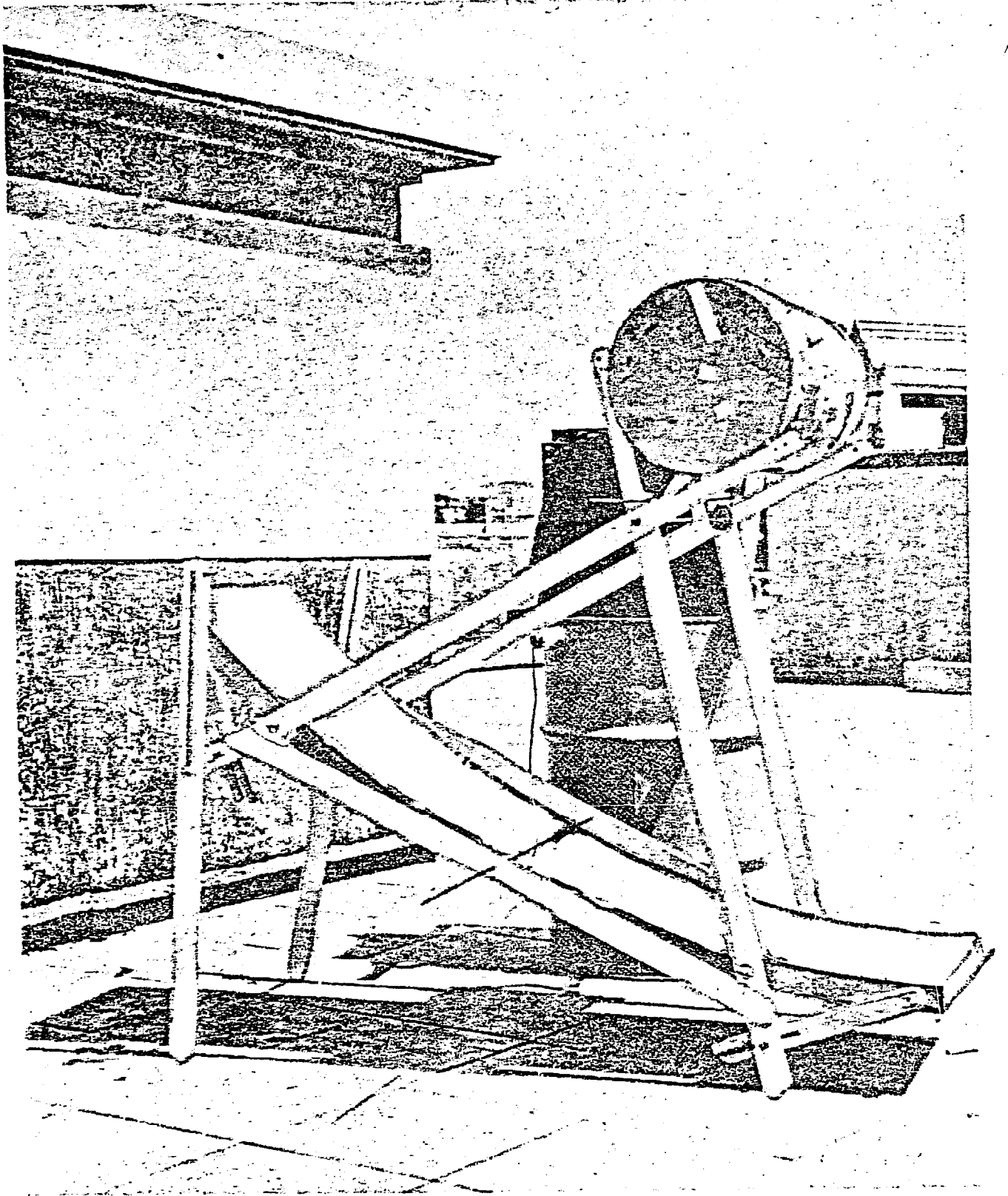
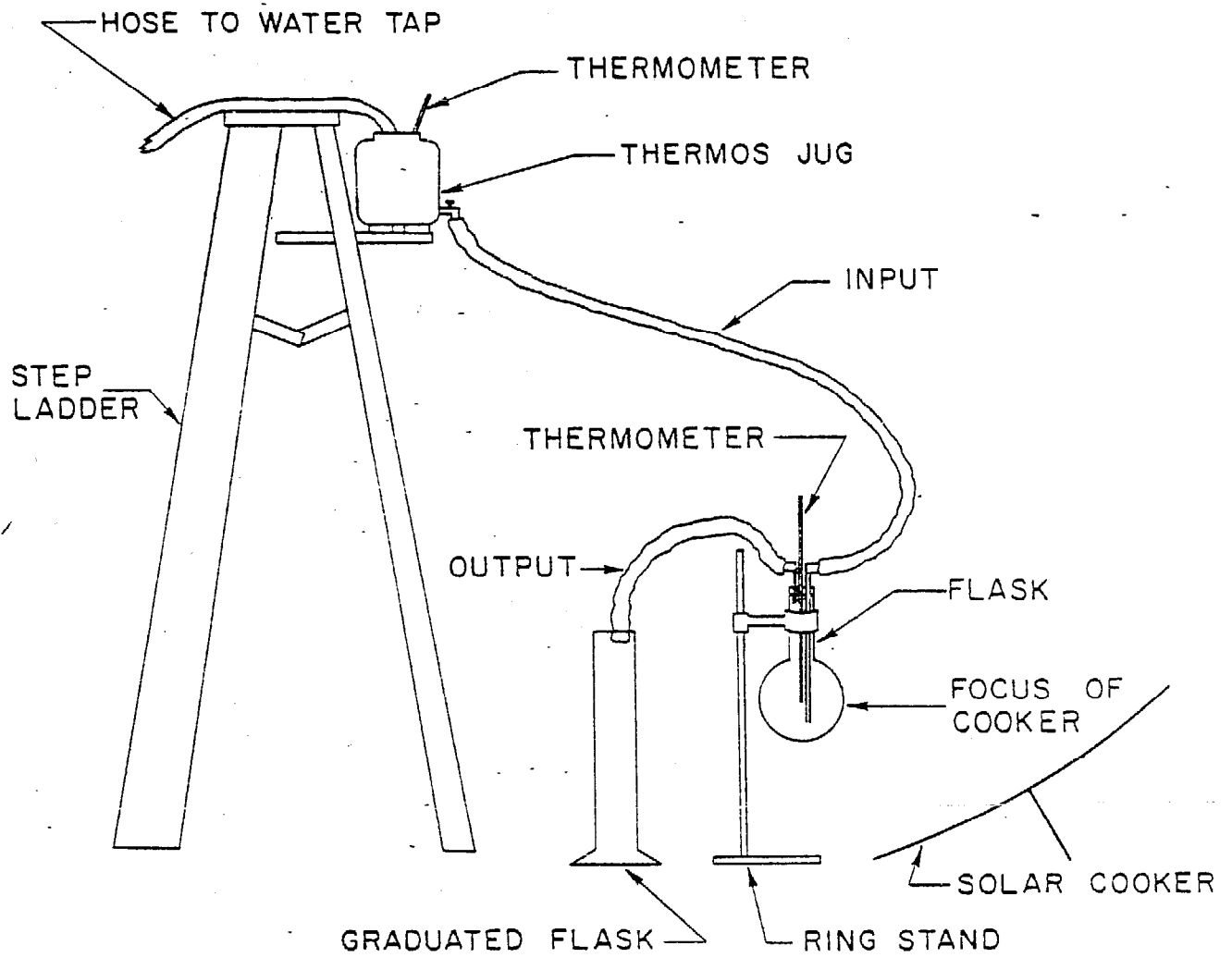

FIGURE 18

Cylindro-Parabolic Solar Cooker Viewed from the Side of the Slip Rings





CALORIMETER  
 TEST ARRANGEMENT

FIGURE 19

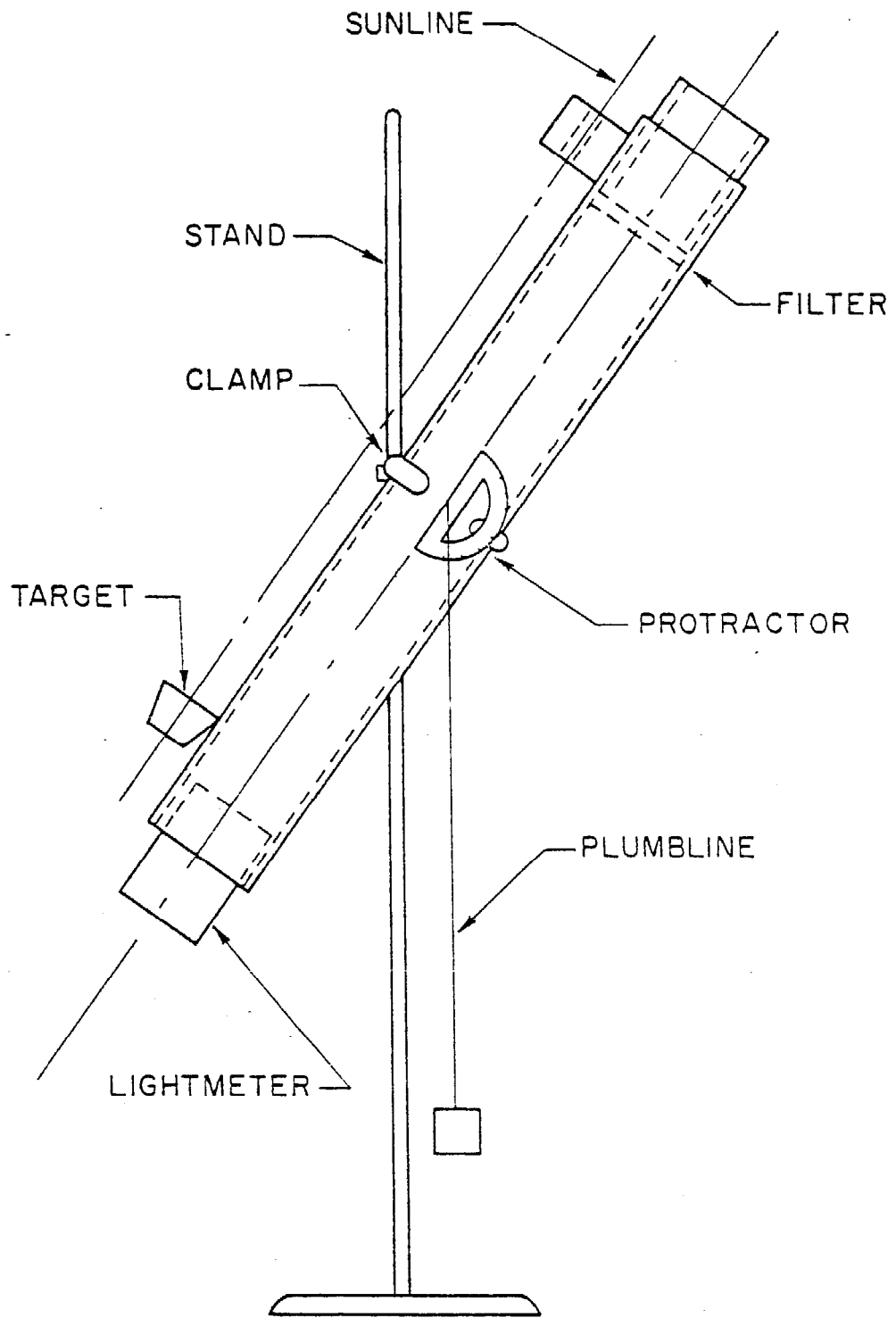

CRUDE PYRHELIOMETER

FIGURE 20

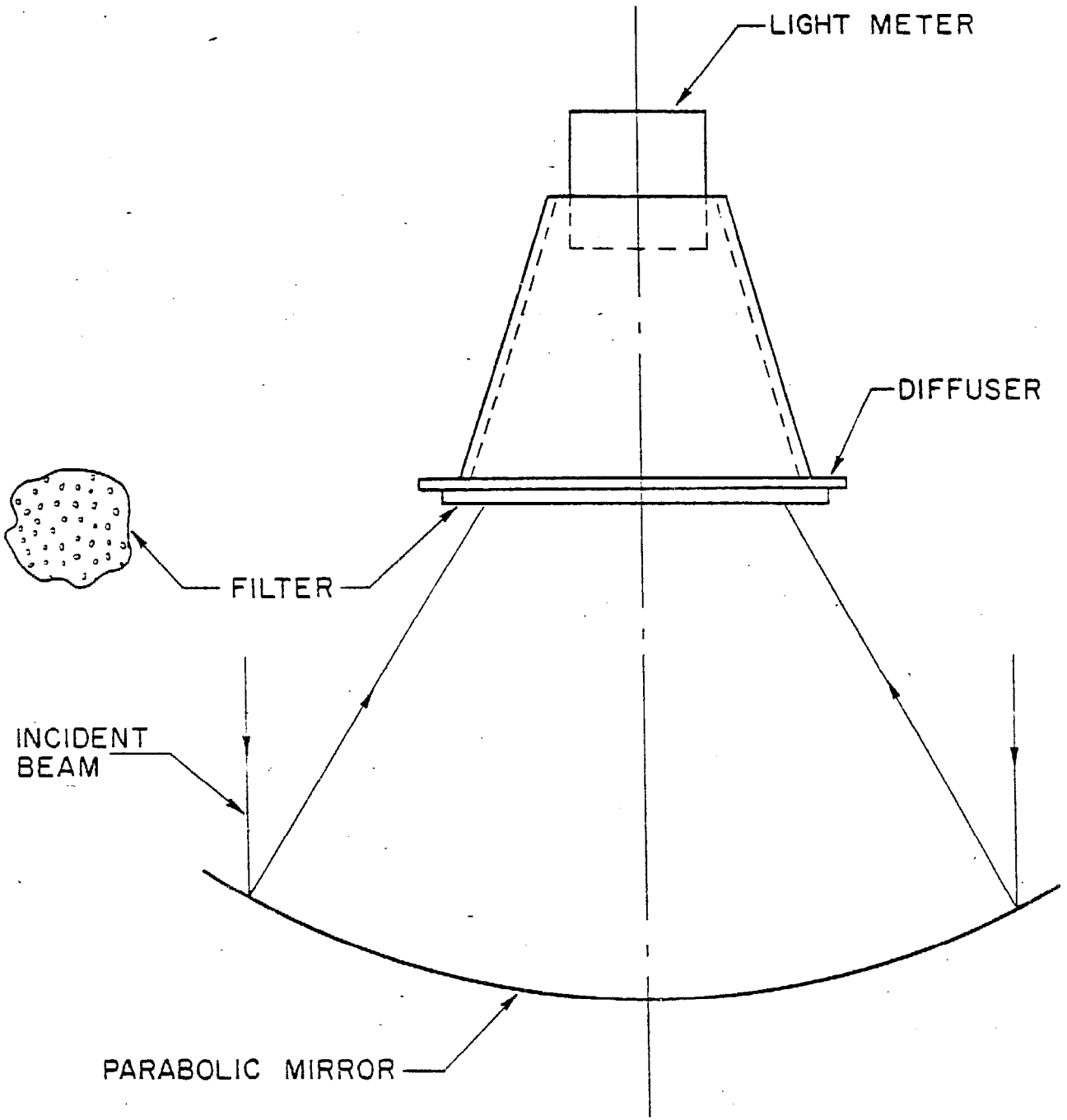

ARRANGEMENT FOR  
INCIDENT LIGHT MEASUREMENTS

FIGURE 21

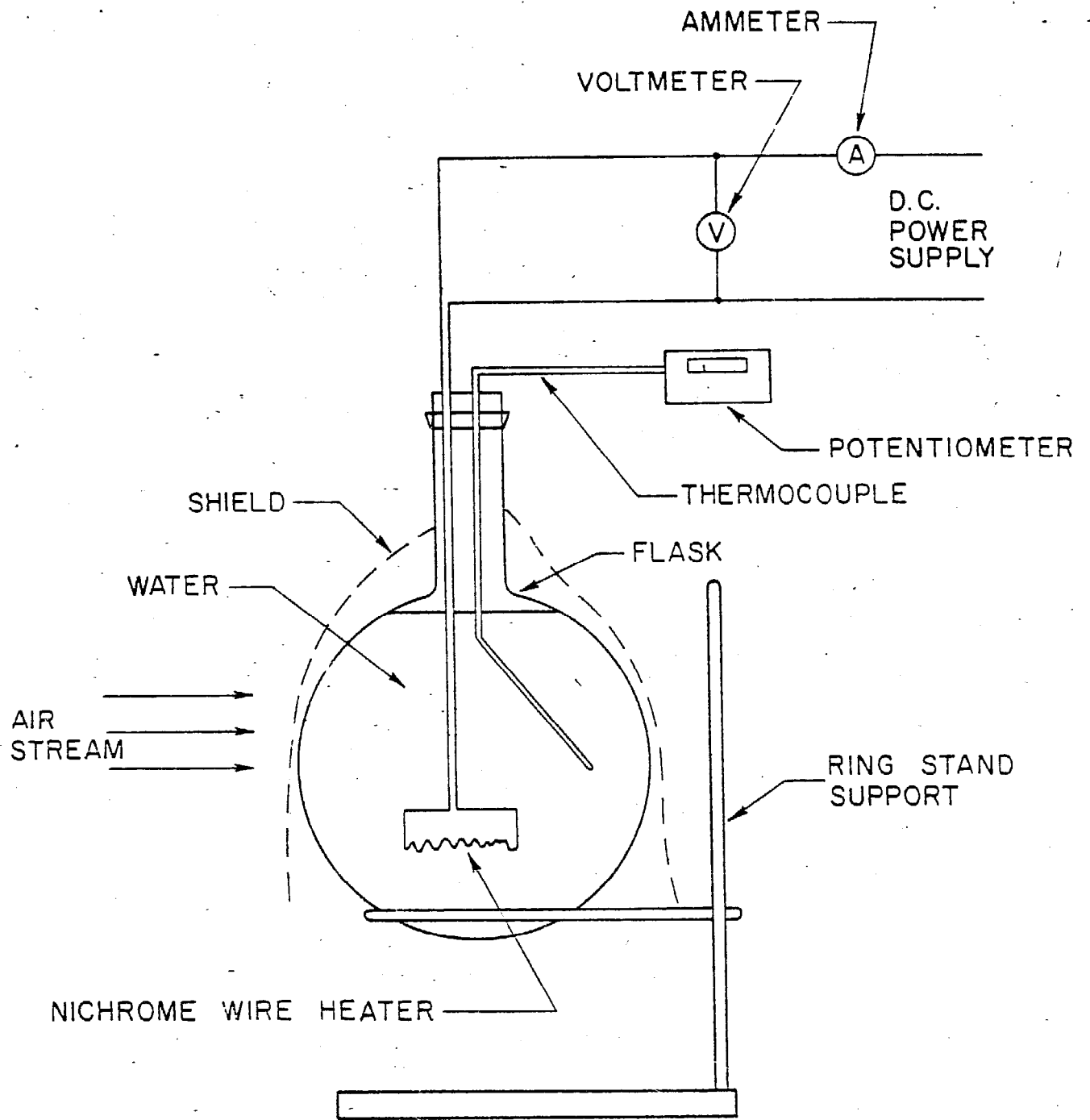

ARRANGEMENT OF  
HEAT LOSS EXPERIMENT

FIGURE 22

Heat Loss - (watts)

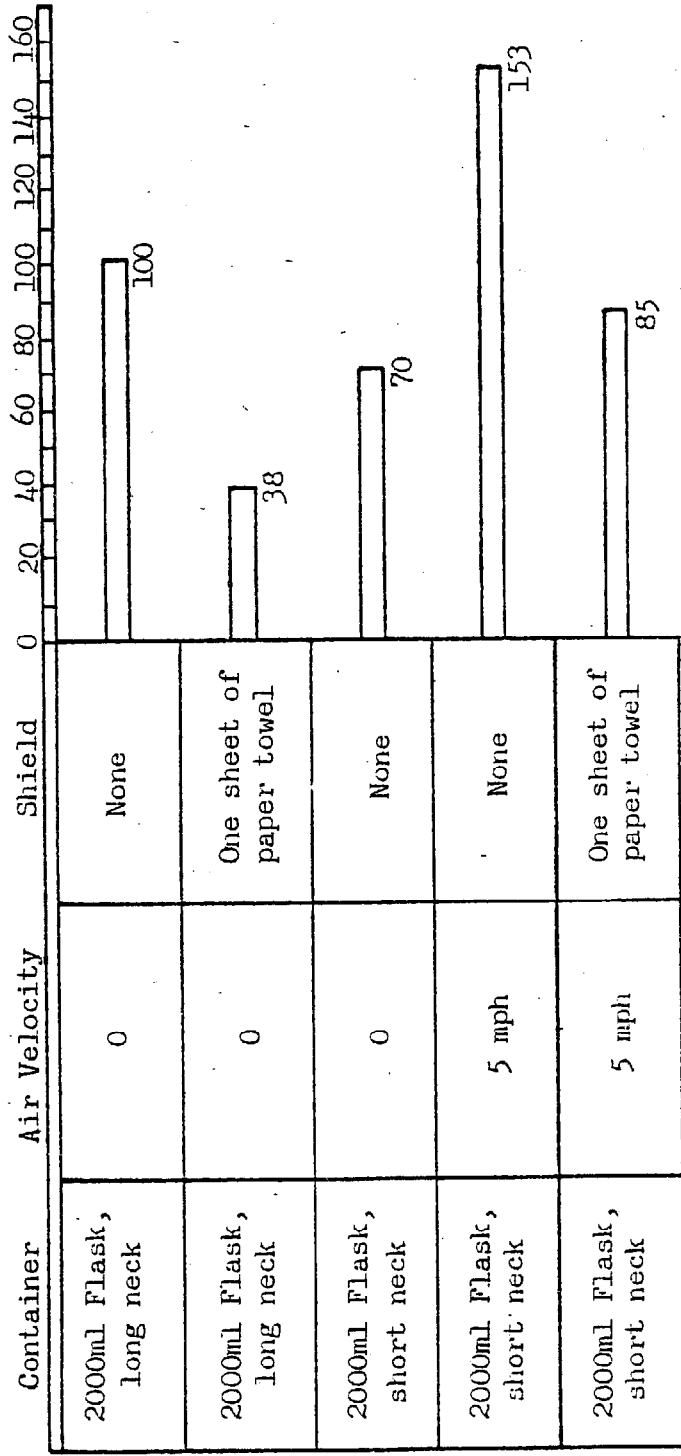

RESULTS OF HEAT LOSS TESTS

Figure 23