

AT MICROFICHE REFERENCE LIBRARY

A project of Volunteers in Asia

The Use of Bamboo and Reeds in Building
Construction

Published by:
United Nations
New York, NY 10017 USA

Paper copies are \$3; ask for publication number
E.72.IV.3 when ordering.

Available from:
Publications Sales
Room A-3315
United Nations
New York, NY 10017 USA

Reproduced by permission of the Department of
Public Information, United Nations.

Reproduction of this microfiche document in any
form is subject to the same restrictions as those
of the original document.

THE USE OF BAMBOO
AND REEDS
IN BUILDING CONSTRUCTION



UNITED NATIONS

ST/SOA/113

Department of Economic and Social Affairs

**THE USE OF BAMBOO
AND REEDS
IN BUILDING CONSTRUCTION**



UNITED NATIONS

New York, 1972

NOTE

Symbols of United Nations documents are composed of capital letters combined with figures. Mention of such a symbol indicates a reference to a United Nations document.

The designations employed and the presentation of the material in this publication do not imply the expression of any opinion whatsoever on the part of the Secretariat of the United Nations concerning the legal status of any country or territory or of its authorities, or concerning the delimitation of its frontiers.

ST/SOA/113

UNITED NATIONS PUBLICATION

Sales No. E.72.IV.3

Price: \$U.S. 3.00
(or equivalent in other currencies)

PREFACE

Shelter is man's basic need. Those who live through the torrential rains, the cold nights and the scorching heat of midday in tropical and subtropical regions know that shelter is as important there as in arctic and temperate climates. A man's home is still the centre of family activities: providing facilities for cooking, sleeping and personal hygiene, and protection from animals and the elements.

Bamboos and reeds are the oldest and chief building materials in rural areas and villages throughout the world's tropical and subtropical regions. It is a simple fact that more people live in bamboo and reed buildings than in houses of any other material. Bamboo and reed construction is popular for good reasons: the material is plentiful and cheap, the villager can build his own house with simple tools, and there is a living tradition of skills and methods required for construction. This tradition has been augmented in recent years by experiments carried out principally in India, Indonesia, the Philippines and Colombia. The bamboo and reed housing is easily built, easily repaired, well-ventilated, sturdy and earthquake-resistant.

Deterioration by insects, rot fungi and fire is the chief drawback of bamboo and reeds as building material. Many buildings of untreated bamboo must be replaced every two or three years. Most bamboo and reed houses have no interior toilets, indoor water supply, or interior cooking facilities. It is easy to speculate about the relation between the absence of these facilities and the rapid deterioration.

Improving the material properties of and construction techniques for bamboo and reed buildings would be a giant step towards improving the quality of life for millions of rural dwellers in the world's developing countries.

This study has two purposes. The first is to acquaint national Governments, ministries of housing, regional housing authorities, village and community development officers, rural aid societies, building co-operatives, building contractors and the villagers themselves with new or not well-known techniques of bamboo and reed building construction. The techniques may be directly transferable or may be only an indication of possibilities.

The second purpose is to stimulate additional research on improving the properties of bamboo and reed as a building material and on improving the techniques of building construction with bamboo and reeds.

The study reflects the concern expressed at various sessions of the Committee for Housing, Building and Planning; the Commission for Social Development and the Economic and Social Council. The General Assembly, in its resolution 2036 (XX), requested the Secretary-General to undertake the preparation of periodical reports, *inter alia*, on the "measures to develop a building material industry utilizing local raw materials to the maximum".

This study was prepared for the United Nations Secretariat by two special consultants, D. Narayanamurty, Director, Indian Plywood Industries Research Association, and Dinesh Mohan, Director, Central Building Research Institute, Roorkee, Utta Pradesh, India, and edited by Professor Adam Wiener, Nassau Community College, New York. It forms part of a continuing project under the direction of the Centre for Housing, Building and Planning of the United Nations Secretariat on the important subject of "Improvement and development of building technologies based on locally available materials".

The authors have drawn on Bamboo as a Building Material by F.A. McClure, published by the United States Department of Agriculture. The Secretariat of the United Nations wishes to express its appreciation to the author and the Department for permission to use the material quoted herein.

CONTENTS

	Page
Preface	iii
I. BAMBOO AND REEDS AS BUILDING MATERIALS 1	
Geographical distribution	1
Cutting, curing and storage	2
Physical characteristics	11
Physical structure	14
Preservative treatment against insects, rot and fire	19
II. BAMBOO AND REED BUILDING COMPONENTS 28	
Shapes: full, half, split, board, mat and slab	28
Foundations	40
Framing	42
Flooring	43
Roofing	45
Walls	51
Trusses	57
Doors and windows	57
Pipes and troughs	60
Joints and fasteners	62
III. OTHER USES OF BAMBOO AND REED IN BUILDING CONSTRUCTION 70	
Concrete with bamboo and reed reinforcing	70
Earthquake-resistant construction	76
Recommendations for further research	78

ANNEXES

I. Distribution of species of bamboos and reeds used in building construction	81
II. Strength of bamboos used in building construction	90
III. Recommended preservatives for different end uses of bamboo	91
IV. Tools used in bamboo and reed construction	93

I. BAMBOO AND REEDS AS BUILDING MATERIALS

Geographical distribution

F.A. McClure reports that

Bamboos occur as more or less prominent elements in the natural vegetation of many parts of the tropical, subtropical, and mild temperate regions of the world, from sea level to altitudes of more than 13,000 feet, wherever a suitable combination of ecological factors prevails. Their natural distribution is very uneven, both as to abundance and variety of kinds in a given area. Through the agency of man, the distribution of many species of bamboo has been greatly widened. This process probably has been going on for a long time, and the actual extent of it has not been surveyed. However, some of the most valuable species have not been distributed to any important extent and much remains to be done to make these more generally known and available.

The greatest concentration of bamboos and the highest development of their use are to be found on the southeastern borders of Asia and on adjacent islands. This area extends from India to China on the mainland, and from Japan to Indonesia among the islands. Some 20-odd species of bamboo have been reported from the little-known flora of Africa, and many of these are used... for house construction. The Island of Madagascar, whose flora is more fully known, has been found to have more native species of bamboo than are known to occur in the whole of Africa. Australia has perhaps a half-dozen native species. Europe none. In the Western Hemisphere, the natural distribution of bamboos extends from southern United States to Argentina and Chile. Some 200 species are native to this area, but they are very unevenly distributed. Many of the recorded species are very imperfectly known, and some kinds have been recorded under more than one name, but the known bamboo flora of the world probably totals more than 700 species, classified in about 50 distinct genera. ^{1/}

Most bamboo grows in forests and propagates through natural regeneration. Owing to rising commercial demand, bamboo plantations are now common in many countries. The cultivation of bamboo has resulted in the introduction of new species into countries where native species do not meet local needs. One species native to China, Bambusa textilis, is now successfully cultivated in the southern United States of America and Puerto Rico. Another species, Bambusa vulgaris is possibly the most widely cultivated species in the Americas. In Guatemala and Nicaragua, this species has largely replaced the native Guadua species.

More research is required to test and select outstanding varieties of Bamboo in order to determine their potential as building material. One candidate for such research, the Guadua angustifolia species of Peru, Colombia and Ecuador, is reported to have outstanding resistance to attack by insects and rot.

^{1/} F.A. McClure, Bamboo as a Building Material, United States Department of Agriculture (Washington, D.C., 1953), p. 12.

In Asia, bamboo grows in virtually every country, including Nepal. The major producing and consuming centres are India, Indonesia, Burma, China, Pakistan, Japan and the Philippines. In the Americas, bamboo grows in every country except Canada. It is especially important in Colombia, Ecuador, Venezuela and the Central American countries. In Africa, though less important economically, bamboo is found in the tropical belt from Ethiopia to Ghana and in the Malagasy Republic. The distribution of the important species is listed in annex I. Figures I, II and III show three types of bamboos.

Cutting, curing and storage

Habitat

Bamboos form the most important component of the forests in many parts of the world. In tropical areas, they form the understory of the evergreen, deciduous forests. In most cases, this understory consists of a single bamboo species, but several species are sometimes found together. Bamboos thrive best and attain their maximum development in monsoon forests, but they dwindle into shrubs in temperate regions, and at high altitudes some species look almost like grasses. Bamboos are good colonizers. In Burma, East Pakistan and other parts of Asia, pure bamboo forests are found on hill slopes where shifting cultivation has been practised. Bamboo occurs in a variety of soils, which are not too acid or alkaline. It prefers well-drained sites, avoiding marshy or waterlogged areas.

Due to the increased demand, large-scale bamboo plantations have been established in India, Japan and other countries. The plantations use nursery-raised seedlings. The seedlings are planted on a grid 4m x 4m to 6m x 6m. This spacing facilitates the cutting, bundling and removal of the bamboo. Occasionally, small tractors are used and generally plantations hold greater promise for mechanizing the growing and cutting bamboo.

Cutting

New bamboo culms or trunks are produced annually, growing in clumps out of the underground rhizomes or roots. The culms mature in 4 to 6 years, although the larger species may take longer. Cutting is worked on a cycle varying from three to five years. The culms are cut 25 or 50 centimetres above ground. The cutting from each clump is selective. The mature and dead culms are removed but a few are left standing to give the young culms proper support. The cutting is generally done by hand with axes, machetes or saws. Chain saws are occasionally used on bamboo plantations but the cost of labour generally makes them uneconomical. The same equipment is used to remove branches and cut the culms into standard lengths. Most bamboo harvesting uses this selective cutting method.

Another method occasionally used is clear cutting. Using this method every culm, young or old, is cut. The use of this method permits more extensive use of mechanized equipment. After the culms have been cut, the forest is left clear except for stumps. The chief disadvantage of the method is that it permits cutting only once every 10 to 12 years. Perhaps with an assured market for all the culms cut, young, old and dead, this method could be made economical.



Figure I. Dendrocalamus giganteus. A large-diameter bamboo
(Forest Research Institute, Dehra Dun, India)



Figure II. Dendrocalamus brandisii. A large bamboo
(Forest Research Institute, Dehra Dun, India)



Figure III. Bambusa polymorpha, much favoured in House construction
(Plantation at the Forest Research Institute, Dehra Dun, India)

The annual yield varies greatly depending on the species. The annual yields range from less than one to seven air dry tons per hectare. Some species are reported to yield as much as 20 and 30 tons per hectare. Few reliable statistics are available about the comparative annual yields, and costs of plantation bamboo and of forest bamboo.

Insect attacks are minimized by cutting when the starch content of the culm is at the lowest level. This usually occurs during the early part of the cold weather. In India, the best cutting period is from October to February. In Japan, the best cutting period is reported to be October to November. Susceptibility to rot fungi also bears some relationship to the cutting period but for most species this has not been sufficiently investigated.

Curing

A simple method of increasing the resistance of freshly cut culms to beetles is clump curing. Clump curing consists of resting newly cut culms upright against living culms for four to eight days without removing leaves. The objective is to make the culms as dry as possible and decrease the starch content that insects feed on. The freshly cut lower end of the culm is dusted by patting with a dusting bag filled with a 5 per cent mixture of DDT and talc. The culm is raised off the ground on a stone or brick. A stick is thrust into the lower end of the culm to prevent fungus attack. The dry culms are removed, trimmed and transported to storage.

Transportation

After cutting, the bamboos and reeds are dragged to the nearest track, or rough path weaving through the forest. Here the culms are bound into bundles with bamboo, rope or wire. The bamboo bundles are loaded on bullock carts, donkey carts or trucks for the trip to the storage yard (see Figure IV). Often the bamboo is taken to the railhead or river dock for transport to a more distant market (figure V).

Storage

At the storage yard, the bamboo is usually dried by air seasoning under cover for a period of six to 12 weeks to increase its strength and avoid cracking. Sun seasoning can do the same job in two to three weeks, though at the risk of splitting the outer membrane of several species if the seasoning is too rapid.

Effective protection against decay in storage is obtained by guarding bamboo and reeds against wetting by rain or by contact with soil. Good ventilation and frequent inspection are also important.

The storage of bamboo requires special care. Before laying out the storage ground it should be thoroughly inspected and cleaned and all refuse and useless timber and bamboo should be removed. If the area is infected with termites the ground should be sprayed with a 4 per cent emulsion of DDT or 0.2 per cent emulsion of BHC or other suitable insecticide. Termite colonies in mounds should be destroyed by breaking open the mounds and pouring in insecticides. The ground should have good drainage facilities.

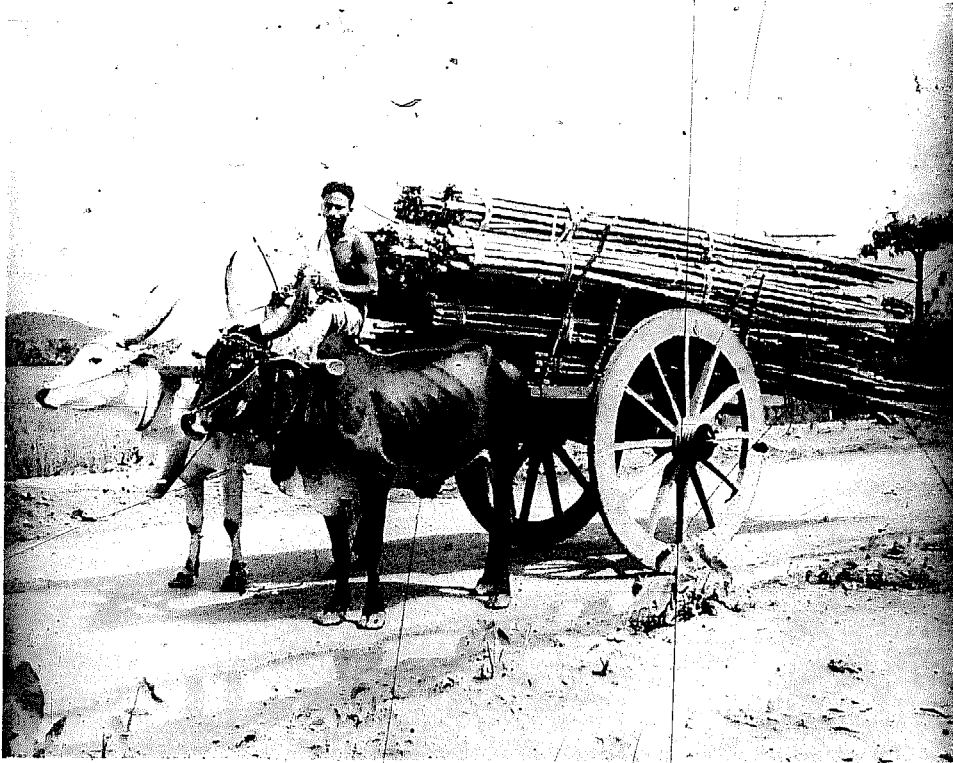

Figure IV. Bamboo being transported by bullock cart in Kerala, India.

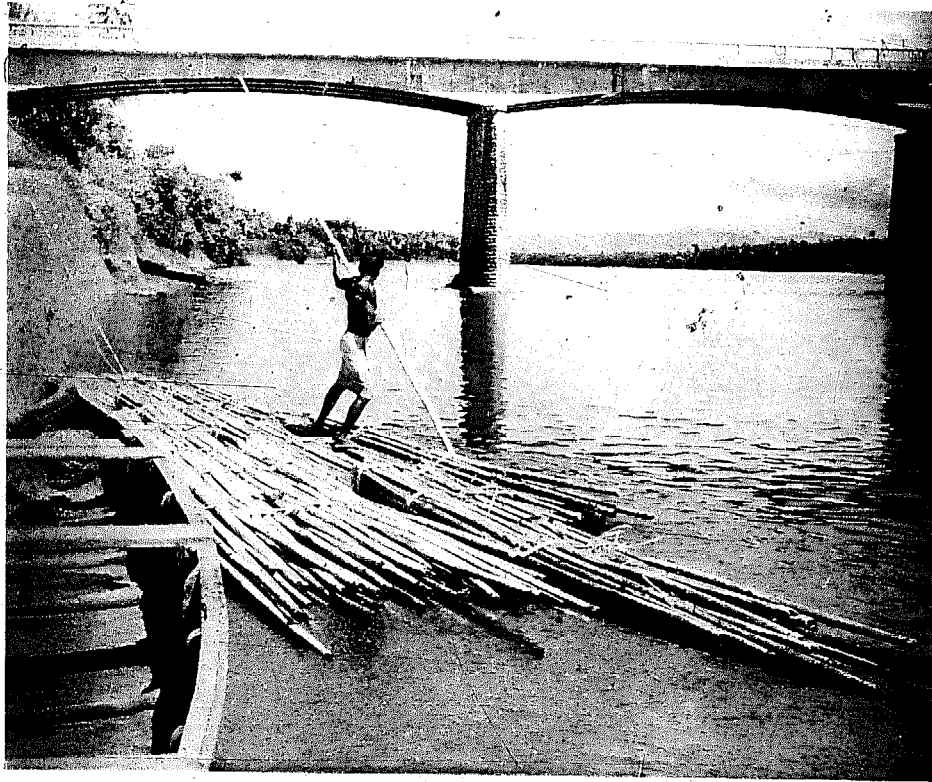

Figure V. Raft of bamboo, Kerala, India

Bamboo should be stacked on high skids or raised platforms, at least 30 centimetres above the ground, for prevention of termites attack. Storage under cover will reduce liability to fungal attack. The stack should be inspected at regular intervals. Bamboo should be stored in such a way that all sides of the stored bamboo may be readily inspected (see figure 11). Infested bamboo should be removed or treated.

Reeds

Reeds grow almost in all the countries of the world, but the densest reed thickets are found in the tropics. The area under reed coverage in the USSR constitutes about 5 million hectares. The largest areas infested with reeds in the USSR are found in the South of Russian Federation, in Kazakh SSR, in Uzbekh SSR. More than 75 per cent of the total reed thickets in the USSR are located in these three republics. Reed which could be used in the industry should be clean, weedless and easily transportable; the yield should not be less than 4-5 tons per hectare.

The actual practice in the cultivation of canes and reeds have shown the high effectiveness of creating artificial conditions by controlling the water level in the reed thickets at different seasons. If the water conditions are properly selected and controlled, the yield increases by a few times and reaches 40 tons per hectare. The initial investment on the earth works and the installation of pumping stations is recovered in 4-6 years.

In the USSR the preparation of reed for industrial purposes starts in December and January when the reeds are ripe.

In those places where mechanization of labour is not possible due to natural conditions, the reeds are cut manually by means of a short scythe with a wooden handle. The cut reed stems are immediately bound into sheafs.

The reeds for industrial purposes are cut with special tractor-drawn or tractor-mounted harvesters. Horse-drawn mowers are also used. The mowers with special binder heads are the most productive machines. On these mowers, the cut reed stems are automatically made into sheafs bound with binder twine and are either thrown on the field or delivered to transport vehicle by special conveyor devices. Horse-drawn carts and sledges, tractor sledges and trucks with trailer are used to transport the reeds to its storage sites. Similarly, the reeds are also dragged directly over ground or on special metal pallets. The actual practice shows that tractor-drawn sledges are the most economical means to transport reeds over a distance of 10-15 kilometres on hard surface. Dragging method justifies itself over short distances up to 1.5 - 2 kilometres. In this method, up to 5 tons of reeds are bound together with ropes and dragged over ground by a tractor. Of course, there is some loss due to dragging, yet the economy in handling compensates for these losses. Transport costs reach up to 50 per cent of total expenditure on preparation and therefore most effective transport methods have to be used in each particular case.



Figure VI. Bamboo storage yard

"Long experience in reed preparation with the help of tractors has revealed that the specific pressure of wheels or caterpillar on the ground should not exceed 80 g/cm² in wet and soft soil. At higher pressures the root buds are damaged, thus the development of off-shoots is hampered. The yield at those places, where root buds were damaged during the harvest, drops down by a few times. Therefore the mechanisms used in reed mowing must have wider rubber caterpillars. The specific pressure against soil can be considerably reduced by replacing steel caterpillars by rubber ones.

"The reed sheafs are piled at dry places into conical or cylindrical stacks with conical roofs or into rectangular stacks. The normal volume of a stack is about 400-500 cubic metres." 2/

Physical characteristics

Dimensions

Bamboo and reed culms vary in height and diameter. Some bamboos and reeds grow to a height of 36 metres, and others are no more than shrubs. The diameter varies from 1 to 30 centimetres. The variability between species is far greater than the variability within species. The variability makes difficult the mechanization of processing and fabrication. When the supply of culms is very large, this variability may be partially overcome by careful selection and grading. The range of heights and diameters of the principal species used in construction are listed in annex I.

Where nodes or rings are very prominent, they will interfere with close fitting construction. The prominent node can be dressed to size but more commonly the use dictates the selection, and these culms are not used for close-fitting construction.

Splitting

Bamboos and reeds have a tendency to split easily. This tendency is particularly pronounced in the internodes, which have a lower coefficient of shear than the nodes. Wherever possible, cuts in the culm should be made just beyond the node to minimize splitting. The splitting tendency precludes the use of nails, screws or pegs unless pilot holes are drilled beforehand. Often, splitting is preceded by cracking. Cracking is usually controlled by air or kiln drying.

Durability

Bamboos are highly susceptible to destruction by wood-eating insects, fungi and fire. Within the culm, the middle and tip portions are less resistant than the bottom portion. There is also a considerable variation in durability from species to species. McClure reports that the Guadua bamboo of Ecuador, Peru and Colombia (Guadua angustifolia)

2/ V.G. Zezin, "Production and application of building materials and elements made of reeds", a paper presented to the United Nations Seminar on Organizational and Technical Measures directed towards Increasing the Production of Building Materials, held at Moscow, September-October 1968, pp. 2-4.

"has a relatively high resistance to both rot fungi and wood-eating insects. It has been observed repeatedly that ordinary hardwoods used in conjunction with this bamboo have had to be replaced because of insect damage while the bamboo still remains serviceable. The original untreated siding, consisting of boards of this bamboo, in a 40-year-old plantation house at Pichilingue in the Department of Los Rios, Ecuador, was still in a serviceable condition in 1945, long after the hardwood floors had had to be replaced because of insect damage. 3/

The durability of untreated bamboo is however, in general, short. Bamboo posts embedded in the ground are destroyed in six months to two years. Bamboo stored above the ground have, in tests, a useful life of 22 to 41 months. Bamboo under cover and not in contact with the ground may last from two to seven years.

Moisture content

Owing to anatomical changes caused by drying, the moisture content of bamboo has a great influence on its treatability with preservatives. Freshly cut bamboo with high moisture content is far easier to treat with the Roucherie process than dry bamboo.

Moisture content in bamboo decreases with the height of the culm from the ground. It also varies with the age of the culm and the season. For one species, the highest value in August (rainy season) was nearly three times the lowest value in June (hot dry season). The moisture content at the base of the culm was about twice that at the top in June and 1.3 times in August. Along the length of the culm the moisture content undulates, the internodes showing 2 to 7 per cent more moisture than the nodes.

Older culms (6 to 9 years) contain less moisture than younger (3 to 4 years) ones. The youngest culms (6 months to 1 year) show the highest moisture content. The differences due to age, however, are not as great as the differences due to the seasons.

Old culms undergo considerable seasoning while still standing in the clump. Unlike wood, bamboo starts shrinking from the very beginning of drying. This shrinkage is, however, not continuous. Between a moisture content of 70 per cent and the saturation point, dimensions do not change more than about 20 per cent; the magnitude of shrinkage depends on the original moisture content. In drying from green condition to about 20 per cent moisture content, the shrinkage in mature culms of different species of bamboos lies between 4 and 16 per cent in wall thickness and between 3 and 12 per cent in diameter. Shrinkage along the culm is negligible, being about 0.1 per cent. For the same species, shrinkage of mature culms is less than that of immature culms. The latter often develop cracks and collapse during the drying process.

Weight

Bamboo and reed are light in weight compared to construction timber. The specific gravity of bamboo varies from about 0.5 to 0.79 with a median of about 0.65.

3/ F.A. McClure, op. cit., p. 37.

Owing to its greater wall thickness, the basal portion of the culm is significantly stronger in the modulus of rupture and allows a greater fibre stress at the elastic limit, in both the green and the dry conditions. There is hardly any difference in the compressive strength between the basal portion, the middle and the top. The modulus of elasticity is generally lower for the bottom portion. In splints of bamboo, the compressive strength of the outer layers from the culm is higher than for the inner layers, following the difference in specific gravity. Bamboo splints with and without nodes, when tested in static bending gave higher values when the face nearest the periphery was in compression.

Physical structure

Botany

Bamboos are perennial, grasslike, woody plants. In botany, they are an order of the Gramineae class. Bamboo is subdivided into four families, an estimated 50 genera, and over 700 species. Each of the species has widely differing characteristics affecting its usefulness as a building material. The species of bamboo and reeds most commonly used in building construction are listed in annex I.

The rhizome

A characteristic feature of bamboo is its gregarious habit. The woody pointed stems of bamboo, commonly called culms, grow closely together in clumps. A new bamboo culm grows from a bud at the base of an old culm. This bud develops and grows slowly at first until, under the stimulus of rainy weather, the growth accelerates till the culm is about half of its full height. Subsequently, it slackens gradually. The growth of bamboo is rapid, about 7 centimetres per day, and can be as much as 35 to 40 centimetres a day. Growth at this rate is continuous for about a month.

The basal nodes of the new culm remain close together at or below the surface of the ground. This part of the culm grows a little horizontally so that the new culm is able to grow up clear of the previous ones. The horizontal part of the new growth bears roots and is called a rhizome. The collection of culms resulting from the rhizome is called a clump. In some species, the rhizome gives rise to closely packed, distinct clumps. In other species, the rhizome continues to grow horizontally for an indefinite length and the new upright culms are formed by well-separated lateral buds upon it. If individual culms mature and die, the rhizome maintains its growth, regenerating itself and putting forth new culms.

The culm

The individual bamboo shoots complete their growth within a period of four to six months in the very first growing season. Once the maximum height is attained, lignification of the culm takes place during the subsequent two to three years. The culm reaches maturity after the fifth or sixth year or even later depending on the species.

The young culm grows to its full height before branching. Usually one or more secondary branches grow from the lower nodes of each of the main lateral branches (see figure VII). The process may be repeated on these secondary branches, so that from each node will appear to come a tuft of small branches.

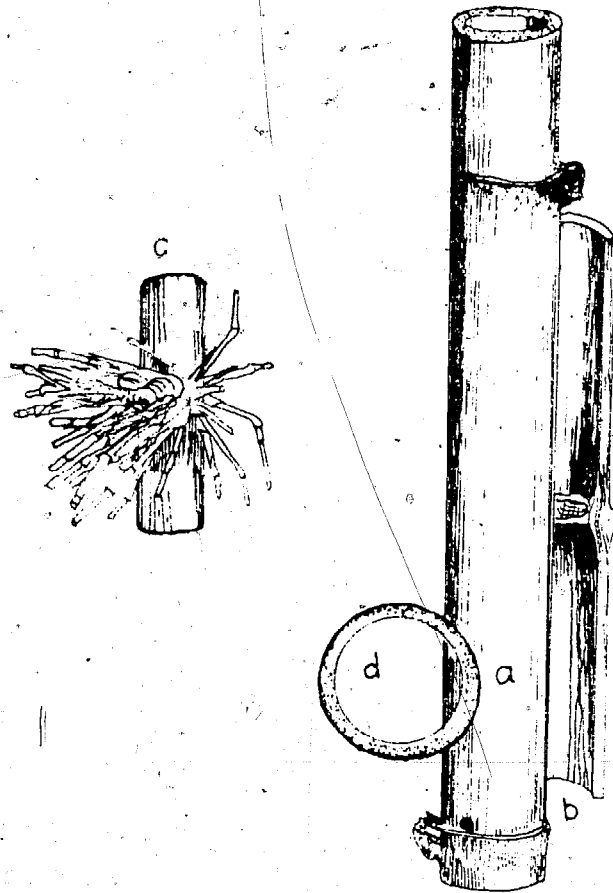

Figure VII. Gross features of a bamboo culm
(a) The culm
(b) Vertical section of the culm
(c) Branches of a node
(d) Cross section of the culm

The maximum diameter of culms, the thickness of the walls (in the middle of an internode), the length of the longest internodes, the prominence or otherwise of nodes are also important characteristics. These can be noted from old culms. Young plants or plants growing under poor conditions have smaller culms than mature, well-grown plants of the same kind. It is also sometimes not easy to judge whether one is dealing with a young or impoverished plant or with a distinct species which never attains a larger size.

Bamboo culms are generally cylindrical and smooth. They are usually hollow and have transverse dividing walls at the nodes. Culms may be almost, if not entirely, solid when grown in dry localities. Solid bamboos are sometimes called male bamboos. The culms have prominent rings at intervals bearing sheaths, often characteristic of each species.

Ordinarily, culms do not bear any branches for a considerable height above the base. Some culms have very large and prominent branches. Others have branchlets, but these are arranged alternately in dense clusters. The lateral branches and the circle of false rootlets at the lower nodes of a few species harden into spines and give a natural armour to clumps.

Flowering and propagation

Interesting facts have been recorded about the flowering habits of bamboos. Many bamboos, especially those which flower at long intervals, die soon after flowering and fruiting. Subsequent regeneration appears in the ensuing rainy season but this takes some years to mature into full-size culms. Many variations from this normal practice have also been observed in India and other countries. At times only some of the culms of a clump flower and die while the remaining culms do not. Some species flower annually without dying. Cases have been recorded of bamboos of different species recovering after flowering. Generally, the absence of new culms is held to be a reliable sign of prospective flowering in the following year but this has not been found to be universally true.

There are two types of flowering in bamboos: sporadic and gregarious. In sporadic, a stray clump flowers and seeds here and there in the bamboo forest. In gregarious flowering, all the bamboo clumps growing in the forest flower and seed. Gregarious flowering occurs at periodical intervals of several years and varies with the species of bamboos.

Abundant natural regeneration follows a gregarious flowering and the soil is covered with a thick carpet of seedlings. The seedlings develop in due course and clump formation is complete during a period of six to 12 years, depending on the species. Artificial regeneration on a large scale was not resorted to in the past owing to abundance of natural regeneration in the forest following gregarious flowering. In recent years, large-scale plantations of bamboos have been undertaken. Regeneration by sowing is impractical in the case of species that do not often flower or when flowering does not produce seed. Bamboos may be propagated artificially by seed or by planting out vegetative offsets. Direct sowings are not generally resorted to. The most common method is the planting of nursery-raised seedlings. The planting of vegetative offsets is generally adopted where bamboo plantations have to be raised on a small scale.

Culm anatomy

The culm is cylindrical and is divided at intervals by raised nodes from which the branches arise. At each node is a transverse wall which completely separates the cavity of one internode from the next. The cavity of each internode is very variable in diameter. In some species, this cavity may be vestigial and the culm practically solid.

The tissue of the bamboo culm is built up by parenchyma cells and vascular bundles consisting of vessels, thick-walled fibres and sieve tubes (see figure VIII). The movement of water in the culm takes place through the vessels. The fibres are responsible for the strength of the bamboo. Nutrients such as starch granules are stored in the parenchyma cells which fill up to about 70 per cent of the tissue. The vascular bundles become progressively smaller in size and denser towards the periphery. The orientation of all the cells is in the vertical direction. The culm is covered outside and inside by hard waxy cuticles which offer considerable resistance to the absorption of water, particularly when dry. This characteristic is of importance when impregnation by chemicals is required.

Fibres constitute 60 to 70 per cent by weight of the wood of the bamboo. The fibre content is greater in the periphery than inside where parenchyma predominates. Fibre distribution is highest in the internodes situated at one quarter to one half the height of the culm. This region also contains the longest and most mature fibres of maximum wall thickness. Towards the top the fibres show gradual decrease in length, degree of maturity and cell wall thickness. Bamboo fibres show considerable variation in shape, size and wall thickness. They are usually long and straight with tapering ends. The average length of bamboo fibre is about 100 times its diameter.

Parenchyma tissue percentage is highest in the bottom internodes and gradually decreases towards the top. Similarly, the percentage is reduced towards the periphery and shows marked increase towards the inside.

The vessels occupy only about 15 per cent of the culm. In the internodes all vessels are oriented parallel to the stem axis without any branching or contact. Inside the nodes, however, an intensive branching takes place making the horizontal transportation of liquids possible. In the nodes the vessels are connected with each other by pits. As the vessels also go through the diaphragms inside the nodes they connect the sides of the culm. From the nodes some vessels go into the branches. The distribution of vessels affects preservative treatment which can take place not only through the upper and lower ends, but also through the cut branches at the nodes. From the nodes, the preservatives can penetrate the culm in both directions towards the top and bottom. The number of vessels available for treatment generally becomes less from bottom to top.

When the bamboo is dried, the sap present in the vessels dries up and the vessels fill with air. During the drying process, the pits inside the nodes close and the pit openings of the parenchyma cells are closed by their own dry cell sap. These factors have a very important bearing on the preservative treatment of dry bamboo. If a preservative is to penetrate into the vessels it has to overcome surface tension and friction forces in the vessels, and in order to enter parenchyma cells it has to dissolve out the dried sap closing their pit pores or diffuse through the cell walls.

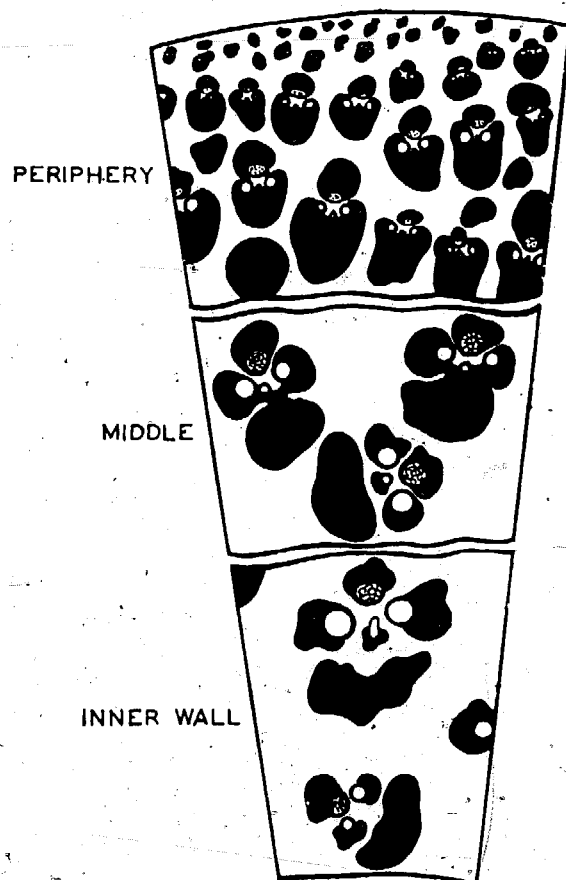

Figure VIII. Diagrammatic transverse section of part of an internode of *Dendrocalamus strictus* from periphery to the inner wall showing greater concentration of fibre in the peripheral region (Ghosh and Negi, Forest Research Institute, Dehra Dun, India)

Reeds

Reeds, like bamboos, belong to the class Gramineae and for the purpose of this study may be defined as giant grasses (see figure IN). They are water-loving species. Like bamboos, they also have vertical, cylindrical hollow stems strengthened at intervals by transverse septa known as nodes. The stem, also known as the culm, is thus made up of a series of nodes separated by internodes. The leaf blades are borne on sheaths which encircle and strengthen the stem.

Most of the internodes of reed culms are hollow, but there are exceptions. Young culms of some species of reeds are filled with a snow-white pith which is gradually reabsorbed. The internodes may be filled with pith which shrivels and shrinks on drying.

Some reeds contain deposits of silica in the tissue and become hard. All stems contain chlorophyll in the outer cells when young, but as they mature they lose their chlorophyll to a large extent, if not entirely.

Reeds may be annual or perennial. Most flowering grass-culms, whether the species be annual or perennial, die down to the base after the lapse of a year, but some reeds persist for several years if they escape grass fires.

Preservative treatment against insects, rot and fire

Need

Deterioration by insects, rot fungi and fire is the most serious drawback to bamboo as a building material. Often this deterioration requires that bamboo structures be rebuilt every two or three years. With proper preservative treatment, the life of bamboo housing can be extended to 15 years or longer. If the life of bamboo housing is lengthened, a number of consequences follow. The initial investment can be increased fivefold. This permits a larger, better built and better equipped house. Before building such a house, the villager might investigate various architectural layouts and facades. He might want to use commercially available fasteners, roofing and concrete block foundation posts. With a permanent structure, there might be good reason to build an extension for an indoor toilet, to build an indoor water supply, and with adequate fireproofing, to consider an indoor cooking facility. These consequences would greatly improve the quality of life of the average villager.

Protective treatments suited to the village level of skill and technical knowledge are as important as commercial impregnation treatments similar to those used successfully with timber. Protection techniques suited to various levels of skill and situations are available. Traditional methods which are widely used to increase the durability of bamboo cost very little and can be carried out without any special equipment or technical knowledge. These include leaching in water and whitewashing. Each of these methods increases the durability of bamboo, particularly against Bostrichidae and Lyctidae beetles. It is also often necessary to provide further protection to bamboo with chemical preservation. Techniques for its application include brushing, spraying, swabbing, dipping, hot and cold bath treatment, Boucherie method and pressure treatment.



Figure IX. Arundo donax, giant reed, variegated variety,
Roorkee, India

Water leaching

The most common treatment for protecting bamboo from Bostrichidae and Lyctidae beetle attack (see figure X) is to leach out the starch, sugars and other water-soluble materials from the freshly cut stems by submerging them in water. Removal of starch and sugars renders the bamboo unattractive to the beetles. Successful application of this technique has been reported from India, Burma, Fiji, Jamaica and other countries. The bamboo must be completely immersed in water, weighted down, if necessary, for periods ranging from three days to three months for freshly cut bamboo and two weeks longer for partly dry bamboo. Running water gives better results. Stagnant water sometimes leads to staining of the bamboo. Immersion in sea water appears to be satisfactory if marine borers are absent.

Whitewash and other coatings

A variety of coatings, such as tar, limewash, tar and limewash and tar sprinkled with sand, are used by housebuilders in Indonesia, but these can be effective only to the extent that they give a continuous coating at cut surfaces, exposed internodes, abrasions and slits. Inner wall of internodes made accessible by splits in the bamboo cannot be effectively protected.

Brushing, swabbing, spraying and dipping

These surface treatments are adopted for bamboo in storage or before it is given impregnation treatments. It can also be used in locations where the danger of biological deterioration is not serious.

Various chemicals are recommended for the temporary protection of bamboo. Dieldrin 0.05 per cent, or Aldrin 0.15 per cent, in aqueous emulsion gave almost complete protection against Dinoderus beetles, for over a year. DDT, 7 to 10 per cent, in kerosene oil and BHC, 0.24 per cent, were even more effective. Spray application is recommended for stacks of bamboo.

Dipping green and partly dry bamboo for 10 minutes in a 5 per cent solution of DDT in fuel oil produced a highly significant degree of control of Dinoderus beetle for about 12 months in Puerto Rico. Soaking in the same solution for a longer period resulted in protection for 24 to 30 months. BHC and DDT emulsions have also been reported to have performed satisfactorily in Taiwan. For exposed bamboo where rainfall is likely, oil-borne insecticides should be preferred.

Except for treating large stocks, no expensive spraying equipment should be required for prophylactic treatment of bamboo. Hand-operated sprayers should normally be suitable. The most effective nozzle is one which produces a dense fog of the ejected solution/emulsion. This ensures uniformity of spread as well as economy in the quantity of insecticide.

Dipping is to be preferred to spraying as the latter leads to some wastage of the preservative. Dipping air-dry bamboo in hot preservatives gives good results. The chemicals mentioned above give protection only against borers and, to some extent, termites. For protection against fungi and borers a five-minute dip is recommended in a solution containing 2 per cent borax and 1 per cent pentachlorophenol in which 1 per cent is dispersed. Alternatively, a Dieldrin-PCP-Copper emulsion made up as follows may be used: Dieldrin 1 part,

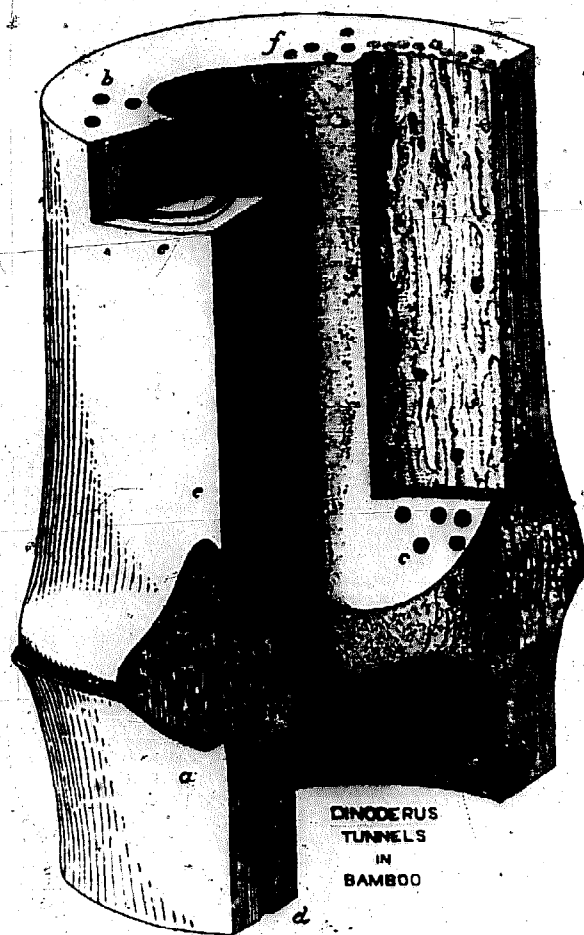

Figure X. Bamboo showing attack of Dinoderus

- (a) Entrance holes bored by the beetles into the surface exposed by cutting off side-shoots
- (b) Entrance holes bored by the beetles in the exposed transverse section of cut ends
- (c) Entrance holes in the internal wall of the internode which has been rendered accessible to the beetles by cutting across the bamboo before the next node
- (d) Entrance tunnels carried in the wall from the cut end
- (e) Entrance tunnels in vertical and horizontal sections
- (f) Larval tunnels exposed diagrammatically in transverse section
- (g) Larval tunnels exposed diagrammatically in tangential section after removing the inner wall

PCP 4 parts, water 75 parts; and Copper Nephthenate (1 per cent C_u) 1 part. In Japan, mercury and tin compounds have also been used for protection against borers and fungi, respectively.

Steeping

Preservation by soaking is the cheapest and simplest chemical treatment method. The culms, preferably in the green condition, have only to be kept immersed in a preservative solution for a period of five weeks or more, depending on the species, age, thickness and absorption to be obtained. The longer period of soaking would be required if the bamboo is needed for locations in contact with the ground. Adequate absorption in quantity and depth can be obtained by soaking. The main disadvantage is the long time required.

In split bamboo, the soaking period can be reduced by 33 to 50 per cent. Penetration of the inner and outer wall can be 100 per cent. Puncturing the outer skin and use of high temperature can speed up penetration. Puncturing the nodal partition wall, where possible, with an auger would be useful in obtaining better and quicker treatment. Diffusion rates appear to be different for different species of bamboos. Absorption of preservative was found to be directly proportional to the depth of penetration.

The soaking method can be universally specified for the treatment of bamboos for all purposes. It requires little equipment and technical knowledge, provided the schedule of treatment, such as the type of preservative, concentration and period of soaking, is carefully worked out.

Boucherie process

If bamboo is required in the round shape with internodal partition wall intact, the Boucherie process of treatment is most effective. In the normal Boucherie process, the preservative is pushed into the stems by gravity from a container placed at a height of about 10 metres through pipes. This method is improved by using a simple hand pump by means of which air pressure is applied to a container of the preservative standing on the ground. This reduces the period of treatment considerably.

The modified Boucherie process has been adapted for treatment of several culms at the same time (see figures XI and XII). The container used to hold the treating solution, which should be of the water-soluble type, is provided at the bottom with side tubes fitted with stop-cocks and rubber tubes to which are attached the green bamboos with branches on. In order to secure leak-proof contact between the rubber tubes and the bamboos, suitable metallic clamps or other devices are used. The tank is also fitted with a screw cap to which is attached a motor-car tube valve. The tank is filled to about two thirds of its height with the treating solution and after the cap has been tightened, air is pumped through the valve to a pressure of 1.0 to 1.4 kg/cm². Under this pressure, the treated liquid forces the sap out of the walls and sents of the bamboos through the open end and replaces it in course of time. After a few preliminary experiments, the concentration of the treating solution and the period of treatment can be determined to obtain the requisite absorption of the preservative. The preservative liquid that flows out of the bamboo can be reused after bringing it up to the required concentration and pH.



Figure XI. Modified Boucherie process for treating bamboo showing four culms connected to reservoir of preservative and hand-operated pump for applying pneumatic pressure
(Forest Research Institute, Dehra Dun, India)

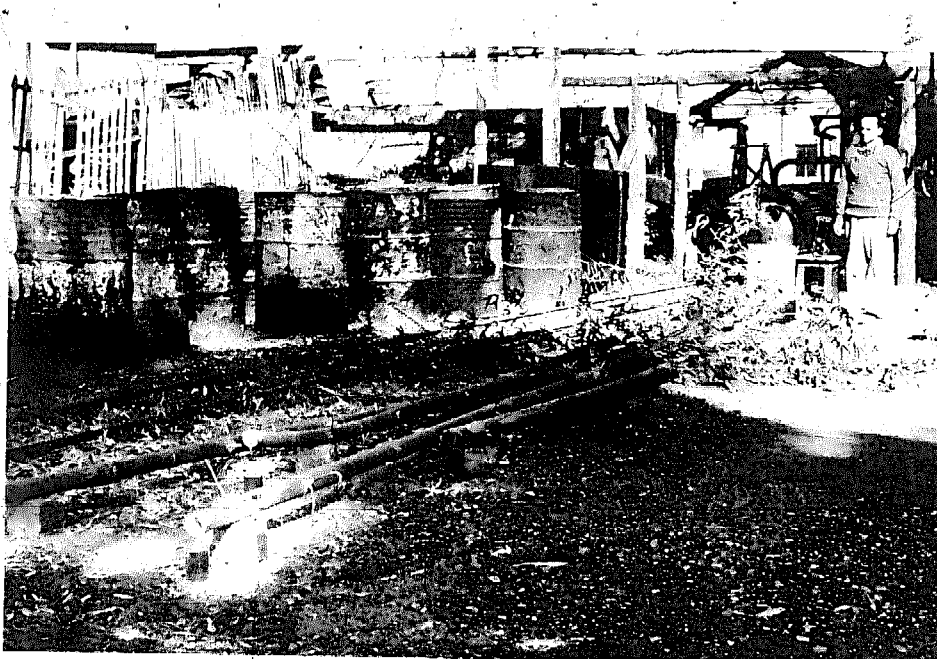

Figure XII. Modified Boucherie process for treating bamboo
developed at Forest Research Institute, Dehra Dun,
India

Boucherie treating equipment can be designed to handle as many as 500 or more bamboos at the same time. The installations are easy to transport and may even be used in the forest. Preservatives suitable for application by the Boucherie process are given in annex III. The process is, however, applicable only to freshly felled green bamboos, and for the treatment to be satisfactory, harvesting should be done only at the time of year when the vessels in the culm are full of sap. Over-mature bamboos cannot be treated by these methods.

Stepping method

When only a few culms are to be treated, the Boucherie process as originally developed may be used. The process, better known as the stepping method, consists in allowing freshly cut culms, with the crown and branches intact, to stand in a container holding the preservative solution, to a depth of 30 to 60 cm. Through transpiration of moisture from the leaves, the solution is drawn up the stem. The period of treatment depends on the species, length of the culm, climate and preservative used. One to two weeks may be required to obtain complete penetration.

Capping method

Simple adaptations of the Boucherie process may be used for the treatment of small quantities of bamboo. For example, a length of bicycle tube or an inner tube of a motor tyre, may be slipped over the butt end of the bamboo and secured with thread to serve as a reservoir for the preservative solution. The preservative is then poured into the tube, the bamboo being kept suitably inclined with its butt end up.

The basal internode of the culm may itself be used as a reservoir for the preservative solution. A cut is made in the inner wall of the bamboo to facilitate penetration by the solution.

Hot and cold bath process

When pressure impregnation facilities are not available, the hot and cold bath or open-tank process, similar to that used in the treatment of timber, may be used for air-dry bamboo also. In order to facilitate penetration and avoid cracking the walls, the nodal septa are bored through; the bamboo is then submerged in a tank of preservative which is heated either directly over a fire or indirectly by means of steam coils in the tank. The bath temperature is raised to about 90° C, is held at that temperature for the desired period and then allowed to cool. Absorption of 70.4 kg/m³ creosote has been recorded using this method.

When using fixed-type preservatives which may precipitate on heating, it is best to heat the bamboos rapidly in water and then to drop them in a tank containing cold preservative solution. For organic solvent-borne preservatives like PCP, the bamboo should be heated in a liquid of suitable specification and then transferred to a tank of cold preservative.

A simple tank may be improvised by cutting the top and bottom out of one or more drums, depending on the length of bamboo to be treated, welding them together to form a long cylinder closed at both ends and cutting the cylinder lengthwise into two halves. Two cylindrical open tanks are thus obtained.

Pressure treatment

Pressure treatment is suitable for dry bamboos. The moisture content of green bamboos would have to be brought down below 20 per cent before satisfactory penetration could be obtained with this method. Bamboos treated in the round may split under the pressure. To avoid this, a hole should be bored through the septa of the nodes with an auger. This also ensures more thorough treatment.

Both the full-cell and Lowry pressure processes used in the treatment of timber may be used with bamboos. Absorption of about 85 and 70 kg/m^3 , respectively, of creosote have been recorded with these methods. In Taiwan, round bamboos, with nodal septa intact, have been treated with aqueous solutions at a pressure of less than 5 kg/cm^2 to prevent cracking. Absorption was of the same order as that attained by one week's soaking. Soaking for five weeks resulted in absorption 1.5 to 2 times that obtained by pressure treatment.

Preservation for bamboo

Preservatives and methods of treatment recommended for various uses of bamboo are given in annex III. Borax, boric acid and sodium pentachlorophenate are good against borers and are readily absorbed by bamboo. The last is good against sap stains also. Because of its leachability, treated bamboo should be given a water repellent treatment with a material such as paraffin wax or tung oil.

Fire retardant treatment

Although not much work has been done on the protection of bamboo and reeds against fire, it is possible to treat them with fire retardant chemicals in the same way as wood. The cost, however, is likely to be too high for the types of houses generally built of bamboo and reeds. It is worth while to treat bamboo with the following fire-resistant-cum-antiseptic composition:

Ammonium phosphate	3 parts
Boric acid	3 parts
Copper sulphate	1 part
Zinc chloride	5 parts
Sodium dichromate	3 parts
Water	to 100 parts

A few drops of concentrated hydrochloric acid are added to the solution to dissolve the precipitated salts. The pH of the solution is about 3.5.

II. BAMBOO AND REED BUILDING COMPONENTS

Shapes: full, half, split, board, mat and slab

A variety of bamboos and reeds are used as building components. Each of the various shapes usually has a number of uses. For example, the board shape may be used for walls, roofs and flooring. The methods for producing these shapes vary from the use of the simple tools of village handicrafts to the continuous-operation horizontal presses used in the Soviet Union which produce 40 square metres of reed slabs per hour.

Full

By far the most common shape in the full culm. Although no equipment is required to produce this shape, several methods are used to make it suitable as a building component. First, the culm is usually tapered at the tip end. This is a disadvantage in close-fitting construction and is best dealt with by cutting the culms into shorter lengths. The cutting may be done with a long-handled knife, machete, hand shear or power shear.

Many culms are curved and this, too, presents difficulties in their use as building components. Generally, the curved portion is not used for framing or in close-fitting construction. Curved culms may be straightened but the process is not economical on a large scale. It consists of heating partially dried culms and placing them in forked pegs on the ground or pushing them through holes cut in upright wooden posts.

Half

Half shapes are produced by splitting full culms longitudinally. Two cuts, 180° apart, are made by knife or axe in the cross section of the culm. Wedges are placed in the cuts. The cuts are placed on an iron or hardwood bar and the culm is pushed in the direction of the bar (see figure XIII). This completes the splitting of the culm in two. The most common use of half shapes is in roofing, where the split culms are interlapped convex and concave to permit rain run-off. Quarter shapes are produced in a similar manner as half shapes except that four cuts are made and a cross rather than bar is used for splitting.

Split

The term "split" is used for any shape smaller than a quarter of the culm. Generally, splits are not used as building components but are woven into mats or made into lashing. Splits are made from quarters by dividing the quarter radially or longitudinally. The radial splits are used as cut. When longitudinal splits are produced, the hard outer strip is prized open and the soft inner strip is usually discarded. Bamboos and reeds split easily with a long-handled knife (see figures XIII, XIV and XV).

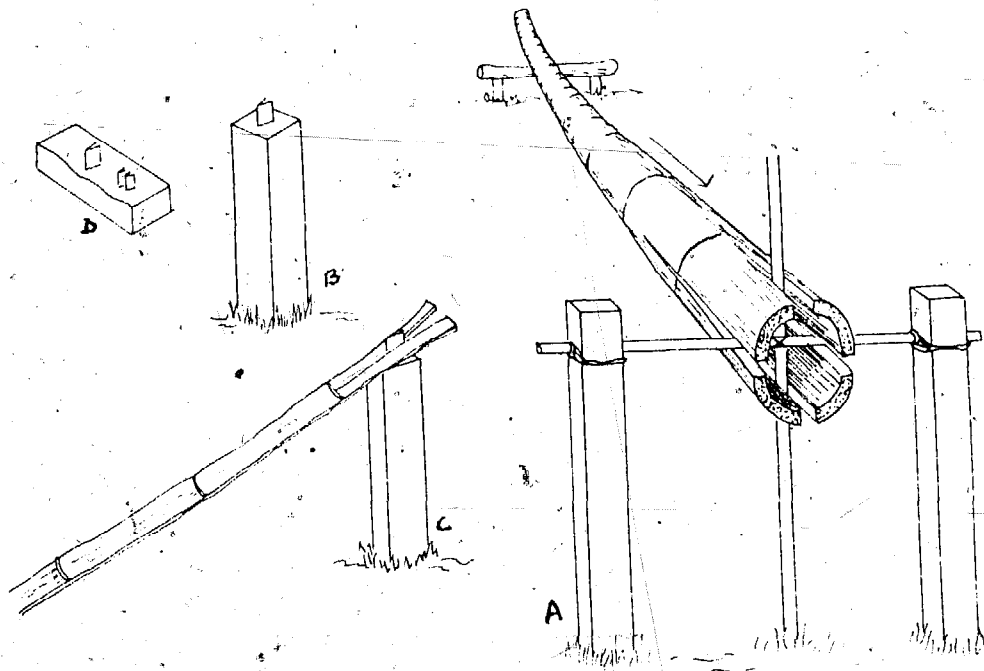

Figure XIII. Devices for splitting heavy culms

- (A) A cross of iron or hardwood bars (about 1 inch thick) supported by posts (about 4 inches thick and 3 feet high) is set firmly into the ground; with an ax, two pairs of splits are opened at right angles to each other at the top end of the culm; these are held open with wedges until the culm is placed in position on the cross; the culm is then pushed and pulled, by hand, in the direction indicated by the arrow
- (B) and (C) Steel wedge for splitting quartered culms
- (D) Block with single and paired steel wedges for mounting on a heavy bench; adjacent faces of the paired wedges should be slightly closer together at the cutting edge than at the back (McClure)

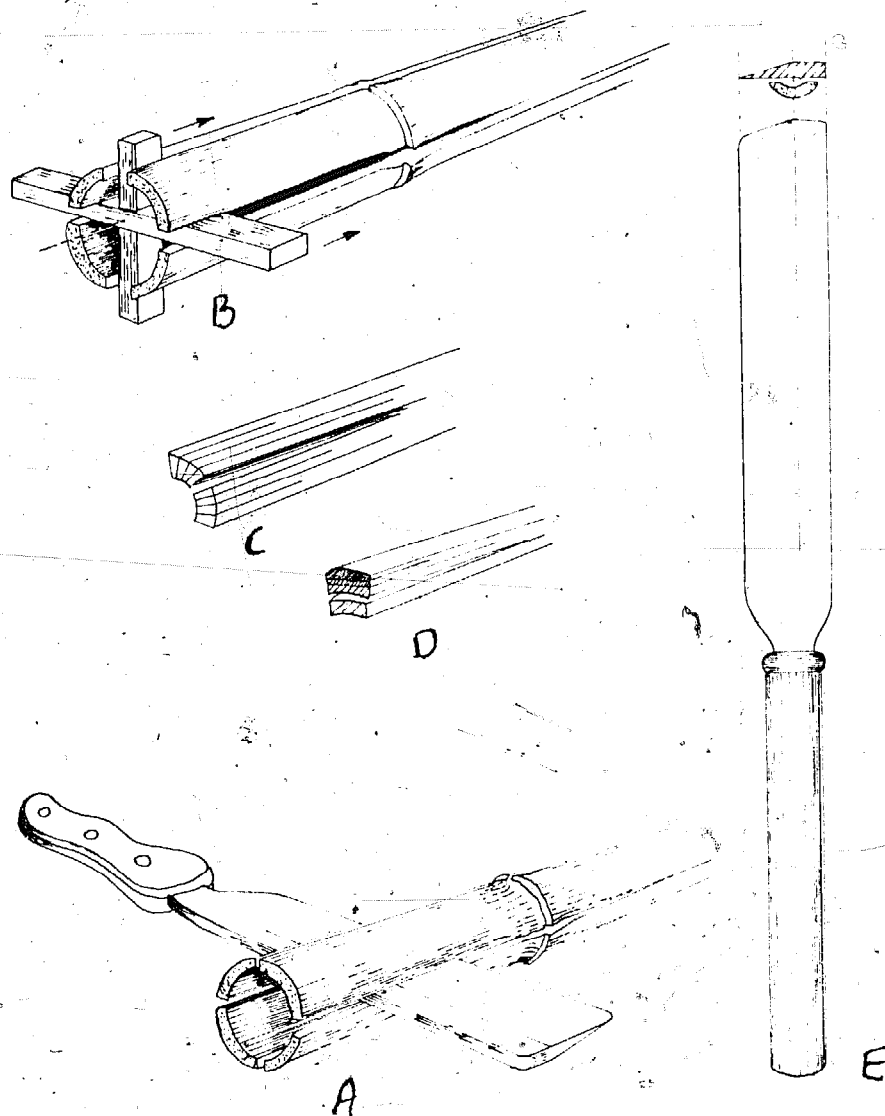

Figure XIV. Splitting of moderate-sized culms to make withes for weaving and lashing

Quartering a culm:

- (A) Starting four breaches at upper end;
- (B) Driving a hardwood cross along the breaches to complete the splitting;
- (C) Dividing quarters radially, making centre splints first;
- (D) Splitting radial divisions tangentially; the hard outer (convex) strip is best, and the soft, pithy inner (concave) strip is sometimes discarded;
- (E) Long-handled knife used for (C) and (D); some workers hold a strip of bamboo on the blade to add to its effective thickness when they wish to speed up the work (McClure)

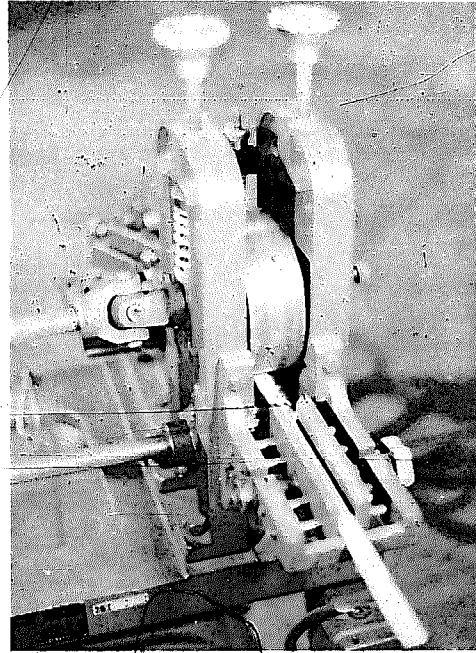

Figure XV. Machines for splitting and sizing bamboo

Board

Bamboo and reed boards are commonly used for flooring, walls, and even roofing. A board consists of culm that has been cut and unfolded until it is almost flat (see figure XVI). The full culm is cut at each node with an axe. Then, using a greased bit, a long split is made and the culm is spread wide open. The thick walled base part of the culm is not used for making boards. After the culm is spread open, the diaphragms at the nodes are removed with a machete, adze or spud. McClure describes the preparation of bamboo board in Ecuador as follows:

"The operator called picador holds the bamboo culm in position on the ground with his foot and strikes the blade of an axe into each node at intervals of an inch or so right round the culm. The incision in the different nodes are short and entirely independent so that the wall of the culm clings together as a fabric in spite of the great number of splits with which it is rent (figure XVII). When every node through the length of the culm has been cracked in this way, the picador makes a single continuous split from one end of the culm to the other. The culm opens out and may be pressed flat. The boards thus made are stacked, first one with the inner surface up, then one with the outer surface up. The stack is weighted with stones to prevent curling, and the boards dry out flat."

Mat

Bamboo and reed mats are made by plaiting splits (see figure XVIII). The matting is used for partitions, ceilings, floors, doors and windows, and sometimes for walls. Usually single-ply matting is used. Mats are produced in a variety of shapes and patterns. The strips are generally woven by hand although small machines have been used with some success. Ply-bamboo consists of woven bamboo matting glued together in much the same way as plies of wood in plywood. The most common types of assemblies are two or three ply, either all bamboo or with a core of wood or plywood. Ply-bamboo mats are glued together with phenol-formaldehyde and malamine-formaldehyde hot-press resins. Casein and urea-formaldehyde glues are also used. One-ply bamboo is made by pressing at 30 kg/cm² and 140°C mats containing 15 per cent phenol-formaldehyde resin. This ply-bamboo gives considerable resistance to termites and weather (see figure XIX).

Reed slabs

Reed slabs, also known as reed boards, are common in the USSR, Romania, Austria, India, China and other countries. They are used in the construction of homes, temporary buildings and agricultural buildings such as poultry houses, cowbarns and sheep pens. Generally used as non-load-bearing members in wall and roof construction, reed slabs are also used as short-span roof members over suitable framing.

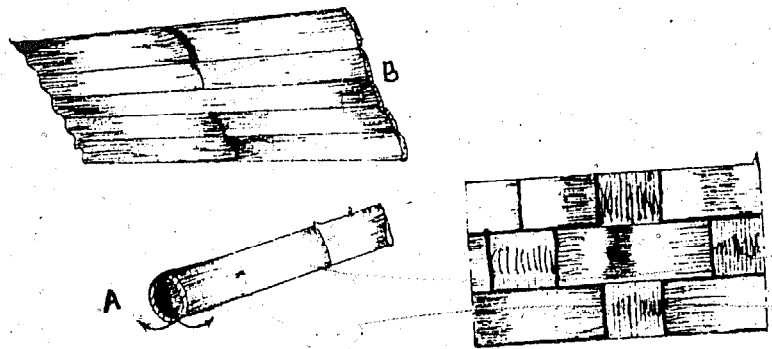

Figure XVI. Bamboo board

- (A) A large-diameter culm is opened out as indicated to give board (B)
- (C) A plaited board

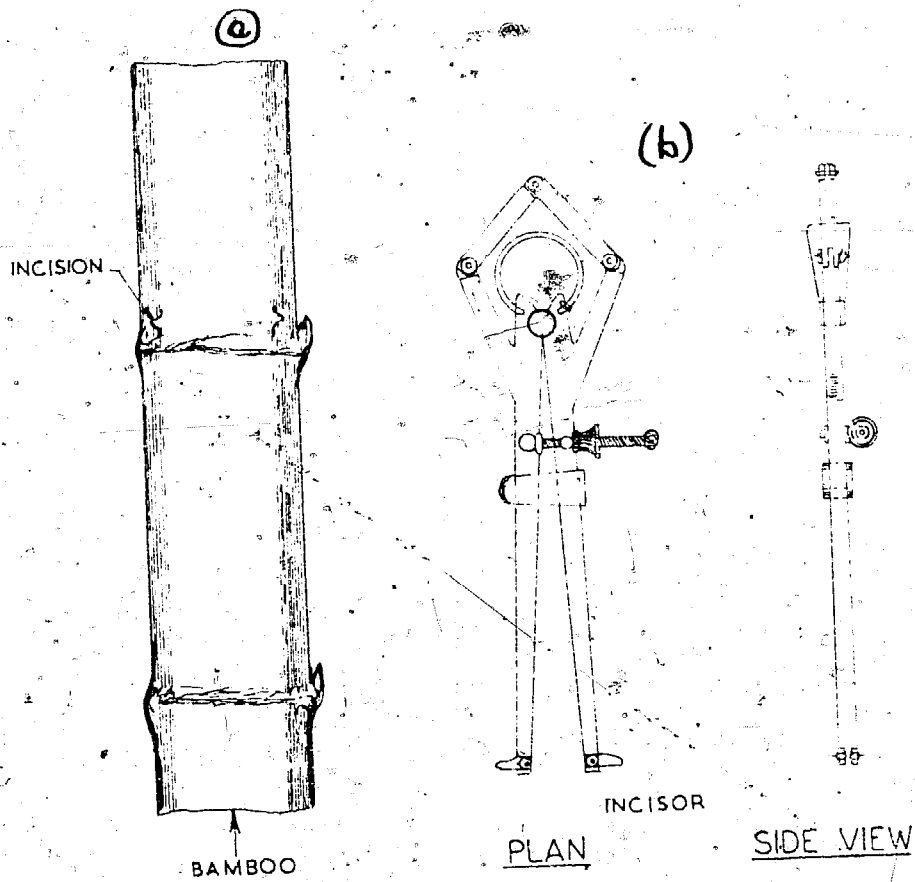
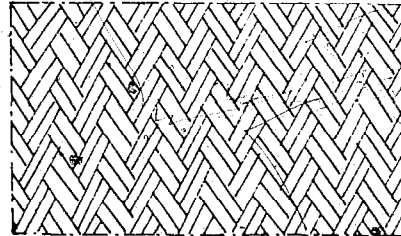
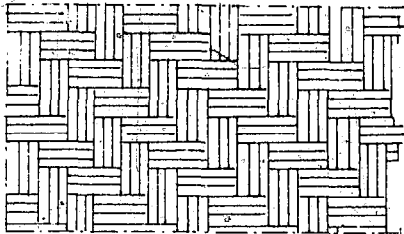
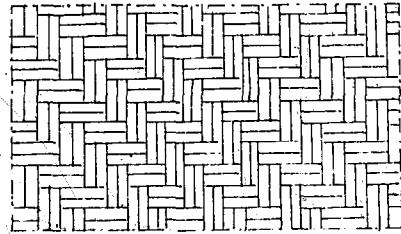
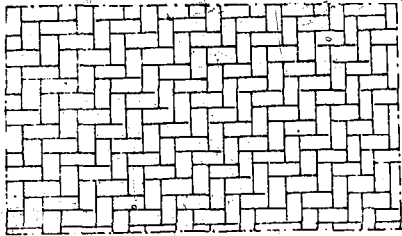
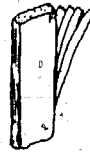

Figure XVII. Bamboo culm with incised basal internode (A) and incising tool (B)



SPLIT
TANGENTIALLY



SPLIT
RADIALLY

Figure XVIII. Different designs in weaving

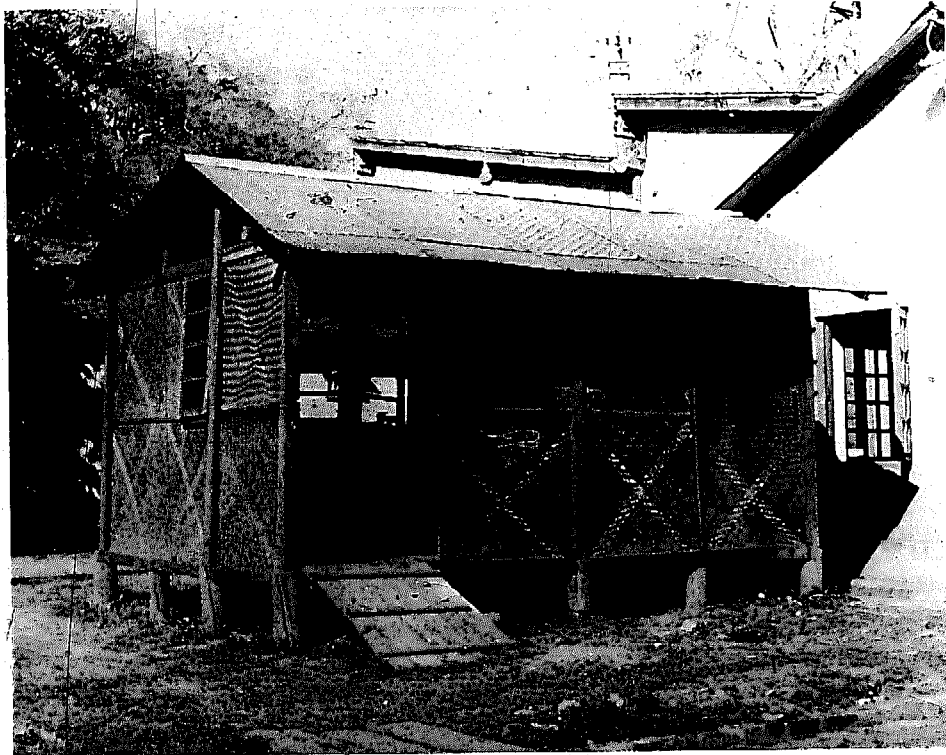

Figure XIX. Experimental structure of ply-bamboo with wood frame
(Forest Research Institute, Dehra Dun, India)

V. G. Zezin gives the following description of the manufacture of reed slabs in the USSR:

"Reed slabs are rectangular blocks from reed stems and bound together with wire during pressing [see figure XX]. The quality of these reed slabs should meet the requirements of [USSR] State Standards.

"There are more than 70 plants in the USSR, which produced above 20 million square metres of reed slabs in 1965.

"The basic laws on the preparation and application of reed slabs are incorporated in the 'Provisional rules on the manufacture of reed slabs and their application in building constructions'.

"The reed slabs are manufactured in two types: type A in which the reed stems are arranged crosswise, i.e. the stems lie parallel to the shorter side of the slab; and type B, in which the stems are arranged longitudinally, i.e. the stems lie parallel to the longer side of the slab. The dimensions of reed slabs according to the State Standards are in (in mm).

length - 2400, 2600, 2800
width - 550, 950, 1150 and 1500
thickness - 30, 50, 70 and 100
1.6-2 mm galvanized steel wires are used in stitching pressed blocks.

"The distance between the frame wires constitutes from 140 to 300 mm, and the distance between wire staples constitutes from 40 to 140 mm depending on the length and the thickness of the slabs.

"The consumption of wire per square metre of reed slab for type A is from 490-700 grams, and for type B from 260 to 415 grams.

"The basic physical and technological indices of the reed slabs are given in table 1.

Table 1

Thickness mm	Volume weight Kg/m ³	Coefficient of heat conductivity Kcal/m.per hr.deg.	Bending strength Kg/cm ²
70, 100	175-200	0.04-0.06	0.75-1.25
30, 50	200-250	0.06-0.08	1.25-2.0

"The above bending strength is calculated for slabs in which the reeds are placed perpendicular to the supporting frames.

Figure XX. Reed board as paneling fixed by nails and straps

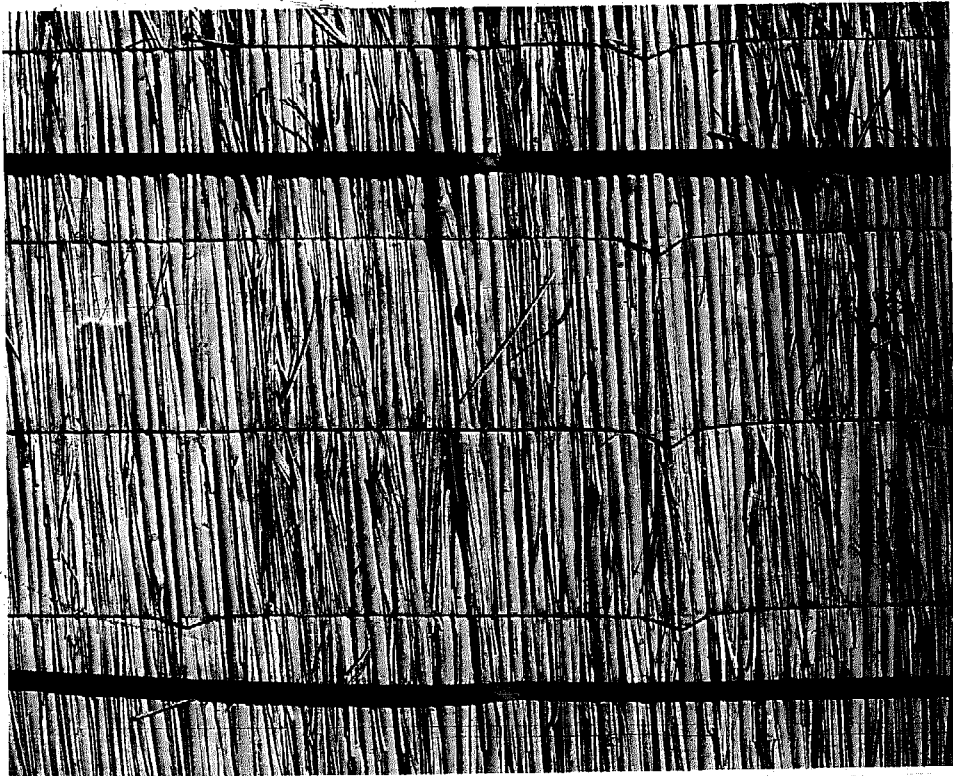

Different hand-operated machines can be used in the small-scale production of these reed slabs, say up to 20 thousand square metres per annum. An example of such a machine is the Omskiy Hand Machine M-200 which was used in the construction of Collective farms in Siberia. This is a vertical machine of periodic action. During the pressing process, the reed slabs are stitched with wire staples which are fixed on the wire frames preliminarily stretched on both sides of the pressing gauge. Special automatic or hand-operated machines are used to prepare the wire staples. Automatic staple making machines driven by (0.75-1.0 kW) electric motors produce up to 10,000 staples per hour.

"Type B reed slabs with longitudinally placed reeds are manufactured on hand-operated vertical machines. The output on these machines depends on the skill of the operator. On average three experienced workers produce 6-8 square metres of slab per hour.

"It is advisable to manufacture these reed slabs in power presses when the annual production exceeds 30 thousand square metres.

"Continuous-operation horizontal presses, AKC, KTP-3, and KA-2, are used in the production of type A reed slabs with transversally placed reeds, whereas vertical press B-1000 of continuous action is used in the manufacture of type B slabs with longitudinally placed reeds.

"Besides these presses, the other equipment required in this production is wire-coiling and reed-cutting machines.

"The capacity of AKC press is about 30 square metres per hour. A team of 14-15 workers operate two presses.

"The production technology with the KTP-3 presses is analogous to that with AKC presses, but due to the special cutting device incorporated in its design, there is no need of precutting the reeds. Its capacity is about 40 square meters per hour.

"The B-1000 presses for the manufacture of type B slabs have been designed incorporating the Soviet and foreign experience in this field. This press is transported on a 5-ton truck and is installed on a dismantable metal supporting stand. The reeds are loaded directly from the tractor to the charging table, therefrom they are fed in preset doses to a conveyor which delivers the reeds on to a cutting table where they are cut to the required length. After the cutting process and prepressing are over, the reeds are fed into a vertical chamber where they are finally pressed into slabs. The stitching mechanism binds the reeds with wire staples. Then the slab ends are cut and trimmed. Ready pressed slabs come out of the chamber in the form of a continuous band which moves vertically and is sliced into slabs of required sizes. The capacity of the B-1000 press is above 100 square meters per hour.

"Reed slab production can be organized in stationary enterprises as well as on mobile workshops.

"It is reasonable to organize stationary production only when profitable conditions are available for the transport of reeds to the factory and the produce from the factory. When the reed thickets are spread over large areas the production is organized with a central base and a few mobile workshops located close to the places where the reeds are stacked. All the repair shops, stores for technical facilities, garages etc. are located at the central base. Presses and other equipment, as well as the mobile power generators are attached to the mobile workshops.

"After the raw materials are consumed, the mobile workshops are moved away to a new place.

"The AKC, KTP-3 and B-1000 presses can be used both in stationary enterprises and in mobile workshops." 4/

Reed slabs are also manufactured in villages, where a wooden frame is used to assemble and compress the reeds. Reed slabs used as roofing require a cement plaster finish topped by a bitumen felt waterproofing. Because of their rough surface, reed slabs take plaster readily. Both cement plaster (1:6) and lime (1:3) are suitable. The plaster should be applied in two coats to a thickness of not more than 15 mm for plain and 20 mm for rough cast. Where mud plaster is used, it should be stabilized with bitumen. Reed slabs are susceptible to decay, termite attack and fire. They should be treated with preservatives and used with termite-resistant construction.

Reed slabs, also known as reed boards, have been commercially produced in Austria under the trade name of "Esterplan" and in India under the trade name of "Jambboard" (see figure XXI).

Foundations

Bamboo and reed posts driven directly into the ground are a common feature of bamboo and reed housing. McClure states:

"Examples of the use of bamboo posts instead of a conventional foundation for low-cost houses /are available/ in both hemispheres. Unless they are treated with some effective fungicidal preservative, however, such posts are not expected to last more than two or three years on the average, or five years at most under unusually favourable conditions. Although no experimental data are available, it seems reasonable to expect that the lasting qualities of bamboo culms set in the ground may ultimately be extended appreciably by applying pentachlorophenol in an appropriate form.... Until reliable and economical treatments have been developed for preserving bamboo that is frequently wetted or is constantly in contact with damp earth, it is considered better to use some material that is more durable than untreated bamboo for foundations - concrete, for example, or stone brick, or some durable hardwood.

4/ V. G. Zezin, op. cit., pp. 4-8.

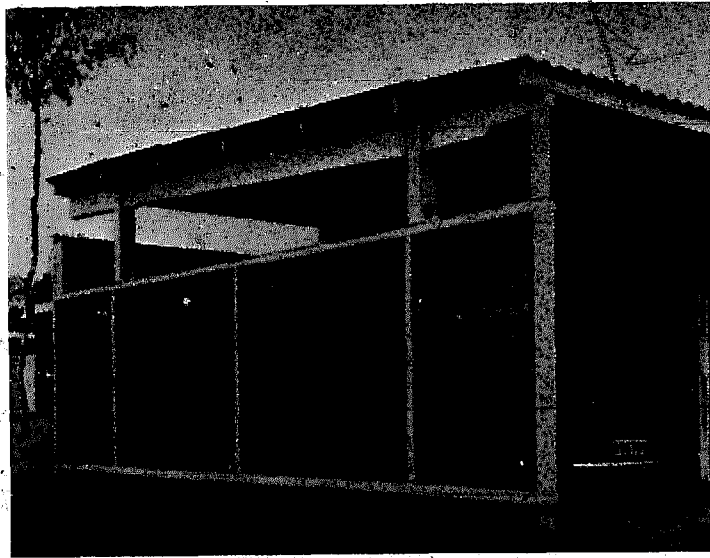

Figure XXI. Reed board panelling used in carport.

"When used as supporting posts in low-cost houses, culms should have a fairly large diameter, thick walls, and nodes (points at which transverse diaphragms occur) close together to give maximum resistance to bending. Where large bamboos are not available, smaller bamboos with suitable structural characteristics may be bound together to make composite pillars." 5/

Since bamboo and reed posts in direct contact with the earth are subject to rapid deterioration, it would be useful to investigate their protection by use of concrete encasement and other means.

Framing

"Next to the foundation and the roof covering, the most basic frame is the part of a house most often made partly or wholly of materials other than bamboo. In many regions, those who can afford the difference in cost prefer to use some durable hardwood for frames. They do so partly because hardwoods make stiffer joints and more rigid construction than bamboo, partly because a greater prestige is generally attached to hardwoods, and partly because certain hardwoods are naturally much more resistant to rot fungi and wood-eating insects than untreated bamboo.

"There are certain circumstances, however, under which the superior resiliency of a bamboo frame confers important advantages over a rigid construction. In regions where sharp earth tremors or quakes occur frequently, a bamboo-framed house may survive and remain serviceable longer than any other type.

"In the selection of materials for the several types of structural elements, the characteristics of the bamboo should match the function to be performed. Only /full/ culms are used for the principal parts of a bamboo frame. The dimensions of the various structural elements, and their spacing, are governed by the nature and importance of the function they perform. Stiffness and ultimate strength are important in elements of the frame. To get relatively uniform diameters, and maximum thickness of wood wall (for stiffness and strength), the upper, highly tapered, relatively thin-walled portion of the culms is removed. These tip cuts may be used in wattle-and-daub partitions, or for roof sheathing, where close spacing may make up for the inferior properties of the individual units.

"The individual structural elements that compose the frame of a conventional all-bamboo house correspond closely to those found in an all-timber frame: Corner posts, girders or plates, joists, studs, struts or braces, tie beams; King posts, purlins, ridgepoles, rafters, sheathing, and so forth. The use of bamboo imposes certain limitations, however. Mortice and tenon joints cannot be used in framing bamboo: any cut, such as notch or mortice, drastically reduces the ultimate strength of a bamboo culm. The only exception is the notch or saddle-like cut used at the upper end of posts to cradle more securely the horizontal elements that rest upon them.

5/ F.A. McClure, op. cit., p. 3.

"With the exception of those of certain species of Quadua... and of Chusquea, the culms of most bamboos will not take nails without splitting. For this reason, the impinging elements are generally lashed to each other at their intersections. In the Far East the withes used for lashings are commonly split from bamboo, more rarely from rattan. Where the available bamboos yield brittle withes, tough vines or the bark of certain trees and shrubs may be used for lashings. In some areas, soft iron wire, most of it galvanized, is used." 6/

Bamboo scaffolding

Bamboo poles lashed together have been in use as scaffolding from ancient times. They are admirably suited for the purpose because of their strength, resilience and shape. Bamboo scaffolding is still used extensively in Asia, Africa and Latin America to support the various operations of building, painting and repair or even multistoreyed structures (see figure XXII). The platforms on which masons stand while working and building materials are kept also often consist of bamboo culms laid side by side and lashed to supporting members. When lifting devices are not used in building construction, ramps constructed from bamboo often serve for vertical transport of materials. Bamboo scaffolding is also erected against dwellings to support bamboo matting for protection against the sun and rain during summer.

Flooring

"Many bamboo houses have no floor other than the surface of the earth on which they are built. This surface should be, and usually is, raised somewhat by filling with earth, to prevent inundation by drainage water; it may be compacted by pounding. If the fill is made with clay, so much the better, for clay affords a relatively stable surface. The surface of a dirt floor may be made more stable by paving it with bamboo boards. The soil should first be graded to provide natural drainage, but not compacted, before the bamboo boards are laid in place. These may then be pounded with a tamper of suitable design, to drive them into close contact with the surface of the soil, which is compacted by the same operation.

"In better houses, the floor is raised above the ground. This arrangement is more hygienic, and provides a sheltered space below the floor, which has many potential uses. In some areas this space is devoted to the rearing of various domestic animals; elsewhere it may be used for the storage of tools and farm equipment, or even farm produce. It may provide a welcome sheltered play space for children in inclement weather.

"Serviceable and attractive raised floors may be made entirely of bamboo, given suitable species and a sound structural design. The principal features in conventional design are the supporting beams (part of the basic frame) and the floor covering.

6/ Ibid., pp. 3-4.

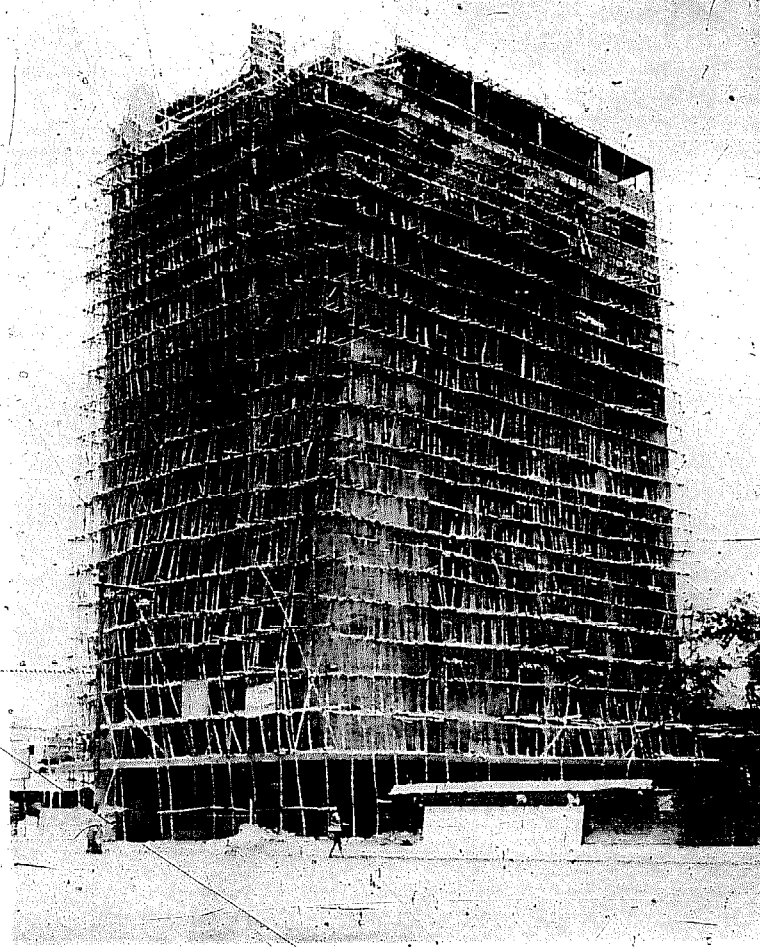

Figure XXII. Bamboo scaffolding for multistoreyed building

"Bamboo culms are more resilient than conventional timbers, and the space between supports should be reduced accordingly. Spacing specifications must be worked out locally for the individual species of bamboo and the size of the culm used.

"The floor covering may be made of small whole culms, strips, or bamboo boards made by opening and flattening out whole culms. When the floor consists of bamboo boards, it is generally fastened down by the use of thin strips of bamboo secured to the supporting members by thongs, wire lashings, or small nails." 7/

Roofing

Bamboo and reed are commonly used for both roof framing and roofing. Where tile or thatch is used as roofing, the supporting frame is frequently of bamboo or reed.

Bamboo tile roofing

The simplest form of bamboo roof covering is made of halved bamboo tiles running full length from the eaves to the ridge (see figure XXIII). Large-diameter culms are split into two halves, the diaphragm scooped out and the tiles seasoned in a sheltered place. The framing is of bamboo culms not less than 7 cm in diameter. The first layer of tiles is laid side by side with the concave face upwards and tied to the purlins. The second layer is then placed over the first with the convex face upwards, the whole interlocking to form a pattern similar in appearance to "Roman pattern" or "Allahabad pattern" tiles. The minimum pitch of the roof should be 30°. The roof, though simple, can be made completely watertight.

Bamboo shingle roofing

Bamboo shingles are made from mature but still green culms of maximum diameter, the shingles being formed of split segments 3-4 cm wide air dried in the shade. The maximum length is equal to the distance between nodes. A "hanging-split" is formed on the outside of the shingle at the node end and the tiles are fixed to split bamboo battens by hooking this hanging-split over them (see figure XXIV). Roof framing is made of culms not less than 7 cm in diameter and the battens and bracing of bamboo splints not less than 4 cm wide. Tile battens are spaced at about 15 cm apart on the rafters and some 200 shingles are required to cover 1 square metre of roof. The minimum pitch should be 30°.

Thatched roofing

Thatch is one of the most ancient forms of roof covering. In general, palm leaves are preferred for thatching (see figure XXV). Though in remote forest areas, bamboo leaves are themselves used as thatch. Bamboo framing often forms the base over which the thatch is laid and tied. This framing may consist of

7/ Ibid., p. 4.



Figure XXIII. Bamboo tile roof of a hut at the Forest Research Institute, Dehra Dun, India

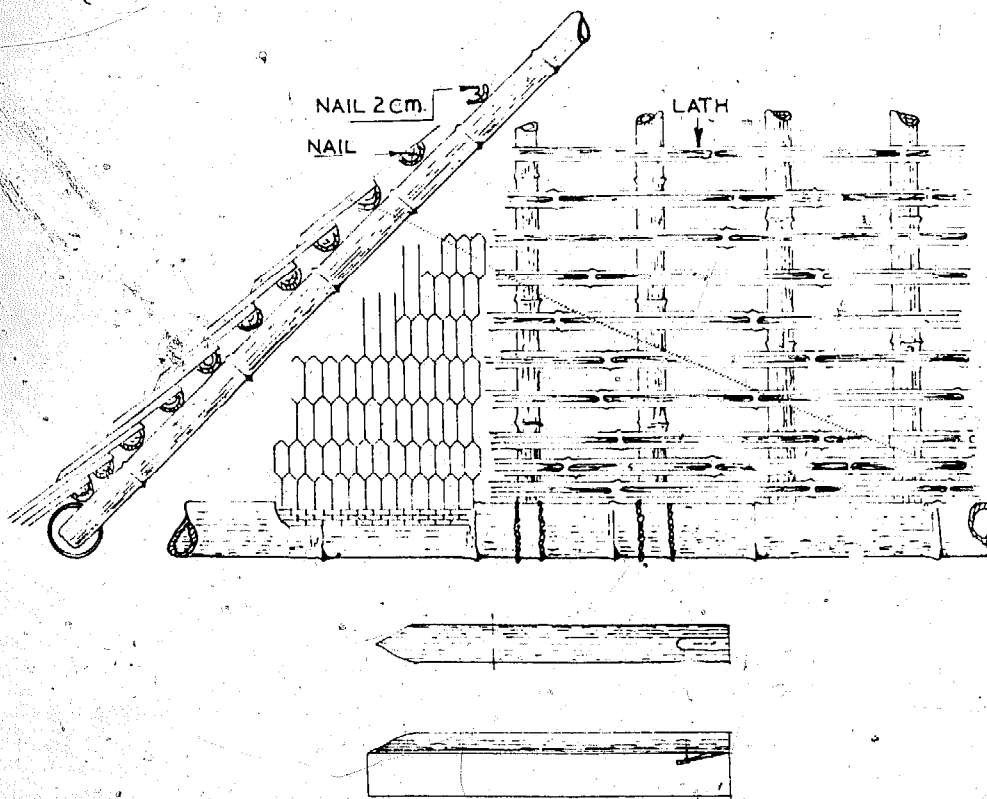

Figure XXIV. Bamboo shingle roof construction. Details of one shingle are shown at the bottom

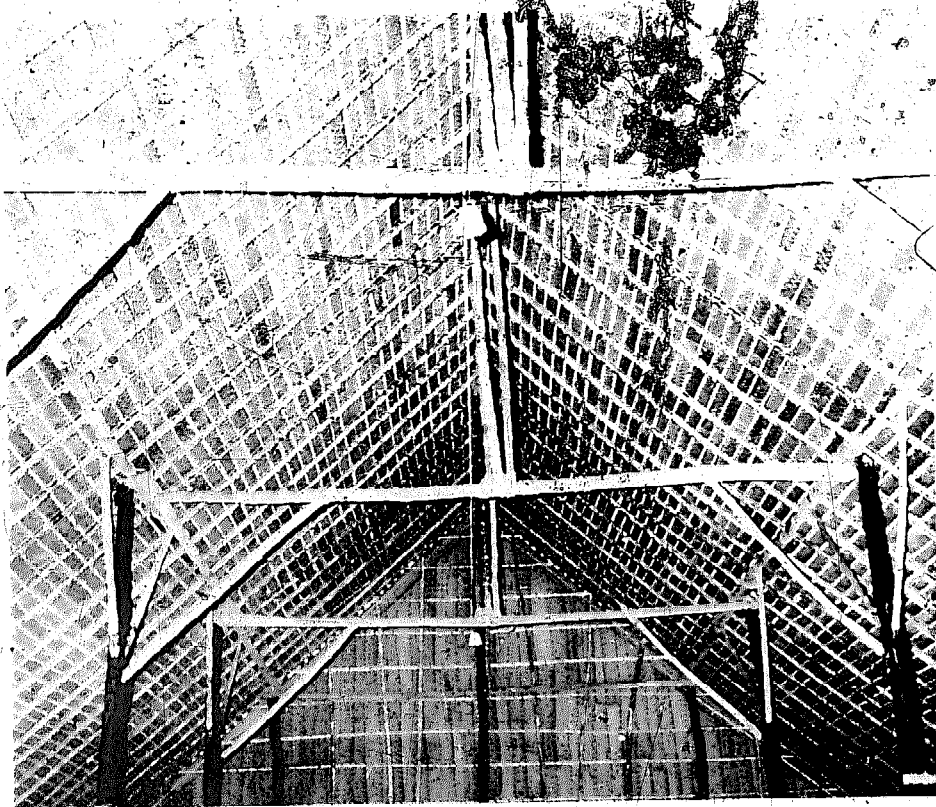

Figure XXV. Bamboo roof framework on wooden posts; plaited coconut leaf roof covering

vertical bamboos 40 mm in diameter laid 30 cm apart, over which split bamboos are securely fastened at right angles 15 cm apart. While straight bamboo culms are best for the framing, bamboo rafters and purlins that are not quite straight, either individually or in their alignment, are also used, since the straw adapts itself to the irregularities of the surface. Split bamboo runners and spars are used to pin down the thatch at valleys and ridges.

Reed thatch

Reeds make a more durable thatch than does straw, and a well-laid reed roof is known to last from 60 to 100 years in Europe if it is cleaned every seven years. This interval, however, differs with the climate. The length of reeds usually varies from 1 to 3 m. The shorter stems are used for circular roofs and for working patterns in the thatch, while the longer ones, being coarser and less flexible, are employed for the main portion of the roof.

The method of fixing is the same as that for straw roofs. The gauge or distance at which the battens are fixed is 25 cm in this case, owing to the increased lengths of the stems. The thatch is secured to the battens by laying the reeds in position, and then placing a stiff runner or spar along on top parallel with the battens and tying it firmly to the latter with tarred rope. The runners are placed near the top ends of the reeds, about 55 cm apart. If the underside of the roof is plastered, the rope is tied to iron hooks that are driven into the timbers, instead of being passed round the rafters where it would be in the way.

An old reed roof can be repaired when necessary by raking all loose and decayed reeds off the surface and "half coating" it with a 15-cm thickness of new material, in the same way as straw. The thickness of a new roof varies from 25 to 35 cm and is governed by the pitch of the rafters. A pitch of 45° is suitable for a 25-cm coat. The weight of this type of roof is about 40 kg/m² when the reeds are 30 cm thick, and is about the same as straw.

Reed board roofing

Reed boards are used as roof covering in a manner similar to other sheet roofings. But the boards are butt-joined and the roof waterproofed (see figure XXVI). When the reeds' span is at right angles to the direction of span of the supporting member, the board is capable of carrying a substantial load. For example, a 25-mm board with a purlin spacing of 75 cm can carry a load of 730 kg/m² without excessive deflection. For laying a 1.5 m long board, the roof framework is designed in the conventional manner but with purlin spacing at 75 cm centres. The reed boards are laid so that each sheet is supported at mid span and at either end by a purlin. Sheets are butt-ended and fixed by screws with diamond washers to timber purlins, or with J-hooks if mild steel purlins are used. Ridging is cut from reed board sheets and laid with the direction of span of reed parallel to the purlins. Adjacent ridge panels may be bound together by galvanized iron wire. The boards are given a 12-mm cement-sand plaster cover before being waterproofed with bitumen felt. Such a roof offers excellent insulation against heat and cold and is weather-proof.

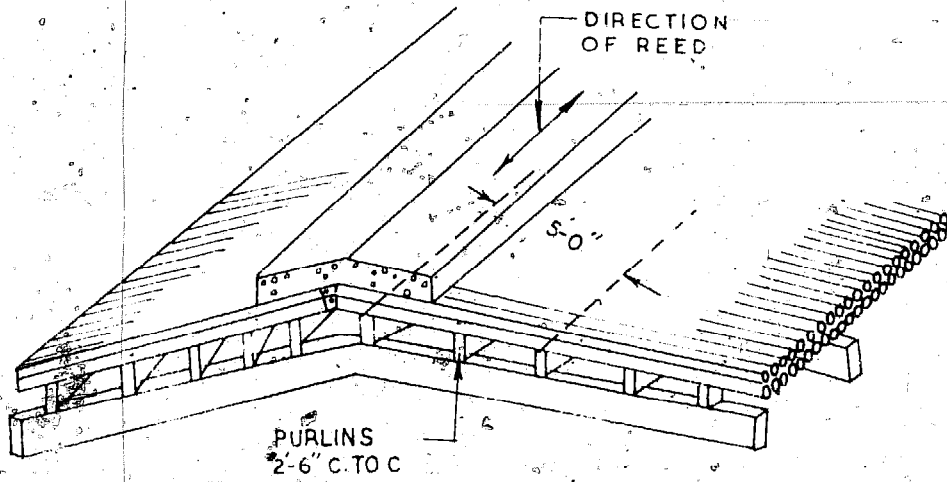

Figure XXVI. Reed board roofing showing ridging and purlin distances for 5-ft wide board

Fire protection of thatched houses

Large numbers of village dwellings thatched with straw, grass and palm leaves are burnt down every year in India. Fire usually originates inside a dwelling but spreads rapidly through flaming or glowing fragments carried by wind. Fire-resistant treatments consisting of impregnation with ammonium salts and other chemicals are too costly for use in village dwellings. Moreover, they are leached out by rain. They also promote growth of mould, leading to accelerated physical break-up of the thatch. Another method to reduce the rate of burning of thatch roofs is to restrict the flow of air through the thatch in the event of a fire. This could be done by sealing the underside of the roof with a non-combustible material, such as asbestos cement sheets. The use of bitumen stabilized mud plaster for this purpose is under investigation at the Central Building Research Institute, Roorkee (1967), and tests on straw and palmyrah palm leaf thatch roofs show that plaster-sealed roofs take a longer time to burn. Whereas the fire spreads readily on both sides of untreated roofs, there is no flaming on the lower surface of treated roofs. Loss of life and property within dwellings by externally spreading fire can thus be reduced by mud plaster sealing of thatch roofs. The treatment can also be applied to walling of reeds, grass, straw and leaves. The lower rate of burning of treated roofs also makes it possible to approach close to the burning dwelling to fight the fire. The practice of plastering the underside of the best quality of reed thatch roof helps reduce the risks of rapid fire spread.

Strong wind usually carries glowing and flaming fragments even from slowly burning roofs. A thin coat of stabilized clay on the exterior reduces this danger considerably and also helps to prevent rapid ignition of similarly coated roofs where the wind-borne fragments settle. Periodic application of the clay wash is necessary. A spray gun can be used for the purpose.

Walls

"The construction of bamboo walls is subject to infinite variation, depending on the strength required (for resistance to natural forces, such as hurricanes and earthquakes), the protection desired from rain and ordinary winds, and the need for light and ventilation. Either whole culms or longitudinal halves may be used, and they may be applied in either horizontal or vertical array. They function more effectively, however, when they are vertical, and are more durable; for they dry more quickly after rain." 8/

Bajareque wall

"A form of wall construction widely favoured in Latin America is called bajareque. . . It is made by nailing or lashing bamboo strips or slender culms, horizontally and at close intervals, to both sides of hardwood or, more rarely, bamboo posts. The space between the strips is filled with mud alone or with mud and stones /figure XXVII/. During this operation, the bamboo strips are more or less completely covered with mud but in time they /may/ become exposed by weathering. This form of construction is relatively massive, though less so than walls made of conventional stone, rammed earth, or adobe bricks." 8/

8/ Ibid., p. 4.

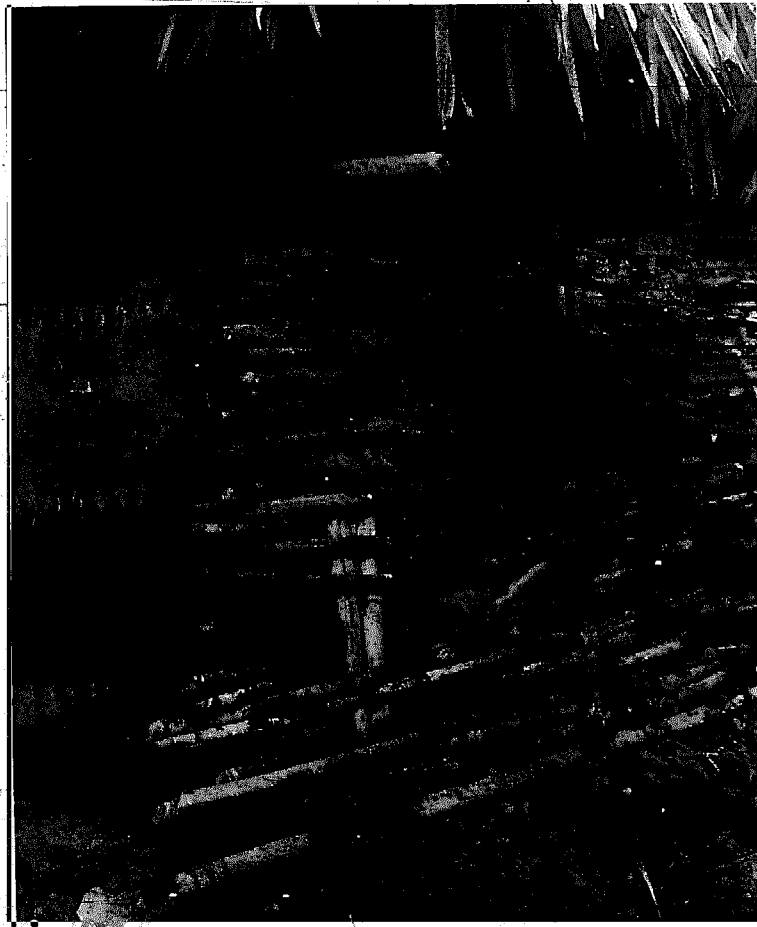

Figure XXVII. Whole bamboo culms plaited on bamboo stakes form the support for a mud plaster finish

Bamboo board wall

A common method of wall construction in Indonesia is by the use of bamboo board. These panels are placed vertically and lashed or pinned to horizontal round members which in turn are fitted to mortices made in the vertical bamboo framing poles of the structure. To make it weathertight it is covered with closely plaited matting. Outer walls are finished with plaster on one or both sides.

Bamboo board walls are used in Ecuador, India and other countries. If these boards are stretched laterally as they are fixed, they provide a suitable base for plaster or stucco. As further anchorage for stucco, barbed wire may be nailed to the surface of the board. When whitened with lime or painted with cement, this exterior is very attractive. A plaited bamboo board is also employed for walls in Indonesia. An open weave is adopted if plastering is to be applied. Closer-woven board may be whitewashed, plastered or coated with asphalt and sand sprinkled over. A finer-weave version is generally applied without paint or other finish. For external walls the hard bamboo skin is placed on the outside.

Wattle wall

There are many variations in wattle wall construction. Some of these are known as wattle and daub, stud and mud, lath and plaster, and sprung strip construction (see figure XXVIII). In Peru and Chile, the technique is known as quincha. In all these constructions, bamboo or reed lath is used as a base for the application of a mud plaster that is applied to one or both sides. Mixtures of clay and organic fibre or clay and cowdung are frequently used as the plaster. The plaster may be mixed with 16 litres/m³ of a 0.5 per cent emulsion of Dieldrin as anti-termite protection.

When larger full or half sections are used for lath, the interstices are first filled with mud, and the plaster is applied after the mud has partially dried. Occasionally, the wall is finished by application of cement sand plaster and lime wash. Horizontal lath is plaited between main and supplementary posts driven into the ground. Vertical lath is plaited between horizontal members fastened to the mainposts. Spacing of framing members varies with the species and diameter of the bamboo and reed used.

Mat walls

A technique used for low-cost housing in Indonesia is the plastered bamboo mat wall. Three types are generally used: (1) a thin bamboo mat is nailed on both sides of a braced timber frame; (2) a single thickness of bamboo mat is attached to the timber or bamboo frame; and (3) strips are plaited horizontally between vertically stretched wires. The plaster is then applied to one or both sides (see figure XXIX). The plaster used is cowdung, mud, sand, lime and portland cement with or without organic fibres. Bamboo and reed mats attached to suitable framing and not plastered are also used for light walls and partitions (see figure XXX). Such walls are also suspended from rafters on verandahs as protection against sun, wind and rain.

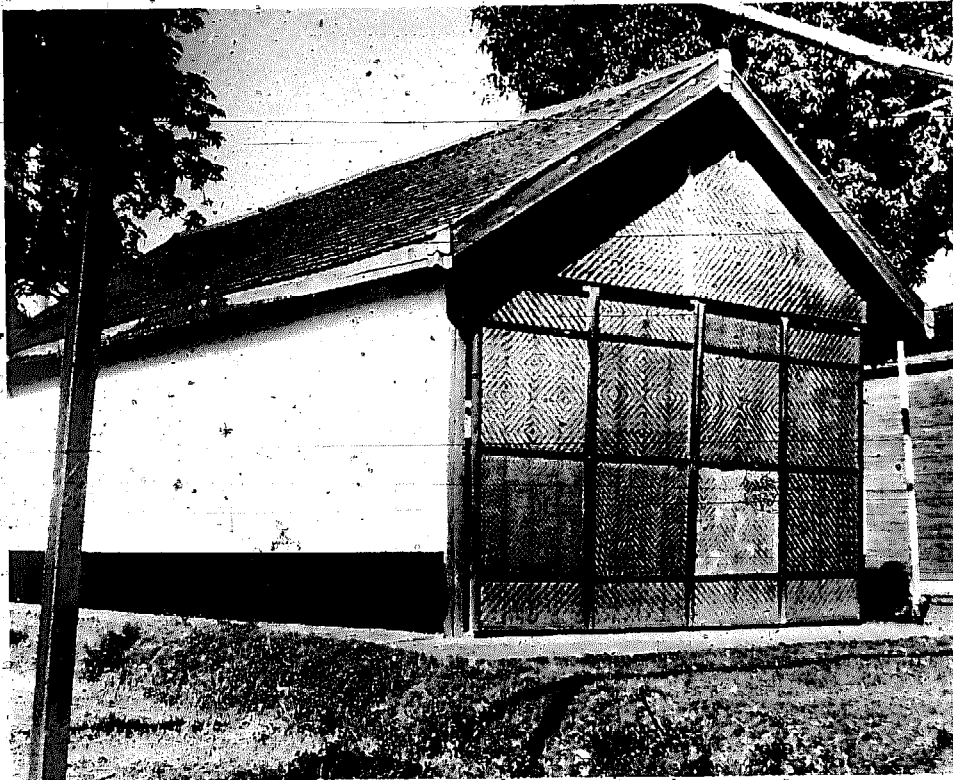

Figure XXIX. Experimental structure with walls of bamboo matting
and bamboo and mud wall
(Forest Research Institute, Dehra Dun, India)

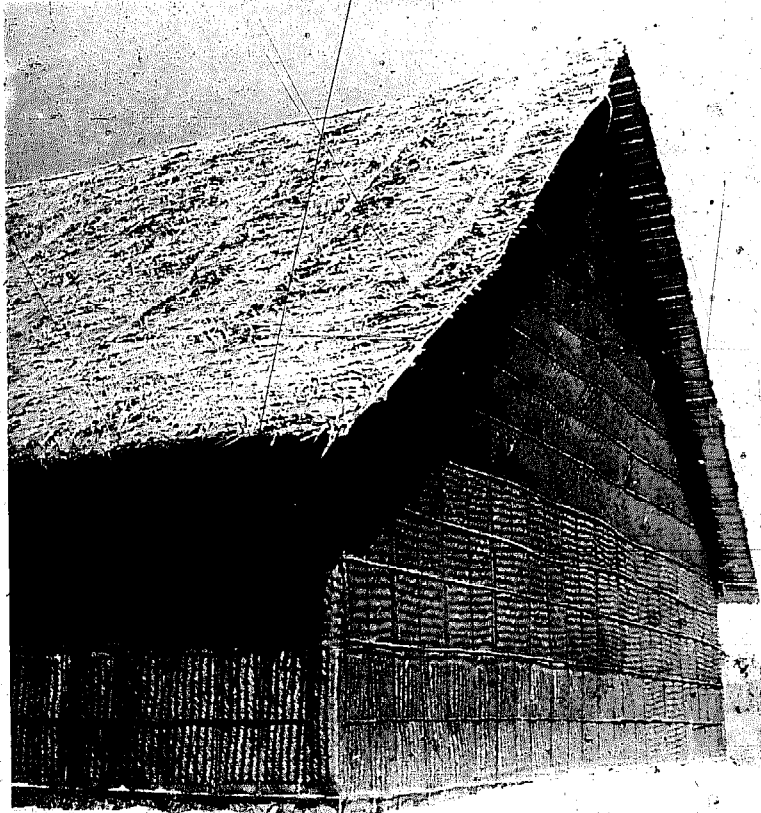

Figure XXX. Bamboo matting is fixed to wall frames with bamboo battens and given a coat of coal tar for durability.

Solid wall

A simple wall, used in many Asian countries, consists of full or split sections of reed or bamboo culms placed vertically side by side in a frame (see figure XXXI). The wall is then made watertight by attaching closely woven mats on both faces.

Reed slab wall

Reed slabs are used as panels for exterior and partition walls and for wall insulation. These panels are treated as non-load-bearing. The panels are attached directly to frames using nails, screws or J-hooks and washers. The slabs are placed with the culms vertical on horizontal supports spaced at about 1-1.5 m centres. Adjacent slabs are butt-jointed at the centre of the horizontal supports.

Trusses

Bamboo trusses offer good possibilities for roof framing of larger structures such as schools, infirmaries, storage sheds and commercial buildings. In addition, trusses are used for light bridges and in scaffolding. Because of their high strength/weight ratio, bamboo trusses offer important advantages for roof framing. They may be assembled on the ground and readily hoisted into place. There is little in the literature describing the use of such trusses.

One notable exception is a series of tests performed on bamboo trusses at the Building Material Development Laboratory in Indonesia. The structure tested was a bamboo roof truss having a span of 6.0 m and a height of 3.0 m. The bamboo used (*Gigantochloa apus*) had a tension strength of 1,060 to 2,300 kg/cm², and was about two years old. The truss was of the "Kingpost" type and the members were fastened using bamboo pins and "indjuk" rope with a 6.0 mm diameter and an ultimate tensile strength of 1,000 kg/cm². The load was applied at the three upper joints through 1,000-kg capacity dynamometers. The load was applied in two stages: first up to nominal loading and then to failure.

The conclusions reached by the experimenter on the basis of the tests were: (1) failure was caused by yielding at the joints due to a low radial resistance rather than tensile or compressive failure; (2) the deflections were considerably greater than those based on theoretical calculations; (3) the location of nodes at joints greatly increased the strength of the truss; and (4) a safety factor related to the ultimate load could not be considered because many defects developed in the members before ultimate load was reached. The author recommends further study to increase the strength at joints.

Doors and windows

"Window and outside door openings are generally kept to a minimum. They may be framed with wood or bamboo. The doors themselves may be wood or they may be woven bamboo matting [see figure XXXII] stretched on a bamboo frame, a panel of bamboo boards set in a hardwood frame, or a sturdy gate-like barrier constructed of bamboo bars. Doors are side-hinged, and fastenings vary from the traditional latch-string to lock-and-chain....

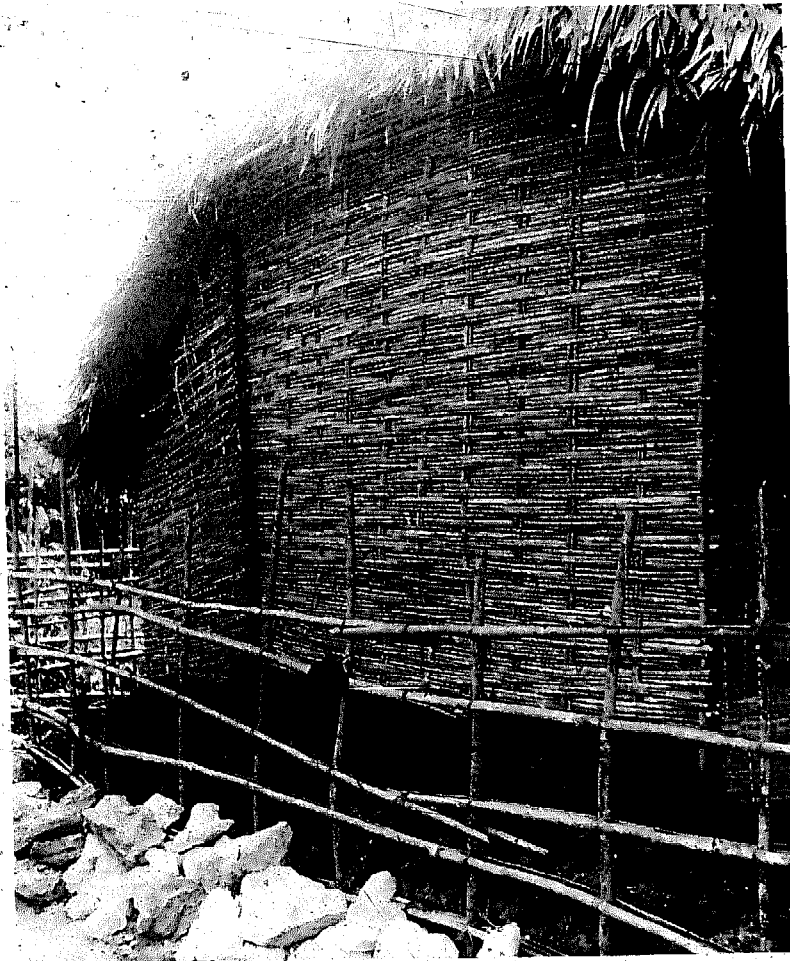

Figure XXXI. Plaited bamboo splints of superior weave used as walling without plaster



Figure XXXII. Doors of bamboo matting woven on a frame and stiffened with bamboo splints

"If window openings are provided, they may be framed with bamboo or wood. Most windows are left unglazed and unscreened. Closure may be provided in the form of a bamboo or wooden frame, covered with bamboo matting or palm-leaf thatch. Windows are usually hinged at the top, when open - as they are during most of the daylight hours - they serve to exclude the sun's direct rays or light rainfall. At dark the house is closed, to keep out the "night air", generally considered unhealthful. Actually, the closing of houses at night is justifiable on other, more realistic ground: it prevents the entrance of mosquitoes, rats, bats, and other unwelcome visitors. Permanent window bars of bamboo, many of them painted black to simulate iron bars, are frequently used to frustrate would-be trespassers." 9/

Pipes and troughs

"The culms of certain bamboos, with diaphragms removed, serve admirably for the fabrication of pipes and troughs.

"Longitudinal halves of bamboo culms make very satisfactory eave troughs. Where rainfall is light and water must be conserved, they are used to collect rainwater from the roof and send it into a barrel or cistern for storage. Where rainfall is heavy, they are used to carry the water from the roof to a distant point, in order to avoid excessive dampness around the house.

"Under certain circumstances wash water from the kitchen may be disposed of through bamboo pipes or troughs. For this purpose a sloping trough is more practical than a pipe since it is more easily prepared and, if clogged, may be cleared with greater facility.

"Longitudinal halves of bamboo culms with the diaphragms removed make suitable conduits for bringing water for domestic use from its source to the house by gravity. In Japan, closed-pipe water systems are constructed of bamboo but it is very difficult to make the joints leakproof [see figure XXXIII].

"Underground drainage may be effected by means of bamboo pipes of simple construction. The steps in preparing the bamboo for such use are (1) halving the culms, (2) removing the diaphragms from one half to make the lower section of the drain pipe, (3) cutting notches in the edge of the other half to permit the free entrance of water, (4) treating the two halves with preservative (5- to 10-percent pentachlorophenol in light oil), (5) placing them together again in their original relation, and (6) binding them together with wire. Such drains may be extended to any length by placing the smaller tip end of one pipe into the larger basal end of the succeeding one.

"To be suited for the uses just described, the bamboo culms should have a diameter large enough to give the required carrying capacity, the walls should be thick enough to prevent collapse under use." 10/

9/ Ibid., p. 5.

10/ Ibid., p. 6.

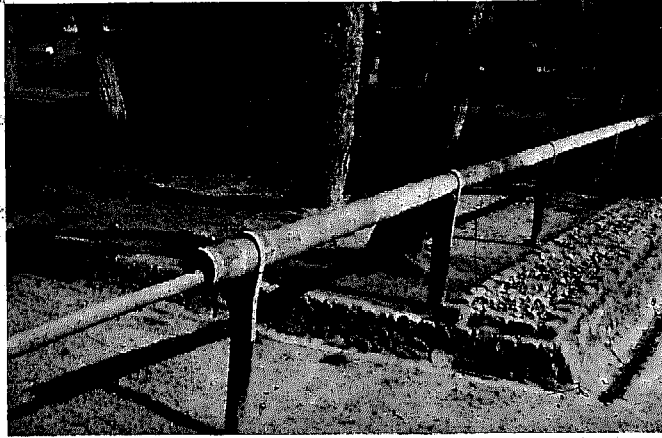

Figure XXXIII. A bamboo water pipe in a Japanese garden

Joints and fasteners

Joints between bamboo and reed members are crucial to the assembly of efficient framing (see figures XXIV and XXXV). Joints between two horizontal members are generally simple; that is, one horizontal member rests on top of another and the two members are then lashed together. Where the two horizontal members must be at the same level, a butt joint is used. The joint between a vertical and a horizontal member may be a saddle, butt or seated joint. A saddle joint occurs when a horizontal member rests on top of a vertical member. The top of the vertical member is shaped to form a saddle for the horizontal member, and the two are lashed together. In a butt joint, the end of the horizontal member is shaped to fit the vertical member. The two members may then be lashed together. Sometimes a tongue is left at the end of the horizontal member which is wrapped around the vertical member and back onto the horizontal member. The tongue is then lashed to the horizontal member from which it extended. For heavy-duty work, a hardwood tendon and key holds the two members together. The seated connexion uses either the stump at a node or an inset block to support the horizontal member. Both the inset block and the horizontal member are lashed to the vertical member. Frequently, a small hole is drilled in the members to facilitate the lashing. Where a small-diameter horizontal member is framed with a large vertical member, a hole is drilled in the vertical member to permit the horizontal member to pass through. The joint may then be made rigid with a hardwood pin passing through both members and at right angles to the horizontal member.

The withes used for lashing are commonly split bamboo. The withes are thin twisted strips over 1 cm wide and 60-100 cm long. Where the available bamboo is unsuitable, tough vines, rattan, bark, coir rope and galvanized iron wire are used. The lashing frequently outlasts the frame (see figures XXXVI to XL).

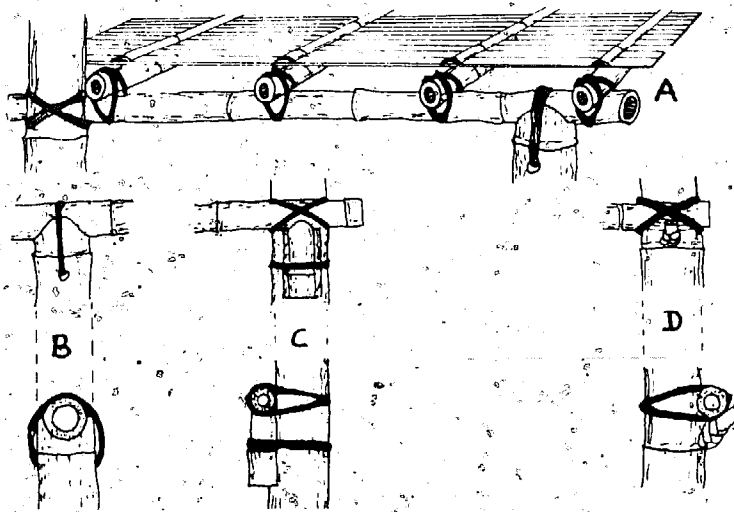

Figure XXXIV. Joints used in building with bamboo
 (A) Fitting and securing bamboo boards of floor
 (B) Saddle joint
 (C) Use of inset block to support horizontal load-bearing element
 (D) Use of stem of branch at node of post to support horizontal load-bearing element (McClure)

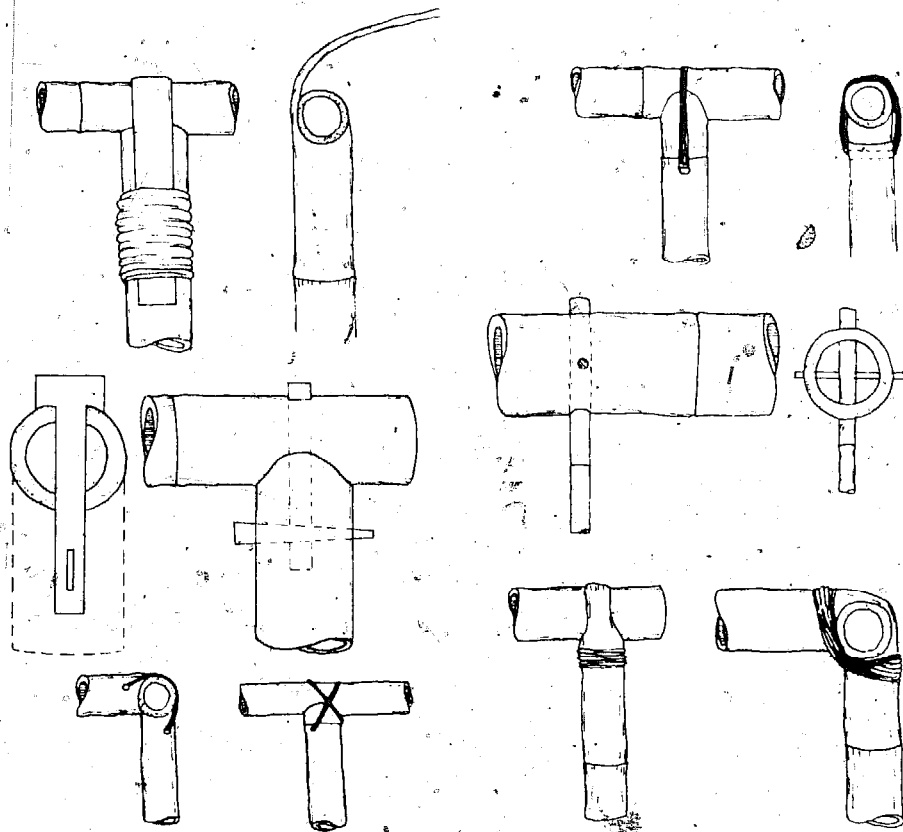

Figure XXXV. Joints used in building with bamboo

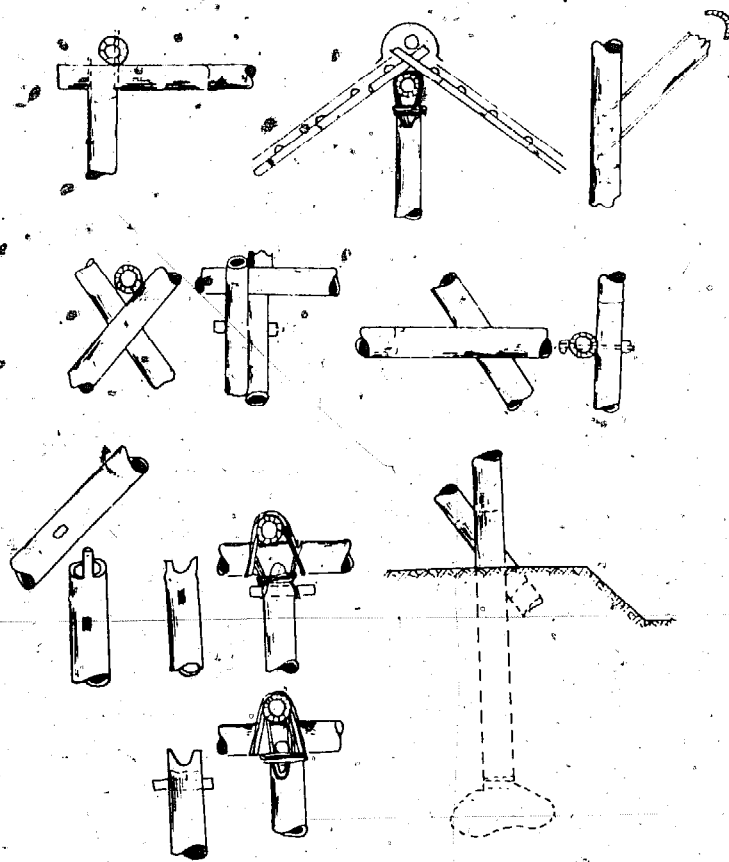

Figure XXXVI. Joints used in building with bamboo

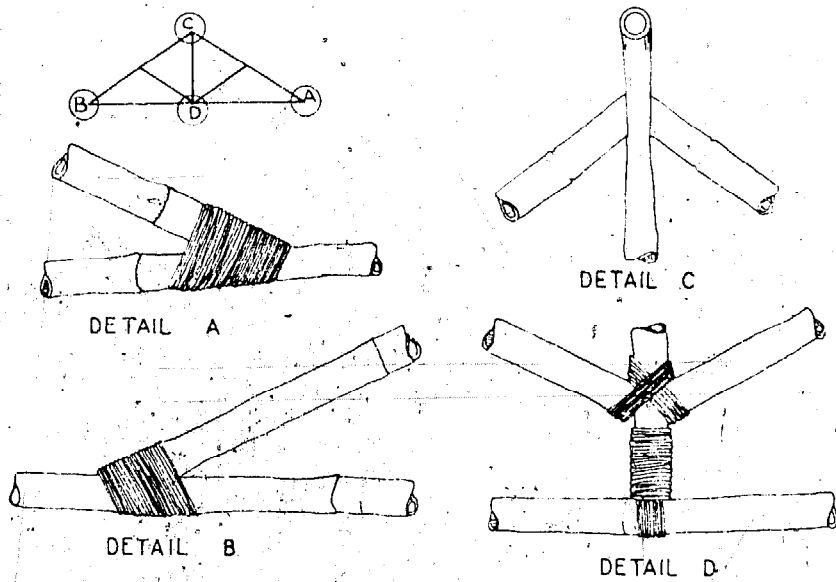

Figure XXXVII. Joints used in building with bamboo

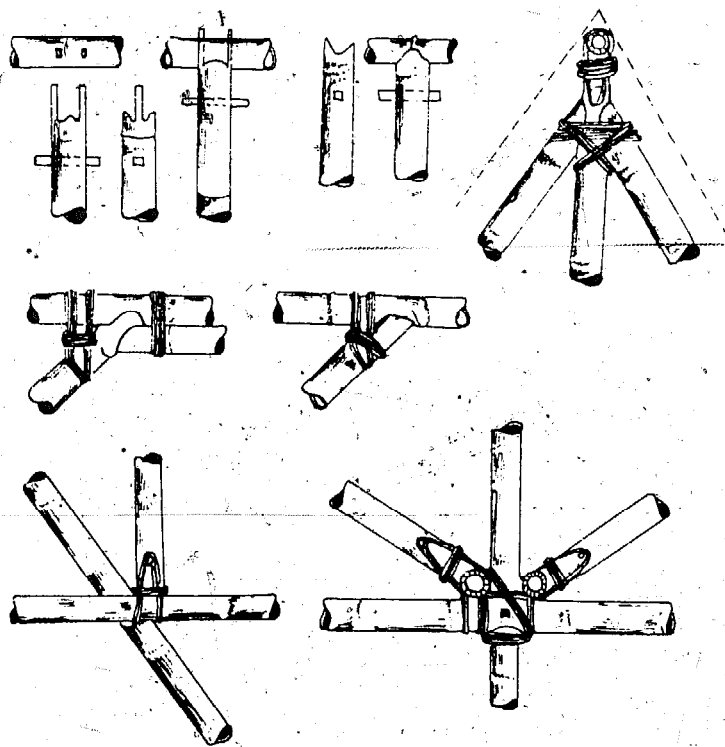

Figure XXVIII. Joints used in building with bamboo.

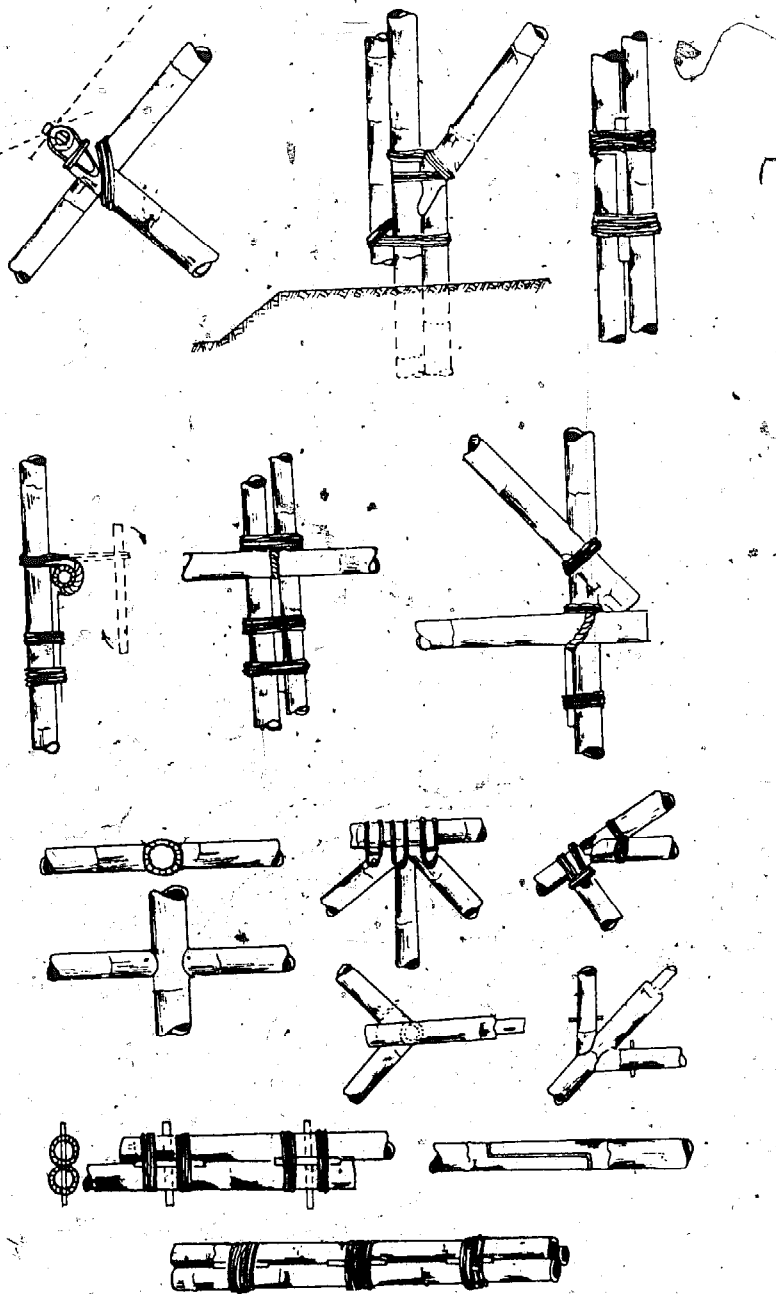

Figure XXXIX. Joints used in building with bamboo

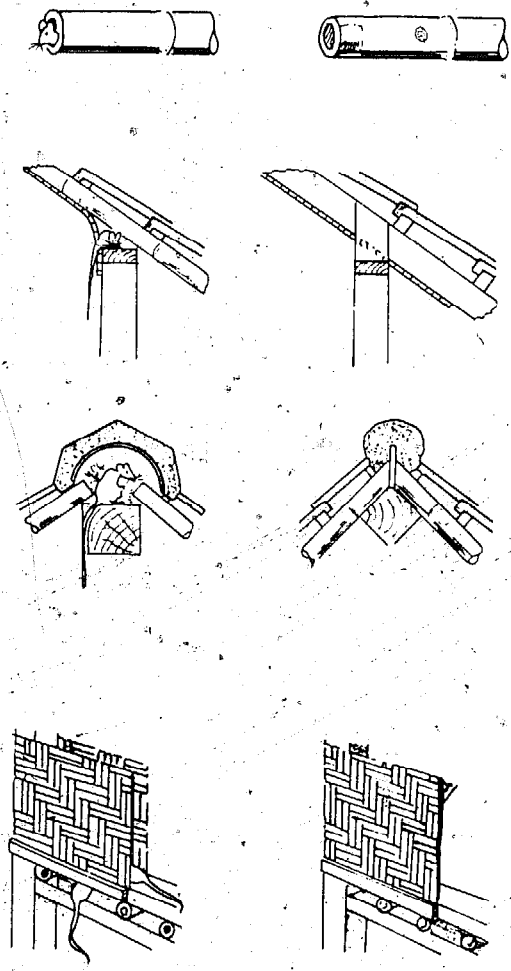

Figure XL. Vermin-proofing bamboo construction
Left: incorrect method
Right: correct method

III. OTHER USES OF BAMBOO AND REED IN BUILDING CONSTRUCTION

Concrete with bamboo and reed reinforcing^{11/}

In places and times of steel scarcity, bamboo has been considered as a reinforcement for concrete. It has certain obvious advantages such as high tensile strength, high strength/weight ratio, ready availability and low cost. It has been used as concrete reinforcement in Japan, China and the Philippines. Investigations carried out in several countries have shown that bamboo reinforcement in concrete increases the ultimate load capacity of the member considerably above that to be expected from an unreinforced member. However, there are a number of practical limitations involved in the use of bamboo as concrete reinforcement.

The experimental work in this field is summarized as follows. Concrete flexural members reinforced with bamboo show cracking at loads materially in excess of those to be expected from an unreinforced member having the same dimensions. Bamboo reinforcement does increase the load capacity four-five times at an optimum percentage of reinforcement of 3-4 per cent of the cross-section. Above this optimum there is no increase in load capacity (see figure XLI). The unit stress in longitudinal bamboo reinforcement in concrete members decreased with increasing percentages of reinforcement. The ultimate tensile stress of a bamboo-reinforced beam was dependent on the amount of bamboo and was not affected by changes in the cross-sectional area of a beam for a given breadth/depth ratio. Members with the optimum percentage of bamboo reinforcement could produce tensile stresses in the bamboo from 560 to 700 kg/cm². Increasing the strength of the concrete increases the load capacities of the concrete members reinforced with bamboo. The ultimate load-bearing capacity was increased by using diagonal tension reinforcement, especially where vertical shear was high. However, it was not always possible to provide diagonal tension reinforcement in sufficient amounts in beams. Capacity could be increased further by bending up the upper rows of the split bamboo from the bottom of the member.

Split bamboo showed better load capacity than did whole culms. Methods adopted to increase the bond strength between bamboo and concrete, which is one of the major limitations of bamboo as a reinforcing material, appreciably contributed towards the maximum load capacity. Other factors observed to influence strength were seasoning effects, size of the bamboo splints, and care taken in placing and anchoring the reinforcement.

Design of a "tee" section did not show any advantage over rectangular sections, as long as the breadth of the stem of the "tee" section was equal to that of the rectangular section and the effective depth of both was the same.

^{11/} The experimental data included in this section are based in large part on H.E. Glenn, "Bamboo reinforcement of portland cement concrete structures", Clemson College Engineering Experiment Station, Bulletin 4 (Clemson, South Carolina, 1950).

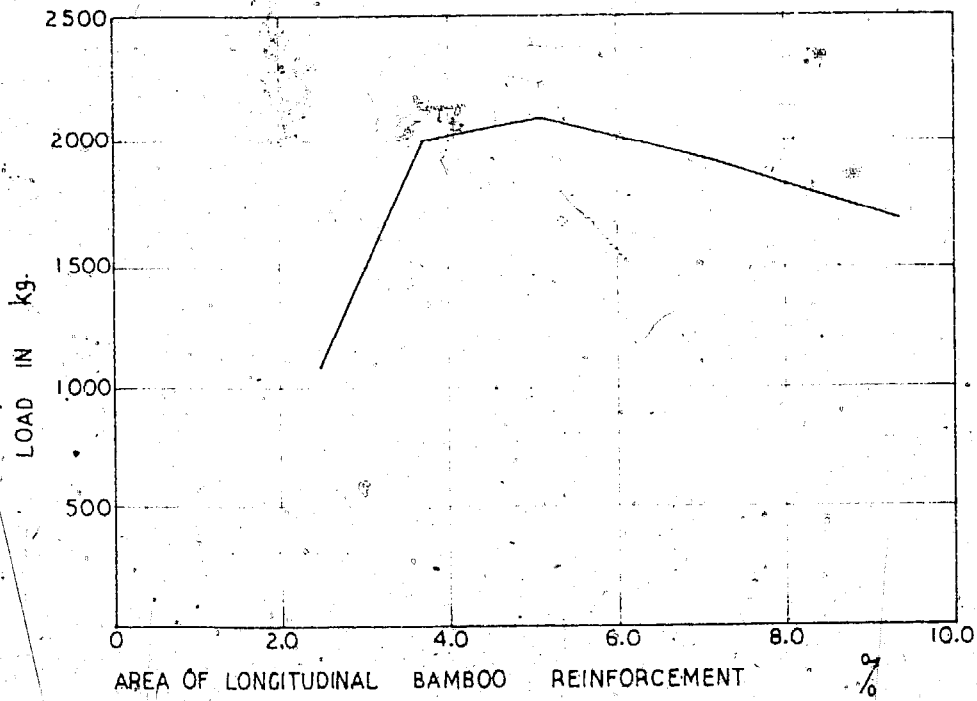

Figure XLI. Load at failure versus the percentage of bamboo reinforcement (Glenn)

Large deflections and wide cracks appeared in bamboo-reinforced concrete members before ultimate failure occurred. The deflection of beams when tested followed a fairly straight line relation until the first crack appeared in the concrete. There was a flattening of the deflection curve probably due to local bond slippage after the first crack. This was further followed by another fairly accurate straight line until failure.

Using whole bamboo culms of diameter up to 3.7 cm, it was found that with integral shear connectors there was no slippage of bamboo, and the load-deflection curve remained linear up to failure (see figure XLII). The total deflection was also reduced. The load capacity was higher with both integral and mechanical connectors, the former being more effective. The method is, however, not likely to find much use because of the difficulties of stabilizing and protecting the bamboo and the labour involved in preparing the integral connectors.

These results show that the maximum load that a bamboo-reinforced concrete member will withstand depends on the tensile strength of the bamboo, the compressive strength of the concrete, the effectiveness of the diagonal tension reinforcement, and, most important, on the bond between concrete and longitudinal bamboo reinforcement.

Tensile strength

The ultimate tensile strength of some species of bamboo in direct tension is about the same as that of mild steel at its yield point. On an average, it varies from 1,400 kg/cm² to 2,800 kg/cm². It was this high value which attracted the attention of investigators for the use of bamboo as reinforcement for concrete. However, as already indicated, the results of their investigations showed that in practice it is not possible to make use of the complete tensile strength of bamboo when it is embedded in concrete as reinforcement. Poor bond strength between bamboo and concrete and the low modulus of elasticity of bamboo are the two main factors which prevent the effective exploitation of the high tensile strength of bamboo as a tensile reinforcement in concrete members.

The modulus of elasticity of bamboo is slightly higher in direct tension than in flexure and compression. This value ranges from 1.5×10^5 kg/cm² to 2×10^5 kg/cm², which is almost the same as for 1:2:4 cement concrete. It suggests that bamboo as reinforcement in concrete does not contribute anything to reducing the deflection or preventing cracks at loads near the ultimate failure figure for a member in which no bamboo is only about one twentieth of that of mild steel. This low elasticity value of bamboo decreases correspondingly the value for modular ratio (m) of concrete and bamboo so that bamboo reinforcement does not help in increasing the moment of inertia (I) of a bamboo-reinforced section over that of an unreinforced one. This means that bamboo reinforcement, unlike steel, will not contribute to reducing the deflection when used as a reinforcement. Therefore, the span/depth ratio should be such that the total section will take care of the deflection.

Reasons for cracking in the member before ultimate failure are large deflections, bond slippage, shrinkage and swelling of the bamboo and also differential thermal expansion between bamboo and concrete. From these it may be concluded that effective methods must be developed to overcome the limitation of bamboo as reinforcing material.

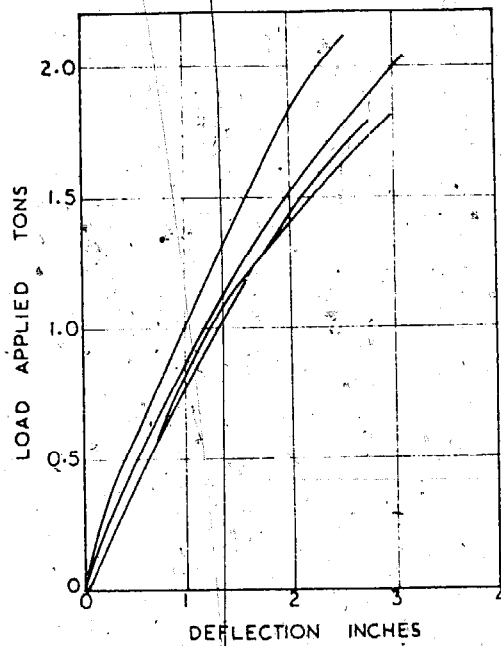
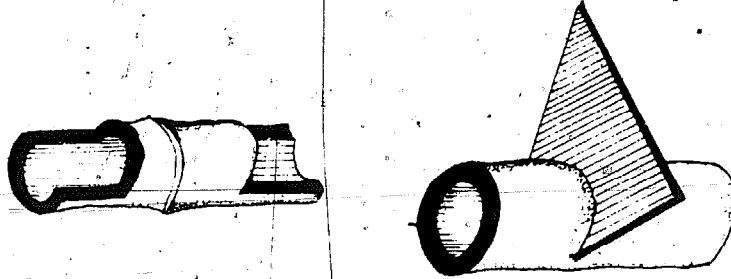

Figure XLIII. Shear connectors: (top left) integral, and (top right) mechanical; (bottom) load deflection curve for concrete beams reinforced with bamboo having integral shear connectors (Narayana and Rehman)

Compressive strength

The load capacity of bamboo-reinforced beams increased with increasing strength of the concrete for a given section. The average ultimate direct compressive strength of bamboo varies from 400 to 700 kg/cm². The corresponding value of 1:2:4 concrete is 158 kg/cm². The effect of bamboo as a compressive reinforcement does not seem to have been studied. The use of bamboo in doubly reinforced concrete members may result in increasing the load capacity.

Diagonal tension reinforcement

Studies have been made of the effect on diagonal tension of using bamboo dowels spaced vertically and also of bending the upper rows of longitudinal reinforcement. Both increased the load capacity and the combination proved better. But even after providing the above type of diagonal reinforcement, ultimate failure occurred owing to diagonal tension stresses. More effective ways of reinforcing this zone of the member must be developed. This can probably be achieved by using steel stirrups. Bamboo can be more effectively used in slabs than in beams, because shear failure generally does not occur in slabs.

Bond

An important disadvantage of bamboo as reinforcement is its tendency, if already seasoned, to absorb a large amount of water present in the wet concrete, resulting in initial swelling and subsequent shrinkage as the concrete dries out. This phenomenon results in the development of longitudinal cracks in the concrete, which lower the load capacity of the members, and in poor bond formation between concrete and the reinforcement. The cracks are more where the percentage of bamboo reinforcement is high. Green bamboo used as reinforcement also shrinks as the concrete dries out, and the bond strength is poor.

A remedial measure adopted to overcome the high water absorption and swelling of bamboo embedded in concrete was the application of a water-repellent coating. Seasoned bamboo splints treated with one brush coat of asphalt emulsion or coal tar gave more bond stress than did seasoned untreated and unseasoned ones. Concrete reinforced with treated bamboo developed greater load capacities than that reinforced with untreated bamboo. Excess of asphalt on the surface of the bamboo splints is, however, harmful; it lowers the bond between the concrete and the bamboo. Poor adhesion of bamboo to concrete may be overcome by coating the air-dry bamboo strips with white lead in varnish. Three coats of a 40 per cent solution of rosin in alcohol and a subsequent coat of white lead also prevented water absorption but the coatings were disturbed while the concrete was being rodded and cracks developed in the concrete. A mixture of 80/100-grade bitumen and kerosene in the ratio 4:1 by weight may be used for the same purpose. Soaking the bamboo in a 50:50 mixture of linseed oil and turpentine for four days is also reported to be satisfactory.

Bond stress between untreated bamboo and concrete has been found to range from zero to 13 kg/cm². About 50 per cent increase in bond stress may be obtained by treating bamboo with coal tar/asphalt emulsion. Bond stress values range from 4 to 24 kg/cm² for treated bamboo. Bamboo specimens with node developed higher bond stress than those without, because of the uneven surface of the former.

Design and construction principles

The same principles as those used for the design of structural concrete members reinforced with conventional steel are adopted for the design of concrete members reinforced with bamboo. The percentage of reinforcement used should be in the optimum range. Selection, seasoning, preparation and treatment should be carefully carried out. Mature bamboo, often characterized by the brown colour of the culm in the clump, should be selected. Unseasoned material should not be used, especially in flexure. Unseasoned bamboo is reported to be satisfactory in concrete which will not dry out, as for example, in water tanks. Split bamboo shows better load capacity than do whole culms. The size of the splints is important. Width greater than 2.0 cm may lead to horizontal cracks because of swelling. Whole culms when used should also be of a diameter less than 2 cm. Proper spacing of bamboo is important. Tests indicate that when the main longitudinal bamboo reinforcement is spaced too closely, the flexural strength of the member is adversely affected. Minimum spacing should not be less than the maximum size of the aggregate + 0.75 cm, or the width of the bamboo splints + 0.75 cm, whichever is the greater. In placing bamboo reinforcement, care should be taken to alternate the basal and tip ends of the bamboo culms in all rows. This will ensure a fairly uniform section of reinforcement throughout the length of the member.

Permissible stresses

Since the actual stress developed in bamboo when it is used as reinforcement is far less than in direct tension tests, permissible stresses should be based on the actual test results obtained on bamboo-reinforced members. Based on the observed tensile stresses in bamboo in concrete, a safe tensile stress of 350-420 kg/cm² may be used in design. However, design values not in excess of 210-280 kg/cm² should usually be used if the deflection of the member is to be kept under 1/360 of the span length. Permissible bond stress of 3.5 kg/cm² has been recommended for bamboo compared to 6 kg/cm² for mild steel in 1:2:4 concrete.

Behaviour of bamboo-reinforced structures

A number of experimental concrete structures, including farm residences, have been constructed with bamboo as reinforcing material. The condition of these structures, which have a pleasing appearance when viewed from the outside, was not satisfactory three to five years after construction. The majority of the structural members, such as beams, girders and slabs, developed cracks within two weeks to two months after construction. Fresh cracks generally did not develop after the first six months. Some of these cracks did not affect the safety of the structure, but some of them were serious and grew larger and larger until they impaired the safety of the structure. These cracks may have been due to improper placing of reinforcements and other factors. Some cracks were the result of the use of unseasoned bamboo. Roof slabs were safe in most cases. Supporting beams and girders showed cracks in general. Small cracks in some roof slabs were not structurally objectionable but showed leakage, and waterproofing had to be applied later. Deflections in beams and slabs were very small even where cracks had appeared. Pre-cast units used for interior walls were very satisfactory.

Bamboo reinforcement had a tendency to move towards the top of the mass of concrete. In order to avoid this defect, it may be tied to insert blocks by means of galvanized iron wires. A 3.6-m roof slab using seasoned, treated bamboo was constructed with integral shear connectors as embedded reinforcement (see figure XLIII). The slab developed cracks but was otherwise sound at the end of eight years. An experimental house was constructed in Indonesia having walls and roofs of volcanic pozzolana lime concrete reinforced with bitumen-coated bamboo strips. After six years, the flat roof suddenly developed dangerous cracks owing to the deterioration of the bamboo.

Beams and slabs of a room 4.2-m x 3.0-m constructed in Manila using *Bambusa blumeana* splints as reinforcement were in good condition at the end of seven years. Bamboos about six years old had been selected, seasoned, cut and shaped, and the splints coated with asphalt emulsion before they were embedded in the concrete. In the Philippines, bamboo is recommended as reinforcement for small building structures, working tables in kitchens and markets, cover for septic tanks, shelves, pipes and hollow block construction for walls and partitions in small buildings.

This sums up the present position with respect to the use of bamboo as a reinforcement for concrete.

Phragmites gramineae reed culms were traditionally used in Iraq as a reinforcement for lime mortar in lintels and arches before reinforced concrete was introduced. Reeds embedded in gypsum mortar have been found to be in perfect condition when examined 40 years later.

Split reeds are considered as most suitable for reinforcing concrete. Adhesion is thus improved by ensuring contact on all sides. The danger of rotting is also reduced by eliminating entrapped air and water in the hollows of the reed.

Dry reeds soaked for two to three hours in water to wet the surface without causing much swelling are considered best for reinforcement. Subsequent swelling of the reeds is not considered likely to cause cracking of the concrete because of the small dimensions, high transverse compressibility and low coefficient of elasticity of the reeds. Tests on joists, slabs and cubes reinforced with reeds showed that the maximum load was decided by failure of adhesion between concrete and reeds. Vibrating the concrete improved adhesion. Strong dividing walls at the nodes of reeds increased the bond with concrete thereby increasing the load-carrying capacity of the slabs. Methods to improve adhesion further must still be developed.

Earthquake-resistant construction

Earthquake forces that a building has to withstand are proportional to its weight and are predominantly horizontal. The heavier a building, the more likely it is to get damaged during an earthquake. Lightweight material such as bamboo and reeds, with a high strength/weight ratio, are therefore preferred in regions where earthquakes occur.



Figure XLIII. Bamboo culm reinforcement with integral shear connectors in position for concreting. Steel has been provided as negative reinforcement at supports

Experience in different seismic regions of the world has shown that a house built of bamboo, properly lashed together, is earthquake resistant. In this respect bamboo is somewhat superior to timber. It has the capacity to absorb more energy and shows large deflection before failure occurs. A bamboo frame structure therefore yields readily to the vibrations and contortions of the earth during an earthquake and does not readily collapse. Even if such a mishap were to occur, loss of life and property is not large because it is a lightweight structure.

The use of bamboo as a specific earthquake material has not been developed in comparison to timber, steel and concrete. Nevertheless, the principles applicable to a timber structure could be applied to bamboo structures also. In bamboo frame structure construction details should be adopted at the joints of the framing members and wall panels so that the structure as a whole behaves as one unit against earthquake forces. Experience in India suggests that a closed frame construction should be adopted with horizontal connecting members for the columns at foundation level. Walls and partitions should be provided with diagonal braces and anchored properly to the vertical and horizontal struts. Observations on the behaviour of framed structures during earthquakes in Assam have led to the conclusion that the superstructure should rest on a foundation of masonry. Small one-storey buildings (50 m²) may rest on firm ground. However, in larger buildings, the posts should be attached to foundations by means of pins or straps, bolts and nuts.

Bamboo board, matting and plastered matting walls and reed slab walls, being light and flexible, are suitable for seismic areas. Experience in Colombia has shown that the bajaraque wall construction, which is more massive than wattle and daub but less massive than rammed earth or adobe, is earthquake resistant.

Load-bearing adobe and heavy mud walls, which fail under relatively slight tensile or bending force, are the first to fall during a seismic vibration. It is recommended that a bamboo lattice should be used in mud walls to strengthen them.

Brick masonry walls also have poor resistance to earthquake shocks, especially when a weak mortar such as mud is used. In ancient Babylonia and Ur, reeds embedded in asphalt appear to have been used as horizontal reinforcement in brick walls. Vertical steel reinforcement is now specified for brick masonry walls at corners and junctions. Vertical steel at door jambs and a lintel band are also recommended. The use of bamboo splints or reeds in place of steel in these places should prove beneficial, especially in single-storey houses.

A false ceiling should be tied rigidly to the roof. Plaster on the ceiling should be avoided or kept to a minimum thickness. Light roofing materials are advantageous in reducing the inertia force at the top of a building. Bamboo tile, bamboo shingle and thatch are satisfactory roof coverings in this respect.

Recommendations for further research

Improved preservative treatment for insects, rot and fire

By far the most pressing need is research to improve the resistance of bamboo and reeds to insects, rot and fire. The treatment should be simple and economical.

when used on a relatively small scale. A treatment effective with every species of bamboo and reed would be preferable to a different treatment for each species. A single treatment with modifications for different species would be an acceptable compromise. A single-step treatment for insects, rot and fire would be best but a continuous process of several steps would be acceptable. The treatment should take as little time as possible but an economical, effective treatment of any duration would be a great improvement. The aim of the treatment should be to increase the durability of bamboo and reeds to 20 years, and to provide a material that does not support its own combustion.

Architect designed model houses

There is a great need for new designs in facade, layout and mechanical equipment of bamboo and reed housing. Houses using these designs should be built in rural areas where they can serve as models for villagers. The new designs could be sponsored by regional housing authorities or even architects' associations. The design of such a house would prove a great challenge to an architect with a knowledge of functional design and an awareness of the potential of bamboo and reed as building material. The new designs should specify vermin-proof, well-ventilated, waterproof, and earthquake-resistant construction.

Selection of species for cultivation

Just as different species of lumber have widely variable characteristics, different species of bamboo and reeds have wide variability in characteristics such as durability, strength and splitting. Research is needed to select species for cultivation that will be used in building construction. Perhaps new species can be found or developed which will combine high strength, low susceptibility to insects, rot and fire, and high resistance to splitting that will permit the use of nails.

Improved methods of fastening

A fastener that would be more permanent, simpler to install, and make for a more rigid joint is needed. Of course, such a fastener must be economical and easily manufactured. The use of modern epoxy glues should be investigated. Metal ring and plate connectors have proved their worth in timber construction. Hollow plastic T and L fasteners using wedges may be the answer. Perhaps specially developed screws and bolts with rounded toothed washers will prove most efficient.

Bamboo and reed particle board

A cheap and strong particle board using bamboo and reeds would be useful for sheathing and forming. Such a particle board should have properties and characteristics similar to plywood. Such a board would find a use in both bamboo and reinforced concrete construction.

Annex I

DISTRIBUTION OF SPECIES OF BAMBOOS AND REEDS
USED IN BUILDING CONSTRUCTION

As far as we know, most of the bamboos of greatest usefulness and greatest versatility for building construction come from a few groups of related species, called genera. These genera are Arundinaria, Bambusa, Cenhalostachyum, Dendrocalamus, Gigantochloa, Melocann, Phyllostachys and Schizostachyum in the eastern hemisphere, and Guadua and Chusquea in the western hemisphere. But this is not to say that all of the most useful species are found in these genera.

For the purpose of those who wish to find and keep track of the best bamboos in any given locality, the vernacular names will serve better than the Latin. Latin names, however, are generally more useful in correlating information found in the literature. In this annex, which sets forth some of the most useful species with their locations, sizes and uses, both Latin and vernacular names are given in so far as they are available.

Bamboos

1. Arundinaria alpina: Alpine Bamboo, Bambu Alpina (Italian).
Africa: Kenya, Sudan, Uganda, Zaire; 8,000-10,000 ft. Abundant in large stands.
Culms: 60 ft by 4 in, commonly 45-50 ft by 2 1/2 in; rather thin-walled.
Use: General.
2. Arundinaria callosa: Uskong, Uspar, Spa (Khasia).
India: E. Himalayas and Khasia Hills, Assam; to 6,500 ft.
Culms: 12-20 ft by 1/2-1 in.
Use: Tying thatch.
3. Arundinaria elegans: Jillli (Naga).
India: Naga Hills; 5,000-7,500 ft.
Culms: 12-20 ft by 1/3-4/5 in.
Use: Walls of huts.
4. Arundinaria falcata: Himalayan Bamboo, Ringal, Nirgal, Nigal, Nagre, Narri, Garri, Gorwa, Spikso, Ningalo, Kewi, Tham, Utham, Kutino.
India: W. Himalayas.
Culms: 15-20 ft by 1/2-3/4 in.
Use: Lining for roofs of houses.
5. Arundinaria griffithiana: Khnap (Khasia), U-Spar.
India: E. Himalayas, Khasia and Jaintia Hills, Assam; to 4,500 ft.
Culms: 12-20 ft by 1-1/2 in.
Use: Tying thatch of houses.

6. Arundinaria intermedia: Nigala (Nepal), Darmiok (Lepcha), Titi Nuala, Prong Nok.
 India and Nepal: E. Himalayas; to 7,000 ft.
 Culms: 8-12 ft by 2/5-1/2 in.
 Use: Mattings to cover walls and partitions.
7. Arundinaria khasiana: Namlong, U-Kadac Namlong.
 India: Khasia Hills; 5,000-6,000 ft: often cultivated.
 Culms: 10-12 ft by 1/2 in.
 Use: Wattle and daub walls of houses.
8. Arundinaria manni: Boneng (Khasia).
 India: Jaintia Hills, Assam; to 3,000 ft.
 Culms: to 30 ft by 1/2 in.
 Use: Withes for binding frames of houses.
9. Arundinaria prainii: Kevva, Kevo, Sampit (Mara).
 India: Khasia, Jaintia and Mara Hills; to 9,500 ft.
 Culms: Slender.
 Use: Lath for walls of houses.
10. Arundinaria racemosa: Maling (Nepal), Phyun, Miknu, Mheem, Phoons, Pithiu.
 Nepal and India (Sikkim); 6,000-12,000 ft.
 Culms: 5-15 ft by 7/10-1 in.
 Uses: Roof construction and mattings for houses.
11. Arundinaria spathiflora: Ringal, Garu, Deo Ningal.
 India: N.W. Himalayas; 7,000-9,000 ft.
 Culms: 25-30 ft by 1 1/2 in.
 Uses: House construction, pipe systems.
12. Arundinaria wightiana: Chevairi.
 India: Southern and western parts; especially abundant on the Nil-iris.
 Culms: 10-15 ft by 1 in.
 Use: Mattings.
13. Bambusa arundinacea: Thorny Bamboo, Berua, Kata, Koto (Assam), Ily, Mulu (Malay), Bans, Behor Bans (Bengali), Mulkas, Vedru (Telugu), Mundray (Bombay), Bambu duri, Bambu oriduri (Indonesia), Phai Pah (Siamese).
 India: Pantropic in cultivation.
 Culms: 25-30 m by 15-20 cm; thick-walled; commonly rather crooked; only moderately strong and durable to very durable; lower branches very thorny.
 Use: General.
14. Bambusa balcooa: Balku Bans (Bengali), Baluka (Assam), Boro-bans, Sil Barua, Teli Barua, Wannah, Beru, Botwa.
 India: Assam, lower Bengal and Bihar.
 Culms: 50-70 ft by 3-6 in.
 Use: General; very suitable for building and scaffolding.

15. Bambusa blumeana: Buloh Duri (Malay), Kida (Semang), Bambu Duri, Bambu Gesing, Pring Ori, P. Gesing (Java), Haur Chuchuk (Sudan), Phai Sisak (Siamese), Kouyan-tinik, Spiny Bamboo (PI).
Malaya, Java, Sumatra, Borneo, India and Philippines (cultivated).
Culms: 30-60 ft by 3-4 in; thick-walled; internode 16-24 in.
Use: General.
16. Bambusa dolichoclada: Chang Chih Chu (Chinese).
Taiwan (cultivated).
Culms: 6-20 m by 4-10 cm.
Use: General.
17. Bambusa khasiana: Serim, Tyrah (Khasia).
India: Khasia and Jaintia Hills, Assam and Manipur, to 4,000 ft.
Culms: 30-40 ft by 1-1 2/5 in.
Use: General.
18. Bambusa multiplex: Hedge Bamboo, Silver Leaf Bamboo, Ngau Kan Chuk (Chinese), Mai-liang (Siamese).
China: Kwangtung; to 1,000 ft; now virtually pantropic in cultivation.
Culms: To 30 ft by 1 in; internodes long, thin-walled, resistant to Dinoderus, the powder post beetle.
Uses: Sheathing for roofs, wattle and daub wall construction (Jamaica).
19. Bambusa nutana: Pichle, Bidhuli, Pal Bans, Ghukial, Makal, Mehlu, Mahl, Paoshi-ding-ying, Jotia, Doo-bans, Namalonf, Spring-jai.
India: Sub-Himalayan tract from the Jumna to Assam and Sikkim; to 5,000 ft.
Culms: 10-15 m by 4-8 cm; fairly thick-walled; internodes 35-45 cm; wood strong, straight, hard, much esteemed.
Use: General.
20. Bambusa pallida: Phai Sonkham, Mai-Phiu (Siamese).
India, Thailand.
Culms: 12-18 m by 5-8 cm; thick-walled.
Use: General.
21. Bambusa polymorpha: Kyathaungwa (Burmese), Betua (Assam), Jama Betua (Bengali), Mai-Salom (Siamese).
India, East Pakistan, Burma and Thailand; to 3,500 ft.
Culms: 50-80 ft by 3-6 in.
Uses: General; considered one of the best bamboos for walls, floors and roofs of houses.
22. Bambusa stenostachya: Tzu Chu (Chinese).
Taiwan: Cultivated.
Culms: 5-24 m by 5-15 cm.
Use: General.
23. Bambusa textilis: Wong Chuk, Mit Chuk (Chinese).
China: South-eastern provinces.
Culms: To 40 ft by 2 in; internodes longish; wood rather thin.
Uses: Withes for binding house frames; matting for walls.

24. Bambusa tulda: Tulda, Jowa, Djowa Bans, Mak, Makor, Kiranti, Matela, Mati, Mamana, Wapi, Nalbans, Deo-bans, Bijuli, Jati, Jao, Shora, Theiwa, Theikwa, Phai Bong (Siamese).
India, East Pakistan, Burma and Thailand; most common bamboo of the rice country.
Culms: 20-70 ft by 2-4 in.
Uses: General, roofing, scaffolding, matting etc.
25. Bambusa tuldoidea: Puntin-pole Bamboo, Chaang-ko Chuk, Yau-chuk (Chinese).
China, Malaya, Brazil and El Salvador.
Culms: to 55 ft by 2 in.
26. Bambusa vulgaris: Common Bamboo, Bambu (Spanish American), Buloh Minyak, Haur, B. Tutal, B. Gading, Aur Gading, Pau, Po-o, Look (Malay), Jajang Ampel, J. Gading, Pring Ampel, P. Logi, P. Tutal (Java), Awi Ampel, A. Gading, A. Haur, A. Konen, A. Tutal (Sudan), Auwe Gading, A. Kunieng, B. Kuring-kuring (Sumatra), Phai Loung (Siamese), Kauayan-Kiling (Philippines).
Pantropic in cultivation, in two colour forms of culm: plain green and green-striped yellow.
Culms: 20-70 ft by 2-4 in; internodes 8-18 in; wood moderately thick and strong; susceptible to invasion by Dinoderus, the powder-post beetle.
Use: General.
27. Cephalostachyum pergracile: Tinwa (Burmese), Latang (Naga), Madang (Singho).
India (Assam), Burma and Thailand.
Culms: 30-40 ft by 2-3 in; internodes thin-walled.
Use: General.
28. Chusques spp.: Chusque, Suro, Carrizo.
Central and South America; especially in Andean Highlands, Mexico to Chile and Argentina.
Culms: Generally long, slender and relatively weak; pithy at centre.
Uses: Sheathing for roofs, and lath for wattle and daub walls.
29. Dendrocalamus asper: Bulah Betong, B. Panching (Malay), Kuur (Sakai), Deling Petung, Jajang Betung, Pring Petung (Java), Awi Betung, Bitung (Sudan), Bambu Batueng, Pering Betung (Sumatra).
Malaysia, Indonesia, Philippines and Thailand. Much planted.
Culms: To 100 ft by 6-8 in; short lower internodes very thick-walled.
Use: General.
30. Dendrocalamus brandisii: Kyelowa, Waya, Wapyu (Burmese), Wakay, Maklu (Karen), Mai Bongyai (Siamese).
India: North-eastern hills; to 4,000 ft.
Culms: 60-120 ft by 5-8 in.
Use: General.
31. Dendrocalamus virantous: Wabo (Burma), Worra (Assam), Phai Pao (Siamese).
India: Calcutta, northwards to Tenasserim in Burma, Thailand, Ceylon.
Culms: 80-100 ft by 8-10 in.
Use: General.

32. Dendrocalamus hamiltonii: Wabo-myrtan-ye (Burmese), Tama (Nepal), Pao (Lepcha), Kokwa (Assam), Pochā (Bengali), Onay (Miki), Wanoke (Garo), Phai Nualyai (Siamese).
India, Burma and Thailand: Central and E. Himalayas, N. Bengal, Assam, Khasia Hills, Sylhet, east to upper Burma and west to Sütlej. The common bamboo of the Darjeeling Hills, Terai etc.; much cultivated.
Culms: 40-60 ft by 4-7 in; internodes 12-20 in long; somewhat soft and relatively thin-walled.
Use: General; not highly esteemed.
33. Dendrocalamus hookerii: Ukotang, Patu, Tili, Kawa Ule.
India to Upper Burma: To 5,000 ft.
Culms: 50-60 ft by 4-6 in; internodes 18-20 in long; walls about 1 in thick.
Use: General.
34. Dendrocalamus latiflorus: Ma Chu (Chinese), Phai Zangkum (Siamese).
Thailand, Taiwan and Philippines: Cultivated.
Culms: To 25 m by 20 cm; walls 0.5-3.5 cm; internodes 20-70 cm.
Use: General.
35. Dendrocalamus longispatus: Khang, Orah, Wa-va, Phai Lammalot (Siamese).
East Pakistan, Burma and Thailand.
Culms: To 60 ft by 3-4 in; internodes 10-24 in long; walls 1/2 in thick.
Use: General; "not highly esteemed as building material but used when better kinds are not available" (Watt).
36. Dendrocalamus membranaceus: Wa-ya, Wa-yai, Wa-mu, Wapyu (Malay), Phai Nual (Siamese).
India, Burma and Thailand: Moist forests at low elevations.
Culms: To 70 ft by 4 in; internodes 9-15 in long; wood 1/4-3/8 in thick.
Use: General.
37. Dendrocalamus merrillianus: Bayog (Ilocos), Kawayan-bayog (Pangasinan);
Philippine Islands.
Culms: 18 m by 6-10 cm; walls 2.5-3 cm; internode 15-22 cm.
Use: General.
38. Dendrocalamus sikkimensis: Pappiang (Lepcha), Wadah (Garo Hills), Tiria, Vola (Nepal).
India (Sikkim and E. Himalayas) and Bhutan: 4,000-6,000 ft.
Culms: 50-70 ft by 5-7 in.
Use: General.
39. Dendrocalamus strictus: Male Bamboo Bans, Bans Kaban, Bans Khurd, Karail, Mathan, Mat, Buru Mat, Salia Bans, Halpa, Vadur, Bhiru, Kark, Kal Mungil, Kiri Bidru, Sadhanspavedru, Kauka, Myinwa, Phai Zang (Siamese).
Throughout India and Burma except in N. and S.E. Bengal and Assam; Thailand. Commonest bamboo in India.
Culms: 5-15 m by 2.5-8 cm; very strong; often solid.
Use: General.

40. Gigantochloa apus: Bamboo Apus, B. Tali (Malay), Delingi Apoos, D. Tangsool, D. Pring, Pring Apus, P. Apoos, P. Tali (Java), Awi Tali (Sunda), Pereng Tali (Madura).
 Java, Surinam and Thailand: Widely planted.
 Culms: To 65 ft by 4-6 in; internodes up to 26 in long; wood 1/4-1/2 in thick.
 Use: General: one of the most useful bamboos.
41. Gigantochloa levis: Kawayan-bo-o, K. Cina, K. Puti, Boho (Tagalog), Bdo, Botong (Bisaya), Bolo (PI).
 Philippine Islands and Malaysia: Wild and cultivated.
 Culms: To 20 m by 15-23 cm; walls 1.5-3.0 cm; internode 29-36 cm; very straight, easily worked.
 Use: General.
42. Gigantochloa macrostachya: Tekserah, Madi, Madawa, Wanet, Wabray.
 India (Assam), East Pakistan and Burma.
 Culms: 30-50 ft by 2 1/2-4 in.
 Use: General.
43. Gigantochloa verticillata: Whorled Bamboo, Bamboo Andong (Malay), Pring Soorat (Java), Andong Kakes, Awi Andong, A. Gambong, A. Liah, A. Soorat (Sunda).
 Java.
 Culms: To 68 ft by 6 in; internodes with pale yellow stripes; wood up to 4/5 in thick; culms straight, easily worked.
 Use: General.
44. Guadua aculeata: Tarro (Central America).
 Mexico to Panama.
 Culms: To 75 ft by 5 in; internodes relatively short, wood of moderate thickness.
 Use: General.
45. Guadua amplexifolia: Cauro (Nicaragua, Mosquito).
 Venezuela to Mexico.
 Culms: To 60 ft by 4 in; internodes relatively short, lower ones semi-solid.
 Use: General; the least desirable of the listed species for the purpose, but much used in Nicaragua.
46. Guadua angustifolia: Guadua (Colombia), Cana Brava (Ecuador).
 Ecuador, Colombia, Peru and N.E. South America from Argentina to Panama.
 Culms: To 90 ft by 6 in; internode relatively short; wood up to 3/4 in thick.
 Uses: General; most versatile of the genus. Used in nearly every house, and some houses built entirely of it in some areas. Resistant to both rot fungi and wood-eating insects.
47. Guadua superba: Marona.
 Brazil: Acre, Rio Purus.
 Culms: To 75 ft by 5 in.
 Use: General.

48. Melocanna baccifera: Terai Bamboo, Muli, Metunga (Bengali), Tarai (Assam), Wati (Cachar), Arten (Ihikir), Turiah (Naga), Watrai (Caro), Kayeungwa (Magh), Kayinwa (Burmese), Pala, Taria, Pagutulla.
India, East Pakistan and Burma.
Culms: 50-70 ft by 1 1/2-3 in; internodes 12-20 in long; straight, thin-walled, but strong and durable.
Use: General; principal material for economical housing in East Pakistan.
49. Ochlandra rheedii
India (Kerala).
Culms: 15-20 ft by 1-2 in; thin-walled.
Use: Woven mats.
50. Ochlandra stridula: Batali Battagass.
Ceylon (low country in the south).
Culms: 6-18 ft by 1/2 to 3/4 in.
Use: Roofs of huts.
51. Oxytenanthera abyssinica: Arkai, Chomiel, Savannah Bamboo.
Africa: Ethiopia to Angola and Ghana.
Culms: 25-50 ft by 1 1/2-3 in.
Use: General.
52. Oxytenanthera albociliata: Phai Rai, Phai Khai (Siamese).
Thailand.
Culms: 7-10 m by 1.5-3.0 cm; walls 0.5-1.0 cm; internodes 15-40 cm.
Use: General.
53. Oxytenanthera nigrociliata: Podah (Andaman), Washut (Caro), Bolantzi Bans (Orissa), Lengha (Java), Phai Phak (Siamese).
India, Andaman Islands, Burma, Java and Sumatra and Thailand.
Culms: 30-40 ft by 1/2-2 in.
Use: General.
54. Phyllostachys aurea: Buddha Bamboo, Hotei-chiku (Japanese), Fat-to Chuk (Chinese).
China and Japan. Now cultivated nearly all over the world in temperate zone. Probably most common exotic bamboo next to Bambusa vulgaris.
Culms: 25 ft by 1 in.
Use: Suitable for light elements of house construction.
55. Phyllostachys banbusoides: Giant Timber Bamboo, Madake (Japanese), Kuei Chu, Kam Chuck (Chinese).
China and Japan. Cultivated in other countries.
Culms: To 75 ft by 6 in; straight; wood of moderate thickness but excellent quality.
Use: General.
Note: In China, numerous other species of this genus are much used in building houses.
56. Phyllostachys edulis: Meng Tsung Chu (Chinese).
Taiwan.
Culms: 4-20 m by 5-18 cm.
Use: General, scaffolding.

57. Pseudostachyum polymorphum: Filing (Nepal), Purphiok, Paphok (Lepcha), Wachall (Garó), Bajal, Toli, Nal (Assam), Bawa (Burmese).
India (E. Himalayas, Assam, Sikkim) and Upper Burma.
Culms: To 50 ft by 1 in; internodes long, thin-walled.
Uses: Lath, matting, withes for tying frames of huts.
58. Schizostachum brachycladum: Buloh Nipis, Buloh Lemar, Buloh Padi, Buloh Urat Busa, Buloh Pelan (Malay).
Malaya and Philippine Islands.
Culms: To 8 cm dia.; thin-walled, very straight; easily split and flattened.
Uses: Walls and floors of houses.
59. Schizostachum hainanense: Tang Chuk (Chinese).
China: Hainan Island.
Culms: To 100 ft by 1 in; internodes long, thin-walled.
Uses: Lath, matting.
60. Schizostachyum lima: Anos.
Philippine Islands: Luzon, Mindoro, Palawan, Mindanao.
Culms: 6-10 m by 2.5-4.8 cm; walls 0.3-0.5 cm; internodes 80-100 cm.
Uses: Matting, shingles, thin lath.
61. Schizostachyum lumampao: Lakap (Bosayan), Tamblang (Bila-an), Ruho.
Philippine Islands: Luzon, Penang.
Culms: 12-15 m by 7.5 cm; walls 0.4-0.6 cm; internodes 30-50 cm, straight.
Use: Boards.
62. Schizostachyum zollingeri: Buloh Tulu, B. Tekor, B. Palang, B. Nipis, B. Dinding, B. Pauh, B. Kasap, B. Lemang, Phai Po (Siamese).
Indonesia, Malaysia and Thailand.
Culms: To 15 m by 2-10 cm; thin-walled; internodes commonly to 40 cm. Easily split and then flattened.
Uses: Wall and floors of houses.
63. Teinostachyum dullooa: Dolu (Bengali), Dullooa (Assam), Paksalu, Pogslo, Wadru, Gyawa.
India (Assam) and East Pakistan.
Culms: 20-30 ft by 1-3 in; internodes to 40 in long; thin-walled.
Uses: Lath, matting.
64. Thyrsostachys oliveri: Thanawa (Burmese), Maitong (Kachin), Phak Ruak (Siamese).
India, Upper Burma and Thailand: To 2,000 ft.
Culms: To 25 m by 5-8 cm; rather thin-walled; internodes 30-60 cm.
Use: General.
65. Thyrsostachys siamensis: Mai Ruak, Mai Huak (Siamese), Kyaungwa.
Thailand and Burma.
Culms: 25-40 ft by 1 1/2-3 in; thick-walled; internodes 6-12 in; very strong and straight.
Use: General.

Reeds

1. Arundo donax: Giant reed (Hitchcock), Vara de Coheta (El Salvador),
Bamboo reed (S. Australia).
Pantropic and extending into milder parts of the temperate zone in
cultivation.
Culms: To 20 ft by 1 in; hollow, thin-walled, the surface smooth
and shining.
Uses: Wattling, roofing and mats for walls and roofs.
2. Cyperium sagittatum: Uva grass (Hitchcock), Cana Arava (Cuba), Cana Blanca
(Panama), Cana amarga (Venezuela), Vara de Tusa (El Salvador),
Uba (Brazil), Heste Clarissa Rolfs).
Tropical America: Principally at low elevations.
Culms: Commonly to 25 ft by 1-1/4 in: the internodes filled with
pith, which shrivels and shrinks upon drying; covered with persistent
sheaths.
Uses: Walls and partitions, ceiling finish, roof sheathing. Tied in
small bunches as rafters for tile roofs.
3. Phragmites communis: Common Water Reed.
Old and new worlds.
Culms: 5-10 ft.
Uses: Reed boards (Austria), thatching, ribs of ataps in Malaya.
4. Phragmites gramineae: Qassab (Arab).
Iraq.
Culms: 3-4 m by 2.0-2.5 cm; walls 0.9-3.0 mm thick. Thicker walls
and stronger partitions for northern reeds.
Uses: Roofs, wall panels, insulation, reed boards; tied into bundles
for column, beams and arches. Termite-resistant.
5. Phragmites karka: Nal, Sarkanda.
India (plains and Himalayan valleys to 900 m), Burma, Ceylon, extending
to S.E. Asia and N. Australia.
Culms: To 15 ft; hollow.
Uses: General, reed boards.
6. Saccharum arundinaceum: Munj.
India, Burma, Ceylon
Culms: Straight, strong
Uses: Walls of huts, matting, ropes from sheaths.
7. Saccharum spontaneum: Ekra.
India: Westwards to the Mediterranean.
Culms: Tall, robust, smooth, polished.
Uses: Reed boards (India), walls of huts.

Annex II

STRENGTH OF BAMBOOS USED IN BUILDING CONSTRUCTION*

Species	Location	Age (Years)	Condition and moisture content (percentage)	Splint or Full round	Specific gravity	Static bending			Crushing strength parallel to grain (kg/cm ²)	Shear strength (kg/cm ²)	Tensile strength parallel to grain (kg/cm ²)	Author
						Fibre stress at elastic limit (kg/cm ²)	Modulus of rupture (kg/cm ²)	Modulus of elasticity (kg/cm ² x 10 ⁴)				
<u>Dendrocalamus strictus</u>	Dehra Dun, India	Average of 1/2 to 2 1/2	Green 72.2	Full	0.575	594	696	124	520	Limaye
"	"	"	Kiln-dry 10.6	"	0.732	668	1,139	159	578	"
"	"	Average of 1 to 6	Green 98.9	"	0.570	548	1,034	174	372	"
"	Madhya Pradesh, India	Average of 1 to 6	Kiln-dry 12.7	"	0.698	885	1,665	225	646	"
"	"	"	Dry 14.9	"	0.707	649	1,064	176	652	Sekhar
"	"	"	Dry 9.8	"	0.679	582	872	155	500	"
"	"	"	Dry 5.8	Splint	0.655	658	1,118	145	568	"
"	"	"	Dry 5.8	Splint	0.666	1,214	1,926	175	"
<u>Dendrocalamus strictus (solid)</u>	Dehra Dun, India	2 1/2	Dry 13	Full	1,190	183	619	Limaye
<u>Dendrocalamus strictus</u>	Puerto Rico	...	10	"	0.62	1,017	1,709	177	534	Heck
<u>Dendrocalamus strictus</u>	Puerto Rico	...	10.1	Splint	0.57	447	850	82	422	Heck
<u>Bambusa arundinacea</u>	"	...	10	Full	0.580 ^b	529	918	120	367	"
"	"	...	9.4	Splint	0.508 ^b	363	682	80	320	(results averaged)
<u>Bambusa balcooa</u>	U. Pradesh, India	...	Green 42	Full	0.783	...	651	73	466	Limaye
<u>Bambusa nuntans</u>	Dehra Dun, India	Average, 1 to 4	Green 95.1	"	0.631	334	623	98	453	Sekhar
"	"	"	Kiln-dry 12.1	"	0.693	492	869	124	719	"
"	Bengal, India	"	Dry 12	"	658	111	"
<u>Bambusa spinosa</u>	Philippines	...	Air-dry	Splint	1,180	...	535	Espinosa
<u>Bambusa tulda</u>	Bengal, India	...	Dry 12	Full	875	123	Limaye
"	Puerto Rico	...	10	"	0.79 ^b	931	1,247	166	703	Heck
"	"	...	9.6	Splint	0.64 ^b	742	1,229	129	650	"
<u>Bambusa tuldoidea</u>	South America	...	Air-dry 11.1	Full	0.83	844	1,547	162	"
<u>Bambusa vulgaris</u>	Puerto Rico	...	10	"	0.70 ^b	653	1,224	159	584	"
"	"	...	9.5	Splint	0.61	659	1,171	120	562	"
<u>Guadua angustifolia</u>	South America	...	Air-dry 10.3	Full	0.82	843	1,448	176	"
<u>Phyllostachya schilis</u>	China	...	Green	Splint	0.666	490	995	81	424	115	123	Chinese publication (results averaged)

* The information contained in this annex has been obtained from various sources.

a/ Based on oven-dry weight and volume.

Annex III

RECOMMENDED PRESERVATIVES FOR DIFFERENT END USES OF BAMBOO

End use of bamboo	Recommended preservatives ^{a/}		Concentration of preservative (percentage)	Loading of dry chemical in bamboo (kg/m ²)	Proposed treatment	Expected service life (years)
	Dry bamboo	Green bamboo				
Use in the open and in contact with the ground (e.g., posts, pale-fencing etc.)	a	80 to 128	Open tank for pressure process	15
	b and c	...	6 to 8	8 to 12	Pressure process	
	...	b and c	6 to 8	5 to 8	Modified boucherie for 6 to 8 hours or steeping for 35 to 40 days	
Use in the open but not in contact with the ground (e.g., bridges, scaffoldings, ladders etc.)	a	48 to 80	Hot dipping or open tank or pressure process	15
	b and c	...	5	5 to 8	Pressure process	
		b and c	5 to 6	5 to 8	Modified boucherie for 4 to 6 hours or steeping for 20 to 25 days	
Use under cover:						
(a) House building, walls, trusses, purlins, rafters, tent poles etc.	a	32 to 48	Hot dipping or open tank or pressure process	20 to 30
	b and c	...	4	4	Pressure process	
	d, e and f	...	6	8	" "	
		b and c	4	4	Modified boucherie for 4 hours or steeping for 15 to 20 days	20 to 30
(b) Screens, ceilings, doors and door panelling, furniture etc.	d, e and f	...	6	8	" "	
	b and c	...	3	3	Pressure process	10
	d, e, f, g and h	...	5	5	" "	10
		b and c	3	3	Modified boucherie for 2 to 3 hours or steeping for 8 to 12 days	10
	d, e, f and g	...	5	5	" "	
Prophylactic treatment: green bamboos including splints and round bamboos for eventual full-fledged treatment after air-drying	i and j	Dipping for 5 minutes	

a/ The letters in these columns refer to the entries in the following list of preservatives:

List of preservatives

- a. Coal tar creosote and fuel oil, 50:50 by weight.
In highly termite-infested areas it is preferable to add 1 per cent dieldrin, and in highly decaying areas 1 per cent pentachlorophenol.
- b. Copper-chrome-arsenic composition (Ascu).
A typical composition of this preservative comprises copper sulphate ($\text{CuSO}_4 \cdot 5\text{H}_2\text{O}$), arsenic pentoxide (As_2O_5) and sodium or potassium dichromate ($\text{Na}_2\text{Cr}_2\text{O}_7 \cdot 2\text{H}_2\text{O}$ or $\text{K}_2\text{Cr}_2\text{O}_7$) in the proportion of 3:1:4.
- c. Acid-cupric-chromate composition (Celcure).
A typical composition of this preservative comprises 1.68 parts of chromium sesquioxide (Cr_2O_3) (equivalent to 2.5 parts of sodium dichromate), 50 parts of copper sulphate and 47.5 parts of sodium dichromate.
- d. Copper-chrome-boric composition.
This consists of boric acid (H_3BO_3), copper sulphate and sodium or potassium dichromate in the proportion of 1.5:3:4.
- e. Copper-chrome-zinc-arsenic composition.
A typical composition of this preservative comprises 28 parts of arsenic acid (H_2AsO_4 , $1/2 \text{H}_2\text{O}$), 25 parts of sodium arsenate (Na_2HAsO_4 , $12\text{H}_2\text{O}$), 17 parts of sodium dichromate and 30 parts of zinc sulphate (ZnSO_4 , $7\text{H}_2\text{O}$).
- f. Chromated zinc chloride.
This consists of zinc chloride (ZnCl_2) and sodium or potassium dichromate in the ratio of 1:1.
- g. Boric acid-borax, 2.5 per cent each.
- h. Copper naphthenate and zinc naphthenate.
These are salts of naphthenic acid and should contain 0.5 per cent of copper and 3 per cent of zinc by weight, respectively.
- i. Dieldrin-pentachlorophenol emulsion.
Dieldrin 18 per cent emulsifiable concentrate, 1 part;
PCP 12 per cent emulsifiable concentrate, 4 parts; water, 75 parts by weight. To this may be added copper naphthenate (1 per cent copper) in emulsifiable form, 1 part by weight.
- j. Water solution containing borax 2 per cent, sodium pentachlorophenate 1 per cent, and gammexane (water dispersible), 1 per cent by weight.

Annex IV

TOOLS USED IN BAMBOO AND REED CONSTRUCTION

Bamboo is notorious for its dulling effect on edged tools. This effect is due to the silica with which the tissues are more or less heavily impregnated. The effectiveness of edged tools will be maintained at a higher level, and the time consumed in sharpening will be greatly reduced, if tools made of molybdenum steel or an equally hard alloy can be secured for working bamboo.

Tools essential to building with bamboo are relatively few and simple. In fact, many a bamboo house has been built with no more tools than a machete. But wherever the use of bamboo is to be refined or elaborated to any extent, additional tools are required. Some of these may have to perform work peculiar to the processing of bamboo and, for this reason, would not be available at the sources of standard carpentry tools. The Chinese tub- and bucket-maker who uses bamboo as his raw material requires an array of some 30 different tools and gadgets, all of which are employed at one stage or another in the measuring, cutting, fitting and assembling of the various parts. With the following tools, the standard bamboo elements for building purposes may be processed and assembled.

<u>Tool</u>	<u>Use</u>	<u>Recommended specifications</u>
Adz	Removing diaphragm fragments and excess soft wood at basal end of bamboo boards. Spud is more convenient, but the adz is more generally available	Standard design; best-quality steel
Axe	Felling bamboo Cracking the nodes of large culms to make boards	Light-weight axe Light-weight axe with a narrow but thick, strongly wedge-shaped bit
Carpenter's saw	Cutting bamboo and reed boards	Large size (30-60 cm); molybdenum steel, about 3-6 teeth per cm
Chisel	Making holes in culms to accommodate lashings for end ties	Best steel (molybdenum steel if available); 2 cm bit
Drill	Making holes to accommodate bamboo pins or dowels	Hand or power-driven drill; metal drilling bits, best steel, assorted sizes, 2-12 mm
Gouge	Removing diaphragms to make troughs and drainpipes from splint or opened culms	Curved (front bent); 2 cm and 4 cm bits

<u>Tool</u>	<u>Use</u>	<u>Recommended specifications</u>
Hacksaw	Felling culms, removing branches, cutting culms to length	Large size, ample supply of molybdenum steel blades, 7 and 10 teeth per cm
Hammer	Driving or extracting nails	1-2 lb, one face for nail driving, other for nail extraction; material, wrought iron forged; provided with wood handle 30 cm long
Hatchet or small axe	Cracking the nodes of smaller culms for making boards	Similar to the axe, but smaller in size and fitted with a short handle
Knives	For splitting small culms For making bamboo withes Cutting and trimming	Short handle; broad blade Long handle, blade bevelled on one side only Various types depending on preference of user
Machete	Miscellaneous; felling and trimming culms, and cutting them to lengths; removing fragments of diaphragms from bamboo boards, etc.	Preference of the user to decide type of blade selected; long, fairly heavy blade recommended
Rods of reinforcing steel	Breaking out the diaphragms of unsplit culms	Suggested minimum: one each of 2 cm by 3 m and 1 cm by 3 m. Other dimensions to meet special needs. Hardwood or bamboo pole may be substituted
Screwdrivers	Driving screws	In lengths of 15, 22 and 30 cm; material, high carbon steel
Splitting jig	Facilitating the splitting of whole culms or sections into several strips at once	
Spud	Removing diaphragm fragments and excess softwood at basal end of bamboo boards	Long handle; broad blade set at an angle to operate parallel with surface of board
Thatching needle	Sewing reed thatch	A thatching needle may be made from a 40 to 45-cm length of heavy gauge fencing wire as follows: one end is filed to a rough point and the other is beaten flat so that a 5-mm hole can be drilled to form the eye

<u>Tool</u>	<u>Use</u>	<u>Recommended specifications</u>
Tripods or trestles	Elevating culms and holding them firm for sawing to length, cracking nodes	May be made locally, following the pattern locally preferred
Whetstone	Sharpening edged tools	Carborundum, coarse-grained on one side, fine on the other
Wire pincers	For handling wire used for lashings	Conventional type with long, narrow jaws and wire-cutting feature
Wood rasps	Levelling prominent culm nodes	Large size, with one flat side, one convex: coarse, medium and fine teeth

HOW TO OBTAIN UNITED NATIONS PUBLICATIONS

United Nations publications may be obtained from bookstores and distributors throughout the world. Consult your bookstore or write to: United Nations, Sales Section, New York or Geneva.

COMMENT SE PROCURER LES PUBLICATIONS DES NATIONS UNIES

Les publications des Nations Unies sont en vente dans les librairies et les agences dépositaires du monde entier. Informez-vous auprès de votre librairie ou adressez-vous à: Nations Unies, Section des ventes, New York ou Genève.

КАК ПОЛУЧИТЬ ИЗДАНИЯ ОРГАНИЗАЦИИ ОБЪЕДИНЕННЫХ НАЦИЙ

Издания Организации Объединенных Наций можно купить в книжных магазинах и агентствах по всем районам мира. Понайдите справки об изданиях в вашем книжном магазине или пишите по адресу: Организация Объединенных Наций, Секция по продаже изданий, Нью-Йорк или Женева.

COMO CONSEGUIR PUBLICACIONES DE LAS NACIONES UNIDAS

Las publicaciones de las Naciones Unidas están en venta en librerías y casas distribuidoras en todas partes del mundo. Consulte a su librero o diríjase a: Naciones Unidas, Sección de Ventas, Nueva York o Ginebra.

Litho in United Nations, New York
06567—July 1972—4,000

Price: \$U.S. 3.00
(or equivalent in other currencies)

United Nations publication
Sales No.: E.72.IV.3