

AT MICROFICHE
REFERENCE
LIBRARY

A project of Volunteers in Asia

57 How-to-Do-It Charts on Materials, Equipment,
and Techniques for Screen Printing

by: Harry L. Hiatt

Published by:

Signs of the Times Publishing Co., Inc.
407 Gilbert Avenue
Cincinnati, OH 45202 USA

Paper copies are \$ 3.00.

Available from:

META Publications
P.O. Box 128
Marblemount, WA 98267 USA

Reproduced by permission of Signs of the Times
Publishing Co., Inc.

Reproduction of this microfiche document in any
form is subject to the same restrictions as those
of the original document.

HOW-TO-DO-IT CHARTS

ON MATERIALS • EQUIPMENT • TECHNIQUES FOR SCREEN PRINTING

FLOATING BASE *with* STATIONARY GUIDES

TWO METAL STRIPS ARE FASTENED TO UNDERNEATH SIDE OF FLOATING BASE

THE FLOATING BASE IS HELD TO LOWER BASE WITH FOUR METAL ADAPTORS TWO OF WHICH ARE SO CONSTRUCTED AS TO CONTAIN WING-HEAD BOLTS FOR TIGHTENING AFTER CORRECT REGISTRATION HAS BEEN MADE.

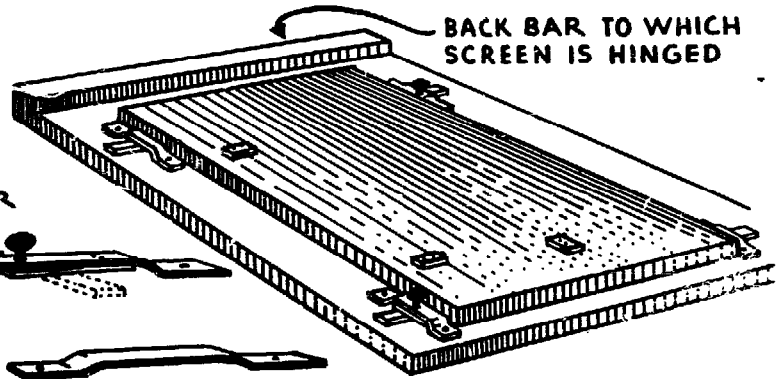

BACK BAR TO WHICH SCREEN IS HINGED

The WOOD GRAIN SQUEEGEE

BY PLACING A SERIES OF NICKS OR CUTS IN THE BLADE *and* PRINTING THROUGH A BLANK SCREEN WITH TRANSPARENT COLORS *an* EXCELLENT WOOD GRAIN EFFECT CAN BE PRODUCED.

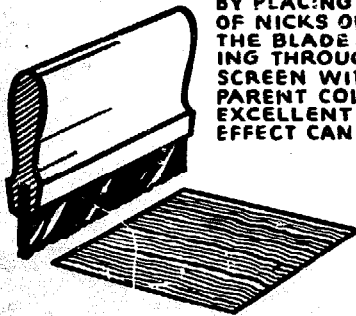

SEVERAL SUPPLY DEALERS FURNISH 2" x 72" MOULDED RUBBER STRIPS WHICH REQUIRES NO CUTTING EXCEPT FOR LENGTHS.

SHEET RUBBER CAN BE CUT ON A PAPER CUTTING MACHINE *or* WITH A CLAMPED DOWN STEEL STRAIGHT EDGE *and* SHARP KNIFE.

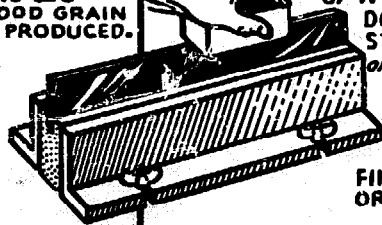

THERE *are* SEVERAL WAYS TO RESHARPEN USING FINE GARNET CLOTH *OR* SAND PAPER

STRAINING

PRIOR TO USING SOLUTION CHILL to 60°F. *or* UNDER *and* STRAIN

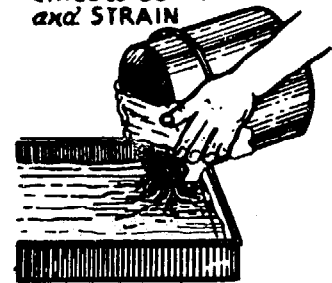

The MEGILL "PERFECT" GUIDE

MADE FOR LETTER PRESS WORK, THEY MAY ALSO BE USED FOR SCREEN PRINTING OF PAPER, ESPECIALLY DECALCOMANIA PAPER, BECAUSE OF ITS ADJUSTABLE FEATURES AND GRIPPER TONGUE.

FOR SCREEN PROCESS WORK IT IS NECESSARY TO GRIND OR FILE SMOOTH THE RIVET HEADS AND NIB.

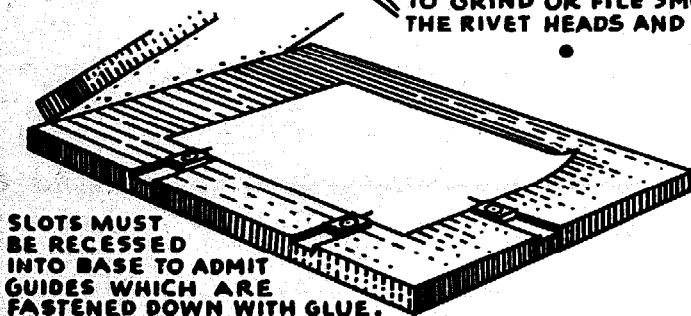

SLOTS MUST BE RECESSED INTO BASE TO ADMIT GUIDES WHICH ARE FASTENED DOWN WITH GLUE.

COMMON METAL GUIDE

TAKING ADVANTAGE OF THE COUNTERSUNK SCREW HOLES ALREADY MADE IN A 2" x 9/16" PIN HINGE SECTIONS ARE CUT WITH HACK SAW AS SHOWN

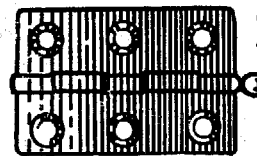

IF GUIDE IS TO BE USED FOR PAPER PRINTING THEN A BRASS TONGUE CAN BE SOLDERED ON

AND SLOTS RECESSED INTO BASE TO ADMIT GUIDES.

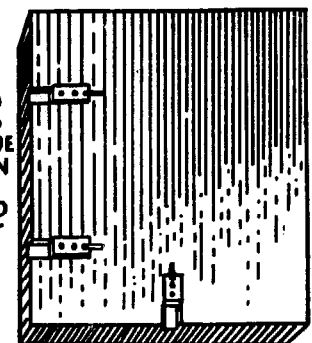

57

How-To-Do-It Charts

by

HARRY L. HIETT

on

Materials—Equipment—Techniques

for

Screen Printing

**Signs of the Times Publishing Company
407 Gilbert Avenue
Cincinnati, Ohio 45202**

**Copyright, 1980, by the Signs of the Times
Publishing Company, Cincinnati, Ohio. The
contents of this book may not be reproduced,
either in the whole or in any part, without per-
mission of the publisher in writing.**

**SECOND EDITION
FIRST PRINTING, 1980**

ISBN: 0-911380-48-5

PREFACE

Assembled in this booklet form, the following collection of fifty-seven "How-To-Do-It" Charts, originally designed by Harry L. Hiett in full page format, as presented, will have historic as well as educational value for the reader.

Harry L. Hiett, now retired, was one of the pioneers of the screen printing industry through whose developments and their publication, screen printing enjoyed its early spread in popularity as a versatile printing and decorating medium, subsequently mushrooming into today's gigantic, world-wide industry.

Although commercial materials have, for the most part, supplanted many of the shop formulas explained in the charts, the information given will be of extreme value to the student, the experimenter, the serigrapher and the operator of the smaller shop, especially those whose income from screen printing does not currently warrant large capital investments in equipment and automatic machines. It is expected that the how-to-do-it details presented by Harry Hiett will ease the path of progress by advancing ideas which will enable the operator to develop his technical knowledge more rapidly, at the same time giving him a basic background that will prove to be of time-and-again aid in planning expansions and working toward the planned goals.

As a quick reference manual for class instructors, the file-sized book is expected to prove of inestimable value as a supplement to basic texts used. Except for information on inks themselves and the support materials to which they may be applied, which are not included in this booklet, it stands alone as a class reference, providing visual appreciation of mechanics and techniques — both those which would be of every-day value, and those which are presented as only occasional, but none-the-less important, problems.

Those who are familiar with the monthly publication, in SCREEN PRINTING magazine, of some forty-eight of these charts will note that they are not presented in this booklet in the same order in which they were originally published. The arrangement progresses with step-by-step smoothness, from the first basic charts covering screen frame assembly, in the natural order in which the steps would be used to set up a screen printing unit, in class or industry, or a small commercial screen printing operation.

For quick reference, the charts have been arranged into six categories, as listed below, and a complete index will be found in the back pages of the booklet.

Basic Printing Equipment	Pages	6 to 32
Printing Table Assembly	"	33 to 37
Tools and Tips for Stencil Cutting . .	"	38 to 39
Knife Cut Stencils	"	40 to 43
Hand Filled Stencils	"	44 to 51
Photographic Stencils	"	52 to 59
Index	Page	60

Making The STENCIL SCREEN FRAME ELEMENTARY PLATE

FOR A GOOD LEVEL *and* STURDY FRAME *the* FIRST CONSIDERATION IN ITS CONSTRUCTION IS *the* KIND OF WOOD TO USE ITS THICKNESS *and* WIDTH WHICH WILL BEST CONFORM WITH ITS LENGTH *also* THE TYPE OF JOINT WHICH WILL GIVE THE MAXIMUM STRENGTH

FOR EXPERT WORKMANSHIP ALL LUMBER SHOULD BE DRESSED ON ALL FOUR SIDES

LONG WOOD SCREWS SHOULD BE USED INSTEAD OF NAILS ON THE LARGER FRAMES

KINDS OF WOOD SUGAR PINE COMES FIRST, MAHOGANY WHICH IS NOT MUCH MORE EXPENSIVE OFFERS AN EXCEPTIONALLY GOOD MATERIAL, THEN THERE IS C. SELECT WHITE PINE, BUCKEYE, SPRUCE, BOXWOOD *and* REDWOOD *and* HEMLOCK FOR CONSTRUCTION *of* LARGER FRAMES.

FRAME MATERIAL CHART
SHOWING PROPORTIONATE SIZES *in* WIDTH *and* THICKNESS ACCORDING *to* LENGTH

INSIDE DIMENTIONS

SMALL FRAMES UP TO 15" x 15"
USE 1/4" x 5/8" OR 1" x 1"

UP TO 24" x 24" FRAMES USE 1 3/4" x 3/4" OR 1 1/2" x 1 1/2"

FRAMES UP TO 32" 2" x 1 1/4"

FRAMES UP TO 48" 2 1/2" x 1 1/2"

AROUND 72" 3 1/2" x 1 1/2"

AROUND 144" 2" x 4"

LONGER LENGTHS 3" x 6"

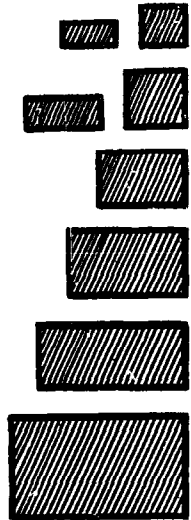

CORRUGATED FASTENERS



PLAIN EDGE IN VARIOUS SIZES
SAW EDGE

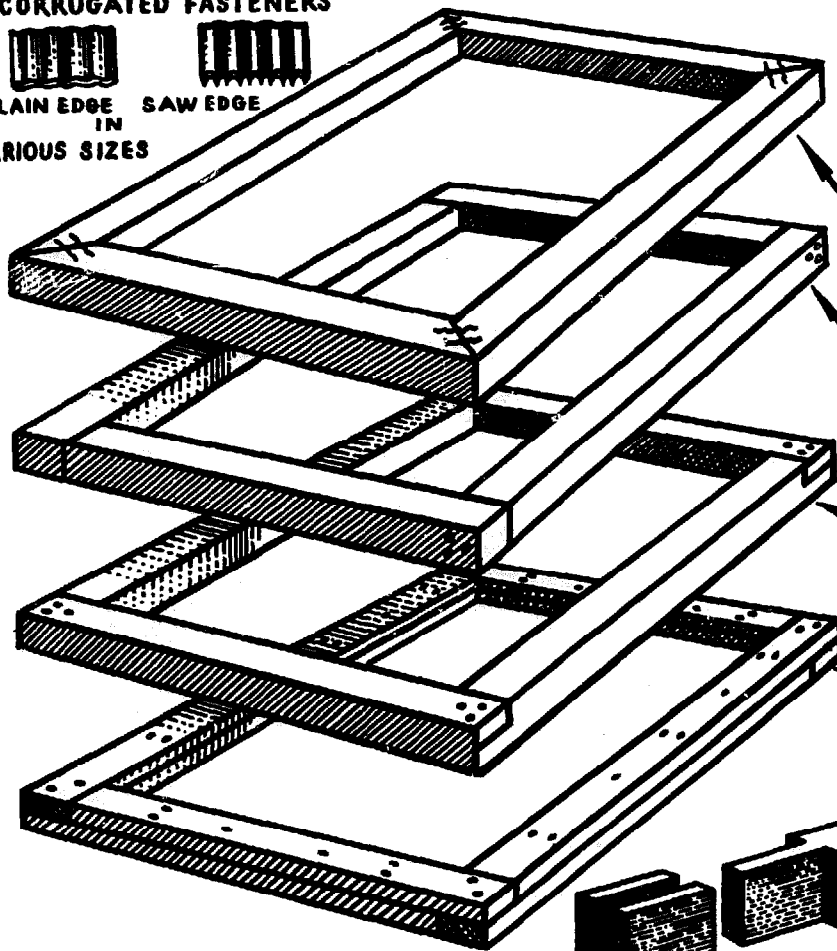

FRAME JOINTS

THE ONE MOST COMMONLY USED, BECAUSE IT IS THE QUICKEST AND SIMPLEST TO MAKE IS THE MITERED JOINT, FASTENED TOGETHER ON BOTH SIDES WITH CORRUGATED FASTENERS.

THE SQUARE JOINT USING WOOD SCREWS TO FASTEN.

THE END HALF LAP JOINT.

A SIMPLE END HALF LAP JOINT CAN BE MADE WITHOUT MILLING BY USING DOUBLE PIECES, IN THIS FASHION.

FOR THOSE HAVING ACCESS TO POWER CUTTING EQUIPMENT THESE TWO TYPES OF JOINTS MAKE EXCELLENT ONES.

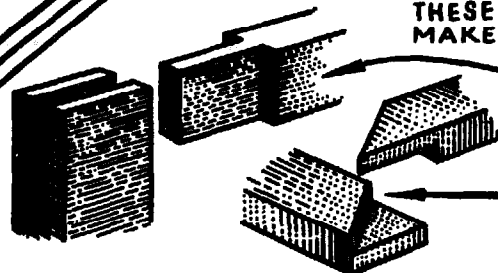

The BRIDAL JOINT.

The MITERED HALF LAP.

Making The STENCIL SCREEN FRAME ADVANCED PLATE

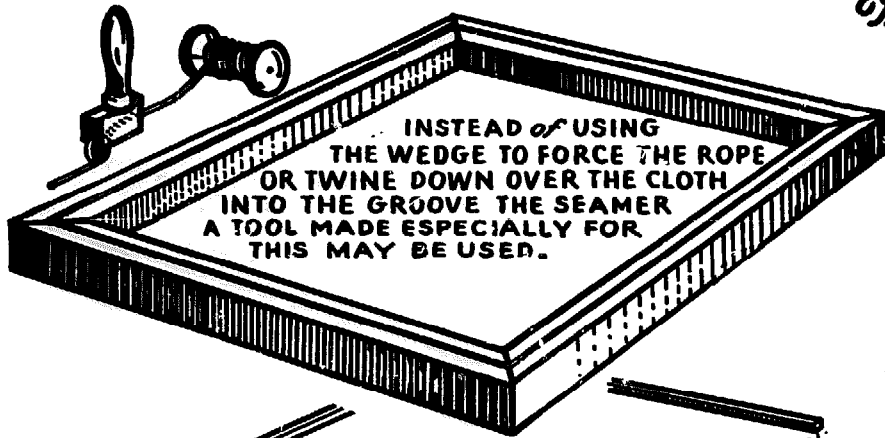

INSTEAD OF USING THE WEDGE TO FORCE THE ROPE OR TWINE DOWN OVER THE CLOTH INTO THE GROOVE THE SEAMER A TOOL MADE ESPECIALLY FOR THIS MAY BE USED.

The GROOVED FRAME

THE STENCIL CLOTH IS ATTACHED BY FORCING FIBER or WAXED TWINE DOWN INTO THE GROOVE OVER THE CLOTH WITH A SEAMER or WEDGE

THE 3/32" GROOVE CAN BE MADE WITH A ROUTER OR WITH A TABLE SAW. PRE-SIZED GROOVED FRAME STOCK CAN ALSO BE PURCHASED FROM A SCREEN PRINTING SUPPLIER.

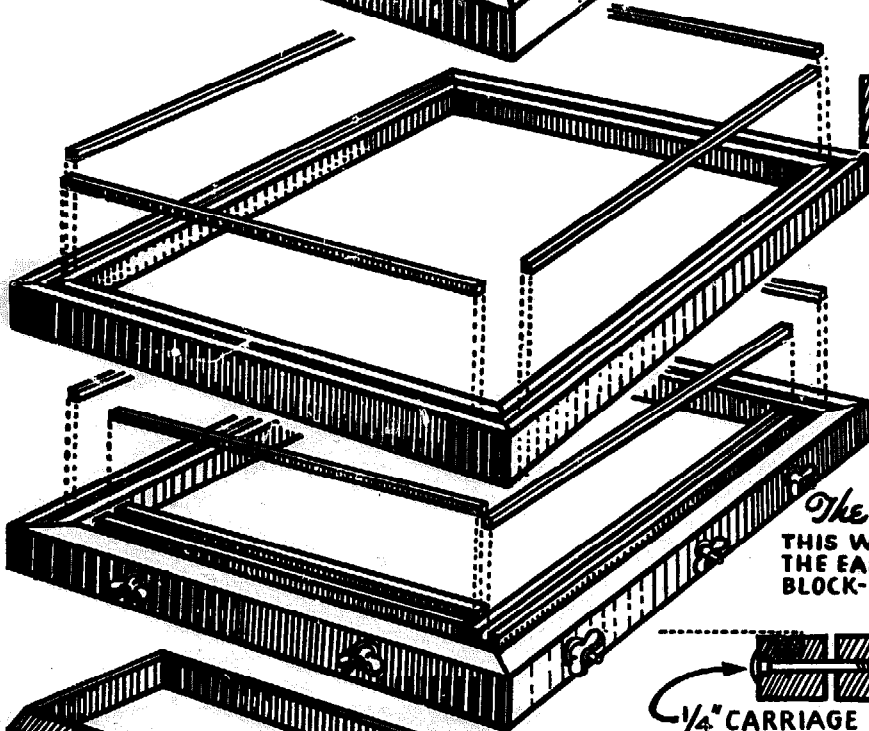

The GROOVE and CLEAT FRAME

LUMBER PREPARED at the MILL. GROOVE 1/2" x 1/2" THE CLOTH IS FIRST STRETCHED OVER FRAME and is HELD in POSITION WITH SMALL BRADS AROUND THE OUTSIDE OF THE GROOVE, THE CLEATS ARE THEN FORCED DOWN INTO THE GROOVES OVER THE CLOTH AFTER WHICH THE BRADS ARE REMOVED and THE CLOTH TRIMMED. DOWEL STICKS MAY BE USED INSTEAD OF SQUARE CLEATS

The DOUBLE FLOATING BAR FRAME

THIS WAS THE TYPE OF FRAME USED BY THE EARLY SCREEN PRINTERS USING THE BLOCK-OUT SYSTEM of PLURALITY COLOR WORK, IF ONE COLOR WAS OUT OF REGISTER WITH THE OTHER THE BARS WERE DRAWN UP or LOOSENED A TRIFLE to SUIT.



1/4" CARRIAGE BOLT

BY CLEANING OUT THE BLOCKING-OUT MEDIUM SCREENS WERE USED OVER and OVER AGAIN.

THERE IS NO NEED TO USE MORE THAN TWO BARS EVEN on LARGE FRAMES.

SQUEEGEE



1/16" METAL STRIPS NAILED TO INSIDE OF WOOD

END PIECES OF WOOD

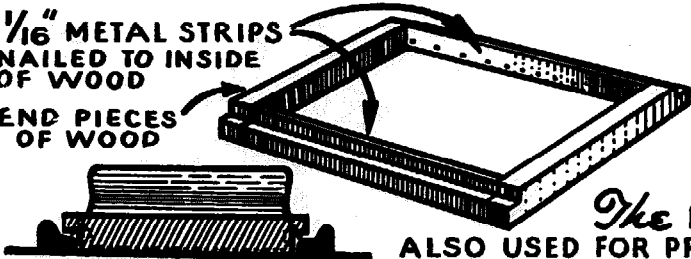

The OUTSIDE BEVEL FRAME

FOR PRINTING ON SURFACES where the DESIGN or LETTERING COMES EXTREMELY CLOSE TO the INSIDE OF the FRAME or IN BETWEEN A HALF-ROUND MOULDING as on SOME PANEL TRUCK BODIES - STENCIL CLOTH is STAPLED UPON the BEVEL

The METAL STRIP FRAME

ALSO USED FOR PRINTING CLOSE TO FRAME and IN BETWEEN CLOSE PLACES.

FABRIC STRETCHING PRINTING FRAME

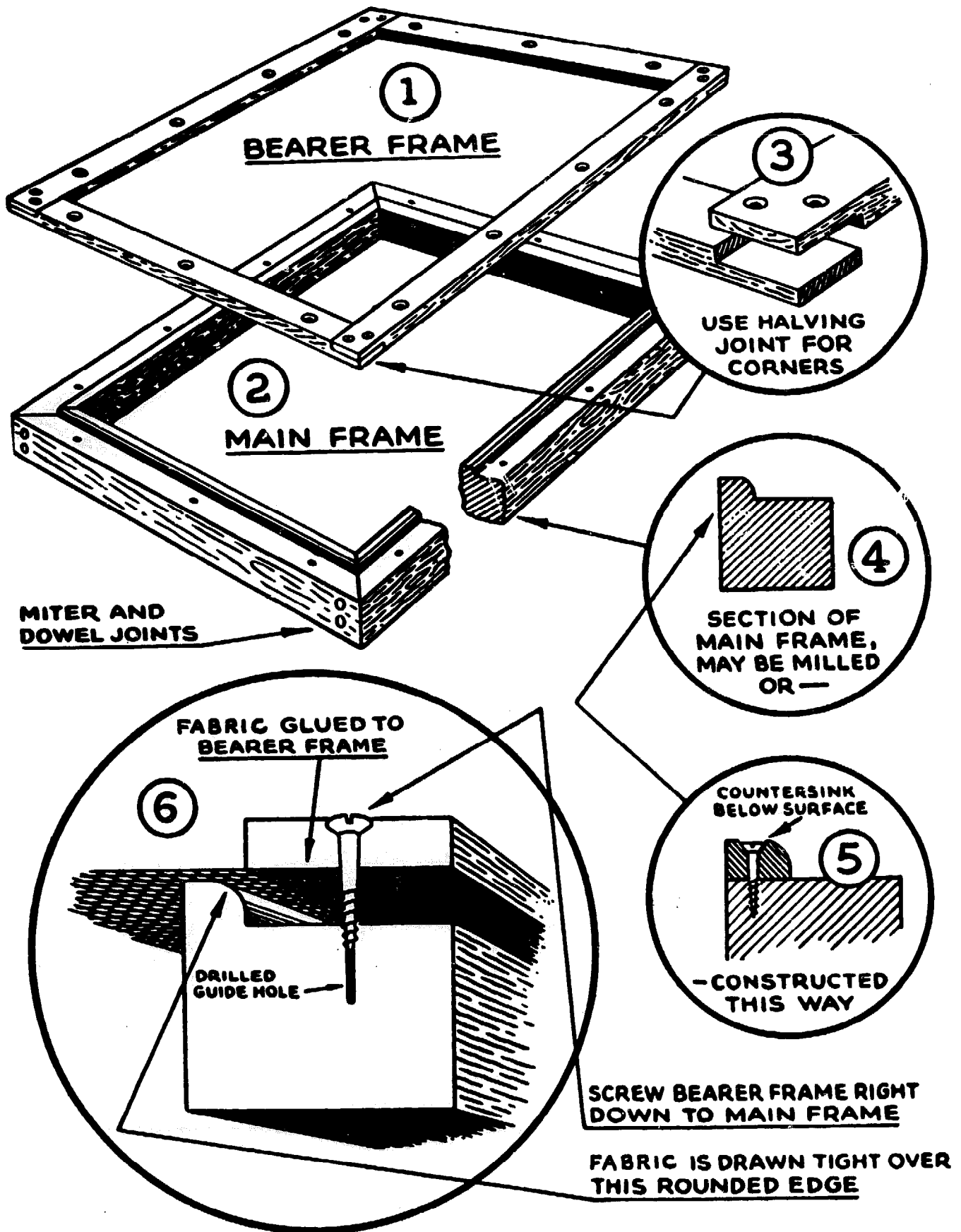

STENCIL SCREEN MESH MATERIALS

ENLARGED DRAWINGS SHOWING DIFFERENCES BETWEEN SILK, MULTIFILAMENT AND MONOFILAMENT FABRICS

Complete specifications on all fabrics are available from your
screen printing supplier.

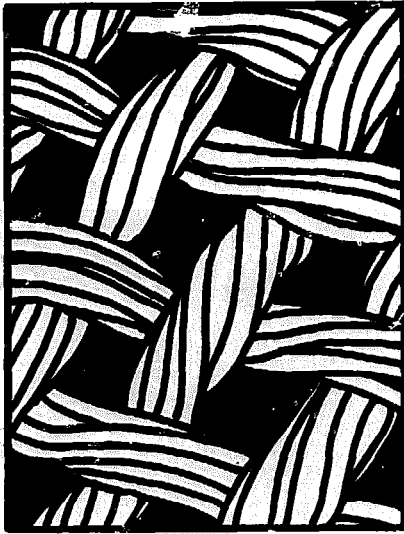

NATURAL SILK THREAD

FABRICS WOVEN FROM NATURAL SILK THREADS, THOUGH STILL AVAILABLE,
ARE BEING RAPIDLY REPLACED BY MULTIFILAMENT POLYESTERS,
MONOFILAMENT POLYESTERS *and* MONOFILAMENT NYLONS.

ALL TYPES OF STENCILS CAN BE USED WITH SILK, WITH THE
EXCEPTION *of* DIRECT *and* DIRECT/INDIRECT STENCILS,
WHICH ARE NOT RECOMMENDED FOR USE *with* NATURAL
SILK.

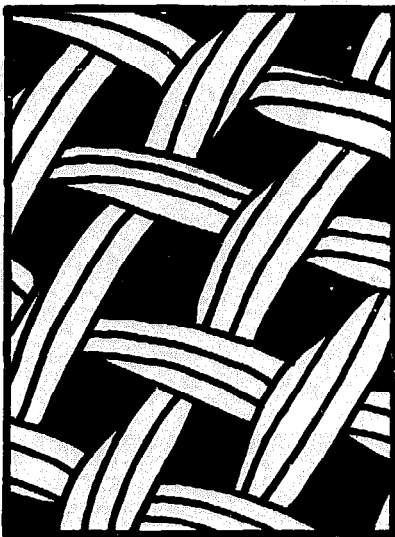

MULTIFILAMENT THREAD

MULTIFILAMENT POLYESTER IS A DIRECT REPLACEMENT FOR SILK
and IS IDENTIFIED BY THE SAME MESH COUNT NUMBERS, *ie.*, 6XX,
8XX, 10XX, 12XX, 14XX, 16XX, 18XX, 20XX *and* 25XX.
WIDTHS ARE 40", 50", 60", 66", 80" *and* 90".

ALL METHODS OF STENCIL SYSTEMS CAN BE USED *with* MULTI-
FILAMENT POLYESTER, *ie.*, HANDCUT FILMS, PAPER, TUSCHE/
GLUE, BLOCKOUT *and* PHOTOGRAPHIC.

ILLUSTRATIONS FROM PHOTOGRAPHS COURTESY OF TETKO, INC., ELMSFORD, N.Y.

STENCIL SCREEN MESH MATERIALS

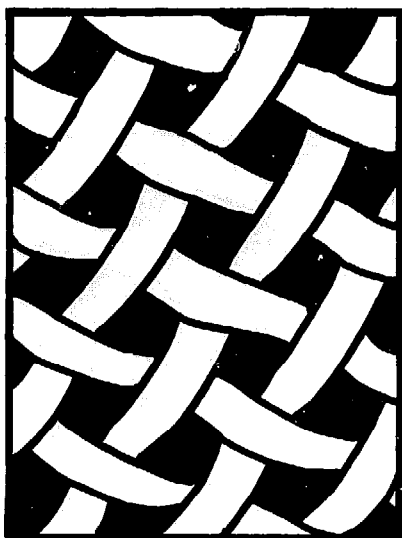

MONOFILAMENT THREAD

MONOFILAMENT FABRICS ARE USED WITH DIRECT *and* DIRECT/INDIRECT PHOTOGRAPHIC EMULSION STENCILS, BUT MAY ALSO BE USED WITH TUSCHE/GLUE OR BLOCKOUT STENCILS. DOES NOT WORK WELL WITH TRANSFER STENCILS UNLESS THE FABRIC HAS BEEN PREPARED ACCORDING TO THE STENCIL MANUFACTURER'S INSTRUCTIONS.

MONOFILAMENT POLYESTER CAN BE USED FOR ALL FLAT SURFACE PRINTING, BUT NOT FOR CONTOUR PRINTING, SUCH AS BOTTLES. FOR CONTOUR PRINTING, THE USE OF MONOFILAMENT NYLON IS RECOMMENDED.

MONOFILAMENT POLYESTER MESH COUNTS ARE AVAILABLE FROM 16T TO 470T. THESE FIGURES INDICATE THE NUMBER OF THREADS PER INCH IN BOTH WIDTH AND LENGTH.

WIDTHS OF MONOFILAMENT POLYESTER ARE 40/42", 51/52", 56/57", 60/61" *and* 79/80". THE STANDARD THREAD IS A "T" THREAD, ALTHOUGH "S" *and* "HD" ARE AVAILABLE. MONOFILAMENT NYLON MESH COUNTS ARE AVAILABLE FROM 16T TO 420T *and* IN WIDTHS EQUAL TO MONOFILAMENT POLYESTER. STANDARD THREAD IS ALSO "T", WITH "S" *and* "HD" AVAILABLE. RECOMMENDED STENCILS FOR MONOFILAMENT NYLON ARE THE SAME AS FOR MONOFILAMENT POLYESTER.

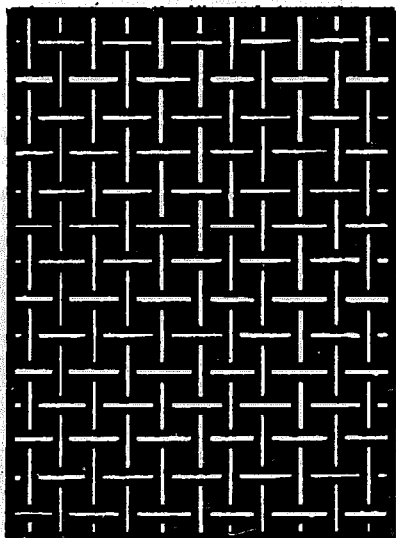

WIRE MESH

WIRE MESH FABRICS ARE AVAILABLE AND ARE MORE COMMONLY USED FOR SCREEN PRINTING OF ELECTRONIC PARTS SUCH AS ETCHED (PRINTED) CIRCUIT RESISTS OR OTHER HIGH TOLERANCE DIMENSIONAL REQUIREMENTS. TYPE 304 OR TYPE 316 STAINLESS STEEL IN A PLAIN WEAVE IS THE STANDARD MATERIAL. AVAILABLE WIDTHS ARE 36", 40" *and* 48". MESH COUNTS RUN FROM 30 x 30 TO 400 x 400. A TWILL WEAVE (NOT ILLUSTRATED) IS ALSO USED AND IS AVAILABLE IN MESH COUNTS OF 270 x 270 TO 635 x 635. THESE NUMBERS DESCRIBE THE NUMBER OF THREADS PER INCH IN WIDTH AND LENGTH. THE MOST SUCCESSFUL STENCIL METHOD FOR STAINLESS STEEL IS DIRECT OR DIRECT/INDIRECT. OTHERS MAY BE USED, BUT TESTS SHOULD BE MADE TO DETERMINE STENCIL COMPATIBILITY.

*METALIZED MONOFILAMENT POLYESTER (NOT ILLUSTRATED) IS A RELATIVELY NEW PRODUCT DEVELOPED TO BRING THE CHARACTERISTICS OF METAL *and* POLYESTER TOGETHER IN A FABRIC FOR CLOSE TOLERANCE PRINTING, PROVIDING EXCELLENT ADHESION OF INDIRECT STENCIL SYSTEMS, RESISTANCE TO ABRASION *and* MANY OTHER QUALITIES WHICH MAKE THE FABRIC UNIQUE, MESH COUNTS AVAILABLE ARE 123 TO 470. WIDTH IS LIMITED TO 40/41".*

METALIZED POLYESTER WILL ACCEPT MOST ALL STENCIL METHODS.

ASK YOUR SCREEN PRINTING SUPPLIER FOR DATA.

SCREEN FINDER AND MESH COUNT

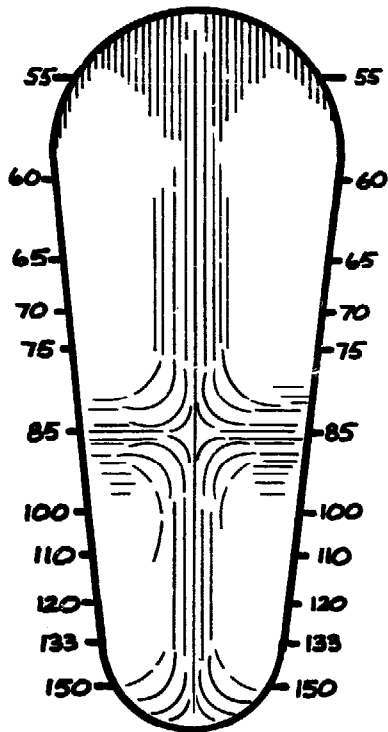

SCREEN FINDER

A SCREEN FINDER GAUGE, WHICH IS PRIMARILY USED TO DETERMINE THE LINE COUNT OF HALFTONE IMAGES, MAKES AN IDEAL MESH DETERMINER FOR MULTIFILAMENT FABRICS.

PLACED AGAINST THE STRETCHED FABRIC AND ROTATED, A MOIRE STAR WILL APPEAR, GIVING A THREAD COUNT, THUS IDENTIFYING THE MESH. OTHER OPTICAL DEVICES ARE AVAILABLE TO DETERMINE THE MESH COUNT ON MONOFILAMENT FABRICS.

FOR DETERMINING MESH COUNT OF THE VARIOUS MESH MATERIALS THE THREAD COUNTER OR MAGNIFYING GLASS IS OF GREAT CONVENIENCE

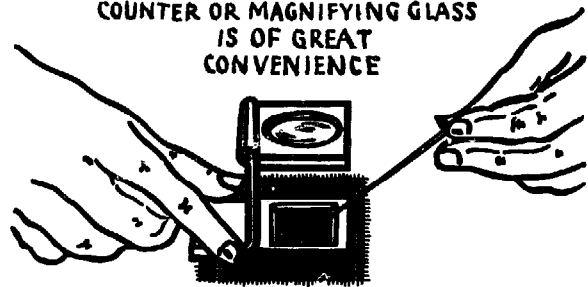

Comparative Meshes for Same Ink Deposit

MONOFILAMENT NYLON	POLYESTER	MULTIFILAMENT POLYESTER	SILK	WIRE MESH
157	110	6xx	6xx	80 x 80
166	139	8xx	8xx	105 x 105
185	157	10xx	10xx	135 x 135
196	200	12xx	12xx	165 x 165
230	225	14xx	14xx	200 x 200
240	245	16xx	16xx	230 x 230
260	260	18xx	18xx	250 x 250
283	280	20xx	20xx	270 x 270
306	300	25xx	25xx	325 x 325

THE ACCEPTED METHOD OF STRETCHING AND STAPLING THE MESH TO THE FRAME

STENCIL SCREEN PRINTING in all that the name implies is derived from the combined use of a STENCIL FORM, a MESH material upon which the stencil is applied, and a simple WOOD FRAME or one of other suitable material upon which the mesh material is attached to form a SCREEN.

The mesh material can be nylon organdy, natural silk, multifilament polyester, monofilament nylon, monofilament polyester, metalized monofilament polyester or stainless steel wire cloth.

THERE are VARIOUS WAYS in which the MESH MATERIALS can be attached to the FRAME, REGARDLESS the IMPORTANT THING IS that it is STRETCHED and FASTENED to the FRAME as UNIFORM and as TAUT as is possible WITHOUT TEARING. The MOST COMMONLY USED METHOD of ATTACHING is with STAPLES and an AUTOMATIC STAPLING DEVICE.

BELOW IS SHOWN THE CORRECT PROCEEDURE TO FOLLOW where staples are used

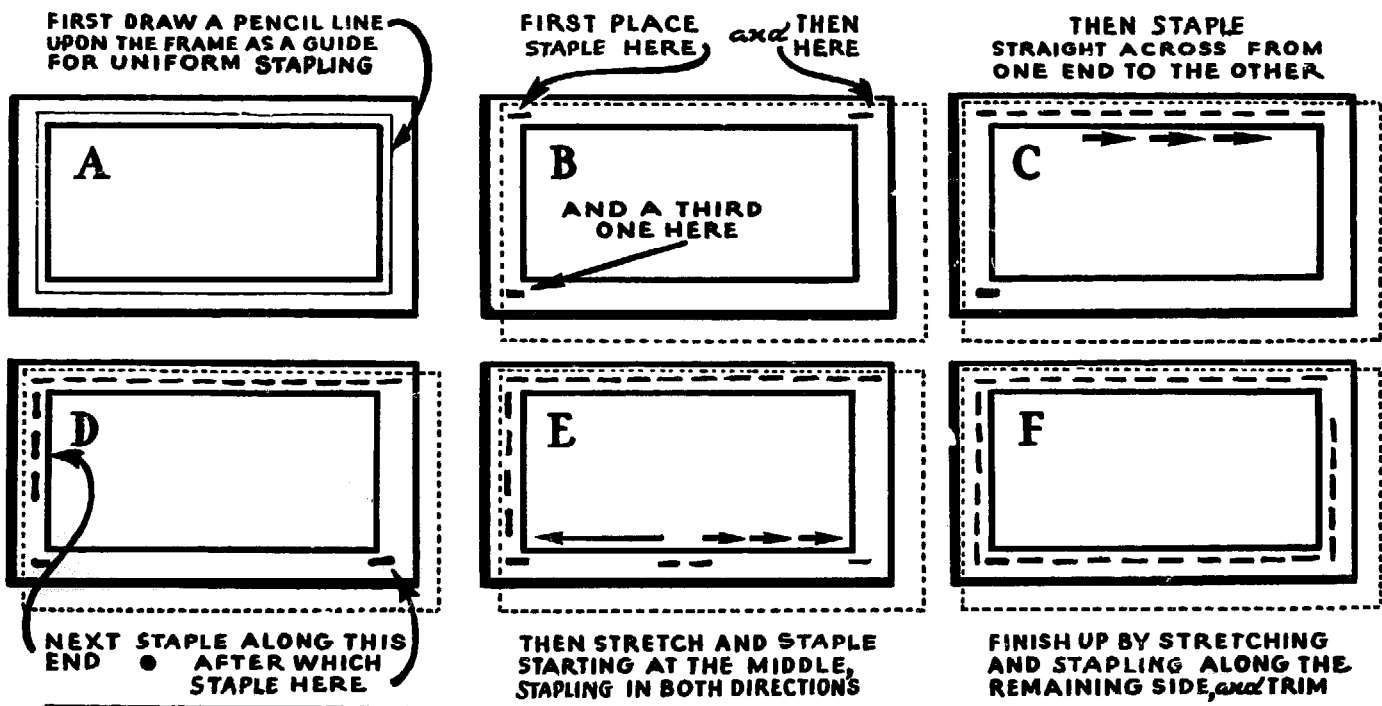

TO ATTACH WIRE CLOTH USE AN AUTO BODY TOOL "THE SEAMER"

IN STRETCHING, THE CLOTH IS FOLDED ON THE EDGE ON SIDES TO BE STRETCHED AND PLACED BETWEEN JAWS OF STRETCHER

LEVERAGE IS MADE ON ON EDGE OF FRAME

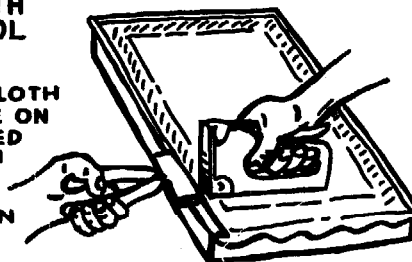

LARGE FRAMES and FASTENING and STRETCHING of FABRIC

STAPLING AND STRETCHING FABRIC ON LARGE FRAMES

WHILE THE SINGLE, DOUBLE OR FULL FLOATING BAR FRAME IS CONSIDERED BEST FOR LARGE OR LONG SCREENS, THESE ARE NOT ALWAYS IMMEDIATELY AVAILABLE. WITH THE FOLLOWING SYSTEM OF STAPLING AND STRETCHING A SMOOTH TAUT JOB MAY BE DONE WITHOUT LEAVING EDGE FRILLS OR LOOSE FABRIC GAPS

WHILE THE SYSTEM SHOWN DIRECTLY BELOW IS MOST SATISFACTORY FOR SMALL SCREEN WORK, IT IS UNSATISFACTORY FOR FASTENING FABRIC TO LARGE FRAMES. THE REASON IS EXPLAINED IN THE LOWER ONE OF THE FOLLOWING DRAWINGS

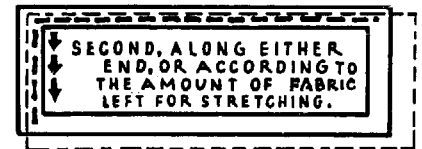
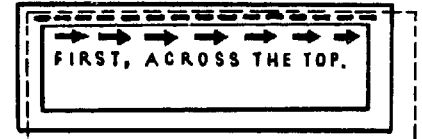
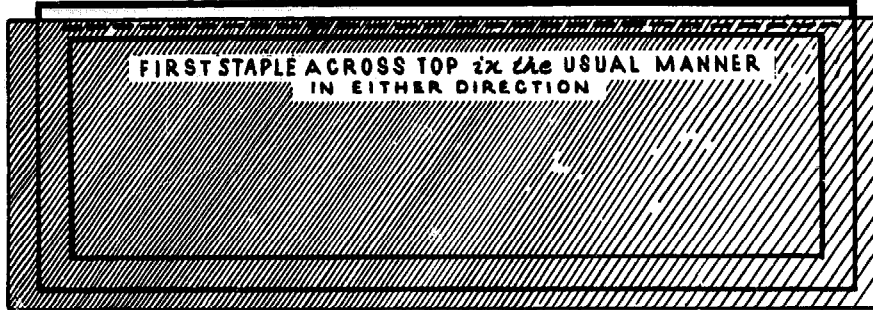

ASSUMING THAT THIS FRAME IS APPROX. 30 IN. BY 10 FT.

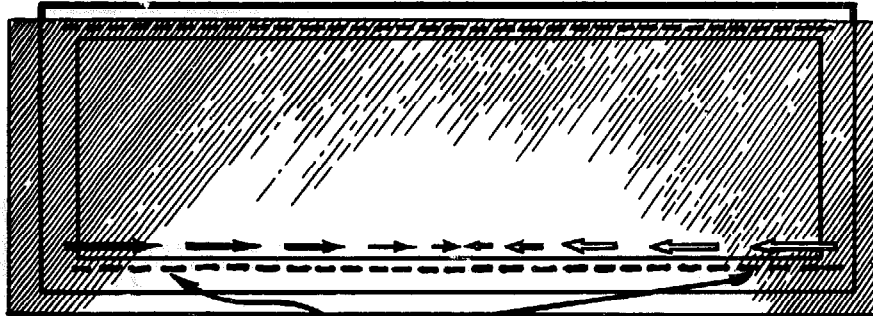

GET YOUR HARDEST PULL ALONG ABOUT FROM 12 TO 15 INCHES FROM THE INSIDE END OF FRAME WORKING TOWARDS THE CENTER. FROM THE POINT OF THE HARDEST PULL THE TENSION IS GRADUALLY LESSENED AS THE CENTER IS BEING REACHED. THIS IS REPEATED LIKEWISE BEGINNING AT THE OPPOSITE END. IN STAPLING THE FREE ENDS, BOTH ARE STRETCHED AS TAUT AS IS HUMANLY POSSIBLE WITHOUT TEARING THE FABRIC.

LOOSE FABRIC GAPS THIS IS WHAT HAPPENS WHEN THE ABOVE METHOD OF STRETCHING AND STAPLING IS USED ON LARGE FRAMES.

UNTIL YOU HAVE MASTERED THE RIGHT DEGREE OF PULL ALONG THE BOTTOM, YOUR FIRST ATTEMPTS MAY NOT BE COMPLETELY SATISFACTORY.

THE TRIPPLICATE FLOATING BAR FRAME For EXCEPTIONALLY LARGE PRINTING

IN PLANTS SPECIALIZING IN LARGE PRINTING ONE WILL GENERALLY FIND WOOD WORKING EQUIPMENT FOR PRODUCING THESE TYPES OF FRAMES.

IN SOME INSTANCES THE FULL FOUR FLOATING BAR IS PREFERRED, HOWEVER WITH THE USE OF THE TRIPLE BAR THE RESULTS ARE JUST AS GOOD, THUS ELIMINATING THE WORK REQUIRED FOR MAKING THE ADDITIONAL BAR.

FASTENING FABRIC

SPREAD OUT OVER FRAME AND THUMB TACK. THEN FORCE CLEATS DOWN ON THIS SIDE. THEN ALONG OPPOSITE SIDE. THEN ENDS. REMOVE THUMB TACKS. THEN TRIM. DRAW UP BOLTS TO TIGHTEN.

THUMB TACKS

ASSUMING THAT THIS FRAME IS 46 INCHES WIDE BY 72 INCHES LONG, INSIDE FROM BAR TO BAR AND TO FRAME, USING 60 INCH WIDTH FABRIC

IN THIS INSTANCE THE FRAME PROPER MAY BE CONSTRUCTED OF 3" X 6" MATERIAL WHILE THE BARS CAN BE MADE OF 3" X 3".

CARRIAGE BOLTS WITH WING NUTS

ALL GROOVES MAY BE EITHER OF 1/2" OR 3/4" SQUARE WITH THE CLEATS MADE A TRIFLE NARROWER

HEAVY LAG-SCREWS OR 1/2" DOWEL PINS AND GLUE MAY BE USED FOR JOINING, USING CORNER IRONS FOR BRACING

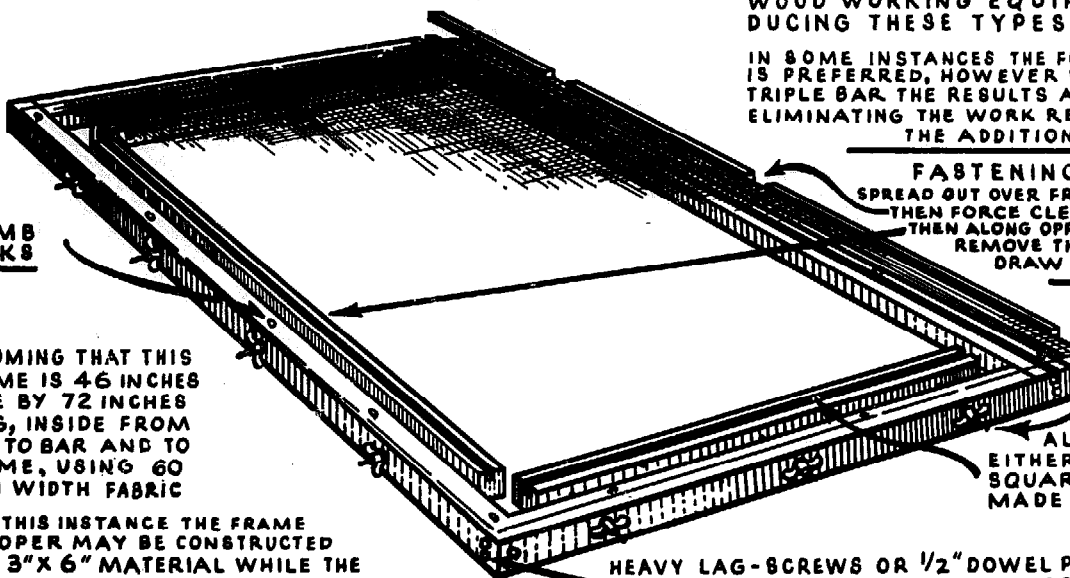

ANOTHER PLATE ON STENCIL SCREEN FRAME WORK

A SPEEDY *and* ECONOMICAL MEANS for FASTENING FABRIC to GROUPS of SMALL FRAMES ALL OF ONE SIZE or of VARIOUS SIZES without STAPLES

A LARGE FRAME IS FIRST MADE, WITH THE FABRIC STAPLED IN THE USUAL FASHION.

THE LARGE SCREEN IS THEN LAID, CLOTH SIDE DOWN UPON A FLAT SURFACE, PREFERABLY PLATE GLASS, WITH WAXED PAPER PLACED BETWEEN — NOW WITH CABINET MAKE'S GLUE, GLUE THE SMALL FRAMES TO THE CLOTH OF THE LARGE FRAME AND THEN PLACE A WEIGHT OVER THE ENTIRE GROUP — WHEN DRY, CUT APART.

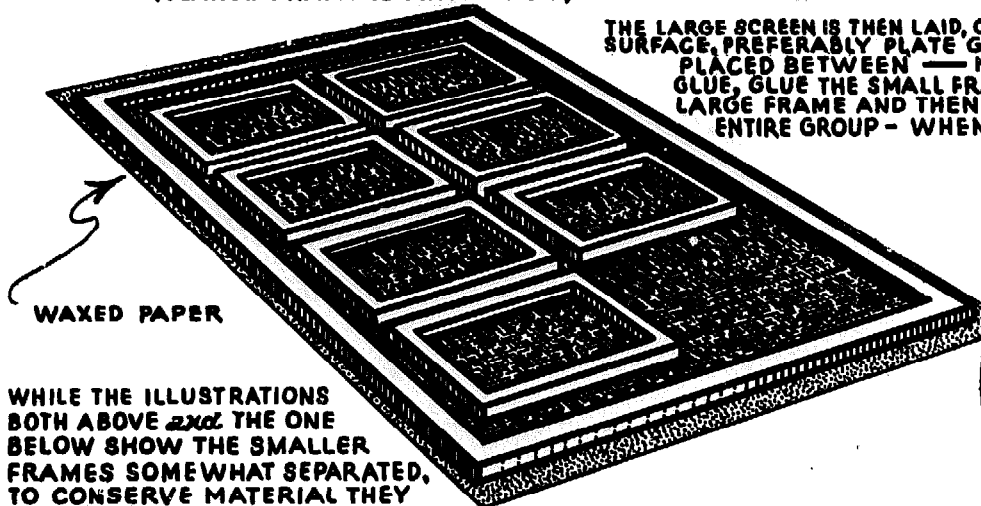

WHILE THE ILLUSTRATIONS BOTH ABOVE *and* THE ONE BELOW SHOW THE SMALLER FRAMES SOMEWHAT SEPARATED, TO CONSERVE MATERIAL THEY MAY BE BUTTED AGAINST EACH OTHER

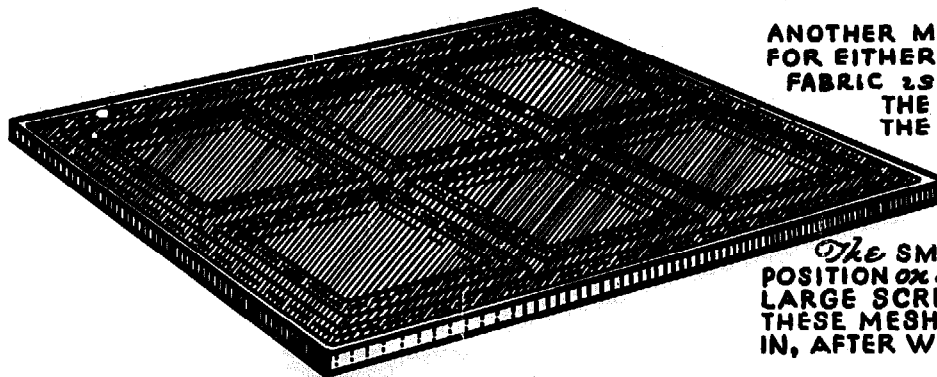
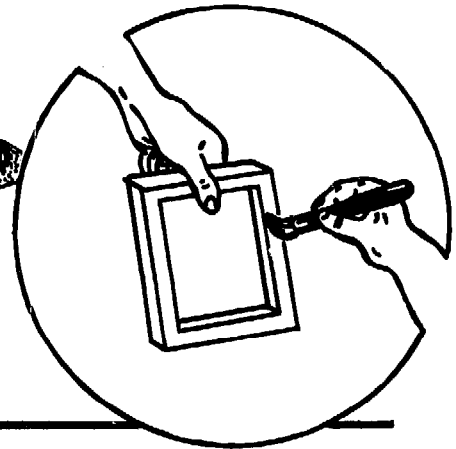

ANOTHER METHOD QUITE OFTEN USED FOR EITHER WIRE CLOTH OR SCREEN FABRIC IS TO STRETCH AND STAPLE THE MATERIAL TO THE MASTER FRAME

The SMALLER FRAMES ARE PLACED in POSITION on a FLAT SOLID SURFACE the LARGE SCREEN is PLACED DIRECTLY OVER THESE MESH SIDE UP, THESE ARE THEN STAPLED IN, AFTER WHICH THEY ARE CUT APART.

STAPLING *and* STRETCHING FABRIC for PHOTOGRAPHIC TRANSFER FILM SCREENS

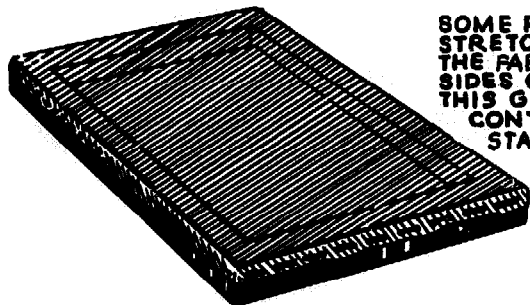

SOME PROCESSORS STRETCH *and* STAPLE THE FABRIC TO THE SIDES OF THE FRAME. THIS GIVES PERFECT CONTACT without STAPLE INTERFERENCE

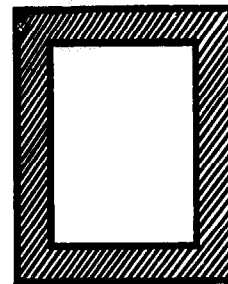

FRAMES FOR SMALL WORK CAN BE MADE BY CUTTING OUT the CENTER SECTION of HEAVY WALL-BOARD, PLYWOOD or PRESS-WOOD with a JIG SAW or CUTAWL.

WHERE WALLBOARD or PRESSWOOD is USED the CLOTH IS FASTENED with GLUE,

IF WALLBOARD is used HINGES are FASTENED in this MANNER by NAILING WALLBOARD to STRIP of WOOD

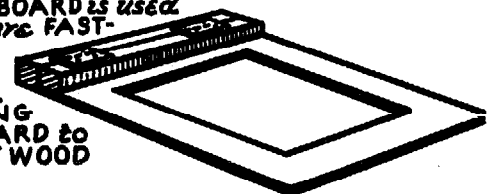

STENCIL SCREEN SEALING

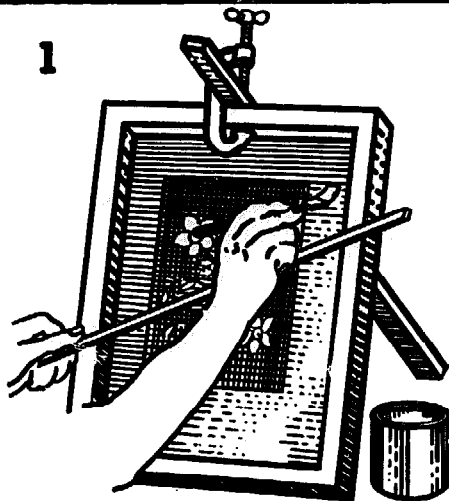

1
AFTER THE FILM, WHETHER PHOTOGRAPHIC OR HAND CUT HAS BEEN MOUNTED TO THE FABRIC, THE OPEN SPACE AROUND THE FILM MUST BE FILLED.

CLEAR OR COLORED BLOCKOUT MAY BE USED
PREFERABLY THE CLEAR OR LIGHT COLORED.

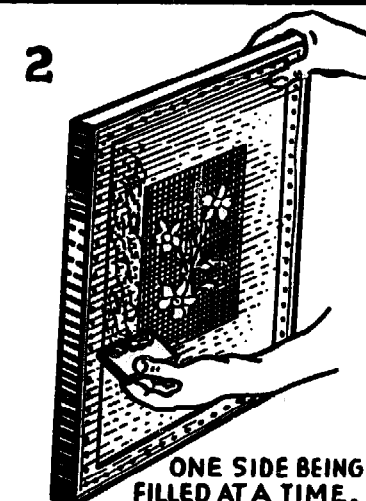

2
ONE SIDE BEING FILLED AT A TIME, THE SCREEN IS IMMEDIATELY TURNED AROUND AND WITH A PIECE OF HEAVY CARDBOARD DRAWN UPWARDS THE SURPLUS BLOCKOUT THAT RUNS THROUGH AFTER FILLING WITH BRUSH IS EVENED OFF. EACH OF THE FOUR SIDES IS DONE ACCORDINGLY

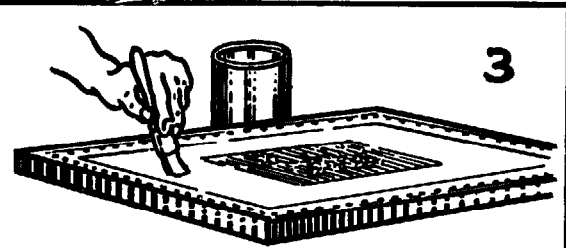

3
TO DOUBLE SEAL AFTER SCREEN HAS BEEN FILLED WITH BRUSH AND CARDBOARD, SCREEN WITH FABRIC SIDE UP IS LAID FLAT AND IS PAINTED AGAIN WITH THE SAME BLOCKOUT OVER THE SAME SPACE INCLUDING STAPLES AND FRAME.

4
THE SCREEN IS THEN TAPED IF NECESSARY OVERLAPPING BOTH UPON THE SIDES OF THE FRAME AND FABRIC ON THE INSIDE TO PREVENT LEAKAGE IN PRINTING,

PERFECT SEAL FOR SMALL SCREENS without the use of BLOCKOUT or TAPE WHEN USING THE REGULAR STENCIL CUTTING FILM

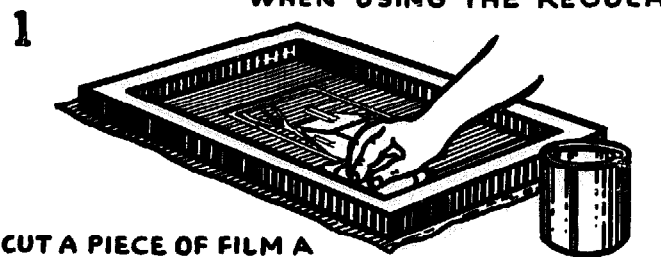

1
CUT A PIECE OF FILM A TRIFLE LARGER THAN THE SCREEN, CUT DESIGN AND MOUNT IN THE USUAL WAY, APPLYING SOLVENT TO FILM COMPLETELY INSIDE RIGHT UP TO FRAME

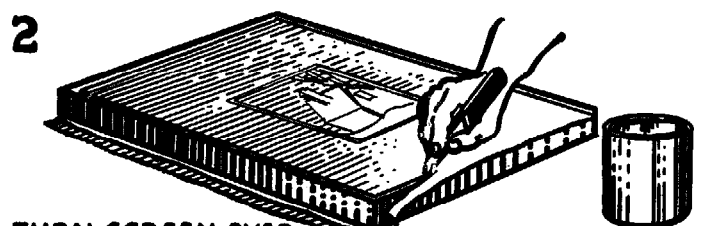

2
TURN SCREEN OVER AND TRIM OFF FILM ABOUT 1/4" IN FROM EDGE OF FRAME

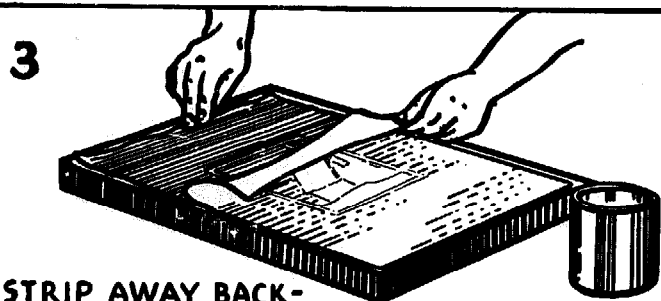

3
STRIP AWAY BACK-SHEET IN THE USUAL MANNER, THIS LEAVES A LOOSE EDGE OF FILM ALONG THE THE TOP OF FRAME

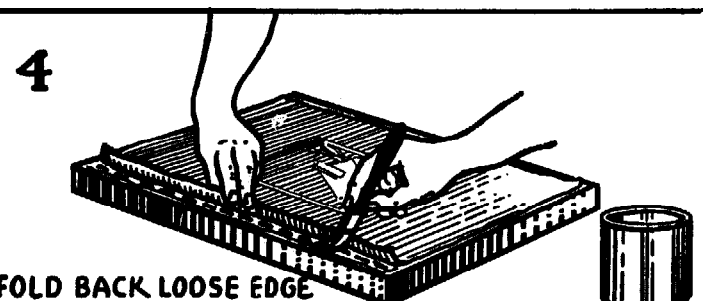

4
FOLD BACK LOOSE EDGE OF FILM as SHOWN ABOVE, THEN PAINT FRAME WITH SOLVENT, BRING LOOSE FILM BACK DOWN ON FRAME AND SMOOTH OUT WITH SAME BRUSH. REPEAT LIKEWISE ON OTHER THREE SIDES

The STENCIL SCREEN SQUEEGEE

THIS IS ONE OF THE MOST IMPORTANT PIECES OF EQUIPMENT USED IN SCREEN PRINTING THE ASSEMBLY *and* CARE IS OF UTMOST IMPORTANCE IF GOOD CLEAN SHARP PRINTING *is* MAINTAINED.

The HANDLE CAN BE MADE IN VARIOUS WAYS AND SHAPES OF HARD, SOFT WOOD, PLYWOOD OR METAL SHAPED HANDLES REQUIRE SPECIAL CUTTING KNIVES AND MILLWORK FOR SHAPING.

The BLADE VARIOUS TYPES OF RUBBER OR URETHANE PLASTIC MAY BE USED. THE STANDARD PROFILE OF EITHER IS 3/8" THICK BY 2" WIDE. OTHER WIDTHS AND THICKNESSES ARE AVAILABLE. LENGTHS WILL VARY FROM INCHES UP TO 10 FEET. *The* BEST BLADES ARE THOSE MADE FROM URETHANE PLASTIC. RUBBER AND PLASTIC ARE AVAILABLE IN VARIOUS DUROMETERS (DEGREE OF SOFTNESS/HARDNESS) CONSIDERED SOFT, MEDIUM OR HARD. SOFT FOR HEAVY INK DEPOSITS AND HARD FOR THIN INK DEPOSITS. THE MEDIUM IS MOST GENERALLY USED.

SHAPED WOOD HANDLES

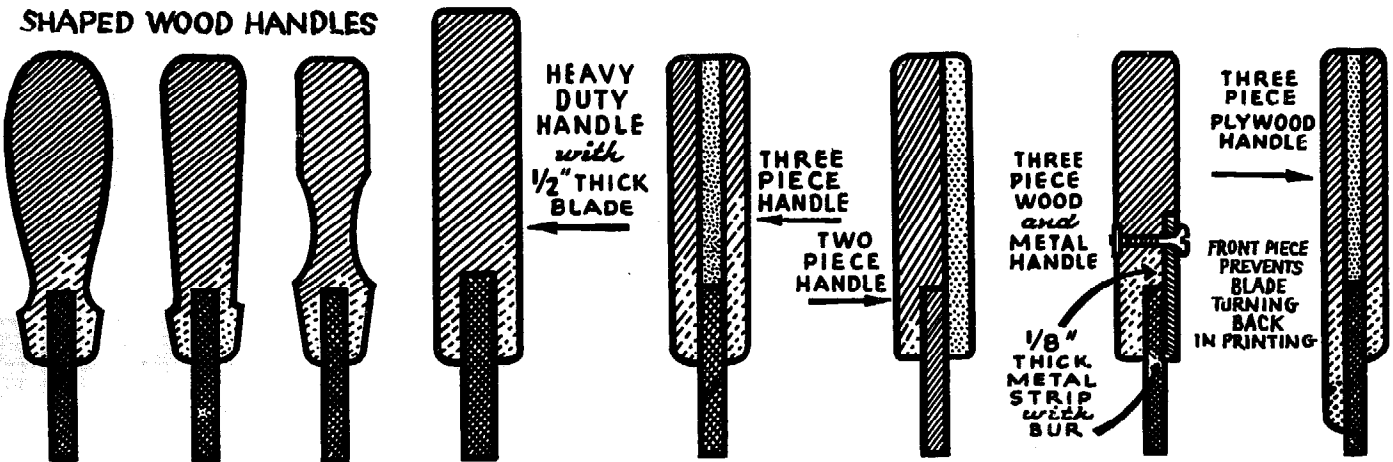

The CENTERED SINGLE HANDLE FOR SMALL *and* MEDIUM PRINTING

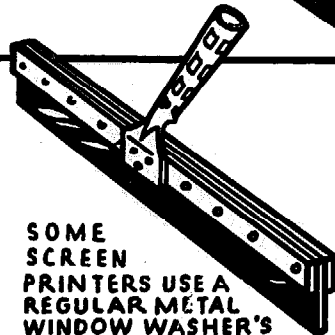
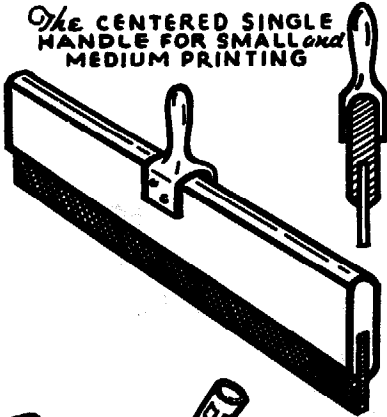

SOME SCREEN PRINTERS USE A REGULAR METAL WINDOW WASHER'S SQUEEGEE HANDLE

REPLACING THE THIN BLADES *with* REGULAR PRINTING BLADES

The CURVED SQUEEGEE FOR PRINTING CURVED OBJECTS

FIRST, A PIECE OF PLYWOOD IS PLACED AGAINST ONE END OF THE OBJECT AND A LINE IS DRAWN

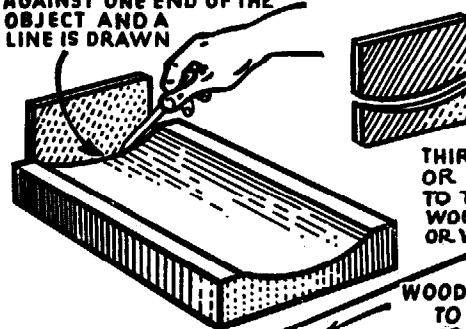

SECOND, THE WOOD IS CUT APART ON *the* LINE WITH A JIG-SAW

THIRD, A PIECE OF RUBBER OR PLASTIC IS CEMENTED TO THE LARGER PIECE OF WOOD WITH WOOD TO RUBBER OR WOOD TO PLASTIC CEMENT.

THE SHORTER PIECE OF WOOD IS THEN CLAMPED DOWN TO HOLD THE RUBBER OR PLASTIC IN PLACE WHILE CEMENT IS SETTING.



COMPLETED SQUEEGEE.

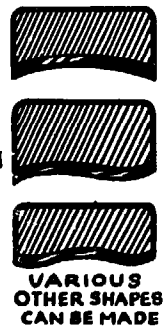

VARIOUS OTHER SHAPES CAN BE MADE

The WOOD GRAIN SQUEEGEE

BY PLACING A SERIES OF NICKS OR CUTS IN THE BLADE *and* PRINTING THROUGH A BLANK SCREEN WITH TRANSPARENT COLORS AN EXCELLENT WOOD GRAIN EFFECT CAN BE PRODUCED.

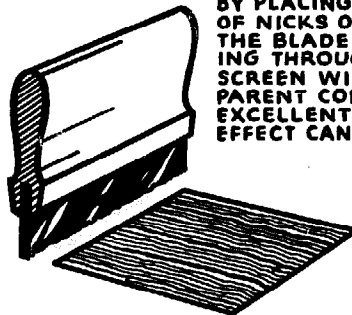

SUPPLY DEALERS FURNISH 3/8" x 2" RUBBER OR URETHANE PLASTIC STRIPS WHICH REQUIRE - NO CUTTING - EXCEPT FOR LENGTHS.

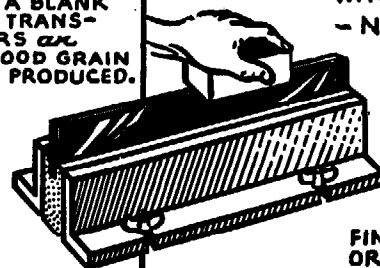

There are SEVERAL WAYS TO RESHARPEN USING

FINE GARNET CLOTH OR SAND PAPER.

SCREEN REGISTRATION

PLATE ONE



1
AS AN EXAMPLE THIS THREE COLOR Master Sketch, IN RED, YELLOW, GREEN & FULL COLOR, LEAD PENCIL OR THE PEN AND INK MUST BE IN EXACT SIZE OF THE STOCK WHICH IS TO BE PRINTED

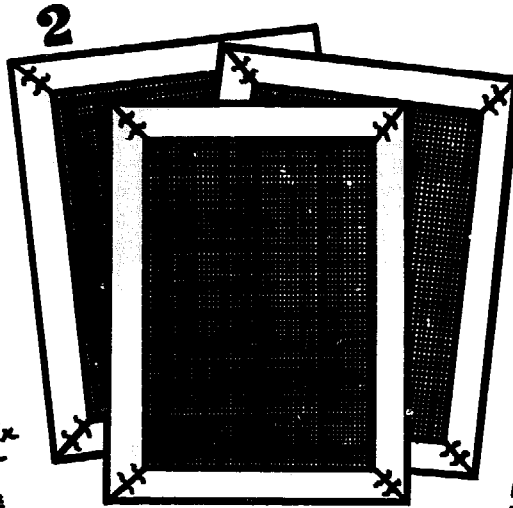

2
NOW MAKE THREE FRAMES SAME SIZE AND ATTACH FABRIC THIS GIVES US A SCREEN FOR EACH COLOR

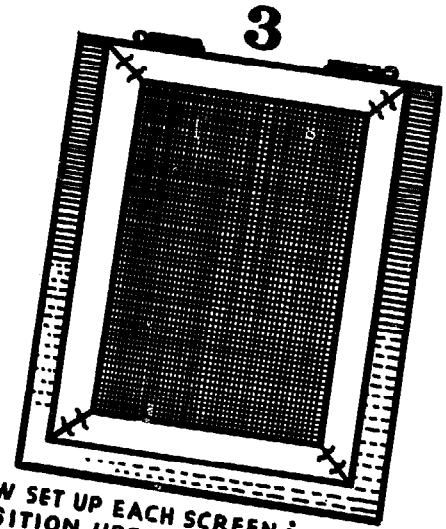

3
NOW SET UP EACH SCREEN IN IDENTICAL POSITION UPON THE PRINTING BASE USING PIN HINGES TO FASTEN



4
NOW CUT THREE FILM STENCILS ONE FOR EACH COLOR DIRECTLY FROM MASTER SKETCH. IF NOT USED IMMEDIATELY THEY MAY BE PLACED BETWEEN GLASS FOR PROTECTION. SHELLACKED OR LACQUERED VELLUM PAPER MAY ALSO BE USED.

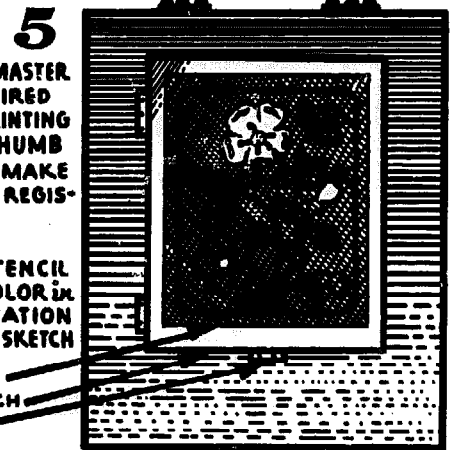

5
NOW FASTEN MASTER SKETCH IN DESIRED POSITION ON PRINTING BASE WITH THUMB TACKS AND MAKE SECURE THE REGISTER GUIDES

PLACE CUT STENCIL FOR FIRST COLOR IN CORRECT LOCATION UPON MASTER SKETCH

CUT STENCIL MASTER SKETCH GUIDES

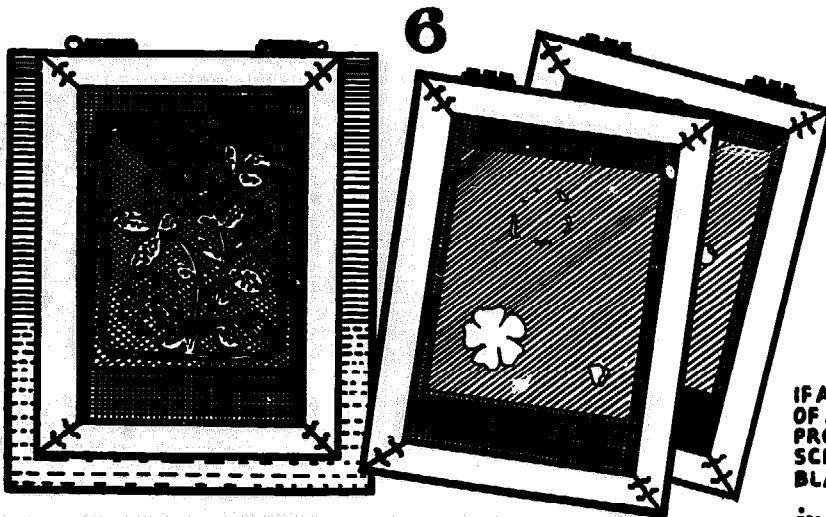

6
NOW FASTEN ONE OF THE BLANK SCREENS TO THE PRINTING BASE WITH THE HINGE PINS AND BRING SCREEN DOWN TO REST UPON THE POSITIONED CUT FILM STENCIL AND SPOT WITH FILM SOLVENT ON INSIDE OF SCREEN. DETACH SCREEN CONTAINING THE PARTIALLY ATTACHED FILM FROM THE PRINTING BASE AND FINISH SOLVENT APPLICATION IN THE USUAL FASHION. THIS SAME PROCEDURE IS CARRIED ON FOR THE OTHER SCREENS.

TO COMPLETE, THE SCREENS ARE SEALED AND TAPED AND ARE READY TO PRINT.

IF A SINGLE SCREEN IS TO BE USED FOR THE PRINTING OF ALL COLORS INSTEAD OF A PLURALITY SET THE PROCEDURE IS THE SAME EXCEPTING THAT THE SCREEN IS CLEANED THOROUGHLY OR MADE BLANK AGAIN AFTER EACH PRINTING RUN. MASTER SKETCH IS REMOVED FROM BASE IN EITHER CASE PRIOR TO PRINTING.

SCREEN REGISTRATION

PLATE
TWO

TO REGISTER TWO OR MORE COLORS ON ROUND, OVAL OR SIMILAR CUT-OUT SHAPES, WHETHER OF PAPER, CARDBOARD, CLOTH, PLASTIC, GLASS, WOOD OR METAL THE ACETATE REGISTER FLAP IS A PRACTICAL AND CONVENIENT SYSTEM



1 TAKING AS AN EXAMPLE THIS THREE COLOR MASTER SKETCH, WHICH CAN BE IN FULL COLOR, PENCIL OR IN PEN AND INK.

IT MUST HOWEVER BE OF SAME SIZE AND SHAPE AS STOCK TO BE PRINTED.

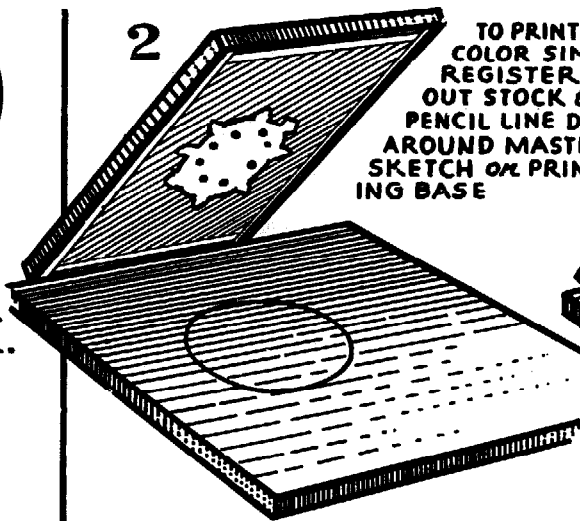

2 TO PRINT FIRST COLOR SIMPLY REGISTER CUT-OUT STOCK TO A PENCIL LINE DRAWN AROUND MASTER SKETCH ON PRINTING BASE

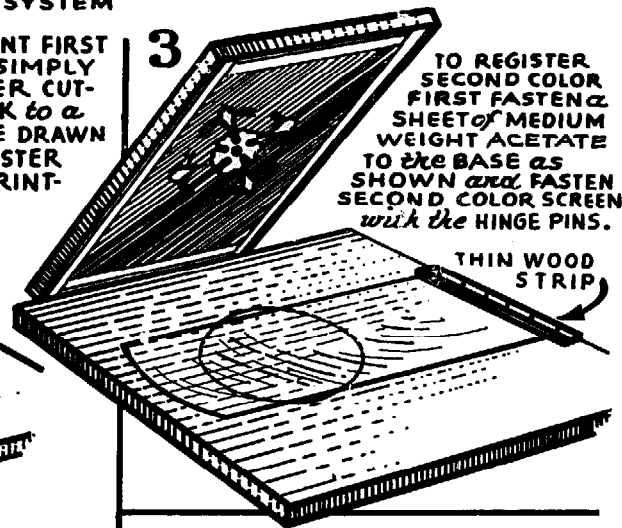

3 TO REGISTER SECOND COLOR FIRST FASTEN A SHEET OF MEDIUM WEIGHT ACETATE TO THE BASE AS SHOWN AND FASTEN SECOND COLOR SCREEN WITH THE HINGE PINS.

THIN WOOD STRIP

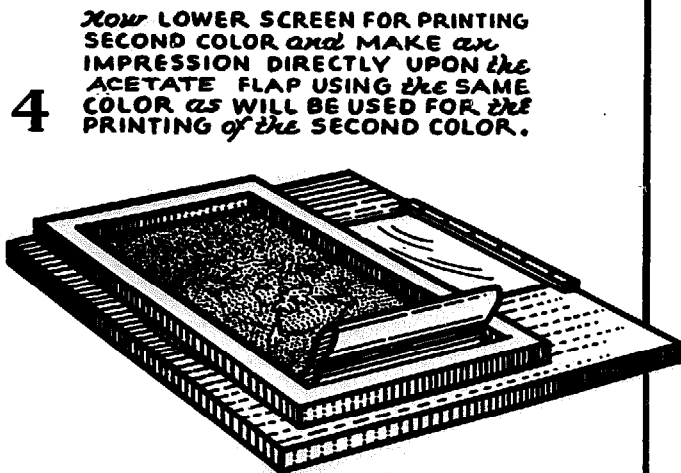

4

NOW LOWER SCREEN FOR PRINTING SECOND COLOR AND MAKE AN IMPRESSION DIRECTLY UPON THE ACETATE FLAP USING THE SAME COLOR AS WILL BE USED FOR THE PRINTING OF THE SECOND COLOR.

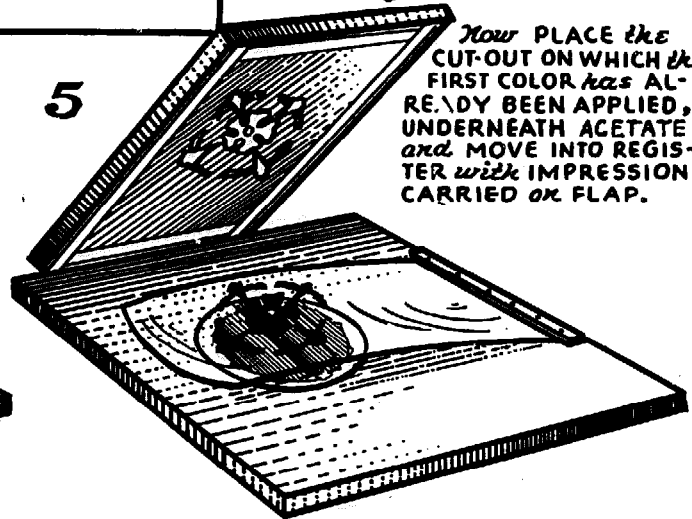

5

NOW PLACE THE CUT-OUT ON WHICH THE FIRST COLOR HAS ALREADY BEEN APPLIED, UNDERNEATH ACETATE AND MOVE INTO REGISTER WITH IMPRESSION CARRIED ON FLAP.

AFTER REGISTRATION HAS BEEN MADE BETWEEN FLAP AND FIRST COLOR ON CUT-OUT, THE FLAP IS TURNED BACK AS INDICATED BELOW AND THE PRINTING IS CARRIED ON IN THE USUAL FASHION. THE PROCEDURE IS THE SAME FOR PRINTING THE THIRD COLOR EXCEPTING THAT THE ACETATE FLAP IS CLEANED OFF AND THE THIRD COLOR IMPRESSION IS MADE THEREON.

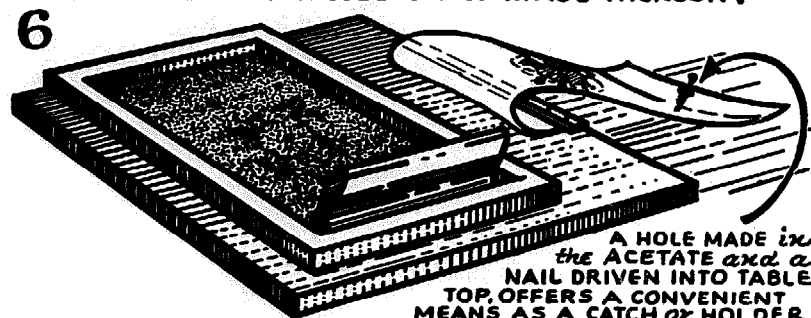

6

A HOLE MADE IN THE ACETATE AND A NAIL DRIVEN INTO TABLE TOP OFFERS A CONVENIENT MEANS AS A CATCH OR HOLDER.

ANOTHER GOOD METHOD

MOUNT THE CUT-OUT DISK, OVAL OR THE LIKE TO BE PRINTED IN SEVERAL COLORS UPON HEAVY CARDBOARD SHEETS OF IDENTICAL SIZE WITH RUBBER CEMENT WHICH HAS BEEN THINNED SLIGHTLY WITH RUBBER CEMENT THINNER.

FOR MOUNTING METAL, GLASS OR PLASTIC DISKS OR OVALS TO CARDBOARD USE CONTACT TYPE ADHESIVES

THE GUIDE LINE FOR MOUNTING CAN BE SCREEN PRINTED

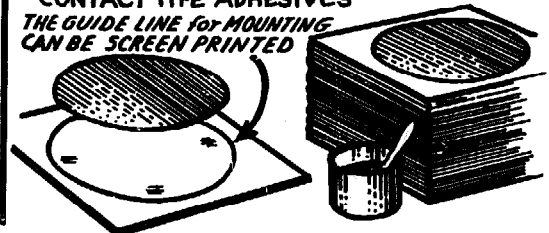

REGISTER GUIDE SUGGESTIONS

ECCENTRIC DISK GUIDE

DISK CAN BE ABOUT THE SIZE AND THICKNESS OF A HALF DOLLAR IN WHICH A COUNTERSUNK HOLE IS MADE OFF CENTER.

THE TWO BARS OF $\frac{1}{4}$ " METAL, MUST BE FLUSH WITH TOP OF BASE

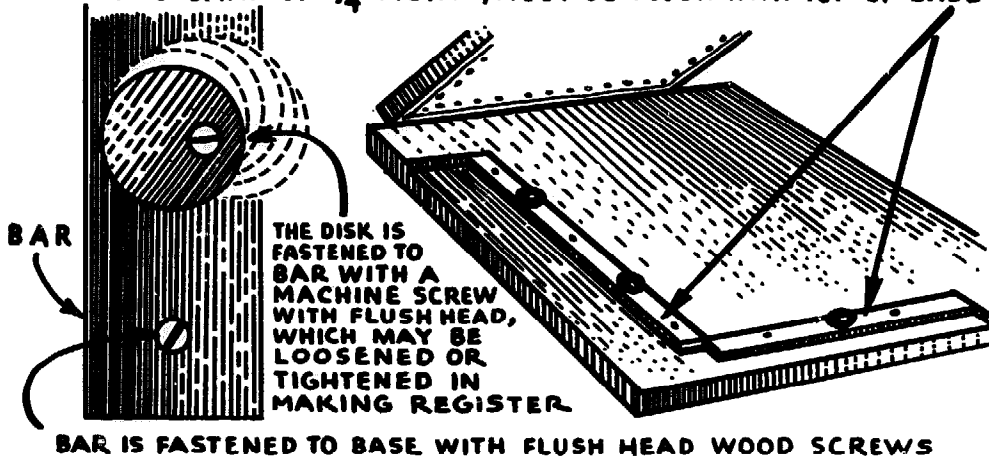

THE DISK IS FASTENED TO BAR WITH A MACHINE SCREW WITH FLUSH HEAD, WHICH MAY BE LOOSENED OR TIGHTENED IN MAKING REGISTER.

BAR IS FASTENED TO BASE WITH FLUSH HEAD WOOD SCREWS

MOVABLE SLOT GUIDE

TO EACH METAL GUIDE IS BRAZED A $\frac{1}{4}$ " BOLT WITH FLUSH HEAD. AFTER REGISTRATION HAS BEEN DETERMINED THE GUIDES

ARE TIGHTENED WITH WASHER AND WING NUT UNDERNEATH

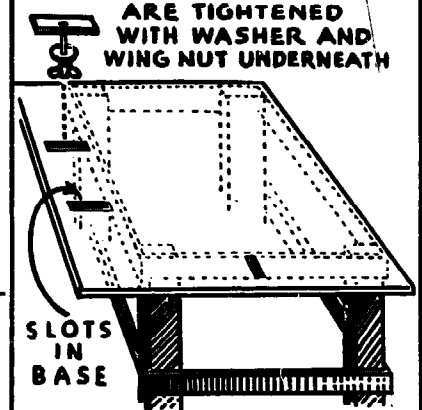

SLOTS IN BASE

FLOATING BASE with STATIONARY GUIDES

TWO METAL STRIPS ARE FASTENED TO UNDERNEATH SIDE OF FLOATING BASE

THE FLOATING BASE IS HELD TO LOWER BASE WITH FOUR METAL ADAPTORS TWO OF WHICH ARE SO CONSTRUCTED AS TO CONTAIN WING-HEAD BOLTS FOR TIGHTENING AFTER CORRECT REGISTRATION HAS BEEN MADE.

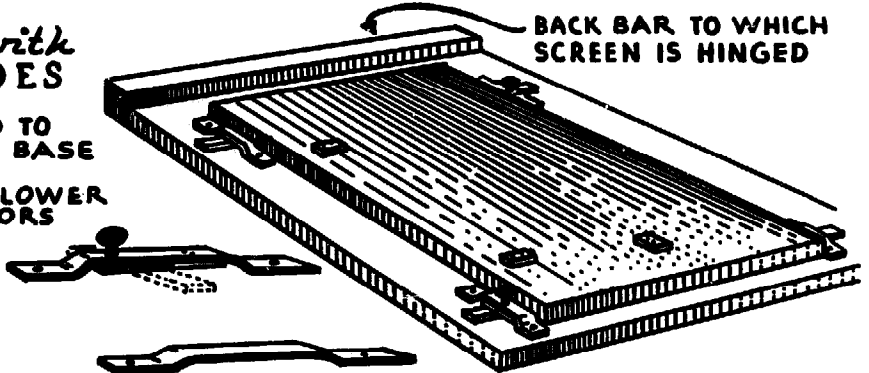

BACK BAR TO WHICH SCREEN IS HINGED

The MEGILL "PERFECT" GUIDE

MADE FOR LETTER PRESS WORK, THEY MAY ALSO BE USED FOR SCREEN PRINTING OF PAPER, ESPECIALLY DECALCOMANIA PAPER, BECAUSE OF ITS ADJUSTABLE FEATURES AND GRIPPER TONGUE.

FOR SCREEN PRINTING WORK IT IS NECESSARY TO GRIND OR FILE SMOOTH THE RIVET HEADS AND NIB.

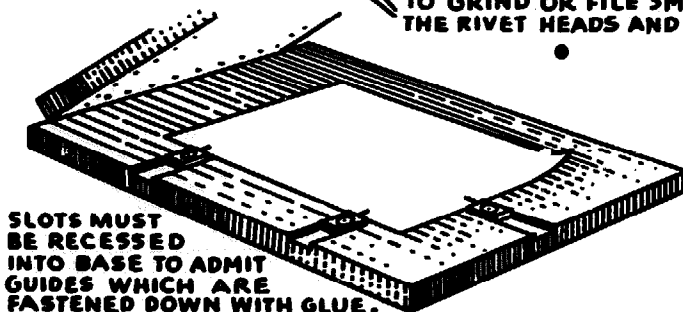

SLOTS MUST BE RECESSED INTO BASE TO ADMIT GUIDES WHICH ARE FASTENED DOWN WITH GLUE.

COMMON METAL GUIDE

TAKING ADVANTAGE OF THE COUNTERSUNK SCREW HOLES ALREADY MADE IN A 2" x $\frac{3}{16}$ " PIN HINGE SECTIONS ARE CUT WITH HACK SAW AS SHOWN

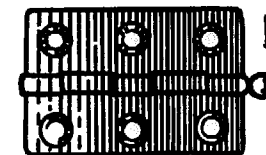

IF GUIDE IS TO BE USED FOR PAPER PRINTING THEN A BRASS TONGUE CAN BE SOLDERED ON

AND SLOTS RECESSED INTO BASE TO ADMIT GUIDES.

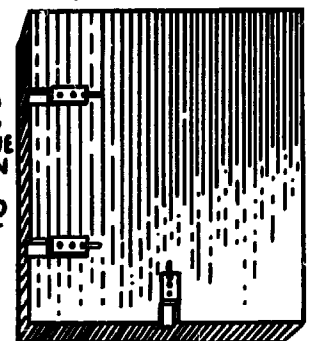

HELPFUL PROCESS SUGGESTIONS

"SAVE TIME"

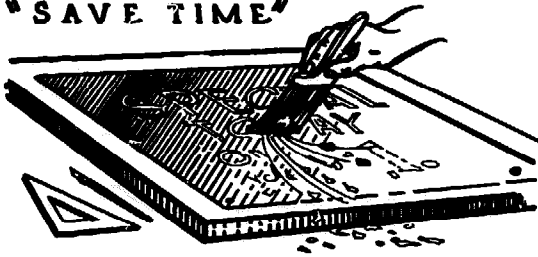

BY USING A 3 OR 4 INCH STIFF BRISTLE PAINT BRUSH TO REMOVE CUT FILM PARTICLES INSTEAD OF PICKING OFF WITH STENCIL KNIFE.

"STRAIGHTENING A MITERED JOINT LOPSIDED FRAME"

MITER BOX MAY GIVE A PERFECT CUT BUT IF FRAME LUMBER IS SLIGHTLY WARPED A LOPSIDED FRAME WILL BE THE RESULT.

FIRST TAP END OF FRAME WHICH EXTENDS UPWARDS IN THIS MANNER, AND TEST FOR LEVELING.

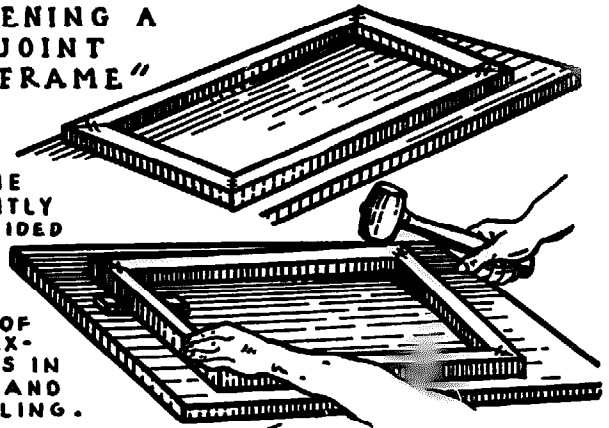

"COUNTERSINK PUNCH"

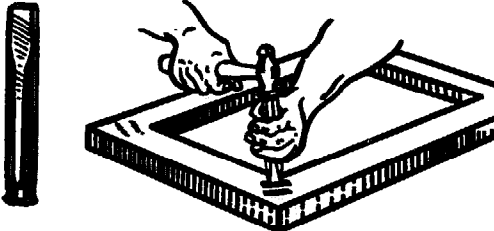

TO COUNTERSINK CORRUGATED FASTENERS, SO A NEAT JOB OF SANDING FRAME MAY BE DONE, USE A GROUND OFF COLD CHISEL.

THEN DRIVE A THIN WOODEN WEDGE INTO THE CORNER JOINT WHICH HAS BEEN SPREAD OR BROKEN. BREAK OFF THEN SAND.

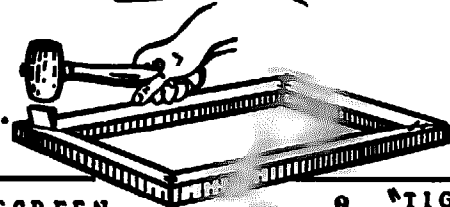

"GLUE FILLED SCREEN TIGHTENER"

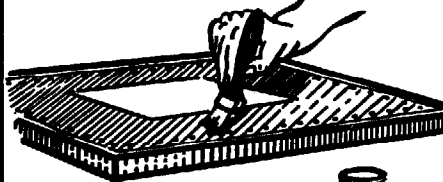

TO PREVENT A GLUE FILLED SCREEN FROM BECOMING LOOSE DUE TO ATMOSPHERIC CHANGES SIMPLY PAINT THE FILLED PORTION WITH A SOLUTION OF 1 OZ. POWDERED ALUM DISSOLVED IN 1 PT. WARM WATER.



"TIGHT FITTING HINGE"

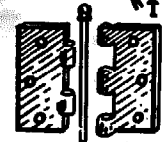

TO TAKE THE PLAY OUT OF SMALL PIN HINGES SIMPLY BEND OR CRIMP THE REMOVABLE PIN AND DRIVE INTO PLACE



"OLD TIME SQUEEGEE HOLDER"

STILL THE BEST FOR SMALL WORK

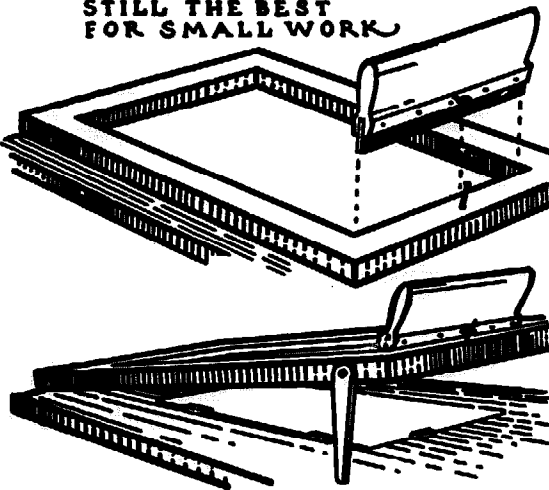

PLACE SMALL SCREW-EYE IN HANDLE OF SQUEEGEE. AFTER MAKING THE PRINTED IMPRESSION AND SCREEN HAS BEEN ELEVATED THE SQUEEGEE IS HUNG INTO POSITION BY DROPPING SCREW-EYE DOWN OVER FINISHING NAIL DRIVEN INTO FRAME.

"TRIMMING SQUEEGEE BLADE"

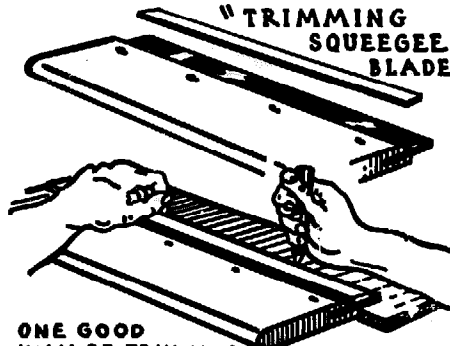

ONE GOOD WAY OF TRIMMING DOWN A NICKED OR DULL SQUEEGEE BLADE IS TO CUT A STRIP OF METAL IF YOU HAVE ACCESS TO CUTTING SHEAR AND USING THIS FOR A TRIMMING GUIDE.

"HINGE HOLDER"

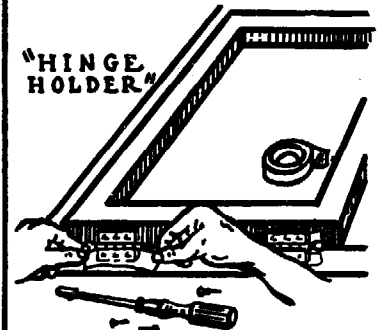

TO HOLD HINGES INTO PLACE WHILE DRIVING IN SCREWS FASTEN DOWN WITH TRANSPARENT PRESSURE SENSITIVE TAPE.

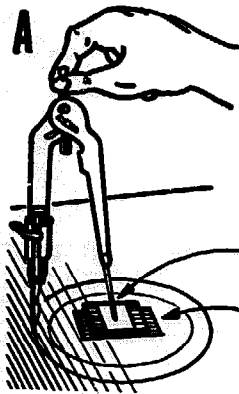

A TO PREVENT DAMAGE TO CUTTING FILM AT COMPASS POINT IN CUTTING CIRCLES

TRANSPARENT BLOCK, LUCITE, PLEXIGLASS ETC. FASTEN BLOCK TO FILM WITH SCOTCH TAPE

B UNIT FOR PRINTING TOYS, FLAT SIDED BOTTLES, BOXES ETC.

FRAME IS LOCKED TO BASE UPRIGHT SUPPORTS WITH BOLT, WASHERS AND NUT. WHEN ELEVATED SCREEN WILL STAY IN POSITION UNTIL AGAIN FORCED DOWN INTO PRINTING POSITION

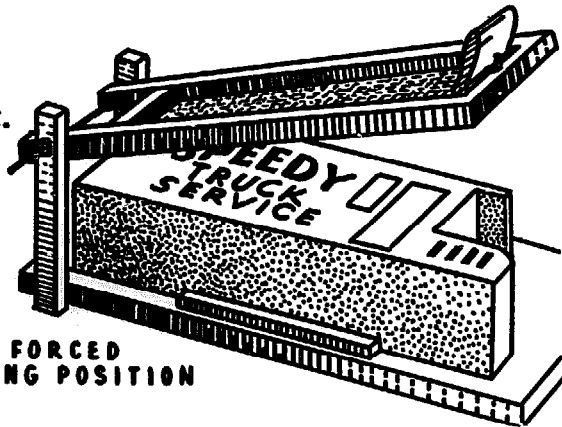

C

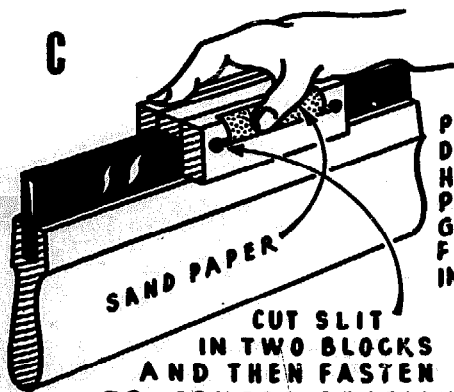

A GOOD PRACTICAL DEVICE FOR HOLDING SAND PAPER, OR GARNET CLOTH FOR SHARPENING SQUEEGEE BLADE.

CUT SLIT IN TWO BLOCKS AND THEN FASTEN TO CENTER SECTION.

D

FIRST CUT A PIECE THIN HARD WOOD INTO THIS SHAPE

AUTOMATIC KICK-LEG

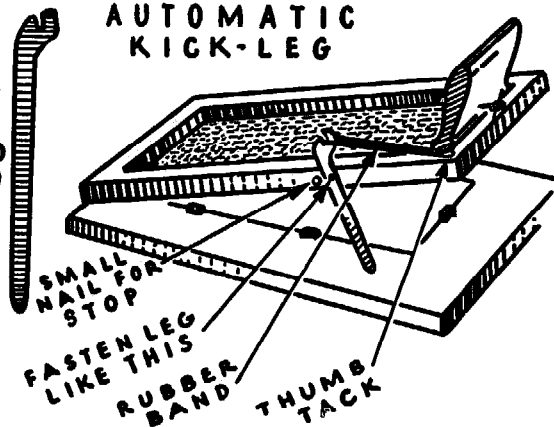

SMALL NAIL FOR STOP
FASTEN LEG LIKE THIS
RUBBER BAND
THUMB TACK

E

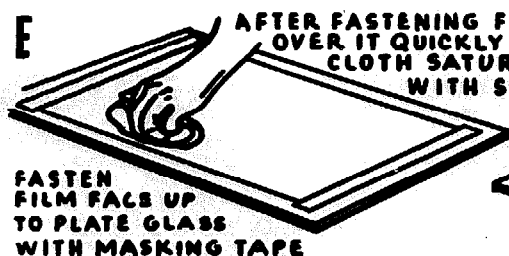

FASTEN FILM FACE UP TO PLATE GLASS WITH MASKING TAPE

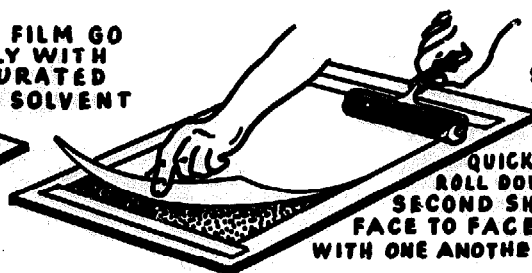

QUICKLY ROLL DOWN SECOND SHEET FACE TO FACE WITH ONE ANOTHER

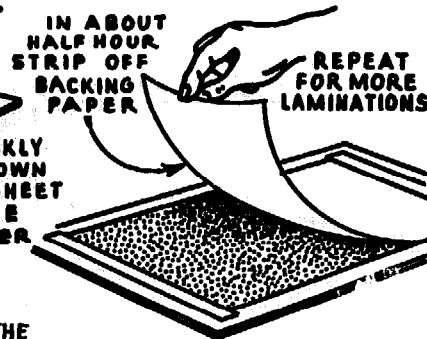

IN ABOUT HALF HOUR STRIP OFF BACKING PAPER

REPEAT FOR MORE LAMINATIONS

PRINTING FELT PENNANTS REQUIRES A HEAVY PAINT DEPOSIT. IN PLACE OF THE CUSTOMARY STENCIL, ONE CAN LAMINATE THREE OR FOUR SHEETS OF LACQUER SOLUBLE CUTTING FILM TOGETHER. THIS THEN IS EASY TO CUT, PEEL OUT AND APPLY TO SCREEN.

OFF-CONTACT STENCIL SCREEN PRINTING

OF LETTERHEADS, FINE PAPERS, PARCHMENT, FILMS, CARDS, ETC.
WITH THE FOLLOWING SYSTEM STATIC, FEATHER EDGES, AND BLURRING ARE ELIMINATED

①

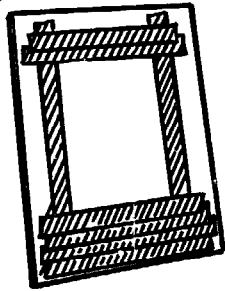

FIRST TAKE A SHEET OF GLASS ABOUT 4 IN. LARGER AROUND THAN THE SIZE OF LETTERHEAD STOCK TO BE PRINTED.

NEXT FASTEN DOWN 2 IN. PRESSURE SENSITIVE PAPER MASKING TAPE AS SHOWN SO THAT THE INSIDE BLANK AREA IS ABOUT 1 IN. SMALLER AROUND THAN LETTERHEAD STOCK.

②

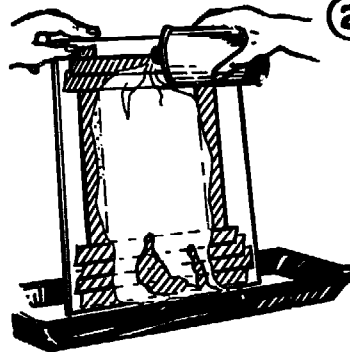

NOW FLOW ON A COAT OF THINNED RUBBER CEMENT AND STAND SCREEN IN FRONT OF A FAN FOR A FEW MINUTES— THEN STRIP OFF MASKING TAPE.

THE GLASS IS THEN FASTENED TREATED SIDE UP TO TOP OF WOODEN PRINTING BASE *with* ADHESIVE, BY EDGE TAPING OR BY OTHER SUITABLE MEANS.

③

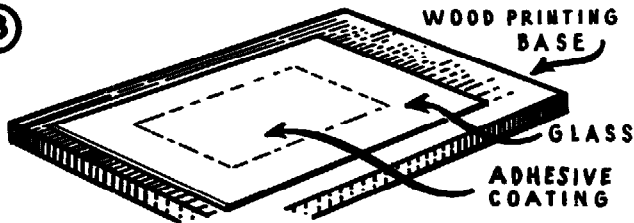

NOW PREPARE THE COMPLETED STENCIL SCREEN FOR OFF-CONTACT PRINTING BY FASTENING CARDBOARD STRIPS OF ABOUT 14 PLY OR .50 POINT ALONG BOTH ENDS OF FRAME.

④

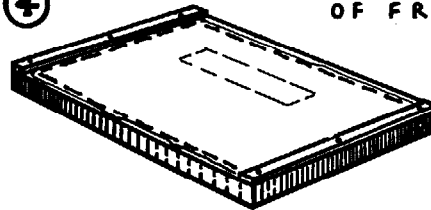

THE SCREEN IS THEN FASTENED TO PRINTING BASE WITH REMOVABLE PIN HINGES. AFTER REGISTRATION BETWEEN STOCK AND SCREEN HAS BEEN DETERMINED, CARDBOARD GUIDES ARE GLUED DOWN TO GLASS INTO LOCATION.

⑤

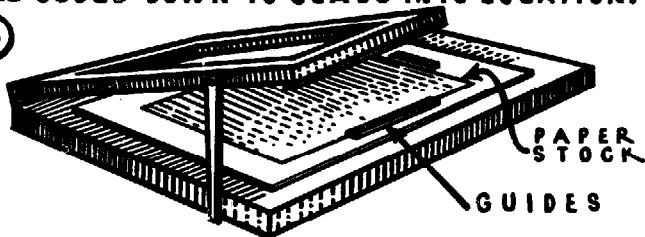

⑥

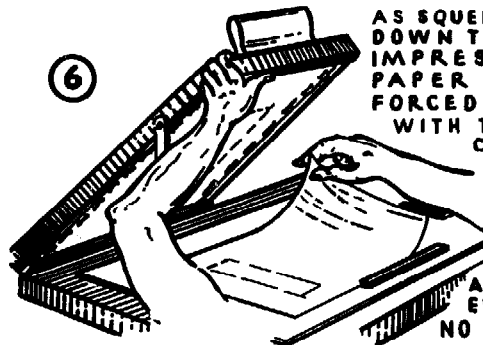

AS SQUEEGEE IS FORCED DOWN TO MAKE THE IMPRESSION THE PAPER LIKEWISE IS FORCED INTO CONTACT WITH THE ADHESIVE COATING.

THE PAPER IS THEN EASILY PEELLED FREE FOR RACKING.

A PERFECT PRINT EVERYTIME WITH NO FEATHER EDGES.

2 IN. PRESSURE SENSITIVE PAPER MASKING TAPE ALSO MAY BE USED

①



FIRST DUST SENSITIVE SIDE OF TAPE WITH TALCUM

②



THEN TURN TAPE OVER AND PAINT WITH ADHESIVE

③

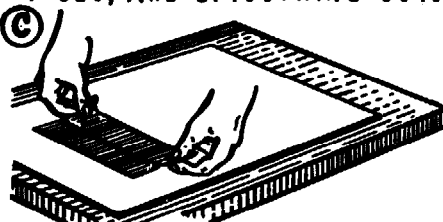

NOW FASTEN TAPE TO GLASS TOP, BUTTING TOGETHER BOTH PIECES, AND SMOOTHING OUT.

④

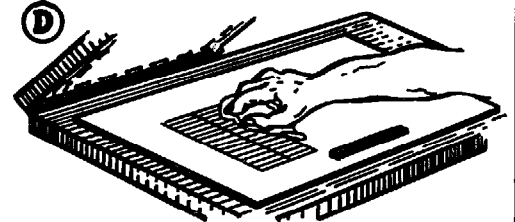

AFTER SETTING UP SCREEN TO REGISTER, TAPE IS WASHED LIGHTLY WITH MILD SOLVENT TO BRING BACK ADHESION.

ONE WAY OF STENCIL SCREEN IMPRINTING OF ONE OR TWO GALLON BARRELS, JUGS, JARS, ETC.



① ONE PRACTICAL WAY OF PREPARING A CURVED STENCIL SCREEN USING HAND CUT FILM STENCIL FOR IMPRINTING FAIRLY SMALL GLASS, WOODEN BARRELS, COOKIE JARS, ETC., EITHER WITH CERAMIC OR COLD COLOR FOR GLASS, OR CROCKERY, and ENAMEL FOR WOOD. FOR EXAMPLE THIS 2 GAL. GLASS ICE TEA BARREL

② FIRST IT IS NECESSARY TO CUT TWO FRAME SIDE PIECES TO CONFORM WITH THE CURVATURE OF BARREL. THIS CAN BE DONE BY BENDING A STRIP OF LEAD AROUND BARREL, FROM WHICH AN OUTLINE IS DRAWN ON WOOD FOR CUTTING. *The* END PIECES ARE SMALLER AND THICKER. THIS PERMITS HAND ROOM WHILE SQUEEGEEING

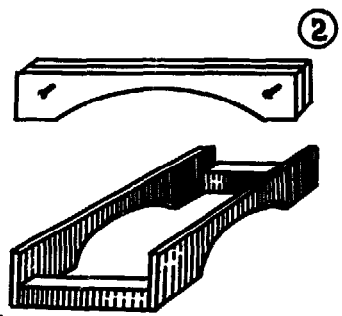

③ STAPLING AND STRETCHING THE FABRIC PREFERABLY 10XX OR 12XX OR EQUAL

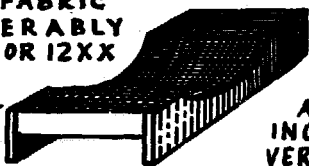

③ THE FABRIC IS FIRST STAPLED ALONG ONE SIDE. STRETCHING AND STAPLING IS THEN DONE ALONG THE OTHER SIDE STARTING AT THE CENTER AND WORKING IN EITHER DIRECTION. VERY LITTLE STRETCH SHOULD BE MADE AT ENDS. TO PREVENT FABRIC BELLING.

④ SET-UP SHOWING BARREL WITH CUSHION SUPPORT

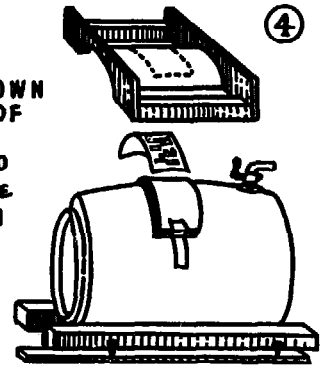

④ FIRST LOCK BARREL AS SHOWN THEN BUILD UP A CUSHION OF THREE OR FOUR PIECES OF BLOTTERS AND FASTEN TO BARREL WITH TAPE. *The* CUT FILM STENCIL IS THEN LAID INTO POSITION ON CUSHION. *The* SCREEN IS THEN BROUGHT DOWN INTO CONTACT WITH STENCIL.

⑤ ATTACHING THE CUT FILM STENCIL

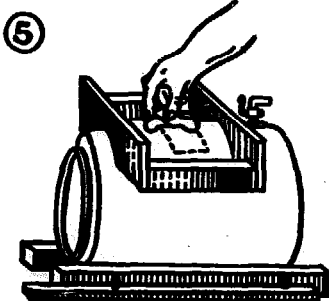

⑤ WHILE A SECOND PERSON (*NOT SHOWN*) HOLDS THE SCREEN IN CONTACT, THE ADHERING LIQUID IS APPLIED IN THE USUAL FASHION. *The* BACKING SHEET IS THEN PEELED FREE AND OPEN SPACES AROUND FILM PATTERN FILLED IN WITH CLEAR OR COLORED BLOCKOUT

The JIG SET-UP

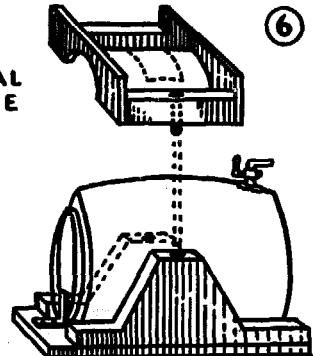

⑥ WHILE THIS IS ONE PRACTICAL WAY OTHER MEANS MAY BE DEVISED TO SUIT. A HOLE IS MADE IN BOTH END SECTIONS OF FRAME AND A PEG DRIVEN INTO THESE HOLES AS SHOWN. *The* HINGE SYSTEM MAY ALSO BE USED PROVIDING THE IMPRINT IS PRINTED BY OFF-CONTACT

⑦ ACTUAL PRINTING

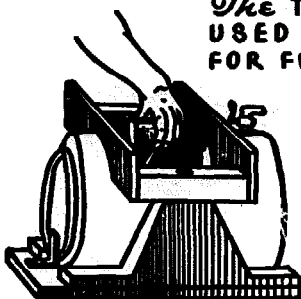

⑦ *The* TYPE OF COLOR TO BE USED WHETHER CERAMICS FOR FUSING ONTO GLASS OR POTTERY OR SCREEN PROCESS ENAMELS, THE COLOR IS DRAWN OVER AND AROUND MAKING A PERFECT IMPRESSION.

⑧ AFTER IMPRESSION HAS BEEN MADE SQUEEGEE IS LAID ASIDE OR RESTED IN THE SCREEN. *The* SCREEN IS THEN LIFTED STRAIGHT UP OFF THE BARREL. WHILE THE PRINTER HOLDS THE SCREEN A HELPER REMOVES THE PRINTED BARREL AND INSERTS THE NEXT ONE INTO PRINTING POSITION

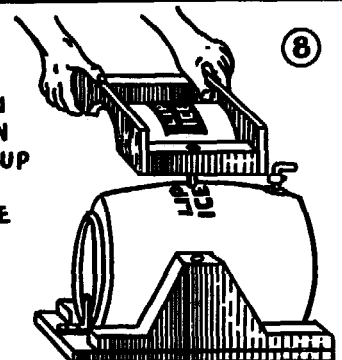

HOW TO MAKE AND USE THE FLAG STENCIL SCREEN



① WHILE THIS METHOD CAN BE USED FOR PRINTING LARGE AND SMALL METAL DRUMS, GREASE PAILS, FIBER DRUMS, ETC., THE CURVED FRAME TYPE MAY BE USED ALSO, HOWEVER WITH THIS TYPE OF FLAG SCREEN THE MAKING OF THE CURVED FRAME IS ELIMINATED.

BUILDING THE FRAME, STRETCHING MESH, MOUNTING CUT STENCIL FILM OR ONE OF PHOTOGRAPHIC ALL IS DONE IN THE USUAL FASHION. HOWEVER SCREWS ARE USED TO PUT FRAME TOGETHER.



AFTER THE MESH HAS BEEN CUT ALONG SIDES OF THE FRAME AND THE SCREWS REMOVED, THE STENCIL SCREEN WILL LOOK LIKE THIS.

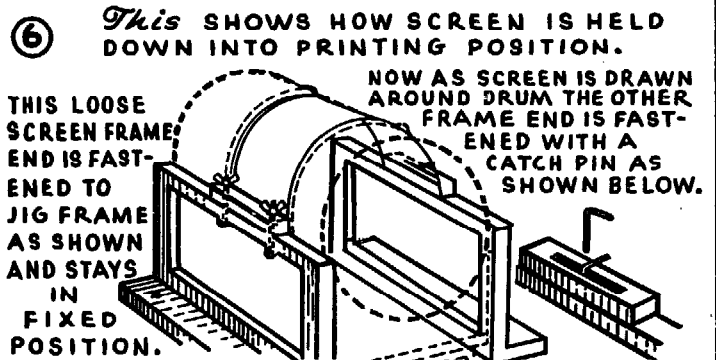
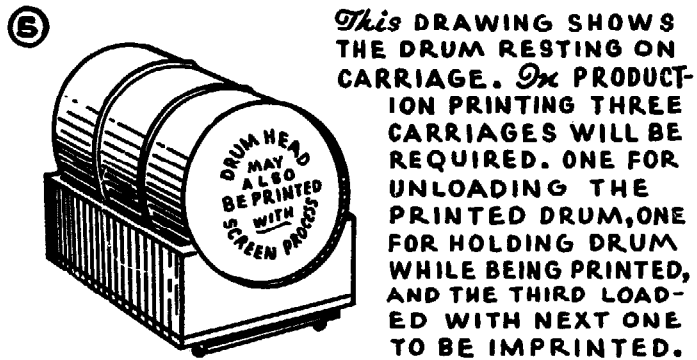
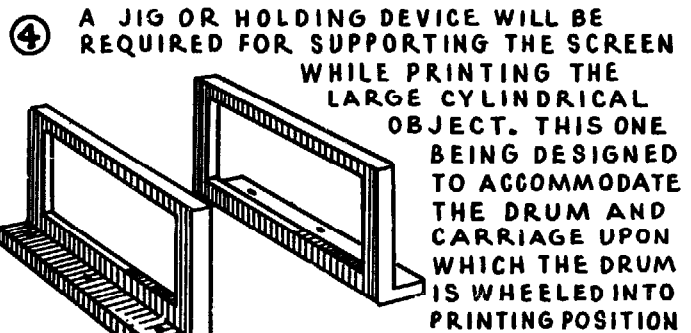
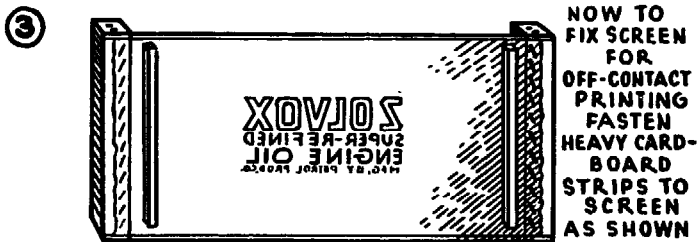

⑦ AFTER SCREEN HAS BEEN FIXED INTO PRINTING POSITION AND SQUEEGEE LOADED AS SHOWN BELOW SQUEEGEE IS DRAWN AROUND DRUM IN A CIRCULAR MOTION.

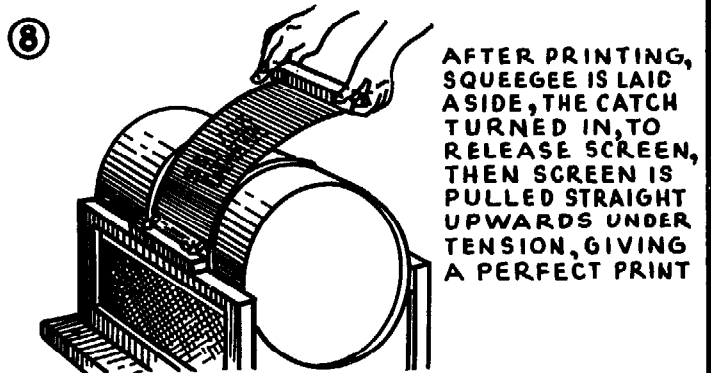
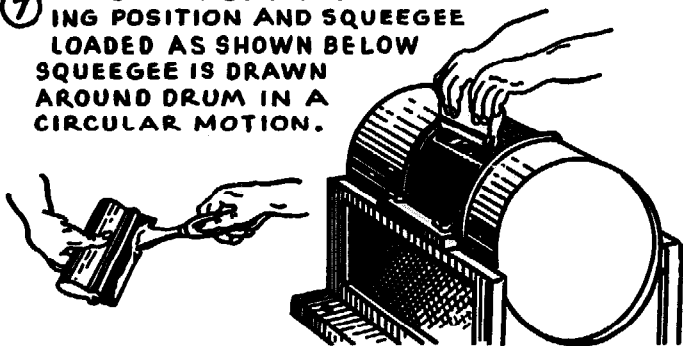

Two Practical Methods PRINTING STENCIL SCREEN Cylindrical Surfaces

TO MAKE THE SIDE PIECES OF THE STENCIL FRAME, TAKE A SMOOTH FLAT BOARD DRAW CENTER LINE, PLACE OBJECT AND DRAW AROUND IN THIS MANNER

THEN SAW APART ON CENTER LINE

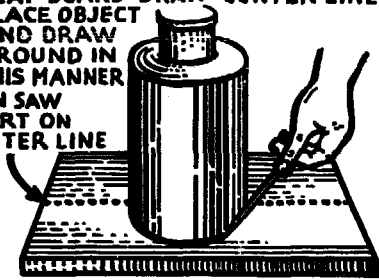

FASTEN BOTH PIECES TOGETHER WITH NAILS OR SCREWS AND CUT HALF ROUND OUT WITH JIG SAW THEN BUILD FRAME AS BELOW

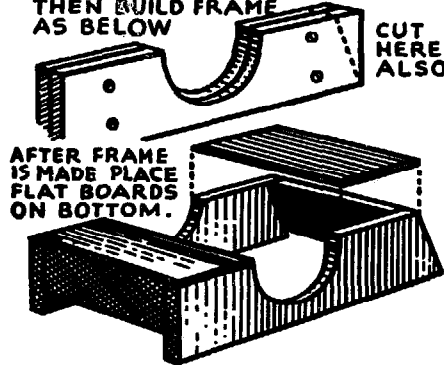

AFTER FRAME IS MADE PLACE FLAT BOARDS ON BOTTOM.

CUT HERE ALSO

IF STENCIL SCREEN IS TO BE PHOTOGRAPHIC OR HAND FILLED, THEN THIS IS MADE IN THE USUAL WAY



THEN CUT FROM THE FRAME TO BE FASTENED TO THE SPECIAL MADE FRAME

NOW FASTEN THE STENCIL WHICH HAS BEEN CUT FROM THE PREVIOUS FRAME, STAPLING ONLY ON THE THREE SIDES SHOWN

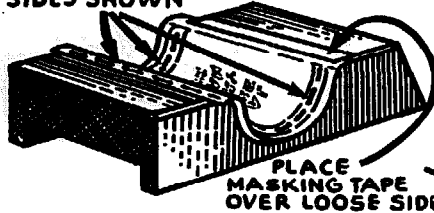

PLACE MASKING TAPE OVER LOOSE SIDE

OR IF FILM CUT STENCIL IS TO BE USED

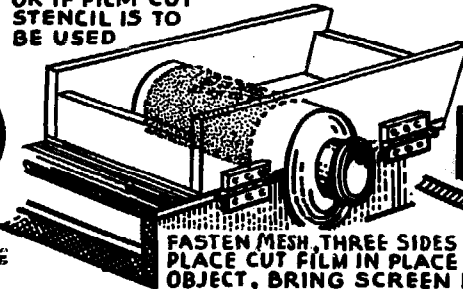

FASTEN MESH THREE SIDES TO FRAME PLACE CUT FILM IN PLACE OVER OBJECT, BRING SCREEN DOWN, APPLY SOLVENT, REMOVE SCREEN STRIP BACKING SHEET AND SEAL.

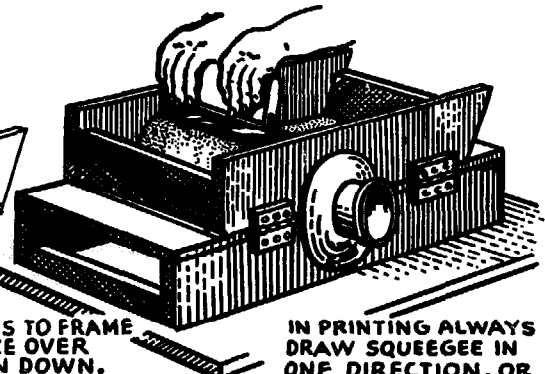

IN PRINTING ALWAYS DRAW SQUEEGEE IN ONE DIRECTION, OR TOWARDS THE LOOSE SIDE OF MESH

JIG SET-UP for PRINTING ROUND SURFACE using the FLAG TYPE of STENCIL SCREEN

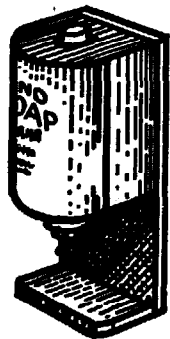

JOIN FRAME TOGETHER WITH SCREWS LIKE THIS
MAKE SCREEN IN USUAL WAY FILM CUT OF PHOTOGRAPHIC

CUT MESH ACCORDING TO DOTTED LINES



REMOVE SCREWS FROM ENDS OF FRAME AND FOLD BACK EDGES OF MESH



OBJECT and SCREEN SET UP IN JIG FOR POSITION

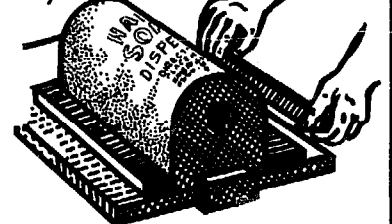

SQUEEGEE LOADED IN THIS MANNER

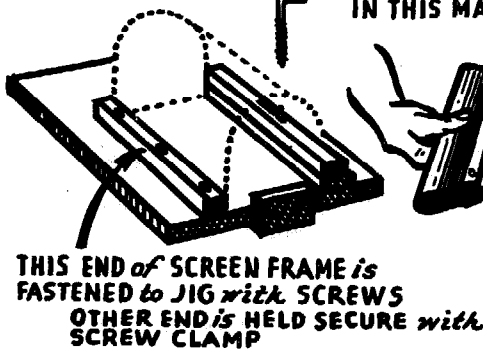

AFTER IMPRESSION HAS BEEN MADE SCREEN IS LIFTED, A SECOND PERSON REMOVES OBJECT and SETS IN ANOTHER

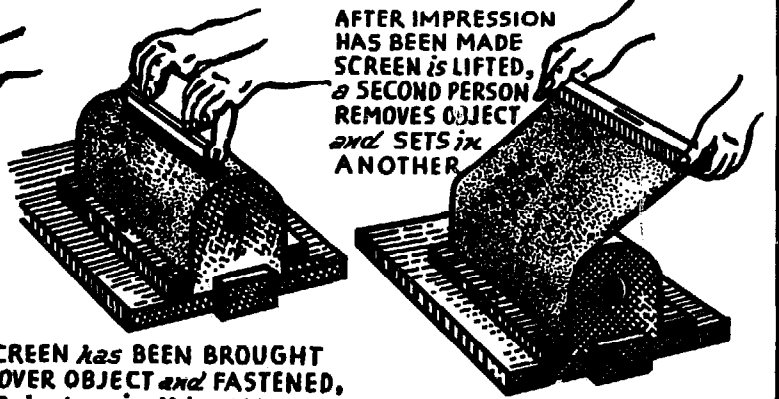

AFTER SCREEN HAS BEEN BROUGHT AROUND OVER OBJECT and FASTENED, PRINTING IS DONE IN THIS MANNER

TWO INTERCHANGEABLE NUMERAL STENCIL SCREEN METHODS

1 FIRST MAKE YOUR NUMERAL SKETCH

THEN CUT STENCIL USING CUT FILM, CUT PAPER, HAND FILLED OR PHOTOGRAPHIC

THEN APPLY TO 8XX FABRIC SCREEN IN USUAL WAY

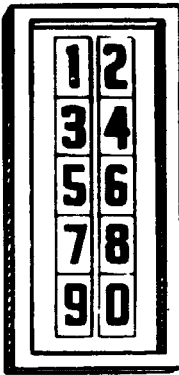

2 NOW, LAY THE COMPLETED SCREEN FACE DOWN UPON A PIECE OF CARDBOARD AND SEPARATE BY CUTTING IN THIS MANNER

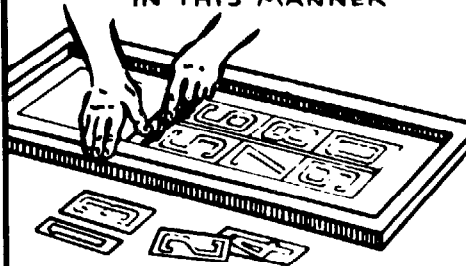

3 NOW MAKE ANOTHER SCREEN USING 8XX MULTIFILAMENT FABRIC WITH AN OPENING AS SHOWN BELOW, FOR THIS YOU CAN USE CUT FILM, OR HAND FILLED.

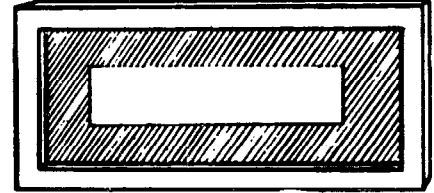

4 SELECT THE NUMERAL CUT SCREEN STENCILS DESIRED AND FASTEN DOWN IN POSITION UPON SCREEN WITH OPENING USING MASKING TAPE - OVER LAPPING AT THE EDGES

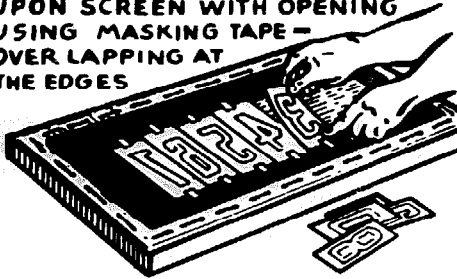

5 THIS FORMS A DUPLEX TYPE OF STENCIL SCREEN, AND YOU ACTUALLY PRINT THROUGH TWO PIECES OF FABRIC

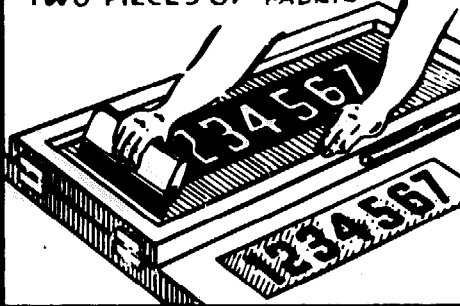

6 NOW FOR A QUICK CHANGE OF ONE OR MORE NUMERALS SIMPLY REMOVE THE ONES TO BE REPLACED BY OTHERS WITHOUT CLEANING ANY PART OF THE SCREEN

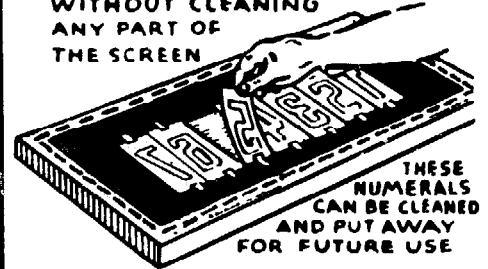

1 FIRST MAKE YOUR MASTER SKETCH

THEN PLACE THE CUTTING FILM OVER IT AND CUT AND PEEL OUT

THEN CUT APART AS PER LINES ON SKETCH



2 NOW MAKE TEN SMALL INDIVIDUAL FRAMES OR A DOUBLE SET IF NEED BE

WOOD ENDS AND 1/8" THICK BY 1" WIDE STEEL SIDES

COUNTER SUNK HOLES AND FLAT HEAD SCREWS



3 NOW FIRST STAPLE THE FABRIC TO THE WOODEN ENDS THEN STRETCH AND GLUE WITH EPOXY ADHESIVE TO THE METAL SIDES

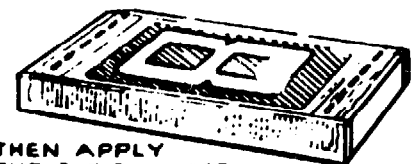

THEN APPLY THE CUT FILM STENCIL IN THE USUAL WAY AND SEAL

4 NOW MAKE ANOTHER FRAME SO THAT THE SMALL SCREENS WILL FIT CLOSELY LENGTHWISE

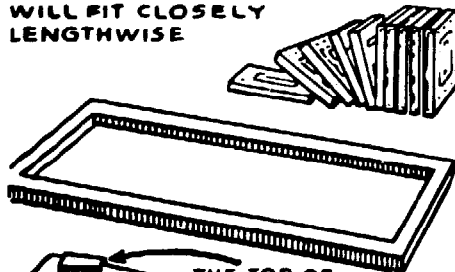

THE TOP OF WEDGE FOR TIGHTENING OR LOOSENING WITH TAP HAMMER

5 NOW INSERT THE SMALL FRAMES CONTAINING THE NUMERALS DESIRED AND LOCK UP USING THE DOUBLE WEDGE AT ONE END, SIMILAR TO A CHASE USED BY THE PRINTER FOR LOCKING UP HIS TYPE AND PLATES

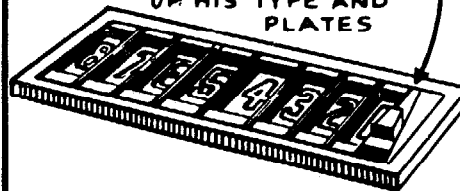

6 NOW THE NUMERALS CAN BE SCREENED ALL AT ONE TIME WITH A DIVIDED BLADE SQUEEGEE

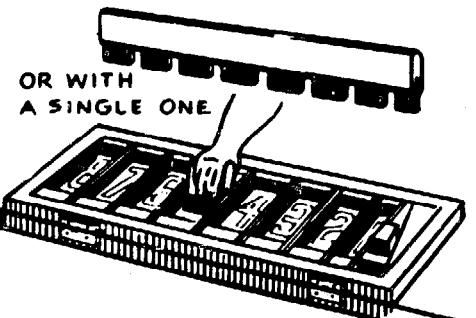

SINGLE STENCIL SCREEN FOR RIGHT AND LEFT PRINTING

MAKE MASTER SKETCH

FULL SIZE IN ONE OR MORE COLORS

ALLOW AT LEAST 1/4 IN. BLEED IF TO BE CUT OUT

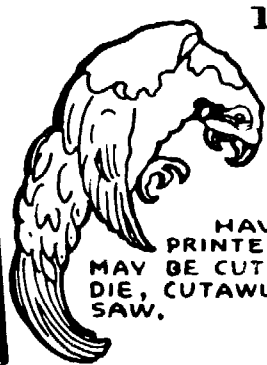

1

AFTER BOTH SIDES OF CARDS

HAVE BEEN PRINTED, THEY MAY BE CUT-OUT WITH DIE, CUTAWL OR BAND SAW.

TO BEGIN WITH AFTER MASTER SKETCH HAS BEEN MADE, TRACE UPON 14XX OR 16XX FABRIC WITH INK.

2

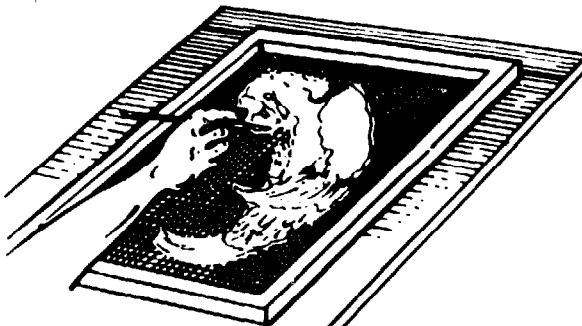

NOW USING THE KEY-LINE LACQUER BLOCK OUT - THE GLUE-TUSCHE WASH-OUT - OR THE DIRECT PHOTOGRAPHIC METHOD PROCEED WITH MAKING THE SCREEN STENCIL

WITH EITHER ONE OF THE ABOVE METHODS THE MASKING MEDIUM IS EMBEDDED INTO THE FABRIC MAKING BOTH SIDES OF FABRIC SMOOTH

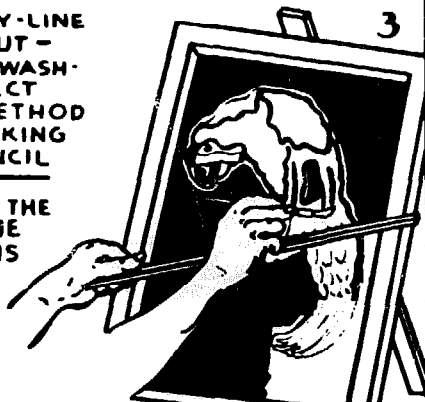

3

AFTER THE MASKING MEDIUM HAS BEEN APPLIED, ATTACH ANOTHER IDENTICAL SIZE FRAME

4

SANDWICHING THE FABRIC IN BETWEEN

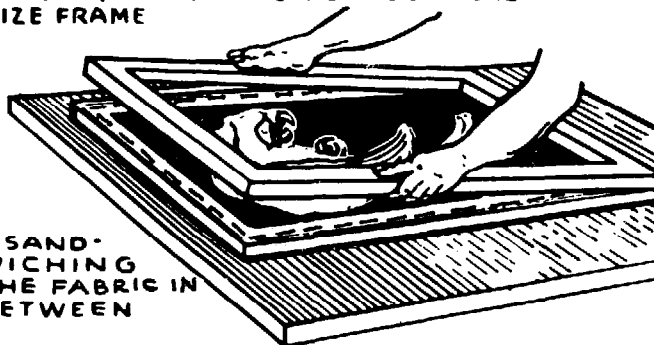

NOW SET THE DOUBLE FRAME SCREEN TO THE PRINTING BASE, FASTENING MALE SECTIONS OF THE PIN HINGES TO BOTH FRAMES, IN PERFECT ALIGNMENT WITH THE FEMALE SECTION FASTENED TO THE BASE

5

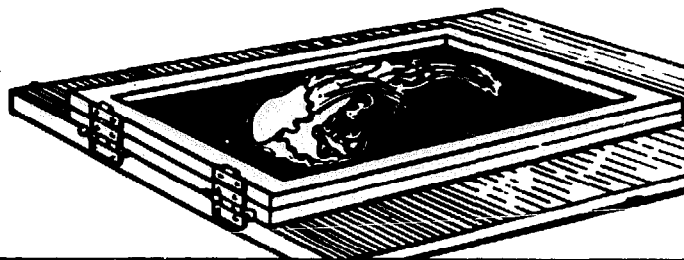

NOW FASTEN ANOTHER BASE UPON REGULAR BASE, OF ALMOST THE SAME THICKNESS OF A SINGLE FRAME, AND TO FIT INSIDE THE LOWER FRAME

6

THEN ADJUST MASTER SKETCH TO DESIGN ON SCREEN

AND SET REGISTER GUIDES

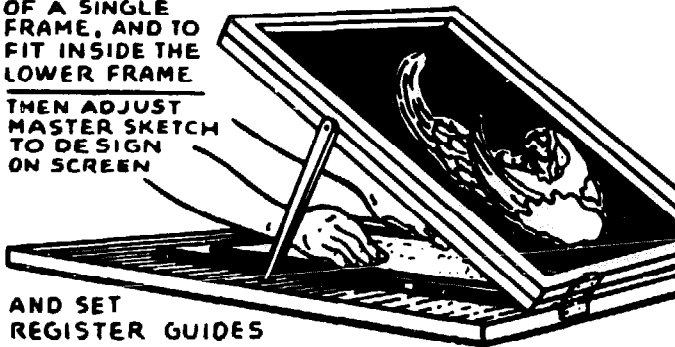

LINE WITH TAPE AND SEAL, THEN PRINT, IN ONE OR MORE COLORS AS THE CASE MAY BE

7

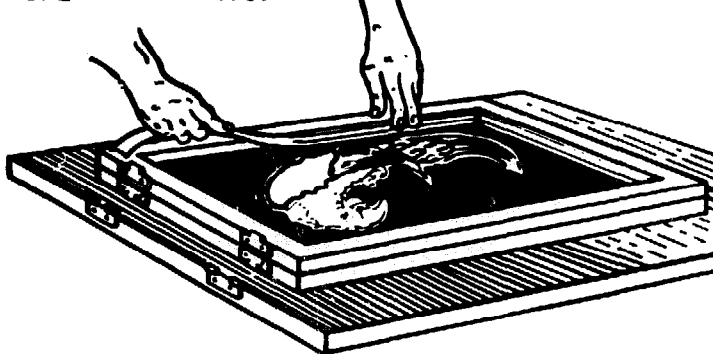

NOW TO PRINT ALL CARDS ON THE REVERSE SIDE SIMPLY TURN SCREEN OVER AND FIT INTO BASE HINGE, TAPE, THEN PRINT

8

IF ALL IS IN PERFECT ALIGNMENT NO ADJUSTMENT OF ANY KIND IS NECESSARY

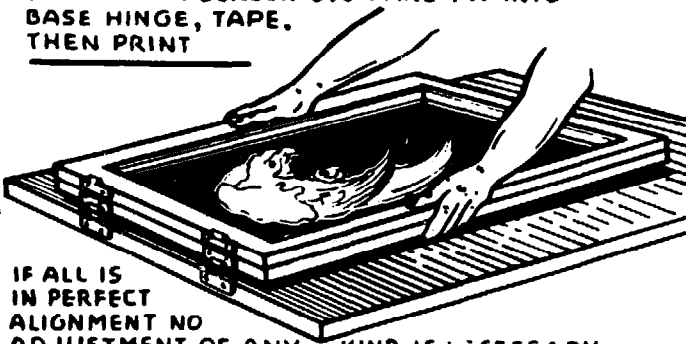

DUPLICATE TRANSFER PRINTING STENCIL SCREEN

ONE OF THE METHODS USED BY THE TEXTILE PRINTING INDUSTRY

1
FIRST, PREPARE YOUR MASTER SKETCH, FULL SIZE IN PENCIL, INK OR FULL COLOR

FOR EXAMPLE THIS SIMPLE DESIGN IN BLACK AND WHITE

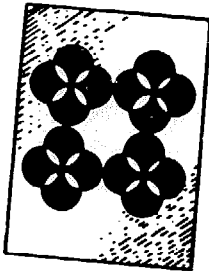

2
TRACE THE MASTER SKETCH UPON THE SMALL SCREEN WITH PEN AND INK, THEN CUT-IN WITH A GOOD GLUE FILLER

THE GLUE FILLER RESISTS THE LACQUER INKS WHICH WILL BE USED ON THE LARGE PRINTING SCREEN

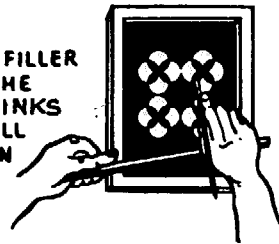

3
NOW TOO, TRACE THE MASTER SKETCH IN DUPLICATE UPON THE LARGER SCREEN WITH PEN AND INK

THESE INK LINES ACT AS A GUIDE WHEN THE SMALL SCREEN IS PLACED IN LOCATION FOR PRINTING UPON THIS LARGER ONE

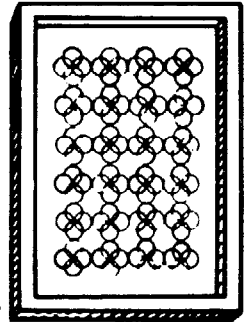

4
THEN MIX UP A STARCH SOLUTION, USING ORDINARY LAUNDRY STARCH

MIX EXACTLY ACCORDING TO DIRECTIONS

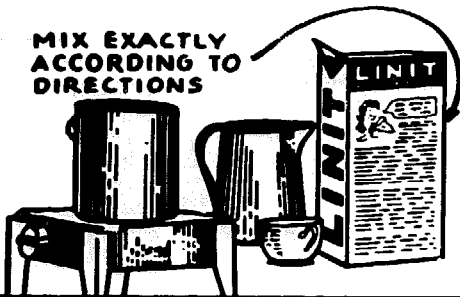

5
WHILE THE STARCH SOLUTION IS STILL WARM POUR OVER INSIDE OF SCREEN

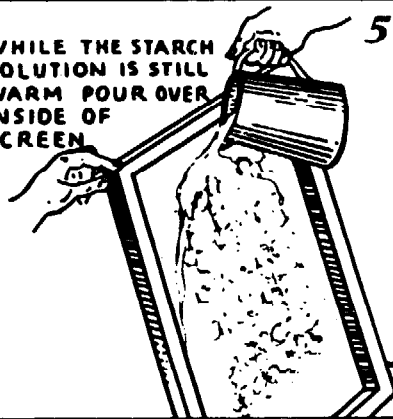

6
AFTER STARCH IS DRY ON SCREEN, THEN USE A BLOCK OR OTHER MEANS FOR A SUPPORT, SAME THICKNESS OF SCREEN FRAME AND PLACE INSIDE UNDERNEATH

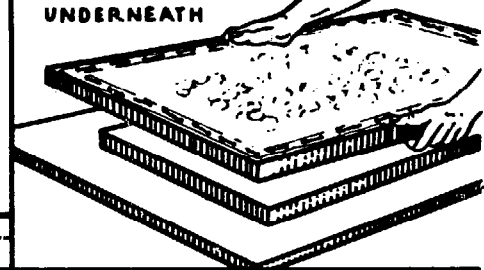

7
NOW TAKE THE SMALL, OR TRANSFER SCREEN AND PLACE IN POSITION WITH THE INKED DESIGN ON THE LARGER SCREEN AND PRINT WITH LACQUER INKS

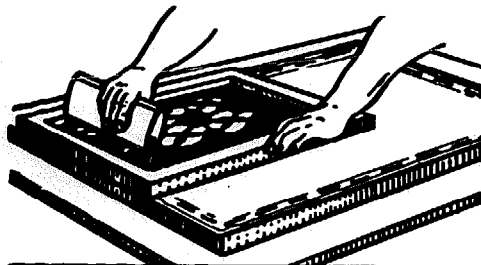

8
CLEAN SCREEN (PRINTING COLOR) AFTER EACH IMPRESSION. LET THE PRINT DRY BEFORE PROCEEDING WITH THE NEXT SCREEN PROCESS ENAMEL COLORS MAY ALSO BE USED, BUT EACH PRINT MUST DRY OVER NIGHT

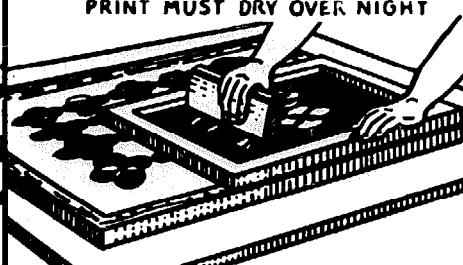

9
FILL IN AROUND THE PRINTING AREA WITH BLOCKING LACQUER

YOU CAN USE CUT FILM OR REGULAR BLOCKING LACQUER

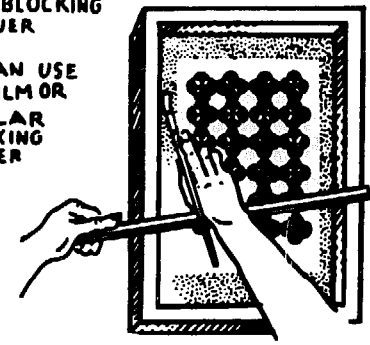

10
NOW WASH OUT STARCH WITH WARM WATER

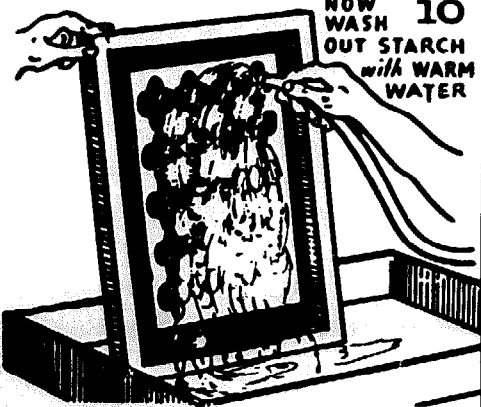

11
THEN TAPE, AND SEAL TAPE WITH THE BLOCKOUT LACQUER TO PREVENT TAPE FROM LIFTING WHILE PRINTING

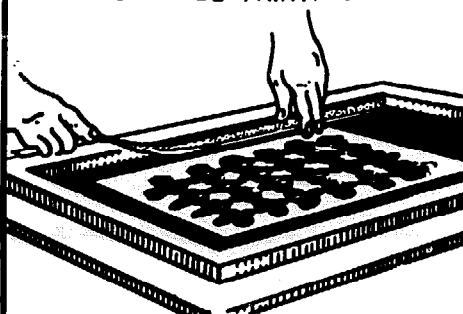

12
THEN SET SCREEN TO REGISTER UPON PRINTING BASE, AND PROCEED TO PRINT IN THE USUAL FASHION, USING THE TYPE OF PRINTING COLOR BEST SUITED FOR THE PURPOSE

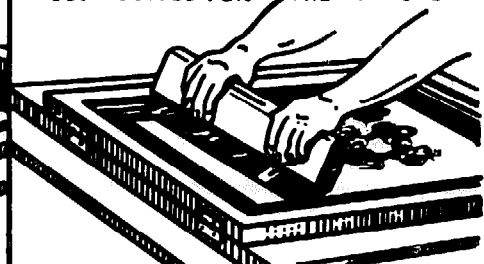

STENCIL SCREEN FOR PRINTING TWO OR MORE COLORS AT ONE TIME

1 FIRST, AS USUAL PREPARE YOUR MASTER SKETCH IN LEAD PENCIL FULL SIZE



2 NOW, CUT YOUR FILM AND APPLY TO SCREEN IN YOUR REGULAR WAY

THEN SEAL AND TAPE



3 NOW TAKE STRIPS OF THIN WOOD AND APPLY GLUE OR SEVERAL COATS CLEAR LACQUER FOR ADHESION AND FIT INTO SCREEN



4 OR YOU CAN PREPARE CARDBOARD STRIPS INTO THE SCREEN A FASTENING DOWN WITH MASKING TAPE AS SHOWN BELOW

SEAL THE TAPE WITH CLEAR LACQUER



5 NOW PRINT THE TOP SECTION WHICH IN THIS CASE FOR EXAMPLE WILL BE BLUE

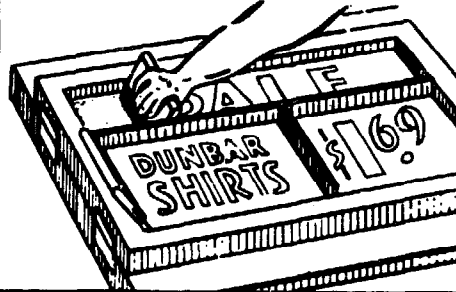

6 THEN WHILE THE SCREEN IS STILL INTACT PRINT THE OTHER TWO SECTIONS WHICH WILL BE GREEN AND RED

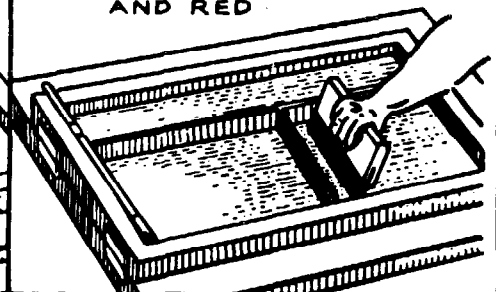

RUBBER LINED FLEXIBLE STENCIL SCREEN

1 FIRST - SECURE FROM YOUR HARDWARE STORE SPONGE RUBBER STRIPPING COMES IN VARIOUS THICKNESSES



RUBBER PRESSURE ADHESIVE CLOTH BACK

2 FIRST STRIP OFF THE BACKING CLOTH FROM THE RUBBER AND STICK RUBBER INTO PLACE ON THE FRAME ON ALL FOUR SIDES

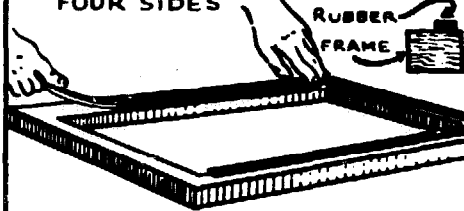

3 STRETCH FABRIC OVER SPONGE RUBBER AND STAPLE ALONG TOP EDGE OF FRAME

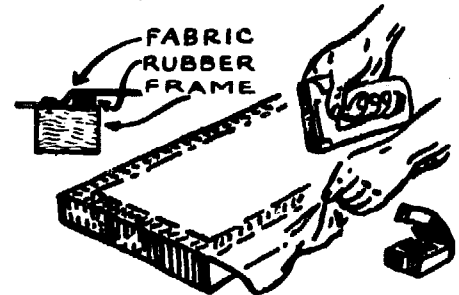

4 FROM YOUR MASTER SKETCH CUT YOUR FILM - THEN MOUNT UPON SCREEN - SEAL AROUND STENCIL IN THE USUAL WAY

TAPE AND SEAL TAPE WITH LACQUER BLOCKOUT.

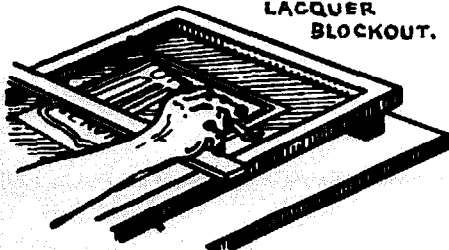

5 IN PRINTING A CURVED AUTO DOOR PANEL FOR EXAMPLE, SIMPLY FORCE SCREEN DOWN TO CURVATURE OF PANEL THIS IS A TWO MAN JOB

REMOVABLE RESERVOIR



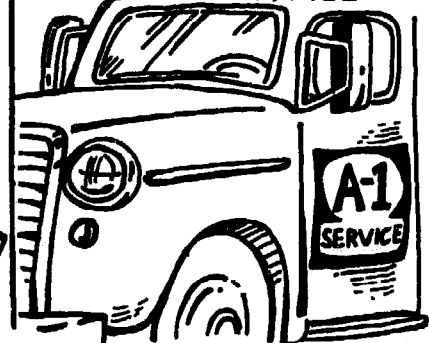

6 FINISHED EXAMPLE OF A PRINTED AUTO DOOR PANEL





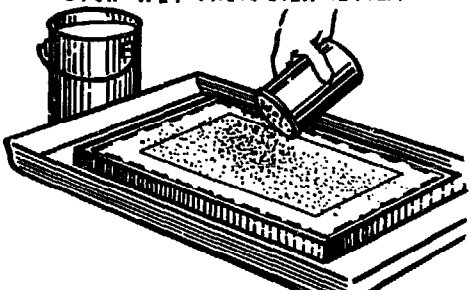
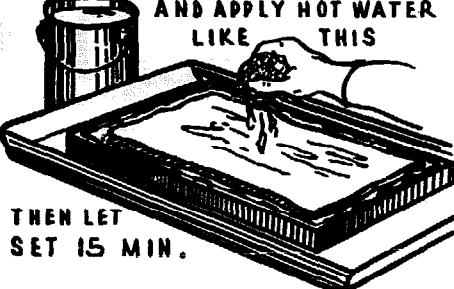
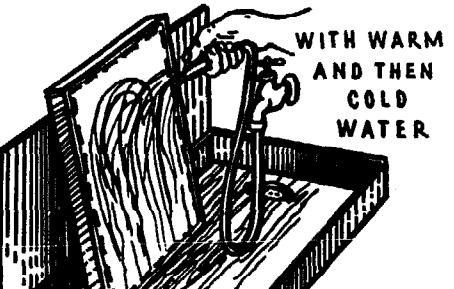
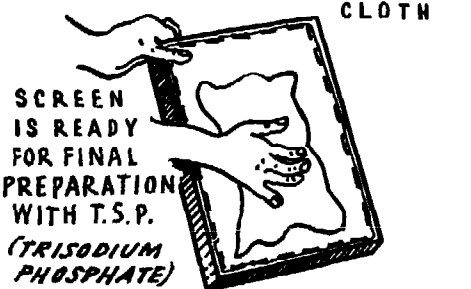

The PERFECT SCREEN CLEANER

FOR THE REMOVAL OF LIGHT HARDENED PHOTOGRAPHIC TRANSFER STENCIL FILM.

CAUTION: SOLUTION CAN BE INJURIOUS. PROTECTIVE COVERING SUCH AS RUBBER GLOVES, GOGGLES AND APRONS MUST BE WORN. HAS NO EFFECT ON THE FINEST GRADE FABRICS.

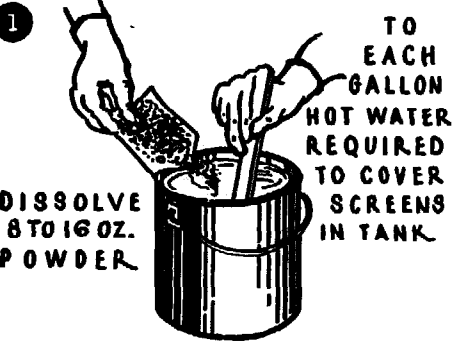
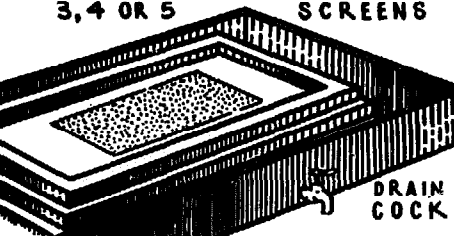
<p>1</p>  <p>ENZYME POWDERS ARE AVAILABLE FROM SCREEN PRINTING SUPPLIERS UNDER VARIOUS TRADE NAMES. <i>Ask for a stripping compound for use on photo transfer film.</i></p>	<p>2</p>  <p>FIRST PLACE SCREEN IN TRAY AND SATURATE PHOTO STENCIL FILM WITH WARM WATER</p> <p>AND LET SET FOR A FEW MINUTES</p>	<p>3</p>  <p>SPRINKLE POWDER SPARINGLY UPON WET PHOTO STENCIL FILM</p>
<p>4</p>  <p>LAY A FOLDED CLOTH ON SCREEN AND APPLY HOT WATER LIKE THIS</p> <p>THEN LET SET 15 MIN.</p>	<p>5</p>  <p>SUBJECT SCREEN TO RINSING WITH WARM AND THEN COLD WATER</p>	<p>6</p>  <p>THEN WIPE DRY WITH CLEAN CLOTH</p> <p>SCREEN IS READY FOR FINAL PREPARATION WITH T.S.P. (TRISODIUM PHOSPHATE)</p>

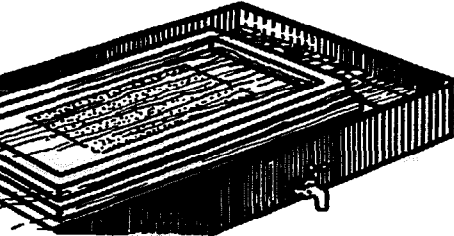
WHERE A NUMBER OF SCREENS ARE TO BE RECLAIMED AT ONE TIME THE FOLLOWING IS RECOMMENDED. FOR A SECOND BATCH OF SCREENS THE SOLUTION IS DRAINED FROM TANK *and* REHEATED. WHEN SCREENS ARE LEFT IN SOLUTION A SUFFICIENT LENGTH OF TIME, SOME HARDENED INKS WILL DISINTEGRATE.

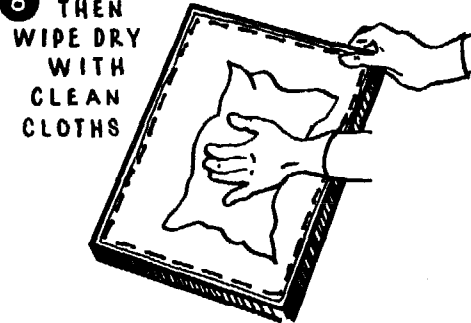
<p>1</p>  <p>TO EACH GALLON HOT WATER REQUIRED TO COVER SCREENS IN TANK</p> <p>DISSOLVE 8 TO 16 OZ. POWDER</p>	<p>2</p>  <p>HAVE GALVANIZED METAL TANK MADE SO AS TO ACCOMMODATE 3, 4 OR 5 SCREENS</p> <p>DRAIN COCK</p>	<p>3</p>  <p>THEN POUR HOT SOLUTION INTO TANK HOLDING 3 SCREENS</p>
<p>4</p>  <p>NOW LET SCREENS SET IN WARM SOLUTION ABOUT 15 MIN.</p>	<p>5</p>  <p>RINSE SCREENS FIRST WITH WARM WATER THEN COLD</p>	<p>6</p>  <p>THEN WIPE DRY WITH CLEAN CLOTHS</p>

PRINTING IN WARD CURVES

In THE PRINTING OF INWARD CURVED SURFACES LIKE PICTURED, ALL DEPENDS ENTIRELY UPON ONE'S SKILL and ACCURACY in MAKING THE FRAME, ATTACHING THE FABRIC CONTAINING THE FILM DESIGN and MAKING THE SQUEEGEE.

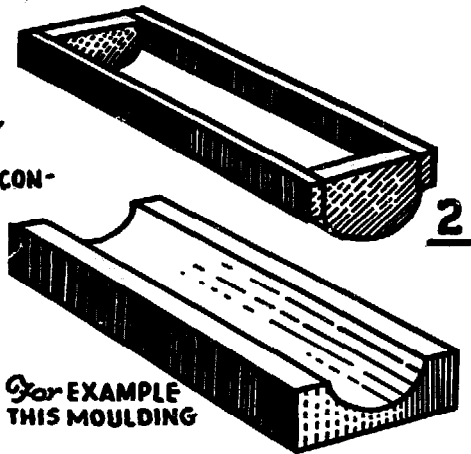
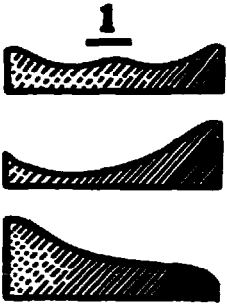

For EXAMPLE THIS MOULDING

FIRST CUT THE FRAME END PIECES TO CONFORM WITH THE CURVATURE OF THE MOULDING and ASSEMBLE INTO A FRAME WITH THE SIDE PIECES AS PICTURED ABOVE

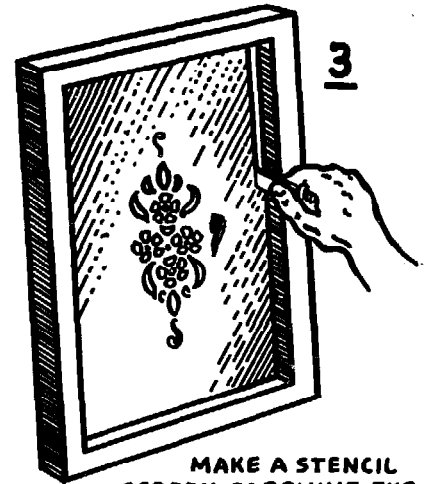

MAKE A STENCIL SCREEN CARRYING THE FILM DESIGN in the USUAL MANNER and CUT FROM FRAME.

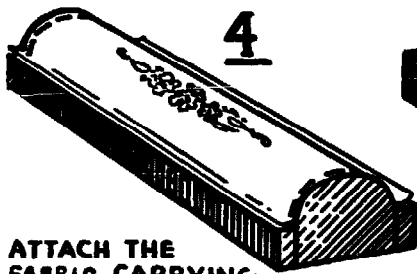

ATTACH THE FABRIC CARRYING the FILM DESIGN UPON the FRAME, STRETCHING and STAPLING TO END PIECES OF FRAME ONLY.

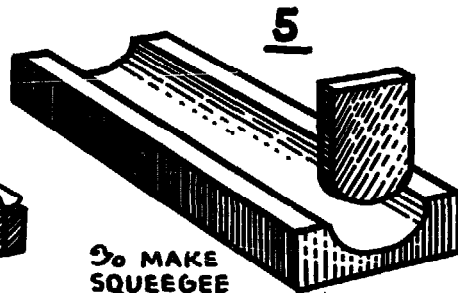

To MAKE SQUEEGEE CUT ONE END 3/8" THICK PLYWOOD TO CURVATURE OF MOULDING

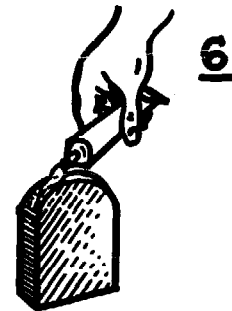

SPREAD EPOXY CEMENT UPON CURVED END OF PLYWOOD HANDLE

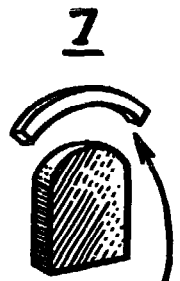

CUT A 3/8" PIECE OF SOFT PLASTIC OR RUBBER SQUEEGEE BLADE

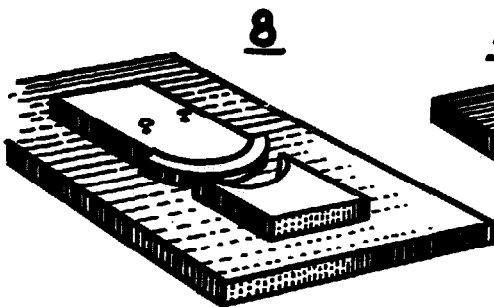

LAY BLADE STRIP AGAINST HANDLE and CEMENT and LOCK UP IN THIS MANNER UNTIL CEMENT SETS

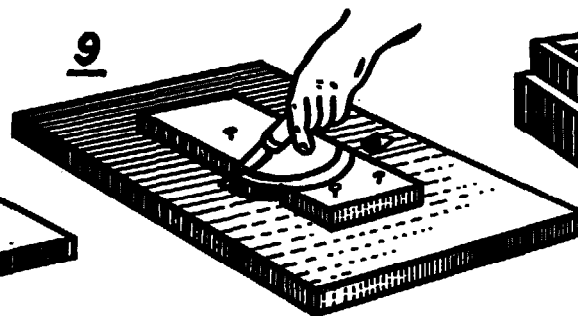

WITH A SHARP KNIFE CUT OFF ENDS OF BLADE and SQUEEGEE is THEN UNLOCKED BY REMOVING NAILS.

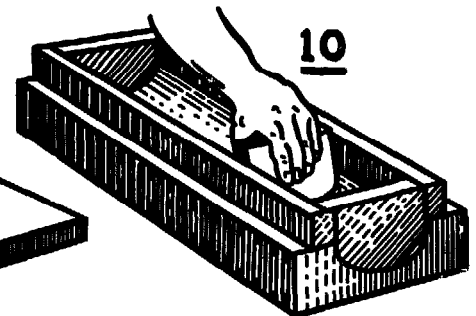

ABOVE, STENCIL SCREEN and SQUEEGEE in USE.

A COMMON MAGNET and STACK PAPER PRINTING BASE DESIGNED AND USED BY THE AUTHOR

The COMMON MAGNET BASE

FOR USE IN PRINTING SMALL STEEL OR TIN-PLATE SIGNS, NAME-PLATES, CLOCK AND DIAL FACES, INDICATORS, ETC., HAVING INTRICATE DESIGN, CALIBRATIONS OR CHARACTERS.

The SIZE SHOWN IS OF THE CORRECT SIZE FOR PRINTING UP TO 8 X 10" PLATES. LARGER ONES OR SEVERAL OF SIZE SHOWN CAN BE USED FOR PRINTING LARGER OR HEAVIER PLATES.

To MAKE MAGNET SECURE A BAR OF COLD ROLL STEEL 16" LONG BY 1 1/2" BY 3/8" AND FORM BY HEATING INTO U SHAPE

TO MAGNETIZE TAKE TO AN ELECTRICAL SHOP, OR TAPE TO A DIRECT CURRENT GENERATOR FOR A FEW HOURS

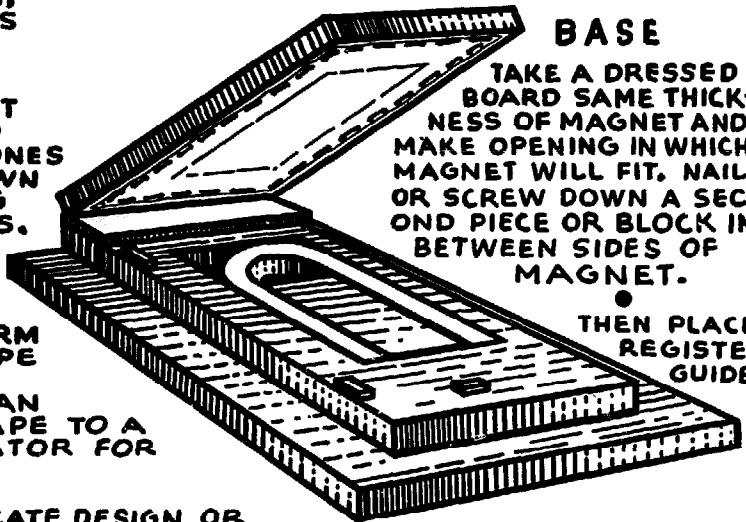
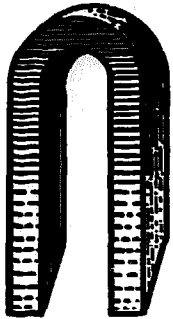

BASE

TAKE A DRESSED BOARD SAME THICKNESS OF MAGNET AND MAKE OPENING IN WHICH MAGNET WILL FIT. NAIL OR SCREW DOWN A SECOND PIECE OR BLOCK IN BETWEEN SIDES OF MAGNET.

THEN PLACE REGISTER GUIDES

FOR CLEAN SHARP PRINTING OF INTRICATE DESIGN OR CHARACTERS, FOR BEST RESULTS PRINT OFF-CONTACT.

STACK PAPER PRINTING BASE with ADJUSTABLE BOX GUIDES

FOR FAST PRODUCTION PRINTING OF PAPER, SIGN-CLOTH, OIL-CLOTH, CANVAS ETC., IN WHICH SINGLE SHEET INSERTION IS ILLIMINATED, PRINTING CAN BE INCREASED TO AT LEAST TWICE AS FAST WITH THIS OR A SIMILAR DEVICE.

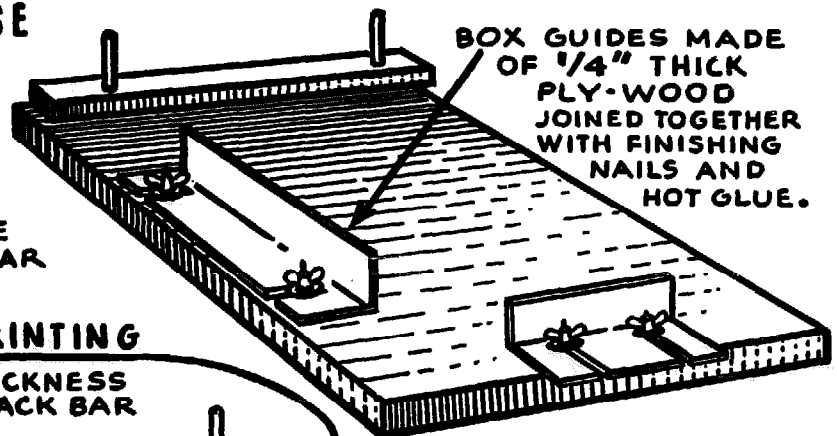

BOX GUIDES MADE OF 1/4" THICK PLY-WOOD JOINED TOGETHER WITH FINISHING NAILS AND HOT GLUE.

BASE LOADED READY FOR PRINTING

WOODEN BACK BAR OF SAME THICKNESS OF SCREEN FRAMES USED. BACK BAR CONTAINING TWO HOLES RIDES UPON TWO POLISHED STEEL RODS OR TUBING, CAUSING BAR WITH FASTENED SCREEN TO AUTOMATICALLY DROP AS SIZE OF STACK DECREASES

RODS OR TUBING WHICH SUPPORTS BACK BAR IS FLANGED TO UNDER SIDE OF BASE.

1/4" CARRIAGE BOLTS FASTENED SECURELY TO UNDERNEATH SIDE OF BASE, FOR HOLDING AND ADJUSTING GUIDES.

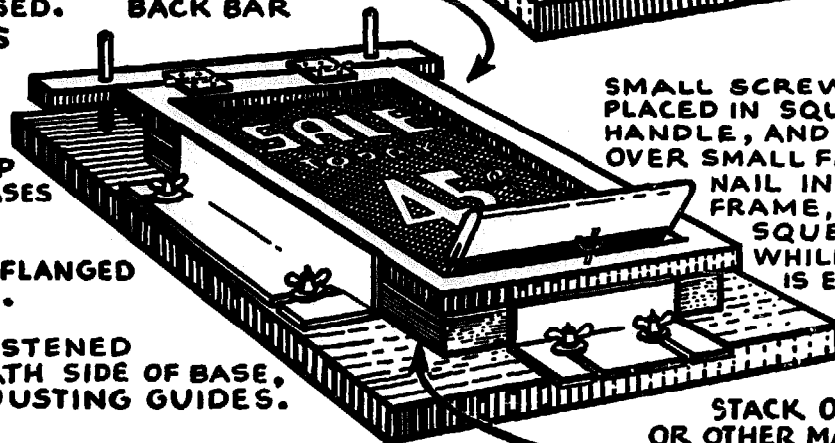

SMALL SCREW-EYE PLACED IN SQUEEGEE HANDLE, AND SLIPPED OVER SMALL FINISHING NAIL IN SCREEN FRAME, HOLDS SQUEEGEE WHILE SCREEN IS ELEVATED

STACK OF PAPER OR OTHER MATERIAL

Quick Screen Changes ^{WITH THE USE OF} C. CLAMPS

ALSO SHOWN IS AN AUTOMATIC SCREEN LIFT

HINGED PRINTING BASE

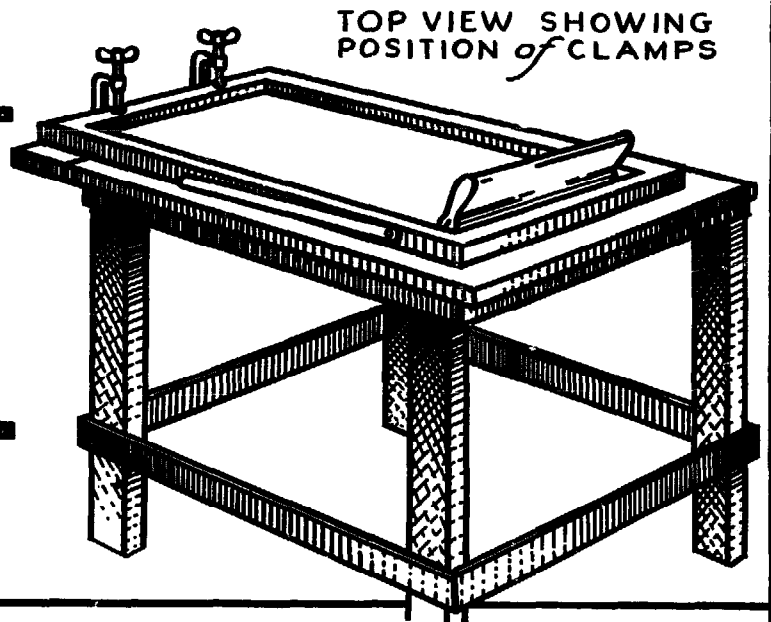
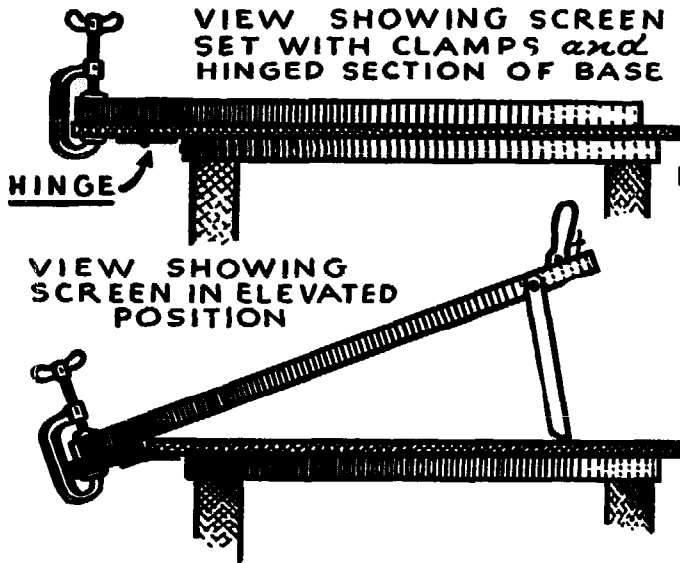

BACK BAR SHOWING HINGE, SCREEN and CLAMP SET-UP.

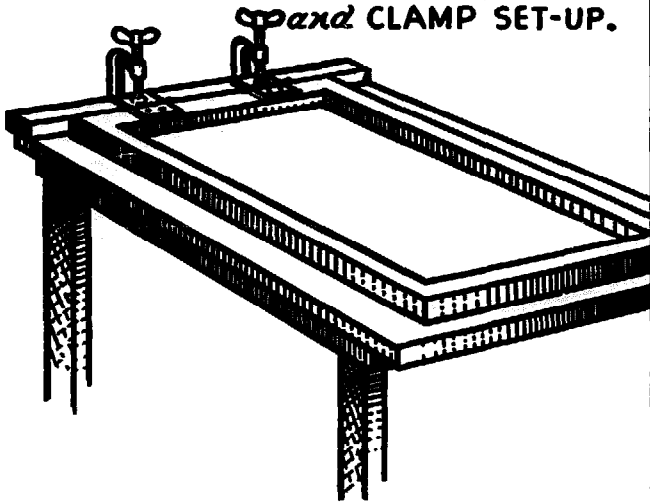

The HINGED BEVEL BASE

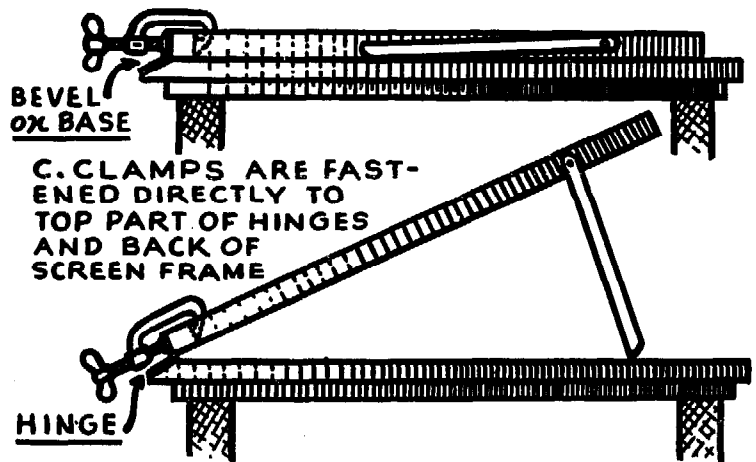

AUTOMATIC SCREEN LIFT
 TO ELEVATE GIVE SCREEN A SLIGHT UPWARD MOVEMENT, ARM AUTOMATICALLY DROPS INTO POSITION. FOR PRINTING POSITION SIMPLY FORCE SCREEN DOWN TO PRINTING SURFACE



CUT A PIECE OF THIN HARDWOOD TO THIS SHAPE

FASTEN TO SIDE OF SCREEN FRAME IN THIS MANNER



RUBBER BAND or COIL SPRING

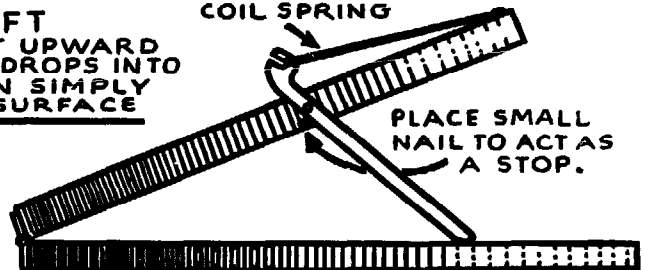

HINGE-FRAME AND OFF-CONTACT SCREEN SET-UP

THE HINGE BACK-BAR

WHILE SATISFACTORY FOR OFF-CONTACT PRINTING AND FOR MATERIALS WHICH REQUIRE PEELING FROM SCREEN AFTER PRINTING, SMEARING AND FEATHER-EDGING WILL RESULT IN THE DIRECT PRINTING OF HEAVIER MATERIALS

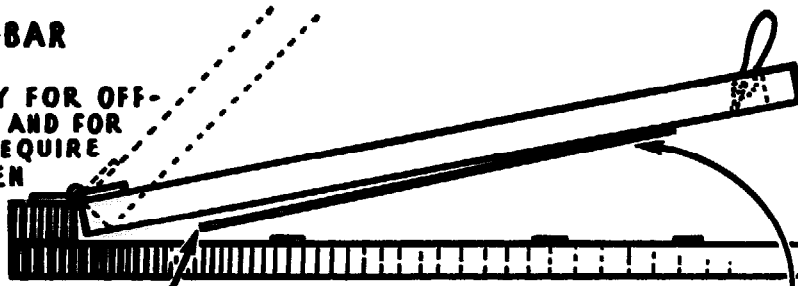

THE WEIGHT OF THE END WHICH DROPS FROM SCREEN FIRST AND WITH THE SCREEN MOVING UPWARDS IN THE OPPOSITE DIRECTION THE END WHICH DROPS LAST IS SMUGGED.

THE REASON. AS SCREEN IS BEING ELEVATED THE HINGED END MOVES IN AN UPWARD CYCLE, FORCING THE SCREEN TO SLIDE AGAINST THE END OF CARDBOARD, GLASS, METAL ETC., BEING PRINTED, WHICH DROPS FROM SCREEN LAST.

CORRECT HINGE-FRAME SET-UP

AS SCREEN IS BEING ELEVATED NOTICE HOW CURVE EXTENDS AROUND WITH TOP AND END OF SCREEN FRAME.

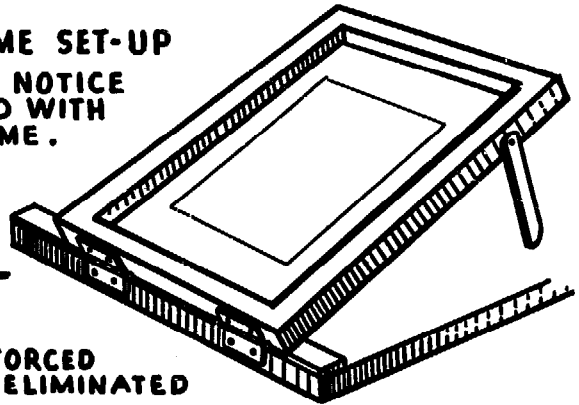
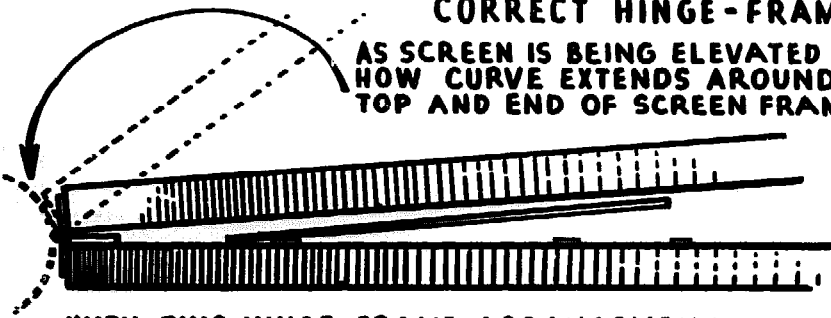

WITH THIS HINGE-FRAME ARRANGEMENT THE FORCED SLIDING ACTION BETWEEN SCREEN AND PRINT IS ELIMINATED

THE PRINCIPLE IS THE SAME WHEN HINGES ARE FASTENED IN THIS MANNER.

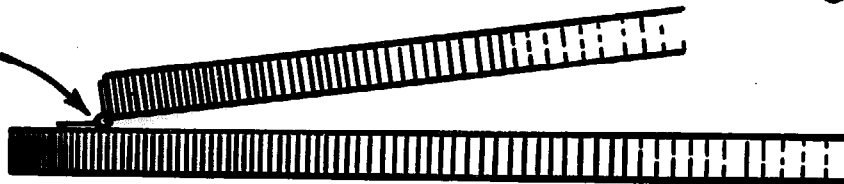

OFF-CONTACT PRINTING

WHEN PRINTING UPON HEAVY CARDBOARD, GLASS, METAL, WOOD ETC., THE MOST LOGICAL METHOD FOR CLEAN, SHARP DETAIL PRINTING IS WITH THE OFF-CONTACT PROCESS.

POINT OF CONTACT

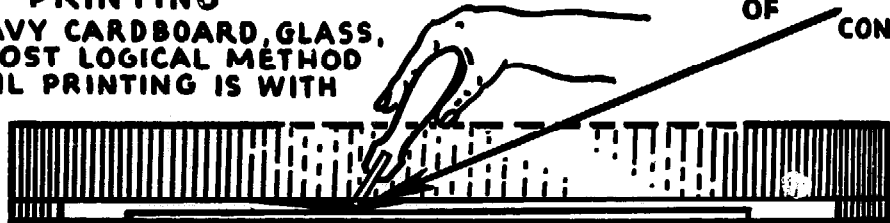

WHILE STRIPS OF CARDBOARD ARE USUALLY FASTENED TO THE FRAME ENDS, FLAT HEAD WOOD SCREWS ARE BEST BECAUSE THEY MAY BE ADJUSTED TO OFF-CONTACT HEIGHT DESIRED.

PLENTY OF MARGIN SHOULD BE LEFT AROUND DESIGN PATTERN TO PREVENT DISTORTION OF THE SILK WHERE FASTENED TO THE FRAME

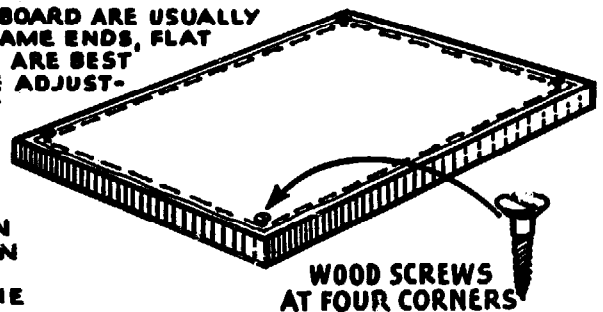
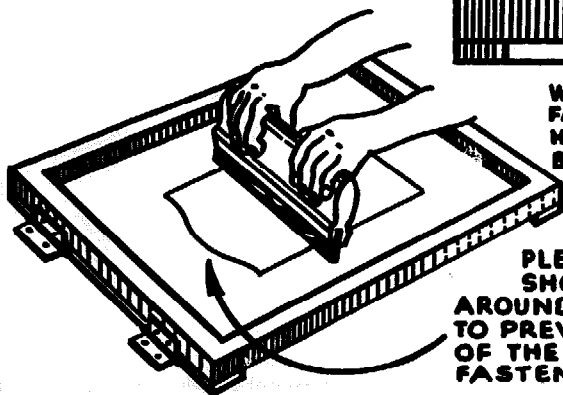

WOOD SCREWS AT FOUR CORNERS

SCREEN PROCESS EQUIPMENT

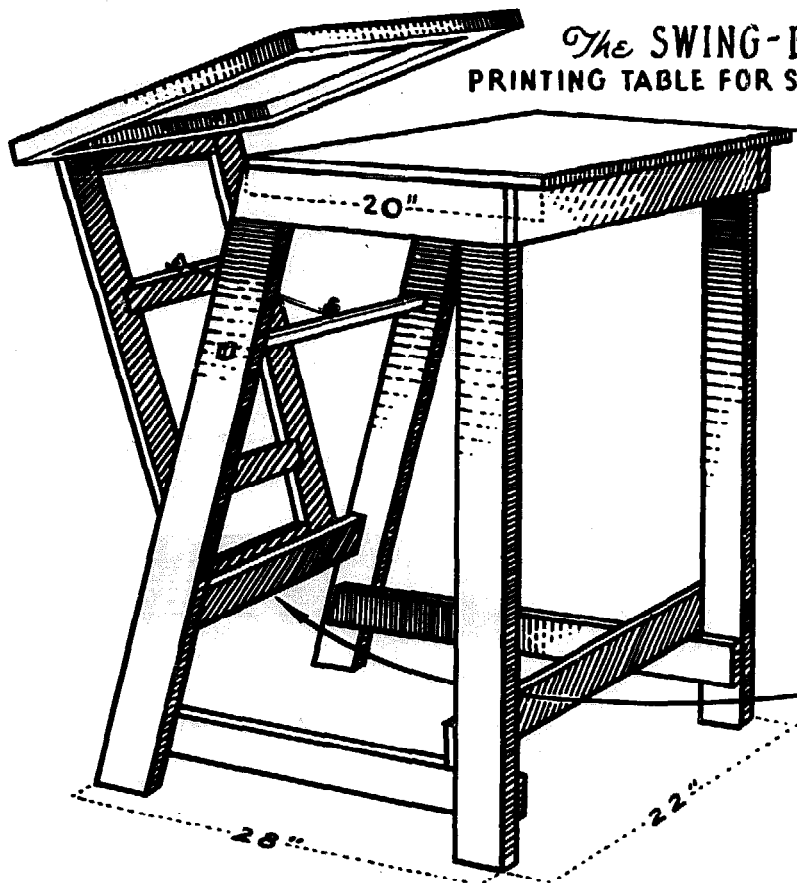

The SWING-BACK
PRINTING TABLE FOR SMALL WORK

YOU CAN USE
THE
MASTER FRAME
ARRANGEMENT
DESCRIBED ON
FOLLOWING
PAGE

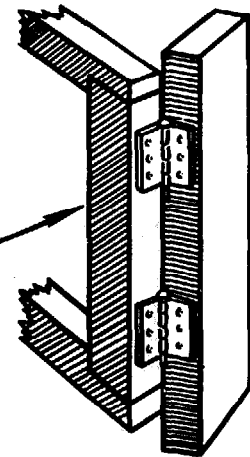
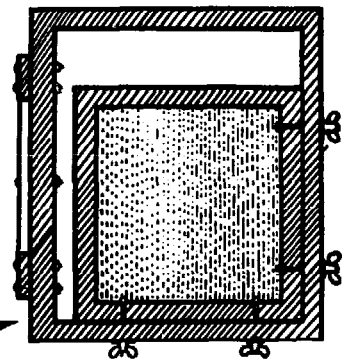

BOTTOM
VIEW
OF
HINGED
SUPPORT

ANOTHER EASILY CONSTRUCTED UNIT
FOR PRINTING COMPATIVELY SMALL
CARDS, GLASS SHEETS, WOOD, METAL ETC.

The SPRING-LIFT
WITH ADJUSTABLE HINGED METAL
BACK BAR

BACK VIEW

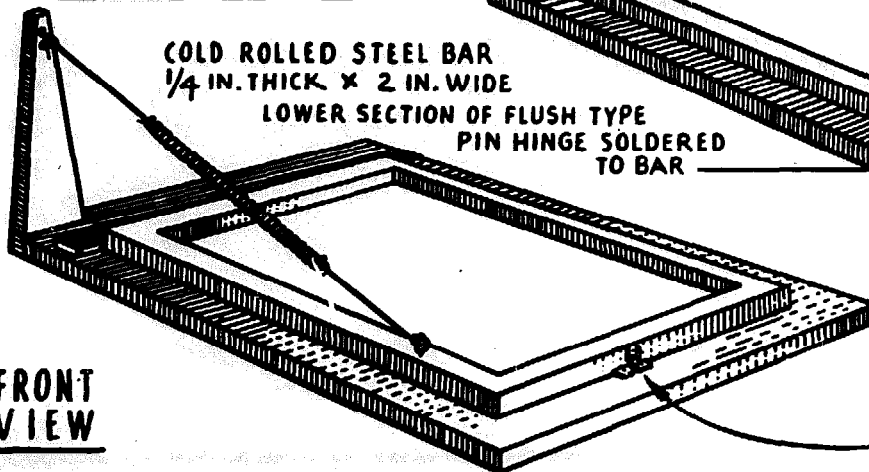
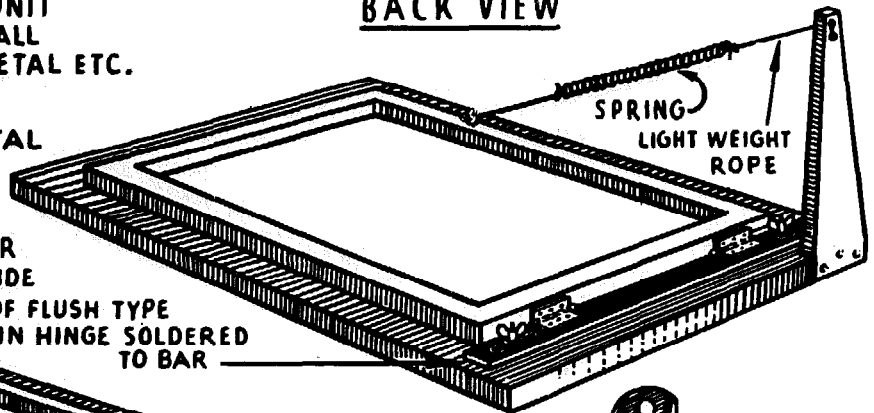

COLD ROLLED STEEL BAR
1/4 IN. THICK X 2 IN. WIDE
LOWER SECTION OF FLUSH TYPE
PIN HINGE SOLDERED
TO BAR

FRONT
VIEW

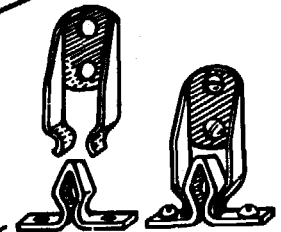

POLAR FRICTION CATCH

SCREEN PROCESS EQUIPMENT

A PRACTICAL COUNTER BALANCING
PRINTING TABLE UNIT *with*
MASTER FRAME *and* PRINTING
FRAME QUICK CHANGE
FEATURES

FRONT VIEW
SHOWING MASTER
FRAME AND PRINTING
FRAME IN
ELEVATED POSITION

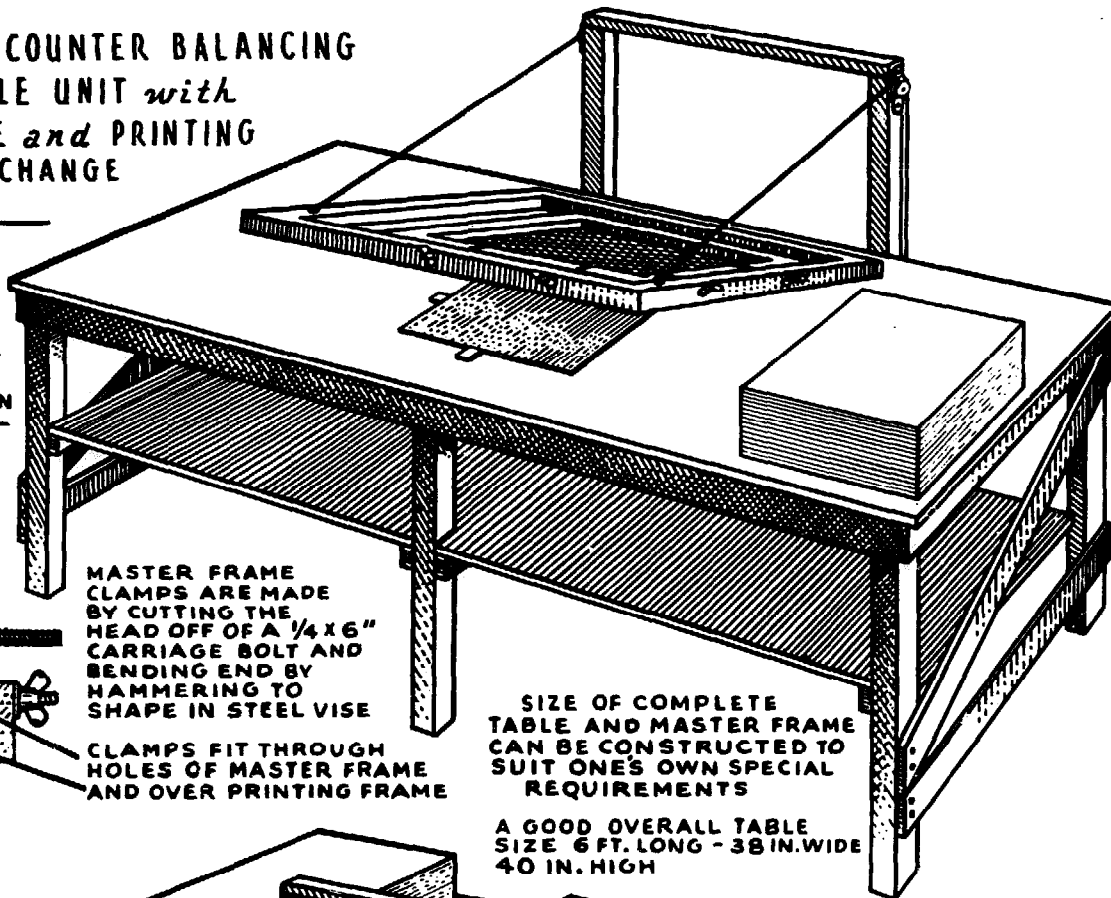

MASTER FRAME
CLAMPS ARE MADE
BY CUTTING THE
HEAD OFF OF A 1/4 X 6"
CARRIAGE BOLT AND
BENDING END BY
HAMMERING TO
SHAPE IN STEEL VISE

CLAMPS FIT THROUGH
HOLES OF MASTER FRAME
AND OVER PRINTING FRAME

SIZE OF COMPLETE
TABLE AND MASTER FRAME
CAN BE CONSTRUCTED TO
SUIT ONE'S OWN SPECIAL
REQUIREMENTS

A GOOD OVERALL TABLE
SIZE 6 FT. LONG - 38 IN. WIDE
40 IN. HIGH

BACK VIEW

SHOWING SCREEN
LOWERED INTO
PRINTING
POSITION

PIN HINGES ON
MASTER FRAME
ARE BUTT FLUSH
TYPE

PULLEYS OF THE
STANDARD SIDE
TYPE, SAME AS
THOSE SHOWN
ON FOLLOWING
PAGE

SIZE OR SHAPE OF
COUNTER BALANCE WEIGHT
MATERIAL, IS OPTIONAL

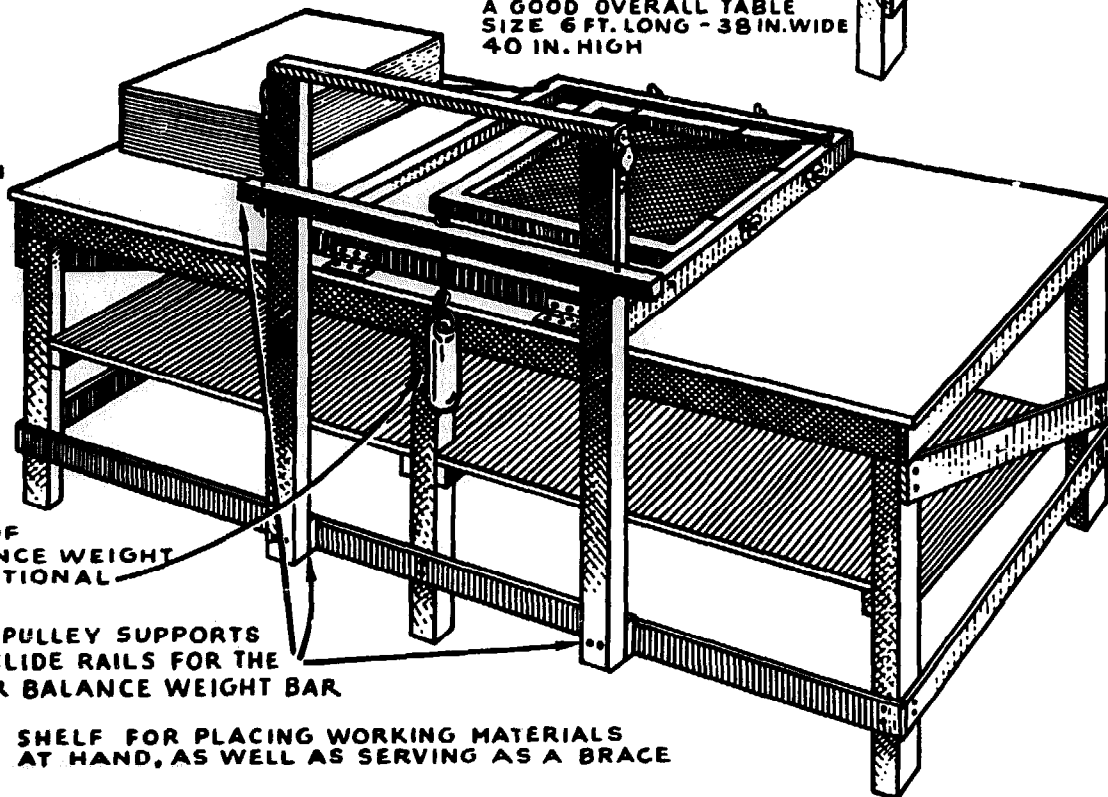

UPRIGHT PULLEY SUPPORTS
ACT AS SLIDE RAILS FOR THE
COUNTER BALANCE WEIGHT BAR

SHELF FOR PLACING WORKING MATERIALS
AT HAND, AS WELL AS SERVING AS A BRACE

SCREEN PROCESS EQUIPMENT

Medium Size JACK-SWING, ADJUSTABLE MASTER FRAME PRINTING TABLE UNIT

HOLES IN MASTER FRAME ARE COUNTER SUNK ON REVERSE SIDE CORRESPONDING HOLES IN EACH END OF BARS AND FASTENED TO MASTER FRAME WITH BOLTS FOR DIFFERENT SIZE PRINTING FRAMES

PRINTING FRAME FASTENED TO BARS WITH BOLTS OR WOOD SCREWS

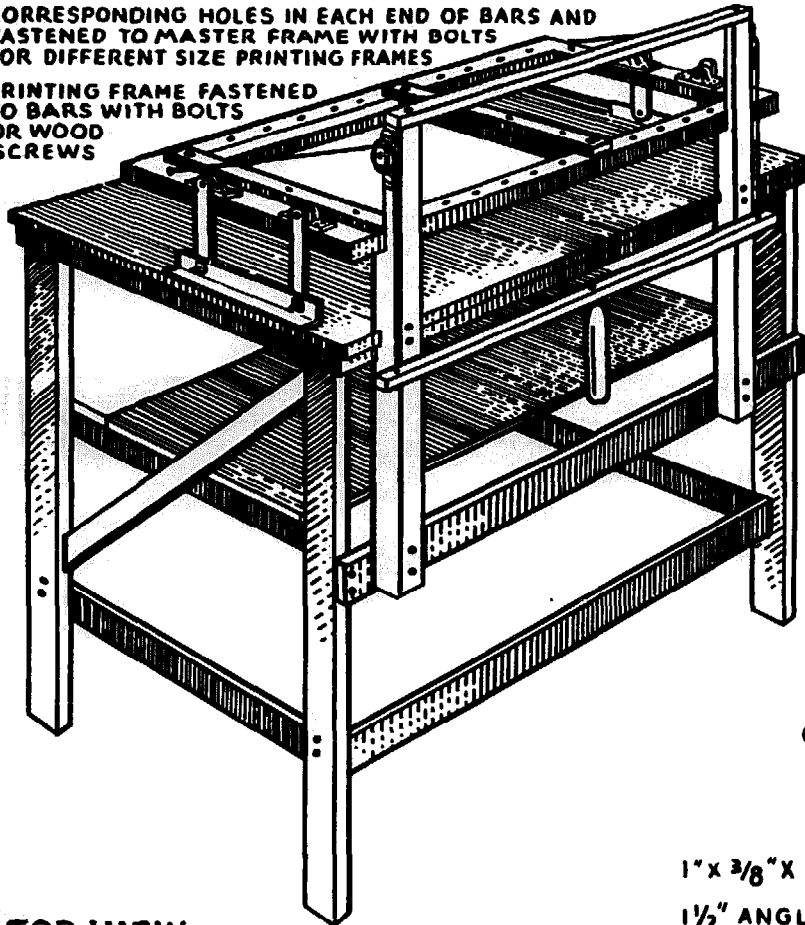

PULLEYS FOR SUPPORTING COUNTER BALANCE LIFT, COME IN SEVERAL VARIOUS TYPES

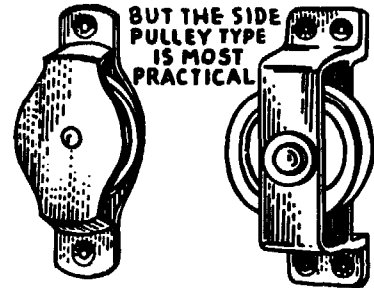

BUT THE SIDE PULLEY TYPE IS MOST PRACTICAL

FOR HOLDING THE SIDE ARMS YOU CAN USE A PLAIN OR DOUBLE EAR PILLOW BLOCK



OR YOU CAN MAKE THE SIDE ARM SUPPORTS FROM 2 X 1/2" ANGLE IRON



TOP VIEW

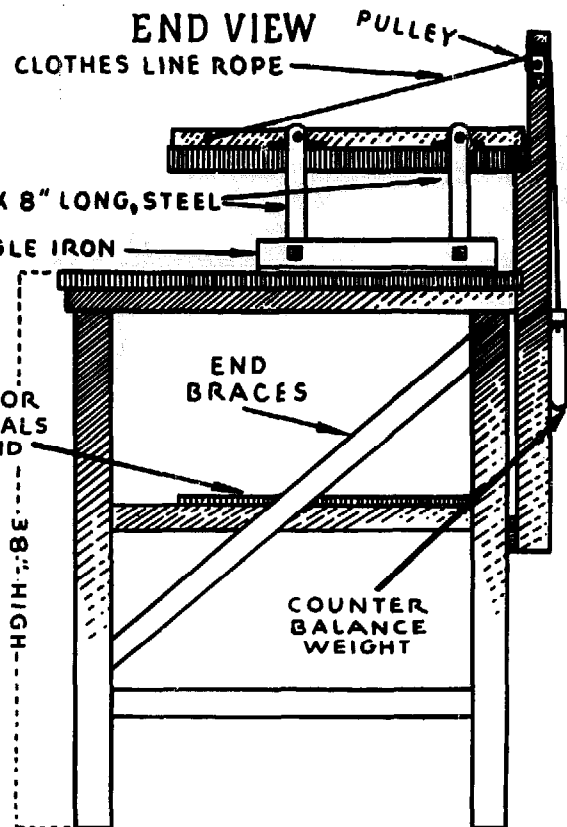
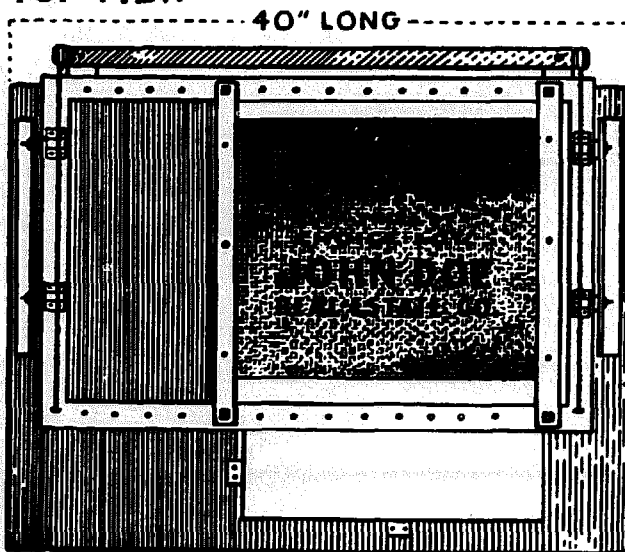

SCREEN PROCESS EQUIPMENT

The ADJUSTABLE PEDAL-LIFT PRINTING TABLE

1/4" STOVE BOLTS WITH WING NUTS

HOLES IN END SUPPORTS FOR ADJUSTING SCREEN FRAME HOLDING BARS

SCREEN FRAME HOLDING BARS, WITH HOLES FOR PLACING WOOD SCREWS FOR ATTACHING DIFFERENT SIZE PRINTING FRAMES

COMPLETE ENDS SLIDE UP AND DOWN WITH PEDAL ACTION

ALL PARTS UPON WHICH ENDS SLIDE CAN BE PARAFINED FOR EASY ACTION

CENTER UPRIGHT BAR, TOP CROSS BARS AND PEDAL ARMS OF HARD WOOD

3/8" BOLTS WITH WASHERS AND NUTS

HARD WOOD PEDAL LOCK SWINGS OUTWARD TO RELEASE PEDAL

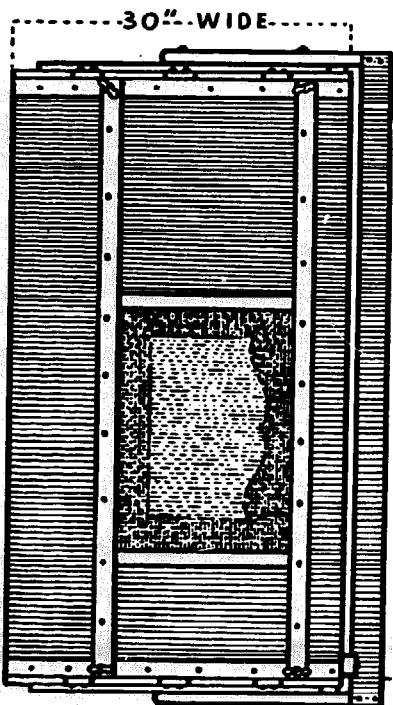
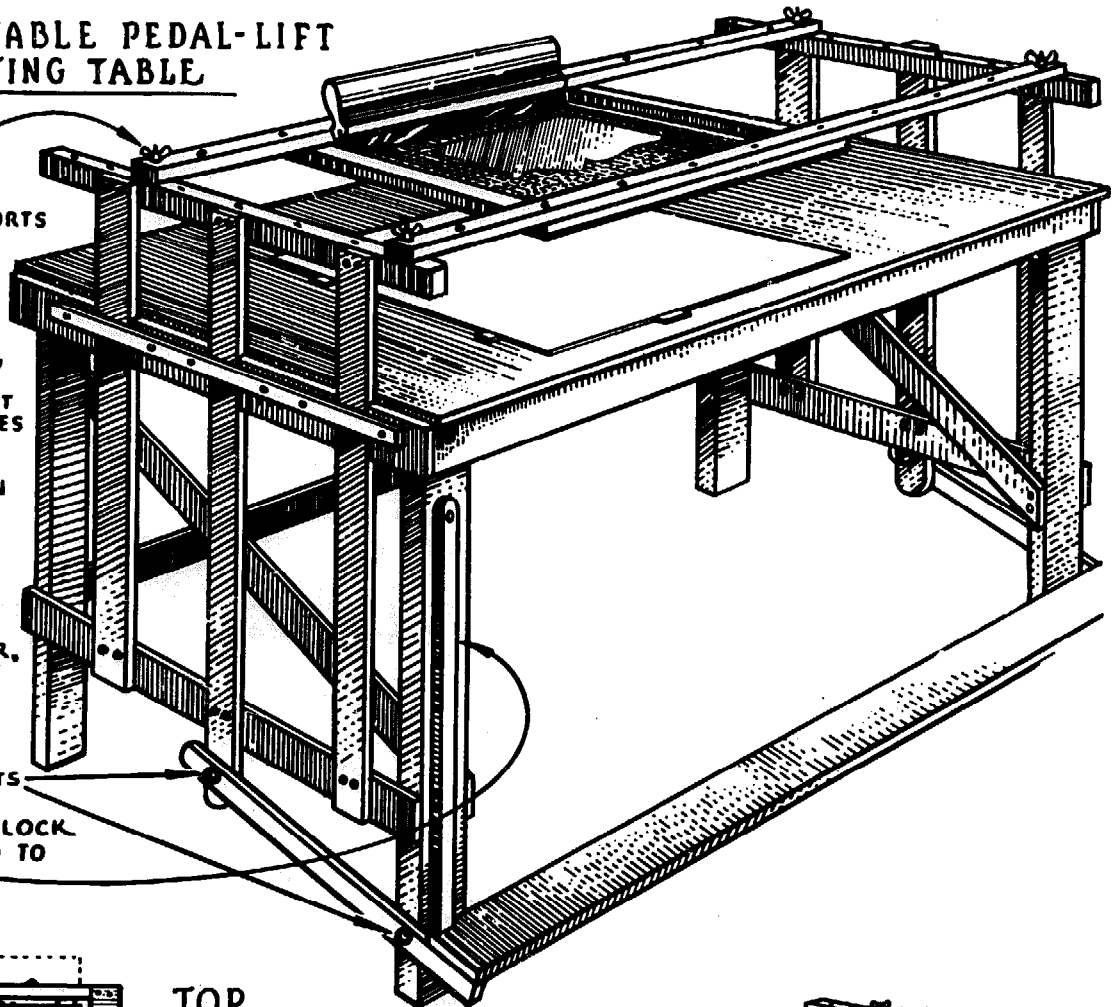

TOP VIEW

TABLE TOP 48" LONG

30" WIDE

HEIGHT TABLE TOP TO BOTTOM 38"

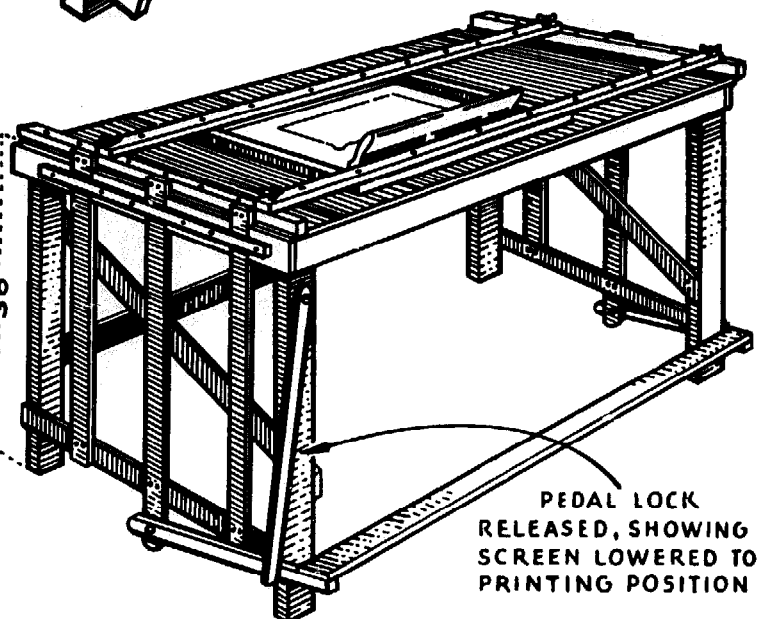

PEDAL LOCK RELEASED, SHOWING SCREEN LOWERED TO PRINTING POSITION

SUGGESTIONS IN TOOLS FOR THE STENCIL FILM CUTTER

① AN INEXPENSIVE STENCIL FILM KNIFE



USE NO 16 BLADE FOR STENCIL FILM CUTTING



USE NO 11 BLADE FOR PHOTO FILM CUTTING TRIMMING SILK, PAPER CUTTING, ETC.

THIS MOST POPULAR TOOL CAN BE FOUND IN MOST HARDWARE, ART AND HOBBY STORES AS WELL AS FROM YOUR FAVORITE SCREEN PROCESS SUPPLY DEALER.

⑥ THE SMALL PRECISION CIRCLE CUTTER

LOCK SCREW CAP FOR LOCKING EXTENSION BARS



A MOST WORTHY INSTRUMENT FOR ANY FILM CUTTERS KIT.

CUTS FROM 1/16 TO 3 3/4 IN. CIRCLES

⑪ AN EXCELLENT CIRCLE CUTTER CAN BE MADE FROM AN ORDINARY SCHOOL COMPASS

TAKE THE TOOL SHOWN IN NO 1 ILLUSTRATION AND SAW OFF PART OF HANDLE AND INSERT BLADE OR CHUCK END INTO PENCIL HOLDER.

ADJUST BLADE TO CUTTING POSITION

CUTS FROM 1 IN. TO 8 IN. CIRCLE

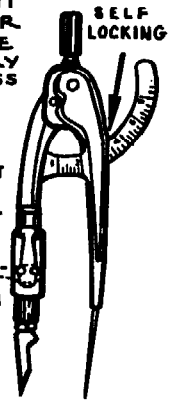

②



LINE LOOP CUTTERS COME IN SETS CONTAINING THREE CUTTERS OF DIFFERENT SIZES. EXCELLENT FOR CUTTING FILMS OF DRAWINGS AND SKETCHES. CUTS AND PEELS FILM ALL IN ONE OPERATION.

⑦ A GOOD INEXPENSIVE CIRCLE CUTTER



CUT SLOT IN CARDBOARD OR HEAVY CELLULOID STRIP THEN PLACE TRANSPARENT TAPE OVER SLOT

WITH TAPE SIDE DOWN PLACE POINT OF BLADE BARELY THROUGH TAPE. TAPE WILL HOLD KNIFE POINT FROM SLIPPING



⑫ TWO WAYS OF MAKING A CIRCLE CUTTER FROM THIS TYPE OF COMPASS

USE THE TYPE OF COMPASS WITH CENTER WHEEL ADJUSTMENT

SLIP IN A SHARPENED NEEDLE IN PLACE OF PENCIL LEAD. SAW AWAY THIS SECTION OF PEN, USING THE PART LEFT AS BLADE.

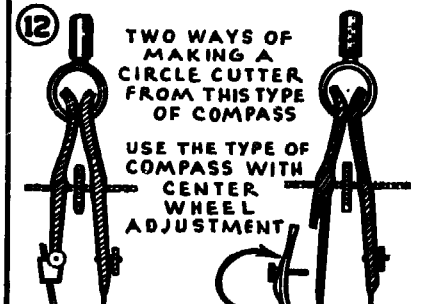

③ MANY STENCIL CUTTERS PREFER THE "SWIVEL BLADE" TYPE



EXTRA BLADES ARE OBTAINABLE FROM YOUR SUPPLY DEALER. HANDLING THIS TYPE OF TOOL.

④ THIS IS ANOTHER IMPROVED TYPE OF SWIVEL STENCIL FILM CUTTING TOOL. MADE ESPECIALLY FOR INTRICATE CUTTING



THE BLADE WHICH IS REMOVABLE CAN BE TILTED TO ANY DESIRED CUTTING ANGLE.

⑤ THE FIRST STENCIL KNIVES USED BY THE EARLY SCREEN PROCESSORS WERE FASHIONED FROM THE LITHOGRAPHER'S SCRAPER.

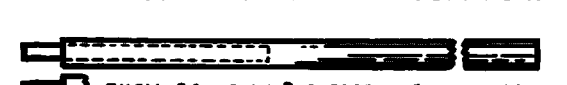

THEY COME IN 3 DIFFERENT WIDTHS IN THE FLAT BLADE. BLADE EXTENDS INTO HANDLE 3 INCHES.



WHILE THESE KNIVES ARE NOW SUPPLIED READY TO USE, IT USED TO BE NECESSARY FOR THE PROCESSOR TO GRIND DOWN THE BLADE, AND SHAPE THE HANDLE.

⑧ THERE ARE MANY MAKES OF BEAM COMPASS CUTTERS. PRACTICALLY ALL ARE VERY GOOD. HOWEVER THIS HEAVY DUTY TYPE IS EXCEPTIONAL

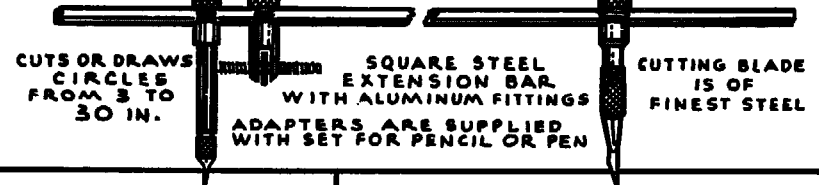

CUTS OR DRAWS CIRCLES FROM 3 TO 30 IN.

SQUARE STEEL EXTENSION BAR WITH ALUMINUM FITTINGS

CUTTING BLADE IS OF FINEST STEEL

ADAPTERS ARE SUPPLIED WITH SET FOR PENCIL OR PEN

⑨ MAGNIFIER FOR INTRICATE FILM CUTTING. USE THIS TYPE HAVING A 1 IN. FIELD

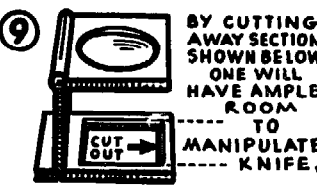

BY CUTTING AWAY SECTION SHOWN BELOW ONE WILL HAVE AMPLE ROOM TO MANIPULATE KNIFE.

⑬ AN IMPROVED TYPE OF MAGNIFIER FOR USE IN CUTTING OR DRAWING

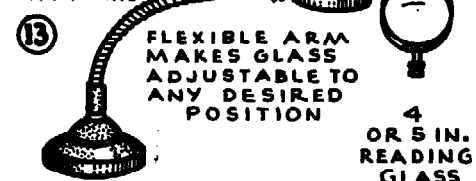

FLEXIBLE ARM MAKES GLASS ADJUSTABLE TO ANY DESIRED POSITION

4 OR 5 IN. READING GLASS

⑩ A FILM CUTTER'S KIT WOULDN'T BE COMPLETE WITHOUT A TRUE 24 IN. STEEL STRAIGHT EDGE, AN ASSORTMENT OF TRIANGLES AND FRENCH CURVES.



SUGGESTIONS FOR THE SCREEN PROCESS ARTIST

OLD AND NEW TRICKS OR METHODS WHICH WILL HELP HIM TO DO HIS WORK FASTER AND BETTER.

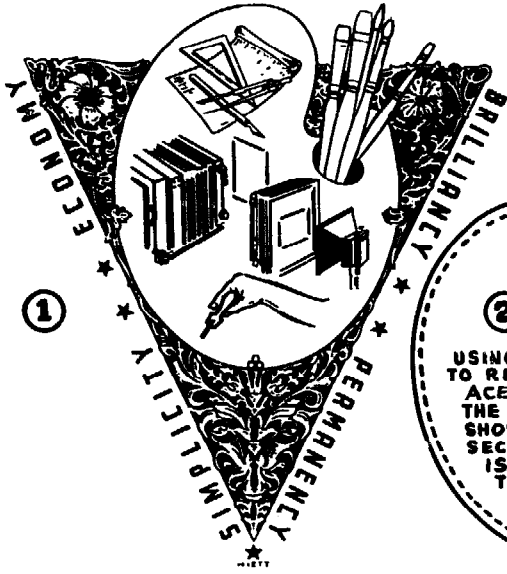

A SIMPLE METHOD FOR DRAWING ACCURATE PEN LINE CURVES FOR PHOTO-SCREEN REPRODUCTIONS WHICH OTHERWISE MIGHT BE IMPOSSIBLE BY FREE HAND. *The* ARTIST'S PALETTE IN THE NO 1 BLACK AND WHITE REPRESENTING SCREEN PROCESS BY HIETT WAS MADE BY THIS METHOD. *The* NO 2 SHOWS THE SAME PALETTE DRAWN IN HEAVIER PEN LINE.

FIRST, THE PENCIL DRAWING IN OUTLINE IS MADE ON WHITE PAPER BY FREE HAND OR WITH CUT-OUT PAPER PATTERN.

A CLEAR SHEET OF ACETATE ABOUT .015 OR .020 THICKNESS IS FASTENED DOWN ON TOP OF THE LEAD PENCIL DRAWING.

WITH A SHARP POINTED STENCIL KNIFE THE ACETATE IS CUT PART WAY THROUGH, FOLLOWING PENCILLED OUTLINE UNDERNEATH.

AFTER CUTTING THE DESIGN IN THE ACETATE IT IS REMOVED FROM THE PENCIL DRAWING THEN THE OUTER SECTION IS EASILY BROKEN FREE WHERE PARTIALLY CUT, BY BENDING THE ACETATE SLIGHTLY. *The* EDGES OF THE PART WHICH WILL BE USED IS THEN SMOOTHED UP WITH FINE EMERY PAPER OR CLOTH.

NOW TO COMPLETE THE PATTERN FOR DRAWING WITH INK AND RULING PEN A SECOND ACETATE PATTERN IS CUT ABOUT 1/4 OF AN INCH SMALLER AROUND THAN MAIN PATTERN AND CEMENTED TO UNDERNEATH SIDE. THIS CLEARS THE RULING EDGE AND PREVENTS INK FROM SPREADING UNDERNEATH.

1

2

USING THIS DRAWING TO REPRESENT THE ACETATE CUT-OUT, THE DOTTED LINES SHOW WHERE THE SECOND CUT-OUT IS CEMENTED TO THE UNDERNEATH SIDE OF THE FIRST

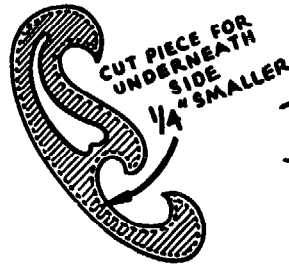
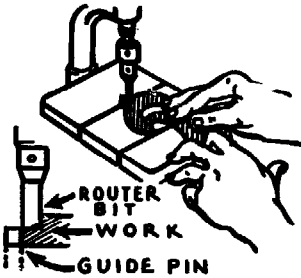
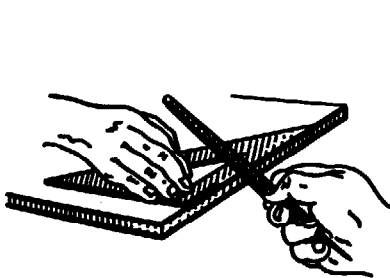

HOW TO MAKE YOUR TRIANGLES OR FRENCH CURVES USABLE FOR DRAWING LINES WITH RULING PEN AND INK

TO PREVENT THE INK FROM SPREADING UNDERNEATH AT THE EDGES UPON THE DRAWING, UNDERCUTTING OF TRIANGLE OR CURVE IS NECESSARY. A FINE TOOTH FILE AS SHOWN ABOVE MAY BE USED.

OR UNDERCUTTING MAY BE DONE WITH A SMALL ROUTING BIT UPON A DRILL PRESS. THE BIT MAY BE MADE FROM A BROKEN FLUTED DRILL.

THE TRIANGLE OR FRENCH CURVE CAN BE BUILT UP WITH A PIECE OF ACETATE CEMENTED TO THE UNDERNEATH SIDE.

IN EITHER INSTANCE AND REGARDLES OF HOW THE DRAWING TOOL IS FIXED, DRAWING PERFECT PEN LINES IS SIMPLIFIED.

The PANTOGRAPH IS AN IMPORTANT INSTRUMENT AMONG COMMERCIAL ARTISTS FOR ENLARGING OR REDUCING DRAWINGS, LABELS, DESIGNS, ETC., TO CORRECT PROPORTIONS.

TO PERMIT THE TRACING POINT TO GLIDE SMOOTHLY OVER COARSE OR ROUGH PAPER A

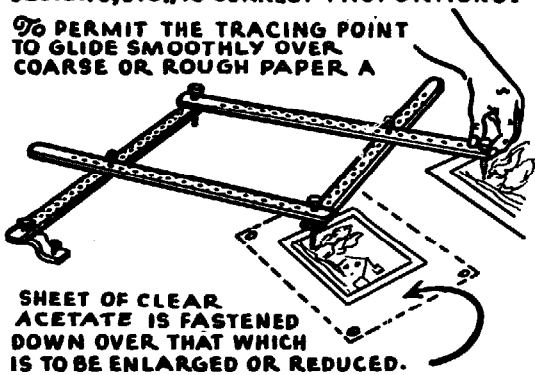

SHEET OF CLEAR ACETATE IS FASTENED DOWN OVER THAT WHICH IS TO BE ENLARGED OR REDUCED.



TRACING PAPER OVER DRAWING

ESSENTIAL KEY LINE 7/8 GOVERNING FACTOR

THE STANDARD RULE FOR DETERMINING CORRECT PROPORTIONS IN WIDTH AND LENGTH OF DRAWING WHICH IS TO BE REPRODUCED IN REDUCED OR ENLARGED SIZE IS SHOWN ABOVE. TRACING PAPER IS GENERALLY USED OVER DRAWING TO DETERMINE THIS.

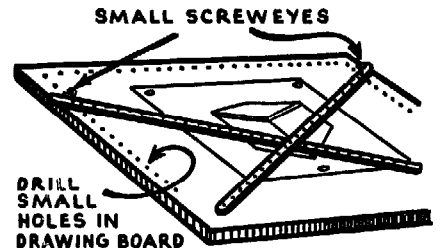

DRILL SMALL HOLES IN DRAWING BOARD

FOR MAKING SMALL PERSPECTIVE DRAWINGS USE A PAIR OF ARMS FROM A DISJOINTED WOODEN PANTOGRAPH

LOOSE PAPER *KNIFE CUT* STENCIL SCREEN

CUT PAPER STENCIL HELD SECURE TO SCREEN *with* THE PRINTING COLOR

1
MAKE PENCIL LAYOUT DIRECTLY UPON THE STENCIL PAPER, USING UNTREATED TRACING PAPER OR NEWSPAPER STOCK.

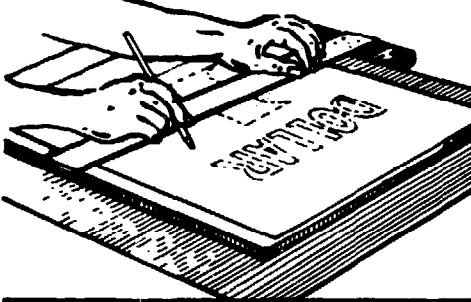

2
CUT OUT WITH SHARP KNIFE PLACING CENTERS ABOVE IN ROTATION AS THEY ARE BEING CUT

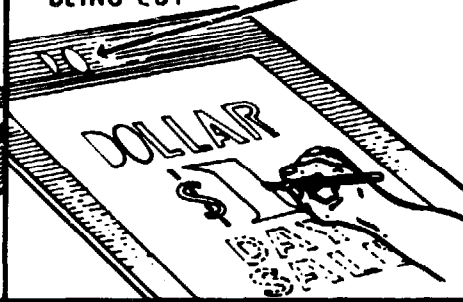

3
NOW
TAPE SCREEN ON INSIDE ONLY

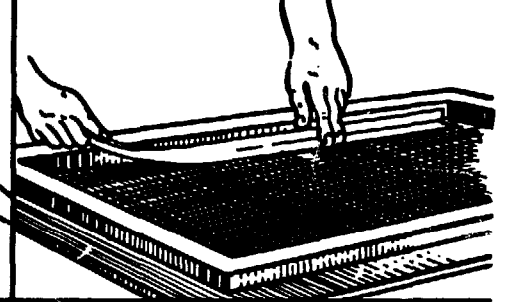

4
SET SCREEN UP IN POSITION ON PRINTING BASE
USE PIN HINGES

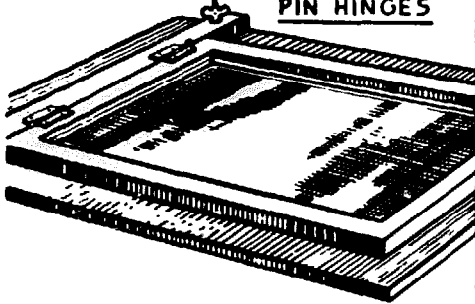

5
PLACE CARDBOARD OR PAPER STOCK TO BE PRINTED, UPON PRINTING BASE AGAINST GUIDES

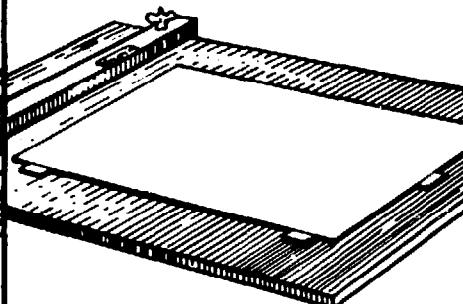

6
PLACE THE CUT STENCIL OVER PRINTING STOCK AND INSERT CENTERS

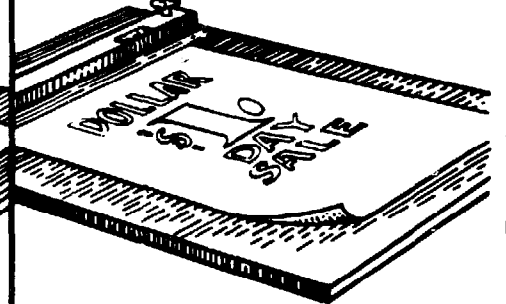

7
SET SCREEN TO PRINTING BASE, AND PAINT SCREEN FRAME WITH RUBBER CEMENT OR HEAVY VARNISH

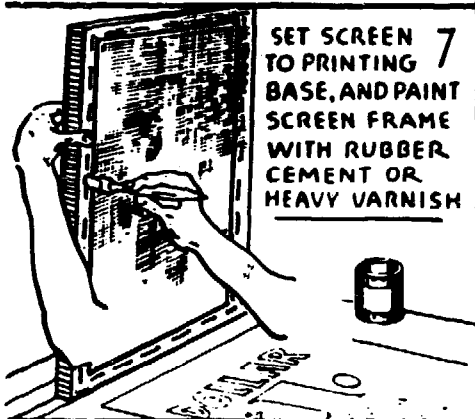

8
LOWER BLANK SCREEN DOWN UPON STENCIL AND PRINTING STOCK — SCREEN HOLDS STENCIL AND CENTERS IN PLACE

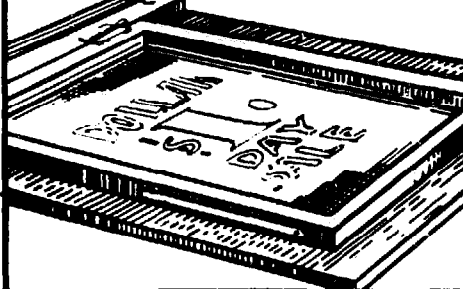

9
NOW PRINT IN THE USUAL FASHION, THE PRINTING COLOR ALONE MAKES THE STENCIL STICK TO SCREEN

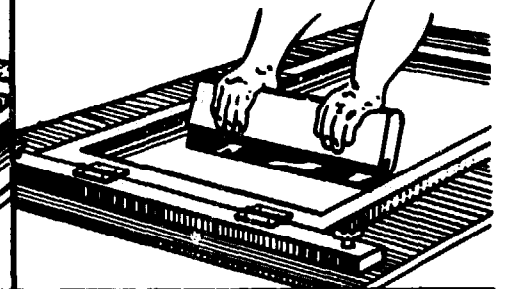

10
HERE THEN WE HAVE THE COMPLETED SCREEN AND FIRST PRINT

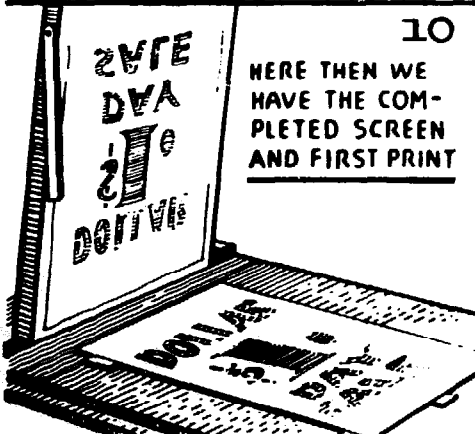

11
AFTER RUN DETACH PAPER STENCIL AND DISCARD

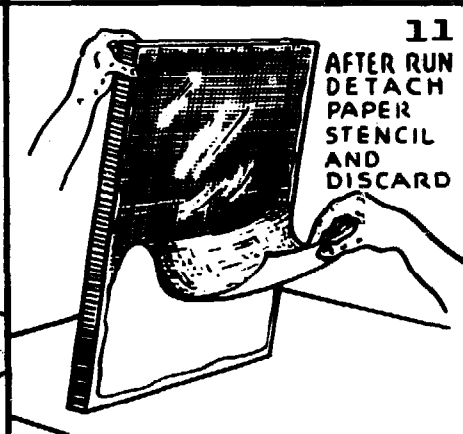

12
CLEAN SCREEN IN USUAL WAY THIS LEAVES A CLEAN SCREEN FOR ANOTHER SIMILAR JOB

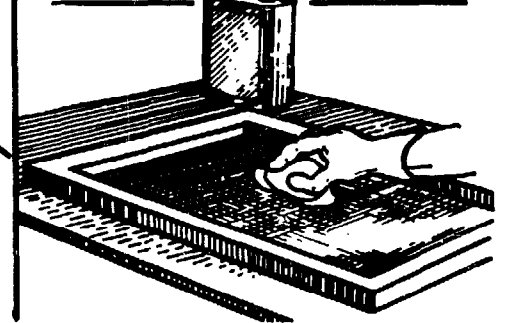

DUPLEX DECAL PAPER

*Shellac Coated
Knife-Cut*

STENCIL SCREEN

1 FIRST, CUT THE DUPLEX DECAL PAPER TO DESIRED SIZE, ABOUT INCH AND A HALF LARGER THAN SKETCH

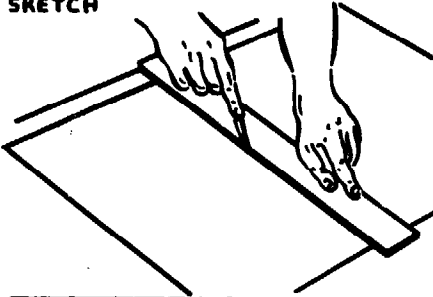

2 APPLY TWO COATS OF CLEAR SHELLAC, THE SECOND COAT AFTER FIRST IS DRY, UPON THE GUM-COATED SIDE

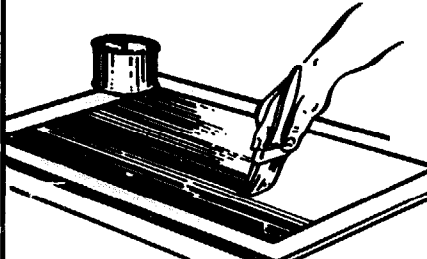

3 NOW, AFTER SHELLAC IS DRY, TURN OVER AND OIL THE BACK WITH SEWING MACHINE OIL, THEN WIPE OFF WITH DRY CLOTH
THIS MAKES THE PAPER TRANSLUCENT

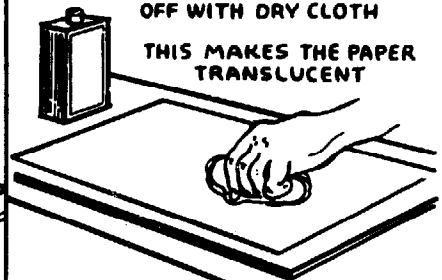

4 PLACE THE TREATED PAPER UPON THE MASTER SKETCH SHELLACKED SIDE UP AND THUMB TACK DOWN



5 THEN CUT AND PEEL OUT OPEN PORTIONS THE SAME AS WITH REGULAR CUTTING FILMS



6 OR IF ONE PREFERS HE MAY MAKE THE SKETCH DIRECTLY UPON THE PAPER AND SHELLAC AFTERWARDS
THIS ELIMINATES OILING



7 AFTER THE STENCIL HAS BEEN CUT, PLACE THE SCREEN IN POSITION DOWN UPON IT

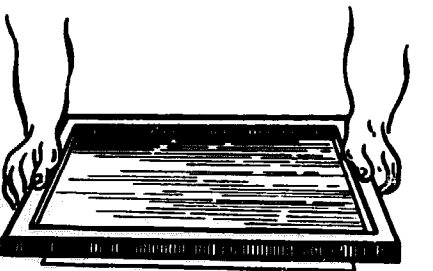

8 NOW IRON ON INSIDE OF SCREEN WITH MEDIUM HOT IRON USING A PIECE OF NEWSPAPER BETWEEN

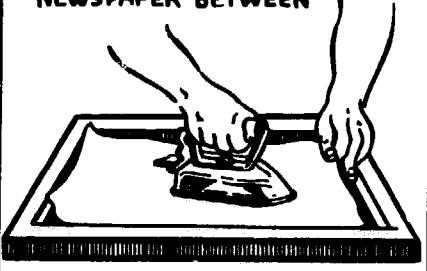

9 NOW STRIP AWAY THE BACKING SHEET

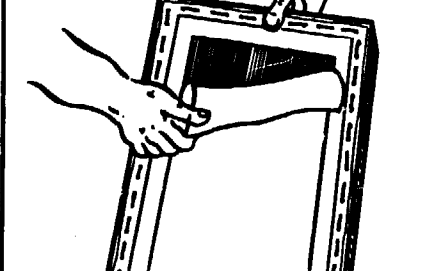

10 AFTER BACKING PAPER HAS BEEN REMOVED, THE THIN VELLUM MAY ALSO BE REMOVED BY SPONGING.
THIS THEN LEAVES ONLY A THIN STURDY SHELLAC FILM

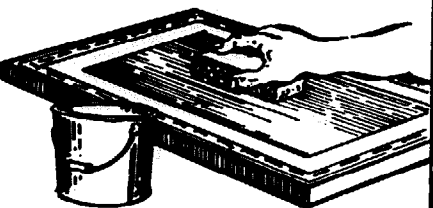

11 AFTER A THOROUGH SPONGING, THE THIN VELLUM RELEASES EASILY

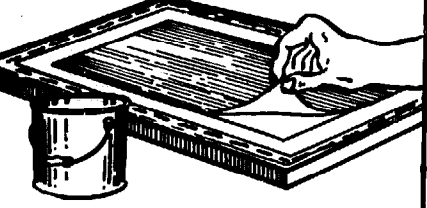

12 FILL IN THE OPEN SPACE BETWEEN FILM AND FRAME WITH LACQUER BLOCKOUT

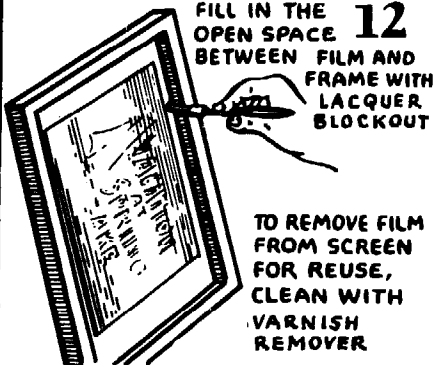

TO REMOVE FILM FROM SCREEN FOR REUSE, CLEAN WITH VARNISH REMOVER

DUPLEX DECAL PAPER *Glue Coat Knife-Cut* STENCIL SCREEN

THIS TYPE OF STENCIL SCREEN FOR PRINTING *with* LACQUER, ACETATE *or* OIL BASE PROCESS COLORS



1
DIFFERENT TYPE GLUES *and* GELATIN MAY BE USED FOR BRUSH COATING BUT THIS TYPE IS PREFERABLE AS IT CAN BE STENCIL SCREENED EASILY *and* EVENLY



FIRST-DISSOLVE 1/2 OZ. BLUE OR GREEN ANILINE DYE IN 2 OZ. OF HOT WATER

2
THEN MIX THIS INTO 1 QT. OF THE DECAL GLUE. THIS GIVES COLOR FOR EASE IN CUTTING OF FILM

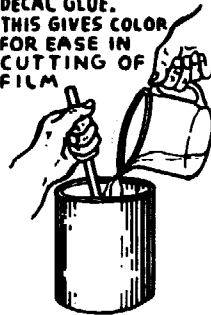

3
SQUEEGEE GLUE UPON SEVERAL SHEETS DUPLEX PAPER, OVER GUMMED TREATED SURFACE

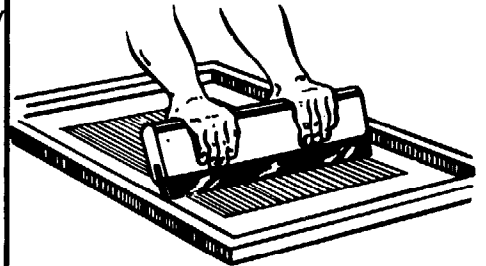

4
AFTER FIRST COAT IS DRY, THEN SQUEEGEE A SECOND COAT DRYING TIME OF EITHER COAT ABOUT ONE HOUR

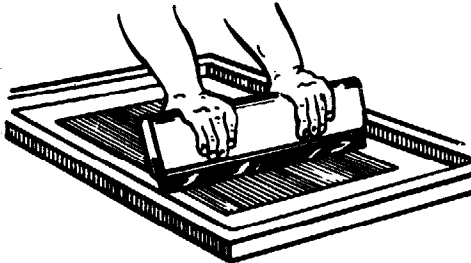

5
OR IF ONE DESIRES HE MAY BRUSH TWO COATS THIS TYPE GLUE IS EXCELLENT FOR THIS PURPOSE

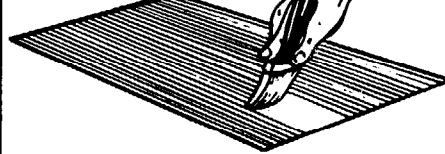

6
WHETHER SCREEN OR BRUSH COATED, OIL BACK SAME AS IN THE OTHER DUPLEX PAPER METHODS OUTLINED

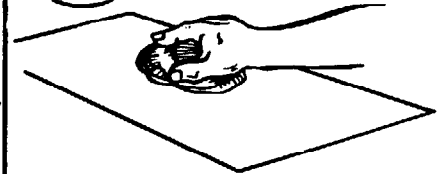

7
NOW PLACE A SHEET OF THE TREATED PAPER, GLUE COATED SIDE UP, UPON MASTER SKETCH

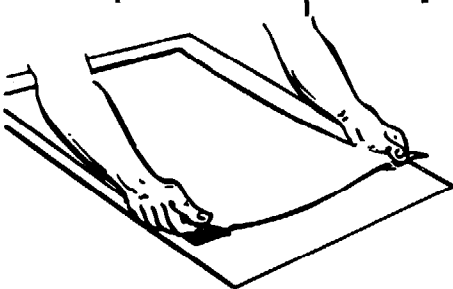

8
CUT THE THIN COATED VELLUM FILM AND PEEL AWAY, SAME AS WITH REGULAR CUTTING FILM

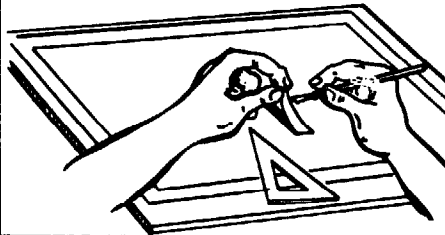

9
NOW PLACE BLANK SCREEN UPON CUT STENCIL IN DESIRED LOCATION

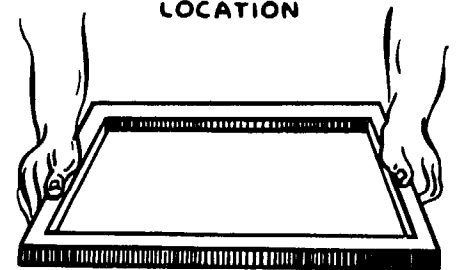

10
DIP SPONGE OR CLOTH IN WATER, WRING OUT, THEN DAMPEN A PIECE OF CARDBOARD IN THIS MANNER

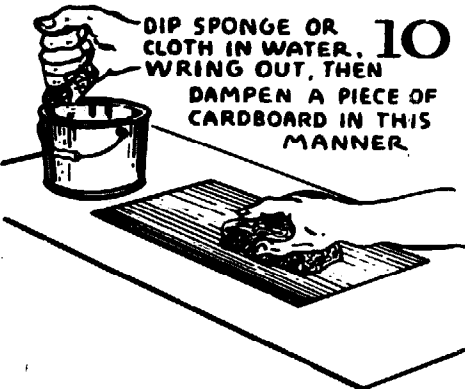

11
PLACE CARDBOARD DAMPENED SIDE DOWN INSIDE OF SCREEN, AND IRON WITH WELL HEATED IRON

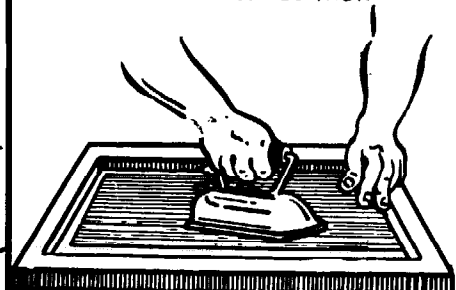

12
AFTER IRONING TURN SCREEN OVER AND STRIP AWAY BACKING PAPER SUPPORT, THEN SEAL AND TAPE TO COMPLETE

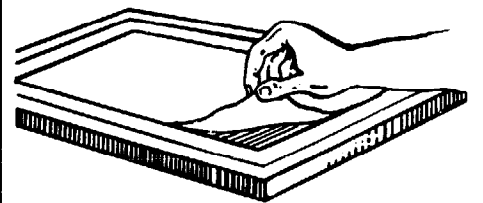

The DUPLEX TYPE OF STENCIL SCREEN

In ACTUAL PRINTING THIS SYSTEM INVOLVES TWO SCREENS THE FRAMELESS SCREEN WHICH CARRIES DESIGN *and* A BLANK MASTER SCREEN TO WHICH IT IS FASTENED, AND THEN REMOVED FOR REUSE

①



PURCHASE FROM YOUR LOCAL DEPARTMENT STORE A PIECE OF MUSLIN HAVING A FINE OPEN MESH

STAPLE AND STRETCH TO FRAME IN THE USUAL WAY.

THIS IS A FINE GAUZE INEXPENSIVE MATERIAL COMING IN 40 IN. WIDTHS.

②

NEXT, SENSITIZE, EXPOSE, DEVELOP, CARBON TISSUE AND ATTACH TO THE MUSLIN SCREEN IN THE USUAL WAY.

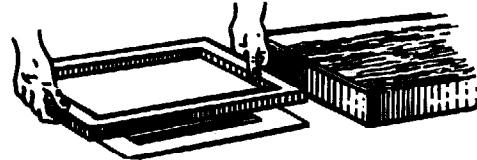

PHOTO STENCIL SCREEN FILMS MAY BE USED ALSO.

③

BESIDES PHOTO SCREEN TRANSFER FILMS, STANDARD CUTTING FILM STENCILS MAY ALSO BE USED, PREFERABLY BLUE OR GREEN OR ANY OF THE THINNER LACQUER COATED FILMS.



④

REGARDLESS OF HOW THE MUSLIN STENCIL IS PRODUCED, WHEN COMPLETED IT IS CUT FROM THE FRAME AS SHOWN

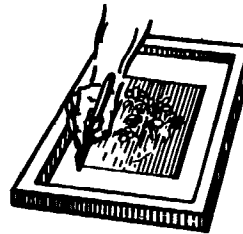

THE FLAT OR FRAMELESS STENCIL SCREEN IS THEN LAID ASIDE TO BE READY FOR FASTENING TO THE BLANK OPENING OF THE MASTER SCREEN.

⑤

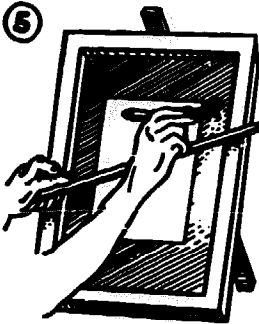

MASTER SCREEN

NOW PREPARE A SECOND SCREEN USING 8XX OR 10XX FABRIC AND FILL IN AS SHOWN USING BLOCKING OUT LACQUER, GLUE FILLER OR EVEN CUT STENCIL FILM MAY BE USED.

⑥

MAKING READY FOR PRINTING

NOW TAKE THE FRAMELESS SCREEN CONTAINING DESIGN AND ATTACH TO OPENING OF MASTER SCREEN FILM SIDE UP

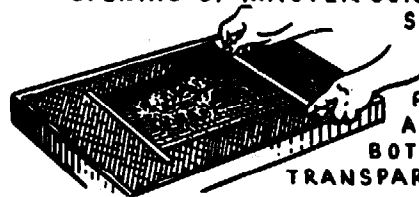

FASTENING AT TOP AND BOTTOM WITH TRANSPARENT TAPE.

⑦

NOW SET SCREEN UP INTO PRINTING POSITION IN THE USUAL MANNER. In PRINTING, THE COLOR IS FORCED THROUGH BOTH SCREENS GIVING A PERFECT IMPRESSION ALTHOUGH TRIFLE HIGHER RELIEF



AFTER PRINTING RUN HAS BEEN COMPLETED THE TOP STENCIL SCREEN IS DETACHED, AND BOTH SCREENS CLEANED IN USUAL WAY.

⑧

TO PRESERVE THE SCREEN CARRYING THE DESIGN FOR FUTURE USE, FIRST APPLY A THIN COAT OF PETROLEUM JELLY OR CUP GREASE TO A PIECE OF DECORATORS OILED STENCIL BOARD AND WIPE OFF.



Then FILE AWAY IN ENVELOPE



HAND-FILLED LACQUER OR GLUE STENCIL SCREEN

1

PREPARE MASTER SKETCH IN PENCIL, INK, OR FULL COLOR IN FULL SIZE

2

STAPLE 12XX, 14XX OR PREFERABLE 16XX FABRIC TO THE FRAME IN THE USUAL WAY

3

THEN - PLACE SCREEN DOWN ON MASTER SKETCH and TRACE WITH PENCIL OR BALL POINT PEN.

4

IN FILLING IN YOU CAN USE AN ILLUMINATED FROSTED GLASS TOP TABLE

5

OR - YOU CAN STAND THE SCREEN UP AND CUT-IN IN THIS MANNER

USE RED SABLE SHOW CARD BRUSH

6

THE FILLING IN SOLUTION CAN BE EITHER BLUE BLOCKOUT LACQUER or BLACK BLOCKOUT LACQUER or LIQUID GLUE, TO WHICH HAS BEEN ADDED SHOW CARD WHITE FOR BODY, WATER and GLYCERINE.

7

TAPE INSIDE OF SCREEN WITH SCOTCH PAPER TAPE

THEN OUTSIDE OF SCREEN

8

SEAL THE TAPE ON THE INSIDE OF SCREEN WITH GLUE or BLOCKOUT

9

SET SCREEN UP TO REGISTER and PROCESS IN USUAL WAY

10

AFTER PRINTING and SCREEN IS CLEANED, THE BLOCKOUT CAN BE REMOVED, IF LACQUER USE LACQUER SOLVENT IF GLUE use WATER

11

CLEAN A SECOND TIME AND WIPE DRY





12

IF TWO OR MORE COLORS ARE IN EFFECT, TRACE, CUT-IN AND PRINT FIRST COLOR, THEN REPEAT SAME OPERATIONS OF CLEANING, TRACING ETC. FOR SECOND and THIRD COLORS

ALL LACQUER FILM

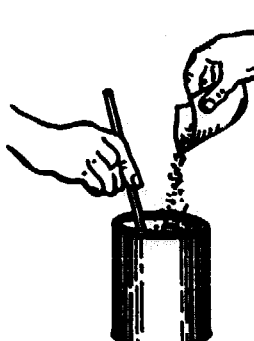
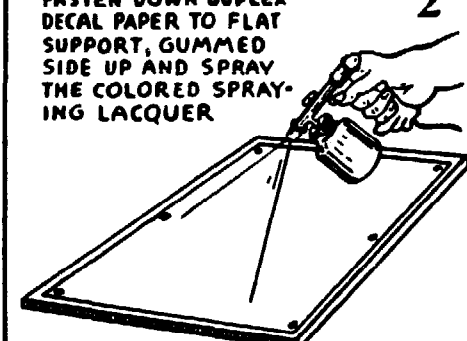
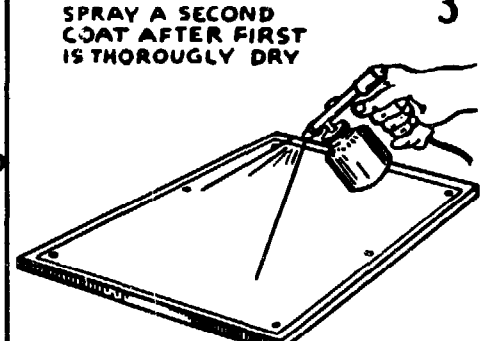
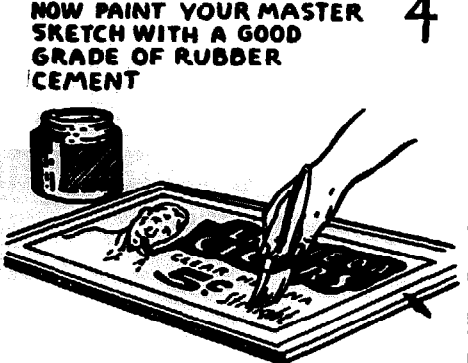
Duplex Transfer

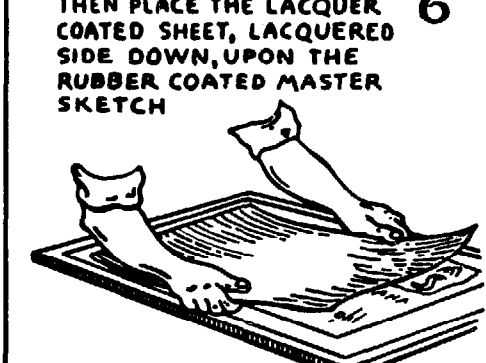
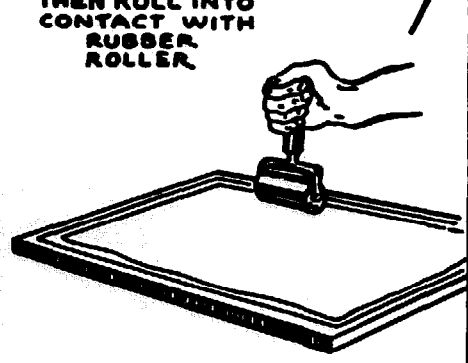
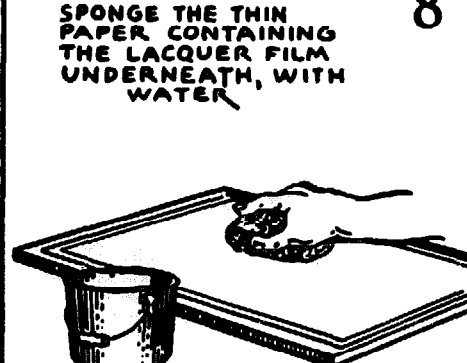
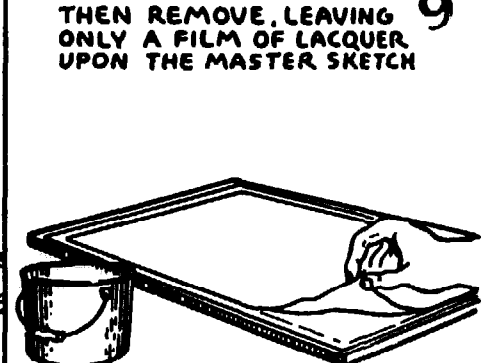
STENCIL SCREEN

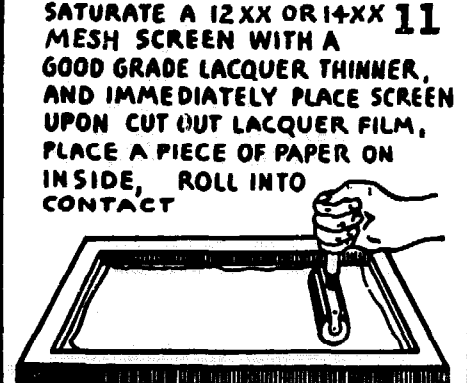
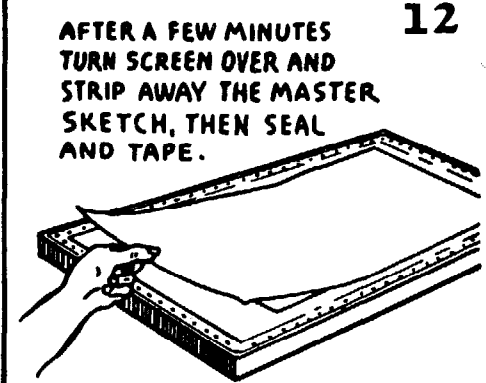
<p>1</p>  <p>FIRST, MIX ¼ OZ. BLUE OR ORANGE SPIRIT SOLUBLE ANILINE DYE INTO ONE QUART OF REGULAR CLEAR SPRAYING LACQUER.</p>	<p>2</p>  <p>FASTEN DOWN DUPLEX DECAL PAPER TO FLAT SUPPORT, GUMMED SIDE UP AND SPRAY THE COLORED SPRAYING LACQUER.</p>	<p>3</p>  <p>SPRAY A SECOND COAT AFTER FIRST IS THOROUGHLY DRY.</p>
<p>4</p>  <p>NOW PAINT YOUR MASTER SKETCH WITH A GOOD GRADE OF RUBBER CEMENT.</p>	<p>5</p>  <p>NOW SEPERATE THE HEAVY BACKING SHEET FROM THE LACQUER COATED SHEET.</p>	<p>6</p>  <p>THEN PLACE THE LACQUER COATED SHEET, LACQUERED SIDE DOWN, UPON THE RUBBER COATED MASTER SKETCH.</p>
<p>7</p>  <p>THEN ROLL INTO CONTACT WITH RUBBER ROLLER.</p>	<p>8</p>  <p>SPONGE THE THIN PAPER CONTAINING THE LACQUER FILM UNDERNEATH, WITH WATER.</p>	<p>9</p>  <p>THEN REMOVE, LEAVING ONLY A FILM OF LACQUER UPON THE MASTER SKETCH.</p>
<p>10</p>  <p>NOW CUT AND PEEL OUT, THE CUT SECTIONS SAME AS WITH OTHER CUTTING FILMS.</p>	<p>11</p>  <p>SATURATE A 12XX OR 14XX MESH SCREEN WITH A GOOD GRADE LACQUER THINNER, AND IMMEDIATELY PLACE SCREEN UPON CUT OUT LACQUER FILM, PLACE A PIECE OF PAPER ON INSIDE, ROLL INTO CONTACT.</p>	<p>12</p>  <p>AFTER A FEW MINUTES TURN SCREEN OVER AND STRIP AWAY THE MASTER SKETCH, THEN SEAL AND TAPE.</p>

KEY-LINE *BLOCK-OUT* STENCIL SCREEN

MAKE MASTER SKETCH IN FULL COLOR *and in* FULL SIZE

FOR EXAMPLE THIS ONE IN 4 COLORS



1 USE A SCREEN WITH 14XX OR 2 16 XX FABRIC. PLACE SCREEN DOWN UPON SKETCH AND TRACE with PEN AND BLACK WATERPROOF INK

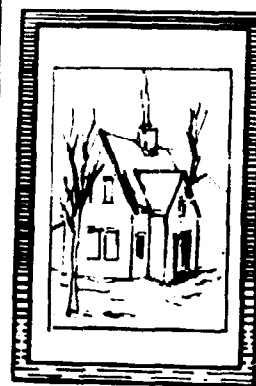
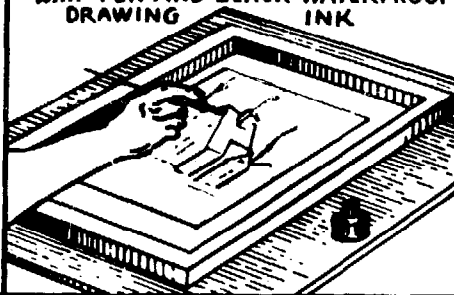

3 AFTER SCREEN HAS BEEN INKED, IN OUTLINE IT WILL HAVE THIS APPEARANCE

THESE INK LINES WILL REMAIN PERMANENT.

FIRST, CUT-IN, USING BLOCKING LACQUER, THE OPENING FOR PRINTING THE BACKGROUND

THIS ACTS AS THE DARKEST COLOR OF THE SKETCH

FOR EXAMPLE DARK BLUE



4 SET SCREEN UP TO REGISTER with 5 PIN HINGES

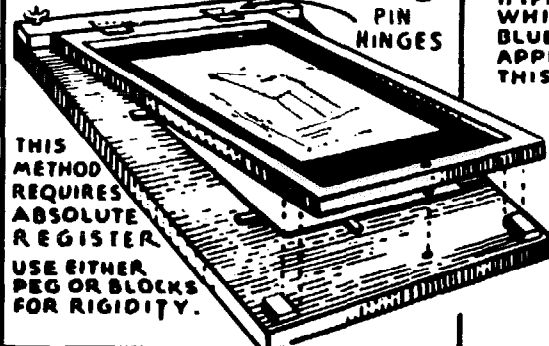

THIS METHOD REQUIRES ABSOLUTE REGISTER.

USE EITHER PEG OR BLOCKS FOR RIGIDITY.

6 THE FIRST IMPRESSION WHICH IS DARK BLUE WILL APPEAR LIKE THIS.

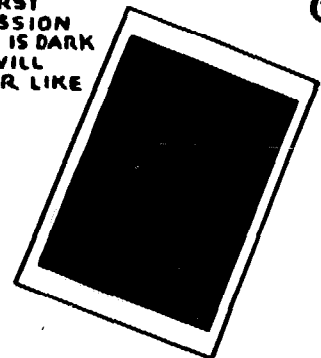

7 NOW - PAINT IN UPON THE SCREEN THE PORTIONS WHICH WILL REMAIN DARK BLUE. INDICATED WITH SOLID BLACK.

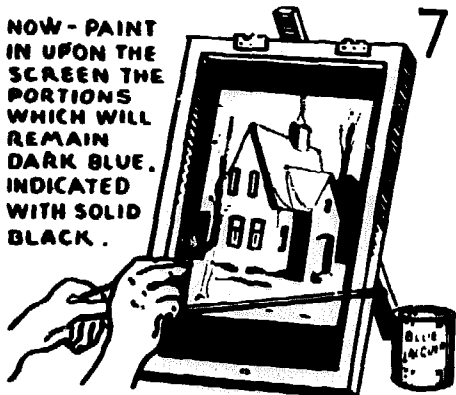

8 FASTEN SCREEN TO PRINTING BASE WITH HINGE PINS, AND PRINT SECOND COLOR WHICH IN THIS INSTANCE WILL BE MEDIUM LIGHT BLUE

THIS IS HOW IMPRESSION WILL APPEAR WITH THE SECOND PRINTING



9 NOW, BLOCK-OUT THE PORTIONS WHICH ARE TO REMAIN MEDIUM LIGHT BLUE

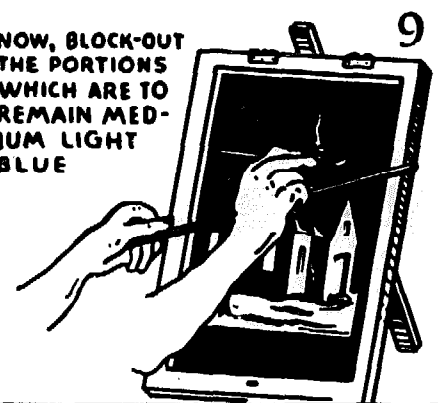

10 SET SCREEN UP AND PRINT THIRD COLOR A VERY LIGHT BLUE

THE PRINT THEN TAKES THIS FORM



11 THEN, BLOCK-OUT, WHAT IS TO REMAIN THE LIGHT BLUE

NOTICE THE SCREEN IS COMPLETELY BLOCKED-OUT EXCEPT FOR THE LAST COLOR WHICH WILL BE WHITE

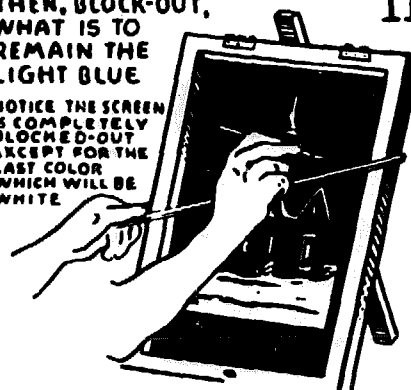

12 AFTER PRINTING THE FINAL COLOR OR WHITE, THE FINISHED PRINT SHOULD BE AN EXACT REPRODUCTION OF THE ORIGINAL MASTER SKETCH

WITH THIS METHOD THERE IS NO LIMIT TO THE NUMBER OF COLORS WHICH CAN BE PRINTED



The OWENS KEY-LINE STENCIL SCREEN

FIRST, MAKE MASTER SKETCH, 1
FULL SIZE

FOR EXAMPLE,
THIS ONE IN
FOUR COLORS

BLUE, GREEN
YELLOW, RED
ON
WHITE CARD



LAY SCREEN UPON SKETCH AND TRACE IN WITH PENCIL OR PEN AND INK, 2
14XX OR 16XX FABRIC -

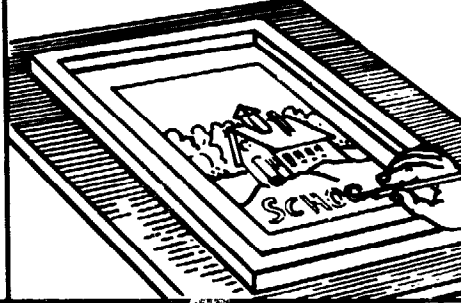

PAINT IN DIVISIONAL LINES AND OUTSIDE AREA WITH LIQUID GLUE, 3

THIS WILL REMAIN PERMANENT



AFTER PRINTING FIRST COLOR, WHICH WILL BE BLUE, THE CARD WILL TAKE ON THIS APPEARANCE, 4

NOTICE THE KEY LINES



NOW BLOCK OUT THE SECTIONS WHERE THE BLUE IS TO REMAIN, USING GLUE, 5

THIS, TOO, WILL REMAIN PERMANENTLY IN THE SCREEN

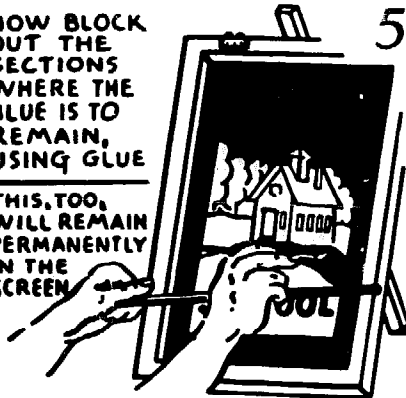

NOW BLOCK OUT WITH LACQUER; EVERYTHING EXCEPT WHERE GREEN IS TO PRINT, 6

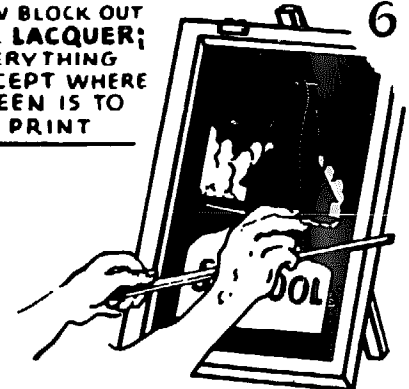

THE CARD WILL THEN TAKE ON THIS APPEARANCE, 7

NOTICE THE KEY LINES SHOWING THROUGH IN WHITE

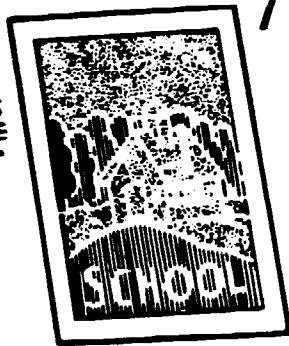

AFTER PRINTING AND CLEAN-UP, WASH SCREEN INSIDE AND OUT WITH LACQUER SOLVENT, 8

THIS REMOVES ONLY THE LACQUER, AND DOES NOT EFFECT THE GLUE

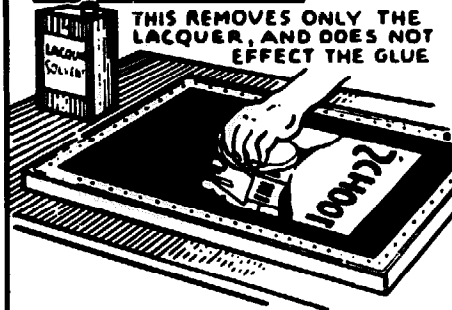

NOW BLOCK OUT WITH LACQUER EVERYTHING EXCEPT WHERE YELLOW IS TO PRINT, 9

STILL USING THE KEY LINES FOR YOUR GUIDE

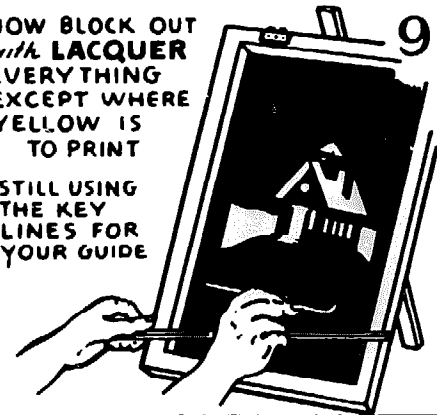

AFTER PRINTING the YELLOW, 10 THEN AGAIN WASH SCREEN WITH LACQUER SOLVENT

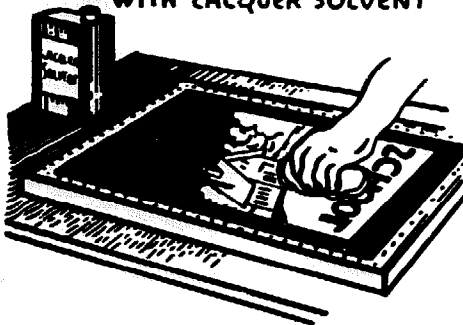

NOW BLOCK OUT WITH LACQUER EVERYTHING EXCEPT WHERE RED IS TO PRINT, 11

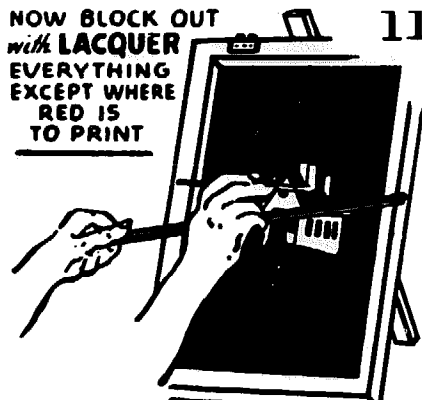

THE COMPLETED PRINT WILL LOOK LIKE THIS, 12

NOW, TO RECLAIM THE SCREEN, FIRST WASH WITH LACQUER SOLVENT TO REMOVE THE LACQUER, THEN WITH WATER TO REMOVE THE GLUE



GLUE TUSCHE WASH-OUT STENCIL SCREEN

1

FIRST MAKE PENCIL SKETCH OR LETTER A SHOWCARD IN THE REGULAR WAY



EXACT SIZE

2

STRETCH AND STAPLE 14XX OR 16XX FABRIC UPON FRAME IN USUAL MANNER

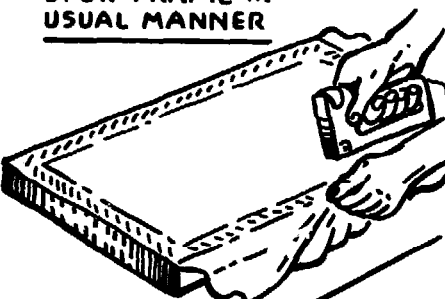

3

MATERIALS

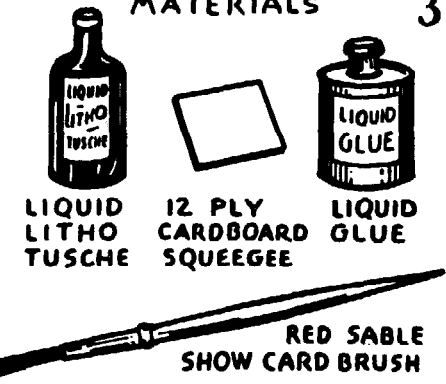

LIQUID LITHO TUSCHE
12 PLY CARDBOARD SQUEEGEE
LIQUID GLUE
RED SABLE SHOW CARD BRUSH

4

TRACE IN SKETCH ON FABRIC with LEAD PENCIL OR with BALLPOINT PEN OR FELT TIP PEN



5

NOW PAINT IN TUSCHE SAME AS LETTERING A SIGN



6

PAINT A SECOND COAT OF TUSCHE OVER FIRST THIS IS IMPORTANT



7

GLUE SOLUTION LIQUID MEASURES

1/2 OZ. GLYCERINE
6 OZ. LIQUID GLUE
6 OZ. WATER

MORE OR LESS ACCORDING TO STRENGTH OF GLUE USED

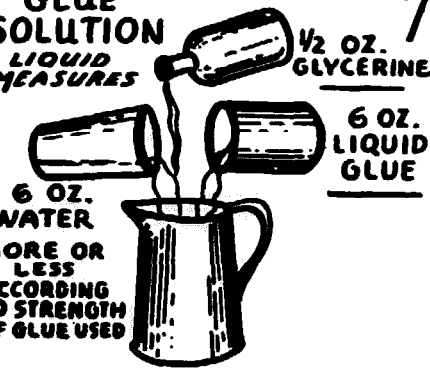

8

NOW - POUR A SMALL AMOUNT OF THE GLUE SOLUTION IN ONE END OF SCREEN

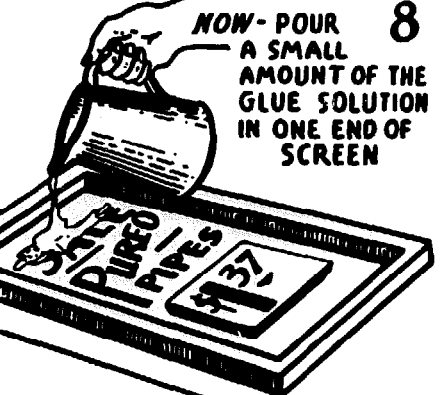

9

THEN - SPREAD THE GLUE SOLUTION with CARDBOARD COVERING DESIGN and ALL

LET DRY



10

TURN SCREEN OVER AND WASH OUT THE TUSCHE USING NAPHTHA, TOLUOL, TURPS OR LACQUER SOLVENTS

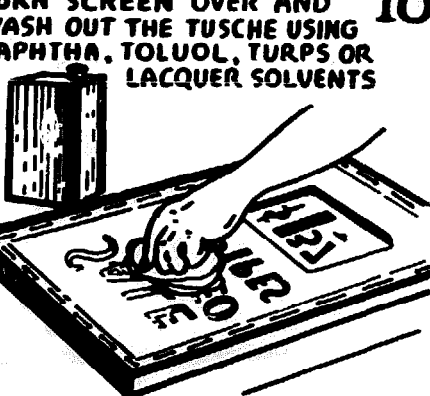

11

WASH AGAIN ON INSIDE and WIPE DRY



12

THEN TAPE INSIDE

THEN ON OUTSIDE

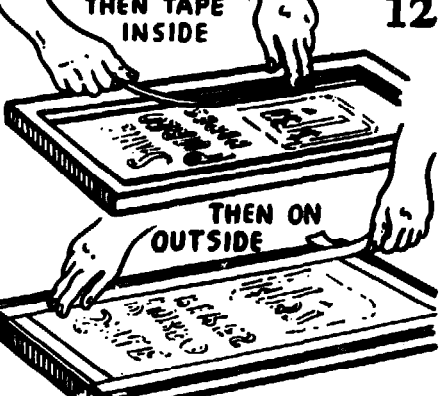

TUSCHE-ENAMEL WASH-OUT TYPE WATER-PROOF STENCIL SCREEN

FOR PRINTING LONG RUNS OF TEXTILE MATERIALS WITH WATER SOLUBLE DYE COLOR

①



FIRST THE MASTER SKETCH IN EXACT SIZE.

FOR EXAMPLE ONE LIKE THIS FOR PRINTING SILK HANDKERCHIEFS.

NOW FASTEN OVER THE SKETCH A THIN SHEET CLEAR FILM WITH TRANSPARENT TAPE. THIS PROTECTS THE SKETCH WHILE BEING TRACED IN ON THE SCREEN FABRIC WITH INK.

CLEAR FILM.
TRANSPARENT TAPE.
MASTER SKETCH.

PLACE SKETCH UNDERNEATH BLANK SCREEN CONSISTING OF 14XX OR 16XX FABRIC AND TRACE WITH WATER-PROOF DRAWING INK USING A FINE ROUND BALL POINT PEN.

②

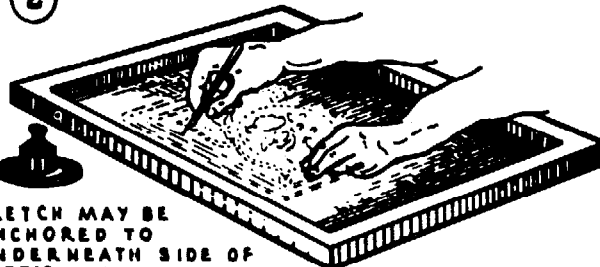

SKETCH MAY BE ANCHORED TO UNDERNEATH SIDE OF FABRIC WITH MASKING TAPE.

THE SCREEN IS THEN PLACED IN AN UPRIGHT SLANTING POSITION, OR BRIDGE MAY BE USED AS SHOWN IN INSERT OVER ILLUMINATED GLASS TABLE TOP. TUSCHE IS THEN APPLIED TO THE

INSIDE OF TRACED-IN LINES.

③

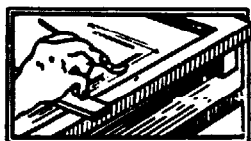
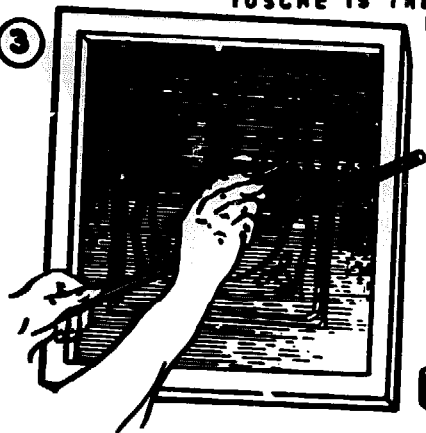

NOW WITH REGULAR SYNTHETIC SCREEN PRINTING WHITE ENAMEL OR CLEAR SYNTHETIC VARNISH EITHER, OF WHICH HAS BEEN REDUCED TO THE PROPER SQUEEGEEING CONSISTENCY THE OVER-ALL BACKGROUND FILLER COAT IS APPLIED IN THIS FASHION.

④

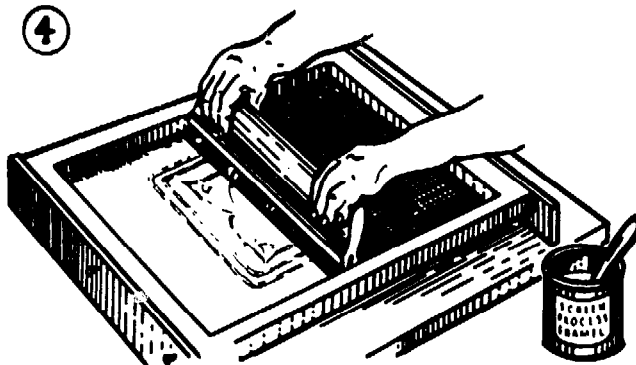

THIS IS IMPORTANT AFTER FILLER COAT HAS BEEN APPLIED, THE SCREEN IN THIS STATE IS SET ASIDE FOR A FEW DAYS OR UNTIL THE ENAMEL IS THOROUGHLY CURED OR HARDENED.

THE TUSCHED-IN DESIGN IS THEN LOOSENED ON FACE SIDE OF SCREEN WITH NAPHTHA. THE SCREEN IS THEN SCRUBBED OVER THE INSIDE WITH NAPHTHA AND A PIECE OF BURLAP SACK OR

OR SMALL HAND BRUSH TO REMOVE ENAMEL FILM OVER TUSCHE.

⑤

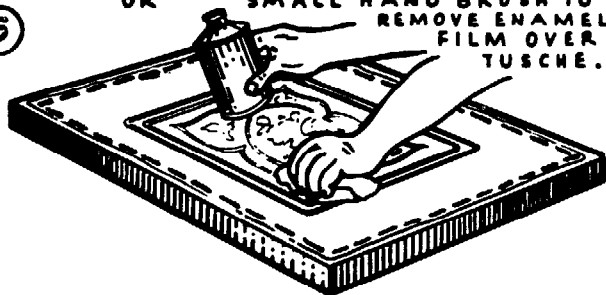

⑥

THE SCREEN IS THEN MADE READY FOR PRINTING BY APPLYING TAPE BOTH ON THE INSIDE AND OUTSIDE TO PREVENT COLOR LEAKAGE ALONG FRAME EDGE DURING PRINTING.

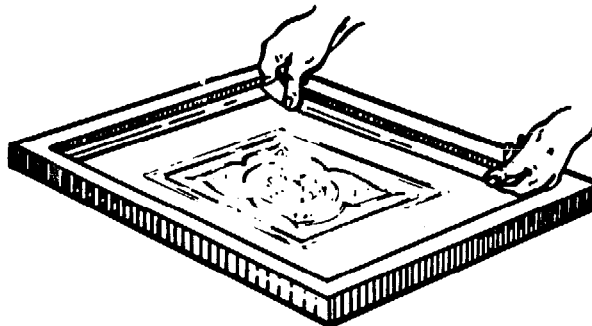

CRAYON-TUSCHE WASH-OUT STENCIL SCREEN

I
 FIRST PREPARE MASTER SKETCH FULL SIZE IN LEAD PENCIL PEN AND INK CRAYON OR COLOR



2
 NEXT- PLACE STENCIL SCREEN OVER MASTER SKETCH AND TRACE IN OUTLINE WITH INK

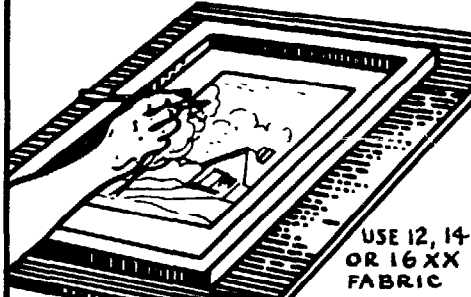

USE 12, 14 OR 16 XX FABRIC

3
 NOW FILL IN WITH BLOCKING-OUT LACQUER UP TO OUTER EDGE OF DESIGN

THIS REMAINS PERMANENT

USING RED SABLE BRUSH

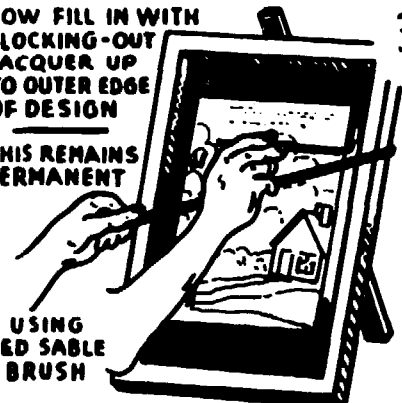

4
 THEN PAINT IN LINES AND OTHER SOLID PORTIONS WITH LIQUID TUSCHE GO OVER TWICE FOR GOOD RESULTS

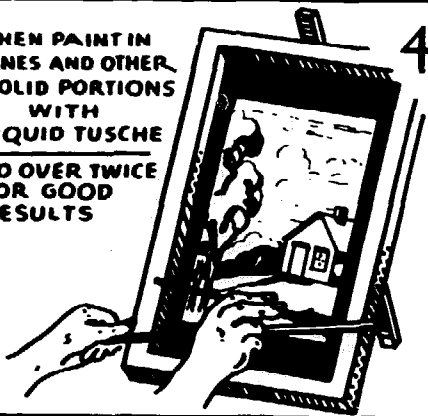

5
 FOR A BLENDED CRAYON EFFECT USING A NO 0-1-OR 2 LITHOGRAPH CRAYON YOU CAN WORK DIRECTLY UPON THE FABRIC IN THIS FASHION



6
 OR- BY USING ANY MATERIAL HAVING A RAISED TEXTURED OR EMBOSSED SURFACE A VARIATION OF TEXTURES IS OBTAINABLE- FOR EXAMPLE

SAND PAPER WHICH HAS HAD THE SHARPNESS REMOVED

LARCO OR ROSS BOARD OF WHICH THERE ARE MANY DIFFERENT DESIGNS

OR A DEEP ETCHED BEN-DAY ZINC PLATE FOR SIMULATING HALF-TONE

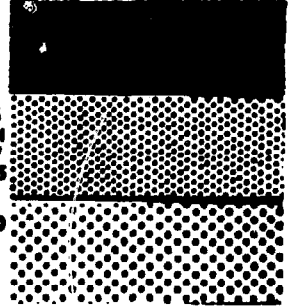

7
 THEN PLACE THE DESIRED PIECE OF EMBOSSED OR PEBBLED SURFACE BENEATH THE SCREEN AND RUB CRAYON OVER THE PORTION OF THE DESIGN DESIRED

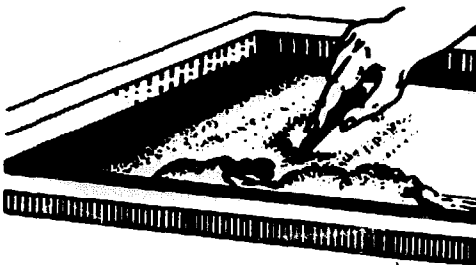

8
 NOW USING THE GLUE SOLUTION MENTIONED IN THE GLUE TUSCHE METHOD, POUR A SMALL AMOUNT IN ONE END OF SCREEN

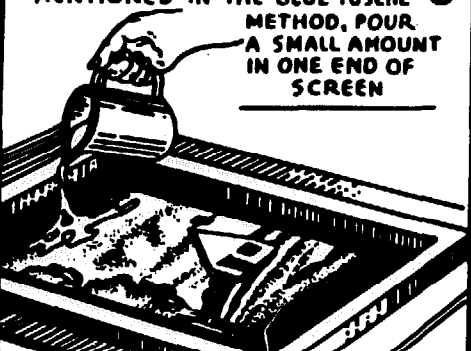

9
 DRAW THE GLUE SOLUTION OVER THE DESIGN ON INSIDE OF SCREEN WITH A PIECE OF CARDBOARD ELEVATE SCREEN WITH STRIP ON ENDS OF FRAME

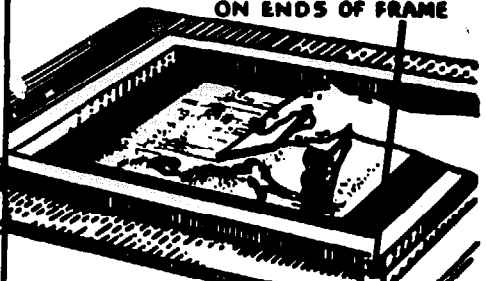

10
 AFTER GLUE COATING IS DRY WASH OUT ALL CRAYON AND TUSCHE FROM BOTH SIDES OF SCREEN

USING BENZINE, TURPS OR PREFERABLY SOLVENT NAPHTHA

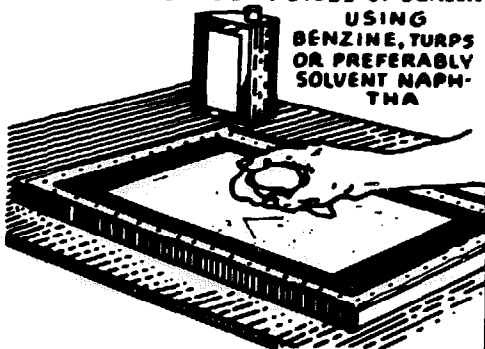

11
 SEAL AND TAPE INSIDE AND OUT

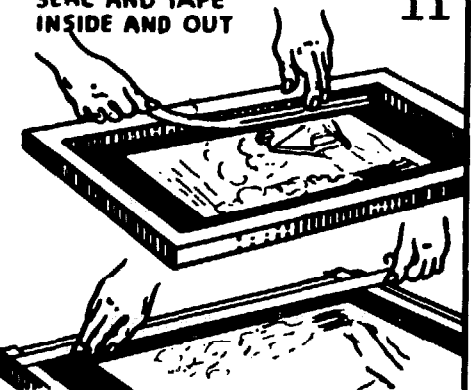

12
 FOR COLOR WORK, FIRST PRINT BLACK OR OTHER DARK TONE FROM THE CRAYON-TUSCHE SCREEN THEN SUPERIMPOSE TRANSPARENT TONES OVER THIS KEY PRINT, USING CUT FILM OR BLOCKED-OUT SCREENS, OR YOU CAN PRINT FLAT COLORS FIRST AND THEN PRINT WITH KEY SCREEN LAST



AIR BRUSH *GLUE TUSCHE* STENCIL SCREEN

1 PREPARE MASTER SKETCH IN FULL COLOR AND FULL SIZE —

FROM SKETCH MAKE SCREEN, BY FILM OR OTHER METHOD FOR PRINTING THE ROSE IN SOLID COLOR FOR EXAMPLE, LIGHT PINK, AND PRINT IN USUAL FASHION.



LIKewise, PRINT LEAVES AND STEM IN TWO LIGHT TONES OF GREEN.

THIS GIVES US OUR BASE COLORS FOR PRINTING OVER WITH OUR AIR BRUSH SCREEN WITH RED

2 NOW, TRACE IN DESIGN UPON INSIDE OF MESH WITH BALLPOINT PEN INCLUDING DIVISIONAL LINES INSIDE OF DESIGN

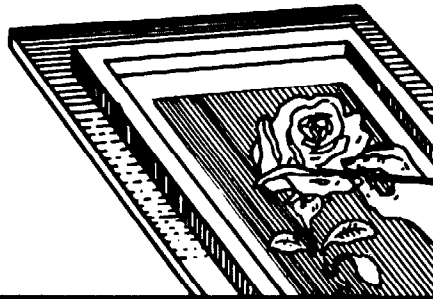

3 THEN FILL IN AROUND DESIGN, ALSO HIGH LIGHTS WITH BLOCKING OUT LACQUER

THIS REMAINS SEMI-PERMANENT

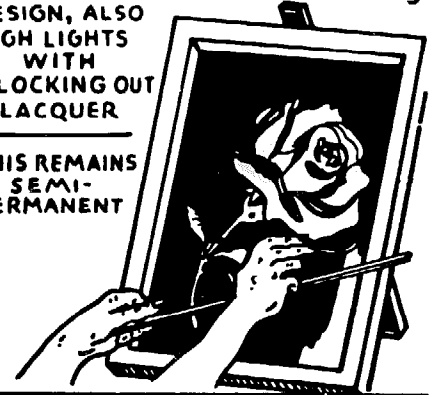

4 NOW PREPARE CORN STARCH SIZING FOR BASE ON SCREEN FOR AIR BRUSHING

CORN STARCH 6 OZ.

HOT WATER 5 OZ.

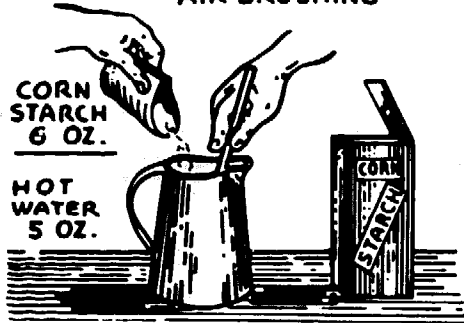

5 NOW, FLOW STARCH SOLUTION OVER FACE SIDE OF SCREEN

LET DRY USING FAN IF DESIRED

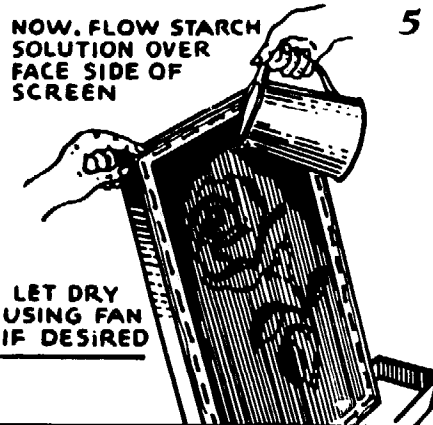

6 HEAT LIQUID TUSCHE BY PLACING BOTTLE IN WARM WATER, 15 OR 20 MIN.

THIN WITH A SMALL AMOUNT OF WATER IF NECESSARY FOR SPRAYING

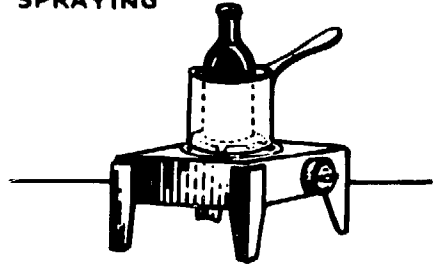

7 AIR BRUSH WITH THE LIQUID TUSCHE, USING MASKS IF DESIRED — WHEN COMPLETED LET DRY AT LEAST HALF HOUR

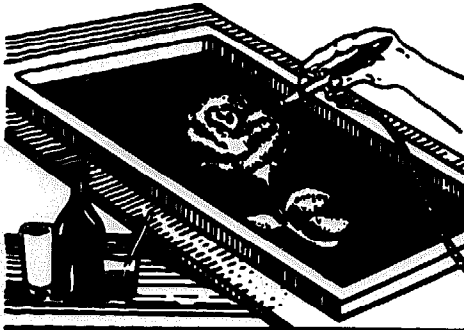

8 AFTER AIR BRUSHING IS DRY, TURN SCREEN OVER, AND REMOVE STARCH BY SIMPLY WIPING OFF WITH A DRY CLOTH

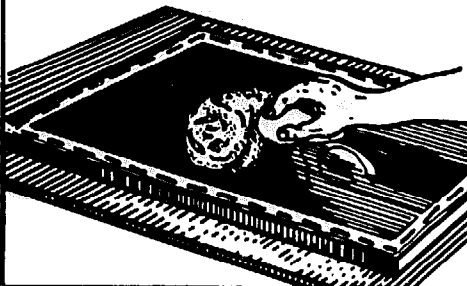

9 NOW POUR A SMALL AMOUNT OF THE GLUE SOLUTION UPON INSIDE OF SCREEN

"USE GLUE SOLUTION MENTIONED IN 'GLUE-TUSCHE METHOD'"

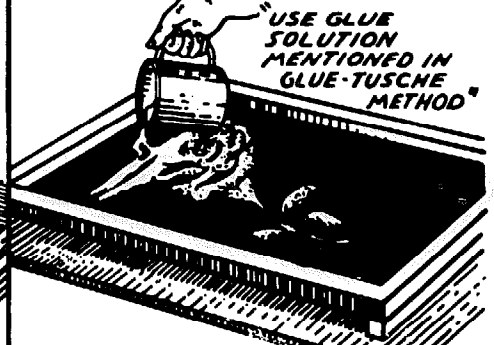

10 AND DRAW GLUE SOLUTION OVER DESIGN WITH A CARD BOARD SQUEEGEE THEN LET DRY

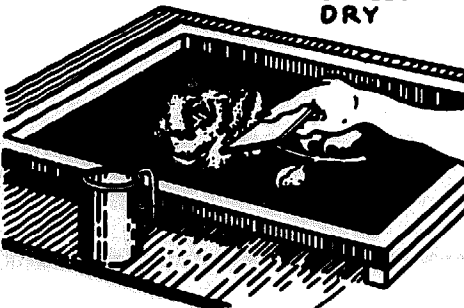

11 NOW, PLACE SCREEN DOWN UPON PLAIN PAPER AND WASH BRISKLY WITH A CLOTH AND NAPHTHA

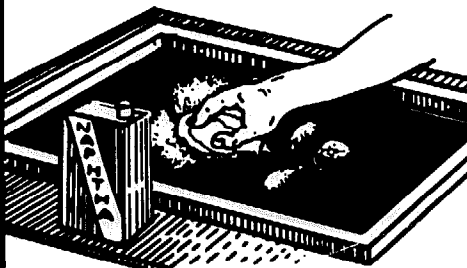

12 REPEAT CLEANING ON BOTH SIDES OF SCREEN USING SMALL HAND BRUSH IF NEED BE

TAPE AND SEAL AND SCREEN IS READY

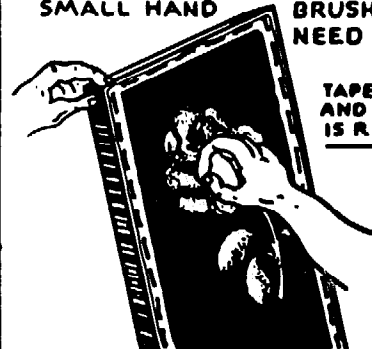

CARBON TISSUE—WET METHOD

CAUTION: POTASSIUM BICHROMATE IS TOXIC. USE PROTECTIVE GLOVES, GOGGLES AND APRON.

1 SENSITIZING SOLUTION



DISSOLVE 2 1/2 OUNCES OF POTASSIUM BICHROMATE IN 1 GAL. OF PERFECTLY CLEAR HOT WATER. GOOD FOR TWO WEEKS USE

2 CHILLING SOLUTION

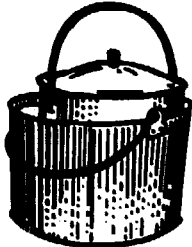

TO USE SENSITIZER CHILL FIRST TO 60°F. OR UNDER IN COLD RUNNING WATER OR IN ICE WATER OR IN REFRIGERATOR

3 TEMPORARY SUPPORT

CUT A PIECE OF .008 CLEAR ACITATE 2 1/2 INCH OR SO LARGER THAN 6 1/2 SIZE OF TISSUE TO BE USED. CLEAN AND POLISH USING A GOOD PASTE WAX

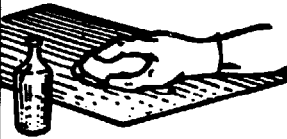

4 STRAINING

EACH TIME SENSITIZING SOLUTION IS USED, STRAIN THROUGH A PIECE OF SCREEN MESH.

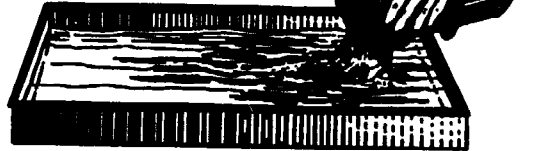

5 SENSITIZING TISSUE

CUT TISSUE TO DESIRED SIZE, SUBMERGE EMULSION SIDE UP IN BATH UNTIL IT FLATTENS OUT

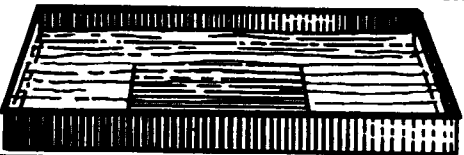

6 REMOVE TISSUE FROM SENSITIZING BATH AND PLACE, EMULSION SIDE DOWN AND SQUEEGEE TO WAXED TEMPORARY SUPPORT

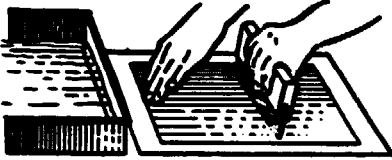

7 NOW PLACE SUPPORT CONTAINING TISSUE BETWEEN TWO LARGE BLOTTERS OR WIDE EXCESS SENSITIZING SOLUTION FROM BOTH SIDES WITH A CLEAN CLOTH



8 TO MAKE READY TO PRINTING FRAME WITH EMULSION SIDE TO READ RIGHT SIDE UP

PLACE SUPPORT FACE DOWN IN CONTACT WITH POSITIVE SO THAT PAPER BACKING SIDE OF TISSUE IS UP THEN LOCK UP

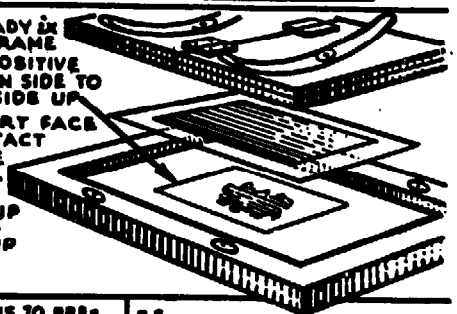

9 EXPOSURE

WHEN WET GELATIN RUNS OR MELTS AT TEMPERATURES OF FROM 76 TO 80°F. TO PREVENT HEAT FROM LAMP FROM MELTING EMULSION IN FRAME A PLATE GLASS BAFFLE PLATE AS PICTURED MAY BE USED

EXPOSURE TIME FOR WET TISSUE REQUIRES ABOUT THREE TIMES LONGER THAN THAT OF THE DRY METHOD

USING NO 2 PHOTO FLOOD LAMP WITH REFLECTOR 15 TO 18 MIN. AT 20 IN. 2 1/2" 15 AMP. ARC 15 TO 18 MIN. AT 32 IN.

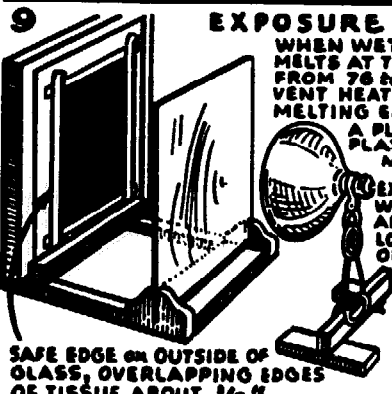

SAFE EDGE ON OUTSIDE OF GLASS, OVERLAPPING EDGES OF TISSUE ABOUT 1/2"

10

A GOOD MEANS TO PREVENT TISSUE MELTING DURING EXPOSURE IS AN ICE BOX CONSTRUCTED AROUND THESE LINES

AN AIR CONDITIONED COMMERCIAL (MEAT) REFRIGERATOR CAN BE USED FOR DARK ROOM WITH EXPOSURE FROM OUTSIDE THROUGH WINDOW

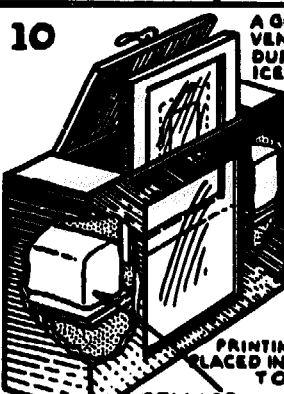

DRY ICE

11 AFTER EXPOSURE HAS BEEN COMPLETED REMOVE TISSUE WITH SUPPORT FROM PRINTING FRAME, FASTEN TO A METAL PLATE OR TO A HEAVY SHEET OF WHITE PLASTIC WITH MASKING TAPE

WHITE PLASTIC OR METAL PLATE TEMPORARY SUPPORT

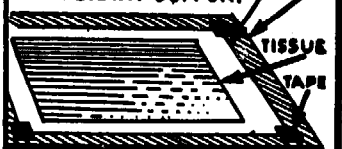

12

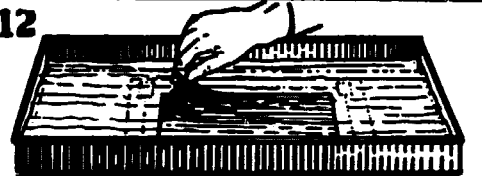

PLACE SUPPORT WITH TEMPORARY SUPPORT AND TISSUE IN 110°F. HOT WATER, AFTER ABOUT 5 MIN. PEEL AWAY BACKING PAPER.

DEVELOPE OUT BY AGITATING BACK AND FORTH

13



14 AFTER DEVELOPMENT CHILL IN COLD WATER



REMOVE FROM COLD WATER, TAKE OFF TAPE RELEASING RIGID SUPPORT, PLACE CLEAR SUPPORT ON SMOOTH SURFACE IMAGE UP, PLACE WEIGHTS

PLACE SCREEN, BLOT GENTLY



DRY WITH FAN

WHEN TISSUE IS PERFECTLY DRY STRIP OFF TRANSPARENT SUPPORT

IN THIS MANNER:

16

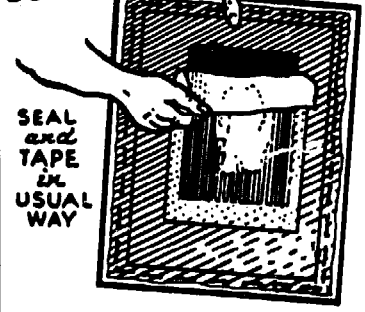

SEAL AND TAPE IN USUAL WAY

CARBON TISSUE *DIRECT CONTACT* WET METHOD

CAUTION: POTASSIUM BICHROMATE IS TOXIC. USE PROTECTIVE GLOVES, GOGGLES AND APRON.

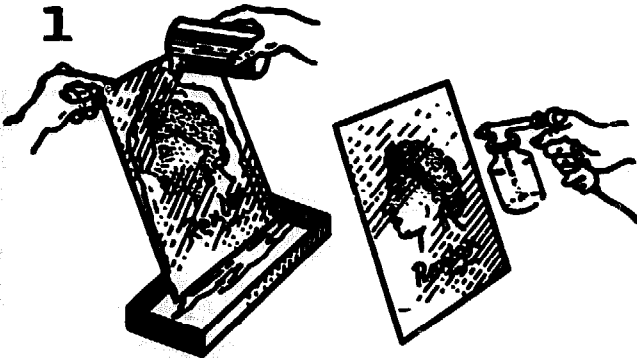

1
BEST RESULTS ARE OBTAINED WITH A REGULAR FILM POSITIVE IN EITHER LINE or HALF-TONE WITH THE EMULSION SIDE READ RIGHT SIDE UP. THIS IS THEN FLOWED or SPRAYED WITH A GOOD GRADE OF CLEAR SPRAYING LACQUER.

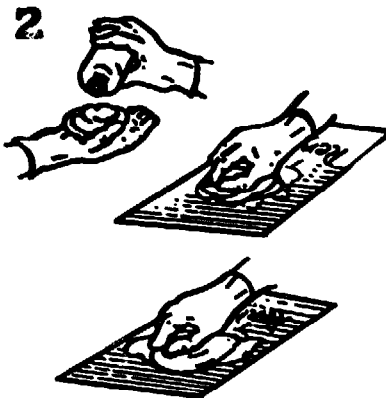

2
AFTER LACQUER PROTECTIVE COATING HAS BECOME HARD DRY (OVER NIGHT) IT IS THEN WAXED AND POLISHED WITH REGULAR LIQUID PASTE WAX



3
PREPARE SENSITIZING SOLUTION BY DISSOLVING 2 1/2 OZ. OF POTASSIUM BICHROMATE IN 1 GAL. OF LUKE WARM WATER — CHILL TO 60° F. OR UNDER BEFORE USING GOOD FOR TWO WEEKS.

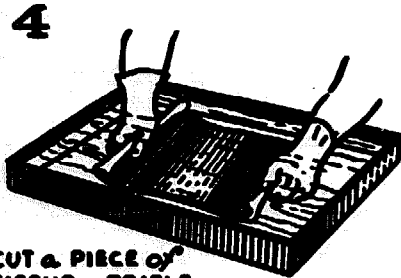

4
CUT A PIECE OF TISSUE A TRIFLE SMALLER THAN THE POSITIVE AND SUBMERGE, EMULSION SIDE UP IN THE CHILLED AND STRAINED SENSITIZING BATH UNTIL IT FLATTENS OUT, WHICH TAKES FROM THREE TO FIVE MINUTES.

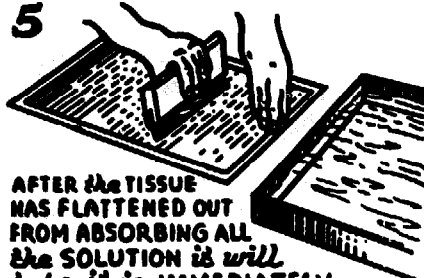

5
AFTER THE TISSUE HAS FLATTENED OUT FROM ABSORBING ALL THE SOLUTION IT WILL TAKE, IT IS IMMEDIATELY REMOVED FROM THE BATH AND SQUEEGEED GELATIN EMULSION SIDE DOWN UPON THE LACQUERED AND WAXED AND POLISHED POSITIVE WHICH ACTS ALSO AS THE TEMPORARY SUPPORT.



6
NOW TURN POSITIVE OVER SO THAT THE ATTACHED TISSUE IS ON THE UNDERNEATH SIDE AND PROCEED TO SAFE-EDGE WITH BLACK TAPE OVERLAPPING EDGE OF TISSUE 1/2 IN.

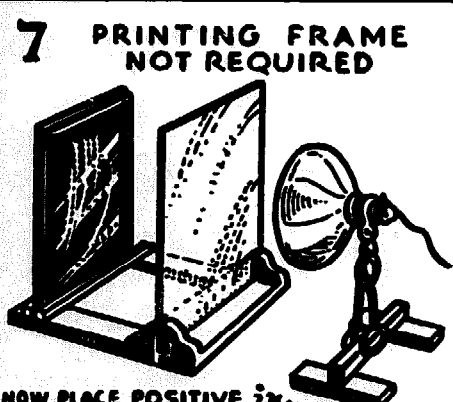

7 PRINTING FRAME NOT REQUIRED

NOW PLACE POSITIVE IN HOLDER AS PICTURED WITH SAFE-EDGE SIDE TOWARDS LAMP. PLACE A PIECE OF CARDBOARD OVER BACK OF POSITIVE TO PREVENT LIGHT REFLECTION FROM PENETRATING INTO BACK OF TISSUE DURING EXPOSURE. EXPOSE 15 MIN. AT 30 IN. WITH NO. 2 PHOTO FLOOD LAMP, OR 15 MIN. AT 40 IN. WITH CARBON ARC LAMP.



8
AFTER EXPOSURE PLACE POSITIVE IN HOT WATER ABOUT 110° F. AND AFTER 5 MIN. STRIP AWAY BACKING PAPER AND DISCARD.



10
AFTER RINSING IN CLEAN HOT WATER PLACE IN COLD WATER 60° F. OR COLDER TO HARDEN

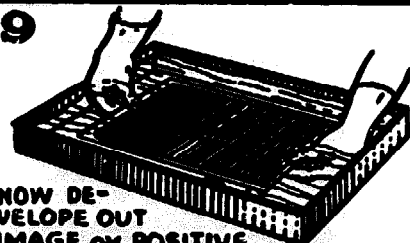

9
NOW DEVELOPE OUT IMAGE ON POSITIVE BY ROCKING BACK AND FORTH UNTIL IMAGE COMES UP CLEAR AND DISTINCT.

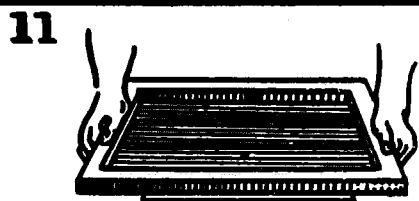

11
REMOVE FROM COLD WATER AND PLACE ON FLAT SURFACE IMAGE SIDE UP. PLACE SCREEN IN CONTACT BLOT GENTLY AND DRY WITH FAN.

CARBON TISSUE-DRY METHOD

CAUTION: POTASSIUM BICHROMATE IS TOXIC. USE PROTECTIVE GLOVES, GOGGLES AND APRON.

1 SENSITIZING SOLUTION

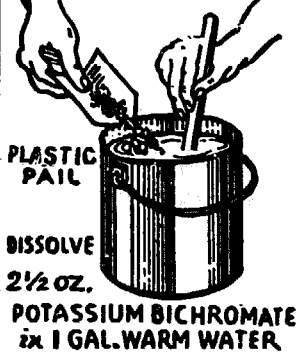

2 DRYING SUPPORT

USING A FINE NON-SCRATCHING CLEANER, CLEAN A LARGE SIZE POLISHED SHEET OF CHROME-PLATED STEEL OR TIN PLATE, RINSE COMPLETELY AND DRY.

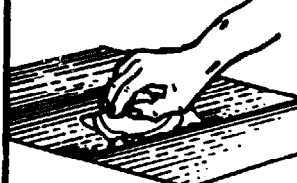

3 STRAINING

PRIOR TO USING SOLUTION CHILL TO 60° F. OR UNDER AND STRAIN



4 SENSITIZING THE TISSUE

CUT A PIECE OF CARBON TISSUE AN INCH SMALLER THAN THE DRYING SUPPORT AND SUBMERGE, EMULSION SIDE UP UNTIL IT FLATTENS OUT

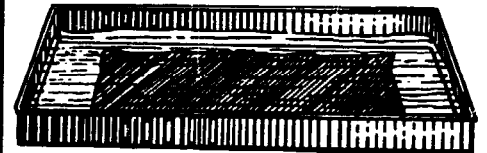

5 REMOVE FROM SENSITIZING BATH AND SQUEEGEE, EMULSION SIDE DOWN UPON THE CLEANED DRYING SUPPORT

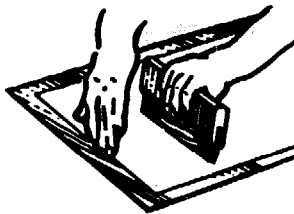

6 THEN DRY WITH FAN

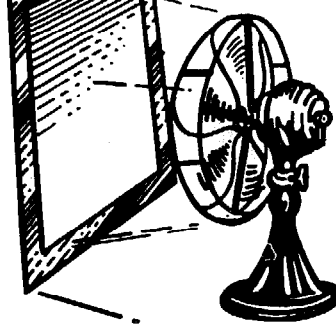

7 AFTER PAPER IS DRY

BUT BEFORE IT RELEASES, STRIP FROM PLATE AND PLACE BETWEEN TWO BLOTTERS UNDERNEATH PLATE GLASS TO PREVENT CURLING

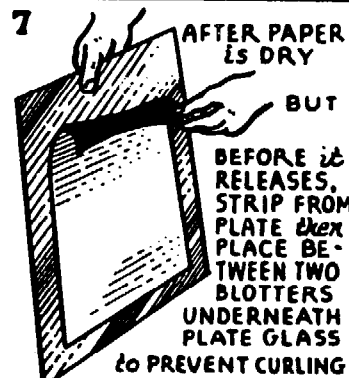

8 TEMPORARY SUPPORT

CLEAN A SHEET ¼" THICK WHITE PLASTIC WITH SAME CLEANER AS IN STEP 2. THIS DOES NOT REQUIRE WAXING OR A PIECE OF POLISHED TIN PLATE, POLISHED BRASS OR STAINLESS STEEL. THESE REQUIRE WAXING AND POLISHING

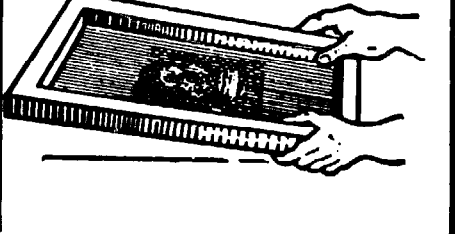
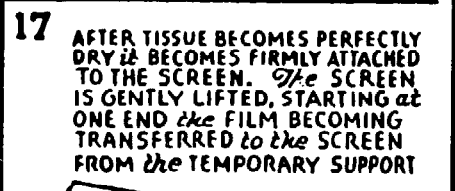
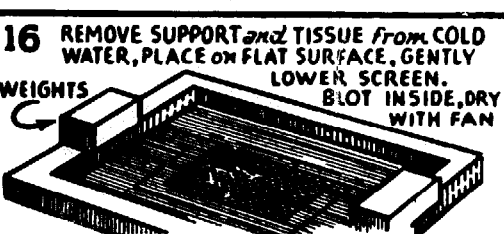
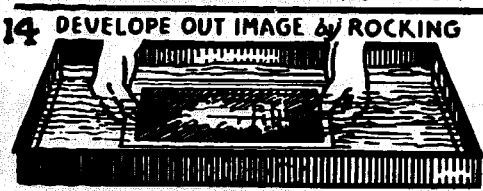
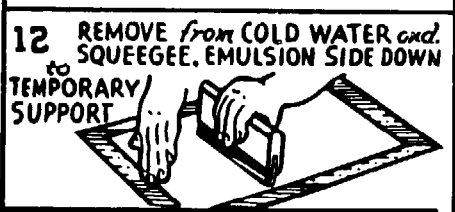
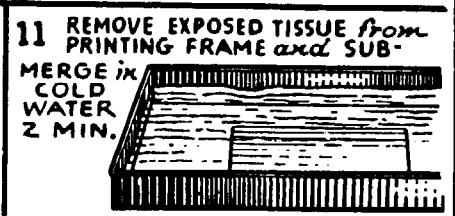
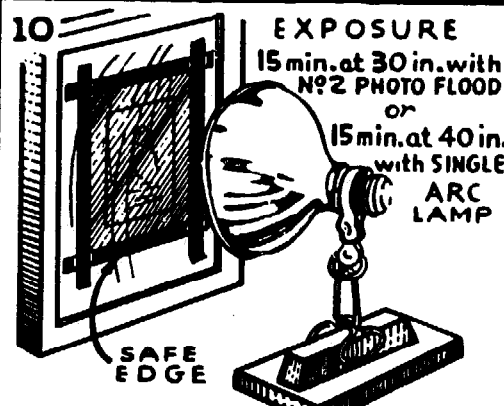
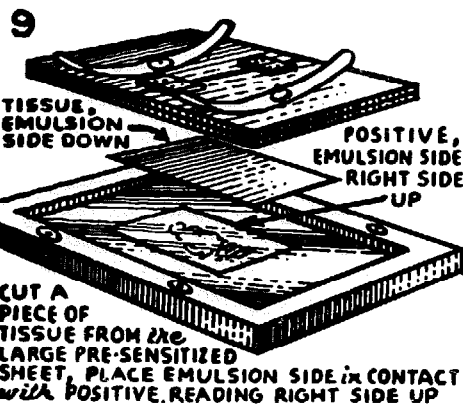

ALTERNATE *Plate or Dry Process* PHOTO STENCIL

CAUTION: POTASSIUM BICHROMATE IS TOXIC. USE PROTECTIVE GLOVES, GOGGLES AND APRON.

The SENSITIZER



GOOD FOR TWO WEEKS

DISSOLVE
2 1/2 oz. of
POTASSIUM
BICHROMATE
IN 1 GAL. COLD
DISTILLED
WATER

WAXING SOLUTION

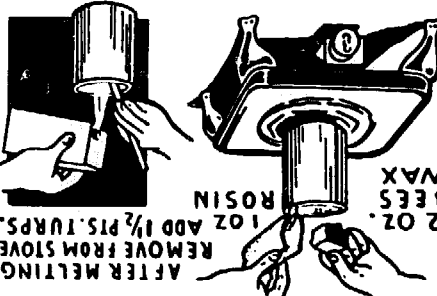

AFTER MELTING
REMOVE FROM STOVE
1 OZ. ADD 1/2 PIS. TURPS.
WAX

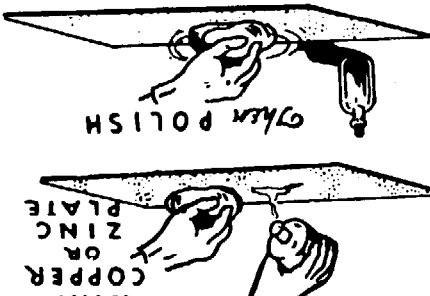

WAX
COPPER
OR
ZINC
PLATE

THEN POLISH

Now - CUT CARBON TISSUE TO DESIRED SIZE - SENSITIZE

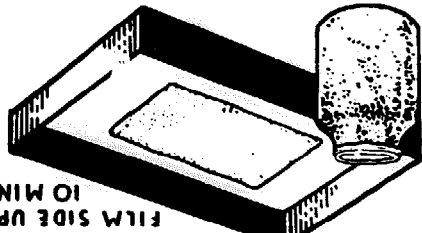

FILM SIDE UP
10 MIN.

PLACE ON METAL PLATE

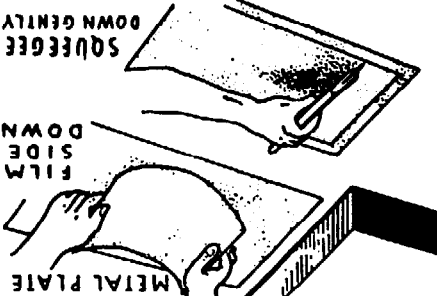

FILM SIDE DOWN

SQUEEGEE DOWN GENTLY

IMMEDIATELY AFTER SQUEEGEING PEEL FROM PLATE AND HANG UP TO DRY.

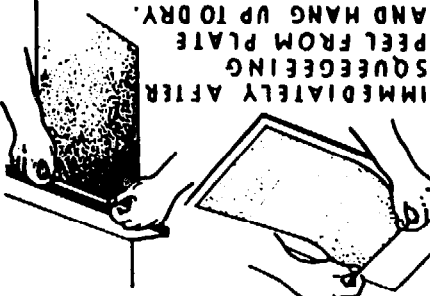

WHEN DRY PLACE IN PRINTING FRAME

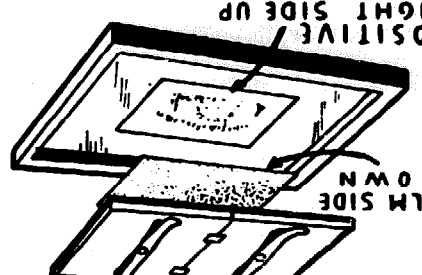

FILM SIDE DOWN

POSITIVE RIGHT SIDE UP

EXPOSE 10 MIN. at 30 IN. WITH NO. 2 SAFE EDGE

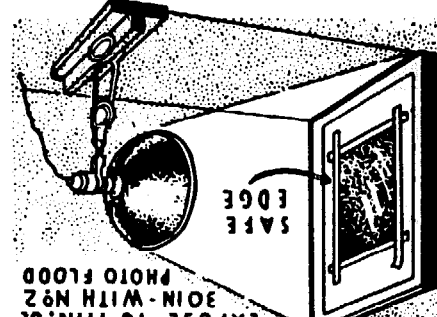

PLACE ON WAXED PLATE

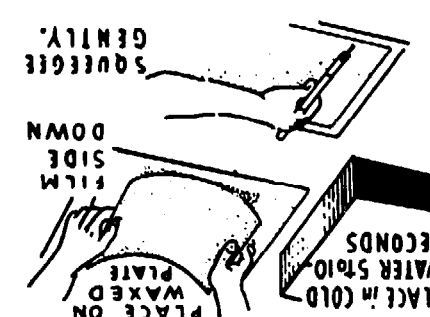

FILM SIDE DOWN

SQUEEGEE GENTLY.

PLACE WAXED PLATE WITH TISSUE ATTACHED IN

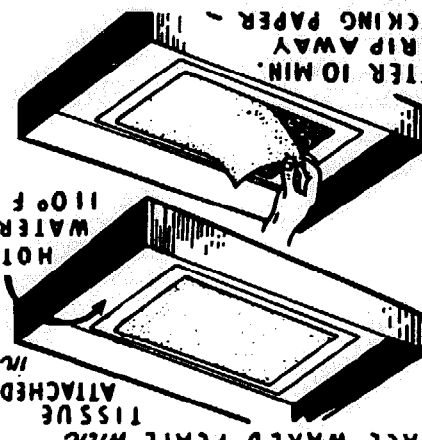

HOT WATER 110° F

AFTER 10 MIN. STRIP AWAY BACKING PAPER -

DEVELOP OUT BY ROCKING

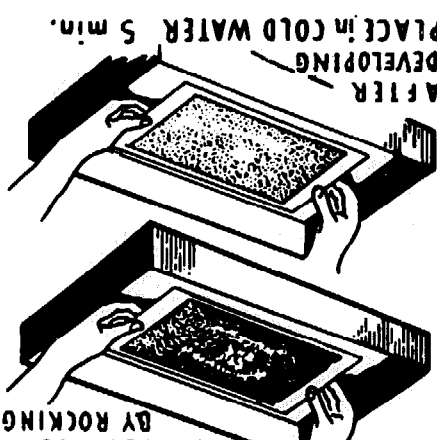

AFTER DEVELOPING PLACE IN COLD WATER 5 min.

LAY PLATE ON FLAT SURFACE and PLACE SCREEN



BLOT GENTLY and DRY WITH FAN WHEN DRY, LIFT SCREEN from PLATE

HIETT'S *Shellac* PHOTO STENCIL

CAUTION: CHEMICALS MENTIONED BY AUTHOR ARE TOXIC IN BOTH HOT AND COLD CONDITIONS. WEAR PROTECTIVE GLOVES, GOGGLES AND APRON. THOROUGH VENTILATION OF AREA REQUIRED DURING ENTIRE PROCESS.

PAINT EITHER ORANGE OR CLEAR SHELLAC UPON SCREEN, USING 10-12 or 14 XX FABRIC-SMOOTH BOTH SIDES WITH CARDBOARD SQUEEGEE

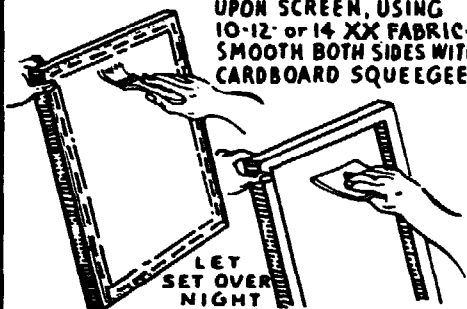

LET SET OVER NIGHT

NOW WASH SHELLAC-COATED SCREEN, TOP SIDE, WITH A SOLUTION COMPOSED OF WHITE OF ONE EGG OR AN EQUAL AMOUNT OF DRIED ALBUMEN IN 28 OZ. COLD WATER AND LET DRY

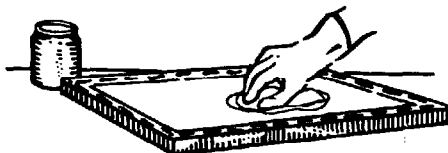

SOAK 2 OZ. HIDE GLUE IN 8 OZ. OF COLD WATER OVER NIGHT

3/4 OZ. BICHROMATE
1/2 OZ. BORAX
1/2 OZ. RED ANILINE

LIQUEFY IN DOUBLE BOILER

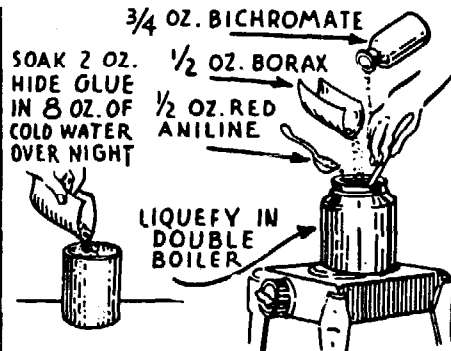

AFTER STRAINING HOT EMULSION, FLOW or BRUSH ONE COAT OVER FACE OF SCREEN

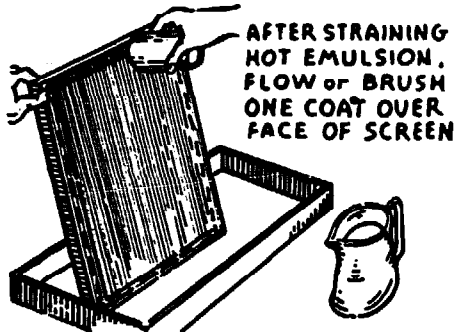

IMMEDIATELY AFTER COATING PLACE IN FRONT OF HEATER AND LET DRY - DO NOT GET THE HEATER TOO CLOSE TO SCREEN. TOO MUCH HEAT WILL CAUSE THE SHELLAC TO BLISTER

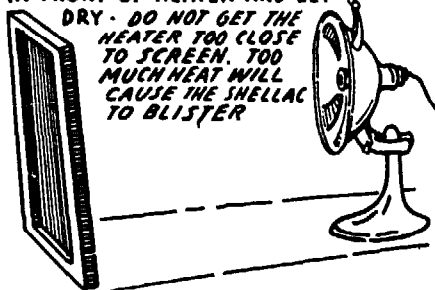

NOW - SET DRIED SCREEN AGAINST POSITIVE IN PRINTING FRAME

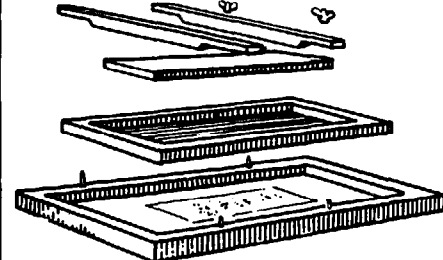

EXPOSE AT 20 INCHES WITH NO 2 PHOTO FLOOD 15 MIN.

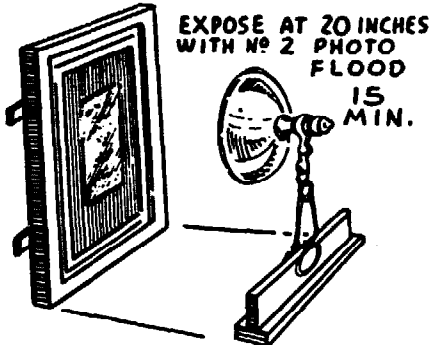

ETCH OUT IN WARM WATER, then RINSE and CHILL in COLD WATER

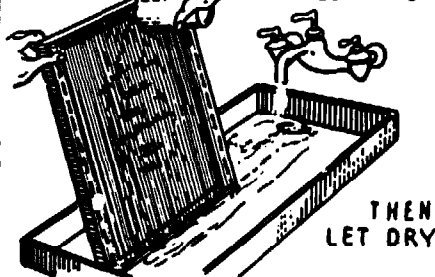

THEN LET DRY

NOW - BRUSH A HEAVY COAT OF HOT LIQUID HIDE GLUE FREE FROM BICHROMATE, OVER INSIDE OF SCREEN

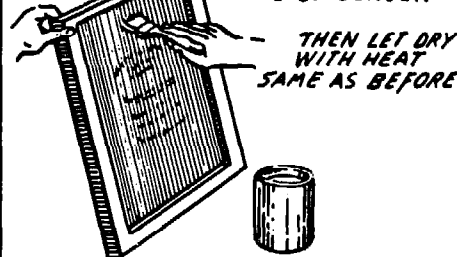

THEN LET DRY WITH HEAT SAME AS BEFORE

NEXT ETCH OUT OPEN PORTIONS OF THE LIGHT-FIXED RESIST with ISOPROPYL ALCOHOL, AND A FEW DROPS OF OLIVE OIL.

KEEP BRUSHING FRESH SOLUTION UNTIL CLEANLY ETCHED

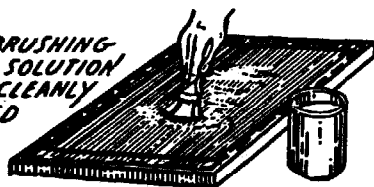

WASH OFF GLUE COATING from INSIDE OF SCREEN with WARM WATER

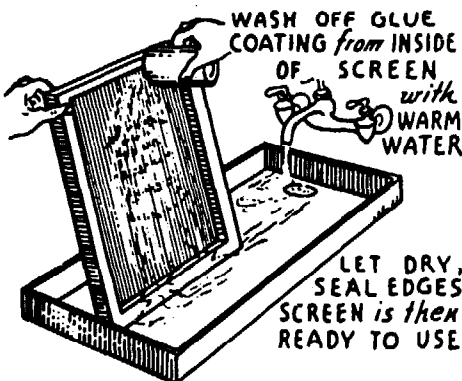

LET DRY, SEAL EDGES SCREEN is then READY TO USE.

IF PHOTO EMULSION RESIST IS TO BE REMOVED

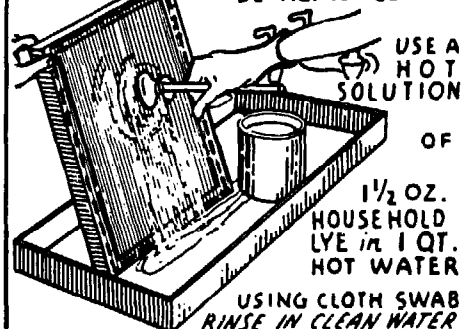

USE A HOT SOLUTION OF

1 1/2 OZ. HOUSEHOLD LYE in 1 QT. HOT WATER

USING CLOTH SWAB. RINSE IN CLEAN WATER

HIETT'S *The Paint-a-graph* PHOTO STENCIL

NEGATIVE OR POSITIVE AND PRINTING FRAME NOT IN USE

CAUTION: BICHROMATE IS A TOXIC CHEMICAL. USE PROTECTIVE GLOVES, GOGGLES AND APRON AT ALL TIMES.

STAPLE 12XX MULTIFILAMENT POLYESTER TO FRAME

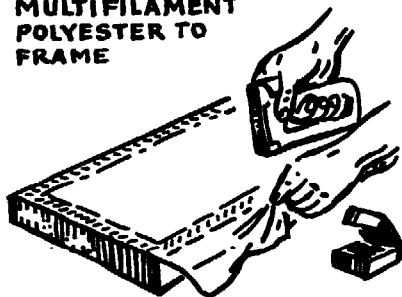

NOW- PLACE 1½ OR 2 IN. SCOTCH MASKING TAPE UPON FABRIC OVERLAPPING ON FRAME

THIS WILL BE FOUND TO BE IMPORTANT LATER

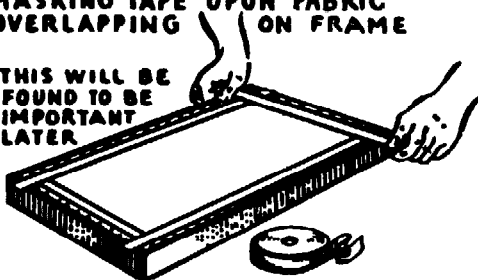

CUT UP 1 OZ. GELATIN INTO 8 OZ. COLD WATER, LET SET ABOUT AN HOUR.

HEAT IN DOUBLE BOILER IN WARM WATER

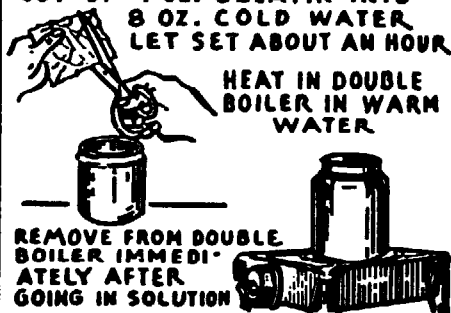

REMOVE FROM DOUBLE BOILER IMMEDIATELY AFTER GOING IN SOLUTION

NOW- COAT FACE SIDE OF SCREEN WITH EMULSION

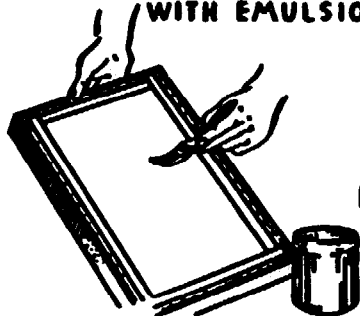

THEN- SMOOTH BOTH SIDES INSIDE AND OUT WITH SMALL SQUEEGEE

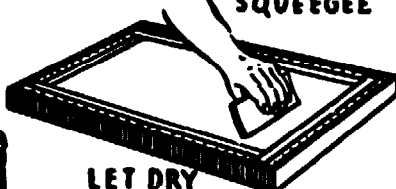

LET DRY WITH FAN TO HASTEN

MAKE PENCIL LAY OUT ON PAPER

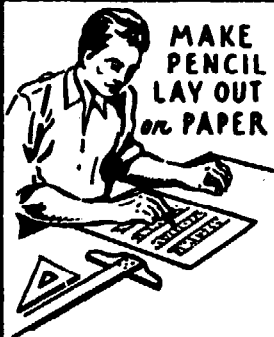

PLACE PENCIL LAY OUT UNDERNEATH GELATIN COATED SCREEN and LETTER UPON INSIDE WITH BLACK OR RED SHOW-CARD COLOR

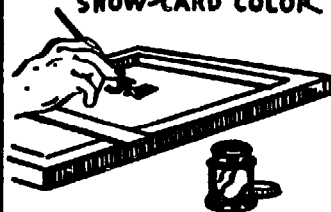

OR, YOU CAN STICK IN BLACK DIE-CUT PRESSURE SENSITIVE LETTERS CAN BE HAD IN DIFFERENT STYLES and SIZES.

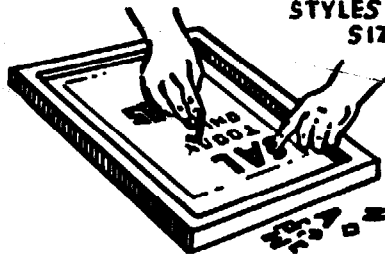

SENSITIZER: STIR 1 OZ. GLYCERINE AND 1 OZ. BICHROMATE INTO 1 QT. OF WATER

APPLY SENSITIZER TO FACE SIDE OF SCREEN USING 2 IN. CAMEL HAIR

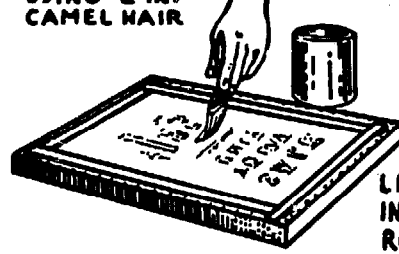

LET DRY IN DARK ROOM

REMOVE TAPE AND EXPOSE FROM INSIDE

15 MIN.

PLACE BLACK CARDBOARD

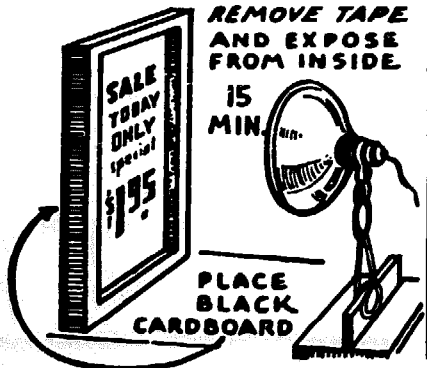

DEVELOP in HOT WATER

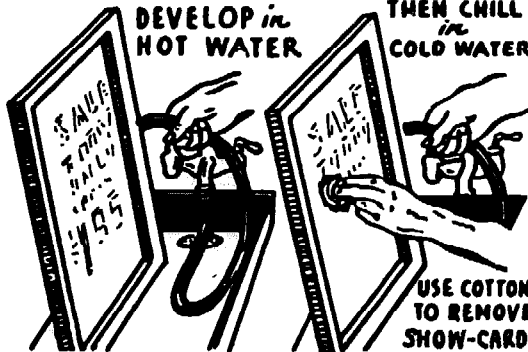

THEN CHILL in COLD WATER

USE COTTON TO REMOVE SHOW-CARD COLOR

FILL IN WITH LACQUER

WHERE TAPE COVERED.

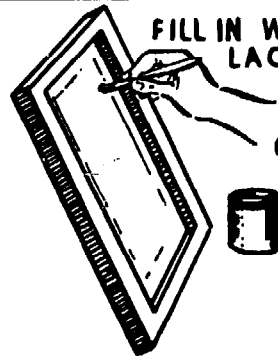

POLYVINYL ALCOHOL PVA DIRECT PHOTO SCREEN

FOR USE ON POLYESTER, NYLON FABRICS OR WIRE CLOTH. NOT FOR SILK.

CAUTION: POTASSIUM BICHROMATE IS TOXIC. USE PROTECTIVE GLOVES, GOGGLES AND APRON.

① POLYVINYL ALCOHOL COMES IN VARIOUS GRADES OF FINE WHITE POWDER INCLUDING THE NEWER TYPE CALLED "ELVANOL"



WITH THIS SYSTEM DEVELOPED BY THE AUTHOR THE TYPE SHOWN ON THIS LABEL IS RECOMMENDED

TYPE B - MEDIUM VISCOSITY

② IN 12 OUNCES COLD WATER (LIQUID MEASURE) BEAT IN AS WELL AS IS POSSIBLE 1 OUNCE OF THE DRY PVA. POWDER

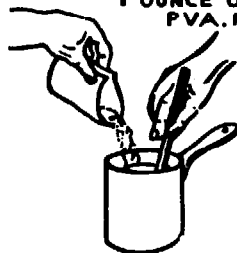

HOWEVER SOME PARTICLES WILL NOT DISSOLVE COMPLETELY IN THIS OPERATION

③ NOW COOK THE COLD WATER MIXTURE UNTIL ALL BALLS OR LUMPS WHICH HAVE FORMED ARE COMPLETELY DISSOLVED TAKES ABOUT 15 MINUTES.

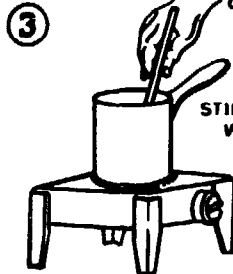

STIR CONTINUALLY WHILE COOKING AND DO NOT BRING TO BOILING POINT

④ WHILE THE SOLUTION IS STILL WARM ADD 1/4 OUNCE POTASSIUM BICHROMATE AND DISSOLVE

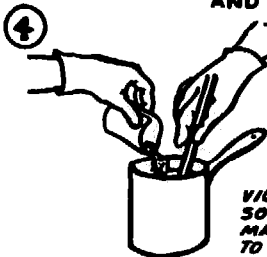

TO COMPLETE STRAIN MIXTURE THROUGH A COARSE PIECE OF SCREEN MESH

VIOLET WATER SOLUBLE DYE MAY BE ADDED TO GIVE COLOR

⑤ NOW FLOW THE WARM SOLUTION OVER THE FACE SIDE OF SCREEN IN THIS MANNER.

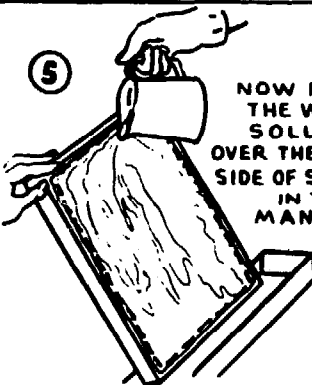

⑥ IMMEDIATELY AFTER POURING ON, SQUEEGEE DOWNWARDS WITH CARDBOARD SQUEEGEE IN THIS FASHION

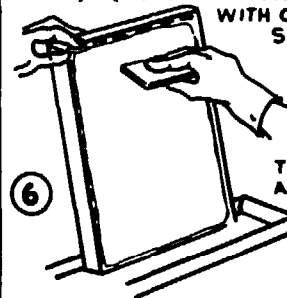

THIS GIVES A UNIFORM COATING

⑦ NOW STAND UP TO DRY EITHER IN DARK ROOM OR IN SUBDUED LIGHT TAKES ABOUT 20 MIN.

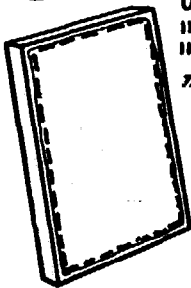

⑧ USING THE DIRECT METHOD TYPE OF PRINTING FRAME PLACE SENSITIZED SCREEN AND POSITIVE AND LOCK UP

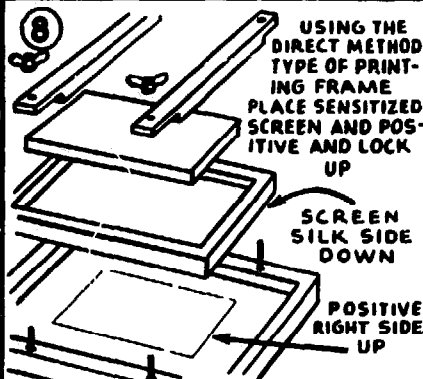

⑨ EXPOSURE 35 AMP. ARC CARBON LAMP 15 MIN. AT ABOUT 30 IN.



DIRECT SUNLIGHT ABOUT 8 MIN.



⑩ BLACK LIGHT EXPOSURE INSTEAD OF CARBON LAMP OR SUNLIGHT

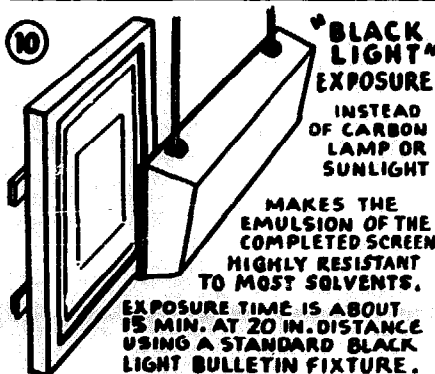

MAKES THE EMULSION OF THE COMPLETED SCREEN HIGHLY RESISTANT TO MOST SOLVENTS.

EXPOSURE TIME IS ABOUT 15 MIN. AT 20 IN. DISTANCE USING A STANDARD BLACK LIGHT BULLETIN FIXTURE.

⑪ DEVELOP EXPOSED SCREEN, FLOWING OVER BOTH SIDES WITH WARM WATER IN THIS MANNER OR WITH HOSE TAKES ABOUT 5 MIN.

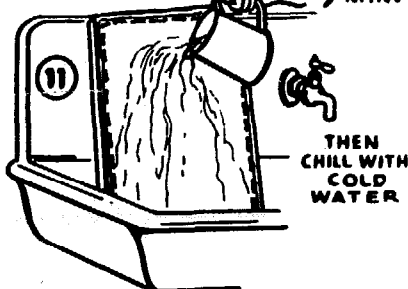

⑫ STAND UP IN FRONT OF FAN TO DRY IF THESE INSTRUCTIONS ARE FOLLOWED CORRECTLY THERE WILL BE NO SCUM



WIRE SCREEN DIRECT PHOTO METHOD

CAUTION: BICHROMATE IS TOXIC. USE PROTECTIVE GLOVES, GOGGLES AND APRON AT ALL TIMES.

THE BEST TOOL FOR STRETCHING STENCIL WIRE CLOTH IS THE AUTO BODY WORKER'S TOOL

The
SEAMER



PRECISION
STEEL EDGES

FOLD WIRE CLOTH AND PLACE BETWEEN JAWS IN STRETCHING

STAPLE THIS SIDE SECOND

STAPLE THIS SIDE FIRST



GET LEVERAGE ON EDGE OF FRAME FOR TIGHTENING

THEN, TRIM WIRE CLOTH OUTSIDE OF STAPLES WITH

STRAIGHT EDGE AND SHARP KNIFE.

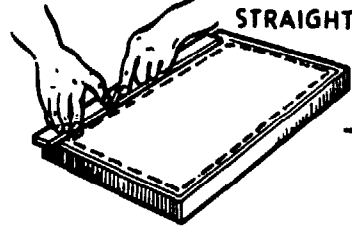

BRUSH FREELY BOTH SIDES, IN A WELL VENTILATED ROOM OR OUT IN THE OPEN, ONE PART FULL STRENGTH AMMONIA, AND TWO PARTS WARM WATER

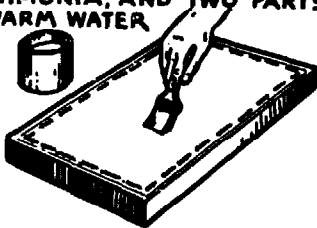

THEN RINSE THOROUGHLY

In
VERY HOT WATER

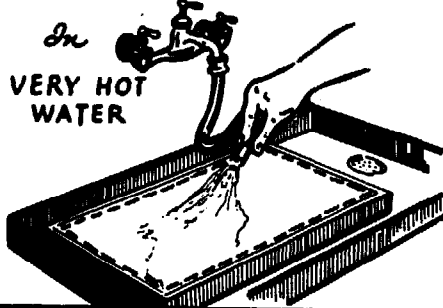

ADD 15 DROPS GLYCERINE
1/2 OZ. SUGAR
1 OZ. BICHROMATE
THEN LIQUEFY IN DOUBLE BOILER

SOAK 1/2 OZ. KNOX GELATIN AND 2 OZ. HIDE GLUE IN 12 OZ. COLD WATER TWO HOURS

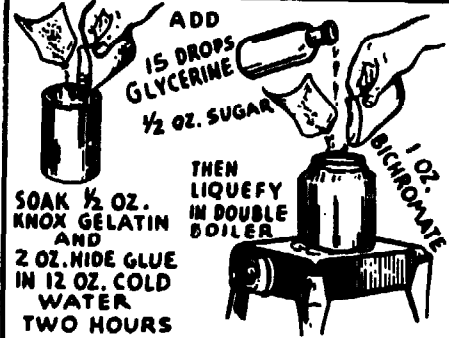

FLOW OVER BOTH SIDES

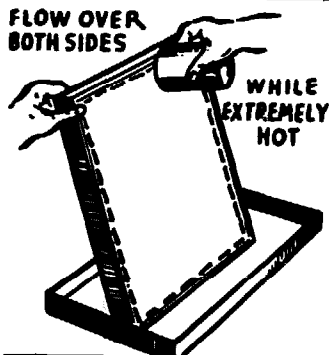

WHILE EXTREMELY HOT

DRY WITH HEATER AT LEAST 30 in. DISTANCE



EMULSION LEVELS OUT EVENLY WITHOUT CONGEALING

DARK ROOM OPERATION

SET UP IN PRINTING FRAME

FACE SIDE DOWN AGAINST POSITIVE

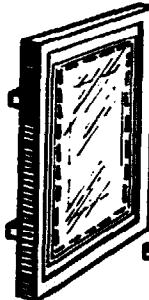
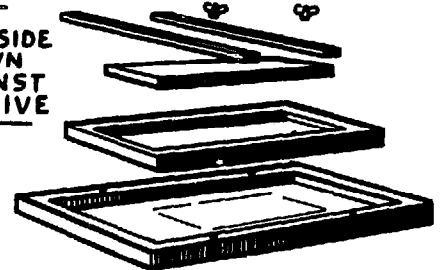

CARBON LAMP 10 TO 15 MIN.

BRIGHT SUN 5 MIN.

NO. 2 PHOTO FLOOD 20 TO 30 MIN.

DEVELOP OUT IN WARM WATER ABOUT 130° F.

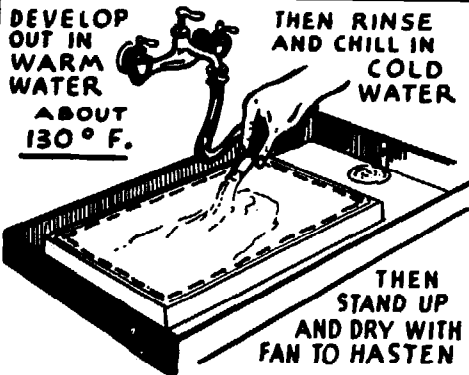

THEN RINSE AND CHILL IN COLD WATER
THEN STAND UP AND DRY WITH FAN TO HASTEN

IF A COLORED EMULSION COATING IS DESIRED SIMPLY BRUSH ON BOTH SIDES, WITH SOFT CAMEL HAIR BRUSH

A COLD DYE SOLUTION OF

1 OZ. OF EITHER RED OR PURPLE DYE IN 8 OZ. WATER.

LET SET 10 MIN.

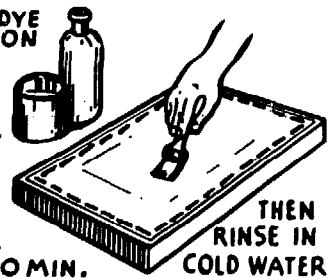

THEN RINSE IN COLD WATER AND DRY

INDEX

- A**
- Adjustable Guides 31
 - Pedal-Lift Table 37
 - Air Brush Glue Tusche Stencil Screen 51
 - Automatic Kick Leg 20
 - Screen Lift 32
- B**
- Base, Floating 18
 - Hinged 32
 - Magnetic 31
 - Beam Compass 38
 - Blade Sharpener 20
 - Squeegee 15
- C**
- Carbon Tissue 55
 - Dry Method 54
 - Photo Stencil 55
 - Wet Method 52, 53
 - Circle Cutters 38
 - Clamps, "C" 32
 - Cleaner, Screen 29
 - Cloth, Wire 59
 - Stack Paper 31
 - Compass 20, 38
 - Beam 38
 - Cornstarch 51
 - Counter Balance 35, 36
 - Crayon, Lithographic 50
 - Crayon-Tusche Wash-Out Stencil Screen 50
 - Curves 39
 - French 38
 - Inward 30
 - Curved Screens 22
 - Squeegee 15, 30
 - Cylindrical Surfaces 24
- D**
- Decal Paper Stencil Screens 41, 42
 - Double Floating Bar Frame 6
 - Duplex Decal Paper 41, 42, 45
 - Duplex Stencil Screens 43
 - Duplicate Transfer Printing Screens 27
- E**
- Eccentric Disk Guide 18
- F**
- Fabric Stretching Printing Frame 7
 - Flag Stencil Screens 23, 24
 - Flexible Stencil Screens 28
 - Floating Base 18
 - Frame, Double Floating Bar 6
 - Grooved 6
 - Hinged 33
 - Inward Curves 30
 - Frame Joints 5
 - Frame, Large 12
 - Metal Strip 6
 - Outside Bevel 6
 - Fabric Stretching Printing 7
 - Stencil 5, 6
 - Triplicate Floating Bar 12
 - French Curves 38, 39
- G**
- Glue Tusche Wash-Out Stencil Screens 48
 - Groove and Cleet Frame 6
 - Grooved Frame 6
 - Guides, Adjustable 31
 - Common Metal 18
 - Eccentric Disk 18
 - Megill "Perfect" 18
 - Movable Slot 18
 - Register 18, 31
 - Stationary 18
- H**
- Hand-Filled Screens 44
 - Hiett's Shellac Photo Stencil Screen 56
 - Hinged Base 32
 - Frame 33
 - Hinges 18, 19
 - Holder, Hinge 19
 - Squeegee 19
- I**
- Interchangeable Numeral Printing 25
- J**
- Jack Swing Printing Table 36
 - Jigs, Curved Printing 22, 23
 - Cylindrical Printing 24
 - Joints, Frame 5
 - Straightening 19
- K**
- Key-Line Block-Out Screens 46, 47
 - Knives, Stencil 38
- L**
- Lacquer Film Stencil Screens 45
 - Lift, Automatic Screen 32
 - Spring 34
 - Lithographic Crayons 50

Loop Cutters	38
Loose Paper Stencil Screens	40

M

Magnetic Base	31
Magnifier	38
Mesh Count	10
Metal Strip Frame	6
Monofilament Thread	9
Movable Slot Guide	18
Metal Guide	18
Megill "Perfect" Guide	18
Multifilament Thread	8

N

Numeral Printing	25
------------------------	----

O

Off-Contact Printing	21, 33
Outside Bevel Frame	6
Owens Key-Line Stencil Screen	47

P

Pantograph	39
Paper, Duplex Decal	41, 42, 45
Paper Stencil Screens	40
Photo Stencils, Carbon Tissue	55
Hiett's	56, 57
Paint-A-Graph	57
Wire Screen	59
Photo Transfer Stencil Film	29, 43
Polyvinyl Alcohol Direct Photo Screens	58
Printing Base	32
Printing, Cylindrical Surfaces	24
Interchangeable Numerals	25
Inward Curves	30
Off-Contact	21, 33
Round Objects	22, 23

R

Reclaiming Screens	29
Register Guides	18, 31
Registration, Screen	16, 17, 26
Right and Left Printing	26
Rubber Lined Flexible Screens	28
Rubber, Sponge	28

S

Screen Cleaner	29
Screen Finder	10
Screen Registration	16, 17, 26, 46
Tightener	19
Sealing Stencil Screens	14
Sensitizing	52, 53, 54, 55, 57
Shellac	41, 56
Single Screen, Right and Left Printing	26

Silk	8
Spring Lift	34
Squeegee	15, 30
Holder	19
Stack Paper Printing Base	31
Stapling Fabric to Frame	11, 12, 13, 30
Starch	27
Stencil Screen Frame	5, 6
Stencil Knives	38
Stencil Screen Mesh Materials	8, 9
Stencil Screens, Air Brush Glue Tusche	51
Carbon Tissue	52, 53, 54
Crayon Tusche Wash-Out	50
Decal Paper	41, 42
Duplex	43
Duplicating Transfer Printing	27
Flag	23, 24
Glue Tusche Wash-Out	48
Hand-Filled	44
Hiett's Shellac Photo	56
Key-Line Block-Out	46
Lacquer Film	45
Loose Paper	40
Numeral Printing	25
Owens Key-Line	47
Paint-A-Graph Photo	57
Photo	55, 57
Polyvinyl Alcohol Direct Photo	58
Right and Left Hand Printing	26
Rubber Lined Flexible	28
Shellac	41
Two or More Colors	28
Tusche Enamel	49
Stretching Fabric	11, 12, 13
Swivel Knives	38

T

Table, Adjustable Pedal-Lift	37
Counter Balancing	35
Jack-Swing	36
Swing-Back	34
Taping Screens	12
Tightening Screens	19
Tools, Stencil Film	38
Triplicate Floating Bar Frame	12
Trisodium Phosphate	29
Tusche	48, 49, 50, 51
Tusche Enamel Stencil Screens	49
Two Color Screens	28

W

Weave Formation	8, 9
Wire Cloth	59
Wire Mesh	9
Wire Screen Direct Photo Method	59