

AT MICROFICHE
REFERENCE
LIBRARY

A project of Volunteers in Asia

Low Cost Printing for Development

by Jonathan Zeitlyn

Published by:

Jonathan Zeitlyn
51 Chetwynd Road
London NW5
UNITED KINGDOM

Available from:

same as above

Reproduced by permission.

Reproduction of this microfiche document in any form is subject to the same restrictions as those of the original document.

Low cost printing for development

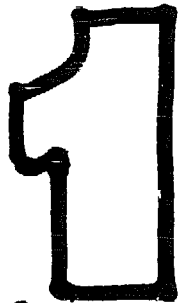

introduction
and
design

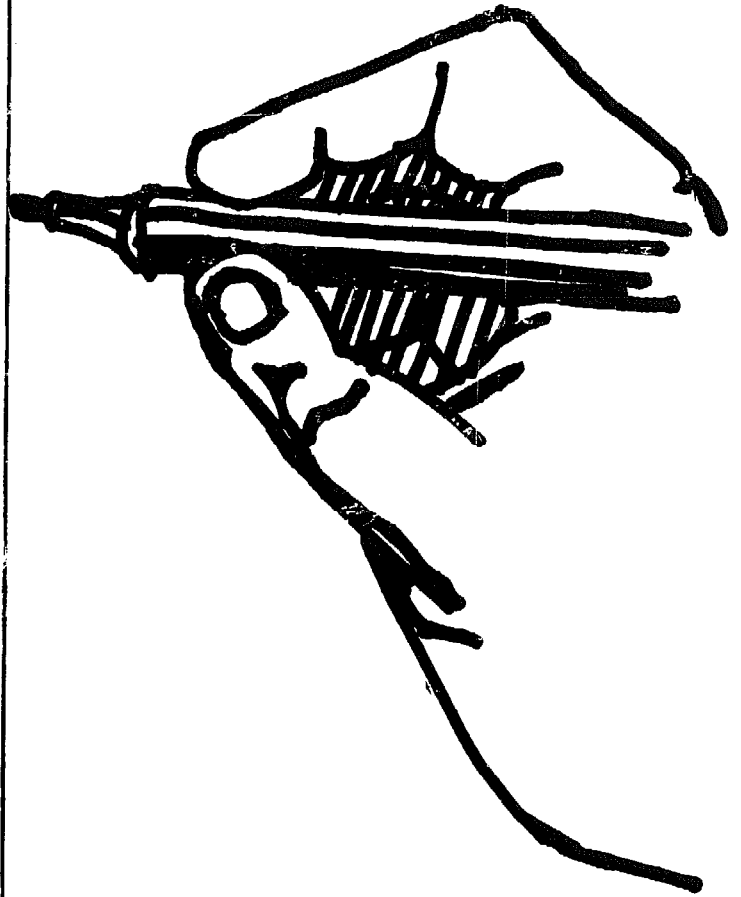

by
Jonathan
Zeitlyn.

Low cost printing for development

by
Jonathan
Zeitlyn.



Published by CENDIT
Centre for development
of instructional
technology.
D1 Soani Nagar
New Delhi 110 017
India

and Jonathan Zeitlyn
51 Chetwynd Road,
London NW5. UK.

with assistance of
FAO - Action for
Development / Freedom
from Hunger Campaign
PO Box 3059. New Delhi
110 003 India.

© Jonathan Zeitlyn 1982

Printed at Raj Bandhu Industrial
Company. New Delhi 110064.

This is the 1st section of
the handbook on low cost
printing for development.
There are 4 separate
sections.

The 2nd section on do-it-
yourself printing covers:
block printing
stencil duplicating
screen printing
hecto jelly pads
spirit duplicating
and photo copying

The 3rd section is on using
a printer and covers:
dealing with a printer
colour
imposition
offset litho printing
letterpress printing
and words

The 4th section is on setting
up your own printshop and
covers:

Having your own printshop
setting one up
what you will need
running a printshop
projects
further information on
books and organisations
paper

and how you can make a 5th
section yourself.

Low cost printing for development

Introduction and design.

Contents

Introduction	1
background	3
alternatives	4
planning	5
choosing a print method	6
Design: ideas	7
Design: approaches	8
Design: techniques	13
Grids	14
roughs	15
text	16
typesetting	17
copyfitting	18
typesetting machines	19
letterpress setting	19
marking up	19
headlines	20
pictures	22
line images	22
continuous tone	23
borders	24
proof reading	25
artwork	26
layouts	27
Finishing	28
Acknowledgements	30

Introduction

Low cost printing is easy to do. It is done by using simple and appropriate printing methods.

You can use these methods yourself. Do-it-yourself printing saves the expense of going to a commercial printers.

Producing only a few copies is possible with these processes. This reduces the overall cost. And makes possible local small scale publishing.

The cost can be kept down even for the printing processes that have to be done by a printer. Knowing what is involved and doing as much as possible yourself can save money and overcome problems.

Low cost printing can be used to print pictures as easily as words. It can be used to print on fabric as well as on paper. It is possible to make your publication look good even if it is to be printed cheaply.

Low cost printing methods are usually easier to use, maintain and get the materials locally.

Printing can be organised so that lots of people can use it in a self help way. Printshops or resource centres can be established to serve particular areas or organisations. When printing becomes accessible to lots of people they create publications that are very different to what is normally published. All kinds of groups can afford to publish their views. People who would never have thought of it can publish once they have access to a printshop. They gain the freedom of the press, though they may have to get their hands inky in the process.

Printing is changing. These changes are now affecting the Third World. It is important to select the useful techniques from both the traditional and the new methods. So that printing can be appropriate for the conditions in the Third World and make printing as accessible as possible.

Printing can therefore contribute to the spread of literacy and the democratic development of the country.

Local publishing, made possible with low cost printing, can be useful in lots of ways. It can use the local dialect or language with illustrations that the local readership can understand and relate to.

Local publishing can be used to get through to rural people. This will be useful for lots of organisations involved in health, education and development. But hopefully it will be taken up by anyone involved and active in giving a voice to the poor.

Local craftsmen can use these methods of printing. The whole process can be controlled locally. The gap between the designer, printer, writer and the reader can be reduced. They can all be part of the same community.

A decentralised and appropriate form of communication can be created.

David Werner's view of the problem

Two approaches to health care

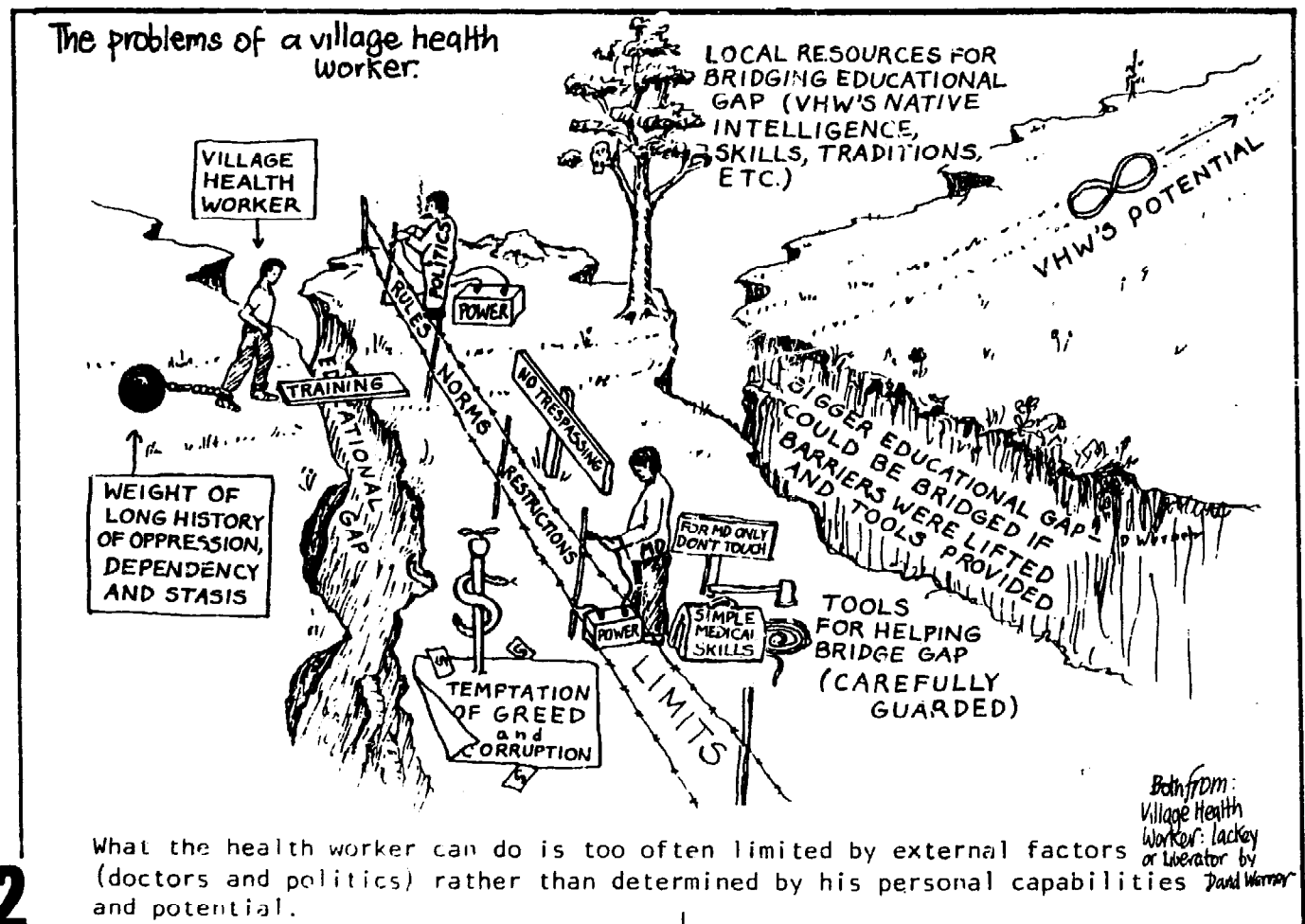
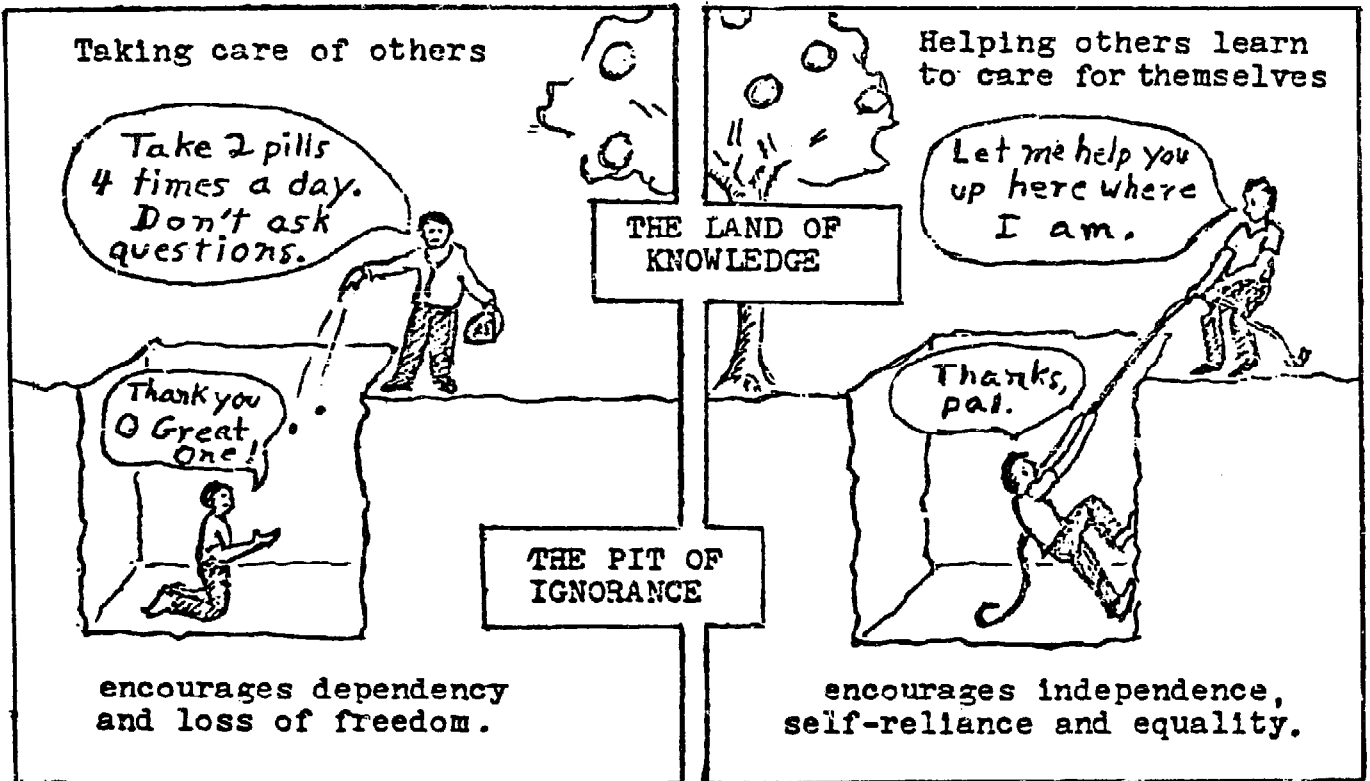

Alternatives

Printing and publishing may not be the whole solution to any communication problem. Sometimes they are resorted to as they are obvious and fairly easy to do. Printing a poster or newsletter for example may be useful as part of the campaign but should not be confused with the campaign itself. It should be part of an overall plan.

Examine if you really need to print anything at all:

- are there alternatives ?
- what are the aims of publishing?
- who is it for and will they read it?
- and how are they going to get the publication ?

interpersonal communication

Some alternatives may include better interpersonal communication. Try organising a 'communication tree' where each person is delegated to tell three people who will tell three others etc.

a wall newspaper

This can be a wall strategically placed with hand drawn articles, headlines and illustrations. Photos can be taken or just cut out of magazines to illustrate the articles. It can be changed every week and involves no printing at all.

wall paintings

Large wall paintings, with slogans and pictures can be very effective. They may be cheaper and easier to do than getting something printed. A good site where lots of people pass by is very effective for reaching a large audience.

Traditional forms

Traditional forms of communication should also not be ignored. Story telling, puppetry, drama, music and song are all effective communication.

Also the occasions in which these occur - Festivals, fairs etc are a very good context for exhibitions or even to distribute a magazine.

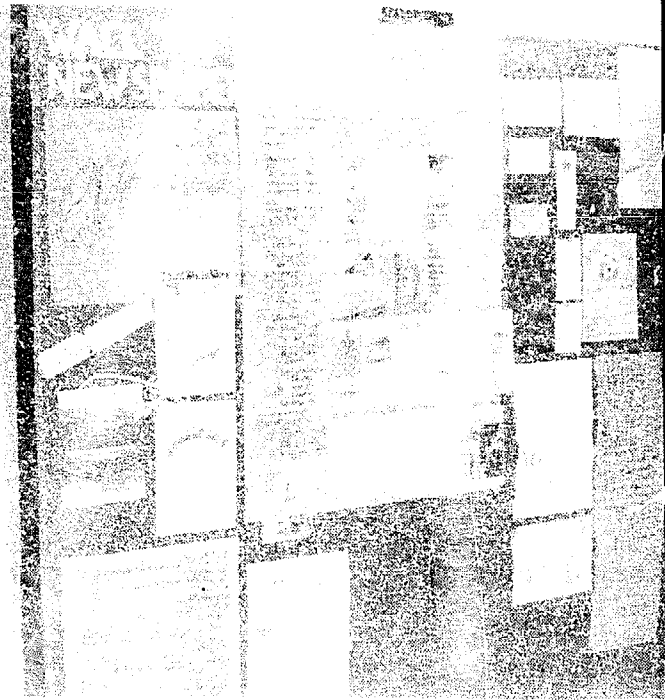

A wall newspaper in a community education centre in London UK

तीर्थराज पुष्कर

पत्रिका

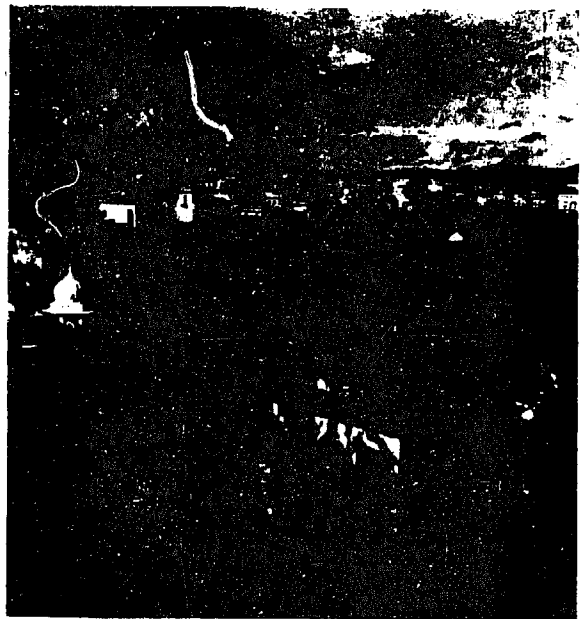

A magazine that is given away free during Pushkar Mela in Rajasthan, INDIA.

Planning

The first step in any printing and publishing project is to plan well. It will involve the co-ordination of the work and effort of many people.

Most publishing involves a group effort. If the group is motivated and involved in the planning it can work well together.

The aims of publishing have to be established. And the question of who the publication is really for must be investigated. The information about your readership (which may be obvious) has to be gathered. Find out about their interests, culture, level of literacy and the sort of publications they are used to. It should influence the writing and all the decisions about format, design and therefore printing. Testing your material and especially the illustrations may be useful to make sure they are understood correctly.

distribution

You should consider distribution early in your planning. Important points to consider are:

- The number of potential readers
 - How you can get your publication to them.
 - Whether to sell it or give it away.
- These points may directly affect how the publication is to be designed and printed. For example if it is to be sold it may well need a large attractive cover. And if it is to be posted it may need to be printed on light paper to save postage.

cost

When you are working out the overall cost of the publication you must include the cost of transport, postage the telephone etc as well as the cost of the printing and distribution.

It will not cost much more to print a larger than a smaller number of copies. Consider therefore the cost per copy, the unit price, for various lengths of print run. You can then fix the selling price Commercial publishers often multiply their

printing costs by 5 to get their cover price. If your publication is to be free, you can work out the sum of money which you will have to raise.

design and printing

All these factors involved in planning will give you the outlines of the design and format. To help these discussions as a group, look at similar sorts of publications. Look at the ones you like or think your readership likes. These examples may give you ideas about what you want or do not want in terms of design and print. It will involve discussion of what sort of 'look' and images will be required. This will help you consider what sort of printing method to use.

In planning you may have to consider what your group can do for itself:- work out who can do the typing, design illustrations, artwork, layout and or what will have to be done for you. Also consider what access you have to printing that you can do yourself And is it really what you need for your particular sort of publication ?

If you are having it printed for you commercially you will have to find a suitable printer to print it. See on for the pages on choosing a print method and using a printer.



Choosing a printing method

Choose the correct method for printing the particular sort of publication you want. This is the main way of keeping costs down.

Important points to consider are:

- 1 the number of copies you need - the 'run'
- 2 the size and format of the publication
- 3 the sort of images needed - photos typesetting, colour etc
- 4 timing - how long will it take to produce? - when do you need it?
- 5 Access - have you access to print equipment? Can you do it yourself? Or are you going to have it done for you?
- 6 what can you afford?

method	number	size	image	timing	access	cost	comments
relief: block printing and rubber stamps	for 2 to 500	up to 5x5 ins	only simple images	D.I.Y laborious rubber stamps take 2 days to make	D.I.Y use when you need!	very cheap	Useful for small images or addresses. Can be printed only when needed!
Stencil duplicating and with Scanner	for 10 to 2000	foolscap A4 and Sometimes A3	Typing, line drawings cuttings, simple artwork	D.I.Y Takes 1/2 hour to run off one sheet printing both sides	many in offices and special shops less common.	Doing your own duplicating means that you only pay for materials. fairly cheap	Very easy to use and quite accessible
Screen printing and photo stencil	for 10 to 1000	most sizes up to 30x40 ins	Varies with type of stencil Prints any colour Photo quality. Large dots needed for half tones	D.I.Y Takes one day to print one poster of 500 copies	make it yourself Accessible in colleges, schools etc or use a commercial screen printer	Doing your own screen printing means that you pay for materials only. Quite cheap.	Easy to use and good for printing large areas for posters and on fabric.
letterpress photo engraved blocks	for 500 to 10,000	most sizes up to 20x30 ins	Good for type But more expensive for pictures For photos and artwork but not good for fine dots	Takes a printer 2 to 3 days to print and set an 8 page leaflet.	In most towns in commercial printshops of various sizes. Small jobbing printers are common.	Small hand set jobs are quite cheap.	Accessible due to the number of small jobbing printers.
offset litho printing	for 1000 to ∞	A4 → A2	Any colour. Most images photos etc. good quality.	2 to 3 weeks (3 to 7 days for a simple job printed by a small printer.)	In most large towns, larger commercial printers may have effect.	It costs more than letterpress. (But don't forget the costs of typesetting and artwork).	Good quality. Gives you the flexibility of a photographic process so that you can make your own artwork.

design: ideas

Printing and the design of that printing needs time and thought. Time may be spent writing the pamphlet, but the idea of supervising the printing or even doing it themselves is alien to many non-commercial publishers. This may be one of the reasons they have badly produced publications that cost more than they need to. Often you can produce well designed and well printed publications cheaply. You can even use the same methods that are used to produce the normal low quality publications.

You can print pictures, diagrams, symbols etc as easily as words. Printing is a visual as well as a literary form. And pictures often get over some information more effectively than words.

There is a whole range of graphic techniques which are a way of getting over information visually. These should not be ignored, and they are not difficult to use.

Design therefore is something that needs time, thought and imaginative effort. It is not something that only professionals can do. There is no monopoly of expertise. Nor is there a 'correct' way to design. There is only what works, and that is what communicates best to the people you want to reach. The likelihood is that you will be closer and know more about your readers than any professional designer.

One of the main difficulties of centralised publishing is that the producers of those publications come from a different background than their readership. In fact each group involved, the writer, designer, editors and printers probably are also divided by background and their present role from each other.

Localised, low cost printing can avoid this altogether.

What is needed is to extract what is useful from conventional design

practice and to do it yourself.

involvement

As in planning it is good to involve your group in decision making about design. Contributions at this stage can be as effective as contributing writing. People learn and gain confidence by controlling the production process as well as having their writing published. Their contribution in doing a drawing or a headline will show!

To achieve this involvement, make a 'rough' (see on) which can be big enough to discuss as a group. Examine other publications similar to your own. Think about and discuss the design techniques used. Which do you like? What looks attractive and what communicates the message effectively?

print methods

Each print method has limitations and capabilities that the designers have to take into account. Therefore it is necessary to find out about each method before you commit yourself to a design. Stencil duplicating, for example, cannot print large solid areas of ink. This is avoided by making the headlines in out line. (see choosing a method and each section on the methods)

Out line headlines

avoid some of the problems of small scale printing methods such as stencil duplicating

design: approaches

Many people find it hard to start thinking visually. They have been educated to think in words. Here are some approaches (ideas) to the problem of design which may help you start:

• Visualisation

Design is a process of turning ideas words etc into a visual and physical thing. It is therefore important to think in visual terms. Try imagining the whole page of your publication as a picture. Produce a rough drawing of an ideal page. Mark headlines with big squiggles, and text as thin lines. Illustrations can be indicated with outlines and rough shading. This should give you an impression of the page.

Try then to turn at least one important idea in the text into a picture, diagram or other sort of illustration..Do not worry if you have not got any at hand. Imagine what would be ideal and once the idea is worked out you can then decide how to put it into practice.

An idea for the overall design may develop from these exercises.

• creative ideas

Design is about creative solutions to problems of communication. Try and think of 3 to 5 completely different ways of designing your publication. Try out all kinds of ideas. Even those that seem silly or simplistic may work on paper. Make quick sketches (roughs) and compare them. Choose the best or make a design based on the best parts. Thinking simply can often be the best way to solve the problem. Many designs do not work

8 because they have too many ideas. Choose the one idea that really works.

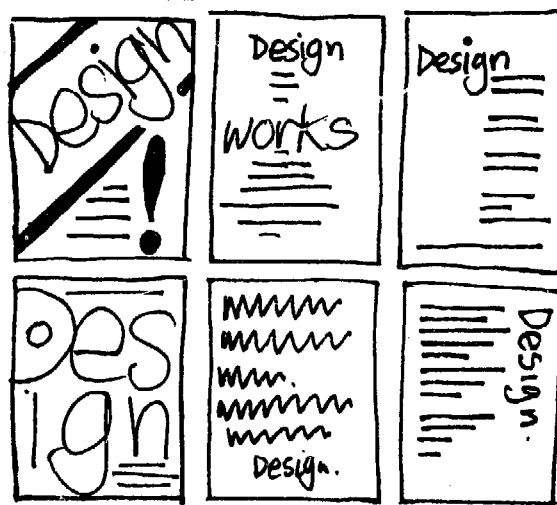
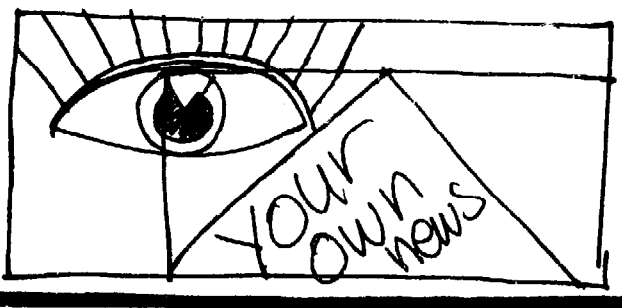
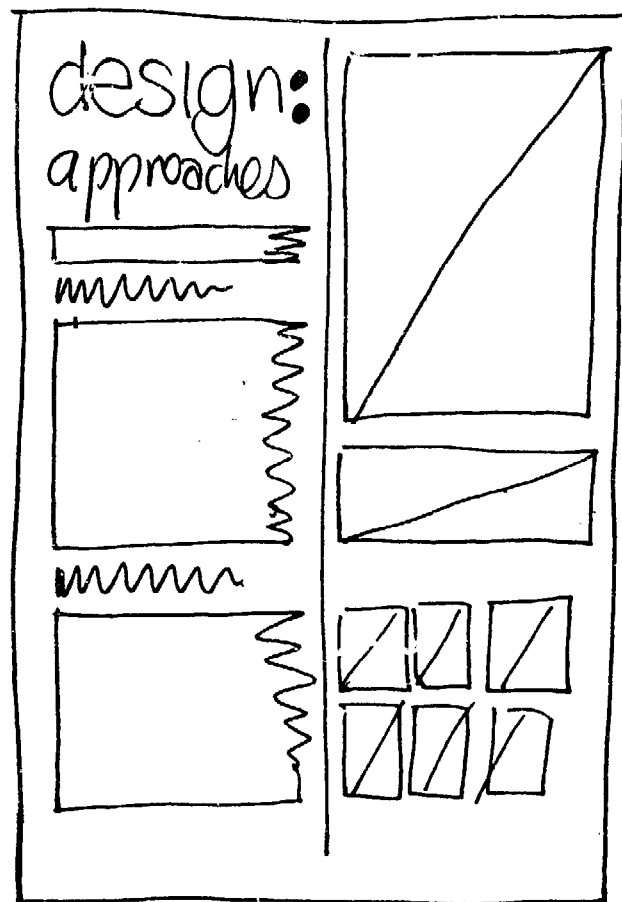

● information analysis

Design is also about communicating definite information. Try and analyse that information carefully. Work out what is really important in the information; what it really means; who is it for; and in what situation it is to be read; what is the most appropriate form for that information.

Number the information in the order of importance. Put the most important in the largest size of lettering. And you have one design!

There are lots of other ways of emphasising part of the information that is important or different:

The word can be in a different **style**.
in **bold**
in colour
underlined
in **CAPITALS**
in *italics*

have space round it

or be aligned differently.

A picture may underline or emphasise a particular point best of all.

● format

Sometimes people have a clear idea of what kind of publication they want. This may be different from what the readers expect.

A rigid format may in fact be unsuitable for your publication and the readers. But it can be a starting point. Choose a well designed model that fits what you want. Study the layout and design. You could even use the same grid for your own publication

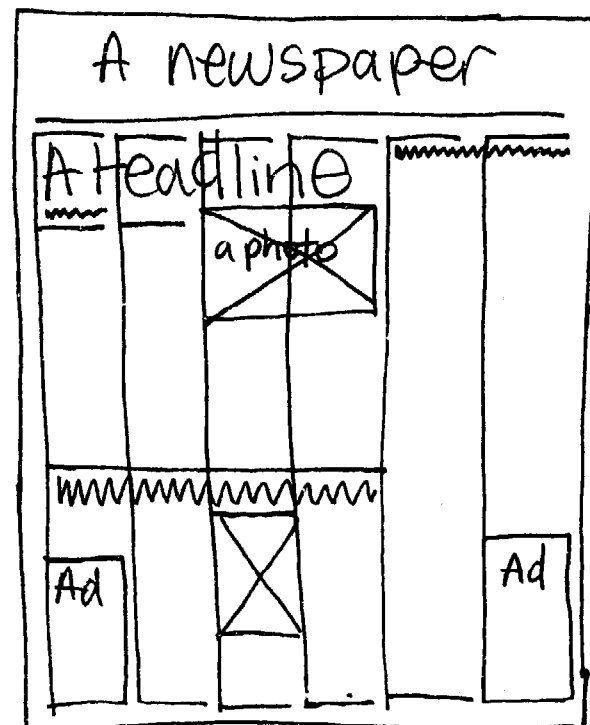
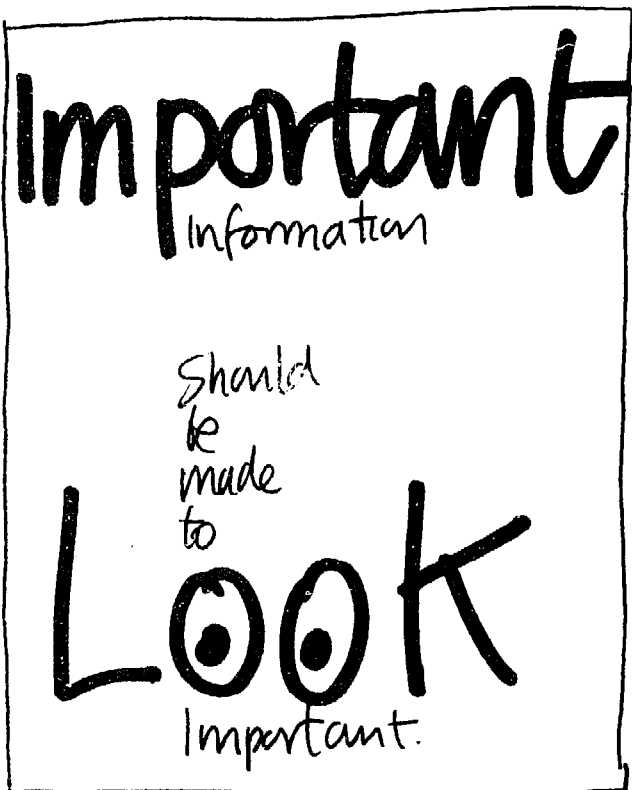

• Popular imagery

Your readership may be familiar with some form of popular visual culture. You may be able to use this successfully. Obviously a familiar form is far more acceptable and understandable to people who are not used to reading a large variety of material.

Cartoon conventions have been used to convey quite serious information. With an imaginative approach most popular and traditional forms can be revitalised. They can be incorporated to convey what ever information you want to get over.

• Ideograms, symbols & pictograms

One approach is to produce an 'ideogram', 'symbol' or 'pictogram' for a campaign, organisation or for a particular publication.

An ideogram or word image is a way of drawing a word. It suggests the meaning visually as well as still being able to be read as a word.

A logo is a simple ideogram that is used commercially. This is often a brand name which is printed in a particular style and becomes associated with the product. 'Coca Cola' or 'Kwality' are always printed in the same style and suggests visually the product.

A symbol can be used in the same way as a logo. If it is well thought out it should be able to be understood visually by people who find words difficult to read.

To establish a symbol as a logo it has to be used alot. Use it on everything you print or publish. To work it has to become associated with the publication or the group.

Pictograms are simple symbols or pictures that can be easily identified and understood. Good pictograms may have more impact than words.



from 'Las Sales Rehidratantes' Mexico. 2 1/2 x 4 ins. Made to fit inside the packet.

CUP

Coca Cola

Kwality



As an exercise, write a list of simple words and then try to draw them out as ideograms, symbols or pictograms. Show them to people not involved in the exercise and see if they can put a word to your drawings and read them quickly.

• legibility

There are few definite rules that make print more legible.

Basically almost anything can be understood if the reader is keen to find out. But clear design can help reading by not getting in the way of the reader. Perhaps it should not even be noticeable.

Length of line can affect reading. If it is too long it is difficult to find your way back to the start of the next line. If it is too short it may be unclear and difficult to type or set. Between 5 and 10 words a line is usually about right.

People often scan a whole line when reading. So with Roman scripts it is slightly quicker to read lower case letters than a line of capital letters.

Making each line the same length, called 'justifying' has no advantage for legibility. Though breaking words in the middle for short lines may be confusing especially if it is done in the wrong place.

Pictures can be made more legible by removing unnecessary detail. The backgrounds of photos can often be quite unnecessary and confusing. Sometimes good clear drawing may be as useful as photos.

Picture recognition:
from 'Communicating with Pictures in Nepal'
a report of a study by NDS and UNICEF.



recognised by 28%



recognised by 48%



recognised by 94%

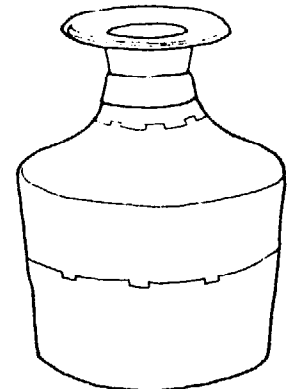

recognised by 91%

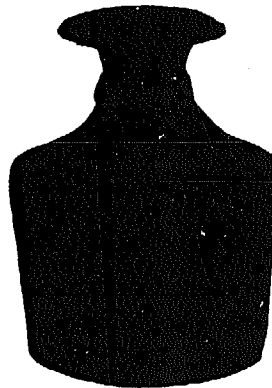

recognised by 88%

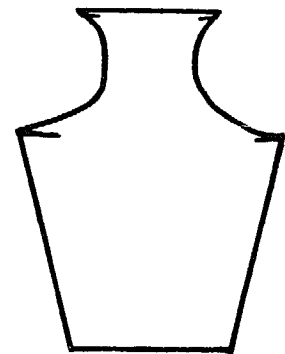

recognised by 75%

The caption under each illustration shows the percentage of people in rural Nepal who recognised the object.

•testing

Do not presume that the words and images that you like and understand will be the same for your readership.

People who are not familiar with reading may interpret both words and images quite differently than the artist or writer intended.

So before you go to print, test both the text, images and the final combination on a sample readership.

Test for comprehension and associations. In one area for example people may drink water with their hands and associate a picture of someone drinking from a cup with drinking tea. Make your illustrations as culturally relevant as possible.

Perhaps you may be able to test two styles of illustration or design and see which one people prefer/understand and relate to. Or how quickly they read each one.

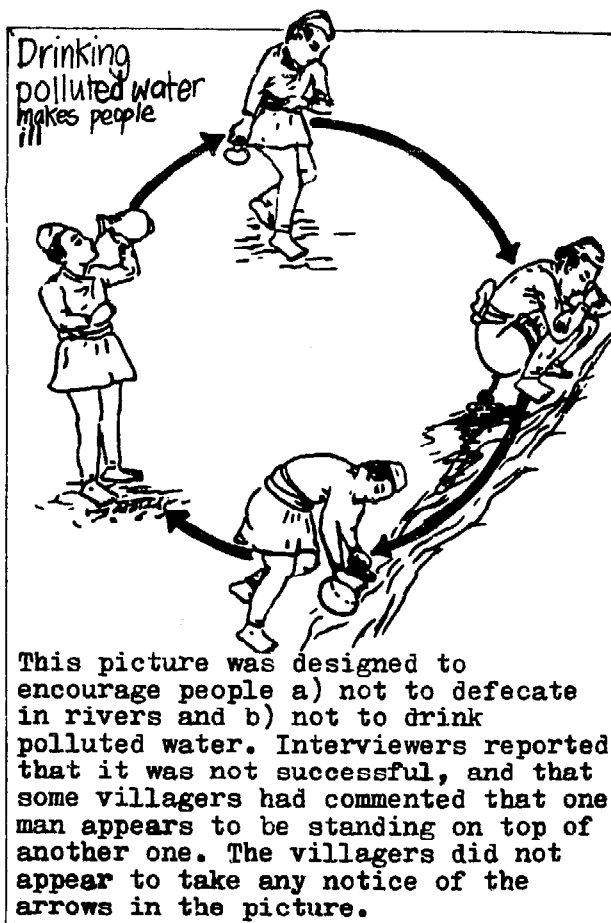

from 'Communicating with Pictures in Nepal'



None of the villagers who were asked about these drawings could see any connection between them. Some could see there was a dog, a crow and a man eating in one drawing, but no one assumed they had anything to do with each other.

No one recognised the flies. Some villagers said they could see butterflies. Magnifying glasses are not generally found in villages



so the process of enlarging the fly was not understood.

The idea of the flies moving from one place (the garbage pile) to another (the food) was not understood. The sick man was not recognised as such. Some villagers said he was sitting on a chair or on a table (most villagers sleep on mats on the floor rather than on a bed).

Design: techniques

Each printing method requires a different form of finished design

Photographic processes require an exact original (called the artwork) which is photographically copied -

- for letterpress printing it is copied onto a block.
- for offset litho printing it is copied onto a plate.
- for screen printing it is copied onto a stencil.
- for photo copying it is copied straight onto the paper.

With Direct processes the design can either be typed, drawn, cut or painted directly onto -

- a stencil for stencil duplicating or screen printing.
 - the screen with filler paint for screen printing.
 - the plate for offset litho printing.
- or the master for spirit duplicating.

Letterpress printing requires a skilled compositor to assemble all the elements of the design, in metal relief type and blocks. They usually follow their own design but can follow a layout if it's provided by the customer or a designer. This is a drawing and instructions showing where to put the type, headlines, borders and pictures on the page.

Once the design as a whole has been worked out it can be put into practice. How this is done will obviously depend on which method of printing you are using. The following information will be useful, though for quite a few methods. It may also make you think about using a different method and producing a better result. For example though typing is cheap and easy to do, typesetting can fit far more words per line and so save paper and printing costs if you are printing a large number of copies.

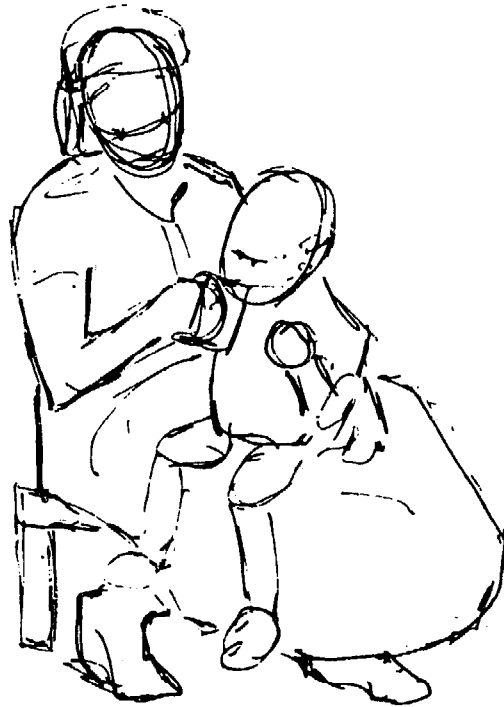

from illustrations for development



Bottles are difficult to clean.

It is safer to cup-feed your child.

Grids

A grid is made of lines marking the margins and columns of text on a page. This forms the basic foundations of a page design. It is also the basic guide to composing the page or to pasting up the artwork. It is useful for books, magazines and newspapers where the page design has to be consistent.

For artwork the grid is drawn or printed on card in light blue. This does not show up when photographically copied. The text, headlines etc can be pasted up on the grid in exactly the right place, on each page.

For letterpress printing the printer will have to know what grid you want. The type can then be set the correct width and the page made up with the margins and arrangement you want. Draw up the grid in pencil. Show the margins, columns, folds, where the page numbers are to go and where the text and headlines are to go.

It is useful to have a bit of card or paper round the grid to write instructions on or put in registration marks.

This grid can be used for various layouts:
-- An A4 page with 3, 4 or 2 columns.
or Two A5 pages with 2 columns

It is designed by
Redesign 9 London Lane
London E8 UK.

A 3 or 4 column grid for A4 pages

2 column A5 page grid

roughs

Whatever process is used 'roughs' are useful to show you how the publication is going to look.

The first rough can be a small sketch mapping out the arrangement of the various elements. It will give you an idea of the visual form the publication will take. Even a limited drawing, on paper will help you think about how your ideas and words will look on paper.

The next stage, perhaps when you have the text written and pictures obtained, is to do a more finished rough. This should be the same size the final publication is going to be. Indicate the text by parallel lines. Trace the headlines and do an outline drawing for the illustrations.

If your work is typeset a copy of the typesetting is given to you to check spelling and other mistakes - this is called a 'proof'. You can use this to make an even more exact rough.

If you move all the pieces of paper with the headlines, pictures and text around you can see what a variety of arrangements will look like. Then glue down the design you think best. This will indicate where you would like everything printed.

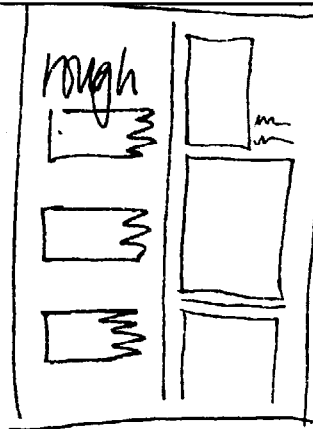

a first rough

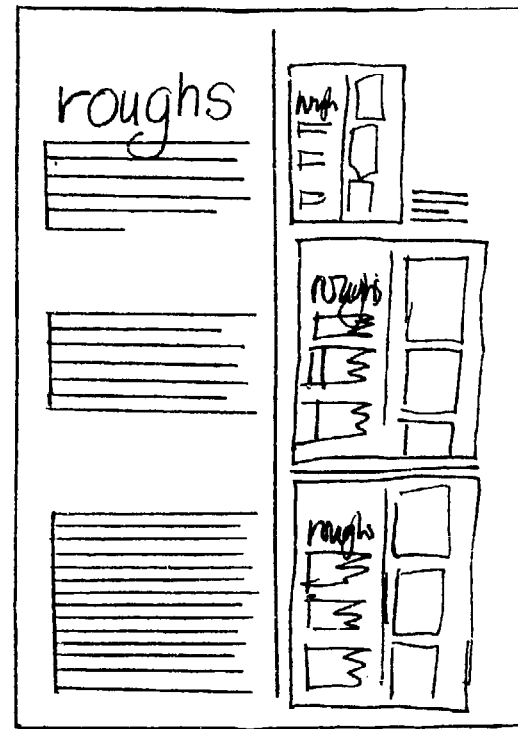

a same size rough.

roughs

Whatever process is used roughs may be useful in formulating your ideas about how the publication is going to look.

An initial rough can be a small sketch mapping out how the various elements are going to be arranged. It will give you an idea of the visual form the publication will take. Even a limited drawing, on paper, will help you think about how your ideas & words will look.

The next stage, perhaps when the text & pictures have been written and obtained is to do a more finished rough in the same size the final publication is going to be. Indicate the text by parallel lines and trace the headlines and do an outline drawing for the illustrations.

If your work is typeset an initial copy of the typesetting is given to check spelling & other mistakes - called a proof - this can be used to make an even more exact rough cutting it up and placing it down in place on paper as an indication of where it is to be like it printed.

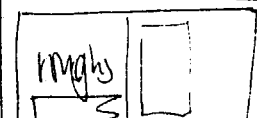
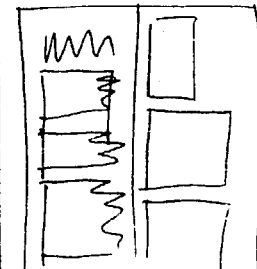

the text

Both the text and the headlines can be printed from hand drawn originals or 'Calligraphy'. This ancient art may well be worth reviving.

Using a photographic or direct process beautiful results can be made cheaply and simply.

typing

Typewriters use the same width space for each letter, so that the 'm' is the same width as the 'i'. This means that fewer letters fit onto a line than with typesetting which sets letters of varied width.

The typewriter used should be in good repair and have cleaned out letters e not e. It is better if it is an electric typewriter with a carbon ribbon but a manual will do.

Try typing in columns of between five and ten words per line. Leave enough space between columns so people do not read across the 2 columns instead of down them one at a time.

Before typing directly onto a stencil or plate you need to do some designing and calculations. How many words will fit in to two columns? How much margin to leave etc? It may be safer to type a test column on paper to see how things will fit before you type onto the stencil or plate.

To type for photographic processes, use a good white paper and make sure the type is as black as possible. If you do not have an electric typewriter with a carbon ribbon you can use a manual one. But use a new ribbon on it and hit the keys evenly and hard. You can use a new carbon paper placed on top of the paper face down, to get a strong black image. Then cut the typed column to the required length and glue it in place with the headlines and illustrations.

Corrections are easy to do when the typing is to be printed photographically. A new correct line is typed and simply glued on top of the line with the mistake in it.

With the photographic processes typing can be reduced to fit in more text. It is not difficult to read if it is only reduced 20%. Or it can be enlarged to make an introduction paragraph or sub-heading.

With the photographic processes typing can be reduced to fit in more text. It is not difficult to read if it is only reduced 20%. Or it can be enlarged to make an introduction paragraph or sub-heading.

With the photographic processes typing can be reduced to fit in more text. It is not difficult to read if it is only reduced 20%. Or it can be enlarged to make an introduction paragraph or sub-heading.

Or it can be enlarged to make an introduction paragraph or a sub-heading.

Or it can be enlarged to make an introduction paragraph or a sub-heading.

typed with a carbon ribbon.

To type for photographic processes, use a good white paper and make sure the type is as black as possible. If you do not have an electric typewriter with a carbon ribbon you can use a manual one. But use a new ribbon on it and hit the keys evenly and hard. You can use a new carbon paper placed on top of the paper face down, to get a strong black image. Then cut the typed column to the required length and glue it in place with the headlines and illustrations.

typesetting

There are various ways of making text into printing letters - or type. But all follow the terms and measurements devised for letterpress type.

All typesetting involves using letters of a varied width, the 'm' being wider than the 'i'. This means more words fit on a line than with typing. In most typesetting you are able to get a variety of sizes and styles of type giving you a greater flexibility of design. Important words can be emphasised by putting them into **bold** or *italics*.

Type size is measured in points. The size is the distance from the top of the tallest letter to the bottom of the lowest, basically the size of the piece of metal that the letter is on.

The main part of the letter, the 'x' height can vary with the design of the particular type face. This may give the impression of the type being of different sizes even though the body size is the same. The type is therefore labelled as the same size.

The space between lines is also measured in points and can be varied. It is called 'leading' pronounced 'ledding'. If you want the lines of type squashed up you only need one point leading or if you have space you may have two or three points. It depends on the size of type you are using. The leading is usually referred to as though it were part of the body of the type. You would say you want 10 on 11 that is 10 point type on a 11 point body which means using one point leading.

The width of column is called the 'measure' and is measured in either picas or ems. There are 12 points to a pica or em. Picas are also used to measure the margins and other details of page layout.

There are various ways of making text into printing letters - or type. But all follow the terms and measurements devised for letterpress type.

All typesetting involves using letters of a varied width, the 'm' being wider than the 'i'. This means more words fit on a line than with typing. In most typesetting you are able to get a variety of sizes and styles of type giving you a greater flexibility of design. Important words can be emphasised by putting them into **bold** or *italics*.

10 point
Press Roman 18M
set 10 on 11 pt.

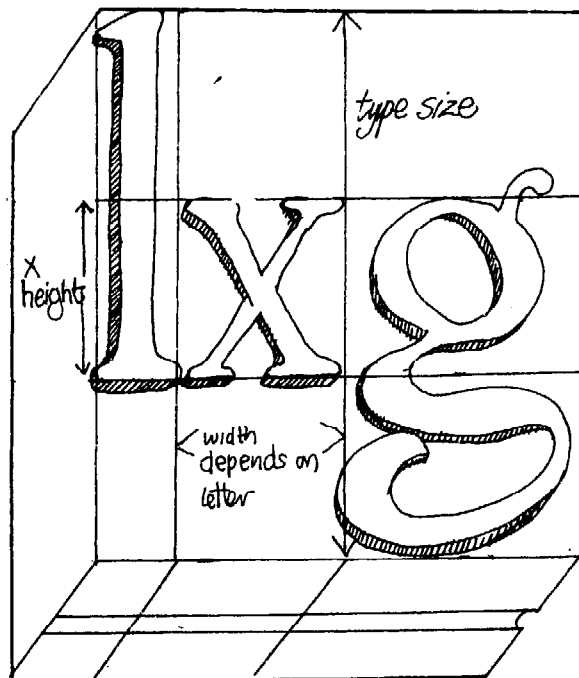

The space between lines is also measured in points and can be varied. It is called 'leading' pronounced 'ledding'. If you want the lines of type squashed up you only need one point leading or if you have space you may have two or three points. It

10 point
Press Roman 18M
set 10 on 13
set 10 on 12
set 10 on 10
set Solid

depends on the size of type you are using. The leading is usually referred to as though it were part of the body of the type. You would say you want 10 on 11 that is 10 point type on a 11 point body which means using one point leading.

Set 10 on 13

Copy Fitting

Typesetting is far more flexible than typing. It is possible to change sizes of type, the measure and the leading. This means that the typesetting can be made to fit the space available.

To calculate how much space the text will take once typeset is called copyfitting.

Depending on the particular job you can do this accurately or less accurately.

less accurate copyfitting

1. Estimate the number of words in the text.
 - 1.1 Count the average number of words per line
 - 1.2 Multiply this by the number of lines in an inch.
 - 1.3 Measure how many inches of text there are.
 - 1.4 And multiply the number of words per column inch by the number of inches.
2. Look at a specimen of the typesetting you have in mind.
 - 2.1 Count how many words there are in a line of this typesetting. And measure how many lines in an inch.
 - 2.2 Multiply these together to get how many words in a column inch.
 - 2.3 Divide this into the total words of the text and you will get the number of column inches of typesetting you will end up with.
 - 2.4 If this is too much or too little choose a different size of type and repeat the calculations.

← 36 characters in this line width
 ① 39 lines ($36 \times 39 = 1332$)

② 10pt Times Roman characters in a 20pica line = $55 \cdot 2$.

$\frac{1332}{55} = 22.5$ lines of 10pt type
 10 or 12 leading would give almost 4 inches of setting

Average number of characters per pica (c.i.)

	8pt	9pt	10pt	11pt	12pt
TR55	3.45	3.07	2.76	2.53	2.30
TR56	3.37	2.99	2.70	2.47	2.25
TR65	3.21	2.85	2.57	2.35	2.14
TR66	3.19	2.84	2.55	2.34	2.13

a copyfitting table for Times Roman.

accurate copyfitting

1. Count the number of letters and spaces you have in the text.
 - 1.1 Rule a line down the right hand margin of your text where the the shortest line ends.
 - 1.2 Count the letters and spaces in that line and multiply by the number of lines.
 - 1.3 Then add the remainder of the letters at the end of the longer lines on the other side of the line you ruled. This will give you an exact 'character count'
2. Look up in the copyfitting charts the type you have in mind.
 - 2.1 These will tell you how many characters on average fit into any particular length of line of typesetting.
 - 2.2 Divide this number into the total in the text. This will give you the number of lines of typesetting you will get.
 - 2.3 You can do this calculation for a variety of type sizes. And so work out which type size will fit your text into the space most comfortably.
3. To work out the number of lines of typesetting on a page measure the height of the area for the text on the page.
 - 3.1 Use a depth scale - a typographers ruler marked out in points and picas. With this measure how many lines of any particular size plus leading can be fitted onto the page. For example 10 point type on 2 point leading can be measured on the 12 point scale.
 - 3.2 The area of the text on a page will exclude the margins, space for the headlines and illustrations.
 - 3.3 The leading can be increased or reduced depending on the amount of space available.

Typesetting machines

Typesetting for photographic processes is needed on paper. It is cut up and pasted down on the card as part of the artwork.

There are two sorts of typesetting machines in use:

Photosetting machines and complicated electric typewriters. Both types of machines are expensive which makes the typesetting expensive as well. Therefore getting the copyfitting calculations right is important. You may not be able to afford to get it all reset if it does not fit!

Letterpress setting

Letterpress typesetting is often set by hand - a slow and quite expensive job. Or it is set by a 'hot metal' machine. This moulds the relief letters from molten metal and sets them in words and lines at the same time. This is an expensive and difficult machine to run, but is quicker than hand setting.

It is possible to get a good print made of the letterpress setting called an 'Art Pull'. This is used to make artwork which will be printed by a photographic print process.

Marking up

Marking up

The text to be set has to be 'marked up' so that the typesetter knows what is wanted.

This involves detailing the size, style measure and leading wanted at the beginning of the text.

It is also necessary to mark on the text what is to be put into italics or into bold; whether to indent at the start of new paragraphs, or to leave a line space. You use proof reading symbols to convey this information. And its always advisable to go through the text with the typesetter to make sure they understand what you want.

ABCDEFGHIJKLMNPOQRSTUVWXYZ
 abcdefghijklmnopqrstuvwxyz
 1234567890@*/(a £\$& %'()!^&^0^1^2^3^4^5^6^7^8^9^:;...
 ●||- 1 2 3 4 5 6 7 8 9 0 ? ! " # \$ % & ' () * + , - . : ; < > [\] ^ _ ` { | } ~

ABCDEFGHIJKLMNPOQRSTUVWXYZ
 abcdefghijklmnopqrstuvwxyz
 1234567890+°/=\$& %'()!^&^0^1^2^3^4^5^6^7^8^9^:;...
 ●○||- 1 2 3 4 5 6 7 8 9 0 ? < > X = + # \$ - : ;

ABCDEFGHIJKLMNPOQRSTUVWXYZ
 abcdefghijklmnopqrstuvwxyz
 1234567890@*/(a £\$& %'()!^&^0^1^2^3^4^5^6^7^8^9^:;...
 ●||- 1 2 3 4 5 6 7 8 9 0 ? ! " # \$ % & ' () * + , - . : ; < > [\] ^ _ ` { | } ~

ABCDEFGHIJKLMNPOQRSTUVWXYZ
 abcdefghijklmnopqrstuvwxyz
 1234567890+°/=\$& %'()!^&^0^1^2^3^4^5^6^7^8^9^:;...
 ●○||- 1 2 3 4 5 6 7 8 9 0 ? < > X = + # \$ - : ;

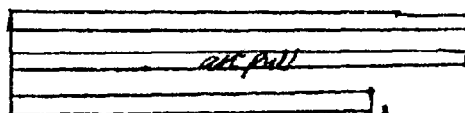

Set in Times Roman, 9/10 pt
 14 picas wide
 one line space for new paragraphs.
 using medium bold and italics
 where indicated

headlines

The simplest headlines to use are hand drawn. They are not difficult to do with practice and care. Beginners should draw out the words in pencil to practice a few times. The version that looks best and is the right size and length can be gone over in black ink and used in the artwork. Use guide lines to keep the headline even and straight.

Try copying styles you like from printed examples. Or you can trace the headline if it's the right size from the example or from a type book.

Draw out the outlines of the letters first. Then fill them in, make them as clearly black as possible, for the photographic process.

For stencil duplicating it is better to use outline headlines. Remember that solid letters need a lot of ink and they will therefore stick the paper to the stencil while being duplicated.

Hand drawn headlines can be made using stencils or lettering guides. These are made in many different styles and sizes.

You can also cut out letters from other printed publications to make headlines. Stick them down to make your own headline in the artwork. It is possible to make a photo negative from the page of a type book of a particular style of lettering. From this photo prints can be made in any size. These can be cut up and each letter can be glued in place to make the word.

20 HEADLINE
cut from a magazine

hand drawn headlines

Headlines

Headlines

STEE

a duplicated booklet made with stencil lettering guides

PEBAL JOSE MARIA ARGUEDAS

NECESITAMOS
AGUA POTABLE



agua limpia es
buena salud y
un derecho

PROMOCION COMUNAL

ARZOEISPADC QUINTA REGION DE EDUCACION

Headlines

A quicker and more expensive way is to use the dry transfer lettering (like letraset). This consists of a plastic sheet with letters of one style and size. Place the transfer sheet over a sheet of paper. On the paper a guide line has been drawn. The letter is positioned on the guide line using guides on the transfer lettering sheet. The letter is gone over with an old ball point pen.

The pressure of the pen turns the letter grey and transfers it onto the paper beneath. Judge the space between letters by eye and go on rubbing the letters until the whole headline has been set. It can then be cut out and stuck on the artwork. This method is easy to do and makes first class headlines in a wide range of styles.

Letterpress

Headlines can be set in letterpress type and a good copy or 'art pull' taken. This is usually done by hand and is expensive. There may not be a great range of styles to choose from. You will have to use the size and style that the printer has in stock.

There is a large variety of styles and families of type face available. Especially in the roman script used in English.

Each style of type 'face' is available in a variety of sizes. Often in a variety of widths, bold or light (black or white) and in condensed or italic form:

a a a a

There are now hundreds of different sorts of type faces. Some are so eccentric they may be difficult to read. The choice of which to use is one of personal taste. Work out which style fits your particular job and design.

A foundry catalogue or transfer catalogue will give you an idea of the range available.

There are 2 main sorts of type face:

those with a serif

T B 'Garamond' a serif type face

those with out
rif: a 'sans
rif'.

T B 'Franklin Gothic' a sans serif type face.

Times Roman

ABCDEFGHIJK
LMNOPQRSTU
VWXYZ àbcdé fgh
ijklmñôpqrstüvw
xyz 1234567890 B)(&
?!£\$¢%«»≡; a serif type

Univers 45

ABCDEFGHIJKLM
NOPQRSTUVWXYZ
YZ àbcdé fghijklmñ
ôpqrstüvwxyz 123
4567890 B)(&?!|£
\$¢≡*=-: a sans serif type

Letter spacing

To get a headline to look evenly spaced may require a bit of practice and judging by eye. It is necessary to leave more space between letters like l, m, and n than between letters that contain space in their design like y, a, o, w etc.

lmonx

Pictures

There are two main types of pictures: (1) Black and white pictures which are called line images. (2) Pictures made of greys, like photos which are called continuous tone images.

Line images

There are all sorts and styles of line images such as cartoons, diagrams and illustrations.

Experiment with different styles of illustration. Make them support the point of the text. Everyone can draw - if they try. The simplest illustration can be very effective in getting across an idea.

Simple illustrations that are made in line can easily be printed. With the photographic processes this does not cost extra and can be done as easily as printing the text.

For letterpress a photo engraved block has to be made, but line blocks are cheaper than tone.

Draw out the picture on good white paper or card in black ink. Light blue pencil can be used as a guide as it will not show up when photographed. Avoid the greys of pencil and make the image as clearly black and white as possible. You can use cross hatching to give the impression of tone.

Photographs can be printed in line as well. They will however lose all the tones and become a black and white image. Some photos can stand this treatment and become very strong clear images. If you are not sure what will go black and what white get a line print made of your photo to see. Then if it is suitable use it in the artwork.

Illustrations that have already been printed can be used. It is just a question of cutting them out and sticking them down in your own artwork. Use only black and white line images.



In one prestigious public school for boys, teachers take five classes of 40 minutes a day, and there are 52 children in each class. This means that in 200 minutes they deal with 250 children - less than a minute a child.

from Manushi No. 8.

from illustrations for development



Continuous tone

Pencil drawings, photos and quite a few other images use tone - greys - to make the picture. It is not possible to print tone directly. It has to be converted into a pattern of dots 'half tone' which gives the impression of tone. So in a dark area of the picture the dots are small white dots in a black background and in a light area the dots are tiny black ones. Look closely at any printed photo and you can see the dots.

To print successfully the full or almost full range of tones is difficult. It requires a good printer or block maker and needs to be printed on good quality paper. Offset is usually better than letterpress for this. To have a photo converted into half-tone (called screening) will cost more than rephotographing in line.

The dots size can be varied. The more lines you have in the screen the smaller the dot will be. The printed photo will look cruder and the dots more obvious. But larger dots are easier to print and on less good quality paper are usually clearer.

Lines or other patterns are used instead of dots for special effects.

Halftone prints can be made which are pasted directly onto the artwork. More usually the halftone is made on film as a negative. This is cut into the main negative and used to expose the plate, stencil or block.

The halftone is made by rephotographing the photo on a process camera. A screen of lines on plastic or glass is placed between the film and the photo. This gives the halftone the pattern of dots of different sizes.

While this is being done the original photo can be reduced or enlarged to fit the column width of the design.



enlargement from the photo below. Showing the half-tone dots



Specialist and the farmer—meeting face to face photo from SWAC report

The photo can be reduced or enlarged to any size that you want. But it will retain the same proportions.

To work out the new sizes is quite simple:

- 1 draw a diagonal line on the back
- 2 draw in the new width that you have decided on
- 3 Then measure off the height that the photo will be when reduced.

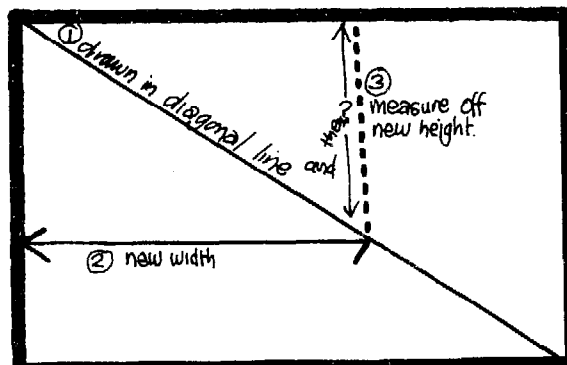

This method can be used for all scale calculations

Borders, Rules etc

There are many useful graphic images such as borders, rules and other symbols.

Borders can be decorative or plain. They can be useful to box in particular information or give character to a particular job.

Techniques:

● **Letterpress.** Printers will have some like this in stock:

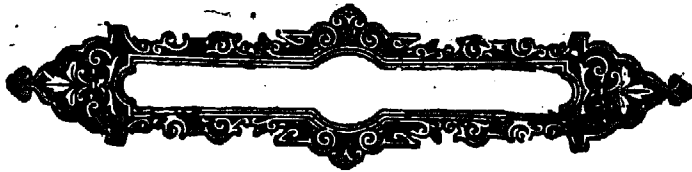

● **Hand drawn:**



● **Dry transfers:**

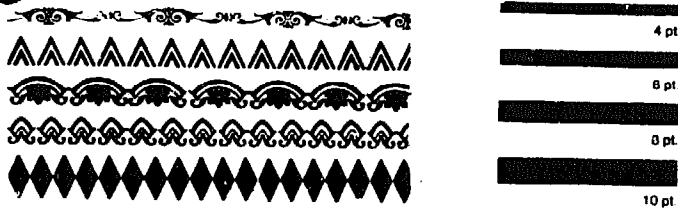

● **or Cut out:**

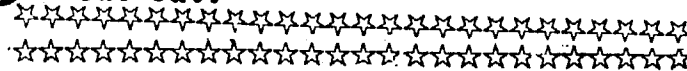

'Rules' are the printers term for lines. They can be useful for dividing columns, or stories, underlining and boxing.

Just hand rule in for photographic processes. Be careful that it is nice, straight and even. Rule the line on a clean bit of white paper and then cut up and paste down.

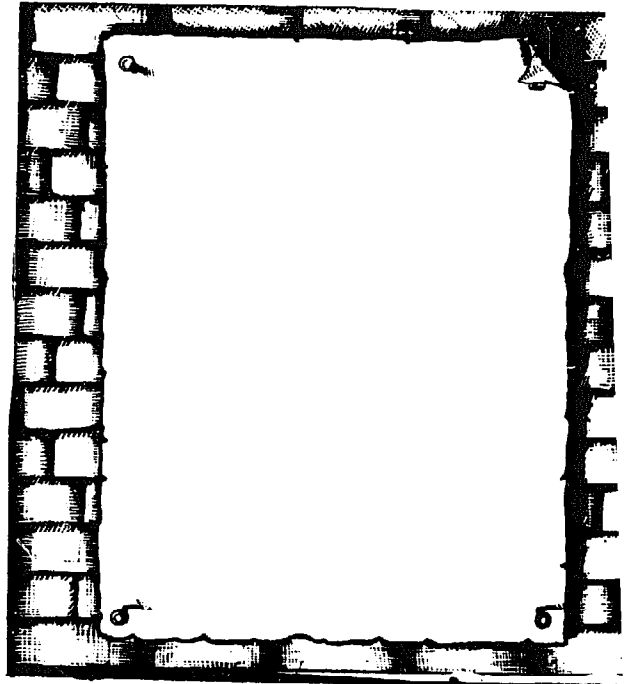

proof reading

Once the text has been set it has to be proof read. This involves reading through a copy of the typesetting and marking any spelling or setting mistakes so they can be changed before printing. Use the standard proof reading symbols.

Authors' corrections are charged extra. So make sure the text is correct and finished before giving it to the typesetter or printer.

Do not rush proof-reading as printers can make mistakes. At least two people should read it. Make sure one of them has never seen the text before. Watch out for missing paragraphs as well as simple spelling mistakes. If you are not doing your own paste up make sure you see proofs of the typesetting as well as the finished pages before they are printed. You can then see that the text corrections have been done and that there are no more mistakes with the headlines, position of pictures and the design generally.

proof reading symbols

explanation	mark in the margin	Mark in the text.
inset text in margin	of k	Mark position/missing text
delete	of	Cross out letters or words that to be deleted.
leave as printed	stret. (v)	Dotted line under a word means it is to remain
set or change to italics	ital or LI	A single line under a word means it is to be set in <u>Italics</u> .
set or change to capitals	cap ≡	treble line under a letter means it should be set or changed to a capital
set or change to bold	bold or ~~~~~	A wavy line means that the word should be set in <u>bold</u> .
change words or letters to lower case	lc or ≠	Encircle letters (T) (B) (A) ltered
replace line	X	Encircle (words) that need (retyping)
close up	○	Marks to link up wo <u>o</u> rds
put in space	# or Y	Mark to <u>put in space</u> Mark to increase space between lines.
reduce space	←	Mark to reduce space between lines.
transpose	┌┐	Mark between <u>or</u> characters/ words
move to right	┌	Mark at left side of line to be moved
move to the left	┐	Mark at right side of line to be moved

Artwork

For the photographic print processes the original has to be photographed. It has therefore to be black and white and a complete, clear and perfect copy.

For letterpress printing, the pictures are photographed and made into blocks. All the illustrations that are to be enlarged or reduced by the same amount can be stuck on the same sheet of paper. The block maker can then photograph them together. Mark them carefully so the printer knows where each block is to go.

For the photographic printing processes the artwork should be the complete original. Halftone photos or drawings which have been screened should be kept separate.

Artwork should be made on card or thick paper on which the light blue grid should be ruled.

Each element of the design can be cut out leaving a bit of paper round each image. Check that they all fit in the right place by putting them down on the grid. If it all looks good you can start at the bottom of the page pasting down.

Use a petrol glue like Cow Gum which sticks paper down flat. Cover the back of each piece with a thin layer of glue. Press down into place and use a set square to position each bit straight and square. The glue takes a few minutes to dry, so it is possible to move it around or pull it off if necessary. When it is all pasted down, rub off the dry glue with your finger or with a lump of dried glue.

To protect the artwork cover it with tracing paper. Tape this on the back and fold over the artwork. On the tracing paper you can write instructions about the size it will be when printed, the colour etc.

artwork for the green printing



Bits of artwork for printing 3 colours from a Christmas card from the Philippine Rural Reconstruction movement 1981.

artworks for the yellow printing

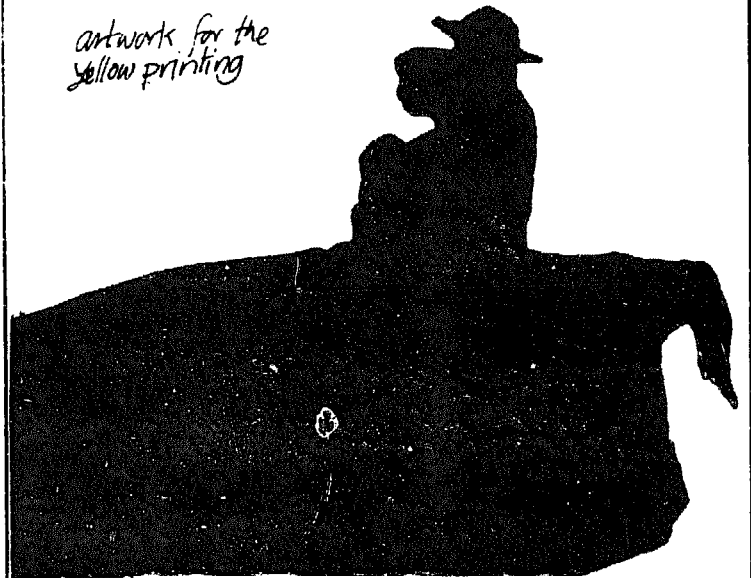

A screened and reduced version of the whole card



artwork for 2 or more colours

The colour of the finished print depends on the colour of ink in the press and not on the artwork. To prepare artwork for a second or subsequent colour a separate piece of artwork has to be prepared from which a separate plate or stencil is made.

To make artwork for the second colour fit into the first colour, do it on tracing paper. This can be taped in place on top of the first piece of artwork. The artwork for the second colour can be glued onto this overlay or can be drawn in. It has to be made to fit exactly with the first colour.

Register the two pieces of artwork with crosses that will be printed outside the finished page size.

artwork
for the black
printing

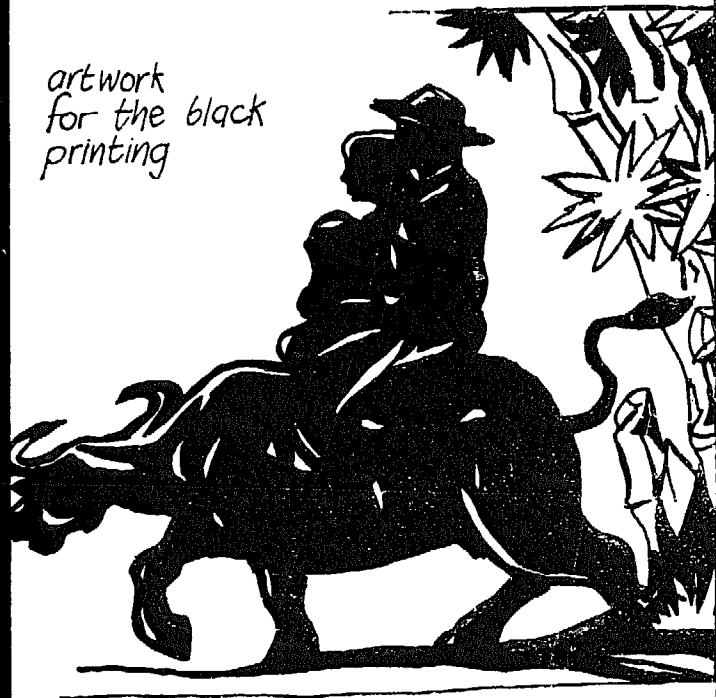

Layouts

The letterpress printer or compositor may well design most things they print themselves. Following only a vague request from the customer. The compositor will follow their own ideas, tastes and habits, doing it the easiest way possible.

You may not be satisfied with this. It is best if you make up your own mind how you want your own publication to look.

So produce your own layout. This can be a drawing of the grid showing where each element is going to be on the page. Mark how large the margins and columns are with the size and style of type, and the position of headlines, text and pictures shown and marked.

The headlines can be traced in and their size and style marked. Use picas to show the grid measurement and points for the type sizes.

Go through the layout with the printer or the compositor to make sure they understand what you want and that it's possible for them to do it. Listen to their advice on avoiding expensive ways of doing things. But make clear what you want and how you want it done.

The text can be marked with an outline or as lines, but it should be copy fitted so that it fits the space available.

3	3	2	3 1/4
3	Low cost printing		3 1/4
		for development	1 1/2
	by		5
	Jonathan		AMS.
	Zelty		
	Introduction and		1 1/2
	design		
3			

Finishing

Finishing is the name given to all the processes done after the job is printed. Finishing can add considerably to the cost of the job if it is not considered and planned for in the design stage.

Depending on the size and shape of the publication it can be a quite simple operation. You could do it yourselves if you have a lot of helpers or pay and have it done for you.

Folding can be done by hand or machine. Printing books on big sheets may involve several folds and each has to be accurate. It may be worth getting a printer or a specialist finisher to do it for you. For a newspaper why not fold the paper while you hold your editorial meeting.

Collating is the process of putting together the printed sheets in order. This can be quite easily done by hand but there are machines which do this.

Cutting or trimming can be done to trim off the edge of the paper. This is used so that the image comes to the edge of the paper - called a 'bleed'. Or it is just used to cut off register marks etc. Some books are trimmed once they are folded and bound. Printers or finishers have large guillotines with which they can cut through 100s of sheets at a time cleanly.

Binding. Simple staples are usually the cheapest way of binding a pamphlet or booklet. You can bind up to about 100 sheets. Stapling through the fold (the gutter) is best though you can staple through the side.

Binding is better done with thread. There are a lot of ways of stitching books that produce very strong bindings.

Find a specialist finisher and book-binder and ask their advice. You may find that simple stitching will be quite cheap and last much longer than staples.

Concertina fold

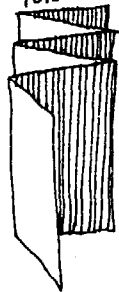

parallel fold

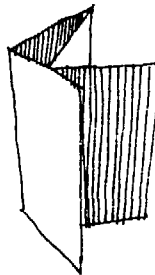

Gate fold

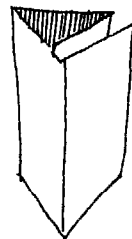

Right-angle fold

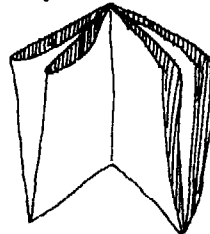

four page fold

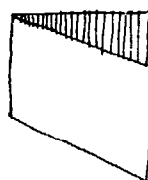

Six page fold

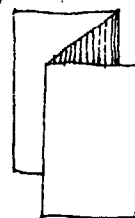
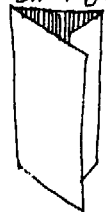

eight page fold

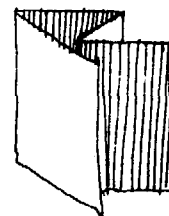



For books the sheets are usually folded into sections. Then they are stitched together and the cover board is glued on.

For paper back books just glue is used - called perfect binding. This is quite easy to do but will not last as long as 'proper binding'

Glue binding can be done by simply putting 20 or 30 collated books together in a pile. Making sure they are square, and then putting them in a frame and screwing down compressing them together. Then with sand paper roughen the end of the books to be bound and paint glue on. When the glue is dry undo the books and cut each one off the glued pile. Next fold the cover so that it fits round the spine of the book and glue that on.

Glue with flour may well attract ants or other insects. Mix an insecticide in the glue so your stock of books are not eaten before you have had a chance to sell them!

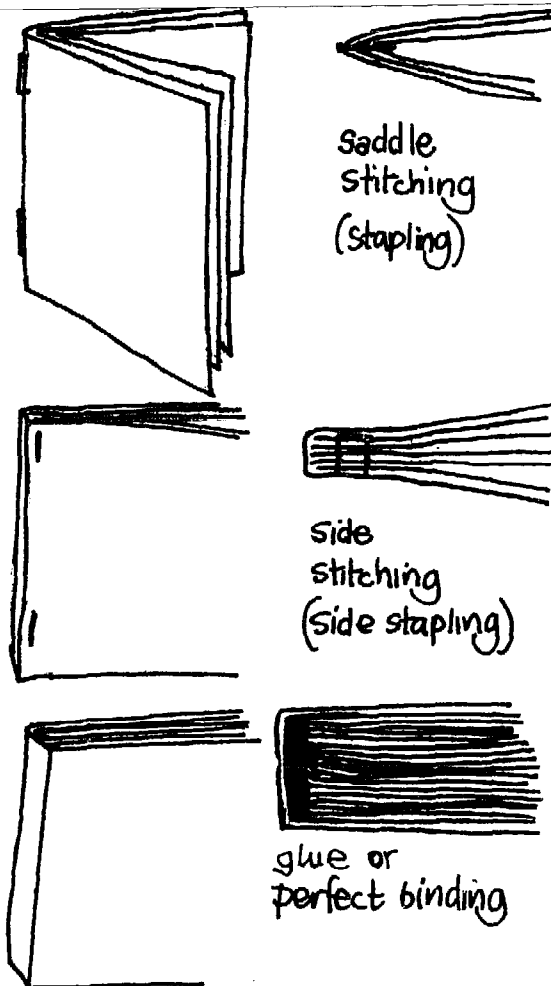

Sewn books ①

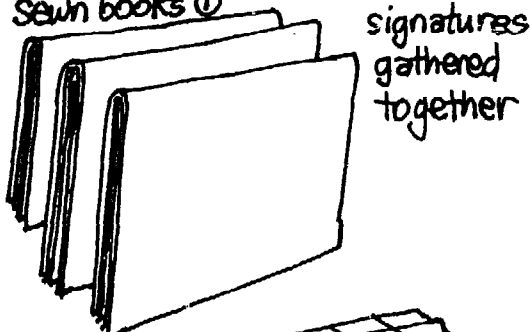

sewn together ②

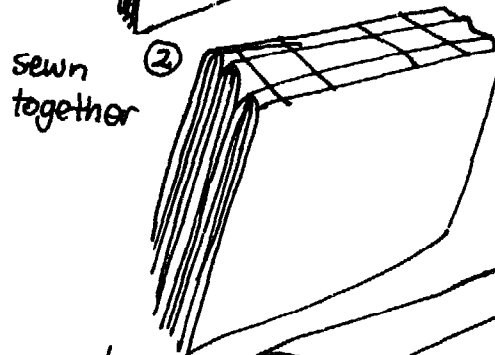

hard cover ③
glued on

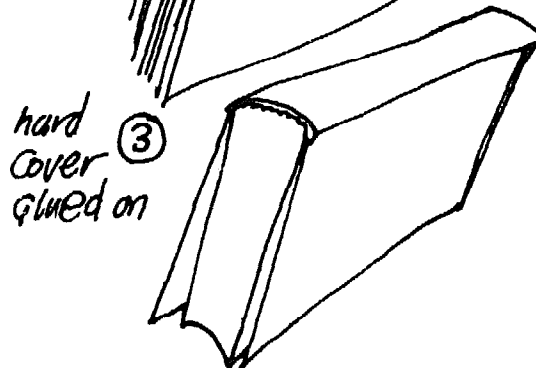

Acknowledgements

for initial information & encouragement:

Nick Cutler, David Morely, Judith Wilkinson,
Brian Wills, Ian Macclaren, Denise Ayres,
Keith Smith, Tony Fry, Peter Sutherland,
Chris Garforth.

for help in India:

Sashi Rawal, Bunker Roy & the SWRC,
Janardan Sharma, Dev Dat Sharma,
Mr Ahmad, Mr Huga, VN Chhabra, Kamala
Bhasin, Julian Francis, Davendra Jain,
Sk Jain, Madhu Kishwar, Vikram Panchal,
NID, Dr Baidh Prasad, Dasrath Patel, Raj &
Himmad Singh, Kishore Saint & Ajay Paul,
Ganesh Chandra, Jeffrey Saltkve, Augustine
Velath. The Vishwa Yuvak Kendra & all
the participants of the Do-it-yourself workshop.
Alfred de Sousa, Vinay Aditya and
Avik Ghosh, & Shampa Bannerjee of C-NDIT.

for further information & advice

Frank Barton, George Bambury, Pat Stocker
& C.I.R., Jean Gimpel, Maurice Goldsmith
Rex Winsbury, Duncan Cuthrie, Ha Nazareth,
Tilak Raj & NCERT, John Rowley, Nancy
Bergau, Lindsay Brown, Chris Whitbread.

for help getting the book out:

Sam McArthur, Sushila Zeitlyn,
Ana Vainstoc, Alan Stanton, Breadn'Roses,
Redesign, Peter Philips, Uniprint &
the Islington Community press.

for illustrations:

David Werner, Janardan Sharma, NDS Nepal,
Afrolit, Redesign, Pebal Jose Maria Arquedas,
Manushi, SWRC, Sharma Printers, Philippine
Rural Reconstruction Movement, Ravi Bharti,
AFPRO, Archana Prakashan, Sindicato de
Trabajadoras del Hogar-Cusco, Child to Child
programme, Seva Mandir, Art Studio Africa
Literature Centre, Graphic Media Development
Centre, Lipikar Industries, ITDG, Vikram Panchal,
Audio Visual Aids Centre, Eneas Tavares dos Santos.

ISBN 0 9508523 0 9

Low cost printing for development



2 Do-it
yourself
methods

by
Jonathan
Zeitlyn

Low cost printing for development

2

do it
yourself
methods

This is the 2nd section of the handbook on low cost printing for development. There are 4 separate sections.

The 1st section is an introduction and about design. It covers:

- the background to this work
- alternatives to print
- planning
- choosing a print method
- design: ideas
- design: approaches
- design: techniques
- and finishing.

The 3rd section is on using a printer and covers:

- dealing with a printer
- colour
- imposition
- offset litho printing
- letterpress printing
- and words

The 4th section is on setting up your own printshop and covers:

- Having your own printshop
- setting one up
- what you will need
- running a printshop
- projects
- further information on books and organisations
- paper
- and how you can make a 5th section yourself.

Low cost printing for development

2 do it yourself methods

Published by CENDIT
Centre for development
of instructional
technology.
D1 Soami Nagar
New Delhi 110 017
India.

and Jonathan Zeitlyn
51 Chetwynd Road,
London NW5. UK.

with assistance of
FAO - Action for
Development / Freedom
from Hunger Campaign
PO Box 3059. New Delhi
110 003 India.

© Jonathan Zeitlyn 1982

Printed at Raj Bandhu Industrial
Company. New Delhi 110064

contents

Introduction	1
Block printing	2
cutting the block	3
stamping the block	4
printing blocks	5
rubber stamps	6
Stencil duplicating	7
electronically cut	
stencils	8
combined stencils	9
how to operate the	
stencil duplicator	10
the flat bed	
duplicator	11
problem solver for	
stencil duplicating	13
Screen printing	16
equipment	16
stencils	18
printing	22
Hecto jelly pads	24
Spirit duplicating	25
Photo copying	26

Introduction

Do-it-yourself printing methods can be easy to do and cheap to use. Even the equipment is often easy to make yourself or cheap to buy locally.

These methods are used either commercially in offices or as art techniques. But each method can be used for real communication in a creative way.

It is not difficult to pick up the necessary knowledge and experience. Some of the knowledge is in books like this. But the experience has to be gained from doing the work yourself and getting your hands dirty.

The equipment is fairly widely available. It may be possible to use some one else's equipment if you do not think it is worth buying or making it yourself. This accessibility makes 'do-it-yourself' printing so useful.

advantages

Doing your own printing has many advantages. It gives you much greater control over the design and printing. You are able to choose the exact colours of ink and paper. You are also able to design the publication and put the design into practice. You have the final editorial (and legal) control over what is printed. It can be produced when you want it and need it. Not having to pay someone to do the work for you is also cheaper.

A small number of copies is possible with do-it-yourself techniques. This saves money, and can make publishing possible for small groups, or for limited areas and for special interests. These would not be possibilities for commercial publishing.

Do-it-yourself often involves alot of people in the production of a publication. This may be a useful



learning process and help them to relate to the publication as their own.

Do-it-yourself printing can also make people understand the process of publishing far more effectively than any book. It can help people become more critical of other 'professional' publications.

The special roles of printer, designer editor, and writer will be lessened or even removed. When everyone helps they learn about their own hidden capabilities. They become collectively responsible for their own publication and their own voice.

disadvantages

Doing-it-yourself will use up your own time. Many of the stages of printing described in this book are unmechanised. So there will be times when it becomes worth paying someone else to do all or part of the work.

These methods of printing are fairly simple. They cannot produce very high quality printing with photos etc.



Block printing

Printing from relief blocks was one of the first printing methods. It was developed by the Chinese and is still used today. It is used in many ways: as a stamp, for printing fabric, for illustrations in letterpress printing and by artists.

The block is cut so the image to be printed is raised above the rest of the block. The ink is spread by a roller or by a pad. The ink covers only the raised image.

This is then pressed or stamped onto the paper or fabric and a print is produced.

Cutting the block

The block can be made of many materials. It is easier to cut softer materials but they do not last long when printed. Blocks are made from potatoes or other vegetables, cardboard, eraser or packing rubber, linoleum and soft or hard wood.

Special knives are made for cutting out relief blocks. They are made in different thicknesses to cut either the fine details or the larger areas of the image. But any sort of knife can be used. A scalpel or craft knife would do. A knife used by barbers in India for cutting nails is particularly useful.

The image on the block has to be cut in reverse so that the print will be right way round when printed. This is important when printing words or symbols. To do this draw out the image on tracing paper in pencil. Turn over the tracing paper so that you can see the image or word in reverse. Put this onto the block and draw over the reversed image pressing onto the block. A faint pencil reversed image will be transferred onto the block and be a guide for you to cut the block.

Materials for making blocks

Potatoes or other vegetables can be used to cut out simple blocks. Use a medium sized potatoe cut in half. Cut an image out in relief from the flat side. The image should be about $\frac{1}{4}$ inch above the main body of the potato. Use the block soon after cutting.

Soft balsa wood or rubber can also be used to cut out simple blocks and stamps. Balsa wood can be made into a block by simply pressing an image onto the flat surface of the wood. Eraser rubber can be used to make little stamps of initials, symbols or borders. Both are so soft they can very easily be cut for simple images.

a wood engraving knife



lino cutting knife

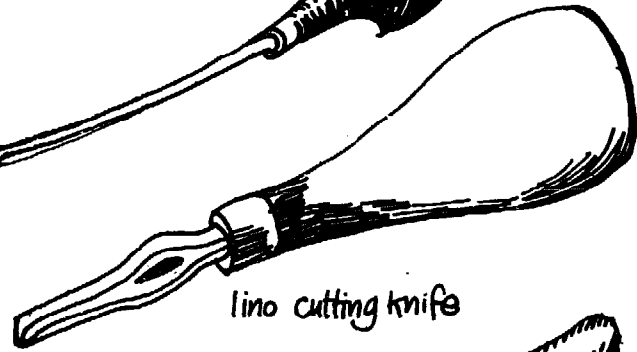

indian Barber's knife.

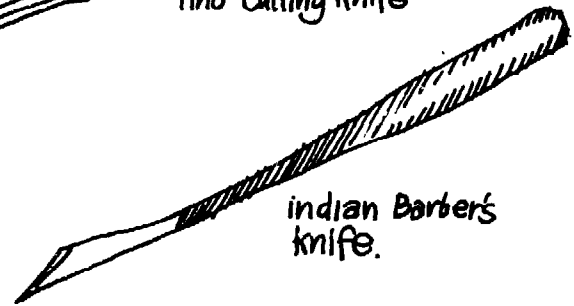

The V-tool for wood engraving

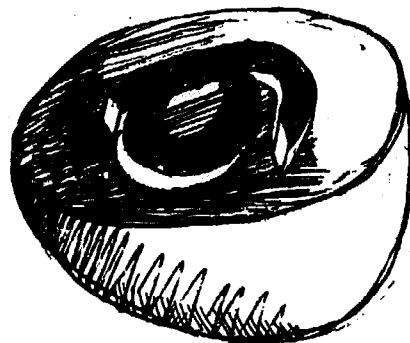
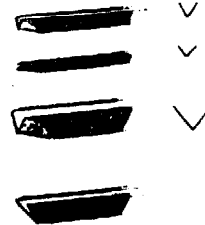
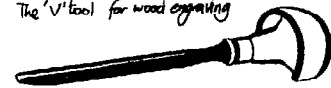

a potato block

Cardboard is easy to cut out. Cut out letters and other images from one sheet. Then turn them over and glue them onto another sheet of cardboard making a reverse relief image. String and other material can be glued on as well. With a good press or other way of making the impression this sort of block is useful for printing quite large and good prints.

Linoleum or rubber can be used to cut blocks for stamps or printing. Linoleum is used for floor covering. It is quite soft to cut but strong enough to be printed. The best type of linoleum to use is the one with a matt surface. Rubber packing is used for packing piping or other engineering products. It is also soft enough to cut the image but will stand up to the pressure of printing. You may be able to get this rubber quite cheaply or for nothing.

Both rubber or linoleum are quite thin materials and care should be taken to keep the block in one piece. It is only necessary to cut away the non printing areas by a little bit under $\frac{1}{8}$ of an inch. Blocks can be mounted onto wood for printing or stamping.



Wood is one of the best materials for cutting blocks. It is especially good if it is to last a long time and if the image has to be fine. Harder woods will be more difficult to carve but will take finer details and last longer.

4 Experiment with locally available materials that fit your needs.

Stamping blocks

The quality of the print from a block depends on the evenness of inking, and of the impression. The impression is how the paper is pressed against the block.

Potato blocks can be painted directly with the ink. A more even inking may come from pressing them against a sponge soaked with paint and then stamped onto paper or fabric.

Other small blocks can be mounted on wooden handles and used as stamps. Use a rubber stamp pad filled with special ink. You can also use a sponge or other home made pad arrangement with paint or normal ink.

Making a pad for inking blocks.

1 make a box to fit your largest block.

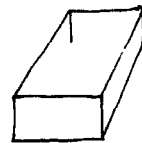

2 make a raft of bamboo sticks tied together at the end.

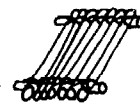

Tie one stick at each end. This will raise the raft above the floor of the box.

3 Cover the surface of the raft with felts and fabric. Pour on the ink which stays under the bamboo



4 When the block is pressed onto the felt the bamboo dips into the ink. This soaks the felt above with fresh ink.



Printing blocks

For blocks larger than 3sq. inches it will be necessary to use a roller to ink up the blocks. Letterpress ink or special block ink is good for this. Roll the ink out on a sheet of glass to spread the ink evenly on the roller. Roll it over the block very carefully so that the ink is spread evenly.

The pressure used to press the paper or fabric onto the block has to be as hard and even as possible. To do this ●

- you can use the back of a spoon to rub all over the back of the paper.
- or you can stand on a plank placed on top of the block and paper.
- or you can use a heavy roller.
- But best of all is to use a press of some sort.

presses

Small screw down presses can be used or any local equivalent. Old fashioned flat bed presses may be available and can be used to produce very good prints. These old letterpress presses still exist and are ideal for printing blocks. I have seen one covered with dust and unused in an Indian newspaper printshop. They may be available if you search around.

Letterpress proofing presses also are ideal and could be quicker to use than screw down presses. Small proofing presses are made that are used to print signs. But they could also be used to print off blocks.

Cover the block with ink, the paper and then padding. Then pull the pressure roller across or screw down with the press. Undo and pull the paper off and you should have a perfect print from your block.

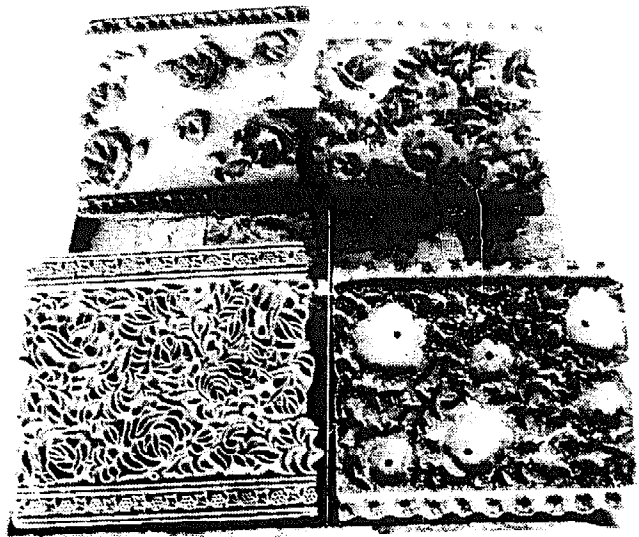

four
wooden blocks
used to print
four colours on
fabric. From Jaipur
India.

USES

Hand cut blocks made of linoleum, rubber or wood can be used to print illustrations with letterpress printing. They can be mounted on block board to make them 'type high' (.918 of an inch). This is the same height as the type. They can then be used exactly as type and be printed with the type by a commercial letterpress printer (see letterpress.)

Stamp blocks can be used to give colour to black and white print. A logo could be stamped in colour on the top of a duplicated sheet.

Stamps may also be used with fabric ink to print in patterns on the fabric.

Wood blocks of single letters have been used as stamps in literacy projects. They are used to produce posters and give their students the experience of using printed words.

Blocks can be used to print cards, and even posters if the press is large and good enough. The card-board blocks have been used for small runs of posters.

rubber stamps

Rubberstamps are made commercially for offices. But this very cliché of beauracracry can be used in a creative way.

Rubberstamps made commercially are quite cheap. The cheapest ones are made from letterpress type that the stamp maker has in stock. Look at examples of their work and show them which style of type you want. Draw out the information showing the arrangement you want and what exactly the information is.

uses

You can use rubber stamps to give 'spot' colour for cheap black and white prints. The name of a newsletter, for example, can be stamped. You can have your own name address and symbol on a stamp which can be stamped onto paper envelopes or cards for personal use.

The printers name can be rubber stamped onto the screen printed poster. Rubber stamps can be made to date or number tickets or cards etc.

Rubber stamps do not give good prints if they are bigger than 3 square inches. It is difficult to get an even pressure on a stamp so large. The ink pads also tend to be quite small.



THE HESPERIAN FOUNDATION
P. O. Box 1692
Palo Alto, CA 94302

6

kits

It is possible to buy rubber stamp kits. These consist of individual rubber letters, a holder for these letters which has a handle for stamping and an ink pad.

The letters are assembled in reverse by hand in the holder. They are stamped in the normal way. When you are finished with the particular message you can take out the letters and use them for some other stamp.

inking

Rubber stamps use a special ink which is put onto a pad. The stamps are inked up by pressing against this pad. To get good prints it is necessary to keep the pad well inked.

It is possible to buy the pad without ink and fill it up with the colour of your choice. You can get a rainbow effect on your stamps by inking in strips of more than one colour.

Photo engraved stamps

Rubber stamps are also made from photoengraved blocks. This however is far more expensive than using type. It enables you to produce a stamp from artwork. Which gives you a much larger range of lettering than the stamp maker will have in stock.

Photo engraving also enables you to use pictures or symbols as your stamp. But half tones are not possible using rubber stamps.



Stencil duplicating

Stencil duplicating is also called cyclostyling and mimeographing. Certain manufacturers have tried, we hope unsuccessfully, to call it by their own names.

Stencil duplicating is a very simple stencil process. It can be used to print coloured and illustrated copies easily by anyone with a bit of experience.

It was developed for office use. But it can be used to produce much more creative publications than are normal for offices.

Stencil duplicating works by:

1. First cutting holes in a wax coated stencil with either a typewriter, stylus or with an electronic stencil cutter from artwork.
2. Once the stencil is cut it is put on a drum on the duplicator. Ink is forced from the drum through the holes in the stencil onto absorbent paper.

Stencil headings



Each stencil has a card heading which fits onto the duplicator drum. Make sure you use a stencil that fits onto the duplicator you are going to use. Or use a stencil with a 'universal' heading designed to fit any duplicator.

cutting stencils: hand cut.

There are several sorts of hand cut stencils:

- Some are made to be cut with a typewriter.
- Others are made to be cut by drawing or writing or tracing with a stylus or ball point pen.

To type onto the stencil press hard without using the typewriter ribbon. Make sure the letters are cut out clearly. Look through the stencil at the light. Each letter should show the light through clearly if it is cut properly.

Drawing can be done with a special stylus or an old ball point pen. Again it has to be a clear cut through the stencil if it is to print well. Care should be taken not to rip or tear the stencil when drawing. Special drawing stencils are easier to draw on but are a bit more expensive. Work on a hard clean surface like a sheet of glass and hold the stencil flat when working. You can get a backing sheet to help draw a good cut image onto typing stencils.

Be careful that the image fits onto the stencil. And on the paper you are going to use. Remember the paper will be smaller than the stencil.

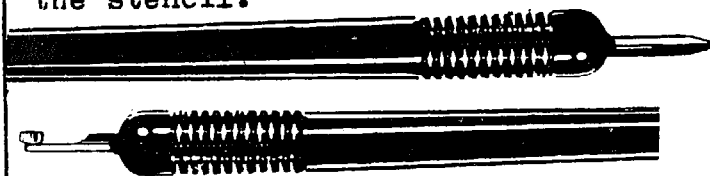

There is a stylus that cuts dots instead of lines. This is useful for cutting an area of dots on the stencil as well as dotted lines.

Sheets of plastic can be brought with a relief pattern on. You put the sheet under the stencil. Then rub over the relief pattern, which is cut onto the stencil. The same effect can be made using sand paper under the stencil.

Electronically cut stencils

An electronic stencil cutter or scanner, cuts stencils photo-mechanically from an original or artwork.

The artwork is fastened flat round one drum. A special plastic or carbon stencil is put round the other.

The drums go round and the photo cell scans the artwork. When it sees a black image in the artwork it makes a needle cut a tiny hole in the stencil.

The artwork has to be foolscap size or smaller. It should not have too fine detail or have large solid images. Some scanners can be adjusted to cut stronger or lighter depending on the sort of artwork. So they can be adjusted not to pick up unwanted background. If you are using one of these adjustable scanners - do a test strip on an old stencil first to make sure the setting is suitable for you artwork.

Photos come out with much increased contrast, just in black and white and none of the grey tones between. Photos therefore should be carefully chosen if they are to be identifiable. They also have to be quite small to make them easy to duplicate.

It is possible to cover photos with a white dot screen to make them better for scanning and duplicating.

You can use two sorts of special stencils on a scanner. Plastic stencils can reproduce fine detail and last longer. The carbon stencils are cheaper.

Both hand cut and electronic cut stencils should be carefully examined for unwanted holes or mistakes. These can be painted out with corrector fluid. Allow time for it to dry before putting the stencil on the duplicator.

8

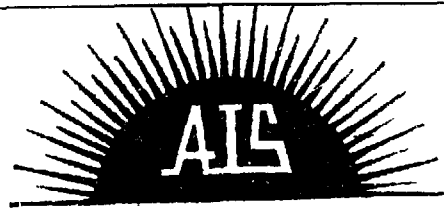

ଅନୁଗୋପନୀୟ ସୂକ୍ଷ୍ମ
ସ୍ତମ୍ଭ.

ପାର୍ବତୀପୁର, ଭୁବନେଶ୍ୱର

୧୦.୯.୧୯୮୧

Aslik.

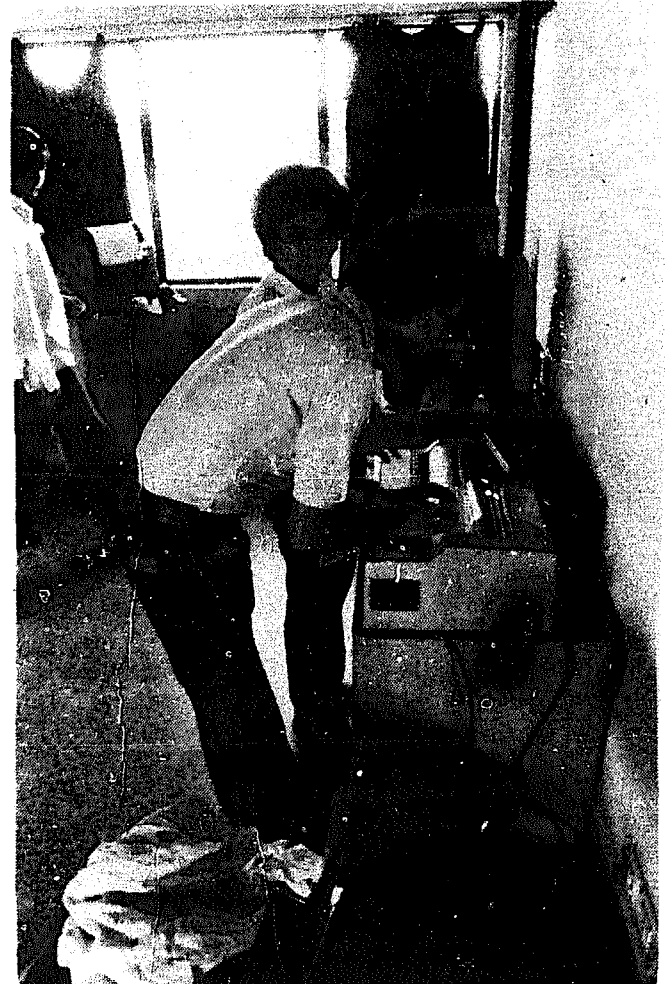

combined stencils

Bits of different stencils can be glued together. This makes it possible, for example, to duplicate a scanned logo on a typed stencil. To do this the logo or symbol is scanned onto a stencil many times. Then one can be cut out and glued onto the typing stencil when and where it is needed.

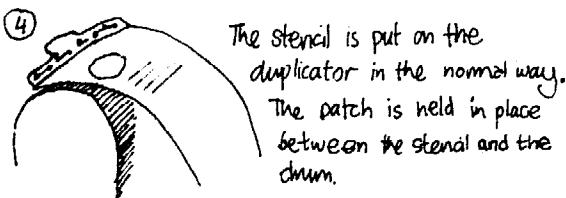
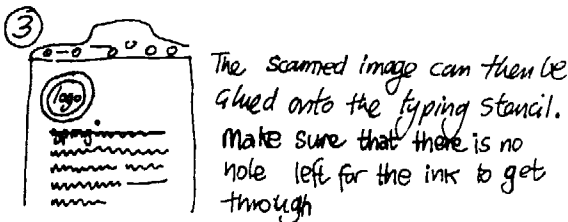
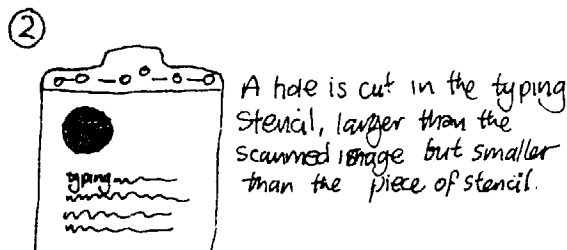
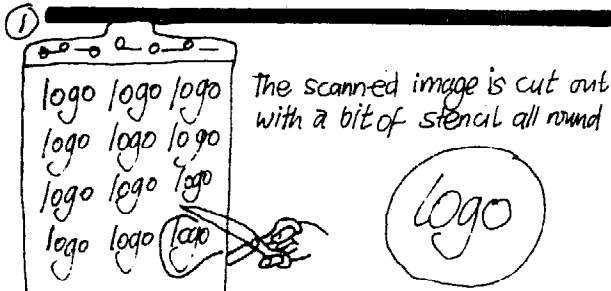

An organisation with a scanner can use this technique. It can send out to its branches scanned stencils with symbols or other illustrations. These can be cut up and used with locally produced typed stencils.

photo stencils

Stencil duplicating like screen printing uses a stencil principle. It is therefore possible to use photo stencils made for screen printing on a stencil duplicator. (see screen printing page 16). The photo stencil is either made on stencil film or in emulsion put directly onto the screen.

But stencil duplicating does not have the same tight screen as with screen printing.

On a two cylinder duplicator you could take the screen off the cylinders. Wash the ink off the screen and put the stencil on it. Then restretch it on to the duplicator.

Or you could put the stencil on another piece of screen mesh. This could be attached to a stencil heading and used just like any other stencil.

Or it is possible to dissolve the wax surface of a typing stencil using a laquer thinner. This should leave you with a paper mesh on which you can put the stencil.

Like most stencil duplicating an image that is too bold and large does not duplicate well. And the ink does not get through the very fine details.

Experiment. This is a way of producing good stencils without buying an expensive scanner.

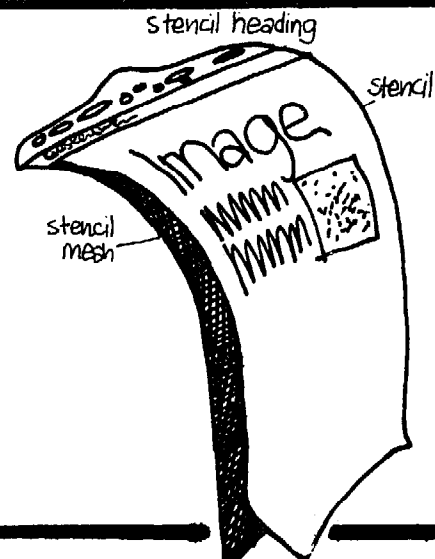

how to operate the stencil duplicator

There are three types of duplicating machines:

1. the flat bed duplicator
2. A two cylinder duplicator like the Gestetner
3. A one drum duplicator like the Roneo.

Each make and model of machine has different controls. Consult the instruction manuals, the company representative or someone who uses the machine a lot for exact operating instructions.

Pump up the ink so that the screen, the surface of the drum, is inky.

Fasten the stencil heading onto the duplicator. Flatten the stencil face down onto the drum. Turn the drum round and flatten the stencil down with the other hand.

Remove the stencil backing sheet. Make sure the stencil is flat on the screen without wrinkles or air bubbles.

Print a few scrap pieces of paper to check that the image is printing well. And the position of the image on the paper is right. This can be adjusted by moving the paper left or right. Or by turning a wheel to move the image up or down. When it is all set up - print the number of copies you require.

two cylinder duplicator

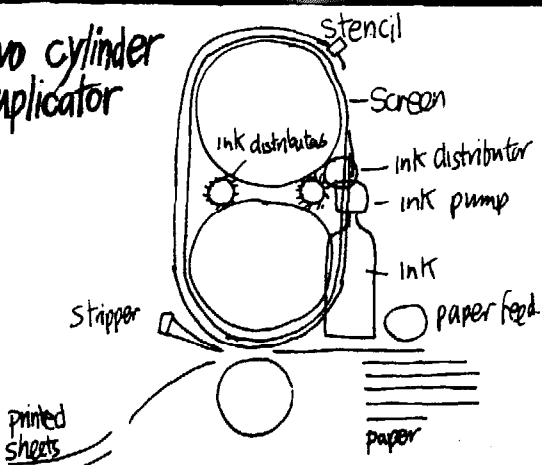

The 2 cylinder machine has a screen which goes round the 2 cylinders. The stencil is fastened onto this screen. As the machine goes round the ink is pumped up and distributed over the cylinders. This can be varied to put more ink at the sides or in the middle.

If a second colour is needed the ink pump, distribution rollers and screen can be replaced and the cylinders cleaned. A colour change kit of a different coloured ink pump, rollers and screen can be kept until needed. Gestetners sell quite a number of different coloured inks.

one drum duplicator

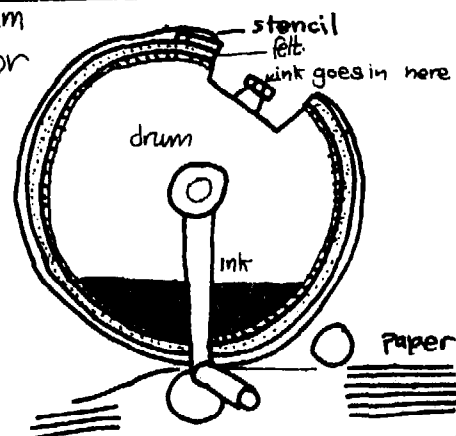

The one drum machine uses one big drum in which the ink is kept. The ink comes out through the holes and into a felt sheet which covers most of the drum. The stencil is fastened onto this felt. The drum can be removed and one with a different colour put in its place quite easily.

Ink

Ink for the one drum machine is of a different consistency than for the two cylinder machine. So be careful not to use the wrong ink in the wrong type of machine.

Paper

Both inks are slow drying, they do not dry on the duplicator but only on the special absorbent paper. This explains the greyishness of the copies and the 'show through' common with stencil duplicating.

But this does not mean you have to buy specially made absorbent paper. Experiment - most normal cheap paper is absorbent too.

The flat bed duplicator

A flat bed duplicator uses the same methods as a normal rotary duplicator. It also uses the same sort of ink, stencils and paper.

But it is worked completely by hand. It is very easy and cheap to make yourself.

how to make the flat bed duplicator

- 1 With wood 2x1 inches, make a frame with inside measurements 7x13 inches.

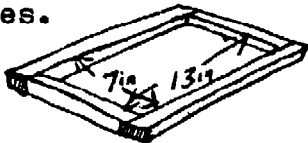

- 2 Make a base board from a piece of plywood 9x16 inches. And at one end put two pieces of 2x1 wood to pivot the frame about 2 inches above the base board.

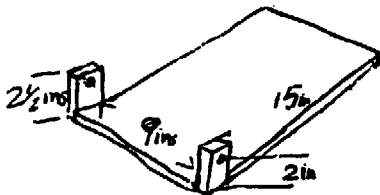

- 3 Fasten the frame onto the supports with screws, so that the frame can be moved up and down.

- 4 With drawing pins fasten fabric (a fine mosquito net or cotton or nylon organdie) to the short side of the frame. It has to be evenly stretched and be loose enough to drop about one inch below the frame. So roughly a piece 9x16 inches should be alright.

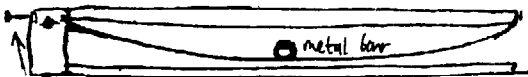

- 5 Hammer in a series of nails along the hinge end of the screen to hold the stencil heading. Get a metal rod or bar about 1/4 inch in diameter which is used to force the ink through the stencil.

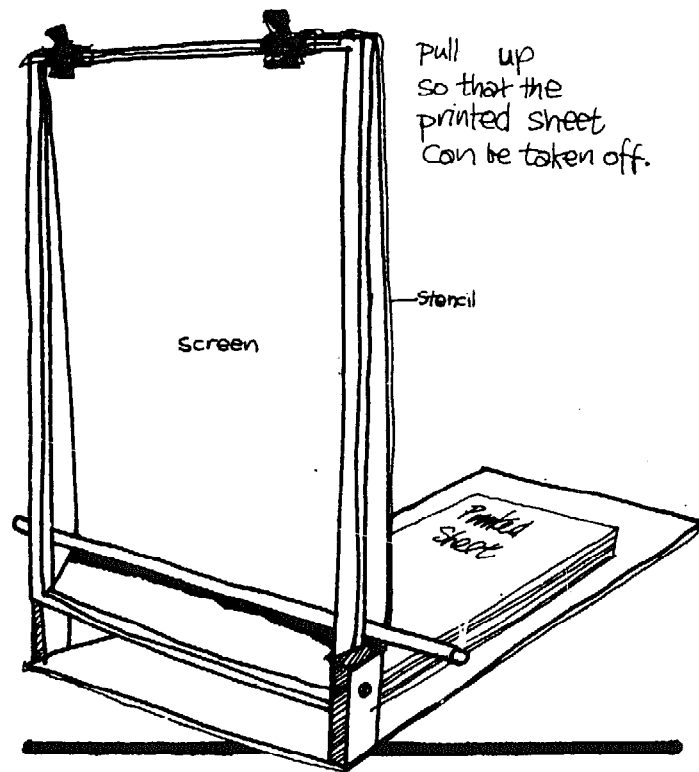
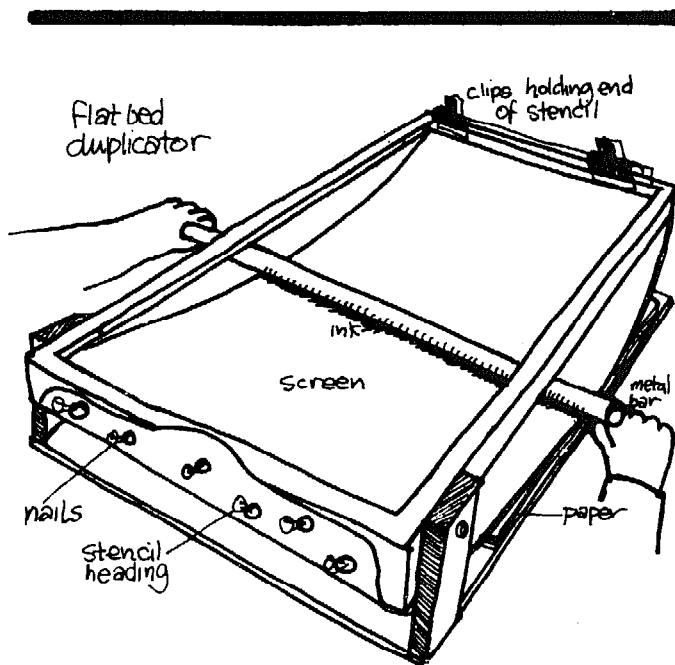

how to print with the Flat-bed duplicator

- 1** Cut the stencil in the usual way.
- 2** Place a pile of paper under the screen (of up to 500 sheets).
- 3** Put the stencil face up under the screen. Fasten the stencil heading onto the nails at the hinge end of the screen.
- 4** Ink the screen with a squeeze of ink. Spread it across the screen with the metal bar.
- 5** Run the metal bar across the screen again from the hinge end. This time press against the stencil underneath. With care this should stick the stencil to the screen - without any creases or wrinkles.
- 6** Pull off the backing sheet.
- 7** Use the metal bar to force the ink through the stencil onto the top sheet of paper on the pile below. Use scrap paper to start with until the prints are what you want.
- 8** Pull up the screen and take off the first print. Is the image in the right place on the paper? Reposition the pile of paper to get the print in the right place.
- 9** If the inking is uneven try putting more ink in the places it is needed. Just squeeze out a line of ink at the top or hinge end. Use the metal bar to spread it out while printing. The pressure this is done with can effect the print quality and also break the stencil. So it has to be done firmly but not too hard.
- 10** Once everything is printing well you can remove the scrap paper. Then print onto the proper paper to make as many copies as you want.
- 11** Each print only needs one pull. Take the ink with the bar as you pull it across the stencil. Pull up the screen with the bar once you have made the print and remove the top copy - the printed sheet.
- 12** Duplicating ink is slow drying use an absorbent paper. And so leave the printed sheets out to dry.
- 13** The screen need not be cleaned after each printing. It may be necessary to do so when you have not used it for a long time. Use kerosene or white spirit to dissolve the ink onto old newspaper.

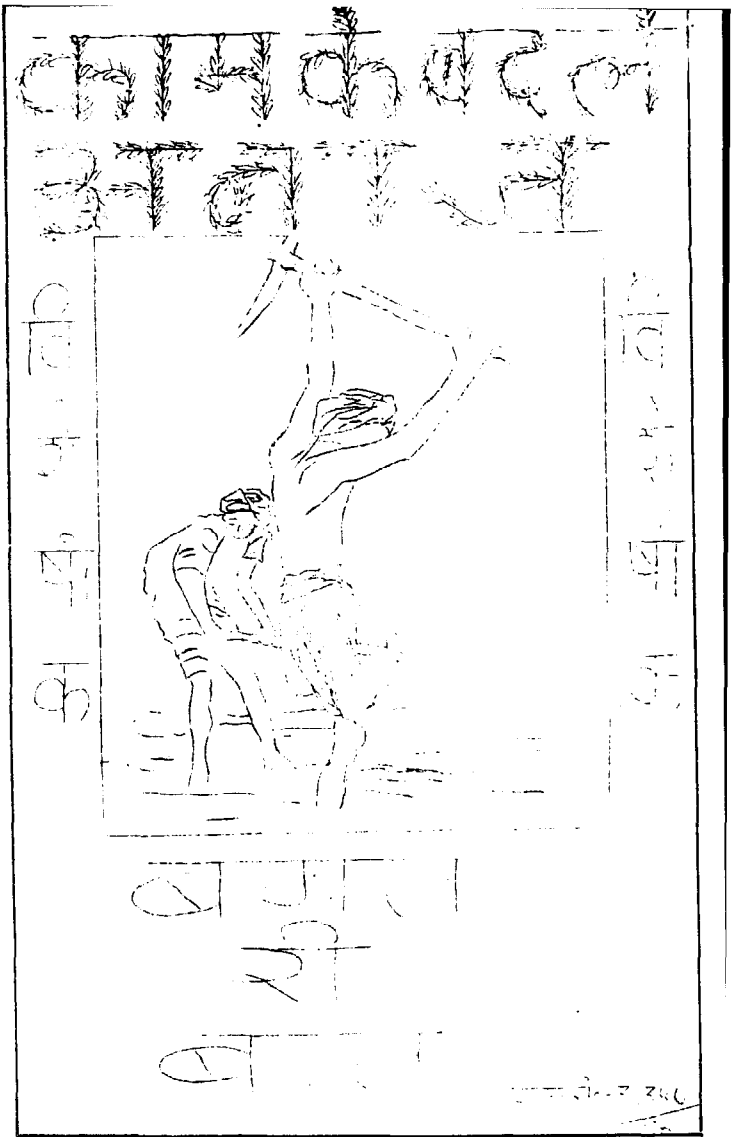

Problem solver for stencil duplicating

problem: faint typing

When cutting a stencil with a typewriter remove the typing ribbon. Some typewriters have a ribbon setting which stops the ribbon getting between the keys and the stencil. When typing the stencil press harder than usual.

problem: faint image

The stencil will print only a faint image if it is not properly cut. Check this before you put the stencil on the duplicator by holding it up to the light. The image should show up as clear holes. If it is not cut properly go over it again with the stylus or ball point.

problem: size of paper

Most stencils are larger than foolscap paper 8x13ins but are used to duplicate on smaller sized paper such as A4 or quarto. So be careful when cutting the stencil not to cut the image larger than the size of paper that you are to duplicate on.

problem margins

Duplicators can not print right to the edge of the paper. It is necessary to leave about $\frac{1}{4}$ inch margin around your image.

problem: bits of the image not appearing on the paper.

The stencil has to be flat on the duplicator's screen without any wrinkles to print all the image. If the stencil is wrinkled and not flat, take it up and try again. The screen should have a thin covering of ink on before putting on the stencil.

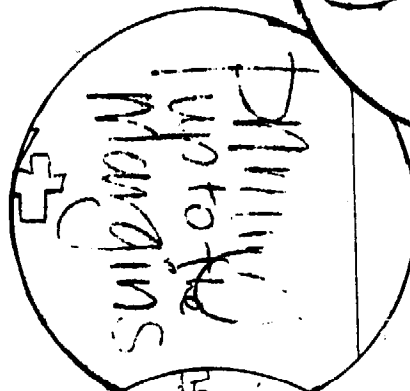
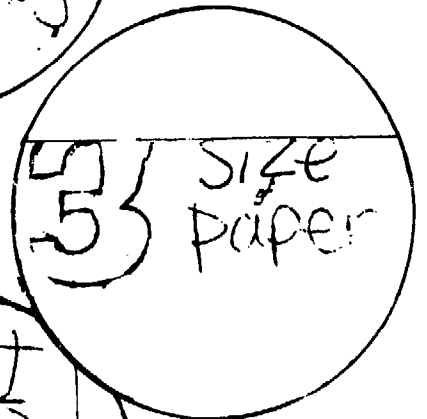
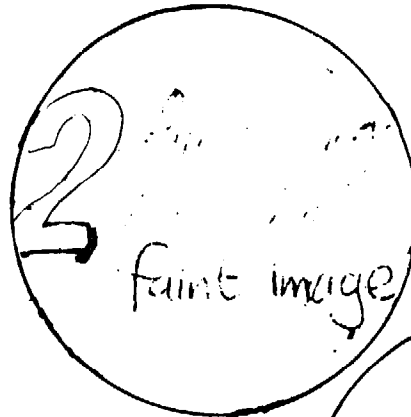
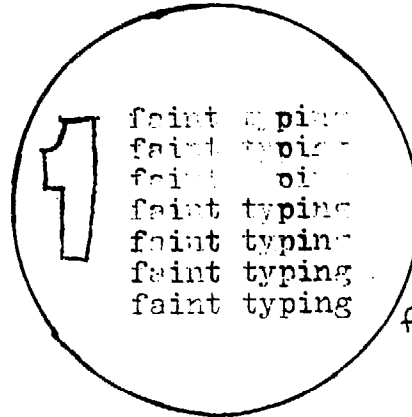

problem: ripped stencils

If the stencil is wrinkled and you go on duplicating you can rip or tear it. This produces black tear lines on the copies. Small tears can be repaired with masking tape or correcting fluid. If they are too large you may have to remake the stencil. Make sure there is enough but not too much ink on the screen before starting to print.

problem: inky blotches

They are usually caused by over inking. Clean off the ink around the stencil. Print on scrap paper until the blotches have gone.

problem: images and blotches on the back of the paper.

When the duplicator missfeeds a sheet of paper the image can get on the impression roller. This will then transfer a faint image onto the back of the next few copies. When this happens feed in scrap paper until the unwanted marks are removed.

problem: set off

A large image with a lot of ink may not have dried before the next copy is placed on top of it. A faint image will therefore get 'set off' onto the back of the paper that has just been printed. This can happen when using less absorbent paper or card. One way round this problem is to put sheets of scrap paper between each print as they come off the duplicator.



a ripped stencil

inky blotches

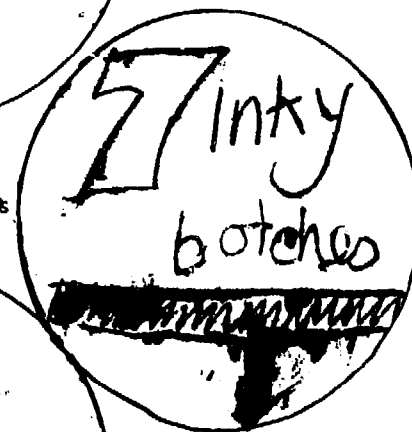

blotches on the back

set off

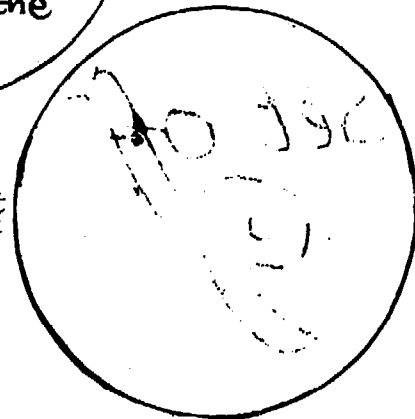

problem: uneven inking

Duplicators are not able to vary the ink across the page. So try and make the ink requirement as even as possible. Duplicators are not able to deliver more ink to dark areas of the artwork. So you should try to make the solid images as small as possible by using outline or cross hatching for both lettering and illustrations. If enough ink is not getting through to make the printed image dark enough try duplicating more slowly. If it is still too light it must mean that the stencil is not cut properly.

problem: paper sticking to the stencil.

If you are trying to duplicate a large image the ink may make the paper stick to the stencil while it's being fed through the duplicator. If this happens peel the stuck page off the stencil and try turning the duplicator a bit faster. This will reduce the amount of ink getting onto the paper.

One other solution is to equip the duplicator with 'strippers' which will pull off each sheet as it comes out from under the stencil. It is also possible to put the large image at the end of the stencil. So that it is duplicated after the rest of the paper which will pull the printed large image off the stencil.

problem: badly cut scanned stencils.

If you are getting badly cut stencils from a scanner that can be adjusted try making a test strip. This can be done by scanning the most difficult part of the artwork onto a test stencil. You only need about 1/2 an inch to be scanned. Stop the machine and take the stencil out and look closely at the scanned strip. If it is cut properly you can scan the whole original on another stencil or if there is still some problem you can adjust the scanner and do another test strip.

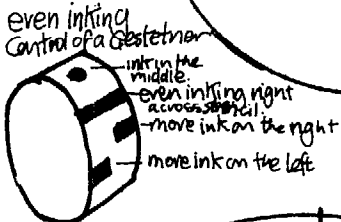
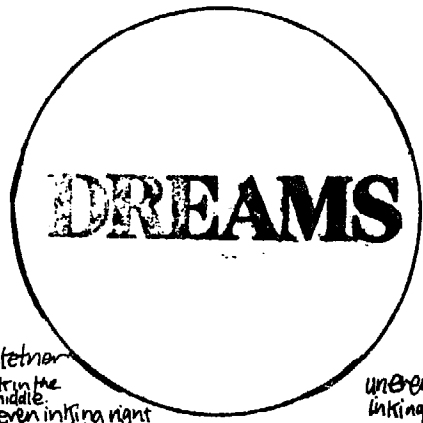

uneven inking

too much ink & the image is sticking to the screen.

too little ink & the image is going grey

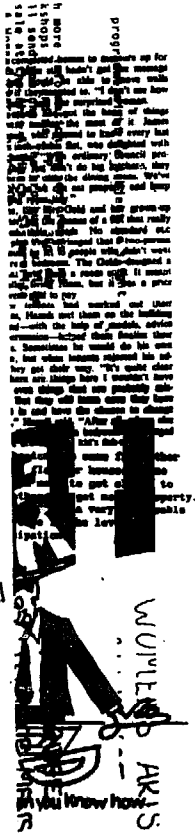
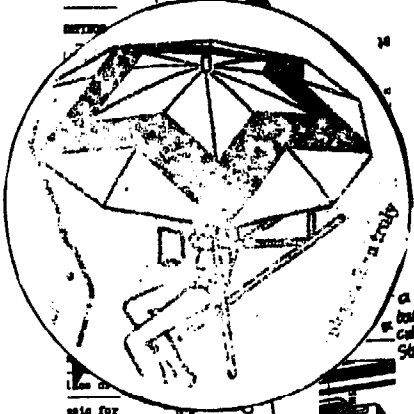
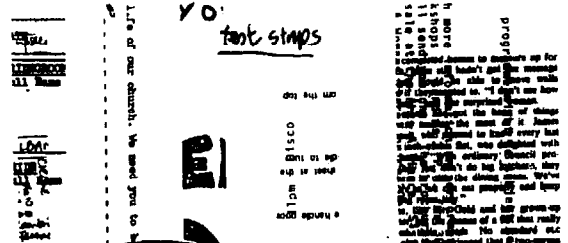

Screen printing

Screen printing uses the stencil principle just like stencil duplicating. The screen is stretched tight and flat onto the frame. This can be made any size that is needed. The ink is forced through the holes of the stencil by hand with a rubber blade - the squeegee.

Screen printing can be used to print posters, fabric, any large print without very fine details. It is usually used commercially and by artists. But it can also be used by anyone without a great deal of skill and knowledge. Not only is it easy to do but the equipment can be easily made by any carpenter. It is an ideal do-it-yourself method.

the equipment

The screen is a wooden frame stretched with fabric. The frame needs to be 2ins larger than the biggest image that it is likely to print. It should be made of 2x3 ins wood and be stable and lie flat on the base board. The wood should not be too hard for nails or drawing pins. It is good to hinge it to a base board of plywood.

The frame should be easy to unhinge so that it can be taken off and washed.

The wooden frame is stretched with a mesh of fabric. This has to be fine enough to hold the details of the stencil but open enough to let the ink through easily. Use 'Nylon Bolting' if the printing is going to consist of fine details. Cotton organdie can be used if the printing is not too detailed. A normal white nylon with a square weave, which you can see your hand through, like a fine mosquito netting, could also be used. It should not be too stretchy or have a pattern in it. Nylon or any material that expands when wet should be stretched when it is damp.

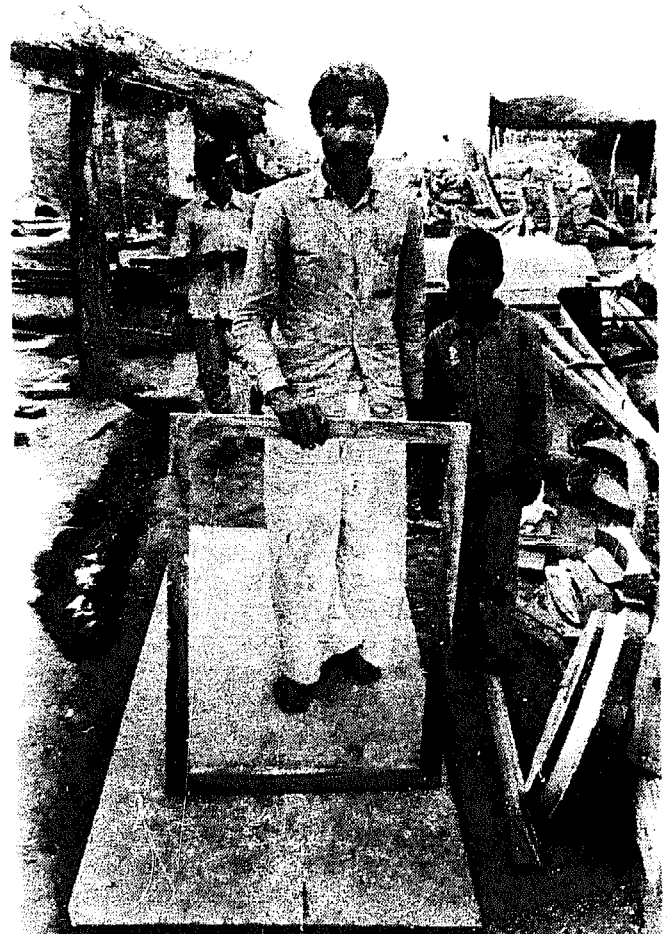
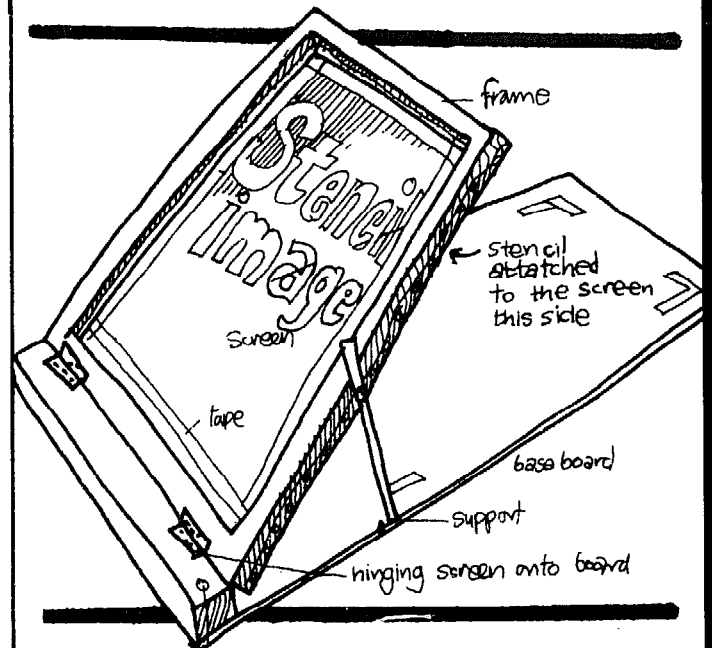

A Village carpenter making a screen (Tilonia, Rajasthan India).

To stretch the fabric cut it at least 4 ins. larger than the outside frame measurements.

Using a staple gun, nails or drawing pins fasten the mesh to the frame. Start with the middle of one side and pin it so that it is even and tightly fastened. Pull across to the other side making sure the mesh is square and tight on the frame. Pin every 4 inches along that side. Then pin along the remaining sides pulling the mesh so that it is tight and square.

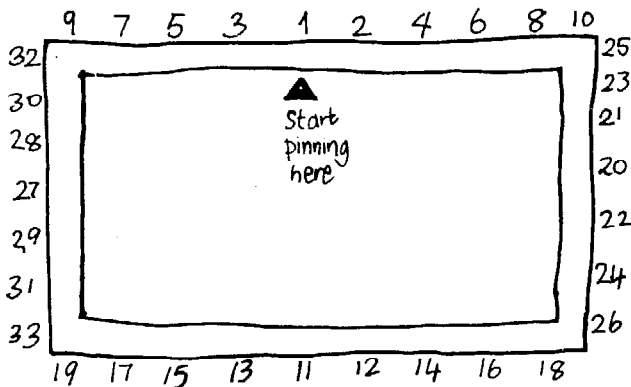

It may be necessary to go over the screen again. Pull the mesh tighter, and pin between the pins put in already.

The loose mesh around the outside of the frame can be trimmed and pinned to the frame.

The frame can then be hinged to a piece of wood which is nailed to the plywood base board. A support can also be screwed to one side of the frame. This should be made so that it will swing flat when the screen is put down to print.

Some mesh may need 'degreasing'. Do this by washing with warm water, soap or cleaning powder like Vim.

Tape over the gap between the frame and the mesh on the inside of the screen. This will stop ink getting through the join. Use brown gummed paper tape and put at least 2 inches at the hinge end. Make sure the tape is well stuck and fills each corner as well as the sides.

Squeegee

The ink is forced through the screen and stencil with a squeegee. This is a rubber blade held in a wooden handle. It is brought from specialist suppliers. They also supply the rubber separately which can be different for different jobs. It will be softer for fabrics and harder for paper. But it is easy to make your own squeegee. The rubber for the blade can be brought at the shoe makers. The rubber used for soles of sandals is just right for squeegees. It should be about $\frac{1}{4}$ inch thick and as long as the widest poster to be printed.

A handle can be made to hold the rubber blade firmly in place. It is important that the squeegee blade has a straight and even edge.

Sqr. egees.

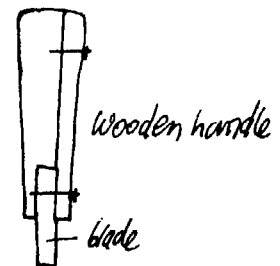
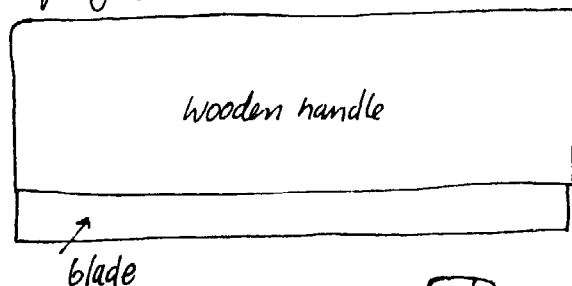

a Do-it-yourself squeegee

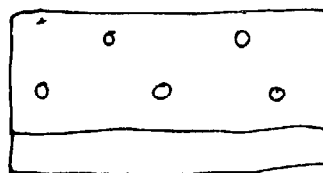

a commercially made squeegee

Stencils

There are lots of ways of making stencils for screen printing. Essentially they stop ink getting through part of the screen.

Paper cut Stencils

The simplest method is to draw out the image or words on thin paper. Cut out that image with a sharp knife. The ink will go through the holes cut onto the fabric or paper.

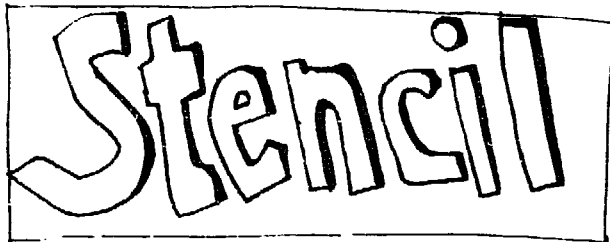

Put the cut paper - 'the stencil' on top of the fabric or paper so that the image reads right way round. Put the screen on top and make sure there aren't any holes other than those that make the image. Pour on the ink and with the squeegee pull the ink across the inside of the screen at 45°. This forces the ink through the screen and stencil onto the paper underneath. The ink of this first print will hold the stencil on the underside of the screen quite flat. The ink can also hold small bits of paper in the middle of the centres of the letters like the 'O'.

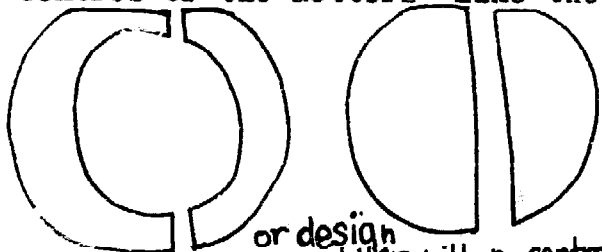

Care should be taken that the paper is really stuck to the screen, that it has not wrinkled. No ink should get on the wrong side of the stencil.

duplicating Stencils

Duplicating stencils can be used effectively on the screen to print smaller text or line drawings. Both typed and hand drawn stencils work well. Scanned stencils can be used but the plastic sort can not be used with the oil based screen inks.

By combining typed duplicator stencils and paper cut screen stencils it is possible to make a poster newspaper:

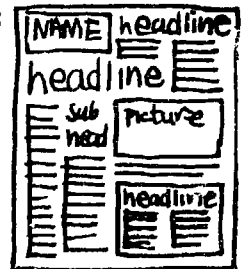

- ① Draw out the design of your newspaper onto a thin paper like newsprint.

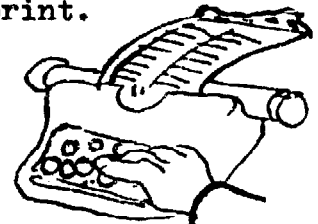

- ② Type the text in columns on duplicating stencils. Make sure that the letters are cut well. Hold up to the light and if the letters are cut well they will be completely clear.

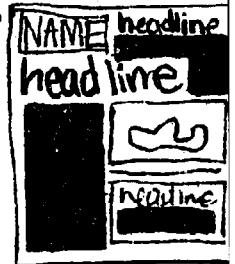

- ③ Cut out from the design, holes for the columns of text. They should be bigger than the text on the stencil but not too big leaving unwanted holes between the paper stencil and the duplicating stencil.

- ④ Cut out the headlines, lines and pictures from the design. Each letter or image is then a hole through which the ink can go.
- ⑤ Remove the duplicating stencil's backing sheet and cut up the columns of text. Place them on top of the paper stencil.

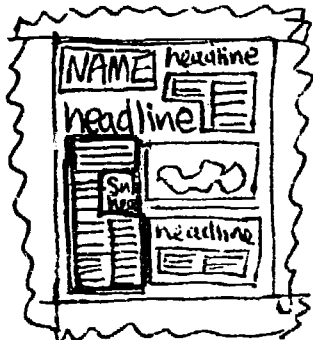

- ⑥ Make sure that there are no unwanted holes or gaps in the stencil. Put pieces of newspaper round the edges so no ink can get round the stencil and onto the paper underneath, apart from going through the stencil.

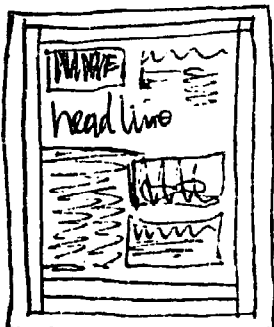

- ⑦ Put the screen on top of the paper stencil and print. Duplicating ink is best for this, but it takes a long time to dry!

A poster newspaper can be printed on one side of the paper. Put it up on a suitable wall or notice board. If none exist try using a charpoy or similar bed base standing on end.

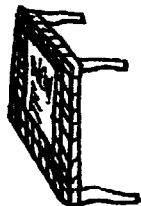

A wall chart printed at the Audio Visual aids Centre, Ajmer India, using Stencil film and screen printing

Stencil film

The stencil can be cut out of special stencil films. These are double layered with one side a base film and the other the stencil. This is cut just like the paper but take care not to cut the base film. Stencil film is often transparent enough to trace from a design when cutting. The base material holds all the stencil in place. When the cut stencil is put under the screen you can read it properly through the screen mesh. It is then stuck to the screen by using the right solvent - water or methylated spirit and heat. This is done by evenly wiping over the screen with the solvent and pressing the stencil onto the mesh. Use a wad of rags or cotton wool and gently go over the stencil a bit at a time. Some stencil films need to be ironed on and this has to be done evenly and gently.

When the stencil is firmly stuck to the screen and is dried, peel off the base film leaving the stencil on the screen. Any unwanted holes can be filled with blocking or filler paint.

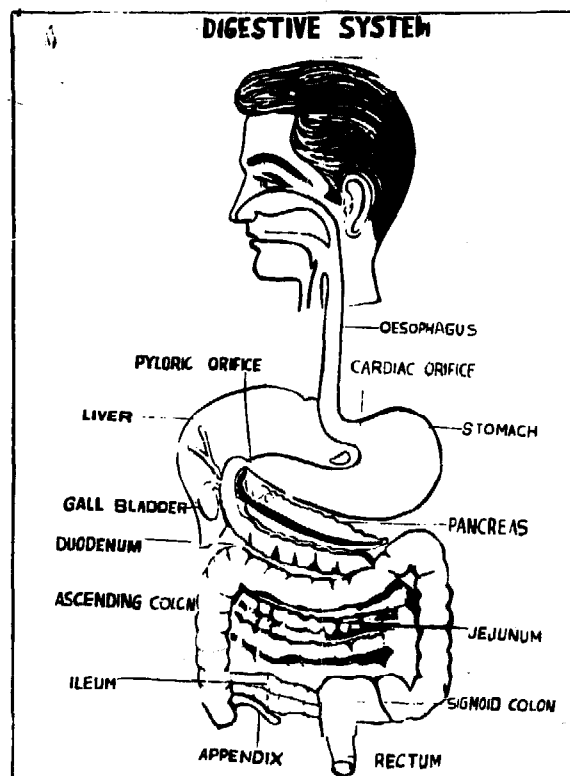

filler

Another way of making stencils is to paint directly onto the screen with filler. This paint is usually a water based paint. When it is dried on the screen it stops the oil based ink from getting through certain parts of the screen. Directly painting onto the screen involves painting what is not going to print. Therefore the image you want to print is the part of the screen that is left un-painted.

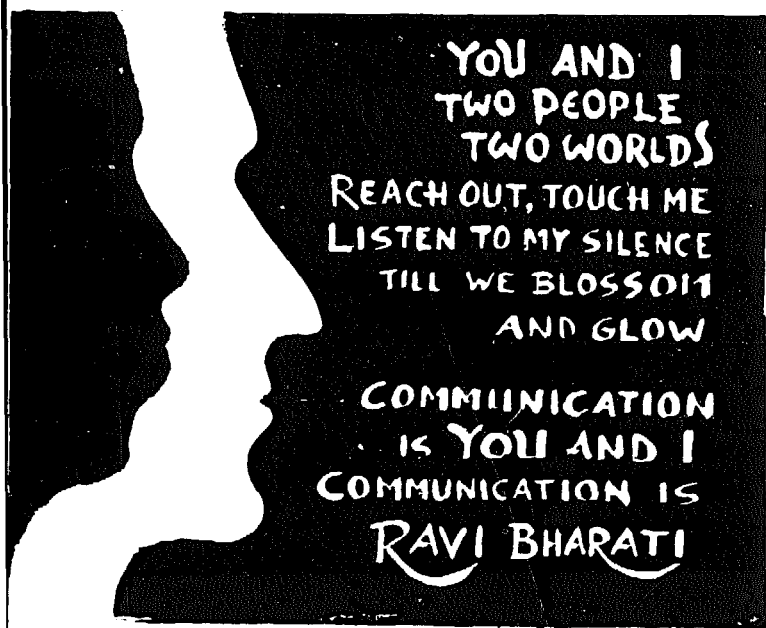

It is possible to make a filler stencil by painting with an oil based ink or using wax crayon. When this is dry the screen is covered with the water based filler. This fills the whole screen apart from where the oil based paint is. When the filler is dry the oil based paint is washed out with spirit creating a hole or stencil.

If you are printing with water based ink or dyes the filler will have to be oil based, so that it does not dissolve while it is being printed.

photo stencils

It is possible to cut stencils using photographic methods. This is done by using a stencil emulsion or film that is hardened by Ultra Violet light. The stencil is covered by an opaque image and exposed to the Ultra Violet light. The non image area is hardened but the image is dissoluble in water - so creating a stencil.

The opaque image is made on clear film or tracing paper and is called the positive. It is made the size that it is to be printed.

The positive image can be made of paint, cut paper or photographic film. This will work if the light can only get through the non-image area.

Photos can be photographically printed onto film instead of paper to make a positive. But to look like the original photo they will have to be in the form of dots (half tone).

The dots have to be 3 times larger than the hole in the mesh of the screen. This is necessary to avoid moire patterns or loosing the small dots.

The positive can be made from artwork photographically. But it is obviously cheaper to work directly on clear film or tracing paper. Use the old backing sheets from stencil film. You can use clear sticky tape to stick the various bits in place. These can be hand painted on the tracing paper or acetate.

The positive is essentially a mask stopping UV light hitting the sensitive film or emulsion. This is hardened by exposure to light. The image is protected under the positive and is not hardened. The image can be washed out making the stencil.

The emulsion is spread evenly over the screen in dim or yellow light. Do this with a piece of card or squeegee on both sides of the screen. When it is dry the positive is placed on the outside of the screen so that it is in reverse. It is taped onto the mesh and pressed firmly against the mesh by a sheet of glass.

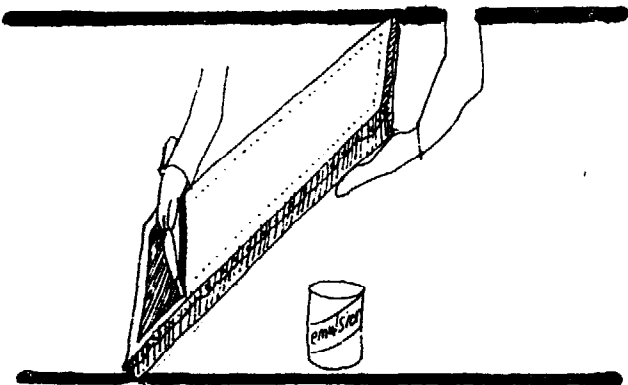

Exposure is made to UV light. This can either be an artificial light source like a light box with 2 UV light bulbs. Or the sun has enough UV light to make the exposure.

The exposure time depends on the light source and the sensitivity of the stencil emulsion or film. You will need to experiment to get the right time. With the light box I have worked on the bulbs had to be allowed to warm up for 5 minutes. Then the doors were opened and exposure took 6 minutes. Exposing to the sun can vary depending on the seasons.

Most emulsions and stencil films are washed out with water until the image is quite clear.

The stencil film should be put on the screen to dry. Once dry, the backing sheet can be removed and any unwanted holes can be painted out with filler.

These stencils can then be printed in the normal way just like any other stencil.

exposing the photo stencil :

① using sun

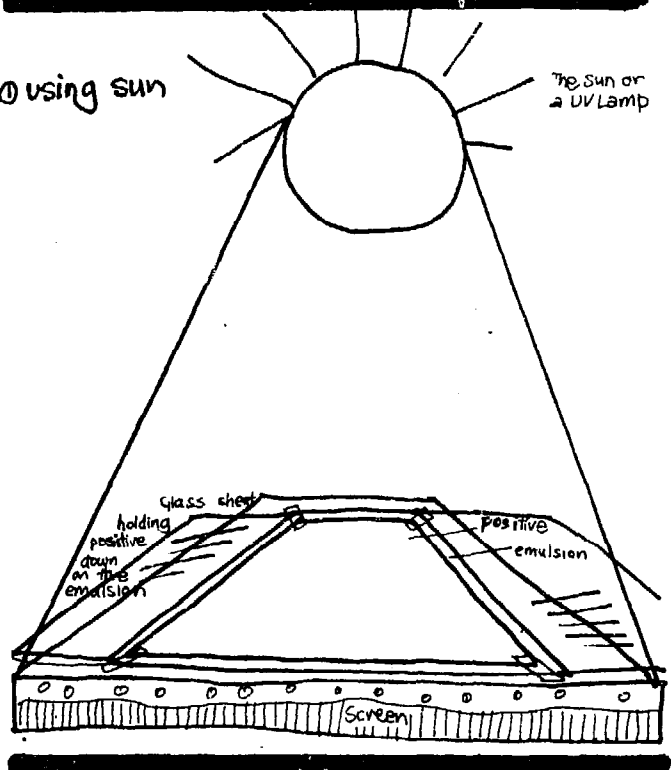

② wooden light box

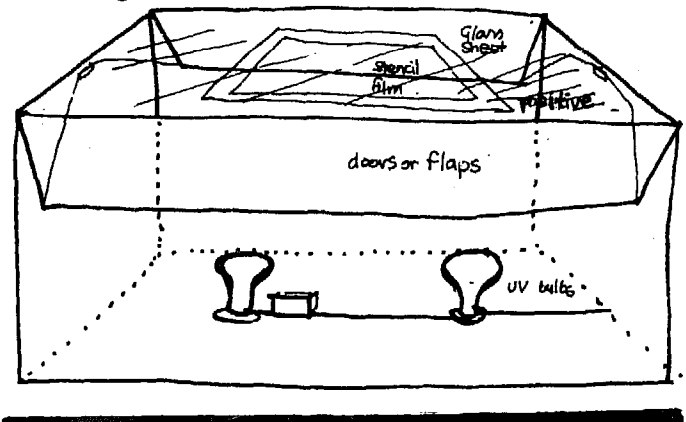

printing

The stencil is always stuck onto the side of the mesh which comes in direct contact with the paper. It will be read right way round by reading through the screen mesh.

ink

The ink can be water or oil based. Oil based ink is best for posters. Fabric dyes are usually water based. Simple screen printing with children is best done with water based inks. The stencil must be resistant to the inks. But you can use paper cut stencils with either.

Special screen printing inks are produced but are quite expensive. Its possible to use letterpress inks or even duplicating ink on screens.

Water based inks can be made from poster colours or dyes mixed with glue or flour. Special fabric dyes are made that are water based and need ironing once printed to make them fast. Traditional vegetable dyes are used and printed using gum Arabic as a base. The gum is washed off after printing leaving the dye in place fast on the cloth.

Experiment with locally available materials.

The ink you buy in tins is often quite thick in the tin. To print it needs diluting with the correct solvent to a fairly runny consistency. This depends on the fineness of the image. The finer the detail the thinner the ink needs to be.

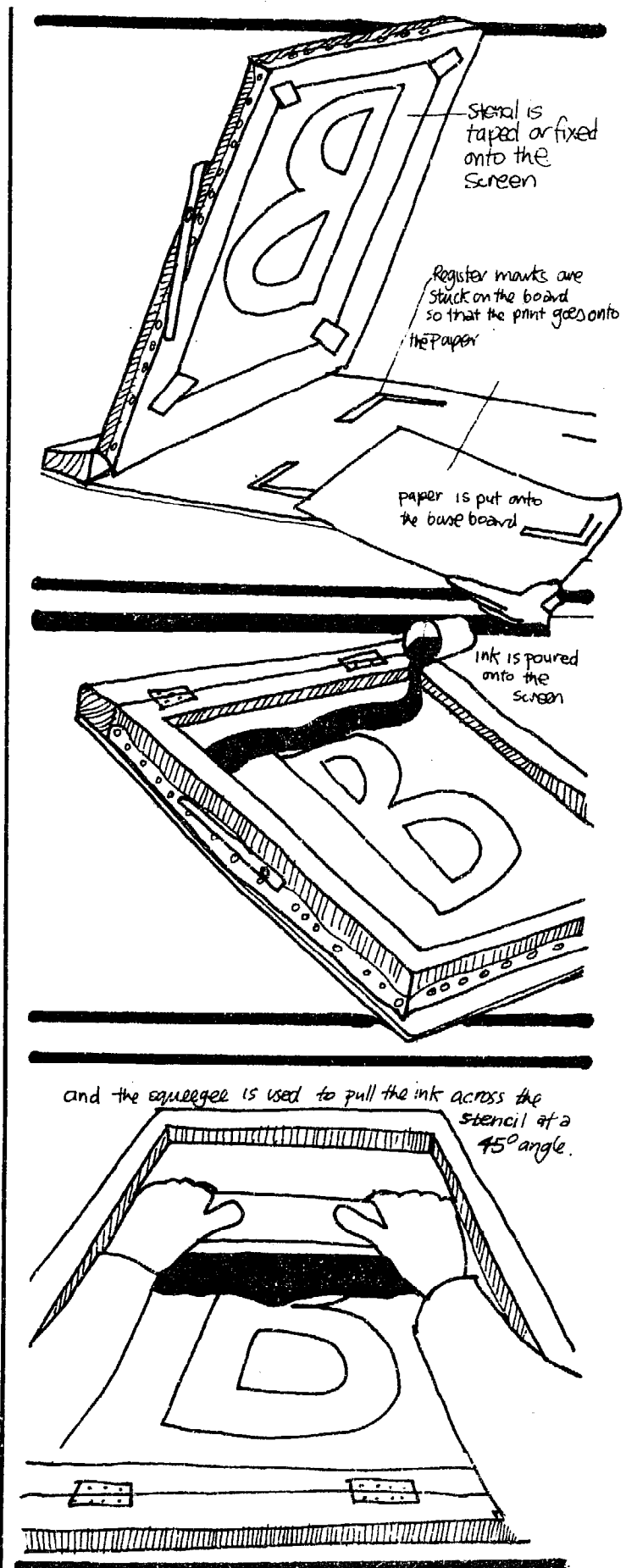

To print the stencil on the screen put a sheet of paper or fabric under the screen. Put the screen down. Pour in the ink at the hinge end. Pull the ink across the screen twice with the squeegee. When all the ink and squeegee is back on the tape at the hinge end, pull the screen up. It will be supported on the wooden leg. Then take off the print. If the image is not in exactly the right place on the paper, move the position of the next sheet of paper into the correct place. Mark this position with bits of sticky tape. These can be folded to make an easy stop on which to place the paper.

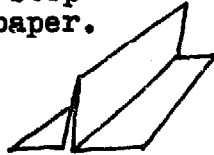

Getting the print in exactly the right place each time is important for printing 2 or more colours. This will make sure that the colours will inter-relate correctly. This is called 'registration'.

Screen ink is slow drying so that it doesn't dry on the screen but only on the paper. Once the print has been made it has to be hung up to dry. You will need a line with clothes pegs or some other arrangement where the print can dry without sticking to each other or getting dust all over them.

Screen printing on fabric

T shirts can be printed easily with screen printing. Put some paper in the middle of the shirt so that ink does not seep through onto the back of the shirt.

Screen printing is used commercially to print displays and to print on metal and other surfaces. Much commercial fabric printing is also done with screen printing. (See on for using a printer).

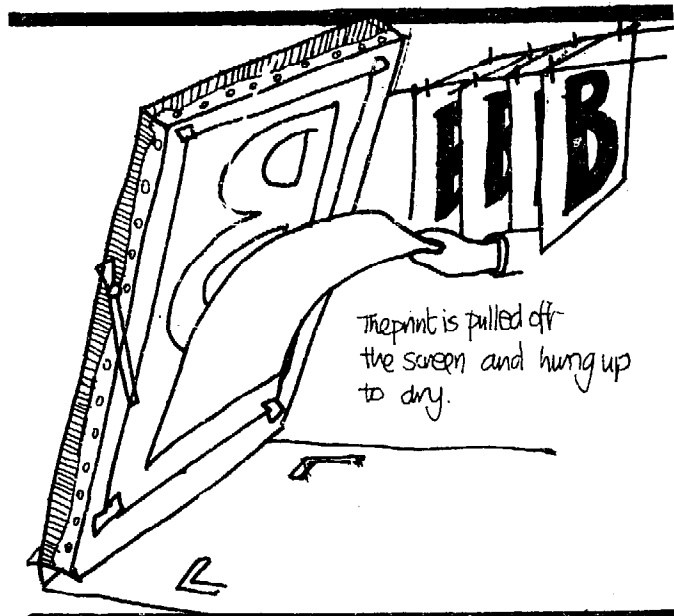

Fabric has to be printed with 4 or more pulls of the squeegee. The fabric must be made to lie flat under the screen. It may be necessary to iron it first and pin or tape or glue it to the base board or table.

Long tables are used for fabric printing. The screen is not hinged to a base board but moved along the length of fabric on the table.

Hecto jelly pads

Jelly pads are a simple, cheap and easy way of printing up to a 100 copies. The copies can be printed in 4 different colours.

The jelly pad is made up from chemicals which are obtainable from Hecto Colour Duplicator Co, Freepost Ormskirk, L40 2RL, UK. You can also obtain materials needed to make your own jelly pad. Write to them asking for their 'Hecto Colour Duplicator Starter Kit'.

The master is made on good quality paper that is not too absorbent. Make the image by either drawing or typing with hecto ink, hecto pencil and hecto carbon paper.

The jelly is covered with cool water for 2 minutes. The excess water is removed and blotted off.

The master copy is placed face down on the jelly. Smooth down removing all bubbles to make close contact. Leave for 30-60 seconds and peel off.

The image will be on the jelly and copies can be taken immediately using any paper or card or fabric. Roll each sheet onto the jelly pad and leaving for a second before lifting it off.

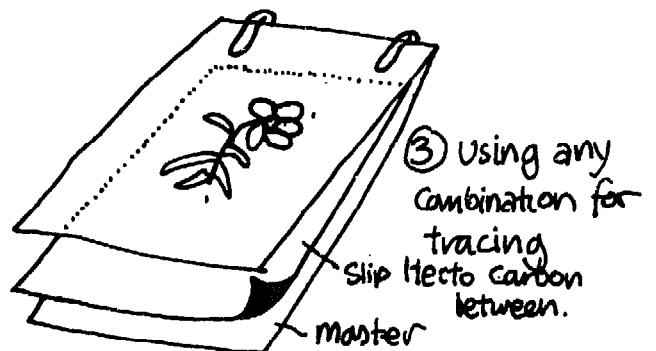
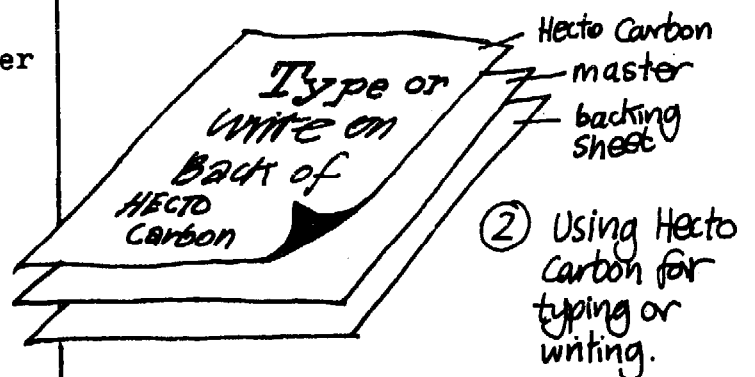
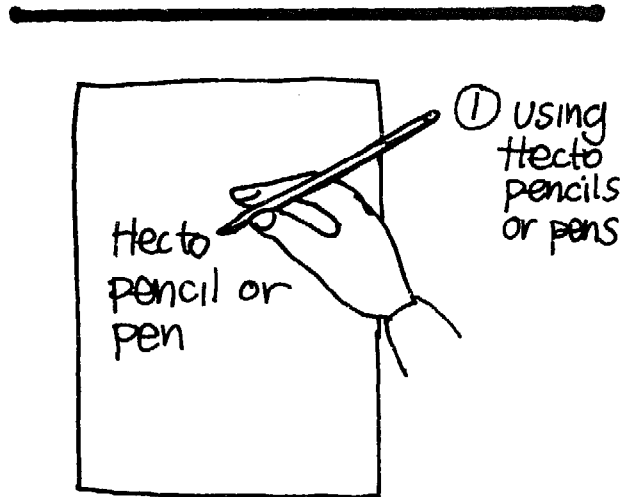

Spirit duplicating

Another useful method is spirit duplicating.

The master is made on a paper with a shiny and a matt side.

The master matt side up is put on top of the transfer sheet coated with dye. By writing, typing or drawing on the master a mirror image is formed on the back (the shiny side).

The master is then put round the drum of the spirit duplicator.

The shiny side is on the outside with the image on it in reverse. You turn the drum round and the master is dampened with Methylated spirits. The damp master is pressed against the paper that is fed under the drum. The image is dissolved by the spirit and transfers onto the paper.

100 to 200 copies are possible from one master. The colour of the copies depends on the colour of the dye sheet used. So it is possible to use up to 7 dye sheets of different colours to produce a multi coloured master. So multi coloured copies can be made from one printing with one master that has been prepared with different dye sheets.

You can type and draw on a master but care should be taken not to dent the master by pressing too hard.

The paper used for duplicating should be a good quality paper that is not too absorbent. Special paper is made for spirit duplicating which is expensive. But the less absorbent the paper, the more copies you can make from the one master.

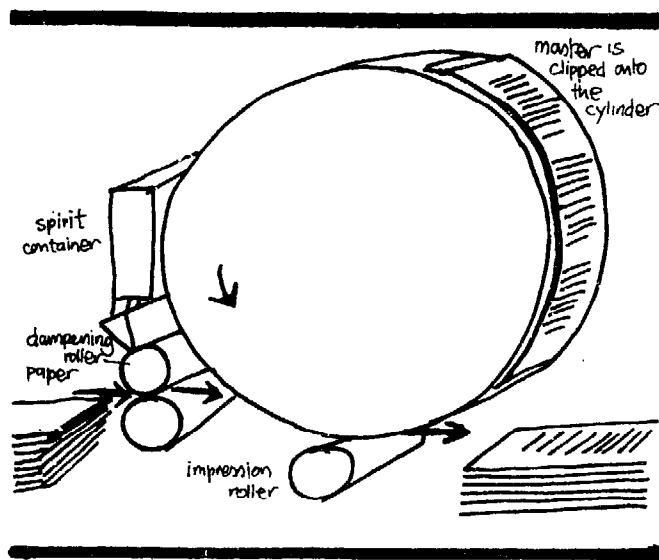

Crackers



Materials

Crêpe paper Coloured foil Paste motifs
Cardboard tubes Coloured thread

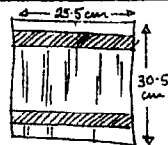

Paste 2-5cm strips of paper on back of crêpe



Paste on strips of coloured foil on right side

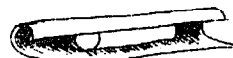

Wrap crêpe around cardboard tube.



Tie ends with thread



Decorate with motifs



Finish ends

a spirit duplicated work sheet.

photocopying

Photo copying is an expensive but useful method of printing a few copies. It is being developed and improved all the time. It is used increasingly for 'printing' jobs in the west.

Typical of modern developments in printing the new photocopiers working parts are all locked up. The operator just puts the original (artwork) in place on the copier and pushes the button. And out come the copies. Easy!

Do you have people in your group who work in offices with copiers? They may be able to do some copying without paying. This is the only way photocopying can be a low cost method.

The Indian photocopiers are of an older design. This enables the operators to do more of the process. They therefore have more control technically of what is happening.

With these sort of copiers it is possible: to reduce or enlarge the size of the image; you can also clean off unwanted background images. Make offset litho plates; and make up to 6 or even 10 copies from one exposure. It is then cheaper the more copies you have of any one original.

These copiers copy onto plain paper. They also copy onto both sides of the paper or onto pre-printed paper.

Most copiers are limited to copying onto foolscap paper. Some can copy onto larger paper up to A3 size.

Photocopiers are useful if you have to copy some already existing material. But if you are originating things yourself it is easy to use carbon paper to produce a few copies. Or type and draw onto a duplicating stencil for more. This way you can avoid the necessity and expense of copying at all.

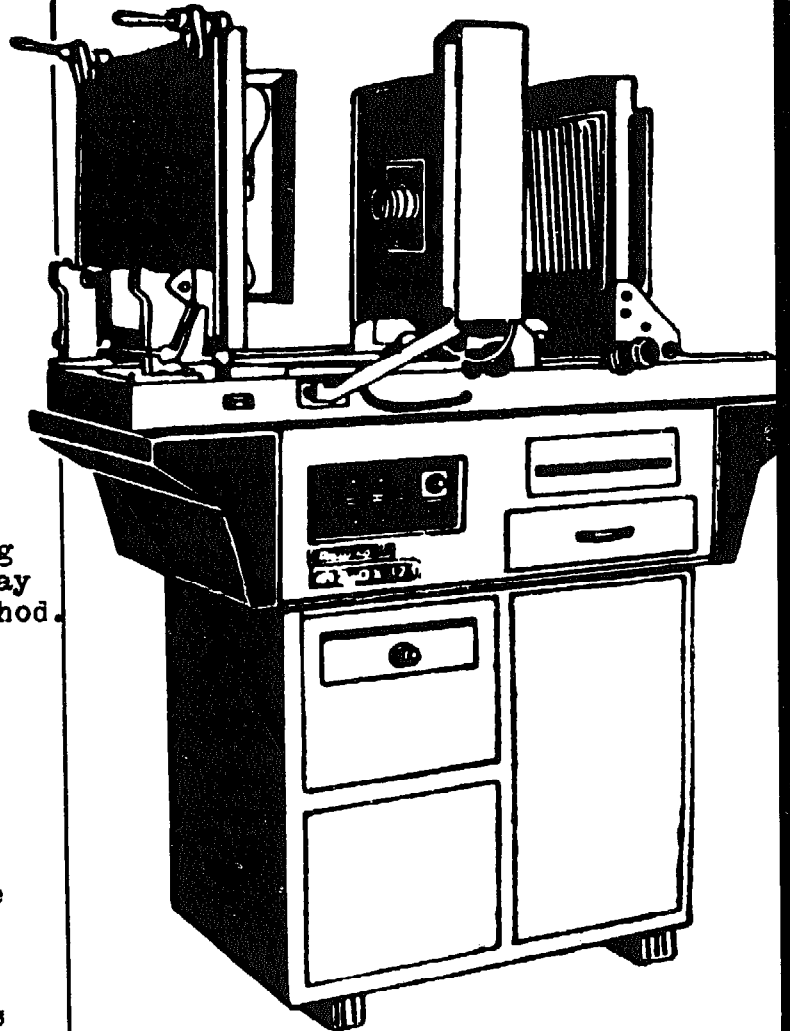

Deluxe 11 Majox 121 Copier

ISBN 0950852309

Low cost printing for development

3

Using
a
printer



by
Jonathan
Zeitlyn

Low cost printing for development

3

Using a printer

This is the 3rd section of the handbook on low cost printing for development. There are 4 separate sections.

The 1st section is an introduction and about design. It covers:

- the background to this work
- alternatives to print
- planning
- choosing a print method
- design: ideas
- design: approaches
- design: techniques
- and finishing.

The 2nd section on do-it-yourself printing covers:

- block printing
- stencil duplicating
- screen printing
- hecto jelly pads
- spirit duplicating
- and photo copying

The 4th section is on setting up your own printshop and covers:

- Having your own printshop
- setting one up
- what you will need
- running a printshop
- projects
- further information on
- books and organisations
- paper

and how you can make a 5th section yourself.

Low cost printing for development.

3

Using a printer

Published by CENDIT
Centre for development
of instructional
technology.
D1 Soami Nagar
New Delhi 110 017
India

and Jonathan Zeitlyn
51 Chetwynd Road,
London NW5. UK.

with assistance of
FAO - Action for
Development / Freedom
from Hunger Campaign
PO Box 3059. New Delhi
110 003 India.

© Jonathan Zeitlyn 1982

Printed at Raj Bandhu Industrial
Company. New Delhi 110064

Contents

Dealing with a printer	1
choice of printer	1
specialisation	1
timing	2
checklist	2
getting an estimate	3
how to keep costs down	3
do it yourself	4
things to watch out for	4
Colour	5
Imposition	5
Offset Litho printing	6
offset litho	
principles	7
direct litho	8
photo copy plates	9
metal plates	10
printing	11
Letterpress printing	12
layouts, marking up and specifying	13
composing	14
hot metal	15
proofing	15
pictures	16
hand cut blocks	17
photo engraved blocks	19
printing	20
problems	21
words	22

Dealing with a printer

It may not be possible or worthwhile to do your own printing. You will then have to use a printer.

Employing a printer to do work for you is sometimes difficult. Treat their labour with respect and pay them adequately. Give clear instructions about what you want and the results you expect.

To make this easy you should know something about:

- Printing
- The terms used to 'specify' what you want
- and design.

The printers are in the best position to advise you how to achieve the best results, and how to keep the costs down. So it is a good idea to be friendly with them. It may help if your printer knows why you are publishing. Visiting the print shop can give you a very good idea of the processes involved. You will also see the problems and the sort of set-up that the printers work in.

Choice of printer

This may be one of the most important decisions you make. Once you get to know a good printer they will be able to help you in a way no book can do.

Look for a printer in the local community. First find out what other publications are printed locally and if they recommend their printer. Ask for advice about their printer and what problems are involved in using them.

Draw up a list of recommended printers who are near enough to visit.

Ask each of the printers on your list for a guide price on a simple job, for example to print one sheet of paper. You will then find out which of these printers are the cheapest. Try to find out about the quality of work each one does.

With this information, ask three printers for a definite estimate. Then choose your printer.

specialisation

One factor affecting choice is that many printers specialise. They may print one sort of publication using a particular method and machine. The size and nature of their business also leads them into specialising though there is considerable flexibility. Once established with a printer it may be worth staying with them. It can be expensive to choose the wrong printer for a particular publication.

There are two main methods of printing used commercially:

1. Letterpress printing is used by very small jobbing printers to produce wedding invitations, leaflets, cards, business stationary etc. Medium size printers use letterpress to print magazines, small scale newspapers and books. Most large newspapers are printed by letterpress.

2. Offset litho printing also fits into the same sort of divisions as letterpress. But it is used also in large factories to print full colour magazines and labels etc.

Printers may have other facilities such as a finishing department. They will be able to both print and bind a book. Another printer without such a department would have to get a specialist finishing work shop to do the binding.

timing

It may take only two days to print your job. But the printers have to fit-it in with all the other work they are doing. So your job takes much longer. This may be a factor that decides your choice of printers or doing it yourself. Printers can be very vague about time and make unrealistic promises. So when you are getting estimates, ask for a completion date, if necessary, in writing.

Some printers have a booking in system. Let them know in advance that the job is on its way. They can then fit it into their schedules and so produce it in a shorter time.

It may take longer if you choose a special paper or other materials which need ordering or delivering. Try buying the paper yourself from a paper supplier. This may save time when you come to printing. It may also be cheaper if you buy alot at a time. Do this in consultation with the printer.

Hand-setting letterpress printing will take longer to do than offset litho printing.

Larger printers are usually more reliable about time than the smaller ones. If one man goes ill it may be impossible for the smaller printer to do the job on time.

check list

You must know exactly what your job consists of to get an estimate and to choose a printer.

Here is a list of points to consider before you go to the printers:

- The size of paper and image which they print.
- The number of pages and sheets of paper in the job.
The number of copies you want printed.
- The finishing involved - will it be trimmed ? folded? collated? or bound?
- Number of colours you want printed.
- Sort of paper that is easy to print and that you want. Consider the colour, weight (thickness) and its finish.
Find out if the printer will supply the paper
- Are you providing complete artwork or will there be half-tones to make ? (offset litho)
- How many blocks are to be made - the size, in halftone or line? (letterpress)
- Are you supplying layouts for the composition and is it going to involve special work?
- Delivery date.
- Payment details. Credit etc.

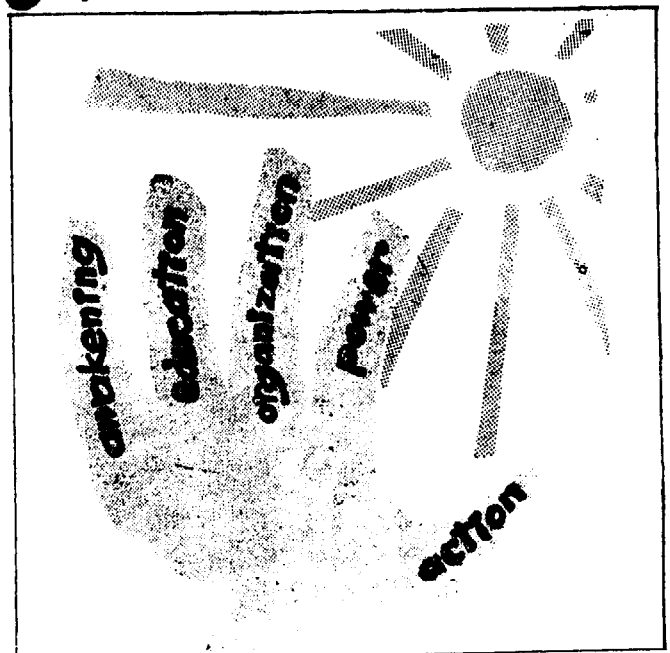

from the Panchshila of development. A.F.P.R.O. Delhi

Getting an estimate

Printers may give you an estimate from brief details of the job. But they will only give a definite quote once they have seen the text or artwork.

The cost varies a lot from printer to printer. This is because some printers are geared up to deal with a particular sort of job. They then increase the price for a job which is difficult for them to do.

Smaller jobs are often estimated from standard rates that printers have as guide lines. This will be useful in planning publications. But remember pictures and other 'extra' work will cost more.

For large scale jobs get a definite quote in writing.

A publishing project may involve many different publications. It will be a lot of work for the local printer. The project may then be able to ask for tenders and dictate the price it will pay. It may also be possible to buy all the paper at once. This will save money, though storage may be a problem.

When you get a quote ask the price for printing extra copies at the same time - 'a run on' price. The difference between the 1st 500 copies and a 1,000 may be quite small.

Make sure that printers estimate and quote for the same specifications, that is for the same quality of paper etc. Ask the printer to give special quotes for any different materials.

Some printers need to keep their presses going all the time and so have to take 'filler' work. This they charge at cost price. If you are on good terms with the printer you may be able to get your jobs printed as filler work. Though this may take time, it can be much cheaper.

How to keep costs down!

- Printers will charge extra for changes made by the customer once the setting has been done. So make sure the text is agreed before you give it to the printers.
- Design for cost. Workout how to fit your material in as few pages as possible, so that it still looks good.
- Halftones and other pictures will cost extra with letterpress.
- With offset do your own artwork.
- Choose coloured paper instead of coloured ink.
- Choose the right printers - get at least 3 quotes.
- Work out the right number of copies to print. A small number of copies will work out expensive per copy, too many and they may not all sell.
- Do the finishing, folding, and stapling yourselves.

Archana Prakashan

Archana Prakashan

Archana Prakashan

Archana Prakashan

Archana Prakashan

Archana Prakashan

Archana Prakashan

Archana Prakashan

Printers samples of type styles available.

do-it- yourself

There is a lot you can do for yourself, even if you are getting a printer to do the main work for you.

With offset litho printing you can do your own artwork. See the design section.

With letterpress you can also do quite a lot for yourself. You can buy your own paper if you are having a job printed that will use more than 2 or 3 reams of paper. (there are 500 sheets in a ream). This will involve you in working out how much paper you will need. Remember to allow for about 5% for wastage.

Shop around to find the best deals from the paper merchants.

Avoid cheap lots of paper where some sheets are not the right size, wrinkled and not square. These can create problems in printing and so involve more waste.

See page 23 in the fourth section, which talks about paper.

You can also buy blocks directly from the block maker. Be careful not to use too fine a dot in the photos as it may not print well on the paper you are using.

Before you decide on the size of blocks make sure of the design. They are the easiest to move around to get all your material into the space available.

See pages 12-14 for details of Letterpress printing.

things to watch out for

Small printers - jobbing letterpress printers who charge by the page will try to fit as little as possible on each page.

They use large spaces between lines and large margins so they can set the pages as quickly as possible.

They may use wooden 'furniture' and wooden strips between the lines for the leading. This may expand in the wet seasons and shrink in the dry seasons. So their work may not be that exact.

Printers also try to extend their ink as much as possible. Some use motor oil mixed with the ink. This makes the image 'show through' the paper very strongly and leaves a yellow stain.

Letterpress printers may have only a small selection of type, furniture and rules. Therefore they will only be able to set a few pages at a time. They will print these and then rearrange or distribute the type and do the next few pages. This will take a long time. It may also be more expensive than a printer who can print the whole job in one go.

Archana Prakashan

Archana Prakashan
ARCHANA PRAKASHAN

Archana Prakashan

Archana Prakashan

Archana Prakashan

Archana Prakashan, Ajmer

colour

The colour of the printing depends on the colour of the ink used on the the press

For each colour an offset plate or letterpress block and type has to be prepared. New ink is put on the press. The paper is then fed through the press and printed again. This makes colour expensive to print. It is often cheaper to print black on coloured paper.

Choose the colours you want carefully. Look at other publications. Tell the printer exactly what colour you want. If you can, give them an example.

The separate plates or 'chases' for each colour will involve separate pieces of artwork or layouts. These are done on tracing paper over-lays over the main piece of artwork. They will have to fit exactly in the right place.

The artwork can be made for two colours using tones and over printing to give a finished print with quite a few colours.

Full colour - naturalistic colour as in colour photos - is made of 4 colours printed on top of each other. These 'process colours' are yellow, magenta - a redish purple, cyan - a blue green and black. Process colours have to be printed in exactly the right place on each sheet. For this a printer needs good equipment, good plates and separation negatives. This makes colour printing very expensive and only possible for long runs of magazines etc.

imposition

Usually several pages are printed on one sheet of paper at the same time. Putting the pages in the right place for printing is called 'imposition'. This enables the sheet to be folded and cut easily to make the finished publication.

If you are folding a sheet of paper once and printing on both sides, the imposition would look like this:

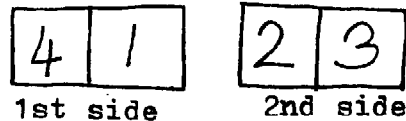

For books printed on a big machine but with small pages the sheet may be folded and cut many times. This makes the imposition quite complicated. For example:

An 8 page imposition

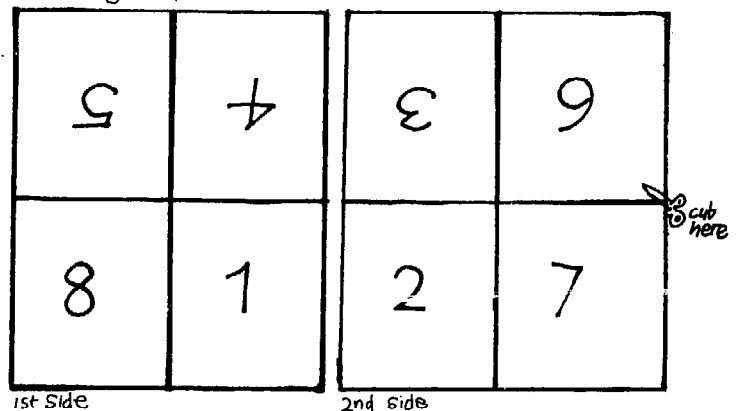

'Print and Turn' work is the name given to printing a sheet of paper on both sides from only one plate or chase. This is done by turning the printed sheet over and round and printing it a second time. The printed sheet is then cut in half.

offset litho advantages

- Offset prints pictures, photos and illustrations as easily as words and also gives the best quality.
- It gives much more freedom to the design/artworker or customer.
- Reprints or jobs where the artwork is simple, can be done quickly and cheaply with offset.
- The artwork is quite easy to do yourself. Thus you save money and gain control over what your publication looks like.
- Offset is very quick.
- The photographic platemaking involved in offset allows you to have a lot done to the image. The image can be reduced or enlarged. It can be made into a negative image - 'reversed out', and tone can be put in behind parts of the image.

An offset litho magazine from Peru.

LLALLISUNCHIS

VENCEREMOS

BOLETIN
DEL SINDICATO
DE TRABAJADORAS
DEL HOGAR-CUSCO
25 de Diciembre de 1,966
Nº 7
S/. 100.00

printing disadvantages

- Offset litho machinery is usually less available than letterpress and is more expensive.
- Offset uses different skills and techniques than letterpress. But it only requires a few days training to pick up how to run small offset presses.
- It uses good quality paper which is more expensive than that used for letterpress.
- The films and plates are expensive and may have to be imported.

a photo cartoon story page. From Cusco Peru.

¡Ten cuidado, somos un grupo de chicas explotadas y te vamos a ayudar!

¿Acaso lo vas a creer? Entre nosotros las pobres nunca podemos confiar, los ricos siempre tratan de engañar para explotarnos más.

¡No es asunto del Sindicato que dicen? Mi madrina decía que eso era malo.

En el sindicato nos reunimos y reclamamos nuestros derechos de todas las empleadas. Allí nos defendemos y nos damos cuenta de la explotación, por eso las patronas le tienen miedo al Sindicato.

¿Habrá cambiado mi suerte?

No es asunto de suerte, sino que de lo que sufrimos tienen la culpa los ricos. Sólo organizados los pobres, podremos vencer y cambiar esta sociedad.

principles

Offset litho printing is a comparatively new method of printing. It uses the lithographic principle of grease repelling water.

An image is put on a metal plate photographically and processed. So when it is put on the press the non printing surface of the plate will hold dampness and the printing image will pick up the greasy ink.

Next the ink image is 'offset' onto another roller - the blanket. Then it is printed onto the paper. This enables the image to be right way round on both plate and paper.

The photographic nature of this process splits printing in two. You can easily make the original - the artwork - which is to be photographed - for yourself. Then take it to the printer who makes the plate from the artwork and prints it.

If you would like to do your own artwork see the design section. If you would like it done for you, look around for a designer, typesetter or paste up artist,

Design students may do it for you as an exercise.

Most offset printers have design and artwork departments. They could therefore do the whole job. But they may charge as much for the artwork as they do for the printing.

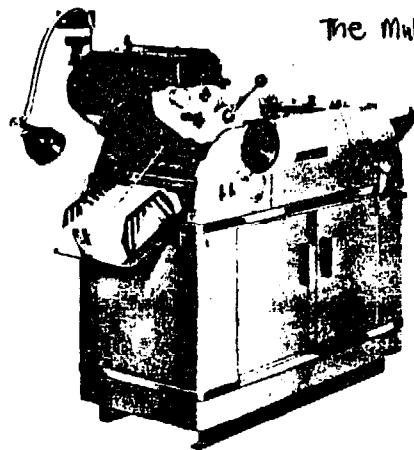
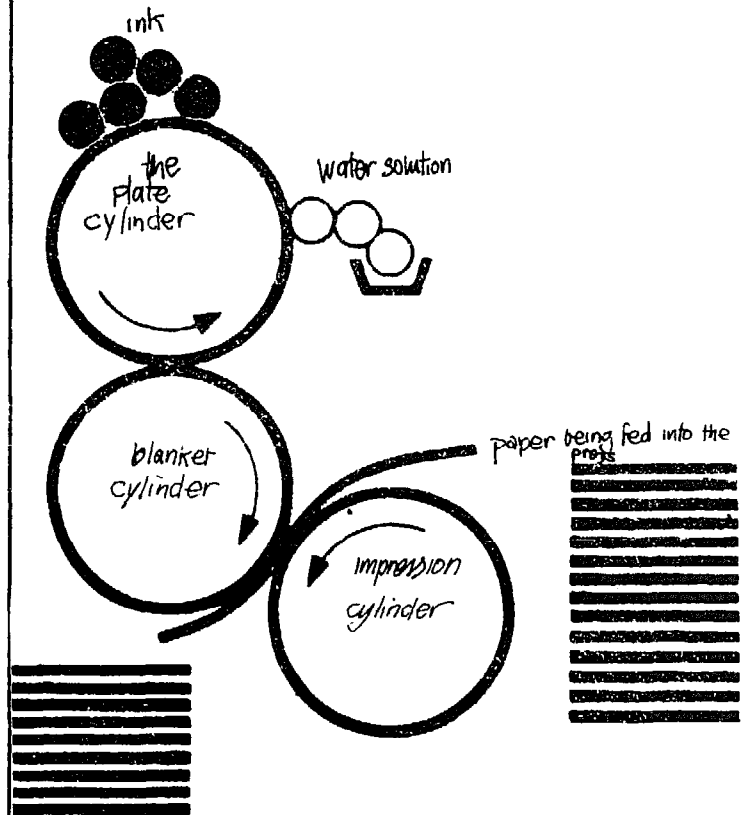

The Multi Lith 1250
prints up to 11x14in.

Direct litho

The quality of the offset printed image depends on the quality of the offset plate. There are various ways of making plates. The old method was to draw out the image in reverse on flat stones and a print was taken from this. This method is still used for Fine Art Lithography and Urdu printers - who use metal plates.

Urdu and other scripts that are difficult to print by letterpress are easy to print by Direct Lithography.

The text and pictures are drawn with special ink on transfer paper. The transfer paper is then placed on the plate face down. It is pressed onto the plate and a reverse image is transferred to the plate. Prints can then be taken directly from this reversed image.

The Direct Lithography presses are old machines and hand fed. They are quite simple mechanically and a lot simpler than offset litho presses.

Offset litho usually uses photographic methods to put the image on thin metal, plastic or paper plates. These are curled round the plate roller on the rotary offset press.

Sorts of images the Direct litho plate will print - pen

ink



crayon.



finger prints.

روز ایک بجے سے لے کر تین بجے تک سہ کو اس کلاس میں شامل ہونے کی اطلاع تو کام بیچھ سکتی ہیں جو ان کی دیکھ رہی ہیں۔
 حضرت نے بیسیوں جہانی کی ٹیلیوں کر سکتی ہیں

direct image paper plates

Direct image plates are made of paper. You draw or type on them directly. Greasy ink and special typewriter ribbons are used to put the image on the plate. This is then covered with 'fix' and printed.

These plates are made for short runs of 1000 to 5000 copies. They are cheap and easy to use. Try and ask your printer to print from the plates you draw up yourself.

Most Direct Image plates are A4 or A3 for use on small offset presses.

Work out the design of your material carefully before starting on the plate. Corrections are difficult if not impossible.

With a non-reproducing pencil you can draw out a grid or image on the plate. Then go over it with special inks or type the text.

Carbon ribbons for typewriters and carbon paper work on direct image plates. So do some spirit based felt tips and normal wax crayons as well as specially made pens, pencils and inks.

Even the grease on your finger tips may produce an image. So be careful when working on the plate not to leave finger prints.

Experiment to see what works on the direct image plates and produces the results you want.

Press gently so that you do not indent the plate surface. This will stop the image printing clearly.

It takes a bit of time to become familiar with the process of putting an image on the Direct Image plate. Once you have, they can become very useful as they are so quick to use. They do involve doing it yourself but they are much cheaper than other sorts of plates.

photo copy plates

It is possible to make offset litho plates using photocopying principles. Cheap and quick plates make offset printing more accessible. It becomes part of the 'copying' industry as well as the printing industry.

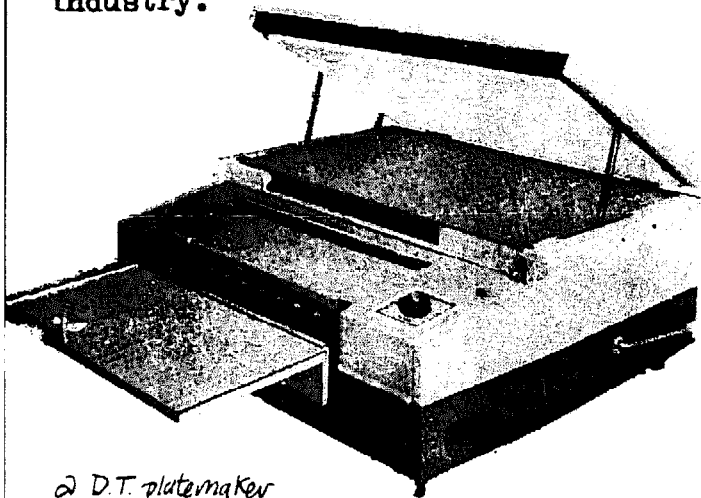

2 D.T. platemaker

Generally photocopy plates are not as good as metal plates. They are not able to print fine dots smaller than 80 dots to the inch. Also the paper and plastic plates most often produced on copiers can only print a limited number of copies. Some can print only 1000 copies. Most photocopy platemakers cannot reduce or enlarge the original. It is more difficult to get rid of shadows or paste up lines from these plates. The original or artwork therefore has to be as flat and clean as possible.

You can make offset plates on normal plain paper photo copiers by copying onto Direct Image plates. Or you can use specially made photo copiers which use special plastic or paper plates.

The Diffusion Transfer system is used to copy onto metal plates. They are more expensive than the other copier plates. But DT plates can produce a large number of copies of fairly good quality.

CHILD-to-child programme



Early signs of illness the Idea

Young children often fall ill suddenly and cannot tell older people what they feel.

Older children often notice early signs of illness while they are in charge of babies and young children. If they can learn which SIGNS are more dangerous, they can tell the RIGHT PERSON and prevent unnecessary suffering and even death.

the Healthy Child

If a child knows how a healthy baby behaves and looks, he will know more easily when a child is ill.

1 BEHAVIOUR a healthy baby is active, playful, sucks at the breast or eats well and is interested in what goes on around.

2 APPEARANCE: the healthy baby has strong arms and legs, bright eyes and firm smooth skin.

ACTIVITIES: 1 Older children can observe healthy babies, notice what they do when they see a bright object or hear a loud noise.

2 Older children can observe the young child's arms, legs, eyes, ears, nose, belly and see how they look, feel and smell.

3 Observe how often a baby sucks at the breast or eats.

This sheet should be read with sheet 'Caring for Children who are Sick'

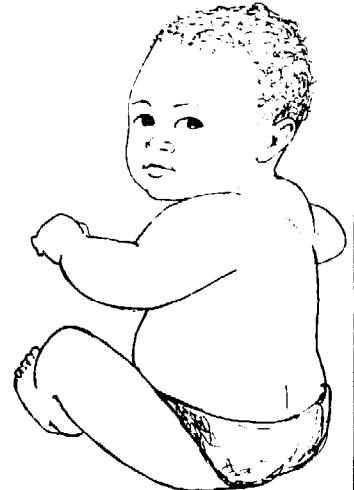

Particular danger signs

Sometimes signs of illness are very common, children should learn which ones are most dangerous and when immediate action needs to be taken.

Examples:

1. very rapid or noisy breathing.
2. fever which lasts more than 3 days.
3. blood in urine, stools or sputum.
4. delirium, high fever.

Sometimes there are several signs together

Examples:

1. vomiting, many loose stools and wrinkled skin (dehydration diarrhoea or cholera).
2. fever, rash and runny eyes (measles).
3. vomiting, crying, fever and stiff neck (meningitis).
4. vomiting and cough ending in whoop (whooping cough).

REMEMBER:

If a child is very thin and malnourished he is more likely to fall ill. Any of these signs would be more dangerous in his case.

IMMUNISATION:

An important way to protect children from some diseases is to immunise them.

At the health centre children can be immunised against:

- Tuberculosis (B.C.G. vaccine)
- Measles
- Polio
- Diphtheria, tetanus and whooping cough

ALL THESE ILLNESSES CAN KILL OR CRIPPLE SMALL CHILDREN

Activities

It is important for children to recognise different types of BREATHING.

Example: PNEUMONIA, causes young children to have fast, shallow breathing. The child takes small breaths.

In other illnesses the kind of breathing can be: fast, noisy, gasping, coughing, whooping, wheezing.

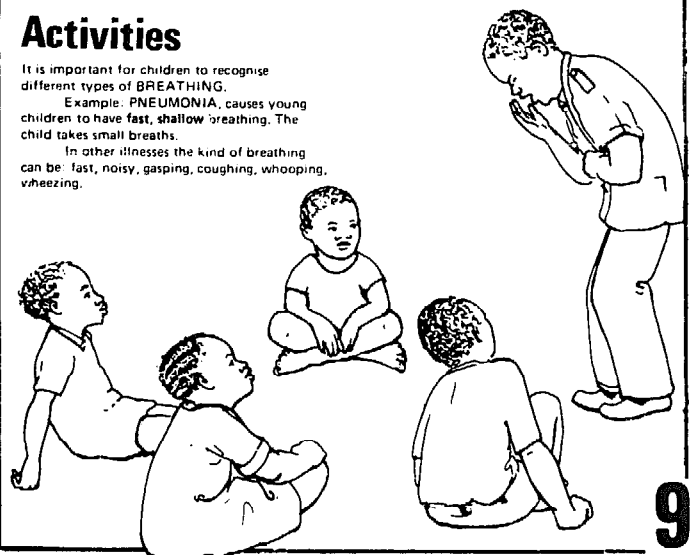

Metal plates

Most offset plates used now are metal plates. They can print fine halftones and long runs.

These plates are made of zinc or aluminium. They have to be processed to make them sensitive to Ultra Violet light. They are then exposed through the negative to put the image on the plate. After that they are developed and etched to make them ready to print.

Different materials and chemicals are used in different plants. But essentially the metal plate has to be first of all grained. This makes the flat metal receptive to water. It is then covered with an even coating of light sensitive emulsion. This is done on a machine called a whirler which revolves the plate very fast. This distributes the emulsion by centrifugal force evenly over the plate.

The image is put on the plate by exposing it through the negative to UV light. The negative is made on a process camera so that it is the same size as the print.

The negative is made in line film for the line images. That is the black and white drawings, type, and headlines. Or it is screened into a dot pattern - a halftone for the continuous tone images such as pencil drawings or photos. The screened negative is taped into the main line negative to make up a complete negative.

While making the negative on the camera the image or part of the image can be reduced or enlarged. The photos have to be rephotographed for screening. They can be enlarged or reduced whilst this is being done easily.

Part of the image can be reversed out. This makes the image white on a printed background. Or tone can be put in as background if so desired.

Once the negative is made, it is placed on the metal plate and exposed to U.V. light. The easiest source of this is the sun. It is then developed and can be etched to make it able to print off long runs.

The photographic process involved and the skill needed makes these sorts of plates expensive. The process takes time and is often done at specialist workshops rather than by the small offset printers. Platemaking costs the same for 500 as 5000 copies.

But the plates can be kept quite easily once the first printing has been done. So reprints are much easier and cheaper.

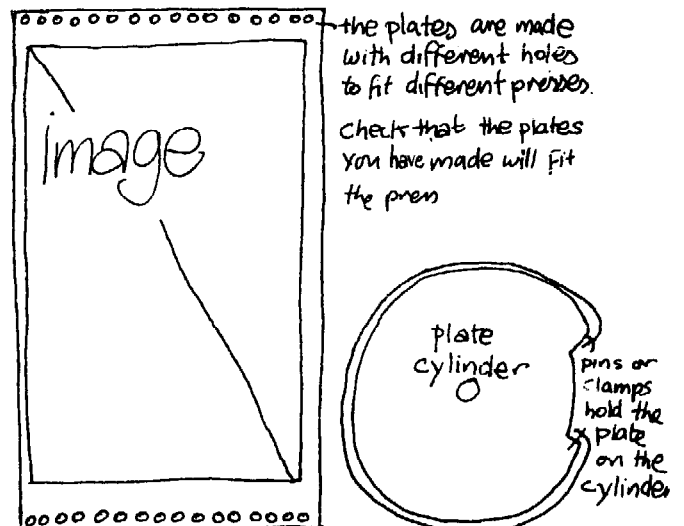

Pre sensitized plates

Presensitized metal plates are much quicker to use. They are supplied already light sensitive and only need exposing and developing. They are able to take fine images and print long runs. Whirling and graining machinery are not needed. But presensitized plates may not be available locally. They will need importing and will be quite expensive. They may also be a problem to store for a long time in a hot and damp climate.

printing

Once the image has been put on the plate, it is put round the plate roller of the litho press. The plate goes round and round on the press and is covered with water (fount solution) and ink. The image picks up the ink and the non image area picks up the water.

The balance between water and ink is vital for good printing. Too much ink and you get black streaks. Too little water and you get scumming - a grey mess.

The ink image is transferred from the plate onto a rubber roller (the blanket). The blanket roller then transfers it onto the paper. The intermediate (offset) stage enables the image to be printed right way round.

Offset litho presses can print on most papers and cards. They are automatic machines and are not as flexible as hand fed letterpress or screen printing. So printing on material of different thicknesses and quality can be a problem.

They are however very quick and are not difficult machines to operate. The main job is to keep the paper flowing through the press and the balance between ink and water right.

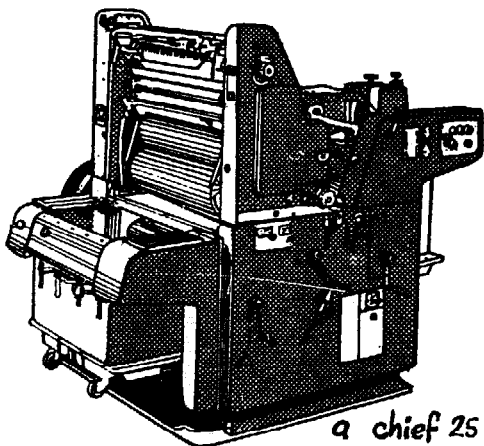

a chief 25
sheet fed offset
press (printing 18 x 25")

cross sections of offset litho presses.

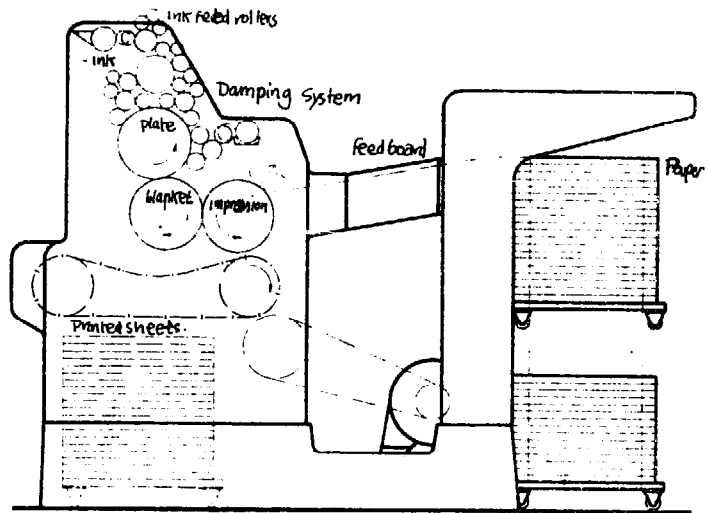

A single colour sheet fed offset press A2.

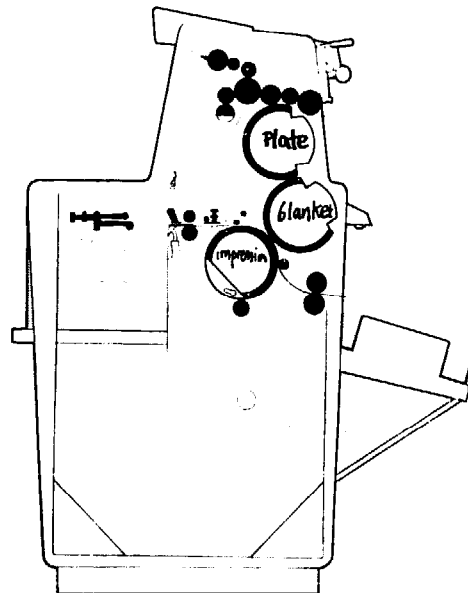

A Rotaprint 30/90 prints one colour on A3 size paper

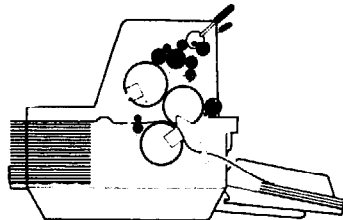

A Rotaprint TTK prints on A4.

Letterpress

Letterpress printing is the traditional method of printing. It has been used for centuries. The lettering or text and headlines are printed from moveable relief metal letters called type. Pictures are printed from separate relief blocks. These are usually photo-engraved. The image is raised above the body of the block so that only it will be printed.

The type is taken out of cases and put together to make words, lines and columns of text. These are put with borders, rules, and pictures to make pages. This is called composing. All these elements are locked up in a frame. The frame is put on a press which inks the raised type and blocks. It then prints them by pressing the paper against the inked type and blocks.

advantages

- letterpress printers are the most widely available form of printing (in India).
- it is cheap.
- it is suitable for printing on most paper, card, envelopes etc. The paper can be cheap.
- Small printers use labour intensive hand methods of letterpress. This gives lots of people jobs and creates a readily available skilled labour force.

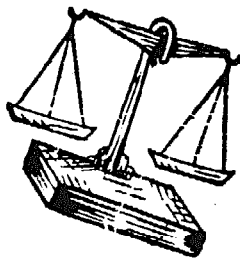

printing



disadvantages

- The cost of setting type by hand is reflected in the cost of the first 1000 copies. So for a print order of 500 the cost is almost the same as 1000.
- Reprints may be difficult as a printer may not be able to keep your type standing. It may have to be used for other jobs.
- A page design that is very free and has a lot of pictures will be expensive and difficult.
- Handsetting may be slow, inaccurate and expensive.

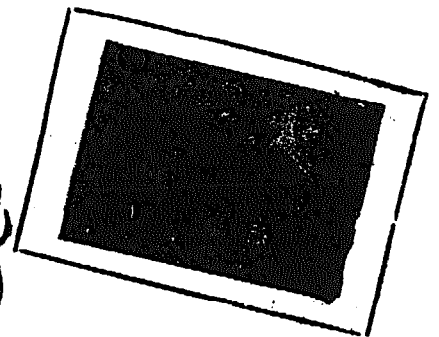

layouts, marking up and specifying

The text you give the printer should

- be typed with double spacing
- be on one side of the paper
- have clear instructions about the way you want it set.

Many printers like to take decisions about setting themselves. They will rarely, therefore ask the customer what they want. Their excuse is that they know what they are doing or that it costs too much to change their way of doing things.

This way of working though will not give you a cheap or necessarily an attractive publication. So it is important that you the customer say clearly what you want. Or consult the printer and approve each of their decisions.

Points to consider:

- the size and style of type.
- the leading.
- size and style of headlines.
- the grid - the margins and width of column.
- the position of each element on the page.

(see the design section.)
Use type measurements and proof reading symbols to give these instructions on the text. Write out the instructions at the beginning of the manuscript and any place where the basic style changes.

Hand setting in the composing room of Archana Prakashan Ajmer, India.



Give the compositor a layout. On this show where everything is to go on the page, on which page each article and pictures are to go.

Any changes in the setting or the layout is expensive. Therefore it is important to do your own copyfitting and layout accurately so that there will be no need to reset. It will also look bad if the printer squashes up a paragraph so that an article fits onto the page allotted to it.

One way round this is to proof read the 'galley' proofs. This is the copy of the type before it has been made into pages. Use this to make a layout by pasting it up as pages.

From this dummy you can measure off exactly how much space you have left. You will then be able to reduce or enlarge the photos, illustrations or headlines to fit the space.

The leading between the lines can also be reduced or enlarged to make the text longer or shorter if necessary.

You can use the dummy to show the compositor exactly what you want. It gives you control over the design of your publication.

Composing

The type is assembled with the blocks, rules and borders by hand. This process is called composing. The type is stored in trays - 'cases'. Each case has little compartments for each letter, space symbol and number.

To make the words the type is put in a metal holder which is called a 'stick'. This can be adjusted to the length of line you need. Each line of type has to be made the same length. All the lines together make a rectangle which can be gripped tight when locked up.

The type is arranged upside down and read right to left, so that it will print right way round on the paper. Therefore it takes time to learn to set type by hand accurately. Space is put in to make the line of type the length required. This is done by putting spaces either:

- between the words to make the right hand margin a straight edge. This is called justification.
- or the spaces can be put on the end of the lines. This is called unjustified setting.

The complete lines are taken from the stick and put on a tray - a 'galley'. They are assembled into columns and tied with string.

The headlines, rules, borders, and blocks are then assembled on the 'stone' - a flat iron topped table. Then the type is put in place with all the other elements. Pieces of wood are used to keep them all together. This is called the 'furniture'. The complete page or pages are then locked into an iron frame called the 'chase'. This is then put into the press and the prints are taken from it.

h	[]	()	:	:	:	Mobile Spaces								
h	b	c	d	e	i						s	o		
h	i	m	n	h	o						y	p		
z	v	u	t	Thick Spaces	a						r	k	i	Quads
x														

LOWER CASE.

The lay of a lower case tray

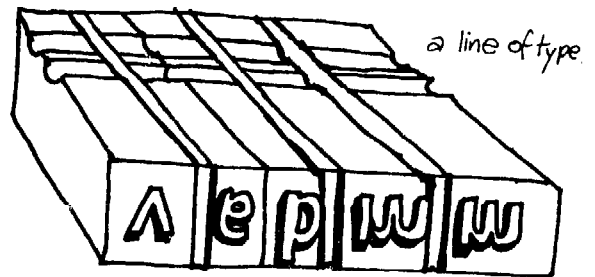
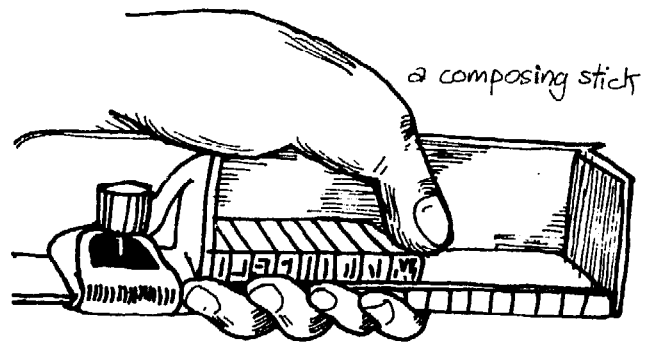

a justified line of type

This line is justified

an unjustified line of type.

This line is unjustified

The pages of type are locked in the chase

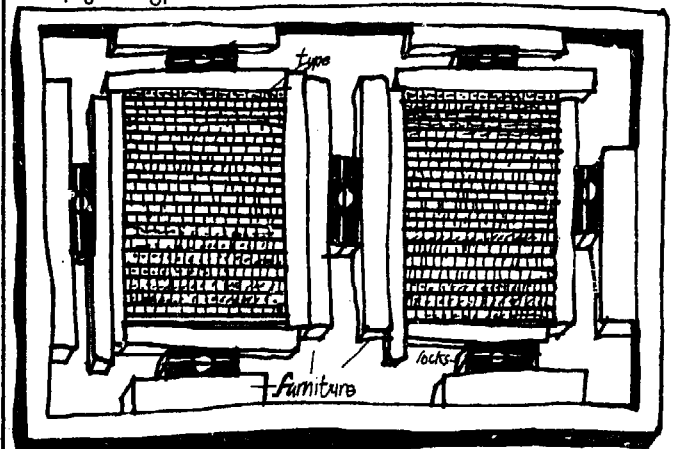

hot metal

Hot metal machines are used by large printers, newspapers and type-foundaries. These machines assemble a line of type moulds from what the operator types in. The machine then casts new type from these moulds. Hand setting and storing type therefore becomes unnecessary.

proofing

Once the type is set it is printed on a small flat bed proofing press. to check for mistakes. This is called a 'galley' proof. It is important to read very carefully through the setting. Look for mistakes in setting as well as spelling mistakes. Sometimes even whole words, lines or paragraphs are missing and sometimes the printers use the wrong kind of type.

Corrections are quite easy to do. The type is changed and then locked up again.

Proofs are also taken of the whole page - called 'page proofs'. These enable you to check if the correct headlines and pictures have been put in the right place.

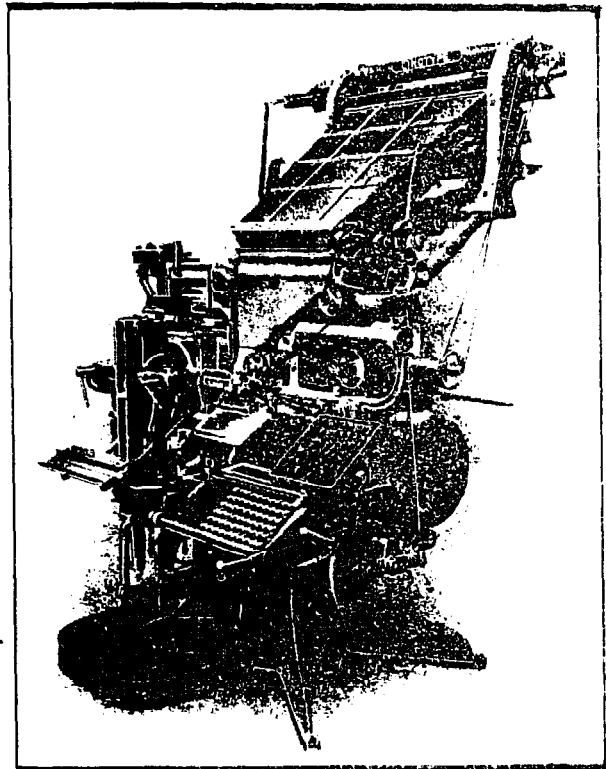

A Hot metal type casting machine, a Linotype.

Proofing presses come in all sizes. Some can be useful for printing short run, notices, posters etc without going any further to a proper press. The type is placed on the flat bed. It is rolled over with ink and paper is put on top. The impression roller is pulled across, pressing the paper against the type. The printed paper is taken off by hand.

The type is sometimes fastened in place on the flat bed with magnets. This avoids locking up, necessary for the printing on proper presses.

Make sure that the printers understand the proofing symbols you are using.

See page 25 section 1 for more on proof reading.

pictures

Pictures are printed by letterpress from blocks. These are relief blocks specially made with the picture on top in relief.

Small blocks are made of solid metal. Larger ones are made by nailing the engraved image on to a wood base. The engraving is usually done photographically on to a thin plate of zinc, an other metal or on plastic. Photo-engraving is usually done by a specialist company and can be quite expensive.

A cheap way to make your publication more visually interesting is to use the blocks, borders and rules that the printer has in stock. Look through their catalogue or samples of what they have done. Draw out a layout showing where each block is to be used. Even by using simple rules - solid lines - a publication can take on a visually interesting style.

Blocks held in stock are used for wedding cards, religious notices, political parties etc. Some printers may have a large selection. Some of these blocks may be quite useful for your publication.

You may have your own symbol, which can be made into a block by the photo engraver. Once made you can keep this block and use it whenever you are having something printed.

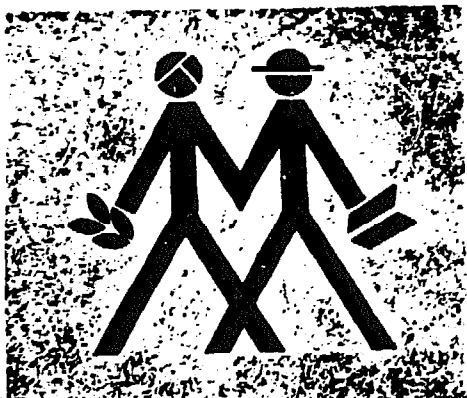

The SWRC's symbol, which they keep and use on their publications and other printed jobs.

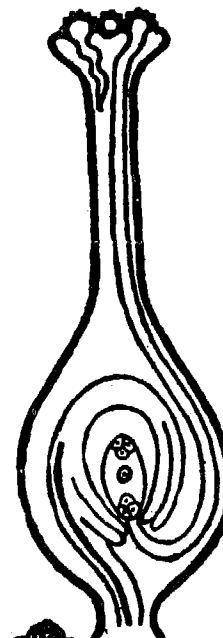

blocks from Sharma Printers, Ajmer.



hand cut blocks

One way of avoiding the cost of photo engraving is to get or cut your own blocks by hand. This is good way of making your publication visually interesting.

Local artists may be able to carve a block. They may also be able to do the illustrations in a local style which people relate to and understand.

Blocks are cut in wood but softer materials like linoleum or packing rubber are also suitable. They are easier to cut and good for printing short runs.

Before photography, all illustrations were engraved on wood by hand. The skills to this have been lost and destroyed in the West. They may exist in the Third World - being used for other art and carving work. They could be developed and adapted to produce blocks for printing pictures.

The image is cut on the linoleum or rubber and is mounted onto the block board to make it the same height as type. It can then be printed with letterpress type. This means the block has to be 'type high' - which is .918 of an inch. This has to be fairly exact so there is no problem in printing both block and type together.

The image will be reversed in printing. So any image and words will have to be drawn and cut in reverse on the block. To do this draw the image out on tracing paper in soft pencil. Turn the paper over. Press it against the front of the block material. Go over the image again so that the pressure of the pencil will apply a light pencil image, in reverse, onto the block.

Cut away the material around the image by at least $\frac{1}{2}$ of an inch. So that only the image to be printed is raised above the block and will be able to be inked and printed.

There are special cutting tools for cutting blocks. But a small sharp



a hand cut block, made from packing rubber. Printed for Seva Mandir, Udaipur INDIA.

knife, chisel, scalpel or even a small nail knife, used by barbers, in India, will do. A variety of knives of different thicknesses are useful for cutting out details or larger areas.

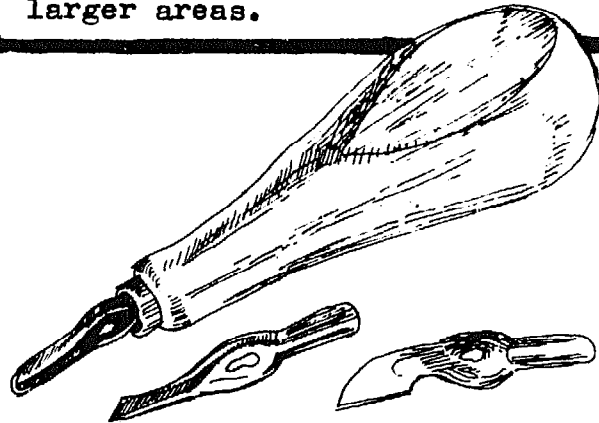

The material of the block must be strong enough to print, but soft enough to cut easily. You will have to experiment with locally available materials. Wood is the best for finer detail and longer runs, especially if the carver is used to working in wood. The wood should be 'type high' that is .918 of an inch. Linoleum is a floor covering and the thick matt sort is the best to use. Cut out a piece you need from the sheet and cut away the non

printing area without going right through the linoleum. This will then be easier to mount on block board to make it up to the right height. Rubber as used for packing piping and other engineering products can also be used. It should be quite strong and at least $\frac{1}{2}$ of an inch thick. This will also have to be mounted on wood to make it type high.

Photo engravers use zinc on which to cut their blocks. You may be able to get pieces of this zinc. On it you can paint pictures with an acid resistant paint which the photo engraver uses. The block is put in engravers acid. This cuts away the block except where the paint has been applied. Then mount and print the zinc block just like any other.

Before you cut a block first work out how it is going to fit onto the page. Being able to make illustrations cheaply and easily yourself gives you a freedom of design. This could change the way your publication looks.

Once the block is cut and mounted, take it to your local letterpress printer. Provide a layout to show where this block will go. The printer should be able to do the rest and print your block with their type at the same time.



A hand painted Zinc block made by Tridibesh Sanyal. MID Ahmedabad. INDIA.



an old wood cut block used in a letterpress printers in Rajanthon. INDIA.

photo engraved blocks

A block can be made photographically from most sorts of images. In line or in halftone. Line blocks are cheaper and print better than halftone blocks.

The blocks are made using a process camera to photograph artwork. While doing this the size can be reduced or enlarged quite easily to fit the design. Mark the width you want the blocks made on an overlay or on the border of the picture.

Halftone blocks are a bit more expensive than line blocks. They involve more work and skill in getting all the dots right and maintaining the range of tones in the picture.

You will have to decide the size of dot screen you want used. Large dots produced by a 60 lines to the inch screen will look a bit crude and obvious. But it prints the photo more clearly than the finer screens. The choice of screen depends on the quality of paper you print on. In some books the halftones are printed on specially glossy paper. While the text is printed on rough cheaper paper.

Generally letterpress does not print halftones very well. It is therefore advisable to use line images instead. Go to the block maker yourself and get the blocks made. This can avoid extra charges and delays and give you more control over the job.

When you take the pictures to the block makers you will have to tell them:

- the size of picture you want
- the size of dots in the halftone.
- and any other work you want done to the image, such as reversing out or putting in a flat tone background.
- they can also cut out unwanted background from the image.



60 Dots to the inch

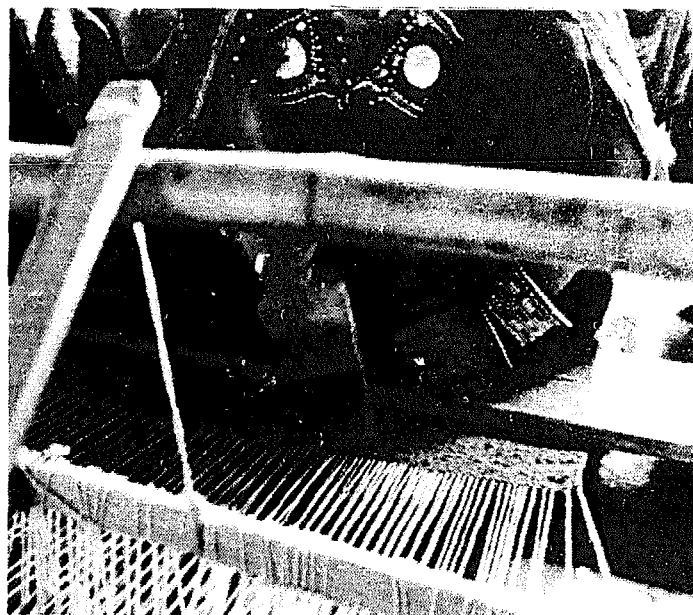

80 Dots to the inch

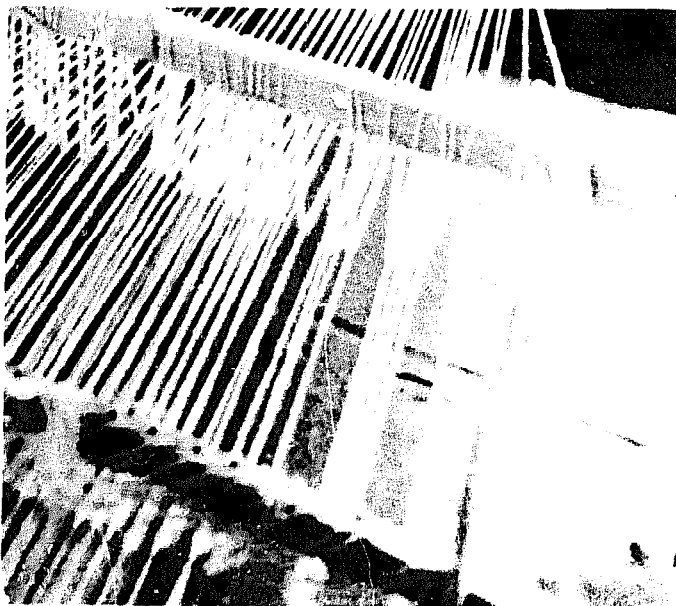

100 Dots to the inch

printing

After the composing, all the type, blocks and furniture are locked in the metal frame, the 'chase'. It is fixed to the press. The type is tightly locked in so that none falls out when carried round.

the presses

There are a lot of different sorts of letterpress presses. They all involve the inking of the type with rollers and the pressing of paper against the inked type - the impression.

The evenness of impression and of inking are important in good printing.

The oldest sort of press still in use is similar to those used by the earliest European printers but it is now made of metal.

The paper is put on top of the inked type and covered by padding and a pressure plate. The bed with type, paper and pressure plate is slid under the screw which presses down the paper against the type.

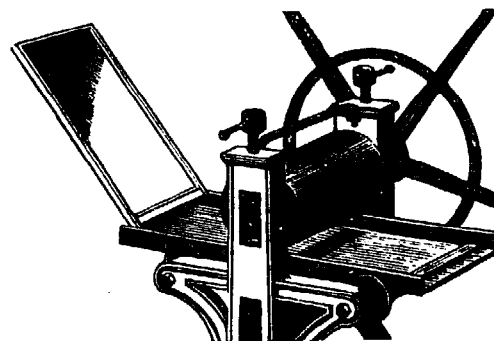

Proofing presses are flat bed presses in which a roller presses the paper down against the type.

Cylinder flat bed presses use similar principles. They print bigger sheets of paper. With this sort of press the paper is held on the impression cylinder. This goes round as the type is moved under it.

With older and smaller machines the paper is fed in and taken out by hand. Most have a motor that makes it move but some are operated by the machine minders foot.

More modern machines have an automatic paper feed. They can print far more quickly than the old hand fed presses.

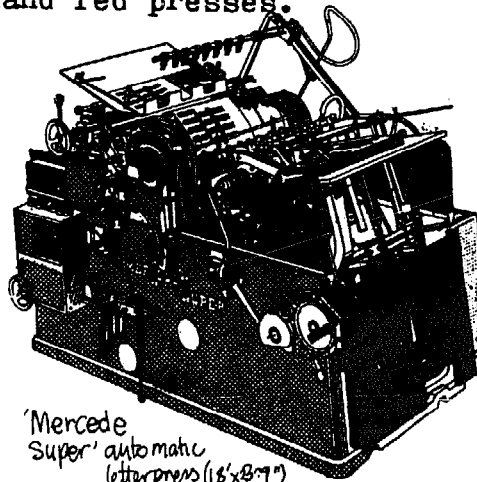

'Mercede
Super' automatic
letterpress (18x28-7)

problems

The margins on each page should be in the same place through out the publication. Hold up the pages to the light to check that the pages back up properly. You will then see if the margins on both sides of the paper are in the same place. A good printer can do this easily.

Show through

When printing 'shows through' the paper it can make reading double sided work difficult. Letterpress ink on some thin papers can do this. Care should be taken to use the right ink and paper. A thicker paper will be more expensive but may well be worth it.



Photos

Photos of fine dots printed on rough paper can be quite unrecognisable black squares. Care should be taken to choose a photo with good black and white contrasts. Use a good photo engraver. And make sure the dots are the right size for the paper. Use larger dots for rougher paper.

Letterpress indent

Correct printing with letterpress is meant to make the type just touch or 'kiss' the paper. Often the impression is harder and indents the paper. You can often feel the print and tell if it is letterpress because of this.

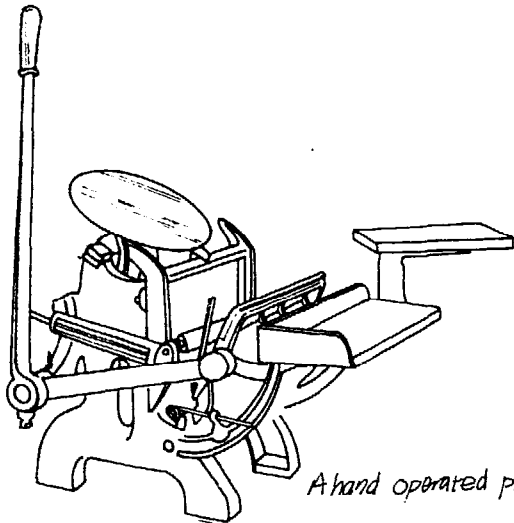

A hand operated platen press

The platen presses are the most common sort of press. They came in all sizes. Some only print on cards and fit on a desk. Others print on 20x15 ins. paper and are used by commercial jobbing printers. With platen presses the paper is brought up to the type which is held upright.

The rotary letterpress machine is used for very long runs, to print books and newspapers. The type has to be recast to fit round a cylinder. From this 1000s of copies are printed onto a roll of paper which is called a web.

A motor driven platen press

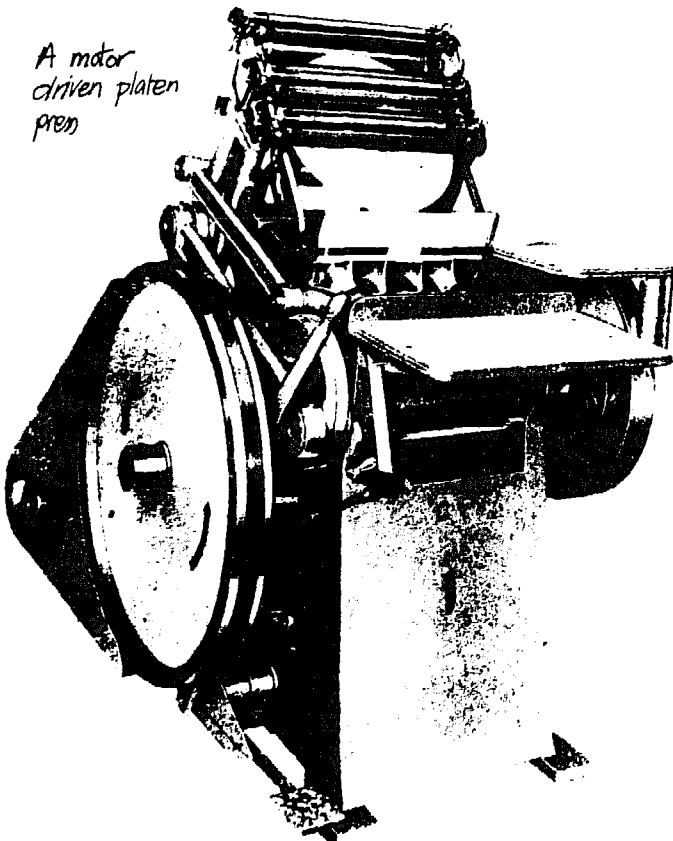

Words

A sizes - The Standard International Metric paper sizes.

Artwork - The original from which photographic print processes copy.

Blanket - The rubber roller that is an intermediate roller between the offset plate and the paper.

Bleed - To make an image go to the edge of the page. This is done by printing $\frac{1}{4}$ inch more image and trimming the sheet to the finished size.

Block - A piece of metal or wood with a raised image on the top of it. From which a picture is printed in letterpress printing.

Bold - heavy or thick typeface
Black - same as bold

Casting off - calculating the number of lines and spaces the text will take when typeset. Copy fitting is the same process but starting from a given space.

Chase - The frame in which the typeset page is held in letterpress printing.

Collating - putting each sheet of printed paper in the right order for binding.

Continuous tone - An image - like a photo - that is made of tones. To be printed they have to be converted into half tones.

Compositor - the printer who sets the type and arranges the page in letterpress printing.

Emulsion - usually the light sensitive chemical which is used on film & stencil.

Grid - the basic pattern of lines - marking margins and columns of a page.

Grip edge - the edge of the paper that is fed into the press first. It must be straight & square. It is usually impossible to print right to this edge, allow about $\frac{1}{8}$ to $\frac{1}{4}$ inch.

Gm² - grammes per square metre. A unit for measuring paper weight. Also 'gsm'.

Halftones - the photo or drawing in the dot pattern to represent the continuous tones of the original.

Imposition - the arrangement of the pages on the printed sheet of paper.

Impression roller - the roller which presses the paper against the stencil or blanket to make a print.

Knocking up - to make a pile of paper square by banging it against a flat surface.

Layout - A plan or drawing of the design of a page used to instruct compositors how to arrange the page.

Line film - a film that produces black and white images only. Used in plate and block making.

Letraset - a make of dry transfer lettering

Linotype - a make of hot metal casting & type setting machines that produce a whole line on one piece of metal.

Lower case - small letters, not capitals.

Make ready - the work adjusting the press to print a particular job.

Monotype - a make of hot metal typesetting machine; this one casts individual letters.

Moire - a pattern caused by putting two screens on top of each other.

Negative - how the film is once exposed and developed. The black image becomes clear film and the white image becomes emulsion.

Offset - short for offset litho printing. But also the process where the inked image is transferred from the plate onto the blanket and then on to the paper.

Opaque - not letting light through.

Paste up - to stick down artwork

Point - a unit of measurement used for type, 72 points in an inch

Perfect binding - a glue binding used for paper backs.

Pica - a unit of measurement used for layouts 6 picas in an inch

Proof - an initial copy of typesetting used to check for mistakes.

Page proof - an initial copy of type and page design - also used to check for mistakes.

Quire - 25 sheets of paper

Registration - printing in the right place on the paper so that the printed colours will fit together correctly.

Ream - 500 sheets of paper

Rules - used to print lines in letterpress

Scanner - an electronic stencil cutter

Screen - as in screen printing - a mesh of nylon or cotton stretched on a frame and used to print stencils.

- as in half tones - a sheet of glass or plastic with fine lines drawn on it. Through this photos are rephotographed to convert them into dots or half tones.

See through - When the printed image on the other side of the paper shows too clearly through the paper.

Tints and tones - a pattern of dots or other patterns that give the impression of a grey of other lighter colour.

Type high - the height of letterpress type and blocks - .918 of an inch.

Trim - to cut the edge of a printed sheet

Ultra Violet - light of a high frequency used to process plates and stencils

Upper case - capital letters

Web - printing paper in a roll, therefore a Web press will be one that prints onto a roll of paper rather than onto sheets.

ISBN 09508623 0 9

low cost printing for development

4

setting up
your own
printshop



by
Jonathan
Zeitlyn

Low cost printing for development

4

Setting up your own printshop

This is the 4th section of the handbook on low cost printing for development. There are 4 separate sections.

The 1st section is an introduction and about design. It covers:

- the background to this work
- alternatives to print
- planning
- choosing a print method
- design: ideas
- design: approaches
- design: techniques
- and finishing.

The 2nd section on do-it-yourself printing covers:

- block printing
- stencil duplicating
- screen printing
- hecto jelly pads
- spirit duplicating
- and photo copying.

The 3rd section is on using a printer and covers:

- dealing with a printer
- colour
- imposition
- offset litho printing
- letterpress printing
- and words.

Low cost printing for development Setting up your own printshop

Published by CENDIT
Centre for development
of instructional
technology.
D1 Soami Nagar
New Delhi 110 017
India

and Jonathan Zeitlyn
51 Chetwynd Road,
London NW5. UK.

with assistance of
FAO - Action for
Development / Freedom
from Hunger Campaign
PO Box 3059. New Delh:
110 003 India.

© Jonathan Zeitlyn 1982

Printed at Raj Bandhu Industrial
Company. New Delhi 110064

4

Contents

Have your own printshop decentralisation	1 1
Is there a need for a print shop ? and of what sort	2 2
Setting up:	
sharing resources	3
finding resources	3
organisation	4
as a community press	4
funding	4
What you will need:	
for stencil duplicating	5
for screen printing	7
for offset litho printing	9
for letterpress	12
Running a printshop	14
Project: the Graphic Media Development Centre	15
Project: A rural press in Africa	16
Project: The Lipikar Duplicator	17
Project: A low cost letterpress printing press	19
Project: A training workshop	20
Project: Screen printing in schools in Rajasthan	21
Further information	22
Paper	23
Fifth section	25

Have your own printshop!

The best way to be sure of access to low cost printing is to have your own printshop.

Access to print can create demand. Even the simplest printshop can begin to show people what they can do. Once they realise printing is accessible new uses will be discovered. New ways will be found to teach, to learn, and for people to communicate!

An accessible and non-commercial printshop can create a different relation with its customers.

Your own printshop can become specialised in solving your own problems. But it may also be relevant to other educational and development projects.

A printshop need not be a large factory concern, especially in the beginning. It may just be a cupboard and a space that can be used when the need arises.

decentralisation

The decentralisation of printing facilities can make printing more accessible to everyone. This can mean that access to print is gained where it is needed, in the countryside as well as in the cities. This creates a form of communication that is quite different from the usual use of print.

An example of this is the spread of 'in-plant' printing in the West. Small offset litho presses have been developed which are easy and convenient to use in offices. The office is therefore able to send out its own information without using an outside printer. Everything is in the control of the people who work in that office.

This example could be followed where there is a much greater and more real need. Schools, colleges, community centres, education, development and health projects could all make greater use of print. Every town could have some form of non-commercial community press. Instead of the large centralised printing factories a whole system of self-supporting small scale printshops could be established. A back-up service would be needed. But this would be easier with a simpler technology than with the large scale high technology.

Most of the methods described in this book are ideal for the creation of a decentralised printing network.

is there a need for a printshop?

If you are thinking of setting up a printshop, consider carefully :

- what you want to print at present and in the future.
- the number of copies you want.
- the sort of images you will use.
- the print method that is appropriate for the job.
- the cost of paper and other materials.
- the total cost of having it printed for you or doing it yourself.
- whether you would publish more if it were cheaper.
- the time - would it be quicker for you to do it yourself or for an outside printer to do it?
- whether other organisations and resources in your area could share the cost of running a printshop with you. They could perhaps be customers or help with buying the equipment or give money.
- whether your organisation has the time and space to organise and staff a printshop.

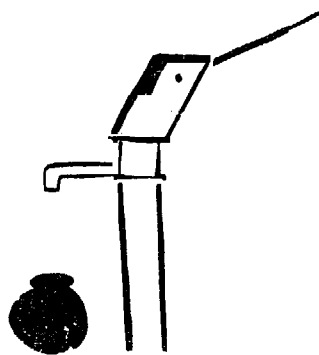

क्या आपके प्प में

- 1. क्या प्रकृतिक है ?
- 2. क्या कोकले का गणक है ?
- 3. आकरो के लिये पाठ्य है ?
- 4. एक और प्रकृतिक वाली है ?

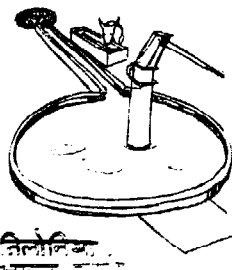

क्या नहीं है कलें नहीं ?

निलोनिज
अपना प्रकृतिक

and of what sort ?

Roughly there are three different sorts of non-commercial printshops.

1 Do-it-yourself printshops or resource centres.

Printshops can be places where people go to print their own publications themselves. These printshops will have fairly simple equipment. They will only need staff to show people how to use the equipment. They will also order materials and make sure that the equipment is running.

Screen printing and stencil duplicating are the most useful methods for these sorts of print shops.

2 In-plant

Many non-commercial organisations benefit from having their own print shop. This could be of varying scale, depending on the size of the organisation and its needs.

It may be worth re-thinking how the resources are used and sharing them with other groups and letting more people use them.

3 Independent presses

There are quite a few sorts of independent presses.

They are started:

- as a way of helping groups in an area develop and communicate.
- as a job creation project
- as a co-operative
- or as a private press for an individual or group.
- with political, social or educational objectives.

Setting up: Sharing resources

One of the best ways of setting up a printshop is by using existing facilities. Often they are more effective when more than one organisation uses them.

One organisation can give money, another a duplicator, another the space for the printshop itself and yet another workers to run the printshop. If the equipment and materials are taken out of the office and put in a printshop open to all, printing becomes more accessible. The more people use the printshop, the better it serves the community, and the more equipment and materials available the greater the possibilities.

Work on a larger scale at one printshop makes things cheaper. The paper, inks and other materials can be bought in bulk. Even staffing the printshop does not come too much work.

People working together and sharing equipment develop links. This could be useful in lots of ways and be extended into other areas. For example a local newspaper could cover health, agricultural and general development news.

In the printshop a small display of the work done can give people an idea of what is possible. It also acts as a source of news and information. This may become a small shop selling the publications produced at the press.

Finding resources

You may be surprised what resources you find under used or waiting to be used. If official permission is not possible you may be able to get access to printing resources after hours and unofficially.

The printing resources in many schools and colleges are under used. As well as producing its own material a school could produce educational material for other schools or local community groups. Then students would be learning about printing and design and helping the community at the same time.

Students will come to understand the subject better when they are required to design and print educational material for it. Students could even be paid to work after school to print off the educational material that the school needs. This may still be cheaper than buying commercial materials in the market.

Many institutions have useful printing, duplicating or other equipment. Often the problem is to get access to it. Local groups should find out about what these institutions have and demand access. This may benefit both sides and could improve the facilities.

Often in an institution the use of the printing equipment is restricted. Outside pressure ought to join with those inside who want access too. Apply to the people who run the institution but also to the people who use the equipment.

Organisation

Printing is often organised so that it is difficult for many people to use. The duplicator in the office for example may have a limited use because of where it is.

Small scale printshops can be organised differently.

Make sure people know how to use the equipment and can do so when they want. This is also important in keeping the printshop going when the main workers go away or are sick.

Larger printshops have to be legally organised.

Often an independent co-operative basis is a good way to work. It gives the people who do the work involvement and control. It frees the parent organisation from the legal responsibility without losing the easy access to print.

as a 'community' press.

What ever basis you start we hope you will become a 'community' press. That is serving your community.

As a non-commercial press you will also be free of commercial pressures. You can encourage small scale local publishing as well as helping useful educational projects.

funding

Low cost printing may be important to all kinds of concerns. And funding for print projects could be obtained under many headings.

Your printshop could be funded as a training or job creation project. It could be funded as a resource for health education, schools, adult literacy etc.

International aid and charitable organisations as well as government sources give grants. Care should be taken however that they do not try to operate censorship or lay down conditions on which you should operate. Make sure they do not give you equipment that will not be able to use or run effectively.

It may be possible to get a loan with which to buy the equipment and set up shop. The wages and running costs could come from the income of the press.

Some presses have begged, borrowed or been given equipment. Some government offices or commercial printers may have unused equipment stored away. Asking for equipment may be easier than asking for money. Though you may find old equipment for which it is impossible to get spare parts or repairs done.

Print projects have been funded by:

- Government-education departments
 - health education
 - agricultural extension
 - adult education
 - small scale industry
 - and co-op development

Aid from other governments and international charities independent agencies missionary projects and by self help.

What you will need:

A printshop will need space, people and equipment.

for stencil duplicating.

1 space

Stencil duplicating machines are often kept in a cupboard or on the table or floor. They hardly take up any space, and you can bring them out when you need to. But stencil duplicating can produce much better results if you give it a special space to work on it. And if you consider it in a new way.

To encourage this it may be useful to move the duplicator from the office to a special print or communications room. Here the duplicator and the stock of paper, stencils etc can be set up so they can be used easily. A stock of different coloured card and papers will encourage people to experiment and use them. A typewriter and table for cutting stencils should be set up as well. Examples of good duplicating on the walls will also encourage people to try out new ways of doing things.

Flat tables or working space make it possible for a group of people to take part. Everyone can gather round, learn what is done, and give their suggestions.

2 people

Stencil duplicating is so simple it is easy to presume that everyone can do it without help. But a

Kasturba Gandhi National Memorial Trust

STATION FOR THE SALES OF BOOKS AND PAMPHLETS

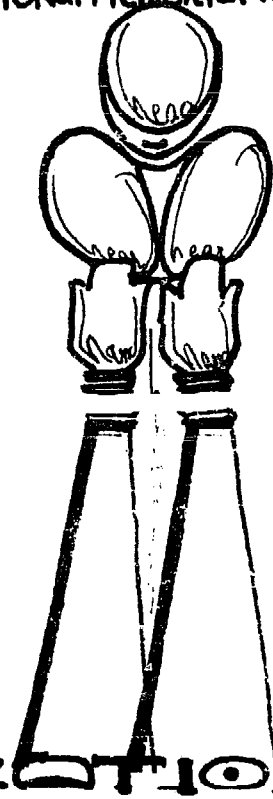

TRUST FOR THE SALES OF BOOKS AND PAMPHLETS

stencil duplicating self-help printshop must be staffed. Everyone who wants to use it should be trained how to do so properly without damaging the equipment. Remember an electronic stencil cutter is more delicate than the duplicator. So people are needed to teach everyone how to use it carefully and get the best out of the equipment available.

The print room will also need supervision. The stocks will have to be ordered and kept up. And if something goes wrong someone will have to be on call to mend it or get it mended.

You could run the stencil duplicating printshop on a service basis. This could be combined with a typing service and could be useful to small organisations. It could be run by one or two people. And they could pick up how to use the equipment quite easily.

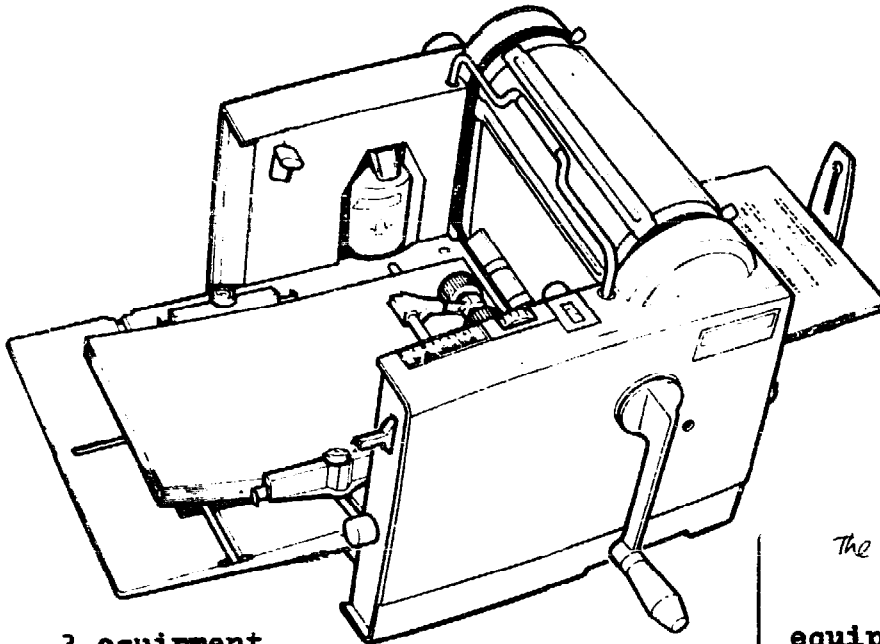

The Godelner 145.

3 equipment

A stencil duplicator can be bought quite cheaply without an electric motor. It is easy to use by hand without a motor, which is often an unnecessary luxury.

An electronic stencil cutter will extend the use of your duplicator. This is quite an expensive piece of equipment. It requires a regular electricity supply and is likely to go wrong and need maintenance. But it does enable you to duplicate all kinds of cuttings, pictures etc.

A duplicator can be used to print different colours and not just black. So more than one duplicator can be useful. The second one can be inked up in a second colour all the time. If this is not possible you can get a colour change kit for a 2 cylinder machine or a spare drum for a one drum machine. Or you could build yourself a flat bed duplicator to print the second colour.

Duplicating equipment is simple to maintain yourself, with the exception of the scanner. Stock up on spare parts and learn as much as possible how the machine works, and how it is taken apart and fits together again.

equipment list a duplicator

with an electric motor
or without.
with a colour change kit
or a spare drum.

a 2nd duplicator for a 2nd colour
or a flat bed duplicator.

an electronic stencil cutter

a typewriter

old ball point pens or styluses
and a stencil cutting sheet.

materials: typing stencils
drawing stencils
scanning stencils
black and other
coloured ink
absorbent paper and card
correcting fluid

spare parts: spare screens
drive belts
impression rollers
paper feed rollers
drum felt

What you will need:

for screen printing

1 space

Screen printing can be done on a very small scale. It needs just a cupboard to store the equipment and a table to use when printing. But it can be used for more sophisticated production on a full time basis which requires quite a large space.

Space is needed for printing and drying. Everything printed will need hanging up or spreading out so it can dry without touching the other prints. A drying rack is the best, but a clothes line will do.

Remember screen printing ink and solvents are not good to inhale. The screen printing room should therefore be well ventilated.

2 people

Screen printing is a manual process and requires a lot of work. But it is easy to do. It can be set up as a self help printshop or as a service press.

Screen printing takes quite a lot of time to do yourself. A poster will take about a day to print. After printing a few posters you will have picked up the process so that you will not need any further teaching.

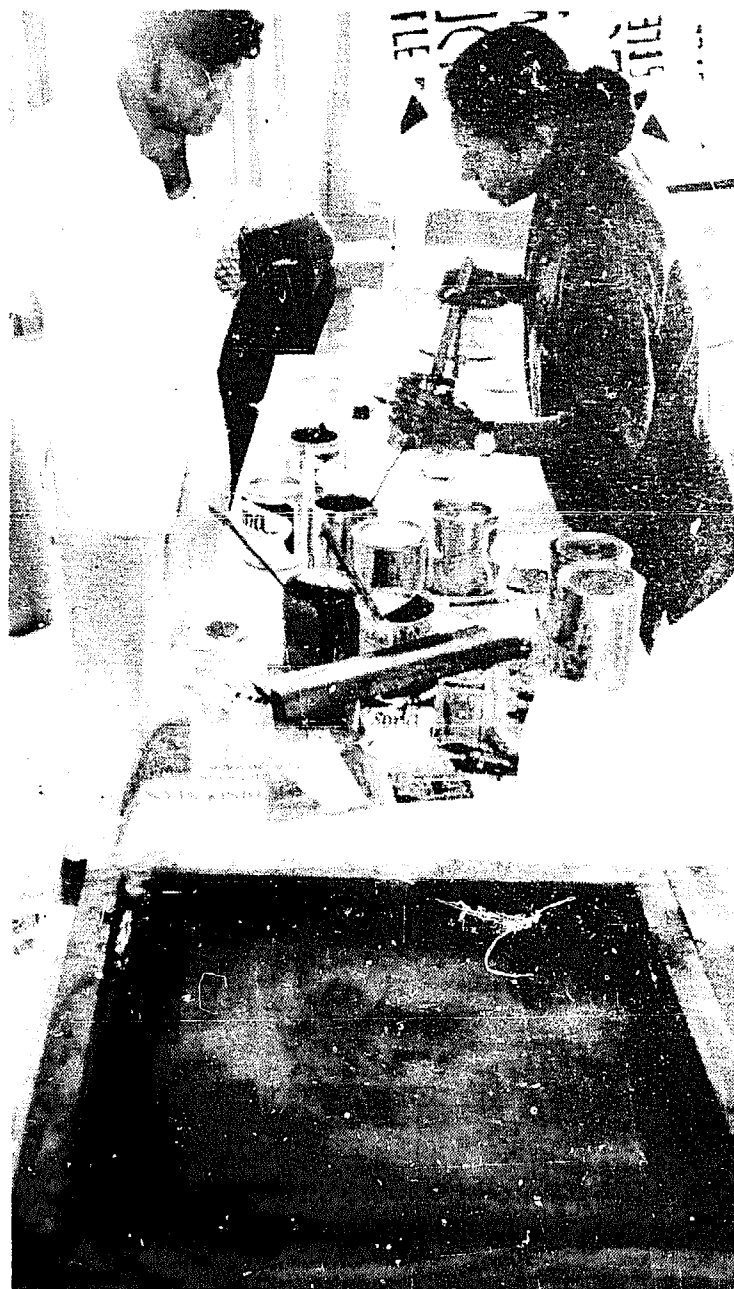

Mixing the screen ink at the training workshop.

It is best to do the printing with two or more people:

- one to print
- one to put the paper down under the screen
- and one to hang up the prints to dry.

Screen printing is cheap to set up. It is very useful for printing all kinds of things in fairly small numbers. It is therefore the ideal method for starting a printshop.

PRINT YOUR OWN RURAL NEWSPAPER



Materials needed: ① From a Silk-screen supply Company (eg. Coates Bros) - a piece of silk-screen silk (or nylon) 100x (add at least 10cm. each to outside dimensions of printing frame, a squeegee the width of the printing area. ② A rubber roller may be substituted for the squeegee-obtained from a Photographic supply or an Art supply store. ③ From Gestetner Company - Duplicating stencils come in two sizes: standard size, 23cm. x 16cm, and double size, 46cm. x 16cm. Make your frame to fit the size of stencil you want to use. Gestetner duplicating ink. You can obtain a stylus, a signature sheet and other accessories, but you can substitute a dry ballpoint pen for it and make a signature sheet by stretching silk-screen silk over cardboard. ④ From a hardware store - a gun stapler is easiest to use for stretching the silk, but it is expensive. Carpenter nails 1 1/2" and a hammer work just as well. Staple or tack the silk to the outside of the frame. Use brown paper tape on the inside of the frame over the corner near to the silk to keep ink from between the silk and frame. Shellac or varnish the paper after adhering. Use paraffin or turpentine for clean-up after printing. You can print your newspaper with just a loose frame. You can make a simple printing press by hinging the frame to a wooden base. For a fancy three-leg printing press use the scale drawing supplied. It's more fun to design your own from what you find in your local hardware store and your own back yard. ⑤ Patience and perseverance - you will need plenty of these, encouragement obtainable from sympathetic friends. For technical advice write Art Studio Africa, Transure Centre, P.O. Box 1319, Kitwe, Zambia.

3 equipment

You can make all the equipment yourself from locally available materials. Though you can also obtain it from specialist suppliers. It is worthwhile buying the fabric for the screen mesh and the squeegees from these suppliers.

Make several screens of different sizes for different sorts of jobs. Some with fine mesh for printing fine details and others with larger mesh for simpler jobs.

If you are using photo stencils you will need access to a darkroom or a room where you can work in yellow safe light.

Equipment list:

wooden screens of various sizes covered in fine nylon mesh or with cotton organdie.

base boards for screens
squeegees to fit inside screens
sharp knives for cutting stencils
paint brushes, pencils etc
spoons and jars for mixing ink.

Exposing frame for photo stencils and UV light source (though you can use the sun)
sink and running water to clean screens and wash out stencils

clothes line and pegs for drying prints or other arrangement.

materials

brown tape
stencil film and adhering fluid
filler
newsprint paper or other thin paper for cut stencils
screen inks
fabric dyes and binder
solvents and thinners

cotton rags and old newspapers for cleaning

paper to print on
masking tape

What you will need:

for offset litho printing

1 space

Offset litho presses are made in different sizes. Some presses are the size of duplicators and are used in offices. Others are huge presses used in large factories.

To keep an expensive press going involves quite a large turn over of work. You will therefore need space for paper storage, darkroom and platemaking, print storage, design and artwork areas and an office.

Offset presses have been set up in old garages, small shops or in a van (see page 15 on the Micro Mobile). But its good to have space in which to work effectively. A shop front for customers to come off the street easily would be useful.

The press itself will be heavy, noisy and vibrates. So it will need a strong floor, preferably stone or concrete.

2 people

Offset litho presses can be operated by just a few people. The makers of small offset presses offer 5 day courses in operating their presses. Many people have just picked up how to operate a machine. All it needs is a bit of help from other printers, the instruction manuals and the ability to learn from running the machine. But it is different from other printing methods. It requires a good knowledge of the particular machine to get good results.

Some printshops have arrangements for people to come and learn on the job. Obviously you will learn a lot from how another printshop solves the day to day problems.

Five people could run an offset printshop:

- two people as press operators
- one making plates and operating the process camera
- one doing paste up and design work
- one typesetter
- one office worker.

These roles can be interchangeable with everyone learning each job.

Offset litho printing is a specialised job. It involves a particular skill and craft. A community printshop with offset printing can advise people. It can help them produce their own artwork and show people whats involved in the printing of their job.

Essentially it is a full time occupation that requires trained and experienced workers to do successfully. The printshop will be a service press and not a self-help one.

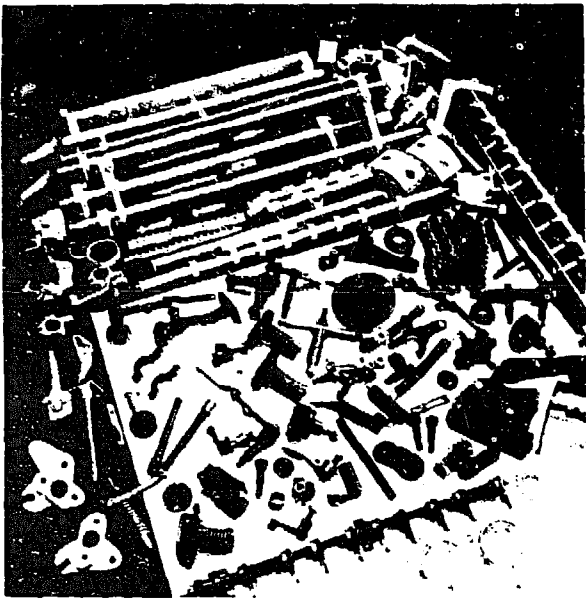

3 problems

Offset litho presses and ancillary equipment are quite complicated machinery. They need maintenance, skilled operators and the correct materials- chemicals, films, plates.

The problems of getting all of these in India have defeated quite a few organisations. They receive the latest offset equipment from well meaning foreign charities. But they find that the offset presses are too expensive to run. Also they cannot find the staff to operate this equipment. And cannot have the machines maintained and repaired. They have either left the machines unused or sold them.

Things will change, and the materials, maintenance and operators will become more available. This, we hope, will enable a wider use of small offset presses, making print cheaper.

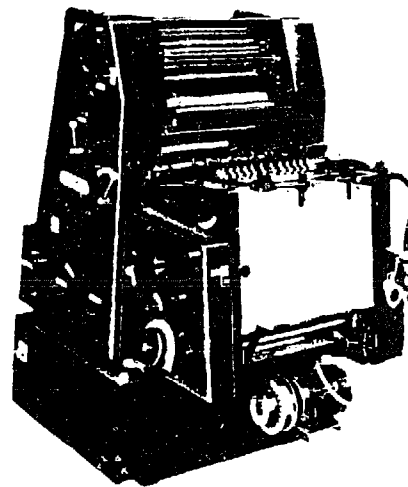

A Heidelberg offset press. It prints a one colour 13x18ins.

4 equipment

The equipment is mainly made in Europe, America and Japan. It is therefore expensive and involves all the difficulties of importing.

India is starting to produce it's own offset presses. Locally-produced machines are easier to have serviced and obtain spare parts. You must consider these two points when you buy complicated machinery like offset presses.

Small offset litho presses printing A4 or A3 paper have had quite an impact in the West. They have reduced the cost of printing and made it more available. It is these presses that are used in community printshops. They are bought second hand and are used for years. These printshops lack the capital to buy the latest equipment. They have learned how to keep old presses going, taking parts from older machines that do not work. This experience is more relevant to printers in the Third World than the techniques the western commercial printers use.

Some of the older offset presses were made to last longer and are easier to repair than the newer presses.

Offset litho presses are more expensive than letterpress presses. They are therefore less likely to be available cheap and second hand. But once established an offset press is cheaper to run.

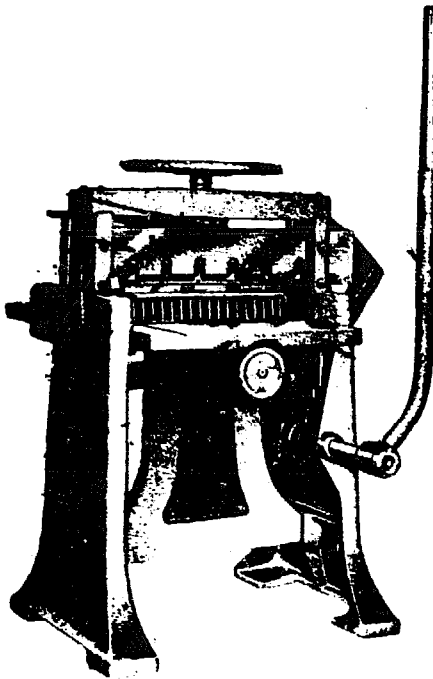

*a hand
operated
guillotine*

Remember the process of offset printing does not involve setting up a composing room with type and paying compositors to set type by hand.

Platemaking equipment could be avoided for some jobs. If you use direct image plates. But it is useful to make your own plates either with a copier or a process camera. Photographic materials and plates are expensive and require skill to use well. A whirler and a printing down frame will also be necessary to coat the plate and expose it.

Equipment to make artwork may be needed. Typesetting machinery is often very expensive. IBM compositors or the Varitypers are not as expensive as the latest photo setting machines. You can always get art-pulls from letterpress type. Or you can use a typewriter and hand drawn headlines. (like this book).

A guillotine for cutting paper to the right size for the press is useful as well. Many jobs need trimming after they have been printed.

Equipment list

Process camera
darkroom equipment
a whirler to coat plates
or
a photo copy type plate maker

An offset litho press

A guillotine

materials:

films and chemicals for use with the process camera

plates and chemicals

inks, thinner and solvents
fount solution
cleaning rags
knife to mix ink

stock of paper and card

Spare parts:

spare blanket covering
blades for guillotine
fount solution rollers

What you will need:

for letterpress printing

1 space

Letterpress needs room for the press and for composing. Composing will take up more space and more work than the printing. The presses are often large and old. Some are operated by hand or feet on a treadle though most use electric motors.

The composing room needs a lot of space because the type has to be stored there. The compositors who set the type by hand need space and light to work in. Once the type is set it has to be put together into pages and proofed, this requires more work space.

The composing and printing are separate processes. They can be set up in different places, though this involves taking set type from one place to the other all the time. One printer had his composing room in his front room and on his veranda, while the press was in a workshop in town!

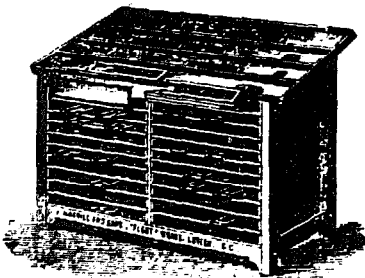

a stand holding type cases.

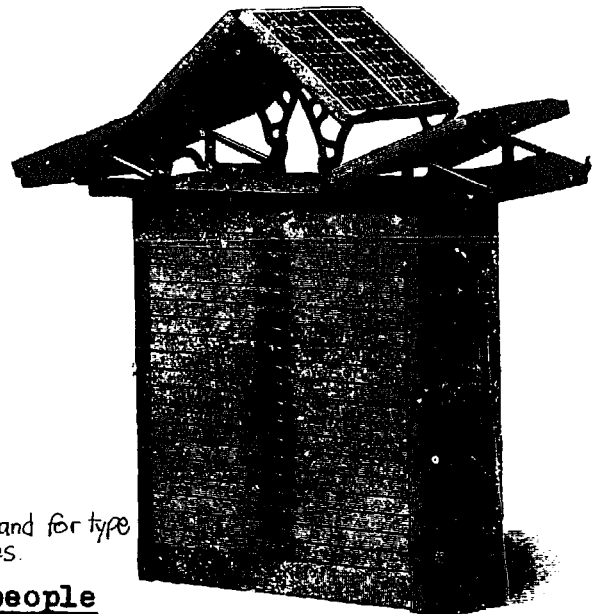

a stand for type cases.

2 people

The skill of setting type by hand takes between 3 to 6 months to acquire and to get quick at it. The process of hand setting and printing by letterpress is labour intensive. This is an advantage where there are a lot of unemployed people. Compositors are well paid when they are in a strong union.

A small press needs about 12 people:

- two for operating the press
- eight for composing
- one for proof reading
- one for doing the office work.

Hand setting may take time but a good compositor will be able to set 80 characters per minute. Though 120 are set by hand on newspapers.



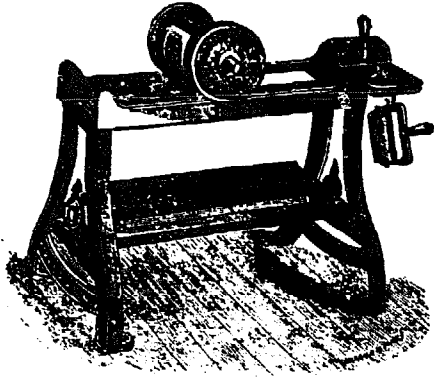

a proofing press

3 equipment

Old letterpress equipment is quite well distributed and therefore available second hand. It can vary from the old and basic to the small and modern.

The presses are usually slow. Many depend on feeding the paper by hand. The heavy job of the impression is usually done by a motor.

Buying all the type from the foundry, the cases to store it in, the furniture and frames is expensive.

You need to buy a lot of type to print longer works and to have the flexibility of design to print posters, leaflets and cards. Each will involve different styles and sizes of type.

A hot metal type casting and setting machine avoids this. It moulds and sets the type in one go from the text that is typed into the machine.

There are three basic machines:

- The Linotype, that produces lines of type
- The Monotype, that produces individual letters
- and Inter type.

These machines are complicated and expensive. They are quick and so are used for newspapers and books.

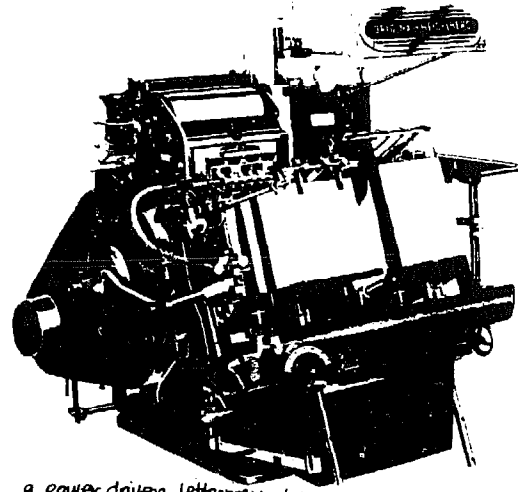

a power driven letterpress platen press

equipment list

Trays of type of different sizes and styles

Rules and ornaments
 composing sticks, furniture, frames and locks etc
 metal topped table and storage racks for type and frames etc.

a proofing press and roller

a letterpress press

a guillotine to cut paper and trim printed sheets.

materials

ink, thinner and cleaner
 paper and
 card.

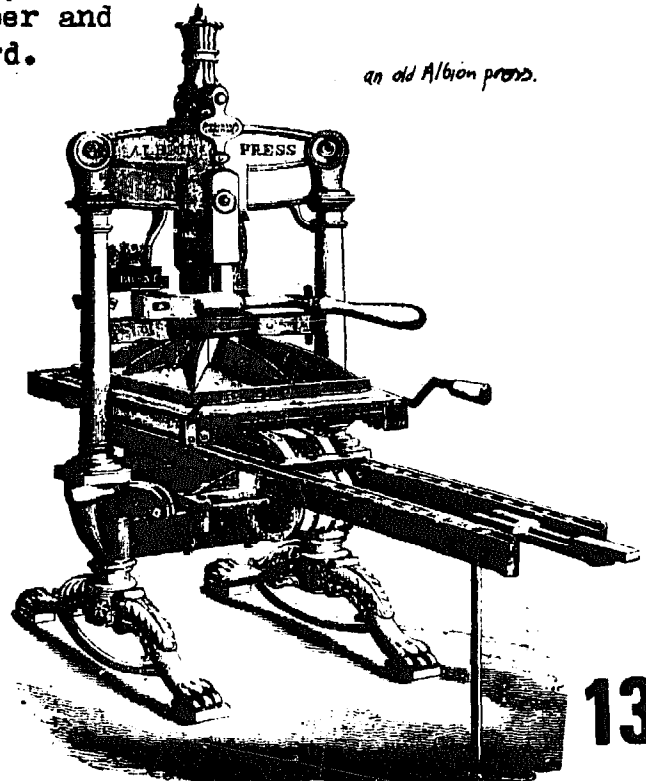

an old Albion press.

Running a printshop:

Cost

Whatever sort of printshop you are running it will be important to work out the true costs of the day to day work.

These will have to include all kinds of hidden costs:

- the electricity
- light
- rent
- insurance
- etc

It may be useful to add on 10% on each bill to cover replacing or buying new equipment.

The administration such as ordering paper etc has to be paid for or done by someone even if it is a Do-it-yourself resource centre.

Charges

You will have to decide what your charges will be. Obviously it will depend on if you have to cover all the costs or if the printshop is subsidised or is trying to make a profit.

You will have to decide what sort of work you are going to take on. Commercial work could be charged at commercial rates and this could be used to subsidise the non commercial work.

You could have a sliding scale of charges. So that groups with lots of money pay more than poorer groups.

advice

Keep two copies of everything that is printed in the printshop. This is a good way of keeping a record of the work that is being done.

It may be useful to have the name and address of the printshop on everthing that is printed. You can make a rubber stamp with this on.

Some printshops have instructions on the walls on how to operate the machinery. Instruction leaflets on printing, making artwork etc are also useful. They will be good reminders as well as advertising your services. Instructions on the walls on what to do if there is an accident are also useful.

Some printshops do not do any commercial work. While others have decided not to print any racist or sexist material. It is useful to discuss this before a test case comes up. Being clear what is commercial, racist or sexist may be difficult in the day to day working conditions.

Sharing the jobs in a printshop can be a good idea. Some Co-op presses rotate the different jobs of the press. This enables everyone to learn each job and for everyone to work equally.

project: The Graphic Media Development Centre

The Graphic Media Development Centre GMDC has been established by the Netherlands Government Printing and Publishing House. Within the framework of bilateral and multilateral development co-operation this graphic communication firm has since the middle sixties been involved in assisting printers and publishers in developing countries in their book and press development activities.

It has rendered assistance in the establishment of a book and press development centre in Indonesia (the Pusat Grafika Indonesia at Jakarta) and in the development of a number of university publishing houses. It has furthermore been involved in programmes of graphic communication in Columbia and Kenya and in communication projects in other countries in Africa, Asia and the Caribbean area. In Africa GMDC now takes part in the IFCAT project in Ghana, supporting visual communication expertise and technology and in Mozambique GMDC is in charge of the development of a Graphic Training and Production Centre.

GMDC aims with its activities at the development of graphic communication media in non-industrialized nations and seeks for that purpose to develop basic conditions for the establishment of graphic communication infrastructures. In supporting graphic media development GMDC works in an integrated approach. The development of graphic communication media in non-industrialized nations asks for a careful tuning of technical, editorial and managerial components as parts of a single entity. In this connection GMDC emphasizes the importance of operation models in which the employment of production facilities is effectively organized.

The design and construction of a micro mobile printing unit as a means for graphic media production in rural regions should be viewed within the context of this infrastructural and integrated approach. In developing this unit GMDC has worked together with the Press Development Co-operation Committee of the World Federation of Newspaper Publishers FIEJ in its efforts to find ways to reach rural readers. Within the framework of FIEJ rural press development activities 2 micro mobile printing units will be operated in non-industrialized nations i.e. in Indonesia and Kenya. Six more units will be used by the Indonesian Ministry of Education and Culture for purposes of non-formal education.

GMDC offers its services on a non-profit basis to international and national organizations for multilateral and bilateral assistance to governments and private institutions in developing countries in Asia, Africa and Latin-America.

Based upon former experiences those services are located in the following fields of practical action:

1. the preparation, implementation and/or advisory guidance of projects which primarily aim at the development of graphic media in non-industrialized nations.
2. participation in the preparation and/or execution of development projects as far as a support of the primary projects objectives can be obtained by the employment of graphic media.
3. the provision of advice and/or information concerning the set-up and implementation of graphic media development activities in non-industrialized nations.
4. the development and/or execution of training programmes in the field of graphic communication which are intended to be applied in developing countries as well as for training of people who from those countries are sent to GMDC.
5. the performance of research, among other things in the field of possible development of graphic systems which contribute to a socialization of graphic production techniques.

The micro mobile printing unit is the result of such a practice-oriented research.

Although during the past 10 years the Netherlands Government Printing and Publishing House has organized and implemented a considerable number of training courses, those courses were always project-bound and tailored to specific needs in the projects concerned.

Based upon these training experiences GMDC aims at the development in the nearest future of a number of standardized courses in the fields of print management and publishing management. Two standard classes in Print Production and Graphic Design can be taken.

Training may be supplied in graphic techniques, graphic design, publishing techniques, cost calculation and production administration but those skills will always be treated in their contribution to the overall print or publishing organization and management.

GRAPHIC

MEDIA

DEVELOPMENT

CENTRE

netherlands government printing
and publishing house

1. christoffel plantinstraat
p.o. box 20014 2500 EA the hague

the netherlands
telephone (070) - 78 95 53

telex 3 24 88 STDRU
gsm 42 50 50

Pictures of the micro mobile printing unit



project:

a Rural press in Africa

In several countries in Africa the need for a rural press is being acted on. Various levels of technology have been tried.

Many projects have used stencil duplicating. Most notably in Liberia duplicating is used to produce newsheets. These have been going for quite a few years.

In Zambia the district community development officers produce district newsheets using stencil duplicating.

In Zambia and in West Africa a version of the flat bed duplicator has been developed and put into use. Called the Limograph, it is a simple small screen set up using duplicating ink and stencils. In Niger these are used successfully at Village level.

PERSPECTIVE DRAWING OF SILK-SCREEN DUPLICATOR - PRINTING POSITION.

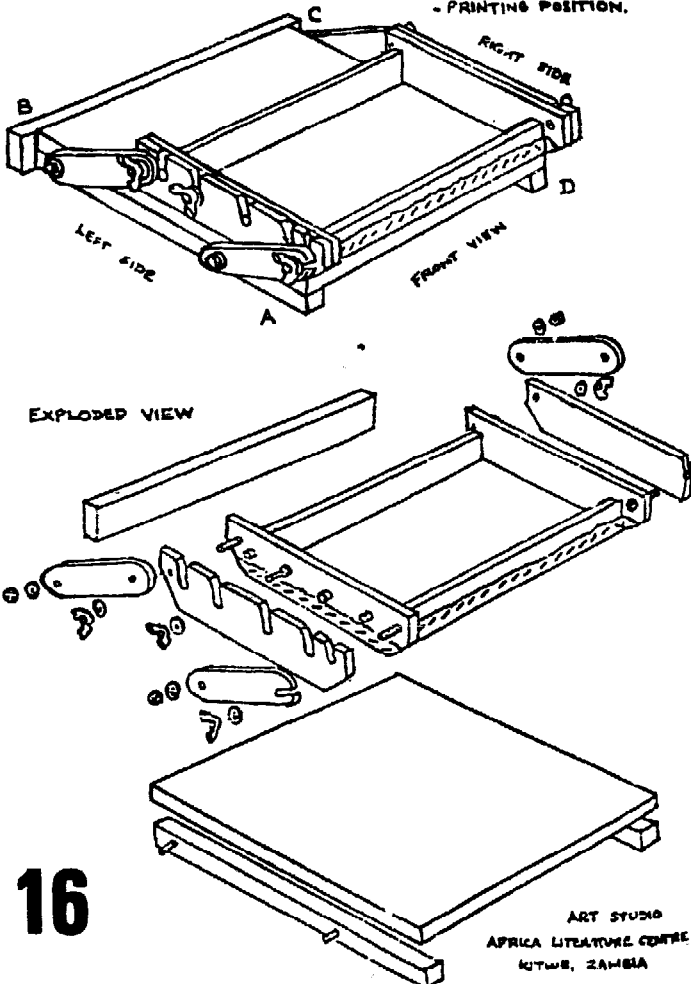

16

N°1. DECEMBRE 1977
5^e séminaire biennal
Panafrique d'Afrolit
NAIROBI - KENYA

AFROLIT
Informations

JOURNAL BI-ANNUEL EDITÉ PAR LE GROUPE FRANCOPHONE

Editorial

NOUS FERONS L'IMPOSSIBLE

A politique, non gouvernementale et non confessionnelle, "AFROLIT" désigne un organisme international groupant les éducateurs des adultes et les communicateurs de masses en vue de combattre l'analphabétisme en Afrique.

A-t-elle réellement atteint son but? ou tout au moins, a-t-elle progressé vers son accomplissement?

En dix ans de temps, pensons-nous, prématuré de formuler un jugement de valeur pour une association de nature professionnelle quelque peu ambitieuse.

Beaucoup de gouvernements n'ont pas planifié l'éradication totale de l'analphabétisme avant la fin de ce siècle?

Certes, le continent africain demeure

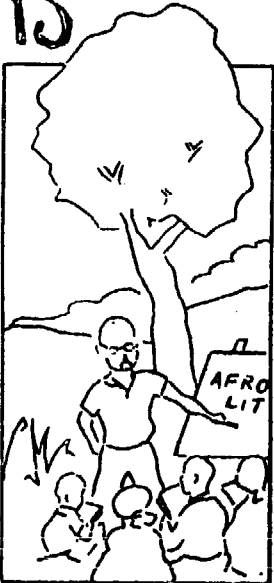

Sommaire:

- Presse Rurale ou Presse Rurales? ... P. 3
- Comment faire une bonne illustration P. 5
- Du limographe à la machine offset... P. 7
- La description dominicaine ... P. 11

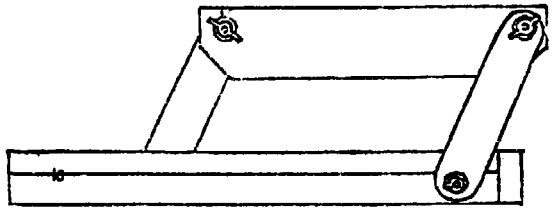

ELEVATION (RIGHT SIDE) - RAISED POSITION.

For more information and plans of this design for a flat bed duplicator contact:
The Art Studio
Africa Literature Centre
PO Box 1319
Kitwe, Zambia
or
Afrolit Society
PO Box 72511
Nairobi, Kenya.

project : the Lipikar Duplicator

The Lipikar duplicator was developed originally during the Emergency of 1971 in Bangladesh by Dr Salahuddin.

Lipikar Industries has been set up to make these duplicators. They can be made quite simply - they have only ten components, are easy to maintain and they need minimal training to operate.

In Bangladesh they cost £15-£30 compared to imported duplicators which cost around £400.

Lipikar Industries are being helped to develop their machine by 'ITIS' a part of the Intermediate Technology Development Group.

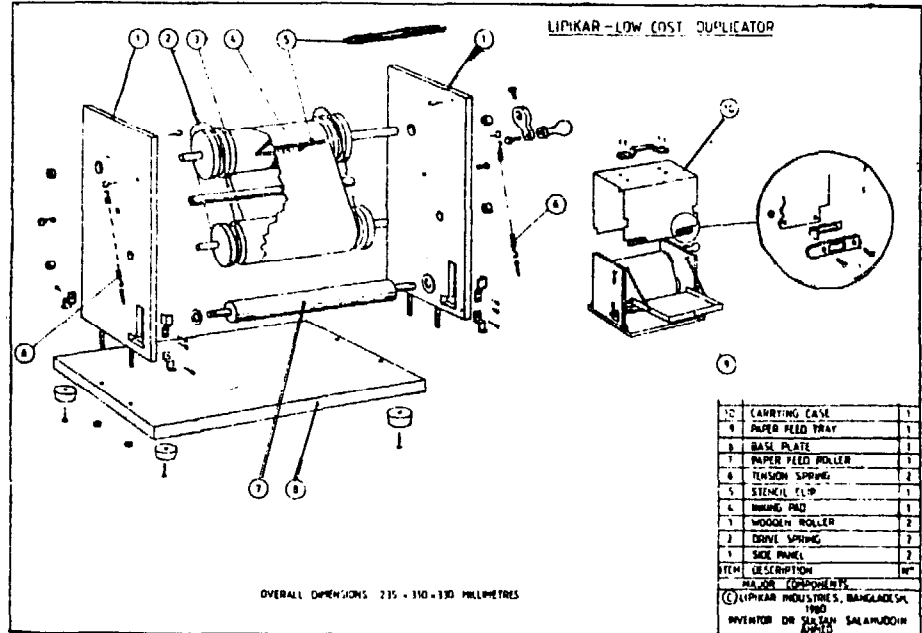

Metal-covered Redesigned Model of Lipikar Duplicator



Dr. Salahuddin with a wooden version of his invention.

Further Information from
ITIS
Myson House
Railway Terrace
Rugby CV21 3HT
or
Lipikar Industries
31 D.O.H.S. Dacca Cantt.
Dacca
Bangladesh.

The Low Cost Wooden stencil duplicator is a cheap printing machine which can be made for use in schools, colleges and small organisations. From one inking, with practice you can produce over 200 copies of good quality print. The quality of the print is nearly as good as that from much more expensive machines. The duplicator is made mostly from wood and you need only simple woodwork tools to build it. It is very easy to use and maintain. Broken or damaged parts are simple to replace because you can probably make them yourself. Because the machine is small and made from wood it is very easy and light to carry around.

1 A single drum is covered with an ink absorbent material which the stencil is placed over.

2 The pressure roller is turned by a simple handle, this rolls the paper over the stencil and ink is squeezed onto the paper.

3 The pressure roller and stencil drum are squeezed together by rubber bands. These can be made by cutting bands from a bicycle tyre inner tube. Different thicknesses of paper may require extra bands to give greater pressure.

4 The hinged covers which give protection for carrying and storage are also the serving and collecting trays for the paper.

5 The deflector plate guides the paper to the front of the machine.

When closed the unit stores the handles, clamp, inking roller and duplicating ink inside the box.

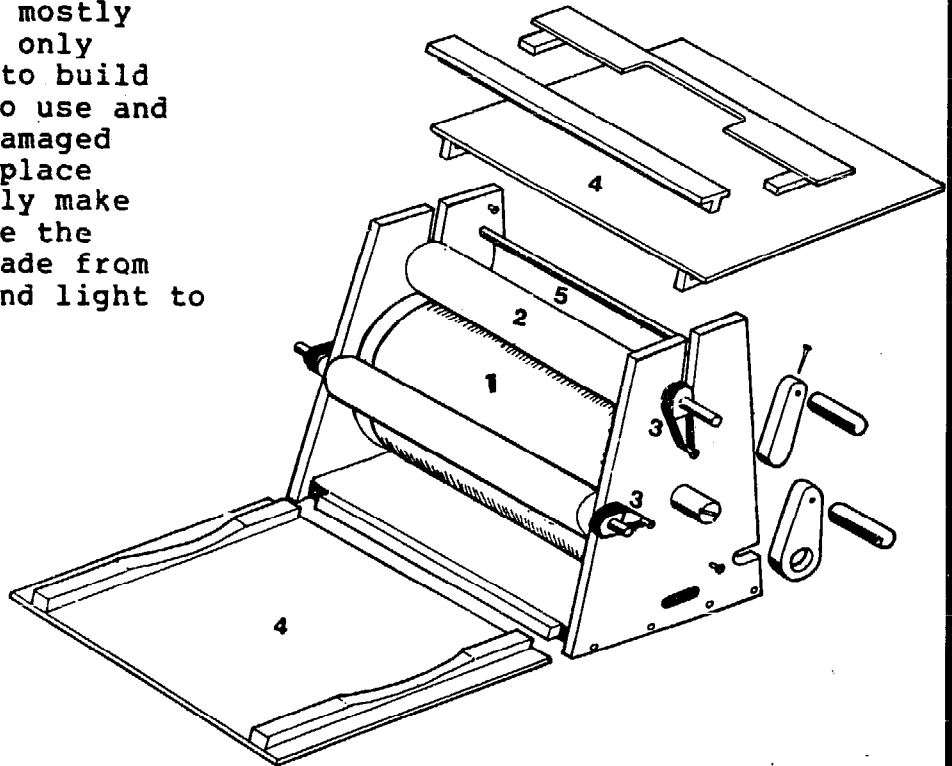

The redesigned wooden duplicator.

The original idea for a low cost, alternative technology duplicator came from Dr Salahuddin, of Lipikar Industries in Bangladesh, who are now making their own versions with the help of the Intermediate Technology Development Group Ltd. The industrial services section of ITDG has also instigated further developments with the help of David Elcock, Senior Lecturer in the Combined Engineering Department at Coventry Lanchester Polytechnic. These improvements have been incorporated in this machine.

ITDG Printing Panel

ITDG have a panel of experts who can advise on all aspects of printing and they meet regularly to discuss enquiries from overseas. After seeing the initial low cost duplicator, they gave full support for further developments.

The panel would be willing to answer any specific requests on printing techniques with this device. All you need to do is to write to ITDG, 9 King St, London WC2E 8HN, UK.

Project:

a low cost letterpress printing press.

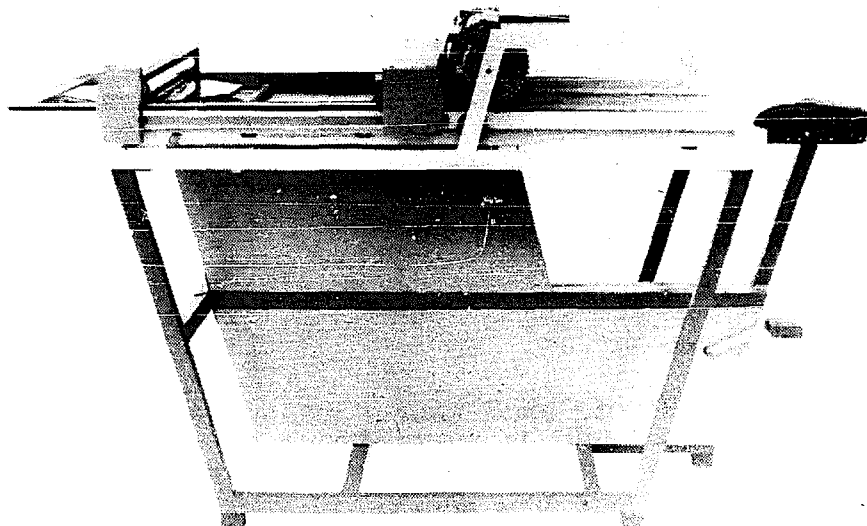

Most small presses in India use Letterpress. They do not have the capital or knowledge to keep up with the larger printers and buy the latest machinery.

To help these small printers a designer, Vikram Panchal at the National Institute of Design in Ahmedabad India has designed a new sort of press.

He has looked at the problems of the small printers and all the technical possibilities. From this work and using simple components and available techniques he has produced a prototype.

It uses the basic cylinder press design but with several clever developments. The operator powers the machine by pedal just like a bicycle. Though it can be powered by an electric motor or by hand.

It could be a very useful machine. It needs however to be taken up by a manufacturer or a sponsor, so that it can be tested in use. It also needs to be produced in quantity and at a price that the small printer can afford.

The machine works on a flatbed principle. It can print paper up to 9x12 inches. It uses the conventional type and blocks of letterpress printing. Being a flat bed it can have the type just

locked in place with magnets instead of the normal frame.

It has:

- an ink duct for controlling ink flow,
- an ink distribution disc
- ink distributing rollers
- an impression cylinder with built in grippers
- and a paper feeding platform with a paper margin.

The ink distributing rollers are adjustable for pressure. Paper feeding and removing is done by hand.

This machine has an adjustable seat and can be operated by hand with either foot or electric power. When it is to be manually operated, the superstructure can be removed and the machine can be used on a table top. The space below can be utilised for storage. The machine is made of mild steel and other standard parts. It occupies a space of 6x3 ft.

For more information contact
Vikram Panchal
National Institute of Design
Paldi, Ahmedabad. 380007
India

project: A training workshop

One of the most useful contributions to this handbook was from a training workshop run in Delhi in September 81. It was organised by CENDIT and the Vishwa Yuvak Kendra.

The training workshop is a way of raising the possibilities of Do-It Yourself printing. It encourages the sharing of resources and the development of resource centres.

For 6 days people who had come from all over India, got together to print. We had 2 duplicators and a scanner lent to us by Gestetner.

We also had 4 screens hand made for the workshop. Most of the participants had never printed with this sort of equipment before. And the scanner and the coloured ink in the duplicators proved popular. Two or three colours were used on some leaflets.



Screen printing also worked well. The screens were stretched and stencils made and posters printed there and then.

Most participants produced one or more duplicated sheets. Nearly everyone made a poster using screen printing. We also talked about design and planning and letterpress printing.

The workshop finished with every one being presented with a certificate that had been designed and printed in the workshop.

The workshop succeeded in letting people experiment and use the equipment. Hopefully it also made them think about its potential for their work.

More information from
CENDIT

D1 Soami Nagar
New Delhi 110 017
India.

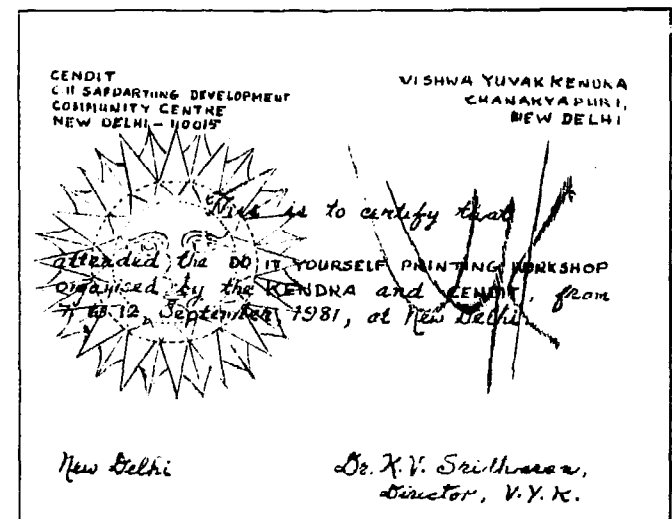

The 'certificate' produced by the participants of the training workshop for themselves.

Project: Screen printing in Schools in Rajasthan, India.

It is difficult to get posters showing simple geographical and scientific ideas in Rajasthan, India. The Audio-Visual Aids Centre of the Rajasthan Government education Department has used screen printing to solve this problem.

They recently held a training session for teachers from schools through out Rajasthan. They showed them how to screen print their own wall chart and posters.

The Audio-Visual Aids Centre assembled a 'kit' of screens, mesh, inks solvents and stencil material. So each school that attended the workshop could set up their own print unit. This could then be used to print wall charts and anything else that the schools needed in their district.

It is hoped that school students will help with the work. They will then be able to learn printing as well as produce useful educational material.

Further Information from
Mr Ahad

Audio Visual Aids Centre
Opposite the Bus Station
Ajmer, Rajasthan,
India

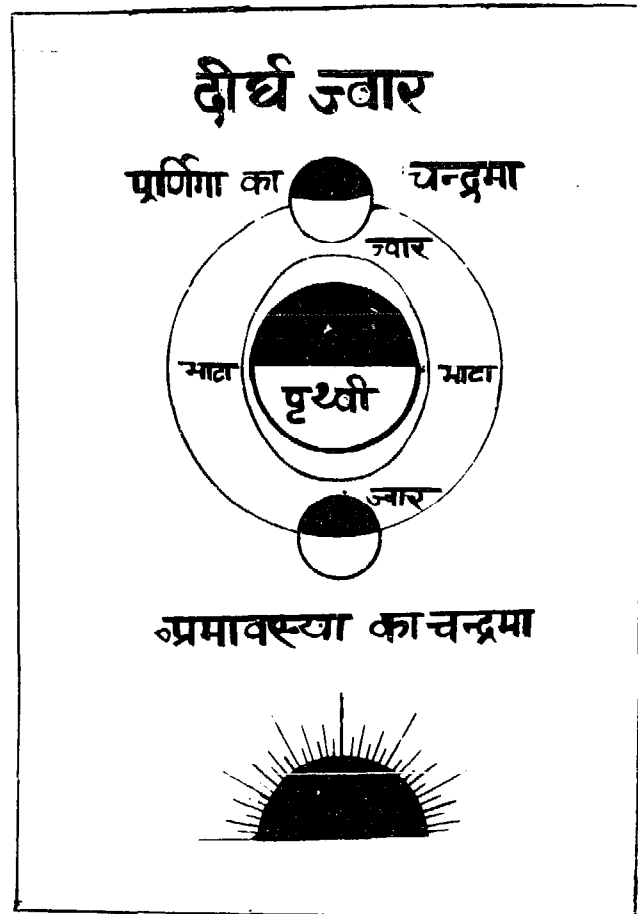

A Poster screen printed at the Audio Visual Aids Centre Ajmer, Rajasthan India.

अभ्यास हेतु एक और चित्र-संयोजन का नमूना

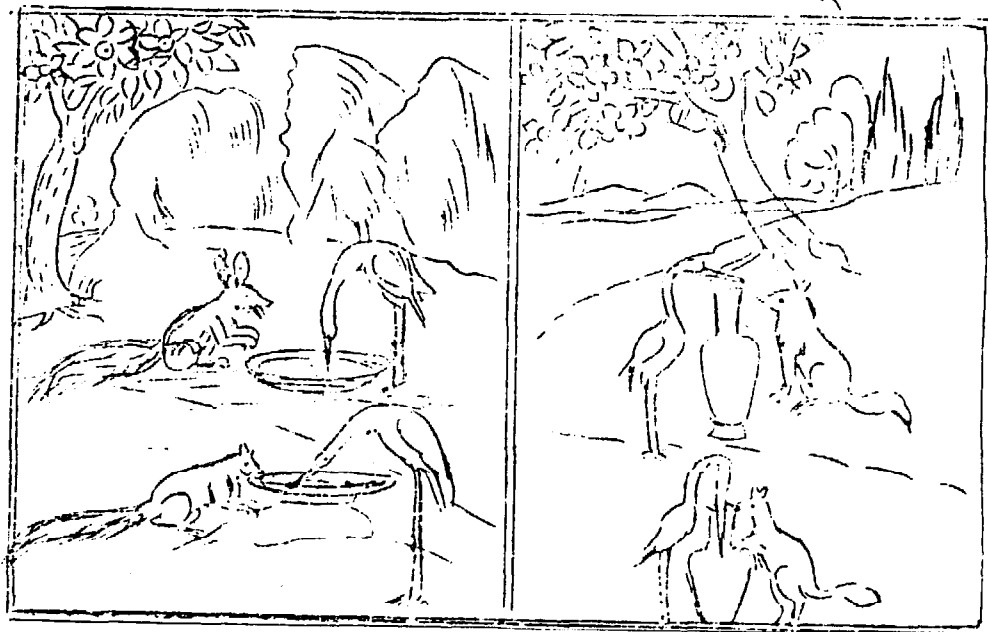

A duplicated Visual Aid from the Audio visual Aids centre Ajmer.

Further Information. organisations

Afrolit
PO Box 72511
Nairobi, Kenya

CENDIT
D1 Soami Nagar
New Delhi 110 017
India

Development Communication Report
Clearinghouse on Development
Communication.
1414 22nd St NW
Washington DC. 20037
USA

Graphic Media Development Centre
Netherlands Government Printing
and Publishing House
1 Christoffel Plantijnstraat
The Hague, The Netherlands

IFID
Information for International
Development.
Denmans, Aller, Langport
Somerset TA10 0QN
UK

Skills
Elliot's Beach Rd
Besant Nagar, Madras, 600 090
India

Intermediate Technology Development
Group. 9 King St London WC2. UK.

Books

Printing It
By Clifford Burke
Wingbow Press, Berkeley, USA
from Book People, 2940 Seventh St.
Berkeley, California 94710, USA

Graphic Communication
By Richard J. Broekhuizen
McKnight Publishing Co
Bloomington, Illinois 61701, USA

Production for the Graphic
Designer
James Craig
Watson-Guptill Publications
New York &
Pitman Publishing
39 Parker St
London WC2. UK

Studio Tips
Bill Gray
Van Nostrand Reinhold Co
Molly Millars Lane, Wokingham
Berks. UK

Printing Reproduction Pocket Pal
edited by Leslie H May
Advertising Agency Production
Association
44 Belgrave Sq London SW1. UK.

Illustrated Graphics Glossary
Ken Garland
Barrie & Jenkins
3 Fitzroy Sq
London W1. UK

Print: how you can do it yourself
J Zeitlyn
Inter-Action Inprint
15 Wilkin St London NW5. UK.

Photomechanics and printing
by J.S. Mertle & G.L. Monsen
Oxford & IBH Publishing Co
Oxford Bldg. N88 Connaught Circus
New Delhi, India

Appropriate technology for low
cost printing
By Reginald Payne
Caribbean Reprographics unit
PO Box 792 St Johns Antigua.

Paper

There are a large variety of different papers. They differ in size, thickness or weight and in finish - the surface quality.

Paper usually comes in packets of 500 sheets - called a ream.

Paper sizes

There are various standard systems of paper size. The standard international metric sizes (the A sizes) the American and the British traditional paper sizes.

You save money if you design your publication using a standard paper size. That is, a size that fits the press and doesn't involve wastage when cut from a large sheet.

The Standard International Metric Sizes:

- A0 841mm x 1189mm
- A1 594mm x 841mm
- A2 420mm x 594mm
- A3 297mm x 420mm
- A4 210mm x 297mm
- A5 148mm x 210mm
- A6 105mm x 148mm

A1 and A2 sizes are also made slightly larger so that they can be trimmed down to an A size when printed. These are the SRA and the RA sizes:

- SRA1 640mm x 900mm
- SRA2 450mm x 640mm
- RA1 610mm x 860mm
- RA2 430mm x 610mm

The American system:

The American system has a different 'basic weight' standard sizes for different sorts of paper. They are:

- Bond 17 x 22 inches
- newsprint 24 x 36
- book 25 x 38
- cover 20 x 26
- duplicator 17 x 22
- ledger 17 x 22
- offset 25 x 38

The common cut sizes are:

- 8 $\frac{1}{2}$ x 11
- 8 $\frac{1}{2}$ x 14
- 11 x 14 $\frac{1}{2}$
- 9 $\frac{1}{2}$ x 12 $\frac{1}{2}$
- 10 x 13

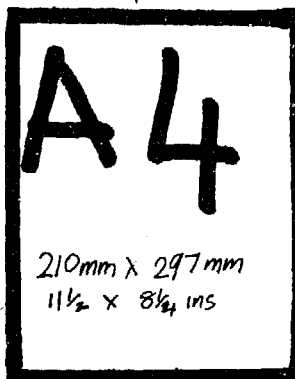
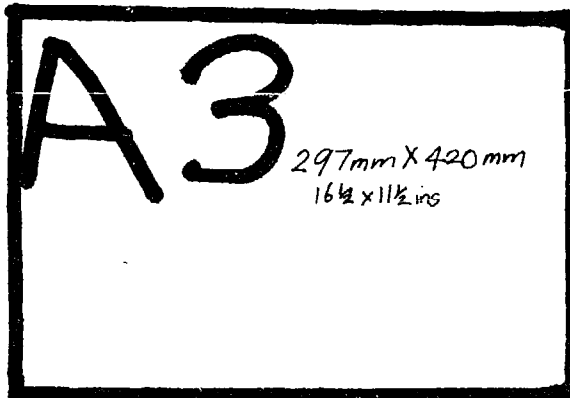
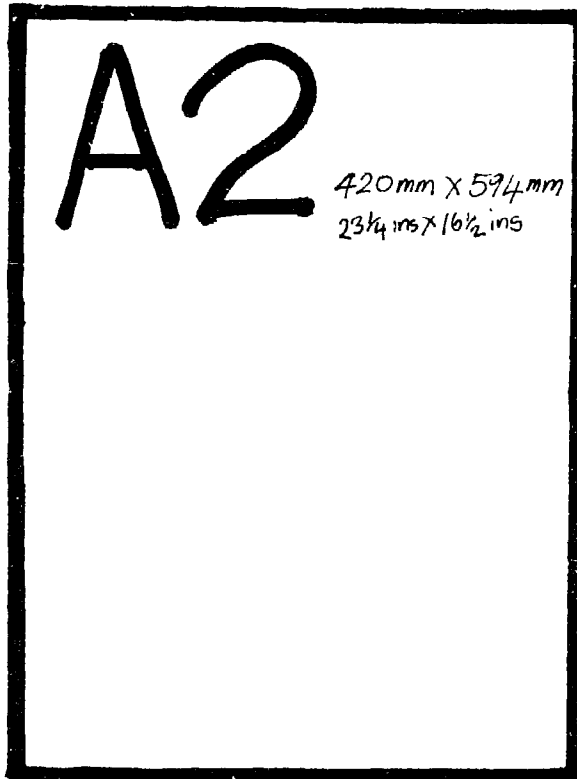

The traditional British paper sizes (in Inches)

Crown 15 x 20 inches
double crown 20 x 30
quad crown 30 x 40
demy 17½ x 22½
small demy 15½ x 20
double demy 22½ x 35
quad demy 35 x 45

foolscap 13½ x 17
small foolscap 13½ x 16½
double foolscap 17 x 27
quad foolscap 27 x 34

imperial 22 x 30

medium 18 x 23
double medium 23 x 36

post 15½ x 19
large post 16½ x 21
double large post 21 x 33

royal 20 x 25
double royal 25 x 40

When the sheet is folded in half the page size produced is called 'folio'. When it is folded again the pages are quarto and so on.

Stencil duplicators take up to foolscap size paper - 8½x13ins and quarto 10x8 ins.

Wiggins Teape, a large paper manufacturer with offices throughout the world make paper in 'A' sizes and in Large Post 16½x21 ins and Double Cap 43x68.5cm. They also cut sizes in Quarto 10x8 ins and foolscap 8½x13ins.

Ask the printers the size of paper that their press takes and work on that.

paper weights

Paper weight is the measurement for how thick the paper is.

In metric units it is measured in Grammes per square metre - 'gsm'. The most usual weights are 70gsm or 85gsm.

Paper is also measured in pounds or kilos per ream - which may be important if the paper price is given per kilo at the paper merchants.

American paper weights

The weight of a ream of the 'base size is used as a standard measure of weight. This varies with the sort of paper. See the American paper sizes.

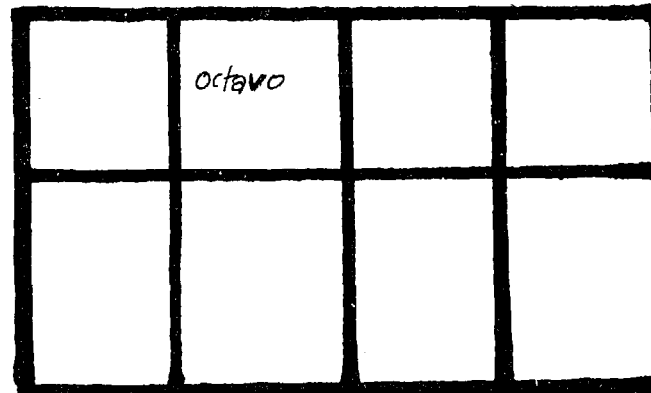
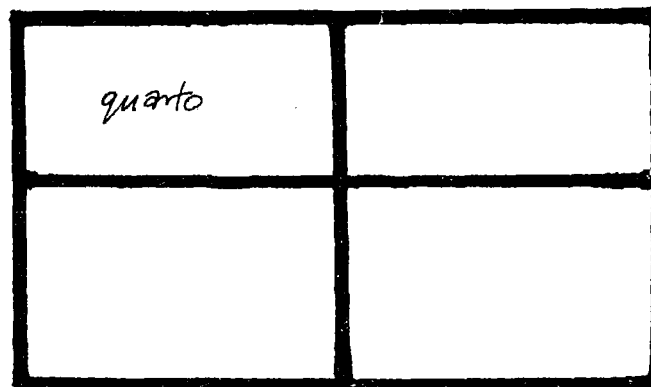
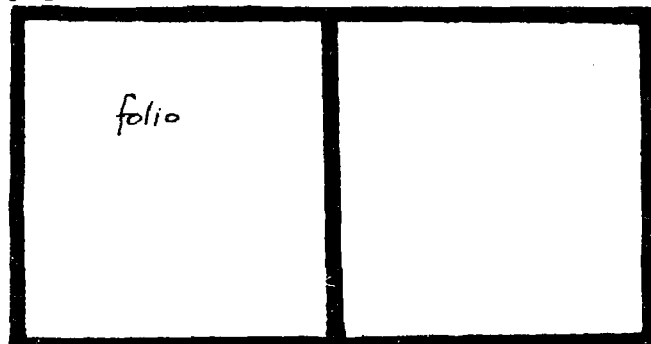

the fifth section

The 4 sections of this book should be accompanied by a 5th section that you will have to compile. You could even print it yourself. It should be a local directory which includes all the addresses and information about:

- small scale publishers
- paper merchants
- suppliers of ink and other materials
- useful printers: offset
letterpress
- photo copiers that can be used
- duplicators that can be used
- resource centres and community presses
- other useful resources
- helpful experts and organisations
- mechanics and engineers who can repair and maintain your equipment
- type foundries
- block makers, plate makers and specialist photo studios
- artshops or suppliers of pens, paints, paper card etc.

Send out a questionnaire and compile this directory. You could print or duplicate it and send it to other interested organisations. You may even be able to get advertisers to pay for it.

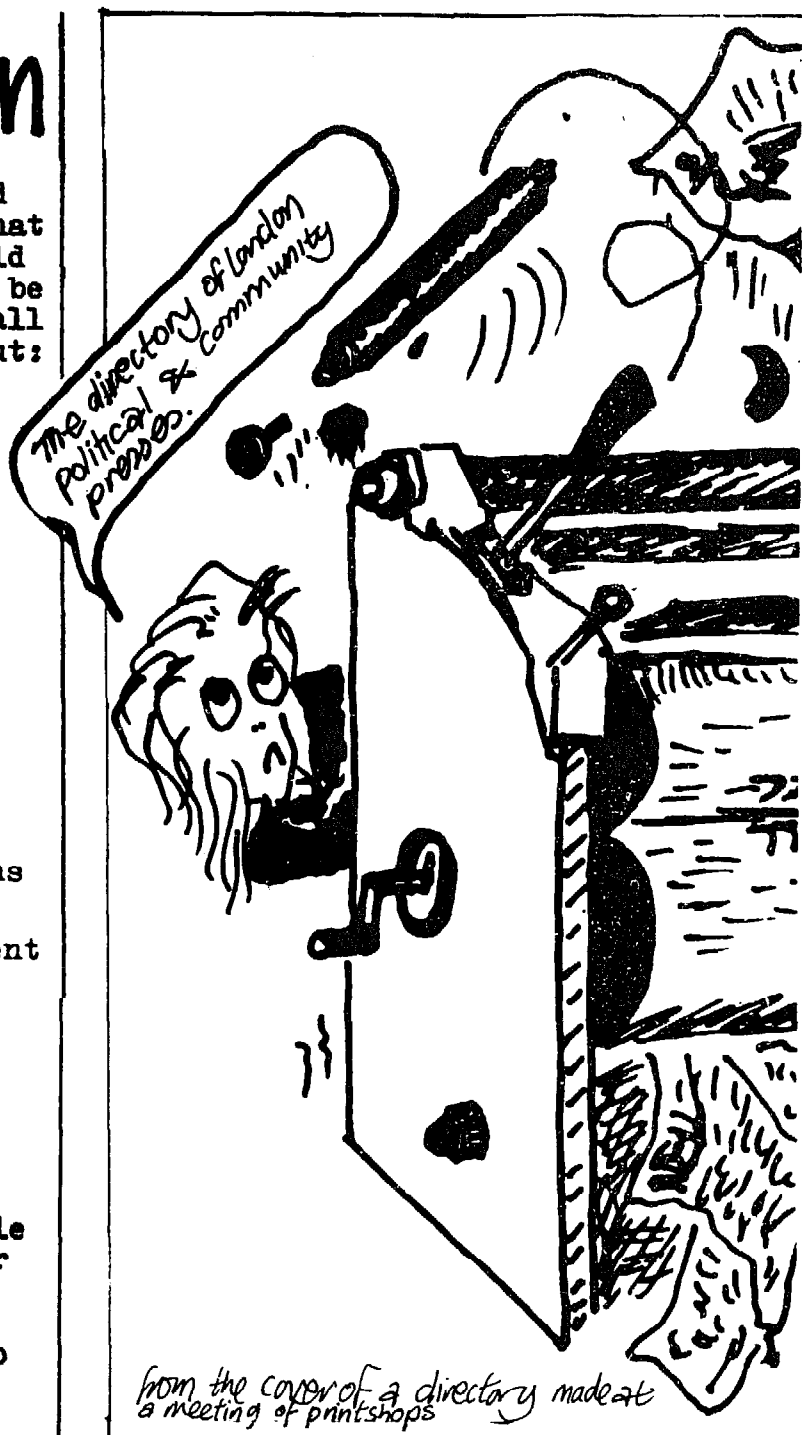

from the cover of a directory made at a meeting of printshops

In Britain various directories of the community presses have been produced. One at a national meeting was made by each press bringing a sheet about themselves. These were then collated by the participants and formed a directory instantly.

Production details...

This handbook was written designed, and layed out by Jonathan Zeitlyn.

Sam McCarter helped simplyfy the text. And Alan Stanton proof read the finished typing.

Bromides were made at Redesign. Typesetting was done at Bread and Roses.

'ITIS', part of the Intermediate Technology Development Group gave a grant to pay for the negatives.

Printing negatives were made at the Islington Community Press. 2a St Pauls Rd London N1. UK.

feedback.

This is a pilot edition.

We hope to publish a revised extended and improved edition. Your help is therefore needed.

We are interested to have your comments, questions, ideas of improvements to make the next edition better.

Did you find any of the text or illustrations confusing ?

Are there areas not covered or not fully explained ?

Have you experiences or information that should be included ?

Which part of the book did you find most interesting or useful?

We are also interested in you.

How did you find out about the book? Can you help distribute it to other groups who would find it interesting ?

What is your work?

What sort of printing do you have access to?

Send your comments to:

Jonathan Zeitlyn
51 Chetwynd Road
London NW5
UK.
or

CENDIT
D1 Soami Nagar
New Delhi 110 017
India

Thank you.
Jonathan Zeitlyn

ISBN 0 9509523 0 9