

**AT** MICROFICHE  
REFERENCE  
LIBRARY

A project of Volunteers in Asia

The ABC and XYZ of Bee Culture

by: A.I. Root

Published by:  
The A.I. Root Company  
P.O. Box 706  
Medina, OH 44258 USA

Paper copies are \$11.95.

Available from:  
The A.I. Root Company  
P.O. Box 706  
Medina, OH 44258 USA

Reproduced by permission of the A.I. Root Company.

Reproduction of this microfiche document in any form is subject to the same restrictions as those of the original document.

# The ABC and XYZ of Bee Culture

An encyclopedia pertaining  
to scientific and practical  
culture of bees



**By A. I. Root**  
Founder of The A. I. Root Company  
and of Gleanings in Bee Culture.

Revised by E. R. Root, LL.D.  
H. H. Root  
J. A. Root  
L. R. Goltz



**Published by The A. I. Root Company, Medina, Ohio, U.S.A.**

**Copyright 1980 By The A. I. Root Co.**

## 1877 Preface to First Edition

In preparing this work I have been much indebted to the books of Langstroth, Moses Quinby, Prof. A. J. Cook, and some others, as well as to all of the bee journals, but, more than to all these, have I been indebted to the thousands of friends scattered far and wide who have so kindly furnished the fullest particulars in regard to all the new improvements as they have come up in our beloved branch of rural industry. Those who questioned me so much a few years ago are now repaying by giving me such long kind letters in answer to any inquiry I may happen to make that I often feel ashamed to think what meager answers I have been obliged to give them under similar circumstances. A great part of this ABC book is really the work of the people; and the task that devolves on me is to collect, condense, verify, and utilize what has been scattered through thousands of letters for years past. My own apiary has been greatly devoted to testing carefully each new device, invention, or process as it came up. The task has been a very pleasant one, and if the perusal of the following pages affords you as much pleasure I shall feel amply repaid.

November, 1877

A. I. ROOT

## Introduction to the First Edition

BY A. I. ROOT

About the year 1865, during the month of August, a swarm of bees passed overhead where we were at work, and my fellow-workman, in answer to some of my inquiries respecting their habits, asked what I would give for them. I, not dreaming he could by any means call them down, offered him a dollar, and he started after them. To my astonishment, he, in a short time, returned with them, hived in a rough box he had hastily picked up, and at that moment I commenced learning my ABC in bee culture. Before night I had questioned not only the bees but every one I knew who could tell me anything about these strange new acquaintances of mine. Our books and papers were overhauled that evening; but the little that I found only puzzled me the more, and kindled anew the desire to explore and follow out this new hobby of mine; for dear reader, I have been all my life much given to hobbies and new projects.

Farmers who kept bees assured me that they once paid, when the country was new, but of late years they were no profit, and everybody was abandoning the business. I had some headstrong views in the matter, and in a few days I visited Cleveland, ostensibly on other business, but I had really little interest in anything until I could visit the bookstores and look over the books on bees. I found but two, and I very quickly chose Langstroth. May God reward and forever bless Mr. Langstroth for the kind

## PREFACE

and pleasant way in which he unfolds to his readers the truths and wonders of creation to be found inside the beehive.

What a gold mine that book seemed to me as I looked it over on my journey home! Never was romance so enticing—no, not even Robinson Crusoe; and, best of all, right in my own home I could live out and verify all the wonderful things told therein. Late as it was, I yet made an observatory hive and raised queens from worker eggs before winter, and wound up by purchasing a queen of Mr. Langstroth for \$20.00. I should, in fact, have wound up the whole business, queen and all, most effectually, had it not been for some timely advice toward Christmas, from a plain, practical farmer near by. With his assistance, and by the purchase of some more bees, I brought all safely through the winter. Through Mr. Langstroth I learned of Mr. Wagner, who shortly afterward was induced to recommence the publication of the American Bee Journal, and through this I gave accounts monthly of my blunders and occasional successes.

In 1867 news came from across the ocean from Germany of the honey-extractor; and by the aid of a simple home-made machine I took 1000 pounds of honey from 20 stocks, and increased them to 35. This made quite a sensation, and numbers embarked in the new business; but when I lost all but 11 of the 35 the next winter, many said, "There, I told you how it would turn out."

I said nothing, but went to work quietly and increased the 11 to 48 during the one season, not using the extractor at all. The 48 were wintered entirely without loss, and I think it was mainly because I took care and pains with each individual colony. From the 48 I secured 6,162 pounds of extracted honey, and sold almost the entire crop for 25 cents per pound. This capped the climax, and inquiries in regard to the new industry began to come in from all sides. Beginners were eager to know what hives to adopt, and where to get honey-extractors. As the hives in use seemed very poorly adapted to the use of the extractor, and as the machines offered for sale were heavy and poorly adapted to the purpose, there really seemed to be no other way before me than to manufacture these implements. Unless I did this I should be compelled to undertake a correspondence that would occupy a great part of my time without affording any compensation of any account. The fullest directions I knew how to give for making plain simple hives, etc., were from time to time published in the American Bee Journal; but the demand for further particulars was such that a circular was printed, and shortly after a second edition; then another, and another. These were intended to answer the greater part of the queries; and from the cheering words received in regard to them it seemed that the idea was a happy one.

Until 1873 all these circulars were sent out gratuitously but at that time it was deemed best to issue a quarterly at 25 cents per year, for the purpose of answering these inquiries. The very first number was received with such favor that it was immediately changed to a monthly at 75 cents. The name of it was Gleanings in Bee Culture, and it was gradually enlarged until, in 1876, the price was changed to \$1.00. During all this time it has served the purpose excellently of answering questions as they came up, both old and new; and even if some new subscriber should ask in regard to something that had been discussed at length but a short time before, it was an easy matter to refer him to it or send him the number containing the subject in question.

When Gleanings was about commencing its fifth year, inquirers began to dislike being referred to something that was published half a dozen years before. Besides, the decisions that were then arrived at perhaps needed to be considerably modified to meet present wants. Now you can see whence the necessity for this ABC book, its office and place we propose to have it fill.

December, 1878

A. I. ROOT

## Preface to this Edition

It has not been thought necessary to reproduce the prefaces of each succeeding edition of this work. All told there have been thirty-four editions with an aggregate total of over 500,000 copies including those printed in foreign countries. It therefore transpires that the book, ABC of Bee Culture, written by A. I. Root, for beginners has finally developed into the ABC & XYZ of Bee Culture.

Although A. I. Root's health allowed him to spend only about fifteen active years in beekeeping and bee supply manufacturing he nevertheless had a very profound effect on the beekeeping industry. In many respects he might be termed a beekeeping evangelist. He preached the doctrine of modern beekeeping. He was among the first to point out that the Langstroth hive and frame were superior to all those preceding. He did much to standardize beekeeping equipment and especially the hive, making supers interchangeable with brood chambers. Prior to his efforts there were practically as many different shapes and sizes of hives and frames as there were beekeepers.

Another of A. I. Root's contributions to the beekeeping industry was his ability to improve on the ideas of others to make beekeeping a practical and profitable vocation. He did not invent comb foundation but improved the production of it to make it commercially successful by developing the foundation mill with the assistance of A. Washburn.

He also did not invent the section comb honey box but he was the first to manufacture pound sections by the thousands.

He improved the crude wooden extractor invented originally in Germany by making it of metal and providing for the reel only to spin in a stationary tank. These are just a few of the many equipment improvements A. I. Root contributed to the beekeeping industry.

Next to his commercial comb foundation, perhaps his greatest contribution to bee culture was his plan for shipping combless bees by mail and express in one-quarter, one-half and one pound wire cages. Today hundreds of thousands of bees without combs are sent from South to North annually and today's modern package bee industry has developed as a result of that invention. Dr. E. F. Phillips, then head of the Federal Bee Culture Research Laboratory said, "More than any other man, A. I. Root blazed the way for practical bee culture. He was in fact, the evangelist who pointed the way to methods of keeping bees that revolutionized the industry. He saw that beekeeping might become a commercial possibility as well as a pastime".

In about 1885, when A. I. Root's health began to fail, it became necessary for him to call upon the assistance of his son, E. R. Root, who assumed the authorship of subsequent editions. E. R., as he was affectionately known by his friends, was as vitally interested in beekeeping and the honeybee as his father. It was an all-consuming vocation and hobby with him throughout his long and active life. So great was his contribution to beekeeping that in 1944 Ohio State University bestowed upon him an honorary Doctor of Laws Degree. At that time fewer than forty such degrees had been awarded by Ohio State University.

Although E. R. Root carefully supervised each revision of ABC until his death in 1953, in about 1949 he relinquished the authorship to his younger brother, Huber Root, who had previously made many contributions to ABC in the fields of his greatest experience. Huber Root, although being well informed on beekeeping in general, is probably best known for his knowledge of beeswax, having

written the book, "Beeswax, Its Properties, Testing, Production and Applications". Although he was not actively involved in the last two revisions of ABC, his past contributions have been many. The last of A. I. Root's offspring, Huber Root passed away early in 1972.

### **The Consulting Editors**

In the preparation of these late editions as well as several of those which preceded, the author has realized that no one man can be an expert in all fields of beekeeping and for this reason he has asked the assistance of certain leading men in the industry, both scientific and practical, who might be considered editors — men who have made a special study of certain lines of work and who are regarded as authorities in their particular fields of investigation.

Some of these contributing editors have written whole articles which the author has placed in their proper alphabetical order, others, perhaps a majority, have furnished suggestions and material which the author has incorporated in articles written by himself.

In all of this the author admits the difficulties in placing proper evaluation upon the work of each one of the editors consulted and he will not attempt to do so.

### **Scientific Articles**

To most of the scientific subjects there is attached a bibliography. The original references of these are to be found in the Dr. Miller Memorial Library at Madison, Wisconsin, or at the Langstroth-Root Memorial Library at Cornell University, Ithaca, New York.

### **Glossary**

This edition contains a glossary which gives the definition of common beekeeping terms. It is hoped this reference will aid the beginning beekeeper in understanding the more technical portions of this work.

## PREFACE

### A. I. ROOT

The founder of The A. I. Root Company and of **Gleanings in Bee Culture** and the first author of the **ABC of Bee Culture**.

At the time of A. I. Root's death in 1923, the following appeared in the Medina County Gazette:

"Amos I. Root was one of the most remarkable men of the past two generations, remarkable not in one way, but in many ways. His was a many-sided character, if any man ever had one. Inventor, writer, manufacturer, publisher, thinker, philanthropist, reformer, moralist, agriculturist, Christian. In all of these his character was marked, and he was a leader. In most of them he loomed large. Even as an agriculturist, he tilled the soil in a modest way, yet as in everything else he excelled in this. For he not only made two blades of grass grow where only one grew before, but he was gifted with the ability to make things grow where they had never grown before. In many ways his reputation was world-wide."

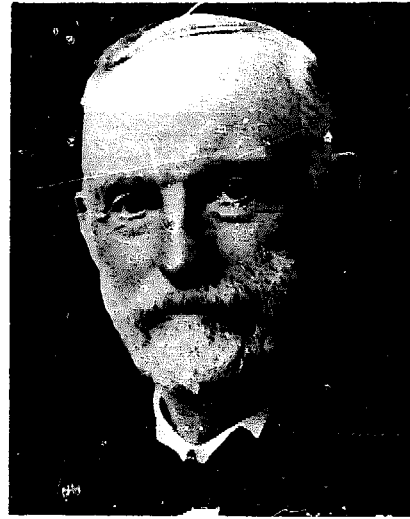

A. I. ROOT



E. R. Root

### E. R. ROOT

If any man can lay claim to having just one business interest, that man is E. R. Root. Next to his family and church, bees and honey have always been his hobby, his profession, his life. As late as May 23, 1950, he pensively said, "I have never cared for fishing, golfing, or other games. I have always liked best to be with and around honey producers. I like to know their worries and problems and I like to help them when I can." He spoke sincerely, referring to a coming beekeepers' meeting, never realizing that his brother would remember his words and record them here. — H. H. ROOT.



### J. A. ROOT

John A. Root is the son of Alan I. Root and the great grandson of A. I. Root who founded **Gleanings in Bee Culture** in 1873. This journal has been published continuously ever since, and it is interesting to note that he is the fourth generation of Roots to serve on the staff, and to have contributed to the editing and revision of the **ABC** and **XYZ** of **Bee Culture**.

John Root graduated from Ohio Wesleyan University, served in the United States Air Force three years and flew as a transport pilot and aircraft Commander. Returning to Medina he took up the duties of Managing Editor of **Gleanings** and has made revisions in the 31st-34th editions of **ABC & XYZ**. He is presently an Associate Editor of **Gleanings in Bee Culture**.



J. A. Root

# A

**ABC OF BEEKEEPING.**—Before the reader plunges into this work he should procure the companion volume, "Starting Right with Bees", a small 100-page book for beginners. In a short time he will get a bird's-eye view of the whole subject, making what now follows under alphabetical headings, very much more easily understood.

Of course, one who has had some experience with bees, does not need a beginner's book, and he can pick out such subjects, found in their alphabetical order, on which he desires further information.

If the beginner does not have this basic knowledge and wishes to proceed immediately, the following list of subjects is here suggested to be taken up in the order given below:

Beginning with Bees; Backlot Beekeeping; Package Bees; Anger of Bees; Stings, subhead How to Avoid Being Stung; Manipulation of Colonies; Apiary; Smoke and Smokers; Hives; Transferring; Robbing; Brood and Brood Rearing; Building Up Colonies; Food Chamber; Feeding; Swarming; Extracting; Comb Honey; Spring Management; Uniting and Wintering. The other subjects may be taken up in any order that may seem best. After reading the matter here indicated, one will have ground-work that will make it easier to understand any particular subject that may interest the beginner in beekeeping.

**AFTERSWARMING.**—All swarms that come out after the first swarm, or are led out by a virgin queen or a plurality of them, are termed afterswarms; and all swarms after the first are accompanied by such virgin queens. There may be from one to a dozen swarms, depending on the yield of honey, amount of brood or larvae, number of queens, and the weather. But, whatever the number, they are all led off by queens reared from one lot of queen cells, and the number of bees accompanying them is, of necessity, less each time. The last swarms frequently contain no more than a pint of bees, and, if hived in the old way would be of little use under almost any circumstances. Yet, when supplied with combs already built and filled with honey, such as every enlightened apiarist should always keep in store, they may develop into the very best of colonies, for they have young and vigorous queens.

It has been said that when a colony has decided to send out no more swarms all the young queens in the hive are sent out, or, it may be, allowed to go out with the last one. Whether this is true or not is uncertain. But during the swarming season some novice usually writes about the wonderful fact of having found three or four, or perhaps half a dozen queens in one swarm. On one occasion a man who weighed over 200 pounds ascended to the top of an apple tree during a hot July day to hive a small third swarm. He soon came down in breathless haste to say that the swarm was all queens; and in proof of it, he brought two or three in his closed-up hand.

In the box hive days (See Box

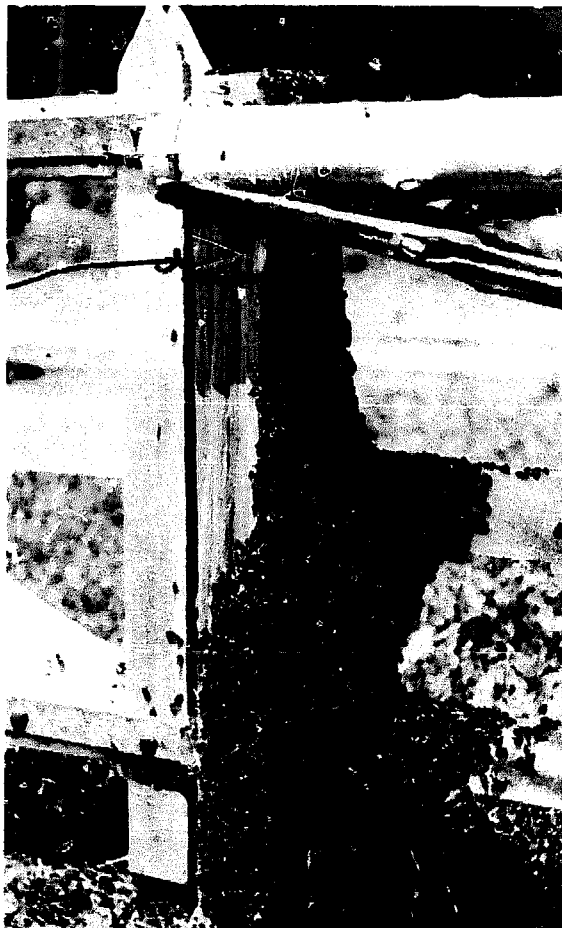

Swarms will land in the strangest places. The swarm shown here will not be difficult to hive since it is close to the ground. An empty hive can be placed on the ground before this swarm and the bees can be coaxed toward the entrance with smoke and light brushing.



Hives) afterswarming was considered a sort of necessary evil that had to be tolerated because it could not be avoided. But in a well regulated apiary it should not be allowed. Many consider it good practice to permit one swarm—the first one—after which all others are restrained. Cutting out all the queen cells but



Mailing and introducing cage.

one may have the effect of preventing a second swarm. But the practice is not here recommended chiefly because one cannot be sure that he destroys all but one cell. If there are two cells not of the same age, the occupant of one of them, upon emerging, is likely to bring out an afterswarm. As long as there are young queens to emerge there is danger of an afterswarm.

Cell cutting\* for the prevention of these little swarms is a waste of time, although some cut out cells to prevent prime or first swarms. There are two plans, both of which are good:

(1) The wings of all laying queens in the apiary are clipped. (See How to Clip a Queen's Wings, under Queens.) As soon as the first swarm comes forth, and while the bees are in the air, the queen, if clipped, is found in front of the entrance of the old hive. She is caged, and the old hive is lifted off the old stand, and an empty one containing frames of foundation or empty combs is put in its place. A queen excluding honey board is then put on top, and on this are placed the supers taken from the old hive. The queen in her cage is placed in front of the entrance, and the old hive is next carried to an entirely new location. In the meantime the swarm returns to find the queen at the old stand, and when the bees are well started to running into the entrance she is released and allowed to go with them. The old or flying bees left in the old colony, now on the new location, will go back to the old stand to strengthen the swarm. This will so depopulate the parent colony that there will hardly be bees enough left to cause

\*For description of cells see Brood and Brood Rearing.

any afterswarming, and a surplus of young queens will have to fight it out among themselves. The new queen will be mated in the regular way. In a comparatively short time the parent colony will be strong enough for winter.

(2) The first swarm is allowed to come forth and while it is in the air the parent colony is removed from its stand and placed a few inches to one side, with its entrance pointing at right angles to its former position. If the old hive faced the East, it will now look toward the North. Another hive is placed on the old stand, filled with frames of wired foundation. The swarm is put in the hive on the old stand, and at the end of two days the parent hive is turned around so that its entrance points in the same direction as the hive that now has the swarm. Just as soon as young queens of the parent colony are about to emerge, it is carried to a new location during the middle of the day or when the bees are flying the thickest. This should be done carefully without disturbing the colony, so the bees will not mark the new location when leaving the hive. Usually this is done on the seventh or eighth day after the

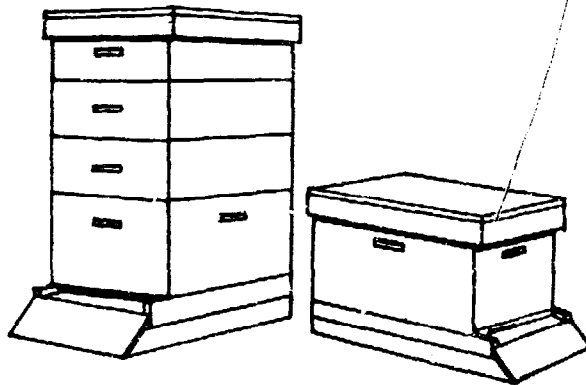

New hive with supers on old stand.  
Old hive turned aside.

prime swarm issues. The result is that these bees will go back to the hive having the swarm.

This, like the other method described, so depletes the parent hive that any attempt at afterswarming is effectually forestalled.

The only reason for turning the entrance of the old hive to one side at first is to prevent any of the bees from entering it while the swarm is being hived in the new one, and until the bees of the new swarm be-

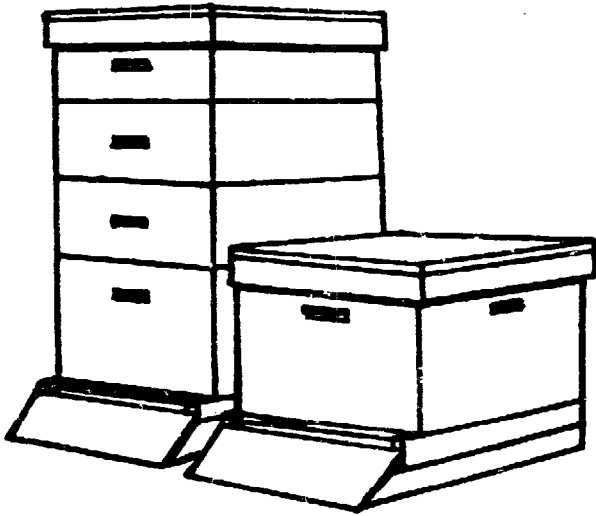

Old hive set close to new to be moved away on seventh day.

come accustomed to the new order of things. In making artificial swarms it is not necessary to turn the entrance of the old hive away, for in this case there is less danger of the bees of the swarm entering the old hive.

While the second plan gives a larger force of bees to the swarm, it requires more work than the first one. It is the better plan at a home yard or where one can be present.

**AGE OF BEES.**—It may be rather difficult to decide how long a worker bee would live if kept from wearing itself out by active labors of the field. It would certainly be six months, perhaps a year, but the average life during the summer time is not over three months, and perhaps during the height of the main bloom not over four or six weeks.

Under normal conditions, roughly the first half of the worker's life, or about three weeks, is given over to hive duties, and the last half to field work. The exact sequence varies according to conditions present for all of the duties within the hive. Although it is commonly accepted that younger bees function as nurses, the relative ages at which such duties as guarding, carrying out debris, taking incoming nectar from field bees, and stowing away pollen have remained unknown till lately. To G. A. Rosch, who has been working with Prof. Dr. von Frisch, of Germany, goes credit for throwing more light on those four duties as well as furnishing interesting details on the nursing period. One difficulty

in this field has been that of marking a sufficient number of bees in any particular colony so that each bee could be recognized individually throughout its life. This difficulty was overcome by using the method mentioned by von Frisch in his paper of 1920 when he first made public his work on the "dances" of the workers. The hive used by Rosch consisted of several frames so arranged that each side of each frame was exposed to view through glass. The work covers three years beginning in 1922.

#### The Duties of Young Bees Before Flight

In general, Rosch confirms earlier work showing that, under normal conditions, about the first three weeks are given over to hive duties, and the remainder of life to field duties. He found the average duration of the worker's life in the busiest period of the year to be about five weeks. The period of hive duties is divided into two parts, the first of which begins with three days devoted to cleaning out cells for the queen to lay in, and is followed by about ten days given over to nursing larvae. The second part of the period of hive duties, about a week—if nursing continues until the thirteenth day—is a period of varying hive duties such as guarding, stowing away pollen, carrying out debris, and the like.

No hard and fast time limits are given for any duties, since, with the exception of the first three days an excess of bees for any one activity may lead to this excess performing other duties, and vice versa. For the first three days, however, the only work performed by the worker after cleaning its body on emergence and getting food from other bees, is to clean out brood cells. In the course of the process the cell is licked with the tongue, and this apparently leaves an odor since the queen was observed to pass over all cells not so treated. Several different bees or even the same bee may visit a cell in succession, but no worker was seen to be the first to clean out the cell from which she had emerged, others usually entering while she was cleaning herself up. These young bees were never seen to gnaw down any capping left on brood cells. This duty remains for older bees. During the first two or three

days young workers were never seen helping themselves to any food in the hive. After cleaning cells for a time they would often remain apparently idling on sealed or unsealed brood. This, together with the fact that bees of such age appear unable to do anything but clean cells, is of prime importance, according to Rosch, because it serves to keep the brood warm. No other bees could do it so well because their duties take them away from the brood.

One of the most important findings by Rosch, if confirmed, tends to further clear up the presence of honey and pollen in the food of worker larvae after the third day. He presents data from histological studies showing that the pharyngeal glands, which secrete larval food, are not completely developed until three to six days after emergence of the worker, and that by the fifteenth day their degeneration is under way. In line with this, he found bees during their first two or three days as nurses, immediately after serving as brood cell cleaners, taking both stored honey and pollen and then feeding larvae which in no case were more than two days from being sealed in. According to his histological studies, the glands of such bees would not be developed sufficiently to secrete larval food. As a matter of fact, he states that the younger larvae were never fed by workers younger than five days. These older nurses, in addition, gave some food to the older larvae.

Orientation flights may begin in the latter part of the nursing period. This period itself, says Rosch, may extend slightly beyond the thirteenth day in case of lack of nurse bees. On the other hand, it may be cut short by a heavy honey flow, since the last period of hive duties begins by relieving incoming nectar gatherers of their load and storing it away. Stowing away pollen, which the gatherers merely kick off the cells, is also performed at this age. Once these duties were begun, the brood was left to others. Longer orientation flights were observed at this time. Since bees so commonly fly a little distance from the hive with debris, Rosch holds that they do not become debris removers until they have made enough orientation flights to find their way back to the hive. Thus he explains why older bees

dispose of cappings from brood cells. Guarding was found to be one of the last duties before taking to the field. Rosch observed an individual bee on guard for three successive days. He did not find any definite sequence in field duties, nor did he find the first field trip caused by any "dance".

During the summer months the life of the worker bee is cut short by the wearing out of its wings, and at the close of a warm day hundreds of these heavily-laden, ragged-winged veterans will be found making their way into the hives slowly and painfully as compared with the nimble and perfect-winged young bees. If the ground around the apiary is examined at nightfall, numbers of these old bees may be seen hopping about, evidently recognizing their own inability to be of further use to the community. The author has repeatedly picked them up and placed them in the entrance, but they usually seem bent on crawling and hopping off out of the way where they can die without hindering the teeming rising generation. During the height of a honey flow workers probably do not live more than six weeks.

Some new information on this subject was presented in 1952 by C. R. Ribbands, in a report to the Rothamsted Experimental Station in England. The following summary, prepared by the author, involves a new concept of the division of labor in a honeybee colony.

Newly emerged bees in a colony were individually marked, and their foraging activities were studied by subsequent observations at the hive entrance.

A few individuals gathered pollen throughout their foraging lives; a considerable number gathered none at all. Most bees gathered pollen at sometime, but there was great diversity in the part of the foraging life at which this occurred.

There was considerable variation in the age at which different bees, emerging on the same day and living in the same colony commenced foraging; this age ranged from nine to 39 days. This variation was produced not only by altering the duration of the various hive duties, but also by omitting some of these duties.

Such variation indicates that the division of labor is not determined by the age of the available workers. It is controlled, instead, by the requirements of the colony. The ages of bees in the colony play a subsidiary role, in that the duties of any individual are the resultant of the requirements of the colony and age of that individual.

The requirements of the colony are determined by its food supply, and they are appreciated by the individual as a consequence of widespread food transmission. Food transmission is therefore the most primitive and the most important method of communication in the honeybee colony.

The duration of foraging life was signifi-



A pollen-collecting honeybee. The loads of pollen on the hind leg distinguish a pollen collector from a nectar collector.

cantly shorter in those bees which commenced foraging at a later date. This result indicates that senility played a part in determining the longevity of these bees.

#### Age of Drones

The age of drones seldom exceeds four months (Phillips) but varies according to the season, the condition of the colony, whether queenless or not, or whether the queen, if present, is failing in her egg laying.

In the spring and early summer months, colonies building up for the honey flow rear drones along with workers, but of course in fewer numbers. The drones will be tolerated in the hive while the colony is in a state of prosperity, and as long as honey is coming in fast enough to take care of brood rearing, but when the flow eases up, and especially

when it stops, the rearing of drones will cease. Young drone brood will be carried out at the entrance and the mature drones will be pushed out to starve.

On the other hand, if the colony is queenless even though no nectar is coming in, drones will be allowed to remain in the hive. Likewise, if the queen, if present, is failing, the drones will be tolerated.

It will be seen that the age of drones depends on several conditions. The average age, however, is less than two months. There are times when the drones may live six or eight months, but these cases are rare. (See Drones.)

#### Age of the Queen

As the queen seldom if ever leaves the hive except at mating and at swarming time, one would expect her to live to a good old age,\* and this she does, despite her arduous egg laying duties. Some queens die, seemingly of old age, the second season, but generally they live through the second or third season, and they have been known to lay very well even during the fourth year. They are seldom profitable after the second year, and the Italians will sometimes have a young queen "helping" mother before the beekeeper recognizes the old queen as a failing one. Many and perhaps most beekeepers think it profitable to requeen yearly. A young queen, as a rule, will keep a colony more populous than an old one. A large force of bees in a honey flow is much more profitable than a light force. It pays well to requeen.

Bibliography: V. C. Milum, Champaign, Ill. "The Honeybee's Span of Life." 1930, 1931, Report of the Illinois State Beekeepers' Association, page 94.

\*The record according to the Bee World, London, England, is eight years. Queens rarely live more than four years.

#### The Italian Honey Bee (*Apis Mellifera*)



Worker



Drone



Queen

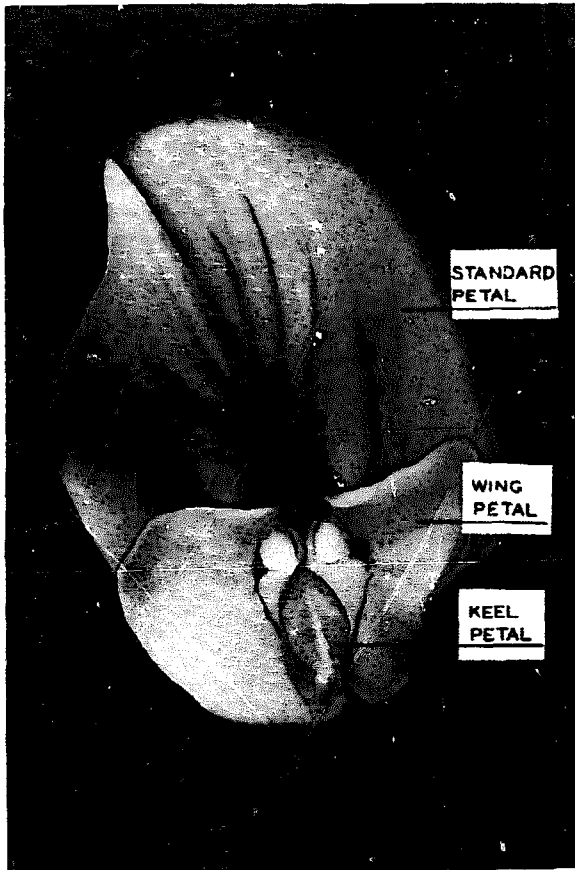

Alfalfa flowers, above, untripped, below, tripped.—Photo courtesy of the University of Utah.

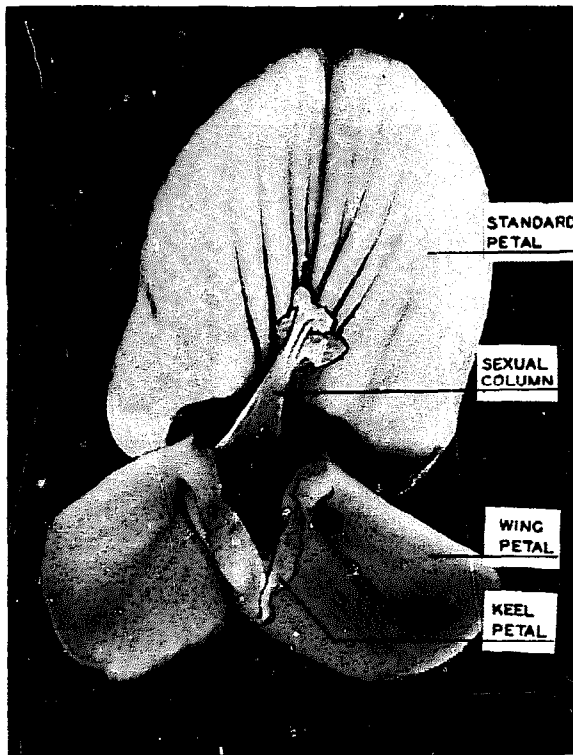

**ALFALFA** (*Medicago sativa* L.).—Alfalfa belongs to the pulse family, or **Leguminosae**, which includes more than 5000 species.

The culture of the plant has become established in every state in the Union and every province in Canada. Its claim to the attention of beekeepers lies in its extreme importance as a honey plant in the West and to an increasing extent in the East. To discuss alfalfa from the standpoint of the beekeeper, the nature of alfalfa honey shall first be considered, followed by alfalfa as bee pasturage.

This family, **Leguminosae**, is of wide geographical distribution, occurring in both temperate and warm climates. Probably no family is of greater importance to the beekeeper than this one, unless it is the **Compositae** (dandelion, goldenrods, aster, etc.). The term "legume" is a popular name applied to members of the **Leguminosae**.

#### Alfalfa as a Honey Plant

Alfalfa is a major crop grown on nearly 27 million acres in the United States. Sixty percent of the alfalfa produced in the United States is grown in 12 North Central states and New York. Alfalfa can produce more protein per acre than any of the other 25 crops commonly grown for forage and grain. Unfortunately for the beekeeper who depends upon alfalfa for his honey crop growers are cutting the legume before it comes into full flower, which means three cuttings and even four where the growing season is long. Earlier and more frequent cutting accounts for a 40 percent greater protein yield so the practice is not likely to be changed. Occasionally adverse weather affects harvesting and gives the honeybees an opportunity to gather nectar while cutting is delayed.

Alfalfa is seriously threatened by the alfalfa weevil and spraying to control this pest is difficult and expensive for the grower and often destructive to bees. Disease and insect resistant varieties are available but selection of varieties by the grower must also take into consideration yield potential and adaptation to local growing conditions. Nectar secretion may vary with varieties.

Much alfalfa is grown on irrigated land in the western states, often providing a steady, high yield of nectar. Alfalfa is a leading honey plant in California (Vansell). Alfalfa will tolerate dry weather and will yield nectar under drouth conditions when other sources fail.

#### Pollination

In Circular 125 of the Utah State Agricultural College we find the following information about the pollination of alfalfa:

"Alfalfa under most conditions is an attractive source of nectar and suffers little from competition with other plants for visits from nectar collectors. It is not an attractive source of pollen, however, and pollen collectors are apt to neglect it in favor of better sources. Consequently, in alfalfa fields nectar collectors nearly always outnumber pollen collectors, in some areas by more than 100 to 1.

"When collecting pollen from alfalfa, honeybees trip the majority of the flowers they visit and compare favorably in efficiency with many wild bees. Nectar collectors, on the the other hand, usually are able to procure nectar without tripping the flowers. This they do by inserting their tongues at the side of the flower between the overlapping parts of the standard and wing petals. However, there is some evidence that bees making their first visits to alfalfa for nectar enter flowers directly and trip them, often getting their face or tongue pinched by the sexual column of the flower in the process.

"The male and female parts of the alfalfa flower, although enclosed in a sheath (keel) and in intimate contact, are non-functional until released. This process of releasing the sexual parts from the keel is known as tripping, and is essential for pod development. About one percent of the non-tripped flowers form pods compared to 50 per cent or more of the tripped flowers under field conditions. When tripping does not occur the flowers usually drop, but when tripped, pollination and fertilization follows.

"While wind, rain, heat, and humidity can bring about tripping, they play a minor role. With few exceptions wild bees visit alfalfa for pollen as well as for nectar. In general, bees more than

three-eighths inch long are more efficient trippers than smaller species and bees less than one-fourth inch long do not trip at all."

#### Alfalfa seed yields as affected by various levels, Newton (1948) and Logan (1949)

Levels of bees	Bees per sq. yd.		Seed yields	
	1948	1949	1948	1949
No bees	0	.....	14	.....
Natural	2.2	4.3	198	666
Bees confined	4.9	13.6	321	1,018

#### Alfalfa Honey

Most alfalfa honey has a pleasing, slightly minty taste. The best alfalfa honey, thick, rich, and delicious, has proved a favorite with the public where the honey can be eaten before granulation commences. Although difficult to handle on that account, dealers hesitate to discard so well favored an article. It sometimes runs 12 pounds or slightly over to the gallon in the arid states of the West, while other honeys seldom reach 12 pounds. (See Honey, Specific Gravity of.)

A marked characteristic of alfalfa honey is its tendency to granulate, especially that from certain localities. In examining a given lot of alfalfa honey it is impossible to say when granulation will be likely to set in. If kept in a warm room some alfalfa honey will continue liquid for an entire season, but on the other hand it may be solid in a very few weeks. When granulated it is fine and creamy, hence it is often retailed in the solid form in tin and glass. (See Honey, Granulation of.)

In tests conducted by the Bureau of Chemistry, Washington, D. C., alfalfa samples shown to be purer than the others—that is freer from other honeys—granulated solid. The statement has been made that pure alfalfa honey will scarcely granulate at all, and that when it solidifies early it is mixed with honey from wild flowers. However, in view of the uniform granulation of samples of known purity tested by the government, this statement is apparently not generally true.

**ALGARROBA.**—See Mesquite.

**ALSIKE CLOVER.**—See Clover.

**AMATEUR BEEKEEPING.**—See Beginning with Bees.

### ANATOMY OF THE BEE.—

The student of bee culture should know something about the anatomy of the honey bee in order that he may be able to better understand the domestic economy of the honey bee, or in other words, how it keeps house, why it does this, and how it does it.

In this highly complicated subject it is perhaps better to make a preliminary statement that will serve to clarify that which is to follow. The general text will be in non-technical terms, something that the average reader will be able to understand, while the more technical matter, with the accompanying scientific terms, will be placed in the legends beneath the engravings. The material here is condensed from the book "The Anatomy and Physiology of the Honey Bee" by Snodgrass, formerly with the Bureau of Entomology, Washington, D.C.

It will be noted that, while there are similarities between the structure of a honey bee and the highly organized human being, there are some marked differences. In the case of the bee, as with all insects, the skeleton is on the outside, serving as a protection to the softer parts within. In the case of man and all mammals, the skeleton is on the inside, covered by the softer parts. In the bee, the heart is aerated by having the lung portion or tracheal system extended clear through the whole structure of its body. (See Fig. 1 where the sacs are shown.) In the case of the human being, the lung portion is confined to the upper part of the body where the blood is aerated and pumped by the heart throughout the entire structure, including the arms, legs, and feet. In the bee we find the honey stomach and the stomach mouth which are not found in any of the vertebrates. The honey stomach is to hold the nectar or honey and the true stomach serves the purpose of a like organ in the human body. It should be noted particularly that between the two stomachs there is a stomach mouth that has the function of allowing some of the nectar to go into the stomach, and at the same time to strain out particles of pollen that should not go below. We likewise find the sting, a highly organized weapon of offense and defense, and mouth parts that are different from anything we find in any animal or human being. The jaws work sidewise or at right angles to the length of the bee, while in man, although the jaws are placed in the head the same as in the bee, they work up and down. The tongue of the bee is a highly complicated organ, consisting of two portions: one, the tongue proper, to suck up the smaller particles in the bottom of the flowers, and the other, a combination of the mouth parts folded up so that the coarser parts of the food can be drawn into the honeysac.

The senses of smell and possibly hearing reside in the feelers—the two little prongs sticking out from the head—technically called the antennae. Without these the bee can neither hear nor smell. In the insect, the body is divided into three parts, hence the name *Insecta*, meaning literally cut into parts. No such division occurs in man.

It is hoped that this preliminary statement will make it easy to go through the description now given by the greatest authority on the anatomy of the honey bee in all the world.—E. R. Root.

The three parts of the body of the bee are well separated by constrictions. The head carries the eyes, antennae, or feelers, and mouth parts; the thorax, the wings, and legs; and the abdomen, the wax glands, and sting.

#### The Head

The head is flattened and triangular, being widest crosswise through the upper corners, which are capped by the large compound eyes. It carries the antennae, or feelers, on the middle of the face (Fig. 2); the large compound eyes, the three small simple eyes at the top of the face (more fully explained under *Eyes of Bees*), and the mouth parts at the bottom of the face. Each feeler consists of a long joint and a series of small ones hanging downward. The feelers are very sensitive to touch, and contain the organs of smell. At the lower edge of the face is a loose flap (Fig. 2) forming an upper lip called the *labrum*. On its under surface is a small soft lobe on which are located the organs of taste. At the sides of the *labrum* are the two heavy jaws (Fig. 2) which work sidewise. In the worker they are spoon-shaped at the ends but sharp pointed and toothed in the queen and drone. Those of the queen are largest; those of the drone smallest. Behind the jaws is a bunch of long appendages, usually folded back beneath the head, which together constitute the tongue.

#### The Tongue

When the bee wishes to suck up any liquid, especially a thick liquid like honey or syrup, provided in considerable quantity, the terminal lobes of the *labium* and *maxillae* are pressed close together so as to make a tube between them. The food is then taken into the mouth by a sucking action of the pharynx, produced by its muscles.

A more delicate apparatus is probably necessary however, for sucking up minute drops of nectar from the bottom of a flower. Such a structure is provided within the *glossa*, or tongue proper. This organ (Fig. 3. D, Gls) ordinarily called the "tongue", is terminated by a delicate, sensitive, spoonlike lobe known as the *labella* (Fig. 3, A, B,

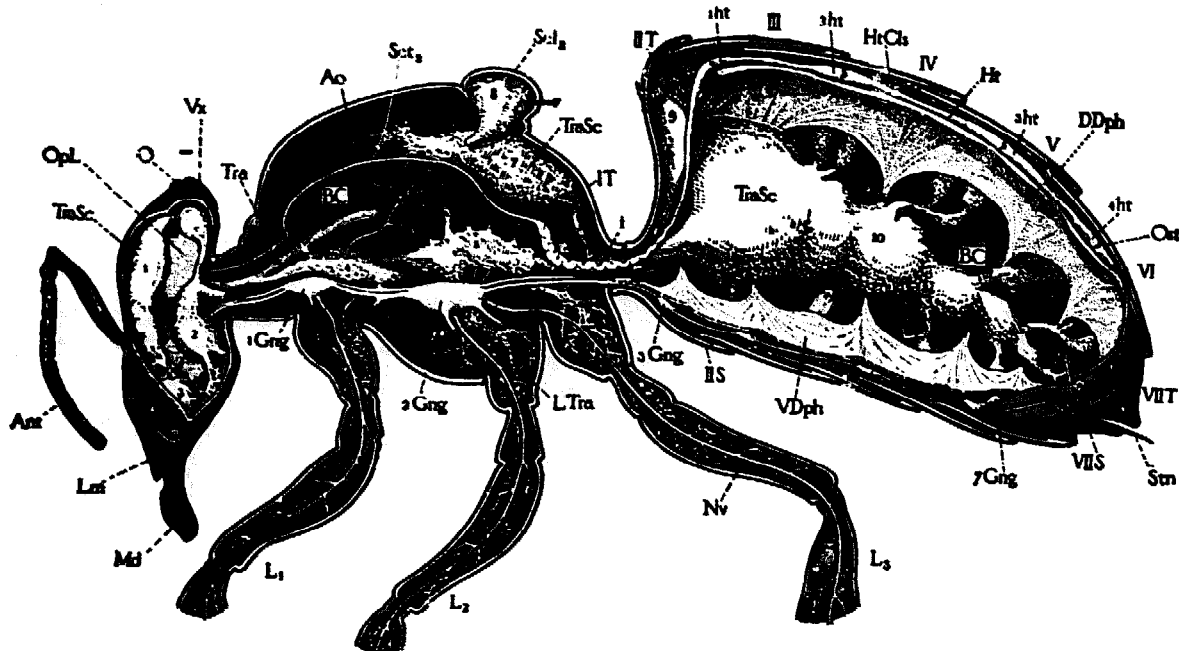

From Bulletin No. 18, "The Anatomy of the Honeybee", by Snodgrass, Department of Agriculture, Washington, D.C.

Fig. 1.—Longitudinal median, vertical section of worker, exposing body cavity (BC) in the right side, with alimentary canal (Fig. 6) removed, but showing tracheal system (Tra, LTra, and TraSc 1-10), heart (Ht), and aorta (Ao); dorsal diaphragm (DDph), ventral diaphragm (VDph), and nervous system (Opl, 1Gng-7Gng). AG, aorta; Ant, antenna; BC, body cavity; DDph; dorsal diaphragm; Gng, ganglion; 1Gng, first and second thoracic ganglia; 3Gng-7Gng, abdominal ganglia; Ht, heart; 1Ht-4Ht, chambers of heart; I, convolutions of aorta; L, leg; L1, L2, L3, prothoracic, mesothoracic, and metathoracic legs; Lm, labrum; LTra, trachea of leg; Md, mandible; Nv, nerve (of leg); O, ocelli; Opl, optic lobe of brain; Ost, ostium (aperture of heart); S, sternum; IIS-VIIS, second to seventh abdominal sterna; Sct2, scutellum of mesothorax; Stn, sting; Tra, trachea; TraSc (1-10), tracheal air-sacs; T, tergum; IT, propodeum; or first abdominal tergum; VIIT, seventh abdominal tergum; VDph, ventral tergum; Vx, vertex.

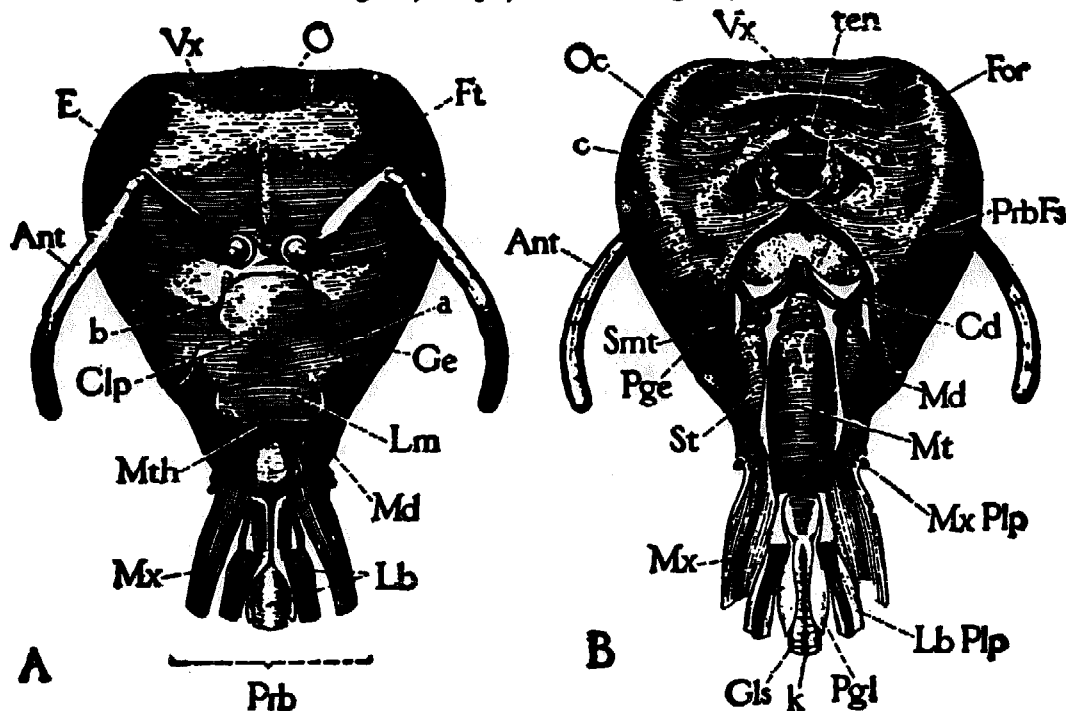

From Bulletin No. 18, "The Anatomy of the Honeybee", by Snodgrass, Department of Agriculture, Washington, D.C.

Fig. 2.—Head of worker with parts of proboscis cut off a short distance from their bases. A, anterior; B, posterior; a, clypeal suture; Ant, antenna; b, pit in clypeal suture marking anterior end of internal bar of head; c, pit on occipital surface of head, marking posterior end of internal bar; Cd, cardo; Clp, clypeus; E, compound eye; For, foramen magnum; Ft, front; Ge, gena; Gls, Glossa, or "tongue"; k, ventral groove of glossa; Lb, labium; LbPlp, labial palpus; Lm, labrum; Md, mandible; Mt, mentum; Mth, mouth; Mx, terminal blade of maxilla; MxPlp, maxillary palpus; O, ocelli; Oc, occiput; Pge, postgena; Pgl, paraglossa; Prb, base of proboscis; PrbFs, fossa of proboscis; Smt, submentum; St, stipes; ten, small bar of tentorium arching over foramen magnum; Vx, vertex.



and D, Lbl) and has a groove (k) running along its entire length on the ventral side. Within the glossa this groove extends into a double-barrel tube (Fig. 3, E, Lum).

A flexible chitinous rod (r) lies along the back wall of this channel which is itself provided with a still finer groove (l) along its ventral surface. Thus the very smallest quantity of nectar may find a channel suited to its bulk through which it may run up to the base of the glossa by capillary attraction. But since the glossal channels are ventral the nectar must be transferred to the dorsal side of the labium by means of the paraglossae, the two soft lobes (Fig. 3, D and F, Pgl).

### The Wings

The thorax or middle portion of an insect carries the wings and the legs. The two wings of the bee on each side are united to each other by a series of minute hooks so that they work together, and the four wings are thus converted into two. Each wing is hinged at its base to the back, and pivoted from below upon a small knob on the side wall of the thorax. The up-and-down motion of the wings is produced, not by muscles attached to their bases, but by two sets of enormous muscles, one vertical and the other horizontal, attached to the walls of the thorax, whose contractions elevate and depress the back plates of the thorax.

### The Legs

The legs of the bee, in connection with pollen collecting and pollen carrying, are described by Casteel under the head of Pollen. Their especial characters, such as the antennae cleaners on the first pollen basket and brushes on the last, are illustrated in Fig. 4. On the end of the legs is a pair of terminal claws, by means of which the bee clings to rough objects, while between the claws is a sticky pad which is brought into play when the bee alights on or walks over any smooth surface like glass.

### The Abdomen

The abdomen of the bee has no appendages corresponding to those of the head and thorax, but it bears two important organs, viz., the wax

glands and the sting. The wax glands are simply especially developed cells of the skin on the under surfaces of the last four visible abdominal segments of the worker. There are only six segments visible in the apparent abdomen. The wax glands occur, therefore, on segments four to seven inclusive. The wax secreted by the glands is discharged through minute pores in the under side of each segment, and accumulates in the form of a little scale in the pocket above the overlapping ventral plate of the segment next in front.

### The Sting

The sting (see Stings) is such a complicated organ that it is difficult to describe it clearly in a few words. Fundamentally it consists of three slender, closely connected pieces forming the sharp piercing organ that projects from the tip of the abdomen (Fig. 1), and of two soft finger-like lobes, sometimes also visible, all of which arise from three pairs of plates belonging to the eighth and ninth segments of the abdomen, but which are concealed within the seventh segment. (See Fig. 5 page 13.)

### The Alimentary Canal

The alimentary canal (Fig. 6) consists of a tube extending through the entire body and coiled somewhat in the abdomen. The first part above the mouth in the head is widened to form the pharynx. Then follows the long slender tube, or technically the oesophagus, running clear through the thorax and into the front of the abdomen, where it enlarges into a thin-walled bag, called in general the crop, but which is known as the honey sac in the bee. Back of the sac is a short narrow bag which is followed by the stomach proper. Then comes the slender small intestine with a circle of slender tubes. Finally, forming the terminal part of the alimentary canal, is the large intestine, or rectum, consisting of an enormous sac, varying in size according to its contents, but often occupying a large part of the abdominal cavity.

### The Honey Sac

The honey sac in the worker is of special interest because the nectar gathered from the flowers is held in

it instead of being swallowed on down into the stomach. From the honey sac the nectar is regurgitated into the cells of the comb, or given up first to another bee. The upper end of the true stomach sticks up into the lower end of the honey sac as a small cone with an X-shaped

valve in its summit. This opening is called the stomach mouth. Its four lips are very active, and take whatever food the true stomach requires from the honey sac, for it must all go into the latter first, while at the same time it affords the bees a means of retaining nectar

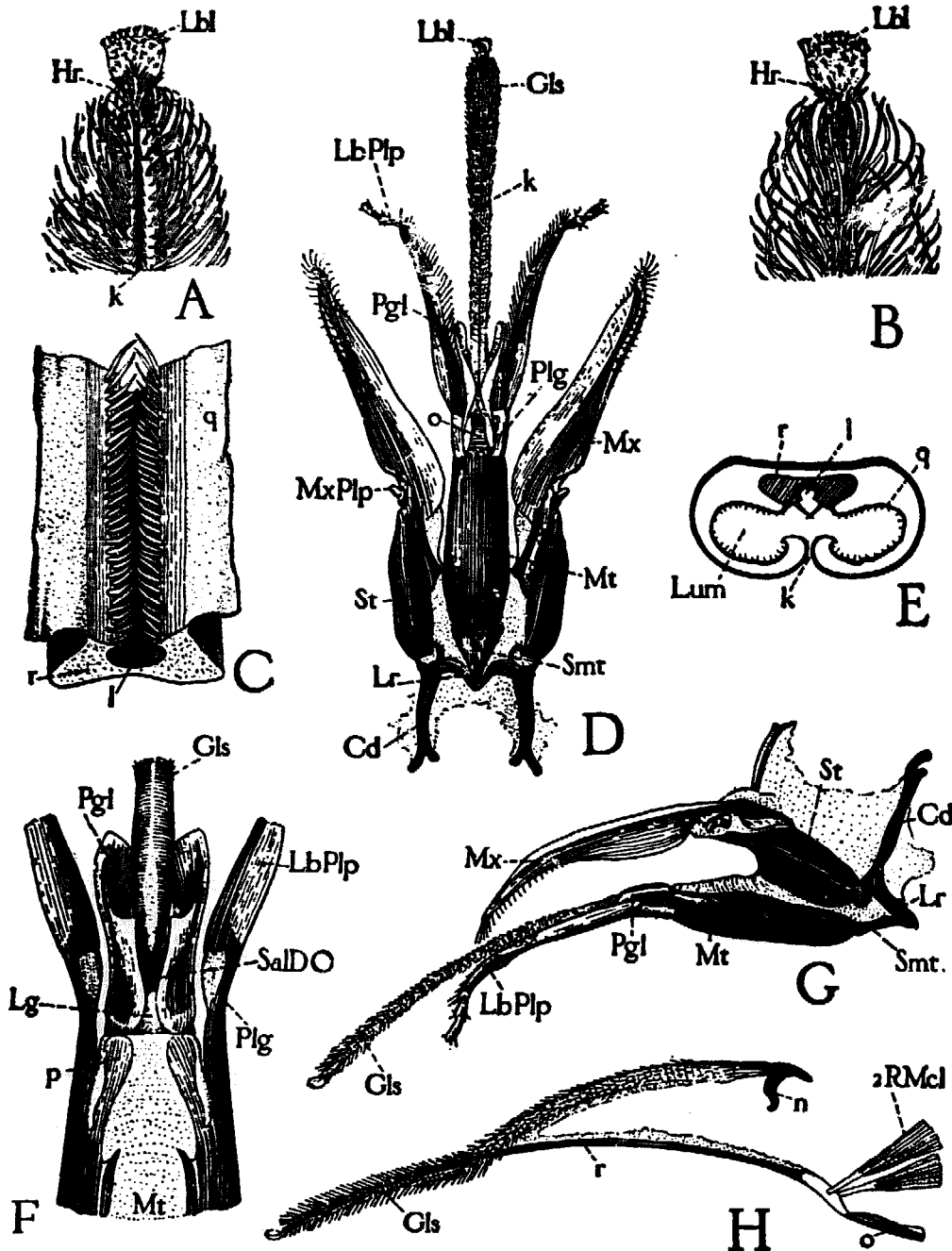

From Bulletin No. 18, "The Anatomy of the Honeybee", by Snodgrass, Department of Agriculture, Washington, D.C.

Fig. 3.—Details of mouth parts of worker. A, tip of glossa, ventral; B, tip of glossa, dorsal; C, piece of glossal rod (r) showing ventral groove (l) with parts of wall (q) of glossal channel attached; D, parts of proboscis (maxilla and labium) flattened out in ventral view; E, cross section of glossa showing its channel (Lum) open below along the groove (k) the internal rod (r) in roof of channel, and its groove (l); F, distal end of mentum (Mt) dorsal, showing opening of salivary duct (SalDO) on base of ligula; G, lateral view of left half of proboscis; H, glossa (Gls) with its rod (r) partly torn away, showing retractor muscles (2RMcl) attached to its base; Cd, cardo; Hr, long stiff hairs near tip of glossa; k, ventral groove of glossa, l, ventral groove of glossal rod; Lbl, labella; LbPlp, labial palpus; Lg, ligula; Lr, lorum; Lum, channel in glossa; Mt, mentum; Mx, terminal blade of maxilla; MxPlp, maxillary palpus; n, basal process in glossal rod; o, ventral plate of ligula, carrying base of glossal rod; p, dorsal plates of mentum; Pgl, paraglossa; Plg, palpiger; q, inner wall of glossal channel; r, rod of glossa; 2RMcl, retractor muscle of glossal rod; SalDO, opening of salivary duct; Smt, submentum; St, stipes.

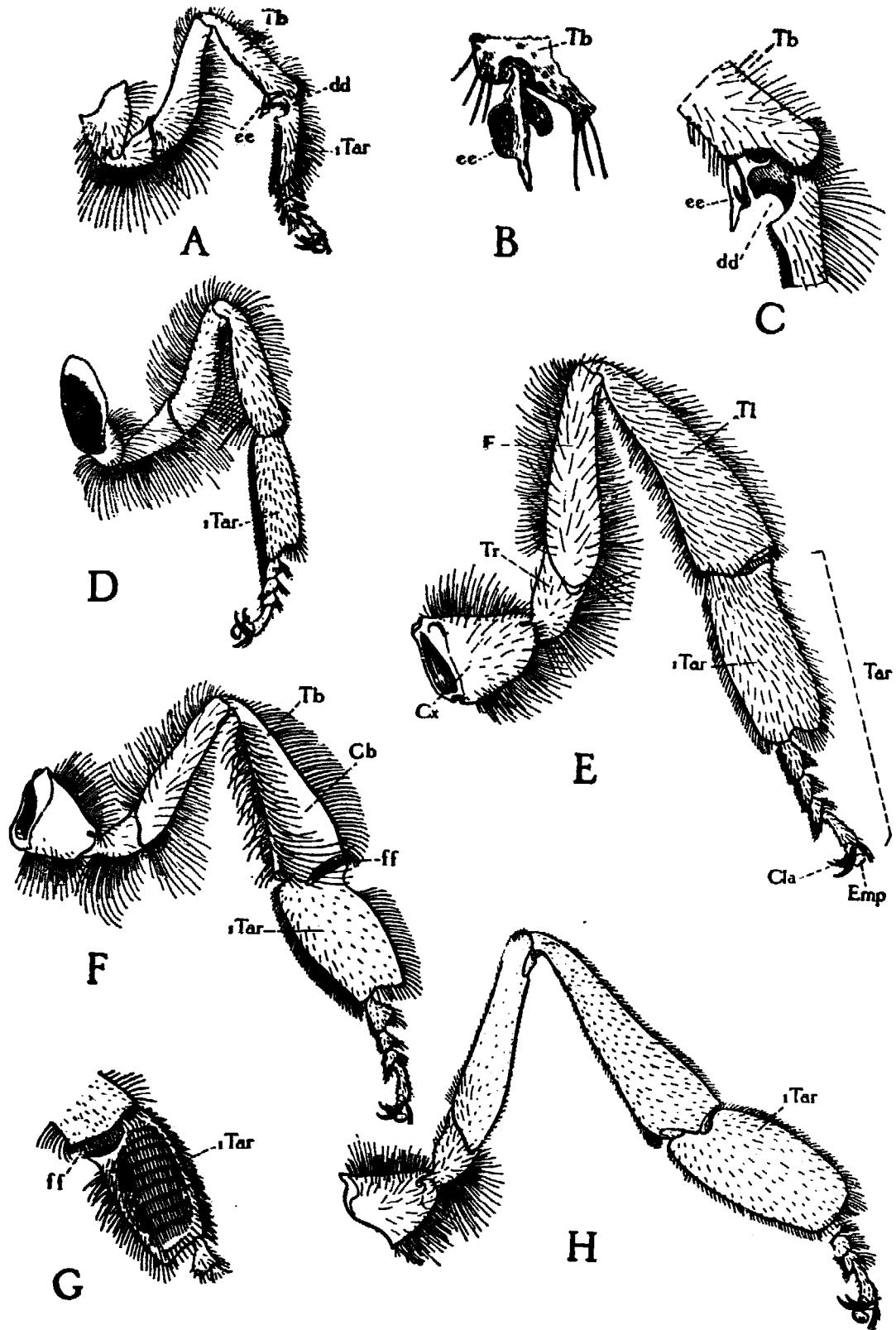

From Bulletin No. 18, "The Anatomy of the Honeybee", by Snodgrass, Department of Agriculture, Washington, D.C.

Fig 4.—Details of legs. A, front leg of worker, showing position of antenna cleaner (dd and ee); B, end of tibia of front leg showing spine (ee) of antenna cleaner; C, antenna cleaner, more enlarged; D, middle leg of worker; E, hind leg of queen; F, hind leg of worker, showing pollen basket (Cb) on outer surface of tibia; G, inner view of basal joint of hind tarsus of worker, showing the brush of pollen gathering hairs; H, hind leg of drone; Cb, corbiculum, or pollen basket; Cla, claws; Cx, coxa; dd, notch of antenna cleaner on basal joint of first tarsus; ee, spine of antenna cleaner on distal end of tibia; Emp, empodium, sticky pad between the claws for walking on smooth surfaces; F, femur; ff, "wax shears"; Tar, tarsus; 1Tar, first joint of tarsus; Tb, tibia.

or honey in the honey stomach.

The natural food of bees consists of pollen, nectar, and honey. The first contains the nitrogen of their diet, and the other two the hydrogen, carbon, and oxygen.

#### Royal Jelly

The salivary glands, located in the back part of the head and in the front part of the thorax open upon the upper part of the labium (Fig. 3, F, SalDo). The saliva can thus affect the liquid food before the latter enters the mouth, or it can be allowed to run down the tongue upon hard sugar in order to dissolve it, for the latter is eaten with the tongue, not with the mandibles. (See Brood and Brood Rearing, Larval Food.)

#### The Blood Stream

The circulatory system is very simple, consisting of a delicate tubular pulsating heart (Fig. 1, Ht) in the upper part of the abdomen, of a single long blood vessel, the aorta (Ao) extending forward from the heart through the thorax into the head, stretching across the back and under side of the abdomen, but leaving wide openings along their sides between the points of attachment. The heart consists of four consecutive chambers (1ht - 4ht), which are merely swellings of the tube, each having a vertical slit or ostium (Ost) opening into each side.

#### The Breathing Apparatus

The respiratory system is very highly developed in the bee, con-

sisting (Fig. 1) of large air sacs (TraSc 1-10) in the head, thorax, and abdomen, and of tubes called tracheae given off from them (Tra, LTra). Fig. 1 shows principally the parts in only the right side of the body. In the abdomen a large sac (10) lies on each side connected with the exterior by short tubes opening on the sides of the first seven segments. Three other pairs of such openings occur in the thorax. Thus there are in all ten pairs of breathing apertures, and they are called the spiracles. None occurs on the head. The tracheal tubes given off from the air sacs branch minutely to all parts of the body and penetrate into most of the tissues. Hence oxygen is carried directly to the cells that use it, and the blood of insects is thus relieved of the work of distributing it—one of its principal functions in vertebrate animals. The respiratory movements are produced by muscles of the abdomen.

#### The Nervous System

The nervous system consists of a series of small masses of nerve tissue called ganglia, lying along the median ventral line of the body cavity (Fig. 1, 1Gng-7Gng), the two of the thorax being much larger than those of the abdomen. Each two are connected by a pair of cords. Nerves are given off from these ganglia to the various organs and parts of the body, and to the legs and wings. In the head there are two ganglionic masses. One is call-

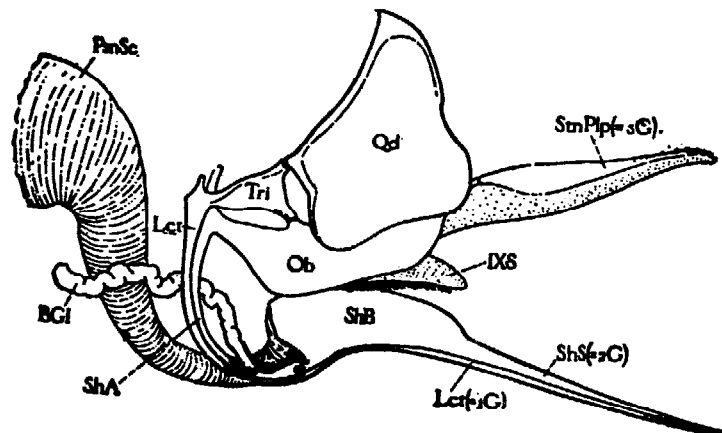

From Bulletin No. 18, "The Anatomy of the Honeybee", by Snodgrass, Department of Agriculture, Washington, D.C.

Fig. 5.—Left side of sting and its accessory plates, with alkaline gland (Bgl) and base of poison sac (PnSc) attached. Bgl, alkaline poison gland; Lct, lancet; Ob, oblong plate; PnSc, base of poison sac holding secretion from acid gland (See Fig. 8); Qd, quadrate plate; IXS, median part of ninth abdominal sternum; ShA, arm of sheath; ShB, bulb of sheath; ShS, shaft of sheath; StnPip, palpus of sting; Tri, triangular plate.

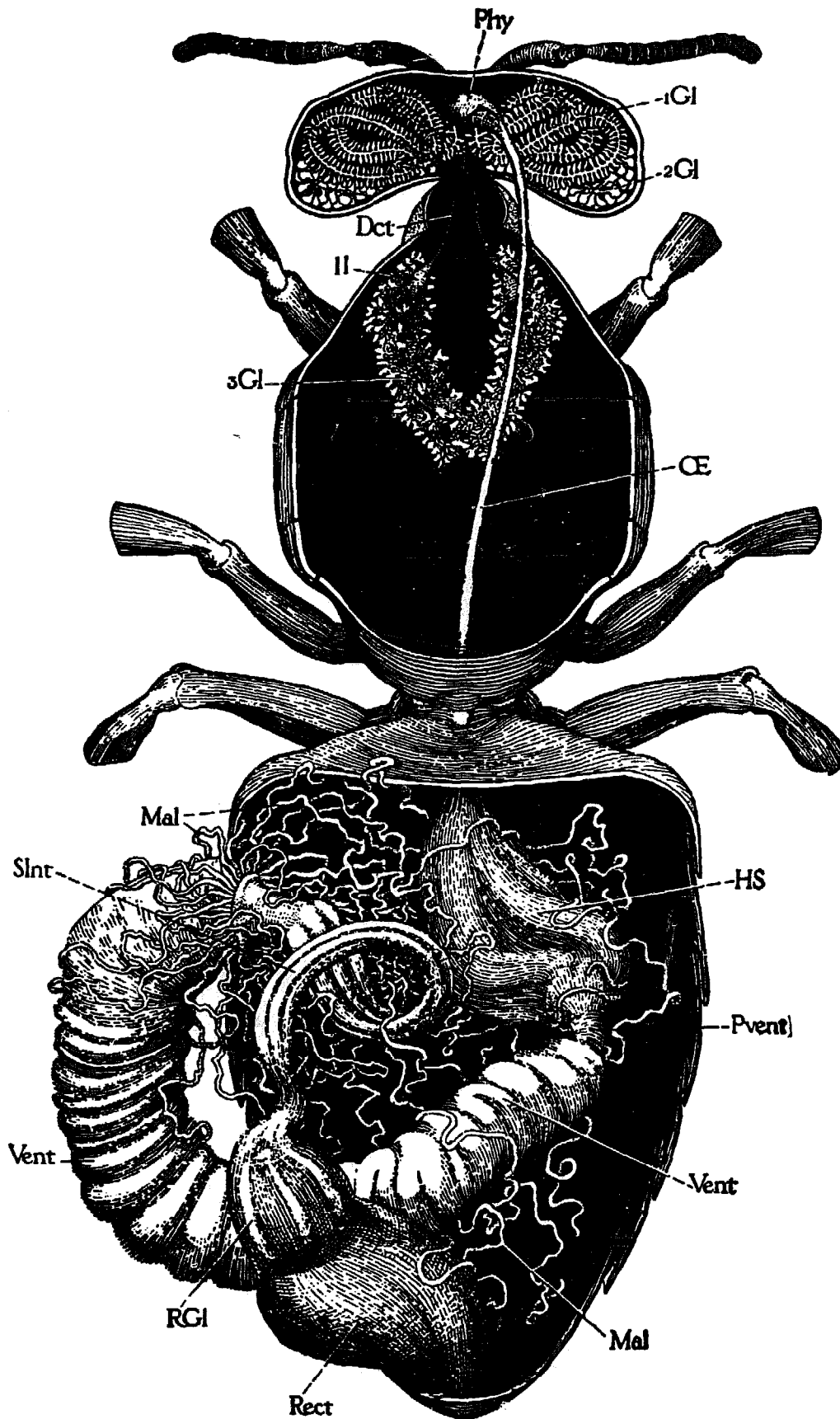

From Bulletin No. 18, "The Anatomy of the Honeybee", by Snodgrass, Department of Agriculture, Washington, D.C.

Fig. 6.—Alimentary canal and salivary glands of worker, dorsal. Dct, salivary duct; 1Gl, pharyngeal glands of head (supracerebral glands); 2Gl, salivary glands of head (post-cerebral glands); 3Gl, salivary glands of the thorax; HS, honey stomach; Il, reservoir of thoracic salivary gland; Mal, Malpighian tubules; OE, oesophagus; Phy, pharynx; Pvent, proventriculus; Rect, rectum; Rgl, rectal glands; Sint, small intestine; Vent, ventriculus.

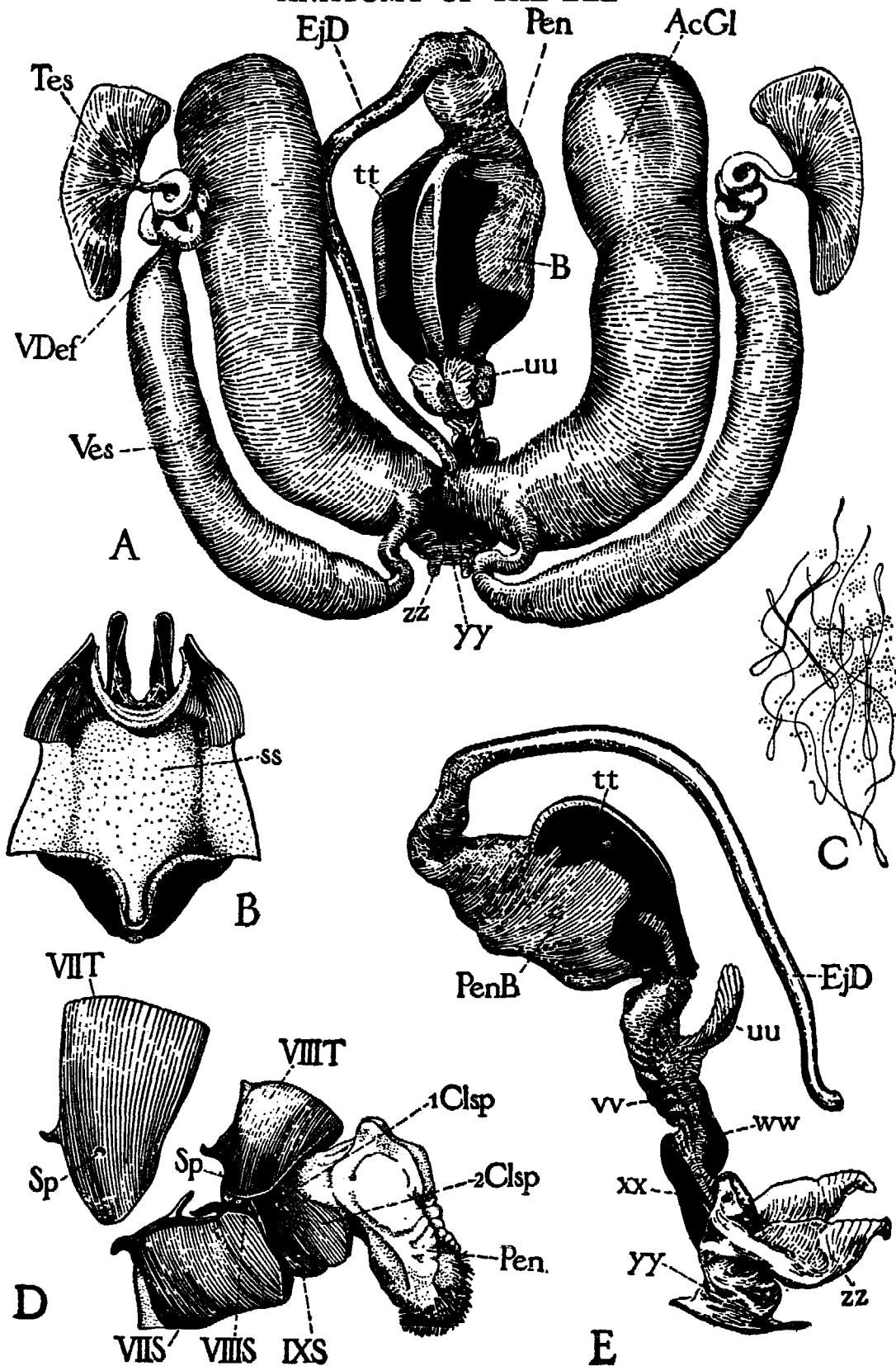

From Bulletin No. 18, "The Anatomy of the Honeybee", by Snodgrass, Department of Agriculture, Washington, D.C.

Fig. 7.—A, reproductive organs of drone; B, inner view of dorsal wall of penis; C, group of spermatozoa; D, terminal segments of drone, lateral, showing penis (Pen) partly protruded; E, lateral view of penis and ejaculatory duct (EjD); AcGl, accessory mucus gland; B, bulb of penis; 1Clsp, 2 Clsp, clasper organs of ninth abdominal sternum; Pen, penis; PenB, bulb of penis; VIIIT-IXS, seventh to ninth abdominal sternum; ss, gelatinous mass of inner wall of bulb of penis; VIIIT-VIIIT, seventh and eighth abdominal terga; tt, dorsal plates of bulb of penis; Tes, testis; uu, fimbriated lobe at base of bulb of penis; vv, ladder-like plates of penis; VDef, vas deferens; Ves, seminal vesicle, ww, xx, dorsal and ventral plates in wall of penis; yy, terminal chamber of penis through which the rest is everted; zz, copulatory pouches of penis.

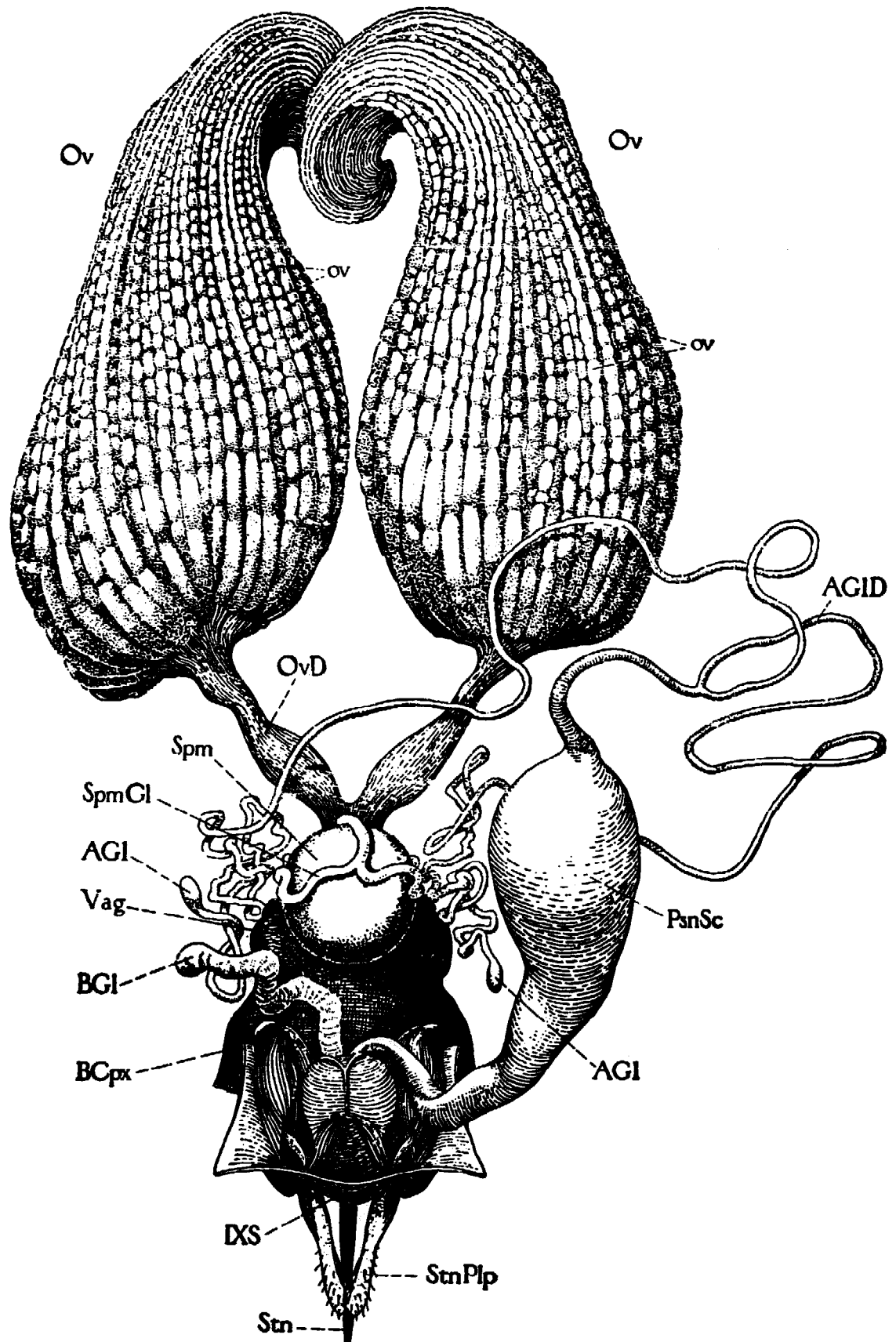

From Bulletin No. 18, "The Anatomy of the Honeybee", by Snodgrass, Department of Agriculture, Washington, D.C.

Fig. 8.—Reproductive organs of queen, dorsal, together with sting, its muscles, glands, and poison sac. AGI, acid glands of sting; AGID, duct of acid glands; BCpx, bursa copulatrix; BGI, alkaline gland of sting; Ov, ovaries; ov, ovarioles; OvD, oviduct; PsnSc, poison sac; LXS, median part of ninth abdominal sternum; Spm, sac of spermatheca; SpmGl, spermathecal gland; Stn, sting; StnPlp, palp of sting; Vag, vagina.

ed the brain (OpL), and is situated above the oesophagus, where it gives off nerves to the eyes, the antenna, the front, and the labrum. The other, called the suboesophageal ganglion, lies in the lower part of the head, and innervates the mouth parts, while it is connected with both brain and the first thoracic ganglion.

**The Reproductive System**

The reproductive system consists of those organs that produce the spermatozoa in the male and the eggs in the female and their accessory parts, the same as in all insects and animals.

During copulation which takes place in the air, the drone ejects the spermatozoa in the upper end of the vagina of the queen. The spermatozoa consists of minute vibratory threads (Fig. 7, C), which probably by their own motion make their way up through a small tube opening into the dorsal wall of the vagina, and so reach a globular sac (Fig. 8, Spm) called the spermatheca. Here they are held during the rest of the lifetime of the queen, to be extruded in small bundles of less than a hundred sperms each, according to Nachsheim, upon the eggs passing out of the vagina. Thus are the female eggs fertilized, and the drone eggs developed without the addition of the male element.

This whole subject of the anatomy of insects and particularly of honeybees is treated much more in detail in a later work by Snodgrass, entitled "The Skeleto-Muscular Mechanisms of the Honey Bee", in 1942, Smithsonian Miscellaneous Collections, Volume 103, No. 2, published by the Smithsonian Institute, Washington, D.C.

No changes in the brief here presented are indicated in the later technical work which is too technical for the average reader who is not an entomologist.

**ANCIENT BEEKEEPING\***

15000 B.C. is the oldest record that we have on beekeeping. It is a painting of the Magdalenian period (Paleolithic Era) found on a rock of the "Cuevas de La Arana" in Valencia, Spain. The painting shows two men climbing up long ropes, probably woven

\* by George P. Georghliou, University of California, Dept. of Entomology, Riverside, California.

of sedge-grass, to a small natural hole in a cliff, evidently intended to represent the dwelling of a swarm of bees. One of the men is shown taking the honeycomb out of the hole and placing it in a basket. Bees are shown flying around.

3000 B.C.—Written records indicate that migratory beekeeping up and down the Nile River in Ancient Egypt was a common practice. Since the season in upper Egypt was earlier than in lower Egypt, beekeepers took their bees up the Nile after the honey was harvested. The hives were placed on rafts from which the bees flew to gather honey. Then the rafts were moved farther down the Nile to a point where there were more flowers.

From the First Dynasty of Pharaohs (3200-2780 B.C.) until the Roman period, the titles of the kings of Egypt were always associated with the sign of the bee. The cartouche containing the name of the king is preceded by a bee. Tombs of the First Dynasty bear the sign of the bee. It is evident that the Egyptians held the bee in honor.

2050-1950 B.C. to . . .—In Assyria, during and following the period of Sargon I, the bodies of the dead were smeared with wax and buried in honey.

1580-1350 B.C.—A wall painting of the 18th Dynasty in Thebes, Egypt, shows a man carrying honeycombs and grapes, and bees hovering over the combs. The striping and coloring of these bees is identical to the Egyptian bee of today.

986-933 B.C.—King Solomon speaks of honey and the honeycombs in many passages. "My son, eat thou honey, because it is good; and the honeycomb which is sweet to thy taste". (Proverbs 24:13).

750 B.C.—The Greeks were well versed in beekeeping as early as this period, with bars in their hives and regulations in regard to overstocking.

640-599 B.C.—Solon (Athenian Lawgiver). One of his laws provides that no new apiaries should be established within a distance of 300 yards from previously established apiaries.

460-370 B. C.—Democritus (Greek philosopher), as well as other Greek writers before Aristotle, make mention of the generation of bees from oxen. Democritus gives instructions on how



to obtain bees in such a way. This belief has persisted for several hundred years, and appeared for the last time in 1842 A.D., when it was stated that a certain Carey had successfully performed the miracle in Cornwall, England.

Democritus' instructions are here presented in some detail:

"Kill an ox and confine it in a one-room building, closing with clay every opening. Then open the building on the 32nd day and you will find it full of bees, crowded in clusters on each other, and the horns and the bones and the hair and nothing else of the bullock left.

"They say indeed that the 'kings' are produced from the brain, but the other bees from flesh. Kings are also produced from spinal marrow. But those that are produced from the brain are superior to the others in size and beauty and in strength.

"But the first change and transformation of the flesh into living creatures, and as it were a conception of birth, you will thus know: for when the building is opened, you will see things small and white in appearance and like one another and not perfect, not yet such as may be called living animals, in great number about the bullock, all indeed motionless. But gradually you may then see the form of the wings with their divisions, and the bees assuming their proper color and seated around their king, and flying, but to a small distance and with tremulous wings on account of their members."

**400 B.C.—Xenophon** (Greek Historian), describes the activities of the queen comparing her work with that of a housewife:

"While she stays in the hive, she does not allow the bees to get lazy, but sends out those who have to work outside, observes what they bring in, takes it and stores it until it can be used. When the time comes she divides it fairly well to each one. Further she supervises the building of the combs in the hive and she sees to it that they are constructed well and pretty and that the brood is reared in an orderly way." Thus Xenophon considers the queen as the guiding brain of the hive.

Xenophon in the 4th book of *Anabasis*, gives the earliest account on rec-

ord of honey causing sickness to man. The ancients believed that this honey was gathered from a species of rhododendron, probably *R. pontica*. (See 1784 A.D. in a later issue.)

**400 B.C.—Aristophanes** (Greek) said that beeswax is good for many purposes, among which are metal protection, modeling, writing tablets, and for sealing love letters.

**384-322 B.C.—Aristotle** (Greek) was the first to deal with the bees in a scientific way. He did not accept anything without putting it to test. His writings contain an immense quantity of accurate observations on bees. However, he had limitations due to the fact that the hives he used had no movable frames (only top bars) and therefore he was compelled to remove from the hive permanently each comb that he examined. Because of this handicap he was unable to examine certain phases of the life of the bees.

He begins the life history of the bee by remarking that after the cells have been constructed, the larvae are placed in them. This is the earliest stage of which he speaks, from his own observation. He describes with great accuracy the growth of the larvae into an adult bee.

In the "Generazione Animalium", however, he concludes that the rulers generate rulers, and the workers generate drones and the drones do not reproduce. Therefore, Aristotle was the first to drop the idea of the generation of bees from oxen. In regard to the "rulers" he stated that there is always more than one in the hive, and that the hive goes to ruins if the rulers are too many or too few. However, he states correctly, that the rulers are connected with the production of brood.

Aristotle also mentions that some beekeepers use what we might call "primitive drone traps" made of a net which keeps the drones out, but allows the little bees to pass through. He states that the honey is carried in the honey stomach of the bees, and that pollen (beebread) is carried on the legs of the workers. He does not understand the origin of wax and states that it is carried in the hive on the legs of the workers. He mentions "foulbrood" and several other enemies of bees, including toads, swallows, frogs, wasps, etc.



Aristotle was the first to notice that honeybees do not visit flowers of different kinds on one flight, but remain constant to one specie. His works remained the basic source of information until after the Middle Ages.

**372-287 B.C.—Theophrastus** (Greek) wrote mostly on plants, but he refers to beekeeping in several places in his works. Although he knew that nectar is connected in some way with flowers, he still mentions the old belief that nectar is spontaneously generated from the air and from reeds.

**116-27 B.C.—Varro** (Roman scholar and author). He mentions a certain Seius, who leased his hives at a yearly rent of 5000 pounds of honey, and another successful beekeeper named Velanius whom he knew in Spain. He inherited half an acre of land, on which he made a garden and used the rest planted with thyme, cytins, and apias-trum, as an apiary. He was successful and cleared on the average 10,000 sesterces a year (\$320).

Varro gives a long list of the materials of which hives are made, including those made of osiers and round in shape (perhaps skeps), those made of wood and bark, those made of hollow trees, of earthen-ware, and last of all those made of reeds. The last named are to be 3' x 1' x 1', narrower in the middle than at the ends, and capable of contraction and enlargement, by pushing in and drawing out the ends.

He mentions that spring diarrhea is said to be due to feeding on almond and cornel flowers, and for a cure, urine is given them to drink. Wax is still

thought to be collected from flowers. It is believed that Virgil (70-19 B.C.) copied largely from Varro.

From Varro's writing it is evident that beekeeping was an established commercial practice in several countries bordering the Mediterranean sea.

**100 B.C.—**In Roman Law, bees which were not enclosed in a hive, were legally considered masterless. "Bees are wild by nature. Therefore, bees that swarm upon your tree, until you have hived them are no more considered to be your property than the birds which build their nests on your tree; so if anyone else hives them, he becomes their owner".

**70-19 B.C.—Virgil** (Roman poet). His poems are characterized by a deep love and admiration toward bees. He refers to bees on about 16 occasions, in Eclogues, Georgics, and Aeneid. He is both a beekeeper and a poet. He gives a lot of realistic information and instructions about bees, but he lacks the scientific method of Aristotle. He considers thyme to be the best honey.

Virgil recommends clipping the wings of the ruler to check the issue of swarms. He speaks about shade and wind protection. He also states that the noise of cymbals is to be used to make the swarms settle. This belief has persisted in many countries until today. He states that bees gather their young from leaves and sweet plants, a statement which Pliny later copied. (See Pliny, 62-113 A.D.)

**60 A.D.—Columella** (Roman practical writer on agriculture). He also wrote on bees. When we move from Virgil to the later authors, we notice an important change. We no longer find the affection for bees so characteristic of Virgil. Instead we meet the commercial side of the business. The writers set out to tell the beekeeper what will be required in his apiary, and what he should do each season.

**62-113 A.D.—Pliny** (Roman author). His books contain a great deal of information on beekeeping, but no critical analysis and no systematic arrangement. He repeats what the previous authors have written, and includes most of the old superstitions, as for example, the genesis of new stocks from dead oxen, the gathering of larvae by the bees from the flowers, etc.

**800-900 A.D.**—Bees were probably brought to America by the Irish and Norwegians who established posts in America between 800 and 900 A. D. They pushed southward as far as Naragansett Bay, where they not only established a colony, but a mission as well. Since honey was practically the only sweet of the ancients and beeswax an imported item, in the Catholic church, it is probable that they brought with them the honeybee.

**950 A.D.**—By order of the Emperor Constantine VII of Byzantium, the series of books named "Geoponica" was written, which is an encyclopedia of the available information to that time. It contains considerable information on beekeeping.

**1448-1482 A.D.**—During the reign of the Inca Tupac Yupanqui, he conquered some sylvan savages who were so poor that the only tribute they could offer to pay was one of macaws, monkeys, honey, and beeswax (probably not honeybees). This is the first reference available on bees in the New

World. Honeybees are not natives of the American continent. Since Columbus landed in America in 1492, it is supposed that bees were brought here earlier. (See 800-900 A.D.)

**1568 A.D.**—Nickel Jacobs (Germany) in his book published 1568, recommends a treatment for American foulbrood (die foule brut) similar to the one used until recently: "First cut out all the honey and combs, keep the bees locked in for three days and starve them. Afterwards take a new hive and put it in the same place where the sick one was standing. Take the sick bees and put them in the new one. Give them new honey and they will improve".

**1590 A.D.**—J. and Z. Janssen (Holland) invented the microscope, enabling man to examine structures so far invisible to the unaided eye.

**1590 A.D.**—Bar-hives and movable combs are referred to in a book on bees published in Italian by Giovanni Rucellai.



**Honey becomes a lethal weapon.** In the far distant past, when Pompey and his cohorts (about 1000 men) were traveling through the mountains, Heptakometes, an enemy of Pompey, placed poisonous honey along the route. When the soldiers of Pompey ate the honey they became senseless. Just at that time they were ambushed and killed.

**1609 A.D.**—According to **Langstroth**, it was an English beekeeper, **Butler**, who wrote the "Feminine Monarchie" who was the first among bee writers to affirm in 1609 that the "Kingbee" was really a queen, because he had seen her deposit eggs.

**1652 A.D.**—**Mewe** (Great Britain) constructed hives of wood, with movable top bars.

**1670 A.D.**—**Swammerdam** (Holland) was the first to ascertain the sex of the queenbee by dissection. However, he did not understand the act of fertilization of the queen. He supposed that queens were fertilized by a seminal exhalation of "odoriferous effluvia" to produce which required a large number of drones.

**1679 A.D.**—**Moses Rusden** (England), who was Bee Master to King Charles II in his "Further Discovery of Bees" still believed that the worker bees gathered from flowers "the actual corporal substance of the young bees".

**1683 A.D.**—**John Houghton** (England) invented a movable-frame hive but his bee spaces were too wide. The frames soon would become immovable.

**1683-1757 A.D.**—**Reaumur** (France) was the first to report experiments of confining a queen and drone together in a glass dish, for mating. This was natural because at that time there was an opinion that the queen mates in the hive.

**1684 A.D.**—**Martin John** discovered that with the point of a needle he could pick scales of real beeswax from the abdomen of a bee working at comb-building. He was the first to notice that wax is a product of the body of the bee. (See 1792.)

**1711 A.D.**—**Maraldi** (France) invented a single-comb observation hive having glass sides.

**1739 A.D.**—Sweet clover was first noticed in America, in the State of Virginia, where it was introduced from Europe. It soon became the most important honey plant and came to be considered as "The Bee Plant".

**1740 A.D.**—First mention about the parasite **Braula coeca** on bees. (Name given by **Nitzsch** in 1818.) **Braula coeca** belongs to the Pupipara which is a group of parasitic **Diptera** (flies), some of which have lost their wings.

The larvae burrow into the combs just under the cappings while the adults can be seen on the back of the queen bees and sometimes the workers, feeding on nectar that exudes from their mouth.

**1758 A.D.**—**Carolus Linnaeus** published the 10th Edition of *Systema Naturae*. In this he used for the first time the binominal system of nomenclature. The honeybee was named **Apis mellifera**.

**1771 A.D.**—**Janscha** (Austria), the royal beekeeper of Maria Theresa, solved the mystery of the mating of the queen, by his discovery that the mating occurs away from the hives.

**1787 A.D.**—**Huber** (Switzerland) noted the flight of virgin queens and their return to the hive with evidences of mating.

**1788 A. D.**—**Huber** first reported that he observed two queens that mated twice.

**1788 A.D.**—**Ernst Spilzner** (Germany) observed that when a worker honeybee returned to the hive with a load of nectar, it performed certain movements, which are now known as the dances of the bees.

**1789 A.D.**—**Huber** demonstrated that queens mate outside of the hive in the air. (See 1771.)

**1789 A.D.**—**Huber** invented the **Huber** hive.

**1790 A.D.**—**Della Rocca** (Italian) in his book on bees, mentions bar hives as in vogue in the Islands of the Greek Archipelago, where he lived for many years.

**1791 A.D.**—**Huber** tried unsuccessfully to "fecundate" a virgin queen artificially by introducing within the vagina, at the end of a hair pencil, a little of the prolific liquid of the male.

**1792 A.D.**—**John Hunter** drew attention to the wax glands by which the scales are produced.

**John Hunter** presented an article entitled "Observations on Bees", in which he gives a very satisfactory account of how the eggs of the queen are fertilized from the content of the spermatheca.

**1793 A.D.**—**Huber** showed that the true source of beeswax was nectar and honey and not pollen.

**ANGER OF BEES.** — The term "anger" hardly applies to bees, notwithstanding there is a general impression that they are always in a towering rage, ready to inflict severe pain on everything and everybody coming near them. Bees on the contrary, are the pleasantest, most sociable, most genial, and best natured little beings that are met in all animated creation, when they are understood. Their beautiful comb can, when one knows how, be broken to bits right before their very eyes without their showing a particle of resentment; and with all the patience in the world they will at once set to work to repair it—and that too, without too much remonstrance. If they are pinched they will sting; and a human being who has energy enough to take care of himself would do as much had he the weapon.

To open hives in such a way as to avoid stings, see Manipulation of Colonies, and Stings, Subhead How to Avoid Being Stung.

During the middle hours of the day when the air is warm and balmy, and the bees are going into the fields, they are generally very gentle. But if a sudden rainstorm comes up, shutting off the supply of nectar, they will sometimes become quite cross, and this temper will last until the normal supply begins to come in again.

Bees are inclined to be cross toward night on cool days. When all are at home and the hives are opened unceremoniously, they may resent the intrusion. It is then that beginners discover, much to their sorrow, that bees should not be handled during cool weather, right after a rain, or at night.

Strong colonies are far more difficult to handle than weak ones.

There is nothing in the world that will induce bees to sting with such wicked recklessness as to let them get to robbing combs or honey left exposed, when they have nothing to do. When the supply is exhausted their frenzy reaches its height. From this little carelessness and nothing else, whole apiaries have been so demoralized that people were stung when passing along the street sev-

eral rods distant. During the middle of the day when bees were busily engaged on the flowers during a good yield, we have frequently left filled combs standing on top of a hive from noon until evening without a bee touching them. But to do this after a hard rain or at a time when little or no honey is being gathered in the fields might result in the ruin of several colonies, and the bees being voted a nuisance by the whole neighborhood.

Colonies that are located in dense shade throughout the day are usually ill-natured, while those out in the sun are good-natured.



Bees are basically good natured.



Sure proof of American foulbrood is the ropy characteristics of the larva as shown above. The diseased material will snap back when stretched too far. A Gleanings photo.

**ANTIBIOTIC, USE OF**—The use of drugs for treating honeybee diseases began many years ago. Dzierzon, in 1882 experimented with chemotherapy and recorded some success using chemicals to treat bee diseases—most notably salicylic acid. It was found that sodium sulfathiazole suppresses American foulbrood when fed in syrup to diseased colonies and Terramycin has also been found to be effective. C.L. Farrar, writing in the April, 1956 issue of *Gleanings In Bee Culture* had this to say about the use of medicinal agents in the treatment of bee diseases. "We cannot assume that a drug that gives control this year will be equally effective in all years to come. It is well known that some strains of pathogenic organisms tolerate drugs that have been active against the more common forms". Whether this proves to be true in the treatment of honeybees remains to be proven. Drug resistance, if such exists in treating honeybee colonies

with antibiotics, has not been thoroughly documented.

It is the consensus of most apiculturists that preventive treatments for American and European foulbrood with Terramycin, the only antibiotic currently available for the foulbrood diseases, are effective. Most states and provinces of Canada enforce their existing laws requiring that colonies having a proven infestation with American foulbrood be treated by burning or by sterilization of combs and equipment. In states with regulations requiring burning of diseased equipment the use of antibiotics is usually restricted to preventive treatments. If doubt exists about what recommendations apply to your state or province in regard to disease treatment with drugs consult your state apiarist or county apiary inspector. In the event of a suspected exposure to American foulbrood the antibiotics have proven to be a first line of defense. Drugs

have been the only recourse of beekeepers who have bees in areas with a high incidence of disease and an inadequate inspection and control program for honeybee diseases.

The list of antibiotics available for use in treating bee diseases has been greatly reduced. Certification of the safety of many of the drugs used in the past to treat bee diseases is a lengthy and expensive procedure. Beekeepers are not considered large consumers of antibiotics when compared to other users, beef and hog farmers, for example, and this has tended to narrow the selection of drugs available to beekeepers.

An alternative to drug treatment has been sterilization in ethylene oxide charged chambers. This type of treatment has proven effective for foulbrood contaminated equipment but the continuation of this method will depend upon investigations being conducted regarding the restraints that may be imposed on the use of ethylene oxide. The fumigation chambers used in this treatment method are too expensive for the individual beekeeper but several states and at least one province of Canada have purchased units and are operating successfully.

Antibiotics must be administered in some manner that insures their ingestion along with the bees' food intake. The drug used should be specific for the disease it is directed at and only the prescribed amounts administered. Dosage may be varied with the colony condition, whether it is strong or weak, and with the season of the year.

#### **Terramycin for AFB and EFB Prevention**

Feeding method-Icing sugar dry mix—One teaspoon of Terramycin animal formula 25 (activity 25 grams/pound with soluble carrier) to five teaspoons of powdered sugar (sixteen teaspoonfuls to one pound). For larger quantities mix 1 pound of TM 25 to 5 pounds of powdered sugar. The first treatment should be done

within four days after hiving a package of bees or an overwintered colony is unpacked and inspected in the spring. For a small colony or package administer 1 level tablespoon of the mixture per colony; for a large colony give two level tablespoons. Up to three applications may be made at five day intervals. Distribute the mixture over the top bars of the frames of the brood chamber but do not apply the dust directly to the brood as it may destroy the larvae. Stop drug treatments at least four weeks prior to the honeyflow. By confining drug treatments to the most active brood rearing season most of the material will be used during this period and any honey in contact with the antibiotic will remain in the brood chamber and be used for feeding the brood.

Terramycin is relatively unstable in honey and sugar syrup and for this reason the best way to administer the antibiotic is with powdered sugar as a dust.

Terramycin can be toxic to honeybees if the recommended doses are exceeded therefore all drug and antibiotic feeding should be done in strict accordance with dosage levels. The feeding of drugs and antibiotics offers only limited protection against AFB and it should not be assumed that a colony of bees has complete protection against foulbrood simply because these drugs are being fed. Periodic inspection of the brood for evidence of disease is still necessary.

#### **Fumidil B and Nosema**

Nosema is often described as an insidious disease for there are no reliable symptoms by which beekeepers may detect the presence of disease in their colonies. While it is commonly suspected that heavy infestations of Nosema occur in the spring a microscopical examination of a sample of bees for spores is the only reliable test. Nosema is probably present in nearly all colonies of bees at all times of the year. It is not always possible to detect the low levels of infestation and treatment is not advised when the analysis indicates

a spore count below a level considered detrimental to the health of the colony. Spore counts taken of bees collected at the colony entrance will likely show higher spore counts than if the bees are taken from the brood nests.

Nosema is seasonal, spring being the time of year when the disease is usually at its peak. Weather conditions have an impact on Nosema levels. Winter conditions place the colony under considerable stress, especially if the food supply is of poor quality. Fecal matter is deposited on combs and hive parts and this is a source of infection and contributes to the spread of spores to all of the bees of the hive when spring brood rearing begins. Once bees become contaminated they become weakened by the effect of the Nosema infection of the midgut. Their effective life is shortened. A colony heavily infected with Nosema will fail to build up in the spring, exhibit poor sanitation (dysentery) and possibly suffer from queen loss. Young bees in a heavily infected hive may be observed crawling out in front of the hive in the grass. Nosema infected colonies endeavor to breed and use more stores than normal. If the midgut is pulled from a bee's abdomen it should be light reddish brown if the bee is healthy. A pearly white midgut may be suspect.

Nosema may not be the only cause of colony deterioration in the spring. Often a hive with Nosema has no dead bees around the entrance and the colony appears to be quite normal. Only a microscopic examination of the midgut of a sample of the bee can definitely determine the condition.

All of the evidence indicates that the antibiotic Fumidil B attacks the actively multiplying disease-producing organisms in the gut of the bee. To be effective Fumidil B must be taken into the digestive tract of the honeybee. Since the infestation is difficult to detect in the early stages and becomes widespread before the effects are noticed it may be wise to feed Fumidil B even before there is evidence of infestation in the apiary, especially in apiaries that have had a record of poor

performance during buildup periods in the spring. It is necessary to feed syrup medicated with Fumidil B continuously for not less than two to three weeks. This continuous feeding is required to destroy the supply of parasites so that the colony can build up sufficient strength to overcome the disease. For package colonies a gallon of syrup medicated with Fumidil B provided as soon as the colony is well established is recommended, two gallons for overwintered colonies in the spring. An inside-the-hive type of feeder is preferable when feeding Fumidil B medicated syrup. Direct sunlight on feeders such as the Boardman entrance feeders tends to reduce the effectiveness of the drug.

For the protection of overwintered colonies the medicated syrup should be fed in the fall of the year if the colony is to be fed only once. There may be advantages to feeding the medication in both the spring and the fall.

#### Feeding Fumidil B

For packages—Where an analysis indicates the presence of 100,000 or more spores per bee feed each colony  $\frac{1}{2}$  level teaspoon of Fumidil B in  $\frac{1}{2}$  to 1 gallon of sugar syrup. If samplings at three weeks after the first feeding indicate high levels of Nosema remaining a second feeding should be given.

For over-wintered colonies—Fall feeding—After the honey supers have been removed feed 1 level teaspoon of Fumidil B per colony in a gallon of sugar syrup. A late winter, late February or early March, feeding should be followed by an early spring feeding in late March or early April if a high level of Nosema is indicated. For colonies packed for winter and where late winter feeding is not possible feed in the fall after the crop is taken off—2 level teaspoons of Fumidil B (200 milligrams of fumagillin) in  $2\frac{1}{2}$  gallons of 2:1 sugar syrup. The medicated syrup should not be fed immediately before or during a honeyflow.

Fumidil will dissolve readily in cold



water. Heat is needed only in order to dissolve the sugar quickly. Water should be heated only warm enough to dissolve the sugar and no heat should be used after the Fumidil B has been added. The best results are obtained when water is heated to between 100 degrees and 120 degrees F, the heat source removed and then the Fumidil B and sugar are dissolved in that order. Forty-four pounds of sugar in twenty-two pounds (2¾ gallons) of water will make roughly six gallons of 2:1 sugar syrup. Three hundred and seventy one pounds of sugar in one hundred and eighty six pounds (23 gallons) of water will make roughly 50 gallons of 2:1 sugar syrup.

If there are any questions about the presence of disease or a suspected exposure to a source of disease by your bees you are advised to contact an apiary inspector at either the local or state or provincial level. It may be wise to confer with the apiary inspection service regarding the administration of any antibiotics.

## ANTS

Beekeepers, especially those living in the South, often go to considerable expense of time and money to keep ants out of honey houses and their colonies of bees.

### Kinds of Ants in Apiaries

There are several species of ants found in or near bee yards in Louisiana. The most damaging one is the **Argentine ant**. This species is prevalent over much of the State but is most abundant in the southern part. Colonies of bees are frequently killed within a few days, if attacked by a large colony of Argentine ants. Larvae, pupae, adult bees, and the honey in the combs are eaten. The bees are not able to keep these ants out of the hive if the colony is attacked.

The **common Fire ant** and the **Imported Fire ant** may be present near apiaries, but they do not cause the damage that the Argentine ant causes. Two other species, **Little black ants** and **Carpenter ants**, sometimes nest in hives. While this black ant causes little or no damage other than possibly annoying the beekeeper when he manipulates the



Little red ants drove these bees out of the front of the hive. Placing the hives up on stands would help to protect the bees.

colony, the large Carpenter ant, on the other hand, can literally hollow out the floor boards of a bottom board if these ants are allowed to become established under the hive.

### Control Measures

**Clean-up:** A clean apiary is less likely to harbor ants than a poorly kept one. Remove all rotten wood, stumps, boards, piles of leaves, grass or brush, and especially old hive stands and bottom boards that are left in contact with the soil. Ants like to nest in or under such material. Underbrush, weeds, and grass should be kept cut close to ground, especially around the hives.

If Argentine or Carpenter ants are nesting in part of the hive or in a hive stand, the infested material should be removed and burned. Bottom boards and hive stands should be raised off the ground to avoid contact with the soil, thus eliminating a moisture condition which would attract Argentine and Carpenter ants. Honey and pieces of bee comb should not be left lying on the ground in the apiary, since ants are attracted to material of this kind.

**Insecticides:** Chlordane applied as a spray is a very effective ant killer; however it is equally as good a bee killer so it should be used in the apiary with extreme caution.

Chlordane spray should be mixed at the rate of four tablespoonsful of 45 per cent emulsifiable concentrate to

one gallon of water or two gallons of 45 per cent emulsifiable concentrate to 100 gallons of water. One ounce of 50 per cent chlordane wettable powder per gallon of water or six pounds per 100 gallons of water also are satisfactory spray mixtures.

Spray thoroughly and carefully the outer perimeter of your apiary, working in toward your colonies to within four or five feet of each hive, using a garden type sprayer with a coarse spray nozzle. Under no circumstances allow a mist from the nozzle to drift over the entrances of your colonies. Saturate any ant hills or nests and also old tree stumps that cannot be moved, but do not spray under or around the immediate area of the hive, or any bees that light in the grass near their colony will be destroyed.

Apiaries should be visited at regular intervals, particularly in the fall when the ants begin to congregate for the winter. Whenever ants are seen in the apiary another application of chlordane should be made. Three or four applications per year should keep ants out of most apiaries.

When ants are a problem in the honey house they should be controlled by spraying around the **outside** foundation of the building.

Chlordane should not be used in an enclosed area when combs or foundation are exposed. This insecticide, when used in an enclosed area, will give off a vapor which can be absorbed by beeswax in sufficient quantity to poison bees that come in contact with the wax. When used on the outside this problem does not exist.

Chlordane has a residual effect. It kills ants that come in contact with it several weeks after the poison was applied. The length of time that an application can be depended on to keep ants out of the beehive depends upon temperature, rainfall and other weather conditions which affect the residual killing effects of chlordane.

**Chlordane is a poison and it should be handled with care. Wash thoroughly with soap and warm water, if chlordane is spilled on the skin. Keep containers labeled, tightly closed, and away from children. Keep livestock off treated areas.**

**Mechanical:** Where beehives are placed on stands or benches, ants may be kept away from the colonies by applying bands of tanglefoot to the legs of the stand. The tanglefoot may be smeared on with a stiff brush or paddle, making a two or three-inch band around each support. Such a band has to be renewed frequently, for it becomes hard and dusty, then the ants can cross it.

**Poison Bait:** Many people are familiar with the use of government formula ant poison to control Argentine ants. Although this poison may be effective in houses and in cities, beekeepers have found that it is of no value in the bee yard. It is not recommended by us for use around the honey house or apiary.

Government formula ant poison should be kept in a properly labeled container, away from children, bees, or livestock.

**APIARIST.**—An apiarist is one who manages one or more yards of bees for pleasure or profit.

**APIARY** (derived from the Latin word "Apis", meaning a bee), is a place where a number of colonies of bees are kept, often called a bee yard.

**APIARY LOCATIONS\***—Here are some general considerations about the apiary site:

Bees which keep men are located to the best advantage of both the operator and the bees. Too often the beekeeper considers only himself when selecting a location and frequently considers neither himself nor the bees. Honey production is the prime consideration but within every honey-producing area sites both good and bad may be selected.

The importance of a good road to the apiary has been mentioned by many persons and any beekeeper who has had to carry equipment to an apiary on a wheelbarrow because of wet conditions would not question this point. However, if one must choose between a good road for his own convenience and a good location so far as the bees are concerned then the bees must be first and the road secondary.

One beekeeper in Ontario draws gravel in his spare time to fix up his roads through pastures and woods. Probably the increased benefit his bees receive covers the cost of this operation.

\* Roger Morse, State Plant Board, Gainesville, Florida.

Four or six wheel drive trucks can be obtained from many manufacturers today at additional cost. Though the original cost is more and also the cost of upkeep, men with these vehicles feel they cannot do without them. Pollination services are likewise speeded up with the use of these trucks.

How the weeds in an apiary should be kept down is a question frequently discussed. A location which is to be used year after year (and in New York State some locations have been permanent for nearly 80 years) deserves some planning and thought. One beekeeper in this area felt it paid him to hire a bulldozer to level a permanent location. This made mowing and walking around the apiary much easier.

Cinders, tarpaper (from the winter packing), and boards have been used in front of hives for a number of years to keep down the weeds. They all require a little attention in the spring but serve the purpose very well. Weed sprayers or other materials to kill the grass in front of the hive have also been used with good results.

Small garden tractors with mowing blades on front can be used successfully in a bee yard. Their greatest disadvantage is that the blade may catch onto a corner of a hive and knock it askew. This frequently means a few stings. Gasoline driven rotary mowing machines also work well in the apiary. They are especially good for cutting down berry bushes and large weeds.

Sheep have been mentioned in the bee journals from time to time as being good "lawn mowers" but they and lawn mowers themselves are scarcely practical for the commercial beekeeper.

Back lotters and persons with only a few colonies could use these last two methods to advantage. One common point of agreement is that some method and preferably the most expedient one should be used to keep the grass away from hive entrances.

Gates and fences are a nuisance and it is not uncommon for a commercial beekeeper to have to open and close two or three gates. A gate and fence around the apiary can serve a useful purpose. Cows and horses when stung will kick the nearest object and if it happens to be a hive this is a serious loss to the beekeeper.

Electric fences have been advised for protection against bears but there are also instances where bears have outwitted the electric fence.

Multifloral roses are now being used as hedgerows and for fences in some areas. They require some fertilizer and cultivation the first year. In three or four years they will serve as a permanent fence and only a gate need be added.

Cedar or pine trees grow quickly and if the tops are trimmed periodically will form heavy hedgerows. Such fences will also force the bees up in the air and above the heads of pasturing animals and people working nearby.

A permanent location deserves these little additions which will pay dividends over the years.

Most of the old established apiaries in this area have small buildings which were used at one time for extracting and storage equipment. One of the greatest advantages of such out-buildings is that they serve for the storage of



A single plant of the castor oil bean affords some protection from the direct sun for this hive.

supers. A fire in a central storage plant would mean the partial loss of crops while foundation was being drawn and combs replaced. Many beekeepers today feel that it is too costly to build out-buildings but the danger of loss of supers through fire alone is sufficient to justify their cost. It would probably be safe not to bother with insurance on combs in such buildings since the loss of any one would not be too serious and this would be a saving for the beekeeper, too. In the spring when supers are needed rapidly there is no delay in getting them to the bee yard because of bad roads or other reasons.

Commercial beekeepers equip their trucks with boxes for holding every-day equipment but most agree that smoker fuel because of its bulk is best left in the apiaries.

Other items which might be left in the beeyard in a small building are excluders, bee escapes where they are used, pallets for loading and moving supers and bottoms and covers. Many beekeepers are switching to a combination bottom board and cover which will serve as either and means that fewer "extras" must be kept available.

#### **Consider the Bees When Selecting a Location**

Bees, not men, are the honey producers. We have learned that cows, chickens, and the rest of our livestock will produce more when properly cared for. The honeybee is no exception and the beekeeper can gain much by choosing the proper location.

The honeybees' life is only about six weeks in the summer months and three weeks of this time is spent in the field. It is fairly easy to determine a bees' age by its shiny appearance and by the condition of its wings. As the bee grows older its wings become frayed and have jagged edges. Fighting strong winds contribute to this wing damage which in turn may shorten the bees' life. The beekeeper can do much to locate the yard to facilitate flight to and from the apiary.

Windy areas do not make good wintering locations and should be avoided. Not only is the inside temperature of the hive affected but more bees may be lost while on flights than is necessary or the location might be so windy that

flight is retarded. A favorite wintering location allows the bees to leave the hive for a short cleansing flight and return on a sunny winter day without interference from wind.

The southern or eastern side of a large building may afford good protection from prevailing winds but a building can also deflect air currents and thus interfere with bee flight. Because of these deflected air currents it is best to establish only a few colonies in protected spots by buildings.

Solid windbreaks of pines or conifers which are sufficiently thick to deflect wind currents should also be avoided for this same reason except in cases where only a few hives are present.

Air drainage also seems to be an important factor in successful wintering though in a less tangible manner. The location should be such that there is a slow but constant flow of air over the area. A slope is therefore best. Locations near constantly moving streams or creeks provide good air drainage. However, streams which move too fast can cause too rapid a flow of air and thus be troublesome.

An area which allows no movement of air would be the opposite of an extremely windy location. Bee flight would either be restricted because the area does not warm up (such as an extremely shaded area) or warms up too much when exposed to the sun. A localized area which warms up or has a higher temperature than that in the immediate vicinity may cause excessive bee flight. If a bee leaves a hive under such conditions it may successfully return to the hive or it may be caught by a pocket of cold air or wind a short distance from the hive and be lost.

#### **A Good Apiary Site Will Help to Control Nosema**

Most beekeepers recognize that the control of Nosema disease is largely a question of management. The Nosema organism grows most rapidly at temperatures slightly less than brood rearing temperature. If brood rearing temperature (92° to 95°F.) can be maintained by the colony there will be less trouble from Nosema.

During the spring those colonies which are protected from winds and have the full benefit of the available sunlight suffer very little from Nosema.

Wooded and shaded areas should be avoided; likewise hills which slope to the west or north. During the honey flow early and late sun will allow the bees to leave the hive earlier in the morning and return later at night. The most desirable location will have shade for the bees part of the day during the hot months.

Bees use large quantities of water in the hive both for cooling the hive and to dilute honey especially in the spring for feeding the brood. Clean water especially in the control of Nosema disease is important. Stagnant pools, holes, or low spots which hold water after rains can serve as a source of Nosema infection. The spores which are in the fecal matter when it is voided remain alive in water and may grow if picked up by a bee gathering water.

The character of the soil in an apiary can have a direct effect on the bees especially during the winter and spring months. Heavy clay or clay like soils are not desirable since they hold too much water. A sandy type soil removes excess moisture immediately.

Equipment, especially bottom boards which are wet, has a shorter life and can also make the bees uncomfortable. A wet bottom board will help to cool a hive and lower the temperature below the desirable point. A wet location with its resulting wet or damp bottom board can thus aid in the spread of Nosema in the spring by lowering the brood

rearing temperature.

During the winter months a damp bottom board may increase the humidity in the hive. High humidity makes the bees uncomfortable and unable to void excess water. High humidity can also aggravate a condition of dysentery. Dysentery and Nosema being more likely to occur in wet and poorly drained locations, has led many people to confuse the two conditions. There is no doubt that either a condition of dysentery or Nosema will contribute to the severity of the other.

### The Drifting Problem

There is always a certain amount of drifting in a beeyard which would appear to do little harm. This is noticed when apiaries are moved. Placing colonies in groups of two is becoming more popular in the northeast states. These groups are usually six to eight feet apart, depending upon the space available. Here the convenience of the operator is considered and the colonies placed so they can be worked easily. Small trees, other markers, or a range of colors in the yard will help to orient the bees. The greatest danger of having colonies too close is that young queens on their mating flight may not be able to find their way back to the hives.

### Make Apiary Easy to Operate

Our modern industrialists have long realized that good working conditions

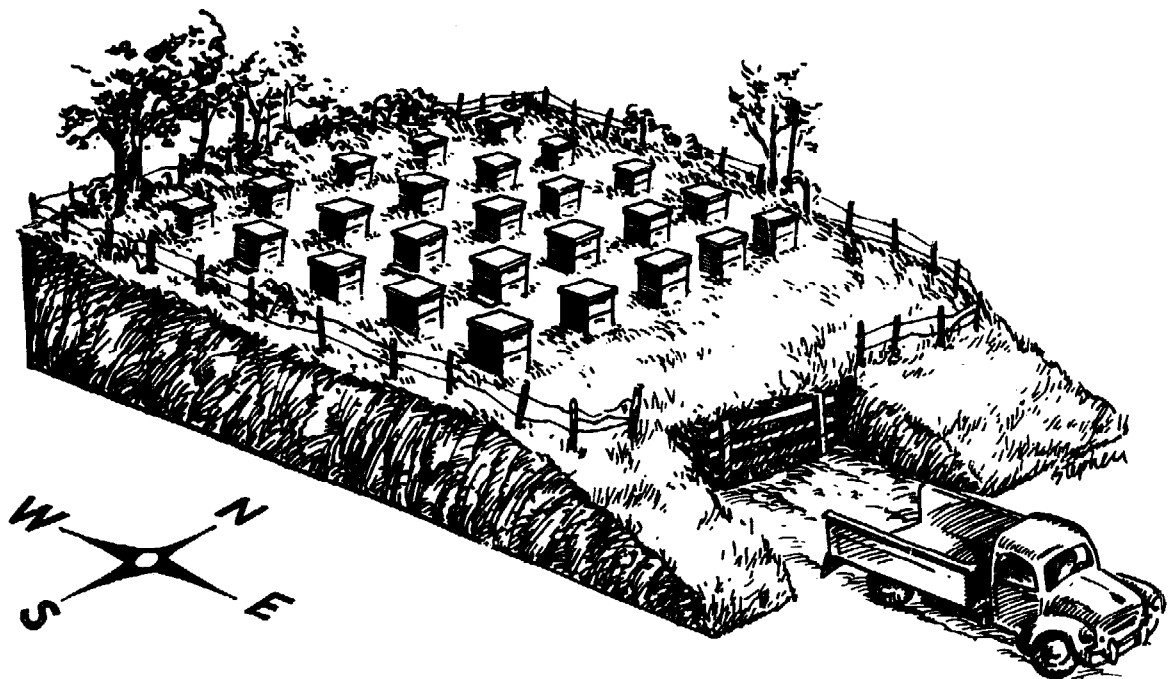

speed up production. The beekeeper and his helpers will work with greater ease and comfort in a well-planned beeyard.

There are many factors which the beekeeper must consider to make his work easier and more convenient. Honey production is the goal so the bees come first if a choice is to be made. But a location should be convenient to work in. A great deal of time is lost every year by beekeepers who have to drive over poor roads and work in locations where bees are not well situated.

A loading hole in a bee yard is a great help. It should be so constructed that when a truck is backed up on it the truck bed is level with the ground. A wheelbarrow with a large pneumatic tire makes it possible to wheel loads of supers on and off the truck. Loading bees is also simplified and considerable lifting avoided.

Hydraulic lifts are popular with some beekeepers but are very costly. The extra weight of a hydraulic tailgate is an inconvenience. In addition to this the truck must be left running and there is always some delay while the gate is being raised or lowered with its load.

Locations with a gentle slope are good for the bees and also make the construction of loading holes easy on the lower side of the yard. If the loading hole is four or so feet high it will serve as a gate into an apiary which is fenced.

The operator must also consider the location of the colonies where loading holes and wheelbarrows are to be used. The truck should be parked so that it won't interfere with bee flight. Using a wheelbarrow in front of colonies may also interfere with bee flight and in fact disturb them to the extent that extra stings result. It is also helpful if empty supers can be pushed uphill and full supers wheeled down.

The beekeeper should do his utmost to protect passers-by and the people in the vicinity from being stung. One cannot depend on keeping people out of the bees' way, so the next best thing is to keep the bees where they won't bother people. In addition to placing the bees some distance from houses, a hedgerow of pines, cedars, or multi-floral roses may be planted around the yard. For a permanent location the time and trouble spent setting out a

hedge would pay. After the hedge has grown to a height of six or seven feet the bees are forced up in the air and above the heads of people.

Every beekeeper with more than one yard has his favorite location. It is usually the one in which the largest crops are secured. At the same time it may be a location more favorable for bee activity throughout the year or it may be a convenient place for the operator. Permanent locations like the homes we live in deserve consideration and planning, and a little extra time spent finding and preparing locations means dollars in future years.

### Importance of Windbreaks

While insulation or packing of hives during winter may be deemed necessary in some localities for additional protection to the bees, it is generally agreed that some sort of windbreak to protect a whole yard of bees from cold piercing winds during winter, is important for all locations, North or South. Experience has shown that colonies, even though well packed, placed where there are sharp wind exposures on an elevation, will often die before spring, or become so weakened as to be practically worthless, while colonies of the same strength in single-walled hives screened against the wind will winter comparatively well.

In a location on a prairie, especially if it is permanent throughout the year, care should be taken to see that the apiary is protected on the north and west. Sometimes the yard can be placed at the bottom of a hill lying at the north, but it would be far better if shrubbery were placed at the brow of the hill to prevent the wind from driving down and striking the colonies with full force.

Avoid placing a yard of bees in a hollow or low plot of ground, especially if surrounded by trees. Cold from the higher ground settles in the low spots and experience shows that colonies in the low spots do not do as well as those on higher ground.

The best windbreak consists of trees or shrubbery of some sort. A solid fence is not so effective because the wind will strike it squarely and glance upward, when the on-rushing blast will cause it to roll and dive.



W. W. Brand Apiary, Hamburg, N. Y. A well protected place with good air drainage and trees that shut off the prevailing winds.

### Hive Stands

While a hive can be set directly on the ground, yet on account of the danger of dampness and the rotting of the bottom board, it is advisable to set it on pieces of boards, bricks,

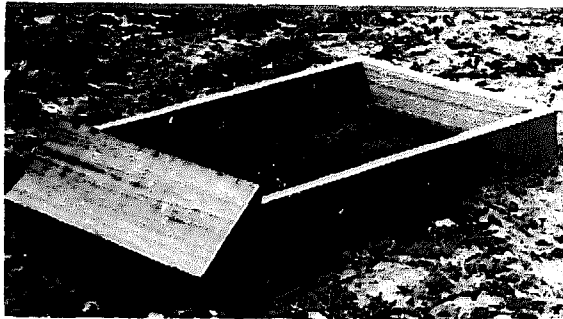

Single hive stand

concrete blocks, or common drain tiles. Bricks or tile, if six-sided or square, are very commonly used, and answer an excellent purpose. Concrete blocks of any shape or form can be cast in wooden forms. Pieces of board, scantling, or plank may be used, but it is far better to nail them together and place them on the ground edgewise.

The hive stands—brick, concrete blocks, tile, or boards—should be firmly imbedded in the soil in such a way that the front end of the hive will be lower than the back. The purpose of this is to allow the water

from beating rains or from condensation within the hive during winter to run out of the entrances.

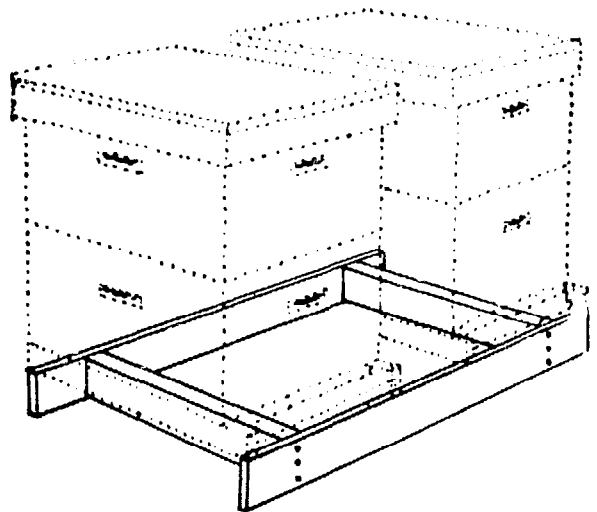

Double hive stand

Some producers use a double hive stand—that is, a stand after the pattern of the plain single stand, but long enough and wide enough also to take on two hives crosswise and yet leave a space of six or eight inches between. (See illustration.)

The front and rear boards are made of one-inch lumber, preferably unplaned, from three to four inches wide. These two pieces are tied together by a couple of scant-



Wood utility poles make good hive stands when higher elevations are necessary.

ling, crosswise as shown. It is advisable to have these last named pieces back five or six inches from the ends of the sideboards. When constructed in this way the hive can be placed more nearly over the point of greatest strength and at the same time allow room for the toes of the operator to project under the hive.

This form of hive stand has much to recommend it. It is almost as cheap as the single hive stand, and yet will accommodate two hives. Colonies worked in pairs on it do very nicely. In the fall, if one of them should be a little weak it is possible to unite them by putting the stronger colony in the center of the hive stand to catch all the flying bees and then remove the other hive. It is also possible to put a one or two frame nucleus on one end of the hive stand, leaving the colony on the other end. This nucleus can be used during the season for rearing queens, and at the close of the season it can be easily united with the full colony on the other end, which should be moved to the center of the hive stand. (See Unit-ing.)

This double hive stand lends itself to the plan of wintering when two colonies are put in a winter case. There is one objection to this

plan, namely, that the bees are liable to drift. (See Drifting.)

The most satisfactory arrangement of the hives can best be decided by studying the plans adopted by some of the prominent apiarists. The lay of the land and exposure to high winds will of course have to be considered.

The usual plan is to arrange the hives in long straight rows, each hive so many feet distant from its neighbor, and on an exact line drawn by a string. While such an arrangement is pretty, it has one serious objection. When hives all face the same direction, in straight rows, each hive by itself, the bees are apt to become confused at the entrances, especially if the hives are only two or three feet apart. When the young bees are on their play flights (See Play Flights under Bee Behavior) they are liable to join the group where the bees are flying the thickest. The result is that their own colony is depleted while the one that makes the biggest demonstration for the time being is getting more bees than it can easily take care of. This causes some colonies to be too strong and swarm too early, while others are too weak and do nothing all summer. (See Tropical Apiaries.)



This whole difficulty of drifting can be corrected by giving each hive or group of hives an individuality of its own. Where the ground and shrubbery or trees permit, it is desirable to put hives in groups of two, three, or five: two here, three there, five there, and so on. There may be regular groups of two or groups of three, but in either case there should be a bush or tree at or near each group to enable the bees to distinguish one group from another. Painting the fronts of the hives different colors helps much.

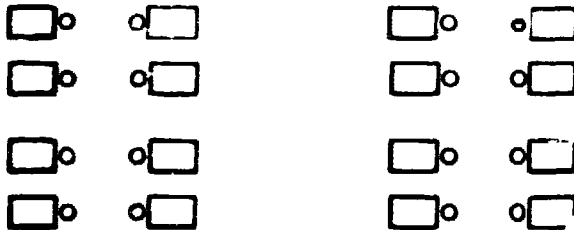

A part of an apiary arranged on the straight-row plan, two hives to a group. Circles indicate entrances.

The circles in the diagram shown above indicate the entrances. There are two alleyways; one six feet wide for the bees, and one ten feet wide for the apiarist and his truck. It will be noticed that the hives are arranged in pairs in such a way that they face each other with entrances six feet apart. In the next alley their backs are toward each other, with plenty of room for a roadway.

#### Keeping Down the Grass at the Entrances of the Hives

If the bees are located in a town or city in some back lot, the grass should be kept down with a lawnmower, for appearance's sake if nothing more. But in large commercial yards, especially outyards (See Outapiaries), it is hardly practicable to do this. If the grass or weeds get very long or in the way enough to impede travel through the yard, they should be cut with a scythe. When honey is coming in freely it is important to keep the entrances clear because bees coming in heavily laden with honey will get tangled more or less while getting to their entrances. At the same time obstructions wear out their wings. No good beekeeper can afford to allow hive entrances to

become clogged. A pair of grass shears or a sharp sickle can be used, but he should not attempt to do this without first blowing a little smoke into the entrance.

Some beekeepers prefer to use a rough board as an alighting board, which should be as long as the hive is wide, and from 12 to 13 inches wide. This reaches from the ground to the entrance, making an easy runway for the bees to get into the hive, and at the same time keeping the grass and weeds away from the immediate front of the hive.

Salt is sometimes used for killing of all kinds of vegetation around the entrances. It must be liberally applied in front of every hive at the beginning of the season.

Sheep are very good for keeping down the grass in the whole bee yard.

**APIARY, RESTRICTIONS ON—**A recent increase in interest in beekeeping centers around the city backlot or suburban property type of hobby beekeeping. The proximity of hives of bees to human habitation sometimes causes conflicts, if not between man and bees, between a beekeeper, his neighbors and zoning laws. The problems usually evolve from misunderstanding of the behavior of honeybees although this fear, or dread of stinging venomous insects has a certain basis in fact when a sting results in a severe physiological reaction by the victim. Whether real or not this fear must be taken into consideration by anyone contemplating keeping bees in a residential area where people other than the beekeeper are possibly exposed to stings.

Most zoning regulations take into consideration that beekeeping is a privilege that should not be denied to those who take reasonable precautions to assure that no one is inconvenienced or threatened by the bees from neighborhood hives. What these necessary precautions are to be is often the subject of controversy between beekeepers, townspeople and zoning officials.

Unless a beekeeper is completely uncompromising, most regulations in restricted neighborhoods do not appear to be unfair or unjust to the beekeeper.

Most regulations restrict the number of hives in a given space, particularly on the smaller city lots. Specified distances usually mean that bees are restricted to the most isolated spot of a back yard and so arranged that the flights of the bees do not interfere with the paths used by people. Walks, streets, alleys and recreational areas that are in the line of flight of honeybees are potential trouble spots for the owner of the bees. Most people are aware, and regulations so recognize that the going and coming of the bees and visitations of honeybees to flowers knows no boundaries. Nevertheless the beekeeper is usually held responsible under regulatory restrictions to divert the flight of the bees from the hive away from, or at least not in a direct line over neighboring property by means of a hedge or constructed flight barrier. Watering sites close to the hive, constantly supplied with fresh water during the warm weather are often required.

The alternative to complying with local beekeeping restrictions is to move colonies to rural areas. If no site is known a short classified ad in a local newspaper often brings many offers for sites from owners of rural land who are pleased to have bees placed on their property, particularly if small gifts of honey from time to time are in the offering. Many people are convinced of the value of having bees for pollinating small garden plots or orchards but hesitate to undertake their care.

The acts of careless or irresponsible beekeepers or misunderstanding by an ill-informed public need not be the end of a hobby beekeeper's dream, but due to increasing population per unit of land, conflicts in land use may force more restrictions on freedoms that we formerly took for granted. Keeping bees in some densely populated residential neighborhoods may possibly come in for more regulatory pressure.

**APIARY, OUT.**—See Outapiaries.

**APIS DORSATA.**—See Giant East Indian Honeybee under Races of Bees.

**ARSENICALS DESTRUCTIVE TO BEE.**—See Poison Sprays.

**ARTIFICIAL FERTILIZATION OF QUEENS.**—See Queens, Fertilization of, by Artificial Means.

**ARTIFICIAL HEAT.**—Various systems for the supplementary heating of beehives wintered out-of-doors have recently been manufactured and marketed.

One system employs a slatted rack equipped with a heating unit placed next to the standard bottom board. A thermostat is used to control the temperature. Up to 25 units, one in each hive can be hooked up to a master control.

Another system features a bottom board wired with a perimeter heating unit designed to provide a low temperature perimeter heat flow. The unit replaces a standard 10-frame Langstroth bottom board.

Perhaps the most extensive use of controlled environment overwintering of bees is a plan such as used by James Kuehl of the firm of Cook and Beals of Loop City, Nebraska. Mr. Kuehl's wintering facility is a 24' x 28' (7.3m x 8.5m) wood frame addition to an old barn. Two or three pounds of bees in one story colonies are made up in the fall with new queens, at least three frames of honey and one of pollen. The colonies are moved to the building in November. The hives are stacked five high in rows. The entrance is left open and no top entrance is provided.

A temperature of 48 to 50°F. (8.9 to 10°C.) is maintained by a separate heater and air conditioner automatically controlled. A small fan runs continuously and a larger fan operates at 15 minute intervals. The fans force air into the building, flows through exhaust ducts running along the floor between the rows of stacked hives. As the heavier carbon dioxide laden air sinks to the floor it is forced by the positive pressure fans into the exhaust ducts and out of the building. In this way there is never a buildup of foul air in the building.

Total darkness is maintained at all times. The colonies are removed from

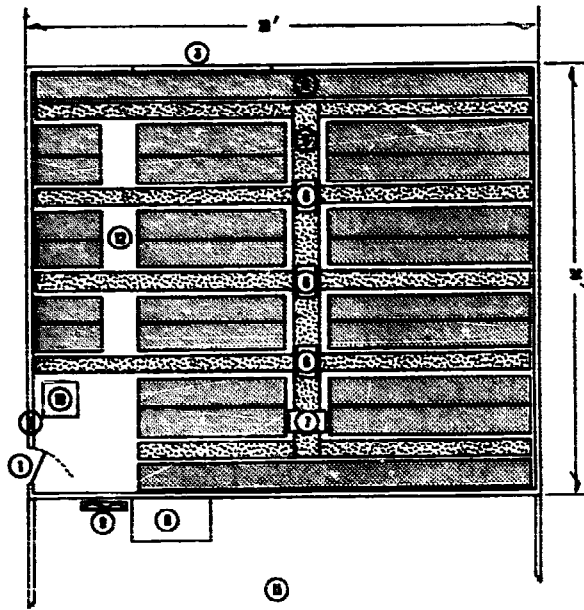

1. Main entrance
2. Hall - 2 x 4 studs 4" fibre glass insulation
3. Large door
4. Rows of colonies stacked 5 high
5. Exhaust ducts supported 3/8" off floor
6. Exhaust vents to ceiling
7. Air conditioner evaporator coils suspended 6" off floor
8. Air conditioner
9. Two fans one mounted above the other - 1 fan small continuous running fan  
2nd fan larger centrifugal fan
10. Heater
11. Unused barn to which wintering facility was attached
12. Island

Wintering facility at Leup City, Nebraska.

the building when weather permits in the spring. Colonies are fed sugar syrup if necessary and given pollen substitute to stimulate brood rearing.

A similar arrangement is employed by the Artesian Honey Company of Artesian, South Dakota. A large metal building is divided into three separate rooms. Each holds seven to eight hundred colonies, each room with its own environmental controls.

At the end of November full two-story colonies are moved inside. Each colony must weigh 80 to 90 pounds (36 to 41 kg.) and contain four to six pounds (1.8 to 2.7 kg.) of bees. These two brood chamber colonies are stacked three high and left under totally dark conditions at a temperature of from 42 to 44°F. (5.5 to 6.5°C.) until the end of March. The temperature is maintained by the use of a split system heat pump which is thermostatically controlled.

The ventilation system consists of two fans. One is a small continuously running exhaust fan (negative pressure) which draws the heavier carbon dioxide-laden air off the floor at one end of the

building. At the other end is a centrifugal fan (positive pressure) which forces air in. Fresh air from the outside, mixed with the inside warmed air at about a one to nine ratio is distributed through a ceiling duct to all parts of the wintering chambers.

#### ARTIFICIAL BEE PASTURE.—

One of the major concerns of beekeepers is the lack of sufficient nectar sources for honeybees. More and more land is being planted to crops that produce little or no nectar. Corn and the cereal grains produce no nectar. While some varieties of soybeans produce nectar, others do not. Many areas with large acreages of soybeans cannot support bees because the varieties grown do not yield nectar or the soil or climatic conditions are not favorable for the secretion of nectar. The destruction of wild flowering plants by the practice of intensive land use and the liberal use of herbicides has eliminated many nectar sources that formerly yielded substantial, or at least some forage for bees.

Some beekeepers are now attempting to supplement their nectar sources by planting additional flowering trees, shrubs and herbs, not only for their value to the honeybee but also for their benefits to the environment and their aesthetic value.

The opportunity to grow additional bee pasturage along roads and highways and on land set aside for parks and other recreational and conservation areas is limited only by the resistance to changing the present planting guidelines. The argument that foraging honeybees may interfere with the public's use of, or are a hazard to the people entering recreation areas has little validity unless bees are placed without regard to roads, trails and other peopled byways. Honeybees obviously cannot be placed in compact and intensively used recreational areas but vast land tracts which are not used for agriculture can be improved by planting to nectar producing forage for honeybees. Such improvements are not incompatible with the goals of improvement of water, soil and air commonly stressed in all conservation practices. Plants attractive to honeybees are in themselves of considerable

value and when bees are present to pollinate and gather the nectar and pollen the benefits derived from the planting are multiplied.

### The Future\*

Apiculture stands on the threshold of a great advancement in utilizing artificial bee pasture which heretofore has played a very minor role in agriculture outside of the successful extensive plantings of the Tallow tree (*Sapium sebiferum*) in Louisiana and the usual small patches of buckwheat or sweet clover occasionally planted near an apiary.

At this printing, a promising new technique in tree growing may prove to be revolutionary in producing quick growing deciduous flowering tree seedlings and, for the first time, make the economics of artificial bee pasturage for nectar feasible. In the past, and in most cases, developments of this kind were only a byproduct of the growing of plants for food and fiber. However as for trees, some flowering varieties excel in nectar secretion as well as having valuable wood qualities in the market-place.

\*By Bernie Hayes, Wellsville, New York.

In recent years the world-wide energy and food requirements has renewed interest in forestry land utilization both as a source of fuel and a useful by-product such as nectar pasturage to meet the increasing market demands for a natural sweet food.

In newer living patterns, the spread of the suburbs has altered the face of the rural landscape in many areas, and often with trim homes surrounded with an assortment of ornamental trees such as the colorful crabs, columnar pear, graceful locust and stately maples. These country homesites frequently provide abundant early dandelion pasturage and with small fruits and gardens providing a seasonal bloom in areas heretofore usually wooded or covered with coarse grasses and weeds.

Conservation and beekeeping go hand in hand and some state departments of conservation are showing a stronger interest in their relationship with agriculture—all for the advancement of apiculture in general. Roadside plantings of the legumes, particularly the vetches, are becoming more common on the thousands of acres devoted to roadways through which our expressways/thruways are built.



The Bee Bee tree (*Evodia danielli*) is very attractive to bees.

Fortunately, the era of uncontrolled roadside and commercial site weed spraying has come to an end and the pesticide applicators are held to a strict accountability with registration and training requirements by the Federal Environmental Protection Agency affecting all states equally.

From the standpoint of the ecology, a renewal of interest in our flowering trees would not only benefit beekeeping but serve to fight the problems of our

air pollution from auto emissions. At time of this printing, a pollution hazard to the northeast grape industry in the Great Lakes area is a real threat. Needless to say, if the small fruits are threatened, beekeeping is also. Deciduous trees have a freshening and cooling effect on the climate and tend to equalize the extremes.

In summary, the future of artificial bee pasturage appears to be bright with technical change around the corner.



It doesn't take a bee long to get a full load when the basswood blossoms are yielding nectar.  
—Photo by Alex Mullin.

Woody Plants of Value to Honeybees	Source of		Conditions					Characteristics				Use		Hardiness Zone(s)
	Nectar	Pollen	Full Sun	Partial Shade	Dry	Moist to Wet	Adverse City Conditions	Time of Blossoming	Flower Color	Showy Fruit	Good Fall Color	Specimen Planting	Hedges Screens	
Alder ( <i>Alnus</i> spp.)		X	X			X		E. Spg.	White					3-7
Alder, black ( <i>I.verticillata</i> )		X				X		E. Spg.	Catkin	X		X		3-8
Arrowwood ( <i>P.sericea</i> )	X	X	X			X		Summ.					X	5-10
Arrowwood ( <i>V.dentatum</i> )	X	X	X	X		X	X	Summ.	White	X	X		X	8-10
Baccharis, Coyote bush ( <i>B.pilularis</i> )	X	X	X			X		Summ.						7-10
Barberry ( <i>B.vulgaris</i> )	X	X	X	Some	X		X	Sprg.	Yellow	X	X	X	X	3-6
Bearberry ( <i>Arctostaphylos uva-ursi</i> )	X		X		X			Winter						4-8
Blueberry ( <i>Vaccinium</i> spp.)	X		X			X		Summ.	White	X	X	X	X	2-5
Broom, Scotch ( <i>C.scoparius</i> )	X	X	X		X			Summ.	Yellow			X	X	3-10
Buckbrush, Snowberry ( <i>S.albus</i> )	X	X	X		X			E. Spg.	Yellow					5-10
Buckthorn ( <i>Rhamnus</i> spp.)	X			X	X			Summ.	Yellow					5-10
Buffaloberry, silver ( <i>S.argentea</i> )	X	X	X		X			E. Spg.		X			X	2-6
Buttonbush ( <i>C.occidentalis</i> )	X	X		X		X		Summ.	White					4-10
Chamise ( <i>A.fasciculatum</i> )	X		X		X				White					5-10
Clethra ( <i>C.alnifolia</i> )	X			X		X		Summ.	White		X	X		3-8
Cotoneaster ( <i>Cotoneaster</i> spp.)	X	X	X	Some				Sprg.	White	X	X	X	Some	4-6
Creosote bush ( <i>L.tridentata</i> )	X	X	X		X			Summ.	Yellow					7-10
Dogwood ( <i>Cornus</i> spp.)	X		X	Some		Some		Sprg.	White	X	Some	Some	Some	3-8
Elder ( <i>S.canadensis</i> )		X		X		X		E. Sum.	White	X			X	3-6
Farkleberry ( <i>V.arboreum</i> )	X		X		X			E. Sum.	White	X			X	7-8
Grape, wild ( <i>Vitis</i> spp.)		X		X	X			E. Summ.						4-7
Haw, black ( <i>V.prunifolium</i> )	X	X	X	X	X			Summ.	White	X	X	X		4-8
Hazelnut ( <i>Corylus</i> spp.)		X		X				Sprg.	Catkin			X		4-6
Honeysuckle ( <i>Lonicera</i> spp.)	X	X	X	Some			X	Summ.	White	X		X	Some	4-7
Knotweed, Japanese ( <i>P.cuspidatum</i> )	X	X	X		X	X		Summ.	White				X	4-8
Pricklypear ( <i>Opuntia</i> spp.)	X	X	X		X			E. Spg.						4-10
Privet ( <i>Ligustrum</i> spp.)	X	X	X	Some	X		X	Sprg.	Cream	X			X	3-10
Pea Tree ( <i>C.arborescens</i> )	X	X	X		X			Sprg.	Yellow				X	2-8
Quince, flowering ( <i>Chaenomeles</i> spp.)	X	X	X				X	Sprg.	Pink	X		X	X	4-5
Serviceberry ( <i>Amelanchier</i> spp.)	X	X	X	X		X		Sprg.	White	X	X	X		2-5
Snowberry ( <i>Symphoricarpos</i> spp.)	X		X	X			X	Summ.	Pink	X				4-5
Soapbush ( <i>A.angustifolium</i> )	X		X		X			E. Spg.						8-9
Vitex ( <i>N.incisa</i> )	X		X			X		Summ.	Purple			X	X	6-8
Yucca ( <i>Yucca</i> spp.)	X		X		X		X	E. Sum.	White			X		8-10



Paulownia, royal ( <i>P.tomentosa</i> )		X							X	X	6-10
Peach ( <i>P.persica</i> )		X				X			X		4-8
Pear ( <i>P.communis</i> )		X		X					X		3-7
Peppertree, California ( <i>S.molle</i> )	X	X							X		10
Persimmon, eastern ( <i>D.virginiana</i> )		X							X		6-8
Plum ( <i>Prunus</i> spp.)						X			X		4-7
Poplar, Balsam ( <i>P.balsamifera</i> )		X					X		X		1-6
Pricklyash ( <i>Z.americantum</i> )		X							X		7-8
Redbud ( <i>C.canadensis</i> )						X			X		4-7
Russian olive ( <i>E.hortensis</i> )	X				X		X	X	X	X	3-6
Sassafras ( <i>S.albidum</i> )		X							X		6-8
Sumac ( <i>Rhus</i> spp.)	X	X	X			X		X	X		2-7
Tallowtree ( <i>S.subiferum</i> )		X							X		9
Tamarisk, athel ( <i>T.aphylla</i> )	X					X					10
Tree-of-Heaven ( <i>A.altissima</i> )			X		X		X			X	4-8
Tuliptree ( <i>L.tulipifera</i> )				X	X					X	6-8
Tupelo ( <i>Nyssa</i> spp.)		X				X				X	7-8
Willow ( <i>Salix</i> spp.)		X							X		3-8
Yellowwood ( <i>C.lutea</i> )		X				X			X	X	6-7

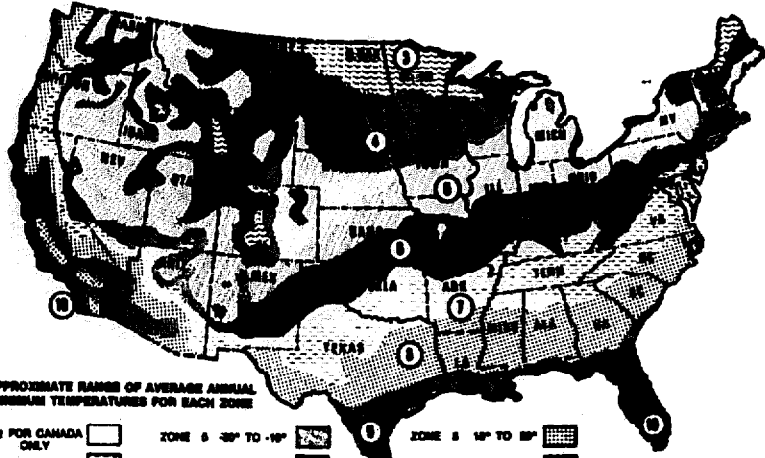

Use the hardiness zones as a guide to choosing the shrub or tree best adapted to your region. Avoid, if possible attempting to grow nursery stock in conditions (zones) that are listed as widely different than the one in which you live. Poor or no growth and no blossoming will result, if indeed the plant survives. Do not attempt to transplant "wild" stock from a zone in which it is found growing to a less hospitable zone. The map shows hardiness zones three through ten, each representing an area of winter hardiness for the woody plants and trees listed on pages 39 to 41. Variations in local conditions can affect all of the zones, even to the extent of having "mini-climates" within zones.



## ARTIFICIAL BEE PASTURE PLANTING TABLE

TREE	FRUIT (seed)	RIPE	NO./LB.	GERM.%	TREATMENT	HOW TO STORE
Almond	Drupe	Sept.	150	50	Remove flesh	Plant or stratify "A"
Basswood	Samara	Oct.	4,500	5-50	Remove stems	"C"
Boxelder	Samara	S-Nov.	12,500	40-60	Remove wings	Bury in sand, keep moist
Catalpa	Capsule	S-Oct.	19,500	40-70	Remove pod	Store in dry, cool place
Cherry	Drupe	A-Sept.	4,500	75-80	Remove pulp	Bury in sand, keep moist
Ailanthus	Samara	S-Oct.	20,000	40-50	Remove wings	Dry, or plant
Apple, domestic	Pome	Oct.	12,000	50-60	Remove pulp	Plant, or stratify "A"
Apple, crab	Pome	Oct.	60,000	50-60	Remove pulp	Plant, or stratify "A"
Apricot, domestic	Drupe	Sept.	300	50(est.)	Remove pulp	Plant or stratify "A"
Buckeye, Horse Chestnut	Capsule	Oct.	175	75	Remove burr	Bury and freeze
Caragana, Peatree	Capsule	Oct.	17,000	50(est.)	Remove pods	Dry, or stratify "A"
Indigo, River locust	Pod	Sept.	12,000	40(est.)	Remove pod	Plant, or stratify "A"
Hawthorn	Pome	Sept.	15,000	30	Remove pulp	Plant, or stratify "A"
Locust, black	Legume pod	Oct.	3,000	60-80	Remove pod	Dry and before planting "C"
Maple, sugar and Norway	Samara	Oct.	10,000	40-70	Remove wings	Sow at once
Maple, silver	Samara	May	21,000	25-50	Remove wings	Sow at once
Olive, Russian	Drupe-like	S-Oct.	5,000	50-60	Remove pulp	Dry, store in cool place "D"
Olive, Autumn	Drupe-like	S-Oct.	27,000	50-60	Remove pulp	Dry, store in cool place
Orange	Mod. berry	S-Oct.		60-75	Remove pulp	Sow at once
Pagoda tree	Capsule	S-Oct.	1,600	30-40	Remove pod	Dry, store in cool place "B"
Paulownia	Capsule	E. fall	2.82M	Unknown	Remove caps	Dry, store in cool place
Pear, domestic	Pome	Oct.	10,000	30-40	Remove pulp	Wash, stratify "A"
Persimmon	Berry	L. fall		Unknown	Remove pulp	Dry, or stratify "A"
Poplar, tulip	Nutlet	S-Oct.	18,000	0-10	Remove cone	Sow at once
Sourwood	Capsule	S-Oct.	5½ million	Unknown	Remove cap	Dry
Sumac	Drupe	S-Oct.	15,000	30-40	Remove cluster	Dry
Vitex	Drupe	S-Oct.	20,000	Unknown		Dry, plant in spring

"A" Stratify 3 to 4 months at 33 to 41 degrees F. in moist sand.

"B" Pour boiling water over seeds, let stand overnight.

"C" Soak in nitric acid ½ to 2 hours, stratify as in "A".

"D" Cut ends into inner pulp, soak overnight, start indoors or plant.

**ASSOCIATIONS, BEEKEEPERS.—**

People interested in bees and beekeeping are naturally drawn together because of this common interest. Local organizations drawing members from a community, county or district have shown a remarkable growth rate with many new associations being formed. If sufficient interest in beekeeping is evidenced the leadership for the initial steps in forming an association of interested beekeepers can usually be found among local beekeepers though they may or may not be experienced in community affairs.

As communities become larger and more integrated community interaction becomes more complex. Those having bees may find that their hobby or business tends to draw more attention from neighbors who may protest, with or without basis in fact, that honeybees pose a threat to their security. Prompt action by a beekeepers' group often can make factual information available to the agencies responsible for public welfare thus forestalling laws or ordinances which would ban bees from a community. Positive approach by a responsible, well-informed committee from a beekeepers' association is more effective than the testimony of individuals who may be under pressure to defend their own rights before a community hearing.

A beekeepers' association must be organized by a chartering body which will adopt by-laws, arrange meeting dates and arrange for the election of officers.

By-laws are subjective to the aims of the organizing body and members but must incorporate important principles that become evident in the example following.

**Article I — Name**

The name of the club shall be The Long Island Beekeepers' Club.

**Article II — Purposes**

**Section 1.** The purposes of this club are to assist its members and others interested in bees with their beekeeping problems, to provide those interested in bees an opportunity to meet to discuss their problems; to cooperate with the Cooperative Extension Associations of Nassau and Suffolk Counties, the New York State College of Agriculture

and Life Sciences at Cornell University, other colleges, the United States Department of Agriculture and the Eastern Apicultural Society, to disseminate the latest beekeeping information and to provide those interested in bees an opportunity to get together for a social time.

**Article III — Membership**

**Section 1.** Any person interested in bees is eligible for membership in the club.

**Section 2.** Any eligible person requesting membership may become a member upon the approval of such request by the membership chairman, and by the payment of the annual membership fee of \$2.00 or an annual family membership fee of \$3.00. The membership year shall be from January 1 through December 31. New members joining after October 1 shall be considered paid up members for the following calendar year.

**Section 3.** After admission, a membership card shall be issued to each member. Membership is not transferable. New members will be given a manual of procedure of good practice for keeping bees.

**Section 4.** Membership shall be on an annual basis as outlined in Section 2. Dues become payable on January 1 of each year. In order to vote at the annual meeting a member must have been a paid-up member in good standing for the previous year. Only members in good standing and members of their immediate families who are present can enter contests.

**Article IV — Fiscal Year Meeting**

**Section 1.** The fiscal year of the club shall begin on January 1 and end on the following December 31.

**Section 2.** The annual meeting of the club shall be held within three months after the close of the fiscal year, at any place designated by the Board of Directors, within the area served by the club.

**Section 3.** Special meetings may be called by the president, or may be called upon request, in writing, by one-quarter of the membership or by five members of the Board of Directors. Not less than 10 days written notice shall be given prior to any such special meeting.

Section 4. Notice of the time and place and topics of each regular meeting of the club shall be mailed to each member at least eight days previous to such meeting.

Section 5. Eleven members of the club shall constitute a quorum for the transaction of club business at regular meetings. A committee requires a majority of its members for a quorum.

Section 6. Each member in good standing shall be entitled to one vote, only. No vote by proxy shall be permitted.

Section 7. The order of business for all meetings of the club, unless changed by a majority vote of members present, shall be as follows:

- a. Call to order
- b. Salute to the American flag
- c. Reading of minutes of the last meeting
- d. Communications and bills
- e. Report of Officers
- i. Report of Committees
- g. Unfinished business
- h. New business
- i. Acceptance and presentation of new members
- j. Program
- k. (At annual meetings only)  
Election and installation of officers
- l. Adjournment

Section 8. In parliamentary matters "Roberts Rules of Order, Revised" shall be used in all cases where they are applicable, subject to the by-laws of the club.

Section 9. Payment of all bills shall be made upon the approval by a majority vote of the Board of Directors or a majority vote of members at a regular meeting.

#### Article V — Directors and Officers

Section 1. The officers of the club shall be a President, Vice President, a Recording Secretary, a Corresponding Secretary, a Treasurer, a Membership Chairman, Historian, Librarian and a Program Chairman. The term of each such officer shall be one year. The President may not succeed himself for more than one year. All other officers may continue in office at the discretion of the membership.

Section 2. The Board of Directors of the club shall consist of the officers

of the club, namely President, Vice President, two Secretaries, Treasurer, Membership Chairman, Historian, Librarian and Program Chairman, and nine who shall be elected from the membership of the club and shall hold office until their successors have been elected. Directors-at-Large, elected by the membership at the annual meeting, shall also serve on the Board. Vacancies shall be filled for the unexpired term by the President. At the next annual meeting, following the adoption of these By-Laws, three directors shall be elected for a three-year period, three for a two-year period and three for a one-year period. At future annual meetings, three shall be elected to fill the expired terms.

#### Article VI — Duties of Directors

Section 1. The Board of Directors shall direct the business and affairs of the club and make the rules and regulations for the use of its services by its members, consistent with these By-Laws

Section 2. No director, officer or member of the club shall receive, directly or indirectly, any salary or compensation for services rendered this club either as such director or officer or in any other capacity unless authorized by the concurring vote of the quorum of the club at a meeting.

Section 3. A majority of the Board of Directors shall constitute a quorum for the transaction of business at any meeting of the Board.

#### Article VII — Duties of Officers

Section 1. The President shall:

- a. Preside over all meetings of the club and the Board of Directors.
- b. Call special meetings of the club and of the Board of Directors.
- c. Perform all acts and duties required of an executive and presiding officer including the appointment of various committees that may be required for the proper functioning of the club.
  1. The Nominating Committee shall consist of five members of the club, two of whom shall be appointed by the President and three to be elected by the membership

body at the regular meeting prior to the annual meeting. The committee's recommendations for officers shall be submitted at the annual meeting. Nominations may also be made from the floor. Consent should be obtained from the nominees proposed for office before submitting their names to the membership.

2. The Auditing Committee, consisting of three club members, at least one of whom shall be a member of the Board of Directors and shall act as Chairman, shall be appointed by the President. Their duties shall be to audit the books of the Treasurer and make a report at the annual meeting.

**Section 2.** In the absence of the President, or because of his disability or inability to serve the Vice President shall perform all duties of the office.

**Section 3.** The Recording Secretary shall:

- a. Keep a complete record of all the meetings of the club and of the Board of Directors.
- b. Perform such other duties as may be required by the Board of Directors.

**Section 4.** The Corresponding Secretary shall:

- a. Write letters as directed by the President and/or Board of Directors.
- b. Notify the officers and all members of committees of their appointment.
- c. Serve all notices required by law and these By-Laws.
- d. Perform such other duties as may be required by the Board of Directors.
- e. Maintain a complete record of all physical property and equipment owned by the club and the location of same.

**Section 5.** The Treasurer shall:

- a. Sign as Treasurer with the President all checks and other obligations of the club, unless authorized to sign alone by a vote of  $\frac{2}{3}$  of the membership present.

- b. Receive and disburse all funds, and be custodian of all the securities of the club.
- c. Keep a full and accurate account of all the financial transactions of the club in books belonging to the club, and deliver such books to his successor in office.
- d. Shall make a full report of all matters and business pertaining to this office to the members at the annual meeting, and to directors, whenever requested.
- e. Deposit all moneys of the club in the name and to the credit of the club in such depositories as may be designated from time to time by the Board of Directors.
- f. Perform such other duties as may be required by the Board of Directors.

**Section 6.** The Membership Chairman shall:

- a. Keep a complete list of members and their addresses.
- b. Turn over to the Treasurer the money received from memberships.
- c. Give new members a manual of procedure of good practice for keeping bees.
- d. Notify those who have not paid their dues that they are due.
- e. Perform such other duties as may be required by the President and/or Board of Directors.

## Article VIII — Good Neighbor Policy

**Section 1.** No more than four hives of honeybees for each one-quarter acre or less of lot size shall be maintained on any lot.

**Section 2.** No hive of honeybees shall be maintained within 10 feet of a boundary line of the lot on which said hive is located.

**Section 3.** A six-foot hedge or fence (partition) shall be placed between the hive and the neighbors if the hive is 10 feet from the neighbor's yard and the entrance faces the neighbor's yard.

**Section 4.** No hive of honeybees shall be maintained unless an adequate supply of water shall be furnished within 20 feet of said hive at all times between March 1 and October 31 of each year.

Section 5. No hive of honeybees shall be maintained unless such hive is inspected not less than four times between March 1 and October 31 of each year by the owner or his delegate. A written record including the date of each such inspection shall be maintained by said owner and shall be available by authorized individuals.

Section 6. No hive of honeybees shall be maintained in a residential area in such a manner as shall constitute a substantial nuisance.

### Article IX — Amendments

Section 1. These By-Laws may be amended at any meeting of the club of which the members shall be given at least 10 days' notice, by a  $\frac{3}{4}$  vote of paid-up members present, and that the proposed amendment be read at the meeting of the club prior to said meeting and that the notice of such proposed amendment shall have been included in the call for said meeting.

**ARTIFICIAL SWARMING** — Or, ungrammatically, "shook swarming". This was practiced in the early 90's as a means of causing bees to swarm at the convenience of their owner and not at a time when he might be away or unable to take care of them. When initial or swarming cells were being formed (see illustration) and especially if they contained an egg or small larva at the beginning of the honey flow, the hive was removed from its stand and another containing frames of foundation was put on the old stand. The bees were then shaken from all the combs of the old hive and made to run in at the entrance of the new hive now on the old stand.

It was thought at the time that this procedure would make the bees really believe that they had swarmed. Whether they did so, no one knows. The supers, if any, were taken off the old hive and put on the new.

The removal of all the brood, or most of it, would of course deplete the old colony strength so that natural swarming would not occur. Sometimes the removed brood was put on top of the super, or it was distributed in colonies not up to swarming pitch. When the brood was put back, the colony strength

would be maintained and a crop of honey might be secured.

Did this procedure prevent natural swarming? Yes, in the majority of the cases, but sometimes at the expense of no honey, particularly if the brood was not returned to the old colony that had been shaken.

The plan looks good on paper, and many practiced it in the belief that it was a clever trick to make the bees believe they had swarmed.

In late years the practice has all but been abandoned and in its place the Demaree plan to prevent swarming has taken its place. (See Demaree Plan of Swarm Control.)

**ASTER.**—(Aster, the Greek word for star.) Asters are also called starworts, and in England, Michaelmas daisies. This is a genus of *Compositae*, the largest and most important plant family to which also belong goldenrods, sunflowers, thistles, and daisies.

Aster honey is gathered chiefly from the very common species *A. multiflorus*, *A. vimineus*, *A. latericulatus*, *A. tradescanti*, and *A. paniculatus*, all of which produce dense clusters of small white or pale blue-white rayed heads, except *A. multiflorus*, which has the rays white or purplish. Over large areas in Kentucky, Indiana, and other states the bloom is so abundant that the fields appear to be covered with snow. The plants are often very bushy, growing from six inches to three feet tall. When the weather is favorable colonies will pack their combs with aster honey, or if combs have already been filled from an earlier source a surplus is often stored.

Many beekeepers insist that they lost many colonies when wintering on aster honey. So strong has been the opposition to it for wintering that its removal and replacement by sugar syrup has been advocated repeatedly. This is a mistake if the honey is sealed in the combs. It is probable that if aster honey is gathered so late in the season that it only partially ripens and remains unsealed, it is liable to deteriorate, but any other honey under similar circumstances would be objectionable. Its tendency to granulate quickly and solid-



**Frostweed—Aster (*Aster pilosus*)**

ly, making it only partially available for the bees, has also added to its poor reputation as a winter food. Mismanagement by the beekeeper seems likely in some cases to have been laid to the fault of the aster honey. If this honey held properties that were actually in-

jurious to the bees, they would appear uniformly everywhere, but this is certainly not the case. The experience of scores of beekeepers, continued through many years, proves that aster honey, well ripened and sealed, is an excellent winter food for bees.

## B

**BABIES, HONEY FED.**—See Honey, Food Value of.

**BAIT SECTIONS.** — See Comb Honey, to Produce.

**BAKING, HONEY IN.**—See Honey Bread, and Honey, Cooking Value of.

**BALLING OF QUEENS.** — See Queens, Queen Rearing, and Introducing.

**BANAT BEES.** — See Races of Bees.

**BASSWOOD.**—This tree is not a dependable source, but it is seldom that it fails entirely to yield nectar. Even when the trees are laden with flowers no surplus will be obtained if the weather is cold, cloudy, and windy. Hot clear weather and a humid atmosphere are the conditions most favorable for the active secretion of nectar. Small drops may then be seen sparkling in the bloom, and a bee may at times obtain a load from a single blossom. The best yield of honey ever secured from a single hive at Medina, Ohio, was from basswood bloom, the quantity being 43 pounds in three days.

The length of the honey flow from basswood may vary from five to 25 days, while the date of blooming is influenced by locality, altitude, and temperature. The date of blossoming may be from 10 to 15 days later in a cold season than in

a hot one. In localities where basswood grows both in the valleys and on high hills the bees will have a much longer time to gather the nectar, since the trees in the lowlands will bloom earlier than those at a greater height.

In some localities there are two or three different varieties of basswood, all blooming at different times. This prolongs the flow from that source.

Basswood honey is white and has a strong aromatic or mint-like flavor. It is easy to tell when the blossoms are out by the odor about the hives. The taste of the honey also indicates to the beekeeper the very day the bees begin to work on the flowers. The honey, if extracted before it is sealed over, has so strong and distinctive a flavor as to be disagreeable to some persons. The smell and taste have been likened to that of turpentine or camphor—not pleasant when just gathered, but when sealed over and fully ripened in the hive almost every one considers it delicious. A pure basswood extracted honey, on account of its strong flavor, should be blended with some honey of milder flavor such as mountain sage or clover.

The flavor is so pronounced that a little basswood mixed with a large amount of white or sweet clover gives a taste that is very pleasing. The author prefers above all other honeys a white clover, sweet clover, or alfalfa with a trace of basswood.



Basswood in full bloom, life size

The combination flavor is better than any one of them alone. Unfortunately, basswood trees have been cut so much for timber that only young trees are left and they yield only in certain seasons.

The fine illustration on page 49 shows the basswood flowers and leaves. The clusters of from five to 15 flowers are drooping, thus protecting the nectar from the rain. The stem of the cluster is adnate to an oblong membraneous bract. The nectar is secreted and held in the fleshy sepals and it is often so abundant that it appears like dewdrops in the sunlight. The blossoms are small, light yellow, and exhale a honeylike fragrance. The stamens are numerous and the anthers contain a small amount of pollen, but honeybees seldom gather it when the nectar is abundant. However, if the nectar supply is scanty, then both honey bees and bumblebees may be seen with little balls of pollen on their thighs. In England basswood seldom sets seeds. The inner bark is tough and fibrous and was once used by agriculturists and florists for binding purposes.

**BEAR DAMAGE.**—Bears ravaging apiary sites continues to be a problem where bears populate protected areas or where a favorable habitat tends to bring them into contact with beehives during their foraging for food. While trapping and shooting are sometimes used as a last resort preventive measures often are necessary or preferable.

An electric fence, properly constructed, will turn a bear away from the bee yard.

#### Electric Apiary Fence\*

An almost endless variety of electric fence designs have been developed, but for this particular purpose, one has proven itself both effective and economical. With this fence, an area 50 x 50 (2500 square feet) can be enclosed for about \$90, plus labor. Materials required are: Studded seven-foot T-shaped metal posts, 16 gauge barbed wire, snap-on insulators, spring attached for studded T-posts, corner insulators, a 6-volt hot shot battery, plastic gate handles, 12-inch plastic tent pegs and several rolls of 24-inch wide, 2-inch mesh chicken wire.

It's important that the fence be erected and operational before hiving takes place. Thus, any inclination a bear may have to get into the habit of paying you regular visits will be nipped in the bud.

Drive the metal posts two feet into the soil at 12½-foot intervals. Have the corner posts lean slightly outwards to compensate for the inward pull of the wire. Using snap-on plastic insulators, attach strands of barbed wire to the posts at 6, 20, 36 and 48 inches above the ground. Place the corner insulators on the inside of the corner posts — the rest outwards.

\*Manitoba Dept. of Mines and Resources.



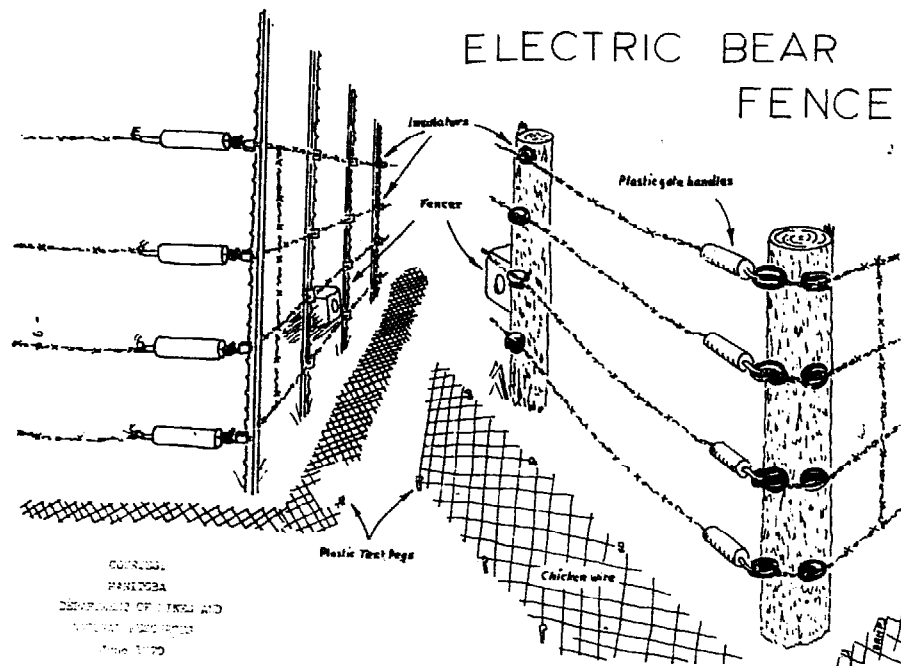

This electric apiary fence has proven bear-proof if properly constructed. Weeds and brush must not be allowed to grow up among the wires as this will break the circuit.

Once the fence wires have been strung connect the four strands of barbed wire together with a length of wire placed at two opposite corners of the enclosure. It is necessary to place a negatively charged wire mat on the ground to ensure good contact. Use the chicken wire for this purpose, securing it in place with 12-inch plastic tent pegs. This is an essential part of the fence construction.

For convenience in servicing the hives, a gate can be located between two posts. Fasten the loose ends of the barbed wire to plastic handles which can be hooked into looped ends of the fence wire to close the opening.

Place the fencer, powered by a 6-volt hot shot battery, near the gate post just inside the fence so that it can be reached from outside the enclosure. Connect the positive lead to the lower strand of barbed wire. Connect the negative or ground lead to the chicken wire and ground rod. A good connection is essential.

Where wood posts are readily available, they can be substituted for the metal posts. If this is done, it is also necessary to use insulators designed for wooden posts instead of snap-on type. Reinforce the corner posts with a 45-degree angle brace.

The following precautions should also be taken. Place the battery in a plastic bag to guard against corrosion.

### BEE BEHAVIOR.

There is probably nothing in all animated creation that shows such a spirit of cooperation as a colony of bees. There is no king bee, boss, or ruler. As is well known, the queen herself is little more than an egg-laying machine. She does not direct the policies of the colony except perhaps in sometimes leading forth a swarm, and even then it is generally believed that she follows rather than precedes. As noted in several places in this work, the queen not only has special duties but the worker bees themselves are divided into two main groups—the house or nurse bees and the field or control bees. The latter, under normal conditions, do little or no work in taking care of the young, building comb, or, in fact, anything else that young bees can do as well or better. The young, or nurse bees, on the other hand, do not as a rule go to the field until they are from ten days to two weeks old. Soon after they emerge from their cells and get over that feeble, downy look they begin feeding the larvae (Rosch says the old larvae first), polishing out the cells where the queen can lay, building comb, cleaning house, carrying out the dead, and guarding the entrance. The division of labor is so perfectly accomplished that

every bee seems to know its own work and does it. (See Age of Bees.)

After the active season is over, when there is little or no brood rearing and no nectar coming in, all the bees seem to hang over the combs in a sort of listless, quiescent state. As the weather becomes cold they form a cluster as noted under Temperature of Cluster in Winter, and Wintering.

#### Colony Morale

It is well known that some colonies will gather very much more honey than others of equal strength. It is also true that a weak colony will sometimes gather relatively more honey than a strong one. Some bees are better workers than others and it is usually the custom to breed from queens that are the mothers of these good workers.

An attempt has been made to explain the difference in morale between one colony and another. One colony may have the same numerical strength as another. The one that does poor work in the supers may have a large proportion of very old and young bees and a comparatively small proportion of active field workers, or, as Latham calls them "control bees". (See next paragraph.) The active bees in the prime of their lives are the ones that do the real work in getting together a good yield of honey. Colony morale may depend upon a difference in the strain of bees or it may depend upon the right proportion of active field workers to the rest of the bees. Probably both factors have a bearing on morale.

#### Control Bees

Since there is no queen bee or king bee that controls the policies of a colony, it is the workers themselves that direct or boss not only the queen herself but the actual work of the colony. Mr. Allen Latham, in an article in *Gleanings in Bee Culture* for January, 1927, and July of the same year, calls attention to what he calls the "control bees of the colony"—"These bees," he says, "are not made up of the very young or the very old. They are probably between the ages of 14 and 21 days and are in the height of their prime."

Armies are not made up of boys

or of men past middle life, but men of an age at which they can do their best work, and at such age too that they can endure the maximum of hardships. The same principle is usually true in the hive. "These control bees," says Latham, "are the ones that decide when the swarm shall issue, that defend the entrance, and, when necessary, start the offense. They are the stingers."

When a swarm leaves the parent colony it is important that it should have bees in the prime of their lives. Very young bees cannot fly. Some that are somewhat older have not yet reached the age for field work and they are yet at home. Very old bees whose wings are worn or frayed out would not be able to do effective work in starting a new home. Latham thinks that the "control bees" are the ones that usually leave.

Formerly it was supposed that all the young bees were left at home when a swarm issued and all the old bees joined the swarm. While this is true to a large extent, yet on the basis of the survival of the fittest only the best and most active bees should join the swarm, and they are probably the ones that make up the swarm that first leaves the parent colony. There must be in the new home bees to build comb, bees to feed the young, and bees to go to the field.

In the same way "control bees" will ball the queen when she fails; they will carry out the bees that are worn out and the young that are crippled or feeble. In fact, they will rule the whole colony. The young bees and the very old bees seem to accept it as a fact, according to Latham, that they are to do as they are told, and there is not wanting evidence to prove that he is right.

#### The Resting Period of Bees

When rid of her load, the worker may return at once to the field, but usually she loiters about the hive for a while—from a few minutes to half a day. So frequently do such bees crawl into a cell and go to sleep for a half-hour or so that it is reasonable to assume that such is the customary procedure. By sleeping is meant as nearly a complete

suspension of movement as possible. The customary pulsation of the abdomen nearly ceases or is suspended for minutes at a time, and the occasional pulsation is very slow.

When the nap is over, the bee backs out, combs off her head just as if "scratching for a thought", and starts off in more or less of a hurry.

Presumably all the bees of a colony do this sleeping, and drones and queen are no exceptions, but in the case of the latter two the sleeping is not usually done in cells.

When bees are getting stolen sweets a very different condition arises. A feverish excitement is noticeable in the returning workers and it is not long before the whole colony is in a more or less disturbed state. Sleeping is not then in evidence. Why a load or several loads of honey should make so marked a difference from several loads of nectar is unknown, and until we know more about the bee it is idle to speculate.

#### The Bee Sleep

There is another resting period quite different from that described above. If there is no honey flow on, making it necessary for the bees to evaporate the nectar, the ordinary colony at night will go into a quiescent state approximating sleep. In our lecture trips exhibiting live bees from the platform, as noted elsewhere, we have repeatedly observed that the bees are much more sleepy or "dumpy" at night than during the middle hours of the day. They seem to form in listless masses and are not disposed to fly out to the footlights as they are in the daytime. They remain in quiescent clusters, either in a hat or in any other receptacle in which they may be placed, making little or no effort to fly.

However, if bees have been confined for any length of time during winter and are then released at night or at any other time, they will fly out toward the light, dropping their feces all over everything.

As cool weather comes on, the colony draws up more and more in a compact cluster. When the weather is very cold a large force of bees will contract to a ball about the size of a three or four quart oval jar.

When weather warms up this cluster will expand enough to cover all the combs. The average novice is led to wonder how it is possible for so large a force of bees to get into such a small compact mass.

In very cold weather when the temperature drops, the bees inside of the cluster will begin to exercise. (See Temperature.)

#### Colony Odor and Queen Odor

Every colony has its own odor.\* Strange bees of another colony can not enter a hive without being grabbed and stung to death. Drones or young bees, on the other hand, can enter another hive, but adult bees are usually regarded as robbers and are dealt with accordingly. Were it not for this colony odor it would be possible for strange bees to enter a hive, rob it out, and ruin the colony. As a dog recognizes his master by his keen sense of smell, so do the bees distinguish between one of their own colony and a stranger.

Besides the colony odor, there is what is known as the queen odor. Every queen carries her own odor, so that a strange queen coming into a hive will be immediately recognized. So far as the queens are concerned, beekeepers wish that the bees could not make this distinction between their queens. It would be a great convenience to be able to take out one queen and put in another—a better one.

In the height of a honey flow, however, queens of two different colonies can often be exchanged without the loss of either. The bees are so intent upon gathering honey that a mere exchange of queens

\*I have always been more or less skeptical about colony odor. I have always felt that the alien bee is known by its behavior rather than by its odor. The alien bee knows its own home and when it gets into a strange home it begins to act in a suspicious manner. The study of robber bees is very enlightening, as is the study of queens. I have more than once dropped a strange queen right amongst strange bees and had her accepted at once, even though the colony already had a queen. On the other hand, if this queen shows any fear or acts in any abnormal manner, she is at once pounced upon.

However, I do not deny colony odor. Sometimes a queen acts normally and though quiet and undisturbed for several minutes, along comes a single bolshevik bee who attacks that queen. There must be something about that queen that arouses the suspicion of this particular bee. Odor seems most likely.—Allen Latham.

apparently does not make any difference with them. Even after the honey flow a whole frame of brood with its queen can sometimes be exchanged for a whole frame of brood with its queen from another hive, provided the exchange is made without disturbance.

### The Language of the Honey Bees\*

One of the most outstanding research workers on honeybee communication has been Dr. Karl von Frisch, who recently retired as Professor of Zoology at the University of Munich, Germany. Professor von Frisch was not satisfied that the language of the honeybee should remain a mystery. He has spent much of his life studying bees and most of the items mentioned below are discussed in greater detail in his book, "Bees, Their Vision, Chemical Senses, and Language."

It has been determined that only man has a form of communication which is more complicated and superior to that of the honeybee. The language of the honeybee is not a spoken language but is built around intricate dances.

Only last fall a graduate student at the University of Michigan, Mr. A. M. Wenner reported that there was a sound associated with the dance. The sounds were not produced by the wagging of the abdomen but their source had not been determined. Further work is in progress on this subject and it is hoped that it will be determined where the sound is made and what function it has in understanding the dance of the honeybee. The fact that the presence of such a sound was discovered only recently is indicative of the problems of research. It is extremely easy to overlook things that seem so obvious. There are undoubtedly numerous phenomena taking place about us and in the honeybee colony which are rather simple but which we have not observed.

Most of the experiments undertaken by Professor von Frisch can be easily repeated by anyone with a little experience in beekeeping. Very little expensive or complicated laboratory equipment is required. The language of the

honeybee may be studied by using a single frame observation hive and small feeding stations located at various distances from the hive.

### Von Frisch Experiments

Von Frisch records that in order to start these experiments he would, "place upon a small table several sheets of paper which have been smeared with honey." It was then necessary to wait until a bee discovered the feeding place. Sometimes this takes only a few minutes or a few hours but it may take several days. Soon after the feeding place is discovered by the first scout bee and she has returned to the hive other bees will appear at the feeding station in large numbers. One of the problems connected with undertaking such experiments is that other bees in the vicinity may find the feeding spot and they may not belong to the hive which one is interested in observing. It is, therefore, desirable to have some degree of isolation when undertaking these observations.

A bee which is taking up nectar or a honey solution with its mouth parts is very intent. While a bee is at a feeding dish it may be easily marked with a paint so that it can be distinguished when it returns to the hive. Von Frisch used dry artist's pigment which was mixed with shellac in alcohol. Fingernail polish would probably work equally well. A very fine pointed brush can be used to make applications. Bees may be marked on the thorax or on the top of the abdomen. Different colors may be used. In his book von Frisch outlines a method of using five colors on different parts of the body so that the bees may be numbered up to 599.

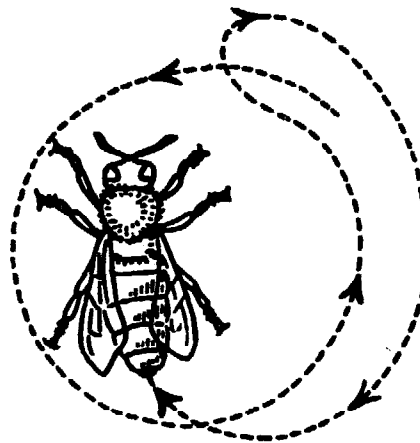

\* From a review of Dr. Karl von Frisch's book "Bees, Their Vision, Chemical Senses, and Language", by Dr. Roger A. Morse, Assistent

### Round Dance

When a scout bee returns to the hive she first gives most of the nectar which she has collected to one of the house bees and then she begins to perform a dance to indicate this food source to the other bees in the hive. Basically there are two types of dances. Von Frisch has called the first dance the "round dance" (figure 1). The dance may last as long as a minute and the dancer may then move to another location and repeat the dance or she may return immediately to the feeding place. Von Frisch says, "The bees near the dancer become greatly excited; they troop behind her as she circles, keeping their antennae close to her body. Suddenly one of them turns and leaves the hive. Others do likewise, and soon some of these bees appear at the feeding place."

### "Tail-wagging" Dance

The round dance indicates that the food source is close to the hive. As the distance of the food source from the hive approaches about 100 yards, the bees no longer perform the round dance but rather the "tail-wagging dance" (figure 2). The round dance apparently means that food is in the immediate vicinity of the hive and that workers interested in finding this food should go out and seek near the hive.

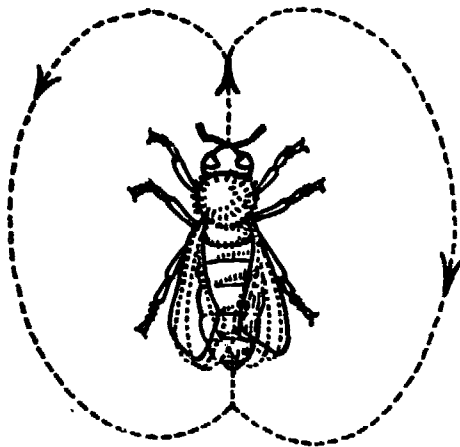

Fig. 2. "Tail-wagging" Dance

The tail-wagging dance tells the other bees in the hive both the distance and the direction in which the food might be found. "The distance is indicated in a rather exact manner by the number of turns in the wagging dance which are made in a given time."

After nearly 4,000 observations, a graph was prepared (figure 3) which

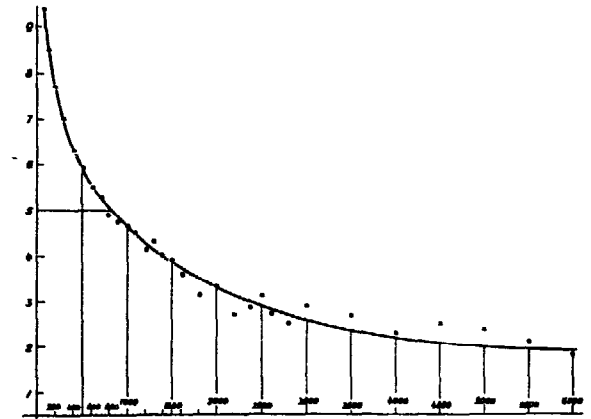

Fig. 3. Vertical scale represents the number of turns in a 15 second period. Horizontal scale represents distance of nectar source in meters.

shows the relationship between the number of turns made in the wagging dance and the distance of the food source from the hive.

The direction of the dance indicates the direction of the food from the hive in relationship to the sun. When the straight part of a dancer's movements on the comb are in an upward direction, the feeding place is in the same direction as the sun. When the straight portion of the dance is directed downwards on the comb the food source is in the direction opposite from the sun. When

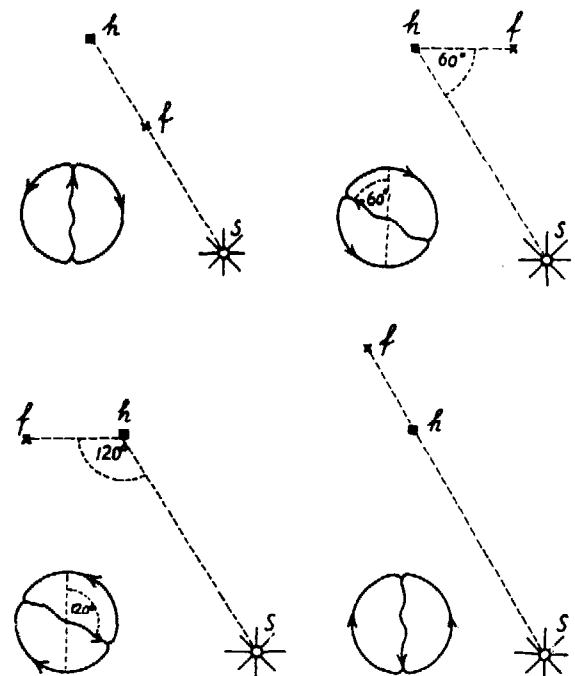

Fig. 4. h equals hive, f equals feed, s equals sun. At the left of each diagram is shown how the bees dance on the comb to indicate the direction of the feeding place with respect to the sun's position. Note that the top of the comb or upward direction represents the sun.

the dance is to the right of the vertical the food source may be found to the right of the sun. (figure 4.) Dr. Esch of Germany has also found that sounds are associated with the tail wagging dance. The frequency of the sound indicates the distance of the food source. A very low or slow beating sound means the nectar is very distant.

Thus, one bee communicates to other bees the information which is necessary to find the food source. Occasionally the dancer stops and feeds the bees which are following the dance and thus they learn the scent of the source. Esch found during the dance one of the following bees give a "beep" sound which is a command to the dancer to give her a taste of the nectar. In his work with an artificial dancing bee and tape recorded sounds the "following bees" attacked the dancer when it failed to respond to the "beep" command. In the case of nectar sources close to the hive, the scent may also be obtained by the bees from the scent which adheres to the dancer's body.

One of the unsolved mysteries concerns the finding of a food source which might be behind a hill or so located that the bees cannot fly a "bee line" directly from the hive to the food. The dance indicates the direct distance to the food despite the fact that the seeking bees must take the detour.

One of von Frisch's interesting experiments concerned locating a hive on one side of a steep hill and a food source on the opposite side. It was thought that the bees would fly around the hill but instead they flew over it. The distances were measured and it was determined that the distance over the hill was slightly shorter than the distance around the hill.

#### **Bees Working on One Source of Nectar or Pollen at a Time**

One of the most interesting of all facts in bee culture is that a bee will not, as a general rule, visit more than one kind of tree or plant on a single trip when it goes into

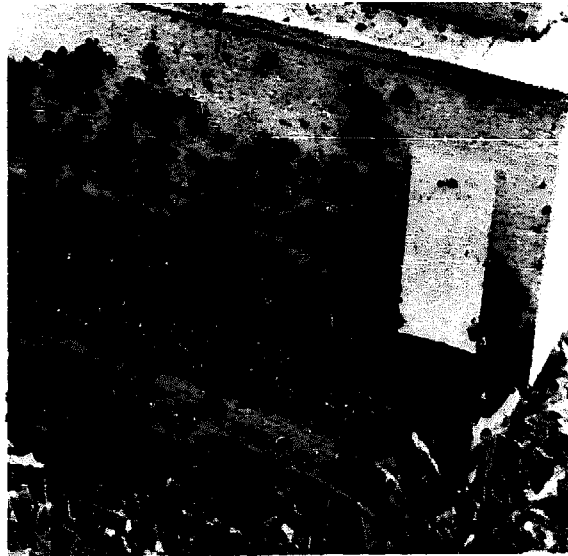

#### **THE WASHBOARD MOVEMENT**

At the close of the season or after the main honey flow, when bees don't have much to do, they may sometimes be seen over the front of the hive with heads pointing down in a forward and backward movement much as a washerwoman scrubs her clothes over a washboard. The picture shows a typical case.

the field in quest of pollen or nectar. If it starts gathering nectar from white clover it will not on the same trip take nectar from sweet clover, basswood, or any other source. In the same way, if a bee is gathering pollen from the dandelion it will not gather any other kind on that one trip. While there are exceptions\* to this rule, its application is so nearly universal that it may be stated as a fact that a bee usually visits only one source on a

\*Sladen says: "It was formerly believed that a bee hardly ever visited more than one species of flower on the same journey, but careful observers have found that under certain conditions, changing from one species to another is not rare, and this has been proved by the presence of variegated loads of pollen. Bumblebees are more inclined to change from one species of flower to another than are honey bees. This is especially true in the case of the common European species *Bombus terrestris*, which is closely related to the Canadian species *B. terricola*. In a nest of *B. terrestris* that I kept under observation in July of this year, 40 percent of the workers returned home with variegated loads. In order to discover exactly how the pollen basket is loaded I took sections of a number of variegated loads collected by the workers in this nest. In one of the most interesting of these, no less than eight successive kinds of pollen were distinguishable."

trip, either for pollen or nectar. (See further discussion under the head of Pollen, subhead Constancy of Honey Bees in Collecting Pollen or Nectar.)

#### **How Bees Deposit Their Load of Nectar**

The honey-laden bee on returning from the field is not in a hurry to get rid of her load, and it is not at all unusual for her to keep it for half an hour or more before depositing it or she may pass it to another bee and then hike back to the field. If there is a rush of nectar she will pass it to a bee that is not a fielder. This is a beautiful case of cooperation. Or, if there is no rush of nectar she may walk aimlessly about or settle quietly down somewhere and seemingly forget the world, or she may, after an extended journey over the combs, select a cell for her load. She enters the cell with her back down and feet up. If the cell has no honey in it she goes in until her mandibles touch the upper and rear-most angle. The mouth and mandibles are opened and a drop of nectar appears, welling up until it touches the cell wall. Slowly the bee turns her head from side to side, spreading the nectar against the upper part of the cell. All this time the mandibles are kept in motion; and as the nectar covers the gland openings it is possible that the secretion is being added to the nectar.

When the bee is adding her load to honey already in a cell the proceeding is the same except that the mouth parts are submerged in the honey already there. The mandibles are kept in motion as before. The tongue in neither case takes any part. (See Honey, Ripening of.)

#### **How Bees Ventilate Their Hives**

When bees gather nectar it is largely water. Thin nectar stored in the combs with this excess of water would ferment and sour, and hence the bees drive out the excess moisture until there is not more than 20 percent of actual water to actual sweet in honey.

How then do the bees drive out the moisture? When the load of nectar is stored in the cells there is still a large amount of water, probably three parts of water to one of actual sweet.

During the day, and especially at

night, the bees will form into two groups, one group forcing the air out of the hive and the other group forcing the air into the hive. There seems to be perfect cooperation, so that a strong circulation of air passes through the hive. This air forced in and out of the hive all night and during the day causes the freshly-gathered nectar to evaporate to less than 20 percent of water.

It is a very interesting experiment that any beginner can try out for his own satisfaction. After the bees have worked hard all day in the fields and have made a gain of five or ten pounds of nectar, which is little better than sweetened water, the entire force goes to work ventilating the hive. By listening one can hear a low hum. On one side of the entrance bees are found fanning the fresh air in and on the other side of the entrance they are fanning the moisture-laden air out of the hive. By holding a lighted match on one side of the entrance and then on the other it will be observed that there is a strong current of air going in and an equally strong current of moisture-laden air coming out on the opposite side.

The process by which the bees evaporate and gradually convert the thin nectar into thick honey is called ripening. (For full discussion see Honey, Ripening of.)

#### **Comb Building and its Relation to the Ripening of Honey**

Comb building is rapid when most of the bees are ripening nectar. If the flow is good and many bees have to retain their loads for a while, as with a recently - hived swarm, wax secretion is rapid. Or if the flow is heavy and nearly all have to work at the ripening process, wax secretion is forced. The bees can not help producing it then. Its production seems to be closely connected with the conversion of nectar into honey. If this view is correct it affords an explanation of the failure to obtain satisfactory results in feeding back ripe honey to have sections completed. Honey extracted "raw" or "green" (that is, before it is sufficiently ripened) and fed to comb-building colonies gives much better results. (See Combs.)

### The Color Sense of Bees

That bees can detect colors as well as odors is now pretty well established. When hives are placed in straight rows and entrances are pointed in the same direction the bees often get confused and go into the wrong entrances. (See Apiary, subhead, Arrangement of Hives.) This can be corrected by painting the hive fronts different colors. Now for the proof: If a hive with a red front is exchanged with one having a blue front the bees belonging to the blue will go to the blue, and the bees belonging to the red will go to the red, notwithstanding that the position of the two hives has been reversed.

In the same way, Dr. Karl von Frisch, of Germany, placed on a table variously colored cards. He placed a small dish of syrup on the blue card. After the bees got nicely started on the syrup he rearranged the cards, but this time he placed an empty dish on the blue card remote from the position it formerly occupied. First, the bees located the blue card and then clustered on the empty dish, but reluctantly departed. The experiment was repeated with the same result.

In the *Bee World* for April, 1935, page 40, P. Koch reports that bees seem to favor dark colors. He noticed that there was a drifting of his bees toward the hives with dark fronts. This meant that the colonies with the darkest fronts had the most honey. Dark blue came first and then in order: black, brown, white, and pale green.

Nature has endowed some nectarless flowers with bright colors, the evident purpose being to attract insects.

### Bees are Red-Blind

Professor von Frisch has also trained bees to other colors: orange, yellow, green, violet, and purple, but bees trained to red seemed confused when confronted with other dark colors. This is particularly interesting because it enables us to understand why red flowers are so rare. Botanically speaking, red is of comparatively frequent occurrence in America, but only in bird blossoms—the bird eye is very sensitive to red. In Europe red-flowered plants are fertilized almost exclusively by butterflies, the only insects which are not red-blind.

### Taste Sense of Bees

W. J. Nolan of the Government Bee Culture Laboratory at Beltsville, Maryland, reported some work on the taste sense of honey bees by von Frisch in *Gleanings in Bee Culture* for 1935, page 112, as follows:

"von Frisch conducted his experiments by placing a solution of the substance being tested in a feeder to which bees flying freely from their hives had been trained to come. These bees were marked. It is interesting to learn that several of the bees came to these feeders for four weeks and one came for seven weeks.

"In all, 34 sugars or other substances were tested for sweetness. Thirty of these taste sweet to the human tongue, but for the bee apparently only the following nine are sweet: sucrose, dextrose, levulose, alpha-methylglucosid, maltose, trehalose, melezitose, fucose, and inositol. The last two proved somewhat less sweet to the bee than the others, and according to B. Vogel have no food value. Each of the other seven is said to sustain the bee's life equally well. Various other sugars were found to have little or no taste or even to be repellent in their effect. Raffinose, for example, which is sweet to the human tongue, was apparently tasteless to the bee. On the other hand, dextrose (glucose) is about as sweet as levulose to the bee while to us dextrose is only about half as sweet as levulose.

"von Frisch's results lead directly to the conclusion that natural honey sources have higher sugar concentrations. In comparing his results on sucrose solutions with analyses of nectar, particularly O. W. Park in Iowa, and by Miss Beutler and Miss Kleber in Germany, von Frisch notes that of 40 honey plants only five were reported to have less sugar content than would be present in a 1-molar solution. Park recently stated that honey plants of Iowa during flight hours have a sugar concentration of 30-65 percent. Many low concentrations which have been found were obtained on nectar collected in the early morning. (See Nectar, Sugar Content of.)

"It is of interest to note that the sweeter the solution the livelier was the nectar dance on the return to the hive, and the greater the use of the scent gland in spreading the



bee's own odor at the source of food. A thin solution was borne in without any resulting dance. The quantity of the sugar solution which a bee carried back to the hive was found to be greater, the sweeter the solution. It also varied somewhat with the temperature."

#### Time Sense in Honey Bees

Some work has been done by Dr. Ingeborg Beling, a student of Dr. von Frisch, which goes to show that bees have a time sense. Various feeding experiments were undertaken, showing that bees would come for food at certain intervals when it was set out, would retire, and then return when the food was out again.

It is well known that certain plants yield nectar at certain intervals. Buckwheat, for example, will furnish honey in the morning and again at night when the atmosphere is cooler. (See Buckwheat.) Bees will rush to the buckwheat nights and mornings when they will be absent during the middle hours of the day.\* (A fuller discussion of this time sense will be found on page 710 of *Gleanings in Bee Culture* for November, 1929.)

#### Homing Instinct

As the old saying goes "Chickens will come home to roost at night". While they may stray all over the premises during the day, toward night they will gradually work toward their coop and finally go to the roost. But chickens carried miles away from their home surroundings will find a place to roost and thereafter roost in the same place.

Similarly this same homing instinct is found in bees. The bees of a colony moved from their old location to a new place will, on their

\*Though bees may have a certain amount of time sense, I feel that your statements have not taken into consideration an entirely different factor. I do not believe that bees rush to the buckwheat mornings and nights because of the darkness or the time of day. This is what I believe: At all times of the day whenever the temperature is right there are some active bees on the search all the time. So long as no nectar is found there will be little activity. In the early morning hours one of these bees filled with the secreting nectar of the buckwheat and rushing home does the dancing act. In a few minutes there are scores of these bees doing the dancing act. The nectar stops and all day long the bees are quiet but all the time there are a few bees on the search. About 5 p.m. a bee gets nectar and rushes home with it and the activity again begins. No time sense is here at all.—Allen Latham.

first flight, mark the location. As the bees fly out they will apparently take a survey of all the surroundings adjoining their home. The circles become larger and larger until they are lost to sight. They will in a few minutes return, however, unerring, to the entrance whence they came. There is no marking of the location thereafter except by young bees that go out for their first flight, and then their behavior is very much the same.

If the hive be moved a few feet only, the bees that have so thoroughly and so carefully marked the location will fly to the old spot. While this is true of Italian bees, the ordinary black bees, no matter where the hive is placed, will relocate their hive, apparently doing so through their sense of smell. In this respect the black race and the yellow race of bees behave very differently.

#### Electrical Charges

Worker bees become irritable when the air is highly charged with electricity, researchers have observed. Scientists also have found that bees' electrostatic charges increase during periods of atmospheric electrical activity before storms.

In studies at Madison, Wisconsin, ARS entomologist Eric H. Erickson found that early in the day, electrical potentials on worker bees leaving the hive were slightly negative to earth ground. As the day advanced, the potentials turned slightly positive.

As the bees fly they may acquire positive potentials, says Dr. Erickson. He found that bees returning to the hive had positive voltages—up to 1.5 volts d.c.—on bright, warm days with low humidity, and the peak voltages occurred at midday or early afternoon. Honeybees entering their hives after flights on a fair, summer day carry electrical charges that are more positive than charges they carry on cool, cloudy days.

The difference in electrical potential between flower and bee may cause pollen transfer when the bee comes close to but doesn't actually touch the male part of the blossom, says Dr. Erickson. And besides possibly increasing pollination efficiency, the electrical phenomena may be components of learning as bees communicate.

Dr. Erickson has seen evidence that intensities of electrostatic charges that bees acquire, as they return to the hive, are influenced by both distance they fly and solar radiation. A daily cycle of changes in solar radiation is related to a daily cycle of changes in positive electrical potentials on bees.

#### Survival of the Fittest

For ages bees have pursued the relentless policy of dropping out the old bees. When an old bee has toiled, worked almost an entire season, contributing its mite to the wealth of the colony, its wings become so frayed and worn that it can no longer fly. The younger members of the colony are not at all grateful to this old bee for helping to fill up the hive with honey they will eat. They seem to take particular delight in picking up these old bees and dragging them to the entrance where they die of starvation, or in carrying them up into the air and dropping them a half-mile away. They cannot fly back and they cannot walk back, so they die.

Similarly any young bees that are "born" with defective wings or legs, or any other bees that are not perfect in every respect, are pushed out and allowed to die in front of the entrance. But some of these bees will crawl back again, the able bodied control bees will carry these defective bees out into the air and drop them a half-mile away where they perish like the old bees.

The law of the survival of the fittest works all through the bee hive, even including the queen bee. When she fails to lay eggs in sufficient number to take care of the needs of a prosperous colony, she too must step aside. It would be foolish to carry her out and drop her half a mile away. This would be worse than "killing the goose that lays the golden egg". So the bees allow her to keep on laying eggs, but in the meantime they start queen cells from one of which a new queen will be forthcoming. As soon as she begins to lay, the old mother steps aside. Perhaps her daughter kills her. Perhaps the worker bees sting her to death or may carry her out, or perhaps she may be allowed to lay eggs alongside of the young queen. But when she cannot lay another egg and can be of no further use to that colony, out she goes. "If you

can not or will not work, you shall not eat" is the inexorable law of the hive. To allow these old bees, the crippled bees and defective queens, to remain in the hive might result in the loss of the whole colony, so nature decides that only the fittest shall be allowed to survive and all else shall die.

In the bee hive the old bees would be consumers and die anyway before spring. Nature decrees that they shall die when their period of usefulness is over and thus make room for young bees.

#### The Queen

This individual is unquestionably the most interesting member of the bee community and more talked of and written about than any other, and perhaps more misunderstood. From earliest infancy she is the subject of more vagaries than any of the other bees.

The presence or absence of the functional odor may have something to do with the introduction of alien queens or it may be wholly their behavior.

After handling a laying queen, bees from any hive will run over one's hand, apparently eagerly seeking the queen, and the behavior of all workers is the same whether they are from the queen's hive or from another.

There is much difference in the temperament of queens. Some are very timid and will run on the slightest disturbance, and if handled or anointed with any foreign substance seem to become really frantic. Such queens are very apt to be balled or killed by the bees. Other queens will passively submit to all sorts of treatment, and as soon as they are let alone will quietly resume their duties.

Virgin queens are nearly always nervous or timid, and if put into a strange colony, large or small, very often run out and fly away, by no means always returning.

#### How the Queen is Fed

Before mating, a queen hunts up her own food from the combs, but after she begins to lay she turns to the workers for virtually all her food. Occasionally she will dip her tongue into a cell of honey, but not often. As she goes about her duties she crosses antennae with workers from time to time. Finally one

is found with a supply of food, the worker's mouth opens, and the queen inserts her tongue and begins to eat. The worker's tongue is kept folded behind the head. It is quite common to see several other workers extend their tongues and try to get a taste of the food, and sometimes one will succeed in putting her tongue in with the queen's. It is not at all unusual to see two workers getting food thus from another worker, and the drones obtain their food in the same way.

#### Variation in Egg Laying

Egg production is influenced by several factors. Queens differ in fecundity, and egg development is dependent on food. The food supply comes chiefly from the younger bees, and if they are not numerous the queen can not produce eggs in abundance. If honey and pollen are scarce or the temperature is low, food is not prepared freely.

If the queen is young and vigorous and the colony small, she may deposit several eggs in each cell. If comb surface is insufficient and bees abundant, she will use cells of any shape—deep, shallow, or crooked, and will put in each one an egg which will produce a worker. If no drone cells are available, a normal queen may at times put into worker cells eggs which will produce drones.

So many are the vagaries of a queen that only by observation and experience can most of them be learned, and the seasoned veteran not infrequently runs across some new peculiarity.

A normal laying queen proceeds over the comb depositing drone eggs in drone cells and worker eggs in worker cells, apparently being able to lay either drone or worker eggs at will. After an egg is put in a cell a worker is pretty sure to pop in and inspect it, and it has been supposed that possibly it did something to it. Inspection of thousands of bees occupied in examining eggs has failed to find a single one that touches an egg in any way. Bees often take their nap in cells containing eggs or larvae.

During a heavy flow of nectar the bees often deposit it in cells containing eggs, sometimes filling the cells half full. Such nectar is removed within a few hours and the eggs hatch as usual.

#### Balling of Queens

As explained under Queens and Queen Rearing, whenever bees are dissatisfied with their queen for any cause, they suddenly form in a mad ball around her, all trying to sting her or pull off her legs and wings. First a few bees start the attack, then dozens of others join in it. The reason why she is not stung immediately is that so many bees are clinging around her that it is impossible for them to turn and deliver their stings. Sometimes the queen is stung to death\*, but more often she is found dead when the ball is taken apart, either from fright or from suffocation, but without a sting.

Balling of the queen is apt to take place immediately after a hive is opened, if it is done needlessly and bunglingly, or after a disturbance. The bees, apparently thinking something has gone wrong, blame the queen and proceed to attack her. Careful observers have repeatedly noted that as soon as the hive is opened, the bees for some unaccountable reason sometimes ball their own mother, even though she has been doing good work—a mother that has been in the hive for six months or a year. Just why this sudden mania of attack occurs no one has been able to explain. Of

\*In stating that a queen is often found dead in the ball of bees but shows no sting, you overlook the fact that the sting is not normally left in the body of another bee. Only when it catches in the tight joints of a leg or is pinched in some way does it come out. It never is pulled out by the soft tissues of the bee. I have seen hundreds of queens stung to death with no sting left in. I have seen thousands of worker bees stung to death and no sting left in. I believe that nearly every queen dead in a ball of bees has been stung, though I will admit that there may be exceptions.

Balling their own mother—yes. But did you not know that there are two forms of balling? One is the balling of a strange queen to keep her from doing harm. The other is the balling of the reigning queen to protect her from harm. At a field meet once I was manipulating a colony and found the queen balled. I opened up the ball and showed the queen to the onlookers and then let her run amongst the bees. At once a howl of protest went up. I had doomed that queen. I then said that the bees were balling the queen for protection, for I had seen that from the first. A few days later I had a chance to ask the owner about that queen and he told me that she was all right. When bees ball their own queen they act in a very different manner than do bees balling a strange queen.—Allen Latham.

course, if she is a strange queen they ball her because she does not belong there.

It is believed that one or two bees start the rumpus by chasing after and attacking the queen. This develops into a sort of mob because queen balling and the mob spirit brought on by a single leader in the human family have many things in common. The mob in either case is neither intelligent nor reasoning. It seems to be bent upon destruction of life and property, no matter what the consequences, even though the bees are the chief losers. They are not unlike a human mob. (For further particulars in regard to balling, see *Queens and Queen Rearing, Introducing.*)

#### Bees Caressing the Queen

When everything goes well the bees of the colony, especially the young bees, can often be seen standing around the queen in a circle, extending their tongues ready to feed her, and all of them ready to clean her. They not only caress her, but comb her hair, give her a bath, and remove her feces. As she moves about in stately fashion, as all queens do, all the bees seem to vie with one another in showing her attention. But apparently these kindly acts are not inspired by any feeling that the queen will reward them. When a politician in the human family becomes overly nice to a voter, it is known that he is expecting a vote or some favor in return. No such political snobbery exists in the bee hive. The motive is clearly for helping the queen.

#### Queen Cramps

A queen will sometimes develop cramps, either through bunglesome handling on the part of the apiarist or through fright. Her body will kink up in a small semi-circle, she will drop down on the bottom board of the hive and appear to be almost lifeless. The bees, on the other hand, will be kindly disposed toward her, standing around her ready to feed or clean her. The novice is apt to conclude that the queen is dead or almost dead. If he will close the hive and let her alone she will come out of her cramps, nine time out of ten, and be lively as ever. Just what the cause of these cramps is no one seems to know. Apparently it is a sort of "crick in the back", a kink in the body in some way, from which

she seems to be entirely helpless. She seems to be breathing normally because the abdomen expands and contracts and the antennae move, but there is no other movement. The beginner is apt to conclude she will die.

#### How Bees Transfer Eggs

There has been some question whether bees in an emergency can and do transfer eggs from one part of a hive to another. The author has seen them carry eggs; so has the late M. T. Prichard.

Mr. A. H. Perring in the *American Bee Journal* for September, 1933, reports that he has both seen the bees transport eggs and then deposit them into cells. A further proof is that queen cells will be found above an excluder where there were neither eggs nor larvae but plenty of both below. (For further proof see *Bee World* for 1933, page 138.)

#### Drones

Drones have many interesting habits and are well worth closer study than they have yet received. They are much slower to mature after emergence from cells than are the workers. They are very fond of warmth and often in cool weather may be found massed shoulder to shoulder on outlying sealed brood.

It seems to take a lot of preparation on the drone's part before he can take wing. Drones pay no attention to a virgin among them in the hive, no matter what her age. The mating must take place in the air. (See *Drones, subhead Mating of Queen and Drone.*)

**BEEBREAD.**—A term in common use, applied to pollen when stored in the combs. In olden times (and in parts of the South yet) bees were killed with sulphur to get the honey, more or less pollen usually being found mixed in with the honey. It has something of a "breadly" taste, and hence, probably, came its name. Since the advent of the extractor and section boxes, it is very rare to find pollen in the honey prepared for table use. (See *Pollen.*)

**BEE DRESS.**—See *Veils.*

**BEE ESCAPES.**—See *Comb Honey, Extracting, and House Apiary.*

**BEE HUNTING.**—Like all other hunting of small game, or fishing with the rod, bee hunting is a real

pastime, and similarly not profitable from the standpoint of money making. If one desires to get more bees it will be far cheaper to buy them from a neighbor or to order package bees from the South. (See Package Bees.) It is sometimes necessary to hunt bee trees that may possibly contain foulbrood. Before one can expect to get his apiary clean, all bees in trees should be located.

There is no use making a general hunt for bee trees except during a dearth of nectar, when the home bees are inclined to rob. Neither is there any use chasing after wild bees when the trees or caves where they are supposed to be located are more than a mile and a half away. While bees will sometimes fly farther than that distance from their homes in quest of nectar, these cases are rather rare. (See Flight of Bees.)

The possibility of locating a bee tree is based on the principle that during a dearth of nectar bees may be attracted by sweets, and once having filled up and after having made a few circles they will fly in a direct line towards their home. But it should be understood that while the general line is direct, that line is not straight as a bullet would fly, but somewhat irregular and wavy.

#### Equipment for Bee Hunting

This is neither elaborate nor expensive. While one can use a common tumbler and a square of cardboard to trap bees gathering nectar, it is very much better to have a special box. This can be made from an ordinary cigar box, but it should be well aired, as there might be an odor of tobacco which is repellent

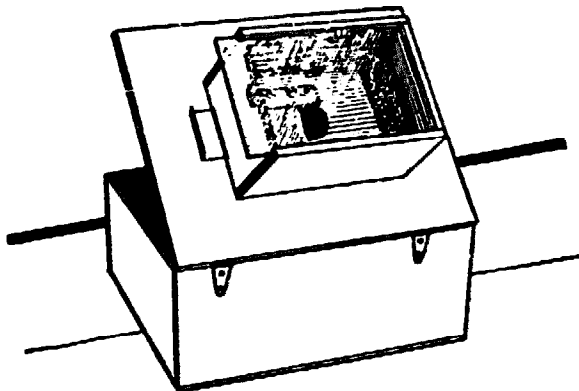

Bee hunting box

to bees. Through the top should be made a circular hole about an inch in diameter. Over this should be placed a tin slide so that the hole can be closed at will. On the cover

of the cigar box there should be mounted a smaller box without bottom and with a glass slide in the top that can be opened or closed. In the bottom of the large box should be placed an empty comb or a small bee feeder.

To attract bees it is better not to use a comb containing honey because the honey would be too thick. The trapped bees will take about half a load of thick honey, with the result that their flight will be difficult and somewhat irregular, owing to air currents. For that reason it is best to take along a bottle of honey diluted in warm water. Honey is better than syrup because it has more odor. It is likewise advisable sometimes to put into the honey water two drops of anise to four ounces of syrup. The inside of the cigar box itself may be coated with anise so as to give the bees confined in the box more odor.

In addition to the box one should provide himself with a field glass, a pair of climbers such as the telephone men use, a rope, and an axe. The last named articles, however, are not necessary where one goes out alone and only expects to locate the bee tree. Having found it he will then need the axe, the rope, and a pair of climbers and some one to help him. One can not work alone to advantage.

If one suspects bee trees in a piece of woods, he should make a little survey of the country, say a quarter of a mile distant. He should watch carefully for bees that are working upon some blossoms.

Old bee hunters say: "Avoid bees that are gathering pollen." Use only those that are apparently taking nectar and which show no pollen upon their bodies or legs.

Trap one of these bees in the cigar box by shutting the lid over it or enclose bee and blossom with the tin slide shoved over the hole. Hold that bee in the lower compartment long enough so that it will fill up with the honey water previously poured into the comb or the feeder. Place the box with its confined bee on the top of some fence post, stump, or other object. If none of these is available, a stake with a small platform on top may be driven into the ground with the box placed on top. The operator should now pull back the tin slide, allowing the bee, now filled with honey water and well

scented with anise, to go into the upper compartment. Gently draw back the glass slide and allow the bee to escape, then step backward quickly to watch the bee. It will circle around and around the box, taking a general survey, with the intention of coming back. The circles enlarge and become more elliptical until the long axis of the oval flights will point in the direction of its home. It will then strike off in a bee line, somewhat irregular, to its bee tree.

An experienced bee hunter writes that the bee will come back in a few minutes, the time gone being regulated by the distance. This same man, who has hunted bees as a pastime and as a real sport, says that to make a round-trip flight it takes a bee about eight minutes for a half-mile and 13 to 14 minutes for a full mile. Other distances would be in proportion, of course. This allows for circling when a bee starts, the time in unloading without unnecessary delay, and the return flight. The usual custom is to start one bee at a time.

Other bees can be trapped, fed, and released while the first bee is on its way to and from its hive. If all the bees take the same general direction as soon as they are released, the bee hunter should mark some tree or other object on the horizon that indicates the direction.

Sometimes it happens that there will be three or four bee trees in the vicinity, with the result that there will be three or four directions. In that case one will have to decide on one of the directions. In the meantime the hunter will wait until the first bee has gone out and returned. The box should be opened and the glass slide should be drawn back so as to allow the returning bee to go down into the cigar box. On the second or third trip the returning bee will in all probability bring back other bees. Watch the direction that these bees take, mark the line by some distant object as accurately as possible. Note also the distance, according to the time they have been gone. Every bee that is released should be carefully timed by watching. The average of the times will show approximately the distance.

After the bees are going and coming pretty rapidly one may move the box, or another one, on the same line toward the distant place where the bee tree is supposed to be locat-

ed. It would perhaps be wise to move pretty well toward the woods if they are a half-mile away. Line the bees up as before and this time take note of the object toward which the bees go. Again mark the spot, perhaps the other side of the woods, but in the same general direction. If the bees go back, then it is apparent that the bee tree is somewhere between the two places whence observations were taken. The next move will be to establish a crossline by putting the box over to one side some distance. The bees should be started in exactly the same way they were on the initial line. Where the two crosslines meet, of course, will be somewhere near the spot where the bee tree is located.

It is seldom worth while to look for bees in dead trees because this same bee-hunting authority says that bees will seldom establish a home in a dead tree. Apparently they know that they would be blown over or that the rains would soak into the rotten wood, even penetrating into the cavity where the bees are located.

With the opera glass look over the immediate location indicated by the bee lines, watching especially for holes or hollows in the trees. Make a very careful search and if it can not be located make still another crossline and where the three lines meet it is evident that the bee tree will be located.

Mention has been made that there might be other bee trees as shown by two, three, or four distinct lines from the original spot where the bees were lined up. One can now go back to the first position and take up one of the other lines, follow it out as already indicated for line No. 1, until the bee tree is located. In the same way other lines can be traced. Of course it is useless to waste any time tracing lines that go in directions of well-known apiaries.

#### Getting the Bees Out of a Bee Tree

After having located the bee tree it is the usual custom for one to mark his initials on the tree. Under common law the marking of these initials, if they are the first ones on the tree, gives the bee hunter ownership of the bees, but not the legal right to cut down the tree or take the bees out of the tree without permission from the owner. Usually such permission can be obtained



with little difficulty, especially if the owner of the tree is promised part of the honey that may be secured. In some cases it is unnecessary to cut down the tree. It is then that climbers and a rope are needed. If the bees are located in a hollow limb, it can be cut off. There is no harm in allowing this limb to drop onto the ground. The very fall itself will so jar the bees that they will be very easy to handle afterwards.

But one can not very well cut off a limb or chop into a tree if he is up in the air without blowing plenty of smoke into the entrance of the hollow limb to quiet the bees. A bee smoker is always a necessity in bee hunting. If the bees are located in

The illustrations show a bee tree cut by W. P. Kinard of Louisville, Miss., which is typical of most bee trees that are hollow and therefore are of no value for timber. When this fact is explained to the owner of the tree he usually will raise no objections to its being cut. He is glad to have it done, in fact, as the sections can be easily split into firewood for the fireplace or kitchen stove.

In most cases the entrance to the bee cavity is up 20 or 30 feet from the ground, as shown in the top picture at the left. Mr. Kinard says the area around the hole was covered with a thin film of wax. It is probable that as the bees flew or crawled into the hole wax scales fell off and under the action of the sun melted, leaving this thin film of wax over and near the entrance hole. Had it not been for this fact Mr. Kinard says he could not have located the bees as the tree was cut in March before the bees were out flying.

The next picture at the top right shows a young boy without veil. After a bee tree has fallen the concussion and the subsequent sawing and chopping cause the bees to become gentle as flies. They are demoralized and being in a state of fright offer no resistance.

In the middle picture the section of the log containing the bees is stood on end. Mr. Kinard's brother is shown at the left wearing the bee veil. While this headgear was needed at the moment the tree fell, it was not required later as the boy at the right had no protection.

The last picture shows the log standing upright in the home apiary with a super on top to catch the surplus honey. Evidently the combs naturally built reached from the entrance hole to the super.



a hollow in the body of a tree, about all one can do is to cut down the tree.

As a rule, a hollow tree is of little value to the owner from the standpoint of lumber. After it has been cut one may then chop into the cavity where the bees are located and take out the honey and the bees. When the tree comes crashing down, the bees in the hollow will come rushing out. If one has a bee veil and smoker there need be little trouble. First use smoke. After a few blows on the tree with an axe the bees will quiet down and the smoker will not be needed thereafter.

If it is discovered that the bees are in some giant tree five or six feet in diameter, and the owner will not allow the tree to be cut, the bees can be removed by driving twenty-penny spikes into the body of the tree at intervals of eight or ten inches. These spikes can be used somewhat as the rounds of a ladder until the opening in the tree is reached. Generally bees located in such enormous trees had better be abandoned if permission cannot be secured. Their value is not worth the risk.

### How to Get Bees Out of Bee Trees or from Between the Sidings of a House Without Mutilating Either the Tree or the House

A colony of bees will sometimes take its abode in some fine shade tree in a park which the authorities will not allow to be cut, or it will domicile in the woods of some farmer who will allow the bee hunter to get the bees, provided he does not cut the tree. The swarm might make its home between the plaster and clapboarding of a house. How, then, can such bees and their honey be secured without doing any damage to the tree or building that gives them a home and protection? The matter is made very easy by the use of a wire cloth cone as shown below.

After the bees are located in the bee tree, the hunter prepares a small colony of bees or nucleus with a queen cell, putting it into a light hive or box which can be carried to the scene of operations. He takes along with him a hammer, a saw, nails, and lumber with which he can make a temporary platform. On arriving on the spot he lights his smoker, blows smoke into the flight hole to drive back the bees, then

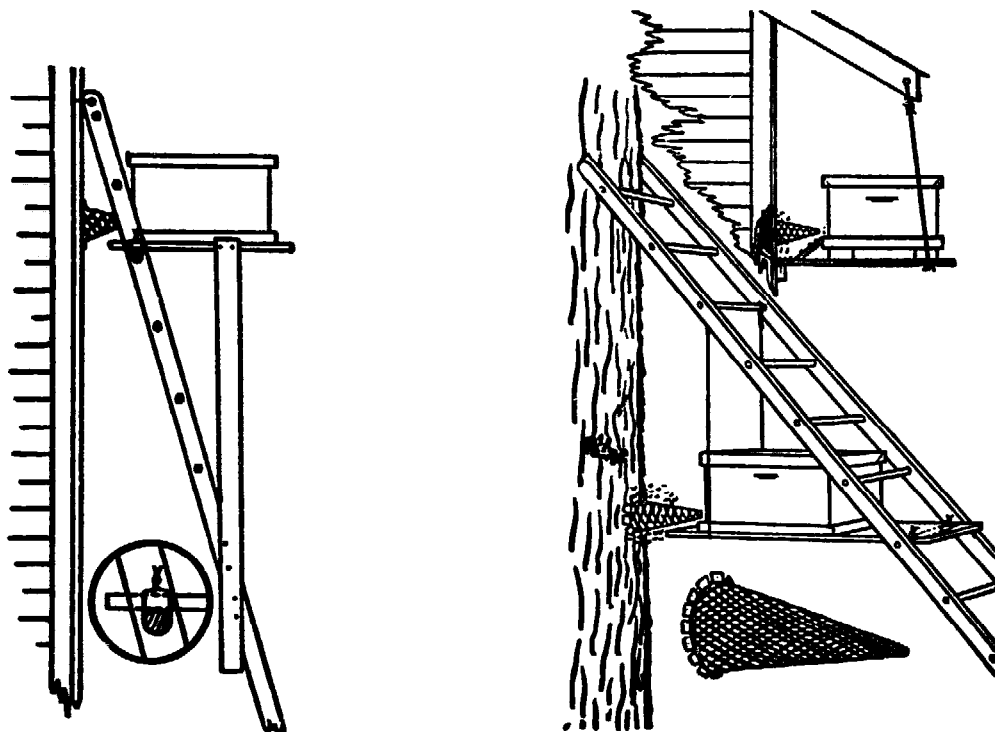

How to hang a hive from or on top of a ladder. The wire cloth cone is shown at the right. The large end should be tacked over the hole and the small end with  $\frac{1}{4}$ -inch opening should feed to the entrance of the hive. The bees as they return will direct their flight to the large end. Finding that they cannot enter the old hole, they will work over to the hive with the brood when they will make it their permanent home. The bees in the tree will feed directly into the new hive until the old cavity is emptied.



he places a bee escape over the opening of the tree or building in such a way that the bees can come out but not go back in. Last of all he places his hive with the bees which he has brought, with its entrance as near as possible to the bee escape.

A ladder or stepladder may be used to hold the platform in the manner shown on the previous page.

His work is now complete, and he leaves the bees to work out their own salvation.

As the bees from the tree or building come out they, of course, are unable to return. One by one they find their way into the hive on the temporary platform. At the end of four or five weeks the queen in the tree or dwelling will have very few bees left, and there will also be but little brood for that matter for lack of bees to take care of it, for her subjects are nearly all in the hive on the outside.

At the end of six weeks the queen is likely to come out and join the new colony.

At this time the bee hunter appears on the scene. He loads his smoker with fuel, removes the bee escape, and kills what is left of the old colony—by this time it is probably not more than a handful of bees with the queen.

Again he leaves the scene of operation, but the bee escape is not replaced. What happens now? The bees in the hive, including those which were captured, rob all the honey out of the old nest in the tree or house in the course of three or four days, carrying it into the hive on the extemporized platform.

The bee hunter now takes away the hive, removes the temporary hive stand, and carries the bees home. If they are taken a mile or a mile and a half they will stay where placed. If the distance is less, the colony should be moved to a temporary location two miles or more away and left a week before being taken home. The old entrance to the tree or building should be closed up or other bees will occupy the quarters. The old comb would attract scouts for a swarm to follow.

In the meantime no damage has been done either to tree or building, as the case may be. All that will be left in the tree will be some old dry

combs which, in the form of wax, probably would not amount to 50 cents, if the time of rendering were taken into account. Very shortly the bee moth will occupy the combs, consume them, and leave a mass of web behind. (See Moth Miller.)

This method of taking bees could not be very well practiced where the bees are located in inaccessible positions as in high trees, but it will be found very useful where a colony is located in some building or shade tree which can be reached by a ladder. (See Transferring.)

Where it is necessary to exterminate a colony of bees from a building and the services of a professional are not available there are commercial preparations of pesticides available. Directions on the container should be followed carefully.

If the extermination is done in the spring, summer, or fall, the entrance to the nest should be closed when all the bees are inside. The insecticide is then forced into the nesting cavity with a low pressure sprayer, if a liquid, or by a squeeze bottle or dusting apparatus, if in powder form.

#### BEEKEEPING AND FARMING. —See Farmer Beekeepers.

**BEEKEEPING AND FRUIT GROWING.**—Under Pollination of Fruit Blossoms it has been shown that beekeeping is very intimately related to fruit growing. The production of much of the fruit from many trees and shrubs is dependent upon the pollen being carried by bees to the bloom from different trees or plants, or varieties of the same species. In most cases the quantity is increased and the qual-



An apiary well located in an orchard

ty of the fruit is improved when bees are present. The two industries can therefore be united with great advantage. Intelligent fruit growers have learned to appreciate the valuable work performed by bees. As they become convinced that the services of these little friends are indispensable they not only begin buying colonies of bees, but gradually increase their number until it is not uncommon for a fruit grower to own a large apiary. So, far from adding to the expense of fruit culture, the surplus of honey obtained has proved that beekeeping may become a very profitable sideline to fruit culture. One man, or a force of men, can care for the bees a part of the time and for the fruit the other part and thus be able to furnish two of the finest sweets in the world—the sugar in fruit and the sugar in the nectar of the flowers.

**BEEKEEPING AND GARDENING.**—Beekeeping can be managed in connection with truck gardening, but they do not make nearly as good a combination as bees and poultry. The difficulty in combining bees with gardening is that the latter requires its greatest attention when the bees also need a large amount of care. There are times and circumstances, however, when beekeeping, fruit growing, and poultry keeping might all three be worked together, but in most cases probably the man who attempted this would be a "Jack of all trades and master of none".

**BEEKEEPING AND HONEY REFERENCES IN BIBLE\***—"In the beginning, God created the heavens and the earth" Genesis 1:1 (Revised Standard Version), and "all things were made and came into existence through Him, and without Him was not even one thing made that has come into being" John 1:3 (Amplified Version). Surely this creation included the honeybee; for there are 68 references in the Bible to bees, honey and honeycomb. It is interesting that the Bible contains 66 Books, two less than these references.

Ever since my childhood years, spent on the farm where we had many hives of bees, I have been deeply interested in bees, honey and honeycomb. My

mother, a Baptist minister's sister, used to read the Bible to her three sons; and I can clearly recall the story of Sampson's killing of the young lion, and later his finding of bees and honey in its carcass. Equally impressive were the many references in the Bible to "a land flowing with milk and honey" Exodus 3:8(RSV). Recently, I made it my business to look up (in the Bible Concordance) <sup>1</sup> all the references pertaining to bees, honey and honeycomb. Being a reader of the Bible and a hobby beekeeper, as well as a busy obstetrician, I resolved to put in writing an article that would include all references in the Bible to bees, honey and honeycomb. I am sure that there are hundreds of beekeepers in the world who feel that God really created the honeybee for the specific purpose that man, whom "God created in His own image" Genesis 1:27 (RSV) might be supplied with honey, the one universal natural food for all ages.

The phrase "A land flowing with milk and honey" occurs 20 times in seven books of the Old Testament, beginning with Exodus 3:8 (RSV). It certainly was used enough to emphasize the fact that man can live satisfactorily on a diet of milk and honey, with very little of other foods. As a matter of record, Doctor Mykola H. Haydak, now Professor of Entomology, University of Minnesota, lived three months on a diet of milk and honey in 1934. <sup>2</sup> He says that he neither gained nor lost weight and was able to do all his daily duties successfully. He did have to add orange juice during the dieting because of the low vitamin C content of milk and honey.

We read in Judges 14:8,9 (RSV) that Sampson went back to look at the carcass of the lion, which he had previously killed, and found a swarm of bees in its carcass. Since they had produced honey in it, he scraped the honey out into his hands and ate it as he went along, giving some of it to his father and mother. They ate it, but he did not tell them he had taken the honey from the carcass of the lion. <sup>3</sup>

It was recognized that milk and honey were essential for babies' formulae, even in Biblical days. Isaiah prophesied: "Therefore the Lord himself will give

\* W. W. Maxwell, M. D.

you a sign. Behold, a young woman shall conceive and bear a son and shall call his name Immanuel. He shall eat curds and honey when he knows how to refuse the bad and choose the good" Isaiah 7:14,15 (RSV). Many pediatricians today prescribe honey for their babies instead of sugar. Honey is readily absorbed by the stomach because it has been predigested by the bees. Also, all milk must be changed into curds as soon as it reaches the stomach as a necessary part of digestion, whether in babies or adults.

In Proverbs, the wise thoughts inspired by the Lord, as expressed by David give us much information about honey, such as: "My son, eat honey, for it is good, and the drippings of the honeycomb are sweet to your taste" Proverbs 24:13(RSV); and again as a warning to us all, "If you have found honey, eat only enough for you, lest you be sated with it and vomit it" Proverbs 25:16(RSV). It is written wisely; "It is not good to eat much honey, so be sparing of complimentary words" Proverbs 25:27(RSV). However, ancient people believed that honey and sweet words were good for the health and soul of man. As the writer states in Proverbs 16:24(RSV), "Pleasant words are like honeycomb, sweetness to the soul and health to the body." Many may fear the judgments of God, but twice in the Psalms we are told that the judgments of God are sweeter than honey, Psalms 19:10 (King James Version) and Psalms 119:103(KJV).<sup>4</sup>

The Bible shows in many ways how important articles of food honey and honeycomb were for the people of that day; often used, no doubt, as the greater portion of their daily diet. This was so in the case of John the Baptist, for the Bible says that "his food was locusts and wild honey" Matthew 3:4(RSV). Honey in the honeycomb has been the natural product of the honeybees since the beginning of Creation. It is Nature's one universal predigested food which can be readily absorbed by the most delicate stomach of all people of all ages, from infancy to senility, producing growth, energy and normal good health. Therefore, it seems proper, according to Isaiah's prophecy, that Jesus (Immanuel) should be given milk (curds) and honey as a baby that He

might grow into manhood normally. Also, it is very interesting to note that the First Meal that Jesus had after His Resurrection is thus described by Luke; "And while they yet believed not for joy, and wondered, He said unto them 'Have ye here any meat?' And they gave Him a piece of broiled fish and of an honeycomb. He took it and did eat before them" Luke 24:41 (KJV).

In conclusion, I hope that these correlations between the Scriptures and Nature's most useful food, honey, will give every beekeeper throughout the world a deep spiritual satisfaction, knowing that he is carrying out the Will of the Creator as he uses his God-given talents in producing more honey for more people.

What food used today by millions of people is mentioned in the Bible as many times as are honey and milk? It is the wish and purpose of this compilation that all beekeepers, and others interested, will look up and read the references as they appear in the bibliography.

#### BIBLE REFERENCES:\*

Genesis	43:11
Exodus	3:8,17
"	13:5
"	16:31
"	33:3
Leviticus	2:11
"	20:24
Numbers	13:27
"	14:8
"	16:13,14
Deuteronomy	1:44
"	6:3
"	8:8
"	11:9
"	26:9,15
"	27:3
"	31:20
"	32:13
Joshua	5:6
Judges	14:8,9,18
1 Samuel	14:25,26,27,29
"	14:43
2 Samuel	17:29
1 Kings	14:3
2 Kings	18:32
2 Chronicles	31:5
Job	20:17
Psalms	19:10
"	81:16
"	118:12
"	119:103

Proverbs	5:3
"	16:24
"	24:13
"	25:16,27
"	27:7
Songs of Solomon	4:11
" " "	5:1
Isaiah	7:15,18,22
Jeremiah	11:5
"	32:22
"	41:8
Ezekiel	3:3
"	16:13,19
"	20:6
"	27:17
Matthew	3:4
Mark	1:6
Luke	24:42
Revelations	10:9,10

\* In several of the above references both bees and honey, or honey and honeycomb are mentioned in the same verse.

#### BIBLIOGRAPHY:

1. Strong's Exhaustive Concordance of the Bible, 1958 Edition.
2. Haydak, Mykola H. - ABC and XYZ of Bee Culture, 1951 Edition, Page 420. Also, Gleanings in Bee Culture, 1938 Volume 66, Page 624.
3. Maxwell, W. W., M.D., - The Uses of Honey in Diets and Medicine. Gleanings in Bee Culture, Volume 85, Pages 50-52.
4. Chaloner, Reginald, Reverend, - Bible Bees. Bee Craft (England) Volume XLIII, No. 3, March 1961, Pages 23-24.

**BEEKEEPING RECORDS.—R. A. Luening**, professor of community affairs and agricultural economics and **W. L. Gojmerac**, professor of entomology, both of the University of Wisconsin, Madison have compiled a manual, **A2655 Beekeeping Records**, which outlines the procedures and forms a beekeeper needs for income tax purposes and business analysis. The **Farmers Tax Guide**, USDA publication (IPS 225) is useful and is available each year from your County Extension Office.

Perhaps a listing of terms and their definition as used in beekeeping records would be helpful.

#### Definition of Terms

**Accounts Payable:** money you owe but have not paid, that is, operating expenses not paid.

**Accounts Receivable:** money someone owes you but has not paid.

**Capital Item:** any item expected to last longer than one year.

**Cash Operating Income:** all items sold for which you have received payment.

**Cash Operating Expenses:** all items purchased and paid for which you use in production, such as sugar, drugs, bottles, labels, bees, queens, etc. List items which are left over at the end of the year on an inventory.

**Depreciation:** the lowering in value because of age, use or obsolescence. For tax purposes: the amount any item loses in value is a depreciable expense. The depreciable balance is that remaining cost or book value left to depreciate—also called adjusted basis.

**Depreciable Expense:** the cost basis of the item divided by expected years of life. Example: an extractor costs \$50, you expect it to last 10 years, therefore, the depreciable cost is \$5 per year.

**Depreciable Item:** any item which has an expected business life of longer than one year.

**Equity Capital:** the amount of your money invested in the project.

**Inventory:** items which are left over at the end of the year but are not depreciable.

**Profit or Loss:** the return to unpaid labor, management and equity capital.

**Salvage Value:** the value of a depreciable item at the end of its useful life.

#### Depreciation Schedule and Investment Summary

Start with the Depreciation Schedule on Fig. 1. List all your depreciable capital purchases on the Depreciation Schedule. Even though you purchased foundation, frames, wire and supers separately you might want to accumulate the individual items and list them collectively as the cost of one super with ten frames on foundation or as one super with brood or extracting comb. A reasonable life expectancy for drawn comb is 10 years. While drawn comb may have more value to the beekeeper than a frame with foundation, the differences are probably not important.

Add the first column, called Depreciable Balance, Beginning of the Year. Also add salvage value from that column of only those assets which are presently in use. Enter this as the beginning inventory of Depreciable

THREE-YEAR DEPRECIATION SCHEDULE 19__ THROUGH 19__													
Asset Descriptions (capital purchases)	Date Acquired	Years Life	New/Used	Dep. Method	Invest. Credit	Cost Basis	Salvage Value	19__		19__		19__	
								Depreciable Balance Beg. of Year	Depreciation for the Year	Depreciable Balance Beg. of Year	Depreciation for the Year	Depreciable Balance Beg. of Year	Depreciation for the Year
<b>Total Depreciable Items</b>						\$	\$	\$	\$	\$	1/	\$	1/

1/ Transfer to Line 1 of the Investment Summary

Fig. 1

Items on line 1 in Investment Summary, Fig. 3. All expense items purchased and remaining at the end of the year should be inventoried on the Inventory Record section, Fig. 2. Transfer the total inventory value to line 2 of the Investment Summary, inventory items. Any assets not appearing on the Depreciation Schedule or Inventory Record can be put on line 3, Other Items, in the Investment Summary. Include items such as accounts receivable as a plus figure and accounts payable as a minus figure. This provides a beginning value of all assets as you start the record.

At the end of the year add all depreciable assets purchased during the year to the Depreciation Schedule (Fig. 1) and remove all the sold items. Then determine the depreciation for the current year and add up the Depreciable Balance Beginning of the Year column, add in salvage value of those items. Calculate ending inventories by the same method as the beginning inventory and enter them in the Investment Summary, Fig. 3. The ending investment for the year becomes the beginning investment for the next year.

### Operating Income and Expenses

In the operating Income and Expenses section (Fig. 7) enter all operating income along with a good description and quantity sold. If you have a large number of small operating sales, you might accumulate them on separate sheets and enter monthly totals. Handle operating expenses such as sugars, jars,

drugs, labels in the same fashion. At the end of the year add up all of your operating income and expenses and transfer those totals to lines 1 and 2 respectively of the Cash Summary.

### Capital Sales and Purchases

Record Capital Sales and Purchases in the appropriate section, Fig. 5. When you sell a capital item remove it from the Depreciation Schedule (Fig. 1) or Inventory Record (Fig. 2) and add all additional purchases to the appropriate section. At the end of the year total your Capital Sales Income and Capital Purchase Expenses. Add these totals to the Total Operating Income and Total Operating Expenses (lines 1 and 2, Cash Summary) and enter on lines 4 and 5 of the Cash Summary, Fig. 6.

Transfer the Net Cash Income (line 6, Fig. 6) figure to the Profit or Loss Statement (Fig. 4). Calculate the Inventory Change Fig. 2 (plus or minus) by subtracting your beginning inventory figure from the ending inventory. The Capital Item Change (plus or minus) is calculated by subtracting the depreciable balance at the beginning of the year from the depreciable balance at the end of the year.

**The Net Cash Income plus or minus Inventory Change plus or minus Capital Item Change equals Profit or Loss.**

This is your return for unpaid labor, management and equity capital. This is a good gross measure of the profitability of your business or hobby for that year.

THREE-YEAR INVENTORY RECORD				
Item Description	Beginning Value Jan. 1, 19__	Ending Value Dec. 31, 19__	Ending Value Dec. 31, 19__	Ending Value Dec. 31, 19__
Bees No. _____				
Bees No. _____				
Bees No. _____				
Honey Lbs. _____				
Honey Lbs. _____				
Honey Lbs. _____				
Wax				
Wax				
Wax				
Supplies				
<b>Total Inventory <sup>1/</sup></b>	\$ _____	\$ _____	\$ _____	\$ _____

1/ Carry to line 2 below Three-Year Investment Summary.

THREE-YEAR INVESTMENT SUMMARY				
Item	Beginning Value Jan. 1, 19__	Ending Value Dec. 31, 19__	Ending Value Dec. 31, 19__	Ending Value Dec. 31, 19__
<b>1 Depreciable Items</b>				
<b>2 Inventory Items</b>				
<b>3 Other Items</b>				
<b>4 Total Investment (Lines 1 + 2 + 3)</b>	\$ _____	\$ _____	\$ _____	\$ _____

THREE-YEAR PROFIT OR LOSS STATEMENT				
Item	19__	19__	19__	
<b>1 Net Cash Income (Line 6 Cash Summary)</b>				
<b>2 + or - Inventory Change</b>				
<b>3 + or - Capital Item Change</b>				
<b>Profit or Loss Line 1 ± Line 2 ± Line 3</b>	\$ _____	\$ _____	\$ _____	

Fig. 2, 3 and 4

**Other Records**

Any other information pertinent to your beekeeping can be added to your

beekeeping records. Information on colonies overwintered, number of single and double queen colonies, total honey production, colony averages, requeening

19__					
Capital Sales Income			Capital Purchases Expense		
Date	Item	Amount	Date	Item	Amount
Total Capital Sales Income		\$	Total Capital Purchases Expense		\$

CASH SUMMARY	19__	19__	19__
1 TOTAL CASH OPERATING INCOME (From Operating Income of Expense Page)			
2 TOTAL CASH OPERATING EXPENSE (From Operating Income of Expense Page)			
3 NET CASH OPERATING INCOME (Line 1 Minus Line 2)			
4 TOTAL CASH INCOME (Line 1 + Capital Sales)			
5 TOTAL CASH EXPENSE (Line 2 + Capital Purchases)			
6 NET CASH INCOME (Line 4 Minus Line 5)			

19__ OPERATING INCOME AND EXPENSES					
Operating Income			Operating Expense		
Date	Item	Amount	Date	Item	Amount
Total Cash Operating Income		\$ <sup>1/</sup>	Total Cash Operating Expense		\$ <sup>2/</sup>

1/ Carry to line 1, Cash Summary. 2/ Carry to line 2, Cash Summary.

Fig. 5, 6 and 7

dates, date of first overwintering inspection and the number of colonies lost may help to make your beekeeping more interesting and orderly. The dates

of the first pollen gathering, start of the honey flow, supering, first honey removal and fall feeding may be recorded for future reference.

**BEEKEEPING SCOUT MERIT BADGE.**—Just as beekeeping projects are available for 4-H and FFA programs, there is also a Boy Scout beekeeping merit badge. A scout can work on merit badges any time during his scouting career but he usually puts most emphasis on it after he has received his First Class Award and is striving to become an Eagle Scout, the highest achievement award in scouting. The merit badge is awarded to the scout after he has completed a prescribed series of tasks and testing in the many specialized fields available for such awards. The badge is round, made of cloth, and the beekeeping badge has a bee emblem sewn onto it. The Boy Scout wears the badges he has earned on a special cloth sash which runs diagonally across his chest.

If a boy is interested in a beekeeping merit badge he can easily obtain the beekeeping merit badge book from his Scoutmaster. This book consists of 66 pages of information about beekeeping and can also be purchased for a nominal fee from any scouting supply store or by writing Boy Scouts of America, New Brunswick, New Jersey.

To obtain a merit badge for beekeeping, a scout must:

1. Examine a colony of bees; remove the combs; find the queen; and, determine the amount of brood; number of queen cells; and, the amount of honey in the hive.

2. Distinguish between the drones, workers and eggs; larva and pupa at various stages of development; honey, wax, pollen and propolis; tell how the bees make the honey and where the wax comes from and explain the part played in the life of the colony by the queen, the drones and the workers.

3. Have had experience in hiving a swarm or artificially dividing at least one colony. Explain the construction of the modern hive, especially in regard to the "bee space".

4. Put bee comb foundation in sections or frames and fill supers with frames or sections, and also remove filled supers from the hive and prepare the honey for market.

5. Write an acceptable article of not more than 200 words on how and why the honeybee is used in pollinating farm

crops. Name five crops in your area pollinated by honeybees.

The book itself covers the following subjects, pollination, how honey is made, differences in honey, food for the bee, how beeswax and combs are made, propolis, the queen, the drone, the worker, bee races, the brood, importance of temperatures, the hive, comb foundation, tools and clothing, apiary location, buying bees, installing package bees, opening the hive, finding the queen, requeening, giving supers, house cleaning, examining over-wintered colonies, first manipulations, uniting colonies, adding package bees, clipping the queen, spring feeding, robbing, overcrowded brood nest, swarming, hiving a swarm, artificial increase in colonies, producing extracted honey, equipment needed, putting on supers, extracting, chunk honey, producing comb honey, hive management, taking off honey, getting ready for winter, windbreaks, packing, winter chores, American foulbrood, European foulbrood, other brood diseases, dysentery, Nosema disease, paralysis, poisoning, enemies.



Most boys who undertake this project should have a competent adult advisor and this advisor should remember that one of the most important parts of teaching beekeeping is to give the novice confidence. One of the best ways to do this is to be sure he is properly equipped so that it isn't possible for him to be badly stung during the first few sessions.

**BEEKEEPING PREFERABLE TO OTHER PURSUITS\*.**—I keep bees because I know of no other useful creatures that provide so much enjoyment and interest, both for my-

\*By Clarence M. Carroll, New York City.



self and others, with so little attention and work. It's a hobby, but one that is decidedly not "in the red"—in other words, it is profitable, too.

Consider any other livestock. Poultry, pigs, cattle, horses, goats, rabbits all have to be fed or must have feed and pasture provided 365 days every year—no, not 364, but 365. They must have bedding and shelter. The bedding and the offal (the latter of course is useful but disagreeable) must be removed at regular intervals. You can't skip it. Even sheep have to be dipped and clipped. Fencing and housing of animals runs into a large investment per head, and requires constant expenditures of labor and material for upkeep, and in addition a lot of space and land.

Bees require comparatively inexpensive equipment that has little depreciation and can be easily kept in tip-top shape. I have some hives still in excellent condition after 24 years. The bees' living quarters do not involve messy work to keep them clean and sanitary—bees don't live that way. Bees do not smell to high heaven as many animals do, neither do they wake me or my neighbors at unearthly nocturnal hours with snorts, neighs, moos, quacks, grunts, or cackling and crowing. Even a large apiary takes up only the space equivalent to a city lot.

Considering the investment in bees, hives, extractor, filter, heater, clothing, and tools, and the very few hours per colony necessary to produce a honey crop and supervise the whole business, nothing I know about compares with beekeeping. It is clean, fascinating, and of interest not only to the bee man but to nearly all to whom it is mentioned. The surprising interest and real desire to know something of bees among average people is a constant source of wonder to me. "Oh, do you keep bees?" "Don't they sting?" "How do they make honey?" and many other questions.

Sure they sting. This notion some people have that bees know their keeper is all wishful thinking. My bees come at me under some conditions like tracer bullets, and I have to be well armored. But, even with the armor on I can still walk into the living room. You can't come in

from the stable like that—not if you expect to stay married!

Can you take a three-week vacation in summer or autumn if you keep cows? Can you spend Christmas with Aunt Martha in Punkin Hook if you have 1000 hens? Well, hardly, unless you have good and accommodating neighbors. Can you, Mr. Milk and Egg Man, move your critters to greener pastures easily? I can move mine, all at one time, in an hour.

I find it is profitable, in spite of giving away most of the honey. If I didn't give any away, and sold it all, I find from fairly accurate records that cover a period in which the retail price of honey went down to 12 cents and up to 35 cents per pound, that I would have netted \$1.60 per hour, so it costs real money to be so generous. On a large scale the returns may be less per colony, but I still wouldn't have to get up on dark cold winter mornings to mix bran mash or throw down hay, squeeze milk from a reluctant bossy, or clean an odorous hencoop.

Now of course we know that there would be no America without cows, pigs, hens, their products and by-products. But for a small farm or city or suburban dweller, bees are a fine proposition. And is that honey good on hot waffles!

**BEE SPACE.**—This term is applied to spaces left by the bees both between the combs they build and between the parts of the hive and the combs. It varies all the way from  $\frac{1}{4}$  to  $\frac{3}{8}$  inch; but  $\frac{1}{8}$  is considered the correct average. But in hive construction it has been found that a space of  $\frac{1}{4}$  inch will be more free from the building of bits of comb

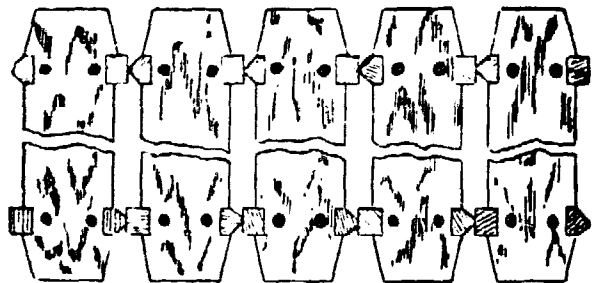

Top view diagram looking on a set of Hoffman frames showing how the Hoffman frames are bee spaced apart by projections on the end bars. Note one edge is V-shaped to keep the frames from being stuck fast by bee glue.

and the depositing of propolis than a little wider spacing. Any space less than  $\frac{1}{8}$  inch will be plugged up with propolis and wax. (See Frames.)

Mr. L. L. Langstroth, in the great invention which he gave the world (the first practical movable frame),

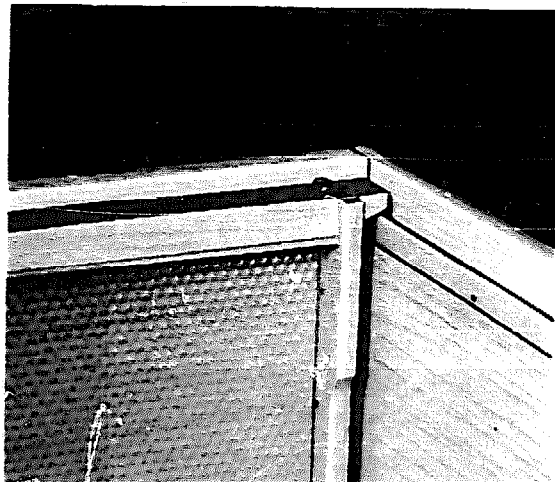

The manner of hanging a Langstroth movable frame having projecting ends which rest in a recess or rabbet in the upper edge of the hive ends. This manner of supporting a frame in the hive was also invented by Langstroth. Mr. Quinby devised a plan of supporting the frame from below in a form we called a standing frame. The hanging principle is now universal.

discovered that the principle of the bee space could be applied to design a hive, in which the frames could be removed. (See Hives, also Frames.) Taking advantage of this fact he made a frame for holding comb so that there would be a bee space all around between it and the hive, and a bee space between it and any other frame. All who preceded him had failed to grasp the fact that bees would leave such spaces unfilled with wax or propolis. Before Lang-

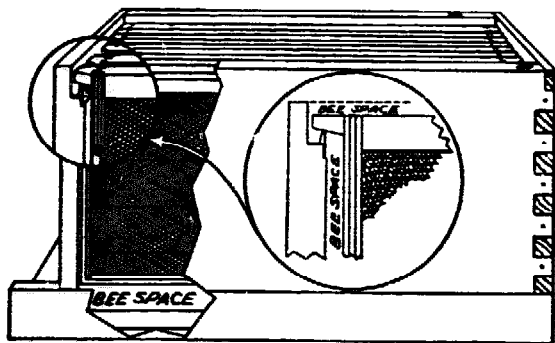

As here shown the hive is so constructed that there is a bee space ( $\frac{5}{16}$  inch) in which bees will not build combs and which they will reserve for passageways for themselves.

stroth's time it was necessary to pull out frames stuck fast to the hives with propolis, or tear or cut loose the combs with a thin-bladed knife, before they could be removed for the purpose of inspection.

By bringing out this bee-spaced frame the "father of modern apiculture" solved, with one great master stroke, a problem that had been puzzling the minds of beekeepers for centuries.

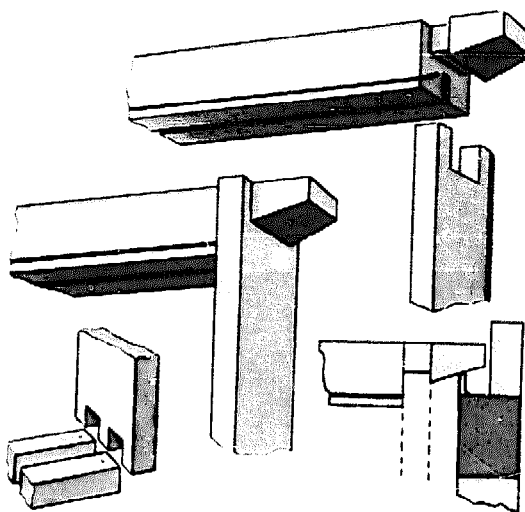

Detail showing the lock corner construction and how the projection rests on the metal support in the upper end of the hive.

In later years, manufacturers of hives have been compelled to recognize this great principle, that there are certain parts inside of the hive that must be bee-spaced from every other part or they will be glued together in a way that will make them practically inseparable. For example, the bottoms of supers containing the sections must be  $\frac{1}{8}$  inch above the tops of the brood frames in the lower parts of the hive. It has come to be a general practice to put the bee space in the bottom board, leaving the bottoms of the frames in the brood nest nearly flush with the bottom of the hive. This makes it necessary to have the sides and ends of the hive project above the general level of the frames about  $\frac{1}{8}$  inch. In the same way the supers have a bee space on top but not on the bottom. If a super is removed and a hive cover put in its place, there will still be a space between the cover and the brood frames.

There are a few who believe that the bee space should always be under the frames or sections. This

would necessarily require that the top of the hive or super be even with the tops of the frames or sections, and that the covers have cleats on the outside edges a bee space thick. Such a combination is objectionable because these cleats could not be made tight enough to keep out rain and cold, and because there are many beekeepers who like to use a flat board cover that may be used either side up. It is very much more satisfactory to have the bottom board cleated in the manner stated than the cover. Even if the cleats are not tight, warm air would not escape at this point.

On account of the inevitable shrinking and swelling of hive bodies, the space under the bottom bars is bound to vary.

#### A Deeper Space Over the Hive Bottom

It is customary to make a space between the bottoms of the frames and the bottom boards much greater than the space on top. Modern hives usually provide  $\frac{7}{8}$  to 1 inch of space under the frames to allow for plenty of ventilation during hot weather. Such a space should have an entrance  $\frac{7}{8}$  inch deep. This is none too large during the hottest part of the year. (See Entrances.)

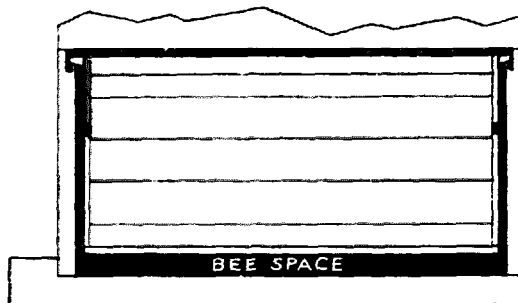

The black shows the bee space in a longitudinal section of a bee hive.

During the winter, whether in the cellar or outdoors, the extra space allows for an accumulation of dead bees under the frames. If the space under the frames is only  $\frac{1}{8}$  it might soon clog up with dead bees, thus preventing ventilation, finally ending in the destruction of the colony. (For further discussion of bee space see Frames and Hives, Langstroth, Life of, and Spacing of Frames.)

**BEES.**—See Races of Bees; also Hybrids.

**BEES AS A NUISANCE.** — It would seem almost out of place to discuss this question in a book intended for study by those who believe—and rightly, too—that bees are not a nuisance, but as will be shown, there are very good reasons why the matter should be calmly discussed in order to avoid trouble that may arise in the future. Certain difficulties have arisen between the keepers of bees and their neighbors. Perhaps the bees, after a long winter's confinement, or after several days of being shut in, have taken a flight and soiled the washing hung on a line in a neighbor's yard. Possibly the neighbor's children are stung, or there have been times when he has been greatly annoyed while in the peaceable possession of his own property by bees coming on his premises and smelling around as they sometimes do during the fruit-canning season when the aroma of sugar and juicy fruits escape through the doors and windows of the kitchen. Possibly the offended neighbor keeps chickens, and members of his feathered tribe have trespassed on the grounds of the beekeeper. The result of all this is that bad feelings arise. Complaint is made to the village officers; an ordinance is proposed declaring bees within the limits of the corporation to be a nuisance and requiring the keeper to remove them at once or suffer a fine or imprisonment, or both. Fortunately the courts have held that the ordinances prohibiting the keeping of bees inside of a city or town are unconstitutional. (See Laws Relating to Bees.)

In some instances livestock has been stung; a cow or a calf or a horse may get near the entrances of the hives which are possibly within a foot of a dividing line between the two properties. Perhaps the stock is stung nearly to death. Damage is claimed and a lawsuit follows, with the result that a feeling of resentment is stirred up against the beekeeper.

Or again, the beekeeper may have an apiary in his front yard bordering on the common highway. A nucleus is robbed out, the bees become cross, and sting passers-by.

In the first case mentioned—the aggrieved neighbor's washing being soiled by the stains from bees affected with dysentery—it will be well for the beekeeper to send over sev-

eral nice sections of honey or offer to pay for the damage done to the washing. Nothing makes a woman more angry, after she has washed her linen nice and white and hung it out to dry, than to have it daubed with frequent ill-smelling brown stains. But if the beekeeper shows a disposition to make the matter good and takes pains to offer an apology before the woman makes complaint, trouble will in most cases be averted. And right here it should be said that if the bees are in the cellar they should not be set out on wash-day; or if they are outdoors and the sun comes out bright so they begin to fly strongly from the hives, one should send word to the neighbors, asking them not to hang out their washing for a few hours, if it is a wash-day. It might be well also to send along a few boxes of honey to keep the folks across the way "sweetened up". With such treatment most neighbors will put up with a great deal of inconvenience.

As to the more serious cases — those in which horses or cattle have been stung—if the beekeeper has been foolish enough to place hives near the highway or near his neighbor's line fence where he has loose stock he may have to pay pretty dearly for it before he gets through. The remedy is prevention. He should always put his bees in the back yard and not too close to a neighbor's line fence. He should also be careful to prevent robbing. He should see that there are no weak nuclei with entrances too large. As soon as the honey flow stops he should contract the entrances of all the weaker colonies. If extracting is done after the honey flow, great caution needs to be exercised. The extracting room should be screened and no honey left exposed to the bees. Whenever possible, he should take off all surplus by use of bee escapes rather than by shaking. (See Robbing and Extracting.)

It is only fair to state that the above instances are only types of what has occurred and may occur again, so it behooves the beekeeper to be careful.

Under the head of Anger of Bees, in the latter part of the article, and under the head of Apiaries, emphasis is put upon the importance of placing the hives so that they shall be screened by shrubbery or small trees from other hives or objects in

the yard. Nothing is more conducive to insuring good behavior on the part of bees than to place the individual hives so that the inmates cannot see from their own doorsteps moving objects in the immediate vicinity. When the space where the apiary is located is open, without shrubbery or trees to screen the hives, the bees are much crosser than when placed behind obstructing objects. The average back-lot beekeeper will have much better bees to handle, and no trouble with his neighbors, if he puts his hives among the bushes. (See Back-lot Beekeeping; also laws relating to Bees.)

**BEES, CROSS.** — See Anger of Bees. See also Stings, subhead How to Avoid Being Stung.

**BEES, CROSSES OF.** — See Hybrids and also Races of Bees.

**BEES, DO THEY INJURE FRUIT?**

—Occasionally complaints have been made that bees injure fruit. To a casual observer they apparently do bite through the skin and extract the juices until the specimen is shriveled up to a mere semblance of its former shape and size. However, careful investigation has shown repeatedly that bees never injure sound fruit, no matter how soft the skin or how juicy and pulpy the contents.

Among the progressive fruit growers and horticulturists there is a general acknowledgment that bees do not injure sound fruit; that the little harm they do to damaged fruit is compensated for a hundred times over by the indispensable service they perform in pollinating fruit blossoms early in the season when no other insects or means of pollination exist. The best fruit growers are now keeping a few colonies of bees in each of their own orchards. In fact, many busy orchardists pay rental on bees. Thus the beekeeper cares for the bees and the orchardist receives the benefits of pollination. (See pollination.)

Some years ago, Prof. N. W. McLain, then in the employ of the Department of Agriculture, Washington, D. C., conducted an elaborate series of experiments in which he placed sound fruit, consisting of

grapes, peaches, apricots, and the like, in hives containing bees that were brought to the verge of starvation. This fruit was left in the hives day after day, but it was never once molested. Then he tried breaking the skin of the fruit, and in every case all such specimens were attacked by the bees and the juices sucked out until nothing but a dried skin and the stones or seeds were left.

Years later, Prof. H. A. Surface, then economic zoologist at Harrisburg, Pa., tried a similar experiment, but in no case did the bees attack sound fruit, although they partook freely of that which he had broken.

At the Wilmington State Fair, held in September, 1908, in Delaware, Joel Gilfilan of Newark, Del., had on exhibition a three-story observation hive containing two combs of bees. In the third story were hung a peach, a pear, and a bunch of grapes. This hive was kept on exhibition during the entire fair where the general public could see it. The fruit was never once visited by the bees. The general verdict of those who saw it, fruitmen and farmers alike, was that bees did not injure this fruit.

The publishers of this book have for many years had colonies located in a vineyard at their home apiary. Notwithstanding the fact that hundreds of pounds of grapes are raised every year, the bunches hanging within three or four feet of the entrances of the hives, the sound fruit is never injured, but during a dearth of honey a broken or otherwise injured bunch of grapes will often be visited by a few bees.

But a casual observer might easily get the impression that bees not only suck such damaged fruit dry, but actually puncture and eat sound fruit.

Some years ago a neighbor sent word that he would like to have us come to his vineyard and he would give us indisputable proof that our bees were actually puncturing his grapes and sucking out the juice. We looked at the luscious bunches as they were hanging down, and sure enough there were small needle-like holes in almost every grape that the bees were working on. It looked like a clear case of "caught in the act" evidence against them. For the time being we were unable to offer a satisfactory explanation.

We brought the matter to the attention of an old farmer who had been a beekeeper for many years. Finally one morning he sent word to us that he had found the real culprit, and that if we would come down to his place early some morning he would point him out. This we did. He showed us a little bird, quick of flight and almost never to be seen around the vines when any human being was present. This bird, about the size of a sparrow, striped, with a long needle-like beak, is called the Cape May warbler (*Dendroica tigrina*). It would alight on a bunch and about as fast as one could count them, would puncture grape after grape. After his birdship has done his mischief he leaves, and then come the innocent bees during the later hours of the day, insert their tongues in the holes made by the birds and finish the work of destruction by sucking the juices and the pulp of the grape until it becomes a withered skin over a few seeds. Thus the grapes were punctured by the birds during the early hours of the day, but the bees, coming on later, received all the blame for the damage.

The Cape May warbler is not the only bird guilty of puncturing grapes. There are many other species of small birds that learn this habit, and among them may be named the ever-present sparrow and the beautiful Baltimore oriole, the sweet singer that is sometimes called the swinging bird from its habit of building its nest on some swinging limb.

Some seasons the bird visitors are much more numerous than others. Several years may pass before any complaint is made, and then the beekeeper will have angry people in the vicinity of his bees calling him on the telephone, saying his bees are eating their grapes. The thing to do is to call on each complainant and prove that the birds are the ones that do the damage in the first place and that it is only by careful watching at intervals that they can be seen at their work.

In order to determine their presence the observer should go away from the grapevine about 50 or perhaps 100 feet. The early morning hours are the most favorable for catching the birds at work.

The Cape May warbler is a shy little fellow, and he will not usually

show himself if any one is near the vines. It is for that reason that the bird is seen on grapes only at brief intervals; and the bees, working on the bunches all day, get the blame for all the damage.

**Insects Other than Honey Bees  
First Puncture Fruit**

Yellow jackets are well equipped with cutting jaws. They are very fond of fruit. They will cut through the skins, suck what juice they want and later on the bees will visit the same punctures. The bees, of course, are more numerous, look like yellow jackets, and are by the uninitiated given blame for all the mischief.

Yellow jackets are particularly numerous in the fall after a frost. They cut through the skins of fruit unpicked; and the bees, because the frost has killed natural sources of nectar, will help themselves to fruit juices made available by the previous act of the yellow jackets.

In the March, 1935, issue of the *Bee World*, published in Great Britain, numerous instances are given of how bees in Europe were accused of injuring grapes. In every case it was shown that wasps or birds had first cut through the skin of the ripe fruit before the bees began their work. It was also proved that bees could not cut through the skin of sound fruit.

(For further information regarding grape-puncturing birds, refer to bulletins by Dr. Merriam of the United States Department of Agriculture, Washington, D. C.)

**When Bees May Damage Fruit**

There are times when bees are a nuisance, and it is then that their owner should compromise, or better still seek means to avoid trouble in the first place. In the fruit-drying ranches of California, apricots and peaches are cut up in halves and laid upon trays exposed to the sun's rays. If there is a dearth of honey at this time and a large number of bees in the locality, this fruit may be attacked. The bees may visit it in such large numbers that they suck out the juices, leaving nothing but the shriveled form of the fruit. The property, of course, is damaged and its sale is ruined. Before anything of this kind can happen, the beekeeper should move his whole

yard to a point three or four miles distant from any fruit-drying operations. Failing to do so the fruit grower might bring suit for damages and possibly recover the value of this crop if the bees cause trouble.

Years ago we had trouble with a cider maker. He claimed that our bees would lick up the cider from the press as fast as he could make it. We easily adjusted this by screening his building with mosquito netting.

In every case of this sort the owner of bees should avoid trouble. In the cases of the fruit-drying ranches and the cider mills the beekeeper should err on the safe side by avoiding suit for damages because no lawyer would be able to give much assistance unless it was clearly proved that the bees were not doing the actual damage.

**Bees Exonerated by a Jury**

In 1899 trouble arose at Amity, N. Y., between two brothers named Utter. One was a beekeeper and the other a fruit grower. The latter averred that the former's bees punctured his peaches, and in consequence of the alleged damage he claimed he was unable to raise any fruit. There had not been very good feeling between the brothers for years. The fruit grower brought suit against the beekeeper and the case was tried on December 17, 18, and 19, 1899, at Goshen. There was no lack of legal talent on either side. The case was a very hard-fought one from beginning to end. Among some thirty witnesses examined was the Government expert, Frank Benton, then of the United States Department of Agriculture, Washington, D. C., who gave testimony to the effect that bees never puncture sound fruit: that it is impossible for them to do so owing to the fact that they have no cutting jaws like those found in the wasp and other insects of that character. He also showed that wasps and birds will under some conditions puncture fruit; that these minute holes they make will be visited by bees during a dearth of nectar. Other expert testimony was offered, nearly all of which exonerated the bees. After all the evidence was in and the arguments were heard, the jury returned a verdict for the defendant.

(For further particulars regarding this case, see Gleanings in Bee Culture for June 1, 1900.)

**BEES, HANDLING.**—See Beginning with Bees, Manipulation of Colonies, and Honey Exhibits.

**BEES ON SHARES.** — Bees are sometimes kept on a share basis, one man owning the bees and equipment, and the other performing the labor. At the end of the season both parties share equally in the crop of honey and beeswax, and half the increase, if any. It is usually the custom for both to pay half the cost of containers to market the crop.

Sometimes the results are very satisfactory but more often one or both parties are dissatisfied at the close of the season. A short crop or a complete failure will leave the operator with no remuneration for his season's work unless there is a provision in the contract giving him an agreed salary, for otherwise he would have nothing to show for his labor and the owner might profit to the extent of stronger colonies for the next season with a possible increase. Again, the problem of disease, Nosema, foulbrood, or winter loss from improper preparation might cause the owner to charge negligence. The operator might in return charge that the disease was already present when he took over the bees.

Taking it all in all, it is much more satisfactory for the owner to pay a minimum salary and a percentage of the crop. In this way the operator does not sustain a complete loss if there is a partial or complete crop failure.

In any case, the agreement should be put in writing.

**BEES, RACES OF.**—See Races of Bees and Italianizing.

**BEES, SHIPPED IN COMBLESS PACKAGES.** — See Package Bees, and Beginning with Bees which follows.

**BEGINNING WITH BEES.**—Beekeeping is one of the few hobbies that furnish both pleasure and profit to their owner. It brings him into the realm of the whole outdoors where he can gain relaxation and health, as well as into the study of

the natural sciences such as botany, chemistry, and insect life, for these sciences are all intimately related to the activities of the most interesting of all insects, the honey bee. (See Beekeeping Preferable to Other Pursuits)

Bees furnish a form of sweet that goes into the blood stream almost immediately — a sugar especially adapted to the use of old people, children, and infants.

Bees furnish wax that is used for the coating of munitions, for floor polishes, and for cosmetics. But the great and important work of the honey bees is along the line of pollination by which they are able to increase the fruit, seed, and general agriculture crops from one to five, and in some cases as high as one to sixteen. This fact was fully realized by the Department of Agriculture, as shown by Circular E-584, issued during the second great World War. (See Pollination for further particulars.)

Nearly everyone can keep bees and the very few who cannot (one in ten thousand) are super-sensitive to the effect of the poison of a single sting and even then such people can become immune by following direc-



These cages with solid ends are a much stronger construction than those with open ends, and are the type generally used.



Package bees as they come from the South usually come in crates of two or three. In this case they arrived in crates of two.

tions given under the head of Stings, subhead How One Who is Seriously Affected by a Sting May Become Comparatively Immune to the Poison.

A single sting causes a sharp momentary pain and results in a local swelling at first. Later on, after one has been stung a few times, the swelling becomes less and less until finally there is none at all.

Of course at first a bee veil and a pair of gloves should be used. (See Veils and Gloves found in alphabetical order.) Don't attempt to open

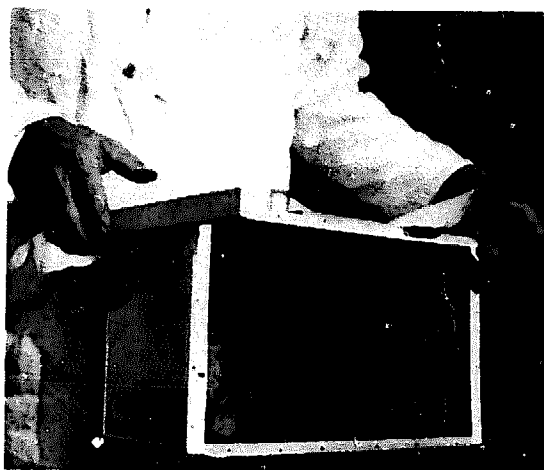

Three-pound package ready to place in an empty hive. The projecting cleats prevent shutting off ventilation. They should be removed before being placed in the hive.

a hive of bees without reading this or you may be sorry—a sadder but wiser man.

In beginning, make a moderate start. Buy one, two, or three hives with supers in the flat. Directions accompanying will show how to assemble. A smoker, veil, and a pair of gloves will also be needed. If possible, visit some local beekeeper who can tell you where you can get the bees and show how to open up the hive.

However desirable a local lot of bees may be, if they are located a hundred or more miles away the cost of trucking or freight plus the risk of disease would make it much safer for the average beginner to buy new equipment in the form of hives, bee smokers, etc., and buy package bees of some well-known



One method used by package bee producers to fill packages. Photo courtesy U.S.D.A.

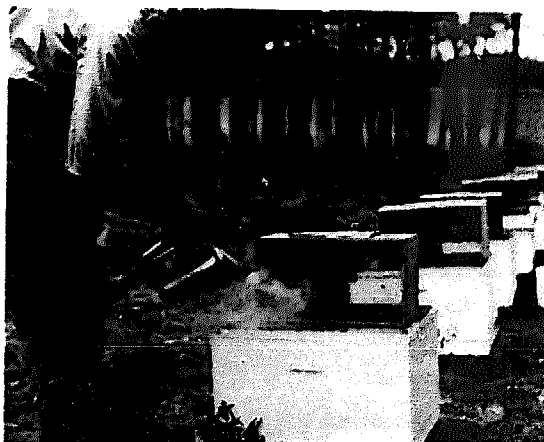

Packages distributed on hives ready to be installed. Note queens being lifted out of package.



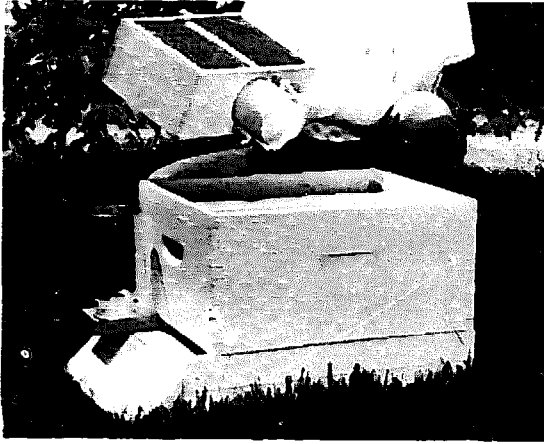

The syrup can is removed by inverting the cage and letting the can slide out.

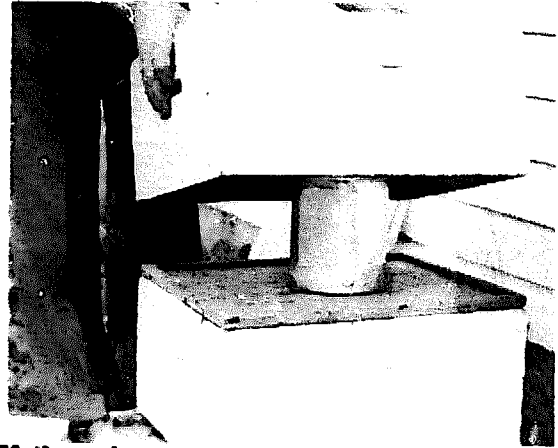

If there is any syrup left in the can after the trip, the can is set over the top of the frames, perforated top down. If no syrup remains in the can, fill it with a syrup of half water and half sugar. Cover with an extra hive body.

breeder whose bees are under surveillance of the state and will be free from any possible infection. (See Package Bees.) By consulting the advertising columns of any bee journal one will be able to get a list of all those who can furnish bees at reasonable rates.

Bees by the pound are less expensive than those on combs and there is little danger of disease.

On account of the great danger of buying local bees unless they have been inspected by a state bee inspector, the author strongly urges the purchase of bees in wire cages, without combs, commonly called package bees. (See full discussion of their merits under the head Package Bees found in its alphabetical order.)

It should be explained that the disease, American foulbrood, may be carried in combs and in honey. Bees alone, if taken from colonies free from foulbrood, will not carry the disease. Moreover, package bees are given sugar syrup and not honey. Taking it all in all, the chances of getting a disease from package bees are very remote.

#### How to Release Packages of Bees

As soon as a package of bees is received at the post office you should be notified. Make certain that your telephone number is available there or other means of notification arranged before the shipment of bees is due. If the weather is very warm place the bees in a shaded place, never in the direct sunlight. Package bees should be ordered to be delivered about the time

fruit bloom is on in your area. Earlier delivery may be taken in the northern states but the risk due to inclement weather may cause losses which will nullify any advantages gained from the earlier installation. Package bees can stand a moderate amount of cool weather and confinement in the hive in the early spring after installation but the food supply must be constant and must be in direct contact with the cluster of bees. Some northern early springs are unfavorable for long periods and a too early shipping date is inviting trouble for the beginner.

While awaiting transfer to the hive a package of bees should be fed generously. The syrup supplied with the package for use during shipment may be exhausted and the bees could conceivably starve while they are being held a day or two before installing in the hive. The sooner they can be installed after receiving, the better. A liberal feeding of sugar syrup just before opening the caged bees will generally settle the bees down and help to avoid flying around during the installation. In extremely hot weather an application of water to the cage screens with a small mist sprayer will settle the bees down if they are restless. Be certain that the sprayer has not been used for an insecticide. Bees suffering from the lack of moisture or food will take up the liquid from the screen surface and from their bodies in a few minutes time.



**If the weather is cool heat the syrup a little and wrap a piece of burlap around the can to keep the syrup warm until the bees take it down.**

Before the bees are expected prepare as many hives as there are packages of bees ordered. The hives should be set up and the frames filled with sheets of foundation unless they already contain drawn comb. A single deep brood chamber will do for the package until the colony expands its population and has extended the brood nest nearly to the outside combs. This will take several cycles of brood, possibly six to eight weeks. A second brood chamber should then be given making a two story colony that will be maintained for the use of the bees the year around where the winters are long and severe.

Begin the installation by removing all of the frames from the hive body but keep them within easy reach. Remove the board nailed to the top of the shipping cage. This will expose the end of the feeder can and the end of the small queen cage suspended among the bees. Slowly remove the queen cage and inspect the queen to be certain that she is alive and healthy. Lay the queen cage aside for the moment, in a shady spot. Tip the bee cage



**The queen in the cage is put between the frames to draw the bees out of the cage.**

at an angle and grasp the rim of the feeder can with the tips of the fingers, slowly withdrawing it. Set it aside. If the bees have been fed generously just before transferring to the hive they will be much less inclined to fly about and will be quite docile. They will rarely sting unless pinched. Invert the cage containing the bees over the opened hive and shake the bees vigorously out of the round opening of the cage. One of the wire screen sides may be opened to speed up the removal of the bees. Shaking the bees will not anger them if they are well fed. Place the nearly empty cage near the opening of the hive and the remainder will crawl to the entrance. Replace the frames by slowly lowering them among the bees. Place the queen cage between two of the center frame top bars or lay it wire side down on top of the frames. To prevent immediate release of the queen replace one of the corks in the end of the queen cage with a soft wad of tissue paper soaked in sugar syrup. The bees will chew out the plug of tissue and the queen will pass out of the hole and join the colony in a few hours or a few days. Place the inner cover on the hive and if a pail feeder is used an empty super shell must be placed over the pail which is inverted over the inner cover hole. The newly hived package must be fed continuously for as long as they continue to take syrup, perhaps for two or three weeks, or, until they begin to gather fresh nectar. Check the combs in about five days to be certain that the queen has been released from her cage; if not, she should be freed from the cage. If she has already been released, check the bottoms of the cells for eggs. If none can be seen check again in about a week.

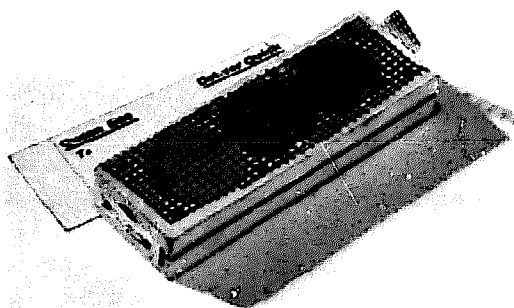

**Queens are sent in a mailing cage like this**

If the weather is very cool when the package is placed in the hive some insulating packing should be placed around the syrup can to prevent heat loss. Warm syrup may be used. The cluster of bees must be very close to the source of food during cool weather or they may starve. Combs of honey may be placed in the hive in place of feeding sugar syrup.

Most of the failure in package installation result from interference by the weather with a steady supply of food to the newly hived bees, or, as a result of queen failure. Queen failure may be due to a number of causes: Poor quality queens, disease or injury of the queen, failure of the queen to lay fertile eggs or failure to be accepted by the colony.

Purchasing package bees is not the only way to begin with bees but it may be the most convenient for the beginner. A hive containing a colony of bees may be purchased, which is perhaps the most certain method of beginning with bees. A hive may be purchased and a small colony of bees called a nucleus may be obtained from a local beekeeper and placed in the hive. A nucleus consists of several frames of brood, pollen and honey along with the bees covering the combs. The nucleus is placed in the center of the empty hive and the remaining space filled with frames of foundation or drawn combs. The nucleus should be fed if the honey is used up before the bees begin to forage for their own needs. If a queen does not accompany the nucleus one should be ordered and introduced as soon as the queenless nucleus is purchased. As with package bees, a mated queen usually comes with a nucleus but she is usually already released among the bees.

Some fortunate beginning beekeepers owe their beginning to having captured and hived a stray swarm of bees. Sometimes a colony of bees can be removed from a bee tree or the side of a building but this is a difficult procedure and is best left to experienced beekeepers.

The first exposure to bees and beekeeping can be a pleasant, interesting experience if approached in a relaxed manner. Proper preparation for handling your first hive of bees begins with proper instruction about what to do and what to expect from the bees. Proper instruction may begin with reading and perhaps classroom instruction. Confidence in handling bees comes with experience but there is no reason to fear bees, even if you have never worked with them before. Starting with one or two colonies of bees does not involve a large investment in time or money and one season's experience will usually teach you the most important principles in bee handling. Always use your two most important tools in beekeeping, the bee smoker and veil when opening your hive. Time your hive opening to when the bees are the most active, during the middle of the day when it is sunny and warm.

**BELFLOWER.** — See Campanilla.

**BITTERWEED.** — Although the honey from this source is very bitter and unfit for human consumption, the plant is an important source of pollen and honey for winter stores and spring brood rearing in the southeastern states comprising particularly Georgia, Florida, Mississippi, and Alabama where package bees are produced.

The weed is so bitter that cattle avoid it and the honey is of such poor quality that beekeepers leave it on the hives rather than extract it. In combination with some aster and goldenrod, it makes excellent winter stores and is excellent for early spring brood rearing so necessary for the production of package bees. It is the bitterweed more than any other honey or pollen plant that has made an eldorado of the southland for the production of package bees. Its poor quality of honey for human consumption prevents it from going on the market.

It is, in fact, a blessing in disguise for the package bee business of the South, and a great boon to the north-



**Boneseet or Thoroughwort (*Eupatorium perfoliatum*)**

ern beekeeper and fruit grower, both of whom will need and must have package bees. (See Beginning with Bees, Package Bees, and Pollen.)

**BLACK GUM.** — (See Tupelo.) Also called black tupelo and water tupelo, a forest tree growing in swamps from southern New Jersey to Florida and Louisiana.

**BLIGHT.**—See Fire Blight.

**BONESET**, or Thoroughwort (*Eupatorium*) is a honey and pollen plant of which there are some 25 species that yield a little honey and pollen at a time after the main honey flow when it is most needed to supply young bees to replace the old ones worn out or dying. It is found mostly in the northeastern states although it is also found as far south as Florida and as far west as California. (See previous page.)

The honey is amber or dark and more suitable as a winter food for bees than for table use. In rare cases a surplus is secured but its value lays in the fact that it helps make up the winter food from other honey coming at the same time, such as aster and goldenrod. (See Aster and Goldenrod.)

The most conspicuous, possibly the most beautiful of the species is the Joe-Pye weed (*E. purpureum*), found largely in the East in the fall. Some seasons it yields a little honey and some pollen. Perhaps the most common and more important for honey and pollen is *E. album* and *E. urticaefolium*.

**BOTTLING HONEY.**—When honey is put into any container other than glass or clear plastic it is impossible to determine its character, its color, or its specific gravity—that is, how thick it is. In a clear container its color attracts the eye and teases the palate. When a bottle of it is turned upside down a large air bubble in the form of a beautiful transparent sphere will slowly rise, thus indicating that the contents are not only beautiful in color, but thick and waxy.

There are thousands upon thousands of people who do not eat hon-

ey. In order to interest them it is first necessary to tease their appetite by showing them a product that is externally attractive as well as intrinsically good. For this reason honey in a retail way and for table use is often sold in glass just as jellies and jams and all other commodities of like nature are sold. After the consumer—or more exactly the housewife—who buys the food discovers what honey is from the purchase of a small bottle, she will be interested in getting a larger supply in 2½, 5, and 10 pound pails or tin cans. The larger the package the cheaper the honey is per pound.

There is another class of customers, mainly working people, especially those in the cities who cannot afford to buy a large quantity of anything. They will purchase a little of this and a little of that, and perhaps a tumbler or bottle of honey. No matter how well they like it they will never be able to buy a larger quantity. Probably they will never get to the stage of buying their foods in large quantities at a time. For this class of people (and it probably represents a large proportion of the honey buyers) the glass package is the best suited.

#### Honey in Glass or Clear Plastic

For a small local trade it is all right to use white flint Mason jars, large and small sizes, and jelly tumblers, such as can usually be obtained from the grocery store. Either Mason jars or jelly tumblers can be used over again for holding canned food or for jellies and jams.

There are some who will prefer the regular honey bottle holding from a few ounces to a couple of pounds. They make a very pretty appearance and when placed alongside the Mason jars and jelly tum-



Jars of chunk honey.

blers the customer may select for herself. As a rule the fancy trade in the large groceries, especially in the large cities, prefer the regular honey jars.

### Labels for Glass Jars

Labels should be neat and attractive. The bottler can buy his labels from his regular bee supply dealer who can furnish him a large assortment of different sizes and styles in different colors. The name and address of the bottler can be put in black or any other color of ink at a very small cost on stock labels. Labels made by printers who make a special business of doing such work are cheaper than those bought locally of a printer who is not equipped for this specialized work.

The labels should be relatively small because it is the honey that is attractive, and which is supposed to make the sale. If the label is too large for the package it covers up the honey. (See Labels for Honey.)

The National Pure Food Law, and in most cases state laws, require that the labels shall indicate the exact contents of the package in pounds and ounces. Anything under a pound should be stated in ounces. That over a pound should be stated in



Extracted honey in tall thin bottles appears lighter than in a round bottle.

pounds and ounces in the lower third of the label.

Government regulations now require that all packages of food products shall be marked "Produced by", "Packed by", "Distributed by", or "From the Apiary of". This must be printed on all honey labels with your name and address, if not listed in the local telephone directory.

### When a Blend of Honey?

It is illegal to say "Pure Clover Honey" when some other honey is used, as for example, alfalfa or mountain sage. It is very much wiser to use the simple words "Pure Honey", and then it will be possible to use a blend of any honeys that one may happen to have on hand or any honeys that one can purchase at a fair price.

In this connection it should be stated that only the best light-colored honeys should be in glass. White clover, sweet clover, alfalfa, mountain sage, and orange blossom are all good. In the South, catsclaw, guajillo, sourwood, gallberry, tupelo, palmetto, cotton, and mesquite are all excellent. In most localities of the North and South the average beekeeper will not have enough of any one particular kind of honey to supply his trade. He will therefore find it necessary to make up a blend of the best white honeys. In the Northwest, alfalfa, sweet clover, fireweed, and vetch will be the main sources and, of course, will be the only honeys used. The large bottlers use a blend which they keep the same from year to year.

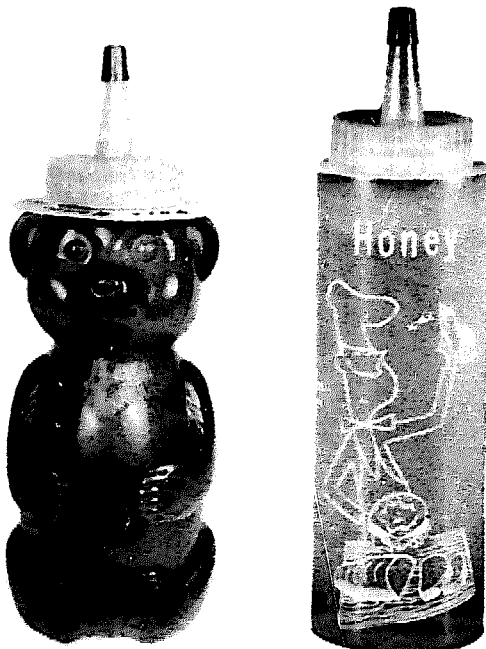

Plastic squeeze bottles help sell honey and are popular with the public for dispensing honey at the table.

### The Advantage of a Blended Honey

A blended honey usually consists of white clover, sweet clover, alfalfa, and sometimes mountain sage or orange blossom. This makes it possible to keep the blend always the same. If one year a beekeeper puts up white clover only and the next year alfalfa, and the year after that buckwheat, the average customer becomes suspicious and wonders whether the honey is adulterated because it does not taste like that which he had the year before. If, on the other hand, the honey is always the same year after year, consisting of a blend of the very best honeys, the consumer will buy from year to year.

### Washing and Cleaning Bottles

It is a great mistake to use bottles without washing. It is far better to run them through a tub of warm water to rinse out the dust and occasional small particles of glass. The bottles should then be allowed to stand upon a tray upside down where they will dry quickly if the water is hot enough. The water should not be too hot, as it is liable to break the glass, and moreover it would make it almost impossible to handle the bottles.

### Preparing the Honey for Bottling

In preparing honey for bottling it is heated to facilitate handling and prevent fermentation.

No one should attempt to heat or process honey without the use of a good dairy thermometer which can be obtained from any hardware store. It will save many times its cost. Without the use of such an instrument there is great danger of overheating the honey, resulting in impairment of the delicate flavor as well as in the discoloration of the honey itself. Some of the bottled honey on the market has been overheated. The "burnt" taste will ruin future sales. The temperature should never go above 160 degrees nor should honey be kept hot for several hours at even a lower temperature. After being put into containers honey should be cooled as soon as possible.

So important is this matter of temperature that the author has felt it necessary to repeat this caution all through this work, even to the point of frequent repetition.

By referring to Honey, Granulation of, it will be noted that all pure honey, with the possible exception of tupelo and mountain sage, will granulate in from a few weeks to a few months, especially after cold weather comes on. Whether honey is granulated or not it should be heated to a temperature of from 140 to 150 degrees Fahrenheit—certainly not higher than 160.

Some believe that a lower temperature of 120 to 130 degrees will answer the purpose, but it will then be necessary to keep the honey hot for a much longer time. Experience shows that continued heat at a lower temperature has more of a tendency to impair the flavor and darken the color than a short or quick heat at a higher temperature.

### How to Process Honey

While the large bottlers use jacketed tanks, one tank inside of another with water between the two tanks, it will be the purpose here to show how a small beekeeper, desirous of taking care of his local trade, can heat his honey safely without the expense of a double boiler or any special apparatus.

### Straining the Honey

At this point the reader is referred to Extracting and to Honey, Filtration of. All honey as it comes from the extractor and before it goes into bottles should be run through a strainer to remove sediment and wax cappings. Two thicknesses of wet cheesecloth makes the cheapest and best strainer for the small bottler. It is highly important that there should be no sediment in bottled honey.

### How to Liquefy Granulated Honey

When a bottle or tin can of honey begins to granulate it can be liquified by placing it on top of a steam radiator or a hot air register for a couple of days, but prolonged heat impairs the flavor and darkens the honey. It is safer to use a quick heat of higher temperature, so put the container in a pan of hot water just a little hotter than one can bear the hand in. After an hour this honey will become liquid and pour readily. If the honey is granulated solid in the first place it may take two hours, in which case the hot water will have to be renewed, but one

must be careful and not let the temperature go too high. In degrees of Fahrenheit, the honey should never go above 160, and we advise beginners not to allow the honey itself to remain hot any longer than necessary. The temperature of the hot water into which the container is immersed may be as high as 160 or even 180 degrees. In that case the pan of hot water with the honey should be removed from the stove. Remaining too long in the hot water will injure the flavor.

**Liquefying Honey on a Large Scale**

Plans thus far given are applicable to the beginner or the amateur beekeeper. But when the number of his colonies reaches 50, 100, or more, a more elaborate means must be provided. The most common

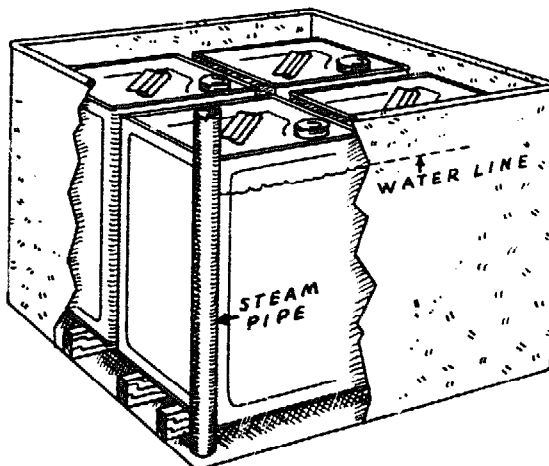
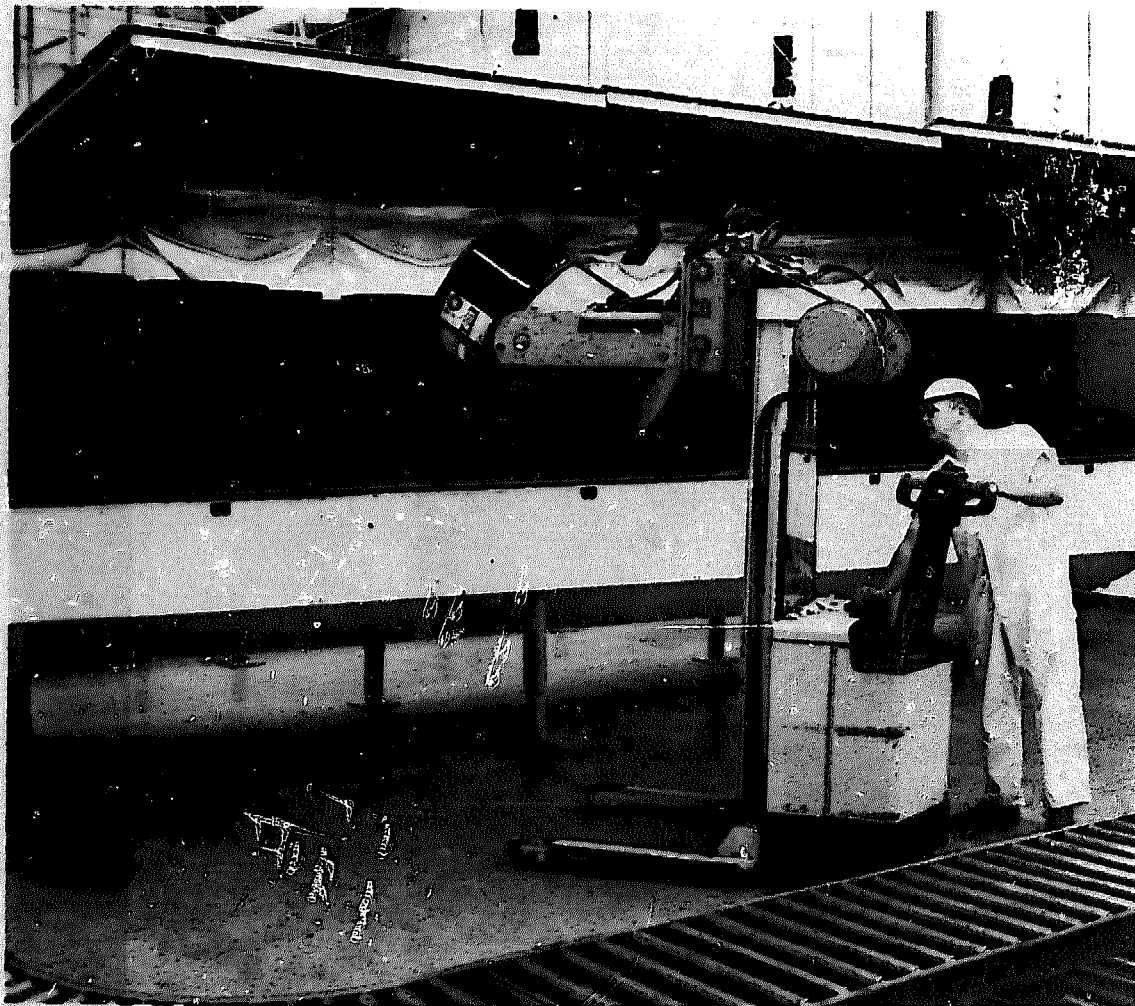

Fig. 2.—A four-can outfit to go on top of an ordinary stove. Hot water should go no higher than the water line shown.

way to liquefy honey in the original 60-lb. cans is in a vat of hot water.



Honey packers who process large quantities of honey must have facilities for melting honey in drums. This heat cabinet holds a number of drums of granulated honey.



But when one is in the business in a wholesale way, he should use a square or oblong tank made so it will take six, eight, or more cans. The illustration, Fig. 2, shows a four-can tank. The water in this tank can be kept hot by placing it on top of a stove, or it can be heated from a jet of steam from a small boiler. Steam for heating a vat can also be used for blowing the bee glue off of hive equipment like queen excluders, frames, and the like.

#### Hot Room for Liquefying Honey in Square Cans

Some large bottlers and packers of honey use a hot room employing steam coils to bring the temperature up to 180 degrees. If the honey in

the square cans is granulated solid, the cans are left in the room for about 24 hours, when they are emptied and the honey is allowed to run into a large vat. While the temperature of the room may be 180, that of the honey should not go above 160 and, as has been pointed out, a higher temperature for a short time is advisable. The honey, whether liquefied by hot water or hot air, should be cooled as quickly as possible. Some packers let the bottles of honey travel through a stream of ice water.

Small air bubbles scattered all through the honey give it a cloudy appearance. They are caused from pouring the honey into the bottles.



A dry heat cabinet will liquefy 60 pound cans of granulated honey for repacking.  
— University of Guelph Photo.

### How to Fill the Bottles

As almost every small beekeeper has a hand-driven honey extractor he can use this to very good advantage in bottling. First remove the gear bar and the reel inside. Thoroughly wash out and cleanse the can. Put it upon a bench or table

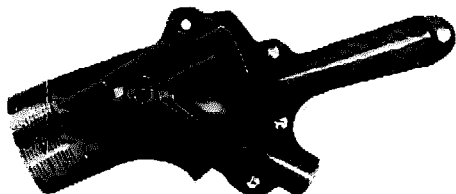

**Adjustable flow honey gate.** It can be easily and quickly adjusted so as to feed a stream of honey the full size of the bore or down to  $\frac{1}{8}$  inch.

and pour the hot honey into it. Just below the honey gate place a lower table or box so that the mouths of the bottles will come just beneath. Place the mouth of the bottle beneath the honey gate, open the gate, allow the honey to run in until the bottle is filled, and then quickly shut it off. It will take a little practice to enable one to fill the bottles so that each one will have the same amount of honey. If some bottles should be short in weight the pure food inspectors might put in a complaint, so it is important to have each bottle filled so that it will contain the exact number of pounds and ounces. It is better to vary on the side of giving a little too much than not quite enough.

### Bottle Filler

As it is a little difficult to handle the honey gate to the extractor it is much better to use a special honey bottle filler which may be obtained from a bee supply dealer. This can be attached directly to the honey extractor or can or it can be attached to the end of a piece of rubber hose connected to the tank of hot honey. The latter arrangement is much better because it is then possible to move this bottle filler from bottle to bottle without handling a single bottle.

Where one has much honey bottling to do, especially if he supplies more than one town with his honey, the special bottle fillers will be found much more satisfactory than the ordinary honey gate to an extractor for the reason that one can

regulate the exact amount of honey to each bottle. With the honey gate

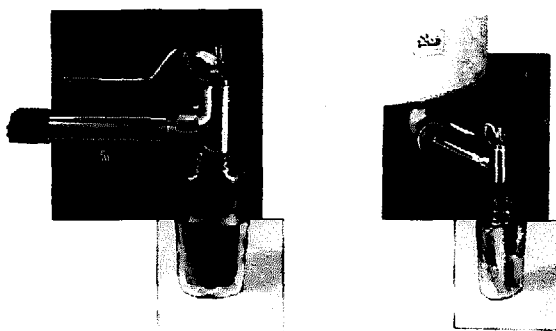

**A filler built especially for filling bottles and other small containers with honey.** It employs a poppet valve which opens and closes quickly. This is important in filling the bottles to an exact level without drip.

it is necessary to fill the bottle with slightly more than the required amount and the difference in the honey saved would pay for the bottle filler in a few days' use, and at the same time enable one to work much more rapidly and easily. With a bottle filler one could take care of a trade which would require thousands of pounds of honey.

### Caution

The author regrets to say that some of the honey put up in bottles and tin cans coming direct from the beginner beekeeper is of poor quality, not because it was not first class in the first place but because it was not properly processed. All through this work we have cautioned against overheating honey. It should never go higher than 160 and usually for bottling purposes 130 or 140 degrees is high enough. If the honey is allowed to go to 160 and is kept at that point for a day, both its flavor and color will be injured. The honey will have a caramel or burnt taste and the color will be considerably darker than that which came directly from the hives. (See Honey, Effect of Heat on, by Phillips.)

Again the reader should be cautioned on the manner in which he processes and strains his honey. The cheapest and simplest plan is to run the honey while hot through several thicknesses of cheesecloth. The number of thicknesses depends upon the coarseness of the weave of the material. Sometimes two thicknesses are enough but three may be used.

### **Bottling Honey in a Commercial Way**

There are several large bottling concerns in the country that have put up honey in glass in an extensive way. During the active season they will send out two or three carloads a week. They have to employ expensive apparatus — something which at the same time will be sanitary. First, the bottles must be washed and sterilized; the honey must be heated in large glass-lined tanks, and it must then be conveyed to a bottle filler which automatically fills the bottles just so full and no more. The bottles are then carried by a traveling belt to a capping machine, then to a labeling machine, and finally to the box which receives the packages after they have been sponged off. (See Honey, Filtration of.)

Commercial bottling requires a clean operation. Check with your local health department for their sanitation requirements. Also expect an unannounced visit from a federal food inspector. For information on this write the Consumer & Marketing Service, Fruit & Vegetable Division, U.S.D.A., Washington, D. C.

**BOX HIVES.**—These hives, as the name indicates, are merely boxes containing neither brood frames nor movable fixtures. They usually consist of a crude, rough box about 12 or 15 inches square and from 18 to 24 inches high. Through the center there are two cross sticks, the purpose of which is to help sustain the weight of the combs built in irregular sheets within the hive.

At the close of the season it is the custom to "heft the gums". Those that are heavy are marked to be brimstoned, and those that are light are left to winter over to the next season if they can. The bees of the first named are destroyed with sulphur fumes, and then beebread, honey, and everything are cut out.

No matter what the season is, even though the crop has been only half harvested, the colony must be brimstoned and the honey taken off at some particular phase of the moon.

### **Box Hives Neither a Thing of the Past Nor a Necessary Evil**

Box hives are somewhat in evidence not only in the Southland but in some of the northern states. As

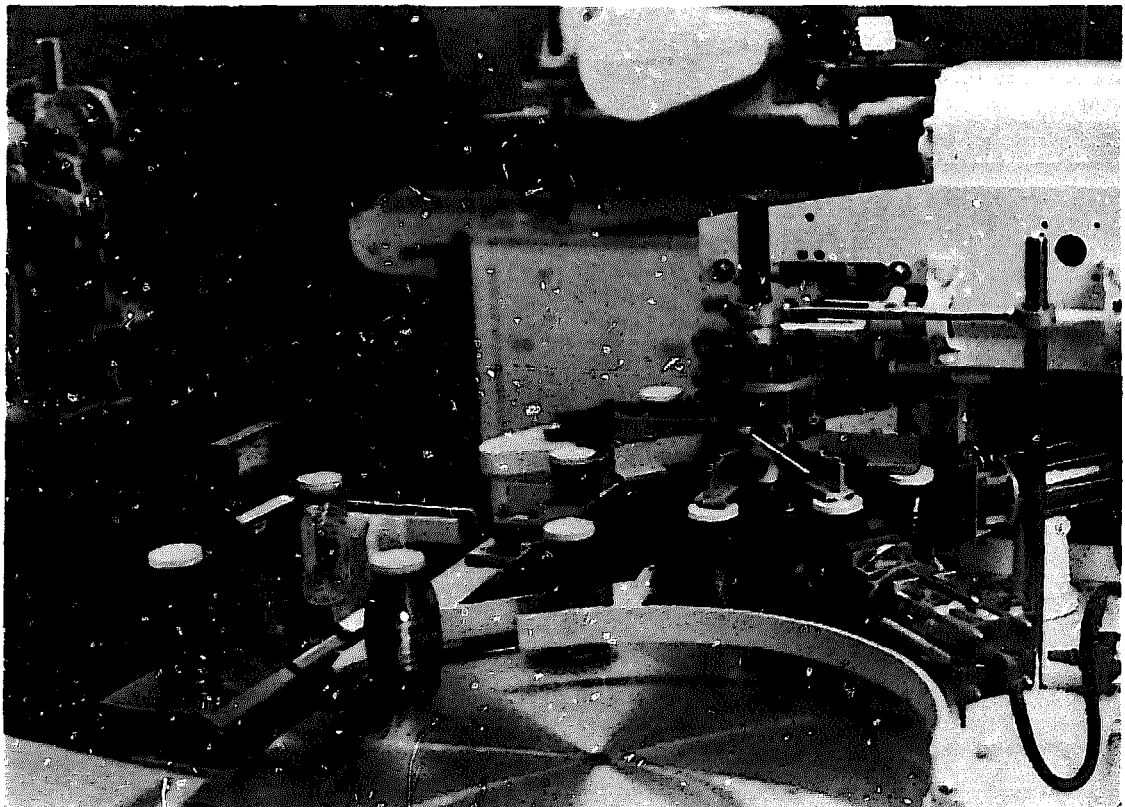

After being filled the jars of honey are capped and the weight is checked.  
—Photo Courtesy of Stewart Honeybee Products.

the combs are not interchangeable and the hives seldom sold, AFB does not attack the bees in them as one might suppose. In most states they are not tolerated under the law and the bees must be transferred into modern hives. The wisdom of this law is shown by the fact that it is difficult for an inspector to examine the combs to determine whether disease is present.

The moth miller, swarming, and poor wintering are the handicaps that prevent them from getting much honey. The most of them, for example, know nothing of having the first swarms on the old stand, and placing the parent colony to one side or in an entirely new location in order to catch all the flying bees in the swarm. They leave the parent colony on the old stand and, of course, it continues to swarm itself weak. In the meantime the moth miller and winter get in their destructive work. The result is that little or no increase is made and the prime swarms are the only ones that yield any return. If foulbrood ever gets a foothold here the business, such as it is, will be wiped out.

**BRACE COMBS.**—See Thick-top Frames under Frames.



Bees being transferred from an old hollow log gum hive into a modern removable frame hive for greater honey production and easier disease inspection. See Transferring.



Two old log gum hives made from sections of hollow logs.

**BRANDING HIVES**—The increased value placed on beekeeping equipment, honey and wax has had some undesirable side-effects for the beekeeper who keeps outyards in unprotected sites; particularly where the yards are isolated and visited only occasionally. Aside from vandalism, the greatest threat to unprotected bee yards is having the hives stolen.

Don Shenefield, an Indiana commercial beekeeper illustrates the growing feeling of helplessness among beekeepers when he says, "It used to be that we lost a colony or a super once in a while but now we have bee and honey rustlers operating within our states in an extensive manner. This is of concern to us all because it doesn't take long to put three, four or ten hives on a pick-up and make off with them". He continues, "the worst part of it all is that after the equipment is gone from your location it is nearly impossible to prove it is stolen."

The answer to the problem of stealing is not simple. One suggestion made by Mr. Shenefield bears repeating. "Brand equipment with a branding iron in several places so that it is recognizable and cannot have the brand removed without destroying the equipment. For smaller beekeepers it might be advisable to buy a branding iron through your local organization and all of you use it. You will have to buy your own letters or brand."

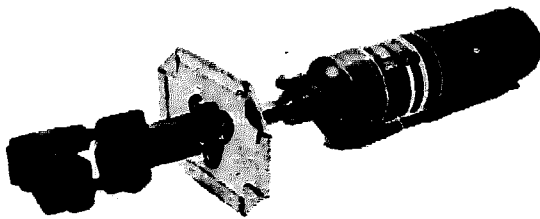

Branding the hive body with a fire brand is an effective way to imprint a brand that would require severe mutilation of the equipment to erase. With a propane bottle gas attachment many pieces of hive equipment can be branded in a short time.

Punch branding is slower but effective. A router may be used to make your own distinct brand but may prove to be too slow for large quantities of equipment. A stencil must be used to guide the machine.

Perhaps the most common practice at the present time is painting the name of the owner or of the apiary on the hives. While this system can be a deterrent to a would-be thief the identifying marks can be easily painted over upon removal to a new location. "Initial" brands used by many beekeepers may not necessarily provide positive identification of stolen goods and a return to the rightful owner. Secret branding with hidden identification marks may be used but the method is not always effective.

Once hives are branded with a large, clear and preferably deeply imprinted brand there still remains the matter of tracing, identification and recovery of the stolen equipment. This often involves criminal investigation and legal action. Beekeepers can help to avoid situations which help to encourage stealing. Refuse to purchase bees or equipment unless you get a bill of sale for them. Receiving merchandise which the purchaser knows has been stolen is against the law. Investigate strange bee yards in your area; find out who they belong to and note any suspicious movements in and out by trucks or trailers. Don't be afraid to ask questions. Beekeepers moving and placing hives legitimately most likely will appreciate your vigilance as it is for your common good. Report stolen property to your state or local association, your inspection service, particularly your local inspector, and the local law enforcement agency.

If all or nearly all beekeepers brand their equipment with a distinguishing identification in a permanent manner the illegal movement of bee equipment will be much easier to control, even between states.

**BREAD, HONEY.** — See Honeybread.

**BREEDING STOCK.\*** — Domestic chickens, cattle, sheep, pigs, horses, etc., have been selectively bred by man for thousands of years. Consequently, when modern breeding practices came into use, much selection had already been done; the modern animal breeder

\*Thomas E. Rinderer and John R. Harbo, Bee Breeding and Stock Center, ARS, USDA, Baton Rouge, La.

began with man-selected "breeds". The races of honeybees (Caucasians, Carniolans, Italians, etc.) are often regarded as one would regard breeds of cattle or dogs. They should not be, for the honeybee races were not strongly controlled and bred by man and are much more variable than a breed of domestic animal.

The honeybee was not strongly selected by man because man did not understand basic bee reproduction until 1845. Without this understanding, very little could be done. In 1851, when this basic understanding was becoming widely accepted, Langstroth developed the movable frame hive. Suddenly beekeepers not only understood bee reproduction, they could also manipulate the hive and control the queen.

Controlling mating was the only obstacle remaining. Island isolation was one means, but it was of very limited value. Between 1860 and 1940 there were dozens of reported attempts to induce queens and drones to mate in the confines of a jar, cage, tent, or greenhouse. Some claimed success, but the successes could not be verified or repeated. With the development of instrumental insemination as a practical technique in the 1940's, controlled bee breeding began.

Therefore, as man began breeding bees, he enjoyed the benefits of having a large and variable population with which to work. Breeders quickly discovered that honeybees respond well to selection. In part, this is because man is just beginning to modify the bee through selection and controlled breeding.

The basic principles of genetics still apply to bees. The chromosomes contain hereditary units called genes. And the specific place on a chromosome where particular genes are found is called a **locus**. Different forms of a gene that can occur at a single locus are called **alleles**.

Honeybee eggs hatch whether or not they are fertilized. The female bees (queens and workers) develop from fertilized eggs which contain 32 chromosomes. These 32 chromosomes consist of two sets of 16, one set from each parent. The males, drones, develop from unfertilized eggs which contain only one set of 16 chromosomes

from their mother. This reproduction by the development of unfertilized eggs is called **parthenogenesis**.

At one time parthenogenesis was thought to be the basis of sex determination in bees. The thought was, that a chromosome dosage effect occurred such that the two sets of chromosomes resulted in females and one set resulted in males. While this is a reasonable explanation, it is now known to be untrue.

Investigating what seemed to be nonhatching of a high proportion of the eggs in inbred lines, Dr. Otto Mackensen (Research Entomologist, Bee Breeding Laboratory, ARS, USDA, Baton Rouge, La.) discovered the real cause of sex determination in bees. Sex in bees is determined by the alleles at a single locus. If the alleles are not alike at this locus, the egg will develop into a female. If they are alike or if there is only one allele present (an unfertilized egg), the egg will develop into a male.

The apparent nonhatching eggs found in the inbred lines were fertilized eggs that had like alleles at the sex locus. The eggs did, in fact, hatch, but the worker bees selectively removed and destroyed these larvae shortly after they hatched. As many as 50% of the fertilized eggs produced by a queen can have sex alleles in common, and the subsequent removal of newly-hatched larvae gives a colony a spotty brood pattern. Since inbreeding increases the chances of having alleles in common, spotty brood pattern is often used as an indicator of inbreeding.

### The Function of Drones

The true function of drones can be best explained by the use of two terms, **gamete** and **segregation**. An animal gamete is an unfertilized egg or a sperm cell containing half of the chromosomes needed to produce a worker or queen. Segregation is the random sorting of paired chromosomes to produce gametes. In most animals, segregation occurs in the ovaries and in the testes. In bees, segregation occurs only in the ovaries of queens.

Therefore, in honeybees, all new gametes originate with a queen. We say "new" gametes because drones propagate only existing gametes. The

drones then have two reproductive functions: first they convert and extend the queen's female gamete (the single unfertilized egg that develops into a drone) into about 10 million identical male gametes (sperms). Secondly, they serve as a vehicle to move the propagated gametes to the queen (the act of mating).

#### Colony Structure

The family relationships within a colony of bees are different from other agriculturally important animals as a consequence of mating habits, social structure, and drones developing from unfertilized eggs. The honeybee colony found in nature is a complex family group, best described as a **superfamily**. This superfamily, illustrated in Fig. 1, consists of: (1) one mother queen, (2) several father drones present as sperm in a sperm storage organ (spermatheca) of the queen, and (3) the worker and drone offspring of the mother and fathers.

Within a superfamily are usually 7 to 10 **subfamilies**. A subfamily is a group of workers fathered by the same drone. Since all the sperm produced by a drone are genetically identical, each subfamily is composed of sisters that are more closely related than full sisters of other animals. Thus, workers belonging to the same subfamily, often called **supersisters**, have three-quarters of their genes in common by descent. They receive identical gametes from their father and on the average half identical gametes from their mother.

Workers belonging to different subfamilies have the same mother but different fathers. They are half sisters and are related to each other just as are human half-sisters. On occasion, brother drones mate with the same queen. In such instances, their subfamilies are related to each other as full-sisters rather than half-sisters. Through natural mating such full-sisters are probably uncommon.

#### Controlled Mating

Some degree of controlled breeding has been practiced by queen producers for over 75 years. Since that time beekeepers had the capability of producing hundreds of queens from a selected colony rather than relying on natural supersedure or swarming. Thus, the female line was controlled.

Controlling the mating has been possible only by establishing isolated mating yards or through instrumental insemination. Isolated mating yards have two major shortcomings: (1) absolute control of matings is difficult to achieve because a queen can mate with drones that are up to five miles away, and (2) one isolated mating yard is needed for every drone line used in a breeding program. Mating yards are usually not used for breeding stock, but rather for production queens where absolute control of matings is not quite as critical. Controlled breeding through instrumental insemination has been well established since 1947 and has solved the controlled breeding problem for bee researchers, but commercial queen producers rely primarily on natural mating.

Recently a few commercial queen producers have tried instrumental insemination for mass queen production. In most cases, however, their reason for using it was to eliminate the mating nuc rather than to make specific matings.

Instrumental insemination is, in itself, not a complicated process. Simply stated, it is a mechanical transfer of semen from the drone to the oviduct of the queen. To make this transfer there are many designs for insemination stands and syringes. All the designs employ carbon dioxide gas to make queens motionless, have a device to hold the queen in position, and use some type of syringe to collect the semen and discharge it into the queen. Probably the most popular apparatus is that developed by Dr. Mackensen (Fig. 2). To become proficient at instrumental insemination a learner usually needs to practice with 50-100 queens. Thereafter, the major problems and the major workload involve drone rearing, holding adult drones to maturity (about two weeks), queen storage, coordination of queen and drone production, queen introduction, and record keeping.

The behavior of instrumentally inseminated queens differs slightly from naturally mated queens. Instrumental insemination doesn't stimulate late egg laying as does natural mating. A typical naturally mated queen mates when about six and seven days old and begins laying when eight or nine days old. A typical instrumentally inseminated

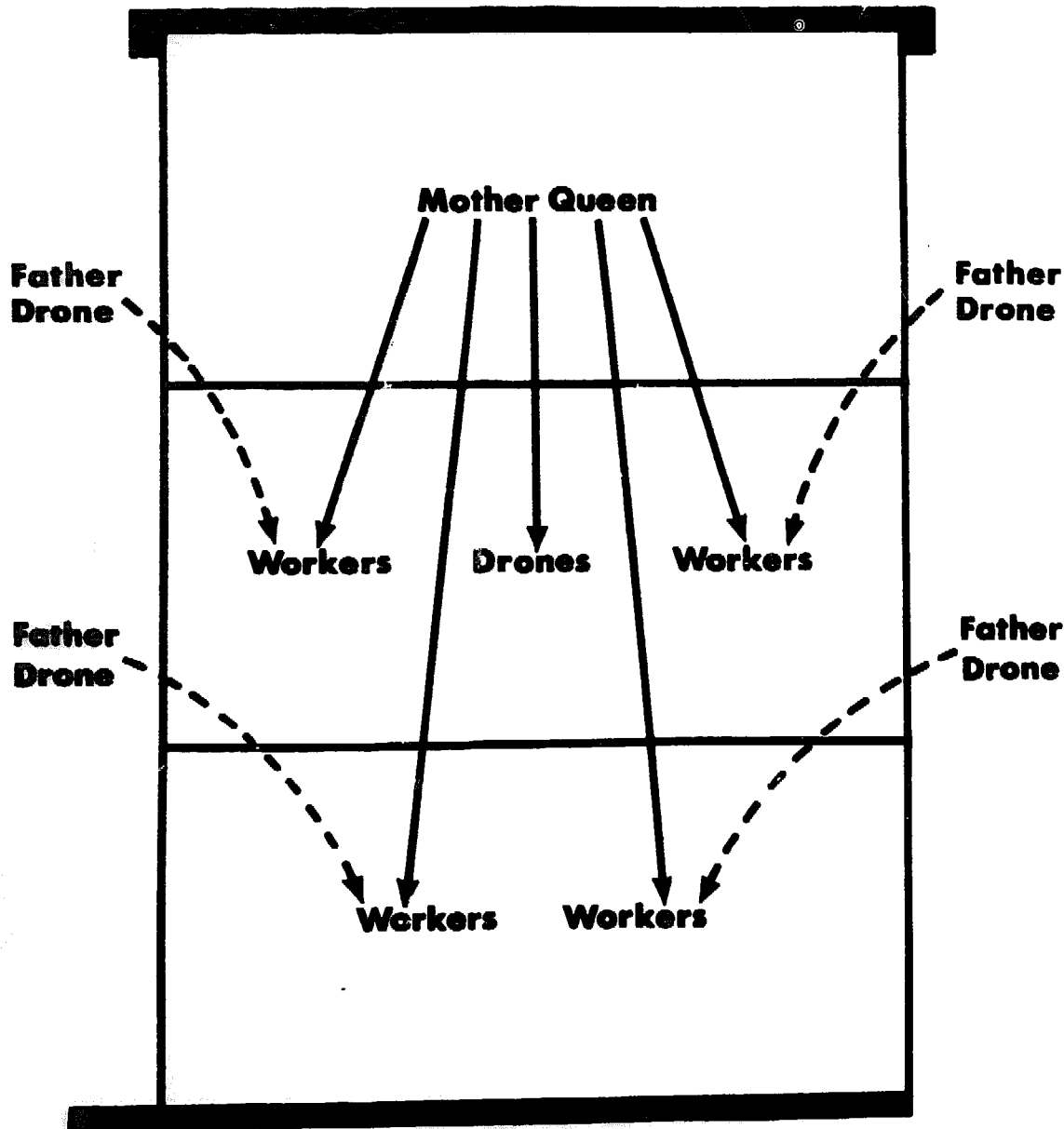

**Fig. 1—A representation of a colony of bees as a genetic superfamily. The colony in the figure has four subfamilies, but there can be more or fewer. The workers within each group are related as supersisters and are half-sisters to workers in other groups. If two father drones are themselves brothers the two subfamilies sired by them would be related as full-sisters rather than half-sisters. The figure may give the false impression that the subfamilies are grouped within a colony, and also that the father drones are alive. The brood and adult workers of the subfamilies are mixed in a colony, and father drones survive only as sperm in the spermatheca of the queen.**

queen can be mated at any age from two to 30 days, but unless she is gassed with carbon dioxide (CO<sub>2</sub>), she will not begin laying eggs until she is about 30-50 days old, the age that a virgin would normally begin laying.

Carbon dioxide, therefore, serves dual purposes in the instrumental insemination of queens. It is used during insemination to make queens motionless, and it is used to stimulate egg laying. To stimulate egg laying, caged queens are



placed in a jar, CO<sub>2</sub> gas is piped into the jar until the queens are motionless and the queens are left in the jar for 5-10 minutes. The usual procedure is to treat queens in this manner on each of the two days following insemination.

### Germplasm Storage

Germplasm is the hereditary material that can produce new individuals. In honeybees this includes eggs, sperm, and tissue that can potentially produce eggs or sperm. Since every breeding

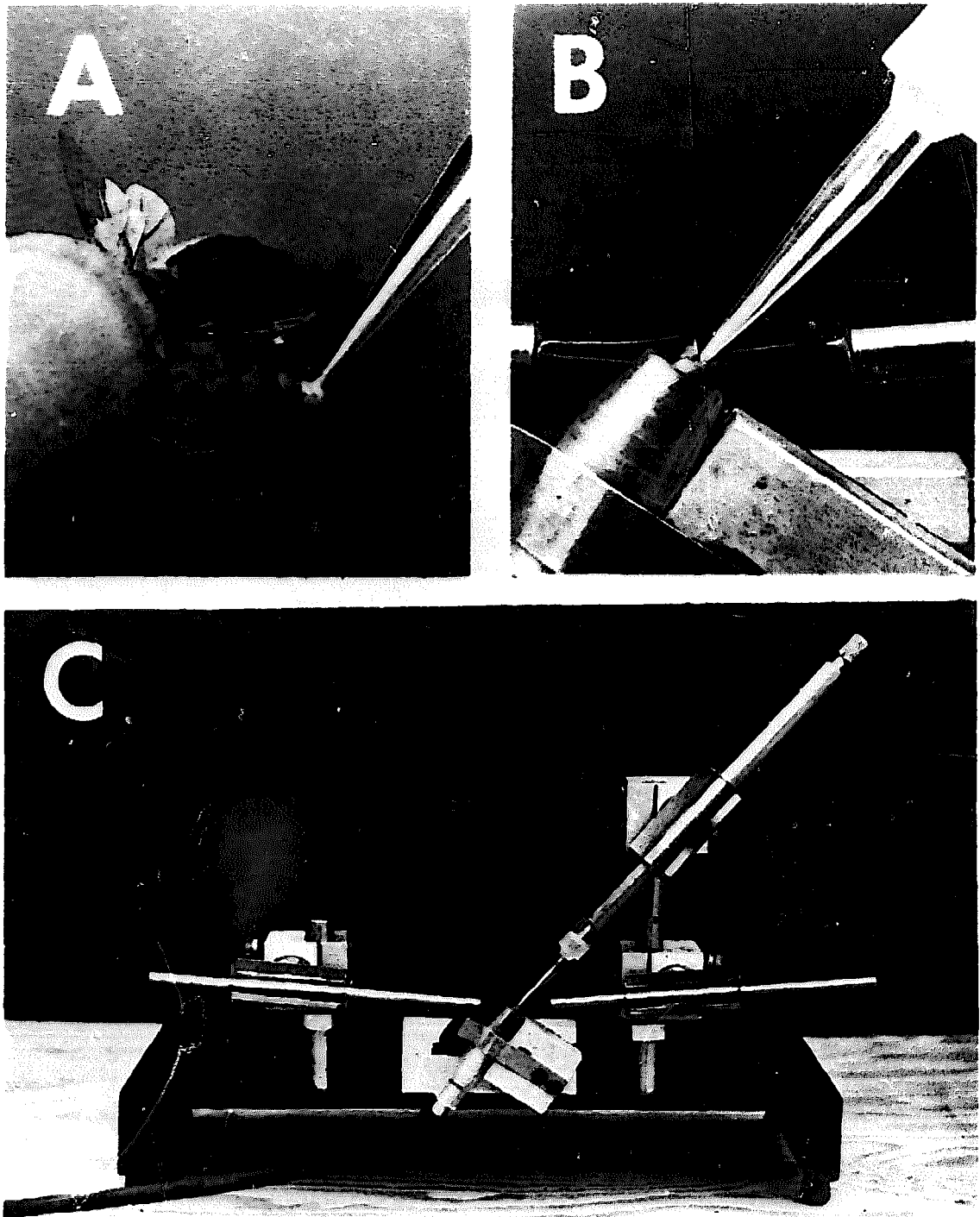

Fig. 2.—Semen collection and queen insemination with the Mackensen insemination apparatus. 2A shows collecting semen from a drone, B shows the insemination of a queen, and C is a wider view of figure B.

program needs to keep certain stock for current and future use, the problem becomes one of either storing it (as with seeds on a shelf) or continually propagating it.

At the present time honeybee germplasm is kept primarily through propagation. Thus, germplasm is usually in the form of mated queens—their ovaries and the sperm in their spermathecae. Alleles are gradually lost through inbreeding, so each generation of propagation reduces the variability of the germplasm slightly.

To avoid this loss and the labor involved in propagation, attempts have been made to store honeybee germplasm. Among the possible candidates for storage (eggs, larvae, pupae, virgin queens, sperm), sperm storage has been the most widely tried and the most successful. Sperm stored less than two weeks at nonfreezing temperatures seems to be as viable as fresh sperm, but longer storage results in fewer sperm reaching the spermatheca. Storage of sperm at subfreezing temperatures (in liquid nitrogen at  $-196^{\circ}\text{C}.$ ) leads to successful, although inferior inseminations, even after short-term (48 hour) storage. None the less, liquid nitrogen shows great promise for long-term storage where survival of the germplasm is the major concern.

#### Mutations

More than 30 specific visible mutations have been described in bees, and a number of these are maintained by research laboratories. Generally, these mutations produce a striking effect, and most were easily observed by their discoverers. Undoubtedly many mutations are yet to be observed because they produce only subtle changes. Known mutations affect the color, shape, and presence of eyes; the color and hairiness of bodies; the shape and size of wings; and nest-cleaning behavior.

In addition to their value as curiosities, these mutants have value as scientific tools. For example, by studying various colors of eye mutants, the biochemical pathway for the production of eye pigments in honeybees was determined.

In addition to contributing to work on eye pigment biochemistry, mutants have been used as tools to investigate

a variety of other questions. Resistance to American foulbrood, mating behavior, sex determination, pollination activity, fertilization technology, sperm storage, population dynamics, longevity, and bioacoustics all have been explored with experimental designs utilizing bees identifiably different because of mutations they carry. Because of this history of usefulness and further potential applications, it is desirable for the scientific community to maintain a number of mutations. Newly discovered mutations may have special applications in science, so it would be helpful for beekeepers to report mutations they observe to a research laboratory.

Mutations are often first observed in drones because drones have only one set of chromosomes. Queens and workers often carry mutations, but because they have two sets of chromosomes the mutation must exist on both sets for it to be expressed by the individual queen or worker. For example, if a mutation is visible in one of every 1,000 drones, it would be visible in only one of every 1,000,000 workers or queens.

#### Gene Pool

Across the world bees are quite diverse. Time, mutations, and selection pressures have resulted in populations of bees called races, somewhat isolated from each other, that excel for various combinations of characteristics. These combinations of characteristics are finely tuned for survival in specific local environments. Worldwide, the races of bees form the gene pool or genetic base available to bee breeders for stock improvement.

Since North and South America lacked native honeybees, European settlers imported them. Early importations were the brown bees common to northwestern Europe. Through time beekeeping developed as an industry in North America and beekeepers, happy with some characteristics of the European brown bee and unhappy with others, made further imports.

Prominent among these imports were bees from other European areas. However, bees were also brought from Africa and Asia. The search by beekeepers for better bees led to a wide variety of genetic material being brought into America until 1922, when importation of adult bees was banned

to prevent the mite *Acarapis woodi* (Rennie), the cause of acarine disease, from entering the country. However, eggs and semen were still imported, but at a much reduced rate. After 1975 importation of any honeybee germplasm was banned by public law.

The bees presently in the U.S. are the result of free-mating crosses of the various imports. Most probably, racially "pure" stocks no longer exist in North America. Rather, this new genetic mix of bees can best be termed American. By the same token, exports from the United States and cross breeding have influenced the nature of bees abroad.

The great virtue of our past imports is that we can breed highly desirable bees from the numerous and variable selection of stocks that we now have on the continent. Yet there are still those who would import more stock. Importation is usually the first thought that comes to mind when there is a desire for improved stock. It seems like a simple solution. Importation, however, should not be used as an easy substitute for a selection program. If used, importation would be only preliminary to a selecting program, an effort to expand the genetic base from which one selects.

Thus, further stock imports are of questionable benefit. Such imports may result in acarine disease, may be themselves undesirable, or may combine with local stocks to produce undesirable hybrids. Many past imports of "select stock" have proven to be poor or even undesirable in North America. There is also a good chance that imported bees may have originated from bees exported by American queen producers. Therefore, for those interested in improving bee stock, it is probably best to select from the plentiful gene pool already available in North America.

#### Stock Improvement

Using improved stocks of bees is an effective way to improve the productivity of a beekeeping operation. Regardless of the stock of bees used, basic operational expenses will remain much the same.

Success in improving bee stocks is a reachable goal. As we have seen, there is great variation in bee stocks available to North American bee breeders.

This variation is the raw material used by bee breeders. Working with the tool of selection, bee stocks can be molded to show high performance for desired characteristics.

#### Selection Methods

The first task of a bee breeder is to describe in rather specific terms what characteristics are desired in the bee stock to be produced. Almost certainly a number of characteristics will be listed. Generally, desired characteristics will relate to the production needs of a group of beekeepers who are in similar localities or have similar needs. Desirable characteristics might include fast spring buildup, intensive honey production, frugal and strong overwintering ability, disease resistance, and good handling qualities. A different list might emphasize heat tolerance and pollination activity.

A knowledgeable bee breeder will be careful to be only as specific in his stock descriptions as good information permits. Unless scientific proof is developed to the contrary, physical characteristics such as color, size of bees, and shape of wings are poor choices. Generally, if such characteristics are important, they will be selected and improved automatically along with more general characteristics such as honey production or disease resistance.

A knowledgeable bee breeder will also set reasonable goals. Some characteristics, such as frugal use of winter stores, and early strong buildup are not likely to be highly compatible. Also, a list of a few well-chosen characteristics is more likely to be achieved than a longer list.

Overall, there is a need in the beekeeping industry for a number of bee stocks, each having a collection of characteristics economically important to different segments of the diverse beekeeping community. No one bee stock can possibly be universally acceptable, and attempts to produce such a stock would prove fruitless. Thus, communication between an individual bee breeder and the beekeepers using the breeder's stock is important. This communication will help the breeder decide on which characteristics will be emphasized in the breeding program.

Once the breeding goal has been established by describing the desired

stock, choices need to be made as to how the various characteristics will be measured. Although more precise ways to evaluate colonies may be devised in the future, at present the bee breeder must choose his stock from the on-site performance of colonies established in apiaries.

Test apiaries should be established and management procedures should conform reasonably well to the management procedures used with production colonies.

Test colonies will be evaluated for the various characteristics to determine which colonies will be used as breeding stock. In all cases, beekeeping judgment will be brought to bear on the evaluation. However, the power to more accurately select the best breeders will be enhanced if each colony is given a numerical score for each characteristic being evaluated. This will require the keeping of extensive records on colonies.

#### Breeding Methods

**Line-breeding.** The common method of breeding practiced by queen breeders is known as line-breeding. It can be defined as breeding and selection within a relatively small closed population. The bee breeder's colonies constitute such a population to the extent that mismatings with drones outside his stock do not take place.

The general procedure in line-breeding is to rear queens from the best colonies. These queens are both sold as production queens and used to requeen the bee breeder's test colonies. The queens are allowed to mate with the drones present in the bee breeder's outfit at the time the queens are reared.

A number of variations can be made on this general procedure which would be of benefit. General control of drone brood in the majority of colonies, coupled with purposeful propagation of drones in a good number of more exceptional colonies, would improve the selection progress by controlling, to a limited degree, the male parentage of the stock. Of course, this procedure is used with the best success in areas where mating yards can be reasonably isolated.

In line-breeding some inbreeding is inevitable. Its main effects are (1) fixation of characteristics so rapidly that

effectiveness of selection for good qualities is reduced, (2) the stock loses vigor as a general consequence of inbreeding, and (3) the detrimental results from homozygous sex alleles. These effects can be lessened by using as many breeding individuals as possible for every generation.

To keep inbreeding at a minimum, one should rear queens from as large a number of outstanding queens as possible and requeen all the field colonies with equal numbers of queens from all the breeders. Each group of queen progeny is then considered a queen line and each year, after testing, at least one queen in each queen line is used as a grafting mother.

Despite these several precautions against inbreeding, stock may begin to show a spotty brood pattern and other symptoms of inbreeding. When this occurs, new stock must be brought into the operation. At least 10 virgin queens from each of several promising stocks should be mated with drones of the declining stock and established in apiaries outside the mating range of the beekeeper's queen-mating yards. They should be evaluated there to determine which stock(s) combine best with the deteriorating stock. Once this evaluation is made, the preferred stocks can be established as new queen lines.

In the 1930's, a four-year selection project using simple line breeding resulted in an increase in honey production from 148 to 398 pounds per colony. Two important features of this project were culling the poorer queens and grafting from the best queens.

**Hybrid breeding.** When inbred lines, stocks, or races of bees are crossed, the hybrid progeny are often superior to either parent for one or many traits. This phenomena is called **hybrid vigor** or **heterosis**. Hybrid bees have more heterozygosity in their genome than do inbred or line bred bees. This heterozygosity is thought to be the basis for hybrid vigor.

Hybrid breeding programs in bees are considerably more complicated than line-breeding programs. At the very least, three inbred lines must be combined so that both queens and their worker daughters are hybrids. An inbred queen mated to inbred drones will produce hybrid workers. However, the

egg-laying qualities of the inbred queen would probably be inadequate. Therefore, there is a need to mate hybrid queens to inbred drones so that both queens and workers in production colonies are hybrids.

Four-line hybrids are also possible and commercially available. Such a hybrid may involve lines 1, 2, 3, and 4 and could be combined in the following way. An inbred queen of line 3 artificially mated to drones of line 4 is used as a grafting queen to produce hybrid (3 x 4) queens. These are allowed to mate naturally and are used to produce drones. Queens of line 1 are then mated to drones of line 2 and hybrid virgin queens (1 x 2) are reared from the mating. Production queens are produced from a cross of virgin queens (1 x 2) mated to the drone progeny from the 3 x 4 queens. Colonies produced by this cross will be headed by two-way hybrid queens, which will be uniform in appearance, whereas the worker bees will be four-way hybrids and variable in appearance unless the color markings of the parent lines are very similar.

Comparative tests of hybrids have shown their superiority. Increased productivity of 34-50% over the average of line-bred strains has been reported. Segregation and random mating in the generations following hybridization are likely to result in only colonies that are no better than the average supersedure queen. Hybrids are an end product, and to make best use of them it is necessary to requeen every year.

Whatever the specific choice of breeding scheme, hybrid breeding requires the use of instrumental insemination and careful record keeping. As a consequence, few bee breeders have undertaken the entire operation of a hybrid program. However, many have become involved as producers of hybrid queens with the breeding stock supplied by an outside source.

#### Acknowledgment

James Baxter, Biological Technician at the Bee Breeding Laboratory, ARS, USDA, Baton Rouge, La., prepared Fig. 1.

#### BIBLIOGRAPHY

- Cale, G. H. Jr., and Rothenbuhler, W. C. 1975. Genetics and breeding of the honeybee, in Dadant and Sons (ed.), *The Hive and the Honey Bee*, pp 157-184. Journal Printing Co., Carthage, Ill.
- Dzierzon, J. 1845. Gutachten uber die von Hr. Direktor Stohr im ersten und zweiten Kapitel des General-Gutachtens aufgestellten Fragen-Bienen-Zeitung (Eichstatt) 1:109-113, 119-121.
- Laidlaw, H. H. Jr. 1977. Instrumental insemination of honeybee queens. Pictorial Instructional Manual. Dadant and Sons, Inc. Journal Printing Co., Carthage, Ill. 144 pp.
- Mackensen, O. 1951. Viability and sex determination in the honeybee (*Apis mellifica* L.). *Genetics* 36(5) : 500-509.
- .....and Tucker, K. W. 1970. Instrumental insemination of queen bees. U.S.D.A. Handbook No. 390. 28 pp.
- Moeller, F. E. 1976. Development of hybrid honeybees. USDA Production Research Report No. 168. 11 pp.
- Polhemus, M. S., Lush, J. L., and Rothenbuhler, W. C. 1950. Mating systems in honeybees. *Jour. of Heredity* 61(6) : 151-155.
- Rinderer, T. E. 1977. A new approach to honeybee breeding at the Baton Rouge USDA Laboratory, Am. Bee Jour. 117(3) : 146-147.
- Rothenbuhler, W. C., Kulinovic, J. M., and Kerr, W. E. 1968. Bee Genetics. *Ann. Rev. Genetics* 2: 413-438.

#### BROOD AND BROOD REARING.

—"Brood" is a term commonly used to designate the young of the bees that have not emerged from the cells. It may be young bees just before they come from the cells, the larvae in various stages of growth, or even the eggs.

Sometimes the beginner is confused because he is not able to distinguish capped honey from capped brood; nor does he know the difference between drone and worker brood. Sealed brood is of light to dark brown color, depending on the age and color of the comb itself. In ordinary worker brood, in cells nearly five to the inch\*, the cappings are made of wax and fibrous material, smooth and slightly convex if the brood is not diseased. Drone brood is the same in appearance except that the cappings are more convex with four cells to the inch. The cappings over honey are white, bluish-white, or yellow, are more or less irregular, and somewhat flattened. The honey may be in either worker or drone cells. By comparing the illustration shown on the next page with the cappings of comb honey under Comb Honey, the beginner will easily make the distinction.

The pictures shown on the next few pages will make the distinction

\*The exact measurements show 4.83 cells to the inch. (See Cells, Size of in Honey Comb.)

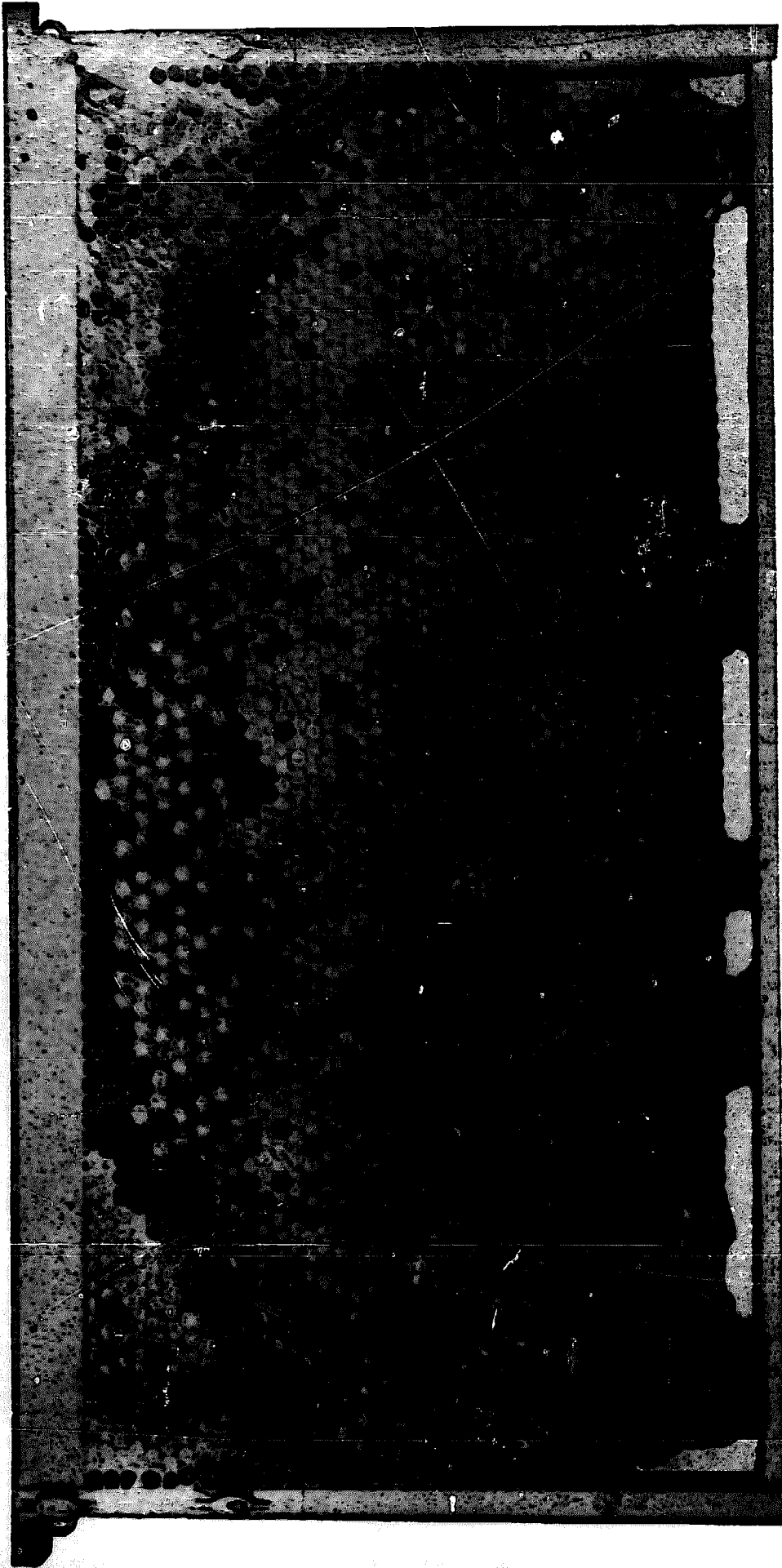

Above is shown an ordinary frame of sealed brood containing both drone and worker cells. The drone brood appears at the top and at the lower corners. The cappings are larger and much more convex than those of the ordinary worker cells. When comb is built from full sheets of foundation there is not much drone brood, but sometimes, when a colony is determined to rear it, they will enlarge the cells as they did in the case above. The unsealed brood is shown scattered here and there in the open cells, most of it worker, but a little of it drone. Some of the older brood have emerged, leaving here and there empty cells in which the queen will lay again. In the midst of a heavy flow these cells will be filled with honey. Sealed honey is shown in the upper corners. The unsealed is shown just above the brood and below the capped honey. The color of the cappings over honey is usually white, while that over brood is from a light to a dark brown and is more fibrous. (Also see page 103.)

between the two kinds of brood even plainer. Notice the larger capped cells with rounding heads above the surface of the comb at the top, bottom, and corners of the combs. These are drone brood. Worker brood, on the other hand, which covers most of the combs is flat on top and smaller in size. Worker brood, roughly speaking, has five cells to the inch while drone is only four cells to the inch.

Notice that the comb, Fig. 3, page 106, is not built on non-sagging foundation. In drawing out the foundation the cells have been stretched by the weight of the honey of the previous season. If the queens lay in them at all they will put drone eggs in stretched or enlarged cells. These eggs develop drone brood with the convex or rounding cappings. Where the cells are worker in size the queen will lay worker eggs which

will have cappings flat instead of convex.

When bees have no foundation at all they are apt to build both drone and worker in the same comb. If a honey flow is on, most if not all of the cells will be store or drone comb and a cell of drone brood is equal to a cell of honey. This, as will be pointed out, means a loss in the crop of honey of from 10 to 50 pounds. Worker brood adds to the force of workers to gather the crop, and the larger the force at the right time the larger the crop.

The beginner may not be able to see eggs at first. One trouble is that he does not know where to look nor what to expect. When he peers down into the bottoms of the cells and sees tiny little objects standing on end at an angle he hardly knows what they are. The illustration below shows the eggs in the bottoms of

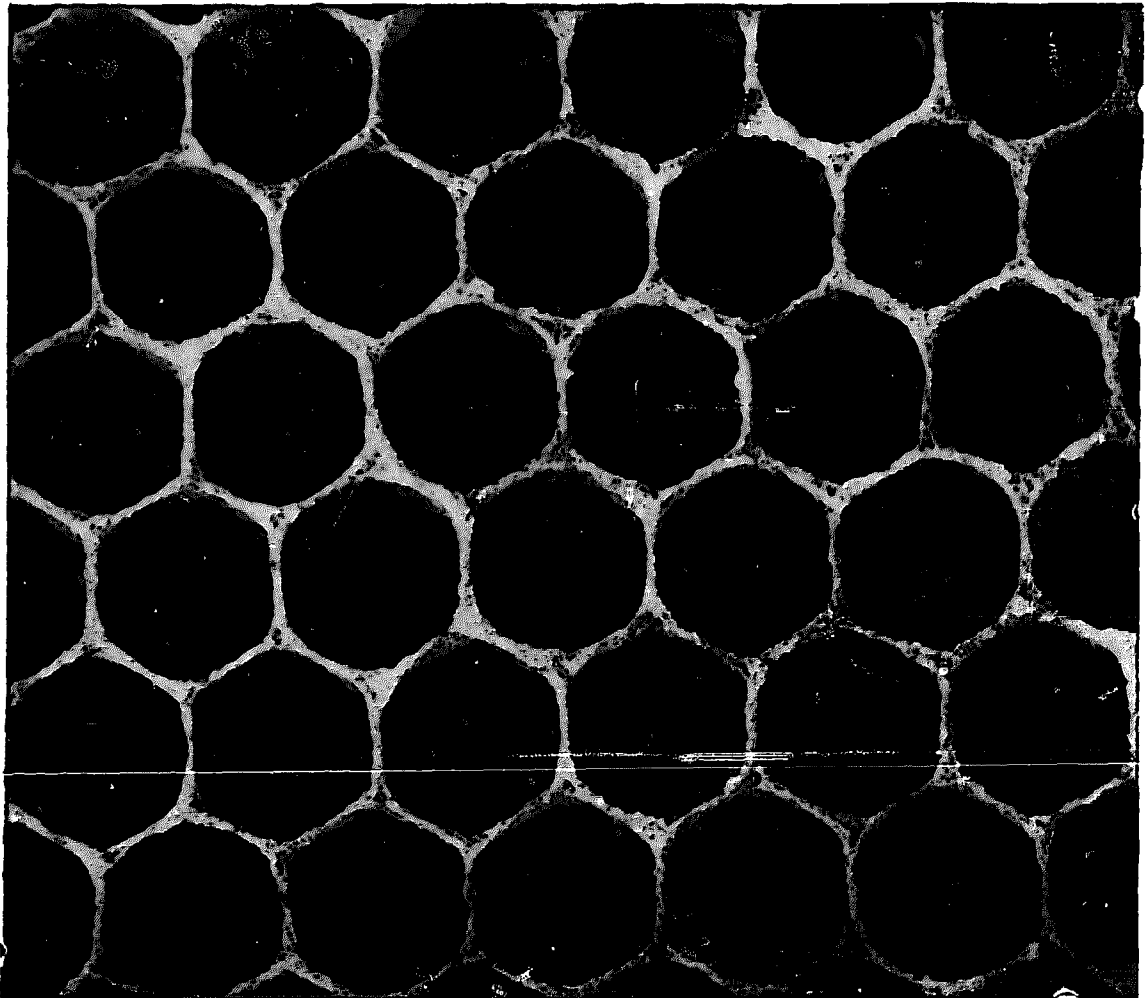

Close view and greatly enlarged worker comb with eggs in the bottom of the cells. Some of the eggs stand at an angle. Photo by E. F. Bigelow.

the cells, although photography is not able to show the depth of the cells. The pictures on page 106 show brood in various stages of development.

#### **How the Presence or Absence of Brood Reveals the Real Condition of the Colony.**

It is the presence of eggs or young larvae that shows that the bees have a queen and are beginning to rear brood. This may show even during January and February in the North; or it may occur, as it usually does, in early spring. Brood will be found in all stages of growth as the season progresses.

On the other hand, the absence of unsealed brood, and especially the absence of eggs, may be an indication that the colony is queenless. During spring and early summer there will be, or should be, brood in all stages, including eggs. Such a condition indicates general prosperity, and the beekeeper can feel that his bees are doing well. But if there are no eggs nor young larvae, and the queen can not be found, and if there are also initial queen cells (see page 43) the probabilities are that the queen has recently died or that a swarm has issued. It may further be said that the absence of eggs and the presence of initial

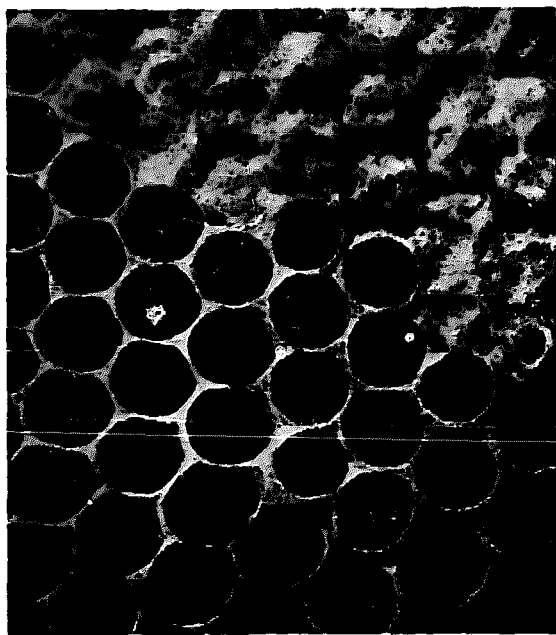

**Unsealed, partially sealed, and fully sealed honey, which may be in either worker or drone cells. Capillary attraction prevents the unsealed honey from running out.**

queen cells during the active season are almost absolute proof either that the queen is not in the hive or that the one that is there is about to be superseded. (See Supersedure.)

After the main honey flow which usually stops in the northern states from August 1 to September 1, the activity of the queen in egg laying will decrease and the amount of brood even, in a normal colony, will be very much less than at any time preceding the honey flow. Sometimes there will be almost no larvae nor eggs, and but very little sealed brood. The beginner will be inclined to think the queen is failing when, as a matter of fact she and her colony are pursuing a normal course. Nature evidently works on the plan that there is no use producing a lot of worker bees and consumers when they can be of no possible help to the colony; so she husband her strength until another honey flow comes on toward fall. At that time brood rearing may start up again, and possibly the hives may have as much brood as at any time during spring or early summer. But if cool or frosty nights come on, the amount will probably not go beyond one or two frames. If considerable brood is in the hive when a severe cool or cold spell comes on, it is apt to result in a lot of chilled brood.

Sometimes during the flow when late flowers are in bloom the bees and queen apparently become excited and begin breeding heavily. A chilly, rainy period may come on for four or five days, but not cold enough to kill the blossoms in the fields. During the interim the cluster contracts, especially at night. The young brood outside of the cluster chills and dies. In a day or two these larvae will be found scattered around the entrance of the hive, and the beginner will be inclined to come to the conclusion that something is wrong—that some bee disease like foulbrood is in the hives. (See Spreading Brood, and Diagnosing Colonies.)

The statement was made that egg laying would begin to decrease after the main honey flow. This is true with all except young laying queens. A queen reared in June or July in the northern states will probably continue laying all through the summer, and the colony will contain brood in all stages. One reared in



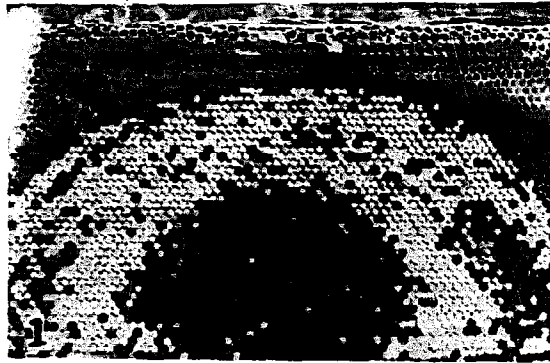

Fig. 1.

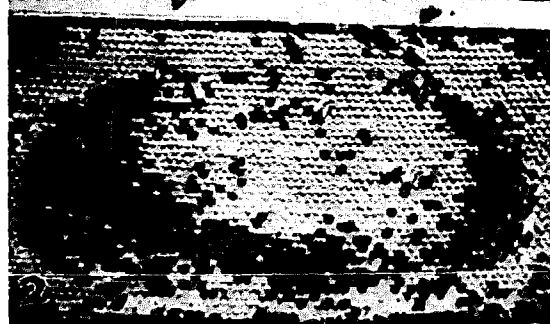

Fig. 2.



Fig. 3



Fig. 4.



Fig. 5.

September will begin laying immediately, no matter what the conditions, and she will keep it up until cool or cold weather shuts it off.

In some localities it is an advantage to use young queens in order that there may be a large force of young bees for the honey flow that will follow the main one. The secondary flow will perhaps be from buckwheat, aster, goldenrod, or all of them. It is important to have a strong force of bees for it. Brood rearing should therefore be continued from the first flow by having young queens if there are good prospects of a fall flow from buckwheat, goldenrod, or aster in the North. (See Building Up Colonies.)

### Concentric Circles of Brood Rearing

As one goes over his colonies in the spring he will often find brood in concentric circles in all stages of growth, as shown opposite.

Later on in the season when the weather is warmer and brood rearing is at its height, he will find solid masses of brood over the entire surface of the combs as shown at the bottom of this column. The reason for the first mentioned is that in early spring the queen begins to lay in small circles under the small cluster and before it spreads over the surface of the combs.

This brood in small circles on both sides of the comb and the ones contiguous to it is soon capped over. In the meantime the cluster expands and the queen begins to lay in a larger circle or crescent around the first sealed brood. As the cluster continues to expand, the queen starts another crescent of egg laying around the first crescent which now has brood ready to seal. About this

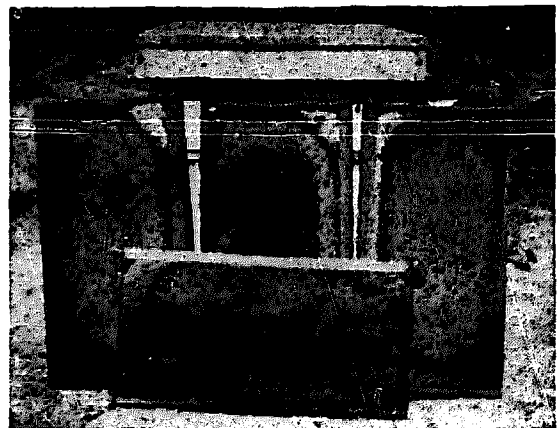

Fig. 6.

stage the first brood emerges when the queen begins to lay where she began at first. In a short time the brood in the second crescent has emerged and the patch with its second brood is sealed over.

The process will continue until we have solid sheets of brood as shown in Fig. 6.

It should be noted that there will not be solid sheets of sealed brood on one or both sides unless, first, the combs are built in the first place from a non-sagging foundation, either Three-ply or vertically wired; and secondly, unless there is an upper story above in which the bees and queen are at work. A third condition is that the weather is warm, pollen coming in, and a strong force of bees.

It will be noted further that there are empty cells scattered in the solid frames of brood. This is probably due to the fact that the eggs in these cells failed to hatch. Unless promptly supplied with pap the eggs will not hatch. While the queen may deposit eggs in these cells if empty, it is more probable that worker bees just in from the field filled them with honey. It is seldom that one will find a solid comb of brood with no empty cells.

Fig. 3 and comb below are not built on a non-sagging foundation. Note that these stretched cells at the top are filled with drone brood. Also at a little to the right of the cen-

ter there is a bulge in the comb in Fig. 3.

Nolan has made a complete study of this. See United States Bulletin, Department of Agriculture No. 1349, September, 1925.

**"By Their Fruits Ye Shall Know Them."**

The amount of brood and the manner in which the eggs are laid—whether in scattered or irregular little patches—give one a fair idea, even though he has not seen her, of the kind of queen in the hive. If there is only a scant amount of brood, and eggs are scattered when other colonies are well supplied, the presumption is that the queen is failing and that a better queen should be put in her place. After she is found, the probabilities are that she will be small—not much larger than a worker.

On the other hand, if brood is found in six or seven frames in the spring in all stages of growth from eggs to the emerging bees, in a ten-frame colony, the conclusion may be drawn that the queen is a good one even though she has not been seen. "By their fruits ye shall know them." When located, the queen will probably be discovered to be large, handsome, long or full-bodied. By waiting a moment, one may have the pleasure of seeing her lay an egg, for such a queen is usually on the job night and day.

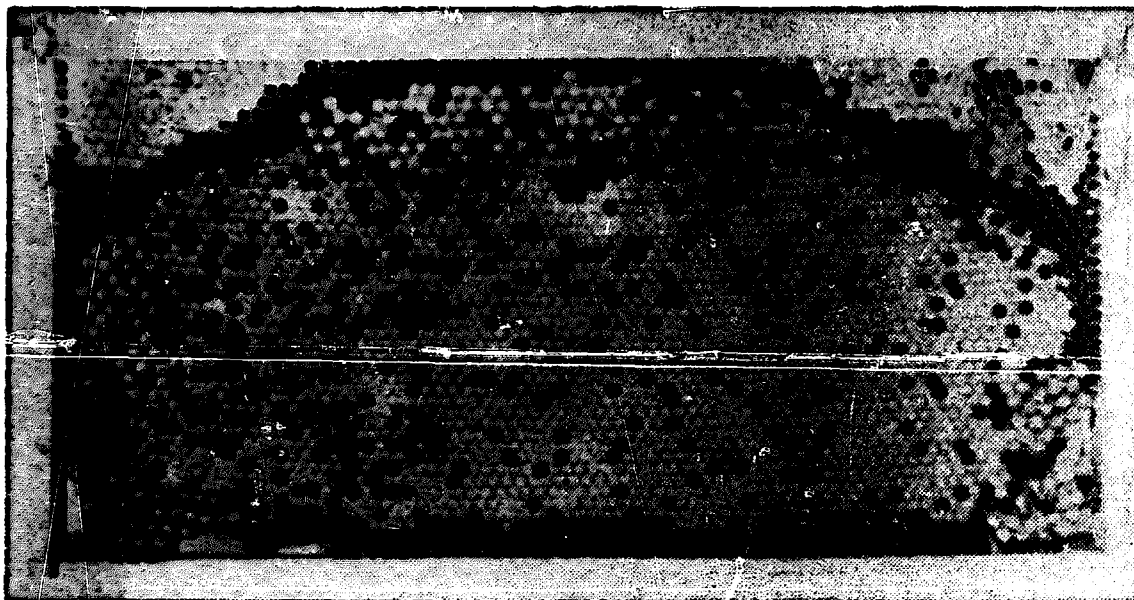

Comb containing sealed worker brood in the center, sealed honey in the upper corners, and sealed drone brood in lower corners.

### Amount of Brood to Colony Strength

The Government Bee Culture Laboratory at Laramie, Wyoming, says that results show a high negative correlation of straight line character between the colony population and the amount of sealed brood present. Typically, a colony having 10,000 bees will have approximately 80 percent as many cells of sealed brood as bees, and this percentage relationship decreases 10 to 14 percent for each increase of 10,000 bees throughout the normal population range of 10,000 to 60,000 bees. While the large colony has more brood, the smaller colony increases at a more rapid rate.

### Drone Brood

This has the general characteristics of worker brood, except that the cells are larger and the cappings more convex. While worker brood emerges in from 20 to 21 days from the laying of the egg, drone brood emerges in from 23 to 24 days.

A drone-laying queen or a laying worker (see Laying Workers) may lay drone eggs in worker cells. In that case the brood will be worker size but the cappings will be more convex than ordinary worker.

Drone brood will often die from neglect. It will smell like foulbrood, but lack the characteristics of either European or American foulbrood. Beginners sometimes suppose it to be a disease. In any case, the unnecessary rearing of drone brood in defective combs having stretched cells is both expensive and wasteful.

### Egg-Laying Capacity of a Good Queen.

Various estimates have been made as to the number of eggs a queen can lay in a day. These figures range all the way from seven or eight hundred to six thousand in a single day. While the last named are certainly high, the first certainly are low. For many years it has been believed that the maximum capacity of a good queen under favorable conditions would be about 3000 eggs in a single day, or perhaps an average of half that, covering a period of two or three weeks in the height of the brood rearing season just before or during a part of the honey flow.

It should be noted that there is considerable difference between the actual capacity of a queen to lay a certain number of eggs and the number of eggs that will be developed into brood.

As will be pointed out further on, the eggs will not hatch unless they are supplied with larval food by the nurse bees just before the larva breaks the egg case surrounding it, and if this food is not so placed eggs will never hatch. Unless the weather is warm, colonies populous, and unless there is a large amount of natural stores or nectar coming in, large numbers of eggs will not hatch. Without a maximum number of bees of the right age to go to the field, the actual crop of honey secured will be far short of what it should be. All through this book emphasis will be placed upon the importance of plenty of natural stores and the colony sufficiently strong so that it can take care of the eggs and the brood later on.

### How the Birth Rate and Death Rate Vary During the Season.

During the height of brood rearing in the spring the death rate is very much lower than the birth rate. In other words, in the early part of the season and just before the honey flow, the strength of the colony increases very rapidly. After the crop has been secured, the death rate is very much more rapid than the birth rate. The queen either lets up on her egg laying or stops altogether. In the meantime the old bees that have toiled during the season with worn-out wings die by the many thousands in the fields and never come back into the hive.

### The Development of Brood

Some very interesting work has been done in the study of the development of brood, notably by Berthof, Lineburg, Sturtevant, and Nelson. They were formerly connected with the Bee Culture Laboratory of the Bureau of Entomology, Washington, D. C. The development of the larva as it grows from day to day, and its movements in the spinning of its cocoon, have been observed through cells having glass sides. While it will not be possible to tell the whole story here, some things can be shown that will be helpful and useful to the student as

well as to the one who is earning his living from the bees.

We will start with the egg. Instead of having a hard shell, the outer covering is soft and membranous.

The means by which the queen determines whether a cell shall receive a worker or a drone egg has always been a mystery to beekeepers and investigators. There have been many hypotheses about this but none seemed to fit into the behavioral or biological limitations of the honeybee queen. Dr. N. Koeniger, writing in the *Australian Beekeeper*, 73(7) 1972 of his observations of a laying queen said he did not notice any difference between oviposition in drone cells and worker cells. The decision, he claims, as to whether or not to put an egg into a cell is taken by the queen during the inspection. He describes the initial inspection as follows, "If the queen finds a suitable cell she stops at its opening and puts her head into it together with her forelegs. She remains a moment in this position and then takes her head and forelegs out. This part of the oviposition process is known as cell inspection. After the inspection the queen continues the process of laying an egg: alternately, she leaves the cell and starts again with inspection of another cell. Egg laying without inspection has never been observed."

So it seems probable that during the inspection she recognizes the type of cell and whether or not the egg is fertilized depends on this recognition.

Dr. Koeniger designed several devices which prevented the queen from inspecting the cell yet did not prevent her from laying an egg in it. Attaching a spur-like obstruction to the forelegs of the queen, which prevented cell inspection with the forelegs the queen nonetheless laid eggs in some of the drone cells. Eighty percent of the eggs deposited in the drone cells hatched as workers. This indicated that hindering cell inspection affected cell differentiation.

In the process of inspection the queen can only be using her antennae or forelegs. Amputation of the antennae caused the queen's death. Lindauer showed that the workers antennae are

not necessary for the construction of comb cells so Koeniger concentrated on the influence of the forelegs. His results are as follows: "Before each test I gave drone cells to every queen to make sure that she did in fact lay only unfertilized eggs in drone cells. Queens which did not lay in drone cells at all, or which laid drone eggs in worker cells were rejected."

"In some experiments I amputated all or part of the queen's forelegs. After the amputation I put the queen directly back into her colony. The results (Table 1) were accepted as valid only if the queen laid eggs in drone cells within three days after the amputation."

Table 1

Treatment of foreleg(s)	No. of cells counted	Percent containing worker pupae
Spurs on both	6511	89%
Amputation of:		
both trochanters	3305	78%
both femora	3984	18%
both tibiae	1189	3%
one complete leg	1407	0%

From the results Dr. Koeniger concluded that the queen seems to recognize a drone cell mainly with her front legs during cell inspection, although there must also be some other mechanism of cell differentiation.

In no experiment did he find drone in worker cells, though the queens laid some eight to ten times as many eggs in worker cells as in drone cells.

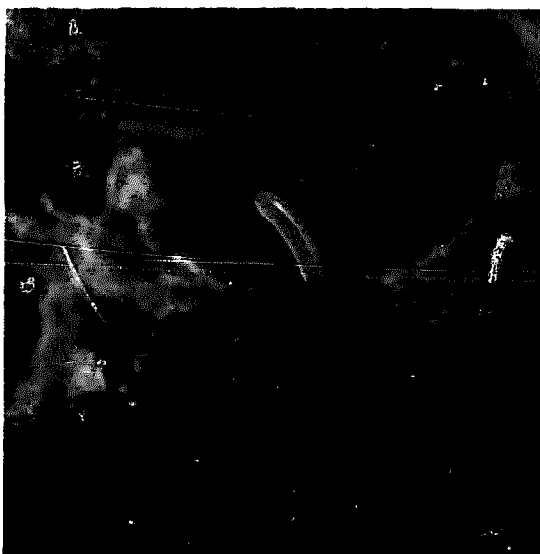

Honeybee egg attached to the base of the cell. The cell wall has been torn down to photograph the egg.—Photo by C. Divelbiss.

"This seems to indicate" says Dr. Koiniger, "that the fertilization of the egg is prevented by a specific stimulus of the drone cells, and that the laying of fertilized eggs in queen cells (as in worker cells) depends on a lack of the stimulus in these cells."

It is quite interesting to watch the queen in her egg laying. One would naturally suppose (if it is possible, for example, for her to lay 2000 eggs in a day) that she would have to move much more rapidly and lay faster than she really does. On the contrary, her movements are very deliberate as she moves among her throng of busy workers, and when she deposits the egg in the cell she seems to be in no hurry. But in view of the fact that she works long hours with short intervals of rest, she is able to accomplish a large amount of work.

Let us watch her for a few minutes. If she is given an empty comb which the nurse bees have cleaned out and made ready for her, she will lay pretty rapidly, taking one cell after another. But as already pointed out, some of these eggs may not hatch. As the brood begins to develop later on she apparently checks up on her work. She will go all over the brood hunting out here and there the stray cells which contain no eggs or brood. She will deliberately examine each of those cells one at a time. After having picked out her cell, in spite of all the jostling and crowding on the part of her busy throng of workers, she will circle about and finally push her abdomen down into the precise cell she has just examined. She then crouches deliberately down with her legs on the sides of the other cells and her wings out behind until she reaches the bottom, remains there from 10 to 15 seconds, then pulls herself out and walks deliberately over and inspects another cell where she repeats the operation. In each case it will be noted that the egg is deposited in the base of the cell, standing at right angles to the cell base and parallel with the sides of the cell. The egg will hold itself in this position until within a few hours of hatching. It will then be observed that the egg case, or what might be called the shell, becomes more transparent and the larva ready to

hatch can be seen within. (See page 108.) Just about this time the egg will assume another angle. It will lie flat in the bottom of the cell. About this time the worker bees that have been poking their heads into the cells from time to time evidently to determine the growth of the larva within will deposit a very small amount of larval food at a point just above the attachment of the egg. The egg will not hatch\* until this food runs down upon the egg and then the little life within bursts the shell or egg case. Shortly afterwards the larva curls up like the letter "c", the two ends meeting. The nurse bees continue to add more larval food and the little grub wriggles around in the form of a circle. It continues to grow until it fills the bottom of the cell. As it gets a little larger, it straightens out lengthwise of the cell, moves back and forth, changing from end to end, and finally when it has filled the cell completely it turns its head toward the opening and remains motionless, taking no food from that time on until the young bee emerges by cutting off the capping. During its development the honeybee molts or sheds its skin five times during its larval life and once more shortly before it emerges as an adult from its cell, according to Dr. L. Berthof, a former employee of the Bureau of Entomology. (See *Journal of Economic Entomology* for April, 1925, pages 381-384.) The various stages of growth can be seen in the illustrations here shown.

It should be remembered that there are three stages of brood: the egg, the larva, and finally the pupa.

A study of the movements of the larvae up to the time it becomes motionless, lying as still as death, is very interestingly shown by an article in *Gleanings in Bee Culture* for June, 1924, by Lineburg:

#### How Larval Food is Fed

Royal jelly is supplied directly by the mouth and not through the proboscis. During the first days of larval life this food is placed in the cell beside the larva. The food is not placed within the circle which the larva makes as it moves around and around within the cell, but it is placed at the border of the mass of food already

\*Herrod Hemsall of the *British Bee Journal* takes issue on this point. See *Bee World* for January, 1937, page 1.

present. The young larva, accordingly, is surrounded by a mass of food, as previously stated. At first, this food covers only a portion of the bottom of the cell. Later this mass is increased in size until the whole bottom of the cell is covered with food. After several days food may be placed within the ring formed by the body of the well-developed larva as well as on the sides of the cell outside this ring.

Returning now to a consideration of the feeding conditions on the first day of larval life, it must be remembered that, although the food present in the cell is about four times the size of the larva, the mass of food is in reality but little larger than the head of a pin. If cells containing larvae of this age are covered with wirecloth so as to exclude nurse bees, it will be found that evaporation within the hive is so great that within a few minutes a thin crust is formed over the surface of these minute quantities of food. Within an hour or two the whole mass is reduced to a tough jelly-like substance in which the larva is utterly helpless either to move or to feed. Such observations must be made under a microscope.

#### How Larval Food is Kept Moist

Under normal conditions the nurse bees prevent the drying out of the food. This they do by supplying the fresh food frequently. In fact, nurse bees have been seen to visit day-old larvae on an average of once every two minutes. Not all of these visits are made for the purpose of feeding. When food is given it is placed on the border of the mass already present. The nurse bees apparently seek to avoid actual contact with the larva.

With those facts in mind it is possible to

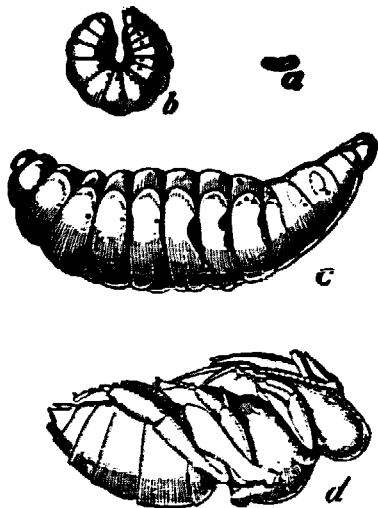

Four stages in the development of the honey bee: a, egg; b, young larva; c, old larva; d, pupa. From "Beekeeping" by E. F. Phillips.

understand the importance of the circular movement of the larva. By this movement the larva not only brings itself frequently into contact with the fresh supply of food wherever it is added, but the movement itself serves constantly to mix the old supply with the new and thus keep the entire mass at all times and in a condition suitable for ingestion. The movement continues throughout larval life except for periods of rest. It is this same movement which enables the larva to straighten out in the cell and also to move about while spinning its cocoon.

#### The Method of Movement

As is well known to students of entomology, the honey bee larva has no legs. It is therefore unable to crawl as most insect larva do. In fact, if a young larva is placed on a glass slide with a mass of food just in front of its head or even touching its head, it is unable to move forward the distance of its own length. It perishes accordingly because it is unable to regain a position where it is surrounded by a mass of suitable food. A full-grown larva, likewise, is utterly helpless when placed upon a flat dry surface, but under its normal conditions it probably moves 150 times from end to end of its cell while spinning its cocoon\*.

The method of movement is probably the same in both the young and fully-developed larva. In the fully-developed larva this activity appears to be due largely or wholly to a peculiar use of the heavy folds which are conspicuous on its sides and back. These folds are retracted and later protruded again in a more advanced position. The movement somewhat resembles the crawling of a caterpillar, if one can imagine each of the caterpillar's legs to disappear into the body when not actually aiding in the support of the body, the legs appearing again in a more advanced position instead of the usual caterpillar method of raising the leg and moving it forward. Doubtless, these movements of the larva are an aid in its breathing and to the circulation of its blood much as muscular activities are in the case of our own bodies.

When the hatching larva frees itself from the egg case, it forms a small semi-

\*Lineburg suggests that the larva turns about some 150 times. Have you any evidence? I watched larvae spinning their cocoons and observed that it took the larva some 20 minutes to shift from one end to the other while spinning. Now as she was not spinning quite 48 hours it would be very difficult for her to get in 150 turns. I never counted the turns but am inclined to believe that there are not more than a dozen or so.—Allen Latham.

circle with its back on the outer circumference. As it grows it occupies more and more space until its back is pressed tightly against the walls of the cell. Continued growth produces still greater distortion until finally all semblance to the larval shape is lost and the larva appears as a six-sided plug which filled considerably more than half of the cell.

Because of the extremely compressed condition of the full-grown larva, not only its back but a considerable portion of its side are actually in contact with the walls of the cell. It appears, therefore, that any creeping movement which is produced must be accomplished by these parts of the body. Such is actually the case. The folds of the back and sides act as locomotor appendages in the manner previously described.

To straighten itself out, the fully developed larva curled in the bottom of the cell simply turns its head slightly toward the cap of the cell, and the same movement which carried it around in the bottom of the cell now serves to lengthen it out into a short spiral coil (see illustrations). This same movement likewise enables it to reverse its direction readily within the cell while spinning its cocoon.

When the work of spinning its cocoon is finally finished, the larva turns its head toward the cap of the cell and stretches out for a long rest. Stretched out thus, it passes through the various stages of pronymph, pupa, and finally reaches the adult stage. Not until this stage is reached does the creature turn over on its ventral side, thus removing its back from the walls of the cell.

After sealing, the larva begins to change into three segments. The rudiments of mouth parts, compound eyes, legs, and wings begin to form. Development goes on until a perfect white bee is seen. The large compound eyes turn pink; the body turns darker. Later the eyes turn to brown and then to black, and in the meantime the body turns to the natural color and markings. All of these wonderful changes can be seen by cutting off the cappings of the sealed brood at different stages of growth.

#### Rate of Larval Growth

Dr. E. F. Phillips of Cornell University in his book "Beekeeping" has this to say:

The excessive rate of growth of the bee larva is shown by data obtained by Nelson and Sturtevant, from which the following table is drawn:

The average weights of bee larvae at intervals of 24 hours.

Age in days	Av. weight in mg.	% of daily increase
0 hatching	0.100	.....
1 day	0.650	550
2 days	4.687	621
3 days	24.640	426
4 days	94.692	284
4½-5 days	157.642	66 maturity

This great growth is made possible by extensive feeding, which is done by the nurse bees. Lineburg finds that the number of visits made to each developing bee from the time the egg is laid until the larva is fully grown averages about 1300 a day. For the first two days of larval feeding, food is given in quantity (mass feeding), whereas after that time it is given frequently (progressive feeding). The total number of visits made to a developing larva is about 10,000, a total expenditure of time amounting to 4.75 hours. At the close of the second day of larval feeding, the character of the food changes to include undigested pollen and honey, a change which was supposed by earlier writers not to occur until the fourth day. During the last day of feeding there is on the average a nurse bee feeding each bee larva almost 20 percent of the time. During this period of rapid growth the bee larva molts its skin at intervals of about 24 hours, each molt being indicated by changes in size of various structures.

For further particulars refer to article by Bruce Lineburg in *Gleanings in Bee Culture* for 1925, page 18; Bulletin No. 1222, U. S. Department of Agriculture by Nelson, Sturtevant, and Lineburg; to Dr. Jas. A. Nelson's book "The Embryology of the Honey Bee". See also his paper "Morphology of the Honey Bee Larva," reprinted from *Journal of Agricultural Research* for June 21, 1924.

In his book "Beekeeping," page 114, Phillips has thus summarized the daily growth of the baby bee from the egg to the adult of the queen, worker, and drone:

	Development stages in days		
	Queen	Worker	Drone
Egg	3	3	3
Larva	5½	6	6½
Pupa	7½	12	14½
Total	16	21	24

(See Larval Food, Nature and Source of and Development of Worker and Queen, also Royal Jelly.)

#### After Young Bees Emerge

When it gnaws its way out of the cell, the young bee commences to rub its own nose, straighten out

its feathers, and then push its way among the busy throng, doubtless rejoicing to become one of the vast commonwealth. Nobody says a word nor apparently takes any notice of the youngster. If a colony is kept without young bees for a time one will see a new energy infused into all hands just as soon as young bees begin to gnaw out.

If one should vary the experiment by putting a frame of Italian eggs into a colony of black bees, he will be better able to follow the newly emerged young bee as it matures. The first day it does little but crawl around, but about the next day it will be found dipping greedily into the cells of unsealed honey. After about the first day it will begin to look after the wants of the unsealed larvae—old larvae first—and very

soon assists in furnishing the milky food for them. While so doing, a large amount of pollen is used. Bees of this age or a little older supply royal jelly for the queen cells, which is probably the same as the food given very small larvae. Three days before they are sealed, larvae are fed on a coarser, less perfectly digested mixture of honey and pollen, to produce worker bees and drones. Young bees have a white downy look until they are a full week old and continue a peculiar young aspect until they are about two weeks old. At about this latter age they are generally active comb builders of the hive. When a week or ten days old they take their first flight out of doors. There is no prettier sight in the apiary than a host of young Italians taking a play flight

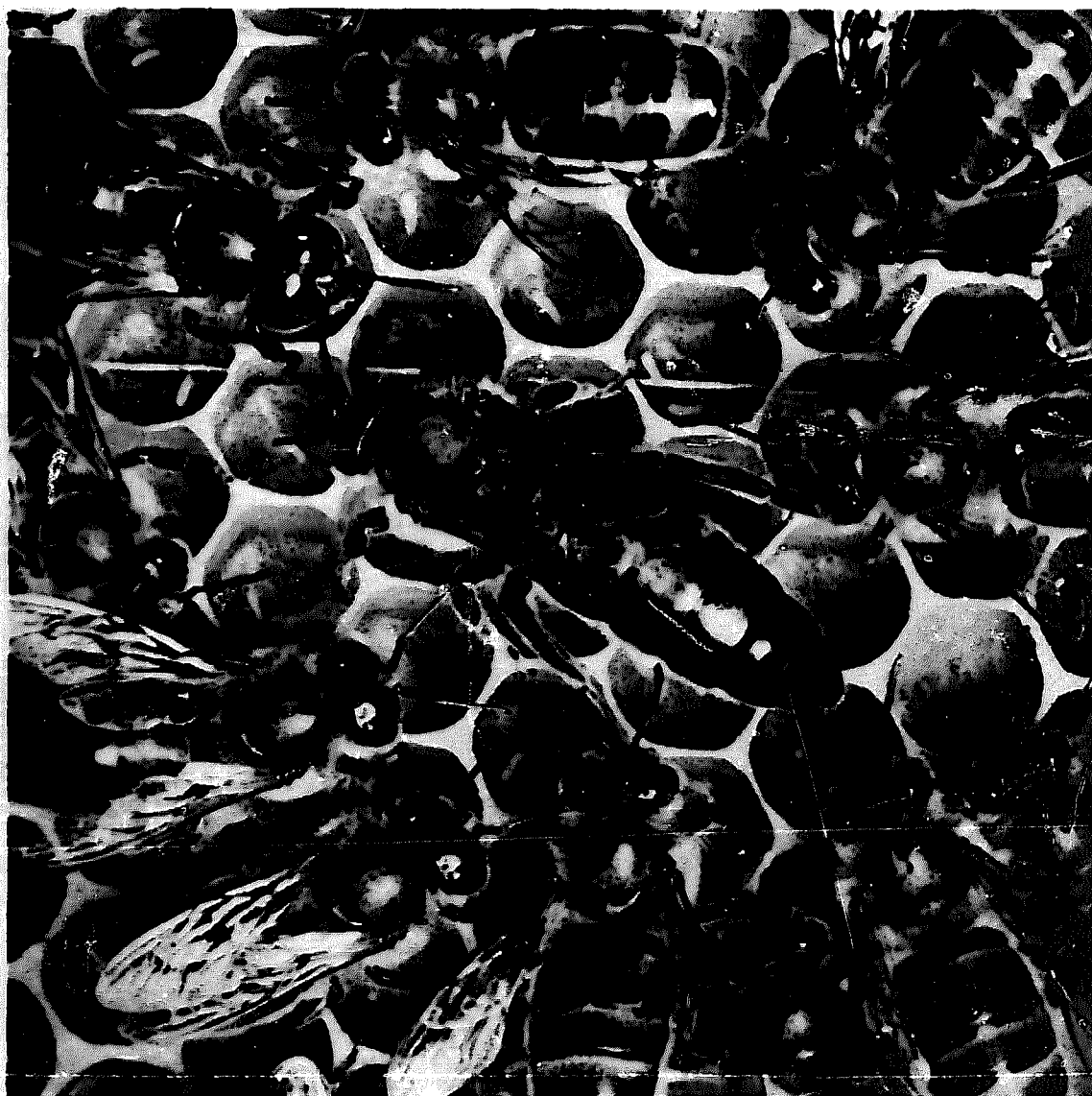



**BUCKWHEAT.**— Buckwheat was extensively grown in the states of New York, Pennsylvania and Ohio as well as in Michigan, Wisconsin, Minnesota, the New England States and in the mountainous sections of Maryland, West Virginia, Kentucky, North Carolina and Tennessee. Large acreages were grown also in Europe and Asia. The acreages sown to this crop has been declining steadily until only a fraction of the original production remains. Recently, however the interest in natural foods has led to a limited revival of a kind in buckwheat. Increasing prices for the grain has caused some farmers to show an interest in again growing buckwheat. Beekeepers look favorably on the opportunity to secure a crop of buckwheat honey, a dark rich honey especially appealing to those who have a taste for the pronounced flavor.

Buckwheat grows best in a cool, moist climate such as is found in the eastern Great Lakes states. Although it is sensitive to freezing temperatures it does not do well in hot arid climates. Buckwheat is not a true cereal as are wheat, barley or oats. It is an annual,

planted in the spring after danger of frost is past, but not so late that it will not mature before the first killing frost. Buckwheat blooms four to six weeks after sowing and matures ten to 12 weeks following planting. Planting in New York, for example, is usually between mid-June and early July. Blooming begins after other honey sources have passed the peak of their flow and when colonies have reached near maximum field bee population. In spite of some regional inconsistencies in nectar yield buckwheat usually produced reliably and often lavishly according to beekeepers who kept their bees within range of the hundreds of acres accessible to each yard. A series of planting dates by individual growers prolonged nectar yield from the middle of July until the middle of September when the fall wild flowers began to bloom.

The plant itself is of interest. Buckwheat is a broad-leaved plant from one to three feet tall. The small white flowers are clustered and possess a strong fragrance. The sepals act as petals since the flower is without petals. The nectar is secreted by eight round,



**A field of buckwheat in full bloom**

yellow glands located between the same number of stamens. Buckwheat is related to a number of common weeds including heartsease, or smartweed and dock.

Much more specific information can be obtained about growing buckwheat by writing to your State field crop specialist if you live in a district that has conditions suitable for growing the crop.

Buckwheat is not particularly demanding in its soil requirements, doing very well on acid soil of low or moderate fertility. Good drainage and light soils are more suitable than heavy (clay) soil though buckwheat is grown satisfactorily on newly cleared land or drained marshland. Soil with above neutral levels of alkalinity due to limestone derivation is not suitable for buckwheat culture.

Varietal selection of seed is based on locale. Most often grown in the United States were the varieties of Japanese, silverhull and common gray, but through the years much intermixing resulted in what is now called common buckwheat. Other varieties have been developed and introduced but none persisted and are likely not available at present. No information relating to nectar secretion and variety is available unless it be from beekeepers who harvest buckwheat honey from fields near home-bee yards where they can observe the bees at work and are acquainted with the varieties grown.

Buckwheat is rather unique in that it is a feed grain of high protein content, yet due to its low total digestible nutrients and high fiber content, buckwheat has a lower feed value than the grain of the cereals such as corn, wheat and oats.

For human consumption buckwheat is used mostly for flour for buckwheat pancakes. Buckwheat honey commands favorable prices in health food stores. It is the one honey which seems to benefit from being the exception to the generally accepted color standards, in fact, it finds many advocates among the natural food users who use no other honey if buckwheat is available. Dark honeys are richer in minerals and possibly other food elements. Buckwheat honey sold in areas where it is

well known, and we might add, appreciated, commands a retail price comparable to the clovers and other light honeys.

The prospect of producing buckwheat honey is discussed by Dr. Richard Taylor in his column "Bee Talk" in *Gleanings in Bee Culture* 103(9) 298. We quote, "One year a large field (of buckwheat) bloomed within sight of one of my apiaries, and the bees got no honey at all there. On the other hand, I do get good crops of buckwheat some years, and often from small fields. Last year I got about a super per colony jammed full of buckwheat from one of my smaller apiaries and it seems to have come from a field of not over 10 acres nearby. Another year there was a small patch of buckwheat near another yard where I had never gotten buckwheat before. That patch wasn't over a quarter of an acre. I had some comb honey supers on there and the outermost sections were buckwheat and they were stored just when the patch bloomed.

"What does all this show? To me it indicates that when conditions are right you can get good crops of buckwheat honey from very limited foraging areas whereas even huge plantings won't do the beekeeper much good if conditions are not right."



A field of buckwheat in western Pennsylvania.

**WILD BUCKWHEAT.** (*Eriogonum fasciculatum*)—is an important honey plant in some sections of California and to a lesser extent in many southern states. It is often mixed with sage and other species. The honey is a medium amber and has a good flavor. It is often sold in New York as buckwheat honey.

**BUILDINGS.** — Producing honey from one or two or several colonies of honeybees does not usually require working space other than that which can be made available in the basement of a residence, a garage or even the family kitchen. With electricity, water and sometimes natural gas available these facilities are usually sufficient to handle the extracting and processing of several hundred pounds or more of honey. Sanitary standards, always a consideration when handling and processing raw foods are easily maintained in residences or nearby buildings that have the basic utilities of water and electricity available.

Expansion in the business of beekeeping is a natural progression when experience and a substantial beginning is achieved. In addition to the increasing number of colonies and greater amount of equipment the beekeeper may find that he has outgrown his original space for storage and processing the honey crop.

Buildings constructed exclusively for honey houses have the advantage of certain features which greatly aid the orderly flow of the honey supers, honey and supplies through the various steps of processing and storage. Some buildings converted to honey houses do not have all of the features usually associated with honey houses built specifically for this purpose. Usually included in custom-built honey houses are inside unloading docks, electric lift hoists, heating panels and ducts installed in the floors, walls and ceilings, a smooth cement floor with drains and the utilities of water, heat and power. Many of these basic requirements can be added to existing buildings to convert them to use for honey houses at moderate expense. It must, however, be kept in mind that the original building needs to be structurally sound. Being a food processing plant the honey house may be subject to regulations that require more than ordinary precautions to maintain cleanliness. These require-

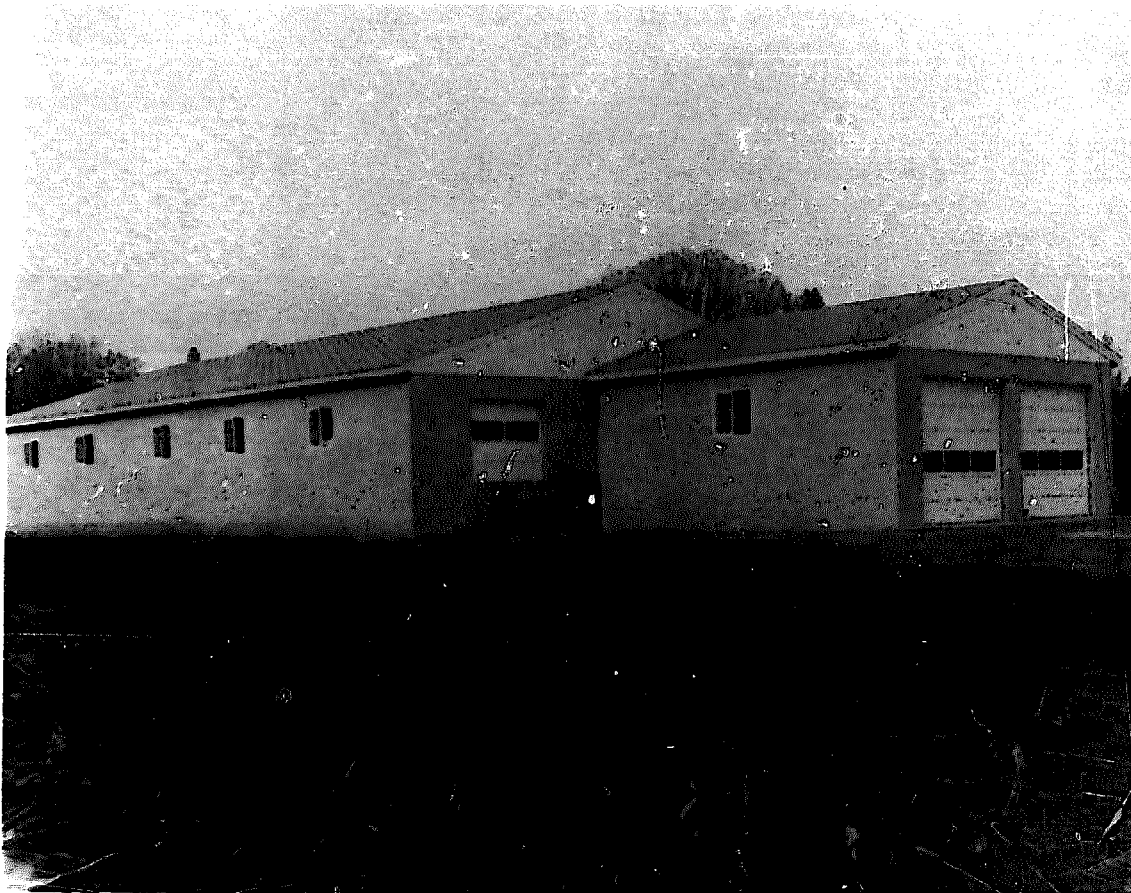

Masonry construction with wood roof gable ends was the choice of the Sundbergs of Fergus Falls, Minnesota.

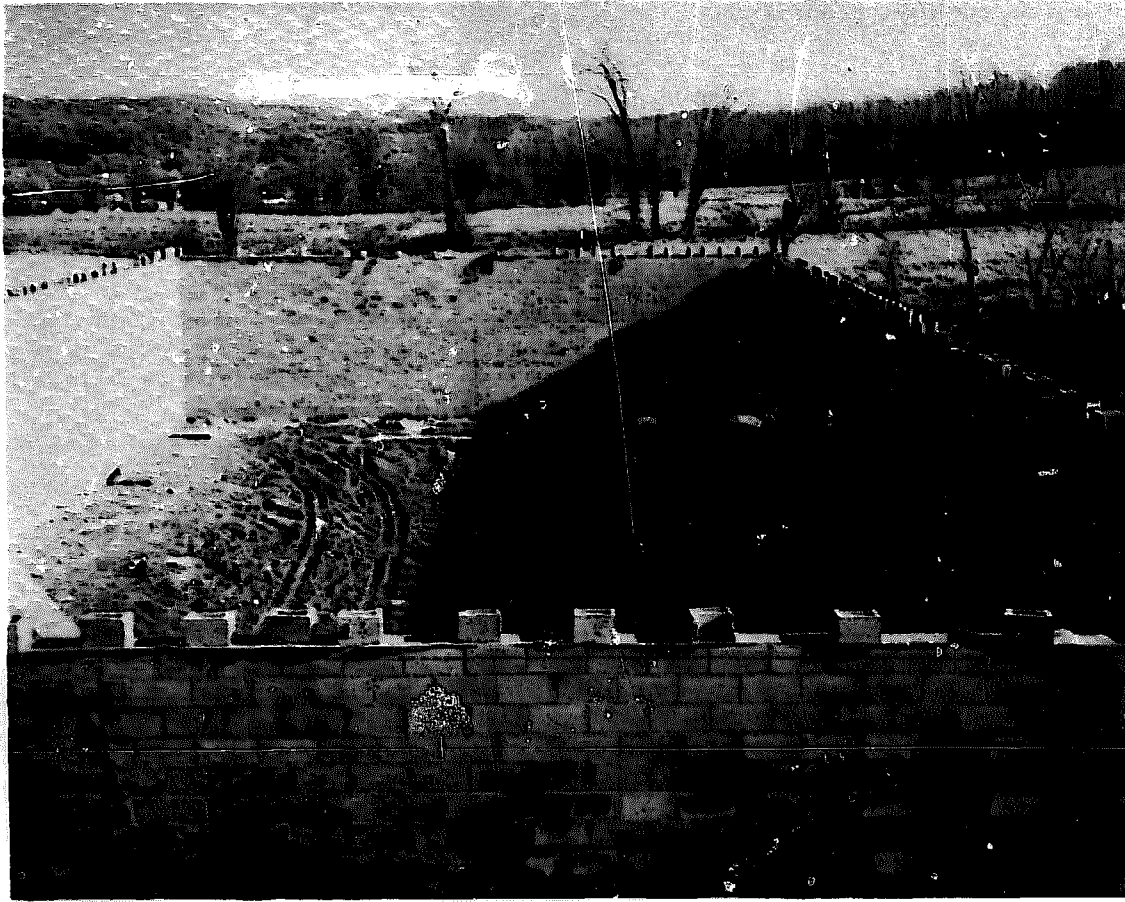

The latest addition at the MacDonald Honey Co. brought the floor area up to a total of 17,000 square feet. Block construction was favored as it is cheaper and can be considered finished inside and out when construction ends.

ments should first be checked into before construction or remodeling begins.

Building materials to construct or remodel are usually the larger part of the cost of a honey house if all or part of the construction is done by the beekeeper. Tradesman or machinery hired to excavate, place foundations and floors, lay cement block, do the plumbing, electric wiring and interior finishing adds progressively more as their skills are utilized. Most beekeepers have neither the time or the skills to perform all of these stages of construction although it is usually within the capability of everyone to perform at least some of the construction if time and ability warrants attempting some of the construction or remodeling.

Before construction or remodeling of existing building begins future requirements of space for working and storage should be carefully considered. Personal circumstances and local conditions which are limiting factors towards

expanding the number of colonies you are able to care for will have a decided effect on how large the building is to be. The extent of the investment in dollars needs to be considered along with the possible need for expansion in the future. Local building and zoning requirements must be checked and the necessary permits obtained. A preliminary study of other honey houses adds to the knowledge that may be invaluable to one planning and constructing his own.

Basic construction materials usually depend upon the availability and cost if a choice of materials is a possibility. Jon E. MacDonald of Sequoit, New York wisely aimed for the maximum amount of space when he expanded by adding a 10,000 square foot concrete block enclosure. He based his choice of wall construction on material cost, availability and durability plus the fact that his insurance rates on cement block construction were lower in his location than they were for frame construction

and wood siding. All metal buildings with full insulation was the choice of Osage Honey Farms of Sibley, Missouri. The all-steel building has an overhead storage over part of the floor space for two transport loads of honey jars. The building design is planned to accommodate a one thousand colony operation.

A limited commercial operation in a marginal honey producing region with 500 to 700 hives led Kenneth Garman of East View, Kentucky to construct an 18 x 34 foot cement block building that can be expanded later for the storage of supers. Floor space allows the clustering of the uncapping tank, a 33 frame extractor, sump with honey pump and storage tanks along wall, leaving an area clear for material and honey super handling and storage. An overhead loft 8 feet by 21 feet by 5 feet high gives him additional storage space. Facing an outside loading dock is a 9 foot overhead door.

The necessity for holding down costs made the Garman honey house a cooperative family project. A number two grade of eight inch concrete blocks was used, 12 rows high. Corrugated galvanized metal roofing was nailed to spaced strips of one inch by four inch sheeting. The outside gable ends are one by 12 inch primed siding lapped and nailed to solid sheeting. Family labor probably did as much as two-thirds of the work.

Sundberg apiaries of Fergus Falls, Minnesota, constructed a new honey house of cement block with a free span truss wood rafter roof. It is built so that trucks can back up to and unload on the honey house floor level which is four feet above ground level. The walls are painted inside and out with epoxy paint. The windows are all sliding style with hinged screens to make it easy to release any bees that may collect. There is also an electric bee killer installed in the warming room where most of the bees which manage to elude the bee blower and cling to the supers are killed. The capacity of the Sundberg honey house is designed for the several thousand colony operation.



The Garman honey house, a size for the 500-700 colony operator. A five foot loading dock and the overhead door is shown.

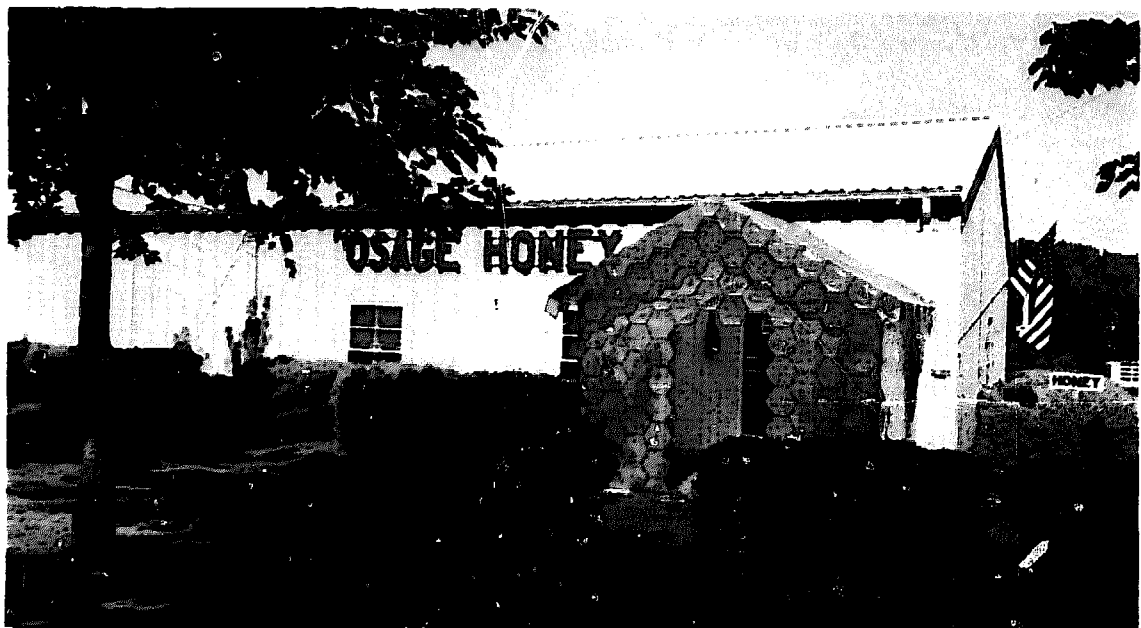

The all-metal honey house of Osage Honey Farms, Sibley Missouri. All steel buildings have the advantage of pre fabrication, can be assembled at the site. The entire building is insulated.

**Building a Honey House**

To a beekeeper an apiary piled high with filled supers of honey can be a source of satisfaction and profit if he is prepared to handle the work load involved in extracting and processing the honey. On the other hand a bountiful harvest or even an average crop from a rapidly expanded production can be quite stressful when extracting and processing facilities have not yet kept pace with production of honey.

Very often for the hobby beekeeper sufficient space and the basic conveniences of water and electricity are available in a residence, perhaps in the basement when processing may be done without causing inconvenience in the family kitchen. Sometimes garages or

other out-buildings may be utilized. For the commercial honey producer or the expanding hobby beekeeper who wishes to become a sideline or fully commercial beekeeper much more space and a specialized structure is needed, in short, a honey house.

A honey house built to plan naturally serves its purpose best but remodeling an existing building may be necessary and can do nearly as well if the location is convenient, the basic structure is sound and the remodeling meets the standards of good building construction. Local building regulations and food handling standards must always be considered in constructing a honey house.

Space requirements should be one of the first considerations in selecting

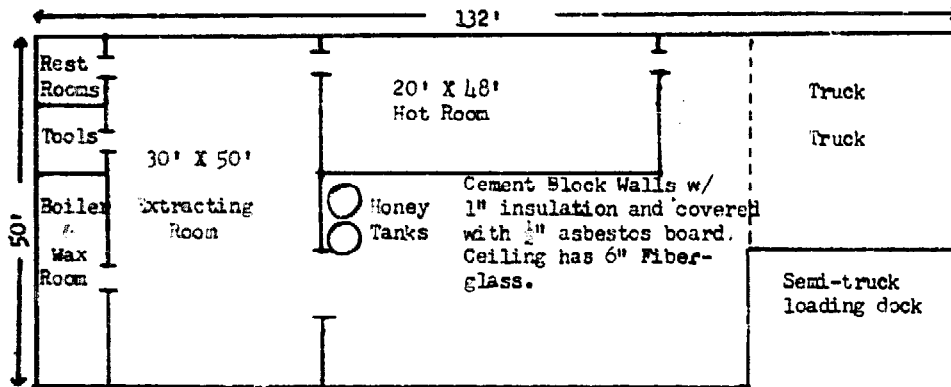

Overall Building Plan

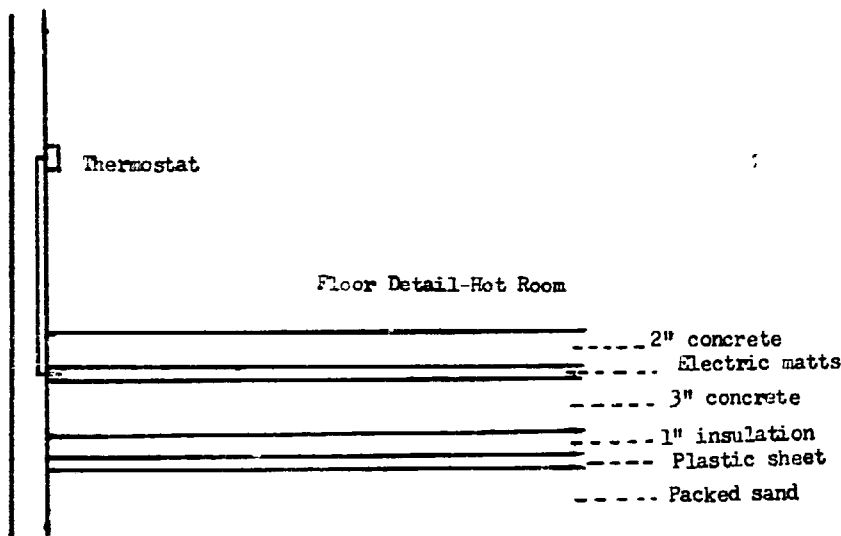

Sundberg Honey House  
Fergus Falls, Minnesota

plans for the honey house. Jon MacDonald of Sauquoit, New York, who at present, has a medium size beekeeping business, says "My pet idea is to have plenty of space! I would advise to build too big and maybe too high. Bigger buildings are cheaper per square foot than smaller buildings, remembering that in a year or five your construction may be just the right size."

MacDonald started with 1,500 square feet, then was forced to go to a 5,000 square foot building which seemed crowded in a year. He recently started an expansion which will give him 10,000 square feet. Claiming insurance rates are better on concrete block buildings he favors this form of construction over all wood. "All steel buildings have the disadvantage of melting in a fire and have poor insulation value," Mac Donald states.

Inside floor plans may vary with the requirements and preferences of the beekeeper, but certain recommendations become virtual requirements if the experiences of commercial beekeepers such as Jon MacDonald who process honey is any criterion. The honey business is a material handling problem and

wheeled vehicles should take the place of human transport wherever possible along with aids such as barrel hoists and fork lifts. Skate wheel conveyors can be used to handle cartons and empty supers. Trucks are used to haul the filled supers home and upon arrival at the honey house can be rolled from the truck using a two-wheeled cart, pallets and pallet jack or a fork lift. Heavy supers should be rolled around the honey house, not carried. This method of handling honey supers requires an unloading dock and smooth concrete floors the specifications for which will be determined by the size of the planned apiary expansion in the future, not just with the present scope of operations in mind.

### The Warming Room

The first place the beekeeper applies supplementary heat to his honey is when it is in the comb in the heat room. Heat rooms become an important part of the honey house when cool and rainy weather prevents the proper "ripening" of the honey, the honey becomes too cool to extract or when humidity is so high that absorption of moisture is a problem. Comparatively high temper-

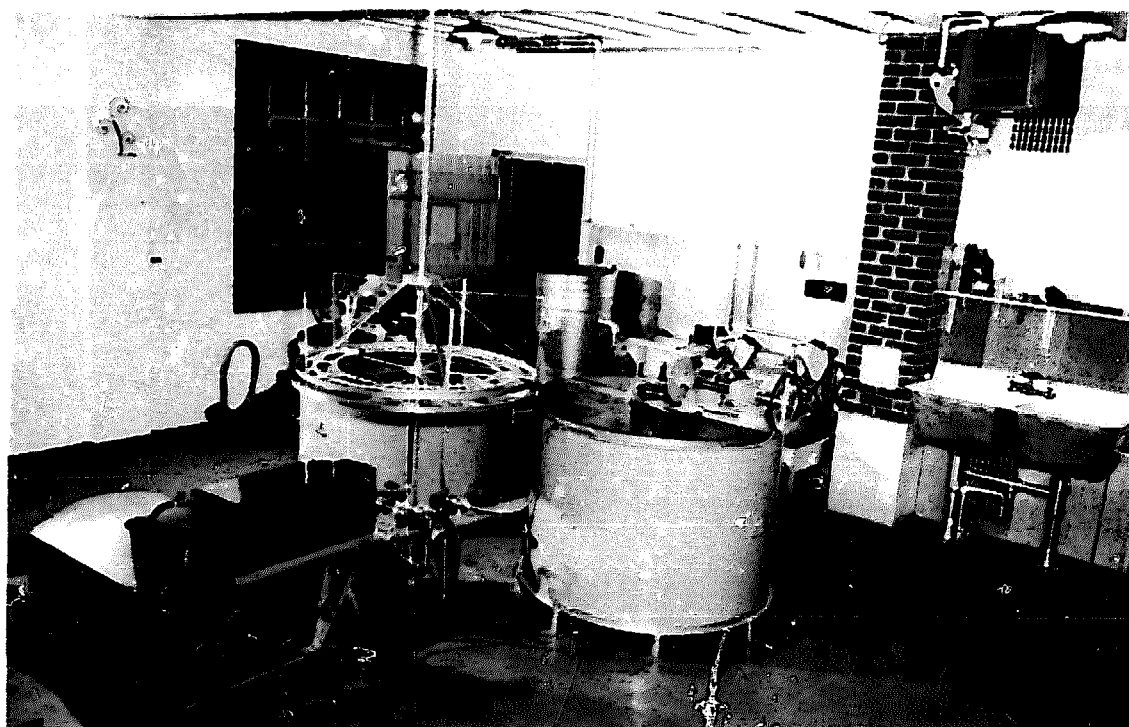

A clean modern honey house. Note the wash basins with plenty of soap and disinfectant on the shelf above. The extractors are slightly elevated for easy cleaning.

atures are necessary to overcome the natural viscosity of honey. The sticky nature of honey causes it to resist movement through the extracting process, pump, pipes and strainers. In order to prepare the combs for uncapping and extracting we have to lower the viscosity of the honey while yet in the supers. To do this the supers are placed in a warm room and warm dry air is driven or circulated through the stacks of supers. Townsend<sup>1</sup> states that the rate of moisture removal depends upon the dryness of the air and the volume passed through the supers. The temperature of the air should not exceed 95°F. (35°C.). The efficiency of this system may be increased by permitting the warm, moist air to escape and by providing a separate intake for fresh air. A unit which is operating efficiently will remove from one to three percent moisture in 24 hours. Moisture removal may not always be necessary but the warming room is very nearly indispensable to warm combs for extracting. The heat room should hold

at least a two-day supply of extracting supers according to S. E. Bland, Provincial Apiarist of Saskatchewan, Canada<sup>2</sup>. He also recommends a ceiling of seven to eight feet unless fork lifts are used. The air temperatures should be 90-95°F. (32-35°C.) and provision should be made for the circulation of the warm air in the room to avoid layering of hot and cool air.

Bees brought into the warming room with the supers will fly to a window where they can be trapped to the outside by a wire cone or bee escape. If there are no windows in the room other methods such as an electric grid can be used to dispose of the stray bees.

Sundberg Apiaries of Fergus Falls, Minnesota have an electric furnace installed in the ceiling of the warming room and electric cables in the floor of the honey house.

### The Work Area<sup>3</sup>

The tank room should be separate from the other rooms and kept dark to exclude bees.

If natural or propane gas is used as

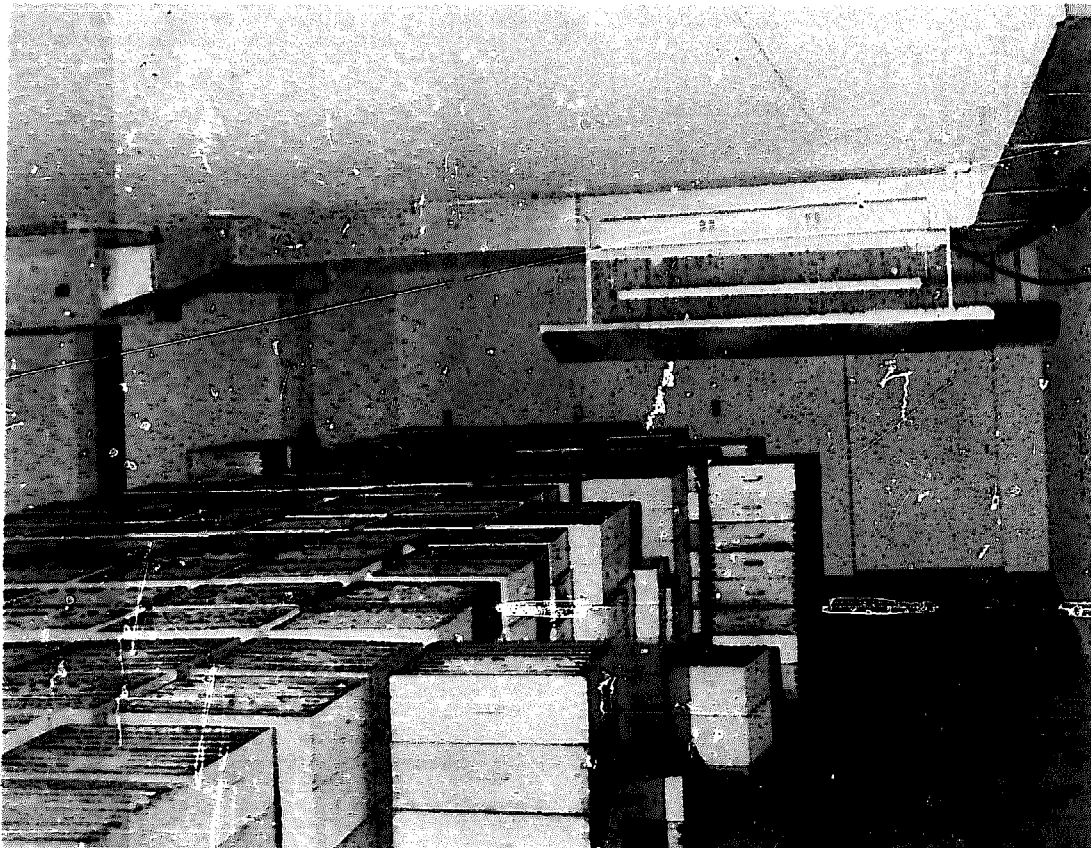

Warming room full of honey with an electric bee killer, electric furnace in ceiling and electric cables in floor.—Photo by Sundberg Apiaries.



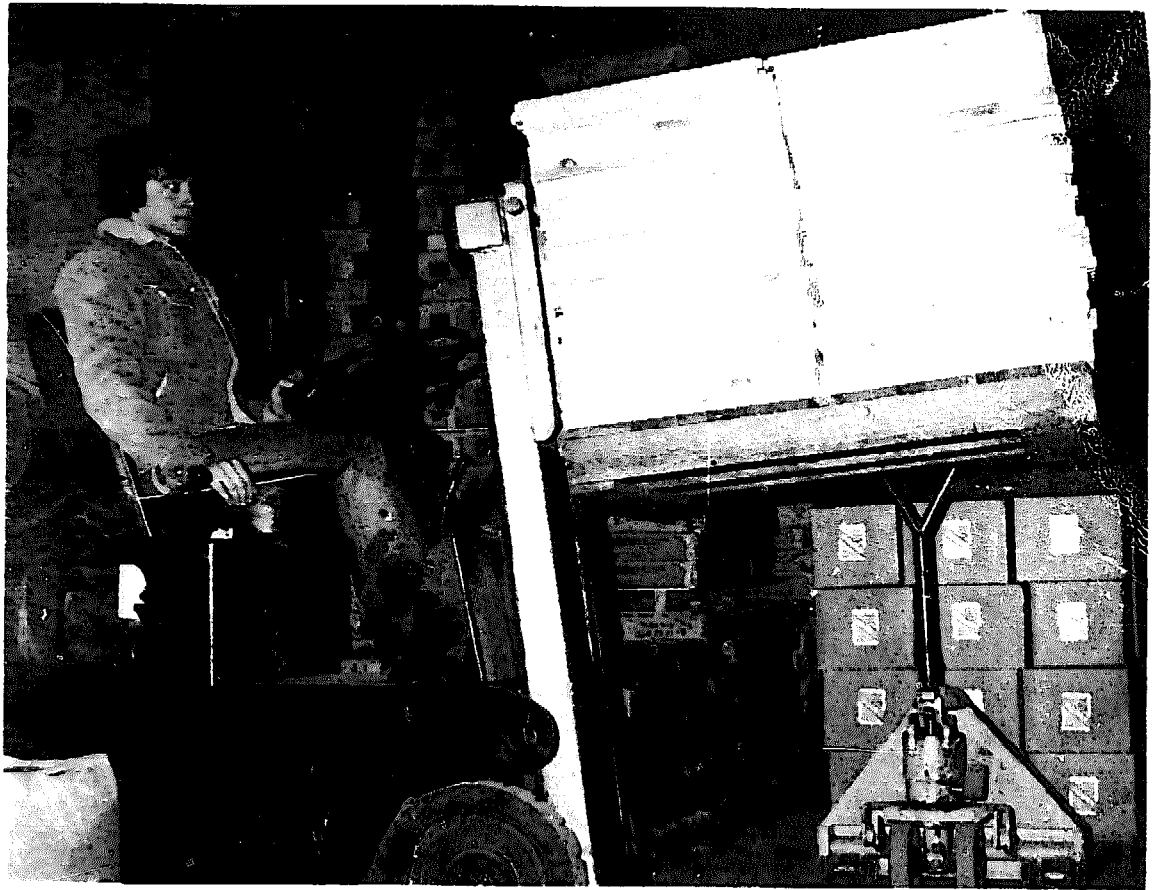

Higher buildings give cheaper cubic feet but a means of stacking is necessary.  
 -Photo by Jon MacDonald.



Staggering supers in the hot room allows air circulation. Note pallets with castors.—Photo by University of Gueiph.

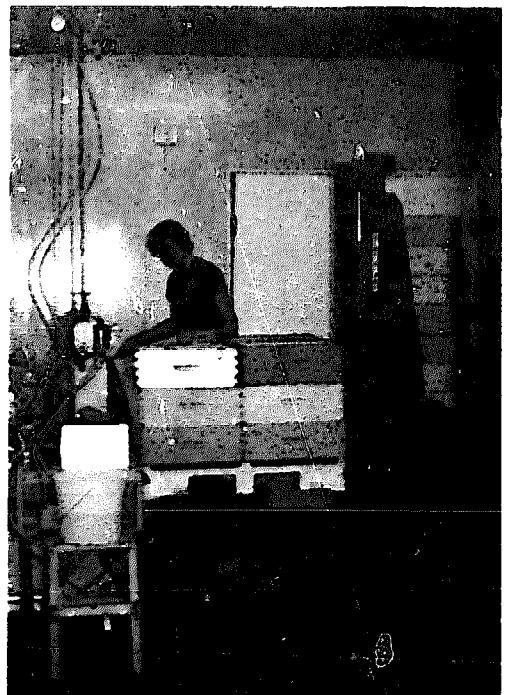

A fork lift moves supers to uncapping machine.—Photo courtesy of Taylor Honey Farm.

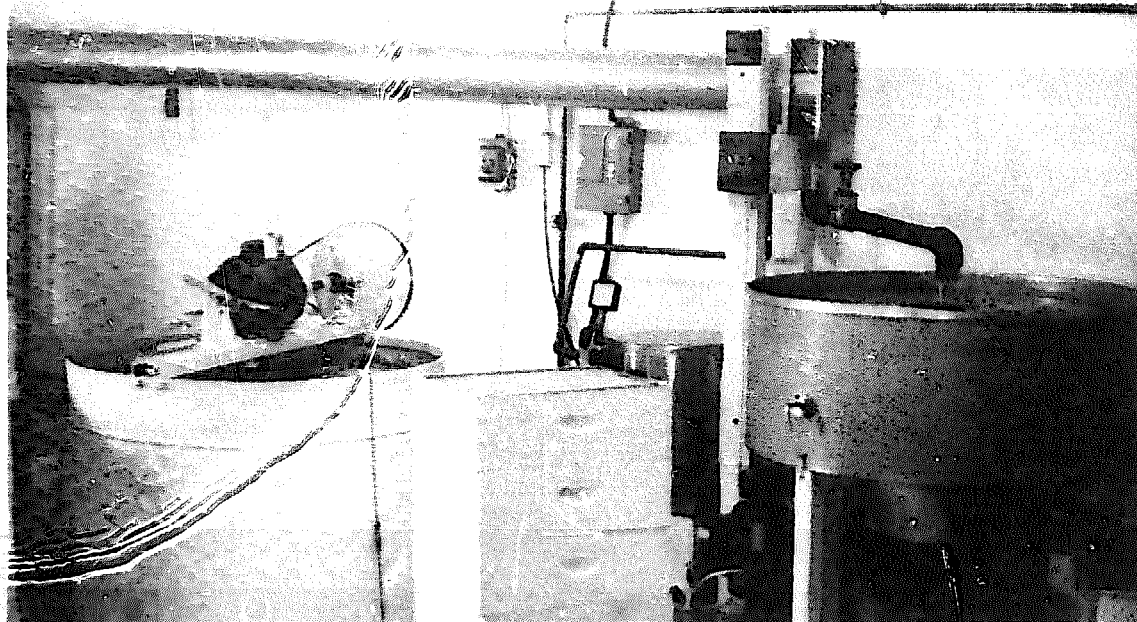

A smooth flow of honey depends on integrated machines.—Photo courtesy of Richard Blake.

heat, the furnace and water heater can be in the tank room. The welded steel tanks mounted on a strong trestle should be tall and each tank of sufficient capacity to hold one days extraction. They should be fitted with four-inch honey gates. All tanks can be connected a foot from the top to prevent spills but should also be fitted with a float alarm system to ring a bell when the tank is full.

Try to design a free flow of one way traffic for supers to move only in one direction with no intersections.

All equipment should be integrated into a smooth production line, each machine able to meet the demands of the other machines. The radial extractor while requiring a longer length of time with each batch of combs holds more combs and does away with the reversing of the combs which is necessary with the basket type extractor. Two matched radial machines work well, one being emptied and filled while the other is extracting. When only one radial is owned the uncapped combs should be racked on a merry-go-round or a portable cart. Drip pans and pails or pipe are used to catch any honey.

Honey from the extractor should be directed into a large sump passing through coarse screening and under and over one or more baffles to the

pump. The sump should be jacketed with warm water heated by a thermostatically controlled electric immersion heater.

The honey pump should be designed to handle viscous fluids. Allow the honey to flow into the pump rather than have the pump lift the honey. This keeps the pump primed. Run pump slowly to avoid incorporation of small air bubbles in honey.

The distance over which honey must be pumped should be kept as short and direct as possible. Avoid right angle bends if possible. Use large diameters of pipe to cut down resistance. For example if a one-inch pipe at 20 pounds pressure was delivering five gallons per minute; a 1¼-inch pipe at the same pressure over the same distance would deliver 10 gallons per minute. Although galvanized iron, copper, and black plastic pipe is frequently used by the honey industry I think we should adopt the clear, sanitary flexible plastic hose used by the dairy industry and the brewing industry.

#### References

- 1 Townsend, G. F. "Honey from the Hive to the Honey House," *South African Bee Journal*, Vol. 45 No 4 (July-Aug. 1973) 5-9. From paper delivered at the First All Australian Bee Congress, Queensland, October 1972.
- 2 Bland, S. E. "Extracting and Straining Honey," *Bee Lines* (Jan. 1975) No. 43 pg. 9.
- 3 *Ibid.* 10-16.

**BUILDING UP COLONIES. —**

Under the heads of Pollen, Spring Management, and Food Chamber will be found hints on building up colonies in the spring and fall, but this article will confine itself to building up colonies so that they will be ready for the honey flow.

The number of worker bees in a normal colony varies during the different seasons of the year from a few thousand up to probably 60,000 to 80,000 or even more in some cases. The number is usually lowest in established colonies in early spring at about the time the first young bees begin to emerge in any considerable numbers. From this time on if conditions are favorable for brood rearing the amount of brood is increased rapidly until the greatest capacity of the queen for egg laying has been reached. This maximum egg laying is maintained for a short time only, after which the amount of brood is greatly reduced and later in the season, as the older bees die off, the number of workers in the colony decreases to that which is normal for winter. Thus in early spring a colony is strong as to numbers if it contains as many as three to four pounds of bees, but it is not really strong two months later unless it contains ten or more pounds, the increase in numbers during the spring build-up period being usually more than five-fold in prosperous colonies. In tropical and sub-tropical countries the increase is not so great. (See Brood and Brood Rearing.)

It is fortunate for the beekeeper that the bees regulate their numbers in this way according to the needs of the season, for this makes it possible for them to store a surplus of honey during the honey flow and reduce the amount they consume at other times, provided the large population comes on at the right time for the honey flow. It is most important to have the largest number of workers come on the stage of action at the right time to take full advantage of the honey flow.

**Building Up for Early Honey Flow**

Building up for an early honey flow, especially in the North, is a relatively simple matter with colonies that have

wintered well and have a good queen. Colonies that come through the winter with two or three pounds of bees that have not been unduly aged by winter and that have a vigorous queen need only to have abundant food—honey, pollen, and water—ample room for the queens to lay eggs, protection from cold winds and low temperatures of early spring to cause them to build up to powerful colonies within two months. Weaker colonies build up slowly, sometimes requiring three or four months to reach full summer strength.

During the first half of the build-up period it is better if the bees rear brood only moderately. The cool weather of early spring—April in the North, February or March farther south—is advantageous in tending to hold back extensive brood rearing during the first month of the build-up period.

**Stimulating Brood Rearing\***

The rate of brood rearing always varies in relation to variation in the intake of nectar and to the amount of pollen available in the hive. If weather conditions inhibit flight for any length of time, or if there is a constant decline in the amount of nectar and pollen available in the field, the rate of brood rearing will always be reduced. This in turn means a reduction in the level of stimulation of the bees, and so the intensity of foraging will vary in harmony with variations in external conditions.

When a beekeeper supplies supplementary foods for his bees, he is injecting energy into the system within the colony. This removes the main limitation on brood rearing which may continue at a high level.

The provision of sugar syrups is an important part of any plan for supplementary feeding. An intake of sugar provides the primary stimulus for oviposition — the first phase of brood rearing. Pollen and pollen supplements provide the essential nutrients that enable bees to rear larvae, but in them-

\*Keith M. Doull, "Feeding Pollen Supplements", *New Zealand Beekeeper*, 38 (March 1976) 11-14.

selves do not provide any strong stimulus for oviposition. When the colony is rearing brood and the bees are consuming a pollen supplement candy, the sugar component of the candy may possibly provide a weak stimulus for oviposition, but overall this is unlikely to be significant. Moreover, bees in broodless colonies do not normally eat pollen supplement candies, and in such situations the sugar component of the supplement is unlikely to influence oviposition.

The provision of supplementary sugar syrups to stimulate oviposition should always be considered when supplements are to be used to include colonies to increase their rates of brood rearing.

It is particularly important to control the rate at which sugar syrups are taken down by the bees. It is necessary only to provide a stimulus for oviposition and not to simulate a nectar flow. If the bees receive the syrup too fast, "false information" of a nectar flow will induce them to fly and robbing may occur.

Most nectars that bees collect contain 30-40 percent sugars. Supplementary syrups should conform to this concentration, and in fact syrups with higher than 50 percent sugars do not appear to provide the same degree of stimulation for oviposition.

### Spring Supplements

The biological drive for reproduction in the colony is particularly strong in spring. Early brood rearing, however, is often carried out under difficulties, since the weather is not always suitable for flight or for flowering of plants. Most colonies appear to be able to begin brood rearing in late winter or early spring, but this is usually at a low level and there is no excessive stimulation for flight.

Supplementary feeding at this time of the year needs to be more carefully controlled than at any other period. Supplementary syrups in particular, although they are usually necessary, are most likely to result in overstimulation, with the attendant problems of stress on the colony. The use of syrups should be controlled very carefully, and in general they should

not be provided in quantity until regular flight becomes possible.

### Other Stimuli to Colony Buildup\*

Soon after the first inspection and approximately eight to nine weeks prior to the time when you can expect a surplus honey flow, all colonies are again examined, inspected and a determination made as to the status of the queen. If the queen has produced only through one season but has a very poor brood pattern she should be destroyed. If the queen has already produced through two seasons then she should be replaced as they do their best job of egg laying the first two years of their life.

During this examination it is advantageous to equalize the brood. Timing this procedure is very important. Again, eight to nine weeks prior to when the surplus honey flow is anticipated, each colony should be reduced to approximately four frames of brood.

The advantage to this type of equalization program is its flexibility of adjustment to fit certain conditions. For example: If the colony manipulation is executed a week or ten days nearer the surplus honey flow an additional comb of brood may be added.

Most colonies will develop at that time of year with more than the four frames of brood. It is here that the equalization takes place and all additional combs of brood and bees are placed in an empty hive body until another four frames of brood and bees have been collected. This new colony is then moved to another apiary, requeened with a caged queen and is equal in production to other colonies. In each of these colonies two or more frames of honey are inserted, along with some pollen, and two or three empty drawn combs for the expansion of the brood. At this time all colonies are reduced to a single story brood chamber. This enables the bees to warm the area much easier and development of the colony will be much faster. Within about three weeks the colony will be crowding the single brood chamber and the second brood chamber must then again be added.

\*Glenn L. Stanley, "Colony Management for Honey Production!" 1976.

### Harvest Hands of the Hive

After brood rearing is begun in earnest in the spring in the region of the white clover belt it usually requires about two months for colonies of normal early spring strength to build up to full working strength, the gain during the first month usually being slow but becoming rapid during the second. In localities where the main honey flow usually begins about two months after the beginning of spring brood rearing, this works out well for the beekeeper, since it furnishes a large force of young workers just when they are most needed. For example, in the northern portion of the United States where the honey flow usually begins in June, most of the workers that gather the crop must be reared during April and May, and in order that these workers shall be young and vigorous when the honey flow begins, most of them should be reared during May. Colonies which build up most rapidly just before the main honey flow usually store more surplus than those of equal numerical strength which build up more slowly, since more of their workers are young and are therefore capable of a greater amount of work.

These workers are the "harvest hands" of the hive, and if the flowers and weather do their part, the crop of honey will usually be much or little according to whether the workers to gather it are many or few. A great horde of workers coming on the stage of action at just the right time is the goal toward which the beekeeper has been working since last summer. So far as he is concerned, this great army of workers born at other times have existed. The bees reared previously have been useful only inasmuch as they have contributed to the final production of these "harvest hands", and bees reared later are useful only inasmuch as they are able to contribute to the maintenance of the colonies until next season, unless there is a later flow which they may help to gather.

Since the tendency to rear brood is the strongest in the spring, the beekeeper whose location furnishes the main honey flow immediately after the period of natural brood rearing is fortunately located, for he

then produces his workers for the honey flow at the time the bees are most willing to cooperate. If anything prevents the colony from reaching its peak in brood rearing in the spring, such as weakness, insufficient food, lack of pollen or a good queen, it may climb to its max-

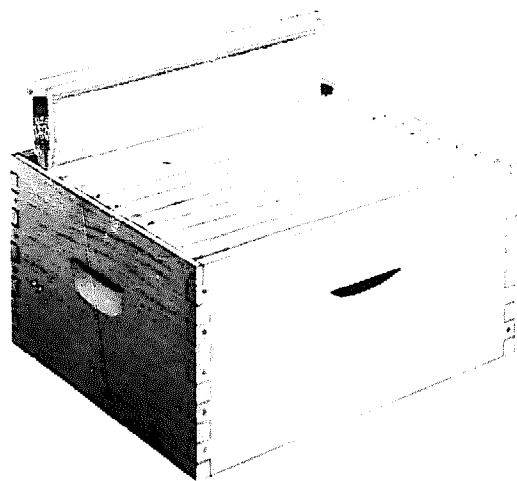

The food chamber is simply a hive body well filled with honey.

imum strength later when normally the tendency to rear brood would be less intense, but after the first spurt of extensive brood rearing of the season it is difficult to induce colonies to again rear as much brood during the same season.

When there is a succession of honey flows during the season having an interval of dearth between, the bees usually increase brood rearing in response to each honey flow. They can also be induced to rear a large amount of brood after the natural period of heavy brood rearing in the spring by stimulative feeding (see Brood and Brood Rearing, Feeding and Feeders, and Food Chamber), but during the natural build-up period of spring they will rear brood extensively even in the absence of an early flow and without stimulative feeding provided they have enough bees to take care of a large amount of brood, a good queen, plenty of honey and pollen stored within the hive, and water easily available. Brood rearing at this time is apparently stimulated chiefly by the oncoming of spring, though even in the spring more brood is usually reared if some early nectar and pollen is available.

### **Influence of Good Combs**

In order that the bees may rear the great army of workers for the honey flow there must be sufficient room in the combs for the greatest amount of brood that the colony can produce. While this might be crowded into nine or ten standard combs, it is usually spread over more. For this reason the combs should be as nearly perfect as possible, for imperfect combs in the brood frames not only reduce their capacity for brood rearing, but they also stand in the way of the rapid expansion of the brood nest in the spring. (See Combs.) If a comb which is not suitable for brood rearing is between the comb on which the queen is working and the other combs beyond, this imperfect comb stands as a barrier to progress in brood rearing. Drone comb in the lower corners of the brood frames and combs that are too badly stretched to be used for worker brood in its upper portion greatly reduce the capacity for worker brood, and when two stories of such combs are used to supply additional room for brood rearing, these imperfect combs near the top bar stand as a barrier to the free expansion of the brood nest through the two stories.

### **Influence of Abundant Food**

Most colonies that are normal in April but which fail to develop their full strength before the honey flow in June, fail because of a lack of stores. One of the hardest things for beekeepers to learn is the surprisingly large amount of food needed for the colony to rear the large force of workers required to gather the crop of honey. During the latter half of the build-up period the amount of brood is increased with astonishing rapidity, provided the bees have sufficient food and pollen to convert into young bees. When there is no opportunity to gather nectar from the fields at this time on account of cold or wet weather, the stores of honey within the hives disappear rapidly, but if the reserve supply runs low, brood rearing is reduced to a degree that is ruinous at the very time that the "harvest hands" are being reared. (See Brood and Brood Rearing.)

### **An Automatic Feeder**

During the month of May in many of the northern states, and during

April or earlier farther south, most of the bees which are destined to make the "harvest hands" are being reared. Whether the food used in rearing them is being brought in from the fields or is being supplied by the beekeeper through feeders or is stored in the hive, the amount must be sufficient if the colony is to attain full strength in time. One of the easiest ways to insure this is to give each colony a second story of combs which are about two thirds or more filled with honey. This second story becomes an automatic feeder, feeding the bees only as food is needed. In many localities such a feeder, in addition to being automatic in its action after being filled the first time, is usually filled each season without cost to the beekeeper because of the better condition of colonies. (See Food Chamber.)

Such a large supply of honey apparently stimulates brood rearing in the spring, and as the honey is consumed the queen usually enters the second story, expanding the brood nest into it during the period of greatest brood rearing when a single story may not furnish enough room for brood, pollen, and honey. This second story partly filled with honey not only acts as an automatic feeder but it also supplies room for additional brood rearing at the time this is most needed. One such super is supplied for each colony. This is tiered up among the other supers during the honey flow so it is filled with good honey, and at the close of the season, when the regular supers are taken off, this food chamber, now filled with sealed honey, is left on the hive.

In a few localities where there is an early flow from dandelion or other spring sources, shallow or half-depth supers filled with honey may be used in place of full depth.

In most localities this is not safe because of the danger of starvation of the bees just before the flow.

If a second story is not used to supply the bees with ample stores for spring brood rearing, the next best way is to save combs of sealed honey and give these to the colonies as needed during the spring. Each colony should have the equivalent of at least two full combs of honey on hand as a reserve supply at all times throughout the build-up period. If combs of honey have not been

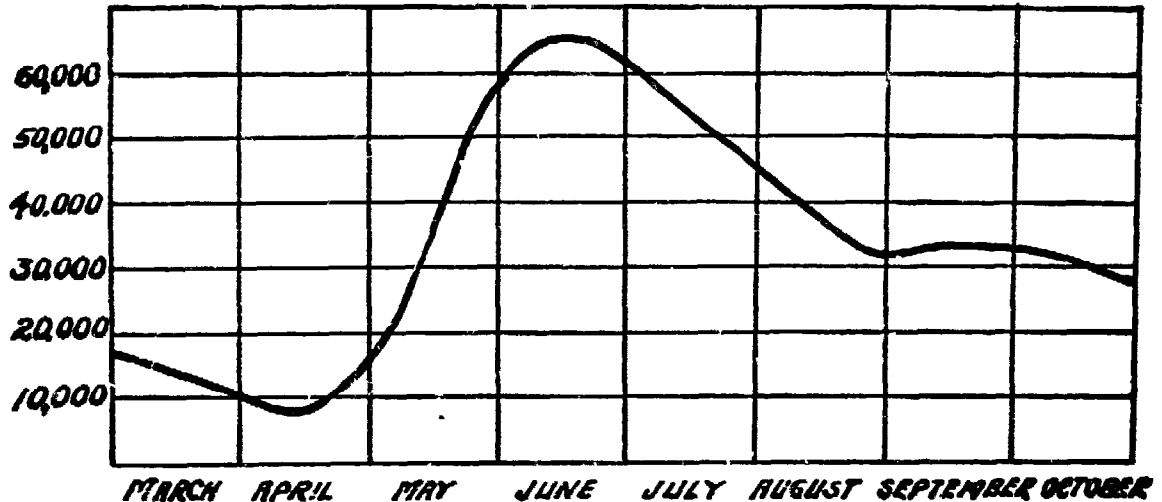

The curved line shows the variation in colony population through the breeding season. Figures at left indicate approximate number of bees. The month of greatest population varies for different localities

saved for this purpose it is necessary to feed the bees during the build-up period unless the colonies were unusually well supplied with stores the previous fall or early nectar is abundant. The syrup may be given in small amounts daily as in stimulative feeding, or 10 to 15 pounds may be given at one time if more convenient.

It is important that bees in early spring should have reserve stores of pollen. These are almost as important as combs of sealed stores. In some localities where there is no natural pollen in the hive the bees will rush out in the early spring, go to some barn searching for feeding troughs in stables and help themselves to ground feed, for brood can not be reared without something besides mere honey or syrup. (See Pollen, subhead Necessity of Pollen for Brood Rearing.) Of course, after bees get natural pollen from the fields during warm weather they usually find an abundance for all their needs.

#### Peak of Population at Right Time

Sometimes the main honey flow does not follow immediately after the period of heavy brood rearing of spring and these "harvest hands" may become consumers instead of producers, but these strong colonies can usually gather enough to live on, being better able to gain a living from minor sources of nectar than weaker colonies, except during a

complete dearth of nectar. But after the colonies have built up to great strength it is difficult to maintain their strength until a later honey flow on account of the reductions in the amount of brood.

When the main honey flow comes at the same time that the bees are rearing the great horde of "harvest hands" in the spring, as too often happens in the case of weaker colonies and in an early honey flow, a full crop of honey can not be secured, for the field force is then small and the amount of brood to feed is large. The only hope in such cases is that the honey flow will last long enough to permit the bees to gather some surplus before it closes, but the remedy is better wintering or adding a pound or more of package bees early in the spring to strengthen them.

When there is a possibility of a honey flow still earlier, at the beginning of the heavy brood rearing period of spring, as sometimes happens in the North when the maples yield profusely, or in the citrus region when the bloom comes unusually early and the bees are late in building up, brood rearing is greatly stimulated and but little honey is stored because of lack of "harvest hands".

**BULK COMB HONEY.** — See Comb Honey.

**BURR COMBS.** — See Thick-top Frames under the head of Frames.

## C

**CAGES FOR BEES.**—See Package Bees.

**CAGES FOR QUEENS.**—See Introducing.

**CALIFORNIA BEEKEEPING.** — See Tropical Beekeeping.

**CALORIES IN HONEY.** — See Honey, Calories in.

**CAMPANILLA.**—It is an important honey plant of western Cuba. The honey is white and equal to alfalfa or sweet clover.

**CANDIED HONEY.**—See Honey, Granulation of.

**CANDLES OF BEESWAX.**—See Wax Candles.

**CANDY FOR BEES.** — There is just one kind of candy that is used universally by beekeepers for queen cages. While excellent for this purpose it should not be used as winter food unless in pans, which will prevent it from running down and killing the bees if it becomes soft.

This is what is popularly called the "Good" candy, after I. R. Good of Nappanee, Indiana, who introduced it into this country. It was first made many years before by a German named Scholz. (See "Langstroth on the Honeybee," page 274, 1875 edition.) By Europeans it is therefore called the Scholz candy.

#### How to Make Candy

It is made of a first quality extracted honey or invert sugar and powdered sugar. If honey is used it should be the best quality table ex-

tracted honey from an apiary where there is no foulbrood, and if possible from a locality where there has never been any disease. The powdered sugar must be cane or beet with no starch. There are two kinds of frosting sugar: one with starch and the other without. The latter should be used. While starch in the candy is not necessarily fatal to queens, experience shows that queens can be sent only short distances on a food containing it.

The honey (or invert sugar syrup) if granulated, should be heated to a temperature of 140 degrees to liquefy and allowed to cool to about 100 degrees. The pulverized sugar should then be stirred in a little at a time with a big strong spoon or stick, adding all that is possible for the honey to absorb. When the stick or spoon can not stir in any more, some powdered sugar should be spread on a molding board and the mixture removed from the pan to the board. The dough should then be kneaded the same as ordinary bread dough, adding sugar from time to time to prevent sticking. The candy should be worked and worked by some good strong arms and hands until all the sugar has been incorporated that is possible and yet not have it too stiff nor too soft and moist. The proportion should be about two pounds of invert sugar or honey to five pounds of powdered sugar. The kneading should be kept up for at least half an hour. If the candy has been handled properly it should hold its shape and not become sticky or run out of the candy hole in a queen cage at a temperature of 80 degrees. Summer temperature will seldom exceed this, and if the candy holds its shape at this temperature it will do so when it is colder. It may then be



set away in a closed tin pan and used as a food to fill cages.\*

During very moist hot weather it may be necessary to knead in a little more sugar just before filling the cages.

During exceptionally hot summers it requires two pounds of invert sugar or honey to six of powdered sugar.

In the Bee World for 1934, page 91, Herr G. Sklenar offers some suggestions on how to make a good candy that will not become too soft nor too hard that is worth reproducing here. He writes:

When as much sugar as the honey will take up has been kneaded in to it, the lump should be put in a warm oven over night, when it will be found to have run down into the dish. More sugar must be worked in and again the lump must stay in the oven over night. The process is repeated until one has a firm but plastic mass. It is not ready yet, however, for should the weather be very hot, it may run and smother the bees. It should be kept for at least a year before use.

Herr Sklenar puts three layers of candy in his cages, three-year candy at the bottom, then two-year, and then softer year-old candy on top.

One, two, and three-year-old candy has not been tried in this country although it is worth trying.

The holes for holding the candy in queen cages should be lined with paraffin or beeswax, and the top covered with paraffined paper. The object of this is to prevent the moisture of the candy from evaporating and being absorbed into the wood. This absorption and evaporation would make the bee feed dry and hard. It should be kept slightly moist and soft and not sticky to the journey's end.

Postal regulations in the United States require of every queen breeder who sends queens by mail one of two things: a certificate of inspec-

\*I note that you make Good candy just as Mr. Henry Alley used to make it—that is, nearly the same way. It is wasting a lot of energy. I have made hundreds of pounds of Good candy, often not taking over ten minutes to make ten pounds. Instead of letting the honey cool, the sugar is stirred into the hot honey (I usually heated it to nearly 160 degrees), half would be stirred in then, still keeping the mixture fairly hot, then half the remainder of the sugar was worked in, and finally the last of it. I used this candy to feed mating nuclei. In making it for queen cages I did not heat the honey quite so hot and probably took 10 to 15 minutes to prepare two pounds or so. I succeeded in getting a queen to New Zealand, a trip that took 26 days, and the queen arrived alive.—Allen Latham.

tion from a duly authorized bee inspector certifying that no bee disease has been discovered in the yard in which the queens are reared, a copy of this to go on every package; or in the event that there is no bee inspection law and consequently no inspector, the postal authorities require a statement, duly attested before a notary, that the honey of which the candy was made has been boiled 20 minutes in a closed vessel.

Experience shows that such boiled honey does not make good queen cage candy. The character of the honey is so changed by boiling that queens are apt to die on it in a short time. The real intent of the regulation, which is to prevent the dissemination of bee disease, can be better subserved by using invert sugar in place of honey. (See Invert Sugar.)

This is a syrup having equal proportions of levulose and dextrose, and in this one respect it is very similar to honey, but, of course it lacks the minerals and some of the food elements of nature's product. However, because it has never been in contact with the bees and therefore could contain no germs of disease, and because it is chemically so nearly like honey, it can be used in place of honey in making candy. As there is so much foulbrood present over the country, it is always safer to give to bees a candy that contains no honey.

Invert sugar syrup can usually be obtained from any large candy maker.

Ordinary invert sugar syrup runs from 10½ to 11 pounds per gallon. In order to make a good queen cage candy it is necessary to boil this invert sugar until it is about the same consistency as good thick honey—a syrup running about 12 pounds or over to the gallon. Unless the excess of water is driven off, the candy is liable to get too moist, making trouble afterwards. By boiling out the excess of water one can make almost as good a candy with the invert sugar syrup as he can with honey, although for long distance work a honey candy is better than candy made from invert sugar syrup, as will be shown next.

For long distance shipments, and for valuable queens, where proper precautions are taken in securing a honey that is free from disease, it is

advisable to use a light-colored extracted honey of best quality in making queen cage candy. This honey should come from a locality where there has never been any foulbrood, in order to be really safe. A queen cage candy made with honey will hold its shape and consistency—a soft mealy condition—longer than a candy made from invert sugar. It probably contains some food elements also that are essential to long shipments. For many years the only queen cage candy known was made from honey, but as the latter might convey bee disease to a new locality, an invert sugar candy is recommended for general shipments, using honey only for long distances and for valuable queens.

#### Hard Candy for Winter

Into a dish of hot water on the stove is slowly poured granulated sugar which should be stirred constantly. The syrup should be very thick and the sugar all dissolved before boiling commences. If this precaution is not observed some of the undissolved sugar is likely to burn, injuring the flavor of the candy and almost surely causing trouble with the bees later. If one has a candy thermometer, he should watch the temperature and not let it go above 275 to 280 degrees Fahrenheit. Tests should frequently be made by dropping a very little of the syrup into cold water, about 50 to 55 degrees F. When the boiling has continued long enough the drop of candy, having been cooled in the water, should be hard and brittle when taken out, but when placed in the mouth it should soften slightly and become tough\*. When this time has arrived, the syrup should immediately be poured onto paraffined or waxed paper on a table. The table should be perfectly level and around the outside of the paper should be placed wooden sticks one fourth inch high to confine the syrup and prevent it from running off. When the candy is nearly hard it may be scorched with a heavy knife so that it can be broken up into right sized squares when hard.

The color of the candy when cold

\*Zander's test is good. Dip a small loop of wire in boiling candy and hold it up. If you can blow a bubble the candy is ready to come off the fire.—A. D. Betts, of the Bee World.

should be about that of very light amber honey. If it is darkened very much it is scorched and unfit for the bees. To prevent the scorching the fire toward the last should be reduced so that the syrup will boil slowly.

When the candy is first made it is hard and glassy and perfectly transparent, but after it stands for a little time it becomes somewhat sticky and crystalline. This is all the better so far as the bees are concerned, for they are enabled to take it more easily.

The thin cakes of candy, being only one-fourth inch thick, may be placed over the frames and under the regular cover, and in this way a colony may be saved that would otherwise be lost. The feeding of syrup, especially in the spring, is apt to cause great excitement and possibly robbing, and for this reason the candy or loaf sugar is safer as it is taken slowly. (See Sugar Feeding under Feeding.)

**Caution.** — Whoever makes the candy should clearly understand that if the mixture is scorched, even the slightest, it will make unfit food for spring or winter feeding. When the syrup is cooked nearly enough there is great danger of burning, and it is then that the greatest care should be exercised.

By adding a little white flour or rye meal to the sugar, in making the candy above described, it will greatly increase the amount of brood, especially if there is a scarcity of natural pollen in the hive, said A. I. Root in the first edition of this book. "But the labor of making," says Mr. Root, "is very much more for it must be boiled very slowly and stirred to prevent burning."

The proportion he recommended was "one-fourth part of flour to the sugar", and probably soybean flour that contains a higher amount of protein than either of the flours mentioned, would be better today. (See Pollen Substitutes under Pollen.)

**CANE SUGAR.**—This is the common name applied to the sugar sucrose. Sucrose is made from the sugar cane and also from the sugar beet. Chemically, and for all purposes of canning and cooking, they are the same. Sucrose is found in

pure honey in amounts up to 8 percent. Only in a very few cases has pure honey been found which showed the higher figures. The standards for pure honey allow 8 percent to be present. New honey generally contains more sucrose than old honey. There are present in honey before heating some enzymes (unorganized ferments) which have the power to invert the sucrose. Hence on aging, if heat has not been applied to kill this action, the percent of sucrose decreases. Sucrose on hydrolysis or inversion form equal parts of dextrose and levulose, these latter being the predominant sugars of honey. (See Sugar, Invert Sugar, and Honey.)

**CANS.**—Years ago honey in bulk form was shipped mainly in barrels and kegs, but such wooden receptacles are inclined to leak and cause trouble between shipper and consignee. When second-hand wood containers were used, a taint or unpleasant flavor would be given to the honey. For these reasons, tin cans, usually the five gallon square can, are now generally used for small shipments of wholesale or bakery honey.

Sixty pound plastic pails with snap seal lids are becoming quite popular with many honey producers who have a small operation not requiring 55 gallon drums. Some states have health laws that stipulate where food containers are reused it must be possible to visually inspect all inside surfaces for dirt, rust, etc. This is possible in the 60 pound pail since the entire top comes off. The 60 pound can cap opening is small and the upper surfaces and seams cannot be seen without a mirror and a bright light. The pails also do not rust, are easy to clean, nest in storage and make handy beeswax molds. Because the pail is tapered granulated honey will come out without being heated.

Most bulk honey is now handled in 55 gallon drums which hold about 650 pounds of honey and have a removable top sealed with a round cloth gasket. Obviously substantial hand trucks and/or hoists are needed to handle these heavy loads. If the drums are stacked one on top of the other, a specially equipped lift truck is needed.

Large quantities of bulk honey are also being handled by 20,000 gallon tank



A comfortable grip for moving heavy 5-gallon cans.

trucks and railroad tank cars. Ralph Stone of Billings, Montana stores bulk honey in a 3½ million pound honey tank and two others hold 90,000 pounds each. These tanks have special equipment on the inside to prevent the honey from granulating. The honey is transferred from one tank to the other with compressed air, pressurizing one tank to make the honey flow to the other.

#### A Handy Grip to Lift Square Cans

Any one with hands not used to hard labor will find the little wire bails in the top of a 60-pound square can filled with honey hard on the relatively soft palm of his hand. These slim wires almost cut through the skin, making the lifting painful.

A short piece of an old broom handle with a slit cut half through longitudinally on the one side can slip over the bail and make a grip that will be very comfortable.

Five-gallon square cans are used universally for syrup and liquids of all kinds because this form of container is safe and cheap. The fact that they can be obtained on short notice from suppliers located all over the United States makes them quickly available.

Honey is sometimes shipped in five and ten-pound round pails and square gallon cans in car lots. But all such containers should be boxed not more than a dozen cans to the box. These smaller packages will go through to destination in good



Sixty-pound plastic pail with snap seal top.

order and are immediately available for retail sales. As a rule, all honey put up in tin pails will granulate. It is highly necessary to put on the label instructions for liquefying. Honey is shipped in these smaller containers in small lots whenever there is a retail trade at destination that asks for them. Honey is sold in tin pails of five and ten pound, as well as gallon sizes, in Canada because the trade is educated to granulated honey.

#### New Square Cans versus Used Cans

Sometimes used square cans, especially if they have been used for the shipment of honey for a short distance, can be used over again. The danger is that, weakened by the strain of banging and slamming in the first shipment, they may leak in the second. Sometimes these used cans are rusty on the inside. While the rust itself does no great harm, it is objectionable to the trade, especially if there is rust on the outside of the can.

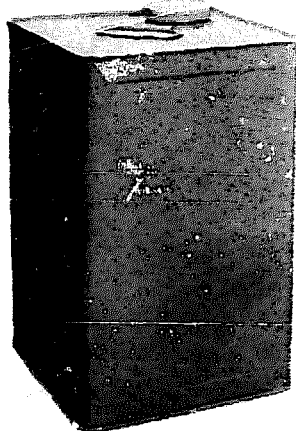

Sixty-pound square can

Honey in used cans sells at a half cent or a cent less than the same honey in new cans. The difference in cost between the used cans and the new cans is so little that the beekeeper can not afford to be penny-wise and pound-foolish in the selection of his containers.

Used containers can, however, be used in a very limited way for the storage of honey in the honey house.

#### How to Convert Used Square Cans into Open Cans

There are two or three ways for accomplishing this, but perhaps the simplest is to take a common hive tool, cold chisel, or a can opener, and cut out the top of an ordinary square can. After the top is cut out, the sharp edges should be folded down so there will be no sharp cutting edge. A wire bail can be attached to make a honey pail.

**CARNIOLANS.** — See Races of Bees.

**CARPENTER BEES.** — See *Xylocopa*.

**CATSCLAW (Acacia).**—Also called Paradise Flower, Devil's Claws, Thorny Chaparral.

Catsclaw is a common term to describe any of the various species of *Acacia* from which the bees secure nectar or pollen.

Long-flowered Catsclaw, or Paradise Flower (*Acacia Greggii*, A. Gray) is the most widespread and best nectar producer of the genus. In south central Texas it is a shrub up to four feet high, very thorny, and a prolific bloomer. It flowers from the last of March to the first of May. It is found on light or gravel soils. In west Texas the same plant becomes a tree up to four inches in diameter and 20 feet high. In the Big Bend country it is the chief honey plant as it also is in the famed Toyah Valley section of the upper Pecos River.

Tree Catsclaw (*Acacia Wrightii* Benth.) This Catsclaw occurs in the river valleys of southwest Texas. It grows to a diameter of 30 inches and a height of 40 feet. During optimum years it produces immense amounts of nectar. It comes into bloom as the long-flowered catsclaw and guajillo are going out of bloom, thus supplementing and prolonging the guajillo-catsclaw honey flow from southwest Texas.

The Mountain Catsclaw, Double-thorned Catsclaw, and Prairie Catsclaw are very similar to the long-flowered variety but are very different if examined. These species occur in quantity along with the two major species and add much to the catsclaw or guajillo-catsclaw honey flow.

The honey from catsclaw is light amber, of good flavor, and body. It is one of the chief honeys, either pure or in combination, that is produced in Texas. Catsclaw, due to its tenacious hold on life and soil, its protective armament of wicked thorns permit this plant to exist in spite of heavy pasturage or cultivation. In many places it has persisted through long periods of cultivation and now has repossessed abandoned farms.

**CAUCASIANS.** — See Races of Bees.

**CELLAR WINTERING.** — See Wintering in Cellars.

**CELLS, QUEEN.** — See Queens and Queen Rearing.

**CELLS, SIZE OF IN HONEYCOMB.**—If the average beekeeper were asked how many cells, worker and drone comb, there were to the linear inch, he would undoubtedly answer five and four, respectively. Indeed, some text books on bees carry that ratio. Approximately it is correct, but not correct enough for the bees, particularly the queen. The dimensions must be exact or there is a protest. In 1876 when A. I. Root, the original author of this book, built his first roll comb foundation mill, he had the die faces cut for five worker cells to the inch. While the bees built beautiful combs from this foundation, and the queen laid in the cells, yet, if given a chance they appeared to prefer their own natural comb not built from comb foundation. Suspecting the reason, Mr. Root then began meas-

uring up many pieces of natural comb when he discovered that the initial cells, five to the inch, from his first machine were slightly too small. The result of his measurements of natural comb showed slightly over 19 worker cells to four inches linear measure, or 4.83 cells to one inch.

In later years, H. H. Root, about to begin work on a new foundation mill, confirmed the measurements of his father, namely,  $19\frac{1}{2}$  cells to four inches linear measure (4.83 cells to one inch), taken across the vertical cell walls. Measurements taken in the two diagonal directions downward between parallel walls were slightly more, if anything. This would make from 825 to 850 cells to the square decimeter, including both sides of the comb. The drone size would be 496. The reader is requested to remember these figures for that which is to follow further on.

When A. I. Root made a comb foundation with the same dimensions as the bees make—4.83 instead of 5 cells to the inch—he found that the bees and queen accepted the new foundation, and this has been the judgment of the bees and beekeepers for the last 65 years. To put the matter another way, 5 cells to the inch, 20 cells to the four inches is too small, while  $19\frac{1}{2}$  cells to four horizontal inches is just right. This has been the standard, apparently, for the best makers of brood foundation in the United States for the last 70 years.

#### Will Larger Cells Develop a Larger Bee?

Taking 825 to 850\* cells to the square decimeter as standard, in-

\*In the Bee World for 1937, page 43, Schwammerdam puts the size of natural worker comb as 870 per square decimeter; Maraldi, 789 and 954; Reaumur, 832; Klugel, 832; Castellon, 763, 828. Two hundred years ago when there was no foundation, the size of natural worker comb was 830 cells to the square decimeter, according to A. D. Betts. The author's figures of 825 to 350 are not far wrong.

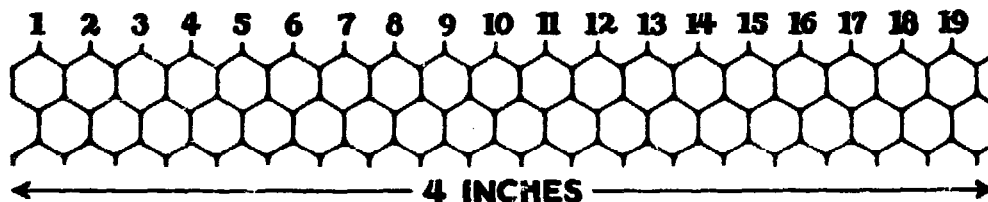

In most worker comb there are  $19\frac{1}{2}$  cells in four inches

cluding both sides, Ursmar Baudoux, a Belgian, in 1893 conceived the idea that cells larger than 850 to the square decimeter would or could develop correspondingly larger bees with a longer tongue reach — and why not? He began testing foundations by stretching from 750, 740, 730 to as low as 700 cells to the square decimeter. By 1896 he apparently proved his theory so that a comb foundation manufacturer built a mill with enlarged cell bases. The result of the tests by Baudoux seemed to show not only larger bees, but a longer tongue reach and larger wings. He also believed that the larger bee would develop more body heat.

In the Bee World for 1934, page 3, January issue, Baudoux gives an elaborate set of figures of cell sizes with the corresponding sizes of the workers along with other sizes of the wings and length of tongue in decimeters. We are reproducing below the table which speaks for itself.

It will be noted that the tongue length bears a constant ratio to the size of the cells. The question has been very properly raised whether the tongue reach bears the same ratio. (See Tongue Measurements of the Honeybee.)

Apparently without the knowledge of what Baudoux was doing, a Frenchman, Mr. Pinchot, was testing out a larger cell foundation of 736 cells to the square decimeter. His results showed likewise a larger bee. He claimed that these bees gathered one third more honey.

In the same way a Russian worker claimed a larger bee from larger cells and he believed these bees would procure larger crops of honey.

Again, H. Gontarski, in the Bee World for 1935, page 81, finds that

the greatest percentage of increase in size of workers occurs when the cells are 5.74 mm. in diameter, which is equivalent to 700 cells per square decimeter. "He points out," says the Bee World, "that the variation in size of individual bees in a colony is partly due to phaenotypic variation due to the cell size and partly to differences called forth by the quality and quantity of food; differences, in fact, that are similar to but less than those which cause a worker larva to become a queen when suitably fed and nursed." He believed further "that the influence of the cell is mainly exerted indirectly by providing more room for food; but does not deny a possible direct influence as well, due to more room for growth".

The evidence thus far presented seems to indicate that a larger cell is only one factor for furnishing larger bees. Some late work, however, seems to show that even if larger cells furnish larger bees, there are other factors necessary to bring about any increase in the size of bees.

**Work Done Under Dr. Park of Iowa State College.**

Under the direction of Dr. O. W. Park of Iowa State College, the problem was attacked in 1930 by Roy A. Grout, then Research Assistant in Apiculture at that institution. Results of this work are reported in Research Bulletin No. 218 of Iowa Agricultural Experimental Station. The following excerpts explain:

The data presented show conclusively that size of brood cell is a factor in determining the size of the adult worker bee and that significantly larger bees are obtained through the use of artificial foundation having enlarged cell bases.

Dimensions of workers and of their cells

Cells per sq. dm.	Span	Wing root width	Wing length		Thorax	Tongue	Body length	Cell width	Comb thickness	Cells volume	Sac capacity	Wing width			Wing weight at
			Fore	Hind								Fore	Hind	Weight	
650	24.000	3.000	10.500	7.500	4.48	8.00	16.00	5.960	23.40	360	47.10	3.20	2.40	145	
700	23.100	2.887	10.106	7.218	4.312	7.70	15.40	5.750	23.00	328	41.95	3.08	2.31	138	
750	22.242	2.780	9.771	6.950	4.152	7.41	14.82	5.555	22.60	301	37.40	2.96	2.22	134	
800	21.428	2.673	9.375	6.696	4.00	7.14	14.28	5.375	22.20	277	33.40	2.85	2.14	129	
850	20.657	2.582	9.037	6.455	3.856	6.88	13.77	5.210	21.80	256	29.90	2.75	2.06	124	
900	19.928	2.491	8.718	6.227	3.720	6.64	13.28	5.060	21.40	237	26.85	2.65	1.99	119	
950	19.242	2.405	8.418	6.013	3.592	6.41	12.82	4.925	21.00	222	24.20	2.56	1.92	115	
1000	18.600	2.325	8.137	5.812	3.472	6.20	12.40	4.805	20.60	206	21.90	2.46	1.86	111	
1050	18.000	2.250	7.875	5.625	3.360	6.00	12.00	4.700	20.20	192	19.90	2.40	1.80	108	

All dimensions are in millimeters and weight in milligrams.—From Bee World.

We cannot agree with Baudoux either in the magnitude of the results he obtained or the consistency of them. While Baudoux records an increase of from 11.9 percent to 25 percent in tongue reach as the size of brood cells increase from 850 cells per square decimeter to 700 cells per square decimeter, we are able to record increases of only 2.07 percent, 1.51 percent, and 1.40 percent in length of proboscis for colonies 25, 21, and 18 respectively.

Our data from colony 25 substantiates those of Michailov which shows that an increase in the size of brood cells is accompanied by a corresponding increase in the weight, length of right forewing, width of right forewing, sum of widths of third and fourth tergites and length of proboscis. Colonies 18 and 21 yielded somewhat conflicting results.

Whether the increases in the measurements of the worker bees recorded in these data are significantly related to honey production has not yet been proved.

It is apparent, however, that the size of brood cells alone is not sufficient to produce a much larger worker bee. It is reasonable to state that selection and breeding of bees plus the application of extrinsic factors such as size of brood cells should accomplish measured results in that direction and that, with selection and breeding for a larger bee, a larger brood cell may be a necessary factor.

It is of interest to mention that difficulties were encountered in getting the queens to oviposit worker eggs in the enlarged cells when all three sizes were in the same hive at the same time. This was particularly true in the case of Cell C.\* While the worker bees apparently recognized no difference in constructing the three sides of cells, the queen bees showed a preference for the normal-sized cells.

#### Queens and Bees Prefer Normal Size of Cells.

I. Root, in the early seventies, and later M. T. Pritchard and H. H. Root, tried out various sized cells in honeycomb. Clearly it was shown that when the worker cells are too small—five to the linear inch—bees and the queen, when given a choice, preferred the larger cells—4.83 to the linear inch. Conversely, when the cells are too large there are difficulties that counter-balance the good.

The bees, and particularly the queen, if given their choice will select the normal-sized cells, or 825 to

\*700 cells per square decimeter.

850 cells to the square decimeter. It is well to note, too, that it is by no means proved that larger bees will produce a correspondingly larger amount of honey. We must not be misled by enthusiasts not trained in scientific research work. Too much may be taken for granted. As Caesar of old said, "Most people are inclined to believe what they want to believe." Again, when cells are larger than normal and the conditions are right—that is, when the queen has the urge to lay drone eggs in the absence of an adequate supply of full-sized drone cells—the queen may and often does lay drone eggs in cells intermediate in size between normal worker and normal drone cells. Here is an economic waste.

Finally, abnormally large worker bees, according to Cheshire, would be out of tune or harmony with most of the plant life. Each flower that depends on insects has its own insect pollinator. Many and most honey-bearing flora are just right for normal honey bees. On the other hand, bumblebees, the right size for red clover, are too big and clumsy for the ordinary clovers. They are slow of flight, too big to get into most blossoms, and what is more, cannot match normal honey bees in honey-gathering qualities. On this point Cheshire has this to say in Volume 2 of "Bees and Beekeeping," pages 317 and 318:

The economics of the question must not be overlooked. In gathering from clover it has been shown that about 1/350th grain is secured at each visit. Let us imagine that our bee is enlarged twice, by which its weight has grown eight-fold. As it flies, carrying its large body from clover bloom to clover bloom, an amount of wear and tear is involved which is eight times as great as that accompanying similar movements in the normal bee. This wear and tear is replaced by food—of course, proportionately augmented, which has to be deducted from the 1/350th grain secured. The net increase to the stock is therefore less at each visit, in the case of the large bee, than in the case of the normal one. The former, however, has the advantage of being able to decrease its return visits to the hive to unload because its honey sac is larger, but this is the only gain, and it is more than counter-balanced by the fact that with normal bees eight independent gatherers would be at work simultaneously for only the same wear and

tear that would permit of the efforts of one if the bulk were increased as supposed. Selection has gone on for ages regulating the proportions of the wondrous insect between these extremes in which the loss by excessively frequent returns to the colony and the loss through excessive bodily weight balance each other, and has thus given us a bee whose size yields the best possible results.

The botanical reason for desiring no alteration was expounded in Vol. 1. Flowers and bees have been constantly interacting. The build of every floret is adapted to that of its fertilizer, and, could we suddenly increase the dimensions of our hive bees, we should throw them out of harmony with the floral world around them, decrease their utility by reducing the number of plants they could fertilize, and diminish equally their value as honey gatherers. Mechanics, physiology, economics, and botany alike show any craving after mere size to be an ill-considered and unscientific fancy for which it would be even difficult to find an excuse.

Literature cited. See *Bee World* for 1933, page 125.

*Bee World* for 1935, page 81, 138; for 1933, page 17, 37, 40; for 1934, page 2.

*American Bee Journal* for 1936, page 178.

Research Bulletin No. 128 by Roy A. Grout, Iowa State College.

Cheshire, Volume 2, page 317 and 318. Cheshire, Volume 1, page 176.

## CENSUS REPORTS ON BEES AND HONEY.—See Statistics.

**CHALKBROOD.**—Chalkbrood is a fungus disease that affects the brood. It is caused by an organism called *Ascosphaera apis*. The disease is usually not considered serious although it can be very damaging under certain circumstances especially in the spring or during wet summers. Weak colonies, poor foraging conditions, and wet weather seem to be favorable conditions for chalkbrood. It has also been suggested that the spread of chalkbrood has been caused by the use of antibiotics which upsets the balance of the intestinal flora of bees and thus allows the fungus to grow. There is a sound precedent for this thinking as this type of situation has been well documented in the use of certain antibiotics in the treatment of human diseases.

Chalkbrood has been prevalent in Europe for many years. It was first reported in the United States by Baker and Torchio in 1968. Later reports then began to filter in revealing its presence in many of the states, and Canada. At the present time the beekeeping industry is expressing considerable anxiety over the role that chalkbrood is playing in their operations. A significant amount of research for the control of this disease has been initiated by both the United States Department of Agriculture and a number of the states.

Chalkbrood infectivity seems low, but the spores are quite resistant and have been reported to be able to infect bees after 15 years.

Honeybee larvae are most susceptible to chalkbrood if they ingest the spores at three to four days of age and are chilled two days later when they have been sealed in their cells. Because the chilled brood are the ones most affected it shows up more in the peripheral brood. After ingestion the spores germinate in the hind end of the larval gut and the mycelium of the fungus begins to grow, eventually breaking out of the hind end of the body of the larva. At first the dead larvae are covered with the fluffy white growth of this mycelia and are swollen to the size of the cell. Later the dead larvae will dry into a hard, shrunken, chalk-like mummy, usually white in color, hence the name chalkbrood. However, sometimes fruiting bodies containing spores are formed by the fungus. In this case the mummies will be dark gray or black. Many of the cells in heavily infected colonies will remain sealed and so the mummies will rattle if the comb is shaken. Most of the larvae will die in the upright stage.

The spread of chalkbrood has been attributed to contaminated equipment, contaminated honey or soil, carrier bees such as drifting bees and the beekeeper himself. This should be a fruitful area of research.

## Treatment and Control of Chalkbrood

In many instances chalkbrood has not been considered serious enough to justify formal treatment. The adult bees usually remove the dead brood and the disease disappears without any



effort on the part of the beekeeper. Destruction of contaminated combs has been recommended in severe cases. Fumigation of combs, after removing the mummies has also been recommended. Requeening has also been suggested whenever the stock has shown signs of being unusually susceptible. Some preventive measures have been suggested as effective such as adequate ventilation to prevent moisture accumulation. This can be accomplished by giving the hives top openings, enlarged entrances and avoiding long grass. Badly affected colonies can be strengthened by adding young adult bees or brood and by feeding extra sugar syrup.

A number of chemicals have been tested for their effect upon chalkbrood. The following gave promising results: 2% thymol solution sprayed on contaminated combs; 4% "Fesia-Form" (formaldehyde base) sprayed on brood combs, hive bodies and bottom boards; and sorbic acid and sodium propionate fed to colonies in pollen-sugar patties. This last method, developed by Taber, appears particularly promising. Seven days after treatment was started with heavily infected colonies the disease had disappeared. Unfortunately at the present time no chemotherapeutic agent has been registered for the treatment or control of chalkbrood in the United States.

**CHUNK HONEY.**—See Bulk Comb Honey, under head of Comb Honey.

**CLARIFYING HONEY.**—See Honey, Filtration of.

**CLIPPING.**—See Queens.

**CLOVER** (Family Leguminosae).—In this discussion under the title clover, only the species of the genus *Trifolium* will be considered. Included are: red clover (*Trifolium pratense*), white clover (*Trifolium repens*), alsike clover (*Trifolium hybridum*), crimson clover (*Trifolium incarnatum*) plus several other species that are not considered major sources of nectar due to their relative scarcity or for other reasons.

The clovers must be considered one of, if not the major source of fine

table grade honey in the world. The clover region is concentrated in the temperate climate in zones of latitude where the average mid-season temperatures favor nectar secretion. The optimum normal temperature for nectar secretion from the clovers is about 70° F. or less.

The clovers contribute mightily to commercial beekeeping. Large areas of the upper mid-western United States formerly supported vast stands of sweet clover but with the advent of mechanized farming and an increasing need of land to place under cultivation the sweet clover was replaced by the cereal grains, soybeans and alfalfa. Sweet



Bees gathering nectar from white clover

clover remains an important honey source where it continues to flourish as an adventitious plant. Weed controls with chemicals have made deep inroads on such former preserves as railroad right-of-ways, roadsides and uncultivated agricultural land. A Department

of Agriculture census reveals that the clovers are remaining fairly stable in acreage as a hay forage crop. Extensive use of red clover in soil maintenance promises some forage for bees if a second bloom period is allowed to mature in late summer. Large acreages of clover particularly alsike grown for hay and white clover, grown in permanent pasture have been replaced by alfalfa. Alfalfa is a harvestable legume suitable for field chopping as silage, drying, or for pasture. Alfalfa has the advantage over the true clovers of having potentially more nutrients per acre due to higher yield obtained from three or even as many as four cuttings per season. The biennial clovers remain important as soil improvement crops as they can easily be seeded with a companion grain crop, the grain harvested and the clover seedlings left to mature the following year. Disease control in the clovers is not usually a major problem although over-grazing can ruin a young stand. Neglect of a stand of clover seedlings by not providing soil conditions up to nutritional and alkalinity standards will soon doom a promising stand of clover to failure before a full stand or full growth is reached. Drought has the same effect

as the smaller clovers do not have the deep root systems of alfalfa or sweet clover.

The various red clovers, including the biennial medium red and mammoth and the annual hubam, have specific planting and growth requirements as well as certain general characteristics that may make one more suitable than the other when planted for either hay, pasturing or for plowing down as green manure. Local conditions of soil and climate will certainly affect the choice. The beekeeper is at the mercy of this selection as a stand of medium red clover destined to be plowed down is not usually allowed to mature through the full bloom stage. Pasturing reduces the nectar potential as does cutting at the early bloom stage for hay or silage.

White clover exhibits a versatility which makes it particularly suited to permanent pastures. If soil and growing conditions are such that white clover seed will germinate and competition from the grasses and weeds does not kill the seedlings, white clover will rapidly become established. No better bee pasture is available anywhere than fields lush with a heavy stand of white clover. Pasture rejuvenation by fertilization, liming and weed control is



An excellent field of white clover.

sometimes sufficient to establish a fine stand of white clover without having to sow seed. The seeds of white clover have an unusually long life span when preserved in the soil.

The clovers are superior soil-building crops, especially for replenishing nitrogen. Free atmospheric nitrogen is not available to plants but the legumes, including the clovers, are able to reduce free gaseous nitrogen obtained from the soil air by a process known as nitrogen fixation. No other green plants can do this. Specialized bacteria that live in swellings called nodules or tubercles on the roots of the legumes are responsible for the conversion. Under normal conditions ammonia is formed during the process of nitrogen fixation and used by the plant. Both the legume and the bacteria benefit from the relationship which is called mutualism or mutualistic symbiosis. In addition to direct benefit to the soil by growing legumes other associated and succeeding crops benefit. Grasses grown with legumes produced better forage. Often the crops following the clover benefit for several years.

#### The Clover Region

In general, the northeastern states, the Great Lakes states and the upper Mid-west are considered the primary clover regions. Roughly, the areas cov-

ered by the last glacial ice sheets favor clover. The best clover sites are those soils which have been formerly covered by glacial lakes and those soils which have been formed from glacial action upon limestone or rock containing limestone. The deposition of sedimentary material on the bottoms of early inland seas formed sedimentary rock such as limestone. The settling of marine residue to the bottom and the chemical precipitation in the warm inland seas formed deposits containing a high percent of calcium carbonate. These deposits hardened into limestone. Later land upheavals, glacial planing and grinding action created soils which contained enough of the calcium carbonate or pulverized limestone rock to raise the alkalinity of the soil to where its level favors the clovers. Other regions which grow clovers include agricultural Canada where climate, rainfall and long days of high solar intensity favor heavy nectar secretion from vigorous stands of clover.

Variations in the frequency of the occurrence of the clovers is common within the general borders of the clover region which is from New England to Minnesota in the west and from the agricultural belts of the Canadian provinces in the north to a southern bound-

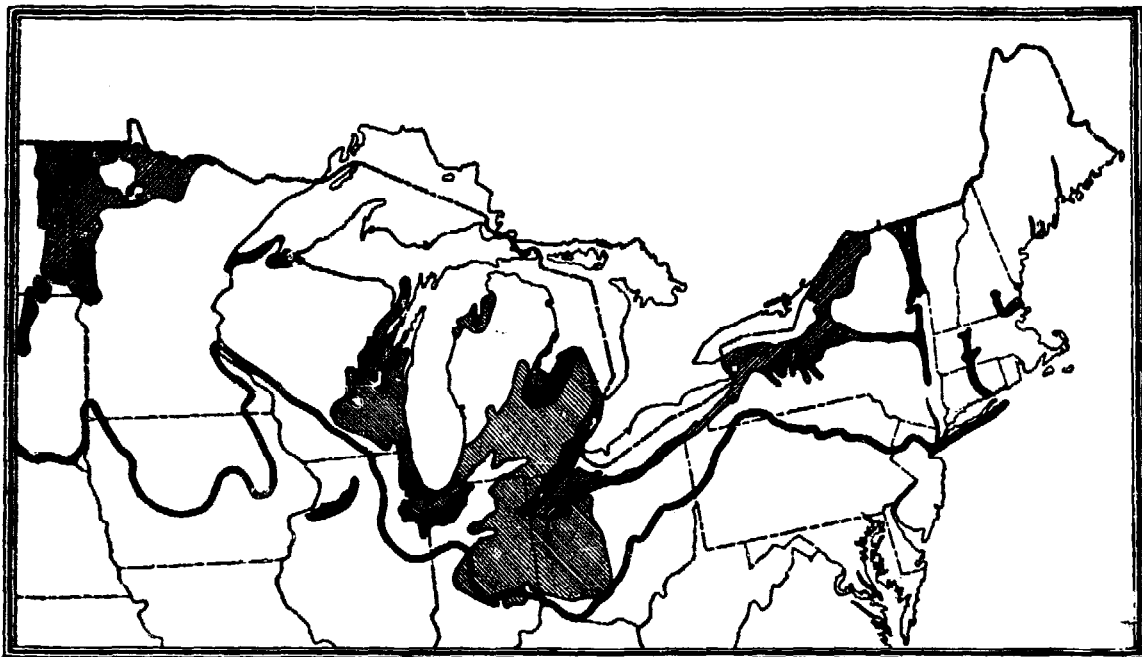

Map of clover region showing boundary of area covered by last glacier. The limestone-derived soils north of the dark line favor the growth of the clovers.—From USDA Farmers Bulletin #1215.

ary near the Ohio River. Poorly-drained soils and those derived from the weathering of shale and sandstone seldom receive adequate treatment to render them suitable for growing clover. Clovers adaptable to conditions which are considered marginal for growing legumes are alsike clover, the closely related bird's-foot trefoil, sweet clover and to a limited extent the red clovers. Topography limits the use of clovers to grazing in some of the eastern states.

The advantages and disadvantages of the various clovers varies, depending upon whether viewed from the standpoint of the grower or the beekeeper. Perhaps more has been written about the clovers than any other honey plant but they still remain an enigma for the beekeeper who counts upon a steady yearly honey flow from this source for his principal honey crop.

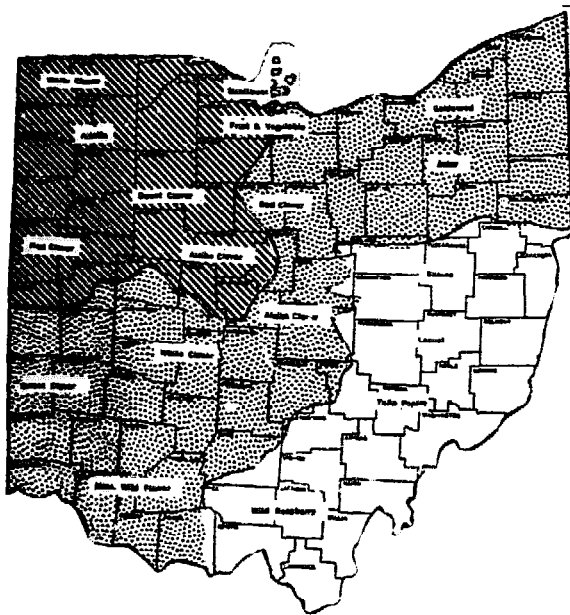

The relationship between conditions favorable for growing clover, topography and soils is illustrated by the map of Ohio. The glaciated northwest two-thirds of the state is favorable for clover. The unglaciated southeastern portion is unfavorable.

### Alsike Clover

Alsike clover (*Trifolium hybridum*) is a perennial but is usually treated in the crop rotation as a biennial. Seeding is in the early spring, usually with a companion grain crop and very often in a mixed seeding with timothy or one of the other grasses. Alsike clover will grow in wet heavy soils, is tolerant of lower soil acidity than is red clover but liming to raise soil pH produces better stands. Alsike clover does not do well under hot dry conditions.

Alsike growth the first seeding year gives a dense stand of four-to six-inch seedlings when four or five pounds of seed per acre is used with a mixed seeding of timothy and red clover. After one cutting is taken the second year the alsike plants die out. Some of the best nectar flows from the clovers came from alsike due to the late cutting for hay after reaching the middle or late bloom stage. The honey is one of the very best, preferred by people accustomed to mild, light honeys. The nectar flow is intense, a strong colony often filling a deep super in a matter of days.

Changing ideas in forage crop preferences has bypassed alsike clover in favor of other clovers, including alfalfa, which is claimed to give higher nutrient yield per acre. In its northern range where land and climate conditions make alsike the most likely to succeed of the clovers, hay and seed production means bountiful harvests for the beekeeper. Growth habits of alsike differ from red clover in that the blossoms are not borne at the tips of stems but rather on flower-bearing branches that grow out of the leaf axil. The youngest flowers are at the top of the plant, the older ones lower down. The florets are easily accessible to honeybees who can siphon out the nectar without difficulty.

McGregor (1976) lists a number of references stating that honeybees do from 85 to 95% of the pollination of alsike clover when seed is harvested. Each floret of the flower head will produce two or three seeds, some heads containing up to 100 or more seeds. The individual florets of the flower head are incompatible so they must be cross pollinated by insects carrying pollen from a flower head on another



**Alsike clover**

plant. Most of the alsike seed is produced in Canada.

#### **Crimson Clover**

Crimson clover (*Trifolium incarnatum*) is widely grown as a winter annual in the South. Under favorable moisture conditions crimson clover seedlings make rapid growth which continues through the winter, the amount depending upon the temperature. Seedlings grow at lower temperatures than most other legumes but will winter kill when grown in the North. Flower stems develop in the spring from the crown formed the previous fall. The bright,

crimson florets form a long pointed flower head. Seed set is heavy with nearly all the pollination being done by honeybees according to McGregor (1976).

Crimson clover is a very important winter annual legume in the southern United States. It is used for winter and spring grazing. When reseeding varieties are permitted to reseed naturally a new stand begins anew each fall. At maturity the parent plant dies. The seed shatters readily.

Crimson clover is rated high as a honey plant in the South, producing an



**Crimson clover**

excellent grade of honey. Each flower head has from 65 to 125 florets per head which are easily tripped by honeybees. Pollen is gathered from this clover in large quantities.

#### Hop Clover

Hop clover (*Trifolium agarium*) is an annual or biennial with bright yellow blossoms. Low growing, it rarely grows above six to eight inches. Hop clover occurs in some pastures and on waste land as a volunteer. It is sometimes included in seed mixtures when planting roadsides for ground cover. Honeybees are sometimes seen on hop clover when stands are sufficiently concentrated to be an attraction to foraging honeybees.

#### Red Clover

Of the red clovers (*Trifolium pratense*) medium red is perhaps the most widely grown of the true red clovers being used primarily for hay and as a green manure crop which, when plowed under, enriches the soil. Red clover and grass mixtures are adaptable to a variety of soil and growing conditions. Red clover sown with alfalfa and timothy, brome grass or orchard grass may be seeded with winter wheat in fields where alfalfa alone may not do well

because of poor drainage or soil acidity. Sown with one of the grasses at the rate of eight pounds of red clover with four to six pounds of grass seed the red clover-grass mixed seeding will give a stand of grass with little or no clover after the first harvest. For the beekeeper pure stands of red clover left for seed harvest after the first cutting of hay usually proves to be the best opportunity for a late summer honey harvest and pollen source.

Medium red clover, though a perennial acts like a biennial under the usual farm conditions, dying out after the last cutting of the second year. The clover root borer and root rot kill many plants after mid-season or the hay harvest year. Winter kill takes a toll of the remaining plants during the second winter. Red clover plants attain their maximum height of 18 to 34 inches the second year of growth and the flower heads appear during late May or early June in the latitude of the Great Lakes States. Each flower head is made up of numerous pale crimson florets which open over a six to eight day period and remain accessible to pollinators for two to four days during which cross pollination must

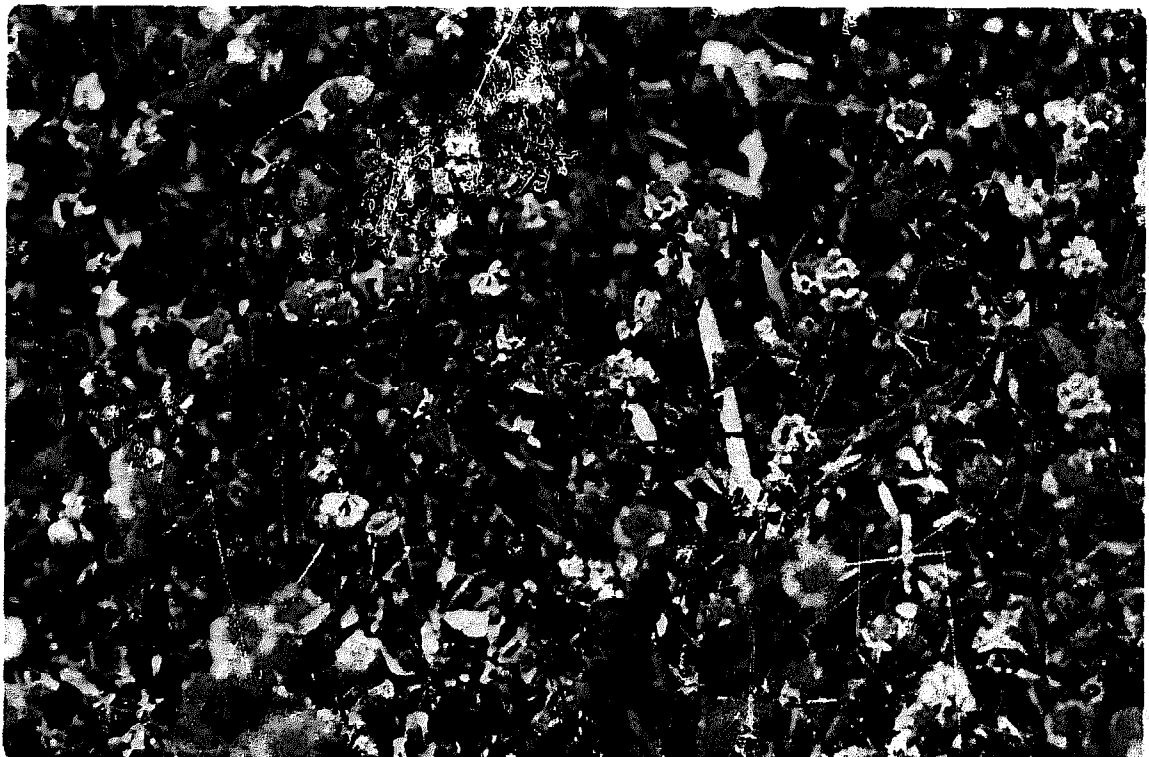

Hop clover.



Peavine, or mammoth red clover, enlarged—Photo by Lovell.



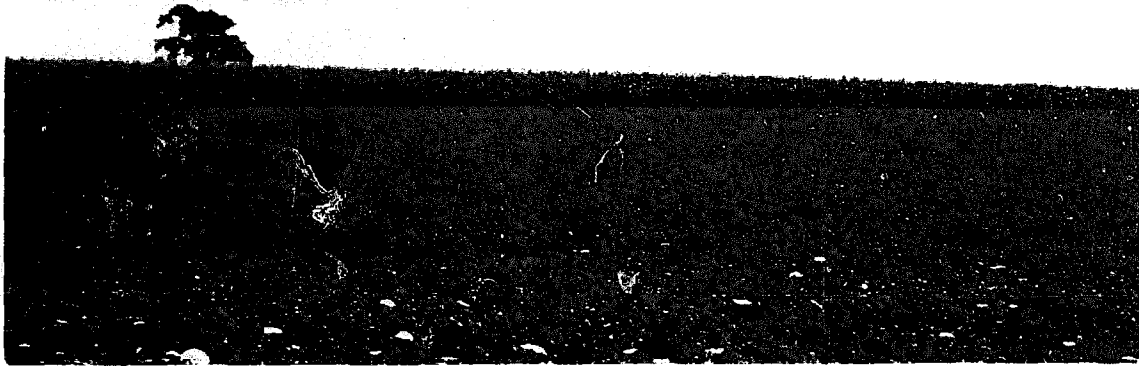

**Red clover field blooming after the first cutting for hay. This is the best bloom period for bees.**

take place if there is to be a set of seed. In the absence of bumblebees, which appear to be the natural pollination agent of red clover, honeybees achieve remarkably good pollination results, though the medium tongue length of the honeybee (approximately six mm.) is a handicap in reaching the comparatively deep nectar pockets at the bottoms of the florets. It is generally accepted as fact that the nectar is more accessible to honeybees during the second bloom period, apparently due to a shorter corolla tube. Nectar is secreted at the base of the corolla tube. When conditions exist that stimulate nectar secretion in red clover the nectar level will rise in the base of the corolla allowing the honeybee to gather the nectar. One of the effects of moisture-short conditions is an abnormally shallow corolla tube and this too allows honeybees to tap the nectar reservoir. The honeybee is an excellent pollinator of red clover as the staminate column with its 10 stamens and the pistil extend out nearly to the opening of the corolla tube allowing easy accessibility to the pollen gathering bee. Field bees can be observed returning to the hive with a liberal dusting of light-colored pollen

over the head and the thorax when they are working in the red clover. As pollination proceeds, the heads of the clover turn brown. The production of red clover seed is directly proportional to pollinator activity according to McGregor (1976). One researcher, showed that only 63 pounds of seed per acre was harvested when local bees were depended upon for pollination while 306 pounds per acre were obtained by using two colonies of honeybees per acre. Strong colonies of bees do a much better job of pollination than colonies with fewer bees. In large acreages of red clover there is a more uniform seed set when pollinating hives of bees are spaced evenly throughout the field rather than bunched at a single location at the perimeter of the field.

Red clover grows in soils with pH values below those necessary for satisfactory growth of alfalfa and sweet clover. It is easier to establish, particularly when spring seeded in winter wheat or other grain. Red clover does well when established with timothy, brome grass or orchard grass as a seeding mixture. The usual proportions when using the clover-grass seeding mixture is eight pounds of red clover and

from four to six pounds of grass seed per acre. Inoculate the red clover seed before sowing if this hasn't already been done by the seed processor. Red clover requires an inoculator specifically grown for this species of clover as the bacteria introduced in the culture medium used for inoculating red clover is somewhat different than the nodular bacteria growing on the roots of the other clovers. The best stands of red clover result from spring seedings made without small grain companion crops. The competition from the growing grain is often too much for the seedling clover. Good soil preparation and weed control using tillage implements and herbicides along with liming and fertilizing will give much better stands of the legumes when seeding without a

clover differs from medium red in that it is later maturing and will usually stand only one cutting per season.

Honey from red clover is usually light to medium amber but with an excellent flavor. The rapidity of granulation as well as the other characteristics of pure red clover honey is difficult to determine as it is usually mixed with other late summer or fall honeys. In northern regions where strong, steady nectar flows from red clover are obtained a better idea of the quality of pure red clover honey may be determined by talking to the beekeepers. Even so, the quality and color may vary by region, as conditions under which the clover grows can have a profound effect on these characteristics.

### White Clover

White clover (*Trifolium repens*) is a native of Europe which was introduced to America. It spread rapidly on introduction as evidently it found conditions in the northern agricultural United States and Canada quite to its liking. White clover is a low growing perennial with stems that lie close to the ground. It spreads by growth of the prostrate stems which root at the nodes, rapidly filling in the available space once it becomes established. If soil and climate conditions are such that they favor growth of white clover it seems to appear from nowhere. If conditions are not favorable, that is, if the soil is acidic or other plants are too competitive no amount of seeding will be successful. White clover seeds are hard coated and remain viable in the soil for long periods of time. Liming the soil to elevate the pH to 5.5 or higher, close grazing or clipping to prevent competition and sufficient rainfall favor the establishment of a good stand of clover if the other conditions are present. It may be necessary to make inquiries among farmers in the areas in which bees are kept to determine whether white clover is adaptable to the region. Close grazing, which is common when sheep are pastured or close clipping such as occurs when it grows in lawns, encourages a good stand of white clover. High temperatures combined with extremely dry weather are unfavorable to the growth of white clover, it being shallow



Bumblebee on red clover.

competing grain crop. A mixed stand of red clover and grass will give protection to the seedling legumes without undue competition. Red clover is better adapted to seeding into winter wheat as it is not bothered as much by the competition. Sow the seed by broadcasting as early in the spring as possible, preferably while the ground is "honeycombed". Thawing on the soil surface covers the seed. Many new seedlings are damaged during the first summer by shading and by competition with other plants for moisture and nutrients. It may be necessary to remove companion grain crops before they mature but usually the grain is harvested at maturity. The remaining grain stubble may have to be clipped and removed if it is so heavy that it threatens to smother the clover seedlings. The stubble may be clipped fairly close without harming the clover seedlings. Mammoth red



White clover.

rooted and this presumably could bring an end to a promising nectar flow although there is a tendency to taper off as the summer progresses along with the arrival of the seasonal hot dry weather. Long periods of nectar flow from white clover are not uncommon if a succession of flowering heads, which have an average of 100 florets each, continue to form through the summer months. White clover is often one of, if not the major honey source, where it grows abundantly. The individual florets of the flower head contain nectar which is easily reached by foraging honeybees. Nectar yield is quite variable due to soil, temperature and moisture conditions which effect the abundance of the plants as well as the nectar secretion.

White clover honey is considered one of the best table grade honeys and the flavor, though mild, is probably acceptable to most people who have no specific preferences for one particular flavor. It is indeed possible that white clover is as close as any to being a honey universally preferred by the average consumer. It is excellent for blend-

ing. White clover also provides pollen for the honeybee. White (1962) rated the color of white clover honey and of the white clover blends on the dark half of white, the granulating tendency as low, generally showing only a thin layer of crystals on the bottom of the container after being stored for six months at room temperatures and with no processing.

White clover, like the other clovers, alfalfa and sweet clover is a soil improving legume although it is not plowed down as green manure crop. Most generally white clover is grown in combination with blue grass or fescue. White, or Dutch clover, as it is sometimes called, furnishes rich and succulent forage in livestock pasture, it often being a predominant herb in permanent pasture land. Because it appears voluntarily in pastures, common white clover seed is usually not included in the recommended pasture seeding mixtures. All that is required is to control weed and grass competition and apply lime and fertilizer to bring forth a stand of white clover if it is adapted to the region.

Ladino is a large type of white clover which is frequently included in pasture seedling mixes. Ladino clover has stems which may reach a length of two to four feet, lie on the surface of the soil and roots from the stem nodes. The plants spread rapidly by this means. Ladino clover is useful as a pasture legume but is very difficult to cure as hay. Caution is necessary in pasturing livestock on stands of ladino; bloat is a possibility when feeding on the lush spring growth. Ladino clover is a poor nectar source.

White clover fills an important niche in the urban and suburban residential communities where it is encouraged to grow in lawns. It can be a fairly significant source of nectar and pollen for the hobby beekeeper who keeps bees in the backyard. Herbicides completely eradicate this clover from lawns and unfortunately it's becoming almost standard practice to include herbicides in many fertilizers used on the lawns. "Selective" weed killers do not differentiate between undesirable "weeds" in the lawn and white clover, only between the broadleaf plants and the grasses.

As a result a valuable bee forage plant, a soil improver and an attractive dark green plant bearing snow white bloom is forever removed from lawns that before bore white clover and grass in a natural blend pleasing to man and bee alike.

**OTHER CLOVERS.** — There are several other species in the large family of Leguminosae (Pulse family) listed as clovers, some of which are closely related to those already given. While they are not major honey plants like white, alsike, red, alfalfa, and sweet clover, they are very important to the honey producer because they yield pollen every year and some seasons a little honey at a time when the colony would slip backward without them, both in numbers and morale. There are some localities where the major honey plants do not yield much nectar but these other clovers boost the bees both in the spring and in the fall.

Under the general heads of Pollen, Brood, Pollination of Legumes, Fruit Trees, and Vegetables it will be shown



A white clover honey flow will fill new comb with excellent quality light honey in a short time.

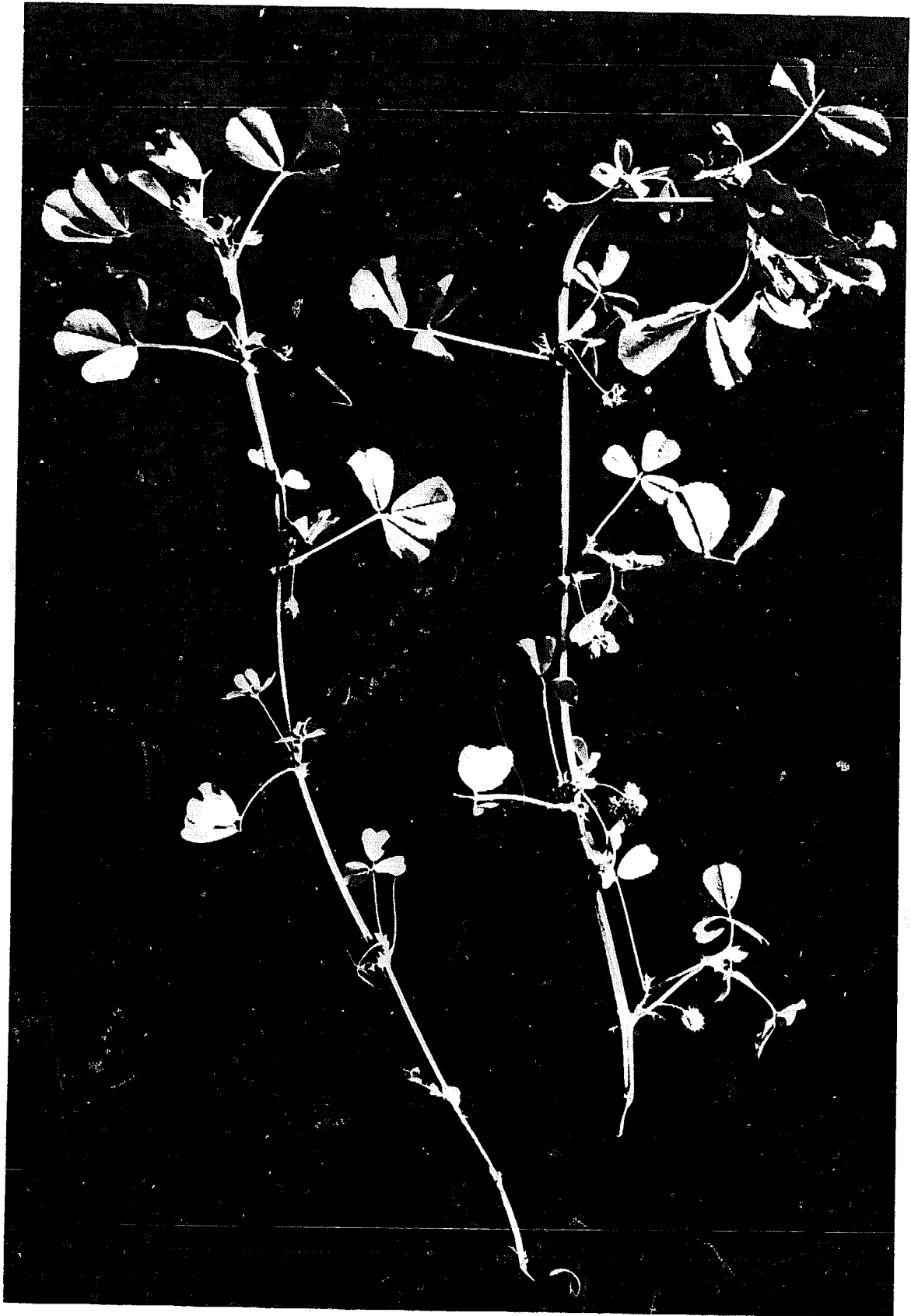

**Bur clover (*Medicago hespida*)**

that pollen is a very important food element both in early spring and late fall, and without sufficient pollen bees cannot successfully carry on brood rearing, and of course, cannot keep up colony strength.

The clover plants next enumerated sometimes come in the spring but usually in the midsummer or early fall when brood rearing is important to give the colony about to go into winter quarters a large force of young bees for good wintering.

In the list of minor clovers useful and important to the beekeeper may be named the following:

**LESPEDEZA.**—Coming to be an important plant of the Southland, is known as bush clover. The Korean Lespedeza is both a pollen and a honey plant. In some localities and in some seasons it yields a considerable amount of honey. Its use to the beekeeper is more as a pollen plant with enough honey being yielded to stimulate brood rearing at the time of the year when it is very important to develop young bees for the fall. It is also useful to the farmer as a hay and a permanent pasture. It is grown over pine lands and sown with oats, the two coming to bloom at different periods. It is also grown with native Carpet Bahia and Bermuda grass. Grown with these crops are grasses which are useful in preventing soil erosion. The fact that Lespedeza is being grown extensively in Florida, Tennessee, and most of the southern states, and that its acreage is increasing almost by leaps and bounds, makes it important to the beekeeper as well as to the farmer, even if the beekeeper measures it only by its pollen. The fact that it makes excellent grazing pasture from July to October makes it a source of pollen and a little honey up until cold weather sets in.

The feature about it that makes it so valuable to the farmer is that it binds the soil, thus preventing erosion from floods and the blowing away of topsoil. Another feature is that it reseeds itself each year.

**BUTTON CLOVER.**—This clover is sometimes called Button Medic. It is a close cousin of alfalfa and of

bur clover. It is an old plant but is a new crop to the South. In some respects it is like Lespedeza. While it is tolerant to an acid soil, it grows much better on land furnished with lime. Farmers in the South are counting on button clover as one of their winter and spring pasture crops. It fills approximately the same place as crimson clover. It yields both nectar and pollen. While it can not be classed as a honey plant, it is useful, like Lespedeza, in late summer and fall in stimulating brood rearing.

**BUR CLOVER.**—This variety is also a near relative to alfalfa and is common in California. Like the other two clovers just mentioned it furnishes a little nectar some seasons but is useful mainly as a stimulant for brood rearing in early spring. The heads are hooded with prickles, hence the name.

**KUDZU.**—This is a perennial legume, sometimes called the telephone vine, which produces large yields of hay, is drouth resisting, prevents erosion, and is a splendid soil builder. It appears to thrive in the Piedmont and Gulf Coast areas of Alabama, although it has been grown farther north.

**SAINFOIN** (*Onobrychis satipa*).—Like the clovers, sweet clovers, and alfalfa, it belongs to the Leguminosae (Pulse Family), and like them it is an important honey plant but

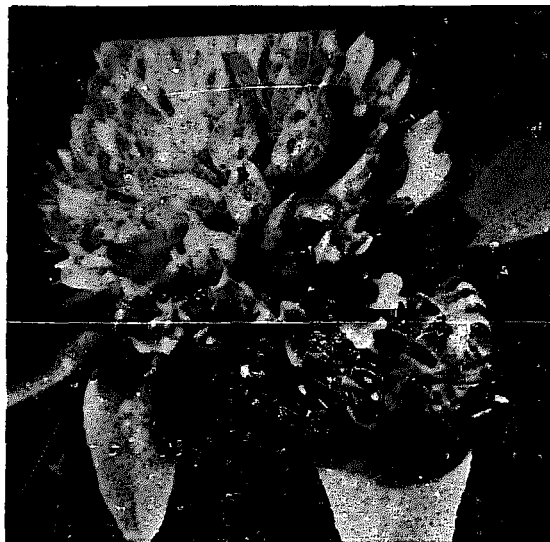

Bee on alsike clover—Photo by Bunch.

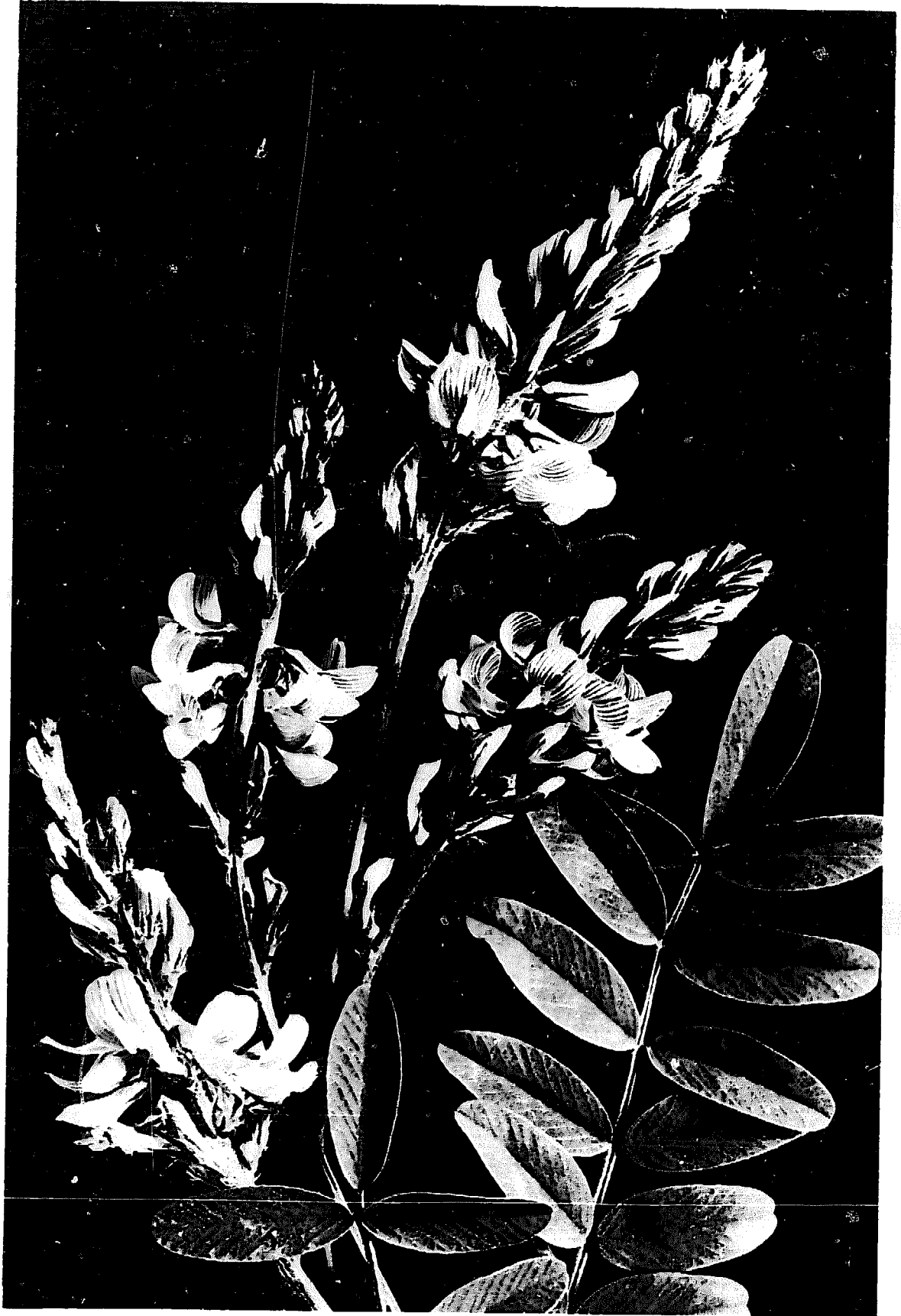

Common sainfoin (*Onobrychis sativa*)—Photo by Lovell

unlike them will not stand a semi-arid soil. It is probably for that reason that attempts to grow it in this country have not been successful. In Europe it ranks as a honey plant with sweet clover and alfalfa in this country. The honey is pale amber and of fine flavor.

**VETCH.**—Vetch is a major honey plant and is therefore given a special heading under Vetch.

**References Cited**

McGregor, S. E. (1976) Insect Pollination of Cultivated Crop Plants, ARS-USDA.  
White, J.W., M.L. Riethof, M.H. Subers (1962) Composition of American Honeys, USDA Tech. Bul. #1261.

**CLUSTER, BEE.**—See Temperature and Wintering.

**COLLOIDAL SUBSTANCES IN HONEY.** — See Honey, Colloidal Substances in.

**COLOR OF HONEY.**—See Honey and its Colors.

**COMB FOUNDATION.**—The invention of the movable frame by Langstroth, the honey extractor by Hruschka, the bellows smoker by Quinby, and last but not least, comb foundation by Mehring, made it possible to keep bees on a commercial scale never before attempted.

Comb foundation is just what its name implies. It is the base, mid-rib, or foundation of the honeycomb without the superstructure of the cells. If a piece of comb is sliced down on both sides nearly to the bottoms of the cells, there will be found the foundation of the comb, with initial cell walls, and hence the name. The comb foundation of commerce is much the same thing except that it is artificial, made of pure beeswax, with walls enough heavier so the bees can use the surplus in drawing out and extending the cells into completed comb.

Comb foundation is made by passing a thin sheet of pure beeswax between a set of rolls, the surfaces of which have been engraved in such a way as to give the imprint of the natural base of the honeycomb itself. The invention, or rather the discovery, lay in the fact that the bees would utilize this article made by man, and build it out into perfect comb inside of 24 or 48 hours when honey is coming in at a good rate.

**The History of the Invention of Comb Foundation.**

To J. Mehring of Frankenthal, Germany, is accorded the credit of having invented comb foundation in 1857, but his product was very crude, having only the indentations of the bottoms of the cells with no cell walls. In 1861 Samuel Wagner, the founder of the American Bee Journal, improved the foundation of Mehring by adding shallow cell walls. Besides giving the bees wax to build the cells, this also strengthened the sheet itself. Up to this time the article had been made between engraved flat metal plates, but Wagner was the first to conceive the idea of turning out the product between a pair of suitably engraved or stamped rolls operated on the principle of a common laundry wringer. But evidently he never developed the principle.

**Foundation Rolls**

In 1866 the King brothers of New York, and in 1874 Frederic Weiss, made foundation rolls, but the product they turned out from these rolls was very crude. It was not until 1875 that A. I. Root, in collaboration with a friend, A. Washburn, a fine mechanic, brought out a machine on the wringer principle that turned out sheets good enough and rapidly enough to be of commercial importance. This old original Washburn machine was so nearly perfect that its product was almost equal to that from cut mills made on a similar pattern today except that the cells were slightly too small. (See Cells, Size of.)

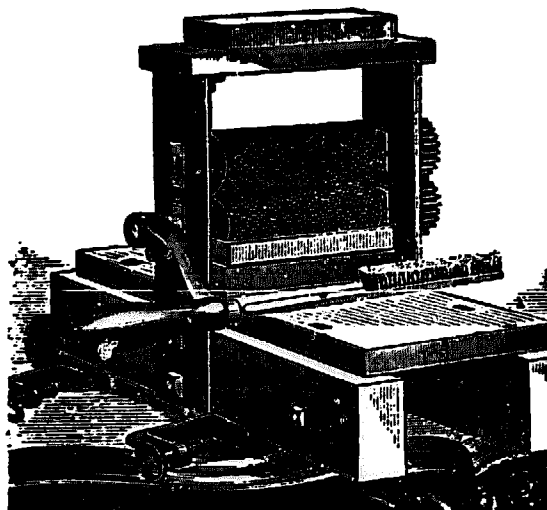

**Original Washburn foundation mill**



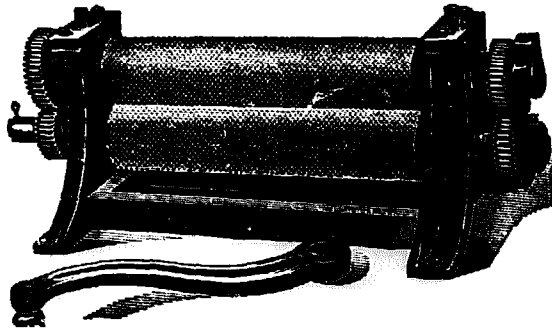

Standard comb foundation rolls

About this time also, or perhaps a little later, Francis Dunham and J. Vandevort of New York built rolls that turned out an excellent product. J. E. Van Deusen also built a machine that made foundation having flat bases, and incorporated in it fine wires. While the flat bases were not natural, the purpose was to get a thinner base and to use wire. The bees, it is true, would reconstruct the bases, but they apparently did not take to the flat-bottomed foundation as well as to the product having natural bases, and it subsequently disappeared from the market. In later years Charles Ohlm of Wisconsin built a machine for engraving rolls with angle bases by the use of cutting knives or gravers.

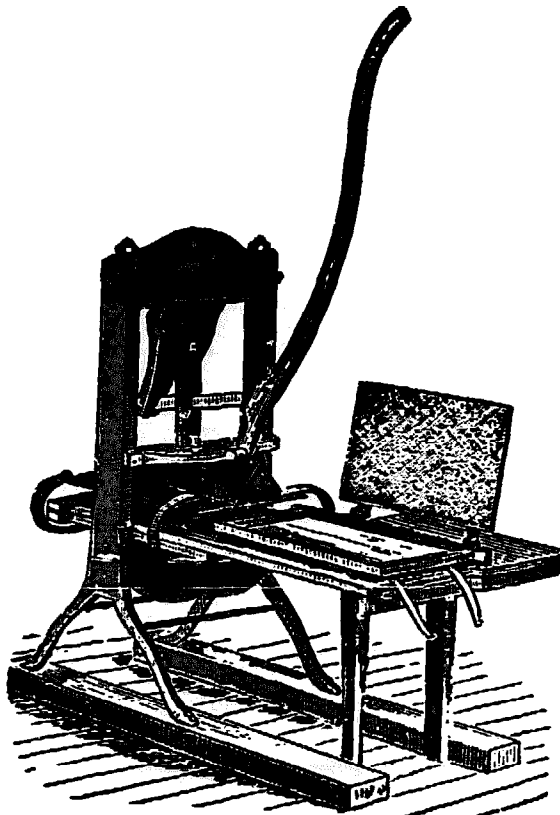

Given foundation press

### Flat-plate Foundation Machines

About the time the Root-Washburn foundation mill was being developed, the Given press using flat die-plates was brought out. Some few preferred the product from that machine because the foundation could be made right on the wires of a frame, and because the bees could work the wax a little more rapidly. The reason for this was that no press at that time (in the early '80's) had been made to exert as great a pressure as that given by a pair of rolls, and the result was a large waste of wax in the bases. The foundation made good combs, and bees worked it readily but the individual sheets were too expensive as compared with the product turned out on rolls by the manufacturers, and so the Given press disappeared from the market.

### Proper Angles at the Bases

In late years great improvements have been made in cutting the die faces, especially in the base of the cells. In the drawing next page, B represents the old base with the thicker cell bottom and the flatter angle which is not quite natural. A represents the new angle, or natural base, with less wax in the rhomboids, or bases. The bees quickly showed their preference for the sharper angle as is shown at A.

Comparative tests in the hive show that the bees have a preference for foundation that they do not have to modify. In making these tests, strips of foundation, old mill-

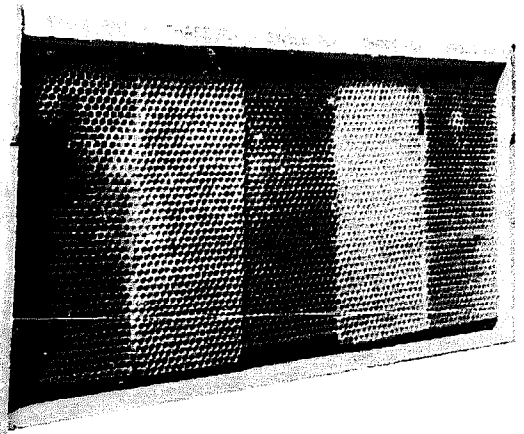

This frame contains sheets of foundation in alternation, one built on the old flat angle and the other on the more acute or natural angle. Note that the bees start building comb first on the latter. See diagram next page.

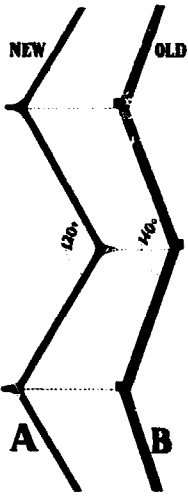

Drawing illustrating the difference between the new foundation A, and the old B. The latter has a thicker base, a flatter angle, and an unavoidable distortion. The bees greatly prefer A.

ing and new, were put side by side in the center of a strong colony. (See illustration on preceding page.) The bees in every case draw out the new or natural-base foundation much more readily than a foundation which has flattened or distorted angles, as shown in the diagram at B.

In the 80's various other flat-plate machines were brought out. Among the number was one using flat dies made of plaster of Paris. By taking a perfect sheet of comb foundation it was possible to take off molds in plaster. But these molds did not stand pressure, and there-

fore it was necessary to pour melted wax over them and close the dies. As soon as the wax cooled the dies were opened and the sheet removed. But difficulty was experienced in removing this cast foundation from the plaster molds. About this time, also, electrotype plates were taken from a perfect sheet of foundation—a process that was comparatively simple, and one that any electrotype found-

er could readily carry through. Various patterns of these copper-faced plates, including the Given, appeared on the market, but the only one that survived at the time was the Rietsche press made in Germany. A good many thousands of these were sold in Europe, but the objection to them was the waste of wax left in the cell base. None of the Rietsche presses have been sold in the United States.

In 1921 The A. I. Root Company built a flat-plate press for making a wood-base foundation. Like all other wood-base foundation, this did not prove to be a success because the bees would gnaw down to the wood.

**Weed Sheeted Foundation**

Until 1895 practically all the sheeted wax used in making comb foundation was made by dipping a thin board into melted wax and then into cold water. Two sheets of wax of the size of the dipping board were thus produced. The thickness of the sheet was regulated by the number of dippings. For thin foundation a single dip was sufficient; for brood foundation two or three dips were required. But the objection to this was that the wax sheet was thicker at the bottom than at the top. This was somewhat overcome by reversing the ends of the board when dipping.

Many efforts had been made to

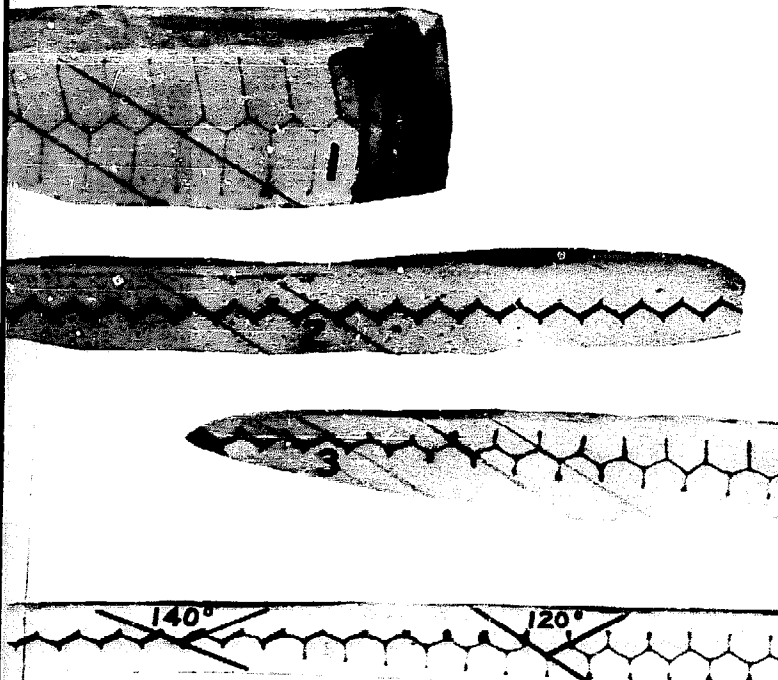

The picture opposite shows natural built comb foundation imbedded in plaster of Paris. After it had hardened a cross section was made. In this way it was possible to discover what the bees require in foundation. Plaster casts of (1) natural comb, (2) new angle comb foundation, (3) new comb foundation with one end drawn out into comb by the bees. Notice that the pencil lines drawn through the various bases are all parallel, showing, therefore, that the angles are the same in all three, or the angle as the bees make it. This is important because it saves the bees much work in reconstructing the cells. A plaster cast cross-section view of the old comb foundation showing flat angle of 140 degrees. At the right the bees have built the same foundation into comb, thinning the cell base and changing the cross-section angle to 120 degrees.

produce wax sheets in continuous rolls, but it was not until 1895 that E. B. Weed proposed a sheeting machine that would turn out wax sheets of any length desired, and of an absolutely uniform thickness. The quality and quantity of this product were such that most manufacturers of comb foundation in the world abandoned the old sheeting methods and adopted the Weed process. Probably 99 percent of all the comb foundation made in the United States turned out by manufacturers is first sheeted by the Weed machine.

#### **Foundation Made in Large Factories**

The art of making foundation is very complicated, and its manufacture has now drifted into the hands of the large supply manufacturers who are able to turn out a product which for quality and thinness of base is far superior to that made by individual beekeepers. It is a trade in itself to make foundation having thin bases because the average beekeeper does not have the skill to make foundation without wasting wax and ruining the delicate die faces of the comb foundation rolls.

Great improvements in filtering hot wax have been made by which excessive propolis stored by the bees has been removed.

Likewise the use of acid in refining has been discontinued. The result of the new treatment is to retain the natural aroma of virgin wax and at the same time make it more dense and ductile for the bees.

#### **What Foundation Has Accomplished**

The invention and introduction of comb foundation has solved many difficult problems of the earlier days. Our forefathers had difficulty, for example, in getting the bees to build combs straight and all worker cells. Before this invention drones were reared in enormous numbers because there was so much drone comb. In modern apiculture only a very few of the most select are reared for breeding purposes. By the use of all worker foundation there will be but very few drones in a hive. The rearing of so many useless consumers not only involved a serious drain on the resources of the colony but it also took the labor of the nurse bees. The elimination of drones by the use of comb foundation materially increases the worker force in a colony and this has made it possible to increase the actual yield of honey per colony proportionally. (See Combs, subhead Economic Waste and Poor Combs; also Brood and Brood Rearing and Drones.)

Mention is made of the fact that our forefathers were unable to secure straight combs in their movable frames. Besides having an excess of drone combs, the combs were more or less wavy, and it was not a little difficult to get the bees to build their product on a straight line parallel with and directly underneath the top bar of the frame. (See Frames; also Combs.) V-shaped comb guides, or narrow strips of

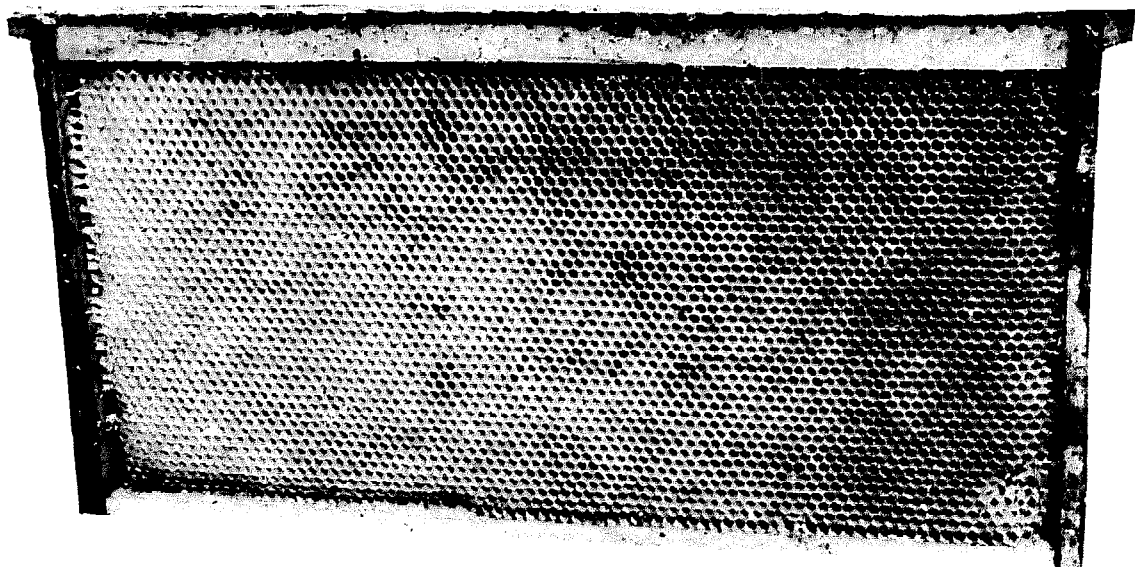

**How comb foundation looks when freshly drawn out by the bees**

wood, the edges of which projected downward, were used as a coaxer to get the bees to build their combs parallel with the top bar. But every now and then they would build them crosswise, zigzagwise, and every other wise except the right way. The use of even a narrow strip of foundation compels the bees to start the comb on a center medial line beneath the top bar of the frame, and when a full sheet is used the comb built from it is not only true and straight but it will be all worker, as before explained. (See Combs.)

### **The Evolution of the Section Honey Box.**

The old box hive of our fathers contained combs built irregularly in small boxes holding from five to ten pounds, the ends of these boxes being glassed. But such a package was too large for retail purposes. The time came when there was a demand for a small package, or one holding about a pound. Comb foundation makes it possible for the beekeeper to compel his bees to build combs straight and even in little boxes holding nearly one pound. Without comb foundation, comb honey in sections would be impossible. The invention of foundation paved the way for the one-pound honey section box that sprang into use shortly after comb foundation was introduced on a commercial scale. (See Comb Honey.)

### **What Size of Sheets to Use in Sections.**

Owing to the tendency of foundation to cause midrib in comb honey, some think that using a starter would remove the objectionable feature. They argue that nearly all the comb would have to be natural, and it would therefore be delicate and friable like the old comb honey on the farm. But it has been shown that in a majority of cases the natural-built comb will be composed of store or drone cells, the bees being able to build these larger, heavier cells more readily. Some recent tests seem to show that natural-built drone comb has as much or more wax to the cubic inch than worker comb built from full sheets of thin worker foundation. If the bees, on the other hand, would make their natural comb all worker, the resultant comb would be all that

could be desired for delicacy and friableness. Drone comb cappings do not have nearly the pleasing appearance of worker cappings, so if for no other reason, full sheets of worker should be used.

### **The Different Weights of Foundation**

There are three weights of comb foundation, each having its separate use: (1) super foundation, (2) brood foundation, and (3) reinforced foundation.

No. 1 is used in comb honey sections of a light weight called "thin super," with an extra thin base and light side walls. There are two kinds: thin and extra thin super. The last mentioned is seldom used now because the bees are inclined to gnaw it down or cut holes in it. Thin super is not so likely to be gnawed.

No. 2, or brood foundation, is used in full-depth Langstroth frames, running about eight sheets to the pound. A thinner grade is now seldom used.

No. 3 is the reinforced three-ply or wired comb foundation running seven sheets to the pound. While reinforced costs slightly more than the ordinary brood foundation, it is far more satisfactory and cheaper in the end. Ordinary brood comb will have stretched cells even when built on horizontal wires. This will be explained under Combs for Extracting and for Brood Rearing.

### **Early Efforts to Prevent Foundation from Stretching.**

Ordinary beeswax, as has already been pointed out, when placed in the form of comb foundation in the hive all summer, is inclined to stretch vertically as well as horizontally. Nature evidently did not contemplate commercial beekeeping. She provided material, however, that answered all practical purposes in a bee tree or cave. No harm was done if the top row of cells in the combs were stretched somewhat. The bees filled these with honey. If the wax was strong enough to hold the brood, nature was satisfied.

There has been almost endless discussion of the question on how to prevent foundation from stretching or sagging in the brood frames while being drawn out. While there is a slight expansion of the sheet horizontally, there is a greater expansion owing to the effect of gravity vertically or downward. The great-

est stretching, however, occurs during hot weather after the combs are fully drawn and are filled with honey. The weight of the honey, together with the temperature of the hive, causes that portion of the comb two or three inches beneath the top bar to be slightly distorted. The upper rows of cells, instead of being hexagonal, will have the two vertical sides of the cells elongated. "A"



represents a cell with all six sides the same length. "B" represents what actually happens in drawing the foundation out into comb. The queen will avoid the stretched cells for egg laying. They are not right for either drone or worker brood, and so they are filled with honey. Sometimes there is a scarcity of drone cells. These stretched cells may contain some drone brood, but the emerging drones will be undersized.

The net results of this stretching or distortion is to reduce the brood capacity of the hive, either 8 or 10 frame Langstroth, about 20 percent. A single brood chamber of 10 frame Langstroth size is not large enough to accommodate the average good queen in the height of the breeding season, and this distortion makes its capacity smaller still. Obviously it is possible for a commercial beekeeper owning hundreds or perhaps thousands of these hives to enlarge the capacity without going to great expense. Under the head of Building Up Colonies and under Food Chamber it will be noted that it is possible to put on a super or an extra hive body, and this is what is done.

But it would be better to have practically all worker cells in every comb, and these can be had, as will be shown later on. But the stretching of the cells and the drawing out of the comb is not the only drawback to comb foundation. Combs built from foundation or built naturally without reinforcement will not stand the ordinary commercial usage in the bee yard, as will be shown under the head of Extracting. Unless combs are reinforced by the methods shown further on, they are

liable to be broken out in shaking the combs to dislodge bees, or while being extracted in the extractor.

Both for the purpose of preventing stretching of the cells and the breaking of the combs while in use, various methods have been employed. One of the earliest was to suggest the use of a midrib or reinforcement of paper, tinfoil, cloth, or wire-cloth, and later on cellophane. In the olden days when comb foundation was in its infancy, the paper or cloth was dipped in hot wax and then run through a comb foundation machine. The product looked like a very nice sheet of foundation and every hope was entertained that this reinforced product would solve the problem, and it would had the bees had sense enough to allow the artificial midrib to stay intact in drawing cells out of the foundation. But unfortunately they had their own notions. They had a disagreeable way of gnawing the wax off the paper or cloth, leaving portions of the comb drawn out with holes or deep depressions here and there on the surface of the comb. In the rush of the honey flow the bees would cover these up, but sooner or later they would come back to the midrib fabric and proceed to tear it out by pulling it away bit by bit. Wire-cloth was next tried. While the bees made fine combs on it, it was too expensive and there were mechanical difficulties.

Later on thin sheets of veneered wood that were dipped in beeswax were resorted to. These were likewise embossed with the cells of comb foundation and placed in the hive. The initial tests of the wood-base foundation were very satisfactory. Some very beautiful combs were made from it. But again the bees objected to the form of reinforcement. They would gnaw away the wax down to the wood.

Some 50 years later attempts were again made to use wood-base foundation. While the comb drawn out was very beautiful in most cases, and while the comb itself was reinforced more rigidly than anything else that had been tried, the bees later on showed their tendency to gnaw away the wax. The result was that wood veneer foundation was abandoned like the many attempts with paper and cloth.

When the new cellophane was brought out it was believed that it

would solve the problem, as the bees would not gnaw it, but it too proved to be a failure.

Along in the early days Van Deusen of New York incorporated wires in a flat-bottom foundation. This at the time reinforced the foundation and the comb, but the foundation itself was very objectionable because the bases of the cells were flat and unnatural. While thousands of pounds of Van Deusen flat-bottom foundation were sold, the product finally disappeared from the market because it took so much time for the bees to reconstruct the cells.

**Wiring to Prevent Sag**

A. I. Root, who had carefully tested all the methods that are here given, finally decided in the early 70's that the solution of the problem lay in stretching the wires back and forth across the frame vertically and diagonally from corner to corner. He then imbedded an ordinary sheet of foundation on these wires. This was in 1878. (See Fig. 1.) This was the first successful attempt to make a reinforced comb rigidly held in the frame. These combs were flat

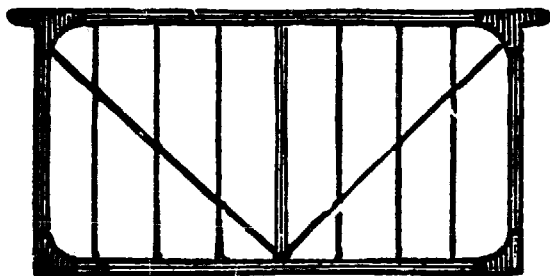

Fig. 1

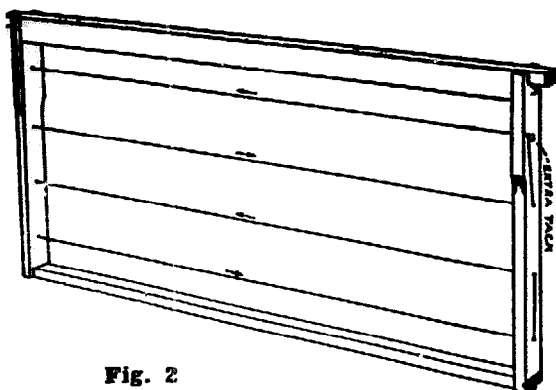

Fig. 2

Fig. 1 shows the form of vertical wiring used by A. I. Root in 1878 before thick top bars came out. A folded tin bar was used to support the thin top bar. Fig 2. shows four horizontal wires now used very extensively to hold Three-ply foundation mentioned further on.

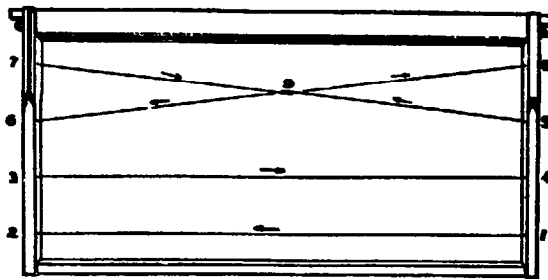

Fig. 3—This is very good. It will prevent sagging of the foundation, but will not permit of electrical imbedding because the wires intersect.

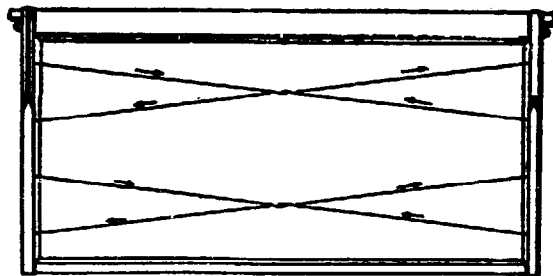

Fig. 4—This, like No. 3, cannot be electrically imbedded, and is more difficult to accomplish.

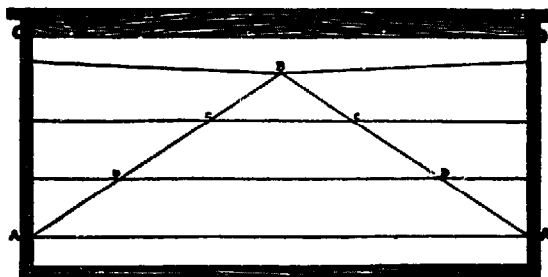

Fig. 5—This plan has been used very largely in California. It was there the author saw that brood in the combs wired this way would go clear to the top bar.

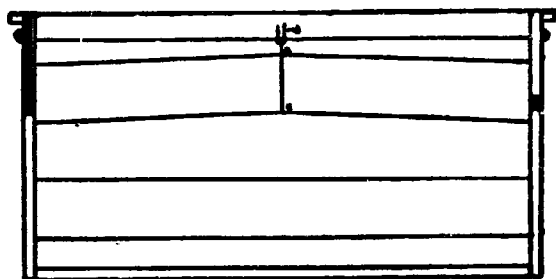

Fig. 6—This will prevent sagging, but is too complicated and does not permit of electrical imbedding.

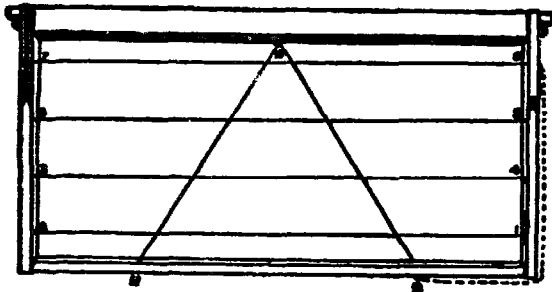

Fig. 7—This plan is good, but it requires two extra holes in the bottom bar.

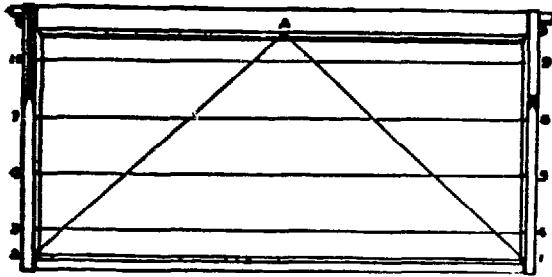

Fig. 8—This and No. 9 are the plans that the author recommends more than any of the other plans for a foundation not reinforced.

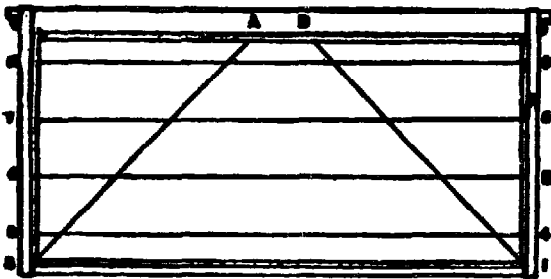
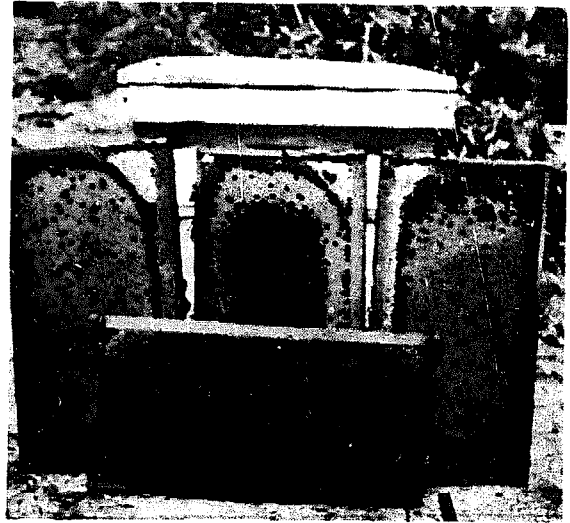

Fig. 9—This is the same as Fig. 8 except that it uses two tacks instead of one for the top support. Both No's. 8 and 9 permit of electrical imbedding.

as a board except that the combs were wavy with slight depressions between the vertical wires. They would stand the rough treatment in the extractor or out of the hive. But in A. I. Root's original frame the top bar was only a quarter of an inch thick. This was supported in the middle by a folded tin bar, the base of which was supported again by diagonal wires reaching to the two upper corners, as shown. But wherever the wires crossed each other, and especially along the line of the folded tin bar, the bees were inclined to gnaw holes or leave a depression.

In the early 90's there came into use the thick top bar frame. (See *Frames and Self-spacing Frames*.) While it is possible to bore holes through the top bar and bottom bar only a quarter inch thick through which to pass the wires, it was not



Combs built from Three-ply foundation. Notice no stretched cells and that the brood goes clear to the top bars.

practical to do this when the top bars were seven-eighths inch thick. It was finally decided in 1890 to run wires horizontally, passing them back and forth through the end bars, as shown in Fig. 2, previous page. This gave very satisfactory combs, flat as a board, and held very firmly in the frame, but it did not prevent the stretching of the cells. Along in 1918, 1919, and 1920 there arose considerable discussion as to how to prevent the first two inches of the comb at the top from stretching. There were very many ingenious schemes of putting in cross wiring, as shown in the illustrations. But the scheme that was the most satisfactory is shown in Figs. 7, 8, and 9. The frames are wired horizontally, leaving enough slack wire so as to pass from No. 4 down to 1, up to B, cross to A, hook over two nails, then down to No. 2 and fasten. But before this was done a sheet of foundation was placed between the horizontal wires and the two diagonal wires. All the slack was taken up when the wire was fastened at the top.

A current of electricity passing through the wires will imbed them into the sheet, making a well-reinforced frame of foundation. When the sheet is slipped between the two sets of wires, electricity can be used to heat the wires.

The scheme of wiring shown in Fig. 9 was the most satisfactory of anything that had been used. But there was an objection to the plan in

that the bees were inclined to gnaw holes at the points of intersection of the wires.

**Reinforced Foundation**

In 1922 and 1923 two plans for reinforcing foundation were developed, one by Dadant & Sons and the other by The A. I. Root Co. The Dadants adopted the scheme of Van Duesen, but used kinked vertical wires, incorporating the same in natural-base brood foundation. These wires were placed about two inches apart. The kinks prevented the foundation from sliding down on the wires and at the same time stiffened the wire itself.

In 1923 The A. I. Root Company placed on the market a reinforced foundation consisting of three sheets or plies of wax pressed together. Originally the two outer plies were made of pure beeswax and the center ply beeswax with a small percentage of vegetable wax. Now all three sheets are beeswax, with the center ply receiving special processing. In milling, the three sheets of beeswax are laminated as they pass through the mill so that they fuse to form a tough, sag-resistant foundation. (See illustration at top of page 162.)

As mentioned, originally the center sheet contained a small percentage of vegetable wax to toughen the foundation. Now in the present manufacture, the center ply, as well as the two outer plies, is made of beeswax only. Additive waxes started to be a problem when low cost microcrystalline mineral wax became available and was used in comb foundation in varying amounts by some manufacturers to stiffen the foundation. The possibility of gross adulteration of beeswax and the resulting lessened market value of wax for commercial purposes became a growing problem. In fact, this disadvantage in using additive waxes grew to such a degree that it offset the proved advantage in the beehive of the hardened foundation. Fortunately techniques have been developed to strengthen, by processing the beeswax in Three-ply foundation, to a point that it makes Three-ply superior to ordinary foundation from the standpoint of resisting sag.

Both methods of reinforcing will produce some very fine combs and

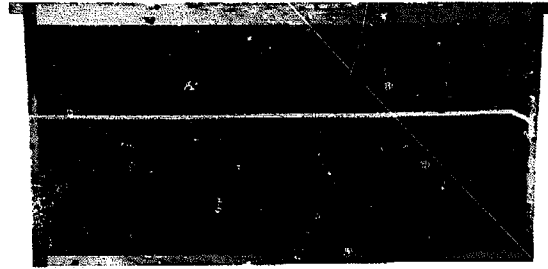

Fig. 1—Note that this old reinforced comb shows no sagging. The line of cells is practically straight. There are no elongated or distorted cells in the upper part.—the entire comb being available for worker brood from bottom bar to top bar.



Fig. 2—The comb built on foundation not reinforced will not stand the weight of the honey or brood in the warm temperature of the hive. The cells in the upper part become elongated and distorted so that worker brood can not be reared in them. The curved line shows the sag.

it may be safely said that the day of stretched combs, half drone and half worker, near the top bar, has now passed.

The illustrations above show how ordinary comb foundation, unless reinforced, will stretch near the top bar, while the reinforced, especially the Three-ply, will furnish a line of cells that are all worker, and combs flat as a board.

When vertically-wired foundation is placed on horizontal wires there is a little tendency on the part of the bees to make holes at the points of intersection of the wires. After the first honey flow the bees will fill these holes up, but sometimes with drone brood.

**Aluminum and Plastic Center-ply**

Another method of reinforcing comb foundation is the use of a thin sheet of aluminum or plastic as a center-ply. In this case a thin layer of hot melted beeswax is sprayed on both sides and then the beeswax coated center-ply is embossed by the comb foundation mill. The plastics which have been most popular for this type of foundation have been polystyrene and acetate because



## COMB FOUNDATION THREE-PLY COMB FOUNDATION

EASILY WORKED BY THE BEES AND NON-SAGGING

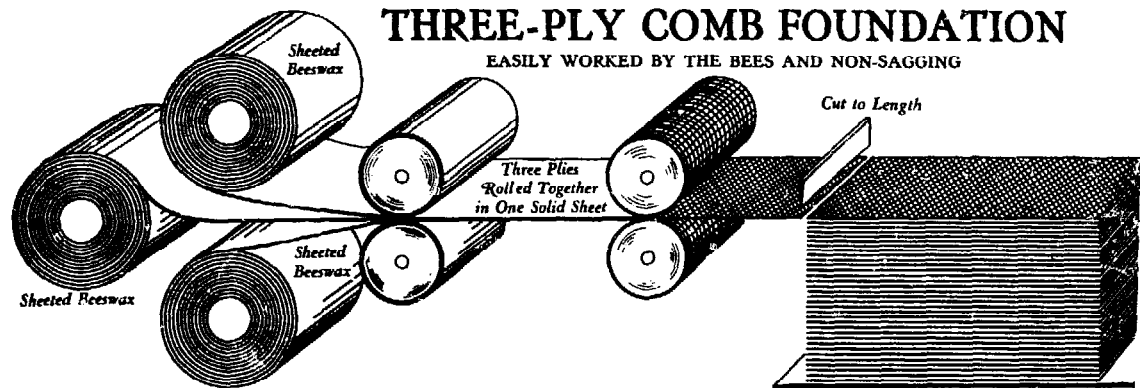

**How Three-ply is made:** As its name implies, this famous foundation is made of three sheets of beeswax rolled together into one to form a tough sag resistant foundation.

they are stabilized to prevent warping in the hive.

Complete plastic combs with no beeswax have been developed by the U.S.D.A. and others, from materials such as Bakelite, and high density polyethylene but the cost of producing these products has been their principal disadvantage. This type of comb, however, is so rigid and strong that it is virtually indestructible in the extractor.

### How to Wire Frames and Imbed Foundation

Complete directions for doing all this work are sent out by the foundation makers with each package of foundation so it will not be necessary to repeat them here.

### When and Why Bees Sometimes Gnaw Foundation

In the off season of the year and especially in the warm climates when no honey and very little pollen is coming in, bees will sometimes gnaw the foundation around the wires, both horizontal and vertical. The reason for this is that a wire, thread, or fabric of any kind, especially the last two, are foreign objects in the wax or comb. When bees have nothing else to do they will attempt to remove the offending object, and hence the gnawing next to the wires. When vertical wires project below the bottom edge of a sheet of foundation hung in a frame, bees will sometimes commence at the projecting ends of the wires and remove the wax from them two or three inches upward. There is less of this trouble if the wax projects through the bottom bar of the frame, but even when the comb is built clear down to the bottom of the frame, bees are inclined to gnaw clear a horizontal space of

a quarter of an inch between the bottom bar and the comb. This is more common in the lower story of the hive than in the second or third. Combs above, if solid to the bottom bar, will not be molested until moved downstairs.

Again, where horizontal and vertical wires are used to reinforce the wax, the bees are quite inclined to gnaw holes in the foundation at the intersecting points, but when honey begins to come in these holes will be closed up, often with drone cells.

Clearly the remedy for this gnawing is to remove frames of foundation not drawn out into combs from all the hives after the main honey flow is over, and this is more important in the South than in the North.

### Freak Comb Building

In rare cases bees of a particular colony will draw out one side of a sheet of foundation and leave the other side untouched. When this is on the outside of the cluster the reason is obvious. Turning the comb around will correct this trouble.

### Starters vs. Full Sheets for Sections

The expert producer will never be content with a narrow sheet. He will buy his foundation of such size that he can cut it to suit his own individual notions. Some beemen cut it in sheets one fourth of an inch narrower and a half inch shorter than the inside of the section. It is then fastened to the top. Others cut the sheets in the shape of a letter V; still others use a half sheet.

Many beekeepers prefer to use two pieces—a large one secured at the top, and a strip about five eighths inch wide fastened to the bottom. The larger sheet is cut so as to reach within one eighth or one quarter inch of the bottom starter when in place to allow for stretching.

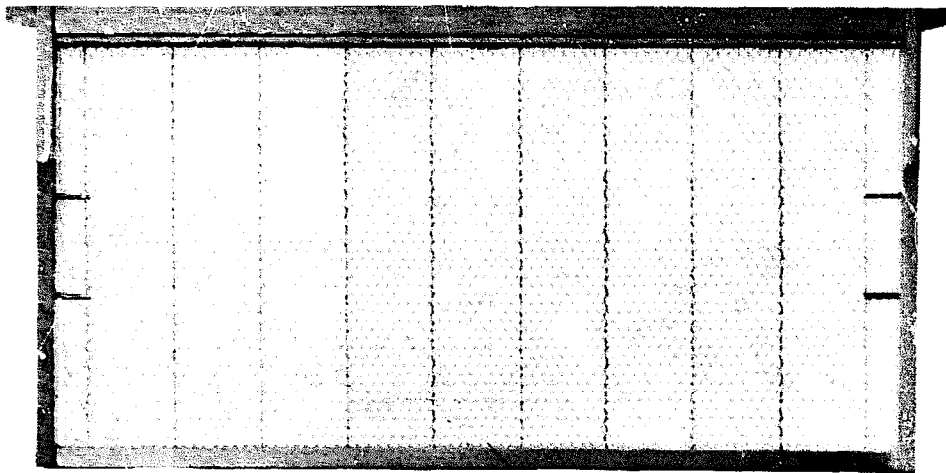

Wired foundation, showing how the corrugated wires are imbedded in the foundation and hooked over the top.

During the subsequent process of drawing out, the bees will make one complete comb, which is fastened to the top and bottom.

A few beekeepers advise cutting the foundation so it will just neatly fill the section on all four sides. A section is then slipped over a block a little less than half its thickness so that when one of these just-right-sized sheets of foundation is laid on the block, the foundation will be perfectly centered in the section. With the Van Deusen wax tube the sheet is then secured to all four sides by the stream of hot wax. While this plan is good, it is expensive from the standpoint of labor.

A plan sometimes preferred—the one that furnishes a very nice comb honey—is the scheme of having the section blanks grooved about one-eighth inch wide and half the depth of the section on a medial line running from end to end of the blank. Squares of comb foundation cut slightly larger than the inside dimensions of the section are slipped into the groove before the section is folded. The foundation should not be cut so large that the sheet will buckle after the section is folded.

Experience shows that when the sheet of foundation fills the section a much more perfect comb honey is produced than when there is a large sheet at the top and a small one at the bottom, and certainly better than when a starter is used and fastened at the top only. If the right methods of production are employed when these full sheets are used, the combs will be evenly filled out without an open corner. Some strains of bees, if crowded for room, will sometimes run the filled cells of honey clear to the wood without leaving any so-called "pop holes," the line of unsealed cells next to the wood.

**COMB HONEY.**—While all honey in the comb is what may be called "comb honey," yet the term as commonly used refers to small squares of comb built in frames of wood technically called section honey boxes, or "sections" for short. These may be full sized holding 12 to 14 ounces, or may be miniature holding an ounce or more. The latter is described further on. References to comb honey, whether in the market quotations or in ordinary litera-

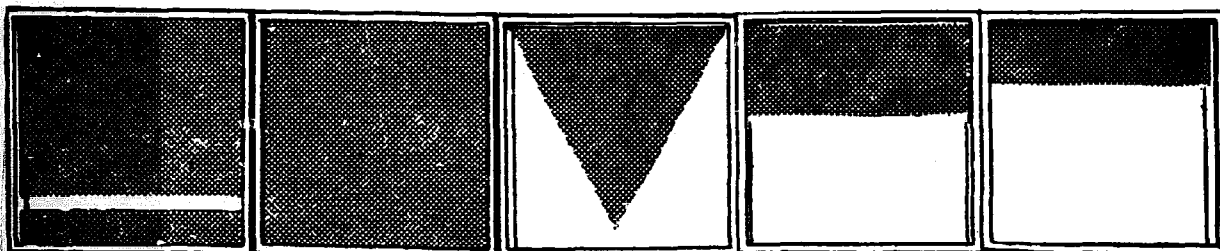

Various methods of cutting foundation for sections

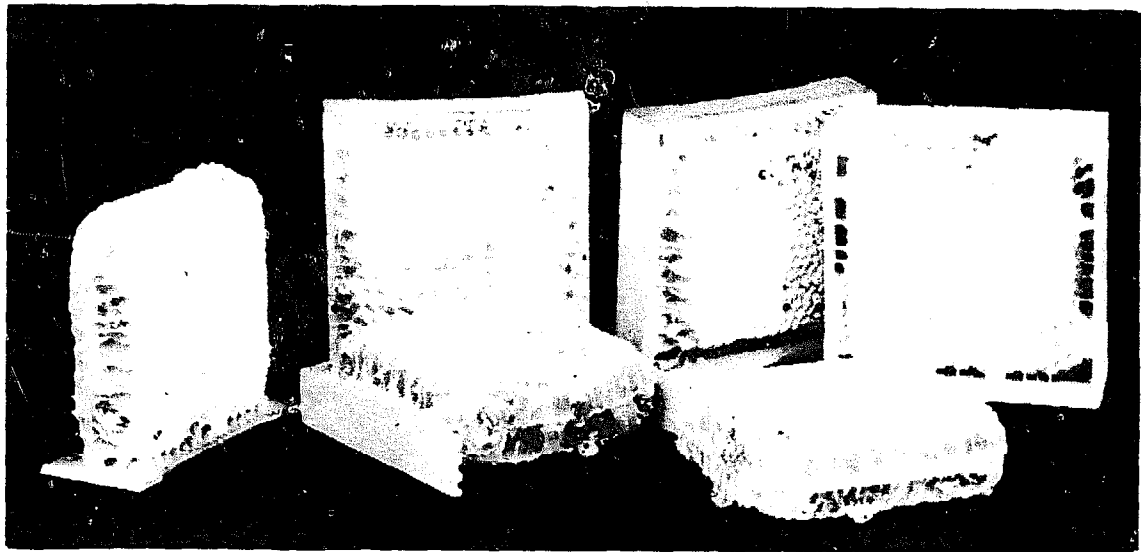

Comb honey in sections

ture relating to bees are usually understood to apply to the honey produced in sections.

#### Cut Comb Honey

In more recent times there has been put on the market cut-comb honey neatly wrapped in cellophane wrappers. The combs are cut in squares of various sizes from shallow extracting frames. The drip is then removed by placing the cut pieces in an extractor and throwing it off by centrifugal force, or allowing them to stand on coarse wire-cloth trays in a warm atmosphere until they drain dry or nearly so. The pieces, square or oblong and ranging in size from two to 10 or 12 ounces, are neatly wrapped in cellophane.

These cut combs in waterproof cellophane wrappers look very attractive and in some markets the smaller packages sell like hot cakes. A "hunk of honey" in its natural container weighing two ounces is very tempting to the housewife. She tries it out and then will buy the larger sizes.

It would seem that this form of comb honey should revolutionize the comb honey business and possibly when the difficulties are overcome it may do so.

In 1920 and for several years thereafter the publishers of this book sold to the Pullman Car Company, fancy restaurants, hotels, and high class grocers what was called individual comb honey. Each chunk of about one and one half ounces was wrapped in paper and then en-

closed in a small carton. The comb honey was cut in small squares and allowed to drip for 24 hours and then wrapped. The product seemed to have a bright future because it was just right for one serving on a Pullman diner or in a restaurant or hotel. Carloads of it were sold and then it began to come back as unsatisfactory. "It has gone back to sugar," they said. Then it was discovered that the dry smear of honey on the cut edges of the little combs would granulate and this granulation once started would penetrate into the comb.

There was another difficulty. Producing a fine grade of sealed white honey from thin foundation in shallow frames was a fine art—more difficult than producing nice combs in sections. To cut these little squares from sections—four to the section—was not practicable either. It was too expensive. A fuller account of the matter was described in *Gleanings in Bee Culture* for December, 1923. The A. I. Root Company finally abandoned the whole proposition.

Cut comb honey wrapped in cellophane is still in the experimental stage.

#### Chunk Comb Honey

In the southern states there is another article called chunk or bulk comb honey. This comprises about 70 percent of all honey marketed in the South. The combs are usually built in shallow extracting frames and are cut out in various sized



A novel bottle of comb honey. It looks like a big peeled orange and sells like hot cakes. The combs are cut in thin strips and pressed against the inside of the jar as shown. The center is filled with cut pieces of comb and extracted honey. Idea belongs to Mrs. H. G. Randall, Morehaven, Florida.

chunks that will slip into tin buckets or glass jars. The spaces between the combs and around them are filled with a good quality of extracted honey. Bulk or chunk comb honey has the advantage that it does not require as much skill to produce as the ordinary comb honey in sections; neither is it necessary that every piece of comb be perfect as to capping, filling, or shape.

A very serious objection to the use of bulk honey in the northern states is the danger of the liquid portion granulating. When this takes place the whole will have to be melted in the wax extractor, even though the comb honey is not granulated.

#### Comb Honey Versus Extracted

When the extractor was first invented in 1865 it was supposed that nothing but honey out of the comb would be sold for the reason that it could be produced more cheaply. But our best connoisseurs now know that even our very best extracted honey seldom has the fine delicate aroma of honey that is held in the comb, just as nature gives it to us. Comb honey holds the flavor and the delicate aroma of the individual flowers from which it was gathered much better than after it is removed from the comb. The flavors of honey, it is said, are given to it by ethyl

alcohols that are very volatile. It follows that when the honey has been removed from its original container and exposed to the air it loses some of its flavor, especially if it is heated. (See Extracted Honey, Bottling Honey, Honey, Colloidal Substances in, Honey, Heat Effect on, Honey, Science of, and Granulated Honey.) If ever a majority of consumers prefer comb honey, it will be because to them it has more flavor and because probably the crushing of the delicate cells in the mouth gives the eater a certain degree of satisfaction since he has something to chew. Extracted honey, on the other hand, is swallowed, while comb honey is masticated as food should be. The little pellets are usually expelled. Many people prefer extracted honey because they like to have something they can eat on bread or biscuit with butter, without having wax mixed with the food. However, the wax is not indigestible. It is really an aid to digestion.

So long as it is admitted that comb honey has a little finer flavor than the same honey out of the comb, beekeepers should foster the demands of all classes of consumers. When it is remembered that comb honey brings more than extracted, it goes to show that there are thousands of consumers who prefer honey in that form, even if they have to pay more.

**COMB HONEY, APPLIANCES FOR.**—In the early history of beekeeping, most comb honey was produced in glass boxes. These were about five inches square, 15 or 16 inches long, glassed on both ends. They were not altogether an attractive package and were never put upon the market without being more or less soiled with burr combs and propolis. As they held from 10 to 15 pounds of honey each, they contained a larger quantity than most families cared to purchase at once. To obviate this, the section honey box was invented, holding a little less than a pound. (See page 164.)

That was what was wanted — a small package for comb honey. Thus was accomplished the introduction not only of a smaller package for comb honey, but one attractive and readily marketable. The retailer is able to supply his customer with a

small quantity of comb honey without daubing, or fussing with plates. The housewife, in turn, has only to lay the package on a plate, pass a common table knife around the comb to separate the honey from the section proper, and the honey is ready for the table.

#### What Size Sections to Use

In the early 80's there were a good many varieties and sizes and styles of sections on the market. There were the two-pound size sections, the half-pound, and three-quarter pound; but in later years sections have been reduced to practically three styles: the  $4\frac{1}{4} \times 4\frac{1}{4} \times 1\frac{7}{8}$  in. beeway sections, the plain  $4\frac{1}{4} \times 4\frac{1}{4} \times 1\frac{1}{2}$  in., and the  $4 \times 5 \times 1\frac{7}{8}$  in. plain sections. Each of these three holds a scant pound of honey, section included, but under the federal

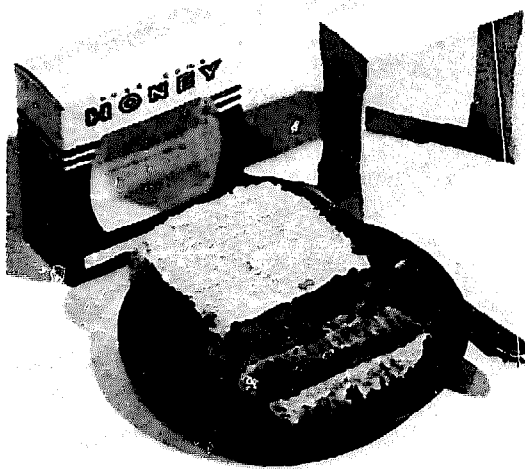

Section comb honey, a delicious food, is truly the beekeeper's masterpiece.

net weight law (see Labels) and most state laws it is not permissible to include the square of wood around it. The section must be sold in weights from 10 ounces for the lightest to 14 ounces for the heaviest. While it might be desirable to have something holding an even pound, yet no two sections will run exactly the same weight. (See Grading Comb Honey.)

While the sizes mentioned above are in almost universal use, there developed at one time a demand for miniature sections,  $2 \times 2\frac{1}{2}$  inches, holding about two ounces of honey,

enough for one serving for restaurant, hotel, and dining car trade. Four of these sections occupy the space of a  $4 \times 5$  section, or 128 for a standard size super with standard section holders for the regular  $4 \times 5$  sections. An expert comb honey producer in a good flow could often get fancy prices for these little sections that were just right for the single customer. It is so difficult to force bees to build combs in miniature sections that their use has been practically abandoned.

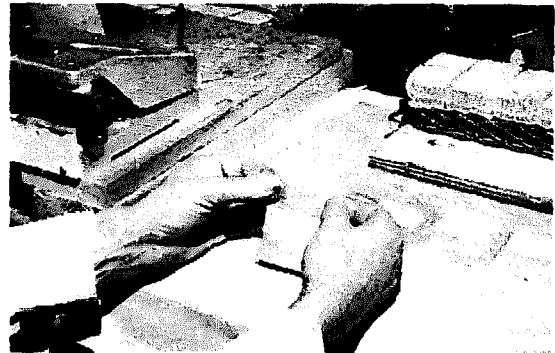

Wrapping small section chunks.

#### Tall Versus Square Sections

The standard section for many years has been  $4\frac{1}{4}$  inches square, but during all this time some beekeepers, principally in New York, have been using a section taller than broad.

Some of the reasons that have been given in favor of the tall sections are as follows:

1. Weight for weight, and for the same thickness of comb, a tall section looks larger than a square one.

2. By long association we have come to like the proportion of objects all about us that are taller than broad. Doors and windows of their present oblong shape are much more pleasing than if square. Nearly all packages of merchandise, such as drugs and groceries, are oblong in shape.

3. A greater number of tall sections holding approximately a pound can be accommodated on a given hive surface.

4. A tall section will stand shipping better because the perpendicular edges of contact of the comb itself are greater than in a square box.

Since the advent of cellophane, window cartons have come into very general use. As the name indicates, it is a regular standard comb honey

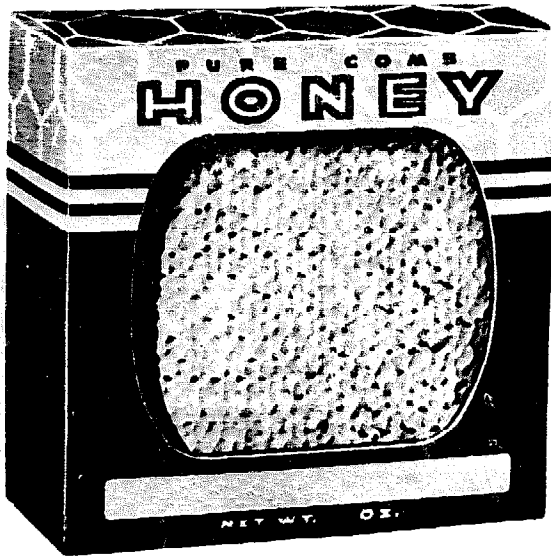

Window carton

carton with the front cut out. This opening is then covered on the inside with a sheet of cellophane neatly pasted in place. This container not only protects the whole section of comb honey but allows the prospective purchaser to see just what he will get. Putting a nice section of comb honey in a carton without the window looks like an attempt to cover up something that is below standard.

#### Cellophane Wrapped Section Comb Honey.

Some of the prettiest section comb honey on the market is cellophane wrapped. Sometimes the cellophane wrappers are decorated with attractive designs. At other times they are plain. In either case the front and back of the section itself can be seen.

After a little practice and by closely following directions, one can make both faces as tight as a drum. The folded edges can be moistened with paste and sealed. Some packers prefer to use the "Eat Honey" stickers to hold the edges down.

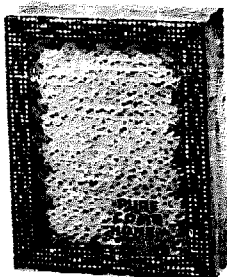

Section of honey wrapped in cellophane

Where comb honey is put on display at fairs it is customary to use decorated cellophane wrapped comb honey. It makes a better display than window cartons. The latter are much to be preferred to hand out to the customer who has her market basket filled with other articles having sharp corners. In the case of general honey exhibits it is desirable to use a variety of containers in glass, cellophane, and tin to avoid sameness. First premiums are usually based upon artistic variety and glass containers so placed that the light will show through them. (See Exhibits of Honey.)

(For hints on marketing see Extracted Honey, Bottling Honey, Peddling Honey, and particularly Marketing Honey.)

#### Devices for Holding Sections While Being Filled on the Hive.

Sections can not very well be placed on the hive to be filled by bees without some sort of arrangement to hold them. There are several different sorts of wide frames, racks, trays, boxes, clamps, all of which possess some special features. It would be impracticable to show all of them, but for the sake of illustrating some principles it may be well to mention some of those that have been used most largely.

What is known as the double-tier wide frame was perhaps the first device for holding sections in the hive. This consisted of a frame of the same inside depth and length of the ordinary brood frame, but of the same width as the section, eight sections to the frame. It was used very widely for a while, but in the course of time it was discovered that it had several objectionable features. First, a whole hiveful of them gave the bees too much capacity to start on and as a consequence this discouraged them from beginning work. Secondly, they did not permit tiering up to advantage.

The Doolittle surplus arrangement consisted of a series of single-tier wide frames having no projections to the top bars, although shallow wide frames have been made with such projections. Both the double and single-tier wide frames had the merit of protecting the surface of the sections from travel stain and bee glue.

### T Supers

The T super at one time was one of the most popular forms of section crates, and a few prefer it to anything else. It is so named for the T tins that support the sections. The tins are folded in the form of a letter T inverted, such construction making a very stiff and rigid support. This appliance takes separators very nicely, the separators resting on the T tins.

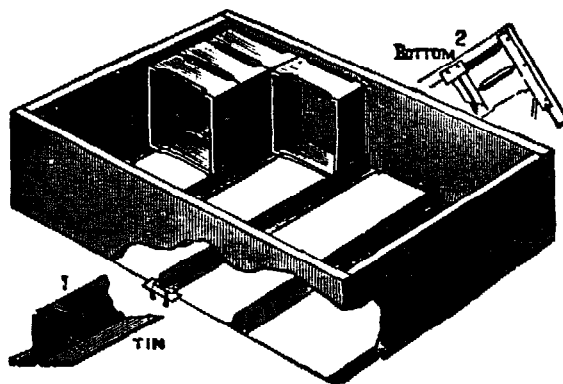

T super

Some beekeepers, like Dr. Miller, preferred to have the T tins rest loosely on a little piece of strap iron or bent staple, both for convenience in filling the supers and in emptying the same after the sections are filled. (See pages 176 and 177.)

### Supers with Section Holders for Beeway Sections.

The dovetailed super with section holders for beeway sections is the form of super that has perhaps been used more largely than any other. It consists of a series of section holders that are open at the top. Each holder is supported at the end by a strip of tin nailed on the inner edge of the ends of the super.

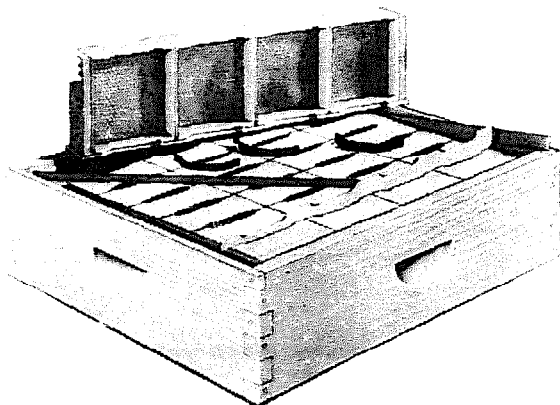

Section holder and super springs

Four sections in each section holder are held snugly and squarely in position with no spaces between the rows of sections. When beeway sections are used the bottom bars of the section holders are scored out to correspond with the beeways. Between the rows of sections is dropped a wooden separator.

There is no denying the fact that in any form of super arrangement the sections and separators should be squeezed together to reduce accumulations of propolis. The objection to thumbscrews or wedges is that if the sections in a super become swelled by dampness the rigid screw or wedge becomes stuck and this sticking makes it hard to remove the sections. If the joints of the sections have been moistened to prevent breaking when the sections are folded at the time the super is put on the hive there is a slight shrinkage. This shrinkage makes more trouble than the swelling, for the contents of the super become loose. The bees, of course, improve the opportunity to crowd a line of propolis in all the cracks.

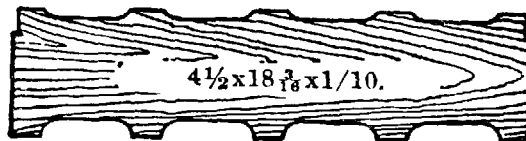

Wooden separator

To remedy all this trouble the steel super spring has come. Its pressure is constant. It adapts itself to any swelling that may occur, and equally adapts itself to any shrinkage, so as to press the parts together enough at all times to prevent the bees from crowding in propolis.

The super spring is crowded vertically between the side of the super and post of the fence. When a follower is used, two springs, one at each end, are crowded vertically or diagonally between the side of the super and the follower. Sometimes only a single spring is used at the middle of the follower.

### Separators

In connection with appliances for holding sections in the hive, there is a device known as the separator or fence. These separators are put in alternately, one in a place between the several rows of sections. Each separator consists of a strip of wood

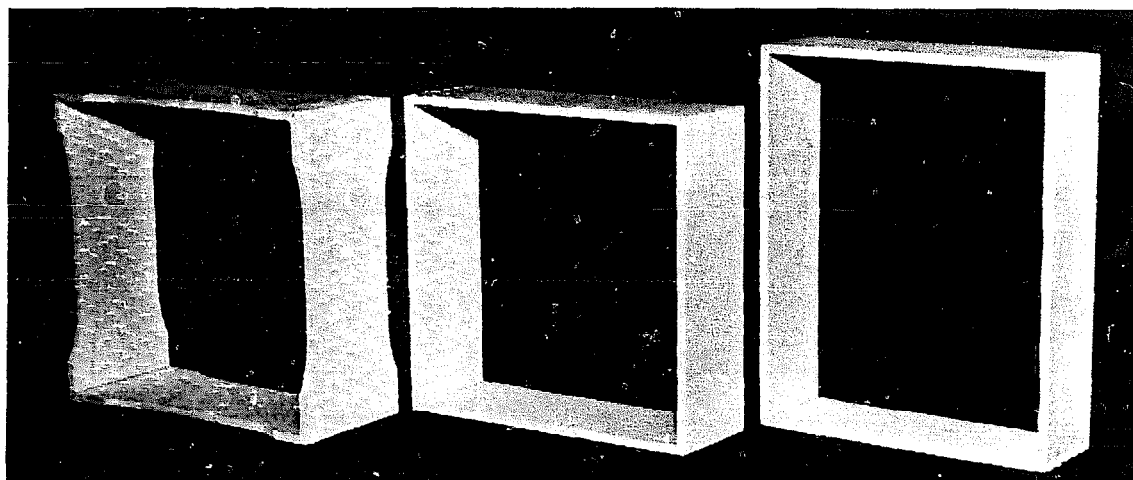

$4\frac{1}{4} \times 4\frac{1}{4} \times 1\frac{1}{8}$ "

$4\frac{1}{4} \times 4\frac{1}{4} \times 1\frac{1}{2}$ "

$4 \times 5 \times 1\frac{1}{8}$ "

Three most popular sizes of comb honey sections.

or metal a little less in width than the height of the sections, and in length equal to four sections standing side by side, or the separator may be a fence made of the same size, but consisting of horizontal strips. The purpose of the separator or fence is to prevent bees from bulging their comb from one section to another. Without them the sections will be irregular in weight and

unmarketable. Some will be too lean while others will be so fat that their surfaces will be bruised by coming in contact with other sections when they are put into a shipping case for marketing.

Since the net weight law went into effect (see Labels; also Grading Comb Honey) unseparated comb honey can not be graded satisfactorily.



Freshly harvested section of Cobana comb honey. (From "How to Raise Beautiful Comb Honey," by Richard Taylor. C. 1977 by Linden books.)



### The Cobana System\*

In the mid-1950's the late Dr. W. Z. Zbikowski, a retired physician and hobby beekeeper living in Dearborn, Michigan, began experimenting with ways to produce comb honey in round sections. He was led to this by his observation that new honey was added to the combs, and capped over, in circular patterns, from which he quite correctly inferred that round sections would be filled faster and better than the traditional rectangular ones. The problem to be solved was, of course, that of the interstitial spaces between the sections. There was no way of fitting round sections into any standard super without creating such spaces between them. At first Dr. Zbikowski tried fitting round sections, made by sawing off sections of plastic tubing, into wooden frames in which holes had been cut to just the size of the tubing. The result of this crude beginning was so promising that he then turned to molded plastic frames, each frame consisting of two halves, into which round sections can be fitted. Each such section consists of two molded rings which, once fitted into the two halves of the frame, come together with foundation between them, exactly like any other split section, except that these are round instead of square. The design of these frames and sections that

\*Richard Taylor

this inventor worked out at that time proved so nearly flawless that it has survived, almost without change, to today.

The Cobana super is ventilated at both ends. It will hold nine Cobana frames, each with four sections, or 36 sections in all, but most beekeepers prefer to use only eight of these frames, thereby creating a space at each side of the super, as well as at the ends. The super, being 4½" deep, is also slightly more shallow than the regular comb honey super. Standard comb honey supers can be converted to Cobana supers simply by cutting them down to this depth on a table saw.

There are three great advantages to using Cobana equipment. For one, the sections do not need scraping, since the outer surfaces of them are made inaccessible to the bees by the special frames, and they cannot become propolized or travel stained. Second, the comb honey supers fill with honey much faster than those with square sections, there being no corners for the bees to fill. Comb honey can therefore be produced by this system in areas of breifer or less intense flows than are normally required for getting comb honey. And third, the comb honey pack is much neater, more attractive, and freer from stickiness than the square wooden sections.

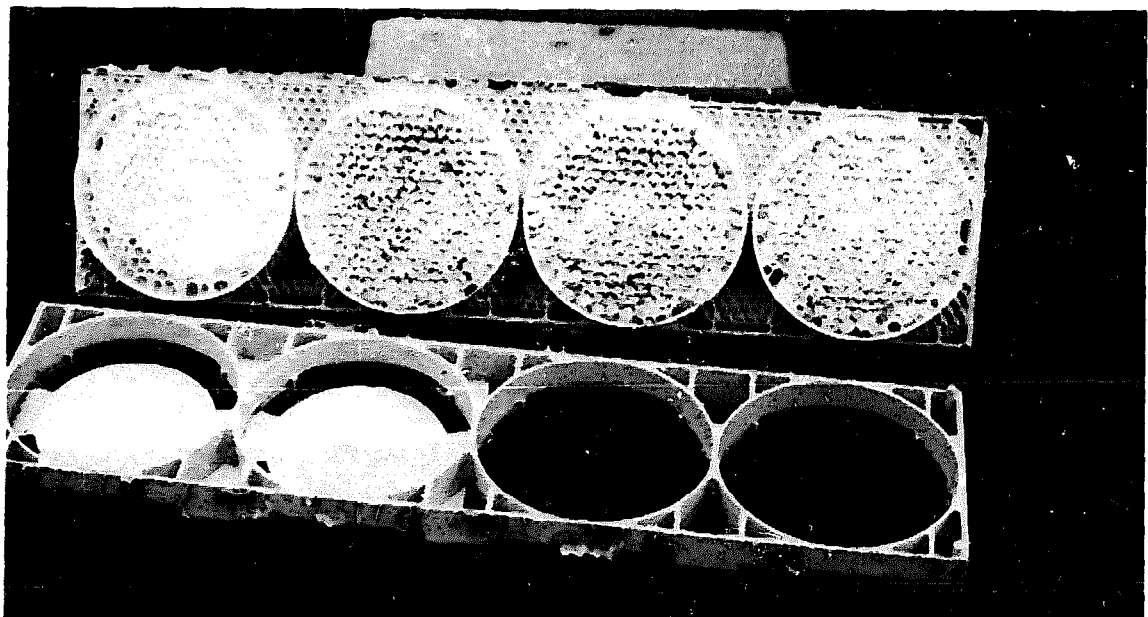

The Cobana frame with honey ready for harvesting.

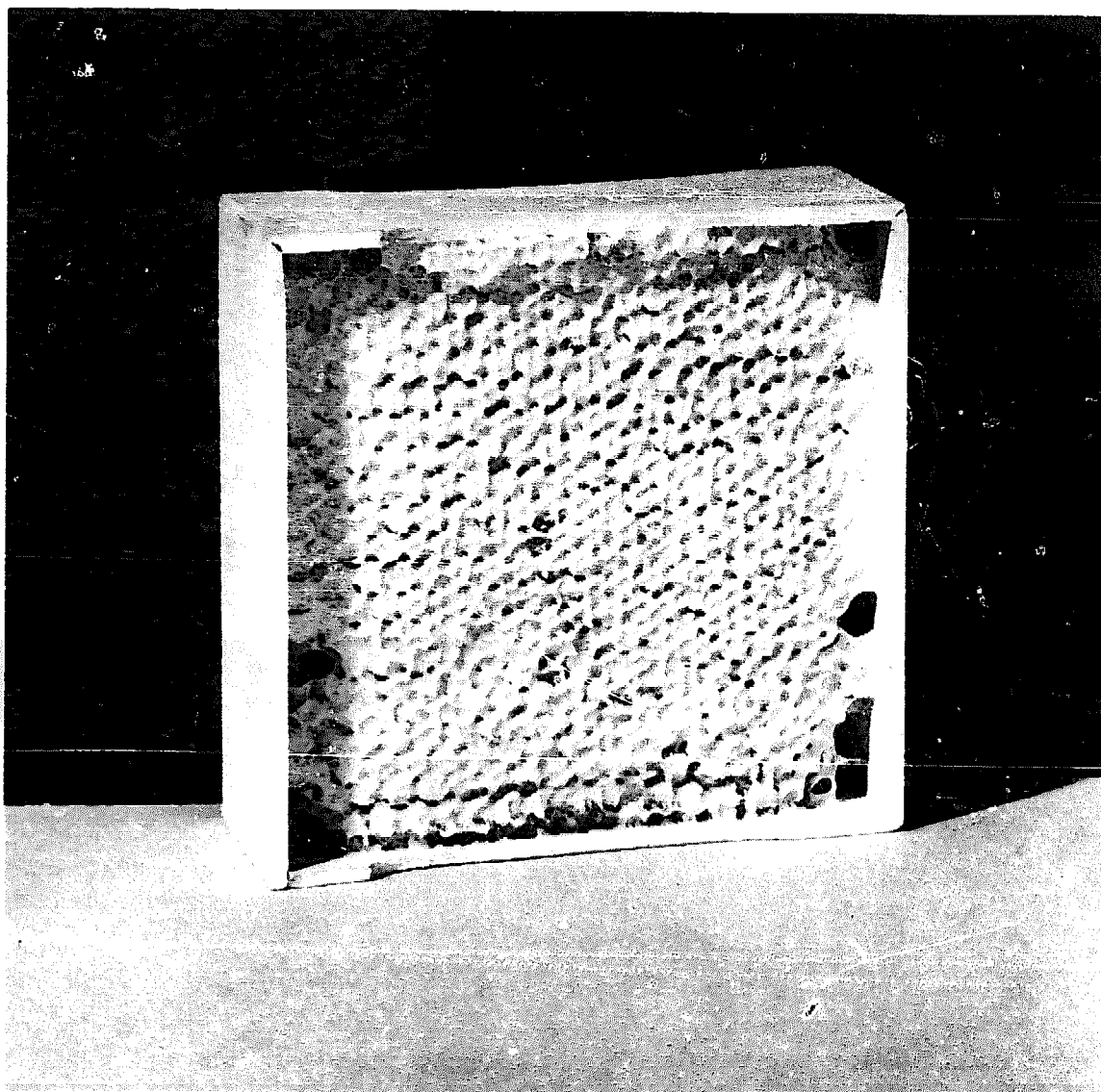

### COMB HONEY, TO PRODUCE.—

Not all localities would be suitable for the production of comb honey. Where all sources of honey are on the order of amber or dark with a flavor below standard, especially if the flows are more or less intermittent, it would be inadvisable to produce comb honey in sections. It would be much better to produce extracted honey only, put up in tin or glass or what is sometimes known as bulk honey. Only localities producing the best table honey, white in color, should be selected for the production of comb honey. However, there is one dark honey, namely buckwheat, for which there is a very strong demand either in sections or in the form of extracted honey. But this honey must be sold in the locality in which it is produc-

ed, as buckwheat is not popular outside of eastern New York and parts of Canada.

In order to secure comb honey the colonies must be very strong—that is to say, the two-story hives must be fairly boiling over with bees—so strong, indeed, that some of the colonies will be inclined to swarm as soon as the honey flow starts. But mention of this will be made further on.

There is not much use in trying to produce comb honey if the colonies are only of two thirds or one half strength. In order to bring all of these up to honey gathering pitch, turn to the general subject of Building Up Colonies and Food Chamber. Be sure that the directions that are given are carefully followed. Assuming that this has been done, it is also important that there should be

the proper proportion of bees of flying age—that is, fielders. A colony might have enough bees, but an insufficiency of them old enough to go to the fields for nectar. The bees should not be younger than 10 days or two weeks. This will require that eggs that have been laid to produce bees for the field should be laid from a month to six weeks ahead of the expected harvest.

If for any reason it is not deemed practicable to build up colonies by uniting or strengthening them with package bees (see Package Bees), or if it is desirable to run for both comb honey and extracted, the medium colonies may be left as they are and run for extracted honey, while those of sufficient strength will be run for comb honey. The weak colonies — those of two or three frame size—should be united to medium strength colonies, or better still, should be strengthened early by adding a three-pound package of bees without a queen.

The medium colonies can be built to proper comb honey pitch without uniting provided the weather conditions are such that the bulk of the eggs can be laid from a month to six weeks ahead of the harvest. (See Building Up Colonies.)

Colonies that are very strong in the spring will build up relatively faster than the weaker ones, and these can sometimes supply frames of emerging brood and bees to weaker colonies.

There should also be a liberal supply of stores in the hives the previous fall, not only to prevent starvation but to make brood rearing possible. If the supply is scant, the amount of brood and bees in the brood nest will be correspondingly small, and then it may be necessary to resort to feeding.

It is much better to give a colony a food chamber of natural stores the previous fall than to feed syrup that is artificial without the minerals, proteins, and other elements found in honey. While syrup is fine for cold weather, honey is far better for brood rearing. (See Food Chamber; also Brood and Brood Rearing, Pollen, and Royal Jelly.)

Having brought the colonies up to comb honey pitch, it will be found that some of them will be inclined to swarm as soon as the harvest opens. There will be some other stocks that will make no effort to swarm at all.

These should be carefully noted, and queens from them should be used for breeding. The swarming nuisance can be very materially reduced by breeding from the queen whose colonies keep on storing honey without swarming. (See Swarming.)

Just as the harvest opens, or a little before, as may be shown by the combs being whitened and bulging near the top, the entrance reducing blocks should be removed or the hive should be lifted up on four blocks placed between the hive body and bottom. It has been proved that the giving of a large amount of bottom ventilation in this way will check swarming to a very great extent. This ventilation should be supplied a little before the harvest opens, to prevent queen cells in colonies that are not inclined to swarm, and discourage the building of such cells in colonies that are inclined to swarm.

Swarming may also be discouraged by giving early a super of extracting combs, and after the bees have started on this, substituting a super of sections. Extracting combs may be put in the side of a comb honey super, or partially built sections from the previous season called bait sections may be used. A couple of these placed in the center of a super on the hives will do much to discourage swarming and will get the bees up into the super.

#### One or Two Stories for Brood

Most comb honey producers use the two stories previous to the honey flow to provide sufficient room for extra stores and brood rearing, permitting the queen free range of both stories. When the honey flow begins the hives are reduced to a single story by taking away most of the honey and leaving most of the brood. At the same time two comb honey supers are usually given so that the total hive capacity is not reduced. (See Food Chamber.)

#### Double Brood Chamber for Comb Honey.

During recent years it has been found possible, under favorable conditions, to produce section comb honey over a double brood chamber (sometimes called a food chamber) colony. Such a colony must be boiling over with bees at the beginning of the honey flow.

There are at least three advantages to this method over the one already mentioned, of removing the upper chamber at the beginning of the flow and reducing the colony down to a single story:

(1) The double brood chamber affords more comb space for brood rearing and helps to avoid congestion which is said to be the main cause of swarming.

(2) The double brood chamber gives ample comb space for storage of pollen and there is therefore less danger of pollen being deposited in the comb honey sections, which by the way, spoils the appearance and salability of section honey.

(3) The double brood chamber method avoids all unnecessary handling — that is, shifting the upper chamber at the beginning of the main flow, then back on later. After the surplus comb honey has been removed each two story colony should have an ample supply of honey and pollen for winter and early spring stores. (See Food Chamber.)

The double story method simplifies apiary management and as time goes on it may supersede other methods of comb honey production that have been used during the years.

In some cases it may be inadvisable to remove the upper story or food chamber if the working field force is too light or if the flow is of short duration.

#### When and How to Put on Supers

The comb honey supers should not be given until about the beginning of the main honey flow. If the colonies are in single story hives at this time and have been equalized by exchanging combs of emerging brood taken from the strongest colonies and given to those less strong, the comb honey supers may be given a few days before the beginning of the honey flow. If the colonies are in two story hives or if they are supplied with food chambers it is well to wait until the honey flow actually begins, so that the hives may be reduced to single stories before the comb honey supers are given.

In order to determine just when to put on the comb honey supers it is necessary to know the source from which the main honey crop is gathered for any given locality. In the northeastern states where the major portion of the honey crop is gathered from white clover and alsike clo-

ver, the honey flow usually begins about ten days after the appearance of the first clover blossoms. This is usually from the first to the middle of June in the northern states. Where sweet clover is the chief source of nectar, and in the irrigated regions of the western states where sweet clover and alfalfa furnish the major portion of the honey, the honey flow usually begins a little later. In some portions of the South the main honey flow may come quite early or there may be a succession of important honey flows with intervals of dearth between.

#### Tiering Up

The old practice was to place the comb honey super on top of the hive as soon as the first real honey began to come in. After this was two thirds filled with honey and the bees were pretty well distributed throughout the super, it was the custom to place an empty super under the one partly filled. The purpose of this was to stimulate greater activity and to reduce swarming by creating extra room on the theory that the bees would attempt to bridge the brood nest more closely with the stored honey in the super above.

Later practice shows that it is better for beginners at least to place additional supers, one on top of the other, when the last super given is about half filled. The danger in the old method was in giving too much room at one time, thus discouraging the bees. They evidently know better than their owners when they can use more room, and if the extra super is placed on top when the lower one is partly filled they will go above when they need storage space. The only possible objection to the latter practice is that the lower super may become slightly travel stained. If so, the sections can be easily scraped clean and made presentable for market. The filled super should be removed as soon as sections are capped to avoid travel staining.

In either case one should always be careful to see that the bees are not crowded for room. If the colony is very strong and the honey flow heavy, it may be necessary to put on two supers at once, especially if the upper story, or food chamber, is removed as already explained. If one is not able to visit the apiary for two

or three weeks it may be necessary to put on two supers or even three. If the colonies are in the home yard where they can be examined frequently it is best not to give room faster than the bees are able to occupy it. As the flow begins to let up, it is advisable not to add any more supers, compelling the bees to fill what they already have.

More beginners make the mistake, at the beginning of a honey flow, of not giving another super in time, than of giving too much room. If the honey does not come no harm is done. Too little room may start swarming.

#### **What to Do with the Food Chambers During the Honey Flow**

If the food chambers are removed at the approach of the main honey flow, some provision must be made to take care of these upper stories. One way of doing this is to tier up these extra hive bodies, or shallow extracting supers, several stories high above colonies selected for this purpose, as previously mentioned. If any colonies are below normal strength they may be used for producing comb honey. The shallow extracting super can be removed by smoking most of the bees down into the brood chamber, then taking it off with but a few bees in it. When full-depth hive bodies are used for the second story the bees should be shaken from the combs at the hive entrance. Several of these hive bodies can then be tiered up on a weaker colony.

Another way of taking care of the food chambers during the honey flow is to set them off without driving out the bees, but being sure the queen is in each brood chamber as explained under Requeening without Dequeening further on. The food chamber is then supplied with a bottom board and cover and is set beside the hive. By giving this removed food chamber a queen cell, a young queen will be reared shortly and then in the fall the food chamber with the queen is put on top of the original hive. The young queen in the top hive will, in the majority of cases, survive and the old queen below will be killed. In this way it is possible to requeen without dequeening and thus save time when time is very much needed.

In producing comb honey a critical time as to swarms comes when

the hive is reduced to one story and comb honey supers are given at the beginning of the main honey flow. The writer has seen colonies occupying three or four stories with bees touching the cover and the floor at the beginning of the honey flow, in which nearly all of the bees crowded down into the brood chamber during a cool night after the hive was reduced to a single brood chamber with two or three comb honey supers added. Such a manipulation is the strongest kind of invitation to the colony to swarm. This is one argument for letting the bees and queen have a double brood chamber.

This is where the producer of extracted honey has great advantage, since he expands the hive by adding supers of empty combs instead of reducing it by taking away the upper story or food chamber and giving comb honey supers. Some bee-men have tried to relieve this condition by lifting up the upper story and placing the first comb honey super between the two hive bodies, but when this is done it is necessary to take away the upper story a few days later, since otherwise the bees would discolor the combs in the comb honey super.

#### **When the Bees Refuse to Go Up Into the Super.**

If one has read carefully the instructions at the beginning of this chapter on the importance of strong colonies for the production of comb honey, he will understand that the chief and almost the only reason why bees do not go into the sections\* when other bees in the yard go up, is that the colonies of the laggards are not strong enough in bee force. The giving of bait sections, or a super of sections partly drawn, may help, but in the end the yield, if any, will be light, and there may be a lot of unfinished sections.

The only real remedy is to run those under par for the production

\*Anent bees refusing to enter supers: This is because of the separators. As you know, I do not use separators in the production of comb honey and I find that bees enter my supers often within five minutes after the super is put on. I have seen all 36 sections full of bees within 15 minutes. I have no more swarming as a rule in the production of comb honey than I do producing extracted honey. At least 99 out of every 100 combs can be put into the cartons with no trouble. It is true that often several sections will be slightly bulged, but not seriously so.—Allen Latham.

of extracted honey leaving the best and strongest colonies for comb honey production.

If all the colonies, whether strong or not, show a disinclination to draw out foundation in the sections it may be assumed that the honey flow is not strong enough to furnish nectar beyond the needs of the brood nest. The season may be ever so promising for a good flow and yet on account of weather conditions may fail when the bloom is at its best.

#### As Close of Honey Season Approaches.

If the beekeeper runs out of supers during the latter part of the honey flow, it may be well to shift supers from one colony to another thus giving a little more room to colonies beginning to be crowded and at the same time reducing the super room in those having more than they need. In fact, there comes a time during the latter part of the honey flow when it is better to have the colonies crowded a little for super room, but the difficulty is to know when this time has arrived. The bees will usually stand a degree of crowding at this time which earlier in the season would have caused them to swarm or to loaf badly. Any new supers that are given at this time should usually be placed on top of those already on the hive.

The second step in preparation for the close of the season is that of reducing the number of supers on each hive to one or two as soon as possible, concentrating the unfinished sections in these supers. Sometimes the bees are slow about sealing the honey, when it may be necessary to tier up the supers four, five, or even six high before any of them are ready to be taken off. At other times they seal the honey more promptly, so it is not necessary to tier up more than three supers high. Usually the bees seal honey more promptly toward the latter part of the honey flow.

As a rule it is not advisable to leave the supers on until all of the sections are finished, for the longer the honey is left on the hives the more travel stained it will become and the more it will be soiled with propolis. This is especially true late in the honey flow. When most of the sections are finished the super should be taken off and the unfinished sections sorted out to give

back to the bees for completion. It is not safe to assume that a super is ready to be taken off by looking in at the top only. It is better to look in at the bottom also, for sometimes the sections of honey are sealed near the top and not near the bottom.

#### What to Do with Unfinished Sections

The supers in which but little work has been done can now be piled up criss-cross near the apiary and the bees invited to help themselves, provided there are enough such supers so that the bees will not crowd each other so much that they will tear down the comb. This, of course, should not be done if there is any foulbrood among the colonies or if the apiary is too close to a neighbor.

The last supers which were given to the finishing colonies should not be left too long, but should be removed as soon as most of the sections are finished. Usually it does not pay to return the unfinished sections from this last lot of supers for completion. Some of these may be sold as culls or cut out and sold as chunk honey. Many comb honey producers extract the honey from these unfinished sections and save the combs for bait sections.

The important thing in taking care of unfinished sections to be used again the next year is to take them off before the wood is soiled with propolis and the foundation gnawed at the edges and also varnished over with propolis.

#### Feeding Back

If the honey flow fails suddenly, affording no opportunity to return unfinished sections to the bees for completion, they may be completed by feeding back diluted honey. In this case the unfinished sections may be sorted into different grades and the lightest ones extracted to secure the honey to feed back in finishing the heaviest ones.

Feeding back diluted honey to secure the completion of unfinished sections was formerly practiced to a considerable extent by comb honey producers, but has been discontinued by most of them. Comb honey finished by feeding back is usually inferior in appearance, tends to granulate early in the winter, and much more honey must be fed than is finally stored in the sections, a large amount being consumed during the process.

### Producing Comb Honey by Artificial Swarming\*

The method of artificially swarming a colony, or "shook" swarming, as it is sometimes quaintly called (see Artificial Swarming), which some beekeepers use as a method of preventing natural swarms, can sometimes be used to produce spectacularly large crops of comb honey. The procedure is as follows.

Select a strong colony, early in the season and when the bees are building up rapidly and likely to begin preparations for swarming. The colony selected should preferably be one which is believed to be likely to throw a natural swarm if left unattended. Set this colony on a new, improvised hive stand immediately in back of its regular stand, and arrange it to face in the opposite direction. On its original stand put a new bottom board and, on this, a standard shallow extracting super fitted with nine frames of foundation only, no drawn comb. On this super put a queen excluder and three comb honey supers, and cover with inner and outer covers.

Next remove the combs and adhering bees, one at a time, from the original colony, and give each comb an abrupt shake in front of the shallow super which you have just set up on the original hive stand, thus dislodging most, but not all, of the bees at the entrance to this new and extremely shallow hive. A sheet or something similar placed before this entrance will help prevent bees from becoming entangled in weeds and grass. Proceed in this fashion with most, but not all, of the combs of the original colony, so as to get about two-thirds or perhaps three-quarters of the bees shaken onto the cloth in front of the new hive. Watch closely, meanwhile, for the queen, to be certain that she enters the new shallow hive, for the entire procedure would be wasted if she did not become part of the artificially created or "shook" swarm. Before she enters the new shallow hive one wing should be about half snapped off or, failing this, a queen excluder should be placed between the shallow extracting super and the bottom board as soon as you

are sure the queen is in that super. Once the queen is inside, the rest of the bees will go in too and, since the queen cannot fly back out, either that same day or the next, then the entire shook swarm will stop put and begin to utilize the shallow super as an abnormally small brood chamber. Meanwhile, the bees will also occupy the three comb honey supers at once, begin to draw out the foundation in all three supers and store honey in them.

A new laying queen should at once be introduced to the parent colony, which is now behind the artificially created colony, facing the opposite direction, and much depleted in population. This colony readily accepts its new queen, since its diminished population consists entirely of young bees which are friendly to a new queen, the older flying bees having joined the shook swarm at the original stand. This parent colony will, with its new queen, rebuild itself to normal strength fairly quickly and, in a normal season, produce one or two shallow extracting supers of honey in its own right.

Consider now the results of the foregoing procedure. The new colony established with the artificial or "shook" swarm is confined to a very small brood chamber, which in a few weeks becomes almost entirely filled with brood, there being no room there for storing honey. The honey, accordingly, all goes into the supers. This new colony also becomes immensely powerful, its population consisting not only of the bees that were shaken from the combs, but also of all the foraging bees—precisely the ones you want for honey getting—who return to their accustomed hive stand rather than entering the hive that is facing in the opposite direction. Moreover, the bees enter the comb honey supers at once, since there is neither brood nor drawn comb down below the excluder to attract them. This is why it is essential that the shallow super that is now to be used as a shallow brood chamber must contain nothing but foundation; otherwise, the bees will concentrate below and, for the time being, tend to ignore the comb honey supers.

It is not uncommon for a swarm, thus artificially created and hived on foundation only, to swarm out of their new

\*Richard Taylor

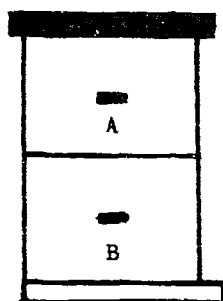

1.

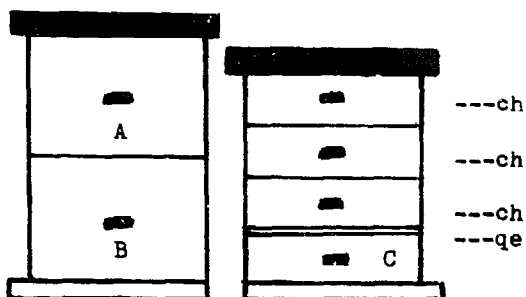

2, 3, 4.

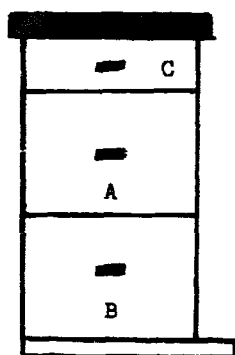

5.

**Shook swarming into a shallow super:**

1. Select a strong colony (AB) that seems likely to swarm if preventive measures are not taken.
2. Set that colony immediately in back of its original stand, and facing in the opposite direction. In its place, on its original stand, place a shallow super (C) fitted with nine frames of foundation, on top of which put a queen excluder (qe) and three comb honey supers (ch).
3. Shake most of the bees from the parent hive (AB) in front of this shallow extracting super (C), including the queen, preferably clipped.
4. Requeen the parent hive (AB) on its new stand just behind its original stand or (less preferably) let them raise their own queen.
5. After the comb honey has been harvested, return the parent hive (AB) to its original stand and facing as it was originally facing, and on top of it place the shallow extracting super (C) that has in the meantime served as a brood chamber. Foraging bees from the parent hive (AB) will find the entrance which has been turned around, the extra queen will be deposed, the brood from the shallow super (C) will all hatch out and be replaced by honey which can be harvested.



hive the next day. This can be expected to happen in about one out of four cases. There is no danger of the swarm absconding, however, so long as the queen is restrained from leaving, either by a clipped wing or by an excluder under her shallow brood chamber. Within two or three days, when the danger of this is clearly past and the bees have settled into their new hive, the queen excluder must be removed from under the shallow brood chamber, but not from over it. The upper excluder will be needed for the rest of the season, to prevent the queen from expanding her restricted brood nest up into the supers.

More comb honey supers will be added as the season progresses, and comb honey harvested as supers become filled. It is not uncommon to harvest 200 sections of comb honey from a single colony by this method in areas of normal honey flows.

When the early honey flows have ceased, and before the fall flow begins, the comb honey colony and the parent colony behind it, facing in the opposite direction, should be united, as follows: Remove all the comb honey supers, and set the shallow brood chamber off to one side. Next return the original or parent colony to its original hive stand, and face it in the same direction that it was facing at the beginning of the season, before you undertook the procedure just described. And finally, place the shallow brood chamber, now filled with brood, on top of this parent colony, and above any extracting supers that are already there, treating it exactly as you would an extracting super. As the brood in it hatches out, the bees will fill this super with honey, which can be extracted along with the rest of the crop. One of the extra queens in the colony resulting from this unification will, of course, be disposed of by the bees.

By the procedure just described a beekeeper can (1) prevent, almost infallibly, the loss of a natural swarm, since neither of the two colonies resulting from this operation will swarm, one of them being deprived of brood and the other deprived of bees, and (2) produce a large crop of comb honey over a strong colony in a drastically reduced hive.

### How to Take Off Comb Honey

There are two methods of removing bees from the filled supers. One is by the use of a bee escape, a device that will allow the bees to pass

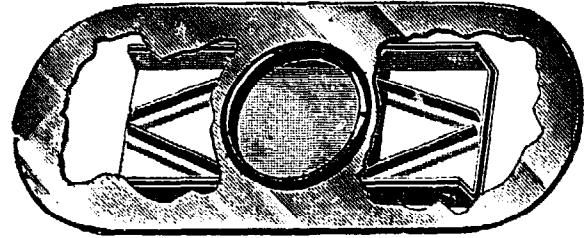

Porter bee escape. The two V-shaped prongs are made of thin strips of brass and are so sensitive that they spread easily to let the bees through at the apex. After the bees pass the springs, the points fly back to position, shutting off a return. If the prongs are bent or damaged they should be reset to 1/16-1/8-inch apart.

through a self-closing exit, and the other is by the use of carbolic acid fumes that are very repellent to bees. The one prevents the bees from coming back into the super by the way they went out, and the other forces the bees out of the super through the means of an offensive gas or vapor like that from carbolic acid. Both are effective, but the carbolic acid method should be used with caution. The first method will be described first as it has been in use much longer.

### The Bee Escape Method

Various forms of bee escapes have been devised. The simplest is a wire cloth cone with a small opening at the top just large enough to let a bee through. Bees will readily go through this but will not be likely to return because they will seek to enter at the large part or bottom of the cone. Several forms of self-closing gates have been devised. The teeth or prongs raise as the bee passes and then by gravity drop down as in the case of some mouse and rat traps. Mr. R. Porter some 50 years ago conceived a plan of a pair of delicate springs between the points of which the bees could push through easily. The points would then close, making an opening so small that they could not go back. As the exit would clog in a few cases, the escapes were provided with double springs or exits, as shown. The Porter escape is far superior.

The escape is mounted in a board, cleated at the ends and sides in such

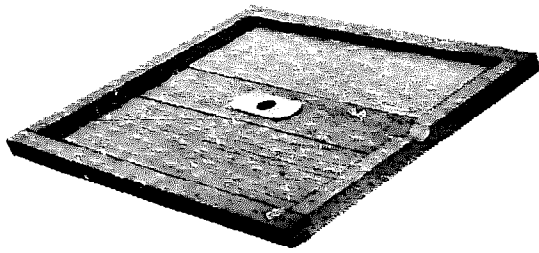

Bee escape in place in escape board.

a way as to provide a bee escape on one side so that it can be placed between the supers and the brood nest beneath. But care should be taken that it be placed right side up—that is, the side up as shown above.

One method of putting on one of these escape boards follows: With one hand tilt up the super at one end enough to make a gap, and with the other hand take the smoker and blow in two or three whiffs of smoke to drive the bees back. Lift the end of the super up a little farther so that it will stand at an angle of nearly 45 degrees. Set down the smoker and pick up the escape board which should be standing conveniently against the leg. Slide this on top of the hive as far as it will go, bee space side up. Let the super down gently on the escape boards, and last of all bring the escape board and super into alignment with the hive. This method eliminates hard lifting, saves time, prevents angering bees, and avoids killing them.

**Blowing Bees**

Blowing bees out of supers is a method developed by the U.S.D.A. It involves some device that produces high velocity air up to 160 m.p.h. which can be a shop vacuum cleaner stripped of its fine mesh bag or a gasoline driven impeller.

Blowing has the advantage of working under all weather conditions, it does not irritate the bees. The procedure is to lift the entrance edge of the surplus super so that the super is almost in the vertical position with the frame bottom bars just above the entrance side of the hive. The operator stands at the back of the hive blowing the bees out the bottom of the super. They catch wing in midair and fly into the entrance.

The blower used with a queen trap is also useful in requeening at those times in the fall when you can spend a lot of

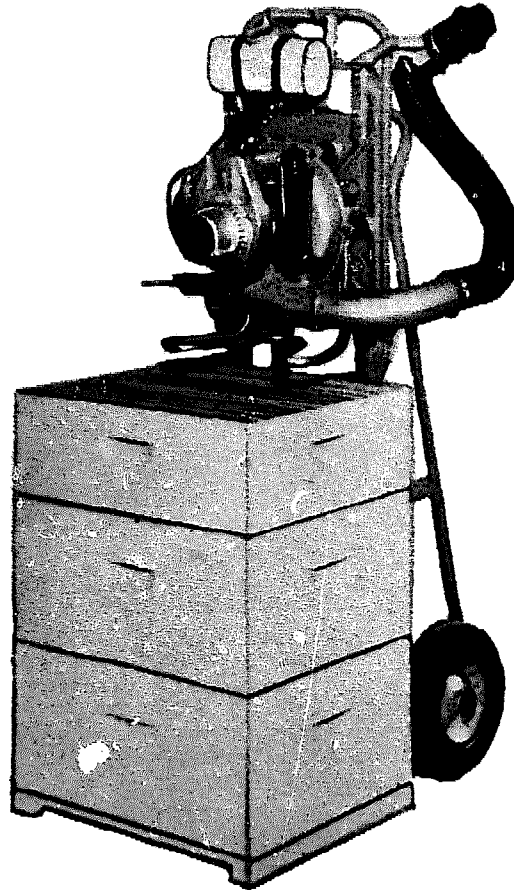

A high velocity bee blower driven by a two cycle engine shown here mounted on a super truck. This is a knapsack type blower normally worn on back of the operator.

valuable time hunting for an elusive queen.

In this procedure the whole colony is blown from the combs. The operation only takes a few minutes. As the bees reenter the hive, much as a swarm would, the queen is stopped by the queen cage and can be found easily.

**Benzaldehyde Repellent**

The most widely used new fume repellent is benzaldehyde. It is mailable and was developed by Professor Townsend of Ontario Agricultural College.

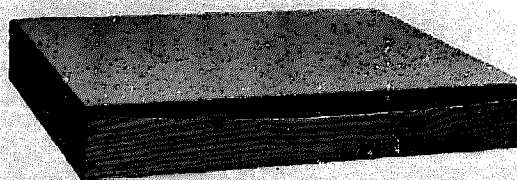

Fume Board

It is most effective at temperatures below 80 degrees but can be used above this temperature if three parts of ben-

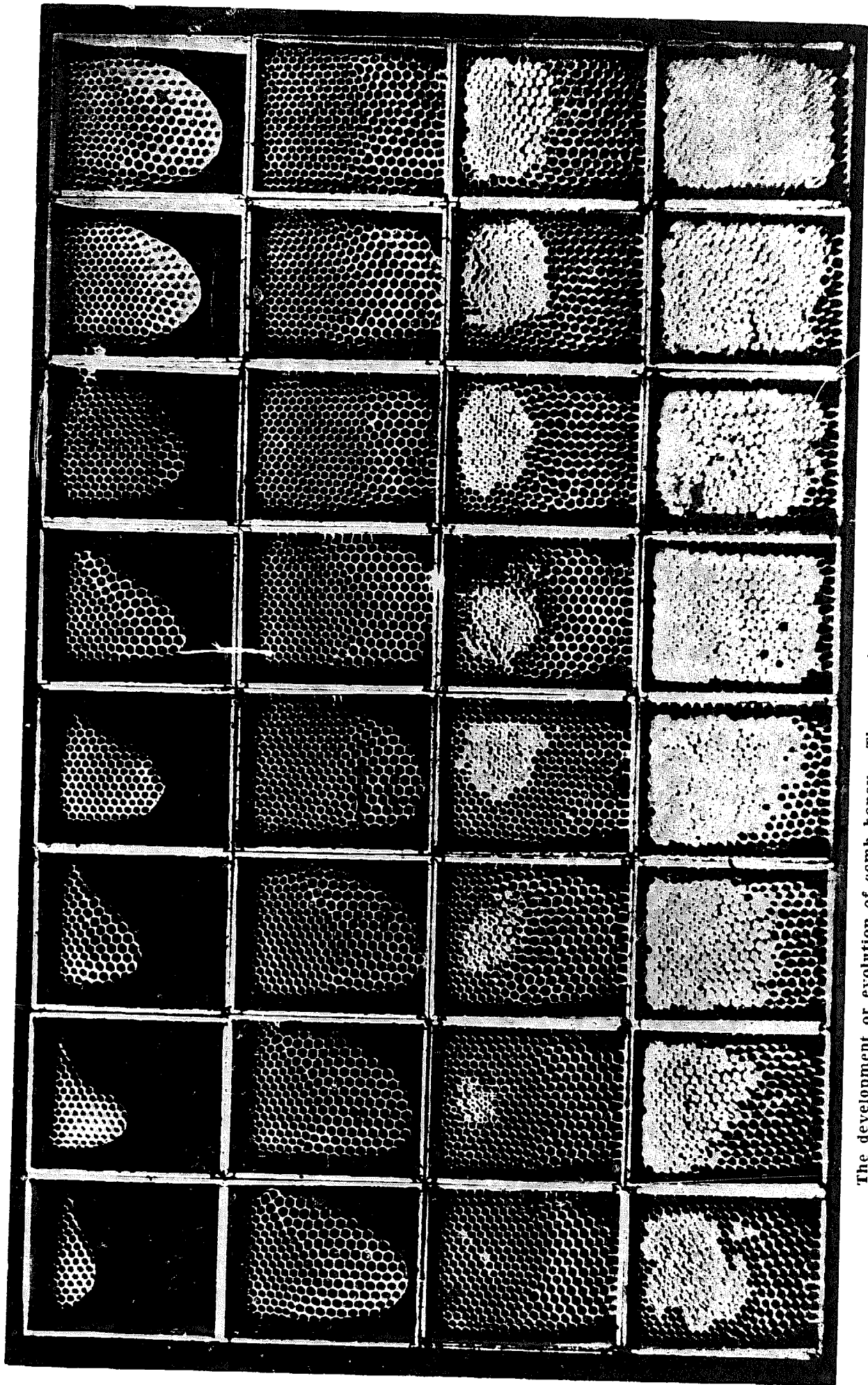

The development or evolution of comb honey. These sections were selected from two supers. of 32 sections.

zaldehyde are mixed with two parts glycerin and one part water.

Under normal conditions one tablespoon of full strength benzaldehyde is sprinkled or sprayed evenly on a fume board. The bees are started down with smoke, the fume board is left on the super five minutes. Stupefied bees indicate an overdose but if the bees are not quite driven out more benzaldehyde should be used.

Benzaldehyde can be used effectively at temperatures as low as 60 degrees Fahrenheit but dosages should be increased as the temperature drops.

After repeated use the fume board will be covered with crystals. They should be removed by washing with a hose or brushing. Benzaldehyde can irritate the skin but can be washed off with liberal amounts of water.

### Scraping Sections

In order to make sections present a clean and marketable appearance all the propolis should be scraped off. Some and perhaps most beekeepers prefer for this purpose a common case knife, and others a sharp jackknife. Sometimes the edge of a scraping knife is ground square and the scraping is done with a corner of the knife. But the general practice seems to favor the ordinary edge. Others prefer to use No. 2 sandpaper. A sheet of it is pasted flat on the table, and the section, edges down, is rubbed back and forth on the rough surface. If the day is not too warm nor the propolis too soft, the sandpaper will do faster work than a knife. But the edges of the section are a little roughened, and more or less fine dust at times gets on the surface of the comb.

When one has a large amount of comb honey the work can be done with sandpaper more expeditiously by fastening it on a revolving cylinder or on a flat surface of a revolving disk operated by foot power or a small motor. The author's experience, however, is that a power-driven cylinder or disk, on account of high speed, does not scratch the sections or leave the surfaces of the comb covered with dust.

### How to Remove Propolis

In scraping sections, fine particles of propolis will fly, get on the back of the hands and in between the fin-

gers. These fine particles irritate and cause burning on some people. The remedy, of course, is to wear gloves, or wash the hands in a solvent to remove the bee glue. Rubbing alcohol obtained at drug stores is the cheapest and most effective solvent.

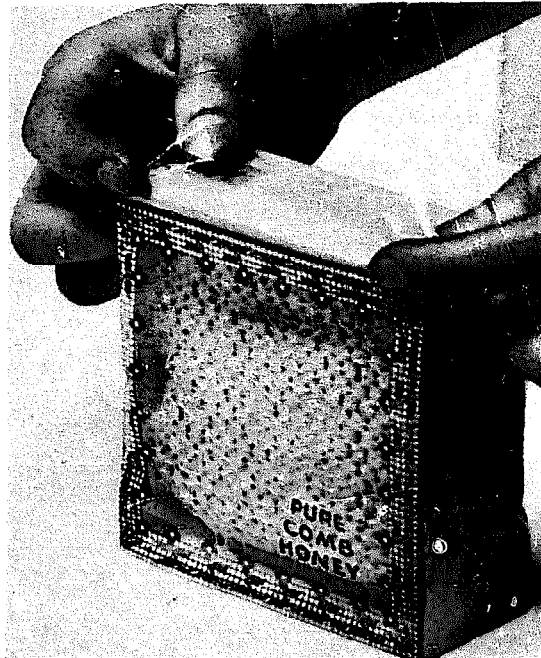

Packaging a clean section.

### Preventing Wax Moth Damage\*

Damage caused by wax moths (*Galleria mellonella*) ruins the marketability of comb honey. The infestation begins when the adult wax moth lays its eggs in the unprotected comb, either in the hive, during removal from the hive or during storage. If conditions are suitable for the eggs they hatch into larvae which cause the damage to the combs and sections. Nearly total destruction results from the proliferation of the larvae feeding on the combs.

If comb honey is to be protected from wax moth damage the honey must be removed from the hive as soon as it is capped by the most expedient method. The adult wax will enter the super of comb honey whenever it is not protected by the bees or the beekeeper.

Storage of section comb honey or cut comb honey without protection from wax moths is certain to result in damage or destruction. To protect comb honey from the wax moth when conditions favor an infestation a cold treat-

ment is recommended by Cantwell and Smith. They exposed various growth stages of the wax moth to low temperatures of 0°, 5°, 10°, and 30°F., in ordinary household refrigeration equipment. The lower two temperatures, 0°F. and 5°F., were obtained in a household deep freezer. The cold temperatures required to get a 100% wax moth kill in the various stages of development are given in the following table.

Stage	30°F.	20°F.	10°F.	5°F.	0°F.
Egg	270	270	180	120	120
Larva	480	150	120	120	105
Pupa	360	120	105	75	60
Adult	360	120	90	60	45

Figures on the table, in minutes, is the temperature-exposure time necessary to obtain 100% kill of various stages in the life cycle of the wax moth.

Facilities for the treatment of quantities of comb honey beyond the capacity of a home freezer requires a storage room and a system utilizing carbon dioxide. Such a system is used by the Sioux Honey Association of Waycross, Georgia. It is described in a manual prepared from the test results of research conducted under a memorandum of understanding between Sioux Honey Association and the United States Department of Agriculture.\*\*

Equipment requirements are given in the manual for the installation operated at Waycross but it may be adaptable to other storage conditions and other locations. Liquid carbon dioxide is supplied from a 9,000 pound capacity tank outside three large storage rooms which measure 48x25x14 ft. Movement of the carbon dioxide into the rooms is regulated by solenoid valves. A vaporizer converts the liquid carbon dioxide into gas. The gas feeds out through perforated pipes in the treatment rooms where it is analyzed and adjusted to the proper concentration and amount by instrumentation. Ultimately, the carbon dioxide concentration reaches 70 to 80%. An analyzer-controller maintains the desired concentration of carbon dioxide in the rooms for four or five days to obtain complete control of all life stages of wax moth which may be present in the material being brought into the rooms. Aeration by fans for at least two hours permits the attendant to enter the rooms

24 hours after the treatment, but the rooms are opened only when necessary.

\*Information taken from technical reports furnished by Dr. Robert Meloy of the Sioux Honey Association, Sioux City, Iowa.

\*\*Edwards G. Jay and Gordon C. Pearlman, Jr., A Manual for Carbon Dioxide Treatment of Comb Honey at Waycross, Georgia, ARS-USDA, Savannah, Georgia.

**COMBS.** — A beautiful thing in nature is a piece of comb honey with its snowy whiteness and its burden of sweetness. Aside from its whiteness and sweetness, the marvelous structure of the comb compels our admiration. The walls of its cells are so thin that from 2000 to 3000 of them must be laid one upon another to make an inch in thickness, each wall so fragile as to crumble at a touch, and yet so constructed that tons of honey stored in them are transported thousands of miles in safety.

Formerly the word "honeycomb" meant both the comb and the honey contained in it — in other words, what we now call "comb honey" was formerly called "honeycomb". Whenever the word "honeycomb" is found in the Bible, it means "comb honey".

It is only in comparatively recent years that the real source of the wax from which comb is constructed has been known. In 1684 Martin John discovered that with the point of a needle he could pick scales of real beeswax from the abdomen of a bee working at comb building.

These wax scales may be found plentifully on the floor of a hive at the time when comb building is going on. They are somewhat pear-shaped as shown on the next page, where is shown also the powerful jaw of the worker by which the wax is worked. The wax scales are much more brittle than the wax that has been worked into comb, and are transparent, looking somewhat like mica. Some observers say they are white—others say they are pale yellow. Probably both are right, the color depending upon the pollen consumed.

These wax scales are secreted by eight wax glands on the under side of the abdomen of the worker bee, as seen in illustration on next page.\* Examine a lately hived swarm and

\*For a description of how these are removed by the bees, see Pollen, subhead How Bees Remove Pollen, by Casteel.



Wax scale



Jaw of worker bee—From Cheshire.

plenty of bees will be found showing this appearance. Wax is liquid when first secreted. It is derived from the blood of the bee by cell action. So it is an expensive product, and one might say it is derived from the "sweat and blood" of the bee for it is sweat out from the blood by the wax glands. Just how expensive it is seems a hard matter to learn. For many years the stereotyped expression was "every pound of wax requires 20 pounds of honey for its production". Later investigations have cut down that estimate greatly. But there is no agreement. Some beekeepers estimate as low as three or four pounds of honey to one of wax. Others say seven, 15, or some other number.

There are those who hold that the secretion of wax is involuntary, and that if not utilized there will be so much dead waste, and so nothing can be gained by trying to save the bees the work of wax secretion. But this is not the general view. Cowan says, in his book, "The Honeybee," on page 171, "Wax is not produced at all times, but its secretion is voluntary." The practically unanimous agreement among beekeepers that a very much larger quantity of extracted than of comb honey can be obtained is hard to explain without admitting that the furnishing of drawn combs saves the bees much labor in the way of wax production, and that production depends on conditions that come largely under the control of the beekeeper.

A high temperature favors the secretion of wax, and when it is produced in large quantities the bees hang inactively in clusters or festoons.

"Wax is not chemically a fat or glycerine," says Cheshire in "Bees and Beekeeping", Vol. I, page 160, "Hence those who have called it 'the fat of the bees' have grossly erred; yet it is nearly allied to the fats in atomic constitution and the physiological conditions favoring the formation of one are curiously similar to those aiding in the production of the other. We put our poul-

try in confinement with partial light to fatten up. Our bees, under Nature's teaching, put themselves up to yield wax under conditions so parallel that suitability of the fattening coop is vindicated.

"The wax having been secreted, a single bee starts the first comb by



New wax secreted by wax glands appears as scales on the bee's abdomen.

attaching to the roof little masses of the plastic material, into which her scales are converted by prolonged chewing with secretion; others follow her example and the processes of scooping and thinning commence, the parts removed being always added to the edge of the work, so that in the darkness and between the bees grows downward that wonderful combination of lightness and strength, grace and utility, which has so long provoked the wonder and awakened the speculation of the philosopher, the naturalist, and the mathematician."

A chief use for the honeycomb being to furnish cradles for the baby bees during their brood stage, the problem is to find what arrangement will accommodate them in the least space and with the least expenditure of wax. If a number of cylinders with rounding bottoms are piled, and just back of them, back to back, and as closely as they can be packed, another series of cylinders are piled, there will be an arrangement that will leave a great waste of room between the lines of con-

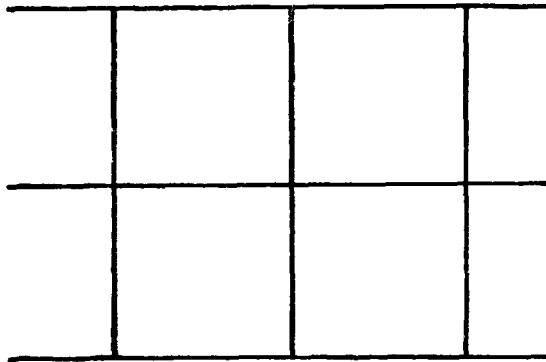

Economical of material but wasteful of space.

tact of those cylinders, and another waste between the points of contact of the rounding bottoms. If pressure is exerted on these cylinders so that the sides and bottoms come into contact, there would be some six-sided cells with bottoms that are made of three lozenge-shaped plates, or what as a whole is an exact counterpart of honeycomb. It has been argued that bees make the cells cylindrical in the first place, and then by pressure from within force the cells in the form of hexagons, but unfortunately for this theory, plaster casts of cross-sections have been made of combs in all stages of construction, which show that bees start their work by making true hexagons and not circles or cylinders. This can be seen by looking through a piece of glass on which combs have been built. However the combs are made, their general construction is such that the greatest economy of space and material is effected for holding either brood or honey. There would be an equal saving of wax if

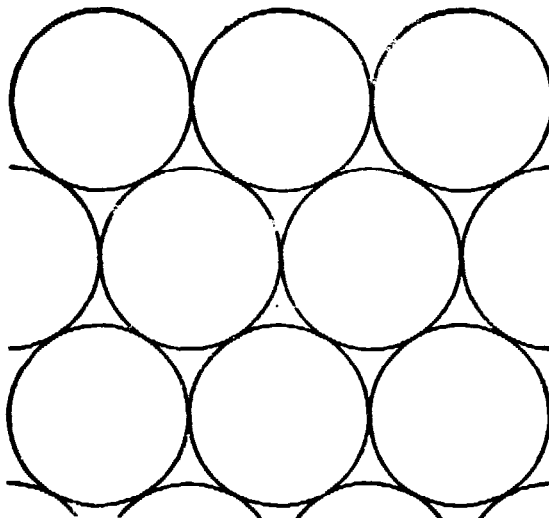

Economical of space but wasteful of material.

the cells could be made square with flat bottoms, but such cells would not fit young bees, nor would the comb be as strong. The hexagonal is the very best form of construction.

By far the larger portion of the cells in a hive will be found to measure slightly less than five to the inch, or more exactly 4.83 cells per inch. (See Cells, Size of, in Honeycomb.) These are called worker cells and may be used for rearing worker brood or for storing honey or pollen. A smaller number of cells will be found to measure about four to the inch. These are called drone cells, and may be used for rearing drone brood or for storing honey—seldom for pollen.

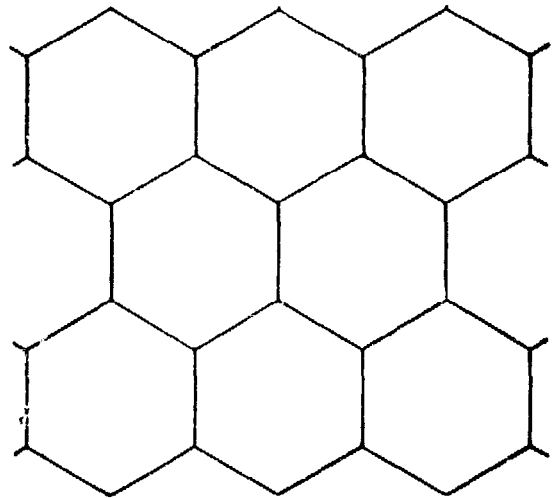

Economical both of material and space occupied.

Instead of lessening our admiration, the slight variation from exactness in the work of comb building when the bees are left free to take their own course, rather increases it, just as a piece of hand-made work is often more admired than that which is machine made. The marvelous ingenuity displayed in adjusting the work to varying circumstances is something far beyond machine-like exactness. Cut a few square inches of comb out of the middle of a frame of worker comb in the middle of a good honey flow, and the chances are that the bees will fill the hole with drone comb. A few cells will be built that are neither drone cells nor worker cells, and these are called accommodation cells. But so skillfully are the adjustments made in passing from worker to drone cells that at a hasty

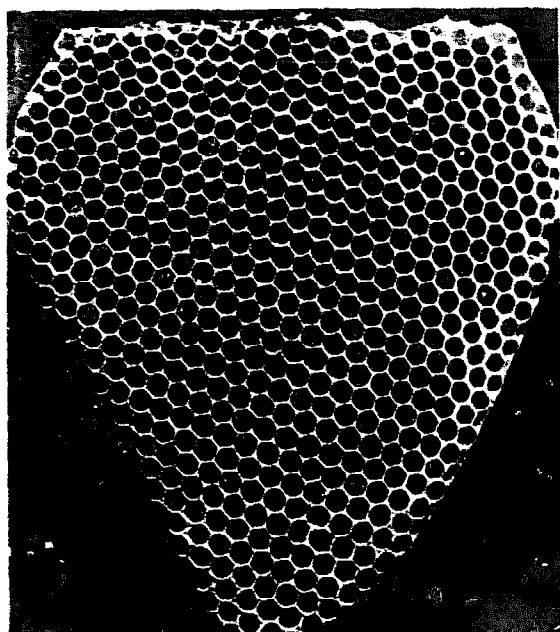

A characteristic spur of natural comb built from a horizontal support one half size.

glance one would be inclined to say they all are either worker or drone cells. Observe the small pieces of comb started at different points on the same top bar on page 187. They may be at such distances apart that when the two combs meet, if built with rigid exactness, the center of the cell in one comb will coincide with the edge of a cell in the other comb. Yet so skillfully are measurements made, and so gradual the change as one comb approaches the other, that the unaided eye can detect no variation from an unbroken comb of worker cells. The whole is such an exquisite piece of work as no human expert can hope to equal. Besides the worker and drone cells, queen cells are built at times, as described.

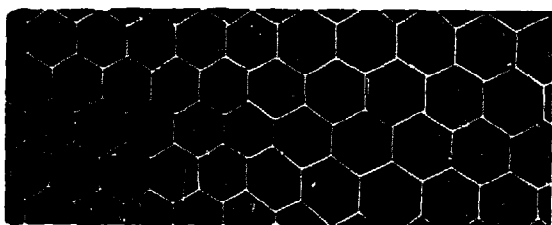

The merging of drone cells into worker

#### Variations in the Angles of Honeycomb.

The discriminating reader perhaps has noticed that there is a slight variation in the angles of the hexagonal cells in the honeycomb made

by the bees. To put it in other words, the hexagons of the honeycomb are not mathematically exact, but the general shape is that of a six-sided cell. There are two parallel vertical walls at an angle to the point of support that are slightly longer than other parallel walls. Apparently there is an attempt on the part of the bees to make their cells true hexagons, but on account of the temperature of the honey bee clusters and the weight of the bees, which is considerable, the parallel vertical walls are stretched slightly, making some of the angles more acute and others obtuse.

Whether this variation is a design on the part of Nature is not clear. Apparently there are mechanical reasons why one set of angles are slightly obtuse and others are slightly acute.

There has been much discussion in the years gone by as to how the bees build their comb, but it is very evident from the combs examined by the author that 95 combs out of 100 have two parallel walls vertical while the other parallel walls are diagonal. (See Fig. 1.)

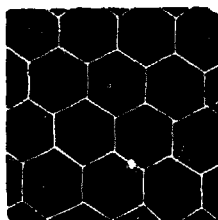

Fig. 1

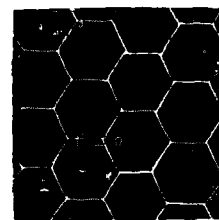

Fig. 2

It must not be assumed from the foregoing that combs with two parallel walls horizontal as in Fig. 2 are in any way abnormal or that the bees do not build the comb as quickly. Such is not the case. Apparently the matter is of little concern to the bees.

Sometimes when the comb was attached to a vertical support there would be two parallel walls that were horizontal. Occasionally there would be an attachment whereby horizontal walls were attached to horizontal supports, but these cases were very rare and the author has come to the conclusion that natural-built combs (without comb foundation) will almost always have two parallel walls hanging vertically from a horizontal support. Apparently there is a reason for Nature





Cross-section of honey comb, with cells filled with honey, shows how comb cells are not constructed horizontal but rather tilt up slightly. Also, note how the bees compensated for the bowed foundation at the bottom.

usually, if not always, follows a policy that is best for its creatures. (See Fig. 2.)

There is another interesting fact that perhaps may not be noticed, and that is that the midrib of comb increases in thickness and strength toward the point of support. The bees make either a very thick midrib to start with, or increase this midrib near the support as the comb is built downward. Apparently this increase in thickness does not prevent comb from stretching and hence the various methods of supporting comb foundation while it is being built out.

For a half century comb foundation has been designed and manufactured so that the combs built from it will be supported as we find

them in Nature, namely, that there will be two parallel vertical walls in an ordinary brood frame. If one will examine the combs built out in section honey boxes, he will find that the parallel walls are parallel to the top of the section, if the foundation is cut across. (See page 187.) Most of the comb foundation comes out of rolls so that the two parallel walls are at right angles to the side of the sheet as it comes out of the comb foundation mill. These sheets are cut up in lengths to fit inside of a Langstroth frame, and therefore the sheets are hung so that the walls shall be vertical in an ordinary frame. When the foundation is made lighter in weight for the section honey box, those same sheets are cut lengthwise so as to leave widths when cut in squares or oblong pieces so as to leave parallel walls, parallel to the top of the section. Apparently this makes no difference to the bees.

It should be observed that when the walls are parallel to the top of the section there will be very little stretching because the other side bars of the section are so close at hand. In a relatively long brood frame, the situation would be different, so wire supports or reinforcements at the base of the foundation are necessary.

In 1875, as reported on page 153, A. I. Root, in collaboration with his machinist, made his first successful comb foundation using type metal rolls, the surfaces of which were stamped with the base of the honeycombs. At the left of the illustration on page 188 is shown one of the later machines using two such rolls which are ten inches long. The one on the right shows the same general type but the rolls were ten inches in diameter in the belief that a better product could be secured as the cell wall angles were reversed to correspond with the angle shown in Fig. 2 on page 185. E. B. Weed, the inventor of the Weed Process comb foundation is shown inspecting the machine. Instead of having two parallel walls vertical to the line of support, it made the foundation so that the two parallel walls would be horizontal and in line with the support. The manufacture of this machine was discontinued because it was not practical. Sufficient pressure could not be exerted upon the comb foundation on

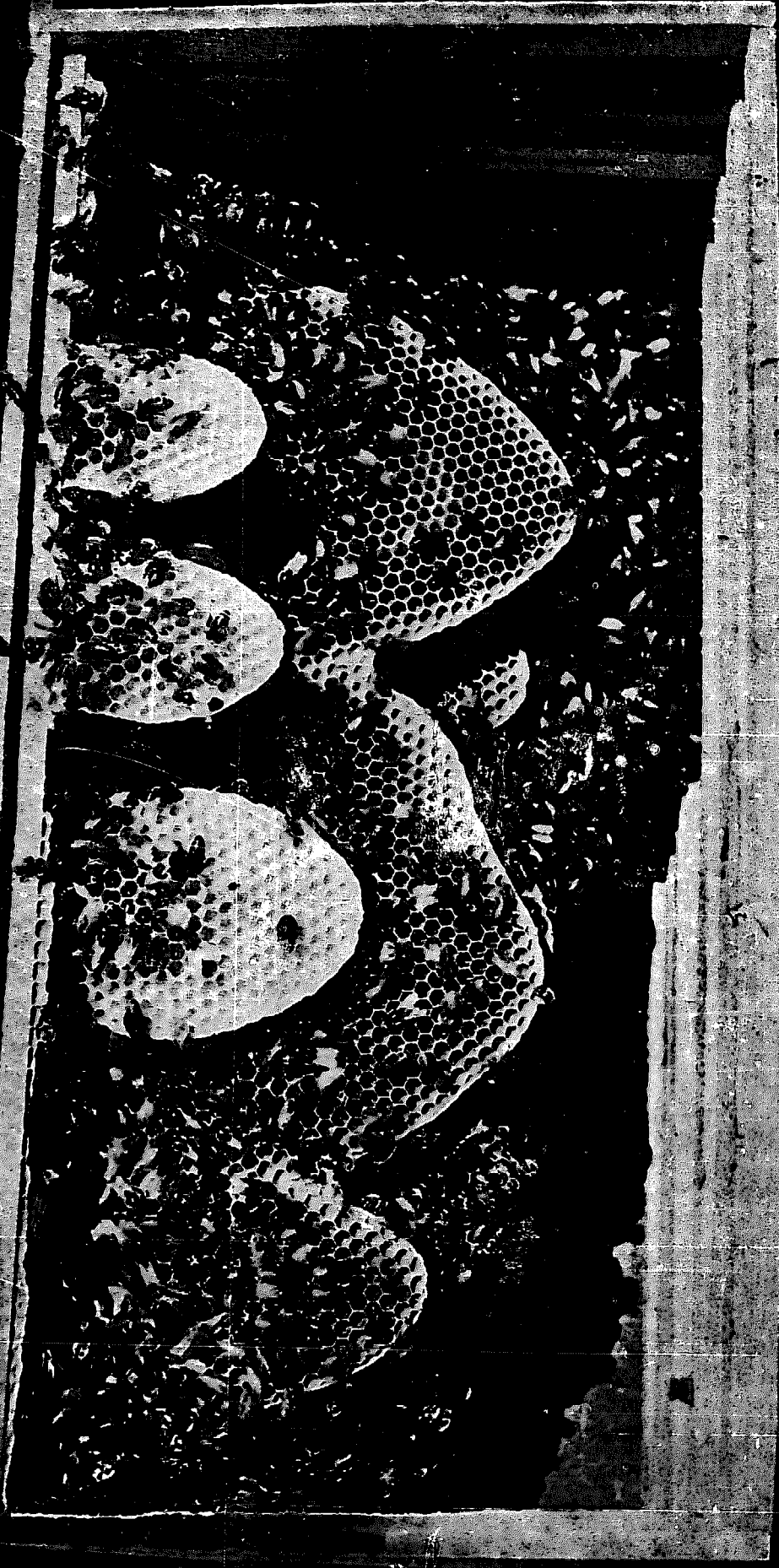

Natural comb building, illustrating how the several pieces of comb are joined together. Photographed by W. Z. Hutchinson.

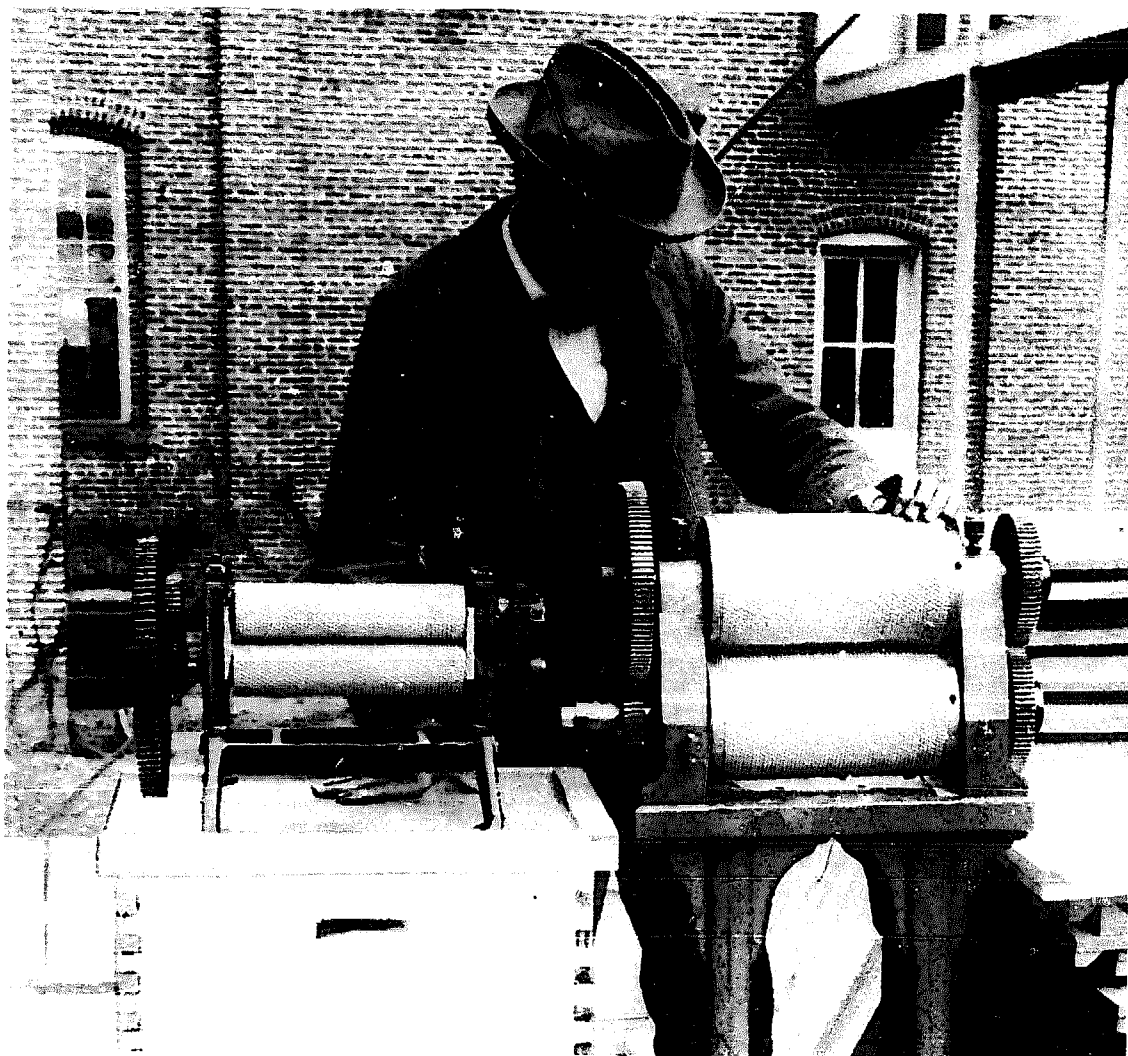

A 2½-inch roll and a 10-inch roll foundation mill with Mr. E. B. Weed standing in the background. The large mill has its angle reversed so that the parallel walls are horizontal instead of vertical as shown in Fig. 2 on page 185. See text.

account of the increased diameter, and what was more, the type used to give the imprint of the bottom of the cell was liable to creep out of its sockets in the roll.

While the cell walls vary in thickness from  $\frac{3}{1000}$  to  $\frac{2}{1000}$  inch, the septum is thinner, sometimes being as thin as  $\frac{1}{1000}$  of an inch when first built. But as successive generations of young bees are reared in the cells, cocoons and secretions are left at the bottom of each, and in time the septum may become  $\frac{1}{8}$  inch thick. From this it happens that, although worker comb is  $\frac{7}{8}$  inch thick when first built, specimens of old comb may be found measuring an inch in thickness since the bees draw out the cell walls at the mouth of the cell to balance the additions made at the bottom of the

cell, so as to maintain the same depth in an old cell as in a new one.

However, when worker cells are used for storing honey, if there is room for it the depth of the cells may be so increased that the comb may be two or three inches thick. Drone comb is even more likely to be thus built out. The cells of both kinds slant upward from the center to the exterior of the comb, yet so slightly that to the casual observer they appear entirely horizontal. Yet when the comb is so greatly thickened for the storing of honey, the slant may be much increased, giving the cell a curved appearance.

Formerly it was thought that the cappings placed over honey were air-tight, and this in spite of the fact that it is a common thing to see white comb honey become watery

and dark when kept in a damp place, the thin honey finally oozing out through the cappings. Cheshire, who at one time held that the sealing of honey cells is air-tight, says in "Bees and Beekeeping," Vol. I, page 174: "By experiments and a microscopic examination, I have made evident that former ideas were inaccurate, and not more than 10 percent at most of the sealing of honey is absolutely impervious to air". The sealing of the brood cells, however, is very much more porous (see Brood and Brood Rearing), which allows sufficient air for the brood. The brood cell cappings are made up of shreds of cocoons, pollen, and almost anything that comes handy, with only enough wax to weld the whole together.

The beautiful white color of honeycomb becomes dark with age, and when used for brood rearing becomes nearly black.

While drone comb measures just about four cells to the inch, the bees seem less particular about the size of it than that of worker comb. They often seem to make cells of such size as to fill out best a given space; and accordingly, the cells differ from worker size all the way up to considerably more than  $\frac{1}{4}$  of an inch in width. Drones are raised

in these extra large cells without trouble, and honey is also stored in them; but where they are very large the bees are compelled to contract the opening, or the honey would flow out. As honey is kept in place by capillary attraction, when cells don't exceed a certain size the adhesion of the liquid to the walls is sufficient of itself to hold honey in place. Where drones are to be reared in these very large cells the bees contract the mouth by a thick rim. As an experiment some dies were made for producing small sheets of foundation having only  $3\frac{1}{2}$  cells to the inch. The bees worked on a few of these same thick rims, but they evidently did not like them, for they tried to make worker cells of some of them, and it proved so much of a complication for them that they finally abandoned the whole piece of comb, apparently in disgust. Bees sometimes rear worker brood in drone comb where compelled to by want of room, and they always do it in the way already mentioned—by contracting the mouth of the cells and leaving the young bee a rather large berth in which to grow and develop. Drones are sometimes reared in worker cells also, but they are so much cramped in growth that they seldom look like fully devel-

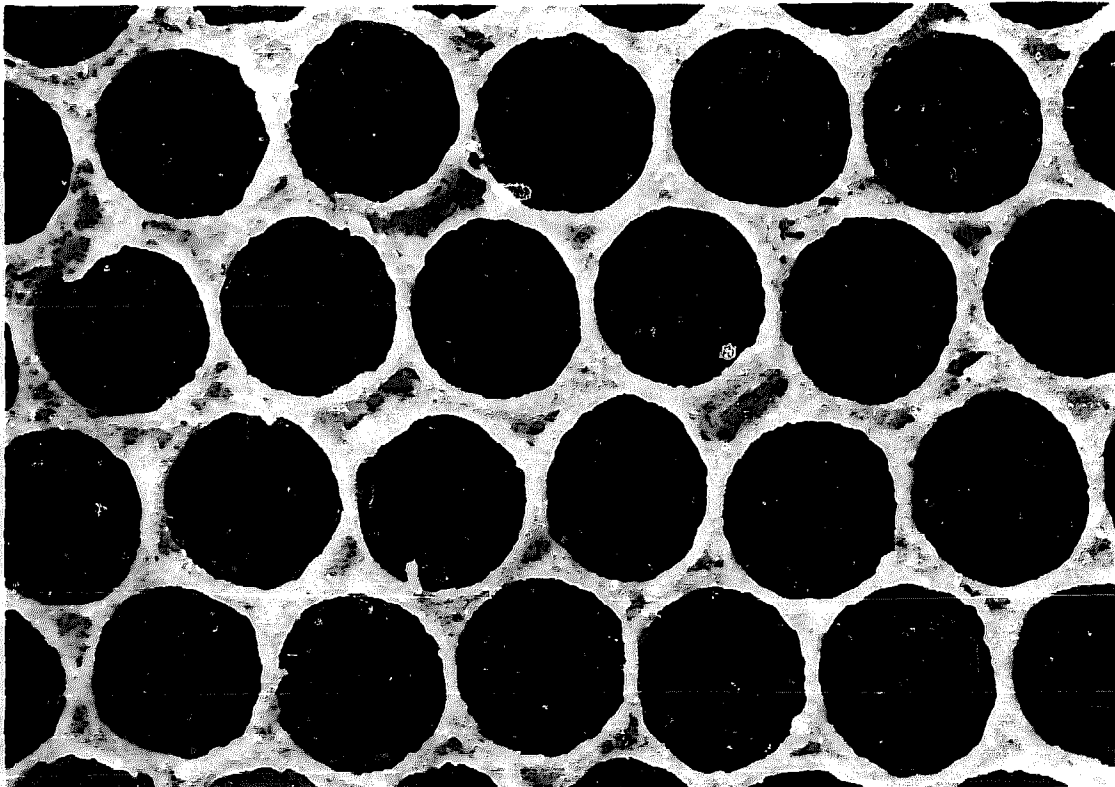

Top view of honeycomb greatly enlarged, showing the thick circular rim or coping at top of cell. Photo by E. F. Bigelow

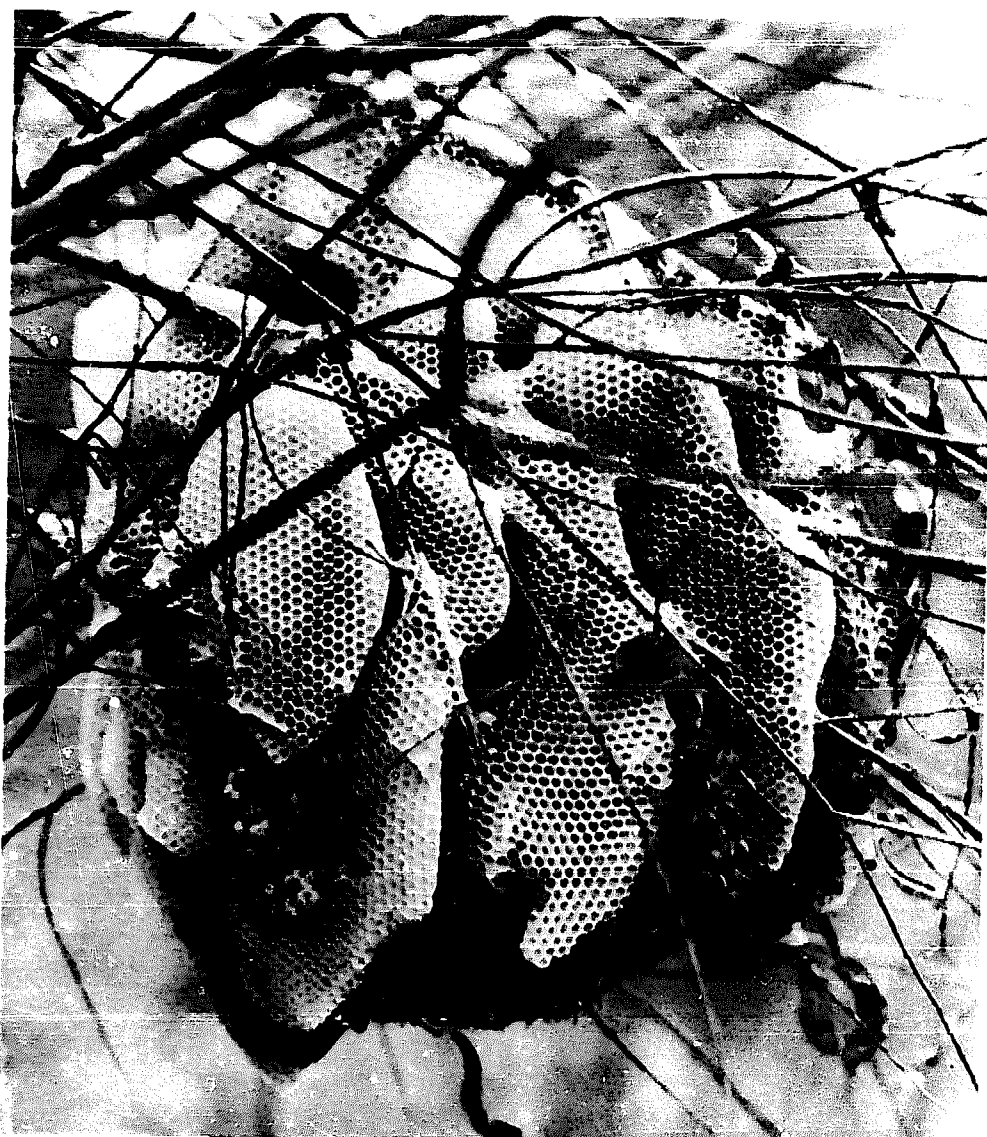

Bees living on combs built in the open air at Medina, Ohio

oped drones. (See Laying Workers, Brood and Brood Rearing, and Cells, Size of in Honey Comb.)

In A. I. Root's original house apiary in 1878 there were dozens of hives where the bees were building close to the glass, and all he had to do in order to see how it was done was to take a chair and sit down before them. But the workers have such a queer sleight-of-hand way of doing that it is hard to follow.

[A. I. Root wrote the matter from here to the finish of the subject and it has stood the test of time.]

If one will examine the bees during the season he will see on the under side of the body of the workers little scales protruding from the segments. (See page 183.) These, Casteel\* explains, are removed by

\*See Circular No. 161, Bureau of Entomology, Washington, D. C., by D. B. Casteel.

the spines of the pollen comb of the third pair of legs and are then transferred to the fore legs. Sometimes in the process the wax scales drop down between the combs onto the bottom board where they can be seen with the marks of the pollen spines.

If a bee is obliged to carry one of these wax scales but a short distance, it takes it in its mandibles and looks as businesslike with it as a carpenter with a board on his shoulder. If it has to carry it a distance it takes it in a way that is difficult to explain any better than to say it somehow slips it under its chin. When thus equipped, one would never know it was encumbered with anything unless it chanced to slip out, when it will dexterously tuck it back with one of its fore feet. The little plate of wax is so warm

from being kept under its chin as to be quite soft when it gets back; and as it takes it out and gives it a pinch against the comb where the building is going on, one would think it might stop a while and put it in place; but not that bee, for off it scampers and twists around so many different ways one might think it was not one of the working kind at all. Another follows after it sooner or later and gives the wax a pinch, or a little scraping and burnishing with its polished mandibles, then another, and so on; and the sum total of all these maneuvers is that the combs seem almost to grow out of nothing; but no one bee ever makes a cell.

The finished comb is the result of the united efforts of the moving, restless mass and the great mystery is that anything so wonderful can ever result at all from such a mixed up, skipping about way of working as they seem to have. When the cells are built out only part way they are filled with honey or eggs, and the length is increased later on. It may be that they find it easier working with shallow walls about the cells, for they can take care of the brood much easier, and put in the honey easier too, in all probability; and as a thick rim or coping is always left around the upper edge of the cell (see page 189), no matter what its depth, they have material at hand to lengthen it. This thick rim is also very necessary to give the bees a secure foothold, for the sides of the cells are so thin they would be very apt to break down with even the light weight of a bee. When honey is coming in rapidly and the bees are crowded for room to store it, their eagerness is so plainly apparent as they push the work along, that they seem to fairly quiver with excitement; but for all that they skip from one cell to another in the same way, no one bee working in the same spot over a minute or two at the very outside. Quite frequently, after one has bent a piece of wax a certain way, the next tips it in the opposite direction, and so on until completion; but after all have given it a twist and a pull, it is found in pretty nearly the right spot. As nearly as the author can discover they moisten the thin ribbons of wax with some sort of fluid or saliva. As the bee always preserves the thick rib or rim of

wax at the top of the cell it is working on, the onlooker would suppose it is making the walls of considerable thickness (see page 189). But if it be cut away and this rim be broken, its mandibles will have come so nearly together that the wax between them beyond the rim is almost as thin as tissue paper. In building natural comb, of course the bottoms of the cells are thinned in the same way, as the work goes along, before any side walls are made at all.

When no foundation is furnished, little patches of comb are started at different points, as shown on page 187. As these patches enlarge, their edges are united so perfectly that it is sometimes difficult, when the frame is filled solid, to determine where the pieces are united, so perfect is the work. At other times there may be a row of irregular or drone cells along the line of the union. The midrib of natural comb becomes thicker as it approaches the line of support and tapers toward the bottom. Why this is so is evident. It seems wonderful that there should be a gradation in thickness from top to bottom in spite of the haphazard, skip-about work on the part of so many different bees.

(For the consideration of the thickness of combs and how far to space them apart, see Frames, Self-spacing, Spacing Frames, and Comb Foundation.)

**COMBS, CELL SIZE OF.** — See Cells, Size of in Honeycomb.

**COMBS FOR EXTRACTING AND FOR BROOD REARING.** — Under Comb Foundation is shown how combs are built by the use of artificial aids. Under Cells, Size of, dimensions are given. Under Manipulation of Colonies, how combs or frames are handled. Under this head will be discussed the economic and comparative value of good and poor combs when used in brood frames.

Next to poorly made hives that require a hatchet or cold chisel to open, or poorly made frames that one can't put in or take out of a hive, are poor combs, especially drone combs. The bad equipment means a big waste of time, infuriated colonies, a painful lot of stings, and a whole apiary in an uproar.

The bee inspector who is obliged to see every inch of comb surface is sometimes made disgusted enough to burn the whole outfit, disease or no disease, but he must grin and bear it because it is part of his job. If he finds disease on top of the skinned knuckles and his stings, he is more apt to burn the colonies, believing that he is doing the owner of the layout a real favor in getting rid of his poor equipment.

The economic waste of poor combs is more often passed over in silence both by the bee inspector and the beekeeper unless the combs are so crooked or uneven that they crush bees in the attempt to remove them. The matter is made worse when the position of such combs must be changed. The crooked combs can be removed from the holes where they were built but can not be put into other places where their two fat sides crush bees. This is shown in the cross section of combs shown

below with the legends beneath that tell the story.

Combs built on reinforced foundation\* on four horizontal wires will be all worker and as even as a board. There is no valid excuse except shiftlessness or laziness for having anything else. Reinforced foundation costs a little more but it saves it in brood, stings, lost time, and in actual honey or money earned. If the crooked comb has much drone comb in it, thousands of useless drones are reared. Even if the comb is as straight as a board but all drone, the queen is quite liable to hunt it out and lay drone eggs in every cell.

Nature left to itself is apt to be lavish in furnishing more males than are necessary. Combs in a box hive, built without foundation, result in thousands upon thousands of drones that are only consumers and thus a

\*Reinforced comb foundation means either Root Three-Ply or vertical wires imbedded in the sheet.

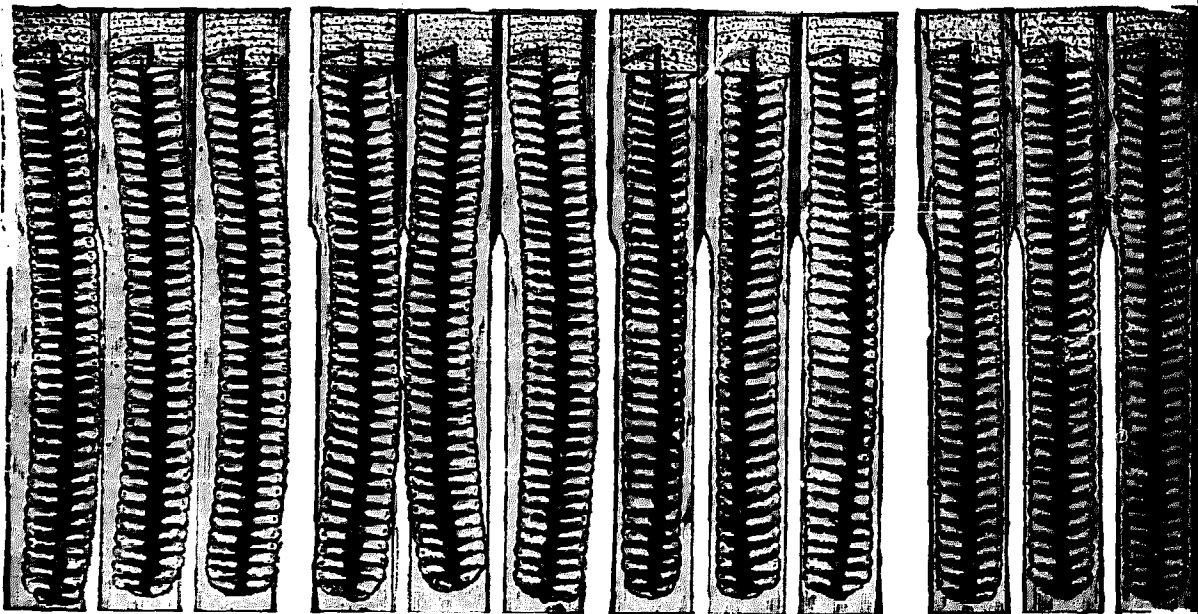

**Fig. I**  
If comb foundation is not reinforced with **HORIZONTAL WIRES** threaded through the end bars, heavy clusters of bees are likely to get on one side and warp the foundation out of the frame, resulting in a bad situation later on. This is almost sure to happen whether the hives are level or not. See above.

**Fig. II**  
But later on, if the combs are interchanged, as they must be, or turned around, there is trouble. The bee space is either reduced to nothing or greatly increased. Either condition makes trouble. The bees do not leave the combs in this condition very long. They attempt to straighten the surfaces, but the centers they can not change. See above.

**Fig. III**  
And finally the bees may straighten the surface of the comb, but the midrib remains warped forever, causing a bad lack of uniformity in the depth of the cells. Bees can not rear worker brood in shallow cells. They are likely to reconstruct very deep cells into drone cells, and the brood nest is thus "patchy". See above.

**Fig. IV**  
The above combs are built on reinforced non-sagging foundation with four **HORIZONTAL WIRES** threaded through the end bars. They are straight combs — straight on the surfaces and straight in the centers — with cells of uniform depth throughout. The queen can thus arrange a compact brood nest. Swarming is reduced. See above.

drain on the future food supply of the colony. The worker bees, their sisters, seem to know this; at the close of the main honey flow they push all drones out of the hive where they starve.

It has been estimated that to rear a cell of brood, either drone or worker, requires the equivalent of nearly a cell of honey of the size from which it came. A worker will be a producer as well as a consumer but a drone will be only a consumer. It is reasonably safe to say that the average drone will eat the equivalent of a cell of honey or more before he dies. It took nearly a cell of honey, plus pollen, to rear him, and it will take more than a cell of honey to keep him ready for a service which a thousand to one he will not be called upon to give. If a frame of drone brood costs two cells

These, together with many more, were thrown on a pile and melted. The owner was going through them in early spring to sort out the bad combs. Spring is a good time to do this because the combs will then be nearly empty. Every beekeeper who has been transferring previously will get many such combs that should be melted for wax and replaced with full sheets of worker brood foundation. As has been pointed out, this will save honey and wasted energy of the bees in raising a hoard of drones that are unnecessary except in a queen rearing yard. Even then only colonies having the very choicest drones and queens should be used for such a purpose.

#### Amount of Wax in Old Combs

Many beekeepers who ship old combs to the wax rendering plant are disappointed in the amount of wax obtained. It is difficult to estimate in advance how much wax can be obtained from a given number of old combs. One report is given of 1240 standard frames of combs which were rendered, yielding 204 pounds of wax, or an average of 2.6 ounces of wax from each frame. This would be one pound and 10 ounces for a set of ten combs. Perhaps it is safe to say that from 1½ pounds to as high as 2½ pounds of wax can be obtained from a set of ten combs.

#### Old Combs Darken Honey

Prof. G. F. Townsend, Department of Environmental Biology, University of Guelph, Guelph, Ontario, Canada has conducted trials on the darkening of honey through staining. He found that old dark brood combs definitely caused staining of the honey. It seems the darkening chemicals are water soluble and affect the honey as long as the moisture content is greater than 21-22 percent. "Unripe" nectar, of course, may average as much as 60 percent water so the best way to avoid this staining is to use only light-colored combs for honey storage.

#### Importance of a Reserve of Good Combs

The importance of having a large stock of empty combs on hand is apparent. If one does not have good ones, how can he get them? They can be secured by giving the bees frames of foundation in the fall



Combs that have been sorted out to be melted. All such combs should be replaced with good ones or frames of foundation.

of honey for every cell it contains, there is the equivalent of eight pounds of honey that has been worse than wasted. Every comb that contains some drone brood will contribute wastage or loss.

The combs shown above came from a modern apiary as is evidenced by the modern Hoffman frames.



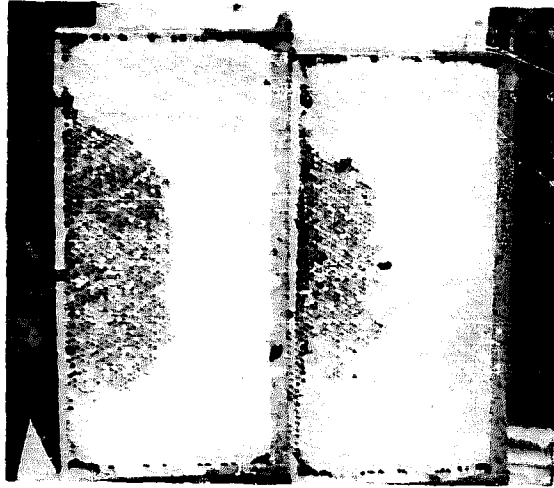

Combs should be approximately three-quarters capped over before they are put into the extractor.

when they are gathering honey. They may then be extracted and held in reserve until the main crop of white table honey comes on the following season. Or better, if the combs are fairly well filled and sealed, he may use them for winter stores. (See Food Chambers.) Of course, one can have the combs drawn out during the main honey flow, but that would probably mean some swarming and a decrease in the crop. The swarming nuisance can be materially reduced by alternating frames of foundation with brood combs and the bees will quickly draw out the combs and the queen will enter them. This will usually check swarming.

#### The Economic Waste from the Use of Poor Combs

At the outset mention was made of the economic difference between good and poor combs. First of all, the combs should be well wired to stand rapid handling, moving full colonies from one yard to another, and more or less rough usage in and out of the extractor. (See Comb Foundation; also Extracting.) When the honey is thick the extractor must be revolved at full speed, and unless the combs are built from reinforced foundation and well wired they are liable to break out of the frames.

It is desirable also that the comb be well fastened to the end bars and built clear down to the bottom bar. If the flow is a good one and the combs are in an upper story the bees may build them down in contact with the bottom bars.

The ideally perfect comb is one that is built from reinforced foundation on four horizontal wires passing through the end bars, the comb being attached to the end bars and to the bottom bars with no holes in it.

There are about 132 square inches in the surface of a standard Langstroth frame, and this will make the average comb contain approximately 6500 worker cells on the two surfaces, provided the comb is perfect. If the combs are not perfect it will be seen that there is a big loss in capacity for worker brood. One may have a ten-frame hive and still have only 50 or 60 percent capacity for worker brood. As it takes approximately a cell of honey to raise a cell of brood, it is apparent that a given area of drone brood will mean an equal area of honey that is actually lost.

It is desirable to have combs built solid to the bottom bar. When they are kept in upper stories or above the brood nest the bottom attachment will remain, but when these combs are placed in the lower story next to the bottom board the bees are quite inclined to gnaw the bottom of the comb, leaving a space between the bottom edge of the comb and the bottom bar. They will also gnaw the corner of the comb next to the entrance. Most combs have the bottom corners rounded off. (See Figs. 4 and 5 on next page.)

#### Mouldy Combs

Otherwise good combs will sometimes be covered with a whitish-blue mould in the spring (see No. 2, page 195), especially if the weather has been damp. A colony insufficiently protected or without a top entrance (see Entrances) will give off considerable dampness and this dampness on the outside combs will develop a little mould. This mould will disappear after the weather warms up.

#### Combs Smearred with Dysentery Stain

Combs in a hive where the bees have died from dysentery will often be so badly stained and so ill smelling that a beginner is apt to think they are ruined. (See Dysentery.) Give all such to a strong colony in warm weather and it will soon clean them up and make them as good as ever.

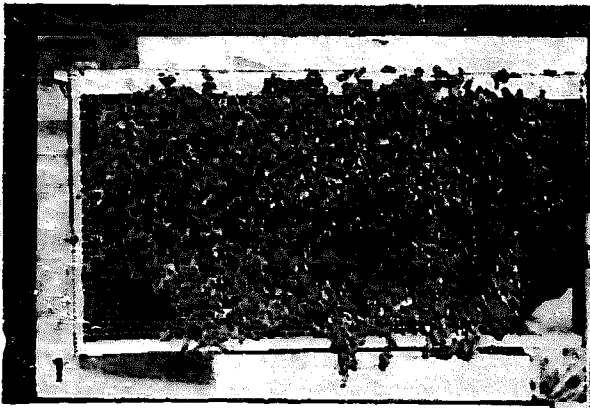

Fig. 1—This comb was taken from the center of a brood nest where the bees had died during the winter. Such combs may be stained but are good if otherwise perfect. At the lower right hand corner is a space that probably was next to the entrance. Bees usually gnaw this away.

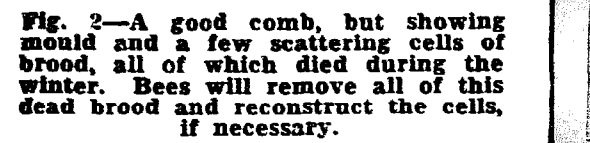

Fig. 2—A good comb, but showing mould and a few scattering cells of brood, all of which died during the winter. Bees will remove all of this dead brood and reconstruct the cells, if necessary.



Fig. 3 — During winter all combs should be stored in hive bodies and sealed against both robbers and mice. This is a sample of how mice may riddle a comb. If put back into the hive, the chances are that the bees will fill it with drone cells.



Fig. 4—At first glance this might be mistaken for a good comb, but close examination shows it to be almost entirely capped drone brood. At some time the comb was probably gnawed or broken and the bees rebuilt it with drone cells.



Fig. 5—A nice comb of worker brood. Note that the brood extends almost to the top bar. It is economical to use combs containing all worker cells, thus making it possible to get the maximum amount of worker brood.

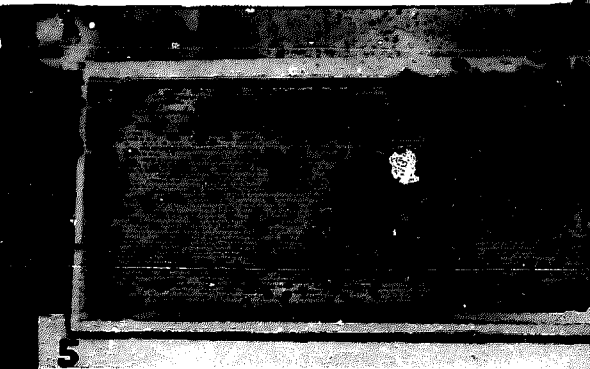
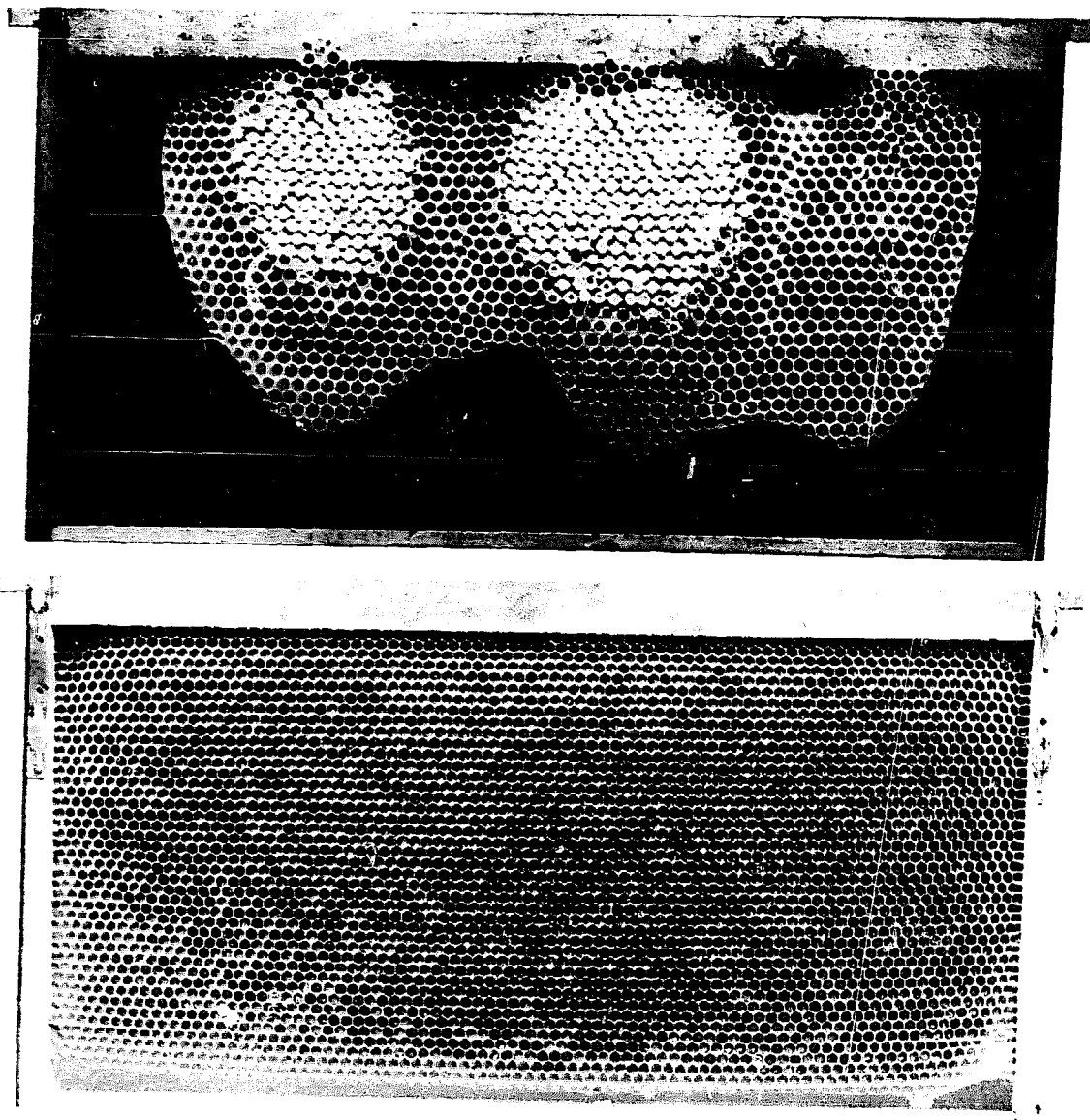

Fig. 6—Comb that is poorly wired and stretched making drone cells. This comb should be rejected. It should be cut out of the frame, and in its place should be put reinforced, well-wired foundation.





The upper frame, by mistake, contained no foundation, although it was wired. Note the drone cells. The lower frame had a sheet of reinforced three-ply foundation and every cell is worker.

#### Good Combs\*

Good honey flows are rapid and often erratic. It is a fortunate beekeeper who can pinpoint within a few days the time that his major honey flow will start. It is standard practice for beekeepers who produce extracted honey to have their colonies well supered in advance of honey flows. However, in the case of making new combs it is best to delay placing the foundation on the colonies until the honey flow is in progress. To do so one must be pre-

pared to move rapidly and to take advantage of the situation.

The very best combs are made during a very short period of time each year. Taking advantage of this time requires planning and preparation.

Most beekeepers and most textbooks agree that it is best to have frames with a large number of worker-size cells. There has been some research in recent years to show that the presence of a large number of drone-size cells in a comb, even 10 to 20 percent, does little harm insofar as the colony is concerned. However, I think most beekeepers will agree that as they inspect combs they

\*R. A. Morse, "How to Make Good Combs", *Gleanings in Bee Culture*, 102 (February 1974) Pg. 38-39.

prefer to see them have a preponderance of worker cells; and while they are inspecting a brood nest they prefer to see as little drone brood as possible. While we know that one may use strips of foundation, stuck with wax to the underside of the top bar, in making new combs, most beekeepers prefer to use a full sheet of heavy brood foundation. Again, the use of heavy brood foundation is most important during the first one or two extractings. It is at this time that the extra weight of the foundation gives added strength to the new comb.

Bees make the best combs during a honey flow. The greater the quantity of honey coming into the hives, the more rapidly the bees will secrete new wax and draw new cells. Combs which are made during other than a good honey flow will usually have holes in the corners and the foundation may not be firmly joined to the wood surrounding the comb.

Persons buying package bees usually install them on foundation. If the new colony is not well fed the new combs will not be properly made and may even contain holes, especially in the lower corners. Contrary to popular opinion there is no need or value in having holes through combs. Holes

through combs are not found in natural nests in trees or buildings and they do not facilitate the movement of bees within the colony.

The best combs are made when new frames with foundation are placed immediately above the brood nest. The very best way to make new combs is to place five or six frames of foundation in the center of a super, with drawn combs on either side, and to place them above a single story brood nest. However, the time and trouble necessary to arrange the colony in this manner is too much insofar as the average beekeeper is concerned. Most beekeepers place partial, or full supers of foundation, as close to the brood nest as is possible soon after the honey flow starts.

New combs full of honey are very fragile and break easily. New comb breakage is especially a problem with beekeepers who use radial extractors. Beekeepers are inclined to run their extractors as rapidly as possible so as to speed up the extracting process.

Some commercial beekeepers have an extra reversible extractor for the express purpose of extracting new combs. They usually reverse the combs more than the usual number of times during the extracting process as this

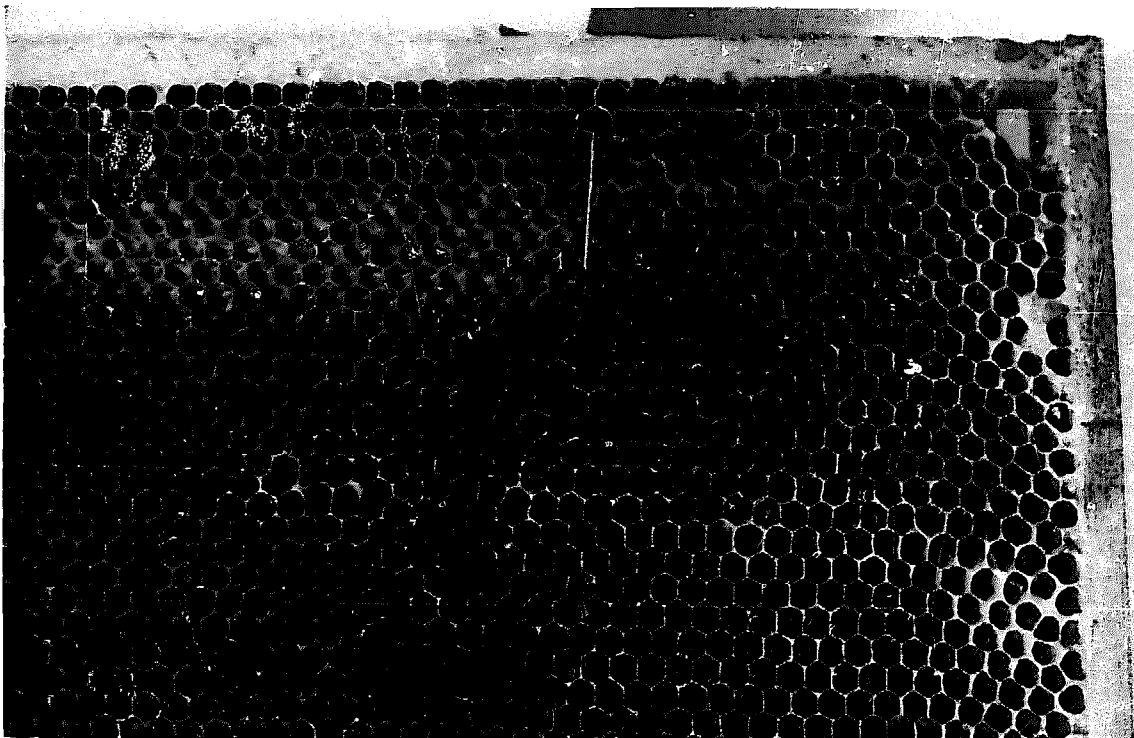

Shallow cells, useless for brood rearing, caused by warped foundation.—Cornell Univ. Photo.

tends to reduce comb breakage. Even when extracting new combs in a radial extractor it may be worth the time and trouble to stop the extractor when only 10 to 20% of the honey has been removed and to reverse any sagging combs before they sag further and break.

It is correct that honey stored in old, dark combs may be slightly darker than that stored in new, white combs. Old combs are dark because they have become stained with pollen and propolis. The same stains which make the wax in an old comb brown or black may color honey when it is stored in them. It is for this reason that some beekeepers have a supply of white combs, which are never used for brood rearing, but which are used exclusively for storing extracted honey year after year.

When bees use combs for brood rearing, cocoons are left in the cells. The cocoons tend to give the combs additional strength. This is part of the reason that old, dark combs will almost never break in an extractor and will withstand rough usage. However, white combs, which are never used for brood rearing, will become strong in time as the bees add wax, and some propolis, to weak points. After white combs have been extracted several times they will become almost as tough and strong as old, black combs.

**COTTON (*Gossypium*).** — Two species of cotton are cultivated in the United States. They are Sea Island cotton (*G. barbadense*) and American upland cotton (*G. hirsutum*). Sea Island cotton yields a very fine long staple (1½ to 2 inches in length), but it is grown only along the coast of South Carolina and inland in southern Georgia, northern Florida, southern California, and Arizona. Upland cotton (*G. hirsutum*) forms more than 99 percent of the cotton crop of the United States. Two principal commercial types are grown in the United States: short staple upland cotton (fibers under 1½ inches in length), which has by far the largest acreage, and upland cotton (fibers 1½ to 1¾ inches long), which is largely confined to the Yazoo Delta, Mississippi, a few counties in South Carolina, and the Imperial Valley of southern California. Egyp-

tian cotton, which has a long staple (1¼ to 1¾ inches), is grown in the Salt River Valley, Arizona.

#### Nectaries

The cotton plant has both floral and extra-floral nectaries. The floral nectary consists of a narrow band of papilliform cells at the base of the inner side of the calyx. The five petals overlap except at their base, where there are five small openings leading down to the nectar. These gaps are protected by long interlacing hairs, which exclude insects too small to be of use as pollinators, but present no obstruction to the slender tongues of long-tongued bees and butterflies. After the flowers have changed in color from pale yellow to red, they cease to secrete nectar, and bees pay little attention to them.

There are two sets of extra-floral nectaries — the involucre nectaries and the leaf nectaries. Below the flower there are three leaflike bracts called the involucre. At the base of each of these bracts there is a nectary both on the inner and outer side—six in all.

The leaf nectaries are located on the underside of the main rib of the leaves, and vary in number from one to five. They are absent from individual leaves and entirely wanting in *Gossypium tomentosum*. They are small pits, oval, pear shaped, or arrow shaped with long tails running down toward the base of the leaves.

#### Cotton as a Honey Plant

The surplus honey obtained depends largely upon locality, soil, season, and atmospheric conditions. There are many factors which influence the nectar flow and cause it to vary in different places and at different times. One of the most important factors is the soil. Cotton is grown on a great variety of soils, as sandy loams and clay loams. Rich alluvial soils and black prairie soils are admirably adapted to its culture, but by the use of fertilizers the poor pine lands of the Atlantic slope and in the vicinity of the Gulf can be made to produce a crop. Lime seems to be required, since the Black Prairie of Texas, the most important cotton area in the United States, is underlaid by Cretaceous limestone. Little nectar is secreted by cotton on light sandy soils, and

even in the black-land area on the lighter soil the plant is unreliable.

Throughout the larger part of the Atlantic and Gulf Coastal Plain cotton does not secrete sufficient nectar to afford a surplus. Opinions differ greatly as to its value as a honey plant and are often contradictory. A series of accurate observations in the different states by a flower biologist is greatly to be desired.

In Louisiana bees are seldom seen on cotton except in the Red River Valley of northwest Louisiana and in the Delta section of the southeast section of the state. In the Arkansas River Valley in Arkansas there is an immense acreage of cotton, and 96 pounds per colony in an apiary of 12 colonies was obtained chiefly from this source. In Pulaski County at Sulphur Springs a great amount of cotton honey is secured.

It is in Texas that cotton rises to the rank of a great honey plant, where it yields nearly one fifth of the entire crop of honey produced in this state. Although there are 10,000,000 acres of cotton under cultivation, it is chiefly in the Black Prairie that cotton secretes nectar abundantly. To the east and to the west of this belt the honey flow shows a marked decrease.

#### Honey Flow

The honey flow may last from June until long after the first frosts, yielding in some localities as much surplus as all the other sources combined. Even after the first frost, if there is pleasant weather the bees may continue for two weeks longer to work upon the plants and make a large increase in the honey crop.

#### Cotton Honey

Cotton honey is very light in color and mild in flavor when thoroughly ripened, and it compares favorably with the best grades of honey. When first gathered, cotton honey has a flavor very characteristic of the sap of the cotton plant itself, but this disappears as the honey ripens. During a heavy flow there is a strong odor in the apiary like that produced by bruising cotton leaves.

During some seasons, especially in Texas where cotton is a major honey plant, there have been heavy losses of bees from airplane dusting of arsenicals to kill noxious insects

that come suddenly in waves. Even if the beekeeper were notified, he would not be able to move his bees in time. One beekeeper lost 600 colonies over night. Fortunately, these destructive insects come only in cycles of years and not every year or beekeeping in these cotton areas would be a thing of the past. (See Poisoning of Bees.)

**CRIMSON CLOVER.** — See Clover.

**CROSS BEES.** — See Anger of Bees; also Stings, subhead Why Bees Sting.

**CROSSES OF BEES.** — See Hybrids.



An apiary in a greenhouse where cucumbers are grown.

**CUCUMBER** (*Cucumis sativus*).— Growing processing pickles as a specialized farm crop has undergone changes in the past few years. An estimated 20% of the pickling cucumbers were machine harvested in 1967, McGregor (1976).

The cucumber, a vining plant with yellow flowers bears separate male and female flowers on the same plant. There are usually about 10 staminate (male)

flowers to one pistillate (female) flower on each plant. Plant breeders have, in recent years, developed gynoecious cucumbers which are better adapted to machine harvesting. On these plants the female flowers predominate in number therefore making it critically important to have ample pollinators to transfer the pollen between male and female blossoms. A large number of crosses of pollen between anthers and stigmas must be made quickly and efficiently in the case of the machine harvested gynoecious varieties of cu-

cumbers. Vines are machine picked clean during the one and only pass through the field.

Even though cucumber blossoms are attractive to bees and yield nectar a surplus of honey is seldom gathered from pickles. Beekeepers who rent out bees to cucumber growers must secure a substantial fee to provide this service.

**Reference Cited**

McGregor, S.E. (1976). *Insect Pollination of Cultivated Crop Plants*, ARS-USDA.

**CYPRIAN BEES.** — See Races of Bees.

## D

**DAISY.**—See Asters.

**DANCING BEES.** — See Bee Behavior.

**DANDELION** (*Taraxacum officinale* Weber).—Other English names are lion's tooth, blowball, yellow gowan, and priest's crown. It is widely distributed over Europe, Asia, North America, and Arctic regions. In many other localities the flowers are so abundant in some years that the fields and lawns are an almost unbroken sheet of golden yellow. The effect is most cheerful and pleasing, and in its season there is no other wild flower that can vie with the dandelion for ornamental purposes on a large scale. Coming as it does in early spring preceding fruit bloom, it is a most valuable plant for bees. Some seasons it furnishes not a little honey, and besides it affords a large amount of pollen at a time when bees require a rich food for brood rearing.

It seems likely that no other broad-leaved lawn invader receives the attention the dandelion does. Herbicides cause nearly immediate destruction of individual plants but complete control is very difficult as the wind-borne seed is easily carried to treated lawns where it once again becomes established. The use of chemical weed controls on lawns and fields which destroys all broadleaf plants, including dandelions and white

clover, is disheartening to the hopes of hobby beekeepers who keep bees in urban or suburban locations. Luckily for them, at least the dandelion is very prolific and becomes reestablished on cessation of the chemical assault. In the bee's favor are the concern of environmentalists that so great a use of chemicals is harmful to the health of people; that fewer and more selective sprays or controls would do as well if used wisely. The dandelion and the white clover in lawn grass had become symbolic of neglect by the homeowner leading to intensified control measures obtainable only with chemicals. This is particularly so in the case of the dandelions which tend to dominate the smooth green mantle of grass with an overwhelming burst of yellow.

What appears to homeowners to be an invasion by pertinacious trespassers is a blessing to the honeybee. Dandelion pollen and nectar is a stimulant to early brood rearing. A surplus honey may occasionally be stored but is usually used up in brood rearing before the next flow. Pollen is gathered in abundance from the dandelion. Pure dandelion pollen is deficient in the nutrients required to stimulate normal brood rearing, one of the missing ingredients being L-arginine. Pollens gathered from other sources at the same time undoubtedly supplement this deficiency. The



A fine specimen of dandelion blossom, buds, and leaves

dandelion makes up in quantity that which it lacks in quality.

#### **Dandelion Not a Pest**

The dandelion has both beauty and utility, and an attempt to exterminate it, even if this were possible, would be a great mistake. Of the attractiveness of the bloom there can be no doubt. It will be seen that it is the model of symmetry. It is of no injury to hay fields, and as a pasture feed it increases the flow

of milk and improves its quality.

The flow from dandelions in May lasts for about two weeks, and is increased by a succession of warm days. The honey varies in color from bright yellow to a deep amber—a little darker than that of goldenrod. Comb built when bees are working on dandelion is a beautiful shade of light yellow, even the older comb becoming yellowish. When newly gathered the honey has the strong odor and flavor of the dandelion flower, but when fully ripen-





Dandelion, normal size. Note bee on one of the heads.—Photo by G. A. Paull.

ed it has an agreeable taste, although persons accustomed to mild honey would consider it too strong.

**DEMAREE PLAN OF SWARM CONTROL.** — This general heading might more properly be considered under Swarming, subhead Prevention of Swarming, but inasmuch as the Demaree plan involves several methods, it has been thought best to avoid confusion by putting the discussion under this head, giving only one method (the best one) under Swarming.

The Demaree plan, has been mentioned in bee literature for the last 70 years. Inasmuch as Mr. G. W. Demaree, the author of it, changed his plans several times improving it, it is well to know the history, as the principles are in general use.

In brief, the Demaree plan means any method for expanding the brood nest by transferring the brood or the queen from one brood nest to an-

other and then confining her activities to one brood chamber (usually the bottom one) by the use of a queen excluder for the purpose of the prevention or control of swarming.

The Demaree plan is not adapted to the brood chamber of a Jumbo or larger hive. It is usually confined to a hive of Langstroth dimensions involving two or more stories, and those stories may be either 8-frame or 10-frame. As the 10-frame Langstroth hive is almost universal, the several different methods of Demareeing a colony are applied to that hive.

Mr. Demaree first began talking about swarm control as early as 1884. (See American Bee Journal for that year, page 619.) In 1892 in the same journal, page 545, he described the scheme bearing his name for the control of swarming. At that time he took only the strongest colonies in a single brood chamber

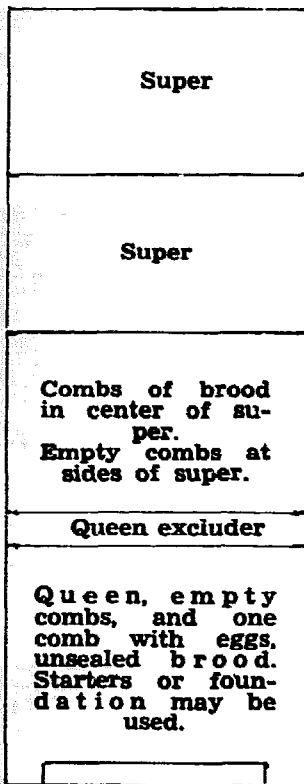

Demaree's plan of 1892 for prevention of increase. Applied to strongest colonies at beginning of swarming, but usually before appearance of any queen cells. If applied after swarm issues, no brood or eggs are left in brood nest.

and lifted the combs containing brood from the lower chamber to an upper story, with a queen excluder between. He left one comb containing some unsealed brood and eggs in the lower chamber with the queen. The remaining space in both stories was filled out with empty combs or with frames containing full sheets of foundation. If honey was coming in, then one or more supers of empty combs were also added.

In 1894 he modified the plan by putting all the brood above in the second story, the queen below the excluder on empty combs. He then made a small hole in the upper story for an entrance so that drones could escape, thus preventing a congestion of dead drones upon the excluder

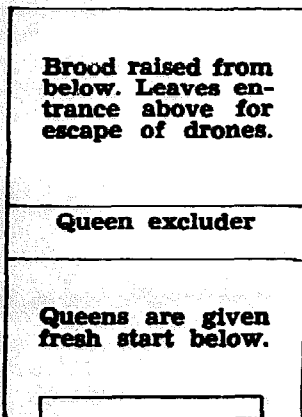

Demaree's plan of 1894 for swarm prevention. All brood is raised.

between the two stories. In 1895 he again modified the plan by putting all of the sealed brood upstairs and the queen and the unsealed brood downstairs.

In all of these three plans it will be noted that the congestion of the brood nest was relieved by (1) putting the queen in new quarters where she would have plenty of room, (2) placing the emerging brood in the upper story away from the brood nest proper, and (3) giving room for the flying or field bees to store their honey. With all the sealed brood upstairs, the emerging brood would gradually make room for the storage of honey. In the meantime, the brood below would be sealed and finally young bees would emerge, adding to the others. The upper story that had contained the sealed brood would be filled

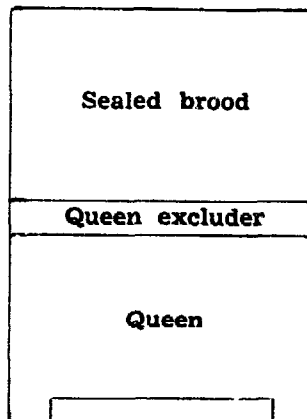

Demaree's plan of 1895. For no increase he used above plan. For increase, allowed to swarm, shaking some bees from old colony into new.

with honey and more supers could be added. This is exactly what takes place when a colony swarms—with this advantage: the parent colony and the swarm are together.

By referring to the general subject of Swarming it will be found that the main causes of swarming are a congestion of the brood nest, the queen honey-bound,\* too many young bees in the lower story, and the flying bees cramped for space in which to store their honey. The Demaree plan, in a word, relieves both the queen and the worker bees, provides extra room for the rearing of more brood, and extra room for the storage of honey. It likewise places the force of young bees (an important cause of swarming) upstairs where they can receive and store the honey in the cells, draw out comb if necessary, and then finally seal the honey. Where there

\*This means that all or nearly all of the cells are filled with honey, thus restricting her egg-laying capacity.

is a large force of young bees in the brood nest where brood is being reared, and the queen is cramped for room, queen cells are liable to be built and general preparations made for swarming.

It will be noticed that several modifications of the plan can be made by any intelligent beekeeper who can grasp the general principles involved. The author some years ago unwittingly adopted the 1895 Demaree plan. He came across one of the outyards where the colonies were strong in single - story hives, the brood becoming congested, the bees needing room, and the honey about ten days off. Having on hand at that yard extra supers with drawn combs, all the combs of sealed brood were lifted into an upper story, where they were crowded together in the center. The unsealed brood with the queen was placed in

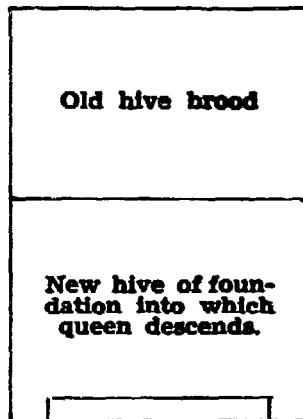

Langstroth's plan of 1865 for prevention of increase.

the lower story. The space on either side of the brood upstairs and downstairs was then filled with empty combs. A queen excluder was placed between the upper and lower story with the queen. In a couple of weeks thereafter it was found that all the brood had emerged from the upper story, and the combs were filled with honey. The lower story had mostly brood in all stages. Where this condition was found, a super of empty combs was placed on top, leaving the queen downstairs where she had been. From time to time supers were added until the close of the season, when the bees were made to complete the supers already partially filled.

By turning to Building Up Colonies, Food Chamber, and Comb Honey, it will be noted that in most of the modern apiaries it is coming to be more and more the practice to al-

low the queens to have the range of two Langstroth brood chambers after the first of May. Where a food chamber is used there will be two stories to begin on. If the bees are wintered in a single story, another story of empty dark combs should be added as soon as the queen occupies seven or eight frames of brood. The queen will soon work upward and begin work in the upper story, and when this is well occupied with brood she will work downward into the lower story. As soon as the season advances and perhaps a few days before the actual honey flow, there may be as high as 14 or 15 frames containing brood in the two stories. The common practice is to put all the sealed brood upstairs above an excluder and the unsealed downstairs with the queen. As the

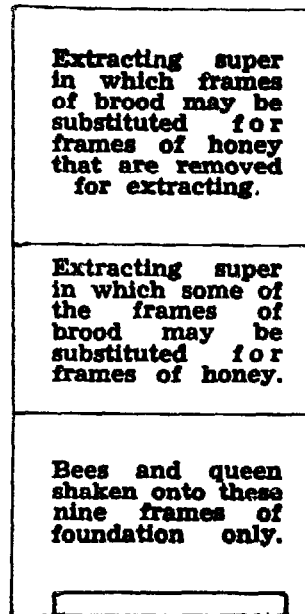

Plan of Samuel Simmins of 1884 for prevention of increase. Brood may be placed above or given to other colonies.

brood emerges from the upper story, room will be automatically provided for the storage of honey. When this is partially filled an empty super is placed on top. It will be observed that the Demaree plan works admirably in all cases where brood is reared in two stories to accommodate a first-class queen.

**DEVELOPMENT OF BEES.**—See Brood Rearing; also Breeding Stock.

**DEXTRIN.**—This may be regarded as an intermediate product between starch and the sugar dextrose. When starch is treated with dilute acid or acted on by heat or by cer-

tain ferments, it becomes soluble in cold water and loses its gelatinous character. It is then dextrin. Dextrin is found in all starchy foods which have been considerably heated, such as toast and brown crust of bread. It is produced commercially for use as an adhesive. Postage stamps and gummed labels are nearly always coated with dextrin. Dextrin is found to a large extent in commercial glucose or corn syrup, and to a small extent in normal honey. Honeydew honeys contain larger amounts. (See Honeydew; also Honey, Chemistry cf.)

**DEXTROSE.** — See Sugar, sub-head Corn Syrup.

**DIABETES, HONEY FOR.** — See Honey, Food Value of.

**DIAGNOSING COLONIES.**— The term "diagnosing," when used in bee culture, applies to a method or methods of determining the internal condition of a colony from surface indications, mainly at the entrance, and without opening the hive. In the height of the honey flow, expert beekeepers, when rushed with their work, can determine pretty accurately what colonies in the yard are or will be needing attention by a glance at the hive. The knowledge of how to do this enables the expert to administer treatment to colonies that would be likely to starve or swarm and go to the woods during his absence, or which might otherwise begin to loaf for the simple reason that they would not have sufficient storage space. When bees are crowded for storage room they will even occupy cells that the queen would use for breeding, and the result is that she is so cramped for space in which to lay eggs that she is "honey-bound". If the honey flow continues there will not be young brood to come on to supply bees to care for the late flow.

All this goes to show the necessity of giving powerful colonies room when they need it. To go through every hive, comb by comb, in the height of the season is both unnecessary and impossible, and so the expert beekeeper picks out by surface indications first those colonies that need attention at one or more of his yards, later on taking care of those that are in no urgent need of

care. But knowing how to pick out those that will swarm or waste valuable time in the height of the season is a trick of the trade worth knowing. Even the beginner who has only a few colonies will find that after a little practice he can locate his best ones by looking at the outside. If Mr. Beginner is a professional man, busy during the hours of the day with other work, he can in his odd moments at home tell which colonies should have immediate attention. This saves his time, of which he may not have too much at his disposal.

#### How to Determine Whether a Colony Needs Room

Now for the "know-how". The most reliable indication of what a colony is doing or will do is the flight of the bees going in and out of the hive. If one colony, for example, has its bees pouring in at the entrance by the score and coming out the same way, and another one right by its side has only one half or one fourth as many, it is evident that the first mentioned is very strong and will shortly need room, even if it does not already. The last-mentioned colony may have a poor queen or insufficient stores. It will not need more room, and for the time being can be allowed to take care of itself. The other colony, with its busy rush of bees going in and out, should be opened. If it has little spurs of wax built along the top edges of the combs; if it is full of brood; and if, further, storage space is being cramped, another super should be added. It is probable, if the weather is getting hot, that the entrance should be enlarged. (See entrances.)

At the same time that the entrances of the strong flyers are being observed it is advisable to get back of the hives of such flyers, and, by lifting, see whether the hive is getting heavy. With a little practice one can gain a pretty fair idea of the amount of honey in the hive by lifting or attempting to lift the back end of the hive. If bees are flying strong and the hive seems light, it will, of course, have plenty of room for the storage of new honey. But if it feels heavy, or too heavy to lift, then, of course, room should be given at once.

In a like manner the apiarist should go through the whole api-

ary, walking down the rows, carefully inspecting entrances and hefting the back end of the hives. In a few minutes' time he can go through 100 colonies, laying a stick, block, or a small stone as a distinguishing mark on top of the strong flyers and heavy hives. All others he will ignore for the time being. He or his man will then proceed to examine the indicated colonies first. These may use up all the extra supplies he has brought with him, if it is an outyard. Later on, when he has more time, he can take care of those that are not flying strong to determine whether the queen herself is inherently poor or the colony did not have a fair chance at the start on account of insufficient food. If it is a nucleus or a late swarm in the fall, no matter how much protection it might have, it would not have sufficient bees to protect it.

#### **How to Know When Honey is Coming in**

Diagnosing conditions at the entrance is not difficult if one knows how. Here is a summary of what can be seen without opening a hive and yet will give a fair estimate of what is going on:

(1) Bees coming out and flying in at the entrance in large numbers may indicate a light flow of nectar.

(2) If they drop down with their bodies poded out it may mean a heavy flow.

(3) If again on the same day at nightfall, bees can be seen in large numbers on one side of the entrance fanning air into the entrance and on the other side with their bodies reversed and fanning moist air out of the entrance, it may be assumed that a large amount of nectar has been gathered and that they are reducing the water content down to specific gravity of honey.

(4) If the bees are busy all day going in and out of the entrance and yet do not fan at the entrance at night it may be guessed that they consumed the nectar gathered in brood rearing or as fast as it came in.

(5) When bees go out in great clouds in one or more directions from the apiary and return flying low, nectar is coming in.

(6) If they fan at the entrance at night the bees may need more supers.

At the height of the season it is

often impossible to examine hives and these surface manifestations may show when and where to put on supers and at the same time save a lot of work.

#### **Play Flights Misleading**

At this point the beginner should make a careful distinction between the play flights of young bees (see Play Flights) and bees that are rushing from the fields. In the case of the former the bees will be seen flying nervously around the entrance, some going in and some flying aimlessly around in the air for several minutes near the front of the hive. When busy at work going to the fields, they will fly from the entrance directly to some distant point as soon as they rise above surrounding objects. In the same way they will come in from the field, going directly into the entrance, or perhaps dropping on the alighting board or ground nearby if heavily laden.

Neither must the beginner mistake a case of robbing for bees that are actually at work in the fields. When the colony is being robbed out, only one hive, or at most two or three, in the apiary will be involved. The sound of flying robbers is different from the sound of actual workers. In robbing, the bees stealthily dodge in at the entrance as if they expected to be grabbed by the defenders of the home. Real busy honest workers going to and from the fields show no such dodging or nervousness. (For the behavior of robber bees, see Robbing.)

#### **How to Detect Inclination to Swarm**

A surface indication of natural swarming is a large bunch of bees—three or four quarts of them—clustered closely around the entrance of the hive during the middle hours of the day, with only a few bees flying to and from the field. The big crowd of bees out in front means nothing if the weather is excessively hot and there is no honey flow at the time. If the entrance is small a strong colony will cluster out in front during very hot weather, and it may do so during a honey flow toward night but not usually during the day unless the hive is exposed to the hot rays of the sun. In that case, shade boards should be applied and the entrance should be enlarged. (See

Apiary; also illustrations of bees clustering out under Entrances.)

If the colony persists in clustering out in front during the time when other bees are actively going to the fields, and not many workers are going in and out, it may indicate that the bees are preparing to swarm. An examination of the hive will show swarm cells more or less toward completion. (See page 43.) Cutting out cells may not prevent swarming. If the entrance has not been enlarged treatment should be applied as recommended under Swarming, sub-head Prevention of Swarming.

During very hot sultry weather in the height of the honey flow, half of the best colonies in an apiary may have a quart of bees clustered out in front at night. This indicates nothing abnormal, but when all the field bees are in the hive there is not room enough to accommodate them and yet provide proper ventilation.

When everything is progressing normally, and the colony is doing just what it ought to do, there will be a contented roar at the entrance of each colony gathering honey. This is especially noticeable at night. If a match is ignited and held near the entrance it will be found by the direction of the flame that the air is going in one side and coming out at the other side. The contented roar one hears in an apiary where the bees are evaporating nectar into honey can be heard distinctly as one goes through the yard. It is a kind of noise that is sweeter than music to the owner of the bees. They have toiled hard during the day and are now working to evaporate the nectar they have gathered. At the same time they evaporate the water they are ripening and converting the nectar, largely sucrose, into invert sugar or honey. Fanning at the entrance eliminates the surplus water and cools the air. It is an indication that the colony has done enough work during the day to require night work. This contented roar that one hears in front of a strong colony occurs only during the height of the honey flow or during excessively hot weather when there is no flow on. But the roar when honey or nectar is evaporating is much more pronounced than the buzz or noise from a hive because of heat. A colony can not stand a higher temperature, no matter what

the weather is, than 97 degrees F. (See Temperature.)

### The Presence and Kind of Queen

There is another indication of the internal condition of the colony, and that is the way the bees carry in the pollen. It was formerly held that they would not bring in pollen if a colony were queenless. This is true only in part. When it needs pollen it will bring it in whether there is a queen or not. But a colony that has a good queen and plenty of room for breeding will require much more pollen than one that has no queen or a poor one. When it is possible to see many busy flying bees going into the hive, and a great deal of pollen going in, it indicates that the hive probably has a good queen and that breeding is progressing in a perfectly normal manner. But when little or no pollen is forthcoming, and the bees are not flying much, it shows that the colony does not have a fair chance during the winter or spring, or that it has a poor queen. On the other hand, the colony may have ever so good a queen, but if there is any large amount of foul-brood, either American or European, there will be but little need of pollen.

### Dead Brood at the Entrance

If one can tell the difference between a young baby queen and young workers dead at the entrance he will be able to tell whether supersedure is taking place within the hive. If the old mother fails, the bees will proceed to raise a number of cells. The first virgin that emerges will be quite liable to puncture the cells of all her rivals and sting them. These victims will be thrown out at the entrance, clearly indicating that some young queen is boss of the hive.

An inspection of the entrances will likewise show, oftentimes, whether a colony is on the verge of starvation, if its brood has been chilled or overheated, or if there are moth worms in the hive. When several full-grown larvae or perfectly formed young bees, brown or yellow, are found dead in front of the entrance, it may indicate any one of the possibilities mentioned. When the bees are on the verge of starvation they will not only stop brood rearing but they will carry out their

young larvae. They apparently go on the principle that they should save able-bodied living bees rather than to lose all in the attempt to raise the babies.

In early spring some of the young brood near the outside edges will become chilled. This brood will be taken out of the cells and deposited in front of the entrance. At other times, if the hive entrance should be closed for a short time on a very hot day so that the bees are on the verge of suffocation, not a little of the brood will be overheated. That which dies will be carried out in front.

When the moth worm is present (see Wax Worms) some of the brood will be destroyed along the line of the tunnels made by the worms. The bee larvae will be deposited in front of the entrance the same as larvae dead from any other cause.

The presence of dead young brood in front of the hive is always an indication that something is wrong. When it is dead from overheating or chilling there is nothing that the apiarist can do because the damage has been done; but when it is dead because of near starvation, colonies should be fed at once.\* (See Feeding.) In the case of the wax moth, injured combs should be removed.

#### Winter Diagnosis

During winter and early spring one can often get a very fair idea of what is taking place in the colony by entrance diagnosis. If the front of the hive and the ground in front are spotted with yellow, yellowish-brown, brown, or black spots, and if there is a large lot of bees out in front with abdomens looking greasy and black and much distended, it shows the presence of dysentery, and probably no attention need be given because nothing can be done, since the colony will die anyway, in all probability. (See Dysentery.) Before the colony actually dies, the entrance should be closed to prevent robbing.

During late winter or early spring in front of some of the best colonies may be found perhaps a hundred or more dead bees. If their bodies are

shrunk and if there are no yellow or brown spots it may be assumed that the colony is in a prosperous condition and that the dead bees in front are only the superannuated that would have died anyway. Beginners very often ask what the matter is when they see dead bees in front of a hive. The fact is, there is nothing wrong. On the other hand, if there should be a quart or two of dead bees, their bodies ill smelling, it would indicate that the colony is not wintering as well as it should. Usually when there is an abnormal number of deaths it is because dysentery has been induced by a cluster too weak, by too much moisture, or because the well-meaning owner has been tinkering with his colony during midwinter to see how it is coming on.

During late winter or early spring it is not advisable to open hives any more than is absolutely necessary.

This "necessary" should be only when the colony needs feeding.

To determine which colonies are running short of stores it is advisable to lift the back of each hive.

**DISEASES OF BEES\*.**—Bee diseases are found throughout the world wherever bees are kept. However, not all bee diseases are found in every geographical location. Some are probably not present in certain locations, but in many instances they have simply not been recognized or diagnosed. Bee diseases were undoubtedly introduced into the United States with our earliest importations of honeybees and continued until 1922 when Congress passed a law restricting the importation of honeybees. Regardless of this "Honeybee Act" and its subsequent amendments, diseases such as chalkbrood have made their appearance in recent years and other diseases may make their appearance due to accidental or in-pocket importations of bees, or importation of contaminated bee equipment or infected pollen for feeding bees. Bee diseases are found widespread throughout the United States and cause large losses in

\*You speak of starving bees carrying out young larvae. I think that if you examine these young larvae and also pupae you will find that all juices have been sucked out. Bees eat their young brood when they run entirely out of honey.—Allen Latham.

\*By A. S. Michael, collaborator, ARS-USDA, Bee Research Lab, Tucson, Ariz. Mr. Michael was a Microbiologist, Investigations Leader of Bee Diseases, Assistant Branch Chief of the Apiculture Research Branch and Chief of the Bioenvironmental Bee Laboratory, Beltsville, Maryland during his career.

bees, honey, and equipment and also add materially to the cost of honey production and crop pollination.

### History

Recognition came early for some bee diseases. Aristotle gave an excellent description of American foulbrood in his *Historia Animalium*. Virgil not only described the disease but gave a prescription for treatment consisting chiefly of wine—an early form of chemotherapy—useful no doubt for the beekeeper if not for the infected bees. It was not until the latter half of the 19th century, however, that observations were made that gave some real insight into the nature and kinds of diseases affecting honeybees. These observations were made possible by the movable-frame hive perfected by Langstroth and by the development of the new science of bacteriology.

Along with recognition of distinct diseases came renewed efforts to develop methods of control. The shaking treatment for American foulbrood was introduced and used for many years both in the United States and in Europe. However, this method was eventually found to be unsatisfactory and ineffective because of the high rate of recurrence in colonies so treated. Attempts were then made to sterilize combs in a disinfectant solution of one part formalin and four parts alcohol. This solution was known as the Hutzelman solution. This solution was sometimes modified by replacement of the alcohol with water. Unfortunately recurrence of the disease in the combs so treated was so frequent that the treatment was also discarded as ineffective and dangerous. In the early 1940's Dr. Leonard Haseman, professor of Entomology at the University of Missouri, introduced the use of sulfa drugs for the treatment of American foulbrood, and thus opened the new era of chemotherapy for bee diseases. Prior to this the only method of treating this disease was by burning the equipment and killing the bees. The burning technique was very effective and in many states had been used so efficiently that the incidence of disease had been greatly reduced. Obviously, however, the burning technique was very expensive and many beekeepers were anxious to embrace the use

of sulfa drugs. But by the late 1940's reports were trickling in that recurrences were taking place. Various factors were blamed for this; one, the sulfa drugs were ineffective in destroying the spores of AFB, two, the beekeepers were not inspecting their colonies properly or were using the drugs incorrectly. In 1951, Gochnauer reported that terramycin (**oxytetracycline**) was also effective in controlling American and European foulbrood. Prior to this the accepted method of controlling European foulbrood was requeening. Today sodium sulfathiazole and terramycin (**oxytetracycline**) are both being used for treatment of the foulbroods. In 1964 Michael demonstrated the effectiveness of ethylene oxide gas against the organisms causing American foulbrood. European foulbrood, Nosema disease and also against the wax moth. Since that time practical methods of using ethylene oxide for decontaminating bee equipment have been developed and are in use in the states of New Jersey, Virginia, Connecticut, West Virginia and Maryland.

### Causes of Bee Diseases

Bee diseases are caused by various parasites, bacteria, viruses, protozoa, fungi, mites and other insects. Many of them can multiply rapidly. One bacterium, for example, under ideal conditions can increase to billions in a 24-hour period. Since microorganisms are invisible and reproduce large numbers in such a short time, the beekeeper must be careful to clean all equipment, including his hands, that may be contaminated by these organisms.

### Transmission of Bee Diseases

Because of the bee's manner of living, any contagious disorder will spread within the colony. The crowding of colonies together in apiaries increases the possibility of the spread of diseases to other colonies by robbing or drifting bees, and the use of movable frames is apt to spread diseases from hive to hive. To repeat, bee diseases are spread in many ways, but mostly by robbing bees, drifting bees and contaminated equipment and honey. If a nectar flow stops suddenly, many foraging bees will



actively seek another source of honey. A colony weakened by disease is unable to defend itself and quickly falls victim to these foraging robbers. The robbers take home not only the honey but also the disease. Unwise manipulation of hives by the beekeeper during a dearth of nectar will stimulate robbing and increase the chance of spread of disease. Drifting bees and drones from a diseased colony may also carry infection to neighboring hives. Drifting can be worse in a windswept apiary or when hives are moved. Disease may also be spread by moving combs from one hive to another, by buying old hives, bees, or equipment from doubtful or unknown sources, or by buying honey from an unknown source and feeding it to the bees.

#### **Bee Diseases and the Environment**

The interrelationship of the honeybee with its environment is a complex and sensitive one. Dramatic climatic changes or changes in the quality or quantity of food are mirrored in the colony behavior pattern. Rapid or unusual changes in the colony behavior pattern can influence the susceptibility of the colony to disease. For instance, unfavorable weather conditions that cause confinement of bees will increase the level of Nosema disease within a colony. European foulbrood in New Jersey seems to be strongly influenced by either climate or nutrition depending upon the geographical zone in which the colonies are located. However, unfavorable weather or crop conditions are not the only factors adversely affecting the colony behavior pattern. Unnecessary or careless hive manipulations, queenlessness, and general neglect of colony maintenance among other things can also have a similar effect resulting in increased disease. Rothenbuhler and his colleagues have made in-depth studies of the genetic and behavioral factors in resistance of strains of bees to American foulbrood. In addition to the development of both resistant and susceptible strains of bees to American foulbrood they showed that drone larvae are more resistant than queen or worker larvae and attributed this resistance to the additional pollen in the diet of the drone larvae. How-

ever, at present, there are no commercially available American foulbrood resistant strains of bees.

#### **Methods of Prevention and Treatment Burning**

Under most conditions inspectors are justified, and in some States required, to burn every diseased colony immediately, because such a colony is a menace to all healthy colonies in the vicinity. The best interests of the industry demand the prompt disposal of all such colonies. Before the diseased colonies are burned, however, the bees must be killed. Calcium cyanide, although not presently approved by the authorities for this purpose, has been used extensively in the past to destroy the bees. A tablespoonful of calcium cyanide spread on a sheet of paper or cardboard and slipped into the entrance of the hive will kill the bees in a few minutes. Occasionally the bees fall onto the poison so rapidly as to prevent the fumes from penetrating to all parts of the hive. Therefore, as an extra precaution additional cyanide has often been placed on a piece of paper above the top bars and under the inverted inner cover and hive cover. The entrance of the hive was then left open so that any returning field bees would also be killed. Gasoline can also be used to kill bees. Close the entrance to the hive, pour a pint or more of gasoline over the frames, and then close the hive tightly. A new material, Resmethrin, developed by Shimanuki at the Beltsville USDA Bee Research Laboratory is available commercially. Resmethrin is a superior material for the killing of bees—safe, effective and very rapid. After the bees have been killed, the contents of the hive must be burned with the least possible delay to avoid trouble with robber bees. Before the bees are killed, a pit must be dug 18 inches or more deep and wide enough to hold all the material to be burned. A brisk hot fire is necessary to burn the brood and honey completely. The bottom board, hive bodies, inner covers, or hive covers are not burned. The surrounding soil is then raked into the pit to prevent bees from healthy colonies having access to any dead bees or honey. Killing the bees and doing the

burning at night lessens the danger from robbing bees.

After the burning, the hive bodies, bottom boards, inner covers, and hive covers are thoroughly scraped to remove all propolis and wax, and then scrubbed inside and out with a stiff brush and hot soap or lye solution. The scrapings are burned and the wash water is disposed of so it is not accessible to the bees. Hands, clothing and tools can also be washed with soap and water to remove any contaminating spores. Hive bodies can also be stacked to form a chimney seven to eight bodies high with the top edges down. The inside walls are then sprinkled with kerosene and ignited. When the inside walls are scorched the fire is smothered by placing a board over the top hive body. A gasoline blowtorch is often used for scorching, but its use is somewhat slower. Disinfecting combs and other equipment with chemical solutions is no longer recommended, although in some States the combs and frames are recovered by removing the wax and melting it and boiling the frames in hot lye solutions.

#### Treatment with Drugs and Antibiotics

Methods of application of these therapeutic agents for the control of bee diseases vary widely. One of the more common methods is bulk feeding in sugar syrup. Dusting with a mixture of powdered sugar and the drug, such as is practiced with terramycin, requires a minimum of effort. Spraying the adult bees with a medicated syrup is an effective method. As the adult bees clean each other, they become engorged with the syrup and distribute it throughout the brood nest, giving a thorough treatment of all the brood at the same time. Pouring the treated syrup over the top brood frames also results in the adult bees gorging themselves. Treated syrup has also been used in preparing medicated patties which has resulted in excellent control. The use of drugs and antibiotics has resulted in increased control of bee diseases but has also presented additional problems such as drug stability and possible contamination of surplus honey.

Terramycin is the principal antibiotic available for treating bee diseases at present. Terramycin is relatively unstable in sugar syrup and so it is usually used as a dusting mixture with powdered sugar. Terramycin animal formula soluble powder contains 25 grams of active material per pound. Mix one half pound of TM 25 to four pounds of powdered sugar. Use two to three tablespoons of the mixture per colony, placing it over the ends of the topbars of the frames, at the outer edges of the brood nest. Higher dosage levels should not be used as they can be toxic to bees. Weak colonies should receive reduced amounts. Drugs should not be fed during the month prior to the beginning of the main honey flow, thus avoiding the risk of having the medication stored along with the honey in the supers.

Dust the colonies at weekly intervals for effective preventive treatments. Usually two or three treatments are given.

Patties are longer lasting than syrup or dusting for continuous use. They can be prepared as follows: (1) Mix  $\frac{1}{4}$  lb. powdered sugar with 1 tablespoonful of TM 25. (2) Cut in  $\frac{1}{4}$  lb. of shortening and blend well. (3) Divide into two parts and drop each into a waxed paper sandwich bag (or between two sheets of waxed paper). (4) Roll out to  $\frac{1}{4}$  inch thick. Feed the prepared patties in early spring by removing the top layer of waxed paper and placing one over the brood nest area of each hive body.

Fumidil-B (Fumigillin) is the only material that has been approved by the Food and Drug Administration for the control of Nosema disease. One level teaspoon (45 grams) of Fumidil-B is mixed with one gallon of 2:1 sugar syrup and is fed at the rate of 1 gallon of the mixture twice in the fall to each colony. A similar feeding can be made to colonies in the winter that normally receive sugar syrup. An early spring-time feeding of the same mixture has also been shown to be useful in suppressing the disease and promoting better growth of the colony. A similar mixture, although using 1:1 sugar syrup, is very useful for installing package bees. One feeding is usually sufficient but if the bees are unable to fly because

of inclement weather a second feeding should be given two weeks after installation.

The successful use of drugs and antibiotics in treating diseased colonies depends upon the severity of the infection, early detection, correct diagnosis, rapid treatment, ability of the beekeeper, and the quantity and quality of the stores in the hive. Drugs or antibiotics should not be fed to colonies prior to or during a honey flow. They should be fed only in the recommended dosages, and they should not be used as a substitute for good management and constant vigilance and regular inspections by the beekeeper.

#### Gas Sterilization

Ethylene oxide gas is widely used in hospitals and food processing plants for sterilizing of materials that are sensitive to heat and moisture and numerous nonflammable formulations of this gas have been made available. Michael in 1964 showed that this gas could be used to kill the organisms of American foulbrood, European foulbrood, Nosema disease and all stages of the wax moth. Practical applications of this gas to the decontamination of bee equipment have resulted from the research of Shimanuki, Lehnert, Knox, Cantwell, Moeller and Detroy of the USDA. Outstanding contributions have also been made by the state workers Matthenius, (New Jersey), Powers (Virginia), Newton (Connecticut), and Thurber (Washington). Gas chambers in use at the present time vary from a \$35,000 unit in New Jersey, obtained from NASA, and used in a stationary location, to a very successful truck based mobile unit in Virginia (cost \$9,000), to an inexpensive unit made of plywood and plastic in Connecticut at a cost of \$500. All units have been reported successful. In New Jersey alone 100,000 pieces of equipment have been treated with less than 1 percent recurrence of disease. Shimanuki has developed an integrated technique for the treatment of AFB utilizing ethylene oxide gas and terramycin that has been especially effective.

#### Breeding Resistance

Dr. O. W. Park pioneered in this work and developed both American

foulbrood resistant and American foulbrood susceptible strains of bees. These strains of bees have not been useful to the beekeeper, but have been very useful in further studies on resistance. Rothenbuhler has extended the work of Park, as have others, especially in clarifying many of the genetic and behavioural factors in resistant bees. However, to date, this research has not produced a commercial American foulbrood resistant strain of bees. There are certain problems inherent in producing and especially in maintaining resistant strains of bees. Unrecognized and unsuspected supersedure can give unsatisfactory results. Area use of resistant strains would be necessary to reduce contamination of apiaries with non-resistant stock. On the other hand, the effectiveness of resistant stock could increase through its continued and general use throughout an area.

#### Preventive Control of Bee Diseases

Preventive methods of controlling bee diseases include isolation or quarantine, requeening, etc. plus good management. Running a modern apiary is like running a modern city. The homes should be warm, well-ventilated and in good repair. There should be a good clean food supply at all times. There should be a pure water supply. There should be good sewage and rubbish disposal. In other words, good sanitary measures should be practiced. A warm well-ventilated hive in good repair will keep a colony at top strength throughout the year and will not allow the entrance of disease-laden robbers through unguarded cracks and crevices. A good food supply means that colonies should be fed only clean uncontaminated honey. An adequate food supply will also help keep colonies at their peak condition throughout the year. A contaminated water supply can spread infection more rapidly and to a greater number of bees than almost any other means. Therefore, if running water is not available, a supply should be provided that can be kept free of contamination. Bees normally dispose of their own sewage. However, when they are sick they will often splatter the hive and entrance with feces. This feces can be teeming with disease or-

ganisms and should be removed whenever possible. Rubbish should not be allowed to accumulate on the bottom board of the hive. This is a fertile breeding ground for all sorts of parasites and disease organisms.

Rubbish disposal also means getting rid of dead bees in an apiary. Any bee that has died of disease may infect bees of its own or neighboring colonies. Dead bees at the hive entrance should be removed and buried.

### Research and Development

One of the most fruitful areas of research in Apiculture in recent years has been that related to bee diseases and their control. This research has resulted in the introduction of new diagnostic methods, the development of resistant stock, the introduction of chemotherapy and gas sterilization for the control of bee diseases, and based upon this research—the development of an excellent nationwide network of apiary inspection. Today the beekeeper has considerably more confidence in his capability to deal with disease problems than his predecessor of just a few decades ago.

The Federal Government supports bee disease research at Beltsville, Maryland; Laramie, Wyoming; Madison, Wisconsin; Baton Rouge, Louisiana; and Tucson, Arizona. Major research and development projects are also carried on at universities in the states of Minnesota, Ohio, New York, California, Florida, Connecticut and Virginia.

Research accomplishments are implemented through the extension apiculturists in a number of states and through the inspection services of most of the states. In fact, the state apiary inspectors function in many of the states not only as the first line of defense in bee disease control, but also as the most important source of new information on methods of disease control for the beekeeper.

### Laws and Regulations

State laws and regulations relating to honeybees and beekeeping are designed primarily to control bee diseases. The first apiary inspection law in the United States was established in San Bernardino, California, in 1877. By 1883, a statewide law was passed by the

California legislature, and by 1906, 12 states had laws relating to foulbrood. At present, almost all states have laws regulating honeybees and beekeeping. There is a lack of uniformity in these state laws and regulations, but considerable agreement on specific points of law. Most of the states require registration of apiaries, permits for movement of bees and equipment interstate, certificates of inspection, right of entry of the inspector, movable-frame hives, quarantine of diseased apiaries, notification of the owner when disease is found, prohibition of sale or transfer of diseased material, and use of penalties in the form of fines or jail or both. Although the destruction of American foulbrood diseased colonies is included in almost all state laws, most states now also allow the use of drugs for control or preventive treatment of this disease. The key figure in the enforcement of bee laws and regulations is the apiary inspector. He may have the entire State, a county, or a community under his jurisdiction. His efforts are directed toward locating American foulbrood and eliminating it whenever found. The effectiveness of bee laws and regulations is based upon the compliance of the beekeepers. In the final analysis, responsibility for disease control remains with the beekeeper, who should routinely examine colonies for disease as a regular part of his management program and take the necessary steps when disease is found.

The Federal Government has no laws or regulations relative to bee diseases within the United States. However, on August 31, 1922, Congress passed a law, popularly known as the Honeybee Act, restricting the importation of living adult honeybees into the United States. This act was amended in 1947, 1962 and 1976. This last amendment reads as follows:

“(a) In order to prevent the introduction and spread of diseases and parasites harmful to honeybees, and the introduction of genetically undesirable germ plasm of honeybees, the importation into the United States of all honeybees is prohibited, except that honeybees may be imported into the United States. . . .

(1) by the United States Depart-

ment of Agriculture for experimental or scientific purposes, or

(2) from countries determined by the Secretary of Agriculture. . . . .

(A) to be free of diseases or parasites harmful to honeybees, and undesirable species or subspecies of honeybees; and

(B) to have in operation precautions adequate to prevent the importation of honeybees from other countries where harmful disease or parasites, or undesirable species or subspecies, of honeybees exist.

(b) Honeybee semen may be imported into the United States only from countries determined by the Secretary to be free of undesirable species or subspecies of honeybees, and which have in operation precautions adequate to prevent the importation of such undesirable honeybees and their semen.

(c) Honeybees and honeybee semen imported pursuant to subsections (a) and (b) of this section shall be imported under such rules and regulations as the Secretary of Agriculture and the Secretary of the Treasury shall prescribe.

(d) Except with respect to honeybees and honeybee semen imported pursuant to subsections (a) and (b) of this section, all honeybees or honeybee semen offered for import or intercepted entering the United States shall be destroyed or immediately exported.

(e) As used in this Act, the term "honeybee" means all life stages and the germ plasm of honeybees of the genus *Apis*, except honeybee semen."

Any person who violates any provision of this Act or any regulation issued under it is guilty of an offense against the United States and shall, upon conviction, be fined not more than \$1,000, or imprisoned for not more than one year, or both.

The Secretary of Agriculture either independently or in cooperation with States or political subdivisions thereof, farmers' associations, and similar organizations and individuals, is authorized to carry out operations or measures in the United States to eradicate, suppress, control, and to prevent or retard the spread of undesirable species or subspecies of honeybees.

Also, "The Secretary of Agriculture is authorized to cooperate with the Governments of Canada, Mexico, Guat-

emala, Belize, Honduras, El Salvador, Nicaragua, Costa Rica, Panama, and Colombia, or the local authorities thereof, in carrying out necessary research surveys, and control operations in those countries in connection with the eradication, suppression, control, and prevention or retardation of the spread of undesirable species and subspecies of honeybees, including but not limited to *Apis mellifera adansonii*, commonly known as African or Brazilian honeybee. The measure and character of cooperation carried out under this Act on the part of such countries, including the expenditure or use of funds appropriated pursuant to this Act, shall be such as may be prescribed by the Secretary of Agriculture. Arrangements for the cooperation authorized by this Act shall be made through and in consultation with the Secretary of State.

In performing the operations or measures authorized in this Act, the cooperating foreign county, State or local agency shall be responsible for the authority to carry out such operations or measures on all lands and properties within the foreign county or State, other than those owned or controlled by the Federal Government of the United States, and for such other facilities and means in the discretion of the Secretary of Agriculture as necessary.

**DISAPPEARING DISEASE.**—Although "Disappearing Disease" has been reported in various parts of the country for a number of years so little solid information exists about its symptoms and conditions under which it occurs it has been difficult to develop a control approach. The following symptoms are those most commonly associated with the condition called "Disappearing Disease:"

1. Most or all cases of "disappearing disease" occur during the fall or spring.

2. Affected colonies die out with plenty of honey and pollen stores available.

3. Most of the bees die in the field away from the hive.

4. Affected colonies are queenright.

It is obvious that these same symptoms can be the result of several different causes. From this viewpoint it may be that the choice of the name "disap-

pearing disease" is an unfortunate one. It has been suggested that it is now being used as an umbrella to cover losses from many and varied reasons. If this is the case then the attempt to solve individual losses or problems has become unnecessarily complicated and the beekeeping industry has been done a disservice. Certainly attempts to find one common cause for an effect that occurs despite a variety of conditions has thus far been singly unsuccessful.

All that is really known is that beekeepers observe an unexplainable loss of adult bees in either fall or spring under a wide variety of environmental and colony conditions.

The term "disappearing disease", in the modern sense, was first applied to losses of bees in Louisiana and Texas in 1960. In 1963 when California experienced a similar loss of bees the term "autumn collapse" was used.

Extensive investigations on the Federal level and in many of the states seem to have ruled out the following possible causes of "disappearing disease": pathogenic organisms, including viruses; pesticide poisoning; toxic nectar or toxic pollen.

Attempts to bring about recovery of affected colonies have been most successful by feeding a thin sugar syrup containing a small amount of pollen to stimulate a good nectar flow. Also the moving of some colonies to new locations having new sources of honey and pollen has proven successful.

Dr. William T. Wilson, of the USDA, has suggested that the cause of "disappearing disease" is a genetic shift in the honeybee population. Undesirable genes may have caused a change in the physiology or behavior of the bees. Dr. Wilson has undertaken extensive research to test his hypothesis.

**DISTANCE BEES FLY.** — See Flight of Bees.

**DIVIDING.**—Under the heads of Artificial Swarming, Increase, Nucleus, and Swarming are shown various methods of dividing. But dividing as it is ordinarily understood has to do with the operation of increasing the number of colonies by taking a part of the frames and adhering bees, with or without a queen, and putting them in another

hive on another stand. For a beginner dividing is often unscientific and wasteful, while artificial swarming or division on the plans described under Nucleus and Building Up Colonies, especially on page 126, are scientific and profitable because they are worked in such a way as to secure a honey crop as well as an increase in the number of bees or colonies. Dividing may be performed so as to ruin all chances of a honey crop, and in addition leave the apiary with a lot of weak nuclei.

#### Making the Division\*

Materials needed: a full depth super and nine or ten frames of drawn combs or some combination of drawn comb and foundation; a specially prepared inner cover, consisting of two pieces of hardware cloth or window screen stapled or tacked to each side of the bee escape hole, with a half-inch opening cut from one of the inner cover's lateral views (see diagram); and finally, a caged queen or capped queen cell.

Now select a strong colony, one that occupies two full depth hive bodies. From this parent colony two frames of sealed brood and a frame of unsealed brood with their complement of bees are placed in the empty full depth super, which is resting on the special inner cover. The frame of unsealed brood is placed between the two frames of sealed brood. The caged queen is placed on either side of the frame containing the unsealed brood. Remember to remove the cork at the candy end of the queen cage. The three frames should now be centered over the screened bee escape hole. If the complement of bees on these frames is small, then additional bees can be added by shaking bees off frames taken from the parent colony. After shaking bees into the newly-prepared super, cover the super with an inner cover or hive cover to prevent these bees from flying out. Next, add at least two frames containing honey and pollen to this super; these frames should be positioned so that each is adjacent to a frame of sealed brood. The remaining part of the super can be filled with drawn comb and

\*Alphonse Avitabile, "How to Increase Your Colonies without Paying for the High Cost of Package Bees", *Gleanings in Bee Culture*, Vol. 102 (Apr. 1974) 113.

some foundation, preferably drawn comb.

Before replacing the frames taken from the parent hive, be sure to coalesce the remaining brood frames so that they are adjacent to each other and then replace the frames previously withdrawn with either foundation or drawn comb.

Make certain the queen of the parent colony is not transferred to the newly prepared super. You may find it more convenient and/or more self-assuring to first find the queen before beginning the manipulations of the frames. When the queen is found, the frame she is on can then be put aside or she can be temporarily confined to a queen cage; in either case she can be returned to the parent hive after all the adjustments have been completed.

After the parent colony has its full complement of frames, the newly prepared super and the inner cover it is resting on are now placed above the second super of the parent colony. A regular inner cover and hive cover are then placed on top of the third super.

The screened bee escape hole will prevent the bees and queens (from what are now essentially two different colonies) from mingling, yet warm air generated by the parent colony will circulate through the screen and will help to maintain the proper brood temperature in the upper colony. The bees in this colony will be able to forage by way of the exit hole in the rim of the inner cover and its restricted size should help to prevent this small colony from being robbed.

Within a month's time and with good weather and nectar flows, a fairly strong colony of bees will result from your efforts. At this time the new colony can be moved to a new site; better still, the parent colony can be moved and the new colony left to occupy its site. In this way, if the parent colony is moved less than a quarter of a mile, foraging bees from the parent colony will return to their original homesite, thereby augmenting the population of the new colony. If this latter procedure is followed, it may be advisable to make the site switch during a nectar flow. The nectar flow need not be a major one—perhaps the dandelion

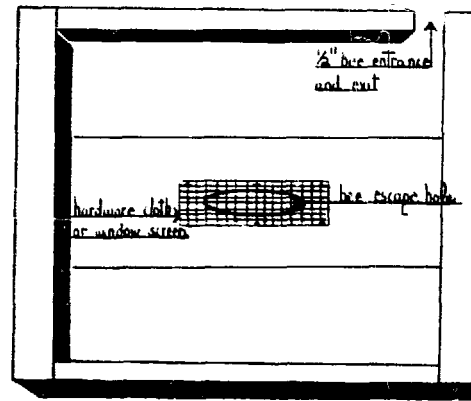

The specially prepared inner cover.

flow, for example. This mild nectar flow rule of thumb, may ensure acceptance by the foragers of their new queen.

#### Method Number Two

Another method that I used successfully in 1973 was to feed two gallons of sugar syrup early in April to ten strong colonies. After the sugar syrup was consumed, a third full depth super with drawn comb was placed on top of each of these colonies. During the next few weeks the queens of these colonies moved into the third super and filled several frames with eggs and brood. Worker bees also deposited some pollen and nectar in this super.

If a beekeeper follows these manipulations, and returns in a few weeks and finds eggs and brood, he can begin procedures which will result in a new colony in the third super. When he is ready, he must check to be sure the queen is no longer in the third super. If she is, he can put her aside as previously explained. If the brood, complement of bees, pollen, and nectar are ample, the beekeeper need only add a caged queen, center the brood over the bee escape hole, and slip a specially prepared inner cover between supers two and three. If additional bees, pollen and honey are needed for this super, the method for augmenting the number of bees, pollen and honey has been described.

Whether you decide to use one or both methods, additional feeding of the new colony with sugar syrup and pollen supplement will not only assist in bringing the colony along but will also serve to guarantee its success if

the weather becomes inclement; indeed, inclement weather is all too often the case in early spring.

**DOMESTIC ECONOMY OF THE HIVE.** — See Bee Behavior, Brood and Brood Rearing.

**DRAGON FLIES.** — See Enemies of Bees.

**DRIFTING.**—Drifting is a word that is used by beekeepers to describe the actions of bees which enter a hive other than their own, usually by mistake. This is not as uncommon as one would suppose but considering the unique social organization of the hive with its formidable detection and defense by guard bees, drifting into another hive has its risks for the returning forager bee.

Young bees in their play flights (referred to under Play Flights of Young Bees and under Robbing) not having yet learned the location of their hive entrance may drift into a hive where other bees are flying the strongest. They go in just as if it were their own hive. Hives that are making the biggest hubbub in front of the hive will attract flying bees from their weaker neighbors.

Newly-installed package bees will drift to other hives during the hiving particularly if the bees are agitated upon release from a long confinement in the cage. Gorging bees in the cage with sugar syrup will keep the bees settled when the cages are opened (see Beginning with Bees). Installing package bees late in the afternoon or near evening tends to allay the excitement of newly-hived bees which can be very intense when a number of packages are installed at one location. The more packages that are opened the more the problem of drifting is compounded under these conditions.

The apiary arrangement is the best deterrent to drifting. Facing hives in different directions or otherwise placing the hives so as to break up the symmetry of long straight rows aids field bees to visually mark the location of their exit and return to the same hive. Foraging bees returning with loads of nectar or pollen which inadvertently approach the wrong entrance are usually accepted, though perhaps momen-

tarily challenged by a guard bee. Robbing bees, in contrast, hesitate at the entrance, seeming to immediately arouse the defense of the colony to this threat.

Colonies at the ends of the row seem to receive a larger share of drifting bees, especially when returning workers are buffeted by strong winds. A pattern of flight formed by obstructions or by the direction of the nectar source may tend to cause drifting to hives nearest the approach end of the apiary.

Hives placed in pairs aid bees to identify their own home as they seem to know the difference between right and left in fixing a hive location. They do not readily distinguish the differences between their own and several other entrances when they are in a row and the openings are painted with the same color of paint and have no other distinguishing features to tell them apart.

The question of what harm can come of drifting is one that is often asked by beginning beekeepers. Even though the bees all belong to the same apiary it must be remembered that each colony is an individual unit that must maintain an equilibrium between its field force for gathering nectar and pollen and the hive maintenance force. The loss of any portion of the hive's field bees to other colonies by drifting will many times seriously curtail the spring build-up leaving understrength colonies for the honey flow. They have lost bees through drifting when they could least afford it while the strong colonies do not benefit proportionately. It is well to mention that drifting may cause the spread of diseases from infected hives as a result of drifting (see Foulbrood).

**DRONES.**—These are the male bees of the colony. They are large noisy fellows that do a great amount of buzzing, but never sting anybody for the very good reason that they have no sting. The beekeeper who has learned to recognize them both by sight and sound never pays any attention to their noise, but visitors are many times frightened by their loud buzzing.

The body of a drone is hardly as long as that of a queen, but it is so much thicker through than that of



either queen or worker that no one will ever mistake him for either. His two compound eyes are much fuller, his head is much thicker, and his wings larger. He has no baskets on his legs in which to carry pollen, and his tongue is so unsuited to the gathering of nectar from flowers that he might starve to death in the midst of a clover field in full bloom.

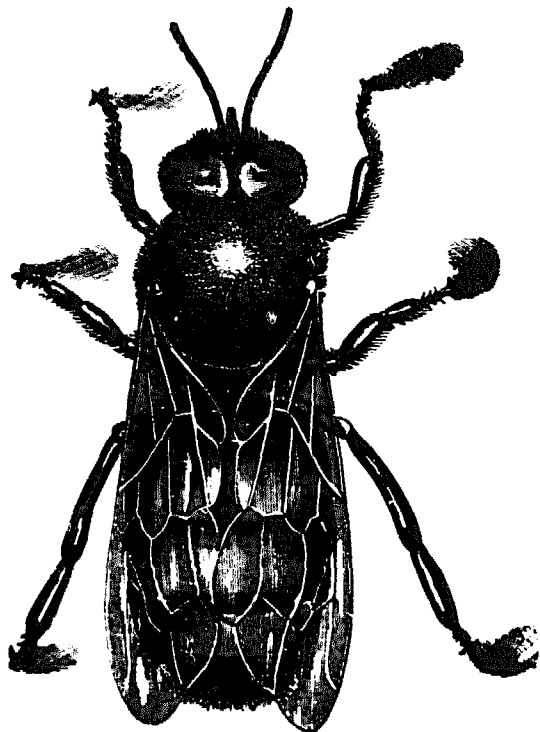

Drone bee enlarged four times.

#### The Anatomy of the Drone\*

In many ways the drone is a less well-developed creature than a worker or a queen. One exception to this generalization is his eyes which are better constructed than those of the worker or the queen. Also, his wings are stronger and his sense of smell is highly developed.

Each eye of the worker, queen and drone honeybee contains about 6300, 3900, and 13,000 facets respectively. The more elaborate construction of the drone's eye is intended, no doubt, in order that he may be successful in pursuing a queen. Even with this superior equipment the drone must depend upon the sense of smell rather

\*Parts of these sections are contributed by Dr. Grant D. Morse, *Gleanings in Bee Culture*, Vol. 98 No. 4, Page 30. and F. Ruttner, Germany. *The Australasian Beekeeper*, April 15, 1968. Page 279.

than sight alone to identify which flying insect is a queen honeybee. Then his stronger wings enable him to make a successful pursuit of the queen.

The brain development of the drone is believed to be inferior to that of the worker. The brain development of the queen incidentally is believed to be the least of the three. The pharyngeal glands which are highly developed in the worker bee, and which are the source of bee milk and royal jelly, are lacking in the drone anatomy. The glands are only vestigial in the queen. Likewise, the postcerebral glands and the thoracic glands which are so well-developed in the worker bee are largely undeveloped in the drone.

#### Drones Nursed

The rich salivary secretions of the nurse bees are fed liberally to queens and drones alike and provide a stimulus to the development of their reproductive organs, and in the case of the drone, encourage the production of sperm. The approximately 94°F. temperature of the brood nest also helps this development.

If the colonies are prosperous one may find eggs in the drone comb of some of the best hives as early as March in the North, but not as a general thing until April. In the southern states drones may or may not be found in the hives every month in the year. The drone cells can be told from the worker at a glance by the size. (See *Brood and Brood Rearing, Combs*.) Whenever eggs are seen in the large cells it may be assumed they are drone eggs. It is not meant by this that the eggs that produce drones look any different from any other eggs that the queen lays, for in appearance they are precisely the same. They are the same in every respect except that the eggs that produce the worker bees have been impregnated, while the others have not. The egg, like those producing workers, remains brooded over by the bees until it is about three days old, and then by one of nature's wonderful transformations it is gone and a tiny worm appears, a mere speck in the bottom of the cell. This worm is fed as before until it is about a week old and is then sealed over like a worker larva except that the

cap to the cell is raised considerably more. In fact, the cappings very much resemble a lot of bullets laid closely together on a board. (See Brood and Brood Rearing.) The young drones will begin to cut the caps of these cells in about 24 or 25 days compared with a worker in 21 and a queen in 16. The caps come off in a round piece very much like those from a queen cell.

### Are Drones a Liability?

Beekeepers over the years have felt that drones are a liability to the colony since they consume honey but do not produce it. Thus, one would assume the more drones, the less honey for the beekeeper. However, Allen Latham (1949) says, "I have never yet seen a smaller surplus stored in a hive with many drones than in a hive with few drones. The amount of surplus is determined by the activity of the working force, and I have always noticed that where drones were numerous the bees were very active." Later Allen, in 1965, showed that there was no significant difference in the amount of worker brood nor in the honey yield between colonies with free drone production and those in which it was restricted. Since the rearing of many drones consumes a lot of honey stores, not to mention the effort put forth by nurse bees, as well as the honey required to maintain a drone through his life, we must then conclude that colonies with free drone production suffer no loss because they are able in some way to work more efficiently than others.

The workers in a hive, not the queen, largely determine when drones shall be produced in the colony and how many there shall be. When there are no drone cells in a hive, they build them. To the beekeeper it seems they seldom build any other kind. Foundation that is not supported with wires or otherwise will sag giving rise to a lot of gnawing of the combs and as a result, the worker bees will replace this area of the comb with drone cells.

### Drone Flights

Under normal good weather conditions drones start flying about noon and keep on until 5:00 P.M. The great

est drone flight is between 2:00 and 4:00 P.M. The period of the drone flight can be shifted experimentally to the morning if flight is prevented for one or several days by confining the colony in a cool room (Taber 1964).

The first flights of young drones are short to orient their hive with its surroundings and to gain strength.

Older hive drones can feed themselves on honey and flying drones feed exclusively on honey from cells (Free 1957). Young non-flying drones consume about one milligram of honey per hour. Older drones (that are capable of flight) while inside the hive consume three milligrams per hour. During flight the food consumption is much higher at 14 milligrams for a half-hour flight (Mindt 1962). This is three times the rate of consumption of worker bees.

Research reveals that drone honeybees congregate in certain locations which they select. A study by Zmarlicki and Morse reports that they were unable to attract drones to virgin queens tethered within approximately 100 feet of an apiary.

Jean-Prost in France (1958-1961) regards a congregation area as a definite location where drones regularly assemble independently of the presence of a queen. There are two critical points involved, one, the place of assembly or congregation remains the same year after year, which is interesting since there is a new crop of drones every year; two, it is independent of the presence of a queen. The diameter of different areas on different days was found to be between 30 and 200 meters. Virgin queens, ready for mating, search out these drone congregation areas.

The areas exhibit an astonishing power of attraction to drones. Even drones which had located a tethered virgin queen, and were trying to copulate with her intensely, left her alone shortly after she was taken out of the area, and flew back into it.

Drone congregation areas can be found in all sorts of terrain, sheltered or unsheltered. The distance from the hive of origin can vary from 50 meters to 5 kilometers. This is what makes it so difficult for a queen breeder to maintain control of the drone blood line in his queen mating area.

Unlike the worker or the queen a drone is readily accepted as a visitor (usually by way of unintentional drifting) in a hive not his own. One authority attributes this exceptional behavior on the part of the guards of the strong colony as their instinctively acquired realization that the "visiting" drone has entered with no slightest intention of carrying out anything with him if he should leave. As a matter of fact, he will likely remain a permanent member and adopt the new domicile as his home.

### Queen Mating

There have been quite a number of observations of queen and drone mating. The technique usually used in this research is to tether a virgin queen on a very light thread suspended from a helium-filled balloon. Before this technique was used few beekeepers had observed the mating act. Most of these observers mentioned hearing a distinct crackling sound or small explosion. This is believed to be caused by sudden rapid rupture of the drone's genitalia with the consequence that the genitalia are everted from the drone's abdomen.

Zmarlicki and Morse in their article on queen mating (1963) include a copy of a photo taken of a virgin queen suspended from a helium-filled balloon being pursued by a "comet-shaped" swarm of drones located behind and slightly below the queen. They pursue her in this fashion until her sting chamber and vagina open wide. One of the drones then flying almost in a vertical position everts his genitalia with a loud pop, enters the queen, and then almost as quickly falls backward and downward paralyzed, in many cases leaving his genitalia in the queen.

Gary has been successful in getting drones to mate with artificial queens which are coated with queen substance. With the help of a boom truck he has taken a movie of the sequence.

Work done by J. Woyke of Poland with 628 virgin queens indicates that 63 per cent of them flew more than once and 38 per cent mated on the second flight. Eight percent of the queens flew yet again and six percent were inseminated the third time. The average number of sperms in the sper-

matheca of all laying queens was approximately five and one-half million. Queens which flew on only one mating flight had fewer sperm than the average and those mated on two and three flights reached approximately seven million sperm stored in their spermatheca.

### Flight Level

Ruttner has found that there is a clear stratification of the flight of honeybees. The worker's flight path is below eight meters. They very seldom ever fly higher than eight meters above the ground. Queens or drones flying below this level are very apt to be attacked by workers.

In research with tethered queens it was found on warm days the drones would begin to visit a tethered queen when she is raised 6 to 10 meters above the ground. The maximum number of the drones appear at 15 to 25 meters. About the highest they will go is 40 meters and no drones have been known to follow a queen higher than 60 meters.

### The Life of the Drone

The drone starts his life being care-

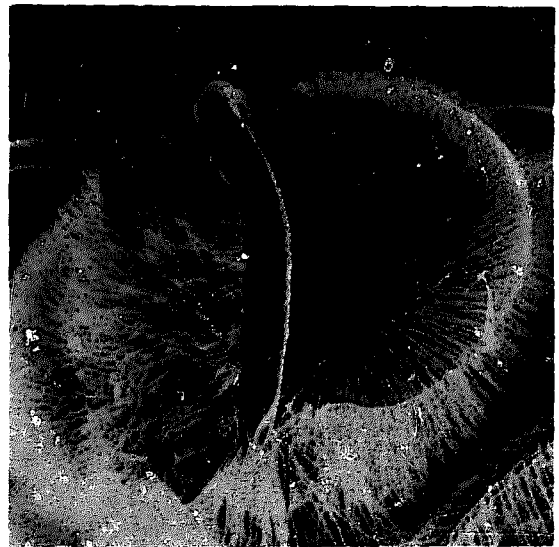

A close-up photo of a drone's head. Note the beak-like mandible at the bottom and the protective hair covering the compound eyes.

fully nursed by the worker bees. According to Oertel (1940) the drone is not sexually mature before 9 to 12 days after emergence from the cell.

Howell and Usinger (1933) state a drone's maximum length of life as 59

days except where retained in the hive after the normal date of autumn expulsion.

Langstroth says, "A colony which neglects to expel its drones after the usual season ought always to be examined. The queen is probably either diseased or dead." Nature in this instance has evidently spared the drones for possible mating with a virgin queen.

Following a severe dearth of nectar supply, but more particularly in the fall following the last major honey flow, the workers react by rejecting the drones from the colony entrance. This is usually preceded by the workers withholding food from them.

Free found that a worker bee's attitude toward drones depended upon the drones' age. Young drones in his observation hive were being fed while older drones were being removed. Free states that workers do not sting drones but in the process of removing them from the hive pull at their wings and legs. Morse (1967) found that the fall discharge of drones is a slow but continuous process, one that continues even after light frosts. He found that drones persist in the hive long after drone rearing has stopped. Latham reports seeing drones in wintering colonies as late as the month of February.

#### **A Drone Normally Has One Parent**

An interesting thing about the drone bee is that he is normally hatched from an egg that is unfertilized. In fact, a queen that has never come in contact with the male bee will lay eggs that will hatch but will produce drones and never workers.

Drones that hatch from infertile eggs have tissue cells which are haploid, that is, they contain only half the normal number of chromosomes.

J. Woyke, a Polish scientist has found that drones can develop from fertilized eggs. This is determined by looking at the drone tissue cells under a powerful microscope. If the nuclei of the cells contain a normal number of chromosomes the egg was fertilized and the drone is diploid. By using heavily inbred queens he found that about one-half of the eggs they laid were fertilized drone eggs. As soon as the eggs would

hatch the adult bees ate the larvae, causing the brood pattern to be very scattered. However, when these eggs were taken from the hive before they hatched and cared for under artificial conditions, adult diploid drones resulted.

#### **Drones from Worker Bees**

Drones are also hatched from eggs laid by worker bees. These drones are usually smaller in size than those from the queen because they are generally reared in worker cells. The question as to whether they are capable of fertilizing queens, so as to be of some value like other drones, has never been decided. Some facts have been brought to light that seem to offer good evidence on each side of the question.

#### **Drones from Drone-Layers**

Queen breeders find that one or more drone-layers of good stock, rearing fully-developed drones, will furnish a fine lot of nice drones in and out of season if supplied with plenty of worker brood, but drones from laying workers or from queens that have never been fertilized probably should be avoided. Drones from queens that have once laid worker eggs and then failed, are as good as drones from any queen.

#### **Destruction of Drones in the Fall**

This does not necessarily occur in the fall, but may take place at any time in the summer, just after the honey flow. Drones have been killed off between apple bloom and white clover only because supplies ceased, causing bees to become discouraged and give up swarming for the time being.

#### **How to Tell When the Honey Season is Declining**

There is no way in which one can tell so well that the yield of honey has ceased as by the behavior of the bees toward their drones. When, in the midst of the honey season, a worker is seen buzzing along on the back of a drone that seems to be doing his best to get away from the hive, it may be concluded that the yield of honey is failing. So far as is known, bees do not sting drones, but they sometimes pretend to do so. It is probable that it is only a



Drones at the close of the honey flow turned out to die. Notice worker about to attack drone near the entrance. Nobody loves him now.

feint to drive them away. The poor drone at such times, after vainly trying to go back into the hive, will sometimes take wing and soar away into the air, only to return after a time to be repulsed again, until perhaps through weakness and want of food he flutters hopelessly in the dust, and so submits to the fate that seems to be part of the inexorable law of nature.

#### Drones with Heads of Different Colors

This is a freak in natural history. Almost every summer some one writes about or sends specimens of drones with heads of different colors. The matter has been reported and commented upon at different times in *Gleanings in Bee Culture*. Not only are drones with white eyes occasionally found, but also with heads of a cherry color; again of a bright green, and at other times yellow. Why should this peculiarity show itself in the drones more than in the queens and workers? Again, why should heads be the subject of these bright rainbow colors? (See *Hermaphrodite Bees*, also *Breeding Stock*, subhead *Scientific Breeding*.)

#### Restraining Undesirable Drones

This can be accomplished by the use of excluders in the form of (1) perforated sheet metal with punched holes or slots just narrow enough to exclude drones but allow workers to enter; (2) by spaced wires mounted in a frame, wires so spaced as to exclude drones and queens.

#### Proper Spacing for the Openings of Excluders

The oblong holes must be of such a size as to permit the easy passage of workers, but to exclude not only drones but even queens. (See *Extracted Honey and Demaree Plan*.) It is easy to make the perforations drone-excluding, but to make them

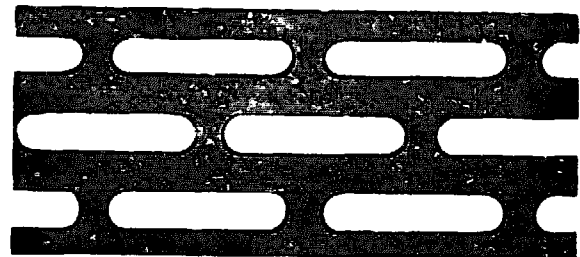

Perforated zinc queen excluder

queen-excluding at the same time, and yet not hinder the easy passage of workers, requires a very nice adjustment in the width of the perforations. Experience shows this to be .163 of an inch.

In 1908 there was put on the market a new form of queen excluder consisting of wire bars held at the required distance apart by means of soft metal cross-pieces at every two or three inches. These bars consist of No. 14 hard-drawn galvanized wire

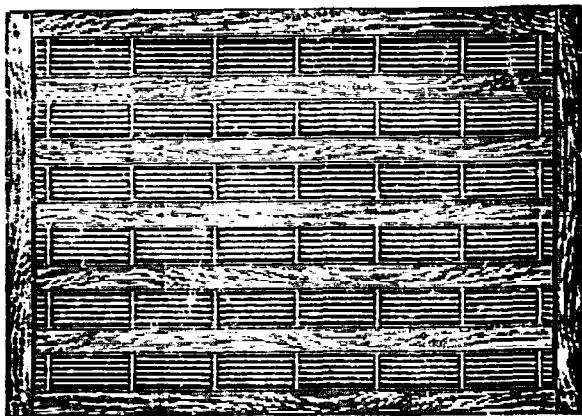

Wood and wire queen excluder

that has been straightened in a wire straightener so that it is as true as a die. Contrary to what one might expect, the spaces between these bars are more exact than the width of the various perforations in sheet metal. In the process of making, the bars are laid in metal forms having grooves that are spaced exactly right, and then a soft metal in a molten state is made to flow in certain cross-grooves of the metal form. As the metal cools almost instantly, the wires are held at exactly the right distance apart. The smooth rounding edges of the bars afford less obstruction to the bees passing and repassing, and practical tests show that this form of excluder is much superior to the old perforated metal. On account of the rounding smooth edges of the wires, they must be slightly closer, or .162 of an inch.

In the manufacture of the perforated zinc, unless the dies are very sharp there will be a slight rough burr edge on the under side of the sheet. This frays the wings of the workers. It is impossible to remove

this edge without reducing the width of the perforation. For this reason the wire excluder has superseded the perforated zinc.

There have recently come on the market all-metal excluders made of wires which are electrically welded together at their intersections. Up to the time of this writing, the author has seen only one of this type of excluder that was accurate enough in spacing to exclude queens. Unless they do this they are useless.

The variations in spacing can be tested by a tapering metal wedge or gauge inserted between the wires as shown opposite. If the wedge goes through too far the wires are too far apart and let the queens pass through. If the wedge does not go far enough the worker bees can not get through easily.

The worst feature of the all-metal excluder with metal binding is

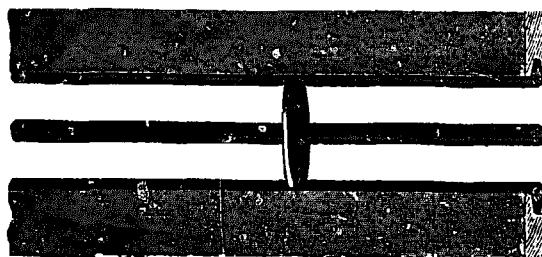

Full-sized wire excluder

that when it is glued down to the hive it bends easily in removing, thus destroying accurate spacings between the wires.

In some localities, especially in the southern states like Florida, bee glue or propolis is very abundant, and on hot days it is very sticky. A wood binding with wooden bars through the center reinforces the wire excluders so they do not bend when removed from the hive. Wires when bent are not queen excluding.

A wood-wire excluder, especially one with only three wires, enables the bees to pass between the wires more readily because they can grasp the wood as they pass through. This can be easily proved by putting the two types of excluders on a hive.

(On the use of queen excluders, see Extracting and Demaree Plan of Swarm Control.)

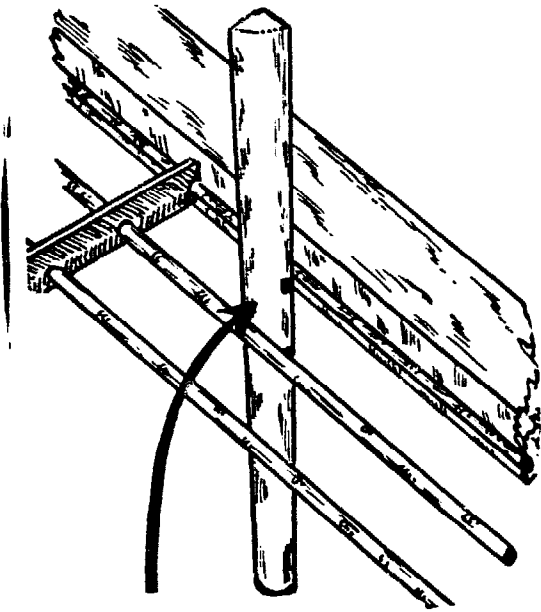

Wedge for measuring space between wires

#### Drone-Excluding Entrance Guards

If a strip of perforated zinc or wire excluder is placed over the entrance the worker bees can go out but the drones can not.

When it is desirable to get the drones all out of a hive without permitting any to get back again, the guard is put over the entrance and all the bees are shaken in front of the hive. The workers, of course, will crawl back on the combs, but the drones will have to stay out, and the queen too, unless she is



Wire entrance drone guard

put in the hive. In the morning, when the drones are stiffened with cold, they may be fed to the chickens or otherwise destroyed. (See Swarming.)

#### Wire Queen and Drone Trap

This is a device to catch queens as well as drones. It has an upper as well as a lower compartment

separated by a horizontal partition on which are mounted two wire-cloth cone bee escapes feeding upward. The whole front is covered with a wire screen excluder as shown.

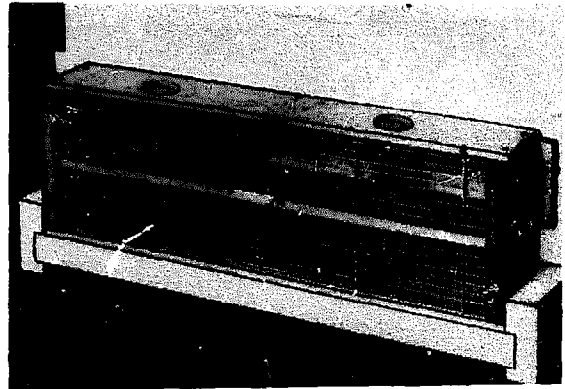

Wire queen and drone trap

In operation, queens or drones in attempting to leave the hive encounter the excluder in front and failing to go through, pass upward through the cone escapes into the upper compartment where they are trapped. In the case of undesirable drones a quart of them can be captured where they soon die. The trap is emptied and put back if the swarm has not issued. When it finally does rush out, the queen is caught above, the trap is removed, and tied to a limb or garden rake. Soon the bees will return and cluster on the trap holding the queen where both are hived.

The idea is pretty in theory but it hinders the workers, heavily laden with nectar, in getting into the hive. Worse than all, it shuts off to a large extent proper ventilation so necessary in a honey flow. It is far better to clip the queen's wings and allow a free entrance and exit. When the swarm issues, the queen can be found in the grass. She is caged when the swarm will return. (See Queens, subhead Queen Clipping.)

To limit drones it is better to use all worker combs.

**DRUMMING.**—A steady rhythmical tapping on the outside of a beehive with a light mallet or similar instrument causes a colony of bees within to move in a mass upward. If bees are needed

to fill shipping packages or need to be removed from a hive for any reason drumming is frequently practiced. A few uncoordinated taps on the outside of the hive frequently bring forth a few guard bees and may provoke an eventual full-scale attack. The point at which the tendency toward full arousal ceases and the point at which the bees succumb to the almost hypnotic influence of steady drumming is revealed only by experience. This point is, in some instances determined by prior conditioning and no doubt in part by environmental influences such as warm, clear weather, by the natural tractability of the bees, or the lack of it, the presence of a honey flow or feeding, the presence of brood and a queen and whether previous disturbances have alerted the colony. Favorable environmental influences such as warm, clear days contribute to the cooperative behavior of the bees and make manipulations such as drumming successful.

The vibration of a sounding surface with which the sensory organs of bees are in contact influence the behavior causing the mass movement of the bees being drummed. The movement is in the direction of the highest exit point in the hive. If the covers are removed

and an empty hive body is placed on top of the hive the empty space will soon be filled with bees as a result of steady drumming. It is then a simple matter to literally funnel them into empty shipping cages.

When there is a need to transfer a colony of bees from an undesirable abode to a movable-frame hive or from an old to a new hive drumming can hasten the transfer. All entrances to the old hive are blocked after giving the colony a heavy smoking. Leave the bees a top exit which should lead into the new hive which has been placed on top of the old. The bottom board may be left off, giving the bees the opportunity to move directly into the new hive body from below. As the bees are smoked and drummed into the new hive they will leave areas of the comb exposed which can then be cut out, fastened into new frames or disposed of. This involuntary behavior in response to drumming causes a mass of bees to move in the desired manner but they may resist because of reluctance to abandon brood combs. A combination of drumming and smoke may eventually overcome this resistance, allowing cutting out and salvaging the combs of brood.

**Drumming on the side of a hive with a wood or rubber mallet is being demonstrated here. Rather than surging out of the entrance as one would expect, the bees tend to move upward in the hive.**





**DYSENTERY\***.—Dysentery is not a disease, but rather a symptom that results from several causes, such as, excessive moisture in the hive, confinement of the bees for long periods, fermented honey, honeydew, Nosema disease, etc.

Bees that have dysentery will have a fecal discharge that is thin, watery, light yellow to dark brown in color, and foul smelling. Sometimes their abdomens are almost double in size. The bees will often have a greasy appearance and act listless. The front of the hive will be stained with yellow, brown or black spots.

Although dysentery appears mostly in winter or early spring, it can occur at other times of the year when the bees have been confined to their hives because of cold or rainy weather. However, as soon as the bees can fly they void their feces and under these circumstances the dysentery is of little consequence. In advanced forms of dysentery the outside of the hive will be badly smeared with brown and black stains and even the combs on the inside of the hive will be smeared.

In the North, where bees are often confined to their hives for months at a time during the winter, many colonies, showing dysentery symptoms will be lost. The presence of dysentery indicates an unhealthy condition of the bees especially when the bees discharge feces within the hive. Dysentery has been considered to be due to excessive accumulation of indigestible materials in the bee gut during long confinement in the hive. It has also been attributed to excessive moisture in the hive or in the honey stores. The accumulation of indigestible materials can be caused by low quality honey or honeydew high in dextrin and resins, or by unnecessary activity of the bees resulting from poor hive protection and winter brood rearing. Commercial beekeeping practices and experiments have shown, however, that most all well-ripened honeys are satisfactory for winter food if present in sufficient quantity.

Unfavorable moisture balance seems to result from high humidity, excessive activity of the cluster, inadequate hive

ventilation, granulation of honey or poorly ripened stores.

If the number of Nosema-infected bees in a colony is high at the beginning of winter, dysentery will show up after a relatively short period of confinement. Such a colony has little chance of survival. Nosema disease is one of the more serious causes of winter dysentery. Infected bees increase the activity of the cluster. If the quality of the stores is poor also, the bees consume more of this honey and thus also accumulate more indigestible material. The water metabolism of the infected bees is not normal causing both accumulation of indigestible materials in the gut and unfavorable moisture conditions in the hive, resulting in a more rapid appearance of dysentery.

#### Control of Dysentery

Settled, warm weather which allows the bees to void their feces is a self-limiting factor in the control of dysentery. However, there are a number of steps that a beekeeper can take to help control dysentery in his hives. Do not attempt to winter bees on honeydew, unripened aster honey, or in fact any unripened or fermented honey. If it is necessary, remove such combs in the fall and substitute with combs of sugar syrup or a nice light honey if available. Do not attempt to winter weak colonies as such colonies can often die with dysentery before spring. Provide adequate ventilation by the use of top entrances, holes, etc. To summarize, provide good stores in well-sealed combs, including both honey and pollen, a young vigorous queen with a strong population of bees and a dry hive with adequate winter protection. Preventive treatment for Nosema disease is also advised. For details see Nosema Disease, Control of Nosema Disease, and DISEASES OF BEES, Methods of Prevention and Treatment.

**DZIERZON THEORY.**—In 1845 the Rev. John Dzierzon propounded what is known as the "Dzierzon Theory", and thus in reality laid the foundation for much of our scientific and practical knowledge of bees. While he was not the original discoverer of parthenogenesis, he threw a great deal of light on the subject. (See Parthenogenesis.)

\*By A. S. Michael. See footnote under Diseases of Bees.

# E

**ECOLOGY AND BEES.**—A biologist's interpretation of ecology may differ from the usage which is implied by the everyday employment of the word. Ecology, by definition, is the study of an organism in relation to its environment. Expanding on this definition we include in the category of organisms all living things that are composed of living molecules. Organisms range in size from the sub-microscopic to the largest animals and plants. The environment is the total of all the living and non-living factors that have an effect on the organism: weather, geography, social organization, time and many more influences, including biotic, those which result from the activities of organisms themselves. Our environment surrounds us and ecology affects us in many ways.

Plants are the producers, so called because they can utilize light energy through the process of photosynthesis to convert raw materials of the atmos-



Sexual reproduction of plants is essential to maintaining a sufficient food supply for all levels of consumers, including man.

phere (carbon dioxide and water) into food. Nearly all other organisms, as consumers, are ultimately dependent upon plants for survival.

During reproduction many plants have evolved an interdependence with pollinating processes that involve living agents of transfer such as insects. Flower organs specific to the sexual reproduction in plants are concentrated in the blossoms of the kingdom of plants known as the spermatophytes or seed plants. Pistils, stamens, sepals, petals, ovaries and other supporting structures make up the reproductive parts of the plant blossom. The sexual reproduction of plants is essential to maintaining a sufficient food supply for all levels of consumers, including man although some plants can be successfully propagated asexually or vegetatively. Our cereal grains such as wheat, corn, oats, barley, rye and rice contribute the bulk of our food supply by virtue of their direct consumption, raw or processed; or, they are consumed as feed for livestock. The plants which bear the cereal grains are not dependent upon insect pollination though they do flower, undergo pollination and fertilization and seed formation as do our fruits and vegetables. The pollinating agent is the wind. The fruits and vegetables which provide us with important variations to our diet are dependent upon wind as well as other pollinators, principal of which are the insects, including the honeybees. Wind-pollinated plants have light fluffy pollens produced in relative abundance while the insect-pollinated plants have a heavy, usually sticky pollen that cannot be carried by the wind. The ecological significance of this plant-bee relationship to our food supply should be understood by every beekeeper because it is so important to everyone, not just the beekeeper.

Ours is a highly productive planet rich in the basic elements necessary to sustain a wide variety and abundance of life. When the environment is subjected to disturbances which interfere with and destroy sensitive natural sys-

tems all living organisms suffer the effects. All elements of the environment, both living and non-living, suffer from some disturbances such as drouth, floods, earthquakes and the erosion of soil and minerals. Like predation and succession of species they are natural events that are not always under the control of man. What we must understand, however, as the principal consumer on the earth, is that these disturbing influences, in some cases no more than man himself, are having a profound effect on all living things. This is ecology in action.

The role of honeybees in agriculture and a healthy environment through their pollinating activities are not always fully understood and appreciated. Our predominately urban population is inevitably bound to influence our environmental protection policies for the years ahead. Information about the role of the honeybee is needed now more than ever before if our agricultural economy is to remain productive and stable along with our environment. Unfortunately, fewer and fewer people have occupational or educational contact with nature, particularly agriculture, and undesirable and misleading concepts have affected beekeeping the past few years. As a result bees are suffering prejudicial banishment in areas where they are performing essential services as well as where they are kept for pleasure. This is a dangerous trend and is not compatible with our increasing stock of general knowledge of the natural sciences, including ecology.

**EGG LAYING.**—See Brood and Brood Rearing.

**ENEMIES OF BEE.**—Older literature on beekeeping often condemned some predatory birds and animals as being highly destructive to bees, this without consideration of their natural habits. Kingbirds do prey on honeybees and in some instances may cause a small loss when they concentrate near a queen mating yard but taking a shotgun in hand until everything in the way of suspected bee-eating birds are killed or driven away does not always solve the problem. Aside from the questionable mortality of such

killing there is the folly of attempting, by these methods, to alter predator-prey relationships by destroying the predator. Birds, and to a certain extent animals, are mobile; populations tend to adjust quickly in a limited habitat such as surrounds an apiary. Killing birds and animals in the vicinity of hives provides only temporary relief as others soon move in to populate the vacant territory, particularly when pest populations are high. During periods of low population, pests are not nearly so troublesome. Skunk populations appear to be cyclic and during years of peak population they can be quite troublesome to beekeepers. No amount of trapping and killing seems to have any effect on local populations. The skunk is primarily a nocturnal animal and are seldom observed in the apiary during the day but evidence of their coming and going can be seen in the trails they leave in the grass before the hives. Muddy paw prints on the fronts of the hives and bare spots in front where repeated scratching has disturbed the grass is unmistakable evidence of nightly raids by a bee-eating skunk or opossum. The skunk approaches the hive entrance, scratches at the hive front until the bees are aroused and come out to investigate. Using the front paws the skunk rolls the live bees on the ground to kill them and then eats them. A skunk family has the potential to seriously deplete the population of several hives as they tend to concentrate on certain ones. Live trapping of skunks is complicated by the problem of disposal without being sprayed. Preventive devices are effective though they may be something of a nuisance to the beekeeper. A two-foot wide strip of one-inch mesh poultry netting laid down in front of the entrances and staked so that the netting is about six inches above the ground surface will impede the skunk's forages at the hive entrance. Boards with protruding nail points positioned in front of the hive entrances in the manner of hive stand alighting boards are an effective barrier to approaching skunks or opossums which have developed a taste for bees. Care must be taken when working around the hives as they are also a hazard to the beekeeper.

### Mice

Mice around a beeyard are as inevitable as weeds. As long as they stay outside the hive they are seldom a problem, even when they make their nests under the protection of the bottom board. White footed and deer mice are particularly fond of such nesting spots and never seem to pass up the opportunity to move into weakly guarded hives if the opportunity is given. It is when mice invade the interior of the hive that the most compassionate beekeeper feels the need to destroy them. Mice can cause an unbelievable amount of damage in a few hours in the process of making a nest among the combs of a brood chamber. A persistent mouse or two will frequently enter a hive in the fall through the unrestricted entrance before the beekeeper acts to place his guards in position. The bees may be loosely clustered and perhaps do not detect the stealthy mouse until it is encountered among the combs in the lower hive body. Once surrounded by a cozy nest the mouse will resist vigorous efforts of the bees to drive it out of the hive. In the spring the de-



A mouse can do extensive damage to brood combs.

struction of the comb is extensive, the hive interior untidy and evil smelling. If the bees survive they are often demoralized and in poor condition by spring. Poisoned bait may be the only alternative when mice populations are extremely high around the apiary. Precautions taken by the beekeeper can usually prevent damage to hive interiors. A year-around mouse guard of wire mesh over the entrance that will exclude the mice but not impede the bees is the best protection. Wood entrance reducers will usually keep out mice if they fit snugly and are put in place early in the fall. Quite often the beekeeper will find one or several chewed very badly by mice attempting to gain entrance, a clue to the desperation of the mouse seeking a winters lodging. Occasionally an entrance cleat does not fit snugly, and unless tacked lightly in place will be pushed aside or pulled out, becoming useless as a mouse barrier.

Mouse damage to stored supers is easily avoided if sensible and timely precautions are taken at the time the stacks of supers are prepared for storage. Providing mouse-proof bottoms and tops to the stacks of supers and sealing holes where the mice may enter should rate the same priority as moth-proofing.

### Ants

If there is one insect beside the honeybee that was known for its industriousness it would be the ant. Not only does the ant inhabit the fields and forests but it also invade buildings, including beehives. This co-habitation with a colony of bees may not be as serious as it first appears upon removing the cover but in some southern latitudes this can mean trouble for the bees and consequently the beekeeper.

If the center opening in the inner cover has been closed it is a good bet that ants will take advantage of this unguarded area by moving in, laying eggs and multiplying between the two covers. Leaving the inner cover hole open the year around, or at least during the time that the bees are active will allow the colony to drive the ants from their sanctuary. At times even this measure is insufficient to ward off ants,

especially when the bee colony is weak or when the ant population is high and particularly aggressive.

There are many kinds of ants, including many species, sub-species and varieties. Like the honeybee, the ants belong to the order Hymenoptera, but to the family Formicidae. Fire ants and harvester ants belong to the sub-family Myrmicinae, while carpenter ants, mound-building ants and field ants belong to the sub-family Formicinae. Ant colony sizes vary from a population of only a dozen or so to upward to many thousands of individuals. Here again we note a similarity to bee colonies but differing in some important respects. Queens and males usually have wings while the workers are wingless. Each colony has one or more queens which do the egg laying. Queens are generally larger than the other individuals, including the males. Queens are mated on the mating flights after which her wings are shed and she begins a new colony or enters an established colony. Ants have an anatomical structure like the honeybee in that the segmentation consists of head, thorax and abdomen. Ants pass through the four stages of metamorphosis; egg, larva, pupa and adult, as does the bee.

Ant nests consist of one queen, at times males and female workers of different sizes and ages. Here too, the female workers are the dominant element in the colony structure. Development in the egg and also the food given determines the ultimate form of adult and the sex.

Some common ant invaders of the hive are: the large black carpenter ants (*Camponotus*) which live in weathered and decaying wood, meadow or mound building ants which build mounds of earth for nests and the little garden and pavement ants which may also enter beehives. In the South the most damaging ant is the Argentine ant. A large colony of them can kill a colony of honeybees in a few days. The common fire ant may be present in southern apiaries but do not cause the damage that the Argentine ant does. It is sometimes necessary to keep hives on stands with legs which rest in cans of oil.

Opinions on how much, if any, damage to beehives occurs as a result of an invasion of ants depends upon one's

personal experience or prejudice. A strong colony of bees with full access to all parts of a hive can successfully repel ants and they are seldom in evidence as a result. Colonies of bees that are weak or even strong colonies that cannot go up between the covers may entertain fairly large nests of ants which may or may not injure the bees. Abandoned hives are soon invaded by ants, particularly when they contain remains of honey or wax giving the erroneous impression that the ants were responsible for the death of the honeybee colony whereas some other cause was to blame.

Ant control recommendations are as varied as beekeeping methods. Professor Frank Robinson of the University of Florida suggests using some type of hive stand so that colonies are not in contact with the ground. Otherwise, he says, every colony will have an ant nest under it. Ants cannot be excluded from hives by simply placing on a stand, but by limiting direct access routes a large scale onslaught by ants may be avoided. Keeping the apiary free of debris removes ant nesting places and lessens ant populations around the bee yard. Hives in good repair are less vulnerable to ant attacks because they are more easily defended by the bees. Clean up spilled honey and discarded pieces of comb which may attract scavenger ants.

There remain a few effective chemical controls that can be safely used in the bee yard according to Professor Robinson. Soak the ground around the hives with kerosene or fuel oil, being careful not to use more than necessary as he fumes may run the bees out of the hives and some odor may be absorbed by the wax or honey. Diazinon, chlordane and heptachlor are chemicals that can be used safely around beehives and will provide long lasting control of ants. These materials are available in granular form which can be sprinkled underneath the colonies (if bottom boards are sound and not full of cracks and holes). Professor Robinson urges the following cautions when using the chemicals he suggested above, "Since these materials are toxic to humans they should always be handled and stored with great care. Read



*Braula coeca*, a bee louse.

and follow instructions on the label before using!" Other substances are being used as repellents with varying degrees of success. Sprinkling powdered borax, a white crystalline salt used in cleaners, or hydrated lime on the inner covers has been suggested. Poison baiting the

ants presents a problem as the same attractor used to lure the ants also draws the bees to the poisoned bait. Adding a bee repellent such as vinegar to the poison bait has been suggested.

Ant control in honey houses is quite different from yard control. A pest

control operator should be consulted. From all indications ants in the northern latitudes are more of an annoyance to the beekeeper than the bees. Nearly everyone who keeps bees has had the experience of removing the outer cover to discover the inner cover crawling with a number of different sized ants, often along with eggs. Beekeepers are sometimes more annoyed by their bites than by threats of stings from bees. The best defense against ants are the bees themselves. Just make sure that the hive defenders can reach all recesses of the hive.

#### Other Enemies

A species of toad introduced to Florida from South America to control insects in sugar cane fields is equally adept at catching bees at the hive entrance. Larger than the native American toads, *Bufo marinus* has a prodigious appetite for insects, including honeybees. This toad is increasing its range and numbers and is causing beekeepers considerable concern in Florida.

Lice and mites that affect bees are less of a problem in North America than in any other parts of the world. *Braula coeca* is a bee louse that clings to head, thorax or abdomen of the adult bee. Eggs of the louse are hatched under the surfaces of the honey cappings. The larvae damage the capped honey.

Parasitic mites are discussed under *Acarapis* disease.

Wasps, mainly yellow jackets are a late season threat to honeybee colonies. An introduction from Europe (*Vespula germanica*) has become a threat in the East and Midwest. Most of the yellow-jackets that are a nuisance to bees are found in predominately rural areas and live in ground cavities near the hives. Weak colonies of bees are especially in jeopardy of attack in the fall when yellow jacket populations are high. Darting in and out of hive entrances they may sometimes be on comb surfaces among the bees. How much of a threat to the honey stores they are can be judged by watching their darting attacks and by examining the combs. Where honey is being robbed from the hive the combs will have a shredded appearance. Controls of yellowjackets

are difficult. Underground nests can be destroyed if they can be located but the best defense is to keep the colonies of bees strong so that they can fend off the intruders.

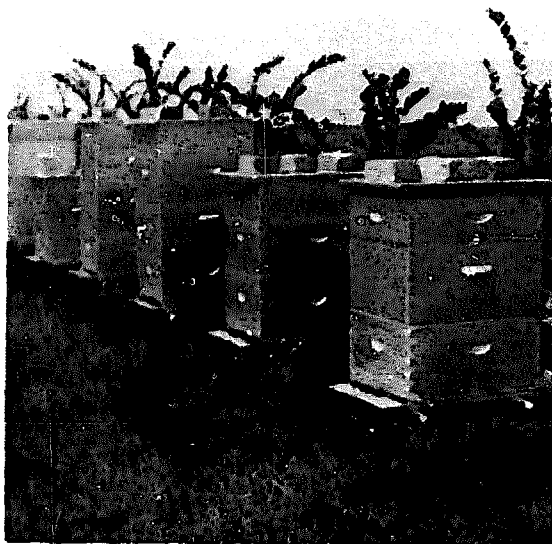

Metal pipe hive stands protect bees from predators.

#### The Worst Enemy

By all odds the most serious enemy to the bees and beekeeping is the careless or ignorant beekeeper himself, who harbors disease in the hives, either because he does not care or because he does not know any better. Such a man places in jeopardy the interest of every other beekeeper for miles around. While bees do not ordinarily fly over two miles (see *Flight of Bees*), and one is usually safe if he is that far from a foulbrood apiary, yet in the course of a year or two the colonies in the diseased yard will die, when bees a mile and a half away can easily rob out the honey from these dead colonies and carry the infection to their own yards. These in turn become diseased, forming new centers of infection reaching out a mile or perhaps two miles further. In fact, this is the way bee diseases proceed from yard to yard by robbing. To prevent this spread arises the need of foulbrood laws and bee inspectors. (See *Laws Relating to Foulbrood*.)

**ENTRANCE GUARDS.** — See *Drones*.

**ENTRANCES TO HIVES.** — At the bottom of the hive is the usual place for the entrance during warm

weather.\* At this low or ground level it is much easier for the bees to clean out dead bees, bits of wax, and dirt. Flying bees in the North chilled in the spring or fall, or incoming bees in the summer laden with honey often fall short of the entrance. If it is low they can crawl into the hive in case they fall short.

In the South, where there is danger of burning grass or rising water after heavy rains, it is customary to put the hives up on benches or raised platforms as shown under Apiaries.

There is not so much chilly weather in the warmer climates so the bees that do fall short and alight on the ground will take wing again and land in the entrance.

#### Keeping Down the Grass

It is impossible to estimate just how much the loss in honey is when grass or weeds are allowed to obstruct the entrance when the hives are close to the ground, but if actual figures could be secured, the producer would be surprised.

A handful of rock salt scattered in front of the entrance and around the hive is very effective in keeping down grass and weeds.

#### Size of Bottom Entrance

The proper size of entrance depends on the location, season of the year, size of colony, and whether the bees are wintered indoors or out. During the height of the honey flow the aperture should be as large as the bottom boards of the hive will permit—not less than  $\frac{7}{8}$  inch deep by the width of the hive. If too small there will be insufficient ventilation, causing loafing and

\*In late years winter top entrances have come to the front.

clustering on the front of the hive, often resulting in swarming. (See Swarming.)

#### Size of Entrances

Nuclei or weak colonies must have no larger entrances than they can easily defend. Entrances should be as small as possible after the regular honey flow, for then it is that robbers are liable to rush in pell-mell and overpower the guards of the little colony, depriving it of the scanty store it may have. (See Robbing.) A two-frame nucleus should not have an opening larger than will admit two or three bees at a time during the robbing season. When the honey flow is on it may be larger, but it should be contracted as soon as the flow ceases up



On excessively hot days strong colonies will cluster out. This may be remedied by staggering the supers, shoving one forward and the next backward. As soon as the hot weather lets up, the supers should be shoved back. When cooler weather comes, cold air should not blow into the supers.

The illustration below shows how the entrance is provided for in a dovetailed hive. The bottom is made

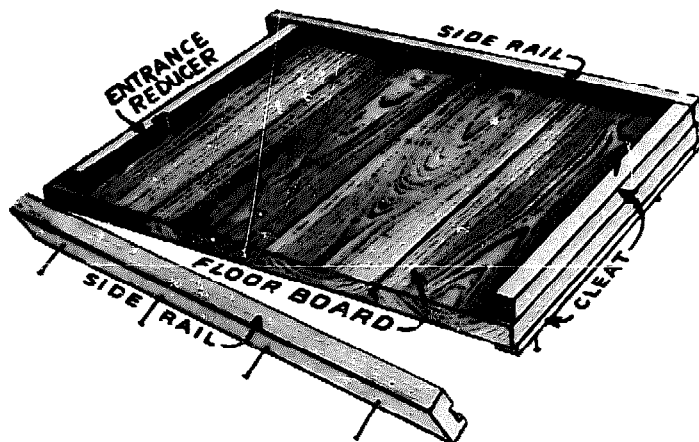

The entrance shown can be regulated to the season and to the size of the colony, and so save bee life by changing the entrance cleat as there are two size openings. The small opening in the entrance reducer is used when starting a colony from a package of bees or when the colony is so weak there is danger of robbing. The larger opening is used with a moderately strong colony during winter and early spring and should be placed so that the opening is on the top of the stick instead of next to the bottom board. This prevents the opening becoming clogged up with dead bees. The entrance reducer is removed during warm weather.



of an outside rim or frame, into which are inserted the floor boards  $\frac{7}{8}$  inch thick. These slide into grooves so cut that on one side the bottom board provides a  $\frac{3}{8}$ -inch space, and on the other side  $\frac{7}{8}$  inch. The usual practice is to use the deep side up, and an entrance-contracting cleat as shown.

While some prefer to use the shallow side of the bottom board up the year around, it is better to use the deep side and then make the necessary contraction of entrance with the contracting cleat as shown. During the warm part of the year when bees need an abundance of ventilation (spoken of under Comb Honey, to Produce, and Swarming, Prevention of), the wide or deep entrance is used without the entrance cleat. As cooler weather comes on, or if the colony is not strong, the cleat is inserted in the entrance with a long narrow slot.

#### Accessory or Upper Winter Entrances

The use of accessory top or upper entrances to provide means for the escape of excess moisture from a cluster of bees wintered outdoors is a new old idea. It was used and recommended by Langstroth 80 years ago. Had he lived longer to exploit it, its use might have been more universal today. (See Gleanings in Bee Culture, page 522 for 1942, and 225 for 1943.)

It was approved by Dr. C. C. Miller years later (1913), J. E. Crane, Arthur C. Miller, F. Dunbar Todd, and by numerous others of the pioneer beekeepers 30 and 40 years ago. In Europe the upper entrance was as common as it is today. But it has been only in the last few years that its merits have been spread abroad in the bee journals in America. In one form or another it is now in general use in this country as an accepted means for the escape of excess moisture.

#### Upper Entrances for the Release of Moisture

Why was it not adopted in the days following Langstroth and C. C. Miller? Probably because no one could or did see at the time that excess moisture surrounding a winter cluster of bees was one of the primary causes of bad wintering in spite of packing. It was argued that if there was enough packing

there would not be condensation on the inner sides of the hive. True, in part, but a cluster of bees will give off a large amount of moisture when it consumes honey. Dr. Phillips writes:

#### Causes and Effects of Humidity in the Hive

In winter, especially in a cold or poorly ventilated cellar, the atmosphere in the hive may become so laden with water vapor that water will condense on the cover, combs, and sides of the hive, drop to the bottom board, and even run out the entrance. The source of this moisture is, of course, the food of the bees. Honey is a carbohydrate and when consumed ultimately becomes carbon dioxide and water one gallon of honey producing approximately one gallon of water. Unless the moisture is carried off in the form of vapor by convection currents in the atmosphere, it will be condensed in the hive, for bees do not ventilate the hive by fanning when clustered.—"Beekeeping" by E. F. Phillips, Professor of Apiculture, Cornell University.

But this is not all. Excess moisture which is bound to accumulate will, if it cannot escape, go directly into the packing and there freeze. If it does not freeze, and leaves the packing wet, it is almost as bad. Wet or frozen packing is worse than useless. Dry insulation is a protection and is a help to good wintering.

In dry climates such as are found in the West, this upper entrance at or near the top seems to be in many, and perhaps, most cases self-sufficient without packing, provided of course the colony is strong enough to fill the hive bodies with plenty of pollen and honey.



Fig. 1.—Two upper entrances and one at the bottom. No crowding but the bees are not using the bottom entrance.

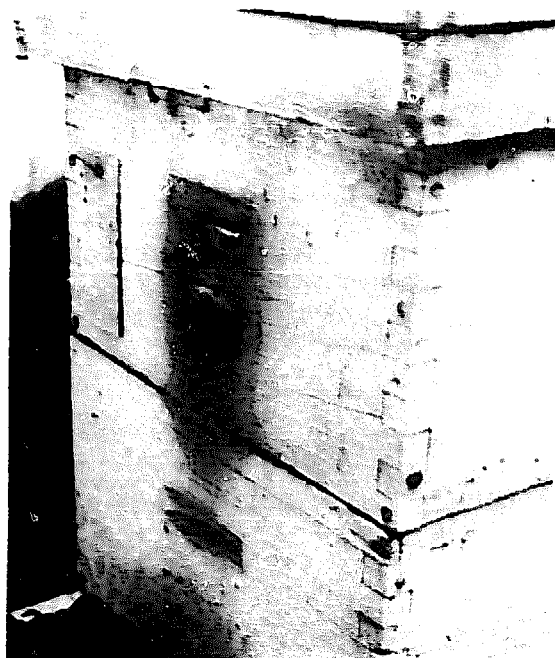

Fig. 2.—This shows a portion of a standard two-story Langstroth hive. Attention is called to a  $\frac{5}{8}$ -inch upper entrance partially obscured by travel stain. It should be explained that bees going from blossom to blossom pick up pollen on their legs, and as they enter the hive they leave pollen stains at the point of alighting, as here shown. Propolis also accounts for some of the discoloration. At the time this picture was taken only a few bees were going in and out of the hive.

#### Upper Entrances in the Spring

In the spring the bees seem to prefer to use the upper entrance largely because the brood and the general cluster are nearer that point. The location of these upper entrances allows the bees to go directly to the cluster rather than to crawl up from the bottom through a set of combs before they reach the point where either pollen or nectar is needed.

Again, it appears in the spring or early summer that possibly the small opening near the top is not large enough to allow the bees of a strong colony to pass in and out without crowding themselves and thus wearing out their wings. The remedy is to shove the upper story back  $\frac{1}{4}$  inch and plug the upper  $\frac{5}{8}$ -inch hole with grass. For a day or two the bees will cluster around the grass, then drop down into the opening below. (See illustration.)

#### Bottom and Upper Winter Entrances

It is the general practice when using an upper entrance to use the bottom one also but restricted to six inches wide by one-fourth deep.

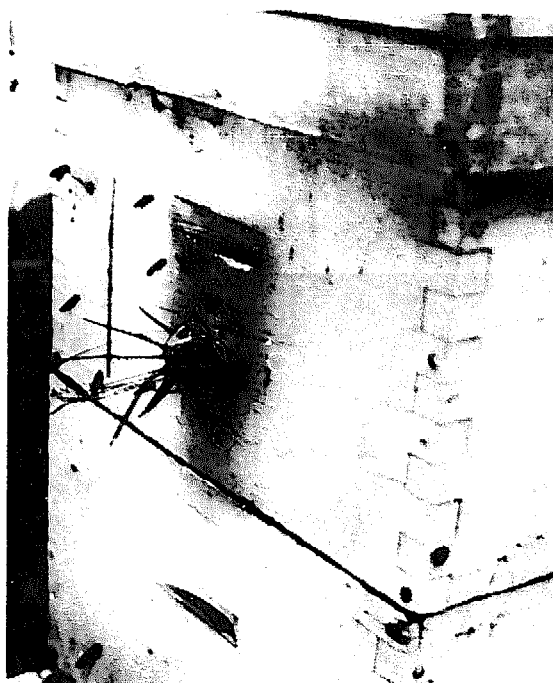
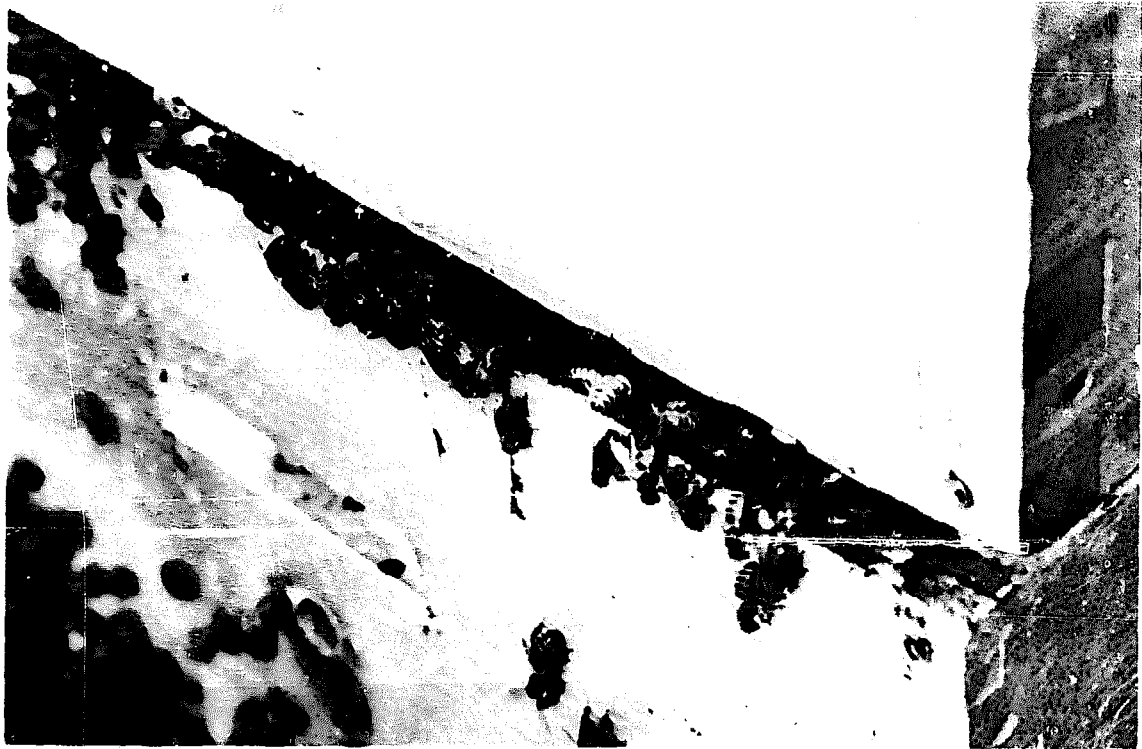

Fig. 3.—This shows the same hive with grass stuffed into the auger hole. Why grass? Because it will wilt away in a few days. In a major honey flow the number of bees going in and out of this hole will cause crowding and will waste valuable time, as well as wearing out the bees' wings, so we divert the flight of the bees to the larger entrance below, about  $\frac{1}{4}$ -inch by the width of the hive. To make this entrance larger we push the upper story back  $\frac{1}{4}$ -inch. Incoming bees will go first to the old entrance plugged with grass, with the result that they fall into the oblong opening. After three days they will go into the new opening thus made, where there is plenty of room for all the bees to go in and out.

On mild flying days bees can remove the dead ones from the bottom easier than from the top. Again, when warm weather comes the bottom entrance should be opened wide. Otherwise the top entrance will be clogged with flying bees.

#### Upper Entrance with the Bottom Entrance Closed During Winter

So far the discussion has related to the use of upper or supplemental upper entrances in connection with a restricted bottom entrance, the former to let excess moisture and old bees or those suffering with dysentery escape, and the latter to make it easier for the bees to carry out their dead. The main argument in favor of any upper entrance is not only to let moisture escape but to prevent the bees from suffocating when the lower entrance becomes clogged with dead bees or ice.



**Fig. 4.**—This shows the bees covering the oblong slot made possible by sliding the upper story back. They form a soft cushion upon which their fellow workers may alight. As the season advances, more fielders will be coming in and the oblong opening can be enlarged by shoving the upper story back still farther. This simple arrangement makes it possible to make the size of the entrance equal to the needs of the colony. As cool weather comes on, the size of the opening can be reduced and later on closed entirely, leaving only the  $\frac{5}{8}$ -inch hole which provides fresh air in connection with the entrance at the bottom of the hive. Under *Wintering, Why Upper Entrances*, it is explained that when the lower entrance is contracted a draft of air will rise from the bottom restricted entrance into the upper part of the hive, affording ventilation and a means for the escape of excess moisture and foul air.

### Entrance Activity

Bee activity is centered around the entrance during the seasons that bees are flying. For this reason it merits special attention. The entire honey crop passes this point, not only the incoming raw nectar but the excess water which is expelled shortly thereafter. Anything that restricts the entrance and interferes with the movement of bees should be removed during the honey flow. Placing the hive on a hive stand has advantages. An inclined landing board aids heavily laden bees returning from the field to crawl up to the entrance if they should fall short on the approach and a hive stand prevents weeds from growing to within inches of the entrance.

The size and position of the entrance influences the internal hive atmosphere. Rapid changes in the hive temperature caused by air currents coming into the hive entrance and cooling the lower part of the hive can be controlled by the addition of slatted racks. One form

of these racks is an insert which slides into a deep bottom board\*. Most slatted racks consist of a frame of the same outside dimensions as the hive body, a baffle of solid wood extending part way back from the entrance and the balance of the rack of slat inserts. The purpose of using a slatted rack is to provide a temperature stabilization in the lower body thus encouraging the queen to utilize the lower unit to a greater extent in brood rearing. Chewing of the combs and foundation along the lower edges next to the entrance is reduced. In climates where hot drying winds sweep into the hive entrances the slatted rack acts as a buffer against the winds.

The entrance is the "window" to a hive. By observing flight activity at the entrance several tell-tale signs signal whether all is well with the colony or whether it needs attention. Experienced

\* Charles J. Koover "The Killion Bottom Board", *Gleanings in Bee Culture*, Vol. 94 (March 1966) 137-40.

beekeepers note whether bees are bringing in pollen as this usually shows that brood is being cared for. Clustering, idle bees at the entrance may preclude the casting of a swarm or an overcrowded condition that may lead to swarming. Heavy clustering during very hot weather, particularly during a heavy

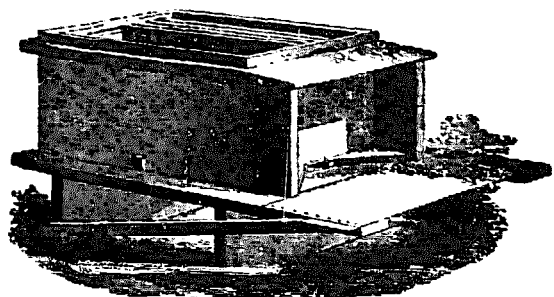

"In my hives, all the lower passages can easily be closed air-tight, and the bees allowed to go in and out through the winter entrance, which is made at the top of the hive. . . . This entrance has been found on trial to be very important where bees are wintered in the open air. The lower entrance should be closed in winter."—Langstroth (1873 edition).

honey flow is an indication that the colony needs more super space for storing fresh nectar; however, very populous colonies will exhibit this tendency to cluster out during warm weather when the field bees are confined to the hive. A glance at the entrance may reveal a need for additional ventilation when these conditions exist.

Bees furtively darting in and out of an entrance of a hive, fighting at the entrance and causing a general row in the apiary is a certain sign that robbing of a weak colony is taking place. To prevent robbing and to halt robbing in progress the first and most important step is to reduce the size of the entrance to the weak colony. Leave space for only a few bees to pass through at one time. An examination of the weak colony or nucleus should be made to determine why it is being subjected to a robbing attack. Weak colonies unable to defend their entrance against robbers may have been so weakened by queen loss, disease or by poisoning to the extent that they should be immediately treated or burned if diseased or combined with another colony if too weak to be saved by requeening.

Large numbers of drones at the entrance may indicate that queen superseding is taking place.

Dead brood being carried out of the entrance should call for an immediate inspection unless the reason, such as chilling or poisoning, is known. Dead brood at the entrance may or may not signal a serious problem with the colony.

Entrances heavily spotted or streaked with dark brown fecal discharge may reveal that the colony is suffering from dysentery or from the effects of bad stores consumed during periods when outside flights are restricted for weeks or months at a time.

Honeybees show a surprising ability to adapt to various sizes and positions of hive entrances. Preferences for the position of an entrance may be noted by the beekeeper. The entrance to the hive is frequently restricted during winter and early brood rearing periods but supplementary ventilation is often given by additional openings provided above the bottom entrance.

Watching bees at the entrance may often reveal to the observant beekeeper many things about the condition of the colony.

**EUCALYPTUS.**—Trees of the various eucalyptus belong to the myrtle family and number in the several hundred species, most of which occur in Australia where they comprise the bulk of the nectar sources. The blue gum (*E. globulus*) has been planted extensively about the San Francisco Bay area and in Southern California where it yields honey abundantly. According to Eckert and Vansell (1941) the blossoming period is in late winter and early spring when the weather is not always suitable for the gathering of nectar. In addition, the blue gum does not blossom heavily every year. The red gum (*E. rostrata*) is planted quite extensively in the hot interior valleys where considerable honey was reported by Vansell to be stored each year.

Eckert and Vansell rate honey from the eucalyptus as having a rather strong flavor, especially when a slow nectar flow is experienced.

Perhaps the best information on the eucalyptus as a honey plant is found in an Australian publication by Blake and Roff (1972). Information in the book was compiled from the author's articles which appeared in the *Queensland Agricultural Journals*.



**Bluegum (*Eucalyptus globulus* Labill)**

The eucalyptus cannot usually endure the temperatures of the northern latitudes and are therefore confined to the warmer climates. In the United States they appear to be best adapted to California where they were introduced from Australia. They grow to a lesser extent in Arizona and the Gulf of Mexico region of Texas as reported by Lovell (1926).

The eucalyptus are commonly referred to as "gum trees" because of the resinous gum which flows from incisions in the bark. The various species of eucalyptus have colorful and descriptive names: blue gum, stringy bark, iron bark, yellow box, red box, gray box and mahogany gum.

The blue gum (*E. globulus*) is said to be the fastest growing tree in the world.

#### References Cited

Blake, S.T. and Roff, C. (1972). *The Honey Flora of Queensland*, Department of Primary Industries, Queensland.

Lovell, J.H. (1926). *Honey Plants of North America*, A. I. Root Company, Pg. 122.

Vansell, G. H. and Eckert, J. E. (1941). *Nectar and Pollen Plants of California* (Rev. 1941) Pg. 36.

**EXCLUDERS.**—See Drones and the Demaree Plan of Swarm Control.

**EXHIBITS OF HONEY.**—Exhibits of honey, bees and other hive products are usually among the most attractive at county and state fairs. A well arranged exhibit with rows or pyramids of glowing amber light and dark honeys, colorful placards, pictures and charts telling the story of bees, honey and pollination attracts the attention of visitors. Ample lighting for the background and overhead is essential for bringing out the best color of the display of honey. A local association, state, or national honey queen in attendance adds the human touch. Other exhibit attendants should be present to explain to visitors the interesting story of bees and honey and perhaps give out printed pamphlets. There is always the opportunity to sell honey or give out samples. Honey sales during such exhibits frequently net beekeepers or associations a substantial part of a years income when honey is sold, usually on a cooperative basis among exhibitors.

While agricultural fairs are still the most popular arenas for beekeeping exhibits, beekeeping has also moved in the direction of the urban population and this is another perspective that should also be emphasized—the keeping of bees for recreation and the ben-



**A County (Stark, Ohio) Fair display of honey.**



Educational exhibits are as important to beekeeping as honey exhibits.



Honey exhibits can be very attractive.

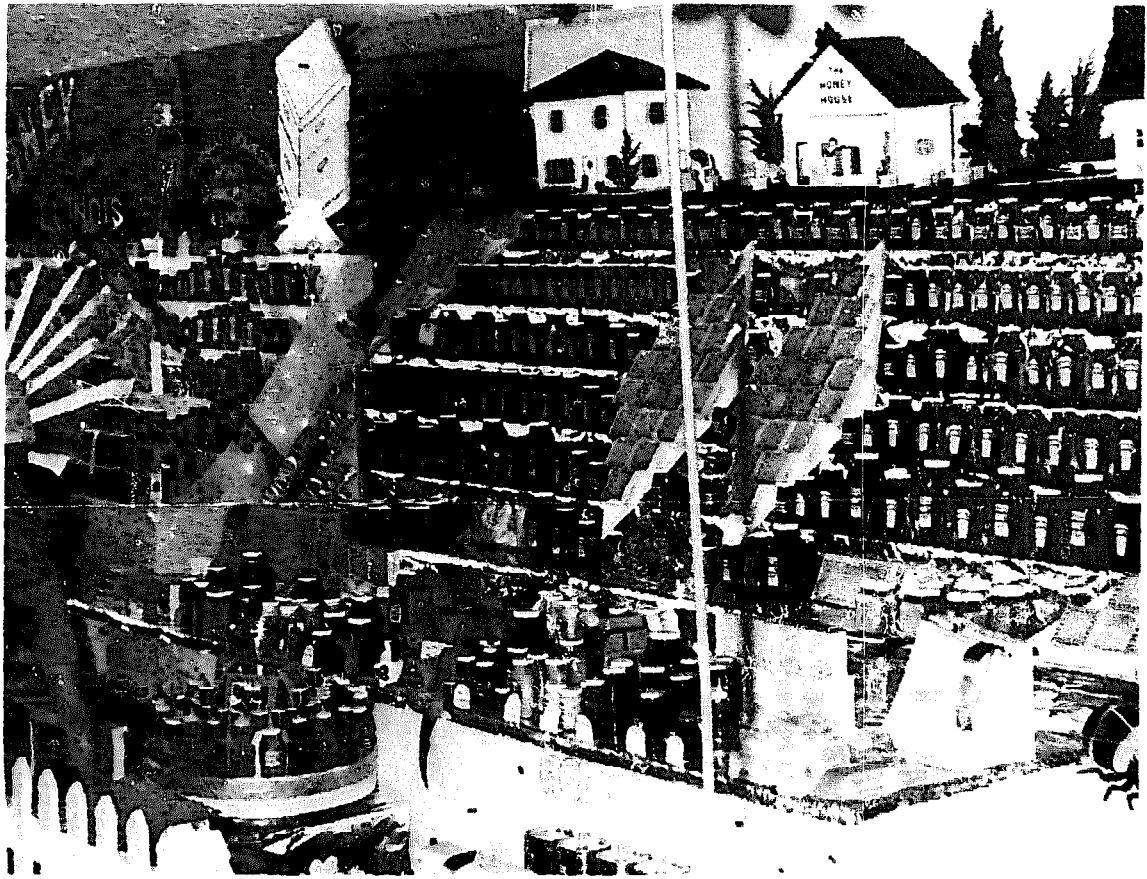

The display of Mr. John Wallanches, Plano, Ill., winner of the Governor's Trophy, Ill. State Fair.

efits of bees to the environment. Honey shows with exhibits of honey, baked goods, gadget shows and honey tasting contests draw attention to the hobby aspect of beekeeping. Initial contacts with potential consumers of honey are often made at honey exhibits.

The beekeeper-producer no longer has the opportunity to furnish honey for the large food merchandising chains unless of course, he packs considerable honey in addition to his own production. Promotional advertising is usually handled by professional advertising agencies, who use all the publicity mediums available, which are considerable. Beyond this commercial approach to honey promotion there is the personal contact with potential consumers which cannot be improved upon no matter how much is spent on advertising. Few agricultural producers, certainly not the grain and livestock farmers, benefit as much from the promotion of their products by thousands of enthusiastic and effective promoters as do beekeepers. Honey has fierce competition from honey substitutes or syrups. The reali-

zation that natural foods have nutritional advantages has boosted the image of honey in the eyes of the consumer but at the same time increases the risk that unscrupulous merchandising will take advantage of the good name of honey to sell honey substitutes or blends with syrup. The word of thousands of beekeepers multiplied many times over by person-to-person contacts strengthens the position of the industry when exhibits of honey and beekeeping demonstrations are displayed before the public.

Visual exhibits should always include live bees on combs if possible. Observation hives can be built to nearly any size in the home workshop or are available from the bee supply stores. If the display of live bees does not last over two or three days there need be no provision for outside flights but longer than this the bees should either be exchanged for fresh bees from a hive or the bees provided with an exit to the outside, particularly where the exhibit is to remain on display for a considerable time. Do not attempt to exchange frames covered with bees at the display



Honey exhibits need not be elaborate. Selected photographs which tell the story of the bees and honey can be arranged in a small space.





Don Cooke, a veteran of many "bee beards" demonstrates for the benefit of the Ohio Honey Queen. "Putting on the bee beard" by Don was one of the highlights of the Ohio Honey Festival for many years.

site. It is better to have two display hives, alternating them every few days. Even though the observation hive is only on display a few days, water or thin sugar syrup should be fed. A one pound honey jar with a few small holes in the lid may be inverted over a hole in the hive cover the exact size of the jar lid.

Marked queens are much easier to locate among the worker bees by interested onlookers. Information placards to help point out various features of the display hive and to help explain some of the interesting facts of bees, honey and pollination should be a part of any display. Keep the display hive clean and well stocked with bees. Bits of comb and propolis tend to accumulate on the inside of the glass panels. It may be possible to slide the glass out for cleaning and if the hive is on display during cool weather when flying is restricted watch for spotting and discoloration by the bees. This frequently happens at the onset of cooler weather, along with a rapid loss of population.



Attractive exhibits of honey on a highway will sell honey. This stand on busy U.S. 20 was operated by Ohio beekeeper, Edwin Selfe.



Honey exhibits at the site of the sale stimulates interest in the product.

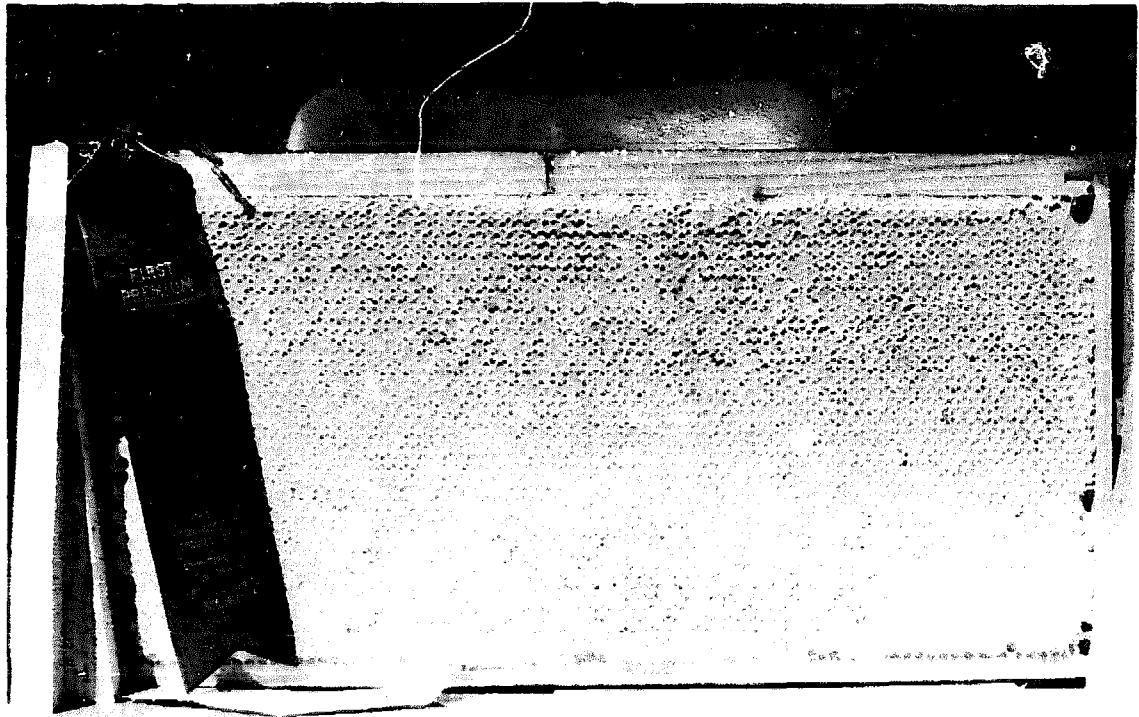

**EXTRACTED HONEY.** — Up to the year 1865 all liquid honey obtainable was pressed and strained from the combs—hence the term “strained” honey. Such a product is generally full of sediment consisting of particles of wax, pollen, propolis, and bees’ legs. The more modern product of liquid honey is extracted from the combs by centrifugal force. A reel holding two or more combs revolves inside of a can, throwing the liquid honey from the cells, and leaving the empty combs intact for the bees to fill again. (See *Extracting and Extractors*.) The honey is free from impurities and not impaired in flavor by bits of pollen and propolis. At present all the liquid honey on the market is separated from the combs by the use of the extractor and is therefore extracted honey. Occasionally there is a honey—for example the far-famed heather honey of Scotland—that it is so thick it cannot be readily separated from the comb by centrifugal force unless it is placed in a warm room for 24 hours before extracting.

Extracted honey may be divided into two general classes: one suitable for table use and the other for manufacturing purposes. Among the first named are the light-colored

honeys such as clover, basswood, sweet clover, alfalfa, sage, orange, tupelo, palmetto, thistle, vetch, fireweed, and raspberry — all of which are of fine body and flavor and of course are suitable for use on the table. While it is not invariably true, yet generally the light-colored honeys are mild and delicious. The darker honeys are nearly always stronger in flavor and must be marketed in a locality where the consumers are accustomed to the flavor, or they must be sold for baking purposes. Some dark honeys like buckwheat, poplar, and heather are highly prized as table honey. Hundreds of carloads of dark honeys are used by the large baking trade for no artificial product\* has ever been produced that quite takes the place of honey for keeping cakes soft and moist for months. (See *Honey in Cooking; Honey Bread*.)

As is pointed out under *Comb Honey*, there is a slight difference in flavor between comb and extracted honey, owing to the fact that the latter loses some of its aroma in extracting and because it usually has to be heated to keep it in liquid condition. Overheating, even for a

\*Invert sugar is used as a substitute for honey when it is cheaper, but it lacks flavor. (See *Invert Sugar*.)

very short time, impairs the flavor of honey. Some producers in their eagerness to obtain all the honey possible, extract it from the combs before it is fully "ripened". Honey, when first stored in the cells, is thin and watery and does not have the exquisite flavor that it has when evaporated and changed chemically and sealed over by the bees. Honey which has been allowed to stay in the hive some time after it is sealed acquires a body and richness that honey only partially sealed does not have.

In 1870 A. I. Root extracted over three tons of honey from an apiary of less than 50 colonies. During the forepart of the season it had been allowed to become capped over, but during the basswood bloom when the bees were fairly crazy in their eagerness to bring in the nectar, some was extracted that was little better than sweetened water. This granulated when the weather became cold, and nearly all of it had to be sold at a loss. Almost all honey will granulate. (See Honey, Chemistry of; Honey, Granulation of; Honey, Spoilage of.) An unripe honey deteriorates, leaving a thin watery part which, if it does not sour, acquires in time a disagreeable brackish flavor. Unripe honey will ferment, developing gas and pushing bungs out of barrels, caps off of bottles, and it may actually burst cans. (See Honey, Spoilage of.)

Before it is fully capped over, new honey sometimes has a peculiar odor and taste. Where there is a great amount of goldenrod a disagreeable smell is noticeable in the apiary while goldenrod honey is ripening. In a few weeks, however, all this passes away and the honey shows nothing of the former disagreeable odor or flavor. In certain localities where onion seeds are raised for market, the honey has so strong a flavor of onions when first gathered that it cannot be used. Later on, however, much of the disagreeable quality disappears.

Even basswood honey, when first gathered, is so strong and has such a pronounced tang that it is often unpleasant. If left in the hives it improves greatly.

#### CAUTION!

Beginners and others should be cautioned against putting on the

market a honey that is not ripe or that is from unsealed combs. It should run not less than 11 $\frac{3}{4}$  pounds per gallon. If it is under that figure it may ferment, causing the cans to bulge and burst, resulting in bad leaks and robbing in a honey house not screened. (See Honey, Specific Gravity of.)

The novice should also be cautioned against putting off-flavored honeys in bottles, and against sending out any honey of good flavor that is not clean and free from bees' legs, bees' wings, dead bees, and other debris. (See Honey, Filtration of; Honey, Effect of Heat on; also Bottling.)

#### How to Keep Extracted Honey

It is usually best to sell the crop as soon as possible after its production. At other times it may be advisable to hold and sell later on. How to keep extracted honey if it is to be held for a few months will depend upon conditions. With a few exceptions all honey, especially extracted, has a tendency to granulate, and when it does some changes may take place. After granulation, fermentation may or may not occur. If the honey has not been heated it may ferment after granulation. To prevent fermentation of any unheated granulated honey, Prof. H. F. Wilson of the University of Wisconsin recommends that it be held at a temperature no higher than 50 or 55 degrees Fahrenheit, that at 60 degrees it will ferment more quickly than at a higher point, and that usually all honey is slow to develop granulation at 75 degrees. Temperature of 80 degrees Fahrenheit is too high, says the same authority, because serious deterioration in color and flavor may take place. All of this is true according to the experience of the author. (See Honey, Spoilage of.)

A honey that has been heated to 160 degrees Fahrenheit to prevent granulation should be put immediately into sealed containers and kept at living room temperature. An unheated honey should never be stored in a basement if the temperature is below 70 degrees, because 55 to 65 degrees is the most favorable point for granulation, followed in a few cases by fermentation.

This matter of keeping extracted honey, heated or unheated, is ex-

plained fully under Honey, Granulation of; Honey, Spoilage of; Honey, Specific Gravity of. A large amount of otherwise good honey on the market is ruined or impaired by overheating or storing under conditions where it will ferment and sour.

#### **Managing for Extracted Honey**

Before one can produce either comb or extracted honey he must have a large force of bees such as he can secure with a food chamber. (See Food Chamber.) He may have ever so good a locality; conditions so far as honey sources are concerned may be the very best; but unless the colonies are strong—very strong—the crop of honey actually taken may be light. Even when the season is poor, an intelligent beekeeper with a large force of bees of the right age in each colony may get a good crop. Success depends more upon strong colonies and good management than upon the locality and the particular season. But good management and strong colonies without a good year may mean a light crop or a failure.

#### **Preparing the Colonies for the Crop**

Before proceeding further, one should read *Building Up Colonies*, *Food Chamber*, and *Pollen*. The reading of these three articles will give the beginner the general principles necessary to success. There are different ways of carrying out these principles. Much will depend upon locality, the season, and the equipment. In some places there is a succession of honey flows with intervals of dearth or no honey coming in, but in most localities there is one main flow, during which the most if not all of the crop is secured. The season may last only ten days or it may last three months, or even longer. In the white clover regions in the North in an off year the flow may not last more than a week, although usually two or three weeks and sometimes a month of continuous flow may be expected. In the sweet clover regions the season is later and may last from two to three months. This gives more time in which to build the colonies up to proper strength. In the southern states there may be a succession of minor honey flows, and when this is the case a little different management will be required. There will

be so much early brood rearing that the queen will be worn out. It may be necessary to requeen once or twice a year to get enough brood for the real flows to follow later.

#### **Early Clover Regions**

We shall first consider the early clover regions where the honey flow continues from the last of May until the last of July. In these localities where clover is produced, bees will not be able to fly much before about the middle of April, and usually not much before the first or middle of May. The time is short, and every effort must be made to get the colonies strong for the flow. But brood rearing may begin as early as January to a small extent, and expand as weather conditions moderate. The article on Food Chamber will show the importance of having a large amount of natural stores available either in one story or in two stories of a Langstroth hive. Sometimes this food chamber consists of a shallow story; at other times a full story. It is much safer to have a large reserve of stores and pollen in the fall than to feed in the spring, and these stores should be made up of the best honey. While sugar stores are excellent for the extreme cold part of the winter, the natural stores and plenty of pollen are very much better for breeding. If a beekeeper can't get away from extensive feeding there is something wrong.

#### **From Fall to Honey Flow**

In the fall the most successful beekeepers will have their bees in a Langstroth-size hive body, and a food chamber consisting of either a shallow or full-depth hive body on top of the brood chamber. Some brood rearing may start in January if the colony is strong and the bees are young. The patches will be small, but as the season advances and the weather moderates, the amount of brood will increase. When settled warm weather comes on, the brood and the cluster will extend if there is plenty of pollen from the food chamber down into the lower hive so that the brood should be found in both the upper and lower stories. As the season advances, the brood chamber will be crowded, and should there be early spring flows, such as honey from fruit bloom or other sources, swarming may take place. To pre-

vent this it is best to give a super of extracting combs. If the colony is strong, both the bees and the queen will enter the super which may be placed on top of the double brood chamber. But when the main flow actually begins it may be advisable in a clover region to confine the queen to one story and put that story, with the queen, at the bottom with a queen excluder separating the other parts of the hive or supers from the brood chamber. (See Demaree Plan of Swarm Control.) Of course, there should be brood and honey in the upper story, but as the brood emerges this will give room for the honey, so that what was once a food chamber now becomes a super for storage of honey. As the season advances another super of empty combs or frames containing full sheets of foundation may be added, but care must be taken not to give the room too fast.

#### When to Give More Room

How shall the beginner know just when he should add the extra super? If the brood chamber containing the queen is filled with brood and honey, and if the second story or possibly a third story is nearly filled with honey that is not sealed, another super of empty combs should be added on top. As the honey flow continues other supers may be added, or supers that are already capped over may be extracted and put back on the hive.

Sometimes the rush of honey is so rapid that the bees will not be able to seal up any of the honey for the time being. It is not recommended to extract the honey before the combs are at least three-fourths sealed. To secure the very finest honey it would be better to wait until they are all sealed. (See Honey, Specific Gravity of.) It is recommended that an extra set of supers be on hand, and at the close of the season after the honey is all in and the combs capped over, the extracting may begin.

On the other hand, if there are not enough supers to carry on to the end of the season, the beekeeper may be forced to extract in the midst of the flow. It will seldom occur, however, that honey will come in so fast that none of the supers will be sealed over, and therefore one can begin extracting the supers most advanced.

#### Supering

Bees may know better than their owner when they need extra room. If the empty super is put under the partly-filled super, it may discourage the bees and result in combs partly filled at the close of the season. It is a good rule to allow the bees to fill the supers they have before they begin on the next one and they will do this if the super is put on the top. The next super should be put on top when the lower super is nearly filled.

The foregoing is the general procedure that should be followed in the early clover districts. In the localities where the season lasts 40 or 60 days, or even longer, or where the honey flows are intermittent, it may be best to modify the procedure at the start by allowing the queen to have access to two stories at once, but this will seldom be necessary. Give her just enough room so that emerging brood will replace the bees that are dying. A good queen should do this providing she is not honey bound in the brood chamber where she is confined. If she is not keeping up with the force, steal brood from a weak colony, or from a strong colony if it is very strong.

Where there is a series of outyards the beekeeper may not be able to put the super on at exactly the right time. He will have to make a general trip, and many of the supers will have to go on a week or ten days ahead of the time when the bees will actually need them. Where one can visit yards only once a month it may be necessary to put on empty combs two or three weeks ahead of time. Usually this gives too much room at the beginning, but when help is expensive and hard to get, and the distance is great, one is often compelled to super when he can, or lose swarms and a honey crop.

#### Shall Queen Excluders be Used?

In all the foregoing it has been assumed that queen excluders would be used at the proper time and place. Some producers, however, feel that such appliances are not needed. The author is convinced that they are worth many times their price for the reason that they can be used to confine the queen to a particular part of the hive. If the queen has

access to all of the supers as well as the brood nest, it is very difficult to find her and she is liable to have brood scattered in the extracting supers, making it necessary to take extra precautions not to throw out the young brood with the honey.

As will be explained further on, combs should be extracted as dry as possible, and if there is brood, especially unsealed brood, the combs cannot be extracted clean. (See Demaree Plan of Swarm Control; also Swarming.)

When excluders with perforated metal are used the objection has been made that the edges are rough, making it difficult for the bees to pass back and forth. This difficulty is entirely overcome when the wood-wire excluder is used, as shown in the accompanying illustrations. The

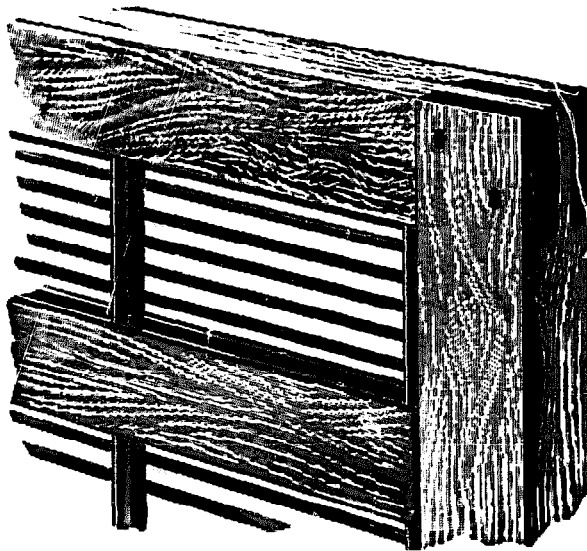

Seven-wire queen excluder

wires have a rounded edge, are perfectly smooth, and are spaced exactly the right distance apart to shut out all normal queens and yet allow worker bees to pass back and forth freely. Perforated metal excluders have almost gone out of use. (See Drones.)

#### Ventilated Escape Board

Where a preference is had for the bee escape method, the Hodgson ventilated escape board (page 251) is generally used. The bee escape in a solid board in very hot weather or in the case of a very strong col-

ony does not give sufficient ventilation. Again sometimes the combs of honey get cold during the night after the bees have left them, making it more difficult to extract them. The ventilated escape board allows the heat of the cluster to ascend into the super, keeping the combs warm.

#### The Control of Swarming

The control of swarming in the production of extracted honey is accomplished much more easily than in the production of comb honey. The same general principles, however, apply in both cases. (For a complete discussion of the whole problem, see Swarming, subhead Prevention of Swarming and Swarm Control; and also Demaree Plan of Swarm Control.)

The reason why control or prevention is easier in the production of extracted honey is that empty combs can be put on the hives, giving immediate room for the storage of the honey. In giving extra room in the form of comb honey sections and comb foundation the problem is not so easy because the foundation must be drawn out into combs, and it sometimes takes a little time before the bees begin to work in the supers. (All of this is fully explained under Comb Honey Production and under Swarming.)

#### What Kind of Super to Use for Producing Extracted Honey

For most localities the best results will be obtained with the standard 10 frame hives of Langstroth dimensions. However, most commercial operators use these supers with only eight or nine frames evenly spaced. In many cases the spacing is provided by a Stoller frame spacer which assures proper spacing between frames.

The reason for the smaller number of frames is that the extra space between the combs causes the bees to build thicker combs that extend well beyond the edges of the end bars, making uncapping much easier.

It seems as time goes on, man has either gotten weaker or decided that he has been overworking himself. Fertilizer sacks have dropped from 100 pound sacks to 50 pound sacks and this same trend has been going on in

beekeeping too. A good many side-line beekeepers and some commercial honey producers have gone to shallow equipment to reduce the amount of weight they are lifting. In this case they use a standard ten frame Langstroth brood chamber and a shallow extracting super having frames  $5\frac{3}{8}$ -inches deep. Another popular size for these smaller supers is the super which holds  $6\frac{1}{4}$  inch frames. This dimension gives a little larger comb size and makes it possible to use a full depth top bar for wired foundation without losing as large a proportion of comb space as with the smaller shallow.

Shallow supers are lighter at harvest time and easier to uncap. Their largest disadvantage is that they require almost double handling because you have to handle two of the shallow frames to get approximately the same amount of honey that would be obtained from one standard full depth comb. This makes extra manipulation and uncapping in taking the frames out of the supers and putting them in the extractor.

Another problem in working with two different size supers is the combs are not interchangeable. Where all supers are the same a comb can be used either for a brood nest or extracting super.

(For further consideration of the subject, see Swarm Control and Swarm Prevention under Swarming; Demaree Plan of Swarm Control; Food Chamber; Hives.)

#### How Far to Space the Combs

Most Hoffman frames are made on a spacing of  $1\frac{3}{8}$  inches from center to center. This is correct for brood rearing. (See Spacing of Frames.) For the production of extracted honey there should be nine combs to the ten-frame super. This will make the combs fat or thick enough to be uncapped more easily, and at the same time not leave any low spots uncapped to be gone over again with the knife. These fat combs are better likewise for the machine uncapper.

#### Removing the Filled Extracting Combs from the Hive

The beginner at least should remember that when one is working

with strong colonies, especially if the bees are busy going to and from the fields, he is liable to be stung not once, but several times, unless he uses extra precaution. Bees do not like to be interrupted in the midst of their work, and for that reason it is advisable to use not only plenty of smoke at the entrance but smoke between the supers just as they are being lifted up. When smoke is not applied at the entrance as the supers are pried apart, one will often be severely stung in separating the supers with the regular hive tool. Bees will be much crosser if the atmosphere is a little chilly or damp. They will likewise be cross immediately if a honey flow is stopped suddenly by a rain or by a temporary spell of cold weather.

#### How to Protect from Stings

Many beekeepers work with bare hands and wrists, using only a bee veil over the head. In taking off

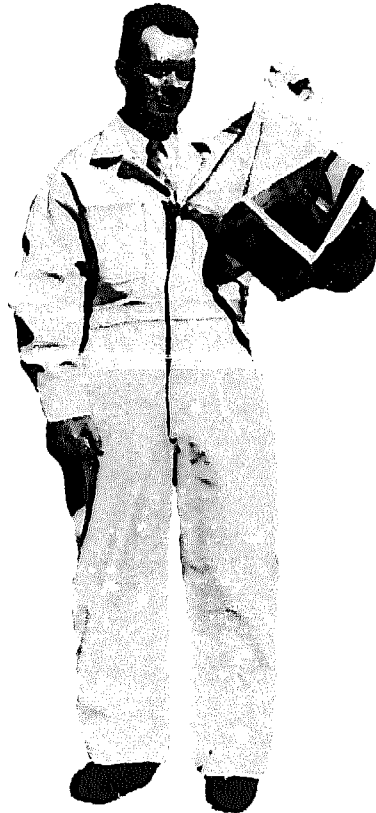

One-piece bee suit

honey the bees rush out, stinging the hands and wrists, go up the sleeves, and cause not only annoyance but interruptions, to say nothing of pain. To avoid as much punishment as possible the operator is



strongly urged to wear a pair of gloves with long sleeves, sold by all bee equipment dealers. Many beekeepers prefer to have the fingertips of the gloves cut off. Most of the bees that rush out and attempt to sting will strike higher up on the glove or sleeve where no damage will be received. Gloves should never fit snugly over the hand. A loose fit will prevent stings from reaching the skin. (See Gloves.)

While one can wear old clothes, it is better to have a coverall suit. These should be preferably white. The bottoms of the trouser legs should be tucked inside of the socks or they should be folded and held tightly in place by trouser guards such as are used by the bicyclist.

#### **How to Break Propolis Connections Between Supers**

There is not much use in trying to separate the supers from each other unless one has a very heavy screwdriver or better yet, a regular hive tool made for the purpose. Beekeepers the world over have developed various devices for loosening the propolis seal between supers. When the weather is warm, the beekeeper is dressed in protective clothing, the supers are stacked high and weigh about 60 pounds each, removing the honey for extracting is hard work. A sticky layer of propolis between the supers further complicates the task.

The most popular method is to pry one side up with a hive tool tilting the super at about a 20° angle, then with a hand in the hand hold, pull on the free end twisting the super and breaking the seal on the other end.

#### **Clearing Supers of Bees**

One of four basic methods are usually used to clear bees from the filled supers. The first is brushing or shaking, or a combination of both. This, of course, involves removing each filled comb separately from each super, brushing or shaking the bees from the surfaces and replacing the comb. A soft pliable bee brush serves best for brushing; one with a flexible bristle. The bristles tend to become stiff and sticky with honey so it is necessary to wash the brush occasionally. As the bees are

brushed off the comb they should fall in front of the entrance of the hive. Brushing bees from combs does not usually irritate bees if it is done briskly and quickly. The main disadvantage to this method is the time and extra handling required.

The second method of clearing supers requires the use of a bee escape, a mechanical trapping device that allows bees to move out of the supers, usually down into the brood chambers below. Some arrangements permit the bees to escape directly to the outside where they re-enter the hive at the entrance. Most of the movement of the bees takes place during the cool of the evening. The house bees and the field bees trapped in the super pass through the bee escape to rejoin the cluster and cannot return due to the one-way trap. The standard inner cover has the center hole cut to receive a bee escape. Some inner covers are screened rather than solid wood to allow ventilation during the time bees are being trapped out of the super. In warm climates an unventilated super of honey in the direct sunlight can melt down in an hour or two. Other escape boards can accommodate two or more escape devices, placed usually in the corners. Ease of placement and a minimum of attention while the escapes are in place are the principal advantages of their use. There is no threat to the safety of the bees or to the honey if the supers are bee tight. If there is the slightest entry where a bee can enter the unprotected honey super, robbing will leave the beekeeper with empty and perhaps damaged combs when he returns for the honey crop.

The principal disadvantage to this method of honey removal is that it requires two trips to the bee yard; one to place the escapes on the hive and another trip to remove the honey. Despite the extra travel time this method is in common use. Admittedly, bee escapes are not efficient as they depend upon a passive means to move the bees. If there is even a trace of brood, much uncapped honey or the queen is unintentionally trapped above the escape board the bees will resist leaving through the escape. Sometimes drones or fighting bees clog the bee escape with the unfortunate result, particularly

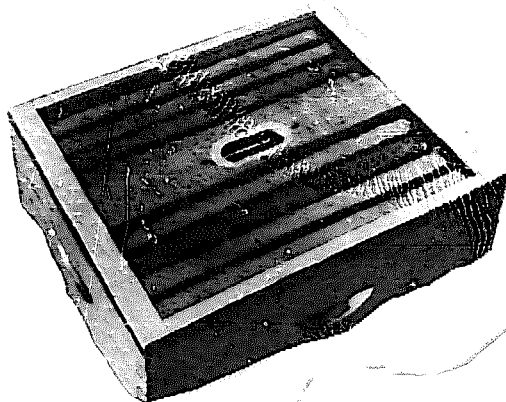

Where the escape is mounted in a solid board there is danger on hot days of the honey melting down from the heat. With this type there is no danger as the bees will keep the temperature down in the lower hive.

under a hot sun, that the trapped bees will suffocate.

The third method depends upon chemicals. Fume boards, available from bee supply manufacturers or fabricated by the beekeeper are constructed to include an absorbent surface on which a chemical repellent is placed. The fume board is placed on the hive so that the fumes will cause the bees to evacuate the honey super. Benzaldehyde is a satisfactory chemical used for this purpose, largely replacing carbolic acid which had the disagreeable side effect of tainting the honey under certain conditions. The use of chemical repellents requires a reasonable amount of skill and caution when removing honey by this method. The most common complaint is that the repellent will not work on deep supers. Attempts to prolong the exposure or to use a greater quantity of chemical will only stupefy the bees and seriously disrupt the colony rather than move them out of the super. Directions on the chemical container or instruction sheet should be followed carefully.

A fourth method of removing bees, the bee blower, has become very popular for forcing bees from supers. Only one visit to the bee yard is required,



Bristle bee brush

no contamination of the honey or injury to the bees results from their use. The greatest drawback is their initial cost. Some bee blowers are designed to operate from compressor units powered by a truck engine while others are self-contained units which can be wheeled about the bee yard or carried on the back from hive to hive. A strong blast of air is directed through the super to be cleared of bees. Bees do not seem to be unduly upset by the process and quickly re-enter the hive.

### Taking Supers to the Honey House

Honey is very heavy, being half again heavier than water. A full depth super of honey which is filled weighs 80 pounds or over. The habit of always using care in lifting and handling supers of honey must be an integral part of every beekeeper's operating procedure. Beekeepers who tend to bees only on occasion and are not accustomed to heavy lifting are particularly prone to severe muscle strain or other injury due to unusual stress from lifting. Shallow



A portable bee blower is a quick method of removing most of the bees from a super. A strong blast of air directed through the super dislodges the bees into the air or grass from where they quickly re-enter the hive.

supers are very popular as honey supers since they are lighter when filled.

Supers removed from the colony to be transported to the extracting house must always be protected from robbing bees, particularly when there is little or no honey flow in progress. When robbing has begun the robbing bees become very persistent and aggressive. Not only are they an annoyance to the people in the bee yard they are also prone to attack other hives and people who pass by or live in the vicinity of the hives.

Many beekeepers allow too many bees to remain in the supers when removing honey. Bringing in a few bees with the supers is unavoidable, but some means of disposing of the bees enroute to or in the honey house should be worked out prior to extracting time. (See buildings). On arrival at the extracting site whether it be a honey house or a residence stacking the supers on rolling drip pans or solid pallets saves continuous floor cleaning chores. Handling any amount of honey calls for planning to take advantage of mechanical aids such as lift trucks, either hand or powered, enclosed unloading docks,

ramps, an outside entrance to the basement or conveyor systems. It would be wise for any beekeeper contemplating construction of a honey house or remodeling an existing building for honey handling to consult with a beekeeper who has had experience with this type of building design. Visit as many honey houses as you can. Ask the owner what changes they would make in it if they were building it today. Many problems which are the result of under-planning can be eliminated if plans are given more careful scrutiny particularly with the aid of an experienced person, before construction is begun.

### Warming and Uncapping

Warming the combs while they are yet in the supers can remove up to one percent of moisture from the honey they contain. Uncapping and extracting are very difficult when the combs are cold and the honey is difficult to pump and strain. Further details on the construction and function of the warming room is given under the heading "Building a Honey House — Hot Rooms".



Handling supers with the aid of a hydraulic tail gate and a hand truck. Note that the stacks are covered to guard against the possibility of severe robbing.



A loader is a powerful and versatile helper around the apiary and honey house. — Photo courtesy of Stewart Honey Bee Products.

### Uncapping the Combs

The cappings and the honey they contain as they accumulate in the uncapping tank are as valuable as the balance of the honey extracted and should rate equal care in processing. Most uncapping is done with some form of hand-held uncapping knife though a larger volume of honey undoubtedly flows from combs which have passed through some form of power-driven uncapper. Hand knives are heated by hot water in a pan, steam or electricity or may be even used cold if extremely sharp and with a serrated edge. Electrically heated knives are controlled by a built-in thermostat. Capping planes are popular in Canada where they are preferred because of the finer cutting edge and better control of the shaving angle. Selecting the type of knife is a matter of personal choice based on many factors. Skill and speed in the use of any uncapping knife improves with practice.

For the smaller volume of honey a shallow tray or tub is sufficient to hold the cappings. When the container is nearly full of cappings or when the extracting is finished the honey which

has drained out of the cappings can be added to the lot which has been extracted. If the extractor is of the type with a perforated reel the cappings may be whirled dry in the extractor. The cappings will yield the finest honey and the best grade of wax so they should be separated and the wax rendered as soon as practical. (See Handling Cappings, Under Wax.) For the small beekeeper the most inexpensive arrangement consists of a galvanized tub about 24 inches in diameter and about 16 inches deep with a bottom drain. This tub can be fitted with a perforated



Uncapping can. This separates the free honey from the cappings as they fall from the uncapping knife. The cappings are held in the perforated basket while the free honey drains into the tub below.

basket which allows the cappings to drain and the honey to be drawn off. A wood cross piece with a supporting arm fastened at right angles and resting on the top edge of the tub will support the comb while it is being uncapped. A nail with the pointed end up placed at the intersection of the two supporting cross-bars will hold the comb stationary.

#### Uncapping Large Lots

Although hand-held uncapping knives can be very satisfactory in the hands of a skilled user large numbers of combs are usually uncapped with a mechanical device, either the vibrating blade type or the more complex machines which carry the combs on an endless belt conveyor to a rotating blade arrangement which slices off the cappings. After being uncapped the frames move along a conveyor to the lower end of the uncapper which catches the dripping honey until the combs are loaded into the extractor. Installations of recent design also load the extractor auto-

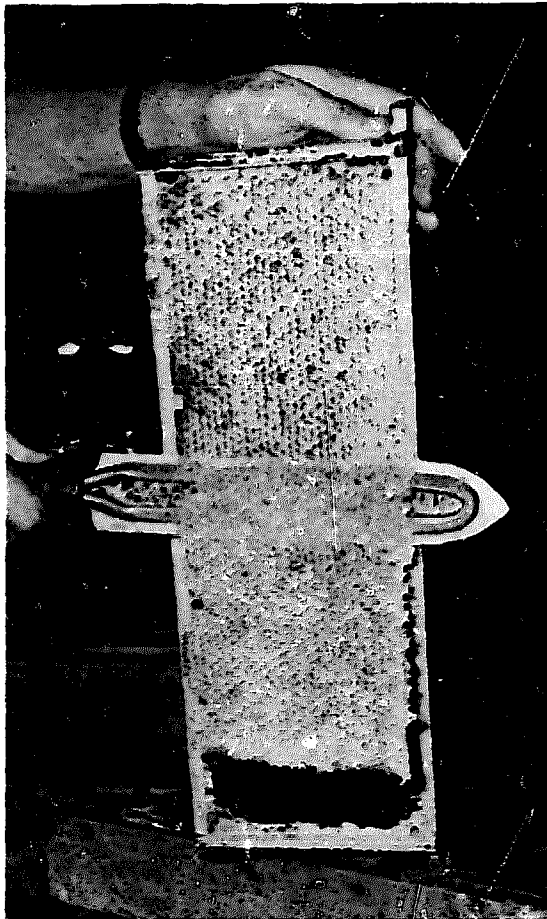

Uncapping with a steam heated knife. As the cappings are shaved off they will fall away from the comb surface if the top of the frame is tilted slightly forward.

matically. Naturally, only high volume production or processing would justify the installation of such a system. There are many styles of equipment available for handling of cappings during the extracting including whirl-drys and the type which melts the cappings by a heated grid arrangement as the cappings are accumulated. Most of the capping melters such as the Brand depend upon heated coils for melting the cappings while the honey separates out by draining away from the heated wax. Usually the grid is of copper and is heated by steam. It is often claimed that this system causes the darkening of the capping honey, and that copper gives the wax an undesirable greenish color which is almost impossible to bleach out. Some successful experiments were tried in Canada which led to the development of an electrically heated hood which acts in the manner of radiant heat to melt wax on the surface rather than from below, sparing the honey exposure to higher temperatures. In this unit, which has been used at the University of Guelph, Canada, the entire bottom of the unit is jacketed with water thermostatically controlled to approximately 124°F. If the hood is adjusted to the right height according to the wattage of the radiant heat units used the wax will run off in liquid form without over heating.

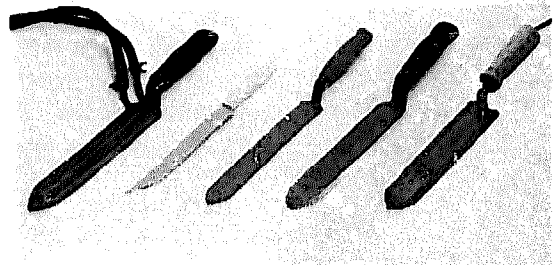

Uncapping knives. Steam heated on the left, electrically heated on the right. The three in the center are heated in a hot water bath.

It is important that slumgum, the refuse that accumulates on top of the melted wax be removed from the surface of the melted wax, particularly when steam is being used for heat in this type of capping melter. Do not allow honey to build up too high or remain too long in the melter. Draining the warm honey in the evening and

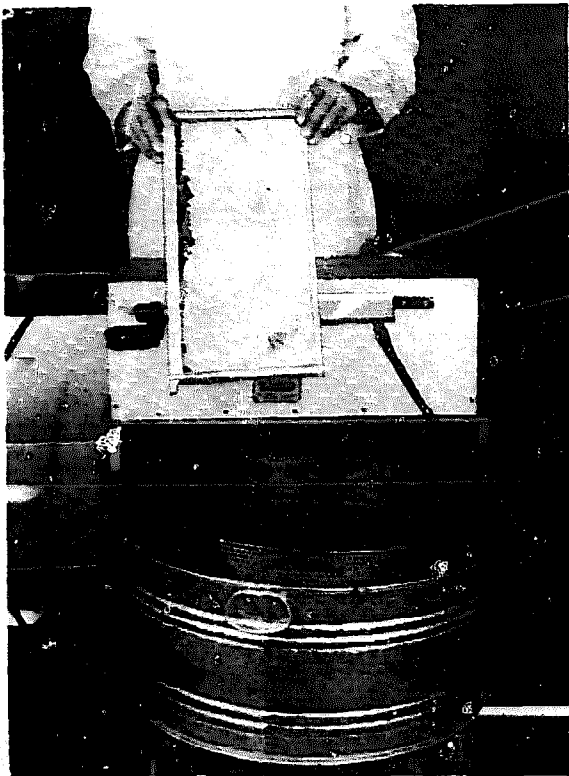

One-blade power uncapping machine. Part of the honey drains into the tub and is pumped directly into the storage tank. Note the pipe at the bottom leading to the honey pump.

replacing with fresh honey from the mornings operation helps avoid darkening the honey.

#### Centrifical Separation of Honey from Cappings

A whirl-dry is commonly used to separate honey from cappings where the volume warrants the operation of a unit of this size. The cappings, along with any honey which they contain, are carried into a spinning drum which throws the honey out through vents while accumulating the wax inside the drum. One of the objections to this system is that it tends to introduce thousands of tiny air bubbles into liquid honey.

#### Preparation for Extracting

In an address before the First All Australian Bee Congress in 1972 Professor Gordon F. Townsend had the following to say about honey extracting, "Preparation of a quality product starts in the bee yard. Too often, in the hurry to facilitate the colony operation the effect on the end product is neglected. Honey should, if at all possible, be produced in honey supers and not dark brood combs. The use of brood combs

for honey will increase pollen content of the honey, thus leading to problems when the honey is filtered. Honey stored in comb darkened by old pupae cases will tend to pick up some of the pigment and become darkened. The darkening takes place very rapidly when the moisture content of the honey is quite high."

About the removal of moisture, when the beekeeper removes unripe honey from the hive, Professor Townsend had the following to say, "Warm, dry air (thermostatically controlled to maintain a temperature of between 90 and 95°F.) is driven through stacked supers of honey. The rate of moisture removal depends upon the dryness of the air and the volume passed through the supers. Air dryness depends to a large extent upon the number of degrees the air temperature has been increased just prior to passing over the combs. A unit which is operating efficiently will remove from one to three percent moisture in 24 hours."

Of course, the ideal condition would be to allow the honey to remain on the

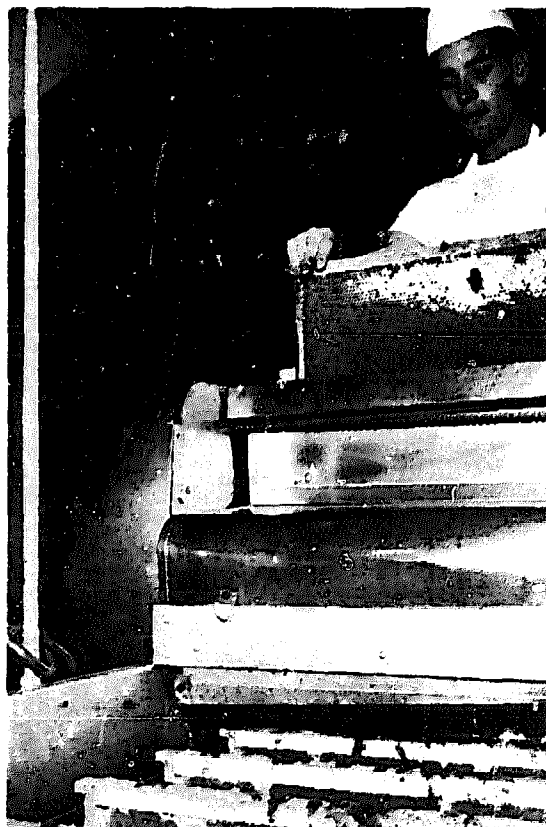

The uncapping proceeds rapidly with this type of equipment in the honey house. The uncapped combs are carried forward on the conveyor for loading into an extractor.—Photo by R. Barth

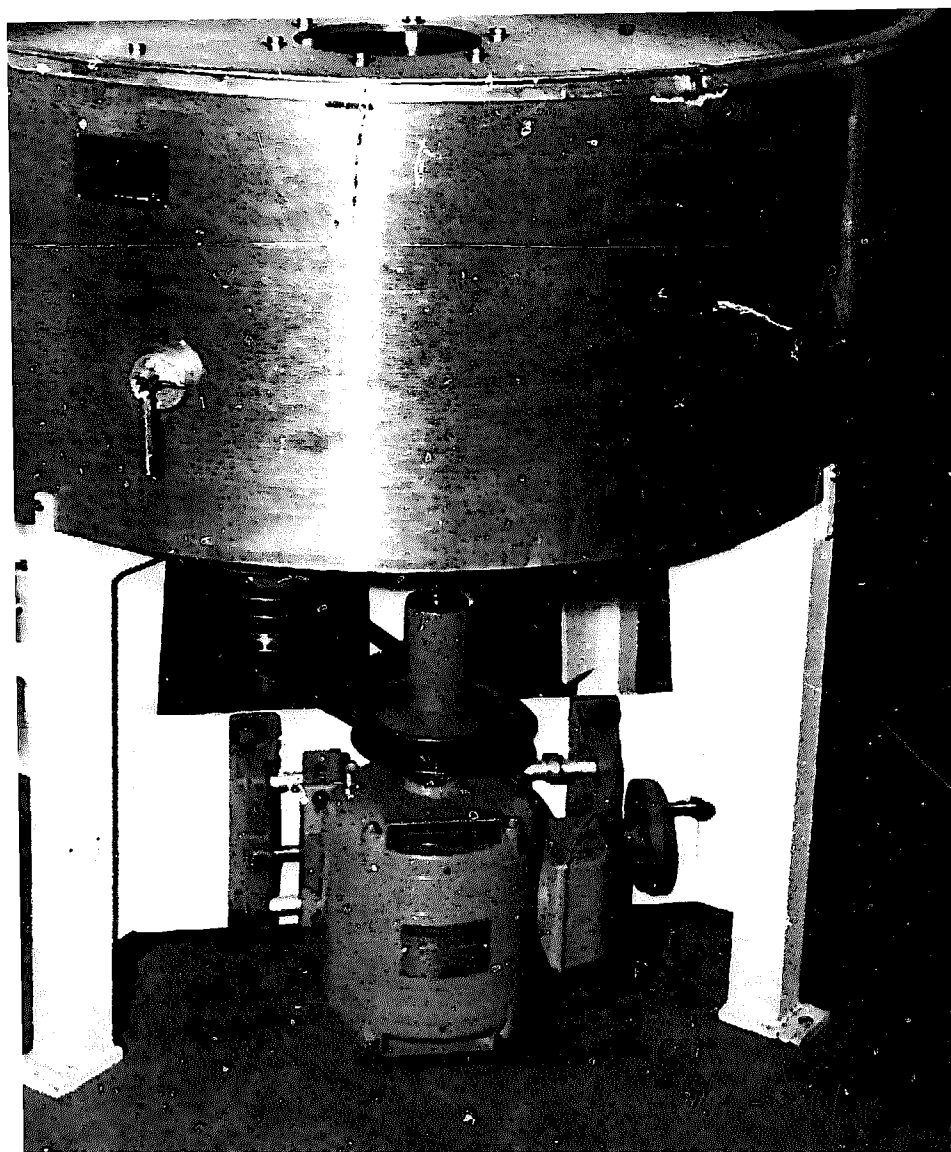

It handle a large volume of cappings and honey. Separation is by centrifugal force when the inside drum is spinning — Photo by J. Bailey.

If the combs are at least three-quarters or more in some circumstances difficult of surplus honey supers have finished ripening season nectar flows, a sudden flow, a rapid change of honey being gathered, supers or the necessity arises. Professor Townsend states that moisture removal is necessary in some seasons

than in others, "but", he says, "it is added insurance for the production of a quality product".

Dr. Richard Taylor in his book **The How-To-Do-It Book of Beekeeping** makes this interesting observation, "The usual rule is to extract only combs that are at least three-fourths capped over, but this rule is virtually useless. Often combs that are only slightly capped over contain thoroughly ripe honey and those that are capped over almost

completely still contain nectar at the edges." A small amount of unripe honey extracted with a large volume of honey that is of satisfactory moisture content will do no harm. Most experienced beekeepers are familiar with the ebb and flow of incoming nectar and arrange honey removal and extracting schedules to allow the hive bees adequate opportunity to evaporate the excess moisture before removing the honey from the colony.

#### Extracting On A Small Scale

Most extracting by beekeepers with from one to 50 colonies can be done with the smaller basket-type extractors holding from two to four frames and up to eight. Often honey extracting is done on week-ends or evenings when the short periods of time available limit the amount of honey that can be handled at one time. Using small extractors is no handicap and is actually an advantage since less space is needed and cleaning up after using a small extractor is much easier.

Spinning the small extractors by hand may be less of an annoyance or even a pleasure to some beekeepers but to others turning a hand-driven extractor is one of the tasks which is best eliminated from the routine of harvesting the honey crop. Nearly all small extractors can be adapted to some form

of power unit by removing the handle and installing a conversion unit which will fit the model of extractor in use. An electric motor in some form is the most satisfactory power source but it must have ample horsepower and preferably some form of speed control. Beekeepers with only a few colonies and producing honey only for their own use usually do not buy power driven extractors unless they plan to expand their beekeeping in the future to include more colonies or to do extracting for other beekeepers. If future requirements will demand a larger capacity it would be wise to invest in a larger extractor in the beginning which usually includes a power drive.

The three-frame machine is especially recommended because the reel consists of a cylinder of perforated metal sides. As soon as the extracting is over, the supports for holding the combs can be easily lifted out, after which the cappings and adhering honey can be dumped into the reel to separate the honey and wax.

The two-frame extractor is somewhat heavier than the three-frame model. It has no provision for separating the honey from the cappings. However, one can reverse the combs for each comb stands in a separate pocket. The two pockets are hinged so that they may be reversed without lifting out the combs. There is

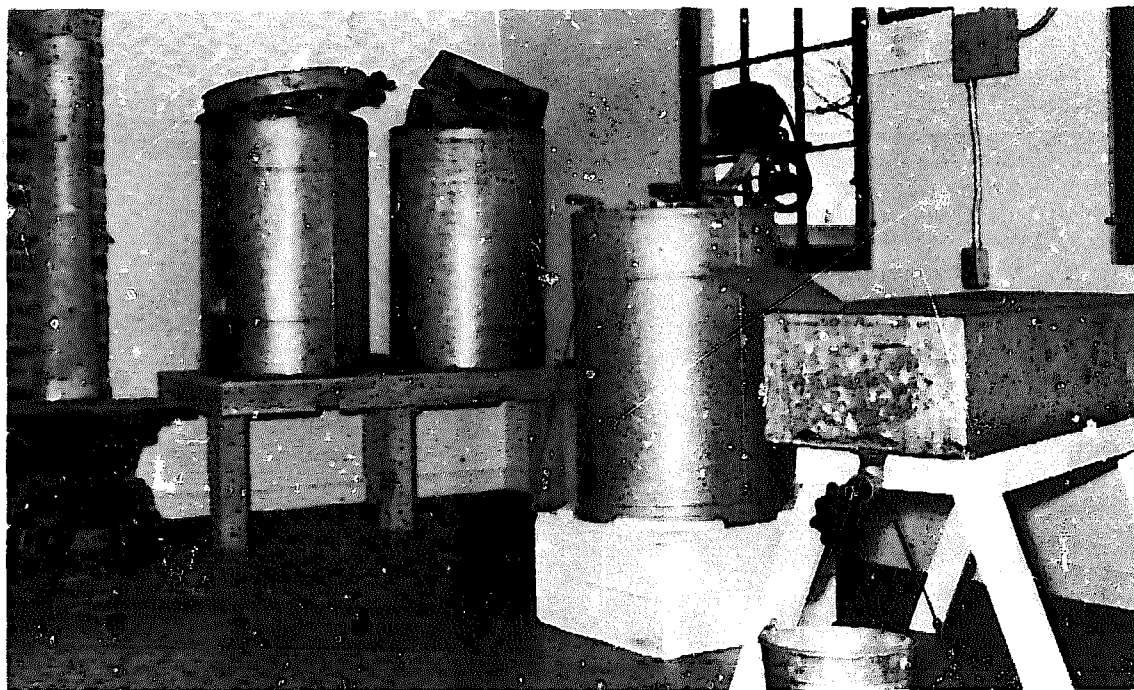

Honey from up to one hundred colonies can be handled by an arrangement such as this.  
— Photo by R. W. Buffham.



not only a saving in time but the work is somewhat easier.

When the two-frame extractor is selected it is necessary to have an uncapping can, either factory-made or homemade. This consists of a tub,

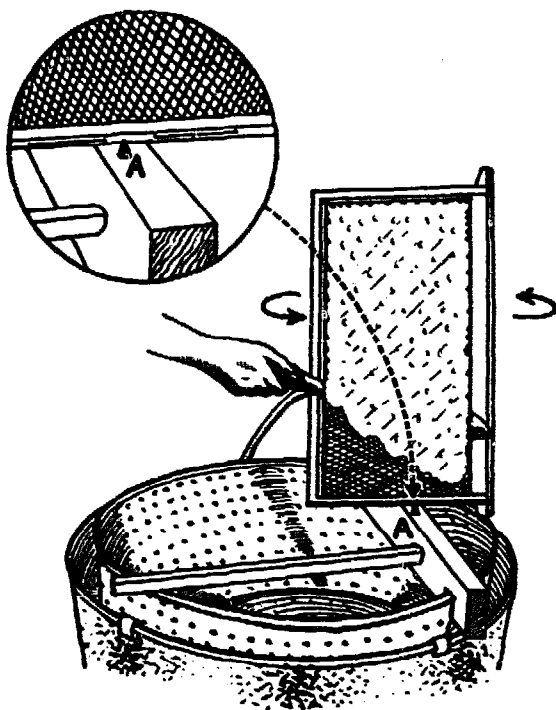

Combs to be uncapped are placed so that the center of the end bar rests on a projecting nail point. When so used it can be easily reversed, end for end, for uncapping one side and then the other. Preferably the comb should be held so that the bottom bar is next to the operator. The knife should start from the bottom.

an inner smaller tub of perforated metal sides and bottom, and a wooden cross-arm with a narrow one-inch square stick. Projecting through the wide bar is a nail point extending up about one inch. The combs are balanced on this nail point while being uncapped, as will be explained further on. From this inner basket which receives the cappings the free honey drains off by gravity into the outer tub and then on through a hole in the bottom into another receptacle below. These cappings that drain by gravity, however, are not nearly as clean as those dried by centrifugal force in the three-frame extractor. If one feels that he can afford it, it is quite an advantage to have not only a three-frame extractor but also an uncapping can.

These cappings can be melted up as soon as they drain nearly dry or are whirled dry. It should be re-

membered that capping wax is the very best wax.

To cut down the expense of the extracting outfit to the very lowest point possible, the back-lot beekeeper should select the three-frame extractor and at least one uncapping knife. It is better to have two knives for reasons to be explained later. The rest of the equipment can be made up of utensils found in any home. The illustration on the next page shows the equipment based on a minimum cost, using utensils such as a housewife finds necessary for her housekeeping.

The extractor must be elevated high enough so that the honey can be drawn off into the pail. The pail of honey is poured on top of two thicknesses of cheesecloth covering the honey tank on the right. In place of the regular honey tank with honey gate an ordinary wash tub may be used, but as in the other case, a cheesecloth should be used as a strainer to catch small particles of wax and dead bees, as well as particles of dirt that may accumulate.

#### Equalizing Combs Before Extracting

It should again be mentioned that before attempting to extract, the combs should be equalized in weight as far as possible. New combs just built from foundation should be extracted by themselves and in all cases should be equalized as to weight. Old combs heavy with honey should likewise be extracted by

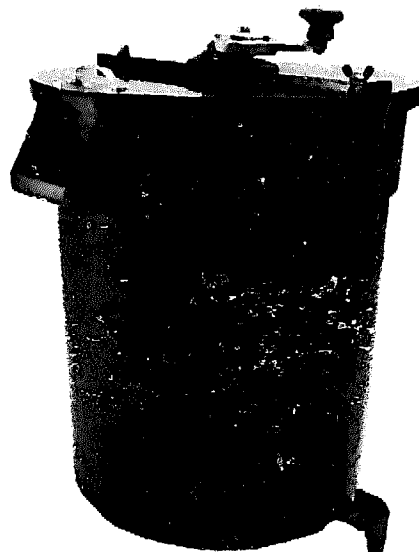

Three frame extractor and capping dryer. A power drive may be used in place of the hand crank. A hand model may be adapted to power by using a hand-to-power conversion.

themselves. An old comb full of honey should not be put into the machine with a new comb only partially filled and therefore weighing half to two-thirds as much as the old comb. An old comb containing a good deal of pollen should not be extracted with other combs for after the honey is extracted the pollen comb is still heavy and therefore more out of balance than ever.

When the combs are equalized the reel is then turned at a slow speed extracting about half the honey from one side of each of the combs. The extractor is then stopped and each of the combs is reversed, presenting the other side. The crank is turned very slowly, gradually accelerating the speed until top speed is reached. After the second side is as clean as possible, the combs are reversed, finally taking out the remnant of the honey in the first side.

### Extracting Room

The beginner, or one who has a small number of colonies, does not need a small building for extracting as is used by those who have a hundred or more colonies. A basement is an ideal place provided there is an easy approach to outdoors. If access is had only through inside cellar stairs it should not be used. An ordinary garage would answer an excellent purpose, but as it is rather difficult to screen a garage it may be necessary to use a screened-in porch having a self-closing screen door. This would make a good place, for after the extracting is over, the floor can easily be washed using water from a hose or hot water from a pail with a scrubbing brush. In case none of these places is available it may be necessary to use the kitchen.

If the honey is to be extracted during a honey flow there will be no danger from robbers, but if the work is to be done after the honey flow is over, a rainy day should be selected or the work done at night. In all cases, a well screened-in building should be used if possible. Provision should be made in the screen to allow stray bees that come in with the combs to escape through the honey house bee escapes. There should be several escapes. (See page 39). One should be placed at one top corner of each of the screens at the windows because during ex-

tracting bees will accumulate in the room. They will naturally go to the screen and finally work themselves over to the escape after which they will go out and return to their hive.

### How to Extract

The extracting combs should be placed in supers or hive bodies wheeled into the room or building and placed just back of the operator who will do the uncapping. Combs are then uncapped and run through the extractor and after extracting they are put back into the hive bodies. To prevent dripping on the floor, these supers of combs should be placed upon several thicknesses of strong paper to catch the drip, or better yet, placed in a dripping pan. After the combs are extracted they should be returned to the hives as soon as possible. If there is an extra

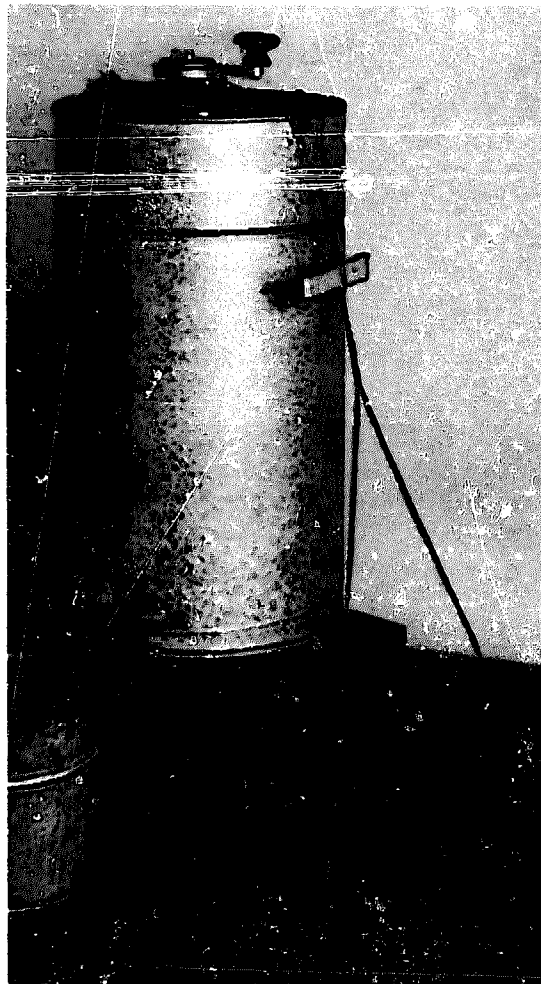

Method of anchoring the extractor to the box and the floor by means of ordinary baling wire. Wire is held taut by twisting the strands with a stick as shown.

set of combs they should be placed upon the hives at the time of taking out the filled ones, but the average beginner will have only one set of combs. He will then be under the necessity of returning them either the same day or the next morning after extracting, if the work is done at night to avoid robbing.

In addition to the extracting equipment, there should be a couple of pails of warm water and wash cloths. One member of the family can turn the reel of the extractor and extract the honey while the other uncaps.

While it is advisable to extract the supers of combs while they are warm and immediately return them to the hive, many will find it more satisfactory to take off all the filled supers and run them into the building or extracting room. Later on they can be extracted at night, on some Saturday half-holiday, or some day when it is raining or when there will be no robbers flying. In the meantime, if the bees do not already have the room, supers of empty combs should be given them to be filled, and when filled these can be extracted and the others first extracted given back to the bees.

If one has only one set of extracting combs to the hive he will be compelled to run them into the extracting room, extract them, and put them back on the hives as soon as they are empty. When this is done, however, a day will have to be selected when the bees are flying, the weather warm, and all conditions favorable for opening of hives.

Care should be taken in all cases that no dripping honey be allowed to get onto the ground or where robbers can get at it. The honey, when extracted and strained, should be put into the regular containers, square cans, or tin buckets, and sealed so that if robbers should get into the building they will not cause any trouble. (See Buildings, Extracted Honey; Cans; and Robbing.)

#### Cleaning the Wet Combs

It is the usual practice to put the slightly wet combs from the extractor back on the same hives where possible for the bees to clean up. It is the only safe way in a yard located in a town or city. If the season

is over and no more honey is coming in, they can of course be stored in the honey house, but the smear of honey will quickly granulate, and when the combs are put back on the hive the new honey will also granulate because of the granulated honey from the previous season. Better by far let the bees clean up the combs in the hives before the next season. (See Honey, Granulation of.)

There are a few who advocate and practice putting the combs out in the open right after extracting and letting the bees clean them up. Unless one has had considerable experience this is a dangerous procedure that may lead to a very bad case of robbing.

#### Heating and Bottling

It is often to the best advantage of the small beekeeper to heat and bottle small lots of his honey crop at a time. As the honey comes from the extractor a preliminary straining through a fine screen or single thickness of cheesecloth will remove most of the coarse particles yet allow honey at room temperature to flow through the fine metal screen or medium fine cloth. Place the screening material in a rigid wire screen support on the top of the honey tank. At the end of 24 hours most or all of the fine pieces of wax or other material will rise to the surface of the honey along with air bubbles which may have been mixed in. After this the surface can be skimmed and the foamy scum easily removed.

Heating honey to prevent granulation is a common practice that can be both effective and without any detectable change in flavor of the honey. Only the improper application of heat or excessive heat will render honey unsalable. Many people are increasingly interested in honey which has not been heated or fine strained. Raw honey, that which comes directly from the extractor and has not been heated or strained through a fine screen, contains pollen and has not had the original chemical composition altered. This means there could be a slightly higher protein content due to the pollen content and a retention of some or all of the less stable minerals, vitamins, enzymes, yeasts and certain flavoring ingredients. A preference for unprocessed

honey can work to the advantage of the smaller producer when he is acquainted with his local market and customer buying habits. When sold retail raw honey should bear additional information on the container label or on a supplementary notice that granulation may take place before the honey is consumed, along with brief instructions on how to liquefy the honey.

Honey is invariably classed among the natural foods, a circumstance which places it in high favor among people who place particular emphasis on the qualities of a food which is both palatable and safe without having undergone excessive processing and can be stored without using preservatives. It should be kept in mind that regardless of what manner or in what form honey is marketed the same high standard of quality, cleanliness and neatness must be maintained.

Honey should be drained out of the settling tank into 60 pound cans or the larger 55 gallon drums although the processor with smaller quantities may find the drums too heavy for convenient handling. Avoid draining honey storage tanks from the lower level where sediment may have accumulated.

Even though it may have granulated, honey in 60 pound cans can be liquefied and brought up to the desired temperature for preservation and bottling by heating in a hot water bath or a dry heat cabinet. Methods used to heat honey vary considerably. In all instances the honey must be shielded from receiving direct, excessive or prolonged heat. A temperature of 160°F. is usually the highest to which honey can be subjected without sustaining damage to the flavor or color, although this arbitrary limit may be exceeded for a very short period when flash heaters are used without damaging the honey. In many cases temperatures below the maximum allowable will be sufficient to prevent granulation during a normal shelf life. Heats lower than 160°F. can damage honey if sustained for any length of time.

Heating honey dissolves crystals which would become the nucleus around which granulation starts and also destroys sugar-tolerant yeasts which cause fermentation. Some of the nutrient constituents of honey may be de-

stroyed or altered in the process of heating. Honey heated beyond the recommended maximum for the particular process used or held at or near the higher temperatures for a longer period than is needed can cause serious changes in the chemical and physical properties of honey. Needless to say this detracts from the appearance or ruins honey which should remain attractive and as delectable as when the bees sealed it in the comb.

### Extracting On A Large Scale

All the equipment used to extract and process honey should be integrated into a smooth flowing production line with each machine or piece of equipment in balance with all others. To match the extractor capacity may mean a more efficient uncapping system or a better method of removing honey at the outyards. Rearrangement of space in the honey house may help the smooth movement of full supers from the truck to the warming room. Sometimes the delay caused by an inefficient warming room can be the reason supers of honey are not reaching the extracting room without delays. Pressures of time and extra heavy yield may cause gluts in the early steps of processing. Warming rooms may be filled beyond capacity and the storage of surplus supers in the honey house may infringe on working space. If problems of this kind can be anticipated they most likely can be avoided by providing extra storage space or improving the flow of material through certain steps that could be suspected of being bottlenecks under heavy loads. As a system becomes more integrated the flow of honey and wax becomes more efficient.

### Cappings

Some of the same problems involved in the handling of small amounts of cappings plague the commercial beekeeper. Cappings handling processes that darken the honey, taint the wax or incorporate air bubbles into the capping honey are problems that remain as long as mechanical performance of the machines in use is below par. Inadequate capacity may slow down extracting.

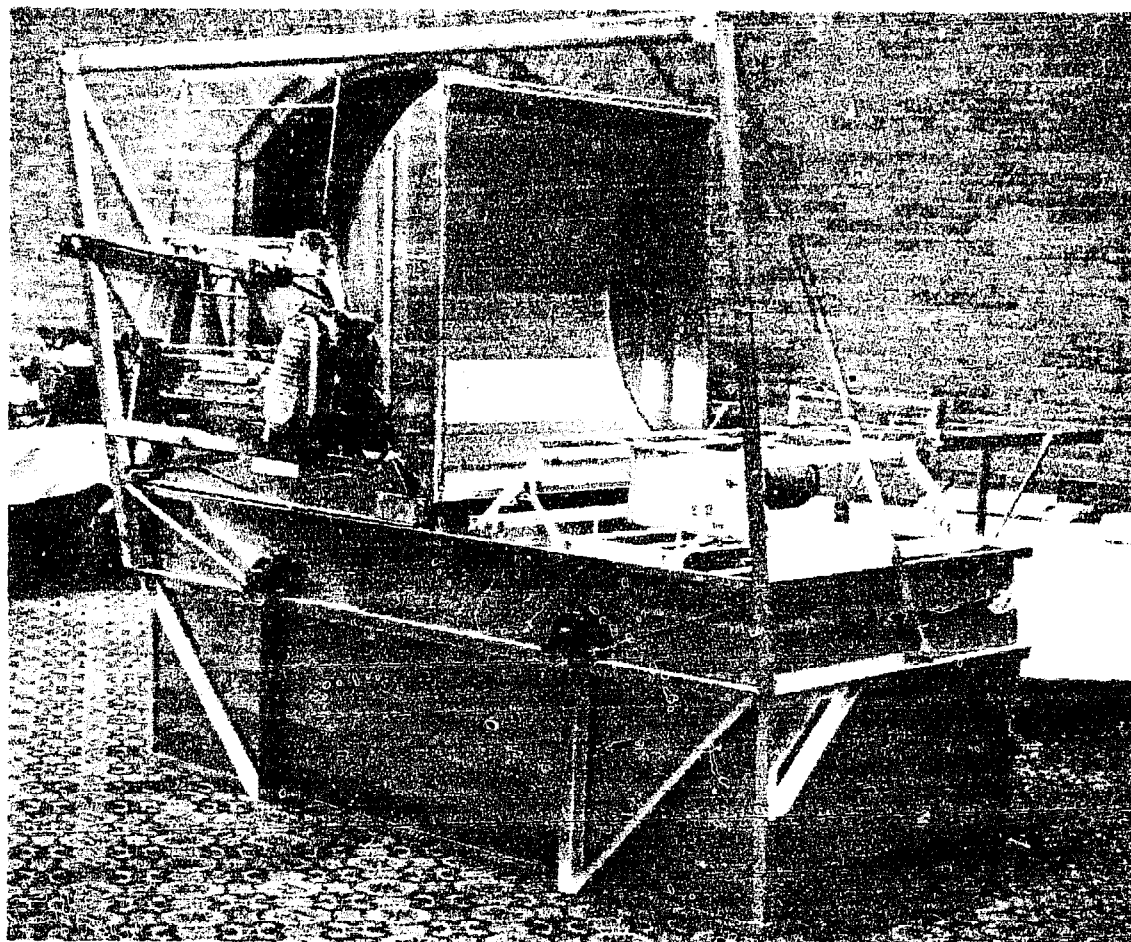

A fully automated system that uncaps the combs and loads them into the extractor.

New systems for handling cappings must be efficient to handle the output of automated systems such as the Cowan which delivers uncapped combs to the extractor and loads in one continuous operation. This system has a 216 frame capacity extractor. An auger carries the cappings away from the automatic uncapper to either a melter or a spin-dry capping processor. Improved versions of many of the standard models of capping handling appliances are available from manufacturers or distributors. Infra-red heating tubes located above the wax melting area and improved circulation of hot water through channels on the bottom of the tank are features which have been introduced to improve efficiency and avoid undesirable changes in honey and wax quality.

#### Extracting

As the chemistry of honey becomes better known the product honey comes under closer scrutiny by regulatory agencies who have responsibility of

consumer protection. The processing of honey all along the line, from the hive to the final packing and shipping may be much more closely inspected in the near future. Beekeepers are one of few remaining agricultural producer-processors handling their product as independents. Larger and larger investments are becoming necessary before the first pound of honey flows through the processing channel, be it at the plant of the producer or at an independent or cooperative packing plant.

Large capacity extractors constructed to handle many combs, usually from 20 to 72 or more, operate by the well-know radial principle. For a discussion of the history and a summary of the various types of extractors we refer you to the section on extractors.

Efficiency in extracting often requires the operation of two or even more radial extractors in unison, one being emptied and filled while the other is spinning out the honey. When only one extractor is available the uncapped combs may be racked in a merry-go-

round or a portable cart. Drainage of honey from the uncapped cells must be caught in a pan beneath the rack and piped to the honey sump.

Dr. Richard Taylor, author of the column "Bee Talk" in *Gleanings in Bee Culture* points out the necessity of understanding two principles having to do with the operation of radial extractors. The first is that the centrifical force exerted on the honey in the combs is a function of both the speed of the rotation and the radius of the extractor. The second principle is that most of the honey is whirled out on the first few full speed rotations, rapidly diminishing the volume until a relatively dry state is reached. The application of engineering improvements to extractor design has improved extractor performance, particularly where automatic timing and variable speed controls act to take the guesswork out of how to obtain dry combs without wasting energy.

Manual dexterity and skills acquired by operators of handling equipment are as important or even more so than the

degrees of performance of the machines. The proper examination and sorting of combs taken from the super is a manual operation and may never be otherwise. Separating combs with granulated honey, unripe honey, patches of brood or weak or broken comb is an acquired skill that does as much as anything to keep the flow of extracting on an even keel. These skills must often be taught to unskilled assistants. Loading the extractor once combs are uncapped requires selection with an eye to their weight. The weight of the filled or partially filled comb is usually related to its original position in the super. Normal distribution of nectar and consequently the storage of honey in the super group the heaviest combs in the center frames and progressively lighter combs toward the outside walls. By placing combs throughout the extractor from the same relative position in each super the balance of the reel holding the frames is maintained without excessive vibration or wobble. In other words, the heaviest combs are uniform-

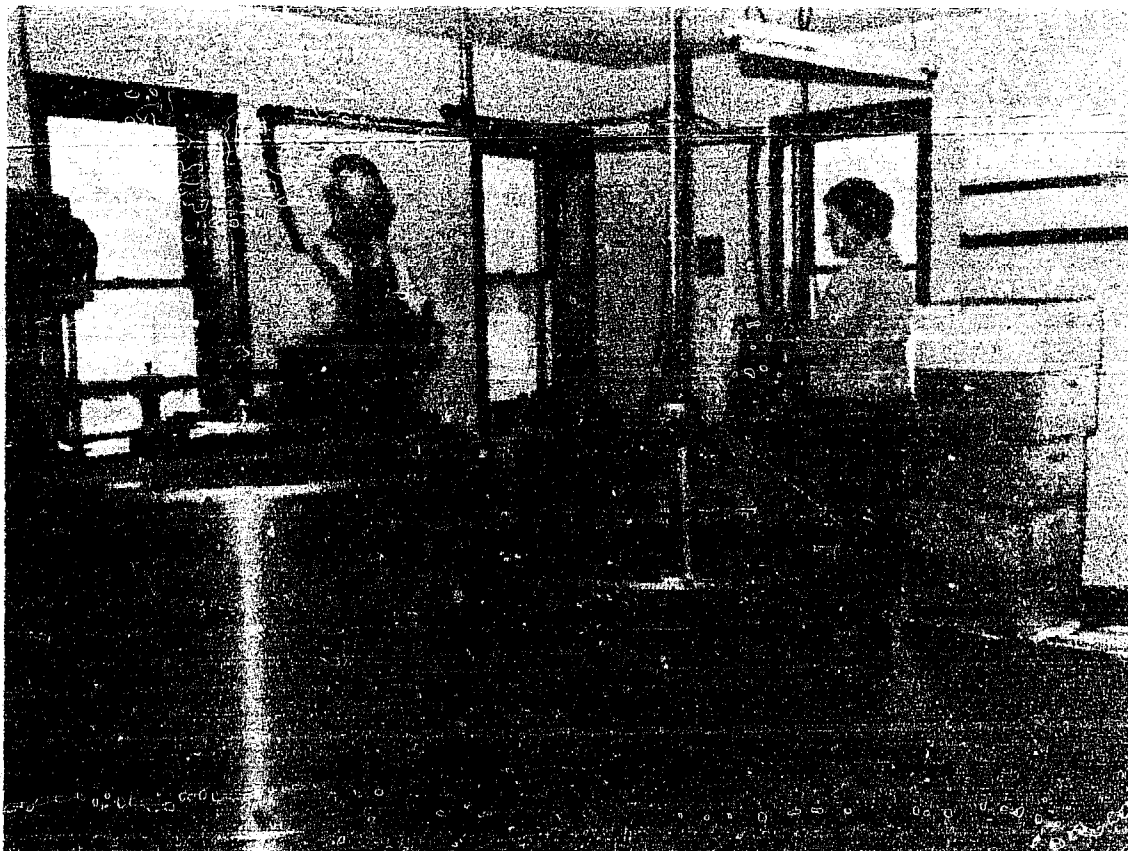

Neatness and efficiency makes working in the honey house a pleasure. Note the merry-ground for uncapped combs placed between the uncapper and the extractor.

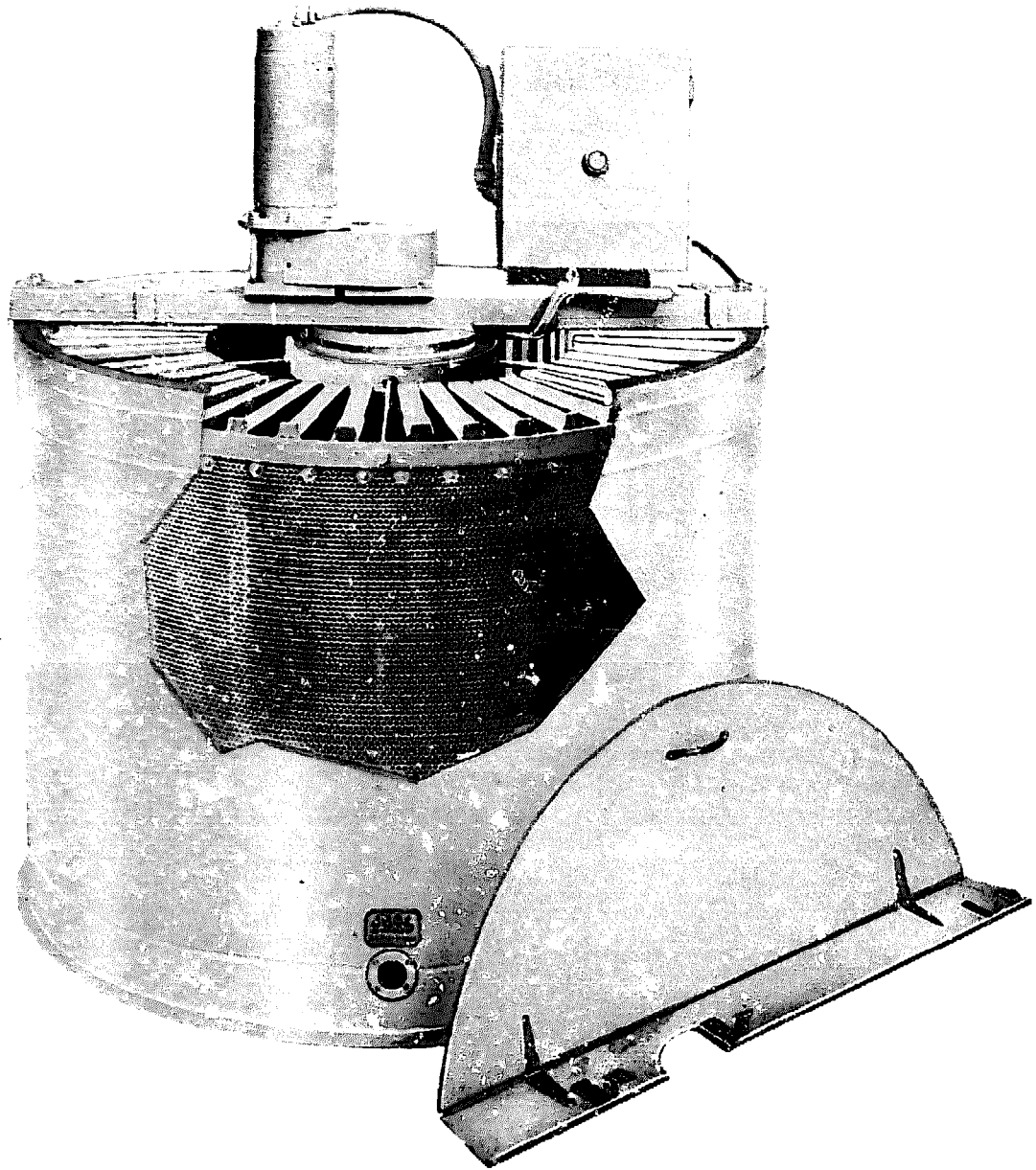

**A 50-frame Simplicity radial extractor with automatic speed and timing control.**

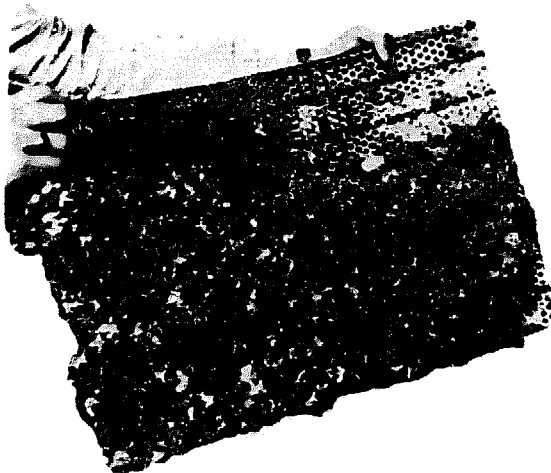

**Removable curved metal capping drying plates for the Simplicity extractor.**

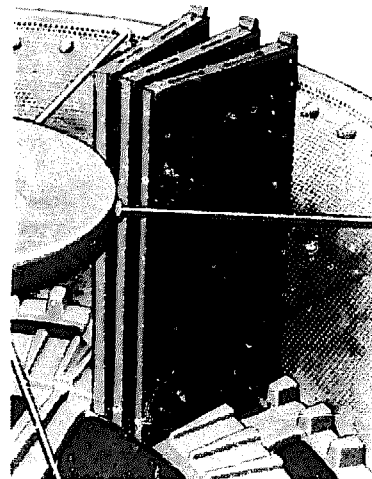

**The combs should be placed so that the top bars will be next to the outside.**

ly spaced around the reel and the lighter combs are distributed equally among the heaviest combs. Experience will soon show that position in the super has a definite relationship to the proper positioning to maintain a balanced reel. The higher the speed at which an extractor is operated the more important it is to select combs for proper balance.

### The Honey Sump

Honey from the extractor should be directed into a sump with a capacity to match the maximum flow of honey from the extractor. The sump should have a coarse screen at the intake to catch large particles coming from the extractor. A series of baffle plates positioned across the tank so as to force the honey to alternately flow over and under the plates catches and traps sediment in the compartments formed by the baffles. This accumulation of foreign material can be removed periodically from the surface of the honey. As the honey flows over and under successive baffles it is clarified to a relatively clear state. The more baffles the more effective is the cleaning pro-

cess up to the point where the flow may be restricted. This baffle arrangement is usually sufficient for clarifying bulk amounts of honey without further treatment. Heat may be applied to the honey by a double jacket surrounding the sump carrying water heated by either steam or an electric immersion heater. Heating the honey coming from an extractor is important; the temperature should be raised to at least between 90 and 95°F. to achieve proper viscosity for straining. The most efficient sumps are fitted with a float and switch to control the level of the honey. Honey pumps controlled by this arrangement are cut off before the pump intake is exposed to the air and before wax enters the chamber under the baffle. The pump is restarted when the honey level again reaches the level of the float arm. Proper use of the honey pump is very important as a pump operating without a full honey flow tends to inject air into the honey causing minute bubbles that are difficult to remove. A cloudiness is imparted to the honey by these many small bubbles and can lead to faster granulation. A continuous flow of honey into the pump keeps it primed, avoiding this problem.

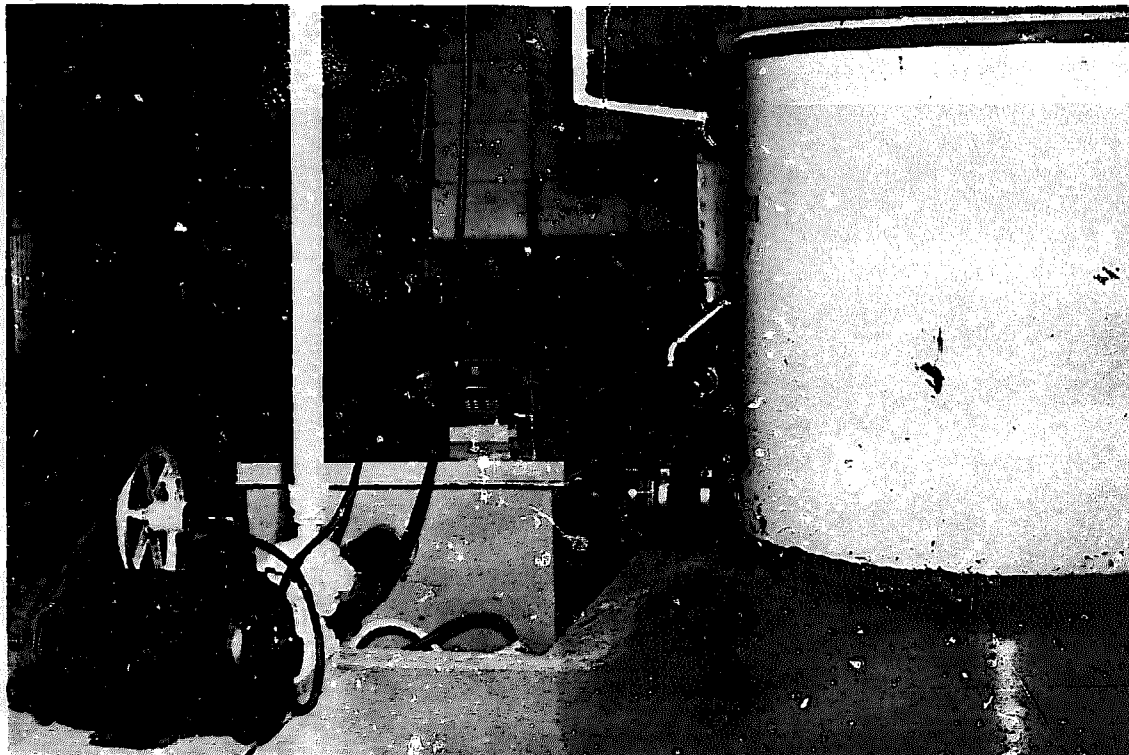

The honey sump (center) performs two important functions; it removes particles of unwanted material from the honey by a series of baffle plates and it warms the honey prior to straining.



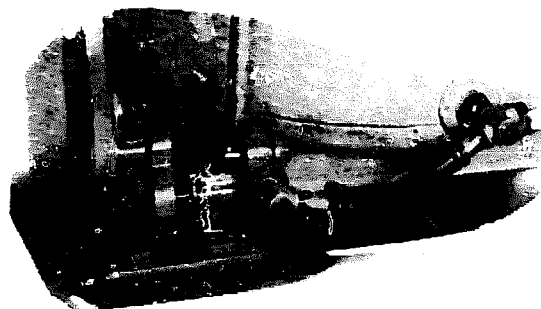

Honey pump attached to the extractor

### Honey Pumps

Honey has a very high viscosity at normal room temperature, 400 times more than water. For this reason a rotary pump should be used instead of a centrifugal pump. The viscosity of honey affects the pressure than can be developed by a centrifugal pump were this type used instead of a rotary pump. Another objection to the use of a centrifugal pump is the whipping action that is caused by the impeller, thereby incorporating air into the honey.

The spur-gear type of honey pump is in general use. This pump has two gears which have very close clearances with the casing. One gear is keyed to the drive shaft and rotates with it while driving the other gear. As the gears rotate the honey is trapped between their teeth and the casing causing the honey to be driven to the discharge side of the pump.

Best results are obtained when the speed of the pump is reduced. All honey pumps when first installed should be tested with a vacuum gauge installed in the pipe on the suction side. This will make it possible for the beekeeper to regulate the RPM so as to avoid the formation of a strong vacuum which could cause air to be drawn into the honey through the drive shaft seal.

Keep the distance and height that honey must be pumped as short as possible. Avoid right angle turns. Use large diameters of pipe to cut down resistance to flow of honey. Various materials are being used for the pipes to carry honey but first consideration must be given to the suitability as a food-use approved material. The flexible plastic hose is finding an increasing use in the honey house. Stainless steel will justify the initial cost of providing durability and long life.

### Warming and Straining

The amount of heat applied to honey during the movement through the extracting and straining procedure is usually limited to a temperature that will provide an easy flow of honey. This temperature range is usually between 90 and 109° F. Warming the honey in the comb in the hot room is not sufficient as most of the heat is lost during extracting. Actually, the principal purpose of the hot room is to remove the excess moisture and to aid in the extracting.

As mentioned earlier heat may be applied by double-jacketing the sump tank. A pipe through which the honey passes to the strainer or the settling tanks may be double jacketed or wrapped with electric heating tape where smaller amounts are flowing. Warming pans through which the honey flows after being pumped from the extractor are also heated by hot water jackets. Regardless of what system of heating is used the honey flow must be continuous and the heat should be thermostatically controlled.

### Straining Honey

Although straining and filtering of honey are intermediate stages in the preparation of a quality pack of honey they are perhaps the most important ones as far as the appearance of the pack is concerned. For this reason beekeepers who are involved in the retail sales of their honey are particularly concerned with these steps in order to be assured a uniformly attractive display when bottled.

Baffling and settling the honey is usually sufficient preparation for bulk honey shipments to a packer. From the honey sump the honey is pumped to settling tanks which may also be baffled. Here the honey remains to settle out for at least 24 to 48 hours. By the end of that time most of the suspended wax particles will have risen to the surface of the warm honey. The honey tanks are sometimes connected in a series which allows flow between tanks. In other honey houses the tanks are filled and drawn from individually. No honey tank is ever completely drained during the time honey is being settled out. Tanks vary in capacity depending upon the volume of storage required. Gal-

vanized iron has been in common use for honey tanks but stainless steel, though more expensive, is to be preferred because of its resistance to the corrosive action of honey and consequently less chance of damage to the tank. Plastics acceptable to food handling standards are being introduced to the honey industry and may provide an alternative to costly metals.

Honey is drained from the settling tanks after it has cleared of sediment and air bubbles. If the honey is stored or shipped to a processing plant it is drained into 55 gallon drums or, in the case of smaller quantities, into 60 pound cans. Honey usually granulates quite soon in these containers. Since storage may be for several months up to a year or more it is extremely important that the commercial producer process honey that meets moisture standards that are low enough to assure that there will be little or no fermentation while in storage. Generally, remelting for packing takes into consideration the fact that most honeys granulate. Honey is essentially a supersaturated solution and crystallization is a natural consequence, even under ideal storage conditions. No manner or method of processing can, however, rectify the undesirable changes in raw honey brought about by fermentation. According to one substantive report the following conclusions about honey in storage were made from the results of physical and chemical examination in the laboratory:

1. Although it is a relatively stable commodity, honey is subject to chemical, physical and biological changes even when stored at 73 to 82°F. During two years of storage about nine percent of the monosaccharides are converted per year into more complex disaccharides and higher sugars. The free dextrose content declines twice as rapidly as does the free levulose.

2. Significant increases were noted in acidity during storage, but some samples showed no change.

3. Diastase (enzyme) values of unheated honey decline in room-temperature storage.

Another consideration to be taken into account when honey is stored is that it darkens slowly with age. Granulated honey is more prone to ferment than the same honey in the liquid condition because of the higher moisture content

in the liquid phase surrounding the dextrose crystals. Since stored honey easily absorbs moisture the probability of fermentation can be reduced by storing honey in air-tight containers in a dry room. It was found that temperatures below 52°F. not only retarded the growth of yeasts which cause fermentation but also tended to slow down changes in color.

Honeys from different floral sources have different storage characteristics. Each honey has an ideal moisture content level at which it is fairly stable, showing little granulation, but this is but a moot point to the honey packer who must contend with honey from several or more sources mixed together. Even the producer-packer who is especially interested in the quality of his own retail pack, and may be fairly sure of the floral source, lacks the means of altering to any degree the moisture content of his honey after it is extracted.

#### Melting and Repacking

The type of equipment used in the process of preparing honey for the retail market varies with the volume handled. While the beekeeper with a substantial number of colonies (several thousand) in a good producing region may find it to his advantage to concentrate on production, other beekeepers may find it profitable to pack and retail their own production. Quite often, to insure an adequate supply of honey, purchases from other beekeepers are necessary. Large packing plants are dependent upon a large number of beekeepers to supply the volume of honey required to maintain an efficient and profitable operation. Many beekeepers are members of marketing cooperatives which are responsive to the specific needs of beekeepers. Cooperatives usually operate under the guidance of a board of directors who are either member beekeepers or are officials of the packing establishment. Other beekeepers prefer to market their crop to privately-owned packing plants. Various arrangements are possible through cooperative marketing, private buyers or the United States Department of Agriculture marketing agencies to secure financing where delayed marketing of all or a portion of the honey crop is to the producer's advantage.

Large melting chambers that will hold as many as 20 drums of honey turned upside down over a heated grill-work until the honey melts and runs out of the drums are used by the largest packers. Pressurized ducts carry the warmed honey to a preliminary straining or shallow settling tank. This cleaning step removes material such as wax that may injure the color and the flavor of honey after the temperature of the honey is raised beyond 120°F.

#### Heating and Filtering

Several types of equipment may be used for the heating and filtering process. When a clear, sparkling final product is desired the equipment requirements include a heat exchanger and a filter press. These are expensive units and the volume of honey handled again must be large to warrant this substantial investment. Heat exchangers vary in design depending upon whether a stainless steel unit is desired. Regardless of whether it be the tube type or the stainless steel type the purpose of the heat exchanger is to quickly and accurately raise or lower the temperature of honey passing through the unit.

Honey flowing in is raised to 175°F. for four minutes. The honey is then forced through the filter or fine strainer unit. In filtering honey a filter aid is mixed into the honey. The mixture is then pumped under pressure through a fine filter paper or cloth to remove the most minute particles of material, including pollens. After the filtering the honey is cooled down by again passing through the heat exchanger, lowering the temperature of the honey to about 140°F. for bottling.

The O.A.C. strainer, which was developed at the University of Guelph, Canada, and has been widely adopted in Canada, consists of a series of four circular screens of different mesh, one inside the other. The honey enters the center screen, passes through to the outer and fine screen and is drawn off by a baffle near the top of the tank. If a sump pump is used first and if there is no granulation in the honey, the O.A.C. strainer will handle honey very satisfactorily at room temperature, provided the straining area is large enough. If the temperature of the honey is raised to 43°C. it will handle very large volumes.

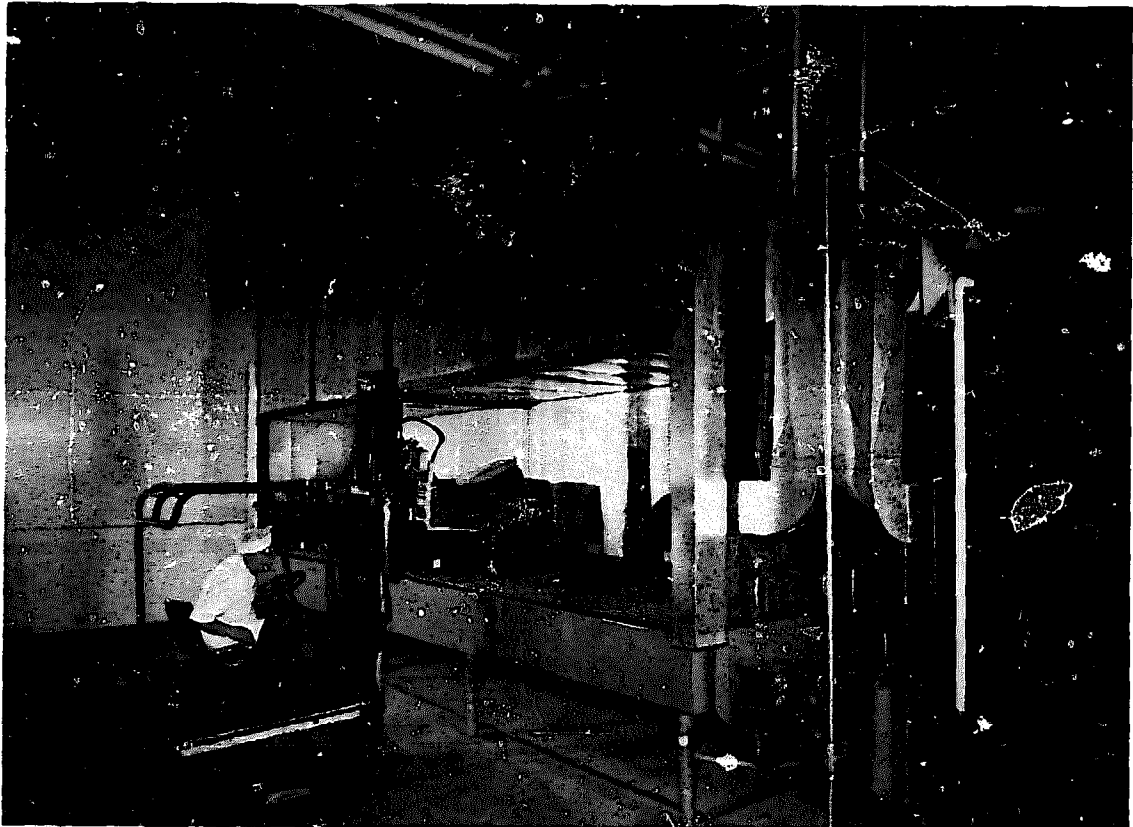

At the Anaheim, California plant of Sioux Honey Association, huge melting chambers empty 20 drums at once and melted honey starts through a pressure duct system to the next processing step. — Sioux Honey Photo.

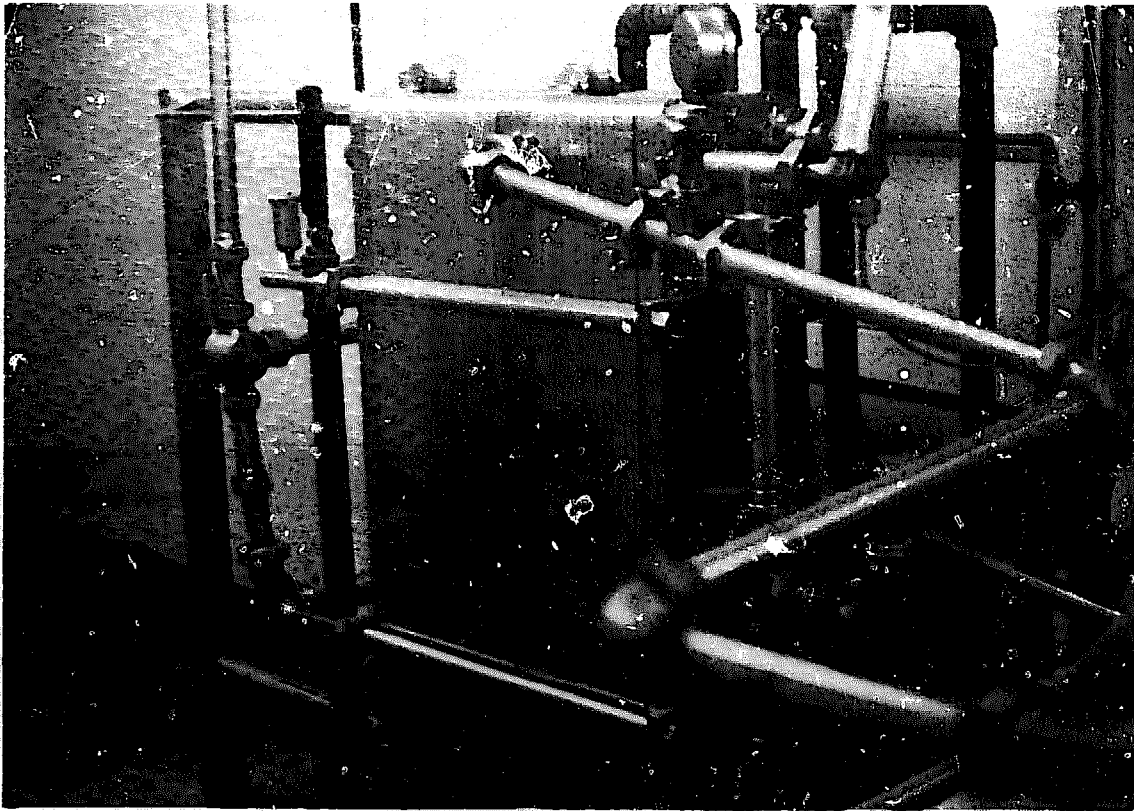

**A stainless steel heat exchanger which gives precise control for quickly raising and lowering honey temperatures during processing — Photo courtesy of Stewart Honey Bee Products.**

**The filter press will clarify honey by removing any material which could impart a cloudiness to honey. Teamed up with a heat exchanger the temperature and the movement of the honey through the filter is rapid and controlled. — Photo courtesy of Stewart Honey Bee Products.**

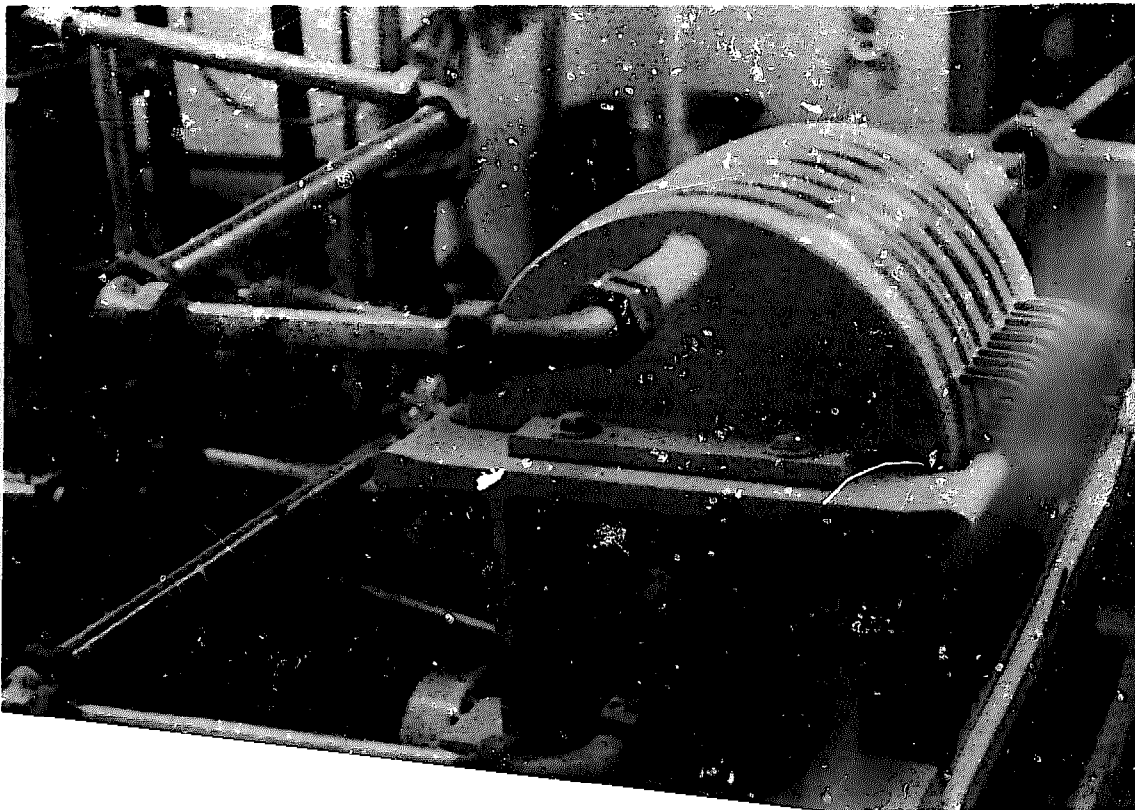

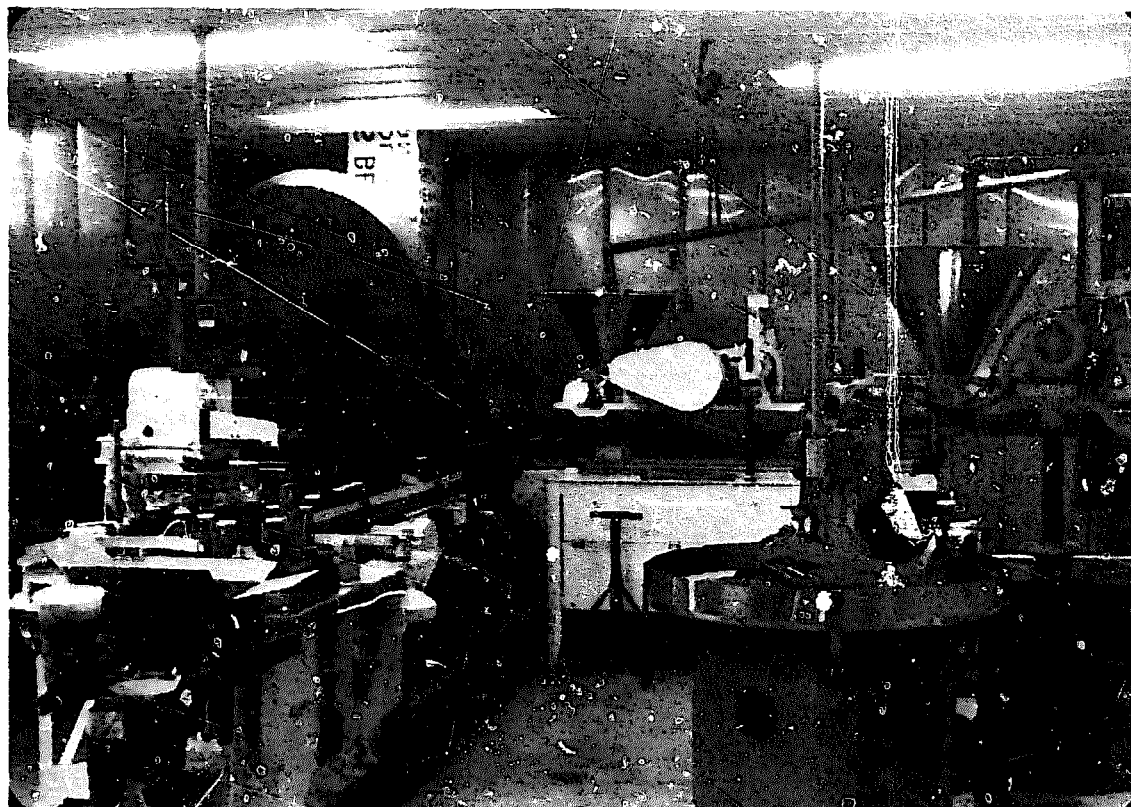

Bottling proceeds smoothly on a continuous conveyor moving from left in picture to right where the filled jar is capped. Note funnel-shaped automatic honey measuring devices. — Photo courtesy of Stewart Honey Bee Products

### Bottling Honey

A volume measuring or weighing device automatically delivers a predetermined amount of the warm honey to the container moving along a conveyor. Bottle caps are fed from an overhead bin into a positioning device which tightens the cap. After the bottles of warm honey are placed in cardboard cartons they must have adequate air circulation to allow the excess heat to dissipate. Avoid stacking cartons closely until they are sufficiently cooled.

The beekeeper contemplating the installation of modern processing equipment should seek technical advice about selection of a unit and its proper installation. Prior experience with food handling systems and the technical problems involved in setting up a smooth operating system to bottle honey would do a beekeeper a good stead. Your state university may offer training courses in food processing technology for beekeepers who are interested in expanding into honey packing. Professional training in food technology is offered either as a major course of study or available for inclusion in other curriculums such as horticulture in some large universities.

**EXTRACTORS.** — In the olden days the only method of securing honey in liquid form was to crush the combs in some kind of press and strain the honey through cheese-cloth. Where there was some brood present in the combs the brood mingled with the honey, and the product was called "strained honey". This term conveys the impression that the honey itself was separated not only from the comb, but from the dirt, pollen, dead bees and brood.

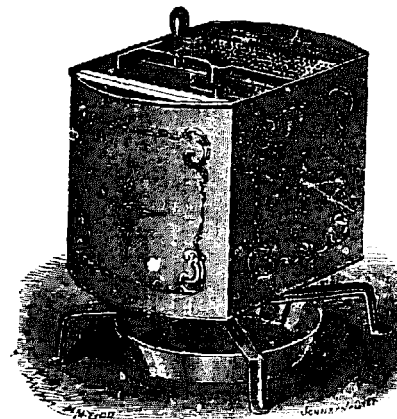

Peabody honey extractor. This is one of the early honey extractors built and sold in this country. It will be noted that this machine had no gearing and the whole can revolved. Without gearing it could not do effective work.

The modern extractor that takes the honey by means of centrifugal force not only saves valuable combs, which can be used over and over, but furnishes a product in point of quality and sanitation that is far superior to the strained honey of old.

#### The First Extractors

In the year 1865 Major D. Hruschka of Venice discovered the principle which led to his invention of the extractor in that year.\*

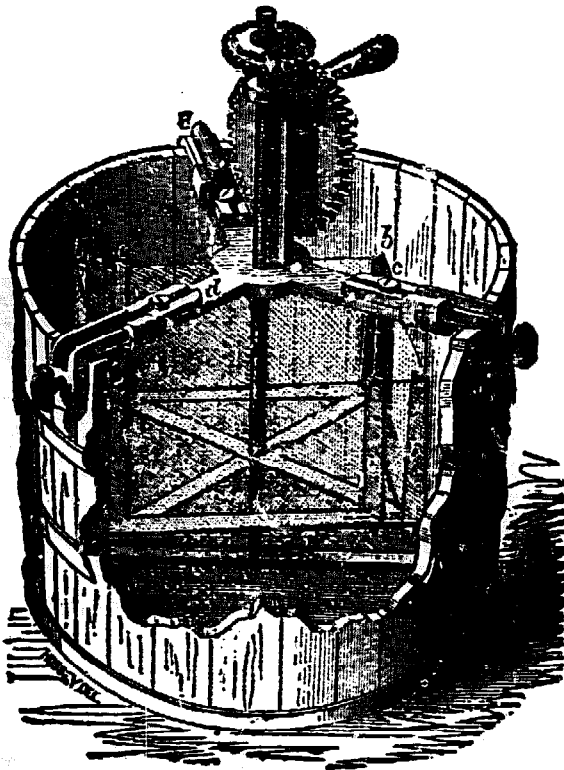

The first extractor built in the United States. Langstroth, the inventor of the hive and frame bearing his name, was the first to build a honey extractor in the United States. With his quick genius for the practical he early saw the necessity for gearing to increase the speed of the reel. —Illustration from American Bee Journal for 1868, page 189.

Apparently his discovery and invention did not attract attention in this country until in 1867 when L. L. Langstroth, the inventor of the hive and frame bearing his name, built and successfully used an extractor geared up as in the modern machines of today, but instead

\*The legend, oft repeated, that Hruschka got the idea of centrifugal force to remove honey from combs from seeing his little boy swing a basket containing uncapped comb about his head and of honey flying out, is not based on fact. That he did attempt to remove the liquid honey from that partly granulated is true. See Bee World for the year 1935, page 118.

of a metal can be used a wooden tub to hold the mechanism as shown below.

Langstroth's quick genius for the practical and useful in bee culture saw the value of centrifugal force

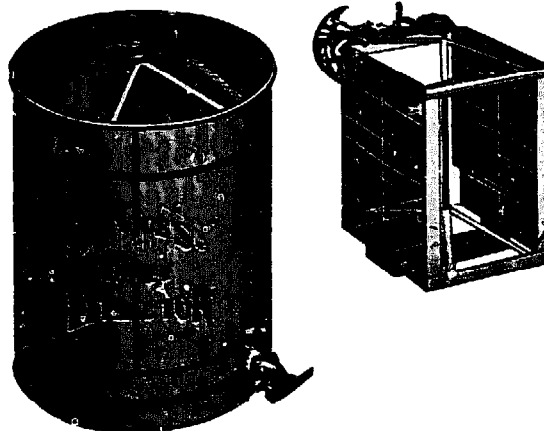

A. I. Root's first all-metal extractor

for removing honey from movable combs. Without his invention of movable combs Hruschka's discovery would have been of little value. The surprising thing was that Langstroth immediately used gearing to increase the speed of the reel holding the combs. A number of these machines were listed and sold by Langstroth & Son in 1867. The ma-



The original extractor made and used during his life by Moses Quinby. Note the heavy spur gears, the oak cross bar, the oak framework underneath, forming a support for the lower bearing.

chine on the previous page was described by L. L. Langstroth in the old American Bee Journal, page 189, for 1868. In the same issue was an article by Moses M. Quinby on another subject. He may have gotten his idea for an extractor from Langstroth. However, Quinby, like Langstroth, saw the value of his "honey slinging machine". In the same or subsequent year Quinby built a machine of his own. This is now on exhibition at the Langstroth-Root Memorial Library at Cornell University and is shown at bottom of second column on page 271. Quinby went one step farther and put his reel and gear work into a metal can.

In 1868 A. I. Root constructed an all-metal honey extractor using the gearing of an old apple paring machine mounted on a wooden cross-arm to drive the reel. With this old machine he extracted 285 pounds with the help of an assistant in seven and a half hours. This was considered a record-breaking feat in 1868. He took in all 1000 pounds of honey from 20 colonies and increas-

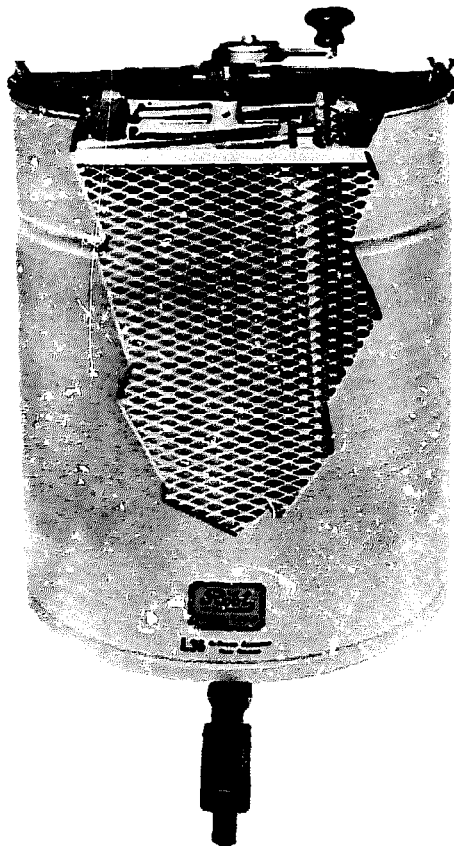

The modern six-frame non-reversing extractor.

ed them to 35. In 1869 he secured over 6000 pounds of honey from 48 colonies. A. I. Root did not keep his light under a bushel. He told the world about it. Then came a call for information as to how he did it, and immediately a demand sprang up for his machines. He sold literally thousands of them under the name of Novice Honey Extractor. One of these original models is shown on the previous page.

A. I. Root's improved Novice was so great an improvement over all that had preceded that it found a ready sale at once. The crank was geared so that one revolution made three revolutions of the combs. (see Extracting).

#### Cowan Reversible Extractor

When the honey from one side of the combs was extracted in the Novice machine the combs had to be lifted out and turned around in order to throw the honey out of the other side.

About the time A. I. Root was experimenting along this line Thomas William Cowan, then editor of the British Bee Journal constructed what was called the Cowan reversible extractor. Several "baskets" holding the combs were hung on hinges like a door. These could be swung from one side to the other so either side of the comb could be next to the outside. The first side could be extracted and then the baskets swung around so that the honey could be thrown from the other side without taking out the comb and reversing it.

#### The Root Multiple Reversing Extractor

To reverse the Cowan extractor it was necessary to stop the machine and with the hand catch hold of the pockets and swing them around to the other position. The multiple reversible extractor shown page 273 reversed the pockets simultaneously when the brake was applied. The lever acted as a brake until the extractor had been reduced in speed to a certain point, when the hub of the reel was held stationary by the brake, and the reel, which continued to turn, accomplished the reversing of the pockets by means of reversing levers located on top of the reel. The strain of reversing was borne entirely by the brake, thus re-

lieving the driving mechanism of all stress.

#### Central Pivot Reversing Extractor

All reversible honey extractors on the market make use of one of two principles for changing the sides of the combs. The first one, that of baskets swinging from hinges on one side like a common door, has been used for many years, and it has given good satisfaction, but it has its limitations. The other one, perhaps just as old but newer in its application, at one time attracted some attention. In the older type the reversing was accomplished by swinging the pockets on their hinges from one side clear to the other. This principle necessitated the stopping of the machine, or nearly so, before reversing could be accomplished. Even at slow speed the centrifugal force tended to throw the baskets over to the reverse side with a bang unless care were used. With new or unwired combs there was a little breakage, especially when careless help did the work.

In modern practice it is almost the universal custom to start throwing out most of the honey on one side at a comparatively slow speed to reduce the weight of the comb. It is then reversed and the other side is extracted clean. The first side is then returned to its first position and extracted again. This makes two reversings, and each time the machine must be slowed down, or stopped and started again.

In the other method, although it is as old as the first the baskets are

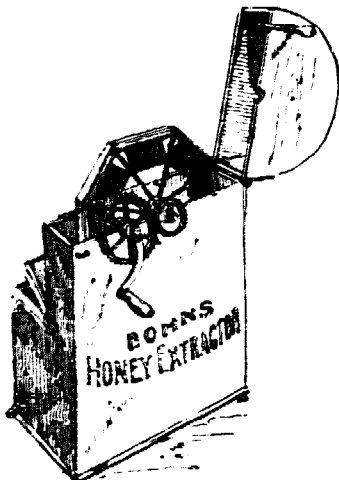
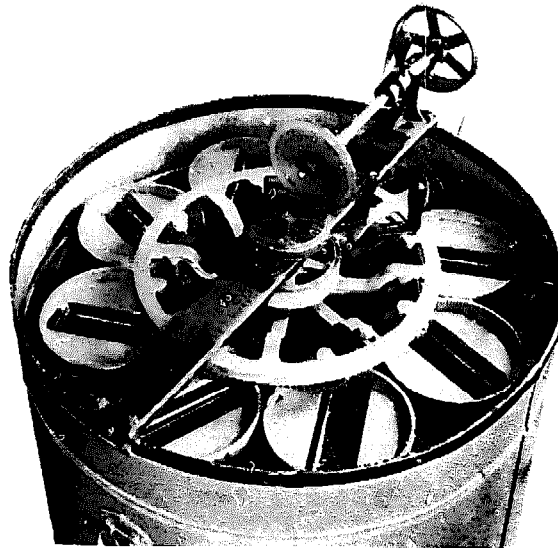
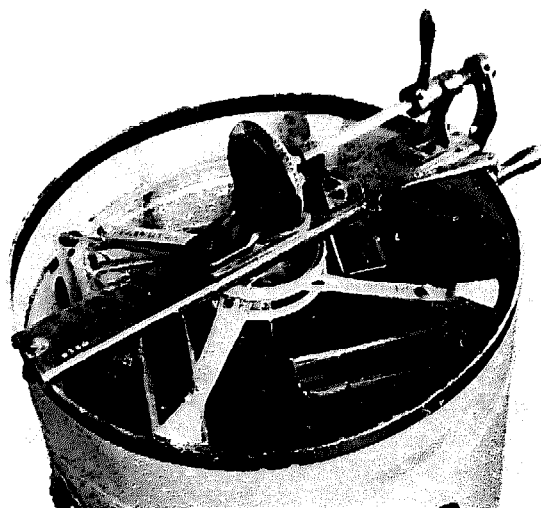

Fig. 2—An early extractor in which the combs are whirled vertically. Reproduced from *Gleanings in Bee Culture* for November 1, 1893.



#### Root Central Pivot Reversing Extractor

This is a top view looking down into the eight-frame Buckeye extractor, the pockets of which are reversed on a central pivot. As will be noted, it is perfectly easy to insert and remove the combs. The tops of the pockets are held firmly in place no matter how severe a strain may be placed on them. The act of reversing is accomplished by means of sprocket wheels that are made integral with the pinions meshing with the internal gear or rims at the top of each pocket. Each of these sprockets is actuated by a chain driven from a sprocket mounted on a hollow shaft loosely journaled on the main shaft from which power is received.



#### Automatic Reversible Root Extractor

This shows the principle of reversing of the extractor. The pockets at the top and bottom are hinged on one side. The levers here shown connect each pocket with the reversing drum. When the reel is stopped, the levers shift from one position to the other, reversing the pockets.



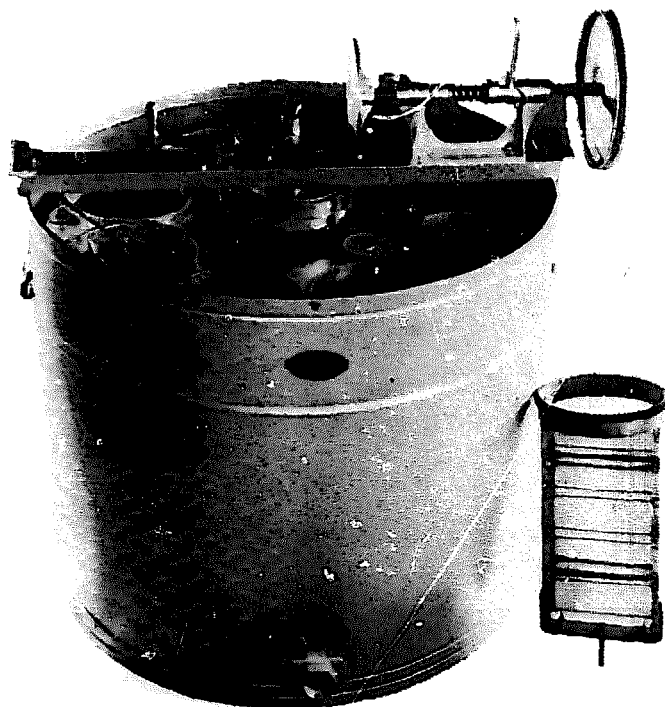

The Lifetime Central Pivot Extractor operates on the same principle as the Root machine and is used on the West Coast where honey is very thick.

pivoted in the center. Of course it is impossible to have a shaft go through the comb, but the basket can be pivoted at top and bottom, thus in effect reversing the comb on its center line.

This type of machine requires a much larger can and heavier reel for the same number of combs and is therefore more expensive. There are some who prefer it, especially in the West where honey is thicker.

#### Extracting Without Reversing

About 1920 a new interest was revived in an old principle that had been exploited some 50 years before (see *L'Apiculteur* for that year) by the author and by Handet in 1867, namely, the possibility of extracting the honey from the combs without reversing. The combs are placed with the end bars pointing toward the center like the spokes of a wheel. The centrifugal force is applied along the midrib of the comb, thus causing a pressure toward the top bar of the frame. Such a pressure forces the honey out of the cells on both sides of the comb at the same time. It then climbs over the surface until it reaches the top bar, whence it flies to the side of the extractor. There are two ways of accomplishing this: (1) placing the combs on a plane at right angles to the center of the revolution; (2) placing the combs on a plane with

the center shaft like the spokes of a wheel (see illustration on page 276).

In the October issue of *Gleanings in Bee Culture* for 1888 on page 773 the author illustrated and described the two methods. One is shown in Fig. 2, page 273, reproduced from that number of *Gleanings*. The second is shown in Fig. 4, page 276, from that same journal. While the author did not try the principle as shown in Fig. 2, he did try the one shown in Fig. 4. He demonstrated then (1888) that it was perfectly possible to extract honey from both sides of the comb at the same time without reversing, but it took from three to four times as long to get the honey out as when an equal number of combs were placed in a machine like those already described in these pages. At that time no attempt was made to increase the number of combs in order to offset the time limit. It would have done no good because this was long before the days of small electric motors or small gasoline engines. It was likewise before the days of commercial beekeeping, when small hand-driven extractors were quite able to do all the work of taking the honey. There were few or no out-yards and of course very few beekeepers who produced honey on a large scale. The hand-driven machines requiring the reversal of the combs would take the honey out in

from two and one-half to three minutes. The other principle, by which the combs were arranged like the spokes of a wheel, required from eight to 15 minutes to do the work. The idea was therefore abandoned as impracticable at that time.

The principle was revived in 1915 and 1916. See United States patent No. 1,176,562 issued to Jacquet on March 21, 1916. In 1916 M. Bernard in *L'Apiculteur* in the March and April issues, gives particulars of his bilateral extractor. See also June, 1926, number of the same journal, for a reproduction of the Bernard extractor. Another U. S. patent, No. 1,334, 585, was granted to G. S. Baird on March 23, 1920. Both of these patents show the principle in Fig 2 and not the idea shown in Fig 4. A French patent, No. 526,342, showing the radial principle, was issued to M. Sicot and published October 1, 1921. The diagram on page 276 shows something similar to the 45-comb machine in Figures 5 and 6. The French Sicot patent and the descriptions of the same general principles of placing the combs radially as shown in *Gleanings in Bee Culture* for 1888 and in various European journals at the time antedate subsequent patents in the United States for non-reversing extractors

having the end bars of the combs placed like the spokes of a wheel.

In 1921 Herr R. Reinartz, the editor of *Die deutsche Biene*, published details of his wheel extractor.

In view of the apparent interest in Europe in this principle of taking the honey from the combs, H. H. Root and Geo. S. Demuth in 1921 again tried out the plan, which could be put to the test very easily in the Buckeye extractor. The pockets were reversed to a point where the combs would stand like the spokes of a wheel. The principle was tested carefully, using an electric motor to drive the machine. It was found that it would extract most of the honey in about three minutes, but it would leave about two and one-half ounces of honey in the comb. Because of this residue the idea was given up for the time being.

A short time later—in 1923—Arthur Hodgson of Jarvis, Ontario, Canada, tried the principle of extracting honey as shown in Bohn's honey extractor in Fig. 2. He discovered that by running the machine 10 to 15 minutes longer, all the honey could be taken. He then built a machine to take 48 combs as shown in Fig. 3.

To Arthur Hodgson and M. Sicot belong the credit of being the first

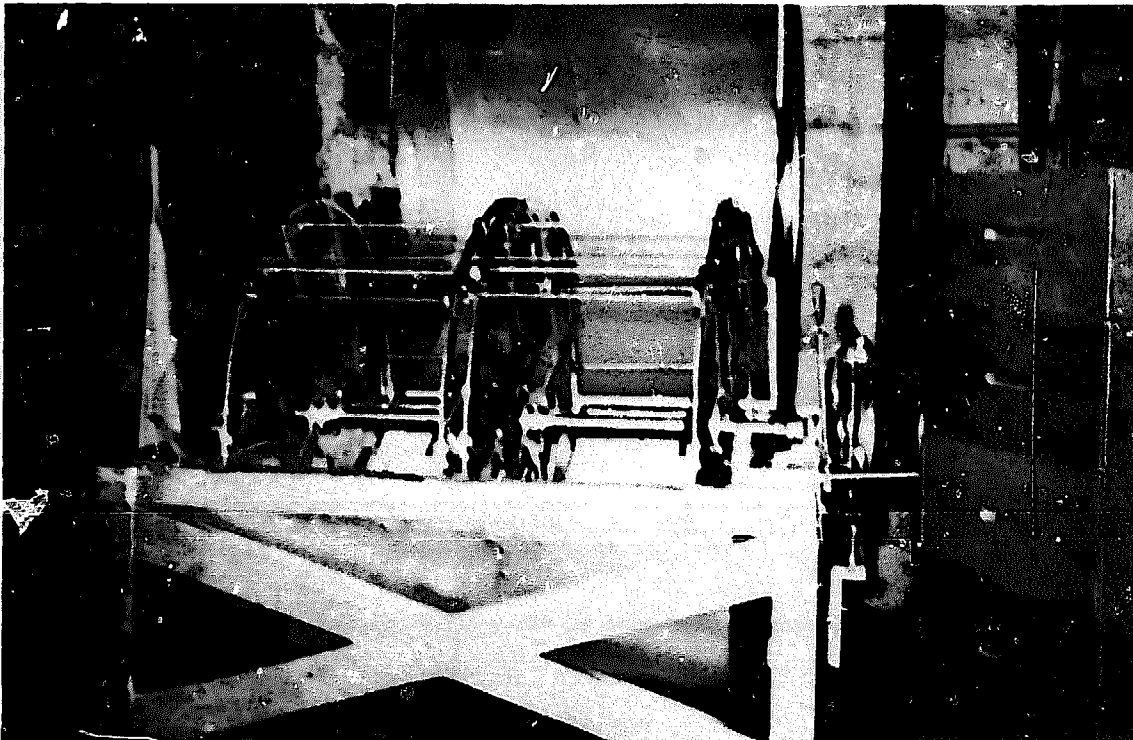
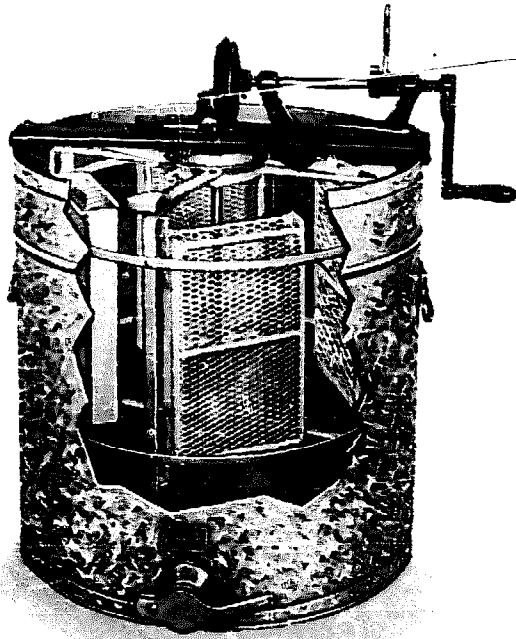

Fig. 3.—The Hodgson extractor, first illustrated in *Gleanings* 25 years ago. The extractor has been improved so as to take 8 boxes of 12 uncapped combs each. The combs revolve in their own vertical plane, front to top—to back—to bottom—to front.



A cutaway of the Root 4-frame Automatic Reversible Extractor.

to eliminate the time element by increasing the number of combs. Mr. Hodgson in 1923 built the first practical machine that would throw the honey out in a commercial way without reversing, and at the same time reduce the time limit per comb below the time usually taken per comb in the ordinary reversible 8-frame extractors.

H. H. Root, who witnessed an early test of the Hodgson machine in 1924, suggested that a cheaper machine holding a like number of combs could be built on the principle as used in the original machine as shown in Fig. 4, with the comb end bars placed like the spokes of a wheel. A machine was built to take 45 combs and is shown in Figs. 5 and 6. It was proved conclusively that this would extract the honey just as efficiently and thoroughly as the Hodgson machine at a much lower cost because of the smaller diameter thus possible.

From the radial principle of extracting without reversing it might appear that one side of the comb would be cleaner than the other, on the theory that the cells preceding the direction of motion would not be as clean as those following the direction. Very extended experience, however, shows no difference. The

combs are so close together that the air between them ~~travels~~ ~~with~~ them, with the result that there is no more pressure on one side than on the other (see Fig. 6).

With either the Hodgson or the principle shown in the Simplicity extractor, the honey is thrown out on both sides of the cells simultaneously because the centrifugal force or pressure is in a straight line away from the center shaft through the center of the combs toward the circumference of the can surrounding the revolving reel. This centrifugal pressure causes the honey to seek the top of the cells. It then climbs over the cells and finally strikes the can surrounding the revolving reel.

It will be clear that the part of the comb nearest to the center shaft will not have the same pull as that portion of the comb near the outer edge of the can. The combs should always be placed with the top bar next to the outside and the bottom bar nearest to the center shaft. Most of the honey in the comb will be near the top and the smallest amount will be near the bottom. But as the pull is the greatest near the top, the two parts of the comb will be emptied in about the same time provided the bottom of the comb is far enough away to receive sufficient centrifugal pull. It is clear that the radial principle can not be applied satisfactorily in a hand machine because the bottom of the comb would be too close to the center shaft.

#### Advantages of the Radial Extractor over the Reversible Power Extractor

The radial non-reversible extractors in the eastern and central states are superior to either of the 8-frame

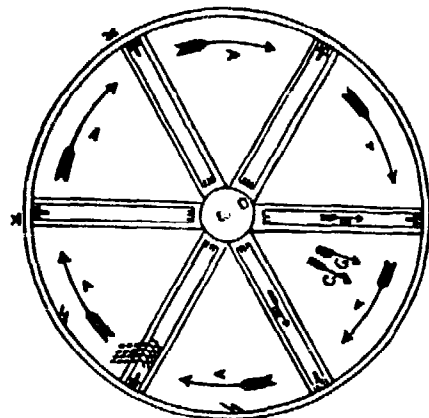

Fig. 4—Diagram of radial extractor from *Gleanings in Bee Culture*, October 1, 1888.

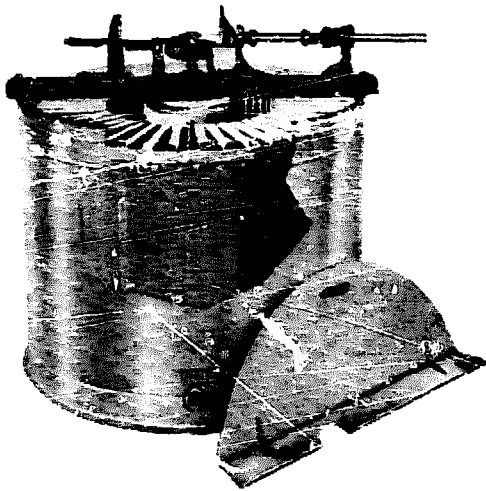

Fig. 5—Root Simplicity radial extractor that does not require reversing. The reel is surrounded with perforated metal to catch particles of comb that would clog the honey pump.

reversible extractors, as already described, for the following reasons: (1) On the basis that the 8-frame extractor of the reversible type takes three minutes to extract a load and that the big machine takes 12 minutes to extract 45 or 50 combs, it is seen that the latter does its work in a little over half the time\*; (2) while the 8-frame reversible requires the constant attention of one man, the big radials are so nearly automatic in the acceleration of speed that they require only about 12 minutes of time per hour. With the reversible it will be necessary to extract partially one side, reverse, extract the other side, come back and extract from the first side. All of this takes labor.

With the radial machine no further attention is required from the operator from the starting of the machine until the combs are ready to remove. It starts at a low speed, gradually increases automatically, throws out three-fourths of the honey at a low speed for about five minutes, then in about three or four minutes more it throws out the residue of the honey at a high speed. It does a cleaner and more thorough job with less breakage of the combs than is done with a power reversible extractor of the old type. During all this time the operator can do other work such as uncapping, allowing the big machine to spin and finish the job. The only time required is to empty and refill it, start

\*Very thick honey requires proportionately longer time in each extractor.

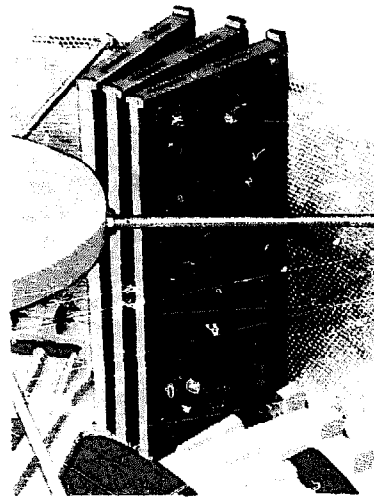

Fig. 6—Detail showing how combs are placed in the reel.

it, and then forget about it until the combs are extracted; (3) the big radials are very much easier on the combs if they are properly handled. The pressure is all against the top bar and not against the surface of the combs, as in the old-type machine. This means that scarcely a comb is broken provided the frames are factory-made, well nailed, and the combs are wired in the frames; (4) the big radial non-reversible machines have twice the capacity with one-fifth the labor; (5) there is only one moving part—the big reel—in the radial machine, while in the reversible type there is not only the revolving reel but the entire reversing mechanism—reversible pockets and arms, and other parts; (6) as explained under Extracting Honey, the non-reversing 45-comb radial machine will extract the honey out of the cappings at the end of the day's run or at the noon hour if preferred. Removing the honey from the cappings by the old method of melting cappings and honey or that of draining is very slow and unsatisfactory. When the cappings are melted with the honey, the flavor of the latter after it is separated from the wax is impaired. With the Simplicity extractor as described under Extracting, the honey comes from the cappings perfectly clear and the cappings are almost dry (see page 269); (7) a perforated metal cylinder surrounds the reel of the 45-comb machine. Broken pieces of comb, dead bees, and such are caught on this screen, thus clarifying the honey to

a large extent before it goes out at the honey gate; (8) As the comb surfaces do not come in contact with any part of the machine during extracting, the danger of spreading foulbrood is very much lessened; (9) it is much easier to get the combs out of the non-reversible machine because the pressure is against the top bar which can not stick to the reel. In the reversible machines, especially those using power, the pressure is against the surface of the comb. So great is it that new or soft combs are forced against and imbedded into the wirecloth or screen of the basket. When the frame is removed or reversed there is danger that some of the comb surface will stick to the screen, with the result that the comb will be broken or defaced. This is not all—it makes it difficult to remove the comb. No such trouble occurs with the non-reversible radial.

#### The Radial Principle is Not Practicable for Hand Extractors

The radial 45 and 50 comb extractors owe their great efficiency and capacity to their size. An extractor on the radial principle holding eight or ten combs would be much slower per comb than a two or four frame extractor of the old type where the combs are reversed. Under conditions requiring 15 minutes to extract 45 combs in the radial, five minutes would be needed to extract four combs in the reversible type machine.

To avoid excessive air pressure on the combs in a radial extractor the combs must be close together. This is not possible in a hand extractor.

Moreover, to extract honey thoroughly from combs in a radial position a speed of at least 250 revolu-

tions per minute is necessary, and the relatively long time required makes the radial principle impractical for a small machine.

#### Power vs. Hand Machines

To determine exactly how much honey is left in the cells after extracting, the authors in 1921 made a number of tests with combs that had been in an eight-frame Buckeye extractor for two and one-half minutes, speeded up to 350 revolutions per minute. Eight combs were carefully weighed before and after uncapping and extracting, then after these weights were secured the combs were cut out of the frames, melted up, and the honey thus separated from the wax was weighed and compared with the original amount of honey extracted from these eight combs. After several tests the amount of honey left in the cells was found to vary from 3 to 3½ percent of the original amount in the combs. When taken from the extractor these combs looked perfectly dry—that is, the exact angular shape of the base could be seen clearly. Where there is honey left in the cell so that the angles of the base all run together it is safe to assume that the percentage of honey left is very high, perhaps between 10 and 20 percent.

In the four-frame hand-driven extractors, the residue of honey left in the cells is much greater than in any of the power-driven machines, especially the power-driven big radial. The reason for this is plain enough—the hand power is not sufficient to maintain a high speed. One's hand or arm gets tired except in case of the two or three frame extractor.

Many are applying power to their small machines in the manner shown above. When power is applied to small extractors there is no reason why they can not do as clean work as a large machine. This is because a higher speed can be maintained.

Flat belts are obtainable anywhere as are flat-face pulleys. They are satisfactory, though they require very careful alignment of pulleys. In late years since V-belts and pulleys have become so efficient they are rapidly replacing flat belts for extractors, pumps, and uncapping machines. There is less difficulty in aligning the pulleys and almost

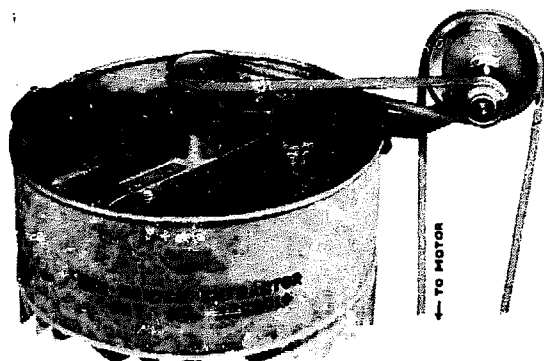

Electric drive for small extractors. A one-sixth h.p. electric motor is large enough for a two- or three-frame hand machine; a one-quarter for a four-frame.



The compound eye.

no danger of slipping. V-belts and pulleys should be kept free from honey or oil. In the interest of "safety-first" all belts should be guarded.

**EYES OF BEES.**—Bees have two sets of eyes, three small or simple eyes (ocelli) located at the fore part of the head and two compound eyes located one on each side of the head. Each compound eye is structurally complex, that of the drone have a numerically greater number of units than the eye of the worker or the queen.

A close look at the anatomy of the eye of the bee reveals that it is faceted, each facet or ommatidium receives only the light which falls along its own axis. There are approximately eight to ten thousand facets in the two compound eyes. Each shares in creating the visual mosaic that guides the bee in flight and

to a somewhat lesser extent in the hive. The single ommatidium functions as an analyzer of polarized light thereby giving the bee the ability to orient itself by the polarization of skylight. Von Frisch<sup>1</sup> concludes that this visual ability is manifested in the dances which point the way to flower nectar sources that have been located by scout field bees.

No less interesting than the ability of the bee to utilize polarized light is the color vision of the honeybee. She has the capacity to differentiate the colors but not in quite the same discriminatory range as does the human eye. To the human eye the range of visible colors is from red through violet; the ultra-violet end of the scale is not visible. The vision of the bees begins with the wave length of light near the orange-red end and continues through the ultra-violet end of the spectrum. The bee has only limited visual ability to see the color red. We are limited somewhat to the same extent by not being able to see ultra-violet. The human eye can perceive many more distinctive colors in the color spectrum while the bee apparently sees only four; yellow, blue-green, blue and ultra-violet. The color vision of the bee has a distinct relationship to the colors of flowers which benefit from bee pollination. Those flowers which have survived are those with colors which fall within the visual range of the bee, this only being true of course, of the flowers which by natural selection have been dependent upon bees for pollination. Many flowers do not need cross pollination, being self-fertile, while others depend upon other insects, birds and in many cases the wind, for carrying the pollen from flower to flower or from stamen to pistil.

There is added complexity to the understanding of the color vision of the bee when it was found that their eyes see colors differently than does the human eye. Von Frisch explains this phenomenon in detail in the section on the color sense of bees in his book **Bees, Their Vision Chemical Senses and Language.**

Reference Cited

1 von Frisch, Karl, *Bees, Their Vision, Chemical Senses and Language*, Cornell University Press, Ithaca, N.Y., 1950, pg. 108-109.

## F

**FARMER BEEKEEPERS.**—Specialization extends to agriculture much as it does to the manufacturing and service industries. Heavy investments in land, buildings, machines and labor requires a high production per acre of land. Profitable livestock farming is more labor intensive than grain farming. No matter what agricultural product is being produced an efficient system must produce a high return to justify its existence. Except for the extensive operations of commercial beekeepers honey production does not fit the concept of mechanization as it is adapted to modern farming. Specialization was brought about in great part by the large scale substitution of machines for family labor and this change over has eliminated the average farm operator from beekeeping just as it has from keeping poultry, tending a home orchard, gardening and home butchering. In areas of marginally productive land where population shifts to the cities or seasonal off-the-farm employment dictates the pattern of farm operation there still remains many family-tended apiaries of modest size. Recently, a back-to-the-land movement has engendered an interest in keeping bees as part of a family farm.

The decline in the numbers of bees in states where farms became larger and highly specialized reflects not only the shift to a mechanized system but to the fact that this type of farming depends less upon nectar-producing crops such as the clovers. The shift to row crops such as corn and soybeans and to grain farming negates the need for bee pollinators. Many large acreages formerly left unattended are now cultivated. Perennial legumes such as the sweet clovers formerly covered these areas. Formerly, family farms of moderate acreage were cropped using a legume as a part of a three or four year rotation of different crops and this assured at least a minimum of forage within flight range of the many small farm apiaries. Small herds of livestock on

family farms required the maintenance of at least several acres of permanent pasture, generally an opportunity for white clover to become established and thrive.

A serious decline in the number of honeybees threatens to affect the production of fruit and vegetable crops that have an acute need for intensive pollination. This need is often extended to crops such as legumes where seed is desired instead of hay. Farmers have come to depend less and less on home-grown fruit and vegetables and consequently have less reason to keep bees.

**FEEDING AND FEEDERS.** — Feeding bees sugar, sugar syrup, or honey has two purposes—to prevent starvation and to stimulate brood rearing at times of the year when no honey is coming in from natural sources. These will be referred to later under separate heads.

Feeding sugar syrup should be avoided, for it is a messy job, is expensive, and is liable to cause robbing. In the spring dry granulated sugar spread on a sheet of paper on top of the frames will avoid robbing (See Dry Sugar Feeding, page 284.) In many instances fall feeding is made necessary by extracting too closely, even from the brood nest. This is a bad practice and decidedly poor economy. Natural stores go farther, pound for pound, than sugar syrup. Where there are no fall sources it is advisable to use the food chamber (see Food Chamber). But there are times when it is necessary to give the bees food either to keep up and stimulate brood rearing or to prevent starvation.

When the natural stores are of inferior quality or are honeydew, it might be advisable to extract and feed sugar syrup. Yet of late years it is becoming more and more to be the practice to let the bees have natural food of their own gathering, provided it is nicely ripened and sealed in the combs, no matter what the source—and it is very seldom

that one will lose bees in outdoor wintering by reason of such food.

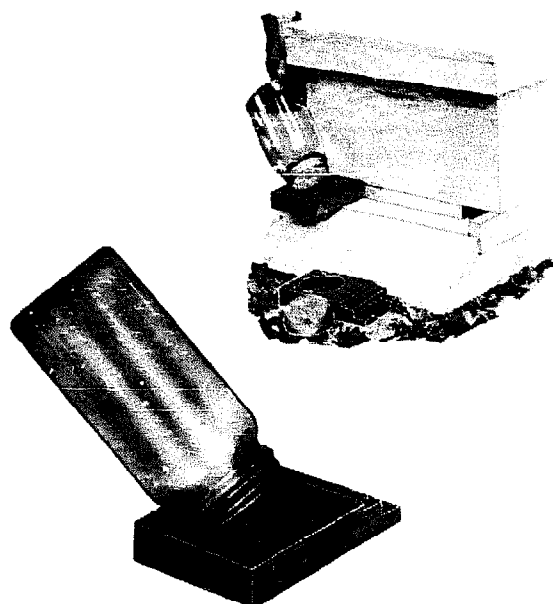

**Boardman feeder**

### Feed Materials

White granulated sugar is the best and most easily obtained material for preparing bee feed and is usually the most economical. Dissolved in water it is easily taken up by the bees. It has very low levels of indigestible material if pure. Some energy expenditure is required by a colony of bees to convert the sucrose sugar to usable forms, evaporate the moisture and store the food in the cells. For this reason it is always best to feed sugar syrup during the active flying season when the bees are best able to convert the sugar to winter stores by adequate "ripening."

Honey fed to bees involves the risk of spreading disease unless you are

certain that the honey came from disease-free colonies. Boiling honey to render it safe for feeding involves high temperatures and long boiling time (see Honey, Boiling for Bee Feed).

Isomerized syrups are becoming cheaper and more plentiful as manufacturing plants increase their capacity. Plentiful supplies should be assured by the new process which uses cornstarch. Cornstarch is digested to glucose or corn syrup by the enzyme glucoase. The corn syrup is in turn treated with the enzyme isomerase that converts the glucose to isomerose. Bland (1975) reported feeding tests with invert sugar syrups, prepared by a commercial process in which "acid hydrolysed carbohydrates" are made for the baking trade, show that this form may be toxic to bees. Other feeding reports from beekeepers are favorable, perhaps due to using invert syrups prepared by an enzymatic process instead of an acid process.

Powdered or confectioners' sugar contains starch which is indigestible to bees. Brown sugar and other partially-refined sugars are unsatisfactory as bee feed.

### Preparing Feed

Using pure white granulated sugar as the basic sugar, syrups are prepared which can be varied in density depending upon the time of year they are fed and the type of feeder used. For warm weather feeding to stimulate brood rearing, a mixture of two parts of water to one part of sugar is recommended. When sugar syrup is being fed to colonies of bees for winter stores a heavier syrup consisting of the proportion of two parts of sugar to one part water



**The friction-top pail that is used so largely makes the simplest and best kind of feeder for supplying winter stores. Punch the lid full of very fine holes, fill with syrup about two parts of sugar to one of water (warm if weather is cool), and crowd the lid down tightly and invert over frames. Invert the pail over the hole in the escape board directly above the cluster in the brood chamber. There is plenty of space to permit the bees to work over the whole surface of the lid. In cold weather use hot syrup and wrap with cloth to hold the heat.**



is best. If the feeding is being done just prior to the onset of cooler weather the proportion of sugar may be increased to 2½ parts of sugar to 1 part water.

Granulated sugar can be dissolved in water at room temperature by adding the dry sugar slowly and stirring, but heating the water speeds up the process. Bring the water to a temperature near the boiling point, turn the heat down to a simmering setting and slowly add the sugar to the water, stirring constantly. The sugar and water should be measured by volume or weight in the proper proportions before combining the ingredients. Keep the temperature below the boiling point and continue to stir constantly until the sugar is dissolved. No purpose is served in boiling the syrup, in fact it can easily be ruined if allowed to burn. Turn off the heat as soon as the syrup becomes clear, which is an indication that the sugar is completely dissolved.

If medication is being added to the sugar syrup it should be mixed in after the syrup has cooled down to room temperature.

Feeding sugar in the form of candy requires somewhat more preparation (see Candy for Bees, Hard Candy for Winter). "Sugar boards", as thin slabs of this prepared material are commonly called, are convenient for feeding in that a square can be inserted between the tops of the frames and the inner cover.

Feeding dry sugar has the advantage that no prior preparation is required unless one wishes to prepare a one or two inch rim to fit over the inner cover to contain the dry sugar. Inner covers with rims that will hold small amounts of dry sugar are sufficient for an emergency feeding. Feeding dry sugar is satisfactory for a short period of time but Foster (1976) found that for feeding bees for a sustained period of time sugar syrup is better. When dry sugar is fed, colonies must collect large quantities of water to liquefy the sugar. Water derived from the consumption of winter stores is used for this purpose if dry sugar is present. Some waste may occur when the sugar crystals spill to the bottom board and are carried out of the hive by the house cleaning bees. A thick slurry of sugar and water

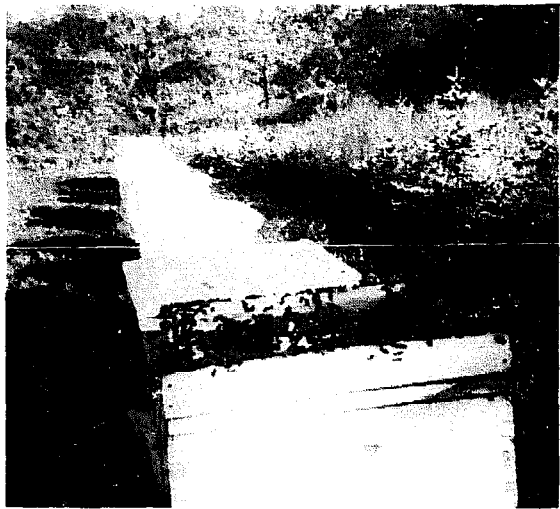

A tray feeder on a hive.

placed on the inner cover or in a shallow rim placed over the inner cover may possibly be taken up better by the bees since part of the needed water is already present. The consistency should be such that the mixture will remain in place on the cover and not run down through the inner cover hole onto the cluster of bees. If the soft mixture is not taken down by the bees within a few days the sugar may harden but will still remain available to the bees for emergency use.

#### Recipe for Bee Candy

Water	Sugar	Cream of Tartar
½ pt.	3 lbs.	½ teas.
1 pt.	6 lbs.	1 teas.
1 qt.	12 lbs.	2 teas.
2 qt.	24 lbs.	1 Tbs.
5 qt.	60 lbs.	2½ Tbs.

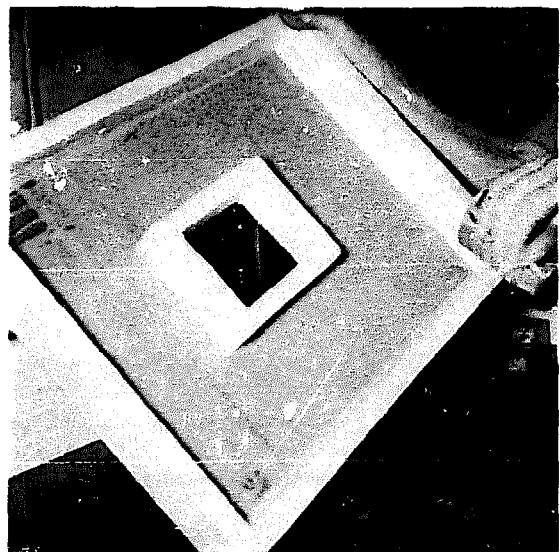

Sealing a tray feeder with paraffin.

1. Prepare shallow pans, dishes or wooden rims of 1½" depth for holding the candy.
2. Line the dishes with wax paper or paint the inside of the "sugar board" with hot paraffin.
3. Bring water to a boil. Add sugar and cream of tartar, stirring until dissolved.
4. Return to heat. Stir continuously. Burned syrup will sicken bees.
5. Continue stirring the boiling syrup until a drop placed on a cold plate sets soft but not sticky when touched with the finger (235°F, 112.8°C. on candy thermometer).
6. Stand container in another container of cold water and stir syrup vigorously until mixture begins to set.
7. Pour immediately into the dishes, pans or "sugar rim" and allow to cool. These candy boards may be stored until needed.

#### Feeders

Feeding in the form of sugar syrup allows a wide selection of feeders. Some feeders, such as those made of closed containers (cans and jars of tin, plastic or glass) with perforated lids provide limited access by the bees and are particularly well suited to spring feeding to stimulate brood rearing. The syrup is taken at the base of the inverted container by siphoning from the droplets which form below the small holes in the lid. When the filled container is inverted, over the frames or over the hole in the inner cover with the lid tightly in place the sugar syrup does not leak out due to equalized atmospheric pressure on the inside and outside. As long as the syrup remains liquid it will continue to feed out through the perforations as the bees take it from below. When refilling the cans or jars make certain that the holes are open. Often they will be sealed by the bees with propolis after the syrup has been drained. The holes may become plugged with granulated sugar crystals. Tin pails tend to rust, glass and plastic do not. Inverted pails of sugar syrup in place on a hive, either over the frames or over the hole in the inner cover should be covered by placing a super shell over them and the

outside cover over this. If the weather is cool the can should be wrapped in an insulating material to prevent heat loss from the syrup and from the cluster underneath.

The Boardman feeder is available from most bee supply dealers and operates by the same feeding principle as the pail feeder inverted over the frames. A wood or plastic block with a rectangular tunnel is inserted in the hive entrance of the hive. A glass jar with a lid that fits the opening of the feeder block is filled with syrup and inverted over the block the lid fitted into the round opening in the block. The bees reach the syrup by way of the tunnel through the block. An advantage of this feeder is that servicing is done quite simply by removing the glass container from the block, refilling and placing back into the holder. There is no need to remove covers as the feed level is always visible. The greatest disadvantage is that to take the syrup the bees must leave the cluster and in cool weather they may find it impossible to do so. By leaving the cluster the individual bee may become immobilized and killed by the exposure.

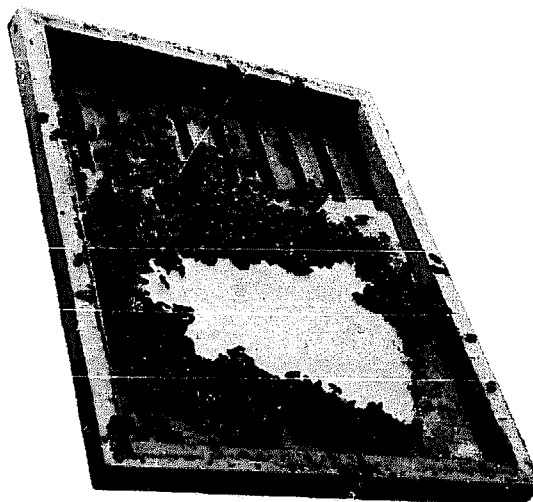

A sugar rim may be used for loose granulated sugar, a slurry mixture of sugar and water or poured fondant. The rim may be placed over the inner cover rather than over the frames as shown here.—Photo by R.A. Stauble.

Package bees installed in early spring must be guarded against this happening when using the Boardman feeder. If the temperatures are such (50°F or lower) that bees are not flying, the Boardman feeder may not be satisfactory due to its position of inaccessibility to the clustering bees.

A tray-type feeder which permits the bees to come up from the brood chamber through an opening in the bottom is one of the most satisfactory syrup feeders. A rim about 2½" deep and the same outside dimensions of the hive (14⅝ x 18¼") is constructed of wood. A bottom of ¾" thick masonite or hard board is nailed to this rim. A hole about 3" square is cut in the center of the hardboard bottom and a wood frame is fastened around the hole by nails driven up through the bottom. The top of this frame must be about ½" lower than the top edge of the outer rim to enable the bees to pass over this center rim to reach the reservoir of syrup. The last step in construction is to seal the inside of the tray feeder with melted paraffin, applied with a brush. The hive should be very nearly level when the tray feeder is filled. It may be left on the hive during the winter and filled with insulating material. Covering the feeding surface with wire mesh allowing the bees to feed only at the edges prevents drowning.

Internal feeders are popular. They are usually constructed of plastic, molded into a shape that fits the space provided by removing one or two frames. They are supported by being suspended from the metal frame rests in the same manner as the frames. A wooden float or a V-shaped piece of folded window screen should be placed in the feeder to give the bees support when crawling down to the syrup. A variation of the internal feeder method is the plastic bag which fits over a frame with drawn comb. The bag is secured with a rubber band at the top. Before securing the bag with the rubber band, fill the plastic bag holding the comb with sugar syrup. The comb gives the bees a firm foothold from which to reach the syrup level and carry it out of the feeder bag. The Doolittle division board feeder is one constructed of wood and hardboard and is used in the same manner as the molded plastic internal feeders.

The mechanics of placing feed where bees can reach it safely during moderate weather involves several important principles:

1. The container must not leak.
2. The food reservoir should not have a large open exposed surface in which bees can drown.
3. The food must be placed as near to the clustering space as possible.
4. The rate of flow or uptake by the bees should be controlled.
5. The syrup must be protected from robber bees.
6. The feeder should be convenient for refilling.
7. The feeder should be simple to construct for economy and easily stored.
8. The syrup must be protected from the rain.

#### Feeding to Stimulate Brood Rearing

To stimulate brood rearing, approximately a half-pint of syrup should be fed daily, but if that amount is given in an ordinary open feeder the bees will take it all up in about an hour's time. The result will be that the colony will be unduly excited when the syrup is given in the morning or even during the middle hours of the day. Bees will rush out into the open air to ascertain where the sudden supply of food may be obtained. If a whole apiary is fed in this way there is a general uproar of excitement, often followed by robbing of some of the weaker colonies and nuclei, for the bees in the field will pry into everything. An entrance unguarded is immediately attacked, and unless there is sufficient force to repel the onslaught, robbing will get so far under way that it may cause the robbing out of the attacked colony. (See Robbing.) When the supply of syrup in the feeders fails, bees are apt to be cross, sometimes attacking passers-by or stock in the fields. This is particularly so if robbing gets started. For these reasons it is usually advisable to feed toward night.

Happily it is possible to avoid all this trouble by using a feeder that will make a quart or a pint of syrup last during the entire 24 hours of the day. In the case of a nucleus,

the amount can be regulated so as to last 36 or 48 hours.

When the supply of food comes in very slowly—about as it would come in from a very moderate honey flow or enough to give the bees and queens encouragement to keep up brood rearing—they will rear more brood than if the supply is intermittent. All excitement—that is, uproar in the air as well as robbing—is avoided. It is impossible to fix the ordinary open or pan feeders so that they will not give out the syrup too fast, but it is possible to regulate the friction-top pail and Boardman entrance feeders. This is accomplished by using lids having but three or four very small holes.

For stimulating, this slow feeding is a great convenience, because one can give his bees a supply of food to keep up the normal functions of the colony for two or three days. For very slow feeding one hole is better than more. A strong colony will require more openings than a weak one and in all cases syrup for stimulating should be in the proportion of about two parts water to one part of sugar, thoroughly stirred until the sugar is dissolved.

#### Feeding for Winter

It is getting to be more and more the practice in late years to recommend from 50 to 60 pounds of honey sealed in the combs of the colony. While it is seldom that the bees ever use 60 pounds, there are seasons when there is a very late spring and there is a shortage of food when the colonies would starve if there is no more than 50 or 60 pounds of honey. On the other hand, if the bees do not use more than 50 pounds, there is some left for early spring brood rearing.

There are seasons when there is an almost entire failure of the honey crop and there will not be enough to carry them through the winter. The deficiency should be supplied by feeding sugar syrup composed of two parts sugar to one of water.

For winter feeding the proportions for the syrup should be about two parts sugar to one of water, by weight or by measure, using a teaspoonful of tartaric acid to every 20 pounds of sugar to prevent crystallization, as already explained. The syrup should be given to the bees

early in September and if the weather warms up and brood rearing starts, another feeding may be given later. Whatever is done, in feeding or otherwise, the winter nest made by the bees must not be disturbed. If there are solid combs of honey or candy the combs should be placed on each side of the winter nests provided by the bees, but never put such solid combs in the center of the brood chamber.

In most localities in the East and to some extent west of the Mississippi, winter feeding of sugar syrup or candy can be avoided. Where there is goldenrod or aster in the fall and dandelions in the spring, feeding will not be required if the weather is favorable.

For this late fall feeding there is no better feeder than the 10-pound friction-top pail previously described. This should be placed on top of the frames in an upper story. It holds 10 pounds, so if one wishes to give a colony a large feed at one time, two or more feeders can be given the colony. They can be quickly put on or taken off without much disturbance to the bees.

It is the usual practice to prepare the feed at home and carry it to the yards hot in the 10-pound feeder pails. A hundred or more of these pails can be carried at a time in a light truck. On arrival at the yard the pails of hot syrup are inverted and set on the combs. There should, of course, be an upper story to receive the pail or pails.

#### Why Syrup Should Not be Given to Bees in Cold Weather

After cold weather comes or on any day that it is too cold for the bees to fly, it is always a mistake to give syrup. The sudden supply of food causes the bees to rush out into the cold air. They chill in flight and drop by the thousands on the ground and never rise again. Hard candy or sealed honey in combs avoids this sudden rush outdoors to see where it comes from.

#### What Does the Bee Do with the Sugar?\*

Bees must invert or "digest" the sugar (sucrose) molecules before they can assimilate them as well as reduce

\*By Murray Reid, Apicultural Advisory Officer, Christchurch, New Zealand. The New Zealand Beekeeper. Vol. 36 (5):41-43.

the water content. In the case of dry sugar they add a great deal of water to the crystals, more in fact than to concentrated sugar syrups or honey. This will mean that the bees will have to make extra foraging flights to collect water. Food containing more than 50 percent or more sugar is diluted first before being ripened. The enzymes (particularly invertase) which are necessary for reducing the sucrose molecules are produced in the thoracic glands of the adult bees.

Bees have the ability to store surplus protein in their fat bodies and also in their blood. However, they do not have any storage organs as such, for sugars. Rather the sugar remains free in the blood and the levels are not regulated as in mammals, but fluctuate markedly according to the diet and activity of the bee. Thus, when a bee first emerges or when it is resting on the comb it has very little sugar in its blood. However, when it is out foraging blood-sugar levels become very high. Converting sugar into honey and storing it is a very exhausting process, in terms of energy used by the bees. The bees must first produce the enzymes, and secrete them; they must suck up the syrup and manipulate it; they need to keep the hive temperature high and the air moving to evaporate excess moisture from the syrup as well as secrete and manipulate the wax to store the honey in. Bees generate a lot of heat from the sugars they eat. Of this heat, Wedmore calculated that 60-70 percent is used to heat the bees, 20 percent is used to evaporate water and 10 percent is used to heat the air. As warm air is able to hold more moisture than cold air it is to our advantage to feed the sugar before the weather gets excessively cold and damp. The warmer the ambient or surrounding air the less energy the bees need to consume solely to keep themselves warm and evaporate moisture. Further the actual consumption of sugar syrup also releases water as the "water of consumption". Some of this water is lost by evaporation but the great majority is stored temporarily in the rectum, then disposed of during cleansing flights. Again, the bees should have

ample opportunity for flying during the period in which they are ripening sugar stores.

One researcher found that one pound of wax can be built into 35,000 cells which would hold 22 pounds of honey. Other workers have found that it takes somewhere between 6 to 10 pounds of honey to make one pound of wax. So a significant amount of our original sugar stores are also going to be used up in producing the wax as well as maintaining a high cluster temperature needed to manipulate the wax scales into comb.

As a rough rule of thumb in estimating stores produced from syrup... the final weight of ripened stores in the comb is slightly less than the weight of dry sugar in the original syrup.

#### References Cited

- Bland, S. E. (1975). "Invert Sugar Syrup as Bee Feed," *Beelines*, No. 46 (Oct. 1975), 11-12.  
 Foster, I. W. (1970). "Effect of Feeding Dry, Refined and Dry Sugar to Honeybee Colonies," *New Zealand Beekeeper* 38 (1) :7, 1976.

**FENCE.**—See Comb Honey.

**FERTILE WORKERS.**—See Laying Workers.

**FERTILIZATION OF FLOWERS BY BEES.**—See Pollen and Pollination of Fruit Blossoms.

**FERTILIZATION OF QUEENS BY ARTIFICIAL MEANS.** — See Breeding Stock, Queens, Fertilization of, by Artificial Means.

**FILTERING HONEY.**—See Honey, Filtration of.

**FIR SUGAR.**—See Honeydew.

**FIREWEED.**—See Willow-herb.

**FIXED FRAMES.**— See Frames, Self-spacing.

**FLIGHT OF BEES.**—The distance bees go in quest of stores varies greatly according to conditions. Usually in level country, more or less wooded, they do not go over one and one-half miles. However, if there is a scarcity of pasturage within that distance and plenty of it along some

river bank three to five miles away, they may or may not go that far. When bees go out after stores they evidently try to find their nectar as near the hive as possible. They will not go over a half mile if they can get a sufficient supply within that distance, but in most cases that range does not supply enough bee pasturage, and it is evident that they keep increasing their flight until they go as far as one and one-half miles. If they are unable to secure enough, and if there is forage beyond, they often go farther.

Bees will sometimes fly over a body of water or a valley, particularly if there are fields in sight that are very showy. Whether they have long-range vision or not has not been proved, but the fact that they will find white patches of buckwheat five miles away across a valley is somewhat significant. In a like manner they will go across a valley four or five miles to orange bloom in California. Whether they are guided by sight or smell is difficult to prove, but it is quite probable that a breeze will carry the odors of a buckwheat field or of an orange grove in bloom to bees five miles away. While we might not be able to detect odors at such a distance, the scent organs of the bee are much more acute than ours, and they might and probably would get a knowledge of its presence in a given locality.

Ruttner of Germany has found that honeybees have definite flight levels. Workers rarely fly higher than 8 meters above the ground. Drones or queens that fly below that level are often attacked by workers.

The author once had a yard located in an aster district. The supply of nectar gave out in the nearby fields, but some of the bees of that yard were traced to asters five miles away. That fall there was a very rapid loss of bees. Colonies that were strong just before the asters came into bloom dwindled to three or two frame nuclei. The surviving bees had their wings badly frayed. The presumption is that in dodging through and over the shrubbery in their long flights they tore their wings more or less, with the result that large numbers of them never got back home.

When bees are going to and from the field, they fly as low as possible to avoid the wind. Instead of flying over shrubbery they dodge through it for forage on the other side. At other times they fly over it. The author has observed, however, at one of our yards, that bees go no farther than a piece of woods a half-mile away. The probabilities are that on rising to the height of the trees they encountered currents of wind in the opposite direction. It is a well-known fact that bees can not fly against a strong wind.

#### The Range of Flight and Its Relation to Outyards

In the location of outyards one should take into consideration the general lay of the land and the character of possible bee forage. In ordinary white clover regions where there are patches of woods, buildings, or much shrubbery bees do not fly much over one and one-half miles, but when clover ceases to yield, and sweet clover can be found two or three miles away, those same bees fly farther. When conditions are right they fly from three to five miles, and even seven miles across a body of water. But locations that furnish such long ranges are very rare.

#### Flights for Pollen and Nectar

The distance, and to a somewhat lesser extent, the direction that a forager bee must fly has a direct affect on the volume of nectar and pollen she is able to gather during the honey flow. By the same determination the efficiency and rate of pollination is affected, particularly when poor weather limits the flying time in the spring. Locations away from the apiary that offer bountiful nectar and pollen attractive to bees undoubtedly distort the searching pattern that we imagine as a circle around the apiary. Forage bees fly directly to the nectar source most attractive to the bee although topography, obstructions and wind may cause many detours. As pointed out by von Frisch (1950) bees have the ability to convey information in the round and wagging dance that will bring them to the nectar source with the most economical expenditure of energy. Presumably, some selectivity is exercised by the bee to tap the richest

nectar source. Finding the most rewarding nectar source within flying range of the colony would require constant communication in the hive between returning foragers and hive bees. While we are aware of many of the methods of communication used by honeybees we cannot all agree to what extent each is used in every instance that honeybees react to stimuli.

During foraging honeybees usually visit only one species of flower and tend to remain constant to that species during the period that nectar is available, even though other nectar stores nearby may be more rewarding. Flower constancy concerns orchardists who rent bees for pollination. Secondary nectar sources such as dandelions blooming in a field near the orchard may divert bees from pollinating the fruit blossoms (see Pollination of Agricultural Crops). Flights of bees between fruit trees making up a row is greater than flights of bees between fruit trees in different rows where the distance is greater, as found by Free (1960). In alfalfa test plots the amount of "tripping", meaning better pollination, is found to be in direct relationship to the distance between the alfalfa plots and the hives. It follows that the greater the distance the foraging bee must fly to reach the nectar source the less the amount of honey that will be harvested in that area from that source.

Anything that can be done by the beekeeper to decrease the length of foraging flights the bees must make to gather nectar and pollen will vary likely enhance the prospects for a better harvest and improve pollinating efficiency.

It has become evident from the experiences of beekeepers in regions where the number of colonies is greater than the available honey flora can support that some regulations must be imposed on placing apiaries too close together. In 1977 North Dakota, for example, placed restrictions on the placement of new commercial apiaries. No one is allowed to move bees to within less than two miles of another established registered site. A few exceptions apply to local residents owning a few hives. As apiary locations become harder to find knowledge of the range of flight of bees will become more vital to beekeepers.

**FOOD CHAMBER.** — The food chamber and its use is the most important development in modern apiculture. It unlocks the door to successful beekeeping. Around it revolve many of the manipulations described in this book. It is not only a labor saver, but it goes a long way toward insuring against winter loss and the failure of a crop. It goes further. The wealth of stores of 50 or 60 pounds of honey and pollen has a direct effect on the queen and the bees. Unless there is a large reserve of food that will be ample before the next honey yield, the bees will cut down on brood rearing.

#### Limitations of the Single Brood Chamber

Most young queens have the capability to lay eggs in two deep chambers during the highest brood period, giving stronger colonies capable of better honey production. The single brood body hive restricts nectar and pollen storage and is a limiting factor in brood rearing. It is not always possible for the bees to utilize all the cell space in a hive for brood rearing. The restricted space of the single brood body hive may in some cases contribute to swarming. It certainly is inadequate for honey storage in the North, but is used extensively in Florida.

#### What is a Food Chamber?

A food chamber is either a shallow or deep extracting super containing well-filled combs of capped honey. Any good grade of honey may be used for this purpose provided it is well sealed in the combs. This is important. Combs containing honeydew (see Honeydew), whether sealed or not, should not be used. Sometimes honey in open cells is fully ripened and if so is a safe food, but the beekeeper can not be sure of that. The necessity of adhering strictly to these requirements will be better understood after considering the next points.

#### The Purpose of a Food Chamber

The purpose of a food chamber is manifestly that of supplying food for bees. But it also supplies comb space, as shown later. In the final analysis the food chamber simplifies apiary management and reduces the

cost of producing honey. This two-fold purpose is certainly needed in the light of present day economic conditions as they affect labor and honey prices. Labor is the expensive item in all industries today. It must be reduced as much as possible in order to realize a living margin of profit.

#### Method of Using Food Chamber

The plan is so simple that it needs very little explanation. In short, a food chamber is reserved for each colony of bees going into winter quarters. This is in addition to what honey may be in the brood chamber of each hive. In order that we may better understand its use, let us review in outline in apiary management throughout the beekeeping year which logically begins about August 1.

#### Spring Management

With the use of the food chamber spring management is greatly simplified. During the spring months, prior to the major honey flow, the two major requirements are ample stores and comb space. The food chamber supplies these requirements. When the queen has occupied practically all of the comb space in the brood chamber proper, more cells are available for the queen in the food chamber as the honey is consumed. Thus she extends her brood rearing into the food chamber.

In localities where there is a heavy spring honey flow from fruit bloom and dandelions it may be necessary to put an additional deep super of combs, preferably dark, on each colony to provide more room for brood rearing and thus lessen overcrowding and the danger of swarming. As a rule, however, a two-story hive will hold a colony until the beginning of the major honey flow unless the spring honey flow is unusually heavy.

#### Fall and Winter Management

During the main honey flow the food chamber is usually left somewhere in the pile of supers, above the queen excluder. After the surplus honey is removed, the food chamber is placed directly over the brood chamber and the colony is wintered in a two-story hive.

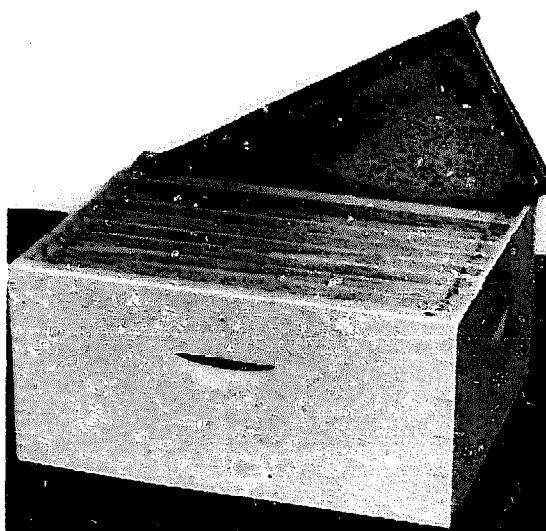

A full-depth food chamber is simply a hive body well filled with honey.

In regions where a fall flow of darker honey follows a summer flow of lighter colored better flavored nectar, the darker inferior flavor can be given to the bees for winter stores provided it is well sealed in the combs. The better flavored lighter honey can be sold and will bring a higher price. It should be made clear that combs containing honeydew, whether sealed or not, should not be used. They can be given to the bees in the spring or when they can fly.

Little if any labor is necessary during the fall except to give colonies the necessary amount of protection against the cold winter weather. The food chamber takes care of the food requirement.

#### Management During the Main Honey Flow

When the main honey flow begins, the queen, which up to this time has had access to the combs in the brood chamber and food chamber, is put down into the brood chamber below a queen excluder, and supers are added as needed.

In the production of comb honey the apiary management is similar up to the beginning of the main honey flow. At that time the food chamber is removed and stored temporarily over a weak colony. This is done at the time of giving the first comb honey supers, or a day or so later. At the close of the main honey flow the comb honey supers are removed and the now well-fill-



ed food chamber is put back on the hive. (See Demaree Plan of Swarm Control.)

### Is the Food Chamber Fulfilling Its Purpose?

Since an ample amount of stores for wintering and spring brood rearing is so essential for success, and since comb space for brood rearing and the storage of incoming nectar in the spring prior to the major honey flow is also necessary for maximum results in honey production, the food chamber certainly fulfills its purpose because it supplies these requirements at the minimum of cost and labor. Let us suppose that all of the honey above the brood chamber should be extracted and the colony is fed sugar syrup in order to make up necessary food requirements. There would be the labor of hauling the honey to the extracting house, extracting it, mixing sugar syrup, hauling the syrup to the apiary, feeding it, and picking up the feeders after the feeding is done. While the honey taken off could be sold, the net amount secured for it would not pay the expense of feeding sugar syrup. (See Feeding.)

That is not all. In the spring, during the fruit bloom honey flow, it would be necessary to haul the supers back to the apiary in order to supply more comb space for brood rearing and incoming nectar. When food chambers are left on the hives all of this unnecessary labor is avoided.

### The Best Size of Food Chamber

In regions where there is practically no fall honey flow the full-depth food chamber is preferable. In localities where there is a dependable fall honey flow the shallow extracting super is usually large enough. The full-depth food chamber, however, is growing in favor for two reasons: First, because it is more likely to contain an ample amount of stores; second, because the frames in the food chamber are interchangeable with the frames in the brood chamber.

In some regions where the fall honey flow constitutes the major flow, the food chamber may not

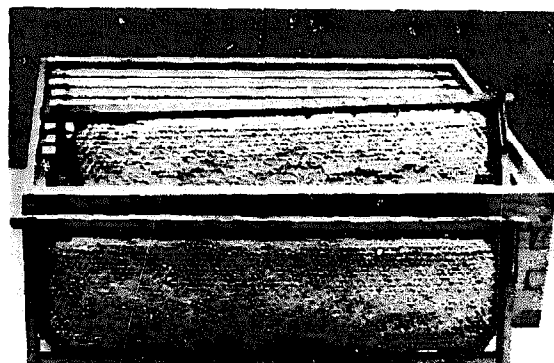

A shallow super of combs of sealed honey. These shallow or half-depth supers will contain enough honey to carry the colony over until next season provided it is not too strong or provided the season when the first honey comes in is not too late.

seem to be necessary. This is especially true where there is a long late honey flow, and the bees practically fill the brood chamber with honey. It would do no harm, however, to reserve at least a shallow food chamber of honey for each colony.

### Some Further Advantages of the Food Chamber

1. When the food chamber is used the queen is likely to use the entire area of the combs in the brood chamber because the brood combs are not clogged with honey in the upper portion. This will result in better combs because the cells do not stretch when the queen once occupies cells of combs to the top bars.

2. With the proper use of the food chamber there is no danger of any left-over dark fall honey getting mixed in with the fresh crop of white honey the following summer, provided white honey and not dark honey is reserved for food. All left-over honey is in the food chamber and not in the brood chamber at the beginning of the major honey flow.

3. The proper use of the food chamber makes it possible to weed out undesirable queens. This in the end will mean a survival of the fittest, resulting in a more hardy, vigorous race of bees with superior honey-gathering qualities. Only genuinely good queens can meet the requirements of food-chamber hives. No other kind of queen is worth while.

### Various Beekeeping Regions

There are a number of beekeeping regions throughout the country each having characteristics different from the others. Each region may call for a method of food chamber manipulation different from another's.

In general there are four types of regions:

1. The one where the major summer flow gradually tapers off in late summer and is not followed by a fall flow.

2. A region where the major summer flow is followed by a fall flow.

3. A region where the summer flow is not heavy and is followed by a major late summer and fall flow.

4. A region that gives a succession of honey flows throughout the season, with perhaps short intervals between flows.

It is difficult, if not impossible, to describe in detail the manipulation of the food chamber for each of the regions throughout the country. Each beekeeper must work out a system that fits his particular locality. The main thing to keep in mind is to have the food chamber well filled with honey and pollen at the close of the season, in addition to the honey that may be found in the brood chamber, so that there may be a super-abundance of stores for each colony until abundant nectar and pollen from natural sources are again available the following season.

#### Is the Food Chamber Needed in the South?

In view of the fact that the food chamber is supposed to be a store house of natural stores to carry bees in the northern states over that period of the year when they can get neither honey nor pollen for six months during winter, is such a store house of food needed in the Southland where it is supposed that bees can get a little pollen and honey every week or ten days during the winter? This question has been raised several times.

Dr. E. Oertel of the U. S. Bee Culture Laboratory located at Baton Rouge, Louisiana, has this to say about it:

Scale colony records show that colonies in Louisiana, and probably in other Gulf

States, must have from 30 to 50 pounds of honey to carry them through the fall, winter, and spring. A study of climatological records here shows that there are many days in the winter when bees are not able to fly, either because of rain or low temperature. Nearly every year state bee inspectors tell us of colonies needing feed or actually starving to death. This indicates that nectar is either not available or, if available, the bees cannot get it.

Southern beekeepers need a food chamber in some form whether it be a double brood chamber or a third super. Our observations at Baton Rouge are that colonies here need better beekeeping management in winter and spring than they do in the North. That is, brood rearing here starts off slowly in January and our major honey flow begins about April 1. According to Farrar, brood rearing starts in January in Wisconsin but the major honey flow does not start until June 15.

#### The Food Chamber Hive or the Double Brood Chamber for Comb Honey Production

Under Comb Honey, to Produce, will be found information on how to produce comb honey over a double brood chamber. It is there mentioned that the plan is still in the experimental stage, and so it is. The orthodox practice in the production of comb honey is to breed in two stories and to remove the top story and put the supers of sections on the lower story at the time when the sections are given. The brood chamber removed is disposed of by any one of the methods already described on page 173.

While the plan of producing comb honey over a double brood chamber is of course in the experimental stage, it should be amplified here on how it may be possible to produce comb honey over a two-story brood chamber when conditions are right. The conditions mean: (1) a good honey flow; (2) a good comb honey region; and (3) last but by no means least, a strong colony that occupies the two stories with brood in both upper and lower stories. If all three conditions are not present, then it may be necessary to remove the upper story, disposing of it in the manner indicated, and putting the supers of sections to be drawn out and filled, on top of the single lower story.

As a general rule, however, when a colony is below normal strength for the production of comb honey, it should be devoted to the production of extracted honey, but where there is a demand for comb honey one can produce it in a strong honey flow when conditions are favorable. But no one should make the attempt unless the colony is very strong. The average beginner should not attempt it. It is better to follow the plan advocated under Comb Honey, to Produce.

#### **A Trick in Food Chamber Management**

This procedure has reference to rearing a young queen in the food chamber. It can be accomplished in a locality that gives a honey flow of considerable duration. Sweet clover regions are especially well adapted to it. All the extra equipment required for each hive is a hive cover and a hive bottom. (See Requeening Without Dequeening.)

The system is as follows: When the major honey flow starts and supers are put on, remove the food chamber, which at this time should contain considerable honey as well as some brood, to a hive stand placed close to and facing the same direction as the parent colony. The food chamber is immediately depleted of its old bees which return to the parent stand, but the young bees remain. A ripe queen cell should then be given to the food chamber hive. In due time a young queen will be mated and laying. She will not be permitted to do much laying because honey will be crowded around the brood nest. This is exactly as it should be.

At the close of the main honey flow, when the surplus honey is removed from the parent colony, the food chamber hive containing the young queen is then placed on top of the original colony after having the bottom board removed. When uniting is done in October no fighting will occur. It has been demonstrated that the young queen is the one that survives in the majority of instances.

With this management the food chamber accomplishes requeening as well as reserving ample food for the colony. But that is not all. In the production of extracted honey,

this method obviates handling the food chamber while supering during the honey flow. Then, too, when the two colonies are united in the fall the resulting colony is very strong in bees.

#### **The History of the Food Chamber**

In 1905, 1906, and 1907 G. M. Doolittle of Borodino, New York, was working out a plan for the production of comb honey and at the same time eliminating swarming. As it was practically impossible for him to make frequent trips to his out-yards both in the fall and in the spring, owing to the condition of the roads, he decided that he would eliminate all feeding by reserving combs of buckwheat honey from the previous fall. He set these aside in supers. When he went to the out-yards, on the first trip he gave the bees one or more of these combs of honey if they were needed. After the colonies were built up in strength he made another visit to the yard and placed on top of the brood chambers a queen excluder, and above that a super containing eight combs of buckwheat honey. This was virtually a food chamber designed to take care of the bees between the time of dandelion and fruit bloom, until white clover honey began to come in. If honey came in, it was added to the supply of stores above. Mr. Doolittle called this upper story his "storehouse," and in a series of articles giving this system, which he published in *Gleanings in Bee Culture* in 1906 and 1907, he spoke of the value of large amounts of sealed natural stores, which are necessary for the bees to have during that period of the year when there is likely to be little or no honey coming in. He argued that the bees would have a comfortable feeling of wealth or "millions at our house". He likewise contended that if the bees were short of stores, or had only those stores that were in the brood nest, they would curtail brood rearing at a time when it was most important for the securing of a honey crop. But Mr. Doolittle did not at this time contemplate giving this large reserve of sealed honey in a hive body or super to the bees the previous fall, but only in the spring.

A. I. Root, the first author of this book, as was seen in the original editions, strongly advised against extracting too closely and then feeding sugar syrup to replace the honey taken out. He argued that it was poor economy even though sugar syrup was cheaper than honey. He further contended that it was not as good for the bees, but none of these old pioneers ever thought of giving a whole super of natural stores in the fall.

As has been explained in the Preface, the author began early to exploit the advantages of breeding in two stories instead of the usual one story. (See *Gleanings in Bee Culture* from 1894 to 1901.) Geo. S. Demuth, for 13 years editor of *Gleanings*, was one of the first to adopt this principle of a full two-story 10-frame Langstroth brood nest and he continued to advocate it after he took over the editorial management of *Gleanings*. It was natural that he should go one step farther and make one of those upper stories a food chamber.

The two ideas of breeding in two stories and the development of the food chamber have revolutionized beekeeping in the United States. Mr. Demuth as early as 1911 advocated reserving a super of good honey for each colony. The bees gradually eat out the stores, forming a winter nest between the upper and the lower stories, and in the language of Doolittle, they have "millions at our house". With this large reserve of natural stores and pollen it was unnecessary to feed in the fall or in the spring. There would be stores enough—from 50 to 60 pounds—to carry over until the next honey harvest. While the bees might not use all the stores they had an abundance, with the result that brood rearing went on at a full pace from mid-winter clear up to the beginning of the harvest, provided there was a good queen. See Mr. Demuth's series of articles on long-range beekeeping and the food chamber in *Gleanings in Bee Culture* for 1920 and 1921.

**FOOD VALUE OF HONEY.**—See *Honey, Food Value of.*

**FOULBROOD.**—Three diseases of honeybee brood carry the term or name "foulbrood". The first of these is perhaps the most serious disease of honeybees and is called American foulbrood (AFB). The second of these while not as widespread or as damaging as American foulbrood is called European foulbrood (EFB) and can be very serious in certain areas and under certain conditions. The third foulbrood is called Parafoulbrood and has been found only in limited sections of North Carolina, South Carolina, Georgia and Florida.

### American Foulbrood

American foulbrood is a very infectious disease of the brood caused by a bacterium known as *Bacillus larvae*, and is the most destructive of the brood diseases. Most diseased colonies are eventually totally destroyed by the disease. The appearance of the brood and brood combs in American foulbrood infected colonies is highly distinctive. For example, in healthy brood combs, where a normal queen has been laying, there is a regularity in the arrangement of areas containing eggs, larvae, pupae and emerging bees and the cappings are uniformly convex. On the other hand, in American foulbrood infected brood combs, the brood is irregularly arranged due to the intermingling of cells of healthy brood with cells of diseased brood having punctured and sunken cappings or uncapped cells. This is sometimes referred to as the "pepper-box" appearance of American foulbrood comb.

Dead brood in cells with discolored, sunken or punctured cappings should always be examined carefully for American foulbrood. In advanced stages of the disease many of the cappings are punctured. Dark brown and shiny cappings may also be broken away at the edge and settled down over the brood. Cappings over dead brood are often completely removed by the adult bees and in advanced cases many dried scales, which are the remains of dead larvae and pupae can be seen in uncapped cells. Death of the larvae usually occurs after the larvae has been capped over, have spun their cocoons and are fully extended on the floor of

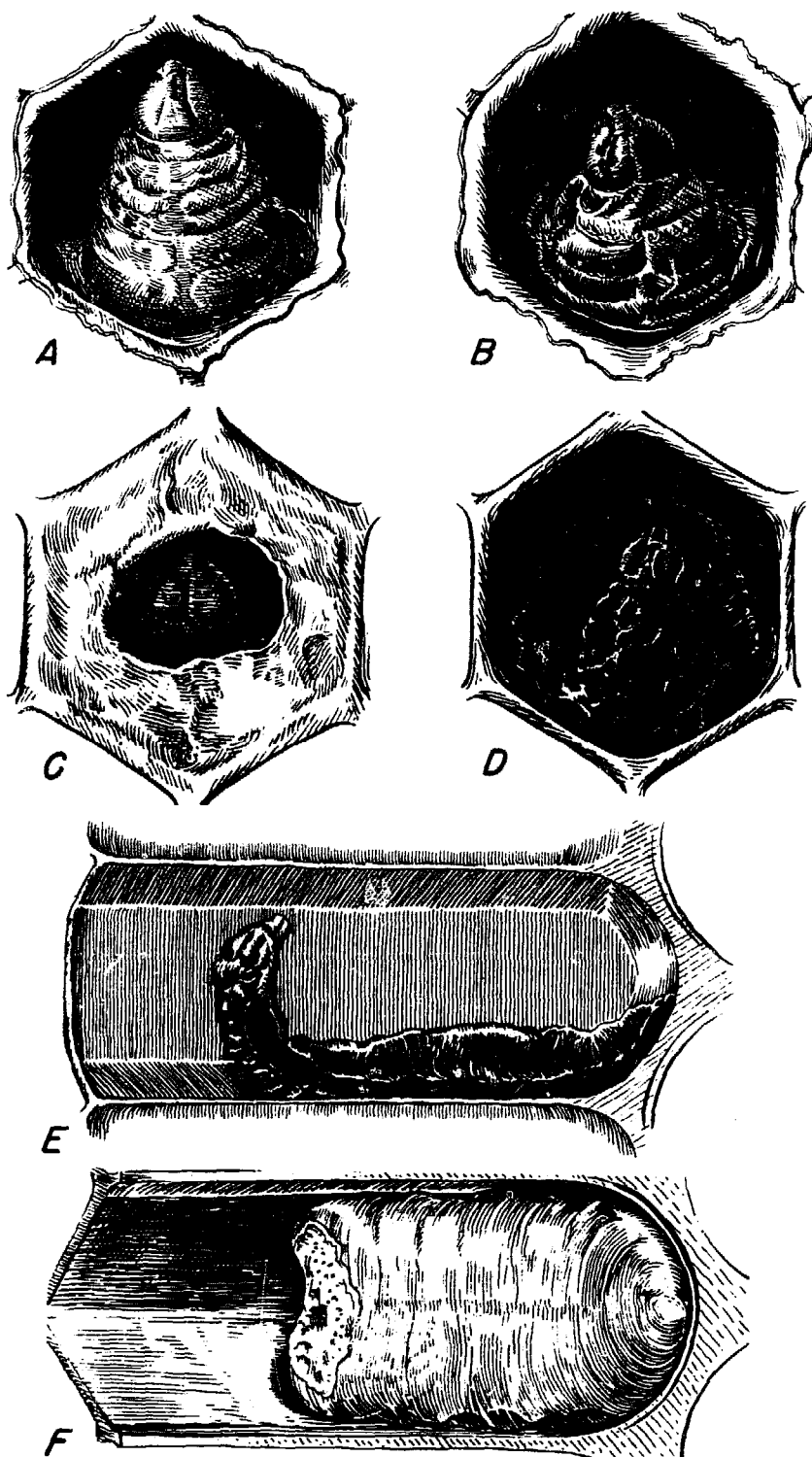

Honeybee larvae killed by American foulbrood, as seen in cells: A, Healthy larvae at age when most of brood dies of American foulbrood; B-F, dead larvae in progressive stages of decomposition (remains shown in F is scale); G, longitudinal view of scale. — From USCA Handbook #335.

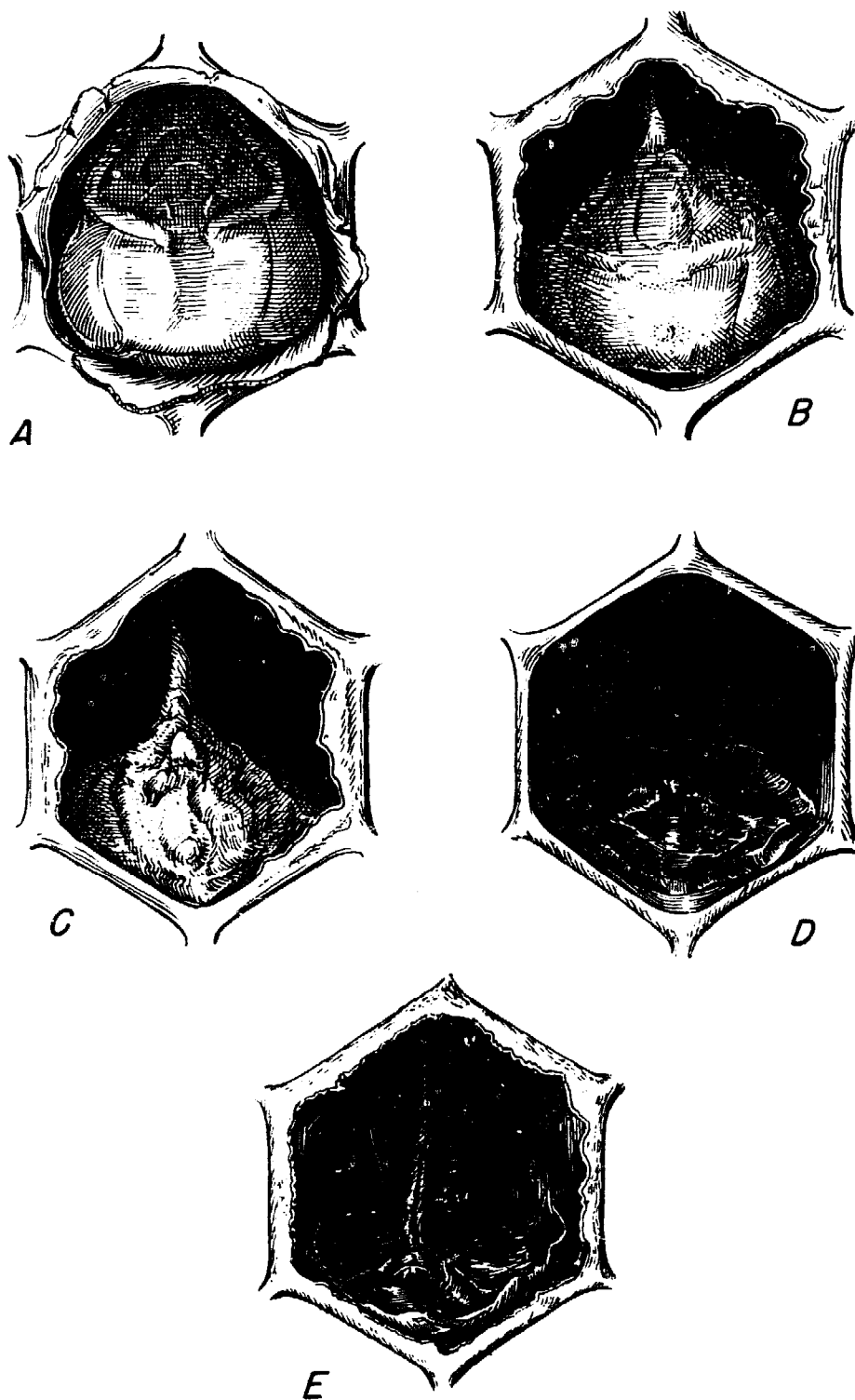

Honeybee pupae killed by American foulbrood, as seen in cells: A-C, Heads of pupae in progressive stages of melting down and decay; D-E, scales formed from drying of dead pupae. In B-C and E, tongue is shown adhering to roof of cell. — From USDA Handbook #335.

the cells. Occasionally death occurs after the pupa has formed but before the body has become pigmented. Soon after death the glistening white of healthy larvae and pupae changes to dull white. About two weeks after death they become light brown and their well rounded appearance is lost. The dead brood gradually sink in the cells during decay and become darker changing from a light coffee brown to a darker chocolate brown by the end of the fourth week. The dead brood eventually form dried scales which are often difficult to distinguish in old brood comb because they are about the same color. They are readily distinguished in new comb.

During the early stages of decay the

body wall of the larvae is easily ruptured and the tissues are soft and watery. Sometimes the body divisions of the dead larvae are more clearly marked than those in healthy larvae. The consistency of the dead brood becomes characteristically glue-like about three weeks after death. If a matchstick is thrust into a decayed larva at this stage and withdrawn the decaying mass will adhere to the matchstick and can be drawn out for an inch or more in a glue-like thread. This is very characteristic of American foulbrood disease. The scales that are formed from the decayed larvae lie extended along the lower side wall of the cells with their posterior end curved in the bottom of

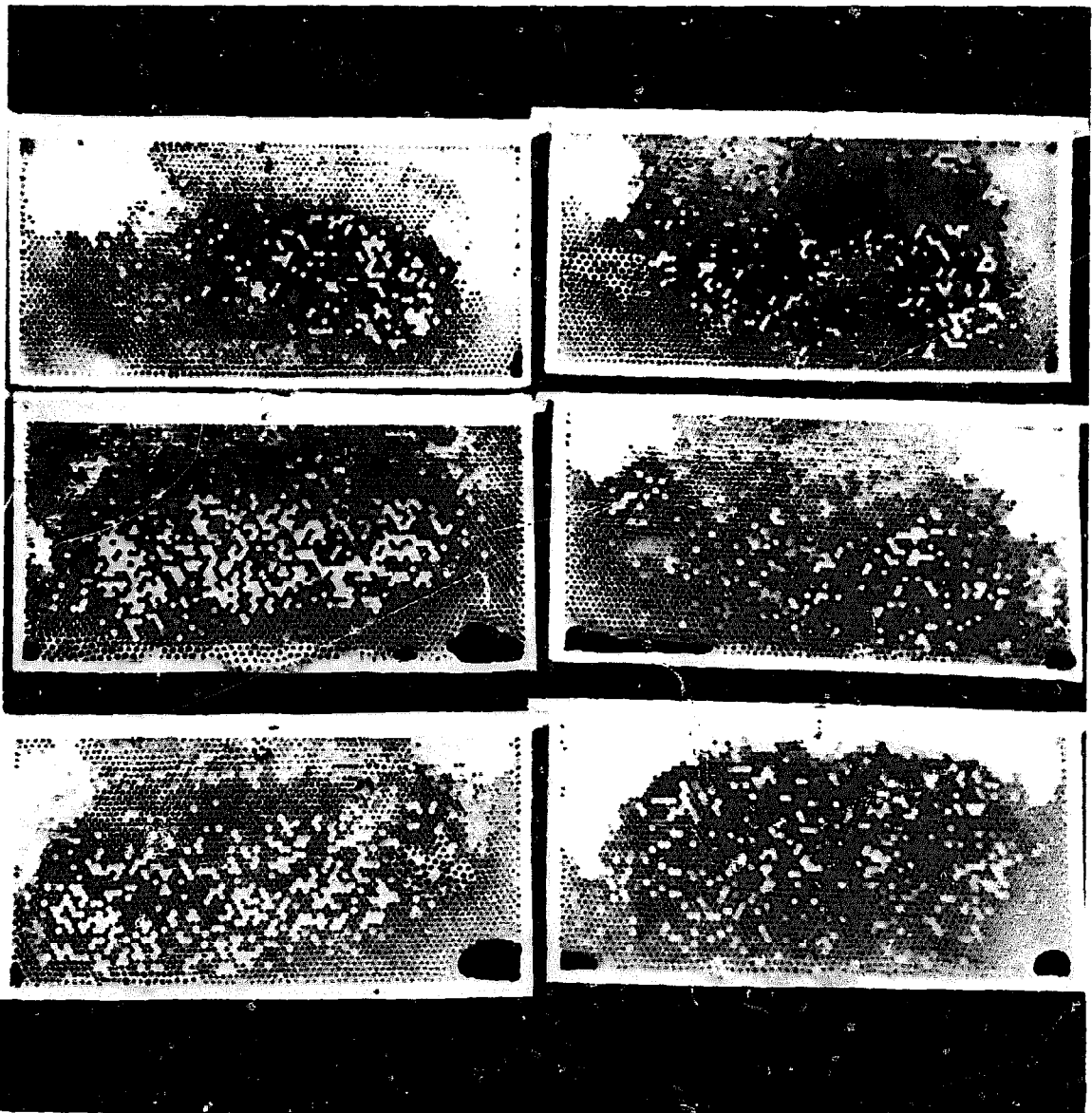

Combs showing the irregular, scattered cells with the perforated and sunken cappings of American foulbrood.

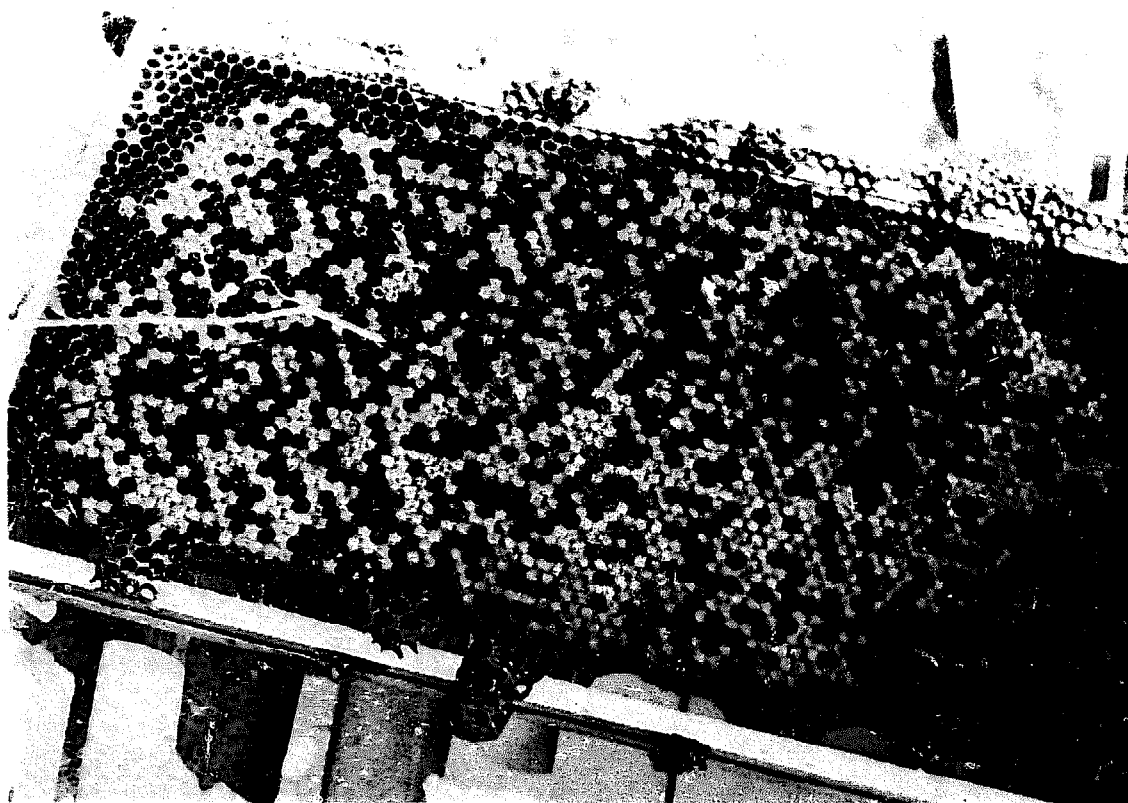

By probing with a straw or stick into a diseased cell the dead larva can be stretched out into a short thread of ropy material.

the cells. A small raised bump sometimes occurs near the head of the scale. In advanced cases of American foulbrood rows of cells may be found containing scales in this position. When completely dried the scales adhere so tightly to the cell walls that it is difficult to remove them without breaking them. When death occurs after pupation has begun the form of the pupa can be recognized in the scale. In fact, the mouth parts of the dead pupa may protrude from the head of the scale as a fine thread slanting slightly backward into the cell and sometimes adhering to the upper wall of the cell.

The odor of the decaying brood is also very characteristic of American foulbrood. In the first stages of decay while the remains are still white there is practically no odor. When the remains begin to turn brown and become ropy an odor develops which is still not the typical characteristic odor of the advanced stages of this disease. When the dead brood becomes definitely brown and decidedly ropy the familiar

characteristic odor of American foulbrood becomes apparent and is always present. In advanced cases when large amounts of decaying brood is present this odor may be detected a foot or more from the combs. One of the best methods of sampling the odor is to hold some of the decayed remains on a matchstick near your nose and breathe deeply.

The above described symptoms are visually shown in Figs. 1 and 2. A comparison of the symptoms of American foulbrood, European foulbrood, Sacbrood and Chalkbrood is made in Fig. 5.

#### **Treatment and Control of American Foulbrood**

For details on this subject please see **DISEASES OF BEES**, Methods of Prevention and Treatment.

#### **European Foulbrood**

Early studies of European foulbrood seemed to indicate that this disease was caused by a rod-shaped bacterium call-



ed *Bacillus alevi*, which is almost always found in the infected brood. Later work by G. F. White, then of the USDA Bureau of Entomology, demonstrated that the most likely cause of European foulbrood was a lancet-shaped organism *Streptococcus pluton*. His work has been accepted and this organism is now considered the causative agent of the disease. Dr. White also established at the same time the fact that *Bacillus larvae* was the causative organism of American foulbrood. He also bears the responsibility for naming the two foulbroods, American and European. These two names bear no relationship to occurrence in the two geographical areas, but rather to their first discovery in those areas. European foulbrood is most commonly found in the spring when brood rearing is at its height, although the earliest reared brood is often not affected. A good honey flow will sometimes hasten recovery. In severe cases colonies are seriously weakened or killed outright. Usually the worker bees are able to remove the dead brood promptly, but it is sometimes allowed to accumulate in weak colonies. In early stages of European foulbrood and occasionally in mild cases the arrangement of the brood in the combs is not irregular. In advanced cases open cells will be scattered among cells of capped brood. Cells with discolored, sunken or punctured cappings may be present, but these are less common than in American foulbrood. Sick larvae lose the plumpness and glistening white of healthy larvae and become dull white. A faint yellow, which is a helpful symptom, may also appear just after death. Sick larvae show restless abnormal movements and occupy unnatural positions in the cells. Most larvae will die while coiled on the bottom of the cells. Many will also die at the age when they would normally be spinning their cocoons. Very few larvae die while fully extended. Larvae dead of European foulbrood, therefore, may be irregularly twisted or fully extended, but are usually found fully coiled on the bottom of the cells. Soon after death larvae become dull and grayish or yellowish white and during decay the color will deepen and become brown or almost black. The tracheae or breath-

ing tubes usually show more clearly in dead larvae than in healthy ones. They appear as radiating white lines in the dead coiled larvae and as narrow white lines across larvae that die while extended. A white line that crosses the radiating white lines can frequently be seen on the side of dead larvae. An elongated, dull grayish or yellowish mass can be seen through the skin along the back of sick and recently dead larvae. This mass is within the gut and consists of a turbid fluid that contains many bacteria. In healthy larvae, on the other hand, pollen in the gut can often be seen through the skin along the back. This pollen is usually a brighter and deeper yellow than that seen in infected larvae. During decay the appearance of the dead larvae gradually changes as the gray and yellow deepen. Larvae that die before the cells are sealed dry rapidly and decay is soon stopped resulting in scales that are light colored. Larvae that die after the cells are sealed result in scales that are dark brown or nearly black. For a short time after death larvae can be removed from the cells without tearing the skin. However, within a few days the skin and tissues become soft. The larvae settle against the lower wall of the cells and appear moist, melting and flattened. At this stage of decay they are translucent and watery and cannot be removed whole. When they dry they become pasty and then rubbery. European foulbrood scales do not cling tightly to the cell walls and are easily removed. Occasionally larvae that die of European foulbrood may become ropy and resemble somewhat larvae dead of American foulbrood. The worker bees remove dead brood from the open cells first. Therefore, sometimes the only dead brood found will be in sealed cells. This is particularly true after the disease has ceased to be active. In these cases it is more difficult to distinguish whether American or European foulbrood are present or both. It is difficult to describe the odors of European foulbrood. A characteristic odor is most often detected when there are many decaying larvae in the combs. The odor of recently dead larvae is slight. A sour odor is sometimes present in partially decayed larvae. Some

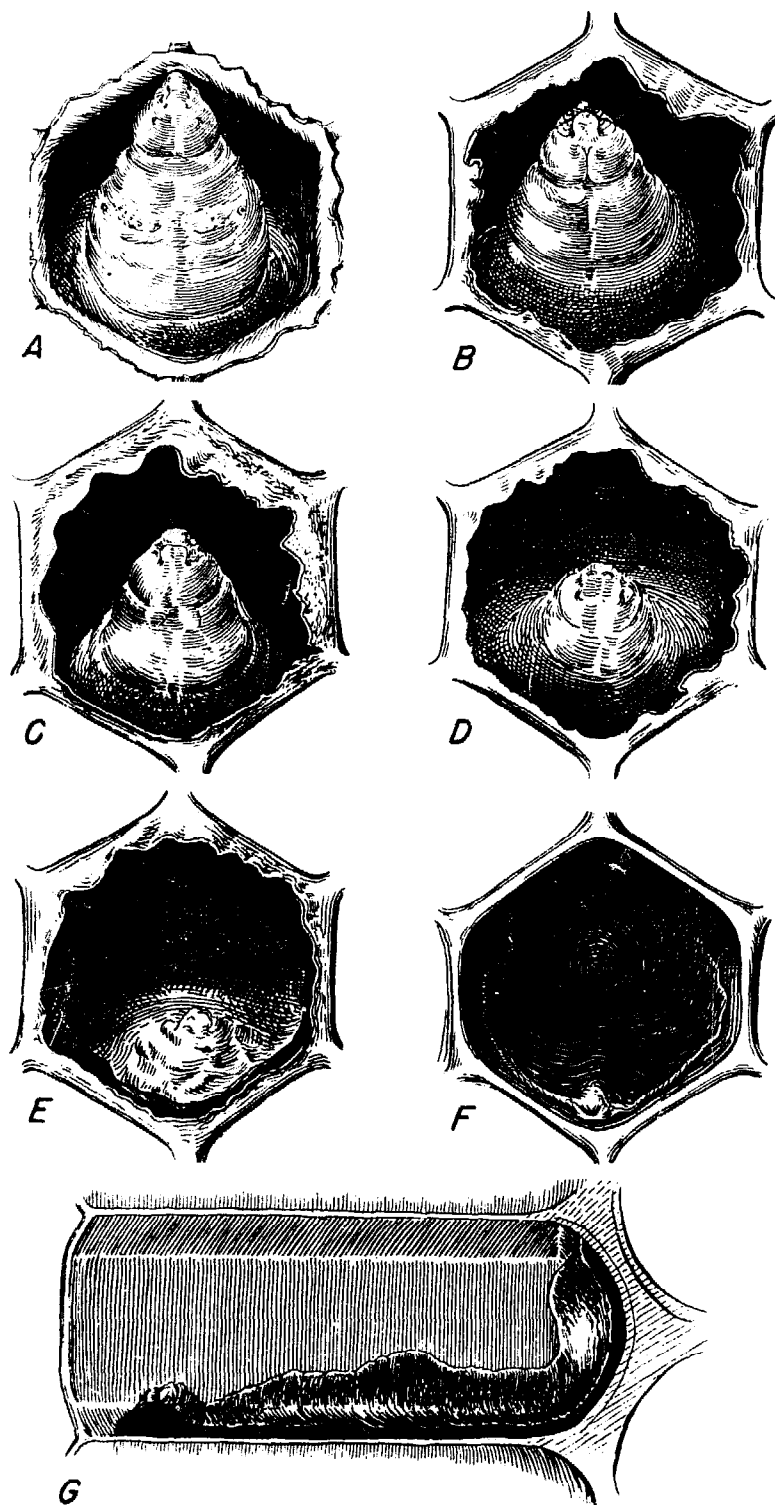

Honeybee larvae killed by European foulbrood, as seen in cells: A, healthy larva at earliest age when brood dies of European foulbrood; B, scale formed by dried-down larva; C one of several positions of sick larvae prior to death; D-E, longitudinal views of scales from larvae prior to death. — From USDA Handbook #335.

larvae, particularly those that die after they have straightened out and the cells are sealed develop a putrid odor resembling that of decayed meat. The above described symptoms are visually shown in Fig. 3. A comparison of the symptoms of American and European

foulbrood and also Sacbrood and Chalkbrood is made in Fig. 5.

#### **Treatment and Control of European Foulbrood**

For details on this subject please see **DISEASES OF BEES**, Methods of Prevention and Treatment.

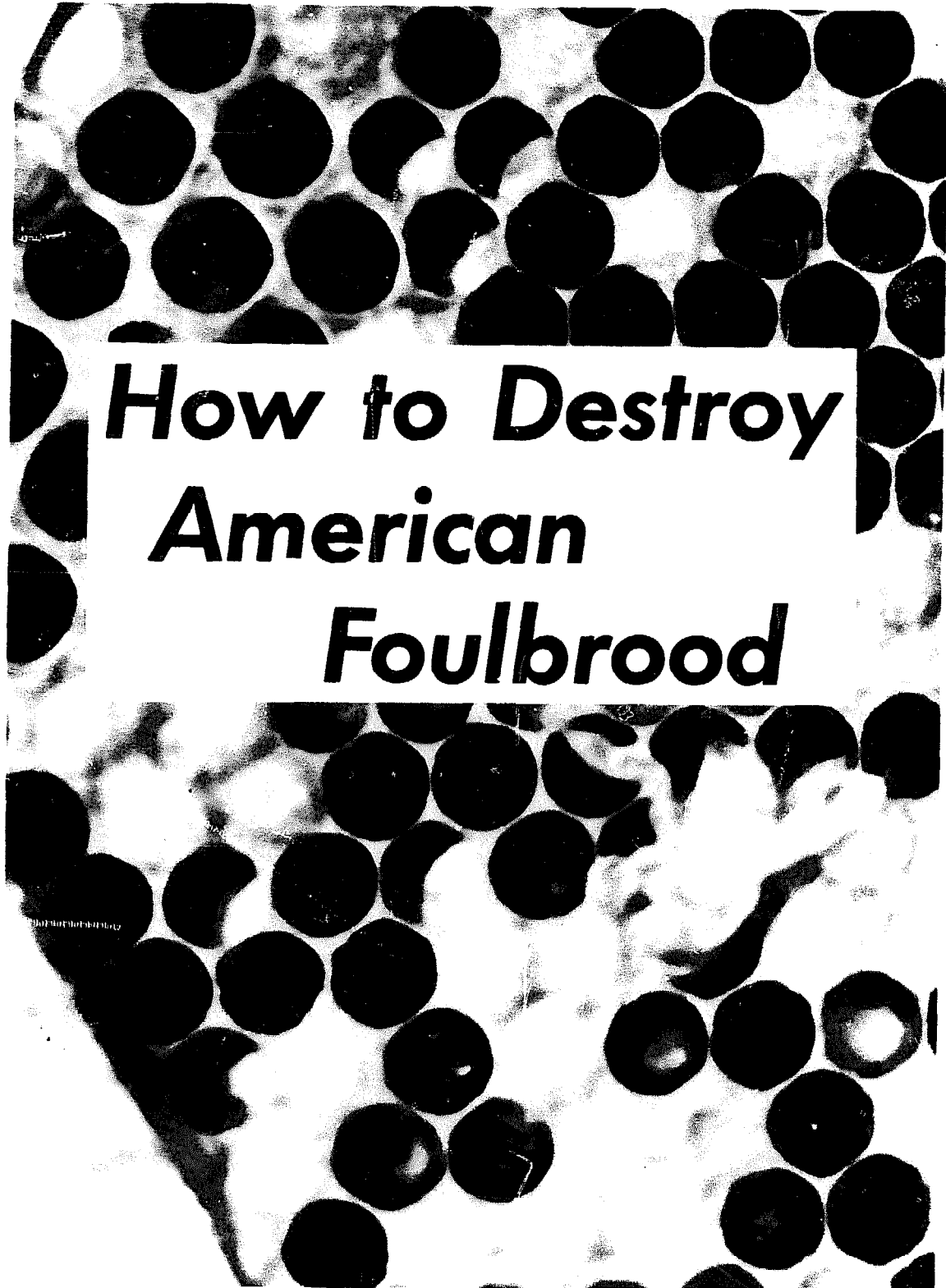



**The first step in the burning treatment of AFB is killing the diseased colony. The killing agent must be quick and lethal to the bees to be effective. All bees belonging to the diseased colony should be destroyed.**

**Most of the dead bees will fall to the bottom board from which they should be collected and placed in the hole in which the combs are burned.**

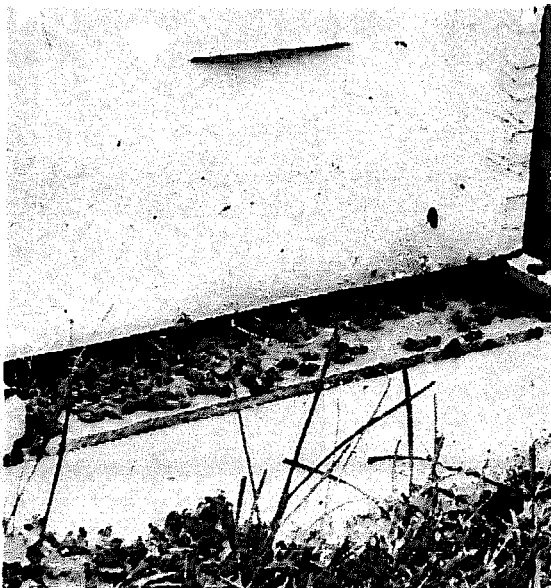



**A hole is dug, a fire built in it. The combs and bees from the diseased hive are piled on top.**



**The remaining ashes are buried.**



Frame spacers or frame rests that may harbor disease spores are removed.



The inside is doused with gasoline.



Hive bodies and supers are stacked. Crumpled paper is dropped in.



The inside of the stack is fired.

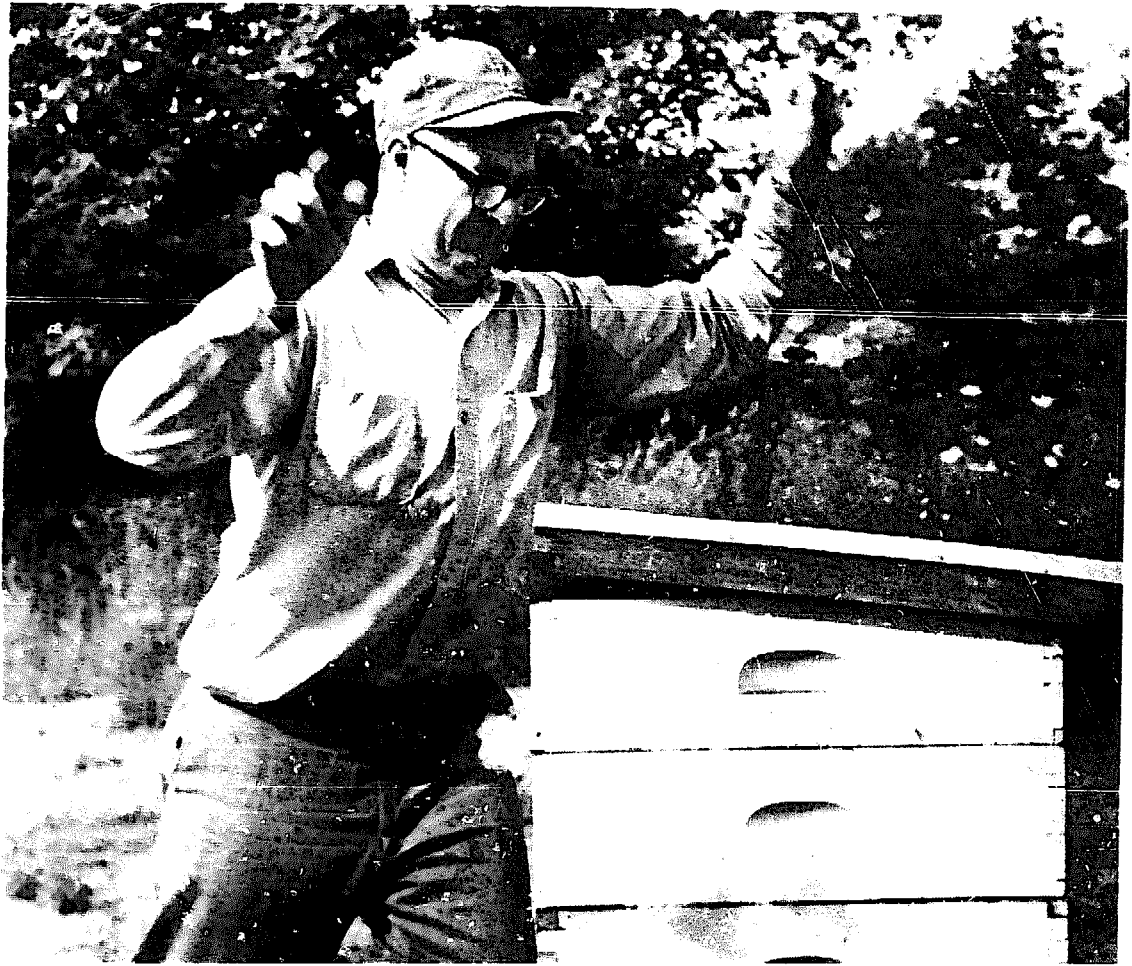

**Covering the stack smothers the fire.**



**Flipping off the cover.**

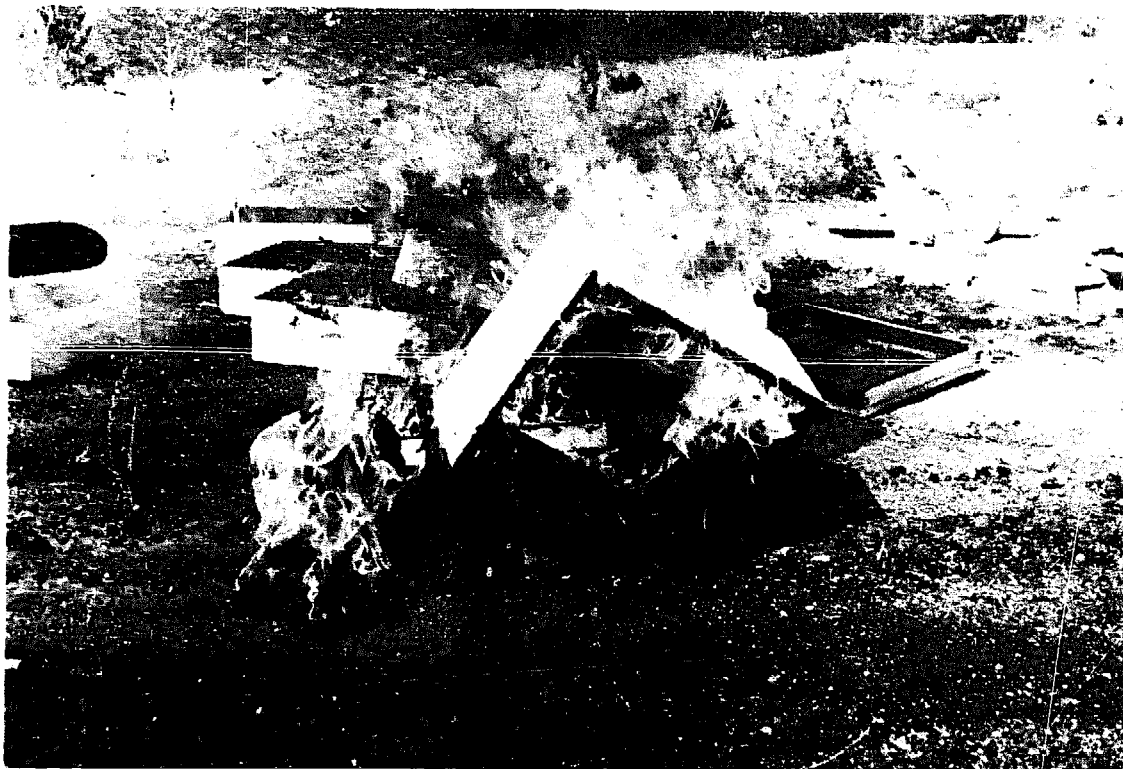

**Hive bodies are reusable after firing.**

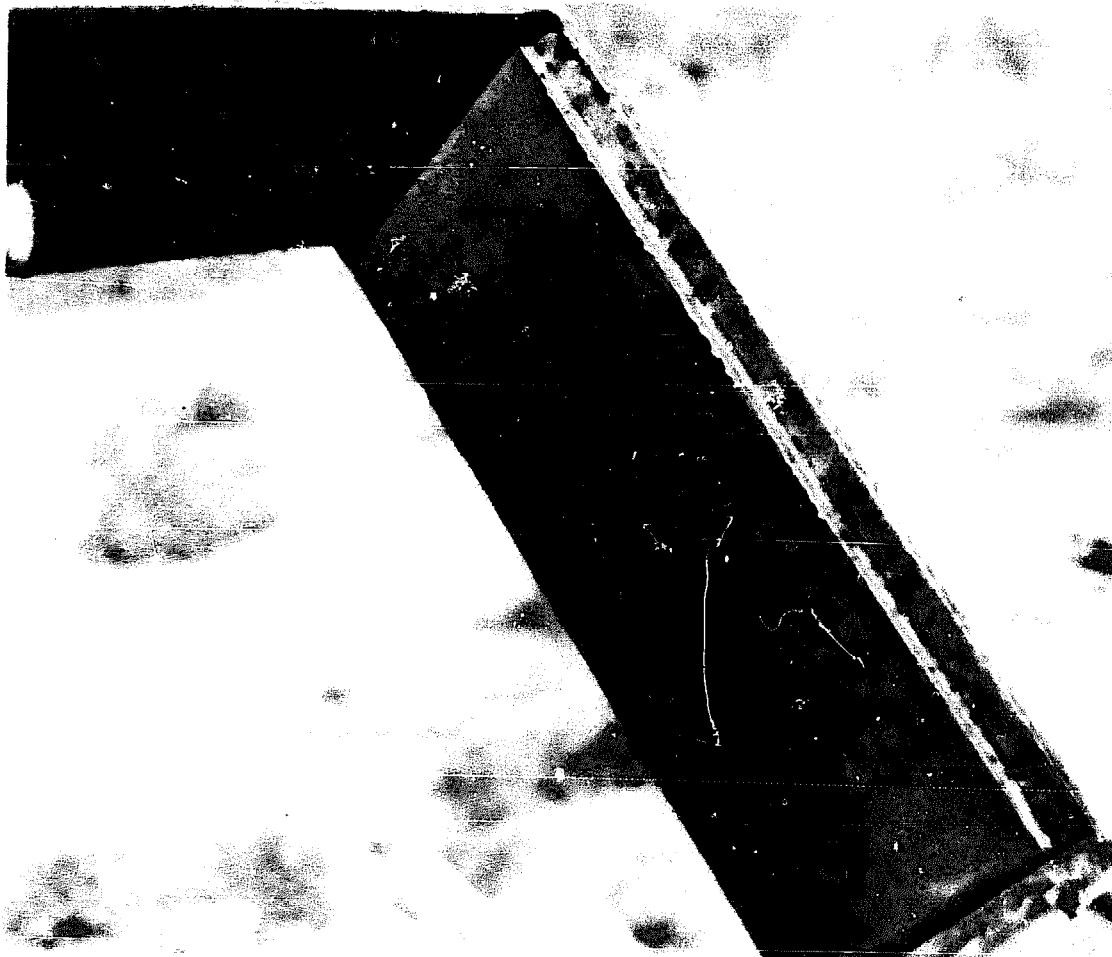

**A sterilized super.**



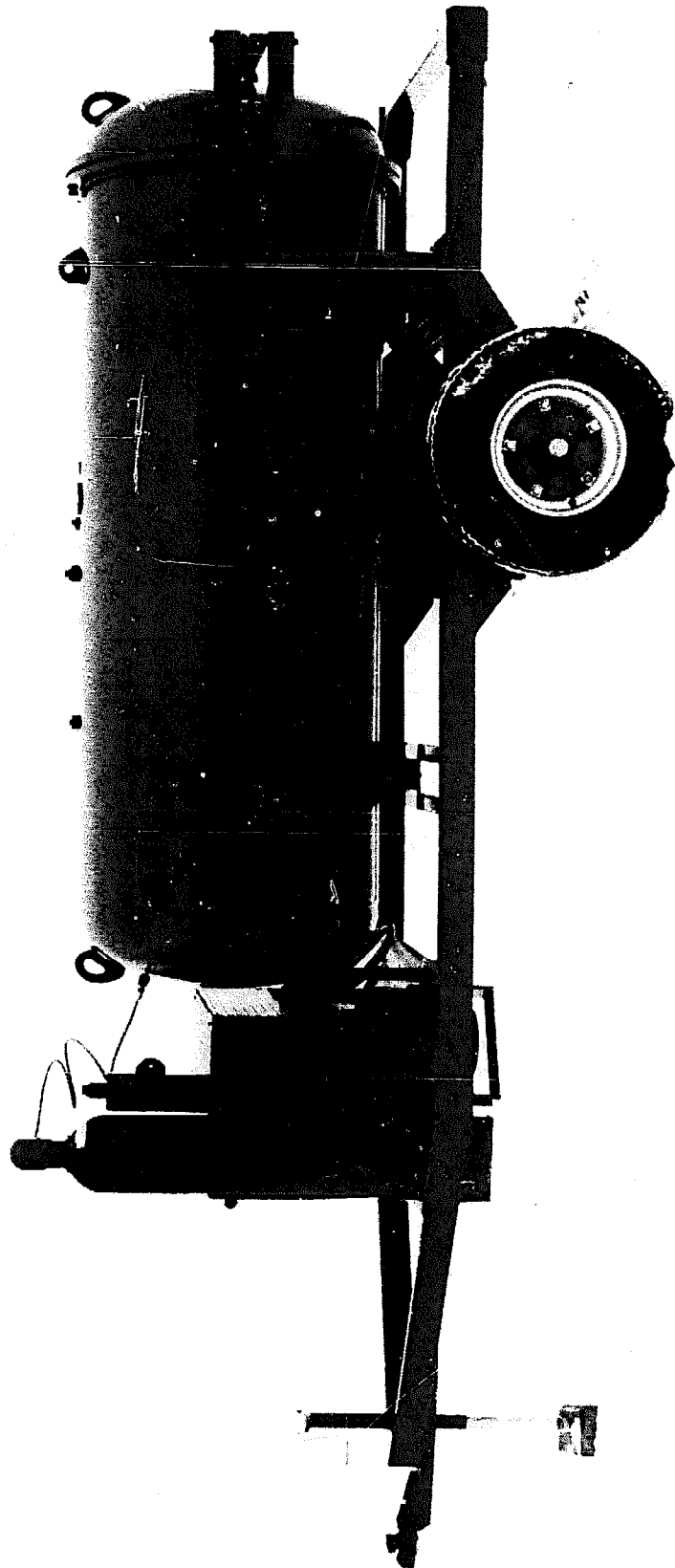

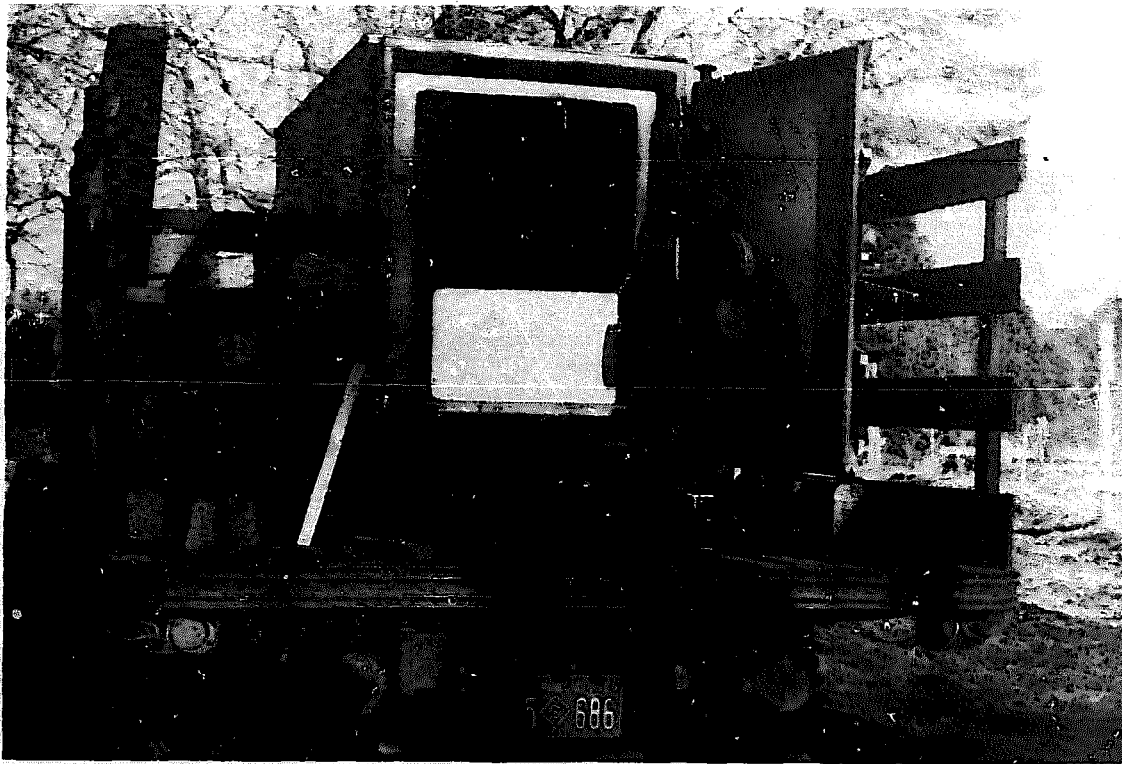

Loading door of the Virginia fumigator shown above. A hive body is shown on the conveyor belt. The door has a safety diaphragm and cannot be opened with pressure in the chamber.

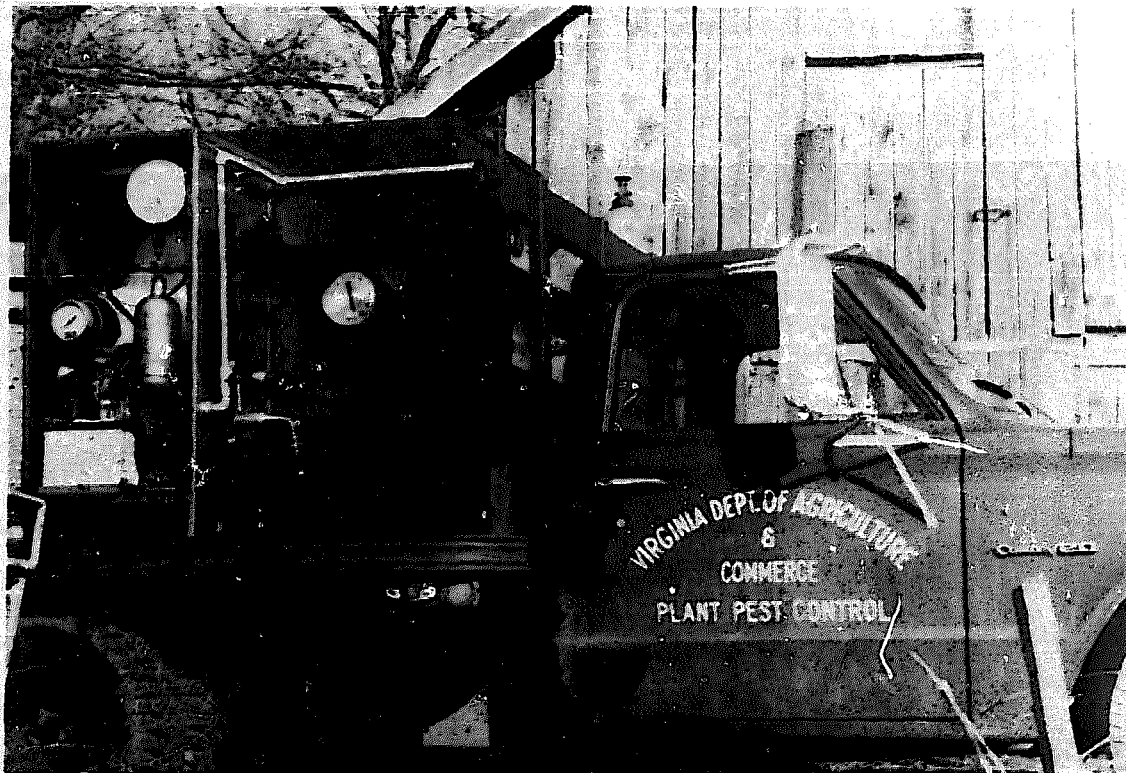

Truck-mounted fumigator used in Virginia. Control box showing gauges which indicate temperature and pressure, the measuring flask on hanging scale and the battery which powers vacuum pump. Note white frost on piping, past vaporizing valve.

## FOULBROOD



Charles Mraz, queen breeder of Middlebury, Vermont, an advocate of breeding resistance to European foulbrood offers as evidence these photographs showing an infected comb (above) and healthy brood (below) after requeening with resistant stock.



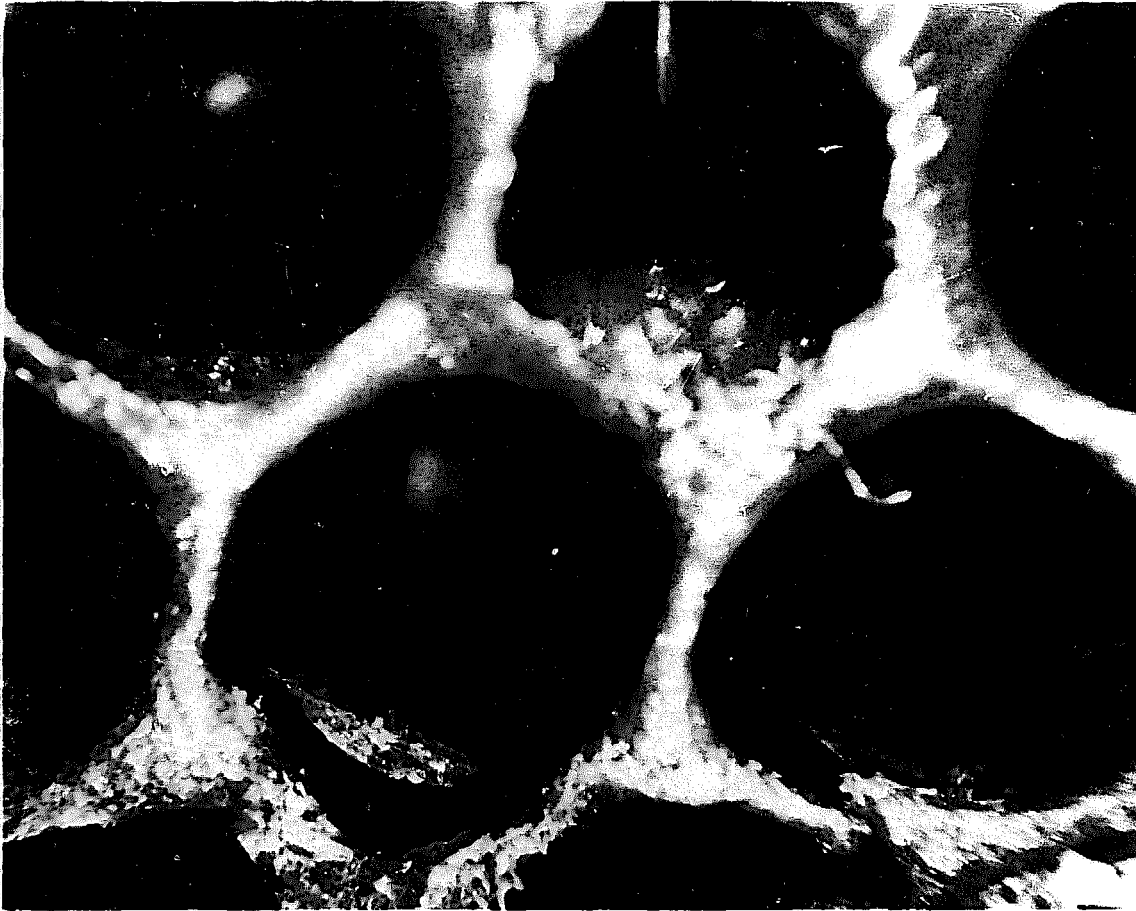

Close up of cells infected with AFB.

### Parafoulbrood

This disease was first recognized by Burnside in 1933 and appeared to be found only in limited sections of North Carolina, South Carolina, Georgia and Florida. He determined its cause to be the bacterium, *Bacillus para-alvei*. Its symptoms were very similar to those of European foulbrood except the cappings over the dead brood were punctured, discolored, sunken, or thickened and sharply depressed in the center. Also the remains tended to be ropy. Very little research has been done with this disease since Burnside's work and indeed today some doubt exists that it is a separate disease.

### Acarine Disease

Acarine disease of bees is caused by a microscopic mite, *Acarapis woodi*. This mite lives as a parasite in the anterior thoracic tracheae or breathing organs of the bee, where it feeds on the tissues. The mites enter the tracheae

at their spiracles or openings. The mites mate within the tracheae. Later some of the females crawl out and enter the tracheae of other bees, thereby spreading the infestation. The walls of the tracheae and other adjoining tissues of infested bees are injured. Bees that contain large numbers of mites are unable to fly and are known as crawlers. Crawlers usually leave the hive and die outside. When large numbers of infested bees crawl from the hive at the same time the condition is known as mass crawling. Bees will continue to work in a normal manner for weeks after they are infested by mites so that the disease may be well advanced in a colony before the symptoms of the disease are noticeable. The gross symptoms most commonly recognized are crawling and inability to fly. Of course these symptoms are also associated with other diseases and conditions so that acarine disease can only be adequately diagnosed by a microscopic examina-

Figure 5. - A COMPARISON OF SYMPTOMS OF VARIOUS BROOD DISEASES OF HONEY BEES

Symptom	American foulbrood	European foulbrood	Sacbrood	Chalk brood
Appearance of brood comb	Sealed brood. Discolored, sunken, or punctured cappings.	Unsealed brood. Some sealed brood in advanced cases with discolored, sunken, or punctured cappings.	Sealed brood. Scattered cells with punctured cappings, often with two holes.	Sealed and unsealed brood. Affected larvae usually on outer fringes.
Age of dead brood.	Usually older sealed larvae or young pupae. Upright in cells.	Usually young unsealed larvae; occasionally older sealed larvae. Typically in coiled stage.	Usually older sealed larvae; occasionally young unsealed larvae. Upright in cells.	Usually older larvae. Upright in cells.
Color of dead brood.	Dull white, becoming light brown, coffee brown to dark brown, or almost black.	Dull white, becoming yellowish white to brown, dark brown, or almost black.	Grayish or straw-colored becoming brown, grayish black, or black; head end darker.	Chalk white. Some times mottled with black spots.
Consistency of dead brood.	Soft, becoming sticky to ropy.	Watery; rarely sticky or ropy. Granular.	Watery and granular; tough skin forms a sac.	Watery.
Odor of dead brood.	Slight to pronounced glue odor to glue-pot odor.	Slightly to penetratingly sour.	None to slightly sour.	Slight, non-objectionable.
Scale characteristics.	Uniformly lies flat on lower side of cell. Adheres tightly to cell wall. Fine, threadlike tongue of dead pupae may be present. Head lies flat. Black in color.	Usually twisted in cell. Does not adhere tightly to cell wall. Rubbery. Black in color.	Head prominently curled towards center of cell. Does not adhere tightly to cell wall. Rough texture. Brittle. Black in color.	Does not adhere to cell wall. Brittle. Chalky white in color.

From United States Department of Agriculture Handbook for the diagnosis of Honeybee Diseases, Parasites and Pests.

tion. This is done by examining the tracheae for bronzed or blackened irregular spots. There may be a few spots or so many that the tracheae will appear black. Of course, the mites can also be seen within the tracheae by microscopic examination.

Mass crawling often follows a period of unfavorable weather when the bees have been confined to their hives. Crawling bees will often show retention of feces, swollen abdomens and disjointed wings. After mass crawling occurs the colony will have lost most of the diseased bees and appear to recovery. This, however, is a temporary condition. The disease will recur.

Acarine disease is transmitted from diseased to healthy colonies by the drifting of infested workers or drones or by robber bees. It also may be transmitted by requeening a colony with an infested queen.

Acarine disease has not been found in North America, but is present in Europe, Asia and South America. On August 31, 1922, Congress passed a law, popularly known as the "Honey-bee Act", restricting the importation of living adult honeybees into the United States. The sole purpose of that law was to attempt to keep United States bees free of acarine disease. A 1976 amendment to this law also now is aimed at prohibiting the introduction of genetically undesirable germplasm of honeybees, including but not limited to *Apis mellifera adansonii*. For further details about this law please see Laws and Regulations.

### Sacbrood

Sacbrood is caused by a virus. Both worker and drone brood may be affected. Pupae may be killed occasionally, but adult bees are not affected. Sacbrood is a widely distributed disease, but usually does not cause serious losses. It may appear at any time during the brood rearing season. However, it is most common during the first half of the season and practically always dies out after the main honey flow has started. Usually the colonies are not noticeably weakened by sacbrood, although in some cases 50 percent or more of the brood may be affected.

Colonies that have sacbrood have

brood that is somewhat irregular. Here and there among the healthy brood will be cells containing dead brood. The cappings over the dead brood are first punctured and then removed by the bees. The holes in the cappings will vary in size and occasionally there will be more than one. Sometimes the size and shape of the hole will show that the cell has never been capped. Dead larvae lie fully extended on the floor of the cell with dark brown heads showing through the openings.

Death from sacbrood almost always occurs after the cell is capped and the larvae has spun its cocoon. At this stage they are fully extended, but in heavily infected colonies a few coiled larvae may be killed. Shortly after death the larvae change from white to yellow, then gradually become darker, beginning with the head and front third of the body and soon change to brown and dark brown. Scales will be almost black for the entire length, with the head end usually darker.

There is little, if any, distinctive odor associated with sacbrood, although some of the saclike larvae in the later stages do have a slightly sour odor. The skins of the dead larvae are tough and the larvae can be removed easily from the cells in an intact condition. However, the internal tissues become watery. Suspended in this watery liquid are numerous fine brown granules. When the dead larva is removed from the cell it resembles a sac. Therefore the name "sacbrood".

As the larvae die the skin becomes wrinkled, particularly on the front third of the body.

Although larvae killed by sacbrood lie extended on their backs on the floor of the cell, in contrast with American foulbrood, the head and front third of the body are elevated. This is a distinctive symptom of sacbrood. However, adult bees often remove recently dead larvae by biting off bits at a time so that occasional cells will be found in which only part of the dead larva will remain.

Scales of sacbrood killed larvae can be easily removed from their cells. They are brown, black and brittle with the head end turned sharply upward. The back of the lower surface is smooth and polished, whereas the upper

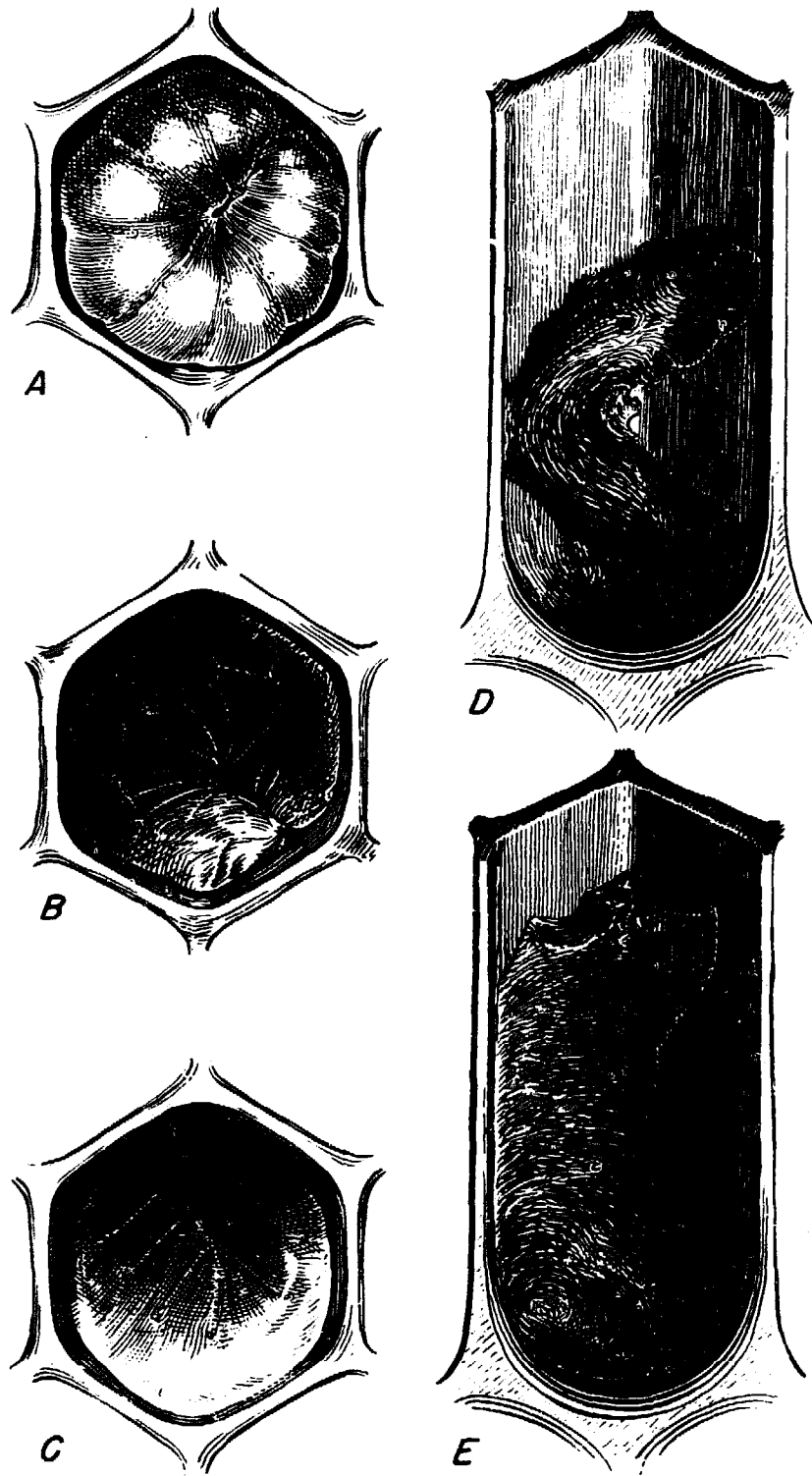

Honeybee larvae killed by sacbrood, as seen in cells: A-B, larvae in different stages of decomposition. C, erect head of dead larva showing through opening made by bees in capping; D-E, views of scale; note how head remains erect; F, remains of larva, head of which has been gnawed away by bees. — From USDA Handbook #335.

surface of the scale will be rough and concave. The entire scale takes on a boat-like appearance, often referred to as gondola shaped.

The symptoms of sacbrood are visually shown in Fig. 4.

#### Treatment and Control of Sacbrood

Sacbrood is generally considered a self-limiting disease, affecting weak colonies early in the spring and then disappearing as the colonies increase in strength. However, requeening colonies that show recurrence of this disease is recommended. No chemotherapeutic agent has been found to be effective against Sacbrood. Of course, general preventive control of bee diseases is described under DISEASES OF BEES, Preventive Control of Bee Diseases.

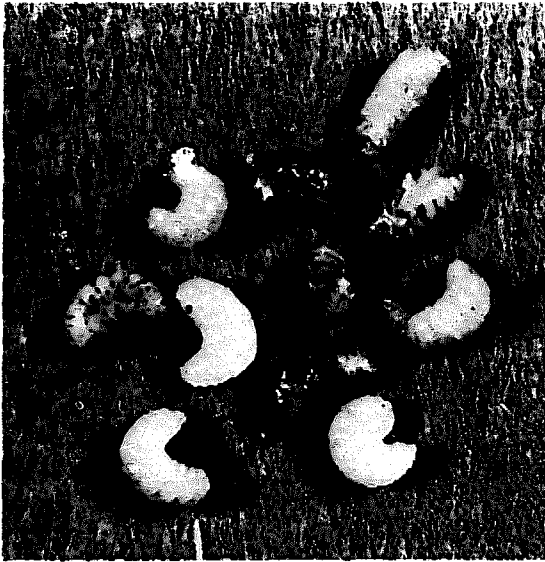

Larvae dead of neglect.

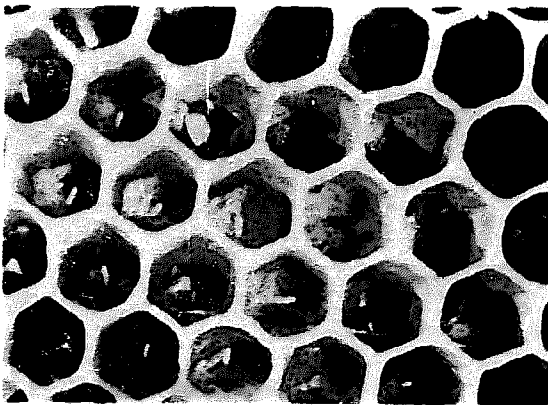

In severe poisoning cases the queen stops laying eggs after the chemical is applied.



Pollen contamination.

#### Starved or Neglected Brood

There is another form of dead brood that very greatly resembles sacbrood, and that is starved or neglected brood. Early in the spring when natural pollen is scarce and brood rearing is well under way, some of the brood will die for the lack of nitrogenous element in their food obtained from pollen. It is starved not from lack of honey but from a lack of proper bread-and-milk diet made up of pollen and honey. Considerable of this dead brood will be found in the early spring. The bees readily pick it out of the cells. As soon as natural pollen comes in, the trouble will disappear.

#### Poisoned Brood

Sometimes brood takes on suspicious symptoms and dies in early stages from poison present in nectar gathered from fruit blossoms sprayed when in full bloom. (See Pollination, subhead Pollination of Fruit Blossoms; also Poison by Dusting or Spraying.) At other times the brood is poisoned from dusting cotton in Texas and California. (See Gleanings in Bee Culture, pages 293 and 357 for 1937.) Brood as well as bees may die from the effects of the gases coming from great smelters in the vicinity.

In the case of the last two named, the obvious remedy is to remove the bees from the affected territory. In the case of spraying or dusting with arsenates or other poisons at the wrong time, the remedy is to edu-



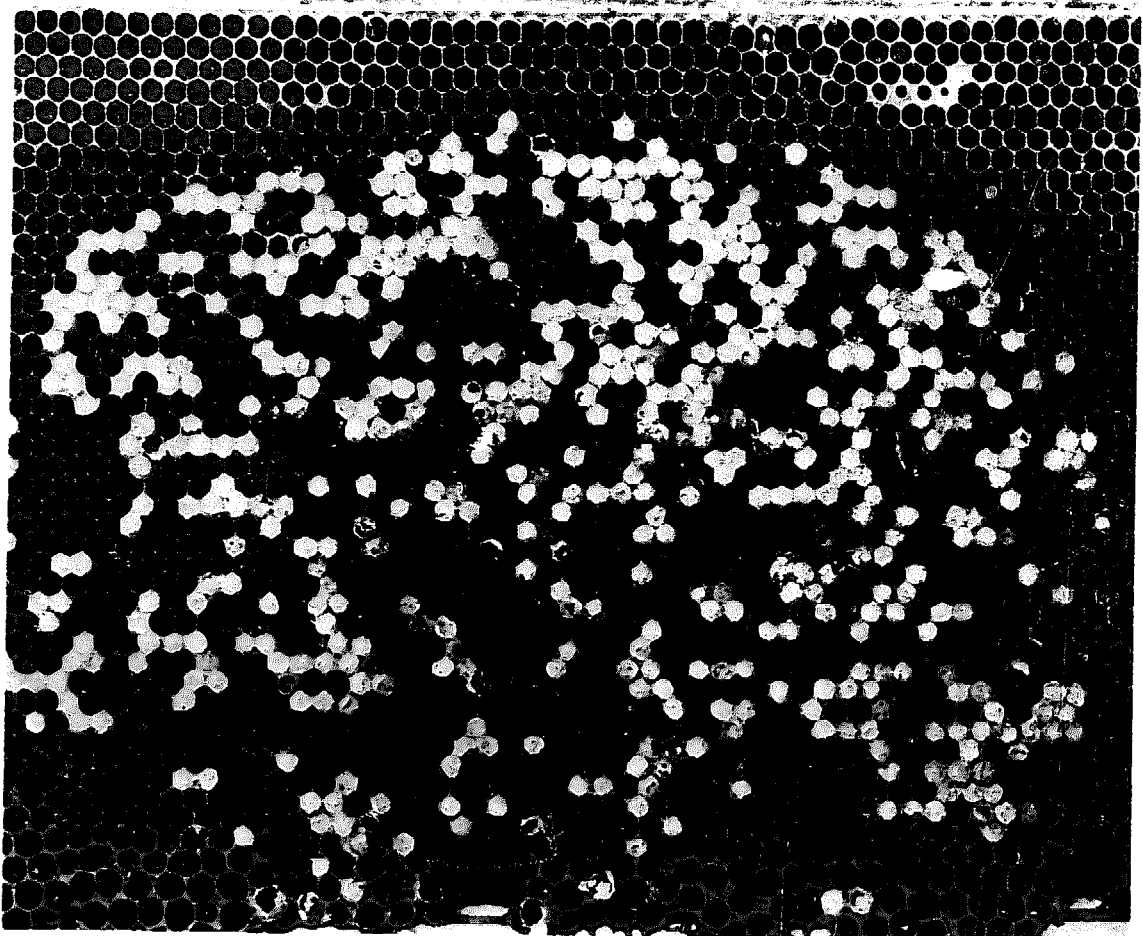

Laying workers deposit eggs haphazardly causing irregular patterns of drone brood. The drones may emerge but do not have a normal healthy appearance.

cate the orchardist as to the proper time for spraying as done by experiment stations. (See Pollination, sub-head Pollination of Fruit Blossoms.)

#### **Drone Brood from Drone-Laying Queens or Laying Workers**

Under Brood, reference is made to the fact that drone brood or laying worker brood will often be found dead in a stinking mass. The cells will be perforated and the odor will be very much like that from American foulbrood in the advanced stage. The fact that it does not rope rather suggests to the inexperienced that it may be European foulbrood. Many times beginner beekeepers write us, describing this trouble and asking whether it is foulbrood.

The remedy, of course, is to remove the drone-laying queen or to break up the laying-worker colony.

**FOUNDATION.**—See Comb Foundation.

**FRAMES.**—The frames make up a very important part of the inside furniture of the hive. As the name implies, they are made of four strips of wood fastened at the corners to hold the combs. They may be square or rectangular, and in the modern form are removable and separable and so designed that they may be held in a vertical position in the hive alone or in groups without special fastenings. While some frames stand on a bottom support, the great majority are suspended on projections at each upper corner.

Frames make possible modern manipulation by which every comb can be removed, inspected, transposed—in fact, the condition of the whole inside of the hive can be determin-

ed. The straw skep and box hive of olden days had no frames, nor does the same hive in use today in parts of Europe and southeastern United States. (See Box Hives.)

As shown under Hives, Evolution of, there were many crude ways of making combs movable—some better than others. Perhaps the crudest of all was to cut them out and put them back again. Later on, combs were built from single bars. This necessitated cutting the combs from the sides and bottom of the hive to effect a removal. To these bars were later attached other bars, making up a complete frame. But such frames were almost immovable. While they could be taken out of the hive, it required a great amount of patience and time, to say nothing about killing bees.

It remained for the Rev. L. L. Langstroth, then a Presbyterian minister, to discover a principle that would make every comb or frame removable. To construct a frame that will enclose a comb required no great act of invention, but to make a frame so it could be readily moved without crushing or irritating bees required the work of a genius, and that genius was Langstroth. (See Bee Space; also Langstroth, Life of.)

Langstroth's predecessors, as will be noted by a perusal of Hives, Evolution of, made their frames close-fitting like drawers in a bureau, and each frame came in contact with its neighbor. These early devices would have been all right had it not been for three things: the ever-present bee glue sticking fast everything with which it came in contact, the crushing of the bees whenever parts of the frames came together, and the shrinking and swelling of the parts, making the frame anything but movable. A few crushed bees, many of them squealing with pain, will infuriate a whole colony. It is no wonder that our forefathers resorted to the use of brimstone and refused to accept the so-called movable frames that were invented before Langstroth's. The so-called movable combs of Dzierzon made it necessary to cut every comb loose. The process necessarily caused a great deal of dripping honey. During a dearth of nectar this would cause robbing. (See Robbing.) When Langstroth, by his great invention

of the really movable frame, demonstrated that he could make every comb movable—that he could take the hive apart without killing a bee and without receiving a sting—he revolutionized the methods for handling bees. While bees will sting, it is now possible under favorable conditions and with proper use of smoke to open and examine a Langstroth hive without receiving a sting. (See Manipulation of Colonies; also see Stings.)

The various crude attempts to make combs movable are set forth under the head of Hives, Evolution of. The methods of adjusting modern Langstroth frames in modern Langstroth hives are described under Hives and Bee Space.

#### Size and Shape of Frames

There has been endless discussion as to the best size of frames. Some beemen prefer one that is square—approximately a foot wide and a foot deep. Others consider 12 inches too great a depth and prefer to have the extra comb area extend laterally. A great majority of modern beekeepers prefer a frame longer than deep, such as we find in the Langstroth dimensions. As the dimensions of the frame determine the size and shape of the hive itself, a further consideration of the subject will be found under Hives.

#### Thick-Top Frames

In the early 90's the thick-top frame was introduced to the public, but some years prior to that time J. B. Hall, then of Woodstock, Ontario, Canada, had been using frames with top bars 1 inch wide by  $\frac{7}{8}$  inch thick. Soon after he began using them he discovered that the tops of these frames were free from burr combs. Likewise there were no brace combs between the frames. He made his top bars thick, he said, not because of the burr or the brace comb nuisance, but because he had desired to prevent their sagging. Dr. C. C. Miller soon called the attention of the beekeeping world to Hall's discovery and in a very few years the thick-top frame came to be almost universal. After the top bars were made stronger and heavier, the end bars as well as the bottom bars were made thicker and wider. The natural result of all this was a stronger and more serviceable frame.

**Burr and Brace Combs Defined.**

Before proceeding further, precisely what is meant by burr combs and brace combs should be explained. The former refer to those pieces of comb that were built in the olden days lengthwise and crosswise of the top bars between the hive and the super or between the two sets of frames when the queen occupies both stories. Brace combs refer to the strips of comb built between the top bars. Burr combs were much more troublesome. While the thickness and width of the top bar are both important in the elimination of these troublesome combs, the width has more to do with their eradication than the thickness. A top bar  $1\frac{1}{2}$  inch wide by  $\frac{3}{8}$  inch thick will almost eliminate burr combs, provided the top bar does not sag. If the top bar sags, as will happen in the case of any top bar less than  $\frac{3}{8}$  inch thick and as long as the Langstroth, it increases the bee space to a point where bees will build burr combs. To prevent sagging, the top bar should not be less than  $\frac{1}{2}$  inch. As the  $\frac{3}{8}$  inch, or more exactly,  $\frac{3}{4}$  inch top bar can be made just as cheaply, it is more practicable to use

the combination of a thick and wide top bar  $1\frac{1}{2}$  inch wide by  $\frac{3}{4}$  inch thick.

Before the advent of the thick and wide bars it was necessary to use a broad-bladed putty knife or a common trowel to scrape the burr combs from the frames every year, and sometimes two or three times a year. During the height of a honey flow, these attachments had to be removed whenever a super or upper story had to be broken between the upper and lower stories—not an easy job, by the way. Each time there would be a lot of dripping honey all over the bees, combs, and clothing, to say nothing of the stings and of the hands being smeared with honey. All modern bee hive factories are now furnishing their trade thick and wide top bar frames.

After the thick top bar was introduced it was impracticable to use vertical wiring that had been used with the old  $\frac{3}{8}$  by  $\frac{3}{8}$  inch thin top bars. Horizontal wiring was then introduced. At the time thick top bars were introduced in the early 90's, comb honey was produced much more generally than within the last few years. It was a great advantage to get away from the burr and brace combs so troublesome between the brood nest proper and the super containing sections. It is not at all strange that when the beekeeper bought new equipment he would purchase that which would relieve him of this nuisance. In later years the tendency of the beekeeping world has been toward the production of extracted honey. This was particularly accentuated during the period of the First World War.

About that time came a general call for a frame that would have more brood to the comb. (See Comb Foundation, subhead Wiring to Prevent Sag.) As a good queen can more than fill an eight or ten frame Langstroth hive, it has become necessary to raise brood in the two stories. (See Food Chambers and also Building Up Colonies.) It has been discovered that the queen will go into the second story more readily where thin narrow top bars are used, but brace combs are built in between. Notwithstanding this is true, beekeepers prefer to avoid the nuisance of burr combs and therefore continue to use thick top frames.

Whether a frame should be made



This is a good example of how burr and brace combs will be built between the top bars and over the tops of them. As explained in the text, if the top bars are of the right width and thickness both can be eliminated. Incidentally, when acid is used to get bees out of supers these burr and brace combs carry the odor. (See page 178.)

reversible is discussed under the head of Reversing. Whether a frame should have the end bars come in contact the entire length or only part way, or whether they should stand rather than hang, is discussed in the next subject.

**FRAMES, SELF-SPACING.**— By these are meant frames held apart at certain uniform distances by some sort of spacing device, forming either a part of the frame itself or a part of the hive. Under Spacing of Frames, Bee Space, and Extracting, the distances that frames should be apart are discussed. Some prefer a spacing distance of  $1\frac{1}{2}$  inches from center to center, but the majority prefer  $1\frac{3}{8}$  inches.

Self-spacing frames may be defined as those which are spaced automatically either  $1\frac{3}{8}$  or  $1\frac{1}{2}$  inches from center to center when they are put into the hive. Loose or unspaced frames differ in that they have no spacing device connected with them and are spaced by eye when placed in the hive—or, as some have termed it, "by guesswork". Such spacing results in more or less uneven combs. Beginners, as a rule, make very poor work of it. The users of self-spacing frames get even, perfect combs with comparatively few burr combs and the combs are spaced accurately and equally. Self or automatic spaced frames are always ready for moving either to an out-ward, to and from a cellar, or for ordinary carrying around the apiary. Unspaced frames, on the contrary, while never spaced exactly, can seldom be hauled to an outapiary over rough roads without having some means of holding them in place.

Self-spacing frames can be handled more rapidly. (See Frames and Manipulation of Colonies.) On the other hand, a few who are using the unspaced frame urge as an objection that the self spacers kill the bees. This depends upon the operator, who may kill a good many bees if he is careless. If he uses a little care and patience, applying a whiff or two of smoke between the parts of the frames that come in contact, he will not kill any bees. The myth that self-spacing frames are hard to handle and crush bees is disproved by the fact that they are now in universal use throughout the country.

There are several styles of self-

spacing frames. Among the earliest of these were the closed-end Quinby. These, as their name indicates, are ones in which the end bars are wide their entire length. The top and bottom bars are one inch wide. When these closed uprights or ends come in direct contact they cause the combs which they contain to be spaced accurately from center to center. All of the closed-end frames are made to stand and have very often been called "standing frames". In order to keep such frames from toppling over, Mr. Quinby invented the strap-iron hook on one corner.

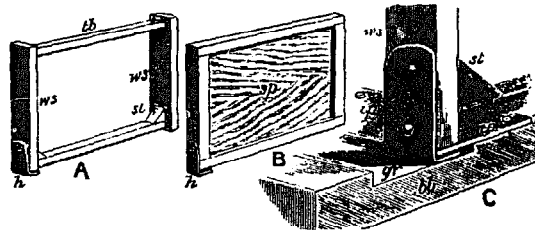

Quinby closed-end standing frame, showing bottom corner hook.—From Cheshire

The combined end bars make the end of the hive, and these hooks are therefore on the outside of the hive proper and hence do not kill bees, nor are they filled with propolis as they would be if made on the inside of the hive.

The ordinary closed-end frames come together laterally. The Quinby frames may be placed laterally up against each other, but the usual practice is to insert them from the end of the hive, sliding the end bars past each other. The movement being endwise will shove all bees aside that may be on the edge of either of the frames.

The Quinby frame is a considerable departure from the Langstroth principle because the Quinby hive and frames have no bee space back of the end bars. None is needed for the reason that the combined end bars make the end of the hive. The frame does have a bee space above the top bars and under the bottom bars. Without the top and bottom bee space, Captain J. E. Hetherington could never have handled 3000 colonies in the Quinby frame as he did in the 60's, 70's, and 80's in the Mohawk Valley in New York. Up to the time of his death P. H. Elwood used a large number of colonies in the same frame in Herkimer County, New York.

With a panel on each side, a cov-

er, and a bottom board, the Quinby-Hetherington hive is complete, the ends of the frames forming the ends of the hive, although for additional protection in the spring the users have an outside case to set down over the whole. With a bee space top and bottom the Quinby could not be tiered up for more than two or more stories without making a double bee space. It was designed for comb honey.

#### Danzenbaker Closed-End Frames

The Danzenbaker had a closed-end hanging frame, likewise reversible. (See Reversing.) The end bars were pivoted at the center, the pins resting on hanger cleats secured to the ends of the hives. These

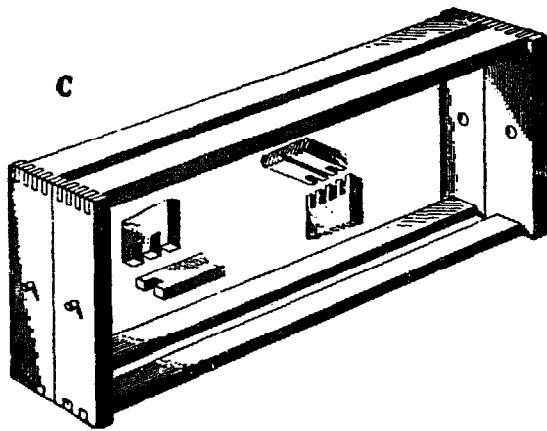

Danzenbaker closed-end frames

pins made a very small line of contact whereas the ordinary standing closed-end frame resting on tins secured to the bottom edge at the ends of the hive will crush some bees. The pins had the further advantage that if there is any reduction in the depth of the hive due to shrinkage, the bee space above and below the frames will be affected only half as much as if the frame were standing. These frames have practically gone out of use.

#### The Advent of Self-spacing Frames

Unspaced Langstroth frames were in general use during the 1890's. With no spacing devices on frames beekeepers were having a hard time getting combs drawn evenly. This made it impossible to interchange the frames in the hive. There would be combs too thick to fit together and likewise some would have brood on only one side, the cells on the

other side of the comb being too shallow.

R. O. B. Manley, in giving at least part of the credit to the inventive American beekeeper for the self spacing Hoffman frame, hastens to call our attention to an 1879 issue of the **British Bee Journal** which published drawings of frames that had the essential features of the modern Hoffman frame except for the beveled spacing surfaces.

A. I. Root related his experiences in America in an earlier **ABC and XYZ of Bee Culture**: "Knowing that some beekeepers in New York were using self-spacing frames with projecting end bars, in 1890 the author took a trip among the beekeepers of that state. I found, as expected, that all the combs in self-spacing frames were uniform in thickness and spaced exactly right. Contrary to what I had expected, far from being more trouble to handle, they were very much easier and took less time. The hives were always ready to move to and from outyards without fastening the frames.

Of the two self-spacing frames, Quinby and Hoffman, we preferred the latter because with a slight modification it could be used in Langstroth hives already in use.

What was more, the Hoffman frame was proof against bad or irregular spacing of frames. The frames could be handled in groups of twos and threes. After the first frame was removed all the rest could be shoved in a hive body or one by one.

When through, all frames could be shoved with one push exactly in place and the right distance apart.

As the result of many tests at our bee yards covering a period of several seasons, we recommended that beekeepers adopt the Hoffman. After some protests and objections the Hoffman frame slowly crept into use. At the present time it is in universal use throughout the country."

#### Other Frames

The evolution of frames saw many styles come into existence. Some were used only in a particular hive and when the hive style was discarded so was the frame style. The modified Dadant hive was an adaptation of the hive used by the famous beekeeper Moses Quinby.

The Quinby or jumbo frame was quite large,  $19\frac{1}{8} \times 11$ " which made it very hard to handle when filled with honey. The Quinby frames were adapted to the modified Dadant hive by reducing the length to  $17\frac{5}{8}$ ", the same as the Hoffman but with a depth of  $11\frac{1}{4}$ ". Eleven frames were used in each brood chamber.

Closed end extracting frames were used by R.O.B. Manley, an English beekeeper and have been copied by some American manufacturers. They were shallow depth with the American version fitted with self-spacing end bars of the closed end Manley type, standard Hoffman top bars and double bottom bars. When used nine to the super the Manley extracting frame resulted in combs that were excellent for extracting.



**OLD STYLE END SPACER**

This spacer would sometimes allow the frames to hop out of place when moving the hives to outyards. When the new style shown at bottom of page is used this is not likely to happen because the point of contact is greater on the hive rabbet.

**Hoffman Self-Spacing Frame**

We first tried out the original Hoffman frame with top bars as well as end bars widened at the end.

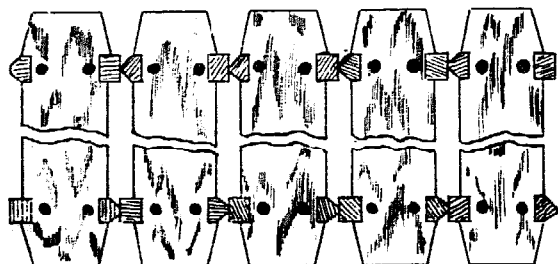

Drawing showing how the sharp edge of the end bar touches the square edge cutting the propolis accumulations.

In the diagram it will also be noticed that one side of the end bars at the top is a blunt V-edge and the other a square. The purpose of the V is to cut the bee glue so that the two end bars may come in close contact.

**Short Top Bars**

Some beekeepers prefer what are called short top bar Hoffman frames to the full-length frames which reach a close contact with the rabbeted-out portion of the ends of the hive. The ends of the top bars are

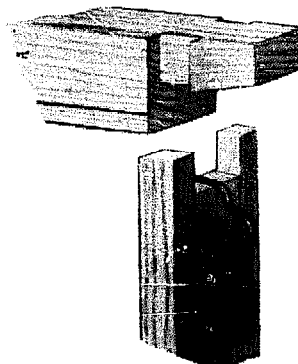

Improved Root-Hoffman end-spaced frame. Some apiarists prefer top bars just enough shorter to leave a bee space between the ends of the frames and the hive. The ends will thus be free of bee glue. End-spacing staples keep the frames from going too far endwise.

cut off so as to leave a bee space around them.

A difficulty experienced with the end-spacing hook shown below was that the frames would sometimes hop out of position and off the metal rabbet at one end when hauled over rough roads. To overcome this difficulty another form of end spacer was devised that interlocks into the

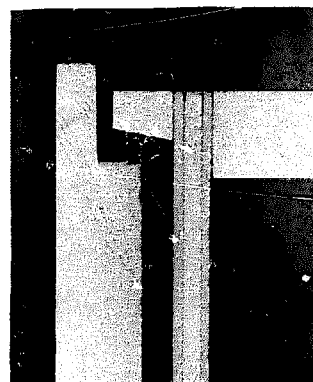

Cross section of short top bar

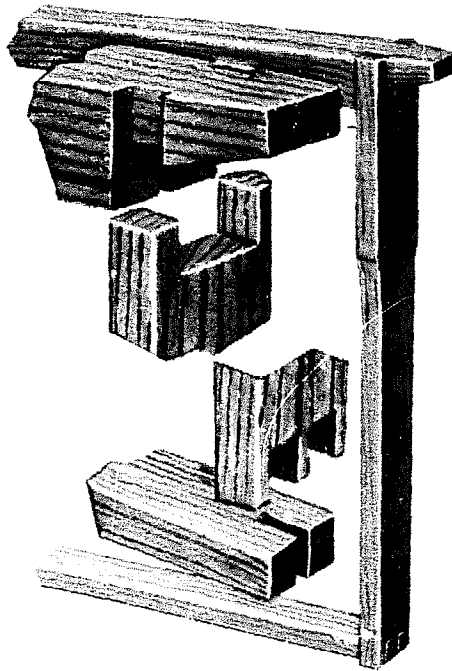

This method of interlocking of frame parts insures strength.

frame corner as shown above.

The top of this end spacer slides into a groove at the top of the end bar and the bottom hook drives into the wood lower down. This form of end spacer interlocks with the notched corner where it is put together and is much more rigid than either of the other of the forms shown. It will not hop out of position on rough roads nor can the end spacing be increased or decreased through pressure.

#### Lock-Cornered Hoffman Frames

In 1927 the Hoffman frames were still further improved by notching and tapering the projections of the top bars. When the fork of the end bar is inserted in the notches, both vertical and horizontal, the frame is very greatly stiffened. (See illustration above.)

When nailed with two nails through the top bar down into the end bars the frame can not get out of square without breaking away the notches, and that is hardly possible. The end bars at the bottom are double notched to receive the slot in the ends of the bottom bar as shown in illustrations on the previous page. If one wishes to have the foundation extend through the bottom he can do this very nicely by using two narrow bars.

The Hoffman is the most exten-

sively used self-spacing frame in all the United States, and there is even a possibility that it is used more generally than any other frame whether spaced or unspaced. All of the hive manufacturers supply it as a part of the regular equipment of their standard hives. (For details concerning its use, see Frames and Manipulation of Colonies.)

#### Staple-Spaced Frames

There are a few others who prefer frames with staples for side

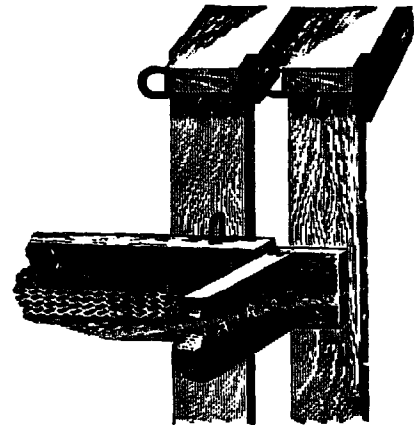

Staple-spaced frame

spacers as shown above. Others use nails in place of staples, but the latter with their rounding edges allow the frames to slide past each other more readily.

#### Metal-Spaced Hoffman Frames

All that has been said in favor of the regular Hoffman frame will apply with equal force to the metal-

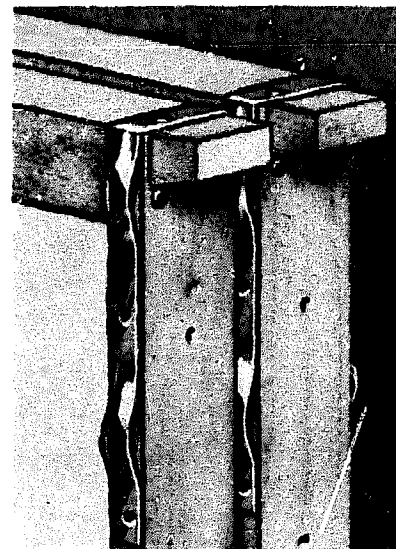

Metal-spaced frame

spaced frame. In some localities where propolis is very abundant, sticky, or hard, the wooden projections of the Hoffman sometimes split off when the frames are pried apart. For localities where this condition prevails the metal spacer is recommended. It can be used interchangeably with the regular Hoffman. The spacers on this frame are stamped out of metal and are accurate. The form of its construction in the shape of the letter U bending over the top bar projection prevents it from breaking through careless handling.

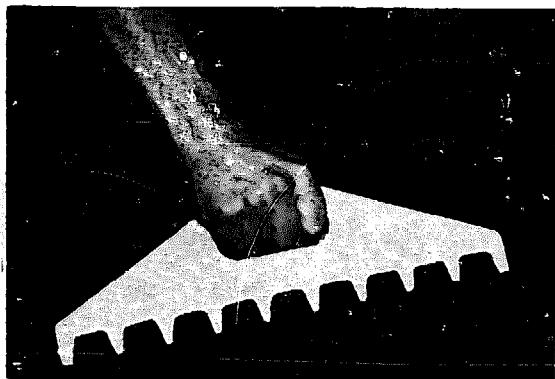

Frame spacing guide.



Frame spacing guide in use. A hive tool is used to move the frames while the guide indicates the proper position.

#### Other Self-Spacing Devices

Various spacing devices have been suggested at different times.

A few are presented here so that the reader can judge of their merits. It will not be necessary to describe them in detail, as the illustrations make plain their manner of construction and use.

It will be noted that there are two kinds of spacing devices. One is made a part of the frame and the other a part of the rabbet. It would seem at first glance that the latter would be a very happy solution to the problem of automatic spacing as it would leave the frames without projections in the way for uncapping, but rabbets or hive spacers have never been very popular and therefore are little used. The principal objection to them is that one can not move the frames in groups, thus saving time in handling the brood nest. The advantage of group handling is made more apparent under *Frames and Manipulation of Colonies*.

#### Stoller Frame Spacers

The frame spacer bearing the name Stoller is marketed by the spacer division of Stoller's Honey Farm of Latty, Ohio. They are made of steel and are designed for two types of application, one to fit over the metal frame rests already in place while for the other application they are made to replace the standard frame rests. Each type is made to accommodate either eight or nine frame spacing. The slip-on type is supported by the metal frame rests and cannot be used otherwise. The second is nailed directly on the wood shoulder at each end of the super. The design is such that the correct bee space is maintained between the top bars of the frames of the lower super and the bottoms of the frames in the upper super.

Frame spacers of the Stoller design are for use in honey storage supers. Their use in brood chambers is of very limited value and the fact that they restrict the free movement of the brood frames from side to side may cause difficulty in the frame manipulations that are often necessary in the brood area. Stoller frame spacers can be fit to shallow supers in either the eight or nine frame spacing and since metal frame rests are not used in this size super the frame spacer is fit directly to the wood shoulder.

Precise spacing is always maintained



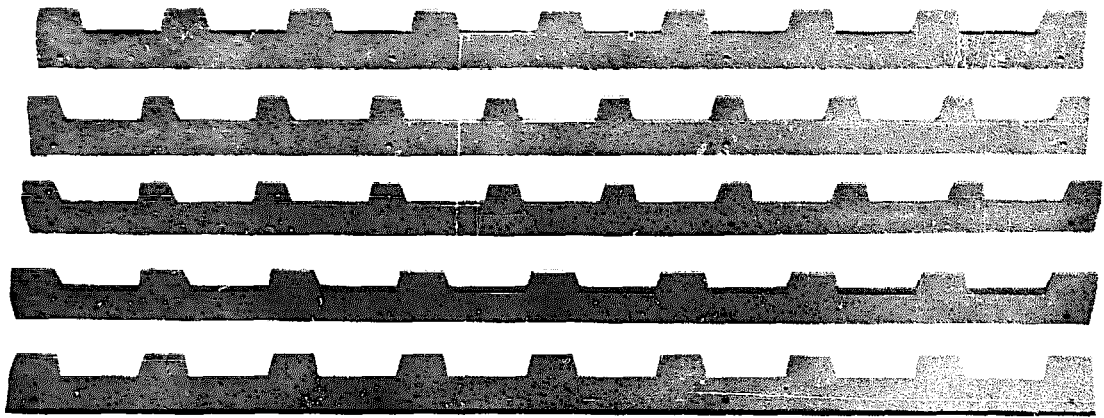

The complete variety of Stoller frame spacers for spacing eight or nine frame supers. Some are designed to fit on existing rabbets, others replace the rabbets.



Naturally spaced combs in a skep type hive after the bees have been destroyed with brimstone smoke.

as long as the frame spacers remain in place thus encouraging the comb builders to extend the cell walls to a uniform depth on both sides of the frame, usually to or beyond the frame edges. This allows the uncapping knife to pass over and uncap the whole comb surface without leaving patches of uncapped honey. Transporting supers of honey or empty supers of comb in which the frames are held fairly securely in position by frame spacers is a convenience. The one possible objection to the use of the fixed position spacer is that the frames cannot be easily slid sideways without first prying them from the slot in which the frame lugs rest. Their initial cost is usually justified when the convenience of having uniformly drawn combs is appreciated at extracting time.

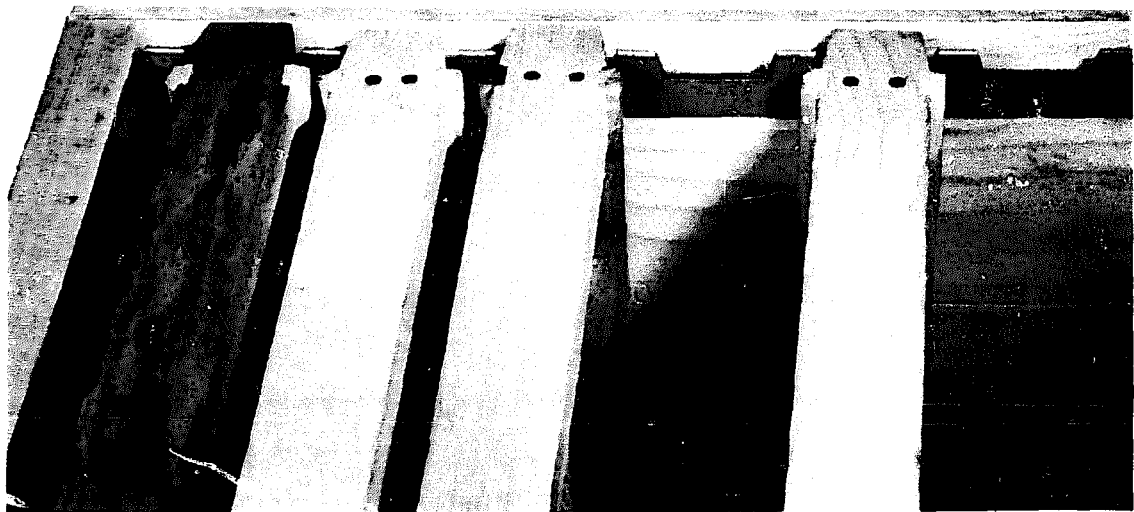

Frames are spaced automatically here with Stoller frame spacers.

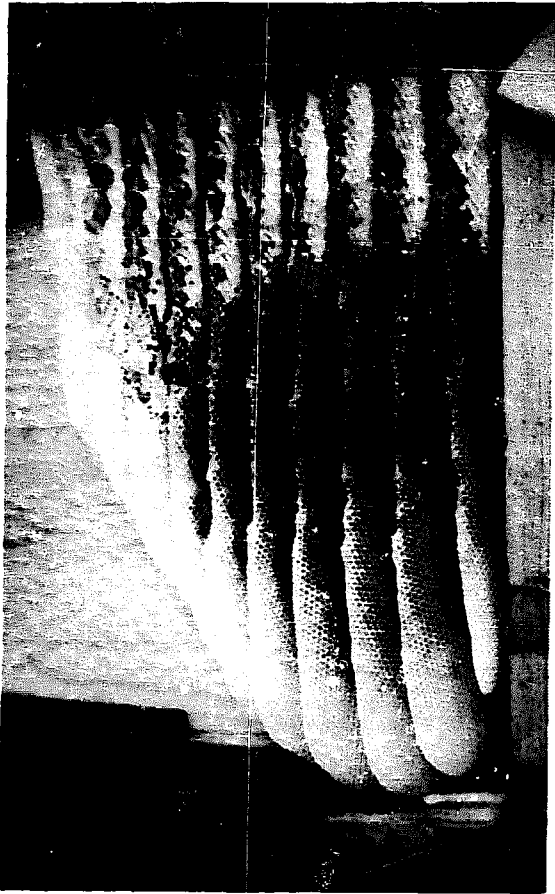

#### AS NATURE DOES IT

This colony, which inhabited a house, shows how bees will build their brood combs one and three-eighths inch apart from center to center. If the frames have no spacing devices, beginners and many other beekeepers space either too closely or too far apart. As here shown, bees will follow their rule of one and three-eighths inch spacing regardless of conditions. The result will be that the combs will be locked together and the whole mass will be immovable. When self-spacing frames are used this cannot happen. Bee glue or propolis will be deposited at the lines that come in contact. In cool weather the glue will snap when the frames are separated. The contents of the hive can be easily determined in comfort by the timely use of smoke which keeps the bees from stinging.

(Also see Bee Space.)

**FRAMES, TO MANIPULATE.** — See Frames and also Manipulation of Colonies.

**FRUCTOSE.**—See Honey

**FRUIT BLOSSOMS.**—See Pollen and Pollination of Fruit Blossoms.

**FRUIT NOT INJURED BY BEES.** —See Bees, Do They Injure Fruit.

## G

**GALLBERRY** (*Ilex glabra*).—Inkberry or evergreen winterberry. This evergreen shrub grows about six feet tall and has numerous small white flowers and black berries which are very bitter—"bitter as gall", hence the common name. Gallberry grows in the swamps along the coastal plain and is most abundant in Georgia and adjacent Florida. The male and female flowers are on different shrubs. It produces a light amber honey with a yellowish cast. The honey is mild but has an aromatic aftertaste which is very popular with consumers in the area. Up to 300 pounds have been stored by a single colony. Gallberry makes ideal chunk honey because it does not granulate, even in cold weather. Highbush gallberry (*Ilex coriacea*) grows in the same area and adds to the surplus but will crystallize eventually. Gallberry honey is often mixed with spring titi or with tupelo, the latter combination being very desirable.

J. J. Wilder says he has never known a gallberry location to be overstocked and believes the swampland would support a lot more hives than there are at present.

**GLOVES FOR HANDLING BEES.**—Although a few apiarists work with bare hands and wrists, the majority prefer to use gloves with long gauntlets, and quite a large number use them with fingers and thumbs cut off. If the bees are cross, and extracting is carried on during the robbing season, or if there is a sudden stoppage of the honey flow, it is a great convenience as well as a comfort to use something that protects the back of the hands and the wrists, leaving the fingers bare, so that for all practical purposes of manipulation one can work as well with protec-

tors as without. There are times when even the gentlest bees are so cross that something to protect the hands and wrists saves punishment from stings. At such times bee veils are a necessity. (See Stings, sub-head How to Avoid Being Stung.)

Woman beekeepers and men who are at all timid, and a very small number who seem to be seriously affected by even one sting, can use gloves to great advantage.

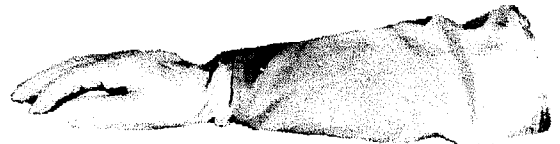

Bee Glove with gauntlet

A very good glove for working among bees is one made of kid or buckskin. While the sting of a bee will often puncture the former, one does not get much more than just the prick of the sting. By removing the glove the sting is removed automatically. The buckskin gloves are stingproof.

There is a kind of glove shown in the illustration which is made of heavy drilling that fits the hand loosely. Tight-fitting gloves do not prevent the stings from piercing through the skin. After one becomes more familiar with handling bees he can cut off the finger tips so that the fingers actually come in contact with the frames. One can work better when he can feel as well as see what he is doing. (For further particulars regarding bee dress, see Veils.)

**GOLDENROD** (*Solidago*).— The goldenrods and asters are the most common and conspicuous of autumn flowers in eastern North America. Goldenrod begins to bloom in mid-



Salt-marsh goldenrod (*Solidago sempervirens*). An excellent honey plant.  
Abundant in salt marsh.—Photograph by Lovell.

summer, or earlier in the case of early goldenrod, and in November there are still visible the flower clusters of the Canada goldenrod and the tall hairy goldenrod, while the salt marsh goldenrod may prolong the season until December.

Although the individual heads are very small, conspicuousness is gained by massing them in great plume-like clusters. Their bright yellow color renders them visible both by day and evening, and as the temperature at night is several degrees above that of the surrounding air they sometimes serve as a temporary refuge for insects. The floral tube is very short, seldom over one millimeter in length, so there are few insects which are unable to gather the nectar. The honey bee visits the florets so rapidly that the number of visits per minute can not be counted. A large amount of pollen is gathered both by the domestic bee and the wild bee. So abundant, indeed, are the flowers, and so ample the stores of pollen and nectar, that four or five of our native wild bees which fly only in autumn never visit any other plants. Some of the goldenrods are pleasantly scented. Others are nearly odorless.

In New England the many species of goldenrod which grow luxuriantly in pastures and waste lands are almost the sole dependence of beekeepers for winter stores. The bees work on the flowers with great eagerness and the activity in the apiary equals that of the mid-summer honey flow. In Massachusetts a marketable surplus is often taken in September, according to Burton N. Gates. Allen Latham states that once in three or four years strong colonies in his apiary on Cape Cod will store upward of 100 pounds from fall flowers. In southern Maine the bees never fail to fill many frames with goldenrod honey which is preferred to white honey by many persons because of its golden yellow color and fine flavor. In other sections of the South and West it is of less importance, but it comes at a time of year when it helps to keep the bees busy, furnishes pollen for winter, and at the same time serves to make up the loss in stores during the latter part of the summer.

The species most common and valuable to eastern beekeepers are

sweet-scented goldenrod (*S. odora*), early goldenrod (*S. juncea*), field goldenrod (*S. nemoralis*), Canada goldenrod (*S. canadensis*), late goldenrod (*S. serotina*), tall hairy goldenrod (*S. rugosa*), and in great abundance in salt marshes and along sea beaches, the seaside goldenrod (*S. sempervirens*). Unlike most of the other species, the inflorescence of the common bushy goldenrod (*S. graminifolia*) is in large flat-topped clusters. It is one of the best nectar yielders and a favorite with honey bees. Once in a woodland pasture largely overgrown with the hairy goldenrod, a dozen or more plants of the bushy goldenrod were found. Honey bees were the only insects present, and they showed a marked preference for the bushy goldenrod. They were repeatedly seen to leave the latter species and, after flying about but not resting on the flowers of the hairy goldenrod, would return to the plants they had left a few moments before. A plant of each of the above species was bent over so that their blossoms were intermingled, appearing as a single cluster. A honey bee alighted on the bushy goldenrod and it seemed very probable that it would pass over to the flowers of the hairy goldenrod, but such was not the case, for presently it flew away to another plant of the former.

The quantity of nectar secreted by the goldenrods varies greatly in different localities. They are most valuable as honey plants in New England and Canada. In a large part of New England beekeeping is chiefly dependent on this plant and the clovers, neither of which would yield much profit alone. The goldenrods are abundant in Nova Scotia and New Brunswick and in parts of Quebec, Ontario, and Manitoba. They yield nectar freely and 40 or more pounds of honey per colony may be obtained from this source, although it is usually mixed with aster honey.

In the white clover belt in Iowa, Illinois, and the adjoining states the goldenrods yield little or no nectar. Great masses of the clustered flowers are visited only occasionally by bees. The conditions which produce the secretion of a great amount of nectar in white clover do not produce the same results in the case of

goldenrod. In the arid cactus region of the Southwest and the semi-arid regions of the Rocky Mountain Highlands these plants are either absent or of no help to the beekeeper. In California they are the source of a small amount of honey. In New England the bushy goldenrod (*S. graminifolia*) and the tall hairy goldenrod (*S. rugosa*) yield the most nectar: In Canada *S. squarrosa* and *S. puberula*; and in California, *S. californica* and *S. occidentalis*.

While the bees are bringing in the nectar the whole apiary is filled with a strong sweet smell which on a calm evening can easily be perceived at a distance of 100 feet. The odor prevailing during a goldenrod honey flow is often unpleasant.

Goldenrod honey is very thick and heavy, with the golden yellow color of the blossoms. The quality is poor when first stored, but when capped and thoroughly ripened the flavor is rich and pleasant. It is the general testimony of New England beekeepers that many persons prefer this honey to any other. They regard its color, body, and flavor as the qualities of an ideal honey. When served on a plate for table use it is hardly less attractive than white clover honey. But the flavor is stronger than that of white clover, which would probably be given the preference.

Goldenrod seldom fails to yield freely even in cold and wet weather, but it does exceptionally well during a warm dry fall. The honey has always proved an excellent winter food for bees, and without it there would be little hope for bee culture in New England.

Goldenrod is an important fall and winter source of pollen where it grows. From the standpoint of pollen it is more important than its honey.

**GRADING OF HONEY, U. S. STANDARDS ON.**—The U. S. D. A. makes available an impartial official inspection service. The service is voluntary and offered on a fee-for-service basis through the Fruit & Vegetable Division of the Agricultural Marketing Service. U.S.D.A.'s inspectors will inspect the product and issue a certificate stating its quality and any other information that may be requested. The certification may be based on the offi-

cial U.S.D.A. grade standards (which are available on request, or on specifications written by the buyer or seller).

If the product carries a grade label of a specified quality level, it must meet the quality requirements of the U.S.D.A. grade standards; otherwise it may be judged mislabeled. The United States Standards for the grades of extracted honey and comb honey can be obtained by writing the Standardization Section, Processed Products Standardization & Inspection Branch, Fruit & Vegetable Division, Agricultural Marketing Service, U.S.D.A., Washington, D. C. 20250.

#### GRADING EXTRACTED HONEY

"Extracted honey" or "honey" is honey that has been separated from the comb by centrifugal force, gravity, straining, or by other means, and is prepared and packed under sanitary conditions in accordance with good commercial practice.

**Types of Extracted Honey.**—The type of extracted honey is not incorporated in the grades of the finished product. Extracted honey may be prepared and processed as one of the following types:

(a) **Liquid honey.** "Liquid honey" is honey that is free from visible crystals.

(b) **Crystallized honey.** "Crystallized honey" is honey that is solidly granulated or crystallized, irrespective of whether "Candied," "Creamed," "Fondant," or "Spread" types of crystallized honey.

(c) **Partially crystallized honey.** "Partially crystallized honey" is honey that is a mixture of liquid honey and crystallized honey.

**Color of Honey.**—The color of honey is not a factor of quality for the purpose of these grades.

(a) The color classification of honey is determined by means of the USDA permanent glass color standards for honey.

(b) The respective color designation, applicable range of each color, and color range on the Pfund scales are shown:

Pfund scale readings (in millimeters)	
Water-white	From 1 to 8
Extra-White	From 8 to 16.5
White	From 16.5 to 34
Extra light amber	From 34 to 50
Light amber	From 50 to 85
Amber	From 85 to 114
Dark	Readings of 114 and over

(c) Crystallized honey and partially crystallized honey are liquefied by heating to approximately 54.4°C. (130°F.) and cooled to approximately 20°C. (68°F.) before ascertaining the color of the honey by means of the U.S.D.A. permanent glass color standards for honey.

Application of U.S.D.A. permanent glass color standards in classifying the color of honey—(a) Sample containers. The sample containers for use in making the visual color determination are square bottles of colorless transparent glass, having an internal width at the center of 3.15 centimeters (1.24 inch), with outside base dimensions of approximately  $1\frac{1}{8}$  inches by  $1\frac{1}{8}$  inches, and having a capacity of approximately two ounces.

(b) Comparator; viewing box. Two comparators or viewing boxes are required for the entire color range in the visual comparison test. Each comparator is divided into five compartments approximately  $1\frac{1}{2}$  inches sq., with each compartment provided with openings approximately  $1\frac{1}{8}$  inches sq. in the two parallel sides. The U.S.D.A. permanent glass color standards are mounted in a fixed position in the front openings of compartments 1, 3, and 5 of the two comparators, compartments 2 and 4 being adapted to receive the sample containers.

(c) Clear blanks. Six clear blanks of distilled water in capped sample containers are required. The clear blanks are placed in the compartments provided behind each permanent glass color standard.

(d) Cloudy suspensions. Three cloudy suspensions of bentonite in distilled water, each in a capped sample container, are required. These are referred to as "Cloudy No. 1," "Cloudy No. 2," and "Cloudy No. 3," corresponding to varying degrees of cloudiness within the range of the different grades of honey. The cloudy suspensions replace the clear blanks when cloudy honey is to be classified for color.

(e) Visual comparison test. The color of a sample of honey is compared with the U.S.D.A. permanent glass color standards in the following manner to determine its color classification:

(1) Place the sample of honey in a clean dry sample container.

(2) Place the clear blanks behind each permanent glass color standard.

(3) Place the container filled with the sample of honey successively in compartments 2 and 4 of the comparator, and visually compare the color of the sample with that of each of the glass color standards by looking through them at a diffuse source of natural or artificial daylight. The color is classified in accordance with the color range as given in table.

(4) If the sample is appreciably cloudy in appearance, the clear blanks are replaced by the cloudy suspensions, "Cloudy No. 1," "Cloudy No. 2," or "Cloudy No. 3," respectively, to facilitate color classification.

Tolerance for certification of color of officially drawn samples. When certifying the color of samples that have



U. S. Department of Agriculture honey color classifier or comparator used to determine the color classification and turbidity of a given honey sample. It has to a large extent replaced the Pfund grader in this use.

been officially drawn and which represent a specific lot of honey, the lot shall be considered as of one color if not more than one-sixth of the containers comprising the sample contains honey of a different color: Provided, however, that the honey in none of the containers falls below the next darker color designation.

**Fill of Container**

The recommended fill of container is not incorporated in the grades of the finished product since fill of container, as such, is not a factor of quality for the purpose of these grades.

**Grades of Honey.**—(a) **“U. S. Grade A”** or **“U. S. Fancy”** is the quality of honey that contains not less than 81.4 percent soluble solids, possesses a good flavor for the predominant floral source or, when blended, a good flavor for the blend of floral sources, is free from defects, and is of such quality with respect to clarity as to score not less than 90 points when scored in accordance with the scoring system outlined in this subpart.

(b) **“U. S. Grade B”** or **“U. S. Choice”** is the same as Grade A but must have a “reasonably good” flavor, be “reasonably” clear and free of defects and score only 80 points.

(c) **“U. S. Grade C”** or **“U. S. Standard”** is honey for reprocessing that con-

tains not less than 80 percent soluble solids, has a “fairly good” flavor for the floral source or blend, be “fairly” clear and free of defects and score not less than 70 points.

(d) **“U. S. Grade D”** or **“Substandard”** is the quality of honey that fails to meet the requirements of “U. S. Grade C” or “U. S. Standard.”

**Factors of Quality**

**Determining the grade.**—The grade of honey may be ascertained by considering in conjunction with the requirements of the various grades the respective ratings for the factors of flavor, absence of defects, and clarity.

The soluble solids content of honey may be determined by means of the refractometer at 20°C. (68°F.).

The relative importance of each factor is expressed numerically on the scale of 100. The maximum number of points that may be given each factor is:

Factors:	Points
Flavor .....	50
Absence of defects .....	40
Clarity .....	10
Total score .....	100

Crystallized honey and partially crystallized honey shall be liquefied by heating to approximately 54.4°C. (130°F.) and cooled to approximately 20°C. (68°F.) before judging the grade of the product.

**Establishing the rating for each factor.** The essential variations within each factor are so described that the value may be given for each factor and expressed numerically. The numerical range for the rating of each factor is inclusive (for example, “27 to 30 points” means 27, 28, 29, or 30 points).

**Flavor.** The factor of flavor refers to the prominence of the honey flavor and aroma and to its conformity to the flavor and aroma of the predominant floral source or blend of floral sources.

(A) **Classification.** Honey that possesses a good flavor for the predominant floral source may be given a score of 45 to 50 points. “Good flavor for the predominant floral source” means that the product has a good, normal flavor and aroma for the predominant

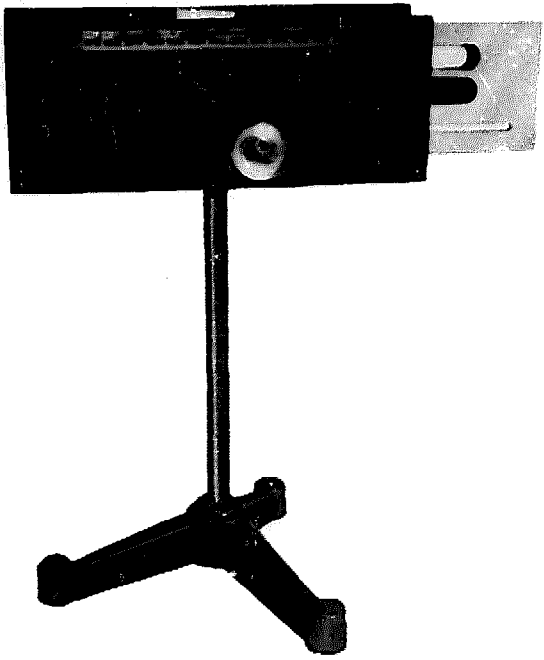

**Pfund color grading instrument**



floral source or, when blended, a good flavor for the blend of floral sources and that the honey is free from caramelized flavor or objectionable flavor caused by fermentation, smoke, chemicals or other causes with the exception of the predominant floral source.

(B) Classification. If the honey possesses a "reasonably good" flavor for the predominant floral source, a score of 40 to 44 points may be given. Honey that falls into this classification shall not be graded above "U. S. Grade B" or "U. S. Choice" regardless of the total score for the product.

(C) Classification. Honey that possesses a "fairly good" flavor for the predominant floral source may be given a score of 35 to 39 points. Honey that falls into this classification shall not be graded above "U. S. Grade C" or "U. S. Standard" regardless of the total score for the product.

(SStd) Classification. Honey that fails to meet the requirements of (C) classification or is off flavor for any reason may be given a score of 0 to 34 points and shall not be graded above "U. S. Grade D" or "Substandard" regardless of the total score for the product.

**Absence of defects.**—The factor of absence of defects refers to the degree of cleanliness and to the degree of freedom from particles of comb, propolis, or other defects which may be in suspension or deposited as sediment in the container.

(A) Classification. Honey that is free from defects may be given a score of 37 to 40 points. "Free from defects" means that the honey contains no defects that affect the appearance or edibility of the product, and shall be at least as free from defects as honey that has been strained through a standard No. 80 sieve, at a temperature of not more than 130°F.

(B) Classification. If the honey is "reasonably free" from defects a score of 34 to 36 points may be given. Honey that falls into this classification shall not be graded above "U. S. Grade B" or "U. S. Choice" regardless of the total score for the product. "Reasonably free" from defects is the same as A Classification but is strained through a standard No. 50 sieve.

(C) Classification. Honey that is fairly free from defects may be given a score of 31 to 33 points. Honey that falls into this classification shall not be graded above "U. S. Grade C" or "U. S. Standard" regardless of the total score for the product. "Fairly free from defects" is the same as A Classification but strained through a standard No. 18 sieve.

(SStd) Classification. Honey that fails to meet the requirements of (C) classification may be given a score of 0 to 30 points and shall not be graded above "U. S. Grade D" or "Substandard" regardless of the total score for the product.

**Clarity.**—The factor of clarity has reference to the degree of freedom from air bubbles, pollen grains, or fine particles of any material which might be suspended in the product.

(A) Classification. Honey that is clear may be given a score of 8 to 10 points. "Clear" means that the honey may contain air bubbles which do not materially affect the appearance of the product and may contain a trace of pollen grains or other finely divided particles of suspended material which does not affect the appearance of the product.

(B) Classification. If the honey is reasonably clear a score of 6 or 7 points may be given. "Reasonably clear" is the same as A but allows more than a trace of pollen grains.

(C) Classification. Honey that is fairly clear may be given a score of 4 or 5 points. Honey that falls into this classification shall not be graded above "U. S. Grade C" or "U. S. Standard" regardless of the total score for the product (this is a limiting rule). "Fairly clear" means that the appearance of the honey may be materially but not seriously affected by the presence of air bubbles, pollen grains, or other finely divided particles of suspended material.

(SStd) Classification. Honey that fails to meet the requirements of (C) classification may be given a score of 0 to 3 points and shall not be graded above "U. S. Grade C" or "U. S. Standard" regardless of the total score for the product.

**GRADING COMB HONEY**

Grading comb honey is quite different than extracted honey because beside the honey in the comb there is the comb itself, the cappings, the weight and general appearance. Section comb honey has four classifications. The requirements for U. S. Fancy are as follows:

1. The comb shall—(a) have no uncapped cells except in the row attached to the section; (b) be attached to 75 percent of the adjacent area of the section if the outside row of cells is empty, or attached to 50 percent if the outside row is filled with honey; (c) not project beyond the edge of the section; (d) not have dry holes; (e) have not more than a total of 2½ linear inches of through holes; (f) be free from cells of pollen.

2. The cappings shall—(a) be dry and free from weeping and from damage caused by bruising or other means; (b) present a uniformly even appearance except in the row attached to the section.

3. The color of the comb and cappings shall conform to the requirements as illustrated for this grade in the official color chart.

4. The honey shall—(a) be uniform in color throughout the comb; (b) be free from damage caused by granulation, honeydew, poorly ripened or sour honey, objectionable flavor or odor, or other means.

5. The section shall—(a) be as free from excessive propolis and/or pronounced stains as illustration A in the official color chart; (b) be smooth and new in appearance, of white to light buff basswood, and shall not contain knots and/or streaks in excess of the amount shown in illustration B in the color chart.

6. The minimum net weight shall be 12 ounces, unless otherwise specified.

U. S. No. 1 is the same as U. S. Fancy except that it can have uncapped cells in the row adjoining the outside row, in the corners and along the lower edge, provided the number does not exceed 15 in a comb section. It only has to be attached to the comb 50 percent, have no more than four linear inches of through holes, and is allowed to have slight irregularities in uniform-

ity and have a minimum net weight of 11 ounces. U. S. No. 1 Mixed Color is the same as U. S. No. 1 except that it allows for a mixture of color grades.

U. S. No. 2 is the same as U. S. No. 1 except it allows many more uncapped cells, two additional inches of through holes but no serious damage caused by cells of pollen, granulation, etc., and does not require uniformity in color nor appearance. The net weight of U. S. No. 2 shall be 10 ounces. Honeycomb sections not meeting these qualifications are considered unclassified.

The grades for shallow frame comb honey are U. S. Fancy and U. S. 1. The U. S. Fancy is about the same as section fancy but the comb thickness must be at least one inch, made from light colored foundation and have a minimum number of uncapped cells. The comb must also have never been used for brood. U. S. No. 1 is about the same as Fancy but allows for as high as 10 percent uncapped cells. It also allows for slight irregularities in the appearance of the comb and fairly uniform color. All shallow frames of comb honey not meeting these minimum qualifications are considered unclassified.

The grades for wrapped cut comb honey are Fancy and U. S. 1 and they are about the same as the previous requirements except that both classes require a transparent, clean and sealed wrapper which does not leak. Fancy grade allows uncapped cells only on the cut edges and the minimum weight shall be 12 ounces. The U. S. No. 1 allows 15 uncapped cells, slight irregularities in uniformity of appearance, fairly uniform color and a weight of 11 ounces.

Chunk and bulk comb honey have two grades—U. S. Fancy and U. S. No. 1. The grade specifications correspond very closely to the previous grades mentioned except that the total weight shall be made up with U. S. Fancy extracted honey and the color of the honey within the container shall be designated according to the color of the extracted honey used to make up the liquid portion. In the case of U. S. No. 1 grade the uniformity of appearance might have slight irregularities in not more than one-half of the comb surface. The chunk or bulk comb

honey which is packed in tin shall have no less than 50 percent by volume of chunk or bulk comb honey. This is not required where it is packed in glass.

#### Tolerances for Grades

Generally speaking no more than five percent of the combs in these various packs in any one lot may be below the requirements for the grade or weight and no more than two percent of the combs in any container shall be allowed for defects causing serious damage.

#### Color Classification

The color classification of comb honey is set according to the grades of extracted honey. Water white, extra white and white extracted honey are designated as white comb honey. Extra light amber and light amber are designated as light amber comb honey. Amber extracted honey is designated amber comb honey and honey that is darker than amber is designated as dark amber comb honey.

**GUAJILLO (*Acacia Berlandieri* Benth).**—The spelling huajilla is often used. This is the French form of the word and is not used in the country where guajillo is native.

Guajillo very much resembles the other species of acacia with the exception that it is inclined to grow as a tall shrub. It possesses some thorns but is mainly a smooth-stemmed plant. The leaves are the largest of the genus and resemble the fronds of a fern. They are sensitive to touch, light, and temperature. The plant is inclined towards being an evergreen but leaves fall in late spring when they are pushed off by new ones. During mild winters there is some bloom on guajillo from the first of November to the first of May. The heavy blooming usually occurs during the first three weeks in April. Some of the heaviest daily flows on record have come from this plant. When first gathered, the honey is water-white with a milky reflection. It granulates very quickly. Because of its mild

flavor and beautiful color, especially in the comb, the honey of this plant has won more first prizes than any other Texas honey.

Guajillo in quantities sufficient to be profitable as a honey plant is restricted to very narrow locations. In southern Texas the plant is found abundantly in a line running southeast by northwest from Corpus Christi through Uvalde. Originally this seems to have been a very heavy stand. At the present time agriculture has reduced it to small isolated areas. It was the presence of many acres of this shrub in the Uvalde territory that made Uvalde world famous for its wonderful spring honey. The plant is found sparingly along the Rio Grande River from Brownsville to the Big Bend where it occurs occasionally as a member of the Desert Shrub Association, especially in the Chisos Mountains. The plants occur in small islands throughout Western Texas and Trans-Pecos Texas but nowhere in sufficient quantity to be a major honey plant.



Guajillo blossom

## H

**HANDLING BEES.**—See Manipulation of Colonies; Frames, Self Spacing; Anger of Bees; Stings; and Hives.

**HEARTSEASE** (*Polygonum Persicaria*)—also known as smartweed, Lady's thumb, and Knotweed is naturalized from Europe and is widely distributed over eastern and central North America, particularly Illinois, Kansas, and Nebraska. This is one of a large family of nectar-bearing plants to which cultivated buckwheat belongs. The honey is generally described as amber and has a strong flavor and odor which damages much clover honey. In the blacklands of Illinois the honey is sometimes white, and heartsease grows to a height of three to five feet. It grows luxuriantly in all waste and stubble land. It also springs up in corn fields, forming dense stands which attract numerous bees.

Surpluses up to 500 pounds have been reported in Kansas but surpluses usually do not exceed 50 pounds.

**HERMAPHRODITE** (or *Gynandromorph Bees*).—These are living creatures which are both male and female, having the characteristics of both sexes, and are often called bi-sexual. These freaks of nature are found among bees. It is not uncommon to find worker bees with drone heads or vice-versa. In rare cases there may be found a bee or drone that is female on one side and male on the other. That is, there might be a drone eye on the left side and a worker eye on the right; likewise there might be a pollen basket on one side, and on the other side drone legs without any pollen receptacle.

Sometimes we find bees, not of the hermaphrodite type but with various-colored heads: white, blue, purple, and distinctly red. They are otherwise normal in appearance. (See Drones, also Breeding Stock.)

According to Nolan, drones with white heads are blind. This may also be true of drones with heads of any color other than black. (See page 221.)

This whole question of hermaphrodite bees, sometimes called hybrids, is fully discussed in the following paper:

Leuenberger, Fr. 1925. Zwitterbienen. In: Schweizerische Bienenzeitung XLVIII, No. 6, p. 234-249, illus. Bibliographical footnotes. June, 1925. (Hybrid or hermaphrodite bees.)

**HIVE MAKING.**—Unless one is so situated that freights are low, and he is a carpenter or natural genius in making things, he would better leave hive making alone. Hives can usually be bought, with freight added, for much less than the average beekeeper can make them himself. Of course, hives made of poor lumber with many knots might cost less than factory-made hives, but experience shows that they would be dear at any price. If spoiled lumber, sawed fingers, and the expense of tools are considered, hives made in large factories, where they are turned out by the thousands by special machinery run by skilled workmen, are much more accurately cut. Many of the home-made fixtures do not fit when made by a carpenter.

**HIVE ON SCALES.**—See Scale Hive.

**HIVES.**—The word "hive", broadly speaking, covers any sort of enclosure in which bees make their home. In the primitive days these consisted of hollow logs two or three feet long with a board for the cover and another board for the bottom. Later, boxes were constructed. (See Box Hives.) In early times straw skeps were used, and they are still used in parts of Europe and southeastern United States. (See Skeps.)

The modern hive consists of a brood body—a box without top or bottom—to hold a series of frames. (See Frames.) Each frame encloses a comb. But no hive is complete without a roof or cover, and a bottom, usually called a bottom board. In addition to the roof and hive body, with its frames and bottom, there are upper stories or supers. A super, just as its name indicates, is an upper story—a box without cover or bottom, to hold either a set of frames or a set of holders to support section honey boxes in which bees store honey. (For a further description of hives, see Frames. For particulars regarding comb honey supers, see Comb Honey, Appliances for.)

#### Requisites of a Good Hive

While it is very important to have well made hives for the bees, it should be understood that the hive will not insure a crop of honey. As the veteran Mr. Gallup used to say, "A good swarm of bees will store almost as much honey in a half-barrel or nail keg as in the most elaborate and expensive hive made, other things being equal." This is based on a good colony in the height of the honey season. Should the bees get their nail keg full of honey they would have to cease work or swarm, and either way a considerable loss of honey would be the result. The thin walls of the nail keg would hardly be the best economy for a winter hive, nor for a summer hive either, unless it were well shaded from the direct rays of the sun.

P. H. Elwood of Starkville, New York, who had over 1000 colonies, said in *Gleanings in Bee Culture* some time ago, "A good hive must fill two requirements reasonably well to be worthy of its name: 1. It must be a good home for the bees. 2. It must in addition be so constructed as to be convenient to perform the various operations required by modern beekeeping. The first of these requirements is filled very well by a good box or straw hive. Bees will store as much honey in these hives as in any, and in the North they will winter and spring as well in a straw hive as in any other. They do not, however, fill the second requirement, and to meet this the movable-frame hive was invented."

The general features of the hive

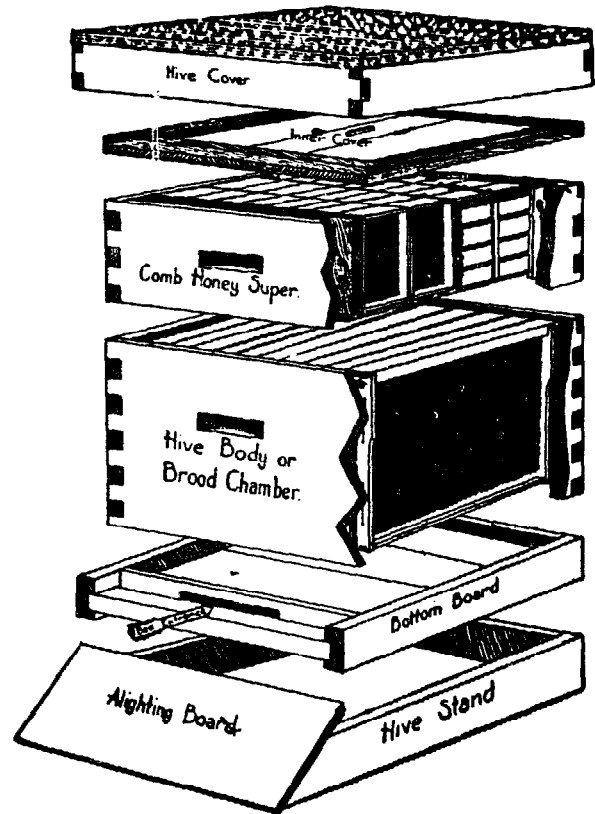

Modern dovetailed hive for comb honey

are shown under Frames, and under this head are shown styles and the special features that belong to each. But there is only one hive that is used universally throughout the United States, and that is the Langstroth—or more exactly, one based on Langstroth dimensions. The frame is  $17\frac{5}{8}$  inches long by  $9\frac{1}{2}$  inches deep, outside measure. This establishes the length and depth of the hive. As to width, that depends upon the number of frames used. It is the rule to allow  $\frac{1}{8}$ -inch bee space between the ends of the frames and the inside ends of the hive. (See Bee Space.) This will make the inside length of a Langstroth hive  $18\frac{1}{4}$  inches, or the outside length 20 inches, if made of  $\frac{7}{8}$ -inch planed lumber. It is the rule to make the depth of the hive  $\frac{3}{8}$  inch deeper than the frame— $\frac{1}{8}$  inch under the frame and  $\frac{1}{4}$  inch on top. For dry climates a greater allowance should be made on account of shrinkage. The selection of the frame, the number to the hive, and the distance they are spaced apart determine the dimensions of the hive itself.

As stated, the Langstroth is the standard hive throughout the United States, but there has been a ten-

dency on the part of a very few toward a frame of the same length but two inches deeper. There was also a tendency to go to the other extreme in adopting a frame of Langstroth length but two or three inches shallower, using two or three stories of such a hive for a single brood nest.

#### Dimensions of Hives

Hives based on Langstroth dimensions are the standard. In the early 80's there were in use the American, Gallup, Quinby, Adair, and Langstroth frames. All of these, of course, required hives of different dimensions. Among the Adair, the Gallup, and the American there was but little comparative difference as they were cubical and very nearly of a size. The Langstroth was long and shallow—the shallowest frame that had then been introduced, and the Quinby, having about the same proportions, was the largest frame in general use. (See diagram on page 342.)

#### Square Frames

In nature, bees have a tendency to make a brood nest in the form of a sphere. Patches of brood are more inclined to be circular than square or oblong. Theoretically, a circular frame would be the best, but that would not be practicable owing to the difficulty in the construction of the frame and hive. Obviously the square frame and a perfect cube for the hive would come the nearest to conforming to nature. The square frame, as a rule, calls for a hive in the exact shape of a cube. For instance, if the frame were 12 inches square, outside dimensions, then the hive should take in just nine American frames if the combs were spaced  $1\frac{3}{8}$  inches apart, and  $12\frac{3}{4}$  inches wide inside. Such a hive, it was argued, would conserve the heat of the bees to the best advantage, would give the greatest cubic content for a given amount of lumber—barring, of course, the perfect sphere. As it economized heat in winter, it would winter bees better than a hive having oblong frames. Later experience shows that this brood nest would be too small unless another story were added. This would not tier up well. A shallow hive like the Langstroth would be better.

The cubical brood nest seemed to

be very pretty in theory. G. M. Doolittle, who used the square frames for years, argued for them. A few years before his death he began using the Langstroth frame and hive. Later he came to the conclusion that bees wintered just as well in it, tiered up better, and because it was standard, he recommended it. The great majority of beekeepers, after having tried the square and the oblong frames, finally decided in favor of the Langstroth, as did Doolittle.

At this point reference is made to the articles on bee spaces found under Bee Space, Spacing Frames, and Frames. All of these articles discuss principles that are vital in the construction of a modern hive.

#### The Langstroth Frame and Hive —Why It Became Standard

1. A shallow frame permits the use of a low flat hive that can easily be tiered up one, two, three, or more stories high. This is a great advantage when one is running for extracted honey, as all that is necessary when the bees require more room is to add upper stories as fast as the bees require them, and then at the end of the season extract whenever it is convenient. Square or deep hives can not be tiered up very high without becoming top-heavy and out of convenient reach of the operator.

2. The long shallow comb is more easily uncapped because the blade of the uncapping knife can reach clear across it.

3. A comb of Langstroth dimensions is more efficiently extracted, especially in an extractor of the radial type.

4. A deep frame is not as easily lifted out of a hive and is more liable to kill bees in the process of removing and inserting frames.

5. The shallow frame is better adapted for section or comb honey. It is well known that bees, after forming a brood circle, are inclined to put sealed honey just over the brood. In a frame as shallow as the Langstroth there will be less honey in the brood nest and more in the sections, for in order to complete their brood circles in the Langstroth, bees with a prolific queen and reinforced comb foundation will often push the brood line almost up to the top bar, and conse-

quently when honey comes in they will put it into the supers or sections just where it is wanted.

6. When bees are left to themselves they will generally form a cluster late in the season, immediately over the entrance of the hive and down two or three inches from the top of the frames. As the season progresses the cluster eats into the stores above it, and on reaching the top it works backward. It therefore happens that the cluster reaches the top of the hive where it is the warmest during the coldest part of the year. In the case of the ordinary square frame the bees will be found just over the entrance, four or five inches from the top. In the midst of the coldest weather the bees may not and probably will not be near the top of the hive, as on reaching the top they can progress backward only a comparatively short distance because the top bar of a square frame is relatively short. In the Langstroth hive the bees stay in the top of the hive where it is warmest, during the entire cold part of the winter. As the stores are consumed they move backward and gradually reach the back of the hive, and by that time warmer weather will probably prevail.

In actual experience bees seem to winter just as well on a Langstroth frame as on any other and, as the shallow frame is better adapted to section honey and extracting, beekeepers turned toward the regular Langstroth, with the result that now probably 95 percent of all the frames in the United States are Langstroth.

7. What has been said so far applies particularly to a single-story hive. In No. 1 mention was made that a relatively shallow hive will tier up better than a square or deep one because for the same cubic capacity it will be less top heavy. It will be apparent that a relatively shallow hive like the Langstroth is better suited for the use of a food chamber. (See Food Chamber.) The combination of the two hive bodies will be less top heavy than two deep or relatively tall units like the Gallup or Quinby, that might be blown over during the winter. Again two units of shallow depth or ten-frame Langstroth size make a more compact spherical winter brood nest

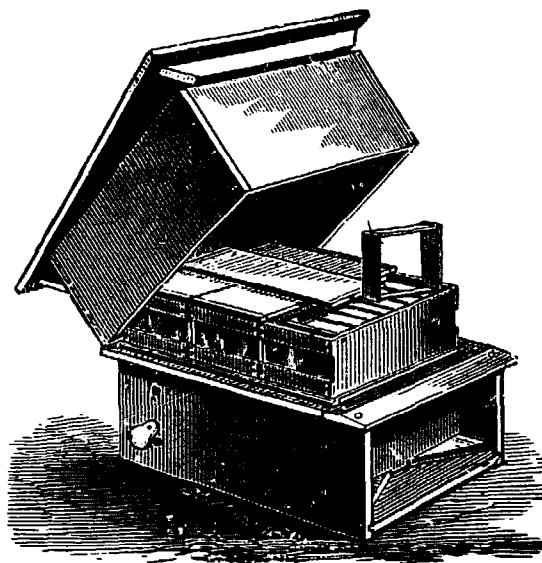

The Langstroth hive with sections

than do two units of a cubical hive body, one on top of the other.

#### Frames Shallower or Deeper Than the Langstroth

All the arguments in favor of the Langstroth frame apply with still greater force to a frame still shallower and exactly the same length. The bodies to hold the shallower frames would be of the same length and width. They would use the same covers, bottoms, and all the other equipment that goes with a hive of Langstroth dimensions, save in the matter of depth. Manufacturers have been putting out shallow supers and frames—frames 5½ inches deep for extracting and the right depth to take 4 by 5 sections. They can also be used as brood chambers as well as for the storage of honey.

The obvious advantage of such a unit is that it can be used either for raising brood or for the storage of either comb or extracted honey. Its weight when filled with honey is only a little more than half that of a full-depth Langstroth hive body that may run 65 or 75 pounds. A super of sealed brood, honey, and bees is almost as heavy as a super of honey. The light weight of such a hive unit that can be used for brood rearing or for the storage of honey appeals to all women and men who can not lift a full-depth Langstroth hive body full of honey or brood. Three of these shallow hives will make a brood nest sufficiently large to accommodate a good queen. And last but not least,

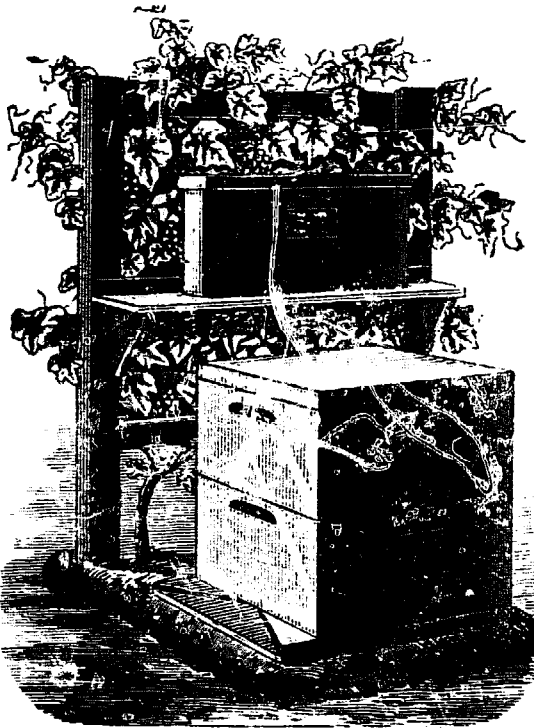

The "Simplicity" hive first manufactured by A. I. Root in the early 70's.

during winter the cluster has two horizontal air spaces so that it can move laterally to where the stores have not been consumed.

There is another class of beekeepers who feel that the Langstroth is not quite deep enough, and who therefore prefer the Quinby. They argue that 10 such frames — or frames of Langstroth length and two inches deeper—are none too large for a prolific queen, and that these big colonies swarm less, get more honey, and winter better.

The original hive, Plate III, No. 5, page 349, which Langstroth put out contained ten frames  $17\frac{3}{8}$  by  $9\frac{1}{8}$  inches.\* Each hive had a portico, and cleats nailed around the top edge to support a telescoping cover, under which was placed the comb honey boxes, or big cushions for the winter. There was a time when this style of hive was the only one used. However, owing to the fact that it was not simple in construction, that the portico was a bad harboring place for cobwebs and that it gave the bees encouragement for clustering out on the hot days

\*The length for over 80 years has been  $17\frac{3}{8}$  instead of  $17\frac{1}{8}$  inches. The change was made to make the length twice the depth to take in four sections  $4\frac{1}{4}$  inches square.

instead of attending to their work inside the hives, a far simpler form of hive was devised. The Simplicity, first brought out by A. I. Root, having Langstroth dimensions, was the result. Instead of having telescope covers, the four upper edges of the hive were beveled so as to shed water and give in effect a telescoping cover. The cover and bottom of this hive were exactly alike, the entrance being formed by shoving the hive forward on the bottom, thus making an entrance as wide or narrow as seemed most desirable. It had one serious defect and that was the beveled edge. It was found to be practically impossible at times, on account of the bee glue, to separate the upper story from the lower one without breaking or splitting the bevel. Finally there was introduced a hive very much the same, having straight square edges, and along with it came the feature of dovetailing or lock-cornering, as shown below.

#### The Dovetailed or Lock-Cornered Hive

This hive was introduced in 1889, and seemed to meet with the general approval of beekeepers. It embodied Langstroth dimensions and used ten frames.

As now constructed the hive embodies the very latest developments in hives and hive construction. It can be handled rapidly and is especially adapted for out-apiary work, where frequent moving from one field to another is necessary. It is standard, being made by all the supply manufacturing concerns, and is for sale everywhere. The lock corner is espe-

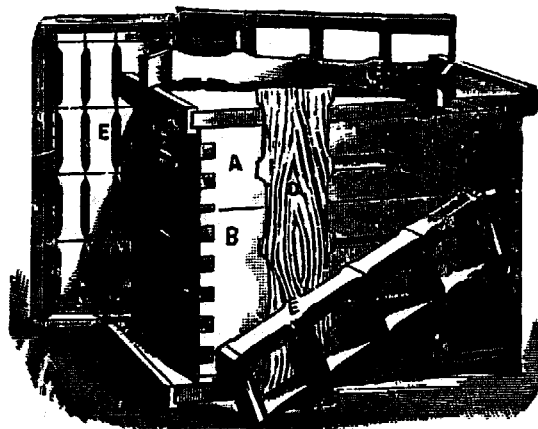

Original dovetailed hive, Langstroth dimensions.



cially well adapted for hot climates. In fact, it is far stronger than corners depending on nails alone. The ordinary miter or halved joint is inclined to pull apart in regions of California, Texas, and Florida which are subject to extremes of heat, or hot dry winds.

A very important requisite of a good hive is a good cover. While the flat cover—one making use of one flat board and two cleats—was a good one, yet, owing to the width

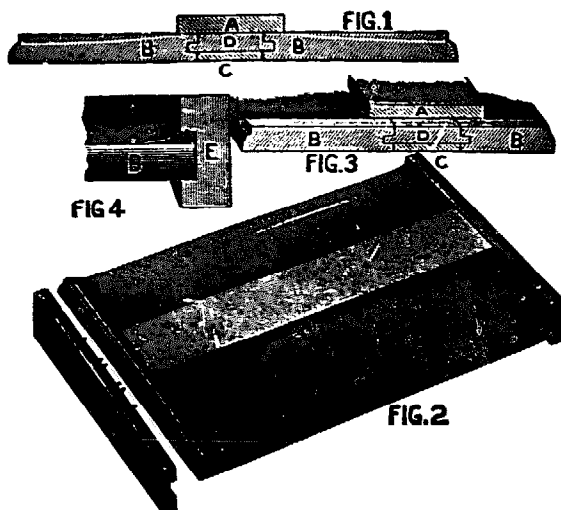

Excelsior flat cover

of the single board and increasing scarcity of such lumber, something made of two or three narrow boards had to be used. Accordingly, the Excelsior was devised. It consists of boards not exceeding  $7\frac{1}{2}$  inches in width because narrow boards can be easily secured and because they will not shrink and check under the influence of the weather like the wide ones. The two side boards B, B, are beveled on one side so that the one edge is left only about three fourths the thickness of the other edge, but the ends are left the full thickness of the boards to shed water away from the edge and to give more nail room for the grooved end cleats E, E, that slip over and bind the whole together. The purpose of the beveling is to shed water to the sides of the hive and away from the centerpiece AD. Of this centerpiece AD, the part A projects beyond D. D is tongued on each edge to fit a corresponding groove in the edges of each of the two side boards that were beveled to shed water. The space under D is filled with a thin board  $\frac{1}{4}$  inch thick, the ends of which project in-

to the  $\frac{3}{8}$ -inch groove of the end cleats E, E, where it is securely held in place.

### Telescope Covers

In later years the telescope cover with a metal roof and an inner cover, while more expensive, is so much better that it has supplanted nearly all other hive covers.

The lower or inner cover has two or more tongue-and-grooved boards  $\frac{3}{8}$  inch thick, with rabbeted rim of  $\frac{3}{4}$  by  $\frac{5}{8}$  inch wood around the edge. At the center there is a hole for a Porter bee escape, so that by inserting the escape the inner cover can be used as an escape board. The inner cover is directly over the frames, and over this is placed a shallow telescoping cover made of  $\frac{3}{4}$ -inch lumber and covered with metal.

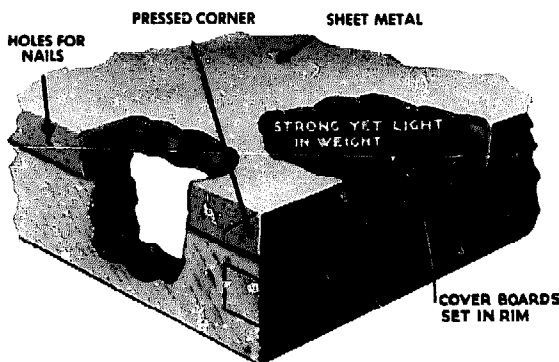

The Root metal telescoping cover

A telescoping top cover is not only better than a single-board cover, but it shuts out the weather. The air space between the two covers gives the bees better protection from the direct rays of the hot sun if the hives are out in the open, and such a cover will last indefinitely if kept painted. The lower cover will be sealed down by the bees. The upper one can not blow off because the downward projecting sides hold it in place. Of course such an arrangement makes extra

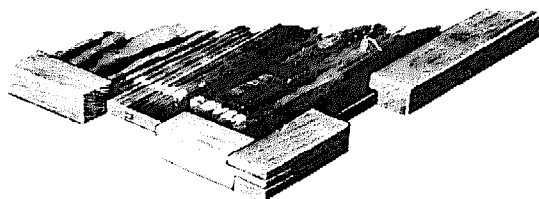

Inner cover  
(Rim cut to show construction)

handling in opening and closing the hive, but the majority of beekeepers are beginning to see that this is more than offset by the greater durability and better protection.

**Hive Bodies for Brood or Honey**

These are plain boxes without top or bottom, preferably lock-cornered. They are rabbeted at the upper inside ends to receive the projections of the frames referred to later.

**Hive Bottoms or Floors**

The general practice is to make the bottom or floor of the hive separate from the hive body. Bodies are made to rest upon the raised edges of the floor or bottom. This floor should preferably have a deep side and a shallow side. During hot weather it is customary to use the deep side to give more space under the hive, affording a larger entrance and better ventilation. This deeper side is usually  $\frac{7}{8}$  inch in depth,

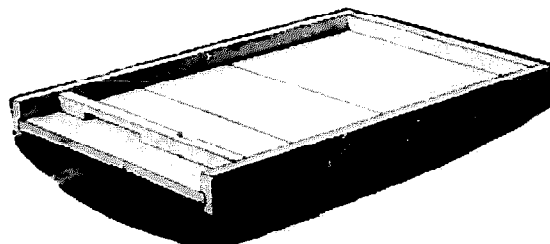

Bottom board

the shallower side only  $\frac{3}{8}$  inch, and is used by those who prefer to have a shallower space under the hive. When the wide space is used it is customary to have a contracting entrance cleat. When colder weather comes on or where the colony is weak, it is a good practice to contract the entrance to  $\frac{1}{4}$  inch by any width from  $\frac{1}{2}$  inch to 8 inches.

**Brood Frames**

The modern hive consists not only of the parts already mentioned—cover, body, and bottom—but a series of frames, each of which holds a comb. In a modern hive the top of the frame has projections at each end that hang in the rabbets of the hive body. All of the frames are removable and may or may not be self-spacing. Some frames have the same width all around. Some have end bars made a little wider near the top, and occasionally some have end bars that make contact with the adjacent end bars their entire

length. The latter are called closed-end frames. (For particulars regarding frames, see Frames, and Frames, Self-Spacing.)

**The Bingham Hive**

Mr. Quinby was the first to apply Huber's principle of the closed-end frames in this country (see Hives, Evolution of). This he introduced shortly after the appearance of the Langstroth hive. Not long after, in 1867, Mr. Bingham brought out his hive with closed-end frames with a narrow top bar and no bottom bar, but still embodying the

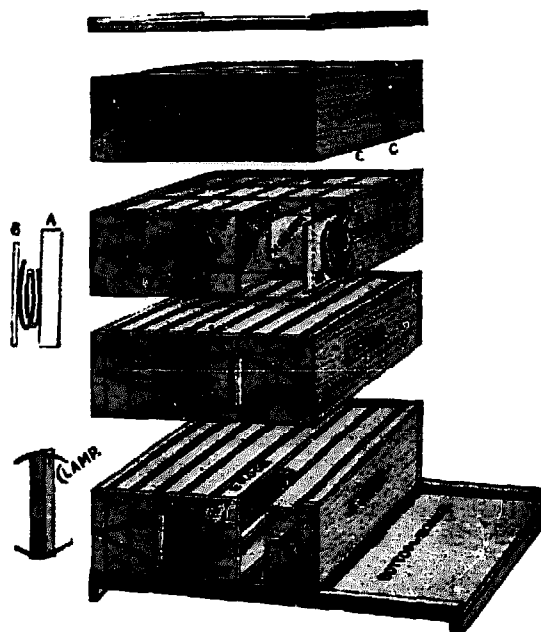

The Bingham hive

chief features of Huber's hive of 1789. But the peculiar feature of the Bingham hive was that it made use of shallow frames only five inches deep, a series of them being lashed together by means of a wire loop and stretcher sticks, the loop drawing on the follower boards in such a way as to bring tight compression on frames enclosed. Seven of these brood frames in the hive made up the brood nest, and an entire brood nest might consist of one or two sets of frames. The top bar was dropped down from the top of the end bars a bee space.

**The Danzenbaker Hive**

The Danzenbaker hive consisted of a brood chamber of the same length and width as the ten-frame Langstroth dovetailed hive, but deep enough to take in a depth of frame of only  $7\frac{1}{2}$  inches. There is a wide

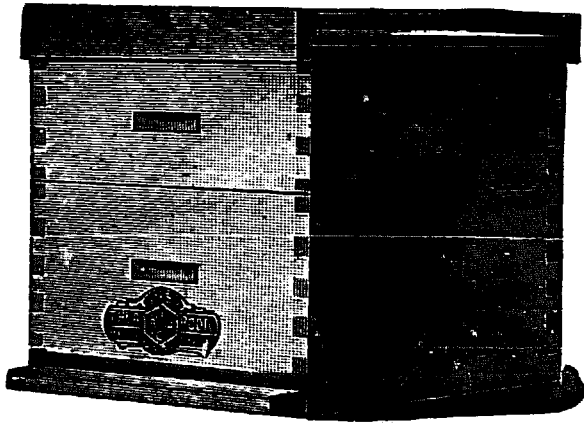

The Danzenbaker hive

cleat nailed on the inside of the ends of the hive. On this support hang the closed-end brood frames pivoted in the center of the end bars by means of a rivet driven through from the inside. Ten of these frames fill the hive. As the frames are pivoted in the center, they can be reversed, and this feature which costs nothing is something to be desired, as it enables one to have all frames filled solid with comb.

This hive was designed primarily for the production of comb honey. As a comb honey hive it is a very good one, but on account of handling the brood frames it has become so unpopular that it has gone out of use.

Where bee glue (propolis) is very abundant the closed-end frames become so badly gummed up that it is almost impossible to separate them.

The same general criticisms apply with equal force against the Heddon hive next described, which likewise, and for the same reasons, has all but gone out of use.

#### The Heddon Hive

This hive was patented and introduced in 1885. Its peculiar and distinguishing feature was the use of one brood chamber divided into halves horizontally, each half containing a set of eight closed-end close-fitting brood frames,  $5\frac{3}{8}$  inches deep by  $18\frac{1}{4}$ . The end bars, as already stated, were close-fitting—that is, the brood frames slid into the hive with just enough clearance to allow their easy removal and insertion. On the bottom inside edge of the ends of each case were nailed strips of tin to support the frames, and the whole set of eight was squeezed firmly together by means

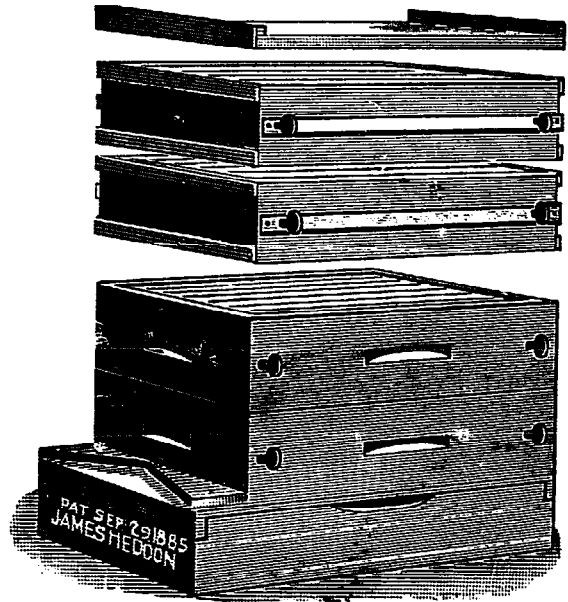

The Heddon hive

of wooden thumb screws as shown. Under the head of Comb Honey mention was made of the value of compression for squeezing sections, section holders, or wide frames. The more tightly the parts are held together the less chance there is for bees to chink propolis into the cracks.

The purpose of the inventor in having the hive divided in this way was to afford more rapid handling and to accomplish contraction by taking from the brood part of the hive one or more sections. The divisible feature of the hive, according to its inventor, enabled him to handle hives instead of frames, to find the queen by shaking the bees out of one or both of the shallow sections. The horizontal bee space through the center of the brood nest he considered an advantage in wintering because the bees could move up and down and laterally between combs. The Heddon principle of small hives and excessive contraction has been shown to be a blunder. (See Contraction.)

#### The Dadant Hive

Almost the very opposite of the Heddon in principle and general construction is the Dadant hive. While Mr. Heddon divided the brood chamber into one, two, or three separate portions, Charles Dadant had it all in one large complete whole. The frames were  $18\frac{1}{2}$

by  $1\frac{1}{4}$ —the Quinby dimensions. There were ten to the hive. Such a hive had about the equivalent capacity of a twelve-frame Langstroth, regular depth. Mr. Dadant held that their ten-frame Quinbys, when compared with the ten-frame Langstroth, averaged up year after year, would give far better results both in honey and economy of labor.

#### **The Ten-Frame Hive of Extra Depth**

It was suggested by A. N. Draper, one of Mr. Dadant's followers, that instead of making a hive after Quinby's dimensions and on the Dadant pattern, a hive be constructed after the pattern of the regular ten-frame dovetailed, having Langstroth dimensions save in one measurement—that of depth. He added to the hive and frame  $2\frac{1}{8}$  inches. As Mr. Dadant used nine frames in his original Quinby hives, ten frames  $2\frac{1}{8}$  inches deeper, with Langstroth top bar, would give the hive equal capacity. Such a hive would take regular Langstroth ten-frame bottom boards, covers, honey boards, supers, winter cases — in fact, everything adapted to the regular ten-frame Langstroth dovetailed hive. As the ten-frame hive is one of the standards, if the large hive is really better, such a hive would be more simple and cost less than to adopt regular Quinby frame dimensions.

#### **The Modified-Dadant Hive**

In 1917 Dadant & Sons brought out something similar to the one just described except that it had 11 frames,  $1\frac{1}{2}$ -inch spacing, Langstroth length, and Quinby depth. The extra frame makes it a little too wide to use supers and hive bodies of standard dimensions without cleats to close up the space as shown. This hive requires a special bottom board and a special cover.

The Dadant hive is very popular in some sections of the country. The principal objection to it is that as a single unit it is heavy for one person to lift when full of bees, brood, and honey.

#### **British Hives**

The lone hold-outs among the beekeepers who have standardized on the

Langstroth hive are those in Britain and to somewhat a lesser degree those on the Continent of Europe.

Three styles of hive predominate among those in use in England, though one, the modified national hive is said to be used by 80% of the country's beekeepers.\* The construction of the hive requires eight separate pieces of wood for each hive body, which is  $18\frac{1}{2}$  inches square. The deep brood boxes accommodate 11 of the standard  $14 \times 8\frac{1}{2}$  inch frames with a 17 inch top bar. Shallow supers take  $14 \times 5\frac{1}{2}$  inch frames.

The W.B.C. hive is an attractive double wall hive which takes 10 frames. Frame spacing is made possible by little tin sleeves known as "metal ends" which fit around the lugs. This hive was designed by W. Broughton Carr. The lumber used to accommodate the overlapping  $1\frac{1}{2}$  inch lugs provides a very convenient ridge for lifting purposes.

The third hive commonly used in Britain is something of a miniature Langstroth. The designer, Mr. Willy Smith of Scotland lent his name to the Smith hive, which is rectangular and is frequently used with Hoffman frames, though many methods of comb spacing are used.

#### **Standardized Hives**

Looking back over 50 years it is evident that the trend has been toward larger hives and brood chambers, for eight frames were considered large enough by many especially for comb honey production. In later years the Langstroth hive of ten frames,  $9\frac{1}{8}$ "  $\times$   $17\frac{5}{8}$ " has been steadily becoming standard, not only in the U. S. but in many other countries as well. When more room is needed, two hives or even three, may be tiered up with the added advantage of horizontal passage-ways between the combs in the different stories.

#### **Two-Story Ten-Frame Langstroth Hives**

Where the ten-frame Langstroth hive is used it is customary to have the colony breed in two stories. As already explained, the average queen will go beyond ten or even

\*K. Stevens, "British Hives Today", *Gleanings in Bee Culture*, Vol. 97 (Dec. '69) 713-718.

twelve frames. If she or the bees are not given unlimited room for breeding, cells may be started and a swarm may follow. To prevent this it is usually customary to put on another hive body, or upper story containing combs.

Ninety-five percent of the honey producers of the country are using hives of Langstroth dimensions. It is possible for the expert beekeeper or the novice, if he will study directions, to manipulate his brood chambers of Langstroth dimensions so that he can secure not only the maximum amount of brood and bees of the right age for the harvest, but he will be able to keep down swarming for the production of extracted and comb honey. (For particulars regarding this matter, see Swarm Control under Swarming; Demaree Plan of Swarm Control; Why Standard Equipment under Extracting; and Food Chamber.)

#### Long-Idea Hives

It has been argued that a hive of two stories causes the queen to be appreciably slow in getting over the rim of honey looping the brood nest, over the  $\frac{7}{8}$ -inch top bar, a  $\frac{3}{8}$ -inch bee space, a  $\frac{1}{4}$ -inch bottom bar and another bee space before reaching the comb in the upper hive body. It is said that in the long hive a queen would move readily sideways from one brood frame to another rather than from one brood frame in the lower body to another in the upper brood chamber.

Another advantage claimed for the long single-story hive is that less lifting of heavy supers is required. Beekeepers still tinker with the idea and actually adapt the idea to their own needs on a limited scale.

#### The Buckeye Double Walled Hive

The A. I. Root Buckeye double-walled hive had a brood chamber made of an outer wall of  $\frac{7}{8}$ -inch and an inner wall of  $\frac{3}{8}$ -inch wood, lock cornered for strength. The space between the walls was covered with a beveled frame to shed water, this was nailed to the inner and outer walls. The space in the double wall was filled with loose packing material such as chaff, straw, sawdust or dry leaves.

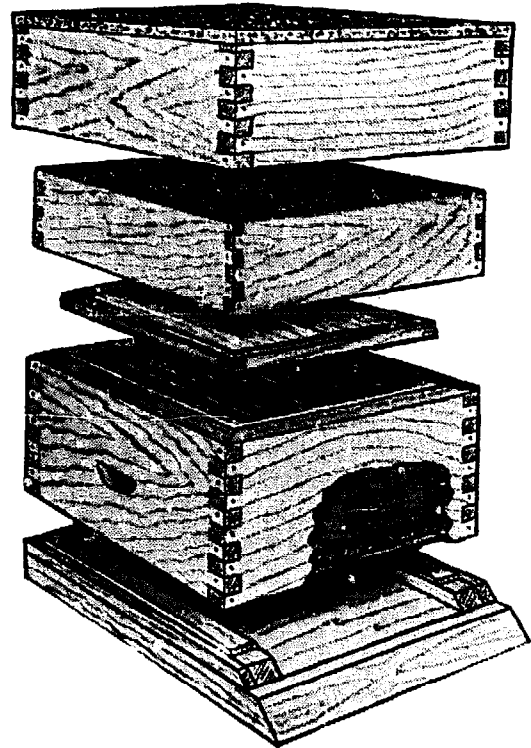

Root double-walled hive

The upper entrance is not shown here. A chaff tray is filled with dry forest leaves or coarse chaff, then placed over the inner cover. The outer telescope cover is placed over all.

#### Hives of Plastic

Over the years hives made of wood could be made more economically than from any other material. This was due to the relatively low cost of wood compared to metal and no substitute material existed that could match wood for durability and ease of working. Even after plastics became an acceptable substitute for wood in thousands of applications the beekeepers were understandably cautious about housing bees and storing honey in plastic hives. Plastics used for hives must be durable, weather resistant and must be non-toxic to bees and stored honey. Manufacturers found that fabricating hives of plastic required a large investment in molds and processes that could only be justified by a comparatively large volume, something that is not generated on a sustained basis by beekeepers, though commercial beekeepers are as interested in investing in improved hives as are hobby beekeepers. Before abandoning wood, which many craftsmen

(including those who do a creditable job of building their own equipment) consider the ideal material for hive construction, it must be demonstrated that plastic is an acceptable substitute for wood in all respects.

The continuing dependence of America for nearly one-half of its petroleum needs on foreign imports gives pause to consider whether a switch to a petrochemical raw material is wise. Wood is a limited but renewable resource that is demonstratively compatible with the biology of the bee, can be worked into hive components by industrial or home craftsmen using power or hand tools. Regardless of these advantages of wood the use of molded material has a future in hive manufacture whether it be plastics or of another material. Plastics with the qualities that from all indications make them acceptable for hive manufacture are available for use and are now being manufactured and marketed. With the possible exception of a need to redesign to resist the effects of stress-caused warping, the plastic hive is at least proving that it is now an acceptable alternate to the wood hive. Good progress is being achieved in tests using plastic for frames and foundation. Many are in commercial use. Plastic comb honey sections are being used (see Comb Honey, To Produce, Cobana Sections). A plastic base comb foundation coated with a thin layer of beeswax has certain limitations on its acceptance by the bees as proven when given during a dearth of incoming nectar, a common cause of the destruction of sheets of pure beeswax foundation when given under these unfavorable conditions. Beekeepers must use discretion as to the proper time to place either type of foundation, wax coated plastic or pure beeswax on their hives for the bees to draw out if good combs are to be expected.

The selection of plastic frame styles and sizes are limited at present but with increasing use of molded materials in hive making there may be a marked trend to follow with plastic frames and foundation, but only if a decided advantage of cost of basic material and

economy of fabrication makes plastic attractive to the manufacturer and the hives fill the needs of the bees and the beekeeper.

**HIVES, EVOLUTION OF.\***—Geological evidence has shown that honey bees existed millions of years before man appeared on the earth and began to rob their nests. The first bees to be "tamed" were probably a swarm which entered a hollow log (see Plate 1, Fig 5, page 347) or a broken crock, for primitive man was unable to cut off or hollow large boughs. The earliest hives of which we have any knowledge are the cylinders of bark closed by a solid plug at one end and a perforated plug at the other. The natives of central Africa still anoint these substances beloved by bees and hang them in trees to attract wild swarms. When one of these is full the bees are ejected by building a fire underneath it after which the hive is emptied, and the honey and wax stored for future use. These hives date from a very remote time for they were found all over the Old World south of the mountains which stretch from Gibraltar to Kamschatka. In different countries they are made of different materials but are always tubes or rectangular tunnels and are laid flat on the ground or a support.

In Egypt they have been made of Nile mud for thousands of years past and are made into piles numbering hundreds which are made into walls by pouring mortar into their interstices. The tomb of Pabu-sa (625 B. C.) now in the Metropolitan Museum of New York shows hives of this type. We find upright hives (introduced from the North) which are found in Northern Italy, and the tunnel hives of the South. A similar mixture of northern and southern influence produced the

\*By H. M. Frazer, Ph. D., an expert of the B.B.K.A., a member of the Council of the B.B.K.A. until the recent reorganization, and Chairman of the Central Association of the B.B.K.A. For many years he has written a weekly article in the *British Bee Journal* and in 1930 he was awarded the Degree of Doctor of Philosophy by the University of London for his book "Beekeeping in Antiquity".

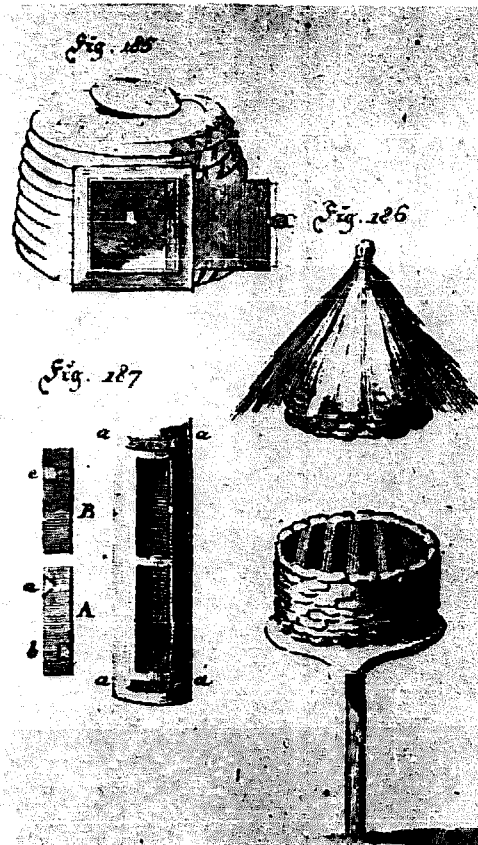

Fig. 1. — Before the advent of movable frames, with and without bee spaces clear around, frames without end bars or bottoms were spaced over the top of the skep or box. In side-opening hives the combs on sides and bottoms are cut loose when bar and comb could be removed.

Greek hive (above). In this, bars to which the bees attach their combs were placed across the hive and in the spring the combs attached to their bars were cut out and divided between two hives. The Greeks knew that the bees in the queenless part could raise a queen from a young larva. There are reasons for believing that Aristotle (342 B. C.) used hives of this type.

To the north of the great mountain range the hives were nearly always upright and were placed on a stand as they had no bases of their own. The earliest of these hives were made of wicker work (Fig. 3) usually "cloomed", that is, covered with a mixture of loam and cow dung to make them air tight, and topped with a straw cap, called a hackle, to keep out the rain. They are probably as ancient as the pipe hives of Southern Lands but are now found in out-of-the-way places only, but until the eighteenth century was well advanced they out-

numbered the straw skeps in England. They were managed in much the same way as skeps but the bees were killed by plunging the hives into hot water. This explains the early discovery of mead which was largely used in Europe before the introduction of the vine. (Fig. 3 shows a wicker hive from Levett, 1634.)

In Eastern Europe, from the Ural Mountains to the River Elbe, the wicker hives were superseded by wooden ones. In the forest regions these were cut out of living pine trees, the tops of which were cut off to prevent the wind from breaking them at the weakest point. Where the forest was less dense, hollow logs were used generally upright but sometimes recumbent (see Fig. 5, Plate I) and outside the forest hives of various designs were made from planks. In some cases the hives were in the form of statues with the bees' entrance in front and the door for manipulating at the back.

In Germany, west (but not southwest) of the Elbe, the straw skep, which is made from a rope of twisted straw, was invented about the beginning of the Christian era and assumed two main forms: those which stood on separate stools and were cloomed and hackled like the wicker hives and those which were kept in penthouses. These spread rapidly over Northwest Europe. (See Figs. 6 and 7, Plate 1, pg. 347.)

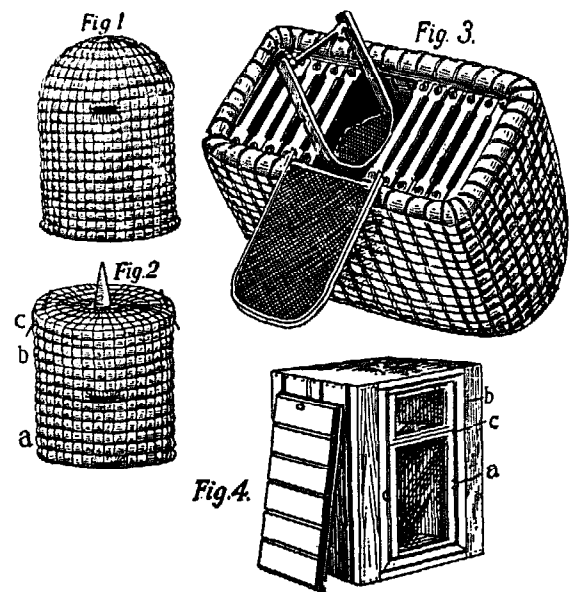

Fig. 2.—Varieties of the straw skep

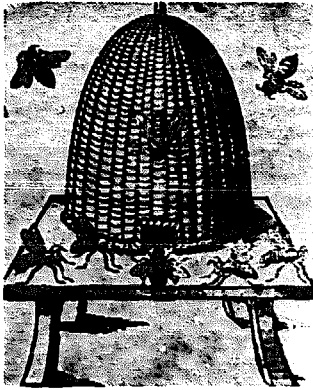

Fig. 3.—The wicker skep differs from those made of straw in that they were made up of slender wooden whips tapering to the end or top. Otherwise they are of the same general form and principle as the straw hives shown in Plate I.

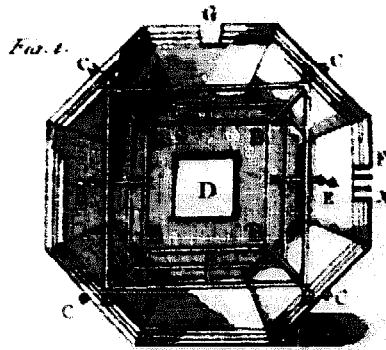

Fig. 2.

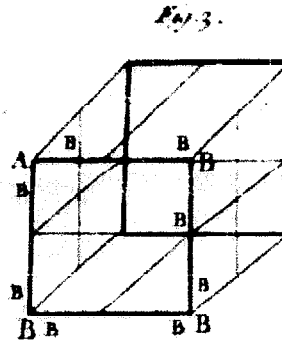
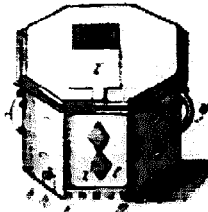

Fig. 4.

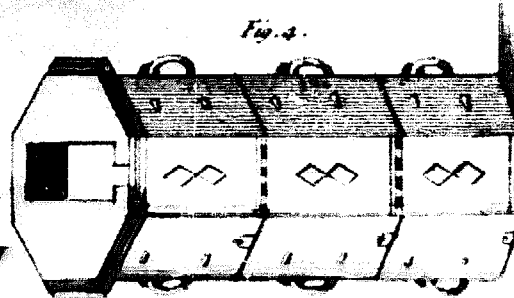

Fig. 4.—Geddes hive

Modern hives may be said to have begun with Mewe's hive, a picture (by Sir Christopher Wren) of which appeared in Hartlib's "Reformed Commonwealth of Bees" (1655). Geddes' Hive which is reproduced here (Fig. 4) was patented in 1675 and embodied the idea of supering and the rough beginning of frames. These hives were intended to be placed in bee houses and so were made of thin wood. This fault, which was repeated by Worlidge, Warder, and Thorley, caused the octagonal hives to die out until in 1819 when Robert Kerr of Stewarton (Fig. 9) built them of thicker timber. They were then gradually improved by the addition of frames, etc., until they were superseded about 1880 by hives of the modern type.

ried to an absurd extent in the tower-like hive of Bromwich (1873).

About the same time J. L. Christ, in Germany, introduced his magazine hives in which square boxes without top or bottom were used as supers. In France the author of the *Traite des Mouches a Miel* (1690)

Meanwhile Rev. Stephen White produced the collateral hive in 1756 in which what corresponded to supers were added at the sides of the brood box (see Plate III for several styles) instead of above it. This type of hive was revived by Nutt in his "Humanity to Honeybees" (1832), but it did not yield much honey. Thomas Wildman (1768) put bars across a skep somewhat as in a Greek hive, and his nephew Daniel placed glasses for honey above holes made in flat-topped skeps. This fashion was car-

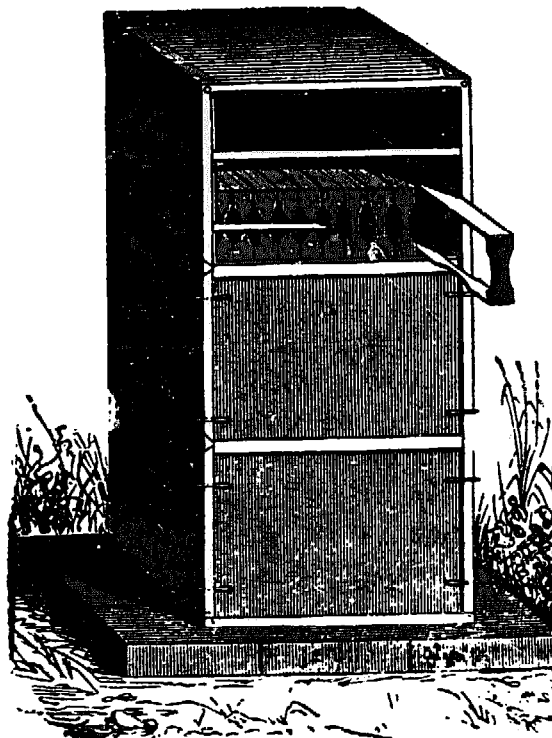

Fig. 7. Prokopovitch's hive, 1807  
—From Framiere



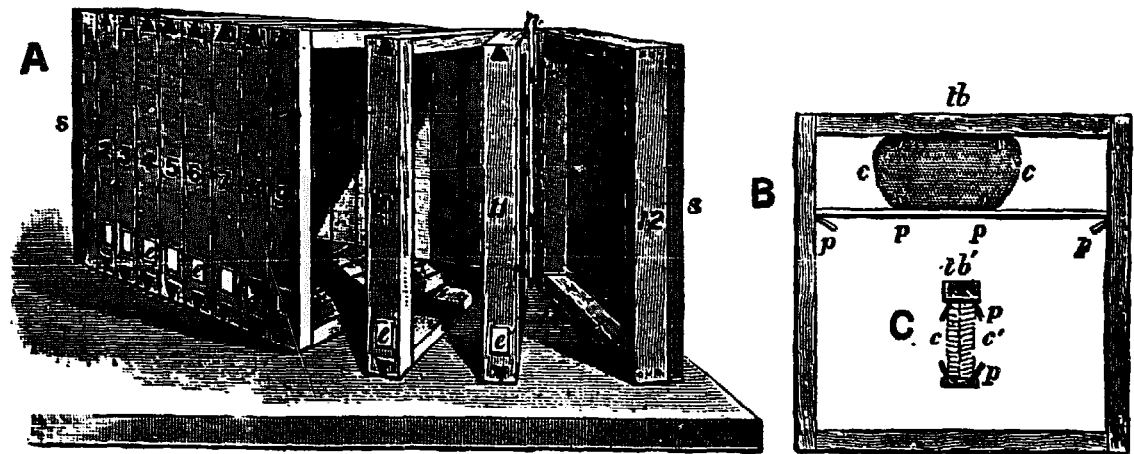

Fig. 8.—Huber's leaf hive.—From Cheshire.

and Count da la Bourdonnaye were working on similar lines, and hives were designed by Duchet, Palteau, and others. In the U. S. A. also, towards the beginning of the nineteenth century, very many patent hives were designed (see Plates I, II, and III), most of which were intended to check the ravages of wax moth. About this time Huber was using his leaf hive which was very useful as a means of studying the life of the bee but had no influence on the development of the hive proper (see Fig. 8).

During the first half of the nineteenth century the designers of hives endeavored to produce a movable-frame hive, and Dzierzon and von Berlepsch in Germany, De Beauvoys in France (Fig. 10), and Augustus Munn in England devised hives which were not successful,

and it was left to Langstroth to discover the practical use of the bee space in 1851 which enabled him to use frames which the bees did not fasten to the hive body.

After Langstroth had introduced the movable-frame hive the invention of the excluder, extractor, and wax foundation soon followed and all the essentials of the modern hive and of the system of beekeeping in which it is used were then available for the use of beekeepers. The advantages of this system are: 1. It has made it much easier to study bees and perform manipulations. 2. The bees are no longer killed. 3. Clean, pure honey is produced. 4. Much larger crops are obtained from each hive.

After we received the foregoing material from Dr. Frazer covering this subject, we secured from the



Fig. 9.—The Stewarton hive, 1819. A shallow-bar hive with glass strips between bars.—From Cheshire.

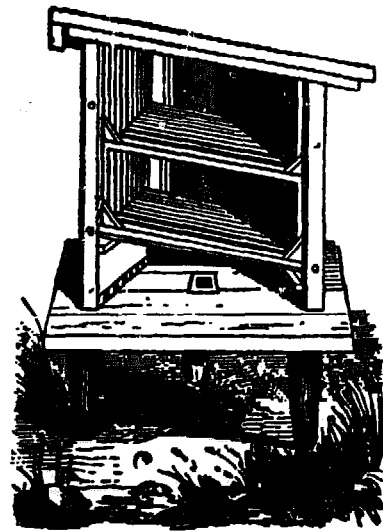

Fig. 10. — DeBeauvoys's hive 1845. Invented in France before Langstroth's hive appeared.



1



2



3



4

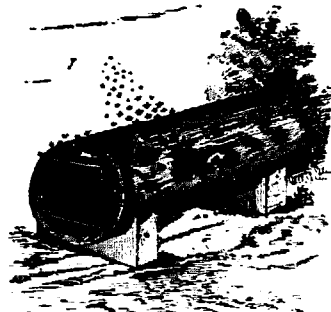

5

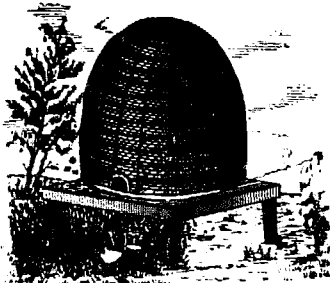

6

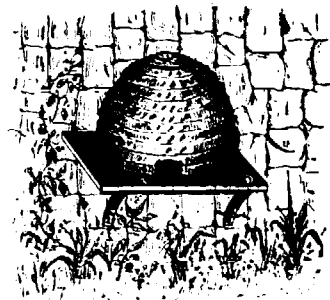

7

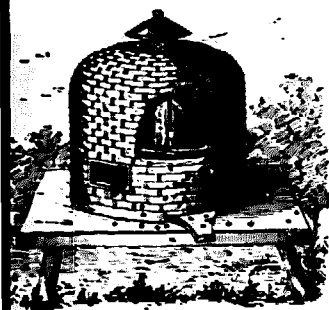

8



9



10



11

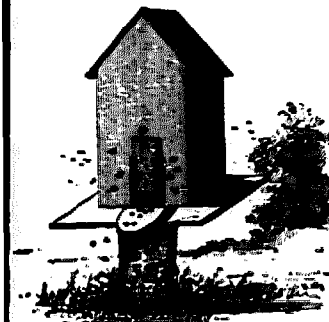

12

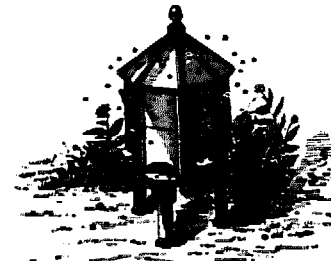

13

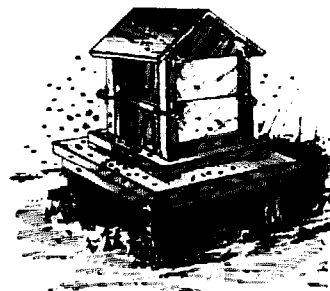

14

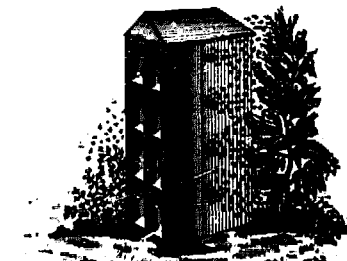

15

**Plate No. I  
EVOLUTION OF HIVES IN AMERICA**

No. 1, Worker; No. 2, Queen; No. 3, Drone; No. 4, Bee Tree; No. 5, Bee Log; No. 6, Pompeian Hive; No. 7, Straw Hive; No. 8, Metal and Cork Hive; No. 9, Upright Gum; No. 10, German Hive; No. 11, Barrel Hive; No. 12, Upright Box Hive; No. 13, Octagonal Hive; No. 14, Observatory Hive; No. 15, Multiple Hive.

[The illustrations of hives with legends in Plates I, II, and III were copied from drawings of hives and equipment covered by patents granted by the U. S. Patent Office, Washington, D. C., to individuals. Collectively they show the development of abodes for bees from hollow trees or logs to the modern hive as shown in the patent granted to Mr. Langstroth in 1852. Not one of these hives shows any useful gadget workable in commercial beekeeping.—Author.]

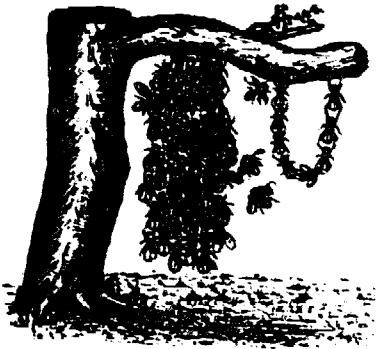

1



2



3



4

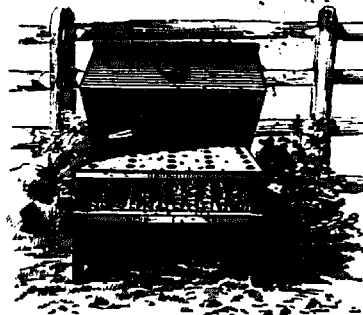

5

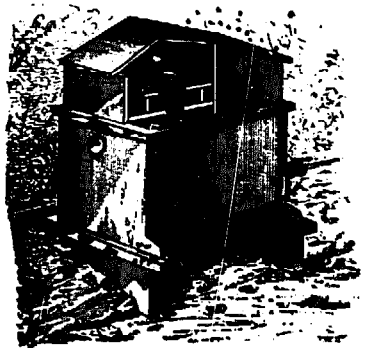

6

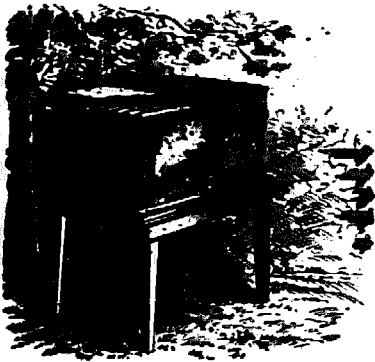

7

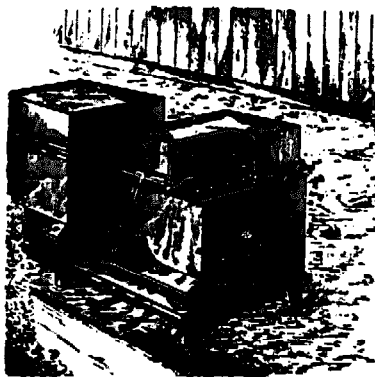

8

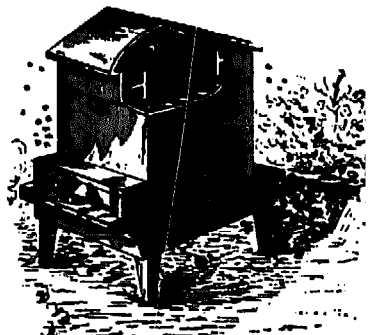

9

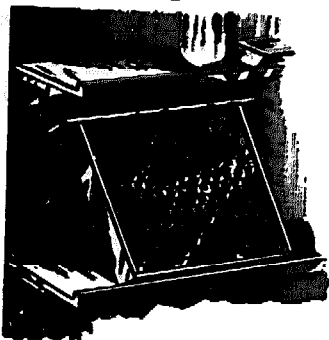

10

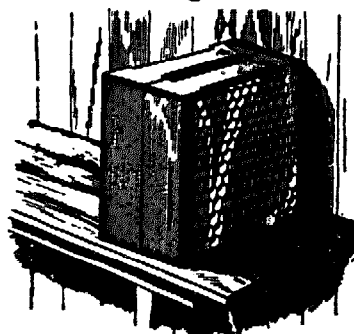

11

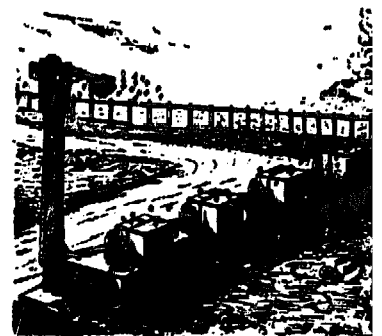

12

Plate No. II

No. 1, Bee swarm; No. 2, Bee swarming; No. 3, Bee hiving; No. 4, Securing swarm; No. 5, U. S. Patent, Comb Frame—A. D. 1852; No. 6, U. S. Patent, Bee Feeder—A. D. 1867; No. 7, U. S. Patent, Comb Bar—A. D. 1868; No. 8, U. S. Patent, Bee Feeder—A. D. 1874; No. 9, U. S. Patent, Bee Feeder—A. D. 1878; No. 10, U. S. Patent, Artificial Comb—A. D. 1881; No. 11, U. S. Patent, Artificial Comb—A. D. 1882; No. 12, U. S. Patent, Hiving—A. D. 1884.

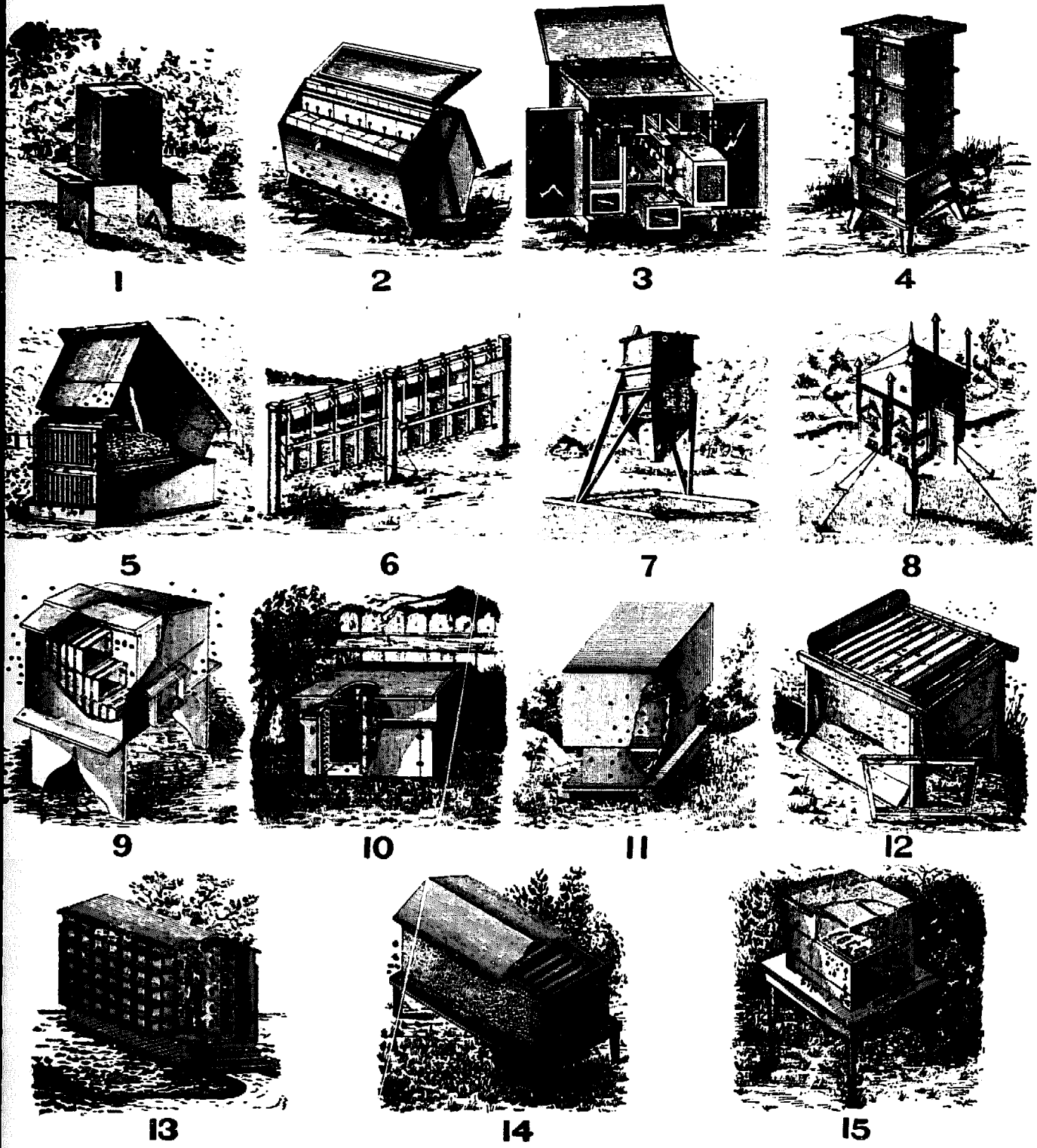

**Plate No. III**

No. 1, U. S. Patent, Compartment Hive—A. D. 1830; No. 2, U. S. Patent, Bee House—A. D. 1836; No. 3, U. S. Patent, Multiple Hive—A. D. 1842; No. 4, U. S. Patent, Ventilator Hive—A. D. 1843; No. 5, U. S. Patent, Hive—A. D. 1852; No. 6, U. S. Patent, Hive Supporting Frame—A. D. 1860; No. 7, U. S. Patent, Truncated Hive—A. D. 1869; No. 8, U. S. Patent, Bee House; No. 9, U. S. Patent, Compartment Hive—A. D. 1872; No. 10, U. S. Patent, Bee Hive—A. D. 1877; No. 11, U. S. Patent, Bee Hive—A. D. 1877; No. 12, U. S. Patent, Frame Spacing Bars—A. D. 1878; No. 13, U. S. Patent, Apiary—A. D. 1878; No. 14, U. S. Patent, Moth Killing Hive—A. D., 1879; No. 15, U. S. Patent, Compartment Hive—A. D. 1884.

United States Patent Office a series of pictures showing the hives patented before and after the Langstroth hive of 1852. Apparently these so-called patentees knew little or nothing about the Langstroth invention, even though he had explained it in the farm papers, because not one of them included covers or movable frames.

These engravings are here reproduced because they indicate the thought of the average American beekeeper at that time. What some of them do show are complicated forms of mechanism consisting of a series of drawers which the bees were supposed to fill with honey. Unfortunately, these became glued fast and any attempt to remove them resulted in kindling wood and a mess of honey.

Few of these beekeepers knew much about bees. Some of these would-be inventors knew about the worms which were to be found in old log gums or crude boxes containing a couple of cross sticks to support the combs. (See Box Hives.) They tried to get rid of the worms by suspending the hives above the ground by means of wires attached to a support above. They thought, of course, that the worms could not get into the hives but did not realize they would turn into moths which could fly and therefore reach the suspended hives. There were other inventors who patented moth traps so that even the bee moths could not get into the hives.

**HONEY\***—Honey is a sweet viscous fluid elaborated by bees from nectar obtained from plant nectaries, chiefly floral, which after transportation to the hive in the honey stomach is ripened and stored in the comb for food. Other definitions may be found, usually more restrictive. For example, the U. S. Food and Drug advisory definition for honey states that "Honey is the nectar and saccharine exudation of plants, gathered, modified, and stored in the comb by honeybees (*Apis mellifera* and *A. dorsata*); is levorotary, contains not more than 25 per cent water, not more than 0.25 per cent ash, and not more than eight per cent sucrose". While this definition served a useful purpose,

\*By J. W. White, Ph.D., Head, Honey Investigations, Plant Products Laboratory, Eastern Utilization Research & Development Division, Agricultural Research Service, U.S.D.A.

it is considered today to allow too high a content of water and sucrose and is too low in ash. It excludes honeydew.

The color of honey may vary greatly, from a nearly colorless fireweed or sweetclover type through yellow, yellow-green, gold, ambers, dark browns or red-browns to nearly black. The variations are almost entirely due to the plant source of the honey, though climate may modify the color somewhat through the darkening action of heat.

The flavor of honeys varies even more than the color. A honey may appear to have only a simple sweetness or may be mild, spicy, fragrant, aromatic, bitter, harsh, medicinal or objectionable. This is again almost entirely governed by the floral source. In general a light-colored honey is expected to be mild in flavor and a darker honey to be of pronounced flavor. The exceptions common to all rules sometimes endow light honeys with very definite specific flavors. Since flavor judgment is a personal thing, one man's favorite may be another's "unflavored sugar sirup" or "ill-tasting medicine". With the tremendous variety available everyone should be able to find his own favorite honey.

The make-up of honey has been studied by chemists in this country for more than 75 years. Probably the first sustained chemical work with honey in the U. S. was that of Dr. Harvey W. Wiley, of Pure Food fame. Dr. Wiley, as Chief of the Bureau of Chemistry, directed a comprehensive program of analysis of common foods, the results of which were published as the celebrated Bulletin 13, **Foods and Food Adulterants**, beginning in 1887. The shocking condition of U. S. foods thus revealed played a major part in the passage of the Food and Drug Act of 1906. In 1890 Part 6 of this bulletin appeared, subtitled **Sugar, Molasses, Sirups, Confectionery, Honey and Beeswax**. The analyses of 500 samples of open-market honey, by ten State Chemists, were given in detail and it was found that at least 37 per cent of them were grossly adulterated. The virtual impossibility of obtaining pure honey in the latter part of the nineteenth century greatly retarded its use. Thus honey was one of the foods that was used

to bring about passage of Pure Food laws in this country.

Many samples of honey of various floral types from over the country were collected for the St. Louis Exhibition in 1903 by the National Beekeepers' Association. These were later donated to the Bureau of Entomology and 85 of them, plus other samples, were analyzed by Dr. C. A. Browne, Chief of the Sugar Laboratory of the Bureau of Chemistry. This work was published as Bureau of Chemistry Bulletin 110, **Chemical Analyses and Composition of American Honeys**, in 1908. It was a definitive work for its time and remained a primary source of information about the composition of honey until recently.

The work noted above was limited in accuracy by the methods available for analysis of sugars. These were largely based on the use of the polarimeter and depended on measuring the amount of rotation imparted to a beam of polarized light by honey solutions after various treatments. Various assumptions were needed and the resulting picture of the sugar composition of honey, though very useful approximations, were still just that. When more modern, specific and accurate systems of honey analysis were developed, a somewhat different idea of the sugar composition of honey resulted.

White and his colleagues in U. S. Department of Agriculture Technical

Bulletin 1261 (1962) have published analyses of 490 samples of U. S. honey and 14 honeydews gathered from 47 of the 50 States and representing 82 "single" floral types and 93 blends of "known" composition. For the more common honey types many samples were available and averages were calculated with the help of a computer for many floral types and plant families. In this bulletin are also given average honey composition for each State and region, and detailed discussions of effect of crop year, storage, area of production, granulation, and color on composition. Some of the tables are reproduced here.

Tables 1 and 2 show not only the average values but give the range of values found for each constituent. Some idea of the great variability can be obtained from this column.

Nearly all of the entries in the tables will be familiar. The levulose and dextrose are the simple sugars making up most of the honey. Sucrose (table sugar) is present in high concentration in nectar from which honey is made. "Maltose" represents a group or at least six more complex sugars that is collectively analyzed and reported as maltose. Higher sugars is a more descriptive term for the material formerly called honey dextrin.

The undetermined value is found by adding all the sugar percentages to the moisture value and subtracting from

**TABLE I**  
Average Composition of Honey and Range of Values Among 490 Samples<sup>1/</sup>

Color <sup>2/</sup>	Average	Range
	Dark half of White	Light half Water-White to Dark Liquid to complete hard granulation
Granulating tendency <sup>3/</sup>	Few clumps of crystals, $\frac{3}{8}$ - $\frac{1}{4}$ " layer	
Moisture (%)	17.2	13.4 - 22.9
Levulose (%)	38.19	27.25 - 44.26
Dextrose (%)	31.28	22.03 - 40.75
Sucrose (%)	1.31	0.25 - 7.57
Maltose (%)	7.31	2.74 - 15.98
Higher Sugars (%)	1.50	0.13 - 8.49
Undetermined (%)	3.1	0.0 - 13.2
pH	3.91	3.42 - 6.10
Free Acidity (meq./kg.)	22.03	6.75 - 47.19
Lactone (meq./kg.)	7.11	0.00 - 18.76
Total Acidity (meq./kg.)	29.12	8.58 - 59.49
Lactone/Free Acid	0.335	0.00 - 0.950
Ash (%)	0.169	0.020 - 1.028
Nitrogen (%)	0.041	0.000 - 0.133
Diastase <sup>4/</sup>	20.8	2.1 - 61.2

<sup>1/</sup> Data from U. S. Dept. Agr. Tech. Bull. 1261, "Composition of American Honeys" by J. W. White, Jr., M. L. Riethof, M. H. Subers and I. Kushnir, 1962.

<sup>2/</sup> Expressed in terms of USDA color classes.

<sup>3/</sup> Extent of granulation for a heated sample after six months undisturbed storage.

<sup>4/</sup> 270 samples.

TABLE II  
Average Composition of Honeydew and Range of Values Among 14 Samples<sup>1/</sup>

Color	Average	Range
	Light half of Amber	Dark half of Extra Light Amber, to Dark
Granulating tendency	1/16-1/8" layer crystals	Liquid to complete soft granulation
Moisture (%)	16.3	12.2 - 18.2
Levulose (%)	31.80	23.91 - 38.12
Dextrose (%)	26.08	19.23 - 31.86
Sucrose (%)	0.80	0.44 - 1.14
Maltose (%)	8.80	5.11 - 12.48
Higher Sugars (%)	4.70	1.28 - 11.50
Undetermined (%)	10.1	2.7 - 22.4
pH	4.45	3.90 - 4.88
Free Acidity (meq./kg.)	49.07	30.29 - 66.02
Lactone (meq./kg.)	5.80	0.36 - 14.09
Total Acidity (meq./kg.)	54.88	34.62 - 76.49
Lactone/Free Acid	0.127	0.007 - 0.385
Ash (%)	0.736	0.212 - 1.185
Nitrogen (%)	0.100	0.047 - 0.223
Diastase <sup>2/</sup>	31.9	6.7 - 48.4

<sup>1/</sup> Data from U. S. Dept. Agr. Tech. Bull. 1261, "Composition of American Honey" by J. W. White, Jr., M. L. Riethof, M. H. Subers and I. Kushnir, 1962.

<sup>2/</sup> Four samples only.

100. The active acidity of a material is expressed as pH; the larger the number the lower is the active acidity. The lactone is a newly found component of honey; lactones may be considered to be a reserve acidity, since by chemically adding water to them ("hydrolysis") an acid is formed. The ash is, of course, the material remaining after the honey is burned and represents mineral matter. The nitrogen is a measure of the protein material, including the enzymes, and diastase is a specific starch-digesting enzyme.

Most of these are expressed in percent, that is, parts per hundred of honey. The acidity is reported differently. In earlier times acidity was reported as percent formic acid. We now know that there are many acids in honey, with formic acid being one of the least important. Since a sugar acid, gluconic acid, has been found to be the principal one in honey, these results could be expressed as "per cent gluconic acid" by multiplying the numbers in the table by 0.0196. Actually there are many acids in honey, so the term "milliequivalents per kilogram" is used to avoid implying that only one acid is found in honey. This figure is such that it properly expresses the acidity of a honey sample independently of the kind or kinds of acids present. (See Honey, acids of).

By comparing Tables 1 and 2 the differences between floral honey and honeydew honey\* can be seen. Floral honey is higher in simple sugars (dextrose and levulose), lower in disac-

charides and higher sugars (dextrins), and contains much less acid. The higher amount of mineral salts (ash) in honeydew gives to honeydew a less active acidity (higher pH; see Honey, acidity of). The nitrogen content, reflecting the amino acids and protein content, is also higher in honeydew.

The composition of the principal sugars of the more common types of honey is shown in Table 3. In all cases levulose predominates. There are a few types, not represented in the table, which contain more dextrose than levulose, such as dandelion and blue curls. This excess of levulose over dextrose is one way that honey differs from commercial invert sugar. Levulose is more soluble than dextrose so that even though honey has less dextrose than levulose, the former is the sugar that crystallizes when honey granulates or "sugars". The sucrose level in honey never reaches zero even though it may contain an active sucrose-splitting enzyme. (See enzymes).

#### Chemical and Physical Properties of Honey

There is a vast literature dealing with the chemical and physical aspects of honey but this subject has so many sides and is so scattered throughout various scientific books and journals of our own, as well as foreign countries, that it is extremely difficult if not im-

\*Strictly speaking, honeydew is an excretory product of several species of insects when sucking plant juices. If it is gathered and stored by bees it becomes honeydew honey. (See Honeydew).

TABLE III  
Carbohydrate Composition of Honey Types<sup>1/</sup>

No. Samples	Floral Type	Dextrose	Levulose	Sucrose	Maltose	Higher Sugars
23	Alfalfa	33.40%	39.11%	2.64%	6.01%	0.89%
25	Alfalfa-Sweetclover	33.57	39.29	2.00	6.30	0.91
5	Aster	31.33	37.55	0.81	8.45	1.04
3	Basswood	31.59	37.88	1.20	6.86	1.44
3	Blackberry	25.94	37.64	1.27	11.33	2.50
5	Buckwheat	29.46	35.30	0.78	7.63	2.27
4	Wild Buckwheat	30.50	39.72	0.79	7.21	0.83
3	Alsike Clover	30.72	39.18	1.40	7.46	1.55
3	Crimson Clover	30.87	38.21	0.91	8.59	1.63
3	Hubam Clover	33.42	38.69	0.86	6.23	0.74
8	Sweet Clover	30.97	37.95	1.41	7.75	1.40
3	Yellow Sweet C.	32.81	39.22	2.93	6.63	0.97
12	White Clover	30.71	38.36	1.03	7.32	1.56
26	"Clover"	32.22	37.84	1.44	6.60	1.39
10	Cotton	36.74	39.28	1.14	4.87	0.50
3	Fireweed	30.72	39.81	1.28	7.12	2.06
6	Gallberry	30.15	39.85	0.72	7.71	1.22
3	Goldenrod	33.15	39.57	0.51	6.57	0.59
2	Heartsease	32.98	37.23	1.95	5.71	0.63
2	Holly	25.65	38.98	1.00	10.07	2.16
2	Horsemint	33.63	37.37	1.01	5.53	0.73
3	Black Locust	28.00	40.66	1.01	8.42	1.90
3	Mesquite	36.90	40.41	0.95	5.42	0.35
4	Cal. Orange	32.01	39.08	2.68	6.26	1.23
13	Fla. Orange	31.96	38.91	2.60	7.29	1.40
3	Purple Loosestrife	29.90	37.75	0.62	8.13	2.35
4	Raspberry	28.54	34.46	0.51	8.68	3.58
3	Sage	28.19	40.39	1.13	7.40	2.38
3	Sourwood	24.61	39.79	0.92	11.79	2.55
4	Star Thistle	31.14	36.91	2.27	6.92	2.74
4	Tulip Tree	25.85	34.65	0.69	11.57	2.96
5	Tupelo	25.95	43.27	1.21	7.97	1.11
7	Vetch	31.67	38.33	1.34	7.23	1.83
9	Hairy Vetch	30.64	38.20	2.03	7.81	2.08
3	Cedar Honeydew	25.92	25.16	0.68	6.20	9.61
5	Oak Honeydew	27.43	34.84	0.84	10.45	2.16

<sup>1/</sup> Data from U. S. Dept. Agr. Tech. Bull. 1261, "Composition of American Honeys" by J. W. White, Jr., M. L. Riethof, M. H. Subers and I. Kushnir, 1962.

possible for beekeepers to get any adequate conception of the subject if left to these sources of information. In dealing with this subject here, an effort will be made to discuss in an understandable way those scientific principles which are important from the standpoint of physical characteristics, as well as the chemical behavior, of honey. Special emphasis will be placed on recent knowledge and advances in the understanding of honey behavior.

Honey differs from most other saccharine products in that its characteristics vary so widely among the various types. This, in turn, of course depends upon the floral source from which the nectar is gathered. Buckwheat honey is dark in color and possesses a very pungent aroma, whereas honey gathered from sweet clover is usually very light in color and possesses a very delicate aroma and flavor. Honey from alfalfa and the clover varieties usually granulates quite readily in contrast to tupelo and sage honey, which remains liquid for long periods of time without any tendency to crystallize. (See Table II.)

In other ways there are contrasting

types, and in addition, every kind of honey has its individual flavor characteristic so that in all a tremendous variation among the different kinds of honey is shown.

Every beekeeper is, of course, familiar in a general way with these facts, but it is doubtful if he fully appreciates their extent or the importance of understanding and allowing for them. This wide variation in physical characteristics and chemical behavior of honey is both an advantage and a disadvantage. Its advantage lies in the fact that we can more nearly suit the individual tastes of consumers. Many people prefer light, mild-flavored honey. On the other hand, some prefer darker honeys of more pronounced flavor characteristics. There are many individuals who prefer buckwheat to any other honey, and consider the milder types as being insipid by comparison. On the other hand, this lack of uniformity in physical characteristics and chemical behavior must be taken into account when honey is to be used for industrial purposes. Great care and a thorough understanding of the behavior of a particular honey type is necessary for complete suc-



cess in its utilization for purposes such as candy manufacture, commercial baking, ice cream manufacture, etc.

In fact, the use of honey in the food industry has been severely retarded by this variability. The effect of such variation of honey on the properties of baked goods has been studied. (See Honey in baking). One of the objectives of the analytical work on U. S. honey reported in Technical Bulletin 1261 was to provide food technologists and others with information on honey variability.

#### Composition of Honey

Honey consists essentially of a water solution of two sugars, dextrose and levulose, with small amounts of more complex sugars. A large number of other substances also occurs in honey but the sugars make up by far the greater proportion of honey. The principal

characteristics and behavior of honey are due to its sugars, but the minor constituents such as flavoring materials, color pigments, acids, and minerals are largely responsible for the differences among individual honeys. Only minute quantities of coloring matter and flavoring substances make the difference between light and dark colored, or mild and strongly flavored honeys. In a similar manner, only very small quantities of amino acids and similar nitrogenous components of honey increase its tendency to darken on storage or when heated. The presence of very small quantities of protein or other colloidal substances is sufficient to greatly increase the tendency of honey to foam or to retain finely-divided air bubbles. On the other hand, the readiness with which honey granulates is determined very largely by the amount of dextrose

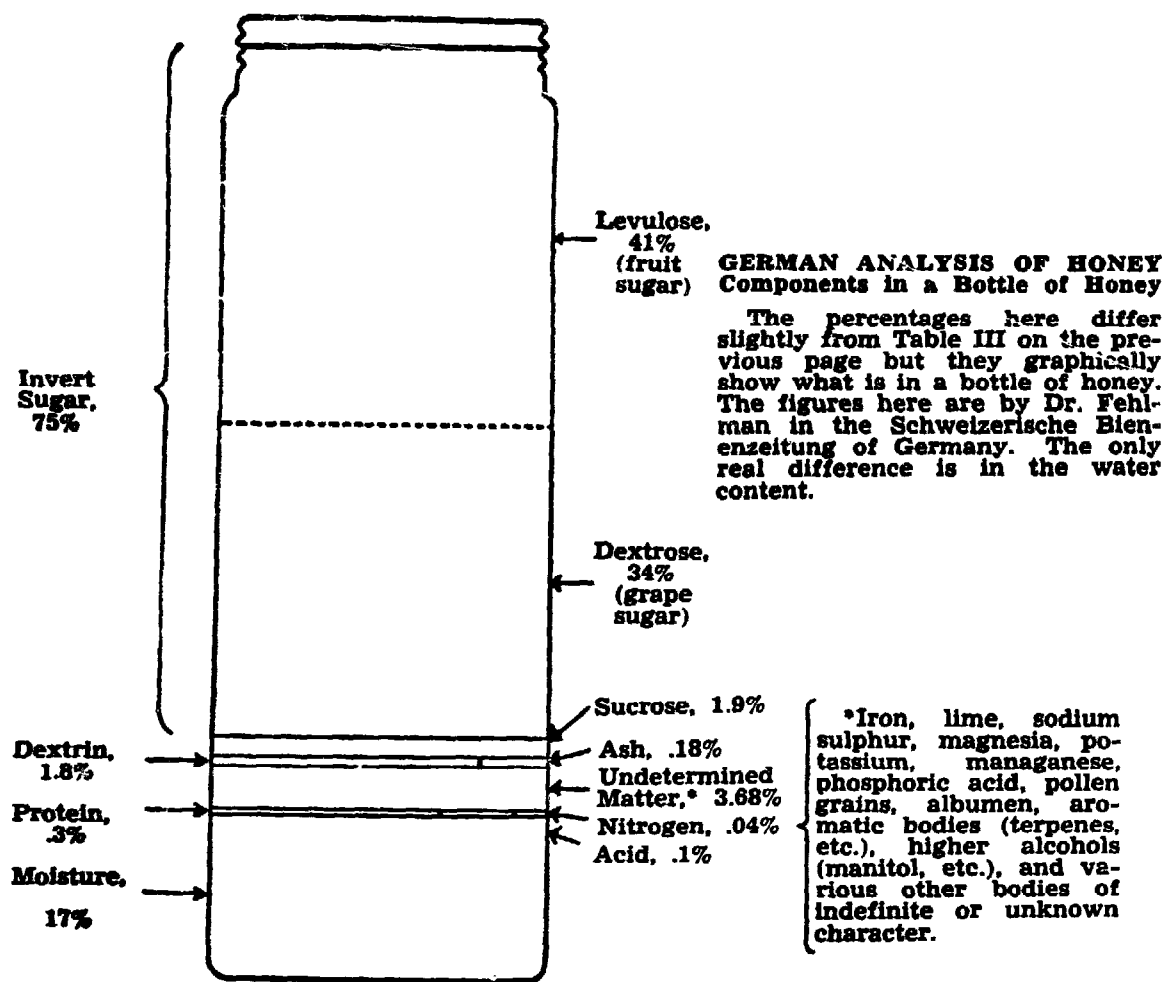

in honey in relation to its water content. (See Honey, granulation *cf.*)

### The Sugars of Honey

Honey is first and foremost a carbohydrate material. Sugars make up 95-99.9 per cent of the solids of honey and their identity has been studied for many years. In a recent survey of the composition of American honeys a great deal of care and attention were given to the accurate and precise determination of the amounts of the various sugars in the honey samples.

In the past ten years or so a quiet revolution has taken place in the field of analytical chemistry. New materials, new methods, and new instruments have brought about better, more rapid, and more accurate analyses of many kinds. As a result of these improvements we now have new information helping clarify the complex picture of the sugars of honey. This new information is both qualitative — what kinds of sugars are present — and quantitative — measuring the amounts of the sugars.

Sugars may be grouped according to the size and complexity of their molecules. The groups of interest to us are three. These include the monosaccharides, or simple sugars. These are the individual "building blocks" of the more complex sugars, and are not further broken down without greatly changing their properties. Examples are dextrose and levulose, the predominating sugars in honey. The disaccharide sugars are also of interest to us; they are somewhat more complex than the simple monosaccharide sugars, being each made up of two such units. The kind of sugar and the type of linkage between them can differ, so that hundreds of disaccharides are possible. The best known disaccharides are sucrose (table sugar), lactose (milk sugar), and maltose. For our purposes, we consider all other more complex sugars together in one group, the higher sugars. These include trisaccharides, made up of three sugar units (such as melezitose) and even more complex sugars with four or more monosaccharide units. As the complexity of these saccharides increases they approach the structure of dextrans and starches.

Honey was long thought to be mainly levulose and dextrose, with some su-

crose and dextrans. These were considered to be poorly-defined complex sugars of high molecular weight.

With the advent of new methods for analyzing and separating sugars, workers in Europe, in this country, and in Japan have found many sugars in honey and in some cases isolated and identified them by suitable physical and chemical methods.

Table 4 shows the names of the sugars and gives some other information about them. Many of these have been considered very rare; some have never been found in a natural product before, though made in the laboratory.

TABLE IV  
Sugars Identified in Honey

Name	Investigators
Monosaccharides	
Levulose	Long known to occur
Dextrose	
Disaccharides	
Sucrose	Long known to occur
Maltose	White and Hoban <sup>1/</sup>
Isomaltose	Watanabe and Aso <sup>2/</sup> ; White and Hoban
Turanose	White and Hoban
Maltulose	White and Hoban
Nigerose	White and Hoban
Kojibiose	Watanabe and Aso
Leucrose	Watanabe and Aso
Higher Sugars	
Melezitose	Reported by Goldschmidt
Eriose	and Burkert <sup>3/</sup> but not
Kesiose	isolated or adequately
Raffinose	identified.
Dextrantriose	

<sup>1/</sup> Arch. Biochem. Biophys. 80, 386 (1959).

<sup>2/</sup> Nature 183, 1740 (1959).

<sup>3/</sup> Z. Physiol. Chem. 300, 188 (1955).

Most of these sugars probably do not occur in nectar, but arise due to either enzymic action during the ripening of honey or by chemical action in the concentrated, somewhat acid sugar mixture we know as honey, during storage.

One of the questions that may arise is whether all honey contains the same sugars, especially the minor sugars, or if possibly certain types of honey would have different kinds of sugars. To check this, all sugar solutions obtained during the analysis of 504 samples of honey and honeydew honey were analyzed by the process of paper chromatography. This is a way to separate the individual sugars from each other and to spread them out on paper so they may be counted and compared. In all of the honey samples the same patterns of sugars were found. There were often differences in the relative

amounts of the various sugars, but all honeys appeared to have all of the sugars. This chromatographic check on the solutions served also to assure that preliminary treatments of the samples were operating properly.

It should be noted that many of the sugars have several names. Dextrose is sometimes termed "grape sugar" and chemically is called glucose. Unfortunately, this latter word is also applied to commercial starch (corn) sirups which may contain, in addition to glucose, maltose and dextrans which are higher polymers of glucose. Dextrose is probably the most common sugar in nature, especially if we consider its occurrence as the constituent "building block" of starch, cellulose, glycogen (animal starch) as well as in the free state. This is the sugar normally found in blood and an important source of heat and energy for the body. Dextrose is produced from starch and cellulose by a process called hydrolysis. By this is meant chemically adding water to the parent substances to produce the simple sugar. Cane sugar (sucrose) produces dextrose and levulose when it undergoes hydrolysis. This hydrolysis can be brought about by means of the enzyme invertase or by treatment with a small amount of acid and warming. In either case 95 parts by weight of sucrose combines with five parts by weight of water to produce 50 parts by weight of dextrose and 50 parts by weight of levulose. To the chemist this means that one molecule of sucrose combines with one molecule of water to produce a molecule of dextrose and a molecule of levulose. In this process the invertase, or the acid, used to promote the change is not used up but remains unchanged at the end of the reaction. Such substances are known as catalysts. In general, enzymes are nature's catalysts, and acids are used by man (usually accompanied by heating) to bring about these breaking down processes of carbohydrates and sugars to produce simple sugars.

Many other substances produce dextrose on hydrolysis. The production of dextrose from starches has already been discussed. Other sugars yield dextrose in hydrolysis. Maltose (malt sugar) produces only dextrose when hydrolyzed. Lactose (milk sugar) produces dextrose

and galactose (a simple sugar) in equal proportions. Many naturally occurring substances called glucosides produce dextrose, along with other products, when hydrolyzed. Cellulose, the substance that makes up the cell wall structure of plants and occurs in almost pure form as cotton and also in wood, can be hydrolyzed to dextrose by means of acid and heat.

Levulose, the main sugar in honey is known chemically as fructose and sometimes is called fruit sugar. It occurs free in many fruits and several polymers of fructose (levans, inulin, fructosans) are known.

#### The Acids of Honey

The acids of honey, although a very minor constituent on a weight basis (less than one-half of one per cent), have a pronounced beneficial effect on the flavor. They also may be in part responsible for the excellent stability of honey against microorganisms. At least eighteen different organic acids have been reported\* in honey, with varying degrees of certainty. Until recently it was thought that citric and malic acids were the principal ones. Now it is realized that gluconic acid is the acid present in the greatest amount in honey. This acid arises from dextrose through the action of an enzyme recently found in honey, called glucose oxidase. (See Honey, antibacterial activity of). Other acids which have been reported in honey are formic, acetic, butyric, lactic, oxalic, tartaric, maleic, pyroglutamic, pyruvic, a-ketoglutaric and glycollic acids.

#### Amino Acids and Proteins

It will be noted in Table 1 that the amount of nitrogen in honey is quite low, on the average (0.04%), though it may range to 0.13%. If this were all from protein in honey, the corresponding protein values would be about 0.25% to 0.8%. Since it is known that other nitrogenous substances occur in honey, the true values for pro-

\*Heiduschka, A., *Pharm. Zentralhalle* 52, 1051 (1911)

Nelson, E. K. and Mottern, H. H., *Ind. Eng. Chem.* 23, 335 (1931)

Vavruch, I., *Chem. Listy* 46 (2), 116 (1952)

Goldschmidt, S. and Buchert, H., *Z. physiol. Chem.* 301, 78 (1955)

Stinson, E. E., Subers, M. H., Petty, J., and White, J. W., *Arch. Biochem. Biophys.* 89, 6 (1960)

Maeda, S., Mukai, A., Kosugi, N. and Okada, Y., *Chem. Absts.* 59, 13275

tein content are somewhat lower. Little is known of the proteins of honey, except that the enzymes fall into this class. The peculiar physical properties of heather honey (see Viscosity) are reported\* to be due to a protein which if added to clover honey will confer these same properties upon it. The presence of proteins causes honey to have a lower surface tension than otherwise, which produces a marked tendency toward foaming and scum formation and encourages formation and retention of fine air bubbles. Beekeepers familiar with buckwheat honey know how readily it tends to foam and produce surface scum, which is largely due to its relatively high protein content.

The amino acids are simple compounds obtained when proteins are broken down by chemical or digestive processes. They are the "building blocks" of the proteins. A number of them are essential to life and must be obtained in the diet. The quantity of free amino acids in honey is quite small and of no nutritional significance. Recent breakthroughs in the separation and analysis of minute quantities of material (chromatography) has revealed\*\* that different honeys contain from 11 to 21 different free amino acids. Proline, glutamic acid, alanine, phenylalanine, tyrosine, leucine and isoleucine are the most commonly occurring.

Amino acids are known to react slowly (or more rapidly with heating) with sugars to produce yellow or brown materials; part of the darkening of honey with age or heating may be due to this. The acidity of honey is measured in two ways: one might be considered a quantity effect—the actual quantity of acid present—and the other an intensity effect—intensity of acidity. The

former can be determined by neutralizing the acid present in the honey with an alkali solution of known strength, and determining the total amount of acid present. The latter requires special apparatus to determine and is usually expressed on the pH scale (see Acidity of Honey). In a simple way it corresponds to the intensity of acidity. This intensity factor is in turn controlled by three factors: the nature of the individual acids present, the total amount of acids present, and the influence of certain other materials present in honey, such as minerals. Since the acids which are present in honey are quite similar in nature, belonging as they do to the group called organic acids, the first of the three factors given above probably does not influence the acid intensity materially. It has been determined, however, that minerals probably exert a greater influence on the intensity of acidity than does the total amount of acid itself. Honeys such as honeydew, that contain comparatively large quantities of mineral matter, have comparatively high pH values (which correspond to a low acid intensity), even though the total amount of acid present is quite high. Similarly, light-colored honeys containing comparatively small amounts of acids generally show a decidedly low pH (which corresponds to a high degree of acidity). This action of minerals of honey in reducing the intensity of acidity (increasing the pH) is called a "buffer effect". This not only is of importance in its influence on the taste or flavor of honey, but also influences such factors as color formation, yeast growth, etc.

### Minerals

When honey is dried and burned a small residue of ash invariably remains. This is the mineral content and as shown in Table 1 it varies from 0.02 to slightly over 1 per cent of a honey, averaging about 0.17 per cent for the 490 samples analyzed.

Honeydew is richer in minerals, so much so that the mineral content of honeydew is said to be a prime cause of its unsuitability for winter stores. Schuette and his colleagues at the University of Wisconsin have examined the mineral content of light and dark

\*Price-Jones, J. in Blair, G. W. S., "Food-stuffs, their plasticity, fluidity and consistency", Interscience Publishers, Inc., New York. 1953 pp. 148-176.

\*\*Vauruch, I., Chem. Listy 46, 116 (1952)  
Baumgarten, F. and Mockesch, I., Z. Bienenforsch. 3, 181 (1956)  
Komamine, A., Suomen Kemistilehti B33, 185 (1960)  
Maeda, S., et al., loc. cit.  
Solvieva, T. Y., and Bazarova, V. T., Vopr. Pitaniya 22, 69 (1963)

honeys. They reported\* the following average values (the first figure is for light, the second for dark honey in each case): Potassium 205, 1676 parts per million; chlorine 52, 113; sulfur 58, 100; calcium 49, 51; sodium 18, 76; phosphorus 35, 47; magnesium 19, 35; silica 22, 36; iron 2.4, 9.4; manganese 0.30, 4.09; copper 0.29, 0.56. Some fourteen additional mineral elements have been reported by European chemists using sensitive spectrographic methods.

### Enzymes

One of the characteristics that sets honey apart from all other sweetening agents is the presence therein of enzymes. These are complex protein materials that bring about chemical changes under mild conditions that may be very difficult to accomplish in the laboratory. Enzymatic reactions are the very basis of life. Enzymes in honey can conceivably arise from the bee, pollen, nectar, or even yeasts and microorganisms. Those most prominent are added by the bee in the conversion of nectar to honey. Invertase (also known as sucrase or saccharase) splits sucrose into its constituent simple sugars, dextrose and levulose. It has recently been found that other more complex sugars are formed in small amount during this action which in part explains the complexity of the minor sugars of honey. Although the work of invertase is completed when honey is ripened, the enzyme remains in the honey and retains its activity for some time. (See Honey, storage of). Even so, the sucrose content of honey never reaches zero. It is known that the enzyme also synthesizes sucrose so that perhaps the final low value for sucrose content of honey represents an equilibrium between splitting and formation of sucrose.

Another enzyme long known to be in honey is diastase (amylase). Since this enzyme digests starch to simpler compounds and starch has not been found in nectar, it is not clear what its function in nature might be. At any rate diastase appears to be present, in varying amounts, in nearly all honeys and can be measured. It has prob-

ably had the greatest amount of attention in the past because it has been used as a measure of honey quality by several European countries. (See Honey, storage of).

Another enzyme has recently\* been found in honey. This is glucose oxidase, which converts dextrose to a related material, gluconolactone, which in turn forms gluconic acid, the principal acid in honey. This enzyme had previously been shown by the German physiologist Gauhe to be in the pharyngeal gland of the honeybee, so it is likely that this is the source. Here again as with other enzymes, the amount in different honeys is quite variable. In addition to gluconolactone, this enzyme forms hydrogen peroxide during its action on dextrose. This has been shown to be the basis of the heat-sensitive antibacterial activity of honey. (See Honey, antibacterial activity of).

Several other enzymes have been reported in honey but in general the results have not been sufficiently confirmed to have confidence. These are inulase, catalase, and phosphatase.

All of these enzymes can be destroyed or weakened by heat. The use of enzyme levels to indicate heating history of honey is discussed under Honey, storage of.

### Viscosity

The thickness, or slowness of flowing of honey, is usually called "body". A thick honey of good body is referred to as having a high viscosity, whereas a thin, free-flowing honey is said to possess low viscosity. Viscosity in honey is very markedly affected by temperature. As every beekeeper knows, honey becomes thinner when it is warmed. Honey mixes more readily when its viscosity is low, so warm honey blends more readily than cold honey. In this connection it should be pointed out, however, that when honey is warmed, the greatest decrease in viscosity takes place between room temperature and 100 degrees F. Above 120 degrees F. the decrease in viscosity with increase in temperature is very small, so no appreciable advantage is gained by warming above this temperature for purposes of blending. In fact, even lower temperatures may be used effectively.

\*Schuette, H. A. and co-workers. *J. Am. Chem. Soc.* 54, 2909 (1932); *Food Research* 2, 529 (1937); 3, 543 (1938); 4, 349 (1939)

\*White, J. W., Subers, M. H., and Schepartz, A. I., *Biochem. et Biophys. Acta* 73, 57 (1963).

The chemical composition of honey influences its viscosity to an appreciable extent. The greatest effect on viscosity is necessarily due to moisture content. An increase of one per cent in the water content of honey produces a very decided decrease in viscosity. The so-called dextrans that are present in honeydew honey in considerable quantities perhaps exert a greater influence than any other single composition factor excepting that of water content. Honeydew or honey containing a high dextrin content is considerably more viscous than floral honeys of corresponding moisture content. In a similar manner, the proportion of dextrose and levulose present in a honey exerts some influence on the viscosity. A levulose solution is less viscous than a dextrose solution of corresponding density, so honey such as tupelo that contains extremely high proportions of levulose is found to be somewhat less viscous than a honey of corresponding water content containing approximately equal quantities of the two sugars. This effect, however, is not so pronounced as is that due to the dextrans. Proteins and other colloidal substances also tend to increase the viscosity of honey. Since the quantity of these substances found in honey is usually quite small, the effect on viscosity is not very great.

In Europe there is produced a honey from heather of such high viscosity that it will not run out of a bottle when it is inverted. Besides being highly viscous, this honey exhibits another peculiar property that is referred to as thixotropy. By this is meant that the honey will change its viscosity merely by agitation—that is, the viscosity is decreased very materially when shaken. Substances that show this behavior are referred to as thixotropic. This property is frequently exhibited by colloidal substances, so the behavior of heather honey in this respect is due to the presence of some colloidal substance. A bentonite suspension, for example, assumes a jelly-like consistency when it stands for some time, but if shaken returns to a fluid state. Honey obtained from heather must be agitated by centrifuging in order to remove it from the comb. While no honey produced in this country exhibits this phenomenon to the same extent as heather, it has been found by J. Pryce-Jones of England that

buckwheat honey and certain other types are thixotropic to some extent.

#### Density and Specific Gravity

The weight of a given volume of honey is called its density (pounds per gallon, grams per milliliter). When the weight of a given volume of a substance is compared with the weight of the same volume of water the result is the specific gravity. These properties vary with the moisture content and temperature of a honey; in fact, the moisture content of honey can be obtained from a measurement of density or specific gravity. This may be done by weighing known volumes (density) or comparing the weights of the same (unknown) volume of honey and of water. A special honey hydrometer is commercially available to obtain moisture content of honey. (See Honey, water determination in).

#### Hygroscopicity

One of the interesting properties of honey is its ability to absorb moisture from the air under certain conditions. This is known as hygroscopicity and may be expressed as the relative humidity value of air in which a material is in equilibrium, i.e. it neither absorbs or loses moisture. A low value for equilibrium relative humidity means that a substance has a very pronounced ability to remove water from air (hygroscopicity).

The hygroscopicity of honey is largely due to its levulose. It varies with the moisture content of the honey; the drier the honey the greater is its hygroscopicity. Average honey is at moisture equilibrium with air at about 60 per cent R.H. Martin\* has shown how the moisture content of a honey affects its equilibrium relative humidity, or stated perhaps more clearly, how the humidity of the air affects the moisture content of honey. His results are shown in Table 5 where it can easily be seen how honey will pick up moisture when

\*Martin, E. C., *Bee World* 39, 165 (1958)

Relative Humidity	Water Content of Honey
52%	16.1
58%	17.4
66%	21.5
76%	28.9
81%	33.9

<sup>1/</sup> Data of E. C. Martin. loc. cit.

exposed to air. (See Honey, fermentation of).

### Sugars Distinguished by Polarized Light

Reference has already been made to the effect that certain sugars have in rotating the plane of polarized light. Many years ago chemists discovered that if a beam of polarized light is passed through certain organic solutions, the plane of the beam of light is rotated either to the right or to the left. Ordinary rays of light are energy waves emanating from the light source and vibrating equally in all directions similar to radio waves but of markedly different wave lengths and rapidity. If a ray of sunlight is passed through a crystal of feldspar, it thereafter vibrates in one direction only instead of in all directions. If this ray of directed or polarized light is passed through a solution of sugar, it no longer vibrates in the same plane as formerly but the plane of vibration is turned to the right or to the left. The amount and direction of this turning is exceedingly valuable to the chemist in the determination of sugars present in a solution, since each one behaves differently in its effect on polarized light. As the names would indicate, dextrose rotates polarized light to the right while levulose rotates the plane of vibration to the left.

The explanation of this effect of the sugars on polarized light is most interesting. Both dextrose and levulose consist of exactly the same number of atoms of carbon, hydrogen, and oxygen, but these atoms are differently arranged in the two sugars. In both cases the arrangement of the atoms is such as to produce a lack of symmetry which is the cause of the turning of polarized light. The extent to which levulose rotates polarized light to the left is considerably greater at ordinary temperatures than the corresponding rotation of the same amount of dextrose to the right. Thus a solution containing equal quantities of the two sugars will show a decided left-hand rotation. This is the reason honey exhibits a left-hand or minus rotation, even if the proportions of dextrose and levulose are approximately equal. In the case of honeydew honey, which shows a right-hand or plus

rotation, the presence of comparatively large quantities of gummy substances called dextrans, which themselves possess very high positive (plus) rotations, counteract the ordinary negative (minus) rotation of the sugars. honeys that show positive rotations are generally considered as honeydew, and those showing negative rotations as floral honey, although this division is somewhat arbitrary.

### How Nature Manufactures Sugar

In the vital processes of the plant, when the rays of the sun fall on the green coloring matter (chlorophyll) in leaves, a very fundamental chemical process is put under way. Carbon dioxide and water vapor, ordinarily difficult to combine, are united to form a carbohydrate. The word carbohydrate refers to this union of carbon and water (hydrate). In the process of formation of the carbohydrates a very large amount of energy is stored in chemical form. This energy is taken from the sun rays falling on the leaves, and the whole process is known as photosynthesis. It is by this process that energy is stored in plants to be used by animals as a source of energy when the plants are consumed as food. The amount of energy given up by starch or sugar when it is burned to form carbon dioxide and water, either in a colorimeter or in the body, is the same as that required to form the carbohydrate by photosynthetic processes in the plant. Starches and sugars are among those classes of substances known as energy foods, and since honey consists largely of sugars, it is primarily an energy food. The simple sugars of which it is composed do not require preliminary digestion in order to split them into simpler form before they can be absorbed into the blood stream. As a food honey is therefore in a form that supplies to the body a quickly available energy.

In certain types of honeydew honey another sugar is sometimes found that imparts rather peculiar properties to the honey. This sugar, known as melezitose, is not very soluble in water and tends to crystallize out very readily. Honeydew containing appreciable quantities of melezitose frequently crystallizes in the comb, and this type

of crystallization is comparatively easy to distinguish from ordinary dextrose crystallization. Honeydew honeys containing very high proportions of melezitose have been reported. Since this sugar occurs only infrequently in certain honeydew honeys and in all probability does not occur in ordinary floral honey, its importance as a constituent of honey is not very great. (See Honeydew.)

#### Honey Colloids

In all types of honey are to be found very minute particles of suspended matter called colloidal particles. These minute particles do not settle out of the honey, but remain suspended indefinitely. They are distinguished from ordinary suspended particles, since the latter tend to settle out and can be removed by ordinary mechanical means such as straining through closely woven fabric, or filtering. The colloidal particles, on the other hand, are much smaller and are not affected by ordinary straining or filtration (see Honey, Filtration of). In normal floral honey these minute particles are kept in suspension by virtue of positive electrical charges carried by them. This causes them to repel each other and thus remain in suspension. In case of certain honeydew and tree honeys, the electrical charges may be negative, which likewise would produce a repelling action, and thus tend to keep the particles in suspension. If the electrical charges on these particles are removed, either by adjusting the acidity, or by addition of the correct amount of a colloidal suspension such as bentonite, carrying opposite electrical charges, they show a tendency to flocculate and settle out of the honey.

While this method of clarification is not recommended for treating honey intended for use as a food, it has been found extremely useful when honey is used as a medium in certain bacteriological work.

Honey colloids appear to be very heterogeneous and to vary in composition very widely among different floral types of honey. There are always present appreciable quantities of protein material, wax particles, pollen grains, silica, and other extraneous matter.

#### Science of Granulation

The formation of sugar crystals in honey, commonly known as

granulation, consists of the separation of the sugar dextrose in solid form. It is generally considered that when dextrose crystallizes from a water solution such as honey, approximately 10 parts by weight of it are combined chemically with one part by weight of water, the combination being known as dextrose hydrate.

For several reasons the control of granulation becomes important when it is considered in relation to packing, distribution, and sale of honey. It is well recognized that honey is more susceptible to fermentation after crystallization takes place than when it remains liquid. Yeasts present in honey gradually adapt themselves to their environment of high sugar concentration and, although in well-ripened honey the concentration of sugars is still too great for appreciable yeast activity, in many cases the separation of any considerable quantity of dextrose in crystalline form increases the percentage of water in the remaining liquid portion of the honey to a point more favorable to yeast activity, fermentation often resulting. A water content of 21 percent has been found by some investigators to be the critical point for yeast activity in honey. This point is not assumed to be a rigid fixed value, since a certain degree of variation occurs. However, it serves to mark the danger point of water content with respect to fermentation. (See Honey, Spoilage of.)

Another way in which granulation assumes importance is with respect to the character of the dextrose crystals present. Some honeys crystallize in a relatively fine state, whereas others are found to crystallize in a very coarse, granular form. It is possible, however, by proper control of conditions, to produce approximately uniform, fine crystals in honeys of a variety of floral types. Such crystallized honey may be prepared by seeding with very fine crystals under proper temperature conditions, and forms the basis of the Dyce process. (See Honey, Granulation of.)

#### How Does Crystallization Start?

Honey consists essentially of a water solution of the two sugars, dextrose and levulose, with smaller quantities of certain other substances. The proportion of levulose present usually exceeds that of dextrose, an average honey contain-



ing in round numbers 40 percent of levulose, 34 percent of dextrose, and 18 percent of water, with about 8 percent of other constituents, of which from 2 to 3 percent may be sucrose (cane sugar). (See tables, pages 352 and 353.) It might appear from the above figures that levulose instead of dextrose should crystallize from honey but, due to the fact that levulose is much more soluble than dextrose and crystallizes much less readily, it does not separate from honey in crystalline form.

If an excess quantity of dextrose crystals is shaken with 100 grams of pure water at a certain fixed temperature, let us say 77 degrees F., the crystals will dissolve until 103.2 grams are in solution. At this point the solution is saturated and no additional quantity of crystals will go into solution. If the temperature is now raised, say to 122 degrees, more dextrose will dissolve until the solution again becomes saturated, but this time 240.3 grams of dextrose will be held in solution in the 100 grams of water. From this it is seen that the quantity of dextrose that dissolves in a fixed quantity of water to form a saturated solution increases as the temperature increases.

#### Super Saturated Solution of Honey

It is possible by carefully separating the excess quantity of dextrose crystals from the saturated solution at 122 degrees F. to cool it back to 77 degrees without separation of dextrose from solution. In this event we have a solution at 77 degrees containing 240.3 grams instead of 103.2 grams of dissolved dextrose—that is, the solution contains 2.3 times as much dextrose as it would contain at this temperature if it were just saturated. Such a solution is referred to as a super-saturated solution.

From the standpoint of the relative solubilities of the sugars present and their concentrations, honey contains excessive quantities of dissolved dextrose—that is, it is super-saturated with respect to dextrose. This excess quantity of dextrose has a tendency to separate in crystalline form. The tendency of honey to granulate is a natural and inherent property which varies in degree, depending ultimately on the composition of the honey, par-

ticularly with respect to the proportions of dextrose, levulose, and water.

Study of solubility relationships of these two sugars has been carried out at the National Bureau of Standards, and from the results of this study it is calculated that every type of honey is highly supersaturated with respect to dextrose at ordinary temperatures. Even tupelo honey (see Table II, page 352) is estimated to be very highly supersaturated. It should be pointed out, however, that the behavior of tupelo honey does not indicate it to be as highly supersaturated as the values calculated from this study show. Even when seeded with dextrose and stored in a comparatively cool place, there is no tendency for dextrose crystallization to take place. Apparently the solubility relationship of these sugars at the concentrations at which they occur in honey are not fully understood.

The presence of dextrose crystals in honey (either present naturally or added) definitely starts the crystallization process. The dextrose crystals may be so minute\* as to escape detection, even with a powerful microscope, yet they are capable of acting as starting points for crystal growth. It is claimed that crystals of any substance having the same crystalline form as dextrose (known as isomorphous crystals) may act as starting points for crystal growth in a supersaturated dextrose solution. However, this question has not been definitely settled, and the part played by small crystals and non-crystalline particles of substances other than dextrose present in honey is not definitely known.

The same is also true of the part played by very finely divided particles of substances present in honey which are known as colloids. When honey such as alfalfa, which ordinarily granulates solid after a few weeks' standing, is treated so as to remove these colloidal particles, granulation is delayed for comparatively long periods of time. On the other hand, the colloidal material removed from this honey was found to have no influence when recovered and tested for its ability to start crystallization of pure dextrose solutions. From this it is apparent that the part played by col-

\*See Honey, Granulation of.

loidal particles in initiating crystallization is not clearly understood, yet these colloidal substances do in some way play a part in this important problem of crystallization.

Apparently the presence of finely divided air bubbles which are incorporated in honey hastens the beginning of crystallization. The formation of the first crystal nucleus in honey (when crystals are not already present) is in many cases observed to take place at the surface. This is evidently due to the presence of a very thin layer at the surface of the honey which is of greater concentration than the bulk of the honey. Concentration at the surface may be due to the evaporation of a small amount of water (also to other surface concentration phenomena) which produces a greater sugar concentration in the surface film, thus creating conditions more favorable to the formation of crystal nuclei that act as centers for dextrose crystallization. The presence of large numbers of small air bubbles in honey increases the surface area tremendously, since each individual bubble in reality represents a surface between the liquid honey and the small air space within the bubble. In this way the opportunity for crystal formation is increased considerably.

As the result of an elaborate series of experiments based principally on various sugar solutions, Kucharenko, a Russian sugar chemist, concluded that it was possible to prepare solutions of sugars of virtually any degree of supersaturation that will not crystallize unless a crystal of the dissolved sugar is introduced into the solution. He took extreme pains in preparing these solutions, however, to remove every possibility of contaminating the solutions with crystal nuclei, and refers to such solutions as crystal-free.

Kucharenko's results indicate the possibility of treating honey so as to render it crystal-free, in which event only the introduction of dextrose crystals would produce granulation. It must be borne in mind, however, that the conditions necessary for producing crystal-free solutions are very exacting. For instance, exposure to the air for a short time would contaminate such a solution since, according to Kucharenko, crystals or crystal frag-

ments of virtually every known commonly occurring crystalline substance are to be found floating about in the air.

Another theory offered to explain the behavior of supersaturated solutions which is more generally accepted is the one advanced by Ostwald and confirmed to a large extent by Miers and his co-workers. From his work dealing with supersaturated solutions, Miers shows that the spontaneous crystallization of a supersaturated solution depends on its degree of supersaturation. In other words, he recognizes two distinct regions of supersaturation, one consisting of relatively low supersaturation strengths, referred to as the meta-stable range, and the other of higher concentrations called the labile range. In the meta-stable range, crystals will grow if already present in the solution, but no new crystals will be found spontaneously. In the labile range, on the other hand, the concentration of the dissolved substance is greater, and spontaneous formation of new crystals takes place whether or not crystals are already present.

Since honey is a water solution which is supersaturated with dextrose, the question arises whether the degree of supersaturation of the dextrose in honey is such as to make it a meta-stable or a labile solution. Little is known concerning the dextrose concentrations that are required to produce either of these ranges, so the question of whether crystals of dextrose in honey may be produced spontaneously or, on the other hand, whether honey granulation takes place in all cases about crystals already existing cannot be answered at present. Further knowledge along this line should throw considerable light on the crystallization process in honey.

#### The Effect of Agitation or Shock on Crystal Forming

In applying the principles outlined above, the question of how agitation or shaking influences the starting of crystallization should not be overlooked. In his studies Miers pointed out that a highly supersaturated solution might remain for long periods without crystallizing due to its being at rest, but would crystallize when agitated. It is generally recognized that granulation

of honey, as well as supersaturated sugar syrups, is hastened by shaking or even by gentle agitation. A sample of honey which was taken to a meeting for exhibition purposes crystallized during the trip, apparently due to shaking encountered in transit, whereas the stock supply from which the sample was taken remained uncrystallized.

The candy maker recognizes the effect of agitation on crystallization, and in certain cases, for instance, in handling crystallizing syrup (a highly supersaturated sugar syrup used by candy manufacturers to form a coating of sugar crystals on candy) he must carefully guard against agitation in order to prevent premature crystallization of the syrup. It is also recognized that "shocking", due to sudden alterations of temperature, tends to promote formation of crystals. The effect of temperature changes on the solubility of dextrose, as well as on the viscosity of honey, might at certain ranges of temperature produce conditions of supersaturation and viscosity more favorable to the spontaneous production of crystals, thereby initiating crystallization. In any event, it is recognized that in certain cases alterations of temperature tends to accelerate crystal formation.

#### **Factors Influencing the Speed of Honey Granulation**

Having considered various possible ways in which crystal formation in honey may be started, attention will next be given to the factors influencing the speed at which dextrose separates from honey in crystalline form. It is a matter of common knowledge that great differences in rate of granulation are exhibited by honeys of various types.

As stated before, honey contains an excessive quantity of dissolved dextrose or, technically speaking, honey is supersaturated with respect to dextrose. The rate at which dextrose crystals grow in honey the process is started is influenced largely by the extent of the dextrose supersaturation, being greater for higher supersaturation values. The dextrose supersaturation of honeys of different types varies considerably, and depends on the composition of the particular honey, especially the proportions of the three principle constituents: levulose, dextrose, and water.

In well-ripened honey the water content is fairly constant at about 18 percent, so that differences in the extent to which honey is supersaturated with respect to dextrose are due essentially to the ratio in which the two sugars, dextrose and levulose, are present. In alfalfa honey, in which the two sugars occur in almost equal proportions, the supersaturation of the dextrose is quite high—in some cases nearly three times as much dextrose being held in solution as would be dissolved if the honey were just saturated. For this reason the growth of crystals proceeds much more rapidly in alfalfa honey than in tupelo or sage honey, which contain considerably more levulose than dextrose, and therefore is not so highly supersaturated with dextrose.

#### **Change in Temperature and Its Effect on Granulation**

Change in temperature influences the speed of crystallization in more than one way. Let us consider, for instance, what takes place if the temperature of honey that is undergoing crystallization is lowered. Since the solubility of dextrose is less at the lower temperature, the supersaturation becomes greater, resulting in a tendency to speed up granulation. Lowering the temperature produces an opposing tendency that acts to decrease the speed of crystallization. (See Honey, Spoilage of, by Prof. Wilson.) At the lower temperature honey becomes more viscous, so that diffusion of the dissolved dextrose through the viscous mass to the growing dextrose crystals is slower than at the higher temperature. At certain temperature ranges lowering the temperature of honey actually retards the speed of granulation. It has been determined that for honey of average composition the critical point at which these opposing tendencies produce a maximum effect on crystallization speed is about 50 degrees F. (See Honey, Granulation of.) In other words, both above and below this temperature the crystallization speeds tend to decrease.

A factor of considerable significance which influences the speed of granulation is the extent of crystal surface exposed to the honey during the granulation process—that is, the total surface area of the dextrose crystals that are present. It is

a well-known fact, for instance, that a definite weight of fine sugar crystals will dissolve much more rapidly than the same weight of coarse crystals. The dissolving action of water on crystals takes place at the plane of contact of the water and the surface of the crystals so that the greater the extent of crystal surface in contact with water, the faster the crystals will dissolve. This accounts for the more rapid rate at which fine crystals dissolve, since a given weight of fine crystals possesses considerably greater crystal surface than the same weight of coarse crystals.

The processes of formation of crystals and dissolving of crystals have much in common, being merely opposite in direction. In one case crystals are coming out of solution and in the other case crystals are going into solution. The factors controlling the speed in each instance are closely related. The addition of a small amount of crystallized honey to liquid honey accelerates the rate of crystallization due to the large increase in the surface of dextrose crystals present in the honey. The addition of very small dextrose crystals to honey will increase the granulation rate enormously.

Stirring or agitation of any kind increases the speed of crystallization of honey by keeping the dextrose crystals in contact with fresh portions of honey. Without agitation the liquid portion of the honey immediately in contact with each crystal tends to become exhausted of its dextrose, thereby decreasing very greatly the rate at which dextrose continues to be deposited on the crystals, thus causing the crystals to grow in size. Since the high viscosity of honey retards the diffusion of the dissolved dextrose towards the dextrose crystals, the question of agitation and its influence on the speed of granulation of honey becomes important. This principle is recognized in the crystallization of cane sugar in factories where agitators are used for keeping the crystallizing mass called *massecuite* in motion during the crystallization process.

Although the effect of the non-sugar substances present in honey, such as salts, acids, dextrans, proteins, and colloidal substances, on the speed of crystallization of dex-

trose has not been accurately determined, it is recognized that they do have an influence and perhaps a very significant one. Such substances may influence crystallization by increasing or decreasing the solubility of dextrose by increasing the viscosity of honey, as colloids have been shown to do, or by being deposited on the surface of the dextrose crystals, thus interfering with the regular growth of the crystals.

The net effect of the non-sugar substances appears to be in the direction of slowing down the granulation rate, as solutions of dextrose and levulose alone under the same conditions have been observed to crystallize considerably faster than honeys containing the same proportions of dextrose and levulose as these solutions.

#### Control of Honey Granulation

The method customarily employed to delay or prevent granulation is to heat honey to a certain temperature for a period of time sufficient to thoroughly liquefy it. The effect of heating under these conditions may be to dissolve all or almost all of even the exceedingly small crystals of dextrose that are capable of acting as nuclei for further crystallization, or to form decomposition products which themselves act as retarders of granulation. In all probability the latter factor does not play an important part except when honey is heated to excessively high temperatures, in which case the color and flavor are materially affected. The slow, coarse type of granulation frequently observed when honey granulates after it has been heated tends to emphasize the importance of the first factor, since subsequent granulation apparently takes place around the few remaining crystal nuclei that in some way have escaped solution in heating. If granulation takes place under these conditions and without any stirring or agitation, the dextrose crystals produced will be relatively few in number and large in size.

The control of crystal size depends to a great extent on the number and size of the crystals present at the initial stage of granulation, and also of course on the temperature and whether or not the honey is agitated. In order to produce granulation of the fine, smooth

type, a great number of very small dextrose crystals should be present in the honey at the beginning of granulation. In this way the dextrose crystals produced will be relatively large in number and small in size.

The control of granulation either from the standpoint of delaying or preventing it, or for controlling crystal size, depends on the application of certain physical principles. Careful consideration of these points when dealing with honey granulation should result in a better understanding of the entire process and should be of considerable value from this standpoint in the handling of honey.

Contribution No. 140 from the Carbohydrate Research Division, Bureau of Chemistry and Soils, U. S. Department of Agriculture.

**HONEY, ACIDITY OF.** — Along in the late 70's and early 80's of the last century there were rumors to the effect that bees used their stings as trowels to form the cappings of honey combs and that when the job is done they thrust their stings through the cappings and thereby inject bee poison, supposedly formic acid, into the honey. As this acid is antiseptic, it was argued that honey was a preservative. That bees used their stings as trowels was even seriously argued by the editor of one of the leading bee journals.

Although the sting trowel theory was absurd on the face of it, it occupied columns and columns of space in some bee journals at the time. From there it found its way into the public press, carrying the inference that honey contained poison and therefore was not fit to eat. Even some medical men hold that it is the formic acid that gives honey its tang.

It is now proved beyond a doubt that the acid\* in honey is malic and citric and not formic and that while the latter may be present, it will at most be only a trace, too little to

\*Substances responsible for the acidity of honeys ordinarily amount to around 0.1 percent, says George P. Walton of the Bureau of Agricultural Chemistry, U. S. Dept. of Agriculture, if the calculations are based on the assumption that the acid is formic acid. Actually formic acid constitutes only a small part of the total acidity of honeys. A more practical measure of acidity to the food technologist is the pH value, which expresses the active acidity or alkalinity of a dissolved substance. The pH value of honeys commonly ranges between 3.6 and 4.2. The

have any effect one way or the other. Malic acid is that which is found in apples and other fruits and, of course is harmless. Citric acid is found in all citrus fruits such as oranges, grapefruit, and lemons.

The following references gathered by W. J. Nolan of the Bee Culture Laboratory, Washington, D. C., should dispel the old heresy that formic acid is an active constituent in honey.

Theodor Merl, *Zeitschrift fuer die Untersuchung der Nahrungs und Genussmittel*, Vol. 42, p. 250, reported that no formic acid was found in bees.

A. Hilger, *ibid.*, Vol. 8, pp. 110-126, reported malic acid is a normal constituent of floral and coniferous honeys.

A. Heiduschka and G. Kaufman, *ibid.*, Vol. 21, p. 375, determined volatile acids, including formic acid, on six samples and found very little formic acid. The same authors, *Sueddeutsche Apotheke Zeitung*, Vol. 53, pp. 118-119; abstracted in *Zeit. f. d. Unt. d. Nahr. u. Genussm.*, Vol. 32, p. 472, reported the presence of formic, lactic, malic, phosphoric, and tartaric acids.

K. F. Farnsteiner, *Zeit. f. d. Nahr. u. Genussm.*, Vol. 15, p. 598, reported the acidity of honey as being due only about one-tenth to formic acid and the rest mainly to malic acid. This reference also gives a literature review of the question of formic acid in honey up to 1908.

The Entwuerfe zur Festsetzungen ueber Lebensmittel of the Kaiserlichen Gesundheitsamte, Heft 1; Honig 1912 (?) or 1917 (?), reported the acidity of honey as due to malic acid with perhaps traces of formic acid.

E. K. Nelson and H. H. Mottern, Division of Food Research Bureau of Chemistry and Soils, Washington, D. C., after some very careful work, reported that malic and citric acids were found in all samples of honey examined, and that formic acid, formerly assumed to be an important acid in honey, exists only as a trace.

#### **HONEY, ADULTERATION OF.**—

Honey adulteration is not something new. Gleanings in *Bee Culture*, as far back as 1897, and likely even earlier reported instances of honey being mixed with glucose or corn syrup. The refinement of the corn syrups of the day

lower the pH value the higher is the active acidity. Extreme ranges reported for honeys are 3.2 to 4.9. Now vinegars show pH values from 2.4 to 3.4, the average being 3.12. Strange as it may seem, therefore, the most acid honeys have an active acidity equal to that of the least acid vinegars. This means that were it not for the sugar content of the most acid honeys, they would taste as sour as some vinegars. The pH value of honey is an important factor to the food technologist when he attempts to combine honey with milk products.

left something to be desired, often imparting a "metallic" taste to the honey-corn syrup mix. Improvements in refining produced improved glucose syrups which could often defy detection by tasting when used to adulterate honey.

Efforts by the honey industry to get pure food laws passed that would protect honey from adulteration emerged along with the new Pure Food and Drug Laws of the early 20th century. Sporadic violations were evidently handled under existing restraints imposed by these strong and respected laws. Also, as long as an ample supply of domestic honey flowed into the marketing channels honey was able to maintain a preferred position in the sweetener field, esteemed by those who wished a sweetener they could rely upon for purity and nutrition.

In the early 1970's the specter of honey adulteration again raised its ugly head. The short supply and rapidly increasing demand for honey created conditions favorable for attempts to circumvent the existing honey adulteration regulations (see Honey, Imitation).

Honey adulteration proved to be a persistent problem; one that would obviously need more attention than could be directed by existing pure food laws. State after State passed new legislation or revised their control measures on labeling of honey but there yet remained a need for an unassailable test that would detect honey diluted with the high fructose syrup. Such a test was needed to substantiate testimony resulting from charges of adulteration of bulk and bottled honey.

In March 1975, Jonathan W. White Jr., mailed a letter to members of the American Beekeeping Federation asking for samples of honey. The letter repeated what was already known by many in the industry, that honey was going into sales that contained adulterants; at this time the principal adulterant being the new high fructose corn syrups. One such product, Isomerase®, manufactured by Clinton Corn Processing Company had become firmly established as a sweetening agent in the food industry due to the utilization of corn-starch as the basic raw material. This plentiful resource allowed this sweetener to become very competitive with sugar. The demand for honey, its relative high price and a tightening supply was too much for opportunists to resist.

Honey and high fructose syrup blends began to occupy shelf space in stores that was formerly reserved for honey. Not satisfied to allow these "honey blends" to stand on their own merits which were open to question when compared to pure honey, promoters used the good name of honey to attempt to gain recognition through spurious labeling practices.

Concurrent with efforts to legislate new labeling laws The American Beekeeping Federation together with other concerned organizations and individuals were able to bring about a resumption of government-sponsored research at the Eastern Regional Research Center. This followed the raising of funds by private industry with which to initiate the very costly research of a means to detect adulteration of honey.

The composition of the typical product known as high fructose corn syrup (HFCS) was listed by Dr. White as follows: Dextrose 50%; Levulose 42%; Maltose 2.5%; higher sugars 3.7%. An average sample of American honey would likely contain approximately the following percentages: Dextrose 31.28%; Levulose 38.19%; Sucrose 1.31%; Maltose and other reducing disaccharides 7.31%; and higher sugars 1.50%. From this it can be seen that honey and HFCS share the same predominant sugars although it should be pointed out that honey contains many minor components such as flavors and aromas, enzymes and antibacterial substances (inhibine) that is not found in HFCS. White pointed out that the superficial resemblance of HFCS to honey in its major sugar components and its highly refined nature made it a potential adulterant of honey. He said, "Whereas the 'conventional' adulterants with which enforcement officers have contended for many years (invert sugar and corn syrup) are relatively easy to demonstrate in mixture with honey, HFCS does not, in our experience respond to the same tests. . . . Perhaps the most obvious approach to this problem is the study of the nature of the mineral constituents (of honey). Since HFCS is refined by ion exchange its original cations will have been replaced by sodium ions. Honey has long been known to be relatively low in sodium but rich in potassium; this is true in most natural products. Examination of



The word **HONEY** has always been prominently displayed and is assumed to be synonymous with a pure product.

the ratio of these two constituents might therefore reveal the addition of HFCS to honey."

In his next report to the American Beekeeping Federation in 1977 Dr. White outlined his objectives for the past 18 months. He had pursued a different tact from his initial approach of using the sodium-potassium ratios as described in *Bee World* (Vol. 58, No. 1, 1977, Pgs. 31-35). Dr. White had begun preliminary work in 1976 on his approach to isotope ratio analysis but had to postpone it until mass spectrometric instrumentation was available for this analysis. Isotope ratio analysis is based on the fundamental difference in the atoms of carbon which make up the sugars of HFCS and those making up the components of all honeys examined by Dr. White. "The mechanisms responsible for this difference are now fairly well understood," said Dr. White.

"It has been shown that there are two general groups of plants with respect to the ratio of the carbon isotopes of atomic weight 13 and 12. One group, the more enriched in carbon 13, includes most of the grasses, lower plants, marine plants and monocotyledons. The other group includes most flowering plants." A third group exists. Each uses different enzymes to fix carbon from atmospheric CO<sub>2</sub> into the plant constituents according to Dr. White. By a comparison between the results of an analysis of samples of honey, HFCS and mixtures the fact was established that by this method significant amounts of HFCS or materials of similar properties could be detected. "Further," said Dr. White, "that even if HFCS is fed to the bees and stored with honey we can detect it after extraction." Reiterating this statement later in his report



Dr. Jonathan W. White Jr. — USDA Photo.

Dr. White cautioned beekeepers that when using HFCS for bee feed care should be taken that no appreciable amounts of stores from feeding are mixed in with any surplus which is to be marketed. "A test by isotope ratio analysis cannot tell whether the HFCS was mixed with the honey before or after extraction," warned Dr. White, adding that sucrose syrup made from table sugar commonly used for bee feed will also respond to the test. While good beekeeping practices guard against this happening the difference is now that this can cause a honey sample to be declared adulterated in the eyes of enforcement agencies.

**HONEY, ALKALINE FORMING.** —In addition to the question of the nature and quantity of mineral elements contributed to the diet by honey, we must consider the reaction of the minerals present, since this also is a dietary factor. (See Honey, Minerals in.) By reaction is meant whether the minerals are predominantly acidic or predominantly alkaline. The classification of foods as acid foods or alkaline foods, is dependent almost altogether on the nature of the mineral elements present. Oranges, lemons, and fruits in general are quite acid to the taste, but as foods they are potentially alkaline. Like them,



honey is also slightly acid to the taste, but as a food is potentially alkaline. This might seem somewhat paradoxical at first, but it is quite simple to understand if we consider what takes place when foods undergo digestion and metabolism in the body. Certain foods such as oranges, lemons, and even honey, are sour or acid to the taste because they contain organic acids such as citric, malic, and others. These acids, along with sugars and starches present in foods, are very largely burned up in the body during digestion and metabolism. These acids, therefore, do not play a part in the acid-alkaline balance of the body. The reaction of the food then is dependent almost altogether on mineral elements present.

Foods vary widely as potential sources of acid or alkaline products in metabolism. In general, meats, fish, eggs, bread, wheat, and the cereals contain a preponderance of acid-forming elements. Fruits, vegetables, and milk, on the other hand, contain a preponderance of alkaline-forming elements. The mineral content of commercial fats, sugars, and starches is too low to be of any significance from this standpoint.

There is no general agreement among food authorities as to the relative importance of the acid-alkaline balance of the diet. Some feel that the importance of maintaining somewhere near a balance between acid-forming and alkaline-forming foods, or of maintaining an alkaline balance in the diet, is greatly overstressed.

There is no record of any work having been done relative to the determination of the acid-alkaline balance of honey as a food. Many food authorities consider that the mineral content of honey is too small to be of much importance in the diet.

In order to obtain some definite information on various types of American honeys from this standpoint, an investigation was carried out by the Bureau of Chemistry and Soils of the U. S. Department of Agriculture, utilizing a number of the more representative types of American honeys. The samples used in this work varied in color from water white to dark, as determined by

the U. S. Standard honey color grader.

The method of Davidson and Leclerc was used for determining the acid-alkaline balance of the honeys. It consists of igniting a definite quantity (50 grams) of honey in a platinum dish under controlled temperature conditions until all organic matter (sugars, etc.) is completely burned, leaving a white ash as a residue. This ash was found to be distinctly alkaline in case of all honeys studied. The ash is then neutralized with acid of known strength the quantity of acid used being a measure of the alkalinity of the ash.

The value obtained in this way is not a true measure of the acid-alkaline balance of the honey since part of certain mineral elements (chlorine and sulphur) is volatilized in the burning process and therefore is lost to the determination. The quantities of these elements lost in the ashing process must be determined separately and a correction made in the value obtained by neutralizing the ash, in order to correct for the loss of these elements that occur in burning.

The principle of this method of determining the acid-alkaline balance of foodstuffs is based on the assumption that the processes of animal metabolism foods are undergoing combustion with ultimate effects approximating those that result from combustion either in an electric furnace or other equivalent heat.

All of the honeys tested in this manner gave definite alkaline values. With a few exceptions, the darker honeys gave higher alkaline values than the lighter varieties due to the generally higher ash content of the darker types. In consideration of the low mineral content of honeys in general, it might be interesting to note that alkaline values for some of the honeys studied compare favorably with some of the fruits and vegetables.

In conclusion it might be stated that if the question of maintaining the proper acid-alkaline balance in the diet is important, then definite significance can be attached to the reaction of the mineral constituents of honey from this standpoint.

**HONEY, AMERICAN IMPORTS.**

—By referring to the heading Statistics on Bee and Honey Industry considerable information can be read concerning world honey production and American imports and exports of honey and beeswax. The most significant recent development in the import-export statistics on honey is the rapid rise in honey imports. At the end of November 1976 approximately 63,200,000 pounds of honey had been imported during the previous ten months. This was an increase of about 20,000,000 pounds over the total 1975 imports. This was against United States exports of approximately 4,500,000 pounds in 11 months of 1976, principally to West Germany, The Netherlands and Japan.

American honey producers, becoming more concerned with the rapidly increasing imports of honey, were hoping for a Presidential signature to legislation that would impose a 30% ad valorem duty on all imported honey over a 30,000,000 pound figure for the first three years, decreasing to the original one cent a pound after a five year period. The measure was not signed by the President. A concurrent resolution before a new Congress in 1977 failed to become law so no limitations on honey imports seems to be in prospect at the present time.

One of the concerns, besides the beekeeper's fear of lowered price and demand for domestic honey, is that a dependence on imported honey may deprive American agriculture of the pollinating benefits of our honeybees. At the time the proposal to raise the import tax was turned down by the President a pledge was made to those concerned about pollination to investigate the possibility this turn of events could have on the domestic needs for honeybee pollination. Federal research on this problem would be provided if the issue was found to be a threat to domestic food production.

As compared to prices paid to American producers for bulk honey, imported honey buyers usually pay several cents less per pound including duty paid, FOB point of entry. Mexico is supplying much of the honey being currently imported, augmented by imports from Argentina, Central America,

Brazil and Canada. In 1975 an all-time record was set at 46½ million pounds of imported honey. Estimates for 1976 indicate that the total may go to 65 or 70 million pounds by the end of the year. In that year the American Honey Producers, the Mid. U.S. Honey Producers Marketing Association, the Nebraska Honey Producers Association, the Great Lakes Honey Marketing Association, the Michigan Beekeepers Association and certain independent Kansas and Missouri beekeepers filed a petition with the United States International Trade Commission to place an ad valorem tax on imported honey. Hearings were held in several parts of the United States, including Washington, D. C. concerning the proposal. As a result of a decision reached by the commission it recommended to the President that a 30% tariff be imposed on all imported honey over an amount of 30,000,000 pounds. The President refused to sign the bill and subsequent action in the Congress failed to gather enough support to pass the legislation over the disapproval of the President. Imports of honey from Canada were exempt from this tax.

Reasons for the increase in honey imports are many and varied but inter-related. Perhaps the impetus came from the increased demand for honey, a demand that could not be supplied from domestic production. The rather sudden escalation of demand, brought on in part by an awakened interest in natural foods began in the early 1970's. This, coupled with the rise in price of sugar provided the stimulus that led to the interest in foreign sources of honey. In addition to the United States other nations with large consumer populations sought to bid for world honey supplies. Many, such as Japan, Germany and Great Britain had the resources to purchase large supplies of honey on the world market. Their own domestic supplies were negligible. Vigorous bidding followed. The exporting countries of Mexico, Brazil, Argentina, Central America and Australia responded to this demand with increased production. Beekeeping was expanded, better bees and improved management contributed to available supplies. In the predominately producing nations

the domestic consumption was low, hardly sufficient to stabilize the market when the importing nations decided their stocks were adequate.

American producers who had long been plagued by depressed prices for honey, diminishing productivity and suffering severe losses from pesticides were unable to respond to the comparatively sudden spurt in honey demand. Imported foreign honey was the only channel available to packers. Foreign honey had a lower bulk price, and provided a fairly stable supply when considered on the basis of a world market commodity. The only question was whether honey being imported was up to the standards of purity usually expected of domestic honey. Importers with prior experience were aware of the pitfalls of buying from new and untested sources while the inexperienced soon learned that honey could be adulterated with impunity in many of the producing countries and that the safeguards at the port of entry could spell economic disaster for the careless buyer who attempted to bring in honey that was of questionable purity or quality.

American honey producers saddled with high production costs were quick to respond to increasing dependence upon imported honey supplies for sales to American consumers. A basic right to protection from cheaper imported manufactured or agricultural products which threaten to disrupt the domestic industries or American commodity markets was exercised by the American honey producer through his actions during the import crisis. Similar producer groups, such as those who supply a portion of our sugar needs from domestically grown cane and beets were afforded protection by legislation which imposed higher duties on imported sugar. World demand for food supplies continually press consumer nations to seek new world supplies and the same challenge works to force or inspire food producing nations to increase their production. As a result, particularly in Agriculture, and notably in the labor intensive types of agriculture such as fruit and vegetable growing (and beekeeping) the tendency is for production to shift to areas where labor is plentiful and cheap. Labor costs (or the alterna-

tive, mechanized systems) is undoubtedly the most significant factor in production costs. The domestic honey industry, at least the producer, is a victim of the freedom accorded the American buyer to take a fairly unlimited hand in the free market. Unfortunately oblivious of the possible harm to the American commercial beekeeper that dependence on foreign sources of honey can cause, the case for import protection has been at least temporarily suspended. This decision could cost the American consumer dearly if, for the sake of satisfying a temporary imbalance in honey supplies, the need for bees as pollinators is neglected.

**HONEY, AMERICAN PRODUCTION OF**—The statistical reporting service of the United States Department of Agriculture reports that there are about 1,700 commercial beekeepers in the United States with 300 colonies or more.

In 1977 commercial beekeepers produced 178,499,000 pounds of honey from 4,346,000 colonies. In 1978 commercial beekeepers produced 230,309,000 pounds of honey from 4,084,000 colonies, up 29% from 1977. There was an increase in average colony production from 41.1 lbs. in 1977 to 56.4 lbs. per colony in 1978. Favorable weather was a major factor in this increase.

The commercial beekeepers' production in the 20 major producing states was 147 million pounds in 1978. These apiaries with 1,912,000 colonies accounted for 63.9% of the 1978 American honey crop. Their yield per colony of 77 pounds was 20.6 pounds more than the U.S. average yield of 56.4 pounds per colony.

There are two reasons for the difference in averages. One being the commercial operator with his increased knowledge and skill can manipulate his colonies so they will function with a higher degree of efficiency. The other being, out of economic necessity, the commercial beekeepers have had to seek out and locate in areas which afforded more abundant bee pasture.

There had been a steady decline in colony numbers in the United States, until 1972, since the nation reached its peak in colony count in 1947. By 1972 we had declined to 4,068,000 colonies. From 1972 to 1977 there was a slight gain in colony numbers, quite likely due to the influx of large numbers of hobbyist beekeepers and an increase in the colony numbers being operated by side-line and commercial beekeepers. An increased demand for honey followed by higher honey prices accounted for at least a share of the colony increase and brought about a reversal in the downward trend in colony numbers. The trend in 1978 was again downward but it remains to be seen if this is only a short term trend. Severe winter losses in several major midwestern producing states may be a factor in this decline.

Pesticide losses in the nation as a whole must be evaluated to determine their effect on colony numbers in 1977 and 1978.

Limited bee pasture may now be exerting a much more significant influence on colony numbers.

Following are excerpts taken from an address by Richard Adee, a commercial honey producer given before the Beekeeping Industry Conference in 1973 at Beltsville, Maryland.

"Most of the commercial beekeepers' honey is sold as raw honey to private or cooperative bottlers or handlers who in turn bottle, label and sell it at the wholesale level. Until recently the buying and selling of honey between the beekeeper and the packer was carried out pretty much on an individual bargaining basis. With economic collapse staring them in the face, beekeepers in the late sixties saw that they would have to organize better ways of marketing honey if they were going to survive. Marketing associations have now been organized in the major honey producing areas to disseminate and act as a clearing house for information in regard to production and to set a price on the honey based on supply, demand and cost of production. With this new tool, the price of raw honey has advanced to the point where now the beekeeper is being compensated financial-

ly for his investment and labor.

"To meet the challenges of beekeeping today, many beekeepers have turned to migrating with their bee colonies. This means that the beekeeper moves his bees south in the fall and back again in the spring. By doing this, the beekeeper can cut down on the amount of honey stores needed to winter a colony and he can also replace colonies lost during the past season due to queen failure, pesticides, etc.

"Today's modern beekeeper must have adequate warehouses. He must have a honey processing plant equipped with the most modern and efficient equipment available. This will include large speed controlled extractors, automatic uncappers, honey-wax separators, coupled with adequate pumps, honey heat exchangers and honey storage facilities. Once the honey is extracted today's beekeeper handles it in either 55 gal. drums or else in trailer load lots.

"We must have more sophisticated equipment which will increase our productivity per unit of labor. Correlated closely with this will have to be the development of superior lines of bees whose behavior will be predictable within very close tolerances. This will greatly reduce the cost of colony management and enhance the using of more unskilled labor.

"In summary, the future of commercial beekeeping and adequate pollination for the country's crops is going to depend on: (1) The price of honey in relation to the rest of the economy. We cannot allow ourselves the luxury of a static price for honey in a society with an inflationary cost of living scale. To do so would be fiscally irresponsible. (2) It is going to become imperative that in the immediate future non-chemical means of control of injurious insects be developed. Beekeepers are reluctant to do any long range planning and put up substantial blocks of new capital for investment as long as the threat of annihilation by pesticides hangs over their heads. (3) The availability of adequate bee pasture from which substantial

crops of surplus honey can be gathered. Emphasis must be placed on protecting the secondary sources of honey as well as the primary source.

"The key to the future of commercial beekeeping is going to depend on the managerial ability of the beekeeper. If he is able to roll with punches and adjust accordingly, he will survive and our industry will prosper. If he can't, he will be forced out of business. There is no middle ground."

**HONEY, BAKING WITH.**— (See Honey Bread.)

**HONEY, BOILING FOR BEE FEED.**—Honey which is dark, off-flavor or which has been lowered in grade by being extracted from melted cappings may be rendered safe for bee feeding by a carefully controlled boiling process. Dr. Jonathan W. White, Jr. and A. P. Sturtevant worked on the problem of sterilization of honey at the request of the USDA Division of Production and Marketing. The details of a safe honey sterilization process were published in *Gleanings in Bee Culture* 82 (11):658-661.

Honey from unknown sources must always be suspected of carrying the potential for infecting bees with American foulbrood when fed. Adding antibiotics does not lessen the chance of infection.

The following process was recommended to prepare honey for feeding to bees. Prepare diluted phosphoric acid (17%) as follows; mix one part concentrated orthophosphoric acid with four parts of water. Mix one 60 pound can of honey with 30 pounds of water (about three and one-half gallons), add five fluid ounces of diluted phosphoric acid and heat to boiling. Note the temperature at which active boiling begins and continue boiling for the time given below.

215°F.	2¼ hours
220°F.	1½ hours
225°F.	1 hour

If much foam is formed it should be skimmed off and disposed of, since spores could possibly survive the heating if they remain in the surface foam.

Tests on colonies of bees known to be free of American foulbrood revealed no disease when infected honey boiled by this process was fed. It can therefore be considered as a safe way to treat honey for bee feeding.

Feeding honey in the comb from colonies known to be healthy is always the safest and most convenient method. Avoid the feeding of honey extracted from brood combs. Do not feed burnt or caramelized honey. The feeding of honey is best done after bees have begun to have unrestricted flights in the spring. Be careful in the feeding of fermented honey. It is best to prepare honey/water mixtures just prior to use as this prevents some of the natural fermentation from taking place.

Feeding boiled honey does not necessarily guarantee against infection entering the colony from other means. It is important also to keep up a well-planned and executed disease prevention program.

**HONEY BREAD.**—By referring to Honey, Cooking with, and to Honey Cakes, it will be noticed that honey contains levulose and dextrose. The first mentioned is hygroscopic or moisture absorbing. It has been conclusively shown that all baked goods containing honey will remain soft and moist longer than a product using brown or granulated sugar.

As shown under Honey, Chemical Properties of, the principal sugars in honey, dextrose and levulose, are quite variable and for this reason some honeys give a pronounced flavor to the bread, where a double amount of certain other honeys would impart no flavor other than sweetness. A survey of the American Bakers' Association has revealed that they have been using from 2 to 9 percent liquid honey in a bread where honey is used exclusively, and from 1 to 8 percent where honey was used with other sugars. Apparently the use of honey in a bread is not so much for the honey flavor as it is for the moisture-absorbing feature, although both are important. It has also been found that honey is one of the best sugars to provide food for the yeast, and a

rich brown color for the loaf due to the caramelization in the presence of heat.

The fact that bakers and other food manufacturers prefer honey to an invert sugar syrup may perhaps be explained on two grounds: (1) honey contains more levulose — moisture-absorbing property— than invert sugar syrup which has only equal parts of levulose and dextrose. We are told that honey may be even more hygroscopic than levulose; (2) honey contains minerals, protein, and general undetermined matter that invert sugar does not have. While the amount of these is relatively small in proportion to water, levulose, and dextrose, science has shown that they are important. More work will have to be done to show their exact value. (See Honey, Alkaline Forming; Honey, Mineral Constituents of; and Honey, Hygroscopic Properties of.)

#### Other Sugars in a Honey Bread

It will be noted that some bakers use a combination of sugar and honey in their honey bread; others use straight honey and no sugar. By referring to Honey, Cooking with, it will be observed that most of the honey recipes contain more sugar than honey. The reason for this will be discussed under Honey Recipes. R. B. Willson recommends the use of no sweet but honey in a percentage of 5 percent solid or 6 percent liquid.

In any event, we notice that the amount of honey used in a honey bread is relatively small and for that reason the Food and Drug Administration evidently felt that a honey bread should contain a larger proportion of honey to carry the honey flavor.

A hearing was finally called in 1941 by the Food and Drug Administration to determine how much or how little honey could be used in a bread and call it honey bread. A tentative ruling was drawn up requiring not less than 16 parts of honey solids to each 100 parts of flour by weight or which would be equivalent to 20 percent honey in a liquid condition. Vigorous protests were filed from all over the country, not only from beekeepers but from housewives, honey packers, large and small bakeries, and from the American Honey Institute. Mrs. Grace, Executive Director of

the Institute, testified that a 16 percent solid or 20 percent liquid in a bread would make it too sweet, soggy, and difficult to make. The bakers at the hearing testified that it is possible to make such a bread in a laboratory but when that amount is used in the commercial bakery it involves such difficulties that the bakers refuse to use it. They further showed that in a mechanized shop under commercial practices if much more than 4 percent honey solid is used to 100 parts flour there is difficulty in controlling the enzymatic action of the honey, that the sticky dough is hard to work, and that unless a mild-flavored honey is used a bread containing large proportions of honey may have an unpleasant flavor so that it will lessen consumers' acceptance. Witnesses for the bakers also contended that too much honey gives a rubbery crust to the bread.

Notwithstanding that the hearing was held in August, 1941, no immediate decision was made. In the Federal Register of August 3, 1943, there appeared a report of the Food and Drug Administration that made it appear that the FDA would not insist on a 16 percent solid or 20 percent liquid in a honey bread. It contented itself with listing both the individual proposals of the FDA for 16 percent honey solid and also the proposal of the American Bakers' Association that the 16 percent be reduced to 4 percent, and finally concluded that there was "no demand on the part of the consumer for bread or rolls containing the proportion of honey proposed by the FDA. The evidence does not establish that such a proposed definition and standard of identity would be reasonable". In other words, the FDA had not established a definition and standard of identity for honey bread, rolls, or buns.

While the FDA would not require a 16 percent, it might compromise on a 5 percent solid which R. B. Willson says would not be out of reason. He favors a straight honey and no sugar. A 5 percent solid honey such as is used in the baking trade would show a distinct honey characteristic to the bread in texture, color, fresh-keeping qualities, and flavor. And honey for the baking trade is often darker and stronger in flavor than a milder-flavored light honey used on the table.

**HONEY - BUTTER COMBINATION.**—In a warm atmosphere or when the butter is soft from 20 to 30 percent of good honey can be paddled in. The honey must be thoroughly worked in after which it must be kept in a refrigerator or it will soon become rancid. The proportion of honey to butter will depend upon the taste of the individuals or family who use it. Try the smaller proportion of honey first. One should not prepare too large a batch of the mix as it will not keep more than two or three weeks even under refrigeration.

A good mix of butter and honey is very fine and some people make up a batch for winter griddle cakes. The combination of the butter and the honey is just right to put on bread or cakes without the addition of other sweets.

A mixture of honey and dairy cream has been worked out by Prof. P. H. Tracy of the Dairy Department of the University of Illinois. He thus describes it in *Gleanings in Bee Culture* for August, 1932:

One of the limiting factors in the use of honey as a spread has been its fluidity. This difficulty has been overcome, however, by a new product that is made by combining honey with heavy cream. The resulting mixture, when cool, solidifies so that it can be spread on bread or waffles with ease. Since the honey cream, as it is called, contains about 40 percent butterfat, no butter is needed.

Although it is possible to use any type of marketable extracted honey, the milder flavored ones seem to meet with greatest approval when mixed with cream. Sweet clover honey has been found to be very satisfactory.

To prepare honey cream, a sweet cream containing at least 75 percent butterfat should be used. To secure a cream of this test it is necessary to change the usual procedure somewhat. The following methods may be used:

(1) Pasteurize milk by heating to 142-145 degrees F., 30 minutes.

(2) Separate without cooling, reducing the rate of inflow to about one-fourth or until a heavy viscous cream is discharged. An especially constructed cream spout may be secured for some separators that will permit this heavy cream to be discharged from the bowl without clogging.

(3) Heat honey to 130-140 degrees F. and mix with cream in proportions of 42 percent honey (if mild in flavor) and 58 percent cream.

(4) Package immediately. Glass or paper containers may be used.

Honey cream should be kept refrigerated as it has keeping qualities somewhat similar to those of butter.

This product can be made by milk dealers or by farmers themselves. If the small separator is used to separate the high-test cream it is advisable to secure the special tinware made by some companies for use on their machines.

Because of its delicious flavor honey cream is meeting with widespread popularity and should prove to be a valuable outlet for additional butterfat and honey. —Prof. P. H. Tracy, Dairy Department, University of Illinois, Urbana, Ill.

**HONEY BUYING.**—See *Marketing Honey*.

**HONEY CAKES.\***—The American Honey Institute and other honey interests are naturally anxious to see a more general utilization of honey in cookery. As cakes require more sweetening than most cookery products, a study was undertaken by the Division of Home Economics of the University of California at Davis to determine: (1) the maximum amount of honey that could replace sugar in a basic plain-cake formula; (2) whether several varieties of common California honeys could be used interchangeably in a basic plain-cake formula, and (3) whether cakes made with honey retain moisture longer than cakes made with sugar.†

**Method:** The basic cake formula used had proved ideal for the altitude and general laboratory conditions at Davis, where such environmental factors as humidity, temperature, and air currents could not be controlled. All ingredients were weighed on a torsion balance. The sweetening alterations were made by weight. The amount of honey required to replace a specified amount of sugar was calculated according to the average chemical composition of honey (1), which includes 17.7 percent moisture and 76.4 percent carbohydrate, the remaining 5.9 percent being composed of dextrans, gums, ash, pollen, and certain aromatic compounds. The amount of liquid furnished by this amount of honey was also calculated from the average chemical composition of honey; the liquid ingredient in the basic formula was decreased proportionately. The same standard grades of cake flour and baking powder were used throughout the work. The same mixing and bak-

\*Reprinted from *Journal of Honey Economics*, Vol. 29, No. 1, Jan. 1937.

†Acknowledgments are made to Prof. J. E. Eckert, Division of Entomology, for his cooperation and also for supplying the honeys; to Mrs. Georgia L. Fryer and Lura A. Henle for assistance with the cookery processes; and to J. T. Manchesian for the necessary chemical analyses.

ing utensils were used, and an attempt was made to standardize method and time of manipulation. The cakes were all baked in thermostatically-controlled electric ovens. The temperature and time of baking varied somewhat with the amount of honey incorporated in the formula, cakes containing all honey as the sweetening ingredient requiring a lower baking temperature and a longer cooking time than cakes made with sugar.

The maximum amount of honey that can replace sugar in a basic plain-cake formula: To determine the maximum amount of honey that can replace sugar in a basic cake formula, honey was added in the proportions of 25, 50, 75, and 100 percent of the total sweetening. Star thistle honey, one of the commoner kinds, was used in this preliminary work. The basic plain-cake formula and the modifications with the various proportions of honey are shown in Table 1.

Cakes in which honey replaced 75 to 100 percent of the sugar were heavy, low in weight, and yellow, with a pronounced astringent flavor. Cakes in which honey replaced 25 to 50 percent of the sugar rose to a desirable height and were tender, light colored, and delicately flavored. These differences indicate that honey may be added to a basic cake formula in amounts equivalent to 25 and 50 percent of the total sweetening without modifying the basic recipe. If honey is added in proportions of 75 and 100

percent of the total sweetening, the basic recipe must be changed.

Daniels and Heisig (2) report that from one-twelfth to one-half of a teaspoonful of soda is required to neutralize the acidity of one cup of honey. This suggests that the undesirable characteristics of cakes made with 75 and 100 percent honey might be attributable to the free acid present in the star thistle honey. Sodium bicarbonate, therefore, was added to the formula in the proportion of one-half teaspoon to one cup of honey. Cakes made with this modification and with 75 to 100 percent honey rose as high and were as light in texture as the cake containing no honey. They were, however, decidedly darker at the bottom, and this portion of the cake had an unpleasant alkaline taste, indicating that an excessive amount of sodium bicarbonate had been used. Judging from this experiment, the amount of soda used should be calculated on the basis of the known free acid content of the honey.

When cakes were made in which 75 and 100 percent of the sweetening was honey and the amount of soda used was that which would exactly neutralize the acid in honey, they were tender, light colored, delicately flavored, and not distinguishable in appearance from the cake that contained no honey. Evidently the undesirable characteristics of cakes made with 75 and 100 percent honey are directly attributable to the acid in the honey.

Table 1  
Basic cake formula and honey modifications\*

Ingredients	Basic Formula	25% Honey	50% Honey	75% Honey	100% Honey
	grams	grams	grams	grams	grams
Sugar .....	200.0	150.0	100.0	50.0	
Honey .....		85.4	130.9	196.3	258.8
Milk .....	206.3	194.7	183.1	171.4	159.8
Fat (Crisco) .....	113.4	113.4	113.4	113.4	113.4
Flour .....	210.0	210.0	210.0	210.0	210.0
Baking Powder (S.A.S. phosphate) .....	8.5	8.5	8.5	8.5	8.5
Salt .....	3.0	3.0	3.0	3.0	3.0
Vanilla .....	4.4	4.4	4.4	4.4	4.4
Eggs .....	92.1	92.1	92.1	92.1	92.1

\*Any white-cake recipe may be modified to substitute honey for sugar by the use of the following formulals:

$338.8$  (weight in grams of 1 cup of honey)  $\times .764$  (percent of sugar in honey =  $258.8$  (weight in grams of sugar in 1 cup of honey)

$338.8 \times 200$  (weight in grams of 1 cup of sucrose) =  $261.8$  (grams of honey which will furnish sugar equivalent to 1 cup of sucrose)

$261.8 \times .177$  (percent moisture in honey) =  $46.3$  (grams of liquid to be subtracted from that specified in recipe)

In other words, in substituting honey for sugar use  $261.8$  grams (about 9 ounces or  $\frac{3}{4}$  cup) of honey in place of 1 cup of sugar; and for each substitution decrease the amount of milk by  $46.3$  grams (about 1.6 ounces or  $3\frac{1}{2}$  teaspoons).



Can different varieties of honey be used interchangeably in a basic plain-cake formula? Ten common California honeys of known sources were tried: bean, alfalfa, sage, cotton, buckwheat, star thistle, blue curl, orange, resin weed, and eucalyptus. The density, free acid, and invert sugar content of each honey were determined. A refractometer method (3) was used to determine density, the density being read directly from tables. The amount of free acid present was determined by titrating with phenolphthalein (4.) Since honey solutions are naturally colored, it was difficult to note the end point when titrating with phenolphthalein; the figures for the number of cc. of 0.1N NaOH required to neutralize the free acid are therefore the least reliable of those obtained from this work. The acid content of honeys varied considerably. The method of analysis of the Association of Official Agricultural Chemists (4) was used to determine invert sugar. The results are given in Table 2.

Table 2  
Analysis of honeys

Kind	Weight per Gal.	Free Acid (cc. 0.1N NaOH)		Invert Sugar	Sucrose
		10	10		
Bean .....	11.81	3.28	72.4	0.66	
Valley Alfalfa ....	11.99	3.28	77.4	1.14	
Sage .....	11.92	2.17	72.8	2.94	
Cotton .....	11.97	4.20	77.6	1.42	
Buckwheat .....	11.92	3.56	72.4	3.80	
Star Thistle .....	11.94	4.14	74.1	4.38	
Blue Curl .....	11.89	3.18	76.9	1.04	
Orange .....	11.78	2.36	72.8	3.32	
Resin Weed .....	11.81	3.46	73.3	1.24	
Eucalyptus .....	11.74	3.67	73.1	1.62	

Since the initial experiment had indicated that 50 percent honey to 50 percent sugar was the ideal proportion for a delicious cake, this was used. As the acid content of the honeys varied considerably, the amount of soda necessary to neutralize each honey had to be calculated separately.

As far as texture and lightness are concerned there was no difference in the cakes made with the various honeys. The flavor of the cakes made with the stronger honeys such as resin weed, eucalyptus, buckwheat, star thistle, and cotton

was less delicate than in those with the milder-flavored honeys. The flavor of cakes made with strong-flavored honeys was improved by the addition of spices. It is interesting to note that the strong-flavored honeys were more acid than the mild.

Do cakes made with honey retain moisture longer than cakes made with sugar? Not uncommonly one reads that cakes made with honey keep moist longer than cakes made with sugar. It is of interest, therefore, to determine the difference, if any, in the moisture retention of cakes made with and without honey. Duplicate moisture determinations were made on each cake when freshly-baked after drying 12 hours in the air, and after 48 hours in vacuo at a temperature of 65 degrees C. The results showed that cakes made with honey did retain moisture longer than cakes made with sugar. (See Honey, Hygroscopic Properties of.)

It was also found that moisture retention was proportional to the honey content. The moisture content of cakes made by the basic formula, with 25 percent honey, and with 50 percent honey, was noted when fresh and at the end of a 27-day period; their initial moisture contents were respectively: 24.8, 26.0, and 26.6 percent. At the end of the 27 days the corresponding figures were 14.0, 16.4, and 18.1 percent.

To determine whether there was a variation in moisture content with the various kinds of honey, duplicate moisture determinations were made on each cake at 3-day intervals over a period of 10 days. The results are presented in Table 3. They show that the percentage of moisture in each cake was greatest

Table 3  
Moisture content of cakes with different kinds of honey.

Kind of Honey	Moisture Content of Cakes			
	May 12	May 16	May 19	May 22
	%	%	%	%
Bean .....	29.94	27.17	26.20	23.04
Valley Alfalfa ..	26.42	27.96	26.44	22.93
Sage .....	25.51	26.06	24.28	19.76
Cotton .....	25.25	26.33	26.48	23.04
Buckwheat .....	25.47	27.20	25.88	20.17
Star Thistle .....	27.20	27.92	26.88	23.13
Blue Curl .....	25.66	25.54	24.68	21.57
Orange .....	24.51	25.67	25.72	22.32
Resin Weed .....	25.44	26.70	26.44	22.67
Eucalyptus .....	26.86	28.27	27.82	23.59

on the third day. The uniform behavior with respect to the variation of the moisture content in each cake suggests that the kind of honey had little or no influence.

**Summary:** Star thistle honey may be used in a basic plain-cake formula up to 50 percent of the total sweetening if the amount of the liquid ingredient is adjusted. It may be used in proportions greater than this if the acid in honey is neutralized.

The various other California honeys tested may be used interchangeably in amounts equivalent to 50 percent of total sweetening if the acid in honey is neutralized. Cakes made with stronger-flavored honeys are improved by the addition of spice.

Cakes made with honey retain moisture longer than cakes made with sugar. The water content of honey cakes is greatest on the third day. The kind of honey appears to have little or no influence on moisture.

**Practical Significance of Results**

Honey may be used as a sweetening ingredient in cakes up to 50 percent of the total sweetening if the amount of the liquid ingredient is lessened in accordance with the water content of the honey.

Honey may be used in proportions greater than 50 percent of the total sweetening if, in addition to adjusting the liquid, the acid in the honey is neutralized with sodium bicarbonate, the amount needed depending on the free-acid content of the honey.

If labels on honey containers gave the approximate composition of the honey and its acidity it would be easier to use honey as the sweetening ingredient in various food recipes. (See Honey Recipes.)

**References:**

1. U. S. Government Chart: Average chemical composition of honey. *Bees & Honey* 14: (1933) p. 164.
2. Daniels, A. L., and Hetsig, E. H. The acidity of various sirups used in cooking. *J. Home Econ.* 11 (1919) p. 193.
3. Marvin, G. E. Methods for determining the weight per gallon of honey. *Am. Bee J.* 73: (1933) p. 426.
4. Official and Tentative Methods of Analysis of the Association of Official Agricultural Chemists, Third Edition, Washington, D. C.: A.O.A.C., (1930) p. 388.

**HONEY, CALORIC VALUE OF.**

—Calories, in the sense here used, mean the measure of value of a food

in terms of energy to produce certain work. The last edition of the New Merriam Webster's Dictionary gives this very appropriate illustration. We quote:

"The statement that a tablespoon of honey contains about 100 calories means that when oxidized in the tissue of the body, it will release that amount of energy to be expended in muscular work or other bodily activities."

While the caloric system may not be an accurate measure of a food's energy value, it is here adopted as a basis of comparison generally accepted by dietitians.

These figures are taken from "Feeding the Family" by Mary Schwartz Rose, Department of Nutrition, Teachers' College, Columbia University.

	100 Calorie portion measure	Distribution of Calories, Fat, Pro-Carbo-tein hydr.	
	oz.		
Corn Syrup .....	1 3/4 tbls.	1.5	100
Honey .....	1 tbls.	1.1	99
Maple Sugar .....	4 tbls.	1.1	100
Maple syrup .....	1 1/2 tbls.	1.2	100
Molasses .....	1 1/2 tbls.	1.2	97
Sugar, white gr. ....	2 tbls.	0.9	100
Sugar, white loaf ..	3 1/2 lumps	0.9	100
Sugar, wh. powd. ..	2 tbls.	0.9	100
Sugar, brown .....	2 tbls.	0.9	100

In other words, 1 tablespoon of honey, based on caloric value, is equal to 1 3/4 tablespoons corn syrup, 4 tablespoons maple sugar, 1 1/2 tablespoons molasses, etc. The above chart concerns the calories within given portions of various types of sugars. Honey has about 50 percent more sweetening value than the best cane molasses. The best grade cane syrup contains about 30 percent of water, while honey contains 17 percent water.

In the *Bee World* for February, 1941, page 13, Hubert Macey presents a table of English caloric values of various foods including honey, and here it is:

	Calories per lb.
Apples .....	219
Carrots .....	159
Eggs .....	624
Herrings .....	373
Greens .....	124
Tomatoes .....	106
Honey .....	1380

It is apparent from these two tables that honey from the standpoint of energy or caloric food value stands ahead of the other syrups and sugars in the first table and

very much ahead of the other foods mentioned in the second table.

Therefore, when the housewife complains about the higher cost of honey as compared with other foods, she should be told that it goes further and from an energy food value is as cheap as if not cheaper than most foods.

**HONEY CANDIES.**—See Honey, Cooking with, and Honey Recipes.

**HONEY CANNING.\***—Use a large kettle when canning with honey because honey has a tendency to foam and boil over when being cooked.

Use honey in place of at least half the sugar called for in recipes which formerly called for all sugar.

If fruit shows sign of fermentation within 2 or 3 days, cook it over.

For successful home canning it is well to organize your work a day or two in advance.

Prepare a list of the canning and preserving you plan to do and make out a marketing list.

Decide on method to use and study recipe.

Assemble and wash equipment thoroughly the day before you plan to use it. Test jars and covers for leaks.

Purchase staples such as honey and spices.

Select fruit when it is at its best—sound and fully ripe. Wash fruit carefully. Remove all spots and bruises. Sterilize jars, covers, rubbers. Place jars (on their sides) and covers in cold water. Bring water to boiling point and boil about 10 minutes. Do not remove jars or covers from hot water until ready to use. Dip rubbers in scalding water before using.

**Syrup Table**

Sweet Fruits—1 cup honey, 1 cup sugar to 4 cups boiling water.

Slightly Acid Fruits—1 cup honey, 1 cup sugar to 3 cups boiling water.

Acid Fruits—1 cup honey, 1 cup sugar to 2 cups boiling water.

Very Acid Fruits—1 cup honey, 1 cup sugar to 1 cup boiling water.

Add honey and sugar to the water and boil together for 5 minutes. The amount of sweetening used depends on individual taste. Too much

sweetening spoils the natural flavor of fruit.

Note: If an all-honey syrup is desired, replace the sugar called for in the foregoing chart with an equal amount of honey.

Allow 1 pint of syrup to 1 quart jar of large fruit.

Allow ½ pint of syrup to 1 quart jar of small fruit.

Estimate 2 pounds fruit for each quart jar.

Can a small amount at one time.

**Cold Pack Method**

Pack fruit in sterilized jars.

Add syrup according to syrup table. Fill to within 1 inch of top of jar.

Adjust new rubbers and covers. Seal jar only partly. If fruit is brought to the boiling point and packed hot, it is not apt to shrink.

Make sure that all jars are hot when placed in hot water to avoid cracking jars.

Process by placing the jars upright in a boiler with a false bottom on which to place jars. Have water in boiler hot. It should come at least one inch above the top of the jars. Keep water at this level by adding more boiling water as it boils away.

Process number of minutes according to time schedule, after water boils.

When done, remove jars and seal immediately. Invert jars to test for leaks. Avoid placing in a draft to prevent breakage.

When cool, wipe off jars, label, and store in dark, cool, dry place.

**Time Table for Canning**

(Count time after water begins to boil.)

	Hot Water Bath Minutes	Steam Pressure 5 to 10 Pounds Minutes
Apples .....	30	10
Apricots .....	20	10
Blackberries .....	20	10
Blueberries .....	20	10
Cherries .....	20	10
Currants .....	20	10
Gooseberries .....	20	10
Peaches .....	20	10
Pears .....	20	10
Pineapple .....	30	15
Plums .....	20	10
Quinces .....	35	15
Raspberries .....	20	10
Rhubarb .....	20	10
Strawberries .....	20	10

(For recipes see Honey Recipes.)

**HONEY CARBONATED DRINKS.**

—See Honey Beverages

\*From circular of the American Honey Institute entitled "Use Honey for Canning and Preserving".

**HONEY, CLARIFICATION OF.**  
See Honey, Filtration of, and Honey, Specific Gravity of.

**HONEY COLORS.**—The various kinds of honey differ very much in color, flavor, and density. One source may be practically colorless while another, produced in the same locality under the same conditions by the same bees but from different flowers, may be a dark brown. One kind may contain less than 17 percent of water while another may contain over 20 percent. (See Honey, Specific Gravity of.)

The lightest-colored honeys are usually spoken of as water-white, and, although this is not quite correct, still it is near enough for all practical purposes without coining a new word.

Clover honey may be taken as the typical white honey by which others may be conveniently judged. For the purpose of comparison some may be a little lighter and others a little darker shade, but these nice distinctions are visible only to experts.

Taken by this standard, in the North there are all the clovers—white, alfalfa\*, crimson, mammoth, alsike, sweet clover—and the European sainfoin, basswood, wild raspberry, willow-herd (or fireweed), milkweed, Canada thistle, apple, cucumber (pickle), and Rocky Mountain bee plant. In the South white honey is obtained from the following: gallberry, sourwood, tupelo, mangrove, cotton, palmetto, bean, guajillo, catsclaw, huisache, mesquite, California sage, orange, and some others of less importance. In the American tropics the chief white honey is from logwood or campeche; on all tropical seashores (Florida), campanilla (Cuba) and the mangrove.

Amber-colored honey comes from many sources. Among them only the more familiar one can be noted in a popular book of this kind—namely, goldenrod, wild sumac, poplar, gum, eucalyptus, magnolia, marigold, horsemint, horehound, carpet-grass, hog plum (hobo), rose-apple, and royal palm of the West Indies.

Of the dark honeys there are two great examples—the buckwheat of the United States and Europe, and

\*This is a light amber in Southern California and Arizona.

heather which is confined to Europe alone. The latter, though dark, is a rich, strong-flavored thick honey, so dense that the extractor is not used to take it from the combs. That produced in Scotland commands a very high price, while that of England is cheaper, being gathered from another species of heather. In north Germany the heath or heather honey commands a good figure. It is largely produced by migratory beekeepers, their bees existing on white clover during summer, and in the fall being moved to the heaths.\*

Buckwheat, a dark honey, is highly prized where produced but is usually not popular elsewhere. However, it is so liberally produced in buckwheat localities that it is a paying crop to the beekeeper. It blooms late, hence the bees can be prepared in ample time to profit by its bloom. This feature alone makes it very valuable to the beekeeper who is fortunate enough to live in a buckwheat growing section. In those parts of the country where buckwheat is grown largely, consumers are willing to pay as much as they will for fine white honey. Many prize it more highly.

In France there is a great demand for buckwheat honey from bakers of a certain kind of bread which has been made for centuries. No other sort of honey is desired by these bakers who derive nearly all their supply from Brittany where buckwheat is commonly sown. Attempts to get bakers to use other dark honeys have had little success.

In Europe there are some prominent honeys which are almost unknown in this country. Heather has been mentioned. Sainfoin is another which is quite common, being almost the same as our alfalfa honey. Narbonne honey belongs to this class. In Southern Europe romarin (rosemary) honey is very highly prized; and in Greece there is the classically famous honey of Mt. Hymettus from wild thyme. In Australia the honey of the eucalyptus is highly appreciated. In California eucalyptus has a limited demand.

\*See my remarks in the Bee World, page 114; also page 174 for 1937. The heather of Devon is largely Erica, but Hants, Surrey and Essex Counties have tracts of Caluna vulgaris which is the principal heather of large tracts of Northern Europe. I used to produce it in my old home. Lloyd George won several firsts on his heather honey.—A. D. Betts of *The Bee World*.

**HONEY, COOKING WITH.\***—One-third of the annual U.S. crop (See Statistics) goes into baking bread, cakes, and cookies. These honeys are usually a little darker and a little stronger-flavored and as such blend better with other foods. But too much honey in a bread, cake, or cookies is not desirable, as was shown under the heading of Honey Bread on page 374.

As will be noted under Honey Recipes, most of them with the exception of salads and fruit juices, call for more or even twice as much sugar as honey. The reason for this will be explained under that heading.

While honey is well adapted to the making of candies and blends well with other sugars, it should be understood that it is not uniform in its water content (See Honey, Specific Gravity of) nor in its proportion of the sugars dextrose and levulose. Some honeys are high in water content and some low; some are high in levulose like tupelo honey. The average honey, however, contains a little more levulose than dextrose. It is the levulose that makes the bread or cake hygroscopic. Cakes and cookies made with honey retain moisture longer, says the American Honey Institute. The ability of honey to absorb and retain moisture, thus preventing drying out and staling of baked goods, is of great importance to the home-maker who wishes to do her baking well in advance. This property in honey is also very valuable in the making of bread.

Honey, the only natural sweet that can be obtained in quantity, contains other ingredients: a small amount of sucrose averaging 1.9 percent; minerals, .18 percent; acid, .1 percent; undetermined matter, 3.68 percent. There is also a small amount of proteins—.05 percent, enzymes, colloids, and coloring matter. The purpose and function of all of these is explained under the general head of Chemical and Physical Properties of Honey and under Honey Recipes.

It will be seen that honey is variable, so much so that some honeys require a modification of the reci-

pes. (See Honey Recipes.) The candy maker especially may have to modify his formula to accommodate the different lots of honey that come from practically the same locality and are supposedly the same identical honey. White clover, sweet clover, and alfalfa are fairly uniform and can be relied on without changing the recipe. But it is best to make a small trial batch before making a large lot. This is especially true of honey candies. The candy maker should be warned against using a honey that is high in levulose. Tupelo, for example contains twice as much levulose as dextrose. It is the levulose that causes the candy to absorb moisture. Sometimes a heavy coating of chocolate, paraffin, or beeswax may not be sufficient to hold the candy within bounds. Many candy makers find it desirable to wrap their product in paraffin or cellophane paper because the moisture-absorbing levulose in the honey may cause the whole box to become sticky and unsalable.

Under the head Honey Bread it is shown that a high percentage of honey—20 percent liquid in a bread—will spoil it. The best bakers of the country have found that it is not possible to go much beyond 4 percent solid or 5 percent liquid to be safe.

It is best to use recipes worked out for honey and thoroughly tested. In experimenting in replacing sugar with honey in a recipe the amount of liquid should be reduced one-fifth for each cup of honey used. There are 16 tablespoonfuls to the standard measuring cup. After measuring the liquid remove 3 tablespoonfuls and 1 teaspoonful of the liquid to figure out how to fill the standard cup. The guesswork method will not work with honey. Measurements must be exact.

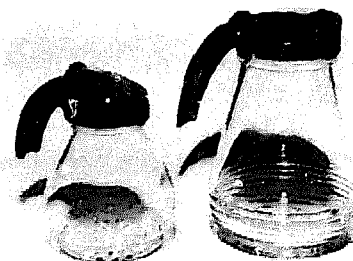

Drip-cut honey dispenser

\*The material for this subject was obtained largely from *Old Favorite Honey Recipes* published by the American Honey Institute.

Honey has the power to hold moisture and for that reason honey cakes and cookies may be made well in advance of the time required. It is a fact that some cakes or cookies made with honey are better after aging from one to three weeks. (See Honey, Hygroscopic Properties of, and Honey Cakes.)

Here are some general directions put out by the American Honey Institute headquarters at Madison, Wisconsin.

### Weight of Honey

A cup of honey weighs 12 ounces of which not quite one-fifth is moisture. The same cup holds 8 ounces of water.

A cup of sugar weighs about 7 ounces.

In a cup of honey there are approximately  $9\frac{1}{4}$  ounces of sugar.

Honey then contains a little more sugar than the same measure of cane sugar. This is because there are many air spaces between the granules of sugar.

### Measurements and Ingredients in General

1. Accurate level measurements are most important for successful results. Always use standard measuring units—the  $\frac{1}{2}$ -pint or 8-ounce cup, the tablespoon, teaspoon,  $\frac{1}{2}$ -teaspoon and  $\frac{1}{4}$ -teaspoon sizes.

2. In measuring flour, sift first; place in cup lightly with spoon; level with back of knife; do not pack flour. Flour leavening agents and spices are sifted a second time before incorporating.

3. Flour containing husks or bran coats like cornmeal, graham, and bran should be mixed without sifting.

4. Brown sugar should be packed firmly when measuring.

5. Baking powders vary and the best results are obtained by following the directions given on the baking powder can. If your favorite brand indicates 2 teaspoonfuls per cup of flour, use that proportion. If it indicates 1 teaspoonful per cup of flour, then that is the amount to use.

6. The amount of soda needed to neutralize the acidity in one cup of the average honey is one-fifth teaspoonful. When sour milk and honey appear in a recipe it is not necessary to add any extra soda for the honey.

7. The recipes specify definite temperatures and periods of baking or cooking. More uniform and better results are obtained when thermometers are used. If your stove is not equipped with an oven control, you will find the portable oven thermometer a good investment.

8. Unless specified, the honey is in liquid form. Granulated honey may be used with equal success in any combination that is heated.

### To Measure Honey

To measure honey use a moist or greased cup. Measure the fat first, then the honey in the same cup. The honey pours out readily to the last drop since the fat has formed a light coating around the inner surface of the cup. Any type of cooking oil, melted butter, or egg white will serve the same purpose as a solid fat. If the recipe calls for granulated sugar and honey—say, a half cup of each, place sugar in lower half of cup, lightly run greasing brush around the remaining unfilled portion of the cup, then pour honey on top of the sugar until exact measure is reached. In measuring tablespoonfuls or teaspoonfuls of honey, dip the spoon first into cooking oil, melted oil, or any type of liquid fat, then fill with honey. The honey comes from such a spoon very quickly.

### Replacing Sugar with Honey in Your Favorite Cake or Cookie Recipe

Try honey in your favorite recipes. Cooking authorities vary a bit on their recommendations for substituting honey for sugar in recipes that call for sugar. Some recommend reducing the amount of honey in comparison to sugar, but the most generally accepted rule of thumb is to replace with the same amount of honey but reduce the liquid called for in the recipe by  $\frac{1}{4}$  cup for each cup of honey used. For example, if the recipe calls for 1 cup of sugar and  $\frac{1}{2}$  cup liquid, use 1 cup of honey and  $\frac{1}{4}$  cup of liquid. The baking temperature should also be reduced 25 degrees to prevent over-browning.

**HONEY COSMETICS.\*** — Honey has long been recognized as a true cosmetic. It is an ingredient of many fine creams and lotions today. And it is very nourishing and refining to

\*By Gladys Glad, beauty expert

the skin. However, we personally think that honey is much more effective as a skin beautifier when combined with other ingredients. A most effective honey lotion, for instance, can be made by blending one tablespoonful of sweet almond oil and two tablespoonfuls strained honey. This lotion should be used on the face after the skin has been thoroughly cleansed. It should be permitted to remain on the skin for about a half hour. Then it should be removed with a soft cloth and tepid water, and a mild astringent applied to close the pores and tone up the skin.

Honey also can be employed in making an effective face pack. To prepare this pack enough honey should be mixed well with a half cup of bran to make a smooth paste. If the paste seems too thick, a little rose water may be added to make its consistency smoother. Then the face should be cleansed and the mixture spread generously over it. This pack should be permitted to remain on for 30 minutes. Then it should be removed with warm water and a soft cloth, and as the final step, a good astringent should be applied in order to tone the skin.

#### Honey Pack Leaves Skin Soft and Velvety

Honey packs are indeed beneficial to the skin, as they cleanse, bleach, and soften it. To prepare the pack, add enough honey to a half cup of almond meal to form a thick, smooth paste. Cleanse the face thoroughly with a good cleansing cream, and after removing the cream spread a bit of nourishing cream around the eyes and mouth. Then apply the paste generously over the entire face with the exception of the eyes. Permit the pack to remain on the face for at least a half hour. Then remove it with tepid water and a soft cloth. The procedure will leave the skin soft and velvety.

**Honey Mask for the Complexion**—(Taken from the Boston Sunday Globe.)—Mix a tablespoonful of honey with a tablespoonful of fine white flour; add a few drops of rose water, just enough to make the honey paste smooth and as liquid as you need it. Spread carefully over the face, let stay on a half hour, then wash off with cold water, using soft cloth. Try this mask twice a week for a month. Result: youth back in the face.

**Honey Facial by Mme. La Faire**—Honey, a beauty aid in our grandmother's day, is coming back into use and some of the beauty parlors are using it successfully in facials. First massage cleansing cream into your face and wipe off; then place a soft cloth dipped in warm witch-hazel over the entire face for five minutes. After this treatment dip the fingers into pure strained honey and pat gently into the skin until the entire surface has a good coating of honey. A treatment now of patting the face with the fingers, occasionally dipping them into the honey, should be kept up until the face tingles, then relax for about 20 minutes and then remove the honey with cloths dipped into warm water. Finish by rubbing the face with a piece of ice or cold applications of water.

**Honey for Freckles**—A half pound of honey, 2 ounces of glycerin, 2 ounces of alcohol, 6 drams citric acid, 15 drops of ambergris. Apply night and morning.

**Balm of Gilead Salve**—Four ounces of mutton tallow, 1 pint of balm of Gilead buds, 3 ounces of honey, 1 ounce of castile soap, 1 ounce of rosin, 3 ounces of beeswax, 1 ounce of alum, and 1 pound of lard. Put all the buds in a kettle with the lard and boil slowly for a half hour, stirring often. Strain and take the buds out. Put in the rest of the ingredients and cook slowly until done. This usually takes from one half to one hour. Excellent for chapped hands or lips, sores or cuts, frost bites, and piles.

**Honey as a Softener of the Hands**—Many are unaware that the very best cosmetics are made with honey as a prime ingredient. Here is one for the hands which is said to be very fine: Rub together 1 pound of honey and the yolks of 8 eggs; gradually add 1 pound of oil of sweet almonds; during constant stirring work in  $\frac{1}{2}$  pound of bitter almonds, and perfume with 2 drams each of attar of bergamot and attar of cloves.

**Honey Soap**—Cut 2 pounds of yellow soap into thin slices and put into a saucepan with sufficient water to prevent soap from being burned. Place on a fire, and as soon as the soap has dissolved add 1 pound of honey and stir until the whole begins to boil. Then remove from the fire, add a few drops of essence of cinnamon, pour into a deep dish to cool, and when cut into squares. It improves by keeping.

**HONEY CREAM.** — See Honey Butter and Honey, Granulation of.

**HONEY, DELIQUESCENT OF.** See Honey, Hygroscopic Properties of.

**HONEYDEW.\*** — Honeydew is a sweet glutinous liquid excreted† in large quantities on the foliage of plants by homopterous insects, chiefly plant lice and scale insects. It is often so abundant on the leaves of trees and bushes that it drops upon the grass and sidewalks, covering them with a glistening coating resembling varnish. At times it falls in minute globules like fine rain. Although readily gathered by honey bees, it has an inferior flavor and is detrimental to beekeeping. The ancient Roman naturalist Pliny supposed that honeydew fell from the stars, and this belief was generally accepted for centuries, hence the name. Honeydew gathered by bees is produced chiefly by families of insects belonging to the order Homoptera: plant lice (Aphididae), bark lice or scale insects (Coccidae), lantern flies (Fulgoridae), jumping plant lice (Psyllidae), and white flies (Aleyrodidae). A small amount of honeydew is also secreted by a few species of tree hoppers (Membracidae) which are attended by ants.

#### Honeydew from White Flies

The white flies (Aleyrodidae), small winged insects covered with a whitish powder, were formerly classed with the scale insects, as in their immature state they are scale-like in form. In warm regions they are reported to exude honeydew in large quantities, but in the temperate zone they are not sufficiently abundant to produce this excretion.

#### Honeydew from Scale Insects

The Coccidae are commonly known as scale bugs, scale insects, bark lice, mealy bugs, and coccids. The species are very numerous and infest the bark and foliage of a great variety of plants and also nearly every kind of fruit. They excrete great quantities of honeydew both in temperate and tropical regions. Only the adult females exude honeydew.

#### Honeydew from Plant Lice or Aphids

Probably more honeydew is pro-

\*By John H. Lovell, Waldoboro, Maine.

†On this point there has been considerable discussion. It is generally believed, however, that the greater portion of honeydew from aphids is an excretion since it is passed through the anal opening.

duced by plant lice or aphids (Aphididae) than any other family of insects. They occur on a great variety of trees and shrubs, a part of the species living on the leaves, a part on the limbs, and others on the roots. Among the deciduous-leaved trees on which honeydew is very frequently found are oak, beech, poplar, ash, elm, hickory, chestnut, maple, willow, basswood, gum, fruit trees, grapevine, currant, blackberry, and hazel.

#### How Honeydew is Ejected

The dew is forcibly ejected or flipped from the end of the abdomen, and when there are many aphids it falls in a spray of minute globules. If the dew were not thrown a little distance from their bodies they would soon be glued together.

#### The Quality of Honeydew

The quality of honeydew varies greatly according to the plant on which it occurs and the insects producing it. When freshly gathered it may be clear, sweet, and agreeable in flavor, or at least not unpalatable. The better grades find a sale to bakers. Usually it is inferior in quality. It often has a smoky, cloudy appearance. If the bees are left on the summer stands and can obtain frequent flights, they may winter on it in fair condition, but if they are placed in a cellar they will all probably perish from dysentery.

#### Composition of Honeydew

Most honeydew honey contains less invert sugar but more sucrose or cane sugar, dextrin or gums, and ash. It is because of the larger percentage of gums and ash that it is unsuitable for winter feeding. Honeydew honey may also be distinguished from floral honey by means of a polariscope. A ray of light passed through a solution of floral honey is turned or rotated to the left, but passed through a solution of honeydew honey it is turned to the right. If floral honey turns the ray to the right it is adulterated with glucose. No floral honey is obtained from the wind-pollinated flowers of hickory and white oak.

#### Fir Sugar from Conifers

Investigations by Davidson and Teit show that from the tips of the leaves of the Douglas fir in British



Columbia and Washington State west of the Cascades, there is exuded a sweet liquid in large quantities. "Fir sugar" was known to the Indians of British Columbia long before the discovery of America, and in recent years its presence has repeatedly been reported by beekeepers, but it does not occur every year.

**HONEY, DEXTROSE IN.** — See Honey, Sugars of.

**HONEY, DIASTASE IN.** — See Honey, Enzymes in.

**HONEY, DISCOLORATION OF.\***

—The color and individual flavor of a honey from a particular kind of plant is due to the chemical nature and the variation in the amounts of the various constituents of the original nectar. The greatest variations of these constituents apparently are related to differences in types of soil on which the same species of honey plants are growing and the rapidity of the honey flow or volume of nectar secretion. In general, a particular type of honey from a given kind of honey plant is lighter in color as the honey flow is more abundant and darker in color with a less abundant nectar secretion. Likewise, as the flavor of honey is affected, the darker the honey of a given plant source the stronger is its flavor, and vice versa. This darker color and stronger flavor is probably due to a greater proportion of the elements which produce color and flavor in relation to the total amounts of the sugars in the nectar secreted.

As flavor is closely associated with or related to color in the original nectar as gathered by the bees and evaporated into honey, likewise are the two physical characteristics closely bound during handling, processing, and storage by the beekeeper. Many factors which affect color also affect flavor, especially in heating to prevent granulation. In turn, granulation is sometimes followed by fermentation if the yeasts have not been destroyed by sufficiently heating or the processed honey is later contaminated. Thus the proper procedure in handling

honey is influenced by a variety of considerations including prevention of granulation, elimination of fermentation, avoiding discoloration, and maintaining the original delicate flavor of a natural sweet.

Generally speaking the greatest amount of damage to the natural color of honey or discoloration with a corresponding loss of its delicate and particular flavor is due to the practice of holding all or part of the honey at too high a processing temperature for too long a period, or the subsequent storage at a high temperature over a long period. Other factors involved are contamination, the types of processing receptacles and the nature of the storage containers, especially the lids or closures for same. (See Honey, Heat Effect of.)

While a temperature of 145 degrees F. for 30 minutes is satisfactory to pasteurize honey so far as yeasts that cause fermentation are concerned, such a temperature is usually not sufficient to melt all of the dextrose crystals which are chiefly responsible for further granulation in that these unmelted granules serve as nuclei for the formation of other granules. The most common recommendation for heating honey or processing to prevent granulation is to heat the honey in a water bath with some means of agitation until it reaches a temperature of 160 degrees F. and hold it at that point for 30 minutes. Some claim that this temperature is too high and that there is some discoloration and loss of flavor, but if carefully done in a closed container with agitation and surrounded by a water bath our experiments show very negligible deteriorating effects. At temperatures as high as 175-180 degrees F. for 30 minutes there may be considerable loss of flavor and some slight discoloration. However, this discoloration is not as pronounced as the discoloration due to storage continued for a period of time at high temperatures. (See Honey, Granulation of, and also Honey, Heat Effect on.)

Since the processing temperature does have some effect on color every effort should be made to process at as low a temperature as possible that will prevent granulation by melting all the dextrose crystals present in the honey. Thus it is highly important that every attempt

\*Contribution from the Entomological Laboratories of the University of Illinois, No. 204, by Dr. V. G. Milum. After reading this article see article entitled Honey, Heat Effect on, by Phillips.

be made to prevent their being added to the new crop of honey. The first consideration is the use of combs built from new foundation or extracting combs from which the bees have a chance to remove all honey of the previous season. Care should be taken to prevent mixing the extracting frames with frames from the food chamber of the previous winter. Likewise all utensils and containers used for storage should be cleansed before the new crop is placed in them, paying especial attention to the cracks and crevices where crystals may collect requiring persistent effort to remove them. As any of these introduced crystals may serve as nuclei for further granulation which then requires a higher processing temperature for a longer period, it is important that the crystals be eliminated as much as possible and that the honey be processed as soon as possible after it is thoroughly ripened by the bees. By careful observation of these precautions and tests with each particular kind of honey a somewhat lower processing temperature may be found to be satisfactory.

Having decided upon a proper temperature that will prevent granulation in a particular honey by melting all the crystals, after the honey has been processed it should be strained and bottled while hot and sealed immediately to prevent further contamination with dextrose crystals and yeasts. Because of discoloration from prolonged heating honey should be cooled as quickly as possible. Above all it should not be placed in cardboard cartons or cases and stacked in large piles since it has been shown that "stack heat" may exist for as long as 30 days in stacks of canned foods.

The literature on this subject of processing honey or heating to prevent granulation and fermentation is full of danger signals, warning against carelessness and improper methods. Likewise the limits of temperature due to the possibilities of discoloration and loss of flavor, and the correlated loss of the delicate flavors while being held in storage both before and after processing, is a matter in honey handling that has not received proper attention. Most beekeepers who have kept samples of honey for any length of time eventually have

learned that the samples were becoming darker in color and considerably stronger in flavor. This is a serious phenomenon which occurs when honey is stored at high temperatures which has no relation to the original processing temperature except that the temperature of processing may actually accomplish a part of the results that might later develop in storage.

Ramsey (145)\* in 1923 reported that the black color of honey preserved in tinned containers is due to the formation of iron tannates, although he did not distinguish between this and discoloration due to high temperatures of storage.

Starting in 1931, some writers have called attention to the discoloration of honey when stored at high temperatures, among these being Wilson and Marvin (156, 157), Lothrop and Paine (160, 161, 162), Paine, Gertler, and Lothrop (163), Milum and Ramsay (135), DeBoer (126), Lynn, Englis, and Milum (131), and Becker (123). A summary of the work of these investigators is given by Milum in a series of articles appearing in 1939 in the *American Bee Journal* with additional observations not previously reported on the actual factors which are responsible for storage discoloration which is always accompanied by loss of the delicate flavor and aroma of honey.

As a result of the observations at the University of Illinois it was shown that the discoloration of honey in storage was quite pronounced at 98 degrees F. which may often be the temperature of some honey houses during July, August, and September. With samples stored at five-degree intervals of temperature from 55 to 80 degrees F for a period of 168 days, while there was a slight increase in color at storage temperatures up to 70 degrees F., these were quite insignificant, but above this point the curve of rate of discoloration increased more rapidly with increase of storage temperature. Using the Pfund honey grader, periodic readings at frequent intervals of the color of honeys which had been processed at different temperatures and stored at 98 degrees F. indicated that the rate of discoloration during the first 133

\*See bibliography of references at the close of this article for the figures in parentheses.

days was directly proportional to the time of storage, amounting to approximately 0.4 of a point (0.4 mm.) for each day of storage. The importance of a proper consideration of honey house construction and temperatures is thus evident. For the following 190 days the rate of discoloration decreased, being only 0.15 of a point (0.15 mm.) per day. It was also shown that the previous heating or previous storage at high temperatures had no effect upon the discoloration at a later period except to decrease the rate of later discoloration. This is exactly contrary to the erroneous idea of some who state that high processing temperatures increase the rate of discoloration during storage.

Observations and color readings of samples processed by commercial bottlers of honey using more modern filtering methods as well as samples of the same honey filtered by the method outlined by Lothrop and Paine (160) indicated that there was no significant difference in colors of such filtered honey and unfiltered samples of the same original honeys after storage for as long as two years and nine months.

Samples of honey both unfiltered and filtered when stored in darkness become darker in color than corresponding samples stored unprotected from light even though not exposed to sunlight, indicating a bleaching effect on honey when stored in the light. During a two-year storage period dark-stored samples increased 2.99 color points as compared to 1.90 for light-stored samples—a difference of 1.09 grader color points, while the color increase in processing of a sample at 180 degrees F. for 30 minutes was only 0.74 color points as compared to 0.31 for samples heated to 145 degrees F. for 30 minutes.

As Ramsey (145) has shown that honey stored in tin containers may darken due to the formation of iron tannates, likewise darkening of a similar nature may result when honey comes in contact with other improperly tinned or galvanized storage and heating tanks and those with iron fittings and faucets. A similar cause of darkening may result when an oozy black mixture forms near the seal of the lids of glass containers. Some of this discolored honey may then get inside

the jar, causing a general discoloration of the top layer of the honey. This type of discoloration can be distinguished from the discoloration due to higher storage temperature, the latter being uniform throughout the sample.

In general, caps for honey bottles contain two kinds of liners: the so-called mica liners which are thin and have a smooth hard surface, and the thicker liners. If the latter type are well waxed, they can be compressed more easily as the cap is turned down and it therefore furnishes a better seal. Some cheap caps with dark liners have been known to cause discoloration.

The actual chemical reactions which are responsible for the discoloration of honey in storage are listed by Lynn, Englis, and Milum (131) as (a) an animo acid-aldol combination, (b) the combination of tannates and other polyphenolic substances with iron salts and (c), the instability of fructose (levulose) which is probably of primary importance. In contrast to other authors, they believe that the colloidal content of honey has only a minor influence on the discoloration of honey in storage at room temperatures and above. This last supposition seems to be in agreement with the observation of Milum as shown in the results of the experiments reported in the American Bee Journal and the 1938 report of the Illinois State Beekeepers' Association. (See Honey, Hygroscopic Properties of.)

#### Partial Bibliography of References on Physical Factors Affecting Honey

- 123—Becker—H. C., 1936. The effect of methods of processing and heating and of storage upon the composition and color of honey. Unpublished Thesis for B. S. Degree in Chemistry, Univ. of Ill., 1936.
- 126—deBoer, H. W., 1934. The influence of age on the composition of honey. *Chem. Weekblad*, 31: 482-7. After C. A., 29: 6320 (1935).
- 127—Browne, C. A., U. S. Dept. Agr. Bur. Chem. Bul. 110.
- 128—Dyce, E. J., 1931. Fermentation and crystallization of honey. *Cornell Agr. Exp. Sta. Bul.* 528: 3-76.
- 129—Fabian, F. W., 1932. Some causes of honey fermentation. *Am. Bee Jour.* 72: 280-1; 296-7.
- 130—Fabian, F. W. and Quinet, R. I., 1928. A study of the causes of honey fermentation. *Mich. St. Col. Tech. Bul.* 92, 41 pp.
- 131—Lynn, E. G. with D. T. Englis and V. G. Milum, 1936. Effect of processing and storage on composition and color of honey. *Food research* 1: 255-61.
- 160—Lothrop, R. E. and Paine, H. S., 1931. Some properties of honey colloids and

the removal of colloids from honey with Bentonite. *Ind. Eng. Chem.* 24:328-32.

161—Lothrop, R. E. and Paine, H. S., 1931. The colloidal constituents of honey and their influence on color and clarity. *Am. Bee Jour.* 71: 280-1; 291.

Lothrop, R. E. and Paine, H. S., 1933. Colloidal constituents and effects on foaming and scum formation. *Am. Bee Jour.* 72: 444-50.

Marvin, G. E., 1930. Further observations on the deterioration and spoilage of honey in storage. *Jr. Econ. Entom.* 23: 431-8.

133—Milum, V. G., Lynn, G., and Crum, K., 1935. The effect of methods of processing, heating, and storage temperature on the crystallization of Illinois honeys. *Ann. Rpt. Ill. St. Bkprs. Assn.* 33-34: 63-69.

162—Paine, H. S. and Lothrop, R. E., 1933. Influence of colloidal constituents on the development of color in honey. *Am. Bee Jour.* 73: 23-7.

163—Paine, H. S., Gertler, S. T., and Lothrop, R. E., 1934. Colloidal constituents of honey. Influence on properties and commercial value. *Ind. Eng. Chem.* 26: 73-81.

134—Ramsey, R. J., 1932. The use of corn sugar in sweetened condensed skimmed milk. Master's Thesis, Univ of Ill.

135—Ramsey, R. J. and Milum, V. G., 1933. The discoloration of honey. *Am. Bee Jour.* 73: 305-6.

145—Ramsey, A. A., 1923. Discoloration in honey from lids of containers. *Agr. Gaz. New South Wales*, 34:60. From *Chem. Abstracts*, 17:3552 (1923).

Richmond, R. G., 1932. Honey heating tests. *Am. Bee Jour.* 72:327 (Aug.).

149—Schuette, H. A., 1933. What value color in honey? *Am. Bee Jour.* 73:308-9.

Tanner, 1932. *Microbiology of Foods.*

150—Willaman, J. J. and Easter, S. S., 1929. Factors affecting color in sorghum syrup. *Ind. Eng. Chem.* 21:1138-45.

151—Wilson, H. F. and Marvin, G. E., 1929. Preventing fermentation in honey. *GL in Bee Culture* 57:434-5.

155—Wilson, H. F. and Marvin, G. E., 1931. The effect of temperature and storage on honey. *Jour. Econ. Entom.* 23: 430; 24: 589-97.

156—Wilson, H. F. and Marvin, G. E., 1931. The effect of temperature on the keeping qualities of honey. *Am. Bee Jour.* 71:32-3.

157—Wilson, H. F. and Marvin, G. E., 1931. The relation of temperature to the deterioration of honey in storage. *Wis. Beekeeping* 7:105-7.

Wilson, H. F. and Marvin, G. E., 1932. The relation of temperature to deterioration of honey in storage. *Jour. Econ. Entom.* 25:525.

Wilson, H. F. and Alfonsus, E. C., 1933. Ripe honey. *Am. Bee Jour.* 73:335-6.

**HONEY, ENZYMES IN.** — Enzymes are mentioned occasionally in various discussions under different heads in this book. As the average reader is not a chemist or dietitian, he may fail to understand their function or purpose, so an explanation should be made.

The human stomach has one set of enzymes, saliva another set, various parts of the small intestine other sets, and their presence only

starts the show of enzyme action. There are enzymes in the liver, the kidneys, the blood, the muscles, and everywhere that living cells exist, and each one or each set has special functions.

The enzyme invertase, found both in the body of the bee and in honey, is not all used up in the ripening of honey when first stored. (See page 354.) This enzyme can and does continue to split any sucrose left not yet inverted into dextrose and levulose, until the honey is fully ripe. But invertase can not continue to work if the honey is overheated to a point that would kill the action of the invertase and right here it should be noted that a too high temperature on unripe honey will destroy the action of both the invertase and diastase. A word of caution should be entered at this point: An unripe or thin honey of less than 11 pounds and 12 ounces to the gallon should never be sent to market—much less to Europe. To stop or prevent fermentation it is the usual practice to heat the honey to kill the yeasts. (See *Bottling of Honey; Honey, Granulation of; and Honey, Heat Effect on.*) The very act of heating, if carried too far, would prevent further inversion. An overheated honey, although fully ripe, would probably be rejected if shipped to Europe.

This phase of the matter is covered by Dr. Geo. H. Vansell of the U. S. Bee Culture Laboratory at Davis, California, in the *American Bee Journal*, page 293, 1929.

Dr. Vansell says:

All beekeepers are probably familiar with the fact that the German Government at one time placed an embargo on honeys that failed to show, upon examination, a certain diastase content. Diastase is the name applied to enzymes or ferments that have the ability to break down starch in sugars. Inasmuch as honey contains very little starch and the amount of diastase in even the most heavily diastase-charged honeys is negligible in comparison with a small drop of human saliva, it seems certain that the objection to honey poor in diastase can not be based on the dietetic value of the diastase. Despite the fact that our investigations have shown some comb honeys practically devoid of diastase activities, German authorities consider any honey with a low or slow diastase content to be overheated or adulterated.

Practically all of our bottled honeys must be heated to a temperature of 160 degrees F. to destroy yeasts and primary crystals of granulation in order to prevent granula-

tion. (See Yeast in Honey; and Honey, Granulation of.) By the time the honey reaches the bottler it is supposed to be thoroughly ripened and therefore not needing the further effect of invertase or diastase to complete inversion which is already complete.

As the presence of diastase is in such small quantities it can have no effect on the flavor or purity.

Some work done by the U. S. Bureau of Chemistry and Soils, Carbohydrate Division, by R. E. Lothrop, shows conclusively that there are some pure honeys in the United States that have little or no diastase even though they have never been heated. It therefore follows that the presence or absence or even a deficiency of diastase in any given honey is not a proof of the purity of such honey. While it may be admitted that this factor may suggest that the honey has been overheated, the fact remains that very little of American honeys are ever heated before they leave the producer in bulk. With the exception of tupelo and sage the honeys are allowed to granulate before they are shipped in bulk because there is less chance of leakage.

**HONEY EXHIBITS.**—See Exhibits of Honey.

**HONEY, FILTRATION OF.**—Before we enter into the general subject of filtration and the different methods of accomplishing it, it should be made most emphatic that all honey should be strained through several thicknesses of cheesecloth as soon as it comes from the extractor, as described further on. Too many beekeepers extract their honey, allow it to run into general receptacles and cans containing dead bees, larvae, parts of bees, legs, wings, and other sediment which, if left in the honey for even a short time, will taint the honey. Honey will absorb bad odors and flavors if the material that gives rise to them is left in the honey.

After straining, the honey should be placed in tall tanks to allow the particles to rise to the surface where they can be skimmed off the surface of the honey. Honey, as it comes from the extractor, is usually warm and the foreign matter can easily be sieved out before it does damage to the honey.

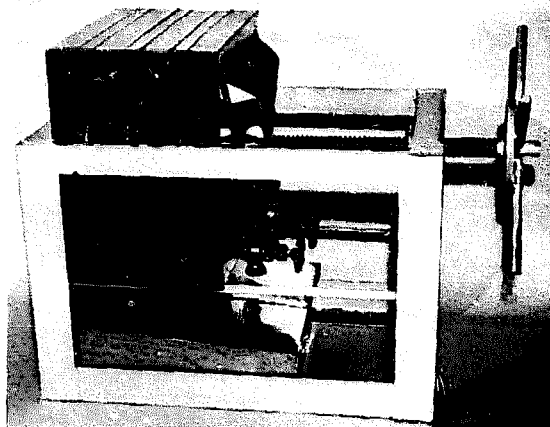

Fig. 1.—Small Filter Press.

Again, it is important that honey should not be stored in open tanks to accumulate dust, flies, and insects. A cheesecloth covering should be tied around the top to keep out all foreign substances.

There are several general methods by which honey can be clarified, either in part or in whole. First, by straining; second by gravity or sedimentation; third, by a combination of the two; fourth, by filtration under pressure.

Plan No. 1 is described in part under Extracting. However, the usual practice is: First, use two or three thicknesses of wet cheesecloth spread over a light framework mounted on a tub to receive the honey or, second, to spread the strainer cloths over a tank direct. The cloths, in either case, should bag down in the center and then be fastened with a string near the top of the crate or can, and tied.

The second, or tank clarifier, is shown under Extracted Honey. The strainer cloths should bag down to within a few inches of the bottom of the can, but should not touch the vertical sides for reasons that will be explained later. (See Fig. 5.)

Still another plan is that of supporting the strainer cloths on an inverted cone of coarse-mesh wire-cloth as shown next in Figs. 2 and 4. The cone is held by lugs hooking over the side. This has the merit that when the strainer cloths are clogged with sediment they can be easily removed and clean ones used.

A hot or warm honey will pass through cheesecloth or a filter more readily than will a cold honey. The same is true to a lesser extent of a relatively thin cold honey. Usual-

ly three thicknesses of wet cheese-cloth are about right. Why wet? Because it will take some time for honey, hot or cold, to pass through dry cloths. The cloths should first be immersed in water and then wrung nearly dry before attempting to pass honey through them.

It is important that the strainer cloths be renewed often as they will soon clog with sediment so that the honey has difficulty in passing through. It is a simple matter to wash them in hot or warm water, when they can be used again. Frequent renewing with fresh cloths will greatly facilitate the process of straining honey.

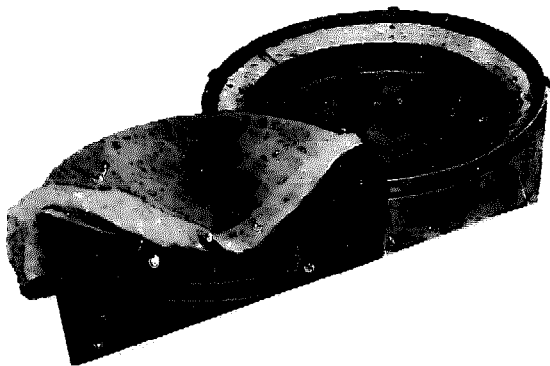

Fig. 2.—A honey straining outfit for larger beekeepers.

It is also very important that as the honey passes through the strainer, it should not fall in little streams a distance of several inches through air space because in so doing these little streams will carry down with them thousands of minute air bubbles into the body of the honey. (See Fig. 3.)

It is these same air bubbles that make the honey look cloudy when put up in bottles. It is advantageous in running honey through the strainers in the manner described that the streams of honey either fall on an inclined plane or are caught in a funnel just under the strainer where the cloths rest on an inverted cone of coarse wirecloth, as shown in Figs. 2 and 4. Fig. 4 shows how this should be accomplished. The funnel should be separated from the cloth in the hook-up by about an inch, or close enough so that the honey as it oozes through the strainer cloth will not gather air in its downward fall. The funnel catches the honey when it flows by gravity over a smooth surface into the spout of the funnel. This

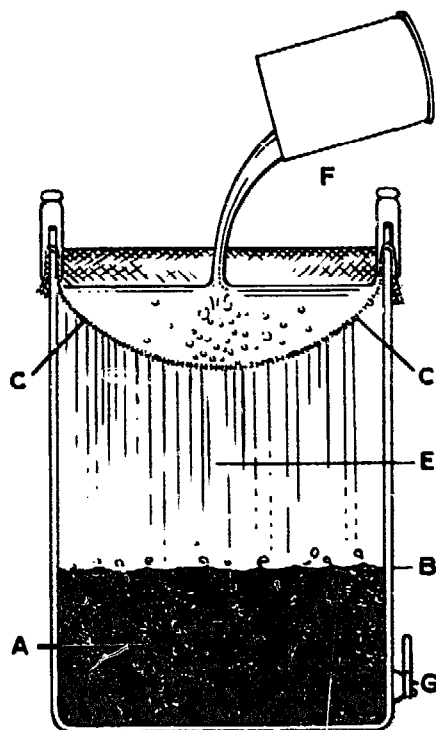

Fig. 3.—The wrong method of straining honey.

spout should be on a slant and long enough to extend down into the honey near the bottom of the tank. The strainings will cling to the spout and finally pass into the strained honey below without carrying air bubbles large and small. The coarse-mesh wirecloth funnel should be detachable and separate from the funnel of solid metal. The latter should be hooked on first over the top of the tank as shown in Fig. 4. On top of this and an inch above it should be set the

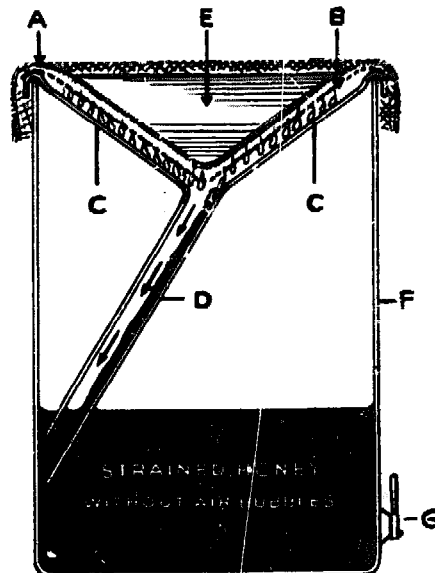

Fig. 4.—The right method of straining honey.

coarse-mesh wire funnel and over this the several thicknesses of cheesecloth. The number of thicknesses should be adjusted to the temperature of the honey and its density.

#### Strainer for a Small Beekeeper

A much simpler strainer for the small beekeeper can be made of a large-size lard can and several large squares of cheesecloth. Into the bottom of the can should be soldered

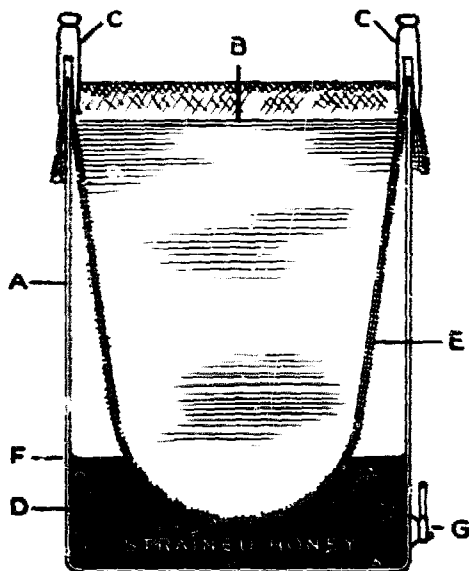
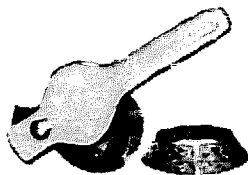

Fig. 5.—A method of straining honey for the small beekeeper. Fig. 1, however, is a better arrangement.

a honey gate. The squares of cheesecloth—two or three thicknesses—should be large enough when spread over the top of the can to push down to within two or three inches of the bottom of the can, leaving a clear space between the bag and the vertical sides of the can. When properly adjusted, clothespins pushed over the top of the cloths and the top of the can will hold the strainer in place.



A honey gate with a V-shaped lip to regulate the size of the stream.

This cheaper outfit, Fig. 5, like the other in Fig. 4, avoids having small streams of honey from the strainer fall a distance through the air space, carrying with it air bubbles into the strained honey. A sep-

arate funnel is not needed because the relatively deep bag of cheesecloth extends down into the strained honey. The honey on the vertical sides of the bag will ooze through the strainer cloth and flow down into the honey that has been strained without carrying down particles of air.

It should be clearly understood that this strainer will not work if the honey that has gone through the strainer is equal in height to the honey in the bag not yet strained. The pressure will be equal on both sides and, of course, the filter can not work until the filtered honey has been drawn down through the honey gate to the point F, or below, in Fig. 5. One can, if necessary, draw off the honey into bottles as fast as the honey oozes through the sides of the filter bag. But remember this: Don't let the filtered honey rise above F in Fig. 5.

#### Honey Should be Hot to Strain Well

While cold honey may in time pass through either one of the strainers just described, a warm, or better, a hot honey—no hotter than 130 degrees F. — will go through much more rapidly.

#### Clarification by Gravity or Sedimentation

Plan No. 2 has already been described in part under Extracted Honey on page 245 and again under Extracting on page 258. The basic principle of this method is that air bubbles, large and small, bees' wings, legs or hairs, pieces of comb, and particles of foreign matter are lighter than the honey itself. If the honey is run into relatively tall tanks after extracting and allowed to stand in a warm room for several days or perhaps weeks, depending on the temperature, the air bubbles and foreign matter will rise to the top in the form of scum and can be skimmed off. During summer, especially July and August, sunlight from several windows will make a closed room warm enough for sedimentation. The honey below the surface, especially that near the bottom of the tanks, should be relatively clear. Then it will be ready for market.

The process of sedimentation can be greatly hastened by heating the honey to about 130 degrees F. But here is both a difficulty and a dan-

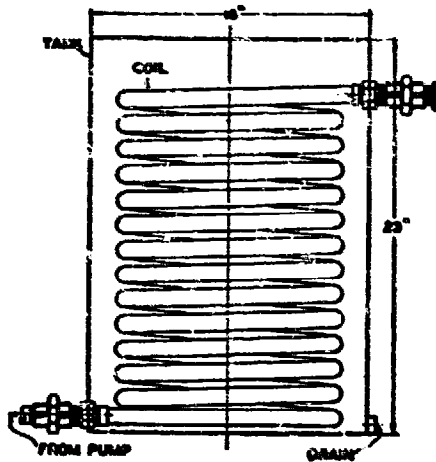

Fig. 6.—Hot water coil for heating water in a tank.

ger. The cost of heating the honey in a tank by means of coils submerged in the honey and through which hot water is made to pass is considerable. The danger is in overheating and heating the honey unequally, and in impairing both the color and the flavor. If care is taken, however, there will be no damage to the honey. (For a simple means of heating honey, see *Bottling Honey*; also *Honey, Heat Effect on*.)

Plan No. 3, a combination of No. 1, straining through a cheesecloth, and No. 2, sedimentation, obviously is preferred to either one alone. When the honey is warm just from the extractor it should be passed through a filter or cheesecloth before being pumped into storage tanks, by either of the two methods shown in Figs. 4 and 5, to remove all foreign matter. There will be left small particles of foreign matter and some small air bubbles that cause cloudiness in the honey. These should be removed as far as possible by plan No. 2, or the gravity method already explained.

The diagram and legend on next page will explain its operation. The tanks may be of any size but they should be relatively tall — twice their diameter in height. There are no strainer cloths to clean or renew.

The honey does not require heating provided the connecting valves are large enough to allow cold honey (temperature of the room) to pass through freely.

The other methods here described require heat and expensive heating coils.

### Removing Cloudiness in Bottled Honey

After honey has been clarified by any or a combination of the methods just given, it may still show some cloudiness after being put into bottles. This slightly milky color, as has been explained, is due to very minute air bubbles not yet removed by straining through cheesecloth or by sedimentation. Perhaps the honey was too cold or not kept long enough in the gravity tanks to remove the bubbles. This cloudiness can be removed by placing the bottles with the caps loosely screwed down out in the hot sun for several days. The cloudiness will gradually rise and finally disappear. In mid-summer with plenty of hot sun to warm up the bottles, the bubbles will quickly rise to the surface and disappear. The caps should then be screwed down.

If the weather is cold, a hot room of about 100 degrees F. will do nearly as well. Honey in bottles stacked around a hot stove or over a furnace register for several days will clear up in the same way. If later on this honey should show granulation, the bottles can be put in trays of water heated to 160 degrees F. and kept there until the granulation disappears. This method of restoring the honey to a liquid condition would be practicable only for the small beekeeper who desires to give his customer liquid honey.

### The Vacuum Pump for Removing Air Bubbles

Those who do a considerable business in bottled honey often use a vacuum pump for removing the fine air bubbles. If the honey is heated to a temperature of 160 degrees F. the bubbles under a vacuum will rise to the surface in from 30 to 60 minutes. If the honey has been run through cheesecloth the quick removal of the fine air bubbles will make it clear and sparkling. To use the vacuum method a heavy closed tank should be used, capable of resisting atmospheric pressure.

### Filtration of Honey as Worked Out by Bureau of Chemistry and Soils

In the Carbohydrate Division of the Bureau of Chemistry and Soils, Washington, D. C., H. S. Paine and R. E. Lothrop in 1934 and 1935 worked out a method of clarifica-



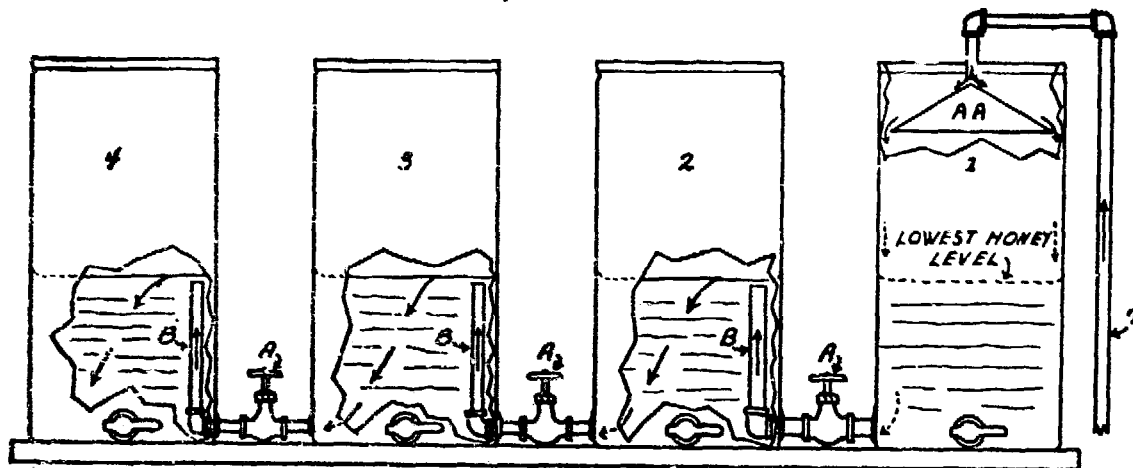

**The Gardner Hook-Up of Four One-Ton Settling Honey Tanks.**

The arrangement of tanks shown here provides for the continuous sedimentation in each of the tanks simultaneously. It is based upon the principle that small particles of wax, dead bees, wings and legs, and pollen will rise to the surface of the honey in a relatively deep tank or tanks. The usual plan is to pump the honey in at the top of each tank. This carries over the debris as well as air bubbles. After standing one or more days, depending on the temperature of the honey, the surface is skimmed off and the honey is drawn off at the bottom but not clear down. The honey from the extractor goes in tank 5 at D. It is then pumped on the spreader A A in tank 1.

Note by this scheme of piping into tanks 2, 3, and 4 that the delivery pipe B from the preceding tank in each case extends up 24 inches from the bottom. The sediment will rise to the top or near the top over night of each day leaving that portion below the top of these several standpipes B B B relatively clear. This means that the honey as it goes from tank to tank will be clear—that is, with less sediment or air bubbles—as it proceeds to the final tank No. 4 from which the honey is finally drawn. The debris is constantly rising to the surface in all four tanks over night when pumping or extracting is suspended until some time the next day.

The valves between the tanks are used only during the first filling of all the tanks. After that, they are left open and extracting and filling goes on continuously during the day. During the night the valves are all open and sedimentation goes on all night in all four tanks.

#### The Exact Method of Procedure

The honey is pumped from the receiving tank No. 5 into No. 1 storage tank. (The valves between all tanks at the beginning are closed.) When No. 1 tank is filled the valve between No. 1 and No. 2 is opened permitting the honey to enter No. 2. Pumping is continued until both are nearly filled at which time the valve between No. 2 and No. 3 is opened and the process continues until all tanks are practically filled.

The honey is allowed to stand until the next morning or from 12 to 14 hours before it is drawn off from No. 4. Experience has shown that under ordinary circumstances when the weather is fairly warm, sedimentation (the rising of small particles to the surface) will be nearly complete and what remains will be completed within the time usually required in the drawing-off process at gate 4.

It can be readily seen from the drawing that only the clearest honey from each of the four tanks will flow into the next or succeeding tank because of the location of the inlets which are the upright pipes about halfway up in tanks 2, 3, and 4. The honey is drawn ONLY from tank No. 4 so that the process may be completed.

Thus it follows that ONLY tank No. 4 can be entirely emptied. The level of the honey in Nos. 1, 2, and 3 will remain at a point the height of the upright inlet pipes B B B. And of course in order to have only clear honey drawn off, tank No. 4 should not be drawn much below the halfway mark.

After the process is once started, it becomes a continuous operation. The honey drawn from tank No. 4 has settled practically 12 or 14 hours before it is drawn off each succeeding day, as the honey is never drawn off the same day it is extracted.—Lloyd C. Gardner.

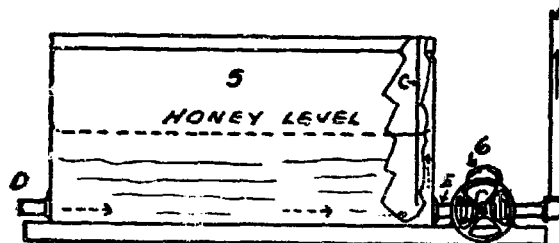

tion of honey that goes further than those just described in that it makes the honey crystal clear.

It is called the rapid or flash method. It consists of intimately mixing a small proportion of an inert filter aid, diatomaceous earth, with the honey, after which it is pumped through a metal coil immersed in water, the temperature of which is maintained at the desired point (140-160 degrees F.) Neither charcoal nor bentonite should be used as a filter as they carry the process too far. After the honey has been heated it is forced from the coil into an enclosed filter press which is kept hot automatically as the warm honey passes through it. Upon emerging from the press 15 minutes after the work was begun, the honey, crystal clear, is ready for bottling. During the filtration the added filter aid is removed and with it particles of suspended matter and minute air bubbles which, as has already been pointed out, are the common causes of cloudiness in the honey. The diagram shows the detail.

The filter press, of special construction, requires pressure. The other filters previously described use only gravity. This one shown in Fig. 7 is made up of a series of metal frames between which there is a special fabric or paper. The whole is clamped together by bolts

as shown, and when clogged the press can be taken apart and cleaned.

The upright plates having a facing of cloth or paper in this type of press would soon clog up with foreign matter. To overcome this an inert rapid filter aid of diatomaceous earth is introduced into the honey which, when heated and under pressure, leaves a deposit of porous material on the cloth or paper so that the plates do not clog up and the press can be operated continuously without being taken down. When cheesecloth or other porous fabrics are used on the common gravity filter plan already described, it soon clogs up and fresh cloths have to be substituted.

Originally, the pressure filter plan called for the mixing of the filter aid in water, forming a paste which had to be thoroughly stirred and incorporated with the honey in mixing tank B. This diluted the honey with water which had to be removed, increasing the expense. Now, the filter aid is introduced into the honey direct in tank B where the slowly revolving arms do a thorough job of mixing. While the amount of filter aid—usually less than 1 percent—is relatively small, it catches the foreign matter on the pads coated with filter aid and at the same time allows the honey, less the filtered matter and

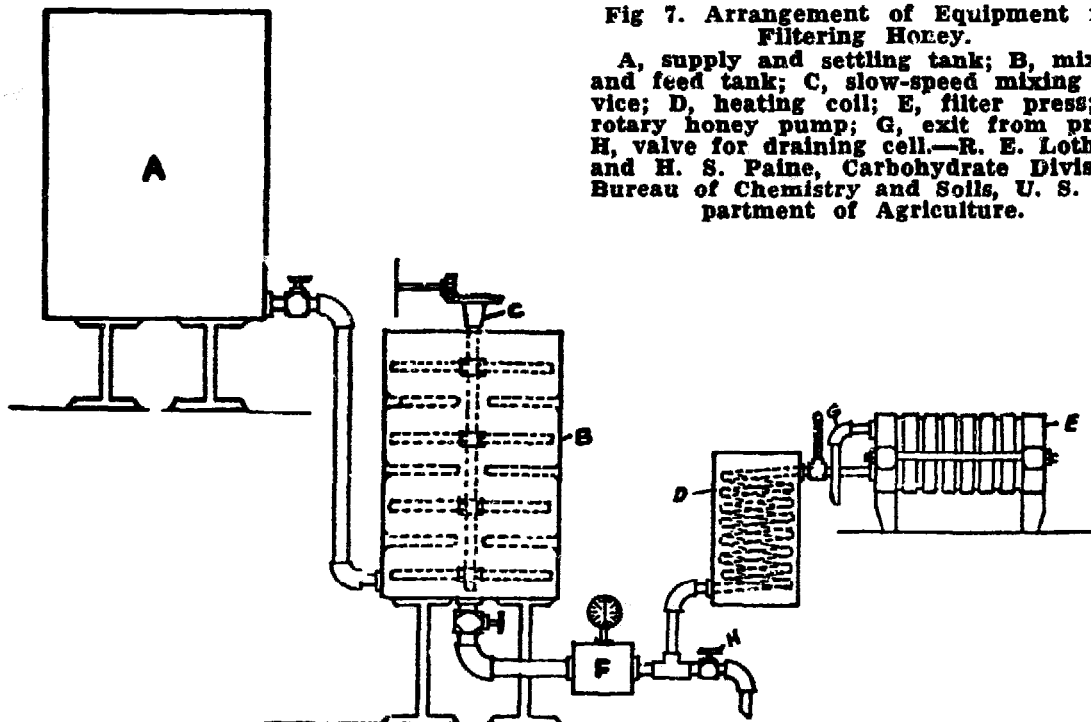

Fig 7. Arrangement of Equipment for Filtering Honey.

A, supply and settling tank; B, mixing and feed tank; C, slow-speed mixing device; D, heating coil; E, filter press; F, rotary honey pump; G, exit from press; H, valve for draining cell.—R. E. Lothrop and H. S. Paine, Carbohydrate Division, Bureau of Chemistry and Soils, U. S. Department of Agriculture.

aid, to pass through the press so it will come out sparkling clear. It is claimed that such honey carries its original flavor. After any type of filtering the heated honey should be cooled as soon as possible to avoid discoloration.

The criticism has been made that the pressure filters eliminate certain essential elements of honey. When the matter was referred to the Bureau of Chemistry and Soils it was stated that the diatomaceous earth, a finely pulverized shell matter, would remove neither the color, flavor, nor any of the essential elements in the honey, and that all such filtered honey would pass the standard put out by the Government as a pure honey. It was also explained that any material that removes color or flavor, such as bentonite or activated charcoal, acts as an absorbent rather than a filter.

#### Does Pressure Filtering Remove Vitamins?

Some criticism has been raised since the discovery of vitamins in honey (see Vitamins) as to whether or not this pressure filtering may remove some of them.

A sample of pressure-filtered honey was submitted to the U. S. Food and Drug Administration and reply came back that:

"The particular product that you submitted here does seem to have a pronounced honey flavor and we are not disposed at this time to object to its sale under the name 'Filtered and Clarified Honey' or 'Honey, Filtered and Clarified'... If it develops that consumers are being misled by this name, in that the changes in physical and chemical properties are more pronounced than would be anticipated in an article so labeled, it will be necessary to devise some other form of labeling." P. B. Dunbar, Associate Commissioner, Food and Drug Administration.

As stated earlier, the objection to pressure filtering is the expense. There is some loss due to the fact that the filter aid diatomaceous earth absorbs a slight amount of honey—anywhere from 3 to 5 percent. It may be said, on the other hand, that cheesecloth or any other media under no greater pressure than gravity would also absorb a certain amount of honey. While the honey cloth could be put

through a wringer, there would still be some loss.

It has been many years since Government chemists introduced pressure filtering or the flash method of filtering honey, and during that entire period not a single complaint, much less a suit, has been filed, alleging that such filtered honey is not strictly pure in the meaning of any state or federal law.

#### The O.A.C. Strainer\*

The O.A.C. strainer, which has been widely adopted, consists of a series of three circular screens of different mesh, one inside the other. The honey enters the center screen, passes through to the outer and fine screen, and is drawn off by a baffle near the top of the tank. If a sump tank is used first and if there is no granulation in the honey, the O.A.C. strainer will handle honey at any rate of extracting at room temperature, provided the straining area is large enough.

The modified O. A. C. strainer employing one sheet of either nylon or silk will work just as satisfactorily as the O.A.C. strainer if the temperature

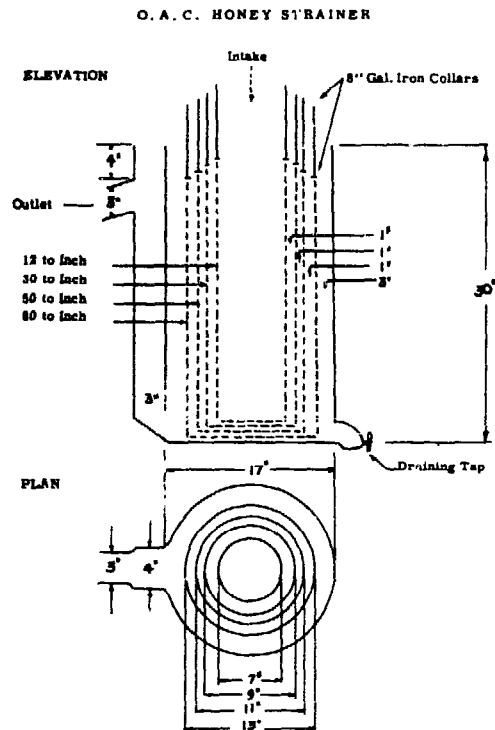

Each screen is equipped with a gate at the bottom to facilitate drainage. These gates may be opened from the top.

#### O. A. C. Honey Strainer

\*Townsend, G. F. and Adie A. 1954 Circular No. 207, Straining Honey. Ontario Agricultural College, Canada.

of the honey is raised to 110°F. The cloth is placed in a round screen support inside a tank in such a manner that the cloth lies against the walls and bottoms of the supporting screen. Since the screen is raised from the bottom of the tank by about one inch and the honey is taken off near the top of the tank, the straining takes place below the surface.

Centrifuge strainers are fast and will handle large quantities of honey with some granulation. There is no draining problem at the end of the day's run, and the screens may be readily changed or washed. The most practical one to date is built on the same principle as the O.A.C. strainer with a series of three screens. The only serious objection to the centrifuge strainer is the incorporation of small air particles, which are difficult to remove. These, however, do seem to be kept to a minimum by the three-screen type.

**HONEY, FLAVORS OF.\***—Every beekeeper knows the delicious flavor of different honeys, and those familiar with honeys from various flowers are able to determine their origin with considerable accuracy. It is reported of one honey taster that he was put to the test to determine the accuracy of his judgment in the sources of honey and that he was able to distinguish and to estimate with fair accuracy the percent of an addition of five percent of pure sweet clover to a pure alfalfa honey, both of which have flavors of rare delicacy. The discrimination of honey flavors of most beekeepers is far less acute than this, yet they all recognize the flavor as one of the most important characteristics of honeys.

#### The Delightful Odors of Honeys

That the pleasing effect of honey is chiefly odor rather than taste is evident when one enters a bottling plant where honey is being warmed for bottling, for at such times the odor is sometimes almost overpowering. The materials, whatever they may be, are volatile and it is safe to assume that they affect the sense of smell rather than that of

taste, although it is often difficult to distinguish between these two senses.

Many plants and flowers present delightful aromas, sometimes at the same time offering to the bees a liberal supply of nectar but sometimes without secreting nectar. The odor of the flower or plant and the odor of nectar or honey are usually similar, but since many odoriferous flowers are nectarless and many nectar-secreting plants are virtually odorless, it must be concluded that the odor of the flower may be quite distinct from that of the nectar. Buckwheat of an afternoon fills the air with the odors of its flowers, although the nectar has ceased to fill the blossoms at noon. The strong but delightful odor of new-mown hay is well known, but hay gives no nectar.

The floral origin of honey odor is quite clear, at least to the extent of its principal amounts. Those familiar with different honeys can distinguish the delightful flavor of clover honey from the more penetrating odor of basswood. The mint-like flavor of alfalfa honey and the vanilla-like flavor of sweet clover honey are easily recognizable.

In the work of E. K. Nelson, Division of Food Research, Bureau of Chemistry and Soils, entitled "The Flavor of Orange Honey", published in *Industrial and Engineering Chemistry* 22:448, May, 1930, Nelson says: "The pleasant floral odor of orange honey suggests the presence of methyl anthranilate...." Again a paper published in 1932 by R. E. Lothrop, "Specific Test for Orange Honey". *Industrial and Engineering Chemistry, Anal. Ed.* 4 (4) :395-6, October 15, 1932, makes the statement a little stronger by saying: "As pointed out by Nelson, the distinctive pleasant aroma of orange honey is due to the presence of methyl anthranilate."

It is impossible to describe these flavors in any manner other than to suggest a similarity to some other flavor, for there are no words which enable us to describe these properly. While these aromas are characteristic of the floral source, yet honey which has remained with the bees for a considerable time carries a richness of flavor not to be found in freshly-gathered honeys. Those who have tasted com-

\*By Dr. E. F. Phillips, Cornell University, Ithaca, New York.

pletely ripened and aged honeys, left with the bees a long time, must realize that some odor or taste has been acquired by the honey which it did not formerly have, and which did not come wholly from the flowers.

It is well known that a minute quantity of perfume may give rise to odors which permeate a large room without appreciable loss of weight of the perfume. In ordinary chemical analyses of honey there is left an undetermined amount consisting of a variety of things, among which are the following materials. Evidently the total amount of flavoring material is small, and it is also well known that by improper handling and especially by overheating in open vessels the flavor of honey may easily be lost, leaving behind merely a sweet syrup without character. (See *Bottling Honey, Granulated Honey, and Honey, Heat Effect on.*) It is thus seen that the total amount of this highly essential and most important constituent is scant in most honeys.

In all probability the flavoring material is not of the same nature in all honeys, although there are no adequate analyses which show what these materials are. Various statements, or perhaps more properly, guesses, have been made of which the following are examples. In Browne's excellent bulletin on American honeys he lists among the undetermined materials without a definite decision "aromatic bodies (terpenes, etc.)". Other authors have mentioned volatile oils as present, so far as known without chemical evidence to support such a theory. Others have believed that the flavoring materials are members of the higher and more complex alcohols. Probably a highly important constituent of the flavoring substances are volatile acids and acid compounds, of which several are known to occur in honeys. (See *Honey, Acidity of.*)

In order that any material may give rise to an odor, it must be volatile, that is, it must freely and quickly pass from a liquid or solid state to that of a gas. Heat facilitates this transformation and also the escape of any odoriferous material into the air so that it may reach our nostrils and be perceived as an odor.

### Precautions to Prevent Loss of Flavor

Considerable amounts of odoriferous material are lost during the ripening process in the hive, for on still evenings the odor of honey in the apiary during the honey flow is often quite marked. This much of the loss of odor is unavoidable and perhaps often desirable, at least for certain honeys. In the process of extracting, a valuable amount of odoriferous material is often lost, as must be appreciated by any person who has been in a honey house as the honey passes through the extractor. It is well known to experienced beekeepers that comb honey has a delicacy of flavor not possessed by extracted honey, for there is an inevitable loss even with the best of mechanical operations in extracting. It is, unfortunately, one thing to appreciate this loss and quite another to point out a remedy for it. If honey could be extracted at lower temperatures a considerable amount of this loss might be avoided, but every beekeeper knows how difficult or impossible it is to extract honey that is not warm from the hives or later warmed to about the same temperature. When honey is uncapped and put into the extractor, it passes from the combs to the outer can in fine threads, thus greatly increasing the exposure of the honey to the air and permitting the odor to escape. While still fairly warm it passes down the can and into the settling tank. A delightful odor arises from these tanks, showing that the loss of odor still goes on. By covering the extractor, as advised in some makes of machines, and especially by keeping the settling and storage tanks sealed as tightly as practicable, some of the odor may be saved, but in spite of all that one can do in all ordinary methods of handling, there is an odor in the honey house during extracting that proves to us that the most important material in honey is to some degree escaping.

All beekeepers know from personal experience how good it is to eat cappings as they are removed by the knife, and also how good extracted honey is just as it comes from the extractor. It rarely is so good again, more is the pity. But the most severe and avoidable losses come from subsequent han-

dling, in the various stages of preparation for bottling. (See Bottling.) To bring honey to a temperature sufficient to insure complete liquefying of all dextrose granules in a vessel or container that is not tightly sealed means a loss of flavor which can not be measured but which is high. In the final heating of honey to a temperature for bottling, in order to insure a liquid condition for a considerable time, there is still a greater danger of loss of flavor and at this point honey is often ruined. To overcome these losses so far as practicable, many bottlers keep the honey while it is being heated in closed and even in hermetically sealed containers, and this is a practice to be commended for any time or place that honey is being heated. It is one thing to point out places of danger and still another to provide remedies, but about all that one can do to add to the merit of our honeys from the standpoint of flavor is to see to it that at no time when avoidable is the honey left exposed to air, especially when it is warm.

Not all honey flavors are pleasant. Bitterweed in some southern states provides a honey that is inedible, and chinquapin honey is also undesirable. Mountain laurel honey (see Poisonous Honey) causes unpleasant physical effects, and is so bitter that one could not eat much of it, and many honeydew honeys are far from pleasing. Freshly collected goldenrod honey sometimes has a most unpleasant odor, comparable only to something decaying. Fortunately the unpleasant honeys are rare, but we also have another group of honeys that are strong yet pleasing. Of the stronger honeys that find a ready sale, buckwheat may be mentioned, and it is possible to state from a personal experience that this honey grows on one. In contrast to the stronger honeys, there are those in which the odoriferous material is so scant and the odor is so delicate that only a connoisseur can appreciate them. Some eastern beekeepers refer to certain western honeys as tasteless, whereas those more familiar with these honeys recognize them as delicately and deliciously flavored.

#### Flavor Affected by Physical Conditions

The subject of honey flavors must

not be passed over without comment on the changes in taste which occur in honeys under different physical conditions. The explanation of these changes is still a mystery. All honeys seem to undergo a change in taste or flavor when granulated, and while all edible honeys are equally good in liquid or crystallized form, the tastes are not the same. Not only is this true, but when the so-called honey butters are made, either by causing a finer granulation or by the breaking of the normal dextrose crystals, the taste is still different from that of the usual granulated honey of the same floral source. (See Honey Cream under head of Honey, Granulation of.)

Warm and cold honeys do not taste alike. It is easily understood that warming might facilitate the escape of odoriferous materials and thus cause a change in the effect which a honey would have, yet somehow in some honeys there seems to be a change in quality of flavor rather than of quantity. If one may be permitted to express a personal preference, it is that a delicate honey chilled to refrigerator temperature just before serving surpasses anything in the way of honey that is otherwise possible to find. Of course, honey should not be stored under such conditions, but it seems to bring out all the delicacy of the flavor simply to chill the honey before serving. And possibly, even probably, this is merely imagination.

The flavors of honey place it in the class of foods with spices and other condiments. Honey has a food value in itself and enhances our enjoyment of other foods with which it is eaten, so that it serves a dual purpose. As a source of carbohydrate food it is important, but as a source of taste and odor it far surpasses its value as a source of calories. Honey is the only natural sweet except the maple products, its worthy cousins, which are tasty and good of themselves. It then behooves the beekeeper and the ardent advocate of honey to emphasize the aesthetic value of honey, quite aside from its sugar content, so that they may assist their friends, neighbors, and customers to receive a real and worthy satisfaction. If one presumed to place a monetary value on the priceless flavoring ma-

terials in honey, in view of the minute amounts there found, he would perhaps place the figure at over \$1000 a pound, perhaps far more than this if only we knew how small an amount is there present. There is no substitute for this goodness and honey is its unique source. We can add nothing to the goodness of honey as it comes to us from the bees, but we can subtract from this goodness, so it should be a constant care that nothing which we do to honey shall destroy or reduce this virtue.

**HONEY, FOOD VALUE OF.—**A Greek philosopher charmed by the fragrance and flavor of honey declared it to be dew distilled from the stars and the rainbow. While science has laid aside Aristotle's fancy, it has shown the real nature of honey to be not less dainty and tempting.

Its praises have been sung down through the ages, not only through the scriptures, but in song and verse. Its virtues were not proclaimed in the days of Aristotle because of its dietetic or nutritional values but because it was the only concentrated sweet then known. There was no such thing as granulated sugar, brown sugar, glucose, corn sugar, or any of the modern manufactured sweets extracted from the juices of plants. Even today, honey is still the only sweet obtainable in quantities, even by the carload, that does not have to be modified or manufactured before it reaches the human stomach.

It is only within recent years that the nutritional value of honey has been recognized as a superior quickly assimilated sugar, by dietitians and the medical fraternity. Its virtue as a food, its quick absorption into the blood stream, its moisture-absorbing qualities when used in baked goods is well known.

**HONEY FORAGE PLANTS—**One problem of beekeeping that is continuously discussed wherever beekeepers meet is that of diminishing bee forage. There have been sporadic attempts to increase the acreage of honey forage plants on private and public land but the return from honey harvested does not warrant the diversion of land to growing nectar

plants when the honey crop is the only return from the crop planted. Even marginally productive land requires some preparation and a minimum of fertility and moisture to grow most honey forage plants. A site which may prove adequate is more likely to be used to grow crops with a higher return per acre than from the honey crop alone. If acreages of multi-purpose crops can be adapted to marginally productive land, particularly those which are soil builders, such as the legumes, an eventual return in value may be gained that will make the planting of honey forage plants an economic possibility.

One possibility for increasing the resources available to bees are the forest species which are known nectar producers. An interesting experimental planting of locust trees has been maintained at the University of Guelph, Guelph, Ontario, Canada. A study of nectar secretion from various lines of black locust introduced by Professor Gordon Townsend has been completed. Dr. R. W. Shuel of the Department of Environmental Biology, University of Guelph in a report to the Ontario Beekeepers Association (*Canadian Beekeeping*, Vol. 7 #10, 1979, pg.150) gave this promising preliminary report: "Some selections must be ruled out because of winter kill or susceptibility to locust borer attack. Others, while surviving the winters, will sometimes fail to set bloom. The most promising trees appear to be those that bloom in late June. In these trees blossom development seems to be late enough in the spring to escape the adverse weather. Furthermore, over the long run, the later blooming period is more likely to coincide with favorable temperatures for nectar secretion, ie 25 degrees C (77 degrees F.), or higher.

Trees as honey forage plants have several advantages. Those which yield nectar have the capability of producing much nectar in a relatively small area, the blossoms being spread out perpendicular rather than on a horizontal plane. Trees are less affected by drouth than the shallow rooted plants and are longer lived. Wood products may be the primary or at

least a secondary benefit of growing nectar producing forest trees.

The argument most likely heard in opposition of planting trees for nectar is the one concerning the time required for the trees to reach the age when nectar will be available.

Large plantations of eucalyptus trees have been suggested by a group of student engineers at Stanford University. Every five years the plantations would be cropped and the wood used as raw material for producing fuel. Eucalyptus is the fastest growing plant in the world, yields nectar and will grow on marginally productive land with little fertilization. It is resistant to pests and adaptable to a wide range of climates in Southern and Western America. A test planting is planned near Richland, Washington using water from the Columbia river for irrigation. Heated water from the Hanford #2 nuclear power plant may possibly be used to modify the soil environment in the plantations.

Newly developed techniques are shortening the maturation time of some tree species. Some trees requiring one or more decades to begin flowering sufficiently to attract bees gathering nectar and pollen may have their growth rate quickened by treating seedlings or transplanted trees with growth stimulating substances, or by altering the genetic codes which control growth rate.

No single tree is universally adaptable to North America though some kinds of trees will tolerate a wide range of latitude (see page 40-41, **Artificial Bee Pasture**). One example is the willow. This woody shrub or tree is an excellent source of early spring pollen and perhaps of nectar. John Gruszka, writing in **Canadian Beekeeping** (Vol.7 #10, 1979) has the following to say about this common tree. "Willows provide one of the earliest pollen and nectar sources to honey bees. There are more than 40 species found in the (Canadian) prairies and nine of these are common and widespread....during warm springs strong wintered colonies

have been known to store up to 40-50 pounds of surplus willow honey....

"Beekeepers may have little power to decrease the rate of brush cutting (in Saskatchewan). We can, however, promote the propagation of plants that are beneficial, perhaps necessary, to the beekeeping industry. After all, shelter belts and brush areas still exist and willows can be an integral component of these areas. The possibility of planting willows in established year-round apiaries also exists, just be sure to take your cuttings from staminate, pollen-producing trees." Willows have separate male and female trees but they both secrete nectar.

A list of trees and shrubs which have the potential to produce nectar would be a long one but a dozen and a half, more or less, are major sources of honey in North America. Woody plants which are important nectar sources found growing in the West and Southwest are: The eucalyptus



The willow, a source of nectar and pollen is easily propagated by cuttings.



(*Eucalyptus* spp.); orange (*Citrus*); acacias (*Acacia* spp.); cascara sagrada (*Rhamnus*); sage (*Salvia*); manzanita (*Arctostaphylos* spp.) and mesquite (*Prosopis*). In the South are found: Black mangrove (*Avicennia*); ti ti (*Cyrilla*); gallberry (*Ilex*); tupelo (*Nyssa*); sourwood

(*Oxyaendrium*); and citrus. The most important tree sources of nectar in the Midwest and the East are: Sumac (*Rhus*); tulip tree (*Liriodendron*); basswood or linn (*Tilia*); locust (*Robinia*); and willow (*Salix*).

Cultivated crops continue to be the



One of the best nectar sources is the basswood tree and the clusters of blossoms are eagerly worked. (Photo by Alex Mullin)

mainstay of most honey producers but continually changing cropping patterns makes it imperative that beekeepers observe agricultural practices carefully in the neighborhood of their apiaries. A farmer's choice of crops which are best suited to his conditions will have an extremely significant effect on the amount of honey forage plants available to honeybees. The common grain crops produce no nectar but other cultivated farm crops grown for their cash value, sunflowers, soybeans, rape, cotton, tree and small fruits and buckwheat may make the difference between profitable and unprofitable beekeeping. The acreages planted to some of these crops varies dramatically in some areas from year to year. Even though acreages of these honey plants may remain fairly stable they may not yield consistently each year. Changes in varieties sown may influence the honey potential. Soybeans grown in the lower midwestern states yield considerable nectar but in the mideastern states soybeans

often fail to yield nectar or are an insignificant source.

Specialized crops including the tree fruits, minor fruits and citrus fruits; vegetable crops such as cucumbers, cantaloupe, water melons and lima beans, for example, are not usually major sources of nectar but may be locally important to apiaries placed near them to pollinate. Beekeepers should be alert to placing bees near to areas having concentrations of these specialized crops. Insecticide spraying which is frequent and sometimes uncontrolled may damage colonies placed near these fields.

The legumes constitute the single most important class of plants to a great number of North American beekeepers. The acreage of alfalfa, red clover and sweet clover grown for seed has declined approximately 50% in the last three decades. White clover harvested for seed dropped from 28,000 acres to 10,000 acres



Grain feeding has replaced legume mixed hay as livestock feed

from 1958 to 1967. Alsike and crimson clover grown for seed declined dramatically during the decades of the 50s and 60s. This decline was in response to a declining market for legume seed, an indicator of the changing feeding habits in livestock management. The grasses and grains replaced the legumes which were formerly

grown as pasture and in mixed hay for livestock feed. The great increase in inorganic fertilizer use and improved varieties of wheat, soybeans and hybrid corn made growing these crops more profitable. These crops are more adaptable to machine planting and harvesting. The legumes are no longer used extensively

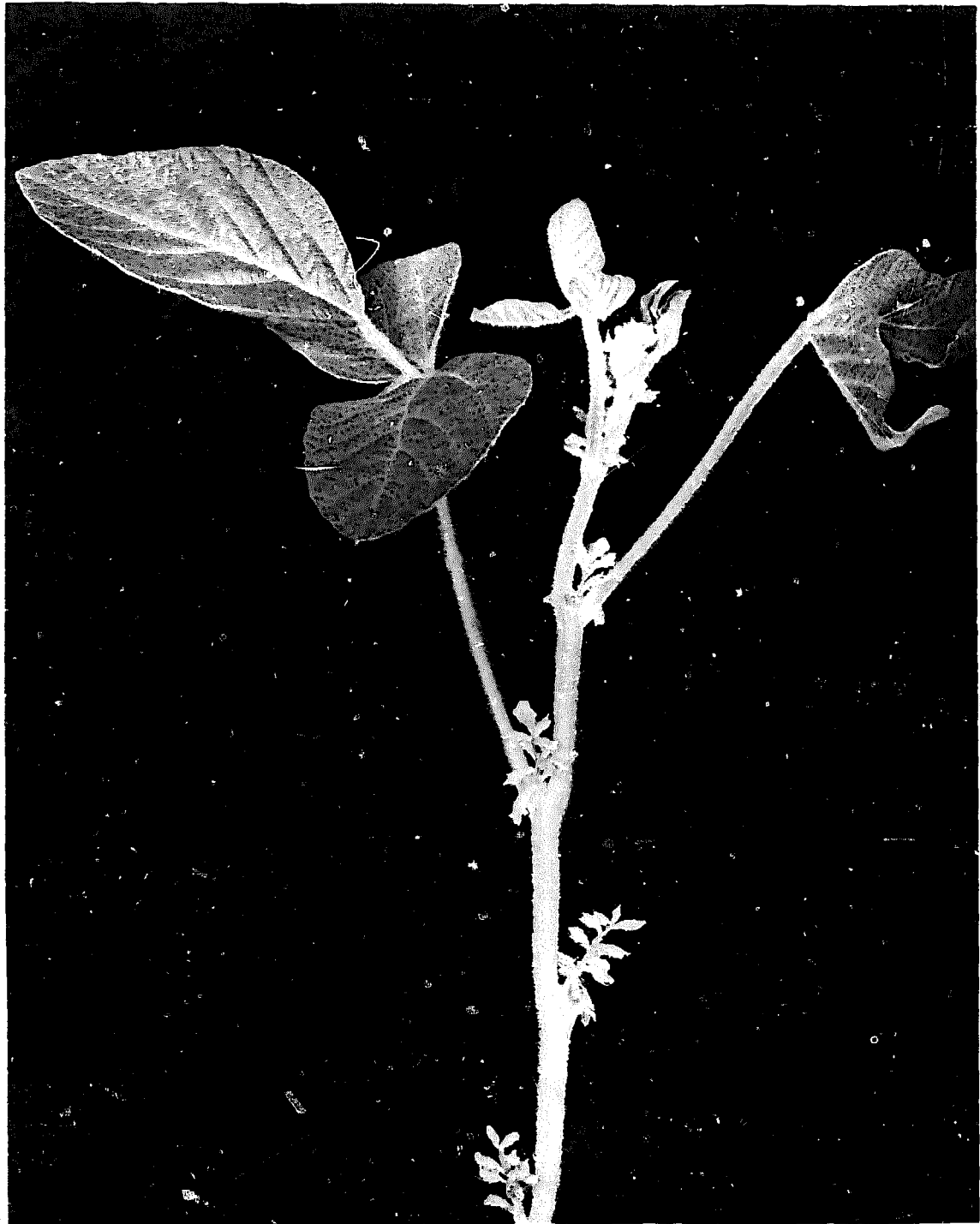

Soybeans have the potential of being more important to the beekeeper.

for soil builders. Despite these inroads on the sown acreages of legumes used in soil building and for pasture the estimated amount of acreage in mixed hay has remained fairly constant since 1950, approximately 42 million acres. Legumes used for hay are principally alfalfa, alfalfa mixtures, clover and clover and grass mixtures. Most of the hay is grown in the midwestern states and a few western states.

The beekeeper would naturally like to see an increase in the legume acreage but unless some unforeseen changes occur in North American farming practices there is unlikely to be a return to a dependency on the legumes for other than a minor role on the large grain farms. Perhaps the legumes will be called upon for an increasing role in soil management in underdeveloped agricultural land and livestock feeding. Although larger acreages may be given over to alfalfa, for example, the most efficient use of this valuable honey plant demands that it be cut before a full bloom stage is reached, rendering the crop all but useless to beekeepers.

Despite these rather gloomy predictions about the future of some of the legumes there are some which have the potential of being much more important to the beekeeper. Soybeans, a legume, is also a cash crop of considerable value to the midwestern and south central U.S. farmer. It is becoming an increasingly important nectar source. The factors affecting nectar secretion of the soybean plant appear to be the soil, climate and variety. Two of these factors, soil and climate may be inalterably limiting in some areas. Variety selection may be changed if farmers can be assured that a nectar yielding variety is as productive or more productive than the one presently being grown in latitudes that grow the non-yielding varieties. Other oilseed crops as sunflowers and rape show promise of being grown in increasing amount. Rapeseed acreage has increased in Canada as has sunflower acreage in the United States. The rising prominence of sunflower oil in world edible oil markets has stimulated increased interest in expanded production in the United States. U.S. acreage devoted to

oilseed sunflowers has expanded rapidly, with over 600,000 acres grown in 1972. Production had been concentrated in the Southern cotton belt states and in the Red River Valley area of Minnesota and North Dakota.

Plants growing on uncultivated land, the so-called "wild plants" constitute both major and minor sources of honey in North America. A list of even the major ones would be extensive since they are so diverse and numerous. The minor sources of nectar among the wild plants may be important pollen plants.

It seems to be an irreversible axiom that our naturally occurring plants be treated as something to be dispatched by every conceivable means at our disposal. Herbicides and ground clearing machinery are employed with little thought as to what effect the denudation of the soil will have.

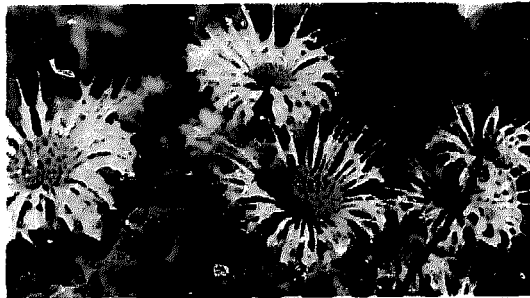

"Wild" plants are major and minor nectar sources

Rearrangement of farm fields to accommodate modern farm machinery had reduced the amount of land used for fence rows and eliminated irregular plots of land that were formerly left idle and had furnished for bees a variety of secondary nectar and pollen sources. The general effect on bees is that they do not build up as rapidly in the spring, often requiring supplementary feeding and additional pollen in the form of substitutes, both costly for the beekeeper. A lack of fall forage, which had become acute in many of the intensively farmed areas, prevents normal fall brood rearing. Colonies do not go into winter as strong and the colony survival rate is lessened when the normal complement of "winter bees" is not raised in the fall. Colonies depend upon the fall flora for the pollen required in early spring brood rearing.

Preservation of the honey forage plants in North America will continue to demand attention if productive beekeeping is to continue. It will be the responsibility of each beekeeper and every organization of beekeepers to promote conservation and use every opportunity to expand our present acreage of honey forage plants.

### **HONEY, FORECASTING AND REPORTING\*.**—(See also Statistics on Bee and Honey Industry).

Bee and honey statistics were first issued in 1940 by Statistical Reporting Service and are currently included in two reports issued each year. The September release provides estimates of the number of colonies, yield per colony, and honey production from commercial operations in 20 States. A commercial operator is one controlling 300 or more bee colonies.

The January report contains estimates of the number of colonies, yield per colony, and production for the preceding year for all operations in all States and the Nation, wholesale and retail prices received by producers for all honey, value of honey production, stocks of honey held by producers in mid-December, and beeswax production, price and value.

#### **Number of Colonies**

The estimate of the yearly change in the number of colonies is based primarily on SRS sample surveys and State inspection records.

SRS maintains nearly complete lists of honey producers in each State, stratified by size of operation, for surveying and estimating purposes. During surveys, an attempt is made to obtain a complete response from all the largest producers and a return from a sample of the smaller operations.

Questionnaires mailed to producers for the September and December surveys ask about the number of colonies on hand at the beginning of the honey flow. The number reported by a respondent on the 20-State September inquiry is matched with the number

reported by him a year earlier for that month. A summary of these matched reports provide an indication of change from the previous year and is a basis for estimating the number of colonies in each State.

In addition to current year data, the 50-State December questionnaire asks for number of colonies on hand at the beginning of the honey flow the preceding year. A summary of the current number of colonies matched with the number reported for a year earlier on the same questionnaire provides another indication of the percentage change in colonies.

Data on number of colonies inspected are available from some State inspection agencies and are given consideration in making the estimates. The September estimates of colonies in commercial production are revised in January, based on the additional data received from the December survey.

#### **Honey Production**

The first estimate of the yield of honey per colony is made in September and is based on the amount of honey commercial producers have already taken and expect to take from the hives.

A final estimate is made in January when producers are asked for the amount of honey harvested from hives during the preceding year. The total reported pounds of honey produced annually is divided by the reported number of colonies to obtain an average yield per colony. The average yield for each size group is computed and weighted to arrive at a State average yield. The weighting is particularly important, because yield per colony is significantly higher for larger operations, which manage their colonies more effectively and move them from one location to another during the year.

The reported yields are summarized by strata and weighted by the proportion of total colonies in each stratum to arrive at a State average yield. The adopted yield per colony is multiplied by the estimated number of colonies to obtain the estimate of total honey produced for each State.

#### **Beeswax Production**

In January, an estimate is made of

\*From Scope and Methods of the Statistical Reporting Service, Publication #1308, USDA.

the amount of beeswax produced during the preceding year. The estimate is based on the reported amount of beeswax produced in relation to reported honey production and on the average pounds of beeswax produced per colony.

#### Value of Production

Estimates of prices received by farmers for all honey and beeswax sold are published in January. The total price is obtained by combining reported prices for each size container sold, both wholesale and retail. Quantities of honey sold are estimated by categories for each State and are used as weights to obtain a price for all honey. The quantities are derived from pounds of honey sold in each category as reported on the December questionnaire and from other available sales data. These weights are also used to compute regional and U.S. average prices for wholesale and retail sales of extracted, comb, and chunk or bulk honey, and for all honey.

These average prices are multiplied by the quantity produced to derive value of honey production for each State and the United States. Value of beeswax production is derived in a similar manner. These value estimates are published in the January Honey Production report.

#### Stocks of Honey

Stocks of honey as of mid-December are estimated and published in January. A percentage indication of honey stocks is derived by dividing the total stocks reported by producers in the survey by the reported total pounds of honey produced. After the percentage of honey on hand is determined for each size group, a weighted percentage is obtained, then expanded into a stocks estimate by multiplying it by the total estimated honey production for the year.

#### HONEY, FREEZING POINT OF

—Honey, of course, never freezes at any temperature at which it has been kept and there appears to be no record of its having been exposed to such extremely low temperatures as that of liquid air. The freezing point of a sugar solution is lowered by the increased concentra-

tion of sugar, and at the same time the boiling point at ordinary barometric pressures is raised. It is, of course, well known that the boiling point of honey is higher than that of water, yet we can not make observations on the boiling point of honey without causing disintegration changes which ruin it, except under partial vacuum. The lowering of the freezing point depends not on the weight of the sugar in solution for any given amount of water but on the number of molecules of sugar in solution in water, or whatever the solvent may be. A solution of cane sugar containing a given weight of sugar freezes at a higher temperature than does a solution containing an equal weight of dextrose or levulose, since the last two sugars are simple sugars and a given weight contains twice as many molecules.

**HONEY, GRADING.**—See Grading Honey, U. S. Standards on.

#### HONEY, GRANULATION OF.—

[For the science of granulation of honey, see Honey, Chemical and Physical Properties of, by Dr. Lothrop. That which follows deals with the preparation and commercial exploitation of granulated honey in the form of honey creams under various commercial names.]

Nearly all kinds of liquid honey and most comb honey, if given time enough, are liable to partially solidify at the approach of or after cold weather. The honey assumes a granular condition. The granules may be about the size of grains of ordinary sugar or they may be much finer. Comb honey granulates less readily than extracted, and only after a much longer period. While cold weather is much more conducive to solidification, yet in some localities, and with some honeys especially, the granulation takes place even in warm weather. Some honey will granulate within a month after being taken from the combs, while others will remain liquid for two years. A honey that granulates quickly is extracted alfalfa. Mountain sage from California and tupelo from Florida may remain liquid for several years. The alfalfa is high in dextrose and the tupelo high in levulose.

Ordinary comb honey in sections,

if well ripened, will usually remain liquid as long as the weather is warm. When it becomes cold there may be a few scattered granules in each cell. These gradually increase in number until the honey becomes almost one solid mass. In such condition it is unsuitable for the market, the table, or for feeding back, and should be treated by the plan described farther on.

#### **Why Extracted Honey Granulates Quicker than Comb Honey**

Honey stored in new extracting combs just built from foundation will not crystallize sooner than that stored in sections, but honey stored in old combs from which one or more extractings have been taken will usually granulate much more quickly than that in comb honey sections. In old combs primary crystals from former extractings may start granulation within two or three months. If the combs are stored wet from extracting, crystallization in the new honey will start much sooner. Even if the combs have been cleaned out by the bees there will be enough primary crystals left to start granulation. These primary crystals are very small and may not be seen with the naked eye.

#### **Cause of Granulation**

As explained under Extracting, some beekeepers at the close of the season store their wet combs from the extractor in the honey house and do not put them in the hives until the next extracting season. Unless these wet combs are cleaned up by the bees before storing for the next year, the thin varnish of honey on the insides of the cells will form crystals of granulation. This seed will very soon start granulation on the first extracting of the next season. The first extracting of honey will granulate quicker than that which comes from the second or subsequent extracting.

From what has been said by Lothrop, and by Wilson (under Honey, Spoilage of) liquid honey if well ripened will be less liable to ferment than granulated honey.

On the whole the author advises that all extracting combs at the close of the season be put in the hives to be cleaned up by the bees. Never expose them to robbers in the open air on top of the hives to be cleaned up before storing. It is

desirable to keep honey from granulation as long as possible. It will assume the crystallized state soon enough. (See Honey, Spoilage of.)

There is no plan to prevent honey from granulating or to restore a granulated honey to a liquid condition except by the use of heat, but it should be made emphatic that in the employment of steam, hot air, or hot water, one may seriously impair the flavor of a good honey or ruin it altogether unless great care is taken. If the temperature goes too high or if a low heat is maintained too long, the honey will be made several shades darker in color and the flavor will be greatly impaired or ruined beyond recovery. Some of the honey on the market sold by individual beekeepers or by small packers is of inferior quality just because heat was improperly used.

Dr. E. F. Phillips regrets that much of the honey sold—good before it was processed to prevent granulation—is so poor that the housewife will not buy even a good honey.

Carelessness or lack of knowledge on how to process honey on the part of the small packers will react on the honey market and also on the beekeeper.

The author believes that while most of the honey in groceries and in the roadside stands is of fair to good quality, a word of caution should be here offered to the beekeeper and to his customer to use great care in processing his honey with heat.

That means that the directions here given should be followed very carefully. The temperature of the honey should not go above 160 degrees F. and then should be cooled as quickly as possible. It should never under any circumstances be kept hot long. In order to watch the temperature it is essential to have a tested thermometer. The ordinary house instruments are not suitable for such work. A good dairy thermometer that can be had at hardware stores answers an excellent purpose for the beekeeper or the small packer. If not marked "tested", it should be compared with some tested thermometer and the correct reading point for 160 degrees should be marked. This is near the danger point in heating

honey, and it is highly important that it should be accurately indicated. (See article by Prof. Richmond in *Gleanings for December, 1932*, page 747.)

Where there is a large amount of granulated honey to be rendered as in the case of the large honey packers, a special thermometer should be used. One such can be obtained from scientific instrument makers.

Emphasis can not be made too strongly that honey, on reaching the 160-degree mark should, if the crystals of granulation are all dissolved, be sealed immediately in the bottle or tin can and then cooled as soon as possible. Sometimes a cool or cold atmosphere is sufficient. At other times running water from a well or a tank of water kept cool with ice should be used.\*

(For particulars on equipment for liquefying granulated honey, see *Bottling Honey*.)

#### Marketing Granulated Honey

That natural granulated honey is delicious and fine as a spread on bread and butter, every beekeeper knows. Many prefer honey either granulated or in a semi-solid condition.

In the United States, and, to a large degree, in other countries the resistance to purchasing honey in the solid or granulated condition has had a great influence on the predominance of honey being sold in the liquid packs. Even in Canada, where granulated honey once enjoyed a prominent place on the market, honey sales have now adjusted to about 50 to 70% liquid as against 30 to 40% sold as granulated. In contrast nearly all of the extracted honey sold in Canada in the 1940's was in the granulated form. By the middle of the 1960's the demand was divided equally between liquid honey and the granulated form. Consumers in Western Canada show a greater preference for the solid form of honey than do those in the Province of Ontario.

Before the development of a process to prepare a finely crystallized honey (see Dyce process) beekeepers left honey to crystallize in the most convenient way. With the onset of cool fall days after harvest, honey will begin to granulate if left in storage without processing. Some honeys exhibit a greater tendency to do so than others; alfalfa

honey and the fall-gathered honey from aster and goldenrod are examples. The faster honey granulates the finer will be the texture. Several considerations enter into the granulation process affecting both the rate at which it proceeds and texture of the final form; the floral source, moisture content, temperature of the storage room and whether or not the honey contains "seeds" of granulated honey. Granulation that takes place after honey has been heated will have a coarse crystal structure. If the honey is packed in glass and natural granulation follows, the pack will not have an attractive appearance to the buyer. The process of granulation is not usually understood by the honey purchaser, and the jar of granulated honey, possibly containing air spaces and with an uneven texture does not show the honey to the best advantage even though the flavor may be as good as or superior to when it is prepared in a processed liquid pack.

From the standpoint of preserving the original quality marketing honey in the granulated form has much to commend it. Aside from the possibility of fermentation, if the moisture is too high, there is little in the way of transformation takes place other than changing its physical form from liquid to semi-solid. This absence of impairment to the quality is in contrast to honey subjected to uncontrolled heating. Quick granulation does not appreciably affect heat-sensitive vitamins, enzymes and yeasts. The percentages of sugars in honey has a direct bearing on the tendency to granulate but much the same percentage of each sugar remains after granulation. Granulation does, however incur the possibility of spoilage since it results in an increase in the moisture content of the liquid portion of the honey. Long-term storage of honey, two years and beyond, for example, with the usual accompanying granulation causes changes in the sugars, enzymes, free acidity, lactone and total acidity. Color and nutritive value is also affected. The rate of change is determined by the storage conditions.\* Since most honey is processed and packed within or soon after the year of

\*Jonathan White Jr., Mary L. Riethof, Mary H. Subers and Irene Kushnir, *Technical Bulletin #1261 USDA*.



production the changes due to storage are usually negligible. If preservation of the natural goodness of honey is desirable the possibilities of marketing honey in the granulated form should be considered. The rather intricate Dyce process may not be suitable for the beekeeper-packer with only a few hives but the fact that granulated honey is a superior form in respect to quality may lead to the introduction of a solid honey pack that is to the liking of the customer.

Savings in methods of packing, lowered container costs and better marketing methods may result from packing a larger proportion of the commercial honey crop as granulated honey. Consumer preferences for traditional packaging methods is always a safe guideline for the honey packer but the acceptance of a new product form can be an extraordinary success if the idea catches on with the buyer. Even a moderate change in customer preference may be desirable if large quantities of, for example, honey processed by costly technology, is required to keep the trade supplied.

Packers of large quantities of honey usually set the trends in consumer packaging and are understandably cautious about altering marketing methods that have in the past been proven to be profitable because of customer acceptance. What many small producer-packers do in the way of stimulating honey sales may not be adaptable to a larger volume but if the idea is innovative and successful anyone with a unique pack of honey in the granulation form should be encouraged to expand it further. A good-selling line of granulated honey could eventually bring about some significant changes in the style of our present packaging of honey. Total honey sales may benefit as well if new, innovative honey marketing methods are successful.

Many people do not like the stickiness of honey and the difficulty of spooning it out of the jar according to some surveys of consumers. The introduction of non-drip servers and the plastic squeeze bottle has overcome these objections to a degree but there yet remains the possibility that the good spreadability of honey sold as a semi-

solid will further reduce this resistance on the part of the potential buyer of honey.

Dining out in restaurants is an increasingly important facet of American life. Very little honey reaches the diner by this route. A convenient pack of honey suitable for use in public dining places may be prepared from a form of pure granulated honey. Cost is the most critical consideration, aside from convenience. Cost reductions via increased sales is perhaps the approach most likely to justify experimenting along this line. Marketing a soft, spreadable honey may lend itself to restaurant use and may involve fewer costly processing procedures.

Some subsidiary products of the honeybee such as pollen have attained some popularity as dietary supplements for human consumption recently. Pollen could much more likely be mixed with a solid form of honey than in liquid honey but it would remain to be determined if his form would be as popular as the present pollen tablets. Any such introductions must be very carefully investigated against possible violations of honey packaging and labeling regulations.

In summary; though granulated honey has been popular in the past and continues to enjoy a preferred status with many people, the present predominance of liquid honey packs reflects a rather restricted approach to the possibilities of increasing the consumption of honey. Considering the excellence of a granulated honey prepared by the Dyce process it has evidently not elevated the level of honey use to a great degree; a shortcoming incomprehensible to someone who has had the good fortune to obtain honey prepared by this process. So many possibilities exist for promoting honey through marketing in the granulated form that it could be a boon for increased per capita consumption of honey throughout the world.

#### Crystallized Honey\*

All honeys will crystallize naturally; some do so in weeks and others may not granulate in a year or more. The

\*By Roger A. Morse, Professor of Apiculture, Cornell University, Ithaca, N. Y.

rapidity with which crystallization takes place depends upon many things including the ratios of the two\*\* principal sugars in honey, the presence of nuclei on which the crystals may grow and temperature.

Granulated honey which has fine crystals has a much better flavor than that with coarse crystals. Crystallized or finely granulated honey made under controlled conditions is now sold around the world. The crystals in properly made granulated honey are so fine that they cannot be detected with the tongue and in the mouth the granulated honey has a texture much like that of butter. The fact that granulated honey had much appeal tastewise, in addition to being a product which would not drip, was long recognized and beekeepers made many attempts to develop a process to make a finely granulated product.

#### The Dyce Process

Dr. E. J. Dyce, then Professor of Apiculture at Guelph University and later Professor of Apiculture at Cornell University, developed the first practical process for making a granulated honey in 1928. Dyce later patented the process and in Canada gave the patent rights to the Province of Ontario. In the United States the rights were given to Cornell University. Much of the money earned in the United States was invested and the income is still used to support research on bees and honey at Cornell. The patent has now expired and anyone may manufacture and market the product.

#### Some Facts About Granulation and Fermentation

When Dyce began his studies there was little known about honey granulation and fermentation. He was aware that all natural honeys contain yeast. When the moisture content of the honey

is somewhat above 19 percent, these yeast cells grow, producing carbon dioxide and alcohol. The yeasts found in honey are not the same as those used to make alcoholic beverages or bread, but belong to the genus *Zygosaccharomyces*. However, carbon dioxide may be produced in such quantity in fermenting honey as to burst the drums or containers in which the honey is packed. The foul odor produced by the fermentation makes the honey unmarketable. If it is not damaged too badly it may be used as bee food.

When honey granulates a small amount of the water in honey is taken into the sugar crystals. However, the quantity of the water so contained is not proportional to the amount of water in the honey. Thus, one may have a jar, drum or container of partially crystallized honey in which the liquid fraction has a moisture content higher than that of the original honey. When this occurs the honey may ferment. Dyce recognized that if he was to control the granulation of honey he must first pasteurize the product. Any sized

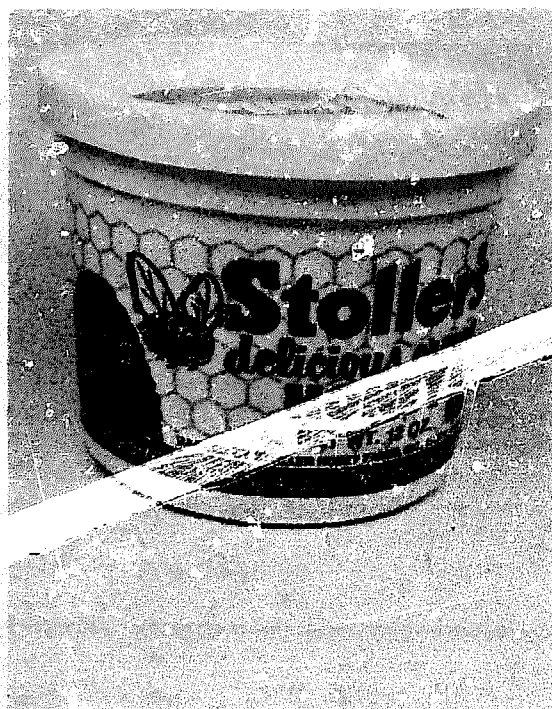

"Creme" or finely granulated honey has a texture like butter and an appealing taste.

\*\*The two most common sugars in honey are fructose and glucose. Fructose is sometimes called levulose and glucose is sometimes called dextrose. The first terms mentioned are considered most correct. Both sugars contain six carbon atoms and are made when honeybees add the enzyme invertase to sucrose which is a 12 carbon sugar and the common sugar in nectar. The ratio of fructose to glucose varies greatly; when more fructose than glucose is present the honey is less likely to crystallize naturally and vice versa.

crystals that he added must also be made from honey which had been pasteurized.

Dyce found that the optimum temperature for honey granulation is 57°F. (14°C.). There has been much conflict about this question in the literature. Many people were of the opinion that a fluctuating temperature speeded up granulation; Dyce showed this was not true. Most granulated honeys will have a firm texture six to 14 days after the introduction of seed crystals if held at the proper temperature. In commercial practice rooms used for holding honey the process of crystallizing are held within about 10°F. of the optimum temperature.

Pasteurization of honey destroys the nuclei on which crystals might grow. Dyce found that he could introduce previously granulated honey, that which had been ground and the crystals broken, into honey to be crystallized. These crystals are called starters. When five per cent of a ground, finely granulated honey was introduced into newly pasteurized honey there is a sufficient quantity of seed to produce a high quality, finely crystallized honey. In commercial practice most firms use eight to ten percent starter; under ideal conditions less may be used. An important factor is that the seed crystals must not be warmed too long and thereby caused too melt partially.

#### Dyce Processed Honey

Dark, strong-flavored honeys have a lighter color and a milder flavor when made into a finely granulated honey; this fact has lead some packers to use less than desirable honey in making granulated honey. Honeys used to make granulated honey should be of table quality. The optimum moisture content is 17½ to 18 percent; in the northern states 18 percent in the winter and 17½ percent in the summer. In the southern states a moisture content of 17½ percent is used throughout the year. The moisture content of a crystallized honey has a great effect on its hardness and therefore its spreadability. Honeys which have a higher or lower moisture content will be too hard or too soft and will not spread properly when used at room temperature. The first step, then is the selection and blending of honeys of proper color and moisture contents.

Honey to be used for the Dyce process need not be filtered. In fact, filtering removes certain of the natural elements present in honey, especially pollen. The honey should be heated to about 125°F. at which temperature it should be carefully strained. Dyce recommended that the honey next be heated to 150°F. (66°C.) and then cooled rapidly. This temperature is sufficiently high to kill the yeast present. Prof. G. F. Townsend of Guelph University showed that yeasts in honey were killed if it was held at 160°F. (71°C.) for one minute or 140°F. (60°C.) for 30 minutes or some combination of time and temperature between these two extremes. In commercial practice there is time involved in heating and cooling the honey which also has an effect on the yeasts. If honey in a bulk tank is heated to 150°F. (66°C.) and then cooled, even under optimum cooling conditions, it will have been heated enough to kill any yeast cells present.

#### The Starter Crystals

For a starter one uses granulated honey which has been previously made by the Dyce process. It is not satisfactory to take previously granulated honey from a grocer's shelf to be used as seed since the high temperature at which this honey is held in a store will have started to melt the crystal nuclei present. One method of obtaining a yeast-free, finely granulated honey to use as a starter is to grind with a mortar and pestle a small amount of coarsely crystallized honey, that had been heated (pasteurized) previously. The honey must be ground very finely and preferably at a temperature in the vicinity of 57°F. (14°C.) as the crystals may melt if held at higher temperatures. The honey into which the crystal nuclei are introduced must also be cooled before the starter is added.

Most of the grinders used for starter for Dyce crystallized honey are homemade or modifications of meat or food grinders on the market.

#### Air and Crystallized Honey

Honey which is in the process of granulating and which is held at lower than room temperatures is viscous. Often a number of air bubbles are incorporated into it in the process of cooling and/or adding the seed. These small air bubbles may rise to the surface

of the product and give it a white, frothy appearance. This white froth may be avoided by allowing the honey to settle for a few hours before it is packed, or packing and cooling the honey rapidly so the air bubbles are incorporated in the final product. The air has no objectionable effect on flavor.

Granulated honey in glass may pull away from the glass. The honey may assume a white, froth-like surface between the honey and the inside of the glass. Customers usually do not realize what has happened and may think the honey has spoiled or become moldy. (Mold cannot grow on or in honey.) It is for this reason that granulated honey is usually packed in plastic tubs or glass jars with labels which wrap completely around the container.

#### Stack Heat

The seed crystals are usually added to the cooling honey when the temperature has reached about 75°F. (24°C.). It is very difficult to force honey to flow at lower temperatures. This temperature is higher than desired but if not held for too long little damage is done. However, when cases of newly packed, crystallized honey are placed on pallets or trucks the cases must be carefully spaced so that air can flow between and around the cases. If this is not done the stack of newly packed jars will retain heat. This heat could have an adverse effect on seed crystals and cause them to be less effective as crystal nuclei.

#### Shelf Life

Properly made granulated honey has a long shelf life, longer than most liquid honey. Honey packers have observed that they may make and hold granulated honey for long periods of time, much longer than they would have stored packed, liquid honey. Granulated honey made and held under controlled conditions retains its fine texture, color, appearance and taste. There is probably a wider market for honey in this form than is now being exploited.

#### HONEY, HEAT EFFECT ON.\*—

Vast amounts of honey are reduced in value by something that the bee-

keeper or the bottler does or fails to do in preparing honey for market, and most of the damage has been done innocently or ignorantly by overheating the honey. This is the greatest source of damage to honey at any stage of handling.

It is no new discovery that overheating damages honey by making it darker in color and in impairing the flavor, and on this point there is no disagreement. Bottlers heat honey to about 160 degrees F., bottle it while hot, and seal the bottles hermetically to prevent crystal formation. There is some disagreement regarding the advisability of this practice, since there are honey enthusiasts who maintain that the destruction or weakening of the enzymes contained in unheated honey is detrimental. The reduction in enzymes causes little concern, since it is not clear that their retention is important. It is agreed at any rate that quick heating, bottling, and immediate cooling do not damage either color or flavor of a honey. Whatever discrepancies occur in this practice arise from the length of time required for heating or cooling, and honey is often seriously damaged in the bottling processes. Even some of the larger bottlers are offenders in this respect, and their mistakes may include both overheating and the removal of unknown ingredients by uncontrolled filtering.

Some of the changes which occur when honey is overheated are merely hastened and are not caused solely by heating. They may occur at ordinary temperatures, and any person who has made a collection of honeys from various floral sources has found that the collection becomes worthless. Honeys in a collection made by N. E. France for the St. Louis Exposition all became inky black. A beekeeper once presented me with an exhibit bottle filled with what had been the lightest water-white sage honey, produced in one of the banner years. After 20 years at ordinary house temperatures (which perhaps were a bit warm at times), this honey had changed to a beautiful wine red, as clear as crystal instead of having the turbidity normal to honey. Sage honey is said to be non-granulating, and this honey was still liquid except for a few giant crystals at the bottom.

\*By Dr. E. F. Phillips, Cornell University, Ithaca, New York.

When heat is applied to a solution in which some chemical change is occurring, the speed of the change is accelerated. For many chemical processes, a rise in temperature of 10 degrees C. (18 degrees F.) doubles or triples the rate. There could be no definite rate established for change in color of honey because this varies with different honeys, but one might expect that if it required 20 years for the sage honey to become wine red, the same change would occur in 6 to 10 years if the temperature were raised 18 degrees F. By further rise of temperature, the change would be more accelerated. Of course, no honey could be kept at a temperature over 100 degrees F. for a year without ruining it. (See Honey, Discoloration of.)

It follows that whatever changes occur on heating do not wait until the highest temperature is reached, nor do they cease when the heat is turned off. It is then inaccurate to state, as is sometimes done, that honey may be safely heated to 160 degrees F. since the duration of the heating, the period of high temperatures, and the slowness of cooling are all important. A consideration of time is fully as important as the temperature at the highest point. The usual statement that honey can safely be heated to 160 degrees F. is false and misleading unless the time elements are included. If honey is heated quickly to 160 degrees (of course without scorching any of it), and if then it is quickly cooled, no color or flavor change can be detected, but if anything occurs to retard cooling, serious damage may occur. Also if because of the use of improper methods, some of the honey is heated to too high a temperature, serious damage may occur. This kind of damage usually results from the use of metal vessels, through which the heat in the jacket is transmitted too rapidly to the warming honey, before it becomes liquid enough to diffuse rapidly.

If honey is properly heated to 160 degrees F., bottled at once, and the bottles are allowed to cool quickly, the result will be highly satisfactory. But if the hot bottles are immediately packed in shipping containers, a high temperature is retained adequately to cause change of color. Similarly if the blending

tank is emptied slowly, the last honey from it will be darker than the first. It seems to be at this point that many bottlers make their most serious mistake. In the interest of assumed efficiency, large tanks are often used, and the bottling equipment is not correspondingly fast. It is a good working rule that the tank should be completely emptied in not more than a half-hour. If such precautions were taken there would be fewer 500 or 1000 gallon tanks used by bottlers. (See Honey, Filtration of.)

The equipment used by bottlers is usually better than that used when honey is heated in the honey house. Let us suppose, for example, that the beekeeper heats his honey to facilitate straining or settling. The honey is run over or through some heating device and then passes into a storage tank while still quite warm. The capacity of honey for retaining heat is so great that such tanks are often warm the next morning. Settling demands retention of heat for a considerable period, hence one has a right to be frightened whenever he sees a beekeeper using heat in settling. Straining might be a different matter, for this requires heating for a short time only, but to make this procedure safe, quick subsequent cooling is required, and not many beekeepers have provided for this. A beekeeper rightly desires to produce a honey free of foreign material and as clear as feasible, but in most cases more harm is done by heating than the good amounts to from straining and settling, by the methods in use in most honey houses.

There is often added danger in honey house heating because of the vessels used. Only a few tests have been made of the chemical action of honey on metals. Most honey tanks are unfortunately made of galvanized sheet steel which is more readily acted upon than tin. The zinc plating appears to be rather safe, but when broken so that the iron is exposed, darkening occurs. Honey contains several acids, one of which is tannic acid, and when iron is acted upon by tannic acid, ferric tannate is formed, which is old-fashioned black ink. Most beekeepers have seen instances in which a black spot or ring has been

formed at places where iron is exposed in honey tanks or cans. Such coloring matter may be rather harmless but it is not desirable. This action is hastened by heating.

Honey bottlers have found that glass-lined tanks are preferable to metal tanks, which is true for two important reasons. Heat is transmitted through the glass lining slowly, thus reducing the chance of scorching of the honey at the rim. When an agitator is used, as it should always be, the heat enters all parts of the honey simultaneously and the possible damage is reduced. A second important advantage of the glass lining is that it contains nothing to injure the honey by chemical action. Few beekeepers feel that they can afford the glass-lined tanks, and get along with metal tanks, and a metal tank without a stirring device is dangerous when heating honey.

Too much emphasis cannot be placed on the use of efficient stirring devices, and it is just as important to use this during the cooling process as during the application of heat. A good stirring device greatly reduces the time necessary for either heating or cooling and at the same time reduces the chance that any of the honey will be scorched. Stirring with a paddle is of course in no degree a substitute.

The sugar levulose is the one which occurs in honey in largest proportions. This sugar is partially broken down on heating, and there seems to be no evidence that dextrose, cane sugar, or traces of malt sugar which occur in honey are injured by heating. Levulose kept at ordinary temperatures in a supposedly dry crystalline condition will darken in time, and this change occurs in honey on standing. It is speeded up by heating, and the scorching which occurs when honey is overheated seems to occur chiefly with this sugar. Levulose is the finest sugar in honey, imparting to it a major share of its sweetness and also somehow modifying the flavor. Since there is no manner in which tastes or odors may properly be discussed, this phase must be experienced and not described.

Honey contains small proportions of proteins, and it seems clear that these are affected by heat to a noticeable degree. The unpleasant and

even nauseating flavor sometimes created in honey by overheating appears to arise chiefly from the destruction of some of the protein constituents.

Every beekeeper knows from experience that there is marked variation in honeys with respect to the heating which they can stand without noticeable damage. Strangely enough, most mild-flavored and light-colored honeys may be heated to higher temperatures or for a longer period without any external sign of change than can the dark honeys and those with more pronounced flavor. For example, clover honey can stand considerable heating without easily-detected change of color and this is in general true of the lighter honeys. On the other hand, buckwheat honey, which is about the darkest honey produced in quantity, is extremely sensitive to heating—more sensitive than any other honey produced in considerable amounts.

In a recent test, flasks containing 50 grams each of clover or buckwheat honey were immersed in a water bath kept at 160 degrees F. One flask of each honey was removed as soon as liquefied, for a check, and in neither of these samples was there any trace of color or flavor change due to the preliminary heating. Samples were then removed from the water bath at intervals, first at 15-minute intervals, with longer intervals later. The clover honey kept in this water bath for 3 hours and 45 minutes is darkened to a minute degree scarcely measurable, and there is no serious change in flavor. In contrast to this, the buckwheat honey kept in the water bath for only 15 minutes after liquefying is more turbid (virtually double when measured), and the color under strong illumination has changed from the deep red of normal liquid buckwheat honey to brown. It is distinctly "muddy" in appearance. This deterioration continued steadily with the longer heating, until the final sample removed was spoiled beyond the possibility of being eaten.

Buckwheat honey is damaged for marketing purposes by heat in more than one way. In the first place, this honey is usually produced in the same combs which have been used for an earlier crop of light

honey. The combs, even when cleaned by bees, retain a fine film of honey and in this film minute crystals of dextrose form. When the buckwheat honey is placed in the combs these fine crystals serve as "seed" for subsequent fine granulation of the buckwheat honey. Since heating melts many or all of the minute crystals, thus destroying the seed which induces fine crystallization, heated buckwheat honey usually becomes coarse, sandy, and less acceptable. Furthermore, buckwheat honey pleases the taste of most people better when granulated than when liquid, hence should be sold only in granulated form.

The far greater damage to buckwheat honey comes from the fact that it is more readily scorched than are light honeys. This creates a bitter and sometimes almost nauseating flavor. Whether it is the breaking down of proteins or tannic acid in the honey is not explained.

The conclusion of all this seems clear. Heating of honey in the honey house, especially with ordinary honey house equipment, is attended with serious danger of damage to the quality of the honey crop. The mixing of injured honey with good may tend to obscure the damage, but there seems little justification in lowering the quality of the entire crop in order to hide a greater damage to part of it. Buckwheat honey is at least one of the honeys commonly produced which is quickly injured by exposure to heat for too long a period, and any heating of this honey in the honey house should be avoided.

The general subject of heat and its effect on honey as discussed above by Dr. Phillips is so intimately connected with the cause of discoloration in honey under the head of Honey, Discoloration of, by Dr. Milum, that the two should be read together. The fact that these two authorities through different channels of careful research so nearly agree on this vital question on how otherwise good honey may be damaged or ruined, is significant. This means, of course, that they are right in their conclusions. This should be followed up by a careful reading of Honey, Spoilage of, by Prof. H. F. Wilson. It is one thing to produce a nice article such as honey and quite another thing not to ruin it by improper treatment.—Author.

**HONEY, HYGROSCOPIC PROPERTIES OF\*.**—The fact that honey is hygroscopic constitutes the physical basis for variations in its water content. Browne (1922) and Waters (1923) subjected samples to varying atmospheric

humidities, and drew the general conclusion that honey adjusts its moisture content to that of the atmosphere by which it is surrounded. The early rate of absorption is rapid, but the rate is reduced after absorption has continued for some time. Martin (1939) showed that every sample of honey tended to adjust its water content towards a point of equilibrium with their relative humidity of the air to which it was exposed. He found that liquid honey of 17.4% moisture content was in equilibrium with the water vapour in an atmosphere of 58% relative humidity; he suggested that for best honey storage conditions the relative humidity of the atmosphere should not be over 60%. He found that moisture passed readily through cell cappings. Lothrop (1937) investigated the ability of honey to absorb and retain moisture as a basis for its utilization in industrial products such as bread and tobacco. Barbier (1956) discussed responses of flower nectar to humidity of the air.

Stephen (1941) studied some of the factors related to the removal of moisture from honey, by circulating hot air through combs before extracting. He concluded that air temperature should not be much in excess of 100°F., and that air speed of 760 feet per minute was satisfactory. Killion (1950) removed 222.5 pounds of water from 130 supers of comb honey in 23 days, in a room maintained at 32% relative humidity and 79°F. Townsend and Burke (1952) described the construction of two hot-rooms designed for the removal of moisture from honey in combs. They state that an efficient unit will remove 1-3% moisture in 24 hours, and that honey which would be graded number 3 could be raised to number 1 grade overnight. Fix and Palmer-Jones (1949) stated that New Zealand honey of less than 17.2% moisture did not ferment and Lochhead (1934) that honey of less than 17.1% moisture would not ferment in 12 months.

Fabian and Quinet (1928) also noted that honey was hygroscopic; they suggested 21% as a critical moisture content at which fermentation takes place. They advanced the theory that honey, being hygroscopic, absorbs sufficient water at the surface to lower the concentration of sugars there to a degree

Moisture passes readily through cappings so exposed honey tends to adjust its water content towards a point of equilibrium with the relative humidity of the air.

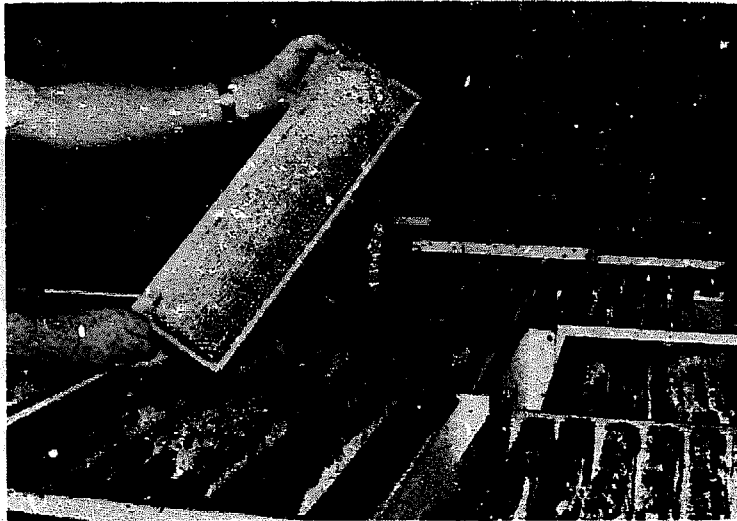

compatible with the life of certain yeasts. The yeasts present gradually become accustomed to the higher sugar concentration and eventually grow throughout the honey.

Martin (1938) showed that liquid honey of 17.4% moisture neither absorbed nor gave off water at 58% relative humidity, indicating that a state of equilibrium existed between the honey and the air moisture. This information has proved useful in indicating a desirable humidity for honey storage. The relationship between honey and the relative humidity of the air is important at all stages of production, both in the hive and in later handling by the beekeeper. Inside the hive the excess water in nectar must be evaporated, and once the beekeeper removes honey from the hive it is subject to increase or decrease in moisture, according to the relative humidity of the air to which it is exposed.

Dyce (1931) noted that screw-top and friction-top closures on honey containers did not control changes in moisture, and that honey in these containers was inferior to honey sealed hermetically. In four commercial-type glass containers with tightly sealed screw-top lids, the water content at the surface increased by 2.5-2.7% when stored at 100% relative humidity for 78 days. Yeast count at the surface increased 300-fold. Such changes would of course be very variable.

Any management practice by which combs of honey are left exposed in a high relative humidity will allow the absorption of water, lower the grade of

the honey and possibly allow fermentation yeasts to develop rapidly. Possibly the most practical procedure in areas of high humidity is to subject supers of honey to drying in a hot room as soon as they are removed from the hives, and then to extract the combs as they are brought from the hot room.

Yeasts produce alcohol and carbon dioxide from sugars in the absence of air according to the following formula (Ingram, 1955):  $C_6H_{12}O_6 - 2CO_2 + 2C_2H_5OH$ . When air is present, however, the following reaction takes place:  $C_6H_{12}O_6 + 6O_2 - 6CO_2 + 6H_2O$ .

The term "Pasteur effect" is rather loosely applied to the phenomenon whereby the access of yeasts to oxygen interferes with the fermentation process, and diverts it from the production of alcohol to the production of large numbers of yeasts.

Previous studies of yeast development in honey have been based on analyses of static samples, usually of normal ripe honey. It is for this reason that the picture has been incomplete, and that reference to the so-called "Pasteur effect" is missing from beekeeping literature. Because many changes in water content take place from the time the nectar is in the flower to final bottling of the honey in the jar, a more complete story of yeast growth has only become evident by tracing yeast development at different levels as water is absorbed at the surface of a honey sample.

The results of experiments point out that two distinct phenomena must be considered if we are to understand and



control honey fermentation. These are (a) that yeasts occur in all natural unheated honey, and that when conditions are right they will grow anaerobically and ferment the honey; (b) that under conditions of high water content (21.5%) yeasts can reproduce aerobically in enormous numbers at the surface of honey. From a practical standpoint, this knowledge suggests that in handling their crop beekeepers should avoid any situation where aerobic yeast growth might take place. For instance if supers of honey were left above a bee escape in wet weather, or left stored in a damp building prior to extracting, water could readily be absorbed, and large numbers of yeasts develop at the honey surface. When the combs were extracted the yeasts would become distributed throughout the bottled honey and fermentation might soon result.

This phenomenon might also be an important factor in building up high populations of yeast in honey still in the comb. In circumstances where partial-ripened nectar remained for several days in the cells, there appears little doubt that high yeast populations would develop aerobically, and the situation might well be accentuated by high humidity and restricted opportunity for ventilation by the bees. Should a second influx of nectar be stored on top of the nectar containing the yeasts, the yeast population of the resulting honey should be high. Circumstances like this may well be the cause of the periodic problem of wide-spread fermentation inside the hive.

Yeasts require sugar, certain salts, nitrogen and nutrilites (yeast vitamins) for proper nutrition. Lockhead and Farrell (1931a) claimed that honey contains an active principle which stimulates fermentation by certain osmophilic yeasts in synthetic media. It is likely that most nutrilities in honey come from included pollen, so pollen may play a significant part in the nutrition of yeasts in honey. The pollen which initially rose to the surface when the honey absorbed moisture was in direct contact with yeasts as they developed aerobically, thus placing a concentrated supply of food where it would be readily accessible. Betts (1932) and Goillot and Louveaux (1955), have reviewed factors concerned with the movement of pollen in honey.

The hygroscopic properties of honey were studied by exposing honey samples in controlled-humidity chambers. Studies of yeast development at different levels in honey exposed in high relative humidities were made by removing samples for observation through the walls of beeswax containers.

Moisture absorbed at the surface was found to diffuse slowly throughout the honey. Honey gradually established equilibrium with the water vapour of the air to which it was exposed, and the following equilibrium points were established:

Percentage water in honey	Relative humidity
16.1	52
17.4	58
21.5	66
28.9	76
33.9	81

In low humidities honey lost moisture more slowly than it gained moisture in high humidities. The rate of water absorption from honey of 17.4% water content was higher at 20, 32 and 42% relative humidity than at close to 0% relative humidity. This may be accounted for by the retarding effect on evaporation of a dry film on the honey surface. It indicates that hot rooms for drying honey in supers can be effectively operated up to more than 40% relative humidity.

When water was absorbed in high humidities, yeasts developed aerobically on the surface in enormous numbers, while yeasts living anaerobically maintained fairly constant numbers below the surface of the honey. Aerobic growth of yeasts took place readily in honey with more than 21.5% water at the surface. This suggests that if supers of honey absorb water prior to extracting, a high yeast count may occur in the packaged product.

#### REFERENCES

- Publication marked B are in the B.R.A. Library
- B BARBIER, E. (1956) Investigations on nectar concentration. XVI Int. Beekeep. Congr. prelim. sci. Meet.
- B BETTS, A.D. (1932) The specific gravity of pollen, and its behaviour in honey. *Bee World* 13(5) : 58-59.
- BROWNE, C.A. (1922) Moisture absorptive powers of different sugars and carbohydrates under varying conditions of atmospheric humidity. *J. Industr. Engng. Chem.* 14 : 712-714.
- B DYCE, E. J. (1931) Fermentation and crystallization of honey. *Bull. Cornell Agric. Exp. Sta. No. 528.*
- B FIX, W.J. & PALMER-JONES, T. (1949)

Control of fermentation in honey by indirect heating and drying. N.Z.J. Sci. Tech. Sect. A31(1) : 21-31.

- B GOILLOT, C. & LOUVEAUX, J. (1955) Etudes sur la sedimentation pollinique dans les miels fluides au repos. Apiculteur 99(5) Sect. sei. : 23-31.
- INGRAM, M. (1955) An introduction to the biology of yeasts. Bath. Pittman Press.
- B KILLION, C.E. (1950) Removing moisture from comb honey. Amer. Bee J. 90(1) : 14-16.
- B LOTHROP, R.E. (1937) Retention of moisture in honey. Amer. Bee J. 77(6) : 281, 290-294.
- MARTIN, E.C. (1938) The hygroscopic properties of honey. Cornell University : M.S. Thesis.
- B — (1939) The hygroscopic properties of honey. J. econ. Ent. 32(5) : 660-663.
- B — (1941) Removal of moisture from honey. Sci. Agric. 22(3) : 157-169.
- B TOWNSEND, G.F. & BURKE, P.W. (1952) Removal of moisture from honey. Circ. Ont. agric. Coll. No. 123.
- WATERS, R. (1923) Honey and atmospheric moisture N.Z.J. Agric. 26(2) : 105-107.

\*E. C. Martin, Some Aspects of Hygroscopic Properties and Fermentation of Honey, Bee World, Vol. 39 (July 1958) 165-178.

**HONEY INSTITUTE, AMERICAN.**—The American Honey Institute is the organization in the honey industry which endeavors to increase the demand and market for honey in the United States and to a limited extent North America.

It was established on March 31, 1928 with its offices located in Indianapolis, Indiana. In 1932 it was moved to Madison, Wisconsin. On January 1, 1939 Mrs. Harriett M. Grace became executive director of the Institute. She was a graduate of the University of Wisconsin and had studied at Cambridge and Oxford Universities in England. With the help of a Board of Directors composed of leaders from all branches of the honey industry, she guided the activities of the Institute until January 1965 when she resigned due to ill health. From the time of her resignation until August 1, 1965 when the Institute was moved to Chicago the members of her staff carried on the activities while the Board of Directors chose new leadership. Their final decision placed Smith, Bucklin & Associates of 111 East Wacker Drive, Chicago, Illinois 60601, as the organization to carry on the future activities of the Institute. As a trade association management organization Smith Bucklin handled 25 such associations, eight of which were food commodities.

The American Honey Institute is entirely supported by voluntary contributions from the honey industry. The various segments of the industry such as the American Beekeeping Federation representing the honey producers, the National Honey Packers & Dealers' Association, the Bee Industries' Association representing the supply manufacturers, and the American Bee Breeders' Association have pledged to raise a certain proportion of the Institute's budget to provide the necessary funds to carry on their activities. Therefore, the program of the Institute can only be as effective as the funds which are available to carry on the promotional work. As of this printing the Institute's funds have been so short its promotional program has been quite curtailed.

The recent upward trend in honey prices caused fewer funds and less effort to be focussed on honey promotion by the honey industry though the need continues to be stressed by those who are not lulled into complacency by an upturn in prices.

The functions of the American Honey Institute have been vested in the Secretary of the Honey Industry Council of America, Leslie Little, 831 Union Street, Shelbyville, TN 37160. It is considered as a division of the Honey Industry Council of America.

**HONEY, IMITATION.**—The first large scale facility for producing high fructose corn syrup began operating in Clinton, Iowa on January 31, 1972. The product, Isomerase® is a high fructose sweetener produced by an efficient low cost process. The use of immobilized glucose isomerase, an enzyme, is one of the key technical accomplishments that have made this process economically feasible.

Fructose, produced by enzymatic isomerization of d-glucose (dextrose) from cornstarch, is a sweetener cheaper and sweeter than sugar. The process had its beginning when a *Streptomyces* organism discovered in Japan was used to produce glucose isomerase enzyme. The patented process was licensed to United States firms who developed a manufacturing system based on making immobilized enzyme and using it in a multiple bed reactor system. The product contains 42% fructose and 50%

dextrose and has the same caloric and sweetening effect as sucrose (table sugar).

As a result of the increased availability and economy of this sweetener it found a ready market as a sweetener in soft drinks and other food processing, including blending with honey. The sugar chemistry of the high fructose syrup was so similar to that of honey that blends with honey were difficult to detect by tasting and even by chemical analysis using known methods. High fructose syrup manufactured by the new process is nearly colorless and ash free, thus leaves few or no detectable signs that an adulterant was being added to pure honey.

A significant rise in cane and beet sugar prices, both wholesale and at retail contributed to the rapid acceptance of the isomerized sweetener. Honey was enjoying a similar boom in popularity at the same time, and in part, for the same reason, but the supply of honey could not be increased as rapidly for reasons quite obvious to anyone with beekeeping experience. Increasing the supply of honey requires considerable investment in new equipment, time and labor, not always an attractive challenge to beekeepers who tend to be conservative, remembering the decades of depressed prices and limited markets that led to a falling off of the number of beekeepers and bees prior to 1970.

Some aggressive honey processors began to look around for ways to supplement domestic supplies of honey. Imported honey filled part of the shortage but never seemed enough to supply the booming demand. The name "honey" had a unique appeal, with flavors and colors that added an air of authenticity to blends of honey with the high fructose syrups now available in volume. The "honey blends", "imitation honey" and "funny honey" as it was variously referred to made its appearance on many grocery shelves, selling below the price of pure honey. Labeling laws pertaining specifically to honey blends were vague or non-existent. Laws regulating labeling in some states existed but were difficult to enforce. The word HONEY was often printed in large letters on the honey blend label

while the word "simulated," "blend" or "imitation" was relegated to a position of less prominence by virtue of smaller print or differential coloring. The merchandisers of "funny honey" were capitalizing on the good name of honey.

The Sioux Honey Association, quick to recognize the threat to the good name of pure honey notified its directors by letter on October 26, 1973 that the honey industry was facing the biggest crisis in its long history. Some of the largest food distributors and retailers in the country were offering the cheaper blends in direct competition with honey. Active promotion was aimed at the consumer with the evident objective of convincing the buyer that the honey blend with its lower price was a wise choice. This assault was aided by the clever devices used in labeling. It was pointed out to the retailers that profits were greater, giving the honey blends an even greater advantage for gaining shelf and display space.

The honey producers and packers who refused to continue to allow the good name of honey to be compromised fought back. Iowa Agriculture Secretary Robert Loundsberry, ordered grocers to remove a prominent brand of the honey blend from their shelves, threatening the use of search and seize warrants if the grocers did not comply at once. Loundsberry said "Iowa labeling laws require that the word 'blend' must be in lettering the same size as the name of the product." Other states, without such laws became alarmed when the honey blends showed up bearing questionable labeling practices. During late 1973 and through 1974, the states of Pennsylvania, Massachusetts, Iowa, Florida, Minnesota, Montana, Arkansas and California either passed new laws, amended existing ones or began to vigorously enforce existing laws pertaining to labeling and marketing imitation or honey blends. State beekeeping associations in Kansas, Maryland, New Jersey, Kentucky, New York, New Mexico, Ohio, Colorado, West Virginia, Nebraska, Illinois and Oklahoma pushed for a honey law. Not all the laws passed the state legislatures or were approved by the governors but the message was clear; the

honey blends were now faced with strict prohibitions aimed to protect the integrity of the name HONEY.

The argument was not so much with the product as with the ill-advised promotion aimed at capitalizing on the good name of honey. What may seem contradictory, some beekeeping research was directed to finding a possible use of the high fructose syrups to feed bees. From tests at the North Central States Bee Research Laboratory in Madison, Wisconsin, Dr. Floyd Moeller, Research Leader concluded that bees used the Isomerase® syrup for feed in a manner similar to cane sugar or honey. No obvious toxicity was shown as far as mortality of bees was in evidence. Further feeding tests were planned at the time.

In an effort to establish a uniform honey labeling law Robert M. Rubenstein, attorney for the Honey Industry Council, proposed the following model:

**Section 1.** The terms "honey," "liquid or extracted honey," "strained honey" or "pure honey" as used in this act, shall mean the nectar of plants that has been transformed by, and is the natural product of the honeybee, either in the honeycombs or taken from the honeycomb and marketed in a liquid, crystallized or granulated condition.

**Section 2. (a)** No person shall sell, keep for sale, expose or offer for sale, any article or product in imitation or semblance of honey branded as "honey," "liquid or extracted honey," "strained honey" or "pure honey" which is not pure honey, nor may the label of any such article or product in imitation or semblance of honey, depict thereon a picture or drawing of a bee, beehive or honeycomb.

**(b)** No person, firm, association, company or corporation shall manufacture, sell, expose or offer for sale, any compound or mixture branded or labeled as honey which shall be made up of honey mixed with any other substance or ingredient.

**(c)** Whenever honey is mixed with any other substance or ingredient and the commodity is to be marketed, there shall be printed on the package containing such compound or mixture, a statement giving the ingredients of which it is made; if honey is one of such

ingredients it shall be so stated in the same size type as are the other ingredients, but it shall not be sold, exposed for sale or offered for sale as honey; nor shall such compound or mixture be branded or labeled with the word "honey" in any form other than as herein provided; nor shall any product in semblance of honey, whether a mixture or not, be sold, exposed or offered for sale as honey, or branded or labeled with the word "honey," unless such article is pure honey.

**Section 3.** The word "imitation" shall not be used in the name of a product which is in semblance of honey whether or not it contains any honey. The label for a product which is not in semblance of honey and which contains honey may include the word "honey" in the name of the product and the relative position of the word "honey" in the product name, and in the list of ingredients, when required, shall be determined by its prominence as an ingredient in the product.

**Section 4.** Any person violating the provisions of this Section shall be guilty of a misdemeanor and upon conviction thereof shall be punished as and for a misdemeanor.

**HONEY, LOANS FOR.**—The U. S. Department of Agriculture reported on November 30, 1976, the total investment of Commodity Credit Corporation in commodity loans and inventories amounted to \$1,967,480,000. Honey was not included in this total at that time as it had temporarily been removed from the list of agricultural commodities eligible for loans. No doubt lack of applications for loans on honey unsold was a factor in the suspension of CCC loan eligibility. Honey has since been reinstated to the program.

Commodity Credit Corporation operations are financed largely by borrowing from the United States Treasury under its statutory borrowing authorization of 14.5 billion, this amount being the limit on loans that may be outstanding at any one time.

Loans are made on such diverse agricultural products as feed grains, cotton, tobacco, dairy products and peanuts.

### Honey Price Support Programs\*

Basically, the honey price support program is a loan/purchase offer to the beekeeper. If he has a surplus of honey the beekeeper allows the government to take over his honey in exchange for a loan; if and when the honey producer finds a buyer, the honey may be reclaimed and the loan paid off. Should no buyer be found, the government permanently purchases the honey to use in school lunch programs, food for the needy or other programs.

The price support program worked primarily as a loan for beekeepers. Significant purchases by the government occurred in the first three years of the program and from 1964 to 1969. No quantities of honey have been acquired under the program since 1970 and it was deactivated after the 1975 crop and then reactivated on April 1, 1977. The purchase program is still in effect and then reactivated on April 1, 1977, as the price of honey remains at its present level and supplies are short.

\*Renee Potosky, Dewey M. Caron, "Beekeepers and the Government," *American Bee Journal*, Vol. 117 (June 1977), 368-370.

### HONEY, MINERAL CONSTITUENTS OF.—

(For the chemical and physical discussion of minerals in honey see Honey, Amino Acids and Related Compounds; also Honey Food Value of. That which follows by Dr. E. F. Phillips of Cornell University concerns itself more with the dietetic values of minerals in foods with particular reference to those in honey. While the relative percentage is small compared to all the other components of honey they do nevertheless exert a large influence not only in the food value of honey but in the flavors. See Honey, Alkaline Forming.)

#### Value of Mineral Material in Human Diet

A vast amount of work has been done on the significance of mineral materials in the diet, and some most amazing things have been discovered. It is, for example, known that goiter is prevalent in regions where there is a deficiency of iodine in drinking water, and in such regions the addition of minute quantities of iodine to the water supply of towns and cities has resulted favorably in reducing or eliminating this disease. This occurs in spite of the fact that iodine is absent from many body tissues and that it is a highly poi-

sonous element if taken in anything except minute amounts. It is known that, in addition to the usual ingredients of our food, carbohydrates, fats, and protein and other organic compounds, mineral substances are of prime importance. Some of these enter the body and remain as compounds with organic substances, in which case they are not detectable except by analysis. Others, like common salt, are taken into the body as such.

At least 18 different elements in addition to carbon, hydrogen, oxygen, and nitrogen have been found in tissues of various animals and plants, but not all of them occur in all species. Sodium, potassium, calcium, magnesium, iron, phosphorus, sulphur, and chlorine are found in all living tissues, the other ten being found occasionally or only in certain animal or plant groups. Some of them have not been found to be necessary elements of living tissues, while others are vitally necessary. As has been stated, copper is poisonous to many animals, but essential to certain lower forms as a constituent of the blood. It is, of course well known that common salt (sodium chloride) is essential to man and animals, and that a region where this is unavailable is often one of great physical suffering.

To discuss in detail the requirements of animals for each of the essential minerals is impossible. Iron is, of course, necessary in blood formation of the warm and red-blooded animals, but not so necessary for cold-blooded animals like insects and crustaceae which use copper in its place, having a different ingredient in the blood for carrying oxygen. Iron must, however, be in combination with organic materials, or be in organic union with them, to be utilized. Calcium is, of course, necessary for bone formation, and is vitally necessary to growing children, but it is interesting to note that an adequate amount of calcium may exist in the food and still bone formation may not progress satisfactorily unless one of the vitamins is present, or unless the growing animal is exposed to the rays of the sun. Chlorine is, of course, a necessity, since hydrochloric acid is employed in digestion. Sulphur is a constituent of certain proteins, and must therefore be available for their formation.

This discussion would suggest that salts are necessary as mere constituents of living matter, but their effect is far more reaching than this would indicate. It is impossible to go into a lengthy discussion of this subject, but the importance of salts may be indicated briefly. The cells of the body have become adjusted to a certain balance of salt solutions. These salts serve to maintain a suitable osmotic relation about the cells and provide a balanced solution in which they may carry on their reactions normally. Furthermore, these inorganic materials are electrically active, and this effect is essential for various bodily functions. Enzymes are inactive except in the presence of electrically active salts. The activity of the hemoglobin of the blood which serves to transport oxygen and carbon dioxide is greatly increased by the presence of salts. Secretion of some glands is impossible in the absence of such electrically active salts. The salts taken into the body enter definitely into the composition of living matter, and new salts must therefore be supplied when new tissues are to be built. Their effect is, however, more important in their activation of organic compounds which are primarily essential.

#### **Honey More Valuable Food Because of Mineral Content**

In the face of such statements of the mineral requirements, one naturally asks to what extent the mineral constituents of honey tend to make it a more desirable food. The percentage is usually small as compared with other available foods. The percentage of ash in honey, for example, is a quarter of the percentage of mineral materials in meats, or less, and usually somewhat less than that of milk. The important thing to learn seems to be what these mineral constituents are and whether they are of such a nature as to make them especially useful in the diet.

Alin Caillas, well-known French honey chemist, in his excellent book, points out that honey contains calcium phosphate and iron phosphate, and states that he has made experiments to show that they are in such form as to be most readily absorbed, whereas apparently identical compounds prepared artificial-

ly are not thus easily absorbed. It is also interesting to note that this author finds the heather honey of the Department of the Landes in France generally the richest in these mineral constituents of any honeys examined so far. One honey from this part of France examined by him contained as much as 0.37 percent of phosphoric acid and 0.17 percent of iron as iron oxide. He states that this honey should receive special attention from the standpoint of its medicinal value. Caillas also found orange honey from Spain high in these ingredients and especially recommends it for medicinal use. (See Honey, Chemical and Physical Properties of.)

Some work done in 1932 by Prof. H. A. Schuette and Kathora Remy of the Laboratory of Foods and Sanitation, University of Wisconsin, goes to show that a deeply pigmented (darkly colored) honey is superior in nutritive value to one of light color and that the darker the honey the higher the mineral content. This would mean in other words that the greater the percentage of minerals the greater the nutritive value of the honey. No claim was made that this was a new idea, but rather that iron, copper, and manganese appear to predominate in the mineral matter of dark honey.

Several American writers on honey have emphasized the greatly added value as a food which the mineral constituents give to honey. Since these components come to honey from and through the plant, they are utilized as freely as are any such compounds, which is a point in favor of this contention. (See Nectar.)

Experts in nutrition no longer place complete reliance on the calories which a food may supply, but using this method we find that this amount of sugar provides an average number of 532 calories per capita per day, which is well over one-sixth of the bodily requirements for an adult. On several occasions when the statement has been made that we use an average of 108 pounds of sugar in this country I have heard housewives insist that their families use no such extravagant amount. All this sugar does not enter the home as such. For example, it has recently been esti-

mated that the average consumption of bottled soft drinks is 100 bottles per capita per year, in which will be hidden away over 4.5 pounds of sugar. The consumption of sugar in candies will reach a much higher average figure.

**HONEY PLANTS.**—Many beekeepers are very knowledgeable about bees, beekeeping, honey handling and other phases of the business but may be more or less mystified by the processes in plants that produce nectar and pollen. The kinds of plants to which honeybees are attracted and their identity may often be of interest to beekeepers but observations of bees in the field tend to leave much to guesswork as to what plants the bees use to gather nectar and pollen throughout the year.

Reference material on honey plants include several books that cover a wide range of bee flora to which honeybees are attracted for nectar or pollen or both. **American Honey Plants** by Pellett has been recently reprinted. **Honey Plants Manual** by Lovell is a shorter version of the original **Honey Plants of North America** by John L. Lovell and published by The A. I. Root Company (1926). The Iowa Geological Survey, **Bulletin #7, Honey Plants of Iowa** by Pammel and King (1930) is an excellent book on honey plants but has long been out of print. **The Flower and the Bee** by John H. Lovell (1918) described plant life and pollination in detail with excellent illustrations. **Plants and Beekeeping** by F.N. Howes (1945) deals with bee plants of the British Isles. **The Honey Flora of Queensland** (Australia) was published by the Queensland Department of Primary Industries (1972). The authors are S. T. Blake and C. Roff. Gonzalo S. Ordetx published **The Flora of Tropical America** in 1952.

Particularly noteworthy is a state publication **Nectar and Pollen Plants of California** (1931, Rev. 1941) by G. H. Vansell and J. E. Eckert. It listed honey plants of California in alphabetical order, each described in non-technical terms, many by illustration. Geographical distribution was shown by the use of maps for each plant of importance to beekeepers in California. **Nectar and Pollen Plants of Oregon**

(1942) by H. A. Scullen and G. A. Vansell described the major and minor honey plants of that state in chart form. Other state publications on honey plants are **Pollen and Nectar Plants of Utah** (1949) by G. H. Vansell, and **Nectar and Pollen Plants of Colorado** (1958) by William T. Wilson, Joseph Moffett and Harold D. Harrington. Lilian H. Arnold compiled a complete listing of important honey plants observed in Florida as did Frank Shaw in Massachusetts. Everett Oertel listed the leading honey plants of 48 states along with their blooming dates in a government bulletin (1939).

Frank C. Pellet, a former editor of **The American Bee Journal** tested a number of honey plants at a nursery and nature preserve in Atlantic, Iowa. This family business is based on nursery stock and seeds sold to customers interested in providing supplementary nectar sources for their bees. The nursery is now operated by Melvin Pellett, a son. An annual catalog lists trees, shrubs and flowers selected especially for their nectar potential. It is the only catalog of its kind. Pellett Gardens is located several miles outside Atlantic, Iowa; it offers seed packets of annuals and perennials valuable to beekeepers plus trees and shrubs. No clovers or other legume seeds are sold. A bee garden collection of garden hyssop (5 plants), purple loosestrife, (5 plants) golden honey plants (6 plants) and wild marjoram (4 plants) is listed in the 1977 catalog.

A natural area across the road from the Pellett homestead is kept intact as a memorial to Mr. Pellett. Plaques donated and installed by members of the Iowa Beekeepers Association and the Iowa State Horticultural Society mark the entrance to the five acres of woodland.

One of the earliest recorded attempts to plant supplementary bee forage was made by the original author of **ABC and XYZ of Bee Culture**, A. I. Root. A basswood grove of 4,000 trees was planted in the spring of 1872. In addition a honey plant garden was experimentally maintained.

Black locust (**Robinia pseudo-acacia**), a tree of the legume family and a nectar source of considerable value is being propagated and grown in experimental

plots at the University of Guelph, Ontario, Canada. The locust is being planted extensively in eastern European countries where it contributes its fair share to the honey harvest.

Past experience has shown that growing honey plants for bee forage is not profitable if the value of the nectar alone is the only return. Where plants are grown for other purposes as well it may often be to the advantage of the beekeeper to attempt to influence the selection of plants valuable to bees if he has the opportunity. The introduction of some alien plants is not wise, even though they are good honey plants. Escapes may prove to be noxious weeds among farm crops, difficult to eradicate once they become established.

**HONEY RECIPES\*.**—For nutritional purposes honey is classified as a sugar and may be used in any recipe where sugar is used, provided certain of its properties are considered. Honey is a mixture composed of approximately 82% simple sugars and 18% water with traces of minerals, vitamins, and enzymes, and when it is used to replace crystallized sugar allowance must be made for the liquid.

Honey is sweeter than cane sugar so in many instances less of it is needed to obtain the desired degree of sweetness. Another consideration is the floral source of the honey which may lend its distinct flavor to the finished product.

A 100 calorie portion of honey measures 1½ tablespoons and weighs 1.1 ounces. By comparison a hundred calories of granulated sugar measures two tablespoons (scant) and weighs .88 ounces.

Honey is hygroscopic, that is it absorbs moisture, so that products made with it will maintain a high quality of freshness and in fact, may improve in flavor.

Generally speaking, honey may be substituted for equal amounts of sugar in recipes for breads, puddings, pie fillings, salad dressings, muffins, sauces, or any other category which uses a comparatively small amount of sweetening. This includes soups, stews, marinades, vegetables, and fruit dishes.

\*Bess Clarke, writer of the column "Notes from the Straw Skop," *Gleanings in Bee Culture*.

Be wary in substitutions for cake and cookie recipes. Some cooks replace half the sugar with honey while using one-fourth less liquid. This may be difficult to achieve with cookie recipes which frequently use no liquid at all. It may be wiser for the novice honey cook to begin with tested recipes. There are several honey cook books available and magazines and newspapers frequent print recipes which include honey.

When measuring honey pour it into the cup or spoon rather than dipping into the jar. Greasing the utensil before measuring makes the task easier. Remember that warm honey pours more easily.

Add honey to batters in a thin stream while beating continuously to obtain a greater volume and a lighter, fluffier finished product.

Baking time may need to be reduced, and temperatures should certainly be dropped 25 degrees as honey aids in the browning process.

A honey pot or squeeze bottle kept at the stove is a sweet idea. Most foods are enhanced by the addition of a few drops of honey. Examples are baked beans, chili, vegetable soup and stir-fried foods.

Fruits are especially good when sweetened with honey. Either fresh fruits with honey drizzled over them, or cooked sauces made with honey are fine desserts.

### Recipe Books

Honey recipe books are available at markets where honey is sold, at specialty stores, and from bee supply houses. **TREASURED HONEY RECIPES** may be ordered from the California Honey Advisory Board, P.O. Box 32, Whittier, CA 90608. **HONEY RECIPE BOOK: Marketing Division Iowa Department of Agriculture, State House, Des Moines, Ia. 50319.** **GEMS OF GOLD: California Honey Advisory Board, P. O. Box 32, Whittier, Ca. 90608.** **HONEY COOKERY: A. I. Root Co., Medina, Ohio 44256.**

### Entrees

**PORK CHOPS SUPREME: Six (6) pork chops, 1 cup catsup, ½ cup honey, 1 large sliced lemon. Blend catsup and**



honey and pour over chops which have been arranged in a single layer in a baking pan. Top each chop with a slice of lemon. Bake uncovered in a slow oven 325°F. for about an hour.

**HONEYED CHICKEN BAKE:** One frying chicken cut into pieces, ½ cup honey, ¼ cup margarine, ¼ cup yellow prepared mustard, 1 teaspoon salt, 1 teaspoon curry powder. Melt margarine in shallow pan and blend in remaining ingredients. Roll chicken pieces in glaze to coat both sides, then arrange with meaty side up in a single layer in the same pan. Bake at 375°F for an hour or until the chicken is tender and richly glazed.

**BARBECUED SPARERIBS:** Four pounds spareribs, ½ cup chopped onion, clove of garlic, 1½ cups catsup, 2 tablespoons vinegar, ½ teaspoon salt, 1 teaspoon prepared mustard, ½ teaspoon black pepper, 2 tablespoons thick steak sauce, 1 cup honey. Cut spareribs into serving portions. Simmer in enough water to cover, plus two teaspoons salt, for ½ hour. Mix remaining ingredients and cook over low heat for five minutes. Drain ribs and arrange in shallow baking pan. Pour barbecue sauce over ribs and bake in 400°F oven for 45 minutes or until tender. Baste frequently with the sauce.

**BULGOWKI:** Three to four pounds tender beef, trimmed carefully and cut into ¼-inch slices. This is marinated overnight in a sauce made of: ½ cup soy sauce, ¼ cup honey, 3 tablespoons sesame seed oil, 3 tablespoons toasted sesame seeds, 2 cloves crushed garlic, 3 finely chopped scallions, 1 finely sliced onion, salt and pepper to taste. Mix sauce ingredients in a bowl. Add the beef slices and turn to coat each piece. Refrigerate overnight in covered bowl. Broil over medium heat, turning as needed. Serve hot.

#### Vegetables

**RATATOUILLE:** One-fourth cup salad oil, ¾ cup sliced onions, 2 cloves garlic, 4 green peppers, cut in strips, 2½ cups eggplant (small ones may be sliced; a larger one diced) 3 cups zucchini slices, 2 cups peeled, quartered tomatoes, ¼ cup honey, 1 teaspoon curry powder, salt and pepper to taste. Heat oil in electric fry pan and saute onions and garlic. Remove garlic if

desired. Add peppers, eggplant, and zucchini. Cover with tomatoes. Drizzle honey over vegetables and season with salt, pepper and curry. Cover tightly and simmer over low heat for an hour, checking to make sure there is enough moisture to prevent burning. Uncover for final ten minutes if liquid needs to be reduced.

**BAKED HONEY LIMAS:** One (1) pound package dried baby lima beans, ½ cup cooking oil, ¾ cup honey, 1 cup chopped onion, 2 teaspoons salt. Soak beans overnight in water to cover. Add more water if needed, and simmer till tender, about an hour. Drain. In a small skillet heat the oil, add onion, and cook gently until soft. Stir in honey, salt, and lima beans. Turn into two-quart casserole. Bake covered, in a preheated 350°F. oven, until beans are glazed, at least an hour.

**RED BEET EGGS:** One can sliced beets, ¾ cup honey, ⅓ cup cider vinegar, ½ teaspoon salt, 6 hard cooked eggs, peeled and cooled. Drain beet liquid into saucepan. Add honey, vinegar and salt. Bring to boil. Place eggs in wide mouth jar and pour hot liquid over them. Place sliced beets on top. Cover and chill overnight.

**THREE BEAN SALAD:** One pound cans of cut green beans, cut yellow wax beans, and kidney beans, 1½ cups chopped celery, 1 chopped green pepper, 1 chopped onion, ½ cup honey, ½ cup vinegar, ¼ cup salad oil, ½ teaspoon salt. Mix honey, oil, vinegar and salt together and pour over drained beans. Marinate overnight before serving.

**VARIATION:** Any combination of vegetables may be used. Fresh ones should be cooked until just tender before marinating. Cauliflower and carrots make a colorful combination with the celery, onion, and green pepper.

#### Fruits

**CRANBERRY RELISH:** One pound fresh cranberries, 2 oranges, 1 cup honey, optional—½ cup chopped nuts. Rinse cranberries, quarter, and remove seeds from oranges. Run through food chopper. Blend together with honey, and nuts if used. Store overnight in refrigerator before using.

**CURRIED FRUIT COMPOTE:** One box dried mixed fruits, 1 cup raisins, 1 lemon thinly sliced, ½ cup honey, 1 teaspoon curry powder. Rinse fruit, cover with water and simmer 20 minutes or until tender. Add lemon slices, honey and curry powder, and cook five minutes longer. May be served hot or cold. Flavor improves on standing.

**PICKLED PEARS:** One cup cranberry juice, ½ cup honey, ¼ cup vinegar, 2 sticks cinnamon, 3 or 4 whole cloves, 1 tablespoon chopped crystallized ginger, red food color if desired, 3 or 4 fresh pears. Combine all ingredients except pears in a saucepan and bring to a boil. Reduce heat and simmer, uncovered, for five minutes. Pare, quarter, and core the pears and add half to the syrup. Cook until barely tender, about five minutes. Lift pears out and repeat process with remaining pears. Store in syrup in covered container. Serve cold.

**BROILED GRAPEFRUIT:** Cut grapefruit in half and prepare by cutting around segments. Drizzle honey over cut side. Place under broiler a few minutes until the honey bubbles. Serve warm.

#### Sauces

**FRENCH SALAD DRESSING:** One and ½ cups salad oil, ½ cup honey, ¾ cup vinegar, 1 can Campbell's tomato soup, 1 tablespoon salt. Seasonings to taste: garlic salt, horse radish, pepper, dill etc. Beat together in mixer or blender until smooth. Keeps well in refrigerator.

**HONEY MAYONNAISE:** One egg, 3 tablespoons honey, 1 teaspoon salt, 1 teaspoon vinegar, 1 teaspoon mustard, ¼ teaspoon pepper, ¼ teaspoon paprika, 1½ cups salad oil, 6 tablespoons lemon juice. Break egg into mixing bowl; add honey, salt, vinegar, mustard and paprika. Beat thoroughly and with beaters running at high speed, add oil in a thin stream until 1 cup is incorporated and the dressing begins to thicken. Add lemon juice slowly, and then the remaining oil, continuing to beat vigorously. This makes a pint.

**TOMATO CATSUP:** Cut 4 quarts of ripe tomatoes into pieces (Italian paste type is best), place in a large kettle with two cups onions and 2 tablespoons salt,

and boil for ½ hour. Run the pulp through a food mill. Add 2 cups honey, 1¼ cups cider vinegar, 1 teaspoon ground ginger, 1 teaspoon dry mustard, and ½ teaspoon cayenne pepper. Use a large kettle with a heavy bottom to minimize chance of scorching. Boil at medium high temperature until the catsup is thick, probably three to four hours. Pour into sterilized containers and seal.

**HONEY OF A DRESSING:** Add ¼ cup honey to ¾ cup sour cream. Mix thoroughly and use on fruit salads.

#### BREADS

**WALNUT HONEY LOAF:** One (1) cup honey, 1 cup milk, ½ cup sugar, 2½ cups flour, 1 teaspoon salt, 1 teaspoon soda, 1 egg, ½ cup chopped walnuts. Combine honey, milk, and sugar in saucepan and heat, stirring constantly, until sugar is dissolved. Cool. Add dry ingredients and egg to the liquid mixture and beat for two minutes until well blended. Add walnuts. Turn into 9 x 5 loaf pan and bake in slow oven at 325°F. for 1¼ hours. Cool in pan 15 minutes, then remove to wire rack.

**HOME MADE BREAD:** One quart hot water, ¼ cup honey, 2 tablespoons margarine, 1 tablespoon salt, 1 cup dry milk solids, 2 packs dry yeast dissolved in ½ cup warm water, about 12 cups all-purpose flour. Mix honey, margarine, salt, dry milk, and hot water in large bowl. When it has cooled to lukewarm add the dissolved yeast and mix. Add 4 cups flour and beat until it gets smooth. Add 4 more cups flour and mix well. Stir in 3 more cups flour, turn out on floured surface and knead until it is smooth and elastic, adding more flour as needed. Form into a ball and place in an oiled bowl, turning to coat the ball on all surfaces. Let rise until double in bulk. Punch down, divide into four pieces and shape into loaves with a smooth skin on top. Place in loaf pans. Brush with melted butter. Let rise again until double in size. Bake at 350°F. for 45 minutes or until done. Remove from pans and cool on rack.

**BALADI (ARAB BREAD):** One-half cup warm water, 2 packages dry yeast, 2 cups warm water, 2 tablespoons honey, 1 tablespoon salt, 1 cup whole wheat flour, 7 or 8 cups white flour.

Dissolve yeast in water. Add to mixture of water, honey, salt, and whole wheat flour. Beat in two cups white flour, add more flour and turn out on board. Knead into a soft ball of dough. Grease lightly and place in bowl. Let rise till double in bulk. Punch down, divide into about 24 balls. Roll out each ball into a flat circle about 1/8-inch thick. Bake immediately on the bottom shelf of a very hot oven—475°F. for 8 to 10 minutes.

### Pies

**BASIC FRUIT PIE:** One and 1/2 cups prepared fresh fruit such as peaches, cherries or berries, 3 tablespoons honey, 3 tablespoons sugar, 1 tablespoon flour, 1/4 teaspoon salt, 1 cup, half and half cream. Mix together and pour into unbaked pie shell. Bake at 400°F. until filling bubbles all over the top.

**HONEY CHEESE PIE:** Eight oz. package cream cheese, 1/2 cup honey, 3 slightly beaten eggs, juice and grated rind of 1/2 lemon, 1/4 teaspoon salt, 1 1/2 cups milk, unbaked 8-inch pastry shell. Beat cream cheese to soften, add honey, eggs, lemon, salt and milk. Blend well. Pour into unbaked pastry shell. Sprinkle with nutmeg if desired. Bake at 450°F. for 10 minutes, reduce heat to 325°F. and bake another 30 minutes.

**SCRUMPTIOUS SHOO-FLY PIE:** 1 cup flour, 3/4 cup dark brown sugar, 1 tablespoon shortening, 1 cup cocoanut (optional), 1 slightly beaten egg, 1 cup honey, 1 teaspoon baking soda, 1 cup hot water, 1 unbaked 9-inch pie shell. Mix flour, sugar, shortening, and cocoanut to form crumbs. Reserve 1/2 cup for topping. In another bowl mix egg, honey, and 3/4 cup hot water. Add to dry mixture. Dissolve soda in remaining 1/4 cup hot water. Add to mixture. Pour into pie shell. Sprinkle crumbs on top. Bake at 375°F. for 35 minutes.

### Desserts

**APRICOT NUT PUDDING:** Two cups dry bread cubes, 1/2 cup dried apricots, 1/2 cup chopped nuts, 1/2 teaspoon salt, 1/2 teaspoon cloves, 1/2 teaspoon nutmeg, 1 teaspoon cinnamon, 1 teaspoon soda, 1/4 cup cooking oil, 3/4 cup honey, 1 cup milk, 1 egg. Combine

bread cubes, apricots, nuts, salt, cloves, nutmeg, cinnamon and soda in a mixing bowl. Measure oil and honey in a cup and pour over bread mixture. Add milk and slightly beaten egg. Stir all ingredients until bread is moistened. Pour into a deep 1 1/2 quart casserole and bake in a very slow oven, 300°F. at least an hour, or until pudding is brown and firm. Stir pudding to remix ingredients after 30 minutes of baking. Serve warm with ice cream or cold with honey-sweetened sour cream.

**IMPOSSIBLE PIE:** Three eggs, 6 tablespoons pancake mix, 3 tablespoons butter, 1/2 cup honey, 1 1/2 cups milk, 1 teaspoon vanilla, pinch salt, 3/4 cup cocoanut. Beat eggs well. Add pancake mix, honey, and butter and blend. Add milk, vanilla, salt, and cocoanut. Pour into buttered 9-inch pie pan. Bake at 350°F for 35 minutes or until set. This pie makes its own crust as it bakes.

**BLACK BOTTOM CUPCAKES:** Combine: 1 8-oz. package cream cheese, 1 unbeaten egg, 1/3 cup honey, pinch of salt. Beat this mixture well and stir in 6-oz. package chocolate chips. Set aside. Sift in bowl 1 1/2 cups flour, 1/2 cup sugar, 1/4 cup cocoa, 1 teaspoon soda, 1/2 teaspoon salt. Mix in separate bowl and add to dry ingredients 1/2 cup honey, 3/4 cup water, 1/3 cup cooking oil, 1 teaspoon vinegar, 1 teaspoon vanilla. Beat well. Distribute batter evenly in 18 paper baking cups. Top with the cream cheese mixture. Bake at 350°F. for 30 minutes. A good variation is made by using mint chocolate chips, or by adding mint extract instead of vanilla.

### Cakes

**TEXAS SPICE CAKE:** One cup honey, 1 cup sugar, 2 cups raisins, 2 1/2 cups water, 1 cup shortening, 1 1/2 teaspoons cinnamon, 1 1/2 teaspoons cloves, 1 teaspoon salt. Place all these ingredients in a pan and boil for 3 minutes. Cool. Add 3 cups flour and 2 teaspoons soda. Pour into greased jelly roll pan 10 x 16 inches and bake in preheated 350°F oven for 25 minutes.

**Fancy Icing:** Melt 1/3 cup butter over low heat, add 1/3 cup honey, 1/3 cup brown sugar, 1/2 cup chopped nuts, 1/2 cup cocoanut. Stir until well blended, cool for 3 minutes and spread over warm cake.

**MRS. SNYDER'S HONEY CHOCOLATE CAKE:** Three squares unsweetened chocolate, melted,  $\frac{2}{3}$  cup honey,  $1\frac{3}{4}$  cups flour, 1 teaspoon soda,  $\frac{3}{4}$  teaspoon salt,  $\frac{1}{2}$  cup shortening (butter is best)  $\frac{1}{2}$  cup sugar, 1 teaspoon vanilla, 2 eggs,  $\frac{2}{3}$  cup water.

Blend chocolate and honey; cool to lukewarm. Cream shortening and sugar till light and fluffy. Add chocolate-honey mixture and vanilla. Blend. Add eggs, one at a time and beat thoroughly. Add dry ingredients, alternately with water beating until smooth. Bake in two 8-inch layer pans at 350°F. for 30 to 35 minutes.

**HONEY CHOCOLATE FROSTING:**  $\frac{1}{4}$  cup honey,  $\frac{1}{2}$  cup sugar,  $1\frac{1}{4}$  cup butter,  $\frac{1}{4}$  cup light cream,  $\frac{1}{4}$  teaspoon salt, 2 egg yolks, well beaten, 3 squares unsweetened chocolate, cut in pieces.

Beat egg yolks well. Combine all ingredients except egg yolks in double boiler and heat till chocolate is melted. Beat mixture with rotary beater until smooth. Pour a little water over yolks beating vigorously. Return to double boiler and cook 2 minutes longer, stirring constantly. Remove from hot water, place in pan of ice water and beat till right consistency to spread.

**MRS. GREGORY'S GOOD CAKE:**

**Topping:** (mix and set aside)  $\frac{1}{2}$  cup honey,  $\frac{1}{2}$  cup chopped nuts, 1 teaspoon cinnamon.

**Batter:**  $\frac{1}{4}$  cup honey,  $\frac{1}{2}$  cup sugar, 1 stick margarine ( $\frac{1}{4}$  pound), 2 eggs, 1 teaspoon vanilla, 1 cup sour cream, 2 cups flour, 1 teaspoon baking soda, 1 teaspoon baking powder.

Beat honey, sugar and margarine at high speed until light and fluffy. Beat in eggs, then vanilla, and sour cream. Blend in dry ingredients. Pour into tube cake pan which has been greased and floured. Alternate the batter with the topping mix in thirds. Bake at 350°F. for 50 minutes.

You may replace sugar with equal amounts of honey in recipes for bread, biscuits, rolls, or muffins.

**FESTIVAL CAKE:** Four cups flour, 1 pound dark brown sugar, 1 cup vegetable shortening, 1 cup honey, 2 cups boiling water, 2 teaspoons soda.

Mix together, the flour and sugar, then cut in the shortening to make

crumbs. Reserve 1 cup of this to use on top of cake. Combine honey with hot water. Pour into crumbs and mix. Dissolve soda in additional  $\frac{1}{4}$  cup hot water and add. Pour into greased 9x12 pan. Top with reserved crumbs. Bake at 350°F. for 40 to 50 minutes.

### Cookies

**ICE CREAM WAFERS:** One cup butter, 1 cup honey, 2 teaspoons soda,  $\frac{1}{2}$  teaspoon each, cinnamon, cloves, allspice,  $3\frac{1}{2}$  cups flour,  $\frac{1}{2}$  cup finely chopped nuts. In saucepan, boil butter and honey for one minute. Cool. Sift together dry ingredients. Add honey mixture and nuts. Roll into 2 logs, wrap in waxed paper and refrigerate until stiff. Slice in  $\frac{1}{8}$ -inch slices, and bake at 350°F. for 8 to 10 minutes. Be careful not to overbake. This makes an elegant cookie for a festive occasion.

**RAISIN HONEY GEMS:**  $1\frac{1}{2}$  cups honey,  $\frac{3}{4}$  cup shortening, 1 egg beaten,  $2\frac{1}{2}$  cups flour,  $\frac{1}{4}$  teaspoon salt,  $\frac{1}{4}$  teaspoon soda,  $2\frac{1}{4}$  teaspoons baking powder, 1 teaspoon cinnamon, 2 tablespoons hot water,  $1\frac{1}{2}$  cups oatmeal, uncooked,  $\frac{3}{4}$  cup raisins, 1 cup chopped nuts.

Cream honey and shortening. Add beaten egg. Stir flour, salt, soda, baking powder, and cinnamon into mixture. Add oatmeal, water, raisins and nuts. Mix thoroughly. Drop by teaspoonful on cookie sheet. Bake at 350°F. for 15 minutes.

### Preserving

**HONEY ORANGE MARMALADE:** Three medium oranges, 1 cup water,  $1\frac{3}{4}$  cups honey, 6 tablespoons lemon juice,  $\frac{1}{4}$  cup liquid pectin. Run oranges through food chopper, using fine knife. Measure to make sure there is at least  $1\frac{3}{4}$  cups of ground pulp. Add water, bring to boil, and simmer 15 minutes. Add honey and simmer 30 minutes longer. Add lemon juice, then liquid pectin. Bring to a full rolling boil and boil 30 seconds. Remove from heat, skim and stir for five minutes. Pour into sterilized jars and seal.

**SYRUP FOR CANNING:** Use 1 cup honey to 3 cups water for thin syrup, and 1 cup honey to 2 cups syrup for medium syrup. A mild-flavored honey is needed for this purpose. Follow usual directions for canning and freezing.

**HONEY FROZEN PEACHES:** 6 ounce can frozen orange juice concentrate,  $\frac{1}{2}$  cup honey, 3 cans warm water, 12 ripe peaches. Stir together orange juice, honey and water. Chill. Fill containers  $\frac{1}{3}$  full of liquid. Peel and slice peaches directly into containers. Add enough juice to cover fruit, leaving head space for crumpled plastic wrap under the lid. Seal and freeze immediately. To serve, partially thaw in container and serve icy cold.

**HONEY, RIPENING OF.\***—It is commonly stated in bee literature that when a bee brings in a load of nectar, she goes to a cell and deposits it there. While this probably does occur at times, the writer (1925) has failed to see it in many hundreds of cases which he has observed with great care in the full expectation of seeing it take place. It is indeed most natural to assume that the returned fielder should deposit her load in a cell. During a good honey flow numerous workers depositing nectar in the cells may be observed readily enough, but this is only circumstantial evidence. Careful observation reveals that the bees so engaged are not fielders but are young bees that have not yet begun to work in the fields.

The idea that the fielder deposits her load of nectar directly in a cell was shown to be incorrect many years ago when Gallup (1868b) reported: "The bees that gather the nectar from flowers are not those that store it in the surplus boxes." And although Gallup's observation has been corroborated by Doolittle (1898) and by Latham (1907), this erroneous assumption has continued to be perpetuated in various publications on bees and still is widely accepted among the rank and file of beekeepers. Arthur C. Miller (1907) asserted: "The gathering bee does not give her load to one of the young or nurse bees but puts it directly into the cell." All of my observations on this point are contrary to this assertion and in harmony with the observations reported by Gallup, Doolittle, and Latham.

\*By Dr. O. W. Park, Research Associate Professor of Apiculture, Iowa State College, Ames, Iowa.

The behavior of the loaded field bee is worthy of special notice and will be reported approximately as the writer described it some years ago (1925). The loaded nectar-gatherer enters the hive with the air of importance. If the source from which she obtained her load is well known to other fielders, she walks about until she meets a "house bee" to which she gives a part of her load. Occasionally she gives her entire load to a single house bee, but usually she distributes it among three or more. It has not been definitely determined why the fielder seldom disposes of her entire load to a single house bee, but there are indications that it is because many of the house bees already have a partial load.

If the nectar source is new or bountiful, the loaded fielder usually performs a peculiar dance during which she shakes her abdomen vigorously from side to side, all the while running in arcs of circles, turning first to one side and then to the other. She usually is followed by four or five other bees and, while she continues her dance, every now and then one or another of the interested followers may be seen to leave for the field until, by the time the dancer is ready to depart, a dozen or more may have left the hive to search out the source of the rich find already discovered by the dancer. It is to be noted especially that most of the new recruits leave the hive before the dancer does. Obviously they do not follow the latter to the source as has been assumed so commonly.

At irregular intervals the dancer (see Bee Dance under Bee Behavior) pauses long enough to pass out a taste of her booty to one or another of the nearby workers. But soon she meets a house bee to which she gives a considerable portion of her load. As they approach each other, the field bee opens her mandibles wide apart and forces a drop of nectar out over the upper surface of the proximal portion of her proboscis, the distal portion being folded back under the "chin". Assuming that the house bee approached is not already loaded to capacity, she stretches out her tongue to full length and sips the proffered nectar from the upper surface of the folded proboscis of

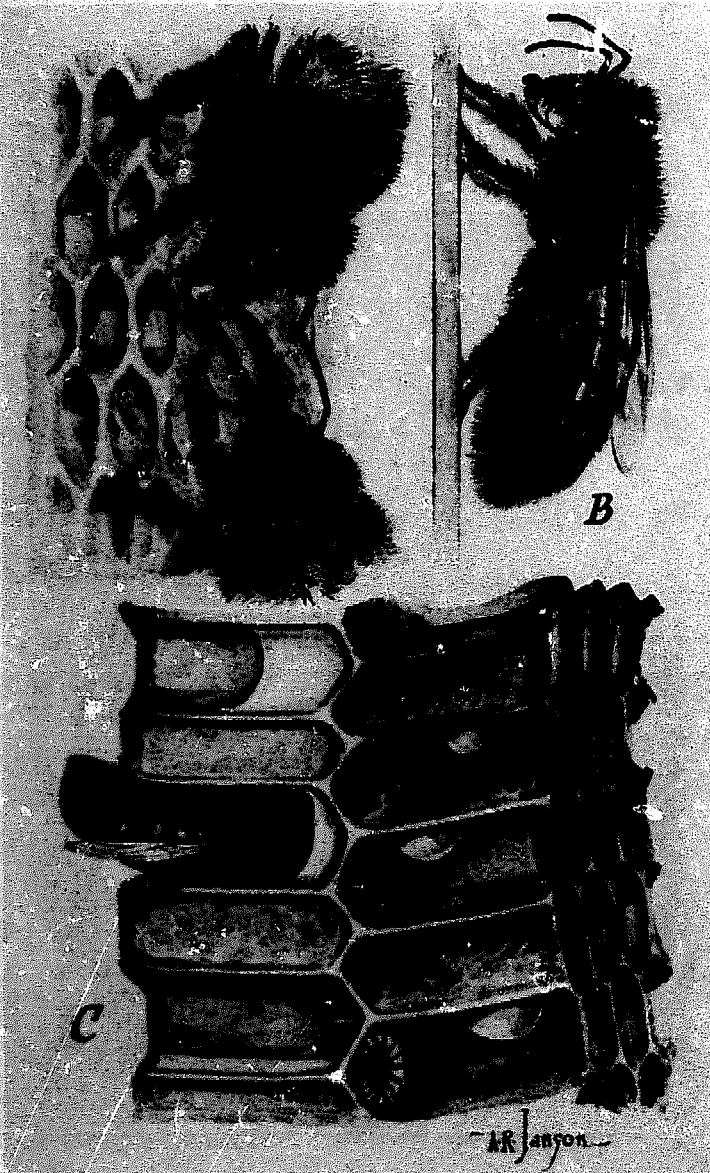

Plate I.—A, Nectar being transferred from a loaded nectar carrier (upper) to the house bee (lower). B, House bee ripening honey. C, House bee depositing honey.—Drawn by A. R. Jansen under the direction of Dr. O. W. Park of Iowa State College.

the field bee as shown in Plate I, A. While the nectar is being transferred in this manner, the antennae of both bees are in continual motion and those of one bee are continually striking those of the other. At the same time the house bee may be seen to stroke the "cheeks" of the field bee with her fore feet as if coaxing for more and more.

When the nectar gatherer has disposed of her load, she may start directly for the field, but in most cases she first secures a small amount of food either from another bee or from a cell. Before making her final start, however, she al-

most invariably gives her tongue a swipe between her fore feet, rubs her eyes, and often cleans her antennae. Then with a quick look around, as if taking her bearings, she sets off for the field in great haste. The process of disposing of her load often is accomplished in less time than it takes to describe it.

In a previous paper, the writer (1922) presented data showing that field bees seldom remained in the hive as long as 10 minutes between field trips and that when working under favorable honey-flow conditions, the most frequent interval spent in the hive was less than four minutes. A few instances were recorded in which a fielder remained in the hive about an hour between trips but these were exceptions.

#### Behavior of the House Bee

In the past it has been difficult to explain the fact that when first deposited in the comb, nectar, or green honey as it should then be called, is already more concentrated than the nectar from which it was produced. Speculation on this point led Brunnich (1919) of Switzerland to formulate the interesting and ingenious "excretion" theory of ripening honey. In the light of more recent investigations carried on at the Iowa Agricultural Experimental Station by the writer (1927, 1928, 1932, 1933), this theory appears to be superfluous and without foundation, as will become evident shortly.

When the house bee has received her portion of a nectar gatherer's load, she meanders about the hive in search of a place where she will not be crowded. Here she usually takes up a characteristic position shown at B in Plate I, with the long

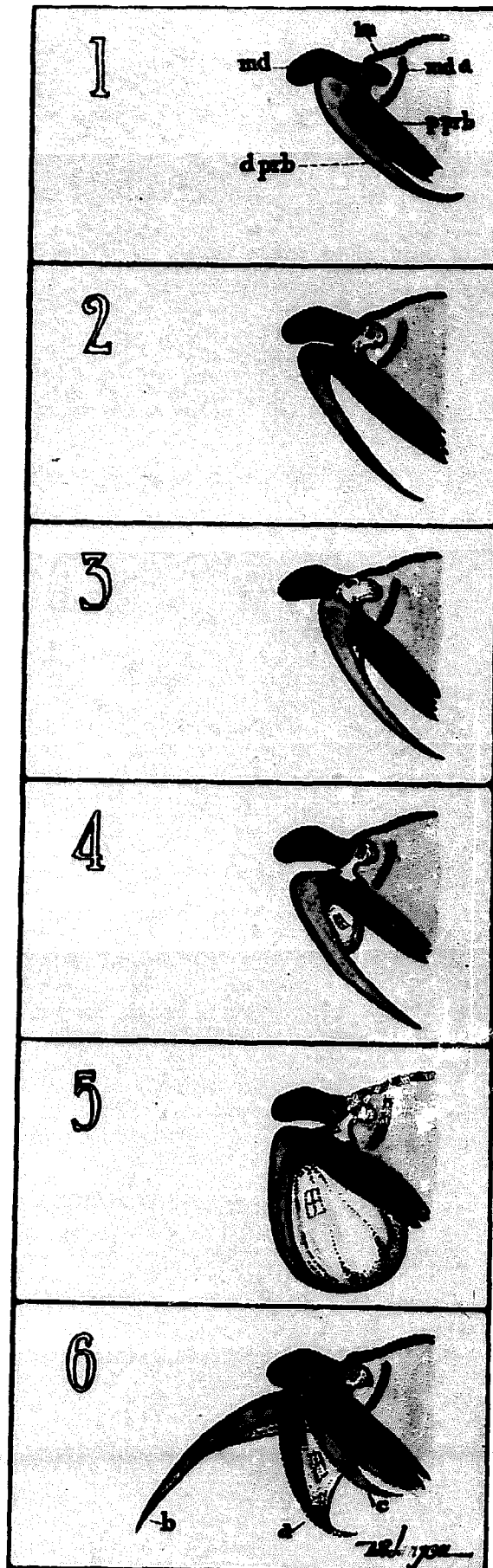

axis of her body in a perpendicular position, head uppermost. She at once begins a series of operations which are illustrated diagrammatically in Plate II. She stands so very still that most observers consider her idle, but they have failed to note that she is manipulating her load of nectar by means of her mouthparts.

Gallup (1868a), Doolittle (1898), Miller (1904) and others have contributed to our understanding of this peculiar process.

Starting with the mouth parts at rest as shown in Fig. 1, the mandibles (md) are opened wide and the whole proboscis is moved somewhat forward and downward. At the same time, the distal portion of the proboscis (d prb) is swung outward a little and a small droplet of nectar appears in the preoral cavity (pc) as shown in Fig. 2. The whole proboscis is then raised and retracted almost to the position of rest, but is depressed again and is again raised as before, and so on. With each succeeding depression, the distal portion of the proboscis swings outward a little farther than before but each time makes only the beginning of a return to its position of rest.

Accompanying the second depression of the proboscis, an increased amount of nectar appears in the preoral cavity, some of which begins to flow out over the upper surface of that part of the proboscis which lies between the mandibles. As the proboscis is raised and retracted the second time, the beginning of a drop of nectar usually may be seen in the angle formed by its two major portions (p prb and d prb), as may be seen in Fig. 3. This droplet increases in size each time the proboscis is alternately depressed and raised until a maximum droplet is produced as illustrated in Fig. 5. The bee then draws the entire drop inside her body. As the nectar begins to be drawn in, the drop assumes a concave surface at its lower end as shown at a in Fig. 6. This distal portion of the proboscis is then extended as at b until the drop has disappeared, when it is again folded

Plate II.—Diagrammatic sketches of the mouthparts of a bee engaged in ripening honey.—Drawn by A. R. Jansen under the direction of Dr. O. W. Park of the Iowa State College.

back to the position of rest indicated at c.

A bee commonly spends from 5 to 10 seconds in carrying out the series of activities illustrated in Plate II. This procedure is repeated with only brief pauses for about 20 minutes although both of these intervals are subject to considerable variation. During the course of these manipulations her load of nectar is exposed little by little in a thin film to the warm dry atmosphere of the hive in such a way that it loses moisture rapidly. This then accounts for the fact that nectar when first deposited in the comb is considerably more concentrated than when it was gathered from the flowers.

Contrary to the conception of ripening by excretion, our experiments (1932) have shown conclusively that when a nectar gatherer arrives at the hive with her load, it actually is slightly more dilute than when she gathered it, instead of being more concentrated as Brunnich contended. Apparently he never had observed the behavior of the house bee in the role just described.

#### Storing New Honey

Upon completion of the foregoing part of the ripening process, the house bee searches out a cell in which to deposit the drop she has been concentrating. Into the cell she crawls, ventral side uppermost as shown in Plate I, C. This position is characteristic of a bee depositing honey. If the cell is empty she "paints" the honey across the rear end of the upper wall of the cell so that it runs down and occupies the rear portion of the cell. But if the cell already contains honey, she dips her mandibles into the honey already there and adds her drop directly and without the painting process. Thus my observations on the deposition of honey in the cell agree in general with those of Arthur C. Miller (1907) and our observations on the ripening process differ mainly in that Miller had observed only part of the process.

When nectar is coming in readily, and particularly if it is very thin, the house bees do not always stop to put it through the ripening process, but deposit it almost at once. Under such circumstances, instead of depositing the entire load in a single cell, the house bee often dis-

tributes her load by attaching a small hanging drop to the roof of each of several cells as shown in three of the cells in Plate I, C. A favorite place for such deposition is within the brood nest where cells already occupied by eggs or small larvae frequently are made to do double duty. Thus with a maximum surface exposed in the warm and relatively dry atmosphere of the hive, evaporation proceeds while the house bee continues to relieve incoming nectar gatherers of their loads. Later these droplets are collected and it seems probable this nectar may then be concentrated further by manipulation, as described above, before being deposited. Whether the nectar ordinarily is put through this type of moisture-reducing process more than once is not known with certainty but it seems probable some of it may be worked over several times.

Another important phase of the honey-ripening process is the inversion of the sugar. Just how this is brought about is uncertain but it is supposed that the inversion process is started by the addition of certain enzymes by the bee. If such enzymes are the product of some of the so-called salivary glands which have outlets among the mouth parts, the process just described would provide ample opportunity for the addition of such substances. This has been pointed out previously by Gallup (1869), Miller (1904), and others.

#### Evaporation from Open Cells

From three different sets of experiments, the writer (1927, 1928, 1933) found that evaporation of moisture from nectar and green honey goes on at a rapid rate within the hive even after having been deposited in the combs. For instance, it was found that combs of newly-deposited honey screened from the bees and placed in a hive lost moisture at such a rate as to attain the concentration of ripe honey in three days. This is the length of time generally accepted for combs of green honey to become ripe when not screened from the bees. These results cast still further doubt upon the theory of honey ripening by excretion.

We found also that the rate of evaporation from cells filled one-fourth full was three times that



from cells filled three-fourths full. When circumstances permit, bees make excellent use of this fact.

Observations show that when adequate comb space is available, few cells are more than half filled with green honey at the close of a day of heavy flow and many contain much less. If such combs are shaken, green honey flies out freely. Examination first thing next morning reveals important changes. The widely scattered cells that contained small amounts the preceding evening now are empty while comb areas that were quite full are now completely filled and cells in adjacent areas are fuller than they were. Scarcely a drop can be shaken from any comb. Surely no one can doubt the wisdom of providing an abundance of comb space to facilitate the ripening process. It is an important consideration in the maintenance of colony morale.

#### Ventilating the Bee Colony to Facilitate the Honey Ripening Process

Joseph F. Reinhardt (1939), a graduate student working under our direction a few years ago, carried out a series of experiments in which varying degrees of hive ventilation were provided. From the results obtained, the following conclusions were drawn:

1. Special provision for upward ventilation is effective in speeding up and completing the ripening of honey under conditions of mild weather and an abundance of nectar.
2. Special ventilation is of little value to the honey-ripening process when weather is hot and excessively dry or the honey flow is light.
3. Temperature, humidity, and the character of the honey flow are important factors in the rate of honey ripening, and they determine whether special provisions for ventilation are of any effect on the speed of the honey-ripening process.

#### Literature Cited

- Brunnich, Karl. 1919. About the bee's honey. *Amer. Bee Jour.* 59: 56.  
 Doolittle, G. M. 1898. Loaded field bees in sections. *Amer. Bee Jour.* 38: 321.  
 Latham, Allen. 1907. Where do the bees deposit their loads of nectar? *Amer. Bee Jour.* 47: 716.  
 Miller, Arthur C. 1904. A mysterious act. *Amer. Bee Keeper.* 14: 7.  
 Miller, Arthur C. 1907. Observing the home life and habits of the bee. *Amer. Bee Keeper.* 17: 42.

Park, Wallace. 1922. Time and labor factors involved in gathering pollen and nectar. *Jour. Econ. Ent.* 15: 129.

Park, Wallace. 1925. The storing and ripening of honey by honeybees. *Jour. Econ. Ent.* 18: 405.

Park, O. W. 1927. Studies on the evaporation of nectar. *Jour. Econ. Ent.* 20: 510.

Park, O. W. 1928. Further studies on the evaporation of nectar. *Jour. Econ. Ent.* 21: 882.

Park, O. W. 1932. Studies on the changes in nectar concentration produced by the honeybee, *Apis mellifera*. *Res. Bul.* 151, Iowa Agr. Exp. Sta.

Park, O. W. 1933. Studies on the rate at which honeybees ripen honey. *Jour. Econ. Ent.* 26: 188.

Reinhardt, Joseph F. 1939. Ventilating the bee colony to facilitate the honey ripening process. *Jour. Econ. Ent.* 32: 654.

#### Ripening Honey Artificially

On account of atmospheric conditions during some seasons and in some locations where the air is heavily laden with moisture and very little air is stirring, bees are unable to ripen their honey properly. The honey is liable to ferment and sour because of a too high water content of from 20 to 25 percent. If such honey is shipped it will bulge and burst the cans. The obvious remedy to reduce this excess moisture to not higher than 18 percent—or better, to 17 or 17.6 percent moisture—is to use heat in a hot room where air can circulate freely. For this purpose an electric fan can be employed to advantage. In former days the thin honey was extracted and allowed to flow slowly over a heated surface until it would reach a normal body of 17.6 percent moisture.

A much better and safer plan is to leave the thin honey in the combs widely spaced in a stack of supers and force a blast of hot air up through. The temperature must never exceed 100 degrees F. or the combs might be ruined.

If available, an electric dehumidifier or a series of them can be very helpful in drying the air which in turn will dry the honey.

Some work using hot air was undertaken by the Bee Department of the Dominion Experimental Farm at Ottawa, Canada. It was described by W. A. Stephen in the *Western Canada Beekeeper* for August, 1941, and reprinted in *Gleanings in Bee Culture* in August, 1942. He writes:

In order to test the feasibility of removing moisture from honey in the comb

several experiments have been conducted.

The basis for these experiments lay in the reasoning that if it were possible to remove the moisture from the thin honey before extracting it would be much easier than waiting until after it was extracted when it would be mixed with the thicker honey.

Several different methods of drying honey in the comb have been tried at the Bee Division, including heated air rising through the supers, heated air blown through by an ordinary electric fan, unheated air forced through by a large blower fan, and finally heated air forced through by the blower fan.

Only the results of the last method are being presented here, as results from the former trials only emphasized the necessity for heat and forced air.

Seven standard Langstroth supers of honey of various weights and varying amounts of cappings, were set above an enclosed steam radiator. The steam radiator was turned to a horizontal position and enclosed in a box. A hole the size of a super was cut in the top and another hole cut in the end, through which air was forced by a multivane fan driven by an electric motor. The air passed through the air spaces of the radiator and up through the supers set above the box. An empty super at the bottom of the pile had a glass door through which one could see the thermometer and hygrometer which were placed inside. A thermometer lying on the combs of the top super registered the temperature of the outgoing air. The rate of flow of air passing between the combs was measured by means of an anemometer.

Each comb was carefully weighed before being placed in the super, again after six hours' running, and again after 12 hours at the close of the heating period.

By means of the refractometer the actual amount of moisture in both capped and uncapped honey was determined before and after the heating period.

#### Results

Experiments not described here show that evaporation took place from the uncapped thin honey at a faster rate than from the uncapped riper honey; also that moisture was removed from capped honey, the wooden frames, and the super itself. There was indication that air forced downward through the super would give better results than air from the bottom, but the latter method is the more practical.

Almost twice as much moisture was evaporated from the honey during the first six hours as during the second six-hour period. While the total percentage, 0.9, may not seem to be great, it should be kept in mind that in some instances this is a sufficient amount to raise honey from third to first grade. The loss is based on heavy combs fully capped which lost little moisture, as well as on the lighter uncapped combs which lost a great deal. One of these lighter combs containing honey of high moisture content lost 7.3 percent of moisture from uncapped honey.

The moisture content for some combs of uncapped honey ran as high as 23.1 percent before heating, while afterwards the highest was 17.3 percent. This means that all uncapped honey after treatment was well within the limit of first grade. Capped honey was also reduced in moisture content, although not to the same

extent. In the case of super No. 314, the total amount of moisture removed was great, yet the capped honey in this super lost only 0.4 percent of moisture as against 5.1 percent for the uncapped honey.

#### General Discussion

While the average rate of air flow in these experiments was 760 feet per minute, it is possible that a lower rate might be satisfactory, as it has been found that for drying fruits the rate should be between 300 and 1000 feet per minute.

As the speed with which the air can pass through a super depends on the number of combs and how well they are filled, so also it depends on the number of supers through which it must pass. It is considered necessary to use a power-driven fan capable of forcing the air through a number of supers at one time.

Since it is heat that does the work of evaporation this must be supplied from some source. Hot water or steam pipes laid horizontally beneath a supporting platform for the supers would be satisfactory in supplying evenly distributed heat.

#### Conclusion

The custom of extracting honey before it was capped has given way to the practice of leaving the supers on the hives until the honey is at least two-thirds capped. Even at this and sometimes when the combs are completely capped some beekeepers find it difficult to produce first-grade honey.

The consequent fermentation resulting in honey of high moisture content has made it necessary to find some means of reducing the moisture content of honey. This is most easily done while the honey is still in the comb. Uncapped honey of high moisture content loses its moisture readily to heated air flowing over the combs. Even capped honey is lowered in moisture content when hot air is blown over the cappings.

The temperature of the air must not be much above 100 degrees F. or the combs will be melted down.

It is satisfactory to use ordinary air from the outside, but the drier and warmer the air used the less heat will be required.

Forced draft is necessary to carry the heat to the combs and carry away the moisture. While a rate of 750 feet per minute has been found satisfactory this is not necessarily the best, and recirculation of the air is desirable.

The rate of evaporation from the honey in combs decreases with length of time. Twelve hours has been found to be sufficient time to use in treating honey of all stages of ripeness. However, experience is necessary to determine the length of time necessary for best results.

It is suggested that beekeepers who have difficulty in producing first-grade honey may, by the installation of a dehydrator room or chamber, consistently produce first-grade honey. The market would thus be rid of low-grade honey which would be a big boost to honey marketing.

Of course, it is much better to let the bees do the evaporating of the nectar when conditions are such that they can do it, as they will do a better job, giving the honey a flavor and richness that the artificial-

ly-ripened product does not have. (See Honey, Specific Gravity of; Honey, Spoilage of; and Honey, Heat Effect on.)

#### HONEY, SENSITIVITY TO.\* —

The most common ill effects from eating honey, disregarding those of simple gluttony, are cramps, heartburn, gastric indigestion, and indefinite general discomforts immediately following partaking. These unfortunate individuals are afflicted with what is known as honey sensitization or honey allergy.

A sensitive or sensitized person is one who is adversely affected by very small quantities of nitrogen, containing substances which do not so affect other individuals. Allergy is a broad term covering sensitization in all of its manifestations. Commonly recognized allergies are: pollens causing hay fever, and various dusts or animal emanations inducing asthmatic attacks. Foods are allergic to some persons and when ingested cause similar local conditions in the alimentary canal.

Babies are much more susceptible to food allergies than grown-ups. This must be remembered in modifying baby's milk with honey.

#### Ingredient Which Causes Distress

Sensitiveness to honey is one of the least common of food allergies. Eggs, for instance, affect hundreds to one affected adversely by honey. The exact reason for honey being abnormally irritating to some is much disputed. Some claim that it is because of the few suspended pollen grains or because of extractives from the pollen coming in contact with the honey while in the comb or in the extraction process. Others claim that the sensitization cause is the aroma incorporated in the honey as a most essential part of the flavor. Some say it is the osmotic action.

#### Influence of Heredity

Some honeys are naturally disagreeable to all persons. This is because of the plants furnishing the nectar. I once obtained a sample of dark, bitterish supposedly cascara honey that had the laxative effect of cascara.†

\*By Dr. W. Ray Jones, Seattle Washington, Gleanings in Bee Culture, page 462, for 1933

†Probably azalea is the culprit but rhododendron may be. We had both in our

Rhododendron honey is supposed to be generally toxic, although what I sampled as such was not. Both of these small trees grow abundantly in localities about the Puget Sound.

#### The Remedy

The ordinary remedy for food sensitization is to leave that food alone for a time, hoping that the sensitiveness will wear off. Quite commonly it does. I suggest that a honey-sensitive person leave honey alone for from two to six months, then try the extracted from some locality with an entirely different flora; if this causes no disagreeable symptoms, try honey in comb. It is a case of try a little at a time, one of trial and error. Foods including honey, like alcohol, affect no two alike.—W. Ray Jones, M. D.

Dr. Bodog F. Beck has this to say on the subject of honey cramps in his book "Honey and Health":

There are, of course, a few people with whom honey does not agree. They will experience a griping soon after its consumption. This is due to the high hygroscopic property of the substance, which readily absorbs gastric and intestinal fluids. The thirst which one feels after consuming honey is due to this circumstance, or rather advantage, because if the craving for water is gratified the system benefits by it. Diluting honey with water or mixing it with other foods will at times prevent such griping.

Certain individuals have an idiosyncrasy for honey. They cannot eat even the smallest amount. This is often an allergic condition—that is, they are honey sensitized like people who suffer from hay fever or asthma are sensitized to certain pollens.

#### Dr. E. F. Phillips says:

When a heavy solution like honey enters the stomach a strong osmotic action is set up, which means that the honey is extracting moisture from the walls of the stomach. . . . This is enough in some persons to cause pain.

Many people who can not eat honey alone find that they can eat it if they drink milk.

#### HONEY, SPECIFIC GRAVITY OF—

It is well known by beekeepers as well as honey buyers that the moisture content of honey varies greatly. On the basis of percentage the water content may run as high as 25 and as low as 13 percent. According to Circular No. 24 "United

garden at Camberly (Hill House) and I once was poisoned by some of our own honey. The room went around and I perspired more copiously than I had ever done before. See Bee World for an account of another case, page 141 for 1929 —A. D. Betts, of the Bee World.

States Grades, Color Standards, and Packing Requirements for Honey", an 18.6 percent, or 11 pounds, 12 ounces weight to the gallon at 68 degrees F. will be accepted as a U. S. standard as the maximum moisture content of a good honey. But even such honey should be processed before it reaches the market—that is, heated to a temperature of 160 degrees F. and sealed while hot. Unless it is so treated it may ferment and sour.

The northern buyers prefer honey at a lower water content—no higher than 17.4 percent, or 11 pounds, 13 ounces weight to the gallon at 68 degrees F. Most buyers prefer, if they can get it, a 17.0 percent moisture content, or 11 pounds, 13½ ounces weight to the gallon at 68 degrees F. Unless an 18.6 percent honey, or 11 pounds 12 ounces weight to the gallon, has been processed, it should be immediately mixed with a honey of lower water content of, say 15.0 percent. The two honeys should be heated to a temperature of not less than 160 degrees F. and thoroughly stirred, as a thick and a thin honey do not readily mix under ordinary temperatures.

Beekeepers have been loosely saying that ordinary honey runs about 12 pounds to the gallon. This would make a moisture content of only 14.02 percent. Honeys of that low a percentage are rather rare. The average of western honeys produced in dry mountain areas will run from 17.0 to 15.4 percent, or respectively 11 pounds, 13½ ounces and 11 pounds 15 ounces weight to the gallon. A 17.4 percent and below honey is usually regarded as one which is reasonably safe from fermentation except when it is granulated. Under Honey, Granulation of, it is shown that even a heavy-bodied honey may ferment and sour when it granulates unless it has been heated to a temperature of 140 degrees, or better, 160 degrees to destroy all yeast germs. (See Yeasts.) When honey granulates, the dextrose crystals separate out, leaving an excess moisture which, combined with the levulose not yet granulated, makes the water content high enough that fermentation can take place under proper temperature. (See Honey, Spoilage of.)

Honey buyers have learned from experience that honey with a high

moisture content may cause them trouble. They have also learned that a heavy-bodied honey may ferment after it has granulated.

It should be noted that a gallon can that will hold exactly 12 pounds of ripe honey at normal temperatures will hold only 11 pounds, 12 ounces when that honey is heated to 160 degrees to prevent granulation. However, when this honey cools, 4 ounces more of cold honey can be added, but as a rule most gallon cans of honey contain that amount less than the 12 pounds, and should be so labeled to conform to state and federal laws.

#### How to Measure Moisture Content

There are two methods commonly used for determining the moisture content of honey: one by the refractometer and the other by the hydrometer.\* The former gives a determination much more quickly

\*It must be remembered that both the hydrometer and the refractometer are instruments for measuring something about a honey which reveals something else, namely the water content. Neither instrument measures the water content directly. The hydrometer measures lifting power of honey, the refractometer measures refraction of light in proportion to the density of sugars in the honey. By interpolation one can get a fairly accurate figure which represents water content, but to get the accurate figure on water content it is necessary to completely dehydrate the honey and measure loss of weight.

Each instrument has its faults for the use to which we put them. The hydrometer requires a large amount of honey, fails to correct for thixotrophy, requires accurate temperature measurements of the sample, etc. The refractometer has a self-containing temperature control because of the water which flows through it, thixotrophy makes no difference, and only a small sample is required. With the smaller sample, freedom from crystals becomes easier. Furthermore the uncorrected reading of the refractometer is more nearly right than with the hydrometer. The refractometer was made originally for determining refraction of simple sugar solutions, for which it seems to be about perfect. From this figure it is a direct reading to water content, since this variation is virtually a straight line. Because of the non-sugar ingredients (variable in amount) in honey, the refractive index does not agree entirely with that of sugar solutions, hence the Chataway correction tables which we must use.

The great obstacle for the hydrometer is inaccuracy of reading the figures because of the surface and because they must be read through an irregular jar (unless it is filled to the top). The placing of a little water on the top surface partially corrects the error of the adhesion of honey to the stem, but still it makes the reading subject to error.—Dr. E. F. Phillips, Cornell University.

HONEY, SPECIFIC GRAVITY OF

Honey tables, showing the relationship between various hydrometer scales and refractive index to moisture content and weight per gallon of honey.\*

Compiled by Dr. H. D. Chataway, National Research Laboratories, Ottawa, Canada.

At the head of each column will be found the temperature at which the figures given below it hold true. If a honey has been examined at a higher temperature than the standard one, there should be added to the observed reading an amount equal to the temperature correction, given at the foot of the table, multiplied by the difference between the observed and the standard temperatures.

% Moisture	°Be (Modulus 145C) at 60°F	Sp. Gr. 20°C at 20°C	°Twaddle at 60°F	°Brix at 20°C	Diff. between use of honey hydrometer tables and Brix tables in %H <sub>2</sub> O	lb. oz. Gal. at 20°C	lb. oz. Gal. at 20°C	Ref. Index at 20°C	% Moisture
13.0	45.29	1.4525	90.5	85.66	1.34				
.2	.19	10	.2	.45	.35	14 8	12 1	1.5041	13.0
.4	.09	1.4495	.0	.24	.36			35	.2
.6	44.99	81	89.7	.03	.37	14 7½		30	.4
.8	.89	66	.4	84.82	.38		12 ½	25	.6
14.0	.79	53	.1	.61	.39	14 7		20	.8
.2	.69	38	88.8	.39	.41		12	15	14.0
.4	.59	24	.5	.18	.42	14 6½		10	.2
.6	.49	09	.2	83.97	.43			05	.4
.8	.39	1.4395	87.9	.76	.44		11 15½	00	.6
15.0	.29	81	.7	.55	.45	14 6		1.4995	.8
.2	.19	67	.4	.34	.46			90	15.0
.4	.09	52	.1	.13	.47	14 5½	11 15	85	.2
.6	43.99	38	86.8	82.92	.48			80	.4
.8	.89	24	.5	.71	.49	14 5	11 14½	75	.6
16.0	.79	10	.2	.50	.50			70	.8
.2	.69	1.4295	86.0	.29	.51	14 4½		65	16.0
.4	.59	82	85.7	.08	.52		11 14	60	.2
.6	.49	67	.4	81.87	.53	14 4		55	.4
.8	.39	54	.1	.66	.54			50	.6
17.0	.29	39	84.8	.45	.55		11 13½	45	.8
.2	.19	25	.6	.25	.55	14 3½		40	17.0
.4	.09	12	.3	.04	.56		11 13	35	.2
.6	42.99	1.4197	.0	80.83	.57	14 3		30	.4
.8	.89	84	83.7	.63	.57			25	.6
18.0	.79	71	.4	.42	.58	14 2½	11 12½	20	.8
.2	.69	56	.2	.21	.59			15	18.0
.4	.59	43	82.0	.01	.59	14 2		10	.2
.6	.49	29	.6	79.80	.60		11 12	05	.4
.8	.39	15	.3	.59	.61	14 1½		1.4900	.6
19.0	.29	01	.1	.39	.61		11 11½	.4895	.8
.2	.19	1.4087	81.8	.18	.62			90	19.0
.4	.09	74	.5	78.97	.63	14 1		85	.2
.6	41.99	60	.2	.77	.63		11 11	80	.4
.8	.89	46	80.9	.56	.64	14 ½		76	.6
20.0	.79	33	.7	.35	.65			71	.8
.2	.69	20	.4	.15	.65		11 10½	66	20.0
.4	.59	06	.2	77.94	.66	14		62	.2
.6	.49	1.3992	79.9	.74	.66		11 10	58	.4
.8	.39	79	.6	.53	.67	13 15½		53	.6
21.0	.29	56	.4	.33	.67			49	.8
								1.4844	21.0

Temperature Corrections

°Baume .....	.024°	Be per °F	or .0430	Be per °C
Specific Gravity .....	.0006	per °C	or .00033	per °F
°Twaddle .....	.07	per °F	or .125	per °C
°Brix .....	.05	per °F	or .09	per °C
Pounds per Imp. Gal. ....	½ oz.	per 5°C	or	per 9°F
Pounds per U. S. Gal. ....	½ oz.	per 6°C	or	per 11°F
Refractive Index .....	.00023	per °C	or .00013	per °F

\*Report on Honey and Honeydew Honey—By George P. Walton (Agricultural Chemical Research Division, U. S. Dept. of Agriculture, Washington, D. C.), Associate Referee.

Since the publication of Chataway's final table summarizing the data in the Canadian Bee Journal for August, 1935 (also reprinted in "The ABC and XYZ of Bee Culture", 1940 edition, page 473), her moisture content equivalents for refractive indices for honey have been generally accepted by the honey industry of the United States, and the equivalent values of the table, in their entirety, have been made official in Canada.

In view of the wide and apparently highly satisfactory use of these Chataway moisture-content, refractive-index equivalents it seems desirable that they be given official recognition in this country as well as in Canada, and this year's study of the determination of moisture in honey was planned accordingly.

Honeydew Honey—The food control official and (from the practical standpoint) the beekeepers appear to be in need of a convenient and reliable method to distinguish between floral nectar honeys and those produced in whole or in large part from honeydew.—Reprinted from Journal of the Asso. of Official Agricultural Chemists, Aug., 1942.

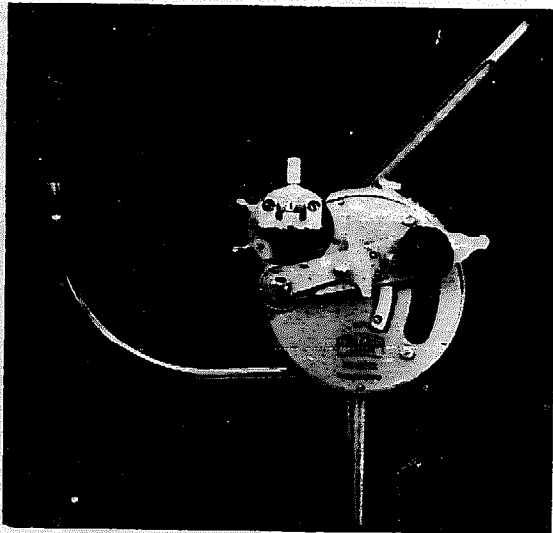

Refractometer

than the latter, but costs all the way from \$100 to \$250. Its use, of course, is necessarily confined to schools, colleges, large buyers, and to large producers of honey. The one used by the author is made by Karl Zeiss of Germany and sold by Eimer and Amend of New York City. It is accurate and quick in results.

#### Damage Done by Thin or Unripe Honey

Bakers and candy makers are very often disappointed because one lot of honey does not react like another which they previously used, and they wonder why. Much of the trouble experienced is due to a varying percentage of water content in the honey. Bakers, candy makers, and tobacco manufacturers sometimes come to the conclusion that they will never again use honey because the formula which was successful with one lot of honey may not be so with the next lot purchased.

Then here is another difficulty, and a very serious one. If a manufacturer purchases a honey that is high in water content he is quite likely to find later on that same honey fermenting. A little acid reaction in honey that is used for baking will do no harm, provided fermentation has not gone too far. But with the candy maker this is a different proposition. (See Honey, Cooking with; also Honey, Spoilage of.)

All this goes to show that there is a general ignorance regarding the properties of honey, an ignorance that is shared alike by the buyer

and the producer. While the latter learns that a honey of normal water content, below a percentage of 18.6 or, better still, one of 17.0 percent, is more salable than a honey of high water content, there will be less trouble between him and the buyer.

What is the lesson to the beekeeper in all of this? That the practical honey producer should, especially if he lives in the East, leave his honey in the hives longer than he has been doing. Too many beekeepers have an idea that when two-thirds of the cells in a comb are capped over, the honey is ready to extract. This may be true at times, but more often it is not true and the extraction of such combs results in a honey too high in water content, and the buyer will therefore pay proportionately less because of this fact or refuse to take it at all. The average eastern producer should leave his honey on the hives until practically all the cells are capped over.

#### Influence of Water Content Upon the Rate of Granulation

The higher the water content the less the tendency of a given honey to granulate.\* Conversely, a normal honey of low water content may granulate. But a honey with a water content of above 18.6 percent may ferment and sour after it starts to granulate, unless heated to a temperature of 160 degrees F. When heated and sealed while hot, a thin honey will remain stable or clear for a year, sometimes longer.

In the Journal of Economic Entomology, Volume 27, No. 3, June 1934, it is shown that the rate of granulation of honey is in general less with increasing water content. It is also shown that when the content is around 20 percent such honey, relatively thin, will remain stable—that is, not granulate if the honey has been heated to a temperature of 160 degrees. As a rule, however, most of the bottled honeys on the market have a water content of not less than 17.4 percent. Such honeys, when heated to 160 degrees, are not only free from any danger of fermentation, but will also be free from granulation crystals for a year, on the average. (For further particulars see Honey, Granulation of, and Grading of Honey.)

\*See Journal Paper No. J176 of the Iowa Experiment Station Project No. 355.

It should be made emphatic that a thin honey having a water content of 18.6 or more is usually not fully ripened. A honey not fully ripened to a water content of 17.4—or better, 17 percent — as a rule lacks some of the aroma. In the eastern states combs should be left in the hive until all the cells are sealed before extracting. In the western states three-fourths sealing will probably be enough to insure a fully ripe honey of around 16 percent water content.

#### Gallonage Test

The average beekeeper will have to go by the gallonage test, and when he does he must make sure of a continuous temperature of around 68 to 70 degrees for 24 hours. An exact gallon measure should be used. It is filled with honey and allowed to stay in a room with a temperature of 68 degrees. After weighing and subtracting the weight of the container, the specific gravity of the honey is determined. The table on page 438 will show the percentage of moisture.

Under Honey, Viscosity of, one will see that the density and viscosity\* of a given honey varies almost directly according to the moisture content. But there are exceptions to this rule. Heather honey, which is one of the standard honeys of Europe, has a high viscosity. The American beekeeper will seldom encounter this condition.

#### Where Honey Should Be Stored

Honey for storage should be heated to 160 degrees F. to prevent fermentation. Unheated honey, says Wilson, should be kept in a building where the temperature can be kept at 50 degrees F. (See Honey, Spoilage of, following.) Comb honey can be kept well at 50 or less but it should under no circumstances be allowed to freeze.

A hydrometer especially designed for honey by Dr. H. C. Chataway is sold by the Central Scientific Company of Canada, Limited, at 119 York Street, Toronto, Canada, or the Precision Instrument Company, Box 654, Church Street Annex, New York City.

\*Density and viscosity are not necessarily the same. The latter will become very fluid on the application of heat of 120 degrees F.

#### Literature Consulted

Circular No. 24, United States Department of Agriculture, entitled "United States Grades and Color Standards and Packing Requirements for Honey"; "The Determination of Moisture in Honey"; by Dr. H. C. Chataway of the National Research Laboratories, Ottawa Canada, in the *Beekeeper (Canada)* for January, 1933; "Honey Tables Showing the Relationship Between Various Hydrometer Scales and Refractive Index to Moisture Content and Weight per Gallon of Honey", by H. C. Chataway in the *Canadian Bee Journal*, page 215, for 1935; "Thixotropy and Elastic Recoil in Heather Honey", by J. Price Jones, M.S.C., A.I.C., in *Bee World*, London, for August, 1936; "Moisture Content of Honey and Nectars", by Dr. O. W. Park, Iowa State Agricultural Experiment Station, Ames, Iowa, in the *Journal of Economic Entomology*, Volume 25, No. 4, for August, 1934; Same Journal, Volume 26, No. 1, February, 1933, "Viscosity of Honey in Relation to Extraction", by P. Risga, B. Sc. A.M., University of Latvia.

**HONEY, SPOILAGE OF.**†—It is generally held by many beekeepers, and others as well, that honey will keep indefinitely, and experience shows that it is actually possible to keep honey in its natural condition over a long period of time if stored at temperatures below 50 degrees F. However, because of the ease with which honey is broken down at higher temperatures, it may be thought of as a product readily perishable under average conditions, and those who have had the opportunity to study numerous samples of honey know that it rapidly deteriorates in color and flavor at relatively high temperatures and, when contaminated with yeasts, it spoils from fermentation at relatively low temperatures.

Honey that is one year old is sometimes considered by bottlers and brokers to be inferior to freshly extracted honey. Furthermore, the bottlers may be suspicious of honey that they buy after the first of January because of the possible danger of fermentation. This fear on the part of bottlers or dealers is well founded, but the reasons have not been demonstrated until in recent years. (See Honey, Discoloration of, by Milum.)

Many beekeepers are unaware that there are good and bad methods of storing honey after it has been extracted. However, we now know on the basis of observations and experiments that temperature

†By Prof. H. F. Wilson, Entomologist of the University of Wisconsin at Madison.

is of the utmost importance when honey is held in storage over long periods of time.

There are three general conditions to be found in the deterioration of honey, any one of which is sufficient to lower the market grade of the product. In order of importance these are: spoilage by fermentation, loss of flavor, and color changes in which the color passes from a lighter to a darker grade. The proper handling of honey after its removal from the bee hive and during its progress to the consumer is a very important problem.

If honey is not well ripened or if it is allowed to absorb moisture while stored in open tanks, fermentation is sure to occur when temperature conditions are favorable for the development of yeasts in honey. Even supposedly well-ripened honey is subject to fermentation as a result of the physical changes that occur during granulation after the honey is extracted and put into cans or jars. Some honeys contain a higher content of dextrose and crystallize soon after being extracted from the comb. The crystallization of the mass is not complete, however, for close examination will show that the crystals are dispersed in a dilute liquid phase. (See Honey, Science of Granulation; and Honey, Granulation of.)

#### Yeasts in Honey

Fermentation in honey is caused by yeasts, and a half-dozen or more species have been discovered and described by scientists. Yeasts are found everywhere, and sugar-tolerant yeasts which are capable of fermenting honey occur more or less abundantly in and about all bee yards as shown by a number of investigators. Spores of these yeasts are to be found in nearly every sample of honey, and fermentation is almost sure to occur in all honeys after complete crystallization if held for a long period of time at temperatures suitable for the development of yeasts. (See Yeasts in Honey.)

#### The Relation of Moisture to Fermentation in Honey

Moisture is necessary for fermentation. Beekeepers have for a long time known that excess moisture has some relation to the spoilage of honey by fermentation, but do not

know just how it came about and more particularly the combined relation of moisture and temperature.

It is known that honey extracted from unsealed combs is more likely to ferment than honey from fully sealed combs or from even partially sealed combs extracted late in the season. Honey from fully sealed combs is generally considered ripe honey by the beekeeper but many believe that the maturing process in honey continues after the combs are sealed if they are left in the hives. For this reason many beekeepers do not remove the honey from the hive until a month or more after it is fully sealed.

The moisture content of honey extracted before combs are partially sealed is undoubtedly higher than honey from fully sealed combs. But honey absorbs and gives off moisture equally well under proper conditions. Even honey that is extracted early in the season will give off moisture and become thicker in a dry atmosphere, also honey will absorb moisture and become thinner in a wet atmosphere. It is therefore difficult to decide when honey is safe from fermentation, but in the humid climates of eastern United States honey should not be extracted until the combs are at least three-fourths filled.

Because of the fact that fermentation begins at the top of the container and works downward, and also because it has been shown that there is more moisture in the top layers of crystallized honey than in the bottom layers, it is quite evident that moisture does play an important part, but temperature is equally important and probably really governs fermentation. Honey containing a high percentage of moisture does not ferment at temperatures below 50 degrees F., and only slowly or not at all at temperatures about 80 degrees F. (See Honey, Specific Gravity of.)

#### The Relation of Temperature to the Spoilage of Honey

At the Wisconsin Agricultural Experiment Station a wide range of samples has been taken at weekly periods during the honey crop seasons of 1929, 1930, 1931, and 1932 and placed in chambers fitted with devices for keeping the temperature constant for long periods of



time. The samples of honey in glass jars have been held for long periods of time in these chambers at temperatures of 40, 60, 64, 75, 80, and 100 degrees F.

The information secured from these experiments shows that any lot of honey is continuously affected by the temperature conditions surrounding it while on its way to market. Below a point of about 50 to 55 degrees F., no changes take place, and honey may be preserved in its natural state for a long period of time. At 60 degrees F. honey ferments more quickly than at higher temperatures. Honey crystallizes more rapidly with the lowering of the temperature, and since most honeys must become crystallized before fermentation begins there is a temperature at which, with rapid crystallization, fermentation develops more rapidly than it does at other temperatures. With our present knowledge of the subject this temperature appears to be near 60 degrees F. Above this point fermentation is delayed by slower crystallization.

At 80 degrees F. normal honeys in sealed containers have not fermented during a period of nearly four years, but serious deterioration in color and flavor takes place after 16 months so that if honey is allowed to remain at temperatures above 80 degrees F. for a long period of time no fermentation is likely to occur, but detrimental changes in color and flavor are sure to occur. (See Honey, Discoloration of.)

As the storage temperatures increase above 80 degrees F, deterioration in color and flavor increases. With this knowledge beekeepers can often prevent losses from fermentation as well as from changes in color and flavor by using care in selecting storage rooms for their honey. Of course, the easiest way to prevent fermentation is to heat the honey to 160 degrees F., then immediately put it into sealed containers. If this is done carefully, honey will not ferment regardless of where it is stored.

One important fact in the whole marketing situation is that the beekeeper should not be held responsible for losses by fermentation, provided the shipment was in good condition when shipped. Dealers buying carload lots of honey should be made acquainted with the danger

of holding unheated honey for any length of time in storage rooms when the temperature is from 55 to 65 degrees F. Beekeepers who do not heat honey before canning should not store it in cool basements and should not leave tanks of crystallized honey open where moisture can be absorbed. The danger of fermentation is too great.

**HONEY IN SURGERY.**—The following is taken from "Honey and Health" by Dr. Beck:

Honey applied to ulcerated surfaces has a unique function. Soon after its application a profuse and intense centrifugal flow of lymph is noticeable and the entire torpid surface of the wound becomes soaked in fluid. This leucocytic lymph collection which honey produces has not only a bactericidal power but the rinsing function of the free-flowing liquid will greatly contribute to the cleansing of the wounds and will stimulate and promote granulation and healing. The ancient Greeks often refer to epomphalia, a naval ointment made from honey, for the newborn. Old mead, which is almost as extinct today as the dodo, was also used as an antiseptic lotion.

#### Honey for Wounds

The rural populations of the European continent, especially that of the Slavic countries, used honey for all kinds of wounds and inflammations. "Honey Ointment" consisting of equal portions of honey and white flour, well mixed with a little water, had a wide usage.

In the "Alpenlaendische Bienenzeitung" (February, 1935) we find the following report: "In the winter of 1933 I heated a boiler of about 35 gallons of water. When I opened the cover, it flew with great force against the ceiling. The vapor and hot water poured forth over my unprotected head, over my hands and feet. Some minutes afterwards I had violent pains and I believe I would have gone mad if my wife and daughter had not helped me immediately. They took large pieces of linen, daubed them thickly with honey, and put them on my head, neck, hands, and feet. Almost instantly the pain ceased. I slept well all night and did not lose a single hair on my head. When the physician came he shook his head and said, 'How can such a thing be possible?'" (See Honey Antiseptic.)

**HONEY WINE (MEAD)\***—Is probably the oldest alcoholic beverage known to man.

A good honey wine or honey-fruit wine, containing about 12 per cent alcohol, may be made at home if one is willing to pay some attention to detail. The production of an alcoholic beverage is easy, but making a wine which tastes good takes a little time, some experience, and a moderate amount of equipment. There is much debate

\*Portions of this section are taken from Honey Wine (Mead) Making. Dr. Roger Morse, Gleanings in Bee Culture. Jan. 1970, page 38.

over how a wine should taste but in the final analysis most people agree that one does not need to acquire a special taste for wine. If a wine tastes good, it is good and if it does not taste good it is well to seek another type or variety.

#### What Kind of Wine Will Honey Make?

A great variety of honey wines may be made. Light colored, mild flavored honeys will produce a light colored, mild wine. Darker honeys, such as buckwheat, make a wine with a reddish or brownish tinge and stronger in flavor. Honey blends well with several fruit juices including apple, elderberry, wild cherries, etc. to make a honey-fruit wine. Spiced honey wine drinks, made by adding cinnamon, cloves or other spices may be popular with some people. Just as one can make a great variety of grape wines so it is possible to produce a great variety of honey wines.

Wine making is a biological process. Yeast cells attack the sugar in the mixture using about five percent for their own metabolism and the rest is turned, about equally, into carbon dioxide and alcohol.

While sugar is the chief food for the yeast cell, yeasts also need certain vitamins, minerals and other nutrients to grow, just as does any animal.

A wine may be made using ordinary bread yeast; however, the resulting product will have a "bread" flavor and will not be too desirable tastewise. To make a good wine it is best to use a good culture of wine yeast.

#### Making Mead

It should be noted that a head of a household may make up to 200 gallons of tax free wine a year for family use. However, you must obtain a Form 1541 from your local Assistant District Commissioner, Alcohol and Tobacco Division, Bureau of Internal Revenue. There is no charge for this.

A beginner in mead making might experiment with the following two small batch recipes:

#### Sweet Mead

5 lbs. mild-flavored honey  
 ¼ oz. citric acid  
 5 liquid ozs. strong fresh tea  
 1 level tsp. Di-ammonium Phosphate Nutrient  
 Wine Yeast

Instructions: The wine making ingredients can be found at your local drug store or wine shop. Mix the honey with 8½ quarts of hot water in a carefully cleaned plastic pail. Crush two campden tablets and mix them into the solution to kill any hostile yeasts that might give the wine an off-flavor. Let the mixture set for 24 hours. Then mix in the citric acid, tea, nutrient and yeast. Cover the pail with a plastic sheet held on with a rubber band and let this must ferment for 10 to 14 days. At this time the liquid portion of the fermenting must should be siphoned away from the dead yeast cells in the bottom of the pail, into plastic or glass gallon bottles filled to the point of which the bottle begins to taper at the top. This is called racking the must and is necessary to prevent the sediment in the bottom from ruining the flavor of the wine. The bottles should then be sealed with a water lock or a sheet of plastic with a fairly tight rubber band around it, and left to age for a year or more. After that time it can be racked into bottles.

Contrary to popular opinion, the alcoholic content of a wine does not continue to increase with time once it has reached 12 to 14 percent. The old stories of wines getting stronger with time are just old wives' tales; sometimes old wines turn to vinegar, giving the wine maker the false impression that it is a stronger product!

#### Dry Wine

3½ lbs. of mild flavored honey  
 ¼ oz. citric acid  
 5 liquid ozs. of strong fresh tea  
 1 level tbs. of Di-ammonium Phosphate Nutrient  
 Wine Yeast

If you are checking the must with a hydrometer the gravity should be adjusted to 1.105 to start fermentation. Below that, add more honey. When it reaches 1.012 it is ready to be racked into the gallon container.

#### Further Information

For a mimeographed listing of bulletins and books on the subject of mead making, as well as addresses of shops selling equipment for home wine making, write the Office of Apiculture, Department of Entomology, Cornell University, Ithaca, New York 14850.

**HONEY, VISCOSITY OF.** — See Viscosity and Thixotrophy, under Chemical and Physical Properties of Honey; Grading Honey; Honey, Specific Gravity of.

**HONEY, VITAMINS IN.** — See Vitamins in Honey.

**HONEY, WATER CONTENT OF.** — See Honey, Specific Gravity of.

**HONEY, YEASTS IN.** — See Yeasts in Honey.

**HOUSE APIARY.**—See Apiary.

**HUAJILLA.**—See Guajillo.

**HUBAM.** — See Sweet Clover,

**HYBRIDS.**—In common beekeeping practice the term "hybrid" has been

generally applied to the progeny resulting from a cross between Italian bees and the native black bees. Since these hybrids were often ill-tempered and susceptible to European foulbrood, hybrids in general received a bad reputation which they did not necessarily deserve. They can be very superior bees.

Hybrids are usually thought of as progeny resulting from a cross between species, races, strains or inbred lines. It is well known that hybrids are often more vigorous and healthy than their parents. This phenomenon is known as hybrid vigor or heterosis. There are genetic explanations for this added vigor which need not be discussed here.

The hybrid vigor phenomenon has been put to good use by man. The hardy common mule, a hybrid between

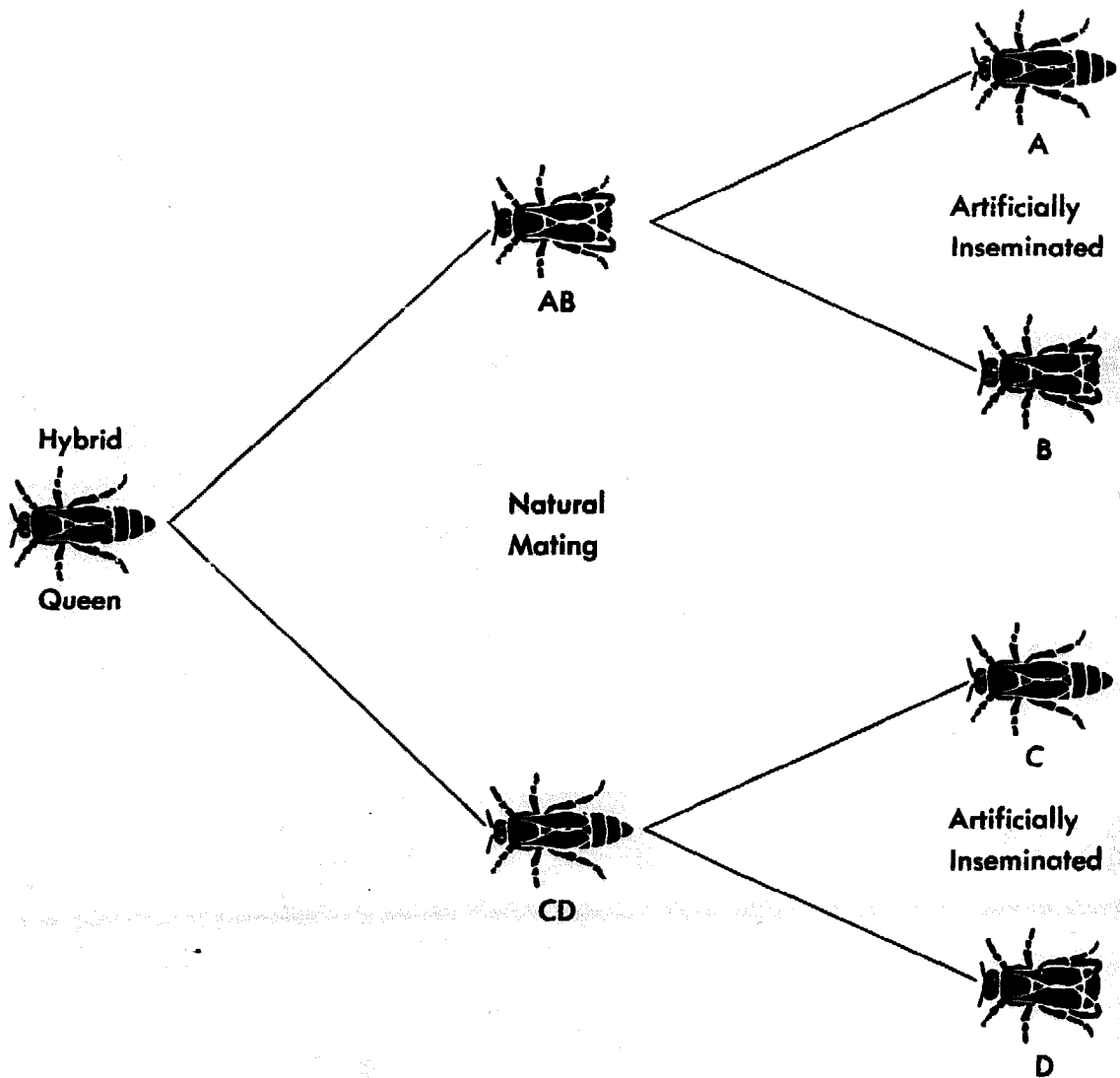

Hybridization pattern.

the horse and ass, is a good example of long standing. The tremendous success of hybrid corn is well known. Scientifically produced hybrids are now available in many other domesticated plants and animals including the honeybee.

Scientifically produced honeybee hybrids were first developed by the Apiculture Research Branch of the United States Department of Agriculture. In general, they followed the methods used in hybrid corn breeding. First, many lines are established by very close mating such as mother-son, brother-sister, or back crossing to a queen for several generations. Then these lines are crossed in various combinations to determine which form the best hybrid. Finally, the chosen lines are used as foundation stock for the mass production of the superior hybrid. Usually four lines make up a hybrid. Two lines are crossed for the production of drones and the other two for the production of queens for the final cross. For example, if the four lines are designated A, B, C, and D, then queens of line A are mated to drones of line B to produce AB daughter queens for drone production. Then queens of line C are mated to drones of line D to produce CD daughter queens. These matings are made by artificial insemination. The final cross, AB drones times CD queens is made by natural mating at isolated mating stations.

Such hybrids involving four lines are called four-way hybrids. Both the queen and the workers of the resulting colonies are hybrid. With a large number of inbred lines a great many combinations are possible from which a variety of hybrids can be chosen to meet a variety of needs. For example, one hybrid might be found to be better

adapted to a certain beekeeping region or system of management than another. In addition to greater vigor, hybrids develop more uniform colonies which makes it easier to manipulate all the colonies of an outyard in the same way at each visit. This is a great advantage in the management of a large beekeeping operation.

A hybrid breeding program based on the outline given above is now being conducted by the Apiculture Research Branch in cooperation with the Apiculture Department of the Ontario Agricultural College, and the Honeybee Improvement Cooperative Association. The production of inbred lines and much of the testing is accomplished at the Madison, Wisconsin, Laboratory of the Apiculture Research Branch. The Ontario Agricultural College maintains a mating station on Pelee Island, in Lake Erie, where the final crosses are made for the production of hybrid queens for test at Madison and in Canada. The Honeybee Improvement Cooperative Association produces the hybrid queens for sale to beekeepers, who report on their comparative performance.

A similar program is conducted commercially by Dadant and Sons, of Hamilton, Illinois. Cooperating queen breeders make the final crosses and sell the hybrid queens to beekeepers.

Reports from the industry on the performance of the several hybrids now available are favorable.

#### Additional Reading

Mackensen, O. and Roberts, W. C., 1952. Breeding Bees, U.S.D.A. Yearbook 1952: 122-131.

Roberts, W. C. and Mackensen, O., 1951. Breeding Improved Honey Bees. Amer. Bee Jour. 91: 292-294; 328-330; 382-384; 418-421; 473-475. (This was also published in Gleanings.)

**HYGROSCOPICITY OF HONEY.**  
—See Honey, Hygroscopicity of.

## I

**IMPORTATION OF HONEY BEES INTO AMERICA.**—It should be understood by the reader that the importation of honeybees into the United States from overseas is now forbidden by federal law. The purpose of this law is to prevent introduction of *Acarapis* disease into this country. (See *Diseases of Bees*).

E. Oertel of the U. S. Bee Culture Laboratory, Baton Rouge, Louisiana, gives some interesting data, particularly of the importations of honeybees across the Atlantic to America. We quote from the *Proceedings of the Louisiana Academy of Sciences*, Vol. 9, April 1945, pp. 71-76, *Historical Notes on Honeybees and Beekeeping in Louisiana and Other Southern States*:

"A letter to the Governor and Council in Virginia probably contains the first reference to the importation of the honeybee and beekeeping equipment into this country. According to Kingsbury (1933), the Virginia Company wrote on December 5, 1621, "Wee haue by this Shipp esnt.. fruit trees, as also Pidgeons,..and Beehiues,..the preservation and increase whereof we recommend unto you." If bees were sent, it is not unlikely that they arrived safely, for Neighbour (1866) reported that colonies of bees shipped by him from England to Australia arrived there safely after being 79 days on a sailing ship. Evidently there was rapid increase in the number of colonies in Virginia, for Bruce (1907) and Campbell (1860) stated that beeswax and honey were abundant in Virginia by 1650. It is possible that these colonies furnished most of the bees that were reported in other sections of the South at a later date.

"The spread of honey bees from the presumed original colonies in Virginia is indicated in the chronological notes at the end of this paper. Post (1933) noticed that honey bees apparently were of little or no importance in Louisiana during the early days of settlement. He says, 'In all the literature on the French Colonial period (1699-1763) bees are not mentioned once.'

Baudier (1939) tells of the lack of wax candles for church use in New Orleans in 1723. Other early histories comment on the wide use of the waxmyrtle berry for candle making. It seems likely that beeswax was rare or it would have been used for making candles. Evidently the early settlers of Louisiana had little interest in beekeeping, for no detailed description of beekeeping in this state prior to 1860 has been found. Probably most of the honey and wax were obtained from box hives or bee trees."

**INCREASE.**—See *Building Up Colonies*; *Dividing*; and *Nucleus*.

**INFANTS, HONEY FORMULAS FOR.**—See *Honey in Infant Feeding*.

**INSEMINATION OF QUEENS.**—See *Queens, Fertilization of*.

**INTRODUCING.**—The success in introducing a queen depends very largely upon the size of the colony and the temper of it. A weak colony or nucleus will accept a strange queen when a strong one will not. When there is a dearth of honey, or weather is chilly, introduction is much more difficult than when the weather is favorable and honey is coming in.

Under normal conditions only one queen will be tolerated in a colony at a time. Should there by accident be two, there will probably be a royal battle when they meet, until one of them is killed. Queens are as a rule jealous rivals, but there are exceptions. Under certain conditions, as when an old queen is about to be superseded, the young daughter may be tolerated along with her mother—both laying side by side—but in the course of a few days or weeks the mother will be missing. Whether she dies of old age or the daughter kills her is not known. There are other conditions where two and sometimes a dozen virgin queens will be found in the hive, but under circumstances which are abnormal. (See *Laying Workers*.) No laying queens can be in-

roduced when there are one or more virgins.

It may be stated that a normal colony of bees will not readily accept a strange queen, even though they have no mother of their own, much less will they accept an interloper when there is already a queen in the hive. It may therefore be set down as a rule that has exceptions,\* that it is not safe to liberate any queen, young or old, in a colony that already has one. Likewise, bees that are queenless will not under ordinary conditions accept another, no matter how much they need one, until she has been "introduced". There are exceptions to this also. A colony long queenless will sometimes accept a new mother without caging if there are no laying workers. It follows that, in the process of requeening, the apiarist is compelled to put a new queen in a wire cloth cage and confine her there where the other bees can not attack her, until she has acquired the same colony odor or individual scent as the bees themselves. This takes from three to six days, at the end of which time the queen may be released, when the bees will treat her as their own royal mother. It is not known how bees recognize each other or how they can tell a strange queen from their own, except by the scent factor.

From what has been stated it is natural to conclude that bees distinguish their own queen from a new or strange one by the sense of smell.

It is learned that if two queens have exactly the same colony odor after being caged for three or four days in a queenless hive, either one may be liberated, and the bees will accept one just as readily as the other, according to Mr. Pritchard. If both are liberated, one in one corner of the hive and the other in the opposite corner, both will be tolerated by the bees, but once the queens themselves come together

there is danger of a royal battle\* resulting in the death of one. From this fact it is inferred that the bees will accept at any time one or more queens, provided they have the requisite colony odor; that, further, when two queens have the same colony odor, both will continue to lay eggs in the same hive without interference if they can be kept apart by means of a queen excluder. This condition will be allowed so long as the colony prospers, or until a dearth of honey comes, when the bees show a disposition to rob. They will then destroy one of the queens.

Bees that have been thrown into a box or pan and then shaken or bumped again and again until they are demoralized or frightened, are much more tractable than those not so disturbed. Such bees, if made queenless just prior to shaking, and confined without combs or brood in a cool place for a few hours, will usually accept a queen at once. The factor of colony odor then apparently does not operate, for the bees are put out of their normal condition. (See Live-Bee Demonstration Work at close of Exhibits of Honey.)

Very often for experiment the queens of two colonies may be exchanged. Two hives can be opened during a honey flow, and before either colony can discover it is queenless the queens may often be exchanged. But when this exchange is made the precaution must be taken to open the hives very quietly, using but very little smoke. The idea seems to be to disturb the colony as little as possible so that its normal condition may continue. Not suspecting any change in queens, the bees are not looking for any, and allow the new mother to go on where the previous queen left off. On the other hand, if either colony is queenless long enough so that it sets up a loud buzzing or a cry of distress, it will be quite sure to ball any queen that may be given it.

Young bees just emerged will at any time accept any queen. When one desires to introduce a valuable

\*If, on returning from a mating trip, a virgin queen enters a hive by mistake where there is an old laying queen, she may and very often does supplant the old one. The virgin is young and vigorous and more than a match for the old queen full of eggs. Even though the colony odor may be lacking, the bees in this case will often accept the supplanter.

\*We say "danger" of a battle. Queens will not always fight when so put together. The relative ages of the queens make a great difference. If one queen is an old one there probably will be no fight, and even if there is, the young queen will be more than a match for the old one.

breeder on which he desires to take no chances whatsoever, he should always release her on a frame of very young or emerging bees.

If a colony has not been queenless too long it will usually accept young queens just emerged, without the process of introducing or even of caging, but when a queen becomes four or five days old she is much more difficult to introduce than a normal laying queen.

When a little honey is coming in it is much easier to introduce and unite bees than during a dearth.

A queen in the height of her egg laying will be accepted far more readily than one that has been deprived of egg laying, as in the case of one that has been four or five days in the mails.

It is easier to introduce toward night, or after dark, than during the day. The reason for this is that after dark the excitement of the day has subsided. There is no chance for robbing and no reason for vigil. In short, bees are not expecting trouble and are not inclined to make any.

A fasting queen, or rather a queen that is hungry, will usually ask for food, and hence will generally be treated more considerately than one that shows fear.

The cages that are sent through the mails are supplied with the soft bee candy (see Candy) so that in case the bees do not feed the queen she will not starve. In some cages the bees release the queen by eating away the candy and letting her out. Other cages are so constructed that the bees outside the cage must tunnel under the cage by tearing away the comb, in order to release her. In still other cases the apiarist himself liberates her after she has been confined the requisite length of time or until such time as she has acquired the colony odor.

Most of the cages are sent out by queen breeders with directions for performing this operation, and it is usually safer for the beginner to follow these directions implicitly.

#### Mailing and Introducing Cage

The mailing and introducing cage called the Benton, that has been used over the country, is shown in the accompanying illustration. It consists of an oblong block of wood with three holes bored nearly

through, one of the end holes being filled with soft candy and the other two left for occupancy by the bees and queen. On the back of the cover are printed full directions for introducing, and at each end of the

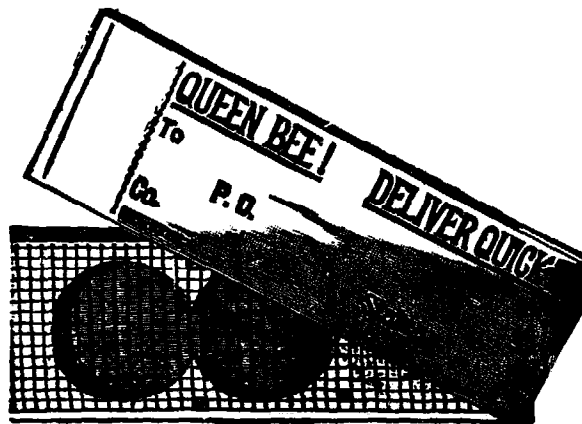

Benton mailing cage. Postage on this cage is 2 cents. A larger size for longer distances requires 4 cents.

cage is a small hole bored through lengthwise of the grain of the wood. One hole, next to the bees, is covered with a piece of perforated metal, secured in place with two small wire nails driven through the perforations. The other hole, the candy end, is covered with a piece of cardboard slightly narrower than the hole. In this way the bees have an opportunity to taste the candy at the edges, and finally pull away the cardboard entirely.

Oftentimes, after the cage has been through the mails, and been on the journey for several days, the bees in the cage will have consumed two-thirds or three-fourths of the candy. If those in the hive to which the queen is to be introduced gain direct access to the candy they will eat what little there is of it in five or six hours, liberate the queen, and probably kill her. In order to accomplish introduction safely the cage should be on the frames where the bees can get acquainted with the queen for at least 72 hours, and longer whenever practicable. As it takes generally from 48 to 72 hours for the bees to gnaw away the cardboard before they can get at the candy, and from 12 to 24 hours to eat out the candy, at least 72 hours are assured before the bees can release the queen. Generally the time is longer—all the way from 72 to 144 hours.

The cardboard has another ad-

vantage. It makes the introduction entirely automatic. The one who receives the queen pries off the cover protecting the wire cloth, and then by the directions he reads on the reverse side of this cover he learns that all he has to do is to lay the cage wire cloth down over the space between two brood frames of the queenless colony, and the bees do the rest. It is not even necessary for him to open the hive to release the queen. Indeed, he should let the colony alone for four or five days, as opening the hive disturbs and annoys the bees to such an extent that often they will ball the queen, seeming to lay at her door what must be to them a great disturbance in having their home torn to pieces.

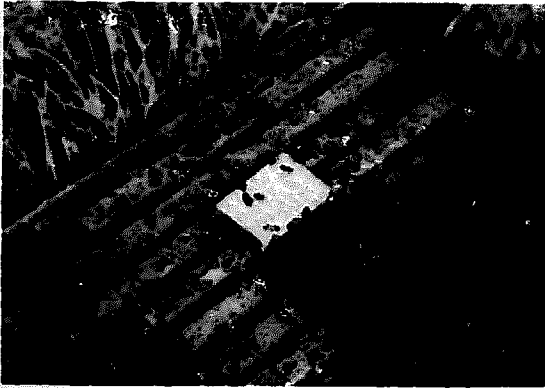

Queens are sent in mailing cages like that shown above. The top is covered with wire cloth. To introduce, the cage containing the queen is laid wire cloth side down over a space between the frames as here shown. The bees can see and feed her and when they accept her by gnawing away the cardboard and the candy beneath in the end of the cage she has acquired the colony odor. The process of introducing is automatic, but it is important to follow the directions sent out with the cage, or the bees may kill the queen.

There are some who object to the use of the cardboard on the ground that the bees may gnaw it away too soon and release the queen before the bees will treat her kindly. These objectors tack a piece of tin over the candy. At the end of three or four days the tin is removed or revolved to one side, exposing the candy. As soon as the bees eat through, the queen is released. The use of the piece of tin makes sure that the queen will be confined long enough for the bees to get well acquainted with her before they get to her. Some colonies will not accept a queen unless she has been confined five or six days. This is

more true during a dearth of honey.

The manner of filling a cage with bees and queen for mailing is to pick up the cage with one hand in such a way that the forefinger covers the hole over which the perforated metal has been nailed, but which, before the time of filling, should be revolved around to one side or taken off entirely. The queen is first to be picked up by the wings and her head pushed into the hole as far as possible. After she runs in, the forefinger is placed over the hole. Worker bees are next picked up in like manner and poked in, selecting bees that are not too young nor too old, preferably those that are filling with honey from open cells. For the small cage there should be about a dozen attendants. If the cage is larger, two dozen may be used, and if it is extra large, four or five dozen. When cages are mailed during cold weather there should be more bees put in to help keep up the animal heat.

There are several sizes of these Benton cages, the larger ones being used for longer distances. The one for export is good for 1000 miles through the mails, although very often used for twice that distance.

Considerable variation is not uncommon in the construction of queen mailing cages. Small corks are now used nearly to the exclusion of the small metal covers over the holes in the ends of the cages. Before introducing the queen it is usually recommended that the accompanying worker bees (which, incidentally, are not included in the queen's cage shipped with packages) be removed. To do so pry out the cork closing the end opposite the one containing the candy. Using the forefinger as a stopper allow the workers to escape while keeping the queen confined in the cage. With a little practice this is easier than it may first appear. Just to be certain that the queen does not fly away, should she be accidentally released, do this inside the truck cab, in an auto or in a closed room. The queen can then be picked off the window if she escapes and returned to an empty cage. Blowing through the wire screen will stir up activity among sluggish bees, speeding up the movement during the release of the workers.



Irrespective of the type of shipping cage used, the basic method of placing the shipping-introducing cage in the hive entails placing the cage where the queenless colony will care for her until she is released. Before placing the caged queen in the hive remove the cork from the candy end and punch a hole through the candy with a nail. The hole should be slightly smaller than that which would allow a worker bee to pass through. The best position for the cage is wire side down, over the tops of the frames or insert the cage between the middle frames, candy end down, making sure that the bees can reach the screened side. If the cage is placed on top of the frames the inner cover will need to be reversed from the normal summer position to allow sufficient space underneath for the cage.

Do not disturb the colony for several days.

At the first check remove the empty cage if the queen has been released. If the queen is still in the cage it is always wise to check the colony again against the possibility of it having another queen somewhere in the hive, otherwise release the queen from the cage. This always involves a certain amount of risk and if the queen seems to attract numbers of agitated worker bees she may be in danger of being balled and killed if she is released. Sometimes a dead queen is found in the cage where she had been killed by bees of the hive who have forced their way into the cage. This is usually the result of already having a queen in the hive, an advanced queen cell from which the colony is determined to hatch a new queen, or, possibly as a result of having laying workers.

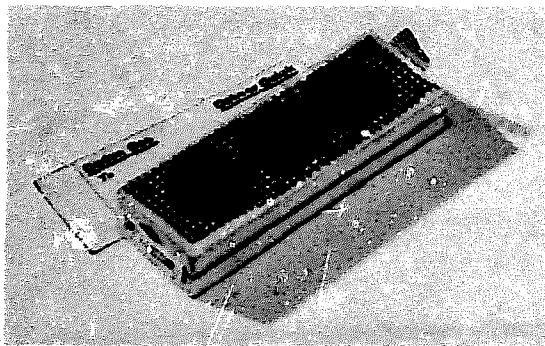

The most popular type of queen cage in use at the present. Some queen breeders are replacing the perforated metal closure shown at the far end of the cage with a small cork.

### The Rothamsted Cage

The Rothamsted cage was designed to facilitate bodily contact between the caged queen and the workers; it is not enough for the workers to get used to the smell of the queen. Free and Butler (1958) pointed out that "it is necessary for the workers outside the cage to be able to feed the queen while she is inside it, and it is also desirable that they should be able to lick the queen substance from her body. The ability of bees to feed one another through wire-gauze depends upon the size of the apertures; these need to be considerably larger than the cross section of the bee's tongue, since feeding will only take place if antennal contact is possible. It is concluded from the experimental results presented that apertures of not less than 2.5 mm (7/64") are desirable in wire-gauze used for queen cages."

Butler and Simpson (1956) made the following suggestions about the cage and its use:

1. The cage should be constructed to enable the workers of the recipient colony to contact the queen and obtain queen substance from her, thus inhibiting the changes that take place in a queenless colony, or in one where the bees have no access to the queen.

2. No attendants should be introduced with the queen, since the presence of strange workers is sometimes sufficient to alert the members of the colony, and this might make successful queen introduction difficult.

3. If no food is given in the cage, the queen is compelled to solicit food from the workers in the colony. She will thus receive food having the same odor as that circulating in the colony, and the bees will be able to take queen substance from the queen's body.

4. Queens are likely to be released after a few hours (in 17 observations release occurred between one and six hours); any alertness caused by the beekeeper's interference should then have died down.

What the Rothamsted experiments brought out was that the mesh be as large as possible. Milne established that the largest apertures that would prevent worker bees passing through are: round, 3.6 mm diameter; square,

3.2 mm across; slots, 2.8 mm wide (9, 8, 7, 64ths of an inch respectively). The size of the cage is not important, but a narrow rectangular box is easy to construct and can be wedged between the frame without disturbing the colony. Convenient measurements are 1.3 x 2 x 9 cm ( $\frac{1}{2}$  x  $\frac{3}{4}$  x  $3\frac{1}{2}$  inches).

Since no comparison was made with other methods of doing the same thing, the experiments provide no direct evidence that the Rothmsted cage and its method of use are better than others, although there are theoretical reasons for supposing that this is so. Moreover, the cage and method did not overcome the difficulties of more hazardous introductions—in particular of a virgin queen to a colony from which a laying queen had been removed, or of a laying queen to a colony that has had occupied queen cells or has been queenless for even a short period before the introduction. Conditions under which queen introduction is difficult are by now largely known, but they are still not entirely understood.

#### LITERATURE CITED

Butler, C. G. & Simpson, J. (1956) The introduction of virgin and mated queens, directly and in a simple cage. *Bee World* 37 (6):105-114, 124.

FREE, J.B. & Butler, C. G. (1956) The size of apertures through which worker honeybees will feed one another. *Bee World* 39 (2): 40-42.

#### Direct Method of Introduction

When it is desired to introduce a queen from a nucleus to a queenless colony, both in the same yard, the operation can usually be performed with safety and with very little labor as follows: Lift out two frames from the nucleus, bees and all, with the queen in between. Put these down in the center of the queenless colony. Close up the hive for at least five days. The bees that have been queenless and broodless are crying for a mother. When she is given to them with a large force of her own subjects, she seems to be protected.

This method may also be used when introducing a queen to a colony that has had an old queen about to be superseded. Be sure, however, that the old queen is removed from the colony before giving the new queen with frames of brood and bees. When this direct method of introduction is used in replacing a young undesirable hybrid queen,

the manipulation should be performed during a honey flow, preferably during the middle of the day when a large percentage of the bees are in the fields.

The main reason why this direct method of introduction meets with success is that the queen is in the midst of her egg laying and is more likely to be accepted than a queen that is shriveled up after having been kept in a mailing cage for a number of days.

#### The "Push-In" Cage

A method of introduction quite popular with commercial beekeepers because of its high percentage of acceptance is the "push-in" cage method. There are many variations on this, but probably the most popular is a cage that is made of eight wires per inch wire cloth. The cage measures approximately 3 x 4". The sides are just 1" flaps bent down. Some have an opening in the end just large enough to admit

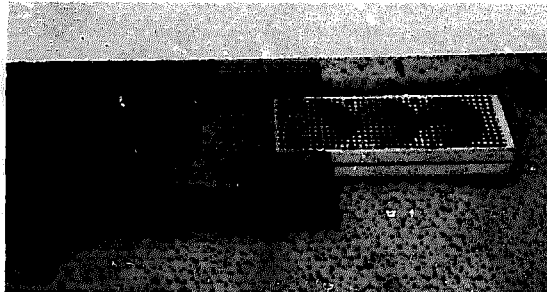

Wire cloth "push-in" cage.

the queen mailing cage. All of the attendant workers are removed from the mailing cage leaving just the queen. The "Push-In" cage is then pressed into a comb with emerging brood at a point in which it will be next to sealed honey. It should be pushed in deeply enough that the bees will not be able to tunnel under. The cork is then removed from



Cardboard "push-in" cage with "gnaw-out" holes.

the mailing cage and it is inserted into the end of the "Push-In" cage. The queen will be fed by the adult bees on the outside through the wire screen. Emerging brood will mingle with the queen and in most cases the queen will even begin to lay on the small patch of brood comb. In a few days when the "Push-In" cage is removed the queen is readily accepted.

Another type of "Push-In" cage that is commercially offered for sale is made by the Stollers of cardboard with a small piece of wire screen at one end. The cage is self-releasing. It has two  $\frac{1}{8}$ " holes on either side which the bees gnaw open to release the queen. Eventually the bees will chew the entire cage out saving you the work of removing it.

#### **How Soon Will an Introduced Queen Begin to Lay?**

She may be expected to begin laying within two days, but sometimes, if the queen has been prevented from laying for a long time, as in the case of an imported queen, she may not lay for three or four days, or even a week. If introduced in the fall, she may not commence laying until early spring unless the colony is fed regularly every day for a week or more. This will usually start a good queen if the weather is warm enough.

#### **How To Determine Whether or Not a Colony is Queenless**

The very first thing to be settled before an attempt to introduce is made is to determine that the colony is certainly queenless. The fact that there are no eggs or larvae in the hive, and that the queen can not be found, is not sufficient evidence that she is absent, although such a condition points that way. But during the earlier part of the summer there should be either brood or eggs of some kind if a queen is present, clear up until the latter part of summer. In the fall in the northern states, or after the main honey flow is over, old queens usually stop laying and shrivel up in size so that a beginner might conclude that the colony is queenless and therefore he must buy a queen. In attempting to introduce a new queen he of course meets with failure as she is stung to death in all probability, and carried out at the hive entrance. If eggs or larvae can not be found at any season of

the year when other stocks are breeding, and the supposedly queenless colony builds cells on a frame of unsealed larvae given them, it may be concluded that the colony is queenless and it is then safe to introduce a new queen. But when eggs, larvae, and sealed worker brood are found, the presence of queen cells simply indicates that the bees are either preparing to supersede their queen or are making ready to swarm. (See Swarming, subhead Symptoms of Swarming.)

The statement was made that old queens would stop laying in the fall if no honey was coming in. It should be noted that young queens will lay, flow or no flow, if there are sufficient bees and stores.

#### **How Long Shall a Colony Be Queenless Before Attempting to Introduce?**

The sooner a queen can be introduced to a colony after the old queen is destroyed, the better. One who supposes that a colony should be queenless one or more days before caging a new queen to be introduced is making a mistake. To dequeen and then send for another, expecting her to arrive at the right time is taking a long chance. If the new queen does not arrive within a week or ten days the probabilities are that the new queen will be killed by the bees when released. If queen cells are well under way the bees are quite inclined to want to do their own raising from the cells rather than take another queen. If one of the cells casts a virgin there is no hope that the queen will be accepted.

In the same way, if a colony is queenless long enough that laying workers begin their scattered egg laying, the new queen will be sure to be killed. (See Laying Workers.)

The author strongly urges that the old queen should not be destroyed until the new one arrives. At the very time the old queen is killed the new one should be put into the hive. The directions for introducing should be carefully followed.

#### **What to do if Bees Ball the Queen**

Very often when the bees decide they will not accept the queen let loose among them they will begin to pull at her, piling on her in such numbers that they form a ball around her. Every bee in the ball

will seem intent on pulling her limb from limb. Unless the owner comes to her rescue she may be stung to death or be suffocated.

When queens were introduced in the old-fashioned way—that is, before cages were constructed so as to release queens automatically—much trouble was encountered by bees balling queens. If they were not ready to accept her when she was released by the apiarist, they were pretty sure to ball her. Right here is a point that it is well to observe: When the bees let out the queen they very rarely ball her. But when it is necessary for the apiarist to perform the work of opening the hive and making a general disturbance, there is danger of balling. Suppose she is balled. The ball should be lifted out of the hive and smoke blown on it until the bees come off one by one, but hot smoke must not be blown on the queen. When the queen is found, get hold of her wings and pull the rest of the bees off her by their wings. Cage her again as at first, and give her another trial. The advice has been given to drop the queen, when she is balled, into a vessel of lukewarm water. The angry bees will immediately desert the queen, when she can easily be taken out of the water and recaged.

Another way of saving the queen, without having to recage her is to carry a small oil can with a spring bottom, such as is used on a sewing machine, filled with thin syrup. When the bees are found balling her, saturate the ball thoroughly by pressing hard on the bottom of the can, causing the syrup to penetrate the ball. Close the hive and the bees will turn their attention to cleaning themselves and the queen, when she will be accepted without further trouble.

#### When the Queen Flies Away

Sometimes a beginner is very nervous and by a few bungling motions may manage to let the queen escape from the hive where he expects to introduce her. Or this may happen: The queen may become a little alarmed because there are no bees about her, take wing direct from the comb, and fly. In either case, one should step back immediately after opening the hive, and in 15 or 20 minutes she will probably return to the same spot and enter the hive. If she is not discov-

ered in the hive within about a half-hour, she may be found in one of the other hives near by. If a ball of bees is found somewhere down among the frames, it may be surmised that here is the queen that flew away, and that she has made a mistake and entered the wrong hive.

#### Introducing Virgin Queens

As previously explained, a young virgin just emerged, generally weak, can usually be let loose in a queenless colony without caging and be favorably received. But one from two to six days old is, as a rule, much more difficult to introduce than a laying queen. One ten days old, more than old enough to be fertilized, is most difficult. Such queens can be introduced to a young strong colony by using the Chantry plan. It is advisable to give a cell or a virgin just hatched, thus saving time and vexation, for even should the old virgin be accepted, she may be deprived of a leg or be so deformed from rough treatment as to become in a large measure impaired for usefulness.

#### Caution

When the bees cling closely to the wire cloth of the cage in which the queen is confined, and resist brushing away, it may be concluded that she will be balled immediately upon release, even though she may have been in the hive for three or four days. Queens never should be released in any case until after the bees have stopped clinging to the wire cloth, especially if they are closely crowded. If the bees cluster closely on the wire cloth after six days, it may be assumed that there is something in the hive that they recognize as a queen. It may be laying workers. If so, the case is hopeless. It may be a small virgin that has eluded the eyes of the beekeeper. In that case give a frame of unsealed brood. If no cells are built it may be assumed that a queen of some sort is in the hive and that any attempt to introduce an alien queen will meet with failure. When the tight clustering has ceased the queen can be let loose. It is the author's opinion, however, that when the queen can be released automatically by the candy plan she has a much better chance of being accepted.

**INVERTASE.** — See Honey. Enzymes in; and Nectar.

**INVERT SUGAR.\*** — Chemically considered, this is a mixture of equal parts of the two sugars, dextrose and levulose, coming from the inversion or breaking down of sucrose. In common terms, sucrose is the ordinary white sugar of commerce, such as beet sugar or cane sugar. This breaking down of sucrose occurs when it is dissolved in water and boiled. The action then is very slow, but by the addition of a very small percentage of any acid the action is made more rapid. Hence, in the commercial preparation of this product white sugar is dissolved in water, then tartaric, acetic, phosphoric, or hydrochloric (muriatic) acid is added and the whole boiled. Of the two sugars of invert sugar, dextrose is easily crystallizable, while levulose remains a liquid under most conditions, but on long standing and under concentration the dextrose will crystallize out. As regards sweetness, dextrose is not so sweet as sucrose, while levulose is much sweeter. Hence invert sugar is generally said to be sweeter than sucrose.

The preparation of invert sugar from sucrose by using water and tartaric acid was patented a number of years ago by Herzfeld in Germany. The proportion he used is approximately as follows: cane sugar, 25 pounds; tartaric acid,  $\frac{1}{2}$  ounce (avoirdupois); water, 1 gallon. Bring to a boil and keep at that temperature for  $\frac{1}{2}$  to  $\frac{3}{4}$  hour.

When prepared as above the product is liable to be yellow or brown in color, but it is perfectly possible by concentrating in vacuum or under reduced pressure to produce an invert sugar water-white.

During the preparation of this sugar a small amount of the levulose is broken down into furfural or methylfurfural. This product even in very small quantities gives strong color reactions with some reagents as resorcin — aniline acetate which forms a partial test for invert sugar.

Attempts have been made to make invert sugar which would not give these color reactions, but on a commercial scale they have not been altogether successful. The enzyme invertase (from yeast) will break down sucrose into dextrose and levulose without the formation

of these furfural bodies, but on concentration these bodies are formed. Other ways have been tried. It is true, though, that invert sugar can be made commercially that gives only slight color reactions, and improvements in manufacture of late years have yielded a product which has very much less of these furfural bodies present, but the chemist does not need these color reactions altogether to prove the presence of commercial invert sugar in honey.

Commercial invert sugar is generally put on the market as a water-white liquid or in granular form called drivert. The liquid form is anywhere from 50 percent to 75 percent invert sugar, from 1.5 percent to 30 percent of sucrose, and from 18 percent to 30 percent of water. If a mineral acid as phosphoric, muriatic, or sulfuric is used for the inversion, this is generally partially neutralized with soda, and hence the product will have from 0.5 percent to 3.08 percent of ash. Where acetic acid or phosphoric acid unneutralized is used, or where tartaric acid is used, there is practically no ash unless the sucrose carried some. (For the detection of commercial invert sugar, see Honey, Adulteration of.)

**ITALIAN BEES.** — See Races of Bees.

**ITALIANIZING.**—The original intent of the term "Italianizing" as used in beekeeping was to characterize the process of changing a colony of black or Dutch bees to the Italian race by the introduction of a mated Italian queen. This change over involved de-queening by removing the original queen and replacing her with one of the Italian race.

In recent years the introduction of the sub-species *A.m. adansonni* to South America and its rapid spread spurred considerable Italianizing among the so-called Brazilian bees. By introducing pure Italian queens to the colonies which exhibited the undesirable trait of over-aggressiveness of the Brazilian bee considerable behavioral modification was achieved.

The queens of all other colonies can be found without much diffi-

\*By Dr. C. A. Browne, former head of the Bureau of Chemistry.

culty as explained under Manipulation of Colonies, subhead How to Find the Queen. The only two races that are outstanding in desirable qualities are the Italians, leather-colored strain, and the mountain-bred Caucasians. It is generally agreed that they are the gentlest of all bees. (See Caucasians, under Races of Bees.)

Until recent years, Italians have

held the supremacy in being the most desirable race. The fact that they are used universally throughout the country is significant. Though not quite as gentle as mountain-bred Caucasians, they can be handled if directions are carefully followed. (See Anger of Bees; Manipulation of Colonies; Stings, subhead How to Avoid Being Stung.)

## L

**LABELING HONEY\*.**—The following information must appear on labels on bulk honey in drums, gallons and larger container sizes and on consumer-size packages of four pounds or under, or under one gallon.

1. The common or usual name of the food, in this case HONEY, must appear on the principal display panel, directly on the drum, other containers or on a label affixed to the jar or other container.

2. The size of type shall be reasonably related to the more prominent printed matter on the label.

3. The name HONEY shall be on a line generally parallel to the base on which the container rests.

4. The name and address of the producer, packer or distributor. If distributor, the name must be qualified by a phrase such as "Packed for", "Distributed by", before the name or "Distributor" following the name.

The street address of producer, packer or distributor is not necessary if the place of business is shown in a current city or telephone directory.

The zip code must appear on the address.

Where the producer or packer packs honey in places other than its principal place of business it may use the address of its principal place of business in lieu of the actual place of packing or distributing.

5. The declaration of net quantity of contents shall be in terms of weight (avoirdupois pound) unless there is a

firmly established general trade custom of declaring the contents of honey by fluid measure in which case fluid measure may be used. The statement of contents shall appear on the principal display panel (which will be the label).

6. An ingredient statement is not required if the product is solely honey. If the product is a mixture or blend of honey with any other substance or substances the ingredients must be listed by common or usual names, in order of decreasing predominance. This ingredient statement may appear on any appropriate part of the label but the entire statement must appear on a single panel of the label.

### Bulk Honey Labeling Only

The following labeling requirements apply to bulk honey in drums, gallons or larger container sizes.

1. Exemptions from labeling requirements apply on shipments of bulk honey in interstate commerce if (and only if) either of the two conditions exist:

- a. The shipper is the operator of the establishment where the honey is to be processed, labeled or repacked: or
- b. In case the shipper is not such operator, such shipment or delivery is made to such establishment under a written agreement, signed by and containing the Post Office address of the shipper and such operator and containing such specifications for the processing, labeling or repacking, as the case may be, of said honey in such establishment as will insure, if such specifica-

\*From "Synopsis of Label Requirements for Labeling Honey" by Robert M. Rubenstein, Counsel, Honey Industry Council, *Gleanings in Bee Culture*. Vol. 105 No. 6 260-261.

tions are followed, that such food will not be adulterated or misbranded upon completion of such processing, labeling or repacking. Both shipper and operator must each keep a copy of such arrangement for 2 years after the final shipment of the honey from such establishment. Also must allow FDA inspectors to examine these copies.

2. Illegal representations on a label is labeling a mixture of honey and another food (e.g. corn syrup) and calling it "honey" even though the other ingredient is listed in an ingredient statement.

Any representation on the label that expressed or implies a geographical origin of the honey unless that representation is a truthful representation of geographical origin, is a trademark, or trade name which has so long and exclusively been used by a packer or distributor of that honey that it is generally understood by the consumer to mean the product of a particular packer or distributor or is so arbitrary or fanciful that it is not generally understood by the consumer to suggest geographical origin.

#### For Consumer Size Packages

The following label requirements apply to consumer size packages of under four pounds or under one gallon.

1. In addition to the information in paragraph 5 under bulk honey beginning with "The declaration of net quantity," etc., the following additional information applies to consumer-size packages. The term "principal display panel" means the part of the label that is most likely to be displayed, or examined under customary conditions of display for retail sales.

(a) To determine the proper type size to be used in declaring the quantity of contents, the term "area of the principal display panel" must be taken into consideration. In the case of a cylindrical or nearly cylindrical jar, the area is considered to be 40% of the height of the jar times its circumference: exclude shoulders and necks of bottles or jars.

(b) The declaration of net quantity of contents must be placed on the principal display panel within the bottom 30% of the area of the label panel, in lines generally parallel to the base of the

package. The contents declaration shall be separated from other printed label information appearing above or below the declaration by a space equal to at least the height of the lettering used in the declaration and by a space equal to twice the width of the letter "N" of the style of type used in the quantity of contents statement, from other printed label information appearing to the left or right of the declaration.

On packages having a principal display panel of 5 square inches or less, the requirement for placement within the bottom 30% of the area of the label panel shall not apply, when the declaration of the net quantity of contents meets the other requirements outlined herein.

(c) The declaration of contents must be not less than  $\frac{1}{16}$ th inch in height on jars or bottles where the principal display panel has an area of five square inches or less. not less than  $\frac{1}{8}$ th inch in height on jars or bottles having a principal display panel area of more than 5 but not more than 25 square inches; not less than  $\frac{1}{8}$ th inch in height on jars or bottles with a principal display panel of more than 25 but not more than 100 square inches; and not less than  $\frac{1}{4}$  inch in height on jars or bottles having a principal display panel area of more than 100 square inches, and not less than  $\frac{1}{2}$  inch in height, if the area is more than 100 square inches. (Reminder: The size of the label is not synonymous with the size of the principal display panel. The label is usually smaller than the principal display panel).

If the declaration is blown, embossed or molded on a glass or plastic surface rather than by printing, typing or coloring, the lettering sizes above mentioned shall be increased by  $\frac{1}{16}$ th inch.

(d) The declaration of contents must be expressed both in ounces, with identification by weight or by liquid measure, and, if one pound or one pint or more, must be followed in parenthesis by a declaration in pounds for weight units with any remainder in terms of ounces or common or decimal fractions of the pound, (e.g., 1½ lb. weight shall be expressed as "Net wt. 24 oz. (1 lb. 8 oz.)", "Net wt. 24 oz. (1½ lb.)" or "Net wt. 24 oz. (1.5 lb.)" A declaration of less than one pound avoirdupois

weight shall be expressed in ounces only. Abbreviations are permitted for weight (wt.) ounce (oz.) pound (lb.)

(e) The statement shall be in conspicuous and easily legible bold face print or type distance contrast (by topography, layout, color, embossing or molding) to other matter on the label. The letters may be no more than 3 times as high as they are wide.

(f) The statement shall include the words "net weight" or "net wt."

(g) If desired, (but not required), an additional weight statement in terms of the metric system may appear on the principal panel or elsewhere on the container.

(h) On a multi-unit retail package, a statement of the quantity of contents shall appear on the outside of the package and shall include the number of individual units the quantity of each individual unit and in parenthesis, the total quantity of contents of the multi-unit package in terms of avoirdupois ounces.

2. Nutritional Claims - If you make any nutritional claims for your product (but only if you make such claims), your label must carry a declaration of nutrition information under the heading "Nutrition Information Per Serving (Portion)". The terms "Per Serving (Portion)" are optional and may follow or be placed directly below the terms "Nutrition Information".

### LANGSTROTH, LIFE OF\*

Lorenzo Lorraine Langstroth was born in Philadelphia December 25, 1810, and died at Dayton, Ohio, October 6, 1895. He was pastor of the Second Congregational Church in Greenfield, Mass., for a time, but failing health compelled him to resign his pastorate, thus ending forever his cherished plans for a life devoted to the ministry of the gospel of Christ. It also became necessary for him to look about for other means of providing for his family.

Several years earlier, while pastor of old South Church in Andover, Massachusetts, he had taken up beekeeping as an avocation and he now resolved to make it a career.

Beekeeping in Europe was regarded as an intellectual pursuit, and so great was the need which he saw in this field that he hoped his labors might yet be of service to his fellow men. With his wife and two daughters, he removed to Philadelphia where he established a school for young ladies, having decided that for a time at least, he would return to his old profession of teaching. He also established an apiary at his home and another at West Philadelphia where he could carry on his experiments in a more extensive way.

Long years of study at Yale had given him a well-trained scientific mind which now served his purpose well. As his interest grew, he devoted every moment that he possibly could to his beekeeping work; and finally, on the evening of October 30, 1851, as he was driving from his apiary at West Philadelphia to his home in the city, pondering as usual on his problem, the idea of a hanging movable frame with a bee space all around it flashed into his mind, and he said he could scarcely refrain from shouting his "Eureka" in the open street. That night he recorded the whole plan in his private journal, with a drawing of the hive and a statement of what he believed it would do for beekeeping. (See Bee Space, Hives, and Spacing Frames.)

It was then too late to make any use of the hive that season, but the following summer he transferred all his bees to movable frames which he had had made for that purpose, and tested them thoroughly in his own apiary. When he was convinced beyond any doubt that his hive was all that he had hoped it would be, he applied for a patent, which was granted that fall. He then returned to Massachusetts to bring out the hive where he was better known as a beekeeper. He also commenced writing on his book, "Langstroth on the Hive and Honey Bee", the first on this subject ever published in the United States and far in advance of anything ever yet given to the English reader. And when, by means of this book, his hive and its management became known, an industry that had struggled but feebly for more than two thousand years was born again.

\*By Miss Florence Nalle



In 1895, the Langstroth family had removed to Oxford, Ohio, and in obtaining material for the Life of Langstroth and for this sketch, the writer visited Oxford several times to meet and talk with older residents of the village, who had known Langstroth as a beekeeper, a neighbor, and a friend. And truly,

"None knew him but to love him.  
Nor named him but to praise."

I wish it were possible to tell you all that was said of his rare education and scholarly ability; of his familiarity with the classics, both ancient and modern; of the remarkable powers of his mind; of his interest in all worthwhile events of the day; and of the many things in his everyday life that proclaim the real goodness of the man.

One of Rev. Langstroth's intimate

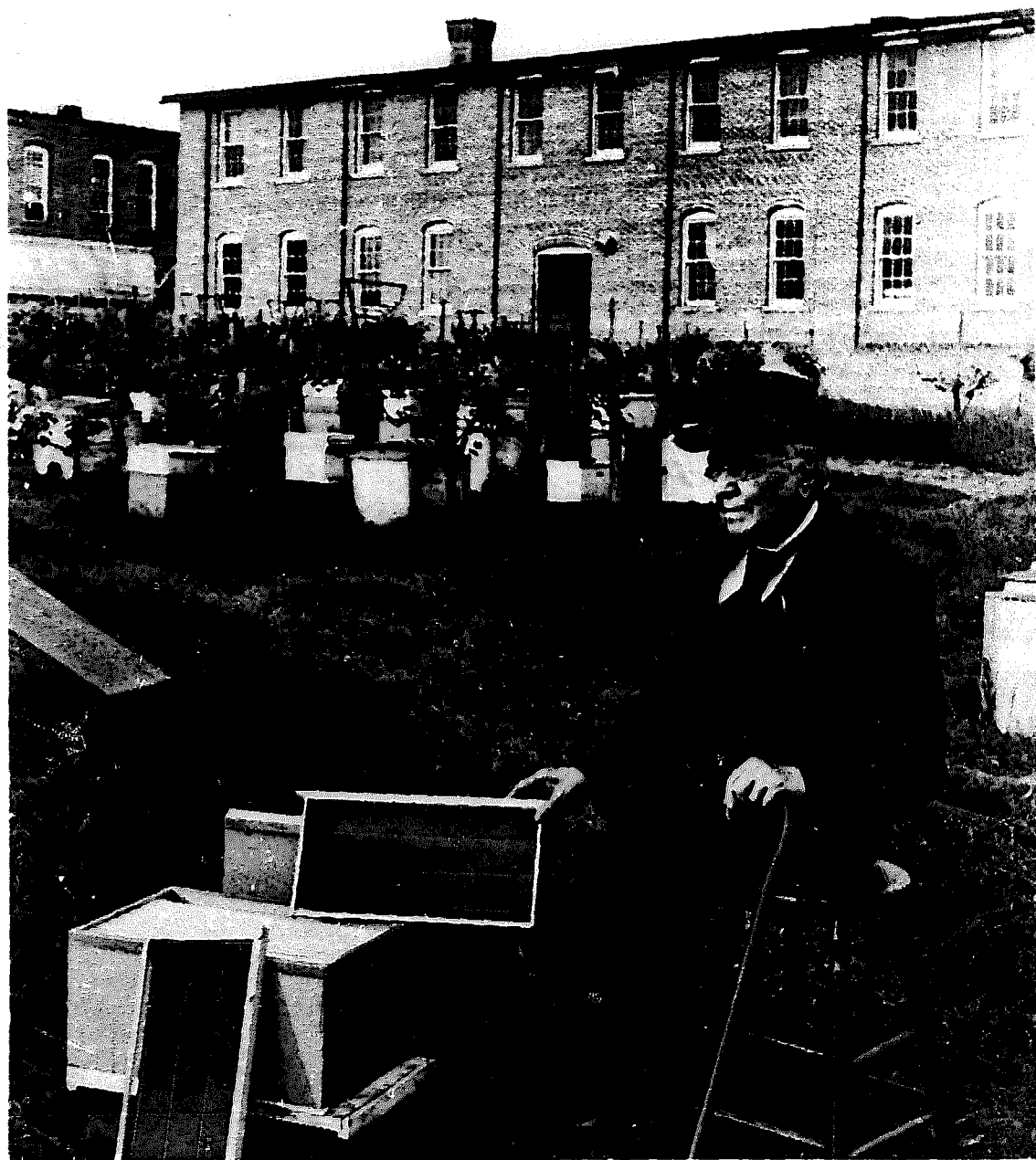

The last visit of the Rev. L. L. Langstroth in 1894, the year before his death. In one of his numerous visits to Medina to see A. I. Root, he was asked to step out in front of one of the buildings in the main apiary, where he could be shown with a modernized Langstroth hive equipped with one of his all-around bee space frames. During the early 90's Langstroth advocated wintering practices that are still considered sound today. It is surprising to see how far ahead Langstroth was of beekeeping practices of his day.

friends in Oxford was the Rev. William McSurely, a retired Presbyterian minister, and from him I learned many things of the life that Langstroth lived among the people there, of his leadership and courage. He was often asked to preach in some one of the churches, and such invitations were to him a source of much pleasure. The church was always well filled when it was known that he was to occupy the pulpit. One Sunday morning he arrived just in time to begin service. He went at once to the pulpit, opened a book which he carried, and began to read aloud; it was the "Battle Hymn of the Republic", lately released, and when he reached these soul-stirring lines

"He has sounded forth the trumpet  
that shall never call retreat;  
He is sifting out the hearts of men  
before His judgment seat;  
Be swift, my soul, to answer Him;  
be jubilant, my feet;  
Our God is marching on!"

every sound in the house was stilled except the well-modulated voice that read on to the end of the poem, in such a way, it was said, that the incident had a profound effect upon the congregation and was fixed indelibly upon their minds.

After the death of President Lincoln, the citizens of Oxford held a mass meeting in the town hall. It was a representative group; working men, doctors, lawyers, professors, all were there, yet no one seemed able to speak. What could they do, if anything, to help in these troublous times now that their great leader was gone? Finally, Langstroth arose and called their attention to this usage in France, "The King is dead; long live the King!" and every face turned hopefully towards the future.

Another fine trait of Langstroth's was his great love for children. This was mentioned to me by every one who knew him, including his grandchildren whom I met later, and which has recently been emphasized by E. R. Root, one of the few persons now living who knew Langstroth personally. Almost every afternoon after school had closed, a group of children might be seen on the Langstroth porch listening to the stories he loved to tell them; he was especially fond of animal stories and these were often con-

tinued from day to day. No child ever missed coming until the story was finished, and as soon as one was over there would be another, so they came again and again to the great delight of Father Langstroth, as he was affectionately called. One day the family had all gone away leaving him alone, which they seldom did; but when they hurried home filled with concern about him, they found him on the porch with a group of children gathered about him listening to the favorite bear story he was telling them.

After the death of Langstroth's wife in 1873, his daughter, Mrs. Anna Langstroth Cowan, and her family lived with him at the old home in Oxford, but in 1887, Mr. Cowan's business called him to Dayton. The dearest spot on earth to Langstroth was a low grassy mound on a gently-sloping hillside in the little cemetery at Oxford half a mile from his home; and every morning that the weather and his health would permit, he walked through the beautiful campus of Western College and down the sunlit road to the place where the wife and mother lay at rest. To leave this hallowed spot and the comfortable home, neither of which he could hope ever to see again, the many friends who had



Langstroth as he looked when he used to visit Medina.

known and loved him for almost thirty years, was one of the saddest events of his life; but he bore it with the same uncomplaining cheerfulness that he had shown so many times before when compelled to give up his cherished hopes and plans.

Langstroth had been asked to preach the communion sermon at the Wayne Avenue Presbyterian Church on Sunday, October 6; he was not feeling as well as usual that morning, but he said that he would preach the sermon as he had promised, and when it was over he would come home and rest. Four generations of the Langstroth family were present at the service. Seeing that Langstroth would not be able to stand while preaching the sermon, the pastor, Mr. Raber, placed a chair for him; he apologized for remaining seated, then said, "It is about the love of God I want to speak to you this morning; what it has meant to me, what it means now, what it will mean—" he paused and wavered. Mr. Raber went to his assistance, and in an instant a grandson was at his side; two physicians were in the congregation and both came forward to offer their services; but he was past all help or need of help; with a wondering look upon his radiant face, he had gone, to realize what the love of God would mean through all eternity.\* The triumphant march was ended.

Out in Woodland Cemetery at Dayton, Ohio, in the southeast section of the city, just north of the University of Dayton campus, a pile of gray granite marks his last long sleep. This monument was the gift of grateful beekeepers throughout the country led by Mr. A. I. Root and Mr. Charles Dadant.

His work is finished, but as long as the holy earth endures with its wealth of seedtime and harvest, and in its bounty sustains the human race, the name of Langstroth deserves to be honored, not by his followers in apiculture alone, but by all who love the quiet ways of nature and of men.

The industry for which he builded so largely will continue to grow and prosper, as long as its people are governed by a steadfast purpose to discover and hold to that which is

\*This account of Langstroth's death was written me by one of his grandsons, Mr. A. H. Cowan of Erie, Pennsylvania.—M. F. N.

good. The pathway may not always be clear nor the outlook bright; but his hopefulness will be an inspiration; his tireless energy will be a source of strength; his faith will be a beacon-fire. He will be honored for his valuable contribution to science; he will be loved for the noble qualities of mind and soul which shed their gracious influence upon all with whom he had contact; and greater even than these will be reverence for the Christian character that led him ever onward and upward, unto the journey's end. He died as he had lived, active in the work to which the providence of God called to him, to occupy till He come.

#### Langstroth Home Dedicated\*

The dedication of Rev. Langstroth's Ohio home marked an important milestone in the history of beekeeping. On that rainy Sunday, about a hundred people assembled at Miami University, Oxford, Ohio, to honor the memory of one of apiculture's great leaders.

The September 26, 1976, commemorative services began appropriately in Kumler Chapel with a church service conducted by the Rev. Paul Varner, Chaplain of the Ohio State Beekeeping Association. Mr. Samuel Moellman gave the welcome and the Talawanda High School Choir sang the anthems. The man being honored was the Rev. L. L. Langstroth, born on December 25, 1810, and who died on October 6, 1895. He was a minister of the gospel and an early graduate of Yale University.

A childhood interest in nature developed into a consuming adult study of honeybees a study which resulted in Langstroth's recognition of bee-space as fundamental in beehive construction. Today, beehive manufacturers throughout the world design their equipment with bee space in mind.

The depth of Langstroth's understanding of honeybee behavior is obtained by a perusal of his journal, which gives the detailed account of his observations. At present, this journal is being transcribed so as to make it widely available to students of apiculture. Many of these observations are recorded in his *Langstroth on the Hive*

\*By W. A. Stephen.



Dedication of the Langstroth home on the Miami University Campus at Oxford, Ohio, September 26, 1976. This event was the finish of a successful struggle to preserve the Langstroth home.



A cast bronze plaque was placed on the home on which Langstroth resided for 30 years. Trees were planted and a brass representation of his hive was installed on the grounds.

**and the Honey Bee — A Beekeeper's Manual**, published in 1853 by Hopkins, Bridgman & Co., Northampton, Mass.

In the afternoon, following the commemorative service, Dr. B. A. Hefner extended a welcome to an indoor program of slides shown by Mr. Gordon Rudloff, Ohio State Bee Inspector, and music by the Miami University Brass Choir. Dr. Richard Taylor, Professor of Philosophy, University of Rochester, New York, presented a scholarly address on "Langstroth and the Quest for Happiness".

The rain having subsided, the outside ceremonies were conducted on schedule. On the steps of the house which was home to Langstroth for almost 30 years, Dr. Walter Havighurst, Professor Emeritus of English, Miami University, recalled some of Oxford history during the life of Langstroth, and presided at the unveiling of the cast bronze plaque which marked the Langstroth "cottage" as a place of national historic interest. The crowd then turned to the lawn area where three memorial basswood trees will be planted. In line with these, is a brass modernistic representation of a Langstroth ten-frame hive. It was designed by Mr. Robert Gaston, and on it is recorded a verse of a poem familiar to Langstroth:

"Like leaves on trees,  
the race of bees is found,  
Now green in youth,  
now withering on the ground;  
Another race the Spring  
or Fall supplies,  
They drop successive,  
and successive rise." — Evans

Pretty honey queens and princesses graced the meeting and assisted in the unveiling of the plaque and commemorative sculpture.

After a century, the beekeeping industry, through incentive supplied by local interested groups, headed by Professor Crossan Hays Curry of Miami University faculty, has secured the preservation of the Langstroth Cottage. It will serve as a reminder to future generations that one life dedicated to the study of the honeybee in its adaptation to the needs of man revolutionized beekeeping. Now, the home and grounds of "Father" Langstroth, "the bee man of Oxford", will be preserved as a memorial to "the Father of Ameri-

can Beekeeping," whose influence is now felt throughout the world.

**LARVAE.** — Brood while in the worm state. See Brood and Brood-rearing, and Breeding Stock.

**LARVAL FOOD.**—See Royal Jelly.

**LAUREL.**—See Poisonous Honey.

**LAWS RELATING TO BEES.\***—The law laid down by Blackstone and other law writers of his time and of times prior is briefly:

That bees are wild by nature; therefore though they swarm upon your tree they are not yours until you have hived them, any more than the birds that have their nests in your trees or the rabbits that run wild through your fields. But when they have been hived by you they are your property the same as any other wild animal that you may have reduced to possession. Animals that are wild by nature and have been captured by you, should they escape, you still have a right in if you follow them with the idea of recovery. A swarm of bees that has left your hive continues to be yours so long as you can keep them in sight and under probability of recovery; 2 Blackstone Com. 392; Coopers Justinian Inst. Lib. 2, tit. 1, No. 14; Wood's Civil Law, bk. 2, chap. 3, p. 103; Domat's Civil Law, vol. 1, bk. 3, pt. 1, Subd. 7, No. 2133; Puffendorf's Law of Nature, 4, chap. 6, No. 5; Code Napoleon No. 524; Bracton's Law, 2, chap. 1, No. 3; and see notes in 40 L. R. A. 687; 62 L. R. A. 133.

During the early development of our eastern states the general principle of law relative to ownership of bees was adjudicated in a number of cases. The questions raised and the decisions rendered are briefly as follows: Where bees have escaped and so properly may be considered as wild bees and without any owner at the time of their discovery it has been held that such bees in a tree belong to the owner of the soil where the tree stands. *Merrils vs. Goodwin*, 1 Root 209; *Ferguson vs. Miller*, 1 Cow. 243; 13 Am. Dec. 519; *Goff vs. Kilts*, 15 Wend. 550.

That bees are *ferae naturae*, that is, wild by nature, but when hived and reclaimed may be subject of

\*By Judge Leslie Burr.

ownership. *State vs. Murphy*, 8 Blackf. 498; *Gillett vs. Mason*, 7 Johns. 16; *Rexroth vs. Coon*, 15 R. I. 35; 23 Atl. 37.

But the finding of a swarm of bees in a tree on the land of another, marking the tree and notifying the owner of the land does not give the finder such property in the honey as will entitle him to maintain trover for the honey. *Fisher vs. Steward*, Smith 69.

Where one discovers wild bees in a tree, and obtains license from the owner of the land to take possession of them, and marks the tree with his initials, he gains no property in them until he takes them into his possession. *Gillett vs. Mason*, and *Ferguson vs. Miller*, supra.

Where bees take up their abode in a tree, they belong to the owner of the soil even though they are reclaimed but if they have been reclaimed and their owner is able to identify them as in a case where he followed the bees and saw them enter the tree, they do not belong to the owner of the soil, but to him who had former possession, although he cannot enter upon the land of the owner of the tree and retake them without subjecting himself to an action for trespass. *Goff vs. Kilts*, 15 Wend. 550.

In a case decided in 1898 and entitled *State of Iowa vs. Victor Repp*, 104 Iowa, 305, 40, L. R. A. 687, it was held that the mere finding of bees in a tree on the land of another did not give the finder any title to the bees or to the tree. The facts were, one Stevens who found the bees trespassed on the land and hived the bees in a gum belonging to another. The defendant Repp removed the bees from where they had been hived and was for that act arrested and tried for larceny, Stevens, the man who hived the bees, being the complaining witness. The trial court convicted Repp, and the case was appealed to the Iowa Supreme Court. The court reversed the trial court and in rendering the decision, Justice Ladd said: "The title to a thing *ferae naturae*, can not be created by the act of one who was at the moment a trespasser, and Stevens obtained no interest in the bees by the mere wrongful transfer of the bees from the tree to the gum. Having neither title nor possession he had no interest then in the sub-

ject of the larceny. As the information alleged ownership in Stevens, and the case was tried on that theory, we need make no inquiry as to any taking from Cody (the owner of the land)."

#### Bees Not a Nuisance

The liability of a beekeeper for any injury done by the bees to another person or the property of another rests on the doctrine of negligence, and not on the doctrine or theory that bees are a nuisance *per se*; that is, in themselves a nuisance. In the case of *Petey Manufacturing Co. vs. Dryden* (Del.) 5 Pen. 166; 62 Atl. 1056, the court used the following language: "The keeping of bees is recognized as proper and beneficial and it seems to us that the liability of the owner as keeper thereof for any injury done by them to the person or property of another rests on the doctrine of negligence." (Also see *Cooley on Torts*, 349.)

As all beekeepers know, there is always a chance of people being stung by bees in flight, and particularly when bees are loaded. Very often they become entangled in the hair, and as a result some one receives a sting. The bee has no intention of stinging, and so far as it is concerned the matter is an accident. However, if there is an apiary near by the person stung generally blames the beekeeper. During the past few seasons there have been a number of cases tried in police courts, where action has been instituted against some beekeeper for such stings, the person quite generally being stung while traversing the highway. In every one of such cases, so far as known to the writer, such cases have been decided in favor of the beekeeper, for the reason that the complaining witness was unable to prove that the sting received resulted from a bee, the property of or under control of the beekeeper made defendant.

#### City Ordinance Declaring Bees a Nuisance

The right to follow any of the ordinary callings of life, to pursue any lawful business vocation, is one of the privileges of citizens of this country; but it must be done in such a manner as is not inconsistent with the equal rights of others. *Butchers' Union vs. Crescent City*, etc., 111 U. S. 746; 28 L. Ed. 591.

A city has a right under what is termed in law "Police Power" to pass ordinances for the public welfare, even though the thing prohibited limits and restricts some persons in the exercise of a constitutional right, if the act is for the public health and welfare. For example, laws prohibiting the maintaining of slaughterhouses in certain districts and the prohibiting of livery stables on certain streets have been held to be valid police legislation. But the act specified in the ordinance must, in the particular instance mentioned therein, be a nuisance. The mere fact that the city has passed an ordinance does not of itself make it so unless the bees are in fact a nuisance.

#### Laws and Regulations

State laws and regulations relating to honeybees and beekeeping are designed primarily to control bee diseases. The first apiary inspection law in the United States was established in San Bernardino, California, in 1877. By 1883, a statewide law was passed by the California legislature, and by 1906, 12 states had laws relating to foulbrood. At present, almost all states have laws regulating honeybees and beekeeping. There is a lack of uniformity in these state laws and regulations, but considerable agreement on specific points of law. Most of the states require registration of apiaries, permits for movement of bees and equipment interstate, certificates of inspection, right of entry of the inspector, movable-frame hives, quarantine of diseased apiaries, notification of the owner when disease is found, prohibition of sale or transfer of diseased material, and use of penalties in the form of fines or jail or both. Although the destruction of American foulbrood diseased colonies is included in almost all state laws, most states now also allow the use of drugs for control or preventive treatment of this disease. The key figure in the enforcement of bee laws and regulations is the apiary inspector. He may have the entire state, a county, or a community under his jurisdiction. His efforts are directed toward locating American foulbrood and eliminating it whenever found. The effectiveness of bee laws and regulations is based upon the compliance of the beekeepers. In the final

analysis, responsibility for disease control remains with the beekeeper, who should routinely examine colonies for disease as a regular part of his management program and take the necessary steps when disease is found.

The Federal Government has no laws or regulations relative to bee diseases within the United States. However, on August 31, 1922, Congress passed a law, popularly known as the Honeybee Act, restricting the importation of living adult honeybees into the United States. This act was amended in 1947, 1962 and 1976. This last amendment reads as follows:

"(a) In order to prevent the introduction and spread of diseases and parasites harmful to honeybees, and the introduction of genetically undesirable germ plasm of honeybees, the importation into the United States of all honeybees is prohibited, except that honeybees may be imported into the United States. . . . .

(1) by the United States Department of Agriculture for experimental or scientific purposes, or

(2) from countries determined by the Secretary of Agriculture. . . . .

(A) to be free of diseases or parasites harmful to honeybees, and undesirable species or subspecies of honeybees; and

(B) to have in operation precautions adequate to prevent the importation of honeybees from other countries where harmful disease or parasites, or undesirable species or subspecies, of honeybees exist.

(b) Honeybee semen may be imported into the United States only from countries determined by the Secretary to be free of undesirable species or subspecies of honeybees, and which have in operation precautions adequate to prevent the importation of such undesirable honeybees and their semen.

(c) Honeybees and honeybee semen imported pursuant to subsections (a) and (b) of this section shall be imported under such rules and regulations as the Secretary of Agriculture and the Secretary of the Treasurer shall prescribe.

(d) Except with respect to honeybees and honeybee semen imported pursuant to subsections (a) and (b) of this section, all honeybees or honeybee semen offered for import or intercepted entering



The key figure in the enforcement of bee laws and regulations is the apiary inspector. Shown is Irving Sibert of Quincy, Massachusetts.

the United States shall be destroyed or immediately exported.

(e) As used in this Act, the term "honeybee" means all life stages and the germ plasm of honeybees of the genus *Apis*, except honeybee semen.

Any person who violates any provision of this Act or any regulation issued under it is guilty of an offense against the United States and shall, upon conviction, be fined not more than \$1,000, or imprisoned for not more than one year, or both.

The Secretary of Agriculture either independently or in cooperation with States or political subdivisions thereof, farmers' associations, and similar organizations and individuals, is authorized to carry out operations or measures in the United States to eradicate, suppress,

control, and to prevent or retard the spread of undesirable species or subspecies of honeybees.

Also the Secretary of Agriculture is authorized to cooperate with the Governments of Canada, Mexico, Guatemala, Belize, Honduras, El Salvador, Nicaragua, Costa Rica, Panama, and Colombia, or the local authorities thereof, in carrying out necessary research surveys, and control operations in those countries in connection with the eradication, suppression, control, and prevention or retardation of the spread of undesirable species and subspecies of honeybees, including but not limited to *Apis mellifera adansonii*, commonly known as African or Brazilian honeybee. The measure and character of cooperation carried out under this Act



on the part of such countries, including the expenditure or use of funds appropriated pursuant to this Act, shall be such as may be prescribed by the Secretary of Agriculture. Arrangements for the cooperation authorized by this Act shall be made through and in consultation with the Secretary of State.

In performing the operations or measures authorized in this Act, the cooperating foreign county, State or local agency shall be responsible for the authority to carry out such operations or measures on all lands and properties within the foreign county or State, other than those owned or controlled by the Federal Government of the United States, and for such other facilities and means in the discretion of the Secretary of Agriculture as necessary.

**LAWS TO CONTROL BROOD DISEASES.** — By turning to Foulbrood it will be shown that there are virulent brood diseases, which if not kept under control by the legislation in all the States might cause the ruination of the beekeeping industry. While the production of honey and beeswax is important, the U. S. Department of Agriculture has shown that bees are by far the most potent agency in causing cross pollination of fruit trees, legumes, and garden truck. That means that bees are a very important factor in increasing our food crops such as fruit and dairy products (See Pollination further on. Also Circular No. E-584 United States Department of Agriculture in Gleanings in Bee Culture, page 100, 1943.)

As a direct result of this need, foulbrood laws have been passed in nearly all the states, providing for the protection of not only the bee and honey industry but for general agriculture, particularly the fruit and dairy interests. These laws further carry sufficient appropriation to cover the expenses of one or more bee inspectors whose duties shall be to inspect all bees, and when disease is found to burn all infected material including bees in the case of American foulbrood, the most deadly of brood diseases, and apply appropriate treatment of diseases less destructive, like European foulbrood.

It will not be necessary to give a copy of a model foulbrood law. One

can be obtained from any state where bee disease legislation is in effect. Write to the State Bee Inspector, Department of Agriculture, State Capitol. Among states that have excellent foulbrood laws are Ohio, Florida, Michigan, Wisconsin, and New York for the East, and California for the West.

**LAYING WORKERS.** — Laying workers are usually the result of neglect or poor beekeeping. These queer inmates (there may be many) of the hive are worker bees that lay eggs, and the eggs hatch, too! The remarkable thing is that they hatch only drones, and seldom worker bees.\* The drones are somewhat smaller than the drones produced by a queen, but they are nevertheless drones in every respect, so far as is known. It may be well to explain that ordinary worker bees are not neuters, as they are sometimes called, but undeveloped females. Microscopic examination shows an undeveloped form of the special organs found in the queen, and these organs may at any time become sufficiently developed in worker bees to allow them to lay eggs, but never to allow for fertilization by meeting the drone as the queen does. (See Parthenogenesis, Dzierzon Theory, and Queens.)

#### Cause of Laying Workers

It is now pretty generally agreed that laying workers may make their appearance in any colony or nucleus that has been many days queenless and without the means of rearing a queen. In the case of Cyprians, Holy Lands, or Syrians and their crosses, laying workers are common.

Not only may one bee take these duties, but there may be many of them; and wherever the beekeeper has been so careless as to leave his bees destitute of either brood or queen for two or three weeks he is almost sure to find evidence of their presence in the shape of eggs scattered about promiscuously, sometimes one or more eggs in a single cell.

Sometimes the eggs will be found stuck on the sides of the cell. In that case it is evident the laying worker can not reach the bottom of

\*In rare cases there may be a worker (See Parthenogenesis.)

the cell. Very often several eggs will be found in a queen cell.

If the matter has been going on for sometime, one will see now and then a drone larva, and sometimes two or three crowding each other in their single cell. Sometimes bees start queen cells over this drone larva.

#### How to Get Rid of Laying Workers

Prevention is better than cure. If a colony from any cause, becomes queenless give it a laying queen, a virgin or unsealed brood of the proper age to raise a queen at once; and when one is raised, see that she becomes fertile. It can never do any harm to give a queenless colony eggs and brood, and it may be the saving of it. But suppose one has been so careless as to allow a colony to become queenless and get weak—what is he to do? If he attempts to give them a queen, and laying workers are present, she will be pretty sure to be killed. It is sometimes difficult to get them to accept even a queen cell. The bees get into a habit of accepting the egg-laying workers as a queen, and they will have none other until they are removed. They are difficult to find, for they are just like any other bee. One can possibly find them by carefully noticing the way in which the other bees deport themselves towards them, or may catch them in the act of egg-laying; but even this fails for there may be many such in the hive at once. A strip of comb containing eggs and brood may be given them, but they will seldom start a good queen cell, if they start any at all. In the majority of cases, a colony having laying workers seems perfectly demoralized, so far as getting into regular work is concerned.

It is practically impossible to introduce a laying queen to such colonies, for as soon as she is released from the cage she may be stung to death. No better results would follow from introducing an ordinary virgin, but the giving of a queen cell, or a just emerged virgin, if the colony has not been too long harboring laying workers, will very often bring about a change for the better. In such cases the cell will be accepted, and in due course of time there will be a laying queen in place of the laying worker or workers. Of-

ten cells will be destroyed as fast as they are given.

When this happens scatter brood and bees among several other colonies, perhaps one or two frames in each. From each of these same colonies take a frame or two of brood with adhering bees, and put them into the laying worker hive. The original bees of this hive, which have been scattered into several hives, will for the most part return, but the laying worker or workers will remain and in all probability be destroyed. Of course, the colonies that have been robbed of good brood will suffer somewhat, but if it is after the honey season no great harm will be done. They will proceed to clean up the combs and if they do not need the drones they will destroy them. Still another plan, and the best one, is to destroy the bees outright.

**LEVULOSE.**—See Chemical Properties of Honey.

**LIME.** — See Sweet Clover and Clover.

**LIMA BEAN (*Phaseolus lunatus*.)**  
—Seventy-five percent of all the beans harvested in the United States are grown in California, and more than 50 percent of the entire crop comes from the southwestern counties of Ventura, Orange, Santa Barbara, and San Diego. Of the various varieties of beans raised in California only the lima bean is of value to the beekeeper, although the black-eyed bean has been erroneously stated to yield an amber-colored honey.

The lima bean is adapted to a coastal strip 20 miles in width, extending from Santa Barbara County southward to San Diego County, which is subject to heavy ocean fogs. Cool sea fogs and the absence of protracted hot spells are required for the maturing of the plant, otherwise it is apt to blight; but the dense fogs often retard the flight of bees.

A bush variety of the Lima bean has been very extensively planted during the past few years. It is grown a little farther away from the ocean and is irrigated. In 1920 thousands of acres of this bean were planted in the San Fernando Valley, which was the haven of many a

migratory beekeeper. Nectar was secreted in abundance by irrigated bush Lima bean fields, while bees dependent on the older variety of pole Limas were starving. The vines bloom in July and August and yield a heavy, white, mild honey which has an agreeable flavor. Most of the honey is secured during the first two weeks of bloom. It granulates quickly. The honey crop from this source is rather uncertain as it is influenced by weather conditions. If there are many days of hot sunshine little nectar is secreted and too much fog prevents the flight of the bees.

**LINDEN.**—See Basswood.

**LIQUID HONEY.**—See Extracted Honey, also Sugar.

**LIVE-BEE DEMONSTRATION.**—See Exhibits of Honey.

**LOCALITY.**—M. J. Deyell, the former editor of *Gleanings in Bee Culture* aptly described the difficulty of a beekeeper whose experience was limited to one locality when he said "There are distinct beekeeping differences in various sections of the country."

No less true today, beekeeping localities have distinct differences though the lines of demarcation between these different areas are not distinct, one often merges with another, having zones in between where conditions suitable to honey flora of two or even more adjoining beekeeping regions flourish side by side.

The geographical distribution of plants is influenced by climate, soils, topography, latitude and many other environmental influences as well as by man. Agricultural practices are the principle determinant of the quality and quantity of honey that will be taken from an apiary locality. This is especially true in the farmed area of the midwest corn belt. Nectar secretion, so important to beekeeping is not uniformly predictable; even the same plants show striking differences in nectar yield when growing in different beekeeping localities. The white clover region extending from the northeastern states westward to roughly the Missouri River and southward to the Ohio River from the Canadian border offers considerably

greater honey crops than south of this area, though white clover is by no means unknown in the South. Alfalfa yields well in the irrigated lands of the western states but is, as a rule not of equal value east of the Mississippi River. New varieties introduced to the mideastern states may prove to be better for nectar secretion proving false this commonly accepted geographical distinction. Breeding plants for the potential of their nectar yield does not command very high priority to most plant scientists; usually breeding for yield, disease resistance, resistance to drought, or nutritional value takes precedence. Alfalfa introductions that are adapted to the cool, moist conditions of New York State, for example, have made significant contributions to the nectar resources of that state. Alfalfa pastured or harvested for hay in Wisconsin yields well when allowed to bloom before cutting, a practice which, unfortunately for the beekeeper, is being changed by methods which call for harvesting before the full bloom stage is reached.

Beginning in the depression years of the early 1930's an accelerating shift of population from rural to city has left an indelible mark on our agricultural land and its plant inhabitants. Abandoned farm land, mostly marginal in productiveness is, or has been absorbed by the cities or set aside awaiting industrial or residential development. The bulk of the land such as was formerly planted to buckwheat in Ohio, Pennsylvania and New York now lies uncultivated or has been planted to other crops. Peculiar transformations take place in land so affected. Acres and acres of goldenrod which succeeded the buckwheat now yields a substantial fall harvest. The milkweed, a dependable and substantial source of a fine light honey in northern Michigan was severely depleted by disease. Wild raspberry which at one time virtually blanketed areas of upper Michigan has been greatly reduced by weed eradication.

The western chaparral and coastal valley beekeeping regions contain many subdivisions, each with its specific honey types which result from growing specialized agricultural crops. Honey plants such as the sages, fireweed and

the thistles, to name only a few, furnish far west and northwestern area beekeepers with bee pasture. Honey crops from alfalfa and sweet clover along with locally occurring nectarous plants differentiates the Rocky Mountain region from the western slopes and coastal valleys of the West.

The extensive alfalfa acreages of the Upper Midwest makes this a primary producing region. The corn and wheat belts are part of this rich agricultural region. Soybeans contribute to the nectar resources along the southern perimeter.

The Southwest region relies on plants adapted to semi-arid conditions: mesquite, catclaw, huijillo and horse-mint are adapted in variable degrees to these conditions. Crops of brush honey vary with the seasons. Beekeepers in Texas and Arizona harvest honey from cotton. The adjoining states are transition areas that contain elements of several different regions among their floral resources. Nectar from soybeans, for example is important in the east central countries of Arkansas, blueweed in Missouri, tulip poplar in Kentucky and Tennessee.

The Southeast region, including Florida, is unique in that Florida has on occasion surpassed California as the leading honey producing state. The balance of the southeastern region concentrates heavily on package bee and queen production. While the honeys of this region tend to run to the amber grades one of the light premium table honeys of the world comes from the sourwood of this region. Tulip poplar, titi, tupelo and orange honey are others that make the southeastern region known for its honey production as well as for its bees and queens.

In the Southeast region, which embraces about ten states, are two restricted regions, the tupelo and the orange regions of Florida. This region has a wider variety of honey plants than has any other region in the United States. It contains honeys of all colors and flavors.

The eastern states comprise a region which includes New England and is quite variable in climate and topography. Yield per colony ranges very widely. Many hobby beekeepers are found in this region and the variety

of honey produced is very interesting. A selected few are always among those widely sought by people who prefer a certain distinct flavor.

**LOCUST (Robinia Pseudo-Acacia).**—Variously called Black locust, Common locust, White locust, Yellow locust, Pea flower, False acacia, Post locust and Locust tree. This is an outstanding honey plant in the eastern and southern states. It is a legume and helps build up the soil. It is an irregularly branched tree with pinnately compound leaves, small thorns on the branches, long clusters of fragrant pea-shaped flowers and has small pods which last most of the winter. It is native to the mountains from Pennsylvania to Georgia and westward to Missouri and Arkansas, but has been extensively planted in New England, Canada and most of the eastern states. It grows very rapidly and large stands have been planted for posts. The wood is hard and very durable. There is a saying that stone will crumble before locust will rot. It is a medium-sized tree and long-lived except where attacked by borers. It spreads by underground roots which send up numerous shoots.

The locust flowers occur in dense clusters in April, May and early June, before the hives have had a chance to build up to maximum strength. The honey is water white with a mild flavor and a good body. The honey flow is dependent upon good weather; a cold rain will end it abruptly in the middle of the blooming period. Claude Rose of Madison, Indiana, regularly obtains a fair surplus of this delicious honey by placing fresh supers in his hive just as locust comes into bloom and removing them at the end of the blooming season, and makes a fair surplus nearly every year. The honey brings premium prices when obtained pure. Most beekeepers let the honey become mixed with that of clover and other spring flowers, which improves the mixture, but fails to take advantage of the high quality of locust honey.

**LOG GUM.**—See Box Hives, also Transferring.



A grove of black locust trees.

## M

**MANGROVE, BLACK** (*Avicennia nitida*.)—In southern Florida there are three different trees called mangrove—the red mangrove, the white mangrove (buttonwood), and the black mangrove, but only the last-named is important to the beekeeper. It grows on the seashore of southern Florida, the Keys, and eastern Texas, also in tropical America. In Florida it is not found to much extent north of Ormond on the east coast. It usually grows back of the red mangrove and in localities where both grow together the red mangrove fringes the shores and makes new land.

The honey is light colored but the flavor has a tang that many do not like. It is sometimes blended with palmetto.

The black mangrove, when it grows to the size of a tree, resembles a scraggly old oak with a rough brown bark. It may be 25 to 50 feet tall, with a trunk diameter of four feet, or on the Keys it may attain

even greater size. Northward it is seldom more than a shrub. The leaves are leathery, oblong, with very short stems, and when they unfold are somewhat hairy, but later become bright green and shining above, pale or nearly white beneath. The flowers are small, inconspicuous, in terminal clusters, appearing at all seasons of the year. The wood is dark brown and very durable in contact with the soil. When used as fuel it burns with intense heat.

Up to the year of the "big freeze" in 1894, phenomenal yields were reported. As much as 400 pounds of honey from one hive in a single season has been recorded. But the severe winter of 1894 froze and killed the mangrove to the ground. It did not recover from this check for 18 years, and not until 1909 did it again yield nectar, and then only in small quantities. Since that year the bushes have gradually grown in size and the yields have increased also.

**MANIPULATION OF COLONIES.**

—Under the head of Anger of Bees (page 22) and under Stings it is shown that bees are not the irascible little creatures that many people suppose; that they are, on the contrary, when their nature is carefully studied, as gentle as kittens, and when one goes about it in the right way, they can be handled almost as safely. (See Stings, How to Avoid Being Stung.) But one can not know this until he has actually opened the hive or seen it opened and handled the combs himself.

The beginner should understand that bees can be worked very much better when weather conditions are right. The day should be warm, the sun shining, and the time selected for the manipulation between ten in the morning and three in the afternoon. With the judicious use of smoke, experienced beekeepers can handle them at any time under practically all conditions, but even the veterans endeavor to do it when they can work to the best advantage. In early spring or late in the fall when the atmosphere is chilly, or at any time immediately following a rain or after a sudden stoppage of the honey flow, bees are inclined to be cross. When it is cold the bee glue in the hives is brittle. In order to open a hive at such times it is necessary to break this bee glue with a snap or jar. This always has a tendency to irritate the bees, even when weather conditions are favorable. At such times always use smoke. The beginner at least should select his time, and of course will endeavor to make his movements very deliberate, avoiding quick jerky movements, all snaps or jars. There are times when one will be compelled to open hives when the bee glue snaps and when the bees sting. If a beginner, he should await a more favorable time.

**Tools for Bee Work**

Before details of manipulation are considered, it will be necessary

to take up tools and conveniences without which the handling of colonies would be difficult or even impossible at times. There are several essentials which may be mentioned in the order of their importance: A bee smoker (see Smokers) for quieting the bees; a bee veil (see Veils), and suitable clothing for protection against stings, and some form of knife, screwdriver, or hive tool to separate the frames and parts of the hive stuck together with bee glue. Without the smoker and its intelligent use one would feel almost inclined to go back to the days of our forefathers when they brimstoned their bees (see Box Hives, page 92.) But with smoke properly applied, one can render bees tractable that would otherwise be nervous and hard to handle. Even when conditions are bad, weather chilly, and propolis hard, they can generally be brought under control. The intelligent use of the smoker will often render the use of the veil unnecessary, but have it conveniently hanging from the hat, so it can be pulled down whenever necessary. A bee veil, however, is generally worn by veterans and beginners alike all the time while at work among bees. It is annoying and disconcerting to have cross bees buzzing around the face with the possibility of a sting in the eye, nose, or mouth. The beginner will always have a greater sense of security when his face is protected, and the veteran works with less interruption.

Gloves (see Gloves for Handling Bees) are recommended to the novice when he opens a hive for the first time, and to the veteran when taking off supers. After he has learned the habits of bees he may dispense with them because he will at most receive only an occasional sting on the hand. Very often experienced beekeepers wear a long gauntlet that reaches from the elbow to the wrist. This should be made so that no bees can get up the sleeve. It should fit tightly around the wrist or, better yet, reach far enough to cover the hand,



Standard hive tool



A side twist of the tool affords a strong leverage by which the frames separate easily and without jar.

leaving the ends of the fingers exposed.

For certain seasons of the year when weather conditions are unfavorable, loose-fitting gloves are a great convenience, if not indispensable for the veteran beekeeper. To go without them often means a lot of unnecessary punishment.

While ordinary coveralls may be used, a specially designed coverall bee suit, tight fitting at the neck, wrists, and ankles is far better. It should be made of white duck cloth, because white is cool and because it is more acceptable to the bees. If bees are to be shaken from the combs as in extracting, the bottoms of the trousers or suit should be tucked in the socks or folded around the ankles and held with a string or bicycle trousers guards.

The illustrations show a form of tool that is almost universal among beekeepers. The V-shape hole is for pulling tacks or nails.

The hooked end is ordinarily used for scraping propolis or wax from the frames or bottom boards, while the other end (also useful for scraping) is pushed between the two parts

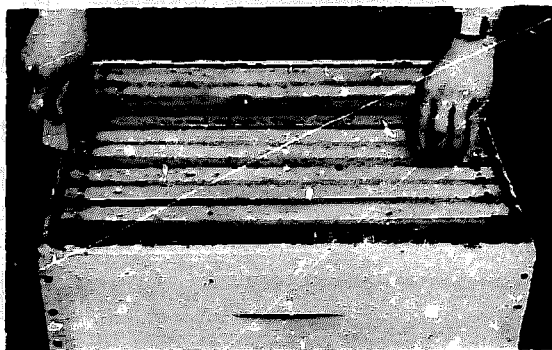

The most popular method of removing the first brood frame is to pry the other frames away, use the hive tool to loosen it at both ends, and lift it out.

of the hive. The bent or curved end should be placed directly against the palm in order that sufficient pressure may be exerted to shove the other or straight end between the two hive parts.

Either end of the tool may be used for separating Hoffman frames, or, in fact, any style of frame that one happens to use; but the author prefers the bent end. This is inserted between the frames to be separated, as shown above at the left, when a side twist will exert considerable leverage, forcing apart the frames very gently.

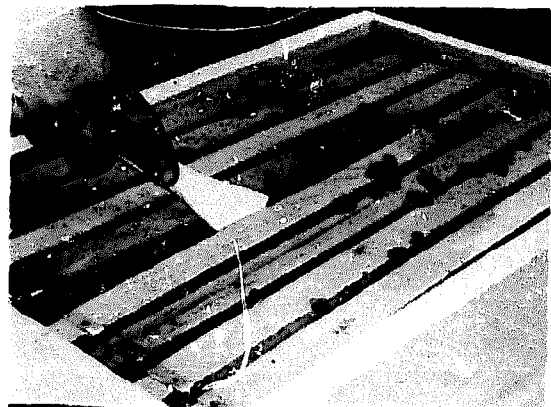

Another way of prying the frames over

#### Caution

Under Stings, sub heading, How to Avoid Being Stung, there are given specific instructions that should be practiced whenever working with bees. Memorizing and using these simple instructions is important to the beginning beekeeper but they cannot prepare everyone for all of the contingencies encountered in manipulating bees. Only experience will bring the confidence that comes from knowing one's own limitations and those of the bees while working among them. Until this experience is gained, a start must be made but the beginner need not approach this initial introduction with the least trepidation if a few preliminary cautions are exercised. Even so, unexpected problems sometimes prove upsetting, raising doubts about ever being able to learn to work easily with bees. Of course, a few people are not temperamentally or physiologically suited to handle or even be around bees but this rather rare inadequacy should not be confused with the lack of adeptness associated with inexperience.

In the initial approach to hive manipulation observing is as important as doing. Speed and skill in moving frames of bees about as well as the dozens of other sundry chores associated with handling bees will come in good time and with practice. A limiting factor in all hive manipulations is the behavior of the bees, even veteran bee-handlers observe this indicator with proper respect, planning his routine accordingly. Excessive stinging is easily avoided by the cautious beginner; a nominal amount of stinging normally poses no more of a threat to the well being of the participant than does any of the other new experiences that add zest and adventure to our lives. In the first exposure to close contact with honeybees it is sufficient to learn the necessary mental perspective; a balance between natural caution and a disregard for the rules of safe bee handling.

#### Opening the Hive

Work from the sides of the hive, never from the front. Do not obstruct the flight of the bees either with the body or with covers, frames or supers removed during examination. Have the smoker lit and operating so that there is always available a good volume of dense smoke. A heavy smoking may occasionally be needed but in most instances a very light or perhaps even no smoking may be necessary. Remove the outer cover. Insert the blade of the hive tool under one corner of the inner cover, raising only slightly, just enough to blow smoke into the opening. Wait at least 30 seconds before removing the inner cover. This allows the smoke-alerted bees to begin feeding on honey, a response that is preferable to a stupor induced by excessive smoking.

A first frame must be removed to provide space for removing the others. Select a frame that seems to be reasonably free of brace combs and propolis, moving it sideways to break the seal of wax. Lift or pry upward, raising it slowly, giving the clustered bees time to move as it is being raised. A light smoking brushed over the frames will drive the bees down between the frames, an essential preliminary step to avoid pinching bees while grasping the frames. Thereafter the actions of the bees as they reappear from between

the frames should determine whether or not to use additional smoke during the time the hive is open. Remove the frames as needed starting with the one next to the hive wall if possible, though this need not be a hard and fast rule; begin with any frame which seems to be the most free as described above. Insert the hive tool between the top bars and use the levering action of the curved end of the tool to gain some freedom of sideways movement of the frame. The possibility of the queen being on the first frame removed must be borne in mind although she will usually move out of harm's way as the frame is smoked and then slowly raised to remove. Removing the first frame eases the removal of the others. As each frame is removed stand on end on the ground or on one of the covers, leaning them against the hive. Place the frames near the front of the hive away from underfoot. If for some reason the bees or the queen should crawl or fall from the frame they will be near the entrance.

Examinations of the brood nest are necessary to maintain a continuous check on the presence of a queen, a condition that is easily determined by checking for the evidence of eggs, larvae and sealed brood. Honey and pollen reserves, colony population, general health and vigor and whether queen cells are being constructed for swarming or queen supercedure are all revealed by careful examination of the center section of the brood nest, frame by frame.

Replace the frames in the same order that they are removed. It will be necessary to squeeze the nine frames very closely together to allow the tenth to be replaced when all ten frames are used in the brood nest. If only nine frames are used, as some beekeepers do, crowding is less of a problem.

#### How to Find the Queen

Perhaps the queen is not to be seen on the first side, so it may be necessary to turn it over and see the other side. If the comb is not heavy with honey, it can be turned right over with the bottom bar resting horizontally. But if the comb is heavy and unwired raise the right hand until the top bar is perpendicular.

Revolve the frame like a swinging



door or the leaf of a book, so that the opposite side is exposed to view.

Having examined this comb, lean it up against the side of the hive, and remove another comb next to the one already taken. Examine this in like manner. Lean this also against one corner of the hive, or return it to its place, lift out another, and so on until all have been examined. Should the queen not yet have been found, look the combs all over again, being careful to examine the bottom edges.

If the queen is not found on the second examination it may be advisable to go over the combs once more, but very often it is better to close the hive and wait an hour or two, after which one can go back and search the combs as before.

In ordinary practice it is not necessary to hunt up the queen. The examination of the surface of one or two combs will show whether eggs are being laid. If eggs and brood in various stages are found in regular order it may be assumed that the queen was in the hive within three days at least.

The location of the queen can be determined somewhat by the manner in which the eggs are laid. If the examination of one comb shows no eggs and an examination of another shows that there is young brood, the position of the queen can be traced by the age of the brood until the eggs are found. The queen may at the time of the examination be on the opposite side of the brood nest. After she goes clear across she is quite liable to move from one side to the other.

Sometimes the behavior of the bees is such as to indicate where the queen is. Her location can generally be determined immediately after releasing the queen after introduction, because the bees will have their heads pointed in her direction; and sometimes by a hum of rejoicing the queen can be traced, especially if she has been well received.\*

\*I am often asked how to find the queen. I generally say, "Look where the queen is." I advise using as little smoke as possible, never smoking into the entrance. Remove an outside comb and then take out the combs in pairs. When you see a comb indicating that the queen is laying in it, split those two combs and you are likely to find the queen between those two combs. If not, split each pair and you are pretty sure to find her quickly. I seldom am over two minutes finding the queen.—Allen Latham.

**MAPLE (Acer).** — The maples bloom so early in the season that their value for pollen and honey is greatly underestimated. In early spring the colonies are so weak that a surplus from this source is seldom obtained, and the maples are regarded as important only for brood rearing. There are about 100 species in the genus *Acer* which are confined chiefly to the northern hemisphere. Many of the trees are very common and the rock maple forms extensive forests. In states east of the Rocky Mountains a small surplus of maple honey has been reported in Iowa and Alabama. (See Pollen.)

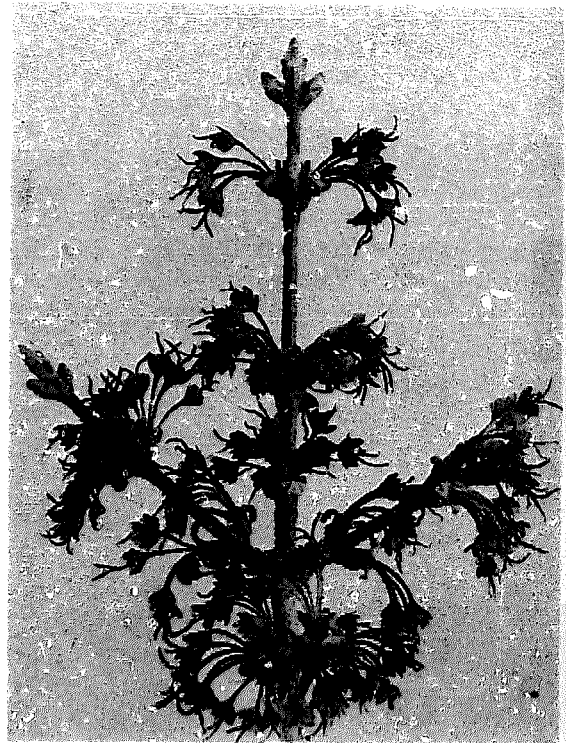

Red Maple.

**MARKETING HONEY.** — Honey produced in the United States during 1976 totaled slightly less than 200 million pounds with a total production value of 99.8 million dollars. Most of this honey was marketed in the form of extracted honey sold in unprocessed wholesale bulk lots. Processed bulk honey sold for slightly higher prices. Processed and packaged honey sold to food wholesalers in assorted retail-sized glass, plastic and tin averaged 20 to 25 percent more per pound than processed bulk honey. The retail price

paid to producers of extracted honey was second only to the price paid at retail for comb and chunk honey in 1976. Irregardless of the fluctuation in real honey prices the comparative differences in unprocessed and processed bulk honey at wholesale, and retail prices of extracted and comb remain fairly constant. As labor, transportation and processing costs are added to the cost of production the wholesale selling price increases correspondingly. The total cost of production, processing, storage and other necessary expenses of marketing determine the eventual retail selling price, whether it be at the beekeeper's home or at a distant city supermarket.

Processing costs are not constant. Variations occur regionally just as do costs of production. In an unregulated honey market trading in bulk products is no different than in any other agricultural commodity. Though the volume may be less than, for example, wheat or corn, many of the same marketing procedures apply. There are some differences however. Honey, unlike some commodities such as wheat, corn, soybeans and other agricultural raw products has the potential of being marketed directly to the consumer by the producer with only a minimum of processing. Though not alone in this respect, eggs, fruit, vegetables and milk, for example, are also already in a form that does not require a great amount of reworking to be sold retail. The volume entailed in marketing truck crops, fruit, poultry and livestock products is such that it is done better and more efficiently by specialized processing plants. Honey, too, has the additional advantage of being adaptable to long term storage without appreciable deterioration or spoilage. Closer controls on food purity have been a blessing to the national health. Pasturized milk no longer carries the potential for carrying dangerous levels of harmful bacteria. Food technologists have developed methods that give reasonable assurance that processed and preserved foods conform to at least minimum standards of purity. Newer methods of detection of adulterants and testing and experience with chemicals added promiscuously to foods in the past show the need to revise our stan-

dards continuously in respect to their possible effect on our bodies. Over-processing of some foods is of present concern though this in part may be due to the increasing demands for convenience foods from the very people who voice concerns about overprocessing of food.

Beginning in about 1970, a noticeable consumer trend became evident, particularly among people who became concerned about the increasing use of chemical preservatives and the seemingly unnecessary tampering with raw foods. Honey, being fairly free of contamination by bacteria by virtue of its chemical and physical properties, caught the fancy of those who sought alternatives to accepting the heavily-processed sweeteners. This demand contributed to the rapid growth in interest in honey, and as a result beekeeping grew rapidly as a hobby. There were some increases in the domestic supply of honey from this new interest but commercial production could not keep pace with the rapidly increasing demand. As a result the wholesale buyers sought honey from outside the country, mainly in Mexico, Central and South America. Imports of honey jumped spectacularly. Since 1963 domestic production of honey had been declining. Prior to 1963 the yearly production of honey was approximately 250 million pounds but since that date Department of Agriculture figures showed that the annual domestic production was down to an average of 206 million pounds during the 1971-75 period. Since 1971 imported honey has been coming into the United States in increasing amounts. Where the United States had been an exporter of honey prior to 1966 it has become a net importer since that year. In 1971 imports amounted to 11.4 million pounds and rose to 39 million pounds in 1972. From a relative low of 11 million pounds in 1973 honey imports increased again in 1974. Honey imports were 46 million pounds in 1975. The year 1976 saw imports rising rapidly in the first half of the year due to the possibility of a duty increase. American producers, alarmed over the increasing amount of honey being imported to augment domestic supplies demanded a higher tariff. An ad valorem tax on imported honey was proposed



Edwin Selfe of Monroeville, Ohio has a roadside sign that is very effective.

but was finally rejected after lengthy hearings by Congressional committees.

#### **Selling Honey Retail**

Much of the honey sold retail to the customer is produced by the seller, although if sales exceed his production most do purchase honey in addition to their own to supply their customers on a year-around basis.

When there is a strong demand for table grade honey, which may be in short supply, there is a temptation to stretch the supply by packing honeys of doubtful flavor. The darker colors do not necessarily signify lower quality, each honey must be carefully judged on its own merits regardless of color. Carelessness by a few inexperienced packers of honey can do irreparable harm to honey sales in general. The proverbial "Once bitten, twice shy" describes very well the usual result when a potentially steady honey buyer is "turned off" by a bad lot of off-flavored or unattractively-packaged honey put up by a disreputable packer.

Retail sale outlets for honey are becoming fewer and fewer. The large population centers are supplied mainly

by retail supermarkets that are serviced by wholesale grocers. Roadside and city produce markets are fewer but are still an important form of retailing in the producing regions along major routes of travel. Farm markets are popular with buyers, particularly for fruit and vegetables in season. Any retail store must maintain a reasonable high volume of sales which demands a steady, reliable source of produce. The stock of honey they carry for sales must be fresh, of good quality and available during the period of peak demand. If the operator of the stand finds the supply of honey to be dependable the opportunity to sell honey retail at a good profit may be lost forever at that particular stand. If a beekeeper can provide his own honey stand or handle sales out of his home the profits may be higher and the opportunity to meet the customer may in many cases justify the extra time and effort needed to handle this type of selling. Not everyone who keeps bees and has honey to sell should or could sell honey in this manner. Some people understandably prefer not to be troubled by catering to the needs of retail

selling. Time and effort needed for retail selling could seriously conflict with apiary work during the busy season, even with personal activities when waiting on customers takes up evenings and weekends.

Despite all the drawbacks selling honey directly to their customers has been an interesting experience for many beekeepers. Most are doing a creditable job, some have increased their volume of honey sales to the point where they are selling not only their own honey but that of other beekeepers as well. In many instances purchase are made in bulk lots outside their own producing area for packing to supply their retail trade that began with selling home-produced honey. The enthusiasm for promoting honey by beekeepers generates sales for the whole industry even though sales of honey is not always the immediate object. The bee and honey industry owes the enthusiastic amateur beekeepers its sincere appreciation for what they have done to help sell honey.

Sidney Gross, a beekeeper in St. Charles, Illinois who produces in the neighborhood of 3,000 pounds of extracted honey a year plus several hundred comb honey sections says the most important factor in successful selling is your own positive self image.

"You and your bees, through an enormous amount of mutual labor, have produced a commodity of which you can be justly proud. Because the harvest is often enough very small, many beekeepers have trouble convincing themselves that they are actually in business. Because of insecurity and inexperience many beekeepers sell themselves short; they leave themselves open to bargaining over prices and perhaps even giving their honey away. Remember, its sad but true that people place no value on what they get free. If you give away your honey to friends, relatives and neighbors will soon think that it's coming to them. If you sell your honey too cheap you are doing a disservice to yourself and to other beekeepers in your locale. Imagine how sales would slump if it were known that someone in your vicinity were selling extracted or comb honey at one-half of the going rate! Obviously, such unsophisticated pricing is the mark of someone with just a few hives who has a good year and now doesn't know what to do with his crop. Whatever your reasons for being in beekeeping, you have an investment in time and money. Your harvest allows you to recoup this investment and more. So whatever else you do, don't sell your bees, yourself, or your fellow beekeepers short.

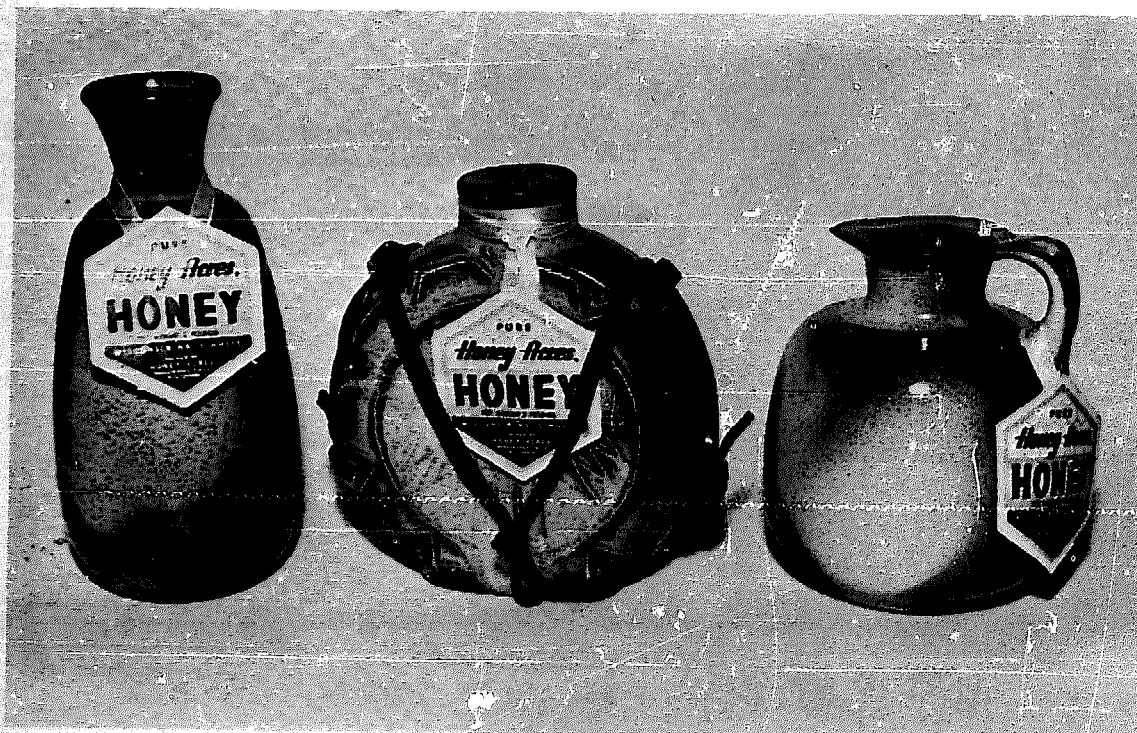

Imaginative packaging is a way of stimulating honey sales.

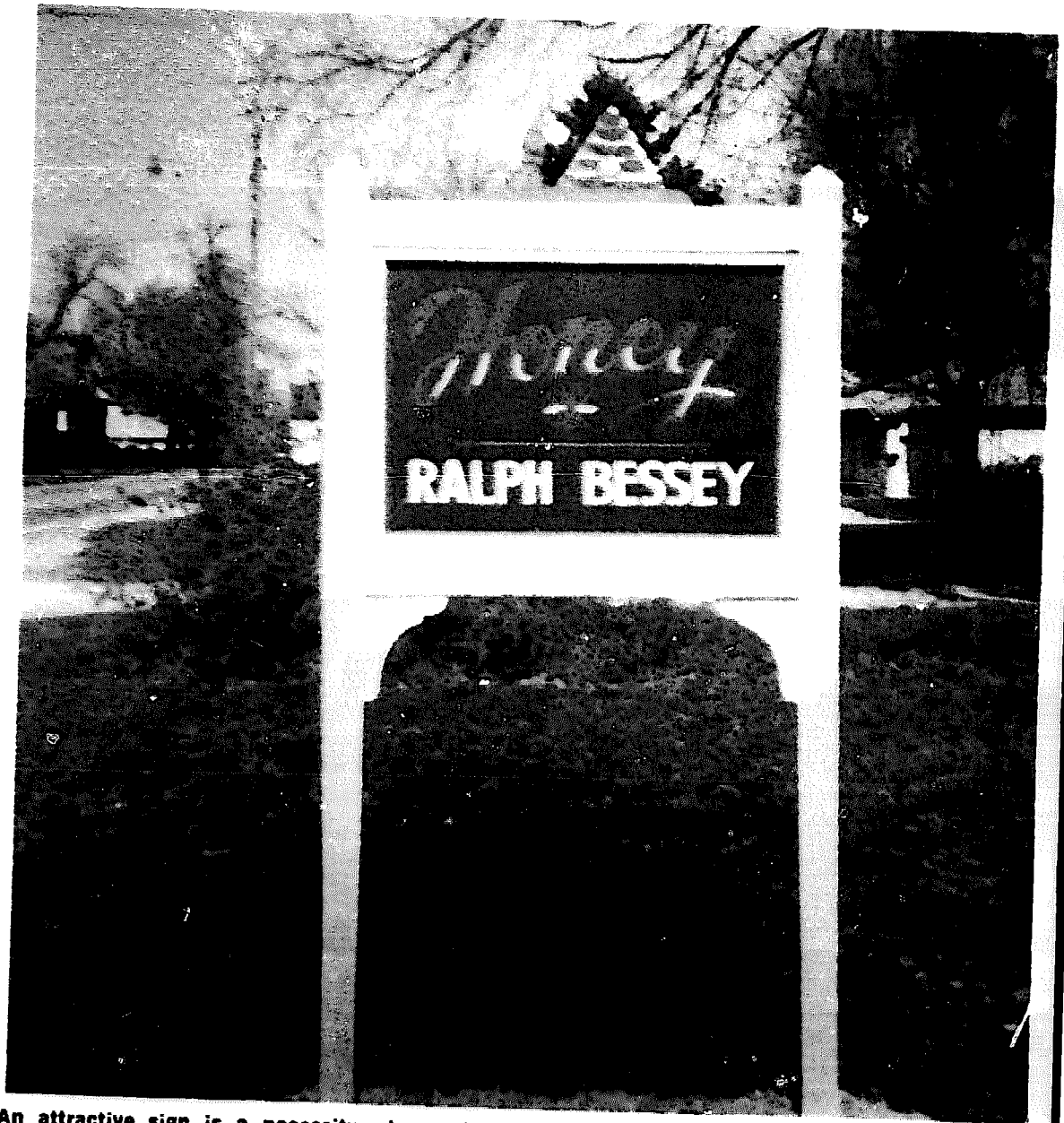

An attractive sign is a necessity when selling honey from an established location such as the home or a stand.



The Higbee Company Department store in downtown Cleveland, Ohio featured honey in their gourmet food department.

"There is no reason why the small beekeeper should not be able to market his entire crop, whether he has a single hive or 50 or more colonies. You have a product which is pure and wholesome, one which you (and the bees) have worked hard to produce. Never give away the fruits of your labor or people will regard them as worthless. Charge fair prices and don't waffle on them. Cultivate the image of the small independent businessman who has strong ties to nature. Display your honey in

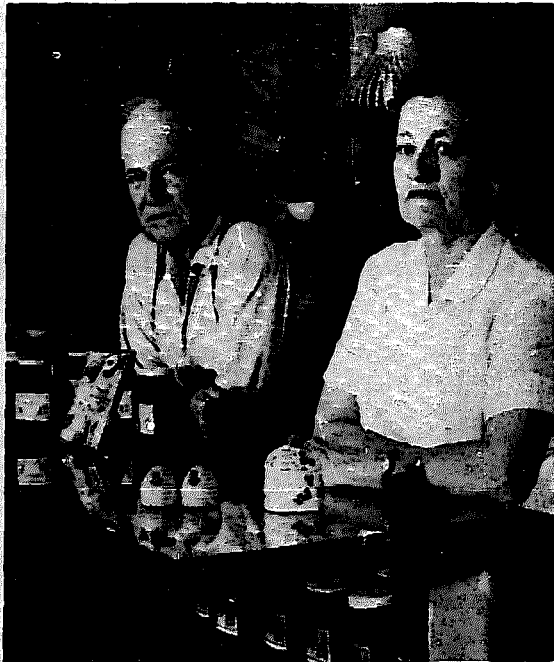

Sales of honey directly to the customer requires the personal touch, and may not be to everyone's liking.

an attractive manner and in orderly surroundings. Find creative ways of letting others know who you are and that you have honey for sale. If necessary, seek merchandising outlets in your community. Finally, learn who your customers are and strive for their repeat patronage by providing personalized service to each of them. If you do all this and do it correctly your crop will be gone before you know it. Your problem then will be not how to sell your crop but how to expand your operation to keep pace with sales."

Selling honey directly to the consumer is an interesting experience. Though the volume may not be comparable to that sold by large retail

stores there is the satisfaction of a personal participation. Seeing your own honey put up in a neat, attractively labeled glass bottle and knowing that you are receiving a top market price from an appreciative customer gives the beekeeper a sense of personal satisfaction. The rather impersonal marketing of vast quantities of honey blended to the same uniform color and flavor leaves something to be desired as far as doing justice to the varieties of flavors and colors of honey are concerned. It may be argued, and with some justification, that this large volume system of processing and marketing is necessary to supply the demand for quantity. Ideally, one method of marketing should compliment the other. Direct customer sales supplies honey to new users having, by personal contact, established the initial introduction to the delights of a new food experience. Later sales will naturally be from the grocers shelf during the routine shopping trips. The personal introduction is important and a follow up with ample supplies of a uniform product or quality put up in attractive packaging is the best marketing combination for the honey industry.

**MESQUITE\*** (*Prosopis glandulosa*.)—Mesquite is a plant in its racial youth. It is rapidly increasing in numbers and yearly occupying new territory. The first explorers found a few of these trees along the Gulf Coast and gave the native name the Spanish spelling of "mezquiz." Its beans formed a part of the native diet, but as these trees were far apart, mezquiznez, as the explorers called the beans, were a luxury. Prairie fires must have been responsible for the fewness of these trees for when the fires ceased, the trees came, as in the memory of men now living, the vast extent of Texas now covered with mesquite trees was an open prairie. This tree is found westward to California and was introduced into the Hawaiian Islands, in 1828, where it is called "algaroba," and is the best honey plant on the Islands. It has even been suggested, because of its aggressive habits, that this plant is not a native but an introduced species, the seed having been brought here from the South by the earliest explorers.

\*By H. B. Parks, American Bee Journal

The tree grows in similar manner to an unpruned peach tree, which it so closely resembles that one town in Texas has the name of Peach Orchard, because it is said, the Northern real estate dealers made this mistake.

The wood of the tree is hard and red brown, making excellent fire wood posts and even paving blocks. The leaflets closely resemble those of the honey locust. The bloom is in tassels of many small flowers. These are white when first opened and turn yellow before dropping. The pods are long, containing ten to twelve beans. The pods never open and transportation by water and animals is the mode of dispersion. As they contain a high percent of sugar and the beans are rich in proteins, during years when mesquite pods are plentiful the cattle do extremely well. The seeds grow very easily. The young sprouts are armed with long, straight thorns.

The mesquite is very susceptible to moisture changes. Its regular blooming period is from May 15 to July 1. If, however, rain comes, the blooming ceases, the tree puts on new branch growth, and the honey flow may end entirely unless weather conditions induce a second blooming. It is a common observation that

there may have been a mesquite bloom, but unless there are pods there was no honey flow.

Mesquite is not a reliable honey plant, as there are many factors governing its nectar flows. In 1914, 1918 and 1921 there were heavy flows, but in the years between there was little or no flow. The ideal conditions seem to be plenty of moisture up to April and then dry, hot weather until the flow is over. When moisture and heat conditions are right it is no uncommon thing to see 5 or 6 sets of different-aged beans on the same tree. Trees standing alone, especially those in yards or roads, bloom almost every year, while those in the chaparral do not.

The honey is light amber, well flavored, and granulates rapidly. The flow comes on rapidly and is very heavy. Surplus up to 200 pounds on individual colonies is recorded. Mesquite and horsemint are rivals for first place in honey production. When mesquite yields, it is far ahead, but when it fails, horsemint holds first place. As with alfalfa, a species of thrips often reduce the mesquite flow. While the heavy flows are restricted to central and southwest Texas, its rapid spread gives hope of increasing yields from this excellent honey plant.



Mesquite leaf, blossom, and branch. One-fourth life size.

**MIGRATORY BEEKEEPING. —**

Experience has shown that the secretion of nectar in a given locality varies sometimes, even within a distance of only a few miles. Sometimes the home-yard bees will be gathering no honey when an out-yard eight or ten miles away will be securing a good crop. This is due to the fact that the character of and moisture in the soil make possible the growth of some plants that will not take root in other locations only a few miles away. For example, a bee yard may be situated in a valley close to a stream, along which there will be heavy growth of honey-yielding plants. Within a few miles from there, perhaps on higher ground and soil less productive, there will be nothing.

Sometimes one finds conditions like this: in one locality a large amount of buckwheat will be grown; ten miles away from there, there will be none whatever. The same is true of red clover and alsike.

Again, in one year when there is an excess of rainfall the location in the valley will be too wet for the proper growth of plants yielding nectar, while on the higher ground, a few miles away, conditions will be just right for a fine flow of nectar.

The knowledge of these varying conditions in localities only a few miles apart has led some beekeepers to practice what is known as migratory beekeeping. For example, in one yard it is evident that bees are not getting any honey, and there is no flora of any sort that give any promise of any. Not far away is another yard that is doing well. It is good business to move the yard that is yielding no returns to the location in which the honey can be secured.

In many eastern states sweet clover and alfalfa are being introduced. Where there is one or both bees can often be moved from white clover and alsike into sweet clover and alfalfa.

**Long-Range Migratory Beekeeping**

In California, for example, it is quite customary for the beekeeper to move from the orange district into one with an abundance of sage, then from sage into the bean fields, or into localities where alfalfa is being grown. Similarly, bees in the East are moved from the clover into the buckwheat fields. Migratory bee-

keeping is being practiced on a large scale in the extreme western part of the United States. Bees are being moved in carlots from Texas, Idaho, Montana, and Nevada into California and back again. In many cases the large producers find that they can move the bees from Idaho, Montana, or Wyoming in one or two carlots in the fall to the citrus groves of California, build them up on eucalyptus during the winter, catch a crop of orange honey in the spring, then mountain sage, after which the bees are loaded on the cars and moved to the state whence they came, where they catch a crop of alfalfa.

**MILKWEED\* (*Asclepias syriaca*.)**

—Milkweed has been listed as a honey plant in many states, as Massachusetts, North Carolina, Tennessee, Texas, Nebraska, California, and Michigan, but it is comparatively rare in the prairie region.

Great stands of milkweed once covered parts of northern Michigan but disease nearly eradicated it. Only in the last few years has it started to recover.

The common milkweed (*A. syriaca*) is the most abundant but swamp milkweed (*A. incarnata*), a semi-aquatic milkweed is common in low-lying land that floods often. The usual color of the milkweed bloom is a pale purple, the plant attaining a height of from 18 inches to three feet or more. It is a perennial. The seeds, borne in a pod which ruptures at maturity, are spread by the wind.

When the weather is favorable the nectar is secreted very rapidly, and a large colony may gather 13 to 17 pounds in a day.

The common milkweed (*A. syriaca*) blooms from about July 15 to August 15. The honey is excellent and compares well with that obtained from raspberry. It is white, or tinged with yellow, and has a pleasant fruity flavor somewhat suggestive of quince, and with a light tang. It is so thick and heavy that it may be necessary to warm the combs before extracting. The cappings of the comb honey are nearly always pearly white. It sells readily by reason of its fine flavor, and is

\*By John H. Lovell.





Common milkweed

in every way suitable for table use. The way in which the pollen masses are clamped to the feet or legs of insects is of much interest to beekeepers, and every season there are many inquiries in regard to this queer phenomenon. The bee can obtain its liberty only by breaking the connecting bands. If this happens, the pollen masses are left in a chamber near the stigma, and the bees bear away the membranous disc with its empty stalks. Disc after disc may thus become attached to an insect until it is crippled or helpless.

In some cases many bees are lost. It was at first supposed that they were being destroyed by a fungus. Many different explanations have been given of these curious structures by persons not familiar with the flowers of the milkweed. Some

think them a parasite, others a protuberance growing on the bee's foot, and others a winged insect enemy of the bee. An engraving of this curiosity, magnified at a, and also a mass of them attached to the foot of a bee is shown on previous page. If the insect is not strong enough to pull out the pollinia, or later to break the connecting bands, then it perishes slowly of starvation.

These dry membranous discs are often described, even in botanical works, as glands, or as being glutinous or sticky, but this is not the case.

**MOISTURE.**—See Honey, Specific Gravity of, also Honey, Ripening of, Wintering, subhead, Moisture Foe of Wintering.

**MOTH MILLER.**—See Wax Worms.

**MOVING BEES.** — Young bees, when they first start out, or old ones on the first flight of the season after a winter's confinement, hover in the air about the hive entrance, take a careful survey of surroundings, making wider and wider circles, each time taking in new objects by which they may familiarize themselves with the home. When the location is once carefully marked they will go back and forth without making any note of distinguishing objects. But when the hive is moved only a few feet there is apparent consternation and confusion.

One can not, therefore, move his bees a few feet or a quarter of a mile during the flying season without having the great majority of them go back to the old spot unless treated as described below. Some strains of black bees when moved will find their hives. The bees that do not come back probably drift into another hive.

If one desires to move his bees, and wishes to take them at least a mile and a half or two miles away, the problem is quite easy, for then they will stay wherever they are placed. As soon as they are liberated in their new position they will

mark the location as thoroughly and carefully as when taking their first flight.

It is sometimes advocated that colonies of bees be moved during the winter when the clustered bees are inactive. Experience has shown that this practice is not to be recommended unless the moving can be completed during the intermediate period after the honey flows have ceased but before or soon after the bees have formed a loose cluster. A somewhat comparable period in the spring after the weather moderates but before regular daily flights begin would be much more satisfactory for moving bees. A period when impending cool and rainy weather confines the bees for several days or more helps to settle the bees in their new location.

Moeller\* showed that colonies moved in late autumn (November) in the vicinity of Madison, Wisconsin consumed significantly more honey during the winter than those not moved; those moved twice, a still greater consumption

\*Floyd E. Moeller, "Effect of Moving Honey-bee colonies on Their Subsequent Production and Consumption of Honey," *Journal of Apicultural Research*, Vol. 14 (No. 3/4) 1975.

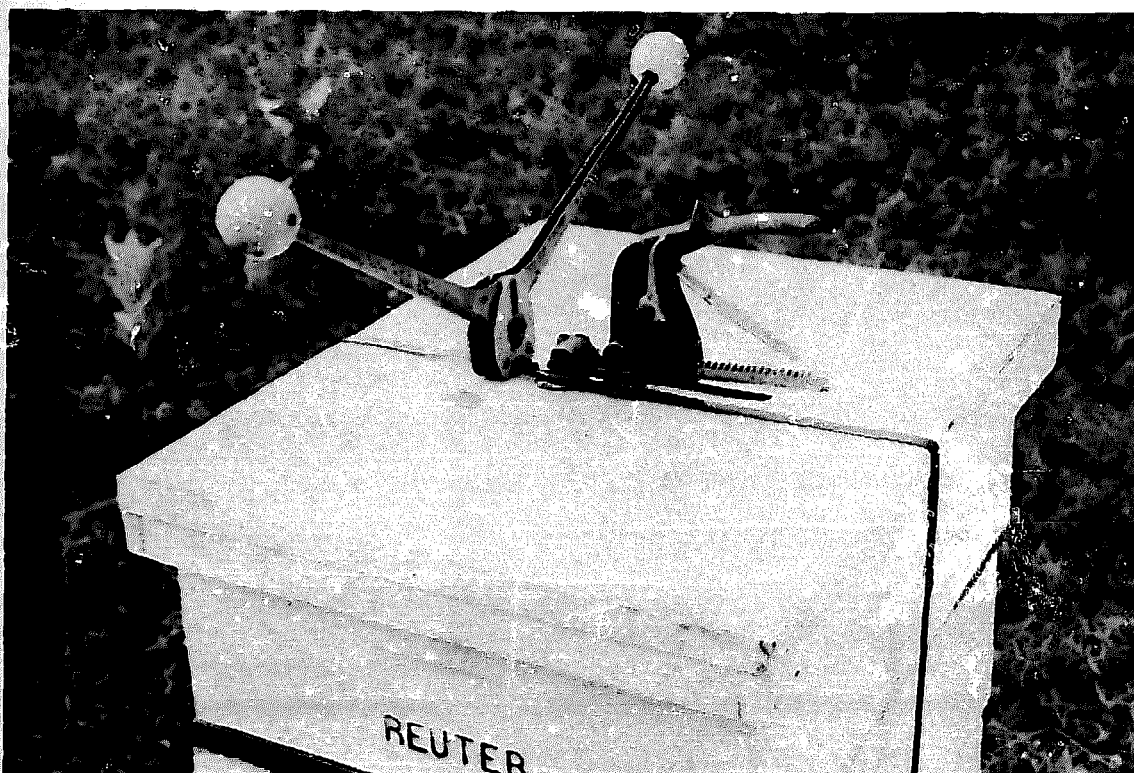

Metal or plastic branding secures hives for moving.

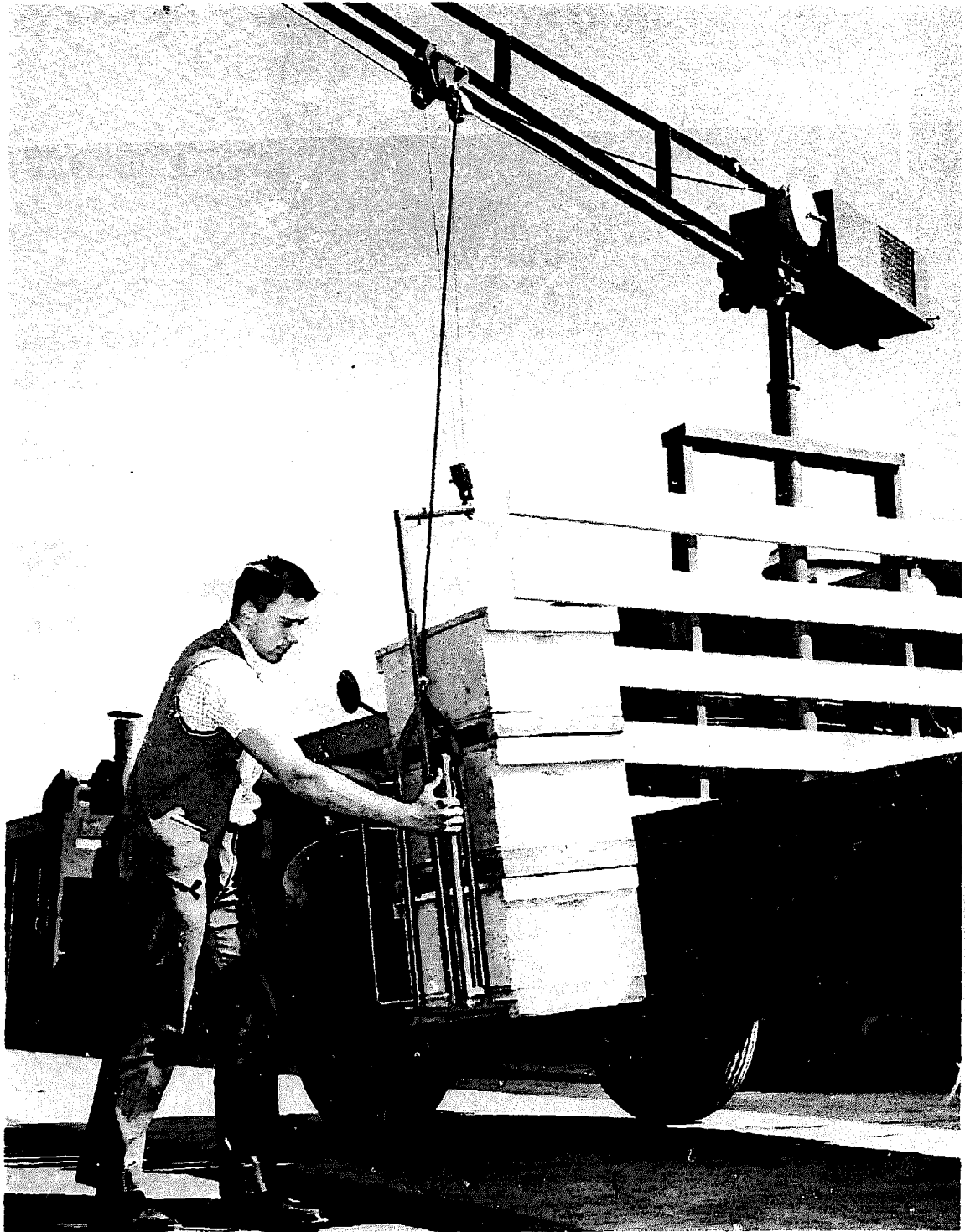

**Mechanical devices are used when large numbers of hives are moved. Truck-mounted booms as above or front end loaders are most commonly used.**

when compared to those not moved at all. It was determined, as well, that colonies of bees moved at night into new territories had smaller increases in weight than similar undisturbed colonies during the seven day period following the move. In most migratory moves bees are taken from an area of

low nectar volume to one of significantly higher yield so that the benefits more than offset the disruption suffered as a result of the moves. After each move the colony must make a satisfactory adjustment to the new location if nectar and pollen gathering is to resume.

### **Moving Bees a Distance of Several Miles**

In warm weather a colony must be safely screened in a manner that allows the bees to cluster outside the entrance or to at least maintain an unrestricted opening for air passage. Several designs of moving screens provide this clustering space but will remain bee-tight if fastened securely to the hive body. Other types of screening devices fit into the entrance, keeping the bees in the hive bodies, not allowing them to cluster in the entrance as is the usual tendency when the hive entrance is closed by screening. The alternative to the screened entrance, or as a safety measure when the weather is extremely hot, is a sturdy, rimmed screen used to replace the inner cover. The outer cover is left off during the move unless it is needed to protect the colony from rain during the move. A top screen should be fastened securely during the move. During many migratory treks experienced beekeepers move colonies without screens, loading them evenings or during the early morning hours when the bees are all in the hive. A light smoking keeps them in the hive during the few minutes that it takes to wheel them on the truck. If their route takes them through populated areas or where stops may be necessary, screens which cover the whole load may be used to confine bees which may threaten to leave the hives when the truck stops. The vibration of the moving truck has a calming effect on the bees.

Before attempting to move any colony of bees certain precautions are necessary. Not heeding a few simple preparations has cost many inexperienced bee handlers needless stings and at the same time created discomfort and inconvenience for people around the bees being moved.

Several important steps should be followed when moving bees: 1. During the late evening of the day before or during the early morning of the day of the planned move close the entrances of the hives with wire screen, including a rectangular piece tacked over the inner cover hole. The entrance screens should be secured to prevent their coming loose during handling and should, of course, be bee tight. If extremely hot weather is anticipated and the bees

will be some time in transit it is better to provide top screening as well. 2. At the same time check the hive for the possibility of other bee leaks. If there is the slightest chance that bees may get out at any point plug or screen the spot. There must not be even the tiniest hole left for bees to escape during the move. By screening the bees during the evening before or in the early morning all field bees will be held in the hive and the colony may be moved at the convenience of the beekeeper, preferably during the daylight hours. Moving bees at night is a very poor practice. Bees are also on guard at night. The least disturbance may send them crawling and stinging over any one handling the hive. Smoke loses much of its effectiveness when used on bees at night. Lights attract the bees, enabling them to direct their attacks on the handlers. Last but not least, the attempts to handle bees at night may lead to accidents, causing injury to the persons working or damage to the hives. 3. Staple together the bottom board, hive bodies and supers. Nail down the inner cover if no top screen is used, otherwise replace the inner cover with a moving screen. Leave the telescoping cover off during the move but keep it within reach in case it is needed to cover the hive during rain. Hive staples are available to fasten the units together but many prefer metal or plastic banding instead. Moving bees on migratory routes or for pollination often requires the installation of devices that will latch together the hive quickly and securely, the fastening device becoming a part of the hive fixtures. These devices are sometimes adapted to the lifting arms of truck-mounted hive loaders. For moving hives that must be lifted and carried by hand there are several types of hive carrying devices on the market. Hive carriers take some of the burden out of lifting and carrying hives but usually require the services of two people to move a hive. 4. Place the bees at the new site in the location they are to remain. Smoke the entrance so as to drive the bees on the outside back up into the hive before removing the screens. Remove the banding strip or the staples unless another move is planned soon. Remove the screen from the inner cover hole.

# N

**NECTAR.**—In former days this was considered only as a very dilute sweetened water containing cane sugar. Later work shows this to be a very complex product of 30 to 70 percent moisture, several sugars, and minerals.

By turning to Bee Behavior, it is shown how bees, by a system of fanning, reduce the water content from 30-70 percent to 17-18 percent in honey.

In general, it may be said that the same conditions which favor vigorous plant growth favors nectar secretion. Exceptions do occur to this rule. The spring season, though sometimes dry may still be favorable for plant growth due to ground moisture accumulated from the previous fall and from heavy winter snows. Nectar secretion may or may not be favorable depending upon the kinds of plants that are present. If the plant has a well established root system it can utilize deep reservoirs of ground moisture during temporary dry spells. Even though vegetative growth may be slower, nectar secretion may still be sufficient to attract bees. Alfalfa is a plant which has a deep root system and will continue to yield nectar in dry weather but at a reduced rate if the water shortage is severe. Some of the clovers, white clover for example, have a fairly shallow rooting habit which makes it more vulnerable to drouth and consequently suffers from a lower rate of nectar secretion during very dry weather as well as reduced vegetative growth.

Temperatures bear a direct relationship to nectar secretion but it is difficult to prove any single cause—effect relationship that is universally true under all conditions. Many observers claim that they have discovered a direct relationship between a wide daily temperature range and copious nectar secretion. This is true in many instances but other interactions may tend to alter the precise patterns that would prove beyond doubt that low evening temperatures and high daytime rises are the dominant factors that stimulate nectar

secretion. Ground moisture, humidity, soils, solar radiation as well as general flying conditions most certainly have their effect. The analysis of the interaction of temperature with these other factors is a difficult project for field studies in nectar secretion and conclusions are not easily extracted from data collected to date. Temperature variations, especially wide variations between day and night do seem to bear favorably on nectar secretion but plants seem to react differently both as to kind and by location.

Plants react differently to the influence of environmental (temperature, moisture, soil) conditions. Nectar is a sucrose sugar solution exuded from the nectar glands of plants, usually located in the base of the flower, although nectar may also be secreted from extra floral nectaries.

The stimulus to nectar secretion comes from the physiological processes of the plant, which in turn are influenced by conditions under which the plant is growing. Bear in mind that some honey plants, the white clover for instance, is adaptable to wide geographical ranges but it does not produce abundant nectar over this full range of distribution. In its northern range, where summer temperatures average not much more than 70°F. white clover yields nectar in abundance if other conditions are favorable. Other plants subject to the same wide distribution will bear nectar only under very favorable conditions or not at all at its northern limits but will be a valuable honey plant farther south. Soybeans seem to follow this pattern. Other plants seem to display very little reaction to local conditions; if they occur, they yield nectar. Many common weeds show this rather universal disposition to yield nectar without fail, though in variable amounts. Dandelion, asters, knapweed, goldenrod and milkweed do so. Sweet clover seldom fails throughout its range. Look for naturally high plant densities of such plants and honeybees will fare well.

**NOSEMA DISEASE.**—Nosema disease is caused by an organism known as *Nosema apis*. Adult workers, drones and queens are affected. Spores of the organism enter the body of the adult bee with food and water and germinate within the gut. Nosema disease is widespread and under favorable conditions causes extensive losses of adult bees. It has been responsible for the superseding of queens in colonies established from infected package bees. When accompanied by dysentery caused by long winter confinement, the disease may spread rapidly within infected colonies and result in their death late in the winter or in the spring; or heavy losses of bees may continue for weeks after the bees have been flying freely and dysentery has subsided. Infected bees usually perform their normal duties until they are too weak to continue. The shortened life of infected bees weakens or kills the col-

ony. The first noticeable symptoms shown by a colony heavily infected by *Nosema apis* are increasing restlessness of the bees and a weakening of the colony. When only a few bees are infected, the loss may be so gradual that it is not noticed. At other times the death rate among adult bees is very high and the colony dwindles rapidly. The queen is usually one of the last to die. Nosema disease may appear each year about the same time.

The symptoms most commonly observed in the individual bee is its inability to fly more than a few yards. Bees will crawl on the ground, on the bottom board, at the entrance and on top of the frames when the cover is removed. Sometimes infected bees will crawl long distances from the hive or crawl up blades of grass in an effort to take wing. They may also collect in small groups on the ground in front of the hive. The older workers are most

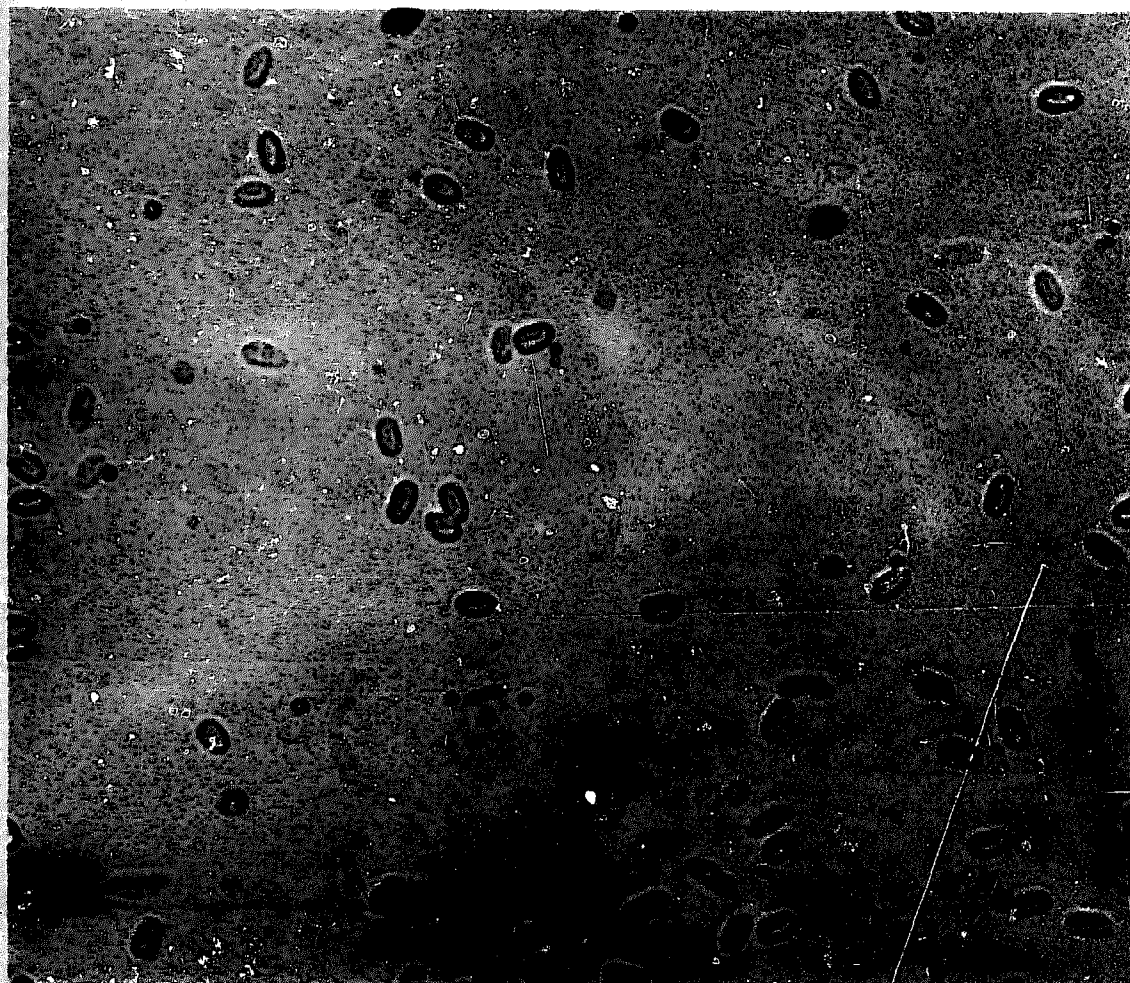

**Nosema spores magnified approximately 600 times. — U.S.D.A. Photo.**

often killed by the disease. The disease is aggravated at times by cold, damp weather which restricts flight activity, especially in the spring.

The intestinal tract of bees infected with *Nosema apis* is often swollen and discolored. This symptom can sometimes be used for diagnosis in the apiary. The entire intestinal tract should be removed as follows: Pinch off the head and hold the thorax with the thumb and forefinger, then grasp the tip of the abdomen with the other thumb and forefinger and pull gently. The entire intestinal tract will be withdrawn. In healthy bees the midintestine is usually brownish red or yellowish. Circular constrictions show for almost the entire length of the intestine and the tissues are tough. Heavily infected intestines, on the other hand, are dull grayish white and some of the circular constrictions will have disappeared. The tissues are soft and watery and are easily crushed, yielding a fluid that is whiter and more turbid than that from healthy intestines.

Although this is at times a useful technique for checking heavily infected bees it is limited in its usefulness and it is suggested that a microscopic examination of suspected bees is the only way to obtain a positive diagnosis, due to the fact that so many of the gross symptoms of *Nosema* disease resemble those of paralysis, acarine disease, pesticide poisoning, starvation and dysentery.

#### Control of *Nosema* Disease

*Nosema* disease can be controlled by the use of good management, fumigation and sterilization of equipment and by the feeding of Fumigillin. Good management will result in strong colonies that will raise young bees faster than the infection can spread within the colony population. Therefore, the beekeeper should maintain colonies headed by good queens, supply adequate food reserves at all times of both honey and pollen, and see that there is adequate space for maximum brood rearing. He should also eliminate or reduce contaminated water sources and hive equipment, supply locations providing maximum sunlight exposure, and reduce drifting of bees whenever possible. Excessive moving of bees will often increase the incidence or intensity of the disease.

Fumigation with acetic acid is an effective method of decontaminating *Nosema*-infected equipment. Soak a pad of absorbent material with  $\frac{1}{4}$  pint of 80% acetic acid and place the pad on the top bars of a hive body. Stack hive bodies, seal and leave undisturbed for a week. Air for one week before using.

Ethylene oxide used at a level of 100 mg. ETO/liter for 24 hours at 100°F. (37.8°C.) will also kill any spores on contaminated equipment.

Heat can also be used to decontaminate *Nosema*-infected equipment. Dry equipment should be heated to 120°F. (49°C.) and held for 24 hours at that temperature to destroy the spores. The combs should not contain honey or pollen and the temperature must not exceed the figure given or damage to the combs may result.

The antibiotic fumagillin, the active agent in Fumidil-B is highly effective in controlling *nosema* disease. The *nosema* problem is so generally acute in package bees and queen nuclei that the feeding of Fumidil-B should be considered a basic requirement in their management.

Fumagillin fed at the rate of 100 mg./gal. (5 gr. Fumidil-B) has given good *nosema* control when fed in sufficient quantity to meet the package colony's sugar requirements for a period of three weeks. It should be fed in heavy sugar sirup because fumagillin must be continuously available in the food supply to be effective. Use of thin sirup would increase the fumagillin dosage while shortening its period of availability. Normally one gallon (10 pound feeder pail) of the treated sirup will give adequate protection to packages installed on combs of honey and pollen. When packages are installed on foundation, the volume of treated sirup should be increased at least 50 per cent since a considerable amount will be consumed in the drawing of new comb in addition to that required to support brood rearing.

Fumagillin added to pollen supplement has given good *nosema* control where colonies are sufficiently vigorous in brood rearing to consume the cakes rapidly. The fumagillin dosage in the sirup required in mixing the supplement should be double that used for sirup feeding (10 gr. Fumidil-B/gal.)

The Fumidil-B should be dissolved in a small amount of warm water (125°-150° F.) and thoroughly mixed with the heavy sirup and water hot enough to dissolve two parts of sugar in one of water would cause the fumagillin to lose activity. Sodium sulphathiazole and the antibiotics useful in preventing brood diseases can be added to the fumagillin sirup where a need is indicated without one inhibiting the effectiveness of the others.

Colonies used to produce market honey should not be fed antibiotics or drugs later than one month prior to the main honey flow. The purpose in feeding them is for disease prevention so that colonies will be strong enough to produce a profitable crop. This means early feeding before a disease situation gets out of hand; also, they must be consumed in order to prevent disease.

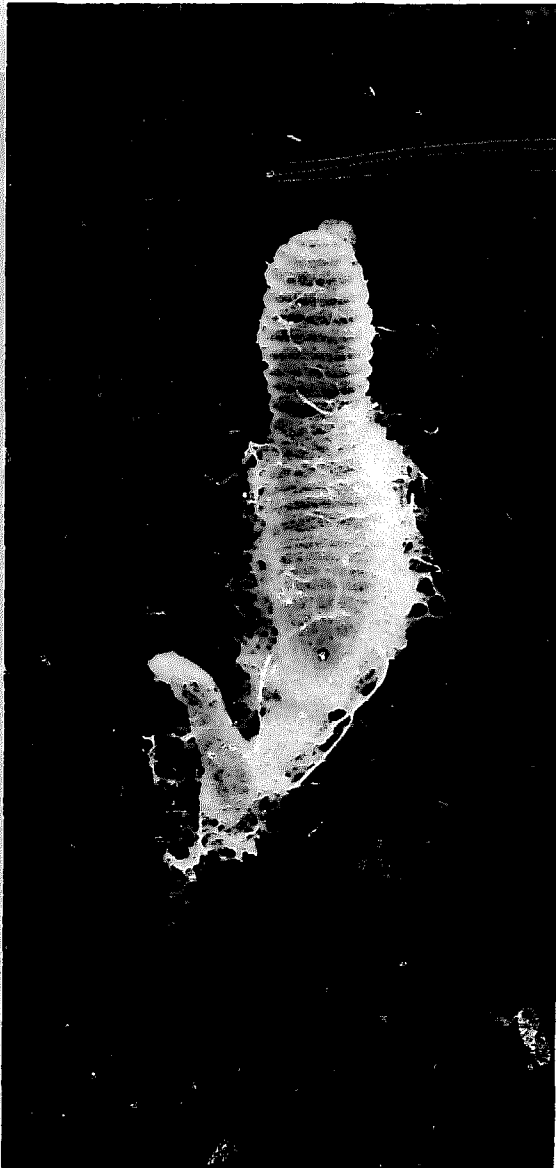

**Healthy midgut of the honeybee. The color is usually brownish red or yellowish. The circular constructions are prominent.**



**Honeybee midgut infected with Nosema Apis. Inspection shows the color to be dull grayish white with no prominent constructions.**



### Nosema and Queen Supersedure

In an article in *Gleanings* (October 1976, Page 373) P. F. Thurber explained his method of treating breeder-raised queens for possible infestation by Nosema. In his words "I have never been happy to see an expensive queen superseded, presumably because of Nosema."

Queen supersedure in package bees and queen loss shortly after introduction to established colonies has often been associated with Nosema infections. A method of treating the new queen using Fumidil® in limited quantity is a measure that has been used by Mr. Thurber. The medication reaches the queen indirectly by the route of the food solicited by the queen from her cage attendants. While the method described by Thurber has not been checked by formal tests under controlled conditions it is presented here on the strength that it may have a practical application for the beekeeper who buys only a few queens and does not require extensive medication for Nosema.

The background from which this method of treatment evolved is described by Mr. Thurber in the following paragraphs.

... "Finally about three years ago I presumed on a slight friendship with a very pleasant and cooperative gentleman in Beltsville. I wrote him for help. I explained that since I had been successful in purging *Bacillus* larvae, the causitive organism of AFB from honeybees, I could probably also purge the *Nosema apis amoeba* from the systems of purchased breeder-raised queens by feeding them Fumidil®. If their systems were purged, they would no longer be superseded because of Nosema in their systems. Right or wrong, I would like to give the idea a try, but I had a problem. My scales were not accurate enough to measure the very tiny amount of Fumidil® one would need to make one ounce, not one gallon of Fumidil® solution. I asked for a cheap, accurate measuring device to measure the amount needed. Since I could not think of anything better, I suggested an inverted nail head might be adequate and enclosed a number four box nail. I asked him to hold the nail by the point, dip it into the Fumidil® and see if that or perhaps a larger nail would hold the right amount.

... The wild guess that a number four box nail might be about the right amount measured turned out to be unbelievably accurate. Actually the nail head amount makes up a 31 cubic centimeters of solution with the same Fumidil® concentration as the one gallon formula given in the instruction sheet that comes with the packaged bottle.

... When incoming queens arrive I get out the little brown bottle, get the number four box nail and measure out a reverse nail head of Fumidil®, drop it in the bottle and then fill the bottle with tap water. I then give the bees caged with the queen a drink of the Fumidil-water mixture as soon as I get them from the post office. I do this by merely dropping a few drops of solution on the screen while the candy end is slightly elevated. If the bees want more, I give them more. Fumidil® does not dissolve in water—it goes into suspension. If you don't shake well before using the mixture it is ineffective. I repeat this again night and morning for at least four days. I then transfer the queen to a new cage and new candy and introduce her first to a nuc made up of nurse bees and then combine the nuc with a hive I want to requeen.

... You should make a fresh ounce of mixture for each set of queens. I do not recommend long storage of the mix because I cannot advise you whether or not the Fumidil® will hydrolyze (decompose in water) or not. After it is made up I store the bottle in the refrigerator between waterings."

### Nosema and Package Bees

Package colonies are so universally susceptible to nosema infection all should be fed the equivalent of a 10-pound pail of heavy treated syrup when the packages are installed. To further minimize the nosema problem, it is important that combs of pollen or cakes of pollen supplement be supplied to insure uninterrupted brood rearing, irrespective of weather conditions that might limit pollen gathering. An investment of 35 to 50 cents per colony for Fumidil-B may increase yields by 20 to 100 pounds per colony. There will also be a substantial reduction in queen supersedures when Fumidil-B is fed.

### Additional Nosema Information

Unlike most protozoa, *Nosema apis* has not been successfully cultured on artificial media. Its life history within the honeybee has been intensively studied by Phantom and Porter, Hertig, and others, yet the stages they described are not easily recognized. Some investigators even suspect that considerable imagination was employed in their descriptions. Only the spores are readily seen and identified.

There is no evidence that *Nosema apis* passes through the egg or is in any way associated with the reproductive processes of the honeybee. In contrast, *Nosema bombycis*, which produces the destructive silk worm disease, is transmitted through the silk worm egg.

*Nosema* is reported to progress most rapidly when bees are kept at a temperature of 88°F. Its development is sufficiently rapid at all hive temperatures to suggest that temperature is not critical to the course of the disease.

*Nosema* does not develop in bees held above 99°F. but this is above the range of normal hive temperatures.

*Nosema* spores held for 10 minutes at 138°F are rendered non-viable. They are also killed when exposed to sunlight for several days.

*Nosema* spores can survive low temperatures for many months and still cause infection when ingested by honeybees.

Fumagillin has no effect on the viability of nosema spores under prolonged exposure yet is highly effective in stopping its reproduction when continuously available in the food of honeybees. Intermittent availability of fumagillin permits too many spores to germinate and reproduce.

It is unlikely that nosema produces any toxic substance harmful to the honeybee, otherwise the bee could not live as long as it does under such heavy parasitism. Its main effect probably is in producing a degree of starvation which becomes progressively worse as the number of parasites increase. *Nosema* invades, multiplies, and destroys the epithelial cell lining of the ventriculus of the bee. The normal regeneration of these cells at about five day intervals, which is a continuous rather than a cyclic process, permits the bee to metabolize some food for a period

of time. Death results when infection of new cells take place more rapidly than the regeneration of new epithelial cells.

This partial starvation theory is further supported by the fact that infected queens live longer than worker bees; that they can produce normal eggs for a period of time but their numbers decrease progressively; and, that the last eggs laid by a heavily infected queen are shriveled and incapable of hatching. The infected queen apparently reaches a stage where she is unable to absorb sufficient food to nourish the eggs developing in her ovaries. Since the worker bees feed the laying queen a glandular secretion, her assimilation of food may be less dependent upon the cells of her own ventriculus than is the case of worker bees. This would permit her to live longer.

The age of bees has no effect on their susceptibility to nosema but older bees are more likely to be infected because they have had more time to pick it up. Brood rearing shortens the life of bees. Active brood rearing therefore counteracts infection potentials by eliminating the most likely infected age group at a faster rate and by adding healthy young bees to the population. However, in package bee colonies only "older" bees are present and these in relatively small numbers. In queen mating nuclei, the bee populations are small and brood rearing is both low and intermittent due to the removal of queens as soon as they lay. Thus the supporting bee populations tend to live longer and maintain an infection when normal colonies are relatively free of nosema.

*Nosema* infected bees seek the warmest part of the winter cluster. They are first to fly, either because of parasitic distress or they have had to ingest more food because of poor assimilation. The latter would cause the accumulation of more feces.

*Nosema* infection appears to be the primary cause of true dysentery in winter. Poor quality of stores and high moisture levels may aggravate the condition but do not in themselves cause dysentery. Feces discharged within the hive are always loaded with nosema spores unless discharged by starving bees. Starving bees discharge feces just before death.

**NUCLEUS.**—This word, when applied to bee culture, means just what the name signifies—a small colony of bees. It may mean a hundred bees with a queen, and as such it is called a baby nucleus. So small a number of bees will not long survive without help. The term more properly means a larger force—anywhere from 500 to 1000 bees with a queen—a force large enough to set up housekeeping in real earnest. Nuclei are used extensively by commercial queen breeders.

Generally speaking, the word "nucleus" signifies one or two full-sized frames of bees, either in a full-sized hive or one just large enough to hold two frames and no more. When it has five or six combs of bees and brood it is usually called a weak colony.

These small aggregations of bees must be built up to full-sized colonies in order to make them useful for honey production. It requires a colony of not less than two ten-frame stories in size to produce honey. While a two or three frame nucleus will furnish a little extracted honey in a good flow, the amount that it will produce in comparison with a large colony is relatively small. Or, to put it another way, ten two-frame nuclei equivalent in bees will produce only a fraction as much honey as one two-story ten-frame colony. (See *Queens, Two-queen System*. How to build up these nuclei into colonies so they will be of some use is fully described under the head of *Building Up Colonies, Dividing, Brood and Brood Rearing, and Food Chamber*.)

Nuclei are used for one or two purposes—for making increase and for the mating of queens. It is a waste of time and bee force to have virgins mate from a full colony. While cells should be raised in such colonies, the queens should be mated in miniature hives having anywhere from five hundred up to one thousand bees. (See *Queen Rearing*.)

#### Forming Nuclei for Increase

As already explained, dividing colonies into nuclei by beginners, for increasing the number of hives containing bees is usually a mistake if honey is the object.\* But after

\*There are times when an expert beekeeper can divide profitably. (See *Dividing*.)

the main honey flow, increase can be made by splitting up the colonies into units of two or three frames, supplying each with a cell, virgin, or laying queen. The process appears to be much simpler than it really is. The question often comes up in the mind of a beginner, "What can be easier than to take a ten-frame colony and divide it into five two-frame nuclei on as many hive stands?" If the bees moved from the parent stand would stay where placed, the problem would be very much easier. Unfortunately the old field bees, especially right after a honey flow, will go back to the parent stand, leaving nothing but the young bees to take care of the brood, which, in a great many cases, is neglected and dies. This is not all. During a dearth robbers will be ready to invade the entrances of these deserted nuclei with just a few young bees, and before the beginner knows it he has a perfect uproar, the loss of some thousands of bees, and perhaps trouble with bees stinging neighbors after the robbers have wrought havoc with the nuclei. (See *Robbing, sub-head Robbing of Nuclei*.)

If the beginner buys a colony of bees from some farmer or beekeeper two or three miles away he can bring it home and make the divisions before the bees mark their location, and the bees of each nucleus will stay where they are placed. This will effect an equal division, and everything will be easy, provided that the entrances are contracted and the beginner uses ordinary caution. At the time the nuclei are formed, each should be supplied with a cell, virgin, or a laying queen. If it is desired to make increase rapidly, the nuclei will make greater progress when supplied with laying queens. If it is desired to let each nucleus raise its own queen, precaution should be taken to see that eggs or very young larvae are in each nucleus. It should be understood that the progress will be very much slower, and that queens reared in nuclei are never the equal of those reared in strong colonies.

It is not wise for a beginner in the northern states to make a division after the middle of July or August. If he splits the colonies up into halves, the problem will be very much simpler. In the morning he should remove about two-thirds of

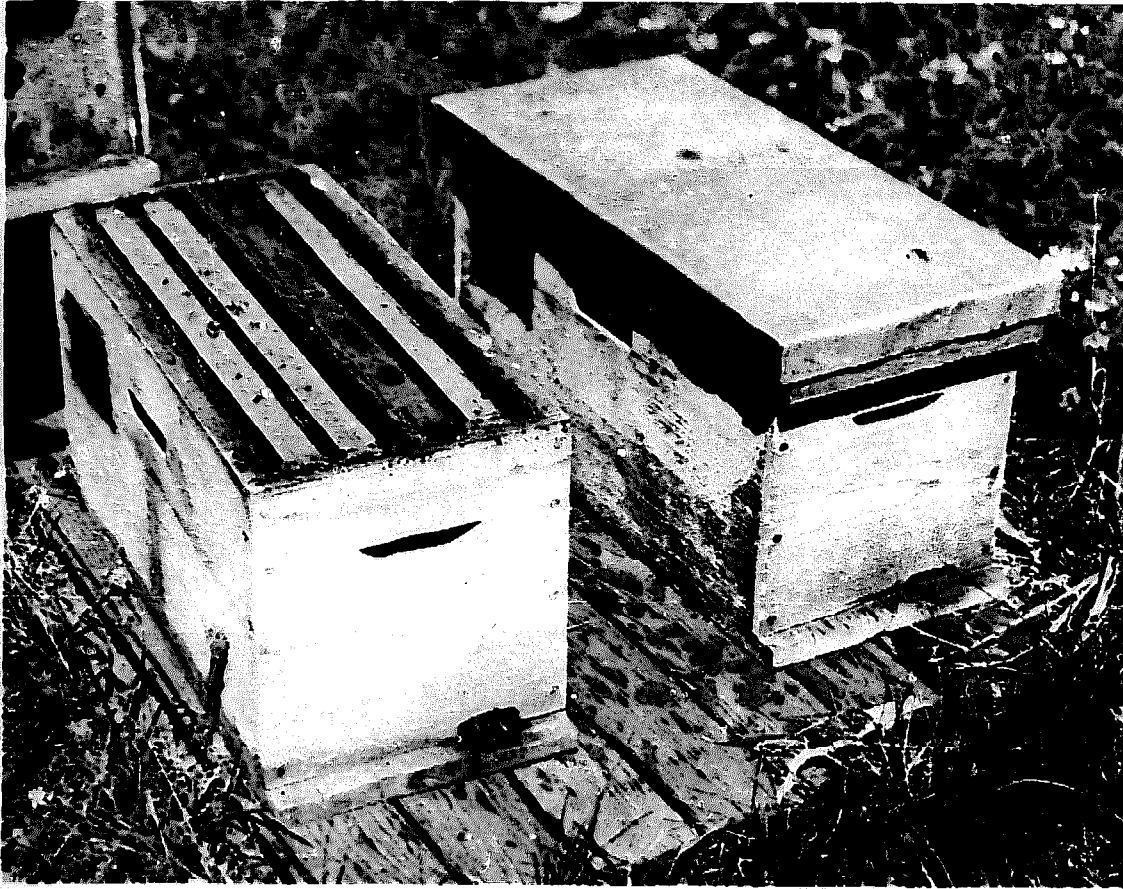

Nucs or small hives used during the mating period of virgin queens. The side of the base of the capped queen cell is carefully pushed into the face of the center comb sufficiently to hold it in a natural hanging position and the comb returned to the small colony.

the bees, all sealed brood, or as much as possible, and the old queen, to the new location, leaving the unsealed brood and about a third of the bees on the old stand. The latter should be given a cell or virgin. Most of the flying bees will return to the old home, making the division somewhere near equal, with the chances that the old hive will have a larger force of bees in 24 hours. But the split-off, or nucleus, on the other stand, will have all the sealed brood and emerging brood, and will soon be more than able to match forces with the old colony. The old queen, which will act as an attraction to hold the bees in the new colony, will soon supply it with eggs and young larvae as fast as the bees can take care of it or as fast as the brood emerges.

In a similar way three colonies can be made out of one, but most of the sealed brood and most of the bees should be given to the nuclei on new stands, always keeping in mind that most of the flying bees will return to the old stand. However, if the entrances are kept closed for three or four days there will not be so much returning. Of course, the nucleus on the old stand will not need to have its entrance closed. If it is discovered that one or both of the nuclei are short of bees, a frame or two of bees from some other colony can be shaken at night in front of the entrances of the nuclei on new stands. When doing this, it may be advisable to cage the queen for a day or two.



**OBSERVATION HIVES.** — The usual type of observation hive consists of a single-comb hive with glass panels with ventilating wire-screen strips below the glass. This is important. Sometimes there is a row of sections on top to show the relative position of the sections and the brood nest while they are being filled by bees in the regular way. See illustration. Of course, it would not be practicable to produce section honey in a single-frame nucleus, but when an observation hive with sections is displayed in a window where honey is on sale it not only attracts prospective buyers but it educates them, in that it shows a part of the brood nest with the bees and the brood, and the sections of honey just as they are on the hive. It advertises honey as nothing else does.

Crowds congregate on the street

watching the bees on the comb "making honey." (See Marketing Honey, and Exhibits of Honey.)

#### Observation Hives for Scientific Study

The single - comb hives can be studied to good advantage in the home or in the school. In either case they are placed on the shelf on a level with the window sill so that the entrance will pass under the window sash. The space on each side is closed with a stick. The bees will set up housekeeping, go to the fields and enter upon their ordinary work as though there were no one on hand to see.

Sometimes an observation hive can be placed some ten or twelve feet from the window or side of the building. In that case a tube connects the hive to a hole through the

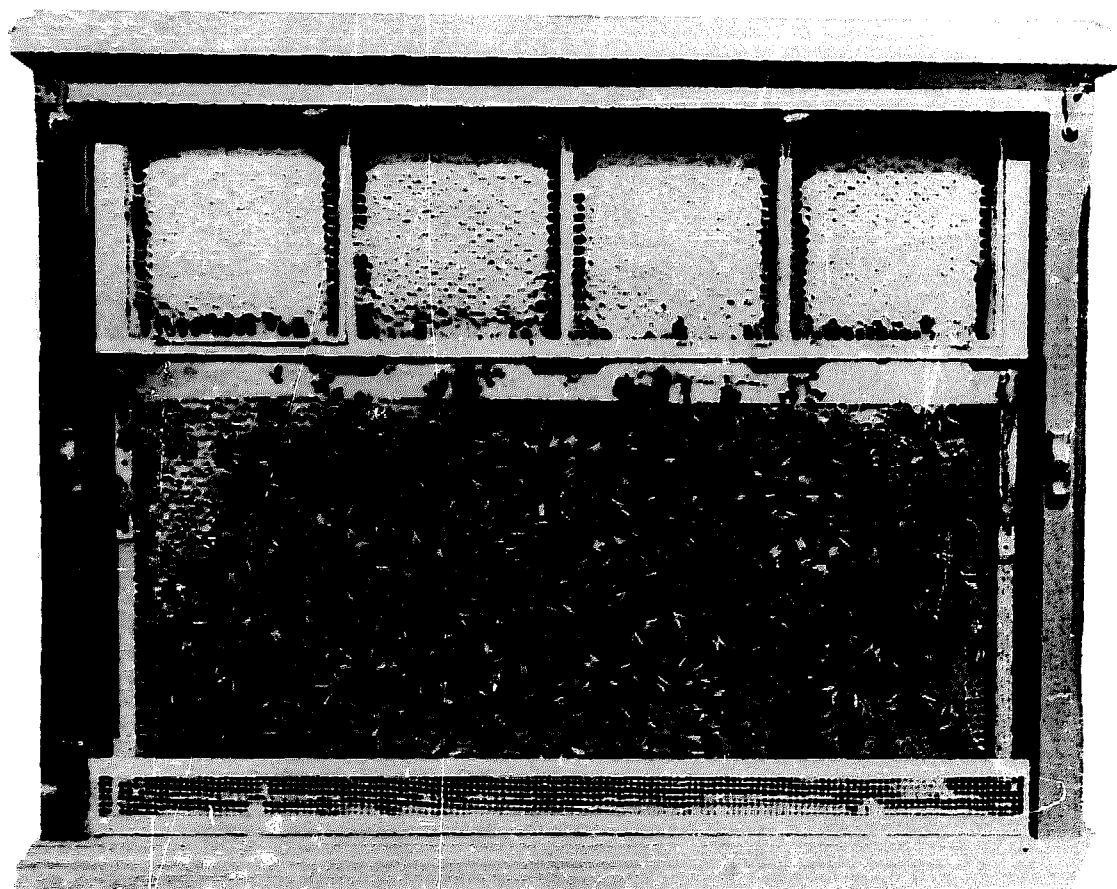

One-comb observation hive showing the relation of comb to sections in the r



This observation hive was used in a talk on bees presented to a Lions Club. The night before the talk the cappings were broken to form the letters. The next day the bees had removed the honey from those cells. If they had then been fed sugar water colored with vegetable dye the letters would stand out in color.

side of the building. (See Exhibits of Honey, also picture above.) Strange as it may seem, the bees will learn to go through this long tube to the outside. At the San Francisco Exposition in 1915, and at the Century of Progress at Chicago in 1933 and 1934, an observation hive was arranged in this way, and the bees used this long tube entrance the entire season.

Where nature study is being taught in schools these observation hives are used to a considerable extent. Very often beekeepers themselves who desire to become more intimately acquainted with the habits of the bees find pleasure and profit in keeping one of these hives in the window of the living room.

When the bees come in with fresh loads of pollen or new honey they show the usual signs of rejoicing by shaking their bodies, apparently to attract attention and thus induce other bees to find the treasures that they have brought home. (See Joy Dance, under Bee Behavior.)

A great many other interesting things can be discovered with one of these hives where the comb is parallel with the glass panel. But what transpires in the cells and behind the cappings can not be determined with this kind of glass hive.

#### Self-loading Observation Hive

Frequently, one of the objections to keeping an observation hive of bees is the difficulty of obtaining and installing a small colony of bees in the hive.

Beekeepers are reluctant to sell an established colony for this purpose. Often the person interested in having an observation hive is inexperienced and timid around bees. The principle of the self-loading hive simply allows the use of the standard wire and wood shipping cage for stocking the hive.

A plastic tube connects an opening in the shipping cage to the hive, allowing the bees to pass between the shipping cage and the hive of their own free will. To provide the incentive to move out of the shipping cage into the hive the queen cage with the queen is transferred from the shipping cage to the entrance of the hive. The queen is introduced by the release method used in regular package bee installations.

The observation hive may be connected by the plastic tube to an exit hole in the wall or a window, or may be placed with the entrance of the hive projecting out through the bottom of the window which has the sill raised several inches.

The small colony established in the observation hive will require feeding until it is well established. Sugar syrup is fed from the plastic bottle which comes with the hive.

As with all glass-walled hives the sun must not be allowed to shine directly into the hive. Over heating may cause the colony to leave the hive. Covers are furnished with the hive for the glass panels for shielding from

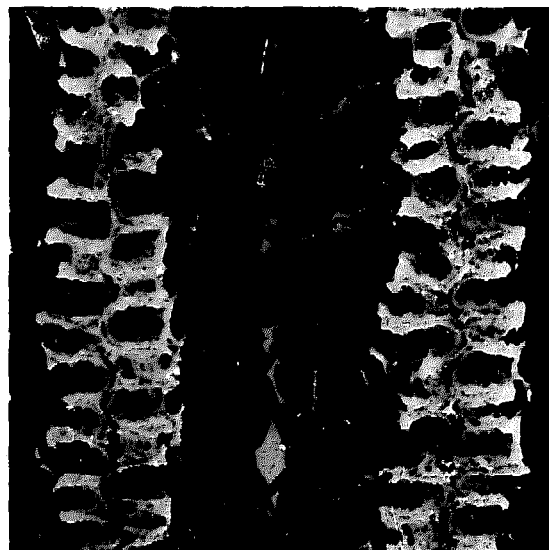

A view of bees between the combs of a hive. This picture is of a transverse section of two combs.

excessive light. This hive can be made portable by fitting it with a handle for carrying. The protective panels should be used when carrying the hive.

Once established the bees will begin to gather any nectar from flowers that are in bloom and will become self sufficient. Many interesting activities of the bees can be observed through the glass walls of the hive. Observation hives are particularly valuable as a visual aid in schools, public places or at stands or sales rooms where honey is sold.

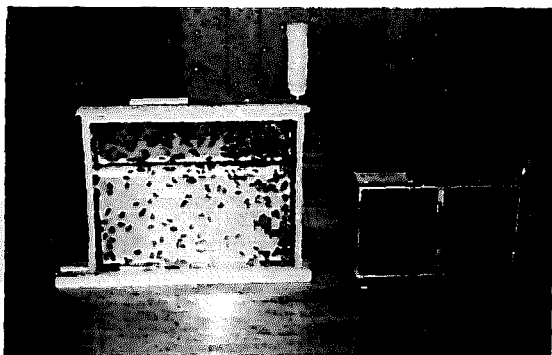

Bees are shown beginning to pass from the shipping cage into the observation hive through the plastic tube connecting the two.

**ORANGE\*** (*Citrus Aurantium*).—The orange is a native of southeastern Asia, whence its cultivation has extended since the tenth century throughout the warmer regions of both worlds. All the species are evergreen trees or shrubs. Most of them have fragrant white flowers.

The cultivation of the orange and other citrus fruits is confined in this country to Southern California, Southern Texas, and to Florida, chiefly to the southern half of the peninsula, although when given special care and protection during cold winters, they will flourish as far north as Jacksonville.

The trees remain in blossom for about four weeks if the weather is not too hot and dry. As a rule, the later the bloom appears, the shorter the time it lasts. Cool and frosty weather will prolong it unless the frost is so severe, as occurred in Florida in 1911, that it injures the blossoms when it brings the flow speedily to a close. The average surplus in a good year is about 40 pounds.

An orange grove in full bloom, displaying innumerable white blossoms among the dark green leaves

\*By John H. Lovell and E. R. Root.

and exhaling a sweet fragrance that can be perceived for a quarter of a mile in all directions, is beautiful beyond description. The bloom is sensitive to weather conditions. Either very hot and dry weather, or sudden changes to cold and wet weather, will lessen the flow.



Orange blossoms

Orange honey is light colored, fine flavored, and clear, without the thick opaque appearance sometimes observed in even clear amber palmetto honey. The flavor and aroma, which preserve the fragrance of the blossom, are delightful and cannot be duplicated in any other honey. It is produced by the carload in California.

Large bottlers of honey prize orange honey as it blends well with clover, sweet clover, and alfalfa.

#### Bees Beneficial to Orange Groves

Some California growers of citrus fruits are not inclined to let beekeepers put bees in their orange groves, notwithstanding the fact that many of the owners of the largest groves in the world want bees and plenty of them. Those who object take the stand that bees among the trees are in the way.

In Florida, there is distinctly a favorable opinion among the growers. Bees are not only welcome but

the growers invite and urge the beekeepers to put their bees among the trees.

While it is admitted that citrus trees are to a large extent self-pollinating during normal years when there has been no drouth or freeze, it is during these off-years when the bees are of great benefit in insuring a normal crop.

Said Mr. Haynes, of House & Haynes, extensive beekeepers at Dunedin, Florida: "In the off years it is easy to see the increase of fruit where there are plenty of bees and a reduced yield in those groves where there are no bees."

The orange growers are beginning to see this as well as the beekeepers, and this is largely the reason why bees are welcome in the citrus groves of Florida. When there is a light frost, the blossoms previously pollinated by bees will resist the effects of the cold better than the blossoms not visited by bees. This has been the experience of the apple growers in the North. Bees, of course, can not avert the effects of a severe freeze like that experienced some winters in Florida.

**OUTAPIARIES.** — This term is used to apply to a bee yard remote or distant from the home yard by about two or three miles. It is a well known fact that only a limited number of colonies, comparatively, can be supported in any one locality, different places being able to support widely different numbers of colonies.

#### Number of Colonies in an Apiary

The number of colonies of honeybees that may be kept in one apiary depends largely upon the bee forage plants available. Outside of the fact that some city locations may be restricted by ordinance as to the number of bees that may be kept at one location the limitations imposed by nectar resources are perhaps the most important. Just how many colonies of bees that can be supported at one location is difficult to measure. Experience will show that one location will support twice as many hives of bees as another, yet this will change from year to year. Over several years an average will likely show, however, that one location has a decided advantage over another.

Diminishing bee forage resources

throughout most of the United States suggests a general reduction in colony numbers in the average commercial beekeeper's locations. In poor or marginal locations as few as ten colonies may be the limit. If abundant, diversified forage is within flying range of the bees upwards of 50 or more colonies may find ample support in one apiary. Large acreages of cultivated forage plants, either legumes such as alfalfa and sweet clover, or others, such as sunflowers, buckwheat and cotton, to name a few, support the greatest number of colonies concentrated in a small area. Bees rented out for pollination usually do not occupy a permanent site and the crop requirements rather than the nectar resources determine the number of beehives that will be placed at one location. Small clusters of less than a dozen scattered over the field or orchard gives a better distribution of pollinators than does concentrating the hives in one location.

Better access roads, transportation improvements and mechanical hive handling have given beekeepers the opportunity to establish outyards in a more efficient manner to take advantage of all the bee forage. Mobility permits moving bees in response to changing local conditions. Beekeepers who can move bees to take advantage of changes in crop patterns or changing conditions caused by weather find that fewer bees need be kept in poor locations and the better locations may be stocked heavier to take advantage of the potential for a honey crop.

The number of colonies in an apiary that will give the highest return per unit can only be determined after several years' experience keeping bees at that location.

#### Distance Between Apiaries, and Location Thereof

A location for an outapiary must, of course, be far enough distant from the home apiary not to interfere much; but just how far is best, it is not easy to decide. Perhaps, all things considered, a good distance is from three to five miles apart.

Many reasons will make it desirable to vary. The roads may run in such directions as to make a difference; no good place may be found for any apiary at some of the points. It may be remarked that the area



of flight is not always a circle. An apiary placed in a valley between two ranges of hills might have an oblong area, the bees perhaps flying twice as far along the line of the valley as in the other directions. When an apiary is on a hill overlooking a valley bees will fly farther than when on a level. Again, the honey sources may all be in one direction (see Flight of Bees). If only one yard is to be placed, it is probably best to go in the direction of the best pasturage—a thing not always easy to determine. Sometimes one location proves to be better than another, year after year, although no apparent reason for it can be seen. It may even be worth while to vary a location a mile or more for the sake of having it where pleasant people live. But one can do much toward making the neighbors pleasant by being pleasant himself. As little trouble as possible should be made, and one should be still more careful than at home to avoid everything that may invite robbing, for robbing begets cross bees on the place.

#### **Importance of Windbreaks**

It is important to have the apiary located where there are suitable windbreaks. (See Apiary and Wintering.) This is especially important if the bees are wintered on the summer stands, for good wintering can not ordinarily be secured outdoors when the hives, no matter how well packed, are exposed to piercing winds.

#### **Rent for Apiary Sites**

In the past it has been customary for beekeepers to pay a small rental for apiary sites. In some instances some honey, instead of money, was given the landowner.

At present, because of the importance of honey bees for pollinating over 50 farm crops consisting of legumes, fruits, and vegetables, farmers who realize the value of bees as pollinators are not asking rentals. As a matter of fact, farmers, as well as fruit and vegetable growers, are anxious to have bees on their farms, and are willing to pay beekeepers for the pollinating service.

At least, beekeepers should not have to pay rentals for apiary locations because the bees are rendering an invaluable service to agriculture.

**OVERSTOCKING.** — This means putting more colonies in a locality than can be supported profitably. Sometimes a local beekeeper makes the mistake of putting too many bees in a place, but it more often happens that another beekeeper observing that the locality is good, brings in one or more yards, thus crowding the territory that was already overstocked in the first place.

#### **Overstocking and Priority Rights**

A new phase of overstocking has been developed within recent years, bringing up a rather difficult and serious problem. In good localities such as, for example, the irrigated regions (see Tropical Beekeeping) the keeping of bees is much more profitable than in some of the less favored localities. It has come to pass that, in recent years, certain beekeepers, learning of the wonderful yields in the irrigated alfalfa regions, have started apiaries within less than a mile of some other beekeepers having 100 to 200 colonies in that locality. When the newcomer establishes another apiary of 100 colonies, the place becomes overstocked, with the result that beekeeper No. 1 has his average yield per colony cut down very materially.

Some states, where overstocking has threatened to get out of control have imposed territorial restrictions, especially in some of the better beekeeping locations. North Dakota imposed such restrictions in 1977. No new commercial apiary location is allowed to be established within two miles of another. Placement is controlled by permits issued by the Department of Agriculture under Chapter 4-12-03.1 of the North Dakota Century Code. Small apiaries established by hobby beekeepers on private land are generally exempted from these regulations.

Often overstocking is associated with the out-of-state influx of over-wintering colonies. In an effort to protect the locations of resident beekeepers from overstocking by having more bees moved in than the location can reasonably support, several states have proposed or passed regulations controlling the movement of bees across their borders. Rigid controls by means of inspections and permits are also designed to prevent the introduction and spread of diseases.

## P

**PACKAGE BEES.**—It was A. I. Root who first conceived the possibility of shipping bees without combs. We find in the original edition of his ABC of Bee Culture, published in 1879, and also in Gleanings in Bee Culture in 1879 1890, and 1881, an account of his experiments in

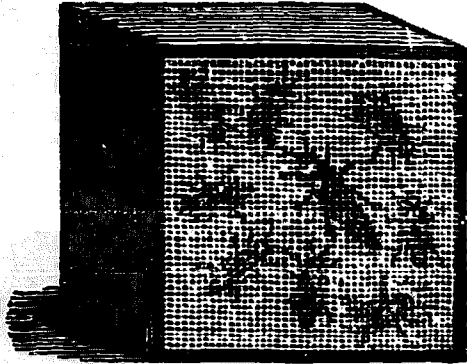

Cage designed and used by A. I. Root in 1879 to ship  $\frac{1}{2}$ -pound package of bees.

shipping bees in wire screen cages without combs, very similar to those now made. His original idea was not to eliminate the possibility of transmitting disease but to reduce express charges. A heavy, bulky hive with a full equipment of combs necessarily made the express charges very high. A. I. Root early saw the possibilities of shipping a half-pound, a pound, or two, or three pounds of bees in a light wire - screen cage. Two or three pounds of bees, enough to make up what would be equivalent to an ordinary colony wintered over, would weigh not over five or six pounds, cage and all, as against 45 or 50 pounds for a whole hive and colony. There might be no more bees in the full colony than would be in the wire cage, and one would gather just as much honey as the

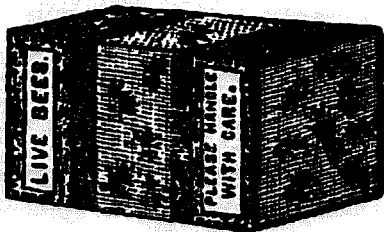

A. I. Root's cage for shipping  $\frac{1}{2}$  pound of bees as made and used 70 years ago.

other, provided it was released upon combs of honey in a hive already prepared. It was A. I. Root's idea to ship hives, frames, and foundation in the flat at a very low freight rate, and ship the bees later in package form to be released in the hives after they were nailed and painted. At the time he worked out his idea he did not see that, in addition to saving enormous express charges, he was also going to prevent the transmission of American foulbrood from a locality having the disease to one that did not have it. At the time foulbrood had not begun to be the menace that it is now.

At first Mr. Root met with many difficulties. His early experiments,

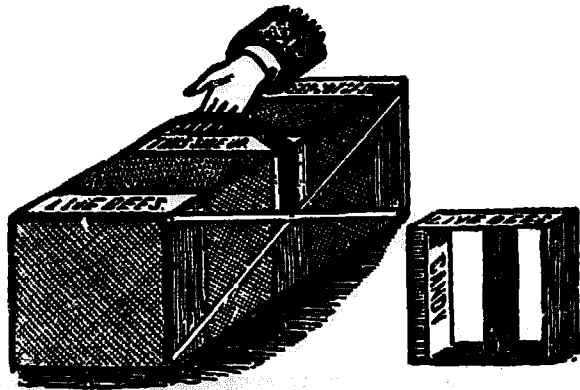

Cages for shipping one pound of bees. These illustrations were reproduced from June 1881 issue of Gleanings in Bee Culture. Note the water and syrup bottle in the center of the drawing at the right above. This package and the one in the opposite column are the original packages as they were made in 1881. At this early date A. I. Root, the original author of this book, blazed the way for the great industry of over a million pounds a year.

while often successful, sometimes met with failure. He was not able to make the candy just right, and the bees starved to death. He therefore used metal containers for syrup or water. With the water bottle and the candy he finally succeeded in making good deliveries even over long distances. But there were so many failures in shipping bees on candy alone without combs that for a time the idea was abandoned. It was taken up later by the author, after having encountered the obstacle of foulbrood being sent with

shipments of bees on combs. Elaborate experiments in 1914, 1915, and 1916 were conducted by beekeepers all over the country. It developed that when the candy was "right," or syrup was used, the bees would go through in good order, especially in early spring. It was shown that syrup is the proper food. A few of the larger shippers finally discovered a method of making candy that would deliver 75 percent of the bees in good condition in the early spring, but they were not able to make such shipments after hot weather came on.

The first to make successful shipments of package bees from the South to North, in 1912, was W. D. Achord, then of Fitzpatrick, Alabama, near Montgomery. For a year or two he was the only one who could make a candy, not too hard nor too soft, to carry bees through to destination. He was willing to show his neighbors how to make the candy, and the result was that in a few years thousands of packages of bees were sent from the vicinity of Montgomery alone to the northern beekeepers and orchard growers. As soon as it was found that syrup was better and cheaper than the best candy the business developed rapidly all over the South.

#### Package Bees to Replace Winter Losses

Heavy winter losses in the more northern states began to bring to the front the possibilities of making good the loss by these package shipments. About 1918 and 1920 it was discovered that two or three pounds of young bees would equal the performance of a fair wintered - over colony in the production of honey. The following seasons several reports were made showing that two or three pounds of bees with a queen, placed on empty combs where the bees had died, would do as well as and sometimes even better than the wintered-over colonies. This was especially true when the packages were made up of young bees and supplied with syrup instead of soft candy.

Prior to the 1950's most package bee shipments were made by railroad express. The increased use of trucks for commercial hauling turned over the delivery of package bees to the United States Post Office and privately

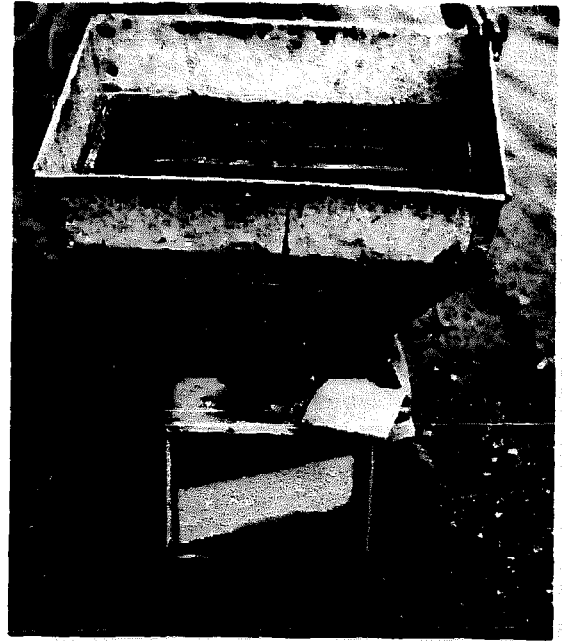

The latest type of funnel to screen out drones or queens through the excluder.

operated carriers. United Parcel, a private carrier operating local delivery trucks, distribute package bees transported from the southern states by commercial trucks. Local post offices are the receiving points for parcel post shipments. Rural mail carriers may deliver package bees or they may be held at the local post office and the addressee called by telephone when the bees arrive. If package bees are expected by parcel post your local postal station should be given a telephone number where you can be reached. Postal procedures contain handling instructions for package bees and are continually revised to provide the best service possible. Most package bee shippers add postage to the price of the package.

If the bees arrive in undeliverable conditions or are dead, a claim must be filed with the postal department on arrival after inspection by the consignee. Forms for this purpose are available from a rural carrier or at the post office.

Packages of bees are usually fastened together in multiple units with wood strips to maintain spacing. This is necessary for ventilation. Bees placed in wood and wire cages form clusters but they are not capable of maintaining temperature controls as do hived bees. Confinement often caused increased

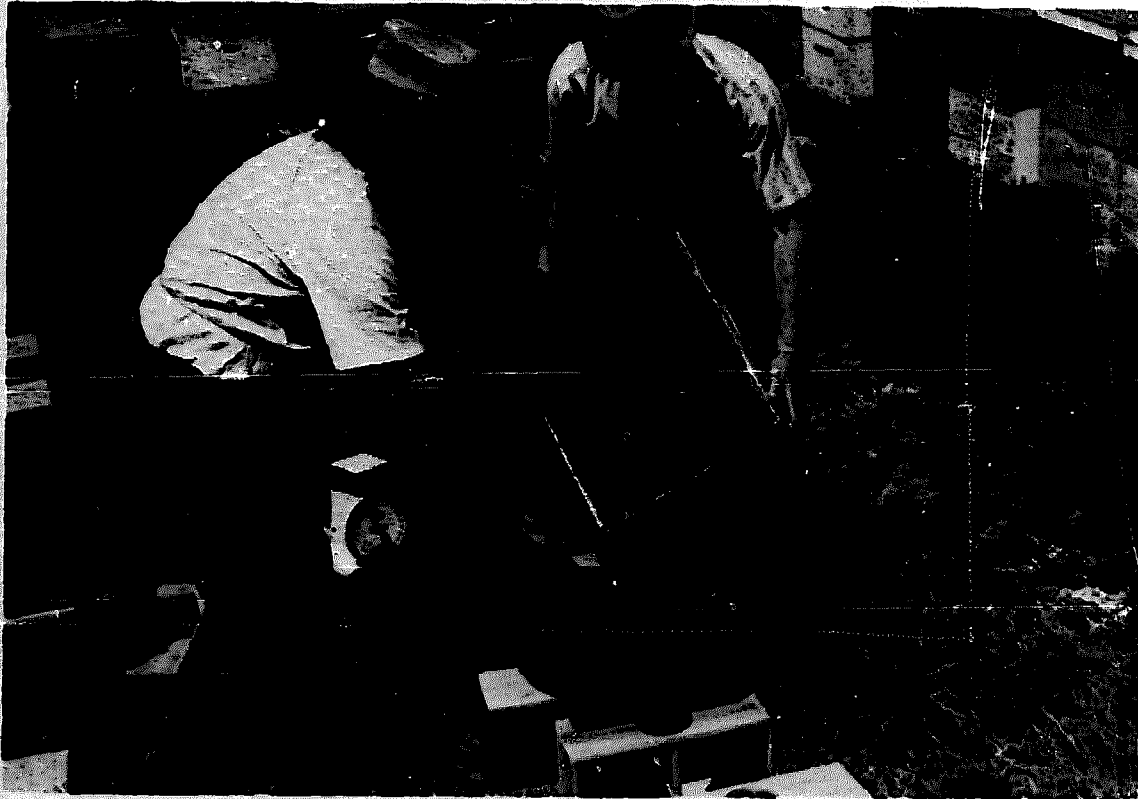

Filling wire screen shipping cages with bees which have been shaken from combs taken from the hives in the background.

activity by the thousands of individual bees in the package and during hot weather this heat can be fatal to the bees if ventilation between the packages is poor during shipment. Even if the temperatures are only moderately warm, exposure to direct sunlight can make it unbearable for the packages of bees and they will likely perish. Package bees in shipment can withstand quite low temperatures, much better than high humidity, high temperature and restricted ventilation.

More package bees are being transported by experienced bee handlers than formerly.

Orders are picked up in the South, loaded aboard trucks and hauled to a central distributing point in the northern states. Their truck beds are fitted with enclosures which may be opened for greater ventilation as the trip begins in the warmer South and as the load is brought north the flow of air through the load may be restricted by closing vents or adding solid panels to the front of the load. The drivers are usually experienced beekeepers who can handle nearly any problem that may occur during the transport. Most pack-

age bees purchased by commercial beekeepers are handled in this manner. The bees are much more likely to arrive in good condition than when shipped by common carrier. Beekeepers desiring only a few packages in the spring would find it to their advantage to pool their orders with other beekeepers to arrange such a shipment with a local beekeeper willing to make the trip south and haul a truckload of packages back north. Beekeeping associations often take the initiative in this service to the members.

#### Package Bees for Strengthening Weak Colonies

Before the day of package bees, heavy winter losses meant that the equipment of combs, hives, and all were idle during the season. It took a whole year to build the bees up to their former strength, and then there was the chance of severe winter losses again. It is evident that the package business is really insurance against heavy winter losses. If one has lost 50 percent of his colonies and the other 50 percent are medium and weak colonies, the whole bee yard, at a cost of new

three-pound packages of bees, can be put into active working condition again.

**Type of Cage with Syrup Can that Has Given Excellent Results**

Various styles of cages were devised for the shipment of bees without combs, but the one that has given excellent results is an oblong cage having a wooden top and bottom, supported by posts at the four corners, the sides and ends being surrounded with wire-cloth. The wooden framework inside is braced by a cross bar which also serves as a support for the feeding can. The top of the cage should have a hole about four inches in diameter through which can be let down a syrup can containing just ordinary sugar syrup, made by mixing about equal parts of water and sugar. This syrup can has one or two holes in the cover the size of a very small wire nail, or 1/32 of an inch in actual measurement. One hole is liable to be clogged and, besides, might not feed the syrup fast enough for a two or three pound cluster of bees. By having two holes this danger is eliminated. If the weather is warm and the cluster is large, three holes may be used but as a rule two give better results than three and are always better than one. To prevent crystallization and clogging the holes, the sugar should be dissolved and thoroughly stirred.

A shipper in the South can shake two pounds of bees into each of a hundred different cages. To place the queen cage in with the cluster of bees, jar the cage downward so that the bees are deposited in the bottom of the cage, quickly insert the cage, and put back the syrup can. The cage should be held near the top with a piece of wire.

On arrival at destination it is easy for the customer to see whether the queen is alive. If she is dead, he should immediately report the fact so that a new queen may be sent to replace her.

**When to Install Packages**

There is some difference of opinion on this subject. Some say packages should be ordered as early as 12 weeks before the main honey flow. The earliest date packages can be shipped from the South varies a bit depending on the weather, but few packages are shipped before April 15th. In general we would recommend that packages be ordered from seven to nine weeks before the honey flow and preferably nine weeks if possible. This gives the colony a chance to raise three cycles of brood and build up its honey gathering force. If you are not sure when the honey flow starts, order them to arrive on or slightly after April 15th. If possible place your order about one month before you want shipment, to be ahead of the rush.

Everything in readiness for the package installation. In the event combs of honey are not available, sugar syrup must be fed. Frames with foundation may be used in place of drawn comb.—Photo by K. Bosch.

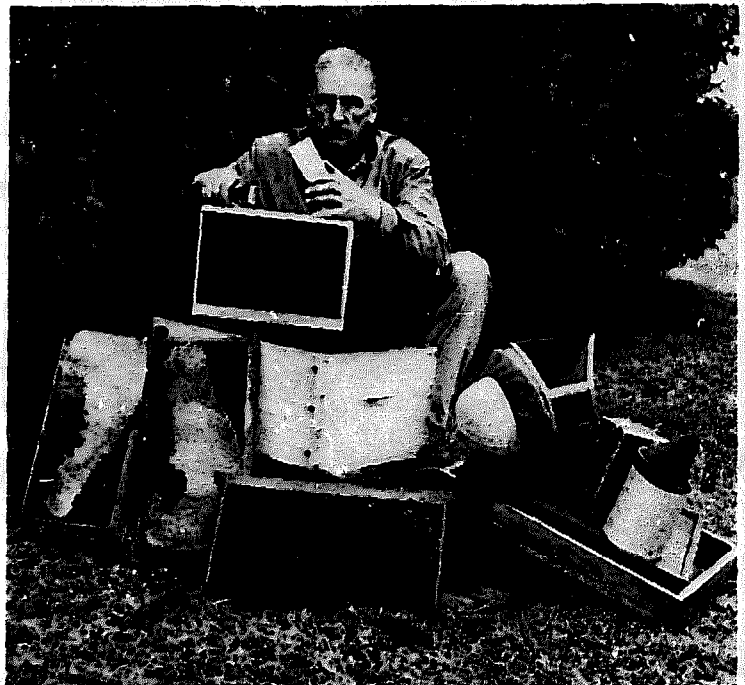



A rank growth of saw palmetto at Palm Beach, Florida

**PALMETTO.\***—In Florida the cabbage, scrub, and saw palmettos are valuable sources of nectar. The cabbage palmetto (*Sabal Palmetto*), so called from the cabbage-like terminal bud, which is boiled and eaten like cabbage, is found in the sandy coast regions from North Carolina to Florida, and also occurs in Cuba and the Bahamas. It grows from 20 to 50 feet tall, and is abundant along the east and west coasts, on the banks of rivers, and in hammocks throughout southern Florida.

In the extreme southern part of Florida the cabbage palmetto begins to bloom about the first of July, but in the northern portion of the state not until August. The flowers are very sensitive to the weather; too much dampness blights, and a hot dry atmosphere blasts the bloom.

The honey is nearly white to light amber-colored, and has a characteristic aroma, which does not resemble at all that of scrub palmetto. It is very thin, and in warm weather runs almost like water, and even in cold weather it never thickens. The flavor is extremely mild, but it is inferior to that of saw palmetto. Gas bubbles may frequently be seen under the cappings of the sealed cells, and during extracting the honey foams considerably, as though it were fermenting, but after it has stood for a few days the bubbles wholly disappear. But honey from unsealed cells will ferment enough to deprive it of its flavor. As it is a

mild honey it blends well with other honeys.

#### Scrub Palmetto

Two low shrubs with creeping or horizontal stems, called scrub palmetto (*Sabal megacarpa*) and saw palmetto (*Serenoa serrulata*) are the most widely distributed honey plants in Florida. Beekeepers frequently fail to distinguish between them, and regard them as a single species. The leafstalks of the scrub palmetto are sharp-edged, but not toothed, while the leafstalks of the saw palmetto are armed with numerous sharp spiny teeth. The true palmetto (*Sabal*) may readily be distinguished by the threadlike fibers on the margins of the leaves. In the scrub palmetto the three cells of the ovary are wholly united, but in the saw palmetto they are free at the base.

The scrub palmetto (*Sabal megacarpa*) is a low shrub with long, crooked, creeping stems, which are partly subterranean. It grows well over the southern two-thirds of the peninsula of Florida, becoming rarer and smaller toward the northern boundry of the state. It reaches the largest size south of a line extending from Tampa to the east coast. On the west coast for miles north and south of Tampa it forms an unbroken sea of green. The honey is lemon yellow, thick and heavy, with an aromatic color and fragrance. It is considered one of the finest honeys in Florida, but possibly is surpassed by white tupelo or orange honey. It

\*By John H. Lovell.

granulates early but not as quickly as orange honey.

#### Saw Palmetto

Saw palmetto (*Serenoa serrulata*) closely resembles scrub palmetto in flower and fruit, and also gives a large honey flow. The honey is similar to that of scrub palmetto, with which it is usually mixed, as both species bloom at the same time. As has been pointed out, the saw palmetto has a much wider distribution extending far beyond the boundaries of Florida. No doubt the saw palmetto and scrub palmetto are often confused.

**PARTHENOGENESIS.**—A virgin development is found in certain plants and animals and means, when applied to bees, that a virgin queen or laying worker may lay eggs but those eggs will produce only drones. It follows that a drone is the son of his mother. In other words, the drone has no father but has a grandfather on his mother's side.

Parthenogenesis has a very important part in the life history of some aphids. An aphid colony in the summer may consist almost entirely of wingless females, with the power of producing generation after generation of living young without fertilization. The young so produced are females, and many of them are wingless. Both winged and wingless females are able to produce young parthenogenically within from ten to twenty days.

At this point we take pleasure in presenting the work of Otto Mackensen of the U. S. Department of Agriculture, Bureau of Entomology and Plant Quarantine, Louisiana State University, and reprinted in the *Journal of Economic Entomology* 36(3) 465.

#### The Occurrence of Parthenogenetic Females in Some Strains of Honey Bees

It has been established beyond all doubt that male honey bees regularly develop from unfertilized eggs, and females (queens and workers) from fertilized eggs, as first set forth by Dzierzon in 1845. This also holds true for most insects of the order Hymenoptera. Females resulting from unfertilized eggs have also been reported in several races of the honey bee, but it has been generally assumed that these were exceptions. Hewitt (1892, reviewed by Anderson 1918), working with Punic, or Tunisian bees, imported from North Africa to England, reported that when a colony of these bees becomes queenless, as for example by the loss of the virgin queen on her mating flight, laying workers will develop promptly, and queens, workers, and

drones will be reared from the eggs produced by them. He states that "the instinct seems perfect in the Punic bees; only partly so in the Syrians, and quite absent in our native bees." In the bees native to the Cape regions of South Africa similar conditions exist, as first reported by Onions (1912) and later confirmed by Jack (1916). Parthenogenetic females have also been found in the parasitic wasp *Habrobracon juglandis* (Ashm.) by Whiting (1924) and genetic investigation by Speicher (1934) has shown them to be normal diploid individuals.

**PARALYSIS.**—Paralysis of honeybees is a widely distributed disorder that seems to cause greater losses in warm climates than in cold climates. Affected colonies usually recover after a short time, but in some cases the disorder continues throughout the active season. In the Northern states it usually disappears quickly or remains confined to a few colonies in an apiary, but in the South it will sometimes spread and cause considerable losses. The losses from paralysis range from a few bees in mild cases to almost all the bees in malignant cases.

During the early stages of paralysis affected bees will remain on the combs and cannot be distinguished readily except that the other bees will often tug and pull at them in a very excited manner. The infected bees make very little effort to defend themselves. They may attempt to escape by crawling away. The abdomens of the sick bees are usually of normal size, although on occasion they will appear abnormal, either swollen or shrunken.

Trembling, weakness and hairlessness, particularly when accompanied by dark, shiny abdomens and sprawled legs or wings seem to be the most dependable symptoms of paralysis. Infected bees tend to collect on top of the frames. A diagnosis can sometimes be made by carefully opening the hive, disturbing the bees as little as possible, and examining the bees on the top bars of the brood nest.

Huber in 1809 and later A. I. Root and E. R. Root in 1913 described the symptoms of this disease—adult bee paralysis. Burnsile in 1933 and 1945 then demonstrated that filtrates from "paralyzed" bees caused symptoms and death when sprayed on healthy bees. Bailey in 1963 isolated two bee viruses that cause paralysis of adult honeybees.

The first of these, Chronic Bee Paralysis Virus, now called CBPV, he isolated from bees naturally infected. The second, Acute Bee Paralysis Virus, now called ABPV, he isolated in laboratory experiments. ABPV apparently does not actually cause paralysis in nature and occurs in the same numbers in healthy bees as in paralyzed bees. CBPV on the other hand has been isolated from paralyzed bees in Britain, North America and Australia.

**Treatment and Control of Paralysis**

No treatment is known for bee paralysis, except that requeening sometimes seems to eliminate it from individual colonies.

**PHEROMONES\***—The coordination of the activities of members of a colony is essential to maintain its organization and unity, and this is largely achieved by the presence in the colony of various chemicals—the so-called pheromones to which the individual bees respond. The transmission of these chemicals may be by direct bodily contact between bees, in their food, or in the air. The existence of such chemicals has been postulated for some time, but their isolation and identification have become possible only with recent advances in chemical techniques, combined with more sensitive techniques for assaying the chemicals biologically.

\* Free, J. B., American Bee Journal. Vol. 107 (12) 1967.

**PHEROMONES THAT HAVE BEEN IDENTIFIED IN THE HONEYBEE**

Name and Chemical Nature	Where Produced	Type
9-oxodec-trans-2-enoic acid (unsaturated fatty acid)	mandibular glands of the queen	Sexual attractant for the drones of all four species Aphrodisiac which stimulates mating Attractant which induces clustering in swarming workers (in association with other pheromones) Attractants towards workers (only in association with other substances not yet identified) Inhibitor of queen cell construction (in association with 9-hydroxydec-trans-2-enoic acid) Inhibitor of worker ovary development (primer pheromone); other substances also influence this process
9-hydroxydes-trans-2-enoic acid (unsaturated fatty acid)	mandibular glands of the queen	Sexual pheromone*, less attractive than 9-oxodec-trans-2-enoic acid Attractant that stabilizes clustering (in association with other pheromones) Inhibitor of queen cell construction (in association with 9-oxodec-trans-2-enoic acid)
isoamyl acetate or isopentyl acetate (alcohol acetate)	entire sting apparatus of the workers	Alarm pheromone for all four species
heptan-2-one (aliphatic ketone)	mandibular glands of the workers	Alarm pheromone for Apis mellifera only (function not yet established)
geraniol trans form (primary terpenic alcohol)	Nasonov gland of the worker (7th abdominal tergite)†	Trail-marking pheromone
geranic acid trans form (terpenic acid)	ditto	ditto
nerolic acid cis form (terpenic acid)	ditto	ditto
citral or geranial trans form (terpenic aldehyde)	ditto	ditto

\* Blum, however, believes that this acid has no sex attractant for drone honeybees.

† Wells and Wenner, however, state that "none of the evidence obtained supports the hypothesis that Nasonov secretion contains an attractant pheromone".



**POISON SPRAYS, EFFECTS ON BEES.** —During the last 20 years bee poisoning has increased in importance, with greater use of insecticides and other chemical materials on a wider range of crops. At the same time, insect pollination of crops has become a more critical problem in the United States and in some other countries, because intensive cultivation and use of insecticides are reducing the populations of wild bees. Growers are finding it necessary to rent honeybee colonies for pollinating an increasing variety of crops in order to obtain good yields.

#### Indemnification

The loss of bees to pesticides reached such large proportions by the late 60's that Congress passed a special program to reimburse beekeepers for losses due to federally registered insecticides.

Generally speaking the beekeeper must have been the innocent victim of the loss thus having done everything he could to avoid it and he must show proof that a registered pesticide was responsible for it. An unbiased witness must testify to the loss.

More details on the requirements of the law can be obtained by contacting your local Agricultural Stabilization and Conservation Service (ASCS) office.

#### Causes of Bee Poisoning\*

Most bee poisoning occurs when insecticides are applied to crops during the blooming period. Other hazards are: drift of toxic sprays or dusts on to adjoining crops which are in bloom; contamination of flowering cover crops when orchards are sprayed; bees coming into contact with insecticide residues on plants; bees drinking or touching contaminated water on foliage or flowers; bees collecting contaminated pollen or nectar; bees collecting insecticidal dusts with pollen (arsenical materials and Sevin are especially dangerous because they may be stored with pollen in the hive and later fed to brood; hazardous amounts of insecticides have not been found in honey.)

#### Signs of Bee Poisoning

The most common sign is the appearance of excessive numbers of dead bees in front of the hives. Aggressiveness in bees may be caused by such materials as BHC. Stupefaction, paralysis, and abnormal activities of bees are commonly caused by DDT, other chlorinated hydrocarbons, and organophosphorus insecticides. Bees have been observed performing communication dances on the horizontal alighting board at the hive entrance while under the influence of insecticide poisoning. Other disorganized behavior patterns can include lack of recognition by guard bees. Regurgitation of substances in the digestive tract is often caused by poisoning, with organophosphorus insecticides.

One forager returning to the hive with a load of contaminated pollen or nectar may cause extreme agitation and death of a number of bees. Several such foragers can cause serious disruption and damage to the colony. Frequently the queen is superseded, due to the agitation of the workers or for some other reason.

Many bees poisoned with Sevin or Dieldrin slow down and appear as though they had been chilled; such bees may take two to three days to die. Dead brood in or in front of the hive is typical of Sevin or arsenical poisoning. Of course, in severe cases, there are simply few living bees in the hives, or the whole colony may be dead.

When not enough hive bees are left to cover the brood frames or care for the brood, the larvae are killed by chilling or starvation. Queens may be affected, especially by slow-acting materials such as arsenicals, Sevin and Dieldrin, which may be taken into the hive with pollen. Queens may exhibit abnormal behavior, for instance laying eggs in a poor pattern. Severely weakened or queenless colonies will not live through the following winter.

#### Labeling Pesticides

In an effort to prevent or reduce damage to honeybees and other important pollinating insects the State of Ohio in 1973 passed an Ohio Pesticide Use and Application Law which requires labeling statements on certain economic poisons.

\*Carl A. Johansen, Department of Entomology, Washington State University, Published in *Bee World*, Volume 47, Spring 1966, No. 1.

### Analyzing Poisoned Bees

Analyses of dead bees are necessary for definite proof of chemical poisoning. Suitable chemical analyses are time-consuming and costly. Samples for analysis must be fresh, and large enough to process. It may be necessary to collect recently killed bees at hive entrances for several days to get a sample of at least one quart or one pound (1 litre; ½ kg.). These should be stored in plastic bags in a freezer until analyzed. In addition, an exhaustive survey must be conducted in the locality of the poisoning to determine which pesticide is most likely to have killed the bees. The chemist must be presented with one prime suspect to search for in the sample.

Pigments and waxes in dead bee material present a terrific problem to the chemists. Such materials interfere with the analytical procedures and must be removed. The cleaning-up processes often prevent any positive findings which might otherwise have been obtained.

The use of living organisms to detect the presence of chemicals in samples of various sorts (bioassay) is especially useful in analysing poisoned bees. The minute traces of pesticide required to kill bees can be accurately assayed, and a clean-up of sample extracts is not always necessary.

### Beekeeper-Grower Cooperation

A major consideration for the reduction of bee poisoning is beekeeper-grower cooperation. Many cases could be cited where a grower, simply through ignorance of the hazard to bees, has caused tremendous damage to a large number of colonies. The timing or materials of his pest-control program could have been modified so that little or no poisoning occurred, and usually this can be done without unduly increasing the control cost or inconveniencing the grower.

Beekeepers should get acquainted with the farmer on whose land they are placing hives. They should find out about his pest-control practices, and about other special problems which might occur.

When colonies are hired by the grower for pollination of his crop, definite verbal or written agreements can be made. One type of written contract

places the emphasis on crop production and has the desirable effect of encouraging closer cooperation between the grower and the beekeeper. Such contracts should include details of the responsibility of the beekeeper in providing strong and effective colonies, of the farmer in safeguarding the bees from poisoning, and so on. In modern agriculture, where the beekeeper often depends on the grower for bee forage, and the grower depends on the beekeeper for pollination, such cooperation and understanding of each other's problems are essential.

### Insecticides

Here are some of the most important points concerning toxicity of insecticides to honeybees (Table 1 gives more details:)

1. Small-scale laboratory tests of toxicity to bees do not necessarily indicate the hazard in the field. For example, Sevin was low in toxicity in certain laboratory tests, but is quite dangerous to bees in the field. Residues may continue to kill up to 12 days or more after application. On the other hand, Endrin showed a high toxicity in the laboratory, but has a short residual action on honeybees in the field.

2. The effect on honeybees is not necessarily an accurate criterion for the poisoning hazard to various wild bees. Endrin usually has less than two hours residual toxicity to honeybees, more than three hours to alkali bees *Nomia melanderi*, and over 24 hours to the alfalfa leaf-cutting bee *Megachile rotundata*. The leaf-cutting bee tends to be more susceptible than the honeybee to many insecticides.

3. Many organophosphorous insecticides are highly toxic to bees and cannot be applied safely to flowering crops. Most of the cyclodiene group of insecticides (Chlordane, Dieldrin, Aldrin, Heptachlor), and Lindane or BHC, tend to have a residual toxicity which is a hazard to bees.

4. Some of the inorganic compounds, especially the arsenicals, are very toxic and have a long residual action.

5. Because of short residual activities, some organophosphorus materials such as TEPP, Trithion, Dibrom, Phostex, Dylox, Delnav, Korlan and Menazon can be applied safely to flowering crops when the bees are not foraging.

Table 1. Summary of the toxicity and poisoning hazard of insecticides to honeybees

P = organophosphorus compound  
 C = chlorinated hydrocarbon  
 D = dinitro compound  
 I = inorganic compound

B = botanical or synthetic equivalent  
 M = specific miticide  
 Ca = carbamate  
 Co = quinoxaline-sulphur derivative

I = hazardous to bees at any time  
 II = not hazardous if applied when bees are not foraging  
 III = not hazardous to bees at any time

Material	Type	Laboratory toxicity	Field application as dust			Field application as spray		
			Toxicity	Residual effect	Use class	Toxicity	Residual effect	Use class
Aldrin	C	very high	very high		I	very high		I
Allethrin	B	low						III
Aramite	M	low	moderate		II-III	low		III
Banol	C					very high	>7 hr.	I
Baygon	Ca	high				high	>1 day	I
Baygon G	Ca		low		III			
Baytex (Fenthion)	P	very high				very high	2-3 days +	I
Bidrin	P	very high				very high	5 hr.-1 day +	I
Bomyl	P	very high				low-high	2 days	I
Calcium arsenate	I	high	very high	long	I			I
Chlordane	C	very high	high-very high	2-3 days	I	high		I
Chlorobenzilate	M	moderate				low		III
Chloropropylate	M					low	<1 day	III
Chlorthion	P							I
Ciodrin	P	very high						I
Cryolite	I	high	high		I	high		I
DDT	C	moderate	moderate-high	2-3 days	I-II	moderate	1 day+	II
Delnav (Dioxathion)	P	low				low-high	2 hr.	II
Diazinon	P	very high	very high	1 day +	I	very high	1 day	I
Dibrom E (Naled)	P	very high				very high	3 hr.	II
Dibrom WP (Naled)	P		high	>7 hr.	I	very high	>3 hr.	II*
Dicaphon	P	very high						I
Dieldrin E	C	very high				high	<2 days	I
Dieldrin G	C		moderate	<2 hr.	II			
Dieldrin WP	C	very high	very high	8 days	I	very high	5-7 days	I
Dilan	C	low	low-high	3 hr.	II	low-high	3 hr.	II
Dimetilan	Ca	moderate				low	3 hr.	II
Dinoset (Dinitrobutylphenol)	D	very high				very high	1 day +	I
Di-Syston (Disulfoton)	P	very high				low	3 hr.	II
Di-Syston G	P		low	<2 hr.	III			
Dithione (Sulfotep)	P	very high						I
DMC (Dimite)	M	low				low		III
DN-111	D	low						III
DNOC (Dinitroresol)	D	high				very high		I
Dylox (Trichlorfon)	P	low-high	high	>3 hr.	I	low-high	2-5 hr.	II
Endrin	C	very high				moderate	<2 hr.	II
EPN	P	very high	high	1 day +	I	very high		I
Eradex (Thioquinox)	Co	moderate						II
Ethion	P	low				low-high	<2 hr.	II
Ethyl Guthion (Azinphos-ethyl)	P	very high				very high	1 day +	I
Famophos (Famphur)	P	very high						I
Fenon	M					low	<2 hr.	III
Genite 923	M	low	moderate		II-III	low	<2 hr.	III
Guthion (Azinphosmethyl)	P	very high				very high	2-4 days	I
Heptachlor	C	very high						I
Heptachlor G	C		moderate	<2 hr.	II			
Imidan	P	very high				very high	1-4 days	I
Isodrin	C	moderate						II
Isolan	Ca	high				low	3 hr.	II
Isopropyl parathion	P	low						III?
Karathane (Dinocap)	D	low						III
Kelthane (Dicofol)	M	low				low		III
Kepone	C	low				low	<1 day	III
Kepone bait	C		low		III			
Korlan	P					moderate	3 hr.	II
Lead arsenate	I	very high				very high	long	I
Lime-sulphur	I	low				moderate		III
Lindane & BHC	C	very high	very high	2 days +	I	high		I
Malathion	P	very high	very high	1 day+	I	moderate-very high	2 hrs.-2 days +	I*
Malathion G	P		low	nil	III			

Material	Type	Laboratory toxicity	Field application as dust			Field application as spray		
			Toxicity	Residual effect	Use class	Toxicity	Residual effect	Use class
Malathion	Ca	high				very high	>3 days	I
Metazon	P					moderate	<2 hr.	II
Metacide	P	very high				very high		I
Meta-Systox (Methyl demeton)	P	high				moderate	nil	II
Meta-Systox-R	P	high				moderate	nil	II
Methoxychlor	C	low				moderate	<1 day	II
Methyl parathion	P	very high						I
Methyl trithion	P	very high				high	<1 day	I
Mirex G	C		low			III		
Mitox (Chlorbenside)	M	low				low	<2 hr.	III
Morostan	Co		low	nil	III	low	nil	III
Morocide (Binapacryl)	D	low				low	<2½ hr.	III
Neotran	M	low				low		III
Nicotine	B	low	low	few hr.	III			
NPD	P	very high				low	2½ hr.	II
Omite	M					low	<3 hr.	III
Oxex	M	low	low-high		II-III	low		III
Paraoxon	P	very high						I
Parathion	P	very high	very high	1 day +	I	high	1 day +	I
Pentac	M					low	<1 day	III
Perthane	C	moderate	moderate	1 day+	II	low	<1 day	II
Phosdrin (Mevinphos)	P	very high	very high		I	very high	2 hr.-1 day	I
Phosphamidon	P	very high				very high	2 hr.-2 days	I
Phostex	P	moderate				high	2 hr.	II
Pyrazat	Ca	very high						I
Pyrethrum	B	low	low	3 hr.	III	low		III
Rhothane (TDE)	C	moderate	moderate		II	moderate		II
Rogor (Dimethoate)	P	very high				very high	1-2 days	I
Rotenone	B	low	low-high	<1 day	II-III			
Ryasia	B	low				moderate	>3 hr.	II
Sevin (Carbaryl)	Ca	low-high	high	3 days +	I	moderate-high	7-12 days +	I
Sevin G (Carbaryl)	Ca		low	<2 hr.	III			
Schradan	P	low-very high				low	1 day	III
Sodium fluorosilicate bait	I		low		III			
Strobane	C	low						III
Sulphanone	M	moderate	moderate		II-III	low		III
Sulphur	I	low			III	low		III
Sunathion	P	very high						I
Systox (Demeton)	P	very high				moderate	<3 hr.	II
Tedion (Tetradifon)	M	low				low	<2 hr.	III
Telodrin (Isobenzan)	C	very high				high	>2 hr.	II
Temik G	Ca		low	nil	III			
TEPP	P	very high	very high	<3 hr.	II	very high	3 hr.	II
Tetram	P	low				moderate		II
Thiocron	P	high				low	3 hr.	II
Thiodan (Endosulfan)	C	moderate				low	<5 hr.	II
Thimet E (Phorate)	P	moderate				very high	5 hr.	II*
Thimet G (Phorate)	P		moderate	<2 hr.	II			
Toxaphene	C	low	low-high	<1 day	I-II	low	<1 day	II
Trithion (Carbophenothion)	P	moderate	high	>1 day	I	high	<5 hr.	II
Vapona (Dichlorvos)	P	very high				very high	1 day +	I
V-C 13 (Nemacide)	P	high				low	2 hr.	II
Zectran	Ca	very high				very high	1-2 days	I
Zinophos	P	very high						I

Much of the research upon which the above table is based was conducted in Washington, but all other available sources of data were also used; the work of L. D. Anderson and E. L. Atkins in California was particularly helpful.

\* Materials which can be applied with reasonable safety only in the evening.

† Undiluted or ultra-low volume technical Malathion spray treatments retain a high residual toxicity hazard to bees for at least 4 days.

Azinphos-ethyl, see Ethyl Guthion  
 Azinphosmethyl, see Guthion  
 Binapacryl, see Morocide  
 Carbaryl, see Sevin  
 Carbaryl, see Sevin G  
 Carbophenothion, see Trithion  
 Chlorbenside, see Mitox  
 Demeton, see Systox  
 Dichlorvos, see Vapona  
 Dicrofol, see Kelthane  
 Dimethoate, see Rogor

Dimite, see DMC  
 Dinitrobutylphenol, see Dinocet  
 Dinitrocresol, see DNOC  
 Dinocap, see Karathane  
 Dioxathion, see Delnav  
 Disulfoton, see Di-Systox  
 Endosulfan, see Thiodan  
 Famphur, see Famophos  
 Fenthion, see Baytex  
 Isobenzan, see Telodrin  
 Methyl demeton, see Meta-Systox

Mevinphos, see Phosdrin  
 Naled, see Dibrom E  
 Naled, see Dibrom WP  
 Nemacide, see V-C 13  
 Oxydemeton-methyl, see Meta-Systox-R  
 Phorate, see Thimet E  
 Phorate, see Thimet G  
 Sulfotep, see Dithione  
 TDE, see Rhothane  
 Tetradifon, see Tedion  
 Thioquinox, see Eradex  
 Trichlorfon, see Dylox

6. Systemic insecticides, such as Phorate, Demeton, (Systox), Di-Syston and Schradan, are a reduced hazard to bees because they are rapidly absorbed by the plants. The bees do not come into contact with the poison if it is applied when they are not foraging. The hazard of Demeton is also reduced by its repellent action toward honeybees.

7. DDT and similar chlorinated hydrocarbons (TDE, Methoxychlor, Perthane) tend to be moderate in their toxicity when applied as sprays and can be used safely while bees are not foraging. Toxaphene, Thiodan, and Endrin also fall in this category.

8. One organophosphorus compound, Schradan, is low in toxicity to bees and can be applied safely at any time.

9. Some of the dinitro compounds (DN-111 and Karathane), the botanical materials (e.g. Pyrethrum, Nicotine, Rotenone), and all the specific miticides (e.g. Aramite, Ovex, Kelthane), are relatively non-toxic to bees.

10. Several investigators have shown that both DDT and Sevin are considerably more toxic to honeybees at low than at high temperatures. In addition, organophosphorus insecticides usually retain a longer residual action at low temperatures.

#### Other Types of Chemicals

None of the fungicidal materials tested so far appears to be hazardous to honeybees. Several of the mercury-containing fungicides have been shown to be toxic to bees by other investigators, but this has not proved true in Washington tests. Tag, Puratized Agricultural Spray, Dodine, Phygon and other fungicides have been used at up to twice the normal recommended dosage rate without any harm to bees.

Of the herbicides, only arsenical and dinitro (especially dinoset) compounds and Endothal have been shown to be highly toxic to bees. Amino triazole, Atrazine and Simazine are low to moderate in toxicity but present some hazard because treated flowers remain open, allowing residual action to occur. Although 2,4-D and related compounds are not dangerous to bees, certain formulations or derivatives (notably alkalamine salts and isopropyl esters) are

toxic. Other herbicides tested are not harmful to bees.

Several investigators have shown that injurious effects may be caused by 2,4-D-type materials to honeybees under large-scale field conditions which would not be shown in small cage experiments. Such effects might be caused by poisoning of the nectar and by reduction of the bee's ability to fly.

Blossom-thinning materials have not been injurious to bees as used in the orchards of Washington.

#### How the Grower Can Reduce Bee Poisoning

The following are some of the ways to reduce bee poisoning hazards:

1. Do not apply insecticides which are toxic to bees on crops in bloom, including cover crops in orchards and adjacent crops or interplants. With aerial applications, do not turn the aircraft or transport materials back and forth across flowering crops.

2. Mow or beat down orchard cover crops before applying sprays hazardous to bees. This is especially important in relation to the first cover spray on apples, which is done during a critical foraging period for bees when they will fly several miles to obtain pollen and nectar from even a limited number of blooms of dandelion, mustard, etc.

3. Apply certain chemicals only while the bees are not actively foraging (generally between 18 hr. and 7 hr. in Washington). Evening applications are usually less hazardous to bees than early morning applications. When high temperatures cause bees to start foraging earlier than usual (e.g. 5.30 or 6 hr.), the morning application time should be shifted accordingly.

4. Do not dump unused stocks of dusts or sprays where they might become a bee poisoning hazard.

5. Use an insecticide that is relatively non-toxic to bees whenever such a choice is reasonably effective in controlling the pest in question.

6. Choose the less toxic types of insecticide formulations. Our tests have indicated that dusts are usually much more harmful to bees than sprays of the same insecticide. Emulsifiable (liquid) formulations usually have a shorter residual toxicity to bees than do wettable powders. Granular formulations are relatively harmless to bees.

7. Establish holding apiaries of honeybee colonies at least 4-5 km. from orchards or fields being treated with toxic materials.

8. Make contact with the beekeeper and get him to remove the colonies from the area (or keep the bees confined during the application period) when such measures are feasible and of value. Our tests have shown that up to 90 percent of the killing of bees by Parathion, for example, occurs during the first 24 hours after application. Do not move hives back into Parathion-treated fields less than 3 days after the treatment is applied.

9. Do not apply insecticides over nesting sites of wild bees where these occur next to fields being treated.

10. When roadside or other weed control operations involve 2,4-D and similar compounds on blooming plants, select the types of formulations or derivatives known to be least harmful to bees. Spraying in late afternoon or evening will also lessen the hazard, since bees will not visit the blooms after they become curled.

11. Do not use chlordane (and possibly similar chemicals) for control of wax moth or ants in beekeeping equipment. This material has been shown to have an affinity for beeswax and to retain a long residual toxicity to bees under such conditions.

### Bee Repellents

Several years ago studies were made of the repellents then known. Materials such as carbolic acid and creosote added to insecticidal sprays did not completely repel bees from the treated fields, so these materials were not sufficiently effective in reducing bee poisoning.

The Department of Entomology, Cornell University in cooperation with the Pennsylvania Department of Agriculture investigated various formulations of Carbaryl (Sevin) to see if some might be more or less toxic than others. In 1971 field tests using the formulation Sevin-4-oil were encouraging. Sevin-4-oil is to be preferred over other carbaryl formulations.

**POISONOUS HONEY.\***—The earliest account on record of honey causing sickness is given by Xenophon in the fourth book of the *Anabasis*. It occurred 400 B. C. during the memorable retreat of the Ten Thousand, in the mountainous country of the Colchians, in the province now called Trebizond bordering on the Black Sea. The soldiers lost their senses but all recovered after a day or two. The ancients believed that this honey was gathered from a species of *Rhododendron*, probably *R. pontica*.

It is noteworthy that the honey was obtained from beehives, not from trees or hollows in the rocks.

### Mountain Laurel Honey Poisonous

Poisonous honey in the United States was reported first by Barton, an early American botanist, in 1794. Since then poisonous honey has been repeatedly reported in the mountains of New Jersey, Virginia, and North Carolina. The honey, it is believed, is gathered from the mountain laurel (*Kalmia latifolia*) and the *Rhododendrons*. Mountain laurel is often called poison ivy in Tennessee and Alabama; poison laurel in Alabama, and ivy in Virginia, North Carolina, South Carolina, and Mississippi.

For several seasons the author has had letters from beekeepers in North Carolina inquiring about a bitter honey coming from mountain laurel and asking whether it was poisonous to man or bees.

It is possible that there is in this honey a poison that the chemist does not know as yet and which he can not now detect.

**POLLEN.\***—The anthers of flowers are composed of four sacs, which contain numerous small dust-like grains called pollen or microspores. Pollen is a highly nutritious food which is eagerly eaten by many insects, and is gathered in large quantities by bees as food for their brood. A pollen grain is protected by an inner and outer coat (in a few species there is but one coat), and is filled with a semi-liquid in which floats many minute granules. Its contents form a complete food, consisting of proteins, substances rich in nitrogen, sulphur, and phosphorus, and carbo-

\*By John H. Lovell and E. R. Root.

hydrates, or starch, oil, and sugar. Pollen thus offers a rich supply of easily obtained nourishment to all insects, especially to those not pre-daceous.

Pollen grains vary in size from 1/100 of an inch in iris to 1/3000 of an inch in some saxifrages. The number of pollen grains is also very variable, but is usually large.

#### Ingredients of Pollen

Pollen is a very rich source of protein; average, 26%. It contains Vitamins A, C, D, E, M, B1, B2, B3, B6 and B72. The minerals it contains consist of calcium, phosphorus, potassium, magnesium, iron manganese, silicon, sulphur, chlorine, copper, sodium and titanium. Other ingredients are essential free amino acids, 11%. Reducing sugars, average 29%, fructose, glucose, stachyose, sucrose, raffinose and pentose. The vegetable oils average 5%, water 3-4%. Also present are biotin, rutin; the digestive enzymes lecithin, lactic acid, giumatic acid, peptones, growth hormones, steroid, vernoid, guanine, xanthine, hypoxanthine, nucleim, polypeptides, DNA, hexuronic acid, ribose, desoxyribose and probably many other substances yet unknown to man.\*

One of the attractant chemicals in pollen, octadeca-trans 2, cis-9, cis-12 trienoic acid is credited with being the key ingredient which the discoverers, Dr. Ralph Boch and his colleagues of Canada\* were able to synthesize. Keith M. Doull, Waite Agricultural Research Institute, Adelaide, South Australia believes that this substance induces bees to produce vital food for bees in the larval stage\*\*.

Present methods of extracting the chemical from natural pollen are lengthy and complex. When this chemical or others that show similar powers of attractiveness can be synthesized economically they could be used to make present day pollen substitutes such as soybean flour, brewers yeast, casein, dried egg yolk, etc. palatable to the bees. This would save the need to trap and preserve natural pollen.

\*Lepage and Boch, Lipids 3: 530(1968)  
Hopkins, Jevans and Boch, Can.J. Biochem. 47: 433 (1969)  
Starratt and Boch, Can. J. Biochem. 49: 251(1971)

\*\* The New Zealand Beekeeper, pg. 35, May 1973; pg. 31 Feb. 1973

#### Constancy of Honey Bees in Collecting Pollen or Nectar

This wonderful trait in bee life is discussed in part under Bee Behavior. While it is true that there are deviations from the general rule, in that bees will under certain circumstances bring in loads of mixed pollen, some careful research work covering several years as recorded in the Bee World for October, 1935, page 112, shows that the average of such mixed loads is "certainly under 5 percent and not over 3 percent at most." Bumblebees are far less constant in that their mixed loads of pollen may reach as high as 32 percent. So far as honey bees are concerned, it is the exception that proves the rule that they stick to one species of plant or tree. When pollen sources are scarce or when two species are close together the bees may jump from one to the other.

Sladen says: "It was formerly believed that a bee hardly ever visited more than one species of flower on the same journey, but careful observers have found that, under certain conditions, changing from one species to another is not rare, and this has been proved by the presence of variegated loads of pollen. Bumblebees are more inclined to change from one species of flower to another than honey bees. This is especially true of the common European species *Bombus terrestris*, which is closely related to the Canadian species *B. terricola*. In a nest of *B. terrestris* that I kept under observation in July this year, 40 percent of the workers returned home with variegated loads. In order to discover exactly how the pollen basket is loaded, I took sections of a number of the variegated loads collected by workers in this nest. In one of the most interesting of these, no less than eight successive kinds of pollen were distinguishable." See also Bee World for October, page 113, for 1935.

#### Behavior of Honeybees in Collecting Pollen

The behavior of the honey bees in collecting pollen has been carefully investigated and described by Casteel. ("Behavior of the Honeybee in Collecting Pollen," D. B. Casteel, Bur. Ent., Bull. 121.) Honey bees collect pollen from flowers by the aid of the mouth parts, the three pairs of legs, and the dense coat of long plumose hairs. The feather-like structure of the hairs enables them better to retain the pollen which falls upon them. The mouth parts are especially serviceable in the case of small flowers, or of those which produce little pollen. The mandibles are actively used in biting and scraping the anthers and freeing the pollen, which is brush-

ed up by the maxillae and slender tongue. All the pollen gathered by the mouth parts is very thoroughly moistened with nectar or honey which comes from the mouth. It is, indeed, so wet that in its transfer to the pollen basket the hair on the breast and the brushes of the legs become so damp that it easily moistens the dry pollen swept from the bee's body.

The act of transferring the pollen from the mouth parts to the middle legs thence to the pollen baskets in the hind legs is so quickly performed as to be little short of sleight of hand. One watching it will have difficulty in seeing it clear through in one complete act. He will have to witness it over and over before he can get the exact detail of the complete transfer or the whole picture.

#### **Ample Pollen Reserves are Key to Large Productive Colonies\***

Research conducted by the United States Department of Agriculture, Agricultural Research Service, at Bee Culture laboratories in Laramie, Wyoming;

\* By Dr. Floyd E. Moeller, USDA-ARS Research Leader, Madison, Wisconsin.

Davis, California; and Madison, Wisconsin over a span of years dating back to the 1930's emphasizes the need for ample pollen reserves at all times of the year to insure healthy, productive colonies of bees. The late Drs. C. L. Farrar and F. E. Todd pioneered this work, and currently Drs. L. N. Standifer and F. E. Moeller and other staff members are working to improve methods and searching for new protein materials to use in pollen supplements and substitutes.

Problems concerning overwintering, spring dwindling, nosema disease, insecticide poisoning, and building colonies with package bees or from overwintered colonies all hinge on adequate pollen reserves to enable the colony to rear sufficient brood at all times of year.

In years gone by, the concept of conservation of bee energy in the overwintering colony was thought necessary. Brood rearing in the winter was thought wasteful of honey, and pollen was removed at times to reduce or eliminate winter brood rearing. Studies by the USDA research scientists, notably Dr. C. L. Farrar, have shown the exact



**Bee showing pollen lumps on the hind legs.**



opposite of this concept, emphasizing the vital importance and desirability of winter brood rearing. He showed that the surviving populations of overwintered colonies are closely correlated with the amount of reserve pollen in the fall. There should be 500 to 600 square inches of pollen in the fall or the equivalent of four to five combs well filled with pollen.

### Pollen Traps

A pollen trap is a device that scrapes off or removes the pollen pellets from the hind legs of field bees just as they return to the hive. The bees are forced to enter through a grid that has five meshes per inch. This is just large enough for a worker bee to enter with some effort, and pollen pellets are dislodged as she passes through. The pellets then drop through a finer mesh screen (about 7-mesh per inch) into a collecting tray. There are perhaps as many different kinds and styles of pollen traps as there are beekeepers who design them. All operate on the same principle. Collecting trays are emptied daily to prevent the moist pollen from molding. The pellets may be stored in a deep freeze at 0°F. or dried and kept in air-tight containers. Pollen can be dried on cheesecloth trays over a few electric light bulbs or in an oven set at lowest heat with the door open. When sufficiently dry, it will spill like grain after squeezing it in the hand.

The traps do not dislodge all the pollen but catch a very large percentage of it. Hundreds or thousands of pounds of pollen, as needed, can be trapped in this way for later use.

### Modified Pollen Trap

The upper portion of the pollen trap frames the hive entrance and accepts the pollen removal grid. The grids are made from 18-gauge perforated steel with 0.1875 (3/16") diameter holes, 51% open. Hardware cloth (5-mesh per inch) is less efficient in removing the pollen (it lacks uniformity of wire spacing). Perforated aluminum or plastic may be substituted for the perforated steel without any loss in efficiency. Each hole in the grid has a jagged burr on one side resulting from the perforat-

ing process. Trap efficiency is improved by inserting the grid with the burred side facing out so that the burr snags the pollen pellets as the bee passes through. The enclosed lower portion (the pollen compartment) of the trap is separated from the entrance area above by 6 or 7 mesh hardware cloth, which excludes bees but permits the pollen pellets to drop into the compartment.

The pollen trap portion of the assembly is attached to the front of the hive over a 3/8" slot made by inserting a cedar shingle wedge along each side between two hive bodies. Two small nails hold the trap in place. Tape is used to make the hive otherwise bee tight. The former entrance is screened (for ventilation) and turned to the rear to hasten reorientation of the bees to the new entrance.

Samples of pollen may be acquired quickly and at precise intervals by unfastening the rubber band holding the trap cover (see pins on ends of trap), removing the cover, sliding the grid into or out of its retaining slot, and replacing the cover. The samples are removed from the trap by inserting a wide funnel beneath the pollen compartment and then sliding out the metal bottom, thus allowing the pollen to drop into a sack.

### The O.A.C. Pollen Trap

In order to trap pollen, it is necessary to force the returning foragers to pass through some type of a barrier that will dislodge the pollen pellets from their legs. Many devices have been developed for this purpose, but all have had certain disadvantages. Frequently, there is congestion and crowding of bees at the entrance. Drones, unable to leave the hive, add further to the confusion. Traps are often difficult to place in position and pollen is awkward to remove. The pollen frequently picks up excess moisture and may mold in the tray.

A pollen trap designed at the Ontario Agricultural College appears to have overcome most of these problems. This trap, is placed on the floorboard and the pollen is collected in a tray beneath the colony where it is well protected from the weather.

To place this trap in position it is first necessary to lift the brood chamber off the floorboard and reverse the floorboard (front to rear). The trap is then placed so its entrance is now in the position of the original hive entrance. The bees will orient to this new entrance without any difficulty. The floorboard now serves to hold the pollen collecting tray. Pollen can be removed by sliding the tray out the open end of the floorboard (now at the rear of the colony) without the least interference with bee flight.

The pollen tray is made of a frame of one inch wooden strips of a size (14½ x 19") that will easily fit inside the floorboard. Over this frame is fastened a piece of cloth — such as a used sugar bag — to act as a floor for the pollen tray. Wooden slats below the tray should hold the cloth about an inch above the floorboard. The pollen is collected in a relatively thin layer over this rather large shallow tray. With air circulation both above and below the pollen it does not tend to pick up moisture or mold, and it need only be emptied every two or even three days. Bees are prevented from gaining access to the pollen by a six or seven mesh galvanized screen horizontally placed above the tray.

The pollen barrier is composed of two thicknesses of five mesh galvanized screen spaced no closer than ¼" to 5/16" apart, and extending horizontally over most of the base of the colony. This gives a relatively large area (approximately 11 x 13") through

which the bees may pass. On the average, a 50% increase in trapped pollen was obtained by using a double screen, rather than a single screen. The pollen barrier is fastened on a plywood slide that may be slipped out of the trap at any time that pollen collections need to be temporarily discontinued. This does not involve lifting the colony off the trap, and would permit an operator to remove the pollen barrier during the honey flow.

Bee lifts are provided by fastening to the lower screen three slats of wood placed on edge. These are placed diagonally in the trap and extend up so they just clear the pollen barrier screens. These lifts permit the bees to readily run up to the pollen barrier, and result in a much more uniform distribution of pollen in the trays.

Drone exits are provided by drilling two one-inch holes through both the front rim of the main trap unit and through the rim of the pollen barrier slide directly beneath it. Two V-shaped notches are then cut to connect the drilled hole to the front edge of the pollen barrier frame, leaving a space at the front margin just wide enough for a single drone to pass through (no more than ½-inch wide). A small piece of screen is then tacked over the lower side of this hole and notch. This simple arrangement permits the drones, and many workers as well, to leave the hive without passing through the pollen barrier screens. Relatively few bees find their way back through these small openings.

Modified pollen trap in place.



Modified pollen trap, end view.

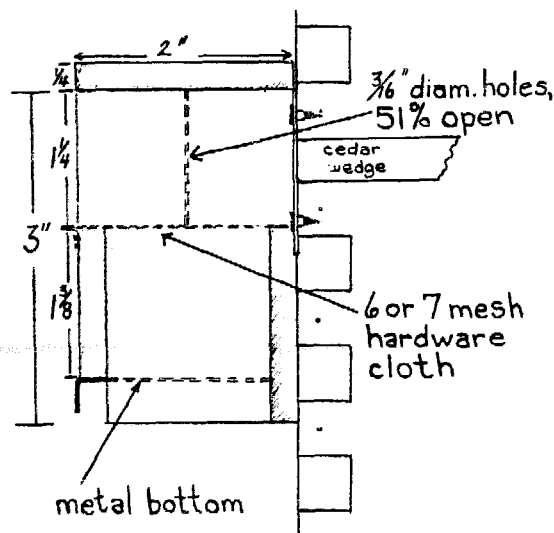

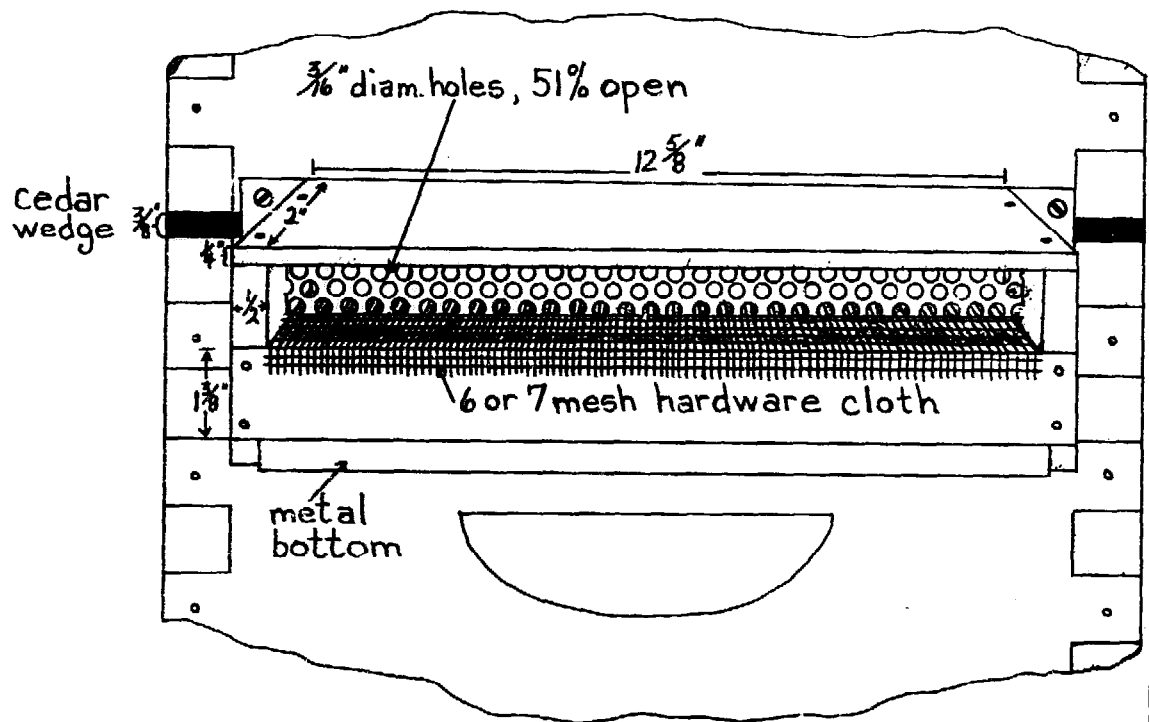

Modified pollen trap, front view.

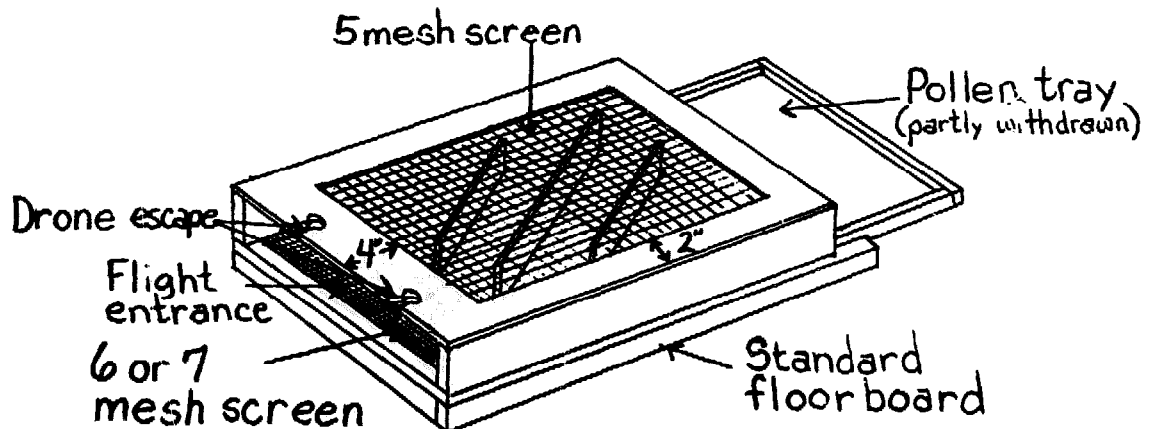

O.A.C. pollen trap.

The weight supporting outer frame of the pollen trap is constructed of  $\frac{3}{4}$ " lumber to form a rim about 3" deep. The balance is made of  $\frac{1}{4}$ " plywood.

Records kept during the season showed that at Guelph an average colony could be expected to yield two pounds of pollen a week. In certain areas, as much as a pound a day has been trapped from a single hive. We found that even with this trap design, at least 33% of the pollen gathered by the bees was carried into the hive through the pollen barrier. There appeared to be no reduction in brood rearing or honey production even when traps were kept on colonies throughout the whole season.

### Pollen Supplement Mixing and Feeding

Pollen supplement does not take the place of honey reserves, in fact honey consumption is increased as brood rearing is increased, causing a greater need for the beekeeper to watch for honey shortages.

Soybean flour produced by an expeller screw press (heat process) must be used for supplemental bee feeding rather than that made by a chemical solvent process. Do not use soybean meal since it is too coarse for the bees to eat. A substitute for soybean flour is brewers' yeast available in quantity

lots at prices comparable to soybean flour.

The formula for the pollen supplement cake consists of one part dry matter (1 part pollen and 3 parts expeller or screw press processed soybean flour) and 2 parts sugar plus water (2 parts sugar and 1 part hot water) by weight. If brewers' yeast or other yeast products are used instead of soybean flour, use 6 or 7 parts sugar to 1 part water.

For pollen supplement using soybean flour: 1 pound pollen, 3 pounds soybean flour,  $5\frac{1}{3}$  pounds sugar,  $2\frac{2}{3}$  pounds water. Yield: 12 pounds supplement.

For pollen supplement using yeasts: 1 pound pollen, 3 pounds brewers' yeast, 7 pounds sugar, 1 pound water. Yield: 12 pounds supplement.

Dry pollen softens readily in water but not in sugar sirup, therefore, the desired amount of pollen should be added to the water before dissolving the sugar. The pollen supplement for one feeding of 45 colonies can be conveniently mixed in a medium sized tub by adding 5 pounds of pollen to 14 pounds of hot water. Then stir in 26 pounds of sugar until dissolved or in suspension. Finally, add 15 pounds of soybean flour and mix thoroughly. If brewers' yeast or other yeast products are substituted for the soybean flour, cut back the water in this mix to 5 pounds and increase the sugar by 10 pounds.

Feeding is usually started in early March in northern areas and continued until bees find pollen in the field. Approximately  $1\frac{1}{2}$  pounds of supplement is placed on a piece of waxed paper for each overwintered colony. The hive cover is removed and the bees smoked down from the top of the frames. The cake should be placed directly over the center of the cluster and the paper left on top. The inner cover is replaced in an inverted position to provide space for the cake. Sufficient supplement is given at one time to last 10 to 14 days and a new supply added before the previous cake is entirely consumed.

In cases where a supply of pollen is not available, soybean flour or brewers' yeast alone can be mixed with the sirup and fed in the same manner provided the bees are able to get some pollen from the field.



The pollen cake in position over the cluster.

Chemotherapeutic drugs can be included in the pollen supplements whenever a disease problem develops in an apiary. Drugs so administered will be used by the nurse bees that feed on the material.

#### Pollen Substitutes

No true pollen substitute has yet been developed. Dr. M. H. Haydak studied various formulations of materials for a number of years at the Minnesota Agricultural Experiment Station at the University of Minnesota in an attempt to develop a possible substitute for pollen. Small colonies, consisting of about  $1\frac{1}{2}$  pounds of freshly emerged bees, which have never eaten pollen, were placed in nuclei kept cages and fed candy made of various pollen substitute formulations. The brood production of these colonies was followed and recorded.

A mixture of soybean flour and dried brewers' yeast was developed from this research and found to be nutritionally similar to pollen. The addition of dry skim milk or powdered casein apparently increased the value of such a substitute diet. Unfortunately, a diet of such material was found unattractive to the bees for feeding. Materials containing some natural pollen (supplements) proved far better in practice.

So-called "pollen substitutes" or plain brewers' yeast or expeller soybean flour can be fed with some beneficial effect, but the addition of a small fraction of bee-gathered pollen greatly improves

the consistency and attractiveness for feeding by nurse bees.

#### Feeding Pollen Supplements or Substitutes

If natural pollen is not available during critical periods, substitutes or supplements can be fed, either in cake form as described, or in dry form.

Throughout the northern tier of states and in Canada, feeding of cakes over the top bars of the brood nest during the early spring just prior to bloom of the first nectar and pollen plants in the field is recommended. If feeding is started in early March, most good colonies will consume 9 to 10 pounds of material by May 1, after which outside pollen becomes available. In the formulas given, one pound of pollen will make 12 pounds of supplement. Thus, for every colony to be fed the following year, one pound of trapped pollen should more than suffice.

Cakes should be wrapped in waxed paper for ease in handling. They should be about 1½ pounds in size and about ¼-inch thick. When placing the cake over the brood nest, smoke the bees back, invert the cake, leaving the wax paper backing in place. The inner cover of the hive should be inverted to accommodate the cake, and the wax paper backing will prevent the cake from sticking to the cover. Particular attention must be paid to getting it in contact with the cluster and adjacent to active brood. Repeat feeding every 7 to 10 days, increasing or decreasing the amount given depending on the rate of consumption.

In areas where pollen dearth occurs when the temperatures are warm, such as may prevail in some areas of the South or in California, supplements or substitutes may be offered in dry form in an open box "feed lot" situation. This works satisfactorily but allows the neighbors' bees to feed as well.

**POLLINATION OF AGRICULTURAL CROPS.\*** — The honeybee is the most important insect in the polli-

\*This section on pollination of agricultural crops was written by S. E. McGregor, collaborator, USDA, Bee Research Laboratory, Tucson, Arizona. Assistance was given by Roy Grout, former editor of the American Bee Journal and now a collaborator at the Bee Research Center.

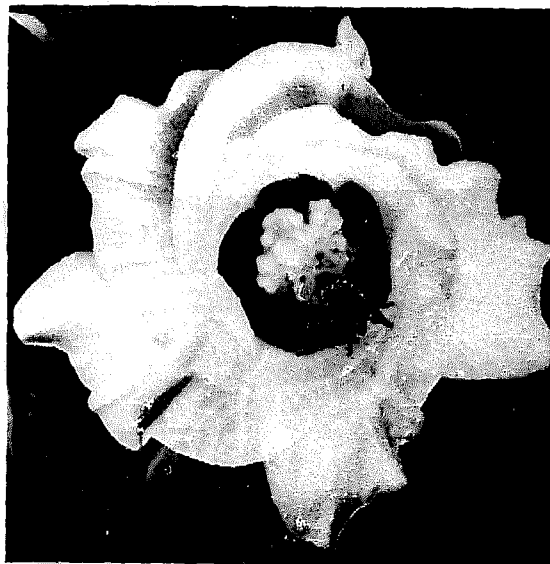

Field bee emerges from a cotton flower covered with pollen grains. Cotton is self-pollinating but the Agricultural Research Service has found that cross-pollination increases cotton yields.

nation of our agricultural crops, but there are other pollinating insects as well as other important pollinating agents.

Wind pollinates many of our grain and nut crops, most forest trees, and almost all of the grasses. It also contributes to the pollination of numerous other crops, which makes it our most important pollinating agent. However, wind is not effective in the pollination of many important fruit, vegetable, legume, oilseed, and miscellaneous crops.

Numerous other agents besides wind and honeybees pollinate plants. These include hand pollination by man, bats, birds, rainfall and moving water, snails and slugs as well as other insects in addition to honeybees.

#### Bees are Best

The term, "bees," may be defined as those insects that provision their nests with nectar and pollen. There are some exceptions to this definition but from the practical standpoint they can be ignored. Bees become important to man as pollinating insects because of their characteristic of feeding almost exclusively on nectar and pollen.

There are many kinds of bees. Some are **solitary**, constructing their nests alone in hollow twigs or other tubular cavities either above or below ground. Some are **gregarious**, living alone in the nest, but prospering only when numerous individuals nest in close proximity.



Alfalfa leafcutter bee on alfalfa blossoms.  
— Photo by W. P. Nye.

For example, a million or more nests of the alkali bee may be found within a few hundred feet on some alkali flats of the West. Still other bees are colonial or social, with numerous individuals living together, and usually with divided duties. The honeybee, of course, is our best-known example of the social bees.

#### Honeybees are the Most Important Insect

A honeybee colony can be moved and established wherever desired, and it will remain a stable functioning unit for years. Honeybees visit numerous plant species for pollen and nectar, whereas most other pollinating insects confine their visits to only a few species. Honeybees do not hibernate (they form a tight cluster to conserve their heat during cold weather, but inside the cluster they remain active), therefore, they must collect and store large quantities of honey and pollen to sustain themselves throughout the year. Of importance to the beekeeper, honeybees produce a surplus of honey and wax that he can harvest. And, finally, the individual bee usually confines its visits to flowers of a single species while on a foraging trip, which makes it an efficient pollinator of that species.

#### Flowering, Pollination, and Fruiting of Plants

The basic part of the plant that relates to pollination should be under-

stood before the pollination of crops is discussed.

#### Flower Structure

All flowers have a simple basic pattern but with almost infinite variations in shape, size, and color. Typically each flower has a **sexual column**, protected by petals that form a tubelike **corolla**, which may, in turn, be partially protected near its base by usually green and more durable **sepals** that collectively are called the **calyx**.

The male part of the sexual column consists of hairlike filaments or **stamens**, which bear on their extremities the pollen-producing **anthers**. At the appropriate time, usually just after the flower opens, these anthers split open and discharge the male element, the usually yellow microscopic grains of **pollen**.

The female part of the flower is collectively called the **pistil**. The base of the pistil is the **ovary**, or rudimentary fruit, with one to numerous **ovules**, or rudimentary seeds. Extending upward from the ovary is the usually rigid **style**, with a receptive tip, called the **stigma**, on which pollen must land for pollination to take place. The ovary may be faintly or clearly divided into sections, or **locules**.

#### Flower Opening

Some flowers are open for only a few hours. For example, chicory and



Good seed and fruit crops are dependent upon bees for pollination.—Photo by Edwin W. Teale.

lettuce flowers open after daybreak and close before noon, never to reopen. The cotton flower is open for a single day, the citrus flower for two or three days, while the alfalfa floret may be open for a week if not pollinated but wilts and closes within a few hours after pollination. Flowers that are not pollinated usually stay open longer than pollinated ones, making it seem as though nature strives in every way possible to perpetuate the species.

Some flowers never open. The botanist refers to such flowers as **cleistogamous**. Lemons, lespedeza, soybeans, and vetch usually have some cleistogamous flowers.

#### Flower Types

If both sexes are present and functional in a flower it is referred to as **bisexual** or **hermaphrodite**. Frequently one sex is vestigial or non-functioning. If the male element is thus affected, or missing, but the pistil and ovary are normal, the flower is referred to as **female**, or **pistillate**. If the pistil is nonfunctional or missing, but the stamens release pollen normally, the flower is referred to as **male**, or **staminate**. When both pistillate and staminate flowers are functional on the same plant but distinct from each other, the plant is **monoecious**. Corn, with its pollen-producing stamens (tassel) on the top of the plant, and the pistils (silk) on the ear several feet below, is a common example of a monoecious plant.

Plants with some bisexual and some unisexual flowers are referred to as **polygamous**. The cantaloup is a common example of a polygamous plant. When the two sexes are on separate plants the species is referred to as **dioecious**. The common holly and our native persimmon are examples of dioecious plants, wherein only the "female" tree produces fruit.

**Pollination:** Pollination is the transfer of pollen from anthers to the stigma of flowers. Certain varieties or kinds of bananas, citrus, cucumbers and figs produce fully developed fruit without the aid of pollination. This is referred to as **parthenocarpic** development. Parthenocarpic fruits usually have no seeds. The big majority of plant species, however, must have the pollen transferred

to the stigma by some agency for fruit to develop.

**Fertilization:** Pollination alone does not insure fruit set. The pollen must be viable and it must be compatible. Then it must sprout a tube, which grows down the inside of the style to the ovary. As the tube grows the germ nuclei move along with it to an ovule in the ovary, then **fertilization** or union of the pollen and ovule cells may occur. Fruiting is the normal development of a fertilized ovary.

About the time the flower forms, certain processes are initiated within the flower leading to its shedding. Then there is a more or less competitive race within the plant between fertilization and fruit setting and shedding of the flower. The grower can influence this race in his favor by providing earliest possible pollination of the flowers. Furthermore, as time passes, the pollen may be lost to insect foragers, wind, rain, heat or cold.



Bees on alfalfa blossoms.

Some plants, for example most peaches, are receptive to their own pollen, and fruit develops if pollen is transferred from the anthers to the stigma of the same flower. Such plants are referred to as **self-fertile**. This does not mean, however, that the flower is self-pollinating. Some outside agency may be required to move the pollen from the anthers to the stigma.

In some plants, for example apples, the pollen must come from another plant. Such plants are referred to as



A tripped alfalfa flower and a pollen-laden bee. — U.S.D.A. Photo.

**self-sterile.** Even pollen from another plant of the same variety is not always acceptable, therefore the grower must plant pollenizer trees intermittently throughout the orchard to provide compatible pollen.

Some fertilized flowers produce only one seed. A watermelon may produce 1,000 or more seeds. Usually one pollen grain must be deposited on the stigma for each seed that develops, although frequently not all pollen grains are viable, therefore an excess is desired. In some plants the pollen grain produces more than one tube and is capable of fertilizing several ovules.

#### **Signs of Inadequate Pollination**

Asymmetrical or lopsided fruit usually is an indication that insufficient pollen reached the stigma or that it did not reach it at the proper time.

Alfalfa and clover fields with a flower-garden appearance are indications that pollination, and the resultant wilting, is not keeping pace with opening of flowers.

Cotton flowers that have been visited by bees form a tube-like roll of the corolla by midafternoon of the day of opening, but non-visited flowers remain flared until sunset, then fold weakly inward without forming a tube.

Laden branches of well-developed berries or fruit, compact clusters, uniform set, well-filled pods, and ripening of all the fruits within a brief period with a minimum of culls, are all unmistakable evidence of adequate pollination.

#### **Additional Assets to Ample Pollination**

Pollinated blooms may set before



frost can damage them, and they seem to be more resistant to frost damage than unpollinated flowers. Early pollination may mean that the fruit will mature before insects can damage it, and harvest may be completed before inclement weather arrives. Earliness and compactness of set are often overlooked but important assets, particularly in mechanical harvesting of the crop. And finally, insect cross-pollination can produce seeds with increased vigor in sprouting or in production of the succeeding crop.

#### **Hybrid Vigor in Plants**

Hybrid vigor, or *heterosis*, is a term used to describe the increased vigor of plants or other organisms when compared to the parents. It may be expressed in size, uniformity, volume, quality, earliness, or resistance to diseases, pests, or other unfavorable factors. For example, vigor or sprouting and emergence from the soil is often a vital factor in the plant's survival.

The classic example of the use of hybrid vigor in plants is corn. In this instance, the tassel of certain plants or rows is removed before pollen is released, then wind brings pollen to the silks from other specific selections to produce the desired hybrid. In other plants, for example, cucumbers or onions, the plant breeder has developed pistillate plants; then bees are utilized to carry pollen to them from a desired pollen-producing selection, to produce the hybrid.

Not all cross-pollinations produce desirable hybrids, and the breeder cannot predict which crossing will do so. For that reason, even after male-sterility is developed, he must make thousands of pollen transfers, never knowing with certainty that a suitable hybrid will be found.

#### **Honeybees Used in Hybrid Seed Production**

Honeybees are being used currently in the production of hybrid cucumbers and onions. Plant breeders are hopeful that in the near future commercial production of hybrid cotton, soybeans, and sunflowers will materialize. Each of these crops will require bees to transfer pollen from the male-fertile to the male-sterile plants.

The profit from some hybrid crops is so great that the flowers are laboriously pollinated by hand. When bees can be induced to do this work there is a tremendous saving in costs. One Russian scientist calculated that, in the pollination of greenhouse cucumbers, a colony of honeybees was as effective as 300 men.

#### **Beekeeping and Crop Pollination**

Pollination fees are sometimes a welcome side income to honey production, however, use of bees for crop pollination frequently creates problems for the beekeeper. He likes to keep his colonies in productive, easily accessible locations, but the grower may want the colonies in an area where little honey is produced, distributed in small inaccessible groups throughout the field, then the colonies removed a few days later when their services have been completed. For example, in alfalfa pollination the practice is to place the colonies in groups of 12 to 20 every one-tenth mile each way within the field, then remove them about three weeks later.

Getting through the field or orchard, over rough and frequently boggy ground at night, when the bees are usually moved, and locating them in the right spot for the grower, usually creates problems. This is why beekeepers frequently say that they prefer a 300-mile haul over the highway to the last mile within the grower's field.

#### **Hive Loaders**

The development of the hive hoist or loader for mechanical loading and unloading hives has reduced some of the moving problems. With this device one person can load, tie down, transport, and unload 100 or more colonies during the nighttime with considerable ease.

#### **Use Strong Colonies**

When bees are used for pollination the colonies should be of adequate population to perform the task for which they are rented. Various terms have been used in defining colony strength. These have included frames of brood, square inches of sealed brood, square inches of all brood, frames covered with bees at a given temperature, supers oc-

cupied by the cluster, bee flight at the entrance, and estimated number of bees in the hive. The size of the hive does not necessarily indicate the strength of the cluster it houses.

#### The Ideal Pollinating Unit

There is no definition of the ideal condition of a colony for the pollination of a crop. Besides the ideal condition for one crop might not be ideal for another. For example, in the pollination of most crops **pollen collection** by the colony is desired, because in the act of collecting the pollen some of it is transferred to the receptive stigmas. In this case, a populous and expanding colony, with considerable unsealed brood and eggs, would be preferred because of the greater need for pollen by the brood.

When crossing between male-sterile and male-fertile flowers is desired, pollen collection is not preferred. The pollen collector tends to confine its activities to the male-fertile row where pollen is available and avoids male-sterile rows to which pollen must be transferred to produce hybrids. In this case a populous colony with little or no open brood, which would be more concerned with **nectar collection**, might be preferable. In every case there should be adequate room for food storage within the hive. There is need for an adequate definition for the most desirable pollinating unit.

#### Comply With Grower Request

The beekeeper should remember that the grower is renting and paying for the services of the colonies, therefore if colonies of a specific strength are requested, to be distributed in a specific pattern, and placed and removed at a specific time, the beekeeper should comply. If extra work or expense results, naturally the grower would be expected to pay. If the grower does not specify these things the beekeeper should keep himself sufficiently informed so as to correctly advise the grower how to obtain the most profitable pollination service.

Recommendations on precise distribution of colonies within the field usually specify that "strong" colonies be placed in groups within or adjacent to each five to 20 acres.

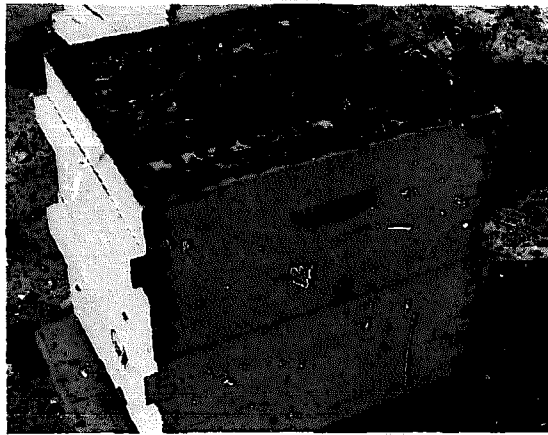

A strong two-story pollinating unit.

#### Pollination Contracts and Agreements

Various kinds of pollination contracts or agreements have been used when bees were rented for pollination purposes. Some have been verbal, others written. The written ones have varied in length from a brief paragraph to several pages. Too frequently a pollination agreement ends in dissatisfaction, to the detriment of both grower and beekeeper, because of some condition not clearly agreed upon in advance. One reason for such misunderstandings may be that conditions peculiar to the use of bees for crop pollination programs are not usually encountered by either grower or beekeeper in other agricultural or apicultural practices.

Because of these and numerous other reasons that may arise, legal as well as good neighbor policy, an explicit agreement should be insisted upon by both participants when bees are rented for pollination. Sometimes a written agreement is no stronger than a verbal one because no penalty for breaking the agreement is included. For example, one agreement form that has been used

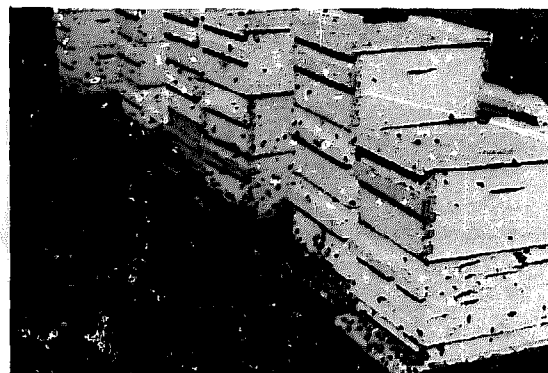

Intensive flight at hive entrance indicates the colonies are strong.

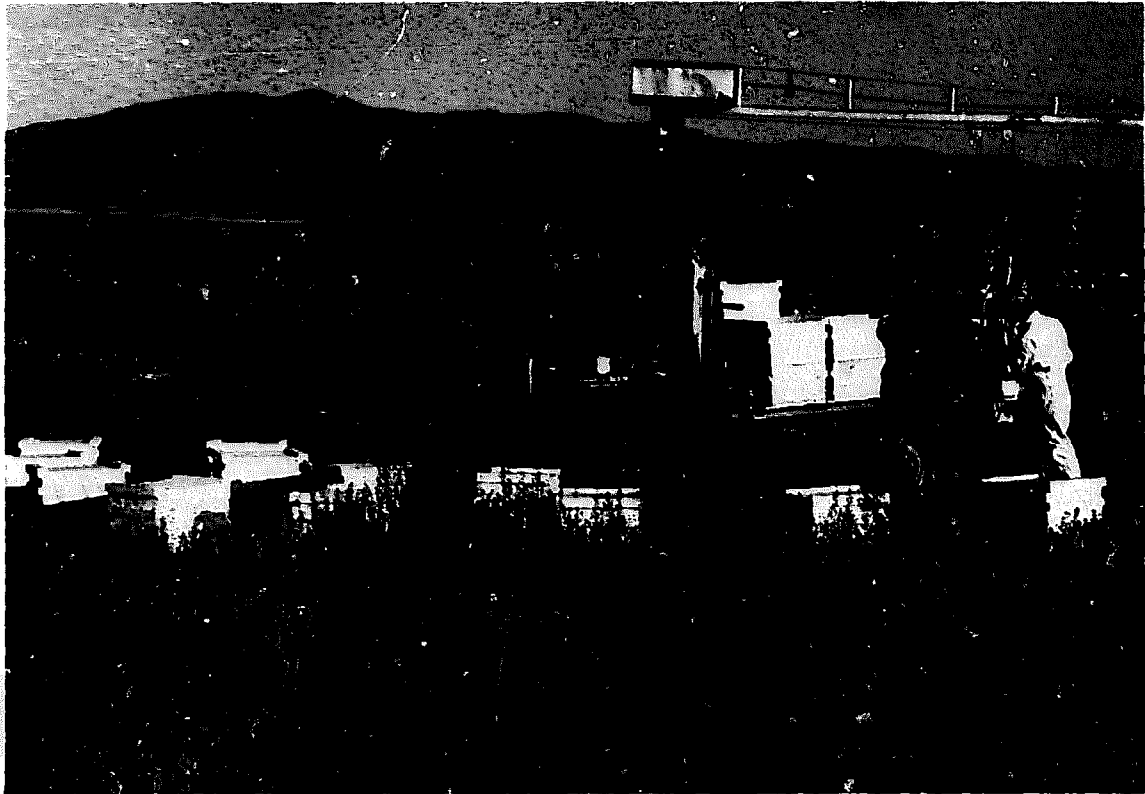

Hive loaders, or mechanical hoists, that lift individual hives onto the truck are most popular in the United States. Some are electrical, others are gasoline powered. — U.S.D.A. Photo.

merely stated: "I, (beekeeper's name), agree to supply . . . colonies of bees to (grower's name) to pollinate . . . acres of (crop) for the year . . . I, (grower's name), agree to pay (beekeeper's name) \$ . . . per colony for . . . colonies of honeybees to pollinate my (crop) for the year . . . (Date). (Beekeeper's signature) (Grower's signature)".

In this agreement neither the grower nor the beekeeper is adequately protected. There is no penalty if the beekeeper fails to deliver the colonies or if he delivers inadequate strength colonies, fails to service the colonies while they are pollinating the crop or to remove them at the time desired by the grower. There is no penalty if the grower allows the colonies to be damaged by any of his farm practices nor an indication that he is obligated to do. Nor is there a penalty for delay in or nonpayment of fees, and no agreed-upon recourse for the beekeeper in the event of nonpayment.

#### Subjects That Should Be Considered in An Agreement

Some factors that should be agreed upon in all pollination agreements include the following, although there might be still others in special instances:

1. Identification of participants, the crop, and its location.
2. A glossary of special or unusual terms.
3. Number and strength of colonies or colony equivalents rented.
4. Precise time of delivery or removal of the colonies.
5. The exact location of the colonies on grower's farm.
6. Operation and maintenance of the colonies, with right of entrance upon the grower's property for this purpose and a decent roadway.
7. Protection of colonies from pesticides and other farm operations.
8. Protection of farm laborers and public from stings.
9. Pollination fees, including amount, time, place, and method of payment.
10. Availability and open lines of communication between participants.
11. Rewards, including discounts for prompt payment, for colonies or services in excess of a prescribed amount, or other benefits to either party.
12. Penalties, for delayed payments, for legal or other expenses in collecting fees, costs of collection



The cucurbits (cantaloups, watermelon, squash and pumpkin) are vine crops that require bee pollination. Usually the rate of one-half to one colony per acre is sufficient. Daytime irrigation of cucurbits can reduce yield by driving off honeybee pollinators and by disrupting pollen germination when water gets into the flower. Also, honeybees will not visit flowers covered or filled with water. Irrigate at night or early in the morning. — Photo by Alex Mullin.

agencies, damage to bees or equipment by the grower, interest on delayed fees, failure to deliver or remove colonies upon specified dates, substandard colonies, lack of adequate maintenance of colonies, unusual bee or colony manipulations, resulting in unnecessary stings to others.

Different laws operate in different states, therefore the beekeeper should have his agreement form reviewed by a legal expert in the states in which he operates.

#### **Cultivated Crops Dependent Upon or Benefited by Insect Pollination**

The benefit of bee pollination upon

different crops varies from a scarcely measurable effect in quantity or quality of production to complete dependency upon pollinating insects. The beekeeper should be careful, therefore, in talking to the grower about pollination of a specific crop, that he does not give the impression that it is completely dependent upon such pollination if the crops has the the ability to set some fruit or seed in the absence of such insects. On the other hand, he should remember that many self-fertile crops, which do not require cross-pollination between varieties nevertheless require pollinators to transfer the pollen from the anthers to the stigma within the flower.

Table 1 lists the cultivated crops that are either benefited by or dependent upon insect pollination.

Table 1.—Crops grown in the United States that are dependent upon or benefited by insect pollination.

Alfalfa	Buckwheat
Almonds	Cabbage
Anise	Caraway
Apples	Carrots
Asparagus	Cauliflower
Avocado	Celery
Blackberries	Cherries
Blueberries	Chervil
Broad beans	Chestnut
Broccoli	Chicory
Brussels sprouts	Cicer milkvetch
Clovers	Muskmelons
Alsike	Casaba
Arrowleaf	Cantaloup
Ball	Crenshaw
Berseem	Honeyball
Crimson	Honeydew
Persian	Honeyrock
Red	Pershaw
Rosa	Persian
Strawberry	Santa Claus
White	Mustard
White Ladino	Nectarines
Coconut	Onions
Coffee	Papaya
Collards	Parsley
Coriander	Parsnips
Cotton	Passion fruit
Crabapple	Peaches
Cranberries	Pears
Crownvetch	Peppers
Cucumbers	Persimmon (native)
Currants	Plums and Prunes
Dill	Pumpkin
Drug plants	Radish
Eggplant	Rape
Endive	Raspberries
Feijoa	Rutabaga
Fennel	Safflower
Figs	Sainfoin
Gooseberries	Squash
Grapes (muscadine)	Strawberries
Guava	Sunflower
JuJube	Sweetclovers
Kale	Tangelo
Kidneyvetch	Tangerines
Kiwi, or Chinese gooseberry	Tendergreens
Kohlrabi	Trefoil
Kudzu	Tung
Lespedeza	Turnips
Lima beans	Vetch
Litchi or Lychee	Watermelons
Loquats	White sapote
Macadamia	
Mandarins	
Mango	

### Fruit Crops

**Pome Fruits:** The major pome fruits are apples and pears. All commercial varieties of apples require cross-pollination between varieties to set satisfactory crops. Insect pollination is essential and in most areas honeybees do the bulk of the crossing. Usually one strong colony per acre is recommended. If the bee supply is ample, one warm, calm, sunny day will permit sufficient set of fruit. Frequent-

ly, however, the weather is raw during bloom; therefore, strong colonies are preferred because they are more likely to sustain flight during marginal temperatures than weaker colonies.

Most growers of Bartlett pears in California make no attempt to interplant pollenizer varieties or to provide bees to their Bartlett pears, although the evidence indicates that during some seasons they would benefit by doing so. Growers of Bartletts and of most other varieties in most other areas would benefit by providing bees. Recommendations for bees have ranged from one-half to two colonies per acre. Pear nectar is quite low in sugar and much less attractive to bees than many other nectars.

**Stone Fruits:** The stone fruits include almonds, apricots, cherries, nectarines, peaches, plums, and prunes. The almond is usually grouped with the nut crops. Cross-pollination is required on almonds, sweet cherries, and most plums and prunes.

The almond grower wants as many almonds to set on the tree as it will support. If greater numbers cause the nuts to be smaller, so much the better, because smaller almonds bring premium prices. For this reason, and because almonds flower early in the season when the weather is likely to be unfavorable for bee flight, highest bee populations within the orchard are desired. From one to three colonies per acre have been recommended, although there are no figures to show that this number is sufficient. Also, in most areas of California where almonds are grown there are vast expanses of wild mustard which blooms at the same time the almond blooms are present, and the mustard flowers lure many of the bees from the almonds. For that reason, the almond grower, surrounded by mustard, might need many colonies per acre of almonds for maximum pollination.

Sweet cherries require cross-pollination between varieties, and some varieties, notable King, Lambert, and Napoleon (Royal Ann) will not cross between each other (inter-incompatible). Tart or sour cherries will set fruit with their own pollen if bees transfer it from anthers to stigma, but better pro-

duction will be obtained if the orchard contains more than one variety. From one to five colonies per acre have been recommended for cherry pollination. Frequently, after bees are rented and have had two or three days of good weather, the sour cherry grower is ready for them to be removed.

Plums and prunes vary from completely self-incompatible, in which they set no fruit with their own pollen, to completely compatible varieties which set a full crop with their own pollen. Pollinating insects are necessary on most if not every variety to transfer the pollen either within or between varieties.

Apricots, nectarines, some varieties of peaches, and tart cherries are self-fertile. Even these require some agent to move the pollen from the anthers to the stigma within the flower. Wind will vibrate some of the branches sufficiently to transfer pollen. Trees kept in greenhouses or otherwise sheltered from the wind and insects, while in flower, set less fruit than trees exposed to these agents. Whether wind, alone, is sufficient for optimum set of fruit has never been established.

Most recommendations call for one

colony per acre of plums or prunes, although there is little data to support the recommendation.

**Tropical and Subtropical Fruits:** Fruits of importance in this category include avocado and citrus, although in Hawaii macadamia and passionfruit are of some importance.

Because of its unusual flower development, the avocado is completely dependent upon bee pollination. The flower opens twice on subsequent days, in two stages. When it opens the first day the stigma is receptive but no pollen is released. The second day, when it opens again, pollen is released but the stigma is no longer receptive. The flowers of some varieties open for the first time in the afternoon and the second time the next morning. Others open for the first time in the morning and the second time the next afternoon. For this reason appropriate varieties must be interplanted which produce pollen at the time of day when stigmas are receptive. One avocado specialist has stated: "Practically every avocado fruit set means that a honeybee transferred pollen to the flower from some other flower."



Most pome fruit, such as apples, require cross pollination among varieties. Honeybees are the principal agents of pollen transfer.

In citrus the pollination picture is less clear. Many growers of oranges, grapefruit, and lemons believe that bees help, but there is little research data to support their beliefs. Certain mandarins, tangelos, and tangerines require bees plus other varieties to provide pollen for cross-pollination.

Macadamia and passionfruit require bee pollination. Honeybees pollinate the former. The carpenter bee is an excellent pollinator of passionfruit.

Other tropical or subtropical crops grown in Hawaii, Puerto Rico, or isolated subtropical areas of California and Florida that are dependent upon or benefited by insect pollination include: coconut, coffee, feijoa, litchi, loquats, mango, papaya and white sapote.

#### Legume Crops

**Alfalfa:** Alfalfa is our most important legume crop. Its sexual column must be "tripped" or released from the sheath for pollination to take place. Tripping sometimes occurs with sufficient force to temporarily hold the bee proboscis, or "tongue," which has been inserted into the throat of the flower. Most alfalfa plants are self-sterile, therefore when the stigma is exposed at the moment of tripping it needs to con-

tact pollen from another plant. Pollination cannot occur after the flower has been tripped

Honeybees frequently insert their tongue through the side of the blossom and obtain nectar without exerting the pressure necessary to cause tripping. When sufficient honeybees are foraging on alfalfa they set a satisfactory crop of seed for the grower. Tripping is easier for the honeybee in the warmer parts of the country than in the cooler regions; therefore, fewer colonies per acre are needed to set the same amount of seed. About two to three colonies are frequently used, although experiments indicate that growers would obtain much more seed if more colonies per acre were used.

Within recent years growers, particularly in the Pacific Northwest, have begun to establish wild bees in or near their alfalfa fields. These bees are much more efficient pollinators of alfalfa than the honeybee. Two species of bees are used: the gregarious alkali bee (*Nomia melanderi*) which nests in the soil of alkali flats, and the equally gregarious leafcutter bee (*Megachile pacifica*) which nests in prepared holes in boards or bundles of soda straws located in shelters in or around the

Opened tubes showing the nests of the alfalfa leaf-cutter bee. Each tube or tunnel is the nest of a single bee. — Photo by W. P. Nye.





Beehives in Ladino white clover fields. — U.S.D.A. Photo.

fields. There should be about 2,000 nesting female leafcutter bees per acre of alfalfa.

**Clovers:** Red and alsike clovers are important in the cooler sections of the country. White clover is important in the North, South, and Pacific Northwest and crimson clover is important in the South. All require bee pollination, although at times the honeybee has difficulty in pollinating red clover. For that reason, where bumblebees are absent and honeybees are to be depended upon, from one to 10 colonies per acre have been recommended. The recommendations for the other minor clovers has been from one to three colonies per acre. Bumblebees should be especially encouraged to nest around red clover fields.

**Lespedezas:** There are two types of lespedeza: annual and perennial. The annual varieties, common, kobe, and Korean, are the most common. The perennial types require pollination; the annuals seem to derive some benefit, although they are not too attractive to bees. One colony per acre has been recommended for a perennial lespedeza but no recommendations have been

made for the use of insect pollinators on the annual types.

**Sweetclovers:** Two important sweet-clover species are grown in the United States; the biennial yellow and the biennial and annual white. Both are highly attractive as nectar and pollen plants to bees and, in turn, bees are necessary for the pollination of both. Because of the attractiveness of sweetclover for honeybees, these agents perform the bulk of its pollination. From one to three colonies per acre have been recommended although some suggestions have been made that as many as ten colonies per acre might be profitable for the grower. In general, the beekeeper tends to set the colony number, based upon the honey production potential of the area.

**Trefoils:** There are three species of trefoils of agronomic importance, and all require bee pollination. Honeybees and bumblebees are the primary pollinators, the former being by far the most important. Because of the shattering habits of dried seed pods, the grower wants to set the seed crop in the shortest time period possible. This may require more than the one to three colonies that have been recommended.



**Vetches:** Several species of vetch are cultivated: common, hairy, Hungarian, narrowleaf, purple and smooth. Hairy and smooth vetch are greatly benefited by insect pollination, purple and Hungarian derive some benefit, but common and narrowleaf are largely self-pollinated. Seed production is increased with from one to "several" colonies per acre. More definite information is needed on the pollination requirements and the pollinator populations required for highest seed production of the different species of vetch. Other minor legume crops that benefit from insect pollination include: cicer milkvetch, crownvetch, kidneyvetch, kudzu, and the excellent honey plant sainfoin.

#### **POLLINATION OF FRESH VEGETABLE AND CANNING CROPS\***

—Vegetable growers interested in producing heavy yields of good quality crops must consider the pollination requirements of the plants they grow. Pollination is a critical event in crop production, because it is one of the first

\* E. R. Jaycox, Extension Apiculturist, Univ. of Illinois.

steps in making the fruit and seed of a plant. The pollen grains, which are the male cells, are transferred to the receptive surface or stigma of the female organ of the flower. After that, fertilization takes place; then the seed and fruit begin to develop. Different crop species have different pollination methods and requirements. In some crop plants, the male and female parts are close together in each flower and the pollen is released automatically onto the stigma; snap bean and pea flowers are of this type. In other plants, pollination may occur within the flowers when they are moved by the wind or by insects; the tomato flower is an example. When grown in the greenhouse, tomato plants must be vibrated mechanically or visited by bees in order to set fruit.

Some crop plants produce separate male and female flowers on the same plant or on different plants. Such an arrangement requires the transfer of pollen from one flower to another or between different plants. In sweet corn, wind and gravity move the dry pollen

**Kiwi or Chinese gooseberry, a crop that requires bee pollination. — U.S.D.A. Photo.**



from the tassels (male flowers) to the silks, which are elongated styles of the female flowers. Separate male and female flowers are also found on plants of the cucurbit family, which includes squash, cucumber, pumpkin, watermelon, muskmelon, cantaloupe, and gourd. In all of these plants, the sticky pollen of the male flowers must be transferred to the female flowers by insects. No fruit is produced without insect visits, and multiple visits, at least 8 to 12 per flower, are required to produce marketable muskmelons and watermelons. The size and shape of the mature fruit is usually related to the number of seeds produced by pollination; each seed requires one or more pollen grains. Cucumbers may be misshaped, however, in spite of adequate pollination.

Honeybees are the most common pollinators of vegetable crops. They visit the plants to collect both nectar and pollen. Some of the pollen sticks onto their hairy bodies and is transferred from flower to flower.

Honeybees used for pollination can return far more than their cost. This is evident from recent studies of the quality of cucumbers grown for the fresh market. Experiments with commercial cucumber fields showed a pronounced reduction in the percentage of second-grade cucumbers, from more than a fourth of the yield where no bees were used to as low as 7 percent where two colonies were provided per acre. Considering the value of first-grade cucumbers on the early market, only a few bushels will pay for the bee rental. In the same experiments, yields increased to about three times the average, depending on the length of harvest. Results were most favorable in fields of more than 15 acres. However, in the smaller fields with good yields, honeybees improved the quality of the cucumbers produced.

Bees help provide "crop insurance" when all other production factors are favorable. If pollination has been limiting, they will usually increase yields, improve quality, and produce a faster and more even set of fruit.

The value of a fast, even set can be important in raising pumpkins. Well-pollinated plants will produce good yields of fruit of fairly uniform size

throughout the field. Such pumpkins will mature evenly and early, thereby making harvesting easier. You can check the adequacy of pumpkin pollination by walking through a field in the early morning. You should see bees in all parts of the field. If you do not, check to see if the female flowers are setting fruit or are dropping from the vines after a few days. An adequate population of bees will remove all the nectar from the flowers before they close each day. Flowers with nectar visible in them late in the morning probably will not produce a good pumpkin because of the lack of bee visits. You can literally pour nectar from unpollinated pumpkin flowers.

The following insect-pollinated crops **MUST** be visited by bees to produce fruit: cucumber, squash, pumpkin, watermelon, muskmelon and cantaloupe.

The following crops set fruit without insect visits, but yields may be increased by honeybees: lima bean, okra, pepper and eggplant.

Although they do not assist in the pollination of snap beans, tomatoes, field beans, soybeans, and peas, bees often visit the flowers for pollen and nectar. It is a good idea to check for the presence of bees before applying insecticides to these crops; otherwise, you may damage nearby colonies being used for pollination.

One strong hive of bees per acre will usually provide sufficient pollination for vegetable crops. An exception is hybrid cucumbers grown at high plant populations for machine harvest. The available hybrids, which are not completely gynoecious, require one hive of bees per 50 thousand plants per acre, or two hives for 100 thousand plants. When fully gynoecious hybrids become available, more bees, two a three times as many, may be required. Adjustments in the number of bees used may also be necessary on small fields and in locations where sweet clover and other plants compete strongly for the bees' attention. Overhead irrigation is detrimental to bee activity and should be done late in the day and at night if possible.

Do not place the bees beside the fields before the first female or perfect flowers appear. If placed too ear-



**Mature fruit of an early harvest blackberry. Although there is some indication that blackberry and raspberry have a range of variability of pollination needs, the presence of hives of bees is good insurance to a grower against the lack of pollen transfer. Blackberries and their close relatives, the raspberries, are a source of nectar where they occur in sufficient quantities and weather and soil conditions are favorable. — U.S.D.A. photo.**

ly, the bees will visit plants in bloom outside the field and will be less effective on the crop to be pollinated. In experiments with cucumbers for machine harvest, delaying pollination for as much as 11 days resulted in an increase in the number of fruits per plant and the value per acre. Such a delay may be practical in areas where there are few bees other than those moved for pollination.

For fields larger than 30 acres, place the bees in two or more groups around the fields, with a maximum of 1/10 of a mile between groups. The colonies need a nearby source of water, such as a farm pond, stream, or lake. If this is not available, something like a stock tank can be used, as long as cork floats or similar objects are provided as a place on which the bees can land.

Insecticides are rated for their toxicity to bees, from highly toxic to relatively nontoxic. Highly toxic materials should not be applied to plants being visited by bees. If such materials are going to be used, make sure the bees are removed from the field first. Moderately toxic insecticides can be used on vegetable crops when the bees are not visiting the plants. For cucumbers and other cucurbits, the best time to apply insecticides is in the late afternoon or evening, after the flowers have closed. Morning applications are less satisfactory because bees visit the flowers very early on hot days.

Honeybees tend to work close to their hives, but they may also visit neighboring fields as far as a mile away. They are attracted in large numbers to sweet corn when it sheds pollen, and are often killed by carbaryl (Sevin) applied for ear worm control. Losses of bees can be reduced if the treatments are made late in the day by ground rig, with the nozzles set to keep the spray off the tassels. Highly toxic insecticides (such as parathion) applied to snap beans will kill the bees visiting the beans; such insecticides may also kill the bees in nearby cucumber and melon fields. Cooperation among growers is essential to prevent damage to honeybee colonies and to minimize a reduction in crop yields due to inadequate pollination of insect-pollinated plants.

### Small Fruits

**Blueberries:** There are two kinds of blueberries: the cultivated highbush and rabbiteye types and the primarily wild, lowbush types. All require insect transfer of pollen between flowers and often between plants. For most efficient production the intermixing of compatible varieties is recommended. Increased production from better pollination has been obtained with up to five colonies of bees per acre. In general, there should be sufficient bees to provide several per square yard of highbush plants when in full bloom and at least one bee per square yard of lowbush plants.

**Blackberries:** Blackberry plant growth may be erect, semierect, or trailing. The "dewberry" is a trailing blackberry. The boysenberry, loganberry, and youngberry are types of improved blackberries. The erect blackberry inflorescence may have 10 or more flowers in a cluster, whereas the trailing types frequently have one or two but may have up to 10 in a cluster. All are highly attractive to bees for both nectar and pollen.

Blackberries range from completely self-sterile to largely self-fertile, but bees are needed to transfer pollen within the flower even within the latter types. With recent development of mechanical harvesting the need for firm berries has increased. Such berries are more likely to be obtained if the flowers are adequately pollinated.

Honeybees as well as numerous wild bees effectively pollinate blackberries. Usually there are not sufficient wild bees available for commercial production of blackberries. Several colonies of honeybees per acre may be necessary in commercial plantings to provide adequate pollination.

**Cranberries:** Cranberry flowers are whitish to slightly pink when they open. If they are not pollinated they may hang on for two or three weeks, during which time they change to rosy pink. A pinkish tinge to the flowers in general is an indication of inadequate pollination.

Bumblebees, when present, are excellent pollinators. Three per square rod are considered sufficient. If they are not present in sufficient numbers honey-



Lowbush blueberries respond to bee pollination with more fruit of better quality.

bees can be used. Cranberry flowers are not highly attractive to honeybees, therefore the area should be well-stocked with colonies. One colony per acre has been recommended but under unfavorable conditions five to ten colonies per acre may be needed for best pollination and highest cranberry production.

**Currants:** Black, golden and red currants, which belong to the genus *Ribes*, should not be confused with the dried currant of commerce, a seedless grape. Most of the research on pollination has been concerned with the black currant.

Usually, when currants bloom, the honeybee is the only or primary pollinator available to the flowers. Some varieties require and most of them benefit from transfer of pollen within the flower. Where production of currants is anticipated, honeybee colonies should be nearby at flowering time.

**Raspberries:** Red, black and purple raspberries require insect pollination for the transfer of pollen either within the flower or between flowers. The flowers are highly attractive to honeybees and these insects are excellent pollinators of raspberries. The concentration of bees on raspberry flowers for best pollination has not been determined.

**Strawberries:** Within the strawberry flower the pollen is thrown by the anthers, when they open under tension, onto receptive stigmas. However, all of the stigmas do not receive pollen in this way, and unless bees are present to distribute it the berry will be undersized and not well-formed. Some flowers have shorter stamens than others, and those with shorter stamens have greater need for bees to distribute the pollen.

Both honeybees and wild bees visit strawberry flowers, but these flowers are not overly attractive to honeybees. For this reason, if heavy honeybee activity is desired a large number of colonies, possibly as many as five or ten per acre, may be necessary.

#### Vegetable Seed Crops

Numerous vegetable crops require or materially benefit by bee pollination in the production of seeds. Some of these crops include: anise, asparagus, broccoli, brussels sprouts, cabbage, caraway, carrots, cauliflower, celery, collards, coriander, cucurbits, dill, eggplant, endive, fennel, kale, kohlrabi, lima beans, muskmelon, mustard, onion, parsley, parsnips, pepper, radish, rape, rutabaga, tendergreens, and turnip.



Huckleberries grow in damp, rocky soils in New England and the northern states.

### Oilseed Crops

**Cotton:** Cotton is grown primarily for its lint, although the seed, valued at about one-fifth that of the lint, is a valuable source of food oil.

Two types of cotton are grown in the United States. The more common upland or short-staple cotton, is grown on 10 to 15 million acres from Virginia south and west to California. Pima, American pima, American-Egyptian, or extra-long staple cotton is grown on less than 100,000 acres in the arid Southwest.

There is some self-sterility in pima cotton, therefore cross-pollination can increase, by about one-fourth, its pro-

duction of lint and seed. Upland cotton is usually considered to be self-fertile, although some benefit is derived from insect-pollination, including earlier completion of fruit setting, larger bolls, and possibly some increase in lint and seed.

Honeybees prefer the nectar in the numerous extrafloral nectaries of cotton over that in the flower. Yet only the floral visitors contribute to cotton pollination. Bumblebees and a few solitary bees confine their visits almost exclusively to the flower. Unfortunately, there is no way known to build up a desired population of these pollinators in cotton. Honeybee colonies can be concentrated in and around such fields.



Cross section of a cotton flower beginning to open about 8:00 A.M. Cotton flowers are capable of being cross-pollinated by bees only from this period to until noon of the same day.—U.S.D.A.



Pollination of cotton plants by bees increases yield. Cotton pile, on left, weighs 5.5 pounds. Pile on right from bee cross-pollinated cotton weighs 7 pounds. — U.S.D.A. Photo.

Recent development of male-sterile cotton holds promise for hybrid cotton production in the near future. Since cotton is an insect-pollinated plant, and since wild pollinators cannot be concentrated in large cotton fields, the use of honeybees may become important and possibly a critical factor in hybrid cotton production. The one unanswered question is whether the honeybees, on a large-scale basis, will effectively cross-pollinate the crop throughout the flowering season.

If honeybees are used in cotton pollination there is need for sufficient bees to "clean up" the nectar in the extrafloral nectaries, plus that in all nearby competing plants, before they can be expected to enter the flowers freely. This may call for several colonies per acre. The use of insecticides on such fields may need to be curtailed, to prevent damage to bees while they are visiting the crop.

**Rape:** Rape is not grown commercially in the United States but there are about four million acres in Canada. About 80 percent of this acreage is devoted to Polish rape, which is materially benefited by insect pollination. The other 20 percent is devoted to Argentine rape which may derive some

benefit from insect pollination. Wind, flies, and bees are given the primary credit as pollinators. Honeybees have been recommended at the rate of one to two colonies per acre.

**Safflower:** The effect of pollination on safflower depends upon the structure of the florets. Within the floret the style is enclosed by five fused anthers that are attached at the base by short filaments. On the day of opening the floret begins to elongate about sunrise. The anthers release their pollen within the fused anther tube after sunrise while the style is elongating. If release occurs **before** the style fully elongates, the stigma is pushed through the mass of pollen in the tube, becomes



Rape is a commercial crop in Canada and is a good source of nectar.

coated with pollen, and is self-fertilized. If pollen is not released until after the style elongates, so that the stigma has passed through the tube, it makes no contact with pollen and self-sterility results. Such flowers must be visited by pollen-carrying insects if pollination and seed-set is to be achieved. The thin-hull type of safflower has this delayed dehiscence, and is therefore functionally male-sterile.

Honeybees, wild bees, and other nectar-feeding insects visit safflower. The crop is especially attractive to honeybees for both nectar and pollen. Two colonies of honeybees per acre have been recommended for the thin-hull type and the grower would probably benefit by having a high population of bees present on all types.



Bee gathers nectar from soybeans under certain conditions. Research is needed to determine what these conditions are. — Photo by R. Blake.

**Soybeans:** The most important oil-seed crop grown in the United States is soybeans. The flowers are not relatively attractive to pollinating insects, and some are cleistogamous (never open), however honeybees visit the flowers at times for both nectar and pollen. Beekeepers in some areas report obtaining a crop of honey from

soybeans while those in other areas indicate that bees seldom visit the plants.

The soybean plant is considered to be self-fertile, but if hybrid soybean production develops there will be a need for insects to transfer the pollen. One soybean specialist in 1969 stated that all of the breeding components have been described for the production of hybrid soybean seeds except that a suitable pollen vector has not been found, although, he said, the honeybee "looks encouraging". Scientists are looking feverishly for soybean types that are attractive to honeybees. If such can be found and incorporated into suitable lines, the use of hybrid vigor in this crop could become a reality. Then honeybees would be required. At present there are no recommendations for the use of honeybees on soybeans.

**Sunflower:** Although sunflower as a crop was a novelty a few years ago, we are now growing almost one million acres. This crop requires insect pollination because the floret of the sunflower head releases pollen from the anthers before the stigma of the same floret is receptive. The pollen must be transferred from one floret to another. If this is done and the florets of the head are compatible, a seed may develop. Most sunflower plants are self-incompatible, therefore pollen must come from florets on the head of another plant for seed to be produced. Insects are best for this, and honeybees are most effective agents. They visit the flowers for both nectar and pollen. There should be one bee per head throughout the bee-working day for best pollination. This may require one to several colonies per acre

#### Pollination and the Environment

A discussion of pollination would not be complete if we failed to mention its relation to ornamentals, wild flowers, pastures, ranges, and forests, and other areas of our environment.

Numerous ornamentals would lose their charm or disappear if it were not for the pollinators to set their seeds or fruits. Fields and roadsides would lose much of their beauty without benefit of pollination of the wild flowers. The birds and many other wild animals



would suffer without the fruits and seeds of the forest and fields, resulting from bee population.

Most important to the beekeeper, many of the obscure wild flowers that contribute to the support of the colony by providing nectar and pollen for maintaining the colonies are, in turn dependent upon the bee for their survival. This mutual relationship, the bee pollinating the flowers which in turn provide food for the bees, is an example of nature's own beautiful way of keeping her house in eternal order and making our environment a pleasant one.

#### Pollination Literature References

- Arkansas Agricultural Extension Service.  
1970 The Indispensable Pollinators — A Report of the 9th Pollination Conference. Hot Springs, Ark., Oct. 12-15, 233 pgs. Miscellaneous Publication No. 127. University of Arkansas, Fayetteville.
- Bohart, G. E.  
1952. Pollination by Native Insects. USDA Yearbook of Agric. pgs. 107-121.  
1960. Insect Pollination of Legumes. Bee World 41(3):57-64, (4):85-97.  
and Todd, F. E. 1961. Pollination of Seed Crops by Insects. USDA Yearbook of Agriculture, pages 240-246.
- Chapman, G. P. 1964. Pollination and Yield of Tropical Crops: An Appraisal. Euphytica 13: 187-197.
- Free, J. B. Insect Pollination of Crop Plants, Academic Press, New York, 544 pages.
- Griggs, W. H. 1953. Pollination Requirements of Fruit and Nuts. California Agricultural Experiment Station Circular 424, 35 pgs.
- Hawthorn, L. R. and Pollard, L. H. 1954. Vegetable and Flower Seed Production. The Blakiston Co., Inc., N. Y., 626 pages.
- Martin, E. C. and McGregor, S. E. 1973. Changing Trends in Insect Pollination of Commercial Crops. Annual Review of Entomology 18: 207-226.
- McGregor, S. E. 1973. Insect Pollination — Significance and Research Needs. American Bee Jm. 113: 249, 294-295, 330-331.  
and Todd, F. E. 1952. Cantaloupe production with Honeybees. Journal of Economic Entomology 45: 43-47.
- Meeuse, B. J. D. 1961. The Story of Pollination. Ronald Press Co., N. Y., 243 pages.
- Purseglove, J. W. 1968. Tropical Crops: Dicotyledons 1, Dicotyledons 2. John Wiley & Sons, Inc., N. Y. 719 pages.
- Smith, M. V. and Bradt, O. A. 1967. Fruit Pollination. Ontario (Canada) Dept. of Agriculture and Food Publication 172, Toronto. 13 pages.
- Todd, F. E. 1957. Insect Pollination of Legumes. IN: Wheeler, W. A. and Hill, D. D. (Editors). Grassland Seeds. D. Van Nostrand Co., Inc., Princeton, 62-76 pages.
- Vansell, G. H. and Griggs, W. H. 1952. Honey Bees as Agents of Pollination. USDA Yearbook of Agriculture, pages 88-107.

**PROVIDING AN ADEQUATE HONEYBEE POPULATION.** — The pollination of agricultural crops discussed in the preceding pages perhaps does not give full justice to the true economic value of honeybees to our food pro-

ducing capacity. On the basis of dollar value the worth of bees as pollinators far exceeds the value of the honey crops they produce. The ability of honeybees to bring about a full crop on otherwise barren plants is of course, dependent upon the bee's opportunity to perform its invaluable service.

A colony of bees placed in a location for pollination purposes must be up to certain standards of strength and morale.

The behavior of bees as pollinators is being researched but until more absolute controls are discovered and proven reliable there is no substitute for vigorous colonies placed for maximum coverage and at the proper time by beekeepers with the experience and knowledge acquired by exposure to the circumstances peculiar to the location and the crop requiring pollination.

**PROPOLIS.** — (From the Greek; pro, before, and polis, city, referring to its use in partially closing the entrance or gateway to the bee commune or city).—Propolis is a gum gathered by bees from a variety of plants, but especially from the buds having some sort of gum or sticky substance. As it occurs in the bee hive, it is from a yellow to a dark reddish-brown in color, and resembles the pitch of commerce. It has an aromatic odor similar to that of the buds of the balm of Gilead, is extremely brittle when cold, melts at about 150 degrees F., is partly soluble in alcohol, only slightly soluble in turpentine, but readily dissolves in ether and chloroform. When wax and propolis are melted in the same receptacle much of the propolis remains permanently in the wax.

#### Chemical Composition of Propolis\*

As a key to further biochemical, pharmacological and clinical investigation of propolis, a more exact knowledge of its chemical composition is necessary. So far, 17 chemical substances in propolis have been described. Kustenmacher (1911) found cinnamic acid and cinnamyl alcohol; Jaubert (1927) found chrysin, and Dietrich (1911) vanillin. Poprawko et al. (1969) described the following: acaetin; kemp-

\*J. Cizmarik and I. Matel. Examination of The Chemical Composition of Propolis, Journal of Apicultural Research 12 (1):63-85 (1973).

ferid; rhamnocitrin; pinostrobin; 5-hydroxy-7,4'-dimethoxyflavone; 5, 7-dihydroxy-3,4'-dimethoxyflavone; 3,5-dihydroxy-7,4'-dimethoxyflavone; 5-hydroxy-7,4'-dimethoxyflavonal. Cizmarik and Matel (1969, 1970) isolated and identified caffeic acid, and Villanueva et al. (1964, 1970) identified galangin and chrysin, tectochrysin, isalpinin and pinocembrin.

Further experiments since the publication of Part I (Cizmarik and Matel, 1970), and the results of paper and thin-layer chromatography, have shown the presence of a number of previously unidentified compounds in propolis.

Recently another component has been identified 4-hydroxy-3-methoxycinnamic acid (ferulic acid). Ferulic acid is an aromatic unsaturated acid characterized by antibacterial effects on certain gram-positive and gram-negative microorganisms.

#### Method of Loading in Pollen Baskets

On a few occasions bees have been observed collecting pollen from pine and other sources. They obtained their material from drops of resin appearing on the bark of trees on both trunks and branches. A bee alights close to such a drop and with the mandibles it tears loose a piece of it which strings out on account of its stickiness, forming a thread that finally separates from the original drop. Such threads are removed from the mandibles with the claws of the second pair

of legs then brought backwards and deposited in the pollen baskets. With the inner surface of the metatarsi of the second pair of legs the thread of resin is now pushed into the right position and molded to the shape of a heap of pollen. This operation is repeated several times until a comparatively large drop of propolis adheres to each pollen basket. After each tearing loose and the deposition of a thread of propolis a worker bee takes off for a short flight, returning to its original place after a few seconds and continues loading up.

#### Help Needed in Unloading Propolis

On returning to the hive a bee never disposes of the propolis by itself. Hive bees tear the drops loose with their mandibles in the same manner as the field bee tore the threads from the bark in the fields. It appears to be a hard piece of work and an enormous strain for both the collector and bees doing the removing work. These bees take a firm hold with their legs on the supporting surface while their mandibles are buried in the propolis. They pull with such effort that the collector often fails to hold on and is pulled away from its position.

Quite frequently propolis collectors do not enter the hive but they are freed of their burden outside on the alighting board. During this removal process it often happens that little pieces or entire heaps of propolis accidentally are dropped and stick to various places on the hive. The bees, however, do not seem to make any effort to remove them. This accounts for the many droplets of colored transparent propolis which appear many places in a bee hive which do not seem to serve any particular purpose. After obtaining the propolis the hive bees carry it with their mandibles to the place where it is needed and apply it there by using their mandibles. The tongue is not used for either collecting or application of propolis.

#### Can Be Handled Only When Warm

Temperature seems to play an important part in the process of collecting propolis. High temperatures always soften waxy and resinous substances, making them more plas-



Fig. 1.—Propolis drop on hind leg of bee collected from pine.



Fig. 2.—Propolis drop on hind leg of bee collected from poplar.

tic and naturally more easily gathered and handled. This may partly account for the large amount of propolis brought in in any season. Propolis collectors are not observed in the early morning hours. They appear first around 10 a. m., and as time advances and temperature rises their number increases steadily. Toward evening fewer loads of propolis come in.

Sometimes in the evening bees can be observed with some propolis still adhering to their legs. On such bees one or both rear legs bear a stick-like projection, consisting of propolis which hardens while being removed. Such bees were marked to find out the fate of these propolis sticks. Bees marked on such occasions did not join the field forces the next morning, but remained inactive on the alighting board, sunning themselves. Later in the day around noon, they appeared free from their stick-like appendages and flew back to their work. It appears that the sunshine helped to re-soften the hardened propolis to make its removal possible.

#### How Bees Use Propolis

Bees do not pack propolis in the cells, but it is applied at once to some portion of the hive. When newly gathered it is very soft, and in an almost liquid state. It is found in every part of the hive but is especially abundant around the edges of the cover and at the ends of the frames, often completely

filling the space between the ends of the top bars and the front and back walls of the hive. It occurs in many parts of the hive where it is entirely useless, as on the wall, bottom board, middle of the cover, and on the frames and sections. In some cases it is found in pellets or small masses, in others in narrow bands. It is stated that empty combs which are not immediately used for brood rearing or honey, are given a thin coating of propolis to preserve them. The spaces between the wires of queen excluders are often partially filled with propolis, but wax is also used for this purpose and is often covered with propolis.

#### When Gathered

While propolis may be gathered at any time during the summer, it is gathered most largely in the fall, when the bee's instinct impels it to prepare for cold weather. During the honey flow very little if any propolis is brought in. In the absence of a natural supply of propolis bees may gather a supply from parts of old hives where it has been softened by the heat of midsummer.

#### How Propolis May be Removed

Either ordinary washing soda, under different brand names, and water, commercial waterless hand cleaners or rubbing alcohol, clear or with a little water will remove propolis from fingers. Hive tools smeared with propolis can be cleaned by punching them into the ground a few times until they are clean.

#### Propolis in Medicine

The use of propolis in therapeutics is being aggressively investigated in Europe but in comparison very little is known about the use of propolis for medicine in America. European investigators describe the "amazingly efficient properties of propolis—its intensive antibiotic action against bacteria—is now ascertained by research which thus endorsed its use in human and veterinary medicine (skin afflictions, disinfection and healing of wounds, dysfunction of the thyroid gland) and cosmetics"\*

From time to time purchases of propolis are made from American beekeepers at fairly high prices, ostensibly

\*....."Report on Apimondia Symposium on Apitherapy," *Apiscta*, X (1) 1975.

reflecting the high regard with which propolis is held in the preparation of pharmaceuticals. Only propolis that was gathered fresh and free of bits of wax, wood and other debris is usually accepted for purchase and processing.

Most of the purchases of propolis are made for European processors who make it into salves, powders and liquid medicines.

**PROPOLIS IN BEESWAX.**—See Wax, Pollution by Resinous Gums.



**QUEEN REARING.**— Before this subject is read the one on Queens, further on, should be gone over carefully. This will make queen rearing more easily understood.

Quite a number of extensive honey producers believe that it is better and cheaper to buy their queens than to attempt to raise them, for the following reasons: (1) When they buy queens they introduce new blood into their yards; (2) to raise good queens requires skill as well as considerable time and equipment, which if devoted to the production of honey, would yield larger results in dollars and cents; (3) there are often so many poor drones flying that the new queens produce poor bees.

However, there are some large producers who raise a few queens of their own, selecting larvae from colonies showing the best average in honey production year in and year out.

#### How to Raise a Few Good Queens for One's Own Use

First of all, it is important to select the best queen in the yard, one that has had a record, say, at least for two years.

The queen selected should be kept in a nucleus well supplied with bees to conserve her energy. If she continues to be the mother of a powerful colony she will not last long.

In order to rear good queens, it is necessary to have a number of young larvae about one day old,\* for

\*There has been a large amount of discussion on this point. Some authorities say that the cells should be started from the egg. Others hold that larvae any time under three days old from the egg will make good queens. M. T. Pritchard.

which the bees are to build cells. When the conditions are right the bees will build queen cells. Those conditions are, first, queenlessness, swarming and supersedure impulse. In the last two the bees already have a queen, but have in prospect raising another. In all three cases the bees select young larvae or eggs from which to rear queens.

We will now go back to the nucleus containing our breeding queen. We remove one frame of brood and bees, being careful not to take the queen. Shake the bees back into the nucleus, and in place of the frame removed put an empty frame having a strip of comb foundation about four inches wide fastened to the top bar. The nucleus should be fed if no honey is coming; in so that the foundation will be drawn out. In a week there will be eggs and brood in all stages. At the end of this time remove the frame, brush the bees off carefully, and with a sharp knife trim the bottom edge of the comb to the irregular line of very young larvae that have just hatched from the eggs. It is right along this scalloped or irregular edge that we desire the bees to start cells.

If this comb were put back in the nucleus the bees would do nothing with it except to build on more comb, so we will now place it in a

veteran queen breeder for The A. I. Root Co., after a long series of experiments found that larvae eighteen hours old give the most vigorous queens providing they are reared in cells given to strong colonies queenless and broodless so that the queen larvae are abundantly supplied with pap or royal jelly. John G. Miller, an extensive breeder of queens, who has never had premature supersedure of his queen says larvae should not be older than three hours.

strong colony that has been made queenless and broodless for three days. The purpose of this is to make the bees cry for a queen. They will be full of royal jelly or pap with no unsealed brood to feed and will rush to build cells over the day-old larvae or, better, 18 hours old. As the comb just built from foundation is soft and easy to work, and larvae of the right age are along the irregular bottom edge, the bees will readily start a lot of cells along this edge rather than build cells in their old tough combs. Some queenless colonies will build more cells than others.

#### Using Supersedure and Swarming Cells Already Built

Instead of securing cells in the manner given above, it will be much easier and simpler to use cells already built either under the swarming or supersedure impulse. As one goes through his hives in May and June in the central North he may find a colony or two building cells in sufficient number to supply a dozen or more nuclei. It is well known that supersedure and swarming cells, when built naturally and well fed, furnish the best queens.

A good many of our colonies have queens reared in this way with a minimum of cost. They are put in nuclei and always ready. Queens taken in the height of their egg laying from nuclei will be accepted more readily than queens from the mails carrying many foreign odors.

As we check through more colonies, we may find a very strong colony that is making preparations for swarming. We may find some nice cells that are not yet capped over. If the colony is extra populous we may make up two nuclei in mating hives from this strong colony in the manner just described, being sure to put combs of young bees and honey in each compartment. Removing cells, brood, and bees from a populous colony ready to swarm is a swarm control measure. Care must be exercised in handling combs containing queen cells that are not capped over. The queen larvae are easily injured in unsealed cells. Sealed cells may be handled without much danger.

#### Direct Introduction of Queens

It is well to have a system of rec-

ord keeping for each nucleus hive. In due time, barring unfavorable conditions for mating, most of these mating hives will contain vigorous young queens. It is well to permit the queens to lay for a time, if possible. The next time the commercial apiary is checked, we are likely to find some queenless colony or perhaps colonies with failing queens. Each failing queen should be destroyed and the colony left queenless for at least three to five hours or until the colony realizes its queenlessness. Two frames of brood with queen and adhering bees are then lifted out of a queen mating hive and placed in the center of the brood chamber of the queenless colony. The two combs which are removed, to make room for combs with the queen, are put into the mating hive or exchanged for the combs taken out. It is well to have at least one comb with some eggs or larvae in the mating hive in order that a new queen may be reared in the event that a cell is not available.

A queen that is laying eggs normally is more likely to be accepted than is a young queen that has traveled in a mailing cage for a number of days, and is dried up and runs around like a virgin queen. It seems that a laying queen with two combs of brood and bees is protected from the bees in the queenless colony by her own bees until the new queen, bees, and brood have acquired the odor of the colony.

If an undesirable young hybrid queen is found and removed it may be more difficult to introduce by the method described. However, if there is a fairly good honey flow on, this method will work in the majority of cases. If little or no honey is coming in, the queen should be placed in a cage with a little candy in the end to permit the bees in the colony to get acquainted with her before she is released from the cage.

The methods here presented thus far require neither skill nor previous experience. The following is an outline of the method used in commercial queen rearing.

#### Commercial Queen Rearing

This method requires special equipment as well as a high degree of skill. It is not recommended for the average beekeeper who

would better devote his time to honey production.

The pictures herewith show the cell cups that are to receive the 18-hour larvae, one to each cell. These cups, a dozen or more, are fastened onto a cross bar mounted into an ordinary empty frame. This is then put down into a colony made queenless and broodless five hours before. If honey is not coming in, the colony should be fed until the cells are capped over. (See Queens.)

The procedure from then on in giving cells to a nucleus is the same as has already been outlined.

The average beekeeper, or honey producer, better by far use natural cells built during a swarming or supersedure impulse. The beginner will make poor work of cell grafting. He will usually get larvae too old to make good queens.

For more detailed information on this subject read *Queen Rearing* by Harry H. Laidlaw, Jr. and J. E. Eckert, 1962, 165 p.

*The Introduction of Queen Bees* by L. E. Snelgrove, 1940. 20<sup>+</sup> p.

*Practical Queen Rearing* by Frank C. Pellett, 1918, 103 p.

*Production of Quality Queens* by J. E. Hastings, p. 212, *Gleanings in Bee Culture*, April 1967.

**QUEENS.**— The most important personage in the hive is the queen. Structurally she is much like the worker bee except that her reproductive organs are fully developed, while in the worker they are only partially so. In appearance the queen has a longer body. (See picture on next page.) The same egg that will produce a worker will also produce a queen. While a worker will lay eggs only under stress of abnormal conditions, and these are usually drone eggs (see *Laying Workers*, and *Parthenogenesis*), a laying or mated queen will lay two kinds of eggs—worker and drone. The workers, instead of being neuters are all females but incapable of reproducing more females except in rare cases. So, far from being a ruler or sovereign, the queen is little more than an egg-laying creature subject to the caprices of the worker bees.

When a colony is deprived of its queen, the bees set to work and raise another so long as they have any worker larvae or eggs in the hive

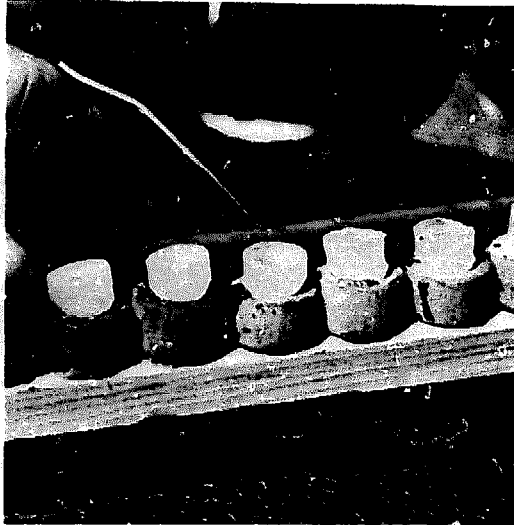

from which to do it.\* (See Queen Rearing.)

#### Undersized or Imperfectly Developed Queens

Some Italian laying queens are small and unusually dark in color, and yet become fertilized. They lay eggs for a little while, from a week to several months, but seldom prove profitable. Sometimes they will not lay at all, but remain in a colony all through the season, neither doing any good nor permitting any other queen to be either introduced or reared. A wingless queen, or one with bad wings, will prevent another from being introduced. The remedy is to hunt her out and remove her. When queens are so nearly like a worker bee as to make it hard to distinguish them, they can often be detected by the peculiar behavior of the bees toward them. (See picture

\*There are two statements often made within beekeeping circles which are misleading if not actually erroneous. One is that "the queen bee is the only complete or perfect female in the hive" and the other is that the worker bees are "undeveloped females". The fact is that both are partially developed females.

Some of the organs of the female develop in the queen but other organs and most of the feminine characteristics are found in the worker bee.

Fully developed females are, in one way or another, able to care for their progeny. Some, such as mammals, provide food from glands within their body. Others, like most birds and solitary bees, provide a more or less unprocessed food.

The queen cannot provide for her larvae except indirectly by laying eggs that develop into workers to supply the missing elements. Even this she cannot do alone. Workers must be present before

on page 550 of workers surrounding the queen.) In the fall after egg laying has stopped, all queens will usually look small and insignificant even though they are good ones. But if the queen looks small during the laying season when all fertile queens are laying, she should be removed.

#### Development of Baby Queens—How a Worker Egg is Made to Produce a Queen

Put a comb containing eggs into a colony having no queen. The tiny eggs will hatch into larvae. (See Brood and Brood Rearing.) As soon as they begin to hatch there will be found a few of the cells supplied with a greater profusion of milky food than others. Later on these cells will begin to be enlarged, but at the expense of the adjoining ones. These are queen cells. They

the queen can commence to lay. She lacks essential female organs and instinct and is therefore but a partly developed female. The worker is the other part.

The ovaries are developed in the queen and she lays the eggs but that alone is not sufficient to continue the existence of her tribe. The worker, with her instinct and wax-producing glands, must be present to build the nest and then to incubate the eggs. The larvae require a processed food or milk and it is in the worker that these processing or mammary glands are developed.

It is the worker only that develops the maternal instincts. She is the one who fusses over the young, feeds and fondles it and defends it, at the cost of her own life if necessary. The queens show no more maternal instinct than does an incubator though for all that she is a necessary part of the colony.—By M. J. Rowland, Kapuskasing, Ont.



Queen

Drone

Worker

are something like peanuts in shape and usually occupy about the space of three ordinary cells.

In sealing the cell the bees put a great excess of wax on it, make a long tapering point, and corrugate the sides something like a thimble. When closely examined, this corrugation or roughness will be seen to be honeycomb, or rather an imperfect representation of honeycomb on a very small scale.

It is very handy to be able to tell when any young queen will be likely to emerge and the bees are very accommodating in this respect also; for about the day before the queen emerges, or maybe two days, they procede to tear down this peak of wax on the tip of the cell, leaving only a thin covering. No one knows why unless they are anxious to get a peep at their new mother. It has been said they do it that she may be better able to pierce the capping; but sometimes they omit



Bees tending supersedure cells.

cell is made is tough and leathery, and therefore, before she gets clear around her circle the piece springs out in response to her pushing. Queens may often be seen pushing the door open and looking out with much apparent curiosity. Often, after taking this look they will back down and stay some time. This is especially the case when other queens are emerging and there is strife as to who shall be sovereign.

### Royal Jelly

Up until recent years opinion was divided as to whether this is a partially digested food regurgitated or a secretion. The best authorities, and among them, Snodgrass, now hold to the latter view. Whatever it is, it is so highly concentrated a food that a larva destined to be queen and fed on it during its entire period of growth emerges in from 15 to 16 days. (For further discussion of how this transformation takes place, see Royal Jelly and Larval Food.)

### Absence of Vitamin E in the Royal Jelly of Bees

It was believed at one time that this wonderful transformation of a queen from a worker egg as just mentioned was due to the presence of vitamin E in royal jelly. Some work was done in 1925 to indicate that this might be true; but later work by Doctors K. E. Mason of the Vanderbilt University School of Medicine, Nashville, Tennessee, and R. M. Melampy of the Bureau of Entomology and Plant Quarantine,

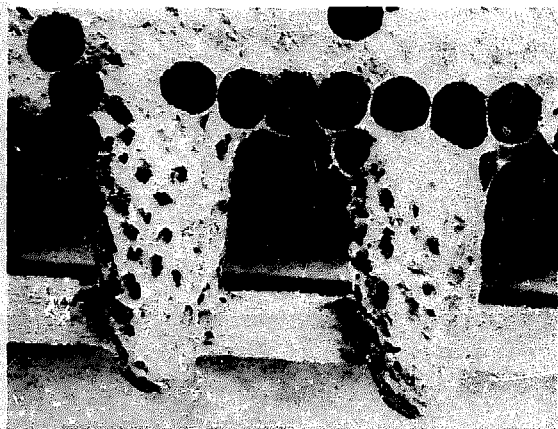

A pair of ripe queen cells from which queens will emerge within a day or two. If one emerges before the other, she may gnaw a hole in the cell and sting her rival.

the proceeding entirely, and apparently she has no difficulty in cutting the cap off. If the cell is built on new comb, or on a sheet of foundation, and is held up before a strong light at about the fourteenth day, or a little later, the queen can be seen moving about in the cell. Afterwards, by listening carefully, she can be heard cutting her way out. Pretty soon the points of her sharp mandibles will be seen protruding as she bites out a narrow line. Since she turns her body in a circle while doing this, she cuts out a circle so true that it often looks as if marked by a compass. The substance of which the



U. S. Department of Agriculture, proves that it is a mistake.

#### Brood Food and Royal Jelly

It was also thought that brood or larval food which appears to be royal jelly actually is not according to Townsend (1970). Young worker larva food will not support continuing larval development. Shuel has also found differences in the sugar, protein, and other food content.

#### What Does the Queen Do While Sealed Up?

The author has opened cells at every stage after they were sealed until the queens were ready to emerge. One day after being sealed they are simply ordinary larvae, although rather larger than worker larvae of the same age; after two or three days, the head begins gradually to be "mapped out," and later, some legs are seen folded up; last of all, a pair of delicate wings come from somewhere. (See Brood and Brood Rearing.) Two days before emerging the author has taken them out of the cell, and had them mature into perfect queens by keeping them in a warm place. He has also taken them out of the cell before they were mature, held the white, still, corpse-like form in the hand, then put it back, waxed up the cell by warming a bit of wax in the fingers and had it emerge three days after, as nice a queen as any. Mr. Langstroth mentions having seen the whole operation by placing a thin glass tube, open at both ends, in the cell, so as to have it enclose the queen, the bees being allowed to cap it as usual. This experiment was made first by Huber. (See Observation Hives.)

#### What Becomes of the Queen After She Leaves the Cell

After she pushes open that hinged door she generally begins by poking her head into the cells until she finds one containing unsealed honey, from which she takes a sip that at least indicates she likes that kind of provision.

After she has had her repast she begins to crawl about, partly to enjoy using the long legs and partly because she knows that it is her allotted task to tear down the remain-

ing queen cells, if such there are. If other queens have emerged before her, it is one of her first and foremost duties to look them up and fight it out. The queen that first receives the sting from her opponent crumples up and dies. The victor may in turn finally be stung. The strongest and usually the oldest finally becomes the reigning mother. When all other cells have been removed, as they usually are where queens are wanted for other purposes, the final victor has nothing to do but to promenade over the premises, monarch of all she surveys. If she ever sits down to take a rest, or takes a rest in any other position, during the first week of her life, the author has never been able to discover it.

But suppose she does find another cell — what then? She sometimes runs around awhile; sometimes the bees tear it down, and sometimes she tears it down herself, with the same strong mandibles that she used to cut her way out of the cell at first. She makes a small opening in the side of the cell, and the bees do the rest. (See illustration, page 548.)

Since these immature queens are very soft, the workers will soon pick them out of the cell, piece by piece. The author has sometimes placed them in an incubator and had them mature, minus a wing, a leg, or whatever portion the mischievous worker had pulled away. From many observations the queen generally tears a hole in the cell, or bites into it in such a way that the workers finish the job, much in the way they do in any mutilated or broken pieces of comb.

When queen cells have been cut out, all the larvae that are in any way injured are at once destroyed, and none but the perfect cells preserved. Bees never fuss with cripples, nor try to nurse any bee that is wounded or maimed. They battle against anything that threatens the welfare of the colony. There are no signs of their caring for one of their number, or even having compassion on their helpless brood when it is wounded and suffering.

When a queen emerges, the remaining cells are very often torn down, but there are many exceptions. When two queens emerge at the same time they also generally

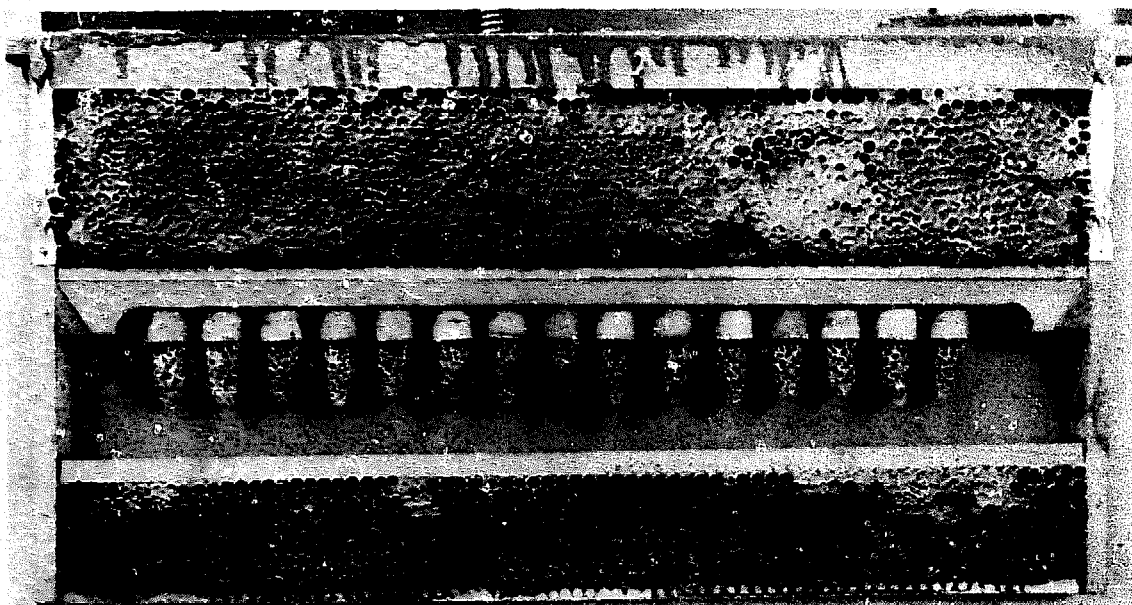

A nice bar of cells built from artificial cell cups. If left too long in the cell-building colony, they may be destroyed by a jealous rival, as shown in the photo on next page.

attempt to kill each other; but both are not killed. This probably results from the fact that they can sting their rivals only in one certain way; and the one that, by strength or accident, gets the lucky position in the combat is sure to come off victorious. This explains how a very inferior virgin queen that has entered the hive by accident may sometimes supplant an old laying queen. Two queens, when thus thrown together, generally fight very soon, but this does not always happen. Several cases are on record where they have lived in peace and harmony for months, even when they emerge at about the same time, and it is quite common to find a young queen helping her mother in the egg-laying duties of the hive, especially when the mother is two or three years old. If the season is good, and the hive populous, they may divide their forces after swarming occurs. (See Afterswarming.)

Sometimes the queen will pay no attention to the remaining cells but will let the young queens emerge, and then their differences are adjusted afterward, either by swarming or by the usual conflict until death. Many losses in introducing queens have resulted from a queen being in the hive, the owner being sure his hive was queenless—because he had removed her. (See Introducing.)

### Queen's Voices

Queens have two kinds of voices, or calls, either one of which they may emit on certain occasions. It is almost impossible, on the printed page, to describe these sounds. One of them is a sort of z-e-e-p, zeep, zeep. Some call it piping, others teeting. Whatever it is, it consists of a prolonged tone or a long zeep, followed by several much shorter, each tone shorter than the preceding one. This piping is made when the queen is out of the cell, either virgin or laying, but usually by a young one. The older ones are generally too dignified to give forth any such loud squealing; but they will squeal, and lustily, too, sometimes, when the bees ball them and grab them by the legs and wings.

The other note that queen bees are known to give forth is called quahking, for that more nearly describes the actual sound than any other combination of letters that can be put together. It is emitted only by a young queen in the cell, before she emerges, and is made in answer to the piping, or zeep, zeep, of one of the virgins that has already emerged, and is trying perhaps to proclaim aloud her sovereignty. The quahk will be heard, then, only when there are queen cells in the hive.

While a young queen is being in-



By accident a batch of cells as here shown was left for a day or so too long in a cell-building colony. The first virgin that hatched, true to nature, waged an unfair war upon her helpless sisters, still in their cradles. Every cell was ruthlessly torn open and the little white queens inside killed. A virgin queen will not stand for competition. This inborn instinct of hatred against a rival does not end with youth. Two laying queens—old enough to know better—will usually fight if placed together even in strange and unnatural surroundings. Place two queens under a drinking glass in the hot sun and watch how they act toward each other.

roduced she frequently utters a note of alarm, a zEEP, zEEP, etc. The bees are nearly always stirred by these notes and they will often run after her and cling around her like a ball when they would have paid no attention to her had she not uttered this well-known note. (See *Balling Queens.*)

Queens, when placed near together in separate cages, will often call and answer each other in tones that are probably challenges to mortal combat. The note is then zEEP, zEEP.

Some queens received one summer from the South called so loudly when placed on the table that they could be heard the entire length of a long room. One voice would be on a high, shrill key, and another a deep bass, while others were intermediate. On watching closely a tremulous movement of the wings was noticed while the queen was uttering the note, and one might infer from this that the sound is produced by the wings.

### Virgin Queens

The newly emerged queen is termed a virgin because she has not met a drone and to distinguish her from queens that have been fertilized and are laying. Virgin queens, when first emerged, are sometimes nearly as large as a fertile queen, but they gradually decrease in size until, when three or four days old, they look so small and insignificant that a novice is disgusted with their appearance and, if hasty, pronounces them useless. For the first week of their lives they crawl about much as an

ordinary young worker does, and it is often very difficult, if not almost impossible to find them unless an amount of time is taken that is more than a busy apiarist can well afford to spare. It is a waste of time to look for them. It is better to insert a frame having some unsealed larvae just hatched from the egg. Then if no cells are started one can decide the queen is there without looking further. This plan answers a three-fold purpose: It enables one to tell at a glance whether the queen is in the hive or not; for as soon as she is lost they will start one or more queen cells. It also enables the bees to raise another queen in case the former queen is lost by any accident on her mating flight, which is frequently the case. Lastly, it serves as a sort of nucleus to hold the bees together and to keep them from going out with the queen on her mating trip, which they are much disposed to do, if in a small nucleus containing no brood. Unsealed brood in a hive is a great safeguard against accidents of all sorts.

### Age at Which Virgin Queens Take Their Mating Flight

The mating flight takes place from four to ten days after emergence. It is seldom before the fifth day. Some difference, doubtless, arises from the fact that queens often stay in the cell a day or two after they are strong enough to leave it. Sometimes a queen will be found walking about the combs when she is so young as to be almost white. Beginners will sometimes rejoice at their beautiful yellow queens, saying that they are yellow all over,

without any black on them; but when looked at again, they will be found to be as dark as other queens. When some of them come out of the cells they will look, both in size and color, as if they might be three or four days old.

Queens generally begin to crawl about the entrance of the hive, possibly looking out now and then when 5 or 6 days old. The next day, supposing of course it is fine weather, they are apt to try their wings a little. These flights are usually taken in the warmest part of the afternoon. There is no prettier or more interesting sight to the apiarist than the first flight of a queen. She runs this way and that, somewhat as does a young worker, only apparently much more excited at the prospect of soaring aloft in the soft summer air. Finally she tremblingly spreads those silky wings, and with a graceful movement that can not be equaled anywhere in the whole scope of animated nature, she swings from her feet, while her long body sways pendulously as she hovers about the entrance of the hive. A worker bee hovers also about the entrance and carefully observes its location when trying its wings for the first time. The queen, seeming to feel instinctively that she is of more value to the colony than many workers, with the most scrupulous exactness notes every minute point and feature of the exterior of her abode, often alighting and taking wing again and again to make sure she knows all about it.

Soon she ventures to circle a little way from home, always returning soon, but being gone longer each time. She sometimes goes back into the hive satisfied, without going out of sight at all, but in this case she will be sure to take a longer flight next day or a half-hour later in the same day. During these seasons she seems to forget all about surrounding things and, instead of being frightened as usual at opening of the hive, she will pay no attention. The queen mating flight usually takes about 13 minutes according to Dr. Norman Gary (Univ. of Calif.) (See Drones.)

#### **When the Queen Begins to Lay**

The third or fourth day after a successful mating one will, as a general rule, find the queen depositing

eggs. The average age at which queens begin laying is about nine days from the cell. Between impregnation and the time the first egg is laid a remarkable change takes place.

After the queen has been out and fertilized, her appearance is much the same as before. She runs and hides when the hive is opened, and looks so small and insignificant that one would not think of calling her a fertile queen. A few hours before the first egg is laid, however, her body increases remarkably in size, and if an Italian, becomes lighter in color, and, instead of running about as before, she walks slowly and sedately. She seems to have given up all her youthful pranks and comes down to the sober business of life in supplying the cells with eggs.

#### **How Old a Queen May be and Still Become Fertilized**

During a spell of bad weather, or when drones are scarce, they may fail to lay until three weeks old. The longest period we have known to elapse between the birth of a queen and her laying fertile eggs is about 30 days. All queens that do not lay at the age of 20 days should be destroyed, unless it is out of season. Many times queens will not lay in the fall at all unless a flow of honey is produced either by natural or artificial means. Queens introduced in the fall often will not lay until the ensuing spring, unless the colony is fed regularly every day for a week or ten days. Likewise young queens that are fertilized late in the season will often show no indications of being fertilized until the following spring. (See Drones.)

#### **Shall Queens' Wings be Clipped?**

Most of the honey producers practice what is known as clipping; that is, both wings on one side are cropped off, leaving about half of the wings. (See next page.) Do not cut so that only a stump is left of what were once wings. The object, of course, is to prevent swarms from going off by making it impossible for the queen to follow and for identification of her age. (See Wings of a Honey Bee also Swarming.)

There are very few who believe that clipping is injurious to the queen. The fact that queens af-

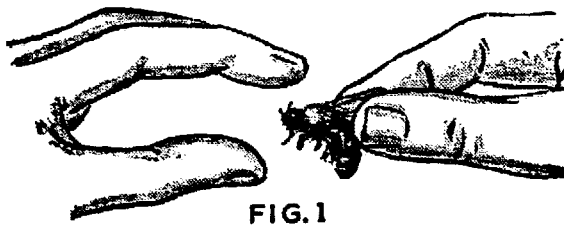

FIG. 1

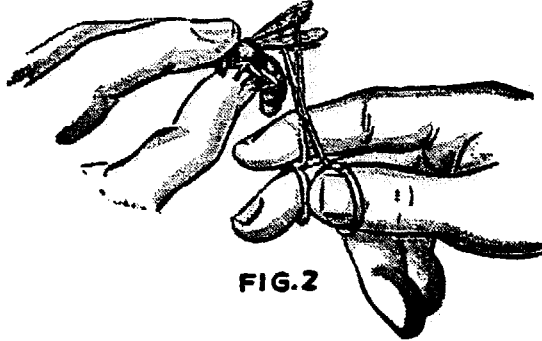

FIG. 2

There is a right and wrong way to pick up a queen, a right and a wrong way to clip her. One should practice on drones first. Clasp the wings of the queen between the thumb and forefinger of the right hand. Be careful not to crush her as her abdomen is very easily injured. If the act is performed properly she will be held so that the thumb is under her and the forefinger is over. Hold by the thorax as in Fig. 2, and clip the wings on one side on top. When clipped this way the queen cannot fly and she can be picked up again if necessary. Don't clip too close to the body of a queen. About half its length slightly on an angle is about right. (See *Wings of Bees.*)

ter being clipped seem to do good service for two or three years, and sometimes four, would seem to show that no detrimental results follow.

#### How Queens Lay Two Kinds of Eggs

That queens lay two kinds of eggs no one now disputes, since the experiments with the microscope have decided the matter so clearly.

No one can decide positively concerning the eggs until the brood is sealed. Then the drones are recognized by the round, raised cappings of the brood, like bullets laid on a board, as explained under Drones. (See illustrations of worker and drone brood under Brood and Brood Rearing.) One can guess by noticing the way in which the queen lays the eggs; if they are few and scattering, and sometimes or often in drone cells, coupled with the fact that she did not commence laying until two weeks or more old, she should be replaced. A very young queen, if properly fertilized, rarely lays an egg in a drone cell. When she commences to lay, she fills cell af-

ter cell in regular order. Her work also has a neat and finished appearance that says at once to the expert, "She is all right." (See Brood and Brood Rearing.)

In rare cases a young queen begins with all or nearly all drone eggs, but after a while lays entirely worker eggs as regularly as one could wish. Again, any queen is liable any day of her life to begin laying drone eggs altogether or in part. A nice young laying queen, taken from a hive and shipped a distance, may occasionally prove to be a drone layer shortly after or immediately after she is received. Out of three or four hundred colonies one may find one drone layer, each spring. During the summer, perhaps one more will be found. It is probable that the queen was not fertilized sufficiently, and that the supply of spermatozoa gave out while she was in full vigor, thus reducing her to the condition of a virgin queen. Microscopic examination has shown an entire absence of spermatozoa in at least one or two instances where queens of this kind were killed and dissected. Similar experiments given by Dzierzon show that spermatozoa may be injured beyond recovery by chilling the queen, and yet the queen



The queen and her court. The behavior of the bees toward her royal majesty, as here shown, is an important means of finding her in the hive. — Authenticated News Photo.

herself be resuscitated. Hardship and being shipped long distances may produce the same result.

Queens not only turn suddenly to drone layers, but they sometimes produce about an equal number of each kind of eggs. In all these cases where the queen lays drone eggs when she evidently intended to lay worker eggs, they are in worker cells. At the same time the number of eggs laid usually rapidly decreases. The bees, as well as the queen, evidently begin to think that something is wrong. Queen cells are soon started, and after the young queen emerges she becomes fertile and begins to help her mother. (See Supersedure of Queens.)

#### Loss of Queen

It is well to know at once when a queen is lost. During the months of May and June in the states east of the Mississippi and north of the Ohio the loss of a queen from the hive a single day will make quite a marked difference in the honey crop. If it be assumed that the number of eggs a queen can lay in a day is 1500, by taking her away a single day there might be just that number of bees short during a yield of honey. (See Variation in Egg laying under Bee Behavior.) To put it very moderately, over 1000 bees might be taken out of the hive by simply caging the queen for a single day. Beginners should remember this, for untimely or, rather, inconsiderate tinkering, just before the flow of honey comes, often cuts short their income to a very considerable degree. Whatever is done, it is very important not to drop the queens off the combs when they are handled at this time of the year, nor should one needlessly interrupt the queen in her work by changing the combs about so as to expose the brood.

With a little practice one will be able to detect a queenless hive simply by the way the bees behave in the hive and on the outside. When they stand around on the alighting board in a listless sort of way, it is well to open the hive and look over the combs. (See Diagnosing Colonies.) If eggs and worker brood are found one may be sure a queen is there; but if not, proceed at once to see if there is a queen of some kind in the hive that does not lay. If one is not

found the bees should be given a comb of eggs to see if they will build queen cells. Incipient ones should be found in about 24 hours if the bees have been some little time queenless. If these are found a queen should be given. If no queen is to be had, they may be allowed to raise one, if the colony has bees enough. If it has not, they should be united with some other colony.

#### The Cry of Distress from a Queenless Colony

A queenless colony will reveal its condition, if not of long standing, by the behavior of the bees in the hive. They will set up a peculiar cry—all through the hive they will be buzzing as if in distress, and they surely are, because they have no queen. As soon as a hive of this kind is opened they will begin this cry of distress. Sometimes only a part of the bees will be involved, and at other times apparently every bee in the colony. This buzzing of the wings is so marked that the practiced beekeeper recognizes it as an indication that a colony may be queenless; and if he finds no eggs nor young brood at a time of the year when both should be present, he is quite sure that the hive has no queen. If he finds queen cells, all doubt will be removed. Sometimes a colony that is not queenless will set up a buzzing as if they were without a mother. It is then evident that the show of distress is not because they have no queen but because of the disturbance. Too much smoke, for example, with most colonies and too little smoke with some colonies will cause them to make this sign of distress. It must, therefore, not be regarded as an infallible sign of queenlessness. Colonies that have been queenless for a long time will no longer indicate their condition in this manner.

#### Odor of a Laying Queen

After bees have been some time queenless they usually become very eager for a queen, if no laying workers make their appearance (see Laying Workers), and in no way can this eager behavior be described so well as to tell of another way of testing a colony that is thought to be queenless. Take a cage or box containing a laying

queen and hold either the cage or simply the cover of it over the bees, or hold it in such a way as to let one corner touch the frames. If queenless, the first bees that catch the scent of the piece of wood on which the queen has been will begin to move their wings in token of rejoicing, and soon nearly the whole colony will be hanging to the cage or cover. When they behave in this manner there seldom is any trouble in letting the queen out at once. Such cases are generally where a colony is found without brood in the spring.

There is something very peculiar about the scent of a laying queen. After having had a queen on the fingers, bees will often follow and gather about the hand. They will often hover for hours about the spot where the queen has alighted for even an instant, and sometimes for a day or two afterward. Where clipped queens get down into the grass or weeds or sometimes crawl a considerable distance from the hive, they may often be found by watching the bees that are crawling about the path she has taken. This behavior is caused by a complex material secreted by the queen called "queen substance". (See Queen Substance.)

### Queens' Stings

There is something rather strange in the fact that a queen very rarely uses her sting on a human being, even under the greatest provocation possible. In fact, she may be pinched or pulled limb from limb without even showing any symptoms of protruding the sting at all, yet as soon as she is put in a cage or under a tumbler with another queen the fatal sting is almost sure to be used at once.

### Caution in Regard to Deciding a Colony to be Queenless

As a rule, it may be said that absence of brood or eggs is a pretty sure indication of queenlessness but it should be borne in mind that, as a rule, all colonies in the eastern and northern states are without eggs and brood in the fall or, in fact, any time when there is a considerable dearth of pasturage. At such seasons beginners are more apt to think their colonies are queenless because the queens are much smaller than when they are laying profusely, and therefore are not easily found. In the North queens sometimes cease laying during January and February. The amount of brood at that time in the North is small, increasing rapidly in March, April, May and June. (See Brood and Brood Rearing.)

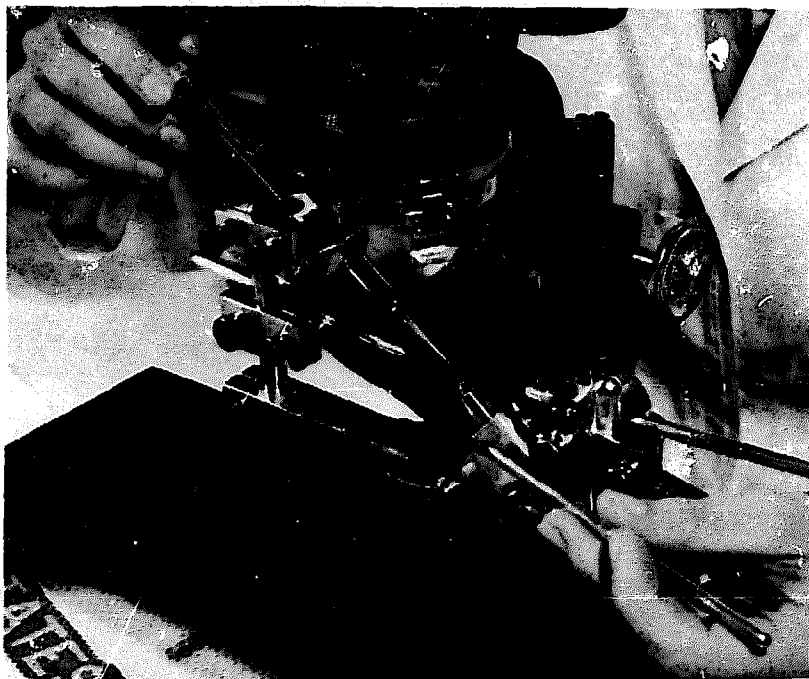

A close-up view of the apparatus designed by the Department of Agriculture for artificially inseminating queen bees.

In California and the semitropical states of the South queens may lay every month of the year.

**QUEENS, HOW TO FIND.**—See Manipulation of Colonies, Diagnosing Colonies, and Introducing, sub-head, To Introduce to Black Bees.

**QUEENS, FERTILIZATION OF, BY ARTIFICIAL MEANS.\*** — For years investigators (2) had attempted to accomplish the insemination of queens artificially before Watson in 1926 became the first to demonstrate convincingly that such a feat can be accomplished. He succeeded only after patient and diligent application to the problem.

In order to understand the principle of Watson's method it is necessary to realize that during the mating act in Nature, which always takes place on the wing, the sperm or discharge from the drone is lodged temporarily in the vagina and oviducts of the queen. It is not until after the return of the queen to the hive that the sperm ultimately finds its way into the spermatheca where it remains until used in fertilizing an egg. Watson was able, by aid of a delicate micro-syringe of about 0.5 mm. bore, to take up from the bulb of a drone into the syringe enough sperm to result in insemination after the syringe had been emptied by injecting the sperm in the genital opening of the queen in imitation of the natural process of mating.

In Watson's method as originally described (5), the queen is tied to a small angle-shaped operating board in such a way that the tip of her abdomen is in position to receive the syringe. A micro-manipulator is employed to hold the syringe so it can be accurately and gently directed in the genital opening. In order to facilitate the entrance of the syringe the abdominal tips and the sting of the queen are kept back by a pair of finely pointed forceps held by hand.

Modification of Watson's method developed at the Bee Culture Laboratory, Washington, D. C., has simplified the technique and made possible an increased output (3). Among other features, the queen is held in a small glass tube, and the abdominal tips are kept apart by two special hooks attached to

the same stage as the micro-manipulator.

Although the Watson method of artificially inseminating queens does not yet give one hundred percent results it is successful enough to utilize in studying heredity in the honey bee. Its present development even warrants the scientist to undertake the improvement of our present races of bees.

A more natural method of approaching the problem was used by Quinn. In 1927, with the aid of his grandson, Harry H. Laidlaw, he gave a demonstration of his method commonly known as "hand mating" before a meeting of the Louisiana State Beekeepers' Association in New Orleans. The method consists of holding the queen by hand, or otherwise, in such a manner that the drone's genital organs may be caused to evert into proper position in relation to the genital opening of the queen when pressure is applied on the abdomen of the drone by hand. When this occurs the drone is cut loose from the queen leaving a part of the drone organs adhering to the queen, so that the queen thus treated appears very much as she would in Nature after returning from a mating flight. In early demonstrations the abdominal tips of the queens were held apart by points of a fine pair of protractors mounted on a fixed support. Later, while employed at the Southern States Station of the Bee Culture Laboratory, Laidlaw (1) modified the method to include the use of a microscope in performing the operation, a glass tube for holding the queen, and a small spring for holding her abdominal tips apart.

By referring to the subject of Government Research Work in Beekeeping there will be found further particulars on this subject. Briefly, it may be stated that substantial progress has been made by the Bee Culture Laboratory, Bureau of Entomology, in developing a strain of bees superior to the ordinary bees in general use. Queen breeders may obtain queens for breeding purposes from the U. S. Bee Culture Laboratory, Beltsville, Maryland.

**Literature Cited**

(1) Laidlaw, Harry H., Jr., 1932. Hand-mating of queen bees. *Amer. Bee Jour.* 72-286.



(2) Nolan, W. J., 1932. Breeding the honey bee under controlled conditions. U. S. Dept. Agr. Tech. Bul. 326.

(3) Nolan, W. J., 1937. Improved apparatus for inseminating queen bees by the Watson method. Jour. Economic Entomology 30:700-705.

(4) Quinn, C. W., 1923. Hand-fertilization of queens. Bee World 5:75.

(5) Watson, Lloyd R., 1927. Controlled mating of queen bees. Hamilton, Ill., Amer. Bee Jour. 50 pp., 11 figs.

#### QUEENS, MARKING OF.\* —

Many beekeepers make a practice of marking their queens for identification by clipping a wing on one side one season and on the other side the next season. This is done to have a record of their ages. Others have marked them by putting a tiny drop of colored lacquer on the thorax. I have marked a few queens in this way. The queens usually showed signs of distress at first and often got the lacquer smeared around.

Ordinary household enamel in white, yellow, or red does not distress the queen. To apply, use a fine-haired brush. Just a dab on the queen's back is enough.

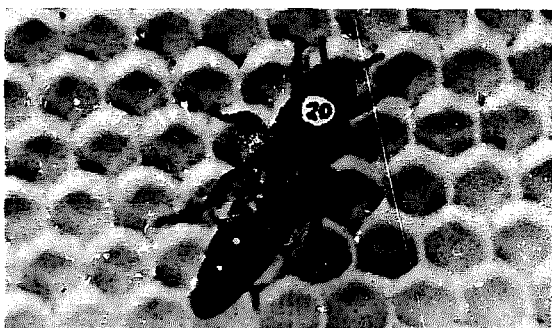

Marking a queen does her no injury

Dr. C. L. Farrar of the U. S. Bee Culture Laboratory at Madison, Wisconsin, says that "celluloid dissolved in acetone makes an excellent adhesive substance for queen marking. Dry paint pigments or aluminum powder are added to the celluloid-acetone solution to give the color mark desired. Single color marks of red or yellow are superior to other standard pigment colors. Two-color marks, made by covering half of a red mark with yellow or aluminum, aid in finding queens and increase the number of queen groups one may wish to identify. The second color may be added on the left, right, front, or rear positions of the queen's thorax to

\*By Mell Fritchard, Medina, Ohio.

identify different groups. The chief advantage of the celluloid-acetone solution over adhesives like shellac, Labrolac, etc., results from its more rapid drying properties; also, the odor of acetone is not irritating to the bees. The composition of commercial products such as fingernail polish varies. These should not be used on a large number of queens without a preliminary trial to determine the reaction of the bees. All marking paints should be rubbed on the queen's thorax sufficiently to penetrate through the hairs and make contact with the chitin. The paint should be moderately thin. A good paint applicator can be made by using part of a paper clip extending through the cork of the paint vial. A quarter-inch extension of one loop in the paper clip is used to anchor the dauber to the cork. Make practice marks on your fingernail or practice marking drones to find the right proportion of celluloid, acetone, and pigment to give an easily handled paint of bright color."

QUEENS, REQUEENING. — See Requeening.

QUEENS, REQUEENING WITHOUT DEQUEENING. — See Requeening Without Dequeening.

QUEEN SUBSTANCE.\*— It is well known that bees readily detect the removal or loss of their queen from the colony within a short period of time. The most notable symptoms of a queenless colony are the construction of emergency queen cells and the enlargement of worker ovaries, eventually leading to the development of laying workers. The actual means by which the queen communicates her presence to all members of the colony and prevents queenless symptoms have remained a mystery until recent times. An explanation was found when it was discovered that the queen produces a chemical, named queen substance by Dr. Colin G. Butler who first discovered it, that is solicited from the queen by some of the workers. Normal food-sharing activities then enable the workers that have received queen substance to share it with other workers, thus keeping all workers informed of their queen's presence.

\*By Dr. Norman Gary, Research Association, Cornell University, Ithaca, New York.

Queen substance is produced in a pair of glands called mandibular glands that are located in the queen's head and empty their secretion onto the mouthparts of the queen. The glandular secretion resembles milk in its appearance and contains other important chemicals used in bee communication. It appears that workers obtain queen substance primarily by licking the body surfaces of the queen, especially her abdomen.

In several interesting experiments it was found that queen substance could be dissolved from queen bodies in solvents such as chloroform or ether. The dissolved queen substance, when fed in sugar syrup or candy to small cages of queenless workers confined on a new comb containing worker larvae, would inhibit queen cell construction by these workers. Similarly confined workers without queen substance constructed queen cells. The inhibition of queen cell construction was complete when bees were exposed to queen odor in combination with queen substance. Furthermore, the materials, including queen substance, dissolved from queen bodies also inhibited ovary enlargement, thus demonstrating that chemicals from the queen prevent the development of laying workers in a colony.

Since queen cell construction is the first apparent step in both swarming and supersedure it is conceivable that queen substance and related materials may someday be employed to control swarming and supersedure. Queen substance has recently been isolated and synthesized and it is the first such chemical messenger that was found in the honeybee. In the pure state the compound is a white, crystalline material that is odorless to humans.

There is good evidence that queen substance is just one of a family of chemicals produced by the queen that controls many of the activities of worker bees. Some of these chemical messengers, also called pheromones, vaporize constantly from the queen in minute quantities and are perceived as odors by bees. Other chemical messengers must be licked from her body and consumed before they are fully effective. Recent evidence indicates that queen substance is a primary part of the odors

liberated by virgin queens on their mating flights to attract drones from great distances.

All social animals such as the honeybee must have efficient means of communication if activities such as queen rearing are to be coordinated effectively for the survival of the society. More extensive research probably will demonstrate that communication by chemicals in the honeybee colony is as important to bees as vocal or visual communication is to humans.

**QUEENS, SUPERSEDURE OF.—**  
See Supersedure of Queens.

**QUEENS, TWO QUEEN SYSTEM OF HONEY PRODUCTION.—**This discussion follows closely the two queen system of honeybee colony management described by Moeller.\*

In normal circumstances only a single queen is found in a colony of honeybees. The introduction and maintenance of a second laying queen in a colony of bees is brought about by installing a barrier between brood nests with a queen excluder. The divided brood nests rest on the same bottom board and are covered by the same inner and outer cover.

The advantage of the two queen system is given as follows: strong colonies resulting from this system produce a greater honey yield per colony at a lower cost per pound as compared to single queen colonies. This greater efficiency results from the advantage of obtaining greater production efficiency per bee; possible when a hive population approaches its maximum of 60,000 or 25 to 30 pounds of bees. Better utilization of equipment contributes to the cost of savings over conventional management of single queen colonies. Swarming is reduced. Winter losses are minimal because ample pollen and honey reserves are usually assured by large field forces of bees.

The two-queen system is an intensive management system that requires experience and skill. Manipulating hive bodies involves handling at least a part of the brood nest during the initial formative stages. This entails some risks for beekeepers lacking skill in queen introduction and little knowledge

\*Floyd E. Moeller, *Two Queen System of Honeybee Colony Management*, Production Research Report No. 161, ARS, USDA, Apr. '76.

of how to properly expand the brood nest without seriously weakening the morale of the colony. For beekeepers lacking experience in these procedures it would be wise to use restraint by trying only a few colonies on the two queen system at first. As experience is gained and the results evaluated the beekeeper will be far better prepared to judge the advantages, if any, over the two-queen system as compared to using a one-queen system in his locality.

#### **Colony Organization for Two Queen System**

Overwintered three story colonies are built up to maximum populations by early spring feeding of pollen supplements. If winter upper flight holes are used they are closed. About April 1st to April 15th the brood nest, which is invariably in the top story, is put down on the bottom board. Between April 20th and May 5th the brood nest is divided by temporarily elevating the sealed brood and about one-half of the bees to the top story, leaving the old queen and the younger and emerging brood below. These dates apply to the latitude of Wisconsin, in other states the dates will vary. An inner cover with the escape hole screened or closed is placed below the top unit. A flight hole is provided by auger hole or a notch is cut in the inner cover rim. A new queen, which should be ordered well in advance of the needed date, is introduced into the new division at once. Careful attention must be paid the division that the overwintered queen is not transferred with the bees and the brood to the top unit.

After two weeks the new queen should be laying well. At this time remove the screened inner cover and replace with a queen excluder. If this can be timed to coincide with an early nectar flow such as from dandelion or fruit bloom so much the better.

As the brood nest expands a second brood chamber is added to the new unit above the queen excluder.

Brood nests above and below the queen excluder should be reversed about every ten days until about four weeks before the expected end of the main honey flow.

Supers are added as needed in the same manner as for single-queen colonies but at usually double the rate.

The advantage of having the second queen ceases when about a month of the honey flow remains but owing to the impracticability of reaching the brood nests the units are usually left as they are until the end of the flow when any supers not removed earlier are taken off. The two brood nests are then combined by removing the queen excluder. One queen will survive, usually the youngest and most vigorous.

Queen supersedure and swarming are not serious in two queen colonies when good queens are kept in the brood nests and space for brood expansion and timely and adequate supering stimulate honey storage.

#### **The Pros and Cons of the Two-Queen System**

The two-queen colony under skillful management in a fair locality will probably produce more honey than a single-queen colony. There are two reasons for this. First, there will be more eggs, more brood, and, of course, more bees. The size of the crop depends largely upon the numerical strength of the colony. Secondly, some queens start out well but begin to fail in egg laying with the result that their colonies will be a liability rather than an asset. It is impossible to tell in advance what a queen will be able to do.

By having two queens, if one fails the other may come up to standard egg laying and her colony will produce some surplus. By having two queens the element of chance is reduced.

But there is another side to this. Not every one will be able to follow directions carefully. The average beginner should not attempt it. The two-queen system requires a top notch of skill and much more work in manipulating supers and queen excluders at the right time than the single-queen plan and lastly it is probably not workable at outyards because gasoline mileage for frequent trips would absorb the possible gain in honey production.

## R

**RACES OF BEES.\***—This chapter is devoted to a discussion of many different races of honeybees. These races are subdivisions of the species, *Apis mellifera*. These two Latin words, as you may remember, mean bearer or carrier of sweets or nectar.

A species may be defined as one of a group of families making up a genus. In this case it is the genus *Apis*. One way to identify a species is to know that it is made up of individuals that can breed among themselves, but cannot mate with individuals of another species.

There are many species of bees, but only four species are honeybees. Three of these are Asian bees: *Apis florea*, *Apis indica*, and *Apis dorsata*. The fourth species is *Apis mellifera*, the carrier of sweets, our bee. It probably originated in Europe or Africa. Since early colonial days in America, it has been imported into North America, South America, Australia, New Zealand, as well as into most other parts of the world, including Japan and China. It has not been able to thrive everywhere, particularly in some parts of Asia.

During the long period of years that *Apis mellifera* has lived and worked in different parts of Europe, it has adapted to the varying conditions of each locality.

The bees in Italy became different from those in the valleys of the Caucasus mountains of Russia. The bees in central Europe became still different from each of these two. The differences developed by bees in these three areas, and in many other areas of the world, eventually became so great, so observable, that they earned individual names for their owners (such as Italian, Caucasian).

A race of bees may be defined as one that encompasses enough colonies in an area large enough so that it is not likely to be wiped out by local catastrophes such as poor wintering, disease, or the like. Further, it must have developed qualities and characteristics so different from those of other

aggregations of colonies of bees, as to make identification of itself ready and certain. The qualities and characteristics might include such ones as size, color, shape, wing spread, nectar-gathering ability, wintering success, tendency to use propolis, susceptibility to disease, swarming inclination, etc.

Today, three races of honeybees are of chief concern to American beekeepers. They are: The Italian; Caucasian; Carniolan.

#### The Italian Bee

##### *Apis mellifera ligustica*

Of them all, the Americanized Italian bee is the most popular with North American beekeepers. This is probably because it has fewer serious faults than the others. Also, it has many very excellent qualities.

#### Good Qualities

The Italian bee is a good honey producer. Its tongue is long (6.3-6.6 mm). Length of tongue helps determine whether a bee can secure nectar from a flower that has a deep corolla, such as red clover. It winters well. Brood rearing is early, begun in midwinter. An Italian colony that has adequate stores and a good queen is usually ready for the nectar flows in any geographical part of North America. This bee does not swarm excessively by comparison with other races of bees. Although it is usually capable of protecting its nest from most invaders, it is not unpleasantly aggressive in stinging the beekeeper and others. Nor does it offensively pursue human intruders for long distances unless the nest has been awkwardly broken open. Its behavior on the combs is steady and restrained. The Italian queens do not ordinarily run on the combs, and so are easy to find since they are of good size, bright colored and generally well behaved. This bee communicates well.

The Italian bee is apparently as resistant to AFB and other diseases as any race used here. It does not propolize excessively. It is moderately successful in pollinating alfalfa and red clover. Comb building is carried on efficiently. Cappings are white. It unites readily

\*Grant D. Morse, Ph.D., Saugerties, N.Y.

with other units of its own race—a great help when joining two colonies. It adheres well when established in a new home site. Blacks, for example, do not do so. Langstroth (Naile 1976).

Kleine (1960) in speaking of the original Italian importations to this country says: "They expel their drones early which has an obvious influence on the preservation of stores." He states also: "Another important quality of the Italians is their mild, tractable disposition."

Brother Adam (1966) says: "The world-wide overwhelming popularity of the Italian bee is beyond dispute. Indeed, I believe modern apiculture would never have made the progress it did without the Italian bee."

#### Less Desirable Qualities

One of this bee's less desirable characteristics is its readiness to rob—particularly if management procedure encourages that practice. Its consumption of winter stores is high but closely related to its early brood rearing which necessitates liberal use of food. This bee tends to drift somewhat. (Does not always identify its own hive entrance and consequently may enter a neighboring hive.)

At the conclusion of the flow, it continues to produce unnecessarily large numbers of workers. The Italian bee builds large areas of drone comb—as much as 17% of the brood area if left to its own devices. Seeley and Morse (1976). It tends to swarm later in the season than some others, according to Langstroth's 1860 Journal. Naile ('76).

#### Origin

The first Italian queens are believed to have been imported here in 1859 or shortly thereafter. Their homeland included all of Italy except Sicily. Langstroth participated in supervising importations in 1860. Naile (1976).

#### Appearance

The color of the Italian bee we know in North America is usually rather light—a somewhat muddy yellow—well defined light bands of yellow on the abdomen. In Italy this bee shows greater variation in color, usually being darker than its Western counterpart. Since American beekeepers favored light-colored bees as attractive contrasts to the Black bee from Europe, which

had been here since early colonial days, queens showing lighter coloration were favored as breeders.

But there are some Italians being sold in this country which tend to be leathern in color. Others are intermediate between light and dark. In some instances breeders may have sacrificed productiveness to light color. Brother Adam (1966) states that in his opinion: "The darkish leather-colored bee which has its native home in the Ligurian Alps is without doubt the best of many varieties."

In view of the fact that the climate of the Mediterranean region is warmer than some of the more northerly parts of North America, the Italian bee has made an excellent adjustment to certain regions here where the winters are rather severe.

The Italian bee figures heavily in all crosses, strains, and mixed races advertised by those who offer them for sale.

#### The Caucasian Bee (*Apis mellifera caucasica*)

##### Good Qualities

The Caucasian bee is gentle. It does not run on the combs. This bee produces large colonies but they do not attain full strength until mid-summer. They are calm on the combs. Do not swarm excessively.

##### Less Desirable Qualities

The Caucasian bee uses propolis lavishly. Even the hybrid that has only one Caucasian ancestor among several, may seal the hive entrance almost shut in the fall. It tends to propolize the interior furniture of the hive to the extent that it is difficult to pry parts from each other. Its tongue, though long, does not seem to master red clover well. Its cappings are flat and dark. The Caucasian bee tends to drift, and to rob. It is rather susceptible to Nosema. It does not produce surpluses of honey equal to those of the Carniolan bee.

##### Origin

As its name indicates, the homeland of the Caucasian bee is in the high valleys of the Central Caucasus.

##### Appearance

In shape and size the Caucasian bee resembles the Carniolan. It tends to be brown in color, sometimes with brown

spots on the first bands of the abdomen. The hairs on the body are lead gray. Like the Italian bee in its homeland, the Caucasian bee varies in color more at home than in America where it has been selectively bred for grayness.

Many strains of Italian bees have been cross bred with the Caucasians, often, it seems, with few, if any, disadvantages to the offspring.

#### **Carniolan Bees** (*Apis mellifera carnica*)

##### **Good Qualities**

The Carniolan bee is known for its gentleness. It is one of the gentlest of bees according to Brother Adam ('66). It winters well in spite of maintaining small clusters—better than the other three races that have been used here. Its consumption of winter stores is comparatively light. Brood rearing during the cold part of the year is deferred until pollen is available. Its buildup after that time is rapid. The Carniolan bee propolizes little. Robbing is not its penchant, as with the Italian bee. Resistance to disease is high. The tongue is long (6.4-6.8 mm). Next to the Italian bee, the Carniolan bee has been more widely used all over the world than any other.

Karl von Frisch (1967) says: "I have worked with the Carniolan bees, whose placid disposition makes them especially suitable for experiments."

Brother Adam (1966) states that this bee in its homeland uses wax instead of propolis to seal its hive.

##### **Less Desirable Qualities**

Fast build-up when pollen becomes available tends to prompt the Carniolan bee to swarm. Its production of honey is not equal to that of the Italian.

##### **Origin**

This bee comes from the Austrian Alps and Yugoslavia, the Danube valley (Hungary, Rumania, Bulgaria).

##### **Appearance**

This bee looks much like the Italian bee. Its hairs are short and plentiful. The drones tend to be gray to grayish brown.

#### **The Black Bee** (*Apis mellifera mellifera*)

This bee is described here, not because of its present value or importance

to North American beekeepers, but because of its former significance in this country. There are few Black bees left in this country. To some small extent, some of their genes may be present in a small number of local hybrids.

The Black bee from Northern Europe and Central Russia was probably the first one imported here by the early settlers. They are believed to have been brought here before the middle of the sixteen hundreds. It was the bee that the settlers had known in the "Old Country." The first importation was from the vicinity of London.

The Black bee was certainly better than no bee at all. It is famous for its industry. It nearly always succeeds in storing a surplus for winter, and it winters well.

##### **Less Desirable Qualities**

The Black bee is known for its inclination to sting. Its tongue is short (5.7-6.4 mm). Its spring build-up is inclined to be late. By nature it is nervous. Both the workers and the queen run on the combs. The queen is consequently hard to identify and to find.

Because of these undesirable characteristics, the Black bee has been displaced almost totally in North America. In instances where it has hybridized, its offspring show good industry and good performance.

##### **Origin**

Probably the earlier introduction into the United States (colonies then) were from England, Holland, Germany and France, the first being from England. The bees from Holland are believed to have been brown rather than black.

##### **Appearance**

The Black bee in North America has varied in color from black to brown depending on what part of Europe contributed it. Just as the Italian bee varies in color and disposition, the Black-Brown bee varies. Without attempting to distinguish between the Black and Brown strains, Ruttner ('76) says of the English black bee: "It is easy to describe: Large body size, short proboscis, narrow wings, long body hairs, uniform color (some spots occur frequently, but distinct bands on the tergites rarely.)"

### **The Africanized Bee of Brazil (and other parts of South America)**

This bee is described here, not because of any current value to North Americans, but because it is considered by some (particularly non-beekeepers) as a potential future threat to the industry.

No other bee in all history has aroused the interest of the lay public as has this bee which originated in Africa.

In 1957 26 absconding units of African bee (*Apis mellifera adansonii*) escaped from an apiary near Rio Claro, Brazil. They fled to the wild where they reproduced rather rapidly, reaching Peru in 1974 and Guyana in 1976.

Orley R. Taylor, Jr. of the Departments of Entomology and of Systematics and Ecology, University of Kansas, Lawrence, Kansas, was appointed by the U.S. Department of Agriculture to study the spread of this bee in the Americas. He reports parts of his finding in *Bee World* (Vol. 58 No. 1, 1977) in an article titled "The Past and Possible Future Spread of Africanized Honeybees in the Americas."

Dr. Taylor estimates that the average rate of spread in 1957-63 was approximately 48 miles per year. It appears that this Africanized bee spread farthest and fastest in the drier areas of tropical South America. The author of the above article believes that "man-assisted dispersal" has not materially contributed to the spread in South America of the Africanized bee.

Dr. Taylor's study reveals a substantial difference today between the African bee of South Brazil (where the bee was first introduced) and its present form in the areas most distant to which it has now spread. These differences are particularly evident in wing and leg characteristics. Taylor estimates that these bees might possibly reach our country in 13-20 years. He suggests a longer period is likely.

Many factors enter into such a determination. One of these is the presence in the area to be traversed of other bees that will inevitably be competitors. There are estimated to be 500,000 colonies of European bees in Mexico alone. Also, the colonies of bees in western Venezuela, northern Colombia, and Costa Rica are to be reckoned with.

Climate may play an important part in slowing the spread of the Africanized bee. But the southern part of the United States and the coastal regions of California should be hospitable to them. This brings small comfort to the people living in these regions.

Although it appears likely that the Africanized bee of South America may reach this country by way of wild swarms in 13-20 years, there is considerable uncertainty about the number that may arrive, and of the degree to which it may have become hybridized by that time.

### **OTHER EUROPEAN RACES**

#### **The Cyprian Bee *Apis mellifera cypria***

This bee is somewhat smaller than the Italian. In color it is more reddish. It has largely disappeared because it was aggressive in stinging, and lower in honey production than the Italian, particularly.

#### **The Syrian Bee *Apis mellifera syriaca***

It has largely been replaced in its homeland by the Italian bee.

#### **The Macedonian Bee *Apis mellifera cecropia***

This Macedonian bee from southern Yugoslavia and northern Greece is believed to be a localized strain of the Carniolan race.

#### **The Sicilian Bee *Apis mellifera sicula***

Black in color, it is closely related to the black bee of Northern Africa—*Apis m. intermissa*. There are unquestionably other European races in existence. But few are of major value.

### **Adaptation Through Genetic Change**

When two or more races of honeybees occupy a territory, they soon become one race through interbreeding.

Different races have developed in different localities through natural selection by genetic change. In addition, a race of bees when introduced to a new environment, are able to adjust and adapt to some degree. If they remain in a new environment long enough, the bees that have made genetic changes

which best suit them to the environment, become predominant. Such changes usually require a rather long time since genetic change normally occurs slowly. Isolated bee populations on such island areas as Kangaroo Island, South Australia, or on Tasmania, and which have inbred to some degree, retain the typical morphological characteristics of their own race. Nevertheless, as in the case of the Kangaroo Island bees, some changes over a 90-year period are in evidence. Wing shape has been in these two cases the chief changes.

Some observers erroneously assume that through inheritance, so-called "acquired characteristics", that is, those acquired through experience, can be passed on from one generation to succeeding generations. It is not so. Except for the influence of example (observation of behavior of other bees), a generation of bees acquires marked adaptive powers only through genetic inheritance.

#### The Distribution of Honeybees

*Apis mellifera* is native to all Europe and Africa, including Madagascar. In the eastern Mediterranean area, *Apis mellifera* is limited to Western Iran. It does not appear to have extended its occupation of Turkey beyond the Caspian Sea and the deserts and mountains of Iran. How far east it prevails in Russia is not clear from the records.

Prior to the occupation by European settlers, no *Apis* species existed in North America, South America, Australia or New Zealand.

The natural distribution of *Apis indica* (*cerana*) is from Japan up to possibly eastern Iran. In the east this species is present on most of the Philippine Islands.

*Apis dorsata* is found throughout the Philippine Islands and other parts of Southeast Asia. *Apis florea* is native to only a few of the islands.

#### *Apis florea*

This bee builds a single comb in an unprotected or semi-sheltered area, not in a hollow tree, a cave, or some other cavity.

Consequently, it is vulnerable to predation from many animals—other bees, other insects such as moths, as well as larger animals. Because of this exposure, *Apis florea* must employ the time and

effort of 60-80% of its working force in protecting its brood, its honey and pollen stores, and its home. It is thus unable, as is our American bee, *Apis mellifera*, to spend the major part of its time in rearing large broods, and in gathering surplus supplies.

#### *Apis dorsata*

Like *Apis florea*, this bee builds a single comb, but a large, beautifully constructed one. However, it too does not locate its nest in a protected cavity, but either in the open, or in a semi-protected place such as beneath a large branch, or under the eaves of a building.

This lack of natural protection compels *Apis dorsata* colonies, like *Apis florea*, to devote the major portion of their time and strength to protecting their nest against predators, and in keeping brood warm.

*Apis dorsata* is renowned for its aggressiveness. An intruder may be met with a simultaneous attack by as many as 5,000 bees from the same nest. Morse (1975). Since they are the largest of the four species, their sting is of imposing proportions. When an intruder receives a sting, the individual bee leaves an odoriferous scent that promptly alerts other members of the nest to attack, and indicates where the enemy is located.

Like other species of bees, *Apis dorsata* has long been the victim of human honey gatherers who have found that if a smoking fire is built under or near the nest, the bees will abscond. In past ages, the threatened colonies that did not abscond, perished. Consequently, we have a *dorsata* species of bee today that is the selective descendant of those that did flee their nest when dangerously threatened. The sex attractant of *Apis dorsata* and of *Apis florea* is the same as in *Apis mellifera*; however, mating between *mellifera* and either of the other two does not occur.

#### *Apis indica* (*cerana*)

Of the three Asian bees, *Apis indica* most nearly approaches our bee, *Apis mellifera*. Its most distinguishing characteristic is that it prefers a protected homesite which enables it to maintain brood rearing activities more economically than in the open, and where it may better protect itself against predators.

*Apis indica* is smaller than our bee.



It is used for commercial purposes in India and in no other parts of Asia. Its colonies do not produce very significant surpluses—seldom more than 10 to 15 pounds of honey. *Indica*, like *dorsata*, has a tendency to abscond, even when brood is present in its combs. It tends to swarm, too, for migrating purposes to secure better nectar sources.

Koeniger (1976) says that *Apis indica* is very similar to the European bee, *Apis mellifera*. He points out one very interesting difference between the two. The position of *Apis indica*, when fanning at the entrance of the hive to produce ventilation, is directly opposite from that of *Apis mellifera*. The abdomen of *Apis indica* is directed to the entrance of the hive; the *mellifera* bee fans with the head to the entrance.

Of the Eastern species of honeybees, only *Apis indica* is able to survive at altitudes much in excess of 3,000 feet. *Apis mellifera* can do so because of its protected nest, and wintering habits.

Experimenters have introduced *Apis mellifera* to all countries of this earth. This is in addition to its former European, Asian, and African habitats. It now thrives in North and South America, Africa, New Zealand, Australia, Japan and parts of China.

The presence of bee mites in most eastern lands has, to date, made introduction of *Apis mellifera* unsuccessful.

*Apis mellifera* appears to be supplanting *Apis indica* in Northern China, Korea and Japan. The use of *Apis mellifera* in China is believed to be responsible for her entry in the early 1960's into the world honey market.

#### What Races Are Best?

As we have indicated previously in these pages, the Italian bee has the widest acceptance among beekeepers in the United States, Canada, New Zealand, and Australia.

But many races of bees today are hybrids that evolved over the centuries through exchange between nations. For example, the Romans had available to them through trade many different races of bees from Anatolia, Russia, North Europe, Syria, North Africa. From these sources they doubtless selected the bee that suited their area best.

And that is what determines what is best from man's point of view. It is a matter of being best adapted to the

peculiarities of a region and the needs of the beekeepers there: temperature (wintering and propolizing); type of flower (length of tongue); readiness to remain constant in one site (loss through absconding); a moderate degree of aggressiveness (adjustment to man's desire not to be stung unnecessarily); moderation in swarming (economic security, and so on.)

Hybridization will doubtless continue in the future, both through the rather indiscriminate custom of mating bees, and through man's selection of breeder queens. Inbreeding can result in lack of vigor and ability to produce surplus. But this does not necessitate hybridizing because, in most regions, there are so many strains, or eco-types, of the same race that an occasional cross breeding of these different strains should not only eliminate the dangers of inbreeding, but help to retain in offspring the peculiar characteristics of the race in question.

What is "best" may depend on a combination of such distinguishing factors as size; color; tongue length; aggressiveness; hair (quantity and length) sensitivity to cold or heat; nervousness; proneness to swarming; ability to gather; ability to communicate.

The honeybee's primary value to man is as a pollinating agent. The bee has changed as flowers have changed. Beekeepers today who approach legislators regarding their desires and needs find their representatives in government primarily interested in the value of bees as pollinators.

There are plenty of insects, other than bees, to accomplish pollination under natural circumstances; but modern man, with his large-scale agricultural operations, is fortunate in having available to him the pollinating honeybee which can be transported and supplied in numbers adequate to take care of concentrated plantings.

On reflection, it is amazing that the honeybee of today is as wild as when man first recognized the bee's existence; the bee takes little recognition of man, and although she accommodates well to man-made habitations, she hesitates not at all to abandon the clean, well-made hive for the often dirty, uncertain cavity of a forest tree. This seems to be universally true of all races of honeybees.

### The Races of Bees in Africa

The North American citizen's recent alert to the presence of African bees in Brazil, and other parts of South America, *Apis m. adansonii*, reminds us that this race of *Apis* is but one of at least 11 in that extensive African continent. All are geographical and cross-bred races of *Apis mellifera*—genetic adaptations.

Smith (1961) reviewed the races of *Apis mellifera* in Africa. F. Ruttner did so in 1976. They, and Brother Adam (1966), are our chief sources of information about the 11 (or more) African races. A brief review of each race follows.

#### *Apis m. intermissa*

This bee, the Tellian bee, is found in North America, north of the Sahara and from Libya to the Moroccan coast of the Atlantic Ocean. A location on high ground is known to the Arabs as a "tell." Since the local bees are usually located on high ground, they have acquired the name, Tellian. Its physical features: a relatively small broad, dark-colored bee with a broad abdomen covered by sparse hairs of medium length. Brother Adam (1966) says it is jet black. It is somewhat smaller than the Spanish bee (*A. m. iberica*), also more slender and has shorter hairs. Its survival in North Africa where the weather alternates between being very wet, or of drought nature, is traceable to its ability to survive the dry periods and make a rapid swarming-recovery in the wet periods. Other races of *Apis m.* that have been introduced into this region have not been able to manage a comparable recovery, and have almost totally disappeared.

During the swarming season a colony may build as many as 100 queen cells. This bee is of a nervous nature; it runs on the combs, and stings with fervor.

#### *Apis m. major*

This is also known as the Rif bee for the fact of its occupancy of the Rif Mountains of Morocco, a small area. It is similar in many respects to the Iberian bee (*A. m. iberica*), but it has a longer proboscis (one of the longest known). In color it is between dark

and yellow. It is a good example of development of different characteristics from those of other bees through a long period of isolation. Its honey yields are not great.

#### *Apis m. sahariensis*

It is said by Ruttner (1976) that this bee is a relict of the true Saharian bee when the Sahara was still a green savanna.

Baldensperger (1924), states that the Sahariensis bee is isolated from *Apis m. intermissa* by a 300 km. broad steppe to the east where there are no bees, and by the mountains to the west. The *Saharensis* demonstrates an amazing capacity to adjust to very sparse nectar flows, and great ranges of temperature of 50°C. in the day in the summertime, to freezing temperatures at night in the winter. It is confined largely to oasis regions.

#### *Apis m. lamarkii*

This Egyptian bee was once known as "fasciata"—so called for the striking gray-white stripes on the worker bees. Their weakness, when attempts have been made to import them to colder climates, is that they fly out when the temperatures are low, and perish. They are not aggressive, but their hybrids are amazingly so. They produce many queen cells in a single hive. It is not a nervous bee. It uses little propolis.

#### *Apis m. nubica*

It is perhaps the smallest *mellifica* bee measured to date. Its habitat is the Sudan. It is a very yellow bee; the body is short.

#### *Apis m. scutellata*

This bee is from central and eastern Equatorial Africa and from South Africa. It is small in size—somewhere between *littorea* and *monticola* (see *littorea* and *monticola* below). It has a short tongue, rather short wings, and a somewhat slender body. It is called the yellow African bee. It is native to Ethiopia, Kenya, Tanzania, Berundi, Rhodesia, and South Africa. It is an intensely aggressive bee. Many from a nest attack simultaneously and then pursue their intended victim. They swarm extensively—both for multiplication and for migration, particularly when nectar is unavailable. Brood rear-

ing is rapid; foraging intense. They adapt to conditions in the tropics. This bee propolizes extensively.

#### ***Apis m. littorea***

This is the bee that Smith (1961) describes as small, yellow-striped, and living on the hot Tanzanian coast. It has a longer tongue than *nubica* which is about the same small size. It is about as aggressive as *scutellata*.

#### ***Apis m. monticola***

This is a mountain bee, large, dark, and very gentle. Its hairs are longer than those of any other African bee. It thrives in the Tanzanian mountains at elevations of approximately 7200-9300 feet. It is widely spread in the Eastern African mountains.

#### ***Apis m. adansonii***

Not too much is known about this bee in its native habitat. Ruttner (1976) says: "The abdomen is remarkably broad (similar to *intermissa*). The hairs extremely short. The yellow color of the tergites and the scutellum is conspicuous, the cubital index relatively small." It is conspicuous for its slender abdomen. This bee often forms migrating swarms.

#### ***Apis m. capensis***

The most remarkable feature about this race is the reported ability on the part of its laying workers to produce female brood from which queens may be reared. (Onions 1912; Jack 1916; Anderson 1963). Alpatov (1938) reported this bee as darker and longer, but with a shorter tongue than the *adansonii* bee in Pretoria. But its most distinguishing characteristic, as we have indicated, is that a laying worker from its colonies has a spermatheca, and a large number of ovarioles. Ruttner (1916) suggests that *capensis* is probably a hybrid with the *scutellata* colonies from the North (which are also maintained in the Cape) and probably also with European races.

The laying workers are regarded as so queenly by the common workers that the latter surround them and pay them tribute much after the manner of most *mellifera* workers toward a true queen. The laying workers produce a large but scattered brood nest exclusively of worker eggs.

#### ***Apis m. unicolor***

This is regarded as a gentle bee, easy to manage. It is small (between *scutellata* and *littorea*) and very dark. Its tongue and legs are short, its abdomen slender, with medium-length hairs. This bee is native to Madagascar.

#### **Review**

The social honeybee of today is probably the evolutionary descendant of solitary bees. Through specialization of work (egg laying, gathering, etc.), and combining of effort, today's honeybee has very distinct advantages over a solitary bee.

Regardless of whether or not the honeybee evolved from earlier forms, it certainly is evolving today, and has been doing so for hundreds of observable years.

This evolving is a process in which, through genetic change, the bees in any comparatively large geographical area adapt to local conditions, and to the needs of man who uses the bee for pollination, for honey getting, and as a source of wax.

As a result of the changes that have taken place in the honeybees of diverse locations, we have 20 or more races today whose appearance, size, color, and behavior make them clearly distinguishable. We see these differences, for example, in the Caucasian bee from the valleys of the Caucasus mountains, and the *intermissa* bee (*Apis m. intermissa*) of North Africa.

The Caucasian bee uses propolis to seal its nest openings against the cold. It tends not to build up to full colony strength until mid-summer, a time at which nectar becomes available in its homeland. And it retains these practices even when introduced to a new location, such as the United States, where these practices do not contribute to its success.

The *intermissa* bee of North Africa has adapted to its sequence of varying temperatures, dryness and wetness. When a lengthy dry season occurs, *intermissa* loses as much as 80% of its worker population. At such times it produces no brood. When nectar becomes available again after rain has renewed the flowers, it builds up rapidly, swarms frequently, and reproduces its numbers.

We see genetic adaptation in some of the other honeybee races of Africa which migrate to an area where nectar sources are more favorable. A Caucasian bee would not do that, nor would the Italian bee.

Some races of bees are the result of hybridization, that is, crossing two different races. It usually requires a long period of breeding before such hybrids produce offspring that breed true. That is one reason why some queen breeders prefer to cross different strains of the same race in order to secure a bee whose dominant characteristics are known and are desirable, rather than take a chance on the fickle variations that can eventuate, particularly over an extended period, from crossing two races.

Hybridization is encouraged by many because of the loss of vigor that takes place when a race of bees is too extensively inbred. For example, Mackensen (1956), in describing the results of inbreeding in a line of honeybees of brother-sister relationship by way of artificial insemination through seven generations, says: "Viability and vigor were so reduced in the last year that colonies could not maintain themselves."

Cale, Sr. (1957) says: "Honey production can rise 25-30% with use of hybrid queens." But he adds that: "This procedure calls for frequent requeening—at least every other year."

My assumption is that if requeening were not resorted to, and if the descendants of the hybrids were allowed to breed uncontrolled, the rate of production might be quite unfavorably different.

As early as 1853, Langstroth advised against too much inbreeding. Naile (76).

Brother Adam (1966) who has probably crossed as many bees of different races as anybody, says: "Mongrels are of no value whatever for breeding." Also, "To introduce a new characteristic, cross breeding must be resorted to. Hybridization is indeed the only possible way whereby the desirable traits of the several races can be integrated in one strain—by which means radical progress can be achieved and entirely new strains evolved."

There is some degree of adaptation on the part of almost any race when introduced into a totally different geo-

graphical area. But such adaptation is limited. To the extent that man is interested in a bee's adaptation to a new environment which is quite different from the homeland where the race developed, man must wait until the bee has changed its genetic make-up, the better to adjust to the new environment.

### Summary

There are many races of honeybees in many different geographical areas of the world.

A large number of them are the result of hybridization. Nevertheless, in some instances this hybridization occurred so long ago that we have today several races whose characteristics and qualities are sufficiently different from those of all other races as to enable us to identify them. This may be done through determining color, size, traits, performance, etc.

Most authorities agree that today the Italian bee is best in many respects. It is the bee that is most widely used by man. Still, man keeps searching for a better honeybee. Many resort to hybridization in an effort to secure improvement. Since it is difficult to control matings of queens through isolation of apiaries, artificial insemination of queens is being practiced widely.

Meanwhile, it is our hope that we may keep enough of our better races purely bred so that we may have quality specimens for our cross-breeding programs.

### References Cited

- Adam, Brother (1966). In Search of the Best Strains of Bees. Eos-Offizin St. Ottilien, Germany.
- Alpatov, W. W. (1938) South African Bee biometrical investigated. Publ. Zool. Inst. Moscow.
- Baidensperger, Ph.J. (1924) L'Apiculture Mediterraneene.
- Cale, G.H. Sr. (1957). How the New Hybrids Affect Management. Am. Bee J. 97:48.
- Frisch, K. v. (1950). Bees, Their Vision, Chemical Senses and Language. Cornell, Ithaca, N. Y.
- Kleine, G. (1960). The Characteristics of Three Races of Bee: the Italian. Am. Bee J. 100:177.
- Koeniger, N. (1976). The Asiatic Honeybee, *Apis cerna*. Apiculture in Tropical Climates.
- Langstroth, L.L. (1853). Hive and the Honey Bee. A.I. Root Co., Medina, Ohio.
- Mackensen, O. (1956). Some Effects of Inbreeding in the Honeybee. Bee World 37# 1 Jan. 1956.
- Morse, Roger A. (1974). The Complete Guide to Beekeeping, E. P. Dutton & Co., New York.

Naile, Florence (1976). *America's Master of Bee Culture; The Life of L.L. Langstroth*. Cornell Univ. Press, Ithaca and London.

Ruttner, F. (1976). *African Races of Bees*. Excerpt from the Proceedings of the 25th International Apicultural Congress of Apimondia, Apimondia Publishing House.

.....(1975) *Races of Bees. The Hive and the Honey Bee*. Dadant & Sons, Hamilton, IL.

Seeley, T.D. and Morse, R.A. (1976). *The Nest of the Honey Bee*. *Insectes Sociaux. Journal International pour L'Etude des Arthropodes Sociaux*. Extrait. Masson, Paris. N.Y.

Smith, F.G. (1961) *The Races of Honeybees in Africa*. *Bee World* 42:255-60.

Taranov, G.F. (1956). *Characteristics of the Gray Caucasian Mt. Bee and Its Use for Breeding Purposes*. 16th International Beekeeping Congress, Vienna. *Apic. Abstract*, 240-56.

Taylor, Orley R. Jr. (1977) *The Past and Possible Future Spread of Africanized Honeybees in the Americas*. *Bee World* Vol. 58 No. 1, 1977.

**REFRACTOMETER.**— See *Grading Honey*, and also *Honey, Specific Gravity of*.

**REQUEENING.\***—It has been truly said that the queen is the soul of the colony. Without a genuinely good queen, young and vigorous, in each colony, the maximum crop of honey can not be secured. It pays therefore, to requeen before the old queen fails. (See *Introducing*.)

Under the present modern apiary management queens are called upon to lay an enormous number of eggs during a single season. This is due to the use of large breeding room with more available comb space for egg laying. In many and most instances double brood chamber hives should be used during the height of brood rearing. (See *Food Chamber*.) Queens under such conditions soon reach the end of their usefulness and must be replaced.

#### How and When to Requeen

Some beekeepers with modern equipment depend on the swarming or supersedure impulses for the rearing of young queens to replace old ones. (See *Queen Rearing*.) Where the owner of an apiary is at hand to hive swarms on parent stands properly, good crops of honey may be secured. The main disadvantage to swarming is that it may occur when least expected and unless queens' wings are clipped swarms go to the woods. *Swarm-*

*ing* should really be controlled in order to keep the working force undivided. (See *Swarming*.)

As a rule, queens reared under the supersedure impulse are of good quality. The main objection to this method of requeening is that frequently old queens are superseded in the spring during the heavy brood rearing season when it is so necessary for queens to lay to their maximum capacity. The population of the hives is thus reduced somewhat and this in turn reduces the honey crop.

There are differences of opinion as to how and when requeening should be accomplished. Since thousands of queens are produced and sold by commercial queen breeders, a large number of beekeepers buy these queens in mailing and introducing cages to requeen their apiaries. Some practice requeening annually and others requeen every two years. Requeening should occur in the North at least six weeks before the first killing frost in order to give the queens a chance to produce plenty of young bees before winter. This helps materially to insure successful wintering of bees. In some sections of the West, in alfalfa and sweet clover regions, requeening takes place in late spring prior to the major honey flow. Young queens introduced at that time are likely to continue brood rearing longer than old queens. This is especially true during a long drawn-out honey flow.

Requeening by the cage method will be more successful during a honey flow than during a dearth of nectar; but there are a few disadvantages to the cage method of requeening. It is practically impossible to get 100 percent acceptance. A few colonies may become hopelessly queenless in this process of requeening. It is sometimes difficult to find the old queens before introducing new ones.

Then, too, there is the danger of buying queens that may be improperly reared, or perhaps produced under abnormal weather conditions. Such queens may be superseded soon after being introduced. (See *Supersedure of Queens*.)

However, when queens are purchased from reputable breeders who have good stock and use the best approved methods of rearing queens

\*By M. J. Deyell.

and when conditions are favorable for safe introduction in mailing and introducing cages, the following method of requeening may be used to good advantage:

#### Directions for Introducing Queen

First, be sure the colony is queenless. If the colony has been queenless from 10 to 16 days, make sure there are no virgins in the hive. It is best not to remove the old queen until the time of introducing the new one; but if several days have elapsed after the old queen was removed be sure to destroy all queen cells.

To introduce, place the cage between or on the top of the frames over the cluster. (See Introducing.) The wire cloth should be down and placed so that bees may contact the screen between the top bars of the frames. The bees will usually gnaw away the cardboard covering the candy, eat out the candy and release the queen. The cage should be examined in 24 hours after it is put in the hive and the card covering the candy removed, if the bees have not gnawed it away. The colony should not be disturbed again for six days at which time the combs in the center of the brood chamber should be examined for eggs to be sure the queen is present.

**REQUEENING WITHOUT DEQUEENING.\***—This method of requeening has a universal appeal because it eliminates the labor of finding queens. It is worked in connection with the food chamber. (See Food Chamber.)

Requeening should take place during the active season. The old queen is permitted to occupy the combs of the brood chamber and food chamber during the spring months prior to the main honey flow. When this starts and it is necessary to add supers, the queen, with the larger proportion of the brood, is confined to the lower hive or brood chamber proper by the use of a queen excluder. The food chamber, which at this time, should contain some fairly well-filled combs of honey and from three to five combs of brood (the amount depending on the strength of the colony) is given a ripe cell and set off onto a bottom board a few feet away and facing the same

direction as the old hive. (If no queen cell is available the queenless bees will rear a queen from larva.) A hive cover is, of course, put on the food-chamber hive.

The old bees in the food chamber will return to the parent stand; but enough bees will remain in the food-chamber hive to care for the brood and to rear a new queen from the cell. A stock of queen cells should be raised in advance. (See Queen Rearing.)

At the close of the honey flow, after the surplus honey is removed from the parent colony the food-chamber hive with young queen is set back onto the parent hive. When this uniting takes place in late September or early October it is unnecessary to put a newspaper between the two hives. (See Uniting.)

The young queen in the upper or food-chamber hive will in most cases be retained and the old queen below will be killed. The theory is that the bees in the upper hive finding it necessary to use the entrance of the lower hive discover the old queen below as they are passing through, and kill her. The bees in the lower hive not having much occasion to enter the upper hive, may not discover the young queen above and therefore she is not molested. In any event the young queen is retained in most cases and thus requeening as well as providing ample winter stores for the colony is accomplished at one stroke. It is obvious therefore why beekeepers generally are interested in this method of requeening. It reduces labor and simplifies apiary management.

**REVERSING.**—One version of the term reversing has to do with a type of frame which was reversible top to bottom, a practice which has been discredited since it proved to be impractical.

A recent application of the term reversing is in relation to the exchange of positions of the brood and food chambers of double story hives. In their normal position on the bottom board the brood chamber is the lower unit and the food chamber the upper. Early in the spring the brood nest tends to expand upward and outward, away from the hive entrance. The worker

\*By M. J. Deyell.

bees determine the pattern of expansion by clearing comb area and cleaning cells. The queen follows, laying eggs in prepared cells forming concentric circles of even-aged brood. As more honey and pollen is used the queen may reach the upper hive body and find that available comb space has become short. Reversing the position of the upper and lower units at this point may provide fresh new comb in which the queen can continue to lay at full capacity. The lower unit will thus be brought into the most desirable position for receiving full attention by house cleaning and nurse bees. A quick shift of position by the hive attendant bees to the top chamber with its partially empty combs encourages the queen to shift her egg laying to the open combs. An increased rate of egg laying is contingent on her capabilities in this respect and the presence of a sufficient number of house bees to cover the expanding brood area.

Reversing hive bodies too early in the season may expose the brood to chilling due to sudden drops in temperature without sufficient numbers of bees to cover the existing brood area. As a result of severe exposure some brood may be killed while in other instances the brood rearing is temporarily impeded because the higher temperatures cannot be maintained throughout the expanded brood nest. Reversing can be used to advantage by the beekeeper but the timing must be in accordance with the natural rate of expansion of brood rearing by the colony. This manipulation does not enable the colony to expand beyond the capacity of the queen to lay eggs and the nurse bees to care for the brood but does prevent constricted brood space if this condition threatens to become a limiting factor in colony development.

In exceptionally favorable springs reversing can begin as soon as the warm weather returns, at about the time the bees begin to bring in the first fresh nectar and pollen. Successive reversals can follow at about ten day intervals until honey storage supers are put on.

**ROADSIDE SELLING OF HONEY.—See Marketing.**

**ROBBING.**—As the term signifies, robbing is an act or series of acts by which bees pilfer or steal from each other, or from any source where sweets in the form of jam, jellies, syrup, or honey are left exposed. Like some human beings, when there is no nectar to be found bees find it easier to steal than to work. The passion for stealing or robbing, if neglected, becomes a habit—a habit that is exceedingly hard to break.

When bees discover that a large amount of sweets can be secured during a dearth of nectar they are quick to profit by it, and in the space of a few minutes they may start an uproar. This not only means pillage, but death to the bees and stings to their owners.

It has been shown that a single bee may visit over 100 clover heads before it obtains a load sufficient to carry to its hive. It is probably true that during a great part of the season a bee will be from a half to a full hour, or during unfavorable seasons, as much as two hours, in obtaining a single load. The time during which a bee may be absent is quite variable. (See *Bee Hunting and Flight of Bees*.) If the nectar is heavy it will return much quicker than if it is light. Is it at all strange

#### **When Bees Will Not Rob**

By reading *Anger of Bees*, one will get a very good idea of the causes that start bees to robbing. (Read also *Bee Hunting, and Feeding*.) As a general thing, bees will never rob so long as plenty of honey is to be had in the fields. During a bountiful flow the author has tried in vain to get bees to take any notice of honey left around the apiary. At such times one can use the extractor right in the open air, close to the sides of the hives, if need be. On one occasion at Medina a comb of unsealed honey was left on the top of a hive from morning until noon, and not a bee touched it. It seems they preferred to go to the clover fields in the regular way rather than to take several pounds from the top of a neighboring hive. It can readily be supposed that they did not have to visit anything like a hundred blossoms at this time, and perhaps they secured a load in going to not more than a dozen.

After the season begins to fail, one must expect that every weak colony or nucleus in the apiary will be robbed if the entrance is too large. As a rule, any fair colony will have sentinels posted to guard the entrance as soon as there is any need of such precaution.

#### How to Know Robber Bees

It sometimes puzzles beginners exceedingly to know whether the bees that come out are robbers, or inmates of the hive out for a playflight. There are times when a playflight looks very much like robbing. (See Playflight of Bees, and Drifting.)

When the robber bee approaches a hive it has a sly, nervous manner, and flies with its legs spread in a rather unusual way as if it wanted to be ready to use its heels as well as wings if required. It will move cautiously up to the entrance, and quickly dodge back as soon as it sees a bee coming toward it. If it is promptly grabbed on attempting to go in, never fear. When a bee goes in and it can not be determined whether it is a robber a close watch should be kept on all the bees coming out. This is a sure way of telling when robbers have got a start even at its very commencement. A bee, in going to the fields, comes out leisurely, and takes wing with but little trouble because it has no load. Its body is also slim, for it has no honey with it. A bee that has stolen a load is generally plump and full, and as it comes out it has a hurried and "guilty look." Most of all, it finds it a little difficult to take wing, as bees ordinarily do, because of the weight. The bee, when coming out of the hive with honey it has very likely just uncapped, feels instinctively that it will be quite apt to tumble unless able to take wing from some elevated position, and therefore crawls up the side of the hive before launching out. When first taking wing it falls a little by the weight of its load before its wings are under control, and therefore, instead of starting out as a bee ordinarily does, it takes a downward curve coming quite near the ground before rising safely and surely. With a little practice one can tell a robber at first glance by its way of coming out of the hive and taking wing.

#### Robbing of Nuclei or Weak Colonies

There is another kind of robbing that is much more common and which is apt to perplex the beginner more than anything else and that is the onslaughts that are often made on weak colonies or those that are disinclined to make a defense especially if queenless. A nucleus with a large entrance is especially subject to the attacks of bees from strong stocks and may be cleaned out entirely before the apiarist discovers it. By that time the whole apiary will be in a perfect uproar. As soon as the supply of honey has been exhausted in the one nucleus the robbers will hover around all other entrances and on finding one poorly defended will get in more bad work. During a dearth of nectar there are always some bees that make a business of smelling around and it is a wise precaution always to have the entrances of nuclei contracted to a width through which only one or two bees can pass at a time.

One of the most prolific causes of robbing is a warped cover on an old hive the corner of which has split open. All such makeshifts should be replaced. In an emergency a handful of mud plastered into the opening or crack or some cotton stuffed in, will go a long way toward preventing serious trouble later on. During a good honey flow cracks large enough for bees to get through do no particular harm. But during a dearth of honey, extra precautions must be taken. Weak colonies especially can not defend several entrances.

#### How to Stop Robbing

The best treatment for general robbing throughout the apiary is prevention. The screen door and other openings into the honey house should be self-closing. Unless they are, some one will be almost sure to forget and leave one of them open. If the doors are not self-closing all the honey or syrup stored in the building should be put into hives, shipping cases, cans or any receptacle where bees can be kept from helping themselves, then if the door is left open accidentally, no harm will come as there is nothing around to attract the bees.



### The Worst Robbing Time and the Remedy

The worst robbing time seems to be after the heaviest or main flow of honey is over, when bees become especially crazy if they get even a smell of honey left carelessly anywhere near the hives. One who has never seen such a state of affairs can have but little idea of the furious way they sting everything and everybody. The remedy is to get a good smoker and put in enough fuel to insure dense smoke; then using one hand to work the smoker bel-lows, with the other contract the entrance of every hive that shows any indications of being robbed. Shut up every bit of honey where not a bee can get at it, and do the work well, for at such times they will wedge into and get through cracks that would make one think inch boards were hardly protection enough.

### ROYAL JELLY—NUTRITIVE INGREDIENTS

There are reports in the scientific literature that royal jelly contains hormones that influence the ovaries of the queen. The presence of a substance which kills germs was demonstrated by several investigators. Fresh royal jelly was found to contain the following vitamins: B1 (1.5 to 6.6 micrograms of thiamine chloride per gram. Microgram equals 1/1000 of milligram; milligram equals 1/1000 of gram; gram is equal to about 1/30 of an ounce); B2 (8 to 9.5 micrograms of riboflavin per gram); B6 (2.4 to 50 micrograms per gram); niacin (59 to 149 micrograms per gram); Biotin (1.7 micrograms per gram); inositol (100 micrograms per gram), and folic acid (0.2 micrograms per gram). Royal jelly is especially rich in pantothenic acid (200 micrograms per gram.) No demonstrable amount of vitamin A was found. A little vitamin C is present. Vitamin E and K are absent.

#### Royal Jelly and Worker Jelly

The white creamy substance fed to very young worker larvae looks exactly like royal jelly and was long thought to be royal jelly. However, Townsend and Shuel (1970) found that this material cannot support continuing larval

development as royal jelly does. Both are secreted by nurse worker bees as a combined product of their hypopharyngeal gland, the mandibular gland and the honey stomach. Both substances are made up of varying proportions of sugar, lipids, protein, pantothenic acid, water soluble substances, bioptrin and neoptrin. Royal jelly has high concentrations of all of these substances except protein which is higher in the worker jelly.

### ROYAL JELLY PRODUCTION\*—

Royal jelly may be defined as the glandular brood food secreted by worker honeybees and placed in queen cells for the nourishment of developing queen larvae. It is a pasty, creamy-white substance with a slightly pungent odor and a somewhat bitter taste. It is fairly rich in vitamins of the 'B' complex and contains rather substantial amounts of sugars, proteins, and certain organic acids. In spite of its high moisture content it is highly resistant to bacterial, mold or yeast spoilage. However, its most striking property lies in its ability, when used as the food for a developing larva, to bring about the rather pronounced morphological and physiological differentiation which results in the formation of a perfect queen. This fact has been largely responsible for focusing considerable interest on royal jelly in recent years.

#### Colony Management

Queen-right units were used as nurse colonies. This is important when the same unit is to be used for royal jelly production for a prolonged period. The queen of each colony was confined beneath a queen excluder in the lower brood chamber. Immediately above the excluder was placed a super of honey combs containing no brood. A third chamber filled with combs of honey, pollen and brood was placed on top of the colony. Additional room was provided as the season advanced by adding honey supers as required immediately above the queen excluder.

Once every week to ten days the colonies were checked and the brood combs rearranged. To assure that a maximum number of young nurse bees

\* Dr. M. V. Smith, Department of Apiculture, Ontario Agricultural College.

would be present to feed the cells, frames of brood from beneath the excluder were raised to the top brood chamber and placed adjacent to the cell bars. Although the same colonies were used for the three-month duration of this project they appeared to suffer no ill effects from this type of management and their honey production was not curtailed.

### Grafting

The operation of grafting or transferring the small larvae from worker combs into the prepared bars of queen cups is the most tedious part of royal jelly production, and any steps that can be taken to simplify and speed up this job will be well worth while.

Larvae about 18 to 24 hours of age were grafted into artificial queen cups mounted on three bars fastened into a standard frame. Each frame contained 40 to 45 cells. An abundant supply of larva can be obtained by confining a colony queen in an excluder compartment on a single comb. Every two days, provide the queen with a new empty comb, and place the frame of eggs outside the excluder compartment for an additional two days. By depriving this unit of all other open brood, the newly emerged larvae will be lavishly fed and will be much easier to handle with the grafting needle.

Good lighting is very necessary for the actual transferring operation. While outside sunlight probably provides the best illumination, it may cause drying of the delicate larvae. The exposing of frames outside near the bee yard may also lead to robbing. It is therefore best to work in a well-lighted building with windows behind the operator. It is also desirable to provide reflector type spotlights above and behind each grafter—particularly for dull overcast days. A table-top rack sloped at an angle of 45 degrees to hold the grafting frame is also a big help.

The practice of 'priming' or moistening the base of the cell with pure or diluted royal jelly before transferring the larvae, is often resorted to. This appears to somewhat increase the cell acceptance especially when queen cups are used for the first time. Re-grafting is done into the original cells after the jelly has been removed. Care should be taken to re-graft before the jelly film in the cell base becomes dry.

The frames of cells containing the grafted larvae should be replaced in the nurse colony as soon as possible. When the grafting is done in the bee yard this is no problem, but if the grafting is done in a central location and frames have to be distributed to bee yards several miles distant, particular care must be taken to prevent the larvae from drying out. Some sort of a high humidity chamber should be made to hold the frames at a relative humidity of 95 to 100 per cent. A closed super with moist cloth on the bottom, sides and top will serve for this purpose. Priming the cells with diluted royal jelly will also help to prevent desiccation. High moisture is much more important than brood-rearing temperature (95°F) in keeping the larvae alive for an hour or two after grafting, although the ideal would be to provide both the correct temperature and humidity.

Frames containing the grafted cells were placed in the top brood chamber of the nurse colonies according to the following three-day schedule. On the first day a frame of grafted cells was placed in the top chamber of each colony. An additional frame of cells was added to each colony on the second and again on the third days. Then on the fourth day the first lot of cells, which was now three days old, was removed, the jelly collected, and the cells re-grafted and replaced on the colonies. Thus each colony was feeding three frames or roughly 120 to 135 cells at any one time, and one lot of cells was collected and replaced each day. A paint spot or colored thumb tack on the top bars of the cell frames (a different color for each day's graft) makes it easy to keep track of the age of the cells.

### Collection and Storage

It was found that a maximum amount of jelly could be obtained by removing the cells from the nurse colony three days before grafting. The three-day-old cells were brought into the laboratory and pared down with a sharp razor blade to just above the jelly level. This made it easier to remove the larvae (with a pair of forceps) and collect the jelly, as well as considerably speeding up the re-grafting.

The jelly was drawn by suction into a collecting tube which is illustrated in

the diagram. This was made of glass tubing  $\frac{3}{4}$ " to 1" in diameter, 6 or 8 inches long, and open at both ends. The cork at the bottom was cut down to fit snugly inside the base of the tube. This tube can be completely emptied, without wasting a drop of jelly, by using the lower cork as a piston and pushing it up from the bottom with a rod or plunger.

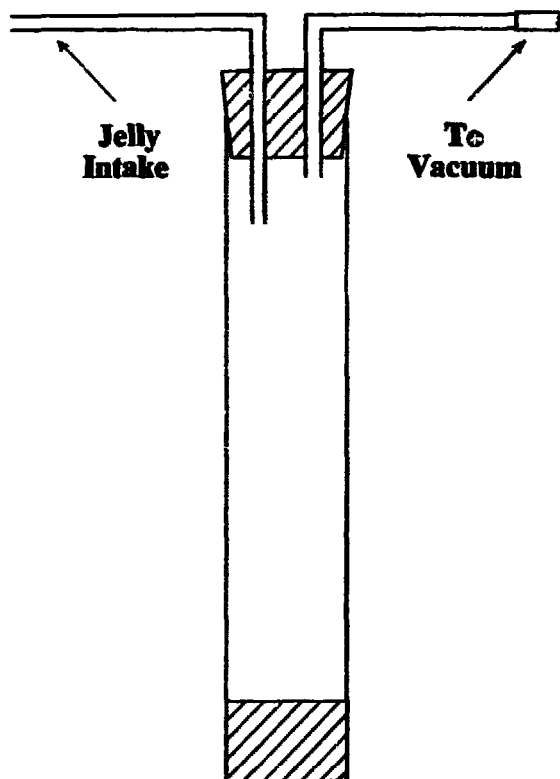

Royal Jelly Collecting Tube.

All freshly collected jelly should be strained. Small bits of wax are bound to get into the jelly. In addition the cast larval skins are left in the jelly as the larvae grow and molt. These can be removed by passing the jelly through a 100 mesh nylon bolting cloth.

The collecting tube shown can also be used for straining the jelly. Remove the top cork and place a 4 or 5 inch square of bolting cloth over the open end. Hold this securely in place with one hand, while the lower cork is pushed up the tube. This will provide sufficient pressure to force the jelly through the straining cloth. The jelly should be strained directly into glass storage vials. We find 1-ounce ointment jars most satisfactory. Each jar should be filled with jelly, and tightly stoppered.

Royal jelly should be placed under refrigeration as soon as possible after collection. Ordinary refrigeration at a temperature of around 35°F will preserve the jelly for up to a year. Fresh jelly which has been lyophilized (freeze dried under vacuum) may be stored as a dry powder for years with very little apparent loss in its biological activity. At room temperature royal jelly deteriorates more rapidly.

Certain organic acids are present in royal jelly — often in fairly large amounts. These tend to crystallize out when the jelly is held under refrigeration—particularly at 35 to 40°F. These crystals can be largely re-dissolved if the jelly is warmed to not above 120°F and thoroughly stirred.

#### Production Data

Age of Cell	2 days	3 days	4 days
Av. jelly per cell (in mg)	147	235	182
Av. No. cells required to produce 1 ounce of jelly	192	120	155

This shows a decided increase in the amount of jelly in cells collected 3 days after grafting.

On the average a producer should be able to count on 1 ounce of jelly per day for every 4 to 5 hives, or approximately one pound of jelly per hive per season (operating on a 3-month production basis), using the system outlined above. One man hour of labor will be required per day for every two hives operated for royal jelly production.

The system described above works most smoothly on a 7 day a week schedule. However, this is often impractical. When Sunday is dropped from this schedule it will be necessary to collect jelly but omit grafting on the preceding Thursday. Then on the following Wednesday there will be no jelly to collect, but a graft will have to be made. Thus each day dropped from the schedule affects two days' production.

**NOTE:** The production of royal jelly is a very specialized procedure and requires a thorough understanding of honeybees and their behavior. Efficient production can only be achieved through practice and experience. Even an experienced operator will require at least a week to bring his colonies into full production.

## S

**SAGE** (*Salvia*)\*. — Sage honey, which is widely known for its mild flavor in Europe as well as in America, is a product peculiar to California. In a good year many car-loads of it are sent eastward for blending with other bottled honeys. It is prized because it is light in color, of mild flavor, and it is a non-granulating honey like tupelo. While the black sage occurs to a limited extent on Mt. Diablo near San Francisco and in localities in San Mateo County, practically the entire sage region of this state is restricted to the Coast Ranges extending from the foothills in the northern part of San Benito and Monterey Counties to San Diego County in the southwest corner. The largest amount of sage honey comes from Ventura and San Diego Counties, while a somewhat less surplus relatively is secured in Riverside and San Bernardino counties.

\*By John H. Lovell and E. R. Root.

The three species most valuable as honey plants in California are black sage, white sage, and purple sage. Black sage is so called because the foliage is a very dark green and also because the flowers after blooming turn black and adhere to the bush until the next season. From the mountain side the general color effect of the shrub is black.

Purple sage has purple blossoms and the foliage has a grayish-purple appearance on the hillsides. When the two shrubs are seen side by side in the distance on the foothills, the contrast is very marked, the one looking darker or blacker and the other purple. The foliage of the white sage is grayish white and the flowers are also white. The black and purple sages are bushy shrubs very leafy at the base, but the white sage has longer stems and is less bushy. The purple sage is much taller than the black.

The white sage grows on the flat



White sage shrub without the blossoms (*Salvia apiana* Jepson).—Photo by Richter.

mesa lands, while the black and purple sages are abundant on the foothills and sunny slopes of canyons.

The sage flow lasts from the middle of March or the first of April until about the first of July. The crop is unreliable every other year, and there is a total failure sometimes several years in succession.



A stem of California black sage in blossom

The black and purple sages do not yield nectar freely unless there has been at least ten inches of rain during the winter, followed by a clear warm spring. The rainfall varies greatly in different years, presenting great extremes, but frequently it is less than 12 inches. Although the plants are well adapted to live in semi-arid regions, if there is a drought they dry up and become valueless to the beekeeper. The flowers are often injured by the sage worm and the foliage by rust. The honey is water-white, thick and heavy, and does not granulate.

The white sage secretes much less nectar than does either the black or purple sage. In districts where both the black and white sages are abundant beekeepers have estimated that the black yielded ten pounds of honey to one from the white species.

To produce a vigorous growth and a profusion of flowers there must be a sufficient rainfall. Unlike black and purple sages, the true white sage honey will granulate and its flavor is not equal to that from the black and purple sages.

**SAINFOIN.**—See Clover.

**SCALE HIVE.**—Some beekeepers have in their yards, during the season when honey is coming in, a sort of barometer of the daily honey flow—a hive on a platform scale. As the honey flow begins, it will be apparent that the hive will gain slightly in weight. This weight will increase during the day when there is a fair honey flow and decrease somewhat during the night, owing to evaporation of the nectar. As the season continues it is very easy to determine the strength of the honey flow, what days are best, what conditions are best for a honey flow, and when the season nears its close the scale will show a smaller and smaller increase.\*

For a scale hive it is advisable to select a strong colony—one of the very best in the yard, because a medium or indifferent one might not show any increase in weight, while the stronger colony would be able to record whether any honey at all were coming in. While it is understood that this strong colony is in the apiary, it indicates to some extent what the nectar secretion is in the field.

The scale hive is very useful in determining how far it is advisable to continue extracting in the yard. If the season is drawing toward a close and one desires to leave enough stores in the hive for winter, or to take care of brood rearing in anticipation of another honey flow to follow in another month or six weeks, then obviously it is not advisable to

\*Frank Beach, Idaho and Geo. Bohne, La., sent me scale colony records and their average colony yields for 10 to 20 years. I found that there was a high correlation between scale colony yield and average colony yield. That is, if the scale colony yield was small the average colony yield also tended to be small and if the scale colony yield was larger, then the average colony yield tended to be large. These results indicate that generally the scale colony represents the average apiary colony, provided the beekeeper doesn't try to manipulate the scale colony in a manner different from that used in the bee yard.—Dr. E. Oertel, U. S. Bee Culture Laboratory, Baton Rouge, La.

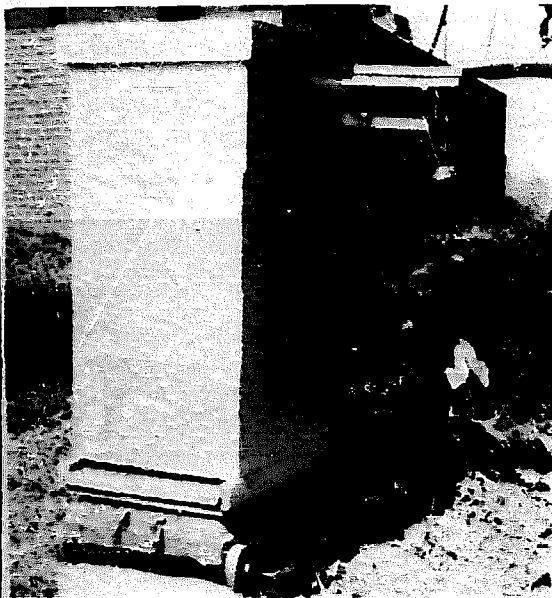

Pelee Island, Ontario, scale hive

extract if it would leave the hives without any stores, making it necessary later on to feed sugar syrup or put on a food chamber.

The yield per day for a strong colony of bees may vary all the way from a half-pound to 20 or even more pounds. Ten or more pounds would be considered a good daily gain from clover, but more than double the amount is often gathered in a day from sage, orange blossoms, or other rapid yielders of nectar.

**THE SCENT GLANDS OF HONEY BEES.** —The abdomen in addition to the alimentary tract bears the reproductive organs and the sting of the females (queens and workers), the wax glands, and the scent gland. The scent gland is located on the top or back of the abdomen on the front part of the seventh segment, being covered up by the overlapping sixth segment. Its purpose is to emit an odor or scent which aids the bees in recognizing the members of the colony and is thus helpful in detecting any strange bees or robbers that may attempt to enter the wrong hive and carry away its stores. The scent gland is also used by the bees when swarming, the odor enabling them to keep together and as the cluster starts to form the bees on the edge of the cluster expose the scent gland while fanning vigorously, throwing the scent back of them to the other bees. Also when the swarm enters

the hive, the scent gland is visible as a white spot near the back tip of the abdomen, as the fanning bees line up in front of the hive entrance. Likewise, it is exposed if the beekeeper shakes some bees from a frame in front of the entrance of the hive.

On another occasion, exposure of the scent gland has a practical significance. When one is examining a colony that happens to be queenless, the bees will soon set up a loud roar, due to the vibration of the wings, and if one looks carefully, he will see that the scent gland of the fanning bees is exposed. It is said that queenless colonies often are able to attract a queen to their hives by this method. In queen-rearing manipulations where the colony is deprived of the queen and its brood to force them to start queen cells, a queen excluder must be put on the bottom or front of the hive to prevent a young queen that may be returning from a mating flight from entering and destroying the developing queens.

While the bees fan with their scent glands exposed on these occasions they also fan on other occasions without their scent glands exposed.

R. Boch of Ottawa has studied the composition of the substance secreted from the scent gland by chromatographic analysis and has found it to contain geraniol, nerolic and geranic acids. In tests where a mixture of these three chemicals in sugar syrup was offered to bees in the field it was found to attract about three times as many foragers as unscented controls.



Exposing the scent gland.

**SECRETION OF NECTAR.\***—Basic to the storing of a crop of honey is the potential of flowering plants to yield or secrete nectar. Not only must the plants be within flying range of the bees and have the potential to yield nectar but the flow of nectar must be triggered by the proper combination of temperature, moisture, humidity, sunlight and soil conditions (see Nectar, Conditions Favorable for Nectar Secretion).

#### Flower-Bee Relationships

The complex relationships between insects and plants seem to have started in the late Permian, when the beetles (*Coleoptera*), true bugs (*Hemiptera*) and others developed. This may have come about as a result of the increased competition between the adults and their young for available food, which could have resulted in the more mobile adults seeking out the early flower foods that were then emerging. The first flowers (*Bennettitales*) seem to have appeared about the Triassic Period, 230 million years ago. These were the earliest seed plants or (*Gymnosperms*) to develop since the land plants came ashore some 200 million years earlier. The development of *Bennettitales* has been traced by Leppik (1972) as dependent on available pollinators; it seems likely their decline coincides with the appearance of more discerning pollinators.

It became more important for the plants to protect themselves from inept visitors; so the early *Angiosperms* (flowering plants that followed the decline of the *Bennettitales*) developed some elaborate armor. This was in the form of flower structure, which protected delicate reproductive organs from clumsy pollinators. By the early Tertiary the more sophisticated pollinators became evident. These were the moths and butterflies (*Lepidoptera*) and the bees (*Hymenoptera*), whose specialized nectar-collecting mouthparts indicated a closer relationship with nectariferous flowers.

#### Nectar Perception

Bees are able to smell the perfume of a flower with her antennae, with possibly other parts of the anatomy

taking a secondary part. The olfactory and tactile receptors, connected to the nervous system, are in the upper eight antennal segments. With them the bee can measure the size of a floral tube and can discriminate the various textures and scents of a flower. Such perception means that the bee can distinguish the subtle changes of a flower, like age, type, and condition. When locating food, the bee must be able to tell what kind of food to look for; so floral odor effects on a forager plays an important role in recruitment and food location.

Bees like to forage about 2.5 miles (4km) from the hive, living off of about 12,500 acres of land (Martin, 1970). While collecting food honeybees are known to be loyal to one flower species at a time; this is called flower constancy. The fidelity is good for the bee because once she learns the location of food of one type of flower, she will not have to relearn it every time. Thus she wastes less energy and can collect food faster. When the species finishes blooming, she will start on another one. The flower obviously benefits from this arrangement since cross pollination by another of the same species is almost guaranteed.

That bees work one type of flower in the morning and another in the afternoon has been observed. Why they did this was not known until it was discovered that the flowers offer their food reward on a very definite time schedule. Some flowers secrete nectar or offer pollen only in the morning, or for a few hours later in the day. Since the bees are constant to one species at a time, they can easily memorize who gives them a reward when. That way they can set up a visitation schedule throughout the daylight hours. In such a way the bees can be extremely efficient in her food collecting routes and conserve much energy by eliminating wasted trips. The flowers are reducing inter-species competition for the same pollinators by staggering their rewards throughout the day.

#### Nectar

It is not surprising to find that flowers offer their food rewards on days which are optimal bee flying weather. Between 50-80°F. (10-30°C.) tempera-

\*Diana Sammataro, "Adaptations in Honey Bees and Beeflowers as a Result of Codependence" (Unpublished), 1977.

tures bees are most active; coincidentally, warm days with high solar activity stimulate flowers. The processes within the plant produce the nectar, pollen, odor and color attractants so vital in welcoming bee visitors.

The sweet liquid secreted by flowers from special nectar glands (nectaries) is the sugary solution so eagerly collected by bees for honey. It has been assumed that nectar contained just the different concentrations of sugars (Percival, 1960). Baker and Baker (1975), after surveying over 300 California flower species found significant amounts of amino acids in the nectars. Thus, some plants were offering a more nutritious food than others.

Upon closer inspection it was determined that those flowers visited by agents living solely on nectar (like butterflies) were allowed to feed on the richer food (Oertel, 1946, 1971; Park, 1929; Ryle, 1973; Shuel, 1955). Since bees collect proteins they were not encouraged to visit these flowers (by inappropriate coloration, shape and smell). In this way the flower could conserve energy by producing a less nutritious nectar if pollination was assured by less greedy insects. By limiting the amount and richness of the nectar the flowers are able to force the bees to fly further to collect the same amount, thus guaranteeing cross pollination.

Blossom perfumes are volatile oils manufactured by plant starch metabolism (Proctor & Yeo, 1972). The scent of a flower freshly opened and unfertilized differs from one older and pollinated. Bee flowers are generally fresh in odor (Faegri & van der Pijl, 1966); pungent night bloomers are for moths, while odorless red ones are for birds. The strength of the perfume depends on oxygen-carbon dioxide concentrations, air and soil temperature, precipitation, nutrients and air pollutants.

Concentrations and amounts of nectar vary between flower species. Heinrich, et al (1972, 1975) determined that the tiny florets within a larger cluster, like the goldenrod (*Solidago*) each offer a minute but very concentrated drop of nectar. This means that the bee can spend more energy by walking (Tucker, 1869; Price, 1975) over the

flowers and still accumulate a surplus of honey.

Heinrich also observed that those flowers with high sugar concentrations appearing in the spring and fall (in temperate regions) were clustered together, rather than scattered. High density would enable foraging insects to receive extra energy rewards needed if the weather was inclement. Conspicuous color contrast in flowers is no mistake. Guidelines on blossoms tell the bee where to land and where the food is located. These are called nectar guides (Manning, 1956; von Frisch, 1967). Noted patterns are lines, dots, blotches, circles, radial patterns and concentric rings (Leppik, '72). Daumer (1958) did extensive work and photographed many flowers with a special technique to show that some nectar guides are ultra-violet and quite invisible to humans.

Altogether, bees, flowers and nectar are closely related by their interdependency. Whether nectar is gathered in copious amounts is of interest to the beekeeper since considerable raw nectar is necessary for the storage of honey beyond the needs of the colony of bees. As experience in beekeeping is gained some of the lesser known elements of management such as where the various colors and flavors of honey come from will challenge the curious to pursue the subject of nectar secretion. The intricacies of bee-flower relationships, which were barely outlined in the preceding paragraphs have a direct relationship to nectar secretion and consequently to honey yield from bees.

#### LITERATURE CITED AND REFERENCES

- Baker, H. G. and I. Baker. 1975. Studies of Nectar-constitution and pollinator-plant coevolution. *Coevolution of Animals and Plants*, Sympos. V, ICSE, Ed. L. Gilbert and P. Raven. University of Tex. 100-140.
- Daumer, K. 1958. Blumenfarben, wie sie die Bienen sehen. *Z. vergl. Arts.* 93. 501.
- Faegri, K. and L. van der Pijl. 1966. *The principles of pollination ecology*. Pergamon Press, Oxford.
- von Frisch, K. 1967. *The dance language and orientation of bees*. Un. Munich. trans. L.E. Chadwick. Belknap Press, Harvard Un. Press, Cambridge, Mass.
- Heinrich, B. 1975. The role of energetics in bumble-bee flower interrelationships. *Coevolution of Animals and Plants*. Sym. V. ICSE, ed. L. Gilbert & P. Raven. Un. Texas. 141-157.
- Heinrich, B. and P. Raven. 1972. Energetics and pollination ecology. *Science*. 176. 597-602.



- Leppik, E. 1972. Origin and Evolution of Bilateral Symmetry in Flowers.
- Lovell, H.B. 1966. *Honey Plants Manual*. A. I. Root, Medina, Ohio.
- Manning, A. 1956. The effects of honey-guides. *Behavior*. 9, 114-139.
- Martin, E. 1970. *Bee pollination ecology*. unpubl. Michigan State Un., E. Lansing, MI
- Oertel, E. 1946. Effect of temperature and relative humidity on sugar concentration of nectar. *J. of Econ. Ent.* Aug. 39.
- ....1971. Solar radiation and honey production. *Gleanings in Bee Cult.* November.
- Park, O. W. 1929. The influence of humidity upon sugar concentration in the nectar of various plants. *J. Econ. Ent.* Vol. 22, June.
- Percival, M.S. 1960. Types of nectar in angiosperms. *Bot. Nov.* 235-281.
- Price, P. 1975. *Insect ecology*. Wiley & Sons, New York.
- Proctor, M. & P. Yeo. 1972. *The Pollination of Flowers*. Taplinger Publ., New York.
- Ryle, M. 1973. The influence of nitrogen, phosphate, and potash on the secretions of nectar. Part II. Aug. 408-419.
- Shuel, R.W. 1955. Nectar secretion in relation to nitrogen supply, nutritional status and growth of the plant. *Can. J. Agri. Sci.* 34, 2.
- Tucker, V.A. 1969. The energetics of bird flight. *Sci. Am.* 220 (5): 70-78.

**SECTIONS.** — See Comb Honey, Appliances for, and Hives.

**SELLING HONEY.**—See Bottling Honey, Extracted Honey, Marketing Honey, Shipping Cases.

**SEPARATORS.**—See Comb Honey, Appliances for.

**SHIPPING BEES.** — See Moving Bees.

**SHIPPING CASES.**—One of the most beautiful products coming from the bee hive is comb honey. It is nature's product just as the bees produce it and when comb honey is properly displayed along with honey in glass, it makes a very attractive exhibit. Nothing is more difficult to ship than comb honey, not even eggs. Most of it is put up in little wooden squares or section honey boxes. (See Comb Honey.)

A part represents honey cut up into small squares and wrapped in cellophane, after which they are slipped into cartons of suitable size. (See Comb Honey.)

The comb honey with which we are concerned under this heading is that which is produced in sections. This product must be carefully packed in suitable cartons in order to stand shipments for the market.

Most honey producers put their comb honey in cartons, preferably those

with transparent or cellophane front. These, when packed in cartons of one dozen or two dozen, are almost sure to go through in good order, providing other precautions are reasonably taken. When the cartons arrive at destination the retailer can take them out of the crate and place them on display.



Window faced carton to hold and protect a section of honey.

#### How to Ship Comb Honey

A single case of comb honey or half a dozen or a dozen of them can not be sent without being put into a special carrier or crate. No matter how modern the cases may be, with plenty of corrugated paper for top, bottom, sides, and ends, if they

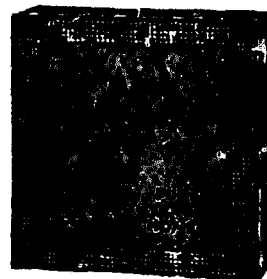

Cellophane wrapped comb honey

are sent uncrated, either by freight or express, there is almost sure to be breakage and leakage of the comb honey. Where a customer wants a single case, or a couple of them, they should be put in a box large enough so that they can be well packed all around in excelsior. Comb honey is seldom shipped in lots of less than four to eight cases at a time, making an aggregate weight of not less than

100 pounds. The carrier or crates that are ordinarily used will take eight cases or the equivalent weight of 200 pounds.

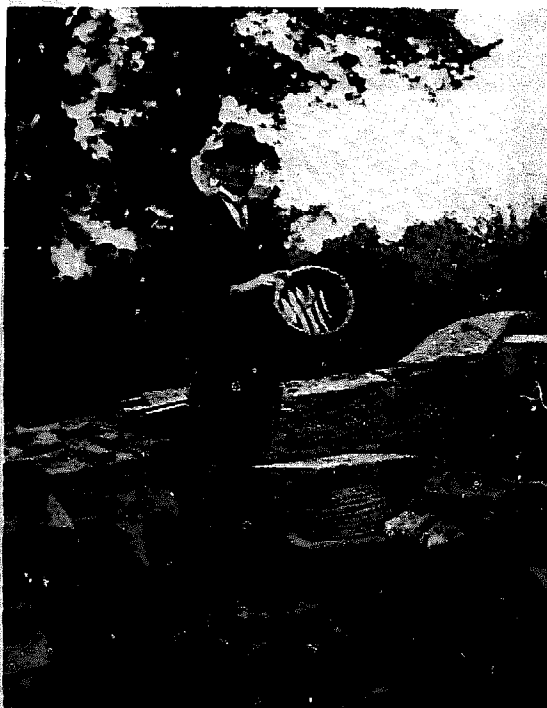

Beekeeping with straw skeps. Honey removal necessitates killing the bees.

**SKEP.**—The term “skep” is often used by old fashioned beekeepers to refer to a colony of bees in any kind of hive; but more properly it applies to box hives and straw skeps—the last named meaning basket in old English. In England and even in Europe the old straw skep is still used quite largely because lumber is expensive and straw cheap. The bees are allowed to build the combs just the same as mentioned under Box Hives, Transferring, and under Hives, Evolution of. On top of the flat-top type of skeps modern supers containing sections are some times used. The making of straw skeps for gardens is a little business in itself requiring some skill.

Straw skeps are not used in this country; and if it were not for the familiar pictures of “ye olden times” Americans would know but little about them.

**SMARTWEED.**— See Heartsease.

**SMOKE AND SMOKERS.**— One can drive cattle and horses, and, to some extent even pigs with a whip; but one who tries to control cross bees without smoke will have much trouble. It is here that the power of smoke comes in; and to one who is not conversant with its use it seems simply astonishing to see bees turn about and retreat in the most perfect dismay and fright, from the effects of a puff or two of smoke from a mere fragment of rotten wood.

There have been various devices for directing smoke on the bees, such as a tin tube containing slow-burning fuel, with a mouthpiece at one end, and a removable cap with a vent at the other end for the issuance of smoke. By blowing on the mouthpiece, smoke is forced out. Others again, have used a tin pan in which was some burning rotten wood. This was put on the windward side of the hive so that smoke would be blown over the frames.

Moses Quinby (in 1870) has the credit for first making a bellows bee smoker. This was a decided step in advance over the old methods of introducing smoke among the bees. It had, however, one serious defect, and that was that it would go out, the fire-pot not being properly ventilated to insure a good draft. Some years after, T. F. Bingham, L. C. Root, son-in-law of Mr. Quinby, and A. I. Root introduced bee smokers on the principle of the original Quinby bellows smoker, but with several decided improvements. The fire-cups, at the same time, were made larger, with a blast vent near the bottom. Through this vent a continuous draft could be main-

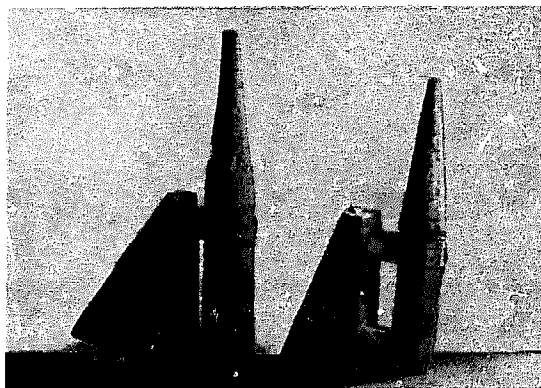

The original Quinby smoker

tained, even when the smoker was not in use, thus preventing them from going out.

All of the smokers of today employ what is known as the hot-blast principle—that is, the blast of air from the bellows is blown through the fire. This makes a heavy volume of smoke.

The angle nozzle on all of the leading hot-blast smokers is to prevent fire from dropping. In the old style smokers it was necessary in blowing smoke to tip the barrel almost upside down, or at such an angle that the fire embers would sometimes fall in the brood frames and the bees.

#### The Anti-spark Tube

There is a special feature in the new smokers, and that is the anti-spark tube just below the grate. It likewise carries the blast of air from the hole opposite in the bellows to the fire box. As the end of the tube reaches to the center of the grate, sparks can not work backward, outward, and onto the clothing of the operator. This was a feature that was very troublesome in older types of smokers.

The flexible hinge makes it possible to fit the cap or snout on the cup more easily, as it allows a lateral movement.

#### Fuel for Smokers

It will be unnecessary to give instructions for using these smokers, as printed directions accompany all smokers sent out by the manufacturers, yet it may be well to allude to the different kinds of fuel that

have been used. Rotten wood is good, and accessible to all, but it burns too rapidly. A few recommend sound hard wood for the smoker. Others prefer turning-lathe hardwood shavings or, if these are not available, planer shavings. In certain localities peat can be obtained very cheaply and it makes an excellent fuel. In some parts of the South, dry pine needles are used.

Some use a special fuel made of old phosphate sacks rolled around a half-inch stick, tied at regular intervals, and then chopped into convenient lengths with a sharp ax. The rolls should, of course, be of the right diameter and length to fit inside the smoker. The sacking must not be rolled too tightly nor made to fit too snugly, or it will choke the draft and put out the fire.

To facilitate lighting with a match one end of the roll is dipped half an inch into a solution of saltpeter, and allowed to dry. If a little red lead be sprinkled into the solution it will be very easy to tell which end of the roll is for lighting.

A quantity of old sacking sufficient for one season's use can be easily secured, as this fuel makes a lasting smoke without sparks.

#### Laughing Gas

When the bees are especially irritable some beekeepers throw a tablespoon of ammonium nitrate into their burning smoker to produce nitrous

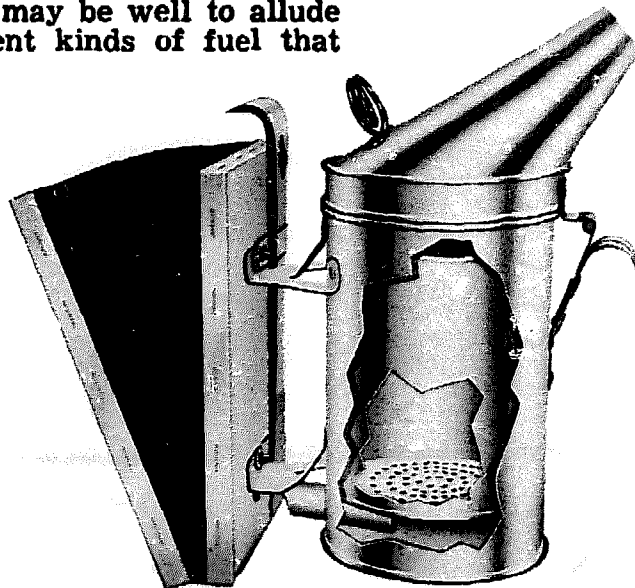

Root smoker showing flexible hinge, hook to hang from a hive, anti-spark tube, and metal binding. Hive tool is in metal holder.

oxide ("laughing gas") which quiets the bees. Although quite effective there is some evidence this can cause early queen supersedure and an overdose can kill a colony. Ammonium nitrate is a fertilizer but can be very explosive if confined.

**Abuses of a Smoker**

A good smoker should last a number of seasons, but it will very quickly cease to be a good implement if it is not well taken care of.

A most common abuse of the smoker is to allow creosote to collect at the top until the cap will not fit down over the fire box. In a new smoker with the flexible hinge there is not apt to be so much trouble in this way, but at the same time it is well to spend a couple minutes cleaning it once a week with a hive tool.

Sometimes beginners in their eagerness to test new smokers work the bellows so vigorously as to blow fire from the nozzle, and before they know it the fire box is red hot. This means, of course, that the coating is burned off, leaving the bare iron to rust through in a short time. The secret of getting plenty of smoke is to have imperfect combustion. For this reason it is best to use fuels that burn slowly.

The grate will usually keep clean, but in some cases when it gets stopped up, insert the point of a file into the holes.

Too much smoke may be used. It is best to use only as much as is necessary and no more. A beginner so often stupefies the bees that they appear completely overcome.

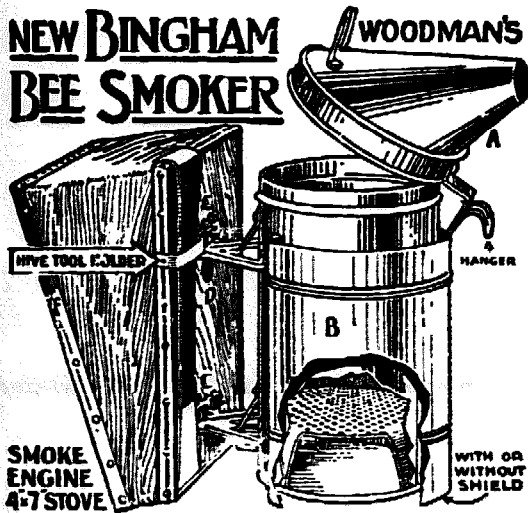
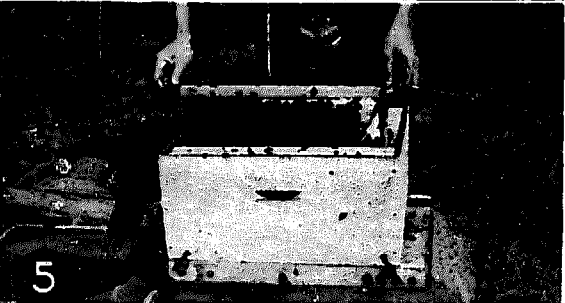
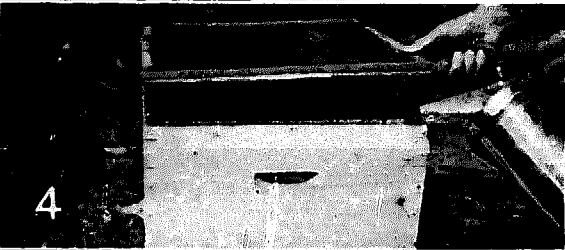
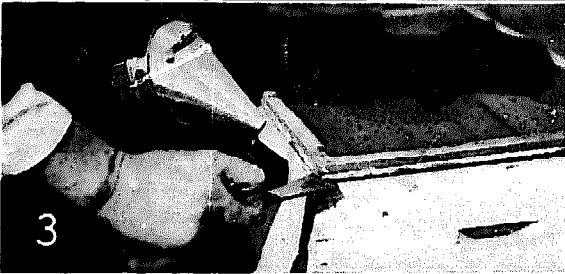
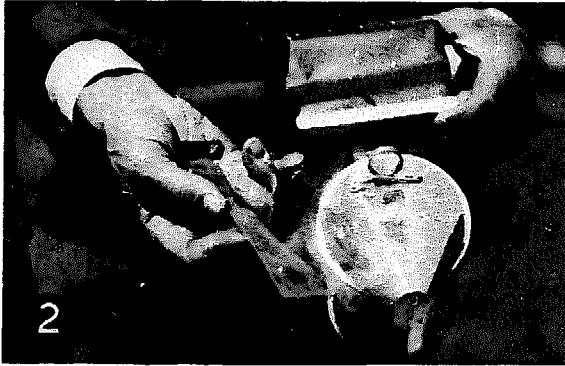
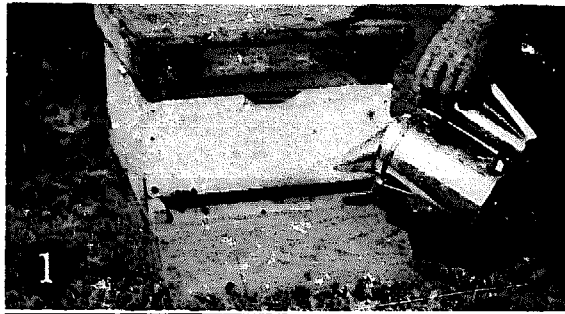

Bingham smoker

**GREASY WASTE AS A SMOKER FUEL**

Ignite a small piece and drop into the smoker until it is all aflame, then add more. Fig. 1.—To use the smoker first blow a little smoke in at the entrance. Fig. 2—Have hive tool ready and then, Fig. 3.—Pry up the super cover and at the crack so made blow in a little smoke. Remove the super cover and then blow over the frames after which they can be removed.

In looking for a queen, use as little smoke as possible, as it is very easy to set the bees running over the combs, making it next to impossible to locate her. At such times the frames should be handled rather

slowly and carefully, the beekeeper doing nothing to disturb or excite the bees.

**SOLAR WAX EXTRACTOR.** —  
See Wax.



Sourwood (*Oxydendrum arboreum*). Single flower cluster.

**SOURWOOD\*** (*Oxydendrum arboreum*).—also called Silver gum, Sorrel tree, Lily of the Valley tree and Elk tree, a fine tree often growing 40 to 60 feet tall and a foot in diameter. The smooth bark is brownish red and the young twigs are light green. It holds its fruits all winter and can therefore be easily recognized when the leaves are shed, which is a good time for beekeepers to spot a stand for their apiaries.

Sourwood is found in a limited area in the southern Appalachians from southern Pennsylvania south to northern Florida in hilly country and on mountain slopes. It blooms in June and July, earlier in the valleys, but later on the highest slopes of the mountains, which greatly extends the season. Sourwood beekeepers put in fresh combs when the tree comes into bloom and remove the supers when the season ends. The combs are very fragile and cannot be extracted. The comb honey is packed in large-mouthed jars and sold as chunk comb honey. The comb is very delicate and the combination of comb and honey is very delicious and brings extra high prices of of 75¢-\$1.00 more a pound. All the honey is sold in the mountains and rarely reaches the general market. Many people drive long distances to purchase this marvelous honey and insist it is the best honey in eastern United States. In a good season surpluses of 50 to 75 pounds per hive are common.

**SOYBEAN.**—Soybeans (*Glycine max*) represent a major farm crop in

the United States which has seen increasing acreages harvested since the 1940's. United States production has risen from 845,608,000 bushels in 1965 to an estimated 1,344,343,000 bushels in 1976. Approximately 49,401,000 acres were planted to soybeans in 1976, most of which were in the corn belt. This compares with an estimated 1976 total of 70,420,000 acres of wheat and an estimated 108,000,000 acres of feed grains<sup>1</sup>.

Soybeans are grown in nearly every region of the United States except New England and the West. Apparently due to variations in soil, climate and varieties nectar yield is quite variable over the range of latitude in which soybeans are grown. Varieties of soybeans are selected for specific latitudes because of their growth requirements. Maturity time, the period from planting to harvest, varies from 75 to 200 days between varieties. Varieties are differentially adapted to day length, soil conditions, temperature, humidity and rainfall. Either variety selection or growing conditions (or both) influence nectar secretion in soybeans. Soybeans grown in the rich alluvial soils of lower Missouri-Mississippi river system yield much nectar. In regions where soybeans apparently do not yield nectar few bees are seen searching among the blossoms. The purple or white blossoms are numerous though less than one-half inch long. On some varieties the flower does not open sufficiently to admit a nectar seeking insect but pollination does take place as the blossoms are self fertile. For all practical purposes all soybeans may be considered as self



Soybeans being unloaded at an Illinois grain terminal. An important cash crop in the midwest, soybeans have replaced many acres of hay and pasture fields. Certain varieties under favorable conditions yield nectar.

fertile, although exceptions to this are not unknown. Dr. Eric Erickson, scientist with the North Central Region Bee Management Laboratory in Madison, Wisconsin attributed some yield gains to honeybee cross pollination of soybeans<sup>2</sup>.

Large soybean acreages are capable of supporting a large number of bee colonies if nectar is being secreted. Robert Sterling, a commercial beekeeper, moves colonies into east central Arkansas where an average of 9,000 acres of soybeans surrounds each apiary<sup>3</sup>. In 1973 the per colony average from his colonies was 83.1 pounds. The best yielding varieties were Lees, Braggs, Davis and perhaps Hills. These are varieties adapted to Arkansas and surrounding territory. A determination of the nectar yield potential of other varieties must be judged by watching the foraging of the bees and honey flow in each local area where soybeans are extensively grown.

In Arkansas, and quite likely wherever soybean honey is produced the temperature must remain comparatively high, 80 to 90 degrees during the honey flow with abundant rainfall. The average annual rainfall reported by Sterling is 48 inches.

Pure soybean honey is very light in color and mild in flavor, making an excellent blend with many of the other honeys. It is fairly high in levulose, making soybean honey slow to granulate.

In Arkansas soybeans bloom 60 days after planting and the maximum nectar secretion lasts for about seven days. The temperature must be above 80 degrees for maximum nectar secretion which stops around 90 degrees if there is low humidity. When the humidity is high temperatures above 90 degrees do not diminish the nectar flow according to beekeeper W. R. Sterling.

A great potential exists for beekeepers who may be called upon to supply bees for the commercial production of hybrid soybean seed. McGregor<sup>4</sup> reported significant progress by plant breeders in respect to development of a high yielding hybrid soybean but that attractiveness of the flowers to the bees was one of the remaining problems. Insects, notably honeybees, are essential for cross pollination in the commercial

production of the hybrid soybeans for seed.

#### REFERENCES CITED

1. Handbook of Agricultural Charts, No. 504, USDA, October 1976.
2. Eric Erickson, Address to Ohio State Beekeepers Association "Soybean Pollination" on March 13, 1976.
3. W. R. Sterling, "Soybeans in Arkansas" Gleanings in Bee Culture, Vol. 102 (9) September 1974, Pg. 286.
4. S. E. McGregor, Insect Pollination of Cultivated Crops, ARS, USDA, Agr. Handbook No. 496, Pg. 336.

**SPACING OF COMBS.**—In nature combs will be found spaced  $1\frac{3}{8}$ ",  $1\frac{1}{2}$ ",  $1\frac{5}{8}$ " and sometimes up to 2" from center to center but the average spacing for worker brood comb seems to be slightly under  $1\frac{3}{8}$ ". In a large number of cases it was noticed that the combs were spaced wider apart at the top of the combs and closer together near the center and at the bottom. Naturally built was found to be on the average  $\frac{7}{8}$ " thick, capped brood 1" thick. On  $1\frac{3}{8}$ " spacing, center to center, this will allow  $\frac{1}{2}$ " between uncapped combs and  $\frac{3}{8}$ " between combs of capped brood. Where wider spacing is adapted there is apt to be more honey stored in the comb, less worker brood but more wax. Closer spacing than  $1\frac{3}{8}$ ", on the contrary, tends to encourage the rearing of more worker brood, the exclusion of drone brood and the storage of less honey below.

The wide spacing of frames in extracting supers is a common practice among beekeepers. Placing nine, or even eight frames in a ten frame capacity super greatly increases the probability of thicker combs. The cells are built deeper, extending out to or beyond the frame edges. Thicker combs have the practical advantage of making uncapping much easier.



Thick combs uncapped easier.



Beggar Ticks (*Bidens frondosa*).

**SPANISH NEEDLES** (*Bidens aristosa*).—Also called tickseed sunflower. This plant has large heads with showy yellow rays and yields an immense quantity of honey in damp lands along the Mississippi and Illinois Rivers and their tributaries. It grows from Illinois, Kentucky and Missouri south to Louisiana, blooming from August to October and yields an excellent yellow honey which is one of the best of the fall honeys.

The honey has a good flavor and a heavy body, weighing nearly 12 pounds to the gallon. It is so thick that there is little water to be evaporated and the cells are capped over promptly.

Raymond Fischer of North Little Rock buys all the Spanish Needle honey he can get and blends it with the white honeys of clover and vetch to produce a golden blend which has proved to be very popular. A related species of *Bidens* produces a good surplus in Maryland and other eastern states. There are many other species of *Bidens* widely distributed, nearly all of which are visited by bees and probably add to the surplus. The common beggar tick (*Bidens frondosa*) is one of the most abundant.

**SPREADING BROOD.** — As is very well known, queens are inclined to lay their eggs in circles in the comb, the circles being larger in the center combs and smaller in the outside ones. The whole bulk of eggs and brood in several combs thus forms practically a sphere which the bees are able to cover and keep warm. When the queen has formed this sphere of brood and eggs she curtails her egg laying for the time being until enough brood emerges to increase the size of the cluster when she will gradually enlarge the circles of brood to keep pace with the enlarged ball of bees.



Bees will sometimes occupy the space between the siding and the inner plaster walls of a building, as here shown. The combs at the right are store combs. Bees occupy the space next to the entrance at the left. —

Photo by G. A. Paul.



Yet the queen very often is over-careful—that is, she errs on the safe side, so that when warm weather has fully set in she sometimes lays fewer eggs than she should in the judgment of the apiarist, and accordingly he inserts a frame of empty comb in the center of the brood nest. In this comb, the queen may commence laying at once to unite the two half circles of brood. More often she does not. In that case more harm than good has been done. If the queen does fill the first one given she will be likely, if the weather is not cold, to go into the second comb and fill it with eggs on both sides; for nice, clean empty cells are very tempting. The practice of spreading brood has been almost entirely abandoned, even by experienced beekeepers. When the queen has room, both bees and queen will ordinarily rear as much brood as they can safely and profitably care for. (Read the whole of Food Chamber, Top Supering, and Building Up Colonies.)

**SPRING DWINDLING.** — Unless there has been a very severe winter, spring dwindling is the result of ignorant or careless management. Frankly, it is generally the result of poor beekeeping. If colonies in the fall are in double brood chamber hives with a young queen, plenty of natural stores, and an ample supply of pollen in the fall, there will be little or no spring dwindling.

Spring dwindling is often accompanied by dysentery, also due to poor beekeeping. (See Dysentery, and Nosema Disease.)

Spring dwindling caused by dysentery may be due to too small a cluster, insufficient housing, or too much moisture. (See Spring Management.)

**SPRING MANAGEMENT.**—It is often said among beekeepers that spring management has its beginning the previous fall. If each colony is provided with a well stocked food chamber above a deep brood chamber, ample pollen reserves and some protection from the cold and moisture of winter during the autumn before, the following spring management will be much easier. The best insurance that colonies will be strong and healthy in the spring

rests on two primary management practices in the fall:

1. Attention to the food chamber (See food chamber). It must be stocked with 40 to 50 pounds of good quality honey. All this honey may not be necessary for winter use as a colony of honeybees in a temperate climate winters on a comparatively small amount of honey; much more is required during the spring period when nectar is scant and brood rearing has started in January, February or March.

2. Requeening with vigorous young queens every second year, if not each year. A colony with a young queen ready to begin heavy egg laying very early in the spring or even late winter in the southern states will be in top condition for honey gathering at the proper time.

Spring management begins with examinations at the first break in the weather after what would be the normal winter period for your area. In the northern latitudes this is usually March or perhaps April or later. If colonies are very light in weight, as determined by lifting the rear of the hive, an emergency feeding should be given at once (see feeders and feeding). An additional check on food stores is quickly made by removing the covers on colonies that are suspected of being low on honey and noting the position of the cluster of bees. If they are gathered in the top center of the upper brood chamber against the underside of the inner cover a feeding should be given immediately. In no matter what form, whether it be solid, semi-solid or liquid, sugar or honey, it must be placed in a position of close contact with the cluster, either on the top bars or near the outside perimeter of the cluster of bees.

A colony of bees with adequate stores of honey may or may not be as equally well provisioned with pollen reserves. Aside from cleansing flights the search for pollen stimulates the bees to take their first forays away from the vicinity of the hives in the early spring. It is at this time that supplementary feeding of pollen substitutes or supplements are most effective. (See pollen). Strange behavior is often seen at this time when the bees, in a frenzy or drive to pick up finely pulverized material in the

manner of gathering pollen will gather in large numbers on bird feeders, cattle and hog feed bins. This often becomes an annoyance, though seldom the menace that those not familiar with the activities of bees may regard such activities. This appears to be an annual phenomenon that lasts for only a few days during the early spring when natural pollen is not yet available.

As temperatures moderate and brood rearing is stimulated by fresh nectar and pollen an examination of the brood nest should be made to determine the quality of the queen and the general health of the colony. If the brood pattern shows that the queen is failing or if no brood is present order a replacement queen immediately. If the colony is weak but queenright a queenless package of bees may be ordered and added to the weak colony to bring it up to normal strength. Combs of sealed brood with the clinging bees may be taken from stronger colonies and added to the weaker colonies. If there is some fresh nectar coming in from the field or if they are fed at the time there will usually be no problem with the addition of the frame or two of bees and brood from another colony to the weak one. Do not use this measure to equalize colony strength if disease is present or suspected. At the first spring examination be particularly alert for evidence of brood or adult diseases. (See Foulbrood and Nosema).

Exchanging the position of the brood and food chamber on the bottom board is a spring management practice used by some beekeepers to stimulate brood rearing. Timing is important. (See Reversing.)

As the population of the colony increases so also does the use of stored honey and pollen. During periods of extended cool weather and rain in the early spring when the bees cannot forage or when nectar or pollen is not available it may be necessary to provide supplementary feed. If combs are being drawn from foundation the stimulation of extra feeding will help to prevent the annoying practice of nibbling away at the edges of the sheets of wax and the accompanying poor comb construction.

If medication is needed it should be administered in the spring, well in advance of the main honey flow. Nosema

is frequently at its highest level of infestation in the spring when the bees are most susceptible due to the stress of early brood rearing and unfavorable weather conditions.

Hives which have died during the winter should be closed tightly to avoid having any remaining honey robbed out. Upon the return of warmer weather those empty hives in which bees have died should be taken apart and examined for evidence of disease. Hives contaminated by having housed infected colonies should be treated in accordance with the recommendations of the apitary inspection service of your state. This varies by state. If disease is not the cause of winter killing, the hives should be given a thorough cleaning. Dead bees may be brushed from the surface of the combs but any dead ones with their heads in the cells may be left to be cleaned out by the replacement bees. As soon as possible the empty hives should be restocked with package bees (See Package Bees, To Replace Winter Losses). Combs of brood and bees from the strongest colonies supplied with a mated queen may used in lieu of a package.

Swarm prevention is an important part of spring management that is discussed at some lengths under the subject heading (Swarming). For the average beekeeper swarming is the most persistent problem in spring management as well as the most perplexing as neither researchers nor beekeepers with long experience have been able to fully understand or devise a fully effective method of preventing swarming that can be easily applied to spring management. The best the average beekeeper can hope to accomplish in swarm prevention is to take whatever measures are necessary to prevent overcrowding in the brood chamber, requeen regularly, provide adequate ventilation and use whatever preventive manipulations are within his skill and means to practice. No two beekeepers view swarming with the same degree of concern. Beekeepers' attitudes range from total unconcern as to cause and effect, usually which means they do nothing (except to possibly try to retrieve the swarms after they have emerged), to the efforts of those who explore the whole gamut of intensive manipulations, including periodically cutting out

queen cells. Only experience with your bees and the variables peculiar to your own region which seem to influence swarming will lead to the adoption of a useful swarm prevention system that works for you. No matter how effective your system may be it will be even at its very best only a more or less arbitrary pact with the bees. Swarming is a biological inclination on the part of the honeybees that evolved early in their history to sustain the species and continued for several million years or more before man tried to control their destinies.

Adding empty supers at the beginning of the honey flow may reasonably be considered the end of the spring management season. All that follows, whether it be a successful harvest season or a failure may hinge, at least in part, on spring management.

#### **STATISTICS CONCERNING THE BEE AND HONEY INDUSTRY —**

For early official statistics of the number of colonies of bees in the honey production of the country, one would naturally turn to Federal census records. The 1849 Census was the first of these reports which gave any honey statistics, but this merely combined the U. S. output of honey and beeswax for a total of 14,854,000 pounds, and did not attempt to segregate the two items. The 1859 Census did, however, list the output for honey and beeswax separately. The total reported production of honey in that year for the entire country was given as 24,566,375 pounds; and for beeswax 1,322,787 pounds.

It is interesting to note that the relationship between the production of the two commodities at that time was 5.4 pounds of beeswax to 100 pounds of honey; for 1973 the ratio was 1.77 pounds of beeswax to 100 pounds of honey. The largest production of honey reported was for the year 1969 when 267,485,000 pounds were recorded.

The first census to make inquiry concerning the number of colonies of bees on farms was the twelfth, which reported the colony count on

June 1, 1900 to be 4,108,239. This held as a record for quite sometime but by 1946 the colony count reached 5,787,000.

The average yield per colony indicated by the census returns in 1900 and 1909 was only 15 to 16 pounds—probably because only a little over half the farms reporting bees gave census enumerators any figures on the amount of honey produced. By 1940 the average yield per colony as recorded by the census was nearly 30 pounds of honey. Probably this increase was more nearly the result of more efficient correlation of census returns than of more efficient colonies of bees or of better beekeepers.

Beginning with the records for the year 1939 the Bureau of Agricultural Economics of the United States Department of Agriculture began to publish annually official bee population and honey production statistics under the supervision of Dr. S. A. Jones and Paul W. Smith. The latter, a practical beekeeper who was well acquainted with the problems confronting beekeepers, has been largely responsible for placing the bee and honey statistical reports of the Department of Agriculture on their present basis of improved accuracy

#### **Distribution of Honey Sales in the United States**

One of the strongest factors affecting the honey market is that of the natural food movement. Modern, highly advertised processed foods have chemical preservatives and other unnatural additives which have become suspect by the buying public and in some instances, by federal health authorities. As a result, the housewife has become skeptical of these products and more and more have leaned toward buying natural foods, those that have not been processed or adulterated.

#### **Consumer Preferences**

A survey conducted under the sponsorship of the American Honey Insti-

Colonies of Bees and Honey Production, 1976-77

State	Colonies of Bees		Yield per colony		Honey production	
	1976 : 1977		1976 : 1977		1976 : 1977	
	1,000 colonies		Pounds		1,000 pounds	
Ala.	45	49	22	23	990	1,127
Ariz.	59	60	57	47	3,363	2,820
Ark.	78	68	33	30	2,244	2,100
Calif.	525	525	26	26	13,650	13,650
Colo.	41	41	61	67	2,501	2,747
Del.	1	3	35	30	35	90
Fla.	360	360	76	40	27,360	14,400
Ga.	139	150	22	25	3,058	3,750
Hawaii	7	7	102	97	714	679
Idaho	109	103	39	46	4,251	4,738
Ill.	45	45	42	40	1,890	1,760
Ind.	80	79	27	39	2,160	3,081
Iowa	80	82	83	74	6,640	6,068
Kans.	50	52	52	46	2,600	2,392
Ky.	60	53	20	22	1,200	1,166
La.	36	36	37	35	1,332	1,260
Md.	13	13	29	22	377	286
Mich.	110	105	50	54	5,500	5,670
Minn.	155	150	92	80	14,260	12,000
Miss.	59	59	23	23	1,357	1,357
Mo.	110	116	50	48	5,500	5,568
Mont.	85	96	112	57	9,520	5,472
Nebr.	138	144	50	50	6,900	7,200
Nev.	9	10	55	55	495	550
N.J.	37	36	28	28	1,036	1,008
N. Mex.	16	17	59	33	944	561
N.Y.	120	120	40	31	4,800	3,720
N.C.	210	205	20	25	4,200	5,125
N.D.	125	120	120	88	15,000	10,560
Ohio	107	97	24	26	2,568	2,522
Okla.	67	65	40	34	2,680	2,210
Oreg.	48	56	29	37	1,392	2,072
Pa.	93	93	31	31	2,883	2,883
S.C.	56	60	19	18	1,064	1,080
S.D.	155	160	58	58	8,990	9,280
Tenn.	156	160	24	22	3,744	3,520
Texas	200	210	47	43	9,400	9,030
Utah	47	48	29	50	1,363	2,400
Va.	78	80	22	20	1,716	1,600
Wasn.	95	91	25	44	2,375	4,004
W. Va.	94	89	19	20	1,786	1,780
Wis.	117	125	88	77	10,296	9,625
Wyo.	36	41	100	64	3,600	2,624
U.S.	4,278	4,318	46.4	40.9	198,699	176,447

tute in 1971 indicated that many youngsters have rarely, or never, tasted honey as a food. Seventy percent of the people responding to the survey used honey but only 30 percent ate honey frequently. Of those who used honey 93 percent used it in the liquid form, 32 percent in honey spread, 26 percent as comb honey and 43 percent used it in cooking.

Of those who bought honey 66 percent put it on their market list while 34 percent bought it as an impulse when they saw it in the store.

The strongest reasons for liking honey were its nutritional value, its good taste and its purity. Those who disliked honey disliked it for its stickiness, the fact that it granulates, is too sweet, and has too many calories.

## STATISTICS ON BEE HONEY INDUSTRY

## UNITED STATES: Honey Imports by Country of Origin (In Lbs.)

Country of Origin	Average 1968-72		Annual 1974-75	
	Average 1968-72	1974	1975	
Argentina	2,902,668	5,737,012	12,439,376	
Australia	266,684	368,068	5,053,772	
Brazil	59,508	3,019,480	3,964,996	
Canada	3,072,376	3,112,048	7,262,180	
China, People's Rep. of	52,896	945,516	458,432	
Dominican Republic	323,988	749,360	733,932	
Mexico	10,138,400	8,765,308	13,490,684	
Guatemala	240,236	119,016	425,372	
Spain	50,692	1,525,168	1,176,812	

Compiled from official records of the U.S. Department of Commerce, Bureau of Census.

## UNITED STATES: Honey Exports by Country of Destination (In Lbs.)

Country of Destination	Average 1968-72		Annual 1974-75	
	Average 1968-72	1974	1975	
Belgium	288,726	81,548	96,976	
Canada	211,584	200,564	198,360	
France	412,148	180,728	171,912	
Germany, West	3,356,692	835,316	1,373,092	
Japan	539,980	879,396	584,060	
Malaysia and Singapore	158,688	196,156	77,140	
Netherlands	720,708	718,504	672,220	
Saudi Arabia	70,528	160,892	105,792	
United Kingdom	1,102,000	469,452	99,180	

Compiled from official records of the U.S. Department of Commerce, Bureau of Census.

## HONEY: Exporting Countries (In Lbs.)

Country	Average 1968-72		Annual 1974-76	
	Average 1968-72	1974	1975	
Canada	11,388,068	6,988,884	10,363,208	
Mexico	56,166,736	48,858,272	66,333,788	
United States	7,555,312	4,568,892	3,989,240	
Argentina	36,249,188	31,852,208	49,846,356	
Brazil	0	1,880,012	7,063,820	
U.S.S.R.	8,242,960	16,309,600	9,644,704	
Hungary	11,460,800	12,064,696	17,385,152	
Spain	10,363,208	13,909,444	12,551,780	
Romania	8,487,604	8,004,928	9,955,468	
Australia	15,751,988	10,387,452	21,180,440	
China, People's Rep. of	39,341,400	28,347,848	38,905,008	

Foreign Agricultural Service. Prepared or estimated on the basis of official statistics of foreign governments, other foreign source materials, reports of U.S. Agricultural Attaches and Foreign Service officers, results of office research and related information.

## HONEY: Importing Countries (In Lbs.)

Country	Average 1968-72		Annual 1974-75	
	Average 1968-72	1974	1975	
Canada	894,824	758,176	2,051,924	
United States	18,174,184	25,991,772	46,367,752	
Austria	6,836,808	7,751,468	654,492	
Belgium & Luxemburg	5,049,364	5,428,452	7,015,332	
France	10,936,840	7,193,856	12,719,284	
Germany, West	100,242,328	93,121,204	111,877,244	
Netherlands	6,609,796	7,063,820	9,605,032	
Switzerland	8,209,900	11,315,336	9,347,164	
United Kingdom	36,963,284	22,639,488	38,523,716	
Italy	3,171,556	3,270,736	2,047,516	
Denmark	2,907,076	1,485,496	2,389,136	
Japan	34,095,880	32,894,700	39,872,564	

Foreign Agricultural Service. Prepared or estimated on the basis of official statistics of foreign governments, other foreign source materials, reports of U.S. Agricultural Attaches and Foreign Service officers, results of office research and related information.

STATISTICS ON BEE HONEY INDUSTRY

BEESWAX: Production, Price and Value of Production 1976-77

State	Production		Price per Pound		Value	
	1976	1977	1976	1977	1976	1977
	1,000 Pounds	1,000 Pounds	Dollars	Dollars	1,000 Dollars	1,000 Dollars
Ala.	27	29	1.06	1.44	29	42
Ariz.	50	45	.99	1.37	50	62
Ark.	38	36	1.05	1.53	40	55
Calif.	314	205	1.19	1.65	374	338
Colo.	48	55	1.18	1.66	57	91
Conn.	6	4	1.15	1.50	7	6
Del.	1	2	1.20	1.68	1	3
Fla.	465	216	1.11	1.61	516	348
Ga.	43	49	1.04	1.50	45	74
Haw.	9	11	1.30	1.26	12	14
Idaho	72	74	1.16	1.46	84	108
Ill.	32	30	1.10	1.55	35	47
Ind.	48	60	1.18	1.52	57	91
Iowa	100	97	1.03	1.50	103	146
Kans.	55	48	1.07	1.66	59	80
Ky.	20	21	1.00	1.41	20	30
La.	24	24	1.09	1.66	26	40
Maine	2	2	1.05	1.40	2	3
Md.	8	8	1.20	1.68	10	13
Mass.	4	5	1.10	1.50	4	8
Mich.	88	85	1.10	1.65	97	140
Minn.	228	228	1.15	1.55	262	353
Miss.	27	34	1.15	1.62	31	55
Mo.	33	139	1.05	1.55	35	215
Mont.	162	104	1.08	1.72	175	179
Nebr.	131	144	1.20	1.56	157	225
Nev.	7	9	1.15	1.75	8	16
N.H.	3	2	1.10	1.50	3	3
N.J.	18	16	1.06	1.70	19	27
N.Mex.	11	10	1.02	1.47	11	15
N.Y.	77	67	1.14	1.61	88	108
N.C.	59	97	1.00	1.39	59	135
N.D.	225	148	1.15	1.63	259	241
Ohio	36	43	1.04	1.62	37	70
Okla.	56	42	1.08	1.60	60	67
Oreg.	25	35	1.10	1.65	28	58
Pa.	46	46	1.05	1.58	48	73
R.I.	1	1	1.10	1.50	1	2
S.C.	22	22	1.16	1.53	26	34
S.D.	153	158	1.17	1.49	179	235
Tenn.	75	84	1.00	1.54	75	129
Tex.	150	163	1.13	1.55	170	253
Utah	20	38	.97	1.61	19	61
Vt.	4	2	1.05	1.50	4	3
Va.	24	22	1.18	1.50	28	33
Wash.	48	68	1.07	1.62	51	110
W.Va.	25	25	1.10	1.70	28	43
Wis.	165	164	1.21	1.66	200	271
Wyo.	76	50	1.16	1.53	88	77
U.S.	3,361	3,067	1.12	1.57	3,777	4,830

BEESWAX: U.S. Imports by Country of Origin

Country	1975		1976		1977	
	Quan. (Lbs.)	Value (\$)	Quan. (Lbs.)	Value (\$)	Quan. (Lbs.)	Value (\$)
Canada	202,423	175,068	324,996	255,769	399,260	377,703
Mexico	248,870	271,953	347,924	396,066	727,652	1,199,610
Haiti	36,011	39,210	85,211	109,124	55,275	109,279
Dominican Republic	330,198	360,461	303,203	377,316	339,044	609,415
Chile	335,941	352,432	772,944	922,244	470,142	866,921
Brazil	556,413	605,345	395,846	482,423	412,348	798,304
Spain			48,910	63,915	26,178	51,700
Portugal	56,196	71,090	44,155	58,508	22,143	44,259
Ethiopia	374,900	434,933	542,169	619,197	277,690	437,958
New Zealand	20,290	25,221	14,367	15,444	13,937	19,518
Egypt					99,620	194,320
U.K. Northern Ireland			46,192	54,549		
Australia			51,267	66,192		

The most popular mealtimes for using honey were in the following order: breakfast, snacks, dinner and lunch.

Forty percent of the honey users spooned their honey from a glass jar, 34 percent poured it from a glass jar, and 26 percent used a plastic squeeze bottle.

#### Imports and Exports of Honey

Prior to World War II net imports of honey exceeded 3 million pounds in two years only, 1920 and 1921, and during most of the time were too small to be a factor in the domestic honey market. With the shortage of sweets which became serious shortly after the beginning of World War II, many firms went into the import business and receipts, almost completely restricted to honey from Latin American countries, increased rapidly, reaching 38,200,000 pounds, including arrivals from Puerto Rico and Hawaii during 1943.

In 1973 the largest amount of U. S. honey exported to West Germany was 6,693,609 lbs. or 38% of the total U.S. exports of honey. The second largest recipient of U.S. exports was Japan at 3,710,982 lbs., 21% of the total. The third largest was the United Kingdom and Northern Ireland who collectively imported 3,187,275 lbs., 18% of the total. All other countries receiving U.S. honey purchased far less.

The importation of honey into the U. S. also varies quite a bit. In 1973 the largest amount of honey was purchased from Mexico, 4,454,315 lbs. or 41% of the total U.S. honey imports. Canada ranked second with 2,249,192 lbs., 21% of the total. All other imports were for lesser amounts.

The previous year, 1972, the U. S. bought much more from all countries and Mexico sold the most 20,681,780 lbs., 53% of the total. Argentina was No. 2 with 7,690,087 lbs., (19%). Canada was 3rd with 5,076,361 lbs. (13%).

#### Imports of Beeswax

The earliest Customs records of the United States, those for the year ending September 30, 1790, included exports of 231,000 pounds of beeswax; and for 134 years — through the fiscal year 1923—exports of beeswax were sufficiently

important to be included in the foreign trade records of the United States. Average exports for this period were nearly 268,000 pounds.

The first recorded imports of beeswax were for the fiscal year 1854 when 54,000 pounds were brought into the country. It was not until 1891, however, that imports exceeded exports. About the time of the Spanish-American War imports of beeswax became an important item. Before World War I started in Europe annual imports had totaled more than a million pounds and have exceeded that figure ever since. In fact, for years we have depended upon imported beeswax for the bulk of the beeswax used in this country for cosmetics, candles, polishes, insulation, and many other uses. (Comb foundation manufacturers prefer to use domestic beeswax.)

#### Honey Market News

Information on honey prices, colony, honey plant and market conditions may be found in the bee journals or the Honey Market News.

Honey Market News is a USDA Publication issued monthly that will be sent on request without charge. Write to: Agricultural Marketing Service, Fruit and Vegetable Division, 2503 S. Agriculture Bldg., Washington, D. C. 20250. Tel: 202-447-2176.

A recording, constantly updated, concerning market information on honey may be dialed by telephone (202) 447-2599 from 10:00 a.m. Friday to 3:15 p.m. on Thursday of every week.

**STINGS.**—Many persons, doubtless, would produce honey were it not for the natural fear of stings; but when bees' habits are thoroughly understood this fear disappears. The average beekeeper pays no attention to a sting or two received on his fingers. When bees are properly handled the number of stings can be reduced to a very low percentage. Very often one can work all day among his bees and not receive a single jab; and at other times if he is a little careless, or if he takes chances, he may get a dozen at a time. One using a well-made

veil and a smoker and suitable gloves, will receive only an occasional sting; and even the effect of that, if he is quick enough, can be minimized to such an extent that it will be difficult for him to find it an hour afterward. The author once worked a whole month without a sting.

As will be pointed out later, the moment a sting is received it should be removed. If it is left in the wound it will gradually work itself into the flesh by muscular contraction, discharging the contents of the poison sac, and the result will be far more severe than if it had been removed immediately. (See Mechanical Construction of the Sting.)

### Why Bees Sting

Under the head Beginning with Bees, and Anger of Bees, some general principles are set forth showing under what conditions bees will sting, and why. Under this general heading a statement should be made explaining the cause more fully than is given elsewhere.

The sting of the honey bee is undoubtedly provided by nature as a means of offense and defense. Without some weapon of this sort their precious treasure, of which both man and beast are fond, would be taken, the colony itself ruined, and in the end the bees would become extinct. In a general way it may be stated that bees sting from one of two causes: (1) to protect their home; (2) because they feel their life is threatened. Bees are temperamental, having their good and bad days the same as their human owners.

Let us take up cause No. 1. No colony can be opened or examined by breaking into the hive in a ruthless or rough manner, even when all other conditions are favorable. A violent breaking into the hive leads the bees to believe that the intruder is trying to destroy their home and take away their honey. But if the hive be opened gently, even without smoke (and this can be done oftentimes in the middle hours of the day when the air is warm), the bees may not sting. The reason for this is that there is no apparent invasion of their hives; no jamming or crushing to indicate that some powerful enemy is trying to destroy and rob their homes. There

appears to be no objection on the part of the bees to having their combs taken out of the hive and placed all around, if the air is warm and there is no disturbance or rough or quick movements.

Bees will also sting if they feel their life is threatened. Normally while bees are in the field and away from their hive they are intent on their work. While mowing the lawn you might come near a honeysuckle bush in bloom and swarming with bees. If your movements are slow and you do not threaten the bees by swatting at them you will not be stung.

Children who run barefoot in the summer can be stung by stepping on a bee in the Dutch clover. This is a case of the bee trying to protect her life. The beekeeper can be stung in the same way by pinching a bee on a frame while he is inspecting a colony.



Bees sting to protect their lives. — Photo by Doering

### The Effect of Smoke on Bees\*

Although the "smoker", as we know it today, was first used less than a hundred years ago, smoke had been a subduing agent for bees for a long time. It is therefore surprising that only during the past two years have experimental studies been published on effect of smoke on bees. These reports, by Dr. J. B. Free and Dr. D. C. Newton, appeared in the Journal of Apicultural Research published by the Bee Research Association.

Most beekeepers have noticed bees taking food from combs after a colony has been smoked. It has long been assumed that engorging is an instinctive reaction of bees to smoke, which may have enabled colonies to escape from forest fires and establish another nest elsewhere. The larger the amount of stores carried, the greater the chance

\* Reprinted from Bee World 51 (1);10-11 1970



of survival would be; yet both Newton and Free found that only about half the bees of a colony engorged under the influence of smoke and that these bees were of all ages. Not all factors which make bees engorge when smoked are known, but both sets of experiments showed that more bees engorge in poor foraging conditions—when bees of all ages have less in their honey sacs—than on good foraging days.

One of the facts that came out of Newton's experiments was that other kinds of disturbance—knocking a frame, vibrating the hive or opening it for examination without smoke—had a somewhat similar effect to smoking; but the effect was less pronounced, and the bees were more inclined to attack. The number of bees engorging after any of these treatments rose rapidly for about two minutes and then dropped off slowly.

It would seem that if you wish to reduce the stinging activity of bees we should handle combs carefully and not to vibrate the hive; we should avoid crushing bees, since this could release an alarm substance; we should use just enough smoke to control the colony; and the hive should not be opened until the smoke has had ample time, at least two minutes, to take effect.

The scientific experiments thus confirm, and also help to explain, what experienced beekeepers have learned to do when they manipulate a colony of bees.

#### Alarm Pheromones of Honey Bees\*

Pheromones are chemical substances secreted by animals to convey information to, or influence the behavior of other animals of the same species. Although the term "pheromone" is comparatively new, the possibility of chemical communication among animals was noted by Huber some 150 years ago as he observed the reactions of bees to certain chemicals present in and on the sting apparatus!

Pheromones play an important role in the behavior of bees, and are therefore of interest to beekeepers and researchers alike. Honeybee pheromones alert bees to danger, stimulate aggres-

sion, and enable the hive to mark an intruder.

Two key pheromones involved here are iso-pentyl acetate and 2-heptanone—generally referred to as **Alarm Pheromones**.

The mandibular gland of the worker bee is the source of 2-heptanone. This alarm pheromone is present in large quantities only when bees assume guard and foraging careers. The chemical is absent in young bees, and is not found in queens or drones.

Iso-pentyl acetate is associated with the sting apparatus. The specific gland or glands involved in its production have yet to be identified. This substance has an odor somewhat similar to banana oil and beekeepers may recall this odor after having been stung. This second alarm pheromone is not found in significant quantities in worker bees until they have reached the age when they assume guard and foraging careers. It is absent in the sting apparatus of the queen. Drones have no sting and do not produce or respond to alarm odors.

The actions of disturbed bees may be observed when a beekeeper removes the hive cover. Guard bees erect their abdomens, open their sting chamber and protrude their sting. Sometimes a droplet of venom appears at the tip of the sting. The scent of the sting, however, is a complex mixture of chemicals, and only one of the several active components of the sting scent is iso-pentyl acetate. After assuming this erect-sting position, the guard bees may run buzzing among the colony. During the winter, alarmed bees on the exterior of a cluster assume a similar position, and the surface of the cluster appears like a porcupine! Quite possibly, these bees may grip the combs or frames with their mandibles, thus releasing 2 heptanone. The chemical serves to alert other members of the colony.

Bees in the hive interior may be provoked by the alarm odor and attack. In the process of stinging the intruder, the bees may also grip his skin or clothing with their mandibles, thereby depositing the mandibular scent on the skin or clothing of the intruder. Thus 2-heptanone is left in the area gripped by the mandibles while iso-pentyl ace-

\*Avitabile, Alphonse, *American Bee Journal*, Vol. 113-3, Pg. 93, May 1973.

tate is left in the area of the sting. The intruder has not only been stung but marked as well. The odor of these chemicals excites other bees; these bees in turn sting in the same general target area.

#### How to Avoid Being Stung

It is always advisable for the beginner to wear a bee veil (see Veils) and a pair of gloves (see Gloves) at the start. A good smoker with the fuel burning well should be at hand. In cool weather, so far as conditions will permit the time selected for handling the bees should be between 10 o'clock in the morning and 3 in the afternoon. In warm weather the operator should never stand in front of the entrance—always to one side. First, a little smoke should be blown in the entrance. The cover should be lifted gently and more smoke blown between the cover and the hive before the hive is opened. More particulars in regard to opening the hive are given further on under this head.

#### Immunity from Stings

Perhaps it may be urged that the pain of the sting could be endured provided there were no further swelling or disfigurement of the features. If one will wear a bee veil carefully fitted to his clothing, there will not be very much excuse for having a swollen eye or a distorted lip. After one has been stung a

certain number of times his system will become hardened or immune so there will be but little or no swelling. The average beekeeper can be stung on his face or hands a great many times; and beyond the mere pain for two or three minutes there will be no after-effects except a slight soreness for a few hours at the point where the bee sting was received. The number of stings that one must get before he becomes immune depends somewhat on the individual himself. A very few never have any swelling, and others will become immune after a comparatively small number of stings. Usually in a season's operations one will become proof against swelling after a sting.

#### Importance of Removing the Stinger at Once

Too much emphasis can not be placed on the importance of removing the sting the moment it is given. This can be done by a quick rubbing or mashing motion and very often one can parry or prevent a sting altogether by smashing the bee or brushing it off before it can get in its work. The bee, in order to sting, must take time enough to sink in its claws before it can force its weapon through the epidermis of its foe. At the precise instant that one feels the claws of a bee sinking into the skin he should dislodge it if he is in position to do so. Sometimes when he is holding a frame with a valuable

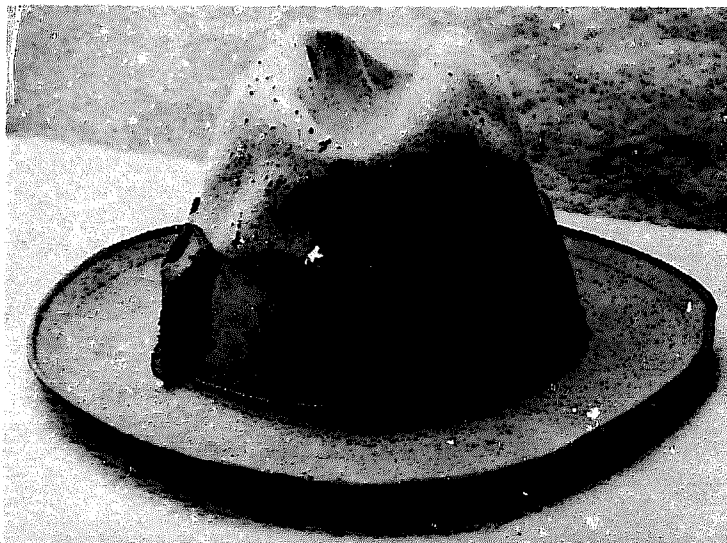

Bees will sometimes become so infuriated that they will sting clothing or hats, especially felt hats, so that even the ball of the finger cannot be placed between them without touching one or more stingers. The illustration here shown is an example of what angry bees can do when they are ignorantly or carelessly handled.

queen on it he must "stand and take it"; but even then the frame can be set down gently and the sting removed. Usually, if there is just a mere prick of the skin, there will be little or no swelling.

#### The Proper Way to Remove a Stinger

With the blade of a knife, scrape the stinger loose, being careful not to press on the poison-sac. A pressure on the latter will force the poison into the wound, making it worse.

When a knife is not handy, push the stinger out with the thumb or finger nail in much the same way.

#### Observing a Sting

It is quite an interesting experiment to let a bee sting one on the hand, and then observe the whole performance without disturbing it. After the bee has worked the sting in so deeply as to be satisfied, it begins to find itself a prisoner and to consider means of escape. It usually gets smashed at about this stage of proceedings unless successful in prying itself away. However, if allowed to work quietly, pulling at the sting to see if it will not come out, it seems to consider the matter a little and then commences to walk around the sting in a circle, just as if trying to twist a screw out of a board. If one can be patient and let the bee alone, it may work it out, but in most cases the sting either tears out from the body of the bee or breaks off. Before either occurs it should be removed from the flesh at once.

#### Mechanical Construction and Operation of the Sting

After a bee has delivered its sting and torn itself from that member a bundle of muscles partly enveloping the poison-bag will be noticed. The curious part of it is that for some considerable time after the sting has been detached from the body of the bee, these muscles will work with a kind of pump-like motion forcing the sting further into the wound, as if they had a conscious existence and burned with desire to wreak vengeance on the party attacked. Even after the sting has been removed from the flesh and thrown away, if it should stick in the clothing so the flesh will come in contact with it it will commence working again, pull itself into the

flesh, and empty the poison into the wound.

Muscular contraction of the sting has been seen by the author under the field of the microscope for over 20 minutes after being detached from the bee. This phenomenon is wonderful, and while watching the sting sink into the rim of a felt hat, one can ponder on that wonderful thing, animal life.

Under the microscope the sting is found to be a beautifully fashioned



E. R. Root often demonstrated the act of placing a hatful of bees on his head. The bees were prepared by shaking them inside a folded newspaper until they were practically defenseless because of their disoriented state.

and polished instrument, whose delicate taper and finish make a most surprising contrast with any instrument man has been able to produce. In shape it appears to be round, but it is in reality egg-shaped and of a dark red color, transparent enough to show the hollow.

The sting proper is composed of three parts—the outer shell or husk D, and two barbed spears that slide partly inside of it. Fig. II shows the spears. The barbs are much like those on a common fishhook, and when the point of one spear, A, penetrates far enough to get one barb under the skin, the bee has made a hold, and has no difficulty in sinking the sting its whole length into the wound; for the pumping



Bees are pleasant, good natured creatures as a rule.

motion at once commences, and the other spear, B, slides down a little beyond A, then A beyond B, and so on. With a motion like that of a pair of pump handles, these spears are operated by small but powerful muscles attached thereto. These muscles will work, at intervals, for some time after the sting has been torn from the bee, as has been explained. They work with sufficient power to send the sting through a felt hat or into a tough buckskin glove. It is interesting to watch the bee while attempting to get its sting started into the hard cuticle on the inside of the hand. The

spears often run along the surface diagonally, so that it can be seen how they work down by successive pumps.

The ducts O, O, it is believed, are for the purpose of conducting the poison from the poison-bag to the barb.

Fig III is a transverse section sliced across the three parts at about the dotted line D. A and B are barbed spears; F and G, the hollows to give them lightness and strength; H, H, the barbs. It will be observed that the husk D incloses but little more than one-third of the spears. The purpose

## STINGS

### Stings, Allergy to

main shaft C is to hold the in place and to allow them up and down easily, and to them while doing this work. ld all together there is a like a sliding dovetailed both spears, with a corre- ing hollow groove in the husk, will fit each other as shown. g. III.) This allows the barbs ect to do their work, and at ne time holds all together for these spears are very torn out of the husk; and sting is extracted they are ft in the wound, like tiny s before mentioned. When and laid on a piece of glass scarcely visible to the naked under the microscope they as in Fig. II.



do not all have the same of barbs. There are as even and as many as nine. spears are held against each shown in Fig. III, and it bserved that the shape and gement of the three parts hollow, E, in their center. king of the spears also own the poison, and quite zed drop will be collected oints, as can be seen under scope.

One of the seemingly insurmountable problems often encountered by the beginning beekeeper is learning to adjust to the occasional sting received during manipulations of the hive. Stings are nearly unavoidable during the course of a season's beekeeping. Aside from the momentary sharp pain when the barbed stinger enters the skin and perhaps a small welt at the sting site, 95% of the population experience no further problem. For some individuals a generalized swelling may occur in the area of the sting. Histamine release is probably responsible for most of the sharp pain produced at the sting site.

The honeybee has a barbed stinger which, when thrust into the epidermal layer of the skin remains imbedded after being torn loose from the bee. Muscles attached to the stinger continue to force the stinger into the flesh and venom is injected at the same time.

Honeybee venom is a concentrated toxic solution of biochemically active molecules. The sting is very effective against the usual honeybee enemies. To receive the same amount of venom as injected by a defending bee into an invading bee, on the basis of a dose to body weight response, a human victim would have to be stung by just less than one million bees at once!<sup>2</sup>

Danger to man from honeybee stings lies in two directions: 'Firstly, serious illness may result from massive stinging by hundreds of bees. This is a direct effect of the large dose of injected venom.

The second danger of venom is the development of an allergy to bee venom. This occurs in perhaps 5% of beekeepers<sup>3</sup> and in one person out of five million of the general population.<sup>2</sup>

There are a number of components in bee venom which can produce severe allergy. Some people are allergic to only one of these factors but others are allergic to any combination or even all of them.

The major components of bee venom are: Hyaluronidase, phospholipase, melittin, apamin, cardiopep, M.C.D. peptide, histamine, minimine, glucose and fructose, and water (88%).<sup>3</sup> Hyaluronidase and phospholipase are the major allergins. The molecules present in bee venom may be classified, based on their structure and biochemical mode of action, into three groups as follows: (1) small non-protein molecules (2) protein toxins and (3) enzyme proteins.<sup>3</sup>

The small non-protein molecules present in bee venom are predominately pharmacologically active compounds classified as amines. On a quantitative basis histamine is the most important. Histamine is a normal constituent of certain human cells and when released can elicit reactions that range in intensity from mild itching to pain, shock and even to death. It is released by our own cells in areas of inflammation or irritation. Pollen from ragweed, for example, inhaled through the nasal passages may set up such a reaction. A bee sting merely augments the amount of histamine which will be present at the sting site, causing the venom components to be more rapidly distributed to the body tissues around the sting area. In 1976 two further amines called dopamine and noradrenaline were detected in venom. Together, these non-protein compounds account for about two percent of the dry weight of bee venom.

Since about 70% of the dry weight of honeybee venom is accounted for by toxic peptides or enzyme protein, we are left with about 30% of the material of non-protein origin.

The protein toxins present in bee venom have profound biochemical effects on the human body. The protein toxins include M.C.D. peptide, minimine, peptide M, peptide 401 and procamine. Together these components account for about 60% of the dry venom weight. Several other toxic peptides have been found recently.

Melittin is the predominant toxin in venom accounting for 50% of the dry weight of venom. When melittin is in-

roduced via venom into the subcutaneous layers of the skin it brings about the lysing or "leaking" of the cell contents into the extra-cellular spaces. Histamine is thus released from its cell storage and an additional amount from the venom is added. The damage caused by the action of the melittin is compounded at the sting site when it constricts or dilates blood vessels.

Apamin accounts for about two percent of the venom dry weight. It is a potent polypeptide neurotoxin. It acts on the nerve cells present in the spinal cord where it disrupts the normal nerve impulse transmissions.

M.D.C. peptide makes up about two percent of the venom dry weight and acts to release histamine from the mast cells in the skin and lungs, much in the same manner as melittin but does not lyse red blood cells.

Enzyme proteins account for the remaining 15% of the dry weight of the venom. Only two enzymes are present in venom; hyaluronidase, which accounts for three percent of the venom and phospholipase A which accounts for twelve percent of the venom dry weight. Hyaluronidase acts to break down barriers in the skin tissue allowing the large foreign molecules of the venom like melittin, apamin and MDC-peptide to penetrate the skin and reach their target cells. Hyaluronidase action is restricted to the locality of the sting so it causes no systemic effects.

Phospholipase is an enzyme which catalyses the specific chemical destruction of phospholipids which are an integral part of all cell membranes. Both melittin and phospholipase A cause cell lysis, but not in the same manner.

### Causes of Allergy

When a substance such as bee venom is introduced into the human body it is capable of producing an immune response; particular types of antibodies are formed and these soon circulate in the blood. Most of the useful immune

responses produce a type of antibody called IgG. These antibodies are beneficial and give good protection. Sometimes, however, an antigen, bee venom, for one, instead of producing IgG, produces a different kind of antibody called IgE. Antigens producing this type of antibody, IgE, are called allergens. IgE antibodies can be dangerous.

Most people experience only a mild, local discomfort at the site of a bee sting unless it is in some particularly sensitive area.

An abnormal reaction to a bee sting is referred to as a hypersensitivity or an anaphylactic reaction. Hypersensitivity is an allergic reaction and is characterized by one or more of the following: Generalized urticaria (itching hives), breathing difficulty, heart and circulatory collapse, generalized itching and generalized skin redness. Sensitive clinical tests can be used to detect hypersensitive individuals in the population. One such test is based on the finding that sensitive individuals release histamine at venom concentrations at least one-tenth lower than normal subjects. Another test involves applying whole bee venom dilutions to a skin scratch and observing the response at the inoculation site.

In some instances individuals sensitive to bee stings show little systemic response to the first bee sting or two and it is only on subsequent stings that the severe anaphylaxis is seen. IgE antibodies are formed in response to the hyaluronidase and phospholipase A of the venom after the first sting. These antibodies do not circulate long in the body but end up attached to the outside of the cell membrane of the mast cells which are particularly numerous in the skin and lung tissues. Successive stings cause increasing reactions to the point where urgent medical attention may be required.

The allergic response can be prevented or stopped in essentially three ways. Blocking antibodies or immunoglobulin G (IgG), can combine with the allergen rendering it unable to reach the cell-bound

IgE. If that fails and the allergen reaches the sensitised cells certain drugs can be used to stop or suppress some stage of the processes that lead to the release of the mediators. Finally, there are the drugs that interfere with the action of the mediators, such as the antihistamines.

In recent years it has become apparent that whole bee extracts are not totally effective. A standardized pure venom extract has proven to be far more satisfactory than the whole bee extract. In March, 1979 a new vaccine was licensed which uses purified venom. Allergists now know that the specific allergens that cause reactions to bee stings occur in the venom. Supported by the National Institute of Allergy and Infectious Diseases, researchers have successfully applied the principle of desensitization and tested it to the satisfaction of the Food and Drug Administration. An obstacle has been the difficulty of obtaining venom but this has been partly solved, at least with honeybees, by using a screen through which a number of bees are shocked into stinging. The shock is administered to the bees covering the screen by a mild electric current. The bees thrust their stingers through the screen, ejecting a tiny droplet of venom on the underside of the sheet of material stretched on a frame. The bees are able to withdraw their stingers without harm to the bees. The venom is collected, sent to a laboratory for processing and preparation of the pharmaceutical material.

It is not necessary to wait for a serious problem to develop before taking action in response to a threatening situation. In individuals who are systemically allergic or have shown evidence of increasing severity of reactions to bee stings should always have some means of preventing or controlling a life-threatening reaction following a bee sting. The necessary medications must be available at all times and should be in a compact form, simple to use and inexpensive. Commercial kits are currently available by prescription. They consist of a preloaded syringe of epinephrine hydrochloride and antihistamine tablets. The kits are compact and easy to use.

They cost between six and eight dollars each. A physician can either dispense the kits or can write a prescription for the components. He may be able to minimize the expense by using drugs designated by generic name. The kits should be kept near at hand for immediate use. A person suffering an allergic reaction must receive medical attention as soon as possible.

#### References

1. Lichenstein, Lawrence M. (1975) "Anaplylactic Reactions to Insect Stings: A New Approach". *Hospital Practice* 10 (3): 67-74
2. McKillen, M. N. (1977) "And Then There Were Stings In Their Tails". *The Irish Beekeeper* 31 (7): 166-168
- 3.— 31 (8): 190-192
- 4.— 31 (9): 213-215
5. Sutherland, Struan K. (1975) "Bee Venom Allergy". *The Australasian Beekeeper* 80 (5) 102-104

**SUCROSE.**—See Cane Sugar, also the following subject.

**SUGAR.\***—The term sugar is applied by common consent to the white sugar commercially prepared from the sugar cane and the sugar beet, or to sucrose. To the layman and possibly to the chemist, the word "sugar" means white granulated sugar; if it is powdered, the adjective "powdered" is added to sugar as "powdered sugar"; if it is moist and soft, and either white or only slightly yellow in color, it is termed "soft sugar"; while if it is brown in color, moist and soft, it is termed "brown sugar." In distinction the word "sugar" refers to the whole class of sugars, of which there are some 150 or more, many of which are rare and some of more common occurrence. Grape sugar is the sugar dextrose, while fruit sugar is the sugar levulose. (See Invert Sugar, and table.)

Common sugar is composed of the elements in the following proportions: Carbon, 12 parts; hydrogen, 22 parts; oxygen, 11 parts. It is found free in nature in many roots, as beets and turnips; in the stems of plants, as sorghum, sugar cane, cornstalks, and in the sap of trees like maple, birch, etc., and in many

fruits. It has never been commercially prepared from the elements.

A white sugar or granulated sugar is practically pure sucrose, while the varying off-colored sugars ranging from light-yellow to brown are mostly mixtures of crystals of sucrose surrounded by molasses. These yellow or brown sugars are all produced by the refineries from the liquors after the production of the white grades. Formerly one had brown sugars direct from the cane, but now these are not produced to any extent in this country. Louisiana sugars in hogsheads used to be these old brown sugars.

There has always been a discussion as to whether white sugar made from beets is the same in every particular as that made from sugar cane. Both contain practically the same amount of sucrose, also water and mineral matter, but the organic impurities which may amount to from .05 to 1 percent are often different in beet white sugar from those in cane white sugar. These impurities may play a part in some manufacturing processes, and prevent the use of beet sugar in all places where cane sugar has been used. However, as a sweetener and for table use or for jelly or preserving work it is doubtful whether there is any notable difference between beet and cane sugar. (See Cane Sugar.)

**SUMAC (Rhus).**—This genus is represented in the United States by about 15 species. Most of them are shrubs, but a few are small trees and one is a shrubby vine. The small flowers are born in dense clusters at the ends of the branches or in the axils of the leaves. The stamens and pistils are usually in different flowers.

**Staghorn Sumac (Rhus typhina).** This species reaches a height of 10 to 25 feet, and has orange-colored wood and crooked branches, covered with soft, velvety hairs, making it resemble the horns of a stag. The clusters of fruit are clothed with acid crimson hair. The staghorn sumac grows in dry soil from Nova Scotia westward to Missouri. The flowers are visited by honey bees in large numbers and, as the nectar is unprotected, by a great company of other insects. The flowers appear in June and July.

**Smooth Sumac (Rhus glabra).** Upland sumac. Scarlet sumac. This

\*By Dr. C. A. Browne, Bureau of Chemistry and Soils, Washington, D. C.



species is an irregularly branched shrub, seldom more than 10 feet tall. It has a very wide distribution, extending from Nova Scotia to Florida and westward to Mississippi and Minnesota. In Connecticut, where much of the surface is covered with glacial moraines, it is very common in hillside pastures and along stone walls. The blooming period lasts for about three weeks from July 8 to the beginning of August. The flowers secrete nectar very freely on hot clear days, but in cloudy, foggy, or cool weather the flow ceases almost entirely. If there are "hot waves" in July strong colonies will bring in 20 pounds of honey during an ideal day, and will store from 40 to 100 pounds each. But if there is much cool or rainy weather there may not be an average of 20 pounds to the colony. At its height the flow is very rapid and heavy. While the bees are busy on the bloom there is a very strong odor in the apiary, and the new honey is more or less bitter to the taste. Fortunately, the bitterness is only transient, and by winter the honey is edible.

One must eat sumac honey to appreciate it, says Latham. There is a richness, but at the same time a mildness about it, that will suit the most sensitive taste. Once a customer, always a customer, if one



Sumac flowers and leaves (*Rhus glabra*)

buys sumac honey. When pure, the honey has a golden color. If properly ripened it has no noticeable odor, but is very heavy, and like apple-blossom honey, waxes instead of granulates. It is safe to say that

**Right:** The dense form of this pistillate cluster makes a satisfactory smoker fuel.

**Below:** Banks of sumac with their brightly colored leaves and dark red blossoms are beautiful in the fall.

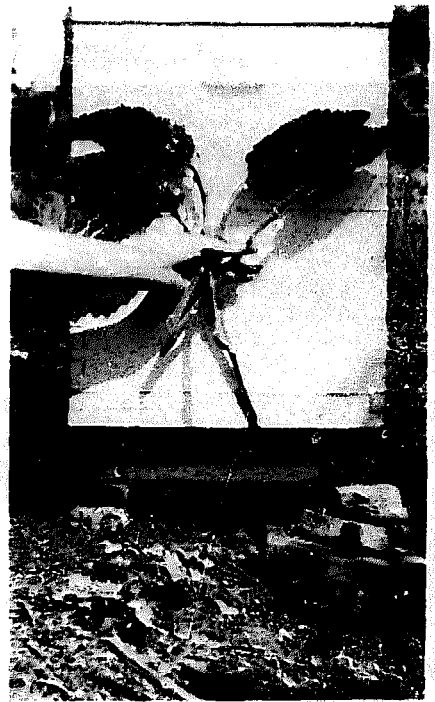

much of Connecticut would be worthless to beekeepers but for this plant and the same is true to a lesser extent of Massachusetts.

#### **SUPERSEDURE OF QUEENS.\*—**

Technically speaking, supersedure is an act of the bees in replacing the old queen with a new or a young one. Requeening is exactly the same thing, but it is the act of the beekeeper. (See Requeening, and Introducing.)

Queens seldom live more than three or four years when the colony is left to itself. After one or two years of heavy egg laying, the average queen will not, as a rule, be of much value to the colony. If she does not die a natural death the bees will probably supersede her, and if they do not, the apiarist himself should replace her. Most of the best bee men requeen every year.

While some queens of an exceptional value are good for two or three years, experience shows that the average queen should be replaced in one year. As a rule, the average colony will supersede its own queen in two years without any attention on the part of its owner. The process is a perfectly natural one and goes on in the best regulated yards year after year. Experience shows, however, that the up-to-date beekeeper better requeen, as explained, after the first year, before the bees supersede their queen.

Some queens in their early larval period have not been properly fed. Perhaps the cells in which they were reared were chilled or overheated. The result is they are weaklings at the very start of their career. They are deficient in egg laying, of which fact their subjects very quickly take note. They start building supersedure cells just as they do in the case of old queens that have given a good record, but are now worn out. The bees seem to know that their very existence depends on a good queen.

It very often occurs that mother and daughter will be found laying side by side on the same comb; but the condition does not last long before the old queen will be missing. It is not known whether she dies a natural death, the daughter disposes of her, or whether the bees kill her.

\*By M. J. Deyell.

#### **Premature Supersedure in Package Bees\***

During the past few years, or since the shipping of package bees has come to be such an enormous industry, there has been not a little complaint that the queens in these packages, even from reputable breeders, are superseded either before they get to laying at all, or sometimes after they have a nice lot of good brood in all stages of growth. If this were the experience with bees or queens shipped from a particular breeder, or two or three breeders, we might say that the cause was due to the improper rearing of the queen bee; but apparently this premature supersedure occurs in queens from nearly all breeders to a more or less extent, even from those of long experience with a gilt-edged reputation for raising not only fine bees, but also good queens. R. H. Kelty, former instructor in bee culture at Michigan State College and also a producer of honey, says, "The supersedure problem is the most serious with which we have to contend today."

To find the proper solution to this problem, the author has read all he could find on this perplexing question of premature supersedure in package bees, including the preliminary work of the U. S. Bee Culture Laboratory at Baton Rouge, Louisiana, and at Laramie, Wyoming. He has come to the conclusion that the trouble is not altogether with the queen breeder nor with the one who receives the bees. Apparently there is a combination of causes some of which can be laid at the door of the breeder and some at the door of the consignee. There has been a disposition to blame the breeder on the grounds that in the rush of the season his queens have been improperly bred and improperly selected. A good queen breeder will throw out all culls and even those which do not come quite up to standard.

What are the causes of premature supersedure that can be traced to the breeder or producer of package bees? The statement has been made that the breeder, in the rush of the season, when short of queens will use those reared from larvae too old, or perhaps too young.

Two of our best authorities on

\*By E. R. Root.

queen breeding, the late M. T. Pritchard, a veteran queen breeder of The A. I. Root Company, and John G. Miller of Corpus Christi, Texas, said that they had little or no complaints from their customers on the ground of premature supersedure. Mr. Miller averred that no larva more than three hours old\* from the hatching of eggs should be used for grafting in artificial queen cells. (See Queen Rearing.) M. T. Pritchard favored the age of 18 hours, and said that larvae of that age are just as good as those much younger. Both breeders said that the larva should be well fed, and to that end the cell building colony should have the queen removed with all unsealed brood for two hours before giving the cells. With no young brood to feed, the bees are filled with pap; but, said Mr. Pritchard, "there must be at least a pound of pollen to a brood frame." Unless there is a great abundance of pollen, he said the queens would be inferior.

The queen breeder often takes the queens out in the height of their egg laying. When the queen is laying a thousand or more eggs a day, to stop her instantly, it is believed, may cause her to become weakened or injured so that she cannot again start properly in egg laying. It has been urged also that no queens that have laid more than a few eggs be used for packages.

Now, let us take the other side of this question, the responsibility of the consignee. Thomas Burleson of Texas said that the average beeman does not feed bees sufficiently with sugar syrup when he receives packages. Bees, he said, should be lavishly fed so that the queens will start laying early. G. G. Puett, one of the extensive producers of queens and package bees, possibly comes very near the solution of the problem in the American Bee Journal for March, 1935. He brings out the point that the average queens in packages do not start laying for three or four days after the packages are installed. After that the queens will begin to lay eggs, but in the meantime there is no sealed

\*How can one tell when the larvae is three hours old, and if so, how can it be handled safely, is a question which has been raised. The author believes that Miller meant the younger the larva the better.

brood from which young bees are emerging. The old bees begin to die off and the colony starts to dwindle. The bees apparently feel something is wrong and so they supersede the queen right in the midst of her best work. The solution, he says, lays (1) in adding another half-pound or pound of young bees to the colony in about 10 days after it is nicely started, or, (2) in giving it a frame of sealed brood, from which, within a day or two, young bees will be rapidly emerging. This keeps the bees contented. He draws attention to the fact that there is little or no supersedure when there is brood in all stages of growth, especially emerging young bees, coming on to take the place of those which are dying off.

#### Nosema a Primal Cause of Supersedure

Dr. Farrar of the U. S. Bee Culture Laboratory, believes that this insidious malady may be a primal cause of supersedure when all other conditions are favorable. If so, it would account for the conflicting opinions. If in doubt, if the dead queen can be found she should be sent to Dr. C. L. Farrar of the U. S. Bee Culture Laboratory at Madison, Wisconsin, for examination. If Nosema is not present, look for other causes. If the report shows that Nosema exists, build up the colony, for good beekeeping is the best protection against Nosema. To that end see that the bees have plenty of pollen. (See Pollen.) It is important also to have available plenty of fresh water.

#### Bibliography

Literature consulted: G. G. Puett, American Bee Journal, page 114 for 1935; H. W. Sanders, American Bee Journal, page 336 for 1935; C. E. Phillips, American Bee Journal, page 113, for 1936; Gleanings in Bee Culture, page 435 for 1939; Gleanings in Bee Culture, pages 77 and 286, for 1940.

**SWARMING.\*** — The term "swarming" is applied to the act of a family of bees leaving their home to establish a new home elsewhere. In the broadest sense the term includes not only reproduction of colonies by normal swarming when the colony divides itself by part of the bees leaving but also swarming out

\*By A. I. Root, E. R. Root and Geo. Demuth.

from various causes when the entire colony migrates.

The term "swarming out" is usually applied to the migration of the entire colony as in the case of lack of food (hunger swarms), recently hived swarms that are dissatisfied (see Absconding Swarms) and small nuclei that swarm out with the young queen when she takes her mating flight or because the little colony is dissatisfied.

The migrating family of bees is called a swarm though this term is sometimes applied to the colony after it has established itself in its new home, to distinguish the new colony from the parent colony. In a strict sense the term swarm applies only during migration. As soon as a swarm establishes itself in its new home it is called a colony.

#### Events Leading to Swarming

A colony of bees that is normal and prosperous increases its brood in the spring as its adult population increases, either until all the available brood comb is occupied or until the queen reaches the limit of her capacity in egg laying. Early in the spring only worker brood is reared, but when the colony becomes stronger the rearing of drone brood is begun, thus providing for male bees in anticipation of swarming. Finally when the brood chamber becomes crowded with emerging and recently emerged young bees and the combs are well filled with brood, several queen cells may be started. When eggs are placed in these partially built queen cells the colony has then taken definite steps in preparation for swarming, the swarm usually issuing eight or nine days later at about the time the more advanced queen cells are sealed. The exact time of the issuing of the swarm depends to some extent upon the weather. Sometimes it must be postponed a few days on account of rain, and sometimes during hot weather the swarm will issue before any of the queen cells are sealed, especially if the bees are Italians. Normal swarms usually issue between 10 a. m. and 2 p. m. In hot weather most of the swarming is over by noon.

#### Symptoms of Swarming

In their natural state and when neglected or poorly managed, the bees usually slow down in their

work after queen cells have been started in preparation for swarming, especially during a few days just previous to the time the swarm issues. The field workers in increasing numbers stay in the hive instead of working in the fields, bringing about a crowded condition sometimes resulting in a great cluster of bees hanging on the outside. The clustering on the outside was formerly considered a symptom of swarming provided it occurred during a honey flow, but it is by no means a reliable symptom. Clustering out during hot weather when there is a dearth of nectar is quite another thing and has nothing to do with swarming.

A more reliable symptom that the colony is preparing to swarm is a lack of the usual flight at the entrance, due to many of the field bees staying at home. When this is noticeable, by looking into the supers it will be found that they are crowded with bees, sometimes wedged into every nook and corner, this being quite unlike the normal condition in the supers. These idle bees are usually filled with honey, which makes them appear unusually large because of their extended abdomens. These conditions, when present during a honey flow, are practically a sure indication that the colony is preparing to swarm. However, in well-managed colonies this slowing down of field work does not always occur, but little if any difference in the work being noticeable even on the day the swarm issues.

The only certain indication of swarming is the presence of queen cells containing eggs or larvae during the swarming season. By noting the advancement of the queen cells it is often possible to predict on what day the swarm will issue. Queen cells built under the swarming impulse are sometimes called "swarming cells" to distinguish them from queen cells built at other times to supersede the old queen.

#### The Prime Swarm with the Old Queen

When the first swarm issues a varying proportion of the adult bees, together with the old queen, fly from the hive, leaving behind many adult worker bees, a large number of unemerged young bees, and several unemerged young queens. This is

tive humidity and carbon dioxide (CO<sub>2</sub>) are essential. All of these functions can be controlled to some degree by proper ventilation.

The primary purpose of ventilation in honeybee wintering facilities appears to be the removal of CO<sub>2</sub> and water vapor produced by the bees. In order to minimize heat and cooling loads the air flow rate must be just enough to accomplish this. Based upon observations of Mr. Brandt's and Mr. Kuehl's facilities an air flow of from 0.15 to 0.20 cfm (.26 to .34 m<sup>3</sup>/h) per colony appears to be a reasonable rate. In addition to the amount of air circulated, its distribution is also important. Because the build-up of carbon dioxide on the floor appears to be critical, a duct system which draws this air off the floor and exhausts it appears to be most desirable. Design of the air inlets is also important in order to ensure proper mixing of the incoming air with that air already in the facility.

Since winter air is colder than the inside air, the ventilation rate has a considerable cooling effect. The amount of supplemental heat required to maintain the desired temperature is the net difference between the heat lost through ventilating air and building heat loss, and the heat gains due to the bees and mechanical sources such as fan motors. Similarly, in fall and spring the cooling load is also affected by the ventilating rate.

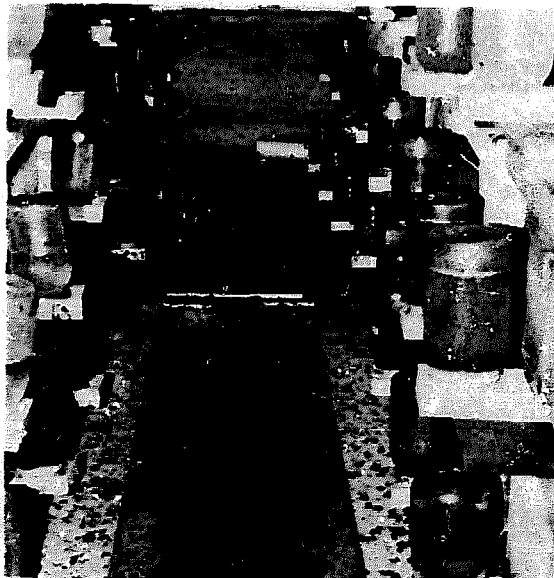

A trench-type exhaust duct with raised plywood covers in place. Feeding is by Boardman feeders.—Photo courtesy Canadian Beekeeping.

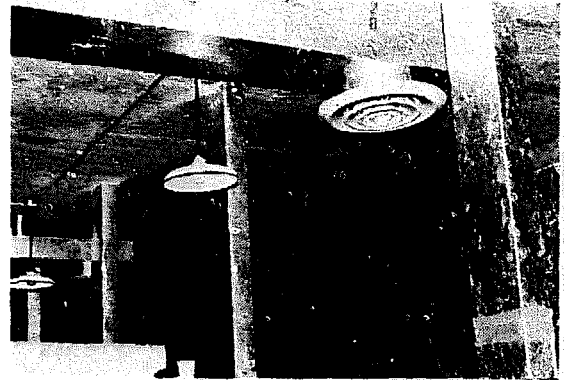

Incoming air diffusers and exhaust stacks passing through the ceiling. Photo courtesy of Canadian Beekeeping.

### Manitoba

Three Manitoba beekeepers, Mr. G. Durnin, Mr. J. Issac and Mr. H. Turnbull began a wintering program in the fall of 1975 and the details were published by R. G. Barker in *Canadian Beekeeping*<sup>3</sup>. The three Manitoba beekeepers constructed new facilities or modified other buildings so that four wintering chambers, each of approximately 800 to 900 square feet and capable of accommodating from 800 to 1000 colonies, were equipped with ventilation systems as well as temperature controls.

The ventilation systems consisted of a constant speed 1200 CFM squirrel cage fan channeling incoming air through a diffuser system on the ceiling and an exhaust ductwork system on the floor. In three of these wintering chambers this exhaust system consisted of a network of trenches in the concrete floor. These trenches ran between the stacked rows of colonies and exhausted the air up through vent stacks which went through the ceiling. These trenches were fitted with adjustable plywood tops to control air flow. In the fourth wintering chamber, which doubles as a large hot room, a series of solid-topped pallets were constructed on which the rows of colonies sit. The lateral supports of these pallets contained slits which allowed free airflow into the pallet and out the vertical exhaust stacks spaced at 10 foot intervals along the center of the pallets.

These ventilation systems included an adjustable recirculation system that allows from 0 to 80 percent of a

constant flow 1200 cfm to be recirculated air. This recirculated air is drawn from the ceiling of the wintering chamber. An automatic damper system was installed to recirculate a maximum amount of air at low outside temperatures to conserve heat. This damper system increases the amount of fresh air to its maximum, as the outside temperature rises, to reduce the use of the air conditioner to a minimum. When fresh air alone can no longer maintain the desired temperature in the wintering chamber, the dampers reverted to 90 percent recirculation and the nominal three ton air conditioner is automatically started.

The heating system consists of three 5 kilowatt electric heaters mounted in the incoming air duct. These were thermostatically controlled and came on one at a time as required.

The preparation of the colonies for wintering differed with each beekeeper involved. Since the environmental controls were not delivered and installed in the wintering chambers until late in the season and since converting to Mr. Kuehl's system of colony preparation, would have meant a great deal of additional labor and equipment, various methods of reducing the colony size for wintering were employed.

One beekeeper, in early September, made up nucs similar to Mr. Kuehl's but rather than introducing a queen cell, a young mated queen was introduced. These were newly purchased queens from the southeastern United

States. These young queens produced some brood and by early November when the colonies were moved into the wintering chamber they contained approximately three pounds of bees.

Another method of making up nucs that was employed in late September was to search out the queen in a producing colony and place her with approximately three frames of brood and bees into a brood chamber with six combs of honey. The remainder of the colony was gassed off. These were also moved into a wintering chamber in early November and at that time contained from three to five pounds of bees.

Each beekeeper attempted to maintain his wintering facility at from 9° to 10° C., but for the two beekeepers with larger nucs, this proved difficult. In estimating the BTU output of one of these nucs, Mr. Kuehl's honey consumption figures were used and as it turned out the amount of heat produced by these colonies, before they settled down, was underestimated. This underestimation, the fact that the air conditioners would not run below plus 4.4°C. and the continual icing of the condenser coils when the air conditioners were running, made it extremely difficult to maintain the temperature of the wintering chamber within the desired limits.

After the outside temperatures cooled to approximately -10°C. or below the temperature of the wintering chamber could be maintained using fresh air

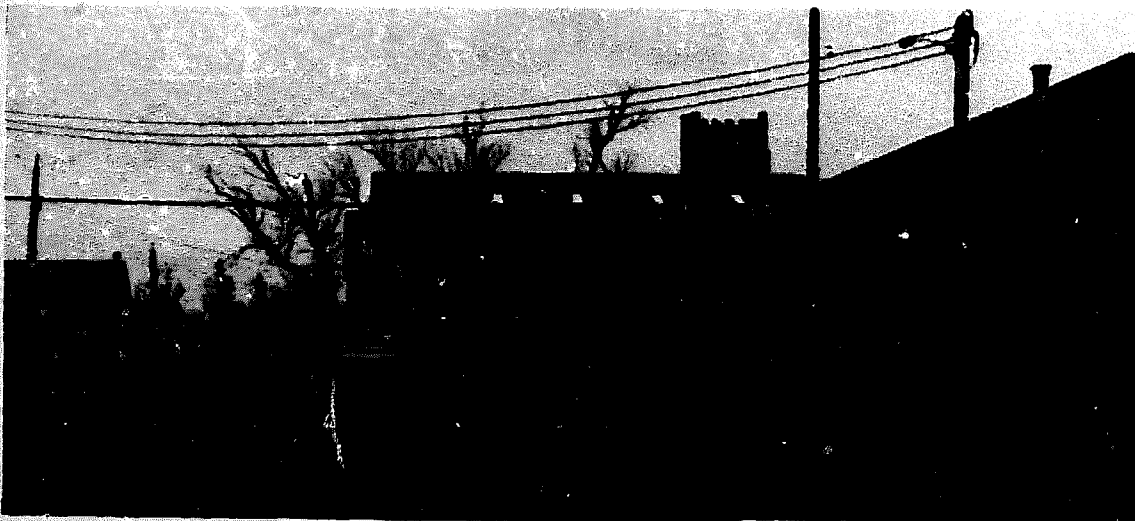

Howard Trumbull's wintering facility at Elgin, Manitoba, Canada.  
—Photo courtesy of Canadian Beekeeping.

cooling only and no further temperature maintenance problems were encountered.

It was found that with 800 plus colonies in a wintering facility, no supplemental heat was required until the outside temperature reached  $-18^{\circ}\text{C}$ . or lower.

It was not until the first warm spring weather that temperature maintenance again became a problem. During this period the air conditioners again were not quite adequate and during operation icing was a problem.

While temperature maintenance in all four wintering chambers was difficult at certain times during the fall and spring, only twice did it become extremely critical.

Once a heavy frost shut off the fresh air intake and the temperature rose to  $26^{\circ}\text{C}$ . Cooling the chamber with a fresh air flow quieted the restless bees. On another occasion, in April, the outside temperature became high enough that the air conditioner was functioning but after several hours of operation the coils iced over shutting off the fresh air supply. Temperatures again rose to plus  $24^{\circ}\text{C}$ . Extra fans held the temperatures down for a few days until the colonies were removed from this facility. A few hours of elevated temperatures induced brood rearing activity and may have some effect on the survival rate of the colonies. It was found that water would be taken by the bees during the winter but that feeding was undesirable. Virtually all of the winter loss due to starvation could be eliminated through stocking the colonies to be wintered with 5, 6 or 7 frames of honey and then feeding these colonies enough syrup or invert syrup to completely plug this brood chamber in the fall.

#### British Columbia

D.M. McCutcheon, Apiary Specialist of the British Columbia Ministry of Agriculture reported indoor wintering results from British Columbia in **Canadian Beekeeping**<sup>4</sup>. Mr. McCutcheon reports that a number of beekeeper-designed controlled atmosphere wintering projects are being carried out in the prairie provinces. In British Columbia the climate is quite different than the long, cold, dry, winters of the other western provinces of Canada.

Here the lower Fraser Valley area has a mild winter climate and a very high humidity. It was the feeling of the beekeepers that bees would winter successfully in a constant cool temperature and moderate humidity situation. Accordingly, nuclei were prepared in August by taking brood and bees from the established hives.

The queen was found in the hive and killed, and the nucleus colonies were established by using two combs of open brood which were placed in the middle, combs of capped brood, one on either side of the two middle combs and two combs of honey, one each on the outside of the brood. The other three combs were empty. The nucleus colonies were moved to a holding yard and the new queens installed the following morning.

Queen checks revealed that 22 colonies required requeening. The colonies were fed terramycin and sulphamycin and fumidil B during September.



Bees in winter chamber.

The building size is  $32' \times 1'$  with a  $14' \times 20'$  room partitioned off for wintering bee storage. A room  $12' \times 14'$  was left at the end for the controlled atmosphere equipment and for storage of equipment and supplies needed for the project. The building is of wood frame construction and the bee wintering chamber is insulated with 6" thick batt insulation with a vapor barrier. The inside is sheathed with plywood and duct work is installed in the ceiling and the floor for air circulation. The building is portable and can accommodate 225 single brood chamber nucleus colonies.

The bees were moved into the building in the second week of November

and it was our intention to keep the wintering chamber at 47°F. (10°C.) and the humidity at 50 percent R.H. After placing the bees in the building the temperature the following day was 55° and the RH 78 percent in the building. The temperatures reached the required level of 47°F two days later and humidity was down to the required level within 5 to 6 days. Temperatures and humidity were constantly recorded by a hygrothermograph both inside the chamber and outside the building.

All colonies were weighed as they were being placed in the building.

On two occasions the control atmosphere equipment failed to operate and temperatures inside the chamber went to 68°F.

The bees were brought out in early March as we were aware that they were light in weight and we wished to provide them with food. Wet, cold weather again in March hampered the feeding operation and the resultant build-up of the hive.

Weather in the Peace area of B.C. was anything but suitable for bee colony development in 1976. Poor weather during the dandelion bloom prevented the collection of pollen and nectar, thus colonies did not build up properly and they went into the honey flow in poor condition. Results were not encouraging, however, package colonies did not do well either. Thus the season was not conducive to a proper evaluation of the potential of these colonies.

In August of 1976 we again made up nucleus colonies from the same two cooperators but only 100 colonies were prepared as we felt that this would enable us to provide more intensive management.

Makeup procedures for establishing the nuclei were streamlined and only about 20 percent of the time required in the previous year was needed to make up 100 nucleus hives in 1976. We did not look for queens in the hives which were used for making up the nuclei. Combs of brood and honey were selected and placed in the nucleus boxes. Two days later it was simple to detect which nucleus colonies had queens and which were queenless. About 80 percent were queenless—new queens were introduced to all hives.

It is obvious that more honey must be placed in the nucleus hive at preparation time in order to overcome feeding problems in both the fall and the following spring. Although the average amount of honey used to overwinter the hives was 16.1 pounds some hives used considerably more than this amount, thus it appears that approximately 30 pounds of stores should be in a hive when they are placed in winter quarters.

### Conclusions

The first year of operation showed there were a number of defects in our operation. The main problems were as follows:

1. The time required to prepare the nucleus colonies in 1975 was too great.
2. Many colonies were too short on honey and pollen to carry them through the winter and spring.
3. More time must be available per hive for spring colony management.

As well it was obvious that pollen must be placed in the colonies in the fall and a pollen substitute fed in the spring to overcome the inability of the bees to collect pollen due to poor weather. In the spring, colonies should not be removed from the building until near the end of March at which time they must be fed syrup, pollen substitute and Fumidil B for Nosema control.

The controlled atmosphere equipment performed as predicted except on two occasions and adjustment to the controls were made which appear to have corrected the problem.

The amount of time required to make up a nucleus colony was drastically reduced in 1976 which makes the practice more economically feasible.

In final summary one can say that the first year of operation was a year of making a great many errors. The second year's operation has already shown that we can overcome some of these errors.

### REFERENCES

1. Barker, R.G. "Wintering Trip, Part I", *Gleanings in Bee Culture*, Vol. 102 (Oct. 1974), 307-8.
2. Barker, R.G. "Wintering Trip, Part II", *Gleanings in Bee Culture*, Vol. 102 (Nov. 1974), 341.
3. Barker, R.G. "Indoor Wintering of Honeybee Colonies in Manitoba", *Canadian Beekeeping*, Vol. 5 Issues 5 & 6 (1975), 36-37, 43-44.
4. McCutcheon, D.M. "Wintering Honeybees in a Controlled Atmosphere Chamber", *Canadian Beekeeping*, Vol. 6 Issue 8 (1977) 98-102.



## X Y Z

**XENOPHON.**—A Greek historian and general who refers to poisonous honey. (See Poisonous Honey.)

**XYLOCOPA.**†—To this genus belongs the carpenter bees among which are the largest bees in the world. They are so called because with their powerful jaws they excavate tunnels a foot in length in solid wood. The cells are about an inch long, and made of small chips cemented together in a spiral. The eggs are laid on masses of pollen, moistened with honey, the pollen masses being about the size of a bean. A common species in the eastern United States is *X. virginica*.

**YEASTS IN HONEY.**\*—Saccharine liquids in general are more susceptible to the action of yeasts than of any other group of microbes, and in natural juices such as sweet cider, grape juice, etc., which in addition to being sweet are acid in reaction, yeasts rather than bacteria find best opportunity for development. Honey, however, through its high concentration of sugar, is able to hinder the growth of ordinary yeasts which are able to grow in solutions of lower sugar content and is therefore immune against the majority of yeasts. Nature, however, has added to the troubles of the beekeeper and has evolved a race of sugar-tolerant yeasts which are able to live and thrive in high concentrations of sugar in which ordinary yeasts are completely restrained. In brief,

then, the microbiology of honey is, for most practical purposes, confined to a study of the behavior of this group of sugar-tolerant yeasts. As far as we know, they are the only micro-organisms capable of affecting honey.

### Honey Fermentation

Our chief concern with yeasts in honey lies in their capacity for spoiling the product by fermentation. The relation of sugar-tolerant yeasts to fermentation was first observed in 1910 by Nussbaumer in Switzerland, and investigations conducted since then have confirmed the view that yeasts are the agents responsible. In recent years spoilage of extracted honey has become a matter of concern to American and Canadian beekeepers and others engaged in the handling and marketing of honey, due partly to the fact that honey is now being held for longer periods of storage than formerly.

### Yeast in Fermented Honey

From every sample of fermented honey examined sugar-tolerant yeasts have been isolated which are capable of fermenting high concentrations of honey when inoculated in pure culture. A number of samples of honey have been analyzed quantitatively for yeasts, and it was found that the actual numbers of yeast cells present varied greatly. In a series of 13 samples of fermented honey the number of yeast colonies obtained ranged from 6,100 to 380,000 per gram (1-5 teaspoonfuls.) The samples in question had fermented approximately 6 months before being examined, and it was probable that in some cases at least

†By John H. Lovell

\*By Dr. A. G. Lochhead, Division of Bacteriology, Central Experimental Farm, Ottawa, Ontario.

the yeasts tended to diminish after the most active stage had passed. In other tests of more recent fermented honeys we have obtained counts of over 1,000,000 yeasts per gram.

The yeasts responsible for honey fermentation are not all of one type. By employing bacteriological methods for isolating them and studying their form and cultural characteristics it is possible to recognize several fairly distinct species.

In the course of our studies of fermented honey samples in which 130 cultures were studied and compared, four different types of yeasts were found, but further studies of sources of infection have shown that the number of types actually capable of fermenting honey is much larger. Studies of types of sugar-tolerant yeasts are still under way, but up to the present at least a score of different types of yeasts have been isolated from various sources capable of fermenting honey, some much more widely distributed in nature than others.

#### Sources of Infection of Honey by Yeasts

With yeasts definitely established as the active agents in fermentation, it will be realized that measures to combat spoiling will be two-fold in scope. Fermentation may be prevented firstly by checking the growth of yeasts already present by such means as heat, the use of chemicals or storage at low temperature; or secondly, by reducing the contamination of honey by such yeasts to a minimum. Hence it is a matter of interest to learn something of the possible sources of infection of honey.

##### (A) Flowers Visited by Bees

The nectar of flowers visited by bees naturally suggests itself as a possible source of contamination of honey by yeasts, and consequently a series of experiments were conducted extending from June to September, in which examinations were made of floral nectar embracing 34 varieties of flowers. Out of 44 examinations made, negative results were obtained in but 3 instances. The yeasts were furthermore isolated in pure culture and studied in detail, with the result that 11 different types were found from a comparative study of 71 cultures obtained from this source. Naturally some

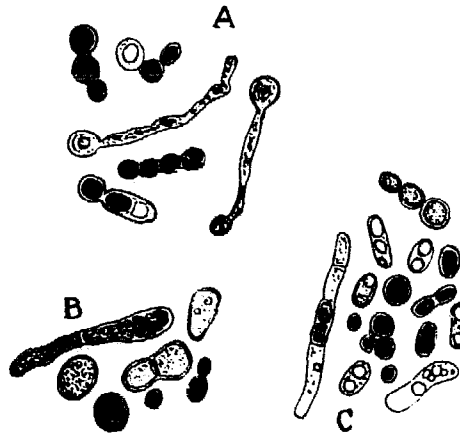

Fig. 1.—Microscopic appearance of most prevalent yeast found in floral nectar.

species were much more prevalent in nectar than others. While some were restricted to one or very few types of flowers, others were encountered in a wide range of flowers throughout a comparatively long period. In Fig. 1 is shown the yeast which was found to be most prevalent, being isolated in 20 cases from such flowers as dandelion, apple blossom, honeysuckle, cherry blossom, Dutch and alsike clovers, sweet clover, buckwheat, and sunflower. This yeast has also been found in fermented honey.

Of the 11 types of yeasts, 3 proved identical with types already reported from fermented honey, although all were capable of fermenting honey in pure culture and must be therefore regarded as potential causes of spoiled marketed honey.

##### (B) Yeasts in Hive Nectar During the Honey Flow

Coincident with the experiments just mentioned a study was also made of the presence of honey-fermenting yeasts occurring in hive nectar during the same period, namely June 1 to September 14. In the course of 57 examinations it was found that in every sample of nectar there was evidence of the presence of sugar-tolerant yeasts capable of causing fermentation. Out of 60 yeast cultures which were isolated from hive nectar and compared, however, but 4 different types were found. Of these 3 proved to be similar to types found in floral nectar, while 2 were, in addition, identical with yeasts actually isolated from fermented honey. In connection

with the yeast infection of floral and hive nectar it is of interest to observe that other investigators have isolated honey-fermenting yeast from the bodies of bees, thus furnishing a link between the flower and hive, and strengthening the assumption that the bees act as carriers of yeast to the comb.

#### (C) Honey-Fermenting Yeasts in the Soil

With the object of learning to what extent soil may be regarded as a source of honey-fermenting yeasts an investigation was carried out, during the course of which soil from a number of different locations was examined throughout a 12-month period. Soil from an old established apiary was tested in addition to new apiary ground being used for the first time. Furthermore, soils from a flower garden, from an orchard, from a clover field, and from a cereal field were likewise examined. Only in the case of the apiary ground is the soil regularly infected by sugar-tolerant yeasts. Samples from the other locations, from May to the end of September, when yeast infection might be considered most probable, all yielded negative results with one exception. The findings support the view that ordinary field soil is not to be regarded as a primary source of infection of honey. In the case of the apiary soil it was of interest to note that the soil from the older part was much more heavily infected than soil being used for the first time. It appears reasonable to conclude that in the apiary the soil becomes more or less rapidly contaminated with yeast from droppings of wax, nectar, and from dead bees. The soil apparently serves as a resting place for honey-fermenting yeasts, yet it may constitute a source of seasonable re-infection through such agencies as wind or insects.

From the soil 166 cultures of yeasts were isolated and compared. These were found to represent 7 types of which 3 had already been recognized in fermented honey. Fig. 2 depicts a yeast found in soil.

#### (D) Yeast Infection During Extraction

The infection of honey from such sources as floral nectar, soil, etc., may be said to be beyond the power of the beekeeper to prevent. The

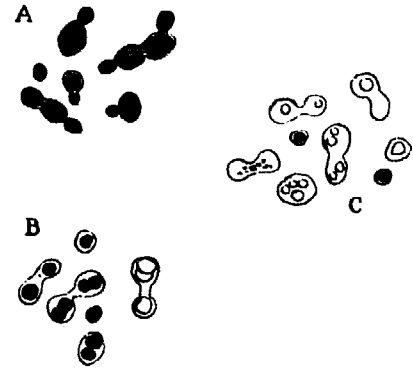

Fig. 2.—Microscopic appearance of yeast found in apiary soil.

blame must be laid chiefly upon the bee, while other insects and the wind may be regarded as lesser agents. The process of extraction, however, is one over which the beekeeper exercises control, and hence he should be able to influence the extent of contamination of honey once it is removed from the comb. The possibility of infection in honey at the time of extraction, through contamination from utensils, from air, etc., was made the subject of an investigation. Examinations made of the interior centrifuge tanks, of holding tanks, and pipe lines showed that these may represent more or less serious sources of infection. From such sources 4 types and from the air of the extracting house one type of honey-fermenting yeasts were isolated, 3 of which had been previously reported from fermenting honey.

In view of these results there is reason for believing that in the case of extracted honey at least, yeast contamination is partly within the control of the beekeeper, and that by exercising careful precautions to maintain strict cleanliness at the time of extraction, and to insure that his containers, tanks, and utensils are as nearly sterile as possible, a portion of yeast contamination may be eliminated. Traces of honey or nectar, particularly if left so that moisture may be absorbed, offer extremely favorable conditions for the multiplication of yeast cells, and there is no doubt that from a well cleaned extracting house a better grade of honey with less tendency to ferment will be produced than

from one where the same sanitary measures are not taken.

#### Yeast Infection of Normal Honey

In view of the possibilities of infection discussed above, it is natural to inquire whether all honey is contaminated by sugar-tolerant yeasts, and if so, whether it makes any difference how heavily it is infected. Information on these points was obtained by a study of 320 samples of honey, obtained in duplicate from all parts of Canada. One sample was kept for storage test, the corresponding one being used for bacteriological and chemical examination.

Of these 320 lots of honey not a single one was found to be free from sugar-tolerant yeasts. The amount of infection, however, varied greatly, ranging from 1 in 10 grams to 1,000,000 per gram. It was noted that the higher the initial yeast count the greater is the tendency for honey to ferment, with moisture being the other chief factor. Yeast count, as distinct from the mere presence of yeast, directly affects spoilage during storage.

The yeasts contaminating normal honey were found to belong chiefly to the genus *Zygosaccharomyces*, one species of which, *Z. richteri*,

being found to predominate in causing fermentation of stored honey.

#### Prevention of Fermentation

From our knowledge of yeast infection, it appears that for practical purposes we must regard all extracted honey as containing sugar-tolerant yeasts in greater or lesser numbers. Danger of spoilage by fermentation can be reduced by maintaining cleanliness of equipment during extraction to minimize yeast contamination, and by care in ripening to avoid honey with too high a moisture content. Yeasts may be prevented from growing by storage at 50 degrees F. or lower, or may be destroyed by heating to 140-145 degrees F. for 30 minutes. By this latter means "commercial sterility" is achieved which results in freedom from spoilage for ordinary purposes.

#### Conclusion

The more we study fermentation the more we are convinced that it is due not to a single factor but to a number of causes, chief of which are moisture and yeasts infection, and naturally conditions which affect yeast infection and moisture, will indirectly affect fermentation.



A comb of fermented honey. The honey in this comb was one year old and granulated. In this form fermentation may take place through absorption of water. The gas formed forces the granulation of cells to the surface of the combs as here shown. (See Honey, Granulation; also Honey Spoilage of.)

Thus crystallization, by altering the moisture relationship in the liquid portion, has an important bearing on fermentation, and if it were definitely preventable, many cases of spoilage in ripe honeys would be avoided. The problem of yeast growth in honey is indeed a many-sided one, and by increasing our knowledge of these micro-organisms in relation to their environment we hope thereby to aid towards a better control of the product which should react to the benefit of producer and consumer. (See Honey, Granulation of, and Honey, Spoilage of.)

#### Bibliography

A study of the Cause of Fermented Honey by Prof. F. W. Fabian, M. A. C., East Lansing, in July issue of *The Beekeeper* (Canadian) 1928. Work by Prof. H. F. Wilson and Geo. W. Marvin.

**YELLOW POPLAR.**—See Tulip Tree.

**YELLOW SWEET CLOVER.**—See Sweet Clover.

**ZINC, PERFORATED.** — See Drones.

**ZINC IN HONEY.**—It is probably known that zinc is the basic metal used in the construction of honey extractors and storage tanks. The question has been asked at different times if the use of this metal would have a deleterious effect upon honey. In former days it was believed that drinking water tanks should not be made of galvanized iron. It was finally determined that unless the water was to stand in the tank for a long period of time, there could be no possible danger. The same reasoning would not necessarily apply to honey because it contains a small amount of acid and the action of the acid might remove some of the zinc. Later research, however, showed there is no danger in the use of galvanized iron for water pipes, for honey extractors, or for honey tanks. In the first place honey remains in an extractor but a short time—just merely to strike the sides of a metal can and then to run down into a tin can where, of course, it would be perfectly safe. Galvanized tanks with a capacity of from 100 to 500 pounds of honey, held in storage for a year, will be safe also, we are assured.

Late work of Drs. H. A. Schuette

and Paul L. Zimmerman of the Department of Chemistry, University of Wisconsin, Madison, Wisconsin, shows that for the purpose of beekeeping, galvanized iron is perfectly safe. They have brought out the fact that practically all natural foods contain a small amount of zinc placed there by nature as an additional aid in nutrition. While analyses have shown a trace of zinc in all honey, the amount is so small that it can do no harm whatever. Even honey in the comb that has never come in contact with any metal contains a slight amount of zinc.

It has been shown, however, that honey which has come in contact with galvanized iron will contain slightly more of the zinc salts but the amount is so small as to be negligible. We quote from a paper by the above named authors, read before the Food Conference of the Institute of Food Technologists in Chicago in June 1940:

Inasmuch as honey normally has an acid reaction—the pH of the honeys used in this investigation were found to lie between 3.16 and 4.52—one may expect to find differences in the zinc content of honey sold in the familiar one-pound comb and that dispensed in bottles or tinned containers....

The occurrence of zinc in biological materials, either of plant or animal origin, is no longer a matter of conjecture. The pioneering investigations of Bertrand and Benzon (1922) were followed by those of McHargue (1926), Hubbell and Mendel (1927), Todd, Elvehjem, and Hart (1934), and Hove, Elvehjem, and Hart (1937). All of them indicate that zinc is not merely an accidental factor in nutrition. The evidence presented by those who have investigated this subject points to the view that traces of zinc are essential to normal growth and reproduction, normal growth of fur or hair, and normal intestinal absorption of nutrients....

Earlier investigators were of the opinion that zinc is extremely toxic and numerous cases of what were termed acute or chronic "zinc-poisoning" have been reported. The results of more recent investigations, however, seem to bear out the conclusion that zinc is toxic only in relatively large amounts.

The mere fact that honey takes up zinc during the extraction process is not necessarily a cause for concern unless, of course, the amounts reach toxic proportions. No such condition was found in this survey.

In later years a little lead has been added to the zinc, in galvanized plate metal, but not enough to modify the conclusions expressed above. It is safe to conclude, therefore, that the use of galvanized iron is perfectly safe for all purposes of bee culture where that metal is used.

In spite of the foregoing evidence, in these days in which foreign matter in foods is measured to parts per billion and many good hard "food approved" coatings are available we would strongly recommend that galvanized equipment be thoroughly cleaned, etched (if fairly new) and painted with such a coating. Your local paint store or bee supply dealer can get this for you if they don't have it in stock.

#### References

Bertrand, G., and Benzon, B., 1922. Sur l'importance du zinc dans l'alimentation des animaux. *Experiences sur la souris*. *Compt. rend. acad. d. sc.* 175, 289-292.

Caughey, R. A., Holland, E. G., and

Ritchie, W. S., 1938. Determination of small amounts of zinc in foods. *J. Assoc. Off. Agr. Chem.* 21, 204-207.

Drinker, C. K., and Fairhall, L. T., 1933. *U. S. Pub. Health Rept.* 48, 955-961.

Gorbach, G., and Windhaber, I., 1939. Die Bestimmung der Mineralbestandteile des Honigs mit Hilfe der Spektralanalyse. *Ztschr. f. Untersuch. Lebensm.* 77, 373-446.

Hove, E., Elvehjem, C. A., and Hart, E. B., 1937. Physiology of zinc in the nutrition of the rat. *Am. J. Physiol.* 110, 768-775.

Hubbell, R. B., and Mendel, L. B., 1927. Zinc and normal nutrition. *J. Biol. Chem.* 75, 567-586.

McHargue, J. S., 1926. Further evidence that copper, manganese, and zinc are factors in the metabolism of animals. *Am. J. Physiol.* 77, 445-455.

Todd, W. R., Elvehjem, C. A., and Hart, E. B., 1934. Zinc in the nutrition of the rat. *Am. J. Physiol.* 107, 146-156.

# Glossary

## A

- ABDOMEN.**—The posterior or third region of the body of the bee that encloses the honey stomach, stomach proper, intestines, sting and reproductive organs.
- ABSCONDING SWARM.**—Bees which leave their hive because of disease, lack of food or other unfavorable conditions.
- ABSORBENTS.**—Materials more or less porous placed on the hive to absorb moisture; chemicals used for repelling bees from supers of honey.
- ACARAPIS WOODI.**—The scientific name of the parasitic mite causing the Isle of Wight or Acarine disease.
- ACARINE DISEASE.**—A malady of adult bees caused by *Acarapis woodi* mites infesting and partially blocking their breathing passages.
- ACHROIA GRISELLA.**—The lesser wax moth, a minor pest of honey comb.
- ACID BOARD.**—A device for removing bees from full honey supers by the use of fumes. Propionic acid is currently recommended, generated by uniting Propionic Anhydride with water.
- ADANSONII BEE.**—*Apis Mellifera Adansonii*, an African bee which when crossed with native Brazilian stock produced a very prolific, aggressive and irritable bee.
- AFTERSWARMS.**—Swarms which leave a given colony with a virgin queen after a swarm of the same season has already left it.
- ALARM ODOR.**—A substance given off by guard bees to alert the colony of danger.
- ALBINO.**—A mutant bee which lacks normal pigmentation and appears white.
- ALIGHTING BOARD.**—The projection before the entrance to a hive to make it easier for bees to land.
- AMERICAN FOULBROOD.**—A contagious bacterial disease of bees which affects the larval and pre-pupal stages and is caused by *Bacillus larvae*.
- ANTENNA (plural, ANTENNAE).**—A pair of slender, jointed feelers extending from the head, which bear certain sense organs.
- ANTHER.**—In seed plants, the part of the stamen which develops and contains pollen.
- APHID.**—A plant louse which secretes a sweet liquid, termed honeydew, which the bees store.
- APIARIST.**—A beekeeper.
- APIARY.**—A collection of colonies of bees; also the yard or place where bees are kept. Bee yard.
- APICULTURE.**—The science and art of raising honeybees for man's economic benefit.
- APIS.**—The genus to which honeybees belong.
- APIS DORSATA.**—See "Giant Bees".
- APIS MELLIFERA.**—See "Honeybee".
- APIS MELLIFICA.**—See "Honeybee".
- ARTIFICIAL CELL CUP.**—See "Cell Cup".
- ARTIFICIAL INSEMINATION.**—The impregnation (mating) of virgin queens in confinement by the use of instruments.
- ARTIFICIAL PASTURAGE.**—Plants purposely cultivated for their nectar.
- ARTIFICIAL POLLEN.**—See "Pollen Substitute".
- ARTIFICIAL SWARM.**—A swarm made by dividing a colony of bees by brushing or shaking. See "Brushed Swarm", "Package Bees".
- ASH.**—The residue remaining after incineration. The mineral constituents of honey ash are iron, calcium, sodium, magnesium, sulphur, potassium, phosphorous, manga-

nese, etc. The total weight of honey ash is about 15/100 of 1 percent of the weight of the honey.

## B

- BABY NUCLEUS.**—A miniature hive containing 200 to 300 bees used for the mating of queens. It is distinguished from a regular nucleus in that it has miniature frames.
- BACILLUS LARVAE.**—The organism which causes American foulbrood.
- BALLING A QUEEN.**—When a queen is unacceptable, the bees cluster on her in a very tight ball, chewing and attempting to sting her. Occasionally a balled queen will survive but her performance is usually less than standard.
- BEE BREAD.**—The pollen of flowers gathered by the bees, mixed with honey, and deposited in the comb. See "Pollen".
- BEE BRUSH.**—A device for brushing bees from their combs.
- BEE CELLAR.**—An underground room used for storing colonies during cold winter months.
- BEE CULTURE.**—The care of bees.
- BEE DANCE.**—The worker bees in a normal colony perform various dance-like movements as a basis for communication. The best known bee dance was interpreted by Prof. Karl Von Frisch. In this dance, the bees indicate the direction, distance, and kind of food available to other bees of the hive.
- BEE ESCAPE.**—A device to remove bees from supers or buildings, so constructed as to allow bees to pass through in one direction but prevent their return. See "Comb Honey".
- BEE GLOVES.**—Gloves worn to protect the hands from stings and from becoming sticky with propolis.
- BEE GLUE.**—See "Propolis".
- BEE GUM.**—A colloquial term meaning "a hive of bees", usually a hollow log hive.
- BEEHIVE.**—A box or other contrivance for holding a colony of bees. See "Hives".
- BEE HOUSE.**—A building constructed to house colonies of bees, allowing them to fly and forage.
- BEE LINE.**—The shortest distance between two points; as the bee flies.
- BEE LOUSE.**—A commensal, found chiefly on queens, young bees, and drones. It is comparatively harmless. The bee louse (*Braula coeca*) belongs to the order of flies (Diptera) and to the family Braulidae. Only a single species is known. The larvae or young cause damage to comb honey by burrowing in the cappings.
- BEE METAMORPHOSES.**—Bees pass through three stages or complete metamorphosis before becoming perfect insects: first the egg, then the larva, and next the nymph. The following will serve to show how this is accomplished:

	Queen days	Worker days	Drone days
Incubation of the egg ...	3	3	3
Time of feeding the larva	5	5	6
Larva spinning cocoons ..	1	2	3
Resting period .....	2	3	4
Pass from larva to nymph	1	1	1
Time in the nymph state	3	7	7
Total period of growth	16	21	24
Hatching takes place on	4	4	4
Bee leaves its cell .....	16	21	24

**BEE MOTH.**—See "Wax Moth".

**BEE PARALYSIS.**—The inability of the adult bees to fly and work normally. A collective term accounting for a number of known and unknown diseases. One type of bee paralysis is known to be caused by a virus.

**BEE PASTURAGE.**—Plants and trees from which bees gather pollen and nectar.

**BEE PLANTS.**—Honey plants. Common plants which yield nectar available to honeybees in quantity sufficient to render them valuable in bee culture.

**BEE SPACE.**—An open space in which bees build no comb or deposit a minimum of propolis. It is a passage between combs or part of a hive of from  $\frac{1}{4}$  to  $\frac{3}{8}$  inch. Five-sixteenths is usually taken as average.

**BEE TENT.**—Tent of wire cloth or netting large enough to contain a hive and the operator, in which bees may be manipulated without being troubled by robbers. Also used in public demonstrations.

**BEE TREE.**—A hollow tree occupied by a colony of wild bees.

**BEE VEIL.**—A net veil for protecting the head from the attack of bees.

**BEE VENOM.**—The poison secreted by special glands attached to the sting of the bee.

**BEE YARD.**—See "Apiary".

**BEESWAX.**—The wax secreted by honeybees from eight glands within the ventral abdominal segments and used in building their combs. It is composed of variable quantities of cerotic acid and palmitic acid. Bees may consume from 8 to 20 pounds of honey to secrete one pound of beeswax.

**BEEWAY SECTIONS.**—Sections having insets at the edges so as to make passages for the bees when the sections are properly placed in the super.

**BLACK BEES.**—Brown bees. German bees. They are less gentle, less prolific, and do not resist brood disease as well as Italian bees. The German bee was introduced into New England in 1638.

**BOTTOM BOARD.**—The floor of a beehive.

**BOX HIVE.**—A plain box used for housing a colony of bees. Illegal in many states because it does not have movable frames.

**BRACE COMB.**—The terms "brace comb" and "burr comb" are often used indiscriminately as meaning the same thing. More exactly, a brace comb is a bit of comb built between two combs to fasten them together, or between a comb and adjacent wood, or between two wooden parts, as between two top bars; while a burr comb is a bit of wax built upon a comb, or upon a wooden part in a hive, but not connected to any other part.

**BRAULA COECA.**—See "Bee Louse".

**BREATHING PORES.**—See "Spiracles".

**BRIMSTONING.**—The operation of killing a colony of bees with sulphur fumes. See "Box Hive".

**BROOD.**—Young developing bees in the egg larval and pupa state not yet emerged from their cells.

**BROOD CHAMBERS.**—That part of the hive in which the brood is reared and stores are maintained for the survival of the colony.

**BROOD COMB.**—One of the combs in the brood chamber. See "Brood" and "Combs".

**BROOD NEST.**—That part of the brood chamber occupied by the various stages of developing brood.

**BROOD REARING.**—Raising bees from the egg to the adult.

**BRUSHED SWARM.**—An artificial swarm made by brushing or shaking part or all of the bees of a colony into an empty hive, thus anticipating and preventing a natural swarm. See "Package Bees".

**BUMBLEBEE.**—A large hairy social bee of the genus *Bombus*; humblebee.

**BURR COMB.**—See "Brace Comb".

## C

**CANDIED HONEY.**—See "Granulated Honey".

**CAP.**—(n) The covering which closes cells containing brood or honey; the capping; the sealing. (v) To cover a cell with a capping; to seal.

**CAPPED BROOD.**—See "Sealed Brood".

**CAPPED HONEY.**—Combs of honey in which the bees have closed the end of each cell with a thin layer of wax. Also sealed honey.

**CARNIOLAN BEES.**—A grayish-black race of very gentle bees from Carniola, Austria. They gather a very small quantity of propolis, but tend to swarm more than other races.

**CAST.**—A second swarm having a virgin queen. Also applied to any swarm after the first and after-swarm.

**CAUCASIAN BEES.**—A gentle race of black or dark-colored bees introduced into America from the Caucasus. They are inclined to propolize heavily.

**CELL.**—One of the hexagonal compartments of a honeycomb. Worker cells are approximately five per linear inch, drone cells about four per inch.

**CELL CUP.**—A queen cell when it is only about as deep as it is wide. Artificial cell cups are made as well as natural. See "Queen Rearing".

**CELL PROTECTOR.**—A receptacle made of wire cloth, or of spirally wound wire, which protects the sides of a queen cell from the attacks of bees, but leaves the apex of the cell uncovered.

**CHILLED BROOD.**—Immature bees that have died from being too cold, frequently due to mismanagement on the part of the beekeeper.

**CHORION.**—The membrane or shell covering the egg.

**CHRYSLIS.**—See "Pupa", the more usual name.

**CHUNK COMB HONEY.**—A type of honey pack containing one or more pieces of comb honey covered with liquid honey in the same container.

**CLARIFYING.**—The removal of foreign particles from liquid honey or wax by the straining, filtering, or settling process.

**CLEANSING FLIGHT.**—The flight of the bees from the hive after long confinement, as in the spring, when they void their feces in the air.

**CLIPPED QUEEN.**—A queen with a portion of her wings removed to prevent her flight.

**CLUSTER.**—The hanging together of a large group of bees one upon another, e.g. a cluster of swarming bees. See "Winter Cluster".

**COLONY.**—A community of bees having a queen, some thousands of workers, and during part of the year a number of drones; the bees that live together as one family in a hive.

**COLOR COMPARATOR.**—A device used for grading the color of honey; water white, extra white, white, extra light amber, light amber, and amber. See "Pfund Grader".

**COMB.**—See "Honeycomb".

**COMB BASKET.**—That part of a honey extractor in which the combs are held. See "Honey Extractor".

**COMB CARRIER.**—A receptacle in which one or more combs may be placed and covered, so as to be easily carried, and protected from robbers.

**COMB FOUNDATION.**—Thin sheets of beeswax embossed to form a base on which the bees will construct a complete comb of worker cells.

**COMB FOUNDATION MACHINE.**—A machine for embossing smooth sheets of wax.

**COMB HONEY.**—Honey in the comb.

**COMMERCIAL BEEKEEPER.**—One who derives most of his income from apicultural endeavors.



**CORN SYRUP.**—Mixture of dextrin, maltose, dextrose and water in nearly equal parts, formed by hydrolysis of cornstarch. Not suitable for bee feed.

**CROSS.**—When races of bees are bred together the resulting progeny is called a cross, eg. cross breed.

**CROSS POLLINATION.**—The transfer of pollen from an anther of one plant to the stigma of a different plant of the same species.

**CRYSTALLIZATION.**—See "Granulated Honey".

**CUT-COMB HONEY.**—Comb honey cut into various sizes, the edges drained and the pieces wrapped or packed individually.

**CYANOGAS.**—Calcium cyanide; used for destroying diseased colonies and fumigating combs. Very toxic to humans.

**CYPRIAN BEES.**—A race of bees native to the island of Cyprus. They resemble Italian bees but are smaller.

## D

**DECOY HIVE.**—A hive placed with the object of attracting passing swarms. Usually a hive that previously had bees in it with drawn combs.

**DEMAREE.**—The beekeeper who devised a method of swarm control which became quite popular; also used as a verb "to demaree". It consists of separating the queen from most of the brood.

**DEQUEEN.**—To take the queen from a colony of bees; to unqueen.

**DEXTRIN.**—A soluble gummy carbohydrate. Honeydew is usually high in dextrin and is unsuitable for winter bee food as the bees are unable to digest dextrin.

**DEXTROSE.**—One of the two principal sugars found in honey. Known also as grape sugar. In granulated honey it forms most of the solid phase.

**DIASTASE.**—An enzyme which helps to convert starch to sugar.

**DIVIDING.**—Separating a colony in a manner to produce two or more colonies. See "Artificial Swarming".

**DIVISION BOARD.**—Any device designed to separate two parts of a hive making two separate units.

**DIVISION BOARD FEEDER.**—A wooden compartment or trough which is hung in a hive like a frame and contains a solution of syrup to feed bees.

**DOVETAILED HIVE.**—A hive having interlocked corners after the manner of lock-cornering. This type of construction gives the hive greater strength.

**DRAWN COMBS.**—Completed brood or honey comb.

**DRIFTING OF BEES.**—Bees do not always return to their own hive in an apiary containing many colonies. This is referred to as drifting. Young bees tend to drift more than older bees and bees from small colonies tend to drift into larger colonies.

**DRONE.**—Male bee.

**DRONE BROOD.**—Brood which matures into drones, reared in larger cells than worker bees and normally from infertile eggs.

**DRONE COMB.**—Comb having cells measuring about four to the inch. Drones are reared in drone comb; also honey is stored in it, but not often pollen. Drone comb has about 18½ cells to the square inch on each side.

**DRONE EGG.**—The egg from which a drone hatches—an unimpregnated egg.

**DRONE LAYER.**—A queen that can lay only infertile eggs which develop into drones.

**DRONE TRAP.**—See "Queen Trap".

**DRUMMING.**—Pounding on the sides of a hive to make the bees ascend into another hive placed over it. In England it is called "driving".

**DUMMY.**—A thin board of the same size as a frame, or a little smaller, having a top-bar nailed on top.

**DWINDLING.**—The rapid dying off of old bees in the spring. Sometimes called "spring dwindling".

**DYSENTERY.**—The discharge of fecal matter by the bees within the hive. Many conditions may contribute to this disease: starvation, low quality food, moist surroundings or nosema infection.

**DZIERZON THEORY.**—The theory that honeybees are parthenogenic. See "Parthenogenesis".

## E

**EMBED.**—To force wire into comb foundation by heat, pressure or both for the purpose of strengthening the resulting comb.

**EMERGING BROOD.**—Young bees in the act of gnawing their way out of their brood cells.

**ENTRANCE.**—Any opening in the hive permitting the passage of bees. Standard hives have a bottom board entrance and may have other smaller openings above, such as auger holes.

**ENTRANCE REDUCER.**—A notched wooden strip for regulating the size of the bottom board entrance.

**ENZYMES.**—A catalyst produced by both plants and animals, including the honeybee, essential to or which hastens the chemical reactions in metabolic processes. See "Diastase" and "Invertase".

**ESCAPE.**—A device which allows bees to pass through an exit one way only. Used for removing bees from filled supers. See "Bee Escape".

**ESCAPE BOARD.**—A board having one or more bee escapes in it, used to remove bees from supers.

**EUROPEAN FOULBROOD.**—An infectious larval disease of bees caused by *Streptococcus pluvion*. See "Foulbrood".

**EXCLUDER.**—See "Queen Excluder".

**EXTRACTED HONEY.**—Honey that has been removed from the comb by an extractor.

**EXTRACTING.**—The act of taking honey from the combs by means of a centrifugal extractor.

**EXTRACTOR.**—A machine for removing honey from the comb, consisting of a round can in which is mounted a revolving reel carrying a set of combs from which the cappings have been removed. The honey is thrown out by centrifugal force without destroying the combs.

## F

**FDN.**—An abbreviation for the words "comb foundation".

**FECES.**—Excreta of bees.

**FECUNDATE.**—To impregnate. The queen is fecundated upon copulation with a drone, and is then capable of laying eggs that will produce workers or queens.

**FEEDERS.**—Appliances for feeding bees sugar syrup.

**FENCE.**—A separator placed between rows of comb honey sections which allows the bees to pass from one row of sections to the other, but forces them to build straight, even combs.

**FERMENTATION.**—A chemical breakdown of honey caused by sugar tolerant yeasts. Associated with honey having a high moisture content.

**FERTILE.**—A fertile queen is one that has mated with a drone and has a supply of spermatozoa in her spermatheca.

**FERTILIZE.**—A queen's eggs that are to produce workers or queens are impregnated on their outward passage by receiving one or more of the spermatozoa contained in the spermatheca of the queen. Drone eggs are unfertilized.

**FIELD BEES.**—When worker bees become about 16 days old, they begin the work of flying abroad to collect nectar, pollen, water and propolis and are then called field bees.

**FLASH HEATER.**—A device for heating and cooling honey very rapidly to prevent it from being damaged by sustained periods of high temperature.

**FOLLOWER BOARD.**—A piece of wood cut in the shape of a frame with comb in it which replaces one of the outer frames and encourages the bees to work in the combs next to the super wall.

**FONDANT.**—A soft bee candy used for feeding bees in winter or for queen or shipping cages; usually made from a syrup of table sugar and water changed into invert sugar by the addition of a small amount of tartaric acid. Enough powdered sugar is added to make a heavy dough. See "Queen Candy".

**FOOD CHAMBER.**—A hive body filled with honey for winter stores.

**FOULBROOD.**—A malignant contagious disease of bees affecting the brood. The foulbrood diseases of major concern are: American foulbrood caused by *Bacillus larvae*, and European foulbrood caused by *Streptococcus pluton*. Two other brood diseases include Sacbrood caused by a filterable virus and Para foulbrood caused by *Bacillus para-alvei*.

**FOUNDATION.**—See "Comb Foundation".

**FOUNDATION FASTENER.**—A device for fastening foundation in brood frames or sections. There are several different patterns of them.

**FRAME.**—Four pieces of wood joined at the end to form a rectangular device for holding honey comb. It consists of one top bar with shoulders, one bottom bar and two end bars. A series of frames are held a bee space apart in a vertical position in a hive invented by Langstroth in 1851.

**FRUCTOSE.**—See "Levulose".

**FUMAGILLIN.**—An antibiotic used in the elimination of *Nosema apis*.

**FUMÉ CHAMBER.**—A device for regulating the distribution of volatile chemical repellents to drive bees from combs.

**FUMIGATE.**—To submit beekeeping equipment to the fumes of a toxic chemical for the purpose of destroying developing wax moths or other pests. Bees are sometimes killed by fumigation.

## G

**GALLERIA MELLONELLA.**—The scientific name of the greater wax moth.

**GIANT BEES, APIS DORSATA.**—Native of India. The largest honeybees in the world. They build huge combs in the open air, often from five to six feet in length and from three to four feet in width, which they attach to overhanging ledges of rock or to large limbs of trees. During periods of dearth they migrate to more favorable locations. Not capable of domestication.

**GLUCOSE.**—A synonym for dextrose, q. v.

**GOLDEN BEES, or GOLDENS.**—Italian bees in which the workers show four to six bright yellow bands on their upper abdomens.

**GRAFTING.**—The process of transferring newly hatched worker larvae from its brood comb into special queen cups used for queen rearing.

**GRAFTING TOOL.**—A needle or probe used for transferring the larva in grafting.

**GRANULATED HONEY.**—Honey that has crystallized or candied and has changed from a liquid to a solid.

**GREEN HONEY.**—See "Unripe Honey".

**GUM.**—A hollow log beehive often from a gum tree.

**GYNANDROMORPH.**—Bees having characteristics common to both sexes, as a worker head, and drone thorax and abdomen, or the reverse; or one-half of the head is that of a worker and the other half that of a drone.

## H

**HALF-DEPTH SUPERS.**—A super, half the depth of a Standard 8, 10, or 12-frame Langstroth super. See "Shallow Super".

**HIVE.**—1. (n) Home for bees furnished by man. The modern hive includes a bottom board, cover, and one or more boxes, stacked one above the other. Inside each box or hive body is a series of movable frames of comb or foundation held in a vertical position a bee space apart. 2. (v) To put a swarm in a hive or to induce it to enter a hive.

**HIVE TOOL.**—A metal tool with a scraping surface at one end and a flat blade at the other, used to open hives, pry frames apart, clean the hive, etc.

**HOBBYIST BEEKEEPER.**—One who keeps bees for pleasure without any intent to profit.

**HOFFMAN FRAMES.**—Self-spacing frames having end bars wide enough at the top to provide the proper spacing when the frames are placed in contact.

**HONEY.**—A sweet viscid material produced by bees out of the nectar of flowers, composed largely of a mixture of the two sugars, dextrose and levulose, dissolved in about 17 per cent water. It also contains small amounts of sucrose, mineral matter, vitamins, protein, enzymes, etc.

**HONEYBEE.**—A social honey producing bee of the class Insecta, order Hymenoptera, superfamily Apoidea and family Apidae. In 1758 Linnaeus named the honeybee *Apis mellifera* (honey-bearer), and three years later (1761) changed the name to *Apis mellifica* (honey-maker). The American Entomological Society has ruled the former will be the correct scientific name for the honeybee. Races or varieties of the domestic bee are also distinguished by the names of the geographical localities in which they occur and from which they have been exported, as Italian, Carniolan, Syrian, Cyprian, Banat, Caucasian and Tunisian.

**HONEYCOMB.**—The mass of hexagonal cells of wax built by honeybees in which they rear their young and store honey and pollen. The cells are built back to back with a common wall. See "Drone Comb", "Worker Comb".

**HONEYDEW.**—A sweet liquid excreted by plant lice and scale insects.

**HONEY EVAPORATOR.**—A machine for removing water from honey.

**HONEY EXTRACTOR.**—See "Extractor".

**HONEY FLOW.**—A time when nectar is plentiful and bees produce and store surplus honey.

**HONEY GATE.**—A faucet used for drawing honey from drums, cans or extractors.

**HONEY HOUSE.**—A building used for honey extraction, storage, etc.

**HONEY KNIFE.**—See "Uncapping Knife".

**HONEY PUMP.**—A device operating on the rotary principle for elevating or moving honey from a honey extractor or tank into another tank.

**HONEY STOMACH.**—Honey sac. An enlargement of the posterior end of the esophagus lying in the front part of the abdomen, the function of which is to hold the nectar gathered by bees from flowers. The walls are very distensible.

**HONEY SUMP.**—A baffle or clarifying tank into which honey from the extractor, uncapping knife and uncapped combs runs by gravity. It is of value in removing pieces of broken comb and particles of wax from the honey.

**HOUSE APIARY.**—See "Bee House".

**HYBRIDS.**—The offspring resulting from a cross between different races, varieties, selections, and occasionally species of bees, as between black and Italian bees.

**HYMENOPTERA.**—The insect order to which honeybees belong. Ants and wasps are also members of this order.

## I

- IMBEDDING TOOL.**—A device for sinking the wire of the frame into the sheet of comb foundation. See "Wired Frames".
- INCREASE.**—To start new colonies with the purpose of adding to the total number of colonies, by dividing established colonies, installing package bees, or hiving natural swarms.
- INTRODUCING.**—See "Queen Introduction".
- INTRODUCING CAGE.**—A small box of wire and wood used for transporting and introducing queens.
- INVERT SUGAR.**—A mixture of equal parts of the two sugars, dextrose and levulose, with or without water. Invert sugar is made from sucrose (cane or beet sugar) by heating with a trace of acid. It superficially resembles honey, q.v.
- INVERTASE.**—An enzyme which speeds the inversion of sucrose to dextrose and levulose.
- ITALIAN BEES.**—The most common race of bees for honey production. They were first successfully introduced into this country about 1860. The first three dorsal segments of the abdomen are banded with yellow. There are also four and five banded strains.
- ITALIANIZE.**—To change a colony of any other race to Italians by introducing an Italian queen.

## J

- JUMBO FRAME.**—A frame 17½" long, 11¼" in depth.
- JUMBO HIVE.**—A regular standard Langstroth hive having Quinby depth but otherwise regular Langstroth dimensions. It is 2½" deeper than the regular standard Langstroth. It uses the same covers, bottoms and supers as the standard hive.

## L

- LANGSTROTH FRAME.**—Most common frame, measuring 17½" long and 9½" deep; also referred to as the Standard frame.
- LANGSTROTH HIVE.**—A hive having frames 17½" by 9½". In one sense, any movable frame hive is a Langstroth hive, since Langstroth invented the movable frame hive.
- LARVA (plural LARVAE).**—A developing bee in the worm stage; unsealed brood. Second stage of bee metamorphosis.
- LAYING WORKER.**—A worker which lays eggs, such eggs producing only drones. Laying workers appear in colonies that are hopelessly queenless.
- LEGUME.**—A species of the Leguminosae, or pulse family, is often called a legume. The name of the fruit of this family, which is a two-valved pod with the seeds borne on the ventral suture only, such as clover, alfalfa, beans and peas.
- LEVULOSE.**—One of the five important sugars. It occurs in all fruits except the grape and is the predominant carbohydrate in honey. It is known also as fruit sugar or fructose.
- LIGURIAN BEE.**—Italian bee, named for the district in which the Italian bees originated.
- LINING BEES.**—Watching the direction of the flight of bees to trace them to their home. An old art used by bee tree hunters.

## M

- MANDIBLES.**—The jaws of an insect. In the honeybee and most insects the mandibles move in a horizontal rather than in a vertical plane.
- MATING FLIGHT.**—The flight taken by a virgin queen during which she mates in the air with one or more drones. Normal queens mate 6 to 8 times with usually 2 or more mating flights.
- MEAD.**—Honey wine.
- MEDIUM BROOD FOUNDATION.**—Comb foundation running about 8 standard sheets to the pound. See "Comb Foundation".
- MELIPONA.**—A genus of stingless bees native to South and Central America. They bite viciously but do not sting.

- METAMORPHOSIS.**—The developing process of a honeybee in four stages: egg, larva, pupa, and adult called a complete metamorphosis. See "Bee Metamorphosis".
- METHYL BROMIDE.**—A fumigant used to protect stored combs from wax moth and other pest damage.
- MIGRATORY BEEKEEPING.**—The moving of colonies of bees from one locality to another during a single season to take advantage of the honey flow in another location.
- MITE.**—See "Acarapis Woodi".
- MOVABLE FRAME.**—A frame of comb which can be easily removed from the hive because it is so constructed to maintain a proper bee space with all other surrounding surfaces to prevent the bees from attaching comb or fastening it too securely with propolis.

## N

- NATURAL SWARM.**—A swarm of bees issuing spontaneously from a parent hive to form a new colony. The old queen leaves with the swarm a few days before virgin queens emerge and fight among each other for the right to carry on the reproductive process for the old colony.
- NECTAR.**—A sweet liquid secreted by nectaries located chiefly in flowers and on leaves of plants.
- NECTARIES.**—Organs of a plant composed of specialized tissue, which secrete nectar.
- NOSEMA DISEASE.**—A malady of adult bees caused by a protozoan parasite, *Nosema apis*, which infects the mid-gut.
- NUCLEUS (plural NUCLEI).**—A small hive of bees, usually covering from two to five frames of comb. Nucs as they are sometimes called are used primarily for rearing or storing queens.
- NURSE BEES.**—Young worker bees that feed the larvae and do other work inside the hive. They are generally three to ten days old.

## O

- OBSERVATION HIVE.**—A hive largely of glass or clear plastic to permit observing the bees at work.
- OCELLUS (plural OCELLI).**—One of the three simple eyes of the honeybee.
- OUTAPIARY.**—An apiary kept at some distance (generally more than a mile) from the home of the beekeeper.
- OVERSTOCKING.**—A condition reached when there are too many bees for a given locality.

## P

- PACKAGE BEES or COMBLESS PACKAGE.**—From two to five pounds of adult bees, with or without a queen, contained in a ventilated shipping case.
- PARAFOULBROOD.**—A relatively rare brood disease caused by *Bacillus para-alevi* and having many characteristics of European and American foulbrood.
- PARALYSIS.**—See "Bee Paralysis".
- PARENT STOCK.**—The original colony that has cast a swarm.
- PARTHENOGENESIS.**—Production of a new individual from a virgin female without intervention of a male; reproduction by means of unfertilized eggs. In bees the unfertilized eggs produce only males. An unfecundated queen, and sometimes a worker, may lay eggs that will hatch, producing drones.
- PDB.**—Paradichlorobenzene; a white crystalline substance that changes into a heavy gas, used to fumigate combs.
- PERFORATED ZINC.**—See "Excluder".
- PFFUND GRADER.**—An instrument used for measuring the color grades of honey. See "Color Comparator".

- PHEROMONE.**—A substance secreted by insects which when sensed or ingested by other individuals of the same species causes them to respond by a definite behavior or developmental process. (See queen substance.)
- PIPING.**—A series of sounds made by a queen, louder than any sound made by a worker, consisting of a loud, shrill tone, succeeded by several others, each sound shorter than the one that precedes it. A laying queen is seldom heard to pipe; a virgin perhaps always pipes at intervals after emerging from her cell, and in response to her piping may be heard the "quahking" of one or several virgins in their cells, if such are in the hive, the "quahking" being uttered in a lower key and in a more hurried manner than the piping.
- PISTIL.**—The ovule-bearing organ of a seed plant. After fertilization, the ovules become the seeds.
- PLAIN SECTIONS.**—Comb honey sections with no insets or scalloped edges.
- PLAY FLIGHT.**—Short flights taken in front of the hive and in its vicinity to acquaint the young bees with their immediate surroundings. Sometimes mistaken for robbing or preparation for swarming.
- POLARISCOPE.**—An optical instrument much used in sugar and honey laboratories for measuring the quantity of or differentiating between the various sugars.
- POLLEN.**—Dust-like grains formed in the anthers of flowering plants within which are produced the male elements or sperm. The protein food essential to bees for the raising of brood.
- POLLEN BASKET.**—A flattened depression surrounded by curved spines or hairs located on the outer surface of the bees hind legs adapted for carrying pollen gathered from the flowers to the hive.
- POLLEN CAKE.**—A cake of pollen substitute or pollen supplement.
- POLLEN INSERT.**—A device placed in the entrance of a colony into which hand collected pollen is placed. As the bees leave the hive they have to pass through the insert and some of the pollen adheres to their bodies and is carried to the blossoms resulting in cross pollination.
- POLLEN SUBSTITUTE.**—Material such as brewers' yeast, powdered skim milk, or soybean flour, or a mixture of these used in place of pollen to stimulate brood rearing.
- POLLEN SUPPLEMENT.**—A mixture of natural pollen and pollen substitute materials. See "Pollen Substitute".
- POLLEN TRAP.**—A device for collecting pollen by removing it from incoming field bees.
- POLLINATION.**—The transfer of pollen from an anther to a stigma of a flower.
- POLLINATOR.**—The agent that transmits the pollen for pollination.
- POLLINIZER.**—The plant that furnishes pollen for pollination.
- PROBOSCIS.**—The tongue or combined maxillae and labium of the bees.
- PROPOLIS.**—A kind of glue or resin collected by the bees and chiefly used to close up cracks and anchor hive parts. Also called "bee glue".
- PUPA.**—The third stage of a developing bee, during which it is inactive and sealed in its cell. See "Metamorphosis".
- Q**
- QUEEN.**—A fully developed female bee; the mother bee.
- QUEENING.**—See "Requeening".
- QUEENLESS.**—Having no queen.
- QUEENRIGHT.**—Having a laying queen.
- QUEEN CAGE.**—A small box of wire and wood in which queens are shipped and introduced to new colonies. Also introducing cage.
- QUEEN CANDY.**—Candy made by kneading powdered sugar into invert sugar syrup until it forms a stiff dough; used as feed in queen cages. See "Queen Introduction".
- QUEEN CELL.**—A cell in which a queen is reared, having an inside diameter of about  $\frac{1}{3}$ ", hanging downward an inch or more in length.
- QUEEN CUP.**—See "Cell Cup".
- QUEEN EXCLUDER.**—Any device having openings permitting the passage of worker bees but excluding the passage of larger drone and queen bees. 0.163" to 0.167".
- QUEEN INTRODUCTION.**—Giving a strange queen to a queenless colony of bees. Unless certain precautions are taken, a colony is apt to kill a queen to which they are not accustomed. The introduction is usually accomplished by placing the queen in an introducing cage plugged at one end by queen candy and then setting the caged queen in the midst of the strange bees. After several days the bees eat away the candy and liberate the queen.
- QUEEN REARING.**—Raising queens.
- QUEEN SUBSTANCE.**—A secretion from glands in the head of a queen which the attendant worker bees collect and pass on to the rest of the colony. The theory of queen substance is that any time the queen's supply of the secretion is not adequate or ceases entirely the colony will be motivated to supersede its queen.
- QUEEN TRAP.**—A device provided with perforated zinc, or wire bars, to be attached to the entrance of a hive, allowing workers to pass, but stopping any queen or drone that attempts to leave. Also called "drone trap".
- R**
- RABBIT.**—A ridge in the upper inside edge of a hive. 2. A narrow piece of sheet metal folded in a manner to form a rest for the bottom ends of the top bars of the hanging frames in a hive.
- REFRACTOMETER.**—A precision instrument for determining the moisture content of honey.
- RENDERING WAX.**—The process of melting combs and cappings to separate the wax from its impurities, usually done by means of hot water or a solar wax extractor.
- REQUEENING.**—The act of introducing a queen to a queenless colony of bees.
- RIPE HONEY.**—Honey left in the care of the bees until it contains 18.6 percent of water or less and has undergone the complete change from nectar to honey. Usually capped honey.
- ROBBING.**—As applied to bees, the taking of honey by stealth or force from the hives of other colonies.
- ROYAL JELLY.**—A milky white finely granular jelly secreted from the pharyngeal glands of nurse bees, used to feed developing queen larvae.
- S**
- SACBROOD.**—A disease of brood. Slightly contagious but not serious. Caused by a virus.
- SEALED BROOD.**—Brood that has been capped or sealed in the brood cells by the bees with a somewhat porous capping; mostly in the pupa stage.
- SECTION.**—A small basswood frame that is placed on a hive to receive surplus comb honey; a section box. Also, the honey contained in a section box. The three most popular sizes are:  $4\frac{1}{4} \times 4\frac{1}{4} \times 1\frac{1}{2}$ ",  $4\frac{1}{4} \times 4\frac{1}{4} \times 1\frac{1}{2}$ ", and  $4 \times 5 \times 1\frac{1}{2}$ ". The walls of a section are only  $\frac{1}{8}$ " thick.
- SECTION HOLDER.**—A device for holding sections while in process of being filled on the hive.
- SELF POLLINATION.**—To transfer pollen from the male to the female parts of the same plant.
- SELF-SPACING FRAMES.**—Frames so made that, pushed together, they will be the proper bee space apart.
- SEPARATOR.**—A very thin board or sheet of tin placed between sections to make the bees build the combs accurately.

**SEPTICEMIA.**—A blood disease of adult honeybees. It is not a major disease but is very damaging to the affected colony. It is caused by *Bacillus apisepcticus*.

**SEPTUM.**—The center wall of a honey comb. The part that was foundation.

**SHAKING BEES.**—Removing bees from combs by jarring the frame or the super.

**SHALLOW SUPER.**—A super which is less than the Standard 9  $\frac{3}{8}$ " deep; supers which take frames 4  $\frac{1}{2}$ ", 5  $\frac{3}{8}$ ", or 6  $\frac{1}{4}$ " in depth.

**SHIPPING CAGE.**—A container made of wood and screen used for shipping bees. See "Package Bees", "Queen Cage".

**SIDELINE BEEKEEPER.**—One who keeps bees for monetary gain but derives less than half of his income from apiculture.

**SKEP.**—A beehive without movable frames, made of straw.

**SLUMGUM.**—The refuse left after old combs have been rendered. Mostly brood cocoons, pollen etc.

**SMOKER.**—A device which burns special fuels to generate smoke for the purpose of subduing bees during colony manipulation.

**SOLAR WAX EXTRACTOR.**—A glass-covered box for rendering beeswax by the heat of the sun.

**SPECIFIC GRAVITY.**—The ratio of the weight of a substance compared with an equal volume of water. The specific gravity of honey is 1.4 (Baume scale 42 degrees). In plain English, honey weighs approximately 11  $\frac{3}{4}$  pounds per gallon. Beeswax has a specific gravity of .97. Water 1.00.

**SPERMATHECA.**—A small sac attached to the oviduct of the queen, in which are stored the spermatozoa received from the drones with which she mated.

**SPERMATOZOA.**—The male reproductive cells which fertilize the eggs.

**SPIRACLES.**—A system of internal tubes, known as tracheae, which branch minutely to all parts of the organism. The external openings of the tracheae, located on the sides of the thorax and abdomen, are called spiracles.

**SPREADING BROOD.**—Putting a comb without brood between two combs of brood to induce the queen to lay in the former.

**STAMENS.**—The pollen producing organs of flowers.

**STARTER.**—1. A small piece of comb or foundation fastened in a frame or section to start the bees building at the right place.  
2. Finely crystallized honey used to seed liquid honey which then granulates in very fine crystals.

**STEAM HONEY KNIFE.**—See "Uncapping Knife".

**STIGMA.**—That part of the pistil of a flower which receives the pollen for the fecundation of the ovules; the end of the pistil.

**STING.**—The queen and worker bees' weapon of offense. It is an ovipositor modified to form a piercing shaft through which a painful organic secretion is injected into the wound.

**STREPTOCOCCUS PLUTON.**—The bacteria that causes European foulbrood.

**SUCROSE.**—One of the five important sugars. Refined white table sugar, either cane or beet, is pure sucrose. An integral part of nectar.

**SUGAR.**—The term sugar generally refers to sucrose, which is the sole constituent of refined white sugar, cane or beet. However, there are four other important food sugars, classified as follows:

Name	Synonyms	Where Found
1. Sucrose	Saccharose "Sugar"	Cane or beet sugar or maple sugar.
2. Lactose	Milk sugar	All milk.
3. Maltose	Malt sugar	Malt products and corn syrup or com'l glucose.
4. Dextrose	Glucose Grape sugar	Honey, invert sugar, com'l glucose or corn syrup, fruits.

5. Levulose Fructose Honey, invert sugar, Fruit sugar ar, fruits.

**SUPER.**—n. A receptacle in which bees store surplus honey; so called because it is placed "over" or above the brood chamber. v.i. To add supers in expectation of a honey flow.

**SUPERSEDURE.**—The natural replacement of an established queen by a daughter queen.

**SURPLUS or SURPLUS HONEY.**—Honey over and above what the bees need for their own use, and which the beekeeper takes from them.

**SWARM.**—The aggregate of worker bees, drones and queen that leave the mother colony to establish a new colony. Swarming is the natural method of propagation of the honeybee colony.

**SWARMING SEASON.**—The period of the year when swarms usually issue.

## T

**TARSUS.**—The 5 terminal segments of a bee's leg.

**TESTED QUEEN.**—A queen whose progeny show she has mated with a drone of her own race and has other qualities which would make her a good colony mother.

**THIN SUPER FOUNDATION.**—Comb foundation running about 12 square feet to the pound. Used in the production of comb honey.

**THIXOTROPIC.**—A peculiarity of heather and some other honeys. The honey jells in the comb but on being agitated it becomes fluid.

**THORAX.**—The middle part of a bee between the head and abdomen, to which the wings and legs are attached.

**TRACHEAE.**—The breathing tubes of an insect which open into the spiracles. See "Spiracles".

**TRANSFERRING.**—The process of changing bees and combs from common boxes to movable frame hives.

**TRANSITION CELL.**—A comb cell with an irregular shape, usually not hexagonal.

**TRAVEL STAIN.**—The darkened appearance upon the surface of comb honey when left on the hive for some time. Caused by bees tracking propolis over the surface as they walk over the comb.

**T-SUPER.**—A comb honey super with T-shaped strips supporting the sections to provide more space for bee travel.

## U

**UNCAPPING KNIFE.**—An implement with a sharp blade usually heated by steam, hot water or electricity to remove the cappings from combs before extracting.

**UNCAPPING PLANE.**—A device resembling a safety razor for removing cappings from combs of honey before extracting. See "Uncapping Knife".

**UNITING.**—The combining of two or more colonies to form one large colony. Usually special precautions must be taken to minimize fighting among the strange colonies as they are united.

**UNRIPE HONEY.**—Honey that is not ripe. See "Ripe Honey".

**UNSEALED BROOD.**—Brood not yet sealed over by the bees. In a general way eggs are often included with larvae under the term "unsealed brood". See "Sealed Brood".

## V

**VIRGIN QUEEN.**—An unmated queen.

**VISCOSITY.**—The property of liquid honey that causes it to flow slowly. As honey is cooled it becomes more viscous and its rate of flow decreases.

## W

**WAX EXTRACTOR.**—An appliance for rendering wax by heat, or by heat and pressure.

**WAX GLANDS.**—The eight glands of a honey-bee which secrete beeswax. They are located in pairs on the last four visible ventral abdominal segments.

**WAX MOTH.**—A moth whose larvae destroy honey combs by boring through the wax.

**WAX PRESS.**—A press in which the wax is squeezed out of heated combs.

**WAX TUBE FASTENER.**—A tube for applying a fine stream of melted wax along the edge of a sheet of foundation to cement it to the top bar of a brood frame or the top of a section.

**WHEAST.**—A dried yeast that is grown in cottage cheese whey. It contains 57% protein. Fed to bees as a pollen substitute either as a dry mixture or as a moist patty.

**WILD BEES.**—Bees living in hollow trees or other abodes not prepared for them by man. Strictly speaking, they are no wilder than bees in hives. Also bees other than honeybees.

**WINDBREAKS.**—Either specially constructed fences or barriers composed of growing trees to reduce the force of the wind.

**WINTER CLUSTER.**—The tightly knit pattern that bees assume during the cold winter months.

**WINTERING.**—The care of bees during winter and in preparation for winter to insure their survival.

**WIRED FOUNDATION.**—Comb foundation which has wires embedded vertically during manufacture for the purpose of preventing the finished comb from sagging in hot weather.

**WIRED FRAMES.**—These are brood frames having wires stretched across them, either vertically or horizontally, for the purpose of holding the comb foundation, and later the comb, solidly in position.

**WIRING FRAMES.**—The act of stringing wires through holes in frames to hold foundation in place.

**WORKER BEE.**—A female bee whose organs of reproduction are undeveloped; well named "worker" because workers do all the work of the colony except laying eggs.

**WORKER COMB.**—Comb having cells which measure about five to the inch, in which workers may be reared and honey or pollen stored.

**WORKER EGG.**—A fertilized egg laid by a queen bee, which may produce either a worker or a queen.

# INDEX

## A

- ABC of beekeeping ..... 1  
 Acacia (catsclaw) ..... 133  
 Acarapis disease ..... 212  
 Acid, tartaric, for sugar syrup ..... 454  
 Acidity, honey ..... 356, 366  
 Adansonii bee ..... 561  
 Adulteration, honey ..... 366  
 Advertising, honey signs ..... 476  
 Afterswarming ..... 1, 606  
 Age of bees ..... 3  
   drones ..... 5  
   queen ..... 5  
 Agricultural chemicals, effect on bees ..... 507  
 Agricultural crops, pollination ..... 518  
 Agriculture, Bee Culture Lab ..... 638  
 Alarm odor ..... 594  
 Alfalfa ..... 6  
   honey ..... 7  
   pollination ..... 7  
   tripping ..... 7  
 Alkalinity, honey ..... 369  
 Allergy, honey ..... 436  
   stings ..... 597  
 Alsike clover ..... 141  
 American foulbrood ..... 293  
   antibiotics for ..... 211  
   resistant bees ..... 210, 308  
   sulfa drugs ..... 211  
 American Honey Institute ..... 419  
 Amino acids in honey ..... 356  
 Analysis, honey ..... 350  
 Anatomy, bee ..... 8  
 Ancient beekeeping ..... 17  
   beekeeping, Egypt ..... 17  
   laws on bees ..... 462  
 Anger, bees' ..... 22  
 Annual sweet clover ..... 618  
 Antibiotics, use of ..... 22, 24, 211  
   fumagillin ..... 24  
   streptomycin ..... 23  
   sulfathiazole ..... 23  
   tarramycin ..... 23  
 Ants ..... 26, 229  
   control measures ..... 26, 229  
   poisons ..... 230  
 Antiseptic properties, honey ..... 372  
 Aplaris, distance apart ..... 497  
   locating ..... 27  
   restrictions for ..... 34  
   windbreaks for ..... 31  
 Apis dorsata ..... 561  
   florea and Indica ..... 564  
   melifera ..... 557  
 Aroma, honey ..... 397  
 Arthritis, stings for ..... 600  
 Artificial bee pasturage ..... 36  
   heat ..... 35, 691  
   swarming ..... 46, 176  
 Associations, beekeepers ..... 43  
   organization of ..... 43  
 Aster ..... 46
- B**
- Bait sections, see Comb Honey  
 Bailing queen ..... 51, 59, 452  
 Basswood ..... 48  
 Bean, lima ..... 467  
   mesquite ..... 479  
 Bear Damage ..... 49  
 Bee, anatomy ..... 8  
   antibiotics for ..... 211  
   behavior ..... 50  
   blower ..... 179, 251  
   breed ..... 61  
   brush ..... 251  
   cage, A. I. Root original ..... 499  
   candy ..... 129  
   colony odor ..... 52  
   colony morals ..... 51  
   communication ..... 53  
   control bees ..... 51  
   Culture Lab. Gov. ..... 639  
   dance ..... 54  
   diseases, antibiotics for ..... 211  
   disease germs not transmissible to  
     humans ..... 372  
   gloves, gauntlet ..... 81, 324, 471  
   hat, folding ..... 644  
   head ..... 8  
   hunting ..... 61  
   louse ..... 673  
   pasture, artificial ..... 36  
   research, USDA ..... 638  
   space ..... 74  
   sting diagram ..... 599  
   suit overall ..... 472, 646  
   tree ..... 63  
   veils ..... 644  
 Bee escape, comb honey removed with ..... 178  
 Beekeeping, ancient ..... 17  
   ancient, Egypt ..... 17  
   and fruit growing ..... 66  
   and gardening ..... 67  
   city ..... 74  
   migratory ..... 481  
   references in Bible ..... 67  
   scout merit badge ..... 73  
   tropical ..... 626  
 Bees, age of ..... 3  
   anger of ..... 22  
   as a nuisance ..... 76  
   beginning with ..... 80  
   city ordinance ..... 463  
   cold blooded animals ..... 683  
   color sense ..... 57  
   constancy of ..... 55  
   control ..... 51  
   dance ..... 53, 54  
   debris removers ..... 3  
   demoralized, more tractable ..... 447  
   diseases of ..... 208  
   do they injure fruit? ..... 77  
   drifting ..... 217  
   electrical charges ..... 58  
   eyes ..... 279  
   feeding and feeders ..... 280  
   female, from unfertile eggs ..... 504  
   flight of ..... 5, 113, 206, 214, 286, 497  
   food, composition of ..... 11  
   guard ..... 3  
   hermaphrodite ..... 333  
   homing instinct ..... 58  
   hybrid ..... 101  
   importation into America ..... 446  
   increase vegetables ..... 537  
   killed by poison weed sprays ..... 507  
   killing or wintering ..... 689  
   language ..... 53  
   moving ..... 483  
   Nosema reduces life ..... 490  
   nurses feed larvae ..... 3  
   old and helpless ..... 4, 59  
   on shares ..... 80  
   open air colony ..... 190  
   package ..... 499  
   play flights ..... 206  
   removing from buildings ..... 65  
   resistant ..... 308  
   resting period ..... 51  
   robbers, to tell ..... 568  
   scent glands ..... 575

- sense of taste and time ..... 57, 58  
 shipping ..... 577  
 stinging ..... 593  
 taste sense ..... 57  
 temperature of cluster ..... 620  
 time sense ..... 58  
 washboard movement ..... 55  
 water for ..... 650  
 wings ..... 678  
 young, activities of ..... 3, 50
- Beeswax, see Wax**  
 ancient history ..... 17  
 imports - exports ..... 591  
 production ..... 591
- Beginner beekeeping** ..... 80  
 equipment for ..... 257  
 queen rearing ..... 541
- Bell ringing for swarms** ..... 608
- Benton mailing cage** ..... 448
- Benzaldehyde repellent** ..... 179
- Beverages, honey** ..... 373
- Bible references to honey** ..... 67
- Bibliography, government bulletins** ..... 641
- Bitter honey** ..... 399  
 mountain laurel ..... 511
- Bitterweed** ..... 84
- Black gum, see Tupelo**
- Bleaching wax** ..... 661
- Blended honey, labels for** ..... 87
- Bloodstream, bee** ..... 13
- Blue gum (Eucalyptus)** ..... 238
- Bogenschutz uncapper** ..... 262
- Boneset** ..... 86
- Bottle washing** ..... 88
- Bottlers, tanks for** ..... 414
- Bottling honey** ..... 86  
 blending ..... 87  
 filling ..... 91  
 glass and plastic ..... 86  
 labeling ..... 87  
 preparation for ..... 88  
 correct temperature ..... 390
- Bottom board** ..... 339
- Box hives** ..... 92
- Boy Scout merit badge** ..... 73
- Brand melter** ..... 656
- Branding hives** ..... 94
- Bread, honey** ..... 374  
 recipes ..... 425
- Breeding, artificial insemination** ..... 96, 553  
 resistant stock ..... 212  
 scientific ..... 94  
 stock ..... 94
- Brewers' yeast, pollen substitute** ..... 517
- Brood, birth rate** ..... 107  
 cell measurements ..... 102  
 circular in form ..... 103
- Brood chamber, comb honey, double** ..... 172  
 crowded, causes swarming ..... 605  
 double, prevents swarms ..... 611
- Brood comb, cells in** ..... 194  
 drone and worker ..... 103, 108, 195  
 good ..... 125  
 wiring ..... 159
- Brood, concentric circles** ..... 103  
 dead at entrance ..... 207
- Brood disease** ..... 295  
 European ..... 297  
 irregular ..... 298  
 sac brood ..... 311
- Brood, drone, disadvantage** ..... 127  
 early in spring ..... 107  
 neglected ..... 313  
 poisoned ..... 313
- Brood rearing** ..... 108  
 concentrated circles of ..... 106  
 development of ..... 108  
 drone ..... 108  
 egg development ..... 109  
 feeding to stimulate ..... 284  
 larva development ..... 110  
 observation hive ..... 494  
 poisoned ..... 313  
 pollen for ..... 511
- pollen supplements for ..... 516  
 stimulating ..... 124
- Brood, roping, diseased** ..... 293  
 spreading ..... 585  
 stimulated by early flow ..... 127
- Brush, bee** ..... 251
- Buckwheat** ..... 114  
 wild ..... 114
- Building up colonies** ..... 124
- Buildings** ..... 116  
 removing bees from ..... 65
- Burned hive, combs unmelted** ..... 647
- Burning AFB** ..... 301
- Burr comb between top bars** ..... 316
- Butter honey combination** ..... 376

## C

- Cabbage palmetta** ..... 503
- Cage, bee, see Package Bees**  
 introducing ..... 2, 448  
 mailing, introducing in ..... 449  
 "push-in" ..... 451  
 queen ..... 83  
 Root, A. I. original ..... 499
- Cakes, honey** ..... 428
- Calcium in honey** ..... 402, 422
- California black sage** ..... 574
- Caloric value, honey** ..... 379
- Campanilla** ..... 129
- Can, new vs. used** ..... 133  
 60-lb., handle ..... 132
- Candied honey, see Honey, Granulation of**
- Candles, beeswax, see Wax Candles**  
 reason for beeswax ..... 662
- Candy, bee** ..... 129  
 hard for winter ..... 131  
 queen cage ..... 448  
 recipes ..... 425
- Cane sugar** ..... 131
- Canning with honey** ..... 380
- Capping melter** ..... 254, 261, 656, 657
- Cappings, brood** ..... 102  
 comb honey, color of ..... 331  
 how to handle ..... 655  
 perforated over diseased brood ..... 298
- Carbon dioxide fumigation** ..... 676
- Carniolans** ..... 559  
 resistant to EFB ..... 308  
 see Races of Bees
- Cartons, comb honey** ..... 167, 577  
 comb honey, cellophane ..... 577
- Catsclaw** ..... 133
- Caucasians** ..... 558
- Cell cutting** ..... 2  
 queen nucleus ..... 492
- Cells, size of** ..... 134
- Cellophane cartons, comb honey** ..... 166
- Cells, brood comb, number** ..... 194  
 enlarged view ..... 189  
 hexagonal, why? ..... 184  
 queen, ripe ..... 545  
 queen, see Queens and Queen Rearing  
 size ..... 134  
 supersedure for queen rearing ..... 542
- Census report, see Statistics**
- Chalk brood** ..... 137
- Chemical properties of honey** ..... 352
- Chemicals kill bees** ..... 507
- Children, honey for** ..... 401
- Chunk honey, see Bulk Comb Honey**  
 under Comb Honey
- Citrus pollination** ..... 496
- City beekeeping** ..... 463
- Clarifying honey see Honey, Filtration of**  
 settling plan ..... 392
- Clipping queen** ..... 2, 4, 549, 607, 680
- Clothing, beekeepers'** ..... 645
- Cloud test** ..... 665
- Clover** ..... 138  
 alsike ..... 141  
 bur ..... 151  
 button ..... 151  
 crimson ..... 142  
 Dutch white ..... 147



- Ladino white .....149  
 pollination .....529  
 red .....144  
 sainfoin .....151  
 hop .....144  
 others .....149  
 seed production, bees increase .....535  
 sweet .....614  
 Cluster, winter temperature of .....620, 683  
 Cobana system .....170  
 Colloids, honey .....361, 388  
   see Honey, Colloidal Substances  
 Colonies, building up in spring .....124  
   diagnosis .....205, 474  
   division of .....215  
   outapiary .....497  
   weak, robbing of .....569  
   weak, uniting, see Uniting  
 Colony cooperation .....50  
   diagnosis .....205, 474  
   dividing .....215, 492  
   manipulation .....471  
   morale .....51  
   odor .....52  
   open air .....190, 584  
   population, variation .....128  
   queenless, detecting .....551  
   room, increasing .....205  
   temperature .....619  
   two queen system .....555  
 Color bleached by filtering .....388  
 cappings, comb honey .....331  
 grader, Pfund .....329  
 honey comb .....189  
 honey, heat affects .....386  
 sense of bees .....57  
 Colors, honey .....381  
 honey, deterioration .....386  
 Comb, box hive, transferring .....629  
   brood, wiring .....158  
   building between top bars .....316  
   cell size .....134  
   cells in .....194  
   color .....189  
   darkening of .....193  
   drone and worker cells .....103  
   dysentery stains .....194  
   enlarged view .....189  
   freak .....162  
   in sections .....180  
   natural .....187, 196, 584  
   old, wax in .....193  
   propolizing .....540  
   relation to ripening .....56  
   reversing .....567  
   sagged cells .....101  
   spacing .....74, 322  
   worker, important .....611  
 Comb foundation, see Foundation  
 Comb foundation .....153  
   for sections .....163  
   history of .....153  
   plastic .....161  
   types of .....157  
   wiring .....159  
 Comb honey, appliances for .....165  
   brood chamber, double .....172  
   cartons .....167, 577  
   cellophane wrapped .....167  
   chunk or bulk .....164  
   cobana system .....170  
   escape method .....179  
   cut .....164  
   fixtures for .....167  
   food chamber .....293  
   grading .....327, 331  
   granulation .....407  
   growth in sections .....180  
   harvesting .....175  
   hive, diagram .....334  
   moths in .....181  
   net weight on package .....455  
   plain sections for .....169  
   production .....171  
   propolis removed .....181  
   section, evolution .....157  
   sections .....166  
   sections, scraping .....181  
   section sizes .....165, 169  
   shipping .....578  
   starters for .....162  
   super, T .....168  
   supering for .....173  
   supers, bees entering .....174  
   tall vs. square sections .....165  
   travel stained .....630  
   vs. extracted .....165  
   weight .....331  
   section sizes .....166  
 Combless packages, A. I. Root original .....499  
 Combs, brood and extracting .....191  
   building .....182  
   burr and brace .....316  
   drone and worker .....195  
   extracting, equalizing weight .....259  
   for extracting .....191  
   good and poor .....191, 194  
   injured by wax moth .....571  
   mice damage .....229  
   moldy .....194  
   natural .....323  
   observation hive .....494  
   old, amount of wax in .....661  
   old, rendering wax from .....660  
   spacing .....584  
   straight and curved .....192  
   unmelted in burning hive .....647  
 Comparator, color .....328  
 Concrete hive stands .....32  
 Containers, granulated honey .....409  
 Control bees .....51  
 Cookie recipes .....427  
 Cooking, honey .....382, 425  
 Cooling as wax moth treatment .....676  
 Cooperation in bee colony .....50  
 Copper in honey .....403, 423  
 Corrugated shipping cases .....576  
 Cosmetics, honey in .....383  
   wax in .....653  
 Cotton, honey plant .....198  
 Cover, hive .....338  
 Coveralls, beekeepers .....644  
 Cramps, queen .....61  
 Crating honey pail .....248  
 Creamed honey, Dyce process .....411  
 Creaming granulated honey .....409  
 Crimson clover .....147  
 Crossness due to robbing .....22  
 Crystal formation, agitation affects .....363  
 Crystallization, heating to prevent .....387  
   honey .....361  
   prevention .....363  
 Cucumber .....199  
 Cut comb honey .....164  
 Cyprian bees, see Races of Bee .....560
- ### D
- Dance, bee .....53, 54  
 Dandelion .....200  
 Danzenbaker frames .....318  
 DDT effect on bees .....509  
 Deliquescence, honey .....359, 416  
   see Honey, Hygroscopic Properties  
 Demaree swarm control plan .....2C2  
 Density, U. S. grade .....328  
 Desserts, honey .....428  
 Dextrin in honey .....204  
 Diagnosing colony .....205  
 Diastase, heat affects .....389  
   honey, see Honey, Chemical Properties  
 Digestive system, honey, no tax on .....4C4  
 Diseases of bees, acarine .....309  
   breeding resistance to .....212  
   brood .....208  
   burning .....208, 300  
   cappings perforated .....298  
   chalk brood .....137  
   dissapearing .....214  
   dysentery .....226, 682

- foulbrood ..... 293  
 gas sterilization ..... 212  
 history of ..... 209  
 laws and regulations ..... 213, 466  
 Nosema ..... 487  
 para foulbrood ..... 309  
 paralysis ..... 504  
 preventive control of ..... 212  
 research and development ..... 213  
 sacbrood ..... 311  
 transmission of ..... 209  
 treatment by burning ..... 210  
 treatment and control of ..... 137  
 treatment with drugs ..... 211  
 varroasis ..... 643  
 Dividing colonies ..... 215, 493  
 Dovetailed hive ..... 337  
 Drifting ..... 217  
 to prevent ..... 30, 34  
 Drone, age ..... 5  
 anatomy of ..... 218  
 brood cappings ..... 102  
 comb, three-ply foundation prevents ..... 161  
 destruction in fall ..... 221  
 eggs in worker cells ..... 221  
 entrance guards ..... 224  
 excluding ..... 222  
 expelling of ..... 221  
 flights ..... 219  
 from unfertile eggs ..... 221  
 heads of different colors ..... 222  
 mating ..... 220  
 matures slowly ..... 61  
 nursing ..... 218  
 one parent only ..... 221, 226  
 queen, worker ..... 544  
 reproductive organs ..... 15  
 trap ..... 224  
 worker cells in comb ..... 102  
 Drones from laying workers ..... 221, 313  
 Drumming ..... 224  
 Dwindling, spring ..... 586  
 Dyce creamed honey ..... 411  
 Dysentery, bee ..... 226, 682  
 stains combs ..... 195  
 Dzierzon theory ..... 226
- E**
- Ecology and bees ..... 227  
 Egg-laying capacity ..... 107  
 circular ..... 106, 585  
 decreasing after honey flow ..... 105  
 see Brood and Brood Rearing  
 variation ..... 60  
 Egg, unfertilized, hatching ..... 107  
 Egg, worker, produces queen ..... 544  
 Eggs, concentric circles ..... 106, 585  
 drone, in worker cells ..... 137, 219  
 enlarged view ..... 101  
 two kinds by queen ..... 550  
 wax moth ..... 672  
 Electric heat for wintering ..... 691  
 Emerging bees ..... 112  
 Enemies, bees ..... 228  
 ants ..... 229  
 mice ..... 229  
 others ..... 232  
 Bingham ..... 339  
 Entomology, Bee Culture Lab ..... 640  
 Entrance, diagnosis ..... 232  
 activity at ..... 236  
 keeping grass down ..... 34, 233  
 size of ..... 233  
 upper ..... 234  
 Entrance guard, drone ..... 224  
 guard, queen ..... 224  
 Enzymes, honey ..... 389, 413  
 Escape, adjustment of prongs ..... 177  
 Escape board, ventilated ..... 251  
 Escape, comb honey removed with ..... 178  
 Ethylene oxide fumigation ..... 305  
 Eucalyptus ..... 237
- European foulbrood ..... 297  
 antibiotics for ..... 211  
 see Disease  
 Evaporating moisture in honey ..... 56  
 Evaporation, nectar ..... 485  
 removed water ..... 430, 433  
 Excluder divides queens ..... 555  
 gauge to measure ..... 224  
 size of openings ..... 222  
 two-queen system ..... 555  
 Exhibits, honey ..... 238  
 Extracted honey ..... 244  
 extracting ..... 255  
 grading of ..... 327  
 harvesting ..... 250  
 heating and bottling ..... 260  
 managing for ..... 246  
 melting and repacking ..... 267  
 ripening ..... 430, 434  
 straining ..... 266  
 storage of ..... 245  
 supering for ..... 247  
 vs. comb honey ..... 165  
 Extracting combs and brood ..... 191  
 equalizing weight ..... 259  
 good ..... 127  
 spacing ..... 321  
 wet, to clean ..... 260  
 Extracting equipment, beginner ..... 257  
 Extracting, large scale ..... 261  
 outfit, backlot ..... 257  
 outfit, central plant ..... 263  
 Extractor, Hodgson ..... 275  
 Langstroth ..... 271  
 Peabody ..... 270  
 power vs. hand ..... 278  
 Quinby ..... 271  
 radial ..... 265, 276  
 Root central pivot ..... 273  
 Root's A. I., first ..... 271  
 solar wax ..... 655  
 Superior Lifetime ..... 274  
 three frames ..... 258  
 Eyes, bees ..... 279
- F**
- Fall management, food chamber ..... 289  
 Fanning air from hive ..... 56  
 Farmer beekeepers ..... 280  
 Fatty acids in beeswax ..... 652  
 Feeders ..... 82, 125, 280, 502  
 materials for ..... 281  
 preparation of ..... 281  
 stimulating ..... 284  
 winter ..... 284  
 Feeding back unfinished sections ..... 175  
 queen ..... 59  
 sealed combs ..... 289  
 syrup cans for ..... 83  
 Fence, see Comb Honey  
 windbreak in winter ..... 691  
 Fences, electric, for apiaries ..... 28, 49  
 Fermentation affected by temperature ..... 441  
 honey ..... 441, 698, 701  
 Fertile workers, see Laying Workers  
 queen, artificial ..... 553  
 Filler, bottle ..... 91  
 Filtering, colloids removed ..... 268  
 honey, see Honey Filtration  
 removes color ..... 388  
 Filtration, Gardner plan ..... 394  
 government plan ..... 395  
 honey ..... 390  
 Flavor, honey ..... 330, 397  
 preservation of ..... 398  
 unpleasant ..... 399  
 Flight, bee's ..... 4, 286, 497  
 first bee's ..... 4  
 length ..... 497  
 mating ..... 549  
 mating, virgin ..... 548  
 orientation flights ..... 4  
 play ..... 206

- Flowers, bees work on one kind ..... 55  
 Food chamber ..... 172, 288  
 comb honey production ..... 171  
 history of ..... 292  
 management of ..... 289  
 size ..... 290  
 Food value, of honey ..... 400  
 Foulbrood, American ..... 293  
 European ..... 297  
 laws ..... 466  
 para ..... 309  
 see Disease  
 treatment and control ..... 137, 301  
 Foundation, aluminum ..... 161  
 comb, invention ..... 153  
 gnawing ..... 162  
 mill ..... 153, 188  
 paper reinforced ..... 158  
 plastic ..... 161  
 press ..... 154  
 sagged ..... 101, 157  
 section ..... 157, 163  
 starters vs. full sheets ..... 162  
 stretching ..... 101, 157  
 3-Ply ..... 161, 652  
 vertically wired ..... 161  
 wax needed for ..... 652  
 wired ..... 161, 163  
 Frame, Hoffman ..... 314, 318  
 Langstroth, standard ..... 335  
 manipulation ..... 472  
 movable ..... 339  
 queen cell bar ..... 547  
 Frame spacers ..... 321  
 spacing ..... 74  
 sizes, various ..... 315, 321  
 square ..... 335  
 unspaced ..... 473  
 wiring ..... 159  
 Frames ..... 314  
 lock-cornered ..... 320  
 self-spacing, ..... 317  
 staple-spaced ..... 320  
 Freezing point, honey ..... 407  
 Fruit, bees not injurious ..... 77, 465  
 Fruit, insects puncture ..... 77  
 pollination ..... 523  
 sugar (levulose) ..... 355  
 Fructose (levulose) ..... 355  
 see Honey  
 Fuel, smoker ..... 580  
 Fume method for removing bees ..... 179  
 Fumagillin for Nosema ..... 24, 211  
 Funnel, bee ..... 500
- G**
- Gallberry ..... 324  
 Gardening and beekeeping ..... 67  
 Germs, bee disease, not transmissible  
 to humans ..... 372  
 Glands, scent ..... 575  
 wax ..... 183  
 Glass, bulk comb honey in ..... 165  
 Glossary ..... 705  
 Gloves, bee ..... 81, 324, 471  
 Gnawing comb foundation ..... 162  
 Goldenrod ..... 324  
 Government research on bees ..... 638  
 research on bees ..... 638  
 restrictions on labels ..... 87, 455  
 Grading honey, U. S. Standard ..... 327  
 Grafting queen cells ..... 543  
 cells for royal jelly ..... 571  
 Granulated comb honey ..... 407  
 Granulated honey, barrels for Canada .. 409  
 creaming ..... 411  
 liquefying ..... 88  
 marketing ..... 409  
 Granulated sugar, see Sugar  
 Granulation, comb honey, to prevent ... 182  
 extracted honey ..... 407  
 heating to prevent ..... 260, 362, 387  
 science of ..... 361  
 temperature affects ..... 364  
 water content influences ..... 439  
 Grass fires, keeping down ..... 233  
 Greeks, ancient beekeepers ..... 17  
 Guajillo ..... 332  
 Guard bees ..... 3  
 Gum, tupelo ..... 637  
 Gums in wax ..... 666
- H**
- Hairs, bees, collect pollen ..... 512  
 Hat, bees stinging ..... 595  
 Hatching, eggs ..... 107  
 Head, worker ..... 8  
 Heartsease ..... 333  
 Heat affects honey ..... 413  
 affects levulose ..... 415  
 artificial ..... 40, 696  
 discolors honey ..... 91, 386, 415  
 drives off yeast ..... 389  
 electric for wintering ..... 40  
 hot water coil for ..... 393  
 prevents granulation ..... 387, 408  
 ripens honey ..... 434  
 thermometer needed ..... 408  
 wax moth treatment ..... 676  
 Hermaphrodite bees ..... 333  
 Hive, bee space in ..... 74  
 bottom ..... 339  
 box ..... 92, 625  
 brood chamber ..... 341  
 British ..... 341  
 Buckeye ..... 342  
 comb honey, diagram ..... 334  
 cover ..... 338  
 Dadant ..... 340  
 Danzenbaker ..... 339  
 dimensions ..... 334  
 dovetailed ..... 337  
 entrances, see Entrances  
 evolution ..... 343  
 food chamber ..... 172, 174, 289, 290  
 glass, observation ..... 239  
 Heddon ..... 340  
 Huber ..... 21  
 Langstroth ..... 334, 341  
 log gum ..... 92  
 long-idea ..... 342  
 making ..... 333  
 moisture ..... 234  
 observation ..... 494  
 packed ..... 687  
 plastic ..... 342  
 scale ..... 574  
 screens for moving ..... 485  
 Simplicity, A. I. Root's ..... 337  
 square frames ..... 335  
 stands ..... 32, 685  
 straw skep ..... 579  
 tool ..... 471  
 two-story ..... 341  
 ventilation ..... 56, 646  
 Hives ..... 333  
 branding ..... 94  
 single-walled for wintering ..... 683  
 Hiving swarm ..... 607  
 Hoffman frame manipulation ..... 319, 473  
 Honey, acidity ..... 356, 366  
 air bubbles ..... 90, 390  
 adulteration ..... 366  
 agitation, effect ..... 363  
 alfalfa ..... 7  
 alkaline forming ..... 369  
 American imports ..... 371  
 amino acids in ..... 356, 358  
 ancient history ..... 17  
 analysis ..... 350  
 antiseptic properties ..... 372  
 ash and nitrogen content ..... 357  
 babies' use of ..... 401, 406, 421  
 bees work one source of ..... 55  
 bitter ..... 84, 399, 511  
 blends, labels for ..... 87  
 boiling, for bee feed ..... 374  
 bottling ..... 86, 270

bread ..... 374, 427  
 bubbles to remove ..... 90, 391  
 bulk, storage of ..... 132  
 butter combination ..... 376  
 cakes ..... 376, 428  
 caloric value ..... 379  
 candies, see Honey Recipes  
 canning with ..... 380  
 chemical properties ..... 351  
 clarifying ..... 266, 390  
 cloudiness, removal ..... 393  
 colloids ..... 361  
 colors ..... 381  
 composition of ..... 354  
 consumption of ..... 350  
 cooking with ..... 382  
 cosmetics ..... 383  
 cream, see Honey Butter  
 crystallization, see Granulation  
 density, U. S. grades ..... 328  
 dental carries, fewer ..... 407  
 discoloration ..... 386  
 drip-cut dispenser ..... 382  
 drums ..... 132  
 Dyce process ..... 411  
 enzymes in ..... 358, 389  
 exhibits ..... 238  
 extracted ..... 244  
 extracting of ..... 255  
 extracted vs. comb ..... 165  
 extractors ..... 290  
 extractor, three-frame ..... 258  
 fermentation ..... 441, 698, 701  
 filtration of ..... 390  
 flavors ..... 330, 397, 399  
 flow, how to know ..... 206  
 food value ..... 400  
 forecasting and reporting ..... 405  
 freezing point ..... 407  
 grading, U. S. Standard ..... 327  
 granulation of ..... 361, 407  
 gravity method clarifying ..... 392  
 heat affects ..... 91, 413  
 heating and bottling ..... 260  
 heating, thermometer ..... 408  
 houses ..... 118  
 hygroscopic properties ..... 359, 416, 445  
 imitation ..... 419  
 liquefying ..... 89  
 Institute, American ..... 405, 419  
 labels ..... 455  
 loans for ..... 421  
 locust ..... 469  
 market report ..... 592  
 marketing ..... 409, 474  
 melting and repacking ..... 267  
 mineral constituents ..... 357, 402, 422  
 minimum amount for winter ..... 681  
 moisture absorbing ..... 416  
 moisture, attracting ..... 359  
 moisture content ..... 437  
 moisture evaporation ..... 56  
 new, storing ..... 433  
 nitrogen and ash content ..... 357  
 pasteurization ..... 386  
 phosphorus in ..... 402, 422  
 plants ..... 40, 424  
 plastic pails ..... 133  
 poisonous ..... 511  
 processing ..... 88  
 pump ..... 266  
 recipes ..... 425  
 refractometer ..... 439  
 ripening ..... 56, 430  
 roadside stands ..... 477  
 Root's, A. I., 1870 record ..... 245  
 sac ..... 10  
 salts in ..... 402, 423  
 saturated solution ..... 362  
 sensitivity to ..... 436  
 signs ..... 477  
 specific gravity ..... 329, 436  
 spoilage ..... 440  
 statistics ..... 589  
 storage tanks, see Tanks

straining ..... 88, 258, 266, 390, 391  
 sugars of ..... 355, 360  
 sump ..... 265  
 sweetening power ..... 379  
 tank, hot water coil ..... 393  
 tanks, storage ..... 121, 246, 393, 414  
 temperature affects granulation ..... 364  
 uncapping ..... 252  
 warming ..... 252  
 thixotropy ..... 359  
 unripe, danger ..... 389, 439  
 unripe, moisture in ..... 441  
 vacuum clarifies ..... 393  
 vinegar ..... 648  
 viscosity ..... 358  
 vitamins ..... 649  
 wax, comparative values ..... 654  
 wax secretion amount needed ..... 654  
 weight ..... 383, 437  
 wine ..... 442  
 yeasts in ..... 441, 698  
 zinc in ..... 702  
 Honeybees, constancy of ..... 512  
 Honey comb .....  
 color ..... 189  
 construction ..... 183  
 cross section ..... 186  
 enlarged view ..... 189  
 feeding ..... 124  
 grading ..... 330  
 granulation ..... 408  
 hexagonal cells, why? ..... 184  
 natural ..... 187  
 size of cells ..... 134  
 Honeydew ..... 385  
 Honey flow, effect on brood rearing ..... 105  
 building up for ..... 124  
 detection ..... 206  
 food chamber management ..... 269  
 orientation flights ..... 4  
 spring, value ..... 128  
 House, bees from ..... 65  
 walls, bees in ..... 585  
 Huajilla ..... 332  
 Hubam sweet clover ..... 619  
 Huber, hive ..... 21  
 discovered wax glands ..... 21  
 Humidity, honey ..... 416  
 Hunting bees ..... 62  
 Hybrid bees ..... 444  
 Hygroscopic properties, honey ..... 359, 416, 445

## I

Importation, bees' ..... 446  
 honey ..... 592  
 wax ..... 592, 661  
 Increase, nuclei forming ..... 492  
 Indemnification, for pesticide losses ..... 506  
 Infant feeding ..... 401  
 Inner cover, hive ..... 338  
 Insecticides, toxicity of ..... 508  
 Insemination, queens', artificial ..... 96, 552  
 Insects, wild, pollinators ..... 519  
 Introducing ..... 446  
 beginner's plan ..... 83  
 cage ..... 2, 448  
 direct method ..... 451, 542  
 laying, when queen starts ..... 452  
 nucleus method ..... 542  
 odor affects ..... 59  
 queen ..... 567  
 virgin ..... 453  
 Invert sugar ..... 454  
 Invertase, honey contains ..... 389  
 Immunity from stings ..... 595  
 Iron in honey ..... 403, 422  
 Italianizing ..... 454  
 Italians fight wax worms ..... 667

## J

Jelly, royal, see Royal jelly

<b>K</b>	
Killing bees, .....	66
vs. wintering .....	689
Kudzu vine .....	151

**L**

Labels, government restrictions .....	87, 455
honey .....	455
jar and can .....	87
Laboratory, gov. bee .....	639
Ladino clover .....	149
Langstroth frame, standard .....	335
life .....	457
Language, bees' .....	53
Larva .....	604
food for .....	4
growth .....	108
royal jelly .....	570
Larvae dead at entrance .....	207
diseased .....	299
prove presence of queen .....	102
see Brood and Brood Rearing	
wax moth .....	669
Larval food .....	4, 108
see Royal Jelly	
Laughing gas .....	580
Laurel, see Poisonous Honey	
Law, net weight, on labels .....	455
Pure Food .....	87
Laws, bee .....	462
ancient laws on .....	19
disease .....	466
Laying, egg, variation .....	60
workers .....	466
Lead salts in honey .....	702
Leg, pollen on .....	5
Legal opinions, see Laws	
Legs, bee .....	10
Lespedeza .....	151
Levulose and dextrose in honey .....	354
heat affects .....	415
hygroscopicity .....	416
see Honey, Chemical Properties	
Lima bean .....	467
Linden, see Basswood, 49	
Liquefying affects color of honey .....	385
granulated honey .....	89
Liturgical candles, why of beeswax .....	653, 662
Live-bee demonstration, see Exhibits of Honey	
locality .....	468
variation .....	291
Location, bees mark temporarily .....	58
Locust .....	469
Log gum bee hives .....	92
transferring from .....	628

**M**

Magnesium in honey .....	402, 422
Mailing cage .....	83, 448, 449
Mammoth clover .....	145
Mandible, bee .....	9
Mangrove .....	470
Manipulation, colony .....	471
Maple .....	474
Marketing honey .....	474
Marking queen .....	554
Mating, age of queen .....	549
artificial .....	553
flight, queen .....	548
Mead .....	442
Medical Association .....	401, 404
Merit badge, scout .....	73
Mesquite .....	479
Metal, galvanized, for tanks .....	702
Methyl bromide, wax moth treatment .....	677
Mice damage combs .....	229
Migratory beekeeping .....	481
Milk in honey for children .....	403
Milkweed .....	481
pollen sticky .....	481
Mill, foundation .....	153, 188
Minerals in honey .....	357, 402, 422
in human diet .....	422
nectar .....	486

Modified Dadant hive .....	341
Moisture absorbing, honey .....	416
affects fermentation .....	441
content, measuring .....	437
driven out .....	56
honey .....	359, 416
humidity controlled by entrance .....	234
nectar .....	485
see Honey, Specific Gravity of	
unripe honey .....	441
winter .....	681
Moldy combs .....	194
Moth miller, see Wax Worm	
prevention, patent hives .....	350
Moths, evidence .....	208
wax .....	667
Motors, power extractor .....	266
Mouth parts .....	11
Moving bees .....	481, 483
migratory .....	481
short distance .....	483

**N**

Nectar .....	486
bees work one source .....	55
constancy, bees .....	512
evaporation .....	207, 433
fruit blossom compared .....	530
minerals in .....	486
pollen, honey, food .....	13
ripening .....	431, 613
secretion .....	468, 486, 576
unloading .....	55
water in .....	56, 651
yeasts in .....	699
Neighbors, bees trouble .....	76
Nervous system .....	13
Net Weight, comb honey .....	331
labels .....	455
Newspaper uniting plan .....	642
Nicotinic acid in honey .....	649
Nosema .....	487
affected by location .....	29
fumagillin for .....	24
Nucleus .....	492
introducing queen to .....	542
queen rearing in .....	541
robbing .....	569, 594
swarming .....	1
Nuisance bees .....	76, 463
Nurse bees, feeding larvae .....	3
Nutritional value of honey .....	400

**O**

O.A.C. strainer .....	396
Oak trees, honeydew on .....	385
Observation hive .....	494
self loading .....	495
Odor, AFB .....	208, 300
bee sting poison .....	599
colony .....	52, 59, 448
laying queen .....	551
Orange .....	496
Ordinance, city re bees .....	463
Outapiaries .....	497
flights to .....	287
Outapiary uniting .....	642
Outdoor colony .....	584
Ovaries, queen .....	16
Overalls, beekeepers' .....	646
Overheating affects color .....	413
affects levulose .....	415
caution .....	91
danger .....	389
Overstocking .....	498

**P**

Package bees, candy .....	129
carry AFB .....	308
for beginner's .....	80, 82
gov. research .....	639
installation of .....	502
Nosema .....	487
pollinators .....	528

- queen caged ..... 502  
 queen supersedure in ..... 603  
 replacing winter losses ..... 500  
 Root's, A. I., original ..... 499  
 strengthening weak colonies ..... 501  
 sugar syrup plan ..... 84  
 vs. wintered-ovar colonies ..... 689  
 Packages, funnel to fill ..... 500  
 Packing, excessive ..... 682  
 light vs. heavy ..... 683, 686, 689  
 Palmetto ..... 503, 635  
 Paradichlorobenzene fumigator ..... 675  
 Paralysis, bee ..... 504  
 Park, O. W., size of cell ..... 135  
 Parthenogenesis ..... 504  
 of drones ..... 220  
 Pasturage, artificial ..... 36  
 Pediatrics, Journal of ..... 401  
 Pesticides ..... 506  
 labeling ..... 506  
 toxicity of ..... 508  
 Pfund color grader ..... 329  
 Pheromones ..... 505  
 alarm ..... 594  
 Phosphorus in honey ..... 402, 422  
 Plant lice, honeydew from ..... 385  
 Plants, see Honey Plants  
 Platform, ant-proof ..... 33  
 Play flights ..... 53  
 see Flight of Bees and Bee Behavior  
 Poison bee sting ..... 597  
 brood ..... 313  
 sprays ..... 506, 508, 510  
 Poisonous honey ..... 511  
 Polarized light distinguishes sugars ..... 360  
 Polish, wax ..... 652  
 Pollen ..... 511  
 brood rearing requires ..... 207  
 bees work one source ..... 55  
 collection of ..... 512  
 constancy, bees' ..... 512  
 dandelion ..... 200  
 goldenrod ..... 326  
 grain, size ..... 512  
 ingredients ..... 512  
 mixed with honey ..... 61  
 natural, for brood rearing ..... 285  
 nectar, honey food ..... 13  
 needed to rear pound of bees ..... 124  
 needed in winter ..... 681  
 not source of wax ..... 21  
 on hairs of bees ..... 512  
 on legs ..... 5  
 substitute, feeding ..... 516  
 trapping of ..... 515  
 worker larva food ..... 4  
 Pollination, agricultural crops ..... 518  
 colony strength required ..... 523  
 contract ..... 523  
 crops dependent upon ..... 525  
 fertilization ..... 520  
 fresh vegetables and canning crops ..... 530  
 fruit crops ..... 526  
 inadequate ..... 521  
 legume ..... 528  
 oilseed crop ..... 535  
 small fruit ..... 533  
 vegetable seed crop ..... 534  
 Pollinating insects killed by poison  
   weed sprays ..... 506  
 Poplar, propolis from ..... 540  
   yellow ..... 635  
 Porter bee escape ..... 177  
   package, see Package Bees  
 Power extractors ..... 263  
 Press, filter ..... 394  
   foundation ..... 154  
   wax ..... 658  
 Propolis ..... 538  
   chemical tests ..... 539, 665  
   collection ..... 539  
   in beeswax, see Wax  
   removing ..... 181, 540  
   use of ..... 540  
 Proteins, heat affects ..... 415  
   in honey ..... 402  
 Pump, honey ..... 90, 265  
 Pumping liquefied honey ..... 89  
 Pure Food Law ..... 87  
 Purple sage ..... 573
- Q**
- Queen, age ..... 5  
   age, fertilized ..... 549  
   and drone trap ..... 224  
   balling ..... 59, 60, 452  
   cage candy ..... 448  
   cage, introducing ..... 448  
   cage, "push-in" ..... 451  
   caressed by bees ..... 61  
   cell bar ..... 547  
   cell cutting ..... 2  
   chasing of ..... 61  
   clipping ..... 2, 549, 607  
   cramps ..... 61  
   destroying ..... 613  
   destroys queen cells ..... 548  
   development of ..... 544  
   drone-laying ..... 106, 221, 314  
   drone, worker ..... 544  
   dual plan ..... 554  
   egg-laying capacity ..... 60, 107  
   eggs laid in circular form ..... 103, 585  
   excluder method of finding ..... 451  
   excluder, size of openings ..... 221  
   fasting, easy to introduce ..... 448  
   fed by worker ..... 60  
   feeding ..... 6, 59, 545  
   fertilization, artificial ..... 96, 553  
   finding ..... 473, 551, 582  
   flying away ..... 453  
   from worker egg ..... 544  
   grafting ..... 543  
   guards, entrance ..... 223  
   hunting ..... 582  
   immature ..... 546  
   imperfectly developed ..... 544  
   indicate swarming ..... 43, 605  
   insemination, artificial ..... 553  
   introducing, see Introducing  
   larvae, hormones for ..... 571  
   larvae, worker from ..... 571  
   laying after introducing ..... 452  
   lays in concentric circles ..... 103, 585  
   lays two kinds of eggs ..... 550  
   leaving cell ..... 546  
   loss, detection ..... 551  
   marking ..... 554  
   mates away from hive ..... 21  
   mating flight ..... 218, 548  
   mating more than once ..... 220  
   nucleus ..... 492  
   odor ..... 52, 551  
   old, supersedure ..... 59  
   ovaries ..... 16  
   scent of ..... 522  
   package bees ..... 502  
   proof of presence ..... 105  
   rearing, commercial ..... 542  
   rearing for beginners ..... 541  
   rearing nucleus ..... 541  
   removal prevents swarming ..... 613  
   renewing without dequeening ..... 567  
   sting ..... 552  
   substance ..... 554  
   supersedure ..... 603  
   temperamental ..... 59  
   undersized ..... 544  
   virgin ..... 548  
   virgin, flight of ..... 21  
 Queens, artificial insemination ..... 552  
   double plan ..... 555  
   exchanging ..... 447  
   reared for home use ..... 541  
   two in the hive ..... 555  
   voices ..... 547  
 Quinby closed-end frames ..... 317  
   smoker, original ..... 579

## R

Rabbit spacers for frames	321
Stoller's notched	321
Races of bees	557
African	563
Asian	561
Carniolan	559
Caucasian	558
Italian	557
other European	560
Radial extractor	265, 276
Rats fed honey	403
Rearing, brood, see Brood Rearing	
Recipes, honey	425
Red clover	144
Refractometer, honey	439
Remedies, bee sting	596
Rendering wax, ideal equipment	658
Reproduction, hormones for	571
Reproductive organs, drone	15
system	17
Requeening	566
Research, U. S. Dept. of Agriculture	639
Resin, chemical tests for	665
Resinous gums in wax	662
Resistant bees	97, 305
Respiratory system, bee	23
Reversing	566
Rheumatism, stings for	600
Rhododendron, effect on bees	511
Riboflavin in honey	649
Ripening, comb building related to	56
honey	430, 434
ventilation for	434
Roadside market	476
selling, see Marketing	
Robbing	568
affects introduction	448
angers bees	22
annoys neighbors	77
bees, cross	594
how to stop	569
nuclei	492
Root, A. I. early smoker	580
Royal jelly	13
collecting tube	572
grafting cells for	571
ingredients of	570
nature of	545
production	570
storage of	571
vitamins in	545, 570

## S

Sacbrood	313
Sage	572
Sagging foundation	101, 159
Sainfoin	151
Saponification cloud test	665
Saw palmetto	503
Scale hive	574
Scales, wax	182, 249
Scent glands	575
School, observation hive	494
Scorching affects levulose	415
Scout Merit badge	73
Scraping sections	181
Scrub palmetto	503
Secretion, nectar	576
Section comb development	180
comb honey	164
honey box, evolution	157
honey grading	330
scraping	181
sizes	165
Sections, removing propolis	181
unfinished	175
Self pollination, see Pollination	
Self spacing frames	317
Senses, bees'	56
Sensitivity to honey	436
Separator, see Comb Honey Appliances	
Settling plan clarifies honey	392
Shade prevents swarming	612

sheds for	31
Shed windbreak	31
Shipping bees	575
cases, comb honey	578
package bees	500
Simplicity extractors	264
hive, A. I. Root's	337
Skeep, straw	344, 579
Sleep, bees'	52
Slumgum testing	656
Smartweed	333
Smell, bees' sense	52
Smoke controls stings	593
smokers	579
uniting without	642
Smoker, beginners'	81
fuel	580
uses of	581
Smoking robbers	570
Solar wax extractor	655
Sourwood	582
Soybean	583
flour, pollen substitute	516, 517
Spacing comb	74, 323, 583
Spanish needles	585
Specific gravity, beeswax	652
honey	329, 436
Spoilage, honey	440
Spores, Nosema	487
Spraying, see Poison Sprays	
Sprays, poison, for weeds	506
Spread, honey butter	376
Spreading brood	585
Spring dwindling	586
Nosema cause	490
Spring management	122, 586
food chamber	290
Starters, foundation for comb honey	163
vs. full sheets	162
Starting Right with Bees, book	1
Starvation, winter	680
Statistics, honey, bee	587
Steam uncapping knife	254
Sterile, self, see Pollination	
Stimulating brood rearing	122
Sting, diagram	10, 598
odor of	595
queen	552
Stings	592
avoiding	595
due to robbing	22
immunity from	595
remedy for arthritis	600
severe reaction to	597
Stomach, bee	10
Storage tanks, honey, See Tanks	
Strainer, backlot	258, 392
Straining honey	88, 258, 390, 392
Straub, W. F.	400
Straw skeps	344, 578
Streptomycin for bee disease	23
Stretching, foundation, to prevent	157
Substance, queen	554
Sucrose, cane sugar	131
in honey	355
Sugar, cane	131, 601
invert	454
nectar	485
of honey	355, 442
polarized light to distinguish	360
tolerant yeasts	700
Sugars, sweetest, bees prefer	57
Sulfa drugs for AFB	211, 311
treatment for disease	23
Sulphur Dioxide, wax moth treatment	677
Sumac	601
Super, bees entering	174
package bees in	84
T	168
comb honey	168
extra, to add	251
propolized	255
putting on	173
tiering up	173
Supersedure, causes	95

cells for queen rearing	542
old queens'	59
queen, package	603
Swarm, age of bees	51
catcher	608
Swarm control	
Demaree plan	202
Swarm detection	206, 605
double brood chamber prevents	611
hiving	607
prevention	202, 607, 611
ventilation prevents	612
Swarming	604
artificial	6, 46, 176
cause of	610
cell cutting prevents	2
cells for queen rearing	542
cells indicate	43
composition of	606
Demaree plan for	202
hiving of	608
season for	606
Swarms, after	1, 606
uniting	642
Sweet clover	614
Hubam	618
localities	468
Sweetening power, honey	379
Syrup feeding, beginner's plan	83
antibiotics for	25
medicated	302
package bees	502
sulfa	311
tartaric acid added	454

## T

Tank, hot water coil	393
Tanks, glass-lined	415
large, inadvisable	414
liquefying	89
storage	88, 393, 414, 440
Taste sense of bees	57
Temperature affects color	386, 413
affects fermentation	441
cluster in winter	620, 683
colony	619
delays granulation	408
Terramycin for bee disease	23, 211
Thermometer for winter cluster temp.	622
needed in heating honey	408
Thiamine in honey	649
Thixotrophy, honey	359
Thoroughwort	85
Three-Ply comb foundation	160, 652
Time sense of bees	58
Titi, honey plant	624
Tongue, bee	8
Tool, hive	471
Top bars, comb between	316
entrance, winter	234, 646
supering	252
Toxicity of insecticides	508
Trachea, bee	9
Transferring	624
age of larva	604
Trap, pollen, Dr. Farrar's	514
queen and drone	223
Travel stain	625
Tree, removing bees from	63, 65
Trees	
bees in	62
for windbreaks	690
open air combs	190
swarms in	608
Trips, bees number per day	3, 206
Tropical beekeeping	626
Truck, moving bees	635
Tulip tree	636
Tupelo	637

## U

Uncapper, Bogenschutz	262
Uncapping, can, home made	257
deep, increases wax	249

knife, steam	254
Unfinished sections, feeding back	175
Uniting	641
Unripe honey, danger	389, 439, 441
Upper entrance, see Entrances	
USDA, artificial insemination plan	553
research	638
standard grading	327

## V

Vacuum pump clarifies honey	393
Varroasis	643
Vegetables, bees increase	537
Veils	644
Venom, bee sting	596, 600
Ventilated escape board	251
Ventilation	56, 646
controls temperature	619
facilitates ripening	434
package bee	449
prevents clustering out	233
prevents combs melting	647
prevents swarms	612
Vetch	648
Vinegar, honey	648
Virgin, development (parthenogenesis)	504
introducing	453
nucleus	493
queens	59, 548
Virgins, dozen in hive	446
Viscosity, honey	358
Vitamins, honey	649
filtering affects	396
royal jelly	545
von Frisch, Karl	53

## W

Washboard movement of bees	55
Washing, honey bottles	92
Water, bees need	650
content influences granulation	439
evaporation from nectar	433, 651
Waterproofing, wax for	652
Watson insemination plan	553
Wax	651
amount in old combs	193, 661
bleaching	661
Brand melter	656
candles	653, 661
cap liners, use	653
cappings	655
chemical tests	664, 666
cloud test	665
color	189
equipment for	658
extractor, solar	654
glands	183
honey, comparative amounts	654
importation	591
in 10 drawn combs	661
insulating	653
melting tank	657
polish	652
press	632, 658
production	654
propolis in	539, 662
purity of	662
rendering	655
resin in	662
saponification cloud test	665
scales	653
secretion	182
specific gravity	652
steam chest	658
temporary comb building increases	654
testing of	664
uncapping deep increases	249
vegetable, in propolis	662
waterproofing	652
worms	667
Wax moth	668
control	181, 673
Weed process foundation	155, 188
Weeds, chemical control, kills bees	506



chemicals for .....677  
 fumigation for .....675  
 Weighing honey, hive scale .....574  
 Weight, bees .....502, 677  
   comb honey .....330  
   honey per gallon .....383, 437  
   labels must show .....455  
 White clover .....147  
   sweet clover .....614  
 Willow herb .....678  
 Willow .....678  
 Wind protection in winter .....686  
 Windbreaks .....690  
   important .....31, 498  
   natural and portable .....690  
 Wine, honey .....442  
 Wings, honeybee .....10, 678  
   hooks .....680  
   queen, clipping .....2, 549, 607, 680  
   wearing out .....4  
 Winter, breeding .....105  
   cluster, effect of packing .....684  
   cluster temperature .....620  
   diagnosis .....208  
   dwindling .....586  
   feeding .....285  
   hard candy .....131  
   losses, packages replace .....500  
   management, food chamber .....290  
   nest, important .....683  
   packing, for .....682  
   stores needed .....681  
   sugar, dry .....286  
   ventilation .....646  
 Wintering .....680  
   artificial heat for .....691, 697  
   gov. research .....639  
   house apiaries for .....40  
   indoors .....692  
   killing bees instead of .....689  
   Nosema causes loss .....490, 686  
   outdoor packing for .....687  
   vs no packing .....682

USDA research .....640  
 upper entrances .....234, 646, 683  
 Wire veil .....645  
 Wired foundation .....161, 163  
 Wiring foundation prevents sagging .....159  
 Women, bee suits for .....646  
 Wood base comb foundation .....158  
 Woods, hunting bees .....62  
 Worker, age .....4  
   and drone comb .....195  
   comb .....195  
   drone cells in comb .....103  
   drone, queen .....544  
   egg produces queen .....544  
   feeds queen .....59  
   head .....9  
   jelly .....570  
 Worker cells, size .....134  
   stretching .....158  
 Worker larvae, development .....108  
 Workers from unfertile eggs .....504  
   laying .....466  
 Worms, wax .....667

X

Xenophon .....698  
 Xylocopa .....698

Y

Yeast, brewers', pollen substitute .....516  
   heat to kill .....389  
   in nectar .....699  
 Yeasts, honey .....441, 698  
 Yellow poplar, see Tulip Tree  
   sweet clover, see Sweet Clover

Z

Zeeping of queen .....547  
 Zinc in honey .....702