

# **AT** MICROFICHE REFERENCE LIBRARY

A project of Volunteers in Asia

Manual on the Production of Rattan Furniture

publication no. ID/299

Published by:

UNIDO

Available from:

Editor  
UNIDO Newsletter  
P.O. Box 300  
A-1400 Vienna  
AUSTRIA

Reproduced by permission.

Reproduction of this microfiche document in any form is subject to the same restrictions as those of the original document.

UNITED NATIONS INDUSTRIAL DEVELOPMENT ORGANIZATION  
Vienna

# MANUAL ON THE PRODUCTION OF RATTAN FURNITURE



UNITED NATIONS  
New York, 1983

### Explanatory notes

References to dollars (\$) are to United States dollars, unless otherwise stated.

The following abbreviations have been used in this manual:

CKD	completely knock-down
KD	knock-down
PVA	polyvinyl acetate
UF	urea-formaldehyde
UWS	unwashed and unsulphured
W	washed
WS	washed and sulphured

The designations employed and the presentation of the material in this document do not imply the expression of any opinion whatsoever on the part of the Secretariat of the United Nations concerning the legal status of any country, territory, city or area or of its authorities, or concerning the delimitation of its frontiers or boundaries.

Mention of firm names and commercial products does not imply the endorsement of the United Nations Industrial Development Organization (UNIDO).

## Breface

One of the most pressing problems of the furniture industry in developing countries is to increase productivity and profitability in their move from craft to industrial-type operations.

Rattan, a product of tropical forests, has been used to produce furniture and wickerware since prehistoric times. In most developing countries rattan furniture is still produced at a craft level in a great number of tiny workshops. Because of the low level of investment required to convert such workshops into industrial enterprises and the high labour intensity of the work, the industrial production of rattan furniture could become export oriented in those countries that have access to appropriate designs and raw materials.

This is of great potential importance to developing countries that possess rattan in their natural forests. The process, even when mechanized, remains quite labour intensive, and rattan furniture is increasingly in demand on the markets of developed countries. Furthermore, there is considerable potential for adding value to the unprocessed rattan that is exported in vast quantities for use in the furniture industries of developed countries.

In recent years, many technical developments have taken place in the production of rattan furniture. The aim of this manual is to familiarize rattan furniture producers in developing countries with these new techniques.

The views expressed in this publication are those of the author, Desmond P. Cody, a free-lance industrial consultant to the furniture industry. They do not necessarily reflect the views of the secretariat of the United Nations Industrial Development Organization (UNIDO).

CONTENTS

<u>Chapter</u>	<u>Page</u>
INTRODUCTION .....	1
I. THE RATTAN PLANT .....	3
A. Description .....	3
B. Classification .....	3
C. Stem system .....	6
D. Identification .....	6
E. Seeding .....	6
F. Local names .....	7
G. Trade names .....	7
II. RATTAN PROCESSING .....	9
A. Harvesting .....	9
B. Preliminary processing .....	10
C. Conversion .....	16
III. MARKETING RATTAN .....	19
IV. DESIGN CONSIDERATIONS .....	21
A. Methods of jointing and binding .....	21
B. Knock-down construction .....	27
C. Market considerations .....	28
V. THE MANUFACTURING PROCESS .....	30
A. Organization .....	31
B. Production flow .....	31
C. Intermediate component storage .....	51
D. Assembly .....	51
E. Surface treatment .....	59
F. Final assembly .....	60
G. Inspection/quality control .....	61
H. Finished goods storage .....	61
I. Upholstery .....	61
VI. PROJECT ENGINEERING .....	62
A. Technology and equipment .....	62
B. Machinery, equipment and auxiliary services .....	64
C. Site and buildings .....	65
D. Plant layout and the organization of production .....	67

	<u>Page</u>
VII. MANAGEMENT AND LABOUR .....	73
A. Department functions .....	73
B. Labour requirements .....	78

#### Annexes

I. Philippine standard specification for rattan and wicker furniture .....	80
II. Portfolio of designs for rattan furniture .....	86
<u>Bibliography</u> .....	105

#### Tables

1. Machinery and labour requirements .....	62
2. Investment costs for machinery, equipment and auxiliary services .....	65
3. Building costs .....	66
4. Labour requirements .....	78

#### Figures

1. Rattan palm .....	5
2. Cross-section of a rattan stem .....	5
3. Rattan-splitting machines for the production of rattan peel and core .....	16
4. Rattan weaving machine .....	17
5. Rattan surface milling machines .....	17
6. Typical rattan armchair .....	22
7. Structural joints for rattan frames .....	23
8. Structural joints for rattan frames .....	24
9. Structural joints for rattan frames and seat frames .....	25
10. Methods of binding rattan joints .....	26
11. Rattan KD chair ready for assembly .....	27
12. Fully assembled KD chair .....	28

	<u>Page</u>
13. Preliminary inspection and classification of rattan poles .....	32
14. Second scraping of rattan poles .....	32
15. "Wigwam" drying in the sun .....	33
16. Further straightening, classification and storage of poles .....	33
17. Hydraulic straightening machine .....	34
18. Rattan components being straightened .....	35
19. Profile sanding machines .....	35
20. Rattan boiler and steaming oven .....	37
21. Steaming rattan components .....	38
22. Rattan components ready for bending .....	38
23. Rattan bending machine .....	39
24. Moulding circular components or rings .....	39
25. Rattan rings drying after moulding .....	40
26. Moulding U-shaped components using a metal jig .....	40
27. Components drying after moulding .....	41
28. Loaded moulding jig for compound moulds .....	41
29. Shaping legs and top back rail for a period dining-room chair .....	42
30. Moulding chair splatts .....	42
31. Subsequent cleaning of splatts by scraping and sanding .....	43
32. Moulding U-shaped components .....	43
33. Moulding decorative components .....	44
34. Metal constructed moulding jig .....	44
35. Complex rattan shape .....	45
36. Metal moulding bench fitted with pneumatic and hydraulic cylinder .....	45
37. Adjusting moulded components to achieve correct bend .....	46
38. Adjusting shaped components with the aid of a kerosene fired blow torch .....	46

	<u>Page</u>
39. Adjusting shaped components with the aid of a kerosene fired blow torch .....	47
40. Buffer sanding machine for moulded components .....	47
41. Drilling a subassembly in preparation for final assembly .....	49
42. Drilling a subassembly in preparation for final assembly .....	49
43. Drilling a chair back leg to take stretcher rail .....	50
44. Grooving frame to take woven cane .....	50
45. Pre-assembly of chair back element .....	51
46. Fixing seat frame to chair .....	52
47. Assembly frame for dining-room chair .....	52
48. Assembly frame for two-seater settee .....	53
49. Stapling sika or small-diameter core to seat frame .....	53
50. Machining rattan core .....	54
51. Machining rattan peel for binding .....	55
52. Rattan peel trimming machines .....	55
53. Rattan peel winding machine .....	56
54. Binding of joint between arm and back leg .....	56
55. Binding of joint between brace and front legs of dining-room chair .....	57
56. Fixing woven rattan caning to chair back .....	57
57. Binding back leg to stretcher rail .....	58
58. Weaving a basket on a rattan ring base .....	58
59. Weaving with rattan peel .....	59
60. Lacquering a settee frame .....	60
61. Process flow chart for rattan furniture processing .....	70
62. Schematic layout of rattan furniture plant .....	71
63. Management structure .....	77
64. Occasional armchair with woven cane seat and back .....	86
65. Occasional armchair with loose cushions .....	87



	<u>Page</u>
66. Occasional armchair with cushions and woven cane sides ...	88
67. Occasional armchair with seat cushion and castors .....	89
68. Occasional armchair with loose cushions .....	90
69. Occasional armchair with loose cushions .....	90
70. Occasional armchair with loose cushions .....	91
71. Windsor type host chair with cushioned seat .....	92
72. Swivel lounge chair with single cushion for seat and back .....	93
73. Swivel occasional or office chair with woven cane back ...	94
74. 3-seater settee with loose cushions .....	94
75. 3-seater settee with shaped cushions .....	95
76. Dining-room chair .....	96
77. Dining-room chair with cushioned seat .....	97
78. Dining-room chair with caned splatt .....	98
79. Dining-room chair .....	99
80. Bar stool with swivel seat and woven cane back .....	100
81. Coffee table .....	101
82. Corner table .....	101
83. Circular dining-room table with veneered ply top .....	102
84. Corner table .....	102
85. Nest of tables .....	103
86. Circular coffee table .....	103
87. Display unit .....	104

## INTRODUCTION

Rattans are the most important group of forest species after timber. Their growth is confined mainly to the tropical forests of South-East Asia, and they have been used for centuries by the people of that area for one purpose or another - from the making of household artifacts to foot-bridges. The material also found its way into many other parts of the world, and there are records and examples of furniture made from it in ancient Egypt and later, during the Renaissance period, in the reigns of Louis XIII and Louis XV of France.

Today the rattan industry has become a multimillion dollar business and, even though its roots still remain firmly embedded in village and small-scale rural cottage-type activities, it generates employment for tens of thousands of people who harvest, process and shape it into a variety of end-products for home and export markets. World trade in raw rattan is in excess of \$100 million and by the time the manufactured product reaches the ultimate consumer it has increased in value 100 fold.

The industry nevertheless remains highly labour intensive, despite the introduction of some degree of mechanization and better production organization. In the processing and manufacturing aspects it is estimated that the average investment per worker in a modern rattan factory is about \$2,000, while that for a worker in a similar type conventional furniture plant is about \$20,000.

As interest in rattan and rattan products increases it is hardly surprising that the industry is attracting close attention, not only from national Governments, in whose territory it forms an important natural resource but also from entrepreneurs and importers who recognize its potential profitability and even research institutes that have finally come to acknowledge the need for more organized research and development on its behalf, especially in the fields of rattan cultivation and utilization.

Since a very large proportion of rattan is destined for the production of furniture, there is no reason why it should not benefit from association with its longer established counterpart, wood. Many of the production techniques, equipment and other raw materials developed by the latter could, with appropriate modifications, be used to advantage in the manufacture of rattan furniture. At the same time, the inherent characteristics of the latter, especially its lightness, flexibility and durability, offer a unique opportunity to both the designer and production engineer to achieve an end-product incorporating shape and form denied them in working with wood.

This, in turn, is enabling rattan furniture to carve a small though increasingly special place for itself in the most sophisticated of world markets, such as Japan, the United States and Europe, where it can command both exclusivity and price on its own merits. Already some sectors of the

industry have benefited by calling on the expertise of the professional designer and engineer to assist them in further capitalizing on the undoubted potential of this unique material. If this movement is accelerated and at the same time coupled with better organization and management of the industry at all levels, there is little doubt that it can become, in countries where suitable species are available, a dynamic force in national industrial development and a significant earner of foreign exchange.

The purpose of this manual is to familiarize those who are engaged directly in the rattan industry and others who may be interested in its current level of development from the points of view of materials, technology and end-products. A further aim is to examine its potential for growth in output and higher productivity with the introduction of more modern production and management techniques.

Annex I contains the Philippine standard specification for rattan and wicker furniture, the only one of its kind so far published.

## I. THE RATTAN PLANT

### A. Description

Rattans are climbing palms that grow abundantly at low and medium altitudes in the virgin forests of South-East Asia and the Pacific. They also thrive in thickets or in second growth forests but are rarely found in open country. Rattans also grow in Africa and Latin America but are used less for furniture there.

The English word "rattan" derives from the Malay word "rotan", the collective name for the climbing members of a large group of palms called Lepidocaryoideae (in Greek, scaly-fruited). The word "raut" in Malay means to pare, smoothen or whittle and refers to the paring or smoothening operation by the rattan harvester who twists the newly dragged-down cane around any convenient rough-barked tree trunk to rub off the prickly leaf sheath.

### B. Classification

The most widespread rattan classification, and the largest genus of rattans and palms, is the genus Calamus, which is reported to occur from West Africa to Fiji and from south China to Queensland. The greatest concentration is said to be in Peninsular Malaysia, in the stable centre of the ever wet areas of the Sunda Shelf.

There are 11 genera found in South-East Asia: Calamus, Daemonorops, Korthalsia, Plectocomia, Ceratolabus, Plectocomiopsis, Myrialepis, Calospatha, Bejaudia and two as yet unpublished genera.

Of the 11 genera of South-East Asian rattans 9 are found in the Malay Peninsula and, of these, Calospatha is found nowhere else. The distribution of the South-East Asian genera is as follows:

<u>Korthalsia</u>	Mainly in the Sunda Shelf, few species found outside this area
<u>Plectocomia</u>	Bali, Java, Sumatra, Borneo, the Philippines, Peninsular Malaysia, mainland South-East Asia north to the foothills of the Himalayas and south China
<u>Plectocomiopsis</u>	Sumatra, Borneo, Peninsular Malaysia, Thailand, and Indo-China
<u>Myrialepis</u>	Sumatra and Peninsular Malaysia
<u>Bejaudia</u>	Indo-China

<u>Calospatha</u>	Peninsular Malaysia
<u>Daemonorops</u>	Found from south China and south India to the island of New Guinea (greatest concentration in Borneo and Sumatra)
<u>Calamus</u>	From West Africa to Fiji and from south China to Queensland
<u>Ceratolobus</u>	Confined to Sumatra, Peninsular Malaysia, Borneo and Java
<u>New genus 1</u>	Peninsular Malaysia, Borneo
<u>New genus 2</u>	Borneo

Generally, most rattan species grow at a wide range of altitudes and may be found from sea level up to about 2,900 m. The altitude at which change takes place varies with topography, soils and climate but is usually confined to the vegetational boundary between 1,000 m and 1,400 m. Few low-land species transgress this boundary.

Rattan species are distributed among the genera as follows:

<u>Genus</u>	<u>Number of Species</u>
<u>Calamus</u>	370
<u>Daemonorops</u>	115
<u>Korthalsia</u>	31
<u>Plectocomia</u>	14
<u>Ceratolobus</u>	6
<u>Plectocomiopsis</u>	5
<u>Calospatha</u>	1
<u>Myrialepis</u>	1
<u>Bejaudia</u>	1
Two unpublished genera	3

Figure 1 shows a schematic diagram of a rattan palm growing in the forest. Part (a) is the crown with leaves, which grows above the tree tops. Part (b) is the young top part, about 3-4 m long, which is usually discarded because it is soft and immature. Part (c) is the middle part, which yields normal commercial rattan after processing. It can be recognized because the leaf sheaths have fallen. The base part (d) contains certain tannins, has a light brownish colour and is sometimes used for making walking sticks.

Figure 2 shows a schematic cross-section of a rattan stem. Part (a) is the epidermis or outer skin with cuticula at the periphery. Part (b) is the bark with thickened cell walls. Part (c) and (d) are the central cylinder or core with (c) containing fibre bundles and (d) the pith with vascular bundles each strengthened with a fibre bundle.

The cuticula consists of a waxy matter that tends to prevent evaporation of moisture in a radial direction. Discarding the cuticula means a considerable reduction in drying time. Parts (a), (b) and (c) give the commercial core peel, or splits, that results when the rattan is split by hand or by machine. This material is used for binding and weaving. Part (d) gives the

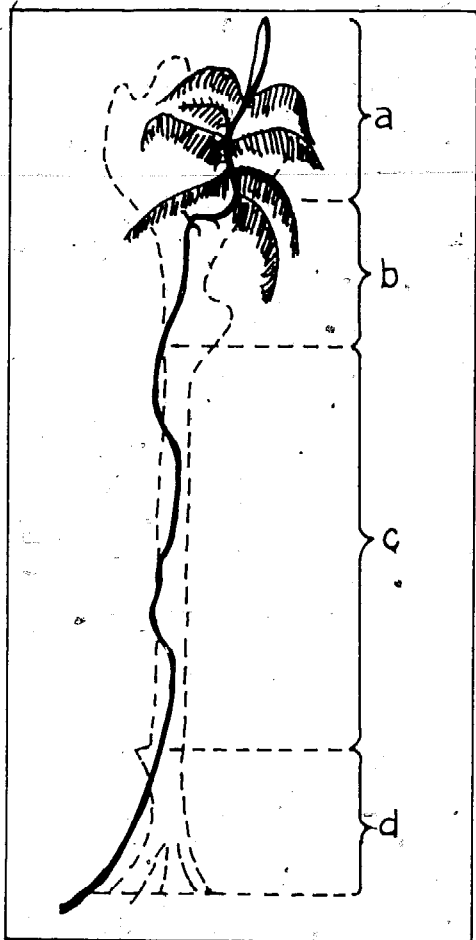
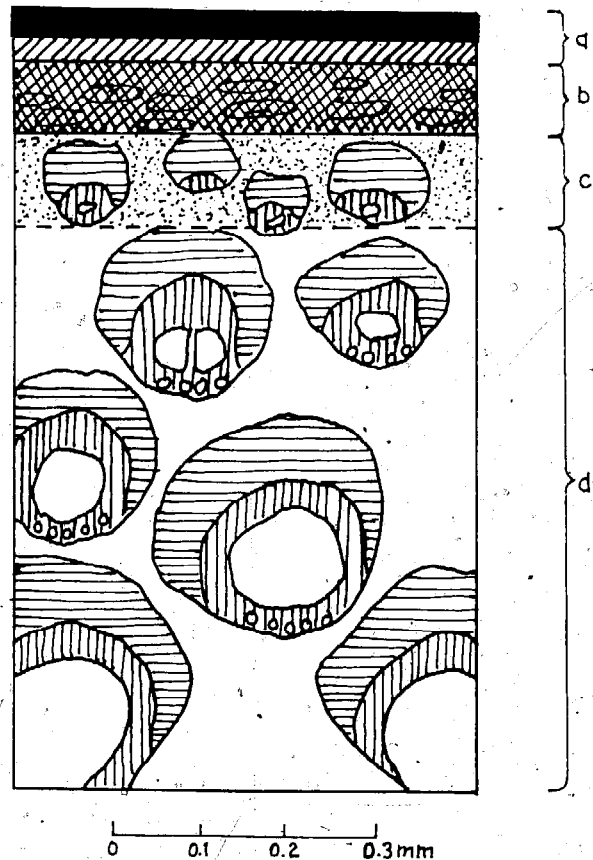

Figure 1. Rattan palm

- (a) Crown with leaves
- (b) Young top (usually discarded)
- (c) Middle (commercial rattan)
- (d) Base

Figure 2. Cross-section of a rattan stem

- (a) Epidermis with cuticula
- (b) Bark
- (c) Central cylinder containing fibre bundles
- (d) Central cylinder with vascular bundles



commercial "core peel" or "pith" being the centre core after the rattan has been peeled. Characteristics such as hardness, stiffness, elasticity, flexibility, workability and strength of rattan are determined by the compactness of the fibro-vascular bundles. These differ from species to species and in accordance with the age of the plant and are important in relation to its commercial quality and use for specific applications.

### C. Stem system

The stem system of rattans is very variable. It affects the general appearance of the plant and hence is of considerable classification value. Some species of Calamus are even "stemless".

One of the most important stem variations, and one that has economic significance, is solitary versus clustered stems. Solitary stemmed rattans like Calamus manan and Calamus laerigatus are one-harvest rattans. Clustering species such as Calamus caesius and Calamus trachycoleus and all species of Korthalsia are re-harvestable. Another important parameter of the stem system is aerially branched versus aerially unbranched. Nearly all rattans, if they branch at all, do so at ground level. Korthalsia branches aerially and profusely.

Stem diameter varies considerably. Some montane Calamus species may be as little as 3 mm in diameter, whereas the species Plectocomia elongata may reach 20 cm in diameter. Stem diameters increase very little with age. Stem lengths vary from the very short ones of species such as Calamus castaneus to the immense 200-m stems of Calamus manan and Calamus caesius. Internodal lengths tend to vary considerably within species, among stems from the same clump or even on the same stem. Surface features, such as colour, gloss and texture, vary considerably among different species of rattan. These features contribute to the economic value of the species.

### D. Identification

Leaf-form variation is considerable. The degree of apical growth of the leaf and the length of the foliage are two major parameters of leaf form. The most important feature for identification purposes is the armature of the leaf sheath, which is very varied and distinct. Few species have unarmed leaf sheaths and these and the climbing organs that anchor the rattan in the forest canopy are the two major hindrances to rattan harvesting.

The two major climbing organs are the cirrus and the flagellum. The cirrus is an elongation of the apex of the leaf that bears reflexed thorns and the flagellum originates from the leaf sheath and bears tightly sheathed tubular scales with a dense covering of reflexed thorns.

### E. Seeding

Rattans are prolific seeders. A single stem can produce clusters of fruits with as many as a thousand individual fruits. They are beautiful in appearance and edible. They range from round to oblong and are characterized by the presence of scales on the outer covering arranged in neat vertical and diagonal rows. The scales are brown and have a high lustre. A gelatinous pulp, either sweet or sour, surrounds the seed. An individual fruit ranges in

size from 0.3 to 1.5 cm in diameter and from 0.5 to 2 cm in length, depending on the species. It has usually only one seed.

#### F. Local names

Many rattans have local names, usually pertaining to specific attributes or characteristics of the plant. These names may refer to the surface of the cane, its thickness or hardness, its want of length, its use, its branching in order to flower, the bitterness of its apical buds, the shape of the sheath or leaves, the arrangement of prickles, the type of resin or sap exuded - all seemed to have influenced the naming of different species.

Nevertheless, there is considerable confusion even within countries. For instance, in Sabah "rotan batu" is a cane 2-4 cm in diameter, but in Peninsular Malaysia it is a cane 0.5 cm in diameter; they are totally different species. Some names are rather consistently applied, e.g. "rotan seta" (Calamus caesius) in Malaysia and "rotan tamam" (the cultivated Calamus caesius) in South Kalimantan.

In the Philippines, out of the 70 or so species and varieties of local rattans, the following may be listed as commercially exploitable:

Ditaan	( <u>Daomonorops mollis</u> )
Limuran	( <u>Calamus ornatus</u> , var. <u>philippinensis</u> )
Lokuan	( <u>Calamus reyesianus</u> )
Podlos	( <u>Calamus microsphaerion</u> )
Palasan	( <u>Calamus merrillii</u> )
Panlis	( <u>Calamus remolusus</u> )
Sika	( <u>Calamus caesius</u> )
Tagiktik	( <u>Calamus filispadix</u> )
Tandulang-parang	( <u>Calamus usitatus</u> )

#### G. Trade names

Trade names are developed by rattan merchants and bear little or no relation to botanical origin. Usually they derive from characteristics of the locality or appearance, e.g. "sega" (smooth or polished) or "rotan batu" (stoney).

According to one authority <sup>1</sup>/<sub>\*</sub> they may be classified into four main groups:

- (a) Sega. All canes with a siliceous outer layer that cracks and springs off when the cane is bent;
- (b) Lunti. Same kinds as Sega except that the silica layer is removed;
- (c) Ayer. Nonsilicious rattan not included elsewhere;
- (d) Sticks. Straight lengths where stiffness and straightness are the main considerations, e.g. for walking sticks and furniture frames.

\*For the notes, see page 79 below.



The Philippines appears to be the only country that has made any attempt to bring some order into trade names and grades. These are defined by the Bureau of Standards as follows:<sup>2/</sup>

(a) Palasan Group. This includes true palasan (Calamus maximus) and others with a diameter of over 2.5 cm and internodes of 25 cm or more. This group is divided into six grades based on diameter size A to E and one mixed grade. The diameter at the small end is measured and increased by 0.25 cm for each grade. The range is from grade E with a diameter of 2.5-2.75 cm to grade A with a diameter of 3.5 cm or more. The mixed grade is a mixture of sizes A to E. Canes of all grades must be mature, clean, thoroughly seasoned, free from fungal stain, scar, bruise, checks and discolourations. Specifications for substandard classes for each of the grades A to E are also given;

(b) Sika Group. Includes Palawan sika (Calamus caesius) and others that are glossy, flexible, bright yellow when dry (sometimes called golden sika) and are less than 1.5 cm in diameter;

(c) Tumalin Group. Includes those with a diameter of less than 1.5 cm but which are rather light cream in colour and therefore not included under Sika.

The basic factors which are taken into consideration for grade classes are:

Size (diameter) - starting as low as 4 mm and going up to 45 mm or more; the size classes may rise by 2, 3, 4, 5 or 6 mm or even as a mixture of those classes

Length of pole

Colour

Hardness

Defects and blemishes

Length of nodes

Uniformity of thickness along the length

## II. RATTAN PROCESSING

### A. Harvesting

Most of the rattan found in the markets comes from plants growing in their natural habitat. Large-scale plantations are to be found in central Kalimantan in Indonesia, but these are usually confined to the smaller diameter canes such as Sika.

Germination takes place in 7 to 14 days and the seedlings are ready to be transplanted to the nursery when one month old, i.e. when each has produced one sucker, which is the beginning of an aerial stem. The first harvest is from 8 to 12 years after planting depending on soil quality and climate. Mature canes attain lengths of 15 m, 18 m or even 20 m. During the harvest, which is done in the drier months, the top 2 m are discarded. Wet months are generally unsuited for harvesting because of floods and the consequent difficulty of access to the growing areas.

Collection methods vary slightly from place to place but are generally very wasteful. The stem is cut 30 cm to 2 m above the ground with a "parang" or cleaver and dislodged from the tree by tugging. This is more dangerous than it sounds, as the falling stem may bring with it all kinds of debris including dead branches, ants, wasps nests and clumps of epiphytes. If the cane gets stuck in the canopy the collector has to climb a neighbouring tree to cut it free. If this cannot be done, the part of the cane that cannot be reached is abandoned. Sometimes a fish-hook tied to a pole is used to dislodge the stalk.

As the cane is dragged down it is twisted around a convenient tree trunk to remove the thorny leaf sheaths. Alternatively, these may be chopped off or the collector may forcibly draw the stem between two pieces of wood to remove them. Two or three workers are required to harvest the largest rattans, such as Calamus manan, because the cane is normally lodged very firmly in the canopy.

Soon afterwards, the rattan is cut into lengths, the size depending on the species, the diameter of the rattan, its intended use, the specifications of the buyer or to suit the convenience of the collectors in carrying it out of the forest. Rattan is usually carried on foot over a distance of from 5 to 7 km to the depots or logging areas through dense jungle or equally difficult terrain, which can cause further damage en route.

Lengths into which the rattans are cut also vary according to the practice in different countries. In Indonesia, Calamus manan and Calamus scipionum are cut into 2-3 m lengths. More slender canes such as Calamus caesius and Calamus trachycoleus are cut into 5- to 7-m pieces and bent in two. In the Philippines, rattans are cut in 3- to 6-m lengths, bent sharply in the middle and tied in bundles for transport. This includes Tumalin (Calamus

mindorensis), Sika (Calamus spinifolius) and Panlis (Calamus ramulosus). Palasan (Calamus maximus) is bundled straight in lengths of 4 m. In Malaysia, large-sized canes are cut in 3-m pieces, smaller canes into 8- to 9-m lengths, bent in two and bundled.

## B. Preliminary processing

Preliminary processing - the preparation of the canes for direct use in manufacturing - varies in different countries and areas, as described below.

### Hong Kong

A substantial quantity of Indonesian rattan is imported into Hong Kong where further processing is carried out.

The rattan is steeped in a solution of sodium hypochlorite in a tank (5 x 1 x 1 m) for about one hour; 75-100 lb (35-45 kg) of the hypochlorite is mixed with water to about 3/5 the height of the tank. After repeated use of the mixture it is common practice to add more chemical and water as and when felt necessary. If bleaching is required, hydrogen peroxide is used.

The rattan is removed and steeped in an adjacent tank of the same size (except that its height may be a little less) and washed with water. After being washed, the rattan is transferred to a sulphur dioxide fumigation chamber (6 x 5 x 3 m), which is fitted with an external container for burning the sulphur and a flue leading into the chamber to convey the sulphur fumes. The rattan is fumigated over night and, if the colour is not sufficiently even, it is fumigated for a longer period.

Treated rattan is sorted into diameter classes as required and machine-cut into the required lengths. Bulging nodes on the larger diameter rattans are scraped to the level of the internodal diameter by experienced labourers who take care not to scrape the internodal skin. The rattan is then separated into quality and length classes. Lower quality material is used locally for the manufacture of low-priced furniture or for core and peel. Better quality material is either exported or retained for splitting.

In addition to this treatment, one other treatment has been noted in Hong Kong and also in Singapore. The rattan is first sorted into "hard", "medium hard" and "soft" as follows:

- |              |   |
|--------------|---|
| Hard:        | When the rattan is bent by hand and released, it springs back and regains its original form quickly   |
| Medium hard: | When the rattan is bent by hand and released, it regains its original form rather slowly but not fully  |
| Soft:        | If the rattan is bent, it cracks at the bend or breaks and if the bent rattan is released before it cracks or breaks, it regains its original form completely |

Hard and medium hard rattan is steeped in water for 24 hours, rubbed with sand and coconut husk, dried in the sun, fumigated with sulphur dioxide for 24 hours, dried again, refumigated for 24 hours, and finally sorted by length, diameter and quality.

Soft rattan is treated (in Hong Kong) in the manner described earlier, i.e. with hypochlorite etc.

### India

In the states of Assam and West Bengal, the larger diameter rattans are rubbed with sand and gunny cloth, treated with linseed oil and heated over a fire for about one minute. The canes are then rubbed with gunny cloth soaked in kerosene and dried upright in the sun for 10 days. Finally they are tied in bundles of 100 for sale.

In Kerala, the Forestry Department authorities stated that some years ago small canes for weaving were steeped in the caldron in which paddy was being parboiled. This process apparently gave the cane a good sheen and protected it from insect attack, but it is no longer popular. Another method, still practiced by some, is to boil small canes for weaving in water containing a mixture of coconut milk and turmeric acid in equal proportion. This is also said to improve the appearance of the cane. Canes for export are steeped in water and rubbed with fine sand.

### Indonesia

In Indonesia, deglazing or "runti" of siliceous species, Calamus caesius and Calamus trachycoleus, is done by some collectors. The inner epidermis of the leaf sheaths adhering to the cane and the silicified epidermis of the cane are removed. Several methods are employed:

(a) Runti Gosok. The rattan is pulled in and out through a hole made in a section of a piece of bamboo tied to a tree;

(b) Runti Jala. The cane is pulled through a loop suspended between three bamboo poles standing about 1 m above the ground and rubbed briskly with a chain. In some cases the cane is passed through a thick metal (tin) ring for better results in removing the leaf sheaths;

(c) Runti Pelari. The cane is hit with a piece of wood or plaited rattan. This method is less satisfactory.

The simplest but most time-consuming method, however, is to twist the cane by hand and rub it with fine sand, steel wool, coconut fibre or sackcloth. This produces a very clean finish. The process of "runti" must be carried out within 24 hours of harvesting. If this is not possible, the canes must be steeped in water to keep them moist because deglazing of dried rattan is difficult. After "runti" the canes are dried for about 7 days, either directly on the ground or on a special framework that is raised above the ground to promote even drying. During wet weather the canes are dried over a fire. Quick drying is essential to prevent or reduce blemishes (fungal stains) and to prevent deterioration of the cane.

Rattan that has gone through the "runti" process is called "rotan asalan". Much of the rattan exported from Indonesia is processed to this stage. When the exporter sorts this rattan, normally 30-40 per cent is rejected.

Further processing is carried out by the exporter, whose methods vary from district to district. Some methods are:

(a) No washing, no fumigation with sulphur dioxide. Depending on its state of dryness, the "rotan asalan" is dried in the sun for a few days until the moisture content is about 5-10 per cent. It is then sorted according to diameter and defects, weighed and tied into bundles with rattan. These rattans are recognized as unwashed and unsulphured rattan (UWS);

(b) Washed rattan. "Rotan asalan" is dried for a few days, then sorted according to diameter, length and defects. Next it is washed in water and at the same time rubbed with white sand and coconut husk. This is followed by drying to a moisture content of 5-10 per cent and sorting into quality classes. Immature tops are removed and the ends are squared. The rattan is then weighed and bundled to order. These rattans are recognized as washed rattan (W);

(c) Washed, fumigated with sulphur dioxide. "Rotan asalan" is dried and sorted according to diameter (medium and large), length and defects. After this sorting, it is washed and rubbed with white sand and coconut husk. Large diameter rattan is scraped before washing. Subsequently, the rattan is fumigated with sulphur dioxide for 24 hours or more, dried in the sun to 5-10 per cent moisture content, sorted into quality classes and trimmed to remove immature tops and ends are squared. These are recognized as washed and sulphured rattans (WS);

(d) Washed, fumigated, and steeped in kapurit. This is the same process as WS above, but before fumigation the rattan is steeped in a solution of kapurit for 24 hours;

(e) Boiling in oil ("Sumatra barat", especially for Calamus manan). "Rotan asalan" is sorted to separate defective canes and canes of unsuitable length. The selected canes are steeped in a hot (150° C, in Padang) 1:1 mixture of diesel and coconut oil for 30-45 minutes. After removal from the oil, they are dried and rubbed with coconut husk, sackcloth or sand. In Padang no drying is done prior to the rubbing. They are then further dried in the sun for 1-12 days, according to weather conditions. Subsequently, the rattan is washed in water and rubbed with coconut husk or sackcloth, while in the water, until the rattan has a glazed appearance. It is then dried in the sun for 2-3 days until it reaches a moisture content of 5-10 per cent, sorted into quality classes, cut into lengths as per the buyers' orders, weighed, and bundled, ready for export.

## Malaysia

The larger diameter canes like Calamus manan, Calamus ornatus and Calamus scipionum and also some smaller sized ones are boiled in a mixture of diesel and coconut oil or a mixture of diesel oil and palm oil for varying lengths of time. Pure coconut oil is said to be the best, and in fact mixtures began to be used only when coconut oil became too expensive for the purpose.

The proportion of coconut to diesel oil or palm oil in the mixtures varies from depot to depot as do immersion periods and oil temperatures. There is no rational explanation for these variations, except that each depot chooses its immersion times, temperatures and "strength" of mixture, either according to the dictates of its customers or according to its own judgement through experience. The size and species of cane to be treated also influences these choices.

The oil boiling process removes the large quantities of gums and resins and most of the moisture in the canes. Removal of the gums and resins is said to make the canes more durable. However, there is considerable controversy concerning the optimum proportion of diesel and coconut oil compound to be used in the mixture, the period of immersion and the temperature at which the mixture is to be maintained.

Mixtures vary from 50 parts of diesel oil and 50 of coconut oil to 90:10; temperatures from lukewarm to 130° C; and periods of immersion from 5 or 10 minutes to 30 or 40 minutes, and even in one case up to 3 hours. Treated canes are rubbed with sawdust, rag waste or gunnysack. The large-diameter canes, which are usually about 3-m long, are tied loosely at one end and stood upright with the untied end on the ground and the basal ends spread out forming a cone. The smaller diameter canes, usually 8- to 9-m long, are hung over wooden stands or bent double and leaned against such stands with their ends down. In some cases, they are spread over the ground, over a wooden frame on the ground, or on wooden racks. Drying time varies from 1 to 2 or even 3 weeks. In all cases, the drying canes are moved into a shed in the evenings and taken out again as the sun comes up. Canes are also taken into the shed if rain is expected. The drying ground is sometimes cemented or covered with about 15 cm of sand to promote quicker drying. Following drying, the rattan is bundled and stored until sold.

The trough for heating the oil mixture is either made of iron (4 m long x 0.6 m x 0.6 m) or of halves of empty oil drums welded together and heated by wood fires from below.

#### Papua New Guinea

Processing consists of (a) cleaning in water, (b) rubbing with kerosene and water, (c) bleaching and drying in the sun, (d) trimming of nodes, (e) grading into quality classes and (f) dry storage.

Though rattan can be stored under running creek water for longer periods, the actual cleaning has to be done within 48 hours of harvesting. Cleaning takes place in clean running water in a creek or river, in a trough or in a sea water near a sandy beach. The poles are rubbed with fine steel wool (or hessian or coconut husk) which removes dust, mud, mosses, lichen etc. The shining green or yellowish skin can then be judged for defects both natural (fungal and insect damage) and mechanical (handling and wrong treatment) and graded accordingly.

After the water has dripped out of the very porous cane poles, the poles are thoroughly cleaned by rubbing the surface with fine steel wool and kerosene using plastic gloves to protect the hands from kerosene burns. This stage removes the waxy layer in the cuticula (see figure 2) and reduces considerably drying and bleaching time.

Drying in the sun (3 to 4 weeks) and bleaching follows the cleaning process. The purpose of sun drying is to reduce the moisture content of green cane from 90-120 per cent to 15-20 per cent, which prevents most fungal growth (mould, blue stain, black rot) and deterioration. During the drying period any contact with water, wet grass or muddy soil must be avoided. Before rain-fall and during the night the rattan has to be moved from the drying racks and stored in an open-sided airy shed.

Bleaching turns the green cane into creamy coloured poles. They should be turned regularly in order to ensure a uniform colour throughout the surface area.

The drying period provides a good opportunity to grade and sort the cane according to quality (rate of defects per pole) and diameters (e.g., 12-16 mm; 16-20 mm; 20-24 mm; 24-28 mm; 28-32 mm etc.). Defects include insect or fungus deterioration, wrinkled soft sticks or poles, too short nodes, surface damages by scratching and mackerel marks (caused by severe bending).

The final treatment is the trimming of all dark and uneven node rings by hand with a sharp steel knife or sanding machine.

### Philippines

Blemishes in rattan are caused by certain fungi (Ceratocystis sp. and Diplodia sp.) that heavily infect the rattan tissue with coloured vegetative structures known as hyphae. Most of these discolourations are caused by soluble pigments that are given off by the fungi and taken up by the cell walls of the substrate. In some instances, however, the pigmentation of the fungus filaments may contribute to the discolouration. The pigmented hyphae penetrate deeply into the rattan tissue and produce blemishes that cannot be removed, even by scraping.

The staining fungi produce spores that float in the surrounding air. Once the spores come into contact with the cut ends and bruises of green rattan poles, they germinate so fast that hyphal penetration may go as deep as 50 mm in 24 hours. The spread of the hyphae continues as long as the moisture in the poles remains favourable for the growth of the fungi. However, fungal growth is inhibited when the moisture content of the rattan is below 20 per cent.

A number of steps can be taken to prevent staining of rattan poles. When possible, harvesting of rattan is done during the dry season when weather conditions are favourable for the cutters to treat the poles with fungicides. Many rattan cutters leave their poles in the woods for as long as three weeks without treatment, which results in heavy loss due to degradation caused by staining.

Rattan canes that are cut in the forests are transported to the treating depot before they are dried and processed either for local use or for export.

Rattan poles are transported from the forest to the treating depot for dipping in anti-stain chemical solution the day the poles are harvested in order to protect them from initial infection. If the dipping is done within 24 hours after cutting, the effectiveness of the anti-stain chemical solution is high. But, it is preferable that treatment take place within 12 hours after cutting so as to ensure complete protection from staining fungi. Further delay in dipping will reduce the effectiveness of the chemical treatment against stain infection.

The anti-stain chemical solution, consisting of Dovicide G <sup>3/</sup> with a concentration of approximately 0.84% by weight (0.63% pentachlorophenate) or 3.18 kilograms of the chemical per 378.53 litres (100 US gallons) of water, has been found to be effective. When applied properly it is effective in controlling rattan stain, provided, of course, that the poles are properly handled before and after chemical treatment. To maintain a relatively consistent concentration, the solution is stirred thoroughly before rattan poles are dipped into it and the tank containing the solution is covered to protect it from the rain.

If it is not possible to bring the harvested poles to the treating depot the day they are cut, preliminary dipping in the chemical solution is done in the cutting area soon after cutting to minimize the risk of infection.

The poles to be treated are hauled to the treating depot, scraped, then dipped for one to two minutes in the Dovicide G solution.

Clean and sanitary conditions are strictly maintained in the treating depot. No rattan trimmings or scrapings are scattered in the area. This waste is burned; otherwise, it provides an excellent place for harbouring and propagating the staining fungi.

Treated poles are air dried by end-racking. While being air dried, the poles must be protected from rain to prevent the washing away of the anti-stain chemical solution. When the poles are thoroughly dry, they are sanded for smoothening and subsequently subjected to another and final anti-stain-chemical treatment. During this last treatment, an insecticide may be added to the anti-stain-chemical solution to protect the pole from both stain and insect attack. The poles are air dried in a well-ventilated and sheltered storage place by the end-racking method for about a month, until the moisture content is below 20 per cent. Once the poles are dried continuous efforts are made to keep them dry, especially when they are in transit.

Before shipment for export, the poles are wrapped in thick water-repellent paper or other material that will protect the poles and minimize the moisture they pick up while aboard the ship.

It should be borne in mind that once the staining fungi have penetrated rattan poles beyond the reach of the chemical solution recommended, cure and prevention of fungal staining becomes impossible.

All poles are treated with pentachlorophenate or saline solution to safeguard against insect borers.

#### Singapore

Importing a substantial portion of its rattan requirements from Indonesia, Singapore processes rattan in a manner similar to that described for Hong Kong.

In addition, the special treatments described for hard, medium hard and soft rattan in the case of Hong Kong are also followed except that in the case of soft rattan, particularly larger canes, the treatment is as follows: the soft rattan is sorted as either good or bad. The good but dry ones are steeped in water for 24 hours before further treatment. The good but wet ones, as well as the ones steeped for 24 hours in water, are rubbed with coconut oil and fumigated with sulphur dioxide several times as necessary. Subsequently they are rubbed with sawdust, tied in bundles, and the bundles are stood erect to dry in the sun. Sorting is done on the basis of colour, diameter and length.

#### Other countries

No special processing of rattan is done prior to conversion and manufacture in the other Asian countries, other than the drying done by collectors and some additional drying done by dealers or manufacturers. The total drying period in all these cases varies from one to three weeks.



### C. Conversion

Rattan canes that are dried and fumigated are sold whole as rattans or are further processed by dealers, exporters or manufacturers into rattan skin and rattan core, which are used for basketry, mat making, binding, weaving, furniture making and other purposes.

To produce rattan peel the outer 1-2 mm is pared off by hand with a special splitting knife or, more commonly nowadays, by using a splitting machine (see figure 3). The inner core is again split into flat core peel strips or into round wicks core for weaving and binding. The best quality peel comes from Calamus caesius and Calamus trachycoleus. Sometimes the former is prepared with its silica unscraped as it enhances the beauty and value of the material. In one of the large factories in Hong Kong, rattan with a small diameter (6 mm) or slightly larger is peeled, planed and trimmed by machines. The peels are woven by machine (see figure 4) into 50-m long pieces 0.3-0.6 m wide that are sold to rattan and wood furniture makers in South-East Asia and elsewhere. (Round or flat core for weaving and binding is also produced by machine). This factory produces 30 varieties of peels, cores or poles for export.

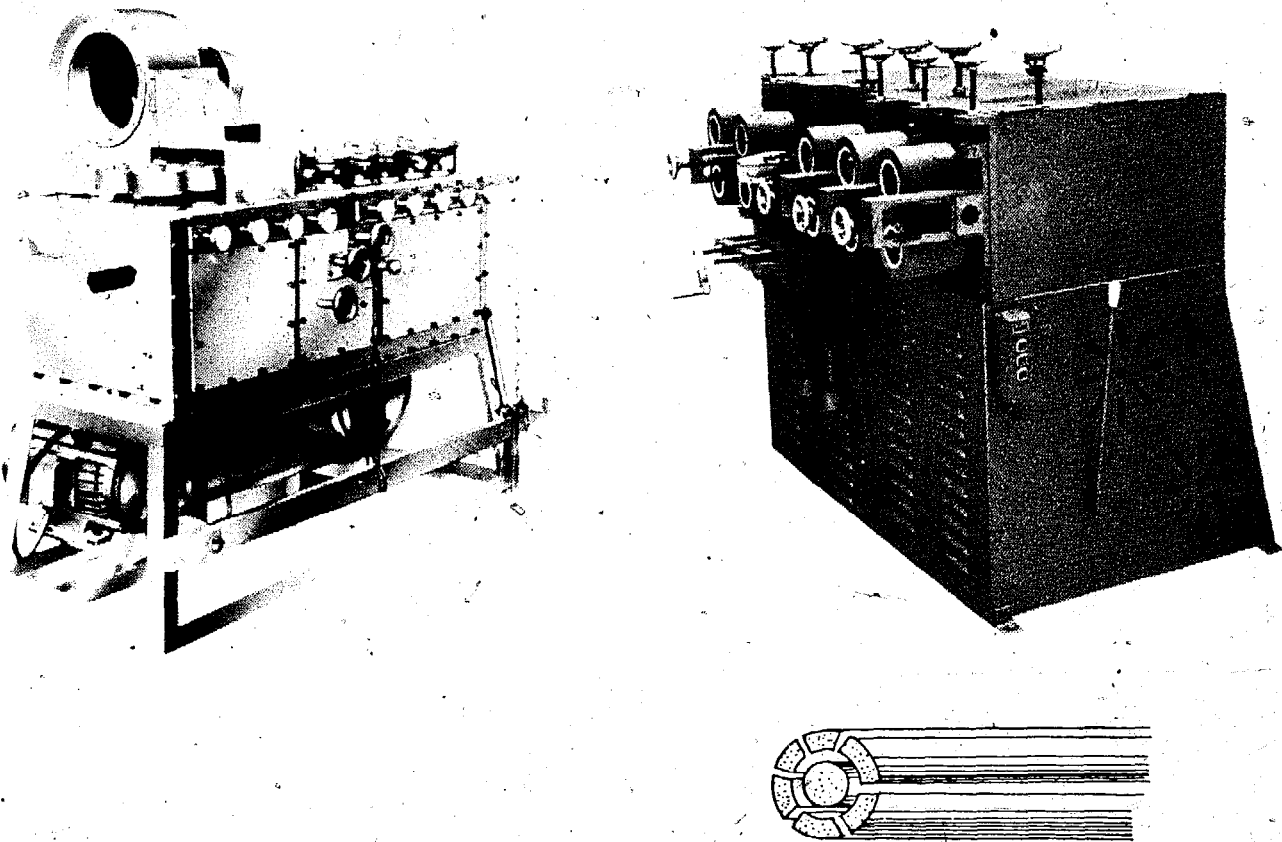

Figure 3. Rattan-splitting machines for the production of rattan peel and core

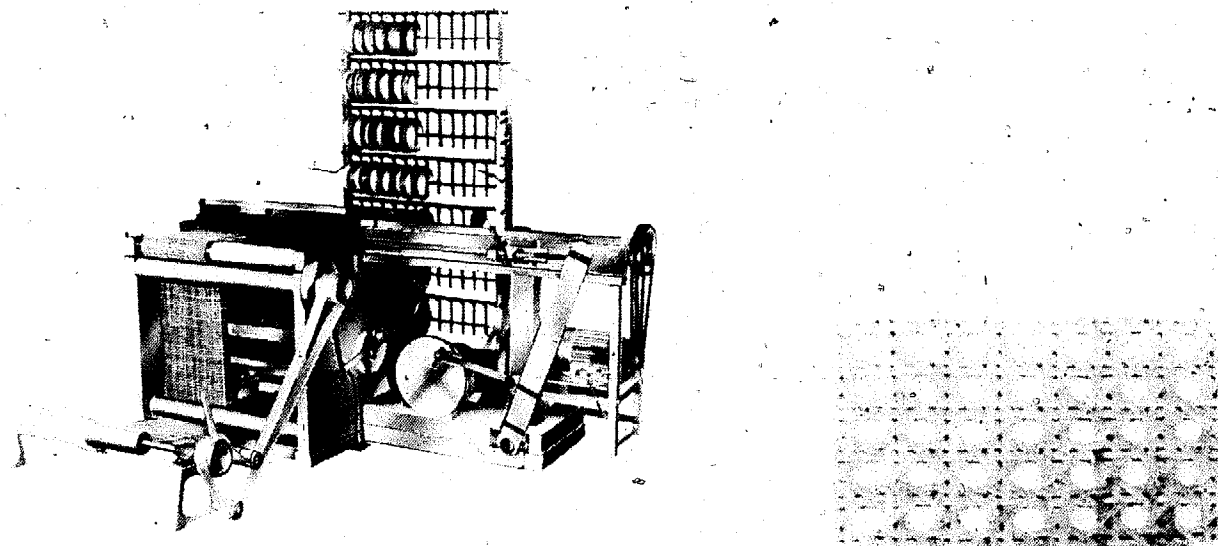

Figure 4. Rattan weaving machine

Large-diameter poles (18 to 34 mm) are used almost exclusively for furniture frame making and lesser diameters (12 to 18 mm) for non-structural and decorative purposes. These include Calamus manan, ornatus, scipionum, maximus, caesius and mindorensis. The poles are usually profile sanded if bought from a rattan collector or merchant and are sanded with a rattan surface milling machine (see figure 5).

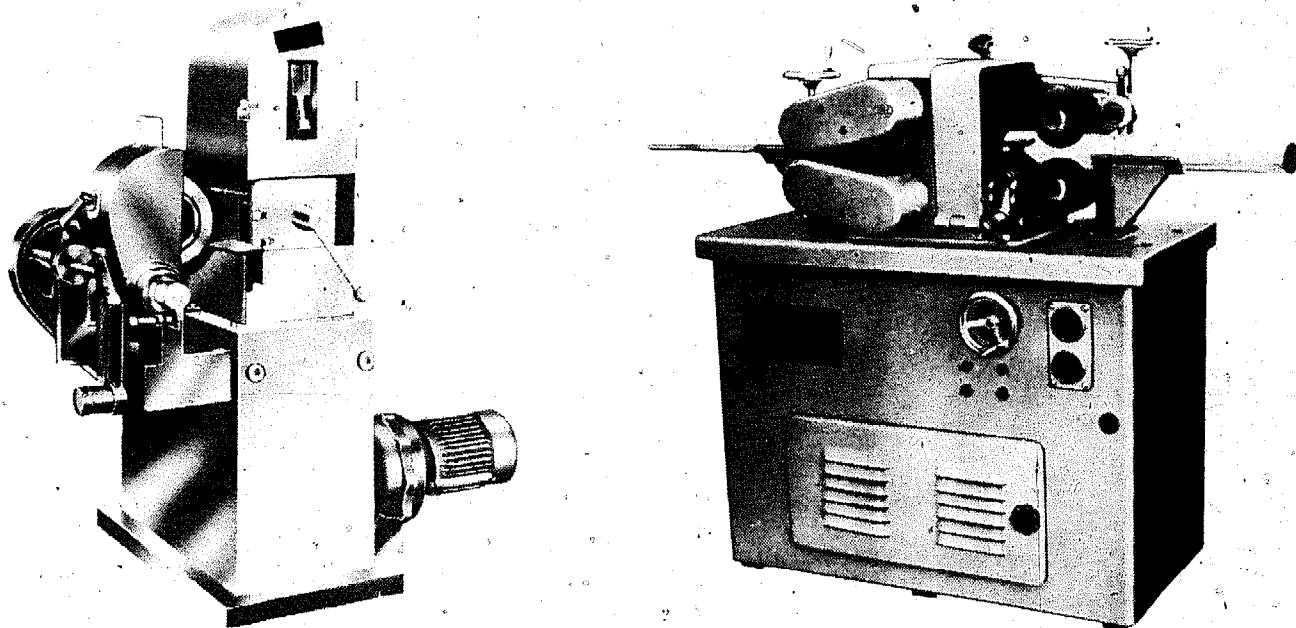

Figure 5. Rattan surface milling machines

In the sporting goods industry, large-diameter rattan is laminated with wood (willows, mulberry, ash etc.) and layers of rubber are used for handles of rackets, bats or sticks. While still very much a small-scale cottage industry, modern factories with high production capacity aimed mainly at export are slowly becoming a feature of the industry notably in Malaysia, the Philippines, Singapore and Thailand. This development is dealt with at length in subsequent chapters.

### III. MARKETING RATTAN

The many inherent characteristics of rattan - it is light, durable, versatile, malleable, renewable, cheap and the finished product is attractive - set it apart as a material in its own right that does not need to fear competition from plastic, metal or wood.

It is evident from the export performance of the various rattan-producing countries that interest in rattan and rattan products has increased dramatically over the past five years. For example, Japan in 1977 imported about \$10 million worth of rattan furniture; by 1979 this had increased over \$40 million. Similar increases in sales have also been experienced in other major markets especially (in descending order) the United States, Canada, Australia and Europe.

Indonesia has been the dominant world supplier of raw rattans, providing 90 per cent (valued at \$120 million) of the world requirements despite the overall increases in exports from other producing countries. Hong Kong and Singapore, though not producers of rattan, have dominated processing, conversion, manufacture and trade in rattan and rattan products. Hong Kong has been absorbing on average 55 per cent of the total exports of raw rattan from the South-East Asian producing countries and Singapore about 25 per cent. The latter is concerned mainly with primary processing and exporting to nearly 60 countries and areas; the main importers are, in descending order, Italy, Taiwan Province, the United States, the Federal Republic of Germany, Hong Kong, Spain and France. Hong Kong supplies raw rattan to China and is also the market for China's finished or semi-finished products.

The Philippines and Taiwan Province are also large exporters of manufactured rattan products, particularly to the United States. In 1982 the value of rattan exports from the Philippines was expected to be about \$50 million. Thailand is also developing its exports, and both it and the Philippines have banned the export of rattan poles in order to ensure a sufficient supply for home manufacturers.

A resume of a seminar of the Japan External Trade Organisation (JETRO) on rattan furniture, held at Bangkok in 1978, indicates the profits from rattan shipped from Bangkok for final sale in Paris as follows:

	<u>Units</u>
Bangkok cost, f.o.b.	100
Landed in Paris (including cost of insurance, freight, transit, customs, transportation and fumigation)	162

Importer doubles this price in  
selling to retailer

324

Retailer sells at

908

---

The cost to the Paris buyer is nine times the f.o.b. Bangkok price. This underlines the significance of the rattan trade in world terms and emphasizes the importance and value of further processing and manufacturing within the producing countries. There is little doubt that the world market for rattan products is increasing, and this will favour countries with rattan resources that also have low labour costs. This, however, must be allied to better styling, improved production facilities and higher levels of skill and technology and more professional marketing.

#### IV. DESIGN CONSIDERATIONS

The design criteria that apply to conventional wooden furniture also apply to furniture made from rattan. This can best be shown using a chair as an example. Technically, it should be structurally safe and stable; ergonomically, it must support the sitter comfortably and should also be aesthetically pleasing. Finally, the product must meet marketing needs.

Fundamental to all of this, therefore, is a full understanding by both designer and craftsman of the nature of the basic raw material being used, namely rattan, and its advantages and limitations in terms of structural stability, workability, drying characteristics and suitability for surface finishing. Production skills and equipment available must also be considered.

As has been pointed out in previous chapters, rattan is elastic, flexible and strong and comes to the furniture maker ready shaped by nature in sectional diameters ranging from 5 to 34 mm. Experience in using the material over many years has enabled a specific type of technology to evolve, particularly in furniture frame production, that combines the properties of rattan with structural jointing and moulding techniques that have successfully stood the test of time. Up to recently, most of these techniques were executed manually, but with increased market demand and the opportunity it offers for a more rationalized approach to production, mechanization, particularly of repetitive processes, is gradually taking hold. This development has not been lost on the designer who sees in it not only the potential for further design variation in shape and structure but also the opportunity for improved quality standards in processing.

##### A. Methods of jointing and binding

Figure 6 shows a typical rattan armchair, in its fully assembled form with seat and back cushions and ready to assemble. With the exception of the seat frame (11), which is usually made up of wood, the remaining components may be subdivided into 17 structural components (arms, rails, legs - 1 to 8) and 8 bracing and decorative components (9).

Figures 7 and 8 illustrate the various types of joints that are used in rattan frame construction and reflect the restraints imposed by the shape and dimension of the material. Probably the most widely used is the coping joint where the horizontal rail (e.g. a seat rail or rails) is scribed around a vertical member and then nailed or preferably screwed to it. A variation of this joint is when the vertical member is bored and the horizontal member is turned and tapered to fit it, the subsequent joint being both glued and screwed. The remaining joints, which are used according to design and construction requirements, are usually made by hand at the assembly stage or, in the case of the cross lap joint, with the aid of a router. Woven cane is grooved into the frame and fixed by means of glue and panel pins. Seat frames made of wood are dowel jointed while sika seat frames (figure 9) are fitted into holes bored in the seat frame and pinned or stapled to the seat support rails.

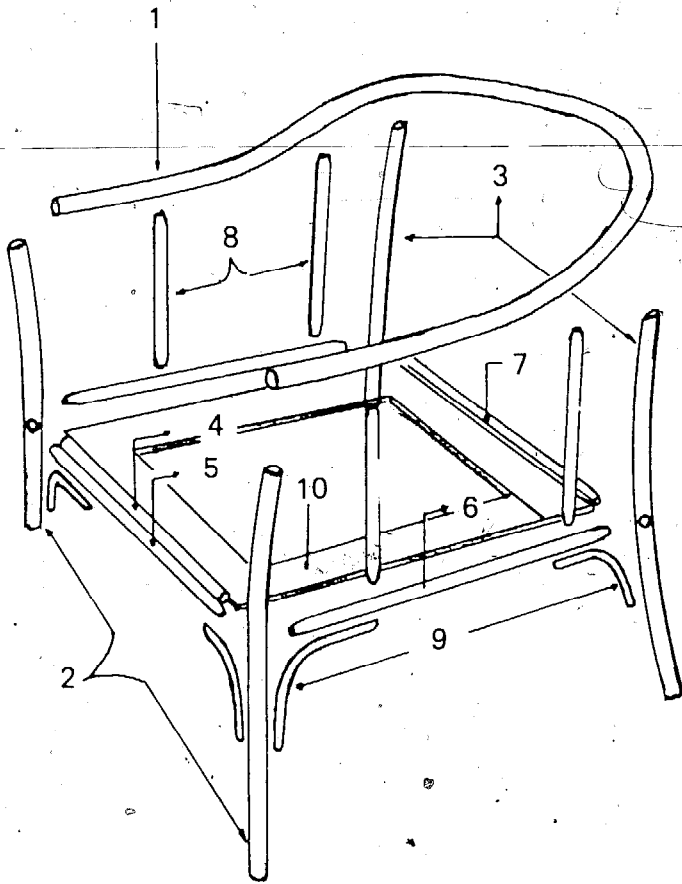

- 1 Arm
- 2 Front leg
- 3 Back leg
- 4 Front seat rail
- 5 Front seat rail double
- 6 Side seat rail
- 7 Back seat rail
- 8 Side slot
- 9 U-brace
- 10 Seat frame
- 11 Caning

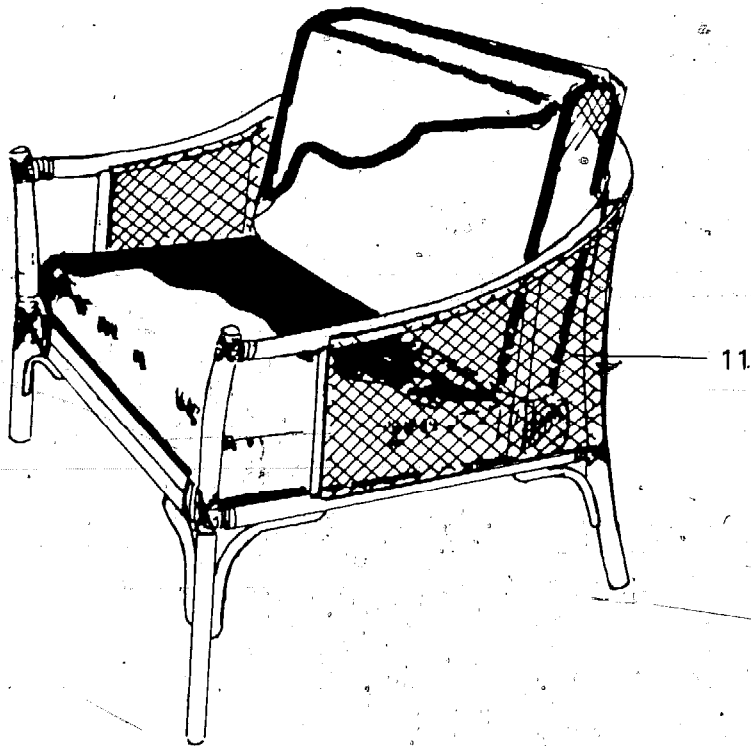

Figure 6. Typical rattan armchair

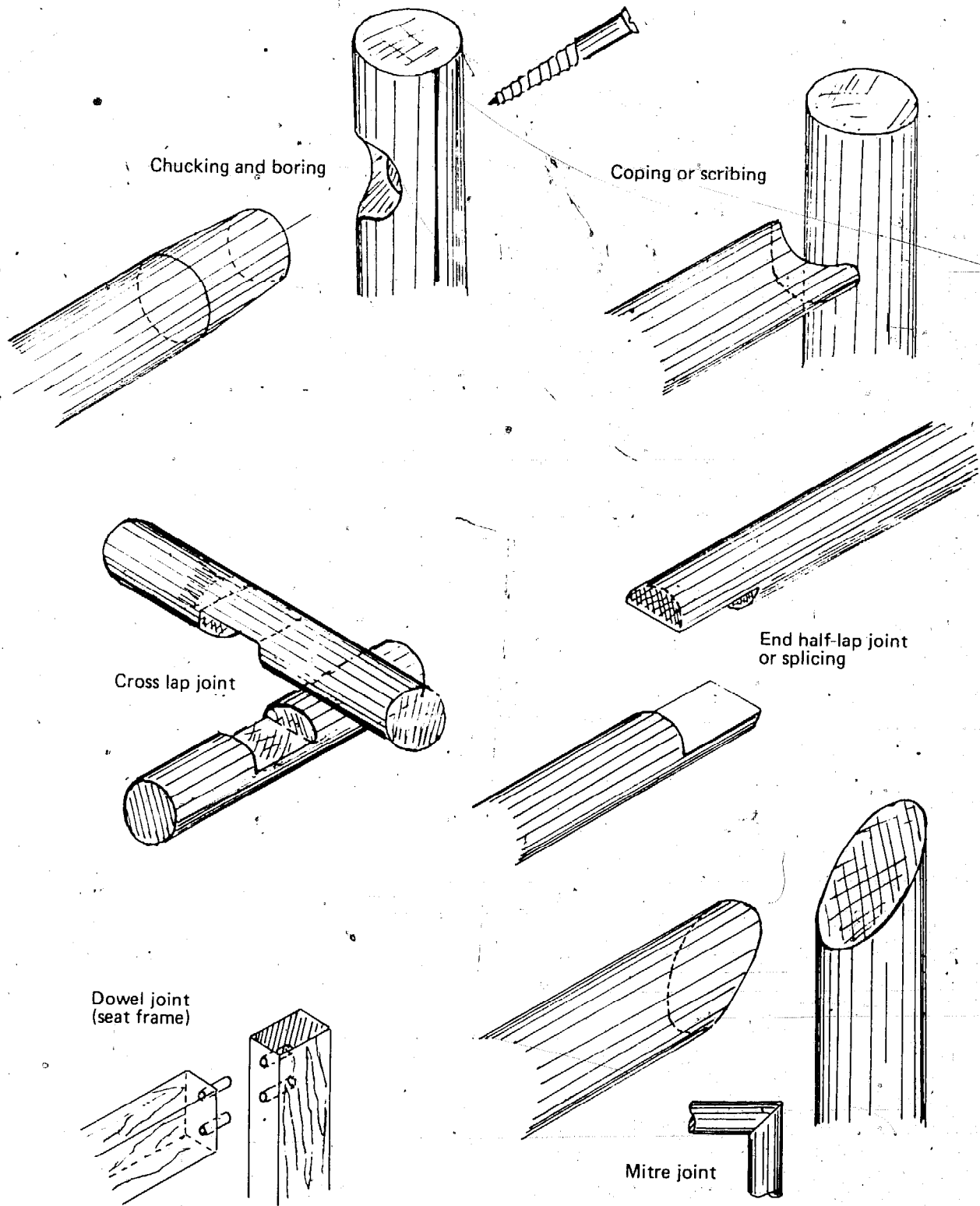

Figure 7. Structural joints for rattan frames.



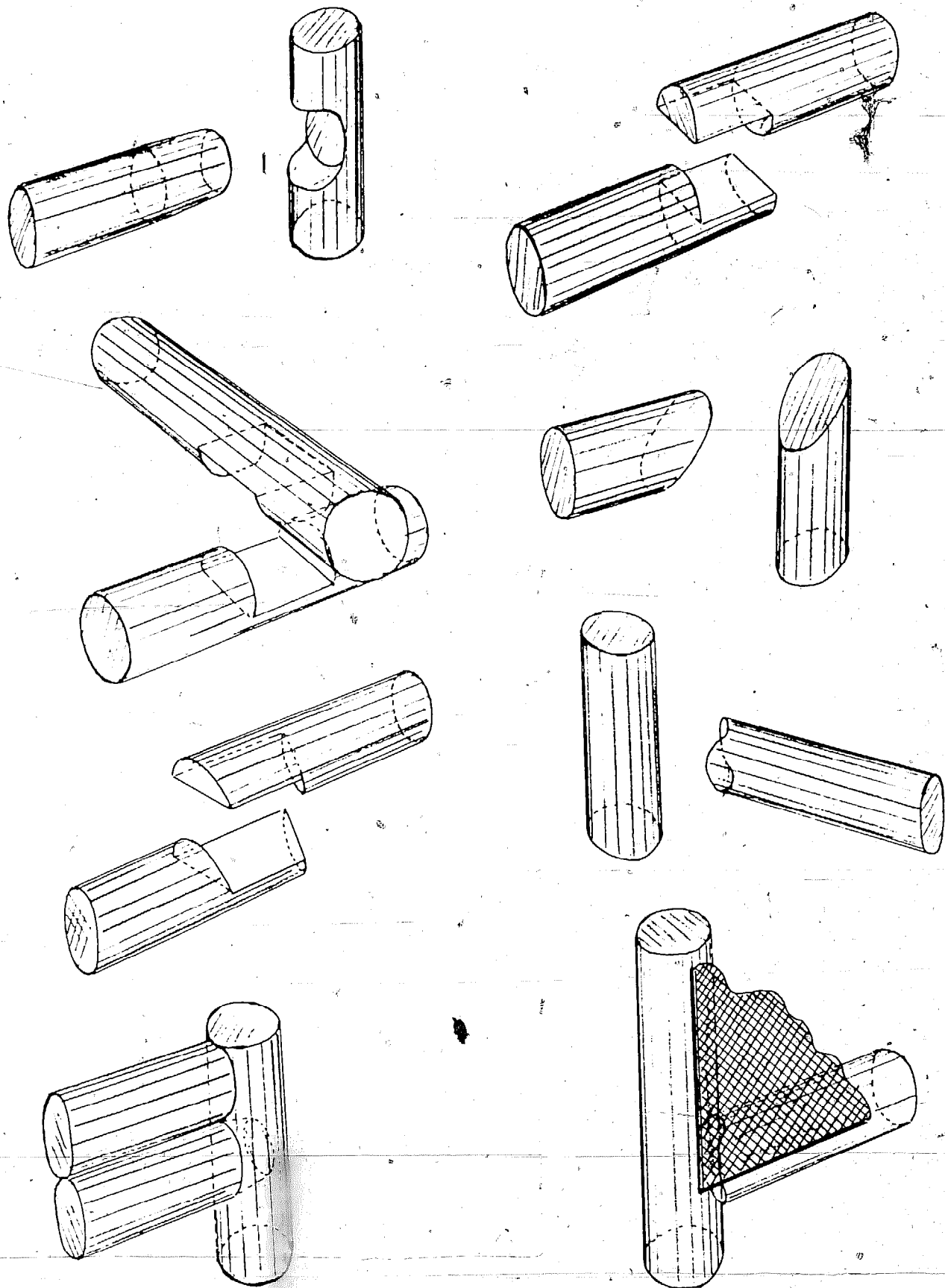

Figure 8. Structural joints for rattan frames

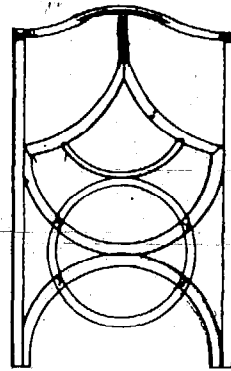
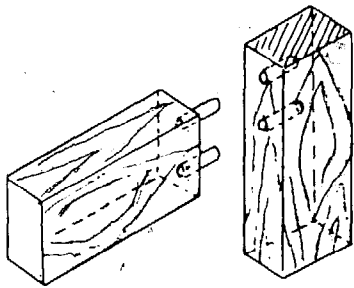
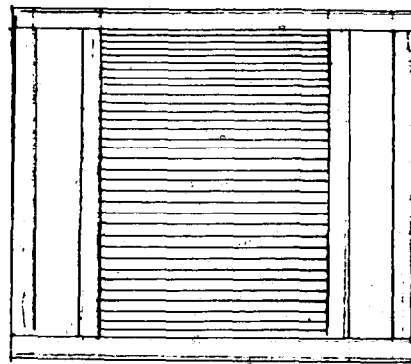
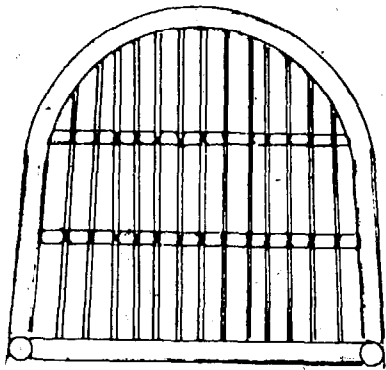
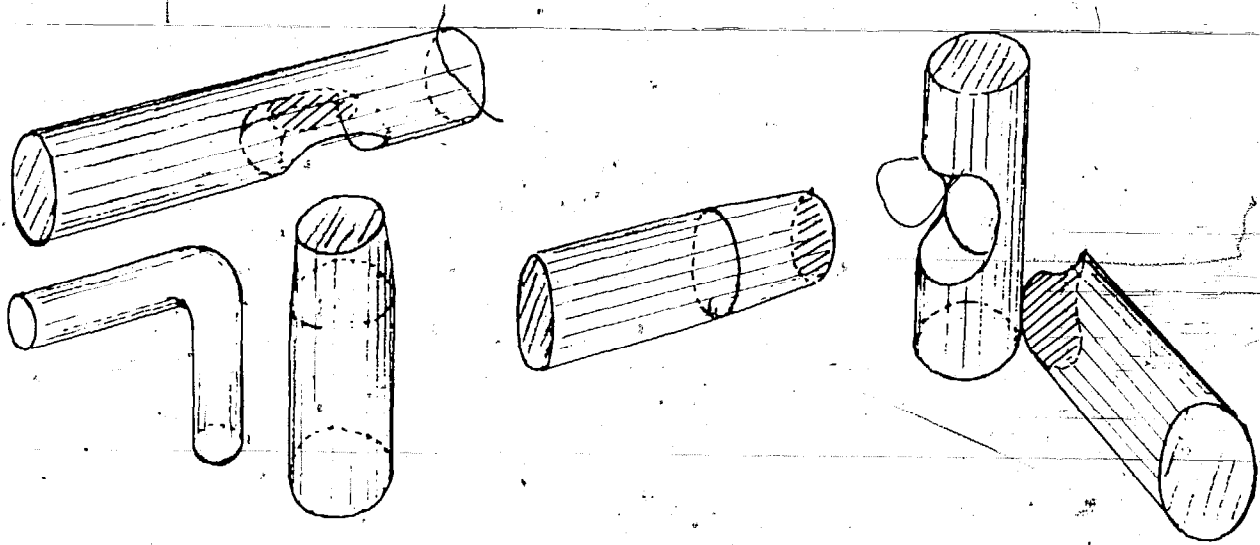

Figure 9. Structural joints for rattan frames and seat frames

Figure 10 shows a variety of designs for the binding of the joints; the binding provides additional strength and is decorative. The binding material is usually rattan peel or flat core but leather, rawhide and strips of parchment may also be used to advantage.

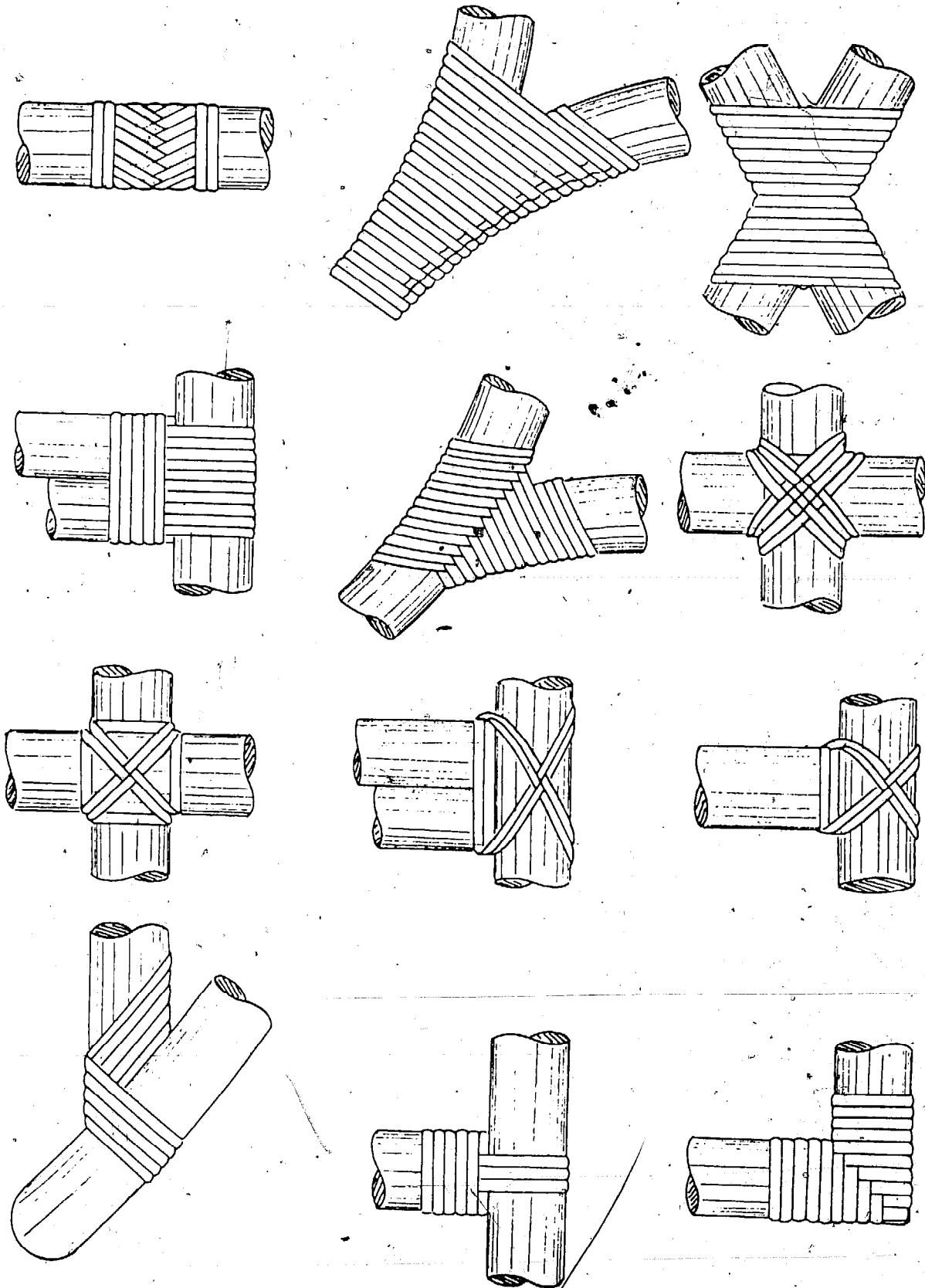

Figure 10. Methods of binding rattan joints

## B. Knock-down construction

Knock-down (KD) construction of furniture, whether of rattan or other material, is aimed at achieving the twofold objective of providing a convenient means of packaging and of saving freight through increased use of containers. The use of KD construction as a production technique, however, does not reduce the strength and performance of the furniture nor should it pose any problems at the point of final assembly.

The design and production of KD rattan furniture is somewhat inhibited by the fact that an integral part of the structure is the binding of the various joints after assembly. This would defeat the purpose of using conventional KD techniques since the importer or retailer is unlikely to want to become involved in this skilled and time-consuming work. Consequently, whatever system is used must ensure that no subsequent binding is required.

Figures 11 and 12 show a KD constructed rattan dining-room chair where binding is not required for final assembly. This problem is overcome by making up, binding and finishing the various elements of the chair independently i.e. ends, seat, back, front and back rails and then bolting them together at the point of assembly. It should be emphasized, however, that this procedure is generally unacceptable to buyers of best-quality rattan furniture.

Some rattan manufacturers supply importers who are also manufacturers with ready-to-assemble rattan components on a subcontracting basis. The latter undertake to assemble, bind, finish and upholster the merchandise before dis-

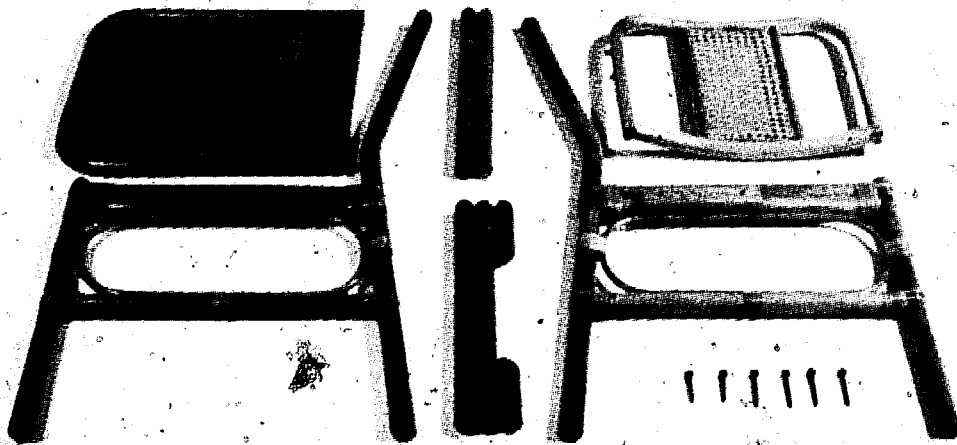

Figure 11. Rattan KD chair ready for assembly



Figure 12. Fully assembled KD chair.  
(Same chair as shown in figure 11)

tribution. This also effects considerable savings in shipping but may be obviated by the added costs of the other activities, including wages, which are likely to be higher in the importing country.

#### C. Market considerations

In the past, rattan furniture tended to be associated mainly with the outdoors as garden and summer furniture. This was probably due to the fact that it was sold uncoloured. When colouring was introduced, its potential for use both in and out of doors the year round was quickly recognized. Nowadays it is equally at home in the living-room, bedroom or dining-room and is also used extensively to furnish hotels, restaurants and similar institutions.

From a starting point of pleasing visual proportion and ergonomically planned construction, the skilled designer can incorporate characteristics from the best periods of classical design or details of sophisticated modern styling that make rattan furniture acceptable to the most discerning tastes. Preferences in major target markets may be summarized as follows:

France. Rustic style designs and well-designed, comfortable modern furniture

Federal Republic of Germany. Rustic look in High German and Bavarian styles. Modern design with emphasis on comfort

Japan. Early American and English period styles. Modern furniture in Scandinavian, German or Italian styles

United States. Early American or period styles particularly English and French reproduction (Georgian, Chippendale, Sheraton, Regency, Louis XV and Louis XVI), garden furniture in casual styles

Rattan furniture lends itself to a variety of colours and finishing systems, including natural i.e. unpolished, lacquered (nitro-cellulose or acid-catalyzed) and stained or pigmented (particularly black, white and antique). In general, staining should be in the colour of the period being reproduced and pigmented finishes should be used for modern designs.

Annex II provides a portfolio of sketches of designs of rattan furniture.

## V. THE MANUFACTURING PROCESS

Up to about 10 years ago, the production of rattan furniture and other products mainly of a handicraft nature was entirely labour-intensive and formed an important part of village life in the regions where rattan grows. A conservative estimate of the number of people employed directly or indirectly in the craft in rural areas must be close to half a million, most of whom are engaged in harvesting, processing and small-scale manufacturing. Activity at this level averages one-half unit per day per person or one unit per person every two days.

In the last 10 years increased interest, especially from United States and European buyers, accelerated the growth and development of rattan factories that would cater specifically to these ever-growing markets. Initially, this simply meant a larger concentration of rattan workers under one roof with little or no change in the methods of production practised in the villages or in the levels of output. Gradually, however, mechanization of processes, derived mainly from the more advanced technology associated with conventional furniture production, began to have an effect. As a result, there are now many large rattan factories to be found throughout South-East Asia, some of which employ over 1,000 persons. Notwithstanding this, the cottage-type workshop continues to prosper mainly through association with the larger factories, which subcontract to them selected models for production and provide marketing skills and sales outlets.

Despite this development, the industry by and large has progressed slowly and there are still many factories where levels of production are not much higher than those in the villages, where every process is done by hand. As many rattan factory owners have learned at a cost, this is because a large number of workers, however skilled and equipped, is not of itself a solution to the problems of present-day large- or medium-scale manufacturing. To these must be added appropriate skills in technical and administrative management so that a well-organized manufacturing unit emerges capable of exploiting to the full all its resources.

The type of unit outlined in the ensuing chapters should be capable of achieving a level of output equivalent to three to four units of production per person per day.

It must be realized that because of its very nature, the technology required for the processing of rattan into furniture is not very different, if at all, from the production of solid wood furniture. Both have materials, equipment and processes in common, and the use to which all these are put is conditioned by the inherent characteristics of wood and rattan. Briefly, rattan is soft and malleable, while wood may or may not be, depending on the species.

One advantage of rattan over wood is that nature provides the raw material in ready shaped sections.

Apart from this, the practices commonly used in machining and assembling wooden furniture - types and sizes of dowels (hardwood, diameter 1/3 of diameter of rattan pole), glues (polyvinyl acetate or urea formaldehyde), nails (round head or oval wire nails of appropriate length), screws (mild steel of appropriate length and gauge) - are also used for rattan. Machines and hand tools are the same as those used for wood, and paints and varnishes are also the same.

An example of the manufacturing process in a modern rattan plant follows.

#### A. Organization

The various components are produced in series in the machining and moulding departments and then put into an intermediate component storage area to await assembly in accordance with order levels and specific customer requirements. This has the advantage of greatly reducing setting-up and moulding times and results in optimum machinery utilization.

#### B. Production flow

##### Rattan stocks

About 100,000 to 150,000 poles, stored in open and in covered piles, should be available at any given time to cope with the supply situation and the need to air dry. Normal consumption is in the region of 20,000 poles per month.

Handling is manual and transport is by means of specially designed bogeys.

##### Drying, selection and classification

Drying, selection and classification of rattan (figures 13 to 16) involves the following steps:

(a) After delivery the poles are inspected and checked for size (i.e., diameter) and quality;

(b) They are then classified as:

<u>Grade</u>	<u>Class</u>	<u>Description</u>
A	First	No brown spots
B	Second	Intermittent brown spots
C	Third	Continuous brown spots

(c) The number of poles in each class is then counted. The usual stock of poles carried is approximately 120,000. The diameters vary from 1/4 in (6 mm) to 1 7/8 in (48 mm) and the most important are: 1 3/8 in (35 mm), 1 1/2 in (38 mm), 1 5/8 in (41 mm), 1 3/4 in (44 mm) and 1 7/8 in (48 mm). Others are 3/8 in (9 mm), 1/2 in (13 mm), 5/8 in (16 mm), 7/8 in (22 mm), 1 1/8 in (28 mm), 1 1/4 in (32 mm) and length 4 m;



Figure 14. Second scraping of rattan poles

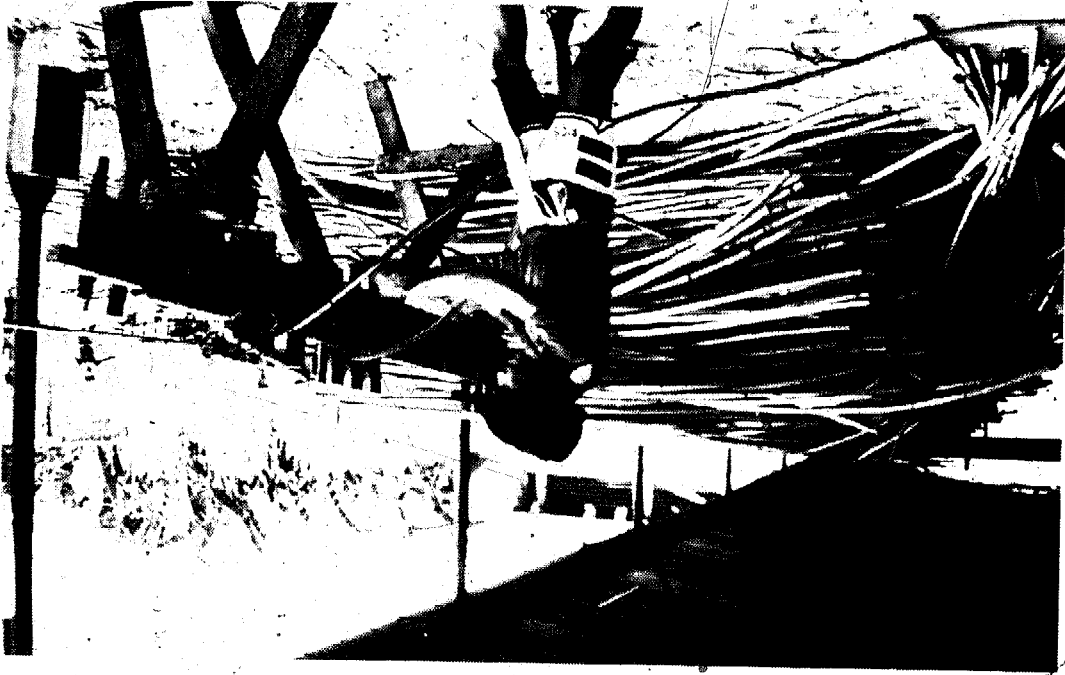
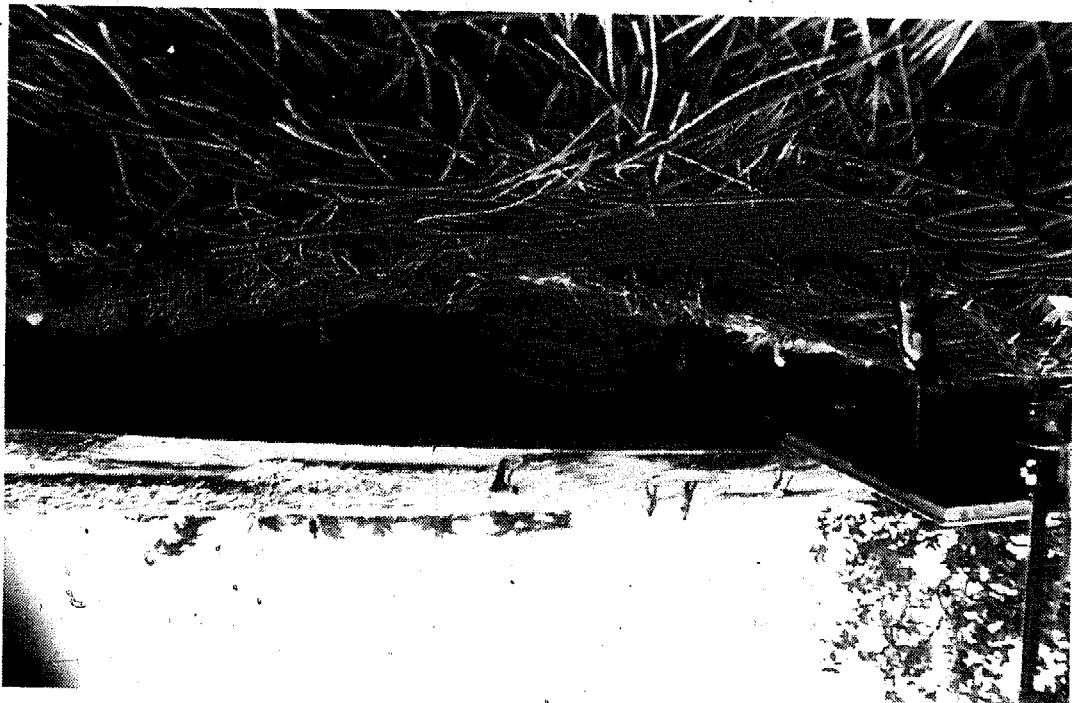

Figure 13. Preliminary inspection and classification of rattan poles



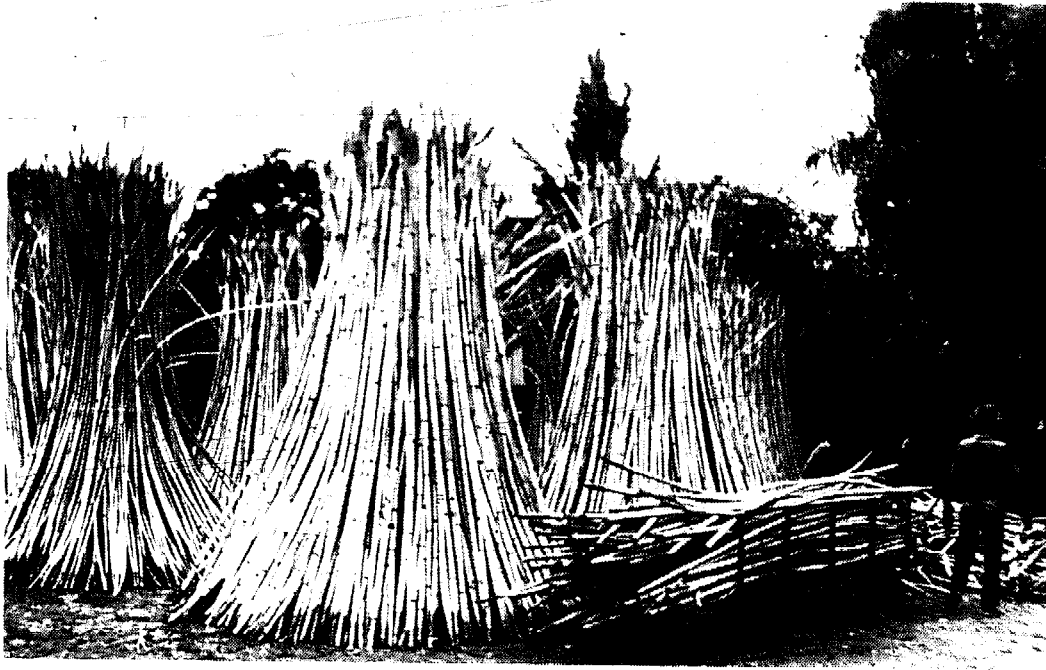

Figure 15. "Wigwam" drying in the sun



Figure 16. Further straightening, classification and storage of poles

(d) The poles are then stacked vertically in wigwam fashion and allowed to dry. Drying time during the rainy season is 3 to 4 weeks and in the dry season 2 to 3 weeks. A second scraping may be necessary at this stage (see figure 14);

(e) The poles are subsequently straightened and stored vertically in accordance with size and classification. Vertical storage enables any residue of moisture to flow to the bottom of the pole and ultimately to evaporate. Aisles are maintained between the different pole classifications in order to provide easy access and to ensure usage in accordance with the normal storage period. There is a permanent staff of six in the pole storage area and this may be augmented should large deliveries of poles arrive simultaneously.

#### Cross-cutting and storage mill

Poles that have been dried and are now ready for production are delivered to the cross-cutting area. Here a buffer stock of all required sizes is maintained, each size being located conveniently behind a cross-cutting saw. There are two saws operating in this section. A daily cutting order is prepared by the supervisor based on the current production programme for each of the sawyers and usually for no more than four different pole diameters. In cutting the poles, the sawyer must use his discretion in following the cutting order so as to ensure maximum pole utilization. The poles are subsequently bundled in accordance with length and diameter and are stacked on trolleys to await delivery to the straightening and sanding areas. In order to reduce unnecessary handling to a minimum and speed up delivery to the straightening sections, special bins with castors are used at this stage. All required dimensions are marked on the extended bench tops of the cross-cutting saws.

Through a reduction in the variety of models and therefore the production of more standardized parts a comprehensive list can be made of blank sizes relating to both models and parts that may be produced for stock.

#### Straightening, sanding, intermediate storage (figures 17 to 19)

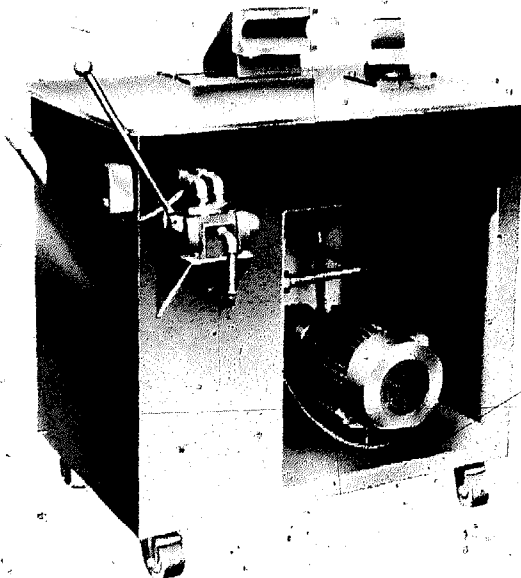

Figure 17. Hydraulic straightening machine



Figure 18. Rattan components being straightened

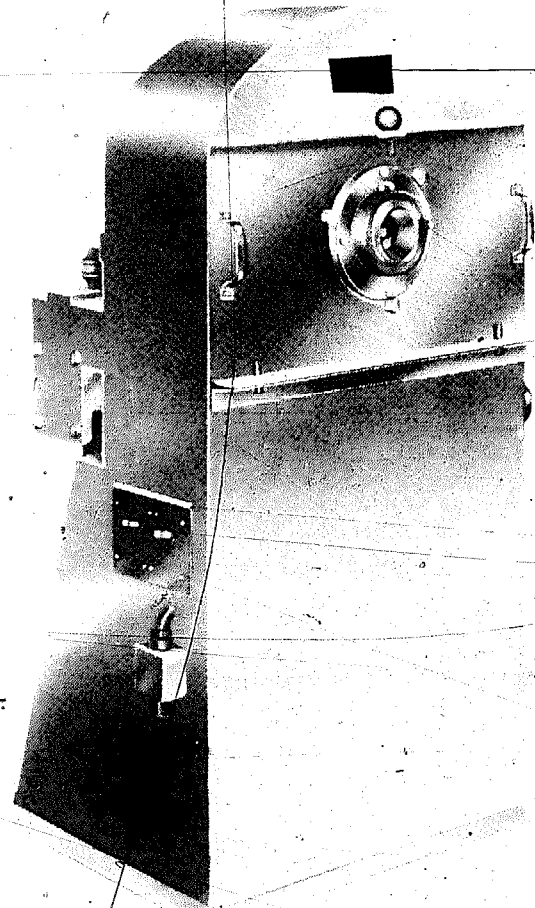
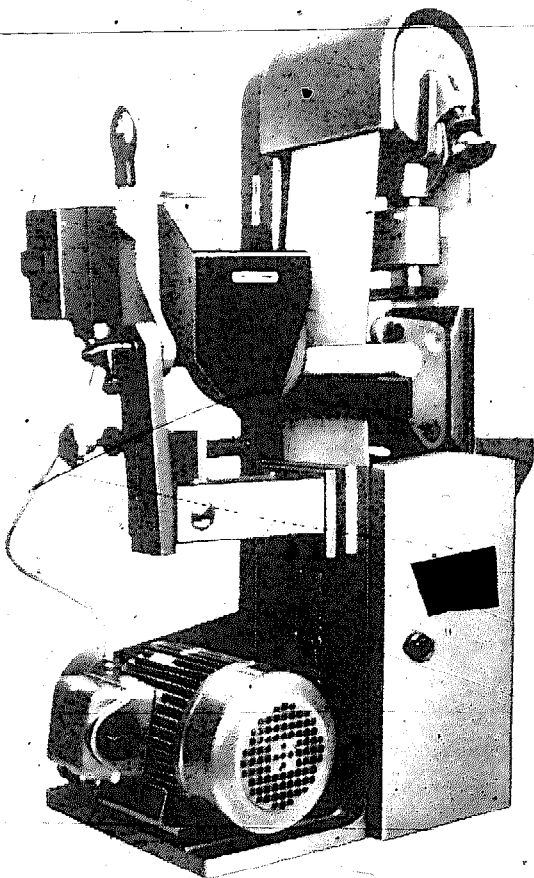

Figure 19. Profile sanding machines

Cut poles are delivered to a storage area immediately behind the straightening machines, where a buffer stock of varying lengths is maintained at all times. After straightening, the poles are conveyed in bins with castors to the profile sanders where they are sanded and then transferred to an intermediate storage area immediately adjacent to the various moulding benches. It is important that the bins feeding the profile sanders are designed to have a convenient height for the sander operators; they should always be located close to his right hand, since he feeds through the machine from right to left. The sanded poles should fall naturally from the machine onto a similar type bin or trolley for delivery to the moulding area.

#### Bending and moulding (figures 20 to 39)

Producers of wood furniture can quickly come to terms with rattan, adapting the technology they use for furniture for rattan if they bear in mind the following points:

(a) Prior to bending, rattan poles should be steamed at 100°C for 20 to 30 minutes. The rattan poles can then be bent to virtually any curvature. Bending can also be achieved by heating the rattan with a blowtorch;

(b) Quality control of bent components should be checked against a full-sized drawing, usually on a plywood sheet.

The equipment in the bending and moulding department includes four steaming ovens (two for short poles and two for long poles), a universal pneumatically operated bending bench and a number of manually operated moulding benches with fixed moulds for various types of bends. The components usually moulded include back legs, front legs, seat bows, arms, side braces, back braces, seat braces, back decoration and arm decoration. The wide variety of models currently being produced in factories in which there are few standardized parts make it almost impossible to introduce any degree of moulding specialization or to designate specific workers or equipment for standardized and highly repetitive production.

Since the aim should be to reduce the variety considerably and at the same time to increase the batch sizes per model to a level consistent with volume production, the opportunity will arise to use more accurate jigs and to manufacture moulded parts that approximate as closely as possible the final shape required. This will have the added advantage of speeding up the framing of sub- and final assemblies, since less time will be required for final adjustment of the part at that stage.

The setting time of simple bends and moulds is about four hours; compound shapes need much longer. This, however, can be speeded up by providing additional storage in the boiler area. "Loaded" moulds will be detached from the moulding benches, placed on trolleys and then stored in the drying room for the required drying period.

#### Sanding and buffing (figures 19 and 40)

Components that are straight poles will bypass the moulding area after straightening and proceed directly to the profile sanding area. Here at least three profile sanders are used (coarse, medium and fine) so that components can be finished in one pass. One operator is sufficient.

Shaped components (i.e., moulded and bent) are sanded on buffing machines using pneumatic cylinders and brush heads. They are then transported to an intermediate storage area to await subsequent machining.

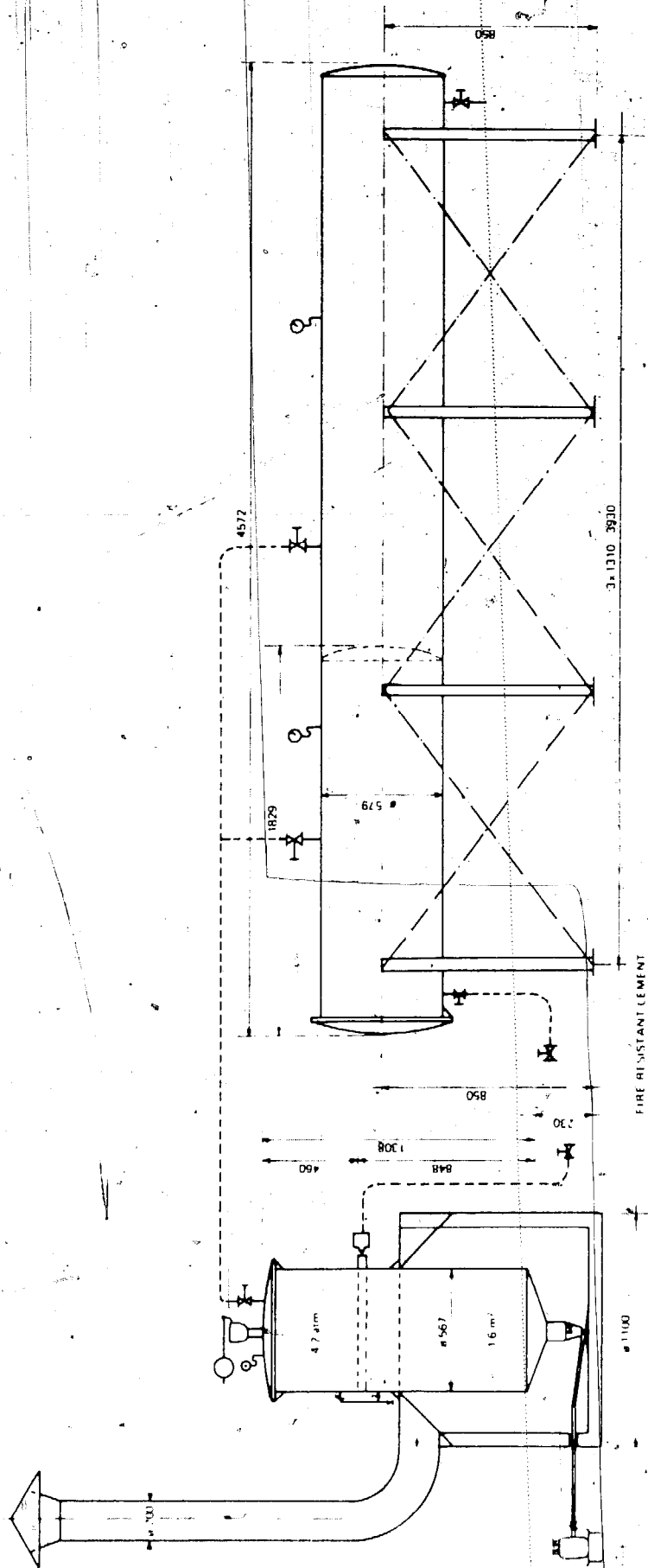

Figure 20. Rattan boiler and steaming oven

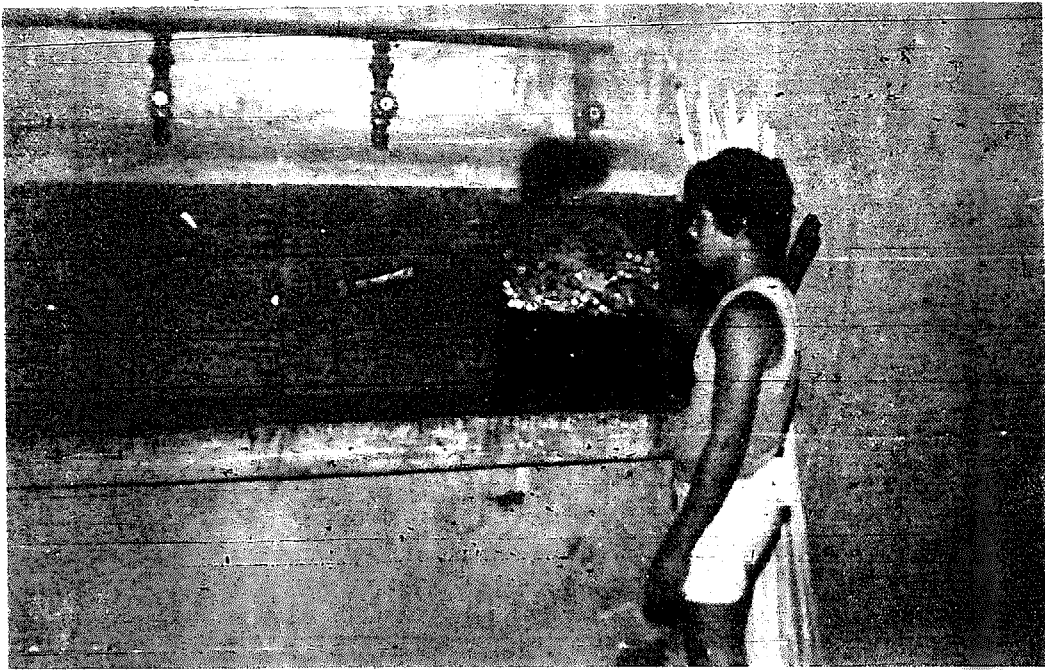

Figure 21. Steaming rattan components

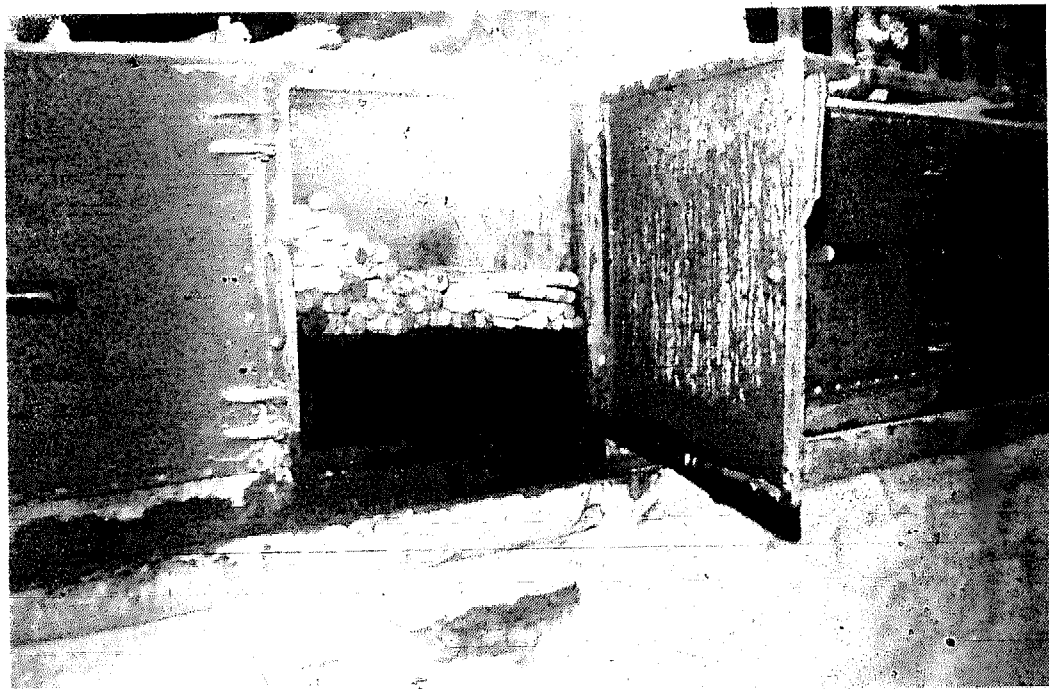

Figure 22. Rattan components ready for bending (Note identification mark on each piece)

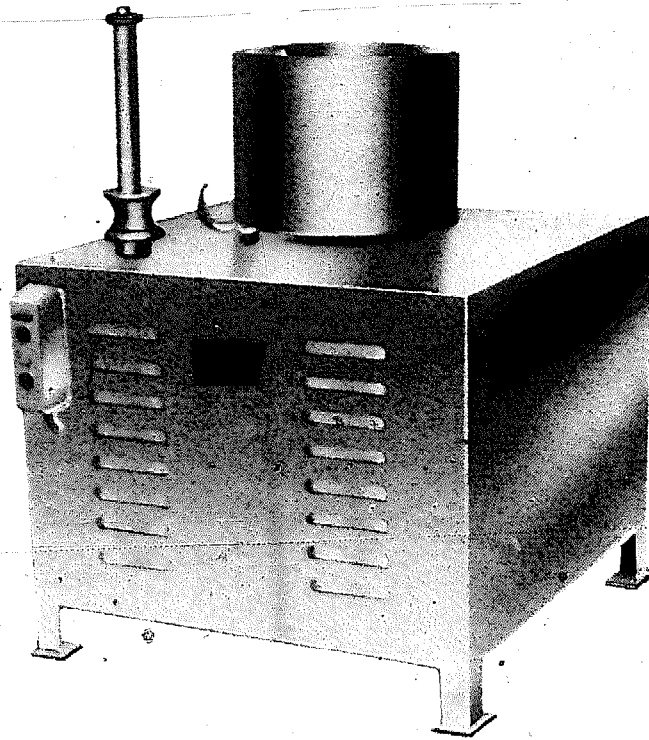

Figure 23. Rattan bending machine

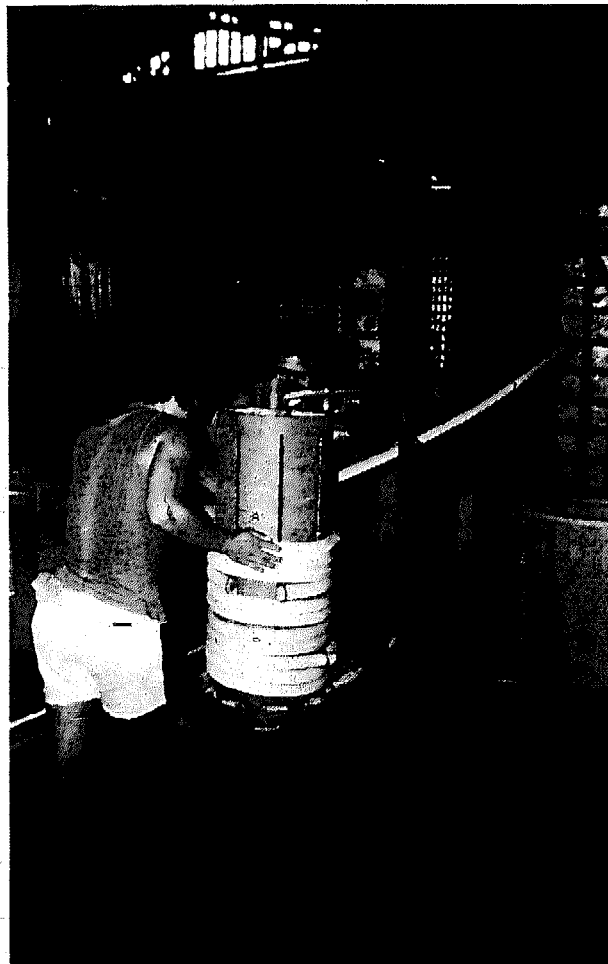

Figure 24. Moulding circular components or rings



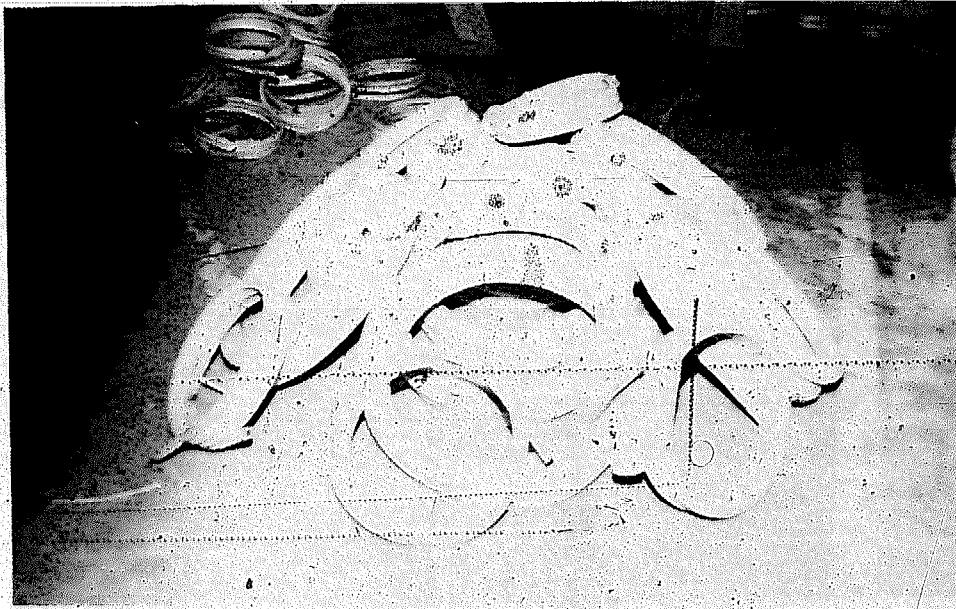

Figure 25. Rattan rings drying after moulding

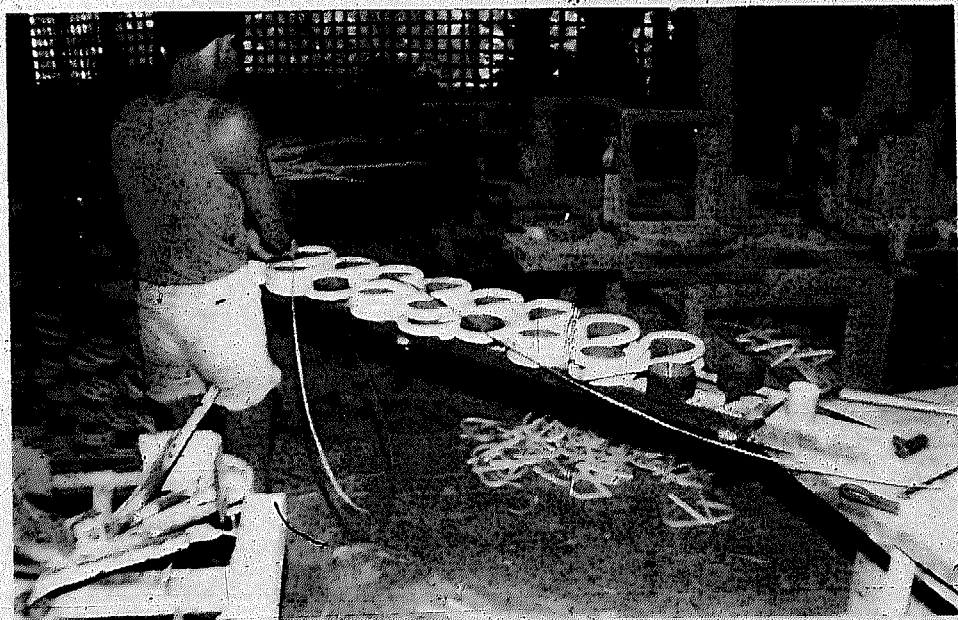

Figure 26. Moulding U-shaped components using a metal jig

Figure 27. Components drying after moulding



Figure 28. Loaded moulding jig for compound moulds

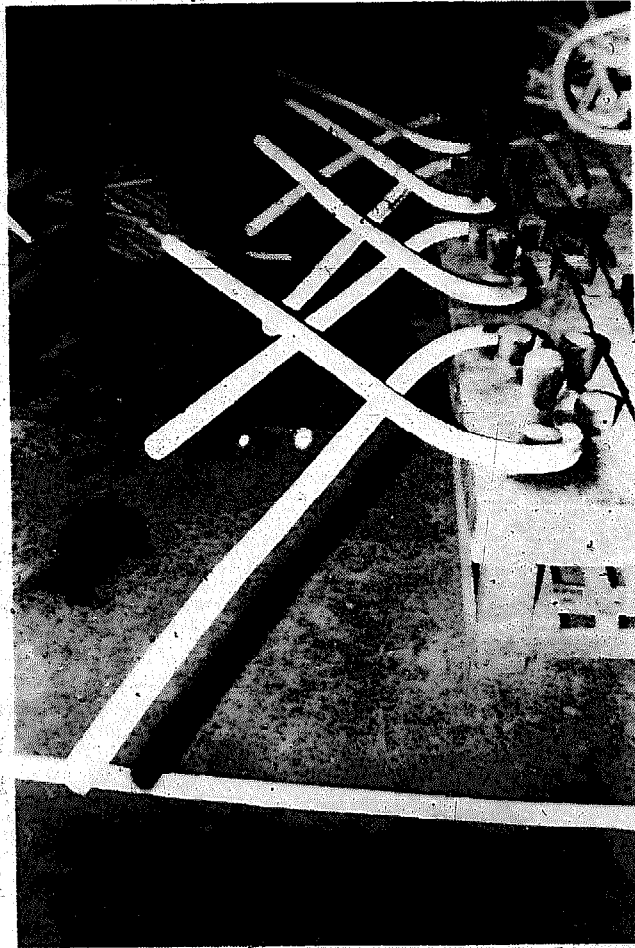

Figure 29. Shaping legs and top back rail for a period dining-room chair

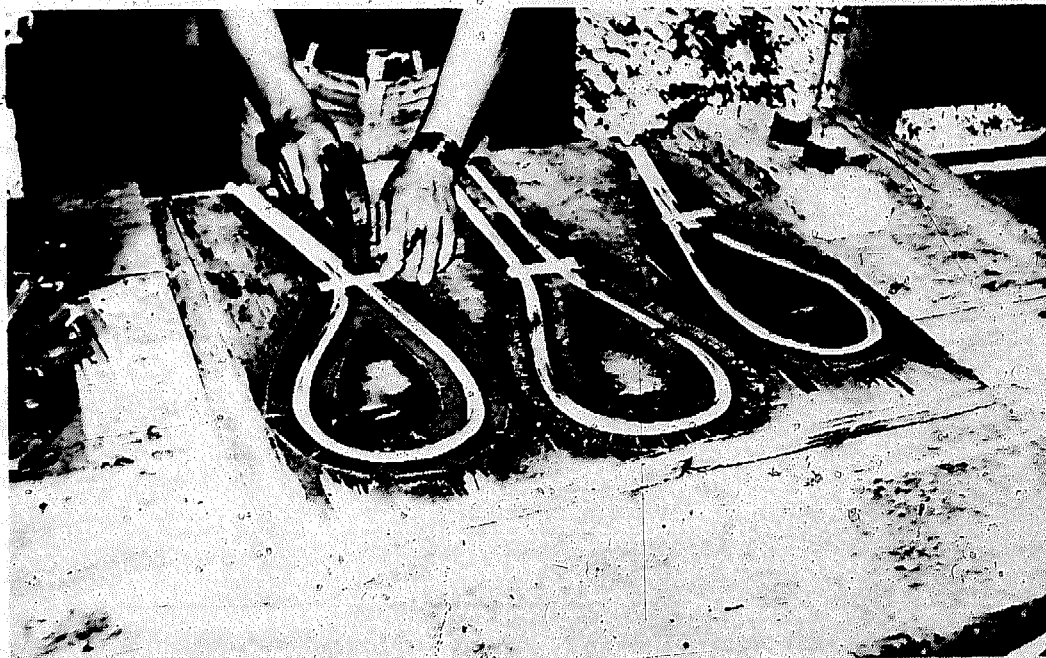

Figure 30. Moulding chair splatts



Figure 31. Subsequent cleaning of splatts by scraping and sanding



Figure 32. Moulding U-shaped components (Note kerosene fired torch used to assist with severe bends)

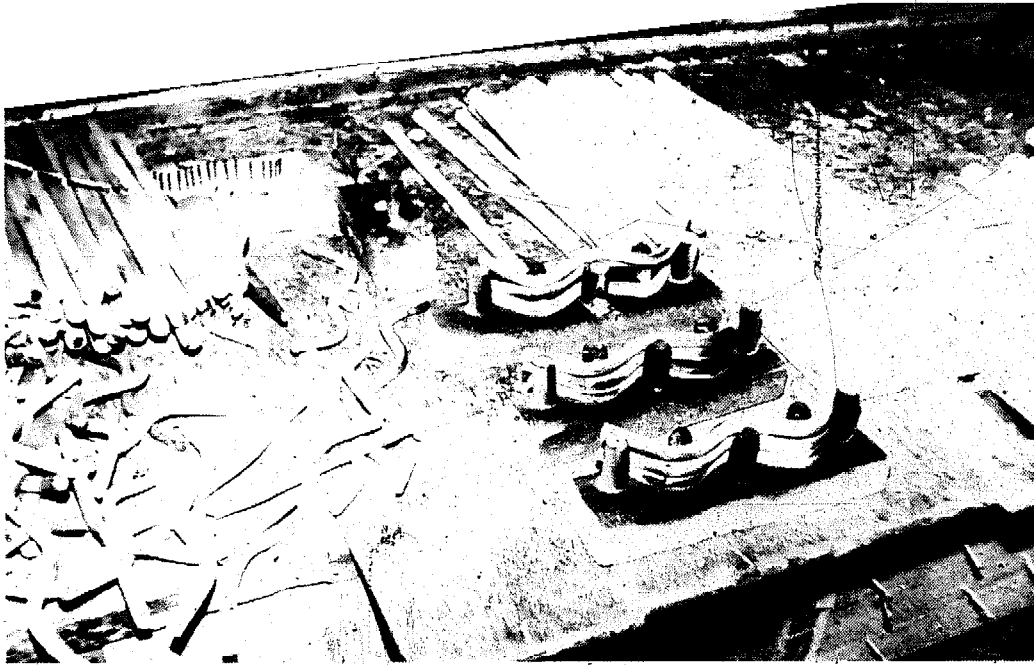

Figure 33. Moulding decorative components

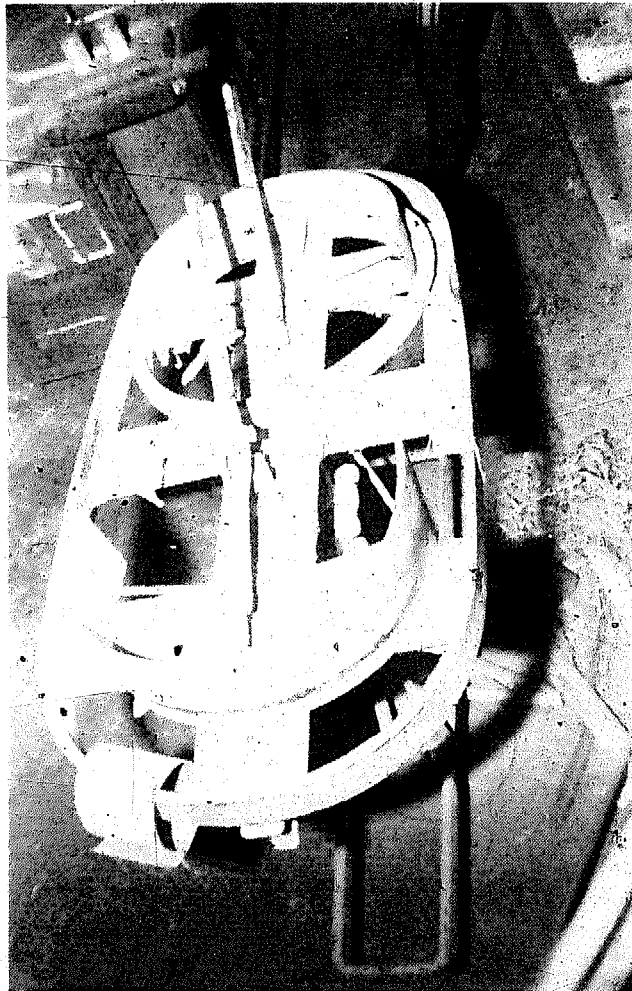

Figure 34. Metal constructed moulding jig

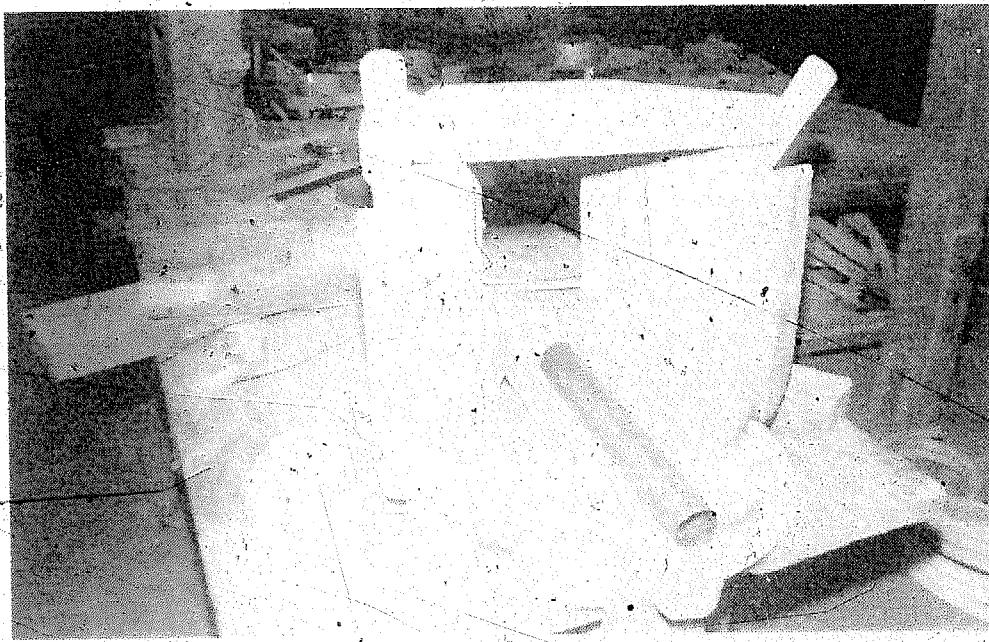

Figure 35. Complex rattan shape (Note metal pipe, which provides additional leverage during bending)

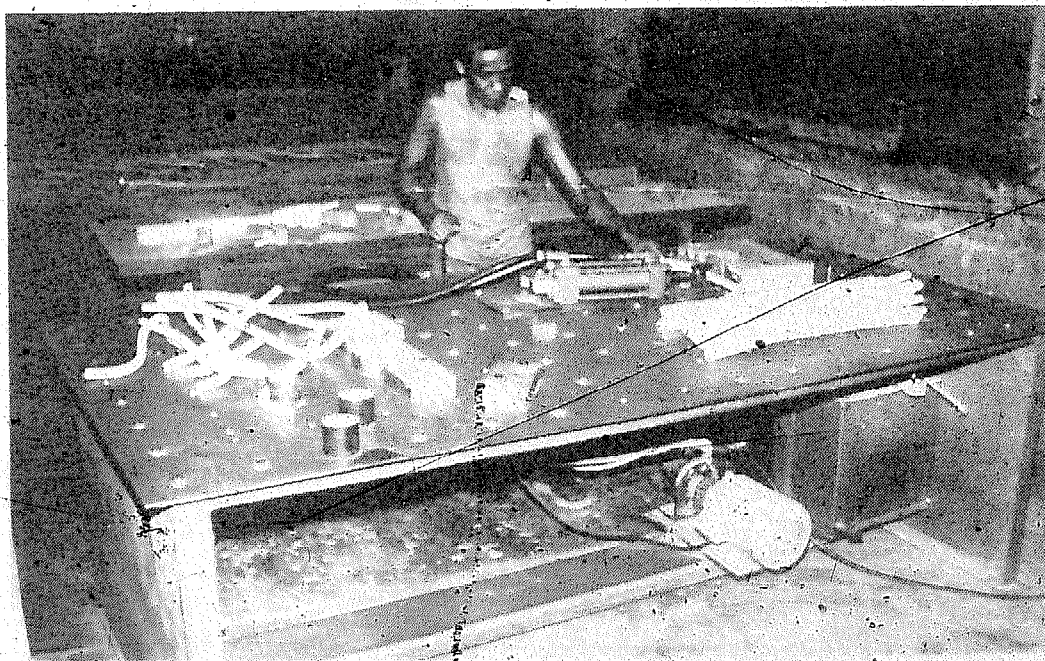

Figure 36. Metal moulding bench fitted with pneumatic and hydraulic cylinder



Figure 37. Adjusting moulded components to achieve correct bend.  
(Note template)



Figure 38. Adjusting shaped components with the aid of  
a kerosene fired blow torch

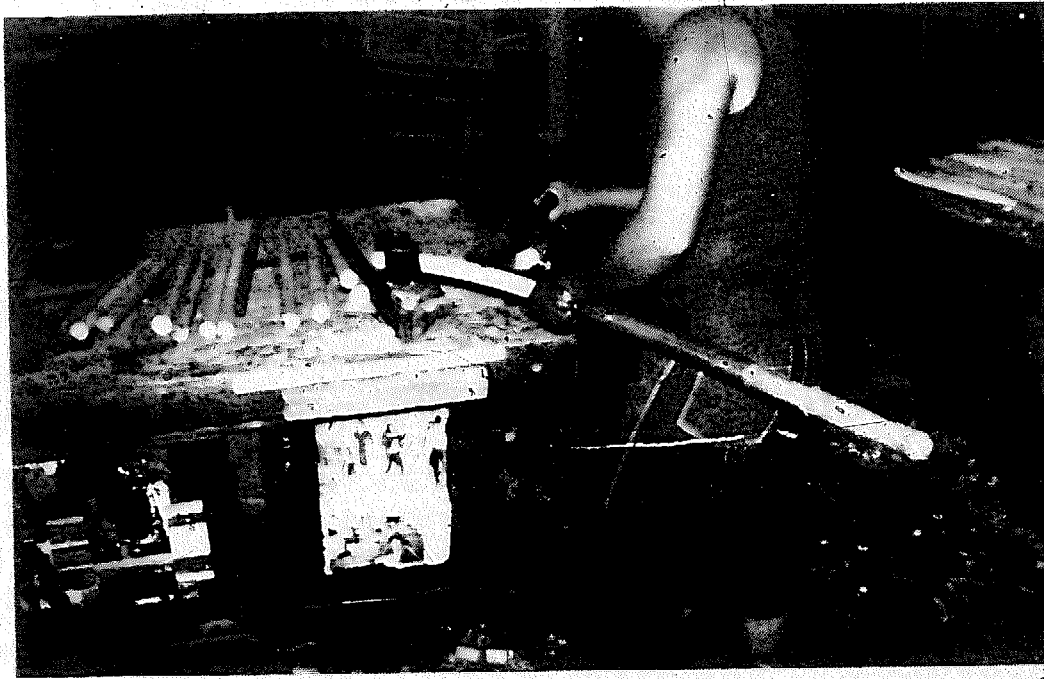

Figure 39. Adjusting shaped components with the aid of a kerosene fired blow torch.

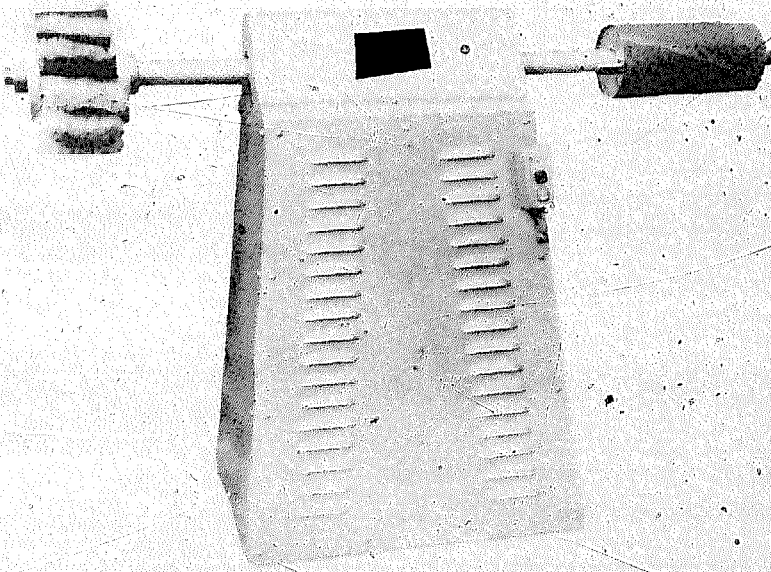

Figure 40. Buffer sanding machine for moulded components



## Dowelling

This is a major constructional technique and is used extensively in rattan production to connect, where possible, all components, e.g. front, side and back legs, to rails etc. Dowel holes are drilled by pneumatic or electro-pneumatic self-feed spindle heads, which are adjustable and can be arranged in accordance with the profile or shape of the component being drilled. The dowels, or spigots, are turned on a specially designed chucking machine that turns each in accordance with the diameter of the drilled holes into which they are expected to fit. Examples of dowel joints are included in figures 7 to 9.

## Coping or scribing

Since all rattan sections are round it is necessary to scribe some components at the fitting stage (e.g., rails to legs, arms to legs) so that a perfectly fitting joint is obtained after assembly. (This is particularly the case for KD furniture where the joint is not subsequently bound and any defects are very evident.) This is done by fitting a specially designed cutting bit to the self-feed drills, which bore and scribe at the same time. It should have a diameter equivalent to that of the rattan section being used. The "feather edge" thus produced on the scribe should be carefully sanded off to avoid spalling. The scribed joint, which is especially suitable for KD, is subsequently screwed through the leg and into the rail. Boring and scribing may also be carried out on a router. In each case the process is carried out in conjunction with carefully designed and accurately manufactured location and holding jigs. Examples of coped or scribed joints can be seen in figures 7 to 9.

## Drilling

In preparation for final assembly, subassemblies may have to be drilled (see figures 41-43).

## Grooving (figure 44)

Grooving is necessary for frames into which woven cane is being incorporated. It is done with either a router or drilling machine to which a special grooving bit has been fitted. The item often cannot be cased until the full frame has been assembled.

## Pre-assembly of rattan components (figure 45)

Back, front and other subassemblies of chairs and frames are assembled in pneumatic or hydraulic cramping jigs or tables. These pre-assembled components are then stacked in an intermediate storage area to await final assembly. During subassembly it may be necessary to adjust some of the moulds in order to achieve the exact contour required. This is done by softening the bend by the application of heat and making it more malleable.

Figure 41. Drilling a subassembly  
in preparation for final assembly

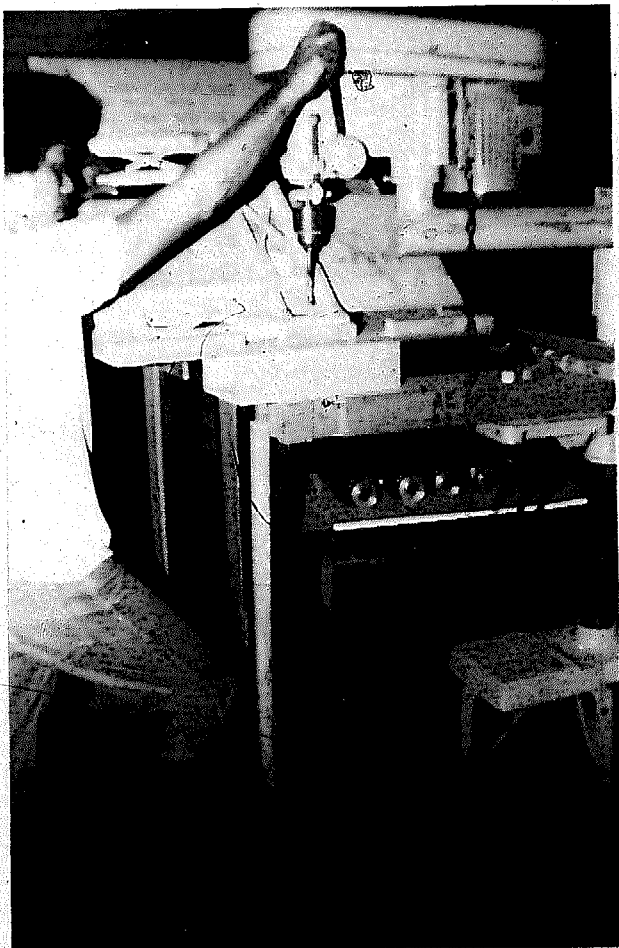
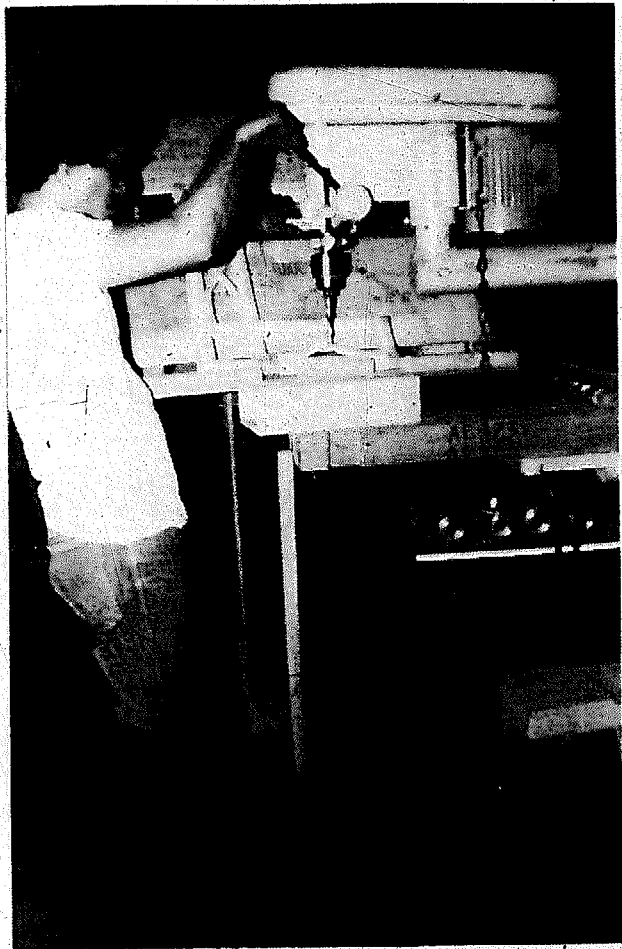

Figure 42. Drilling a subassembly  
in preparation for final assembly  
(Note jig)



Figure 43. Drilling a chair back leg to take stretcher rail



Figure 44. Grooving frame to take woven cane

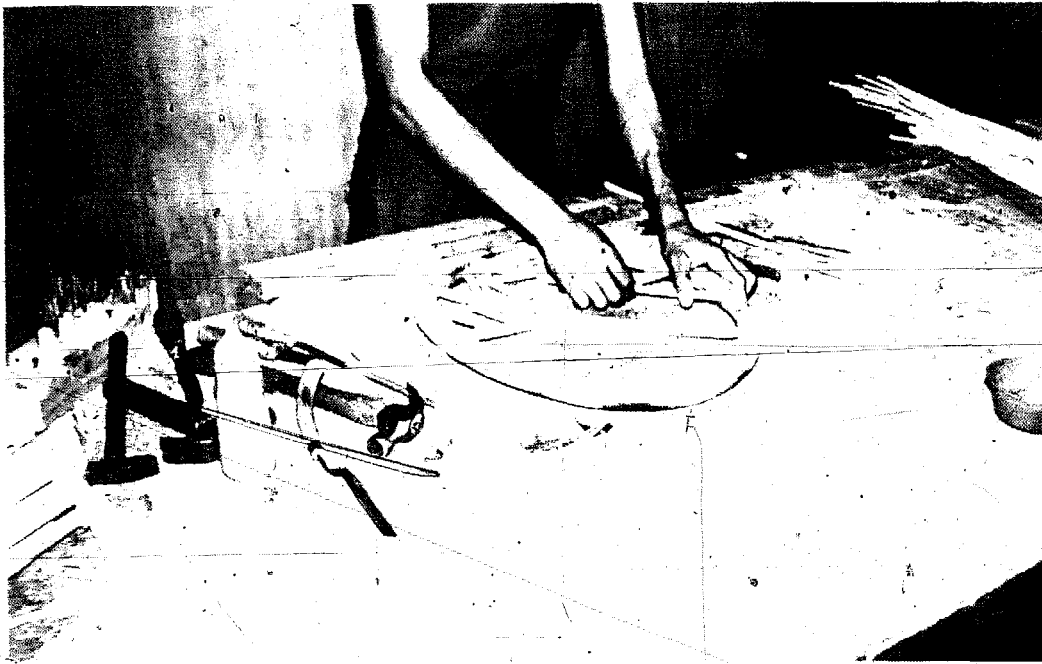

Figure 49. Pre-assembly of chair back element.

#### Moulding of shaped parts (ply-seats)

Shaped parts are moulded in multiple widths, either in a simple spiral press with a pressing matrix or in a moulding press with resistance heating. Suitable adhesives for cold glueing are polyvinyl acetates (PVA) and for hot glueing, urea formaldehydes (UF). The cold method is preferable since parts can be stacked.

#### C. Intermediate component storage

Backs, fronts and occasionally sides of chairs etc. are assembled in the pre-assembly department. The advantages are: no distortion of components, fewer single parts and better storage arrangements.

#### D. Assembly

Daily requirements are taken from intermediate storage; small series are assembled in accordance with orders. Advantages are that well-assorted stock in the component storage area reduces delivery time, and assembly of similar models in small series means that components are not stacked, waiting to be used, for long periods of time at the various assembly points.

Frames of chairs and tables are assembled manually using a frame press and the joints are cleaned off and sanded by hand (see figures 46 to 48). Sika or small-diameter core rattan is then fixed by stapling to the seat frame (see figure 49).

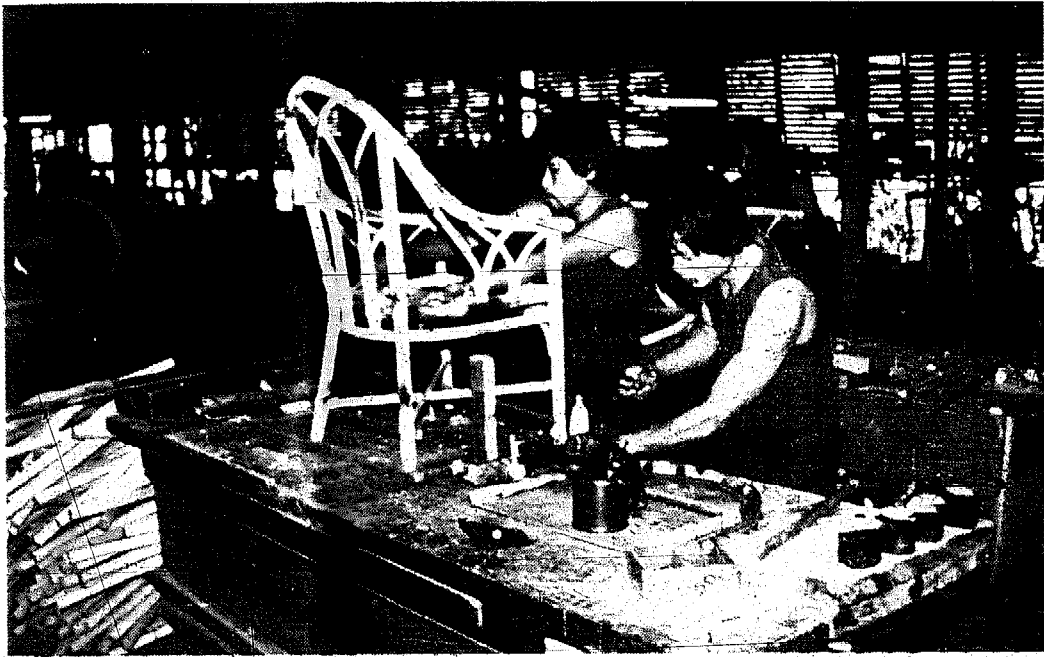

Figure 46. Fixing seat frame to chair

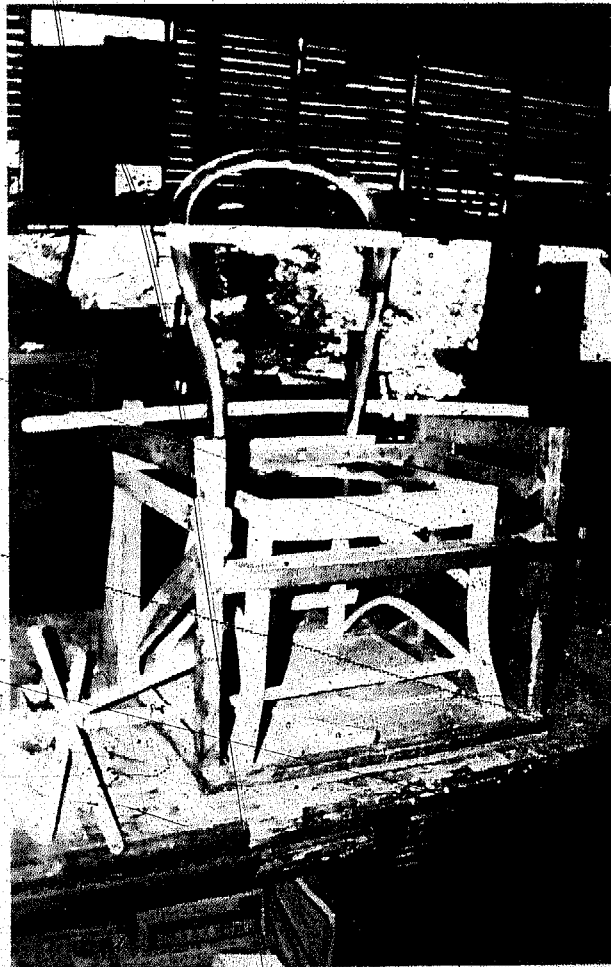

Figure 47. Assembly frame for dining-room chair

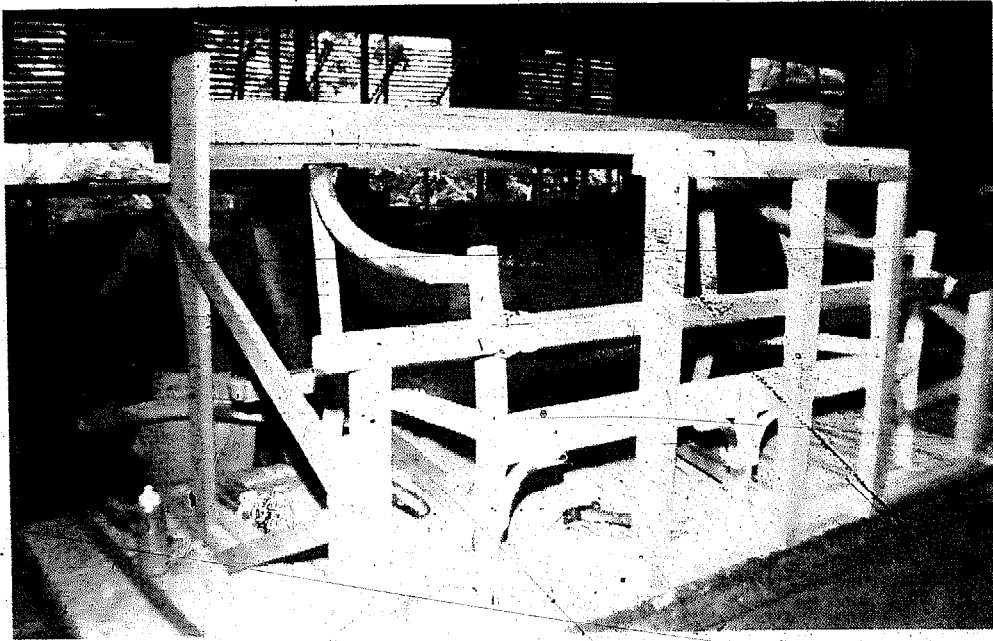

Figure 48. Assembly frame for two-seater settee

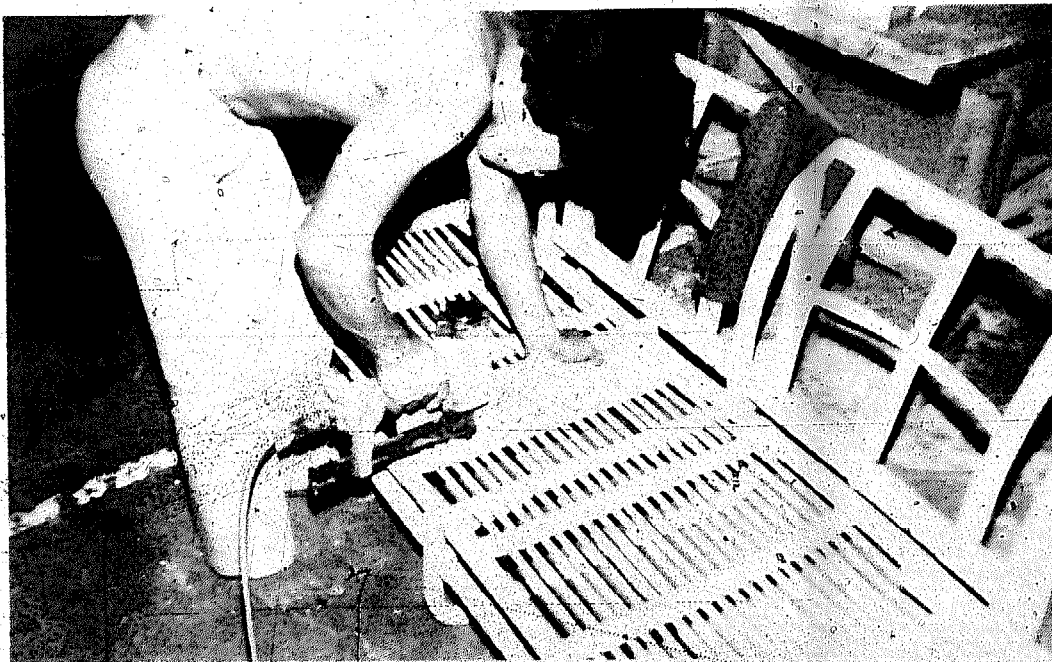

Figure 49. Stapling sika or small-diameter core to seat frame

### Scraping and sanding

Although the sanding of components will have been carried out prior to sub- and final assembly some additional cleaning up is necessary at this stage and before binding. It can be kept to a minimum by good initial sanding before assembly and careful handling subsequently. For example, only staples and pneumatic stapling guns should be used, and arrangements for transport should ensure minimum damage in transit and storage. At most, no more than one hour, and preferably less, should be devoted to this procedure.

### Binding of joints

Various types of materials are used for binding, including leather, rawhide, parchment and, most popularly, rattan peel or core which must be scraped prior to use so that subsequent staining and lacquering will have proper adhesion to the material (see figures 50 to 53). Some binders prefer to sit on a low stool or even on the floor to do this work, while others like to work at a low bench on which the frame is placed. In either event, it is important to ensure good working conditions and that materials are readily available, preferably pre-scraped and sanded, so that the actual binding time is reduced to a minimum. Binding of joints is shown in figures 54 to 57. Sketches of bound joints are shown in figure 10.

The same materials that are used for binding are also used for weaving (see figures 58 and 59).

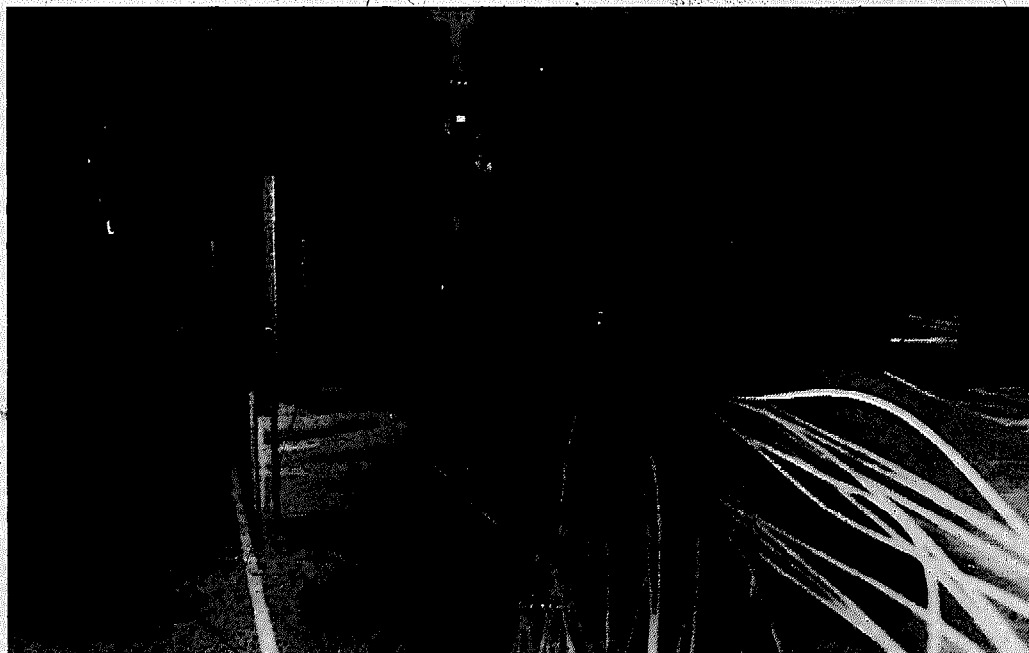

Figure 50. Machining rattan core

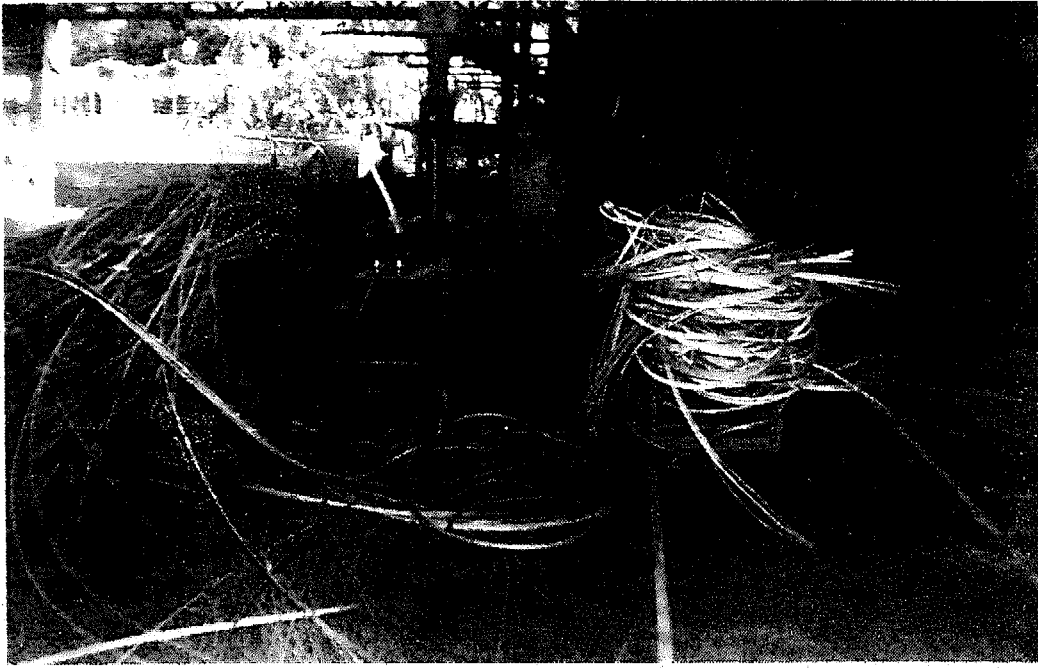

Figure 51. Machining rattan peel for binding.

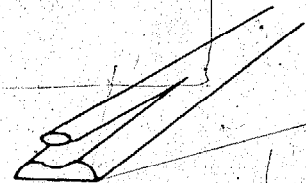
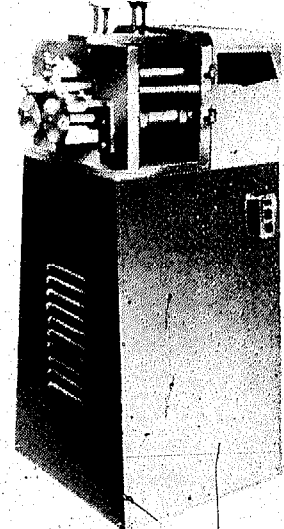
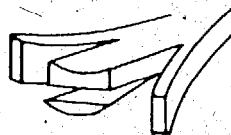
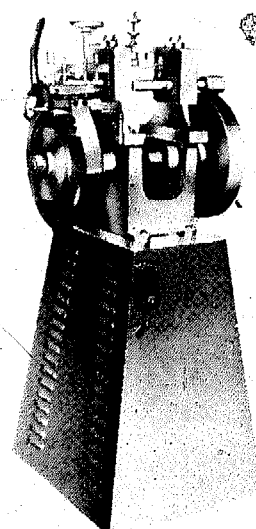
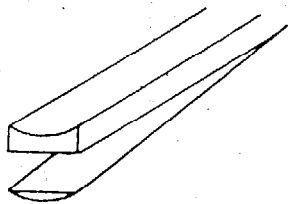
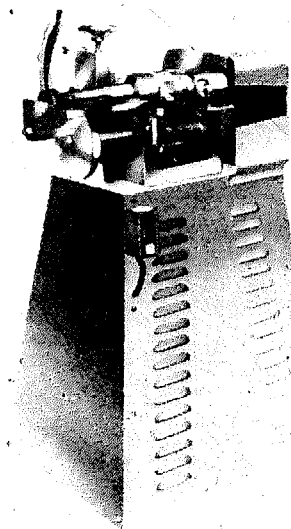

Figure 52. Rattan peel trimming machines.



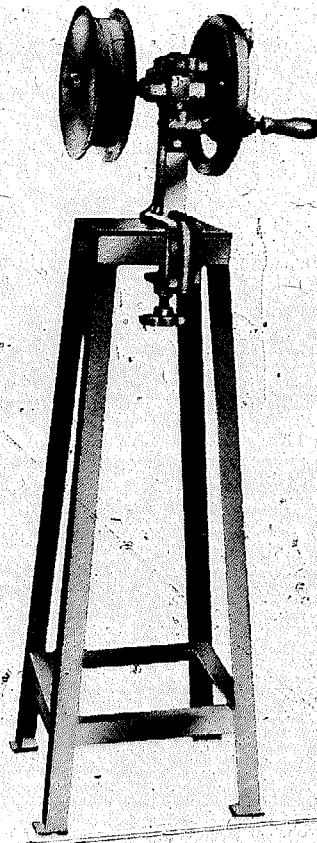

Figure 53. Rattan peel winding machine

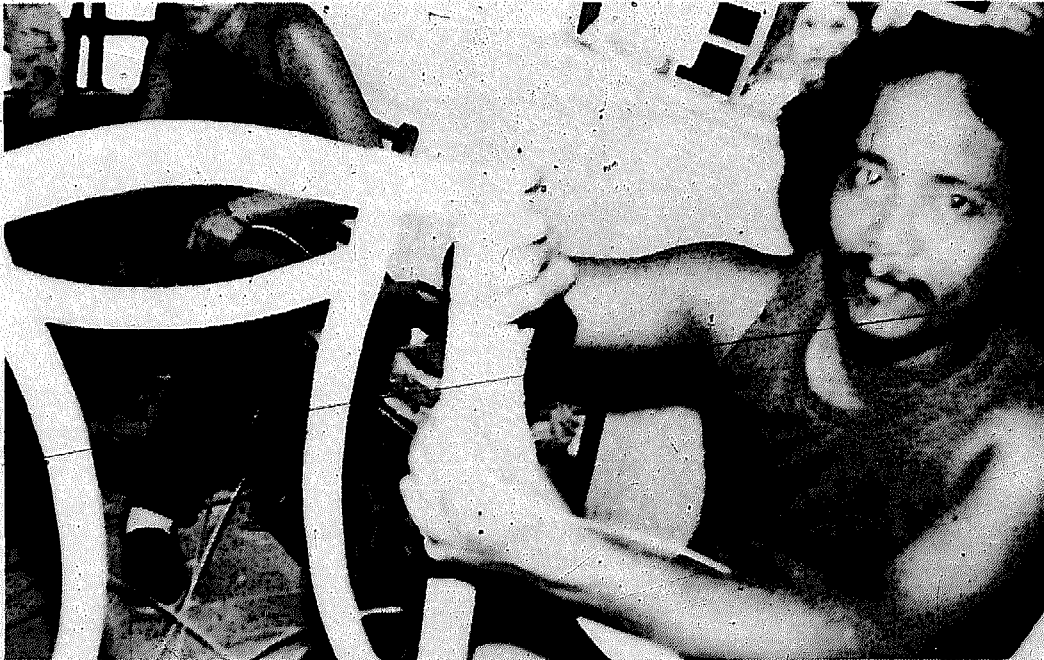

Figure 54. Binding of joint between arm and back leg

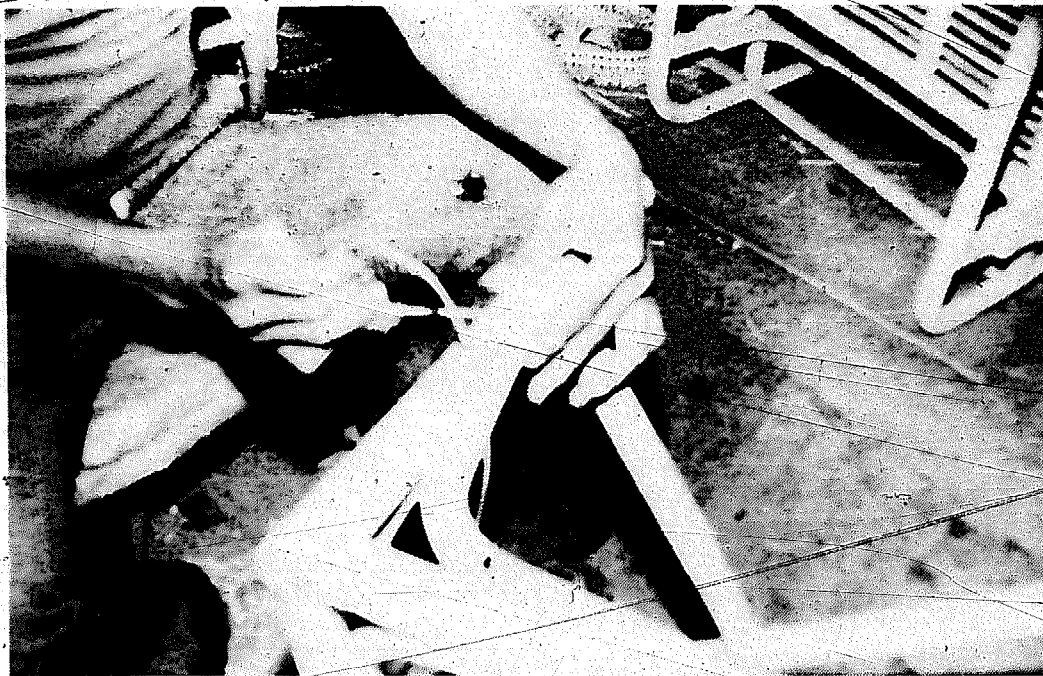

Figure 55. Binding of joint between brace and front legs of dining-room chair

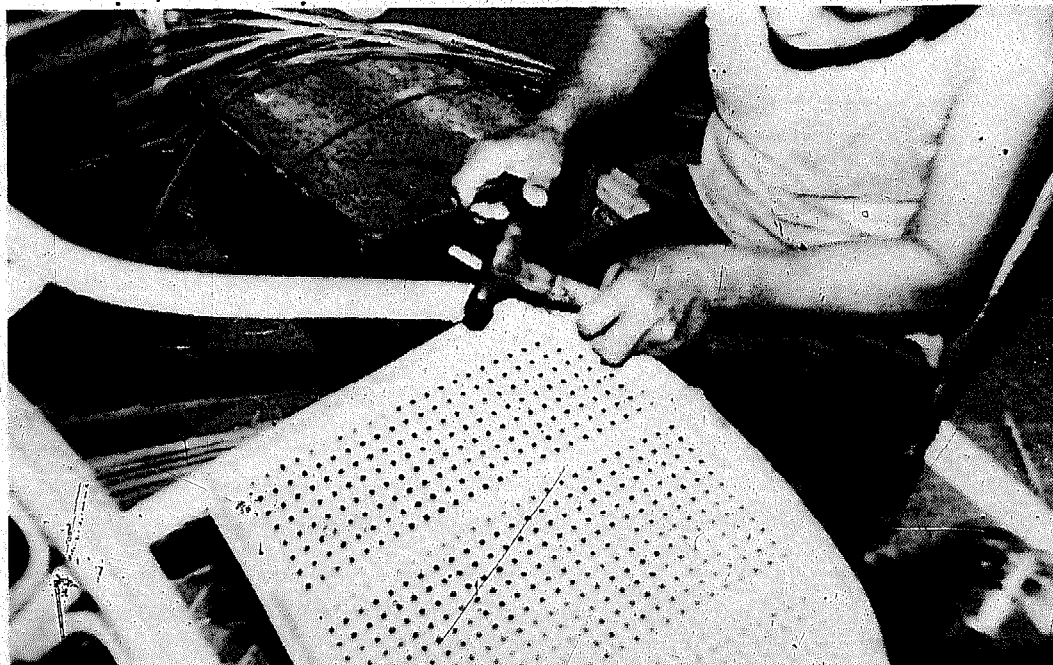

Figure 56. Fixing woven rattan caning to chair back

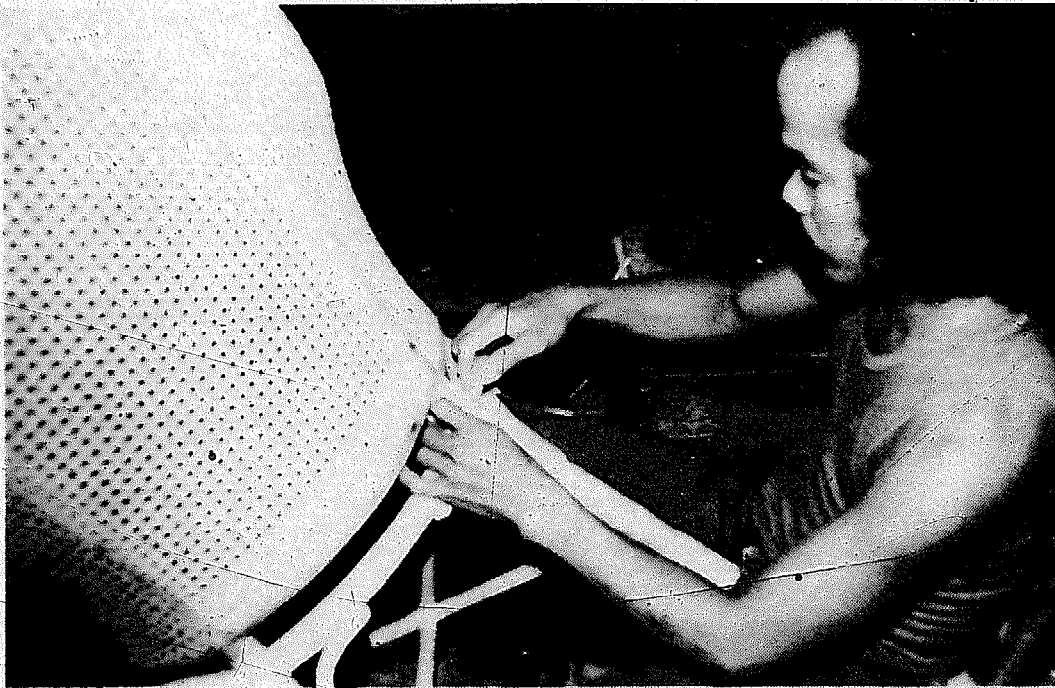

Figure 57. Binding back leg to stretcher rail

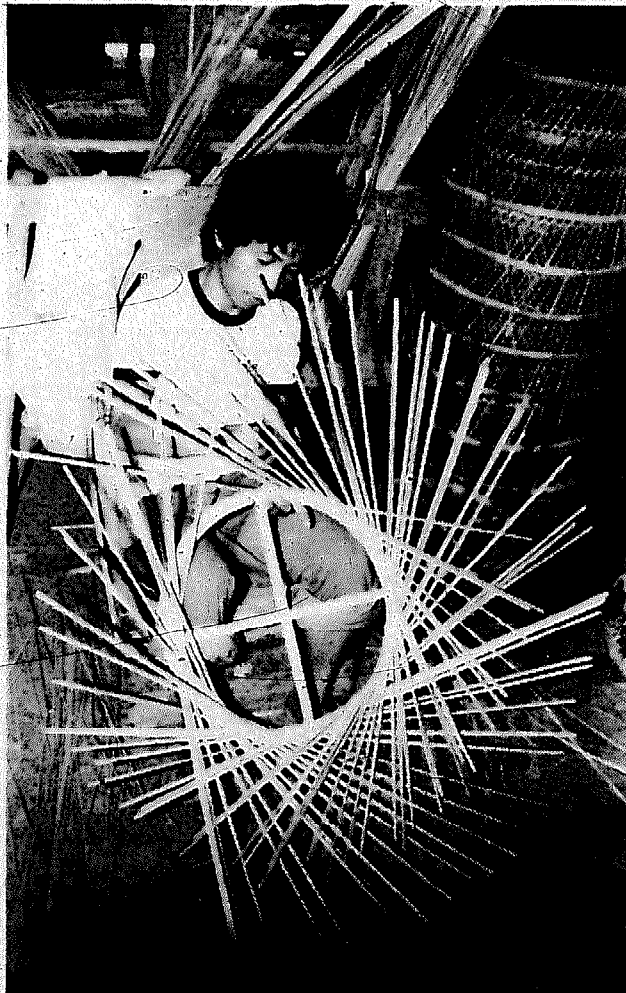

Figure 58. Weaving a basket on a rattan ring base



Figure 59. Weaving with rattan peel

E. Surface treatment (figure 60)

Staining and drying

Glued assemblies are sprayed or dip-stained manually, softened and equalized by means of brush and sponge and put on pallets or roller conveyors and pushed manually to the flash-off or drying area.

Base-coat spraying and drying

Spraying is done at a spray booth on turntables. The frames are put on a pallet or conveyor and pushed manually through a factory-made drying tunnel. Table tops are placed on castorized drying racks, which are also fed into the tunnel.



Figure 60. Lacquering a settee frame

#### Intermediate sanding

After drying the base coat, components, subassemblies and fully assembled frames are sanded in order to smoothen the surface in preparation for the application of the final or top coat. If suitable, hand sanders may be used.

#### Final coat spraying and drying

This follows the same procedure as the base-coat application.

#### F. Final assembly

Final assembly is in accordance with orders and forwarding instructions. Upholstered cushions are fixed to the polished frames. Table tops are fixed to table frames. Hand tools, electric tools and work benches are used.

### G. Inspection/quality control

Final inspection is to assure concurrence with the standard specification<sup>41/</sup> and conformity to colour and surface requirements.

### H. Finished goods storage

All merchandise is stored ready for packing and dispatch.

### I. Upholstery

#### Cutting fabrics and foam

Covering materials and foam cushioning are cut by a straight-knife cutting machine.

#### Foam glueing

A neoprene adhesive is sprayed onto the foam using a spray gun. This should be done only in a special spray booth in which an exhaust fan has been fitted.

#### Cushion profiling

The edges of cushions may be profiled or rounded using a special profiling attachment in conjunction with the spindle moulder.

Loose seats are assembled using a pneumatic jig. Some cushions will be cut square and others made up from a combination of urethane foam and polyester fibre.

Cushion cover make up, closing and zipping is done on an industrial sewing machine.

## VI. PROJECT ENGINEERING

### A. Technology and equipment

Table 1 shows the machinery and equipment and labour requirements for a typical rattan furniture factory.

Table 1. Machinery and labour requirements

Process	Machinery or equipment	Cost (thousands of dollars)	Capacity utilization	kW (hp)	Number of workers
<u>Rattan processing</u>					
Rattan stacking	Manual				4
Classification, storage	Manual				
Drying	Air-drying				2
Cross-cutting	2 overhead cross-cut saws and locally made working tables with adjustable length stop	3.0	100	2.25(3)	2
Straightening	2 hydraulic straightening machines <u>a/</u>	3.2		2.25(3)	2
Profile sanding	3 profile sanding machines <u>a/</u>	3.0		1.5(2)	3
Splitting	1 horizontal splitting machine <u>a/</u>	3.3		2.25(3)	1
Moulding	Variety of locally-made moulds to suit every requirement	<u>b/</u>	100		
Steaming ovens	4 locally made steaming ovens, diameter 0.75 m, 2 ovens 1.75 m long and 2 ovens 1.50 m long	4.5	100		6
Curve and profile sanding	1 buffer sander, fitted with cylinder and brush heads <u>a/</u>	3.0	100	1.5(2)	1
Curve and profile sanding	1 bobbin, brush and disc sander	2.0	100	0.75(1)	1
Shaped cutting	1 band saw (saw wheel diameter 630 mm)	2.3	50	0.75(1)	1

Process	Machinery or equipment	Cost (thousands of dollars)	Capacity utilization	kW (hp)	Number of workers
Edging, splitting, ripping	Circular saw bench, sliding table optional	2.5	50	2.25(3)	1
Surface and thickness planing	Surfacer, working width 510 mm; thicknesser with capacity 500 x 200 mm <sup>a/</sup>	6.0	65	3(4)	1
Boring	10 electro/pneumatic self-feed drills with multiple set-up frame and pedal; locally made bench	5.0	80		
Scribing	6 hand drills, electrically operated	2.4	80		6
<u>Subassembly of machined components</u>					
Pre-assembly of fronts, backs etc.	2 pneumatic jig and assembly tables	1.0	100		3
Moulding shaped panels	Open stroke press using cold glueing method	0.5	30		1
<u>Final assembly</u>					
Assembly of frames	Variety of assembly frames, locally made	0.5	80		4
Levelling	1 chair levelling, trimming and chamfering machine (optional)	0.5	80		
Sub-total		42.7			39
<u>Surface treatment</u>					
Surface treatment	1 stain dipping tank with stirring device	0.8	100		1
	1 built-in fan, capacity approximately 10 times change of air per hour	1.0			
	Manual transport				
	Drying at ambient temperature				
Lacquering	2 lacquer spray booths fitted with exhaust fans, ducting and turntables	5.0	100		2
	Drying at ambient temperature				



Process	Machinery or equipment	Cost (thousands of dollars)	Capacity utilization	kW (hp)	Number of workers
Spraying	1 airless device with two spray guns	2.4			2
Drying	Drying racks	2.0			
Sub-total		11.2			5
<u>Final assembly</u>					
Final assembly and fitting	Portable pneumatic and electric power tools	2.0			4
Sub-total		2.0			
<u>Upholstering</u>					
Upholstering	1 lay-cutting with round or straight knife cutters	0.5			
Glueing	1 adhesive application by spray gun and exhaust booth	2.0			1
Cushion shaping	1 profiling disc	0.2			
Sewing, zipping	1 industrial sewing machine	2.0			1
Sub-total		4.7			2
Total		60.6			50

a/ Specialized rattan processing equipment made in the South-East Asia region exclusively by the following firms in Taiwan Province: Kuang Yung Machinery Co., Feng Yuan; San Weei Industry Co., Taipei; San Yi Iron Works, Tainan.

b/ Made by the product development section of the factory.

#### B. Machinery, equipment and auxiliary services

Table 2 summarizes the investment costs for machinery, equipment and auxiliary services.

Table 2. Investment costs a/ for machinery, equipment and auxiliary services

Item	Cost (dollars)
Internal transport and storage equipment	4 000
Electrical installation	20 000
Processing machinery and equipment, including two years supply of spares	70 000
Chip and dust exhaust system (locally made)	5 000
Compressed-air installation and compressor	15 000
Tool-room equipment <u>b/</u> for machine setting up and maintenance	10 000
Equipment for technical and commercial administration	10 000
Total	134 000

a/ All costs are approximate and are based on the latest information available and relate to conditions in Malaysia, the Philippines and Thailand.

b/ Carbide-tipped tools are preferable but not essential.

### C. Site and buildings

#### Site

The area required for the factory premises and the provision of storage and access should be sufficient to enable expansion to two to three times the original size over approximately two years. The plot required for expansion to three times the original size should be about 8,000 m<sup>2</sup> and for two times the original size about 4,000 m<sup>2</sup>.

#### Buildings

The main manufacturing area will consist of one bay 60 m x 18 m, giving a total production area of 1,080 m<sup>2</sup> and including the following departments:

Rattan storage

Rattan storage and cross-cutting

Straightening, sanding and storage

Moulding

Machining

Sub- and final assembly

Scraping and sanding

Binding

Finishing

Upholstering

Packing and dispatch

Machine maintenance and product development

In addition, office accommodation must be provided.

Buildings should be of simple construction and should incorporate the following:

- (a) Height at eaves 4 m;
- (b) Clear roof span for each bay;
- (c) At least 10% roof lighting;
- (d) High degree of through ventilation;
- (e) Dust-free concrete floors capable of supporting high-speed woodworking machinery.

Table 3 summarizes the costs of buildings, utilities and fees.

Table 3. Building costs<sup>a/</sup>

Item	Area (m <sup>2</sup> )	Cost per unit area (dollars)	Total cost (dollars)
Main manufacturing area	1 080	75	81 000
Rattan storage shed	300	15	4 500
Steam boiler (3.75 kW, 0.4 bar (5 hp, 6 psi))			10 000
Total, buildings	1 380		95 000
Other costs:			
Planning			10 000
Fees (engineer, quantity surveyor, technical consultant)			5 000
Site development			50 000
Access			5 000
Water and power			10 000
Total costs (excluding site)			175 000

<sup>a/</sup> All costs are approximate and are based on the latest information available and relate to conditions in Malaysia, the Philippines and Thailand.

#### D. Plant layout and the organization of production

It is sometimes forgotten that the erection, use and maintenance of buildings, as part of the total capital investment, have to be costed into the product. They must be suited to the manufacturing activity and yet be sufficiently flexible in design to easily absorb any changes that may occur in the future.

Many rattan factories are unsatisfactory in these and other respects; examples are:

- (a) Badly organized processing and assembly lines;
- (b) Excessive capital tied up in stocks;
- (c) Buildings unsuitable for modern rattan processing machinery and internal transport;
- (d) Poor space utilization and work flow;
- (e) Poor quality standards;
- (f) Excessive waste;
- (g) Low productivity with resultant high unit costs.

Such problems result when, at the initial planning stage of the enterprise, all the factors concerned with growth and development are not taken into account, and the factory subsequently pays the penalty for this lack of foresight. In the case of a particle board or sawmilling plant such long-term planning is simple, but in the case of rattan furniture plants it is quite complex because of:

- (a) The multiplicity of the work processes;
- (b) The unlimited number of designs and design combinations;
- (c) The speed with which technological changes (mainly mechanization) occur.

It is therefore relevant to the immediate needs of the industry to consider the factors that go into the planning of new plants, and also the re-organization and future development of existing ones, so that the mistakes of the past may be corrected. Once the building has commenced flexibility is gone, which may result in high maintenance and personnel costs, poor utilization of machine capacity and space, high manufacturing costs and unnecessarily high working capital costs.

The factors that allow for built-in flexibility for future requirements may be summarized as follows:

- (a) Careful analysis of the market potential of the product;
- (b) Structure of and materials used in the product;
- (c) High rates of production through optimum use of modern machinery and equipment;

(d) High levels of productivity per worker through better factory organization and production planning and control systems.

Among the most significant changes that have occurred recently in the rattan industry has been the growth in space required for manufacturing purposes. In many instances this has as much as quadrupled, and while production space has increased at the rate of 20 per cent, storage areas for both work-in-progress and finished goods have increased fourfold. This is because the equipment currently being introduced sets much higher limits on space necessary for storage of processed components and raw materials. This in turn has made necessary the provision of additional space for production planning and control, internal transport, organization and administration.

With regard to building disposal and layout for the achievement of optimum production efficiency, it has been found in practice that a building module of 7.5 m produces a good planning base.

Many types of building layouts have been tried, including E-, F and H-type buildings, but have in the main proved unsuitable. Experience has shown that the U-type building with two long parallel halls connected to one another at one end is the ideal shape, making the whole production line in the factory a complete circuit.

The production flow is interrupted only where the material is fed in and at the point of dispatch. This layout has the following advantages:

- (a) Extension is possible on three sides;
- (b) Each production, storage or control area, while independent, is organically expandable;
- (c) Raw material supply and dispatch can be located on one side;
- (d) The inner yard is a fire lane;
- (e) All expensive equipment is located in one area;
- (f) Building costs are lower;
- (g) Main and auxiliary services are centrally located.

The shape of the main building determines future expansion of the building. The building should be considered as having at least a 20-year life. Department layout and work-flow are produced according to a logical sequence of operations. The criteria that should be applied in the various areas of storage and manufacturing activities are given below.

#### Rattan storage

This should be located beside or close to the cross-cutting or breakdown area and should have the same environmental conditions as the production areas.

#### Machining areas

Since initial installation costs are high, particularly those for the foundations, these should be planned so that when expansion or reorganization

is required a complete removal is not necessary. The main power and service lines should be of flexible design and located mainly at roof-truss height or under the ceiling. Compressed-air lines must be on a ring system with reserve connections in each section. The electric wiring system must be carefully suited to the production areas, and the lighting system must provide general shadow-free illumination.

### Intermediate storage

This area should be regarded as unwanted and should be kept as small as possible. In the case of completely knock-down (CKD) furniture it may even be eliminated. For storage, long, narrow, fire-proof buildings with a minimum width of 7.5 m should be capable of housing both rough and machined parts. Lacquer storage should be on the outside of the building because of the fire hazard.

### Assembly

The investment in this area is the smallest, but it still pays to plan according to the principles of method and work study. Work stations for various stages of assembly should be organized so that the operator is enabled to work quickly and efficiently. The assembly bench, fully serviced pneumatically and electrically, should be designed specifically to suit the assembly processes, and the operator should be provided with the appropriate assembly aids, location jigs and adequate supplies of other tools and fittings required.<sup>5/</sup> Work delivery and disposal should also be planned so that the maximum amount of the assembler's time is engaged directly in production.

### Machinery and equipment planning

The basic arrangement of the operation pattern in a rattan plant is as follows: storage, cross-cutting, straightening, profile sanding, moulding, buffer sanding, intermediate storage, boring, chucking, scribing, parts storage, sub- and final assembly, final sanding, binding, surface coating, fitting and dispatch.

The planning should be based on the installation of the best up-to-date equipment of maximum dimensions, even though this may initially mean that, due to cost or work-load factors, existing or old equipment will have to be used. Identical operations should be carried out in the same work area. In this connection, the following principles apply to the machining department:

(a) Buffer stocks of rattan poles, approximately classified, should be stored parallel to each other;

(b) Moulding benches and mould storage should be located as close as possible to the steaming ovens;

(c) All machining lines must be planned so as to give a minimum distance between individual machines of twice the length of the longest workpiece;

(d) For machines that are not linked to a "line", particular attention should be given to providing a suitable working area around the machine and waiting areas for components awaiting processing or transport to the next work station.

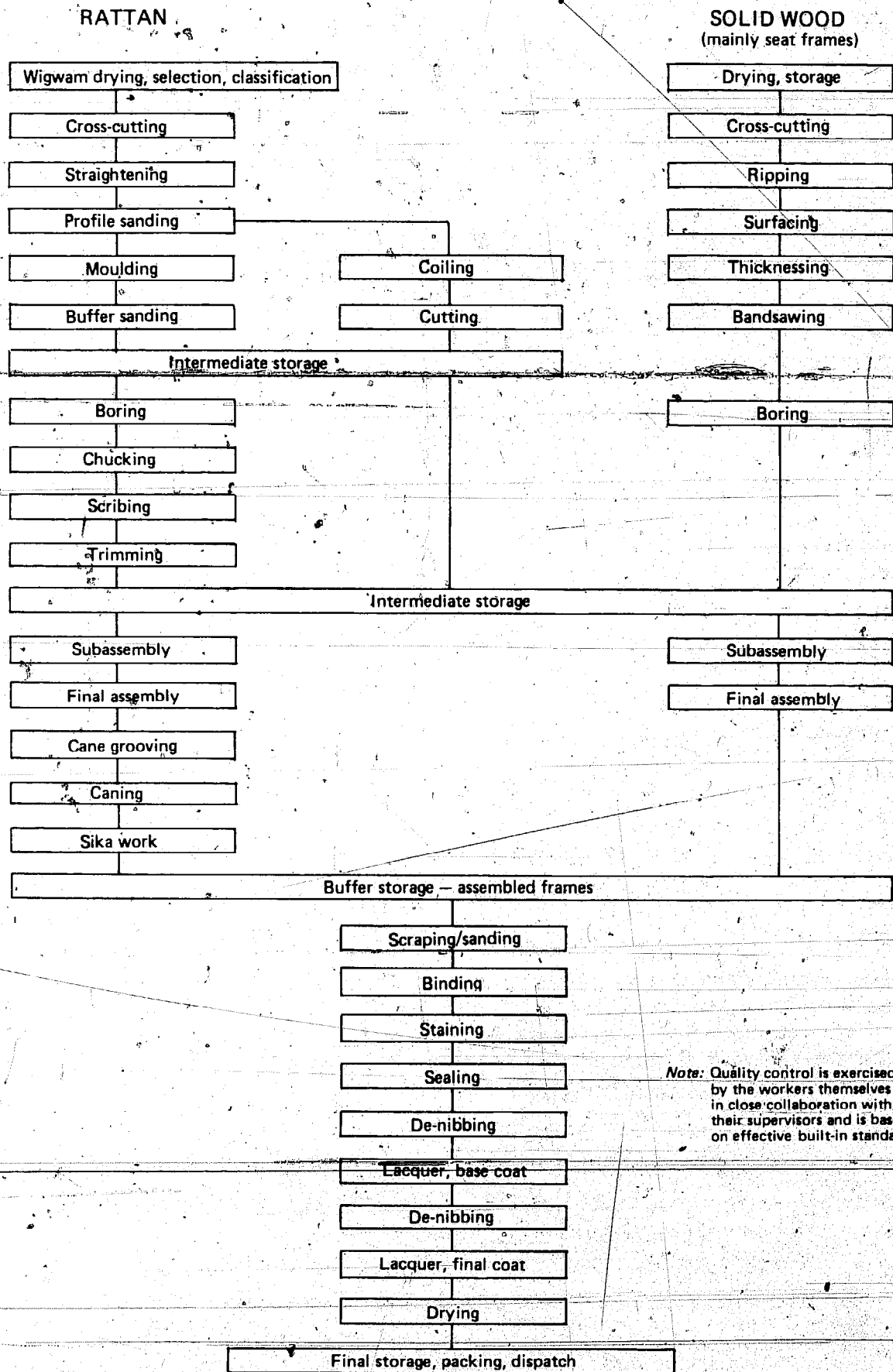

Figure 61. Process flow chart for rattan furniture processing

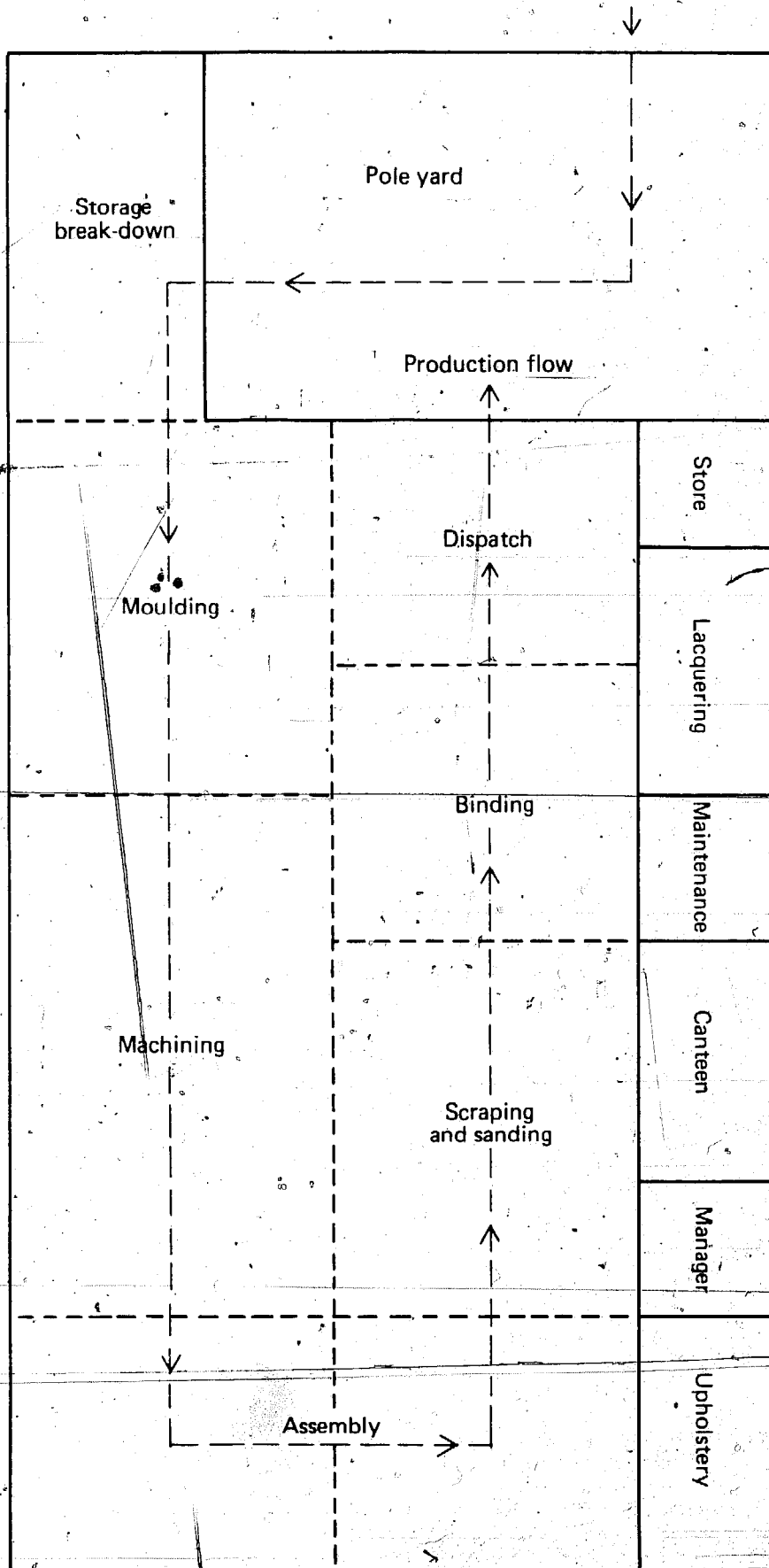

Figure 62. Schematic layout of rattan furniture plant (Not to scale)



Adequate facilities for transport to and from each machine should not interfere with other work places. The choice of a particular transport system will be influenced by the size and shape of the components being processed. In general, however, it may be said that for rattan production castorized trolleys are the most suitable, with live and dead pallets or bins in conjunction with hand-lift and fork-lift trolleys and trucks. Whatever system is used, it should be standardized throughout the factory. Longitudinal and transverse passages should split up the entire production line into areas that can be easily controlled.

Figure 61 shows a process flow chart for the production of rattan furniture. Figure 62 provides a schematic layout of the various work areas in a modern rattan plant.

## VII. MANAGEMENT AND LABOUR

### A. Department functions

The duties of the various departments in a modern rattan plant are listed below.

#### Marketing and sales

Plan and maintain sales of the company's products to its home and export markets

Design and maintain a suitable and profitable price structure for the company's products

Budget and control advertising expenditure

Plan and control special promotions; in particular, showroom displays (permanent or otherwise)

Plan and control selling costs' budget

Set targets for domestic and export sales and maintain or adjust them

Review the popularity and profitability of each model and plan suitable times for discontinuing designs

Advise on the use for new products; prepare marketing specifications

Negotiate terms for bulk purchases and prepare a schedule of incentive discounts for bulk purchasers (e.g., contract sales)

Maintain good customer relations; design and maintain a system for after-sales service

Design and maintain a method for the internal administration of the sales function

Maintain close liaison and good relations with the other main functions of the company, especially product design and development, purchasing and production

#### Design and development

Prepare designs for new models

Prepare detail and assembly drawings

Provide information for estimating costs of new designs

Prepare material specifications

Make prototypes and develop each new design to the manufacturing stage

Design appropriate jigs, fixtures and other production aids

Prepare manufacturing instructions

Integrate activities with other departments

#### Purchasing and raw material stock control

Prepare purchasing budget

Order materials

Check contracts and improve sources of supply

Store materials and record issues and receipts

Establish and maintain a stock-control system

Control stock

Check incoming materials and reject those below standard

Dispose of scrap and surplus materials and plant

#### Production planning

Construct a production programme

Prepare production budgets

Revise production schedules where necessary

Balance production staff to meet schedules

Requisition materials from stores or yard

Provide technical estimates

Investigate and recommend new production techniques

#### Production

Produce according to specification and agreed production levels

Establish and maintain work standards

Determine and maintain machines, equipment and handling systems

Keep methods and layout under review and simplify operations where possible

Ensure that the factory's capacity is being effectively used

Record production and the issue of production materials

Liaise with product development and sales on the introduction of new designs and models

Maintain quality control

Inspect products

Advise on machinery and equipment needing overhaul

Devise ways to improve quality and reduce waste within cost and performance standards

Control costs by effective utilization of manpower and materials

#### Maintenance

Organize and maintain plant register

Prepare preventive maintenance check-sheets for all machinery, equipment and buildings

Maintain register of checks on dust-extraction system, handling equipment and transport system

Carry out repairs to plant and machinery

#### Rattan yard organization

Plan yard layout

Determine and implement yard procedures

Arrange staffing and recommend any capital needed

Establish and implement a system for reporting faulty rattan

#### Administration

##### Accounting

Prepare annual financial plans reflecting the company's policy

Co-ordinate departmental budgets

Provide financial information required by top management

Maintain an administrative system to monitor actual performance against budgeted forecast

Pay salaries, wages and other emoluments

Arrange collection and payment of debts

Keep accounts in accordance with the company's requirements

Carry out internal check systems to safeguard company's assets

#### Office

Establish and maintain office procedures

Investigate and implement improved systems

Authorize and recommend purchases of new equipment

#### Personnel

Engage new personnel

Assign transfers between jobs

Review pay and authorize changes in rates of pay

#### Review performance

Ensure all workers receive adequate training for their existing jobs

Develop the potential of workers with the ability to do more senior jobs

Inform workers regarding department or work area rules including security and safety arrangements

Take disciplinary action within area of responsibility

Deal with problems raised by individual workers

Give leave of absence

#### Safety, fire and health

Establish and administer safety rules and ensure they are complied with

Prepare and submit reports on accidents

Establish and administer fire precautions and ensure that they are complied with

Liaise with local fire authority on fire matters

Maintain standards of working conditions

Figure 63 is an organigram of the management structure:

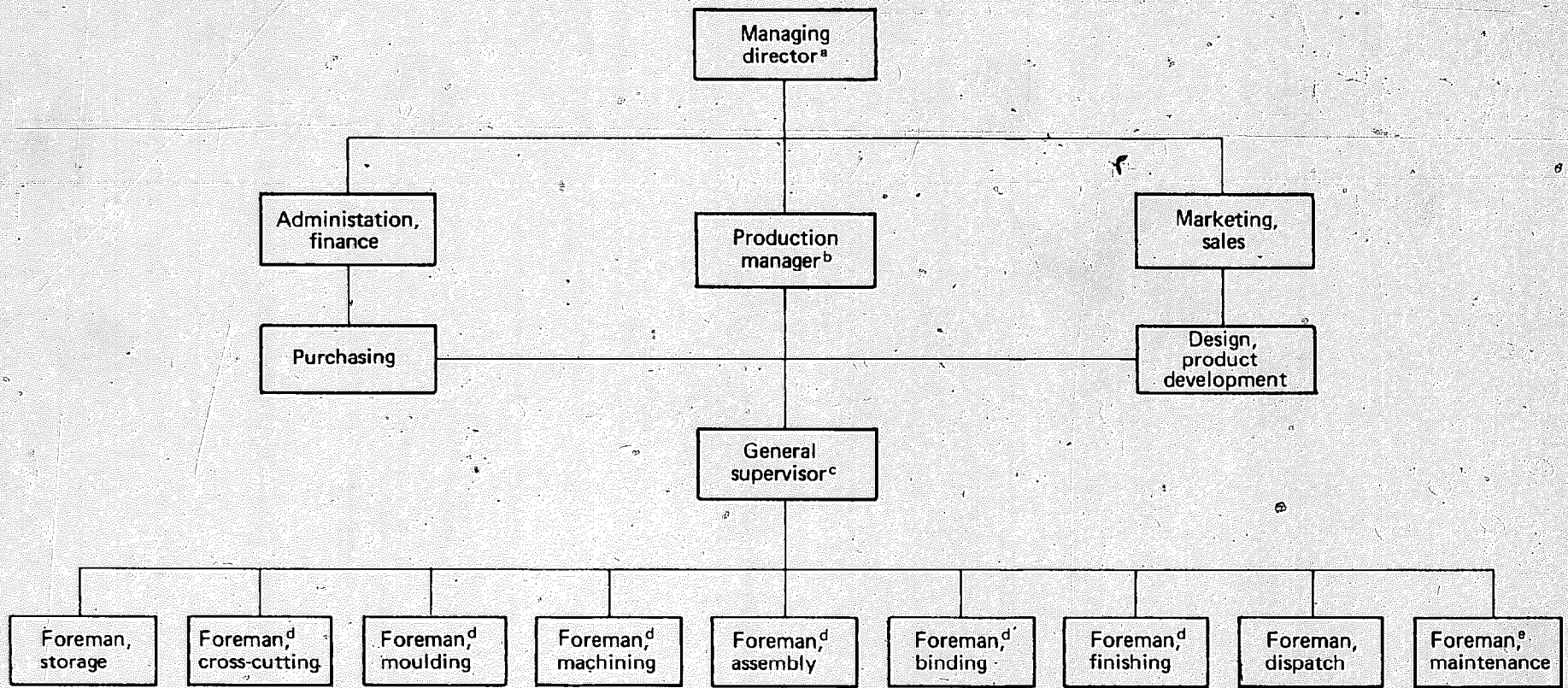

<sup>a</sup> Special responsibility for marketing, finance and purchasing

<sup>b</sup> Fully experienced in all aspects of modern rattan furniture production

<sup>c</sup> Experienced craftsman with supervisory experience

<sup>d</sup> Assistant supervisors, very experienced craftsmen, specially responsible for progress chasing

<sup>e</sup> Good fitter with knowledge of electrics, pneumatics, hydraulics, welding and lathe work.

Figure 63. Management structure

## B. Labour requirements

A summary of the labour requirements for a modern rattan plant are given in table 4.

Table 4. Labour requirements

Activity	Number of workers
<u>Production, direct</u>	
Rattan yard	6
Cross-cutting	4
Moulding	6
Machining	11
Assembly	10
Binding	6
Finishing	5
Upholstering	2
Sub-total	<u>50</u>
<u>Production, indirect</u>	
Product development	1
Maintenance	2
Overhead labour	3
Sub-total	<u>6</u>
Total, production	<u>56</u>
<u>Supervisors</u>	
Rattan storage	1
Cross-cutting	1
Moulding	1
Machining	1
Assembly	1
Binding (including scraping and sanding)	1
Finishing	1
Dispatch	1
Maintenance	1
Sub-total	<u>9</u>
Total	<u>65</u>

Notes

1/ J.H. Burkhill, Dictionary of the Economic Products of the Malay Peninsula, rattans 2 (1966), pp. 1869-1885.

2/ "Standardization and inspection of unsplit rattan for furniture and other purposes", Commerce Administration, Order No. 6 - Standards Administration, Order No. 103 (Manila, Philippines, Bureau of Standards, Department of Commerce and Industry, 1948).

3/ Dowicide G is said to consist of 75% sodium pentachlorophenate, 13% sodium salts of other chlorophenols and 12% inerts. There are other chemicals on the market that are being used for the control of stain in logs and lumber. Some of these chemicals have been tried on rattan but data accumulated regarding their performance are still too limited to warrant their effective use.

4/ For example, see annex I for the standard specification for rattan and wicker furniture issued by the Philippine Bureau of Standards.

5/ For additional information on assembly jigs see UNIDO, Manual on Jigs for the Furniture Industry (ID/265).



Annex I

PHILIPPINE STANDARD SPECIFICATION  
FOR RATTAN AND WICKER FURNITURE<sup>a/</sup>

FOREWORD

This standard specification is hereby promulgated under a fixed designation, PS (Philippine Standard) No. 821-09.03; 1976.

This standard was prepared by the Technical Committee on Furniture and Fixtures with the full co-operation of the Chamber of Furniture Industries of the Philippines.

Suggestions for revision should be addressed to the Philippines Bureau of Standards, P.O. Box 3719, Manila.

1. SCOPE

1.1 This standard specifies requirements for rattan and wicker furniture.

2. DEFINITION

2.1 For the purpose of this standard, the following definitions shall apply:

2.1.1 Rattan Poles - It is a common term that applies to the various species of tropical climbing palms composing the genera Calamos and Daemororpos of the family Palmas.

2.1.2 Rattan Round Core - Sometimes called "wicker", refers to round-shaped material, with size ranging from 2 to 10 mm in diameter, processed from the core of the rattan pole, usually used for weaving.

2.1.3 Rattan Flat Core - Refers to the flat-shaped material, with size ranging from 2 to 10 mm in width, processed from the core of a pole and used for weaving and binding.

2.1.4 Rattan Peel - Also "rattan split", refers to flat-shaped material, stripped from the skin of a rattan pole, with size ranging from 2 to 10 mm or wider in width, usually for weaving and binding.

2.1.5 Check - A separation of the fibers along the pole forming a crack or fissure in the rattan, not extending through the piece from one surface to the other.

<sup>a/</sup> PS No. 821-09.03; 1976.

- 2.1.6 Shake - A separation of the fibers along the pole, caused by stresses developed in the gathering and cutting, or due to improper processing.
- 2.1.7 Break - A separation of the fibers which extends through a piece from one surface to the other usually perpendicular or at right angle to the directions of the grains.
- 2.1.8 Blemishes - Dark spots or discolourations in rattan poles caused by staining fungi or mineral stains.

### 3. MATERIAL REQUIREMENTS

3.1 Rattan Poles - The rattan used in the construction of furniture shall be the "Palasan" or similar variety and shall be of good grade poles: mature, clean, scraped, thoroughly seasoned.

3.1.1 Rattan Poles used for local and export market shall be treated against fungi and insect infestations, and thus, free from mineral and fungal blemishes, scar, bruise and specially pinholes.

3.1.2 All poles are to be treated with pentachlorophenol or Saline solution to safeguard against insect-borers.

3.1.3 Checks, Shakes and Breaks - Checks and shakes shall be permitted provided that they do not exist in close proximity to holes and grooves as to affect the strength. Breaks, however, shall not be permitted.

3.2 Rattan Core and Peel - The rattan core and peel used for weaving and binding furniture shall be of good quality processed from grade rattan poles preferably of the "sika" variety. Rattan core or peel used shall be of uniform diameter or width respectively.

3.3 Wood - All wood materials used or incorporated into rattan furniture such as seat frames, doors, cabinet, etc. shall conform to PS Specification for Wooden Furniture (Section 3).

### 4. CONSTRUCTION

4.1 All furniture complying with this standard shall be of good workmanship and all components including those not specifically referred to in this standard such as materials used in constructing the metal and wooden parts, springs, cushions, upholstery shall be of a quality at least equal to that used in recognized good practice in the trade.

4.1.1 Rattan joints for main members and stress joints, shall be snugly fitted and secured to adjoint members by nails, screws or bolts, and bound with rattan flat peel or core, or other binding materials glued on to the rattan, so as to withstand normal daily wear and tear.

4.1.2 All main members and stress joints shall be of the concave-cut fitted type or dowelled type of construction.

- 4.1.3 All joints of rattan rings used for the seats or for support purposes shall be the half-lap type nailed and glued together.
- 4.1.4 All wood jointings shall follow the PS Specification for Wooden Furniture (Section 4).

## 5. FINISH

- 5.1 All rattan and wood surfaces shall be sanded smooth and all exposed edges and corners shall be eased. All holes, checks and shakes shall be filled and stained or toned to match colour of rattan parts. Exposed nails, screws, and bolts shall be countersunk with the holes with plastic wood fillers and/or wooden or rattan plugs flushed and sanded smooth before finishing.
- 5.2 Furniture finish shall be in accordance with any of the following:
- (a) Lacquer or nitro-based clear finishes
  - (b) Cellulose acetate butyrate (CAB)
  - (c) Acid catalyst clear lacquers
  - (d) Polyurethane
  - (e) Oil or wax
  - (f) Polyester
- 5.3 All materials used for juvenile furniture shall be of the non-toxic type.
- 5.4 All polished, painted or otherwise finished surfaces shall be of good workmanship and brought to a durable finish.
- 5.5 There shall be no excessive stickiness or surface disfigurement of any type such as blistering, marking or change of colour when the furniture is subjected to dry heat. (See Specification for Wooden Furniture PS 821-01.09; 1976).

## 6. SAMPLING

- 6.1 Up to three furniture shall be selected at random for testing. Should one of these fail to pass the tests, the inspector may select as many additional furniture as are necessary within reasonable limits, to satisfy himself on the manufacturer's normal standards of production.

## 7. PERFORMANCE TESTS

- 7.1 The main objective of these series of tests is to determine, by the application of simulated loads and related stresses, whether a given manufacturer's products, specifically load-bearing members and joints hereof, can reasonably withstand normal use.
- 7.1.1 The manner of testing herein described represents the most simple procedure that has been found workable in a majority of furniture, especially chairs. There will however, be cases in which the design precludes the use of this particular procedure. In such cases, the tests to which the furniture are

to be submitted shall be derived from the same principle, as the standard test, using other means of applying either the same load or loads that have a similar effect.

## 7.2 Inspection before Testing.

7.2.1 Immediately before testing, each sample shall be inspected and any apparent defects noted, so that they shall not later be recorded as having been caused by the tests. A report on such defects shall accompany the report on the performance tests and these shall be taken into account in assessing whether the article has complied with the requirements of this standard.

## 7.3 Test Procedure

7.3.1 Each sample shall be subjected to the series of tests specified in Section 7.4 the tests being carried out in that sequence.

7.3.2 If, during or after any of the tests described in Section 7.4 relative movement is apparent between the members at any joint and it is established that the joint is broken in such a way as to impair its serviceability, the furniture shall be deemed to have failed to pass the Performance Tests (Section 7).

7.3.3 If failure of a joint is recorded, or if for any other reason the furniture selected for testing is deemed to have failed to pass the Performance Tests of this standard, the testing of that article shall be discontinued and no further sections of the test procedure shall be applied to it.

7.3.4 If any of the tests specified in Sections 7.4, would cause local damage or is inappropriate for any other reason, it shall be replaced by a test or tests based on the same principle. (Section 7.1).

## 7.4 Tests

7.4.1 Test Samples - Samples selected at random in accordance with 6.1 shall be tested as specified herein.

7.4.2 Level Test - (All items) Casters or glides shall be removed. Items shall be placed on a flat level surface plate. All legs shall simultaneously rest on the surface plate. Any evidence of rocking when light force is applied at any corner shall be cause for rejection.

7.4.3 Sand Bag Test - (Chairs and sofa frames) These items shall withstand six impacts of a 29.5 kg (65 pounds) sand bag, 30.48 cm (12 inches) in diameter, at dropped end, a distance of 106.68 cm (3.5 feet) in each of the following locations: (a) Directly over a leg (b) Midway between the legs on the side frame members (c) On front frame rail at midpoint.

7.4.4 Impact test - Chairs shall withstand 12 drops from a height of 91.44 cm (3 feet) above a concrete floor. The chair shall be

tilted to an angle of 12 degrees diagonally across the plane of the feet to insure that one leg receives the initial impact.

7.4.5 Diagonal Load test - Chair shall be laid back in such a way that the front edge of the seat is directly above the feet of the rear legs. Apply a vertical load of 68.04 kg (150 pounds) to the front edge of the seat. The force shall be applied and completely removed steadily during periods of not less than 5 seconds for 20 times.

7.4.6 Static Load test - (Chair frame with deck). A static load of 68.04 kg (150 pounds) sand bag shall be applied vertically over a 30.48 cm (12 inches) diameter area in the centre of the deck and allowed to remain for 15 minutes. Upon removal of the load, there shall be no evidence of breakage or loosening or separation of frame joints.

7.4.7 Static Load test - (Tables) The height of the table shall be measured accurately. A static load of 45.36 kg (100 pounds) shall be applied vertically over a 30.48 cm (12 inches) diameter area in the centre of the table top and allowed to remain for 30 minutes. Upon removal of the load, the height shall not have decreased by more than 0.31 cm (1/8 inch) and there shall be no evidence of breakage or separation of joints.

#### 7.5 Criteria for Success

7.5.1 No part of the furniture or its components or fittings shall develop any fracture, or any apparent loosening of a joint intended to be rigid, or any deformation which would adversely affect any of its functions.

7.5.2 Each sample tested shall fulfill the conditions of the test described in 7.3.2.

7.5.3 Each sample tested shall sustain each of the forces described in 7.4.

#### 8. MARKING

8.1 Each furniture complying with this standard shall be marked with the PS Certification Mark.

Note: The use of the PS Certification Mark is governed by the provisions of Standards Administrative Order No. 20, series of 1968. "Rules and Regulations Providing for the Marking of Goods Standardized by the Bureau of Standards and for other Purposes". This mark on a produce/producer is a guarantee that the product is in conformity with the standard. Details of condition under which a license to use the PS Certification Mark may be granted are obtainable from the Bureau of Standards, P.O. Box 3719, Manila.

9. EFFECTIVITY

9.1 This Standards Administrative Order shall take effect upon approval.

(SGD) VIDALITO F. RANOA  
Director

RECOMMENDED BY:

(SGD) VICENTE B. VALDEPENAS, Jr.  
Acting Undersecretary of Trade  
Chairman, Philippine Standards Council

A P P R O V E D: September 16, 1976  
(Date)

(SGD) TROADIO T. QUIAZON, Jr.  
Secretary of Trade.

Annex II

PORTFOLIO OF DESIGNS FOR RATTAN FURNITURE

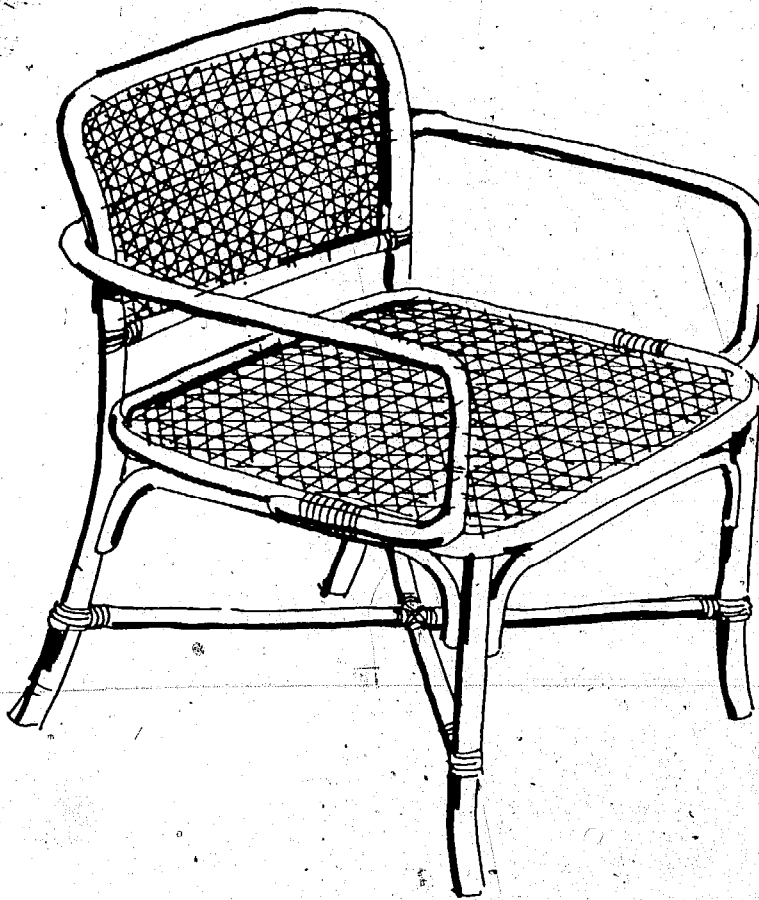

Figure 64. Occasional armchair with woven cane seat and back

Dimensions (WxHxD): 46 cm, 51 cm, 81 cm (18 in, 20 in, 32 in)

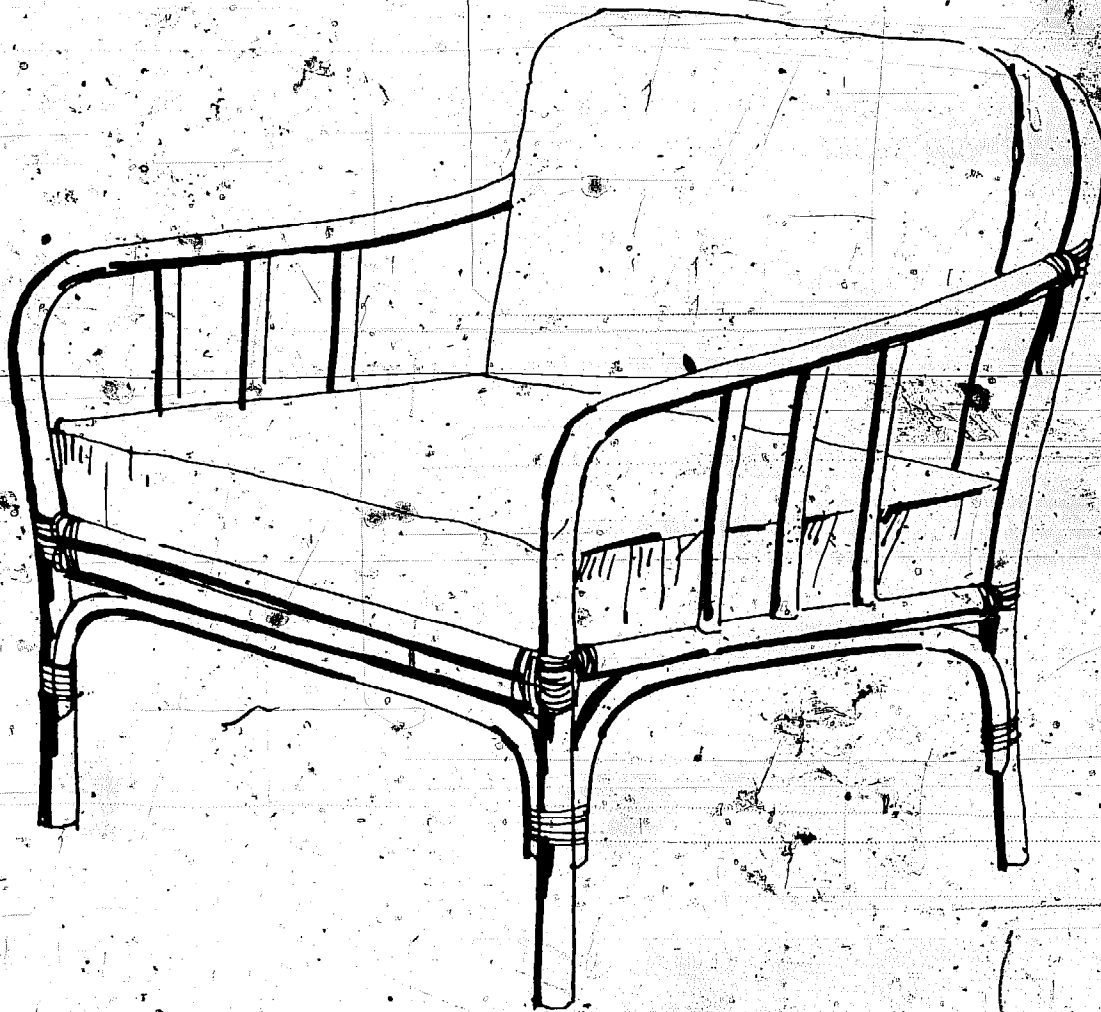

Figure 65. Occasional armchair, with loose cushions

Dimensions (WxHxD): 51 cm, 51 cm, 81 cm (20 in, 20 in, 32 in)



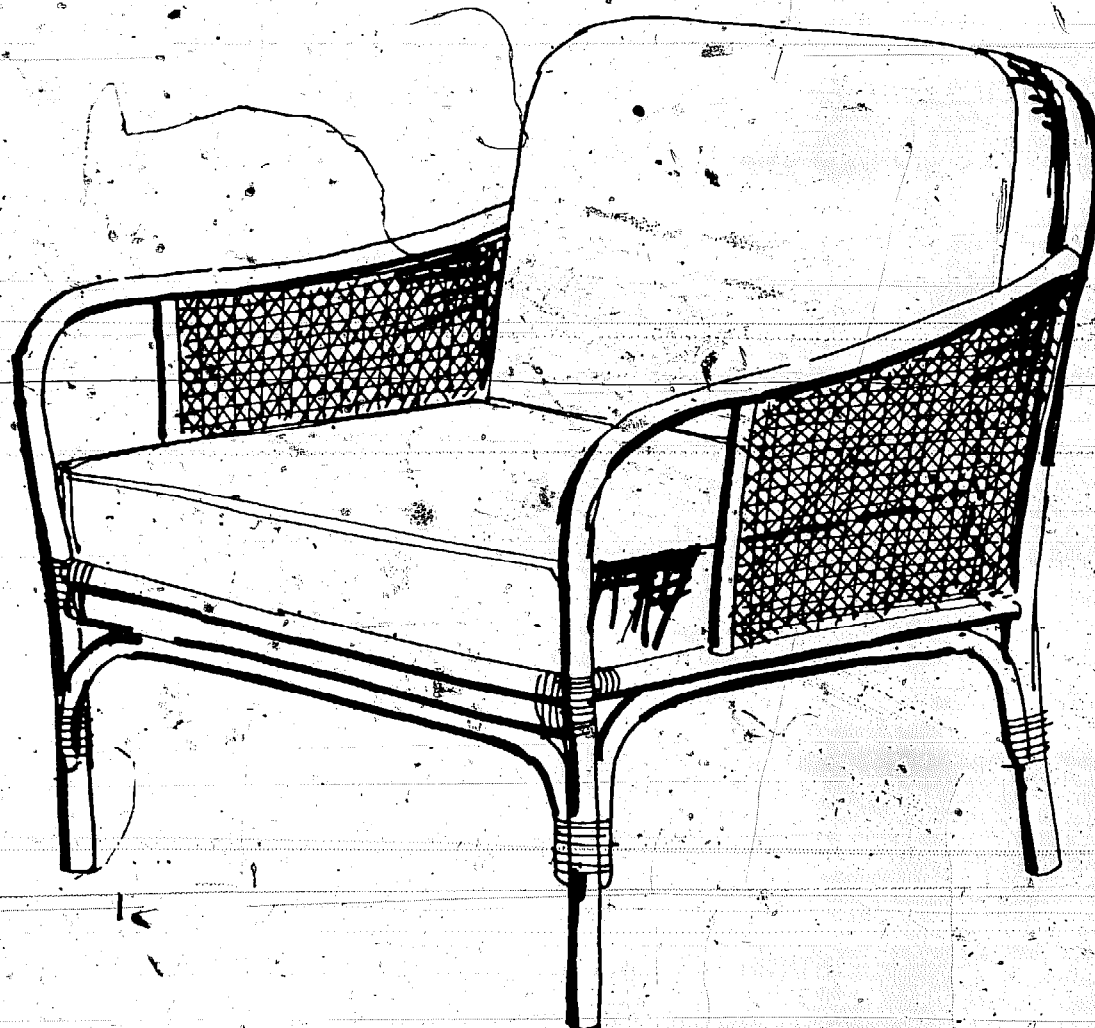

Figure 66. Occasional armchair with cushions and woven cane sides

Dimensions (WxHxD): 51 cm, 51 cm, 81 cm (20 in, 20 in, 32 in)

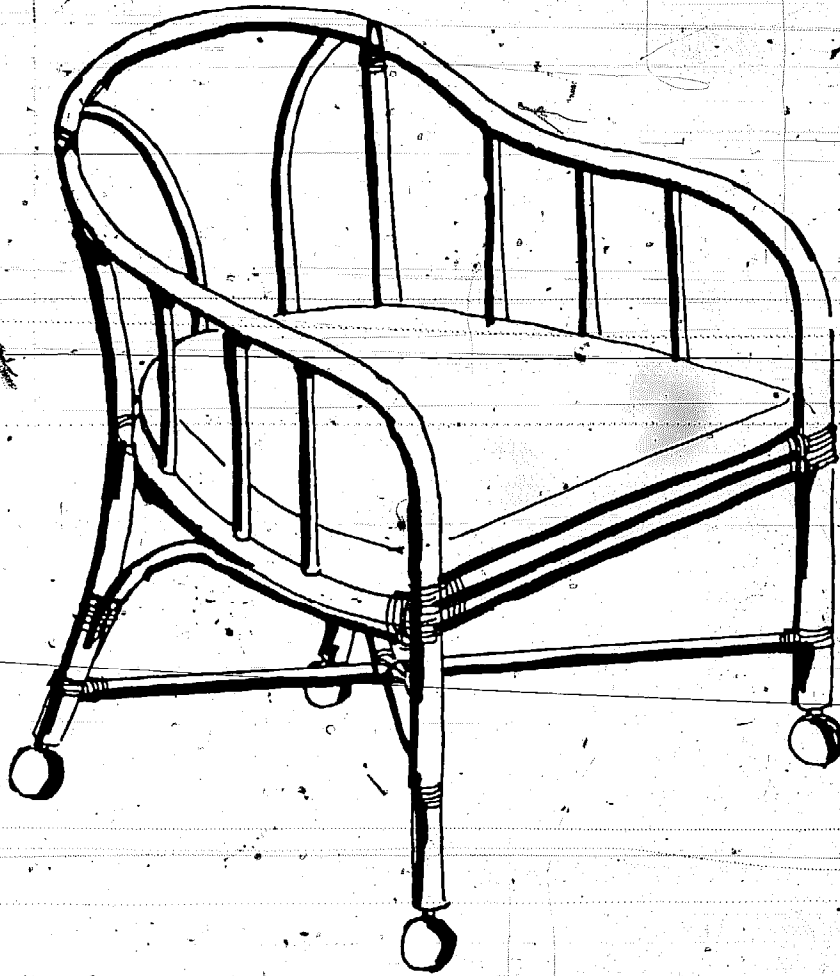

Figure 67. Occasional armchair with seat cushion and castors

Dimensions (WxHxD): 58 cm, 86 cm, 58 cm (23 in, 34 in, 23 in)

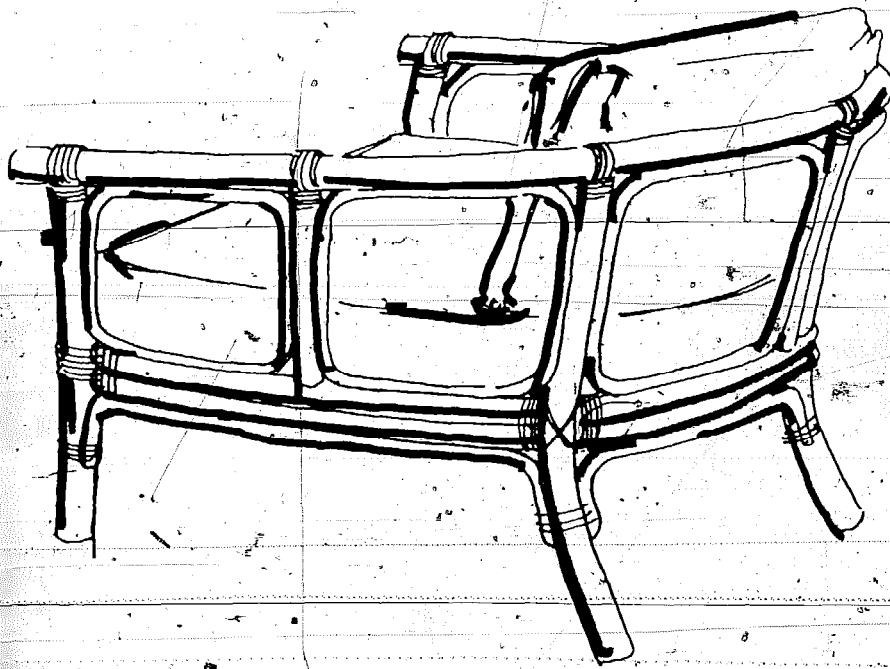

Figure 68. Occasional armchair with loose cushions.

Dimensions (WxHxD): 61 cm, 61 cm, 70 cm (24 in, 24 in, 27.5 in)

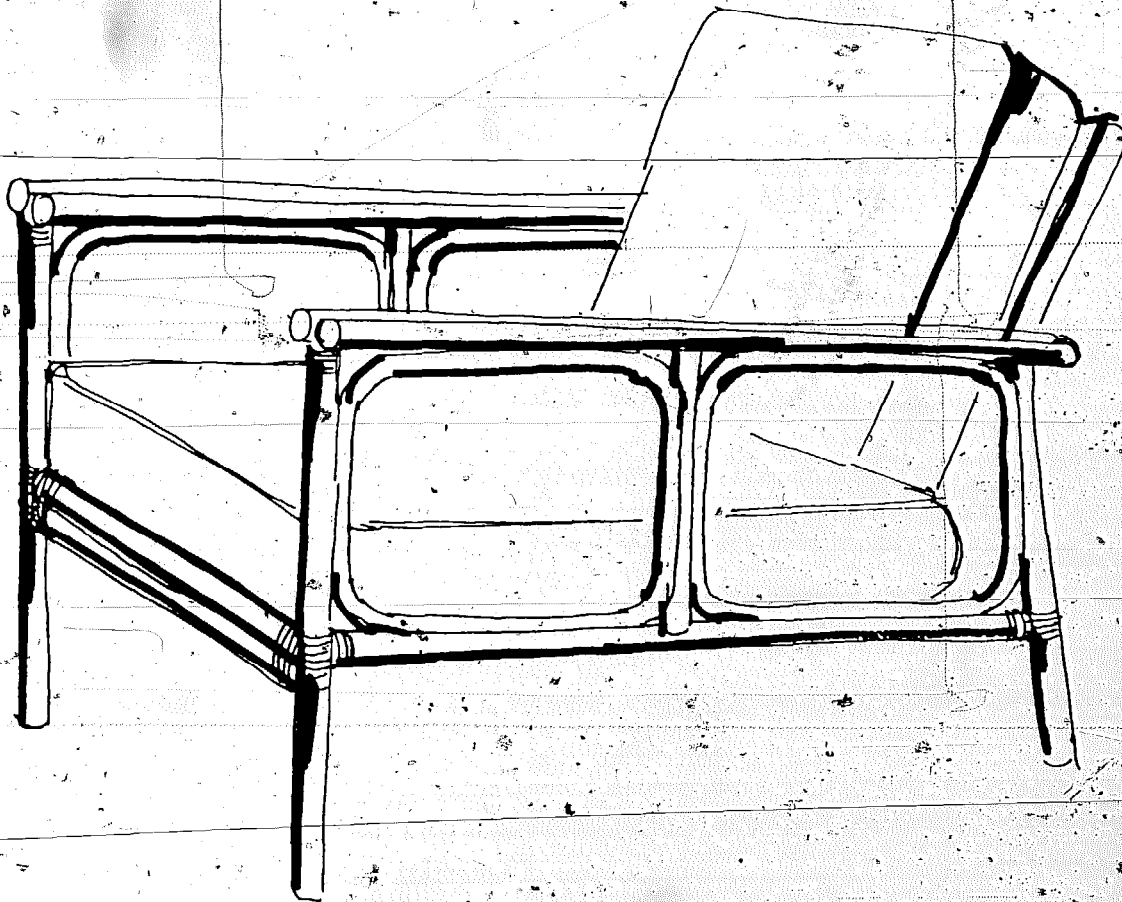

Figure 69. Occasional armchair with loose cushions.

Dimensions (WxHxD): 51 cm, 51 cm, 76 cm (20 in, 20 in, 30 in)

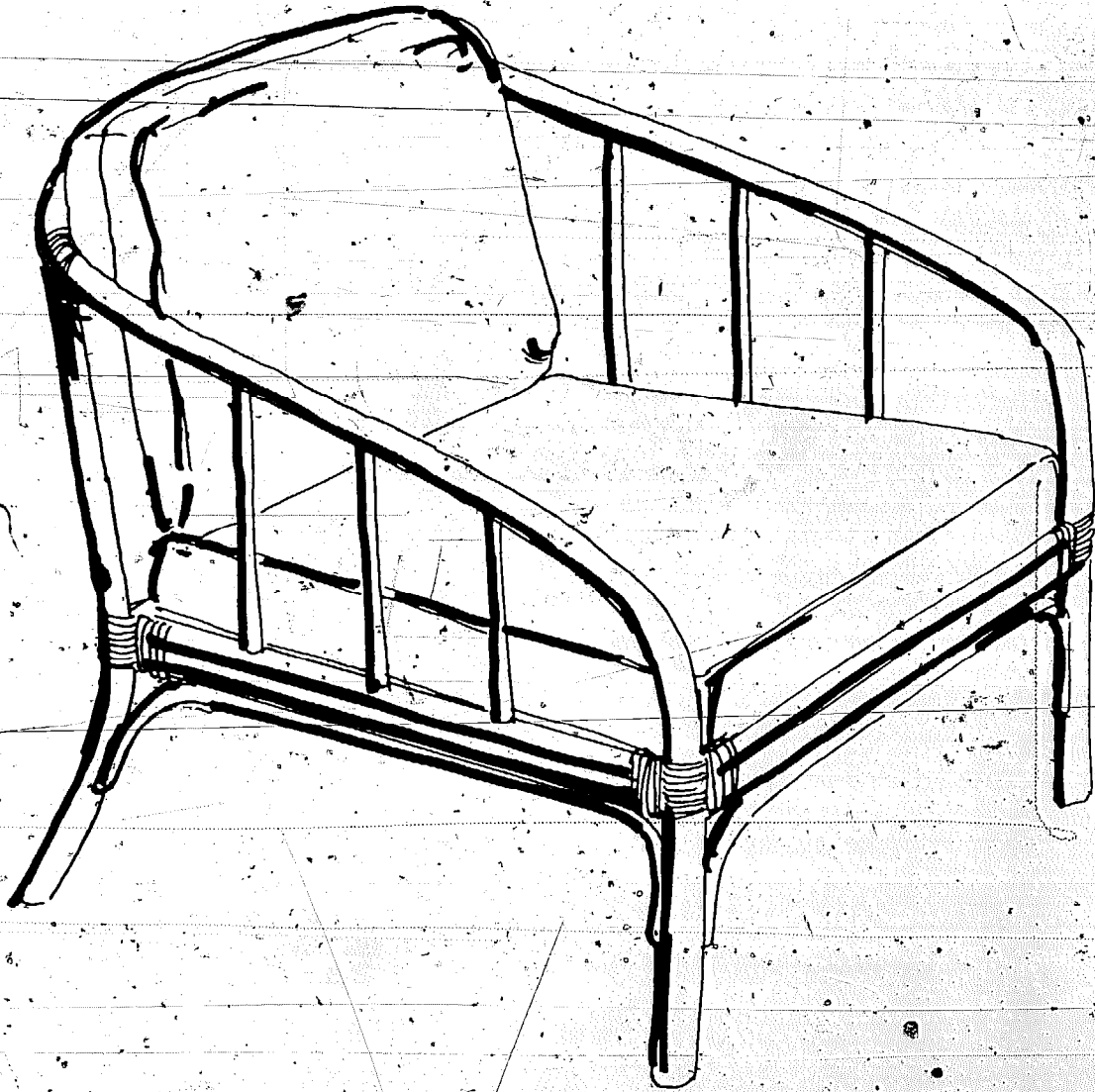

Figure 70. Occasional armchair with loose cushions

Dimensions (WxHxD): 71 cm, 79 cm, 71 cm (28 in, 31 in, 28 in)

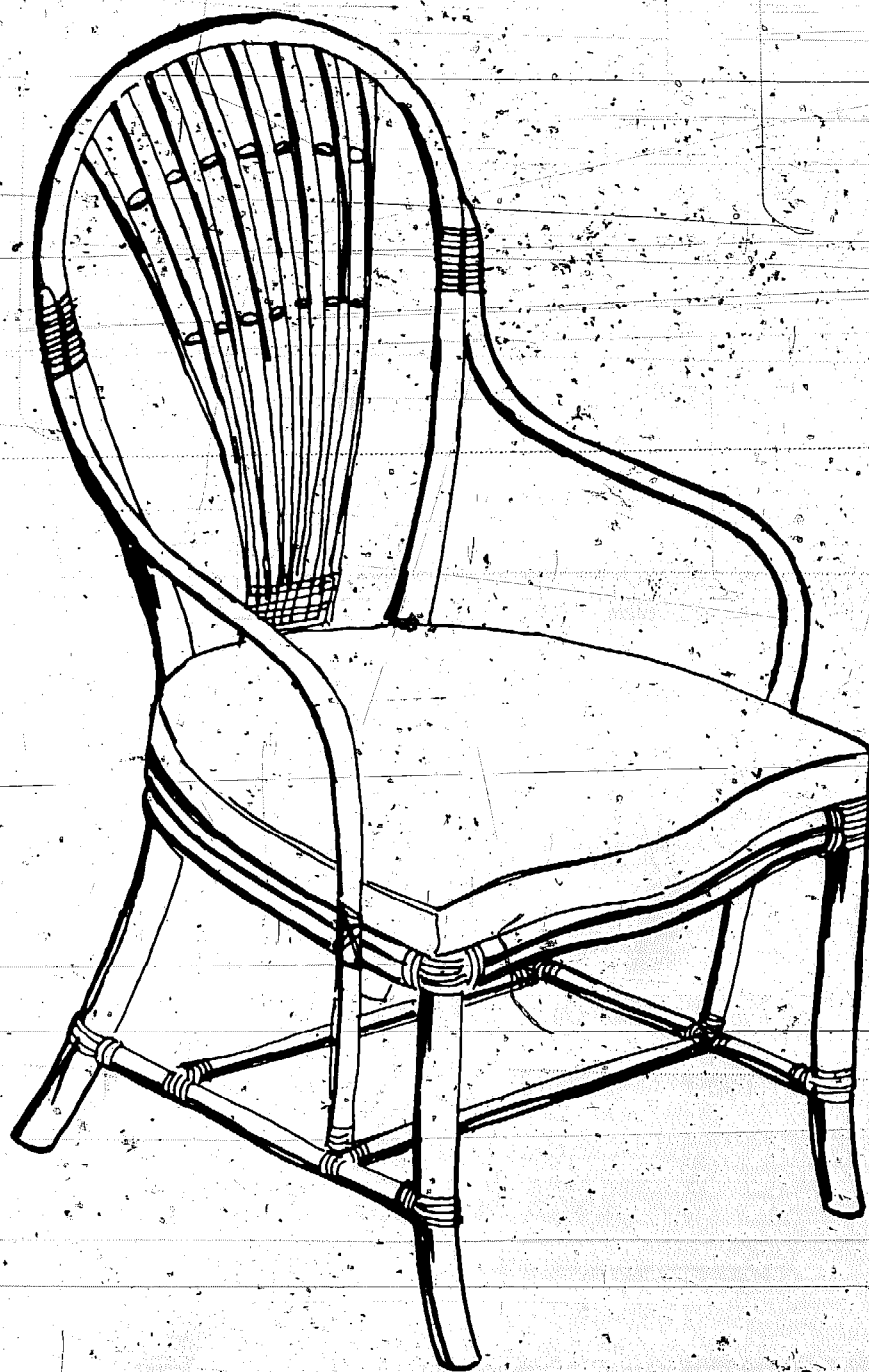

Figure 71. Windsor type host chair with cushioned seat

Dimensions (WxHxD): 56 cm, 56 cm, 97 cm (22 in, 22 in, 38 in)

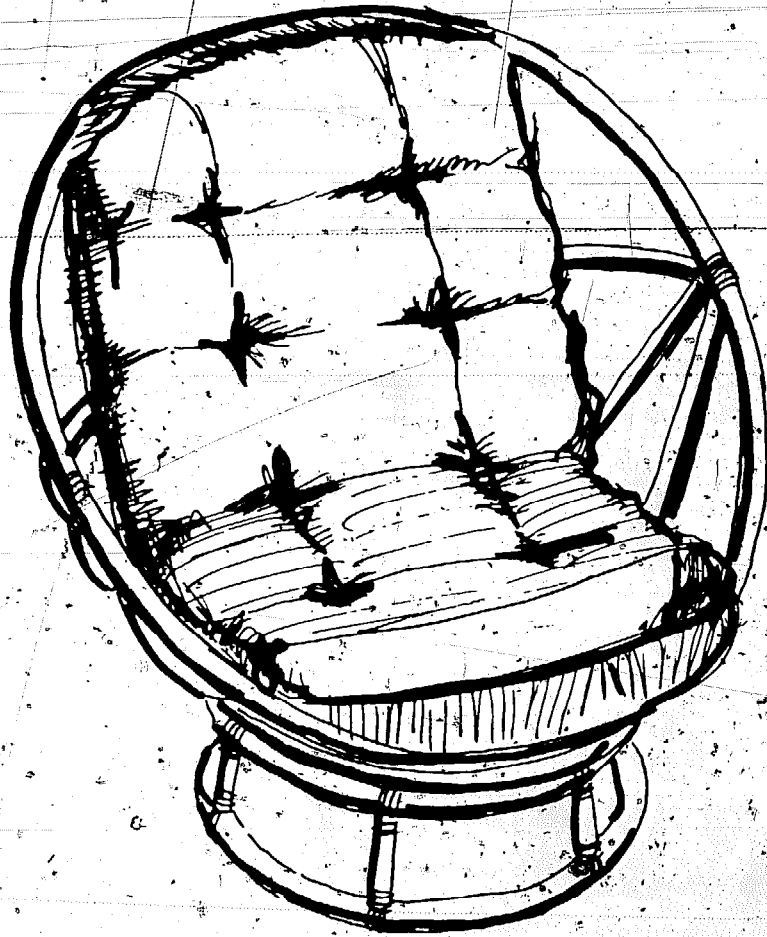

Figure 72.. Swivel lounge chair with single cushion for seat and back



Figure 73. Swivel occasional or office chair with woven cane back.

Dimensions (WxHxD): 61 cm, 64 cm, 76 cm (24 in, 25 in, 30 in)

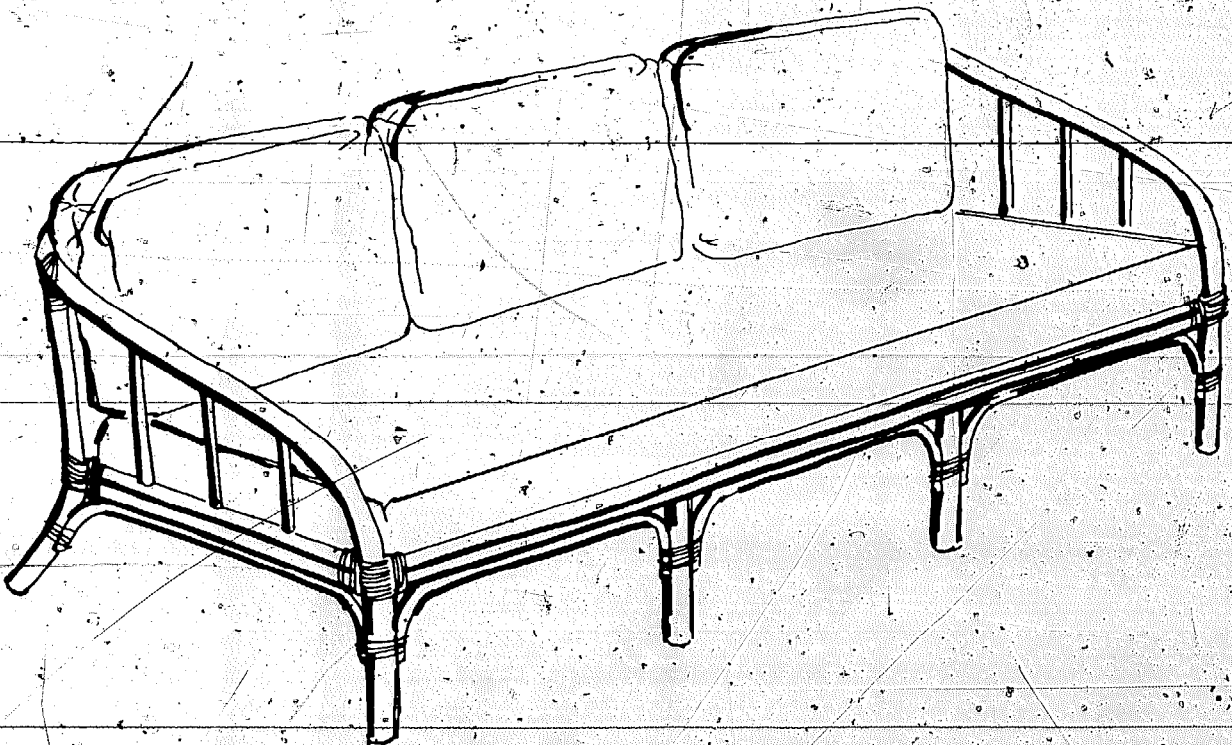

Figure 74... 3-seater settee with loose cushions

Dimensions (WxHxD): 188 cm, 79 cm, 71 cm (74 in, 31 in, 28 in)

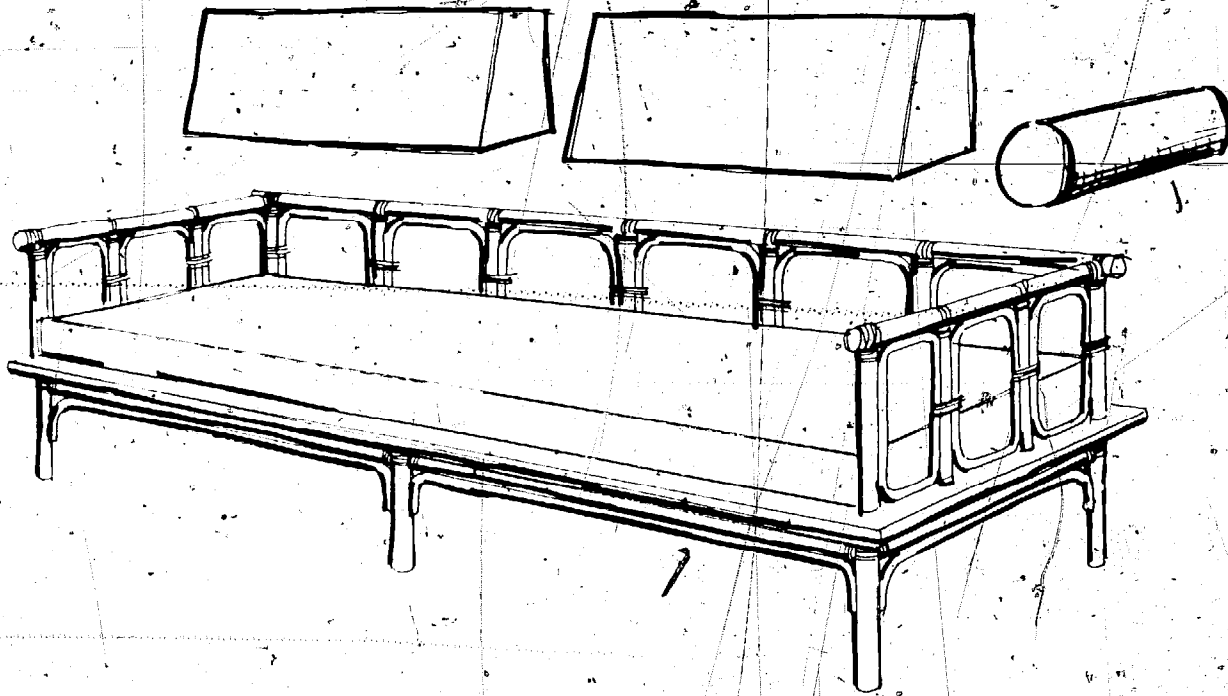

Figure 75. 3-seater settee with shaped cushions

Dimensions (WxHxD). 191 cm, 76 cm, 41 cm (seat) (75 in, 30 in, 16 in (seat))



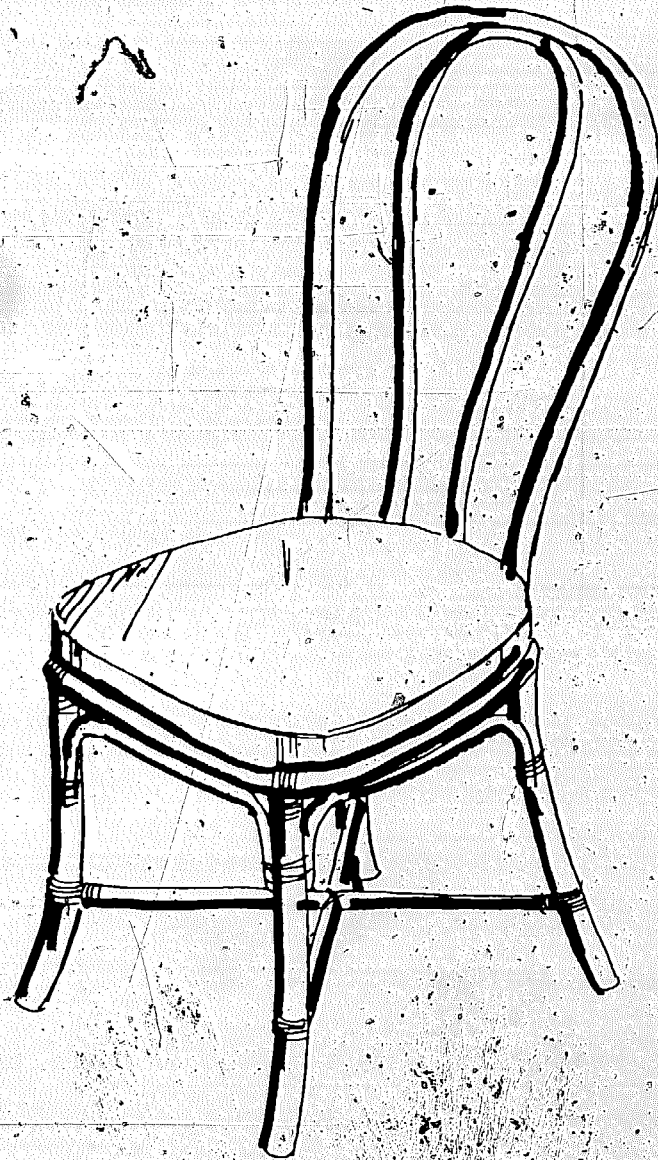

Figure 76. Dining-room chair

Dimensions (WxHxD): 50 cm, 55 cm, 94 cm (19.7 in., 21.5 in., 37 in)

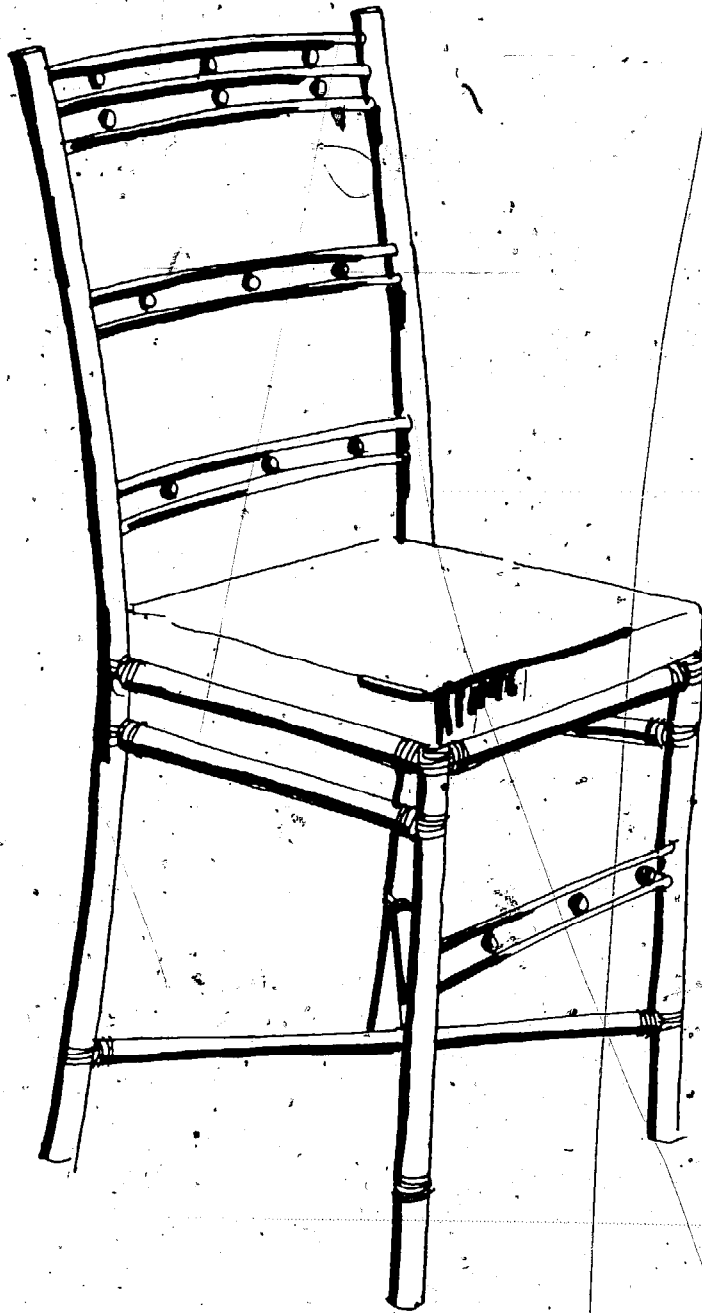

Figure 77. Dining-room chair with cushioned seat

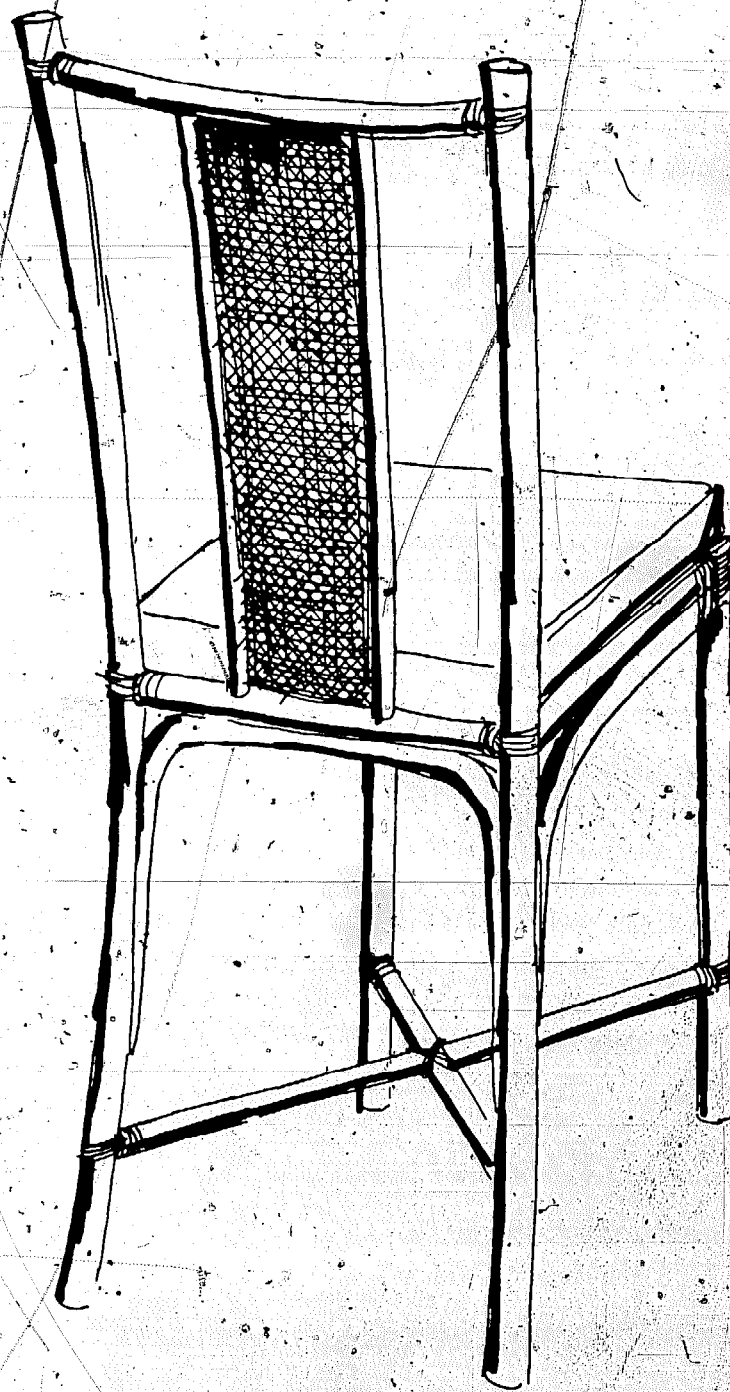

Figure 78. Dining-room chair with catted splatt

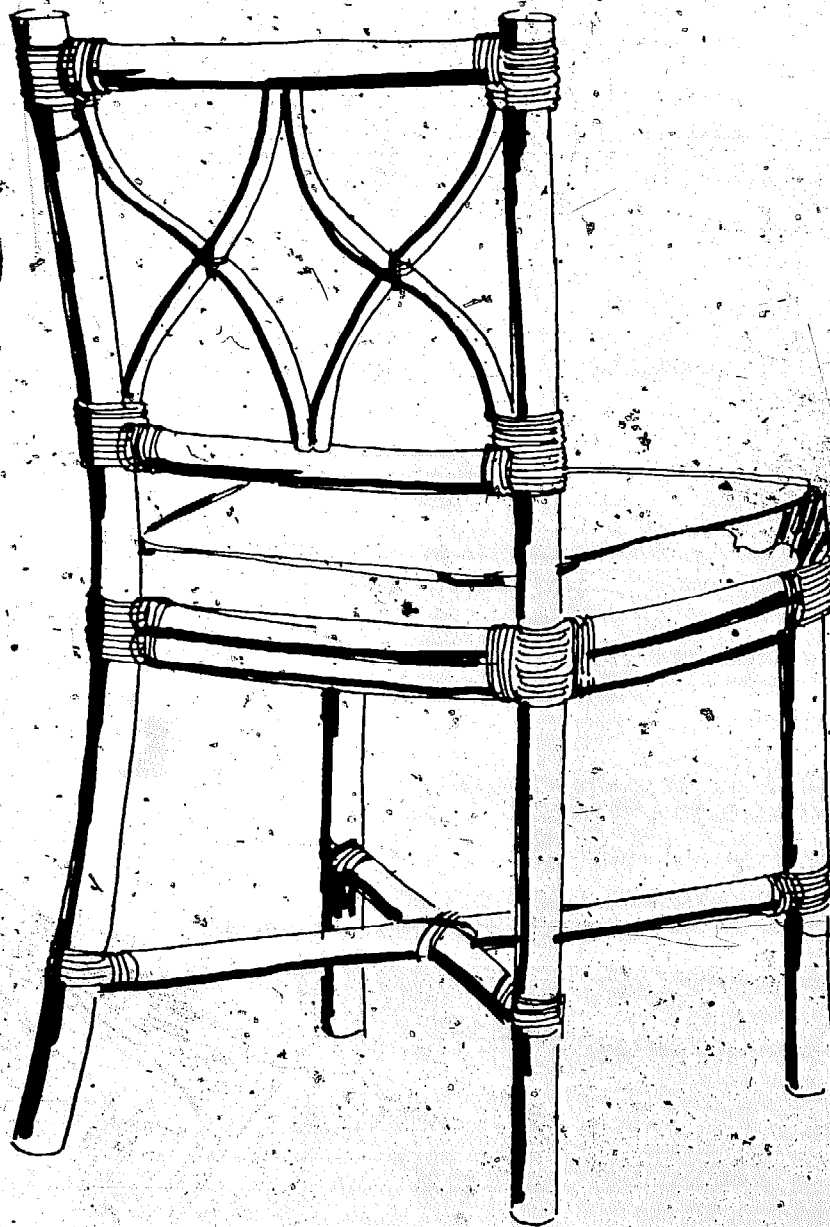

Figure 79. Dining-room chair

Dimensions (WxHxD): 41 cm, 51 cm, 97 cm (16 in, 20 in, 38 in)



Figure 80. Bar stool with swivel seat and woven cane back

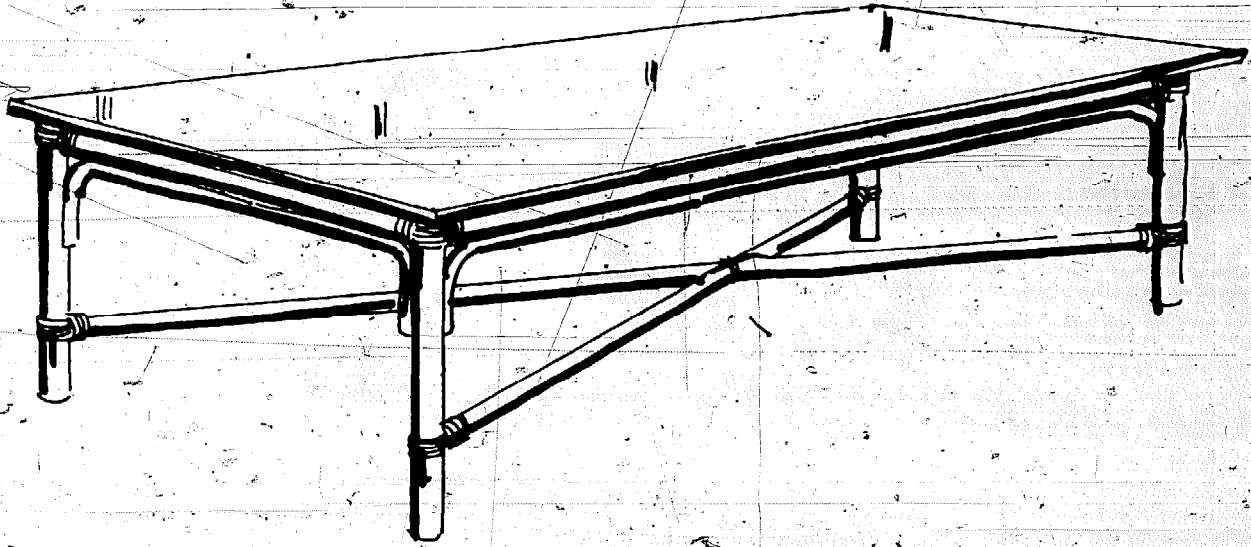

Figure 81. Coffee table

Dimensions (WxHxD): 122 cm, 56 cm, 43 cm (48 in, 22 in, 17 in)

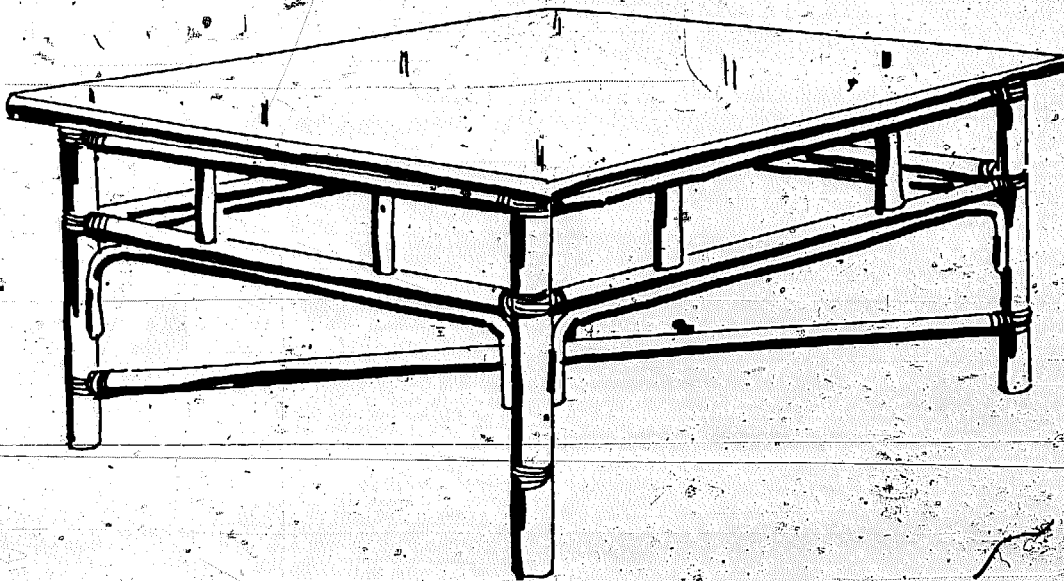

Figure 82. Corner table

Dimensions (WxHxD): 76 cm, 76 cm, 43 cm (30 in, 30 in, 17 in)

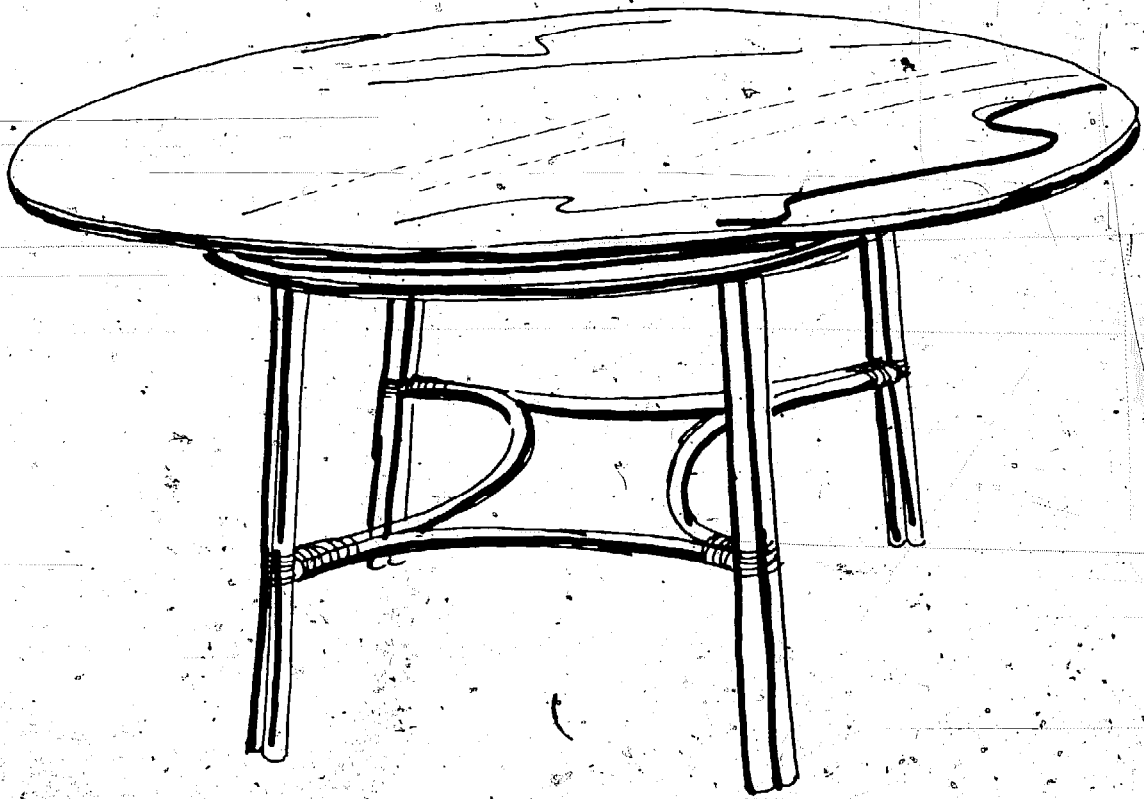

Figure 83. Circular dining-room table with veneered ply top

Dimensions (diameter x H): 122 cm, 76 cm (48 in, 30 in)

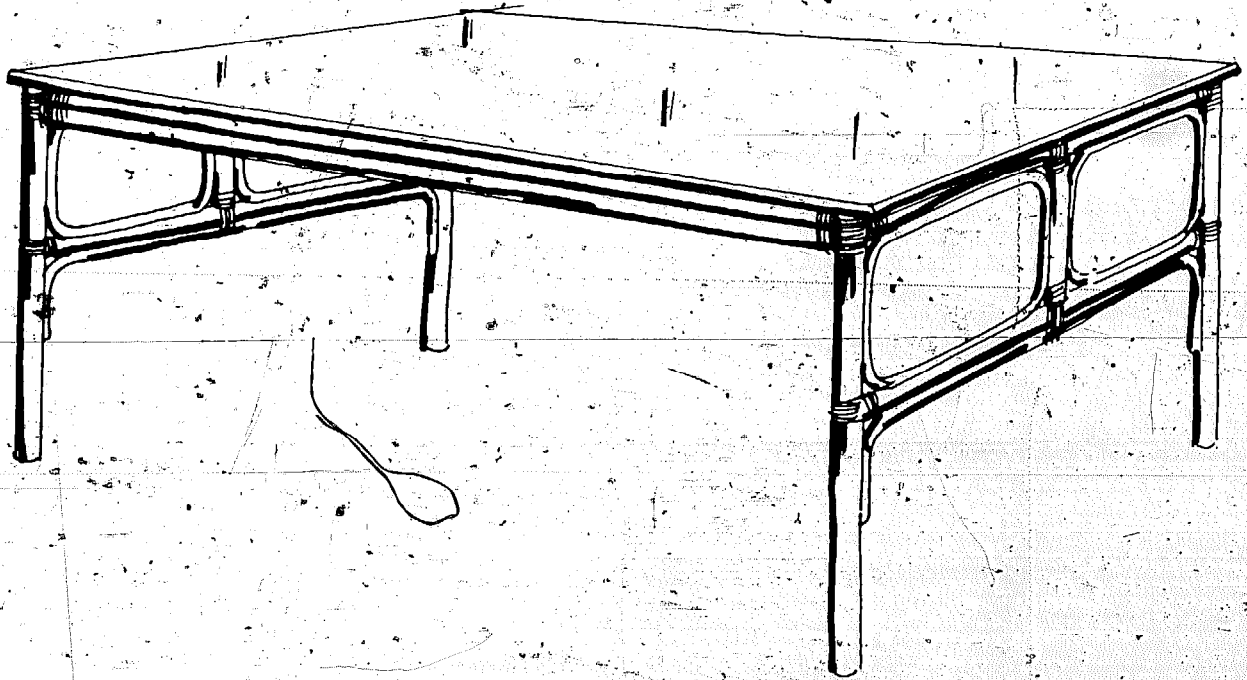

Figure 84. Corner table

Dimensions (WxHxD): 132 cm, 86 cm, 61 cm (52 in, 34 in, 24 in)

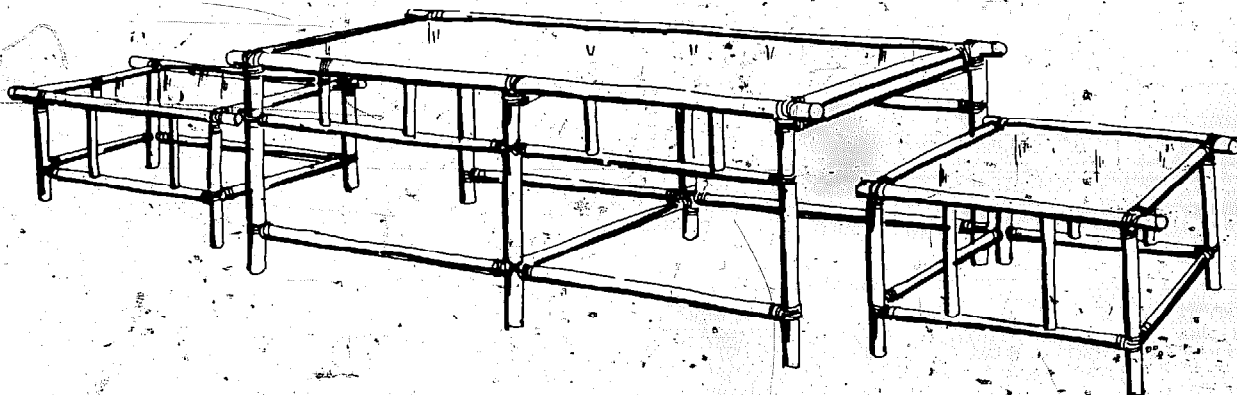

Figure 85. Nest of tables

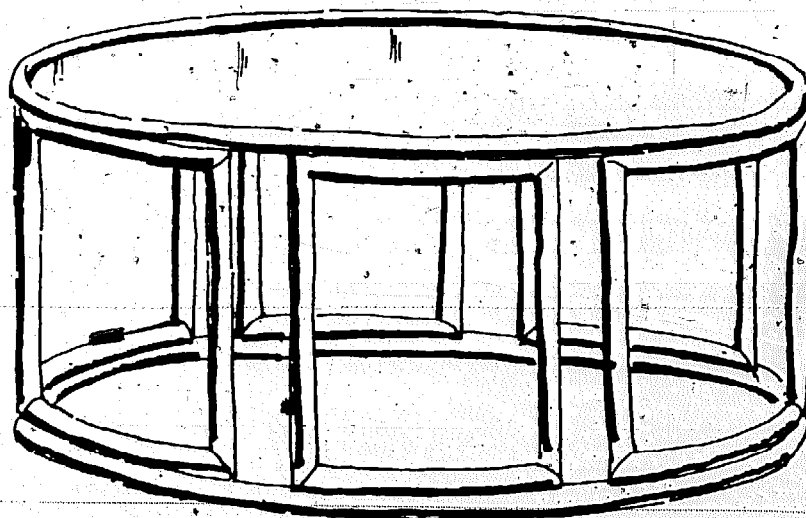

Figure 86. Circular coffee table

Dimensions (diameter x H): 69 cm, 46 cm (27 in, 18 in)



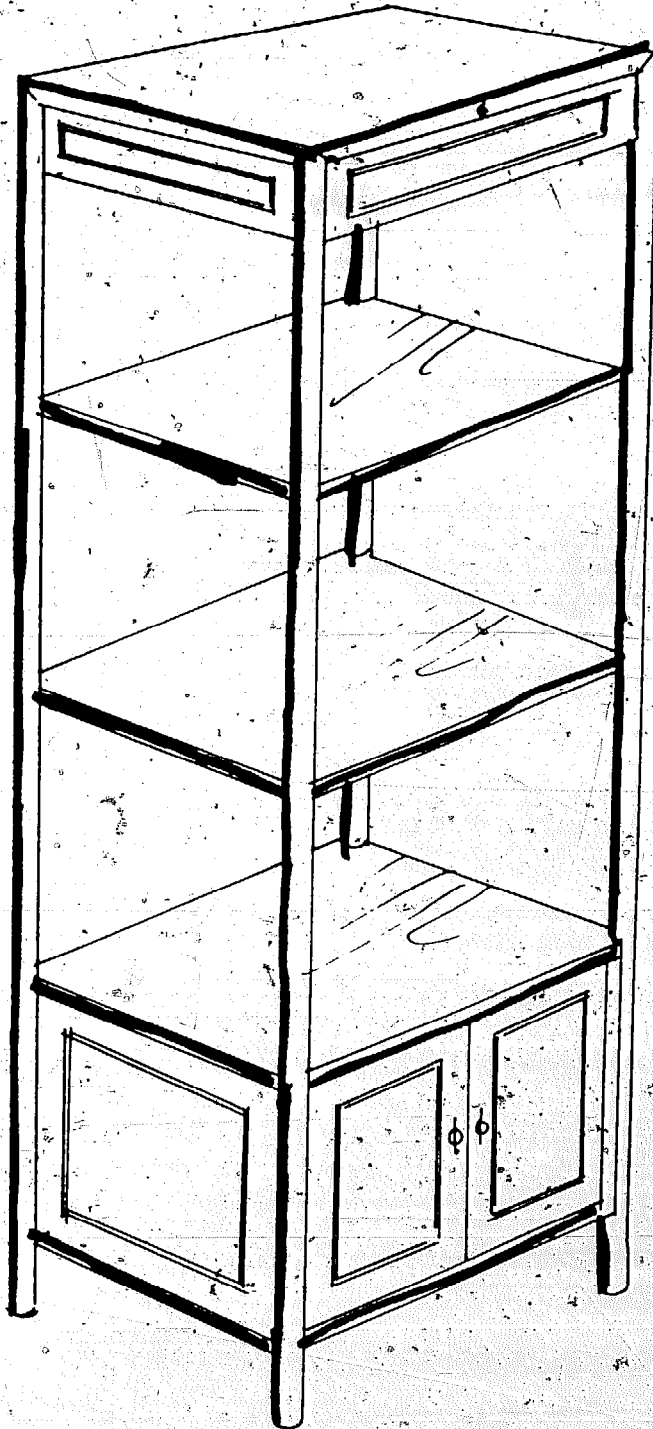

Figure 87. Display unit

Dimensions (WxHxD): 71 cm, 41 cm, 198 cm (28 in, 16 in, 78 in)

### Bibliography

- Alonso, D. S., A. V. Nicolas and R. R. Cabral. Practices and problems of the rattan furniture industry. N.S.D.B. technology journal (Manila) 1981.
- Arenas, V.C. Staining in rattan and its control. Forestry leaves (University of the Philippines) 17:4: 87-89, 1966.
- Burkill, J. H. Dictionary of the economic products of the Malay peninsula. 1966.
- Casin, R. F. Study on the proper utilization of rattan poles specifically on their drying and other related properties. Terminal report. 1975. Terminal report (second phase). 1978.
- Coxtes, R. J. The uses of commercial rattan from the Philippines. Philippine journal of forestry (Manila) 2:4: 329-340, 1939.
- Economic and Corporate Research Office, Private Development Corporation of the Philippines. Wooden and rattan furniture export industry 1978.
- Generalau, Maximino L. How to grow rattan. Laguna, Philippines, Forest Research Institute, College, 1981.
- Jordan, D. Possibilities, yield of rattan exploitation. The planter (Kuala Lumpur) 41:8:376-377, 1965.
- The rattan industry in Malaya. Malayan forester, 28:2, 1965.
- Kamala, B. S., J. C. Jain and M. C. Tewari. Role of wood, cane and bamboo in handicrafts in India with particular reference to Karnataka. Journal of the Timber Development Association of India. 1981.
- Menon, K. D. Rattan. A report of a workshop held in Singapore, 4-6 June 1979. Based on state of the art review of the production and utilization of rattan in South and Southeast Asia. Canada, Intermediate Development Research Centre, 1979.
- Note on the cultivation, harvesting and processing of rattans. London, Tropical Products Institute, 1977. 3 p.
- Philippines. Special Projects Division, Presidential Committee on Wood Industries Development. The rattan furniture industry. Manila, 1977
- Rattan furniture: A national wonder. JETRO seminar in Thailand. Investor (Bangkok) 10:2, 1978.

Report of JETRO team on access to Japan's import market for rattan products. Sponsored by the Japan Export Trade Department. 1981.

Report of JETRO team on furniture industry. Times journal (Manila) 31 December 1973.

Sagardo, M. Effect of submerging unscrapped palasan (Calamus maximus) in swift running water on the occurrence of fungal stains. University of the Philippines, School of Forestry (unpublished), 1953.

Small Business Advisory Centre : An industry study on the rattan furniture manufacturing sector in Cebu, Philippines. Cebu City, 1981.

Zuick, J.F.U. Rattan cane preparation for furniture making and export. Boroko, Papua New Guinea, Forest Products Research Centre, 1976. /

The following studies relating to wood processing industries have been prepared by the United Nations Industrial Development Organization and some have been issued as United Nations sales publications:

- ID/10                      Production Techniques for the Use of Wood in Housing under Conditions Prevailing in Developing Countries. Report of Study Group, Vienna, 17-21 November 1969. United Nations publication, Sales No. E.70.II.B.32
- ID/61                      Production of Prefabricated Wooden Houses [Keijo N.E. Tiisanen]. United Nations publication, Sales No. 71.II.B.13
- ID/72                      Wood as a Packaging Material in the Developing Countries [B. Hochart]. United Nations publication, Sales No. 72.II.B.12
- ID/79                      Production of Panels from Agricultural Residues. Report of an Expert Working Group Meeting, Vienna, 14-18 December 1970. United Nations publication, Sales No. 72.II.B.4
- ID/108/Rev. 1              Furniture and Joinery Industries for Developing Countries
- ID/136                      Selection of Woodworking Machinery. Report of a Technical Meeting, Vienna, 19-23 November 1973
- ID/154/Rev. 1              Low-cost Automation for the Furniture and Joinery Industry [W. Santiano and H.P. Brion]
- ID/180                      Wood Processing for Developing Countries. Report of a Workshop, Vienna, 3-7 November 1975
- ID/223                      Adhesives in the Wood Processing Industries. Report of a Workshop, Vienna, Austria, 31 October-4 November 1977
- ID/247                      Technical Criteria for the Selection of Woodworking Machines
- ID/265                      Manual on Jigs for the Furniture Industry [P.J. Paavola and K. Ilonen]
- ID/275                      Manual on Upholstery Technology [D.P. Cody]

- ID/298 Value Analysis in the Furniture Industry  
[A. Juva]
- ID/299 Manual on the Production of Rattan Furniture  
[D.P. Cody]
- ID/300 Production Management for Small and Medium  
Scale Furniture Manufacturing Firms in  
Developing Countries  
[E.Q. Canela]
- UNIDO/LIB/SER.D/4/Rev. 1  
(ID/188) UNIDO Guides to Information Sources No. 4:  
Information Sources on the Furniture and  
Joinery Industry
- UNIDO/LIB/SER.D/6/Rev. 1  
(ID/256) UNIDO Guides to Information Sources No. 6:  
Information Sources on Industrial Quality  
Control
- UNIDO/LIB/SER.D/9 UNIDO Guides to Information Sources No. 9:  
Information Sources on Building Boards from  
Wood and other Fibrous Materials
- UNIDO/LIB/SER.D/18 UNIDO Guides to Information Sources No. 18:  
Information Sources on the Paint and  
Varnish Industry
- UNIDO/LIB/SER.D/31 UNIDO Guides to Information Sources No. 31:  
Information Sources on Woodworking Machinery
- UNIDO/LIB/SER.D/35 UNIDO Guides to Information Sources No. 35:  
Information Sources on Utilization of  
Agricultural Residues for the Production of  
Panels, Pulp and Paper
- UNIDO/LIB/SER.D/36 UNIDO Guides to Information Sources No. 36:  
Information Sources on Industrial Maintenance  
and Repairs