

JET TRANSPORT MAINTENANCE

As certain items of an aircraft and its systems deteriorate, it is necessary to ensure that the design remains airworthy. Maintenance is the action necessary to sustain or restore the integrity and performance of the aircraft. It includes inspection, overhaul, repair, preservation, and replacement of parts such as to ensure conformity to the basis of certification. This is called continuing airworthiness.

The preceding is an admirable definition, but hardly a complete one. It merely says that maintenance is needed to mend aircraft and to keep them airworthy. Maintenance organizations do more. The maintenance department at any airline must also sustain equipment availability, that is, the ability of the aircraft to fly the published revenue schedule. The definition of maintenance must also include "the management of failure."

The performance of maintenance on an aircraft restores safety and reliability levels when deterioration or damage has occurred. It does not include servicing, which is the replenishment of consumables needed to keep an item or aircraft in operating condition (e.g., cleaning, fueling, catering, fluid replenishment, and lavatory service, etc.).

Maintenance is performed upon aircraft by the airlines to protect their investment, maximize safety, minimize schedule disruptions, and comply with governmental regulations. In the United States, the Federal Aviation Regulations (FARs), arising from federal law require that:

- “The owner or operator, is primarily responsible for maintaining (the) aircraft in an airworthy condition. . . .”
- “No person may operate an aircraft . . . unless the mandatory replacement times, inspection intervals and related procedures . . . have been complied with.”
- “Each certificate holder (airline) is primarily responsible for . . . the airworthiness of its aircraft . . . the performance of maintenance . . . in accordance with its manual and the regulations . . .”

Maintenance is not free; it accounts for approximately 10% of an airline’s employees and 10% to 15% of its operating expenses. It ensures the aircraft is safe and available to fly the revenue schedule, thus enhancing schedule reliability by reducing both the frequency and duration of flight delays and cancellations.

Admittedly, technical delays and cancellations do not constitute a dominant expense compared with most elements of direct operating cost (i.e., those costs associated with flight crew, fuel, airframe and engine maintenance, insurance, depreciation, and interest). But loss of service is unacceptable. It is poor business practice. The direct economic consequences are major to both the airlines and their customers. According to Federal Aviation Administration (FAA) data available for 1994, the calculated annual total operating delay cost to the airlines was \$2.5 billion and \$7.0 billion attributable to passengers. The average duration of a delay was 14.23 minutes. Reported in *The Handbook of Airline Economics*, 1995, “An average of 0.1% to 0.2% of a typical airlines flights will be interrupted due to maintenance problems. As many as 5% to 10% of all flights could experience cancellations or delays due to maintenance problems.”

The cost to the airline includes:

- Loss of ticket revenue
- Poor customer relationships
- Increased spares inventories
- Increased numbers of maintenance stations requiring skills and labor
- Costs arising from reroutes, equipment substitution, passenger handling (hotels, buses, meal vouchers, and so on), substitute service, disruption to the aircraft movement plan. The list is endless.

The cost to the customer takes the form of disrupted plans, missed business appointments, lost time, late shipments, and other delays. It is expected that people and cargo will go to their destination on time.

FAILURE

The primary consideration of all maintenance decisions is neither the failure of a given item nor the frequency of its occur-

rence, but rather the consequences of that failure upon the aircraft and its operation. Consequences of failure are twofold: (1) those affecting safety and (2) those affecting availability of equipment (economic).

Safety Related. Failure that jeopardizes the safety of the aircraft or its occupants must be prevented. Aircraft cannot be of such design that any single failure of the device will have catastrophic results. This is aeronautical dogma. Today’s aircraft are subject to very few single critical failure modes. This safety related reliability is attributed to the design requirements of the relevant governmental regulations as well as the specifications of operating organizations and manufacturers. Current design practice ensures that vital functions are protected by redundancy, fault tolerance, fail tolerance, and fail safe features. This assures that, if there is failure, a given function will remain available from other sources to insure a safe completion of flight. It should be noted there are some safety considerations which create an exception to this single failure concept and which require, at least in practice, the accountability for a second failure (i.e., a second failure or combination of failures may necessitate even further redundancies).

Economic. If the loss or deterioration of a particular function neither endangers the equipment nor its occupants, then the consequences of that failure are economic. Examples include systems, components, or features in a design that are not specifically required to demonstrate conformity to the basis of certification (i.e., aircraft is in a configuration that has been shown to meet all design certification requirements). For example, a fuel system might require two pumps to meet design certification requirements. An extra (third) fuel pump might be added to the design of the fuel system, solely for economic reasons (e.g., to decrease the frequency and risk of flight delays or cancellations caused by pump failures).

FAILURE MANAGEMENT

Safety related failure can be managed. Consider that if the design only addresses the avoidance of single catastrophic failures, the aircraft and its occupants will not be placed in peril. But single failures of components or systems will cause the loss of availability of the equipment once the aircraft lands. For once a single failure occurs, a “no-go” condition arises until repair or replacement is accomplished.

There are three failure management strategies:

1. The components and systems are designed to an exceptional degree of reliability. This is an inordinately costly strategy. Cost effective design trades must be made between the loss of availability arising from “no-go” situations and the cost of exceptionally reliable components.
2. If a high degree of reliability is not cost effective, then the design could instead include a high degree of deferability, that is, a good minimum equipment list (MEL). The MEL is the list specifying the minimum equipment required for flight dispatch. The concept of a MEL arose out of the excess capability in the design that just “happened.” Traditionally, all installed equipment specified by the airworthiness and operating regulations must be operative. However, experience indicates that, with varying levels of redundancy designed into aircraft, opera-

tion of every system or installed component is not necessary when the remaining operative equipment provides an acceptable level of safety. This was recognized in the mid 1950s. Consequently, regulatory agencies granted permission to operate with certain items of equipment inoperative; the intent being to permit revenue operations to a location where repairs or replacements could be made. This action permits economic aircraft utilization as well as offering a reliable flight schedule to the flying public without compromising flight safety. Contemporary practice demands that consideration be given to deferability in the design as a conscious activity when defining system architecture and functionality. It should be noted that even with a MEL, "no go" conditions will not be totally eliminated.

3. A third strategy assures that "no-go" conditions can be minimized. It involves both a design and a maintenance management technique. This design approach embraces the incorporation of features that are extra to those required for certification. The predominant strategy for this is the same as that used to avoid safety related failures; that is the inclusion of redundancy, fault tolerance and fail safe, fail passive features but beyond that required to certify the design. This is not without its price. It increases the number of failure possibilities. It adds more items that can fail. It results in equipment that is more complex and integrated which makes fault isolation more difficult. It adds to the cost of the aircraft. But this approach, judiciously applied, greatly reduces the consequences of any single failure. Excess features in the design put initial failures of a system into the economic rather than the safety related failure category.

AIR CARRIER MAINTENANCE REQUIREMENTS

Maintenance requirements are dictated by numerous factors: regulatory provisions, type of equipment, fleet size, route structure, and flying schedules. The type of equipment establishes maintenance frequency cycles. The size of the fleet determines quantitative maintenance work load. Route structure and flight schedules influence the location and number of stations which must possess the capability of performing the work.

Regulatory Provisions

The definition of maintenance requirements, addressing safety related failure for an aircraft, begins during design and certification. The Federal Aviation Regulations (FARs) are published in the Code of the Federal Regulations (CFR). 14 CFR 25.1329 requires the preparation of instructions for continuing airworthiness. These instructions must include, among other things, the following:

. . . Scheduling information (scheduled maintenance) for each part of the airplane and its engines, auxiliary power units, propellers, accessories, instruments, and equipment that provides the recommended periods at which they should be cleaned, inspected, adjusted, tested, and lubricated, and the degree of inspection, the applicable wear tolerances, and work recommended at these periods. The recommended overhaul periods and necessary references

to the Airworthiness Limitations which set forth each mandatory replacement time, structural inspection intervals, and related structural inspection procedures. In addition, they must include an inspection program that includes the frequency and extent of the inspections necessary to provide for the continued airworthiness of the airplane . . .

. . . Accumulated flight hours, calendar time, number of operating cycles or the number of landings are the generally accepted measurements used when specifying maintenance intervals (i.e., periods). The selection of a specific parameter is dictated by the particular operating environment encountered . . .

Scheduled Maintenance Task Definition

Aircraft, engine manufacturers, representatives of airlines (both foreign and domestic), FAA and foreign regulatory agency observers, develop the maintenance recommendations for a new design. They do this as members of a maintenance steering group (MSG).

The structure, methodology, and composition of this recommending group is defined in the Air Transport Association (ATA) document titled *Maintenance Program Development Document MSG-3*, commonly referred to as MSG-3.

MSG-3 uses a process called "decision tree" analysis. It employs a logic which is task rather than process oriented, designed to uncover hidden failures and to separate safety related from economic failure. It also includes characterizing servicing and lubrication tasks.

MSG-3 consists of:

- Defining maintenance significant items (MSI)
- Analyzing the MSI
- Recommending inspection and check tasks arising from this analysis
- Defining scheduling information for the tasks
- Preparing the maintenance/inspection recommendations into a *Maintenance Requirements and Review Proposal* document.

The proposal document is submitted to the FAA by the manufacturer, in partial fulfillment of 14 CFR 25.1329. The FAA in turn convenes an internal maintenance review board (MRB) for review and approval of the document. The resulting FAA MRB report defines the scheduled maintenance tasks for the aircraft.

Defining Maintenance Significant Items. The MSG-3 process begins by defining which line replaceable units (LRU), system installations, and items of aircraft structure are sufficiently significant in their maintenance requirements to justify special consideration in design to assure safety and optimum maintainability, and for establishing required maintenance inspections/checks. This results in a list called maintenance significant items to be analyzed for relevance to the following:

- Safety related items. Any system or component malfunction which results in the loss of airworthiness is by definition safety related.
- Potential economic impacts. These address such issues as:

High initial design, manufacturing and ownership cost
 High maintenance cost
 Premature removal rates
 Significant access problems
 Potential for mechanical dispatch delays
 Significant weight increase with consequent reduced aircraft performance or increased fuel burn
 System or component redundancies in excess of that required for airworthiness

Components thus selected have priority in design, toward improving operational performance, reducing maintenance requirements, and enhancing their maintainability to lessen the maintenance cost and/or departure delays.

Maintenance Processes. There are three recognized processes in use to define maintenance check intervals: (1) Hard time, (2) on condition, and (3) condition monitoring.

Hard Time. This process applies a fixed period to the component which is the maximum period the component can be continued in service without overhaul or replacement. It is similar to fixed time between overhaul (TBO) and defines the maximum time and/or cycles that an item is permitted to operate on an aircraft between overhauls. Time typically relates to operating flight time or in some instances elapsed calendar time. Cycles relate to operating cycles (e.g., takeoff and landings or the number of takeoff thrust applications). Overhaul means restoration of an item to its service life in accordance with the instructions defined in relevant manuals.

Hard time maintenance should be avoided. It is very costly. Deterioration and failure are not directly related to time. Studies have shown that approximately 90% of the components in an aircraft derive no benefit from using hard time. Items selected for hard time should be limited to:

- components or assemblies which have definite life limits (e.g., metal fatigue) or,
- whose failure would have a direct adverse effect upon airworthiness if they malfunctioned in flight or,
- component deterioration which is not directly observable or easily measured.

An example of a hard time component is the landing gear. Premature failure could have deleterious effects. Also landing gear forgings are subject to fatigue which is not directly measurable.

On Condition. This is a process in which the component's operational condition, as determined by some form of test or check, dictates its time of replacement. It consists of repetitive inspections or tests to determine the condition of units, systems, or portions of structure with regard to continued serviceability. It accepts operation of a component or system until failure (i.e., failure being the inability to perform within specified limits or failing to perform intended function). Its application is therefore limited to items whose failure during aircraft operation will not have catastrophic consequences.

Items and appliances listed as on condition must be restricted to components on which a determination of continued airworthiness may be made by visual inspection, measurements, tests, or other means without a tear down inspection

or overhaul. These on condition checks are to be performed within the time limitations prescribed for the inspection or check. Performance tolerances and wear or deterioration limits are defined in the instructions for continuing airworthiness.

On condition maintenance can involve removal or bench test and is thus not restricted to on-aircraft inspections, although on-aircraft inspection/tests are preferred.

Condition Monitoring. This process is based upon reliability centered techniques. It is a refinement of on condition. The process applies to items that show deterioration over time. It consists of monitoring deterioration of a given component or system as it trends toward failure.

The process is rooted upon:

- An effective data collection system
- A system for effectively assessing the need for changes in maintenance interval or design and for taking appropriate action. Action consists of appropriate reviews of the following:
 - Actuarial or engineering studies employed to determine need for maintenance program changes
 - Actual maintenance program changes involving inspection frequency and content, functional checks, overhaul limits, and times
 - Aircraft, aircraft system or component modification, or repair
 - Other actions peculiar to the operating conditions that prevail.
 - Preparation of appropriate reports

The airlines use appropriate items from the following performance data as the basic data collection elements of the program:

- Unscheduled removals
- Confirmed failures
- Deficiencies observed and corrected but not otherwise reportable
- Pilot reports
- Sampling inspection
- Functional checks
- Shop findings
- Bench checks
- Mechanical reliability reports
- Mechanical interruption summary reports

Condition monitoring has significant advantages:

- Maximum economic, safe utilization of equipment to its airworthiness limits is assured
- Accurate identification of incipient failures is possible, thereby allowing economical repair before the occurrence of extensive costly damage; is most beneficial with high cost items such as engine components
- Better spares inventory control results

The principal disadvantage of condition monitoring is the sizable data collection and analysis requirement imposed upon the airlines.

SCHEDULED MAINTENANCE

Scheduled maintenance (sometimes referred to as routine or recurrent maintenance) includes: (1) the mandatory tasks defined by the FAA Maintenance Review Board (MRB) Report, (2) the accomplishment of recurring airworthiness directives (ADs), and (3) discretionary (economic) checks, inspections or modifications. The FAA issues ADs when an unsafe condition has been found to exist in particular aircraft, engine, propellers, or appliances installed on aircraft, and that condition is likely to exist or develop in other aircraft, engines, propellers, or appliances of the same type design. Once an AD is issued, no person may operate an aircraft to which the AD applies except in accordance with the requirements of that AD.

Discretionary maintenance tasks are those not required by the MRB report. They include for example:

- Repair of items not related to airworthiness that is, economic failures
- Modifications to cabin interiors such as installing passenger entertainment or refurbishing seats
- Exterior painting or refurbishment
- Manufacturer's service bulletins not related to an airworthiness directive

Packaging Scheduled Maintenance

Scheduled maintenance requirements are grouped into work packages known as *blocks*. The principle of blocks is to accomplish all of the mandatory tasks in small packages. This allows greater utilization of the aircraft since the aircraft is removed from service for short periods rather than for a single extended overhaul period. The principle is shown in Fig. 1. Regardless of the means in which the tasks are packaged, all of the required tasks defined by the MRB will be accomplished when all of the defined blocks have been accomplished. The complete package of defined blocks is sometimes referred to as a "complete overhaul cycle."

Blocks have numerous names within the maintenance community. The exact nomenclature, composition and number of blocks varies between airlines. The following typical groupings illustrate the concept.

Daily Check. This exists under several common names; post flight, maintenance pre-flight, service check, overnight to name a few. It is the lowest scheduled check. It is a cursory inspection of the aircraft to look for obvious damage and deterioration. It checks for "general condition and security" and reviews the aircraft log for discrepancies and corrective action. The accomplishment of the daily check requires little specific equipment, tools, or facilities.

It is a basic requirement that the aircraft remains airworthy. Usually this check will be accomplished every 24–60 hours of accumulated flight time. Examples of daily check items include:

- Visually inspect tail skid shock strut pop-up indicator
- Check fluid levels
- Check general security and cleanliness of the flight deck
- Check emergency equipment is installed

A Check. This is the next higher level of scheduled maintenance. It is normally accomplished at a designated maintenance

station in the route structure. It includes the opening of access panels to check and service certain items. Some limited special tooling, servicing and test equipment is required. The A check includes the lower check, the daily check.

Examples of A check items include:

- General external visual inspection of aircraft structure for evidence of damage, deformation, corrosion, missing parts
- Check crew oxygen system pressure
- Operationally check emergency lights
- Lubricate nose gear retract actuator
- Check parking brake accumulator pressure
- Perform tests of certain systems using the built-in-test-equipment (BITE) (See BITE later).

B Check. This is a slightly more detailed check of components/systems. It does not involve, however, detailed disassembly or removal of components. Contemporary maintenance programs do not use the B check interval. For a number of reasons, the tasks formerly defined for this interval have, for many aircraft, been distributed between the A and C check.

C and D Checks. The following two checks are traditionally known as heavy checks. They are normally accomplished at a main maintenance base of the airline where specialized manpower, materials, tooling, and hangar facilities are available. The aircraft will usually be removed from the revenue schedule for several days (3 to 20 days) while these checks are performed. See phase checks later in this article for a description of exceptions.

C Check. This is an extensive check of individual systems and components for serviceability and function. It requires a thorough visual inspection of specified areas, components, and systems as well as operational or functional checks. It is a high level check which involves extensive tooling, test equipment, and special skill levels. The C check includes the lower checks, that is, daily, A, and B checks.

Examples of C check items include:

- Visually check flight compartment escape ropes for condition and security
- Check operation of dc bus tie control unit
- Visually check the condition of entry door seals
- Operationally check flap asymmetry system
- Pressure decay check Auxiliary Power Unit (APU) fuel line shroud
- Inspect engine inlet thermal anti-ice (TAI) ducting for cracks
- Operationally check Ram Air Turbine (RAT) deployment and system

D Check. This can also be known as the structural check. It includes detailed visual and other nondestructive test inspections of the aircraft structure. It is an intense inspection of the structure for evidence of corrosion, structural deformation, cracking, and other signs of deterioration or distress. Structural checks involve extensive disassembly to gain access for inspection. Structural checks are man-hour and cal-

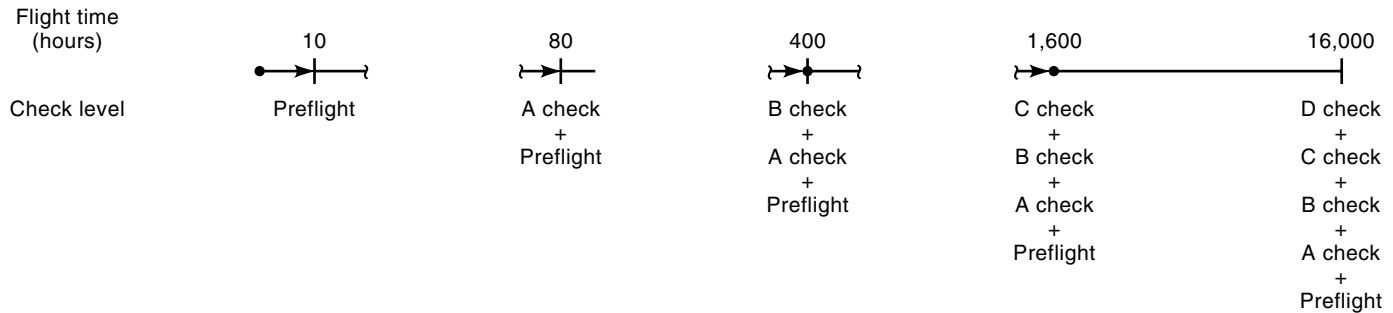

Check type	Number in cycle	Man-hours	A/C daily utilization	Flying days per year	Approximate check occurrence	Out of service time per check	Remarks:
Preflight	1,600	2	8	240	Daily	1 hour	1. The higher check always includes the lower check. 2. Block maintenance addresses inspections of the airframe and installed systems. 3. Individual component maintenance is not included. 4. Repair or replacement arising from inspections is not included. 5. A – Quick opening doors, servicing, detail walkaround. 6. B – Cowl, access panels, compartment doors opened lubrication, filter changes, operational checks. 7. C – Major access panels and fairings removed, system test, corrosion control, lubrication. 8. C – Major structural inspections, NDT work, internal structure.
A	200	8			2/month	1 shift	
B	40	36			3/year	1–1.5 shifts	
C	10	450			1/year	10–12 shifts	
D	1	1,500			8 years	15–18 shifts	

Figure 1. Block maintenance.

endar time intensive. The D check includes the lower checks, A, B, C, and daily checks.

Examples of D check items include:

- Inspect stabilizer attach bolts
- Inspect floor beams
- Detailed inspection of wing box structure

Variations of Scheduled Maintenance

The number of scheduled maintenance tasks for a large aircraft like the 747 are extensive. This is particularly true for the higher C and D checks. Their accomplishment removes the aircraft from service for several weeks. This is considered unacceptable and defeats the concept of removing the aircraft from service in small manageable blocks. A solution is to divide these higher checks into segmented blocks or phases. Such phasing levels the workload as well. This is shown conceptually in Fig. 2.

A typical phase check provides for a thorough visual inspection of specified areas, components and systems as well as operational or functional checks of specified components

Example

- The size of the B and C checks has become too large
- Divide the check into parts
- Allocate the resultant parts or “segments”
- Append them to the A and B checks

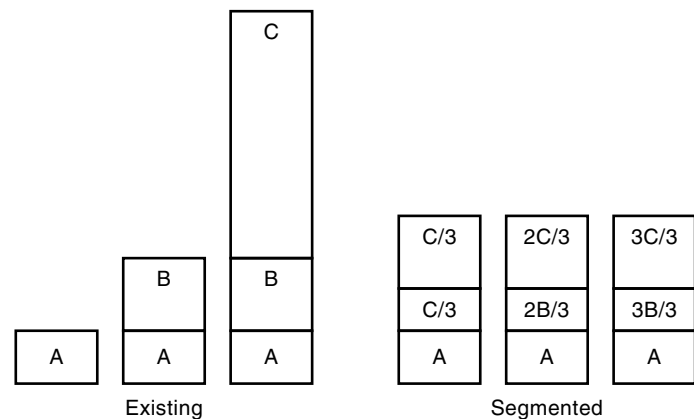

Figure 2. “Segmented” block maintenance.

and systems. Each check includes the requirements of traditional lower check work items and portions of C and D checks at the required task intervals.

Phased checks may occur at 200 to 800 flight hour intervals, depending upon the work packaging plan and other airline operating variables.

Changing Scheduled Maintenance Frequencies

Individual airlines, when first placing a given aircraft model into service, use the aircraft MRB document for defining maintenance tasks and intervals. However, as experience is gained on the equipment, and advanced techniques are developed for flight and maintenance operations, the FAA allows for escalation of task intervals.

Actuarial techniques, using condition monitoring data, are employed by the airlines to petition the FAA for a change in specified intervals.

UNSCHEDULED MAINTENANCE

Unscheduled maintenance (nonroutine, nonrecurrent) is ad hoc. It is maintenance performed to restore an item to airworthiness by correction of known or suspected malfunction and/or defect. The resolution of aircraft malfunctions and/or defects is not always straightforward and often requires troubleshooting. Figure 3 shows a typical process that an airline might follow to troubleshoot an aircraft problem.

Examples of unscheduled maintenance include:

- Resolution of aircraft log discrepancies (both pilot generated and those discovered by the mechanic)
- Special inspections initiated by the airline engineering group
- Special inspections, repairs, or replacements arising from airworthiness directives (ADs)
- Structural repairs arising from damage incurred during operations

The nature of unscheduled maintenance dictates that it may be performed anywhere within the maintenance environment, that is, during scheduled maintenance or on the flight line while the aircraft is assigned to scheduled revenue service.

THE MAINTENANCE ENVIRONMENT

For clarity the maintenance environment is divided into three distinct categories of activity. However, in day to day operations this separation is blurred. Work normally accomplished while the aircraft is removed from the revenue schedule may occasionally be accomplished while the aircraft is flying the schedule.

Line Maintenance

Line maintenance is that maintenance activity performed while the aircraft is committed to the revenue schedule. It may be subdivided into Gate or Turnaround.

Gate Maintenance. This maintenance is performed prior to the aircraft departure. It is incidental to flight operations. The flight line (gate) environment is the most demanding. It

is flight schedule driven. Time available is normally limited, usually 40 to 60 min, but may be as low as 20 min. Equipment and manpower are also limited. It consists of a visual check of the aircraft exterior with particular attention to indications of fluid leaks, obvious discrepancies such as worn or flat tires, low shock struts, fuselage or wing damage, and a review of aircraft log discrepancies. As a minimum, malfunctions affecting airworthiness are either repaired or deferred under the minimum equipment list (MEL).

Turnaround Maintenance. This is performed at terminating locations in the flight schedule. Time available may be 8 to 16 h or more. It can also be known as overnight maintenance.

The work usually consists of a daily check. Log book discrepancies including outstanding MEL deferrals are corrected. Passenger service equipment discrepancies are corrected. Servicing is accomplished. Additionally scheduled maintenance (e.g., portions of a phased check) may be performed at stations having a long turnaround. Depending upon time and manpower availability, discretionary tasks may be included.

Hangar Maintenance

Hangar maintenance is that activity normally affiliated with work on the aircraft when it is removed from the revenue schedule. It is predominately, though not exclusively, associated with the heavy checks (C and D) of scheduled maintenance, the incorporation of aircraft alterations, or structural repairs.

Shop Maintenance

Sometimes referred to as bench maintenance, it consists of repair, overhaul or refurbishment of LRUs or major assemblies (e.g., powerplants) which have been removed from the aircraft.

AIRPLANE SYSTEM DESIGN FOR MAINTENANCE

Jet transport designs incorporate many features and design considerations to support the maintenance and troubleshooting of the aircraft and its many systems. The jet transport aircraft contains approximately 80 different systems providing a wide range of functions such as air conditioning, communications, electrical power, flight controls, hydraulics, navigation, pneumatics, and propulsion.

In general, a system consists of a number of sensors, one or more computers that use signals from the sensors, and, as applicable, one or more actuators, pumps, valves, relays, or other devices that are controlled by the computer(s). For example, Fig. 4 shows the basic elements that make up the air data inertial reference system on the Boeing 737-700. The air data sensors are the pitot probes, the total air temperature (TAT) probe, the angle of attack (AOA) sensors, and the static ports. The air data inertial reference units (ADIRU) receive and monitor signals from these sensors, process this data, and transmit resulting signals (such as barometric altitude, airspeed, and mach number) to other systems on the aircraft. On jet transport aircraft, most system controllers are located in the aircraft's equipment racks, which are typically located throughout the aircraft. Some system controllers, such as an

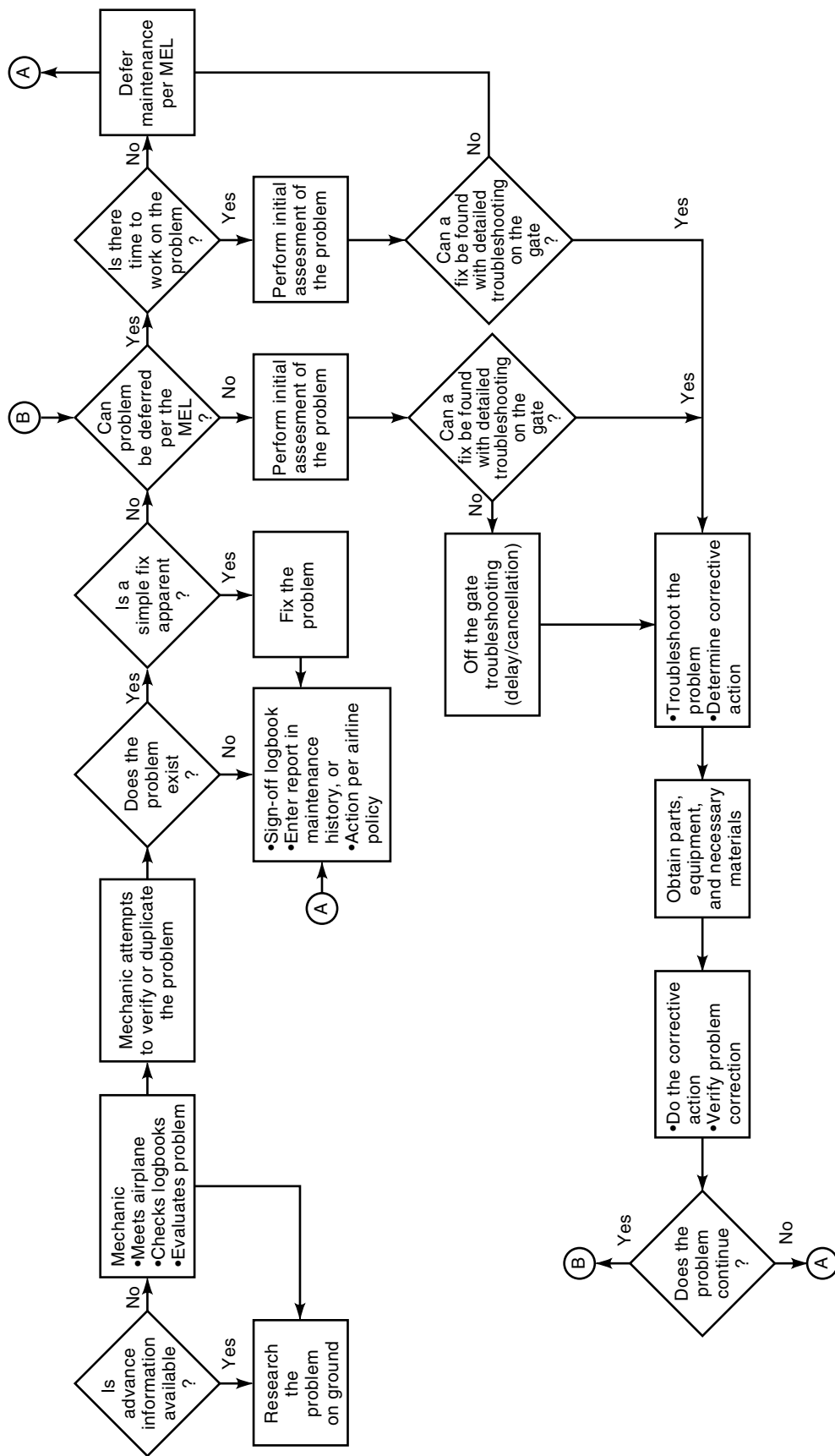

Figure 3. Typical airline troubleshooting process.

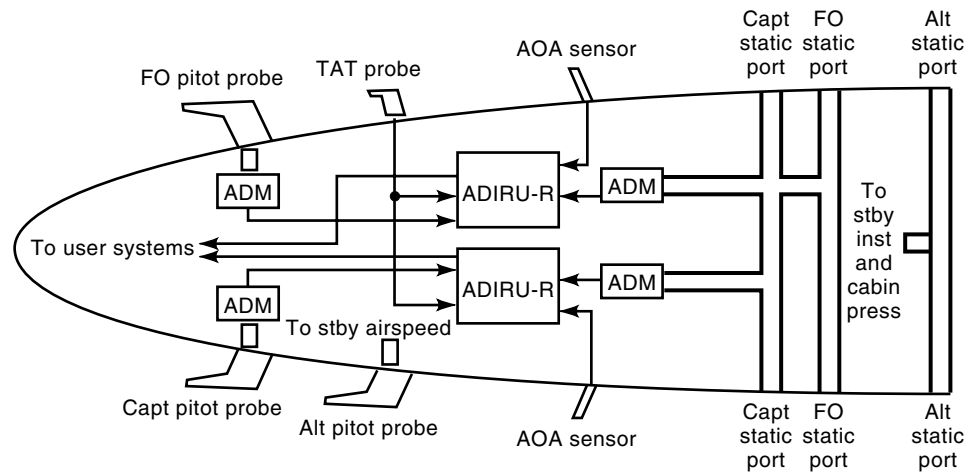

Figure 4. Basic elements of the Boeing 737-700 air data inertial reference system. Note: FO - first officer, ADM - Air Data Module, TAT - Total Air Temperature, Alt - alternate, AOA - angle of attack, stby - standby, inst - instrument, press - pressurization.

electronic engine controller, are often located with the equipment they control (e.g., on the engines). Figure 5 shows the equipment racks and their locations on a Boeing 777. Figure 6 shows the system controllers that are located on the E1 and E2 racks, located in the main equipment center, on a Boeing 777.

Aircraft System Communication

Aircraft systems use a variety of means for communication. Early designs relied almost entirely on analog signals. More recent designs make extensive use of digital data buses of increasing sophistication. Many of the digital data buses used on jet transport aircraft are specified in documents developed by Aeronautical Radio Incorporated (ARINC). ARINC is a corporation initiated and supported by airlines to provide technical services to the airlines. ARINC has developed a wide variety of standards and guidance documents for aircraft systems. Two principal standards for communication between aircraft systems are:

ARINC 429. Until the mid 1970s, communication between aircraft systems was almost entirely accomplished using analog signals, for which a separate wire, or pair of wires, was

needed for each parameter. With the growing complexity of aircraft, and the resulting need for communication of increasing amounts of data between systems, use of analog means for communication was becoming very inefficient, in terms of the cost and weight of installation of the large quantity of wiring needed. In order to improve this situation, ARINC 429 was developed in the late 1970s to provide a standard for digital communication between LRUs. In ARINC 429, each bus contains a single transmitter, and multiple receivers. This is illustrated in Fig. 7. Each transmitter can broadcast a number of 32-bit words on the ARINC 429 bus; in most cases, each 32-bit word is broadcast at a specified periodic rate, and each contains a label for identification, and one or more data parameters. Example data parameters include airspeed, altitude, hydraulic pressure, landing gear position, and cabin pressure. In order to receive any parameter on a given ARINC 429 bus, an LRU must contain a receiver for that bus, and be wired to that bus. The LRU then uses the labels as identifiers to select the parameters it needs to receive. ARINC 429 was first used on the Boeing 757 and 767 aircraft.

ARINC 629. In the 1980s, aircraft complexity continued to increase. The resulting increase in communications between LRUs was making the use of ARINC 429 costly in many areas. As an LRU requires a separate receiver for each bus it listens to, some LRUs required over 100 receivers. Since each receiver requires a pair of wires, the cost and weight of this wiring was becoming a significant burden. To address these and other issues, ARINC 629 was developed in the late 1980s. In ARINC 629 multiple transmitters can share the same bus, which also means that LRUs can receive signals from multiple transmitters with a single receiver. This is also illustrated in Fig. 7. This greatly reduced the number of receivers and amount of wiring from that required for ARINC 429. In addition, many design changes can be accommodated without additional hardware changes, as receiving LRUs can just be reprogrammed to receive parameters from other LRUs on the bus. In ARINC 629, each transmitting LRU broadcasts a number of word strings, each containing an identification label and a number of 16-bit words. The 16-bit words contain the various parameters to be transmitted. A specific parameter may be a single bit (e.g., for use as a Boolean discrete), a series of bits (e.g., for variables with enumerated states), a 16-bit word (e.g., to represent a variable parameter such as

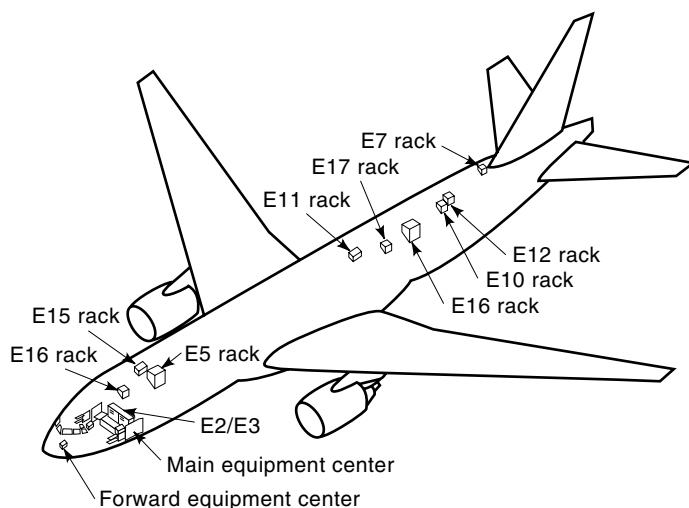
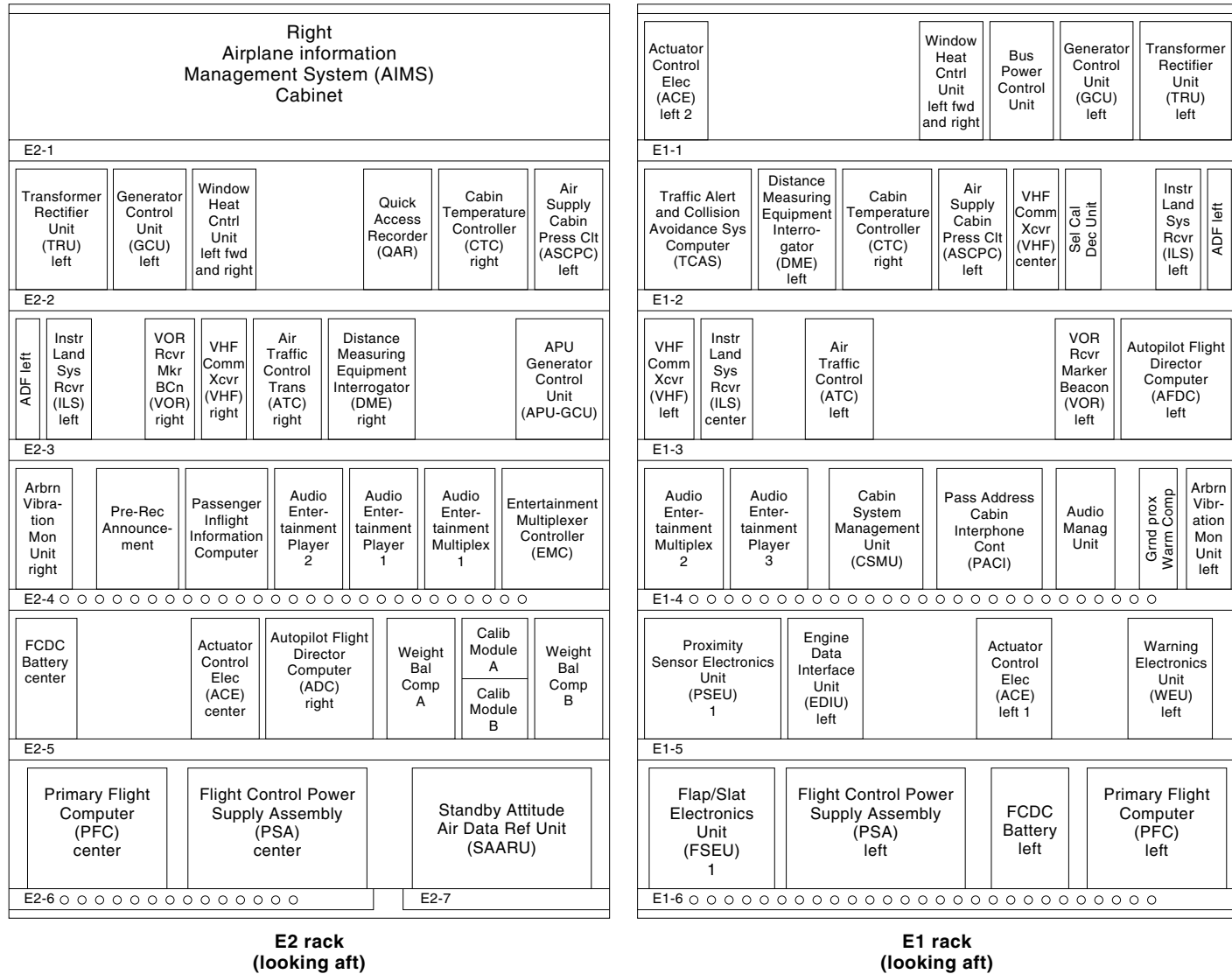

Figure 5. Boeing 777 equipment rack locations.



**E2 rack
(looking aft)**

**E1 rack
(looking aft)**

Figure 6. System controllers located on the E1 and E2 racks on a Boeing 777.

airspeed), or multiple 16-bit words (e.g., where finer than 16 bit resolution is required). The receiving LRU uses the label to identify the word string it needs to receive, and then selects the applicable 16-bit word(s) and, if necessary, bit(s) containing the needed parameter(s). ARINC 629 was first used on the Boeing 777 aircraft.

In addition to ARINC 429 and 629, other types of digital buses are being used on commercial aircraft, including:

- ARINC 636—an application of the fiber distributed data interface (FDDI), a fiber optic local area network
- ARINC 717—flight data recorder
- ARINC 591—quick access recorder
- Ethernet—maintenance terminals, cabin systems
- RS-422—quick access recorder
- Telephone Consultative Committee for International Telegraphy and Telephony, Conference of European Postal Telecommunications Administrations
- ARINC 453—weather radar

The digital data buses have become much more reliable than the analog wires that they replaced. However, when problems do occur in the systems that use digital data buses, troubleshooting requires more sophisticated tools than the voltmeters that were sufficient for troubleshooting most analog systems. Fortunately, aircraft design has evolved over the years to include these more sophisticated tools.

Maintenance Design Evolution

Just as aircraft system design has evolved, electronic support of maintenance has evolved over the years, based on the need and available technology. Since jet transport aircraft can be in service for over 30 years, there are systems in service in each of the categories identified next. As a result, mechanics need to be able to support equipment encompassing a wide range of maintenance capabilities.

Manual Detection and Isolation. Early aircraft systems were relatively simple, and most importantly, were relatively iso-

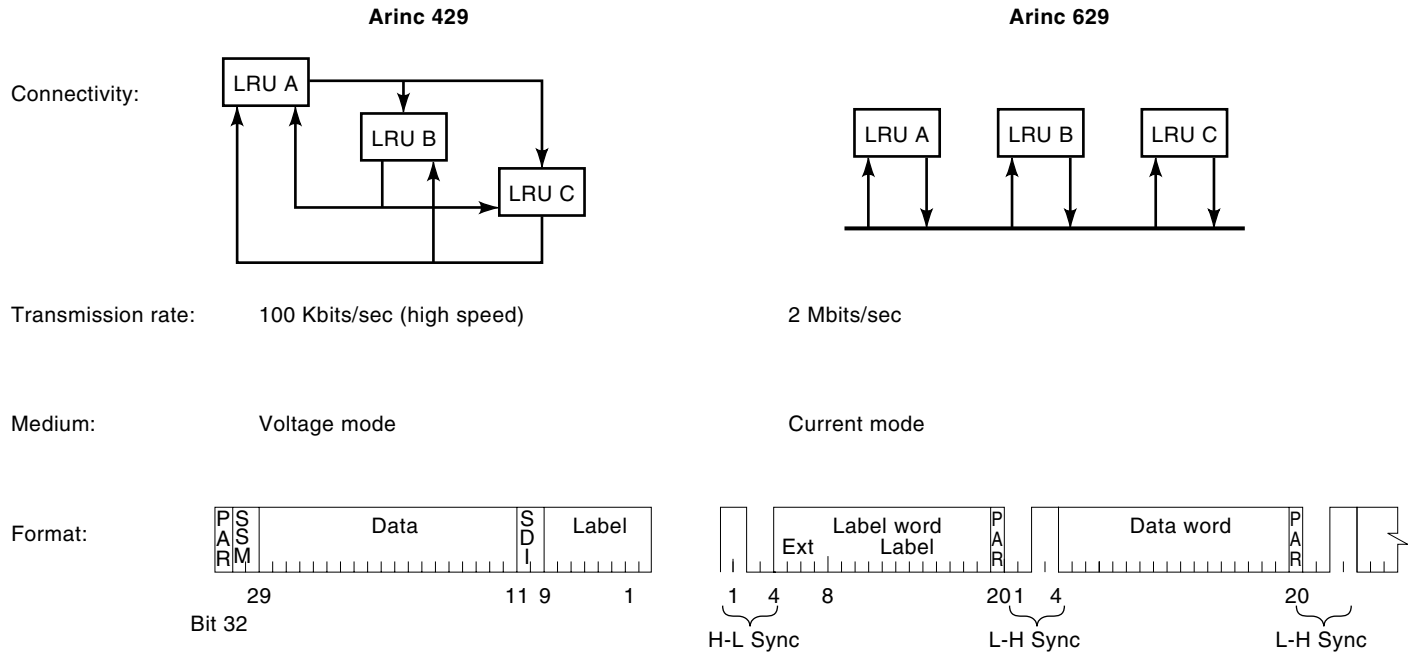

Figure 7. ARINC 429 and 629 data bus characteristics.

lated from each other. A system could contain an actuator, a sensor, and an analog device to control the actuator based on the sensor input. All the interfaces were analog, meaning that the mechanic could generally troubleshoot the system with a schematic and a voltmeter. In this era, thorough aircraft testing relied on extensive use of ground support equipment.

Analog Built In Test. As time passed, the systems added functionality to meet the needs of the airlines. Some of the functionality being provided was becoming more critical to safe operation of the aircraft. To support compliance with safety requirements, fault detection monitors were added to warn the flight crew of improper operation, and often to shut down the operation of the associated portion of the system. This monitoring was known as built in test (BIT). Little additional information was given to mechanics in these designs. They largely relied on flight crew reports, schematics, and voltmeters.

Analog Built In Test Equipment. In time, aircraft design engineers realized that the output of the fault detection monitors could be made available to support mechanic troubleshooting. With these, the concept of “fault balls” was born, and was incorporated on some systems as early as the 1940s. Fault balls are indications, normally on the front of an LRU (i.e., system controller), that a fault has been detected. They were originally mechanical, but later were replaced with small light emitting diodes (LEDs). In many cases, the LRU front panel contained a test switch to command the LRU to test itself, in a manner similar to how ground support equipment could test the LRU. This capability became known as built-in test equipment (BITE). A typical LRU with front panel BITE

is shown in Fig. 8. Front panel BITE began to decrease the need for some of the ground support equipment previously used to test aircraft equipment. Depending on the system, the fault balls or LEDs could effectively point the mechanic in the right direction, but schematics and voltmeters were needed for most conditions. However, the BITE of this era was often confusing, unreliable, and difficult to use. Mechanics often distrusted it. Many systems on aircraft such as the Boeing 707, 727, early 737/747, McDonnell Douglas DC-8, DC-9, and DC-10s, employed this type of maintenance design.

Digital Built In Test Equipment. In the 1970s and early 1980s, some of the increasingly complex systems began to use computers to perform their calculations. With these computers came the ability to display fault detection and isolation information in digital form, normally via numeric codes, on

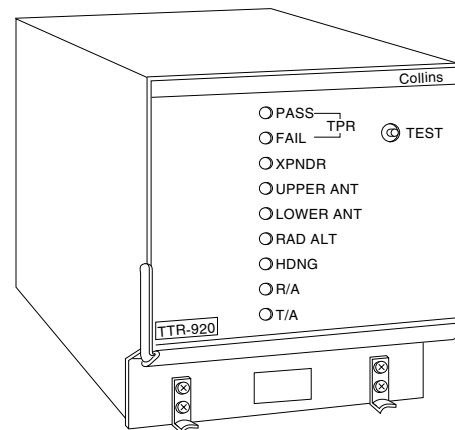

Figure 8. LRU with front panel BITE.

the front panel of the LRU. The digital logic could produce codes that could better isolate the cause of the fault. The digital display, as shown in Fig. 9, offered the capability to display many different codes or even text to identify each type of fault that was detected. Some of the later LRUs had the capability to initiate ground tests and display the results in codes of text. The codes often pointed to some description in a manual that could be used to isolate and correct a fault. Many systems on the Boeing 757/767, Airbus A300/310, McDonnell Douglas DC-10, and Lockheed L-1011 employ this approach.

Common Fault Display System—ARINC 604. As the number of systems grew, use of separate front panel displays to maintain the systems became less effective, particularly since each LRU often used a different technique to display its fault data. In addition, some of the systems had become increasingly integrated with each other. Digital data buses, such as ARINC 429, began to be used during this time period. Autopilot systems, as they were among the first to use these digital data buses and depend on sensor data provided by many other systems, have been a driving force in definition of more sophisticated maintenance systems. The more sophisticated monitoring was necessary to meet the integrity and certification requirements of its automatic landing function. For example, the Boeing 767 Maintenance Control and Display Panel (MCDP) brought together the maintenance functions of many related systems (i.e., flight control computers, flight management computers, and thrust management computers). As the next step, ARINC 604 defined, in 1986, a central fault display system (CFDS) which brings to one display the maintenance indications for potentially all of the systems on the aircraft. This approach enabled more consistent access to maintenance data across systems, a larger display than each of the systems could contain individually, and saved the cost of implementing front panel displays on many of the associated system controllers. In this approach, the CFDS is used to select the system for which maintenance data is desired, and then it sends the maintenance text from that system to the display. This approach was used on some of the systems on later Boeing 737s, and most systems on the Airbus A320/330/340, and

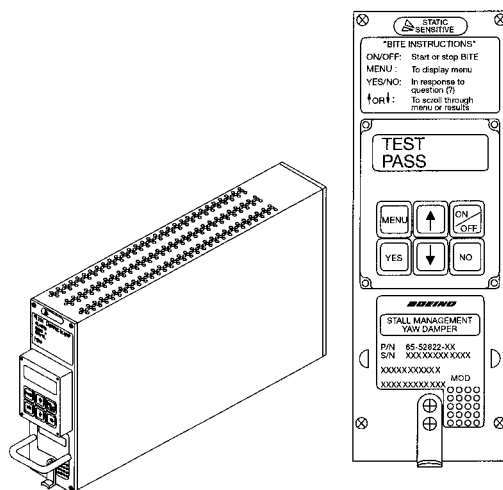

Figure 9. Digital BITE control panel.

McDonnell Douglas MD11. Figure 10 shows several typical CFDS displays for the Airbus A320.

Onboard Maintenance System—ARINC 624. Systems continued to become more complex and integrated. A single fault on the aircraft could cause fault indications for many systems, even when displayed using the CFDS. The mechanic had little help in determining which indication identified the source fault, and which were merely effects. To solve this and related issues, ARINC 624 was developed in the early 1990s. It defines a more integrated maintenance system that can consolidate the fault indications from multiple systems, and provide additional functionality to support maintenance. Minimal ground support equipment is needed to test aircraft systems, as most of this capability is included in the maintenance system. For example, most factory functional tests of aircraft systems on the Boeing 747-400 and 777 aircraft consist of little more than execution of selected tests, monitoring fault displays, and monitoring certain bus data using the integrated maintenance system.

Onboard Maintenance System Architecture

ARINC 624 defines an onboard maintenance system (OMS) as: (1) built in test equipment (BITE) in each member system, (2) central maintenance computer system (CMCS), (3) airplane condition monitoring system (ACMS), and (4) onboard maintenance data (OMD). Figure 11 shows graphically an OMS architecture.

Built In Test Equipment In Each Member System. In ARINC 624, BITE refers to all of the maintenance capabilities of an LRU (the term BIT is not used). Member system BITE detects, isolates, and reports faults. It also runs tests, transmits configuration data, and performs data load when requested by the CMCS. It must perform all of these functions accurately, or the central maintenance computer system (CMCS) becomes little more than an efficient garbage collector.

Central Maintenance Computer System. A CMCS consists of the central maintenance computer (CMC), a maintenance access terminal (MAT), an airplane condition monitoring system (ACMS), and onboard maintenance data.

The CMC consolidates fault reports from member systems into maintenance messages and correlates them to flight crew indications (flight deck effects). It can transmit these messages to ground stations, printers, and disk drives. It also requests member systems to run tests, transmit configuration data, and perform data load.

The MAT provides the display for maintenance data processed through the CMC, and contains storage devices (e.g., disk drives) to support data loading and recording of reports. Figure 12 shows the MAT on the Boeing 777.

Airplane Condition Monitoring System. The ACMS provides a single point for aircraft system operational data monitoring, to support analysis of trends and prediction of future maintenance needs. The MAT provides the display capability for ACMS, just as it does for CMCS.

Onboard Maintenance Data. Onboard maintenance data (OMD) is the electronic availability of maintenance documentation on the aircraft. This is intended to reduce maintenance time and effort by making this data more readily available to the mechanic.

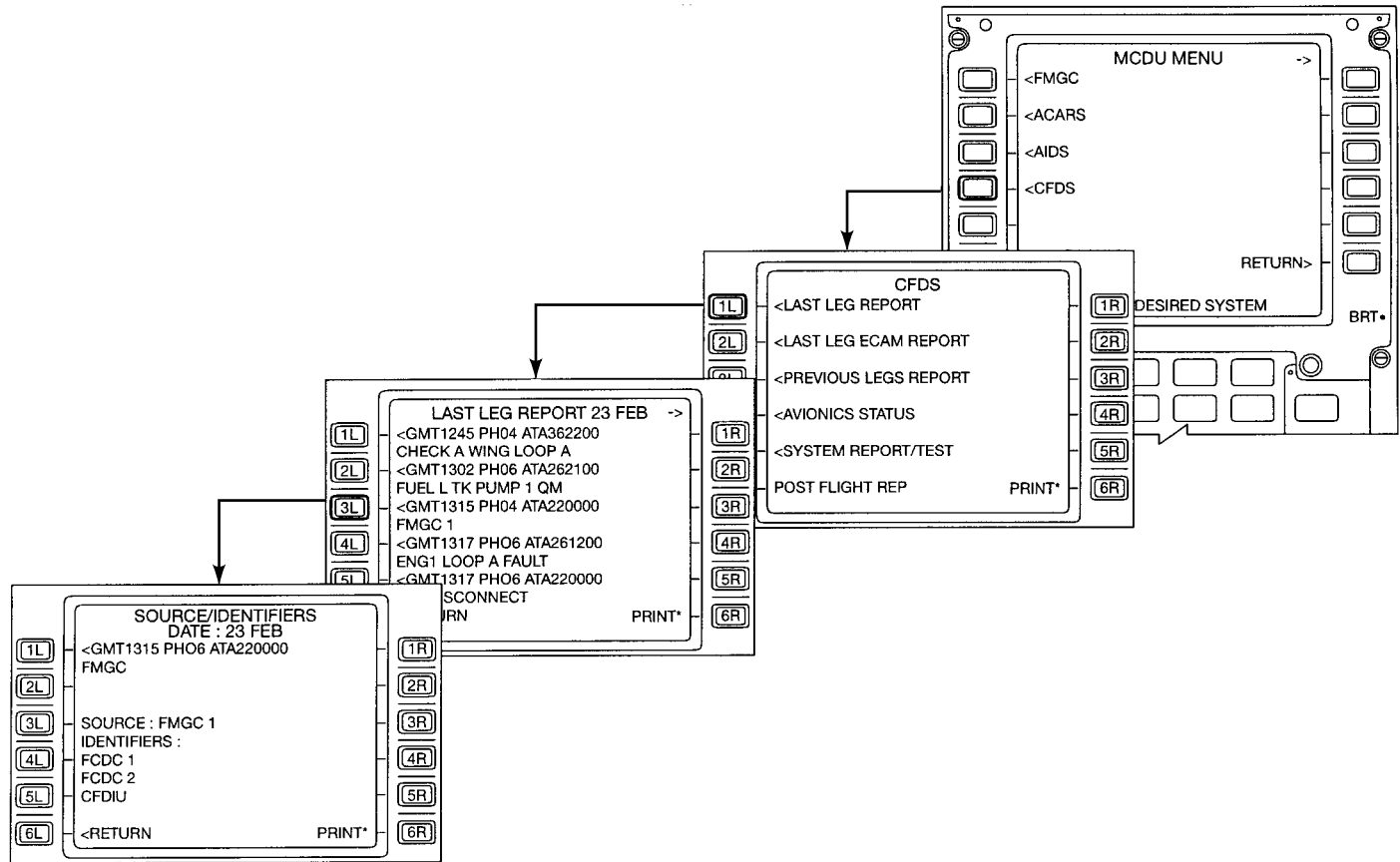

Figure 10. Airbus A320 CFDS menus showing aircraft systems displaying information on the multi-purpose control and display unit (MCDU), which is located in the flight deck.

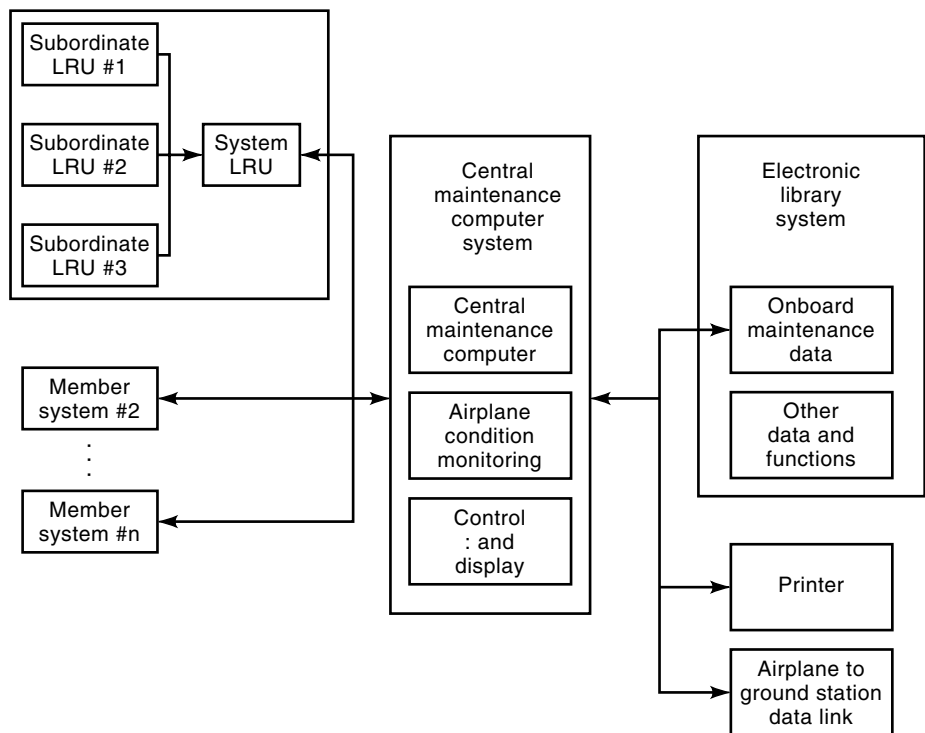

Figure 11. Onboard maintenance system architecture.



Figure 12. Boeing 777 maintenance access terminal.

Onboard Maintenance System Functions. An onboard maintenance system provides the following primary functions:

Detect And Isolate Faults. When equipment fails, the mechanic needs help in determining what has failed. Systems contain monitors to determine whether and where failures have occurred.

Generate Maintenance Messages. A maintenance message is the data (identification number and text) displayed to the mechanic identifying what has failed, and what action should be taken to correct the fault. A maintenance message identifies a specific procedure in a fault isolation manual. The objective is that only one maintenance message is produced when a single fault exists. Note: Multiple maintenance messages (which could be produced by several LRUs monitoring faults and simultaneously detecting one) tend to confuse the mechanic.

Correlate Maintenance Messages to Flight Deck Effects. Flight deck effects (FDEs) are messages to the flight crew identifying loss of function and actions that may need to be taken during the flight due to an aircraft malfunction. The FDEs are not intended to identify how to correct the fault. The flight crew will report FDEs that have occurred, and will expect the mechanic to disposition (i.e., correct or defer) them. The maintenance system relates which maintenance message identifies the fault that caused the flight deck effect.

Store, Display and Report Messages and Related Flight Deck Effects. The maintenance message and related flight deck effects are stored in CMCS memory, displayed to the mechanic and/or transmitted electronically to ground stations. Transmission to ground stations prior to aircraft arrival allows ground mechanics to be prepared to fix or properly disposition the reported faults.

Perform Ground Tests. Many systems require that tests be run to verify that faults have been corrected, and/or the system has been installed correctly.

Perform Data Loading of Systems. The functionality of many systems evolves over time. Much of this functionality is controlled only by software. Loading a new software version is an efficient means to provide updated functionality.

Display and Report System Configuration. For systems that data load, the system must provide a means for the airline to determine what version of software is loaded. This function also displays and reports hardware part number and serial number to support airline tracking of parts.

Monitor Aircraft System Conditions. Degradation in performance of a number of aircraft systems, particularly engines and environmental controls, is more gradual in nature. Fault detection is not always the most effective way to keep these systems performing optimally. For these types of systems, the maintenance system provides a means to record values of key parameters over time, or in response to certain trigger conditions. This data can be analyzed to identify trends in performance, which can then be used to identify recommended maintenance actions to maintain good performance.

Fault Reporting and Correlation

Each system must detect fault conditions to prevent the system from using failed components. Systems contain monitors sufficient to detect faults as necessary to meet safety requirements and other economic objectives. Figure 13 illustrates the fault detection and processing concept used on the Boeing 777. When a member system detects a fault, it:

1. Reports to the flight crew display system that the condition should be annunciated (if necessary) to the level necessary to identify the specific required flight crew awareness/actions, and/or aircraft dispatch limitations. This indication is known as a flight deck effect (FDE). Flight deck effects are normally displayed as a part of the basic flight crew display system. They provide information at the level that will best support flight crew determination of their response to this condition. In general, this means that a function is lost or degraded. For example, a pilot need not know which component caused a function to be lost, as his actions only change based on which function has been lost.
2. Reports this fault to the CMCS (to the level necessary to indicate to the mechanic what needs to be done to correct the fault—sometimes this may require additional monitors to provide better isolation than those used to identify that a fault has occurred). This indication is known as a fault report.
3. The flight crew display system reports to the CMCS that the flight deck effect is being displayed. Based one or more received fault report(s), the CMCS generates a message for the maintenance crew, and correlates it with the flight deck effect. This message is known as a maintenance message. The maintenance message contains an identification number, which points to a procedure in fault isolation manuals, and text to indicate what has been detected, and, optionally, the LRUs that could contain the fault. In a federated BITE system (where there is no CMCS consolidation function, e.g.,

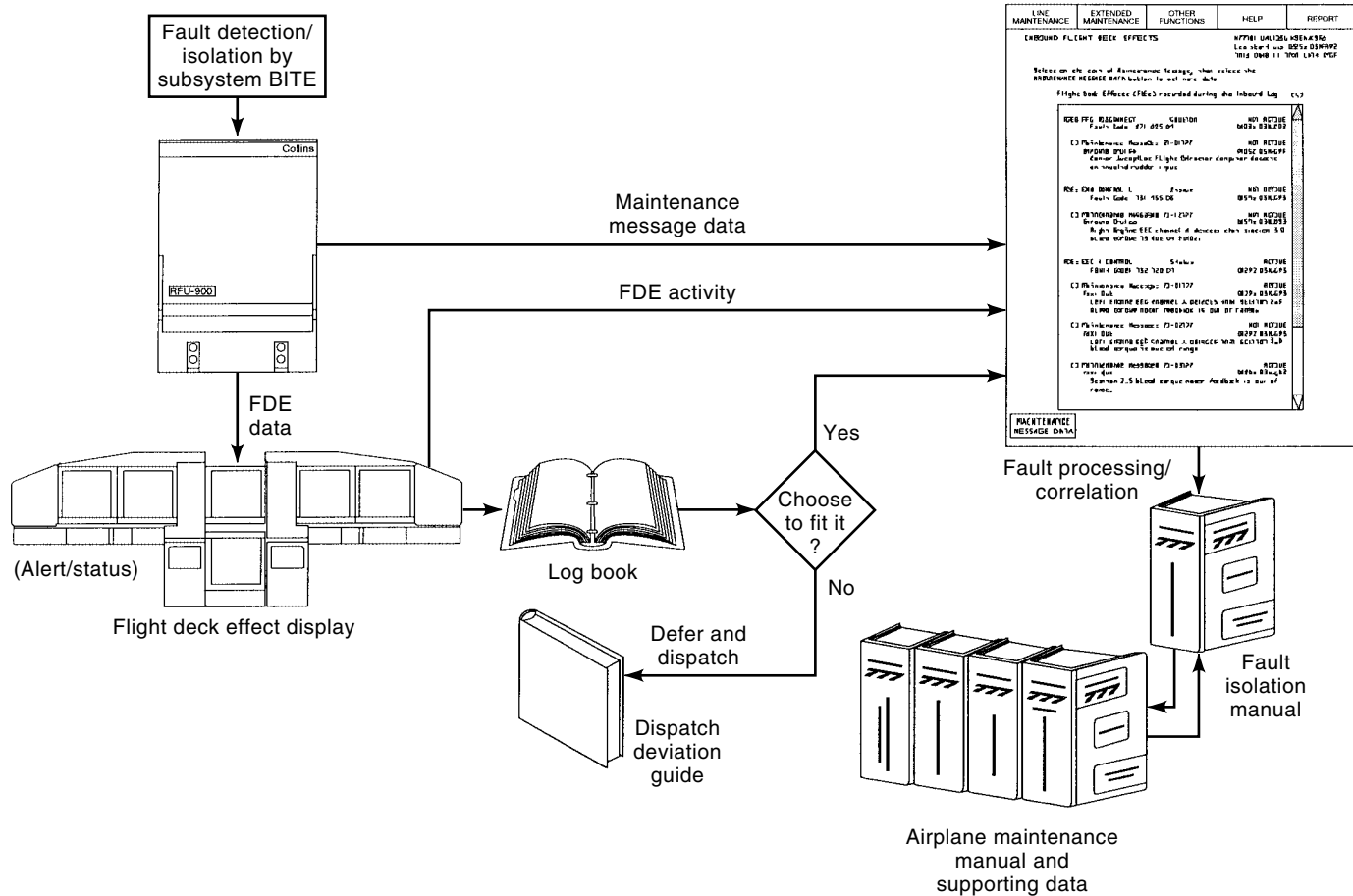

Figure 13. Boeing 777 CMCS fault detection and processing concept.

where BITE data is displayed on LRU front panels), there is effectively a one-to-one relationship between the fault reports and maintenance messages; that is, an LRU will record a fault report when a fault is detected, and display the associated maintenance message when requested by the operator. On aircraft with a CMCS, fault reports are transmitted by systems to the CMCS. Although in many cases there is a one-to-one relationship between fault reports and maintenance messages, the CMCS may consolidate multiple fault reports (usually from multiple LRUs) to produce a single maintenance message.

4. The CMCS stores maintenance messages in fault history memory for later interrogation. As ground maintenance often results in temporary display of maintenance messages, messages are normally not stored when the aircraft is on the ground.
5. The CMCS displays maintenance messages and correlated flight deck effects to the operator or reports them to ground stations via air to ground data links. Figure 14 shows a typical CMCS single maintenance message display for the Boeing 777.

Figure 15 shows a flow diagram of the steps that an airline might follow during turnaround of an aircraft. When the aircraft first arrives at the gate, the mechanic checks for any flight deck effects or log book entries. If there are none, the

aircraft can be returned to service. If there are flight deck effects or logbook entries, the mechanic will normally check the minimum equipment list and defer repair of the condition if allowed. If deferral is not allowed or desired, the mechanic will fault isolate using the CMC and the fault isolation manual (FIM), make the repair, confirm the repair, and then return the aircraft to service. The time is very limited in this condition, so the mechanic may choose to quickly replace multiple LRUs in an attempt to allow the aircraft to leave with minimal delay. This causes removal of some nonfaulty equipment, but may be in the best economic interest of the airline (as the costs of delay or cancellation can be large).

Member System Fault Reporting. The member systems contain monitors that detect fault conditions. Most of these monitors have been incorporated to detect faults that threaten the integrity of the system. Others are incorporated to detect economic fault conditions (e.g., a fault causing increased use of fuel by the engine), or to provide improved fault isolation for maintenance. A wide variety of monitors are used in the various systems on the aircraft.

Some example types of monitors are:

- Memory monitors, that detect if the data in memory has been corrupted, using techniques such as checksum or cyclic redundancy checks (CRC)

LINE MAINTENANCE	EXTENDED MAINTENANCE	OTHER	HELP	REPORT						
Existing Flight Deck Effects - Maintenance Message Data										
Correlated to		AFDC L	EICAS Status							
<div style="border: 1px solid black; padding: 5px;"> Autopilot Flight Director Computer (left) has an internal fault detected by: Autopilot Flight Director Computer (left) </div>										
Maintenance Message: 22-13391 ACTIVE Occured at 1320z 01APR91 during Approach Hard This message occurred in a previous leg										
Recommended Maintenance Action:										
<div style="border: 1px solid black; padding: 5px;"> Possible Causes: 1) Autopilot Flight Director Computer (left), P22101 (p11) </div>										
CORRELATED FLIGHT DECK EFFECTS: (2)										
<table border="1"> <tbody> <tr> <td>NO LAND #3 Fault Code: 221 033 00</td> <td>EICAS Status 31MAR91 2351z</td> <td>ACTIVE</td> </tr> <tr> <td>NO LAND # Fault Code: 221 032 00</td> <td>EICAS Advisory 1APR91 12581z</td> <td>ACTIVE</td> </tr> </tbody> </table>					NO LAND #3 Fault Code: 221 033 00	EICAS Status 31MAR91 2351z	ACTIVE	NO LAND # Fault Code: 221 032 00	EICAS Advisory 1APR91 12581z	ACTIVE
NO LAND #3 Fault Code: 221 033 00	EICAS Status 31MAR91 2351z	ACTIVE								
NO LAND # Fault Code: 221 032 00	EICAS Advisory 1APR91 12581z	ACTIVE								
<div style="border: 1px solid black; padding: 2px; display: inline-block;">GO BACK</div>		<div style="border: 1px solid black; padding: 2px; display: inline-block;">SHOW NOTES</div>								

Figure 14. Boeing 777 CMCS single maintenance message display.

- Wrap-around monitors, that detect whether output circuitry may be faulty, by feedback and interrogation of the output signal
- Activity monitors, that detect if input signals are being received (normally used for monitoring signals received on data buses)
- Out of range monitors, that detect if an input signal is within the expected range of values for that signal
- Comparison monitors, that detect whether two or more signals agree. A comparison between two inputs often cannot be used to determine which input is incorrect; a third input can be used to determine which input is incorrect
- Command response monitors, that detect if components such as actuators, valves, and relays are properly following the command signal. Care must be taken in the use of monitor results for maintenance. If their characteristics are not clearly identified, the resulting maintenance indications may confuse the mechanic or cause unnecessary maintenance actions (such as the removal of equip-

ment that has not failed). Key criteria include: (1) No nuisance indications, (2) line level fault reporting, and (3) "Tell me what you know."

No Nuisance Indications. A key problem with previous BITE designs is that messages were often displayed when no fault existed. This characteristic caused mechanics to quickly lose faith in the BITE indications.

Line Level Fault Reporting. In the past, BITE often reported the occurrence of faults whether or not they may have an effect on airline operation. This caused mechanics to unnecessarily remove equipment from the aircraft, increasing airline maintenance costs. To better support airline operations, faults should only be annunciated on the aircraft if they may have an effect on airline operations. These faults are called line relevant faults.

In addition, even if a fault is line relevant, the information provided on the aircraft should be at a level appropriate for how the information is to be used. The purpose of a maintenance message is to inform the mechanic how a fault is to be

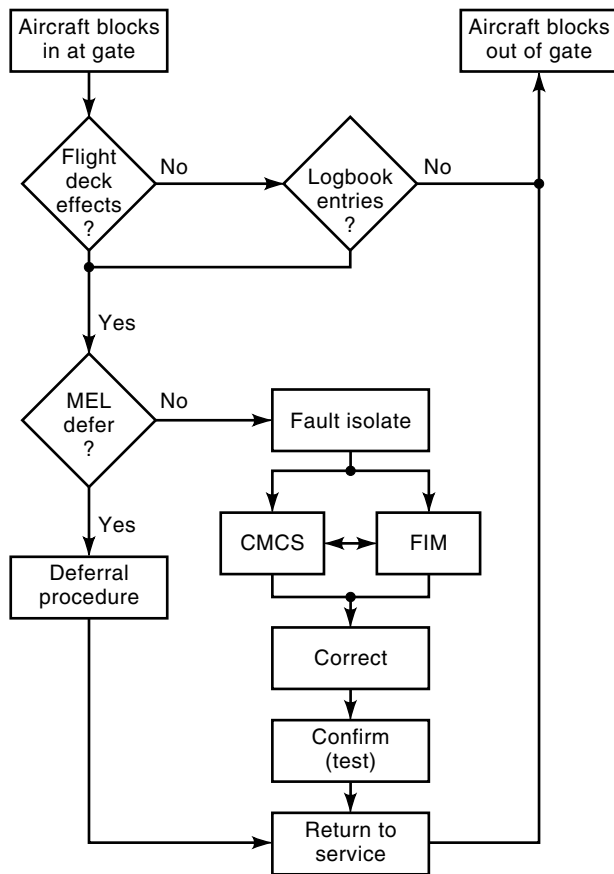

Figure 15. Airplane turnaround flowchart.

corrected on the aircraft. It does little good, and, in general just adds confusion, to provide information more detailed than is needed to perform the tasks. As a result, separate indications normally should not be given to the aircraft mechanic when the maintenance action is the same. For example, there are many faults that can occur and be separately detectable within a single LRU (memory, processor, and others). However, at the aircraft, the mechanic's action is simply to replace the LRU. Therefore, the indication on the aircraft should indicate only that the LRU has failed.

Identification of the components within the LRU that have failed are useful when the LRU is to be repaired in the shop. In order to support this shop repair, this type of information is stored in nonvolatile memory (NVM) within the LRU so that it will be available for interrogation in the shop. This information should be used by the shop to aid repair of the unit, and by the LRU supplier to verify proper operation of BITE and shop fault detection/isolation equipment.

"Tell Me What You Know". Another problem with previous BITE designs, and the resulting indications, is that they often only identified the most probable LRU that has failed. In cases where the fault is in another (unidentified) LRU, the mechanic has nowhere to go; as a result, confidence in the system is lost. BITE cannot always practically identify the cause of a fault to a single LRU. The most important characteristic is to be truthful on what has been detected, including identification of all possible causes.

Central Maintenance Computer System Fault Consolidation and Flight Deck Effect Correlation. Fault consolidation is the process of combining multiple fault reports that result from a single fault into a single maintenance message that identifies the fault and the action to remove the fault from the aircraft. Flight deck effect correlation is the process of relating this maintenance message with the flight deck effect(s) that the fault causes. In general, fault consolidation can be conceptually divided into two categories:

Cascaded Effect Removal. The effects of certain faults may propagate through multiple systems on the aircraft. Each of these systems may report the fault condition it detects using a fault report, and also may cause a flight deck effect to be displayed. The CMCS responsibility in these cases is to display a message for the source fault, and relate that message to all flight deck effects that were caused by that fault. An example of this is a failure of the air data module (ADM) that receives the pitot probe output. The ADM reports this internal fault to the CMCS. Systems using this data, such as the air data/inertial reference unit and the autopilot, will report that they are not receiving valid data, and potentially display a flight deck effect to indicate this condition. This is shown in Fig. 16. The CMCS must then display the maintenance message based on the report received from the ADM, and correlate this message to the autopilot flight deck effect. The maintenance messages for the air data/inertial reference unit and autopilot computer fault reports are suppressed, so that the mechanic can quickly identify the source fault. Note: most aircraft have sufficient redundancy that it takes more than one ADM fault to cause the indicated flight deck effects.

Fault Isolation. Certain faults may be directly observed by multiple systems. Each system will identify, through transmission of fault reports, what condition it has detected. Based on the combination of fault reports received, the CMCS determines the maintenance message that identifies the source fault. (Different combinations of fault reports cause the CMCS to identify different maintenance messages.) Once the maintenance message is determined, the CMCS correlates this to any flight deck effects that result from this fault. An example of this is failure of a radio altimeter to transmit on a data bus, as shown in Fig. 17. As this LRU cannot transmit, it cannot report the fault condition to the CMCS. Instead, the CMCS relies on other LRUs (in this case, the autopilot, the warning system, and flight management system) to determine that the original LRU cannot transmit. Multiple inputs are required in order to determine that a failed receiver is not the cause of the report.

Isolation Versus Cost/Reliability. The goal in fault isolation on the aircraft has always been to identify the single LRU that is the source of the fault. This allows the mechanic to confidently remove the failed component and correct the fault condition. Although in many cases this is possible, there are many others where it is not possible without the addition of sensors or wiring. Addition of these sensors increases the number of components that can fail, and thus sometimes can worsen the maintenance effort. In addition, they add cost and weight to the aircraft. There are clearly cases where the addition of such hardware can be beneficial, but the benefits of improved fault isolation must be weighed against the potential reduced reliability, and increased cost and weight of the additional components.

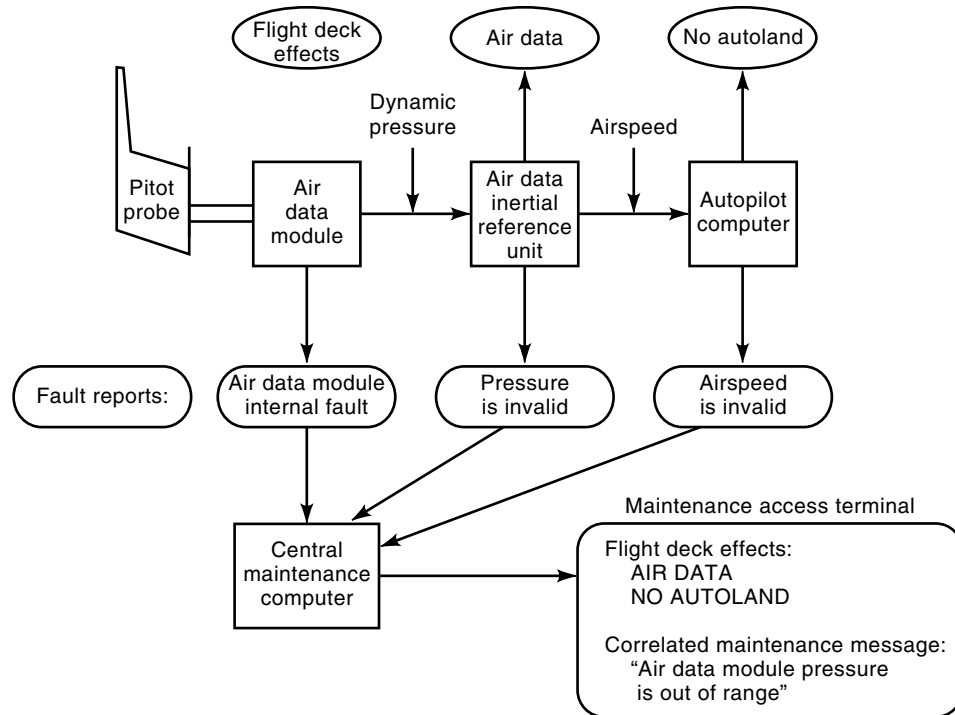

Figure 16. CMCS cascaded effect removal.

As a result, the CMCS cannot practically produce the perfect answer (the single faulty LRU) in all cases. It can point the mechanic to a small group of LRUs in almost all cases. Even in this case, if it is reliable in doing this, it is still a very necessary and effective tool to aid in mechanic correction of aircraft problems.

Central Maintenance Computer System Fault Storage. Once maintenance messages and correlated FDEs are identified, they may be stored for later retrieval by maintenance personnel. This is particularly critical where the fault is intermittent or can only be detected in certain conditions, since in these cases the monitors may not be detecting the fault by the time that the aircraft returns to the ground. This storage of maintenance messages and correlated FDEs is called fault history. In order to be effective, the system must be designed so that maintenance messages are stored in fault history only for fault conditions. In particular, ground maintenance activity often induces perceived fault conditions which are detected by the various system monitors. For example, an LRU is expected to transmit on a data bus when the aircraft is flying; if it stops transmitting in flight, a real fault condition exists, and a maintenance message should be recorded. During maintenance, if a circuit breaker for this LRU is opened, other LRUs will report that this given LRU is no longer transmitting. This is not a real fault in the LRU, and thus, maintenance messages should not be recorded. Therefore, maintenance messages for these conditions are normally not stored in fault history when the aircraft may be undergoing maintenance. The CMCS uses flight phases to determine when a message should be stored. Flight phases identify specific regions of the aircraft flight cycle (including engine start, taxi out, takeoff, climb, cruise, descent, approach, roll-out, taxi in, engine shutdown, and maintenance).

Ground Tests

Ground tests are designed to allow the mechanic to verify proper installation and operation of all or part of the system. They are initiated based on user request. Ground tests are often used to verify whether a fault has been corrected. For some faults, ground tests are designed to re-create conditions under which a fault can be detected, and then determine if the fault exists. One very important issue regarding use of these tests is to make sure that they are not run at an inappropriate time. For example, a flight control system should not run a maintenance test while the pilot is flying the aircraft, as hazardous conditions could result. The applicable systems contain safeguards to prevent such inappropriate ground test operation.

Data Load/Configuration Identification

Data load is used to load new software or data into an LRU. Much of the functionality of modern systems is incorporated into software. As changes to this functionality are desired, either to correct problems or add new features, software updates are required. Data loading provides the means to efficiently install the new software onto the aircraft. Data loading shares one common issue with ground tests. Each system must provide safeguards to make sure that software can only be loaded when it is safe to do so. Otherwise, loading of software into a flight control system while the aircraft is in flight, for example, could have hazardous consequences. Another important issue with data loading is that the airline must make sure that the resulting software configuration is legal for flight. To support this determination, the system must provide a configuration identification function, in which it can request and display software and hardware configuration for any of the applicable systems. This tool can also be used by the airlines to track what LRUs are installed on each aircraft.

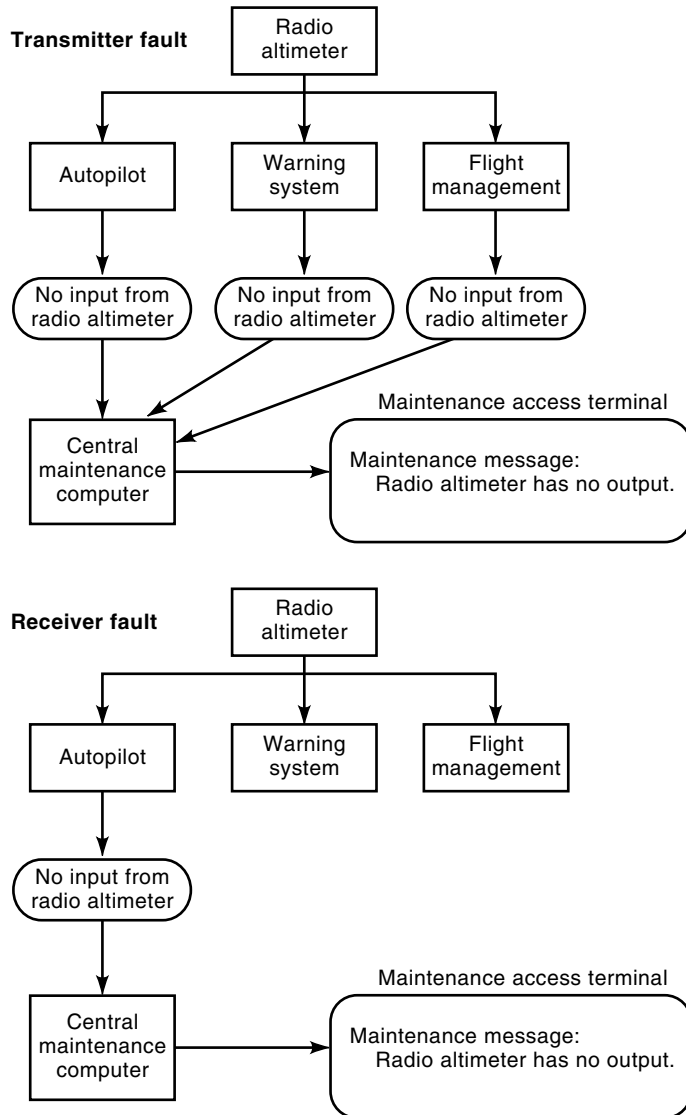

Figure 17. CMCS fault isolation.

Reporting

Reporting consists of the capability to transmit the results of the various CMCS functions to output devices such as a printer, a disk drive, or to ground stations via an aircraft to ground data link. The latter is gaining increasing use, as airlines realize the benefits of knowing what faults have occurred on an aircraft prior to the aircraft arrival. With this information, they can be prepared for any maintenance action that may be required when the aircraft lands. This reporting also consolidates information in the hands of maintenance planning personnel so that they can plan for maintenance activities during overnight or longer maintenance periods.

The CMCS can be programmed to transmit fault information automatically in a variety of ways as desired by the airlines. Reports can be transmitted as faults are detected, or a summary of the faults detected during the flight can be transmitted toward the end of a flight. In addition to this, ground stations can request transmission of fault information or system configuration information at any time. The latter is use-

ful in situations where an LRU has failed, and the airline needs to know the configuration of the remaining LRUs in the system, so that a compatible replacement LRU can be ready when the aircraft arrives.

Airplane Condition Monitoring

The airplane condition monitoring system (ACMS) enables the airline to monitor engine and aircraft systems performance. The data collected and reported by the ACMS also allows the airline to conduct trend analysis of maintenance data. The ACMS capability includes engine and aircraft performance diagnostic tools, which are normally provided by engine and airframe manufacturers, respectively. The reports and event triggers may be customized by the airline to suit their specific needs. Airlines can create specific reports, determine data gathering criteria, select the output device for the reports and create custom screens for display on the maintenance access terminal (MAT).

The ACMS software provides the ability to record data based on predefined triggers, or on real-time manual inputs from the airline. *Triggers* are logic equations that detect conditions such as engine limit exceedances, failures, stable frames, or other airline defined criteria. Data can be recorded for predetermined periods of time following the activation of a trigger, a manual input, or an input via ground stations. Alternatively, an airline may choose to record certain parameters continuously for post flight analysis on a routine basis.

The data reports generated by ACMS may be downloaded, as specified by the airline, to any of the following devices: maintenance access terminal (MAT), data loader diskette, flight deck printer, or optional quick access recorder (QAR). In addition the ACMS generated reports can be downlinked to a ground station via digital communication management function (DCMF).

Onboard Maintenance System User Interface

To be most effective, access to maintenance displays should be provided where the mechanic is performing related tasks. To support this objective on the Boeing 777, the CMCS and ACMS may be accessed from:

- A maintenance access terminal (MAT) in the cockpit
- Side displays in the cockpit (optional equipment)
- A portable maintenance access terminal (PMAT) plugged into remote terminals located in these areas:
 - Flight deck
 - Electronics/equipment bay
 - Nose gear
 - Right main gear
 - Auxiliary power unit (APU) access door

Menus provide access to data for all of the OMS functions. The menus on the Boeing 777 CMCS, as shown in Fig. 18, are structured to efficiently support particular user needs. For example, the functions that would most likely be used by a line mechanic are grouped under a line maintenance menu item. Maintenance messages listed under line maintenance menu items are limited to those that correlate to flight deck effects, as those are the only messages that a line mechanic would normally have reason to correct. The line maintenance menu

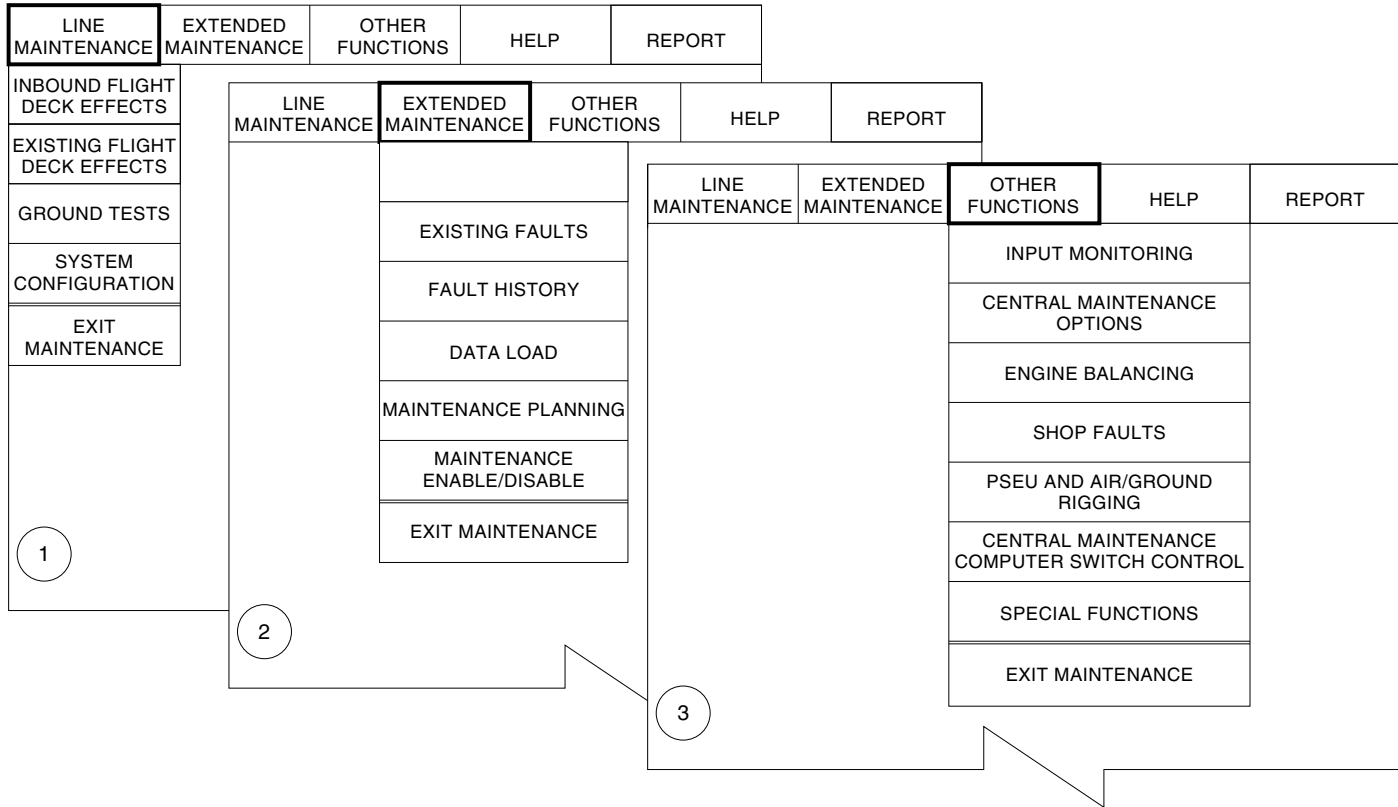

Figure 18. Boeing 777 CMCS menus.

item also contains capabilities to run ground tests (to verify whether a fault has been corrected, or an LRU has been installed correctly) and display configuration data (to verify that the correct LRU and/or software has been installed).

Extended maintenance and other functions menu items provide functions more likely to be used in an overnight or more extended maintenance periods. For example, under extended maintenance are menu items that can display all maintenance messages that are being or have been detected, whether or not they identify a cause for a flight deck effect. Those messages not correlated to flight deck effects are economic faults. These economic faults do not affect safety of the aircraft in any way, but could have economic consequences such as future aircraft availability or increased fuel usage. Certain messages are identified in a maintenance planning menu as maintenance memos. Maintenance memos highlight faults in fault tolerant parts of systems, and indicate that another similar fault will cause some impact on aircraft dispatch.

AIRPLANE MAINTENANCE DESIGN TRENDS

Greater Airplane System Integration

Airplane systems are becoming more and more interdependent. This is due to the increasing use of data buses, which has made data from each system much more available to the rest of the systems on the aircraft. This data availability in turn has enabled increased functionality, which in many cases can result in greater efficiency, weight reduction, and other improvements. This also causes the effects of faults to

propagate more widely between systems. As a result, mechanics are more dependent on systems such as the CMCS to help them determine how to correct a given problem. Devices such as the CMCS will need to grow in complexity to allow accurate identification of the faulty components, and the effects of those faults. Use of aircraft system models in CMCS design is expected to increase in order to support this growing complexity.

Greater Use of Downlinked Information

With the limited amount of time a typical commercial aircraft may have between flights, advance (prior to arrival) information of faults that have occurred can facilitate more timely disposition of these conditions. If the condition is deferrable, this advance information can give maintenance personnel time to consider the options and decide on a course of action. If the condition is to be fixed before the next flight, the information can allow maintenance personnel to be prepared with replacement equipment when the aircraft lands. Transmission of this data can also aid in planning future maintenance activity—faults reported in these transmissions can more readily be scheduled for repair when the equipment, time, and personnel are available. Airlines are making increasing use of this capability as more aircraft support it.

Greater Use of Prognostics

The airplane condition monitoring system provides capabilities to identify trends in performance, in part to determine if and when equipment may benefit from maintenance. Increas-

ing use of these and other prognostic capabilities are expected as soon as sufficient economic benefits can be identified.

Electronic Maintenance Manuals

Traditionally, maintenance manuals have been printed and located away from the aircraft, causing mechanics time and effort to retrieve them. Maintenance manuals are increasingly being distributed electronically, and are often accessed via portable computers that the mechanic may bring onto the aircraft. Other means for making this data available on the aircraft (e.g., installation of computers containing this data on the aircraft) are expected to become more widely available. (See section on “Electronic Performance Support Tools” later in this article.)

MAINTENANCE SUPPORT

All of the previous discussion about design for maintenance and the ability of the aircraft to identify its faulty components and systems is to no avail unless there is accurate and up-to-date technical documentation available and the work force to perform the maintenance is skilled and properly trained. Both of these areas are critical to the success of an airline’s maintenance program.

Technical Documentation

The amount of information and documentation required to support the maintenance of a modern jet transport aircraft is huge. For example, approximately fifty manuals, totaling over 40,000 pages, are required to support the maintenance of a typical jet transport, such as the Boeing 777. Maintenance technicians, depending on their experience and maintenance role, estimate that they spend as much as forty percent of their workday accessing technical information contained in these documents.

The support documentation, mostly written by the airframe and engine manufacturers, ranges from aircraft maintenance manuals, training manuals, wiring diagram manuals, schematics manuals, fault reporting and isolation manuals, BITE manuals and ramp maintenance manuals, to such support documentation as service bulletins. There are also thousands of aircraft drawings that are kept on file because they may be needed to support a modification or repair of an aircraft. Similarly, the component manufacturers, who are contracted by the airframe and engine manufacturers to design and build many of the components for the aircraft and engines, develop and produce component maintenance manuals for each of the components they manufacture.

All of the documentation used to support the maintenance of aircraft must be accurate and kept up-to-date. Much of the documentation is specific to individual aircraft (as designated by tail numbers or registration numbers, etc.) because the equipment or components installed in a given aircraft may not be of the same revision level as that installed in an aircraft produced at a later date.

Most of the documentation is continuously revised throughout the life of the aircraft. For example, nearly all of the documentation supplied by the airframe manufacturer is revised on a quarterly basis. This is expensive for the manufacturers, who must produce and send multiple copies to the

airlines, totaling hundreds of thousands of pages for one model alone. It is also costly for the airlines who must continuously revise their documentation and keep records of the revision. Because of this cost to maintain all of the documentation, there was a great need to digitize it. Beginning in the early 1990s, efforts were made to digitize these documents and allow access through desktop computers and using electronic performance support tools. (See section entitled “Electronic Performance Support Tools” later in this article.)

Often a wide variety of aircraft types are operated by an airline. They may be Boeing models, McDonnell Douglas models, Airbus models, or a combination of them all. With all of the different models operated by the airlines and the resulting wide variety of support documentation, it became necessary to standardize. Almost all of the support documents used today by the airlines conform to ATA standards that are contained in two specifications. ATA Specification Number 100 contains the standards for paper, microfiche, and microfilm documentation and ATA Specification Number 2100 contains the standards for digital data.

Air Transport Association Specification Number 100. When aircraft, engine, and component manufacturers develop manuals to support their respective products, they adhere to the documentation standard in ATA Specification 100. The standards describe how the documents should be organized, so that no matter what aircraft, or aircraft system, one is researching, it can be found in the same fashion.

The standards in this specification are recommendatory in nature, and become mandatory to the extent they may be incorporated into the purchase agreements executed between the individual suppliers and the individual airlines. Specific documents identified by ATA 100 include:

- Aircraft Maintenance Manual
- Wiring Manual
- Structural Repair Manual
- Illustrated Parts Catalog
- Component Maintenance Manual
- Illustrated Tool and Equipment Manual
- Service Bulletins
- Weight and Balance Manual
- Nondestructive Testing Manual
- Power Plant Build-up Manual
- Aircraft Recovery Manual
- Fault Reporting and Fault Isolation Manuals
- Engine Manual
- Engine Illustrated Parts Catalog
- Engine Parts Configuration Management Selection Process Manual
- Miscellaneous Technical Data
- System Descriptions Section
- Maintenance Planning Document

Air Transport Association Specification 2100. As support documents have transitioned from paper/film to digital, and from closed to open systems, a different standard was developed to establish these standards for digital maintenance data. ATA Specification 2100 established these standards for the au-

thoring, interchange, delivery, and use of digital data produced by aircraft, engine, and the component manufacturers. ATA Specification 2100 will replace ATA Specification 100, when all support documents have transitioned to digital format. ATA Specification 2100 is not limited to particular functional areas for aircraft as the ATA Specification Number 100 is, although further development of functional requirements may be added during ATA Specification 2100's lifetime.

Air Transport Association Chapter-Section-Subject Numbering System. Whether in paper or digital form, a standard numbering system is used throughout most jet transport technical documentation. It follows ATA Specification Number 100 which specifies all technical data be organized by this number system. The numbering system specified in ATA Specification 100 is known as the ATA chapter-section-subject numbering system. The numbering system consists of three elements. The first element assigns an ATA chapter number to each aircraft system. For example, ATA Chapter 28 is for the fuel system, ATA Chapter 34 is for navigation systems, and so on. The second element assigns an ATA section number for each subsystem. For example, a subsystem for the fuel system might be "Indicating," and has a section number 30 assigned. Therefore, any document referencing a fuel indicating system component would start with the ATA Chapter section number 28-30. The third element is a unique number assigned by the aircraft manufacturer for a specific component. For example, a fuel system temperature sensor, which is used to provide a temperature indication in the flight deck, might have a ATA subject (or sometimes referred to as unit) number 06 assigned. All references to this component in the technical manuals would use the number (or portions of this number) 28-30-06.

A list of the ATA chapter-section-subject numbering system contained in ATA Specification Number 100 is as follows:

ATA Chapter 5: Time limits/maintenance checks.

Manufacturers' recommended time limits, maintenance checks, and inspections.

ATA Chapter 6: Dimensions and areas. The area, dimensions, stations, and physical locations of the major structural members of the aircraft. Also includes zone locations.

ATA Chapter 7: Lifting and shoring. Charts showing lifting and jacking points for maintenance, overhaul and repair. Standard jacking procedures and lifting and shoring for abnormal conditions.

ATA Chapter 8: Leveling and weighing.

ATA Chapter 9: Towing and taxing.

ATA Chapter 10: Parking and mooring.

ATA Chapter 11: Required placards. The location and pictorial illustrations of placards, stencils, and markings.

ATA Chapter 12: Servicing. Replenishment of all aircraft system reservoirs (fluid and gaseous), oil changes, lubrication, and toilet draining and flushing. Filter types and locations. Also cold weather maintenance and exterior cleaning.

ATA Chapter 20: Standard practices. Airframe stan-

dard maintenance procedures applicable to multiple aircraft systems.

ATA Chapter 21: Air conditioning. Airplane heating and cooling including pressurization and ventilation.

ATA Chapter 22: Autoflight. Autopilot/flight director system, yaw damper, speed trim, and auto throttle.

ATA Chapter 23: Communications. High frequency (HF), very high frequency (VHF), satellite communication (Satcom), ACARS, select call (Selcal), passenger address and entertainment, audio integrating and interphone systems, voice recorder, and static discharger.

ATA Chapter 24: Electrical power. Electrical generation and distribution, 115/200 volts ac, 28 volts ac, 28 volts dc, and battery system.

ATA Chapter 25: Equipment/furnishings. Equipment installed for crew members and passengers, including galley and lavatory, seats, insulation, storage areas, escape and life saving equipment. Includes procedures for cleaning and repair of furnishings. Also includes cargo compartments, and cargo handling equipment.

ATA Chapter 26: Fire protection. Automatic fire and over-heat detection for engines and APU, automatic smoke detection for lavatories and cargo compartments. Fire extinguishing for engines, APU, lavatories, and cargo compartments. Also includes portable fire extinguishers.

ATA Chapter 27: Flight controls. Ailerons, rudder, elevators, horizontal stabilizer, trailing edge flaps, spoilers, speed brakes, leading edge flaps, and indicating components of the flight control system.

ATA Chapter 28: Fuel. Fuel storage, ventilation, distribution, fuel jettison, and indication.

ATA Chapter 29: Hydraulic power. Main hydraulic power, auxiliary, standby, and indicating components of the systems.

ATA Chapter 30: Ice and rain protection. Wing, nacelle, pitot probe, window anti-icing; windshield wipers, repellent and washers; water and toilet drain heaters.

ATA Chapter 31: Indicating/recording systems. Instruments, panels, clocks, recorders, warning, flight crew displays, ACMS.

ATA Chapter 32: Landing gear. Body, wing and nose gears, gear doors, hydraulic and electrical extension-retraction, wheels and brakes, antiskid, nose and body gear steering, and position and warning system.

ATA Chapter 33: Lights. Warning, annunciator, anticollision, navigation, and emergency lights. Also includes area lighting and instrument lighting.

ATA Chapter 34: Navigation. Air data, altitude alert, windshear alerting, inertial reference (IRS), standby instruments (air data, compass, attitude), instrument landing (ILS), marker beacon, radio altimeter, weather radar (WXR), air traffic control (ATC), traffic alert/collision avoidance (TCAS), ground proximity warning (GPWS), VHF omnidirectional ranging (VOR), distance measuring (DME), automatic direction finding (ADF), global positioning (GPS), flight management computing system (FMCS).

ATA Chapter 35: Oxygen. Systems and equipment for storing, regulating, and delivering oxygen.

ATA Chapter 36: Pneumatic system. Distribution of compressed air from source to using system.

ATA Chapter 38: Water and waste. Systems and equipment for storing and delivering fresh water, and removal of toilet and water wastes.

ATA Chapter 45: Central maintenance system. Reports maintenance messages for a number of aircraft systems. The messages reported are existing faults, flight leg faults, fault history, BITE, ground tests, and so on. The system includes the central maintenance computer.

ATA Chapter 49: Airborne auxiliary power. APU, fuel control, ignition, starting, air, APU controls, indicating, exhaust, and oil systems.

ATA Chapter 51: Structures. Identification of various structural sections along with interior and exterior finishing and sealing.

ATA Chapter 52: Doors. Energy and exit doors, landing gear doors, and doors for cargo access and servicing.

ATA Chapter 53: Fuselage. The structural members which make up the compartments for equipment, passengers, crew and cargo including skins, bulkheads, frames, stringers, floor beams, floors, pressure dome, tail cone, fuselage to wing and empennage fairings, and others.

ATA Chapter 54: Nacelles/pylons. Those structural units and associated components/members which furnish a means of housing and mounting power plant. Includes skins, longerons, frames, stringers, clamshells, doors, nacelle fairings, and others.

ATA Chapter 55: Stabilizers. Structure of horizontal and vertical stabilizers including the structure of the elevator and rudder.

ATA Chapter 56: Windows. Passenger windows and crew windshields. Includes windows used for observing compartments and equipment.

ATA Chapter 57: Wings. Structure of the wings, flaps, ailerons, and spoilers.

ATA Chapter 70: Standard practices. Engine-standard maintenance procedures applicable to multiple engine systems.

ATA Chapter 71: Power plant. Power plant, cowling, mounts, and drains.

ATA Chapter 72: Engine. Compressors, combustion chamber, turbines, and accessory drive gearbox.

ATA Chapter 73: Engine fuel and control. Control and distribution of fuel beyond main fuel disconnect on aircraft. Includes fuel control, pump, and heater, and fuel flow, temperature, and pressure indicating systems.

ATA Chapter 74: Ignition. Generation, control, and distribution of ignition current. Includes ignition exciters, igniter plugs, and ignition switches.

ATA Chapter 75: Air. Accessory cooling and bleed air controls. Includes compressor bleed valves and controls, and variable compressor stator vane actuator and control.

ATA Chapter 76: Engine controls. Engine controls including thrust levers and cables, start levers and switches, and engine fuel shutoff components. Also includes engine fire emergency shutdown.

ATA Chapter 77: Engine indicating. Engine pressure ration (EPR), exhaust gas temperature (EGT), and tachometer indicating system. Also includes airborne vibration monitoring system.

ATA Chapter 78: Exhaust. Fan thrust reverser, turbine thrust reverser, thrust reverser controls, and position indicating system.

ATA Chapter 79: Oil. Storage and distribution of engine oil external to engine. Includes oil tank, oil cooler, and quantity, pressure, and temperature indicating systems.

ATA Chapter 80: Starting. Engine cranking, including starter, start valve, and valve position indicating system.

Aircraft Maintenance Task Oriented Support System. In addition to the ATA chapter-section-subject numbering system described previously, a second, more detailed numbering system is often used, which is referred to as Aircraft Maintenance Task Oriented Support System (AMTOSS). AMTOSS is a numbering system designed to further improve the organization of the technical manuals and to facilitate and standardize automated data retrieval. In addition, and separate from the technical manuals, it provides for a databased approach to integrating, interfacing, isolating, and coordinating the aircraft maintenance task accomplishment, job requirements, and resources support analysis typically done by a maintenance department for the airline. AMTOSS is based on the concept of using a standard and unique numbering system that is an expansion of the ATA chapter-section-subject numbering system. The numbering system, which is an expansion of the ATA three element numbering system, uses seven elements. Each element has a specified function which is specified in ATA Specification 100.

Typical Documents for a Jet Transport Aircraft Maintenance. Many different manuals are used by an airline, each used for a specific function or functions. For example, some are used to support scheduled maintenance and some to perform unscheduled maintenance. Figure 19 shows which documents are typically used by an airline for scheduled maintenance and unscheduled maintenance.

Each of these documents is written for a specific aircraft type, such as a Boeing 747. Another set of manuals would exist for every other aircraft type, such as an Airbus A320, McDonnell Douglas DC-10, or a Boeing 767. Some documents are customized for a specific aircraft or series of aircraft (e.g., effectivity to a range of aircraft as designated by tail numbers and registration numbers), and some are not customized and apply to all aircraft of a given type.

TECHNICAL TRAINING FOR MAINTENANCE

An integral part of the maintenance process at an airline is technical training. The maintenance personnel who need to be trained are not only mechanics, but also engineers, instructors, dispatchers, maintenance planners, and management. Maintenance training courses are developed and conducted by training departments at many airlines, as well as by the airframe, engine, and many component manufacturers. In addition, many colleges, universities, and independent aviation

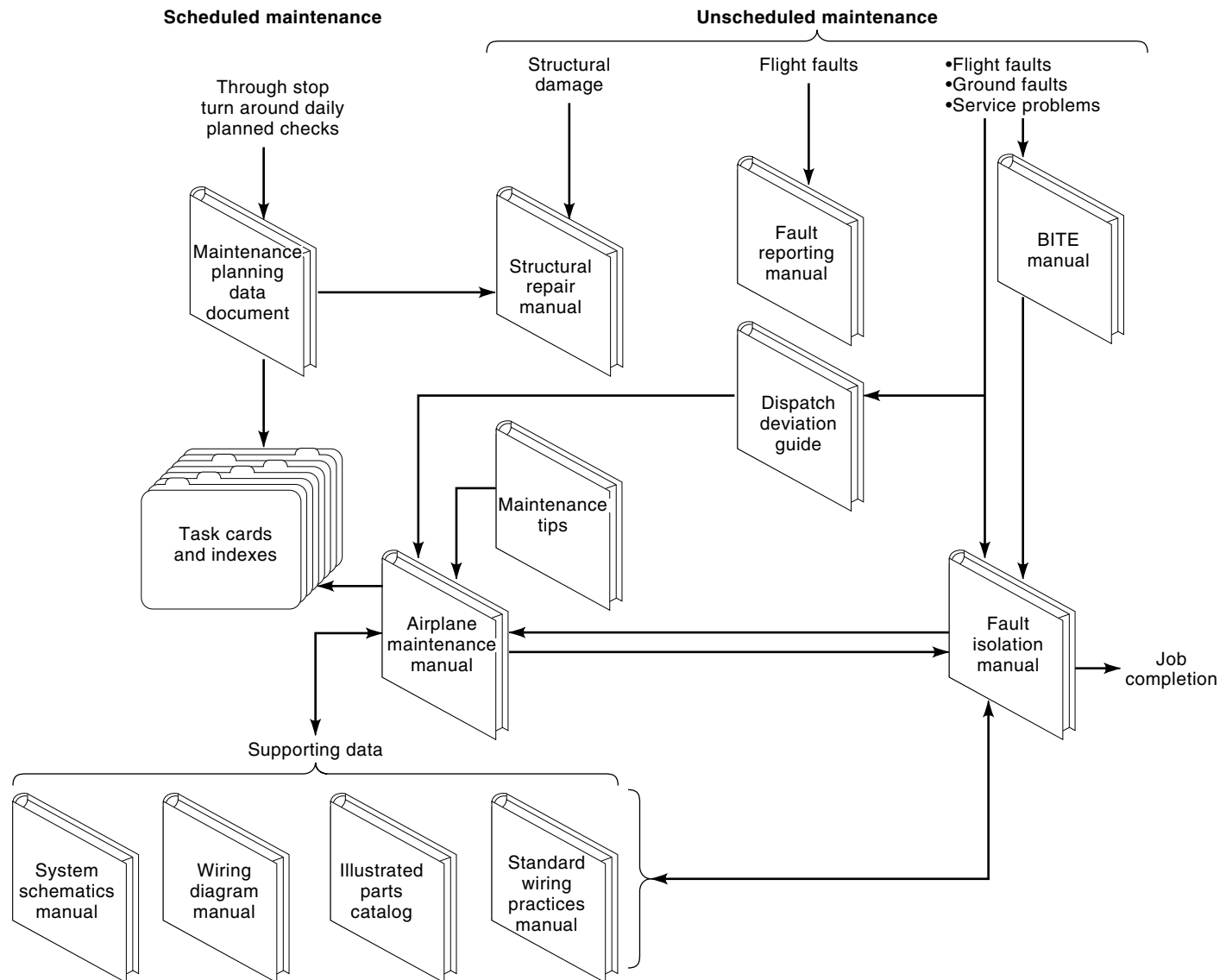

Figure 19. Maintenance documents.

schools (that specialize in aviation training) offer courses on aviation maintenance.

Regulatory Requirements for Training. The training of the mechanics and the many maintenance personnel at an airline is not only necessary for safe and efficient airline operations, but is required and regulated by government regulatory agencies in most countries. In the United States, the FAA regulation which defines the requirement for training is FAR Part 121.375 Maintenance and Preventive Maintenance Training Program. It states that:

. . . Each certificate holder or person performing maintenance or preventive maintenance functions for it shall have a training program to ensure that each person (including inspection personnel) who determines the adequacy of work done is fully informed about procedures and techniques and new equipment in use and is competent to perform his duties.

Each airline typically defines its maintenance training requirements in the airline's overall maintenance program. This maintenance program is reviewed and approved by the government regulatory agency.

Training for Mechanics and Technicians. The initial training for mechanics to get their certification and ratings is referred to as *ab initio* training (meaning from the beginning). *Ab initio* training is offered by specialized aviation schools, at colleges and universities that have aviation programs, or even by some of the airlines. Many of these schools, in addition to preparing the mechanic for his certification and rating, offer various levels of degrees, ranging from diplomas of completion to Bachelors and Masters Degrees in Aviation Maintenance and other aviation specialties. In the United States these training schools are covered under FAR Part 147, Aviation Maintenance Technician Schools. It prescribes the requirements for issuing aviation maintenance technician school certificates and associated ratings and the general operating

rules for the holders of those certificates and ratings. The following ratings are issued under FAR Part 147: (1) Airframe, (2) Powerplant, and (3) Airframe and Powerplant.

The number of courses and the length of time it takes to get a mechanic's certificate and rating varies from country to country. In the United States, to complete all of the required courses and to fulfill the practical experience requirement takes approximately 2 years. Once course work is complete, the mechanic must pass written, oral, and practical examinations before being issued a certificate and associated rating for the particular area they studied. In the United States it is either an Airframe, Powerplant, or combined Airframe and Powerplant (A&P) rating. The regulations for certification of mechanics is covered in FAR Part 65, Certification: Airmen Other Than Flight Crewmembers. It prescribes the requirements for issuing the following certificates and associated ratings and the general operating rules for the holders of those certificates and ratings: (1) Air traffic control tower operators, (2) Aircraft dispatchers, (3) Mechanics, (4) Repairmen, and (5) Parachute riggers. A proposed new FAR, Part 66, specifies new rules for aviation maintenance personnel.

Aviation Associations and Councils. Many aviation associations and councils have been formed by the airlines, manufacturers, and aviation specialty schools to provide guidelines to colleges and universities for aviation maintenance training and accreditation. Several key associations and councils involved in aviation maintenance training are:

Aviation Technician Education Council (ATEC). This organization is made up of FAA approved Aviation Maintenance Technician schools (FAR Part 147 schools), the industry (airlines, manufacturers, etc.), and governmental agencies. It was founded in 1961 to further the standing of FAA approved schools with education and industry, and to promote mutually beneficial relations with all industry and governmental agencies. This organization is very active in FAR 147 regulations and the rewrite of FAR Part 65 and 66.

Council on Aviation Accreditation (CAA). The CAA is an independent council which sets standards for all aviation programs taught in colleges and universities in America. It is responsible for hearing and ruling on accreditation applications by these institutions and to review the quality of these programs every five years. Its members include the faculty of aviation institutions and industry members such as aircraft and engine manufacturers and airlines.

ATA Specification 104 Maintenance Training Subcommittee. This subcommittee of the ATA developed ATA Specification 104. It contains the guidelines for aircraft maintenance training which most airlines and aircraft and engine manufacturers follow (see the next section).

Air Transport Association Specification 104 Guidelines for Aircraft Maintenance Training. ATA Specification 104 Guidelines for Aircraft Maintenance Training was developed by the Maintenance Training Subcommittee, which was made up of representatives from the airlines and airframe/engineer manufacturers. Its purpose is to provide a better understanding of the training requirements of the various job function/skill mixes resident in airline maintenance operations. By following these guidelines, training programs' development/packaging is more precisely oriented to the skill/job of the students. This enhances the student acceptance of the training and in-

creases retention of "need to know" data. Users of ATA Specification 104 include airline training departments, manufacturer training departments, computer based training (see CBT later in this article) vendors, and regulatory agencies.

ATA Specification 104 specifies five levels of target students, their entry level requirements, and the objectives that a particular level of training is intended to achieve. The five levels are as follows:

- Level 1: General familiarization—for management and other support personnel
- Level 2: Ramp and transit—for personnel associated with through flight maintenance activities
- Level 3: Line and base maintenance training—for personnel associated with line and base maintenance
- Level 4: Specialized training—for personnel associated with base/heavy maintenance
- Level 5: Component overhaul training—for shop technicians

ATA Specification 104 further specifies course development guidelines, objectives for each level, course development procedures, training manual format, and issuance and revision policy. It also includes guidelines for computer based learning materials as well as computer managed instruction (CMI).

Technical Training at the Airlines. The training departments at most airlines develop and continually conduct a wide range of courses on maintenance and procedures. These courses typically follow ATA Specification 104, guidelines for aircraft maintenance training, as described earlier. Each airline's technical training department typically has two primary objectives: (1) to establish and maintain an adequate program of training; and (2) to maintain adequate records of the training accomplished.

Training conducted at an airline typically consists of the following four types of training:

Indoctrination Training. This training is designed to familiarize the airlines maintenance personnel with the airline's operations and procedures, and to keep that knowledge current. When maintenance personnel initially join an airline, they will receive an introduction on the airline's policy and procedures manuals, the proper use of the technical manuals and documentation, and instructions on how to use the airlines standard forms and work sheets.

Initial Training. This training is designed as the formal course on each aircraft model type they are to maintain. The training is based on the airframe and engine manufacturer training programs, and often is just a subset of the courses the airline receives when they are trained by the manufacturers. Initial training at an airline is typically customized to the actual configuration of the aircraft model being trained.

Recurrent Training. All training other than initial training is considered recurrent training. Recurrent training is designed to keep maintenance personnel aware of pertinent changes to the aircraft, to the airlines organization, support equipment, policies and documentation, and airport and environmental regulations. Recurrent training is also conducted to make the maintenance personnel aware of aircraft differences as newer models are added to an existing model fleet,

and to inform them of problematic maintenance areas on the aircraft.

Qualification Training. This training is conducted to enable individuals to be certified by the airline to accomplish specific maintenance tasks that require more training than the basic program. Tasks that require this type of training are engine run-up, taxi, engine boroscopying (i.e., where an optical tool is used for visual inspection of the internal components of the engine) and nondestructive testing. Often certain tasks that fall into this category require periodic re-qualification.

Training by the Aircraft/Engine Manufacturers. When a new aircraft model is introduced into an airline's fleet, initial training is conducted by the airframe and engine manufacturers. The students are primarily the airline's technical training instructors and engineering personnel. This training typically takes place at the manufacturer's training center. Different types of courses are conducted for the different maintenance personnel such as an airframe course, an avionics course, and engine run-up courses. The courses conducted at the manufacturer, like the airline's courses, also follow ATA Specification 104, guidelines for aircraft maintenance training.

Maintenance Training Media in the 1990s. Training developed for the jet transports of the 1990s uses an integrated media, each designed to increase the student's comprehension and retention level by making the training more interesting. Courses conducted today by the manufacturers typically consist of the following types of media:

Classroom Lecture. Classroom lecture consists of presentations by instructors using digitally projected line drawings. These are the same graphics that are contained in the System Description Section (SDS) of Part 1 of the Airplane Maintenance Manual.

Computer Based Training (CBT). CBT is a lesson that runs on a computer that has a dynamic presentation and control of graphics and animations. For the Boeing 777, there were two types of CBT lessons; student-paced CBT lessons and instructor-led CBT lessons. With student-paced CBT lessons, the student takes the lesson at his or her own pace and does not require an instructor. Instructor-led CBT is the projection of specially developed CBT in the classroom, controlled by the instructor. Instructor-led CBT is used when animations are needed to more clearly instruct a concept that would be difficult with projection of graphic.

Field Trips to the Factory. Periodically (about once a week), the students visit the aircraft factory to see the actual components they are learning about in the course.

Maintenance Training Simulator (MTS). MTSs are much like the fixed base simulators used for training pilots (i.e., a fully functional flight compartment without a visual system or motion platform), except they contain additional maintenance features. These maintenance features consist of simulated aircraft components such as BITE modules, central maintenance computers, the external power panel, the fuel panel, and pneumatic connectors. Airplane malfunctions can be set by the instructor on an instructor station to simulate aircraft faults. The faults can be isolated by the students, from finding the fault in the flight deck to performing the BITE tests, all while using the real aircraft support documentation.

The MTS lessons typically focus on the maintenance performed on the flight line between flights, either during a turn-around or overnight/base maintenance. This concept, named line oriented scenarios, focuses on the material recently covered in the classroom and CBT. The students put the knowledge gained in the classroom and skill gained in CBT to work by performing real maintenance tasks in the MTS.

ELECTRONIC PERFORMANCE SUPPORT TOOLS

Because of the vast quantity and array of technical documentation that are necessary to perform maintenance on jet transports, digitizing the data and making it accessible from a computer became necessary. Beginning in the early 1990s, aviation manufacturers began digitizing their maintenance documents, thus making them accessible from a variety of devices such as PCs, laptops, or other specially built devices designed specifically for aircraft maintenance support. Because these devices aid in the performance of maintenance tasks, they became known as electronic performance support tools.

Each maintenance electronic performance support tool is essentially an electronic library of maintenance documents. It consists of a digital database of technical data or technical documents that are accessed via a retrieval software program. Typically the tool is nothing more than a CD ROM containing the technical documents already described, loaded into a laptop computer. As electronic support tools evolved, many specially built devices were designed specifically for aircraft maintenance. Figure 20 shows a Boeing 777 portable maintenance access terminal.

Besides the variability of types, electronic performance support tools also vary in what they do or can perform. Often they contain not just the technical documents that are used for a reference when performing a maintenance task, but also additional features such as training programs, case-based-



Figure 20. Boeing 777 portable maintenance access terminal.

reasoning applications that record information, and artificial intelligence. For example, the case-based-reasoning tool may be used to give the mechanic the most probable cause for a aircraft fault. The cause would be derived from a database of maintenance history. Moreover, data about this particular fault and the resulting fix could be added to the case-base reasoning database thus continually improving its “reasoning.”

Maintenance electronic performance support tools can be used by anyone who is involved in the planning or performing of scheduled or unscheduled maintenance on an aircraft. This includes maintenance technicians, controllers, engineers, dispatch personnel, and spares personnel. Because maintenance electronic performance support tools are portable, they may be used at the gate, on the aircraft, at the hangar, or on a person’s desk. Typically the paper-based maintenance documents used by mechanics are voluminous and are located in a crew room or line shack, often far from the aircraft. In effect, maintenance electronic performance support tools allow all the documents to be taken to the aircraft, making the mechanic efficient because he can take all the data he needs to the aircraft to perform his job. This can save many trips the mechanic must take to and from the aircraft to access the traditional paper/microfilm documentation, which saves a large amount of time.

Benefits

Electronic performance support tools offer many more benefits than just portability and relief from the use of paper and microfilm documents. Because they consist of digital data, they are easily updated and can even be on-line. This eliminates the expense of paper revisions and the labor to revise maintenance documentation. As electronic performance support tools have evolved, they also include many user friendly features that paper/microfilm cannot offer, such as indexing systems for ease of access and fast retrieval of information, or hyperlinking, which allows quick and direct movement from document to document.

Future Considerations

As technology has advanced, so have the types of electronic performance support tools. From nothing more than software on a CD loaded on a laptop in the mid 1990s, electronic performance support tools are expected to evolve to small wearable computers seen through dedicated goggles or safety glasses for viewing. Devices, such as a hand held computer with a touch sensitive liquid crystal display (LCD) with low frequency transceiver are expected to be on-line to the airlines computer system. They eventually will be on-line to the aircraft manufacturer and therefore always up-to-date. Peripheral devices such as barcode readers could be connected to these devices to record a multitude of information, such as the users name, the aircraft tail number of the aircraft being worked on, the serial number of the parts removed, and the maintenance task followed.

BIBLIOGRAPHY

1. ARINC Specification 429-12, *Mark 33 Digital Information Transfer System (DITS)*, Annapolis, MD: Aeronautical Radio Inc.
2. ARINC Report 604, *Guidance for Design and Use of Built-In-Test Equipment*, Annapolis, MD: Aeronautical Radio Inc., 1988.
3. ARINC Report 624-1, *Onboard Maintenance System*, Annapolis, MD: Aeronautical Radio Inc., 1993.
4. ARINC Specification 629, *Multi-Transmitter Data Bus*, Annapolis, MD: Aeronautical Radio Inc.
5. A. J. Martin, *Development of Onboard Maintenance Systems on Boeing Airplanes*, *Aerospace*, August 1989.
6. United States Code of Federal Regulations, Title 14, *Aeronautics and Space*, Washington, DC: Federal Aviation Regulations, 1996.
7. Air Transport Association of America (ATA) Specification 100, *Specification For Manufacturers’ Technical Data*, Washington, DC: Air Transport Asso. Amer., 1981.
8. Air Transport Association of America (ATA) Specification 104, *Guidelines for Aircraft Maintenance Training*, Air Transport Association of America Maintenance Training Sub-Committee, 1996.
9. Air Transport Association of America (ATA) Specification 2100, *Digital Data Standards for Aircraft Support*, Washington, DC: Air Transport Assoc. Amer., 1997.
10. M. E. Irrang, *Airline Irregular Operations, The Handbook of Airline Economics*, New York: McGraw-Hill, 1995.

JACK HESSBURG
RICHARD REUTER
WILLIAM AHL
Boeing Commercial Airplane Group

JFET. See JUNCTION FIELD EFFECT TRANSISTORS CIRCUITS;
JUNCTION GATE FIELD EFFECT TRANSISTORS.
**JOSEPHSON JUNCTIONS, HIGH TEMPERATURE
SUPERCONDUCTOR.** See HTS JOSEPHSON JUNCTION
DEVELOPMENT.