

Engineer's Mini-Notebook

Science Projects

Radio Shack

A Division of Tandy Corporation
Fort Worth, TX 76102

PRINTED IN U.S.A.



276-5018

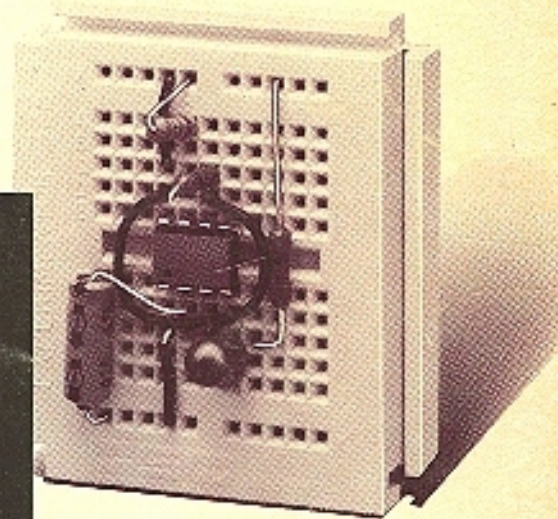
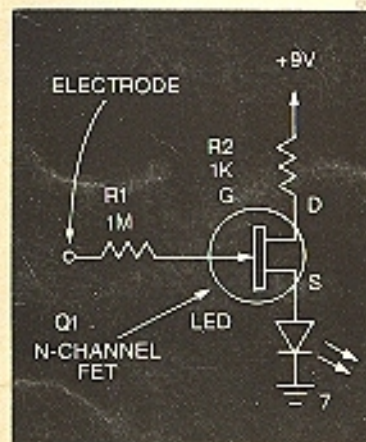

Forrest M. Mims III

Radio Shack

CIRCUIT SYMBOLS

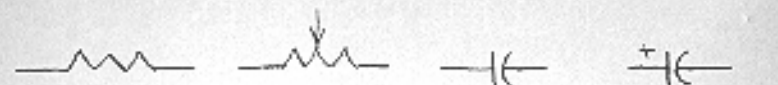

FIXED RESISTOR VARIABLE RESISTOR FIXED CAPACITOR POLARIZED CAPACITOR

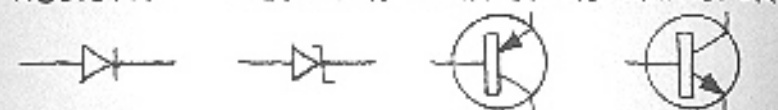

RECTIFIER/DIODE ZENER DIODE PNP TRANSISTOR NPN TRANSISTOR

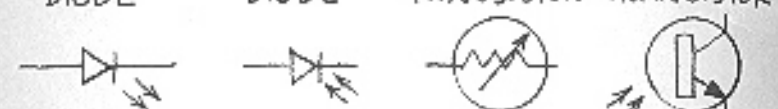

LED SOLAR CELL PHOTO-RESISTOR PHOTO-TRANSISTOR



CONNECTED WIRES UNCONNECTED WIRES POSITIVE SUPPLY GROUND



SPST SWITCH SPDT SWITCH NORMALLY OPEN PUSHBUTTON NORMALLY CLOSED PUSHBUTTON

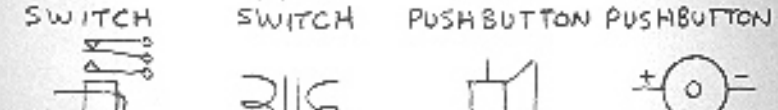

RELAY TRANSFORMER SPEAKER PIEZO-SPEAKER

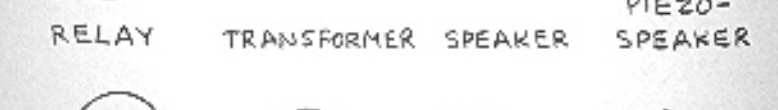

METER LAMP BATTERY OP-AMP

ENGINEER'S MINI-NOTEBOOK

SCIENCE PROJECTS

BY
FORREST M. MIMS, III

CONTRIBUTING EDITOR
MODERN ELECTRONICS

FIRST EDITION

A SILICONCONCEPTS™ BOOK

COPYRIGHT © 1990 BY FORREST M. MIMS, III
ALL RIGHTS RESERVED

PRINTED IN THE UNITED STATES OF AMERICA

CONTENTS

THIS BOOK INCLUDES STANDARD APPLICATION CIRCUITS AND CIRCUITS DESIGNED BY THE AUTHOR. EACH CIRCUIT WAS ASSEMBLED AND TESTED BY THE AUTHOR AS THE BOOK WAS DEVELOPED. AFTER THE BOOK WAS COMPLETED, THE AUTHOR REASSEMBLED EACH CIRCUIT TO CHECK FOR ERRORS. WHILE REASONABLE CARE WAS EXERCISED IN THE PREPARATION OF THIS BOOK, VARIATIONS IN COMPONENT TOLERANCES AND CONSTRUCTION METHODS MAY CAUSE THE RESULTS YOU OBTAIN TO DIFFER FROM THOSE GIVEN HERE. THEREFORE THE AUTHOR AND RADIO SHACK ASSUME NO RESPONSIBILITY FOR THE SUITABILITY OF THIS BOOK'S CONTENTS FOR ANY APPLICATION. SINCE WE HAVE NO CONTROL OVER THE USE TO WHICH THE INFORMATION IN THIS BOOK IS PUT, WE ASSUME NO LIABILITY FOR ANY DAMAGES RESULTING FROM ITS USE. OF COURSE IT IS YOUR RESPONSIBILITY TO DETERMINE IF COMMERCIAL USE, SALE OR MANUFACTURE OF ANY DEVICE THAT INCORPORATES INFORMATION IN THIS BOOK INFRINGES ANY PATENTS, COPYRIGHTS OR OTHER RIGHTS.

DUE TO THE MANY INQUIRIES RECEIVED BY RADIO SHACK AND THE AUTHOR, IT IS NOT POSSIBLE TO PROVIDE PERSONAL RESPONSES TO REQUESTS FOR ADDITIONAL INFORMATION (CUSTOM CIRCUIT DESIGN, TECHNICAL ADVICE, TROUBLESHOOTING ADVICE, ETC.). IF YOU WISH TO LEARN MORE ABOUT ELECTRONICS, SEE OTHER BOOKS IN THIS SERIES AND RADIO SHACK'S "GETTING STARTED IN ELECTRONICS." ALSO, READ MAGAZINES LIKE MODERN ELECTRONICS AND RADIO-ELECTRONICS. THE AUTHOR WRITES A MONTHLY COLUMN, "ELECTRONICS NOTEBOOK," FOR MODERN ELECTRONICS

INTRODUCTION	5
ELECTROSCOPE	6-7
ELECTRONIC ELECTROSCOPE	7
GALVANOMETER	8-9
HOMEMADE BATTERIES	10-11
GRAPHITE RESISTOR	12
LIQUID RESISTOR	12
SUPER CAPACITOR	13
THERMOCOUPLE	14
THERMOCOUPLE AMPLIFIER	15
SMALL D.C. MOTOR CIRCUITS	16
MOTOR REVERSERS	16
MOTOR SPEED CONTROLLERS	17
INVERSE SQUARE LAW	18-19
LIGHT LISTENER	20-21
LISTENING TO NATURAL LIGHT	22
LISTENING TO ARTIFICIAL LIGHT	23
MONITORING SUNLIGHT	24
THE SOLAR SPECTRUM	24
THE SOLAR DAY	24
SIMPLE SOLAR POWER METER	25
OP AMP SOLAR POWER METER	25
ELECTROMAGNETIC PROBE	26
USING THE PROBE	27
WIND SPEED INDICATOR	28-29
MAST INSTALLATION	29

RAIN SENSORS	30
RAIN-ACTIVATED ALARM	31
RAIN-ACTIVATED LOGIC	31
ELECTRONIC THERMOMETER	32
THERMISTOR CIRCUITS	32
THERMISTOR AMPLIFIER	32
THERMISTOR CALIBRATION	33
TEMPERATURE SWITCH	33
MOTION DETECTOR	34
POSITION DETECTOR	35
PRESSURE SENSOR	36
PRESSURE-SENSITIVE SWITCH	37
PRESSURE-SENSITIVE TONE	37
SEISMOMETER	38-39
EARTH MOVEMENT SENSOR	40-41
RF TELEMETRY TRANSMITTER	42-43
SAMPLE CALIBRATION GRAPH	43
LED TELEMETRY TRANSMITTER	44
SAMPLE CALIBRATION GRAPH	44
ELECTRONIC CRICKET	45
SAMPLE CALIBRATION GRAPH	45
ANALOG DATA LOGGER	46
V/F CONVERTER	47
F/V CONVERTER	47
DATA LOGGER OPERATION	48

INTRODUCTION

SCIENCE IS KNOWLEDGE GAINED BY ORGANIZED OBSERVATION, EXPERIMENTATION AND STUDY. AS YOU WILL SEE IN THE PAGES THAT FOLLOW, SCIENCE CAN ALSO BE FUN AND EXCITING.

THE PROJECTS THAT FOLLOW DEMONSTRATE BASIC SCIENTIFIC PRINCIPLES AND TECHNIQUES. SOME WILL LET YOU MEASURE TEMPERATURE, WIND SPEED, LIGHT AND POSITION. OTHERS WILL LET YOU DETECT RAIN, MOTION AND EARTH MOVEMENTS. YOU CAN LEARN MUCH BY TRYING ANY OF THE PROJECTS. YOU CAN LEARN EVEN MORE BY COMBINING PROJECTS AND MODIFYING THEM FOR OTHER PURPOSES. HERE ARE SOME SUGGESTIONS:

1. PLAN YOUR PROJECTS. DECIDE WHAT YOU WANT TO BUILD, MEASURE OR DETECT. SET GOALS AND ACCOMPLISH THEM.
2. KEEP A NOTEBOOK. RECORD YOUR CIRCUITS, MEASUREMENTS AND OBSERVATIONS. BE ACCURATE. SIGN AND DATE EVERY PAGE. (THIS SERIES OF BOOKS EVOLVED FROM THE AUTHOR'S LAB NOTEBOOKS.)
3. EXPERIMENT. FOR INSTANCE, SUBSTITUTE A LIGHT SENSOR FOR A THERMISTOR TO MEASURE LIGHT INSTEAD OF TEMPERATURE.
4. WANT TO KNOW MORE ABOUT A TOPIC? READ OTHER BOOKS IN THIS SERIES. VISIT A LIBRARY. READ ELECTRONICS MAGAZINES.

SPECIAL NOTE TO STUDENTS, PARENTS AND TEACHERS: MANY OF THE PROJECTS THAT FOLLOW CAN BE USED IN SCIENCE FAIR PROJECTS. FOR EXAMPLE, MEASURE BOTH TEMPERATURE AND SUNLIGHT ON CLEAR, PARTLY CLOUDY AND OVERCAST DAYS. GRAPH THE RESULTS. TEST THE INVERSE SQUARE LAW (PP. 18-19) WITH VARIOUS LIGHT SOURCES. GRAPH THE RESULTS.

ELECTROSCOPE

THE ELECTROSCOPE IS A SIMPLE DEVICE THAT WILL DETECT AN ELECTROSTATIC CHARGE AND THE PRESENCE OF NUCLEAR RADIATION. YOU CAN ASSEMBLE AN ELECTROSCOPE FROM COMMON HOUSEHOLD MATERIALS. FOR EXAMPLE:

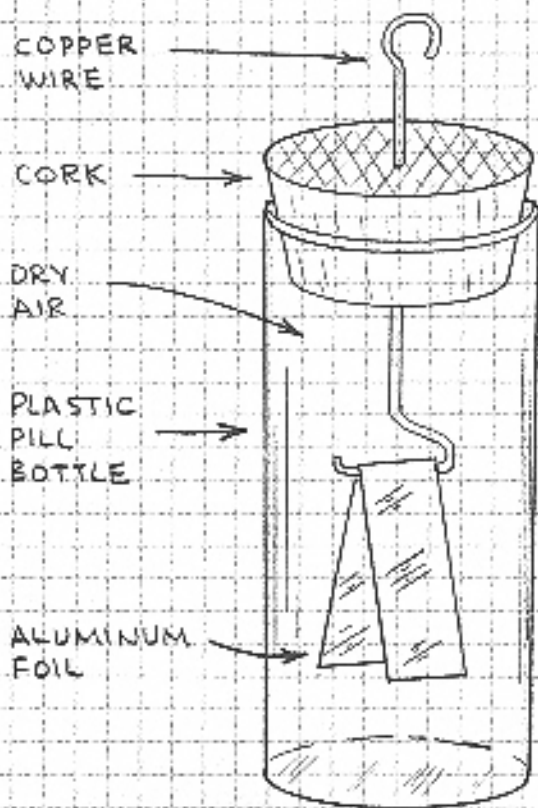

YOU CAN USE MANY DIFFERENT BOTTLES. THE BOTTLE MUST BE GLASS OR PLASTIC. THE STOPPER MUST BE CORK OR PLASTIC BUT NOT METAL. THE FOIL SHOULD BE THIN GAUGE ALUMINUM FOIL. THE AIR IN THE BOTTLE SHOULD BE AS DRY AS POSSIBLE.

PLASTIC OR RUBBER COMB

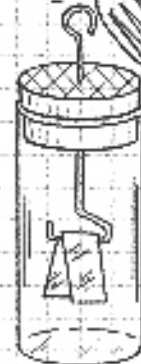

RUB COMB THROUGH DRY HAIR TO GIVE IT A NEGATIVE CHARGE.

NO CHARGE



MEDIUM CHARGE



HIGH CHARGE

FOR BEST RESULTS THE FOIL LEAVES OF THE ELECTROSCOPE SHOULD BE FLAT. CUT THE FOIL WITH SHARP SCISSORS TO AVOID FRAYED EDGES. IF THE LEAVES DO NOT FLY APART WHEN A CHARGED OBJECT IS TOUCHED TO THE ELECTRODE, CHECK TO SEE IF THE LEAVES ARE STUCK TOGETHER. WORKS BEST WHEN AIR IS DRY. RADIATION WILL IONIZE THE AIR AND CAUSE LEAVES TO COLLAPSE.

ELECTRONIC ELECTROSCOPE

NORMALLY LED GLOWS. RUB PLASTIC COMB OR PEN THROUGH DRY HAIR AND PLACE CHARGED COMB OR PEN NEAR ELECTRODE. LED WILL BE EXTINGUISHED.

Q1 - USE 2N3819 OR SIMILAR N-FET.

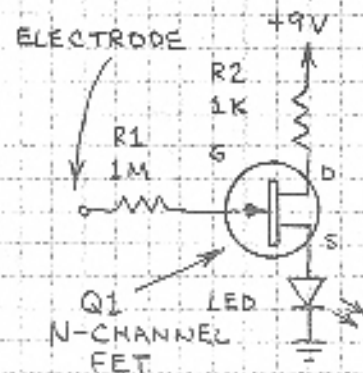

GALVANOMETER

THE GALVANOMETER MEASURES THE FLOW OF AN ELECTRICAL CURRENT. THE SIMPLEST GALVANOMETER IS MADE BY WRAPPING A WIRE COIL AROUND A COMPASS:

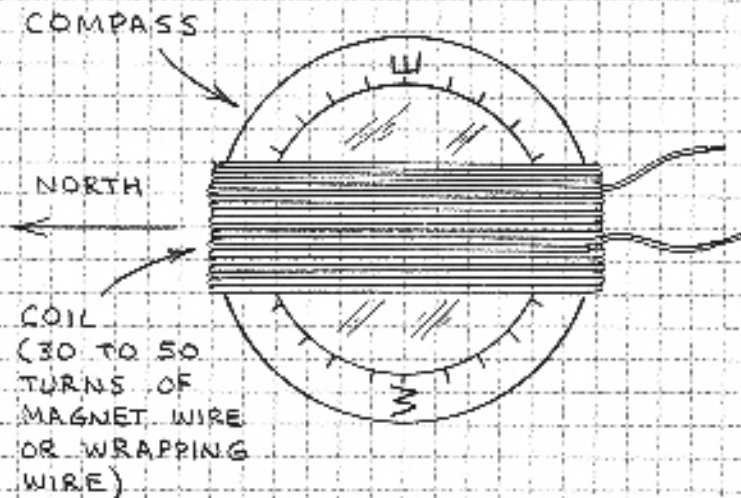

USE TAPE OR HOT MELT GLUE TO HOLD COIL IN PLACE. PLACE GALVANOMETER ON FLAT SURFACE. ALIGN SO THAT COIL AND COMPASS NEEDLE BOTH POINT NORTH. THEN TOUCH THE LEADS FROM THE COIL TO THE ENDS OF A 1.5 VOLT CELL. THE COMPASS NEEDLE WILL IMMEDIATELY SWING TO AN EAST-WEST ORIENTATION.

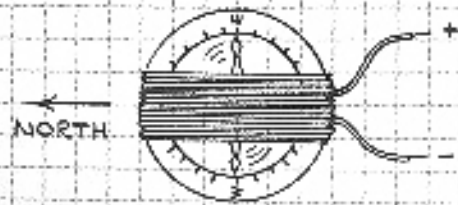

REVERSE POLARITY OF BATTERY TO REVERSE DIRECTION THE NEEDLE SWINGS. MOMENTARY USE WILL PREVENT EXCESS CURRENT DRAIN.

8

YOU CAN USE A COMPASS AND AN EXTERNAL COIL TO MAKE A GALVANOMETER.

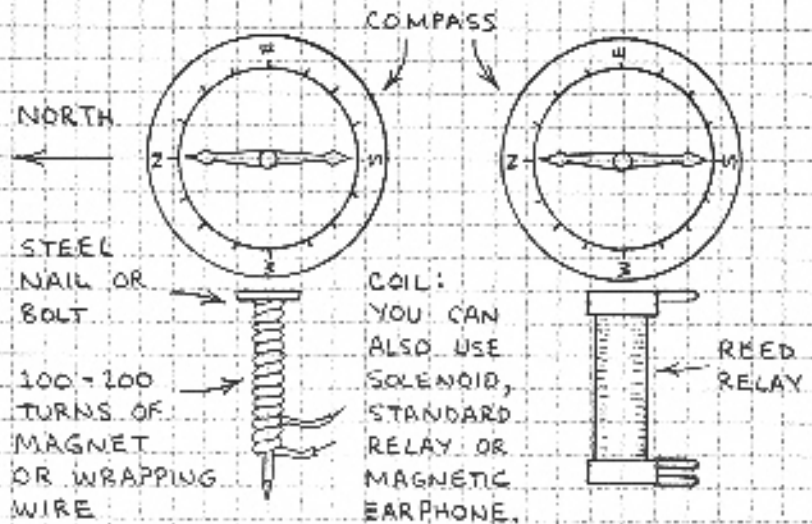

THE CIRCUIT BELOW WILL APPLY PULSES TO THE GALVANOMETER COIL THAT CAUSE THE COMPASS NEEDLE TO BOUNCE BACK AND FORTH LIKE A HORIZONTAL PENDULUM.

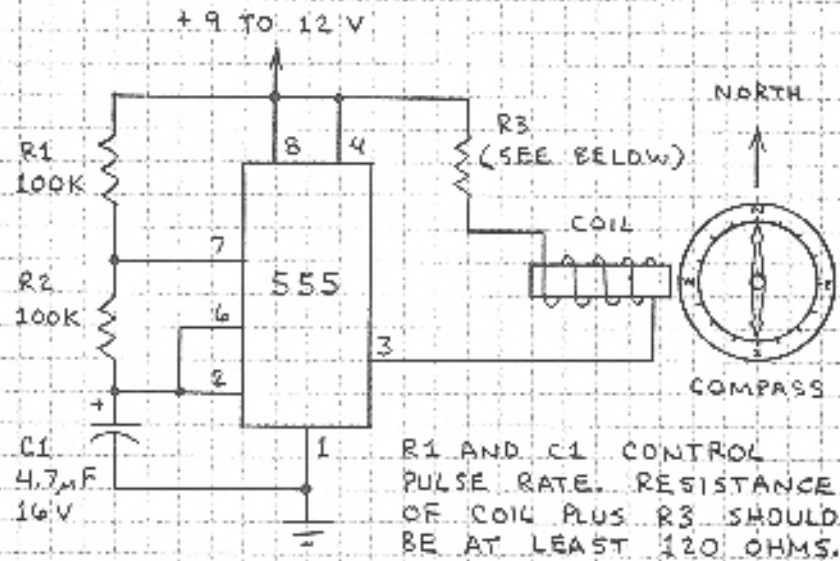

R1 AND C1 CONTROL PULSE RATE. RESISTANCE OF COIL PLUS R3 SHOULD BE AT LEAST 120 OHMS.

9

HOMEMADE BATTERIES

HOMEMADE POWER CELLS AND BATTERIES CAN BE USED TO OPERATE MANY KINDS OF LOW POWER CIRCUITS. A BASIC CELL INCLUDES THESE COMPONENTS:

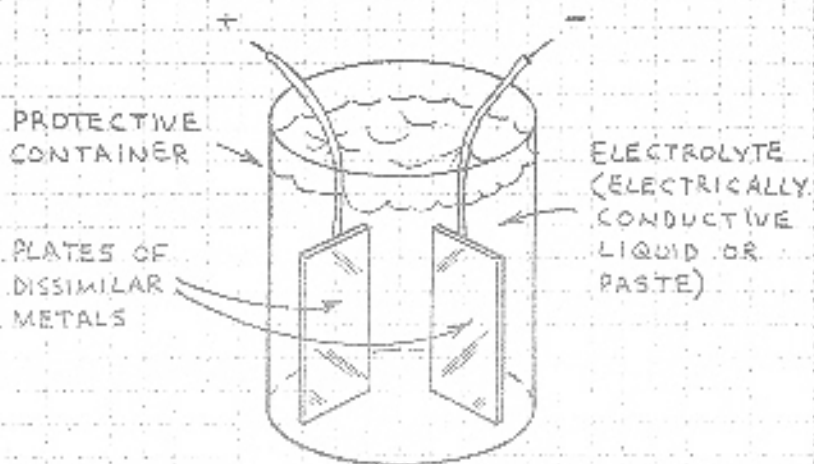

THERE ARE MANY WAYS TO MAKE PRACTICAL POWER CELLS. HERE IS AN EXAMPLE:

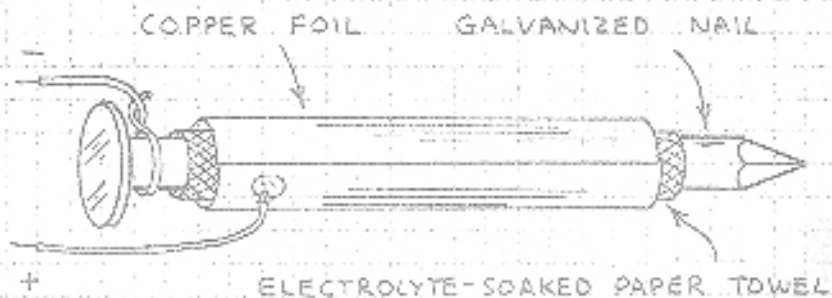

ELECTROLYTE CAN BE TABLE SALT DISSOLVED IN WATER OR POWDERED CITRIC DRINK (MUST CONTAIN CITRIC ACID) DISSOLVED IN WATER. DIP TOWEL IN SOLUTION AND ALLOW TO DRY. ACTIVATE CELL WITH WATER. CLEAN AND REUSE ELECTRODES WHEN CELL STOPS WORKING.

VOLTAGES MEASURED WITH VARIOUS ELECTRODE METALS AND ELECTROLYTES:

ELECTRODES		ELECTROLYTE	
		SALT	ACID*
1.	COPPER (+) ZINC (-)	0.759	1.000
2.	COPPER (-) SILVER (+)	0.200	0.131
3.	COPPER (+) MAGNESIUM (-)	1.400	1.484
4.	COPPER (+) ALUMINUM (-)	0.570	0.720
5.	ZINC (-) SILVER (+)	0.720	0.820
6.	ZINC (+) MAGNESIUM (-)	0.622	0.546
7.	ZINC (-) ALUMINUM (+)	0.248	0.350
8.	ALUMINUM (+) MAGNESIUM (-)	0.778	0.820
9.	ALUMINUM (-) SILVER (+)	0.395	0.450
10.	SILVER (+) MAGNESIUM (-)	1.242	1.231

* POWDERED CITRIC DRINK IN WATER.

WHERE TO FIND ELECTRODE MATERIALS:

COPPER - COPPER FOIL FROM A HOBBY SHOP OR COPPER LAMINATED CIRCUIT BOARD.

ZINC - GALVANIZED METAL AND NAILS FROM A HARDWARE STORE.

ALUMINUM - HOUSEHOLD ALUMINUM FOIL OR THIN SHEET ALUMINUM FROM A HOBBY SHOP.

SILVER - SILVER COIN OR THIN SILVER SHEET FROM JEWELRY SUPPLY STORE.

MAGNESIUM - THIN MAGNESIUM RIBBON FROM CHEMICAL SUPPLY COMPANY OR HOBBY SHOP.

THE VOLTAGES GIVEN IN THE TABLE ABOVE WERE MEASURED WITH A DIGITAL VOLTMETER. IN MOST CASES THE VOLTAGE BEGAN TO DECLINE ALMOST IMMEDIATELY. IN SOME CASES THE VOLTAGE INCREASED TO TWICE ITS INITIAL VALUE AFTER 20 SECONDS OR SO. PEAK VALUES ARE GIVEN IN EACH CASE.

GRAPHITE RESISTOR

RESISTORS RESIST THE FLOW OF ELECTRICAL CURRENT. YOU CAN MAKE A RESISTOR BY STROKING A GRAPHITE PENCIL ON PAPER.

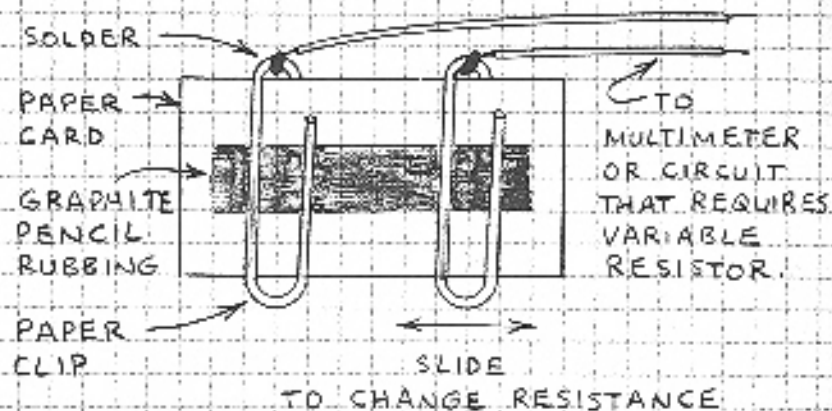

LIQUID RESISTOR

HERE'S HOW TO MAKE A RESISTOR FROM A CONDUCTIVE LIQUID (ELECTROLYTE):

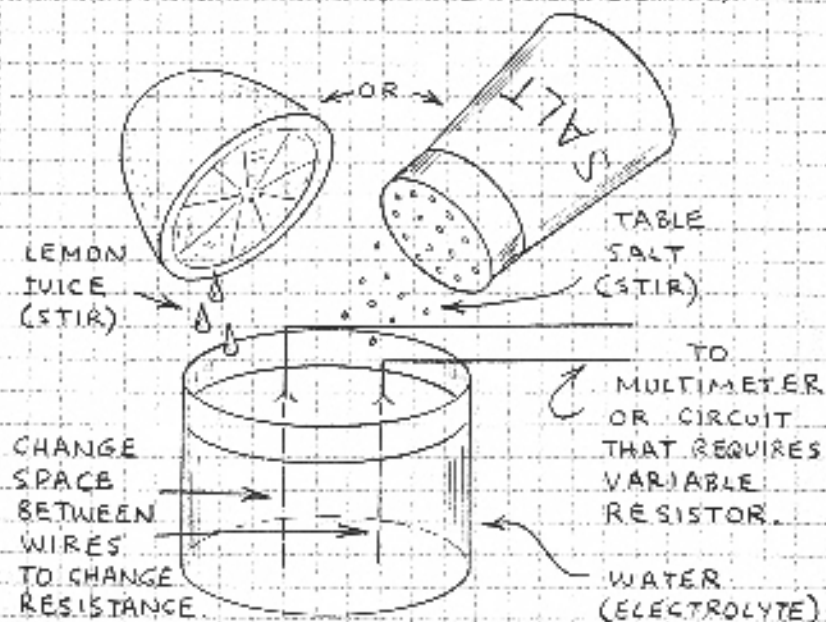

SUPER CAPACITOR

SUPER CAPACITORS STORE CONSIDERABLY MORE ENERGY THAN ORDINARY CAPACITORS. HERE'S HOW TO MAKE ONE:

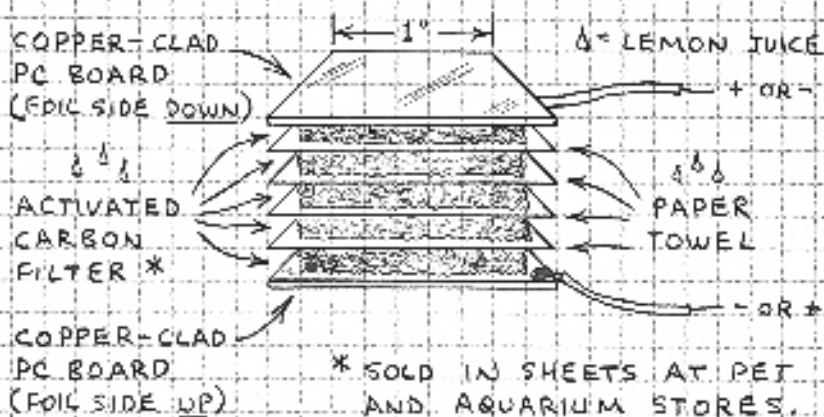

USE RUBBER BAND TO HOLD CAPACITOR TOGETHER. THEN SOAK CARBON FILTER AND PAPER TOWEL LAYERS IN LEMON JUICE (ELECTROLYTE). INCREASE AREA FOR MORE CAPACITY. ADD LAYERS TO INCREASE VOLTAGE (1.2 VOLTS PER LAYER). DO NOT APPLY MORE THAN 1.2 VOLTS PER LAYER OR THE ELECTROLYTE WILL DECOMPOSE.

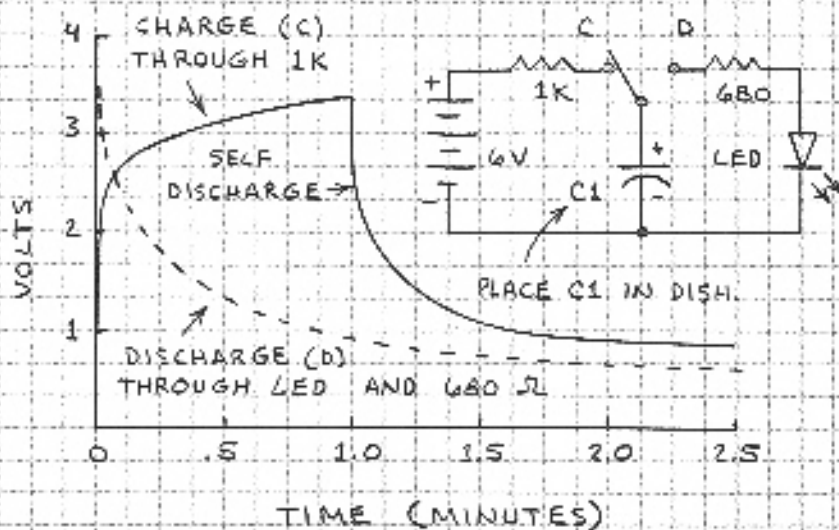

THERMOCOUPLE

A THERMOCOUPLE IS MADE BY CONNECTING A WIRE OF ONE METAL BETWEEN TWO WIRES OF A SECOND METAL. IF ONE OF THE TWO CONNECTIONS OR JUNCTIONS IS MADE WARMER THAN THE OTHER, THEN THE THERMOCOUPLE WILL GENERATE A SMALL VOLTAGE. SOME METALS AND ALLOYS WORK MUCH BETTER THAN OTHERS IN THERMOCOUPLES. YOU CAN MAKE A SIMPLE THERMOCOUPLE FROM A PAPER CLIP AND SOME COPPER WIRE:

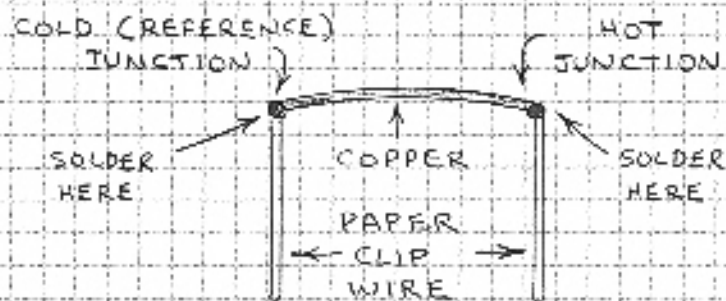

CONNECT THIS SIMPLE THERMOCOUPLE TO A DIGITAL MULTIMETER. IT WILL GENERATE UP TO A MILLIVOLT OR SO (0.001 VOLT) WHEN THE HOT JUNCTION IS HEATED BY A MATCH.

A THERMOPILE IS A SERIES OF MANY THERMOCOUPLES THAT GENERATES MORE VOLTAGE THAN A SINGLE THERMOCOUPLE:



THE JUNCTIONS CAN BE ARRANGED IN A STAR SHAPE WITH HOT JUNCTIONS IN CENTER.

THERMOCOUPLE AMPLIFIER

AN OPERATIONAL AMPLIFIER WILL AMPLIFY THE TINY VOLTAGE GENERATED BY A THERMOCOUPLE.

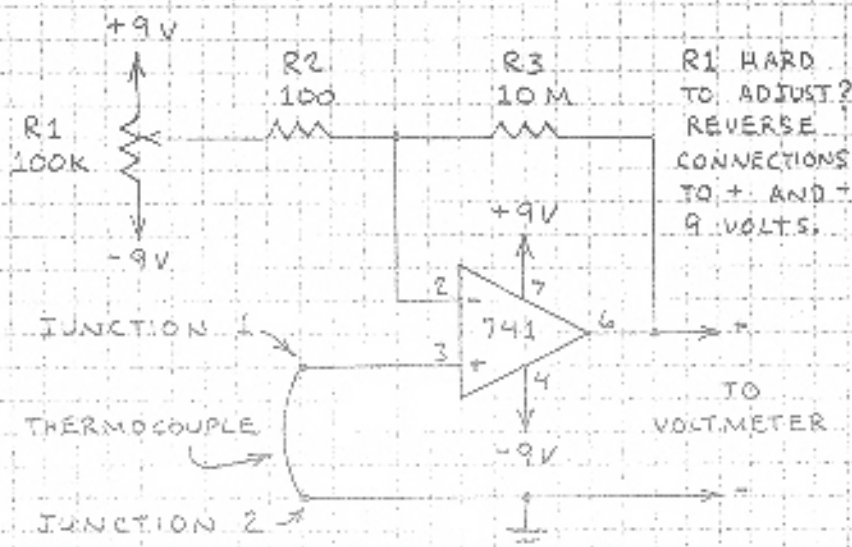

R1 CONTROLS OFFSET VOLTAGE.

THE OUTPUT VOLTAGE FALLS WHEN JUNCTION 1 IS WARMER THAN JUNCTION 2. THE OUTPUT VOLTAGE RISES WHEN JUNCTION 2 IS WARMER THAN JUNCTION 1. FOR BEST RESULTS, USE ANALOG VOLTMETER FIRST. SET R1 FOR OUTPUT OF A FEW TENTHS OF A VOLT. THIS WILL LET YOU WATCH OUTPUT VOLTAGE SWING BACK AND FORTH, DEPENDING ON WHICH JUNCTION IS WARM. AFTER YOU LEARN TO ADJUST R1 (BE PATIENT) YOU CAN USE A DIGITAL VOLTMETER. NOTE THAT THE RISING OR FALLING VOLTAGE CAUSED BY HEATING ONE OF THE JUNCTIONS WILL SUDDENLY STOP AND BEGIN MOVING IN THE OPPOSITE DIRECTION. THIS HAPPENS WHEN THE HEAT IS CONDUCTED TO THE COOL JUNCTION.

SMALL D.C. MOTOR CIRCUITS

USE THESE SIMPLE CIRCUITS TO CONTROL DIRECTION OF ROTATION AND SPEED OF SMALL, LOW-POWER D.C. MOTORS.

MOTOR REVERSERS

S1: DPDT SWITCH
+3 TO 6V

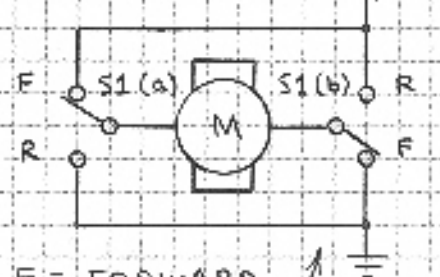

F = FORWARD
R = REVERSE

THESE CIRCUITS CONTROL DIRECTION OF ROTATION OF A MOTOR MANUALLY OR WITH A LOGIC SIGNAL.

IMPORTANT:
MOTOR MUST NOT EXCEED POWER RATING OF POWER MOSFETS.

LOW = FORWARD
HIGH = REVERSE

Q1-Q4: IRF-511 OR SIMILAR POWER MOSFET.

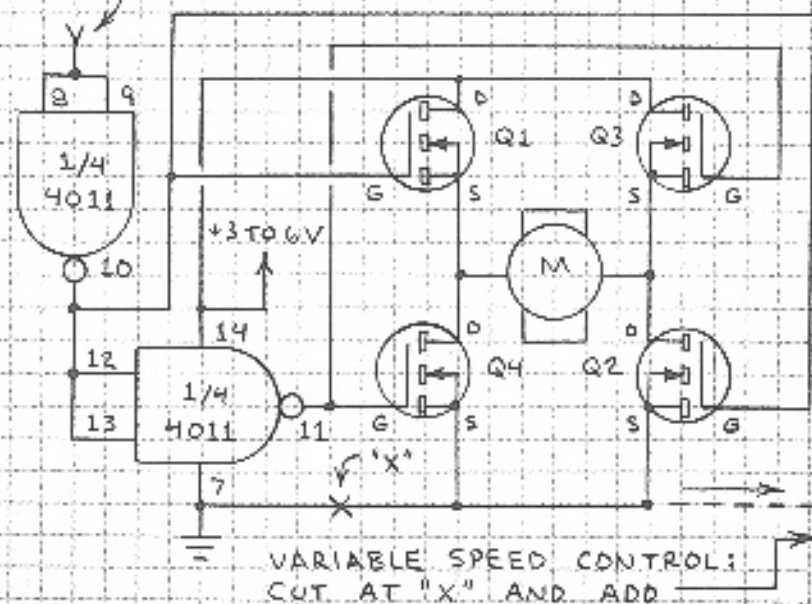

VARIABLE SPEED CONTROL:
CUT AT "X" AND ADD

MOTOR SPEED CONTROLLERS

R1 470 +6V
R2 CONTROLS SPEED OF MOTOR.

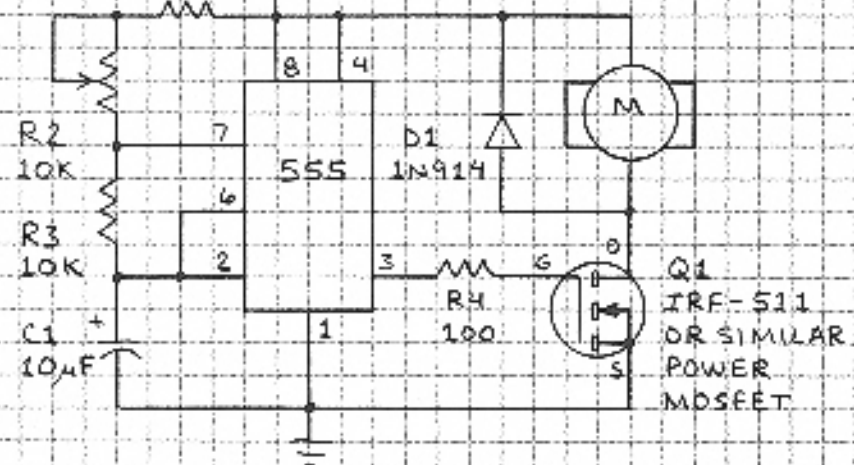

555 AND Q1 DELIVER STREAM OF PULSES TO MOTOR. INCREASING THE PULSE RATE INCREASES THE SPEED OF ROTATION. D1 PROTECTS 555 FROM MOTOR-GENERATED VOLTAGE SPIKES.

LOW = MOTOR OFF
HIGH = MOTOR ON

Q1 - IRF-511
OR SIMILAR
POWER MOSFET

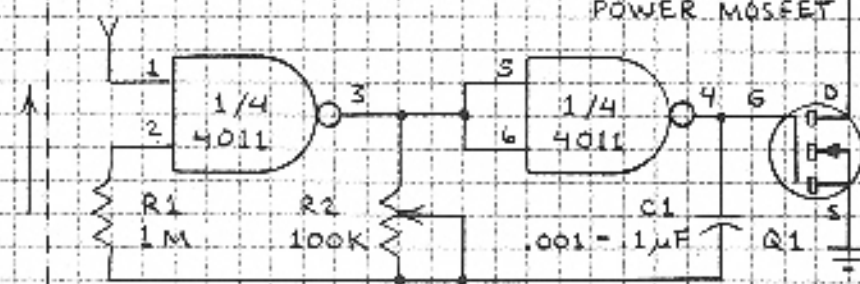

THIS CIRCUIT USES UNUSED 4011 GATES FROM CIRCUIT ON FACING PAGE TO GIVE VARIABLE SPEED AND DIRECTIONAL CONTROL TO MOTOR. R2 CONTROLS MOTOR'S SPEED. IF MOTOR FAILS TO TURN, READJUST R2.

INVERSE SQUARE LAW

SOUND WAVES SPREAD OUTWARD AS THEY TRAVEL AWAY FROM THEIR SOURCE. SO DO ELECTROMAGNETIC WAVES SUCH AS LIGHT AND RADIO WAVES. THE INTENSITY OR STRENGTH OF SUCH WAVES IS INVERSELY PROPORTIONAL TO THE SQUARE OF THE DISTANCE OF THE WAVE FROM ITS SOURCE. IN OTHER WORDS, IF THE DISTANCE IS 3, THEN THE INTENSITY IS $1/9$ THE INTENSITY WHEN THE DISTANCE IS 1.

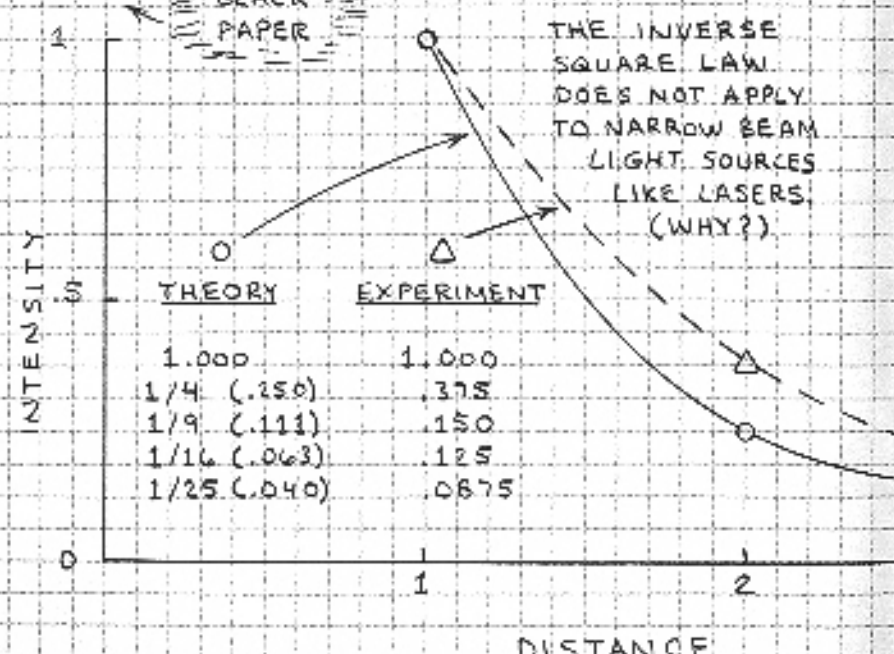
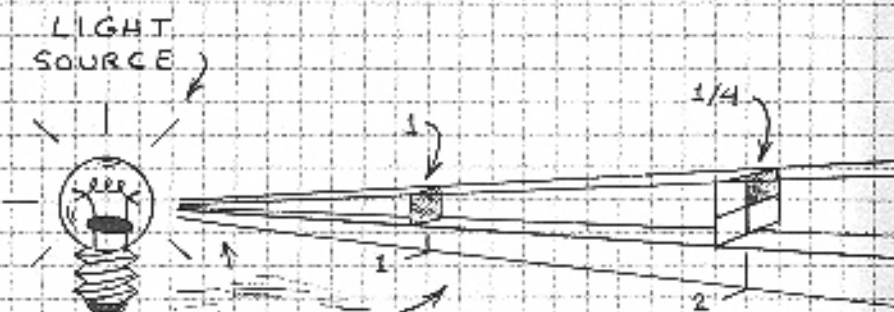

THE INVERSE SQUARE LAW DOES NOT APPLY TO NARROW BEAM LIGHT SOURCES LIKE LASERS. (WHY?)

YOU CAN TEST THE INVERSE SQUARE LAW WITH THE HELP OF A SILICON SOLAR CELL AND A STANDARD MULTIMETER SET TO MEASURE CURRENT.

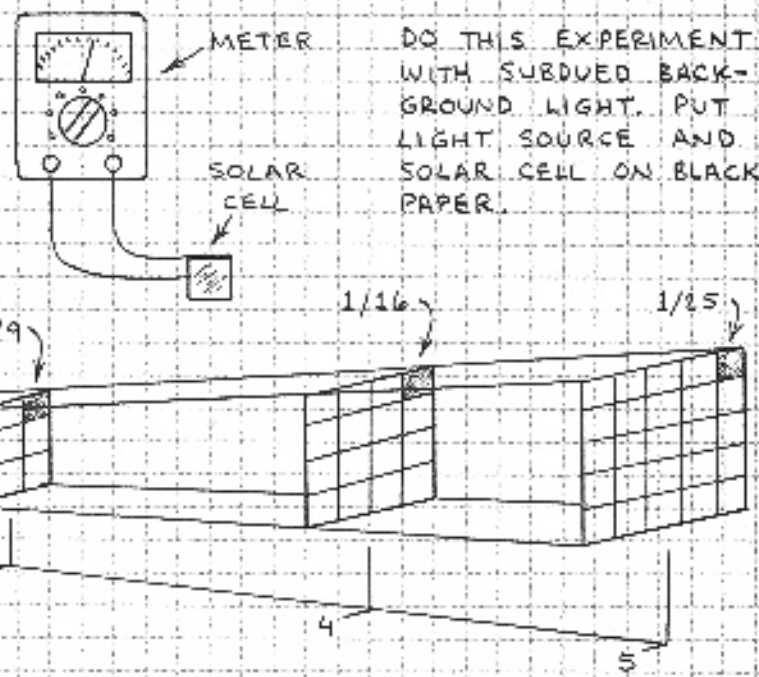

DO THIS EXPERIMENT WITH SUBDUED BACKGROUND LIGHT. PUT LIGHT SOURCE AND SOLAR CELL ON BLACK PAPER.

WHY DOES THE EXPERIMENTAL CURVE DIFFER SOMEWHAT FROM THE THEORETICAL CURVE? THE INVERSE SQUARE LAW ASSUMES THAT THE LIGHT SOURCE EMITS UNIFORMLY IN ALL DIRECTIONS. REAL LIGHT SOURCES DO NOT NECESSARILY OBEY THIS ASSUMPTION. FOR BEST RESULTS, THE DISTANCE TO THE FIRST MEASUREMENT POINT SHOULD BE AT LEAST 10 TO 20 TIMES THE SIZE OF THE SOURCE.

LIGHT LISTENER

THE HUMAN EYE HAS A PERSISTANCE OF VISION OF ABOUT 0.02 SECOND. THEREFORE A LIGHT THAT FLASHES ON AND OFF MORE THAN ABOUT 50 H_z APPEARS CONTINUOUSLY ON. THE HUMAN EAR IS MUCH FASTER AND CAN RESPOND TO SOUND WITH A FREQUENCY UP TO ABOUT 20,000 H_z. THE LIGHT LISTENER TRANSFORMS THE PULSATING AND FLICKERING OF LIGHT THAT THE EYE CANNOT DISCERN INTO SOUNDS THE EAR CAN EASILY HEAR.

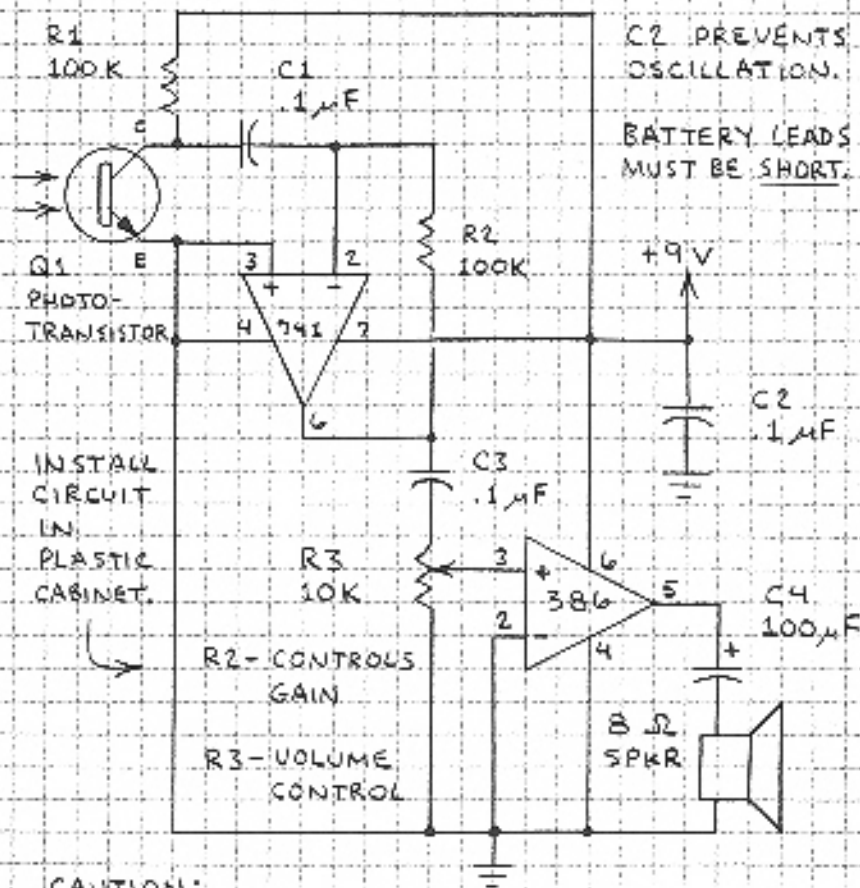

CAUTION:
THIS CIRCUIT CAN PRODUCE LOUD SOUNDS. DO NOT PLACE SPEAKER CLOSE TO YOUR EARS!

TEST THE LIGHT LISTENER BY POINTING Q1 TOWARD AN ARTIFICIAL LIGHT SOURCE. A LINE-POWERED INCANDESCENT LAMP WILL PRODUCE A HUMMING SOUND. A FLUORESCENT LAMP WILL PRODUCE A LOUD BUZZ. AN INFRARED TV REMOTE CONTROL UNIT WILL PRODUCE A PULSING TONE. A CAMERA FLASH UNIT WILL PRODUCE A POP.

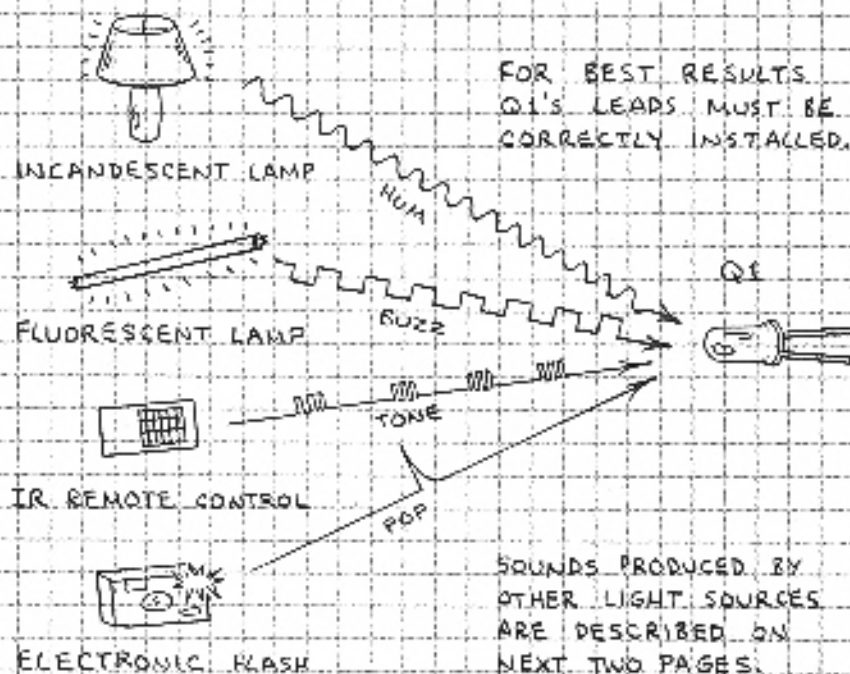

PHOTOTRANSISTOR Q1 CAN BE REPLACED BY A SOLAR CELL. CONNECT CELL'S PLUS (+) LEAD TO C1 AND MINUS (-) LEAD TO GROUND (⊥). OMIT R1.

'INSTANT' LIGHT LISTENER - CONNECT SOLAR CELL TO MICROPHONE INPUT OF BATTERY POWERED AUDIO AMPLIFIER.

USE MAGNIFYING LENS TO INCREASE LIGHT LISTENER'S DETECTION RANGE.

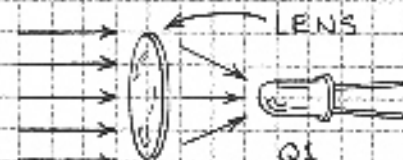

LISTENING TO NATURAL LIGHT

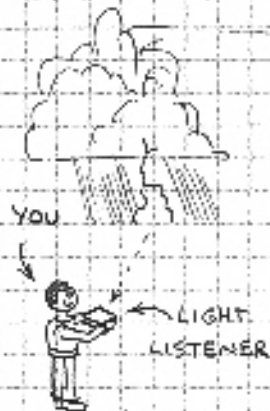

LIGHTNING FLASHES PRODUCE SHARP CLICKS AND POPS. WORKS BEST AT NIGHT. SYSTEM WILL DETECT SOME LIGHTNING MISSED BY EYE. CAUTION! DETECT LIGHTNING WHILE INDOORS OR IN CAR! DISTANCE IN FEET TO LIGHTNING IS 1000 TIMES SECONDS BETWEEN FLASH AND THUNDER.

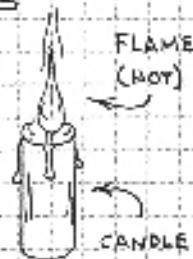

FLAMES PRODUCE VARIOUS SOUNDS. WHEN THE AIR IS STILL, A SOFT RUSHING SOUND IS HEARD. WHEN THE FLAME IS DISTURBED BY MOVING AIR, CRACKLES AND POPS ARE HEARD.

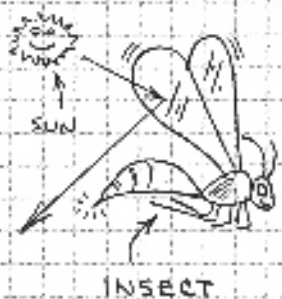

POINT THE LIGHT LISTENER'S DETECTOR AT INSECTS FLYING IN SUNLIGHT. WHEN THEIR WINGS REFLECT LIGHT TO THE DETECTOR, A BUZZ OR HUM WILL BE HEARD. AT DUSK A NEARBY FIREFLY WILL PRODUCE A SOFT CLICK FOR EACH FLASH.

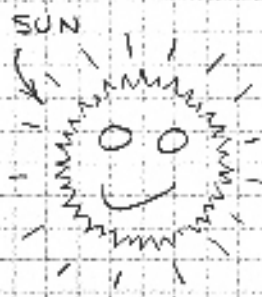

WALK OUTDOORS ON ANY SUNNY DAY. SUNLIGHT FILTERING THROUGH LEAVES PRODUCES VARIOUS SOUNDS. SO DO REFLECTIONS FROM WINDOWS. SUNLIGHT THROUGH A PICKET FENCE PRODUCES A "POP...POP...POP..."

LISTENING TO ARTIFICIAL LIGHT

SWEEP THE BEAM FROM A FLASHLIGHT ACROSS THE LIGHT LISTENER'S DETECTOR. SLOW SWEEPS PRODUCE A SOFT SWISHING SOUND. FAST SWEEPS GIVE POPS. TAP THE FLASHLIGHT WITH A PENCIL AND A RINGING SOUND WILL BE HEARD AS THE FILAMENT VIBRATES.

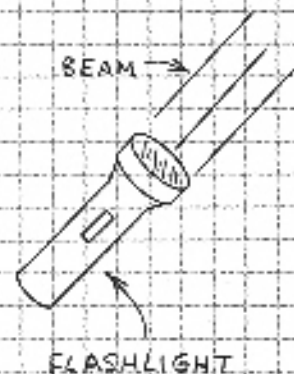

THE HEADLIGHTS OF CARS, TRUCKS AND MOTORCYCLES WILL PRODUCE A DISTINCTIVE RINGING SOUND WHEN THE VEHICLE IS MOVING ON A ROUGH OR BUMPY ROAD.

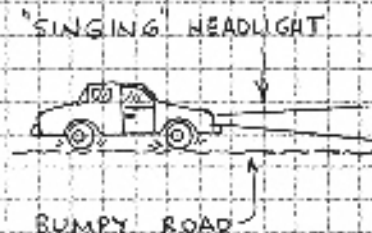

ELECTRONIC DISPLAYS ARE USUALLY POWERED BY RAPID PULSES OF CURRENT. THE FLASHES ARE MERGED INTO CONTINUOUS LIGHT BY THE SLOW RESPONSE OF THE EYE. BUT THEY CAN BE HEARD AS A BUZZ OR HUM WITH A LIGHT LISTENER.

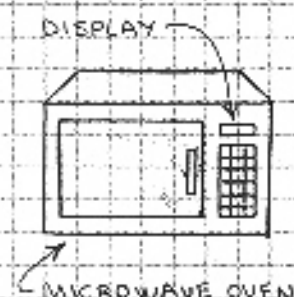

THE DISPLAYS OF TELEVISION SETS AND COMPUTER MONITORS ARE FORMED BY SWEEPING AN ELECTRON BEAM ACROSS A PHOSPHOR COATED SCREEN. THE LIGHT LISTENER TRANSFORMS THE PULSATING PHOSPHOR TO A BUZZ.



MONITORING SUNLIGHT

MUCH CAN BE LEARNED ABOUT THE EARTH'S ATMOSPHERE BY MONITORING SUNLIGHT.

THE SOLAR SPECTRUM

CERTAIN GASES ABSORB SPECIFIC WAVELENGTHS OF SUNLIGHT.

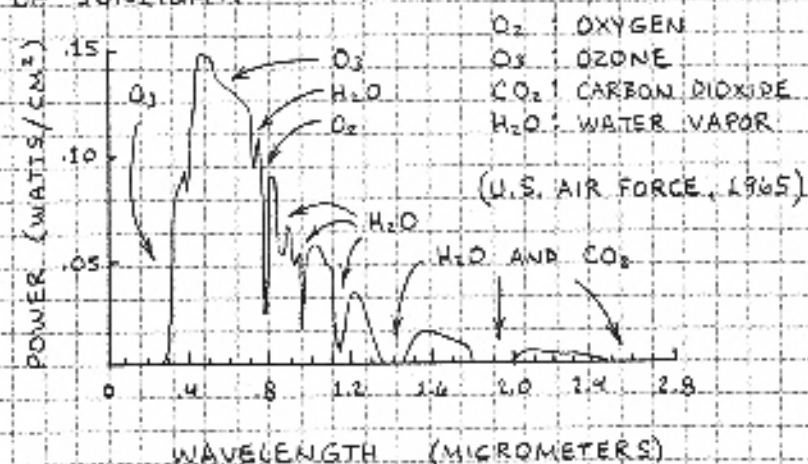

THE SOLAR DAY

THE SOLAR POWER AT THE EARTH'S SURFACE IS INFLUENCED BY THE ATMOSPHERE (CLOUDS, DUST, SMOG, ETC.) AND THE SUN'S ANGLE (TIME OF DAY AND SEASON). HERE'S THE SOLAR POWER FOR A CLEAR SUMMER DAY IN CENTRAL TEXAS:

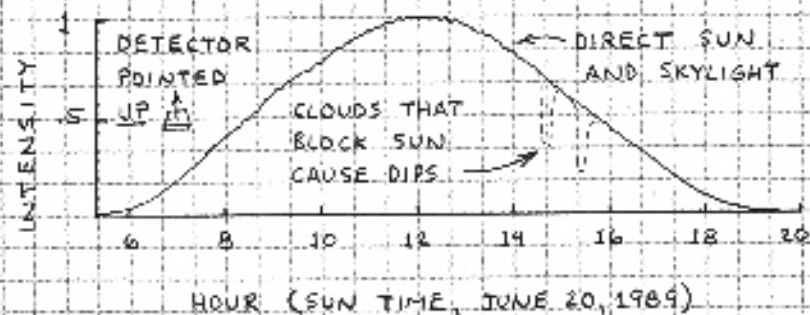

SIMPLE SOLAR POWER METER

YOU CAN MAKE A SOLAR POWER METER WITH A SOLAR CELL AND A MULTIMETER SET TO READ CURRENT. THE CURRENT FROM THE CELL WILL REPRESENT THE SUNLIGHT'S INTENSITY OVER THE SOLAR CELL'S SPECTRAL RESPONSE. USE DIGITAL MULTIMETER FOR ACCURATE READINGS.

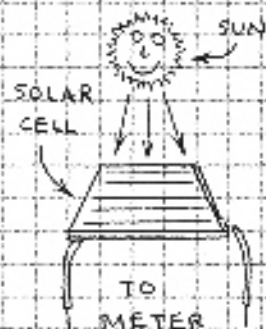

OP AMP SOLAR POWER METER

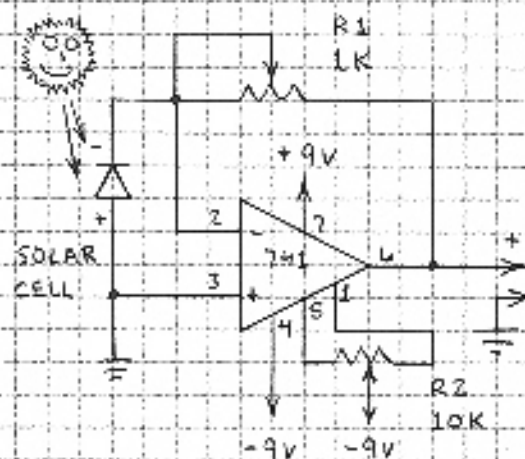

SET R1 TO GIVE OUTPUT OF 2 TO 5 VOLTS AT NOON ON SUNNY DAY.

TO DIGITAL MULTIMETER SET TO READ VOLTAGE.

SET R2 TO GIVE 0 VOLTS OUT WHEN SOLAR CELL DARK.

SOLAR MONITORING EXPERIMENTS

1. RECORD SOLAR POWER EVERY HALF HOUR FOR A DAY. MAKE A GRAPH OF YOUR MEASUREMENTS.
2. STUDY EFFECT OF VARIOUS CLOUDS ON SUNLIGHT.
3. STUDY EFFECT OF SMOG ON SUNLIGHT.
4. RECORD SUNLIGHT AT NOON EACH DAY FOR A YEAR. GRAPH YOUR MEASUREMENTS.

ELECTROMAGNETIC PROBE

ELECTRONIC CIRCUITS THAT OSCILLATE OR SWITCH CURRENT CREATE ELECTROMAGNETIC FIELDS. THIS CIRCUIT CHANGES A PULSING OR OSCILLATING ELECTROMAGNETIC FIELD INTO SOUND.

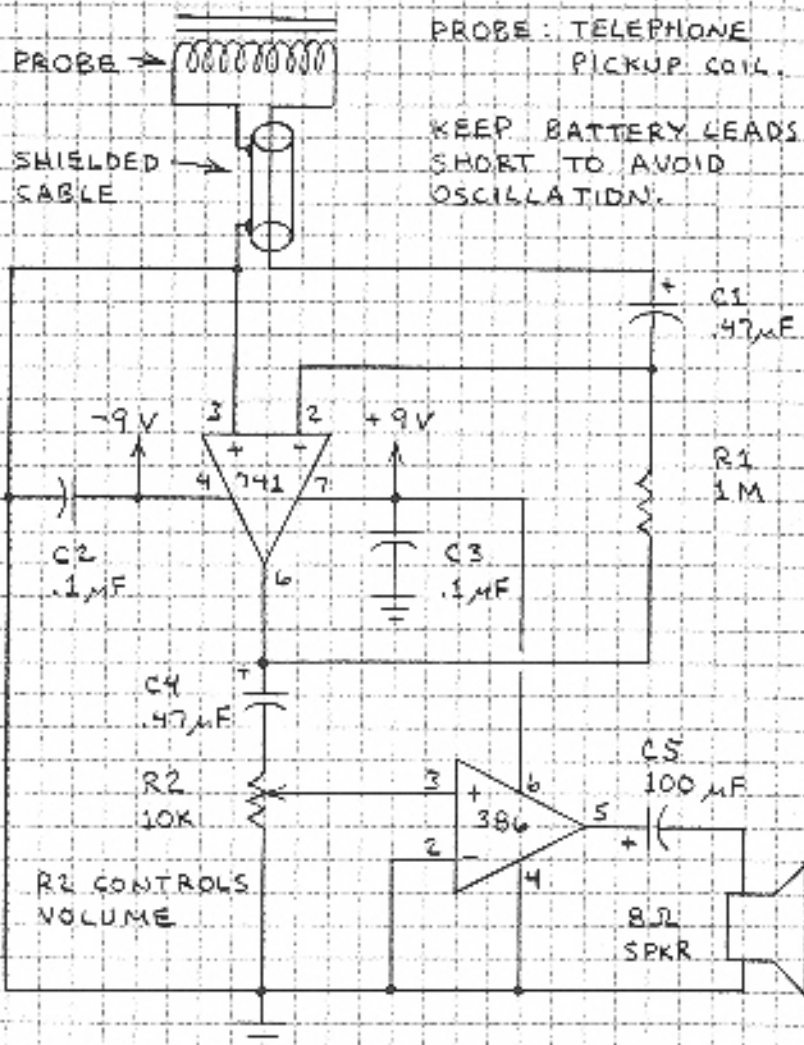

CAUTION: THIS CIRCUIT CAN PRODUCE VERY LOUD SOUNDS. DO NOT USE EARPHONE OR PLACE SPEAKER CLOSE TO YOUR EARS!

USING THE PROBE



HANDSET

TEST THE PROBE BY PLACING PICKUP COIL NEAR RECEIVER OF TELEPHONE HANDSET. YOU SHOULD HEAR A DIAL TONE WHEN HANDSET IS 'OFF THE HOOK.'

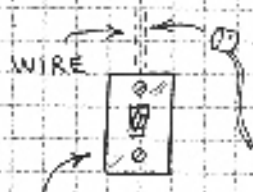

WIRE

LIGHT SWITCH

USE PROBE TO FIND WIRES CARRYING ALTERNATING CURRENT. YOU CAN FIND WIRES INSIDE WALLS WHEN CURRENT IS FLOWING. TURN SWITCH ON AND HEAR A 'POP.'



MAGNET

RUB MAGNET AGAINST PICKUP COIL. YOU WILL HEAR RUSHING SOUNDS. IF AMPLIFIER SQUEALS, REDUCE VOLUME (R2). YOU CAN ALSO REDUCE GAIN OF 741 BY REDUCING RESISTANCE OF R1.



NEARBY LIGHTNING FLASHES WILL PRODUCE CRACKLES AND POPS. SPARKS AT BRUSHES OF DIRECT CURRENT MOTORS WILL PRODUCE A BUZZ OR WHINE.



MANY ELECTRONIC APPLIANCES GENERATE ELECTROMAGNETIC FIELDS. TRY PLACING THE PICKUP COIL NEAR COMPUTERS, RADIOS, TELEVISION SETS, FLUORESCENT LIGHTS, RADIO CONTROL TRANSMITTERS, AND INFRARED REMOTE CONTROLLERS.

WIND SPEED INDICATOR

A SMALL D.C. MOTOR WILL GENERATE A VOLTAGE WHEN ITS ARMATURE IS SPUN. THIS PRINCIPLE CAN BE USED TO MAKE A SIMPLE WIND SPEED INDICATOR. THE MOST DIFFICULT ASPECT OF MAKING SUCH AN INSTRUMENT IS MOUNTING AIR COLLECTION CUPS TO THE MOTOR'S SHAFT. THE BEST METHOD IS TO WELD THE CUP HOLDER TO THE SHAFT. HERE IS ONE WAY TO ATTACH AIR CUPS TO A MOTOR FOR TEMPORARY USE:

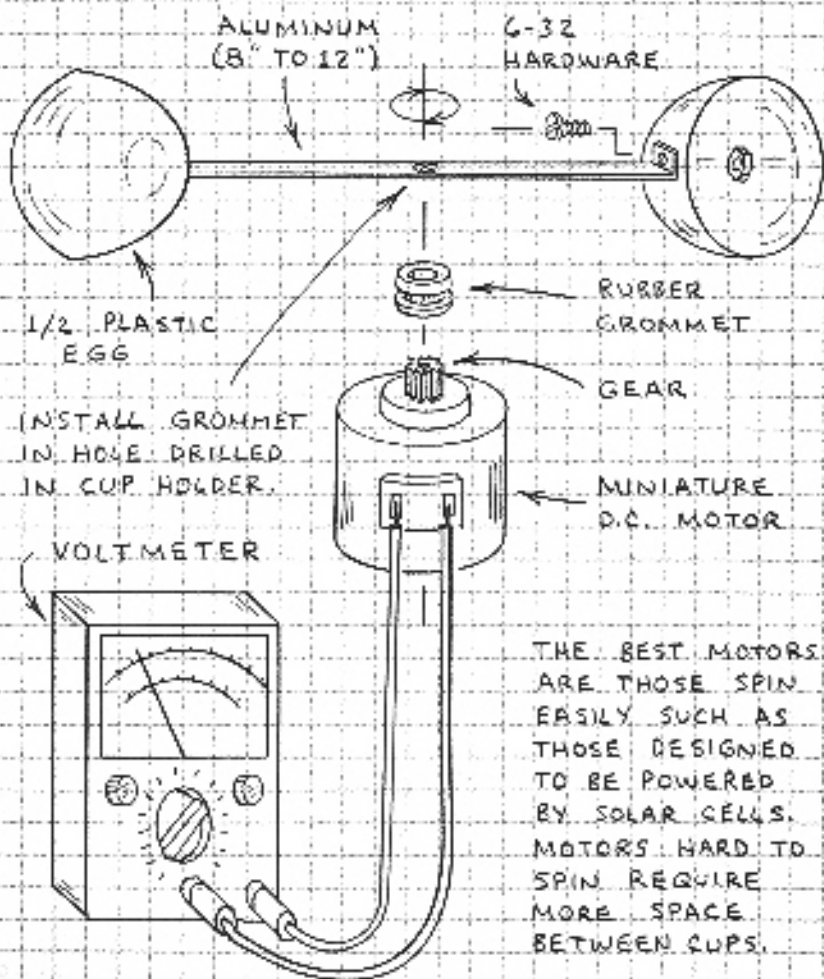

CALIBRATE THE WIND SPEED INDICATOR WITH A COMMERCIAL ANEMOMETER OR HAVE A FRIEND DRIVE YOU DOWN A COUNTRY ROAD WHILE YOU HOLD THE MAST-MOUNTED UNIT (SEE BELOW) OUT A PASSENGER-SIDE WINDOW. RECORD THE MOTOR'S VOLTAGE AT VARIOUS SPEEDS AND MAKE A CALIBRATION GRAPH LIKE THIS:

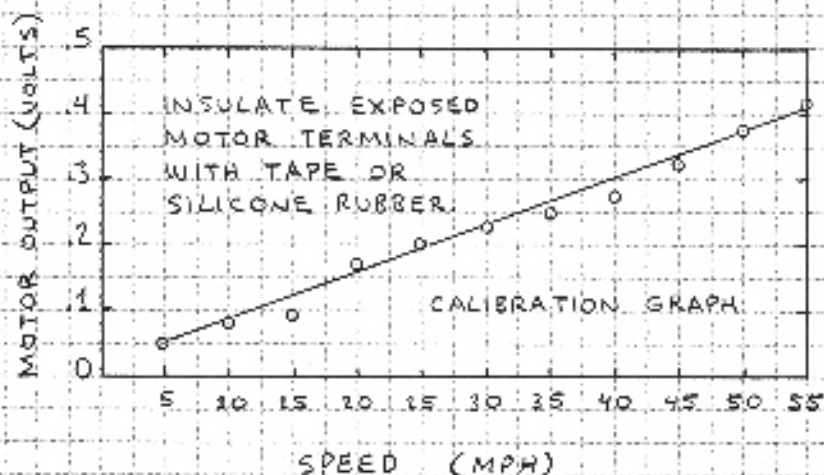

MAST INSTALLATION

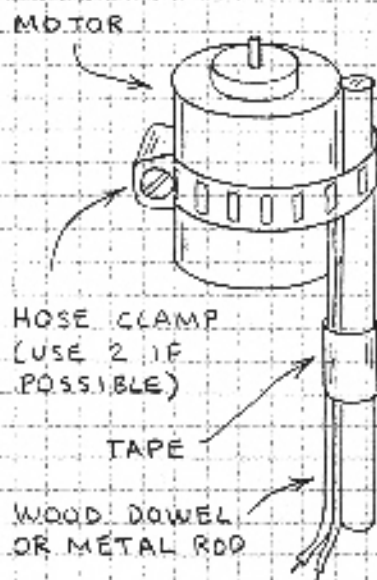

CAUTION!

1. NEVER HOLD THE UNIT AT EYE LEVEL WHEN THE CUPS ARE SPINNING!
2. DO NOT INSTALL THE UNIT NEAR A POWER LINE!
3. USE GREAT CARE WHEN CALIBRATING THE UNIT FROM A MOVING CAR!

RAIN SENSORS

RAIN DROPS CONDUCT ELECTRICITY. THIS MEANS THAT A SIMPLE RAIN DETECTOR CAN BE MADE FROM TWO CLOSELY SPACED ELECTRODES. THE CHANCE OF DETECTING A SINGLE RAIN DROP ARE INCREASED BY INCREASING THE AREA OF THE ELECTRODES. HERE ARE SEVERAL WAYS TO MAKE RAIN SENSORS:

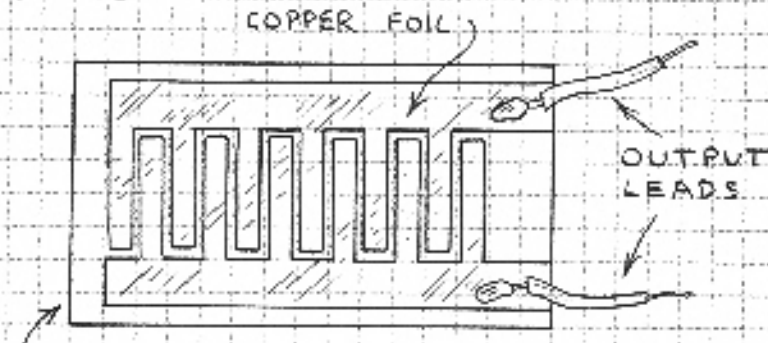

USE TAPE OR INK RESIST TO MAKE ELECTRODE PATTERN, THEN ETCH. REMOVE RESIST.

NOTE: COPPER MUST BE SHINY BRIGHT BEFORE SOLDERING!

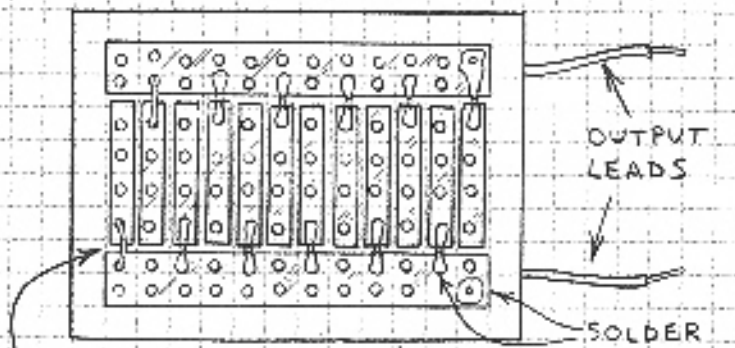

INSERT WIRES BETWEEN ALTERNATING ELECTRODES AND SOLDER IN PLACE.

RADIO SHACK PRE-ETCHED CIRCUIT BOARD SEGMENT.

RAIN-ACTIVATED ALARM

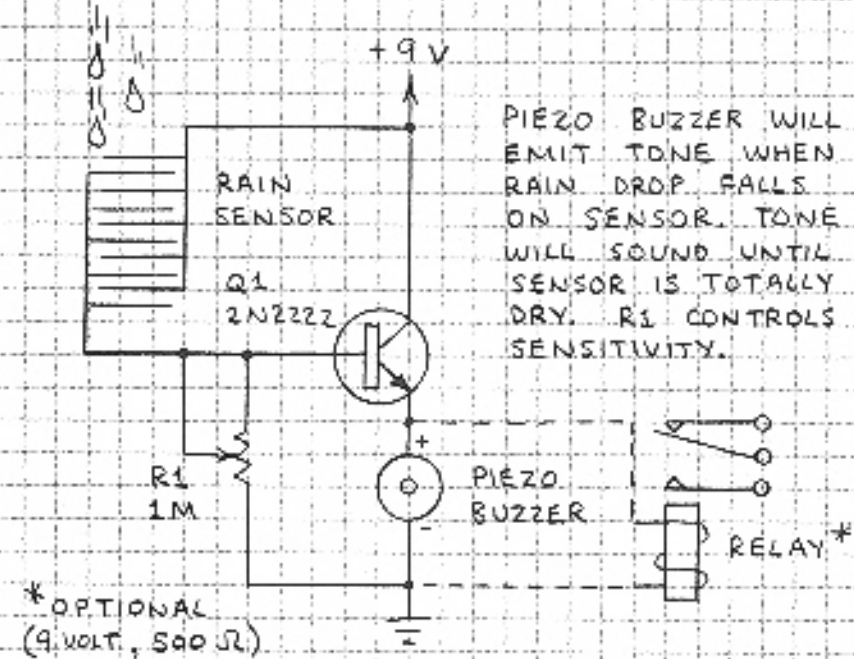

* OPTIONAL (9 VOLT, 500 Ω)

RAIN-ACTIVATED LOGIC

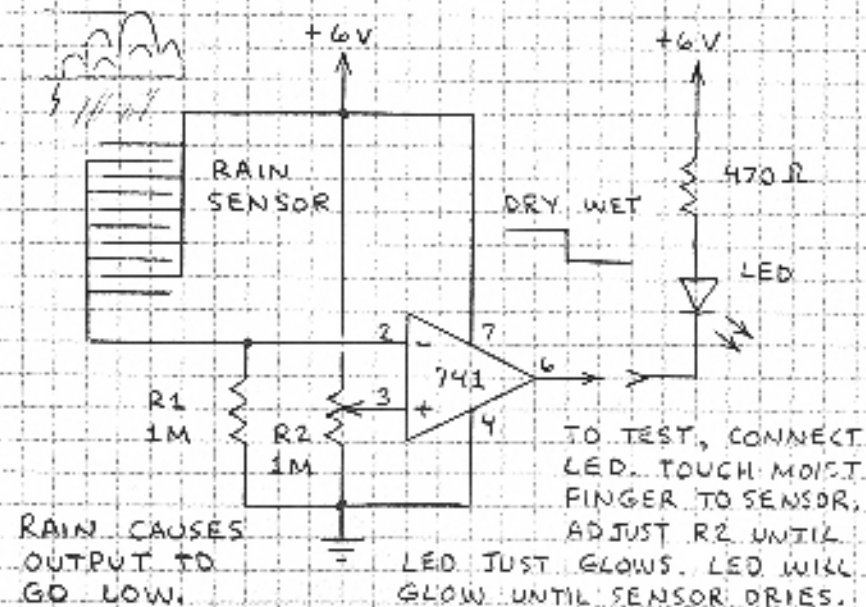

RAIN CAUSES OUTPUT TO GO LOW.

TO TEST, CONNECT LED. TOUCH MOIST FINGER TO SENSOR, ADJUST R2 UNTIL LED JUST GLOWS. LED WILL GLOW UNTIL SENSOR DRIES.

ELECTRONIC THERMOMETER

A THERMISTOR IS A TEMPERATURE DEPENDENT RESISTOR. THERMISTORS CAN BE USED TO MAKE VARIOUS KINDS OF ELECTRONIC THERMOMETERS.

THERMISTOR CIRCUITS

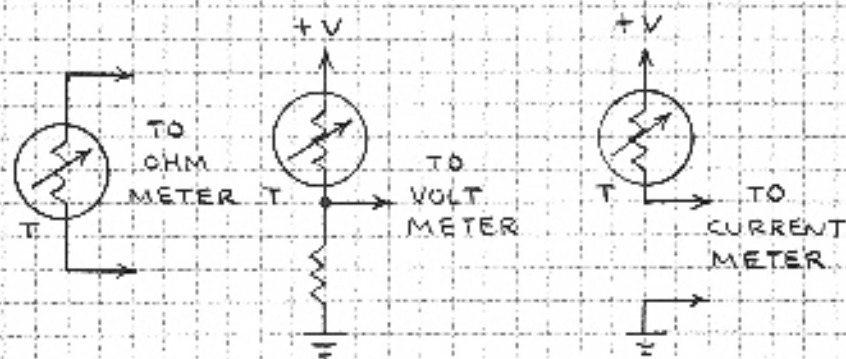

THERMISTOR AMPLIFIER

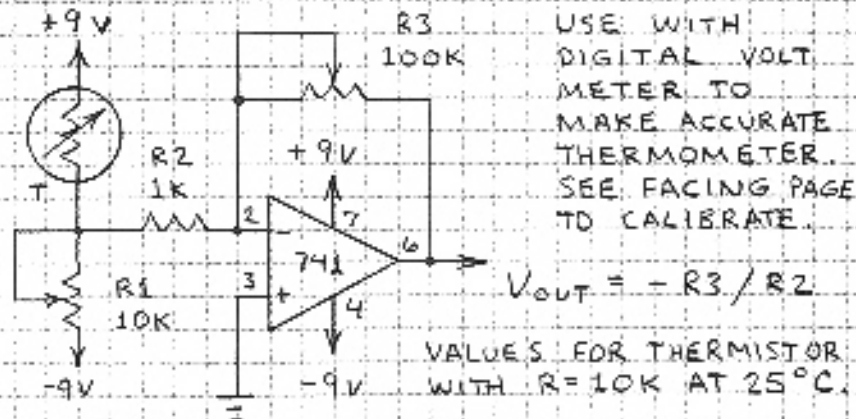

INCREASE R3'S RESISTANCE TO INCREASE SENSITIVITY OVER SMALL TEMPERATURE RANGE. REDUCE R3'S RESISTANCE TO REDUCE SENSITIVITY OVER LARGE TEMPERATURE RANGE. R1 IS ZERO ADJUST.

THERMISTOR CALIBRATION

WATER PROOF THERMISTOR LEADS WITH SILICONE SEALANT AND ALLOW TO CURE. DIP THERMISTOR IN HOT WATER AND RECORD RESISTANCE, VOLTAGE OR CURRENT AS TEMPERATURE OF WATER FALLS. ADD ICE TO SPEED COOLING.

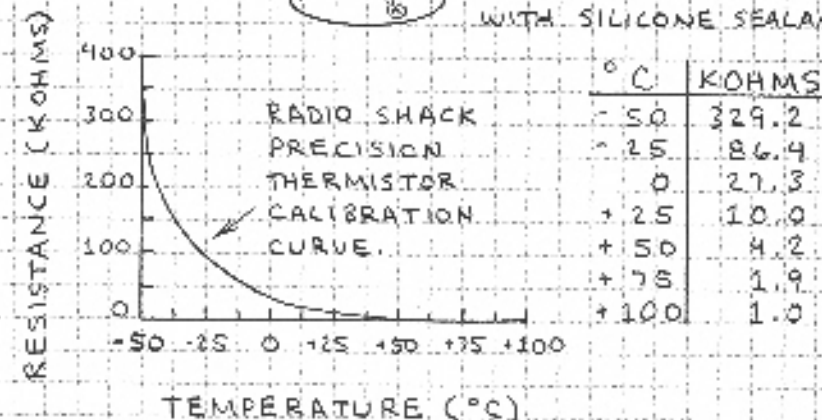
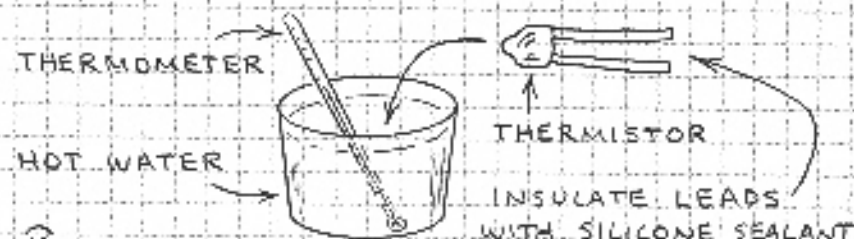

TEMPERATURE SWITCH

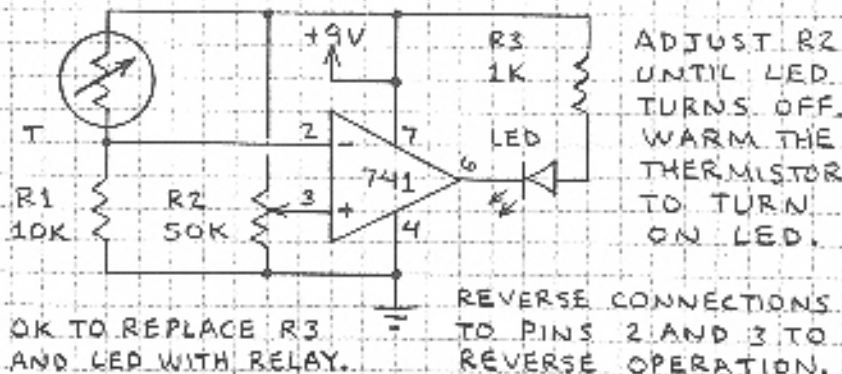

MOTION DETECTOR

WHEN PROPERLY ADJUSTED, THIS SIMPLE CIRCUIT WILL DETECT THE MOVEMENT OF AN OBJECT WITHIN ITS FIELD OF VIEW. THE DETECTION RANGE CAN BE TENS OF FEET.

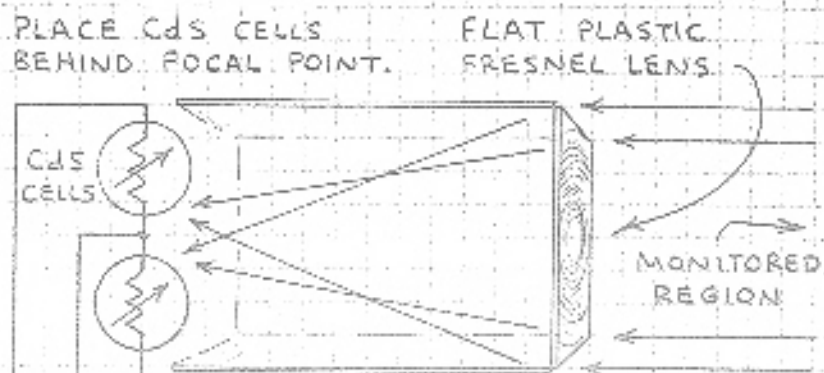

LIGHT-TIGHT ENCLOSURE (PAINT INSIDE FLAT BLACK)

USE FLAT MAGNIFYING FRESNEL LENS AT LEAST 6 INCHES SQUARE. POINT LENS AT AREA TO BE MONITORED. ADJUST R1 UNTIL LED JUST SWITCHES OFF. MOVING OBJECT WILL LIGHT LED.

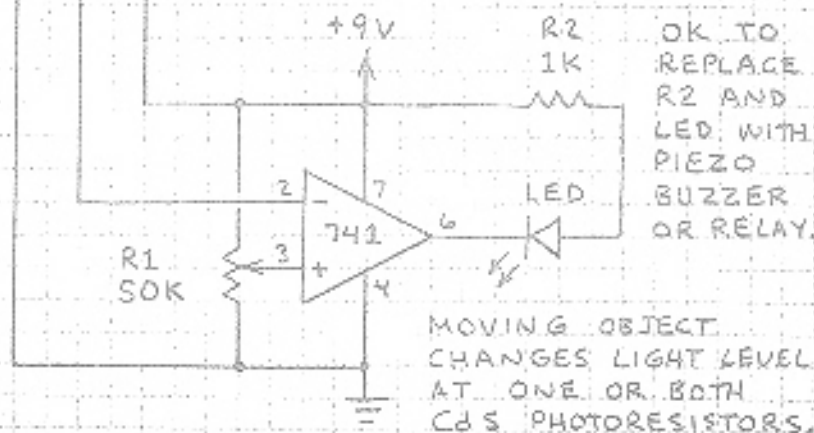

POSITION DETECTOR

USE THIS CIRCUIT TO INDICATE POSITION OF A BEAM OF LIGHT FALLING ON TWO ADJACENT SOLAR CELLS.

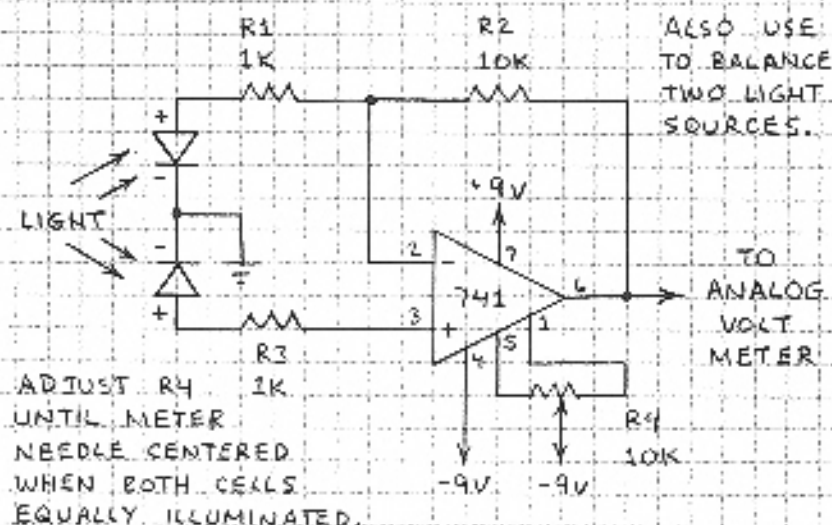

TEST WITH SUPER BRIGHT LED IN CLEAR PACKAGE. BEAM STRUCTURE MAY AFFECT READOUT. IF ONE CELL GENERATES MORE VOLTAGE WHEN LIGHT LEVEL IS BALANCED, REDUCE OTHER CELL'S INPUT RESISTANCE (R1 OR R3).

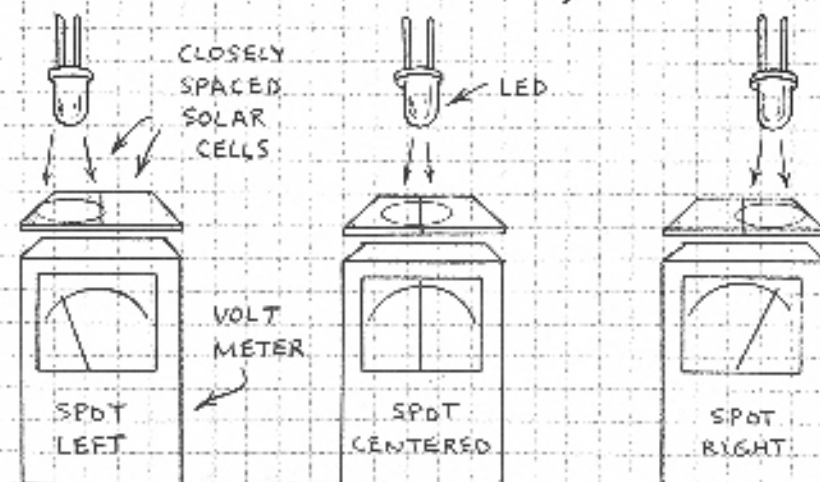

PRESSURE SENSOR

THE CONDUCTIVE FOAM PLASTIC IN WHICH STATIC-SENSITIVE COMPONENT LEADS ARE INSERTED CAN BE USED TO MAKE PRESSURE-SENSITIVE RESISTORS. YOU CAN USE A PAIR OF SUCH RESISTORS TO MAKE A PRESSURE-SENSITIVE COMPUTER JOYSTICK. A PRESSURE-SENSITIVE RESISTOR CAN BE USED TO MAKE AN ELECTRONIC SCALE. A SIMPLE ACCELEROMETER CAN BE MADE BY ATTACHING A LEAD FISHING WEIGHT TO THE MOVABLE CONTACT OF A PRESSURE-SENSITIVE RESISTOR. HERE IS ONE OF MANY WAYS TO MAKE A PRESSURE-SENSITIVE RESISTOR:

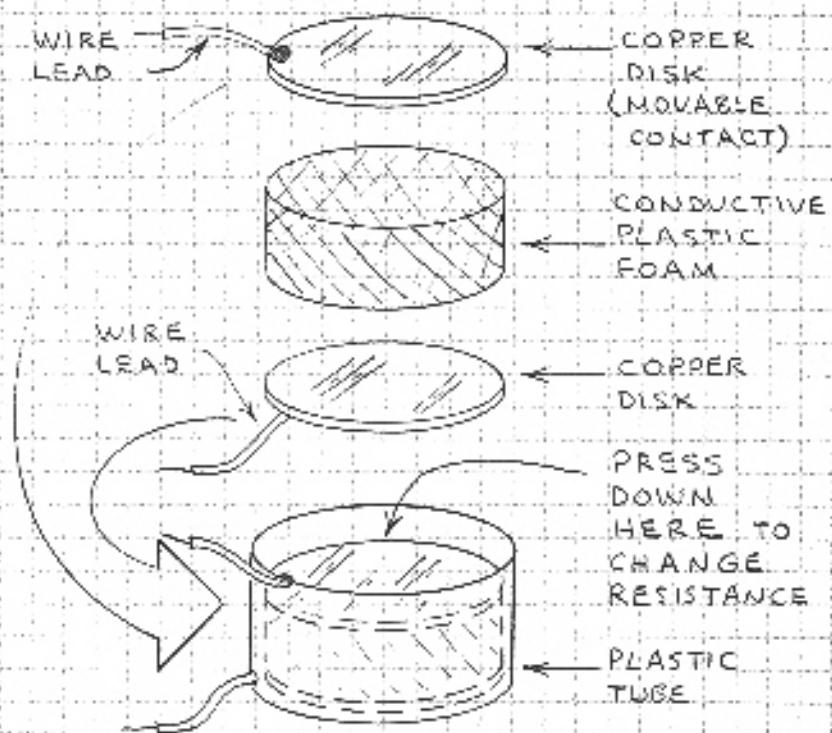

COPPER DISKS CAN BE PENNYS, COPPER FOIL OR COPPER-CLAD CIRCUIT BOARD. POLISH COPPER BEFORE SOLDERING LEADS.

PRESSURE-SENSITIVE SWITCH

R1: PRESSURE SENSOR

+9V

ADJUST R3 UNTIL LED SWITCHES OFF.

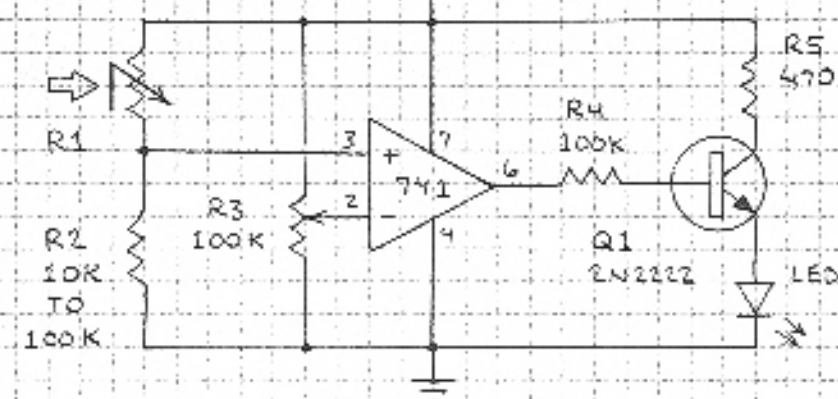

PRESS DOWN ON PRESSURE-SENSITIVE RESISTOR R1 TO SWITCH ON Q1 AND LED.

PRESSURE-SENSITIVE TONE

R1: PRESSURE SENSOR

+9V

NOTE: YOU CAN MAKE TEMPORARY SENSOR SIMPLY BY INSERTING WIRE LEADS IN FOAM.

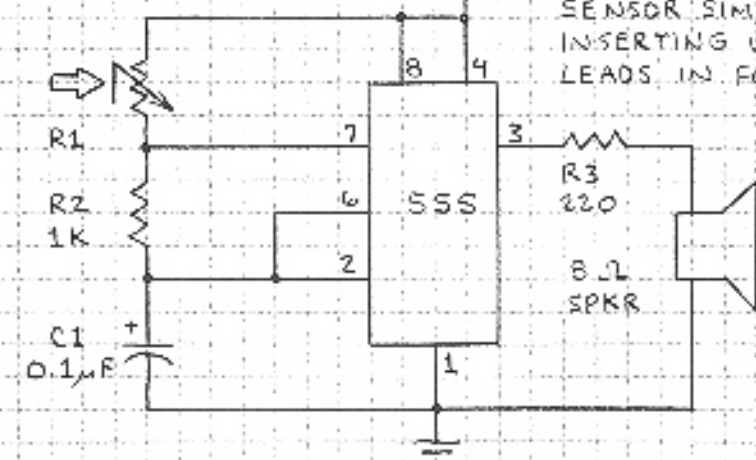

PRESS DOWN ON PRESSURE-SENSITIVE RESISTOR R1 TO INCREASE THE FREQUENCY OF THE TONE.

SEISMOMETER

A SEISMOMETER IS AN INSTRUMENT THAT DETECTS THE EARTH MOVEMENTS CAUSED BY EARTHQUAKES. A SIMPLE SEISMOMETER CAN DETECT EARTHQUAKES THAT OCCUR THOUSANDS OF MILES AWAY. EARTHQUAKES CAUSE SEVERAL KINDS OF SEISMIC WAVES INSIDE THE EARTH.

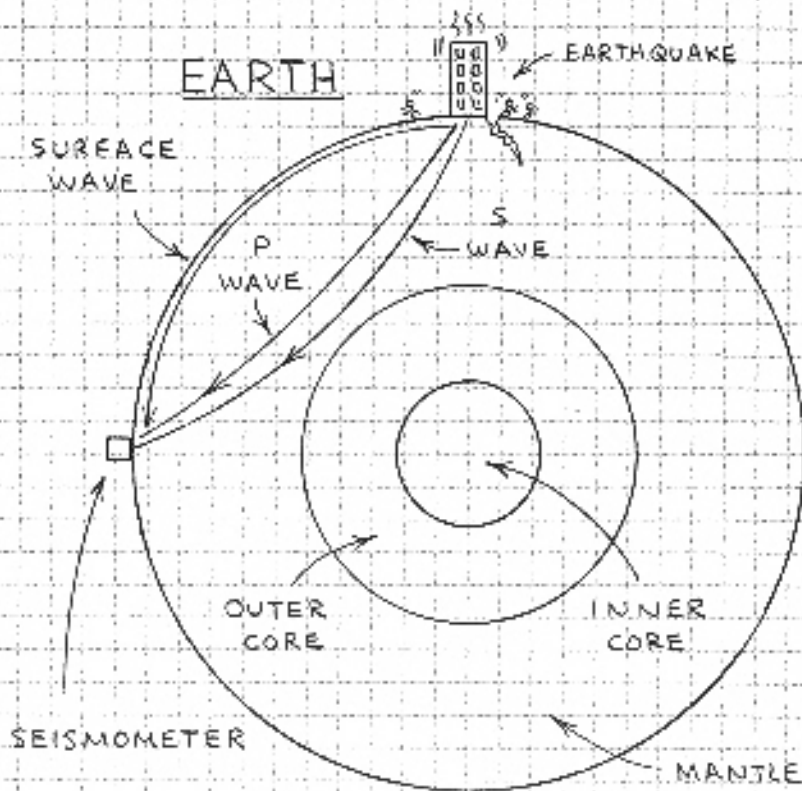

A SEISMOGRAM IS A GRAPH OF THE EARTH'S MOVEMENTS PRODUCED BY A SEISMOMETER.

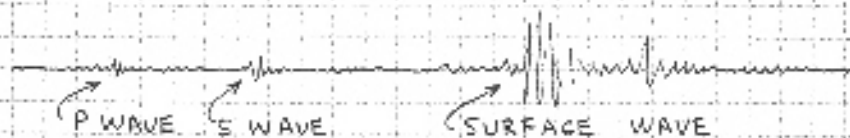

P WAVE ARRIVES FIRST.

MANY DIFFERENT KINDS OF SEISMOMETERS ARE AVAILABLE. TWO EXAMPLES:

WEIGHT AND STYLUS HORIZONTAL PENDULUM

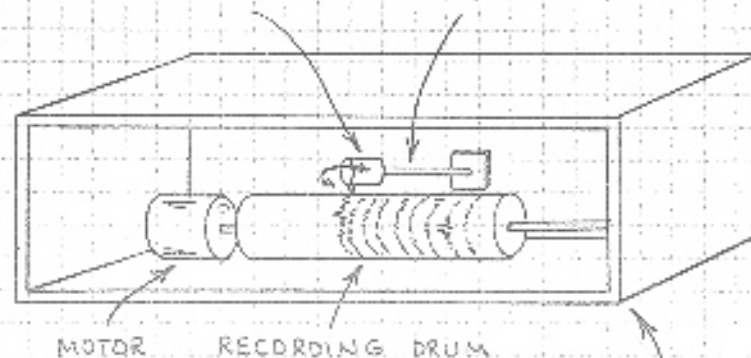

SPRING RECORDING DRUM

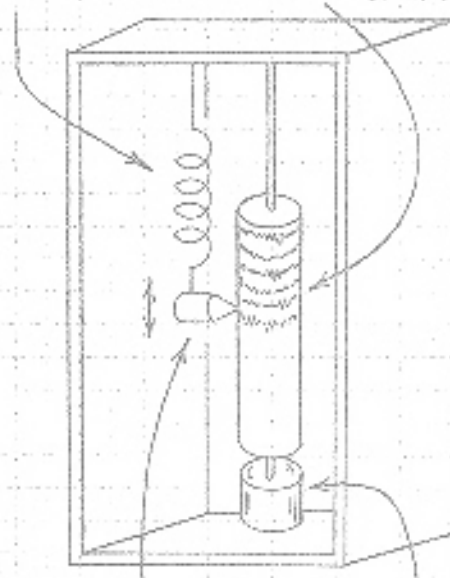

SEISMOMETER FOR SENSING HORIZONTAL (BACK AND FORTH) GROUND MOTION.

SEISMOMETER FOR SENSING VERTICAL (UP AND DOWN) GROUND MOTION.

SEISMOMETERS SHOULD BE MOUNTED ON A FIRM FOUNDATION OVER, IF POSSIBLE, BED ROCK.

WEIGHT AND STYLUS MOTOR

FOR MORE INFORMATION ABOUT SEISMOMETERS, VISIT A LIBRARY. "EARTHQUAKES" (W. H. FREEMAN AND CO., 1966) BY BRUCE BOLT IS A GOOD BOOK.

EARTH MOVEMENT SENSOR

THIS SIMPLE SEISMIC SENSOR HAS DETECTED TRAINS MORE THAN ONE MILE AWAY.

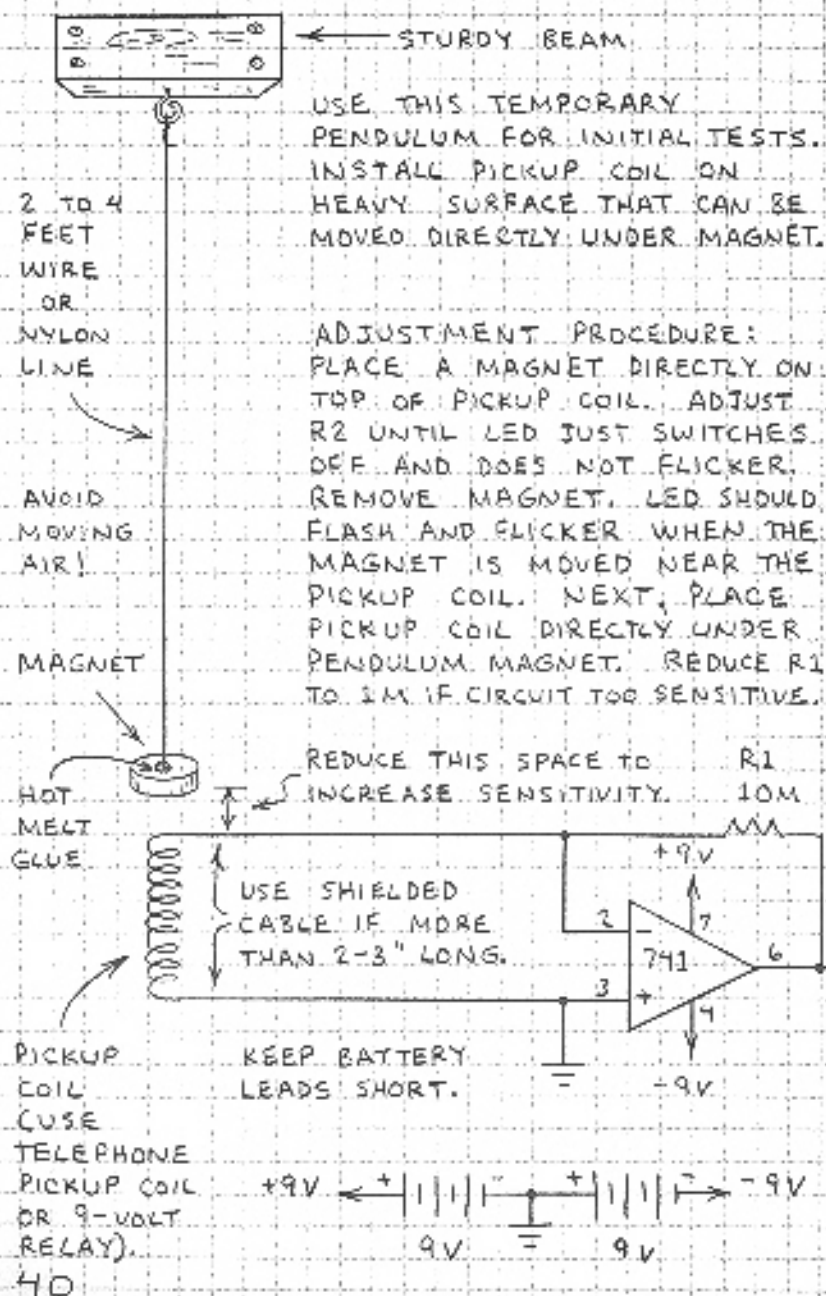

THIS SENSOR IS EXCEPTIONALLY SENSITIVE! IF LED FAILS TO STOP FLICKERING, REDUCE THE SENSITIVITY. EITHER READJUST R2 OR INCREASE SPACE BETWEEN MAGNET AND PICKUP COIL.

FOR PERMANENT USE INSTALL PENDULUM AND PICKUP COIL IN METAL OR PLASTIC PIPE TO PREVENT AIR MOVEMENT FROM MOVING PENDULUM. USE L-BRACKETS TO BOLT ASSEMBLY TO CONCRETE FOUNDATION FOR BEST RESULTS. WHEN HE WAS IN HIGH SCHOOL IN TEXAS, ERIC RYAN MIMS USED SIMILAR ARRANGEMENT TO DETECT UNDERGROUND NUCLEAR TESTS IN NEVADA.

ADJUST POSITION OF MAGNET BY MOVING CAP UP OR DOWN OR BY MOVING PENDULUM THROUGH HOLE IN CAP. MAKE OBSERVATION PORT TO OBSERVE MAGNET. COVER WITH CLEAR PLASTIC WINDOW.

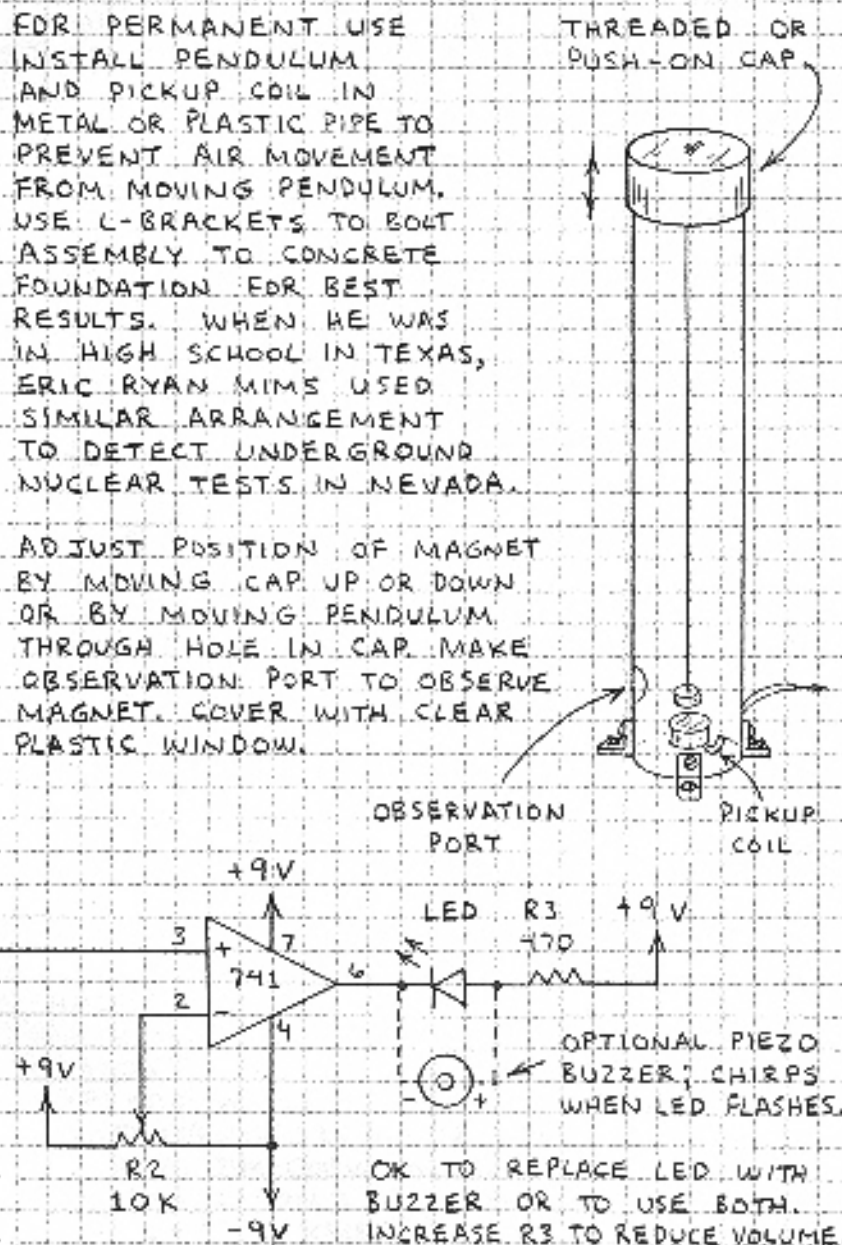

RF TELEMETRY TRANSMITTER

THIS SIMPLE LOW-POWER RADIO FREQUENCY (RF) TRANSMITTER WILL BROADCAST TEMPERATURE AS A SERIES OF CLICKS TO A NEARBY RADIO TUNED TO THE UPPER END OF THE AM BROADCAST BAND.

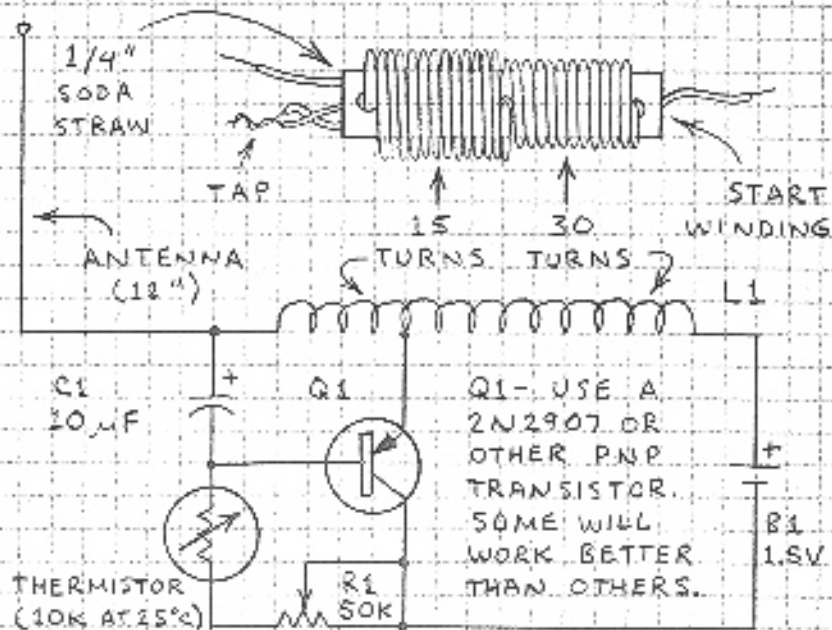

L1: USE 30 GAUGE WRAPPING WIRE OR MAGNET WIRE. (USE MAGNET WIRE FOR SMALLER COIL. BURN VARNISH FROM ENDS OF WIRE AND TAP AND LIGHTLY BUFF CHARRED VARNISH WITH SAND PAPER.) PUNCH SMALL HOLE NEAR ONE END OF STRAW. INSERT 2" OF WIRE THROUGH HOLE AND WIND 30 TURNS. PUNCH HOLE IN STRAW AND INSERT 2" LOOP OF WIRE (TAP) THROUGH HOLE. WIND 15 TURNS BACK OVER FIRST WINDING. PUNCH HOLE THROUGH WINDING AND INSERT END OF WIRE. WRAPPING WIRE: CUT TAP LOOP AND TWIST EXPOSED WIRES.

C1: INCREASE VALUE TO SLOW PULSE RATE.

R1: ADJUST TO CHANGE PULSE RATE.

B1: USE AA PENLIGHT CELL.

SAMPLE CALIBRATION GRAPH

WATERPROOF LEADS OF THERMISTOR WITH SILICONE SEALANT. IMMERSE THERMISTOR AND THERMOMETER IN WARM WATER. SWITCH ON TRANSMITTER AND RECEIVER. COUNT NUMBER OF CLICKS IN 15 SECONDS AND RECORD COUNT AND TEMPERATURE. REPEAT AS WATER COOLS. ADD ICE FOR COLD TEMPERATURES. SAMPLE CALIBRATION:

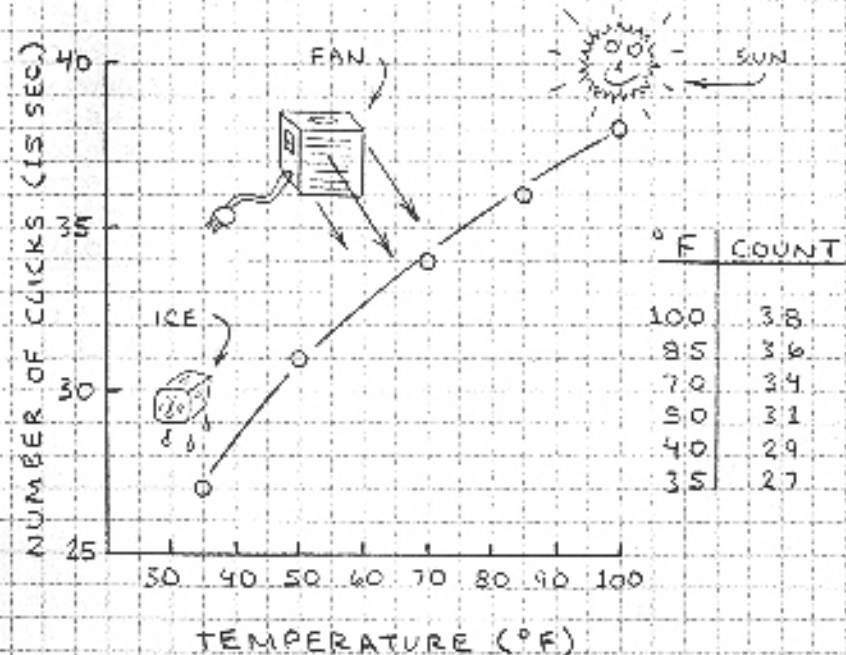

CALIBRATION WILL CHANGE IF R1 IS READJUSTED. OK TO USE FIXED RESISTOR FOR R1. CIRCUIT WORKS BEST WITH THERMISTOR THAT HAS A RESISTANCE AT ROOM TEMPERATURE (25°C) OF 10K.

LED TELEMETRY TRANSMITTER

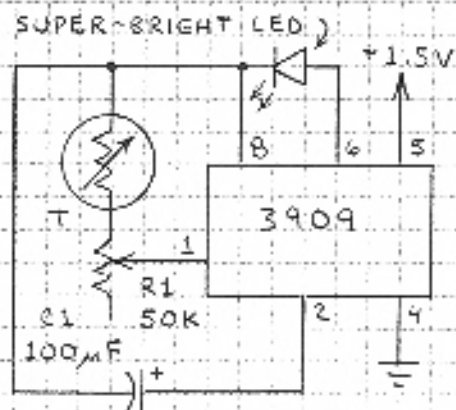

THIS LED FLASHER WILL TELL YOU THE TEMPERATURE AT ITS LOCATION FROM ANYWHERE YOU CAN SEE ITS FLASHES. CHECK TEMPERATURE OF GREENHOUSE, GARDEN, ETC. WHILE YOU STAY INDOORS. WORKS BEST IN SUBDUED LIGHT.

SAMPLE CALIBRATION GRAPH

ADJUST R1 FOR DESIRED ROOM TEMPERATURE FLASH RATE. THEN CALIBRATE TRANSMITTER AS DESCRIBED ON PRECEDING PAGE. HERE IS A SAMPLE CALIBRATION GRAPH:

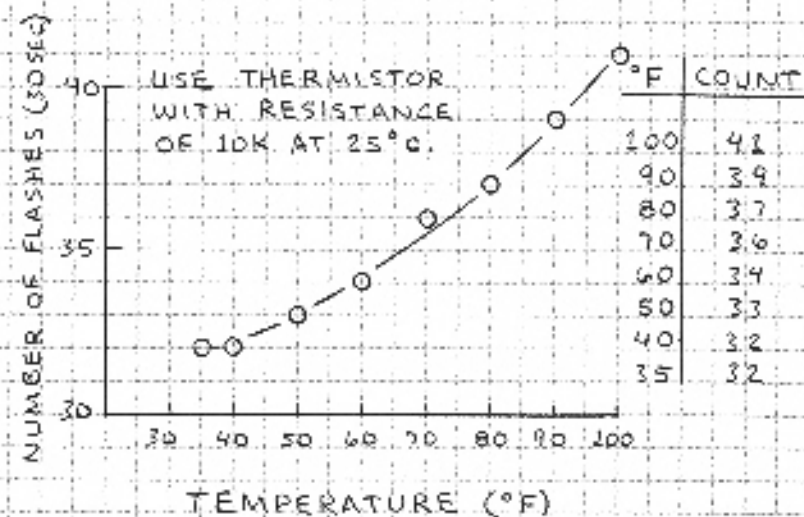

CALIBRATION IS FOR NUMBER OF FLASHES IN 30 SECONDS. YOU CAN MAKE A MORE ACCURATE GRAPH BY COUNTING FLASHES IN 60 SECONDS. R1 CAN BE FIXED RESISTOR.

ELECTRONIC CRICKET

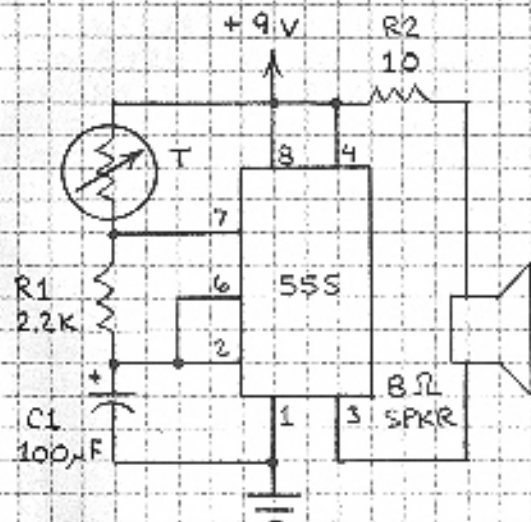

LIKE A CRICKET, THE RATE OF CLICKS EMITTED BY THIS CIRCUIT IS DEPENDENT ON TEMPERATURE. INCREASE VALUE OF C1 TO REDUCE RATE OF CLICKS. OK TO REPLACE SPEAKER WITH LED TO CONVERT TEMPERATURE TO FLASHING RATE OF LED.

SAMPLE CALIBRATION GRAPH

CALIBRATE AS DESCRIBED ON PREVIOUS PAGES. NOTE THAT PLOT IS LINEAR AND THAT IT HAS A WIDE COUNT RANGE.

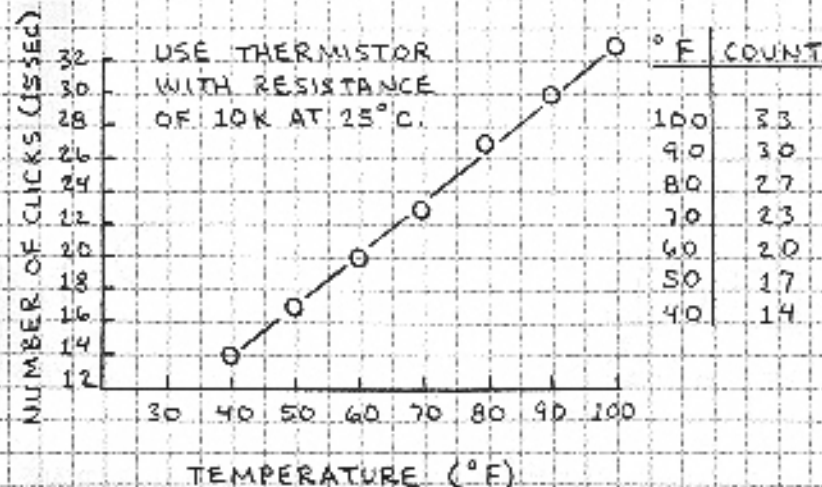

FOR THIS CALIBRATION, TEMPERATURE IS ABOUT 3 TIMES NUMBER OF CLICKS IN 15 SECONDS.

ANALOG DATA LOGGER

YOU CAN RECORD EXPERIMENTAL DATA ON MAGNETIC TAPE WITH THE HELP OF A SMALL CASSETTE TAPE RECORDER. FIRST, CONVERT SIGNAL TO BE SAVED INTO A VOLTAGE. THEN TRANSFORM THE VOLTAGE INTO AN AUDIO-FREQUENCY TONE WITH A VOLTAGE-TO-FREQUENCY (V/F) CONVERTER. RECORD TONE ON MAGNETIC TAPE. RETRIEVE DATA BY PLAYING TAPE THROUGH A FREQUENCY-TO-VOLTAGE (F/V) CONVERTER.

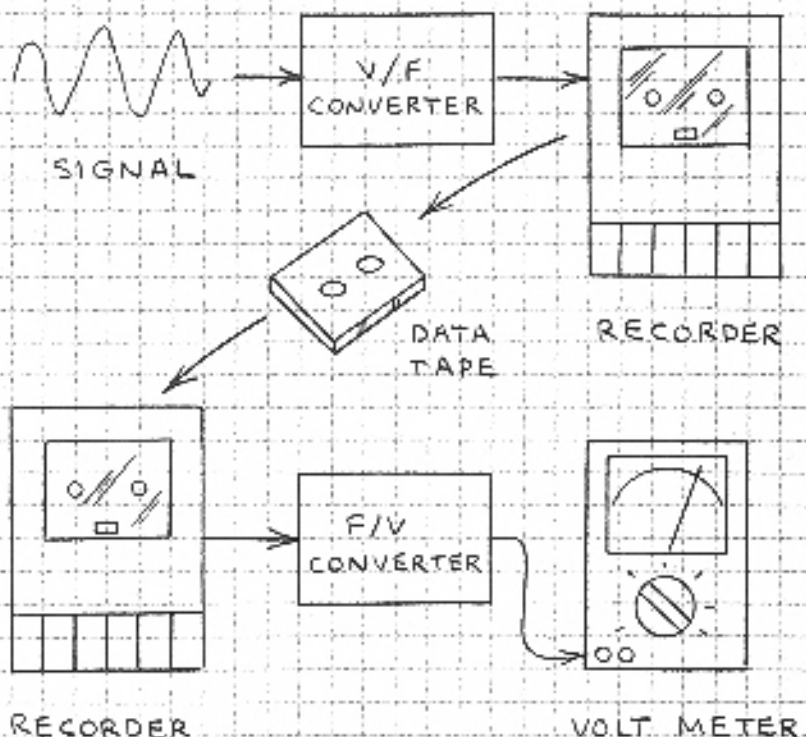

FOR BEST RESULTS, USE QUALITY RECORDING TAPE. BETTER QUALITY RECORDERS WORK BEST. YOU CAN SQUEEZE MORE DATA ON A TAPE BY RECORDING 5 SECOND "SNAP SHOTS."

V/F CONVERTER

SIGNAL VOLTAGE (FROM SENSOR OR SENSOR AMPLIFIER).

OK TO CONNECT V/F CONVERTER DIRECTLY TO F/V CONVERTER TO CALIBRATE SYSTEM. SET R1 FOR DESIRED CENTER FREQUENCY.

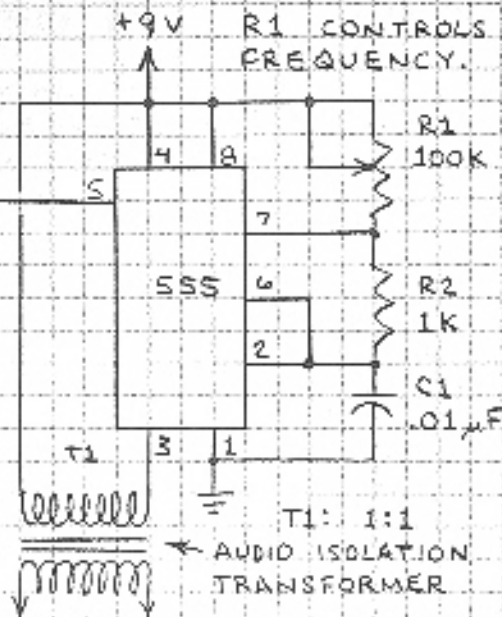

OUTPUT TO RECORDER'S MICROPHONE INPUT.

INPUT FROM RECORDER'S EARPHONE OUTPUT.

F/V CONVERTER

OUTPUT TO VOLT METER

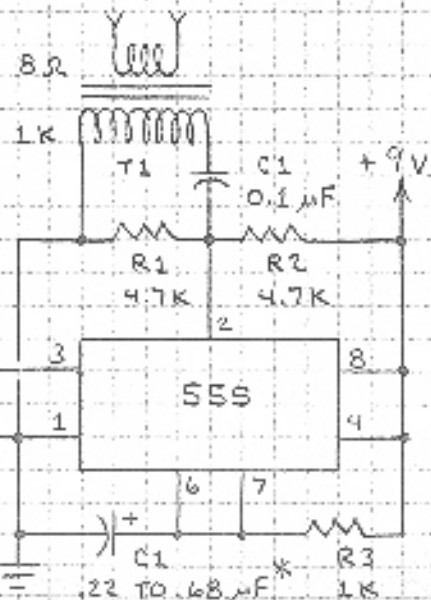

* SEE NEXT PAGE...

DATA LOGGER OPERATION

THE OUTPUT FROM MOST SENSORS CAN BE CHANGED TO A VOLTAGE. FOR EXAMPLE, THESE CIRCUITS BOTH CHANGE LIGHT INTENSITY INTO A VARIABLE VOLTAGE:

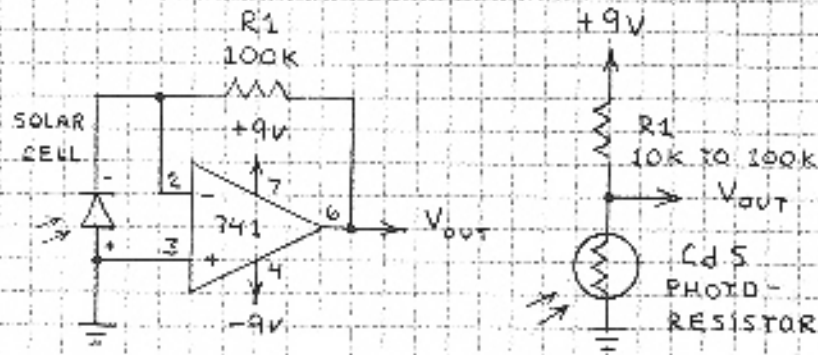

HERE IS A CALIBRATION GRAPH FOR TWO VALUES OF C1 IN THE F/V CONVERTER. THE GRAPH SHOULD BE CONSIDERED AS APPROXIMATE SINCE DIFFERENCES IN COMPONENT VALUES WILL CAUSE CHANGES IN THE GRAPH.

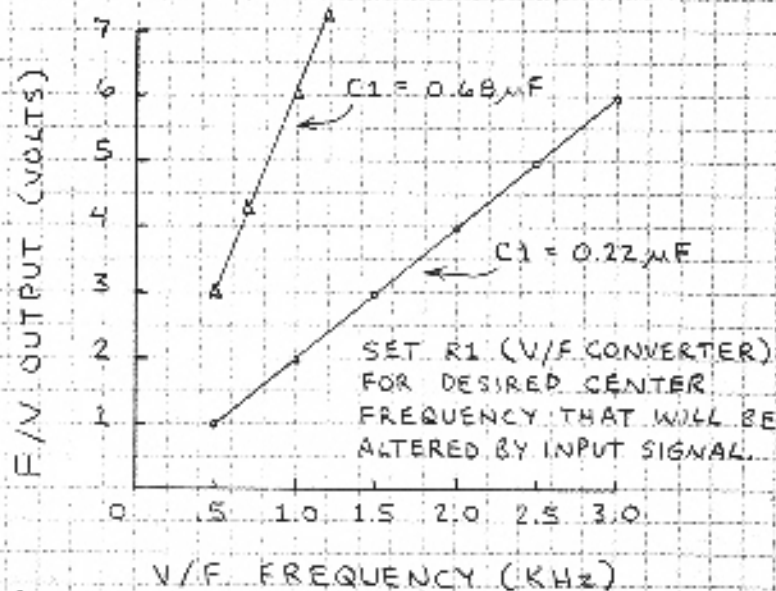

RESISTOR COLOR CODE

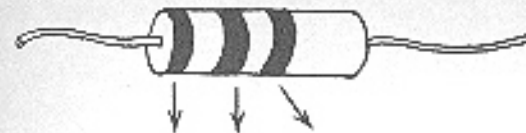

BLACK	0	0	x 1
BRDWN	1	1	x 10
RED	2	2	x 100
ORANGE	3	3	x 1,000
YELLOW	4	4	x 10,000
GREEN	5	5	x 100,000
BLUE	6	6	x 1,000,000
VIOLET	7	7	x 10,000,000
GRAY	8	8	x 100,000,000
WHITE	9	9	—

FOURTH BAND INDICATES TOLERANCE (ACCURACY):
 GOLD = ±5% SILVER = ±10% NONE = ±20%

OHM'S LAW: $V = IR$ $R = V/I$
 $I = V/R$ $P = VI = I^2R$

ABBREVIATIONS

A = AMPERE R = RESISTANCE
 F = FARAD V (OR E) = VOLT
 I = CURRENT W = WATT
 P = POWER Ω = OHM

M (MEG-) = x 1,000,000
 K (KILO-) = x 1,000
 m (MILLI-) = .001
 μ (MICRO-) = .000 001
 n (NANO-) = .000 000 001
 p (PICO-) = .000 000 000 001