

AT MICROFICHE REFERENCE LIBRARY

A project of Volunteers in Asia

The Nursery Manual

by L.H. Bailey

Published by:

The MacMillan Company
New York
USA

Available from:

out of print

Reproduced by permission.

Reproduction of this microfiche document in any form is subject to the same restrictions as those of the original document.

The Rural Manuals

EDITED BY L. H. BAILEY

THE NURSERY-MANUAL

The Rural Manuals

EDITED BY L. H. BAILEY



MANUAL OF GARDENING — *Bailey*

MANUAL OF FARM ANIMALS — *Harper*

FARM AND GARDEN RULE-BOOK — *Bailey*

MANUAL OF FRUIT INSECTS — *Slingerland and Crosby*

MANUAL OF WEEDS — *Georgia*

THE PRUNING-MANUAL — *Bailey*

MANUAL OF FRUIT DISEASES — *Hesler and Whetzel*

MANUAL OF MILK PRODUCTS — *Stocking*

MANUAL OF VEGETABLE-GARDEN INSECTS — *Crosby
and Leonard*

MANUAL OF TREE DISEASES — *Rankin*

MANUAL OF HOME-MAKING — *Van Rensselaer, Rose,
and Canon*

MANUAL OF AMERICAN GRAPE-GROWING — *Hedrick*

THE NURSERY-MANUAL — *Bailey*

THE NURSERY-MANUAL

A COMPLETE GUIDE TO THE
MULTIPLICATION OF
PLANTS

BY
L. H. BAILEY

New York
THE MACMILLAN COMPANY
1922

All rights reserved

COPYRIGHT, 1896,
BY L. H. BAILEY.

NEW EDITION, COMPLETELY REVISED AND RESET.

COPYRIGHT, 1920,
BY THE MACMILLAN COMPANY.
Set up and electrotyped. Published January, 1920.

Norwood Press
J. S. Cushing Co. — Berwick & Smith Co.
Norwood, Mass., U.S.A.

EXPLANATION

THIS Manual is the twenty-second edition of the Nursery-Book, re-written and re-set. The Nursery-Book was first published early in 1891. A revision was made in 1896, as a third edition, when the book was taken over by The Macmillan Co. Since then it has been reprinted frequently. For nearly thirty years the book has enjoyed the confidence of the public even though in the later years it has needed revision. The author can hardly expect it to continue its career for another quarter-century; yet he is glad to have the opportunity to make it new again.

The book deals only with propagation and nursery practice. The temptation is strong to include certain related subjects, but the work will probably be useful in proportion as it confines itself to its single purpose. Therefore the reader must not expect to find descriptions of cultivation, transplanting, the general handling of plants, pruning, seed-breeding, or pollination; nor has it seemed best, in a practical manual, to admit discussions of the interesting scientific questions more or less related to the subject.

When my successor shall revise this book or make a new one, it is to be expected that he will have the results of sufficient matured investigations to enable him to pronounce with confidence on many of the practices that now rest only on empirical and traditional habits.

L. H. BAILEY.

ITHACA, N.Y.

May 1, 1919.

Property of Mary E Thorne

CONTENTS

PART I

	PAGES
THE CLASSES AND KINDS OF PROPAGATION .	1-215
CHAPTER	
I. SEEDS AND SHOOTS	1-10
The phyton	3-4
The commerce in seeds	5-10
II. PROPAGATION BY MEANS OF SEEDS AND SPORES .	11-55
1. The requisites and conditions of germination .	12-24
Regulation of moisture	12-19
Requirements of temperature	19-20
Influence of light on germination	20-21
Regermination	21
Delayed germination	21-23
Keeping seeds	23-24
2. Seed-testing	24-33
Testing for viability	24-30
Testing for purity	31-32
The complete seed-test	32-33
3. The handling and sowing of seeds and spores .	33-55
The stratification of seeds	35-37
Other preparatory treatment	37-39
Transportation of seeds from abroad	39-40
Soil diseases; sterilizing	40-44
Sowing the seed	44-47
English advice	48-50
Sowing spores	50-51
Forestry practice	51-55
III. PROPAGATION BY MEANS OF SEPARATION AND DIVISION	56-68
1. Separation	56-62
2. Division	62-68

CHAPTER	PAGES
IV. PROPAGATION BY MEANS OF LAYERS AND RUNNERS	69-79
The common or natural layers	70-75
The so-called air-layers	76-79
V. PROPAGATION BY MEANS OF CUTTINGS	80-112
1. General requirements of cuttings	80-97
Constructions for regulating moisture and heat	80-86
Bottom heat	87-88
Placing and protecting the cuttings	88-91
Soil for cuttings	91-93
The striking of cuttings	93-97
2. The divers kinds of cuttings	97-112
Cuttings of tubers	98-99
Cuttings of roots	99-101
Cuttings of leaves	101-104
Cuttings of stems	104-112
1. Hardwood dormant cuttings	104-107
2. Greenwood cuttings	107-112
VI. PROPAGATION BY MEANS OF BUDDING AND GRAFTING	113-171
1. Graftage in general	113-120
Classification of graftage	117-119
Times and methods	119-120
2. Budding	121-136
Shield-budding	122-133
Other kinds of budding	134-136
Prong-budding	134
Plate-budding	134-135
The patch-bud	135
H-budding	135
Flute-budding	135-136
Chip-budding	136
3. Grafting	136-171
The whip-graft	138-144
Root-grafted <i>vs.</i> budded stock	141-143
Modified whip-grafts	143-144
The veneer-graft	144-146
The cleft-graft	146-158
Top-working trees by means of the cleft-graft	151-157
Other uses of the cleft-graft	157-158

PROPERTY CONTENTS *Mary E Thorne*

CHAPTER	PAGES
Miscellaneous forms of grafting	158-169
Splice-grafting	158
Saddle-grafting	158-159
Side-grafting	159
Shield-grafting	159-160
Bark-grafting	160
Bridge-grafting	160-163
Inlaying	163-164
Cutting-grafting	164-165
Herbaceous-grafting	165-166
Fruit-grafting	166
Seed-grafting	166
Inarching	166-167
Double-working	167-169
Grafting-waxes	169-171
VII. CERTAIN ELEMENTS IN NURSERY PRACTICE	172-215
Nursery lands in relation to propagation	173-179
Grades of trees	179-182
Stocks for grafted fruit-trees	182-184
The dwarfing of fruit-trees	184-185
Pedigree trees	185-186
Trimming trees in the nursery	186-187
The storing of trees	187-190
Important diseases and insects affecting nursery stock	190-215
Diseases caused by fungi and bacteria	192-209
Fire-blight	192-194
Crown-gall	194-196
Apple- and pear-scab	196-197
Apple powdery-mildew	197-198
Yellow-leaf disease of cherry and plum	198-199
Powdery-mildew of cherry	199
Anthracnose of currants and gooseberries	200
Septoria leaf-spot of currants and gooseberries	200-202
The gooseberry mildew	202
Peach leaf-curl	203-204
Leaf-blight of pear and quince	204-206
Septoria leaf-spot of the pear	206
Raspberry yellows	206-207

X
CONTENTS

	PAGES
Raspberry and blackberry anthracnose	207
Black-spot of roses	207-208
Mildew of rose and peach	208-209
Insect pests of nursery stock	209-215
Plant-lice or aphids	209-210
Woolly aphis	210-211
Red-spider	211-212
Pear psylla	212
Tarnished plant-bug	212-213
Apple leaf-hopper	213
San José scale	213-214
The pear slug	214-215
Currant worms	215

PART II

THE NURSERY-LIST	217-441
INDEX	443

LIST OF PLATES

	PAGE
I. A seed nursery. Flower plants grown for the crop of seeds	10
II. A forest-tree nursery. Seed-beds of white pine seedlings two years old	50
III. Propagation of hydrangeas. House in July; the stock was marketed the following autumn	81
IV. Straddle-row tillage in the nursery	112
V. Tying or wrapping root-grafts by machinery	139
VI. A nursery of ornamental stock; trimming	173
VII. A good stand of blue spruce	201
VIII. A fruit-tree nursery, showing trees two years from the bud	220
IX. Two-year budded cherry, on mazzard and mahaleb	277
X. First-class dwarf apple stock — at left two-year whole- root grafts	333
XI. Horse-help in the nursery. Fitting the land for nursery stock. Digging by mule-power	387
XII. Nursery packing-room, ready for the equipment	423

Property.

Mary E Thorne

THE NURSERY-MANUAL

PART I

THE CLASSES AND KINDS OF PROPAGATION

CHAPTER I

SEEDS AND SHOOTS

THE earth is clothed with plants. All these plants are the results of propagation.

Plants perpetuate themselves and increase their numbers by many means. These means are sexual (by seeds and some kinds of spores), and asexual (by vegetative parts).

Seeds are the results of the fertilization of the ovule (strictly of the egg-nucleus of the ovule) by the germ-nucleus of the pollen-grain. The ovule, with its integuments and perhaps with adhering parts, ripens into the seed. Of many forms, sizes and colors are the seeds of plants. So various are they that we visualize no seed-form, as we visualize heart-form or rose-form, and many of them are hardly recognizable. Yet they all have this in common, that they contain a dormant or quiescent embryo. This embryo is a rudimentary or minute plant. When the conditions are right for the plantlet to resume its growth, we say that the seed germinates.

Not only does the seed reproduce the parent, but it disperses the species. In fact, the word *disseminate* means to sow or scatter seeds, although we now disseminate knowledge as well as seeds. The act of falling from the receptacle places the seed in a different position from that of its parent stock. Often the seed is carried by wind, being whirled by means of wings, as in maple and ash; floated by means of down or plumes, as in thistle, dandelion and poplar; driven on the snow and ice from stalks that stand stiff in the winter. It may be carried

on the coats of animals and in clothing, holding fast by hooks and barbs of many kinds. Some seeds are ejected forcibly from their capsules, as in the jewel-weed or touch-me-not and the witch-hazel. Many seeds and fruits are carried long distances in ocean currents; the coconut is the familiar citation. Seeds are transported in the removal of earth, by the commerce in many commodities and by floods that denude the land and carry away its substance. All over the earth the seeds have traveled. Clear a piece of land ever so carefully, till it until all the germinating seeds are killed, remove all the trees and mow the land for miles around, then leave the place alone for a few years, and behold the vegetation that arises!

Marvelous are the seeds: each one is an epitome of the species condensed into the minutest space, fashioned every one of its own kind, holding within its coats the possibilities of life on the planet. Everywhere they abound, so common and so familiar that they pass unnoticed. We have never thought of a world without seeds.

The abundance of seeds is one of the most significant facts in nature. Every kind of tree and bush and herb yields such numbers that it might populate the earth. Branches bend with seeds; often the winds are laden with them; they rattle along the ground and pile themselves in the still places. The seeds of begonias and orchids are as dust. Thus are the chances multiplied that the species will not fail. In all this profusion one cannot conceive that sufficient seed will not fall on good ground to give the plant its chance to persist and to yield its fruit after its kind. Nature is prodigal in propagation. We do not fear that vegetation will cease from the earth.

Yet as abundant as are the seeds, seeming to make failure impossible, they may not germinate readily even in a state of nature. Many kinds are contained in impervious and stone-like coverings that are penetrated or broken only with difficulty; and the casings may have to rot away or be cracked by frost

or accident before the plantlet can escape. Other kinds have a more or less definite period of dormancy, within which time they will not germinate even though conditions are favorable. Seeds of many of the wild herbaceous perennials will not germinate till the following spring. Other seeds lie in the ground two or three years before germination. On the other hand, the seeds of some species germinate at once on maturity, even while on the parent plant as in the case of the mangrove. Special soils or other media, as to acidity, alkalinity or other qualities, may be necessary for germination and growth, or particular treatment, as etherization, may yield new results; and in some plants, as the orchids, it is now supposed that certain fungi are necessary to germination.

Thus far, the knowledge of conditions and aptitudes is chiefly empirical, mostly the result of repeated and repeated trials, with their failures and successes. We must always learn these requisite conditions by experience; yet we are gradually discovering a rational basis for our operations, and we may expect marked progress in this direction in the years to come, rendering the propagation of plants more definite and predictable.

THE PHYTON

It is not alone by seeds that plants multiply themselves. Many kinds rarely produce good seeds, and some of the cultivated species are multiplied practically exclusively by the non-sexual and vegetative parts. Familiar examples are the sweet potato, horse-radish, sugar-cane in the United States, banana. Some species seem to be losing the power to produce seeds with the enormous artificial development of other parts, as the Irish potato.

We may liken a plant to a colony of potential individuals, one individual being perhaps a node and a leaf, one growing on another and the aggregation making up a complex organism.

Every part of the plant which, when removed, is capable of reproducing itself and its parent, may be considered as an entity for purposes of propagation; this potential individual has been called the phyton (Bailey, "Survival of the Unlike," 84, 101).

The phyton, or propagatable part, often detaches itself naturally. Certain willows shed their twigs, and these parts falling in congenial places may grow into new trees. The offsets of houseleeks (hen-and-chickens) detach easily. The bulblets on the stems of tiger-lilies, the "top onions," the aërial tubers of cinnamon-vine and "air potato," the leaves of bryophyllum, the leafy tufts on the fronds of certain ferns, all are naturally separable phytons or vegetative parts, useful in the propagation of the species. In fact, certain spores are asexual, at least not the result of direct sexual union, and are essentially detachable vegetative bodies or cells.

There are whole ranges of plants that exist in cultivation and are abundantly propagated independently of seeds. Even though the plant produce good seed, the leafy and stem structures may afford the quickest and easiest means of propagation. The class of "bulb plants," represented by the lilies and amaryllis and gladiolus, are of this order. The hop is habitually propagated by cuttings, as are many of the ornamental trees and shrubs; special varieties of rhododendron and the tree-fruits are multiplied and at the same time preserved "true to name" by means of grafting; the cranberry is grown from slips; blackberry from root-cuttings; red raspberry from suckers; strawberry from runners; many kinds of *begonias* year after year by cuttings of stems and leaves; roses generation after generation by cuttings.

In great numbers of domestic plants, seed-propagation rarely intervenes. The cultivator is so accustomed to this fact that he rightly accepts it as the order of nature.

THE COMMERCE IN SEEDS

Once a matter of home-growing and supply, the trade in seeds and bulbs has come to be a business of sufficient volume in the United States to warrant separate statement in the Census. The total value of flower and vegetable seeds produced in 1909 was upwards of \$1,400,000, as compared with \$826,000 ten years earlier; of clover seed, \$6,900,000 in round numbers as against \$5,359,000; all grass seed, \$15,137,000 and \$8,228,000. These figures represent the value of the seed crops themselves, but they are at the same time an indication of the vast agricultural croppage they supply with seed and of the notable increase in general crop-growing. Aside from these reported estimates, the aggregate of seeds grown and saved in the home garden and in the field for home use would undoubtedly surprise us if it could be known.

The increasing total value of seeds probably does not indicate alone an increase in production. Seeds are intrinsically more valuable decade by decade because more carefully grown and bred. Formerly plant-breeding was mostly a question of producing new kinds or varieties; its significance now lies more in the bettering of existing varieties by means of careful and rational selection, whereby yield is increased, as well as quality and uniformity of stand. The importance of seed-breeding is now so well accepted in the public mind that the discriminating planter of staple crops no longer asks merely for "seeds" any more than the stock-raiser asks merely for "cows"; the quality of the seeds is as important to the corn-grower as is the quality of the cows to the dairyman. Many persons now make a particularity of breeding seeds of staple crops with care and skill; this business will increase in volume and importance.

So essential is seed production to the welfare of the people that governments have enacted laws for protection against

impure, unviable and misnamed seeds, as similar laws have been drawn for protection in fertilizers and foods. This body of law is now extensive.



FIG. 1. Special parts of the United States

The United States and Canada have depended largely on Europe for flower and vegetable seeds, and even for some of

the staple field crops, as sugar-beet. The necessary labor has been at command in Europe and the growers there have developed the requisite experience and skill; and the people here have been preoccupied with the large conquest of a continent. The Great War has challenged this situation and has



for the commercial raising of field seeds.

stimulated seed-production in North America; it is to be expected that we shall not be so dependent again. Yet we shall

need the seeds from other countries where special skill has been developed and the handwork is available; and, more-

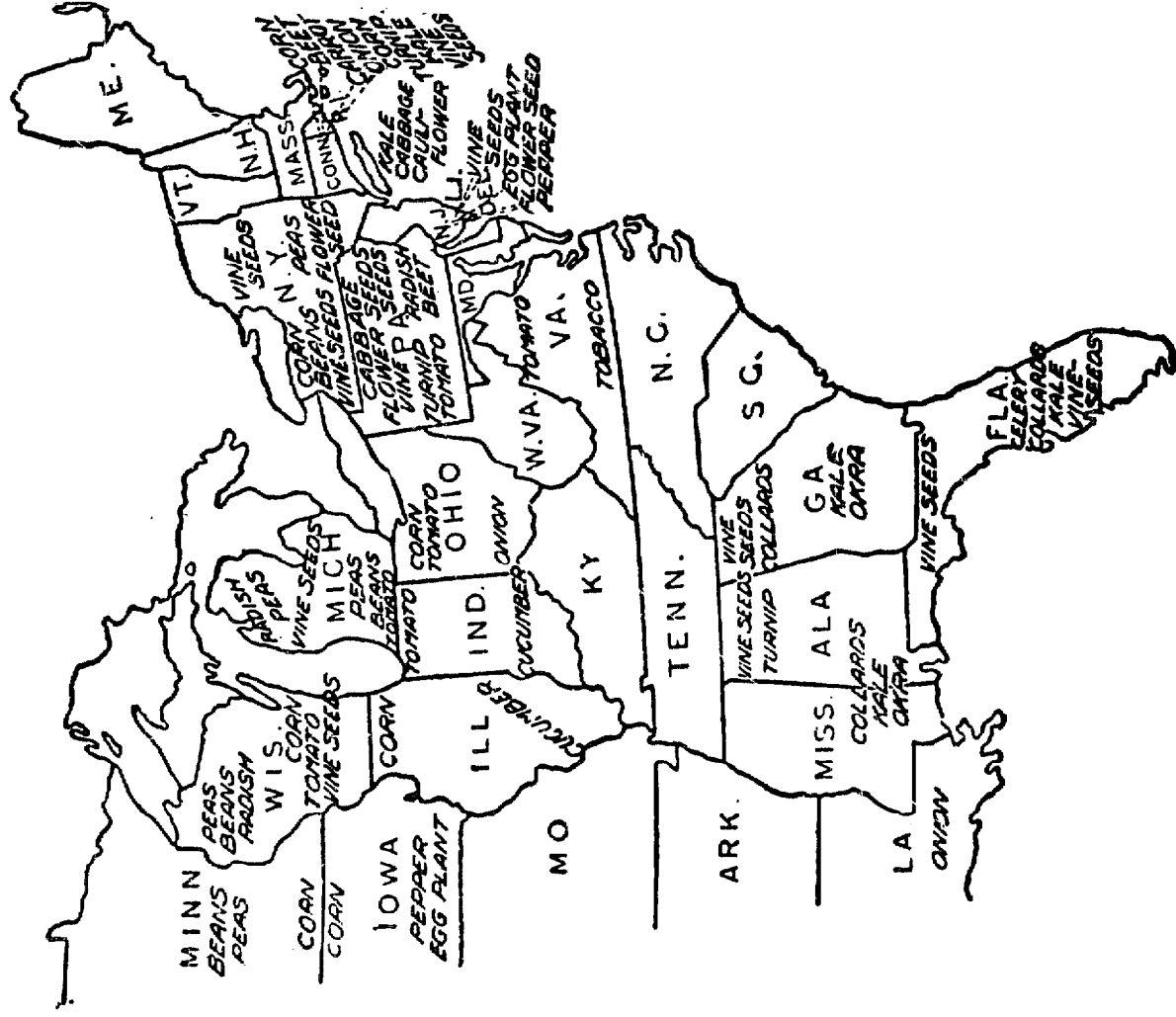

FIG. 2. Special parts of the country in which

over, we need the comity of international trade and supply if we are to develop the proper fellowship among the peoples of the earth. In proportion as all peoples are sufficient unto

themselves will a real league of nations be difficult to accomplish.

Prior to the War, England supplied America liberally with seeds of beet, turnip, carrot, radish, parsley, parsnip, cabbage



vegetable seeds are produced commercially.

and of most of the common annual flowers. Germany and Austria furnished considerable seed of flowers, and also of many of the common vegetables, particularly radish, turnip, beet

and carrot. Denmark supplied beets and other root-crops as well as the cabbage-like vegetables. France sent to us radish, carrot and seeds of annual flowers. Japan supplied seeds of rape and similar plants. What effect the War will have on the permanent sources of seed supply cannot yet be stated.

The accompanying maps, Figs. 1 and 2, show the special sections in the United States for the production of field seeds and vegetable seeds respectively, as reported by R. A. Oakley in an interesting article on "The Seed Supply of the Nation" in the Yearbook of the Department of Agriculture for 1917.

The figures of seed-production given on page 5 will undoubtedly be greatly increased by the forthcoming census. Apparently the United States requires upward of 110,000,000 pounds of red clover seed, for example; at present farm prices (1919), the value of it would be about \$66,000,000.

Persons interested in the seed-production of the United States should be in touch with the Seed Reporting Service, Bureau of Markets, U. S. Department of Agriculture, and should consult the Seed Reporter, a monthly publication.

Not only in seeds but in bulbs and living plants have the North Americans benefited by the skill in plant propagation of the Europeans. Many prized international relations have grown up with this importation; a good literature and personal association have developed. What is to be the future of this fraternalism is a source of anxiety to many thoughtful persons.

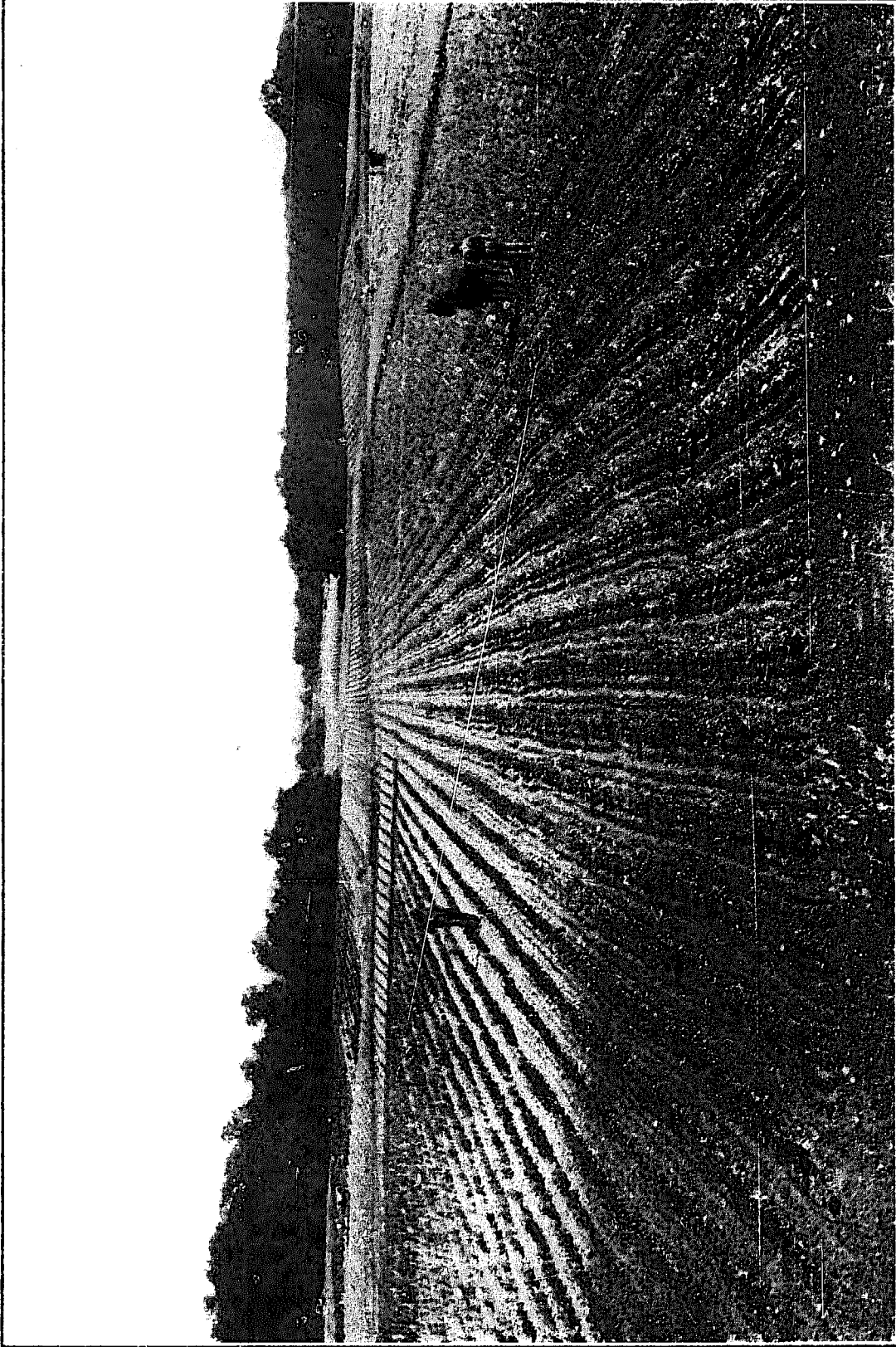

PLATE I. A seed nursery. Flower plants grown for the crop of seeds.

CHAPTER II

PROPAGATION BY MEANS OF SEEDS AND SPORES

THE seed is the epitome of the plant, the result of the final process of the plant's activity. To germinate, to vegetate, to build its characteristic structure, to flower, to seed or to spore, — this is the cycle of the plant. Some plants die when seeding is accomplished, whether the epoch transpires within one twelvemonth as with the pigweed or within a score of years or a century as with certain agaves. Other plants flower and seed perennially for two or three years as with red clover and hollyhock, or year after year indefinitely as with the lilac and the forest trees. Yet whatever the span, the seed or the spore completes a cycle, that new individuals may be born to continue the life of the species.

The characteristic propagative body of the flowering plants (known also as phenogams and spermatophytes) is the *seed*. It is the result of sexual union in the flower; it comprises an embryo contained within integuments, and usually a supply of stored food to support the first growth of the plantlet. The characteristic propagative body of the flowerless plants (known also as cryptogams) is the *spore*; it contains no embryo; it may be only a single cell; some spores are the result of sexual union and others are not. The spore-bearing plants, when the term is used in this sense, are the ferns and their allies, the mosses, fungi, algæ and lower forms. *Germination* is the act or process by means of which a seed or spore gives rise to a new plant. Germination is complete when the plantlet has ex-

hausted the store of food in the seed (or spore) and is able to support itself. A seed may have sufficient vitality to *sprout* and yet not be able to *germinate*. The word *germination* cannot properly be applied to the growing of plants from tubers, as of the potato; *vegetation* is the better term in such cases. A plant arising from a seed rather than from a bulb, cutting or cion is a *seedling*; and from a spore it is a *sporeling*; but even seedlings are usually not so called when they have attained some age and show the features of maturity. The science and practice of the propagation of plants by means of seeds and spores is known as *seedage*; to the details of this subject we now proceed.

1. THE REQUISITES AND CONDITIONS OF GERMINATION

If a seed is viable or able to grow, there are three external requisites to germination — moisture, free oxygen, and a definite temperature. These requisites are demanded in various degrees and proportions by seeds of different species, or even by seeds of the same species when differing widely in age or in degree of maturity. The supply of oxygen usually regulates itself. It is only necessary that the seeds shall not be planted too deep, that the soil is porous and not overloaded with water. Moisture and temperature, however, must be carefully regulated.

Regulation of moisture

Moisture is the most important factor in seedage. It is usually conducted to the seeds by means of soil or some similar medium, as moss or coconut fiber. Fresh and vigorous seeds endure heavy waterings, but old and poor seeds must be given very little water.

If there is reason to suspect the seeds to be weak, water should not be applied to them directly. A favorite method of handling weak and also very small seeds is to sow them in a pot of loose

and sandy loam which is set inside a larger pot, the intermediate space being filled with moss, to which, alone, the water is applied. This device is illustrated in Fig. 3. The water soaks through the walls of the inner pot and is supplied gradually and constantly to the soil. Even in this case it is necessary to prevent soaking the moss too heavily, especially with very weak seeds. When many pots are required, they may be plunged in moss with the same effect. The soil should be only very slightly moist,

never wet. Moisture is sometimes supplied by setting the seed-pot in a shallow saucer of water, or it may be sufficient to place it in the humid atmosphere of a propagating-box. Large but weak seeds may

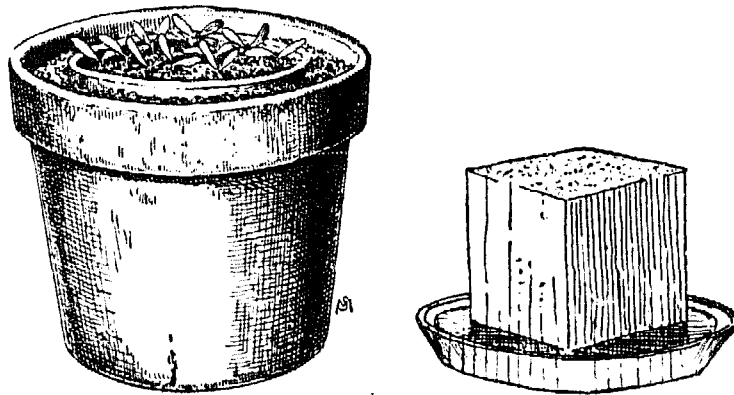

FIG. 3. Double seed-pot, with moss between the two pots; also a block of wood on which certain seeds may be sown.

be laid on the surface of the soil in a half-filled pot, covered with thin muslin and covered again with loose and damp loam. Every day the pot is inspected, the covering taken off and fresh soil added. A modification of this plan, for small seeds, is made by placing the seeds between two layers of thin muslin and laying them in damp loam, which is frequently renewed to avoid the extremes that would result from watering or from allowing the soil to become dry. In these last operations, no water is applied to the seed, and they constitute one of the most satisfactory methods of dealing with seeds of low viability. They are essentially the methods long ago used by Thomas Andrew Knight, who laid such seeds between two sods cut from an old and dry pasture.

Seeds of orchids and certain other plants are sometimes

sown on the end of a porous block of wood that is placed in a dish of water, seen in Fig. 3. The block is covered with a bell-glass (Fig. 5), or it may be placed in a propagating-box.

Even sound and strong seeds should be watered with care. Drenchings usually weaken or destroy them. The earth should be kept merely damp in most cases. To insure comparative dryness in indoor culture, a loose material, as pieces of broken pots or clinkers, should be placed in the bottom of the pot or box to afford drainage. It is to be borne in mind, however, that the seed-bed should be approximately equally moist throughout its depth. The waterings should be copious enough to moisten the soil, top to bottom. A wet or moist surface over a dry substratum should be avoided. Error is common here. It is usually best to apply water with a watering-pot, as watering with a hose is likely to wash out the seeds and to pack the earth, and the quantity of water is not so easily regulated.

At first thought, it would seem that the apparently good results following soaking of seeds are a contradiction of the statements that seeds may be over-watered. But soaking is usually beneficial only when practiced for a comparatively short time. It is not good practice to soak delicate seeds before sowing, and it is of doubtful utility in most other cases, unless it is necessary to soften the integuments of hard-shelled species, as discussed on page 37. The gain in rapidity of germination following soaked, as compared with dry, seeds, is often only apparent, inasmuch as germination actually begins in the soaked seed before the dry samples are sown. The soaked seeds are sown in water rather than in soil, and as conditions are more uniform there, a gain apparently due to soaking may result. In the case of certain strong seeds planted outdoors in cold or uncongenial soil, a preliminary soaking of twelve to twenty-four hours may be beneficial, as it lessens the period which the seeds would otherwise pass in untoward conditions. But soaked seeds, unless of very hardy species, should never

be sown outdoors until the soil has become rather dry and warm. The soaking of seeds should always be regarded as a special practice, to be employed with caution.

Direct exceptions to these cautions against over-watering are provided by the seeds of the aquatic plants, as water-lilies and wild rice (*Zizania*). Such seeds are usually placed in balls or pots of earth and then immersed in water, where germination takes place.

To prevent too rapid drying out in ordinary seed-sowing, the earth should be firmly pressed about the seeds. The pot or box

should be given a shady place, or covering may be applied to check evaporation. A pane of glass is often placed over the pot (Fig. 4) or box, being tilted

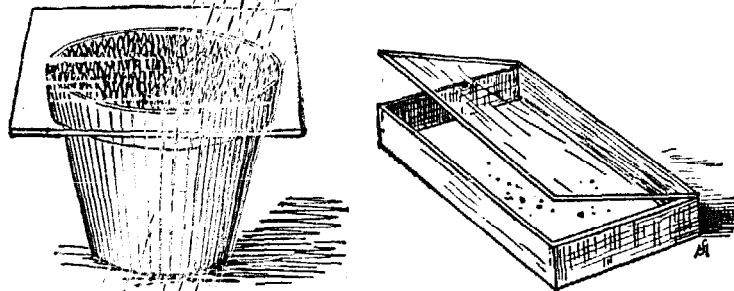

FIG. 4. Seed-pot, covered with glass; also a glass-covered seed-case.

a little at intervals to allow of ventilation and to prevent the earth from becoming soggy or "sour." A seed-case, with a glass cover, as shown in Fig. 4, is neat and handy in the treatment of small seeds. A thin covering of fine moss is sometimes applied, or a newspaper may be thrown over the pots or boxes. The seed-boxes should be protected from strong direct sunshine.

For the careful growing of special plants, the bell-glass (Fig. 5) is most satisfactory, although relatively little known in this country. It is useful also in the rearings of cuttings.

In outdoor culture, only a naturally dry and well-drained soil should be chosen for ordinary seeds, especially for such as are sown in autumn or remain in the ground a long time before germinating. Soils that contain a liberal amount of sand or gravel are specially valuable for this purpose.

To prevent drying in outdoor operations, it is important that

the earth be well firmed over the seeds. Walking on the row, placing one foot directly ahead of the other, is usually the most expeditious and satisfactory practice, at least with large seeds.

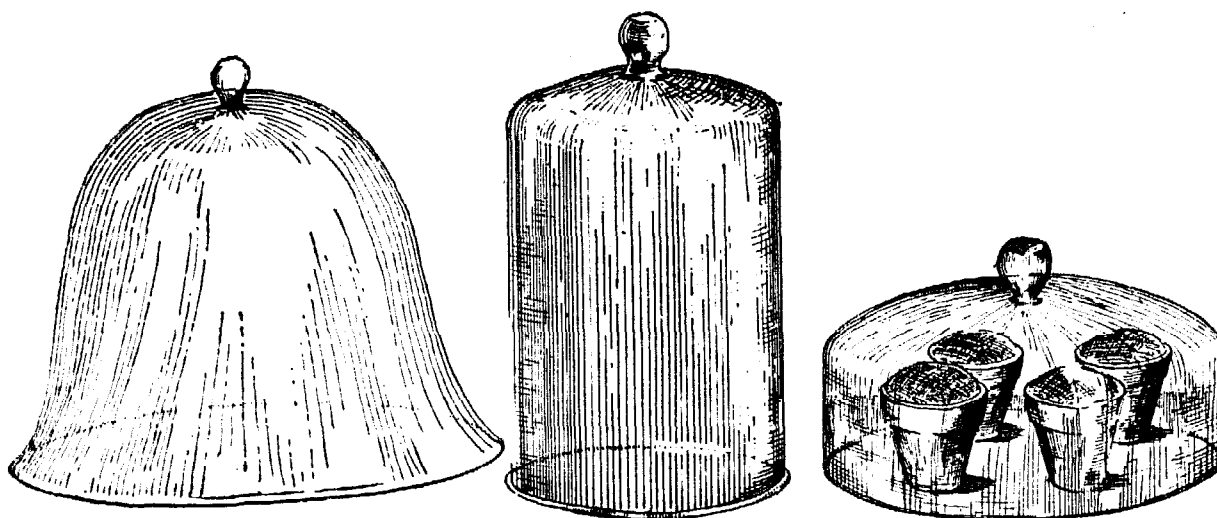

FIG. 5. Bell-glasses of different forms. The one at the left is the *cloche* of the French.

The earth may be firmed with a hoe or the back of a spade, or a board may be placed on the row and then be thoroughly settled by walking on it. For small lots of seeds, it is well to cover them with an inverted flower-pot (Fig. 6), taking care to tilt it frequently to prevent the plants from "drawing."

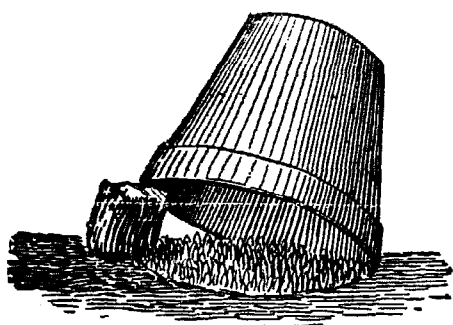

FIG. 6. Seeds covered with flower-pot.

In the sowing of celery and other small and slow seeds, it is a frequent practice to leave the board on the row until the seeds appear, in order to hold the moisture. This is a doubtful expedient, however, for the young plants are likely to be quickly dispatched by the sun when the board is removed. If the board is employed, it should be raised an inch

or two from the ground as soon as the plants begin to appear; but the shade of the board is too dense, and plants do not grow

stocky under it. It is better to use brush or lath screens if protection is desired; or fine litter, if free from weed seeds, may be employed. In most cases, however, screens will not be needed by celery and similar seeds if the ground is in the proper condition so that it will neither bake nor dry out quickly, and is well firmed at planting time, and if the seeds are sown early before hot dry weather comes. It is always advisable, nevertheless, to place the beds for slow and small seeds where they can be watered occasionally and where there is protection from strong winds and perhaps more or less protection from sun. Plants much protected from sun, however, may be burned and sometimes killed when transplanted to the field unless they have been "hardened off" before transference.

Many kinds of screens are in use to prevent the drying out of small seeds in outdoor seedage and to protect the young seedlings. These are used also in the shading of cuttings. The common lath screen (Fig. 7) is the most useful for general

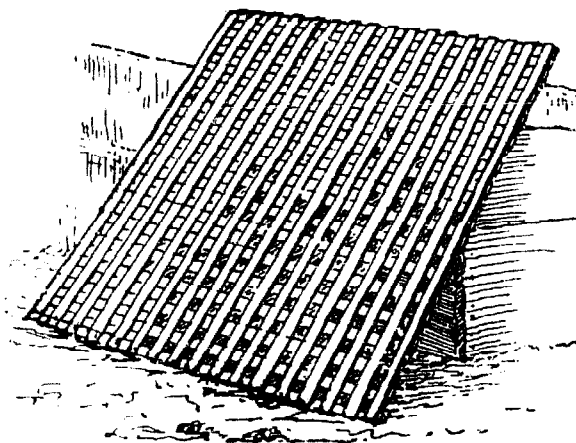

FIG. 7. Lath screen.

purposes. It is simply a square frame made from common laths laid at right angles in a double series. The interstices between the laths are equal in width to the laths themselves. These screens are laid horizontally on a light framework a few inches above the seeds. The passage of the sun constantly moves the shadows over the bed, and sufficient shade is afforded while thorough ventilation is assured. This and all other elevated screens are useful in shading and protecting the young plants as well, but when used for this purpose they are mostly raised a greater distance above the beds. A brush screen, consisting of a low frame covered with boughs, is often used,

as shown in Fig. 8. This is cheaper than the lath screens, and is equally as good for most purposes. The brush is often laid directly on the ground, especially in large beds. This answers



FIG. 8. Brush screen.

the purpose of shading, but it does not allow of weeding, and it must be taken off soon after the seeds germinate, or slender plants will be injured in its removal. Brush screens are sometimes raised three or four feet to allow of weeding.

A good screen for frames is shown in Fig. 9. It is a simple covering of muslin stretched over the top and sides of a rough framework. The cloth is usually omitted from the

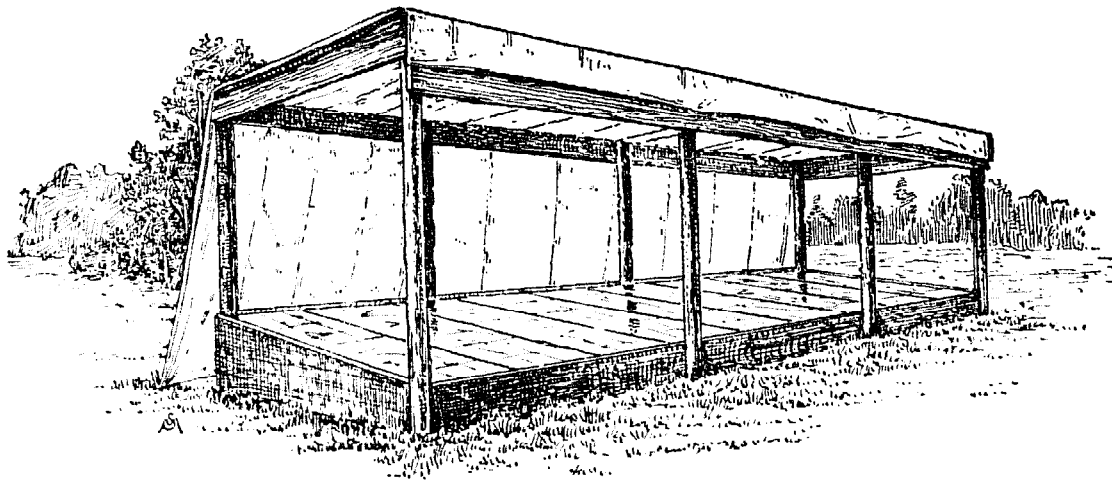

FIG. 9. Cloth screen for frames in which seeds and cuttings may be handled.

front side. This style of screen is much used by nurserymen, especially for cutting-beds. Whitewashing the sashes of coldframes also affords good shading. A more elaborate and permanent screen is shown in Fig. 10. It is built of slats,

usually 3-inch stuff. This shed screen is oftenest used for the protection of tender plants, but it affords an exceedingly useful and convenient place for the storage of pots and boxes of slow-germinating seeds. A more elaborate shed screen, made of lath or slats, and containing seed-beds edged with boards, is shown in Fig. 11.

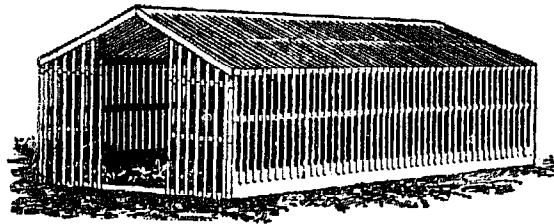

FIG. 10. Shed screen for seeds and plants.

Various frames and covers are employed for indoor seedage, designed to regulate atmospheric moisture and to control temperature. They are more commonly employed in the growing of cuttings, and are therefore described in Chapter V.

Requirements of temperature

Variations in temperature exercise less influence on seeds than variations in moisture. Yet it is important that the extremes of temperature be not great, especially in small, delicate

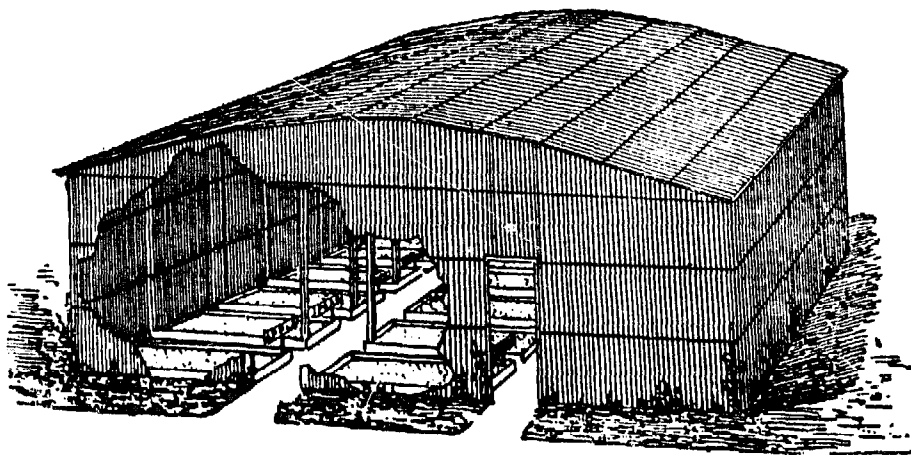

FIG. 11. Large shed screen, with seed-beds.

or weak seeds. Seeds will endure greater extremes of temperature when dry than when moist. This indicates that germinating seeds must be kept in a relatively uniform temperature. For this reason it is poor practice to put seed-boxes in a window in full sunlight. Partial or complete shade serves

the double purpose of preventing too great heat and too rapid evaporation. Various covered seed-boxes are used for the purpose of maintaining approximately the required temperature, but as they are oftener employed in bud-propagation, they are discussed in that connection (Chapter V).

Bottom heat is helpful to germination in most seeds, but, except in the case of certain tropical species, it should not be strong. It is a common practice to place seed-boxes on moderately cool pipes under benches in a greenhouse. Seeds of hardy annuals and perennials do not require bottom heat, although they may be benefited by it. If the earth in seed-beds should become too cool, watering with warm or tepid water may be helpful.

It is impossible to give rules for the proper temperature for different kinds of seeds. In general, it may be said that seeds germinate most rapidly at a temperature a few degrees above that required for the best development of the plant itself. Seeds of hardy plants require a temperature of 50° to 70°, conservatory plants 60° to 80° and tropical or stove plants 75° to 95°. The plantlets should be removed from these highest temperatures, as a rule, as soon as germination is completed.

In outdoor culture, depth of planting has a direct relation to temperature. Seeds may be planted deeper late in the season than early when the soil is cold and damp. Deep planting probably as often kills seeds because of the absence of sufficient warmth as from the lack of oxygen or the great depth of earth through which the plantlet is unable to push.

Influence of light on germination

The influence that light exerts on germination is not definitely understood for all horticultural seeds. It is known, however, that seeds will often germinate in full sunlight, if the proper

conditions of moisture and temperature can be maintained. Seeds sown on a moist surface and covered with a glass present an interesting study. They may have difficulty in getting a foothold, and they present peculiar reactions to light.

It is well known, on the other hand, that some seeds will not germinate, or will at least appear unevenly, if subjected to sunlight. At least some of the delphiniums, papavers and adonises germinate very imperfectly, if at all, in direct light. It is always advisable to keep germinating seeds in shade or partial darkness, especially as there is nothing to be gained by exposing them. Of course, the soil itself is sufficient protection if the seeds are covered.

Regermination

It is a common statement that seeds can never revive if allowed to become thoroughly dry after they have begun to sprout. This is an error. Wheat, oats, buckwheat, maize, pea, onion, radish and other seeds have been tested in this regard, and they are found to regerminate readily, even if allowed to become thoroughly dry and brittle after sprouting is well progressed. They will even regerminate several times.

Wheat, peas and other seeds have been carried through as many as seven germinations after the radicle had grown a half inch or more and the seeds had been sufficiently dried in each trial to render them fit for grinding.

Delayed germination

We noted in Chapter I that most seeds have a natural period of dormancy. This period may be considerably shortened or lengthened in many cases by the treatment to which the seeds are subjected.

If seeds are buried in the ground and exposed to the action of frost, the period of dormancy is usually considerably reduced. Thus Pammel and King report (Proc. Iowa Acad. Sci. xv) experiments by Fawcett showing that "the dormant period of common pigweed (*Amarantus retroflexus*) was nine and one-third days when kept in packages in a dry room, and only six and one-third days after having been wintered out of doors. In the case of wild rye, the dormant period was lessened from nine to five days . . . while the percentage of germination was increased from 22 per cent to 48 per cent, and the pigweed from 40 per cent to 50 per cent. In general, the longest dormant period was found in those seeds which have the hardest and thickest coats."

The better germination of some kinds of seeds after being subjected to freezing is the result of the cracking of the shell and the letting in of moisture, rather than the lessening of an inherent dormancy; perhaps this is always the explanation. Plant-growers resort extensively to the burying of nuts and hard-shelled seeds to insure germination. They also file or notch certain seeds, as those of the moonflowers, to allow water to enter and to start the germination processes, taking care, of course, not to injure the embryo.

How long germination may be delayed and the seeds still remain viable (or germinable) depends on the kind of plant more than on the conditions of storage. The longevity of seeds, in other words, is largely an hereditary trait lying probably in the anatomy and chemical constitution. In this realm, new experiments are needed on a considerable scale, reinforced by the modern understanding of the physiological processes.

The stories of live seeds being taken from the mummies of ancient Egypt are not credible; these statements have often been exposed. Yet certain seeds may outlive a human life. Pammel and King report the following table from Ewart, of Victoria (Australia), on certain rather remarkable longevities:

NAME OF SEED	YEARS OLD	NO. OF SEEDS	PERCENTAGE OF GERMINATION
<i>Malvaceæ</i> —			
Abutilon Avicennæ	57	45	6
Hibiscus Trionum	57	—	12
Gossypium herbaceum (cotton) . .	10	—	80
<i>Leguminosæ</i> —			
Acacia diffusa	57	32	9
Acacia penninervis	57	15	13.3
Cytisus albus	51	54	78
Melilotus alba (sweet clover) . . .	44	250	52
Melilotus alba (sweet clover) . . .	77	1000	18.2
<i>Nymphæaceæ</i> —			
Nelumbium luteum	55	6	63
<i>Rhamnaceæ</i> —			
Ceanothus americanus	15	20	0
<i>Cruciferae</i> —			
Brassica alba (white mustard) . . .	77	115	0
<i>Compositæ</i> —			
Cichorium Intybus (chicory) . . .	10	100	50
Helianthus annuus (sunflower) . . .	15	20	0
<i>Gramineæ</i> —			
Triticum vulgare (wheat)	10	100	75
Zea Mays (Maize)	7	100	36
Bromus mollis	10	250	0

Horticulturists are well aware that seeds of parsnip and certain others of the Umbelliferae are unreliable after one or two years, whereas cucumber and others of the Cucurbitaceae may be "good" after several or even many years. They reduce the risk to the minimum, however, by insisting on "fresh" seeds, that is, on those grown the preceding year.

Keeping the seeds

To keep seeds is to prevent germination and at the same time to preserve the life of the seed.

Seeds should be thoroughly ripe and dry before they are stored. Those of pulpy fruits are removed and cleaned. If the seed-vessels are dry and hard, seeds may be left in them till sowing time, but usually they are removed.

Hard seeds, as of trees and nuts, may be buried as explained on page 35. Most seeds, however, are stored dry in paper bags or boxes in a cool dry room. The receptacles should be tight to keep out weevils; if there are any signs of bug work, a little bisulfide of carbon may be poured in the receptacle, and the vapor of it will destroy animal life. This material is inflammable, and it should be kept away from flames.

If seeds at storing time are moist and the weather is damp, they may be lightly kiln-dried before put away for winter. Rarely are dry seeds injured by freezing. Seedsmen sometimes keep large and more or less fleshy seeds, as musas, in fine dry sawdust, chaff or other material that will insure equable conditions and prevent too great desiccation.

2. SEED-TESTING

While it is not the province of this Manual to discuss the question of the testing of seeds, a few hints on the subject may be acceptable, particularly in the bearing of the remarks on seed-sowing. Seed-testing is for two purposes: to determine the germinating power or growing power of the seeds; to discover the purity or quality of the sample in respect to admixtures, weed seeds, foreign materials and adulteration, a process often called "seed analysis."

Testing for viability

Germination is complete when the plantlet begins to assume true leaves and to appropriate food directly from the soil. The testing of seeds is not always concerned with germination, but with the simple sprouting of the samples. Many seeds

will sprout when not strong enough to germinate completely, and more seeds will be counted as viable when they are tested in a germinating apparatus — where the conditions are perfect — than when they are normally planted in the earth. There is even sometimes a marked difference between the results of seed-tests in earth in the greenhouse and in outdoor planting, as the following comparisons (Bulletin 7, Cornell Experiment Station, 1889) plainly show:

“It has been said recently that the ideal test of seeds is actual sowing in the field, inasmuch as the ultimate value of the seed is its capability to produce a crop. This notion of seed-tests is obviously fallacious, although the statement on which it is based is true. In other words, actual planting rarely gives a true measure of the capabilities of all the seeds of any sample, because of the impossibility to control conditions and methods in the field. The object of seed-tests is to determine how many seeds are viable, and what is their relative vigor; if planting shows poorer results, because of covering too deep or too shallow, by exposing to great extremes of temperature or moisture, or a score of other untoward conditions, the sample cannot be held to account for the shortcoming. The table on page 26 indicates the extent of variations that may be expected between tests and actual plantings of seeds from the same samples.

“Various samples were tested indoors and actually planted in the field. The seeds were sown in the field June 5, and the last notes were taken from them July 5. They were sown on a gravelly knoll. Rain fell about every alternate day, and the soil was in good condition for germination throughout the month. The indoor tests were made in loose potting earth, or in sand in seed-pans.

“The table indicates that actual planting in the field gives fewer germinations than careful tests in conditions under control. This difference in total of germination, even under

SAMPLES	NO. OF GERM. IN HOUSE	PER CENT OF GERM. IN HOUSE	NO. OF GERM. IN FIELD (200 SEEDS SOWN)	PER CENT OF GERM. IN FIELD	PER CENT OF DIFFERENCE
Endive, Green Curled (200 seeds)	88	44	53	26.5	17.5
Tomato, Green Gage (100 seeds)	72	72	93	46.5	25.5
Turnip, Early Six Weeks (200 seeds) .	180	90	65	32.5	57.5
Pea, White Garden Marrowfat (60 seeds)	55	91.6	181	90.5	1.1
Celery, White Plume (100 seeds)	41	41	22	11	30
Onion, Red Wethersfield (200 seeds) .	148	71	84	42	32
Carrot, Early Forcing (100 seeds)	70	70	39	19.5	50.5
Carrot, Vermont Butter (100 seeds) . . .	65	65	45	22.5	42.5

favorable conditions of planting, may amount to over 50 per cent.

“In planting, due allowance should be made for the comparatively bungling methods of field practice by the use of greater quantities of seeds than would seem, from the results of tests, to be sufficient.”

Probably the most truthful test of seeds can be made in earth in earthen pans in a greenhouse or forcing-house. When one desires to show the ultimate percentage of seeds that contain life, the sprouting-test should be used. In this case, an apparatus should be employed in which the moisture and temperature can be controlled to a nicety, and in which the seeds can be examined as often as desired. As soon as a seed sprouts, it is removed and counted as viable, wholly independently of whether it is strong enough to make a plant under ordinary conditions. In other words, the sprouting-test is an attempt

to arrive at a numerical estimate of the viability of the sample, rather than an effort to determine the relative strength of germinative power.

There are many excellent devices for the making of sprouting-tests, only a few of which need be mentioned here for the purpose of illustrating some of the principles involved. One of the best known of these apparatus in this country is the Geneva tester (Fig. 12), which originated at the New York Experiment Station at Geneva. A full account of this device by Professor J.

C. Arthur (Botanical Gazette, 1885, p. 425) is here inserted:

“Various methods have been used for testing the per cent and time of seed germination. Those most commonly adopted in this country and also abroad have been to place the seeds on the surface of porous tile, smooth sand or compacted earth. Without stopping to point out the defects and inconveniences of these methods, I desire to describe an apparatus devised at the New York Agricultural Experiment Station, and which has been found so satisfactory as to supersede all other sorts of germinators at that institution for general use. It consists (Fig. 12) of a pan 10 x 14 inches wide and $3\frac{1}{2}$ inches deep, to be covered with a pane of glass. Along the sides is a ledge $\frac{3}{8}$ inch wide, and as much below the upper edge. The pan is best made of tinned copper, the ledge formed by the proper shaping of the sides of the pan, and the edges on three sides turned over to form a groove into which the pane of glass may be slid from one end. These details are not shown in the cut. The seeds are held in the folds of cloth. A strip of white canton flannel is taken sufficiently wide so that when hemmed on both sides (to prevent seeds slipping out of the ends of the folds) it will be the same as the inside width of the pan. A long enough strip is used to have about twenty-four folds $1\frac{1}{2}$ inches deep, and leave a flap of several inches at each end. The upper margin of the folds is sewn

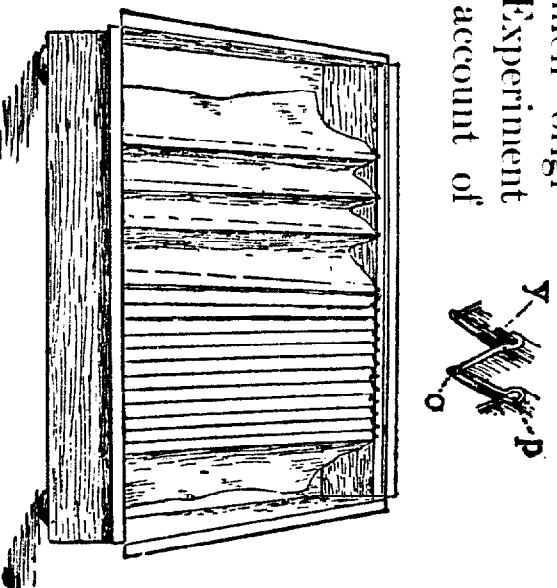

FIG. 12. The Geneva seed-tester.

across to permit a $\frac{1}{8}$ -inch brass rod to be run in (y, p), from which the cloth is suspended in the pan, as shown in the cut. The lower margins of the

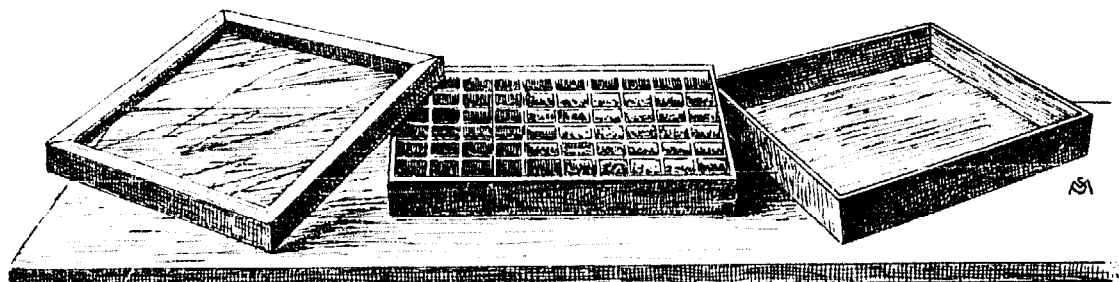

FIG. 13. Absorbing-block seed-tester.

folds (o) are also sewn across to make them stay in place better. The total length of the strip after the sewing is completed is about a yard. Two such strips are used in each pan.

“To put the pan into use, it is filled part full of water, two of the prepared cloths put in, the glass cover adjusted and the whole boiled over a lamp for a short time. This is necessary in order both thoroughly to wet the cloth and to kill any mold or other germs. When again cool, adjust the cloths on the brass rods and put in the seeds. Each fold will hold 25 large seeds, like beans, and a hundred or more small seeds. Water is placed in the pan, but not enough to touch the folds of cloth; the four flaps drop down into it, however, and keep the cloths sufficiently wet by capillarity, which is increased by the long nap on the under surface of the cloth. The folds are numbered consecutively, and the record kept by the numbers.

“The advantages in a pan of this kind are the facility with which the seeds may be examined and counted, the thorough and uniform moisture of the seeds throughout the longest trials, its lightness and cleanliness. It is necessary to renew the cloths from time to time, as they will slowly rot out, even with the best of care.”

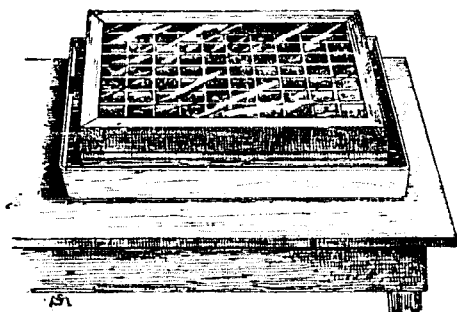

FIG. 14. The tester shown in Fig. 13 set up for use.

A device of different character is shown in Figs. 13 and 14 (*Annals Hort.*, 1890, 268). It consists of three parts: a tin tray (c) for holding water; a block of gypsum (b) that sits in the tray and contains several compartments for the reception of the

seeds, and is kept moist by capillary attraction; a glass cover (*a*). The apparatus is seen set up in Fig. 14. This device works on a principle long utilized in the testing of seeds — the capillary power of earthenware and various species of rock — and there are many applications of the idea in practice. These seed-testers may be placed in an incubator or other heating device, or they may be used in the greenhouse or a living-room.



FIG. 15. Sprouting-cup.

A bulletin (No. 35) of the Rhode Island Experiment Station describes and illustrates a modification of the absorbing-block idea (Fig. 15). Instead of a slab of stone or earthenware, "sprouting cups" are used. "They are 3 inches in diameter and $1\frac{3}{4}$ inches high, including the cover, which is ventilated. The bottom is solid and $\frac{1}{2}$ inch thick. Each cup is placed in a glass dish in which a constant supply of water is kept."

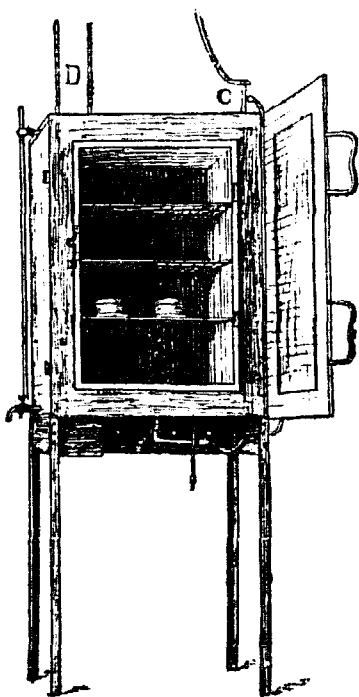

FIG. 16. Sprouting-chamber.

These cups are placed in a "sprouting-chamber" (Fig. 16), supplied with uniform heat. "This holds about fifty cups. Heat is supplied by a gas jet, which is supported beneath the chamber, and it is distributed evenly to all sides of the chamber, except the front, by means of a water-jacket. It is provided with two doors, the inner one being glass. There is an opening in the side and top for ventilating, and a second opening in the top for the insertion of a thermometer. There are also two openings into the water-jacket at the top. In one of these a thermostat (*c*) is placed, which controls the flow of gas at the jet beneath, and in the other a

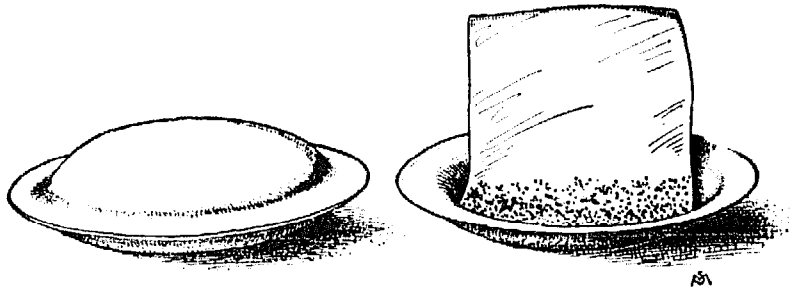

FIG. 17. Home-made seed-tester.

thermometer (*d*) may be placed to show the temperature of the water in the jacket."

A good home-made tester, often illustrated in experiment station bulletins and elsewhere, is shown in Fig. 17. Two plates are used, with water or wet sand in one of them, on which is placed a blotting-paper or piece of canton flannel bearing the seeds.

The "rag-doll" tester is now one of the most popular home-made devices and is often illustrated. It is shown in Fig. 18 (adapted from a Montana Station publication, as is also Fig. 17). A piece of heavy cloth is wet, the seeds placed on it, and the cloth then rolled up tight; sometimes the rolls or "dolls" are stood in a pail of water. In these rolls the seeds soon germinate, and they may be untied frequently for examination. Several of them are shown in Fig. 18. If it is desired to test several kinds of seeds in one doll, a piece of heavy white canton flannel may be used and laid off into squares or compartments with a lead pencil.

The usual practice of testing garden seeds at home is to plant them in boxes of light earth and to place the box in a warm window or near a stove. While this method may be accurate enough for common purposes, it does not allow of easy examination nor are the conditions likely to be under sufficient control.

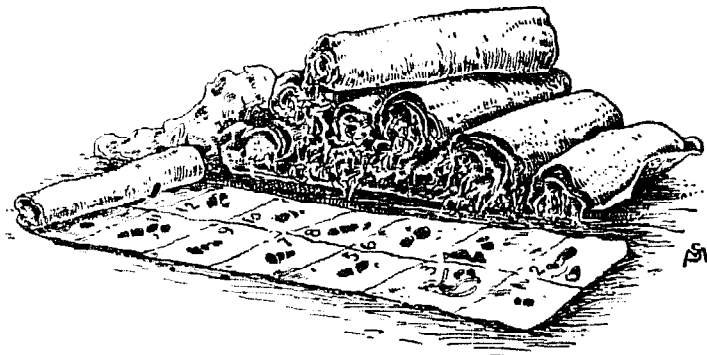

FIG. 18. The rag-doll seed-tester.

Testing for purity

Analyzing a sample of seed for the impurities it may contain is a subject quite foreign to a manual of propagation; yet the reader may desire a few words on the subject. The process consists in examining the sample under a lens and counting or estimating the proportion of impurity or mixture. To make the best and most convincing test, one should be able to identify the impurities. Following is a description of such analysis

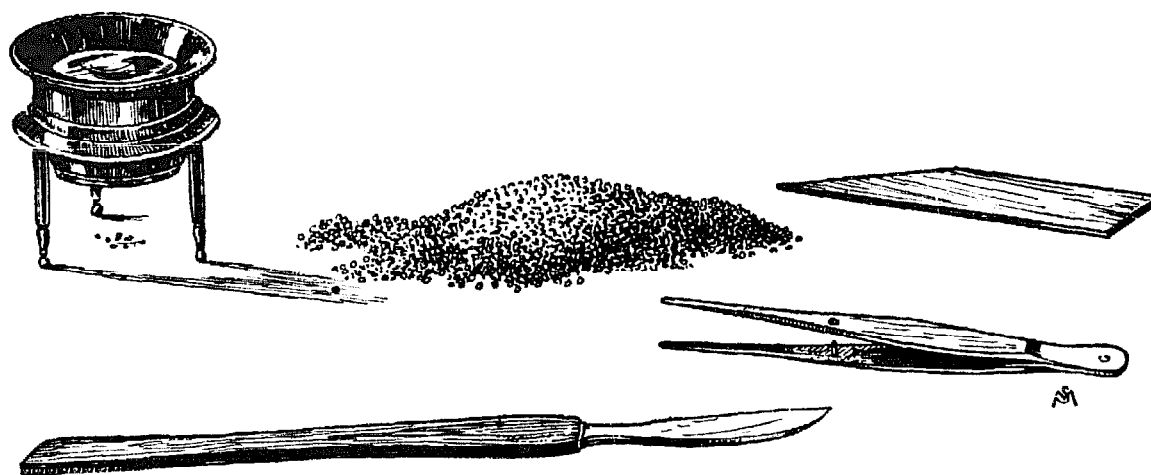

FIG. 19. Instruments for seed examination. — The seed sample; lens; piece of cardboard or other material to separate the sample into piles or parts; forceps; scalpel or knife.

for home use from Circ. 23, Utah Experiment Station (1916), by George Stewart, together with a picture (Fig. 19) adapted from the Montana Experiment Station:

“To find out the quality of the seed that is commonly planted, testing for impurities and germination power is the first important step. Let all seed be run over screens to get rid of as much foreign substance as possible. After a thorough screening, an analysis should be made. The most practical method for ordinary purposes is the hand separation of a well-mixed sample into piles containing (1) good seed; (2) broken and injured seed of the same kind; (3) seed of useful plants or of other varieties of the same crop; (4) dirt, chaff and other inert material; and (5) weed seed.

"In the first place it is necessary to get a representative sample by taking seed from top, sides, middle and bottom of sack or bin and to mix thoroughly on a cloth, paper or smooth table. A thin-bladed knife is a convenient tool with which to mix. The person should exercise care not to lose seed or dirt while mixing, as a good test requires careful weighing. When satisfied with the mixing, let the tester divide the sample into two approximately equal parts, discarding one-half and mixing the other, and repeat dividing and mixing until the pile is small enough to analyze.

"The first step in analysis is to weigh the sample carefully and record the weight. Analysis proper may then begin. This consists of separating the sample into the four or five piles already mentioned. A pair of forceps and a hand lens aid materially, and for small seed, such as grass and clover or alfalfa, are necessary. A needle fastened in a wooden handle or a sharp hat-pin serves to pick out small particles or to separate adhering bodies. After the separation is complete, each pile should be weighed, or closely estimated by counting.

"If possible, the weed seed ought to be identified in order to prevent the introduction of bad weeds new in the locality or not yet started on the farm in question. Identification enables the farmer to know just what he is planting, permitting him to exercise choice as to whether such seed is the best he can find at a reasonable price."

The complete seed-test

If a full test is made, it includes an analysis of purity and a record of viability. Following is the form of report recommended by Circ. 23 of the Utah Station:

A report of the test should show the analysis and percentage germination. The following form of report gives the most essential information:

Kind of seed	—	Variety	—
Source	—	Proposed use	—
Locality to use it	—		
<i>Test</i>		<i>Per Cent</i>	
Purity		—	
Injured seed		—	
Other crop seed		—	

<i>Test</i>	<i>Per Cent</i>
Inert matter	—
Weeds	—
	(Kinds of weeds — notes on)
Germination (per cent)	—

There is an organization of "Seed Analysts of North America," that meets in annual convention. It comprises the officers in the different states associated with the working of the seed laws, representatives of the United States Department of Agriculture and of the Canadian Department of Agriculture. Many of the experiment stations and departments publish results of seed-tests. The influence of all this activity has developed a public consciousness on pure seeds, established legal procedure and developed accurate methods of testing. A representative summary from one of the state publications will indicate the nature of the enterprise. This is from New Hampshire. That state enacted a pure seed law in 1909, requiring the publication annually of a bulletin showing the results of all seed-tests made officially in the previous year, placing the administration of the law in the hands of the State Commissioner of Agriculture, who appointed the agronomist of the Experiment Station as his regular agent for making all tests and analyses. The table on page 34 is from Bull. 180.

3. THE HANDLING AND SOWING OF SEEDS AND SPORES

When one comes to the sowing of seeds, one must be prepared to give them good care and much thoughtful attention. They have been the result of much energy on the part of the plant. Care of the seeds themselves, of the earth in which they are sown and in the follow-up treatment adds much to the satisfaction in growing the plant.

The stratification of seeds

Many seeds demand treatment preparatory to sowing. Nearly all hard and bony seeds fail to germinate, or at least germinate very irregularly, if their contents are allowed to become thoroughly dry and hard. The shells must also be softened or broken, in many cases, before the embryo can grow. Nature treats such seeds by keeping them constantly moist under leaves or mold, and by cracking them with frost. This suggests the practice known to gardeners as *stratification*, an operation that consists in mixing seeds with earth and exposing them to frost or to moisture for a considerable time (cf. page 24).

Stratification is practiced, as a rule, with all nuts, the seeds of forest trees, shrubs, the pips of haws and often of roses, and in many cases with the seeds of common fruits.

Seeds should be stratified as soon as possible after they are mature. Small seeds are usually placed in thin layers in a box alternating with an inch or two of sand. Sometimes the seeds are mixed indiscriminately in the sand, but unless they are large it is troublesome to separate them at sowing-time. The sand is often sown with the seeds, however, but it is difficult in such cases to distribute the seeds evenly, and in sowing large quantities the handling of the sand entails a considerable burden and becomes an item of expense. It is advisable to pass the sand through a sieve of finer mesh than the seeds, and the seeds can then be sifted out at sowing-time. If the seeds are very small or few in number, they may be placed between folds of thin muslin, which is then laid in the sand. Any shallow box, like a gardener's "flat," is useful in making stratifications, or pots may be used with small lots of seeds although pots are likely to be shattered by much freezing. A flat four inches in depth might contain two or three layers or strata of seeds the size of peas.

The disposition of the boxes when filled varies with different

operators. Some persons prefer to bury them. In this case a well-drained sandy slope is chosen. The flats are placed in a trench one to two feet deep, covered with a single thickness of boards, and the trench is then filled with earth. The seeds usually freeze somewhat, although freezing is not considered necessary unless in the case of nut-like seeds. The object attained in burying is to keep the seeds moist and fresh, inducing the rotting or softening of the coverings, while they are buried so deep that they will not sprout. Seeds of most forest trees should be treated in this way. They are commonly left in the ground until the following spring, when they are taken up and sown in drills in mellow soil. If good loam, to which has been added a little well-rotted manure, is used, the seeds or nuts of hardy trees and shrubs may be allowed to germinate and grow for one season in the flats. At the end of the season or the next spring, the plants can be transplanted without losing one of them. This perhaps is the best way to handle rare and difficult subjects.

Many growers place the boxes on the surface in a protected place, as under trees or in a shed, and cover them for winter a foot deep with clean straw or leaves. If boxes are piled on top of each other they should be mulched with moss, else the under ones may become too dry. Or the boxes may be placed, without covering, in a shed, but they must be examined now and then to see that they do not become too dry. Precaution must also be taken to keep away mice, squirrels, blue-jays, and other intruders.

Large nut-like seeds or fruits, as peach-pits, walnuts and hickory-nuts, are usually buried in sand or light loam where they may freeze. Or sometimes the large nuts are thrown into a pile with earth and allowed to remain on the surface. Freezing serves a useful purpose in aiding to crack the shells, but it is not essential to subsequent germination, as is commonly supposed. All seeds, so far as known, can be grown without

the agency of frost, if properly handled. The seeds of some of the pines are liberated by heating the cones.

Fall sowing amounts to stratification, but unless the soil is mellow and very thoroughly drained the practice is not advisable. The seeds are liable to be heaved or washed out, or eaten by vermin, and the earth is likely to bake over them. Under proper conditions, however, the seeds of fruits and many forest trees thrive well with fall sowing. The seeds should be sown as soon as they are ripe, even if in midsummer; or if the ground is not ready for them at that time, they may be temporarily stratified to prevent too great hardening of the parts. It is best to allow all green or moist seeds to dry off a few days before they are stratified. Fall-sown seeds should always be mulched.

Nurserymen practice stratification of large seeds, as peach and plum, by burying them in autumn in trenches or shallow pits. Care is taken to choose a well-drained soil, and a place that can be opened early in spring.

Some seeds rarely germinate until the second year after maturity, even with the best of treatment. The thorns, mountain ash, hollies, viburnums, some roses, and many others belong in this category. Some growers sow them regularly as soon as they are ripe, and allow the beds to remain until the seeds appear. This is a waste of land and of labor in weeding, and the best way is to stratify them and allow them to remain until the first or second spring before sowing.

Other preparatory treatment

Partial substitutes for stratification are soaking and scalding the seeds. Soaking may be advantageously practiced in the case of slow and hard seeds that are not inclosed in bony shells, and which have been allowed to become dry. Seeds of apple, locust, and others of similar character, are sometimes

treated in this way. They are soaked for twenty-four or thirty-six hours, and it is commonly thought that if they are exposed to a sharp frost in the meantime, better results will follow. While still wet the seeds are sown. Scalding water may be poured over locust and other seeds to soften their coverings, but seeds should not be boiled, as sometimes recommended.

The germination of bony seeds is often facilitated by filing or cutting away the shell very carefully near the germ, or by boring them. A bored nelumbo seed is shown in Fig. 20. Moonflower and canna seeds are similarly treated (page 22).



FIG. 20. Bored seed.

Treatment with various chemicals has been recommended for the purpose of softening integuments, and also for some power which strong oxidizing agents are supposed to exert in hastening germination itself, but the advantages are mostly imaginary. Secret and patented "germinator" compounds would better be avoided.

Pulpy and fleshy coverings should be removed from seeds before sowing. Soft fruits, as berries, are broken up or ground into a pulp, and the seeds are then washed out. This separation may be performed immediately in some cases, but when the pulp adheres to the seed, the whole mass is usually allowed to stand until fermentation and partial decay have liberated the seeds. The pulp will then rise, in most cases, leaving the seeds at the bottom of the vessel. Seeds can be liberated quickly by adding a stick of caustic potash to each pail of water. After the mass has stood an hour or so, the seeds can be rubbed out easily after the liquid has been poured off and the water changed. Even tomato seeds may be cleaned in this way.

Seeds that have thin pulp, as the viburnums and many haws, can be prepared by rubbing them through the hands with

sharp sand; or the scant pulp of such seeds may be allowed to rot off in the stratification box. Fleshy coverings of hard and bony seeds may be removed by maceration. Allow them to stand in water at a temperature of about 75° for one to three weeks, and then wash them out. Resinous coverings are sometimes removed by mixing the seeds with fresh ashes or lime, or by treating them with lye. Hard thick-walled seeds are rarely injured by the decay of the pulpy covering, but thin-walled seeds should be cleaned to avoid the possibility of damage arising from the decay of the pulp.

Transportation of seeds from abroad

The transportation of certain kinds of seeds over long distances, especially on sea voyages, is often beset with difficulties. Thick-meated or soft seeds may become too dry if stored in a warm place, or too moist if stored in a cool one. The humid atmosphere of the ocean is fatal to some seeds unless they are well protected, and the moist and hot climates of some tropical countries destroy many seeds of cooler regions before they can be planted, or cause them to sprout in transit. Thin-coated seeds demand dryness and air, and bony seeds usually need moisture and a more confined atmosphere. Most seeds may be sent dry and loose in coarse paper packages under all ordinary circumstances; but if they are to traverse very hot and moist climates, they should be sealed in tin cases or very securely wrapped in oiled paper, in which case the seeds should be thoroughly dried before being packed, and precautions taken to insure the dryness of the air in the package. Small seeds liable to become moldy may be packed in finely powdered charcoal or other dry material. Apple and pear seeds are often imported in this way.

The seeds or fruits of woody plants require more careful management. They should generally be transported in some

sort of stratification. A favorite method is to place them in boxes or jars, mixed with naturally moist sand or sawdust, or slightly moist dead sphagnum moss. Some persons prefer to seal the packages hermetically, but under ordinary conditions this is unnecessary. In transit, the packages should be stored in a medium and uniform temperature. Even acorns, which are often difficult to transport over long voyages, may be carried in this way with safety. It is important that the soil should not be wet. Natural soil from a dryish and loamy pasture is excellent.

In some cases it is better to sprout the seeds in the native country and ship the seedlings in a closed or Wardian case.

Soil diseases: sterilizing

The gardener must always be on the lookout for the rotting-off of seedlings. This damping-off is a common ailment of young seedlings and cuttings. Usually the stem becomes brown and constricted at or near the surface of the ground, and it soon rots and falls over. The top of the plant often remains alive and fresh for several days after it has fallen. Various fungi are concerned in this and similar disorders. The conditions which seem particularly to favor the development of

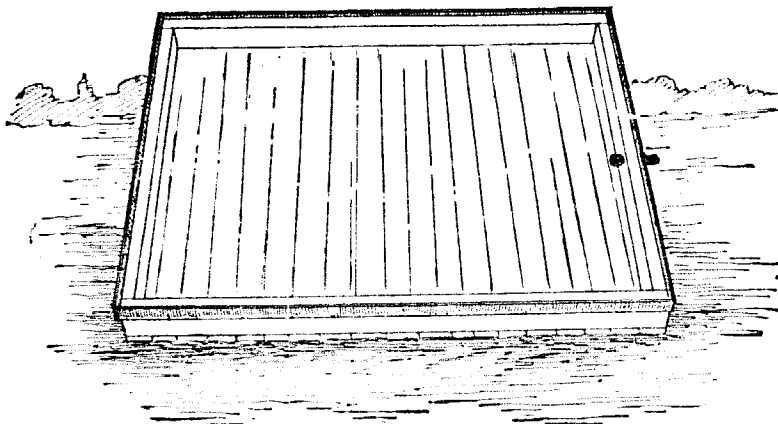

FIG. 21. A sterilizing box or tray, made of matched boards.

these fungi are a moist and close atmosphere, crowding, and careless watering. Plants are supposed to be particularly liable to damp-off if so much water is applied as to keep the surface con-

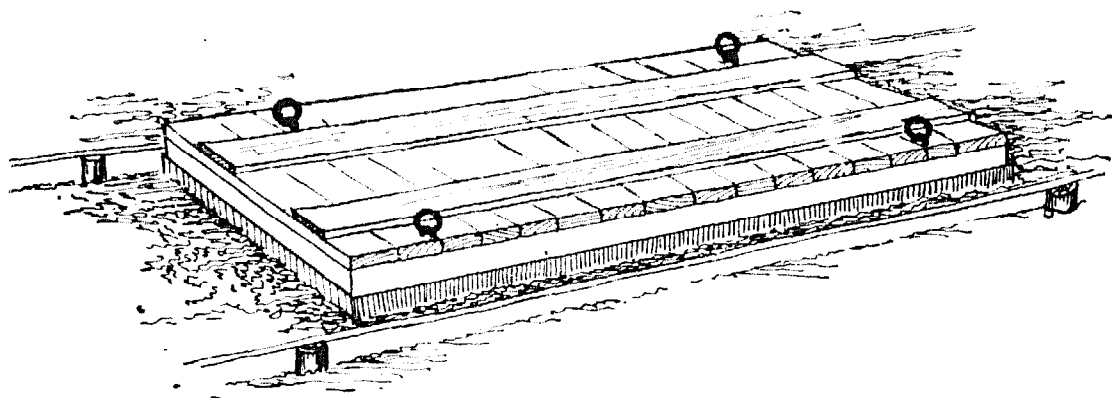

FIG. 22. The sterilizing pan or tray, put face down on a seed-bed.

stantly wet. Hot sand, sifted over the plants, will check it, but there is no complete remedy. As soon as the trouble appears, give more air and prick out the plants.

While there may be no remedy for these soil-borne diseases, there is good preventive in the sterilizing of the earth by means of heat. The commonest method is to invert a large flat shallow pan or tray over the seed-bed and then to inject live steam beneath it. This method is employed extensively in raising lettuce and other crops under glass, and also in frames and yards in the open. Following is an account of the process by E. G. Beinhart in *Farmers' Bulletin 996, United States Department of Agriculture on "Steam sterilization of seed-beds for tobacco and other crops"* (1918), the illustrations (Figs. 21, 22, 23) being adapted:

"The equipment recommended for steam sterilizing seed-beds under average conditions consists of the following:

A portable boiler of 20 horsepower or larger capacity.

Heavy $\frac{3}{4}$ -inch steam hose, 25 feet.

Iron $\frac{3}{4}$ -inch pipe sufficient in length to carry the steam from the boiler to all parts of the beds.

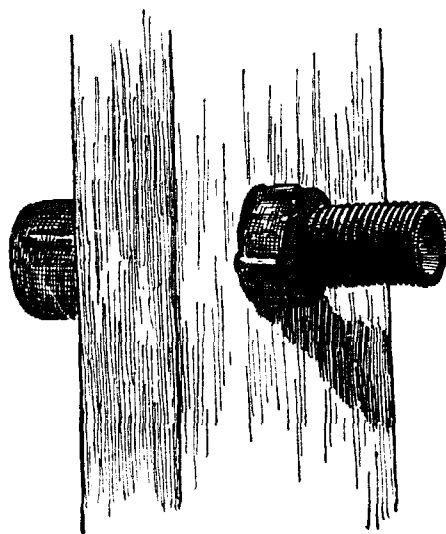

FIG. 23. The nipple connection to the steam box.

Heavy canvas or burlap, 216 square feet.

A steaming pan to cover an area of about 72 square feet.

Attachments for the steaming pan, consisting of 4 ring bolts 6 inches long, with 3-inch rings; 4 bars or ax handles; felt packing 2 inches wide, sufficient in length to extend around the pan; the same length of 4-inch hoop iron or of 2-inch angle iron; one $\frac{3}{4}$ -inch nipple 6 or 7 inches long, threaded on both ends; two $\frac{3}{4}$ -inch leather gaskets; two $\frac{3}{4}$ -inch nuts or threaded washers.

“The boiler is the item of greatest expense, the rest of the equipment being comparatively inexpensive. With proper care the entire apparatus should last for a number of years.

“A boiler of sufficient capacity is the essential factor in successful sterilization, because large volumes of high-pressure steam are required. Experience has shown that a boiler of at least 20-horsepower is necessary for efficient steam production when using a steaming pan of the size mentioned above. In some localities, where seed-beds have been sterilized with steam for a number of years, farmers are supplied with their own boilers; in other places one boiler is used coöperatively by several planters. Road rollers, steam tractors and packing-house boilers are frequently called into use for seed-bed work. In some sections the owners of steam tractors or portable boilers go from place to place, sterilizing beds at fixed prices. Such operators are usually supplied with all necessary equipment, though sometimes they provide only the boiler and a fireman.

“In the permanent seed-bed the pan is of such width as to fit snugly within the sides of the frame, and its length varies according to requirements. A pan having an area of 72 square feet is sufficient for a 20- or 25-horsepower boiler, and a larger pan is difficult to move. On a bed 6 feet wide the pan should be 12 feet long. Where only a small boiler is available, the area of the pan should be correspondingly reduced, so that the boiler can maintain the desired pressure of at least 80 pounds.

“Sterilizing pans made of galvanized iron have been extensively employed, but as wooden pans are cheaper and are easily made at home, wood is the material now coming into general use. The wooden pan further possesses the distinct advantage of reducing the loss of heat by radiation.

“The pan is simply a shallow box (Figs. 21, 22), 4 inches being the preferred depth. If it is deeper, much of the desired effect is lost through the more rapid cooling of the steam in the larger space exposed above the soil. The frame is made of 2 by 4 inch material; across this are laid matched boards ($\frac{7}{8}$ by 4 inches). It is advisable to put white lead in the grooves to prevent the escape of steam. The boards must be securely nailed in the tongue and at the sides to prevent drawing, as they swell by absorp-

tion of moisture during the process of steaming. These cover boards are further secured by two boards or planks which are laid over them on the outside, at right angles to them, extending the length of the box, and which are very securely nailed at the ends (Fig. 21). The cover boards are then nailed from the inside to the outside plants, the object being to prevent the swelling and warping of the cover boards. A good view of the inside construction of the box is shown in Fig. 2.

“Two ring-bolts are set in each side of the frame on the top, one near each corner. Through the rings ax handles or bars are thrust to serve as handles in moving the pan along the bed.

“A strip of $\frac{1}{4}$ -inch felt packing, 2 inches wide, is placed along the lower edge of the frame, on the outside, to prevent the escape of the steam. The hoop iron is then laid on the packing and nailed every 4 inches, one-half its width extending beyond the lower edge of the frame, as shown in Figs. 21 and 23. When the packing cannot be had, the iron is nailed to the inside of the frame instead of the outside. Instead of the hoop iron, 2-inch angle iron is sometimes used. This is fastened to the lower side of the frame, to form a tight joint when the box is laid on the soil. A piece of thin packing serves to prevent the escape of steam between the iron and the bottom of the wooden frame to which it is nailed. Angle iron, because of its heavier character, will not bend and is better than hoop iron, but it requires careful working to fit it to the frame.

“In the middle of one end of the frame is set a $\frac{3}{4}$ -inch pipe-threaded nipple, 6 or 7 inches in length, through which the steam is delivered into the pan. The nipple should project 3 inches from the box, to afford a convenient attachment for the hose, and it should be held securely in place on the 2 by 4 inch end frame by lock nuts, closing on leather gaskets, as shown in Fig. 23.

“The pan is placed on the bed, open side down, the hoop iron or angle bar cutting into the ground to form a knife joint, and the steam leaving the boiler under pressure enters the pan and quickly penetrates the soil.

“The boiler is placed close to the bed and where practicable at an equal distance from each end. Steam traction engines and portable boilers have a marked advantage, because they can be easily moved as the work progresses, allowing the use of a short pipe.

“In sandy soils, after 30 minutes' steaming, the temperatures to be expected in the upper 2 inches of soil directly under the pan are approximately 205° to 212° F., at 3 to 4 inches 170° to 180°, and at 6 inches 120°. Two hours after the removal of the pan the temperature at 6 inches should be about 160° F. If a thermometer is not available, the efficiency of the steaming operation can be easily determined by burying a potato 4 inches under the surface of the soil. The potato should be well cooked when

the pan is removed, and this is a common method of determining the work done by a steaming outfit. Although the temperatures reached directly under the pan are quite high, little heating effect is to be noted away from the edges of the pan."

Sowing the seed

The soil in which seeds are sown, especially in indoor culture, should be such as to allow of perfect drainage and at the same time to hold moisture. Good potting soil, with a liberal allowance of sharp sand, is the best for general purposes. Pure sand becomes too dense, and leaf-mold alone is usually too loose and open. A proper combination of the two corrects both faults.

It is impossible to describe a good potting or seed-bed soil. Experience is essential to the best results in preparing it. It should be of such character that when a damp portion is firmly compressed in the hand it will fall apart when released. It should never bake. Good old garden loam, to which an equal quantity of sand has been added, is usually a good soil for common indoor seedage. There should be no manure in soil used for seeds that produce a delicate growth, as rhododendrons and kalmias. In all such cases, rotted sod or leafy peat is an excellent medium. Live sphagnum moss is also a good material on which to sow various heath-like seeds, as kalmias, andromedas, and the like. Coconut fiber is sometimes used in place of the soil, as it holds moisture, allows of almost perfect drainage, and does not become "sour." Fine dead sphagnum moss may also be used.

Soil should be sifted and thoroughly fined before seeds are put into it. Seeds usually require lighter soil than that in which the growing plant will flourish. Orchid seeds are commonly sown on the live moss in which the parent plant is growing; or they may be sown on damp wood or cork. (See under Orchids, Part II.) Small seeds, as those of cineraria and calceolaria, germinate well in very old cow dung obtained from a pasture, from which the unctuous matters have disappeared,

leaving a fibrous remainder. But all things considered, well-prepared soil is the most satisfactory medium for most seeds.

Seeds of aquatic plants, to be sown in a pond, may be placed in a ball of clay and dropped into the water (page 15). Water-lily seeds may be sown in the greenhouse in submerged pots or pans.

Shallow boxes or "flats" and earthen seed-pans and lily-pans are usually preferable to pots in which to sow seeds. They give more surface in proportion to their contents, and require less attention to drainage (Fig. 24). If pots are used, the 4- to 6-inch sizes are best. All delicate seeds, as tuberous begonias, primulas, gloxinias, and also spores, are usually sown in pots or pans, which are covered with a pane of glass. (See Fig. 4.)

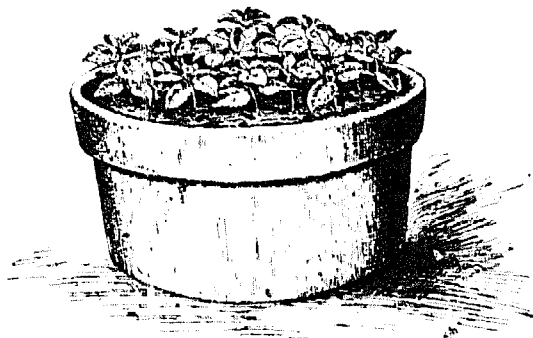

FIG. 24. A pan of seedlings, now ready to be "pricked out" or transplanted.

If delicate seeds are sown outdoors, they should be given protection, if possible. An ordinary hotbed frame gives the best results. In warm weather or a sunny exposure it will be desirable to substitute a cloth screen for the sash. A thin or medium waterproof plant-cloth, either commercial or home-made, is excellent for this purpose. It may be tacked on a simple and light rectangular frame strengthened by iron "carriage-corners." These cloth-covered frames are handy for many purposes, particularly for protecting and supplying a little warmth to seed-pans and young seedlings.

It is essential that good drainage be given all indoor seed-pots or seed-beds. A layer of broken pots or other coarse material is placed on the bottom. Many growers place a thin layer of fine dead sphagnum moss or of peat over this drainage material, and it is useful in preventing too rapid drying of the bottom of the pots. It is particularly useful in isolated pots or small boxes.

Over the moss, coarse siftings from the soil may be placed, while on top only the finest and best soil should be used. The smaller the seeds, the more care must be exercised in the sowing.

The proper depth for sowing varies directly with the size of the seed. A direct advantage of very fine soil for small seeds is the greater exactness of depth of covering which it allows. Very small seeds should be sown on the surface, which has previously been well firmed and leveled, and then covered with a very thin layer of finely sifted soil or a little old and dead moss rubbed through a sieve. This covering

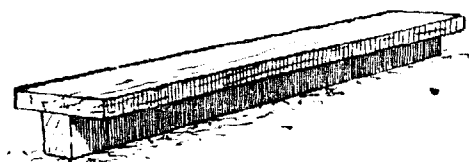

FIG. 25. Planting stick.

should be scarcely deeper than the thickness of the seeds; that is, the seeds should be barely covered. Many persons prefer pressing the seeds into the soil with a block. Or if one has a close propagating-box,

the seeds may remain on the surface and sufficient moisture will be supplied from the atmosphere.

Such fine seeds are rarely watered directly, as even the most careful treatment would be likely to dislodge them. The soil is usually well watered before the seeds are sown, or moisture may be supplied by inserting the pot in water nearly to its rim for a few minutes. If water is applied from a rose, a thin cloth should first be spread on the soil to hold it. Celery seeds, in outdoor beds, are often sown on a smoothly prepared surface and are then pressed in by means of the feet or a board. Cover to prevent evaporation should be given all small seeds. This may be a board or a slate slab at first, but as soon as the plants appear glass should be substituted to admit light. (See pages 16, 17.)

Large seeds demand much less care as to depth of covering, as a rule. One-fourth or one-half inch is a good depth for most coarse seeds indoors. If one wishes to gauge the depth accurately, the drills may be made by a planting stick,

like that shown in Fig. 25. Its flange is made of the required thickness, and it is pressed into the soil until the cap strikes

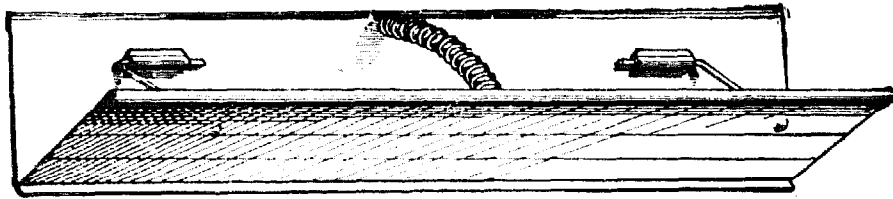

FIG. 26. Tracy seed-planter.

the surface. This is a useful implement in seed-testing. Another device for regulating the depth of sowing, particularly in seed-testing, is the Tracy planter, shown in Fig. 26. It consists of two strips of heavy tin plate about three inches wide, hung on two wire pivots or hinges some two inches long. At their upper edges, and equidistant from either end, the plates are joined by a firm spiral spring, which serves to throw the upper edges apart, and to cause the lower edges to join. The trough is now filled with the required number of seeds, and is then inserted into the earth to a given depth, when the fingers push inward on the springs and the trough opens and delivers the seeds.

Delicate seeds, sown out of doors, should be given a very accessible location, because they will need constant watching in dry weather and during heavy rains. A border along a wall is a favorite site for a seed-bed. A French method of preparing such a bed is shown in Fig. 27 (after Mottet).

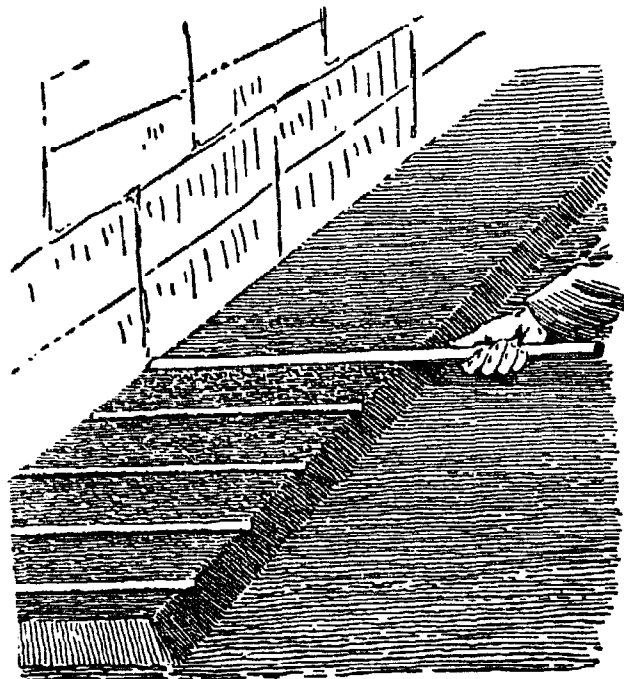

FIG. 27. Seed-border.

English advice

The English gardener is known for his good training and his care to details. The following advice is chosen from *The Garden* (London) for April 14, 1917 :

“The receptacles in which the seed is to be sown need to be selected with some care. Boxes or pans 3 inches or rather more in depth are preferred by many ; but where only a little seed of a kind is needed,

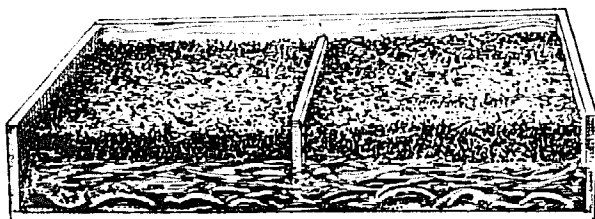

FIG. 28. Seed-box, with side removed to show the drainage and rough material in the bottom and the fine soil on top.

an ordinary flower-pot, 5 inches or 6 inches in diameter at the top, answers well, and does not take up a lot of room. Whatever is used must be scrupulously clean and have ample outlet at the bottom for waste water ; stag-

nant moisture in the soil kills more seedlings under cool conditions than anything else. The boxes ought to have holes three-quarters of an inch or 1 inch in diameter in their bottoms, five holes not being too much for a box measuring 15 inches by 12 inches. Over these holes a layer of broken pots, or crocks as they are termed, must be placed, then some rough fibrous material, and, finally, the fine, sifted soil. Fig. 28 shows a box with one side removed. Note the crocks and rough and fine soil. This is a large box ; consequently a dividing board is placed across the center so that two kinds of seed may be sown in it, one at each end.

“The soil for seed-sowing is quite as important as the drainage. For the majority of the seedlings that the average beginner is likely to want to raise, the following mixture will answer well : Good turfy loam, well chopped and passed through a 1-inch meshed sieve, two parts ; leaf-soil, well decayed and sifted through the same sieve, half a part ; and coarse sand, half a part. Retain the coarse material that is left in the sieve for placing over the drainage. In some

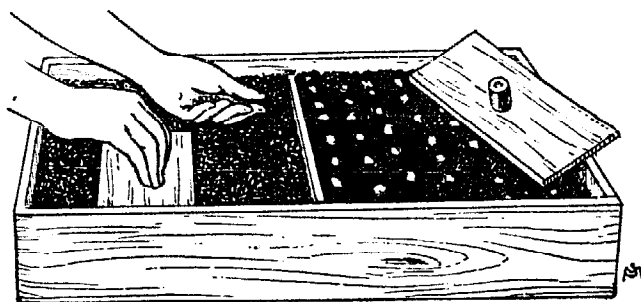

FIG. 29. The sowing in the seed-box (Fig. 28). Large seeds may be placed separately, as shown at the right. The small ones may be mixed with dry sand and firmed into the earth by means of the press-block.

Retain the coarse material that is left in the sieve for placing over the drainage. In some

localities it is difficult to procure turfy loam, but every endeavor to do so should be made, as there is no good substitute. With leaf-soil it is different. Cocoanut fiber refuse or hop manure may well take its place. Having placed the drainage and soil in position, as shown in Fig. 28, press the whole down gently with the presser shown at the right of Fig. 29. The edge of this is useful for making lines when it is desired to sow the seed in rows.

“If there is one thing more than any other that the beginner needs warning against, it is thick sowing. No matter how often this warning is given, it is seldom fully accepted, and thousands of seedlings are wasted every spring by too thick sowing. Seeds differ very considerably in size, and it is not difficult to place the large ones separately, as is shown at the right of Fig. 29. Very small seeds are difficult for the beginner, who may be excused for sowing them too thickly. As an aid to the thin sowing of these small seeds, mix them with some dry silver sand, as shown at the left of Fig. 29. This will make a greater bulk and, if the mixing is well done, will insure a thin and even distribution.

“After the seed is sown it must be covered. Here, again, there is a great deal of difference to be observed. Thus, very small seed will only need pressing into the soil with the presser shown in Fig. 29; while larger seed will need a quarter of an inch thick covering of fine soil. The larger the seed the greater the depth of soil for covering, is a good general rule to follow. Do not press down the covering soil except just to make it level, and it is well to have rather more sand in it than is used for the mixture previously advised for sowing.

“It is no uncommon occurrence to find choice seed that has been carefully sown washed out of the seed-pans or boxes during the process of watering, or, if not actually washed out, carried all to one side, owing to the receptacle not standing level. Therefore, stand all seed-pans, boxes or pots as level as possible and use a fine rose on the watering-can. For very small seeds a sheet of paper, freely perforated with holes, as shown in Fig. 30, may be laid over the soil before watering, or a piece of coarse

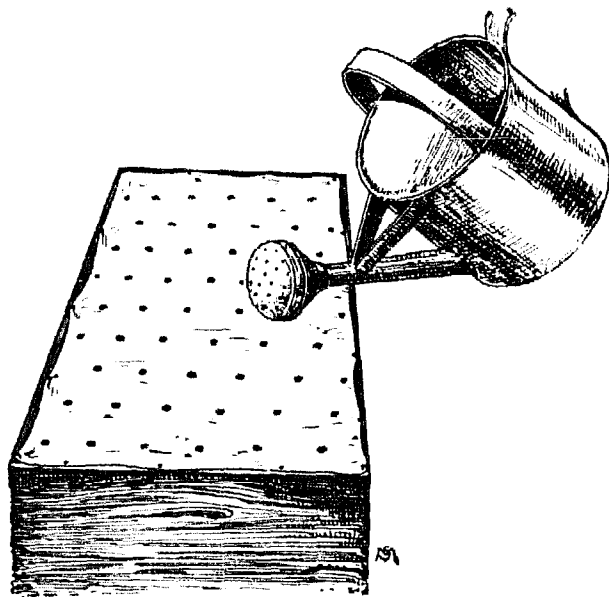

FIG. 30. Watering small seeds through a perforated paper. A coarse muslin may also be used for protection.

muslin may be utilized in the same way, although this is apt to adhere to the soil. Pots and small pans can be immersed nearly to their rims in a bucket of water, allowing the liquid to saturate the soil from below upwards. After the sowing and watering are completed, keep the frame or house fairly close until germination has taken place, after which ventilation must be afforded as freely as outside conditions will admit. Give water whenever the soil is at all dry, but avoid overdoing it. Remember, seedlings in an early stage do not want large quantities of water; but, on the other hand, they must not be allowed to become dry."

Sowing spores

Ferns, lycopodiums and selaginellas are often grown from spores. The general conditions required for the germination of very fine seeds are also suitable for the germination of spores, but extra care must be taken with the drainage. If a pot is used, it should be half or more filled with drainage material, and the soil should be made loose by the addition of bits of brick, charcoal, cinders or other porous materials. The surface soil should be fine and uniform. Some persons place a thin layer of brick-dust on the surface, in which the spores are sown. It is a frequent practice to bake the soil to destroy other spores that might cause troublesome growths.

The spores should be sprinkled on the surface and not covered. The pot should be set in a saucer of water, or in damp moss, and it should be covered by paper or a pane of glass if the sun strikes it or it is in a draughty place. Better results are obtained if the pot or pan is placed inside a propagating-frame or under a bell-glass. In place of earth, a block or small cubes of firm peat or sandstone may be employed (Fig. 3 right; Fig. 5). The block is placed in a saucer of water and the spores are sown on its surface. Water should not be applied directly to the spores, as it dislodges them.

The period of germination varies in different species, but three to six weeks may be considered the ordinary limits.

Spores are so exceedingly small and light that the greatest

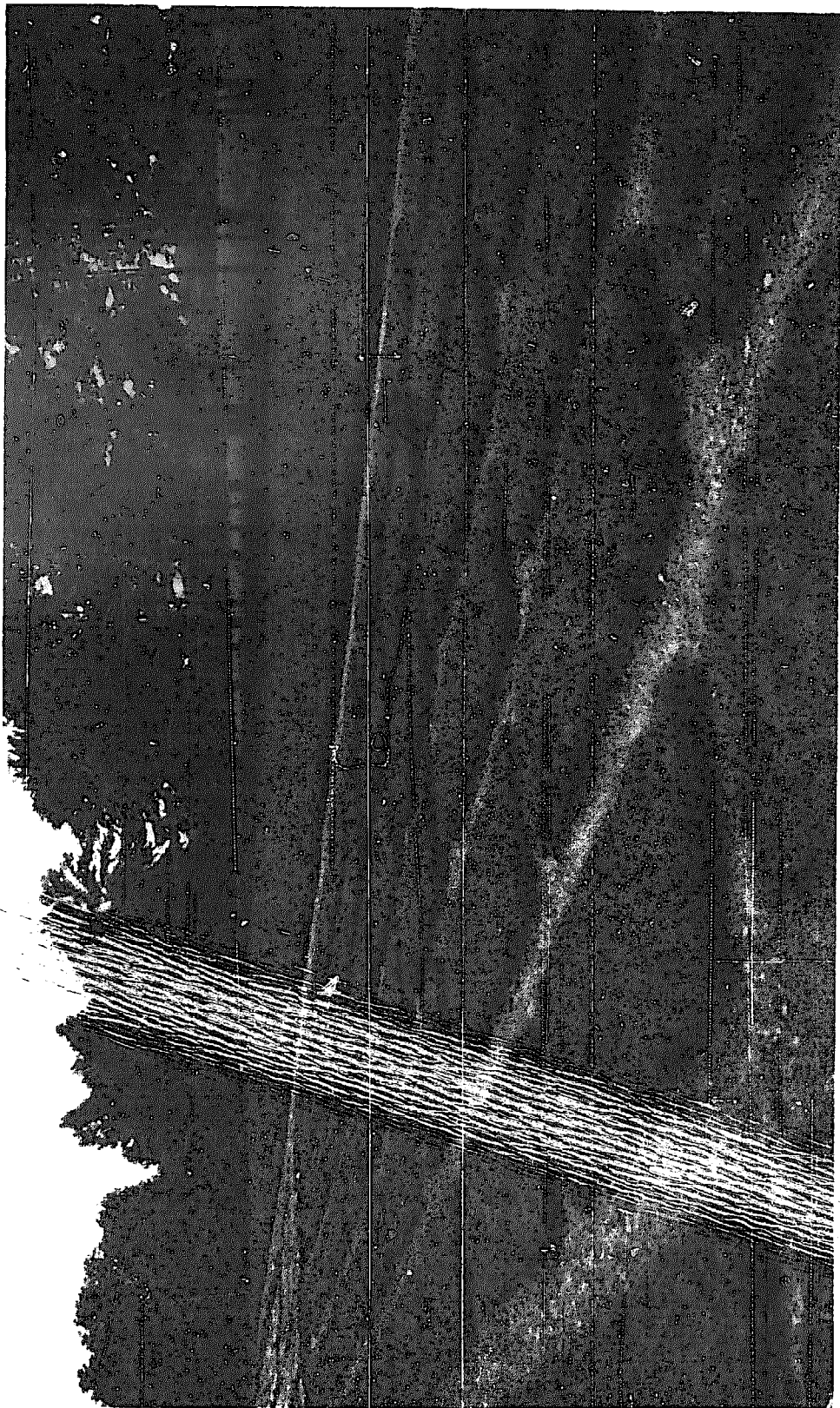

PLATE II. A forest-tree nursery. Seed-beds of white pine seedlings two years old.

care must be exercised in handling them. To gather them, the fronds may be cut as soon as the sori or fruit-dots turn brown, and stored in close boxes or paper bags. When the spores begin to discharge freely, the frond may be shaken over the pot, or it may be broken up and pieces of it laid on the soil.

While still very small, the sporelings should be pricked out, and for some time thereafter they should be subjected to the same conditions as before.

Forestry practice

The propagation of forest trees is conducted on a great scale in many parts of the country, largely as governmental enterprises. This constitutes a special department of nursery practice, and it cannot be discussed in this book; but some of the seed-bed methods may be indicated as a supplement to the discussion. Those who desire to inform themselves on forest-tree nursery work should consult the state and federal publications, chapters in books on forestry, and Toumey's "Seeding and Planting in the Practice of Forestry" (Wiley, 1916). The following descriptions are adapted from "Nursery Practice on the National Forests," Bull. 479, Contr. For. Serv., by C. R. Tillotson (1917), the pictures (except one) being taken from the same publication but mostly re-drawn from the half-tones.

"The seeds are sown in beds, with the exception of certain special cases in which flats or even pots may be used. The beds are staked off uniformly and with mathematical precision, to render calculations easy and to make possible the employment of uniform methods in subsequent work. A 4-foot width facilitates sowing, covering and weeding operations. Forty inches has been found to be a desirable width where burlap is used as a cover. Where damage from rodents or birds is possible small beds 4 by 12 feet are desirable, because they are easily protected by the use of screened frames.

"The seed may be sown in drills or broadcast. For drill sowing across

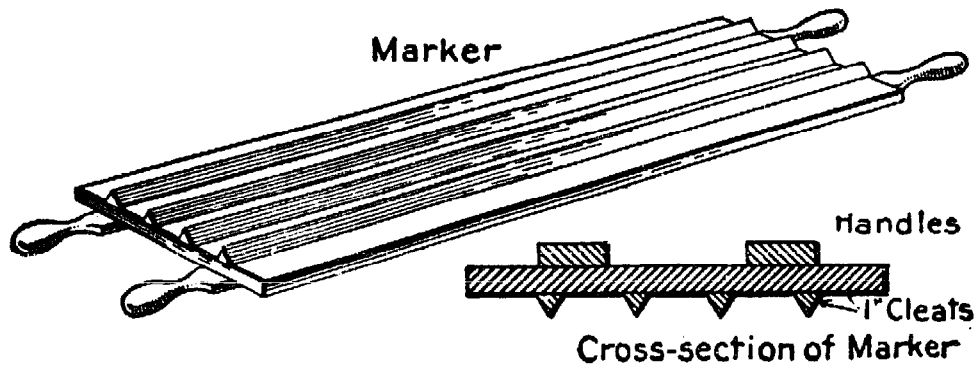

FIG. 31. Marker, for forest seed-beds.

the beds a marker (Fig. 31), hinged seeding-board (Fig. 33), and a seed-trough (Fig. 34) have proved highly efficient.

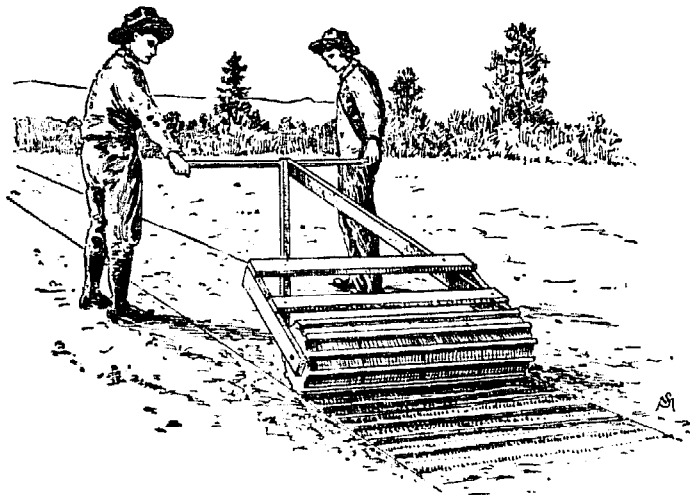

FIG. 32. Concrete marker-roller.

The marker consists of a plank 4 feet long, 15 inches wide and 1½ inches thick, with two handles projecting beyond each end, and with triangular strips of wood from ½ inch to 1 inch thick on a side and 4 feet long, nailed longitudinally and parallel, from 3 to 6 inches apart, on its under side. By pressing these triangular strips or cleats into the soft earth of the prepared seed-bed perfect V-shaped depressions can

be made of the depth desired. Two men can mark from 100 to 200, 4 by 12 foot beds per day with this board, depending on the depth desired

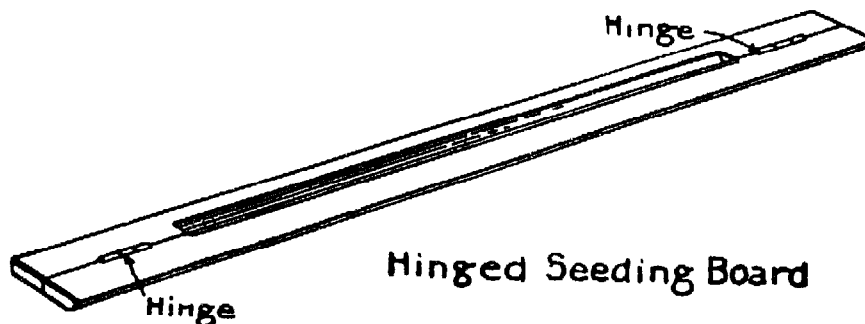

FIG. 33. A seeding-board for forest seeds. A cross-section of this board is shown in Fig. 34.

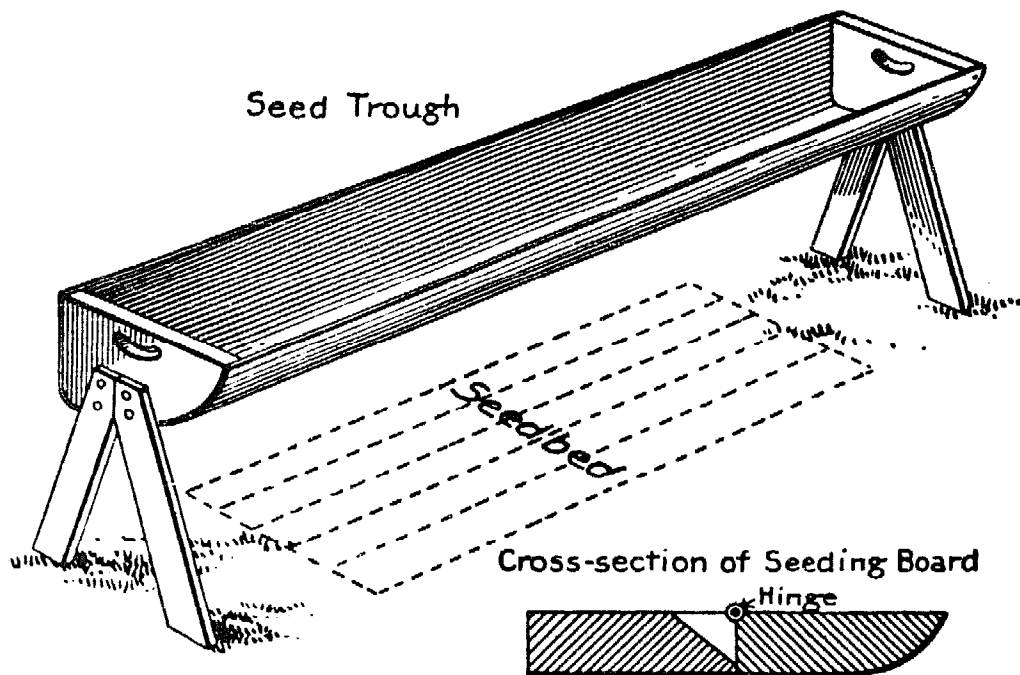

FIG. 34. A seeding-trough, used by foresters.

and the condition of the soil. Another kind of marker, made of cement and drawn by two men, is shown in Fig. 32.

"The seeding-board consists of two strips of board $4\frac{1}{2}$ feet long, 3 inches wide and $\frac{3}{4}$ -inch in thickness (narrow bevel siding is sometimes used), joined edge to edge by a small hinge at each end. The adjoining edges of the boards for a distance of $\frac{1}{4}$ feet (the width of the seed beds) are beveled on the top side between the hinges, one edge much more than the other, so that a shoulder is formed on which seed uniformly distributed will remain when the board is dipped into the trough partly filled with seed, then tipped each way so that all superfluous ones will fall back into the

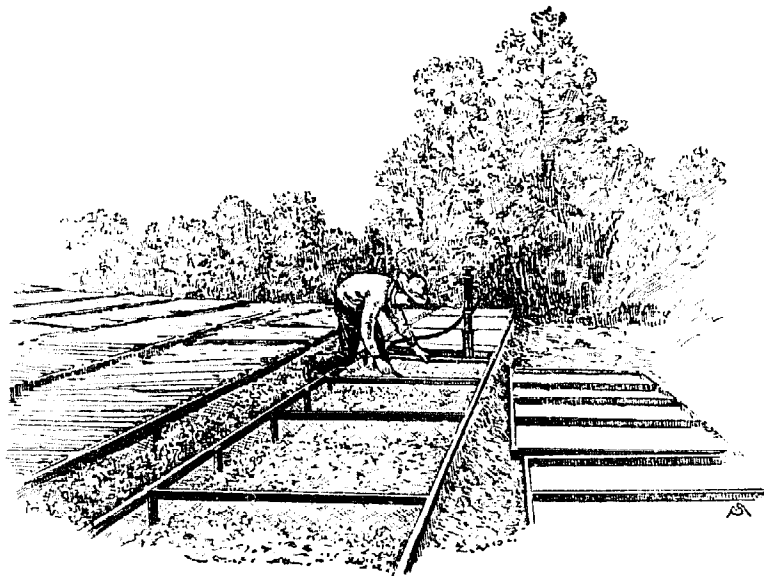

FIG. 35. Protected nursery beds, with and without low cover, and a water supply at hand.



FIG. 36. Overhead protection, with a slat cover.

trough. By varying the depth of the groove and the width of the shoulder on the adjoining side the board can be made to sow any quantity desired. One of the outer edges of the board is beveled far back on the under side so as to offer no obstruction when the seed is dipped. Two men operate it, one at each side of the bed. The board is dipped with a swinging motion into the trough and then lowered and held close over the drill to be seeded; the hinges are bent upward, and the seeds fall into the drill.

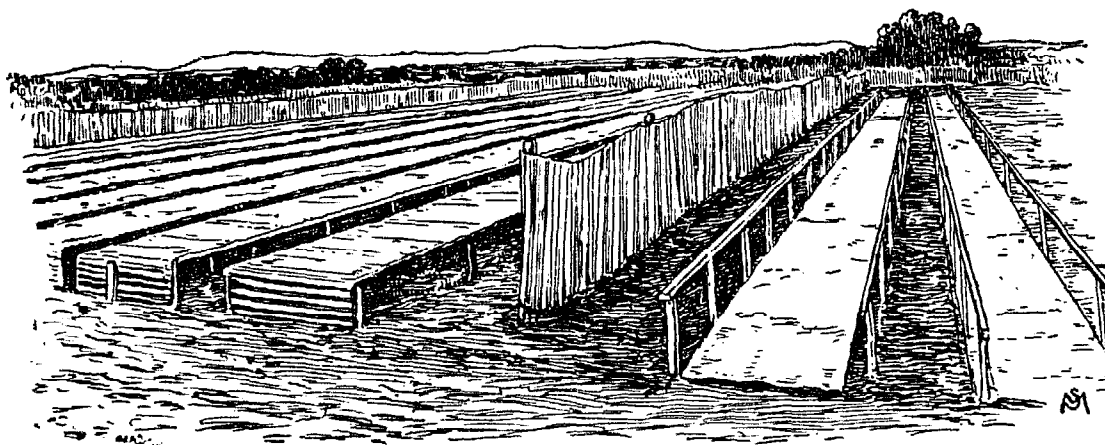

FIG. 37. A form of low shading. The beds on the right are covered with burlap, those on the left protected by slat screen. Windbreaks are provided.

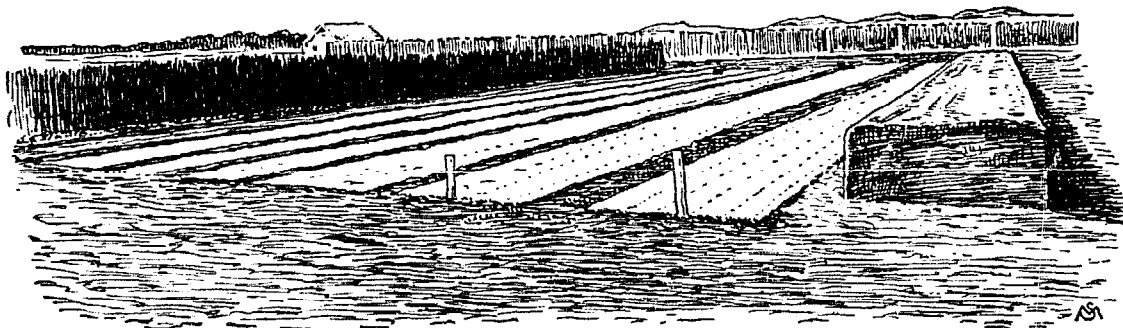

FIG. 38. Nursery beds covered for the winter.

"The seeding-trough is a device for holding the seeds. It is 8 inches deep, rounded slightly on the bottom and up one side, from 10 to 14 inches wide, and 5 feet long. It is mounted on legs, raising it from 16 to 24 inches above the ground.

The trough is set to straddle a seed-bed in which drills have been made, as indicated in the illustration (Fig. 34)."

The beds are provided with protection against winds, rodents, birds, sun and winter cold, by means of windbreaks and divers coverings and screens. Some of these are shown in Figs. 35-38. The seedlings are given careful attention in shading, watering, weeding, tilling, winter mulching and otherwise.

Young seedlings are shown in Fig. 39. A very long and undesirable tap-root system is illustrated in Fig. 40. This development is sometimes corrected by root-pruning in the nursery bed by means of a knife thrust under the plants. Fig. 41 shows a specially good development of a season's growth as a result of fall seeding, whereby the plant gets an early start in spring. Stock larger by one-half inch to two

inches can be produced in one year by fall than by spring sowing. The increased growth may mean the shortening by a year of the length of time necessary for growing stock to a size suitable for field planting.

FIG. 40. Seedling of western yellow pine.

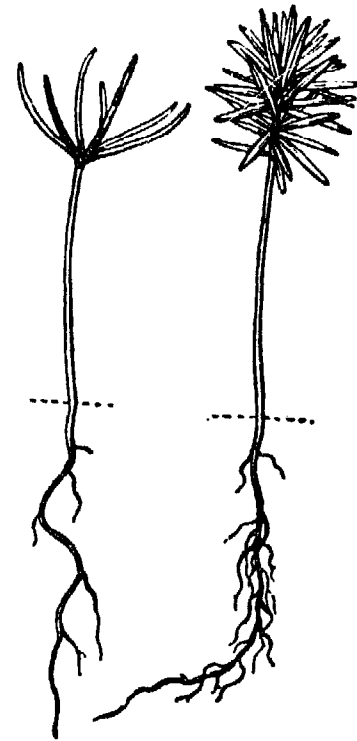

FIG. 39. Conifer seedlings.



FIG. 41. Douglas fir seedling, from fall-sown seed.

Forest nurseries operate with such numbers of plants, which must be cheaply produced, and the species involved in the processes are relatively so few, that highly standardized methods soon arise.

CHAPTER III

PROPAGATION BY MEANS OF SEPARATION AND DIVISION

SEEDS are not the only parts or organs that naturally detach themselves from the parent plant and serve as the beginning of new individuals, as we have learned in Chapter I; and many plants are capable of being divided at the root into two or more parts or plants. The "bulb catalogue" of the seedsmen indicates how extensive is this asexual means of multiplication.

1. SEPARATION

Separation, or the multiplication of plants by means of naturally detachable vegetative organs, is effected by means of bulbs, bulbels, bulb-scales, bulblets, corms, cormels, tubers and sometimes by buds.

Bulbs of all kinds are specialized buds. They are made up of a short and rudimentary axis closely incased in transformed and thickened leaves or bulb-scales. These thickened parts may be stored with nutriment used in subsequent growth. Bulbs occur in plants accustomed to a long period of inactivity. Many bulbous plants are peculiar to dry and arid regions, where growth is impossible in long intervals. A bulb, therefore, is a more or less permanent and compact leaf-bud, usually occupying the base of the stem under ground and emitting roots from its lower part. Bulbs are conveniently divided into two great classes — the *scaly*, or those composed of narrow and mostly loose scales, as in the lily, and *laminated* or *tunicate*, or

those made up of more or less continuous and close-fitting layers or plates, as in the onion.

Bulbs often break up or divide themselves into two or more nearly equal portions, as in *Lilium candidum*, shown one-third natural size in Fig. 42. The parts may be separated and treated as complete bulbs for purposes of propagation. This division or separation of bulbs proceeds in a different way in every species, yet it is so obvious that the novice need not be perplexed by it.



FIG. 42. Bulb of *Lilium candidum*.

Almost any breaking apart of these loose bulbs, if only a "heart" or central axis remains in each portion, is successful for purposes of slow multiplication; but when flowers are desired it is usually advisable to keep the bulbs as strong and compact as possible.

Almost any breaking apart of these loose bulbs, if only a "heart" or central axis remains in each portion, is successful for purposes of slow multiplication; but when flowers are desired it is usually advisable to keep the bulbs as strong and compact as possible.

Bulbous plants multiply most easily by means of *bulbels* — often also called *bulbules* — or small bulbs borne about a large or mother-bulb. These bulbels are sometimes called *offsets*, but this term is more properly applied to more leafy or sucker-like parts, and to rosettes, as the growths on a pineapple the separates in house



FIG. 43. Bulbels of tulip at S, A, S.

leek, and the like (page 4). The bulbels of the tulip are shown in Fig. 43. In one of the lilies (Fig. 44) two bulbs have formed at the crown of the old one.

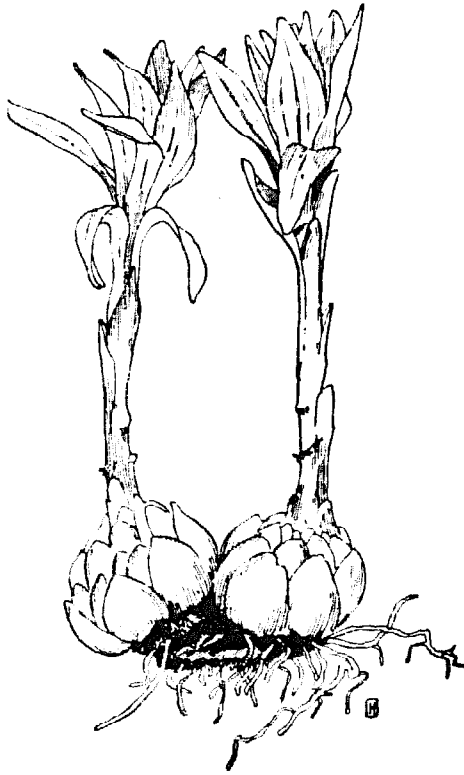

FIG. 44. Two bulbs of lily formed from one.

In some lilies, as *Lilium candidum*, the bulbels form at the top or crown of the mother-bulb, and a circle of roots is found between them and the bulb; in others, as *L. speciosum* and *L. auratum*, they form on the lower part of the flower-stalk. In some species the bulbels are few and very large, or even single, and they bloom the following year. In such cases the bulb undergoes a progressive movement from year to year after the manner of rootstocks, the bulb of one year bearing a more or less distinct one above and beyond it, which continues the species, while the old one becomes weak or dies. This method

of bulb formation is seen in the cut of *Lilium pardalinum*, Fig. 45. In the hyacinth the bulbels form at the base of the bulb.

Bulbels vary greatly in size and frequency in different species. Sometimes they are no larger than a grain of wheat the first year, and in other plants they are as large as hickory-nuts. In some species they are borne habitually underneath the scales of the mother bulb.

The bulbels are often removed when the mother-bulbs are taken up, and they are usually planted in essentially the same way as the bulbs themselves, although

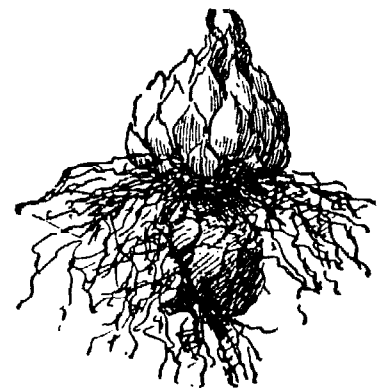

FIG. 45. Bulb of *Lilium pardalinum*.

it is desirable to place them, at least for the first year, in a bed or border where they may receive careful attention; or, if they are especially small and delicate, they may be planted in pots or flats and be treated about the same as single-eye cuttings. In some lilies, the bulbels are allowed to remain attached, and the whole mass is planted in autumn in close drills. Sometimes the larger lily bulbels may produce flowers the following (or first) season, but they usually require the whole of the second season in which to complete their growth. The second autumn they are ready to be permanently planted. Bulbels of some species require even a longer time in which to mature into bulbs.

Bulbels are sometimes produced by an injury to the bulb. Growth of stem and leaves is more or less checked and the energy is directed to the formation of minute buds, or bulbs, as adventitious buds form on a wounded stem. Advantage is taken of this fact to multiply some bulbous plants, and in the case of the hyacinths, at least, the mutilation of bulbs for this



FIG. 47. Hollowed hyacinth bulb.

purpose is practiced to a commercial extent. Hyacinth bulbs are cut in two, or are slashed in various ways. The favorite method is to make deep transverse cuts into the base of the bulb (Fig. 46). The strongest bulbs should be chosen, and the operation is performed in spring or early summer, when the bulb is taken

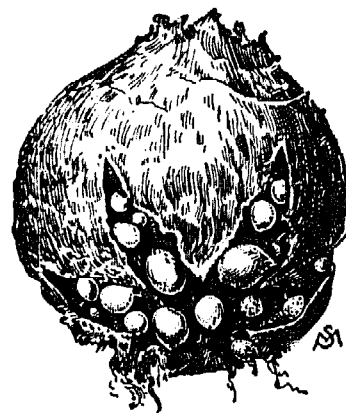

FIG. 46. Cut hyacinth bulb with resulting bulbels.

up. The bulbs are sometimes hollowed out from the under side for half or more

cised that the bulbs do not become too moist, else they will rot. Hollowed bulbs should be well dried before being planted. Both methods of preparing hyacinth bulbs are shown in Figs. 46 and 47, the latter adapted from the *Gardener's Chronicle*. The mutilated bulbs are stored during summer, and are planted in fall or spring. The



FIG. 48. Bulb scale.

wounded bulbs produce very little foliage, but at the end of the first season the bulbels will have formed. The bulbels are then separated and planted by themselves in prepared beds. Several years are required for the bulbels to mature into flowering bulbs. Some of the strongest ones may produce flowering bulbs in three years, but some of them, especially those obtained from the hollowed bulbs, will not mature short of six years. This method of propagating hyacinths is confined mostly to Holland.

The scales of bulbs are often employed to multiply scarce varieties. From ten to thirty of the thicker scales may be removed from the outside of a large bulb without serious injury to it. These scales are treated in the same way as single-eye cuttings. They are usually handled in flats or propagating-frames, and are pressed perpendicularly into a light and loose soil — half sharp sand and half leaf-mold — for nearly or quite their entire length, or they may be scattered in damp moss. Keep the soil merely moist, and for hardy and half-hardy species hold the temperature rather low — from 45° to 60°. Slight bottom heat may sometimes be given to advantage. In three to ten weeks a little bulbel, or sometimes two or more, will appear at the base of the scale, as shown in Fig. 48.

Late autumn or early winter is a proper time for planting bulb scales. The pots or flats may be plunged outdoors in summer if the planting was made in winter, or the scales may be potted off or transferred to the open border as soon as root-

lets have formed. It is the common practice with most hardy species to allow the scales to remain in the original flats during summer and to cover them the next fall, allowing them to remain outdoors over winter. The succeeding spring they are shifted into a bed or border, and by the next autumn — having had two summers' growth — most species will be ready for permanent planting in the flower border for bloom the following season.

A *bulblet* is a small bulb borne entirely above ground, usually in the axil of a leaf or in the flower-cluster. Familiar examples occur in the tiger lily and in "top" onions. In the former example, the bulblets are direct transformations of buds, while in the onion they take the place of flowers. It is impossible to draw any sharp line of separation between bulblets and buds. In some plants, certain buds detach themselves and fall to the ground to multiply the species. Sometimes these buds vegetate before they fall from the plants, as in the case of various begonias and ferns. For purposes of propagation, bulblets are treated in the same way as bulbels, and like them, they reproduce the variety from which they grow. They develop into full-grown bulbs in one to three years, according to the species.

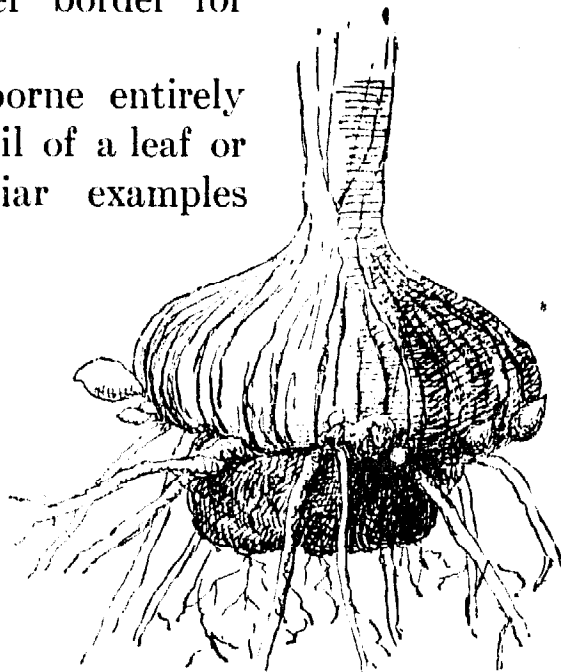

FIG. 49. Gladiolus corm.

Sometimes these buds vegetate before they fall from the plants, as in the case of various begonias and ferns. For purposes of propagation, bulblets are treated in the same way as bulbels, and like them, they reproduce the variety from which they grow. They develop into full-grown bulbs in one to three years, according to the species.

A *corm* is a bulb-like organ that is solid throughout, although it may have a more or less loose covering or tunic. Familiar examples are gladiolus and ixia. Cormous plants are multiplied in essentially the same way as bulbous species. As a rule, a new corm (or sometimes two or more) is produced each year above the old one, and this commonly bears flowers the

following season. This renewal is well shown in the gladiolus, Fig. 49. The illustration shows a gladiolus bottom, half size, when taken up in November. At the base are seen the withered remains of the corm that was planted in the spring, and above it the new corm, which will furnish bloom the following season.

A number of *cormels* or "spawn" has also appeared about the base of the new corm in Fig. 49. These may be planted out in a border or bed, and will produce mature corms in one or two seasons. The larger ones, under good treatment, often produce bulbs an inch in diameter the first season. Some growers keep the *cormels* a year and a half before planting them out (that is, until the second spring), as they are thought to vegetate more evenly under such treatment; in this case they should be placed in sand to prevent too great drying out.

Adventitious *cormels* may be produced by various methods of wounding the mother corm, and this practice is often necessary, as some species do not produce *cormels* freely. Each bud on the top or side of the corm may be made to produce a separate corm by cutting a deep ring around it, so as partly to divide it. Or the corm may be directly cut into as many separate pieces as there are buds or eyes, after the manner of cutting potatoes, but these pieces are usually handled in flats where temperature and moisture can be controlled. Almost any injury to such vigorous corms as those of the gladiolus and crocus will result in the production of *cormels*, if care is taken that the corms do not become so cold and wet as to cause them to rot.

2. DIVISION

The word *division* is commonly applied to that phase of separation in which the parts are cut or broken into pieces, in distinction to propagation by means of parts that naturally separate at the close of the season; but no hard and fast line can be drawn between the two operations. Whilst separation

is mostly concerned with bulb-like and corm-like organs, division operates mostly with tubers, rootstocks, suckers and various kinds of offsets.

A *tuber* is a prominently thickened portion of a root or stem, and it is usually subterranean. The potato, sweet potato and dahlia furnish good examples. The stem-tuber, even if underground, has more or less well-marked eyes or buds, as the common potato; the word *tuber* is sometimes restricted to thickened parts of stems.

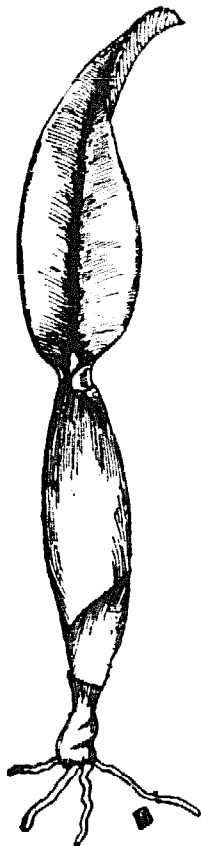

FIG. 51. Pseudobulb of orchid, bearing a leaf at the top.

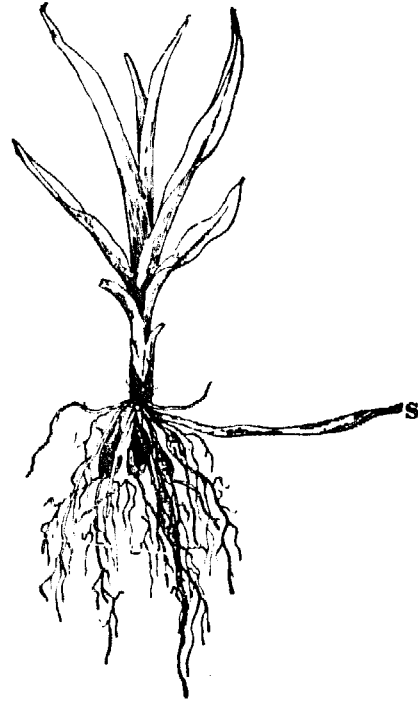

FIG. 50. Oblong tubers under the crown of day-lily.

Tuberiferous plants are multiplied by planting these tubers whole, or in many cases the tubers may be cut into small portions, as described in Chapter V, in the descriptions of cuttings. In hardy species, the tubers may be allowed to remain in the ground over winter, but they are generally dug in autumn and stored in a dry and cold place, but where they will not freeze.

Tubers are of endless conformation. Often they are fascicled underneath the crown of the plant, as in the garden ranunculus and also in the dahlia and day-lily (Fig. 50). They may occur in long strings, as in the ground-nut or apios. In the garden anemone (*A. coronaria*) they are irregular and fantastic in shape.

A special form of stem-tuber is the *pseudobulb* (literally "false bulb") of many orchids (Fig. 51). In some species, the pseudobulb is short

and represents but a single node; in other cases it may comprise two or several internodes or joints and be much elongated.

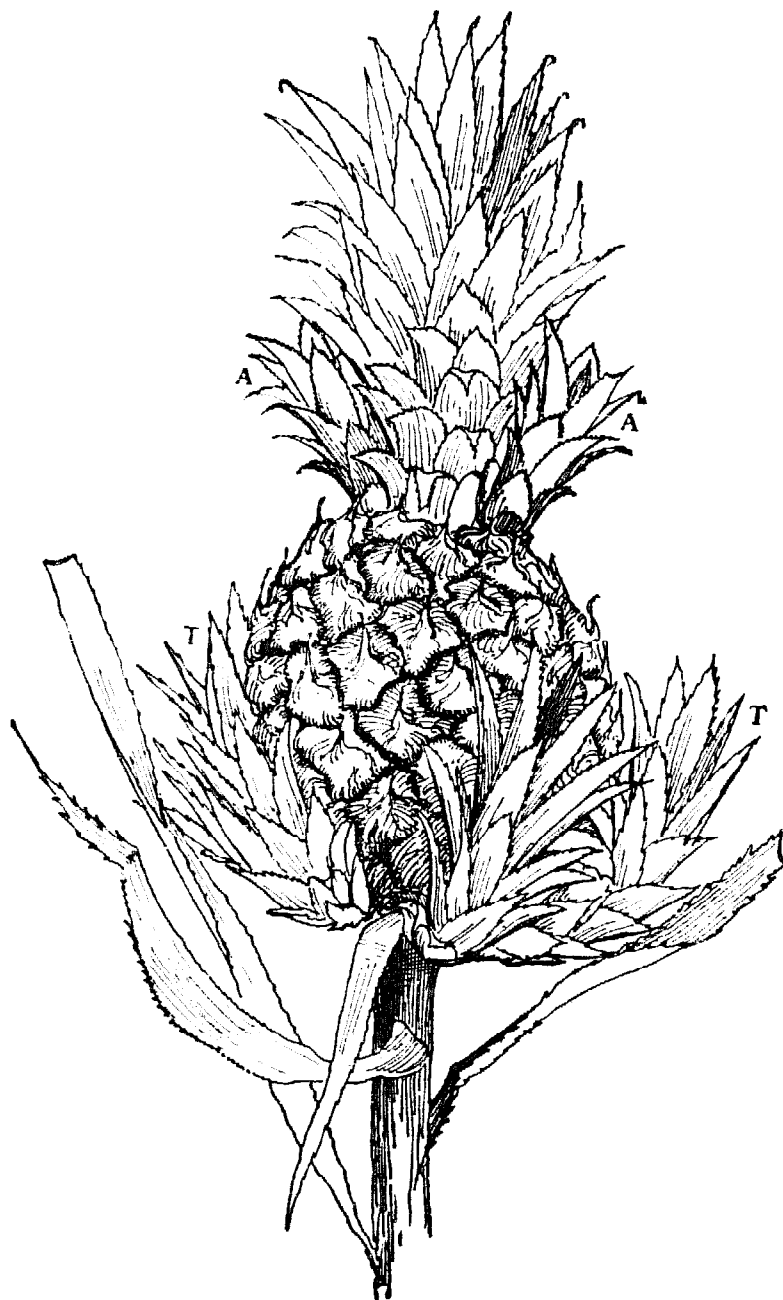

FIG. 52. Pineapple with slips (three showing) at *TT*, and two crowns or crown-slips at *AA*.

It bears only a single leaf, as in Fig. 51, or several leaves or even branches. The rhizomes are divided in some orchids so as to leave a pseudobulb to each piece; or the pseudobulb may be treated as a cutting in some species.

An *offset* is a crown or rosette of leaves, usually borne next the surface of the ground, and which in time may detach itself and form an independent plant. The best examples are the house-leeks, plants more familiarly known as "hen-and-chick-

ens" and "man-and-wife." These offsets take root readily, and in propagating there is no other care necessary than to

remove and plant them. Certain leafy growing offsets are called suckers by gardeners.

Many of the greenhouse plants are propagated by the leafy offsets, as pandanus or screw-pine, billbergias, upright tilland-



FIG. 53. The fruit or pineapple removed and the basal slips developed.

sias. Some of the palms produce offsets or suckers, as, for example, the date palm.

The pineapple is propagated by various kinds of offsets, which receive special names by pineapple growers. There are five general kinds of offset parts: the crown or top-shoot of the fruit, which is not often used for propagation; crown-slips, that arise at the base of the crown (AA, Fig. 52); slips at the base of the fruit (TT, Fig. 52, and Figs. 53-55); suckers from the base of the plant or near the ground; separate shoots from underground parts, known as ratoons. These parts are treated as cuttings and might be classified under Chapter V.



FIG. 54. A slip fully developed and broken from the plant.

the crowns. The rootstock grows in spring and summer, and at the end of the season each branch develops a strong terminal bud, which usually produces a flowering stem the following season. The rootstock gradually dies away at its old extremity or base, and in a few years a single individual gives rise to a considerable "patch." This is well shown in the common May-apple or podophyllum.

In some species these crowns are removed in the autumn, and are planted and handled in much the same

as well as here. The practice of pineapple propagation is explained in Part II.

A *crown* is a detachable portion of a rootstock, bearing roots and a prominent bud. Rhizomes or rootstocks multiply individuals and extend the distribution of the species by means of a progressive movement of

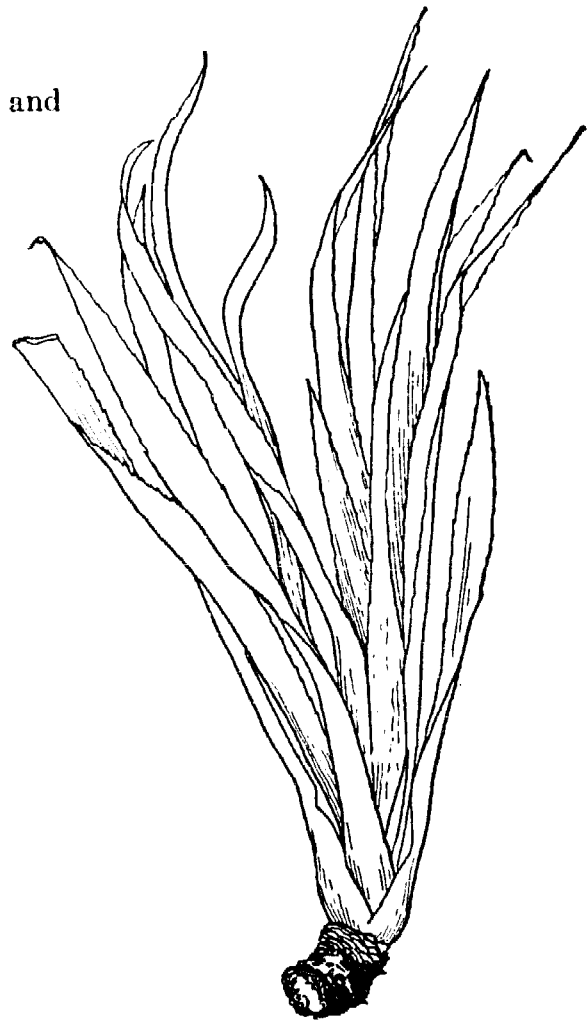

FIG. 55. A pineapple slip stripped and ready for setting.

way as bulbs. The crown or "pip" of the lily-of-the-valley, shown in Fig. 56, is treated in this way.

Rootstocks may be divided into as many parts as there are eyes or buds, and each part is then treated as an independent plant. Familiar examples of such division are the common practices of multiplying rhubarb and canna. A canna rootstock, or "stool," is seen in Fig. 57. The observer is looking down on the top of the stool; and the five pieces show how the operator has divided it. The two lower pieces on the left show the remains of the flower-stalks of the previous year. If the variety were very scarce, some of these pieces could be again divided into two or three.

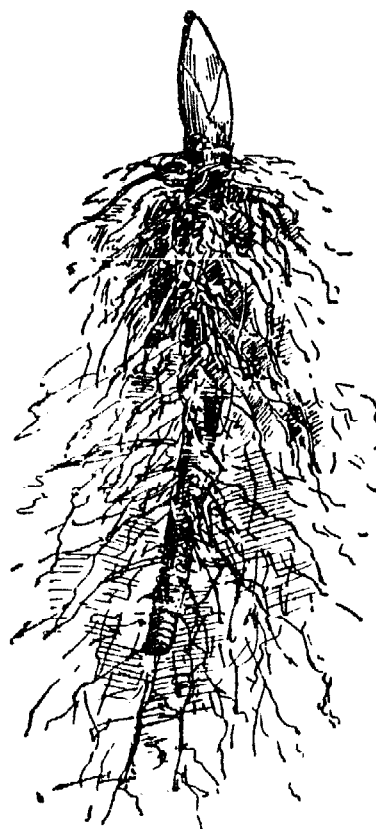

FIG. 56. Lily-of-the-valley crown.

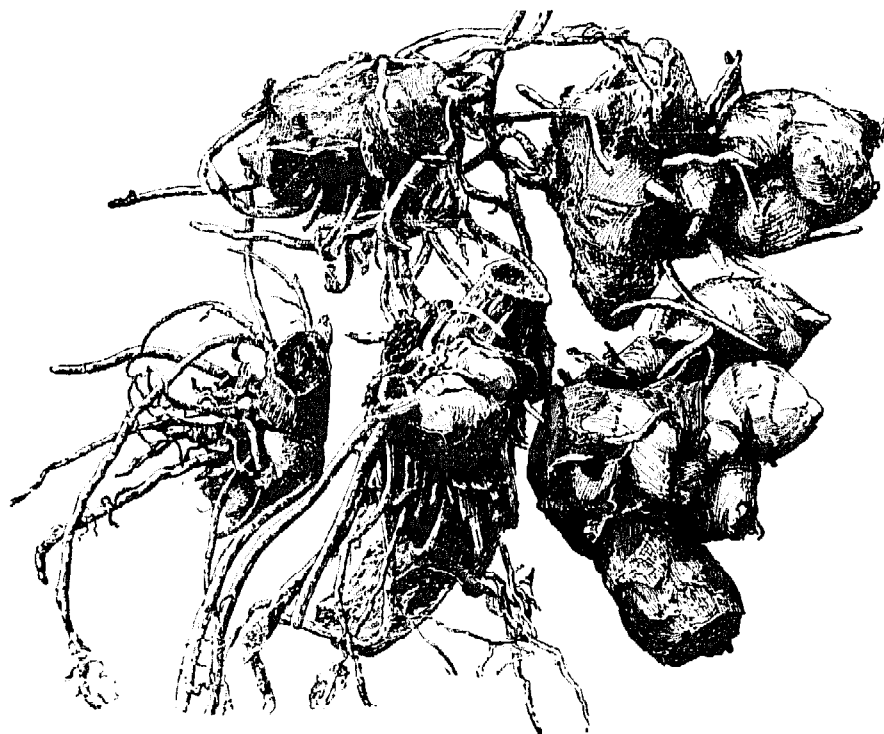

FIG. 57. Canna stool, divided into five plants.

Nearly all perennial herbs may be multiplied with more or less readiness by simply dividing the crowns. Most bushes may be similarly treated, as lilacs, many roses, spiraeas and the like. The general

stock species of herbaceous border plants — as aquilegias, hemerocallis, helianthus — are commonly grown in permanent small areas by nurserymen, and plants are cut out of the plot as orders are received. If, however, the nurseryman is making a special “run” on any plant, he gets his stock by dividing up the crowns or rootstocks into small portions, and then growing these for a season in specially prepared beds, or sometimes in pots.

Recent experience has shown that etherization of plants may have important influence on the stimulation of offsets in certain species; but this and similar treatments are yet too little understood to warrant including them in a manual of standard practices.

CHAPTER IV

PROPAGATION BY MEANS OF LAYERS AND RUNNERS

MANY plants habitually propagate by means of decumbent shoots and runners. These shoots become more or less covered with earth or leaves, and roots are formed, usually at the joints. In many cases, the old shoots die away and an entirely inde-



FIG. 58. A runner of strawberry.

pendent plant arises from each fascicle of roots. In other plants, the shoots remain attached to the parent, at least for a number of years, so that the plant comprises a colony of essentially independent but connected individuals.

Certain definitions should be clearly understood before we proceed with the discussion. A *runner* is a shoot that trails on the ground, taking root at intervals; the strawberry produces true runners (Fig. 58). Sometimes the runner is covered by the accumulating surface mold (Fig. 59). A root may sometimes act as a runner. A *stolon* is a decumbent or lopping shoot which, without artificial aid, takes root and forms an independent plant. It usually starts more or less erect and bends over to the ground as it grows. The honeysuckles, some

osiers (as *Cornus stolonifera*) and many other bushes with long and slender branches, propagate by means of stolons. The black raspberry propagates by a special kind of stolon,

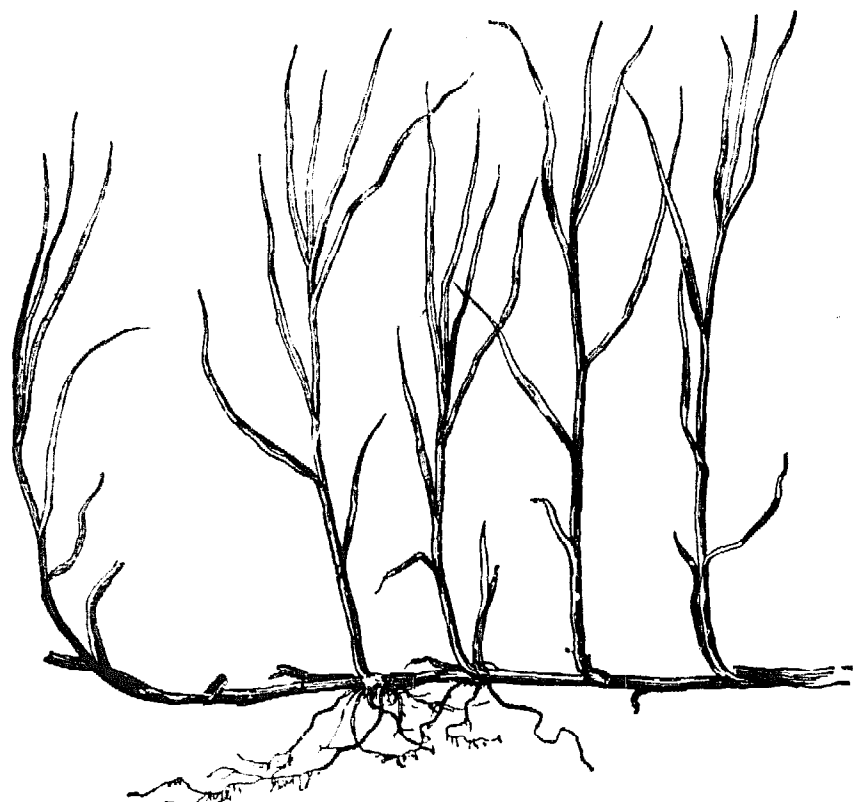

FIG. 59. Runner of sedge, covered in the leaf-mold.

rooting only at its tip. A *layer* is a shoot or root, attached to the parent plant, partially or wholly covered with earth, with the intention that it shall take root and then be severed from the parent.

The operation or practice of making a layer, or the

knowledge

state or condition of being layered, with the knowledge relating thereto, is known as *layerage*.

The common or natural layers

Great numbers of plants that do not propagate naturally by means of layers are readily increased by this means under the direction of the cultivator. In most cases it is necessary only to lay down the branches, cover them with earth, and allow them to remain until roots are well formed, when the parts may be severed from the parent. Layering is one of the simplest and commonest methods of propagation, as the mother-plant nurses the layer-plants until they can sustain

themselves. It is a ready means of multiplying hard-wooded plants that do not grow well from cuttings.

All vines, and plants with runners or long and slender shoots that fall to the ground, may be multiplied readily by layerage. Among fruits, the black-cap raspberry and dewberry are familiar examples. The raspberry canes of the current year bend over late in summer and the tips strike the earth. If the tip is secured by a slight covering of earth, or if it finds lodgment in a mellow soil, roots are formed, and in autumn a strong bud or "crown" or "eye" is developed for next year's growth.

The parent cane is severed in fall or spring, some 4 or 6 inches above the ground, and an independent plant, known as a "root-tip," as shown in Fig. 60, is obtained. In this example, as in most others, it is immaterial at what point the parent stem is severed, except

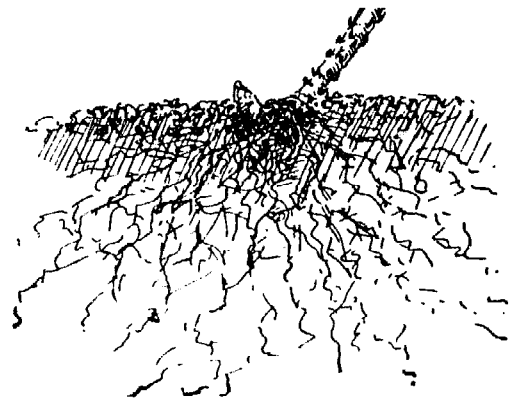

FIG. 60. Raspberry tip.

that a short piece of it serves as a handle in carrying the plant, and also marks the position of the plant when it is set. The black raspberry propagates itself naturally by means of these layers, and it is only necessary, in most cases, to bring the earth into a mellow condition when the tips begin to touch the ground, in order that they may find anchorage. This layering by inserting the growing point has the advantage of producing very strong "crowns" or plants in autumn from shoots or canes of the same year, and it should be more generally practiced. Even currants, gooseberries and many other plants can be propagated in this way.

In most kinds of layerage, it is necessary to bend down the branches and to cover them. The covering may be continuous, as in Fig. 61, or it may be applied only to the joints or restricted parts of the shoot, as illustrated in Fig. 62. In either

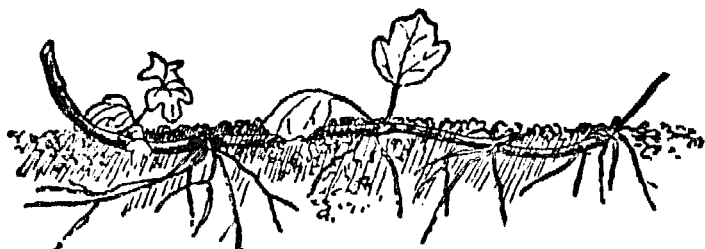

FIG. 61. Covered layer of viburnum.

case the covering should be shallow, not exceeding 2 to 5 inches. If the shoot is stiff, a stone or sod may be placed on it to hold it down; or a crotched stick may be thrust down over it, as in the "pegging down" operation of propagators.

The strongest plants are usually obtained by taking only one plant from each shoot, and for this purpose the earth should be applied only at one point, preferably over a bud somewhere near the middle of the shoot. If the buds are close together, all but the strongest one may be cut out. If more plants are desired, however, *serpentine layering* may be practiced, as shown at A in Fig. 62 (left foreground). The shoot is bent in

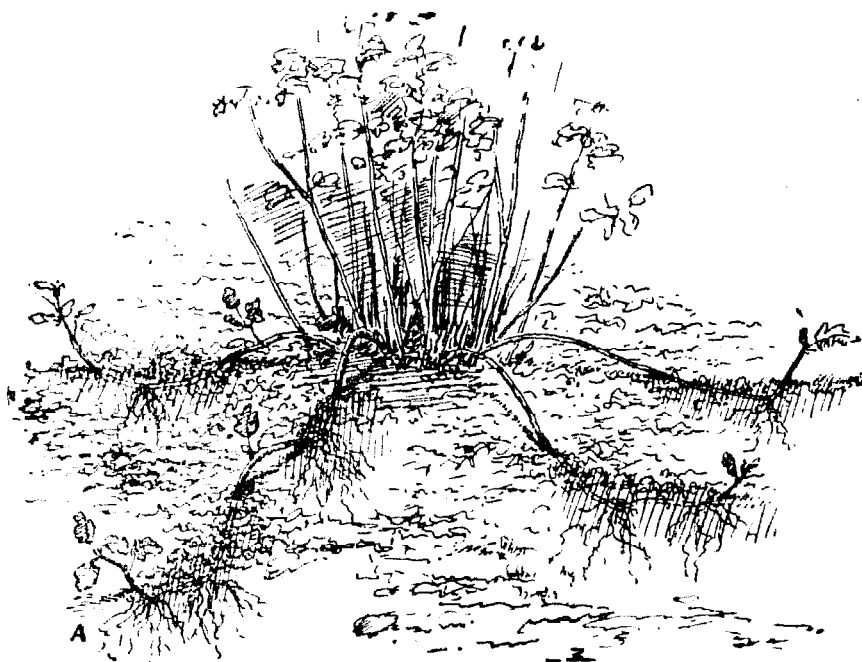

FIG. 62. Layered shoots.

an undulating way and from every covered part roots will form and a plant may be obtained. The completely covered

layer also possesses the advantage of giving more than one plant, but the roots are likely to form so continuously that definite and strong plants are rarely obtained; these rooted parts may be severed and treated as cuttings, however, with



FIG. 63. Carnation layer.

good results. The grape is sometimes propagated by serpentine layering.

Stiff and hard-wooded plants do not often "strike" or root readily, and to facilitate rooting, the branch is wounded at the point where it is desired that roots shall form. This wounding serves to induce formation of adventitious buds at that point, and to check the growth of the branch at the tip. It is a common practice to cut the branch about half in two, obliquely on the lower side. This operation is known as "tongueing." Twisting, notching, "ringing" or girdling, and various other methods are employed, none of which, perhaps, possesses any peculiar advantages in general practice. Some propagators cut all the buds from the covered part. In this case the free and protruding end of the layer is expected to form the top of

the new plant. "Arching," or very abrupt bending, as in serpentine layering, serves the same purpose and is the only attention necessary in most vines. A "tongued" carnation layer is shown in Fig. 63. The layered stem is at S, and the root is seen to have formed from the tongue. This method of propagating carnations is common in Europe, but the plant is always grown from cuttings in America.

When large numbers of plants are desired, as in commercial nurseries, it is often necessary to cut back the parent plant to the ground, or very nearly so, for the purpose of securing many shoots fit for layering. A plant cut back in the spring will produce shoots fit for layering the following spring; or some species produce them in abundance the same year if layers of green or immature wood are desired. These parent or stock plants are called *stools* by nurserymen.



FIG. 64. Mound-layering of gooseberry.

In many species, layerage is performed to best advantage by heaping earth over the stool and around the shoots. This is known as *mound-* or *stool-layering*. The shoots send out roots near the base, and straight stocky plants are obtained. The English gooseberries are propagated almost exclusively in this way in this country. Fig. 64 shows a row of mound-layered gooseberries. The shoots are allowed to remain in layerage two years, in the case of English gooseberries, if the best plants are wanted, but in many species the operation is completed in a single season. Quinces and Paradise apple stocks are extensively mound-layered. The practice is most useful in low plants that produce short and rather stiff shoots. Sometimes these layers are severed at the end of the first season, and the plants are grown in the nursery row for a year before they are placed on the market.

As a rule, the best season for making layers is in spring. Rooting progresses rapidly in that season. Many plants "bleed" if layered very early in the season. Hardy shrubs may be layered in autumn, either early or late, and if an incision is made, a callus will have formed by spring.

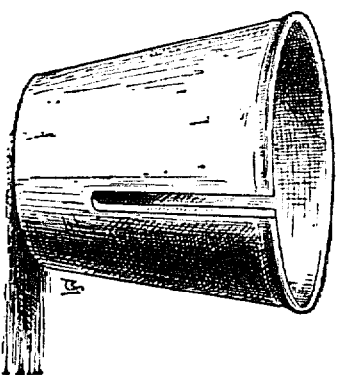

Fig. 65. Layering-pot.

If rapid multiplication is desired, the soft and growing shoots may be layered in summer. This operation is variously known as "summer," "herbaceous," "green" and "soft" layering. (Comparatively feeble plants usually result from this practice, and it is not in common favor.

In glass houses, shoots are sometimes layered in pots instead of in the earth; and the same is often practiced with strawberries in the field, giving the "pot-grown plants" of the nurserymen. The French have "layering-pots," with a slot in the side (Fig. 65) for the insertion of the shoot. In one style of pot, the slot extends from the rim down the entire length of the side and half-way across the bottom (Fig. 66).

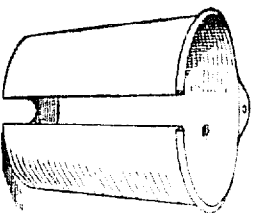

Fig. 66. Layering-pot, another form.

As a general statement, it may be said that bush-like or vine-like plants that do not strike readily from cuttings, nor produce seeds freely, or of which the seeds are very slow to germinate, are to be multiplied by layerage.

The so-called air-layers

Pot-layering, circumposition, air-layering and *Chinese layering* are terms applied to the rooting of rigid stems by means of surrounding them, while in their natural position, with earth or moss, or similar material. The stem is wounded — commonly girdled and preferably just below a node — and a divided pot or box is placed about it and filled with earth (Fig. 67). The roots start from above the girdle, and when they have filled the pot the stem is severed, headed back and planted. Pot-layering is practiced mostly in greenhouses, where it is possible to keep the earth uniformly moist. But even there it is advisable to wrap the pot in moss to check evaporation. Some plants, as *Ficus elastica* and dracena, can be readily rooted by wrapping them with moss alone, if the atmosphere is sufficiently close;

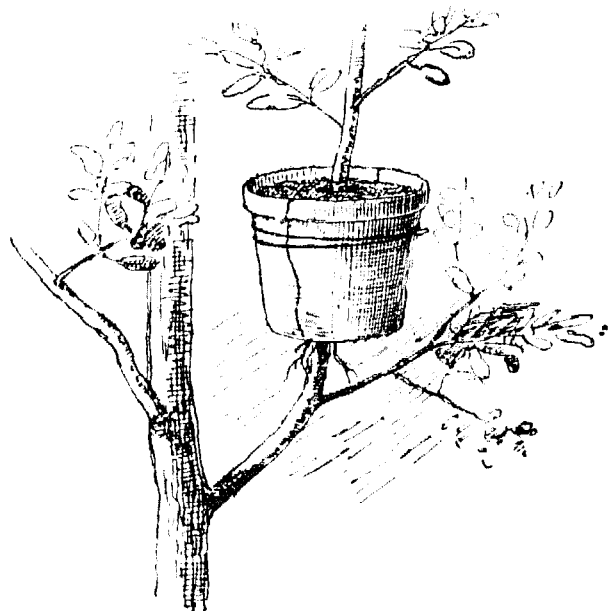

FIG. 67. Pot-layerage.



FIG. 68. A "mossed" dracena plant.

the operation is then called "mossing" (Fig. 68). A paper cone may be used in place of a pot when the atmosphere is not too humid, as in carnation houses (Fig. 69).

Pot-layering is employed not only for the purpose of multiplying plants, but to lower the heads of "leggy" or scraggly specimens. The

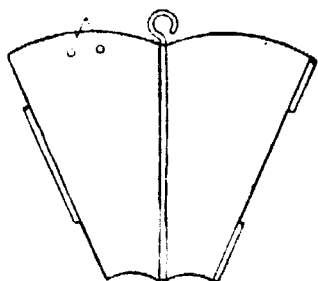

FIG. 70. Layering-cone.

pot is inserted at the required point on the main stem, and after roots have formed abundantly the top may be cut off and potted independently, the old stump being discarded. The French and others have various handy devices for facilitating pot-layering. Fig. 66 shows a layering-pot, provided with a niche in the side to receive the stem, and a flange behind for securing it to a support. The pot shown in Fig. 65 is a similar device. Fig. 70 represents a layering-cone. It is made of zinc or other metal, usually 4 or 5 inches high, and is composed of two semi-conical wings, hinged on the back and secured in front, when the instrument is closed, by means of a hinge-pin. A cord is inserted in one side, with which to hang it on a support. A cup or pot with a removable side is also used. This is shown

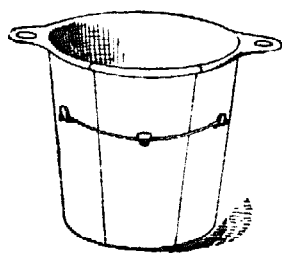

FIG. 72. Layering-cup.

open in Fig. 71 and closed in Fig. 72. An ingenious compound layering-pot is shown in Fig. 73. The main stem or trunk of the plant is carried through the large opening, and the branches are taken through the smaller pots at the side. Kier's layering-boxes or racks

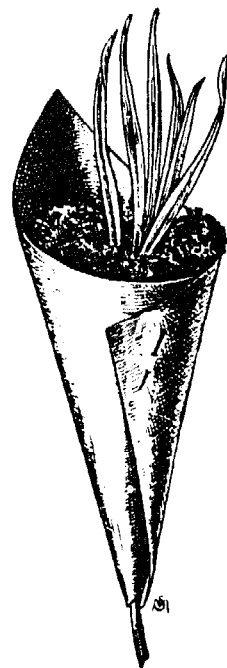

FIG. 69. A method of rooting choice forms of carnation or other plants.

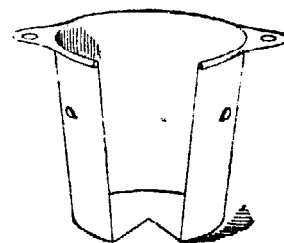

FIG. 71. Layering-cup.

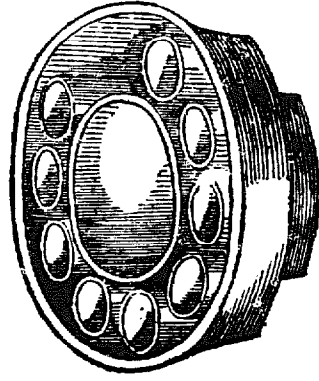

FIG. 73. Compound layering-pot.

are seen in Figs. 74 and 75. The trays are filled with earth or moss, and the branches are laid in through the chinks in the border and are treated in the same way as ordinary outdoor layers. Although such racks may not be used by American gardeners, they are nevertheless suggestive; they provide a neat and convenient means of increasing greenhouse plants which do not readily strike from cuttings.

When layers do not give strong plants, they may be divided into portions, each bearing a bit of root, and treated as ordinary cuttings. This is an important operation in the case of rare varieties which are multiplied by means of soft or green layers, as some of the large-flowered clematises and new varieties of grapes. The small weak plants are handled

in a cool greenhouse or under frames, usually in pots, and they soon make strong specimens.

The term *Chinese layering* applied to this class of work suggests interesting oriental practices. The Chinese make what is called a "gootec," which is a ball of clay plastered around the ring or girdle and covered with moss or fiber to hold it together. The ball is then kept moist by a stream of water that slowly seeps down a soft cord. A receptacle of water is secured above the

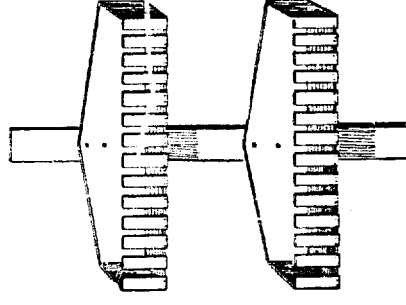

FIG. 74. Kier's layering-rack.

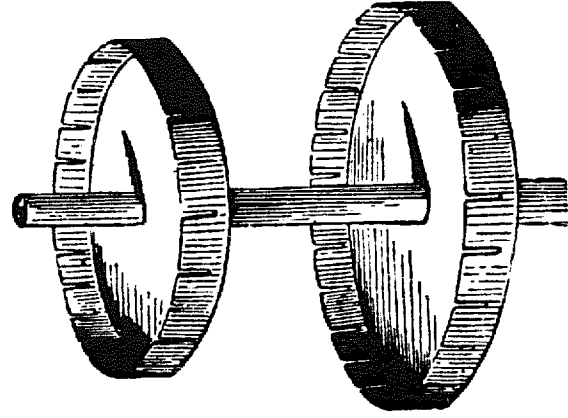

FIG. 75. Kier's circular layering-rack.

gootec; from its bottom the cord is taken out and wound around the ball. By this practice, air-layering may be successful even in the open. The roots penetrate the earthen ball, and the plant is easily transplanted to permanent quarters.

The amateur plant grower, who has the advantage of a greenhouse, may find much entertainment in practicing the divers kinds of air-layering, varying the mode and the operation as his ingenuity may suggest.

CHAPTER V

PROPAGATION BY MEANS OF CUTTINGS

THE regular growth-shoots of plants may grow when severed and placed in earth; as they are cut from the parent, so are such parts known as *cuttings*. Tubers and dormant shoots and leaves, and even parts of fruits as in certain cacti, may also yield materials for cuttings, propagating the plant. The practice or process of multiplying plants by cuttings, with all the craft and science pertaining thereto, is denominated *cuttage*. To this entertaining department we now address ourselves.

1. GENERAL REQUIREMENTS OF CUTTINGS

Cuttings of growing parts demand a moist and uniform atmosphere, a porous soil, and sometimes bottom heat. The requirements vary greatly with the different kinds of plants, yet it is possible to make general statements that will be useful in specific application.

Constructions for regulating moisture and heat

To secure a uniform and moist atmosphere, various propagating-frames are in common use. These frames and boxes or bell-glasses may be used also for seed propagation, but as they find their greatest application in cuttage, they are described mostly in this chapter.

Whatever its construction, the frame should be sufficiently tight to confine the air closely; it should admit light, and allow

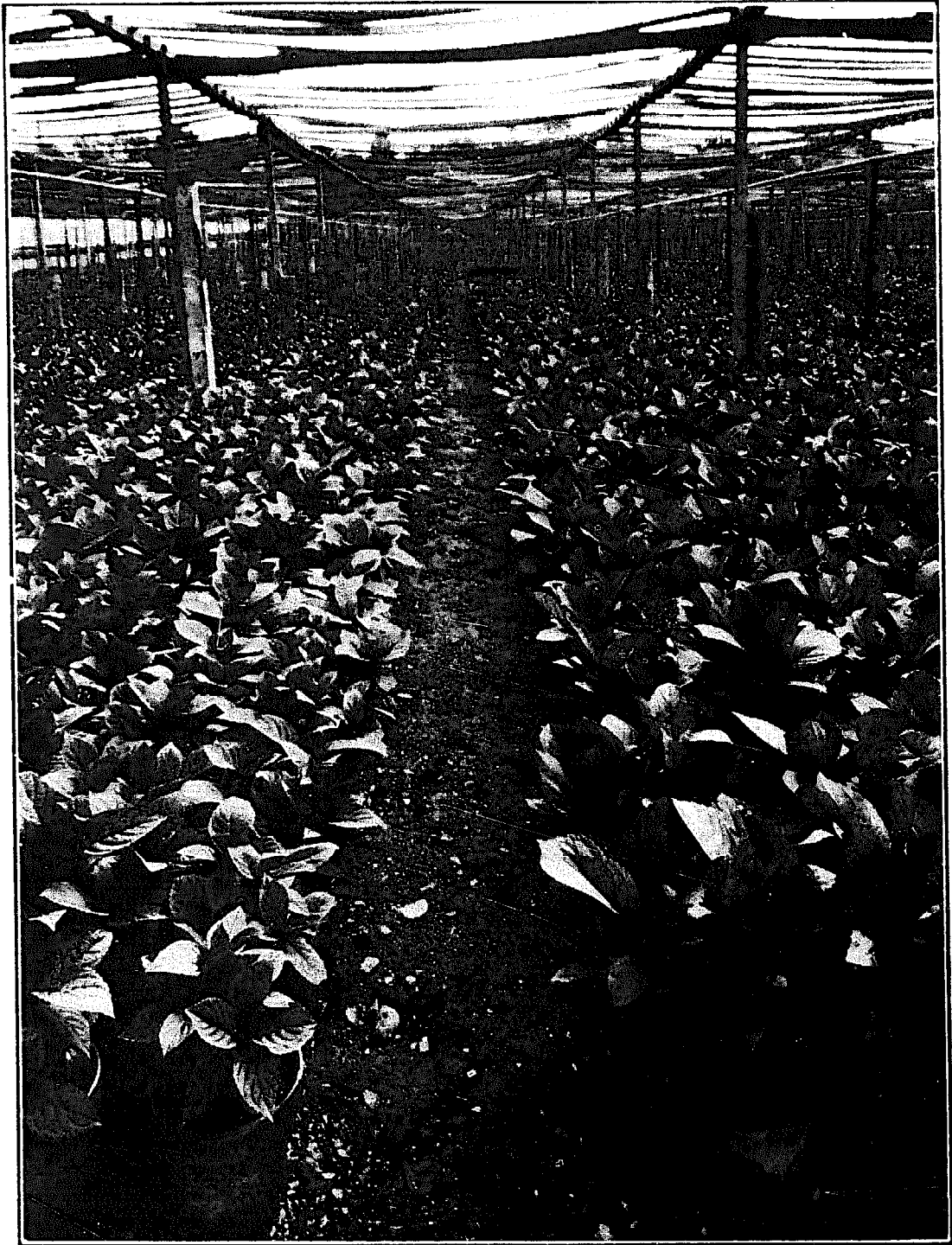

PLATE III. Propagation of hydrangeas. — House in July; the stock was marketed the following autumn.

of ventilation. The simplest form of propagating-frame is a pot or box covered with a pane of glass (Fig. 4). To admit of ventilation, the glass is tilted at intervals, or two panes may be used and a space allowed to remain between them.

A common bell-glass or bell-jar makes one of the best and handiest propagating-frames, because it admits light on all sides and is convenient to handle (Fig. 5). It is particularly serviceable in the propagation of tropical or "stove" plants; and it is in general use for all difficult and rare subjects not propagated in large numbers. A hand-glass or hand-light (Fig. 76) answers the same purpose and accommodates a larger number of plants. For certain limited purposes, a fruit-jar may be used as a bell-glass. Fig. 77 shows such use (adapted from Mulford, Farmers' Bull.

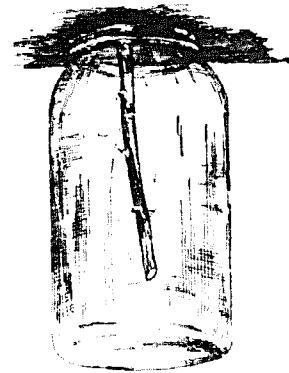

Fig. 77. Fruit-jar used as a bell-glass.

750). A substitute for a bell-jar.

Fig. 78. Muslin substitute for a jar.

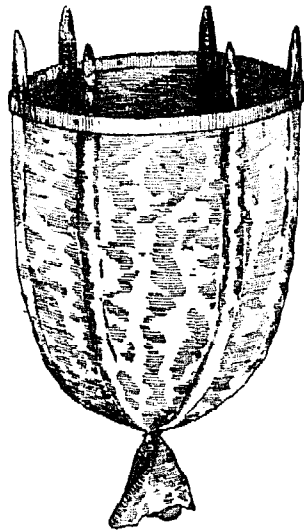

Fig. 78. This device may be used also for protecting plants newly transplanted.

A useful propagating-box for

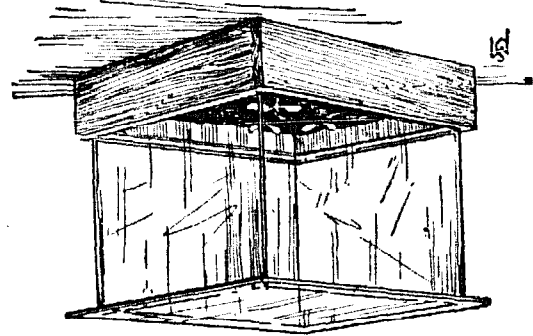

Fig. 79. Small propagating-box.

the window garden or amateur conservatory is shown in Fig. 79. A box 2 or 3 inches high is obtained, and inside this a

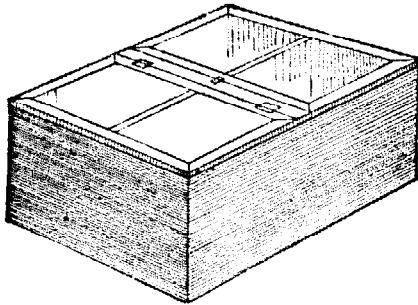

FIG. 80. Propagating-box.

zinc or galvanized iron tray is set, leaving sufficient space between it and the box to admit a pane of glass on every side. These panes form the four sides of the box, and one or two panes are laid across the top. The metal tray holds the soil and allows no water to drip on the floor.

One of the best boxes for general purposes is made in the form of a simple board rectangle without top or bottom, and 15 or 18 inches high, the top being covered with two sashes one of which raises on a hinge (Fig. 80). Four by three feet is a convenient size. Consult also Fig. 85.

An ordinary light hotbed frame is sometimes constructed on the bench of a greenhouse and covered with common hotbed sash. Propagating-houses are sometimes built with permanent propagating-frames of this character throughout

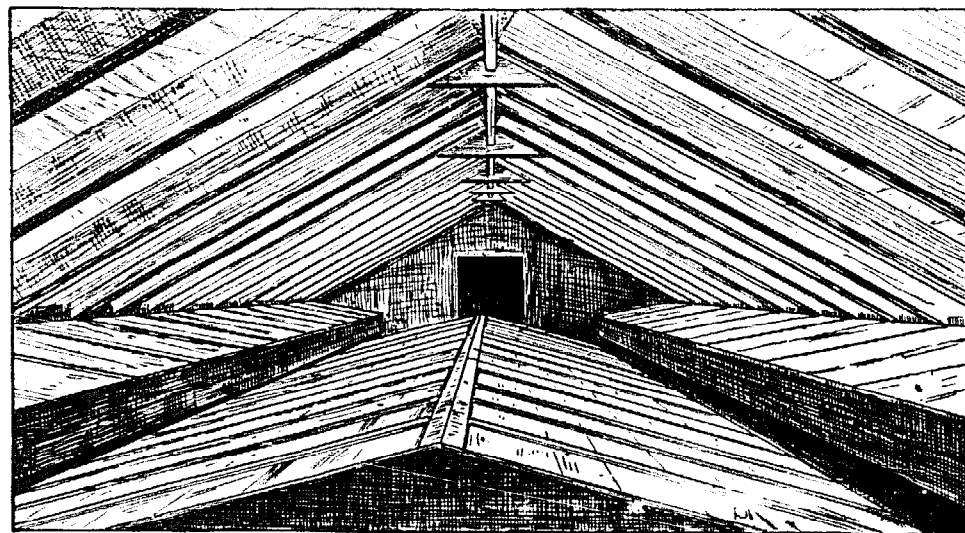

FIG. 81. Permanent propagating-frames in a greenhouse.

their length, as shown in Fig. 81. Such permanent frames are mostly used for conifers, either from cuttings or grafts

(usually the latter) and also for grafts of rhododendrons. (See Chapter VI.)

In all the above appliances, heat is obtained from the sun or from the bench-pipes or flues of a greenhouse. There are various contrivances in which the heat is applied locally, for the purpose of securing greater or more uniform warmth.

One of the simplest and best of these is the propagating-oven shown in Fig. 82. It is a glass-covered box about 2 feet deep, with a tray of water beneath the earth, and is heated with a lamp. Similar but somewhat complicated apparatus has been used in times past, but with the more de-

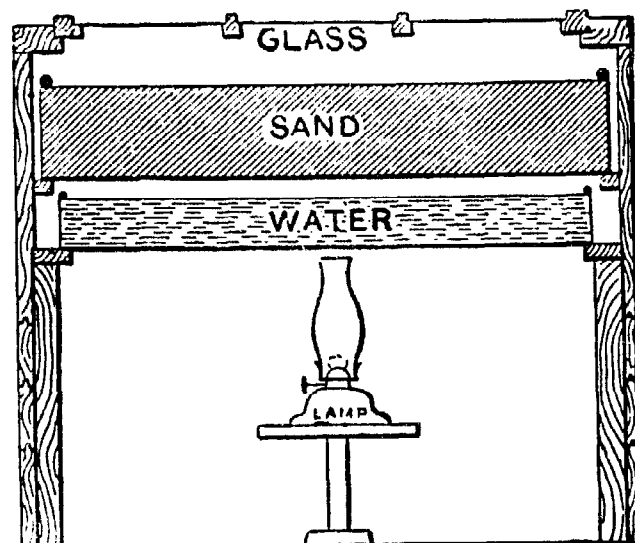

FIG. 82. Simple propagating-oven.

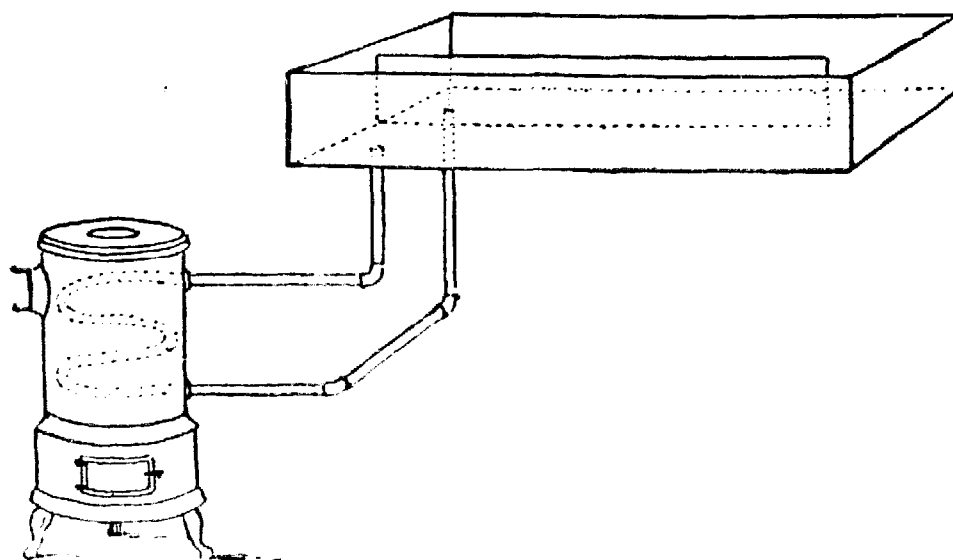

FIG. 83. Barnard's propagating-tank.

pendable heat of steam or hot-water pipes, the old forms are likely to pass out and not need description here. Persons who

are curious about such devices may consult the older European works, and he will find brief descriptions in the previous

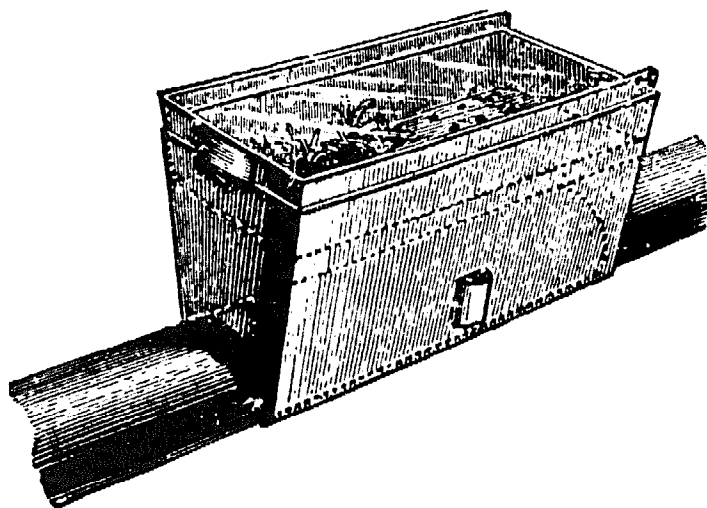

FIG. 84. Zinc propagating-tank.

editions of the "Nursery-Book." Barnard's propagating-tank, Fig. 83, is a practicable device for attachment to a common stove. A similar apparatus may be connected to the pipes of a greenhouse. The tank consists of a long wooden box of matched boards and put together with paint between the joints to make it water-tight. The box should be about 3 feet wide and 10 inches deep, and 10 to 30 feet long, according to the space required. In the middle of the box is a partition, extending nearly the whole length, and on the inside, on each side, is a ledge or piece of molding to support slate slabs to be laid over the entire surface of the box. The slates are supported by the ledges and by the central partition, and should be fastened down with cement to prevent the propagating-sand from falling into the tank. One slate is left out near the end, next the fire, to enable the operator to see the water and to keep it at the right level. Sand is spread on the slates, in which the cuttings may be struck, the sand nearly filling the box. At one end of the box is placed a common cylinder stove, with smoke-pipe to the chimney. Inside the stove is an iron pipe, bent in a spiral. This coil, which is directly in the fire, is connected by pipes with the tank, one pipe leading to one side of the partition and the other to the opposite side, as shown in the drawing. If water is placed in the tank, it will fill the pipes and form a continuous circulating system through-

the pipes and up one side of the box past the end of the partition, and down the other side. A fire in the stove causes the water to circulate through the tank and impart to the bed a genial warmth.

Various tanks are designed to rest on the pipes in a greenhouse. The principle of their construction is essentially the same as of those already described — bottom heat, a tray of water, and a bed of soil. Earthenware tanks are commonly employed, but an English device, Fig. 84, is made of zinc. It is about 7 inches deep, and holds an inch or two of water in the bottom. A tray 5 inches deep sets into the tank. The water is supplied through a funnel at the base.

A useful propagating-box inside a greenhouse is seen in Fig. 85. It is placed where good bottom heat is provided, although no special installation is made for the purpose.

In such a box draughts may be avoided, a uniformly moist air may be maintained, and the heat may be regulated. It is specially useful for tropical things, as nepenthes and many others.

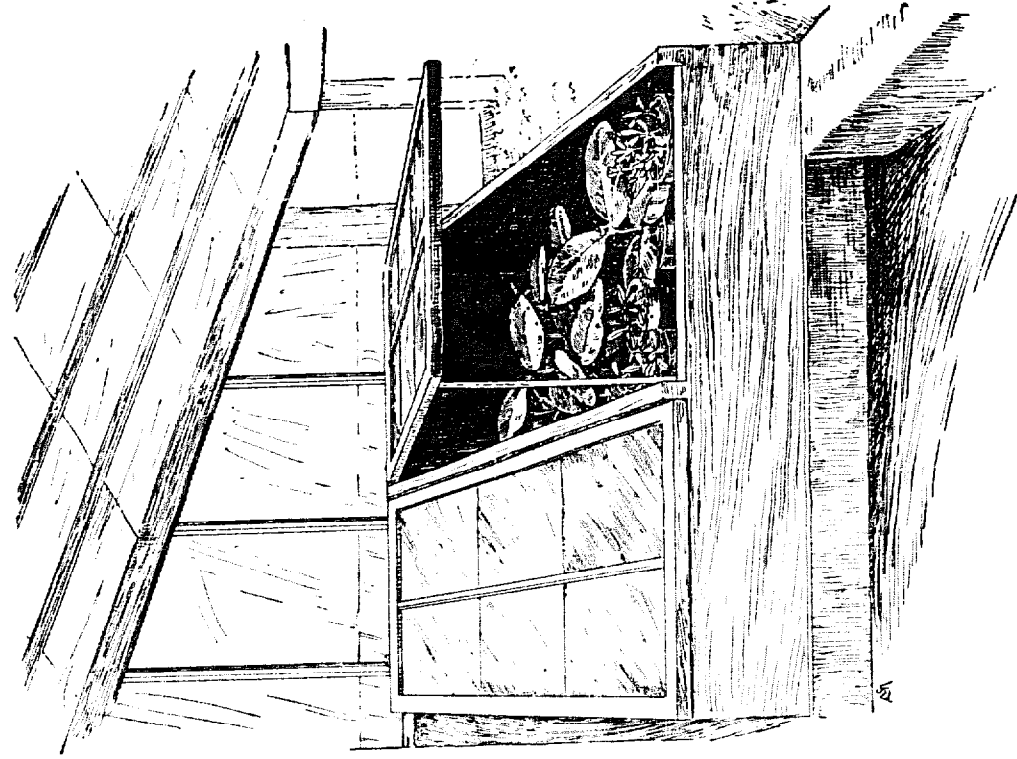

FIG. 85. Greenhouse propagating-box.

In commercial establishments, cuttings are grown extensively in summer. The cuttings are made of growing or maturing

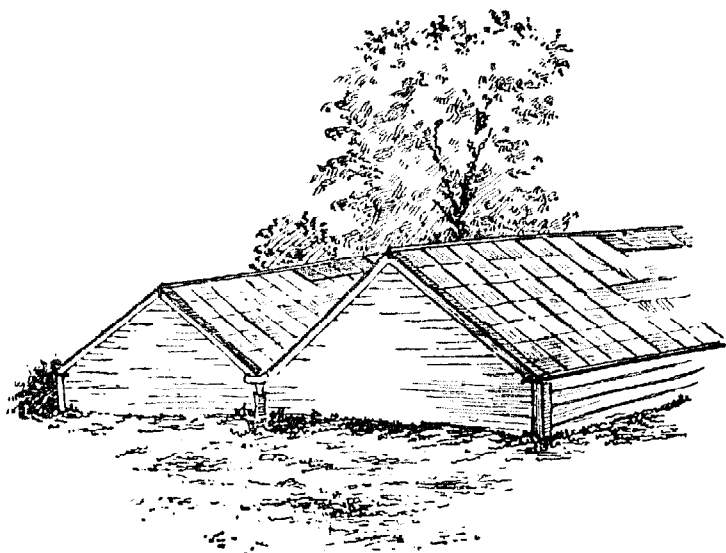

FIG. 86. Propagating-houses, useful for summer work with cuttings.

shoots taken from the natural outdoor growth, as cuttings of similar maturity may be taken from greenhouse stuff in winter and spring. Cover and protection must be provided for these summer cuttings. Low glass-houses, of the forcing-pit type, are much used, being well

shaded. Such houses are indicated in Fig. 86. They may be utilized for seed-propagation or other work, if needed. Frames are useful, as in Fig. 87; and these are also usable in spring for receiving surplus stock from the greenhouse. They are commonly provided with slat-covers, as shown, to go over the glass; or in summer the covers alone may be used. Usually the frames are ranged together in a yard, and high shading is provided by means of muslin as illustrated in Fig. 9 and again in Fig. 88.

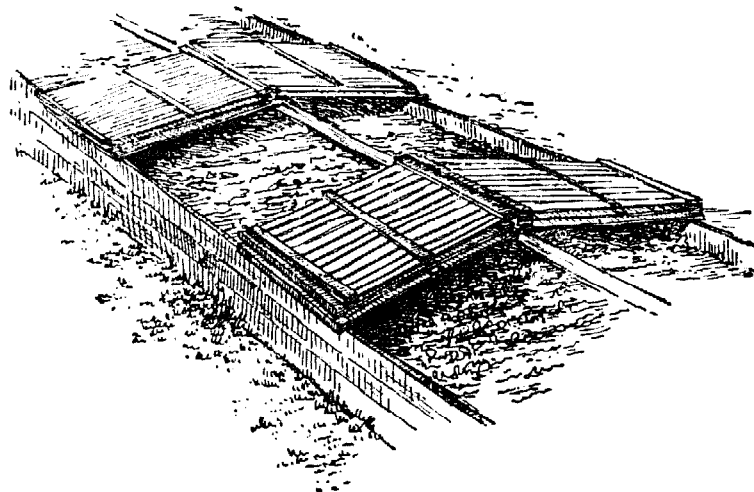

FIG. 87. Propagating-frame.

Bottom heat

Soil somewhat warmer than the air is essential to the best success with cuttings. Bottom or root growth should precede top growth, and this is aided by bottom heat. This heat may be two or three degrees, or three or four times that much, higher than the temperature of the atmosphere.

In outdoor work, this heat is supplied by the natural warmth of the soil in spring and summer, and it is often intensified by

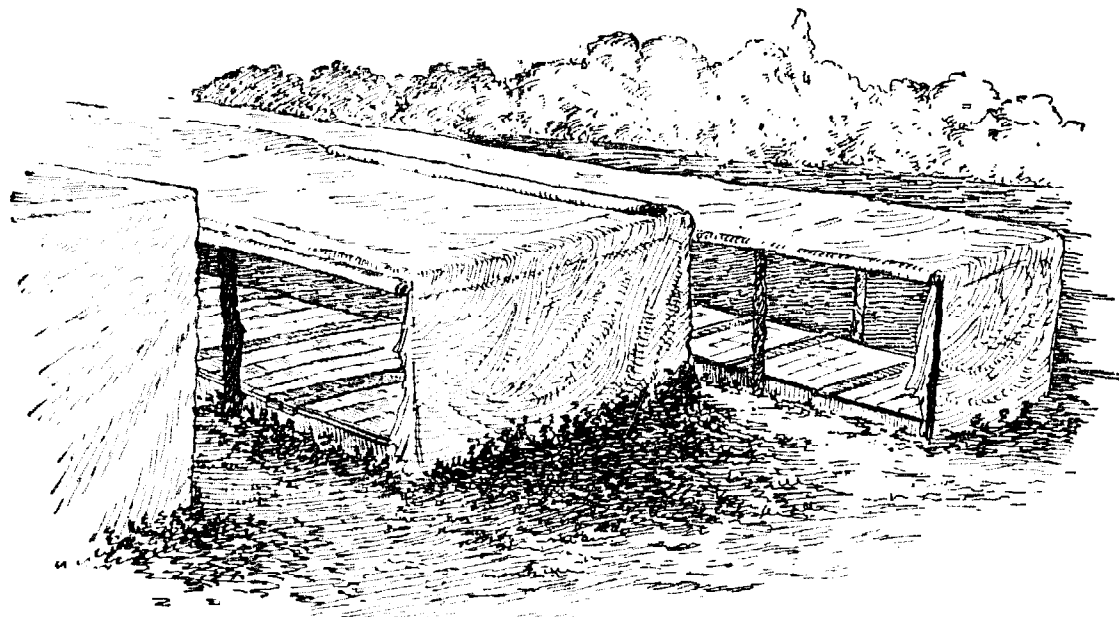

FIG. 88. Nurseryman's frames in a yard, protected by muslin canopies.

burying hard-wooded cuttings bottom end up for a time before planting them, although there may be other reasons and benefits in the inversion of cuttings. This inverting of cuttings is often practiced with grapes, particularly with the Delaware and others that root with some difficulty. The cuttings are tied in bundles and buried in a sandy place, with the tops down, the butts being covered 2 or 3 inches with sand. They may be put in this position in autumn and allowed to remain until the ground begins to freeze hard, or they may be buried in spring and allowed to remain until May or June and then

be regularly planted. In outdoor practice, the cuttings which are of medium length, from 6 to 8 inches, derive more bottom heat than the very long ones, such as were formerly used for the propagation of the grape.

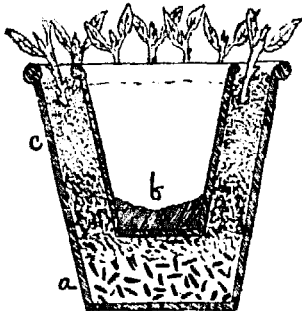

FIG. 89. Forsyth's cutting-pot.

In indoor work, bottom heat is obtained by means of fermenting manure, or, preferably, by greenhouse pipes. Cutting-benches should have abundant piping beneath, and in the case of many tropical and subtropical species the bottom heat may be intensified by inclosing the benches below, so that no heat can escape into the walks. Doors may be placed in the partition alongside the walk, to serve as ventilators if the heat should become too intense.

Placing and protecting the cuttings

Cuttings usually "strike" better when they touch the side of the pot than when they are wholly surrounded by earth. This is probably because the earthenware insures greater uniformity in drainage than the earth, and supplies air and a mild bottom heat; and it is possible that the deflection of the plant-food towards the side of the pot, because of evaporation therefrom, induces better growth at that point.

Various devices are employed for the purpose of securing these advantages to the best effect. These are usually double pots, in one of which water is placed. A good method is that represented in Fig. 89, which shows a pot, *b*, plugged with plaster of Paris at the bottom, placed inside a larger one. The earth is placed between the two, drainage material occupying the bottom, *a*, and fine soil the top, *c*. Water stands in the inner pot as high as the dotted line, and feeds uniformly into the surrounding soil. The positions of the water and soil are frequently reversed, but in that case there is less space avail-

able for cuttings. A double pot, with moisture supplied in a surrounding cushion of sphagnum moss, is seen in Fig. 3. Neumann's cutting-pot is shown in Fig. 90. This contains an inverted pot in the center, *a*, designed to supply drainage and to admit heat into the center of the mass of soil.

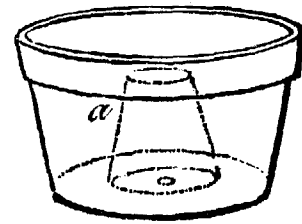

FIG. 90. Neumann's cutting-pot.

A good method of striking difficult subjects is as follows: Fill a saucer with moss; on this place an inverted flower-pot; insert the cutting through the hole in the bottom of the pot, so that it stands in the moss and almost touches the saucer; keep the moss moist.

Some kind of protection, commonly combined with bottom heat, is given cuttings of the soft and growing parts. In indoor

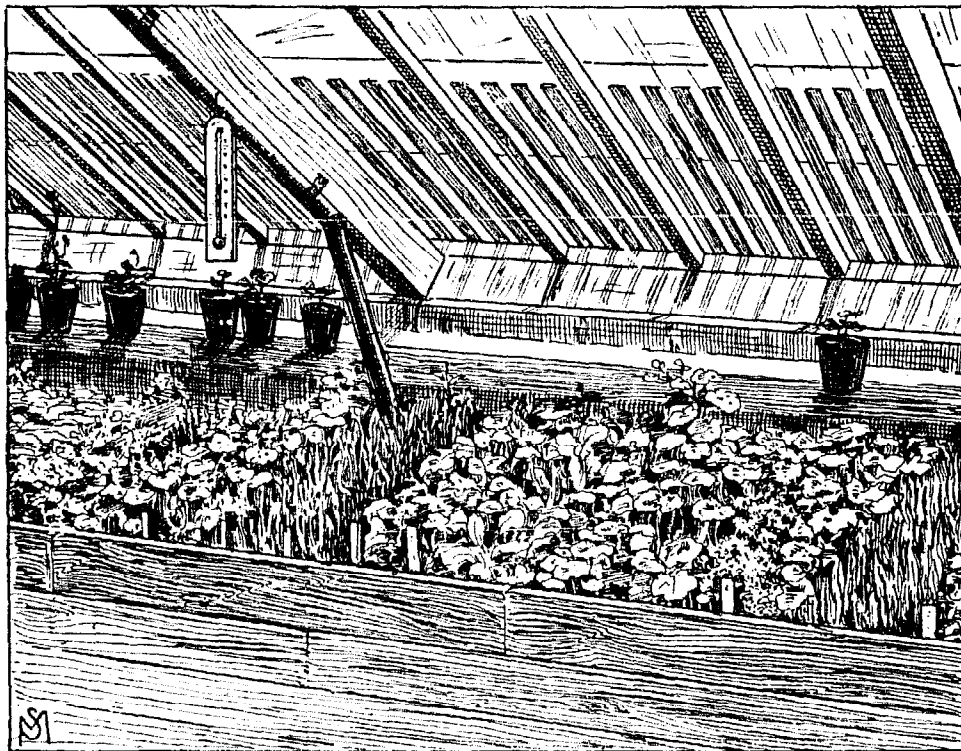

FIG. 91. Cutting-bench shaded with lath.

work, any of the devices named above may be employed, but a box like that shown in Fig. 80 is one of the most useful for

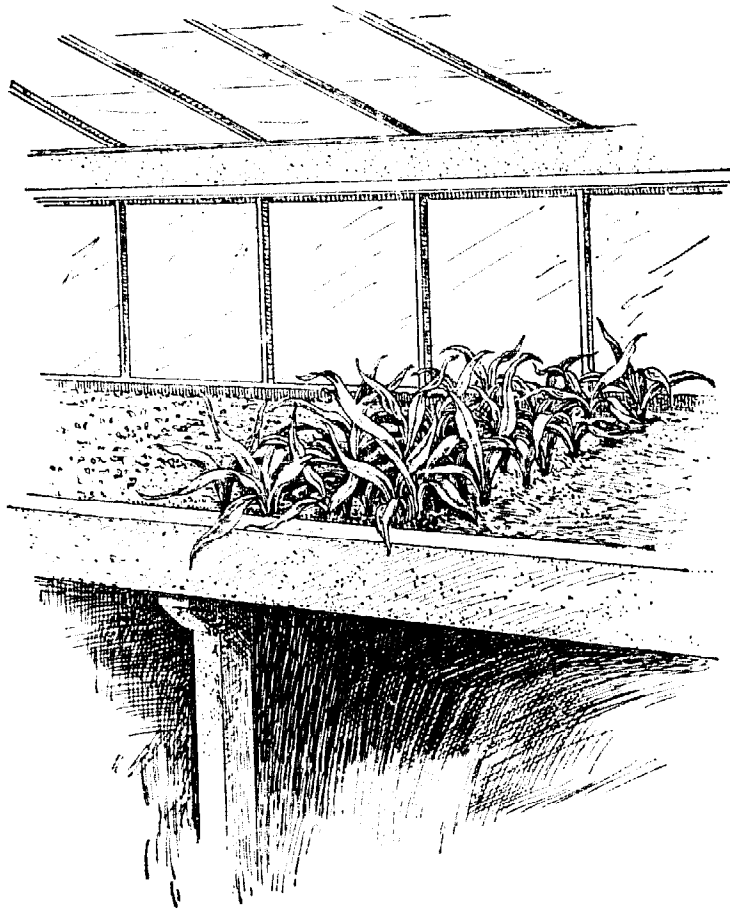

FIG. 92. Dracena cuttings well placed.

cuttings is known as a "cutting-bench." A good cutting-bench should be near the glass, and either exposed to the north or else capable of being well shaded. If the cuttings become too dry or too hot, they will wilt or "flag." A good bench, facing south and shaded over the glass with a lath screen, is illustrated in Fig. 91. A cutting-bench of sand, now bearing cuttings of dracena, is seen in Fig. 92.

In outdoor work, soft cuttings are usually placed in an ordinary cold-

common operations. Or the greenhouse itself may afford sufficient protection, especially if the cuttings are shaded when first set, to check evaporation from the plant and soil, and to prevent too great heat. This shading is usually supplied by whitewashing the glass, or a newspaper may be laid over the cutting-bed for a few days.

A greenhouse table or bench prepared for the growing of

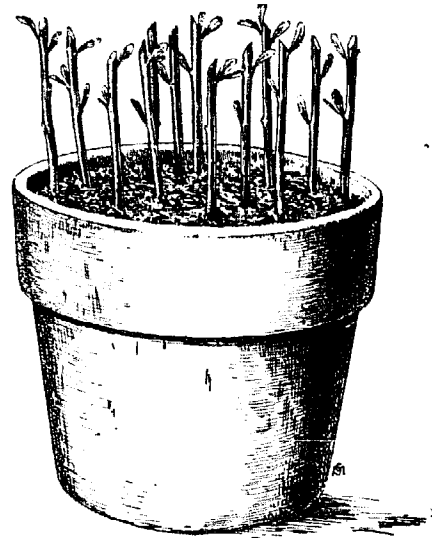

FIG. 93. Pot of hardwood cuttings of Myrica Gale; growth beginning.

frame, and these frames are shaded. They may be placed under trees or on the shady side of a building, or if they are numerous, as in commercial establishments, a cloth screen should be provided, as already explained (page 86).

In regular propagating practice, cuttings are often handled in pots and flats or boxes. Figs. 93 to 96 show the method; note that the cuttings are thickly set; from these boxes the rooted cuttings will be



FIG. 95. Box of juniper cuttings.

transplanted to pots, other flats, or to the nursery row. A "pit" for storing boxes and pots of hardwood cuttings and seeds is shown in Fig. 97. It is a lean-to with glass roof, facing north or else capable of shading. The temperature is kept low, usually little above freezing in winter for hardy things of which cuttings are made in autumn. The walls are preferably of mason work, to keep the temperature more uniform. Such a house or pit affords ideal storage and maintenance conditions for cool stuff over winter.

Soil for cuttings

The soil or earth in which cuttings are grown should be well drained. It should not be so compact as to hold a great quantity of water, nor should it be so loose as to dry out very



FIG. 94. Box of pachysandra cuttings.

for hardy things of which cuttings are made in autumn. The walls are preferably of mason work, to keep the temperature more uniform. Such a house or pit affords ideal storage and maintenance conditions for cool stuff over winter.



FIG. 96. Box of yew (taxus) cuttings.

quickly. It should not "bake" or form a crust on its surface. As a rule, especially for cuttings made of growing parts, the soil should not contain fresh vegetable matter, as such material holds too much water and is often apparently injurious to the cutting, and it is likely to breed the fungi of damping-off.



FIG. 97. Pit or storage house for hardy cuttings and seed boxes.

A coarse, sharp, clean sand is the best material for indoor use. Very fine sand packs too hard, and should rarely be employed. Some propagators prefer to use fine gravel, composed of particles an eighth to a fourth of an inch in diameter, and from which all fine material has been washed. This answers well for green cuttings; but a propagating-frame should be used to check evaporation, and attention be given to watering, because drainage is perfect and the material quickly

permeable. Damping-off is less liable to occur in such material than in denser soils. The same advantages are to some extent present in sphagnum moss and coconut fiber, both of which are sometimes used in place of earth. The "silver sand" used by florists is a very clean and white sand, which derives its particular advantages from the almost entire absence of vegetable matter; but it is not now considered so essential to successful propagation as it was formerly, and fully as good material may often be found in a common sand-bank.

Cuttings that strike strongly and vigorously may be placed in a soil made of light garden loam with twice its bulk of sand added to it. All soils used for indoor work should be sifted or screened before using, to bring them to a uniform texture.

Hardwood dormant cuttings are commonly planted outdoors in mellow and light garden loam, well trenched. Only fine and well-rotted manure should be applied to the cutting-bed, and it should be well mixed with the earth. In most cases, a well-drained soil gives best results, but some cuttings root and grow well in wet soils, or even in standing water, as poplars, willows, some of the dogwoods, the plane-tree and others. In fact, certain cuttings may be rooted in glasses of water, as of the oleander.

The striking of cuttings

When cuttings emit roots and begin to grow, the gardener says that they "strike" or are "struck." The striking of cuttings is the successful rooting of them. The formation of roots is influenced by the way in which the cutting is made, the earth or other medium in which it is set, the temperature and moisture conditions, and other factors.

As a rule, roots arise most readily from a joint, and it is a common practice, therefore, to cut the base of the cutting just below a bud, as shown in the grape cutting, Fig. 98. Sometimes the cutting is severed at its point of attachment to the

parent branch, and a small portion, or "heel," of that branch is allowed to remain on the cutting. This heel may be nothing

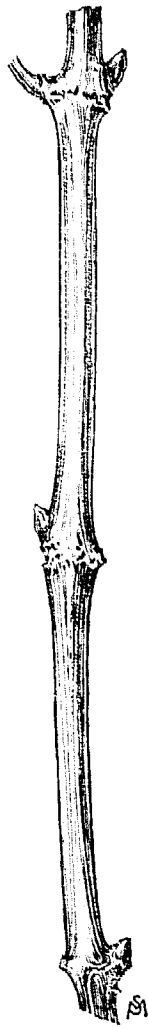

FIG. 98.
Hardwood
grape cut-
ting.

more than the curved and hardened base of the cutting at its point of attachment, as in the cornus cutting, Fig. 99. Sometimes an entire section of the parent

branch is removed with the cutting, as in the "mallet" cuttings of grapes, Fig. 100.

Of course, comparatively few heel or mallet cuttings can be taken from a plant, as only one cutting is obtained from a shoot, and it is advisable, therefore, to "cut to buds" rather than to "cut to heels"; yet many plants demand a heel if the most satisfactory results are to be obtained. The requirements of the different species in this regard can be

learned only by experience; but it may be said that in general the hardest or closest wooded plants require a heel or a joint at the base. Willows, currants, basswoods and others with like soft wood, emit roots readily between the buds, yet even in these cases propagators generally cut to buds.

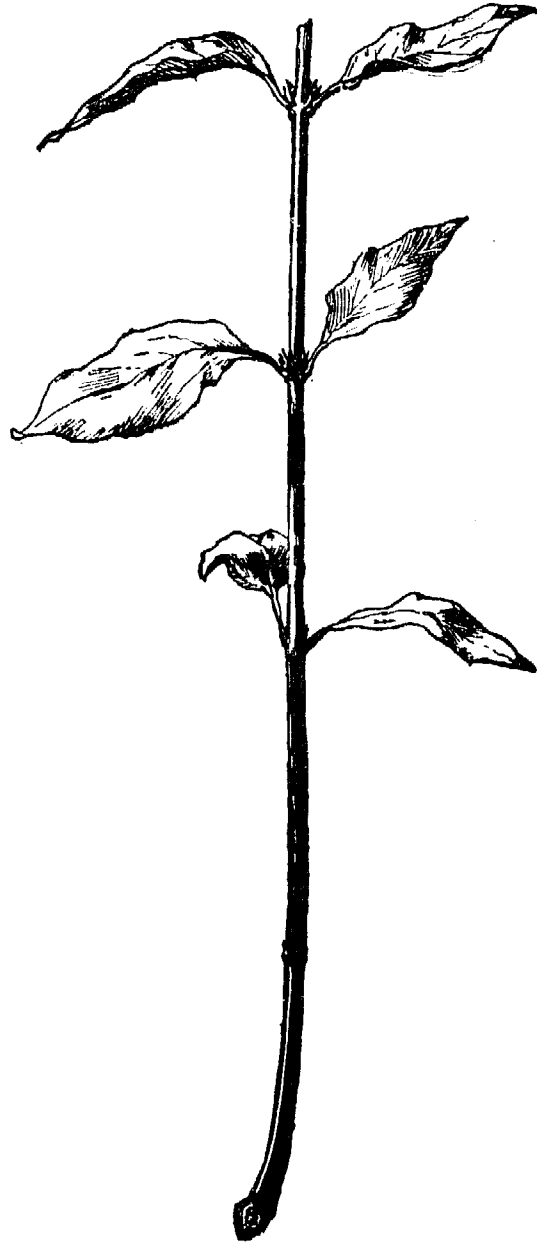

FIG. 99. Heel cutting of cornus ($\times \frac{1}{2}$).

Wounds on plants begin to heal by the formation of loose cellular matter which gives rise to a mass of tissue known as a *callus*. This tissue eventually covers the entire wound, if complete healing results. Usually, the first apparent change in a cutting is the formation of a callus on the lower end, and it is commonly supposed that this process must be well progressed before roots can form. Yet roots do not arise from the callus itself, but from the internal tissue, and in many plants they appear to bear no relation in position to the callus. In willows, for example, roots arise from the bark at some distance from the callus. Yet, as a matter of practice, best results are obtained from callused cuttings, particularly if the cuttings are made from mature wood, but this is probably due to the fact that considerable time is required for the formation of the adventitious buds which give rise to the roots, not to any real connection between the callusing and rooting processes.

Hardwood dormant cuttings give better results when kept inactive for some time after they are cut. They are usually made in autumn, and stored over winter in sand, sawdust or moss in a cool cellar, or buried in a sandy and well-drained place. This, at least, is the practice with hardwood cuttings of deciduous plants, as currants, gooseberries, grapes and many ornamental trees and shrubs. Hardwood evergreen cuttings, when taken in autumn, are usually set at once, as their foliage will not allow them to be buried with safety; but in this case, the cuttings are kept "quiet" or dormant for a time, to allow callusing to progress, as in a pit (Fig. 97). If cuttings are buried so deep that they cannot sprout, callusing may be hastened by placing them in a mild temperature. Single-eye

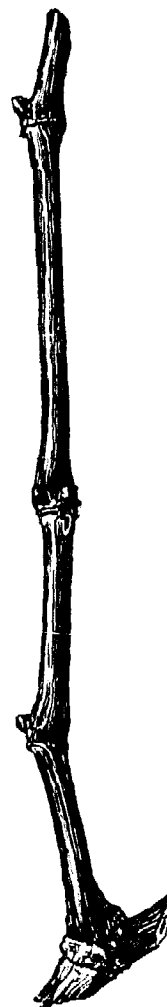

FIG. 100.
Mallet cutting of grape
(x $\frac{1}{2}$).

grape cuttings are sometimes packed between layers of sand in a barrel, and the barrel is set under a forcing-house bench where the temperature is about 50°. Eight or ten inches of sand is usually placed over the top layer. In this way, cuttings taken in winter or early spring may be callused before planting time.

It is a singular fact that the lower end of the cutting, as it stood on the parent plant, produces roots, and the upper end produces leaves and shoots, even if the cutting is inverted. And if the cutting is divided into several parts, each part will still exhibit this differentiation of function. This is true even of root-cuttings, and of other cuttings that bear no buds. The reasons for this localization of function are not clearly understood, although the phenomenon has often been the subject of study. On this fact probably depends the hastening of the rooting process in inverted cuttings by the direct application of heat to the bottoms (page 87), and it likewise indicates that care must be taken to plant cuttings in approximately their natural direction if straight and handsome plants are desired. This remark applies particularly to horse-radish "sets," for if these are placed wrong end up (even though they are root-cuttings), the resulting root will be very crooked.

The particular method of making the cutting, and the treatment to which it should be subjected, to cause it to strike readily, must be determined for each species or genus. Some plants, as many maples, can be propagated from wood two or three years old, but in most cases the wood of the previous or present season's growth is required. Nearly all soft and loose-wooded plants grow readily from hardwood cuttings, while those with dense wood are generally multiplied more easily from soft or growing wood. Some plants, as oaks and nut-trees, are propagated from cuttings of any description only with difficulty, although the hickories grow rather freely from

soft tip-cuttings of roots. It is probable, however, that all plants can be multiplied by cuttings if properly treated.

It often happens that one or two species of a closely defined genus will propagate readily from cuttings while the other species will not, so that the propagator comes to learn by experience that different treatment is profitable for very closely related plants. For example, most of the viburnums are propagated from layers in commercial establishments, but *V. tomentosum* (often known as *V. plicatum*) is grown extensively from cuttings.

2. THE DIVERS KINDS OF CUTTINGS

Cuttings are made from all parts of the plant. In its lowest terms, cuttage is a division of the plant itself into two or more nearly equal parts, as in the division of crowns of rhubarb, dicentra and most other plants that tend to form broad masses or stools. This species of cuttage is at times indistinguishable from separation, as in the dividing of lily bulbs (page 57), and at other times it is essentially the same as layerage, as in the dividing of stools that have arisen from suckers and layers. This breaking or cutting up of the plants into two or more large parts that are already rooted is technically known as division, and is discussed in Chapter III. It is only necessary, in dividing plants, to see that one or more buds or shoots remain on the portions, and these portions are then treated in the same way as independent mature plants, or sometimes, when the divisions are small and weak, they may be handled for a time in a frame or forcing-house as ordinary cuttings.

Cuttings proper may be divided into four general classes, with respect to the part of the plant from which they are made: 1, of tubers; 2, of roots and rootstocks; 3, of stems; 4, of leaves. All these forms of cuttings reproduce the given variety with the same degree of certainty as do grafts or buds.

Cuttings of tubers

Tubers are thickened parts of either roots or stems (page 63), and tuber-cuttings, therefore, fall logically under those divisions; but they are so unlike ordinary cuttings in form that a separate classification is desirable. One form of tuber-cutting is seen in Fig. 101.

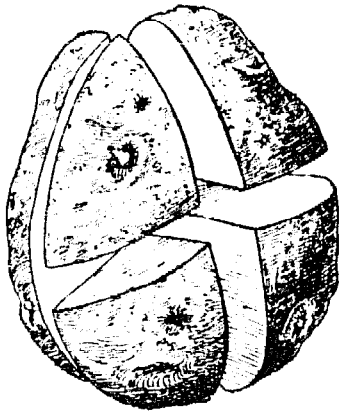

FIG. 101. Cuttings of a potato tuber.

Tubers are stored with starch, which supports or supplies the plant in time of need. Tuber-cuttings, therefore, are able to support themselves for a time if they are placed in conditions suited to their vegetation. Roots rarely arise from the tubers themselves, but from the base of the young shoots that spring from them. This fact is familiarly illustrated in the cuttings of Irish and sweet potatoes. The young sprouts can be removed and planted separately, and others arise from the tuber to take their places. This practice is employed sometimes with new or scarce varieties of the Irish potato, and three or four crops of rooted sprouts can be obtained from one tuber. The tuber is cut in two lengthwise, and is then laid in damp moss or loose earth with the cut surface down, and as soon as the sprouts throw out roots sufficient for maintenance they are severed and potted off. Sweet potatoes are usually propagated in this way.

In making tuber-cuttings, at least one eye or bud is left to each piece, if eyes are present; but in root-tubers, as the sweet potato, there are no buds, and it is necessary only to leave on each portion a piece of the epidermis from which adventitious buds may develop. The pseudobulbs of some orchids are treated in this way, or the whole bulb is preferably planted. A shoot, usually termed an off-shoot, arises from each pseudo-

bulb (Fig. 51), or each piece of it, and this is potted off as an independent plant.

Cuttings of the ordinary stems of some tuberiferous plants will produce tubers instead of plants. This is the case with the potato. The stem-cutting produces a small tuber near its lower extremity, or sometimes in the axil of a leaf above ground, and this tuber must be planted to obtain a new plant. Fig. 102 (from an old print) shows a tuber-like branch on a potato plant, borne a foot above the ground. Leaf-cuttings of certain tuberiferous or bulbiferous plants produce little tubes or bulbs in the same way. (See the gloxinia, Fig. 110.) Hyacinth leaves, inserted in sand in a frame, soon produce little bulblets at their base, and these can be removed and planted in the same way as the bulblets described in Chapter III.

Many tubers or tuber-like parts, that have a very moist or soft interior and a hard or close covering, vegetate more satisfactorily if allowed to dry for a time before planting. The pseudobulbs of orchids, crowns of pineapples and pads of cactuses are examples. Parts of cactuses are sometimes allowed to lie in the sun two to four weeks before planting. This treatment dissipates the excessive moisture, and induces the formation of adventitious buds.

Cuttings of roots

Many plants can be multiplied with ease by means of short cuttings of the roots, particularly all species that have a natural tendency to "sucker" or send up sprouts from the root. Root-

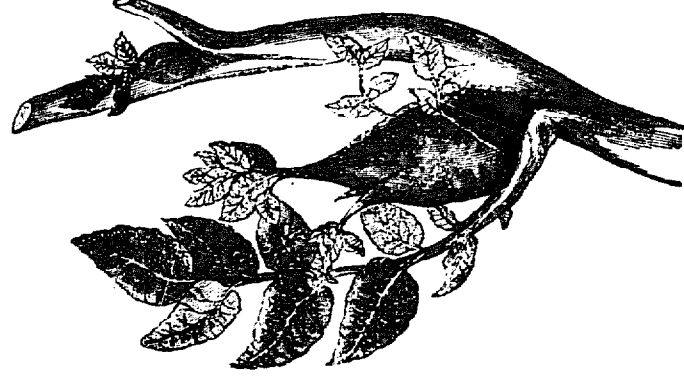

FIG. 102. Stem tuber of potato.

stocks or underground stems can be made into cuttings, as explained under division, in Chapter III; but true root-cuttings possess no buds whatever,



FIG. 103. Root-cutting of blackberry (x $\frac{1}{2}$).

the buds developing after the cutting is planted.

Roots are usually cut into pieces 1 to 3 inches long, and are planted horizontally in soil or moss. These cuttings thrive best with bottom heat, but blackberries and some other plants grow fairly well with ordinary outdoor treatment. A root-cutting of the blackberry is shown in Fig. 103. A growing dracena root-cutting is illustrated in Fig. 104. The cuttings of this plant are handled in a propagating-frame or on a cutting-bench in a warm greenhouse. The bouvardias and many other plants are grown similarly from root-cuttings. Many of the fruit-trees, as peach, cherry, apple and pear, can be grown readily from short root-cuttings in a frame.

Among kitchen-garden plants, the horse-radish is the most familiar example of propagation by root-cuttings. The small side roots, $\frac{1}{4}$ inch or so in diameter, are removed when the horse-radish is dug in fall or spring, and are cut into 4- to 6-inch length as seen in Fig. 105. These cuttings are known as "sets" among gardeners. When the crowns of rhubarb

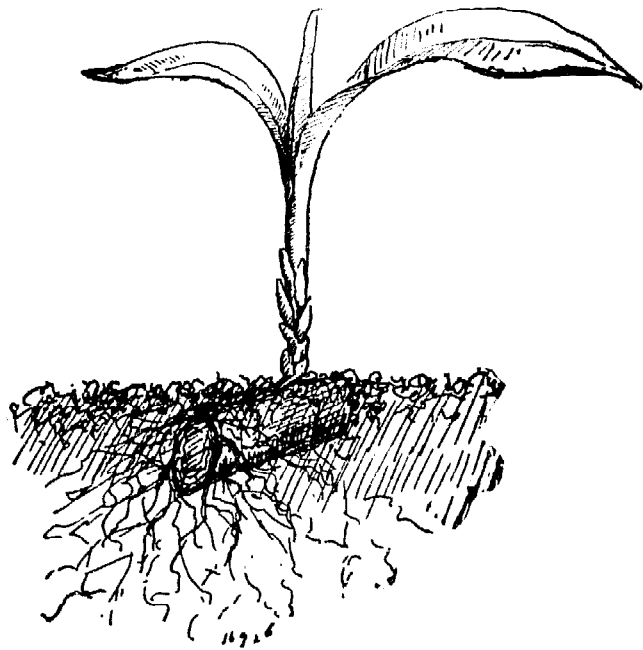

FIG. 104. Root-cutting of dracena.

are cut and used for propagation, the operation falls strictly under division, from the fact that buds or eyes are present;

and the same remark applies to certain other so-called root-cuttings.

While root-cuttings perpetuate the variety, they do not always transmit variegations, or other characteristics of the

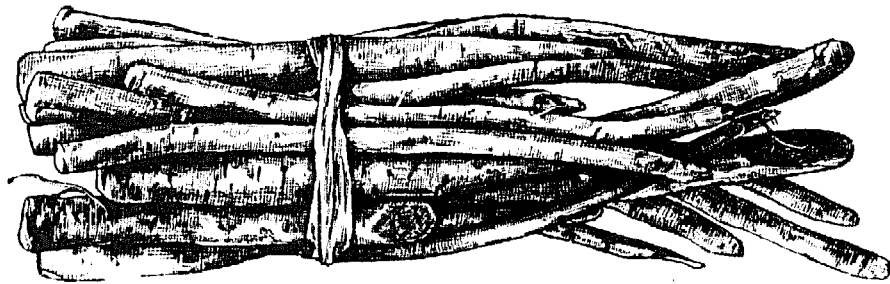

FIG. 105. Horse-radish root-cuttings.

top. For example, the variegated prickly comfrey does not always come true from root-cuttings. If the top is a graft, of course the root-cutting will not reproduce the stock, unless the given roots may have started from the cion. Thus the roots of dwarf pears may be either quince from the stock, or pear from the cion.

Cuttings of leaves

Many thick and heavy leaves may be used as cuttings. Leaf-cuttings are most commonly employed in the showy-leaved begonias, in succulents, and in gloxinias, but many plants can be propagated by them. Even the cabbage can be made to grow from leaf-cuttings. The bryophyllum is one of the best plants for showing the possibilities of propagation by leaves. If one of the thick leaves is laid on moss or sand



FIG. 106. Leaf-propagation of bryophyllum.

by leaves. If one of the thick leaves is laid on moss or sand

in a moist atmosphere, a young plant will start from nearly every pronounced angle in the margin (Fig. 106). In Rex



FIG. 107. Begonia leaf-cutting.

begonias, also, the whole leaf may be used, as shown in Fig. 107. It is laid on moist sand in a frame and held down by splinters thrust through the ribs. The wound made by the peg induces the formation of roots, and a young plant arises. A half dozen or more plants may be obtained from one leaf. Some operators cut the ribs, instead of wounding them with a prick. Many gardeners prefer to divide the leaf into two nearly equal parts, and then set each part, or the better one, upright in the soil, the severed edge being covered. This is shown in Fig. 108. Fewer plants — often only one — are obtained in this manner, but they are strong.

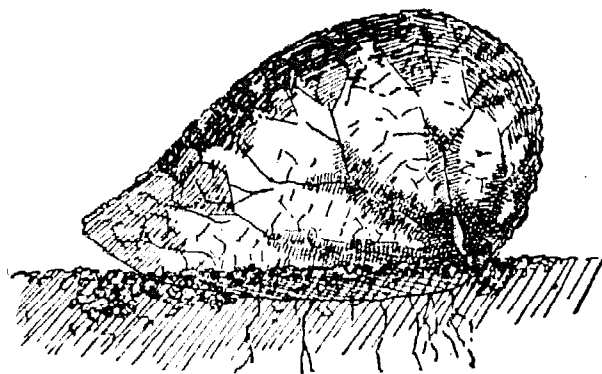

FIG. 108. An upright begonia leaf-cutting.

When stock is scarce, the begonia leaf may be cut into several fan-shaped pieces. The whole leaf may be divided into as many triangular segments as can be secured with a portion of the petiole, a strong rib or a vein attached at the base;

these pieces, inserted and treated like coleus cuttings, will root and make good plants within a reasonable time, say four to six months. This form of cutting should be 2 to 3 inches long by 1 inch or 1½ inches wide. Ordinarily, in this style of leaf-cutting, the petiole or stalk is cut off close to the leaf and the lower third or fourth of the leaf is then severed by a nearly straight cut across the leaf. The somewhat triangular remainder is then cut into as many wedge-shaped pieces as there are ribs in the leaf, each rib forming the center of



FIG. 109. Begonia plant starting from a triangular leaf-cutting.

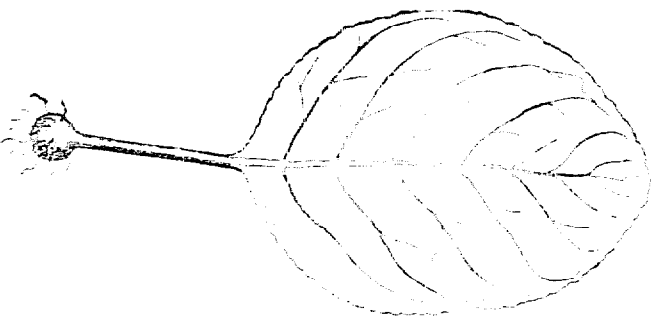

FIG. 110. Leaf-cutting of gloxinia.

a cutting. The point of each cutting should contain a portion of the petiole. The points of these triangular parts are inserted in the soil a half inch or so, the cutting standing erect or nearly so. Roots form at the base or point, and a young plant springs from the same point (Fig. 109).

The gloxinia and others of its kin propagate by leaves, but instead of a young plant arising directly from the cutting, a little tuber forms on the free end of the petiole (Fig. 110), and this tuber is dried off and planted the same as a mature tuber. Most gardeners prefer to cut the leaf-stalk shorter than shown in the cut.

Leaf-cuttings are handled in the same way as soft stem-cuttings, so far as temperature and moisture are concerned.

There are comparatively few species in which they form the most available means of multiplication. In some cases, variegation will not be reproduced by the rooted leaf. This is true in the ivy-leaved geranium L'Elegante; a good plant may be obtained, but it reverts to the plain-leaved type.



FIG. 111.
Currant cutting (x $\frac{2}{3}$).

Cuttings of stems

Cuttings of the stem divide themselves into two general classes: those known as cuttings of the ripe, mature or hard wood; and cuttings of the green, immature or soft wood. The two classes run into each other, and no hard and fast line can be drawn between them.

(1) *Hardwood dormant cuttings.*

By the term *hardwood* is meant wood or tissue that is mature or nearly so and will not grow any more till the following season. The leaves may not have fallen, but the growth of the season (at least in length) is completed.

Cuttings of the hard dormant wood are made at any time from late summer to spring. It is advisable to make them in autumn, to allow them to callus before the planting season, and to forestall injury from a severe winter. They may be taken as early as August, or as soon as the wood is mature, and be stripped of leaves. Callusing then takes place in time to allow of fall planting. Or, the cuttings taken in early fall may be planted immediately, and be allowed to callus where they stand. All fall cutting-beds should be mulched, to prevent the heaving of the cuttings. As a rule, however, dormant hardwood cuttings are buried on a sandy knoll or are stored

in moss, sand or sawdust in a cellar until spring. (See page 87.)

There is no general rule to govern the length of hardwood cuttings. Most propagators prefer to make them 6 to 10 inches long, as this is a convenient length to handle, but the shorter length is preferable. Two buds are always to be taken, one bud or one pair at the top and one at the bottom, but in "short-jointed" plants more buds are retained. Sometimes all but the top buds are removed to prevent the starting of shoots or sprouts underground. Grape cuttings are now commonly cut to two or three buds (as in Fig. 98), two being the favorite number for most varieties. Currant and gooseberry cuttings (Fig. 111) usually bear six to ten buds. All long hardwood cuttings are set perpendicularly, or nearly so, and only one or two buds are allowed to stand above the surface. A hardwood cutting of fig, after it has made roots and a terminal shoot, is shown in Fig. 112 (Reimer, N. C. Bull. 208).

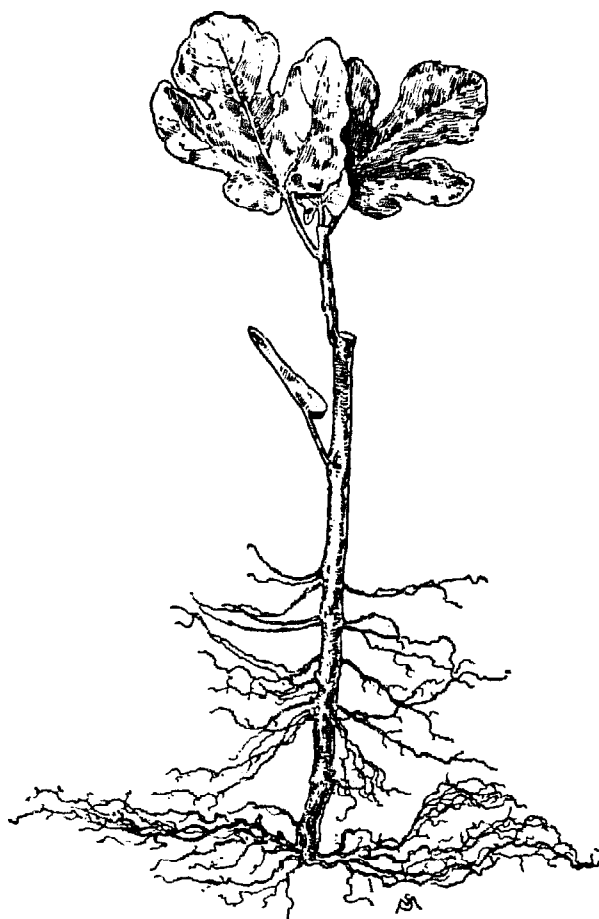

FIG. 112. A well-rooted cutting of fig.



FIG. 113. Single-eye grape cutting (x ½).

When the stock is rare, cuttings are made of single eyes or buds. This is particularly the case with the grape, and currants and many other plants are occasionally grown in the same way. Fig. 113 shows a single-eye grape

cutting. Such cuttings, whatever the kind of plant, are commonly started under glass with bottom heat, either on a cutting-bench or in a hotbed, being planted an inch or so deep in a horizontal position, with the bud up. The soil should be kept uniformly moist, and when the leaves appear the plants should be frequently sprinkled. In thirty to forty days the plants are ready to pot off. Single-eye cuttings are usually started about three or four months before the season is fit for outdoor planting, or about February in the northern states.



FIG. 114. Spruce cutting (x $\frac{1}{2}$).

The most advisable method of treatment varies with the season and locality, as well as with the species or variety. It is well known, for example, that the Delaware grape can be propagated more easily in some regions than in others. A common style of single-eye cutting is made with the eye close to the top end, and a naked base of an inch or two. This is inserted in the soil perpendicularly, with the eye just above the surface. It is much used for a variety of plants.

Many coniferous plants are increased by cuttings on a large scale, especially retinosporas, arbor-vitæ and the like. Cuttings are made of the mature wood (Fig. 114), which are planted at once (in autumn) in sand under cover, usually in a cool greenhouse. Most of the species root slowly, and they often remain in the original flats or benches a year, but their treatment is usually simple. In some cases junipers, yews and *Cryptomeria japonica* will not make roots for nearly twelve months, keeping in good foliage, however, and ultimately giving good plants. They are always grown in shaded houses or frames, and sometimes in inside propagating-frames (Fig. 81). Often the cuttings are handled in boxes, as explained in Figs. 95, 96, and perhaps stored in a pit (Fig. 97).

Most remarkable instances of propagation by means of

portions of stems are on record. Chips from a tree trunk have been known to produce plants, and the olive is readily increased by knots or excrescences formed upon the trunks of old trees. These excrescences occur in many plants, and are known as *knaurs*. They are often abundant about the base of large plane-trees, but they are not often used for purposes of propagation. Whole trunks will sometimes grow after having been cut for many months, especially of such plants as cactuses, many euphorbias and yuccas. Sections of these spongy trunks will grow, also. Truncheons of cycad trunks and tree ferns may also give rise to plants. Even saw-logs of common trees, as elm and ash, will sprout while in the "boom," or water.

(2) *Green-wood cuttings.*

Cuttings of green wood are more commonly employed than those from the mature dormant wood, as they "strike" more quickly, they can be handled under glass in winter, and more species can be propagated by them than by hardwood cuttings.

Green-wood cuttings are of two kinds as respects maturity: those taken from soft and still growing parts, herbaceous in character; those made of shoots that have practically ceased growing and are woody. The shoots are spoken of as "wood" by gardeners, whether actually woody or not; this has become a special technical term. "Slips" are green-wood cuttings, but the term is often restricted to those made by pulling or "slipping" off a small side-shoot, and it is commonly applied to the multiplication of plants in window-gardens. All soft-wooded plants and many ornamental shrubs are increased by green cuttings of one kind or another. House plants, as geraniums, coleuses, carnations, fuchsias, are grown from the soft young wood, and many harder wooded plants are grown in the same way. Sometimes true hardwood is used, as in camellia and azalea.



FIG. 115. Tough and brittle wood.

figure, it is either too old or too young for good results. The tips of the shoots of soft-wooded plants are usually employed, and all or some of the leaves are allowed to remain.

The cuttings are inserted in sharp sand to a sufficient depth to hold them in place,

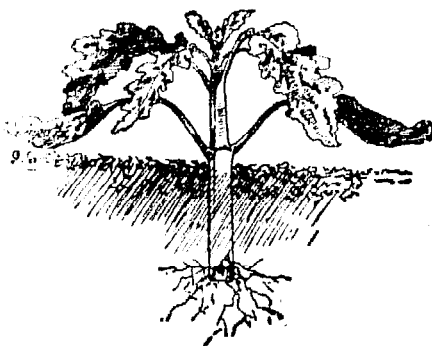

FIG. 117. Coleus cutting (x $\frac{1}{2}$).

In making *softwood cuttings*, the first thing to learn is the proper texture or age of shoot. A very soft and flabby cutting does not grow readily, or if it does it is particularly liable to damp-off, and it usually makes a weak plant. Too old wood is slow to root, makes a poor stunted plant and is handled with difficulty in many species. The ordinary test for beginners is the way in which the shoot breaks. If, on being bent, the shoot snaps off squarely so as to hang together with only a bit of bark, as in the upper break in Fig. 115, it is in the proper condition for cuttings; but if it bends or crushes, as in the lower part of the

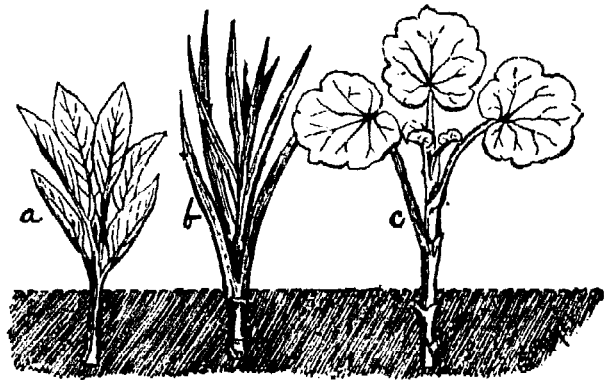

FIG. 116. Soft cuttings (x $\frac{1}{3}$).

and the atmosphere and soil must be kept moist to prevent wilting or "flagging." The cuttings should also be shaded for the first week or two. It is a common practice to cover newly set cuttings with newspapers in the heat of the day. A propagating-frame is often employed. Soft

cuttings are commonly cut below a bud or to a heel, but this is unnecessary in easily rooted

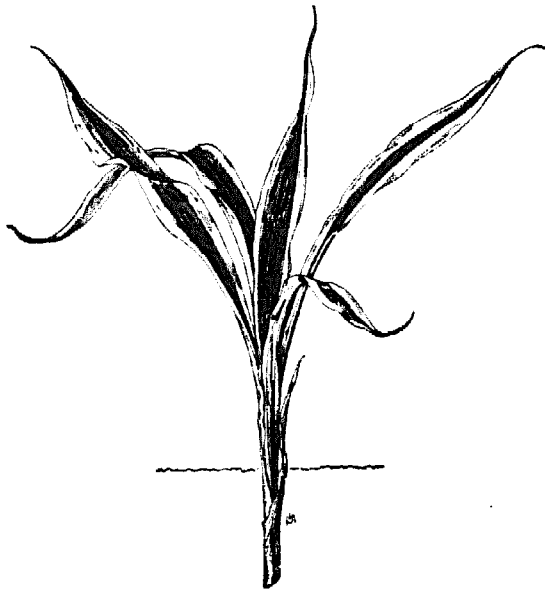

FIG. 119. A dracena cutting.

plants like geranium, coleus, heliotrope. Fig. 116 shows an oleander cutting at *a*, a carnation at *b*, and a geranium at *c*.

A coleus cutting is illustrated in Fig. 117. Many growers prefer to

make a larger cutting of certain firm-wooded plants, like chrysanthemums, as

shown in Fig. 118. A bed of dracenas is shown in Fig. 92, and one of the cuttings is drawn in Fig. 119.

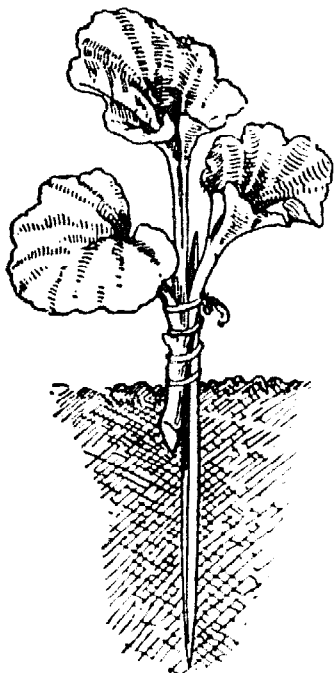

FIG. 121. Cutting held by toothpick ($\times \frac{1}{2}$).

Sometimes the growth is so short or the stock so scarce that the cutting cannot be made long enough to hold itself in the soil. In such case a toothpick or splinter is tied to the cutting to hold it erect, as in the cactus cutting, Fig. 120, or the geranium cutting, Fig. 121.

In the window-garden, soft cuttings may be started in a deep plate half or two-thirds full of sand and then filled to the brim with water, and not shaded; this method, practiced on a larger scale, is sometimes useful in the hot summer

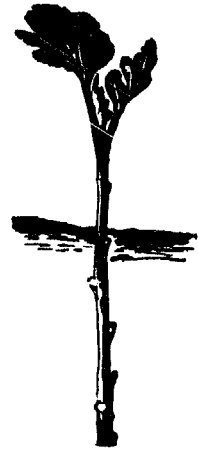

FIG. 118. One form of chrysanthemum cutting ($\times \frac{1}{2}$).



FIG. 120. Cactus cutting held by splinter ($\times \frac{1}{2}$).

months. If bottom heat is desired, the plate may be set on the back part of the kitchen stove. Oleanders usually root

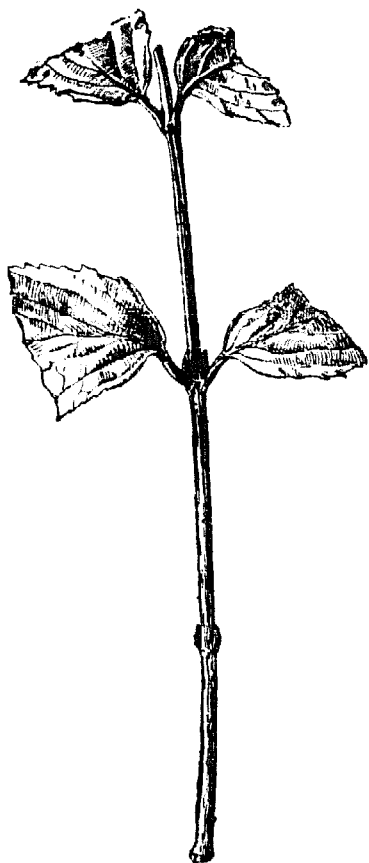

FIG. 122. Hydrangea cutting ($\times \frac{1}{2}$).

best when mature shoots are placed in bottles of water. Refractory subjects may be inserted through the hole in the bottom of an inverted flower-pot, as explained on page 89.

Certain plants are grown from *firmwood cuttings*, as diervillas (weigela), roses, hydrangeas (Fig. 122), lilacs. These plants are woody subjects, and the cuttings represent shoots that have nearly or practically completed growth. The cuttings are taken in essentially the same way as the hardwood cuttings described on page 104. They are often used in summer, when the buds have developed and the wood has about attained its full size. They are cut to two to four or five buds, and are planted an inch or two deep in shaded frames. They are kept close for some days after setting, and the tops are sprinkled frequently. Care must be taken not to set them too deep; they are rarely put in over an inch, if the cutting is six or seven inches long. When taken early in the season, they are known as "June-struck cuttings."

Several weeks are required for rooting the firmwood cuttings, but good plants are obtained, which, when wintered in a cold-frame, may be planted out in beds the next

cut to two to four or five buds, and are planted an inch or two deep in shaded frames. They are kept close for some days after setting, and the tops are sprinkled frequently. Care must be taken not to set them too deep; they are rarely put in over an inch, if the cutting is six or seven inches long. When taken early in the season, they are known as "June-struck cuttings."

Several weeks are required for rooting the firmwood cuttings, but good plants are obtained, which, when wintered in a cold-frame, may be planted out in beds the next

cut to two to four or five buds, and are planted an inch or two deep in shaded frames. They are kept close for some days after setting, and the tops are sprinkled frequently. Care must be taken not to set them too deep; they are rarely put in over an inch, if the cutting is six or seven inches long. When taken early in the season, they are known as "June-struck cuttings."

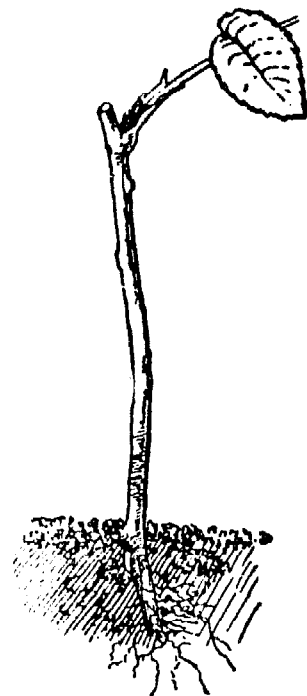

FIG. 123. Rose cutting ($\times \frac{1}{2}$).

spring. Great care must be given to shading and watering. *Hydrangea paniculata* var. *grandiflora* and *Akebia quinata* are examples; or any deutzia or more easily handled plant of which stock is scarce may be cited.

Part of the leaves is removed, as a rule, before these firmwood cuttings are set, as shown in the rose cutting, Fig. 123, and the hydrangea cutting, Fig. 122, and the viburnum, Fig. 124. This last picture (Fig. 124) was made in a western New York nursery September 17. It was then ready to be potted or set in a bed. Clipping the leaves is not essential, but it lessens evaporation and the tendency to "flag" or wilt. In most species the top can be cut off the cutting, as seen in Figs. 99 and 122, but in other cases it seriously injures the cutting. Weigelas are likely to suffer from such beheading; an unusually large callus forms at the bottom, but

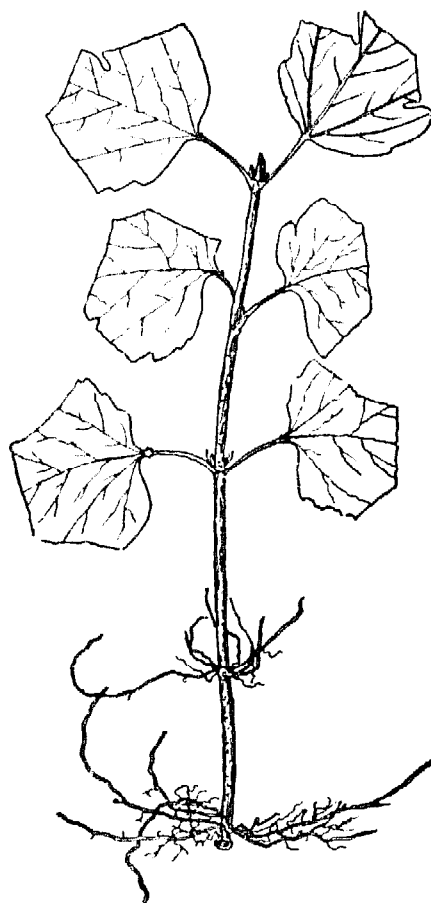

FIG. 124. Summer cutting of Viburnum, ready for potting.

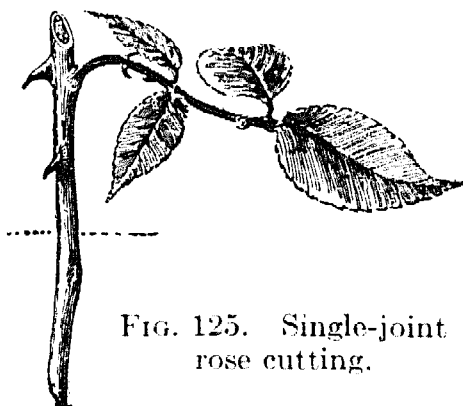

FIG. 125. Single-joint rose cutting.

the leaves shrivel and die. This frequently occurs in what some nurserymen call "end growers," among which may be mentioned weigelas (properly diervillas), the shrubby altheas, *Cercis japonica*, and such spireas as *S. trilobata*, *S. rotundifolia* var. *alba* of gardens, and *S. cantonensis* (*S.*

Reevesii of the trade), and the var. *robusta* (probably properly *S. blanda*).

The reader must not suppose that all rose cuttings are made after the fashion of Fig. 123, although that is a popular style. Tea roses, and other forced kinds, are largely propagated from softer wood cut to a single eye, with most or all of the leaf left on (Fig. 125).

These firmwood cuttings, about two inches long, are often made in the winter from forced plants of many kinds. Cuttings taken in February, in the North, will be ready to transfer to borders or nursery beds when spring opens. Stout well-rooted stock-plants are used from which to obtain the cuttings, and they are cut back when taken to the house in autumn, in order to induce a good growth. Many hardy shrubs can be easily propagated in this way when the work is difficult or unhandy in the open air: *e.g.*, *Spiræa cantonensis* and *S. Vanhouttei*, the roses and the like.

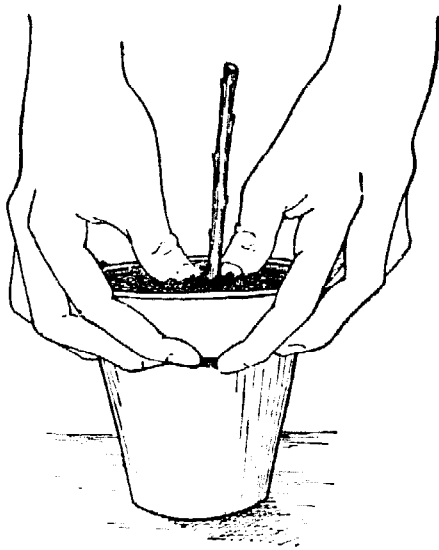

FIG. 126. Firming the earth about the plant.

Stock plants of the soft species, as coleus, lantanas and geraniums, are obtained in like manner.

In the potting of rooted plants, care is taken to firm the earth; and good workmanship requires that the plant be centered in the pot. Fig. 126 shows the operation.

We now propagate only certain plants by means of cuttings, although the number is really large; but we may confidently expect to learn how to multiply all plants by such parts. We have extended new experiments and a study of physiological relations. Such investigations as E. F. Smith's on the growth of tumors (Journ. Agr. Research, Jan. 29, 1917) yield suggestions for difficult subjects.

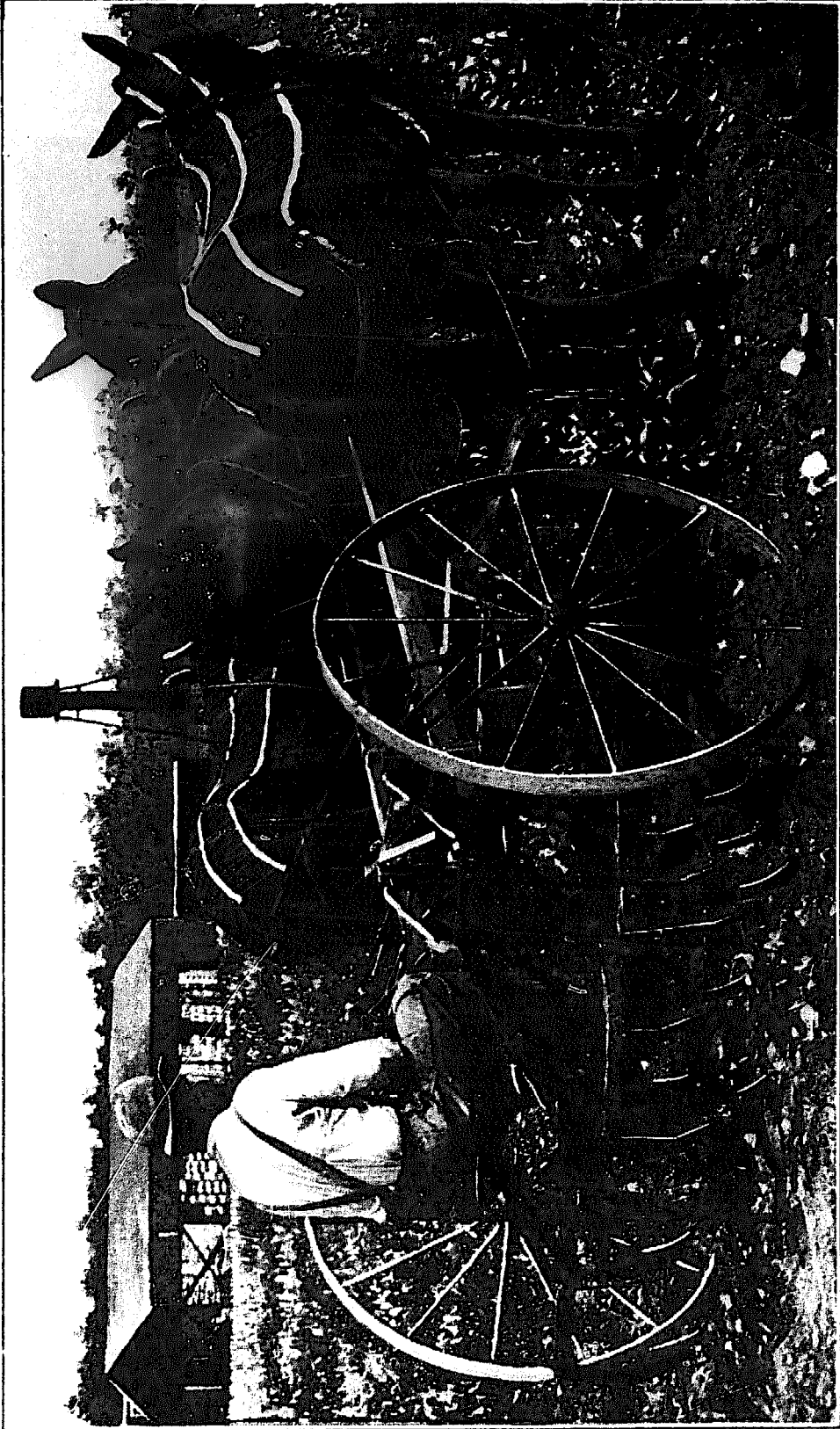

PLATE IV. Straddle-row tillage in the nursery.

CHAPTER VI

PROPAGATION BY MEANS OF BUDDING AND GRAFTING

THE vegetative parts of plants may be severed and inserted in earth or water for the making of new plants. Under certain conditions, severed parts may be inserted in other plants with the intention of making new plants: this process is known broadly as *grafting*. The part removed from the parent and inserted in the foster parent is the *cion* (or scion). If the cion is only a bud with a bit of bark and wood attached, the operation of inserting it is usually spoken of as *budding*, and the term grafting is restricted to the use of a cion consisting of a piece of twig bearing two or more buds; yet the operation is all grafting, independently of the make of the cion. Budding is really only one of the forms of grafting. What is known as the *graft* is the completed work, — the cion set in its new plant; but sometimes the word graft is used in the sense of cion. The plant or part in which the cion is set is the *stock*. The whole subject of grafting, comprising the knowledge and discussion that goes with it, is known as *graftage*. While all plants can probably be grafted, in practice the operation is confined mostly to trees and shrubs.

I. GRAFTAGE IN GENERAL

The reasons for grafting are two: (1) To keep or perpetuate a variety true to name, which is not accomplished by seed-propagation. Thus, if one would grow the Elberta peach one

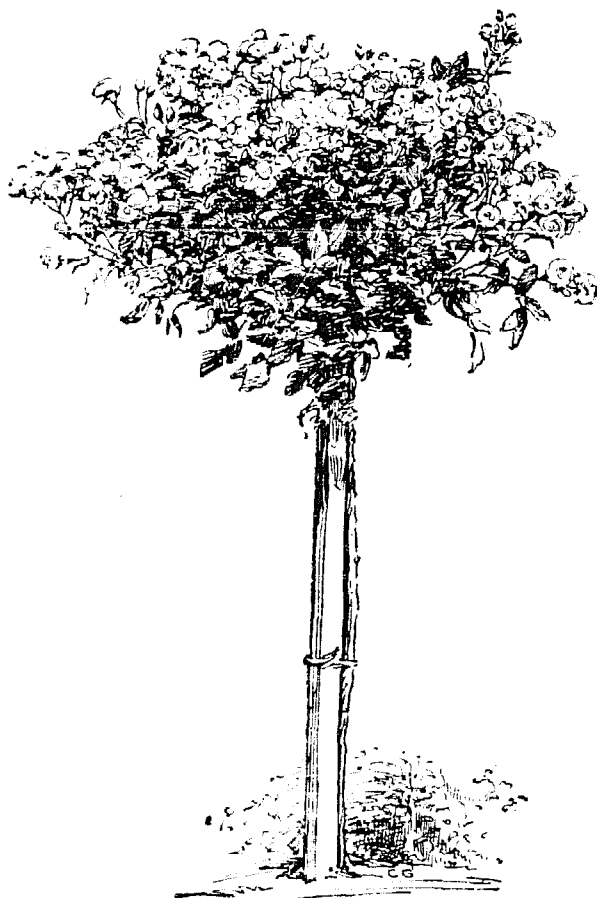

FIG. 127. A "standard" rose, produced by budding on a tall trunk.

and low-growing things are elevated on long trunks as in Fig. 127 (Beal, Cornell Reading-Course Lesson). While the budding of roses far above ground is allowable for the making of "standards," care should be taken in ordinary propagation to have the bud close to the surface, as illustrated by Beal at the right in Fig. 128.

Graftage is always a secondary operation. That is, the root or stock must first be grown from seeds, layers or cuttings, and this stock is then grafted or

would not attempt it by planting the seed of Elberta; on any seedling peach-stock buds from the Elberta could be set and the resulting tree would be Elberta. (2) To multiply the plant, by making many plants from one. Usually both purposes are accomplished at the same time. To these reasons may be added a third: to produce a given change in cion or stock, as when a variety is dwarfed by working it on a slower-growing stock, or fruit-bearing is hastened by setting a cion in an old stock; weeping varieties are grafted high on straight bodies,

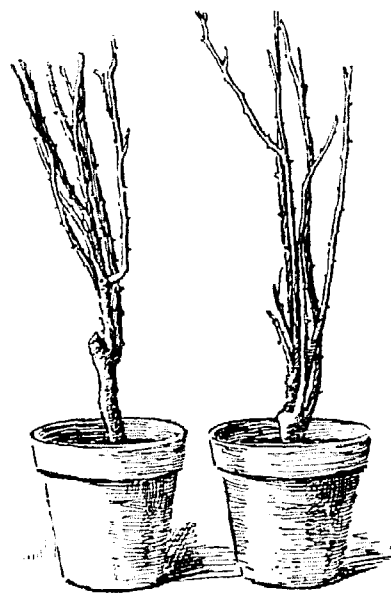

FIG. 128. Budded roses' too high at left.

budded to the desired variety. Graftage is employed in the propagation of the tree-fruits in America, and of very many ornamental trees and shrubs, and it is indispensable to the nursery business.

In some species, which present no marked or named varieties, propagation by seeds or cuttings is for various reasons so difficult or uncertain that recourse must be had to graftage, quite independently of the perpetuation of particular horticultural varieties. This is true in many of the firs and spruces, which do not produce seeds to any extent in cultivation. In other cases, graftage is employed to aid the healing of wounds or to repair and fill broken tops. It has been used to make infertile plants fertile, by grafting in the missing sex in dioecious trees, or a variety with more potent pollen as practiced in some of the native plums.

The old discussion as to whether grafting is a devitalizing process is quite aside from the question, seeing the many necessities that must be met. Poor work and the match-



FIG. 129. A natural graft of forest trees. Similar but manipulated graft at the right.

ing of uncongenial kinds are surely to be avoided, but it is now too late to raise the question in the abstract.

Grafting is not unknown in nature. Often limbs of trees grow together solidly when they cross. Fig. 129 (left) shows a natural graft of two trunks which in some way became entangled. Fig. 129 (right) is a similar case, but here the four trunks were tied together intentionally and are now grown into a firm union. In these cases the trees are of the same kind or species.

The limit within which graftage is possible or desirable between species, is determined only by experience. Probably all exogenous plants — those with a distinct bark and pith — can be regularly grafted. Plants must be more or less closely related to allow of successful graftage of the one on the other. As a rule, plants of close botanical relationship, especially those of the same genus, intergraft with more or less ease; yet this relationship is by no means a safe guide, particularly as the current fashion among taxonomists of splitting up genera into fragments obscures affinities. A plant will often thrive better on a species reputed to be of another genus than on a congener. The pear, for example, does better on many thorns than on the apple. Sometimes plants of very distinct genera unite readily. Thus among cacti, the leafless *zygocactus* (usually known as *epiphyllum*) grows well on the leaf-bearing *pereskia*. It should be borne in mind that union of tissues is not a proof of affinity. Real affinity can be measured only by the thrift, healthfulness and longevity of the cion. The bean has been known to make a union with the *chrysanthemum*, but it almost immediately died. Soft tissues, in particular, often combine in plants that possess no affinity whatever, as we commonly understand the term. Neither does affinity refer to relative sizes or rates of growth of stock and cion, although the term is sometimes used in this sense. It cannot be said that some varieties of pear lack affinity for

the quince, and yet the pear cion grows much larger than the stock. In fact, it is just this difference in size and rate of growth that constitutes the value of the quince root for dwarfing the pear. When there is a marked difference in rate of growth between the stock and cion, an enlargement will occur in the course of time, either above or below the union. If this occurs on the stem, it makes an unsightly tree. If the cion greatly outgrows the stock, a weak tree is the result.

The inter-relationships of stock and cion and the physiological reactions in grafting have been made the subject of prolonged study by the Frenchman, L. Daniel. In this field we are to expect important applications to nursery practice in the course of time.

The mutual influence of cion and stock is a subject of perpetual fascination. It has been much discussed, but without real conclusions or much influence on practical operations outside such matters as the operations of dwarfing and the elevation of weeping heads on straight stocks. Some of the real and supposed reciprocal influences may be mentioned: graftage may modify the stature of a plant (dwarfing and vice versa); adapt plants to adverse soils and climates; correct a poor habit; afford good trunks for weeping and drooping plants; hasten and sometimes augment fruit-bearing; modify the season of flowering or ripening; increase the size and modify the quality of flowers and fruits; transmit disease.

Classification of graftage

There are three general divisions or kinds of graftage, between which, however, there are no decisive lines of separation: 1. Bud-grafting, or budding, in which a single bud is inserted under the bark on the surface of the wood of the stock. 2. Cion-grafting, or grafting proper, in which a detached twig, bearing one or more buds, is inserted into or on the stock. 3. Inarch-

ing, or grafting by approach, in which the cion remains attached to the parent plant until union takes place. This last is so much like grafting proper, and is so little used, that it is discussed under the head of grafting in the succeeding parts of this chapter; it is essentially a mode of layering. Each of these divisions can be almost endlessly varied and subdivided, but in this discussion only the leading practices can be detailed. The following enumeration, after Baltet, gives a fair idea of the kinds of grafting with distinct names:

1. *Bud-grafting, or budding*

1. Grafting with shield-buds.
 Bud-grafting under the bark, or by inoculation.
 Bud-grafting, ordinary method.
 Bud-grafting with a cross-shaped incision.
 Bud-grafting with the incision reversed.
 Bud-grafting by veneering.
 Bud-grafting, the combined or double method.
2. Flute-grafting.
 Flute-grafting, common method.
 Flute-grafting with strips of bark.

2. *Cion-grafting, or grafting proper*

1. Side-grafting under the bark.
 Side-grafting with a simple branch.
 Side-grafting with a heeled branch.
 Side-grafting in the alburnum.
 Side-grafting with a straight cleft.
 Side-grafting with an oblique cleft.
2. Crown-grafting.
 Ordinary method.
 Improved method.
3. Grafting *de precision*.
 Veneering, common method.
 Veneering, in crown-grafting.
 Veneering with strips of bark.

Crown-grafting by inlaying.

Side-grafting by inlaying.

4. Cleft-grafting, common single.
Cleft-grafting, common double.
Cleft-grafting, oblique.
Cleft-grafting, terminal.
Cleft-grafting, terminal woody.
Cleft-grafting, terminal herbaceous.
5. Whip-grafting, simple.
Whip-grafting, complex.
Saddle-grafting.
6. Mixed grafting.
Grafting with cuttings.
When the cion is a cutting.
When the stock is a cutting.
When both are cuttings.
Root-grafting of a plant on its own root.
Root-grafting of a plant on the roots of another plant.
Grafting with fruit-buds.

3. Inarching, or grafting by approach

1. Method by veneering.
Method by inlaying.
English method.
2. Inarching with an eye.
Inarching with a branch.

Times and methods

Grafting of one kind or another can be performed at almost any time of year, but the method must be varied to suit the season and other conditions. The one essential point is to make sure that the cambium layers, lying between the bark and hardwood, meet as nearly as possible in cion and stock. This cambium is always present in live parts, forming woody substance from its inner surface and bark from its outer surface.

In the season of greatest growth it usually occurs as a soft mucilaginous and more or less unorganized substance, and in this stage it most readily repairs and unites wounded surfaces; and for this reason the grafting and budding of old trees are usually performed in the spring. Later in the season, the cambium becomes firmer and more differentiated, and union of woody parts is more uncertain.

It is necessary to cover the wounds to check evaporation from the tissues. In outdoor work, wax is commonly used for all kinds of grafting that wound the wood itself, but in budding, the loosened bark, bound down securely by a bandage, affords sufficient protection. It is commonly supposed that an ordinary cleft-graft cannot live if the bark of the stock immediately adjoining it is seriously wounded, but the bark really serves little purpose beyond protection of the tissues beneath. A cion will grow when the bark is mostly removed from the stub, if adequate protection is given which will not interfere with the formation of new bark.

The cion must always bear at least one good bud. In most cases, only buds that are mature or nearly so are used, but in the grafting of herbs very young buds may be employed.

These simple requirements may be met in an almost innumerable variety of ways. The cion or bud may be inserted in the root, crown, trunk or any of the branches; it may be set simply under the bark, or inserted into the wood itself in almost any fashion; and the operation may be performed either on growing or dormant plants at any season. But in practice there are comparatively few methods sufficiently simple and expeditious to admit of general use; the operator must be able to choose the particular method best adapted to the case in hand.

2. BUDDING

Budding is the operation of applying a single bud, bearing little or no wood, to the surface of the living wood of the stock. The bud is applied directly to the cambium layer of the stock. It is commonly inserted under the bark of the stock, but in flute-budding a piece of bark is entirely removed, and the bud is used to cover the wound. There is every gradation between budding and grafting proper.

There is no general rule to determine what species of plants should be budded and what ones cion-grafted. In fact, the same species is often multiplied both ways. Plants with thin bark and an abundance of sap are likely to do best when grafted; or if they are budded, the buds should be inserted at a season when the sap is least abundant, to prevent the "strangulation" or "throwing out" of the bud. In such species, the bark is not strong enough to hold the bud firmly until it unites; and solid union does not take place until the flow of sap lessens. Budding is largely employed on young fruit-trees, and with the stone-fruits in nursery practice. It is also used in roses and many ornamental trees. Grafting is in common use for working-over the tops of large trees, and it is also employed extensively in certain kinds of nursery practice as the root-grafting of apples and the veneer-grafting of ornamental stock.

Budding is commonly performed in the growing season, usually in summer or early fall, because mature buds can be procured at that time, and young stocks are then large enough to be worked readily. But budding can be done in early spring, as soon as the bark loosens; in this case perfectly dormant buds must have been taken in winter and kept in a cellar, ice-house or other cool place.

Budding is always best accomplished when the bark slips or peels easily. It can be undertaken when the bark is tight, but

the operation is then tedious and uncertain. It is also more certain when performed in dry clear weather.

Shield-budding

But one style of budding is in general use in this country. This is known as shield-budding, from the shape of the piece of bark removed with the bud. Technically, the entire severed portion, comprising both bark and bud, is called a "bud." A shield-bud is shown natural size in Fig. 130. This is cut from a young twig of the present season's growth. It is inserted underneath the bark of a young stock or branch, and is then securely tied, as shown in Fig. 131, which is



FIG. 130.
Shield-bud
(x 1).

adapted from a print once published by the United States Department of Agriculture. Sometimes the positions are reversed, the bud being inserted from below.

The minor details of shield-budding differ with nearly every operator, and with the kind of plant to be budded. In commercial practice, it is performed in the North mostly from

early July until the middle of September. In the southern states it usually begins in June. As a rule, apples and pears are budded earlier in the season than peaches. This is because

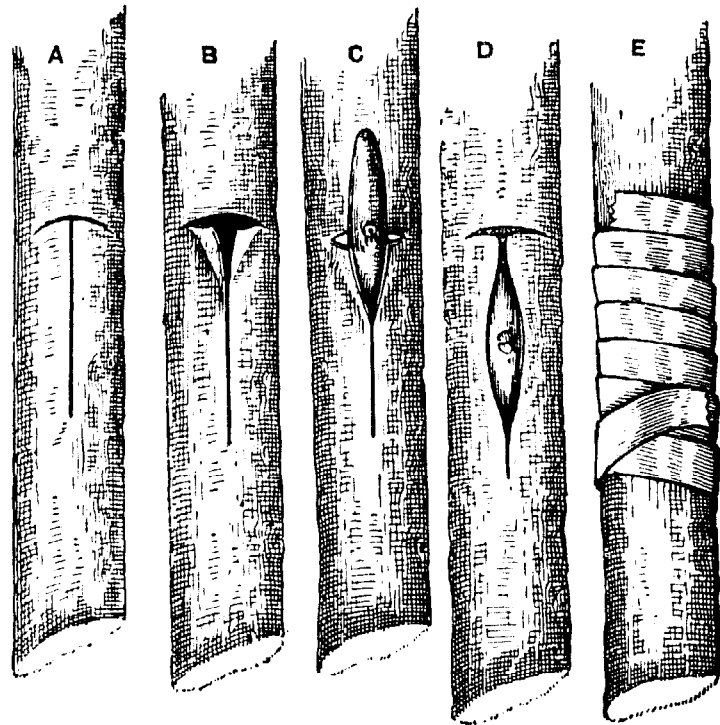

FIG. 131. Shield-budding. *a*, the incision; *b*, the bark opened; *c*, the bud entering; *d*, the bud fully inserted; *e*, the work tied and complete.

peach stocks are budded the same season the pits are planted, and the operation must be delayed until the stocks are large enough to be worked.

Most fruit-stocks, particularly apples and pears, are not budded until two years after the seeds are sown. The plants grow for the first season in a seed-bed. The next spring they are transplanted into nursery rows, and budded when they become large enough, which is usually the same year they are transplanted. The nurseryman reckons the age of his stock from the time of transplanting, and the age of the marketable tree from the time when the buds or grafts begin to grow.

Stocks are sometimes "dressed" or trimmed before set in the nursery. This operation consists in cutting off a fourth or third of the top, and the tap-root. This causes the roots to spread and induces a vigorous growth of top; and such stocks are more expeditiously handled than long and untrimmed ones. A Manetti rose stock, dressed and ready for planting, is shown in Fig. 132. This stock was grown in France, and on being received in this country was trimmed as it is now seen. It will now (in the spring) be set in the nursery row, and it will be budded near the surface of the ground in summer.

Stocks should be at least three-eighths inch in diameter to be budded with ease. Just before the buds are set, the leaves are removed from the base of the stock, so that they will not interfere with the operation. They are usually rubbed off with the hand for a space of five or six inches above the ground. They should not be removed more than two or three days in advance of budding, else the growth of the parts will be checked and the bark will "set." Any branches which might impede

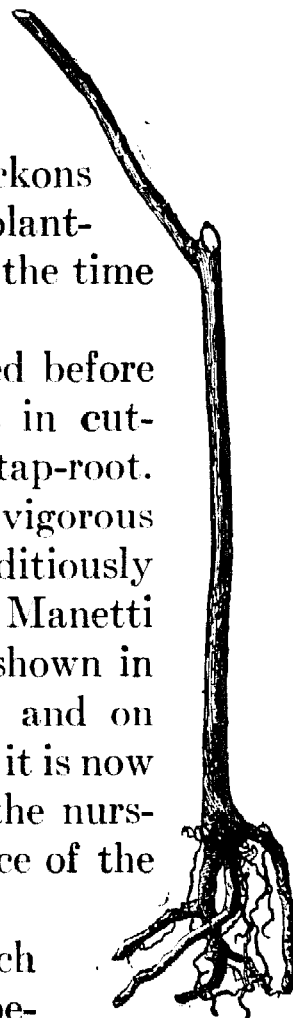

FIG. 132. Dressed rose stock ($\times \frac{1}{4}$).

the work of the budder, as in the quince, are to be cut off at the same time.

The bud is inserted an inch or two above the ground, or as low down as the budder can work. The advantage of setting the bud low is to bring the resulting crook or union where it will not be seen, and to enable it to be set below the surface of the ground when the tree is transplanted, if the planter so desires. It is a common and good practice, also, to place the bud on the north side of the stock to shield it from the sun.



FIG. 133.
Stick of
buds (x $\frac{1}{3}$).

The buds are taken from strong and well-hardened shoots of the season's growth and of the variety it is desired to propagate. Usually the whole of the present growth is cut, the leaves are removed but a part of the petiole or stalk of each leaf is left (as in Figs. 130 and 133) to serve as a handle to the bud. This trimmed shoot is then called a "stick." A stick may bear two dozen good buds when the growth has been strong, but only ten or twelve buds are commonly obtained. The upper buds, which are usually not fully grown and are borne on soft wood, are generally discarded.

The buds are cut with a thin-bladed sharp knife. Various styles of budding-knives are in use (Fig. 134), and the budder usually has preference for a particular pattern. The essentials of a good budding-knife are these: the very best steel, a thin blade with a curved or half-circular cutting end, which is light, and handy in shape. The curved end of the blade is used for making the incisions in the stock. The handle of the budding-knife often runs into a thin bone scalpel at the end, and this part is designed for the lifting or loosening of the bark on the stock. The operation of raising the bark by means of this scalpel is often called "boning." Some budders, however, raise the bark

with the blade. A good form of blade, but one seldom made, has a rounded end, the upper side of the curve being ground

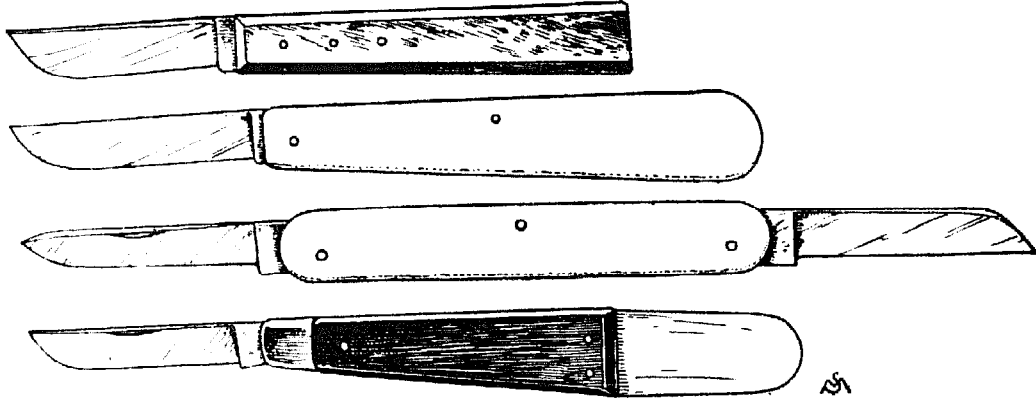

FIG. 134. Budding-knives. The two-bladed form is a combined budding- and grafting-knife.

simply to a thin edge. This blade may be used both for cutting the bark and loosening it, thus overcoming the necessity

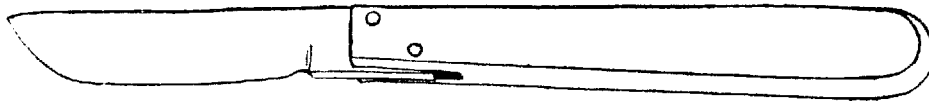

FIG. 135. Budding-knife with stationary blade (x $\frac{1}{2}$).

of reversing the knife every time a bud is set. The blade of a common budding-knife can be ground to this shape. In large fruit-tree nurseries the knife shown in Fig. 135 (and the top one in Fig. 134) is in common use. This is a cheap knife with a stationary blade. When using this knife, the operator loosens the bark with the rounded edge of the blade.

The bud is usually cut about an inch long. Most budders cut from below upwards (as seen in the inverted stick in Fig. 133, and in Fig. 136), but some prefer to make a downward incision. It does not matter just how the bud is cut, if the surfaces are

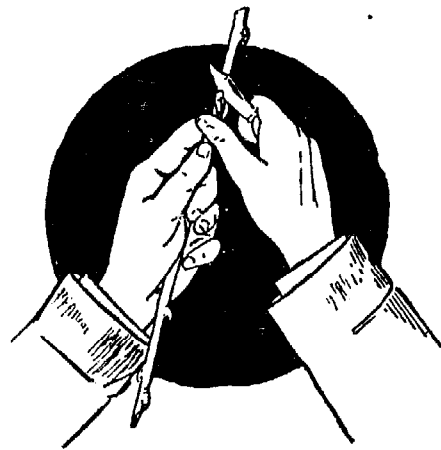

FIG. 136. Cutting the bud.

smooth and even, and the bud is not too thick. Some propagators cut the buds as they go, while others prefer to cut a

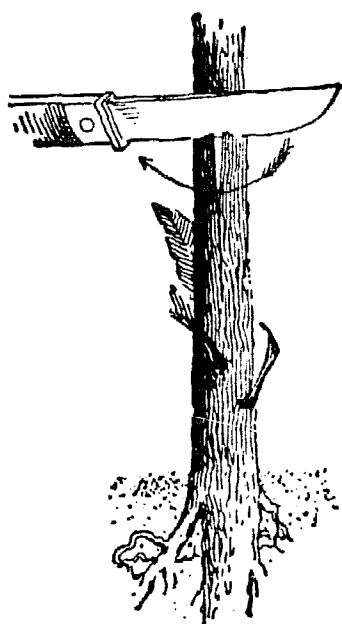

FIG. 137. Preparing the stock ($\times \frac{1}{2}$).

whole stick before setting any, letting each bud hang by a bit of bark at the top, and which is cut off squarely when wanted, as is shown in Fig. 133. On a stick one-fourth or three-eighths inch in diameter the cut, at its deepest joint just under the bud, is about one-fourth the diameter of the twig. A bit of wood, therefore, is removed with the bud, as shown in Fig. 130. There is some discussion as to whether this wood should be left on the bud, but no definite experiments have been made to show that it is injurious to the resulting tree. Some budders remove the wood with the point of the knife or by a deft twist as the bud is taken from the stick. But buds appear to live equally well with wood attached or removed. The bit of wood probably serves a useful purpose in retaining moisture in the bud, but at the same time it interposes a foreign body between the healing surfaces, for the bark of the bud unites directly with the surface of the stock. Probably the very youngest parts of the wood in the bud unite with the stock, but if the budding-knife cuts deep, the denser part of the wood should be removed from the bud. This remark is particularly true, also, of all buds likely to be cut into the pith, as in the nut-trees.

The wound or matrix that is to receive the bud is made by

smooth and even, and the bud is not too thick. Some propagators cut the buds as they go, while others prefer to cut a whole stick before setting any, letting each bud hang by a bit of bark at the top, and which is cut off squarely when wanted, as is shown in Fig. 133. On a stick one-fourth or three-eighths inch in diameter the cut, at its deepest joint just under the bud, is about one-fourth the diameter of the twig. A bit of wood, therefore, is removed with the bud, as shown in Fig. 130. There is some discussion as to whether this wood should be left on the bud, but no definite experiments have been made to show that it is injurious to the resulting tree. Some budders remove the wood with the point of the knife or by a deft twist as the bud is taken from the stick. But buds appear to live equally well with wood attached or removed. The bit of wood probably serves a useful purpose in retaining moisture in the bud, but at the same time it interposes a foreign body between the healing surfaces, for the bark of the bud unites directly with the surface of the stock. Probably the very youngest parts of the wood in the bud unite with the stock, but if the budding-knife cuts deep, the denser part of the wood should be removed from the bud. This remark is particularly true, also, of all buds likely to be cut into the pith, as in the nut-trees.

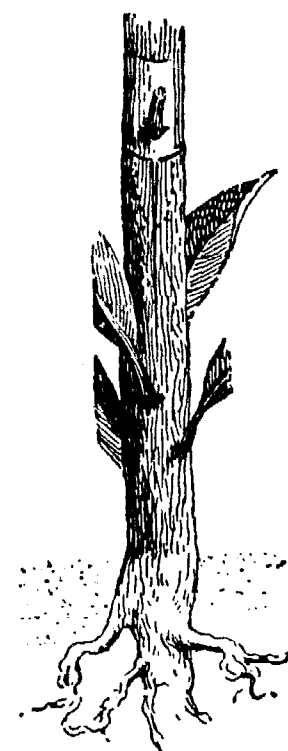

FIG. 138. Bud entering matrix ($\times \frac{1}{2}$).

two incisions, one vertical and one transverse (Fig. 137). These are light cuts, extending only through the bark. The vertical slit is usually made first and by the rounded end of the blade. This is an inch or inch and a half long. The transverse cut is made across the top of the vertical cut by one rocking motion of the blade. The corners of the bark may be lifted a little by an outward motion of the blade so as to allow the bud to be pushed in, but unless the bark slips very freely it will have to be loosened by the end of the blade or by the scalpel on the reverse end of the handle, as previously explained.

The bud is now inserted in the cleft of the bark. It is thrust down part way by the fingers, as in Fig. 138, but it is usually

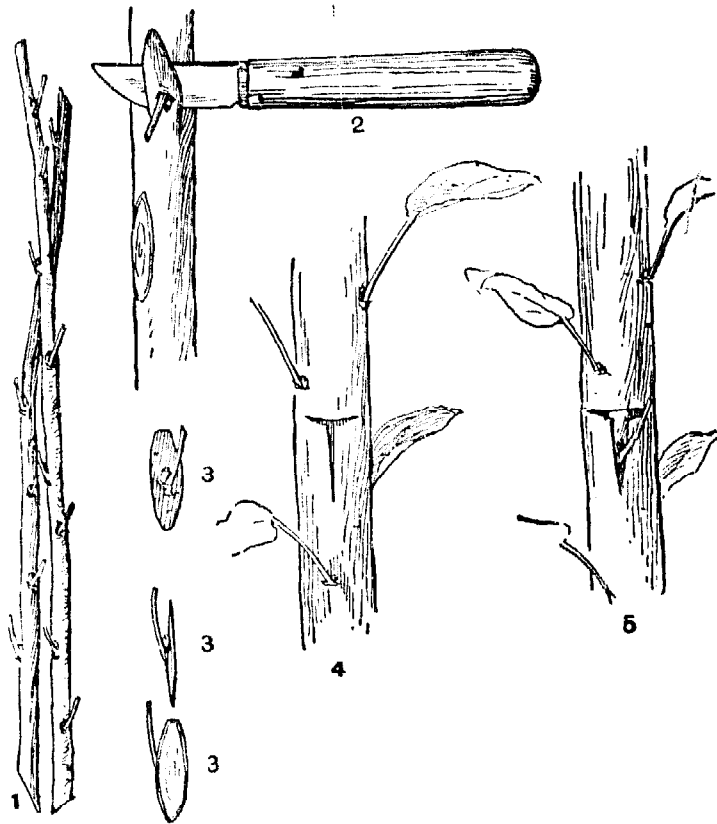

FIG. 139. The details of shield-budding.

driven home by pushing down on the leaf-stalk handle with the back of the knife-blade. The entire bud should pass into the cleft; or if a portion of it projects above, it should be cut off. If the bark peels freely, the bud will slip in easily and will follow the cleft, but if it sticks somewhat, more care is necessary to prevent the bud from running out. If the bark is very tight, it may have to be loosened with the knife throughout the length of the cleft; but budding should be performed, if possible, when such pains is not necessary.

The illustration, Fig. 139, shows some of the details of shield-budding (on a small scale) as described by Peck in a Cornell Reading-Course Lesson: 1, bud-sticks; 2, cutting the bud; 3, the buds ready for setting; 4, the stock made ready; 5, the bud inserted.

The bud must now be tied. The whole matrix should be closed and bound securely, as represented in Figs. 140, 143.



FIG. 140.
The bud tied (x $\frac{1}{2}$).

The string is usually started below the bud, being wrapped twice below and about thrice above it, in fruit-trees, the lower end being held by lapping the second course over it, and the upper end being secured by drawing a bow through under the upper course or sometimes by tying an ordinary hard knot. Waxed string or bandage is sometimes used, as in Fig. 131. Care should be taken not to bind the string directly over the bud itself.

The strings are previously cut the required length—about one foot—and the tying is performed very quickly. Any soft cord may be employed. Yarn and carpet warp are sometimes used. Formerly the most common material was bass-bark. This is the inner bark of the basswood or linden. The bark is stripped in early summer, and the inner portion is macerated or “rotted” in water for four or five weeks. It is then removed, cut into the desired lengths, and stripped into narrow bands—one-fourth to one-half inch wide—when it may be sorted and stored away for future use. If it is stiff and harsh when it comes from the maceration, it should be pounded lightly or rubbed through the hands until it becomes soft and pliable. The best tying material we now have is undoubtedly raffia. It is an imported article, coming from the eastern tropics (the product of the palm *Raphia Ruffia*), and it is so cheap that it is superseding even bass-bark. It is strong and pliable, and is an excellent material for tying plants in the greenhouse or

outdoors. The greatest disadvantage in its use in budding practice is its habit of rolling when it becomes dry, but it may be dipped in water a few minutes before it is taken into the field, or, better still, it may be allowed to lie on the fresh ground the previous night, during which time it will absorb sufficient moisture to become pliable.

In two or three weeks after the bud is set, it will have "stuck" or united to the stock. The bandage must then be removed or cut. It is the common practice to draw a budding-knife over the strings, on the side opposite the bud, completely severing them and allowing them to fall. If the strings are left on too long, they will constrict the stem and often kill the bud, and they also have a tendency to cause the bud to "break" or to begin to grow. The bud on summer- and fall-budded stock should remain perfectly dormant until spring, for if it should grow, it will be injured and perhaps killed by the winter. It should remain green and fresh; if it shrivels and becomes brown, even though it still adheres to the stock, it is worthless. A dormant bud, as it appears in the winter following the budding, is shown in Fig. 141. This bud was inserted in August, the picture was made in March, following; the bud should have started to grow in May.



FIG. 141. Dormant bud of plum (x 1).

Advantage may be taken, when cutting the strings, to rebud any stocks that have failed. If the bud should begin to grow because of a warm and wet fall or other reasons, there is little remedy except perhaps to head the shoot back if it should become long enough. If the stocks are protected by snow in winter, some of the buds at the base of the new shoot may pass the cold in safety.

The spring following the budding, the stock should be cut

off just above the bud, in order to throw the entire force of the plant into the bud. The stock is generally, and preferably cut off twice. The first cutting leaves the stub 4 or 5 inches long above the bud. This cutting is made as soon as the stocks begin to show any signs of activity. Two weeks later, or

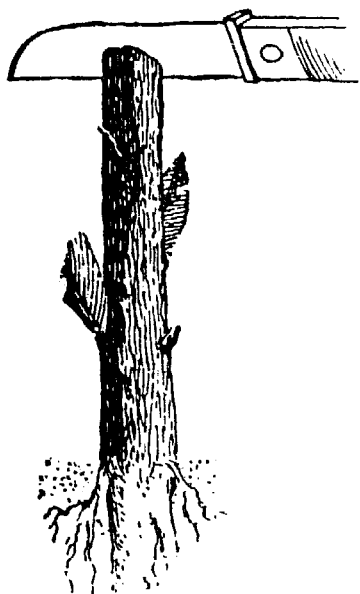

FIG. 142. Cutting off the stock.

when the bud has begun to grow (the shoot having reached the length of an inch or two), the stock is again cut off a half inch above the bud (Fig. 142). A greater proportion of buds will usually grow if this double heading-in is done, in outdoor conditions, than if the stock is cut back to the bud at the first operation. Sometimes the stub of the stock is cut long to serve as a stake to which to tie the bud, preventing it from blowing out and keeping it straight. Fig. 143 shows this at 3; and the total removal of the stub is shown at 3. (Peck, Cornell.)

If the root is strong and the soil good, the bud will grow 2 to 6 feet the first year, depending much on the species. All sprouts should be kept rubbed off the stock, and the bud should be trained to a single stem. In weak and crooked growers, the new shoot must be tied, and some propagators in such cases cut off the stock 5 or 6 inches above the bud and let it serve as a stake to which to tie (3, Fig. 143); but this operation is too expensive to be employed on common fruit-trees. The stock, of course, must not be allowed to grow. Late in the season the stock is cut down close to the bud. Peaches and some other fruits are sold after having made one season's growth from the bud, but pears, apples, and most other trees are not often sold until the second or third year.

“June-budding” is a term applied to the budding of stocks

in early summer, while they are yet growing rapidly. It is employed at the South, where the stocks can be grown to sufficient size from seed by the last of June or first of July. Small stocks are usually employed — those ranging from one-fourth to one-third inch being preferred. A few strong leaves should be left on the stock below the bud, and after the bud has "stuck" the whole top should not be cut off at once, else the growing plant will receive a too severe check. It is best to bend the top

over to check its growth, or to remove the leaves gradually. The bandages should not be left on longer than six to ten days if the stock is growing rapidly. To prevent the constriction of the stem, muslin bands are sometimes used instead of bass or raffia. In hot and dry climates the buds should be set an inch or two higher in June-budding than in

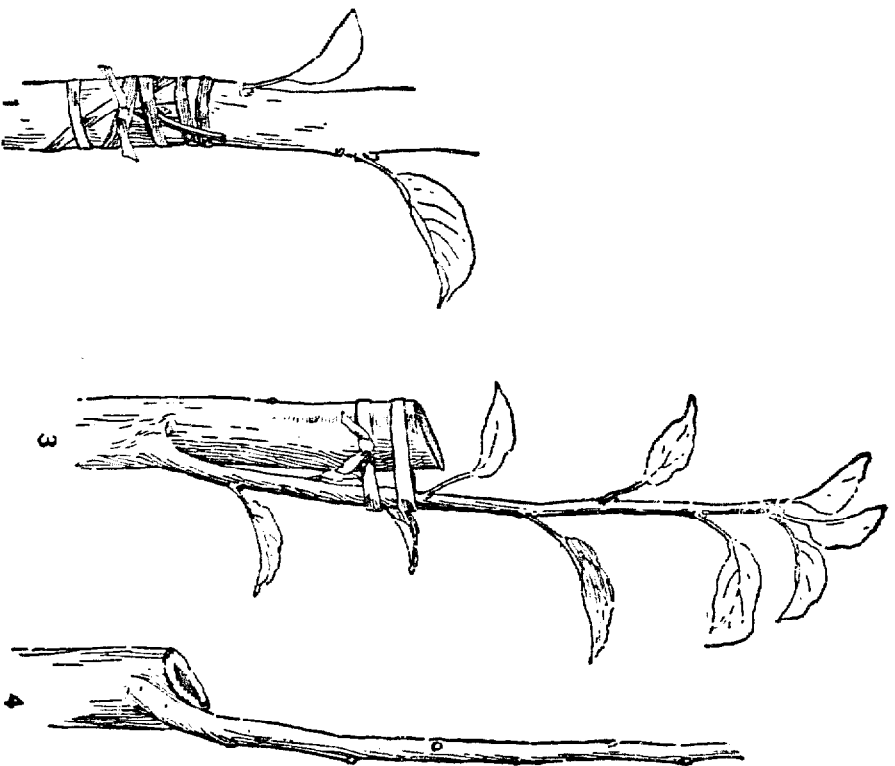

FIG. 143. Shield-budding. The bud tied; new growth of bud tied to stock (the following spring); stub completely removed.

the ordinary practice, to escape the great heat of the soil. June-budding is practiced on the peach more than any other tree, although it can be employed for any species that will give large enough stocks from seed by the June following the

sowing. In peaches, the bud will produce a shoot 3 to 5 feet high the same season the buds are set, so that marketable budded trees can be had complete in one season from the seed.

A different kind of early summer budding is sometimes performed on apples and other fruit-trees. In this case, the stocks are one or two years old from the transplanting, the

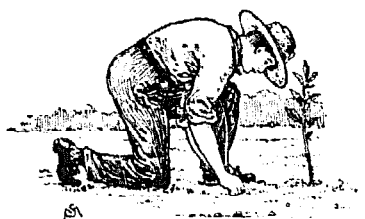

FIG. 144. The operation of budding.

same as for common budding, but dormant buds are used. These buds are cut the previous fall or winter in the same way as cions, and when spring approaches they are put on ice — in saw-dust, sand or moss — and kept until the stocks are large enough to receive them.

The particular advantage of this method is the distributing of the labor of budding over a longer season, thereby avoiding the rush of the regular budding time. It is also a very useful means of top-working trees, for the buds start the same season in which they are set, and a whole season is thereby saved as compared with the common summer or fall budding.

Budders usually carry a number of "sticks" with them when they enter the nursery. These may be taken in the pocket, or some budders carry four or five sticks in the hand. The budder follows a row throughout its length, passing over those trees that are too small to work. It is an old mode to rest on one knee while budding, as in Fig. 144, but some prefer to use a low stool or to sit. It is a common practice, in some nursery regions, for budders to have a low box with half of the top covered to serve as a seat, and the box is used for carrying buds, string, knives and whetstone. The tying is usually done by a boy, who should follow close behind the budder in order that the buds shall not dry out. An expert budder will set from 1000 to 3000 buds a day, in good stock, and with a boy (or two of them for the latter speed) to tie. Peach stocks are more rapidly budded than most others, as the bark is firm

and slips easily, and some remarkable records are made by skillful workmen.

Budding is sometimes employed the same as top-grafting for changing over the top of an old tree from one variety to another. The buds cannot be easily inserted in very old and stiff bark, but in all smooth and fresh bark they work readily, even if the limb

is three or four years old; but the younger the limb, the greater the proportion of buds that may be expected to live. Sometimes

old trees are severely pruned or stubbed the year before the budding is to be undertaken, to obtain young shoots in which to set the buds. The stubbing or heading-back of a citrus tree to get new

shoots for budding

is indicated in Fig. 145 (adapted from a publication by R. A. Davis of the Department of Agriculture of the Union of South Africa). In fruit-trees six or seven years old or less, budding is fully as advantageous as grafting. New varieties are also budded into old branches to hasten bearing of the bud, for the purpose of testing the variety. Here budding has a distinct advantage over grafting, as it uses fewer buds, for the wood of new sorts is often scarce.

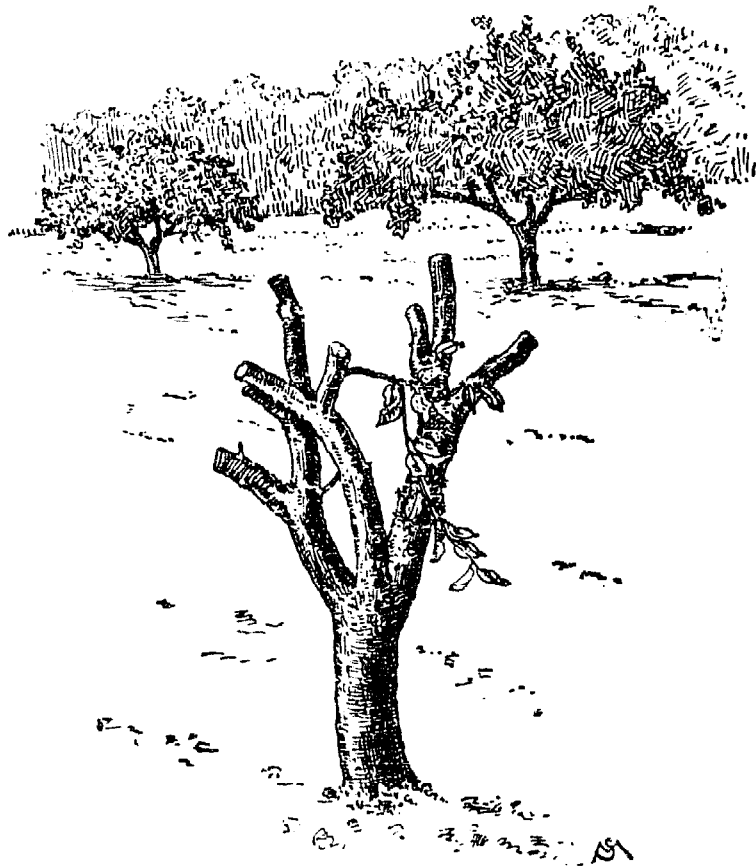

FIG. 145. Tree headed back preparatory to top-budding.

Other kinds of budding

It would not profit us to pause with all the kinds of budding that may have been named. Only those that seem to represent rather distinct classes or departures need be mentioned, and these only briefly.

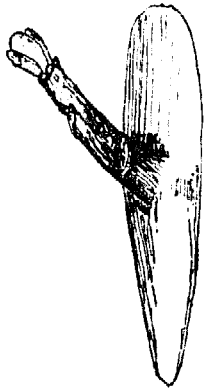

FIG. 146. Prong-bud (x 1).

Prong-budding (sometimes called twig-budding). — A modification of the common shield-bud is the use of a short prong or spur in the place of a simple bud. The bud is cut in essentially the same way as the shield-bud (Fig. 146). This is chiefly used in certain regions for nut-trees, particularly for the walnut, and when the trees are dormant.

The method is very much like grafting, for the stock is cut off just above the bud when the operation is performed, and the wound, in addition to being tied, is covered with grafting-wax.

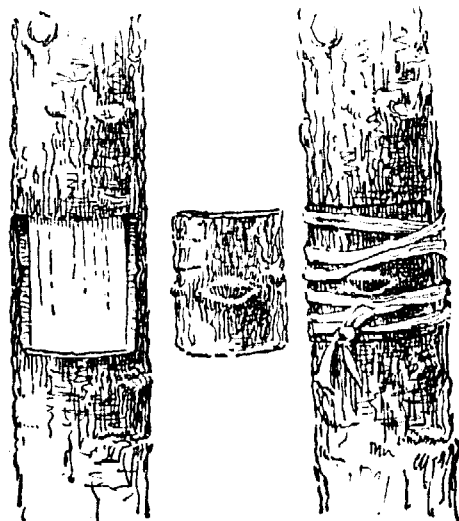

FIG. 148. Budding by means of a rectangular patch.

In budding the walnut, it is essential that nearly all the wood be removed from the bud, to bring as much as possible of the bark in direct contact with the stock.

Plate-budding is sometimes employed with the olive, and is adapted to other species. A rectangular incision is made through the bark of the stock, and the flap of bark is turned down (Fig. 147). A bud is cut of similar shape, with no wood attached, and is inserted in the rectangular space, and is then covered with the flap, which is brought up and tied. The subsequent treat-



FIG. 147. Plate-budding (x 1/2).

ment of the bud is similar to that of the ordinary shield-bud.

The *patch-bud* (Fig. 148) is very like the plate-bud, but the bark is cut away from the stock with no hanging strip. This old method has recently been revived for propagating the mango and certain thick-barked subjects. Brown writes as follows on a home-made knife for cutting the patches (B. S. Brown, "Modern Propagation of Tree Fruits," 1916): "Where very much bark budding is done a special knife for cutting the exact size of the patch is necessary. This can be made by fastening two thin steel knife blades to a block of wood so that two parallel cuts can be made at one time. Such a tool when drawn horizontally across the bark and then vertically, will cut a square patch the desired size. If the blades are set about one inch apart, the patch will be one inch square which will be large enough for

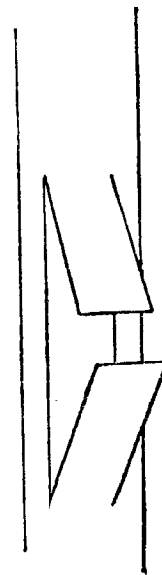

FIG. 149. H-budding (x 1/2).

most work. The same knife can be used in cutting the buds by drawing it around the twig. After the patch containing the bud is removed the sides can be trimmed to secure a perfect fit." The illustration is adapted from Oliver, Bull. 46, Bur. Pl. Ind., U. S. Dept. Agric. It is a form of flute-budding.

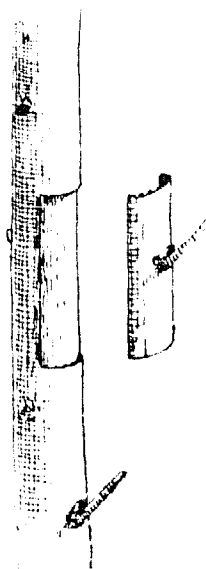

FIG. 150. Flute-budding (x 1/2).

H-budding (Fig. 149) is a modification of plate-budding. In this method, a flap is formed both above and below, covering the bud from both ends, and allowing of more perfect fitting of the bark about the bulge of the bud.

Flute-budding. — In this method the bud is not covered by the bark of the stock. Fig. 150 illustrates it. A piece of bark is removed entirely from the stock, and a similar piece is fitted into its place. When the wound

extends only part way about the stem, as in the illustration, the operation is sometimes known as *veneer-budding*. When it extends entirely round the stem it is called *ring- or annular-budding*. Flute-budding is usually performed late in spring. It is best adapted to plants with very thick and heavy bark. The bud is tied and afterwards treated in essentially the same way as in shield-budding. A species of flute-budding in which

a ring of bark is slipped down on the tip of a shoot, which has been girdled for the purpose, is called *whistle- or tubular-budding*.

Chip-budding (Fig. 151) inserts a chip of bark and wood into a mortise in the stock. It is used in spring, when the stock is dormant and the bark does not slip. The bud is held in place by tying, and it is better for being covered with wax.



FIG. 151.
Chip-budding.

3. GRAFTING

Grafting is the operation of inserting a cion (or scion) — or a twig comprising one or more buds — into the stock, usually into an incision in the wood. It is variously divided or classified, but chiefly with reference to the position on the plant, and to the method in which the cion and stock are joined.

In reference to position, there are four general classes: 1. Root-grafting, in which the stock is entirely a root. 2. Crown-grafting, on the crown or collar of the plant just at the surface of the ground, an operation often confounded with root-grafting. 3. Stem-grafting, in which the cion is set on the trunk or body of the tree below the limbs, a method occasionally employed with young trees. 4. Top-grafting, in the branches of the tree top.

Any method of inserting the cion may be employed in these classes. The best classification, particularly for purposes of

description, is that which considers methods of making the union. Some of these kinds of grafting are catalogued on pages 118 and 119. The most important methods of grafting are now to be considered; but almost endless modifications may be made in the details of the operations. The union of the cion with the stock, like the union of the bud and the stock, depends on the growing together of the cambial tissue of the two. It is essential, therefore, that the tissue lying between the outer bark and the wood in the cion should come closely in contact with the similar tissue of the stock.

Cions are cut in fall or winter, or any time before the buds swell in spring. Only the previous year's growth is used in all ordinary cases, but in maples and some other trees, older wood may be taken. In the grafting of peaches — which is rarely practiced — the best cions are supposed to be those with a small portion of two-year-old wood at the lower end. This old wood probably serves no other than a mechanical purpose, as the recent wood is soft and pithy. It is a common opinion that cions are worthless if cut in freezing weather, but this is unfounded if the species is hardy.

The cions are stored in sand, moss or sawdust in a cool cellar, or they may be buried in a sandy place. Or sometimes, when a few are wanted for top-grafting, they are thrust into the ground beside the tree into which they are to be set the following spring. If the cions are likely to start before the spring grafting can be undertaken, they may be placed in an ice-house. Only well-formed and mature buds should be used. Sometimes flower-buds are inserted for the purpose of fruiting a new or rare variety the following year, but unless particular pains is taken to nurse such a cion, it is likely to give only very indifferent results.

In practice, only three kinds of grafting need be much considered. These are whip-grafting, veneer-grafting and cleft-grafting.

The whip-graft

Whip- or tongue-grafting is employed only on small stocks, usually those one or two years old. Both the cion and stock



FIG. 152. Cions of whip-graft (x 1).

are cut across diagonally, the cut surface extending from 1 to 2 inches, according to the size of the part. A vertical cleft is then made in both, and the two are joined by inserting the tongue of the cion into the cleft of the stock. The operation can be understood by reference to Figs. 152, 153. Fig. 152 shows the end of a cion, cut natural size. The stock is cut in the same way, and the two are joined in Figs. 153, 154, 155, 156. The parts are held firmly by a bandage—as bass bark or raffia—passed five or six times around them. If the graft is to stand above ground, the wound must be protected

by applying wax over the bandage.

Any sharp and strong thin-bladed knife may be used for the making of whip-grafts. For small and tender plants, a common budding-knife is sufficient, but it is too light for most work. A good style of knife for root-grafting is shown in Fig. 157. It is much like a shoe-knife, with large cylindrical handle and a stationary blade.

Root-grafting, particularly of fruit stocks, is performed almost entirely by the whip-graft, in winter. The stocks, either one or two years old, are dug and stored in autumn. In January or February the grafting is begun. In true root-grafting, only pieces of roots are used; but most nurserymen prefer to use the whole root and graft at the crown, making the strong “root-grafts” of commerce known as “whole roots.”



FIG. 153. Whip-graft in position (x $\frac{1}{2}$).

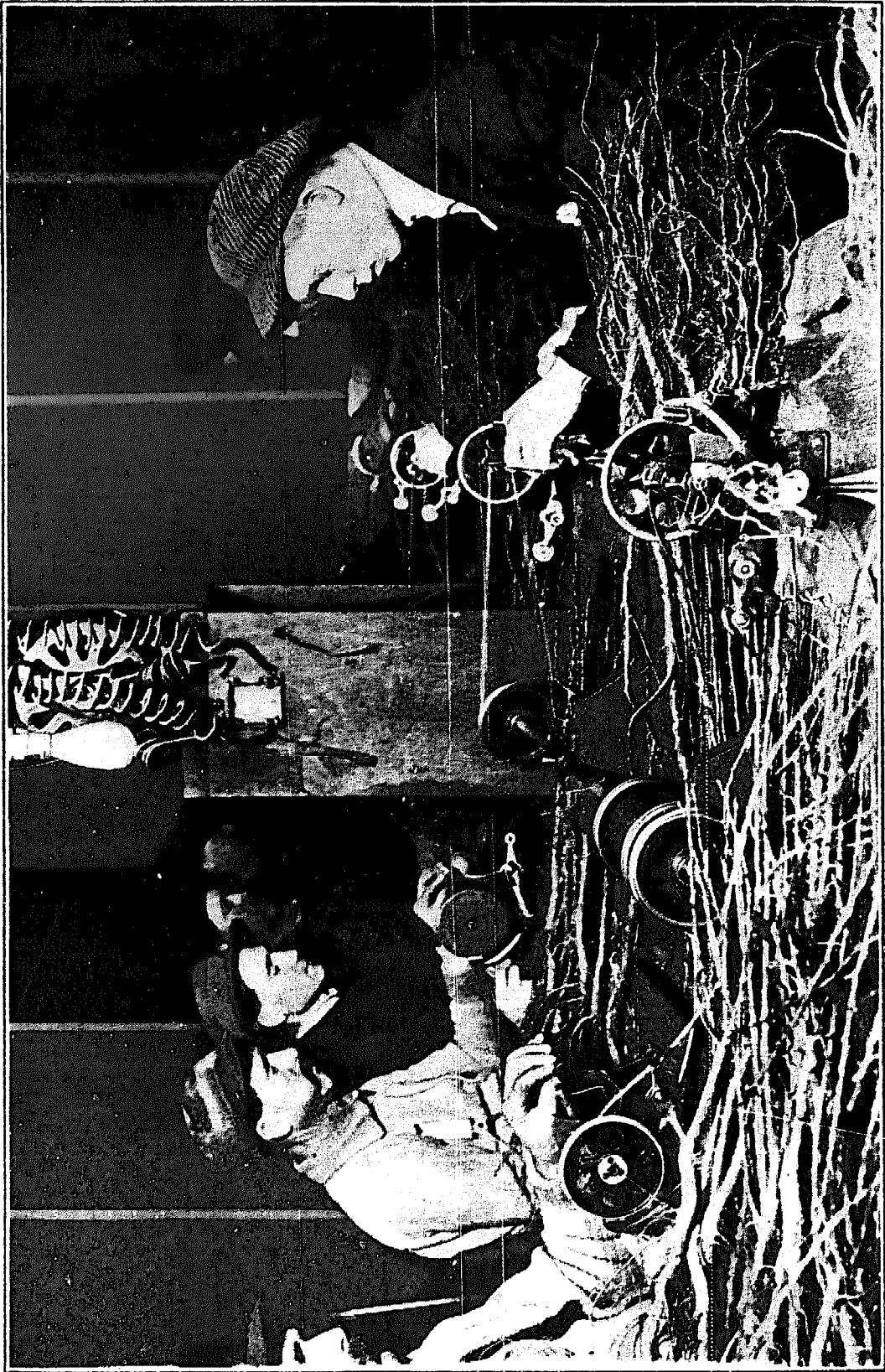

PLATE V. Tying or wrapping root-grafts by machinery.

In piece-root-grafting, from two to four trees are made from a single root. A piece of root 2 to 4 inches long is used, as shown in Fig. 154. The parts are usually held by winding with waxed string or waxed bands. The string should be strong enough to hold the parts securely and yet weak enough to be broken without hurting the hands. No. 18 knitting cotton answers this purpose admirably. It should be bought in balls, which are allowed to stand for a few minutes in melted wax.

The wax soon saturates the ball. The ball is then removed and laid away to dry, when it is ready for use. This waxed string will remain almost indefinitely in condition for use. Waxed bands, sometimes used, are made by spreading melted wax over thin muslin, which is cut into narrow strips when dry. The string is the more useful for rapid work. The completed grafts are packed away in sand, moss or sawdust in a cool cellar until spring, when the two parts will be firmly callused together. Some propagators eliminate all tying of root-grafts. The grafts are packed away snugly, and if the storage cellar is cool — not above 40° — they will knit together so that they can be planted without danger of breaking apart. If the cellar is warm, the grafts will start into growth and be lost. String or bandages that do not soon decay when growth begins will strangle the

graft. The waxed cotton may last too long and do much damage.

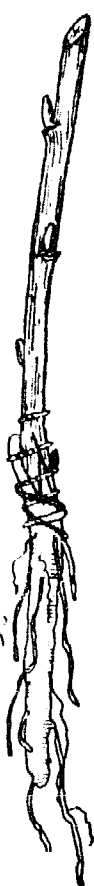

FIG. 155.
Graft on a
short piece
of root.

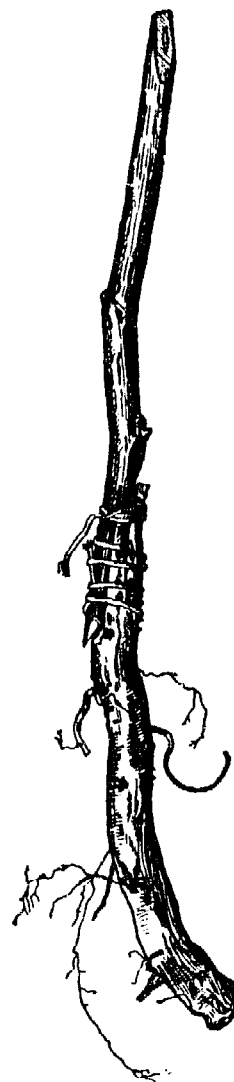

FIG. 154. Piece-
root-graft.

In common root-grafting in the East and South, the cion

(Fig. 161 ; both from Peck, Cornell Reading-Course Lesson). The buyer of apple or other trees is likely to place much importance on the root system ; yet the orchard test may not verify his likes or prejudices. Many years ago there was a decided reaction against the well-formed whole root, and the Stringfellow method practically removed the roots and planted the root-stub. Fig. 162 represents what the planter would call good root systems. How valuable they would

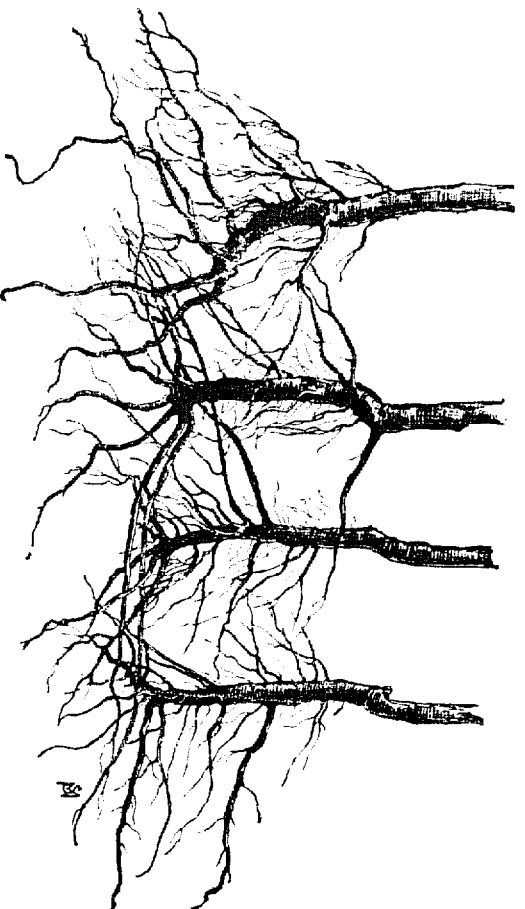

FIG. 162. Good root systems.

be to the orchard is quite another question ; yet inasmuch as abundant roots are the natural product of a tree, it is fair to assume that they should be accepted at face value.

Modified whip-grafts.

There are many modifications of the whip-graft but it will not profit us to pause long with them.

The side whip-graft places the cion on the side of a stock rather than on the end of it. The tongues in cion and stock are cut the same as in the customary method already explained.

An old-fashioned modification of the whip-graft leaves the

end of the cion 4 or 5 inches long, so that it may lead downwards into a bottle or dish of water, thereby absorbing sufficient moisture to maintain the cion until it unites with the stock.

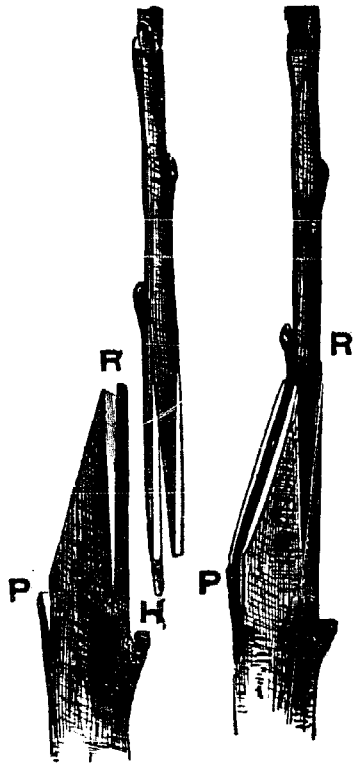

FIG. 163. Double whip-graft ($\times \frac{2}{3}$).

Another modification, with the same purpose in view, is to allow the ends of the tying material to fall into the water. These methods are called "bottle-grafting" in the books. They are really of little account, although they might be employed for certain difficult subjects amongst ornamental plants; but even there, better results can be obtained by placing the grafts in a close frame, or by packing them in moss.

A "double whip-graft" is shown in Fig. 163. In this method, the cion is cut on one side into a wedge, and on the other with a long tongue (H). The stock is provided with two clefts, at R and P. This cion, having two supports in the stock, forms a most intimate contact with its host; but it is too slow, and the rewards too slight, to warrant its general use. This is sometimes, but erroneously, called a saddle-graft.

The veneer-graft

A style of grafting much used, particularly for ornamentals and for rare stocks grown in pots, is seen in Fig. 164. An incision is made on the stock just through the bark and about an inch long (A), the bit of bark being removed by means of a downward sloping cut at its base. The base of the cion is cut off obliquely, and on the longest side a piece of bark is removed, corresponding to the part taken from the stock.

The little tongue of bark on the stock covers the base of the cion when it is set. The cion is tied tightly to the stock (*B*), usually with raffia.

This method of grafting makes no incision into old wood, and all wounded surfaces are completely covered by the matching of the cion and stock. It is not necessary, therefore, to wax over the wounds, as a rule. If used in the open, however, wax should be used. The parts grow together uniformly and quickly, making a solid and perfect union, as shown at *D*. So far as the union of the parts is concerned, this is probably the most perfect form of grafting. This method, which is nothing but the side-graft of the English gardeners with the most important addition of a longer tongue on the stock, is known by various names, but it is oftenest called veneer-grafting in this country.

Veneer-grafting is employed mostly from November to March, on potted plants. Stocks grown outdoors are potted in the early fall and carried over in a cool house or pit. The cion is applied an inch or two above the surface of the ground, and the stock need not be headed back until the cion has united. (See Fig. 165.)

Both dormant and growing cions are used. All plants in full sap must be placed under a frame in the house, in which they may be almost entirely buried with sphagnum, not too wet, and the house kept cool and rather moist until the cions are well estab-

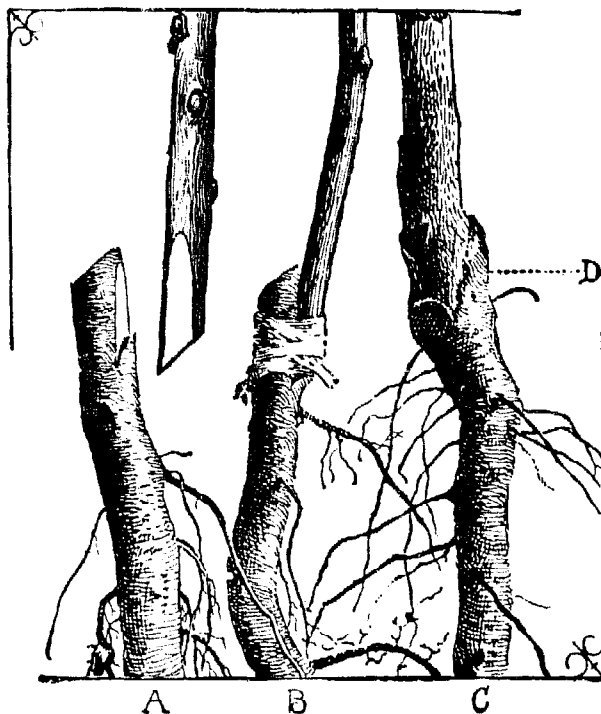

FIG. 164. Veneer-grafting ($\times \frac{1}{2}$).

lished. Some species may be transferred to the open border or to nursery rows in the spring, but most plants grafted in this way are handled in pots the following season. Rhododendrons, Japanese maples and many conifers are some of the plants multiplied by veneer-grafting. Such plants are usually laid on their sides in frames and covered with moss for several days, or until healing begins.

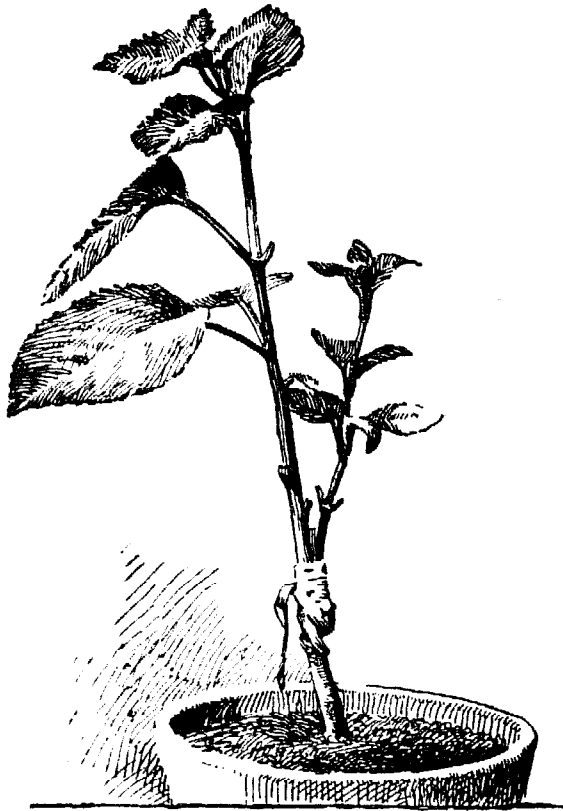

FIG. 165. Veneer-graft (x $\frac{1}{2}$).

This method, when used with hardy or tender plants, gives a great advantage in much experimental work, because the stock is not injured by a failure, and can be used over again many times, perhaps even in the same season; and the manipulation is simple, and easily acquired by inexperienced hands.

The cleft-graft

In cleft-grafting, the stock is cut off squarely and split, and into the split a cion with a wedge-shaped base is inserted. It is adapted to large stocks, and is the method employed for top-grafting old trees, its only competitor being the bark-graft described on page 160. Figs. 166, 167 illustrate the operation.

The end of the stock, technically called a "stub," is usually large enough to accommodate two cions, one on either side. In fact, it is better to use two cions, not only because they double the chances of success, but because they hasten the healing of the stub. Cleft-grafting is at best a harsh process,

especially on large limbs, and its evils should be mitigated as much as possible by choosing small limbs for the operation. In common practice, the cion (Fig. 167) bears three buds, the lowest one standing just above the wedge. This lowest bud is usually entirely covered with wax, but it pushes through without difficulty. In fact, being nearest the source of food and most protected, its chances of living are greater than those of the higher buds.



FIG. 167. Cleft-graft cion (x 1).

The sides of the cion must be cut smooth and even. A single draw cut on each side with a sharp blade is much better than two or three partial cuts. A good grafter makes a cion by three strokes of the knife, one to cut off the cion and two to shape it. The outer edge of the wedge should be a little thicker than the inner, so that the stock will bind on it and hold it firm at the point where the union first takes place. The twigs from which the cions are made are taken in late fall or winter, or very early spring, and are kept as directed on page 137.

The stock or stub must be cut off square and smooth with a sharp and preferably fine-toothed saw. If one desires to be specially careful in the operation, the end of the stub, or at least two opposite sides of it, may be dressed off with a knife, so that the juncture between the bark and the wood may be more easily seen. Professional grafters rarely resort to this

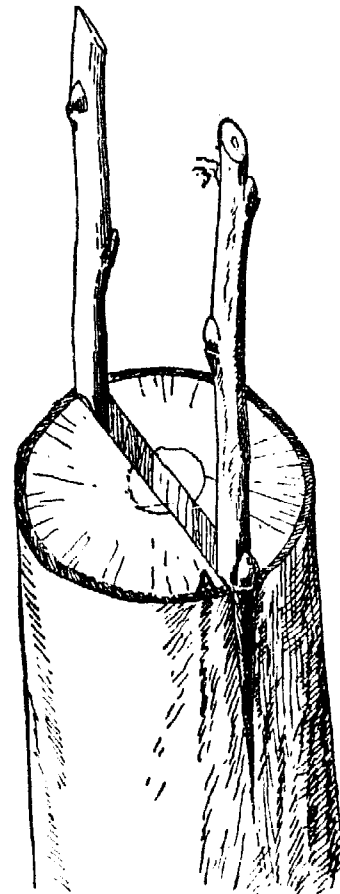

FIG. 166. Cleft-grafting (x 1).

dressin^g, however. The stub is then split to the depth of $1\frac{1}{2}$ or 2 inches. Various styles of grafting-knife are



FIG. 168. Home-made grafting-knife.

used to split the stub. One of the best ones is shown in Fig. 168. It is commonly made from an old file by a blacksmith. The blade is curved, so that the bark of the stub is drawn in when the knife is entering, thereby lessening the danger of loosening the bark. Another style of knife is illustrated in Fig. 169. In this tool, the cutting edge is straight, and, being thinner than the other tool, tends rather to cut the stub than to split it. On the end of these knives is a wedge, about 4 or 5 inches long, for opening the cleft. The wedge is driven into the cleft and allowed to remain while the cions

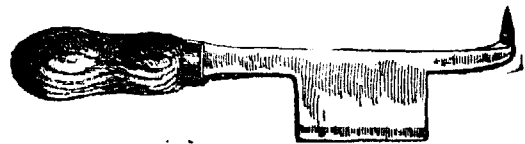

FIG. 169. Cleft-grafting-knife ($\times \frac{1}{8}$).

are placed. If the cleft does not open wide enough to allow the cions to enter, the operator bears down on the handle. It is important that the wedge stand well away from the curved blade in the knife shown in Fig. 168, else it cannot be driven into the stub. In Fig. 169 — showing the style of knife commonly seen in the market — the wedge is too short for most efficient service.

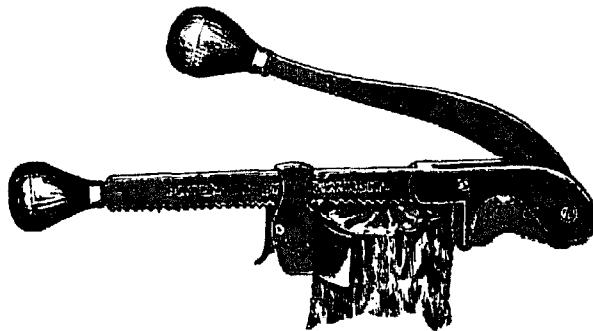

FIG. 170. Hoit's grafter.

There are various devices for facilitating the operation of cleft-grafting, but none of them has become popular. One of the best is Hoit's device (Fig. 170), which cuts a slot into the side of the stub. The machine is held in place by a trigger or clamp working in notches on the under side of the frame. The upper handle is then

thrown over to the right, forcing the knife into the stub. This is a Californian device. A very good grafting-knife for small stocks or trees in nursery row is the Thomas knife shown in Fig. 171. The larger arm is made entirely of wood. At its upper end is a grooved part, into which the blade closes. This blade can be made from a steel case-knife, and it should be about $2\frac{1}{2}$ inches long. It is secured to an iron handle. The essential feature of this implement is the draw cut, which is obtained by setting the blades and the pivot in just the position shown in the figure. The stock is cut off by the shears, and the cleft is then made by turning the shears up and making a vertical cut. The cleft, therefore, is cut

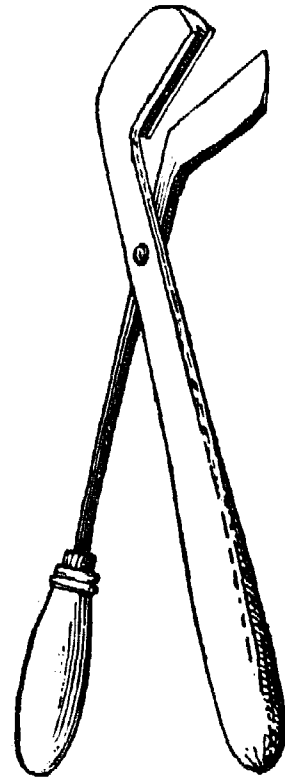

FIG. 171. Thomas' grafting-knife.

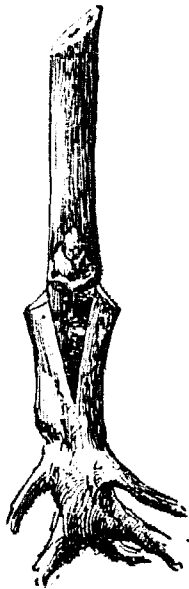

FIG. 172. Rooted grape cutting cleft-grafted ($\times \frac{1}{3}$).

instead of split, insuring a tight fit of the cions. This tool is said to be specially useful on hard and crooked grained stocks.

In cleft-grafting, the cions must be thrust down to the first bud, or even deeper, and it is imperative that they fit tightly. The line of separation between the bark and wood in the cion should meet as nearly as possible the similar line in the stock. The cions are usually set a trifle obliquely, the tops projecting outwards, to insure the contact or crossing of the cambium layers. Writers often state that it is imperative to have the exact lines between the bark and wood meet for at least the greater part of their length, but this is an error. The callus or connecting tissue spreads beyond its former limits when the wounds begin to heal. The most essential points are rather to be sure that

the cion fits tightly throughout its whole length, and to protect the wound completely with an air-tight covering. The practice must be modified, of course, to suit the stock and the occasion.

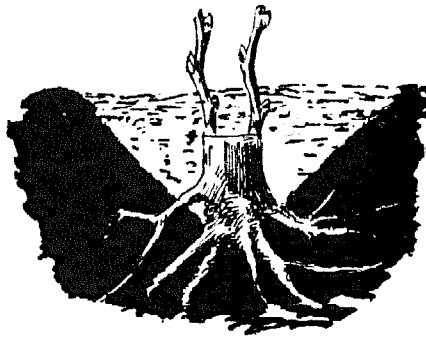

FIG. 173. Cleft-grafting on old grape stock.

Sometimes rooted cuttings of grapes are cleft-grafted (Fig. 172), and these, being in the ground, are well protected, and it is difficult to split the stub deep enough to allow the cion to be thrust in far. If the stub, in this case, has little elasticity after being split, it should be tightly wound to keep the cion in place. An old grape stock, cleft-grafted, and then covered with earth, is seen in Fig. 173. These covered grape stubs are usually not waxed. This is the common, and generally the best, method of grafting the grape.

The wounds must now be covered with wax. Fig. 174 is a stub after the covering has been applied. If the grafting is performed in early spring, when the weather is cold, the wax will have to be applied with a brush. The wax is melted in a gluepot, which is carried to the tree. But if the weather is warm enough to soften the wax, it should be applied with the hands. The hands are first greased to prevent the wax from sticking. The two side or vertical portions are applied first. The end of the mass of wax in the hand is flattened into a thin pad about a half inch wide. This pad is then laid over the lower bud of the cion and held there by the thumb of the other hand, while the wax is drawn downwards over the cleft, being pressed down firmly upon the bark by the thumb of the first hand. The wax

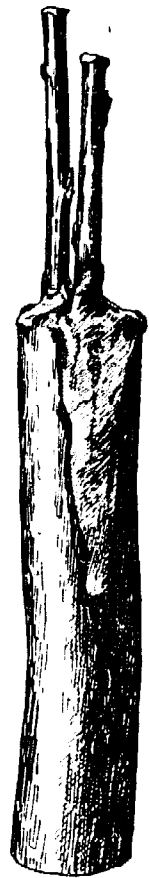

FIG. 174.
A waxed stub
(x $\frac{1}{2}$).

gradually tails out until it breaks off just below the lowest point of the cleft. The flattened upper part is then wrapped around the cion from either side, completely and tightly encircling it. A simple deft wrapping of the wax about the cion makes a tighter joint than can be secured in twice the time by any method of pinching it into place. Another pad of wax is now flattened and applied over the end of the stub. Most grafters apply a bit of wax to the tops of the cion also. All the wounds must be covered securely.

For applying the wax warm, a heater is needed. A good form is shown in Fig. 175 (Peck, Cornell Reading-Course Lesson). The wax is in the top receptacle, standing in a dish or pail of water. In the bottom is a lamp to supply the heat.

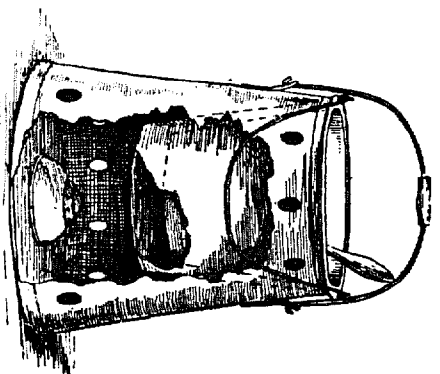

FIG. 175. Pot for heating grafting-wax.

Top-working trees by means of the cleft-graft.

Cleft-grafting is employed not so much to multiply the plant as to change a tree from one variety to another. It is the form of grafting used in old apple and pear orchards, and it may be employed on plum and many other trees. The top-grafting of large trees is an important operation, and many men make it a business. These men usually charge by the stub and warrant, the warrant meaning that one cion of the stub must be alive at counting time in late summer. A grafter in good "setting" can graft from 400 to 800 stubs a day and wax them himself. Much depends on the size of the trees, their shape and the amount of pruning before the grafter can work in them handily. Every man who owns an orchard of any extent should be able to do his own grafting.

An important consideration in the top-grafting of an old

tree is the shaping of the top. The old top is to be removed in three or four or five years, and a new one is to be grown in its place. If the tree is old, the original plan or shape of the top will have to be followed in its general outlines. The branches should be grafted, as a rule, where they do not ex-

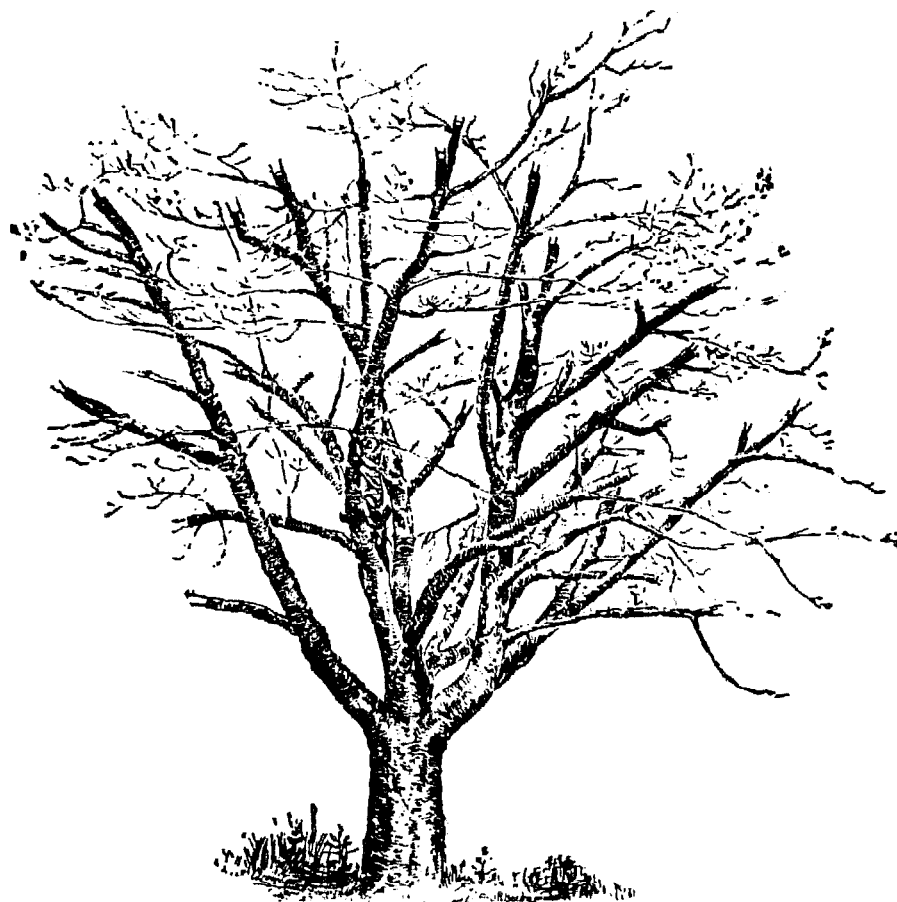

FIG. 176. Top-grafted old tree.

ceed an inch and a half in diameter, as cions do better in such branches, the wounds heal quickly, and the injury to the tree is less than when very large stubs are used. The operator should endeavor to cut all the leading stubs at approximately equal distances from the center of the tree; and then, to prevent long and pole-like branches, various minor side-branches should be grafted. These will serve to fill out the new top and to afford footholds for pruners and pickers. Fig. 176 is a good

illustration of an old tree just top-grafted. Many stubs should be set, and at least all the prominent branches should be grafted if the tree has been well-trained. It is better to have too many stubs and to be obliged to remove some of them in after years, than to have too few. In thick-topped trees, care must be exercised not to cut out so much foliage the first year that the inner branches will sunburn. All large branches which must be sacrificed ought to be cut out when the grafting is performed, as they increase in diameter very rapidly after so much of the top is removed.

A horizontal branch lying directly over or under another



FIG. 177. Showing the upright direction of a graft in a horizontal limb.

should not be grafted, for it is the habit of grafts to grow upright rather than horizontal in the direction of the original branch; and it is well to split all stubs on such branches horizontally, that one cion may not stand directly under another. The habit of growth of the cion is well shown in Fig. 177, illustrating the form and direction of the original branch, and the yearling grafts. It is evident, therefore, that a top-grafted tree is narrower and denser in top than was the tree

originally, and that careful pruning is required to keep it sufficiently open. Each graft is virtually a new tree-top placed into the tree, and for this reason, if for no other, the common practice of grafting old trees close down in the large limbs is seen to be inadvisable.

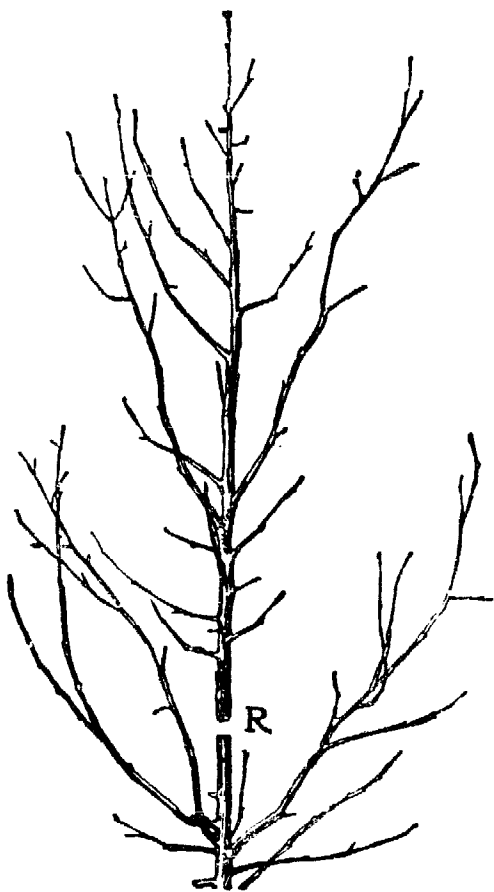

FIG. 178. A part removed in top-grafting.

Small young trees with a central trunk or axis, such as have been planted only two or three years, may be cut off bodily, as at *R* in Fig. 178, only one graft being made. Usually such trees can be changed over in one or two years. When the young tree is well branched, however, it may be grafted in the branches as suggested in Fig. 179 (after Powell). In this case, care should be taken to choose alternating branches, so that crotches will not be formed.

Top-grafting is performed in spring. The best time is when the leaves are pushing out, or just before, as wounds heal quickly and cions are most likely to live.

But when a large lot of grafting is on hand, it is necessary to begin a month, or even two, before the leaves start. On the other hand, the operation can be extended until a month or more after the leaves are full-grown, but such late cions make a short growth, which is likely to perish the following winter.

Professional grafters usually divide their men into three gangs, — one to do the cutting of the stubs, one to set the cions and one to apply the wax. The cions are whittled before the grafter enters the tree. They are then usually moistened by

dipping into a pail of water, and are carried in a high side-pocket in the jacket. The handiest mallet is a simple club or billy, a foot and a half long, hung over the wrist by a loose soft cord (Fig. 180). This is brought into the palm of the hand by a swinging motion of the forearm. This mallet is always in place, never drops from the tree, and is not in the way. The knife shown in Fig. 168 is commonly used. A downward stroke of the mallet drives the knife into the tree, and the return upward motion strikes the knife on the outer end and removes it. Another downward motion drives in the wedge. The sharpened nails and sticks commonly pic-



FIG. 179. Arranging stubs to avoid bad crotches.

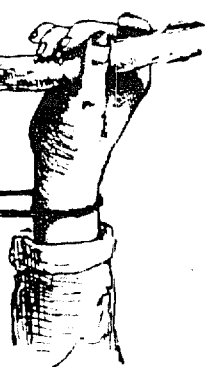

tured as wedges in cleft-grafting are useless for any serious work. The various combined implements devised to facilitate cleft-grafting are usually impracticable in commercial work.

It is very important that the cleft-graft be kept constantly sealed up until all the wounded surfaces are completely covered with the healing tissue. Old wood never heals. Its power of growth is completed. If a limb of an apple tree a half inch or more in diameter is cut off, the heart or core of the wound will be found to be incapable of healing itself. It is covered over by the callus tissue that grows from the cambium underneath the bark. The wound becomes hermetically sealed by

FIG. 180. Grafting-mallet ($\times 1\frac{1}{2}$).

the new tissue. In the meantime, the wound should be protected by a dressing, a wax or paint, to prevent decay. In cleft-grafts, the surfaces should be covered with wax every year until they are closed over by the new tissue. In most cases the wax will loosen the first season, and sometimes it falls off.

The character of the healing process is well depicted in Figs. 181, 182, 183. In Fig. 181 is shown a yearling cleft-graft of apple. The strip of wax along the side of the cleft is seen to have split with the enlargement of the branch,

and the cleft has filled up with tissue and is now safe from infection of disease or rot. The roll of healing tissue on the end of the stub is seen about the border of the wound. This

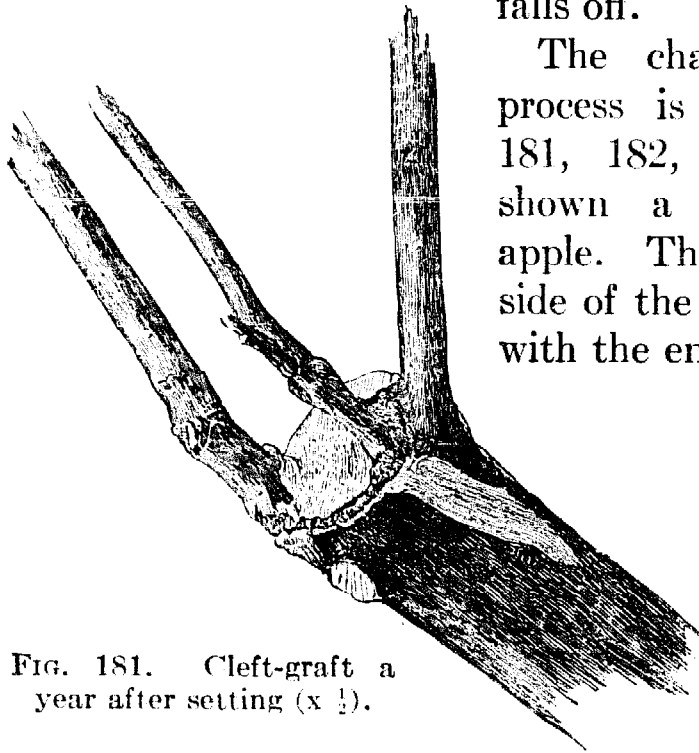

FIG. 181. Cleft-graft a year after setting (x $\frac{1}{2}$).

tissue has not yet covered the cleft across the end of the stub, and this cleft, if exposed to the weather, is a fertile place for the starting of decay, for the cleft does not unite except along the sides of the stub beneath the bark. When this stub is split lengthwise, following down the cleft, we may readily distinguish the location of the healing tissues, Fig. 182. The lower ends of the cions are at E, and they are now inactive and nearly lifeless bits of wood. The new or healing tissue has been built up on the outward side of the cions. On the left, this deposition of new tissue may be traced as far down as H, while it is thick and heavy at E and above. The whole interior part of the stub, represented by the dark shading, is dead tissue, which will soon begin to decay unless it is well protected from the weather.

In time, the old stub becomes hermetically sealed by the reparative tissue. Fig. 183 shows a section of an apple graft nearly fifty years old. The original stub, about an inch in diameter, is still seen in the center, the end of it entirely free from the inclosing tissue. It is a dead piece of wood, a foreign body preserved in the heart of the tree. The depth of the old cleft or split is traced in the heavily shaded part of this central core. When this section was made, the cores of the old cions were still found in the cleft and the grafting-wax — faithfully laid on a half century ago — still adhered to the

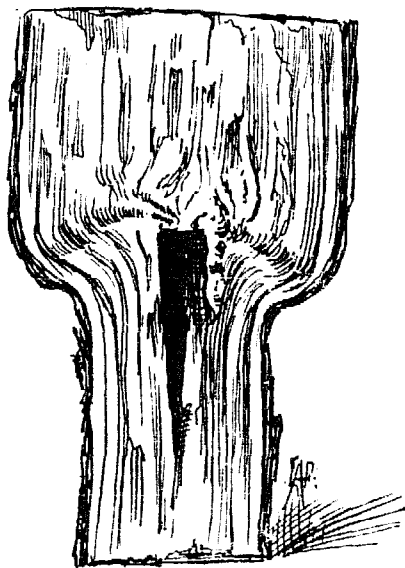

FIG. 183. Section of old cleft-graft on apple tree. Cion has outgrown the stock.

end of the stub, underneath the mass of tissue that had piled itself over the old wound.

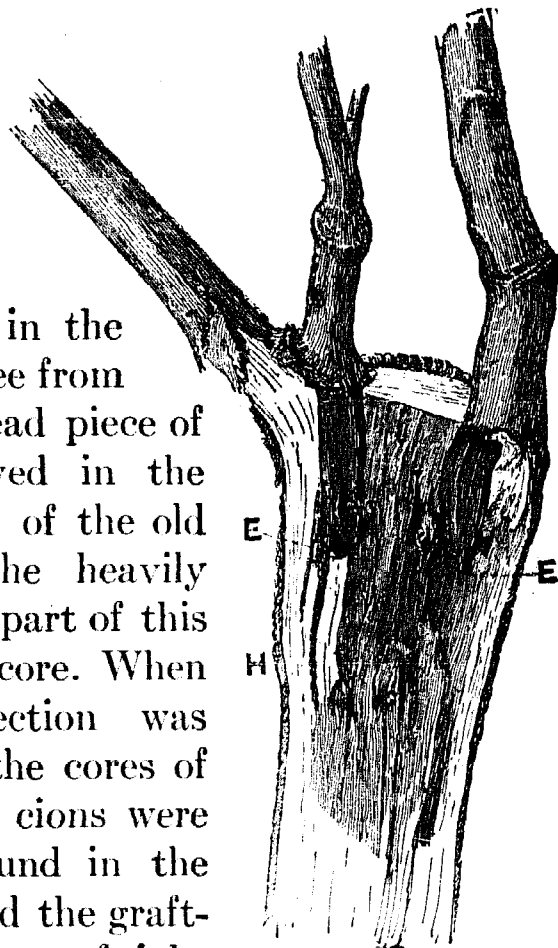

FIG. 182. The stub 181 split through the cleft, and seen from the opposite side.

Other uses of the cleft-graft.

Cleft-grafting is put to various other uses than the top-grafting of old trees. It is in common use on soft and fleshy stocks, as cactuses, and various fleshy roots. Fig. 184 shows a cleft-graft on cactus. The cion is held in place with a pin or cactus spine, and it is then bound with raffia or other cord. Waxing is not necessary.

A similar graft is often made on peony roots. The cleft in the



FIG. 184.
Cleft-graft
of cactus
(x 1/2).

though some operators prefer, in such fleshy subjects, to cut out a section from the side of the stock to receive the cion, rather than to make a cleft, much as in the process of inlaying illustrated in Fig. 192. Hollyhocks, certain ipomeas, gloxinias and other thick-rooted plants may be similarly treated.

Miscellaneous forms of grafting

The ways of grafting are as many as the ways of whittling. (Certain ones of them have gained considerable currency and may be set down here.

Splice-grafting.—The simplest form of grafting is that shown in Fig. 185, in which the two parts are simply cut across diagonally and laid together. The parts are held only by the string, which, together with the wax, is applied in the same way as on the whip-graft. Splice-grafting is frequently used with soft or tender wood that will not admit of splitting. It is adapted mostly to small shoots.

Saddle-grafting.—Saddle-grafting is a simple and useful method for the shoots of small growing plants. The stock is cut to a wedge-shape end by two cuts, and the cion is split and set astride the wedge (Fig. 186). The union is then tied and

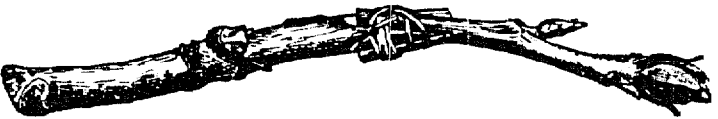

FIG. 185.
Splice-graft
(x 1/2).



FIG. 186.
Saddle-graft
(x 1/2).

waxed in the same way as exposed whip-grafts. It is oftenest employed when a terminal bud is used, as the wood in such cions is usually too weak to work easily with a tongue.

Side-grafting.—There are various methods of inserting a cion into the side of a trunk or branch without cutting off the stock. One of the best methods is shown in Fig. 187. The example on the right shows the cion set into an oblique cut in the stock, and that on the left shows the lower part of a thin-bladed chisel, with a bent shank, that makes the incision. An ordinary chisel

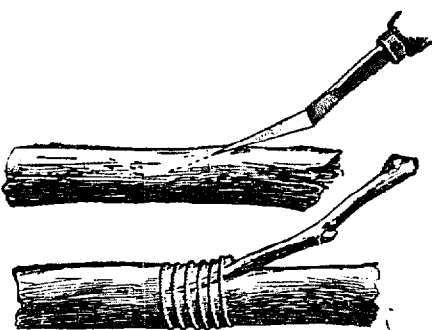

FIG. 187. Side-graft
($\times \frac{1}{2}$).

or a knife may be used, however. The incision should be about an inch deep. The cion is cut wedge-shape, as for cleft-grafting, and it is pressed into the incision until its cut surfaces are concealed in the stock. The wound is then tied, and, if it is aboveground in the open, it is waxed. The stock is headed back vigorously to aid in deflecting a part of the energy into the cion. This kind of grafting may be used to good advantage on rather small grape stocks, below the surface of the ground.

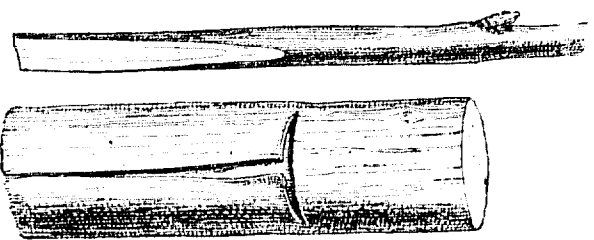

FIG. 188. Shield-graft.

Shield-grafting.—A side-graft that is a combination of budding and grafting is shown in Fig. 188. The incision in the stock is exactly like that for shield-budding (Figs. 131, 137), but a cion, cut wedge-shape, is used in place of a bud. The graft is tied and waxed. This style of grafting is useful for many difficult subjects. It is admirably adapted to the mulberry, in which the operation should be performed just as the foliage is well started in the spring, with dormant cions. The stock is headed back a week or so after

the cion is set, and again at intervals during the season. The cion often makes sufficient growth the first season to form a salable tree by fall. Purple and weeping beeches may be grafted in this way, except that the operation should be performed in late summer or fall, with freshly cut cions, much the same as for summer budding.



FIG. 189.
Bark-graft
(x $\frac{1}{2}$).

Bark-grafting. — A style of grafting suited to large trees is explained in Fig. 189. This is the bark-graft, sometimes unfortunately called crown-graft. The stock is not cleft, but the cions are pushed down between the bark and wood. The cions must be cut very thin, so that they will not break the bark on the stock (Fig. 190). It is cut to a shoulder on either side. Several cions can be placed in a single stub, and as no splitting is necessary, it is a useful method for very large limbs. It is specially useful in repairing trees when very large branches are broken off. The broken stub is sawn off smooth, and a dozen or more cions may be set around it. Only a few of them should be allowed to remain after the wound has been healed. Bark-grafting can be performed to advantage only when the bark peels readily. The cions should be held in place by a firm bandage, as seen in Fig. 189, and then wax should be applied as for cleft-grafting.

Bridge-grafting. — A special form of bark-grafting is sometimes employed for covering girdles about the base of an old tree, made by mice, gophers or rabbits. Inasmuch as it is surgery rather than propagation, a discussion of it is hardly in place in a nursery book, yet the reader is likely to look for it here. (See Chapter IV, "The Pruning-Manual.")



FIG. 190.
Cion for
bark-graft-
ing (x $\frac{2}{3}$).

The edges of the wound are trimmed, and cions are cut an inch or two longer than the width of the girdle, and they are sharpened at both ends. One end is inserted under the bark below the girdle and the other above it. The cions are placed close together entirely around the tree. The two ends are held firmly in place by tying, and the line of union is then

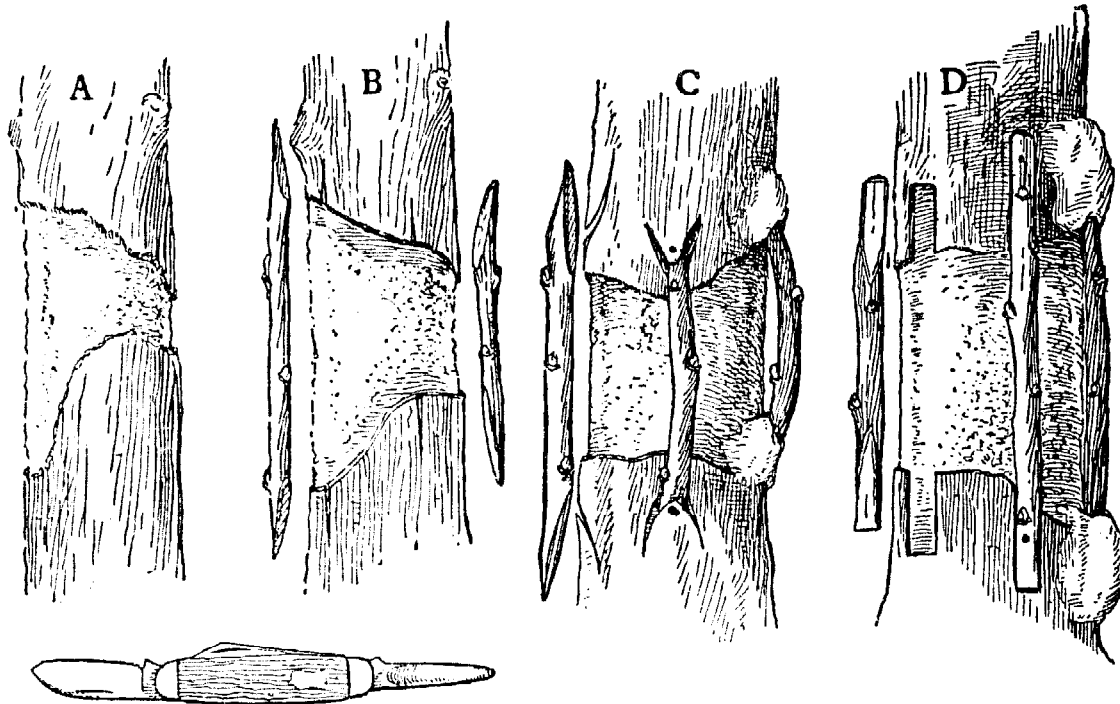

FIG. 191. Bridge-grafting, for the repairing of wounds.

waxed over. This operation is said to be necessary to keep up the connection between the root and the top, but this is in most cases an error, unless the girdle extends into the wood. A good dressing of wax or clay, held on with stout bandages, is often much better than the grafting. This method of grafting is sometimes, but erroneously, called inarching. A complete bark girdle made in spring or early summer will usually heal over readily if it is well bandaged; and in some cases even the bandage is not necessary.

Several forms of bridge-grafting are practiced. Those described by Peck in Cornell Reading-Course Lesson 123 may be taken as examples:

“The ragged edges of the bark around the wound are cut back to live tissue (Fig. 191 *B*). At the points above and below the wound where each cion is to be inserted, the bark is slit about one-half or three-quarters of an inch. The cion should be about one and one-half inches longer than the space to be abridged, and is beveled on each end with a straight cut about an inch long. This beveling exposes considerable cambium layer and facilitates the insertion of the cion under the bark and against the cambium layer of the stock. The bark at the slit below the wound is loosened with the knife, and the lower end of the cion is inserted with the cut side next to the wood of the tree. In order that the cambium layers of cion and stock may be held in close contact, a brad is driven through the end of the cion into the tree. The slit at the upper edge of the wound is then loosened and the other end of the cion inserted and nailed. When the bridging is completed, the area about the ends of the cions is carefully waxed to prevent drying out and possible infection and to exclude air and moisture. In some cases it may be advisable to wrap the parts where the cions are inserted with bandage or raffia to insure their being held in place. For a tree with a trunk one and a half inches or less in diameter, usually three cions in the bridge are enough. With each inch added to the diameter, at least one cion should be added to the bridge.

“If the principle that the cambium layers of stock and cion should come in contact is carefully carried out, other forms of bridge-grafting may be used with success. One of these is illustrated in Fig. 191 *C*. Here cuts are made about half an inch above and below the girdle through the bark into the sapwood, thus cutting across the cambium layer. The cions for this bridge are made very much as those previously described. They are inserted, nailed, and waxed in a similar way. Still another method of bridge-grafting, which some growers have found very satisfactory, is illustrated in Fig. 191 *D*. The cambium layer of the stock is exposed by cutting out pieces of bark above and below the girdle, corresponding accurately in size with the ends of the cion to be inserted. The cions are cut as shown in Fig. 191 *D* and are nailed and waxed as in the method already described.

“Bridge-grafting may be used on any of the orchard fruit trees grown in New York State. More damage by girdling is probably done on apple and pear trees than on any other fruits; however plum, cherry and peach trees are often injured, and bridge-grafting, which is the only method of saving them, is well worth trial. It is advisable to replace very young trees unless the girdled portion is far enough above the root system to permit of cleft-grafting in the trunk just below the girdle. If bridge-grafting is skillfully done, and the bridged portion carefully attended

to afterward to prevent the entrance of injurious insects and fungous diseases, the tree may apparently be as strong and productive as its uninjured neighbor. Some trees, however, will never seem to recover wholly from the injury, and unless bridge-grafting is very carefully done, a high percentage of the trees so treated cannot be expected to live. The essential point to keep in mind is that the cambium layers of the cions must be held in contact with the cambium layers of the stock, both above and below the girdled part, until union takes place."

Inlaying. — There are various kinds of grafting in which a piece of wood is removed from the stock and a cion is cut to fill the cavity. The following methods described by Lodeman for the grafting of grapes will serve as a type of the class: "The stock is cut off, as for cleft-grafting. In place of splitting the stub, one or two V-shaped grooves are made in it (Fig. 192).

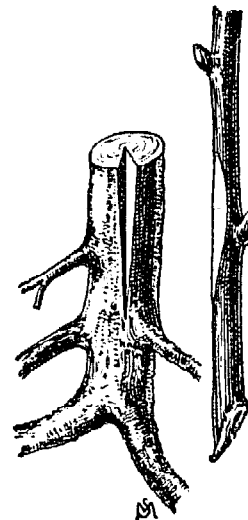

FIG. 192. A method of inlaying.

These grooves are made by means of an instrument especially designed for the purpose. It is shown in Fig. 193. The tip cuts out the triangular part. In the blade itself is a part which is bent at the same angles as the parts forming the tip. This indented portion of the blade is used for cutting away the end of the cion, and with very little practice an almost perfect fit of the two parts can be made. The one or two cions are then placed upon the stock and are firmly tied there. The tying material should be of such a nature that it will decay before there is any danger of strangling the cions. Raffia does very well, as does also bast. No. 18 knitting cotton, soaked in



FIG. 193. Inlaying tool ($\times \frac{1}{2}$).

boiling grafting wax, may be used with entire satisfaction. The ligatures should be made as tight as possible. Although this method of grafting is not so commonly used as others, it still possesses some decided advantages for grape vines. It is a much simpler

and more satisfactory method than cleft-grafting in very curly wood. The tying is a slow process, and for straight-grained wood the cleft-graft is to be preferred. It is also open to the objection of requiring the shoots to be staked or tied to some support, for the wind is apt to break the point of

union more easily than with other methods. A good union admits of a very strong growth, and if the above precautions are kept in mind the vines will equal those produced by the more common methods."

Cutting-grafting.—Cuttage and graftage may be combined in various ways. Cuttings of plants that root with difficulty are sometimes grafted on those that root easily. A good example is in Fig. 159. When the plants are transplanted, the following autumn or spring, the nurse or stock may be removed, the cion having taken root. The connection may be made by means of a whip-graft, veneer-graft or other form.

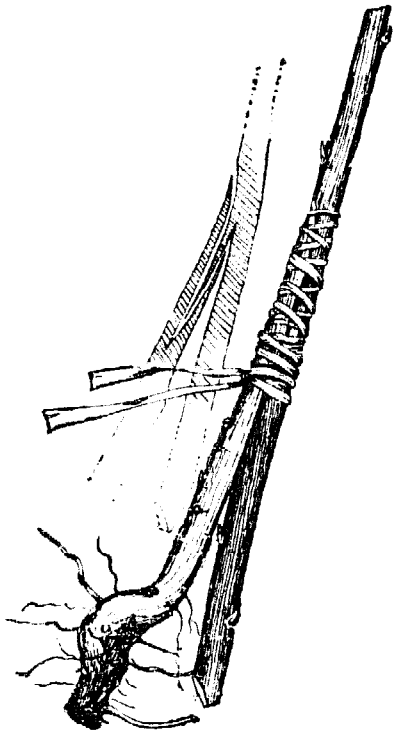

FIG. 194. Cutting-grafting
(x $\frac{1}{2}$).

Root-grafting, described on a previous page (see Figs. 138–143) is virtually a grafting of cuttings. In other cases, union with an uncongenial stock is facilitated by allowing the cion to project downwards beyond the point of union, and to stand in the soil or moss or dish of water. (See also pages 143–144.) Fig. 194 is a good illustration of the practice. The cion extends into the earth nearly as far as the root itself. After union has taken place, the lower part of the cion is removed. This method can be used for magnolias, mulberries, birches and many other plants of which some kinds root with more or less difficulty. "Bottle-grafting," described in most of

the books, is essentially this method, modified by letting the end of the cion, or a piece of the bandage, drop into a bottle of water.

A modification of this style of grafting is the "cutting side-graft," shown in Fig. 195. This is adapted to root-grafting, particularly of the grape. The stock is cut wedge-shape, and is inserted into an oblique incision in the cion.

Herbaceous-grafting.—In the preceding pages, the discussions have had to do with cions dormant or at least well hardened, and with stocks that contain more or less hard woody substance. But herbaceous shoots can be grafted with ease. All such plants as geraniums, begonias, coleuses, chrysanthemums and tomatoes, can be made to bear two or more varieties on the same individual. Almost any style of grafting may be employed, but the veneer-, cleft- and saddle-grafts are preferred. Shoots should be chosen for stocks that are rather firm, or in condition for making good cuttings. The cions should be in a similar condition, and they may be taken from the tips of branches or made of a section of a branch. The union should be bound snugly with raffia, and the plant set in a propagating-frame, where it must be kept close for a few days. It is not necessary, in most cases, to use wax, and on some tender stocks the wax is injurious. Moss may be bound about the graft, but unless the union is first thoroughly covered by the bandage, roots may start into the moss and the parts may fail to unite. The growing shoots of shrubs and trees can also be grafted, but the operation is rarely employed. In various coniferous trees (as pines and spruces) the young shoots are sometimes cleft- or saddle-grafted in May, the parts being well bandaged

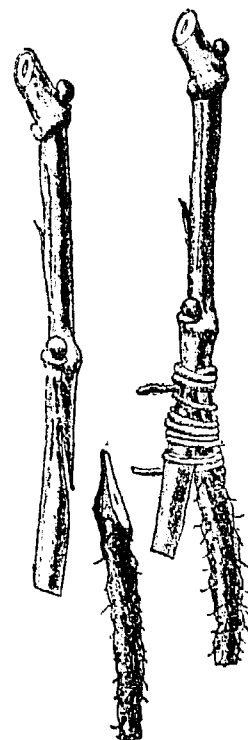

FIG. 195. Cutting side-graft (x $\frac{1}{3}$).

with waxed muslin or raffia, and shaded with paper bags. The walnut and some other trees that do not work readily are sometimes treated in this manner.

Even leaves may be used as stocks or cions. Any succulent and permanent leaves, as those of the house-leeks, crassula, and the like, may have young shoots worked on them, and leaves used as cuttings can often be made to grow on other plants.

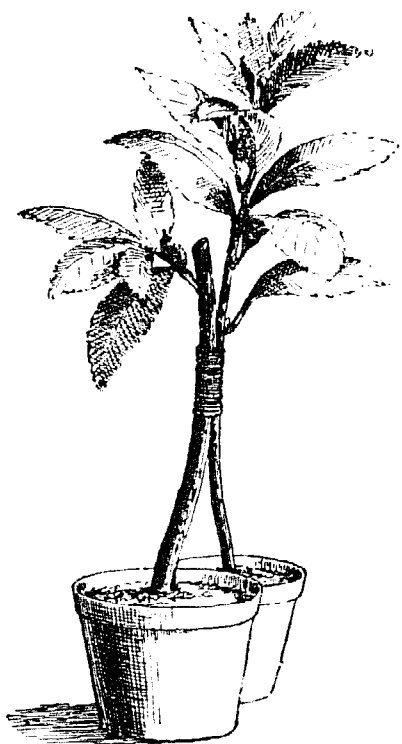

FIG. 196. Inarching.

Fruit-grafting. — A little known species of herbaceous-grafting is the joining of parts of fruits. It is easily performed with fleshy fruits, as tomatoes, apples, squashes and cucumbers. When the fruit is half or more grown, one-half or a piece is cut away and a similar half from another fruit is applied. Better results follow if the severed side of the parent or stock fruit is hollowed out a little, so as to let the foreign piece set into the cavity. The edges of the epidermis of the stock are then tied up closely against the cion by means of bast or raffia. The two parts are securely tied together, but no wax is required. This

operation succeeds best under glass, where conditions are uniform, and where winds do not move the fruits.

Seed-grafting. — An interesting kind of grafting has been described in France by Pieron, which consists in using a seed as a cion. This has been employed in the grape. A seed is dropped into a gimlet-hole near the base of the vine while the sap is rising in the spring. The seed germinates, and after a time the plantlet unites with the stock.

Inarching. — Inarching, or grafting by approach, is the process of grafting contiguous plants or branches while the

parts are both attached to their own roots. When the parts have grown together, one of them is severed from its root.

The practice of inarching is explained in Fig. 196. In this case, the larger plant (on the left) is designed for the stock. When the smaller plant has united, it is cut off just below the union and it thenceforth grows on the other plant. Limbs of contiguous trees are sometimes grafted in this way. It is the process employed by nature in what is called natural grafting (Fig. 129). Grape-vines are often inarched.

A thrifty young branch of a fruit-tree may be inarched into the stem of a fruit on the same tree, thus supplying the fruit with additional food and causing it to grow larger than it might if untreated.

To join the parts, it is necessary only to remove the barks between the stock and cion and then tie the two together snugly. The details are shown in Fig. 197. In M, a branch C is joined at O to the stock H. Other branches, like T, might be similarly treated. In N, the method of cutting the conjoined surfaces is explained at R.



FIG. 197. Details of inarching.

In N, the method of cutting the conjoined surfaces is explained at R. If outdoors, the junction should be waxed over; and it is then necessary, also, to secure the branches so that the wind cannot loosen them. The parts are sometimes joined by a tongue, after the manner of a whip-graft, but this is rarely necessary. Oranges and camellias were often propagated by inarching in the old practice, but this work is now much more easily accomplished by the veneer-graft.

Double-working. — Grafting on a grafted tree is known as double-grafting or double-working. It is employed for the

purpose of growing a variety on an uncongenial root, or of securing a straight and vigorous stock for a weak and poor grower. The operation may be either grafting or budding. It is more commonly the latter.

Some sorts of pears do not unite well with the quince, and if it is desired to obtain dwarfs of these varieties, a variety that unites readily with the quince must first be put on it.

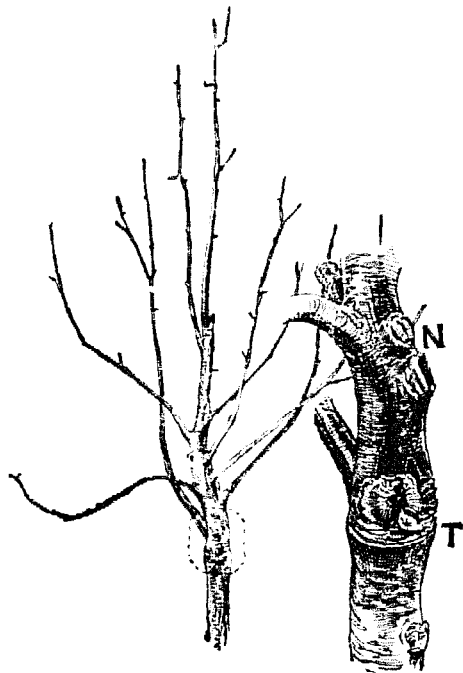

FIG. 198. A double-worked tree.

The Angouleme takes well to the quince, and on Angouleme dwarfs the Seckel and some other varieties are often worked. In double-working dwarf pears, it is imperative that both unions be very close to the ground. The piece of interposed wood is not more than one or two inches in length. The second cion is usually set after the first one has grown one season, although both may be set at the same time.

Double-grafting for the purpose of securing a better growth is often practiced. The Canada Red apple, for example, is such a poor grower that it is often stem-worked or top-worked on the Northern Spy or some other strong stock. The Winter Nelis and the Josephine de Malines pears are often double-worked for the same reason. Fig. 198 shows the top of a double-worked tree. In this case, the body of the tree is two years old and is itself a graft or bud on a seedling root. The second variety is grafted to the point where it is desired to start the permanent top of the tree, by whip-grafting in this example. The figure on the left shows the two-year-old top growing from this cion. The length of the cion is comprised inside the dotted lines, and this region is enlarged in the figure on the right.

The base of the cion was at r — below which is stock — and the top at n. The upper scar at n is the top of the cion itself, but the other scars show where superfluous twigs were removed after the cion had grown a year. This type of double-working of fruit-trees is to be recommended for weak or wayward growers

Another practice now known as double-working is growing up in North American nurseries. It is the effort to produce named own-rooted stocks, thereby having a root of known hardiness and resistance to disease. By the use of the long cion and the short root, the cion becomes own-rooted in two years and this cion is then used for a stock as if it were a seedling (page 139). Success depends not alone on the methods of propagation but on the choice of a variety (for cions) that roots readily. Varieties of apples, for example, differ widely in their ability to form cion-roots. In this field undoubtedly lies opportunity for improvement in nursery propagation (page 182). It is the intention thereby to produce a stronger tree, to escape such diseases as collar-rot of the apple and to circumvent the root-louse (woolly aphis) to which many roots are particularly susceptible. The top of the tree is of known character and quality: the problem is to produce a root of known quality.

Grafting-waxes

There are many recipes for waxes or mastics for protecting grafts and covering wounds. In this country, the resin and beeswax waxes are most used, although certain of the alcoholic waxes are popular in some regions. In Europe, many clay and pitch waxes are in common use. For most purposes, the wax No. 1, in the following list, is one of the best, especially for applying by the hand. The soft alcoholic waxes are liable to melt from exposed stubs in our hot summer suns; but they are useful for indoor work and for cool weather.

In making the resin and beeswax waxes, the materials are first broken up finely and melted together. When thoroughly melted, the liquid is poured into a pail or tub of cold water. It soon becomes hard enough to handle, and it is then pulled and worked until it becomes tough or "gets a grain," at which stage it becomes the color of very light-colored manilla paper. When wax is applied by hand, the hands must be well greased (pages 150-151). Hard cake tallow is the best material for this purpose. In top-grafting large trees, it is well to carry a supply of tallow when waxing, by smearing the backs of the hands before entering the tree.

Common hard resin and beeswax waxes

1. Resin, 4 parts by weight; beeswax, 2 parts; tallow, 1 part. Turpentine, 2 to 4 ounces, is sometimes added.
2. Resin, 6 pounds; beeswax, 1 pound; linseed oil, 1 pint. Apply warm with a brush, one-eighth of an inch thick over all the joints.
3. Resin, 4 pounds; beeswax, 1 pound; and from half to a pint of raw linseed oil; melt all together gradually, and turn into water and pull. The linseed oil should be entirely free from cottonseed oil. A hard wax, for use in warm weather.

Waxes to be applied melted, from a grafting-pot (Peck)

4. A good melted wax may be made by the following formula:

Resin (crushed)	5 pounds
Beeswax (finely cut)	1 pound
Powdered wood charcoal	$\frac{1}{2}$ pound
Raw linseed oil	$\frac{1}{4}$ pint

Melt the resin and the beeswax together, add the charcoal, and stir the mixture briskly to prevent lumping. Add the linseed oil, and mix it thoroughly with the other ingredients. The wax is then ready for use. It is applied hot with a small brush. It does not crack badly, nor does it melt and run during hot weather.

5. Another formula for melted wax is as follows :

Resin (crushed)	6 pounds
Beeswax (finely cut)	1 pound
Linseed oil	1 pint

Melt the resin and the beeswax together. Stir in the linseed oil, and the wax is ready for use.

Alcoholic waxes

6. Liquid wax. — Resin, 4 parts by weight; beeswax, 2 parts; mutton tallow, 1 part; alcohol, $\frac{1}{2}$ or $\frac{5}{8}$ part. Add the alcohol when the other ingredients are melted together and removed from the fire. A good soft wax.

7. Lefort's liquid grafting wax, or alcoholic plastic. — Best white resin, 1 pound; beef tallow, 1 ounce; remove from the fire and add 8 ounces of alcohol. Keep in closed bottles or cans.

Waxed string and bandage

8. Waxed string for root-grafting. — Into a kettle of melted wax place balls of No. 18 knitting cotton. Turn the balls frequently, and in five minutes they will be thoroughly saturated, when they are dried and put away for future use. This material is strong enough, and at the same time breaks so easily as not to injure the hands. Any of the resin and beeswax waxes may be used. When the string is used, it should be warm enough to stick without tying.

9. Waxed cloth. — Old calico or thin muslin is rolled on a stick and placed in melted wax. When saturated it is allowed to cool by being unrolled on a bench. It is then cut in strips to suit. Or the wax may be spread on the cloth with a brush.

CHAPTER VII

CERTAIN ELEMENTS IN NURSERY PRACTICE

THIS Manual deals with the propagation of plants, not with business and commercial management. Yet certain phases of the nursery business naturally follow the treatment

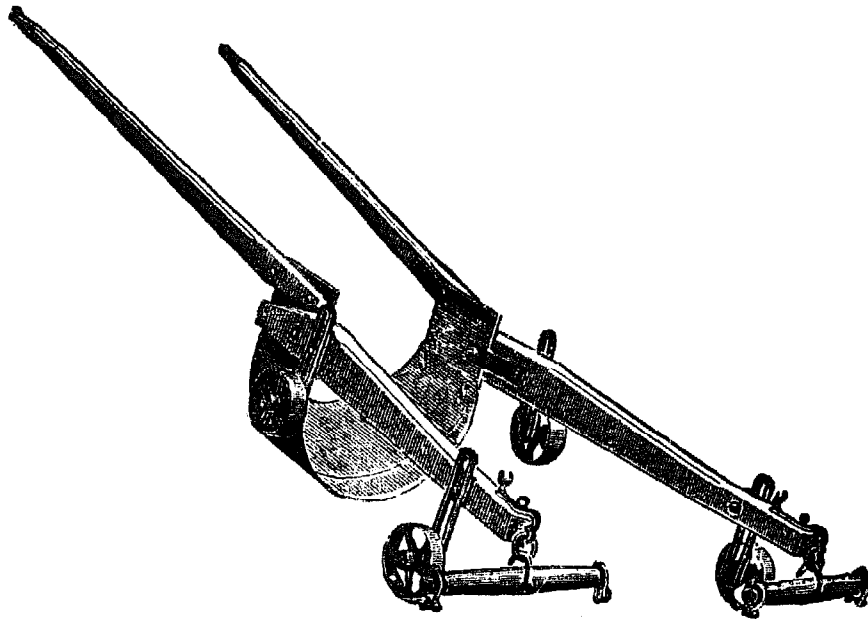

FIG. 199. The Bragg tree-digger.

of propagation, having to do with the growing and saving of the young stock; these subjects we may now consider briefly.

In the United States and Canada a nursery is understood to be an outdoor area, mostly of several or many acres, in which the propagation of trees and shrubs for commerce is the dominant feature. It is this kind of nursery we are now to discuss. Yet, in fact, a nursery is any area or establishment in which plants are propagated and nursed, whether a



PLATE VI. A nursery of ornamental stock; trimming.

greenhouse bench or a garden, whether the plants are orchids or ferns or raspberries, and whether for one's own use or for sale. In North America, the growing of fruit-trees is supposed to be the chief concern of a nursery. We have had a continent to transform into orchards.

Present practice in North American nurseries is to use heavy machinery and implements for major operations. The mechanical tractor is used for road work and sometimes in fitting the land. Heavy soil-cutting tools are employed (Plate XI). Over-row tillage is facilitated by wheel cultivators (Plate IV). A mechanical peach-pit planter is invented. Root-grafts are wrapped by machines (Plate V). Leaf-hoppers are captured on horse-drawn devices.

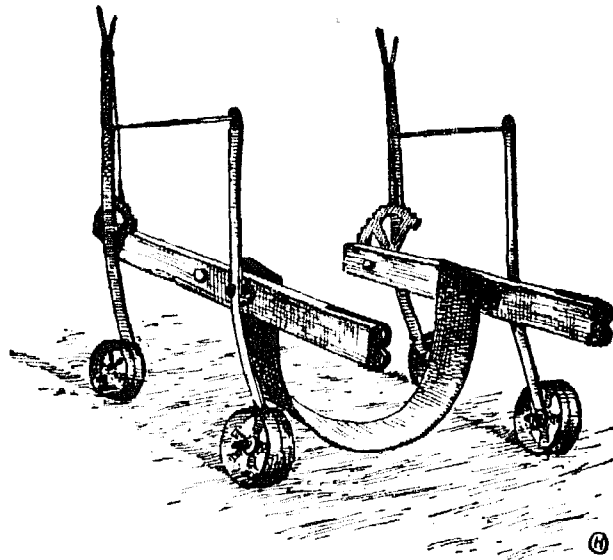

FIG. 200. The Stark tree-digger.

The tree-diggers are now of many kinds, and the old hand-digging by means of the long spades is a thing of the past in the large-area fruit-tree plantations. They are drawn by several teams of horses or mules, and sometimes by wire cables pulled by stationary engines. Two of the tree plows are shown in Figs. 199 and 200, and again in Plate XI. Two forms of tree-diggers used in the United States Forest Service (Bull. 479) are illustrated in Figs. 201, 202.

Nursery lands in relation to propagation

The best land for general nursery purposes is heavy rather than light, containing a good percentage of clay beneath,

loamy on top, and lying as nearly level as possible. Before trees are put on it, the land should be deeply and thoroughly worked for at least one season and perhaps subsoiled. Nat-

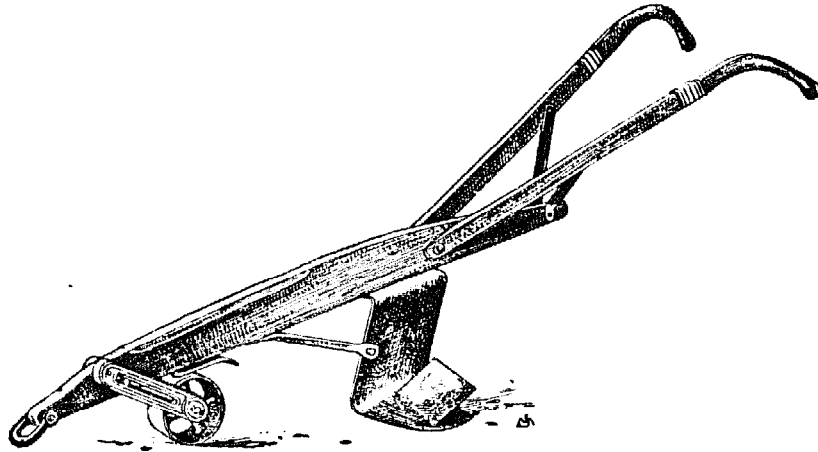

FIG. 201. Tree-digger for forest-tree nursery..

urally drained land is to be preferred, but if the property is of such character as to hold surface water for two or three days at a time, the area should be thoroughly tile-drained. Nursery

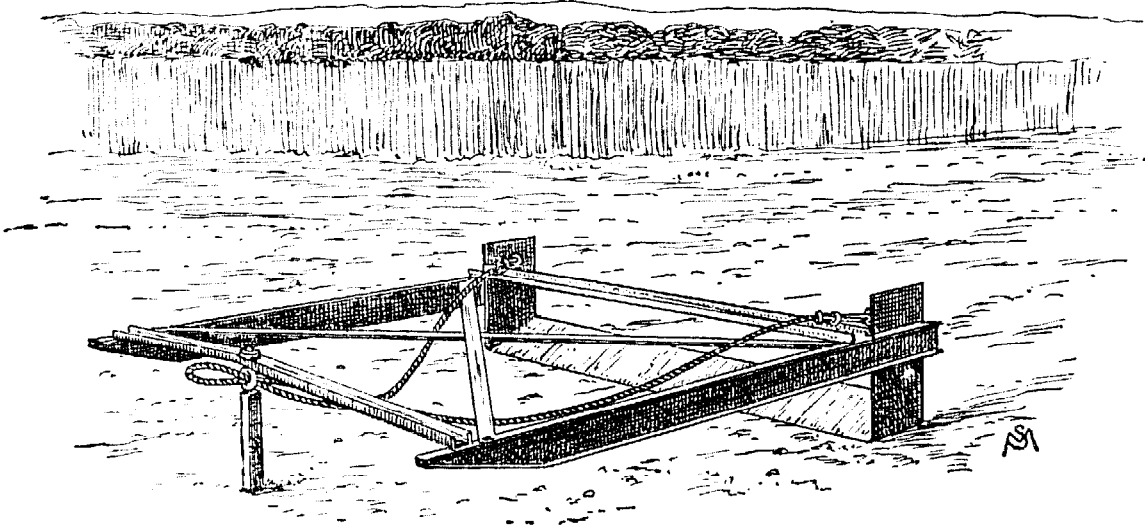

FIG. 202. Tree-digger for a forest-tree nursery.

trees constitute a crop occupying the land for a number of years, and unless this land is in good heart when the trees are planted, there will be little opportunity to raise a good product.

The land should be strong enough to raise a good crop of wheat or corn.

With fruit-trees, the age of the tree determines its salableness; therefore it is imperative that the growth within the given time be rapid and strong. With ornamentals, however, the value is determined by the size of the specimen, with little reference to its age. It therefore follows that lands not sufficiently strong to allow of the profitable growing of fruit-trees may still be useful for growing ornamentals.

In considering the question of the fertility of nursery lands, it is first necessary to determine what are the proportions of the chief elements of plant-food removed by the trees from the soil. The standard investigations of Roberts, at Cornell, still constitute an excellent record:

“Amounts and values of fertilizing constituents removed by an acre of nursery trees in three years:

	APPLES		PEARS		PEACHES		PLUMS	
	Lbs.	Value	Lbs.	Value	Lbs.	Value	Lbs.	Value
Nitrogen	29.07	\$4 36	24.83	\$3 73	22.42	\$3 36	19.75	\$2 96
Phosphoric acid	10.13	71	7.83	54	5.42	38	4.42	31
Potash	19.73	89	13.33	60	11.75	53	11.50	52
		\$5 96		\$4 87		\$4 27		\$3 79

“The above results show conclusively that but a small amount of plant-food is removed from the soil by the growth of nursery stock. They also show that more phosphoric acid is removed by the apples and pears than by the peaches and plums; but any ordinary soil, cultivated as nursery lands are, should easily furnish in three years ten times the plant-food used by the trees. In order to compare the drafts made by nursery stock and some of the common crops raised in mixed

husbandry, the following statement will be useful: The amount of green corn necessary to remove an equal amount of fertilizing ingredients per acre, taking the average of the value of the nitrogen, phosphoric acid and potash (\$4.72) removed by an acre of the trees (3 years' growth), would be 4,779 pounds.

"Silage corn raised in drills usually yields from 12 to 20 tons per acre, and yet does not make drafts on the land which preclude duplicating the yield the following season; hence some other cause than soil exhaustion must be found if the failure to grow a second crop of nursery trees without intermediate crops is explained." These conclusions are supported in analyses made by the New York State Station (Geneva).

All experience proves that a crop of nursery trees does not exhaust the land of its fertility. In fact, it is generally considered that land from which trees have just been removed is in good condition and heart for a crop of beans, wheat or potatoes. Yet, despite this fact, it is also generally considered that land can seldom raise two good crops of nursery trees in succession. Land that has been "treed" must be "rested" in grass or some other crop. This disposition of land to refuse to grow two consecutive crops of good trees is not an invariable rule, however. Nursery lands have produced good plum trees for twenty consecutive years. One frequently sees lands yielding apple and cherry stocks for two or three crops in succession. Plums seem to be particularly amenable to this consecutive cropping, and they are benefited by applications of stable manure. Some other species, as, for example, the pear, do not take so kindly to treatment with manure. Because of this common experience with indifferent trees grown on treed land, nurserymen with a large business prefer to rent land for the growing of trees.

The chief reason for this condition of treed lands seems to be that the soil is injured in its physical texture and robbed of its humus by the methods of cultivation and treatment.

The best nursery lands contain a basis of clay, and these are the kinds that soonest suffer under unwise treatment. The land is kept under high culture, and it is therefore deeply pulverized. There is practically no herbage to protect it in winter. When the crop is removed, even the roots are taken out of the soil. The tree-lifter or digger is likely to be used when the land is wet and easily injured. For four or five years, the land receives practically no herbage that can rot and pass into humus. The trees are dug in the fall, often when the soil is in unfit condition, and this fall digging amounts to a fall plowing. The soil, deeply broken and robbed of its humus, runs together and cements itself before the following summer; and it then requires three or four years of "rest" in clover or other herbage crop to bring it back to its rightful condition. This resting period allows nature to replace the fiber in the soil, and to make it once more so open and warm and kindly that plants can find a congenial root-hold.

It would seem, therefore, that some of this mechanical injury to nursery lands should be prevented by the growing of cover-crops between the rows late in the season, to be plowed under the following spring. It is well known that the plowing-in of coarse manure between the trees in fall or spring, for two or three years, will sometimes so greatly improve the land that a second good crop of trees can be grown with ease. This is particularly true for plum trees, as already noted, but the results do not seem to be so well marked for pears and some other trees. It is probable that one reason for the very general refusal of pear trees to follow pear trees is the fact that they are likely to be grown on heavy clay, and this is just the land most injured by nursery practices. Some lands are naturally so loose and open in structure that two or three crops of trees can be grown in succession but these lands contain little crude clay, and therefore do not suffer quickly from the passing out of the humus.

Nurserymen now often grow a cover-crop between trees to supply the needed humus, the various annual leguminous crops (as crimson clover) being preferred, although rye and buckwheat are good. In regions where they mature, cowpeas are sown. On account of the scarcity and cost of labor, nurseries are likely not to be kept so clean as formerly throughout the season, and the weeds may add useful fiber to the land; yet weeds are not to be recommended for this purpose.

For the resting period or rotation between nursery crops, longer-lived crops may be used. Kains suggests sweet clover as specially valuable (M. G. Kains, "Plant Propagation, Greenhouse and Nursery Practice," 1916), "because this plant burrows deeply and opens up the soil well besides adding considerable humus, both by its decaying roots and its tops, when these are turned under. Perhaps it would reduce the resting period to two or three years, as against three to five or even more under common practice." Usually the nursery lands are rested in red clover or other meadow crop; and if they can be pastured before treed again, the result is supposed to be better.

Although the chemical analyses of nursery trees show comparatively small amounts of the more important plant-foods, nursery lands need fertilizing. Nitrogen is needed in comparatively large amounts. It chiefly conduces to strong growth. It is also augmented by the addition of humus and the improvement of the physical condition of the soil. When nursery stock is making a poor growth, the grower should first see that the tillage of the soil is as thorough and perfect as possible, to supply additional plant-food and to preserve the soil moisture. He may then add nitrogen in the form of chemicals. The application should be made in spring or early summer. He should then be sure that insect or fungous attacks are averted. If the land was originally in fit condition for trees, and adapted to them, these suggestions should afford relief. More attention is being given to the complete fertiliz-

ing of nursery lands, as other agricultural lands are supplemented, and not to rely on the effect of a single ingredient to meet a present difficulty. This is the rational procedure. Undoubtedly nursery lands will respond to good rotations, careful working, and thoughtful fertilizer management as readily as other areas. The nursery practice has been too much like a skinning process. Some nurserymen now feed live-stock and use the manure in preparing and supplementing nursery lands.

Another difficulty in using nursery lands in succession is the danger from soil diseases. The nurseryman must be careful not to infect his land. Rotation seems yet to be the only remedy, if trouble arises.

Grades of trees

Common opinion demands that a tree, to be first-class, must be perfectly straight and comely. This arbitrary standard is but the expression of the general demand for large and good-looking trees. Yet there are some varieties of fruit-trees that cannot be made to grow in a comely shape, and there is always a tendency to discontinue growing them, notwithstanding the fact that they may possess great intrinsic merit. All this is to be deplored. The requirements of a first-class tree should be that the specimen is vigorous, free from disease or blemishes and that it possess the characteristics of the variety. This allows a crooked tree to be first-class if it is a Greening or Red Canada apple, because it is the nature of these varieties to grow crooked. Wayward and often scraggly growers among apples are Williams Early Red, Wealthy, Oldenburg, Wagner, and others. A crooked or wayward grower is not necessarily a weak tree. It is advisable to top-work weak-growing varieties on strong-growing and straight-growing ones. (See pages 167-169.)

A first-class tree is well grown; that is, the various operations to which it has been subjected by the nurseryman have

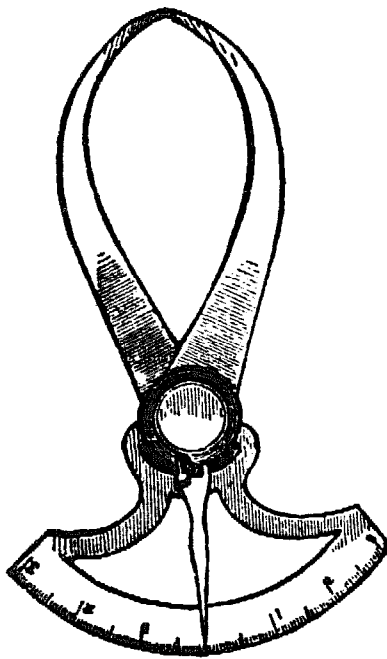

FIG. 203. Self-registering tree-caliper.

been properly performed; the workmanship is good. It must be mature, that is, not stripped of its leaves before the foliage has ripened. It must be of the proper age for planting. It must have a clean smooth bark, a stocky, strong trunk, good roots, and be free of borers and other insect injuries. The union — at the bud or graft — must be completely healed over if sold at two years or above (peach trees are seldom healed at the selling age). Stocky and rather short trees, with well-branched heads, are preferable to very tall ones. Very slender trees, if above one or two years old, should be avoided.

Nurserymen express the size of a tree by its diameter about two inches above the bud or crown. The measuring is made with a caliper or gage (Figs. 203, 204, 205). The diameter of a first-class tree varies with the method of growing and trimming it. In the New York nurseries, a first-class two-year-

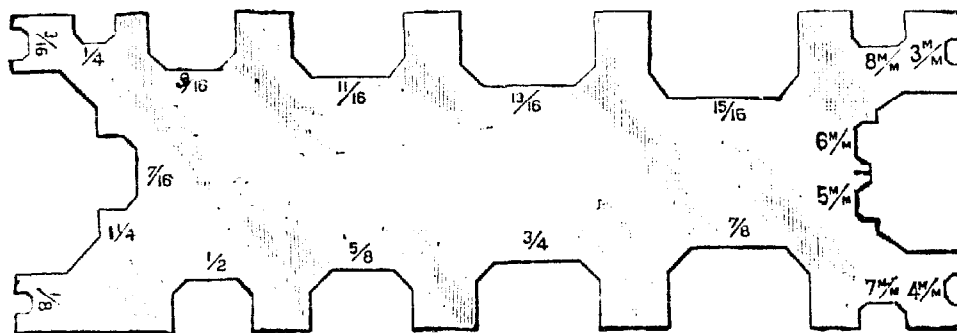

FIG. 204. Heikes' tree gage.

old apple tree (budded) should caliper eleven-sixteenths inch and upward. Plums run about the same. Pears run

the same or a sixteenth of an inch less, and sour cherries about a sixteenth more. Sweet cherries will run three-fourths inch and above.

Fruit-trees are usually assorted into three or four commercial grades, the grade representing age, size, vigor and general excellence. Small and injured stock is usually put in the fourth class, or treated as culls,

The size-grades for fruit-trees are not uniform for the entire country. Much depends on the length of the growing

season and the demands of buyers in particular regions. The size usually comprises height of tree and the caliper or diameter, although the caliper measurement may be omitted as of less importance. Dealers often publish the sizes of stock of various kinds of fruit in the different grades. Following are sizes in parts at least of the northern country:

- Apple, 2 and 3 years, standard, No. 1, 5-7 ft., $\frac{11}{16}$ in. and up
- Apple, 2 and 3 years, standard, medium, 4-6 ft., $\frac{5}{8}$ - $\frac{11}{16}$ in.
- Apple, dwarf, No. 1, 4-6 ft., $\frac{5}{8}$ in. and up
- Apple, dwarf, No. 2, 3-4 ft., $\frac{1}{2}$ - $\frac{5}{8}$ in.
- Pear, 3 years, standard, No. 1, 5-7 ft., $\frac{11}{16}$ in. and up
- Pear, 3 years, standard, medium, 4-6 ft., $\frac{5}{8}$ - $\frac{11}{16}$ in.
- Pear, 2 years, dwarf, No. 1, 4-5 ft., $\frac{5}{8}$ in. and up
- Pear, 2 years, dwarf, No. 2, 3-4 ft., $\frac{1}{2}$ - $\frac{5}{8}$ in.
- Quince, 2 years, No. 1, 4-5 ft., $\frac{5}{8}$ in. and up
- Quince, 2 years, No. 2, 3-4 ft., $\frac{1}{2}$ - $\frac{5}{8}$ in.
- Peach, 1 year, No. 1, 4-5 ft., $\frac{9}{16}$ in. and up

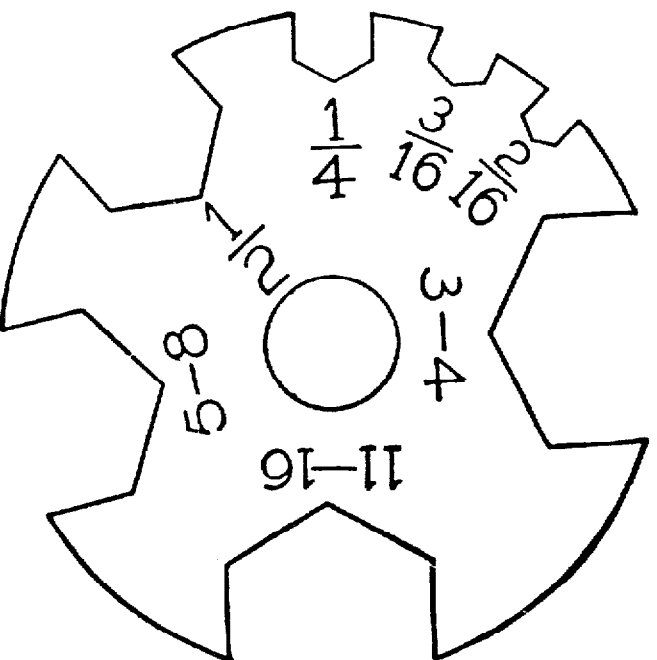

FIG. 205. Another form of tree gage.

Peach, 1 year, medium, 3-4 ft., $\frac{7}{16}$ - $\frac{9}{16}$ in.

Plum, 2 years, No. 1, 5-7 ft., $\frac{11}{16}$ in. and up

Plum, 2 years, medium, 4-6 ft., $\frac{5}{8}$ - $\frac{11}{16}$ in.

Cherry, sour, 2 years, No. 1, 4-6 ft., $\frac{11}{16}$ in. and up

Cherry, sour, 2 years, medium, 3-4 ft., $\frac{5}{8}$ - $\frac{11}{16}$ in.

Sweet cherries will run about 1 ft. taller.

Stocks for grafted fruit-trees

A fruit-tree may be budded or grafted on seedling or cutting-grown stocks of the same species of plant, or on stocks of a related species. The practice is determined wholly by the cheapness of the stock and the ease with which it can be grown and worked, except that in the dwarfing of trees a special definite kind of stock must be supplied. It does not follow that the stocks now commonly used are intrinsically the best. The subject is much in need of careful investigation not only in the nursery but throughout the lifetime of the resulting orchards.

The choice of stocks has usually not gone beyond the species, whether, for example, the cherry shall be worked on mahaleb which is *Prunus Mahaleb* or on the mazzard which is *Prunus avium*, whether cultivated persimmon shall be budded on *Diospyros Kaki*, or *D. virginiana* or *D. Lotus*. Soon, however, we must refine our processes much more than this. We exercise particular care in the variety to be propagated for the top or over-ground part of the plant. We must also discriminate as to the variety, rather than the species, of the stock or under-ground part. We shall find ways to propagate varieties and strains of stocks as we now have ways to reproduce exactly the varieties and strains of the fruit-bearing or flower-bearing part. This may increase the expense of the finished plant, but the time is coming when we must reduce the sources of failure to the minimum and be willing to pay for the extra certainty. We must foresee the time when a man may plant an orchard with all human assurance of

exact results: the character of the stocks must be one factor in the program (page 169). Here opens an important prospect in nursery practice.

The reader will find the customary stocks mentioned under the different entries in Part II (Nursery-List), but it may be well to bring together a brief statement at this place.

The almond is worked on seedlings of almond, peach, myrobalan plum, and *Prunus Davidiana*.

The apple is grown on seedling stock of the same species, *Pyrus Malus*. It is dwarfed by working any variety on the Paradise or Doucin, which are dwarf forms of the apple, grown from mound-layers. The seedling stock is grown extensively in Kansas at present and is also imported from France.

Apricot is grown on seedlings of apricot, peach, and several kinds of plum.

Cherries are grown on mazzard stocks, which is a half-wild form of the sweet cherry, *Prunus avium*, and on mahaleb, which is a distinct species (*Prunus Mahaleb*) that does not produce edible fruit. Sweet cherries are supposed to do best on mazzard and sour cherries on mahaleb, but they are likely to be worked rather indiscriminately.

Chestnuts, whether American, European or Japanese, are mostly worked on native American stocks. Three species of *Castanea* are involved here.

Grapes are grown from cuttings. In regions where phylloxera renders the growing of the wine grape (*Vitis vinifera*) impossible on its own roots, the varieties are grafted on American stocks, chiefly on *V. vulpina* (riparia).

Orange is worked on sour orange stock, rough lemon, grapefruit and trifoliata, all representing different species and the trifoliata now considered to be of a distinct genus (*Poncirus*).

Peach is budded on seedling peach stocks, the seeds being obtained mostly from run-wild trees in the southern states.

Pear is grown on seedling stocks of the same species (*Pyrus communis*) imported from France; also to some extent on American-grown seedlings of Kieffer, and on American-grown and imported stock of the oriental sand pears (*Pyrus serotina*, *P. ovoidea* and perhaps others). The pear is dwarfed by budding it on Angers quince, which is mostly mound-layered.

Pecan is grown on seedling pecan, and sometimes top-worked on established native trees.

Persimmon is of two species, the oriental kaki (*Diospyros Kaki*) and the native (*D. virginiana*). Both kinds are worked on native seedlings, although *D. Lotus* and one or two other oriental species will probably be considerably used in the future for the kaki.

Plum is handled on a variety of stocks. Most of the common plums of the European type (*Prunus domestica*) and the Japanese plums (*P. salicina*) are budded on imported myrobalan plum (*P. cerasifera*). Stocks of common and Japanese plums may be used when seeds can be had and when it pays to grow the seedlings in this country. The American or native plums are worked mostly on seedlings of the native species, and also on Marianna which is sometimes grown from cuttings (probably a hybrid of *P. cerasifera* and a native species).

Quince. — The large fruit-bearing varieties are sometimes worked on imported Angers quince, which is propagated by mound-layerage. The common quince itself may be grown directly from cuttings and mound-layers.

Walnut of the Persian or so-called English type is worked on native walnut stock. In California, the native *Juglans Hindsii* is mostly used; *Juglans nigra*, the black walnut of the East, may also be employed.

The dwarfing of fruit-trees

The dwarfing of trees depends on two factors, — working on a slow-growing stock, and subsequent confining of roots and heading-in. In particular cases, dwarfing is accomplished by growing the trees in pots or boxes. The nurseryman supplies the first factor, — the tree united to the dwarf root. But this factor alone rarely insures a permanently dwarf tree. The vigorous top soon imparts some of its habit to the stock; and if the tree is planted so deep that the union is a few inches below ground, roots may start from the cion, and the tree will become half dwarf, or even full standard.

The possibility of keeping the tree dwarf lies mostly with the grower, although, unfortunately, the grower usually ascribes it wholly to the nurseryman. An excellent illustration of all this is afforded by the cherry. If cherry trees are to be dwarfed, they are worked on the mahaleb cherry; and yet the

greater part of the sweet cherries, and some of the sour ones, are budded on mahaleb roots in eastern nurseries, but cherry trees are not dwarfs thereby. If, however, the grower were to head-in his mahaleb-worked cherries each year, as he is advised to treat dwarf pears, he would be able to have dwarf trees. In like manner, the plum on the myrobalan, the peach on the plum, the apple on the Doucin or even on the Paradise, soon cease to be dwarfs if allowed to grow to their utmost. The pear on the quince affords the most complete dwarf fruit-tree we have, but even this usually soon ceases to be a true dwarf if heading-in is neglected.

Many varieties of plants are dwarf by nature, and they therefore do not require to be worked on slow-growing stocks. The Paradise apple is itself such a natural dwarf, and was originally a seedling. Dwarf spruces, pines, viburnums, beans, dahlias and scores of other plants are well known. Such dwarfs are generally propagated by means of cuttings, although some of them, as the garden vegetables and annual flowers, reproduce themselves from seeds.

With the large areas devoted to fruit-growing in North America, the relatively low price of land and high cost of labor, and the great quantities in which fruit is desired, the dwarf tree is not much in demand.

Pedigree trees

Formerly the wood for buds and cions was taken more or less indiscriminately from nursery-row or other trees of the desired variety. Now, however, bud-wood or cion-wood is chosen with more care from trees of recognized vigor and prolificacy, and the product is advertised as pedigree stock. Of course it is not a pedigree product in the sense in which the term is employed by plant-breeders, for there is no record and no line of breeding. It is merely a form of selection.

One never knows what the so-called "pedigree" may mean in any case or whether it is actually worth an additional price. Yet the exercise of care in any part of the nursery operation is commendable and ought to express itself in the product. There is reason to think that parentage counts in bud-propagation, although there is not the scope for variation and breeding that there is in seed-propagation. The bud-selection work of Shamel in oranges is significant. Nurserymen should encourage a careful selection-product.

Trimming trees in the nursery

One of the prime efforts of the nurseryman is to make his trees stocky. Many factors conspire to produce this result. Any treatment that makes trees grow vigorously may be expected to contribute to their stockiness, if the grower does not circumvent it by some subsequent operation.

Fruit-trees should be given plenty of room. The rows in the nursery should stand $3\frac{1}{2}$ feet apart, for ordinary fruit-trees, and the plants should stand 10 inches or a foot apart in the row. The first year the leaves should not be rubbed off the bodies of the trees, else the trees will grow too much at the top and become too slender. If, however, strong forking or side branches appear low down — as often happens in sour cherries — they should be removed. Budded or whole-root stock of fruit-trees should reach a height of 4 feet or more the first year. The following spring, the stock is headed-in uniformly, reducing it to the height of 3 or 4 feet, according to kind and the uses for which the stock is grown.

Soon after the trees are headed back the second spring, they are "sprouted." This operation consists in hoeing the dirt away from the base of the tree and cutting off all sprouts that start from the root or the crown. After heading-in, the tree "feathers out" from top to bottom. It is a common practice

to rub off these new shoots that appear on the body, allowing only those shoots to remain that spring from near the top of the trunk, and which are presumed to form the top of the future tree. This rubbing off the side shoots early in the second season is generally to be condemned. It tends to make the tree grow top-heavy, whilst the body remains spindling and weak. Usually a better plan is to allow the shoots to remain until July or early August, when they are cut off close to the trunk. The wounds then heal over, or nearly so, by fall, and the tree will have grown strong and stocky.



FIG. 206. Trees heeled-in. —
A single row only.

The tendency at present is to start the heads of fruit-trees much lower than formerly. Trees carried over to two years in the nursery are usually not headed higher than 24 to 28 inches.

The storing of trees

Trees are harvested mostly in autumn. The grower stores them for easy access in winter and spring and to avoid the spring rush. The grower likes to order his stock in autumn, that he may be sure of receiving it, have it on hand when he is ready to plant, and get his choice of varieties and grades.

If the purchaser is not ready to plant in autumn, he stores the stock over winter by heeling it in (Fig. 206). When heeling-in trees in the open for the winter, care should be exercised to choose a well-drained and protected place. The roots are placed in furrows and covered, and the tops are laid down almost horizontal. Another row is lapped over the first, much as shingles are lapped over each other. Loose straw or litter should be removed or tramped down, else mice may nest in it

and girdle the trees. An excellent device to keep mice out of a heeling-in yard is to place a foot board on edge all about the place, leaning the top out a little. Hold the boards in place

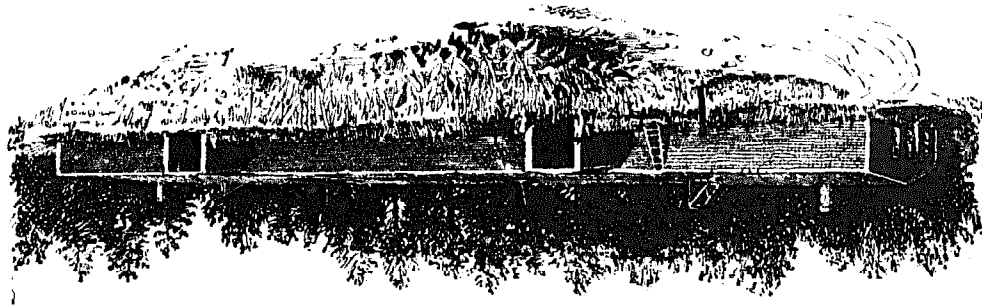

Fig. 207. Store-house for nursery stock, partly beneath the surface.

by stakes, close up the cracks and tramp the earth against the bottom of the boards, and the mice are fenced out. If it is necessary to cover the tops of peach and other tender trees, evergreen boughs may be found to be a satisfactory protection.

Within a generation, the nursery business has been greatly benefited by the free use of cellars for the storing of stock. In

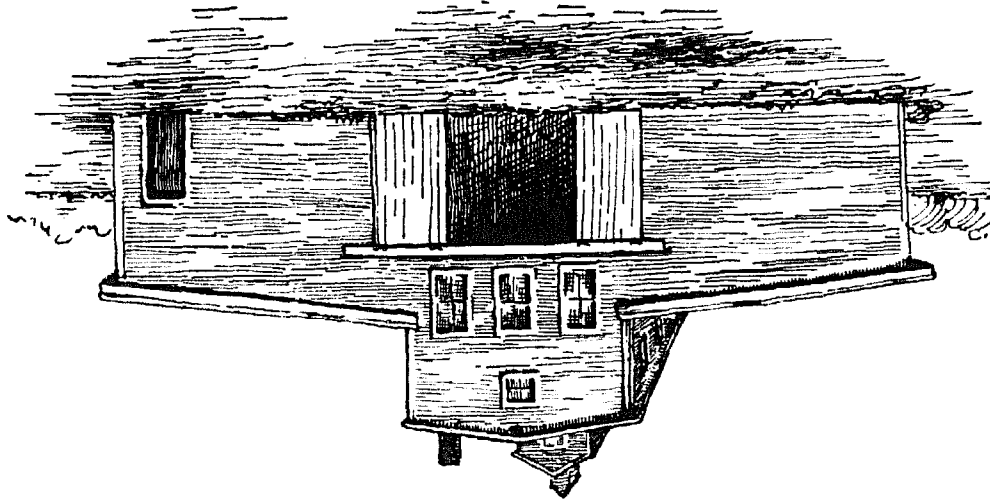

Fig. 208. Store-house or "cellar."

these cellars the stock is safe from winter injury, and it can be moved to customers before the land is fit to dig in the spring. These cellars make the nurseryman somewhat independent

of conditions of weather and trade, and they insure to the planter quick delivery of stock that shows no winter injury. A common style of nursery cellar is shown in Fig. 207 and another in 208; a combined storage- and packing-house is presented in Fig. 209. The store-house is provided with ample facilities for ventilation, either by means of windows along the sides or flues in the roof, or both. It has an earth floor. In this building, the trees are heeled-in very thickly in the fall. They either are stood straight up, or they may be piled in tiers. These tiers are made up of overlapping horizontal layers laid

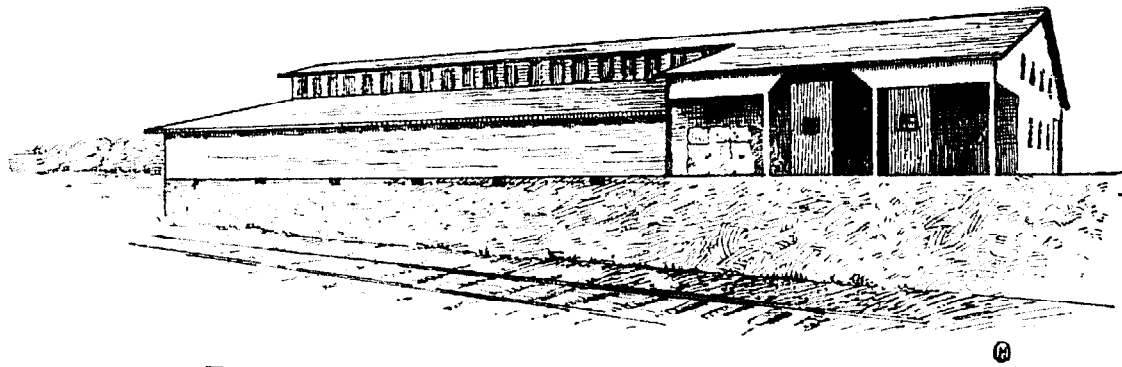

FIG. 209. Combined storage- and packing-house.

in opposite directions. The roots of the first layer are laid towards the center and damp sand thrown over them. On these are laid the roots of the second layer, with the tops in the opposite direction. Earth is again thrown on, when another layer like the first is added. The tops, therefore, are always outward. These tops should lie a little higher than the roots, and in order to raise them, and also to bind the pile, scantlings or boards are often laid crosswise of the layers, at the outward end, at intervals. Moss may be used in place of sand, although the latter is more easily obtained and kept, and is generally used. In piling or cording trees in this fashion, it is important that a sufficient passage or alley be left between each pile to admit of free circulation of air. A passage through which a man can just pass is sufficient. A cellar one hundred feet

long, twenty feet wide and ten feet high in the clear, will winter about 25,000 three-year-old apple trees, if the trees are corded, as already described.

While ventilation should be provided, the house may nevertheless be kept close in cold weather. If the temperature runs but little above freezing, there is little withering nor does mold develop. Some houses are provided with refrigeration. Keeping houses too warm and allowing air to blow through are likely to devitalize the stock.

IMPORTANT DISEASES AND INSECTS AFFECTING NURSERY STOCK

Prepared for this Manual by the late V. B. Stewart, Bureau of Plant Industry, United States Department of Agriculture, and of Cornell University, specialist in nursery-stock diseases. Fumigation and inspection, not dealing with the growing and perfecting of the stock, are not treated here. Growers will do well to consult such works as E. F. Smith on "Bacterial Diseases of Plants" (Sanders, Phila.), and the Rural Manuals by Hesler & Whetzel, Rankin, Slingerland & Crosby.

The important problem confronting nurserymen is the production of the greatest quantity of first-class stock to the acre within the shortest period of time. Such conditions as weather, soil, cultivation, and presence of certain destructive diseases, are some of the factors that influence the development of nursery plantings. Of particular importance is the effect of various plant diseases and insects. The stock may have developed very rapidly and be perfectly healthy, when within a very short time conditions may change and the plants become seriously injured or totally ruined by a destructive disease or insect.

The losses in the nursery caused by diseases are often very heavy. Some diseases, such as fire-blight, completely destroy the stock attacked unless the disease is eradicated by cutting out the affected parts. Other diseases affect only the foliage and are a menace to nursery stock by causing the leaves to

fall prematurely, thus retarding the development and growth of the plants. Not only does this condition make it necessary for a longer time to elapse before the stock is salable, but premature defoliation also prevents proper maturation of the trees and makes them less able to withstand winter injury, adverse conditions encountered in storage, and the like.

Methods commonly practiced for the prevention of diseases of older and maturer plants are in many cases not applicable to the smaller stock in the nursery, while in many cases certain methods of control can be employed in the nursery which could not be used in the treatment of mature plants.

One of the important problems confronting the nurseryman is a satisfactory means of applying the various fungicides and insecticides. An apparatus is desirable that will apply the material with the least inconvenience, permitting the work to be performed with considerable rapidity on a wide acreage and as economically as possible. The materials may be applied in a powdered form with air used as a carrier, or as a spray with water as a carrier.

For spraying nursery stock, there are numerous hand-sprayers that can be used for small plantings, but there is no power machine on the market that is entirely satisfactory for large nursery work. It is difficult to build a machine that can be transported over tall nursery trees. On the other hand, the narrow space separating the nursery rows makes it difficult to construct a sprayer that will run between the rows. With the sprayers that have been used, only a relatively small amount of stock can be covered within a given time; this not only increases the expense, but in many cases it is impossible to cover all of the susceptible stock before it is too late for the application to be effective.

Most of these difficulties are overcome when the materials are applied in the powdered form by means of a dusting ma-

chine. With the dust method, the time of application is not limited by soil conditions, inasmuch as the lightness of the outfit permits its transportation at all times; also blocks of trees on rough or hilly ground or in localities remote from an adequate water supply may be protected without unusual difficulty. The dusting method can be employed in controlling a large percentage of the leaf diseases and foliage-eating insects in the nursery. The cost of spraying solutions is less than dust materials. The actual expense for the dust method, however, is practically the same as for the liquid since the handling of a large bulk of water is eliminated, the outfit is less expensive, and the operators are fewer in number.

Diseases caused by fungi and bacteria

The nursery-stock diseases caused by fungi and bacteria are particularly baffling because the organisms are not seen and recognized. In former days these disorders were ascribed to the weather, to electric currents and to other little understood or occult phenomena.

FIRE-BLIGHT. — The fire-blight disease is most destructive on the cultivated varieties of pear, apple and quince. Usually in the nursery it means total loss of the trees affected and often within a comparatively short time thousands of young trees are ruined by its rapid spread through the blocks.

Description. — The limbs, blossoms, twigs and fruit may be attacked. In the nursery the disease is most commonly found in the twigs (Fig. 210). In the case of two- and three-year-old quince stock, however, the trees often blossom profusely in the spring and when this happens blossom-blight (due to the same organism) frequently occurs. The blight usually first appears two or three weeks after the blossoming period. The first evidence of the trouble is the brown and subsequent

blackened appearance of the young leaf tufts and the blossoms, from which the disease extends rapidly into the fruit-spurs.

The wilted and brown or dead appearance of the stem and foliage is the characteristic symptom of the disease in the twigs (Fig. 210). There is generally a viscid milk-white substance exuding in small drops on the surface of the twig or the petioles, which later becomes oxidized into a dark brown gum. The leaves on the affected twigs shrivel and turn brown or black, and resemble foliage that has been killed by frost.

The blight bacteria often work down the twigs into the trunk of the tree and within a short time may extend into the roots.

Cause. — Fire-blight is a bacterial disease, caused by *Bacillus amylovorus*. The bacteria live over winter in diseased areas in the bark, known as cankers.

In the spring, a gummy exudation laden with the germs oozes from the cankers and this

attracts many kinds of insects, as honey-bees, wasps and flies, which carry the bacteria to the blossoms. Other insects, as the tarnished plant-bug, leaf-hoppers and aphids, also spread the blight. While visiting blighted tissues the insect becomes smeared with the gummy exudate and carries the bacteria to the tender twigs. In sucking the sap from the twigs the insect



FIG. 210. Fire-blight. The dead shriveled leaves above the branch show the presence of the disease.

punctures the tissue and thus furnishes a means of entrance for blight germs.

Fire-blight is frequently introduced into seedling blocks by the use of diseased cions cut from blighted trees. The seedlings budded with the diseased buds, not only blight, but the bacteria are carried on the budder's knives to other seedlings. Later, at rebudding time, the budders being unfamiliar with the disease, frequently attempt to rebud the blighted stocks; their knives become infected and the bacteria are transmitted to other seedlings.

The shipment of cions from one nursery to another may also be a means of transmitting the blight, and blight bacteria have even been known to live over in cions used for grafting purposes. In the winter, when the grafts were cut, the grafting knives became infected and transmitted the blight bacteria to grafts made from healthy cions.

Control. — The elimination of blight-disseminating agents is an important consideration in the control of fire-blight. It has been demonstrated that controlling the aphids is frequently an essential step in preventing the spread of blight bacteria.

All sources of infection should be destroyed, such as neighboring blighted orchard trees, and an attempt made to eradicate all traces of the disease as soon as it appears in the nursery. It has proved profitable to remove the blossom-buds on two- and three-year-old quince trees. By removal of the buds before they open, the danger of blossom infection is eliminated. Frequent systematic inspections should be made and all blighted shoots removed and the wounds disinfected with a solution of corrosive sublimate 1 to 1000. If the blight has extended into the trunk, the entire tree should be removed and burned.

CROWN-GALL. — Crown-gall or root-gall is commonly found in many kinds of trees and other plants in the nursery. Fruit-trees, berry bushes and roses are frequently attacked. The

disease is of special importance on the fruit seedlings grown in the western states. Often a large proportion of the seedlings show galls when dug. This is particularly true in case of myrobalan plum seedlings.

Description.—The galls usually appear at the crown of the plant (Fig. 211), but they are also often scattered over the root system and may occur even on the parts aboveground. Mature galls measure from one-half to several inches in diameter. They are dark in color, with a roughened surface. Young galls are small, greenish and soft or even spongy.

The disease may exhibit itself in another form, known as hairy-root. As the name suggests, there is an excessive production of small fibrous roots which cause the hairy appearance.

Cause.—The disease is caused by the bacterial parasite, *Bacterium tumefaciens*. Presumably the bacteria hibernate in the soil and also in the old galls that persist from year to year. The organism is able to live in dry soil for months. When nursery stock is set in infected soil, the bacteria gain entrance through wounds, and produce the galls. Often the disease is spread by cuttings or grafts from diseased plants.

Control.—But little is known with respect to the control of this disease in the nursery. Care should be exercised to avoid the use of diseased cuttings or cions, especially since the bacteria can be spread by means of pruning and grafting tools. Newly planted grafts are often severely affected. The crown-

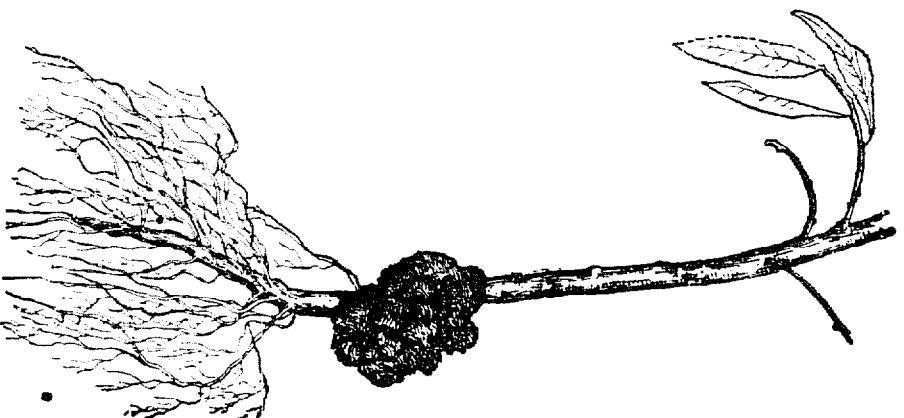

FIG. 211. Crown-gall.

gall infections can be reduced by using a root and cion of approximately the same size and by wrapping the grafts carefully.

APPLE- AND PEAR-SCAB. — The scab diseases exist apparently in every country where apples and pears are grown commercially.



FIG. 212. Scab on apple leaves.

In the nursery, the pear-scab is usually of importance only on the Flemish Beauty buds. The apple-scab is most destructive in the nursery on the varieties McIntosh, Transcendent and Martha.

Description. — The leaves and the fruit and sometimes the twigs are affected. The disease appears on the leaves as olivaceous to dark brown or nearly black spots (Fig. 212). There is a tendency for the lesions to extend along the veins of the leaf, making them irregular in appearance.

Cause. — The scab lesions are caused by the fungi *Venturia inæqualis* and *Venturia pyrina*, which produce a large number of spores in the spots. The spores are disseminated by wind and rain and are responsible for the new infections which occur throughout the summer.

On the diseased leaves that fall to the ground in autumn, special fruiting bodies (perithecia) of the fungi are produced and by this means the organism lives over winter. In spring the perithecia produce spores which attack the new foliage.

Control. — Spraying with lime-sulfur solution 1 to 40, or dusting with 90 parts dry sulfur plus 10 parts powdered arsenate of lead, proves effective in the control of apple- and pear-scab.

For nursery stock, the first treatment should be made soon after the first new leaves appear. This application should be followed by at least three more treatments at intervals of two to three weeks.

As a general recommendation for nurseries, it is not considered necessary to treat varieties of pear trees for scab except the Flemish. In most nurseries it is not necessary to treat apples each year for scab, but in some cases the treatment proves profitable. Where the disease is commonly observed on certain varieties of apples, such as McIntosh and Transcendent crab, spraying or dusting is advisable.

APPLE POWDERY-MILDEW. — This disease is most commonly observed in the nursery on the foliage and young shoots of the apple seedling stock. When it appears early in the summer, the growth of the seedlings is checked and the bark does not peel readily at budding time.

Description. — The disease appears as grayish white, felt-like areas on the foliage, varying in size from a minute speck to an inch in diameter. The diseased leaves are stunted and have a tendency to crinkle and curl up. Affected shoots are stunted and appear much shorter than healthy twigs.

Cause. — The disease is caused by a fungus, *Podosphæra leucotricha*. The grayish patches of mildew on the leaf or the shoot consist of a tangle of fine threads or strands of the fungus. This loosely interwoven mass of threads (known as mycelium) produces spores that are carried by wind and rain to other leaves where they produce new patches of mildew. The fungus lives over winter between the dormant bud-scales or by means of special fruiting bodies.

Control. — Lime-sulfur solution 1 to 40 is effective to a

certain degree, in controlling apple mildew, but the addition of 3 pounds of iron sulfate makes a more effective mixture. Dusting with a mixture of 90 parts sulfur and 10 parts powdered arsenate of lead also has proved satisfactory in checking the mildew.

In some seasons the mildew is more prevalent than in other years, and when the disease is abundant an effort should be made to keep as much as possible of the new growth covered with the fungicide. The first application should be made soon after the seedlings have developed the first new leaves. Three or four subsequent treatments should be made at intervals of two to three weeks.

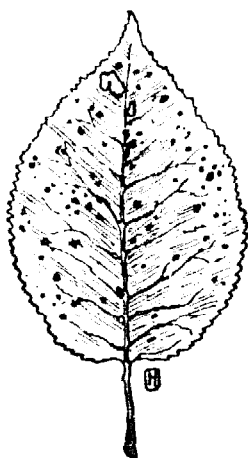

FIG. 213. Yellow-leaf disease of cherry.

YELLOW-LEAF DISEASE OF CHERRY AND PLUM. — The yellow-leaf may be very destructive to nursery trees when weather conditions are favorable. Mazzard cherry seedlings are exceedingly susceptible and often badly defoliated. Mahaleb cherry seedlings are commonly affected, while myrobalan plum seedlings show a considerable degree of resistance. The sweet and sour varieties of cherry and the European varieties of plum are more susceptible to the disease than the Japanese plum varieties.

Description. — The disease appears on the cherry foliage as dark red spots, that may be abundant on the leaves (Fig. 213). In the advanced stages of the disease, a yellowing of the affected foliage may occur and the leaves fall prematurely. On the plum foliage the disease is conspicuous because of the shot-hole appearance of the leaves caused by the dropping out of the circular areas of affected tissue. The same yellowing sometimes appears on diseased plum leaves but never so abundantly as on sweet cherry foliage.

Cause. — The yellow-leaf disease on cherry is caused by the

fungus *Coccomyces hiemalis*, and a similar fungus causes the yellow-leaf or shot-hole of plum. The fungus produces masses of spores that appear as small, white, velvety pustules on the undersides of the leaves, opposite the discolored spots. These spores are produced throughout the summer and being carried by wind and rain to other leaves cause new infections. The fungus lives over winter in the fallen leaves on the ground, and in the spring special fruiting bodies (ascocarps) develop in these old leaves. Spores discharged from the ascocarps produce the first infections that appear on the new foliage.

Control. — Lime-sulfur solution 1 to 50, or a dust mixture of 95 parts finely ground sulfur to 5 parts powdered lead arsenate, is effective for the control of the yellow-leaf disease. The first application should be made when the first-year buds are about six to ten inches high. As a rule, five to seven applications at intervals of about two weeks are sufficient. An attempt should be made to keep as much as possible of the foliage protected throughout the summer. It is usually not necessary to treat myrobalan plum seedlings or the Japanese varieties of plums since the yellow-leaf disease seldom causes much damage on these trees.

POWDERY-MILDEW OF CHERRY. — The mildew of cherry can be recognized by the characteristic upward rolling of the foliage, accompanied by a shortening and an increased thickness of the internodes of the twigs. The curled leaves are covered on the under surface with a tangle of white felt-like threads. Usually after midsummer, small black specks may be observed scattered over the surface of the felt-like mass on the underside of the leaf. The disease is the work of the fungus *Podosphaera oxycantha*.

Control. — The treatments for the yellow-leaf disease of cherry and plum are also sufficient for the control of the mildew.

ANTHRACNOSE OF CURRANTS AND GOOSEBERRIES. — The anthracnose disease often causes heavy defoliation of nursery stock early in the season. Usually the currants are more severely affected than the gooseberries.

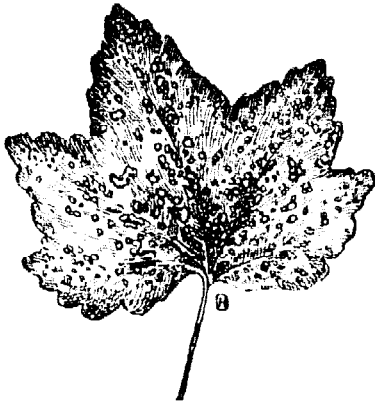

FIG. 214. Anthracnose of currant.

Description. — The disease appears on the leaves as small circular spots, dark brown in color and about one twenty-fifth of an inch in diameter (Fig. 214). Severely affected foliage soon turns yellow and falls prematurely.

Cause. — The disease is caused by the fungus *Pseudopeziza ribis*. Spores of the fungus are produced in the spots on the leaves and being carried by wind and rain to other leaves the spores germinate and produce new infections. Special fruiting bodies (apothecia) of the fungus develop in the diseased leaves which fall to the ground and these apothecia serve to bridge the fungus over winter. In the spring, spores are produced which affect the new foliage.

Control. — Spraying the bushes with lime-sulfur solution 1 to 40, or dusting with a mixture of 95 parts finely ground sulfur to 5 parts powdered arsenate of lead, has proved effective in controlling the anthracnose. It is advisable to make the first application when the leaves are unfolding and other applications at intervals of ten to twenty days until about five or six treatments have been made.

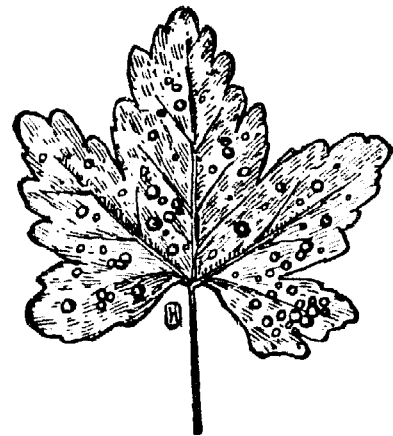

FIG. 215. Septoria leaf-spot of gooseberry and currant.

SEPTORIA LEAF-SPOT OF CURRANTS AND GOOSEBERRIES. — The septoria leaf-spot occurs on various species of *Ribes*. It

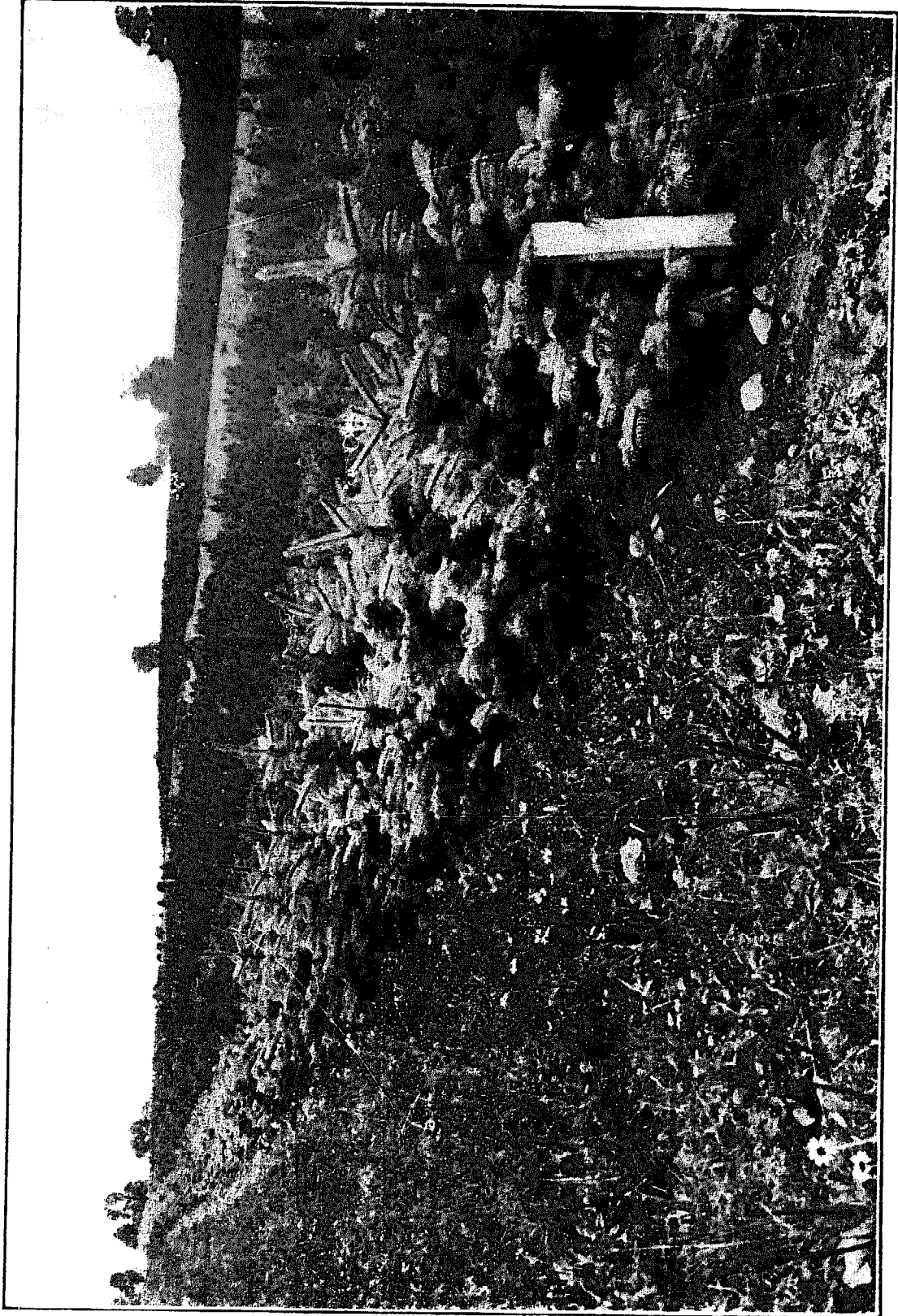

PLATE VII. A good stand of blue spruce.

is often the chief cause of the dropping of currant leaves and may be destructive also on gooseberries.

Description. — The septoria leaf-spot disease causes rather large angular lesions with grayish centers and brown borders. Within the grayish center of old spots may be observed several minute black specks. The spots may be few or many on the leaf; when they are numerous, the leaf turns yellow and falls prematurely (Figs. 215, 216). The septoria leaf-spot is distinguished easily from the anthracnose disease by the much larger and well-defined lesions, with characteristic light-colored centers.

Cause. — The disease is caused by the fungus *Mycosphaëlla grossulariæ*. The minute black specks in the center of the old spots are fruiting



FIG. 216. Septoria leaf-spot of currant and gooseberry.

bodies (pycnidia) of the fungus. The pycnidia contain spores which are disseminated by the wind and rain, and are thus a means for further spread of the fungus. Falling on currant or gooseberry leaves, the spores germinate and produce new infections. The fungus lives over winter in the old leaves on the ground and in the spring special spores are produced that attack the new foliage. As with most leaf-spot fungi, heavy rains, followed by damp cloudy weather, greatly augment the spread of this parasite.

Control. — Measures suitable for the anthracnose disease control also the septoria leaf-spot. The first application

should be made soon after the new leaves are pushed forth in the spring. Four or five subsequent applications should be made at intervals of ten to twenty days.

THE GOOSEBERRY MILDEW. — The gooseberry mildew is often very destructive, and it occurs in all parts of America where gooseberries are grown. It is known to affect currant bushes also. The European varieties of gooseberries, such as Smith and Whitesmith, are more susceptible than the American varieties. The Houghton is the most susceptible of the American varieties.

Description. — The leaves, the stems and the fruit are attacked. In the nursery the mildew is commonly observed on the tips of the young shoots as white felt-like spots. The mildew spots continue to enlarge and may almost completely cover the tips, extending for some distance down the shoots. If the disease is very severe the new growth is destroyed, and the older wood may be considerably injured.

Cause. — The mildew is caused by the fungus *Sphaerotheca mors-uvæ*. This fungus is similar to the organism causing the mildew on roses and resembles in many respects the mildew of apples. Spores borne in the white patches of fungus mycelium on the shoots are a means of further spreading of the parasite. After midsummer, specialized fruiting bodies (perithecia) are produced in the old mycelial patches of mildew on the twigs, and these fruiting bodies carry the fungus over winter.

Control. — Lime-sulfur solution 1 to 40, or a dust mixture of 95 parts sulfur and 5 parts lead arsenate, is effective for the control of this disease. The first treatment should be made early in the season as soon as the mildew appears, and subsequent applications should be given according to the prevalence of the mildew; if very abundant, three or four sprayings at intervals of eight to twelve days may be necessary to protect the developing shoots.

PEACH LEAF-CURL. — Peach leaf-curl is distinctly peculiar to the peach and to forms derived from it, such as the nectarine. In the nursery the damage caused by the leaf-curl is particularly noticeable from the fact that the young trees are affected when in the most critical stage of development, — just as the grafted buds start to grow in the spring. A large proportion of affected buds fail to develop into first-class trees.

Different varieties grown under similar conditions show marked differences in susceptibility to the disease; however, there is considerable variation in the susceptibility of any particular variety when grown under diverse conditions. Usually the Carman and Elberta show less resistance than most varieties.

Description. — The first evidence of the disease is the arching and reddening of the affected areas in the young unfolded leaves as they be-



FIG. 217. Leaf-curl of peach.

gin to protrude from the opening bud-scales. The lesions may be confined to a part of the blade or the petiole, or they may involve the entire leaf and extend into the twig (Fig. 217). The diseased parts are thick and brittle, causing a considerable increase in weight of the affected leaves. With the maturation of the leaves, the pale yellow or red color disappears and the hypertrophied area on the upper surface becomes silvery in appearance. The first leaves to expand are usually the most affected, and the curled leaves finally die and

drop from the tree. The sickly yellow curled foliage and the distorted shoots of the young buds are the striking characters of this disease in the nursery. Also, the badly affected trees are considerably shorter than the healthy stock.

Cause. — The disease is caused by the fungus parasite *Eroascus deformans*. Although not definitely determined, it is presumed that spores of some kind which propagate the fungus are lodged by wind or rain among the hairs of bud-scales of the host plant in spring, and remain dormant over winter. In spring the spores germinate during rains, which cause the buds to swell, and the germ-tube of the spore, passing in between the loosened bud-scales, penetrates and establishes the parasite within the young leaf tissues.

Control. — Bordeaux mixture or lime-sulfur solution 1 to 16 is very effective in the control of peach leaf-curl. Only one spraying is necessary, but it is essential that this application be made before growth starts in the spring and the buds have started to swell. Every bud must be completely coated with the fungicide. It is advisable to spray each year as an insurance against the disease. The spraying should be done as soon as the peach stocks are "snagged" and before the rush of spring work begins. If it is desired to control San José scale also, an application of lime-sulfur solution 1 to 9 will control both the scale and the leaf-curl disease.

LEAF-BLIGHT OF PEAR AND QUINCE. — In the nursery the leaf-blight disease is usually found in abundance on budded quince stock and pear seedlings; it also occurs on cratægus and apple. All standard varieties of quince and pear are affected. Frequently the disease causes heavy defoliation.

Description. — The disease appears first on the leaves as small discolored areas on the upper surface. The spots become carmine-red in the center, with dull borders and finally penetrate to the lower surface. The color soon changes from

red to dark brown, and a minute slightly elevated black area appears in the center of the spot.

The spots are circular in outline and may be so numerous as to involve most of the leaf tissue. When the trees are severely attacked the leaves turn yellow or brown, especially those of quince, and readily fall. The disease also affects the twigs to some extent. Leaf-blight may be distinguished from the septoria leaf-spot as the spots are smaller, more colored when young, and somewhat more circular. The septoria spots are apparent on the under surface of the leaf. In the nursery, septoria spot is generally found on budded pears, while leaf-blight is commoner on quinces and pear seedlings (Fig. 218).

Cause. — The leaf-blight disease is caused by *Fabræa maculata*. The small black specks previously mentioned, which develop in the center of the affected areas of the leaf, are the reproductive bodies (acervuli) of the fungus. Within the acervulus spores are developed, which on being discharged are carried by wind and rain to the foliage. Under favorable conditions, with the presence of moisture, the spores germinate and produce new infections. In this way the fungus is propagated throughout the summer. Some of the spores may live over winter on the diseased twigs and produce new infections when growth starts in spring; but no doubt the greater proportion of infections in early spring is due to the sexual stage (perithecia) of the parasite. The perithecia develop on the fallen leaves, and the next spring discharge many spores which produce the first infections of the season.

Control. — Spraying with lime-sulfur solution 1 to 40, or dusting with a mixture of 95 parts finely ground sulfur and

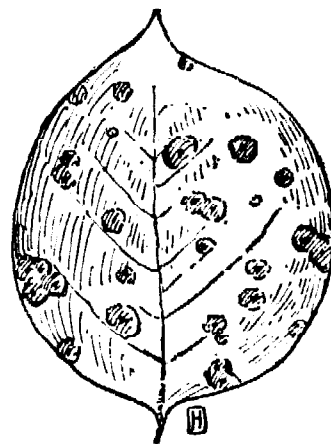

FIG. 218. Leaf-blight of quince.

5 parts powdered lead arsenate, will control the disease. It has been the experience of the writer that, as a rule, the treatment of pear buds for leaf-blight is not necessary in the nursery. For budded quince stock, the first treatment should be made soon after the first leaves are developed or when the young bud-shoots are from eight to ten inches high. Subsequent treatments should follow at intervals of about two weeks until five or six applications have been made.

SEPTORIA LEAF-SPOT OF THE PEAR. — The leaf-spot of pear is confined to the foliage, and in the nursery the budded stock is most susceptible.

Description. — The spots on the leaves are angular in shape; the outer part of the affected area is brown or black in color, while the well-differentiated center is light gray, with six to twelve minute black specks which are especially apparent in old lesions. The grayish center is somewhat transparent.

Cause. — The disease is caused by the fungus *Mycosphaëlla sentina*. The black specks (pycnidia) in the center of the spot contain spores that escape and throughout the summer spread the disease. The fungus lives over winter in the diseased leaves on the ground.

Control. — The treatment recommended for the control of the leaf-blight of quince and pear is also effective for the control of the septoria leaf-spot.

RASPBERRY YELLOWS. — This disease is usually found only on red raspberries. The black-caps and purple varieties are seldom affected. Diseased plants are stunted, sickly and make a bushy growth. The leaves are abnormally small and the margins of the upper leaves curl downward. One of the striking symptoms of the disease is the mottled appearance of the foliage; at first it is light colored, then gradually changes to darker green and finally is reddish bronze.

As yet the causal nature of raspberry yellows is unknown and no satisfactory method of controlling the disease has been perfected.

RASPBERRY AND BLACKBERRY ANTHRACNOSE. — The anthracnose disease is more common on the raspberry than on the blackberry. In general, black raspberries are more susceptible than the red varieties.

Description. — All parts of the plant above ground are affected, but the disease causes the greatest damage on the canes (Fig. 219). The spots on the canes are elliptical, purplish in color with a grayish white center. The purplish margin is slightly raised and thus the healthy and diseased tissues are sharply separated. In advanced stages the spots coalesce and the canes appear blotched. The disease is caused by the fungus *Plectodiscella veneta*.



FIG. 219.
Anthracnose
of raspberry.

Control. — In controlling the anthracnose disease, it is advisable to set only clean anthracnose-free plants. Spraying with bordeaux mixture 4-4-50 also tends to keep the disease in check. The first treatment should be made soon after the new leaves appear in the spring and three or four subsequent applications should follow at intervals of about two weeks.

BLACK-SPOT OF ROSES. — The disease known as black-spot, leaf-blotch or leaf-spot is one of the most destructive diseases on roses. In nurseries the rose plants severely affected become defoliated in summer, in many cases causing the leaf-buds, which should remain dormant until the following year, to open late in the season.

Description. — The symptoms of the disease are black soot-like blotches on the upper surface of the leaves (Fig. 220).

The spots are first small, but they increase in size to a half inch in diameter. Often a number of spots coalesce involving a considerable part of the leaf tissue. A very marked character is the fringed border of the spots. Severely affected leaves usually turn yellow and fall prematurely.

Cause. — The cause of the disease is the fungus *Diplocarpon rosæ*. Spores of the fungus which are borne in the black spots



FIG. 220. Black-spot of rose.

on the leaves are disseminated by wind and rain to new foliage where they produce new infections. Special fruiting bodies which develop in the diseased leaves that fall to the ground carry the fungus over winter.

Control. — Bordeaux mixture, or a dust mixture consisting of 95 parts finely ground sulfur and 5 parts powdered lead arsenate, will control the black-spot disease. The first application should be made in early summer, soon after the first new

leaves are developed. Four or five subsequent treatments should be made at intervals of about two weeks.

MILDEW OF ROSE AND PEACH. — Mildew is found on both the peach and the rose, but it is commoner on the latter. As a rule, peach mildew is of little importance in the nursery, but rose mildew often causes considerable damage. The disease on roses checks the growth of the plants in the field, and some growers are of the opinion that severely mildewed rose stock does not keep well in storage. The affected shoots tend to

decay when subjected to the moist condition of the storage cellar.

Description. — The leaves, the blossom buds and the young shoots of roses are affected by mildew. The disease appears as white irregular blotches, causing the leaves to become curled and dry. The bark of severely affected shoots becomes dead in appearance and shrivels, causing an arching or a curving of the shoots at the tip. Only the current year's growth is affected.

Cause. — The fungus *Sphærotheca pannosa* is the cause of the mildew on peach and rose stock. Spores of the fungus are produced in the white blotches of mildew and these propagate the parasite throughout the summer. After midsummer the special fruiting bodies known as perithecia also may be produced and these serve to carry the fungus over winter.

Control. — Most copper sprays have not proved effective in controlling this disease. A sulfur dust-mixture is more effective than bordeaux mixture or lime-sulfur solution. Applications of a dust mixture employed in the control of the black-spot of roses will also prove effective in checking the mildew.

Insect pests of nursery stock

The insect depredations in the nursery are probably better known as to kinds and causes than the diseases, yet some of them are difficult of control. The treatment for diseases and pests is often much the same, if not even identical, and therefore the two should be understood together.

PLANT-LICE OR APHIDS. — There are numerous species of sucking insects, known as aphids, infesting various kinds of nursery stock, as apple, quince, rose, cherry and certain ornamentals (Fig. 221). The plants are frequently seriously injured, the leaves being badly curled and the growth checked.

Often the aphids secrete a sweet liquid known as honey-dew in which a black fungus develops and gives the infested foliage and twigs a sooty appearance. The green colored species (*Aphis pomi* and *Aphis sorbi*) are commonly found on apple and quince, while cherry buds are often attacked by a black-colored species (*Myzus cerasi*).



FIG. 221. Newly hatched aphids clustering on an opening apple bud.

Control. — The aphids lay small shiny black eggs on the twigs in autumn. Spraying in October with tobacco extract, $\frac{3}{4}$ of a pint in 100 gallons of water, adding 3 pounds of soap to each 100 gallons to make the liquid spread better, will kill many of the aphids before the eggs are laid. Aphid infestations can be greatly reduced by spraying with the above solution just after the eggs hatch in the spring; the first eggs hatch about the time the buds show green. When the aphids appear in abundance, it is advisable to dip the infested branches into the insecticide. The leaves are usually curled and it is difficult to hit many of the aphids by spraying. Infestations of aphids on apple, pear and quince stock should receive immediate attention as often as these insects are important in the dissemination of fire-blight bacteria.

WOOLLY APHIS. — The woolly aphid on apple, pear and quince, is common in the nursery.

The reddish-brown aphids appear on the trunk and branches and roots as bluish-white cottony patches. The same species also passes a part of its life history on the elm, infesting the leaves and causing them to curl. The woolly aphid sucks its food from the bark and often causes abnormal growth or galls.

The nodular swellings or aphid galls are especially common on the roots of nursery stock. The woolly aphid is known to entomologists as *Schizoneura lanigera*.

Control. — The woolly aphid appears first in summer on the trunk and branches aboveground and it can then be readily controlled by drenching the woolly colonies with 15 per cent kerosene emulsion. The treatment should be made as soon as the aphids appear, and this will prevent many of them from migrating to the roots.

RED-SPIDER. — The minute spider-like, oval-shaped, reddish mites are about $\frac{1}{50}$ inch in length. They are usually found on the underside of the leaves where they live under the protection of a delicate silken web. In feeding, they suck the sap and cause the foliage to turn yellowish in spots. Considerable injury may result from the attacks of these mites, especially in the western orchard and nursery sections of Canada and United States. The foliage of peach, prune, plum, apple, cherry, pear, almond, raspberry, rose and many forest trees is attacked. Two species are involved, *Tetranychus bimaculatus* and the clover mite, *Bryobia pratensis*.

Control. — The clover mite (Fig. 222) lays eggs in autumn on the trunk and branches and the eggs hatch early in the spring. Spraying the hibernating eggs while the trees are dormant with lime-sulfur solution 1 to 9 will prove effective. The red-spider (*Tetranychus*) hibernates throughout the winter in the ground and crawls back to the foliage in

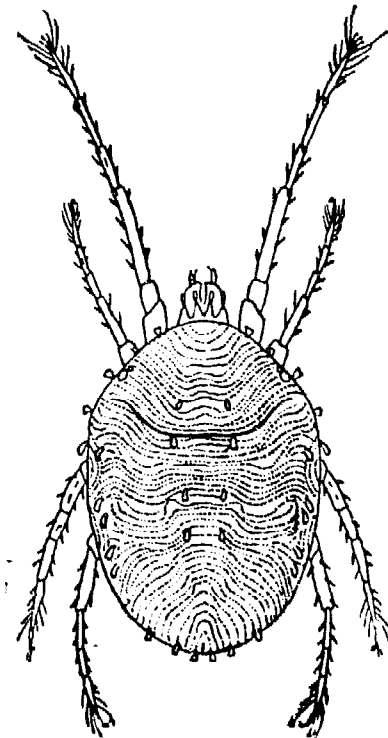

FIG. 222. The clover mite. Redrawn after M. A. Palmer ($\times 37$).

the spring. Dusting the foliage with sulfur will kill the red-spider.

PEAR PSYLLA. — The pear psylla (*Psylla pyricola*) is a minute yellowish flat-bodied sucking insect that occasionally attacks the foliage of nursery pear trees early in the season. The psyllas develop into minute cicada-like jumping lice. The young psyllas secrete a sweet sticky honey dew in which a peculiar black fungus grows, giving the foliage a sooty appearance. There may be four broods annually.

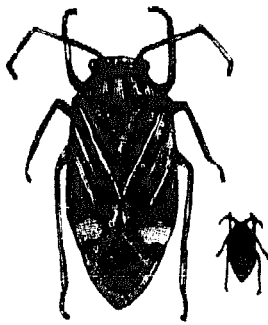

FIG. 223. Tarnished plant-bug.

Control. — Spray for the adult psyllas, during warm periods in December or March, with tobacco extract, $\frac{3}{4}$ of a pint in 100 gallons of water, with 5 pounds fish-oil soap added. Good results have been obtained by making an application of lime-sulfur solution 1 to 8 just after the leaf-buds open in the spring. If the psyllas appear on the new foliage, make another treatment with the tobacco and soap solution.

TARNISHED PLANT-BUG. — This sucking bug (Fig. 223) attacks many species of plants. In feeding, it punctures the buds and tender growing tips and sucks the juices. Peach nursery stock is often seriously injured. The bugs kill the tender tips, causing the tree to throw out lateral branches which are in turn similarly injured, causing an overbranched stunted tree. Pear and apple stock are often attacked but seem able to outgrow the injury more easily than peach trees. This insect is of great importance in spreading the fire-blight bacteria in apple, pear and quince trees. The adult tarnished plant-bug is about $\frac{1}{3}$ inch in length and colored a dull yellowish or greenish, mottled with reddish brown. The species is *Lygus pratensis*.

Control. — The control of the tarnished plant-bug in the nursery is still an unsolved problem.

APPLE LEAF-HOPPER. — The leaf-hopper (*Empoasca mali*) may attack the foliage of apple, currant, rose, gooseberry, raspberry and numerous other plants. These insects (Fig. 224) suck the juice from the leaves, causing them to curl and to assume a mottled yellowish appearance. The insects work mostly on the undersides of the leaves. Feeding on the terminal leaves of the growing shoots in the latter part of June, July and August, they may retard the growth and thus cause such trees as apples to be stunted and undersized.

Control. — It is difficult to hit the young hoppers in the curled leaves by spraying and this method of treatment is not profitable. Dipping badly infested stock with a soap solution, one pound in 8 gallons of water, kills most of the young hoppers. The dipping should be done in the latter part of June and again about a month later. In Missouri nurseries the hoppers are sometimes captured on sticky shields mounted on a two-wheeled cart drawn by a horse.

SAN JOSÉ SCALE. — The San José scale (*Aspidiotus perniciosus*) attacks practically all deciduous fruit and ornamental plants and is often very destructive in the nursery. The insect may be recognized by two forms of scales on the bark and fruit (Fig. 225). The largest scales are about $\frac{1}{16}$ of an inch in diameter, nearly circular, gray, with a central dark nipple surrounded by a yellowish ring. The smaller scales are nearly black with a central gray dot surrounded by a black depressed ring bordered by a grayish ring. Usually the bark appears reddish in color around the scale. When abundant the scale forms a crust on the bark.

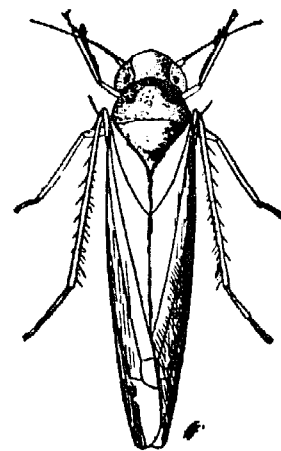

FIG. 224. The apple leaf-hopper, adult (x 11).

The scale multiplies with marvelous rapidity, there being three or four broods annually, and each mother scale may give birth to several hundred young. The young are born alive and breeding continues until late autumn. The small half-grown black scales are resistant to cold weather and many of them hibernate safely.

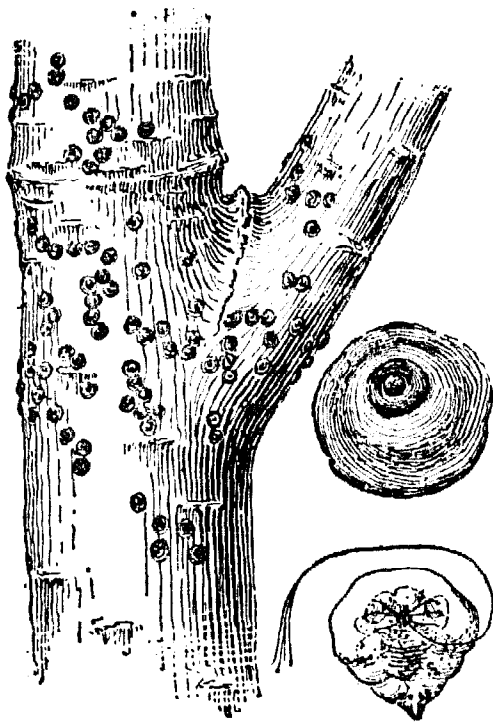

FIG. 225. San José scale.

Control. — San José scale can be controlled by spraying with lime-sulfur solution 1 to 8 in the autumn or spring while the plants are dormant. Cions or cuttings received by nursery-men from another locality should be fumigated with hydrocyanic gas before they are used in order to prevent the introduction of the scale.

THE PEAR SLUG. — This insect (*Eriocampoides limacina*) attacks the foliage of pear, cherry, quince and plum. In the North the small oval eggs appear on the foliage as blisters about the middle of May. About two weeks later the eggs hatch and the dark green larvæ appear on the upper side of the leaf. The larvæ are covered with a sticky slime and have the appearance of small snails. The body is swollen in front and tapers behind like a tadpole (Fig. 226). There may be two or three broods in the summer.

The larvæ feed on the upper surface of the leaves, eating only the epidermis and leaving the skeleton of veins and the lower epidermis to turn brown and wither. Badly injured leaves fall and trees in the nursery may be entirely defoliated by midsummer.

Control. — An application of freshly slaked lime or powdered arsenate of lead will destroy the slugs. The dust mixtures employed in the control of pear leaf-spot or yellow-leaf of cherry will also kill them.

CURRENT WORMS. — The green currant worm (*Gymnonychus appendiculatus*) and the imported currant worm (*Pteronus ribesii*) are often destructive on currant and gooseberry bushes. These worms appear on the bushes two or three weeks after the leaves develop in the spring, and if numerous they are able to strip a bush of its leaves within a few days.

The imported worm is about $\frac{3}{4}$ inch in length, green in color with black spots. The green worm is smaller, has a blackish head but lacks the black spots. There may be three or more broods of the green worm during the summer.

Control. — Applications of a dust mixture or a spray solution containing arsenate of lead will check these insects. The treatment recommended for the leaf-spot diseases on currant will also control the worms if lead arsenate is added to the fungicide.

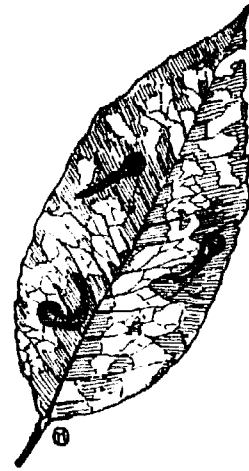

FIG. 226. Pear slugs at work.

PART II
THE NURSERY-LIST

THE NURSERY-MANUAL

THE NURSERY-LIST

This List has been re-compiled for the twenty-second edition. The Editor has had the advantage of many expert advisers. The List has been gone over carefully by Robert Cameron, Botanic Garden, Harvard University; W. H. Judd, propagator for the Arnold Arboretum, Harvard University; J. Jennings, Bobbink and Atkins Nurseries, Rutherford, N. J.; G. W. Oliver, United States Department of Agriculture, Washington, D. C. Special parts have been submitted to experts in many places, from Ontario to Florida and California. Extra care has been taken to make all the statements in the book authentic, but the practitioner assumes his own risk in making applications.

The printed word can never take the place of experience in the propagation of plants; yet the experienced man will probably find a List of this kind of more value than the novice, for he will know what the suggestions mean. It is hoped, however, that the novice will find the List useful in aiding him to acquire experience.

The family to which a plant belongs often gives a clue to the propagation: therefore the name of the family is given after each regular entry. The attention of the consultant is called to certain important group or class entries, as Orchids, Ferns, Palms, Ericaceæ or Heaths, Liliaceæ, Bromeliaceæ, Amaryllidaceæ, Araceæ, Conifers, Cacti, Annuals, Biennials, Perennials.

The consultant should remember that this List deals only with propagation, not with cultivation, transplanting, pruning, breeding, or subsequent care.

Abelia. *Caprifoliaceæ.*

Propagated in spring by layers, and in summer and early autumn by cuttings; seeds in spring, when obtainable.

Abies (Fir). *Pinaceæ.*

Extensively propagated by seeds, which are usually kept dry over winter and sown in spring in frames or in protected borders.

Cones should be matured fully before being gathered. If they hold the seeds tightly, they should be placed in a dry place, sometimes even in an oven, until the scales spread. In some species, as the balsam fir, the cones drop and fall to pieces as soon as ripe, and these cones must be gathered just before they begin to fall. The seeds may be separated by rubbing them in the hands, when they are thoroughly dry, then winnowing them out through a sieve. To obtain stocky plants, the seedlings should be transplanted the following spring.

The named varieties and the species which do not produce sufficient seed are winter-worked on seedling stocks which are potted in the fall. Cuttings of growing tips set in sand in a close well-shaded house or frame are often successful. Stocks the size of a lead pencil are commonly used. One-year-old seedlings are usually preferred, but in some cases the requisite size is not reached until the second or third year. Any of the common operations of grafting may be employed, but the veneer-graft is best. The conifers are not difficult to graft. The European silver fir (*Abies Picca* or *pectinata*) or the balsam fir may be used as a stock, but the common Norway spruce is now the most popular stock for species of both *Abies* and *Picea* (see *Picea*).

Abobra. *Cucurbitaceæ.*

Readily propagated by seeds; also by softwood cuttings.

Abronia (Sand Verbena). *Nyctaginaceæ.*

Propagated by seeds sown in autumn or spring. Sometimes sown in pots of sandy soil, and kept in a frame till the following spring, then placed in their flowering quarters. Also increased by young cuttings, set in spring, in sandy soil. Spring sowing in the open is a common method in this country. The outer coverings of the seed should be removed.

Abrus. *Leguminosæ.*

Propagated by seeds, more quickly by soaking; also by cuttings under glass in sand.

Abutilon (Flowering Maple). *Malvaceæ.*

Propagated by seeds and cuttings. Sow seeds in pans, with same soil and temperature as for cuttings; if planted in March, blooming plants should be secured by autumn. Cuttings may be taken from young wood, at almost any season; the best time is spring

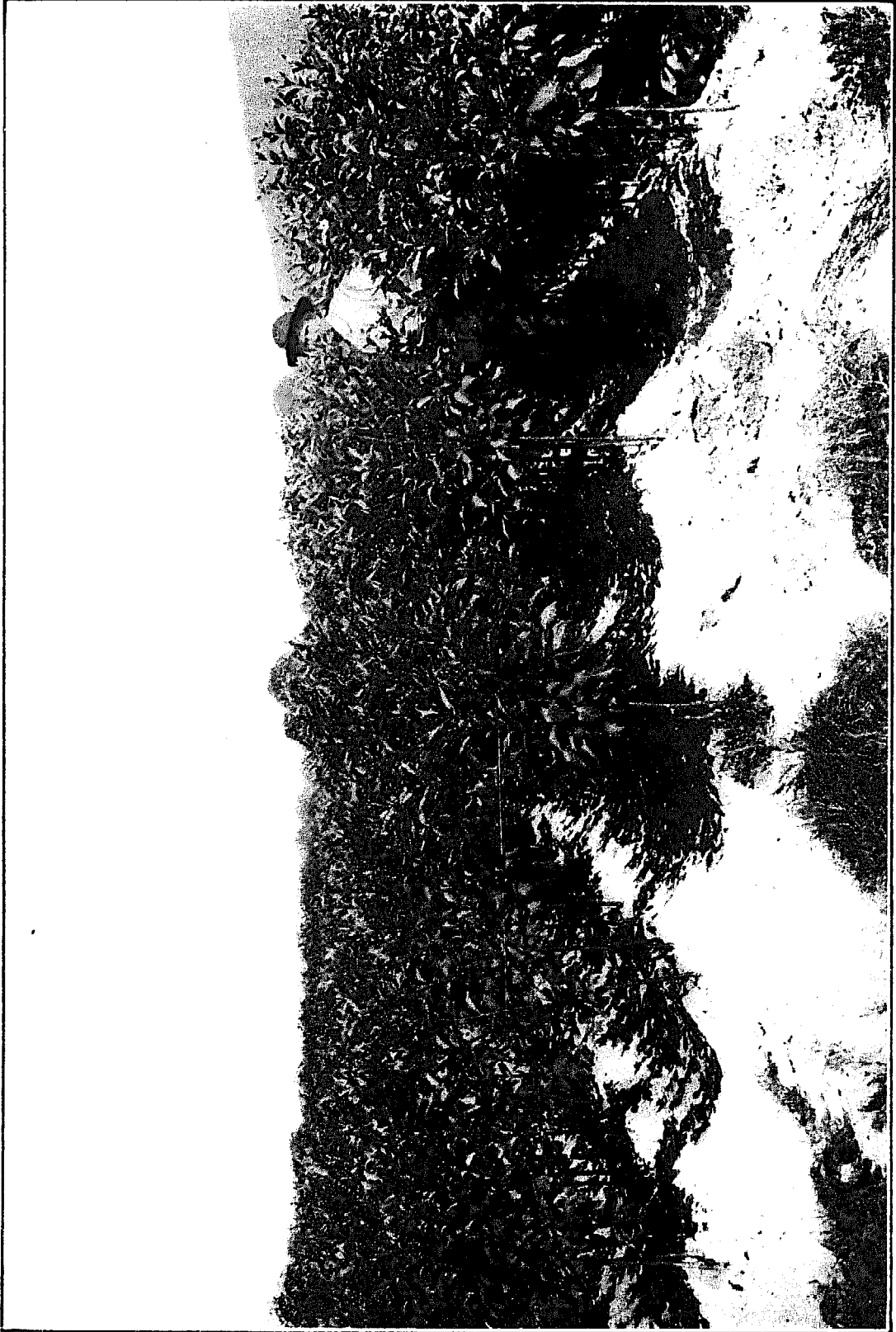

PLATE VIII. A fruit-tree nursery, showing trees two years from the bud.

or fall. The cuttings may be struck in a bench or in pots, in a temperature of 65° to 75°.

Acacia. *Leguminosæ.*

Propagated by seeds as soon as ripe. Soak in warm water twenty-four hours if seeds are not fresh. Keep temperature about 55° or 60°, and pot off when large enough to handle. Also increased by cuttings of the half-ripened wood in a propagating-frame or on a bench. *A. pubescens* is grafted on seedlings of *A. longifolia*, *A. Baileyana* or *A. melanoxylon*; this and some others strike from root-cuttings. See also *Robinia*.

Acalypha. *Euphorbiacæ.*

Readily multiplied by cuttings struck in mild bottom heat. Best results are to be expected from cuttings of well-ripened wood taken with a heel. Old stock plants, kept over winter for the purpose, usually yield best cutting material; but cuttings may be taken directly from plants that may have been bedded in the open, or from cut-back fall-lifted plants. Propagation may be undertaken in autumn or spring.

Acanthopanax. *Araliacæ.*

Propagated by seeds, sown immediately or stratified and sown in spring; also by root-cuttings with bottom heat and by soft-wood cuttings taken from forced plants.

Acanthophœnix. *Palmacæ.*

Handled by seeds, sown in bottom heat, in a well-rotted compost. See *Palms*, page 377.

Acanthorhiza. *Palmacæ.*

Propagated by seeds, sown preferably in spring, in fresh peat over bottom heat. See *Palms*, page 377.

Acanthus (Bear's Breech). *Acanthacæ.*

Increased by seeds in mild heat, and by division in autumn or early spring. Also increased by root-cuttings.

Acer (Maple). *Aceracæ.*

Stocks are grown from stratified seeds, which should be sown an inch or two deep. Some very early-ripening species, as *A. saccharinum* and *A. rubrum* (the silver or soft maple and the red maple) come readily if seeds are simply sown as soon as ripe; they will not keep well until the next spring. Varieties are often

layered, but better plants are obtained by grafting. The Japanese sorts are winter-worked on imported *A. palmatum* (*A. polymorphum*) stocks, either by whip- or veneer-grafting. Varieties of native species are worked on common native stocks. Maples can also be budded in summer, and they grow (usually with some difficulty) from cuttings of soft and ripe wood. Seeds usually grow freely if properly handled. Box elder (*A. Negundo*) grows readily from fresh seeds.

Achillea (Yarrow. Milfoil). *Compositæ*.

Multiplied mostly in spring. Dividing the clumps or stools is the common method. Also by seeds, root-divisions and cuttings.

Achimenes. *Gesneriaceæ*.

Propagated by seeds, sown with care (as the seeds are minute) in well-drained pans, watered with a fine rose. Cover lightly, or not at all, protect from sun, and cover with glass or thin muslin. By leaves in pots as for cuttings, placing all the petiole below the surface, and in bottom heat. By cuttings from any part of the stem; insert in a soil of equal parts of peat and sand, in well-drained pots, in bottom heat; every joint may be used, the leaves not being removed. By rhizomes; remove the scales and plant them as seeds are planted. By scaly buds produced in the axils of the leaves, treated as seeds. See *Gesneriaceæ*, page 318.

Acidantha. *Iridaceæ*.

Propagation by seeds and by corms, usually by the latter after the manner of gladiolus.

Acocanthera. *Apocynaceæ*.

Propagation is by cuttings taken early in the spring.

Aconitum (Aconite. Monk's Hood. Wolf's Bane). *Ranunculaceæ*.

Seeds sown as soon as ripe in a coldframe or border. Also propagated by division of roots in late fall or early spring. Roots are very poisonous.

Acorus. *Araceæ*.

Propagated readily in spring or autumn by division. See *Araceæ*, page 239.

Acrocomia. *Palmaceæ*.

Propagated by suckers. Seeds are not known in cultivation for any species except *A. sclerocarpa*. See *Palms*, page 377.

Actinidia. *Dilleniaceæ.*

Propagated easily by seeds; also by layers and cuttings. Hardwood cuttings should be put in sandy soil, in autumn; cuttings of half-ripened wood may be started in summer in a frame. Seeds should be sown in spring.

Ada. *Orchidaceæ.*

Handled by division when the plant begins to grow. See *Orchids*, page 372.

Adiantum (Maidenhair Fern). *Polypodiaceæ.*

Propagation is by spores, using compost of half each finely screened clean soil and leaf-mold or peat, placing in moderately moist and shady spot in greenhouse in temperature of 60° F. The sporelings will come along if the spores are sown in bunch pots with a pane of glass over them and in a shady place. Also by division of crown and rhizomes, in January or February. *A. Farleyense*, being sterile, must be propagated by division, requiring a higher temperature than other adiantums, 65° to 70° at night and 75° to 80° during the day. See *Ferns*, page 312.

Adlumia (Allegheny Vine. Smoke Vine. Mountain Fringe). *Fumariaceæ* (or *Papaveraceæ*).

Propagated by seeds in spring, sown in a damp cool place. The plant is biennial, blooming the second season only.

Adonis. *Ranunculaceæ.*

Increased by seeds, sown in autumn or early spring. The perennials may be root-divided in very early spring.

Æchmea. *Bromeliaceæ.*

Propagation as for billbergia, which see, page 252.

Aerides. *Orchidaceæ.*

The only method of propagating plants of this genus is by removing the upper part and planting it separately. It should always be severed low enough to include a few roots, otherwise a large proportion of leaves will be lost. A somewhat dense shade, a moist atmosphere and careful watering are essential until the young plant is established. The old stool will soon send out lateral growths, which, in time, may be separated and treated similarly. *Vanda*, *saccolabium*, *anagræcum*, *renanthera*, are increased in the same way. See *Orchids*, page 372.

Æschynanthus: *Trichosporum*.

Æsculus (Horse-Chestnut. Buckeye). *Hippocastanaceæ*.

Propagated readily by stratified seeds in spring, and by layers in spring or autumn; and by grafting or budding on the common horse-chestnut or native buckeye, usually under glass.

Aganisia. *Orchidaceæ*.

Propagated by dividing the pseudobulbs just before growth starts. See *Orchids*, page 372.

Agapanthus (African Lily). *Liliaceæ*.

Propagated by offsets, and more commonly by dividing the old plants in early spring; also sometimes by seeds, if procurable.

Agave. *Amaryllidaceæ*.

Increased by seeds, to secure the production of which the flowers usually need to be pollinated. Propagated more commonly by suckers, which spring naturally from the old plant, or by underground shoots. Some kinds produce buds from the stem which may be detached and planted; a few species bear bulbels in the flower-clusters. The century-plant belongs here.

Ageratum. *Compositæ*.

Easily grown from seeds in the open or started in the greenhouse, growing in any garden soil.

Aglaonema. *Araceæ*.

Propagated by division and cuttings. Put the parts into sand bed previous to potting, to develop new roots. See *Araceæ*, page 239.

Agrostis (Bent-Grass). *Gramineæ*.

Increased easily by seeds, sown in spring in the open; sometimes kept in pots for ornament. Some kinds are agricultural field grasses, sown broadcast or by a drill.

Ailanthus (Tree of Heaven). *Simarubaceæ*.

Propagated by suckers, and by root-cuttings. Seeds are used when large quantities are desired; they grow readily if sown soon after maturing.

Ajuga (Bugle). *Labiataæ*.

Perennials are propagated by seeds sown in the open in spring or autumn, and by division; annuals, by seeds sown where plants are to stand. The plants are readily divided.

Akebia. *Lardizabalaceæ.*

Propagated by seeds, layers of young or ripe wood, cuttings of green or hard wood under glass in summer. Roots are sometimes divided.

Albizzia. *Leguminosæ.*

Propagation as for acacia, which see. The species usually seed freely.

Alchemilla (Lady's Mantle). *Rosaceæ.*

Propagated by seed, and by division of the clumps.

Aleurites. *Euphorbiaceæ.*

Propagated by mature cuttings in sand, under glass. Leaves should not be removed. May also be grown readily from seeds.

Allamanda. *Apocynaceæ.*

Propagation is sometimes by layers. Cuttings of the shoots root well at any time of the year, but spring is usually preferred, as the plants then attain good size before winter. Either old or new wood may be used. Old wood is cut to two or three joints, being taken in spring or late winter from the annual pruning of the plant. Young wood is cut with a heel. Cuttings should be struck in sandy soil in a propagating-box, at a temperature of about 70°. Sometimes the cuttings are started in pots.

Allium (Onion, and onion-like plants grown for ornament).
Liliaceæ.

Easily increased by seeds sown thinly in light soil in early spring. Also propagated by offsets and by bulbels, planting them in autumn or spring 1 to 4 inches deep. See *Onion, Leek, Chives, Garlic.*

Alloplectus. *Gesneriaceæ.*

Propagation as for gesneriads, page 318.

Almonds (*Prunus communis, P. japonica, P. glandulosa, P. triloba,* and others). *Rosaceæ.*

The details of propagating the fruit-bearing (nut-bearing) almonds (*Prunus communis* or *P. Amygdalus*) do not differ materially from those followed in propagating the peach and apricot. Almond seedlings make the best stocks when the soil conditions are favorable, both sweet and bitter almonds being used. When the soil moisture conditions vary widely or where the soil lacks depth or is otherwise at fault, peach seedlings are perhaps prefer-

able to almonds, as stocks. Where irrigation is practiced, preferences are expressed for the peach stocks as they withstand the fluctuating moisture conditions better than the almond. The almond unites well with *Prunus* (or *Amygdalus*) *Davidiana*, the "wild peach of China," and its roots appear to be more resistant to alkali in the soil than are peach roots, but its ultimate influence on the size, longevity, vigor and productiveness of the tree has not been determined. The myrobalan plum has been used as a stock for almonds, and recommended especially for poorly drained soils, but the almond outgrows the plum stock, although the union appears to be strong. The result is a dwarfing of the tree, and apparently such trees do not bear as well as those on almond or peach stocks.

The so-called flowering almonds (several species of *Prunus*) will grow from root-cuttings if on their own roots. Heel-in the plants in fall, and buds will begin to form from the roots in a few weeks; then make cuttings. Results are less satisfactory when cuttings are taken directly on first digging the plants. They are sometimes budded on myrobalan plum stock, but these stocks are likely to sprout or sucker badly and to outgrow the top. See *Prunus*.

Alnus (Alder). *Betulaceæ*.

Propagated usually by seeds, which are gathered in the fall and dried. The seeds are sown in spring under a light covering and the beds are kept moist and protected from sun. Sometimes the bed is covered with a thin layer of moss, which is removed after germination. The seedlings are transplanted the first autumn or the following spring to nursery rows. Alders are also increased by suckers, by cuttings, and by grafting. Hardwood cuttings of some kinds (as *A. glutinosa*) grow in moist sandy soil. Named varieties or rare kinds are sometimes grafted indoors on potted stocks of the ordinary kinds.

Alocasia. *Araceæ*.

Increased by seeds and divisions, as for caladium. Place suckers or cuttings of rhizomes in small pots containing mixture of light fibrous peat and sand in equal proportions, and plunge in close frame or propagating-box with bottom heat. Seeds should be sown in 4-inch pots in light peaty soil, with temperature of 75° F. March is best time for propagating. See *Araceæ*, page 239.

Aloë (Aloe). *Liliaceæ*.

Commonly propagated by suckers, which spring from the base of the plant. Seeds are sometimes employed. When using cuttings, the cut part should be dusted over with powdered charcoal and dried in sunshine before being put in sand to root. See *Liliaceæ*, page 349.

Alonsoa. *Scrophulariaceæ*.

Propagated usually by seeds, sown in spring when weather becomes warm, or started earlier under glass; also by cuttings in sandy soil, in propagating-frame.

Aloysia: *Lippia*.**Alpinia**. *Zingiberaceæ*.

Propagated readily by division in spring; also by firm cuttings of shoots.

Alsophila (Tree Fern). *Cyatheaceæ*.

Propagated by spores. See *Ferns*, page 312.

Alstrœmeria. *Amaryllidaceæ*.

Increased by seeds which should be sown rather thinly in deep pans and allowed to remain without shifting for the first season. Propagated also by a careful division of the fleshy roots, in fall or spring.

Alternanthera. *Amaranthaceæ*.

Much used for carpet-bedding, properly of the genus *Telanthera*. The bedding material is grown from cuttings and division. The cuttings may be made from strong outdoor plants in late summer and carried over winter in flats, being potted off in early spring to get them ready for planting out in their beds. If cuttings are taken in late winter or very early spring from overwintered plants, they will probably not be strong or large enough for good bedding material.

Division of old plants is to be preferred if one has sufficient stock. The old plants are lifted from the beds after the first frosts, cut back to 3 to 4 inches tall, and carried over winter regularly planted in flats. In early spring the plants are divided and all the shoots or parts bearing good roots are potted or else planted with plenty of room in other flats. After four to six weeks they should be large enough to put directly into beds. Both cuttings and divisions are handled in good hotbeds or in a propagating-house.

Athæa (Marsh-Mallow. Hollyhock). *Malvaceæ*.

Increased by seeds, and by division. The biennial species should be raised from seeds every year. See *Hollyhock*.

Alyssum. (*Trucifera*).

Increased by seeds (particularly sweet alyssum and other annuals) sown in the open border or in pans of sandy soil. Also propagated by division and layers and by cuttings of young shoots. The common sweet alyssum (*A. maritimum*) is hardy and seeds may be sown early where the plants are to grow; seedlings also transplant readily. Sweet alyssum is known also under the names *Königa* and *Lobularia*.

Amaranthus (Amaranth). *Amaranthaceæ*.

Readily grown from seeds, which may be sown in the open where the plants are to stand and the seedlings thinned, or started under glass and the plants transplanted.

Amaryllidaceæ. Amaryllids.

Nearly all the plants of this family are bulbous and are readily increased by offsets, suckers, or seeds. The bulbs naturally make other bulbs or give rise to separable parts that are easily usable for propagation. Most of the common amaryllids (as amaryllis, hippeastrum, lycoris, sprekelia, brunsvigia, crinum, pancratium, hymenocallis) are summer or autumn bloomers and make their growth after the flowers are passed. In cold climates the bulbs are lifted in autumn after well ripened or all the possible growth is made, and stored on a greenhouse bench or in a light cool pit with some of the earth adhering. The remaining leaves will then naturally mature, and the bulbs may be kept cool and dormant until spring, at which time they are potted or planted in the open for blooming. Each bulb should make two to four or more offsets if the growth is vigorous. In removing these offsets, see that they have developed sufficient roots to support them.

The amaryllids may be propagated by seeds, which should be sown as soon as ripe, covered lightly with fine soil and kept from drying out. When leaves have developed, put in pots and keep them growing. Good blooming plants should be obtained in one to three years.

Amelanchier (Shad-bush. Juneberry. Service-berry). *Rosacææ*.

Propagated by seeds sown soon after ripening, or stratified and sown in spring; also increased by suckers, layers and cuttings in

autumn and by grafting, in early spring, on *cratægus*, or the stronger-growing species; quince and mountain ash are also recorded as stocks. See *Juncberry*.

Ammophila. *Graminææ.*

Propagated by division and can probably be handled easily by root-cuttings. *A. arenaria* is used for holding sands along sea-shores.

Amomum. *Zingiberacææ.*

Propagated by division in the spring.

Amorpha (Lead-Plant). *Leguminosææ.*

Increased by seeds, usually. Greenwood cuttings strike readily early in the season under glass. Hardwood cuttings may be planted in the open, in a protected place, in autumn and allowed to remain for a year. Suckers and layers may also be used.

Amorphophallus. *Aracææ.*

Propagated by offsets, or cormels, and by seeds, which, however, are usually sparingly produced in cultivation. Place offsets in pots in mixture of loam, leaf-mold and sand, in temperature of 65° to 70°. Some of the large kinds do not increase rapidly, as offsets may not be formed. See *Aracææ*, page 239.

Ampelopsis. *Vitacææ.*

Increased by seeds. Layers or cuttings made in spring from the young soft wood root freely in gentle heat. All species may be propagated by hardwood cuttings taken in September and pricked out under hand-lights or in a frame. Softwood cuttings may also be taken in summer under glass. For Virginia creeper, see *Parthenocissus*.

Amygdalus: *Prunus.*

Anacardium (Cashew). *Anacardiacææ.*

Mature-wood cuttings, with leaves on, root in sand under glass, in heat. Also increased by means of seeds, when obtainable.

Anagallis (Pimpernel). *Primulacææ.*

The annuals are propagated by seeds sown in the open in spring; the perennials, by cuttings from young shoots, or by division. The cuttings should be handled under glass.

Ananas : *Pineapple*.

Anastatica (Resurrection Plant. Rose of Jericho). *Cruciferæ*.

Seeds sown in the spring in heat give good results; or they may be sown directly in the open where seasons are long.

Anchusa. *Boraginaceæ*.

Propagated readily by seeds, sown in early spring in sandy soil; seedlings may be handled in pots to advantage. Also increased by division, and rarely by cuttings.

Andromeda. *Ericaceæ*.

Propagated by seeds, sown thinly under glass as soon as ripe, in pots or pans, with peaty soil. Living chopped sphagnum is an excellent material on which to sow andromeda seeds. Sow under glass early in January in a temperature of 55° to 60°. The young plants should be planted out in spring, if large enough, or pricked into boxes if small. Also increased by layers, which, if carefully pegged down in September, will take twelve months to make sufficient roots to allow of their being separated; layerage is a common method. Some of the plants commonly known as andromeda are now referred to *Pieris*.

Androsace. *Primulaceæ*.

Propagation is by division, seeds and cuttings.

Anemia. *Schizaceæ*.

Propagated by spores; tufted kinds by division in March and April. See *Ferns*, page 312.

Anemone (Anemone. Windflower). *Ranunculaceæ*.

Increased by seeds, root-division or root-cuttings in autumn or early spring. The so-called tuberous kinds make naturally divisible root parts. The seeds are sown in open-air beds in autumn or spring, in a protected place.

Angelonia. *Scrophulariaceæ*.

Multiplied by seeds, which should be planted in spring in hot-beds, and transplanted in the open in May; or in regions of long seasons, sown directly in the open. Also increased by cuttings of the young shoots in spring. These root readily in a propagating-bed. *A. grandiflora*, the most popular kind, will produce flowers the first year from seed. *A. cornigera* is annual.

Angiopteris. *Marattiaceæ.*

Propagation by fleshy scales at base of each frond. These scales should be placed on sand and covered with sphagnum. Also by division. See *Ferns*, page 312.

Angræcum. *Orchidaceæ.*

Propagation as for aerides, which see.

Anguloa. *Orchidaceæ.*

Propagated by dividing the pseudobulbs, just before they begin to grow. Division must be made after the shoots are distinguishable from the old back bulbs: these old bulbs are removed at the creeping rhizome or rootstock. See *Orchids*, page 372.

Anise (*Pimpinella Anisum*). *Umbelliferaæ.*

Increased by seeds sown in the garden in spring on approach of warm weather.

Annona (Custard-Apple). *Annonaceæ.*

Increased by seeds, which, in the North, should be sown in pots in a hotbed; by ripened cuttings, which will root in sand under glass, in bottom heat. Highly valued species are propagated by budding and grafting, shield-budding being most commonly employed after the method of handling the orange. The bud should be taken from wood from which the leaves have fallen, preferably about one year old. On older stocks, cleft-grafting may be employed, using well-matured cions from which the leaves have dropped. The stocks are usually the cherimoyer (*A. Cherimola*) or the pond-apple (*A. glabra*), grown from seeds.

Annuals.

The subjects known to gardeners as "annuals" are ornamental plants producing seed and coming to maturity the year in which the seeds are sown. They may not be strictly annual in duration, in the sense of dying and completing their cycle within a twelve-month. Some of the potential perennials bloom and fruit the first year from seed, and yet may live to the second or even the third year (as eschscholtzia or California poppies, the China pinks, pansy if allowed to do so); these plants are usually classed as annuals by gardeners. Other so-called annuals are woody or even tree-like in warm or tropical countries, as the castor-bean.

The annuals are of easy propagation, being grown from seeds of the previous year. The common flower-garden kinds may be

raised from seeds sown directly in the open ground, but if earlier bloom and a longer season are desired the seeds may be started in the dwelling house, window-garden, hotbed or greenhouse, and the small seedlings transplanted to the garden. Whether the seeds should be started indoors depends on the region, the hardiness of the species, the season in which bloom is desired. Small and delicate seeds should be started under cover for protection from beating rains and winds, whatever the region, north or south. The young plants of some species are so delicate and tender as to demand protection from wind, hot sun and dryness. All these details the gardener learns by experience. Hints on them are likely to be found in seed catalogues.

Sometimes annuals are classed as hardy, half-hardy and tender, having reference to frost and in practice applied to time of sowing. So wide are the latitudes in North America, however, within the limits of a single country, that these distinctions are largely given up here. A hardy annual may be sown even before "settled weather" and when frosts are still expected, as sweet pea, abronia, sweet alyssum; these plants are usually sown directly in the open ground, sometimes even in autumn. The half-hardy annuals, as phlox, alonsoa, petunia, withstand considerable hardship and may be started indoors or sown in the open before the weather becomes very hot. Tender annuals are sown late and are impatient of cold, and are sometimes protected under glass or elsewhere all summer; examples are many ipomœas and cucurbits, maurandia, torenia.

Very few annuals bloom continuously from early to late. When seeds begin to form, the blooming usually halts. The best results are obtained by repeated sowings at intervals, one crop being removed from the beds when it begins to fail and a fresh crop of the same or another species put in its place. The seedlings should be transplanted before they crowd in the pots or boxes, and care should be taken that they do not become "drawn." Annuals are adaptable, and they give much satisfaction when one is willing to take sufficient pains in propagation.

It is sometimes desirable to propagate annuals by other means than seeds in order to perpetuate particular strains or forms. For this purpose cuttings of vigorous young shoots may be taken late in the season and the new plants carried over winter in the window-garden or under glass. Probably not all the annuals can be handled satisfactorily by this method. The perennials that are commonly treated as annuals, as verbena, are readily propagated

in this way; and cuttings may be made of petunias and many others. The number of annuals that can be propagated asexually with success under flower-garden conditions is probably larger than we know.

Anæctochilus. *Orchidaceæ.*

Increased by cutting off the growing top just below the last new root, dividing the remainder of the stem into lengths of two or three joints. Handle under a bell-glass or in a propagating-box. See *Orchids*, page 372.

Anthemis (Chamomile). *Compositæ.*

Propagated by seeds and by division of the clumps, usually the latter as the commonly cultivated species are perennial.

Anthericum. *Liliacæ.*

Increased by seeds sown as soon as ripe, in a frame; readily by division of the roots. Propagation is naturally by stolons.

Antholyza. *Iridacæ.*

Propagated by seeds, sown as soon as ripe, in light soil in a cool house or a frame. They germinate the following spring, and will be fit to plant out in summer. Also propagated by offsets; this is the usual way.

Anthurium. *Aracææ.*

Propagated by seeds sown as soon as ripe in shallow well-drained pans or pots covered with finely chopped sphagnum. Cover lightly and place in a moist propagating-case, in a temperature of 75°-80°; or the pots may be covered with bell-glasses. Keep the soil and air uniformly moist. Also increased by division, which should be made in January, using soil composed of peat fiber, chopped sphagnum moss, sand and charcoal. Suckers are used for propagation, when they form; also cuttings of the rhizomes handled in small pots in a mixture of peat fiber, sand and chopped sphagnum. See *Aracææ*, page 239.

Anthyllis (Kidney Vetch). *Leguminosæ.*

Herbaceous perennials, increased by seeds, division and cuttings. The cuttings of most species will root in sandy soil in a cool house or frame.

Antigonon (Mountain Rose. Corallita). *Polygonacææ.*

Propagated readily by seeds, which are abundantly produced.

Antirrhinum (Snapdragon). *Scrophulariaceæ*.

Increased by seeds sown in early spring for summer bloom or in midsummer for winter bloom under glass; by cuttings, which should be taken in September or in spring, when they will readily root under glass. Most kinds are hardy, and for early spring or summer bloom seeds are sometimes sown in the open in August or September and well protected in winter where they stand; in the spring, the plants may be transplanted from the seed-bed. Plants started in summer may be used for winter bloom under glass.

Aphelandra. *Acanthaceæ*.

Handled by cuttings from half-ripened wood at any time, or from young wood taken with a heel; place in pots of sandy soil, and plunge in good bottom heat. Can be increased by seeds, when these are obtainable.

Apicra. *Liliaceæ*.

Propagation as for aloe, which see.

Apocynaceæ. **Apocynads**.

All the shrubby species are readily increased by cuttings from the young growth or by seeds, while the herbaceous plants are propagated by division and seeds.

Aponogeton, including *Ouvirandra*. *Aponogetonaceæ*.

Propagated rapidly by seeds and offsets. The seeds should be sown as soon as ripe and not dried, in pots sunk in water and covered with glass, or in balls of earth submerged. To obtain good seeds, the flowers should be pollinated and kept above water. The lace-leaf (*Aponogeton*, or *Ouvirandra*, *fenestralis*) is propagated by division.

Apple (*Pyrus Malus*). *Rosaceæ*.

Standard apple stocks are grown from seeds, and dwarf stocks from mound-layers. Apple seeds are either imported from France or obtained from pomace. Formerly "Vermont crab" stocks, grown from the pomace of New England cider mills, and largely from seedling trees, were popular in the North and West. Of late years, with the disappearance of seedling trees, these stocks have lost favor, since they come largely from cull fruit of grafted trees. The French seeds give what are technically known as crab stocks, although botanically not crab-apples. The yearling stocks them-

selves are imported from France in great numbers. It has been supposed that French crab stocks are hardier and more vigorous than ours, but this opinion is much less prevalent than formerly. Of late years they have not been available in large quantity, which has led to the more general use of native stocks. As a rule, nursery-men who grow trees do not raise apple stocks. Stock growing is largely a separate business requiring special experience, and in this country it is an important industry, mostly in Kansas at present on the fertile bottom lands.

The chief present source of apple seeds is the pomace from cider mills. The "cheese" of pomace is broken up, and if the material is dry enough it may be run through a large sieve to remove the coarser parts. The seeds are then removed by washing. Various devices are in use for washing them out. They all proceed on the fact that the pomace will rise in water and the seeds sink. Some use a tub or common tank, which is tilted a little to allow the water to flow over the side. Others employ boxes some 7 or 8 feet long, 4 feet wide and a foot deep, the lower end of which is only 11 inches deep to allow the escape of the water. This box is set on benches, and a good stream of water is carried into it at the upper end. A bushel or two of pomace is emptied in at a time, and it is broken and stirred with a fork or shovel. When the seeds are liberated, they fall to the bottom and the refuse runs over the lower end. Another box is provided with several cleats, at intervals of about a foot, and the ends are left open. The box is set at an angle, and the seeds are caught behind the cleats. Seeds must not stand long in the pomace pile, or they will be seriously injured. Nurserymen like to secure the pomace as soon as it is taken from the press.

As soon as the seeds are collected, they should be spread on tables or boards, and should be turned frequently until perfectly dry. They may then be stored in boxes in slightly damp sand or sawdust, or in powdered charcoal, and kept in a cool and dry place until spring. Or if they are to be sown immediately, they need not be dried, but simply mixed with enough dry sand to absorb the water so as to make them easy to handle. Seeds should not be allowed to become hard and dry through long exposure, or they will germinate unevenly. Apple seeds procured at the seed stores may be worthless because of this neglect. Very dry seeds can sometimes be grown, however, by subjecting them to repeated soakings and then sprouting in a gentle hotbed or mild forcing-

house. Change the water on the seeds every day, and at the end of a week or ten days mix with sand and place in a thin layer in the hotbed. Stir frequently to prevent molding. When the seeds begin to sprout, sow them in the open ground. This operation, which is sometimes called "pipping," may be performed in a small way near the kitchen stove. Seeds are sometimes "pipped" between moist blankets. The more common method at present is to mix the seed with moist sand, which is stirred occasionally. When the seeds begin to swell, in about a month, they are sown either in the coldframe or in the field.

When sowing is made in the fall, the seeds may be sown in the pomace. This entails extra labor in sowing, but it saves the labor of washing. This practice gives good results if the pomace is finely broken, and it is now common among nurserymen.

In loose and well-drained soils, sowing is undoubtedly best performed in the fall, just as early as the seeds are ready. But on land that holds much water and heaves with frost or contains much clay, spring sowing is preferable. In spring, the seeds should be sown as soon as the ground can be worked.

If the stocks are to be cultivated with a horse, the rows should be 3 or 3½ feet apart. Some growers sow in narrow drills and some in broad ones. The broad drills are usually 6 to 10 inches wide. The earth is removed to the depth of 2 to 3 inches, if it is loose and in good condition, the seed is scattered thinly on the surface and the earth hoed back over them. If the ground is likely to bake, the seeds should not be sown so deep; and it is always well, in such cases, to apply a very light and clean mulch. The plants should be well cultivated, and they should attain a height of 6 to 12 inches or more the first year. If the plants come thickly, they must be thinned.

In the autumn of the first year the seedlings should be large enough to be dug and sold to general nurserymen. Sometimes the poorest plants are allowed to stand another year, but they are usually so scattering that they do not pay for the use of the land, and they should be transplanted the same as the larger stock, or the weakest ones may be thrown away. The stocks are dug with a plow or tree-digger and heeled-in closely, so that the leaves "sweat" and fall off. The plants are then stored in sand, moss or sawdust in a cellar. Before they are planted, the tops are cut off near the crown, usually with a hatchet on a block; or if to be used for budding, 10 to 12 inches or more of the top is left on.

The stocks are then graded into budding and grafting sizes. The general nurserymen buy these stocks in fall or early winter. Those that are root-grafted are worked in late winter, but those intended for budding, or which must be grown another season before they attain sufficient size for working, are heeled-in, sometimes being "dressed" (see page 123); in the spring they are set in nursery rows, about a foot apart in the row. The nurseryman reckons the age of his tree from the top or graft, rather than from the time the seed was sown.

The yearling seedlings are graded by the western growers into about four lots: "Extras," or those at least $\frac{1}{4}$ inch in diameter at the crown, and having 12 inches of both top and root; "Commons," those between $\frac{3}{16}$ and $\frac{1}{4}$ inch at the crown, and having 8 inches of root; "Seconds," those from $\frac{2}{16}$ to $\frac{3}{16}$ inch at the crown; and "thirds," or all those under $\frac{2}{16}$. The last class must be grown in the field for one or two seasons before the stocks can be worked to advantage. For nursery-grafting, seedlings of $\frac{3}{16}$ inch and up are preferred, but the seconds ($\frac{2}{16}$ - $\frac{3}{16}$) are often used. For budding, branched seedlings $\frac{1}{4}$ inch and up are most employed. (Directions for budding are to be found on pages 122 to 133.)

In the coldest of the apple-growing regions, the true crab-apple (*Pyrus baccata*) is often used for stocks; and other stocks are under trial.

Dwarf stocks are mostly obtained from mound-layering. The common stock for dwarfing is the Paradise apple, a dwarf variety of the common apple species (*Pyrus Malus*). This variety rarely attains a height of more than 4 feet. A larger or freer stock is the Doucin, also a variety of *Pyrus Malus*, that will produce an engrafted tree intermediate in size between that afforded by the Paradise and free or common stocks. To obtain stools for mound-layering, the tree, when well established, is cut off within 4 or 6 inches of the ground in spring, and in the summer several shoots or sprouts will arise. The next year the stool is covered by a mound, and by autumn the layers are ready to take off. Sometimes, when stocks are rare, mound-layering is performed the first summer, before the young shoots have hardened, but good stocks are not obtained by this method. Common green layering is sometimes practiced the first year, but it is not in favor. The dwarf stocks, in common with all apple stocks, may be propagated sparingly by root-cuttings and by hardwood cuttings. The common cultivated varieties are rooted from hard-

wood cuttings with extreme difficulty, if at all. (For a study of Paradise stocks, used for dwarfing, see Hatton, Journ. Royal Hort. Soc. May, 1919.)

Apple stocks are either grafted or budded. Root-grafting is the most common at the West; long cions are sometimes used in order to secure own-rooted trees, although only a few varieties root well on their own wood. Budding is performed in August and early September in the northern states, or it may be begun on strong stocks in July by using buds that have been kept on ice. Stocks should be strong enough to be budded the same year they are transplanted, but the operation is sometimes deferred until the second summer. Stocks that cannot be worked until the second year are unprofitable, especially on valuable land. For illustrations of the methods of grafting apple trees, consult many of the figures from Figs. 152 to 188, and Fig. 198.

For root-grafting, strong one-year-old roots are best, but two-year-olds are often used. For piece-root work, the root is cut into two or three pieces of 2 to 3 inches each. The lowest piece is usually small and weak, and is generally discarded. Whole-root grafts are to be preferred, unless the tree is to be grown on its own roots by the use of a long cion. For discussion of the relative merits of budded and root-grafted trees, turn to page 141.

The apple is easily top-grafted and top-budded. (See Chapter VI. For grades of trees of apples and others, see pages 179 to 182; measuring devices are shown in Figs. 203 to 205.)

Apricot (*Prunus armeniaca*, *P. dasycarpa*, *P. Mume*). *Rosaceæ*.

The apricot thrives on a variety of stocks. Apricot stocks are used in apricot-growing regions, especially for deep and rich well-drained soils. The pits grow readily if given the same treatment as that detailed for the peach (which see). The stocks are also handled in the same way as peach stocks. Apricots on apricot roots are not largely grown outside of California, in this country. Apricot stocks can be grown from root-cuttings the same as cherries and other stone-fruits, but this is little practiced.

The apricot does well on the peach, especially on light soils. In the warmer parts of the country peach is much used.

Plum stocks are commonly used at the North, especially if the trees are to be planted in moist or heavy soils. The common plum is generally used, but some of the native plum stocks are coming into favor, especially in trying climates. The Russian

apricots, which are a hardy race of *Prunus armeniaca*, are grown in colder climates than the common varieties, and they therefore demand hardy stocks. Any of the native plums make good stocks, but the Marianna is prominent. The myrobalan plum can be used for all apricots, but it is not popular in severe climates. The almond, both hard- and soft-shelled, is sometimes used for the apricot, but the union is likely to be imperfect, and it is not recommended. Almond-rooted trees are thought to be best adapted to light soils. The whole subject of stocks for apricots is in need of investigation.

Varieties of apricots are usually budded, in the same way as the peach, although they may be side-grafted at the crown in the nursery row.

In California, the apricot is mostly worked on apricot seedlings, by budding the seedlings the same year the seed is planted. The peach stock grown in the same way was formerly preferred and of late years is again coming into favor, especially in rather shallow or medium heavy soils. In heavy soils, or on hillsides subject to spring seepage, the myrobalan plum stock is used. On the almond, the union is too imperfect for practical purposes.

Aquilegia (Columbine). *Ranunculacea*.

Increased by seeds, sown thinly, soon after ripe, in a sandy soil or in a frame. Blooming plants should be had the second season. Keep the seed-beds uniformly moist, as the seeds are likely to be slow in germinating. Division of the root is employed for the perpetuating of named or horticultural varieties.

Arabis (Wall-Cress. Rock-Cress). *Crucifera*.

Multiplied readily by seeds sown in the open or in pans, in spring; by division of the root, and by cuttings in a shady place or a frame in summer.

Araceæ. Aroids.

Propagation is by seed, in most cases sown as soon as ripe, using a compost of peat, loam, sand and sphagnum moss, covering lightly, placing the tropical species in a close moist propagating-case where a temperature of 75° to 80° is maintained. Seeds of species from temperate climates may be placed in a temperature of 65° to 70°. The soil should be kept uniformly moist at all times. Some kinds are increased by offsets, others by tubers, while the larger number are increased by division or by cuttings.

Arachis: *Peanut.*

Aralia. *Araliaceæ.*

Propagated by seeds sown in spring and by root-cuttings, also by stem-cuttings, all in heat. The greenhouse kinds are not likely to produce seeds. The plants commonly known to horticulturists as aralias are now distributed in several genera, the true aralias being mostly hardy or half-hardy outdoor plants in the northern and central states. See *Dizygotheca*, *Fatsia*, *Polyscias*.

Araucaria. *Pinaceæ.*

Increased by seeds (when obtainable) sown in pans or boxes, with gentle heat; by cuttings from the leading shoots, placed firmly in sand. For the making of symmetrical plants, cuttings should be taken from upright leading shoots that start from the axils of the branches. Cuttings from side or horizontal shoots make irregular plants. Seedlings themselves are readily grown from imported seed, but they make tall loose plants. To secure compact plants, cuttings may be made from strong seedlings. The top shoot of the seedling is taken as a cutting and rooted in a cool temperature (about 60°). The seedling then produces other leader shoots from the axils of the upper tier of branches, and these in turn are taken for cuttings. The seedling is then cut back to the next tier, and other leader shoots will form there; and so on till the stock is used up.

Arbutus (Strawberry Tree). *Ericaceæ.*

Increased by seeds, which should be sown in sand in early spring or in autumn, and by veneer-grafting, budding or inarching on *A. Unedo*. Propagated also by cuttings from half-ripened wood in autumn, placed in sandy peat soil under glass. Layers usually take two years to root.

Archangelica. *Umbelliferaæ.*

Propagated by seeds sown in autumn as soon as ripe, or the following spring in severe climates.

Archontophœnix. *Palmaceæ.*

Propagation by seeds in heat. See *Palms*, page 377.

Arctostaphylos and **Arctous.** *Ericaceæ.*

Propagation as for arbutus, which see; mostly by division of the plants when possible, and also by seeds and cuttings. If cut-

tings are taken in January and placed in sand in bottom heat, they root readily.

Arctotis. *Compositæ.*

Propagated by cuttings in mild heat. The commonly cultivated kinds are tender annuals and may be raised readily from seeds sown in the open when weather is warm, or started indoors.

Ardisia. *Myrsinaceæ.*

Handled by seeds and cuttings. The latter should be taken from young shoots of half-matured wood, and placed in a cutting-bed with a top and bottom temperature of 70°. The cuttings may be readily obtained from old plants that have been cut back. They should root in a month. Choose cuttings only from plants of good berry-bearing habit. Cuttings give more compact or shorter plants than seedlings. Seedlings give fruiting plants the following year. Usually seeds are sown in late winter or early spring, and plants are ready for potting in early summer. Seeds often germinate slowly.

Areca (Cabbage Palm). *Palmaceæ.*

Grown from seeds, which should be sown in a gentle heat and kept moist. See *Palms*, page 377.

Areghia. *Bromeliaceæ.*

Propagation as for billbergia, which see.

Arenaria (Sandwort). *Caryophyllaceæ.*

Propagated by seeds, division and cuttings; the last placed in a propagating-box or frame will root freely. Seeds should be sown in spring in a coldframe. The best time to divide the plant is early spring, or in summer after most of the growth is made. Cuttings are employed for rare species or varieties.

Arenga. *Palmaceæ.*

Propagated by seeds. See *Palms*, page 377.

Argemone (Argemoney). *Papaveraceæ.*

Propagated by seeds, which may be sown outdoors in spring where they are to stand or else started in a hotbed.

Argyreia (Silver Weed). *Convolvulaceæ.*

Handled by cuttings, which will do well in sand under glass, in gentle bottom heat. May also be increased by seeds, when obtainable.

Arisæma (Indian Turnip). *Araceæ*.

Propagated by seeds and division as for arum. See *Araceæ*, page 239.

Aristolochia (Birthwort). *Aristolochiaceæ*.

Propagated by seeds and layers. The seeds must be fresh. Cuttings of tender sorts root freely in sand, with bottom heat. *A. elegans*, frequently seen under glass, grows readily from seeds which may be had of dealers. The dutchman's pipe (*A. macrophylla*, often known as *A. Siphon*) fruits freely when old and the seeds are used to propagate it.

Armeria (Thrift. Sea Pink). *Plumbaginaceæ*.

Increased by division, separate pieces being planted as cuttings out-of-doors. Seeds are sometimes used, when obtainable.

Arnebia. *Boraginaceæ*.

Propagated by seeds. Cuttings of the strong shoots, taken with a heel, root slowly. Root-cuttings may be used for some kinds.

Arnica. *Compositæ*.

Multiplied by seeds sown in a frame in spring; also by division in spring.

Aronia (Chokeberry). *Rosaceæ*.

Propagated by seeds sown in fall or stratified; also by suckers and layers, or by greenwood cuttings under glass. By many botanists retained in the genus *Pyrus*.

Artabotrys. *Annonaceæ*.

Propagated mostly by seeds; and in the North by cuttings of ripened wood in spring in sand under a frame, with bottom heat. Treatment similar to annona, which see.

Artemisia (Mugwort. Southernwood. Wormwood). *Compositæ*.

The annuals are propagated by seeds, and also the perennials of such kinds as produce seeds. The perennial kinds are commonly increased by dividing the clumps.

Artichoke (*Cynara Scolymus*). *Compositæ*.

Grown from seeds. Although the plant is perennial, a new stock should be started about every other year. It is increased also by suckers or division of the stools, particularly when it is desired to perpetuate special varieties or strains. Seeds are likely

to give more variable results and to be unsatisfactory unless very carefully selected; if seeds are started early, edible heads may be had the same year, but usually not till the second year. For divisions, the buds or shoots are detached from the old crown in spring before growth begins.

Artichoke, Jerusalem (*Helianthus tuberosus*). *Compositæ*.

Commonly multiplied by means of the tubers, which may be planted whole or cut into eyes, after the manner of potatoes. Seeds are very rarely used. The plant is hardy and persistent, and propagates itself strongly.

Artocarpus (Bread-Fruit). *Moraceæ*.

Grown from cuttings of the young lateral growth; also from suckers, when they form; by seeds, when procurable.

Arum. *Araceæ*.

Several very unlike plants bear the name arum in cultivation, as *dracunculus*, *helicodiceros*, *amorphophallus*; propagation is similar for all of them. Most of them produce offsets from the tubers or rhizomes. The seeds or berries may be planted when ripe or stratified until spring. See *Araceæ*, page 239.

Arundinaria (Wild Cane. Bamboo). *Gramineæ*.

Multiplied by division. See *Bambusa*.

Arundo (Reed). *Gramineæ*.

Multiplied by division. In early autumn, the canes can be cut into lengths of 18 to 24 inches for cuttings, and partly buried in sand in a gentle bottom heat, laying them horizontally. It seldom seeds, at least in the North.

Asclepias (Milkweed. Silkweed). *Asclepiadaceæ*.

The glasshouse kinds are increased by cuttings in spring in gentle heat, under glass. Seeds of *A. tuberosa* must be sown or stratified as soon as gathered. Seeds of most native kinds are produced freely, and should give strong flowering plants the second or third year. Some kinds may be multiplied by division.

Asimina (Papaw; see Papaya). *Annonaceæ*.

Propagated by seeds sown in autumn, or stratified and sown in spring; do not let the seeds dry out. The seedlings may be raised in pots. Also increased by layers made in autumn, and by root-cuttings.

Asparagus. *Liliaceæ.*

The common kitchen-garden asparagus is best propagated by means of seeds. These are sown in spring as soon as the ground can be worked, usually in rows a foot or two apart. Thin the young plants to 2 or 3 inches apart in the row and give good culture; the plants may be set in the field the following spring, and they will give a fair crop after growing there two seasons. Small growers usually buy plants of nurserymen. Old asparagus crowns can be divided, but seeds give better plants.

The ornamental species of asparagus are propagated by seeds when they are obtainable; otherwise, by division and separation of the root tubers. *A. asparagoides*, the smilax of greenhouses, is increased by seeds, which germinate readily. The roots may also be divided, but seeds are to be preferred. Seeds sown in February should give strings for cutting the following winter. The young plants are weak and should be handled in pots; they should be ready for planting in permanent quarters by mid-summer.

The so-called asparagus fern (*A. plumosus*) is readily grown from seeds, although seeds are rarely produced by the dwarf form (var. *nanus*). Strings for cutting may be had at the end of the second year, or later, after the seeds are sown. As soon as the berries are ripe, they should be picked and dried for a month or so before planting.

Asperula (Woodruff). *Rubiaceæ.*

Propagated by seeds, and by division of the roots or clumps in spring and early summer. The common *A. odorata* naturally spreads rapidly.

Asphodeline. *Liliaceæ.*

Propagated by division in spring or fall, and by seeds.

Asphodelus (Asphodel). *Liliaceæ.*

Propagated by seeds, and by division of the root or clump in fall or spring.

Aspidistra. *Liliaceæ.*

Propagated by division of the crown in early spring, and by suckers. Old plants divide readily when repotting.

Asplenium. *Polypodiaceæ.*

Propagated by division and by spores. See *Ferns*, page 312.

Aster (Aster, Starwort, Michaelmas Daisy). *Composita*.

Propagated by seeds sown in spring, and by root-division in autumn or spring; also by cuttings, which root freely in sandy soil under a glass. In general, seeds grow freely. The common native asters may be handled as seedlings or by division of stools. The named garden asters (perennials) are increased by division and by cuttings; seeds may be used, but they may not reproduce the variety. For China aster, see *Callistephus*, page 267.

Astilbe. *Saxifragaceæ*.

Propagated by division in early spring, and by seeds, if they are produced, sown in early spring in the greenhouse. Division of the plants in the common method.

Astragalus (Milk Vetch). *Leguminosæ*.

Grown from seeds, which germinate slowly; stratification may be advisable in some cases. Cuttings are sometimes used, struck under gentle heat. Division may be employed if stools are large, but divided plants often die. Seed propagation is to be preferred.

Astrocaryum. *Palmaceæ*.

Increased by seeds in spring under glass; also by suckers, when produced. See *Palms*, page 377.

Atalantia. *Rutaceæ*.

Handled by ripened cuttings, which root in sandy soil under a glass; also by seeds when obtainable.

Atriplex. *Chenopodiaceæ*.

Grown from seed with readiness; shrubby kinds also by soft cuttings. See *Orach*, page 370.

Aubrietia. *Crucifera*.

Multipled by seeds, layers, cuttings, division. Seeds may be sown in spring in a frame. The slender branches may be layered with good results. Cuttings may be taken from bright growing shoots.

Aucuba. *Cornaceæ*.

Readily increased by seeds, sown as soon as mature; and by half-ripe greenwood cuttings struck under glass. The kinds propagate by cuttings in a cool house. The varieties are sometimes grafted on the common form in early spring, under glass. The plant is tender at the North.

Auricula (*Primula Auricula*). *Primulaceæ*.

Choice or named varieties are propagated by natural offsets, or by dividing the plants. Seeds grow readily but may not be expected to reproduce the horticultural forms. They should be sown in pans or pots in early spring (as March), pressed lightly into the soil and thinly covered; provide temperature of about 60°; germination takes place in three or four weeks; as soon as large enough, prick off into pans or flats and grow carefully.

Averrhoa. *Oxalidaceæ*.

Handled in spring by half-ripened cuttings, under glass, with bottom heat; by seeds when obtainable.

Avocado (*Persea americana*). *Lauraceæ*.

Budded stock is to be preferred to seedlings. Shield-budding is usually employed, in late autumn or winter in Florida, and May or June in California. Inarching and grafting under glass are also practiced, and cuttings struck over bottom heat. The seedling stocks are raised in the open, the seeds being planted in pots or directly in ground as soon as ripe. Germination should take place in two or three weeks; plants should stand a foot or so apart in the rows. The fruit is sometimes called alligator pear, but this name should be discouraged. See *Persea*, page 389.

Azalea. *Ericaceæ*.

Although azaleas and rhododendrons are united generically by many botanists, horticulturists usually think of them separately. The azaleas are of two cultural groups, — the Indian or greenhouse evergreen kinds, and the hardy deciduous kinds.

The Indian azaleas (*Azalea indica* or *Rhododendron indicum*) are usually propagated by cuttings and grafting. The cuttings are preferably made of half-ripened wood in August, being struck in a frame with light bottom heat. The choicer varieties may be tongue-grafted or veneer-grafted either in summer or winter on cutting-grown stocks, handling them in a frame or propagating-house. New varieties originate from seeds, which are sown in frames or pots in spring; the soil should be sandy peat, or seeds may be sown in chopped sphagnum and plants pricked out as soon as possible. The young plants are handled in boxes or frames; they should bloom in two or three years.

The deciduous outdoor azaleas are of many kinds. The Ghent azaleas are hybrids of *A. sinensis*, *A. japonica* or *mollis*, and others.

cion is any of the varieties of *Morus alba* or *M. rubra*, as the New American or Hicks, which roots with difficulty from cuttings. In this case, the buds have been cut from the stock to prevent it from suckering.

Root-grafted vs. budded stock

The relative merits of budded and root-grafted trees have been strongly championed in the past, on both sides. The apple is the only tree concerned in the controversy in a large way. After many years of discussion and a considerable number of inconclusive experiments, it is fair to say that the final results in orchard work show no recognizable differences. Good orchards are produced by either kind of stock. In the East, the demand is for budded trees; in the Middle West, probably nine-

FIG. 159. Whip-grafted cutting (x $\frac{1}{2}$).

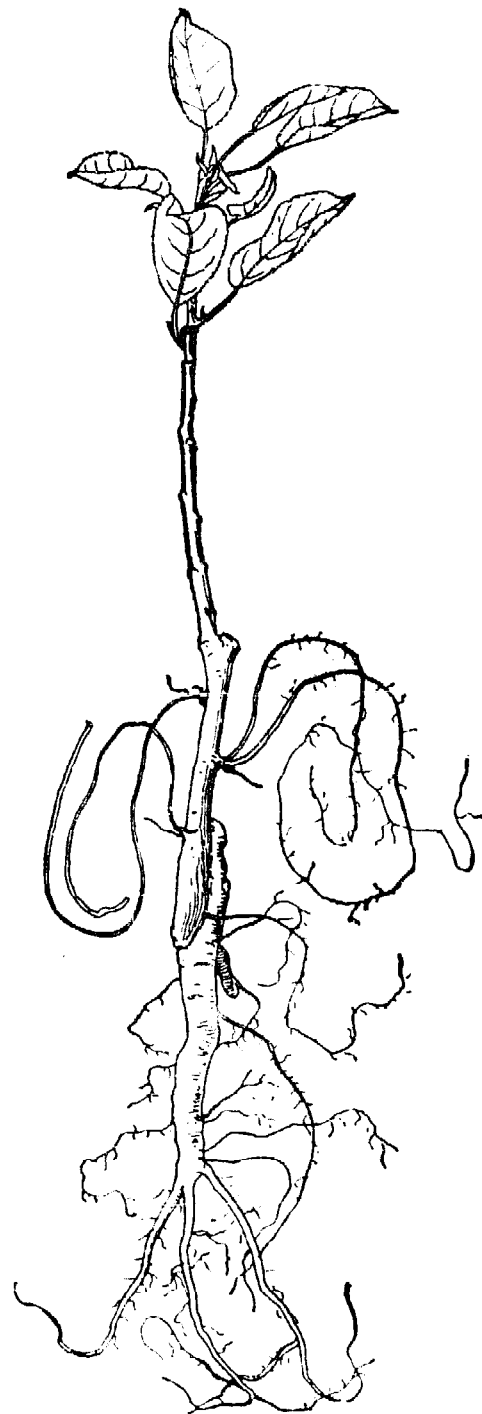

FIG. 158. Growing root-graft (x $\frac{1}{3}$).

tenths of the apple stock is root-grafted. Choice by the planter (so far as choice exists) between budded or whole-root grafts is probably mostly a

matter of habit. The question has practically passed its controversial stage.

Probably the method of propagation — whether by bud or graft — is not the important factor. The test turns on the size of roots in the grafting process and the method of trimming the stock; and the greater number of manipulations the roots receive in the grafting operation may have some significance. A whole-root grafted tree should be comparable with a budded tree, the entire root system (or practically so) being used in both cases. When it comes to piece-roots, the question resolves itself into the sizes of the pieces, their age, whether from young seedling stock or from older trees, whether the pieces are used merely as nurses until the cion becomes own-rooted. In certain experiments, the piece-roots have given better account of themselves in after years than the whole roots; in other tests the reverse has been the case. This indicates that other factors beside the size of the original root enter into the problem; yet one may conclude that the whole root is preferable to the piece-root, other things being the same.

FIG. 160. American-grown apple seedling, 1 year.

The western-grown apple seedling (Fig. 160), produced on deep rich land and with a long growing season, lends itself well to piece-root-grafting. The imported stock, known in the trade as French Crab, is likely to be more branchy

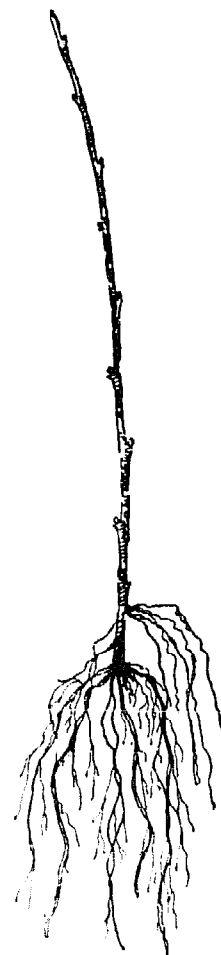

FIG. 161. French Crab, imported apple seedling.

The deciduous azaleas grow readily from seeds, handled as for *A. indica*. The named kinds are grown from heel-cuttings of mature wood taken in late summer and placed under glass. They are also veneer-grafted on any common deciduous potted stock in autumn under glass.

Babiana. *Iridaceæ.*

Multiplied quickly by seeds in pans in a mild heat. Also propagated by offsets or cormels in boxes or planted in the open. A year or two is required to produce blooming plants.

Baccharis (Groundsel Tree). *Compositæ.*

Propagation is by seeds, and by cuttings struck under glass.

Bactris. *Palmaceæ.*

Handled by suckers, which generally arise and grow freely. Rarely propagated by seeds. See *Palms*, page 377.

Balm (*Melissa officinalis*). *Labiatae.*

Propagated by seeds outdoors or in a frame; also division.

Balsam (*Impatiens Balsamina* and others). *Balsaminaceæ.*

Seeds of the garden balsam may be sown directly in the garden when the weather becomes warm, as is the practice in most parts of the United States, or they may be started indoors and transplanted for earlier bloom. *I. Sultani* is better raised from seeds than from cuttings. The greenhouse species are multiplied by seeds, or by cuttings in close frames.

Bambusa (Bamboo. See also *Arundinaria*). *Gramineæ.*

Propagated by division of established clumps in early spring, as new growth is beginning. The operation should be performed with care, so as not to injure the eyes. If young shoots are layered, leave only the end exposed. Seeds are rarely obtainable.

Banana and Plantain (*Musa sapientum*, *M. paradisiaca* and others).
Musaceæ.

Edible bananas rarely produce seeds. The young plants are obtained from suckers, which spring from the main rootstock. These suckers are transplanted when 2 or 3 feet high. These plants themselves may not produce as good crops as the suckers which arise from them, and are not transplanted. Two or three suckers

are sufficient for a plant at a time; what others arise should be transplanted or destroyed. The suckers should be set deep, as low as 2 feet for best results. In fifteen or eighteen months the plants will bloom, if they have had good care. The stem bears fruit but once, but new stems arise to take its place. The ornamental species, as *M. Ensete*, and others, are propagated by seeds in heat, or by suckers. See *Musa*.

Barkeria: *Epidendrum*.

Basella. *Basellaceæ*.

Propagated by seeds, sown either under glass or in the open.

Basil (*Ocimum basilicum* and *O. minimum*). *Labiatae*.

Grown from seeds, sown in a hotbed or outdoors, as soon as the weather is settled; easily managed.

Bauera. *Saxifragaceæ*.

Propagated by cuttings of half-ripened wood in spring; cut into lengths of about 2 inches, insert in equal parts of finely sifted peat and sharp sand in 3-inch pots, cover with a bell-glass in a greenhouse with temperature from 55° to 60°.

Bauhinia (Mountain Ebony). *Leguminosæ*.

Propagated by suckers, and also by seeds when obtainable. Cuttings usually root with difficulty. Wood of intermediate age is taken, and the cuttings placed in sand in heat.

Bean. *Leguminosæ*.

Grown from seeds; sow only after the weather is thoroughly settled for outdoor culture, as the plants are very tender. Lima beans should not be sown till a week or ten days after it is safe to sow the common kinds. The broad or Windsor bean (*Vicia Faba*) is a hardy plant and the seeds may be sown early, as for peas. Soybean (*Glycine Soja*) is tender, and seeds are sown when weather is warm where plants are to stand; plants usually stand in hills 18 to 20 inches apart, the rows being 2 to 3 feet apart.

Beaucarnea: *Nolina*.

Beaumontia. *Apocynaceæ*.

Handled by cuttings, as for allamanda.

Beet (*Beta vulgaris*). *Chenopodiaceæ*.

Grown from seeds, sown very early, for the early crop before frosts cease. The "seeds" are really fruits usually containing

more than one seed, so that much thinning may be necessary after the plants are up.

Begonia. *Begoniaceae.*

Begonias are of such divers kinds that many methods of propagation are employed. Cuttings of stems, rhizomes or leaves are commonly used, although seeds grow readily if given careful attention, and they produce excellent plants.

Seeds of begonia are very small. They should be thoroughly ripe and kept dry till sowing. Sow on the surface of the soil in pans or pots, sift a very little fine earth on them, and cover with a pane of glass. See that the earth is uniformly moist before the seed is sown, and water with great care. Seed-pans should be kept in a propagating-frame or at least in a place free from drafts and strong direct sunshine, at a temperature of about 65° to 70°. As soon as the plants are big enough to handle, prick out into pans or flats, giving plenty of room.

The foliage begonias are grown from cuttings of stems or leaves, at a temperature of about 70°. Of the erect stem-bearing species cuttings may be taken of fresh strong stems in spring, giving good blooming plants for the following late winter and spring. Some kinds make creeping or rambling rhizomes, and division may be practiced. *B. phyllomaniaca* produces plantlets along the stem and on the leaves; these may be severed and planted. *B. diversifolia* bears tubers in the axils of the leaves.

The rex begonias are grown from cuttings of mature but vigorous leaves. Three methods may be employed: (1) The entire leaf may be placed flat on the soil of propagating-bed, under surface down, and pegged or weighted down to hold it steadily in place. The principal nerves or ribs are severed, or cut beneath, and at these places plantlets will form. (2) The leaf may be cut into two parts, and either part, or the stronger part, stood on the cut edge in the soil. Plantlets will form along the lower edge. (3) The leaf may be cut into several wedge-shaped parts, each part having at its point a bit of the top of the petiole or leaf-stalk. The point is inserted in the soil. One or two or more plants will form on each wedge. See Figs. 107-109.

Begonias of the Gloire de Lorraine type are grown from cuttings of well-ripened medium-sized leaves. If taken in early winter and the young plants kept growing vigorously, strong blooming plants should be had for the following midwinter.

Derivatives of *B. socotrana* are grown from the bulbels, that usually form freely.

Tuberous begonias may be propagated by seeds, cuttings, and by division of the tubers. They are commonly grown from seeds, which should be sown early in spring, and the seedlings pricked off and shifted regularly. Cuttings of the young rapidly-growing shoots, if taken as soon as the plants are 4 to 6 inches high, will form good tubers by fall. Cuttings made while the plants are in flower rarely produce tubers of much value; *B. boliviensis* and *B. Veitchii* are particularly likely to fail in this respect. The cuttings should be 2 to 4 inches in length, the lower cut being just beneath a joint; remove one or two of the lowest leaves and insert singly near the edge of thumb-pots filled with a soil composed of about equal parts sand, leaf-mold and loam. Place in a cool shaded position, applying water only to prevent flagging. Dividing the tubers is an unsatisfactory method of propagation. If employed, the tubers should be cut before active growth begins, so that each part shall have an eye or crown. They are then treated as separate tubers. Begonias which have not been improved are most easily and rapidly propagated from seed; the named or improved varieties are best increased by cuttings.

Belamcanda, including *Pardanthus* (Blackberry Lily). *Iridaceæ*.

Increased by seeds, division and cuttings of young growth. The blackberry lily (*B. chinensis*) propagates readily by division and by seeds, the latter being freely produced.

Bellis (English Daisy). *Compositæ*.

Increased readily by seeds, which should be sown in early spring. Also propagated by division after flowering. Seeds do not always reproduce the special kind, and choice forms are multiplied by division.

Benincasa. *Cucurbitaceæ*.

The wax gourd is readily raised from seeds planted after the weather is warm; handle same as for melons.

Benthamia: *Cornus*.

Berberidopsis. *Flacourtiaceæ*.

Multiplied by seeds in spring, by layering in autumn, and by young greenwood cuttings in spring.

Berberis (Barberry). *Berberidaceæ*.

Propagated by stratified seeds, and by suckers, layers and cuttings of mature wood. Seeds should be sown in flats or broadcast in beds in the fall; seeds of rare kinds should be sown in the greenhouse. Most barberries can be propagated from green cuttings of the young wood taken from the first to the middle of June, and placed in sand in a shaded hotbed. Layers are usually allowed to remain two years. Rare sorts are sometimes grafted on common stocks.

Berchemia. *Rhamnaceæ*.

Propagated by layering young shoots in autumn; by cuttings of mature wood and root-cuttings under glass; and also by seeds.

Bertolonia. *Melastomaceæ*.

Grown from seeds and cuttings. Also by healthy ripened leaves which, if the midrib be nicked in several places and then pegged on a pot of sandy peat, soon form roots and tiny tubers at every incision. Place in a moist propagating-frame.

Bessera. *Liliaceæ*.

Usually propagated by offsets.

Beta: *Bet.***Betula** (Birch). *Betulaceæ*.

Increased by seeds, which must be sown as soon as gathered, or else stratified; sow rather thickly in sandy soil, slightly or not at all covered, but pressed firmly into the ground and kept moist and shady. Propagated also by layers and rarely by greenwood cuttings under glass; also by grafting or budding on seedling stocks of *B. lenta*, *B. papyrifera*, *B. nigra* or *B. pendula*. The grafting is sometimes performed in spring under glass on potted stock, but usually the stocks are budded in summer.

Biennials.

Plants that bloom and die the second year from seed, having flowered once, are biennials or two-year subjects. The number of true biennials in the vegetable kingdom is relatively small. The teasel, pasture mullein (*Verbascum Thapsus*), and common evening primrose (*Enothera biennis*) are examples. In the garden, the honesty or lunaria is an example; also the Allegheny vine or adlumia, and the Canterbury bell.

Many of the short-lived perennials bloom most strongly the second year from seed, and they are treated as biennials by gardeners. Examples are foxglove, sweet William, hollyhock, and some of the larkspurs and campanulas. Others are treated both as annuals and biennials, as snapdragon and pansy, although perhaps really perennial.

Most of the plants known in gardens as biennials may be grown from seeds sown in summer, preferably in flats in a frame. In autumn the young plants may be transferred to their blooming quarters, or they may be transplanted to other flats or to pots and carried over winter in a frame. If started in spring, many of the kinds become too large by autumn to handle well, and they may even begin to bloom and weaken themselves for next year's use. Fresh strong well-leaved rosettes or clumps are needed in spring to produce the best bloom for the year. Some of the strongest plants of the perennial-biennials may be carried over for a second season of bloom, as the hollyhock, but the best results are not usually to be had by this practice, specially of the highly bred types.

Particular strains may be propagated asexually, by cuttings and sometimes by division and offsets. The cuttings are treated in practically the same way as seedlings.

If one has a greenhouse or well-heated hotbed, some of the biennials may be made to bloom the first year by starting the seeds in winter or early spring and carrying them forward briskly. In this case, the plants are practically annual, and usually are not bloomed the second season.

Bifrenaria. *Orchidaceæ.*

Propagated by offsets and division. See *Orchids*, page 372.

Bignonia. *Bignoniaceæ.*

The plants known to cultivators as bignonia are now distributed in several genera. Increase is by seeds, when obtainable. Stout short-jointed side growths make good cuttings of the greenhouse species, taken in spring and kept in a warm propagating-box. Rooting takes place in six to ten weeks if they are carefully watered and handled.

Billbergia. *Bromeliaceæ.*

As seeds are rarely obtainable under cultivation, the plants are

propagated by the suckers that naturally arise after the old plant has ceased flowering. The suckers should not be removed until they are firm and well grown. The lower end is trimmed of its poor leaves and the sucker is then potted or mounted as for established plants; they are stimulated by bottom heat, and should be shaded for a time.

Blackberry (*Rubus* species). *Rosaceæ*.

New varieties are obtained from seeds, which may be sown as soon as they are cleaned from the ripe fruit, or which may be stratified until the next spring. If the soil is in prime condition, fall sowing is preferable. Bearing plants should be had in two or three years from seed, depending on length of season and method of handling.

Varieties are multiplied by suckers, by root-cuttings and tips of the canes. The suckers spring up freely about the old plants, especially if the roots are broken by the cultivator; but they have few fibrous roots, and are inferior. The best plants are obtained from root-cuttings (Fig. 103). Roots from $\frac{1}{4}$ to $\frac{3}{8}$ inch in diameter are selected for this purpose. The roots are dug in the fall, cut into pieces 1 to 3 inches long, and stored until early spring. They may be buried in boxes of sand after the manner of stratified seeds, or stored in a cool cellar; callusing proceeds most rapidly in cellar. The pieces are planted horizontally an inch or two deep, in loose, rich soil. It is best to put them in a frame and give them slight bottom heat, although they will grow if planted in the open in April or May, but the plants will make much less growth the first season. Some varieties do not strike quickly without bottom heat. When the variety is scarce, shorter and slenderer pieces of root may be used, but these demand bottom heat. The heat in the frames is usually supplied by manure, or the heat of the sun under the glass may be sufficient. In these frames the cuttings may be started in the North late in March, or some six or eight weeks before the plants can be set outdoors without protection. When the weather has become somewhat settled, the plants may be planted out, and by fall they will be 2 to 3 feet high; they may yield a few fruits the following year.

The Himalaya berry, Evergreen, Dallas, McDonald and certain other blackberries are propagated either wholly or in part by the tips of canes, as are black raspberries.

Blandfordia. *Liliaceæ.*

Multiplied by seeds sown in sandy peat with mild bottom heat ; by offsets ; and by division of the old plants, which must be performed when repotting in early spring.

Blechnum. *Polypodiaceæ.*

Propagated by spores and by division from the end of the rhizome. See *Ferns*, page 312.

Bletia and Bletilla. *Orchidaceæ.*

These are terrestrial, and their flat roundish pseudobulbs are usually under ground. They bear division well, especially *Bletilla hyacinthina*, which may be cut up into pieces consisting of a single pseudobulb. See *Orchids*, page 372.

Blueberry (*Vaccinium corymbosum*, and other species), *Ericaceæ.* (Frederick V. Coville.)

Propagated by removing and perhaps dividing bushes or clumps from the wild ; by layers ; by cuttings ; by seeds ; by graftage.

Seeds washed from fresh berries and sowed at once in two parts of peat to one part of clean sand will begin to germinate in two to four weeks if the night temperature is kept down to 60° F.

Selected and hybrid blueberries do not "come true" from seed. Lowbush blueberries which spread by rootstocks are readily propagated by division, but highbush blueberries usually have no rootstocks and cannot be propagated satisfactorily in this way. Layering and mound-layering are easy but slow. Soft-wood cuttings root with great difficulty because of the excessive heat of summer. Various special methods of propagation have been devised. The most useful of these are "stumping" (which, like layering, is slow), "tubering," and winter cuttings. Budded plants are unsuitable for permanent plantings because they are continually sending up new and undesirable shoots from the stock, but budding affords the quickest means of growing a large amount of cutting-wood from a valuable young hybrid. Grafting is more difficult and less satisfactory than budding.

The sand used in cutting-beds should be clean, with reference especially to clay, bacteria, lime, and salt ; the peat either bog or upland, but formed from ericaceous plants and taken from near the surface ; and the water free from lime.

Stumping. — Cut the bush to the ground in the dormant season, outdoors. Cover the stumps 2 to 3 inches with a mixture of 1

part of sand and about 2 parts of peat. Keep this bed well drained but continually moist. The new growth arising from the stumps after this treatment takes the form of erect scaly rootstocks which continue into leafy stems and which tend to develop roots in profusion. In the following spring, before growth starts, cut the rooted shoots from the stumps, removing the tops down to about 2 inches from the surface of the ground, and set the plants in a peat and sand soil in a cool half-shaded situation sheltered from the wind, preferably in a ventilated frame.

Tubering. — This method involves the same principle employed in stumping, namely, the forcing of small sprouts in such way that their basal portions are morphologically scaly rootstocks, with a strong tendency to root-production. Make cuttings 3 to 4 inches long from unbranched portions of old and hardened stems, a quarter of an inch to an inch or even more in diameter, from vigorous bushes grown in full sunlight and therefore with wood well stored with starch. They should be made in late fall and stored in clean hardwood sawdust, preferably basswood, or clean sphagnum moss for two months or more at a temperature of 32° to 40° F., until their starch has been transformed to sugar, or made in early spring before the buds begin to swell. Start them early, in a cool greenhouse if practicable, otherwise in a coldframe. Make the cutting-bed of 1 part of peat and 2 parts of sand, or of sawdust and peat as described under winter cuttings. Lay the cuttings horizontally and cover them about $\frac{3}{4}$ of an inch with the same material as the cutting-bed. Keep the temperature at 55° to 65° as long as the weather permits, using shades suspended over the frames whenever the sun tends to carry the temperature above 65°, and keep the atmosphere saturated or nearly so by the closing of the sash. The sprouts root at the base, and at the approach of warm weather the old cutting dies. As soon as the sprouts are well rooted, the frame should be gradually adjusted to full ventilation. The rooted sprouts may be potted then, but a larger percentage become established if they remain in the cutting-bed until spring, at a winter temperature of 32° to 40° preferably; but if the cutting-bed is outdoors it should be mulched with leaves during winter to prevent injury of the roots from the "heaving" of the soil in repeated freezing and thawing.

Root-cuttings often make excellent plants when treated in the same way as tubered cuttings.

Winter cuttings. — Make the cuttings in autumn as soon as the leaves are shed. Use well-ripened unbranched wood of the season's growth, produced in well-lighted situations. About 4 to 5 inches is a suitable length. If a greenhouse is available, set the cuttings, upright or at an angle, in a cutting-bed of 4 parts of basswood sawdust to 1 part of peat. Maple or birch sawdust does nearly as well as basswood. For winter cuttings, sawdust and peat provide a better cutting-bed than peat and sand. Cedar or pine sawdust is too acrid. Keep the cutting-bed at a temperature of 55° to 65° for a month, when the cuttings will be callused. Then change to 35° at night and 60° in the daytime. After about two months, the starch-to-sugar transformation consequent on the chilling will have taken place and the buds will begin to swell. Then change again to a temperature of 55° at night and about 60° in the daytime, the air above the cutting-bed being kept saturated or nearly so. After new twigs have pushed from the upper buds, the new growth has been terminated by the browning of the tips, and the new leaves have reached their full size and acquired the dark green color and texture of maturity, roots will begin to form at the lower ends of the cuttings. Rooting is usually followed by secondary twig growth. Ventilation may then increase, and the rooted plants be treated thereafter as described under "tubering."

If no greenhouse is available, the cuttings should be made in the autumn, laid in boxes, covered with pure moist basswood sawdust, and kept in an incubator for a month at a temperature of 55° to 60°, in order to callus. For the remainder of the winter the boxes should be kept at a temperature of 32° to 40°, and as soon as the frost is out of the ground in spring the cuttings should be set very carefully, so as not to injure the calluses, in a cutting-bed of sawdust and peat, or peat and sand, as already described, in a coldframe. The frame should be kept as near 55° to 60° as possible, as early and as long as the weather permits. The later progress and treatment of the cuttings should be as already described.

Budding. — For stocks use the strong new shoots from wild bushes cut to the ground in the preceding dormant season. Bud them in July or early August. Use buds from selected hybrids, choosing from the season's growth those whose scales have turned brown. In the hottest weather sticks of such buds can be carried safely for one or two days if wrapped in clean moist muslin and

properly packed in a thermos bottle in clean chilled sphagnum and cracked ice. Bud by the ordinary shield method, with a T-shaped cut and unwaxed raffia wrapping. Protect the wrapping from rain by a cone of paraffined paper tied tightly around the stem, or in situations free from dust and dirt omit the cones but use for bud wrappings raffia sterilized by boiling. After three weeks the bud wrappings may be removed if the stock is choking seriously. Early in the following spring cut off the stock about half an inch above the bud, and by repeatedly rubbing all stock sprouts, allow no growth from the bush except that from the inserted buds. Tie the new bud shoots to stakes.

Bocconia. *Papaveraceæ.*

Propagated chiefly by suckers, taken from old plants in summer. Cuttings from the axils of the large leaves in early summer will have roots before winter. Root-cuttings of *B. cordata* (*Macleaya cordata*) strike freely. Easily grown from seeds.

Bœhmeria. *Urticaceæ.*

Handled by division; also by seeds when obtainable.

Boltonia. *Compositæ.*

Multiplied by divisions of the root in spring; and by seeds.

Bomarea. *Amaryllidaceæ.*

Multiplied by fresh seeds, in a warm house; also by careful division of the rhizome with some of the roots attached.

Borago (Borage). *Boraginaceæ.*

Propagated by seeds in spring; also by divisions in spring, or by cuttings in a frame or under glass.

Borassus. *Palmaceæ.*

Handled by seeds in a strong bottom heat and abundant moisture. See *Palms*, page 377.

Boronia. *Rutaceæ.*

Increased by seed and by cuttings of young or half-ripened wood. Place these in a thoroughly drained pot with a compost of finely sifted loam, peat and sand, with 1 inch of sand on the surface, and cover with a bell-glass, in a temperature from 45° to 50°. Seeds similarly treated make flowering plants the same season.

Bougainvillea. *Nyctaginaceæ.*

Handled by cuttings from the half-ripened wood from April to June; place in sandy soil in bottom heat; keep moist at temperature 65° to 70°. Also grown from root-cuttings.

Boussingaultia (Madeira Vine). *Bassellaceæ.*

Propagated by seeds, and easily by means of the tubercles on the stem; also by the underground tubers.

Bouvardia. *Rubiaceæ.*

Commonly propagated by root-cuttings, which strike readily; the larger and thicker roots are taken in spring for this purpose. Cuttings of shoots are also used, struck in heat; these cuttings are made of fresh shoots arising from plants cut back after bloom and kept at comparative rest for a time. The cuttings should be 2 inches long and taken with a heel, and placed in pots in brisk bottom heat; it is best to put the pots in a propagating-frame till roots form.

Bowiea. *Liliaceæ.*

Propagated by seeds, or offsets from the great bulbs. The name of this remarkable plant is now *Schizobasopsis volubilis*, rather than *Bowiea volubilis*.

Brachycome (Swan River Daisy). *Compositæ.*

Multiplied by seeds in early spring, and transplanted; or they may be sown thinly outdoors, late in spring in regions of long seasons. Easily grown.

Brahea. *Palmaceæ.*

Grown from seeds in heat. See *Palms*, page 377.

Bramble Fruits: *Blackberry, Dewberry, Loganberry, Raspberry, Wineberry.***Brassavola.** *Orchidaceæ.*

Increased by division. See *Orchids*, page 372.

Brassia. *Orchidaceæ.*

Propagated by dividing the plant when growth begins. See *Orchids*, page 372.

Brassica: *Brussels Sprouts, Cabbage, Cauliflower, Collards, Kale, Kohlrabi, Turnip.* All readily grown from seeds; hardy.

Briza (Quaking Grass). *Gramineæ*.

Multiplied by seeds, sown where the plants are to stand.

Brodiaea, including Hookera. *Liliaceæ*.

Propagated by offsets, which soon bloom when separated. Will also grow readily from seeds, but it requires several years to flower them.

Bromeliaceæ. Bromeliads.

Many of the bromeliads produce good seed and are readily propagated by sowing these in pans of fine sandy soil, and kept in a moist temperature of about 75°. Also increased by offsets which are freely produced after the plants blossom.

Bromus. *Gramineæ*.

Easily increased by seeds sown in the open where the plants are to stand.

Broughtonia. *Orchidaceæ*.

Increased by division, as for epidendrum. See *Orchids*, page 372.

Broussonetia (Paper Mulberry). *Moraceæ*.

Propagated by seeds, sown when ripe or kept till the following spring; and by suckers and greenwood cuttings or cuttings of ripened wood, in a cool house; also by root-cuttings with slight bottom heat and layers. The varieties are also sometimes budded in summer or grafted in early spring on the roots of the type in the greenhouse.

Browallia. *Solanaceæ*.

To have blooming plants for the holidays, they are propagated by seeds sown in summer in flats or pans or pots. If large specimens are desired, the seeds may be sown before midsummer, and the plants kept from premature blooming. For outdoor bloom they may be started indoors in early spring and transplanted into the open when weather becomes warm.

Brunfelsia, Franciscea. *Solanaceæ*.

Propagated by cuttings of the new growth in spring or from pieces of the ripe wood in autumn, placed in sand under glass in moderate heat.

Brunsvigia. *Amaryllidaceæ*.

Grown from offsets of the large bulbs. See *Amaryllidaceæ*, page 228.

Brussels Sprouts (*Brassica oleracea* var. *gemmifera*). *Cruciferae*.

Propagated by seeds, sown in the open where the plants are to stand, but usually in a coldframe or separate seed-bed and plants transplanted to permanent quarters. They are hardy plants, and seeds may be sown early if desirable.

Bryonia (Bryony). *Ucubithaceae*.

Multipled by seeds, and by divisions of the tuber. Cuttings of the shoots will also strike (but with difficulty) in water.

Bryophyllum. *Crassulaceae*.

Propagated by stem-cuttings rooted in sand; or by simply laying the leaf on moist sand or moss, and at the indentations on the margin plantlets will appear, and because of this peculiarity the plant is frequently grown for botanical instruction. Fig. 106. Also grown from seeds.

Buddleia. *Loganiaceae*.

Propagation is by seeds sown in spring in gentle bottom heat; by greenwood cuttings under glass; and by hardwood cuttings taken in fall and kept during winter in a frost-proof room.

Buffalo-Berry (*Shepherdia argentea*). *Elæagnaceae*.

Grown readily from seeds, which are cleaned of pulp in fall and stratified till spring. Sometimes transplanted from the wild to nursery rows. Special varieties or strains can be grafted, if desired, on the Russian oleaster (*Elæagnus angustifolia*).

Bulbocodium. *Liliaceae*.

Handled by offsets of the bulbs.

Bulbophyllum. *Orchidaceae*.

Multipled by division of pseudobulbs. See *Orchids*, page 372.

Bulbs.

Consult the various genera, as amaryllis, crocus, hyacinth, lily, narcissus, tulip, and others. Most bulbs and corms make naturally separable parts, as offsets, bulbels and cormels; these may be grown to large size, making blooming plants in two to four years.

Burlingtonia: *Rodriguezia*.

Butomus (Flowering Rush). *Butomaceae*.

Increased by seeds, and by division of the roots.

Buxus (Box). *Buxaceæ*.

Propagated by seeds sown as soon as ripe, but the plants grow very slowly. They can be increased by suckers and division; by layers of young or old wood, made in autumn or early spring; usually by cuttings made of the young shoots, from 4 to 6 inches in length, in a sandy place in spring or fall. The latter method is the better way in this country, and in the North the cuttings should be handled under glass. Dwarf forms are usually increased by division.

Cabbage (*Brassica oleracea*). *Cruciferæ*.

Cabbage, brussels sprouts, broccoli and cauliflower are treated in the same general way. The plants are hardy and seeds may be sown early. In the middle and southern latitudes (say Norfolk south) cabbage seed may be sown in autumn and the young plants carried over in frames or even planted directly in the open, so that the crop will mature before the long hot weather. Cabbage seeds are sometimes planted in "hills" in spring for the late or fall crop in the North, a few seeds being dropped at each place where a plant is to stand and the plants finally thinned to one; care must be taken to protect from cabbage worms and other pests. Usually, however, cabbage is started in a specially prepared seed-bed or frame and transplanted, even for the main crop. The early crop is grown from plants started in a hotbed or greenhouse; or a home garden may be grown from plants raised in a window in the residence. Cabbage seeds germinate quickly. Take care that the plants do not become "drawn" by too much crowding, insufficient light and too high temperature.

Cabomba. *Nymphæaceæ*.

Grown from cuttings set in the earth in 1 to 2 feet of water, temperature 55° to 70°; also by division of the plant and by seeds.

Cacti. *Cactaceæ*.

The many kinds of cacti are propagated by seeds and by cuttings; and many of them graft readily.

Most cacti yield seeds abundantly. The seeds are usually fertile, and when planted under proper conditions a large percentage of them germinate and with a little care produce plants in abundance. The best soil for growing cacti from seed is a thoroughly decomposed sod mixed with at least its own volume of sand, run through a sieve of about $\frac{1}{4}$ -inch mesh. Reasonable care should be

exercised in preparing the pot for planting. As a rule the drain hole in the bottom is too small and is easily clogged. This hole should be enlarged, as thorough drainage must be maintained in growing cacti. The pot should be filled to one-fourth its depth with small bits of broken pots, and on these the prepared soil should be placed and pressed or shaken together firmly but not packed hard. The surface is then leveled by the use of a round flat-faced tamper of a diameter just to fill the pot. This surface should be about half an inch from the top of the pot. Over it the seeds are evenly distributed and then covered with a very thin layer of soil, upon which is spread a layer of fine gravel to a depth of about one-fourth of an inch. For the first few months, cactus seedlings are but small, globular, balloon-shaped or cylindrical bodies, so tender and delicate that they readily "damp off" if subjected to a sudden change from a high to a low temperature. For watering, a vessel should be used that gives a fine gentle spray, to avoid the danger of washing the seeds from their position or of injuring the young seedlings. Watering should be done at least once a day. The temperature of the propagating-house or frame should be kept as nearly uniform as possible and should not vary much from 70° F. The seedlings should usually be left in the germination-pot until the plant shows at least three or four clusters of spines. It is not advisable to begin with pots smaller than 2½ inches, as they dry out too rapidly.

Nearly all cacti may be propagated readily from cuttings. The plants are so soft and so filled with water that any bruise is likely to be the point of attack of a fungus, which quickly destroys them; therefore, a clean sharp knife must be used and a smooth surface left on the cut end. The cutting should then be placed in a dry atmosphere for a day or more, until, by drying, a kind of cuticle has formed over the cut surface. The cutting may then be rooted in sand on a bench, or planted directly in pots. In the warmer drier regions it may be placed directly in the open ground, provided the soil has perfect drainage. In greenhouse culture it is best not to place much of the cutting below the surface of the soil or sand; 1 inch is sufficient for large plants, and less than that for smaller ones, in proportion to the size of the cutting. When the cutting is long and likely to fall over, a stick should be inserted in the soil by its side and the two securely tied together until roots have been formed.

When mature plants are shipped in from the field, the roots are

always more or less injured. It is always best to cut away the roots, let the wounds dry and heal for a time, and then treat the plants as cuttings. Many of the opuntias are naturally adapted to propagate themselves vegetatively. The stems are readily detached at the joints. These stems fall to the ground and in a short time develop roots and begin to grow as independent plants. In many of the opuntias the fruits are sterile but prolific. These fruits may be removed and treated as cuttings and will readily produce new plants. Many of the smaller kinds, such as echinocactus, echinocereus, and mamillaria, produce branches that are readily detachable and easily rooted as cuttings. Some species of mamillaria have side shoots which are so lightly attached that they break off by a slight touch.

Grafting is easily accomplished in cacti. The possibilities of uniting both species and genera seem to be unlimited. For a long time it has been a practice to graft epiphyllum on pereskia or some upright stiff-stemmed cereus in order to produce a more decorative bush plant. The rat-tail cactus (*Aporocactus*, or *Cereus, flagelliformis*) is frequently treated in the same way. It not infrequently happens that a plant becomes decayed at its base, and when all evidence of decay or disease has been removed there will be so little healthy tissue left that it is next to impossible to get it to grow as a cutting. Such a piece may be grafted on a healthy stock and the plant be preserved, if the growing tip is intact. A cleft-graft or saddle-graft is more desirable when either of these can be employed, since they require less work in preparation and give a large surface for the union of the tissues. The mucilaginous sap that exudes from the cut surface allows the stock and cion to slip apart very easily, and the parts become disarranged unless proper precaution is used to prevent it. For this purpose the needle-like spines of pereskia or opuntia may be used. The two parts are pressed firmly together into the desired position, and then a spine is thrust through the united portions, securely pinning them in that position. No wax is required, but it is best to wrap the graft closely with raffia to exclude the air. The grafted plants are then placed in a warm moderately moist place until the tissues have become thoroughly knitted together. They should not be placed where subject to drying, for under such conditions the cut surface will be the first to dry, and consequently a perfect union will be prevented.

With small globose or thick plants, such as mamillaria, echino-

cactus and echinocereus, a different method is preferable. The head of the plant is cut away with a perfectly smooth transverse cut. A stock is chosen that has about the same diameter as the cion, and it is given a smooth transverse cut. The two flat surfaces are then pressed firmly together and held in place by tying them with a cotton or other soft cord. It is essential that clean instruments be used to prevent inoculation with disease germs.

A number of the upright-growing species of cereus have been used successfully for stocks, and there seems to be no limit to the number of species that may be employed. When it is desired to have the cion a foot or more high, good stocks may be obtained from plants of the old genus *Cereus*, as *Lemaireocereus stellatus*, *Nyctocereus serpentinus*, and other species of similar habit. These stocks are preferable for use in grafting *Aporocactus flagelliformis* and species of epiphyllum and rhipsalis, which normally grow in a pendent direction. When only short stocks are desired the above may be used, and also *C. tortuosus*, *C. Bonplandii*, *Selenicereus nycticalus*, *S. MacDonaldia*, and *S. grandiflorus*. These latter plants are weak-stemmed when allowed to grow tall; hence, they cannot be used for high grafts unless supported by a stake of some kind. All these species are readily grown from cuttings, which should be somewhat longer than the stock is to be. When the cutting is thoroughly rooted it should be potted and kept in good growing condition until a new root system has formed. It will then be ready to receive the cion after having been cut back to the desired height. — *Condensed and adapted from C. H. Thompson, Bull. 262, Bur. Pl. Ind., U. S. Dept. Agr.*

Cæsalpinia. *Leguminosæ.*

Readily propagated by seeds which should be soaked in warm water for some hours before sowing; plant in a bed of sandy soil and shade lightly; pot off when the plants show the first true leaf. Sometimes increased by cuttings, which may not root readily; put them in sand under glass.

Cajanus (Pigeon Pea). *Leguminosæ.*

Grown readily from seeds; in the tropics treated as an annual for its edible seeds. As a glasshouse subject, it may be grown from cuttings struck in heat.

Caladium. *Araceæ.*

Handled by tubers, which have been kept dry or rested for some time. The cut surfaces should be well dusted with powdered charcoal to prevent decay. Place in small pots where the night temperature is maintained from 60° to 65°. Large tubers, if sound, may be divided and the pieces potted; some also by cuttings. New forms raised from seed. See *Araceæ*, page 239.

Calamagrostis. *Gramineæ.*

Multiplied by seeds sown in autumn or spring.

Calamus. *Palmaceæ.*

Increased by seeds in heat. See *Palms*, page 377.

Calandrinia. *Portulacaceæ.*

Propagated mostly by seeds in this country, as they are annuals or treated as such for flower-garden bloom. *C. umbellata*, and other perennials, may also be grown from cuttings.

Calanthe. *Orchidaceæ.*

Readily handled by separating the pseudobulbs when repotting; young bulbs often appear on the top of the old ones; the old bulbs will start again the second year.

Calathea. *Marantaceæ.*

Tubers may be used for propagation, when produced. A common method is to divide the crowns. When secondary growths or suckers arise, they may be taken off below the joints, preferably in spring before growth starts.

Calceolaria (Slipperwort). *Scrophulariaceæ.*

The herbaceous calceolarias, treated practically as annuals, are grown from seed. Sow on finely sifted soil and be very careful with watering; it is a good plan to sink the pan or pot into water when needed rather than to water on top. Temperature should be about 60°; protect from sun. Seeds may be sown from late spring to early autumn to get plants for the succeeding winter and spring.

The shrubby calceolarias may be grown from seeds the same as the others, but cuttings may also be employed with good results. When the plant is trimmed in late summer or early autumn, the cuttings of firm wood are taken, with two joints. The temperature of the house should be about 45° to 50°, and the cuttings should be protected from the sun.

Calendula (Pot Marigold). *Compositæ*.

The common pot marigold (*C. officinalis*) grows quickly from early-sown seeds where the plants are to stand; or the seeds may be started indoors and the plants transplanted for early bloom. The plants of this genus may also be grown from cuttings.

Calla of florists: *Zantedeschia*.**Calliandra**. *Leguminosæ*.

Cuttings in sand over bottom heat are used for propagation.

Callicarpa (French Mulberry). *Verbenacæ*.

Increased by seeds, divisions, and by cuttings of the young shoots in spring or summer under glass; also by hardwood cuttings and layers.

Calliopsis: *Coreopsis*.**Calliphurria**. *Amaryllidacæ*.

Propagated by offsets from the bulb.

Callirhœe (Poppy-Mallow). *Malvacæ*.

Perennials are propagated by seeds, division of roots, and cuttings; the annuals are easily raised from seeds.

Callistemon. *Myrtacæ*.

Multiplied by seeds, and by ripened cuttings (or wood firm at the base) in sand under glass. Seeds should be sown in early spring in finely sifted mixture of sand, leaf-mold and loam and covered lightly, and placed in a cool greenhouse. The seed is gathered in summer, the capsules being allowed to open naturally in a box or on sheets of paper.

Callistephus (China Aster). *Compositæ*.

Quickly grown from seeds. For the main or late crop, seeds may be sown in a seed-bed in the open or even where the plants are to stand. For earlier bloom, seeds may be started indoors in late spring.

Callitris, Frenela. *Pinacæ*.

Multiplied by seeds when obtainable; and by cuttings under glass in autumn, and wintered in a pit.

Calluna (Heather). *Ericacæ*.

Propagated by cuttings of the tender shoots in sand under glass

in a cool house in autumn. Plants for propagating stock should be potted in September and kept in a cold frame or pit till January; on being brought into a warm greenhouse, cuttings may be taken in about two weeks and will root readily in sand. *C. vulgaris* is propagated from cuttings or seeds; its varieties by cuttings.

Calochortus (Mariposa Lily). *Liliaceæ*.

Propagated by seeds, offsets, and by the little bulblets on the stem. Sow seeds as soon as ripe, or early the next year. As they may have to remain in the pans or flats the second year, it is well to sow the seed thinly. Keep in a frame or cool house. Pot them off the third season; that or the following season they should bloom. Offsets are removed when the plants are shifted, or in a dormant period.

Calonyction (Moonflower). *Convolvulaceæ*.

Raised from seeds, which may be cut or filed to hasten germination. For short-season climates, the plants should be started indoors. Often retained in the genus *Ipomœa*.

Caltha (Marsh Marigold. "Cowslip" in America). *Ranunculaceæ*.

Readily increased by division of the plants, or of the rhizomes of some species. Fresh seeds sown in moist cool earth give satisfactory results.

Calycanthus (Sweet-scented Shrub. Carolina Allspice). *Calycanthaceæ*.

Propagated by seeds sown in spring in a frame; by divisions or suckers, and by layers in summer.

Calystegia: *Convolvulus*.

Camassia (Camass or Quamas). *Liliaceæ*.

Seeds grow readily, giving blooming plants in three or four years; also increased by offsets.

Campanula (Bell-flower). *Campanulaceæ*.

Increased by seeds started early under glass. Annuals may be raised in the border by seeds sown late in April or May, or raised in the greenhouse and transplanted. The perennials are also propagated by dividing the roots, or by cuttings of shoots in spring. The Canterbury bell (*C. Medium*) is biennial. Seeds sown in late spring will give good bloom the following year. Plants for

specially good results are sometimes potted and carried over winter in a frame or cool house.

Campsis (Trumpet-Creeper). *Bignoniaceæ*.

Propagated by seeds, by greenwood cuttings under glass, by hardwood and also by root-cuttings and layers. The plant is mostly known as *Tecoma* (rather than *Campsis*) *radicans*.

Canistrum. *Bromeliaceæ*.

Propagation as for *nidularium*, which see.

Canna. *Cannaceæ*.

The named garden cannas are propagated by division of the large branching roots or rhizomes. Every large eye, with some root and rhizome attached, may form an independent plant. Weak eyes usually produce relatively weak plants, unless handled with special care. These rhizome-cuttings are started in pots or boxes under glass, so that the plants may be a half foot or foot high when planting-out time comes with warm weather. The entire clump of roots may be planted directly in the open if one does not need to multiply the plants, or only partial division may be made; this gives stronger plants or masses under ordinary conditions. Fig. 57.

Seeds grow readily if well matured, although they usually germinate slowly and irregularly unless cut or filed to let in the moisture. If sown in late winter or early spring over good bottom heat and the plants shifted as needed, blooming plants may be had the first year. Seeds give rise to new varieties, or at least to variations.

Cannabis (Hemp). *Moraceæ*.

Grown from seeds sown in spring.

Cantua. *Polemoniaceæ*.

Handled by cuttings placed in sand under glass; little known in North America.

Capparis (Caper). *Capparidaceæ*.

In warm countries, grown from seeds. In greenhouses and cold climates, propagated by cuttings of ripe shoots in sand under glass.

Capsicum: *Pepper*.

Caragana (Siberian Pea Tree). *Leguminosæ*.

Seeds are sown in autumn or spring; if kept dry over winter, they are soaked in warm water before sowing. Root-cuttings

may be used ; also layers of the bushy kinds. Rare or choice kinds may be grafted on seed-raised stocks of *C. arborescens*.

Cardamine (Lady's Smock). *Cruciferæ*.

Multiplied easily by division of the roots after flowering, and by seeds.

Cardiospermum (Balloon-Vine). *Sapindaceæ*.

Propagated easily by seeds.

Cardoon (*Cynara Cardunculus*). *Compositæ*.

Seeds and suckers as for artichoke, to which it is very closely related.

Carex (Sedge). *Cyperaceæ*.

Propagated by seeds sown in late fall, and by division of the clumps, usually the latter. Seeds often lie dormant the first year.

Carica : *Papaya*.

Carissa. *Apocynaceæ*.

Propagation by seeds and by cuttings of ripe wood.

Carludovica. *Cyclanthaceæ*.

Propagation by division, in early spring ; also by seeds cleaned of the pulp and sown on surface of a pan of finely chopped sphagnum moss.

Carnation (*Dianthus Caryophyllus*). *Caryophyllaceæ*.

New varieties are grown from seeds, mostly from hand-pollinated flowers. Seeds are usually sown as soon as ripe under glass. Seedlings are potted as soon as the true foliage leaves appear ; bloom may be expected within a year.

The commercial florist's carnation is grown in North America from cuttings rooted in winter and early spring in benches of clean sharp sand over even bottom heat of about 60° and an air temperature 50° to 55°, protected from drafts and direct sunshine. The cuttings are cut to a joint beneath and the leaves are stripped from this joint so that there will be a half inch of clean stem. The spreading upper leaves are cut off, and only the fresh upright foliage is left. The cuttings are inserted about $\frac{3}{4}$ inch into the sand, close together in the row. Keep uniformly moist and not too hot. These cuttings yield the blooming plants for the succeeding winter. Best cuttings are made from the middle side-growths on the flower-stems, care being taken that only healthy and productive

stock is propagated. Good cuttings may be had from stocky cutting-made plants grown only for the purpose of yielding cutting-wood and not grown on for bloom. The carnation soon deteriorates if care is not taken to select from the best parents. Fig. 116.

In Europe, the carnation is also propagated by layering, which should be done at the end of July or the beginning of August. The shoots selected should be denuded of a few of their leaves at the base of the young wood, and a slit must be made from this point upwards, extending through a joint of the bare stem, so that a tongue is formed. Figs. 63, 69.

The outdoor hardy carnation is grown in the same way as pinks. See *Dianthus*.

Carpinus (Hornbeam. Blue Beech). *Betulaceæ*.

Propagated by seeds sown usually in fall, which germinate irregularly. If the seed-bed is kept moist and clean (covered with moss or other material) through the entire season, the remaining seeds may be expected to germinate the second spring. Varieties propagated by budding or grafting on seedling stocks, either under glass in spring on potted stock or in the open in summer.

Carrot (*Daucus Carota*). *Umbelliferæ*.

Grown from seeds sown in spring where the plants are to stand.

Carthamus (Safflower). *Compositæ*.

Raised from seeds sown directly in the open, or started under glass. The common *C. tinctorius* is a garden annual.

Carya: *Hickory, Pecan*.

Caryopteris. *Verbenaceæ*.

Raised by seeds sown in spring, by division, and by cuttings of half-ripened wood in summer or fall under glass.

Caryota. *Palmaceæ*.

Propagated by seeds or by suckers. See *Palms*, page 377.

Cassandra: *Chamædaphne*.

Cassava (*Manihot dulcis* var. *Aipi*). *Euphorbiaceæ*.

Multiplied by cuttings of the stem and by suckers. Propagated in spring, the cassava roots are ready to harvest in autumn. Cut the large main stalks into pieces from 4 to 6 inches long, and set them perpendicularly into the ground in the field. The cuttings can be struck at various times, but spring is usually preferred.

The stalks can be kept over winter by covering with sand on a dry knoll, placing the stalks and sand in layers. Cover the whole with boards to shed the water. Suckers which appear during summer can be removed and planted or made into cuttings. Seeds are sometimes used for growing the early-maturing varieties.

Cassia. *Leguminosæ.*

The perennial and woody kinds are grown from divisions and by cuttings of firm wood struck in heat; the annuals by seeds; *C. marglandica* also by division.

Castanea: *Chestnut.*

The castanea nuts of commerce are Brazil-nuts (*Bertholletia*), not grown in North America.

Castor-oil Bean: *Ricinus.*

Casuarina (Beefwood). *Casuarinacæ.*

Multiplied by seeds; and by cuttings made of half-ripened or firm shoots, in sand under glass.

Catalpa. *Bignoniacæ.*

Increased by seeds sown in spring in the North, with slight bottom heat, and by cuttings of the ripe wood. The named varieties are propagated by soft cuttings in June and July. Grafts are also used on seedlings or on roots of *C. speciosa* or *C. bignonioides* in spring under glass. Layers and root-cuttings are sometimes employed. The *C. Bungei* of nurseries (which is properly *C. bignonioides* var. *nana*) may be worked on seedlings, or grown from cuttings.

Catananche. *Compositæ.*

Propagated by seeds in spring; perennials also by division.

Catasetum. *Orchidacæ.*

Propagated by dividing plants at base; also from very ripe pseudobulbs cut in pieces and put in sand. See *Orchids*, page 372.

Cattleya. *Orchidacæ.*

Raised from seeds, and also by cutting the rhizome between the pseudobulbs. The rhizome is cut almost in two as it stands and allowed to remain until roots are formed, when the parts may be severed and separately potted. See *Orchids*, page 372.

Cauliflower (*Brassica oleracea* var. *botrytis*). *Cruciferæ.*

Grown from seeds much as cabbage, which see.

Ceanothus. *Rhamnaceæ.*

Increased by layers and by cuttings of mature wood in autumn in a coldframe. Softwood cuttings grow readily if taken in early spring from forced plants. Also propagated by seeds sown in spring. Varieties and hybrids may be grafted on roots of *C. americanus* under glass in early spring. Seeds may be sown in spring.

Cedar: *Cedrus, Chamæcyparis, Juniperus, Thuja*; also *Cedrela*.

Cedrela (Bastard Cedar). *Meliaceæ.*

Propagated by seeds and mature-wood cuttings in sand, under glass; also by root-cuttings.

Cedronella. *Labiataæ.*

The herbaceous species are propagated by division of the roots and by cuttings of young wood; *C. triphylla* by cuttings or by seeds.

Cedrus (Cedar). *Pinaceæ.*

Propagated in spring by seeds. Varieties are propagated by veneer-grafts in late summer or fall; may also be grown from cuttings, if the small shoots which spring from the old wood are taken. In the North, *C. atlantica* may be used as stock on which to graft varieties and rare kinds, and in the South *C. Deodara*.

Celastrus (Staff-tree. Bitter-sweet). *Celastraceæ.*

Grown from seeds sown in fall or stratified, and freely by suckers; also by layering in autumn; also by root-cuttings.

Celery (*Apium graveolens*). *Umbelliferæ.*

Grown from seeds; for the early crop, sow under glass, as in a hotbed, early in March. Seed for late crops may be sown outdoors as early in spring as the ground can be worked, in well-protected and carefully prepared seed-beds; keep the soil uniformly moist.

Celosia (Cockscomb). *Amarantaceæ.*

Grown from seed sown in spring indoors or directly in the open. Seeds germinate readily.

Celsia. *Scrophulariaceæ.*

Seeds in pots in the greenhouse, the plants being later transferred to the open; *C. Arcturus* also by cuttings.

Celtis (Nettle-Tree). *Ulmaceæ*.

Multiplied by seeds as soon as ripe; by layers, and by cuttings of ripened shoots in autumn. Rare kinds are sometimes grafted on seedlings of *C. occidentalis*.

Centaurea. *Compositæ*.

Annuals are grown from seeds sown directly in the open or started under glass. *C. Cineraria* and some others grown for foliage may be raised from seeds in August, or from cuttings about the beginning of September and carried over winter. The bachelor's button (*C. Cyanus*) is best known and is an easily-grown annual from seed; often self-sows.

Centradenia. *Melastomaceæ*.

Increased by cuttings at any time of the year. To obtain good plants for the following winter, cuttings should be taken in February or March.

Centranthus. *Valerianaceæ*.

Propagated by seeds in spring, and by divisions.

Cephalanthus (Button-Bush). *Rubiaceæ*.

Propagated by seeds, layers, and mature cuttings in autumn; also by greenwood cuttings taken from forced plants early in spring.

Cephalocereus: *Cactaceæ*, page 261.**Cerastium** (Mouse-Ear Chickweed). *Caryophyllaceæ*.

Raised by seeds and division, or by cuttings after flowering.

Cerasus: *Cherry, Prunus*.**Ceratonia** (Carob). *Leguminosæ*.

Grown from seeds. On the seedlings, choice or named varieties may be budded, the buds from bearing trees yielding fruit in three to six or eight years. Seeds may be soaked in water three or four days to hasten germination. Cuttings may be struck in bottom heat.

Ceratopteris. *Ceratopteridaceæ*.

Propagated by buds which arise from all parts of the leaves. See *Ferns*, page 312.

Ceratostigma. *Plumbaginaceæ.*

Increased by divisions, and by cuttings. *C. Larpentæ* is the *Plumbago Larpentæ* of nurseries.

Ceratozamia. *Cycadaceæ.*

Usually grown from the imported plants. It may be propagated by seeds, when obtainable, and also by offsets. These offsets or suckers arise on the crown when the trunk is injured; to stimulate them, the center of the plant is sometimes burned out with a hot iron.

Cercidiphyllum. *Trochodendraceæ.*

Propagated by cuttings made in the summer and from greenwood cuttings taken from forced plants in spring; by seeds, when procurable, sown in spring, or by layers.

Cercis (Red-Bud. Judas Tree). *Leguminosæ.*

Propagated by seeds in spring, preferably indoors with bottom heat. May also be increased by layers, and by greenwood cuttings from forced plants in early spring. *C. chinensis* is grown from soft cuttings in summer under glass.

Cereus. *Cactaceæ.*

By seeds and cuttings. See *Cacti*, page 261.

Cerithe. *Boraginaceæ.*

Propagated readily by seeds, in spring.

Ceropegia. *Asclepiadaceæ.*

Handled by cuttings of green shoots in spring, preferably with bottom heat.

Ceropteris. *Polypodiaceæ.*

Spores and division. See *Ferns*, page 312.

Cestrum, including *Habrothamnus.* *Solanaceæ.*

Propagated by cuttings in February or early March and inserted in sand in a warm temperature; by seed, when obtainable.

Chænomeles (Japan Quince). *Rosaceæ.*

Propagated by seeds, usually stratified and sown in spring; by root-cuttings in fall or early spring; also from cuttings of half-ripened wood, under glass, and from layers. Rarer kinds may be grafted on stock of Japanese (*Ch. lagenaria*) or common quince (*Cydonia oblonga*) in early spring in the greenhouse. The Japan

quince, grown for its attractive early spring bloom, is commonly known as *Cydonia japonica*; later as *Chænomeles japonica*, and now as *Chænomeles lagenaria*.

Chamæbatiaria. *Rosaceæ.*

The *Spiræa*, or *Sorbaria*, *Millefolium* of nurserymen; seeds in spring, as for spiræas, or by heeled cuttings of half-ripened wood in summer in slight bottom heat.

Chamæcyparis (White Cedar). *Pinaceæ.*

Raised from seeds freely, sown in spring, also by layers, but mainly by cuttings of mature wood put in a frame or greenhouse in autumn and kept cool and close over winter; in spring, gentle bottom heat is applied. The retinosporas (which are juvenile forms of other species) are grown in this way from cuttings, and also many forms of *C. Lawsoniana*. Other species are veneer-grafted in winter on seedlings. Dwarf kinds lose their small stature if grafted.

Chamædaphne (Leather Leaf). *Ericaceæ.*

Propagated by seeds in peat or on live sphagnum moss, scarcely covered, kept uniformly moist and shady. Layers and suckers are employed; also mature wood cuttings under glass in late summer. *C. calyculata* is the *Cassandra* and *Andromeda calyculata* of nurseries.

Chamædorea. *Palmaceæ.*

Grown from seeds. See *Palms*, page 377.

Chamærops. *Palmaceæ.*

Grown from seeds, and freely from suckers. See *Palms*, page 377.

Charieis. *Compositæ.*

Propagated by seeds, either planted in the open or sown indoors and transplanted. *C. heterophylla* is the *Kaulfussia amelloides* of seedsmen.

Cheiranthus (Wallflower). *Cruciferæ.*

The perennials are grown from cuttings taken in autumn and carried over winter in a frame or coolhouse. The annuals and biennials are readily raised from seeds.

Cherry (*Prunus avium*, *P. Cerasus*, etc.). *Rosaceæ.*

Cherry stocks are commonly grown from seeds. If the ground is in readiness and is in proper condition, the seeds may be planted in fall, or even as soon as they are ripe. If stored until spring, they

must be stratified and kept very cool to prevent germination, and they should be sown at the earliest possible moment. They do not need to be cracked by hand. Care must be taken that cherry pits do not become hard and dry. This precaution is more important with cherries than with peaches and plums. At the close of the first season, the seedlings will be a foot or foot and a half high, large enough to transplant into nursery rows, after the manner of apples, where they are budded the following season (second season from the seed). In warm climates the pits are sometimes cracked as soon as they are gathered, and the "meats" planted immediately. They will then make stocks fit for grafting the ensuing winter, or for transplanting and budding the following summer.

Cherries, in common with other stone fruits, grow readily from root-cuttings, in the same way as blackberries. They do better if started over a gentle heat.

The mazzard cherry is the stock on which cherries are recommended to be worked. It is a hardy and vigorous variety, with inferior fruit, of the common sweet cherry (*Prunus avium*). Seeds of this are readily procured in this country. As a matter of fact, however, nearly all sour cherries are worked on the mahaleb in this country, as they take better on it, and the stocks are cheap. Sweet cherries are often budded on the mahaleb, but it is a question whether such practice is best. The mazzard is such a strong grower that the bud is often "drowned out" by the flow of sap. To avoid this exuberance, nurserymen often pinch in the tips of the stocks a few days before they are to be worked. The mazzard is also liable to leaf-blight, and to serious injury from the black aphid, so that the bark often sets before the operator has had time to finish his plantation. Mazzards usually have a shorter budding season than mahalebs, and are less uniform in behavior; and for these reasons, mahalebs are widely used.

Mahaleb is a distinct species, *Prunus Mahaleb*, from southern Europe. The seeds or stocks of it are imported. Mahaleb stocks are recommended in the books for dwarfing the cherry, but the dwarfing depends more on pruning than on the mahaleb root. The mahaleb is naturally a smaller tree than the mazzard, however. It is said that the mahaleb is better adapted to heavy clay soils than the mazzard, but in practice it is used indiscriminately for all soils and nearly all varieties.

Morello (*Prunus Cerasus*) stocks will no doubt prove to be



PLATE IX. Two-year budded cherry, on mazzard (left), and mahaleb (right).

valuable in the Northwest, where great hardiness is demanded. Seedlings do not sprout or sucker badly, but the natural suckers, which are sometimes used for stocks, are likely to be more troublesome in this respect. If strong-growing tops are worked on morello stocks, however, there is usually little annoyance from suckering. Mahaleb stocks are generally used for the morello cherries.

It is probable that some of the native American cherries can be used as stocks. The common wild red, pin, pigeon or bird cherry (*Prunus pennsylvanica*) has already been used to some extent. The sweet and sour cherries unite readily with it, and bear very early. It is yet to be determined how long the trees will persist, but trees sixteen or eighteen years old have been still healthy and vigorous. It is considered to be a very promising stock for the cold prairie states. The dwarf or sand cherries (*Prunus pumila* and *P. Besseyi*) give promise as dwarf stocks.

Cherry stocks are worked both by budding and grafting. Budding is the common method. The stocks should be fit to work the season they are transplanted, or in the second summer from seed. Such as are too small for working then may be allowed to stand until the following year; or if the number is small, the poor ones are rooted out.

In the West, where great hardiness is required, the varieties are crown-grafted on mazzard stocks in winter. Yearling stocks are used, and the cions are 6 to 10 inches long. When planted, only the top bud should be left above ground. The cion strikes roots, and own-rooted trees are obtained.

The ornamental cherries are worked on the same stocks as the fruit-bearing sorts. Mahaleb and mazzard are commonly used for all species, the latter for weeping forms which need to be worked high.

Cherry trees can be top-grafted, as are apple or pear trees. They are usually grafted very early in the spring. The chief requisite is that the cions be completely dormant. They should be cut in winter and stored in an ice-house or a cold cellar. It is probable, however, that durable trees cannot be secured by top-working.

The Japanese flowering cherries are of different species from the fruit-bearing cherries, being forms mostly of *Prunus serrulata*, *P. Lannesiana*, *P. Sieboldii*, *P. yedoensis*, and *P. subhirtella*. These may be worked on mazzard and other stocks of European

origin, but the trees are likely to be short-lived and unsatisfactory. Native Japanese stocks are to be preferred. The ornamental varieties of *P. serrulata* are probably best worked on stocks of *P. serrulata* var. *sachalinensis* from the northern part of Japan, particularly for the northern regions of this country, as this stock is hardy in New England. Forms of the wild *P. Lannesiana* from Japan, particularly the form known as Mazakura, are also recommended. *P. subhirtella* var. *pendula* (known to nurserymen as *P. japonica rosea pendula*) should be grafted high on such seedlings of *P. subhirtella* as assume an upright habit. To maintain an upright stock of good forms of *P. subhirtella* itself, propagation should be from cuttings or it may be grafted on its own upright seedlings.

Chervil (*Charophyllum bulbosum* and *Anthriscus Cerefolium*).
Umbelliferae.

Seed is sown much the same as celery seeds, but the plants are usually allowed to stand where sown. Seed is often sown in autumn.

Chestnut (*Castanea species*). *Fagaceae*.

Chestnut stocks are grown from seed. Difficulty is sometimes experienced in keeping the seeds, as they lose their vitality if dried too hard, and are likely to become moldy if allowed to remain moist. The surest way is to allow the nuts to become well dried off or "seasoned" in the fall, and then stratify them in a box with three or four times as much sand as chestnuts, and bury the box a foot or two deep in a warm soil until spring. They do not always keep well if stored or stratified in a cellar. Fall planting exposes the nuts to squirrels and mice. American stocks are better than European, because the latter are tender in the North.

The stocks are worked by whip-grafting above ground, the wound being well tied and protected by waxed cloth. Care should be taken to have the stock and cion about the same size, in order to secure a good union. Chestnuts can be cleft-grafted like apples and pears; but in small trees it is preferable to set the grafts below ground, as in grapes. The cions should be cut early, before they begin to swell, and kept perfectly dormant until the stock begins to push into leaf. Only vigorous stocks should be grafted. The best results are obtained when the stocks have recovered from transplanting, or when they are from three to five years old. The working of chestnut stocks is far from satisfactory in a commercial

way. The union is imperfect in many varieties, and usually no more than half the grafts take well and live long. In all nut-trees, the skill of the operator is more important than the particular method.

In regions where chestnuts grow wild, orchards are sometimes made by grafting the sprouts or the seedlings that come up in cleared lands.

Chicory (*Cichorium Intybus*). *Compositæ*.

The field crop, for the roots, is grown from seeds sown directly in the drills, 1-1½ pounds to the acre.

As a salad plant, chicory is easily raised from seeds sown where the plants are to stand. See *Witloof*.

Chilopsis (Desert Willow). *Bignoniaceæ*.

Propagated by seeds; and by cuttings of half-ripened shoots in bottom heat.

Chionanthus (Fringe Tree). *Oleaceæ*.

Increased by seeds sown in autumn or stratified till spring; also by layers and cuttings from forced plants in early spring. Grafting or budding on the ash (as *Fraxinus Ornus*) succeeds very well.

Chionodoxa. *Liliaceæ*.

Propagated readily by seeds, which are sometimes self-sown. If sown in a frame as soon as ripe, the seeds may be expected to germinate the following winter or early spring. Also increased by bulbels or offsets.

Chives, or Cives (*Allium Schænoprasum*). *Liliaceæ*.

Propagated by division of the clumps. The stools should be broken up and replanted every few years.

Chloris. *Gramineæ*.

Raised from seeds sown directly in the open, or started under glass and transplanted.

Chlorophytum. *Liliaceæ*.

Multiplied by division of the tough root system before the plant begins new growth, or by the suckers that naturally arise; also sometimes by seeds, when produced. Usually known to gardeners as anthericum.

Chorizema. *Leguminosæ.*

Propagated by cuttings in March from half-ripened wood, in a mixture of two parts sharp sand and one of peat, finely sifted. They should be covered with a bell-glass with a night temperature of 58° to 60°.

Chrysalidocarpus. *Palmaceæ.*

The *Areca lutescens* of gardeners: propagated by seeds in pans, boxes or benches, where they are left until two or more leaves have formed; the pan or box may have gravel in the bottom. See *Palms*, page 377.

Chrysanthemum. *Compositæ.*

Many plants are included in this genus, as the florist's chrysanthemum, flower-garden annuals, pyrethrums, marguerites, Shasta daisy, and hardy perennials grown in the border. All are readily propagated by seeds, the perennials giving bloom the second year or sometimes the first year. The annuals (*C. coronarium*, *C. carinatum*, *C. segetum*) are easily raised from seeds sown in spring where the plants are to grow; and they may be started under glass and transplanted.

The perennials are grown from divisions of the stools and also from cuttings. The marguerite or Paris daisy (*C. frutescens*) is propagated by cuttings of firm shoots in winter or spring; blooming plants should be had the following winter. See *Pyrethrum*, page 405.

The florist's chrysanthemum is grown from seeds to obtain new varieties; these should be sown in spring and plants should yield good bloom the following year. Usually propagated by cuttings about 3 inches long, of firm, healthy, short-jointed shoots, which spring from the base of the plant after the flowering season. They should be made in late winter or spring, and placed near the glass of a rather close frame having a temperature of about 45°. If inserted in pots, only the lower leaf should be removed; if in beds, the remaining foliage should also be trimmed to admit air. Insert about half of the cutting, press the soil firmly, and water. Leaf-cuttings have been employed. Inarching and grafting may also be performed, when it is desired to grow two or more varieties on one plant.

The time at which chrysanthemum cuttings should be taken depends on the season at which bloom is wanted, and the methods of cultivation. The plants may be flowered in pots, or in a solid soil bench. Very good small plants may be brought to perfection

in 6-inch pots, but the best results, in pot plants, are to be obtained in 8- or 10-inch pots or 12-inch pots started in November and December. If the plants are to be used for decoration, they should, of course, be grown in pots, but the best results for cut-flowers are usually obtained by growing in the earth. In any case, the cuttings are made from the tips of basal or strong lateral shoots late in February to May. One form of cutting is shown in Fig. 118. If the plants are to be flowered in pots — in which case they usually mature earlier — the cuttings may be started as late as April, or even June; but if they are grown in the soil and large plants are desired, the cuttings should be taken in February or March. The plants which are flowered in the soil are generally grown in pots until July. The plants are flowered but once, new ones being grown from cuttings each year.

Sometimes the old stools of florist's chrysanthemum are divided before growth begins in spring, but this is unusual. Suckers, partially rooted or used as cuttings, may also be taken from the old crowns.

Chrysobalanus (Cocoa-Plum). *Rosaceæ*.

Increased by seeds; also by cuttings of half-ripened wood.

Chrysophyllum (Star-Apple). *Sapotaceæ*.

Grown from fresh seeds; also by cuttings of well-ripened shoots in heat.

Chufa (*Cyperus esculentus*). *Cyperaceæ*.

Freely propagated by the little tubers, planted in spring where the plants are to grow.

Cicer (Chick-Pea. Garbanza). *Leguminosæ*.

Seeds sown in spring where the plants are to grow propagate the plant freely.

Cimicifuga (Bugbane). *Ranunculaceæ*.

Grown from seeds sown when mature, the seed-bed being kept cool and moist; plants will probably not appear till spring; also from divisions in fall or spring.

Cinchona (Peruvian Bark). *Rubiaceæ*.

In greenhouses, propagated by mature-wood cuttings in heat or from imported seeds. In the tropics by seeds, with only a thin covering of earth; protect from rain and sun and keep uniformly moist; transplanted when about 2 inches high.

Cineraria (*Senecio cruentus*). *Compositæ*.

Raised from seeds, usually from well-grown commercial seed. The florist's cineraria is usually a winter and spring bloomer. Two batches of seedlings are usually raised for succession, one from seed sown in August and another in September or early October. If bloom is wanted for early winter or late autumn, seed should be sown in May. Seed is sown in pans, flats or pots on the surface of finely prepared and leveled soil and covered with sifted sand. Water with care, keep uniformly moist, protect from drafts and direct sun, and prick out as soon as large enough to handle. Keep them shifted as needed, not in too large pots at each shift, and growing without check; do not allow them to bloom prematurely.

Cinnamomum. *Lauraceæ*.

Increased by cuttings and seeds. The seeds should be sown as soon as ripe in a shaded bed, the seedlings being transplanted when very small into pots and kept until set out permanently. Cuttings of half-ripened wood may be rooted in the spring in moderate heat, in coarse sand. In this genus are included cinnamon, camphor and cassia-bark.

Cissus. *Vitaceæ*.

Grown from seeds, when obtainable; also by cuttings of green or mature wood. Handled essentially as for the grape, ampelopsis and parthenocissus.

Cistus (Rock Rose). *Cistaceæ*.

Seeds sown in flats or pans in spring, protected from sun, give good results; by layers; by cuttings under glass in peaty soil in late spring or summer.

Citron (*Citrus Medica*). *Rutaceæ*.

Propagated from seeds; by mature cuttings, the same as the lemon; and more commonly by budding on sour orange, sweet orange or lemon stocks. See under *Orange*.

Citrullus: *Watermelon*.**Citrus**. *Rutaceæ*.

Propagated by seeds, layers, cuttings, inarching, grafting and budding. For particular methods, see *Grapefruit*, *Kumquat*, *Lemon*, *Lime*, *Orange*.

Cladrastis (Yellow-wood. *Virgilia*). *Leguminosæ*.

Multiplied by seeds in the open air in spring, or by cuttings of the root, dug in fall and kept in sand or moss, moderately moist and cool, until spring.

Clarkia. *Onagraceæ*.

Raised readily from seeds sown in spring, either in the open or started indoors.

Clavija. *Myrsinaceæ*.

Propagated by cuttings of half-ripened shoots.

Clematis (Virgin's Bower). *Ranunculaceæ*.

Seeds gathered as soon as ripe and stratified till spring usually grow freely. Layers may be employed, put down preferably in fall or spring. Some species, as *C. recta*, are increased by division.

The kinds of clematis can be grown from cuttings of young shoots, cut to single eyes and rooted in sand under glass in summer. Cuttings of nearly ripe wood may also be similarly used in summer.

The named varieties are grafted on pieces of roots of *C. Flammula* or *C. Viticella* or others, the roots being taken from established plants in the open. The cions are taken from house-grown plants, and the grafts are handled in a cool greenhouse in summer to fall or winter, whenever roots and good cions are available.

Cleome (Spider Plant). *Capparidaceæ*.

The commonly cultivated cleomes are annuals or treated as such. Seeds may be sown under cover in spring and the plants transferred to permanent quarters out of doors; or the sowing may be directly in the open. Cuttings of the perennial kinds may be struck in heat.

Clerodendron. *Verbenaceæ*.

Raised from seeds and cuttings, usually started in small pots in a soil of sand and peat (or leaf-mold). They should be started in a rather close temperature of about 70°. Cuttings are usually taken from half-ripened wood.

Clethra (White Alder). *Clethraceæ*.

Grown from seeds sown in spring in pans in sandy-peaty soil. Propagated also by greenwood cuttings under glass; by layers and division of large plants.

Clianthus (Glory-Pea.) *Leguminosæ.*

The brilliant *C. Dampieri* is raised from seeds, when procurable. *C. puniceus* and others grow from cuttings in sand in bottom heat and also from seeds. In Germany and England *C. Dampieri* has been handled successfully on small seedling stocks of *Colutea arborescens*. The colutea is sown a few days before the clianthus, and after the cotyledons are formed on the colutea the hypocotyl (or stem) is split down the center, the cotyledons being retained; into this cleft is inserted the seedling clianthus, being tied with very fine raffia; in a warm case, union will take place in four or five days.

Clintonia. *Liliacæ.*

Increased by seeds, and by division of the root in spring. The clintonias of seedsmen are downingias (*Campanulacæ*), garden annuals readily grown from seeds.

Clitoria (Butterfly-Pea). *Leguminosæ.*

Easily grown from seeds, which are usually produced freely; also handled from firm-wood cuttings under glass.

Clivia, Imantophyllum. *Amaryllidacæ.*

Propagated by seeds and division. The common species, *C. miniata*, is readily handled by dividing the old roots when the pot becomes crowded.

Clover (*Trifolium* species). *Leguminosæ.*

The clovers are raised from seed. Some of them are annual, as crimson clover; others perennial, as white clover; others short-lived perennials, as red clover. Seed is usually sown in early spring with a nurse crop, particularly with wheat. The quantity of red clover seed sown to the acre in grain fields is 10 to 14 or 16 pounds; of alsike about the same quantity. White clover is sown about 10 to 12 pounds to the acre; for lawns, twice this quantity. Crimson clover for cover-crop in the open field is sown 15 to 20 pounds to the acre. Red clover is usually sown on the surface in wheat fields, without covering, the land at the time being not yet dry and hard. Probably better results are to be expected by waiting till the ground is settled, harrowing lightly for seed-bed and harrowing again after sowing.

Japan clover is a lespedeza; used for hay; sown about 12 pounds to the acre. Sweet clover is melilotus; sown about 2 pecks to acre.

Clytostoma. *Bignoniaceæ.*

Propagation as for bignonia, which see. The tall climber grown as *Bignonia speciosa* is now known as *C. callistegioides*.

Cobæa. *Polemoniaceæ.*

The common *C. scandens*, although perennial, is handled as an annual, and is readily raised from fresh seed in spring, if a gentle bottom heat is supplied. It is often said that the seeds must be placed on edge, but this is a mistake. Exercise care not to keep the seed soil too moist. Also may be grown from young cuttings in spring in bottom heat.

Coccinia. *Cucurbitaceæ.*

Treated as annual climbers, grown from early-started seeds.

Coccoloba (Seaside-Grape). *Polygonaceæ.*

Plentifully propagated by seeds; by cuttings of ripened wood in sand under glass: layering may also be employed.

Cocculus. *Menispermaceæ.*

Propagated by seeds, and also by half-ripened cuttings of side shoots, in summer under glass.

Cochliostema. *Commelinaceæ.*

Increased by seeds, sown in shallow pans of light peaty soil and placed in a warm close atmosphere. Pollination may need to be assisted for the production of good seeds.

Coconut (*Cocos nucifera*). *Palmaceæ.*

The nuts are buried in nursery rows, and the young trees are transplanted. Another practice is to remove the buried nuts, when they begin to sprout, to the place in which the tree is to stand. A nut is then placed in a hole some 2 feet deep, which is gradually filled in as the plant grows. In six to eight years the tree begins to bear. The best method is to plant the ripe nuts in seed-beds and transplant the seedlings to the nursery when about 6 inches high, which will usually be six months or more from the time of planting. See *Palms*, page 377.

Cocos. *Palmaceæ.*

Most species increased by seeds in heat; some by suckers. See *Coconut*.

Codiaeum (Croton of gardeners). *Euphorbiaceæ.*

New varieties are produced by seed, started in heat. Cuttings of half-ripened wood taken in winter or spring make good plants if struck in a bottom heat of 80°. Large branches may be mossed (air-layered) and made thereby into separate plants; this treatment is often also employed with old tall plants: an incision is made in the stem beneath the crown of leaves and moss is tied about the plant, and in about three weeks it should be ready to be severed and potted.

Cœlogyne. *Orchidaceæ.*

Propagated by division and by taking off the back bulbs. See *Orchids*, page 372.

Coffea (Coffee). *Rubiaceæ.*

Under glass as an ornamental or "economic" plant, coffee may be grown from ripe cuttings.

As a crop in the tropics, coffee is raised from seeds. Sometimes volunteer seedlings in old plantations are used, but it is best to plant the seeds, after the pulp is removed, in carefully prepared shaded seed-beds, well protected from heavy rains. In ten to twelve weeks, the plants should be ready to transplant to nursery rows, the first foliage leaves having appeared. The tap-roots are cut back. After about five pairs of true leaves are developed, the plants may be set in the field; they should bear in three or four years.

Coix (Job's Tears). *Gramineæ.*

Grown from seeds, sometimes started indoors with heat.

Colchicum (Autumn Crocus). *Liliaceæ.*

Increased by seeds, as soon as ripe, June to July; also propagated by separation just after the leaves die, end of June or early July.

Coleus. *Labiatae.*

Multiplied by seeds (which grow readily) for new varieties; also by cuttings of soft growing shoots with the greatest ease at any season. Fig. 117.

Collards (*Brassica oleracea* var. *acephala*). *Cruciferæ.*

Grown from seeds, in the South started in February and March so that growth may be made before hot weather, in the North in July or August so that the growth may be made before winter.

Collinsia. *Scrophulariaceæ.*

Propagated by seeds sown in the fall outdoors in well-drained soil and protected over winter; may also be sown in spring for later bloom.

Colocasia. *Araceæ.*

Propagation as for caladium, by offsets of the tubers or "bulbs." Taro is the tuberous roots of *C. antiquorum* or *C. esculenta*. Dasheen is another form. Consult *Caladium*, page 265.

Colutea (Bladder Senna). *Leguminosæ.*

Multiplied by seeds sown in spring, and by cuttings in sandy soil in autumn. Rare kinds are sometimes grafted on *C. arborescens* in spring under glass.

Comfrey: *Symphytum.***Commelina.** *Commelinaceæ.*

Grown from seeds sown in a frame early in April; also by cuttings, which will root in sand, in a gentle hotbed, in March or April. Sometimes propagated by division of the tubers.

Comptonia (*Comptonia asplenifolia*). Sweet Fern. *Myricaceæ.*

Propagated by seeds, by dividing the clumps, and by layers. By some botanists, this interesting native plant is included in *Myrica*, as *M. asplenifolia*.

Conifers. *Coniferæ.*

When procurable, seeds are the readiest means of propagating all the cone-bearing family. Cuttings or grafts are employed when seeds are not obtainable and for forms or varieties that do not come true from seeds or of which seeds cannot be obtained. See *Chamæ-cyparis*, *Thuja* and others. Cuttings usually root readily.

Seeds are gathered as soon as ripe. The cones of some species, as the white pine and the firs, empty themselves of seeds very early and the cones must be taken before they open. Of some species the cones remain closed for years, and they are opened by roasting them in ovens, care being taken that the seeds are not injured by the heat. Seeds of conifers are kept in tight boxes or bags in a cool dry room and sown in spring in a carefully prepared seed-bed; take care not to have the bed too wet.

Seeds of some of the soft-fruited kinds, as the junipers and yews, should be macerated and then cleaned by rubbing in sand. Often these seeds lie a year before germinating.

Convallaria (Lily-of-the-Valley). *Liliaceæ*.

Handled by "crowns" or "pips," which are the separated growing points of the roots, possessing a strong bud. These crowns can be obtained from any well-established bed in the fall, but they are usually imported. Plants may be divided in spring. Fig. 56.

Convolvulus (Bindweed). *Convolvulaceæ*.

Annuals and perennials; the former are easily grown from seeds sown in the open or under glass; the latter by seeds, by cuttings of young wood, and by division.

Corchorus (Jute). *Tiliaceæ*.

Annuals of warm countries easily grown from seeds; others are perennial and grown from seeds, cuttings and division, but they are little known in cultivation.

Cordia. *Boraginaceæ*.

Increased by seeds, cuttings of firm wood in heat.

Cordyline. *Liliaceæ*.

Seeds when obtainable; cuttings; root-cuttings; air-layering. The dracænas of gardeners are cordylines. They are readily handled, as described by Eisele, by cutting the ripened stems or trunks, from which all leaves have been removed, into pieces 2 to 4 inches long. These are laid either in very light soil or in sand in the propagating-bed, where they receive a bottom heat of about 80°, being barely covered with sand or moss. The eyes soon start into growth, and, as soon as they have developed about six leaves, these shoots are cut off with a small heel and again placed in the propagating-bed until rooted, after which they are potted off into small pots in light soil, kept close until they become established. The plant known in the market as *Dracæna indivisa* grows readily from seeds. Figs. 68, 92, 104, 119.

Coreopsis, Calliopsis. *Compositæ*.

The annuals are readily grown from seeds started in the house or sown directly in the open. The perennials are grown from seed, by cuttings of growing wood in summer, and by division.

Coriander (*Coriandrum sativum*). *Umbelliferæ*.

Seeds are sown in fall or spring; they grow readily.

Corn: *Maize*.

Corn-Salad (*Valerianella olitoria*). *Valerianaceæ*.

Grown from seeds sown in spring, late summer or autumn. The plants mature quickly in cool weather.

Cornus (Dogwood. Osier). *Cornaceæ*.

Propagated by seed, suckers, layers and cuttings. Seeds usually germinate the second year, being stratified the first winter. The herbaceous species, *C. canadensis* and *C. suecica*, may be increased by division, as also by seeds. The willow-like soft-wooded cornuses grow from cuttings of ripe wood, *C. stolonifera* and its kin by layers or stolons. They are often raised from firm-wood cuttings in summer in frames. Named varieties and some species are budded in many cases, especially all the weak-growing sorts. If possible, the stock should be the same species as the horticultural variety when graftage is employed. *Cornus mas*, raised from seed, is, however, a favorite stock. Shield-budding in late summer and veneer-grafting are most successful. Fig. 99.

Coronilla. *Leguminosæ*.

Mostly grown from seeds and by division. Cuttings of young wood are sometimes employed, handled in a frame or a greenhouse.

Cortaderia (Pampas-Grass). *Gramineæ*.

Propagated by seeds, started under glass in the North; also increased by dividing the clumps. The pampas-grass was formerly included in the genus *Gynerium*.

Corydalis. *Fumariaceæ*.

Grown from seeds and by division; the bulbous-rooted species by offsets.

Corylopsis. *Hamamelidaceæ*.

Propagated by seeds sown in spring, with slight bottom heat, and by cuttings of half-ripened wood in summer under glass; also by layers which root readily in moderately moist peaty soil.

Corylus (Hazel. Filbert. Cobnut). *Betulaceæ*.

Propagated by seeds, suckers, layers and cuttings. Grafting and budding are each practicable, and are adopted when growing tall standards or scarce varieties. The seed should be sown as soon as gathered, or stored in sand (stratified) till the following spring. All superior varieties should be increased by suckers or layers. Stools kept for layering must be allowed to make more

growth than those used for suckers. Free growth must be encouraged for a year or more, and, any suitable time in winter, the shoots should be bent to the ground, pegged firmly and covered to the depth of 3 inches with earth. They will be well rooted by the following autumn, and may then be removed and planted out permanently.

Corypha. *Palmaceæ.*

Propagated by seeds. See *Palms*, page 377.

Cosmidium: *Thelesperma.*

Cosmos. *Compositæ.*

Readily grown from seeds. In short-season climates the seeds would better be started indoors.

Costus. *Zingiberaceæ.*

Propagated by cutting the canes or stalks into pieces an inch or so in length, and planting in sifted peat or fine moss and sand, covering lightly. Also increased by dividing the roots and by seeds.

Cotinus (Smoke-Tree). *Anacardiaceæ.*

Propagated by seeds, root-cuttings and layers. By many botanists retained in the genus *Rhus*, as *R. Cotinus*.

Cotoneaster. *Rosaceæ.*

Grown from fall-sown or stratified seeds; also by autumn layers, by cuttings of half-ripened wood under glass in late summer. Some kinds may be grafted on seedling stocks of *C. integerrima* (*C. vulgaris*), common quince, hawthorn or mountain ash.

Cotton (*Gossypium*). *Malvaceæ.*

Cotton is grown from seeds dropped where the plants are to stand. In the southern states the planting runs from April 15 to May 15. The plants are thinned as they stand to 12 to 24 inches; the rows are $3\frac{1}{2}$ to 4 feet apart. About one bushel of seed is sufficient to the acre, although two to three times this quantity is sometimes used.

As a greenhouse subject, cotton is sometimes raised from soft cuttings.

Cotyledon (Navelwort). *Crassulaceæ.*

Propagated by seed, offsets, cuttings of the stem and of leaves. The greenhouse kinds (as *C. gibbiflora*) are grown from stem

cuttings 2 or 3 inches long. It is a good plan to stand them on moss in pots; roots will form in the moss. Old shoots past flowering may be cut and crowded together in shallow boxes and kept warm and dry to force side-shoots for cuttings.

The carpet-bedding kinds are propagated in November and December from leaves, giving plants for the next season's work. The leaf is gently twisted off, with the dormant axillary bud intact. The leaves are laid on their backs in a depression in the sand of the propagating-bed in two rows so that the butts touch; at their butts they are covered about 2 inches deep. Withhold water till roots form, and water sparingly thereafter. Three or four weeks are required for rooting.

The above directions apply also to echeveria.

Cowpea (*Vigna sinensis*). *Leguminosæ*.

Frost-tender annual grown from seeds sown when weather becomes warm, 1 to 1½ bushels to the acre.

Crambe (Sea-Kale). *Cruciferæ*.

Raised easily from seed.

Cranberry (*Vaccinium macrocarpon*). *Ericaceæ*. (Elizabeth C. White).

The commercial propagation of cranberries is entirely by cuttings. These are obtained by mowing with a scythe the vigorous vines on a well-established bog. The vines should be cut immediately after the withdrawal of the winter flowage; or, if from an unflowed bog, before growth starts in the spring. In case the new area to be planted is not entirely prepared, the cut vines should be made into bales and entirely submerged in water. In this way they may be kept in perfect condition for planting for a month to six weeks or even longer.

After the ground has been drained, leveled and sanded, — if sanding is desired, — the cuttings, preferably 8 to 12 inches long, are thrust obliquely into the soil at the middle with a blunt instrument, leaving about 2 inches of each end exposed. In planting on sanded ground, care should be taken that the cutting reaches into the muck below the sand. The cuttings should be set three or four in a place and 12 to 18 inches apart. In soft ground the cuttings may sometimes be pushed directly into the soil without previously making a hole, but more frequently it is desirable first to make a hole with a dibble or similar tool, and

to firm the soil about the cuttings after they are placed. Various tools have been developed for making holes and pushing in the cuttings when planting bogs in the various sections where this fruit is grown. The use of some of these implements necessitates the worker kneeling on the ground; others can be used as the workers stand.

Cross-pollination or hybridization by man has had no part in the production of the various commercial varieties of cranberries, Early Blacks, Howes, Centennials, and the like. All these have resulted from the selection of choice wild stocks and their propagation by cuttings. However, seeds may be sown with the hope of obtaining new varieties, the methods being those in general recommended for Ericaceæ (p. 308). The seeds are stratified till spring, and the seedlings are allowed to grow the first year in the seed-box or well prepared seed-bed.

Crassula. *Crassulaceæ.*

Propagated by seeds; usually by cuttings, which should be laid in the sun to dry before planting. If cutting shoots do not form, as in *C. falcata*, the plants may be headed back to encourage adventitious growths.

Cratægus (Haw. Hawthorn). *Rosaceæ.*

Propagated by seeds sown in fall or stratified. The pulp should first be removed by maceration, decay, or rubbing in sand. Seeds may continue to germinate the second and third years. The seedlings should be transplanted when a year (one season) old to prevent the formation of long hard roots. The varieties are grafted, rarely budded, on common stocks, mostly on the European hawthorn, *C. Oxyacantha*.

Cress (*Lepidium sativum*). *Cruciferæ.*

Raised from seeds, sown in spring or late summer. It does best in the cool season. See *Water-Cress*.

Crinum. *Amaryllidaceæ.*

Raised mostly from offsets of the bulbs; also by seeds, particularly for new varieties, in a warm temperature. See *Amaryllidaceæ*, page 228.

Crocoshmia. *Iridaceæ.*

Offsets or cormels are used for propagation, as for gladiolus. Seeds may be employed, sown under glass when ripe.

Crocus. *Iridaceæ.*

Multiplied by the offsets or new corms that form on top or on the side of the old corm. These are handled as are the cormels of gladiolus and similar things, making blooming plants in one or two years. Propagation is often effected by seeds, which are likely to be overlooked because they form near the surface of the ground. The seeds are sown in pots or boxes and exposed to freezing before germination. Blooming plants should be had in three years.

Crotalaria (Rattle-Box). *Leguminosæ.*

Multiplied by seeds sown early indoors, after being soaked in warm water; the shrubby kinds by greenwood cuttings in sand under glass.

Croton: *Codiaum.***Crucianella** (Crosswort). *Rubiaceæ.*

Handled mostly by division of the plants; also by seeds and sometimes by soft cuttings.

Cryptanthus. *Bromeliaceæ.*

Propagation as for billbergia, which see. *C. zonatus* is the common species, usually grown as tillandsia; it makes parts that may be used as offsets.

Cryptomeria (Japan Cedar). *Pinaceæ.*

Propagated by seeds; also by cuttings of growing wood in sandy soil under glass which often, as in the var. *elegans*, root freely. The horticultural varieties are sometimes increased by grafting on stocks of the species itself.

Cucumber (*Cucumis sativus*). *Cucurbitaceæ.*

Propagated by seeds. If sown outdoors, the operation should be delayed until the weather is thoroughly settled. The early outdoor crop is grown from seeds started indoors in pots or pint berry-boxes, as the plants do not remove well if the roots are disturbed.

Cucumis: *Cucumber, Gherkin, Melon.***Cucurbita:** *Gourd, Pumpkin, Squash.***Cucurbitaceæ.** **Cucurbits.**

The common method of propagating all species and varieties of cucurbits is by seeds, which are large and usually germinate

quickly if sown in warm weather or in a warm house. The cucurbits are frost-tender. Seeds retain their germinating qualities for a number of years. Special kinds may be increased by cuttings, which root quickly in brisk heat.

Cunninghamia. *Pinaceæ.*

Propagated by seeds; also by cuttings of growing wood in late summer under glass. For symmetrical specimens, cuttings should be taken from leading shoots on strong branches or from short shoots arising on the old wood.

Cuphea. *Lythraceæ.*

Usually grown from seeds, the plants being treated as annuals. The more shrubby kinds, as *C. ignea*, are grown from cuttings of firm wood.

Cupressus (Cypress). *Pinaceæ.*

Handled as are the species of *chamæcyparis*, by cuttings and seeds.

Curculigo. *Amaryllidaceæ.*

Propagated by seeds; also by suckers from the base of the stem. Before potting, place the pieces in the sand-bed of a warm propagating-house for a few days.

Curcuma. *Zingiberaceæ.*

Increased by division of tubers or roots in spring.

Currant (*Ribes vulgare*, *R. nigrum* and *R. odoratum*). *Saxifragaceæ.*

New varieties are originated from seeds, which may be sown in the fall or stratified until spring. They are planted in a well-protected and carefully prepared seed-bed, and usually grow readily. Bearing plants should be had in three or four years.

Commercial varieties are nearly always multiplied by hardwood cuttings. The cuttings may be taken in spring and placed directly in the ground, but better results are obtained by taking them in the fall or late summer. Many nurserymen prefer to take them in August, strip off the leaves, and bury them in bunches with the butts up. They may remain in this condition or in a cellar all winter, or they may be planted in the fall. Currant cuttings strike readily, however, under any method. Some growers cut out the buds that stand below the surface of the ground, to prevent suckering, but this is not generally practiced; the suckers are cut

off when the cuttings are removed from the cutting-bed, either to be sold or to be transplanted into nursery rows. Strong plants, such as eastern markets demand, are usually obtained by allowing the cuttings to stand for two years before sale. Fig. 111.

Green layering is sometimes practiced with rare sorts, or single eyes may be used, as in grapes. Tip-layering, as in the black raspberry, may also be employed.

Weak or low sorts are sometimes grafted on stronger ones, in order to give them a tree form, but such bushes are grown only as curiosities or as specimen plants.

Cyanophyllum: *Miconia*.

Cyathea. *Cyatheaceæ*.

Propagated by spores. See *Ferns*, page 312.

Cycas. *Cycadaceæ*.

Propagated by seed, and oftener by suckers. The seeds will keep for a month or more after they get ripe. They are best sown in shallow boxes or benches, covered in sand, and potted soon after germination.

Some, and perhaps all, of the cycads can be propagated by sections of the old stem or trunk. Cut the trunk into truncheons 2 or 3 inches thick, usually slanting; let the pieces dry a few days to guard against rotting, then plant in pots or sand. Roots will form between the scales, and new plants will push out. These should be removed and treated as independent plants. The severed crown of the trunk may also be potted, and it will grow.

Cyclamen. *Primulaceæ*.

Propagated by fresh seed, usually sown by florists in early winter. The plants should be shifted as needed and kept growing. Bloom may be expected in about fifteen months. Old tubers may be used for second blooming, but seeds give best results.

The hardy cyclamens, which are little known in this country, are grown from seed handled in frames or seed-beds in the open; also by division.

Cydonia: *Quince*, *Chænomeles*.

The Japan quince is now named in the genus *Chænomeles*.

Cymbidium. *Orchidaceæ*.

Multiplied by division of the roots. See *Orchids*, page 372.

Cypella. *Iridaceæ.*

Propagated by offsets (cormels) and by seed as soon as ripe.

Cyperus. *Cyperaceæ.*

Propagated either by seed-heat, or by divisions. *C. alternifolius*, the umbrella-plant, propagates readily from the crown or rosette of leaves. Cut off the crown, with an inch or two of stem remaining, and set on sand or moss. Cut in the leaves. New plants will start from the axils. See *Papyrus*.

Cyphomandra (Tree Tomato). *Solanaceæ.*

Seeds are employed, started under glass and handled as are eggplants; also by cuttings of growing shoots under glass.

Cypripedium of florists: *Paphiopedilum* and *Phragmipedium*.

Cyrtomium. *Polypodiaceæ.*

Spores; see *Ferns*, page 312.

Cytisus. *Leguminosæ.*

Grown from seeds and cuttings. Seeds are usually sown in spring, under glass or in the open. If well grown and frequently transplanted, seedlings should make blooming plants the second season.

Cuttings of firm young wood may be struck in early spring under glass, making flowering plants the next spring. Layers are sometimes used. Forms of some of the species may be grafted on *C. nigricans* or on laburnum (which see); greenhouse kinds may be worked on the common *C. canariense*.

Dædalacanthus. *Acanthaceæ.*

Propagation is by cuttings as for *justicia*, which see.

Dahlia. *Compositæ.*

Commonly grown from tubers, which are dug in the fall and stored in the cellar, like potatoes. Each fork of the root may be broken apart and planted separately in the field; or the pieces may be started early in pots or boxes. It is essential that each piece have an eye or bud at the top; to insure this, it is well to start the roots in the house in spring before dividing them.

Single varieties, and sometimes the doubles, are grown from seeds. New varieties, or at least many variations, are produced from seeds, particularly if cross-pollination has intervened. Good blooming plants, particularly of the singles, may also be had for

mass-effect the same season if started early under glass. The roots of these seed-grown plants may be used for subsequent propagation the same as from other plants.

Dahlia tubers may be started into growth in heat in winter (say January), and the young sprouts may be removed and handled as ordinary cuttings as fast as they form the third or fourth leaves, the same as sweet potatoes are handled. These cuttings should be removed close to the tuber or else at the first joint (preferably the former); they are set in sand in a propagating bench with bottom heat; when rooted, the plants are handled into small pots, where they will soon form tubers. These cutting-plants, if 6 to 10 inches high when set in the open, make excellent bloom that season, although generally giving dwarfer plants than those grown from tubers planted directly in the ground. If the shoots or cuttings are severed far below a joint, no tubers will form (for the subsequent propagation of the plant), although flowers may be produced. Rare sorts may be increased in summer by cuttings from growing tips.

Dahlias may be grafted, the tuber being used as a stock. Cions made of the growing tips may be grafted on the root-tubers by a cleft- or side-graft or simple laying together of cut surfaces. This method is oftenest employed for the purpose of preserving over winter rare or weak sorts which it is feared may be lost. The grafts are kept growing slowly during winter, and cuttings may be taken from them. Sometimes cions are taken from forced plants in late winter or early spring and set in strong tubers for outdoor planting. The joined part of the grafted plant (the union) is sometimes covered with clay, but usually sufficient protection is secured if the union is partly buried in the earth in which the plant is potted.

Dalbergia. *Leguminosæ.*

Grown from seeds, as are other leguminous trees; also from young-wood cuttings in heat.

Dandelion (*Taraxacum officinale*). *Compositæ.*

Raised from seeds, in early spring, when grown for "greens" or blanched leaves. The plants may be harvested the same fall or allowed to stand until spring.

Daphne. *Thymelæaceæ.*

Propagated by seeds, sown after maturity or stratified; germination is slow in some species. For layers, remove the soil

about the plant in spring to a depth of 2 or 3 inches and fill with fine compost to within 2 inches of the tops of the shoots. The next spring, carefully wash away the compost, and plant the small white buds in pots of fine soil. Place in a cool frame. This method is specially adapted to *D. Cneorum*. Cuttings may be used. Soft wood from forced plants may be taken for this purpose. Mature wood may also be employed, particularly in the evergreen species; the cuttings are set under glass in fall and carried over winter in a cool greenhouse, mild bottom heat being applied in spring.

The plants are sometimes propagated in winter by grafting on seedling stocks or on roots. Seedlings of *D. Laureola* and roots of *D. Mezereum* make good stocks for *D. odora*. The stock most used, probably, is *D. Mezereum* roots.

D. odora is propagated by ripened cuttings in a cool house, in sand; sometimes the old wood can be used; the time is determined by the fitness of the wood.

Darlingtonia. *Sarraceniaceæ.*

Handled by dividing the plants; also grown from seeds sown in pans on live sphagnum and kept cool and moist in a propagating-box.

Dasyllirion. *Liliaceæ.*

Usually grown from seeds; suckers and cuttings of branches, when they arise, may also be used.

Date, Date Palm (*Phoenix dactylifera*). *Palmaceæ.*

The seeds from commercial dates grow readily (if they have been properly pollinated) and without stratification. Brief stratification, of four or six weeks, is sometimes employed for the purpose of softening the seed-coats. As a greenhouse subject the date is usually grown from seed. Seedlings are also sometimes employed in commercial plantations, although the sex of the resulting plants cannot be foretold. Seeds are planted in the nursery, and the plants transplanted in one to three years; or sometimes the seeds are planted in the field where the bearing trees are to stand. A sufficient number of seedlings should be provided so that superfluous males may be eliminated.

Commercial dates are propagated by suckers that arise about the base of the old trunk. These are preferably handled in pots if taken when the ground is cold, but may be set directly in permanent quarters in warm weather, as in spring. The suckers may be

taken as cuttings, without roots, and headed back; if planted in the field, water is applied frequently so that rooting may be continuous, but care must be taken not to set the crown so deep as to invite decay. It is preferable, however, to allow the suckers to grow on the parent until roots of their own have formed.

Datisca. *Datisceae*.

Increased by seeds, and by dividing old plants.

Datura, including *Brugmansia.* *Solanaceae*.

The annual species are propagated by seeds, which are usually started under cover in the North. The perennials are readily grown from cuttings in mild heat. Gardeners like cuttings taken with a heel.

Davallia. *Polypodiaceae*.

Propagated largely by division; also by spores. Should be done in spring months. See *Ferns*, page 312.

Decumaria. *Saxifragaceae*.

Cuttings of greenwood may be made in summer in a frame or in greenhouse. Rarely propagated by seeds.

Delphinium (Larkspur). *Ranunculaceae*.

Grown freely from seeds. For early bloom of the annual kinds, seeds are sometimes started indoors. Seedlings of perennials should bloom the second year. The perennials are readily increased by division. If the flowering stems are cut away after bloom, new growths will quickly form, and these may be divided in autumn or spring. The perennial larkspurs may also be multiplied by cuttings, rooted in a shaded frame. The cuttings are taken from new growth in spring, when it is a few inches long, or from the crown or bottom growth after flowering. Cuttings should give blooming plants the following season.

Dendrobium. *Orchidaceae*.

When a rapid increase of a new or special variety is required, the pseudobulbs more than one year old may be cut into lengths, and fastened on orchid rafts, with a layer of sphagnum beneath them. Suspend them in a hot moist house, if possible over a water-tank. The advantage of this method is that the young plants do not need shifting after they commence rooting on their

own account. The section to which *D. aggregatum*, *D. Jenkinsii*, *D. densiflorum* and *D. thrysiflorum* belong is best propagated by division. See *Orchids*, page 372.

Deutzia. *Saxifragaceæ.*

Commercially, the species are mostly propagated by green hardened cuttings in summer, under a frame. Hardwooded cuttings may be taken in autumn, and be treated in about the same way as currant cuttings. The deutzias are also propagated by divisions and layers. Some of the dwarf sorts are sometimes forced, to make cuttings for winter use. They may also be grown from seeds sown in pans or boxes in spring.

Dewberry (*Rubus* species). *Rosaceæ.*

Seeds are handled in the same way as blackberry seeds. Increased by layers and, like the blackberry, root-cuttings and cane-tips. Layers are made simply by covering the decumbent canes at the joints, but this method is now little used. The tips root freely, as in the blackcap raspberries, and it is from these that the commercial dewberry plants are mostly grown. See *Blackberry*.

Dianthus (Carnation. Pink. Sweet William). *Caryophyllaceæ.*

Annuals and perennials, all easily grown from seeds. The annual kinds are sometimes started indoors; but usually the seeds are sown where the plants are to remain. Best results are to be expected in most species when new plants of the perennial kinds are grown from seeds every two or three years, as strong plants are obtained and the beds are kept clear of grass. Plants bloom the second year from seed. Old plants may be divided, if vigorous. See *Carnation*.

Dicentra, Dielytra (Bleeding-Heart). *Fumariaceæ.*

The clumps may be divided in early spring, or short cuttings may be made of the roots and placed in sand. The native species propagate readily by the underground parts — *D. Cucullaria* by division of the bulbs, and *D. canadensis* by the little tubers. All species grow from seeds that have been stratified or else sown in autumn.

Dichorisandra. *Commelinaceæ.*

Multiplied by seeds, cuttings of green shoots, and division of old plants.

Dicksonia. *Cyatheaceæ.*

Propagated by division mostly, but also by spores. See *Ferns*, page 312.

Dictamnus (Dittany, or Fraxinella). *Rutaceæ.*

Seeds should be sown in fall as soon as ripe and covered an inch or so. Seedlings should bloom in two years. Increased with difficulty by division.

Dictyosperma. *Palmaceæ.*

Propagation as for areca, which see.

Didymocarpus. *Gesneriaceæ.*

Propagated by seeds, when obtainable. Cuttings of young shoots when growth begins, in sandy soil in heat, usually do well. See *Gesneriaceæ*, page 318.

Didymochlæna. *Polypodiaceæ.*

Increased by division. See *Ferns*, page 312.

Dieffenbachia. *Araceæ.*

Propagated by cuttings of the stem, cutting into pieces 2 or 3 inches long which are dried for a few days, then put into boxes of sand. These cuttings should be potted as soon as roots have formed. See *Araceæ*, page 239.

Diervilla (Weigela). *Caprifoliaceæ.*

Increased by suckers and cuttings made in spring, summer or autumn. Hardened green cuttings, handled under a frame in summer, are extensively used by nurserymen. (See page 110.) They are sometimes grown from cuttings in winter from forced plants. Hardwood cuttings, made in winter and planted in spring, like the grape, succeed well. The American native species may be grown from seeds sown in spring.

Digitalis (Foxglove). *Scrophulariaceæ.*

Raised from seeds, sown in spring, either indoors or in the open. The common foxglove (*D. purpurea*) often self-sows; it is best treated as a biennial; seeds for next year's bloom may be started in spring, or in late summer and handled in a frame to prolong the season. Digitalis may also be propagated by division of clumps.

Dill (*Anethum graveolens*). *Umbelliferæ.*

Raised from seed sown in spring where the plants are to stand.

Dillenia. *Dilleniaceæ.*

Increased by seeds; with some difficulty by cuttings of half-ripened wood in sand in bottom heat.

Dimorphotheca (Cape Marigold). *Compositæ.*

The annuals are grown from seeds started indoors or planted in the open. These plants have lately become popular. The perennials are raised from seeds, also by soft cuttings, and perhaps by division.

Dionæa. *Droseraceæ.*

Propagated by seed placed under a bell-jar on moist sandy soil mixed with finely chopped sphagnum moss; also by dividing the plants.

Dioon. *Cycadaceæ.*

Increased by seed. See *Cycas*.

Dioscorea (Yam). *Dioscoreaceæ.*

The dormant tubers may be divided in autumn or spring; start in heat. Seeds are sometimes used; so are the tubers that form in the axils by the leaves. Hothouse species can be propagated by cuttings of the half-ripened wood.

Diosma. *Rutaceæ.*

Propagated by cuttings of young wood, much as for the heaths.

Diospyros (Persimmon. Kaki): *Persimmon.***Dipladenia.** *Apocynaceæ.*

In spring, or as early as February 1, when the plants begin growth, cuttings are made from the young shoots, placed in bottom heat. The pots should be placed in a tight propagating-bed, in a night temperature of 70°. Propagated also by seed when obtainable.

Diplazium. *Polypodiaceæ.*

Propagation by spores and division. See *Ferns*, page 312.

Diplothemium. *Palmaceæ.*

Increased by seeds. See *Palms*, page 377.

Dizygotheca. *Araliaceæ.*

To this name are now referred some of the tender plants formerly included in *Aralia*. Others are now included in *Polyscias*, which see for propagation.

Dodecatheon (Shooting-Star). *Primulaceæ*.

Propagated slowly by seeds. The roots may be divided in spring or autumn. Cuttings of the whole root can be used effectively, the root being taken off the crown, planted upright, and covered with the sandy soil.

Dolichos. *Leguminosæ*.

Increase readily by seeds, which should be handled same as beans. Sometimes cuttage or layerage is employed for the more woody kinds. See *Pueraria* for *D. Thunbergianus*.

Doodia. *Polypodiaceæ*.

Propagation by spores and division. See *Ferns*, page 312.

Doronicum (Leopard's Bane). *Compositæ*

Multiplied by seeds and divisions.

Dorstenia. *Moraceæ*.

Propagated by seeds when procurable; division of the plant when repotting.

Doryanthes. *Amaryllidaceæ*.

Propagated by suckers in pots; they are produced after flowering.

Downingia (Clintonia of seedsmen). *Lobeliaceæ*.

Annuals easily grown from seeds sown in the open or started under glass.

Draba (Whitlow-Grass). *Cruciferaæ*.

By fall-sown or spring-sown seeds; the perennials by division.

Dracæna. *Liliaceæ*.

Propagation as for cordyline, which see, page 288.

Dracocephalum (Dragon's Head). *Labiataæ*.

The annuals are raised easily from seeds, sown in the open in spring or started indoors. Perennials are handled by division or by cuttings of growing wood in spring.

Dracontium. *Araceæ*.

Propagation as for amorphophallus. See also *Araceæ*, page 239.

Dracunculus. *Araceæ*.

Propagation as for arum, by offsets of the tubers and sometimes by seeds. See *Araceæ*, page 239.

Drosera (Sundew). *Droseraceæ*.

Increased by seeds, sown soon after gathering. The root may be divided; or rhizomes may be made into cuttings an inch or less long, which root in two or three weeks in a propagating-box.

Drosophyllum. *Droseraceæ*.

Grown from seed; probably can be propagated much as *drosera*.

Duranta. *Verbenaceæ*.

Propagated by cuttings in spring; also by seeds.

Dyckia. *Bromeliaceæ*.

Propagated by suckers or offsets. See *Billbergia*, page 252.

Ecballium (Squirting Cucumber). *Cucurbitaceæ*.

Treated as an annual, and grown readily from seeds sown indoors or in the open when the weather is warm; tender.

Eccremocarpus (*Calampelis*). *Bignoniaceæ*.

Propagated by seeds in spring in mild heat. Cuttings may be made of green or ripe wood.

Echeveria. *Crassulaceæ*.

Propagation by cuttings of stems and leaves as for cotyledon, which see. By many botanists the two genera are united.

Echinacea. *Compositæ*.

Readily multiplied by seeds and division.

Echinocactus. *Cactaceæ*.

Propagation by seeds, in May or June. If well ripened, seeds at this time of year should germinate in a week or less. Sow in 4-inch pots in finely sifted mixture of leaf-mold, loam, and charcoal dust and silver sand. See *Cactus*, page 261.

Echinocereus. *Cactaceæ*.

As for *cereus*; see also *Cactus*, page 261.

Echinops (Globe Thistle). *Compositæ*.

Seeds sown in spring are used for the biennials, and early division for the perennials; also increased by root-cuttings.

Echinopsis. *Cactaceæ.*

Handled as are the species of cereus. See *Cactus*, page 261.

Echium. *Boraginaceæ.*

Grown from seeds, sown as soon as ripe; the woody species from cuttings and layers.

Edgeworthia. *Thymelæaceæ.*

Propagation is by seeds; also by greenwood cuttings in spring under glass.

Eggplant (*Solanum Melongena*). *Solanaceæ.*

Grown readily from seeds, as for tomatoes; start indoors and transplant. Fruit should be had in a warm climate in 120 to 150 days from seed-sowing. The plant can be propagated by cuttings.

Eichhornia (*Pontederia azurea* and *crassipes* of gardeners). *Pontederiaceæ.*

Propagates naturally by division.

Elæagnus (Oleaster. Wild Olive. Gumi). *Elæagnaceæ.*

Propagated by means of seeds, root-cuttings and layers. Seeds should be stratified and planted the second spring, as they usually do not germinate the first year. Hardwood cuttings of *E. angustifolia* strike readily. The named varieties are often grafted on the most vigorous kinds. Imported seeds of some species are likely to be empty. *E. multiflora* (gumi) can be propagated readily by cuttings of the half-ripened wood in June and July, under glass.

Elaphoglossum. *Polypodiaceæ.*

Propagation by division and spores. See *Ferns*, page 312.

Elettaria (Cardamom). *Zingiberaceæ.*

Propagated by seeds when obtainable; also by division of the plants.

Elsholtzia. *Labiataæ.*

Propagation by seeds sown in spring; the woody species also by greenwood cuttings in summer.

Emilia (*Cacalia* of florists). *Compositæ*

Propagated easily by seeds, sown in heat in early spring, or in the open later.

Empetrum (Crowberry, or Crakeberry). *Empetraceæ*.

Increased by seeds; also by nearly ripe-wood cuttings in late summer under glass.

Encephalartos. *Cycadaceæ*.

Multiplied by seeds, offsets and suckers. See *Cycas*.

Endive (*Cichorium Endivia*). *Compositæ*.

Raised readily from seeds, either in the open where the plants are to stand, or under glass.

Enkianthus. *Ericaceæ*.

Propagation by seeds sown in spring, by cuttings of ripe wood under glass in spring, and by greenwood cuttings in summer; also by layers.

Eomecon. *Papaveraceæ*.

Propagated by seeds; also by division.

Epacris. *Epacridaceæ*.

Grown from tip cuttings in a frame in winter, with bottom heat, much as for erica.

Epidendrum. *Orchidaceæ*.

The tall-stemmed section of this genus is increased by cuttings, the section with short thick pseudobulbs by division. The former also occasionally produces viviparous flower-scapes, thus affording a ready means of increase. See *Orchids*, page 372.

Epigæa (Trailing Arbutus). *Ericaceæ*.

Cuttings of mature wood may be struck in sand in winter under glass. The best method, however, is by seeds. Watch for the seeds to ripen for they are very soon discharged and lost. Remove pulp by rubbing between the fingers, and sow at once (as advised by Coville) in a well-drained shallow box in a mixture of two parts finely sifted kalmia peat and one part clean sand; cover $\frac{1}{16}$ inch deep with same material; protect from evaporation and direct sunlight. Germination takes place in three or four weeks; in three or four months, transplant into pots in mixture of peat and sand. Plants should bloom in two or three years from seed.

Epimedium (Barrenwort). *Berberidaceæ*.

In summer or fall divisions of the roots can be made; sometimes grown from seeds.

Epiphyllum. *Cactaceæ.*

The plants formerly known as *Phyllocactus* are now called *Epiphyllums*, the former name being discontinued. (What have been known as *Epiphyllums* will now be found under *Zygocactus*.) Seeds germinate readily in sandy soil. Usually increased by cuttings of the stems, 5 or 6 inches long, placed in sandy soil, which is kept only slightly moist. See also *Cactus*, page 262.

Episcia. *Gesneriaceæ.*

Cuttings; see *Gesneriaceæ*, page 318.

Eragrostis (Love-Grass). *Gramineæ.*

Raised freely from seeds, sown in the open, in spring.

Eranthemum. *Acanthaceæ.*

Increased by seeds. Cuttings root in spring or early summer in peaty soil in a warm propagating-box. See *Justicia*. The *Eranthemums* of gardeners are now placed in *Dædalacanthus* and *Pseuderanthemum*.

Eranthis (Winter Aconite). *Ranunculaceæ.*

Propagated by division and by seeds.

Eremurus. *Liliaceæ.*

Increased by divisions and more slowly by seeds.

Erianthus (Plume-Grass). *Gramineæ.*

Handled by seeds and division.

Erica (Heath). *Ericaceæ.*

Commonly propagated by very short cuttings, taken from the tips, or made of the lower young or side growth, and made in winter or from December to April, usually cut to a heel. Carefully remove the leaves from the lower parts of the cutting, which should be about 1 inch long, and then firmly insert rather closely in pans or pots, which should be filled two-thirds with crocks, the remainder being fine sandy peat with a layer of clean compact sand on the surface; cover with glass; water well, and place in a temperature of about 60°. Plants are sometimes raised from seed, but mostly when it is desired to obtain variations. They are sown on live sphagnum or on peat, kept cool and handled with care throughout.

Ericaceæ. Heaths.

This family contains some very decorative garden plants. The heaths are readily propagated by cuttings of the young wood inserted in pots of peat and sand surfaced with sharp clean sand and placed in a propagating case. Damp and too close atmosphere is injurious to them. Most of the other genera of Ericaceæ can be increased either by cuttings or seeds.

Erigeron (Fleabane). Compositæ.

Propagated by seeds and divisions, and possibly by cuttings. Division is a good method for the tufted perennial species.

Erinus. Scrophulariaceæ.

Increased by seeds and divisions. After becoming established, they spread themselves by seeds.

Eriobotrya (Loquat). Rosaceæ.

Increased by stratified seeds or half-ripened cuttings under glass. Varieties of loquat, *E. japonica*, are grown from layers or cuttings of ripe wood; it is also worked on seedling stocks or on thorn or quince, after the manner of pears, as seedlings are too variable for satisfactory results in fruit. The usual method in this country is to bud the varieties on loquat seedlings. See *Loquat*.

Erodium (Heron's-Bill). Geraniaceæ.

Increased by seeds and division, usually the former.

Eryngium (Eryngo). Umbelliferæ.

Raised from seed sown as soon as ripe, germination taking place the following spring; sometimes handled by division.

Erysimum. Cruciferæ.

The annuals are grown from seeds sown in the garden or started indoors; the perennials by seeds, division and sometimes by cuttings.

Erythea. Palmaceæ.

Grown from seeds. See *Palms*, page 377.

Erythrina (Coral-Tree). Leguminosæ.

Propagated by seeds. Cuttings of young shoots may be struck in spring or early summer in sandy soil in heat. Herbaceous species are increased by division of the rootstocks. The woody kinds grow from cuttings of growing wood.

Erythronium (Dog's-tooth Violet. Adder's-Tongue). *Liliaceæ*.

Offsets or bulbels are usually employed for the European and East-American species, taken as soon as the leaves die after flowering. Most of the West-American species are grown from seeds.

Erythroxyton. *Erythroxyllaceæ*.

Cuttings of half-ripened shoots in sand under a glass, in heat, are recommended. Seeds, if obtainable, may be employed.

Escallonia. *Saxifragaceæ*.

Seeds, when obtainable, may be used. Cuttings of firm wood strike under glass. Layers and suckers are sometimes employed for propagation.

Eschscholtzia (California Poppy). *Papaveraceæ*.

Propagated readily by seeds where plants are to stand, which should give blooming stock the same season. In gardens treated as a hardy annual, although plants will bloom the second year; often self-sows.

Eucalyptus (Gum-Tree). *Myrtaceæ*.

Planted extensively in California. Grown from seeds gathered as soon as the pods open. It is best to sow in a light loam in flats; young plants usually need shade. The seed is sown in spring, and seedlings should be large enough for transplanting to the field the following spring. As greenhouse subjects, eucalypti may be grown from cuttings.

Eucharidium. *Onagraceæ*.

Increased easily by seeds, sown usually in the open border in spring or autumn.

Eucharis (Amazon Lily). *Amaryllidaceæ*.

Usually increased by offsets from the large bulbs, preferably in spring. Sometimes grown from seeds, when obtainable, under glass.

Euchlæna (Teosinte). *Gramineæ*.

Propagated directly by seed, as for maize.

Eucomis. *Liliaceæ*.

Increased by offsets, sometimes by seeds under glass.

Eugenia. *Myrtaceæ.*

Grown from seeds when procurable; also increased by cuttings of firm shoots in sand in heat.

Eulalia. *Miscanthus.*

By seeds; also division of clumps.

Euonymus: *Evonymus*, below.**Eupatorium.** *Compositæ.*

The greenhouse kinds are grown from cuttings of the growing wood under glass in winter or early spring. Seeds may also be used and the hardy herbaceous kinds are increased by division.

Euphorbia (Spurge). *Euphorbiaceæ.*

A polymorphous genus, one of which is poinsettia (which see). The annuals grow readily from seed. Some of the perennial kinds may be divided. The fleshy kinds (simulating cacti) are handled from cuttings of stems. These cuttings are usually taken in summer and allowed to dry somewhat before planting; they may be struck in sand and charcoal or even in coal-ashes. Some of the succulent species may be grafted after the way of cacti.

Euphorbiaceæ. **Euphorbiads.**

The annual kinds are increased by seeds; herbaceous sorts by seeds and division; succulent or fleshy kinds by cuttings in sand and kept in a warm dry house. With the semi-fleshy species, as poinsettias, as soon as the cuttings are taken off the old plants, immerse them at once in water and then put in wet sand.

Euterpe. *Palmaceæ.*

Propagated by seeds in heat. See *Palms*, page 377.

Evodia. *Rutaceæ.*

Propagation by seeds; for warmhouse species by cuttings of half-ripened wood and also probably by root-cuttings.

Evonymus. *Celastraceæ.*

Grown from seeds stratified and sown in spring, from cuttings and layers. Cuttings usually make better plants than layers. The deciduous species are usually grown from hardwood cuttings, but the evergreen kinds are started under glass, from cuttings of the growing or ripened wood. The small and weak kinds are grafted on the stronger ones. The evergreen species will grow on the deciduous kinds.

Exacum. *Gentianaceæ.*

Grown from seed ; for specimens in 5-inch pots, sow in March of same year ; for larger specimens, sow in August of the preceding year.

Exochorda. *Rosaceæ.*

Propagated by seeds, layers, cuttings and suckers. Layering in June is a common practice. Various kinds of cuttings are employed, but the best results follow short soft cuttings, taken from forced plants and set deep in shallow flats of sand. They require a very strong bottom heat, a close frame, and the water should be applied in a spray on the foliage. Cuttings are sometimes grafted on pieces of roots. It has been regarded as a difficult plant to propagate, but seeds are now easily procured from cultivated plants, and they grow readily.

Fagus (Beech). *Fagaceæ.*

Commonly grown from the seeds or nuts, which should be stratified and sown very early in spring. They may be sown in autumn immediately after they are gathered, if they can be protected from vermin. Seedlings should be transplanted every year or two to prevent the formation of tap-roots. The named varieties are grafted on seedlings of the European or American species in spring, preferably under glass. The purple-leaved beech reproduces itself very closely by seeds, although different shades of purple will appear in the seedlings.

Fatsia. *Araliaceæ.*

Fatsia (or *Aralia*) *japonica* is increased by seeds and cuttings. Root-cuttings, about 3 inches long, also may be used in spring, started in sand or moss.

Feijoa. *Myrtaceæ.*

Usually propagated by seeds ; sow in pans or flats, covering to a depth of $\frac{1}{4}$ inch, a mixture of silver sand and well-rotted redwood sawdust being a good medium. Cuttings of young wood from the ends of the branches can be successfully rooted under glass over bottom heat. Choice forms may be perpetuated by layers, by whip- or veneer-grafting under glass.

Felicia (*Agathæa*). *Compositæ*.

By seeds and by cuttings, as for *cineraria* and *chrysanthemum*.

Fennel (*Fæniculum*). *Umbelliferæ*.

Raised from seeds, usually in spring. See *Ferula*, for giant fennel.

Fenugreek (*Trigonella Fænum-Græcum*). *Leguminosæ*.

Annual, grown from seeds sown where the plants are to stand; in drills 18 inches apart, 7 to 10 pounds of seeds is required for an acre; broadcast, 10 to 20 pounds.

Ferns. *Filices*; now divided into several families.

When division is possible, it is the easiest and most economical method of propagation, and should be practiced just before the plant starts into growth.

Most ferns are readily propagated by means of spores, as directed below and on page 11. Some species rarely produce spores in cultivation, however, and in other cases, as in some tree ferns, it is almost impossible to rear the young plants after the spores have germinated. In all such cases, recourse must be had to separation, division or layerage. Some species, as *Asplenium bulbiferum*, *Cystopteris bulbifera* and others, bear small bulblets or detachable buds on their fronds. These buds often vegetate while still attached to the frond. They may be removed either before or after showing signs of vegetation, and set in pots in a close propagating-frame. Some species produce creeping rootstocks, which emit roots if pegged down into a pot of soil or on a block of peat. Several plants may be produced from such a layer. All these operations are best performed in late winter, before the new growth begins. The tree ferns are rarely propagated to any extent in cultivation, but young plants are imported from their native countries.

Spores may be sown in February and March, or earlier, under glass, in a warm propagating pit. Partly fill a suitable sized pot or pan with coarse peat, giving plenty of drainage; make the surface level, and on this place $\frac{3}{4}$ -inch cubes of well-seasoned peat which is rather dry, watering the whole and scattering on the spores evenly. Cover with a pane of glass, and place in a partial shade. While the process which corresponds to germination is going on, great care must be given to the water supply. This is sometimes done by placing the pots or pans in a saucer, from which

they can suck up the water. Overhead watering may be used, and often is, but it must be done with great care. Be certain that the spores are fully ripe when gathered. The young plants should be pricked out when the true leaf appears, and they are large enough to handle. The same careful treatment should be continued until they are established in pots. There is little difficulty in getting the young plants, if fresh spores are obtainable, but there is considerable trouble in handling the plantlets, and establishing them in their growing quarters.

Ferula (Giant Fennel). *Umbelliferae*.

Raised from seed sown in spring where plants are to grow.

Ficus. *Moraceae*.

The greenhouse species are propagated by layers and cuttings. The cuttings are handled in a close frame, and a leaf or two is usually left on them. For *Ficus Carica*, see *Fig*. Propagation by seeds is sometimes employed in the edible figs, but is not easy with the ornamental sorts. *F. elastica*, *F. indica*, and the like are increased by cuttings (commonly single-eye), leaving one entire leaf and potted singly in 2-inch pots which are plunged; or the cuttings are directly planted in sand or sandy soil or sphagnum, and placed in good bottom heat, in a frame under glass. The large cuttings should be staked, and care should be taken to let the milky juice drain out before planting. Cuttings are usually set in winter, before growth begins. Last season's wood should be used. A common method of multiplying *F. elastica* (rubber-plant) is by means of Chinese or air layers or "mossing" (see page 76). If the house can be kept moist, simply a ball of sphagnum bound on the stem is sufficient, without the use of a split pot or a paper cone (as shown in Figs. 68 and 69). Plants of considerable size, fit for nursery trade, can be obtained more quickly by this Chinese layering (if one has good stock plants) than by cuttings.

Fig (*Ficus Carica*). *Moraceae*.

Figs grow readily from the plump seeds in the commercial fruit. Wash out the seeds, and those that sink may be sown in a frame. The young plants will appear in three or four weeks. In three to five years the plants will begin to bear. New varieties are obtained in this way.

Varieties of the fig are multiplied with ease by layers, suckers and

cuttings. Make cuttings of mature wood in autumn, cutting just below a bud. Scarce varieties may be multiplied by single-eye cuttings. Fig cuttings are handled in the same way as grape cuttings. Some prefer, however, to place the cuttings where the tree is to stand. A well-grown plant will bear at two or three years of age. Fig. 112.

The fig is readily budded and grafted, but these methods are seldom used, because the plant is so easily multiplied by cuttings. Shield, ring or tubular buddings are employed. Various methods of grafting are adapted to it, and cleft-grafting is usually employed on old plants.

In California, the best fig cuttings are made from short-jointed well-ripened wood about 9 inches long, with the terminal bud undisturbed. These should be planted in sandy loam, with top of cutting just above the surface, and kept well irrigated until sufficient growth is made, usually 3 or 4 feet the first year. They grow to best advantage in the warmer interior valleys.

Filipendula (Meadow-Sweet). *Rosaceæ*.

Propagated by seeds sown in fall in pans or boxes and kept in a cool greenhouse, or in spring in a frame; also by division of older plants.

Fittonia. *Acanthaceæ*.

The fittonias grow readily from cuttings of any part of the stem; cuttings from the tips of shoots, cut to one joint, are usually employed. Propagate every year to get compact plants. Also increased by division.

Fœniculum: *Fennel*.

Fontanesia. *Oleaceæ*.

Layers and seed are used for propagation; also by greenwood cuttings in early summer under glass; or it may be grafted on the privet, although this is little necessary as cuttings root so readily.

Forsythia (Golden-Bell). *Oleaceæ*.

Grown extensively from green cuttings in summer, in a frame; also grown from ripe cuttings taken in fall and winter, and planted in the open air in early spring. Also raised from seeds. The shoots of the drooping kinds take root freely at the tips.

Fortunella: *Kumquat.*

Fothergilla. *Hamamelidaceæ.*

Propagated by seeds, sown in spring; by layers which should have two years to root; *F. Gardenii* also by suckers and root-cuttings.

Fragaria: *Strawberry.*

Francoa. *Saxifragaceæ.*

Propagated by seeds, sown in early spring in a coolhouse or frame; also by division.

Fraxinus (Ash). *Oleaceæ.*

Propagated chiefly by seeds, which should be stratified until fall or the spring following the gathering. The seeds are not expected to germinate the year in which they mature, and sometimes remain dormant till the second year. The named sorts are worked on seedling stocks if the sorts are upright growers, or top-grafted if they are weepers. They may be grafted in early spring or budded in summer. Both the European and American species are used for stocks.

Freesia. *Iridaceæ.*

Offsets provide the usual means of propagation, and the strongest ones should give bloom the following year. Freesias grow readily from seeds, sown as soon as ripe; some of the recent kinds will give bloom in six or seven months from seed, but usually one to three years are required.

Fremontia. *Sterculiaceæ.*

By seeds, or by greenwood cuttings under glass in summer.

Fritillaria. *Liliaceæ.*

Propagated by offsets and natural division of bulbs. Plants should be lifted and divided now and then. Also increased by seeds, as soon as ripe where the plants are to stand the first year.

Fuchsia (Ladies' Ear-Drop). *Onagraceæ.*

Fuchsias grow readily from seeds, which should be sown as soon as ripe, and blooming plants ought to be obtained in eight or ten months. Varieties do not always come true from seeds. Cuttings of the young growth strike quickly and easily. Blooming plants of most sorts can be obtained in four or five months. The best

cuttings are secured from suckers that start from the base of plants that are bedded out. The cutting should be 3 inches long and for large specimens potted singly in 2-inch pots, in three parts sand, one part loam and one leaf-mold; place in shady position in night temperature of 60°. Plants for winter bloom are usually started in late spring. For the common window-garden and conservatory kinds, propagation should be effected every year.

Funkia: *Hosta*.

Furcræa. *Amaryllidaceæ*.

Propagated by bulbels, which are freely produced. Several years are usually required to produce blooming plants, and sometimes long periods are necessary.

Gaillardia. *Compositæ*.

The annual sorts are propagated by seeds started under glass or sown in the open where the plants are to stand; the perennial kinds by seeds, cuttings in August or September or division. Sometimes root-cuttings are used in early spring. Vegetative propagation is employed for the perpetuation of particular variations.

Galanthus (Snowdrop). *Amaryllidaceæ*.

Increased commonly by offsets, the strongest of which may bloom the following year; rarely by seeds.

Galax. *Diapensiaceæ*.

Propagated by division of the clumps.

Galtonia (*Hyacinthus candicans* of gardeners). *Liliaceæ*.

Handled by offsets or seeds, as for hyacinths.

Gamolepis. *Compositæ*.

Grown from seeds.

Garcinia (Mangosteen). *Guttiferæ*.

Increased by seeds; cuttings of ripened shoots under a glass, in bottom heat. See *Mangosteen*.

Gardenia. *Rubiaceæ*.

Grown from strong healthy cuttings of three or four buds, early in winter being the best time. They should be placed in bottom

heat of about 75° to 80° in a frame, keeping rather close till rooted; shade the cutting-bed; syringe frequently.

Garlic (*Allium sativum*). *Liliaceæ*.

Increased by "cloves" or divisions of the bulb. In the North these are planted in the spring, but in warm climates they may be planted in autumn.

Garrya, including *Fadyenia*. *Garryaceæ*.

Propagated by seeds, by cuttings of half-ripened wood in summer and shaded until rooted, or by layers; also by budding on *Aucuba japonica* at the crown. Plant sufficiently deep to cover the bud or graft.

Gasteria. *Liliaceæ*.

Propagation as for aloe, which see.

Gaultheria (Boxberry. Wintergreen). *Ericaceæ*.

Grown by seeds, divisions, suckers, layers and cuttings of half-ripened wood under glass.

Gaylussacia (Huckleberry). *Ericaceæ*.

For propagation, see *Vaccinium*.

Gazania. *Compositæ*.

Increased by seeds, and by division. Cuttings are also taken in summer from shoots near the crown of the plant; these should be placed in a sandy soil in a frame.

Gelsemium. *Loganiaceæ*.

Propagated by cuttings under glass, and by seeds when obtainable.

Genista. *Leguminosæ*.

Propagated by seeds sown in spring; also by layers and greenwood cuttings under glass. For the genista of florists, see *Cytisus*.

Gentiana (Gentian). *Gentianaceæ*.

Propagated by seeds and division. The seeds are small and germinate slowly, and often with difficulty. They often lie dormant a year or more. They should be sown as soon as gathered in well-sifted light loam, in pans or flats, and kept cool and shaded. Division must be carefully performed, or the plants will suffer.

Geonoma. *Palmaceæ*.

Multiplied by seeds and suckers. See *Palms*, page 377.

Geranium. *Geraniaceæ.*

Mostly increased by seeds and divisions. The true geraniums are mostly outdoor perennials; for the conservatory plants known as geraniums, see *Pelargonium*.

Gerardia. *Scrophulariaceæ.*

Propagated, but often with difficulty, by seeds, sown in the open air or in a frame or coolhouse. Many of the species are partially parasitic on roots.

Gerbera. *Compositæ.*

Propagated by seeds, and by cuttings of side shoots. Seeds give good results, as a perennial.

Gesneria. *Gesneriaceæ.*

Propagated by seeds, cuttings of the shoots and leaves, and by offsets of the tubers. Handled in essentially the same way as sinningia, which see. See *Gesneriaceæ*.

Gesneriaceæ. **Gesneriads.**

Propagation is effected by cuttings of the young shoots when about 2 or 3 inches long placed in a close moist propagating-frame, using clean sharp sand or sand and peat mixed, in a temperature of 70° to 75°. Or by leaf-cuttings, using mature leaves. Propagation by seeds is the most common method for most of the genera. They should be sown in January or February in small pans of finely sifted soil, composed of leaf-mold, loam and sand in about equal parts. Seeds should be sown very thinly, covered very lightly, carefully watered, placed in a temperature of 65° to 70° and kept shaded. The seedlings damp readily and should be pricked into small pans of fresh soil as soon as they are large enough to handle.

Geum. *Rosaceæ.*

Propagated by division and by seed.

Gherkin (*Cucumis Anguria*). *Cucurbitaceæ.*

Easily grown from seeds, as for cucumber.

Gilia, including Fenzlia. *Polemoniaceæ.*

Seeds may be sown in spring in the open ground or frame, usually in the open.

Gillenia. *Rosaceæ.*

Propagated readily by dividing the roots; also by seeds.

Ginkgo, Salisburia (Maidenhair Tree). *Ginkgoaceæ.*

Propagated by seeds, which are mostly imported, and which should be stratified. Seeds are now produced in some quantity in this country. Also increased by layers, and by cuttings of either green or ripe wood. The cuttings are handled under glass. Named varieties are grafted on common stocks.

Ginseng (*Panax* or *Aralia quinquefolium*). *Araliaceæ.*

Propagated by seeds, which germinate the second spring. As soon as ripe, in autumn, the seed should be gathered and kept moist for twelve months, being planted regularly in beds a year from the time of gathering. The seed may be kept moist and fit by planting it as soon as ripe, but this exposes it to mice and other risks; a safer way is to mix the seeds in several times their bulk of sand (stratify) and keep them in a box, covered with wire netting, until planted. The seed may be sifted from the sand. The seed is sown either in drills or broadcast in well-prepared narrow beds (to admit of cultivation from either side), the seeds being an inch or two apart. Seedlings should be transplanted the first or second season. Commercial mature roots may be expected in five years.

Gladiolus. *Iridaceæ.*

Propagated by seeds, which are commonly sown in pans in spring, in the house; or they may be sown in the border. Seedlings flower in two or three years, but four years is often required to produce good merchantable bottoms. They give new varieties. The common method of propagation is by means of cormels or offsets. These are removed from the parent corm and planted in the open, where some of them will flower the same season, although most of them will require a season's independent growth before they bloom. If cormels are desired in abundance, the large corms should not be allowed to flower. Some varieties do not produce cormels readily, and these may be made to bear them by cutting or ringing.

Aside from cormels, one or two new corms are formed above the old one each year. Fig. 49.

Glaucium (Horned Poppy). *Papaveraceæ.*

The annual and biennial kinds are grown from seeds sown where the plants are to stand; perennials by division.

Gleditsia (Honey Locust). *Leguminosæ*.

Seeds should be sown in spring about 1 inch deep. They should be soaked in hot water before being sown. Varieties are propagated by grafts on seedling stock in spring, *G. triacanthos* being mostly used as stock. Sometimes spelled Gleditschia.

Gleichenia. *Gleicheniaceæ*.

Increased by division of the plant. See *Ferns*, page 312.

Globularia. *Globulariaceæ*.

Propagated by division and by seed.

Gloriosa. *Liliacæ*.

Offsets are commonly employed for propagation when they are produced (about the old bulb); seeds are readily used, started in bottom heat. The bulb-like tubers may be cut in two for purposes of propagation.

Gloxinia (*Sinningia speciosa*). *Gesneriaceæ*.

Gloxinia seeds should be sown the latter part of winter, in well-drained pots or small pans of finely sifted soil, of peat, leaf-mold and sand in about equal proportions. The seeds should be covered slightly, then carefully watered, and placed in a temperature of about 70°. If seeds are sown in spring, blooming tubers should be had the following winter.

Cuttings of the shoots may be taken after the old tubers start in spring, and placed in a propagating-frame. Leaf-cuttings, with a small portion of the petiole attached, give excellent results, especially when the leaves are firm and nearly matured. Leaf-cuttings are made after the manner of Fig. 110; a little tuber forms on the end of the leaf-stalk, and this is removed and handled like any small tuber; or the last leaf may be laid flat, as for begonia, and the ribs cut at intervals. Also grafted on tubers, much as for dahlia and peony. See *Gesneriaceæ*.

Glycosmis. *Rutacæ*.

Cuttings may be used, started under glass; seeds, when obtainable.

Glycyrrhiza (Liquorice). *Leguminosæ*.

Propagated by division and by seeds; roots left in the ground after harvesting may produce a succeeding crop.

Godetia. *Onagraceæ.*

Propagated by seeds, which, in California, may be surface-sown in late fall, or in February lightly covered in sunny or half-shady places. In common garden culture, seeds are sown in spring.

Gomphrena (Globe Amaranth). *Amaranthaceæ.*

The common kind (*G. globosa*) is annual and grown readily from seeds sown in the open. Perennial kinds are propagated also by cuttings and division.

Gongora. *Orchidaceæ.*

Increased by divisions. See *Orchids*, page 372.

Gooseberry (*Ribes Grossularia* and *R. hirtellum*). *Saxifragaceæ.*

Seeds, for the raising of new varieties, should be sown as soon as well cured, in loamy or sandy soil, or they may be stratified and sown together with the sand in the spring. They are handled the same as for currants.

Cuttings 6 to 8 inches long of the mature wood, inserted two-thirds their length, will grow in fair proportion, especially if taken in August or September and stored during winter, in the same way as currant cuttings; but the gooseberry does not start so readily from cuttings as does the currant. Single-eye cuttings may be used for rare kinds. Stronger plants are usually obtained by layers, and the English varieties are nearly always layered in this country (although frequently grown from cuttings in England). Mound-layering is usually employed (the mounding being done in June, or when the new growth has reached several inches), the English varieties being allowed to remain on the stools two years, but the American varieties only one. Much depends on the variety. The Downing, for example, usually makes a merchantable plant in one year after transplanting from the stools, but Smith Improved may require a year more. Layered plants are usually set in nursery rows for a year after removal from the stools. (Fig. 64.) Green-layering during summer is sometimes practiced for new or rare varieties. Strong plants may also be procured by tip-layering, as in the black raspberry.

If it is desired to train the weaker gooseberries in tree form, they may be grafted on the stronger-growing varieties.

Gordonia. *Theaceæ.*

Propagated by seeds, layers, or cuttings from half-ripened wood under glass.

Gourds (*Cucurbita Pepo*, *Lagenaria*, and others). *Cucurbitaceæ*.

Increased by seeds, after the weather is settled and ground is warm, usually planted directly where the plants are to grow.

Grammatophyllum. *Orchidaceæ*.

Propagated from pieces of the pseudobulbs. See *Orchids*, page 372.

Grape (*Vitis*, several species; *V. vinifera* is the wine grape and the source of the European varieties; *V. Labrusca* is the dominant source of the American varieties). *Vitaceæ*.

Grape seedlings are easily grown. If the ground is fit and there is no danger from vermin, the seeds may be sown in autumn, but they are usually stratified and sown in spring. They come readily if sown outdoors, but some prefer to force them under glass with a mild bottom heat. Seedlings do not "come true," and they are therefore grown only for the purpose of obtaining new sorts.

The grape is readily multiplied by layers, either of the ripe or green wood. The ripe wood or canes may be layered either in fall or spring, but spring is usually preferred. The cane is covered 2 or 3 inches deep, and nearly every bud will produce a plant. In August or September the layer should be lifted and cut into plants. Better plants are obtained if only the strongest canes are used and only a part of the buds on each allowed to grow. The cane is usually cut back to four or five buds, or if very strong plants are desired only one bud is left on each layer. Canes of the previous year, those recently matured, are preferred, although wood two or three years old may be used, but in this case it is usually necessary to cut or otherwise wound the joint to induce the formation of roots. Vines or stools grown for the production of layers should be cut back severely in fall or winter, to induce a vigorous growth of canes the following season. These canes are then layered the succeeding fall or spring. Only a part of the canes are layered from any stool, some of them being allowed to grow for cutting back the next autumn in order to get another crop of canes. In some varieties which do not strike readily from cuttings, layering is considerably practiced by nurserymen. The Delaware is often grown in this way.

Extra strong layers can be secured by layering in pots. A large pot, filled with rich soil, is plunged beneath the layer. In this way a layer may be rooted and separated even while carrying fruit. Layering in pots is practiced only in special cases.

In vineyards, layering is often employed for the purpose of filling vacancies. A strong cane is left, without pruning, on a neighboring vine in the same row, and in the spring the end of it is laid down in the vacant place. The vine is covered about a half foot deep, and the free end of it is turned up perpendicularly out of the earth and tied to a stake. By fall or the following spring the layer should be sufficiently rooted to allow the parent cane to be cut away.

Green-layering is sometimes practiced on new and scarce varieties, but strong plants are not obtained unless they are well handled by forceful culture after they are separated. The growing cane is layered in midsummer, usually by serpentine layering.

Cuttings are usually employed by nurserymen to propagate the grape. These are of many fashions. In all ordinary cases hardwood cuttings are made from the ripened canes in autumn or winter when the vines are pruned. It is advisable to take the cuttings before the canes have been exposed to great cold. Choose only those canes that are well matured, solid and rather short-jointed. In common practice, the cuttings are made in two-bud lengths, the lower cut being close to the bud. The cuttings will range from 6 to 10 inches in length. Some prefer three-bud cuttings (Fig. 98), but unless the cane is very short-jointed, such cuttings are too long to be planted and handled economically. Three-bud cuttings usually give stronger plants the first season, because roots start from both joints as a rule.

Very strong plants are obtained from mallet cuttings (Fig. 100), but as only one such cutting can be made from a cane, unless the cane bears very strong branches, they are not much used. Various methods of peeling, slitting and slicing cuttings are recommended, in order to extend the callusing process, but they are not used in common or commercial practice.

Grape cuttings are tied in bundles of 50 or 100, and stored in sand, moss or sawdust in a cellar, until spring, when they are planted in rows in the open. Some varieties, of which the Delaware is an example, do not strike readily from cuttings. Some growers start common cuttings of these under glass in spring. Others bury the bundles of cuttings in a warm exposure in autumn, with the butt ends up and about level with the surface of the ground. This is supposed to induce callusing. (See page 87.) At the approach of cold weather the cuttings are removed to a cellar, or are heavily mulched and allowed to remain where buried. Storing

is safer. Some growers obtain the same results by burying upside down in a cellar. These slow-rooting sorts often start well if they are simply kept in a warm cellar — but where the buds will not swell — all winter, as the callusing is then hastened. At the end of the first season the plants may be transplanted. The plants are often sold at this age, but buyers usually prefer two-year-old plants.

Single bud or “eye” cuttings are largely used for the newer and rarer varieties. These are cut from the canes in the fall, the same as long cuttings, and are stored in boxes of sand or moss. A month before the weather becomes settled, these boxes may be taken into a house or greenhouse, or put in a mild hotbed, to induce the formation of the callus. They may then be planted outdoors, and a fair proportion of most varieties may be expected to grow. The best and commonest way of handling eyes, however, is to start them under glass. They are planted horizontally, or nearly so, and about an inch deep in sand or sandy earth, in a cool greenhouse in late winter — in February in the northern states — and in about six weeks the plants will be large enough to pot off or to transplant into coldframes or a coolhouse. If only a few plants are to be grown, they may be started in pots. When the weather is thoroughly settled, they are transferred to nursery rows, and by fall they will make strong plants. Various ways are recommended for the cutting of these eyes — as cutting the ends obliquely up or down, shaving off the bark below the bud, and so on — but the advantages of these fashions are imaginary. A good eye-cutting is shown in Fig. 113. The foreign grapes are propagated by eyes in the North, although long cuttings also give good results.

Soft cuttings are sometimes used to multiply new kinds. These may be taken in summer from the growing canes, but the plants are usually forced in winter for the purpose of giving the extra wood. Cuttings are taken off as fast as buds form, and they are forced in close frames with a good bottom heat. The cuttings may comprise two buds, with the leaf at the upper bud remaining, or they may bear but a single eye, in which case the leaf, or the most of it, is left on. This rapid multiplication from small soft wood usually gives poor plants; but strong plants may be obtained by allowing the wood to become well hardened before it is used. Soft cuttings will root in two or three weeks under good treatment.

To secure extra strong plants from single buds, the eyes may be saddle-grafted or whip-grafted on a root 2 or 3 inches long. The

root-grafts are then treated in the same way as eye cuttings, only that they are usually grown in pots from the start.

The vine may be grafted with ease by any method. Cleft-grafting is commonly employed on old plants. The cions are inserted on the crown of the plant, just below the surface of the ground. The cleft is bound with string, and then covered with earth, no wax being necessary. The best time to perform the operation is very early in spring, before the sap starts. Vines may be grafted late in spring also, after danger of bleeding is past, if the cions are kept perfectly dormant. Vines are sometimes grafted in the fall, but this practice cannot be recommended in the North. Young plants are usually whip-grafted at the crown, either indoors or outdoors. Grafting the vine is mostly confined to Europe, California, and other countries where the European grape (*Vitis vinifera*) is grown, as that species must be grafted upon some other stock in order to resist the phylloxera. The common wild frost-grape (*Vitis vulpina*) is the most popular stock. The union in these cases must not be much below the ground, unless it is desired that the cion take root. The union is sometimes wound with waxed muslin and the earth is heaped about it until it has healed. Grapes can be grafted by the cleft-graft below ground as readily as pears or apples can be worked. For pictures of various methods of grafting the grape, see Figs. 172, 173, 192, 195. Fig. 173 represents a good type for general use on old vines.

The vine is frequently inarched, and early in spring it can be budded by ordinary methods.

Seed-grafting is a curious practice, which may be applied to the grape (see page 166).

There is so much misapprehension respecting the methods and results of the grafting of grapes, that the following directions by the veteran viticulturist, the late George Husmann, of California (as given in *American Agriculturist*, 1896), are here transcribed in full:

“ A good, thin-bladed, sharp knife to cut the cions, a sharp saw to cut off large stocks — the smaller ones can be cut with good pruning shears — a chisel for grafting having a blade $2\frac{1}{2}$ or 3 inches broad in the middle and a wedge on each side [a knife with but a single wedge, as in Figs. 168 and 169, will answer the same purpose], a wooden mallet, and a few strings of raffia, or other bandage, in case a stock should need tying, which is seldom the case — are the implements necessary for grafting. The cions should be of

selected wood, the size of a lead-pencil, or somewhat larger, cut sometime in winter, tied in bundles, and buried their entire length on the shady side of a building, or under a tree, to keep them dormant. Short-jointed, firm wood is to be preferred. All can be carried in a basket, if one intends to perform the operation alone. If several are to work together, of course the tools must be divided accordingly. In California we work generally in gangs of three, the first man clearing away the ground from the stock until he comes to a smooth place for inserting the cion, whether this be at the surface or slightly below. The former is preferable if resistant vines are to be grafted with non-resistant cions. He then cuts off the stock horizontally about an inch and a half above a knot or joint. The next man cuts the cions to a smooth, long, sloping wedge just below a bud [as shown in Fig. 167], then splits the stock, either with pruning shears or chisel, according to its size. If the stock is not more than an inch in diameter, the shears are best, as only one cion is to be inserted. Keep the blade of the shears on the side where the cion is to join the stock, so as to prevent bruising, and make a long, smooth, sloping cut, a little transversely if possible, as the junction will thereby become all the more perfect. Then push the wedge of the cion firmly down into the cleft, taking care that the inner bark or fiber of stock and cion are well joined, as on this principally depends the success of the operation. To open the cleft, the wedges on the chisel are used if necessary. An expert will depend very little on these, unless the stocks are very heavy, but will open the cleft with knife or shears, and then push down the cion to its proper place. The inner side of the cion, opposite the bud, should be somewhat thinner, so that the stock will close firmly on it; the cion should also be inserted far enough so that the bud is just above the horizontal cut on the stock. The third man follows, presses a little moist earth on the surface of the stock, and then hills up around the junction to the uppermost buds of the cion with well-pulverized soil, taking care not to move the cion, and the operation is finished. It becomes necessary sometimes to tie the stock, when it is not large enough or from some defect in grafting it does not firmly hold the cion. In such a case, pass a string of raffia or some other flat bandage firmly around the stock and tie it, but in no case use grafting wax or clay, as the strong flow of sap from all the pores is apt to drown and sour the cion, while without obstructing it, it will flow around the stock, serving to keep the junction moist and facilitate the union. As the

whole operation is covered with earth, there is no danger of drying up, as is sometimes the case when fruit trees are top-grafted.

“ A very important consideration, to insure success, is to equalize the stock and cion. If, therefore, large stocks are to be grafted, we must have strong, well-developed wood for the cions, and have buds enough to take up the full flow of sap, while small stocks, if used at all, should be grafted with small cions of only two or three buds. When the stocks are strong, I take two cions and insert one on each side of the stock, of full length, say from 14 to 16 inches, and with six to eight buds each. This has many advantages. The principal one is that they will elaborate and work up the entire flow of sap. Another is, that if the cions have well-developed fruit buds, they will produce quite a number of clusters from the upper buds, and thus show the character of the fruit the first year. I have picked a thousand pounds of grapes from an acre thus grafted, the first summer, and a full crop of five or six tons per acre the following season. Another advantage is that it establishes the crown of the graft at the right distance from the ground, as the three upper buds will produce the canes for the next season's bearing. If both cions grow, cut off the weakest above the junction the next spring, leaving only the strongest. I generally find that the whole surface of the stock is covered by the new growth, and that the junction between stock and cion is perfect. Another advantage is — especially in California, where we plow and cultivate close to the vines, and where some of the workmen are careless — they are more apt to run over and disturb the small grafts than the large ones, which are protected by hills of earth above the surface; nor are the young shoots disturbed and broken so easily by careless hands or high winds. A stake should be driven close to the graft immediately after grafting is finished, and the young shoots, when they appear, tied to it for support, as they generally start vigorously and are easily broken off, or blown off by high winds. Do not be discouraged if some time elapses before they start. I have often had them remain dormant until July or August, and then make a rapid growth. If suckers from the stock appear — as is generally the case — they should be removed at once, taking care to cut them close to the stock, so as to have no stumps or dormant buds. Tying and suckering should be repeated every week or ten days at least. As long as the cion remains fresh and green it may begin growing at any time. Of course, care

must be taken not to disturb the cion. If everything does well, there will be three or four canes from the upper buds, which may be pruned just as any other bearing vines."

Grapefruit, Pomelo, Shaddock (*Citrus grandis*). *Rutaceæ*.

Propagated by budding on seedlings of sour orange, rough lemon and grapefruit, also on *Poncirus trifoliata*. See *Orange*.

Grasses, agricultural.

The grasses of meadows and pastures are mostly perennial. They are propagated by seeds, usually sown in the cool of the year as in spring in wheat fields or other grain. Usual quantities of seed to the acre are as follows: timothy, 15 to 25 pounds; blue-grass (june-grass), 25 pounds; brome-grass, 12 to 20 pounds; johnson-grass, 1 to 1½ bushels; orchard-grass, 12 to 15 pounds; sheep fescue, 2½ to 3 bushels; rye-grass, 2 to 3 bushels; redtop, 12 to 15 pounds. Many combinations of these and other grasses are used.

Grasses, ornamental.

The perennial ornamental grasses are in most cases increased by seed or division. It is usually best to propagate varieties with variegated foliage by division, although some of the variegated forms of *Zea Mays* come true from seeds. *Arundo Donax variegata* is increased by division, as it rarely seeds (at least North). The annual ornamental grasses are raised readily from seeds.

Grevillea. *Proteaceæ*.

Grown from seeds, sown under glass in late winter; also by cuttings of half-ripened wood. The common silk oak of green-houses (*G. robusta*) is raised extensively from seeds; it is attractive only in its young stage, and new plants are raised frequently. Most of the species graft readily on *G. robusta*.

Grindelia. *Compositæ*.

Propagated by seeds, sown in the open or under glass, by divisions and by cuttings.

Guava (*Psidium*, several species). *Myrtaceæ*.

The guavas grow readily from seeds, and plants often bloom when a year and a half old. They may also be multiplied by layers, and by cuttings either under glass or in the open. Grafting and budding have also been practiced. The usual method is by seed, but as named horticultural varieties become more prominent, rapid vegetative means of propagation must be perfected.

Gunnera. *Haloragidaceæ.*

Propagated by division. Seeds may be employed when obtainable, but often they germinate with difficulty.

Guzmania. *Bromeliaceæ.*

Propagation as for tillandsia, which see. See *Bromeliaceæ.*

Gymnocladus (Kentucky Coffee Tree). *Leguminosæ.*

Readily increased by seeds, which start better if soaked for a few hours in hot water. Also propagated by root-cuttings.

Gynandropsis. *Capparidaceæ.*

Propagation by seeds as for cleome, which see.

Gynerium. *Cortaderia.***Gynura.** *Compositæ.*

Multiplied easily by seeds; also by cuttings of growing shoots.

Gypsophila. *Caryophyllaceæ.*

Propagated by seeds, division, and sometimes by cuttings. They grow readily from seeds, both the annual and perennial kinds.

Hæmanthus (Blood Flower). *Amaryllidaceæ.*

Propagated by offsets which should be removed and potted when the plants are beginning growth in spring. Rarely by seeds.

Hakea. *Proteaceæ.*

Usually grown from seeds, sown in winter or early spring, in mixture of sand, leaf-mold and loam. Hakeas should be pricked off into boxes and kept in a lathhouse for a season before planting in the open. Well-ripened cuttings may be placed in sandy peat under glass, in a cool house.

Halesia (Silver-Bell. Snowdrop-Tree). *Styracaceæ.*

Seeds, which rarely germinate till the second year, should be stratified or kept constantly moist. Sometimes they are sown as soon as ripe, but accidents are likely to happen before they germinate. Propagation is also effected by layers, and by cuttings of the roots in spring and autumn, and by greenwood cuttings taken

from forced plants. Layers are commonly employed in this country.

Halimodendron (Salt Tree). *Leguminosæ*.

Increased by seeds, layers and cuttings, the layers often rooting tardily; may also be grafted on common laburnum and on pea-tree or caragana. Thin winter cuttings in bottom heat root readily.

Hamamelis (Witch-hazel). *Hamamelidaceæ*.

All kinds grow from seeds or layers, and the Japan species succeed if grafted on American species in the greenhouse in spring. *H. virginiana* may be propagated readily by layers. Seeds usually germinate the second year.

Hamelia. *Rubiaceæ*.

May be increased by seeds. Cuttings of nearly ripe wood will root in early summer under glass.

Hardenbergia. *Leguminosæ*.

For propagation, seeds may be used; also increased by division. Cuttings of firm young side shoots in spring will grow under glass in a warm frame or pit.

Harrisia (one of the segregates of *Cereus*). *Cactaceæ*.

For propagation, see *Cacti*, page 261.

Hattora. *Cactaceæ*.

Propagation as for *Rhipsalis* (*H. salicornioides* is usually known as *Rhipsalis salicornioides*). See *Cacti*, page 261.

Haworthia. *Liliaceæ*.

Propagation as for aloe, which see.

Hedera (Ivy). *Araliaceæ*.

Increased by layers and seeds sown soon after ripening, usually not germinating until the second year. The rooted parts of the vine may be severed and treated as independent plants. Cuttings may be made in autumn placed in pots or in the open ground. Named varieties are grafted on the stock of any strong form. The slow-growing bushy kinds may not grow readily from cuttings; cions of them may be grafted on cuttings of freer-growing kinds.

Hedychium (Garland Flower). *Zingiberaceæ*.

Increased by dividing the rhizomes in spring, when the plants are repotted. Rarely propagated by seeds.

Hedysarum. *Leguminosæ.*

Propagation is by seeds and division.

Hedyscepe. *Palmaçæ.*

Seeds. See *Palms*, page 377.

Helenium. *Compositæ.*

Propagated by seeds, cuttings, and division.

Helianthemum (Rock Rose. Sun Rose). *Cistacæ.*

Propagation is easily effected by divisions, from greenwood cuttings, and by seeds.

Helianthus (Sunflower). *Compositæ.*

Propagated by seeds, which may be sown in pots and the seedlings transferred, or in the open ground in spring; also by divisions. Of perennial sorts, use the underground shoots or "creepers," treating as for cuttings. Some of them (as the Jerusalem artichoke) bear subterranean tubers. See *Artichoke*.

Helichrysum, Elichrysum (Everlasting). *Compositæ.*

The annual species may be raised from seed in early spring and afterwards transplanted; or sown in the open ground when weather is warm. The perennial species are increased by cuttings in spring under glass.

Helicodicerus. *Aracææ.*

Propagation as for arum, by offsets or by seeds when procurable. See *Aracææ*, page 239.

Heliconia. *Musacææ.*

Multiplied by dividing the rhizome, and by seeds.

Heliopsis. *Compositæ.*

Propagated readily by seed and division.

Heliotropium (Heliotrope). *Boraginacææ.*

The common practice is to use cuttings, taken at almost any season if good stout growing shoots are to be had. They start readily in sand on a cutting-bench, or under a frame. Shade for a time. Plants for bedding are struck in late winter from stocks which are in a vigorous condition. For winter flowers, cuttings may be taken in July. Seeds are also employed.

Helipterum, including *Rhodanthe*. *Compositæ*.

Seeds sown in early spring under cover, or directly in the open garden.

Helleborus (Black Hellebore. Christmas Rose). *Ranunculaceæ*.

Seeds sown as soon as ripe may be used for the obtaining of new varieties. Root-divisions are usually employed. See *Veratrum* for white and green hellebore.

Hemerocallis (Day Lily). *Liliaceæ*.

Propagated by division of the clumps, which should also be divided for the good of the plant. Seeds may be used, sown as soon as ripe, of such kinds as produce them; the young plants should remain in seed-boxes until the following spring, when they may be planted out in rows. Fig. 50.

Hepatica. *Ranunculaceæ*.

Propagated by division of the roots in autumn; also by seeds sown very shallow in a moist shaded soil.

Heracleum (Cow-Parsley. Cow-Parsnip). *Umbelliferæ*.

Increased by seeds or division, the former usually growing readily if fresh.

Herniaria. *Caryophyllaceæ*.

Propagated by division and seed.

Hesperis (Dame's Violet. Rocket). *Cruciferaæ*.

The single kinds are grown from seeds; the double forms (which are most prized) by dividing the roots, and by cuttings.

Heterocentron. *Melastomaceæ*.

Propagation as for *Centradenia*, which see.

Heuchera (Alum Root). *Saxifragaceæ*.

Increased by dividing the clumps in spring or autumn, and also by seeds.

Hevea (Brazilian Rubber-Tree). *Euphorbiaceæ*.

Propagated by seed, sown as soon as ripe; also by cuttings.

Hibiscus. *Malvaceæ*.

Cuttings of green wood are commonly used, made in summer for hardy species or in early spring for tender ones. Cuttings of

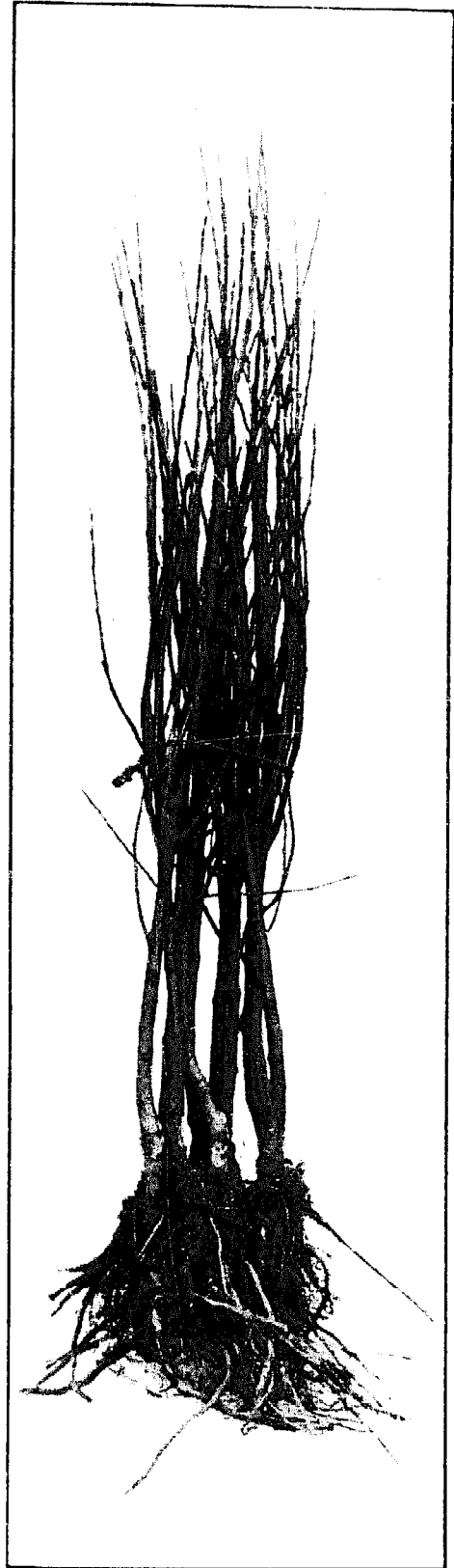
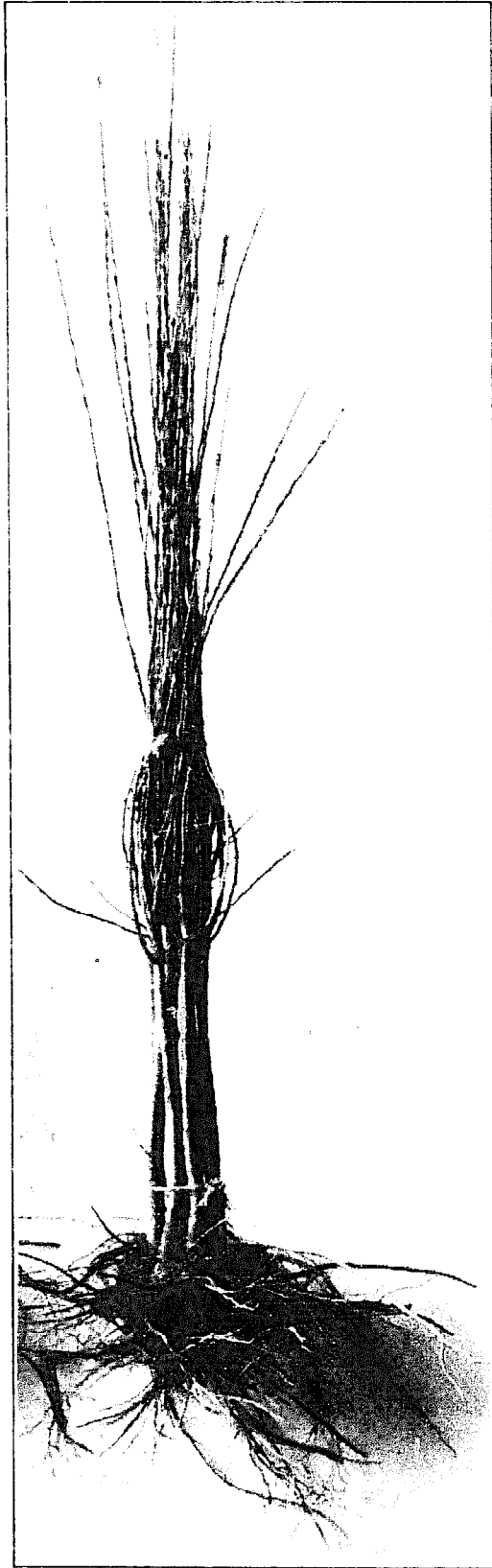

PLATE X. First-class dwarf apple stock; — at left, two-year whole-root grafts.

ripened wood may be taken in fall, and stored until spring in a rather dry place. Also increased by seeds, divisions and layers. The variegated sorts do better if grafted on strong stocks.

Hickory (*Carya*, or *Hicoria*, species). *Juglandaceæ*.

Propagated chiefly by seeds, which should be stratified or planted (about 3 inches deep) as soon as ripe. Seeds are sometimes planted at intervals in the field where the trees are to stand; but this practice is scarcely to be recommended, when there is opportunity to transplant seedlings annually in the nursery (established trees do not transplant well). Seeds may be planted directly in the nursery in autumn, but to obviate loss by rodents it is customary to stratify them till spring, the husks being first removed; the nuts are not cracked. The hickory can be grafted by veneer- or splice-grafting in winter on potted stocks, without special difficulty. Cleft-grafting can be employed outdoors, however, the stub being cut 3 to 6 inches below the ground, and the cions covered with earth, as for grafting the grape. The cions must be perfectly dormant, and are safer, therefore, if they have been kept on ice or in a very cold cellar. Saddle-grafting upon young twigs is sometimes used. Shield- and flute-budding often succeed in the hickories, as in fact many kinds of graftage do; but the skill of the operator is more important than the method. Named varieties may be worked on potted plants of *C. cordiformis* (*C. amara*) under glass in spring. See also *Pecan*.

Fuller's method of propagating the hickory is to employ the side roots of the tree, which are severed and allowed to grow from the severed end. As described by W. A. Taylor, "the severed side roots are straightened up and tied to stakes to hold them in position, with their cut ends about level with the surface of the ground to stimulate the formation of shoots from adventitious buds, one of which is eventually made the trunk of the new tree. The lower end of the root is not severed until the top has formed, when the new tree should be transplanted to its permanent location in rich and mellow soil and kept well mulched until thoroughly established. The method is slow and sharply limited in extent of application, but is perhaps the surest in the hands of the amateur grower."

Hidalgoa. *Compositæ*.

Seeds; also cuttings. Closely allied to dahlia.

Hieracium (Hawk-Weed). *Compositæ*.

The flower-garden species are grown readily from seeds, blooming the first or second year.

Higginsia: *Hoffmannia*.**Hippeastrum** (Equestrian Star). *Amaryllidaceæ*.

As for amaryllis, which see. Usually handled by the offsets that form about the bulb. These are taken when the plants are lifted or repotted. Do not cover the neck of the bulb. In a year or two, depending on size, the offsets should make strong blooming plants. Seeds usually grow readily, sown as soon as ripe. If the young plants are kept growing continuously, blooming specimens may be had in two years.

Hippophaë (Sea Buckthorn). *Elæagnaceæ*.

Increased by seeds sown at once or stratified, by suckers, layers, cuttings of the roots and cuttings of mature wood in spring.

Hoffmannia. *Rubiaceæ*.

Propagated by cuttings of half-ripened shoots in sand, with bottom heat.

Hohenbergia. *Bromeliaceæ*.

As for billbergia, which see.

Holcus (the proper name for the Sorghums and Kafirs). *Gramineæ*.

Propagated usually by seeds; sometimes by cuttings, as also in sugar-cane, which see.

Holly: *Ilex*.**Hollyhock** (*Althæa*). *Malvaceæ*.

Usually grown from seed sown as soon as ripe, in summer. See that the soil is mellow and moist, to encourage the development of side roots rather than a deep tap-root. The seedlings are sometimes carried over winter in a frame. The summer following sowing, plants should give good bloom. Seeds may also be kept over winter and sown in spring. If sown in February or March and plants kept growing rapidly, bloom may be had late the first year.

Hollyhocks are sometimes propagated by cuttings of short young shoots that arise from the crown. A crown may be lifted in spring

and covered with sand to encourage the formation of such shoots. Sometimes the roots of strong fresh plants are divided after flowering, each eye carrying with it a good set of roots.

Holodiscus (sometimes included in *Spiræa*). *Rosaceæ*.

Propagated by seeds usually sown in fall in boxes, slightly covered with soil or on a slight top layer of moss where they require no covering; by layers; or sometimes by greenwood cuttings under glass taken with a heel.

Hop (*Humulus*). *Moraceæ*.

The annual ornamental Japanese hop is grown readily and freely from seeds, often self-sowing. The common field hop (*Humulus Lupulus*), which is perennial, is propagated by cuttings of the underground stems, which are taken in spring, 4 to 8 inches long and with two to six eyes, and usually set two to four together in hills directly where the crop is to grow; sometimes the cuttings are heeled in on a moist place till planting time arrives.

Horse-Radish (*Roripa Armoracia*; formerly *Nasturtium Armoracia*). *Cruciferaæ*.

Root-cuttings ("sets") are made from the small side roots when the horse-radish is dug. They may be anywhere from $\frac{1}{4}$ to 1 inch in diameter, and 3 to 6 inches long, one end being cut slanting, to mark it. These are planted obliquely, 2 to 4 inches deep, in spring. They may be buried in winter. The old crowns may be planted, but they make poorer roots. Fig. 105.

Hosta, also known as *Funkia* (Plantain Lily). *Liliaceæ*.

Propagated by seeds sown when ripe; blooming plants should be had in one to three years. Usually by dividing the clumps in spring.

Hottonia. *Primulaceæ*.

Propagated by seeds, and by division in spring.

House Plants.

The common conservatory plants, as fuchsias, geraniums, carnations, give best results when allowed to bloom but one year. They are then thrown away and their places supplied by other plants; or the old stocks may be cut back, if still vigorous, so that cuttings may be made from the new shoots that arise. Cuttings are generally made in late winter or spring for the next winter's

bloom. These cuttings are slips (page 107) of the growing wood. See the various species, under their respective heads.

Hovenia. *Rhamnaceæ.*

Propagated by seeds, cuttings of mature wood struck under glass, and also by root-cuttings.

Howea (commonly known as Kentias). *Palmaceæ.*

Increased by seeds in light soil, with heat. See *Palms*, page 377.

Hoya (Wax-Plant). *Asclepiadaceæ.*

Handled by layers and cuttings. The common wax-plant, *H. carnosæ*, is readily propagated by layering; the long shoots make roots naturally. Cuttings may be taken in spring of firm wood. Some species may be grafted on stronger-growing kinds.

Humulus: *Hop.*

Hunnemannia. *Papaveraceæ.*

Grown from seed; in the East seeds sown early in May give bloom in summer.

Hyacinthus (Hyacinth). *Liliaceæ.*

For the production of new varieties seeds are employed. These are sown the same season they mature, in light sandy soil, and are covered not more than $\frac{1}{2}$ inch deep. In four or five years, or sometimes even longer, the bulbs will be large enough to flower.

Varieties are perpetuated by means of the bulbels, which form freely on some varieties. These are treated in much the same way as mature bulbs, or they may be handled in pans or flats. They make flower bulbs in two or three years. To increase the numbers of these bulbels, the bulbs are variously cut by the Dutch growers. These practices are described and illustrated on pages 59 and 60, Figs. 46, 47.

Hyacinths can be propagated by leaf-cuttings. Strong leaves should be taken in early spring and cut into two or three portions, each portion being inserted about an inch in good sandy loam, and given a temperature of about 75°. In eight or ten weeks a bulblet will form at the base of the cutting (see page 59). The lower leaves give better results than the upper ones. These bulblets are then treated in the same manner as bulbels. For *Hyacinthus candicans*, see *Galtonia*, page 316.

Hydrangea, Hortensia. *Saxifragaceæ*.

Seeds may be employed when they are produced; but usually the hardy species are propagated by green cuttings in summer, under glass (see Fig. 112). The tender ones (*H. opuloides*, the var. *Otaksa*, etc.) are increased by cuttings taken at any time from vigorous young wood, usually in late winter. Layers are occasionally employed, and suckers can be separated from some species. Sometimes the hardy species are forced for purposes of propagation by cuttage. *H. quercifolia* is propagated by little suckers or "root pips." *H. paniculata* var. *grandiflora* can be propagated easily from the young wood, taken in June and planted under glass.

Hydrastis (Goldenseal). *Ranunculaceæ*.

Seeds sown in autumn or spring in a well-protected shady place should grow readily. Old plants or colonies may be divided.

Hydriastele. *Palmaceæ*.

Propagated by seeds. See *Palms*, page 377.

Hydrocleis (Water-Poppy). *Butomaceæ*.

Propagated by dividing the rooting stems.

Hydrocotyle (Water Pennywort). *Umbelliferæ*.

Increased by seeds, cuttings or layers. Usually spreads by the rooting stems.

Hylocereus (separated from the old genus *Cereus*). *Cactaceæ*.

For propagation, see *Cacti*, page 261.

Hymenocallis. *Amaryllidaceæ*.

Increased by offsets from the bulbs. Treated the same as amaryllis and paneratium, which see.

Hymenophyllum (Filmy Fern). *Hymenophyllaceæ*.

Propagated by spores and by dividing the roots. See *Ferns*.

Hypericum (St. John's-Wort). *Hypericaceæ*.

Most of the species grow readily from seeds. Some of them produce runners that may be used as cuttings or layers. The shrubby kinds are handled by cuttings of green wood under glass in summer. Division may be practiced in some cases, and suckers may be removed when they are produced.

Hyssop (*Hyssopus officinalis*). *Labiatae*.

Grown from seed sown in spring, either in drills where the plants are to stand or broadcast in nursery-beds. It may also be propagated from cuttings or division in spring or fall; greenwood cuttings may be started in shade in early summer.

Iberis (Candytuft). *Cruciferae*.

The annuals and biennials are increased by seeds in spring or autumn. Autumn-sown plants should be slightly protected during winter; these will bloom from spring to July while spring-sown plants bloom from July to September. The sub-shrubby sorts are increased by seeds sown in spring, and by divisions and cuttings taken in September and put in sand, in a cold propagating-frame.

Ilex (Holly). *Aquifoliaceae*.

Propagated by seeds, which should be stratified. They are often cleaned of the pulpy coat by maceration. The seeds rarely germinate until the second year. The evergreen species may be increased by cuttings of ripened wood under glass. Varieties are perpetuated by graftage. The veneer-graft, on potted plants, is usually employed, but other methods may be successful. Budding is sometimes practiced. *I. Aquifolium* and *I. opaca* are mostly used as stocks.

Illicium. *Magnoliaceae*.

Increased by seeds; also by cuttings of young ripened wood.

Imantophyllum: *Clivia*.**Impatiens**. *Balsaminaceae*.

Grown from seeds. The indoor species may be grown either from cuttings or seeds; cuttings usually root freely. See *Balsam*.

Incarvillea. *Bignoniaceae*.

Propagated by division and by seed.

Indigofera (Indigo). *Leguminosae*.

Multiplied by seeds, and by cuttings of young shoots under glass in light heat and hardwood cuttings in winter.

Inula. *Compositae*.

Seeds usually grow readily, giving blooming plants the second year. Old plants may be divided.

Iochroma. *Solanaceæ.*

Seeds and cuttings as for cestrum.

Ipomœa (Moonflower. Morning-Glory). *Convolvulaceæ.*

All the annual species (or those grown as annuals) are raised from seeds. Seeds of moonflowers and similar species should usually be filed or cut on the point, and started in a rather high temperature. The perennials are also increased by seedage, but they may be raised from cuttings struck in a forcing-house or a frame. The moonflowers often do better in the North from cuttings than from seeds; this is true also of some of the greenhouse species that do not produce seeds. Some kinds root with difficulty from cuttings, however, and they may be propagated by grafting cions of well-ripened wood of roots on *I. pandurata* or other species. Division is sometimes employed. *I. pandurata* can be propagated by root-cuttings; also grafted. See *Calonyction*, *Quamoclit*, *Sweet Potato*.

Iresine, *Achyranthes.* *Amaranthaceæ.*

Increased readily by cuttings. For summer bedding in the North, cuttings should be started in February or March; for use as window plants, they should be taken in late summer. Old plants may be carried over winter to provide a supply of cuttings, or plants may be grown for this purpose from cuttings struck in late summer. Rarely propagated by seeds.

Iridaceæ. **Irids.**

The rhizomatous irids are easily increased by offsets or division. The species and varieties of crocus and gladiolus are readily propagated by offsets. The species of irids produce seed freely and are rapidly increased from these. These seeds should be sown as soon as ripe; if carried over until spring the germination is much slower.

Iris. *Iridaceæ.*

Seeds grow readily and give good results, and are usually produced freely, especially in the bulbous species. Sow as soon as ripe in light soil in some protected place. The bulbous species produce bulbels, which may be used for multiplication. The rhizomatous species are propagated by dividing the rhizome into short-rooted pieces; or when the rhizomes lie on the surface of the ground and do not root readily, they may be layered. See *Iridaceæ*.

Isoloma. *Kohleria.* *Gesneriaceæ.*

Propagation as in achimenes; the usual kinds grow readily from seeds, blooming the same year they are sown. See *Gesneriaceæ*, page 318.

Itea. *Saxifragaceæ.*

Multiplied by seeds and by suckers; also by cuttings and division of the roots, and sometimes by layers.

Ixia. *Iridaceæ.*

Seeds may be sown in autumn, and the pans or boxes kept in a cool frame. Seeds should give blooming plants the second year.

Propagation by bulbels or offsets is much quicker, and is the usual method. For greenhouse bloom bulbs should be planted from September 15 to October 30, five or six in a 5-inch pot or eight to ten in a 6-inch pot, an inch deep in a mixture of sandy soil and leaf-mold. The pots should be stored under a bench or in a rather dark cellar, at a temperature of 45°. For outdoor culture, bulbs should be planted as late as November 30, 3 inches deep in a frame and covered with leaves, hay or pine-needles.

Ixiolirion. *Amaryllidaceæ.*

Propagated by seeds, and by offsets from the bulbous rootstocks. See *Amaryllidaceæ*, page 228.

Ixora. *Rubiaceæ.*

Readily increased in spring by cuttings of three or four joints in sharp sand under heat and protected from sun. They may also be propagated by seeds, when obtainable.

Jacaranda. *Bignoniaceæ.*

Seeds when obtainable; cuttings of half-ripened wood.

Jacobinia. *Acanthaceæ.*

Propagated easily by cuttings, much as for fuchsia. New plants should be grown every year for best results in conservatory.

Jacquemontia. *Convolvulaceæ.*

Propagated by seeds and cuttings, much as for ipomœa.

Jamesia. *Saxifragaceæ.*

Propagated by seeds, and by cuttings of ripened wood.

Jasminum (Jasmine. Jessamine). *Oleaceæ.*

Propagated readily by cuttings of nearly mature wood under glass in summer; also by ripe-wood cuttings taken in autumn, by layers, and sometimes by seeds sown as soon as ripe.

Jatropha. *Euphorbiaceæ.*

Readily raised from seeds. Propagated also by cuttings from firm young wood struck in sand over bottom heat; the cuttings should be dried somewhat before setting, as the plants have milky juice.

Jubæa (Coquito Palm of Chile). *Palmaceæ.*

Propagation is by seeds, started in a warm house and kept moist. See *Palms*, page 377.

Juglans (Walnut and Butternut). *Juglandaceæ.*

All the species are readily propagated by means of stratified nuts. Do not allow the nuts to become dry. Artificial cracking should not be practiced. In stiff soils the seedlings are likely to produce a long tap-root which renders transplanting difficult after the first year or two. The tap-root may be cut by a long knife while the tree is growing, or the young seedling may be transplanted. Particular varieties are perpetuated by grafting or budding with any of the common methods; but the skill of the grafter is more important than the method. In the North, they are sometimes worked indoors in pots. Common shield-budding works well, if the sap is flowing freely in the stock. Flute-budding is often employed. The improved native sorts are root-grafted in winter. Old trees can be top-grafted like apple trees (see page 151). If nursery stocks are grafted, it is usually best to insert the cions below ground, as for grapes. In all walnut grafting, it is generally preferred that only one scarf or cut of the cion should traverse the pith. It is important that the cions be kept perfectly dormant.

The "English" walnut (*J. regia*) is mostly grown direct from seed in this country, and the different varieties usually come true. In California, the native walnut (*J. Hindsii* and *J. californica*) is often used as a stock for this species, and flute-budding on branches a half-inch or more in diameter is often practiced. Twig- or prong-budding (Fig. 146) is sometimes employed. See *Walnut*.

Juncus (Rush. Bulrush). *Juncaceæ*.

Propagated by seeds, the perennials also by division.

Juneberry (*Amelanchier* species). *Rosaceæ*.

Increased by using the sprouts which form freely about the old plants; also by seeds. The cultivated dwarf Juneberry is multiplied by suckers. Budding and grafting on seedling stocks may also be employed. See *Amelanchier*.

Juniperus (Juniper. Red Cedar. Savin). *Pinaceæ*.

Increased readily by seeds, which, however, often lie dormant until the second year and sometimes even to the third year. Red cedar seed is one of the kinds which lie dormant a year. They germinate more readily if the pulp is removed by maceration or by soaking with ashes for a few days. Green cuttings, in sand under glass, root easily; or mature cuttings may be taken in fall and placed in a coldframe, in which they will need little protection during winter. Some varieties require a long time to root, even twelve to eighteen months. Most of the named varieties may be grafted on imported Irish stocks, which are much used in some parts of the country. They may be veneer-grafted and handled in a cool house. The shrubby species, especially *J. Sabina*, are also propagated by layers. Fig. 95.

Jussiaea. *Onagraceæ*.

Increased by seed sown in fall or spring in shallow water, using seed-pans or pots; cover seed with finely sifted soil, place pot in water but do not submerge until the second day.

Justicia. *Acanthaceæ*.

Most of the plants commonly cultivated as justicias are jacobinias, which see. The true justicias are propagated by cuttings of firm wood, usually in late winter or spring under glass.

Kadsura. *Magnoliaceæ*.

Increased by seeds; and by cuttings of nearly ripened wood under glass.

Kafir, Kafir-Corn (*Holcus Sorghum*). *Gramineæ*.

By seeds, as for maize.

Kaki: *Persimmon*.

Kalanchoë. *Crassulacæ.*

Propagated by seed when obtainable, but cuttings are more used. They grow readily from several parts, as do the crassulas.

Kale (*Brassica oleracea* var. *acephala*). *Cruciferæ.*

Increased by seeds, sown in the open in early spring in the North, or in the fall in the South. They are hardy plants, standing much frost; should be grown in the cool season.

Kalmia (Mountain Laurel. Calico Bush). *Ericacæ.*

Kalmias may be increased by seeds, which should be sown in spring in shallow pans of sandy peat or sphagnum, and kept in a coldframe until the seedlings are large enough to transplant. After being established, the young plants are hardened off and the next year transferred to frames or open beds. By cuttings of young shoots in sandy peat, placed in a shady situation under a hand-glass (with much difficulty). Also propagated by layers. Usually obtained from the woods. Varieties are veneer-grafted under glass, on unnamed stocks.

Kaulfussia: *Charicis.***Kennedya.** *Leguminosæ.*

Handled freely from seeds sown in spring or summer in pans or flats; also by cuttings of the firm green wood.

Kentia: *Howea.***Kerria.** *Rosacæ.*

Propagated by seeds when these are produced, as on the single-flowered forms; also by division, layers, and by cuttings of young shoots under glass, and by ripened cuttings. In this country, oftener increased by ripe-wood cuttings in fall.

Kniphofia (Tritoma. Poker Plant). *Liliacæ.*

Increased by seeds when they are produced, and by division of the crown in early spring; also by the offsets borne by some of the kinds. Seeds of the common kinds should produce blooming plants the second season, sometimes the first season.

Kochia (Summer Cypress). *Chenopodiaceæ.*

Grown from seeds which may be sown indoors in April and the plants set out in May; or sown in the open when the weather is warm.

Koelreuteria. *Sapindaceæ.*

Grown from seeds, stratified or sown in autumn; also by root-cuttings and young or low plants by layers.

Kohlrabi (*Brassica oleracea* var. *CaULO-RAPA*). *Cruciferæ.*

Propagated by seed sown in the open in early spring, or started in a hotbed and the plants transplanted. Usually sown directly in the open after the manner of turnips or rutabagas.

Kumquat (*Fortunella* species). *Rutaceæ.*

Worked on stocks of three-leaved orange (*Poncirus trifoliata*), rough lemon and sweet orange by the ordinary method of shield-budding. See *Orange*.

Laburnum (Golden-Chain). *Leguminosæ.*

The laburnums are increased by seeds sown usually in spring. Layers and suckers are often used. The varieties are grafted or budded on seedlings of the common sorts. See *Cytisus*.

Lachenalia. *Liliaceæ.*

Seeds usually start readily and blooming plants may be had the same season if kept growing. Offsets from the bulbs are also used, sometimes making blooming bulbs in one season.

Lactuca. *Compositæ.*

The ornamental kinds are grown readily from seeds. See *Lettuce*.

Lælia. *Orchidaceæ.*

Increased by pseudobulbs, as in *cattleya*. See also *Orchids*.

Lagenaria (Gourd). *Cucurbitaceæ.*

Propagated by seeds; in the North these may be started indoors in pots, but usually they are planted where they are to grow.

Lagerstrœmia (Crape Myrtle). *Lythraceæ.*

Propagated by seeds sown in boxes in autumn, and by layers and cuttings of ripe wood. In long-season climates the plant may bloom the first year from seed.

Lagurus. *Gramineæ.*

Increased by seeds, sown in fall and plants set out in spring, or by seeds started in spring.

Lamarckia. *Gramineæ.*

Propagated by seeds, sown in spring or fall, and the plants set out in the spring; also by spring-sown seeds.

Lantana. *Verbenaceæ.*

Increased by seeds, which give new varieties, and by cuttings, in fall or spring, from good growing wood, in sand in a warm house or frame. For florist's use, old plants are lifted or repotted in early autumn to stimulate cutting wood; cuttings are then taken in winter or spring and blooming plants are had for summer.

Lapageria. *Liliaceæ.*

Seeds may be sown as soon as ripe, when procurable, in a sandy peat soil, and kept in a moderate heat. Increased by layers of firm strong shoots from which some of the leaves have fallen. The shoot may be bent back and forth in a box of sand and peat, being pegged down and then covered with the earth; keep moist, and shoots will start from the joints and when rooted may be separated and potted.

Lapeyrousia. *Iridaceæ.*

Increased by division of the bulbs.

Larix (Larch. Tamarack). *Pinaceæ.*

Usually grown from seeds, which should be kept dry over winter and planted early in spring; shade the young plants. Varieties, as the weeping sorts, are worked on common stocks (usually the European larch). The grafting may be done by the whip method, outdoors early in spring. Rare sorts are sometimes veneer-grafted under glass. Rarely increased by cuttings of nearly ripened wood under glass or by layers.

Lasiandra: *Tibouchina.***Latania.** *Palmaceæ.*

Propagated by imported seeds sown in strong bottom heat. See *Palms*, page 377.

Lathyrus (Vetchling). *Leguminosæ.*

Propagated by seeds, sown very early in the open; the perennials also by seeds, something by division, and special varieties by cuttings in the fall, after the flowering season, or in spring from old plants stored in the greenhouse. The sweet pea may be sown before frosty weather is passed, and south of Norfolk it is usually satis-

factory if sown in the fall. See *Sweet Pea*. The everlasting pea (*L. latifolius*) is increased by seeds, division and cuttings.

Laurus (Laurel). *Lauraceæ*.

Propagated by seeds, layers and by cuttings, under glass in sandy soil; also by root-cuttings. The bay tree (*Laurus nobilis*) is grown from cuttings of well-ripened wood 3 to 4 inches long, struck in sharp sand under glass, bottom heat not being essential; the rooted cuttings are potted off and grown under glass or in a hotbed.

Lavandula (Lavender). *Labiatae*.

Cuttings may be made in late fall or early spring, of the season's growth with a heel of older wood. These should be inserted in sandy soil, under a frame. Also propagated by seeds and division; but seeds do not give desired varieties and plants from divisions are more susceptible to disease.

Lavatera. *Malvaceæ*.

Propagated by seeds. The perennial species can probably be multiplied by cuttings.

Layia. *Compositae*.

Handled by seeds, sown in a hotbed, or in the open border in the South and for late bloom.

Ledum (Labrador Tea). *Ericaceæ*.

Multiplied by seeds sown in spring in peaty soil, much as azaleas; also by division and by layers.

Leek (*Allium Porrum*). *Liliaceæ*.

Propagated by seeds, sown very early in the spring, either outdoors or in a coldframe; usually started where the plants are to stand; frost-hardy.

Leiophyllum (Sand Myrtle). *Ericaceæ*.

Increased freely by seeds in boxes or pans and placed in a frame; also by layers in autumn.

Lemon (*Citrus Limonia*). *Rutaceæ*. (H. H. Hume.)

The named varieties are propagated by budding on sour orange or rough lemon stocks. Sour orange stocks are most commonly used as they are adapted to a wide range of soil conditions. For indoor culture *Poncirus trifoliata* stock is best. For methods of propagation, see *Orange*. Lemons may be grown from mature

wood cuttings which are set in sand in a frame or in the open ground in spring. Rooted cuttings may also be used for stock.

Lentil (*Lens esculenta*). *Leguminosæ*.

Grown from seeds, sown in early spring where the plants are to stand.

Leonotis (Lion's Ear. Lion's Tail). *Labiatae*.

Increased by cuttings in bottom heat in early spring and may be transplanted to the open in May; also grown from seed when obtainable.

Leontice. *Berberidaceæ*.

Increased by seeds, and by suckers from the rhizomes.

Leontopodium (Edelweiss. Lion's Foot). *Compositæ*.

Edelweiss may be raised annually from seeds, or the old plants may be divided in fall and wintered in a coldframe. The seeds must be kept in a dry place throughout the winter and should be sown about February 1, which gives plants large enough to be planted out in permanent quarters in late spring. Plants bloom the following year, although a few flowers may be had the first year from seed.

Lepidium: *Cress*.

Leptospermum. *Myrtaceæ*.

Propagated by cuttings of well-ripened wood in fall or of young growth in summer or in spring under glass; also grown from seeds sown in spring.

Leptosyne. *Compositæ*.

Grown readily from seeds, usually started indoors.

Lespedeza. *Leguminosæ*.

Increased by division of the clumps; *L. formosa* (*L. Sieboldii*) by greenwood cuttings under glass; also by seeds when obtainable, sown in spring. *L. striata* is the so-called Japan clover, an annual grown in the South for hay; 15 to 25 pounds of seed are sown to the acre.

Lettuce (*Lactuca sativa*). *Compositæ*.

Raised from seeds, which may be sown under glass or in the open. The early crop is grown from seeds started indoors; the summer crop may be sown in frames or protected seed-beds; sometimes lettuce is sown in the open directly where the plants are to stand

for a home supply. In the middle and southern states, the seeds may be sown in the fall, and the plants protected from cold by a mulch; or the plants may grow in winter in the warmer countries.

Leucadendron (Silver Tree). *Proteaceæ*.

Propagated by seeds, the seedlings being carefully protected from damping off. It is desirable, before the hypocotyl or stem of the germinating plantlet becomes hardened, to sink the pot in water when the plant is dry, not allowing the water to come over the rim.

Leucojum, often spelled *Leucoium* (Snowflake). *Amaryllidaceæ*.

Increased by seeds, which should produce flowering bulbs in a year or two. Propagation is commonly by bulbels, however, which should be taken as soon as possible after the herbage matures.

Leucothoë. *Ericaceæ*.

Propagated by seeds, which should be sown under glass in moss and sand and plants pricked off into boxes; by divisions of established plants in autumn or winter, by layers and the underground runners; cuttings may be rooted in sand over gentle bottom heat.

Levisticum (Lovage). *Umbelliferæ*.

Propagated by seeds sown in the open ground, and division in spring or autumn.

Lewisia. *Portulacaceæ*.

Handled by seeds, or by division in spring. The root of the bitter-root (*L. rediviva*) may live for years out of the ground.

Liatris (Blazing Star. Button Snake-Root). *Compositæ*.

Seeds are usually sown early in autumn or in spring. Some species produce offsets, and of others the clumps may be divided.

Libocedrus. *Pinaceæ*.

Grown from seeds when they are procurable, sown in spring. Cuttings may be started under glass in summer or autumn. It may be grafted on related plants, as thuja and *chamæcyparis*.

Libonia: *Jacobinia*.

Licuala. *Palmaceæ*.

Raised from seeds sown at any time in a sandy soil, in strong bottom heat. See *Palms*, page 377.

Ligustrum (Privet. Prim). *Oleaceæ*.

Propagated by seeds sown in fall or stratified; and by division. Seeds may not germinate the first year. The named varieties are usually grown under glass from cuttings of green or ripe wood, and are sometimes grafted on *L. vulgare* or *L. ovalifolium*.

Liliaceæ. Liliads.

Nearly all liliaceous plants seed freely. Some produce small bulblets on the flower-stems. Others are propagated by dividing the bulbs. The strong growing lilies with thick scaly bulbs may be increased by stripping off the scales and planting them as cuttings. The seeds of hardy kinds may be sown out-of-doors in April or May. The seeds of tender sorts may be sown as soon as ripe in a greenhouse with a temperature of 60° to 70°. Many of the liliaceous plants are propagated by offsets, but the larger number may be increased by seeds.

Lilium (Lily). *Liliaceæ*.

The usual propagation of the true lilies is by offsets from the bulbs, but seeds may be employed for the production of new varieties. With a few species, blooming bulbs may be had the second season after seeds are sown, but usually three to five or even six years are required. Seeds commonly germinate within a month or two if sown in autumn when fresh, but dried seeds may lie dormant much longer. Seeds of some species do not germinate till the first or second spring. Lily seeds are usually sown about $\frac{1}{2}$ inch deep under moss in boxes of sand and kept under glass till they germinate; then out-of-doors protected from direct sun.

Usually lilies are increased by bulbels, which should be planted a few inches apart in prepared beds. The offsets or bulbels are taken about the time seeds would ripen, as the roots are most dormant then; in two or three years blooming bulbs should be secured if the offsets are taken good care of in well-prepared beds. Sometimes small bulblets form in the axils of the leaves, and these are used in the same way as bulbels. Bulb-scales are often employed for the multiplication of scarce kinds, giving blooming bulbs in two or three years. Those that produce large and loose bulbs, as *L. candidum*, may be increased by simple division. These operations are described on pages 57 and 58.

Lily-of-the-Valley : *Convallaria*.

Lime (*Citrus aurantifolia*). *Rutaceæ*. (H. H. Hume.)

Trees produced from seeds vary in size, quality of fruit and productiveness, and to produce trees true to type should be budded on rough lemon or lime seedlings. See *Orange*.

Limnanthemum: *Nymphoides*.

Limnobium. *Hydrocharitaceæ*.

Propagated by division of the runners.

Limnocharis. *Butomaceæ*.

Increases naturally by offsets or suckers from the flower-stem; also by seeds, sometimes self-sowing.

Linaria. *Scrophulariaceæ*.

Annual species (or those treated as such) are readily raised from seed, which, as they are small, are usually sown indoors and the seedlings transplanted; sometimes seeds are sown where the plants are to grow. The perennials are usually increased by means of division, but also by seeds when obtainable.

Linum (Flax). *Linaceæ*.

Multiplied by seeds, the hardy species sown outdoors and the tender ones under glass. Cuttings may be taken from firm shoots of the perennial species and inserted in sand under glass. The ordinary flax (*L. usitatissimum*) is sown directly in the field, from 2 to 6 pecks of seed being used, depending on whether grown for linseed or fiber. See *Reinwardtia*.

Lippia. *Verbenaceæ*.

Usually increased by cuttings of young shoots under glass. Cuttings of the hard wood may be used in autumn, under glass. Also grown from seeds. The running kinds are increased by simple division of the plants. The lemon verbena (*L. citriodora*, often called aloysia) is grown quickly from cuttings taken from cut-back stock plants in late winter or early spring; such plants should be of blooming size by summer. *L. canescens* is now much used as a ground cover or lawn plant in California and elsewhere (under the name *Lippia repens*). It is a creeping perennial, rarely producing seeds. Propagated by sods cut to 2 inches square and planted a foot or two apart.

Liquidambar (Sweet Gum). *Hamamelidaceæ*.

Propagated by seeds, which should be stratified or sown as soon as ripe. Many of the seeds may lie dormant until the second year.

Liriodendron (Tulip Tree. Whitewood). *Magnoliaceæ*.

Increased by seeds, which are stratified as soon as they are ripe, and sown the following spring. The seeds of the tulip tree are likely to be hollow, especially those grown along the eastern limits of the distribution of the species. Layering is sometimes employed for horticultural varieties, or they may be grafted on common seedling stocks.

Litchi (*Litchi chinensis* or *Nephelium Litchi*). *Sapindaceæ*.

The "gootee" method of propagation (as described by Popenoe) is commonly used. "A healthy, well-matured branch is chosen, and a narrow ring of bark removed just below a leaf-bud or node. Around this is formed a ball of clay soil, with an outer covering of coconut fiber, tow, or moss, to hold it together. A little above the ball a good-sized flower-pot or earthen vessel is suspended, and a piece of soft rope is inserted through the small hole in the bottom. The rope should fit the hole snugly, and is knotted on the inside; it is then carried to the gootee, and wound around the ball several times. The water trickles from the pot, which should be filled every day or two, and after running slowly down the rope is distributed over the gootee, keeping it uniformly moist. The gootee is made in spring, from February to April, depending on climatic conditions, and at least three or four months are required for roots to form. When the ball is filled with roots and they begin to show on the surface, the branch is severed from the tree and planted in its permanent location in the orchard" (Standard Cyclo. Hort., Vol. IV). Layering and inarching may also be practiced.

Livistona. *Palmaceæ*.

Propagated by seeds, sown in a sandy soil and placed in a gentle bottom heat. See *Palms*, page 377.

Loasa. *Loasaceæ*.

Mostly raised from seeds; the perennials may also be propagated from cuttings.

Lobelia. *Campanulaceæ*.

The common annual flower-garden lobelias are grown from seeds, usually started under glass but sometimes sown in the open where the plants are to stand. Seeds of perennials may give bloom the first year if started early, but of most of them a year of growth is required for best results. Seeds are sometimes sown in fall, of

the perennials, and plants carried over winter in a frame. Old but vigorous plants may be divided.

Læselia (*Hoitzia*). *Polemoniaceæ*.

Increased by seeds and by cuttings of half-ripened wood under glass.

Loganberry (*Rubus vitifolius* or derivative). *Rosaceæ*.

The loganberry or logan blackberry is propagated by root-tips, root-cuttings and layers. The only commercial method is to root the tips in autumn. Seeds give various plants, but most of the seedlings may be expected to bear fruit closely resembling the loganberry. See *Blackberry* and *Deuberry*.

Loiseleuria. *Ericaceæ*.

Propagation by layers and by cuttings of half-ripened wood under glass; also by seeds, after the method for rhododendron.

Lonicera (Honeysuckle. Woodbine). *Caprifoliaceæ*.

For new varieties seeds should be sown as soon as ripe, or stratified, first removing them from the pulp. The upright species are commonly grown from layers and from cuttings of dormant wood. The creepers are mostly grown from dormant cuttings. Some species do well from greenwood cuttings in summer under glass.

Lopezia. *Onagraceæ*.

Propagated by seeds, mostly started indoors; also by cuttings of firm wood.

Loquat (*Eriobotrya japonica*). *Rosaceæ*.

Readily grown from seeds, removed from fruit as soon as ripe and planted then. Named varieties are budded on seedling stocks in autumn, the buds starting the next spring. Large shield-buds are used. Cleft-grafting may be practiced on trees or large stocks.

Lotus. *Leguminosæ*

Grown from seeds; the woody ones by cuttings and division, and also by layers when the branches are prostrate.

Luculia. *Rubiaceæ*.

Seeds may be used, when obtainable. Cuttings may be employed but require some skill. Nearly or completely ripened wood is taken after flowering, which will be in late winter for plants grown for holiday trade. They are kept under glass with mild bottom

heat; when rooted, the plants should have night temperature of about 60°, being hardened off if to be placed out-of-doors.

Lucuma. *Sapotaceæ.*

The genus comprises several species of tropical fruits, usually propagated by seeds, the outer husk being first removed and the seed planted at once in sandy soil. Of the mamey sapote (*L. mammosa*), seedlings may be expected to bear at five to seven years of age. Seedlings of the ti-es (*L. nervosa*) should bear in three to seven years.

Luffa (Dish-cloth Gourd. Vegetable Sponge). *Cucurbitaceæ.*

Propagated by seed, sown in the open, or in the North better started in pots in early spring. The species are frost-tender and in general should be handled as cucumbers and melons.

Lunaria (Honesty). *Cruciferaæ.*

The biennial species is propagated by seeds and the perennial also by division.

Lupinus (Lupine). *Leguminosæ.*

Seeds may be used for the easy propagation of all the species, usually being sown where the plants are to grow, as they do not bear transplanting well after attaining some age. The perennial species forming stools may be increased by division.

Lycaste. *Orchidaceæ.*

Propagation by division and pseudobulbs. See *Orchids*, page 372.

Lychnis, including *Agrostemma* and *Viscaria*. *Caryophyllaceæ.*

Propagated readily in spring by seeds, the perennials also by division and sometimes by cuttings.

Lycium (Matrimony-Vine. Box-Thorn). *Solanaceæ.*

Propagated by seeds and layers; and also by hardwood cuttings in autumn or spring, and some species by the natural suckers.

Lycopersicum: *Tomato.*

Lycopodium (Club-Moss). *Lycopodiaceæ.*

Increased by spores, as for ferns (which see) and by short cuttings in pans or pots; sometimes by layers. See *Selaginella*.

Lycoris. *Amaryllidaceæ.*

Propagated by offsets, as for amaryllis; also by seed if procurable, but longer time is usually required.

Lygodium (Hartford Fern. Climbing Fern). *Schizæaceæ*.

Propagation by spores, and divisions of the root. See *Ferns*.

Lyonia. *Ericaceæ*.

Propagated by seeds, sown in sandy peat soil, as for other *Ericaceæ*; also by layers.

Lysimachia (Loosestrife). *Primulaceæ*.

Propagation is usually by division in autumn or spring; also by cuttings and sometimes by seeds.

Lythrum. *Lythraceæ*.

Grown usually from division of strong clumps; also by seeds as for other perennials, and some species sometimes by cuttings.

Macadamia (Queensland Nut). *Proteaceæ*.

Propagated by seeds, which may be stratified in sand or planted singly in pots of porous sandy soil. They germinate more rapidly when given artificial heat or planted in summer.

Maclura; known also as *Toxylon* (Osage Orange). *Moraceæ*.

Increased by seed sown in the spring; also propagated by root-cuttings, and by greenwood cuttings under glass. Seedlings usually make plants the first year strong enough for planting for hedges.

Madia. *Compositæ*.

Propagated by seeds sown in spring; the kinds usually grown are flower-garden annuals.

Magnolia. *Magnoliaceæ*.

Seeds are commonly employed, sown as soon as ripe or stratified till spring. The coverings should be macerated in the very pulpy species. The seeds of cucumber tree and some others are sown directly in autumn. The seeds of any species should not be allowed to become thoroughly dry. See *Michelia*.

Magnolias strike well from green cuttings, cut to a heel and handled under glass. Layers of last year's growth put down in spring and tongued or notched are often used; layers are usually severed and transplanted the following spring, but it is safer to take them off early in July, plant in pots and keep in a close frame until established. Named varieties are veneer- or side-grafted upon

strong stocks. The cucumber tree (*M. acuminata*) is used as a stock for all species. The umbrella tree (*M. tripetala*) is also a good stock.

Mahernia. *Sterculiaceæ.*

The honey-bell (*M. verticillata*) is propagated by cuttings of young shoots an inch or two long, under glass.

Mahonia. *Berberidaceæ.*

Propagated by seeds sown when ripe, or stratified and sown in spring; also by suckers, layers or cuttings of half-ripened wood under glass. The general handling is as for berberis (barberry), with which the mahonias are united by many writers.

Maize, Indian Corn (*Zea Mays*). *Gramineæ.*

Raised from seeds (properly fruits), planted when the weather is settled directly where the plants are to stand; frost-tender. To the acre, 6 to 8 quarts of seed is required for check-row planting, and often as much as one bushel of shelled seed for broadcasting for fodder; for silage corn, 8 to 12 quarts. If all the seed germinates strongly, thinning may be required.

Malcomia, Malcolmia. *Cruciferæ.*

The common annual Virginia stock (*M. maritima*) grows readily from seeds sown where the plants are to bloom. In the milder parts, seeds may be sown in autumn.

Malope. *Malvaceæ.*

Seeds may be sown under glass in early spring, or in the open a month or two later; easily grown flower-garden annuals.

Malpighia. *Malpighiaceæ.*

Grown from cuttings of nearly ripened shoots in summer under glass. Also propagated by seeds. The Barbados cherry (*M. glabra*) grows both from seeds and cuttings.

Malus. *Rosaceæ.*

The apples and crab-apples are grown usually from seeds, and the seedlings may be grafted or budded to the desired variety. See *Apple, Pyrus*.

Malva (Mallow). *Malvaceæ.*

The annuals are propagated by seeds only; the perennials by seeds, division and cuttings. The common ornamental kinds, annuals and perennials, are commonly raised from seed.

Malvastrum. *Malvaceæ.*

Propagated by firm green cuttings under glass in late winter or spring; sometimes by seeds, when available.

Malvaviscus. *Malvaceæ.*

Handled by seeds, and by greenwood cuttings under glass. The familiar *M. arboreus* (*Achania Malvaviscus*) grows readily from cuttings.

Mammea (Mammee-Apple. St. Domingo Apricot). *Guttiferæ.*

Usually increased by seeds. Cuttings of half-ripened shoots should be placed in a frame. Inarching and budding probably should be practiced for desirable named varieties, on seedling stocks.

Mammillaria. *Cactaceæ.*

Propagation as for echinocactus, which see. See *Cacti*, page 261.

Mandevilla. *Apocynaceæ.*

Handled by seeds, layers and usually by cuttings of half-ripened wood under glass.

Mandragora (Mandrake). *Solanaceæ.*

Propagated by seeds and division. The plant usually known as mandrake in the United States is podophyllum, readily increased by division of the new shallow rhizomes, leaving a growing end.

Manettia (now called *Lygistum*). *Rubiaceæ.*

Usually increased by cuttings of young shoots started under glass in a temperature of 60° to 65°. Root-cuttings are sometimes made, and seeds are employed when obtainable. This genus now takes the name *Lygistum*.

Manfreda. *Amayllidaceæ.*

Propagation as for agave, which see. Usually known as agaves.

Mango (*Mangifera indica*). *Anacardiaceæ.*

Stocks are readily obtained by seeds. The seeds often have more than one embryo, sometimes as many as ten. Each embryo will produce a distinct plant. The embryos may be separated before planting, but it is preferable to separate the young plantlets soon after germination, before they grow together, as they are apt to do. The seeds germinate better if the hard shell is removed before planting. Seeds retain their vitality but a few days, and if to be shipped

for sowing they should be inclosed in wax. Seedlings begin to bear from the third to the sixth years.

Varieties are inarched, grafted or budded on other stocks. Inarching from a bearing tree to a seedling is an old practice, but laborious and slow. Budding on seedlings about a year old may be performed on pot-grown stocks or on plants that have been transplanted to the nursery row.

Mangosteen (*Garcinia Mangostana*). *Guttiferæ*.

Grown from seeds, and said also to strike from cuttings of ripened shoots under glass in sand. Seedlings should be protected from the sun. The selected forms can be inarched on seedlings of mangosteen and also on stocks of related species of garcinia.

Manihot. *Euphorbiacæ*.

Propagation is by cuttings of rather firm shoots under glass ; some kinds by root-cuttings ; by seeds when securable. For the propagation of *M. dulcis* var. *Aipi*, see *Cassava*.

Maranta. *Marantacæ*.

Increased by division of the crowns in spring. Cuttings may be potted in equal parts of loam, leaf-mold, sharp sand and a small part of broken charcoal. Some of the plants known as maranta are properly species of calathea, which see.

Marguerite, or Paris Daisy (*Chrysanthemum frutescens* and *C. anethifolium*). *Compositæ*.

Increased by seeds or cuttings, as described for chrysanthemum, which see.

Marica. *Iridacæ*.

Handled by division of rhizomes started under glass or with bottom heat.

Marrubium (Horehound). *Labiatae*.

Increased by seeds, in early spring, or division. Seeds of horehound (*M. vulgare*) should give good plants the following year for cutting.

Marsdenia. *Asclepiadacæ*.

Cuttings made in spring when the plants are pruned, struck under glass.

Martynia (Unicorn Plant). *Martyniaceæ*.

Raised from seeds, sown where the plants are to grow, or started under glass in the North ; frost-tender annuals.

Masdevallia. *Orchidaceæ.*

Propagation by division in early winter. See *Orchids*, page 372.

Matthiola (Stock). *Cruciferæ.*

Increased by seeds, sown either under cover or in the garden. Grown also from cuttings. The common annual or ten-weeks' stocks are bloomed mostly from seeds started in late winter and spring, the plants being transferred to the open or carried under glass. The intermediate and perennial stocks are bloomed from seeds sown the summer or fall before, or in winter if carried forward under glass.

Maurandia. *Scrophulariaceæ.*

Seeds should be planted in a compost composed of four parts new loam, two parts leaf-mold, one part sand; place in a house with temperature of about 60° and cover with glass. Cuttings of young growth under glass may also be used.

Maxillaria. *Orchidaceæ.*

Propagation by division of the plants, and also of the pseudobulbs. See *Orchids*, page 372.

Meconopsis. *Papaveraceæ.*

Raised from seeds sown in early spring inside or directly in the garden where the plants are to stand. Also propagated by division.

Medicago (Lucerne. Medick). *Leguminosæ.*

Propagated by seeds or by division; alfalfa (*M. sativa*) by seeds in spring and summer, 12 to 30 pounds to the acre.

Medinilla. *Melastomaceæ.*

Propagated by cuttings of half-ripened wood in heat, taken in spring and kept close and fairly moist. See *Melastomaceæ*.

Medlar: *Mespilus.***Melaleuca.** *Myrtaceæ.*

Grown from seeds; also by firm cuttings, mostly in spring.

Melastomaceæ. **Melastomads.**

Nearly all the species of this family are easily increased from cuttings of the young growth or partially ripened growths; a few kinds by leaf-cuttings. Ringing and mossing are practiced for large growing points of plants such as *Miconia magnifica* and *Tococa platyphylla*. The cuttings should be placed in small pots, in equal parts of peat and sand, with a little powdered charcoal added.

Plunge the pots in a bed with 70° to 75° bottom heat, shading them from the sun. It is best to inclose them in tight frame to avoid drafts.

Melia (China-Berry. Pride of India). *Meliaceæ*.

Propagated by seeds, sown as soon as ripe, and sometimes by cuttings of growing wood under glass. The Texas umbrella tree (*M. Azederach* var. *umbraculiformis*) reproduces itself from seed with great regularity.

Melianthus. *Melanthaceæ*.

Propagated by seeds and cuttings under glass.

Melicocca (Genip. Spanish Lime). *Sapindaceæ*.

Increased by seeds; and by ripened cuttings in sand under glass.

Meliosma. *Sabiaceæ*.

Propagated by seeds sown as soon as ripe; also by layers and cuttings of half-ripened wood under glass.

Melon, Muskmelon (*Cucumis Melo*). *Cucurbitaceæ*.

Propagated by seeds, sown where the plants are to stand. In the North they are often started under glass in pots or pieces of inverted sods or in berry boxes, so that the plants may be transferred to the open without check or injury. Frost-tender annual vines.

Melothria. *Cucurbitaceæ*.

Easily raised from seeds sown in heat or planted in open ground when weather is warm.

Menispermum (Moonseed). *Menispermaceæ*.

Propagated readily by seeds stratified and sown in spring or planted as soon as ripe; also by division and cuttings in spring.

Mentha (Mint). *Labiataæ*.

Propagated by cuttings and division of rootstocks; some kinds produce stolons or runners. Cuttings of the rootstocks of peppermint may be planted directly in the field.

Mentzelia. *Loasaceæ*.

Usually treated as flower-garden annuals (often under the name of bartonia), the seed being sown where the plants are to stand.

Meratia (Chimonanthus). *Calycanthaceæ*.

Propagated by layering in autumn and seeds in spring, as for calycanthus.

Mertensia (Lungwort). *Boraginaceæ*.

Seeds are sown as soon as ripe or the following spring. Established plants may be divided, although this is not advisable.

Mesembryanthemum (Fig-Marigold. Ice-Plant). *Aizoaceæ*.

Propagated easily by seeds sown under glass; by pieces cut off and laid in the sun two or three days and then put in sand as cuttings. The common ice-plant (*M. crystallinum*) is grown as an annual from seeds.

Mespilus (Medlar). *Rosaceæ*.

Stocks are grown from stratified seeds, and the plant may be worked on these, the thorn and the quince. Seeds sometimes lie dormant until the second year.

Metrosideros (Bottle-Brush). *Myrtaceæ*.

Seeds and cuttings. The florist's plants so named are increased by cuttings of the young growth in early spring, set out in good soil at the end of May.

Michelia. *Magnoliaceæ*.

Propagated by seeds and cuttings of ripened wood in summer or fall, in sand under glass, one or two leaves being left on. Seeds are handled as in magnolia, to which the species are often referred.

Miconia, or **Cyanophyllum**. *Melastomaceæ*.

Increased by seed; by cuttings or eyes of firm wood in sand, with bottom heat and shaded from the sun; also by ringing the tops of old plants and covering with sphagnum moss; when roots appear, sever from the old plant and pot on.

Mignonette (*Reseda odorata*). *Resedaceæ*.

Grown from seeds, which may be started indoors in spring or sown in the open where the plants are to remain. For florist's use as a crop for winter and spring and early summer bloom under glass, the seeds are started for succession early in July, August and September. Plants of the September sowing should bloom till the following midsummer and supply seed for resowing. Seeds are usually sown on the benches where the plants are to bloom, several of them dropped at points about 6 by 8 inches; all but two to four are removed by thinning. The mignonette is annual, usually classed among the hardy kinds.

Milla. *Liliaceæ.*

Increased by seeds, bulbels (offsets) and by division.

Millet (species of *Panicum* and of *Setaria* or *Chaetochloa*, and of other genera). *Gramineæ.*

Annual hardy forage grasses grown from seed, usually sown in summer for fall harvesting or feed. Barnyard millet usually requires 1 to 2 pecks of seed to the acre; foxtail and proso, 2 to 3 pecks; German, 1 to 1½ pecks.

Miltonia. *Orchidaceæ.*

Increased by dividing the pseudobulbs. See *Orchids*, page 372.

Mimosa (Sensitive Plant). *Leguminosæ.*

Increased by seeds sown indoors and by cuttings of rather firm shoots in sandy soil under glass. The common *M. pudica* grows readily from seeds, sown under heat or in warm weather.

Mimulus (Monkey-Flower. Musk-Plant). *Scrophulariaceæ.*

Propagated by seeds from January to April. A mixture of loam, leaf-mold and sand in equal parts is good; keep in a temperature of 60° until germination. Also increased by division, and cuttings.

Mirabilis (Marvel of Peru. Four-O'clock). *Nyctaginaceæ.*

Raised from seeds, sown in spring either under cover or outdoors, usually the latter.

Miscanthus (Eulalia). *Gramineæ.*

Propagation by seed and division of the clumps. The variegated forms of *M. sinensis* are increased by division.

Moluccella. *Labiataæ.*

Grown from seeds, started indoors in February and March and transplanted in May. *M. lævis*, the shell-flower, may be sown in the open where seasons are long.

Momordica. *Cucurbitaceæ.*

Raised from seeds sown in heat early in spring, or in the open in the South.

Monarda. *Labiataæ.*

Propagated by division of the roots in fall; also by seeds, as for other herbaceous perennials.

Monstera. *Araceæ.*

Easily increased by seeds and by cuttings of the stem. For greenhouse culture, place cutting in 3-inch pot in mixture of sand, peat and leaf-mold, plunge pot in warm propagating-bed and cover with glass. When new roots form, place on bench in house with night temperature of 55° to 70° and 80° to 85° on bright days. See *Araceæ*, page 239.

Montia. *Portulacaceæ.*

Grown from seed sown in spring and summer where the plants are to stand.

Moræa. *Iridaceæ.*

Propagation by corms and their offsets. See *Iridaceæ*, page 339.

Morus: *Mulberry.***Muehlenbeckia.** *Polygonaceæ.*

Propagated usually by cuttings under glass in early summer; also by seeds when obtainable.

Mulberry (*Morus alba*, *M. nigra*, *M. rubra*, etc.). *Moraceæ.*

New kinds are produced by seeds, which should be handled in the same way as small-fruit seeds. Named varieties are multiplied by cuttings of the root, or of mature wood, and sometimes by layers. They may be cion-budded in the spring. In the South, cuttings of the Downing mulberry are used for stocks.

The common white mulberry was formerly used as a stock for named varieties, but Russian mulberry seedlings are now much employed. The stocks may be top-worked outdoors (as explained above) or root-grafted in the house. The fancy varieties are commonly crown-worked, in the house in winter, the stocks being grown in pots or boxes for the purpose. They are then kept under glass until the weather permits them outdoors. By this method choice specimen trees are procured, but they are readily handled by cheaper methods. The weeping and other ornamental kinds are worked upon the Russian mulberry.

Musa (Banana. Plantain-Tree). *Musaceæ.*

Seeds may be sown in heat during spring. Suckers are used for those species which produce them. Many of the species do not produce seeds freely, and suckers must be relied on. These suckers are taken from the middle of February to April 1st, planted in a compost of fibrous loam three parts, well-decayed cow-manure

one part, sand and bone-meal ; keep in a close and humid atmosphere. *Musa Ensete* is propagated by seeds started in heat. See *Banana*.

Muscari (Grape Hyacinth). *Liliaceæ*.

Seeds and bulb offsets are usually produced freely and provide easy means of increase.

Mushroom (*Agaricus campestris*). *Agaricaceæ*.

Grown from "spawn," which is the mycelium of the fungus grown in a mass or "brick" of earth and manure. Break up the commercial spawn into pieces about as large as a hen's egg, and plant it 2 or 3 inches deep in drills or holes, using from $\frac{1}{2}$ to 1 pound of spawn to each square yard of bed.

Various methods are employed for making the spawn, but the essentials of them all are that the body of the brick shall be composed of a porous and light material, which can be compressed into a compact mass ; fresh mycelium must be communicated to this mass, and then a mild heat must be applied, until the whole mass is permeated by the mycelium. The mass should be kept in heat until the whole of it assumes a somewhat cloudy look, but not until the threads of the mycelium can be seen. Ordinarily, fresh horse-manure, cow-manure and good loam are mixed together in about equal proportions, enough water being added to render the material of the consistency of mortar. It is then spread upon the floor or in large vats, until sufficiently dry to be cut into bricks. When these are tolerably well dried, mycelium from a mushroom bed or from other bricks is inserted in the side of each brick. A bit of spawn about the size of a small walnut is thus inserted, and the hole is plugged up. The bricks are now placed in a mild covered hotbed, with a bottom heat of 55° to 65° , and left there until the clouded appearance indicates that the mycelium has extended throughout the mass.

Soil from a good mushroom bed is sometimes used to sow new beds, in place of commercial spawn.

Old clumps of mushrooms may be allowed to become dry, and they may then be mixed into a bed. The spores may then stock the soil and produce a new crop, although this method is not reliable. The full-grown mushroom may be laid on white paper until the spores are discharged, and these spores may then be mixed into the earth.

Spawn is now made from reliable cultures and the difficulties of

mushroom-growing have been much reduced. Care should be taken to purchase only fresh spawn.

Mussænda. *Rubiaceæ.*

Propagated by cuttings of young growth in spring. See *Rubiaceæ*.

Mustard (*Brassica* or *Sinapis* species). *Cruciferaæ.*

Seeds grow quickly, sown directly in the open early in spring.

Myosotis (Forget-me-not). *Boraginaceæ.*

Propagated by seeds in spring indoors or in the garden. The perennials also by division in spring. The florist's forget-me-not should be sown in spring, summer or early fall for succession of bloom in winter and spring.

Myrica (Bayberry. Sweet Gale. Wax Myrtle. Candleberry). *Myricaceæ.*

Hardy species are propagated mostly by seeds, from which the pulp has been removed; sow as soon as ripe, or stratify. Layers and divisions may also be employed, also suckers. The greenhouse species are increased mostly by green cuttings. Fig. 93.

Myriophyllum (Parrot's Feather). *Haloragidaceæ.*

Propagated by long cuttings inserted in the earth or mud of the aquarium or pond.

Myristica (Nutmeg). *Myristicaceæ.*

Seeds are employed, started in pots or bamboo joints so that the tap-root will not be disturbed in the transplanting. The nutmeg may also be started from cuttings of ripened wood under glass.

Myrrhis (Sweet Cicely or Myrrh). *Umbelliferaæ.*

Increased by divisions and by seeds sown in spring or autumn.

Myrsiphyllum: *Asparagus asparagoides*, page 245.

Myrtus (Myrtle). *Myrtaceæ.*

Grown from seeds, when they can be obtained. Readily propagated by cuttings of firm shoots under glass. Not to be confounded with the periwinkle (*vinca*), which is sometimes called myrtle.

Nægelia. *Gesneriaceæ.*

Seeds are seldom employed. Propagation is mostly by potting the runners in spring or summer in a compost of peat, leaf soil and a little loam. Cuttings of young shoots, or mature leaves,

will also root readily. The treatment for achimines applies in general. See *Gesneriaceæ*, page 318.

Nandina. *Berberidaceæ.*

Increased by seeds.

Narcissus (Daffodil. Jonquil. Chinese Sacred Lily). *Amaryllidaceæ.*

New varieties are grown from seeds, which give flowering bulbs in three or four years. Ordinarily increased by bulbels or offsets from the bulbs, which usually flower the second year.

Nectarine: *Peach.*

Negundo (Box Elder). *Aceraceæ.*

Grows readily from seeds; also by cuttings of mature shoots, as for grapes. See *Acer*.

Nelumbo, Nelumbium (Water Chinkapin. Lotus. Water Bean). *Nymphæaceæ.*

Propagation by seeds, which may be sown in shallow pans of water in the garden, or if sown in ponds they may be incorporated in a ball of clay and dropped into the water. The seeds of some species are very hard, and germination is facilitated if they are carefully filed or bored. Sections of the rhizomes may be used instead; they should always be covered with water, at least a foot or two deep, if outdoors. The false lotus or sacred bean (*N. nucifera*) may be increased by division and seeds. The roots or tubers should not be transplanted until they show signs of young growth. If they are disturbed before growth commences, the tubers should be kept in a warm place where growth will begin at once.

Nemastylis. *Iridaceæ.*

Propagated by seeds and by bulbels.

Nemesia. *Scrophulariaceæ.*

Flower-garden plants growing readily from seeds, which may be started indoors or sown directly in the open.

Nemopanthus (Mountain Holly). *Aquifoliaceæ.*

Handled by seeds, which should be sown as soon as ripe or else stratified; also by division of old plants and by greenwood cuttings under glass.

Nemophila. *Hydrophyllaceæ.*

Annuals grown from seeds.

Nepenthes (Pitcher-Plant). *Nepenthaceæ.*

Grown from seeds and cuttings. The seeds must have good drainage, uniform conditions and strong heat (80° to 85°). Sow on a soil of peat and fine sphagnum, and keep in a moist close frame. Cuttings are usually struck in moss in a frame having strong bottom heat. A good plan is to fill a small pot with moss, invert it, and insert the cutting through the hole in the bottom. The pot then keeps the moss uniform in temperature and moisture. The pot is broken when the plant is removed. When potting off, use very coarse material. Cuttings in a close frame in sharp clean sand, kept thoroughly moist and given two months or more to root, will give new cuttings.

Nepeta. *Labiataæ.*

Grown readily from seeds, the perennials also by division.

Nepheium: *Litchi.***Nephrolepis.** *Polypodiaceæ.*

Propagated by runners. See *Ferns*, page 312.

Nerine (Guernsey Lily). *Amaryllidaceæ.*

Commonly increased by means of bulbels that form about the mother bulbs; also by seeds when obtainable.

Nerium (Oleander). *Apocynaceæ.*

Propagated by layers, but mostly grown from cuttings of strong firm shoots, in a close frame, or rooted in bottles of water and afterwards potted in soil.

Nertera (Bead-Plant). *Rubiaceæ.*

Grown from seeds and by division; and cuttings usually strike readily.

Nicandra. *Solanaceæ.*

Grown from seeds, sown in the open border, or under glass in the North.

Nicotiana. *Solanaceæ.*

Propagated by seeds, started under glass or in a carefully prepared seed-bed; the ornamental species sometimes by cuttings.

N. alata var. *grandiflora* (*N. affinis* of gardens) propagates by root-cuttings. Tobacco is handled essentially like tomato plants.

Nidularium. *Bromeliaceæ.*

Propagation by suckers. These should be placed in small pots in compost of light porous material with broken crocks or charcoal added for drainage. Place under frame with bottom heat and a humid atmosphere. See *Bromeliaceæ*, page 259.

Nierembergia. *Solanaceæ.*

Grown from seeds, which are sold by seedsmen. Cuttings of firm shoots in fall are also used. *N. rivularis* is most readily increased by dividing the creeping stem where it has rooted at the nodes.

Nigella (Fennel-Flower Love-in-a-Mist). *Ranunculaceæ.*

Annuals, grown readily from seeds sown early in the open.

Nolana. *Nolanaceæ.*

Raised from seeds sown in the open border; for early blooming they should be started under glass.

Nolina. *Liliaceæ.*

Increased by seeds imported from their native country; by cuttings, when obtainable; usually, however, by offsets.

Nuphar. *Nymphæaceæ.*

Propagated the same as nelumbo and nymphæa, which see. See also *Nymphæaceæ*.

Nyctocereus. *Cactaceæ.*

For propagation, see *Cacti*, page 261.

Nymphæa, Castalia (Water Lily. Lotus). *Nymphæaceæ.*

Propagated by seeds, which are rolled up in a ball of clay and dropped into a pond, or sown in pots which are then submerged in shallow water, either indoors or out. Usually increased by portions of the rootstocks, which are sunk in the pond and held by stones, or the tender species placed inside, in pans of water. Some species produce tubers on the rootstocks, which are used for propagation.

Nymphæaceæ. **Water Lilies.**

All plants belonging to this family are readily increased from seeds. The seeds should be sown in pots or boxes of loamy soil and sand, submerged in a tank or tub of water, and placed in a sunny position.

Seeds should not be kept too long out of water. Also propagated by dividing the rhizomes, and by tubers.

Nymphoides, *Limnanthemum* (Floating-Heart). *Gentianaceæ*.

Increased by division of the plants.

Nyssa (Pepperidge. Sour Gum. Tupelo). *Nyssaceæ*.

Seeds should be sown as soon as ripe or else stratified; they usually lie dormant the first year. Layers are sometimes employed, but rooting is slow.

Oak: *Quercus*.

Ochna. *Ochnaceæ*.

In summer or autumn, cuttings may be made of firm or half-ripened shoots.

Ocimum: *Basil*.

Odontoglossum. *Orchidaceæ*.

Propagation by division and by seeds. See *Orchids*, page 372.

Œnothera (Evening Primrose. Sundrop). *Onagraceæ*.

Grown readily from seeds, some species blooming the first year and others not till the second. Perennial kinds may be divided.

Okra, Gumbo (*Hibiscus esculentus*). *Malvaceæ*.

Raised from seeds, sown where the plants are to stand, or often started in pots in the North.

Olea. *Oleaceæ*.

The ornamental species are grown from cuttings of mature shoots, either under frames or in the border, and also by seeds. For propagation of *O. europæa*, see *Olive*.

Olive (*Olea europæa*). *Oleaceæ*.

The olive is grown in large quantities from seed, especially in Europe. The pulp is removed by maceration or by treating with potash. The pits should be cracked or else softened by soaking in strong lye, otherwise they will lie dormant for one or two years.

Cuttings of any kind will grow. Limbs, either young or old, 1 or 2 inches in diameter, and from 1 to 2 feet long, are often stuck into the ground where the trees are to grow, or they are sometimes used in the nursery. Green cuttings, with the leaves on, are often used, being handled in frames or in boxes of sand. Chips from old trunks,

if kept warm and moist, will grow. The olive is often propagated by truncheons of trunks. A trunk 2 or 3 inches in diameter is cut into foot or two-foot lengths, and each length is split through the middle. Each half is planted horizontally, bark up, 4 or 5 inches deep, in warm moist soil. The sprouts which arise may be allowed to grow, or they may be made into green cuttings. Knaurs (see page 107) are sometimes used. The olive can be budded or grafted in a variety of ways. Twig-budding or prong-budding and plate- or H-budding (Figs. 146, 147, 149) give admirable results, and are probably the best methods. Twig-budding is the insertion of a small growing twig which is cut from the branch in just the way in which shield-buds are cut. (Fig. 146.) Side-grafting is also successful. (Fig. 187.)

In California, owing to the uncertainty of getting a good stand of cuttings of green wood and the slowness of rooting cuttings of large wood, the practice of raising olive seedlings and budding on them has become more popular. After the pulp is removed, the extreme point of the pit or stone is cut off with ordinary pruning shears, when the seed germinates very readily. This method insures a good stand without injury to the kernel. Ordinary shield-budding may be performed any time in the year when dormant buds may be obtained and the seedling is in condition to receive them. The root system is better under this method of propagation.

Omphalodes. *Boraginaceæ.*

Handled by seeds, division of the plant and of the runners of some species.

Oncidium. *Orchidaceæ.*

Propagated by division or notching the rhizome between the pseudobulbs just before the growing season. In some species detachable buds are produced in the inflorescence, and these give young plants. See *Orchids*, page 372.

Onion (*Allium Cepa* and *A. fistulosum*). *Liliaceæ.*

Onions are mostly grown from seeds, which must be sown as early as possible in spring; or in the South they may be sown in autumn.

They are also grown from "tops," which are bulblets borne in the flower-cluster. These are planted in the spring, or in the fall in mild climates, and they soon grow into large bulbs.

"Sets" are also used. These are very small onions, and when planted they simply complete their growth into large bulbs. Sets are procured by sowing seeds very thickly in poor soil. The bulbs

soon crowd each other, and growth is checked, causing them to ripen prematurely. Good sets should not be more than a half inch in diameter. Very small onions which are selected from the general crop — called “rare-ripes” — are sometimes used as sets, but they are usually too large to give good results.

Some onions — the “multiplier” or “potato onions” — increase themselves by division of the bulb. The small bulb, which is planted in the spring, splits up into several distinct parts, each one of which will multiply itself in the same manner when planted the following year.

Ophiopogon. *Liliaceæ.*

Propagated by division. See *Liliaceæ*, page 349.

Oplismenus. *Gramineæ.*

Propagated by divisions of the rooting stems; seeds, when obtainable.

Opuntia (Prickly Pear. Indian Fig). *Cactaceæ.*

Seeds grow readily, sown as soon as ripe in ordinary sandy soil, either in the house or outdoors. The joints or pads root freely if laid on sand. It is customary to allow these cuttings to dry several days before planting them. See also *Cacti*, page 261.

Orach (*Atriplex hortensis*). *Chenopodiaceæ.*

Raised from seeds, sown where the plants are to stand.

Orange (*Citrus Aurantium*, *C. sinensis* and others). *Rutaceæ.*
(H. H. Hume.)

The orange, in common with other fruits of the genus *Citrus*, is generally propagated by working on orange seedlings or seedlings of related species. The stocks are grown from seeds of sour orange, sweet orange, rough lemon, grapefruit and *Poncirus trifoliata*. In the orange districts of the world, sweet orange stocks have almost wholly disappeared from use in nursery practice owing to their susceptibility to various root and trunk diseases.

Sour orange stocks are most commonly used, and except for special soil or climatic conditions, are to be preferred. *Poncirus trifoliata* is adapted to colder sections and heavy soils and its use has greatly extended orange culture into the colder regions; this is the trifoliolate orange, commonly known as *Citrus trifoliata*. Rough lemon stock is suited to warmer climates and to soils deficient in plant-food. Grapefruit stock is sometimes employed in special cases for rather low lands.

Sour orange seeds will run about 2100 to the quart, rough lemon about 6500 to the quart, grapefruit about 1400, and *Poncirus trifoliata* about 2600 to the quart. Sour orange seed weighs 32 pounds to the bushel after slight drying. It is usual to estimate double the number of seeds for the seedlings desired.

Citrus seeds are easily spoiled by drying, the cotyledons separate and they are then worthless. They can be stored for several weeks or even months if packed in a closed container or box in pulverized charcoal. They should be planted immediately after removing from the seed, or properly packed and examined from time to time to see that they do not dry out.

In citrus nursery districts, the seeds are sown in winter or early spring, either in the open or under slat shades. The young seedlings are easily injured by hot sun and dry winds, and therefore should be well started before spring is far advanced, if planted in the open. The young seedlings of citrus are sometimes killed back to the ground, and when so injured do not sprout out again, but those of *poncirus* will start again from buds on the tiny stems, below the ground. The seed is sown in rows much as apple or garden seeds are sown, at the rate of about 100 to the yard of row. Clean cultivation, applications of commercial fertilizer and plenty of water are necessary for the production of good sturdy seedlings. The use of stable manure as a fertilizer is not advisable because of increased danger from damping-off fungi.

After one or two years in the seed-bed, the seedlings are transplanted to the nursery rows. The rows are usually spaced $3\frac{1}{2}$ or 4 feet apart and the seedlings are set 1 foot apart in the rows, giving about 10,000 seedlings to the acre. Roadways are left at convenient intervals for the passage of teams and wagons. Transplanting from seed-beds to nursery rows is usually done in early spring or during summer, if suitable rainy weather prevails or if water is available for irrigating.

Shield-budding, with buds about $1\frac{1}{8}$ inches long, is the method employed. Sometimes the T-incision is inverted and the bud is inserted from below. This is the method commonly followed in Florida. The buds are usually wrapped with waxed cloth, the bud and all incisions being covered. The wraps are commonly left on from ten days to two weeks depending on growth and weather conditions. The seedlings are dormant-budded just before growth ceases in autumn or in early spring. Better growth can be secured from dormant buds as they have the advan-

tage of the full growing season. In the colder sections where there is danger of dormant buds being injured, they are often protected by banking with earth. In spring as soon as the bark will slip, stocks in which the buds have died are rebudded. For this work bud-sticks of the previous season's growth are cut, the leaves are removed, and the sticks packed in sawdust or sphagnum until needed.

In spring, the tops of the dormant-budded seedlings are cut off close back to the inserted buds. In some sections, the tops are headed back or lopped and later removed entirely, but as this entails additional work it should be avoided if growth is not too vigorous. Sprouts must be removed from the stocks from time to time. About the time the buds start to grow, a stake is set at each one and to this the bud is tied from time to time, throughout the summer, as they grow. This serves the double purpose of saving the buds from breaking away from the stocks and of keeping them straight.

For propagating oranges under glass, seedlings of grapefruit or orange may be used, although the best stock for pot and tub plants is *Poncirus* (or *Citrus*) *trifoliata*.

Orange trees of almost any size may be top-worked to other varieties either by budding or grafting by the usual methods. Sometimes the tops are cut off or lopped, shoots are then thrown out and in these buds are inserted. Buds may be inserted in large branches and after uniting forced into growth by lopping or cutting back the branches.

Orchids. Orchidaceæ.

The method of propagating orchids must in each species be adapted to the habit and mode of growth. The easiest and safest plan for the greater number of kinds is by division, but seeds, cuttings, layers, offsets, and very rarely roots, are also utilized. It is important that artificial means of increase should be adopted only when the individual plants are in robust health. With many orchids the struggle of life under the unnatural conditions of domestication is necessarily severe, and any operation which transforms one weak plant into two or more weaker ones is to be deprecated. In cases in which the only method available necessitates disturbance at the roots, consideration must be paid to the constitution of the species, for some orchids, even when perfectly healthy, strongly resent interference. Many of the orchids are really not propagated under cultivation, but are grown from stock newly imported from

the wild; when the plants fail, they are discarded and new importations substituted.

Seeds. — In no class of cultivated plants is propagation by seeds more difficult and tedious than it is with orchids. In all cases, fertilization must be performed by hand. In England, the length of time required for the capsules to ripen varies from three months to a year. Good seeds form a very small proportion of the whole, and it occasionally happens that the contents of a capsule will not produce a single plant. This, however, as well as the difficulty experienced in England in rearing plants to the flowering stage, is primarily due to the deficiency of sunlight, and in such a bright climate as that of the United States would not be likely to occur. Various methods of sowing are in vogue, such as sprinkling over pieces of wood and cork or tree-fern stem, and on the top of moss and peat, in which established plants of the same or a nearly related species are growing. The last is probably the best, but it is always advisable to try several methods. Of course, the material on which the seeds are scattered must always be kept moist and shaded. The period between germination and the development of the first root is the most critical in the life of a seedling orchid. After they are of sufficient size to handle, they are potted off into tiny pots, and as they gain strength, are given treatment approximating that of adult plants.

The above represents the former gardener's method in the growing of orchids from seed. At the best it was inexact and unreliable. It is now thought that the free germination of orchid seeds requires the presence of the root fungus that is associated with the growing plant. The exacter method now employed is described as follows by Hasselbring in the *Standard Cyclopaedia of Horticulture*: "It is absolutely essential that an association of the seed with the proper root-fungus be brought about. In practice, this has often been accomplished by the sowing of the seeds on pots containing the parent plants. This method, however, has many disadvantages. The plants cannot be repotted while the seedlings are growing, and the seeds are likely to be washed away in watering, since they cannot be readily protected by a proper covering. Better success can be secured by the use of straight-walled glass jars with loose glass covers. These are filled with finely chopped sphagnum, which is well pressed into the jar. The whole is then sterilized in a steam-box for one hour on three successive days in order to kill bacteria and spores of molds which are likely to overrun the seed-

lings. After sterilization, the jars should be allowed to stand for a few days. Those in which molds develop should be discarded. The sterile jars may then be inoculated with the root-fungus from the species of orchid to which the seed-plant belongs. For this purpose, portions of infected roots should be cut into small pieces with a sterile knife and scattered over the sphagnum seed-bed. Great care should be observed at all times to avoid the introduction of foreign spores from the air. It should also be borne in mind that only the covered roots contain the fungus, and that generally only the soft tissues from $\frac{1}{2}$ to 1 inch back from the root-tip are most abundantly infected. As soon as the root-fungus has grown through the sphagnum, the seeds should be sown in the jars. In the collection and handling of the seeds, all possible precaution should be taken to prevent contamination." Recent experience does not confirm the necessity of the fungus in all cases, but the aseptic and controlled methods of germination are good.

Division.—The paphiopedilums (greenhouse cyripediums) afford an example of the way in which division may be employed. The soil is shaken from the roots and by the aid of a sharp knife the plant is severed into as many pieces as are required. It is always advisable to leave one or more leading growths to each portion. This method may be practiced for the increase of phaius, masdevallia, sobralia, ada, the evergreen section of calanthe, and all of similar habit. In nearly all those kinds in which the pseudobulbs are united by a procumbent rhizome, such as occurs in cattleyas, the process is slower. It seems to be natural for these plants to continue year after year, producing a single growth from the old pseudobulb. To obtain additional "leads," the rhizomes should be cut through in early spring, two or three pseudobulbs being reserved to each piece. A bud will then push from the base of each pseudobulb nearest the division, and a new lead is formed. The pieces should not be separated until this is well established, and three years may sometimes be required. Lælia, catasetum, cœlogyne, lycaste, cymbidium, zygopetalum, odontoglossum, oncidium, miltonia, and the like, are treated in this manner. Fig. 51.

Cuttings.—This method is available for those kinds with long jointed stems, like dendrobium and epidendrum. Just before the plants begin to grow, say in February, the old pseudobulbs are cut up into lengths, and laid on a moist warm surface, such as a pan of moss in a propagating-frame. Young offshoots will shortly appear at the nodes, and when large enough are potted off with the

old piece attached. This plan may be used also for *barkeria* and *microstylis*. It is well to remember that in any method of propagation in which the pseudobulb is divided, the vigor of the young plant is proportionate to the amount of reserve material supplied it. However suitable the external conditions may be for growth, it is for some time entirely dependent for sustenance on the old piece from which it springs. *Dendrobium Phalaenopsis* is a case in point. If a pseudobulb is cut into, say, three pieces, it will take at least two years for the young plants to reach flowering strength, but frequently, by using the entire pseudobulb, one can get in a single year a growth quite as large as the old one.

Subsequent handling.—The treatment of young orchids should be founded on what suits the parents. As a rule, however, they require more careful nursing, and some of the conditions must be modified. Drought, intense light and cold drafts must be avoided. For many orchids, especially those from equatorial regions, where the atmospheric conditions alternate between saturation and intense heat and dryness, it is necessary, in order to induce flowering, that nature, to some extent at least, should be imitated. With young plants, by whatever method they may be obtained, the supply of water must only be reduced in accordance with the weather and season, and beyond that, no attempt at resting made. In cases, however, in which plants have been divided or made into cuttings, a very limited supply of water is needed at first; but to prevent exhaustion, the atmosphere should always be kept laden with moisture.

Oreocereus. *Cactaceæ.*

For propagation, see *Cacti*, page 261.

Oreodoxa. *Palmaceæ.*

Grown from seeds. See *Palms*, page 377.

Oreopanax. *Araliaceæ.*

Propagated by cuttings and seeds, from January to March. Place half-ripened growths of extreme tops in a warm propagating-bed with bottom heat of 80°, cover with glass. Seed may be sown in pans, with a mixture of loam, peat and sand; cover with glass and place over bottom heat.

Origanum (Marjoram). *Labiataæ.*

Increased by seeds, which should be shaded until the plants are well rooted. For *O. vulgare*, division in spring or early autumn is usually practiced.

Ornithogalum (Star of Bethlehem). *Liliaceæ*.

Commonly increased by bulbels or offsets, and by division; also by seeds when they can be had.

Orobus: *Lathyrus*.

Orontium. *Araceæ*.

Increased by division, but seeds may be used if there is less haste. See *Araceæ*, page 239.

Osmanthus (Japan Holly). *Oleaceæ*.

Propagated by cuttings of half-ripened wood in late summer under glass, or by grafting on osmanthus stock, or on privet. Seeds are rarely obtainable and do not germinate until the second year.

Osmaronia, **Nuttalia**. *Rosaceæ*.

Propagated by seeds, stratified or sown as soon as ripe; by divisions; by suckers from the roots.

Osmunda (Flowering Fern). *Osmundaceæ*.

Mostly by division; sometimes by spores. See *Ferns*, page 312.

Ostrowskia (Giant Bellwort). *Campanulaceæ*.

Propagated by root- or top-cuttings in spring. Seeds, unless sown fresh, require a long time for germination and seedlings may not mature under three or four years.

Ostrya (Hop Hornbeam). *Betulaceæ*.

Usually grown from seeds sown when ripe or stratified. Also increased by layering; or it can be grafted. The European species is often grafted on the hornbeam (*carpinus*).

Othonna. *Compositæ*.

Propagated by pieces of the stem, treated as cuttings, or taken off after rooting if plant lies on ground.

Ouvirandra: *Aponogeton*.

Oxalis. *Oxalidaceæ*.

Propagated by seeds, division and cuttings; the tuberiferous species are increased by the underground tubers.

Oxydendrum (Sorrel-Tree). *Ericaceæ*.

Increased by seeds, handled as for andromeda and similar things; also by layers, which often root with difficulty.

Pæonia (Pcony. Piney). *Ranunculaceæ*.

Seeds, giving rise to new varieties, are sown as soon as ripe. About three years after germination are required for the production of bloom. The seedlings seldom rise above the surface the first year, all their energies being spent in the formation of roots.

The common herbaceous varieties are oftenest propagated by division of the clumps. Each portion should possess at least one bud. Usually the clumps are divided in early autumn.

All woody species may be increased by layers and cuttings. Cuttings are taken late in summer, cut to a heel, and are handled in a frame or cool greenhouse. In winter they should be kept from freezing. The shrubby species are often grafted, and all species can be handled in this way. The operation is performed in late summer or early autumn, and the grafts are stored in sand or moss where they will not freeze. The next spring they are planted out. The cion is made from a strong short shoot, destitute of flower buds, and is set on a piece of root, as described on pages 157-8. Some prefer to cut a wedge-shaped portion from the side of the stock, in which to inlay the cion, rather than to split the stock; but either practice is good. Strong roots of various varieties or species may be used. The Chinese peony (*P. suffruticosa*), *P. officinalis* and *P. albiflora* are oftenest used.

Rare varieties of the herbaceous species are sometimes grafted in late summer, an eye of the given kind being inserted in a tuber from which all the eyes have been removed.

Paliurus (Christ's Thorn). *Rhamnaceæ*.

Increased by seeds, stratified or sown in autumn, by layers and by cuttings of the roots.

Palms. *Palmaceæ*.

Palms are propagated in the main by seeds; a few by suckers and division. The seeds of the common kinds germinate freely if sown in pans of soil and placed in a bottom heat of 80°. Those that grow in swamps require somewhat different treatment; for these use an open rough soil and stand the pots or pans in saucers filled with water; when they germinate, a regular temperature both at the roots and overhead is of importance and the soil must be kept uniformly moist at all times. In removing palm seedlings from the seed-pans or pots, the roots should be carefully handled, for if broken the seedlings usually die. Palms are known in conservatories and private collections mostly in the juvenile stage. The

seeds are imported by the dealers, and if fresh and fully ripe they germinate well although some of them start slowly. The period of germination runs from two or three weeks to as many years. The seeds are usually started singly in 6-inch pots.

Some of the species sucker freely from the crown as they mature, and these offsets may be removed and repotted singly. A few of them stool, and may be divided.

Panax: *Ginseng, Polyscias.*

Pancratium and Hymenocallis. *Amaryllidaceæ.*

Seeds, sown in pots or pans in heat, are sometimes employed. They should give blooming plants in two or three years. Commonly increased by offsets, which usually form freely. Place the offsets rather close in pans in a light mixture of equal parts of leaf-mold, peat and sand, giving good drainage.

Pandanus (Screw-Pine). *Pandanaceæ.*

Propagated by seeds and suckers, as for palms; also by cuttings of the young growth in heat. The "seeds" are really fruits, and if in good condition several plants, one to ten, are obtainable from each; they should be separated when well furnished with roots. These seeds are easily obtained from the tropics, and are planted in moist black soil in beds or pots. When the plants appear, the little clumps are separated and the plantlets potted off. Suckers often form freely on or near the crown; these may be taken off and potted singly.

Pandorea. *Bignoniaceæ.*

Propagated by seeds and by greenwood cuttings under glass.

Pansy (*Viola tricolor*). *Violaceæ.*

Propagated by seeds, sown from July 10 to August 25 for the next year's spring bloom. The plants may be carried over in a frame, or in mild climates left directly in the seed-bed and protected with loose mulch. Sometimes started indoors in spring or late winter. Good plants may be purchased from regular growers. Named varieties may be multiplied late in the season from cuttings or layers.

Papaver (Poppy). *Papaveraceæ.*

Increased by seeds — usually sown outdoors where plants are to stand — and division. *P. orientale* and allied species are easily propagated by root-cuttings in sand under glass in autumn.

Papaya, sometimes called papaw; see *Asimina*. (*Carica Papaya*.)
Papayaceæ.

As a greenhouse subject, propagated by cuttings of ripe shoots in sandy soil and bottom heat, but branches suitable for cuttings are few.

As a fruit crop, the papaya is grown from seeds. Seeds started in Florida in January or February should give fruiting plants the following winter. The seeds are sown in light sandy soil about one-half inch deep; care should be taken to prevent damping off; plants may be placed in pots when they have made the third leaves, and from the pots (after another shifting) transferred to permanent quarters.

The papaya plant may be grafted, special varieties thus being perpetuated. The old plant is cut off and shoots form along the trunk. These are used as cions, being cut to wedge-shape at the lower end and inserted in vigorous seedlings which have been cut back to 8 or 10 inches high. Shoots about the size of a lead pencil are chosen for cions, and the leafage is partly removed. Seeds started in February in Florida, according to Simmonds, will produce stock large enough to graft in March; the grafted plants are potted, and transferred to the field in late April or in May; they should bear fruit in November or December.

Paphiopedilum (*Cypripedium* of greenhouses). *Orchidaceæ*.

Propagated by seeds sometimes; usually by division. See *Orchids*, page 372; also *Phragmopedilum*, page 392.

Papyrus (*Cyperus Papyrus*). *Cyperaceæ*.

Propagated by seeds sown in early autumn or spring, and division, chiefly the latter.

Paradisea (St. Bruno's Lily). *Liliaceæ*.

Propagated by division, or by seeds sown as soon as ripe.

Parkinsonia. *Leguminosæ*.

Usually raised from seeds.

Parrotia. *Hamamelidaceæ*.

Multiplied by seeds, layers or by greenwood cuttings under glass.

Parsley (*Petroselinum hortense*). *Umbelliferæ*.

Raised from seeds, which are usually sown outdoors in spring. The roots may be taken up in fall to be forced under glass.

Parsnip (*Pastinaca sativa*). *Umbelliferæ*.

Grown from fresh seeds, sown where the plants are to stand.

Parthenocissus, *Pseclera*. *Vitaceæ*.

Propagated by seeds, hardwood cuttings and layers; *P. tricuspidata* and its varieties from greenwood cuttings; Virginia creeper (*P. quinquefolia*) and similar kinds by hard cuttings. See *Ampelopsis*.

Passiflora (Passion-Flower). *Passifloraceæ*.

Increased by seeds, sown under glass. Cuttings of the young growth taken from the middle of January until April root easily in sand in a frame. Varieties are sometimes veneer-grafted on related stocks. *P. carulca* propagates by root-cuttings.

Paullinia. *Sapindaceæ*.

Propagated by cuttings of young shoots in spring.

Paulownia. *Scrophulariaceæ*.

Propagated by seeds, sown in spring in carefully prepared soil, either in a seed-bed or in a coldframe. Cuttings of ripe wood or of roots made in fall or spring are used; also leaf-cuttings, inserted in sand under a glass in a propagating-house, the young unfolding leaves being used for this purpose when about an inch long and cut off close to the petiole.

Pavetta. *Rubiaceæ*.

Propagated by cuttings of half-ripened shoots in sharp sand in a warm moist house.

Pavonia. *Malvaceæ*.

Propagated by cuttings in spring or early summer; also by seeds when obtainable.

Pea (*Pisum sativum*). *Leguminosæ*.

Raised from seeds, sown where the plants are to stand. The plants are hardy and seeds may be sown very early, and deep. For cow-pea, see *Vigna*.

Peach and Nectarine (*Prunus Persica*). *Rosaceæ*. (H. P. Gould).

The peach is perhaps the easiest to propagate of all the widely grown tree-fruits. Propagation is universally by shield-budding and, as a rule, on seedling peach stocks, although hard-shell almond seedlings have been used somewhat in California where it is said

they give hardier and stronger roots than peach seedlings, especially in dry soils. On soils too moist for peach roots, St. Julian plum stocks have been used as well as myrobalan plums, but plum stocks tend to dwarf the trees, and the union is frequently imperfect; they are therefore little used at present. Apricot seedlings have been used, but possess no special merit. The "wild peach of China" (*Prunus*, or *Amygdalus*, *Davidiana*) is attracting attention in some regions as a hardy peach stock, but it has not passed the experimental stage and it clearly is not adapted to growing in all sections. The western sand cherry (*Prunus Besseyi*) is used to a very limited extent as a dwarfing stock.

Peach pits or seeds for growing seedling stocks come mainly from "natural," that is, seedling, peach trees and orchards that abound in the Appalachian mountain districts of North Carolina, Tennessee and adjacent areas. On the Pacific Coast, the pits of certain varieties, such as Salwey, Morris White and Strawberry, are commonly used. Pits from eastern canneries are considered undesirable because of the danger of "yellows" and because they are so variable in size as to interfere in handling them in a peach-pit planter, besides producing seedlings varying widely in size. The conviction among nurserymen is that the "natural" pits produce stronger seedlings, and more uniform in size, than do those from the "budded" or named varieties.

The seeds or pits may be planted in the autumn in drills, where the nursery is to be located, and covered about 2 inches deep, or they may be bedded or stratified in sand in late summer or autumn where they are kept moist and subjected to freezing during winter; this treatment results in cracking the pits, thus releasing the kernels. So long as the kernels remain incased in the pits, they can not germinate. In bedding the pits, an excavation 12 or 15 inches deep is made in a well-drained spot and the pits are placed in it in layers, alternating with sand in essentially the same way as when they are stratified in a box.

In the early spring the pits are separated from the sand by sifting and hand sorting, and planted in drills where they are to grow, being covered $1\frac{1}{2}$ to 2 inches deep. If only a few seeds are concerned, the pits may be cracked by hand without other treatment and planted at once, but this is too slow for commercial work. In the South where there are no hard freezing temperatures, dependence is placed on long-continued subjection of the pits to moisture to crack them. They are kept particularly moist when stratified, or

they may remain over one year in the ground after they are planted before they germinate.

If small, well-graded, "natural" pits are used, running 6,000 to 7,000 to the bushel, 7 or 8 bushels will be required to plant an acre; the larger pits from "budded" varieties secured from canneries may run as low as 2,200 to 2,500 to the bushel, requiring a correspondingly larger quantity to plant a given area. Planted in well-prepared fertile soil, most of the seedlings should attain a diameter of about one-fourth inch by midsummer; that is, a size large enough to bud, this operation being performed principally from the last of July to early September. (The details of shield-budding are described on pages 122-133.) The buds placed on the stocks in this period remain dormant until the following spring, when, with the return of warm weather, they should grow rapidly. After one season's growth in the nursery they are termed "one-year-olds" and are ready for sale and for permanent planting. Peach trees older than one year should rarely if ever be planted, although "June buds" or "summer buds," which have roots one year younger than one-year-old trees, find favor with some growers in the South. These are produced in regions where a very early opening of the growing season in spring produces seedlings large enough to bud by June of the same year. If buds are inserted on such stocks in June or early July, they start into growth at once instead of remaining dormant until the following spring, and by late fall they develop into well-branched trees 2 to 3 feet high. Such trees give excellent results for orchard planting in the experience of many southern growers.

As soon as the bud has "taken," that is, become attached to the stock, which will be within ten days to two weeks after it is inserted, the raffia or string with which the stock was wrapped should be cut to prevent it girdling the stock and choking the bud. And further, as soon as the bud has grown 3 or 4 inches — in midsummer in case of June budding, in early spring in case of later budding — the top of the seedling stock above the bud should be cut away close enough to the bud so that the wound will heal over readily as the tree grows.

In Florida, the May and June budding of peaches is successful only when the leaves are left on the stock except that enough to allow the bud to be inserted may be removed. Leaves must be left above and below the point of insertion. As soon as the bud is inserted, the top of the stock is cut back partly, and this cutting

back process is continued till the buds have developed a length of 3 to 4 inches, when the stocks may be cut off and all the leaves cleaned up.

Peach trees may be grafted and this practice is sometimes followed in top-working trees several years of age; but when it is desired to change the variety, it is better to do so by budding, since the wounds made in grafting do not heal readily.

As buds can be set successfully only in wood of the current season's growth, it is necessary to head back old trees severely and get a vigorous growth of sprouts if it is desired to work them over to other varieties.

Ornamental peaches (as double-flowered varieties) are budded on common peach stock in the same way as the fruit-bearing sorts.

The nectarine is propagated in the same way and on the same stocks as the peach. For *Prunus Simonii*, see *Plum*.

Peanut, Goober (*Arachis hypogæa*). *Leguminosæ*.

Grown from seeds, which, for greenhouses or cold climates, should be sown in heat. In warm exposures and quick soil in the North, seeds planted directly in the open will give satisfactory results for the amateur. The peanut, as a field crop in the South, is grown from seeds planted where the crop is to stand. The seed of the thick-podded kinds is shelled before planting, but not of the thin-podded kinds. The seed is planted at the same season as corn (maize), 6 to 10 inches apart in the row, and the rows $2\frac{1}{2}$ to 3 feet apart.

Pear (*Pyrus communis*, *P. serotina* and perhaps others). *Rosaceæ*.

Pear seedlings are grown in the same way as those of the apple, which see. Pear stocks are imported from France, however, as the leaf-blight is so destructive to them here as to render their culture unprofitable. This leaf-blight is a fungus, and recent experiment has shown that it can be readily overcome by four or five thorough sprayings with bordeaux mixture, so that there is reason to hope that the growing of pear stocks may yet become profitable in this country, although the higher price of labor here, and the drier summers, are serious disadvantages. Heretofore, the only means of mitigating the ravages of this blight was the uncertain one of inducing a strong growth early in the season. Even when pear stocks are raised in this country, they are grown from imported French seed. Aside from its cheapness, however, this foreign seed probably possesses no superiority over domestic seed. But pear seed is so

difficult to obtain in America that it is practically out of the market. Seedlings of the sand pear type (*Pyrus scrotina*) have been strongly recommended for stocks, but they do not attain general favor amongst nurserymen.

Pear seedlings should be taken up and removed from the seed-bed the first fall. The foreign stocks are imported when a year old from the seed. The seedlings are trimmed and sometimes "dressed" (see page 123), and are set into nursery rows the following spring. The next season — that is, the season in which the stocks are transplanted — shield-budding is performed, as with the apple. The budding season usually begins late in July or early in August in the North. If the stocks are small, of "second size," they may stand over winter and be budded the second year. Pear trees are sold at two and three years from the bud. Pears do not succeed well when root-grafted, except when a long cion is used, for the purpose of securing own-rooted trees (see page 140). Dormant buds of the pear may be used on large stocks in early spring, the same as with the apple, and buds may be kept on ice for use in early summer (see page 132).

Pears are dwarfed by working on the quince. The Angers quince is the best stock. The ordinary orange quince and its kin generally make weak and short-lived trees. Quince stocks are obtained from ordinary cuttings or from mound-layering, the latter method giving much the better stocks (see *Quince*). The layers should be removed the first autumn; or, if they are not rooted then, they may be left a year longer, when they will be found to be well rooted, and may then be taken off, trimmed up and fitted to plant as stocks the following spring, and budded in August. Quince stocks are bought in Europe, whence they arrive in the fall. They are "dressed" and set in nursery rows the following spring, and the buds are set the first season. It is imperative to set the bud as low as possible to secure trees that can easily be set deep enough to cover the union (4 to 6 inches below the surface is the common depth of planting dwarf pears). Some varieties do not unite well with the quince, and if it is desired to dwarf them they should be double-worked (see page 168). Some of the common and popular varieties that thrive directly on the quince (without double-working) are the following: Angoulême (Duchess), Anjou, Louise Bonne, Howell, White Doyenne (Virgalieu), Manning Elizabeth, Lawrence. Varieties that usually thrive better when double-worked are Clairgeau, Bartlett, Seckel, and others.

The pear can also be grown on the apple, thorn and mountain ash. On the apple it is short-lived, although pear cions, set in the top of an old apple tree, often bear large fruits for a few years. When pear stocks cannot be had, pears are sometimes worked on apple roots. If the cions are long they will emit roots, and when the apple nurse fails the pear becomes own-rooted. Good dwarf trees are often reported on the thorn. The subject is little understood. The mountain ash is sometimes used for the purpose of growing pears on a sandy soil, but its use appears to be of little consequence. All these special stocks are of doubtful utility.

Pears of the Le Conte and Kieffer type are often grown from cuttings in the South. Cuttings are made of the recent mature growth, about a foot in length, and are planted in the open ground, after the manner of long grape cuttings. Le Conte, Garber, Smith, and other very strong growers of the Chinese type, are probably best when grown from cuttings. They soon overgrow French stocks, as also apple stocks, which have been used to some extent; but if long cions are used, own-rooted trees are soon obtained, and the stock will have served a useful purpose in pushing the cion the first two or three years.

Pecan (*Carya*, or *Hicoria*, *Pecan*). *Juglandaceæ*. (C. A. Reed.)

The species is propagated by seeds, varieties by budding and grafting. Nuts for planting should be gathered as soon as ripe, cured so as to remove excess moisture, without drying, and planted at once, or better stratified or held in storage until spring. The soil should be a fertile loam, preferably underlain with a firm but not hard clay subsoil, and moist without being wet. It should be well prepared and the nuts planted about 3 inches deep, 8 to 10 inches apart in the row and the rows 4 to 6 feet apart. In the South, well-selected nuts planted in January should make seedlings fit for grafting in one to three years. Some of those grafted in one year should be of sufficient size for transplanting to permanent orchard positions the following winter, or two years after the nuts were planted. As budding is performed only in summer, the earliest that any of these seedlings ordinarily can be used by this method is when eighteen months of age.

The advantages of grafting over budding, or vice versa, are dependent more on the convenience and skill of the operator than on the method. In either case preferably the operation should be

performed not less than 18 inches above ground in order to avoid subsequent winter-injury to the smooth trunks forming above the point of union. Obviously crown- or root-grafts are most susceptible to this trouble. Trees worked low should be given a winter wrapping of wooden veneer, heavy paper, burlap, or similar material for four to six years, or until the natural protection of rough bark is developed. Cions of last year's growth cut while dormant and held in storage may be used in early spring for grafting or to afford buds for early summer budding. For late summer budding, bud-sticks may be cut from the earliest of the current season's growth. In the South, root-grafting is usually performed from January to March; in the North from March to May, depending on weather and soil conditions. For nursery grafting the tongue-graft is most in use. With larger stocks, especially in top-working, the bark- or slip-bark-graft gives maximum results. Dormant budding in late winter or early spring is successful at the hands of skilled operators. Later budding may be by the annular or patch methods. Special tools have been devised for these methods by which amateurs soon become successful. No matter what method may be employed in propagating the pecan, subsequent care in unwrapping, rewrapping, removing the wrapping, necessary shading, staking to prevent the new top from blowing out, pruning, guarding against insects, and the like, are equally important to initial operation.

Propagation is sometimes accomplished by cuttings taken from the ends of soft growing roots. See *Hickory*.

Pelargonium (Geranium. Stork's Bill). *Geraniaceæ*.

Seeds, sown in light soil with mild heat, are sometimes employed. Commonly increased by cuttings of firm shoots, which grow readily (Figs. 119, 121). The common geraniums, for conservatory use, should be renewed from cuttings every year. Cuttings of the zonal or "fish" geraniums are mostly taken from stock plants grown in the open and lifted in autumn. The fancy or show geraniums are grown from cuttings taken after blooming, and sometimes from root-cuttings, but often will not come true. Geraniums can also be grafted, the named varieties being worked on related stocks. (See page 165, Herbaceous Grafting.)

Pelecypora (Hatchet Cactus). *Cactaceæ*.

Handled by seeds in moderate heat, and by cuttings made of any small shoots that arise from the base. See also *Cacti*.



PLATE XI. Horse-help in the nursery. — Fitting the land for nursery stock.
Digging by mule-power.

Pellæa (Cliff Brake). *Polypodiaceæ*.

Propagated by spores and division. See *Ferns*, page 312.

Peltandra. *Araceæ*.

Multiplied by seeds when fresh, and by division. See *Araceæ*.

Pennisetum. *Gramineæ*.

Increased by seed but the long-lived perennials give quicker results by divisions of the old plants.

Pentas. *Rubiaceæ*.

Propagated from February to middle of April by cuttings of young shoots in sandy soil in a warm propagating-house.

Pentstemon (Beard-Tongue). *Scrophulariaceæ*.

Propagated by seeds, sown in pans and placed under a frame, or sometimes sown in the border where the plants are to stand; also by division, and rarely by cuttings in summer.

Peperomia. *Piperaceæ*.

Cuttings of single joints of firm stems root easily in a peaty soil, with a bottom heat of 75° to 80°; water sparingly and do not keep too close or they will damp off. Seeds may also be used.

Pepper, Red or Cayenne (Capsicum). *Solanaceæ*.

Raised from seeds, sown outdoors in a seed-bed or in the North oftener started in the house in February or March. For the pepper of commerce, see *Piper*.

Perennials.

What are known to gardeners as "perennials" are herbaceous plants that live three years or more. Of course the shrubs and trees are perennial (that is, perannual) but they are taken for granted and are usually not in mind when perennials are mentioned.

Many of the herbaceous perennials propagate naturally by offsets and divisible parts. Of such are the lilies and other bulbous plants, the day lilies (*hemerocallis*) that produce tuberous parts, and many things that grow into clumps and "patches." Many of the perennials are grown commercially by simply dividing the clumps, stools and mats. Special or named varieties may be grown from cuttings, as the summer perennial phloxes.

Most of the herbaceous perennials known to ordinary commerce propagate readily by means of seeds. The common perennial

larkspurs, campanulas, achilleas, chrysanthemums, asters, helianthus, goldenrods, may be grown easily from seeds sown in the open ground in spring. The plants should bloom the following year. The sowing may be where the plants are eventually to stand, but this means that the place will not be well utilized the first year. It is usually preferable to raise the seedlings in specially prepared beds and to transplant in autumn or spring to permanent quarters. Specially choice things should be handled in pots and carried over winter in a frame, particularly if somewhat tender to cold, heat and drought. Seeds of many early-blooming dry-fruited perennials germinate the same season, if planted when ripe, but special care is often necessary to protect the young plants over winter so they may not get a strong foothold. Usually it is better to keep the seeds till the following spring. Seeds of many perennials, particularly those borne in fleshy capsules or berries, do not grow till they have passed the winter's frost, and some of the woods things will not germinate till the second spring.

In long-season climates, perennial seedlings may become so large by fall, if started early in spring, as to make preparations for bloom and thereby so weaken themselves as to be liable to winter-injury. This is true specially of those that tend to take on a biennial character.

Many of the florist's perennials are practically annuals under the method of culture under glass, with the continuous growth. This is true of the carnation, the florist's chrysanthemum, violets, fuchsias, geraniums, and even of roses, counting the period from cutting to bloom. Even from seed, the epoch may be condensed into a year, as with tuberous begonias, gloxinias, cyclamens, calceolarias, lupines, primulas. In nature the line between perennials and plants of lesser duration is not always sharply drawn. See *Biennials* and *Annuals*, pages 251, 231.

With most herbaceous perennials, the best bloom is obtained with young plants; after the second bloom (or sometimes even after the first) the plant may begin to fail or to become root-bound. There are many exceptions to this, when plants grow stronger and more floriferous for a series of years, as lilies, crown imperial, peonies, dictamnus. Only by experience of oneself or others can one determine these differences; and the distinctions are likely to vary in different climates and soils.

The practice of growing perennials from seeds should be encouraged. One knows a plant better and cares more for it if one

is responsible for the entire process from seed-time to harvest and death. The practice of buying perennials from nurserymen deprives the amateur of one of the choicest satisfactions in plant-growing. To see young things coming up, to handle them with skill and patience, to provide the conditions they most require, to watch the result of a year's good effort, — all this is a part of good gardening.

Pereskia (Barbados Gooseberry). *Cactaceæ*.

Seeds when obtainable. Cuttings, as described under cacti. *P. aculeata* is much used as a stock for zygocactus. *P. grandifolia* is sometimes used for the same purpose, as it is fully as good as the other species. Cuttings of *P. aculeata* can be made a foot or more in length, and of sufficient size for immediate use; or the graft may be inserted when the cutting is made. See *Cacti*, page 261.

Perilla. *Labiataæ*.

Readily raised from seeds sown in the open when weather is warm, or started under glass and transplanted; tends to become spontaneous.

Periploca. *Asclepiadaceæ*.

Increased mostly by layers or greenwood cuttings under glass, in summer or autumn. Root-cuttings succeed. Seeds are also employed.

Peristeria. *Orchidaceæ*.

Increased by division or separating the pseudobulbs, as growth commences. See *Orchids*, page 372.

Peristrophe. *Acanthaceæ*.

Propagated by softwood cuttings taken at any time and placed in a warm bed.

Pernettya. *Ericaceæ*.

Propagation is by seeds, or cuttings of half-ripened wood in summer under glass; also by layers and suckers.

Persea. *Lauraceæ*.

Raised from seeds. For growing under glass, layers of ripened shoots may be made in autumn, or cuttings of firm shoots. See *Avocado*.

Persimmon, Kaki (*Diospyros Kaki* and *D. virginiana*). *Ebenaceæ*.
(H. H. Hume.)

Seeds of *D. virginiana* and *D. Lotus* planted in the winter in the lower South, or in early spring farther north, usually give stocks of sufficient size for budding the first year; or these same stocks may be whip- or cleft-grafted just under the surface of the ground the following winter. Persimmons may also be bench-grafted on whole or piece roots. It is best to grow *D. virginiana* seedlings in closely planted seed-beds and transplant to nursery rows when one year old, thereby vastly improving their otherwise scant root systems. They are there grown on for another season before being worked. *D. virginiana* is the stock commonly used, but for dry or semi-arid climates, *D. Lotus* is much the better. *D. virginiana* and *D. Lotus* stocks are used both for the named or improved forms of *D. virginiana* and for the kaki or Japanese persimmon (*D. Kaki*).

For best results, when persimmons are propagated by shield-budding, the buds should be cut long, and inserted either when the leaf-buds are breaking into growth in spring or dormant-budded just before the bark tightens on the stocks at the close of the season's growth. For early spring work, dormant winter-buds are used. For top-working trees, the same methods of budding and grafting are successfully employed.

Petalostemum (Prairie Clover). *Leguminosæ*.

Propagated by seeds and division.

Petasites. *Compositæ*.

Increased mostly by division; also by seeds after the manner of other herbaceous perennials.

Petrea. *Verbenaceæ*.

Propagated by shoot-cuttings placed in brisk bottom heat; by seeds where they mature.

Petunia. *Solanaceæ*.

Raised from seeds, either indoors or started in the garden. Sometimes they self-sow. Choice and double varieties are often increased by cuttings, as for geraniums, which grow readily.

Phacelia, Eutoca, Whitlavia. *Hydrophyllaceæ*.

The flower-garden annuals are increased by seeds, and the perennials by seeds and division.

Phædranthus. *Bignoniaceæ.*

Propagation as for bignonia, which see.

Phaius. *Orchidaceæ.*

Increased by division of the dormant pseudobulbs. See *Orchids*.

Phalænopsis. *Orchidaceæ.*

The kinds of phalænopsis are very slow and difficult to propagate. In most of the species it can only be done when a lateral offshoot is made from the main stem. Some species, such as *P. Lueddemanniana*, and more rarely *P. amabilis*, *P. Stuartiana* and *P. Schilleriana*, develop plantlets on the old flower-scapes. By pegging these down on a basket of moss, they may be established and afterwards separated. *P. Stuartiana* has been known to produce plants on the roots. Other examples of root-proliferation are recorded in *Saccolabium micranthum* and a species of cyrtopodium. See under *Orchids*, page 372.

Phalaris. *Gramineæ.*

Handled by seeds, but the sports or varieties by division. The perennial *P. arundinacea* may be divided when transplanting. See *Grasses*, page 328.

Phaseolus (Bean. Kidney, Pole, String, Lima, French Bean).
Leguminosæ.

The ornamental greenhouse kinds are grown from seeds planted in light soil in a warm propagating-house. For the edible and culinary kinds, see *Bean*.

Phellodendron (Cork Tree). *Rutaceæ.*

Increased by seeds, layers, root-cuttings dug up in fall and stored during winter in moist sand or sphagnum, and by cuttings taken from the tree in July with a heel of older wood. Seeds usually are employed, when produced.

Philadelphus (Mock Orange. Syringa, erroneously). *Saxifragaceæ.*

Propagated by seeds, layers, suckers and cuttings. Cuttings of mature wood are generally employed. Some well-marked varieties, like var. *nanus* of *P. coronarius*, are grown from cuttings of soft wood in summer in frames.

Phillyrea (Jasmine Box. Mock Privet). *Oleaceæ.*

May be propagated by seeds sown soon after maturity, cuttings of half-ripened wood under glass in summer, layers, and by grafting on the privet (as on *Ligustrum ovalifolium*).

Philodendron. *Araceæ.*

Propagated by dividing the stems, allowing two or three joints to each piece, struck under glass; also by seeds when they are obtainable. See *Araceæ*, page 239.

Phlomis. *Labiataæ.*

Seeds usually grow readily; cuttings of green wood may also be employed; division of strong stools.

Phlox. *Polemoniaceæ.*

The annuals are grown from seeds sown in the open or sometimes started inside. The perennials are grown from seeds, divisions, cuttings of stems and roots. Cuttings made in summer, and handled in a frame, do well. The roots are sometimes cut into short pieces, and are then handled in pans or flats under cover. The showy summer-blooming perennial phloxes (of the *P. decussata* type) are grown from cuttings of side shoots in summer and also of stronger and more mature shoots.

Phoenix. *Palmaceæ.*

The species grown for ornament are generally increased by suckers and seeds, the seeds usually being imported. See also *Date*.

Phormium (New Zealand Flax). *Liliaceæ.*

Seeds sown in February will make good plants for bedding purposes the spring of the following year. Also increased by division of the crowns before growth begins in spring.

Photinia. *Rosaceæ.*

Propagated by seeds and by cuttings of half-ripened wood under glass and by layers; also by grafting on hawthorn or quince. The genus is now usually defined separately from *Eriobotrya*; see *Loquat*.

Phragmopedilum (part of the group of greenhouse cypripediums).
Orchidaceæ.

Propagated by division and seeds. See *Orchids*, page 372.

Phygelius. *Scrophulariaceæ.*

Propagated by seeds; also by cuttings, taken from the late autumn shoots of outdoor plants, or from growths arising from stock plants.

Phyllanthus. *Euphorbiaceæ.*

Propagated by cuttings of ripe shoots taken in August or before, which will root in sand if placed under a glass and in bottom heat.

P. nivosus grows readily from root-cuttings, *P. acidus* and *P. Emblica* may be grown from seeds; the latter also by layers.

Phymatodes. *Polypodiaceæ.*

Spores and division. See *Ferns*, page 312.

Physalis (Ground or Winter Cherry. Strawberry Tomato. Husk Tomato). *Solanaceæ.*

Propagated by seeds, sown outdoors or under cover; perennials by division of the rhizomes and soft cuttings.

Physocarpus (Ninebark). *Rosaceæ.*

Propagated by hardwood or greenwood cuttings and by seeds, as for spiræa.

Physostegia. *Labiataæ.*

Division of strong clumps may be made readily; also grown from seeds, as are other herbaceous perennials.

Phyteuma. *Campanulaceæ.*

Propagated freely by seeds, and division in spring.

Phytolacca (Schoke. Poke). *Phytolaccaceæ.*

Propagated by means of seeds, or by division of the thick roots, usually the former.

Picea (Spruce). *Pinaceæ.*

Propagated by seeds, sometimes by layers, sometimes by grafts; also by cuttings of recent wood. Seedlings must be shaded the first year. The spruces are easily grafted. *P. excelsa* (Norway spruce) or *P. canadensis* (*alba*) makes a good stock; the veneer-graft, under glass, in winter, succeeds better than any method of outdoor work practicable in our climate; if the graft is inserted near the base in young plants, it is quite possible to obtain them on their own roots after a few transplantings. Side shoots can be used as cions, and if started in time will furnish good leaders; sometimes a leader is developed more rapidly by bending the plant over at nearly a right angle, when a stout bud may start from the stem. The balsam fir is also a good stock for flat-leaved species. See *Abies*.

Pieris. *Ericaceæ.*

Propagation by seeds and layers and the evergreen kinds by cuttings of almost ripened wood in August under glass, kept

over the winter in a cool greenhouse. Seedlings are handled much as are rhododendrons and similar things.

Pilea (Artillery Plant). *Urticaceæ*.

Increased by seeds (when available), division and soft cuttings, commonly the last.

Pimelia. *Thymelæaceæ*.

Propagated by cuttings of half-ripened shoots in March, placed in mixture of loam, peat and silver sand, covered with glass, and kept in a temperature of 55° to 60°.

Pinanga. *Palmaceæ*.

Propagated by imported seeds. See *Palms*, page 377.

Pine: *Pinus*.

Pineapple (*Ananas sativus*). *Bromeliaceæ*. (P. H. Rolfs.)

Pineapple fruits as obtained on the market rarely contain seed, but by hand-pollinating it is comparatively easy to produce an abundance of seed. The only use that can be made of these seeds is in producing new varieties. In this country, pineapples are rarely grown under glass for fruit, but specimens are sometimes found in botanical collections and there are stripe-leaved varieties grown for ornament. The indoor propagation is mostly by suckers or offsets from the base.

The stock or trunk of the pineapple, as the plant is grown commercially in subtropical United States, is usually spoken of as the "root" and also as the "stool." This bears a bud in the axil of every leaf. The root proper of the pineapple plant is a small fibrous organ and contains no buds. In commercial pineapple fields, from one to a large number of buds sprout from the old stem after the fruit has been removed from the plant. In local vernacular, these are spoken of as "suckers." In most varieties, the suckers are preferred for the setting of new fields. They are commonly set out when 8 to 14 inches long. The bases are usually trimmed and the tops cut back. The suckers may be allowed to lie on the sand for days, or even weeks, without serious damage. They start into growth more quickly, however, if set out promptly. Sometimes "ratoons" propagate the plant; these are shoots arising from an underground part and developing a plant independently of the parent stock. Figs. 52-55.

When the pineapple plant fruits, a stalk is produced varying in

length with different varieties from a few inches to a foot or even more in length. The pineapple fruit is borne at the summit of this stalk. At the base of the fruit a considerable number of small plants is produced. These are spoken of as "slips." Usually the pineapple fruits can be broken from the top of the stalk after removing the slips. When these slips have grown to be 8 or 10 inches long, they are removed and considered as equal to suckers of the same size.

At the apex of the fruit is an outgrowth spoken of as the "crown." This crown may be used for producing pineapples in the same way that suckers or slips are employed. In some varieties a considerable number of small plants arise around the crown; at times these develop into large enough plants to make it possible to set them in the field. They are then called "crown slips." It is seldom that crown slips are used for commercial propagation.

In case of rare or high-priced pineapples, the old stools may be used successfully for producing new plants. By removing the stools from the ground, trimming off the leaves and roots, these stools may be placed in a horizontal position and covered with a small quantity of soil. In the course of a few weeks to several months, many of the buds, one of which is in the axil of every leaf, will grow into pineapple plants. These are removed from time to time, as they are large enough for transplanting. In greenhouses the same operation may be carried out, sphagnum moss being substituted for the soil. Care should be taken that the temperature of the propagating-bed, indoors or outdoors, does not reach a high degree. It should not reach 90°, and it is preferable to keep it in the 80's. Pineapples do best in those regions where the annual temperature is approximately 72°.

Under favorable conditions, pineapple plants will produce fruit in eighteen to thirty months from the time the rooted plants are set out, varying with different varieties. Red Spanish, which is rarely grown in the greenhouse, comes into bearing in about eighteen months under field conditions. Porto Rico and Smooth Cayenne require somewhat longer time, usually about thirty months.

The production of seedling pineapples may be described, although practiced only for the obtaining of new varieties. In Florida seeds are rarely produced. This is because there are no natural agencies for distributing the pollen. The fruit from the tropics, particularly from Panama, frequently contains viable

seeds. Hand-pollination and cross-fertilization produce a reasonable quantity of seed. The different varieties are readily cross-pollinated, making it possible to secure an endless extent of variation within the limits of the different varieties. This seed can be germinated readily under greenhouse conditions. The method of handling the seeds is simple. They should be removed from the ripe fruit and planted singly, preferably in thumb-pots, and plunged in well-drained beds. A sphagnum-moss covering may be used to maintain the moisture. As soon as the seeds have germinated, the moss may be removed and overhead watering discontinued. Half shade should be maintained. As soon as a sufficient growth has been made, the seedlings may be shifted from time to time to larger pots. The seedlings are delicate and subject to damping-off, and other adverse conditions, but after they are four to six months old they become rather robust and no great care need be exercised. Over-watering is one of the most fruitful sources of failure with seedlings. The most precocious seedlings may come into bearing thirty months from the time the seed was planted. As soon as the seedlings come into fruiting, the multiplication is somewhat certain and rapid. It varies greatly with different individual plants. Usually those that produce the smallest and poorest fruits have the largest number of suckers and slips.

Pinguicula (Butterwort). *Lentibulariaceæ*.

The species mostly seen in collections, *P. caudata*, is propagated easily by leaf-cuttings. The leaves are broken clean from the stem and laid flat in pans of sand protected by glass, the pan being placed in a tray of water. When the roots have formed, the plants may be potted off. All the species may be grown from seeds when these are to be had.

Pink: *Carnation, Dianthus.*

Pinus (Pine). *Pinaceæ*.

Seeds, which should be kept dry over winter, are commonly employed. These are often started in pots, but for most species they are sown in well-prepared beds outdoors. The seedlings must usually be shaded the first season. Varieties, as also species that do not produce seed freely, may be grafted on stocks of white or Austrian pine or other species. This grafting may be performed on the tips of growing shoots early in the season, but it is more often practiced on potted plants by the veneer method. *Pinus Strobus* should be

used for the five-leaved species, and the Scotch or Austrian pine for three-leaved and two-leaved species.

Piper (Pepper. Cubeb). *Piperaceæ*.

All pipers are increased by cuttings of the firm-growing shoots in sandy soil under glass; also by seeds when they are to be had.

Piqueria. *Compositæ*.

The common *Piqueria trinervia* (the *Stevia serrata* of florists) is generally grown from cuttings, like fuchsias and carnations; also by seeds, which are freely produced, and by division.

Pistacia. *Anacardiaceæ*.

Propagated by seeds, cuttings and layers. The pistachio-nut, pistache, or "green almond" (*P. vera*), is grown from seeds, which are planted where the trees are to stand. Named varieties of the pistache are often grafted on stocks of *P. Terebinthus*, or budded on them or other stocks in the nursery row. The best and most available stocks for this country are yet to be determined by longer trial.

Pistia. *Araceæ*.

Propagation is by runners, on which new plants are formed. See *Araceæ*, page 239.

Pisum: *Pea*.

Pitcairnia. *Bromeliaceæ*.

Propagation as for billbergia, which see.

Pitcher-Plant: *Nepenthes*, *Sarracenia*.

Pithecoctenium. *Bignoniaceæ*.

Propagation as for bignonia, which see.

Pittosporum. *Pittosporaceæ*.

Propagated by seeds sown in winter or early spring in ordinary soil in a cool greenhouse, and by cuttings of the growing or half-ripe wood, under glass. Grafting is sometimes practiced, *P. undulatum* being one of the best stocks.

Planera (Water-Elm). *Urticaceæ*.

Propagated by seeds sown soon after ripening in May; also by layers, and by grafting on the elm.

Platanus (Plane-Tree. Buttonwood. Sycamore, improperly).
Platanaceæ.

Usually propagated by seeds, sown in spring, slightly covered with earth and kept moist and shaded, but layers, ripe-wood cuttings and greenwood cuttings under glass in June taken with a heel may be employed. Varieties may be grafted in spring on seedlings of one of the species.

Platycerium (Stag's-Horn Fern). *Polypodiaceæ.*

Propagation chiefly by division; sometimes by spores. See *Ferns*.

Platyclinis. *Orchidaceæ.*

Propagated by side-growths from the old pseudobulbs. When no natural break occurs, the plants may often be induced to break by slightly twisting, or notching the rhizome with a sharp knife. See *Orchids*, page 372.

Platycodon, Wahlenbergia. *Campanulaceæ.*

Propagated by seeds, and old plants by division in spring if care is taken with the fleshy rootstock.

Pleione. *Orchidaceæ.*

Propagation as for *cœlogyne*. See *Orchids*, page 372.

Plum (*Prunus*, many species). *Rosaceæ.*

So many species of plums are in cultivation, and the varieties of the same species are often so different in constitution and habit, that it is difficult to give advice concerning their propagation. All the species grow readily from fresh well-ripened seeds. The pits or stones should be removed from the pulp and then stratified until spring. If they are allowed to freeze, the germination will be more uniform, as the pits will be more easily opened by the swelling embryo. Plum pits are rarely cracked by hand. The strong-growing species and varieties, especially southwards, will give stocks strong enough to bud the first season; but the weaker ones must stand until the next season after the seeds are planted. In all the northern states, however, plum pits are usually sown in seed-beds, in the same way as apple and pear seeds. The seedlings are taken up in the fall, and the following spring set out in nursery rows, where they are budded in August.

Plums are extensively grown from suckers, which spring in great numbers from the roots of many species. In France this method of propagation is largely used. So long as graftage does not intervene,

the sprouts will reproduce the variety; and even in grafted or budded trees this sometimes occurs, but it is probably because the tree has become own-rooted from the rooting of the cion. It is a common notion that trees grown from suckers sprout or sucker worse than those grown from seeds.

Layers are also sometimes employed for the propagation of the plum. Strong stools are grown, and the long and strong shoots are covered in spring throughout their length — the tips only being exposed — and every bud will produce a plant. Strong shoots of vigorous sorts will give plants large enough the first fall to be removed into nursery rows. Mound-layering is also employed with good results.

Root-cuttings, handled like those of blackberry, grow readily, but some growers suppose that they produce trees which sucker badly. Many plums grow readily from cuttings of the mature recent wood, treated the same as long grape cuttings. This is especially true of the Marianna (which is a form of myrobalan, or a hybrid of it and some native plum of the Wild Goose type), which is grown almost exclusively from cuttings. Some kinds of the common garden plum (*P. domestica*) also grow from cuttings.

Plums are worked in various ways, but ordinary shield-budding is usually employed in late summer or early fall, as for peaches and cherries. Root-grafting by the common whip method is sometimes employed, especially when own-rooted trees are desired. In the North and East, the common plum (*P. domestica*) is worked on stocks of the same species, and these are always to be preferred. These stocks, if seedlings, are likely to be very variable in size and habit, and sometimes half or more of any batch, even from selected seeds, are practically worthless. Stocks from inferior or constant varieties are, therefore, essential. Such stocks are largely imported; but some varieties can be relied on in this country. One of the best of these domestic stocks is the Horse plum, a small and purple-fruited variety of *Prunus domestica*, which gives very uniform seedlings. This is sometimes used in New York. It is simply a spontaneous or wilding plum, in thickets and along roadsides. The French stocks in most common use are St. Julien and Black Damas. The myrobalan (*P. cerasifera*), however, is chiefly used for plums, because of its cheapness and the readiness with which all varieties take on it. In large nursery centers it is the prevailing stock. In the colder regions, *P. americana* stocks are used. The peach is often used as a plum stock, and it is valuable in the South, especially for

light soils. In the North plum stocks are better. Marianna is used southwards, very likely too freely. Almond stocks, especially for the French prune and for light soils, are considerably used in California. The apricot is sometimes employed, but results appear to be poor or indifferent, on the whole. Prunes, which are varieties of plums, thrive on the above stocks also.

Various stocks dwarf the plum. The chief dwarf stock at present is the myrobalan. This is imported. It is easily grown from seeds, or sometimes from cuttings. Although the myrobalan, like the mahaleb cherry, is a slow grower, the dwarfing of the top depends more on subsequent pruning than on the root. The mirabelle (a form of *P. cerasifera*), a foreign stock, is sometimes used. The many species of native plums, of the *Prunus americana*, *P. Munsoniana* and *P. angustifolia* (Chickasaw) types, are good stocks for dwarf or intermediate trees. In most cases, the bud or graft grows luxuriantly for two or three years, and thereafter rather slowly. It is best to bud or graft low on these stocks. Unless the tops are freely and persistently headed in, however, dwarf plum trees are not secured. The only exception to this statement seems to be in the use of the native dwarf cherry stocks (*Prunus pumila* and *P. Besseyi*), which have been used in an experimental way with much promise.

The native or American plums are budded on native seedlings, or rarely on *Prunus domestica* seedlings; or they are grown from cuttings, as in the case of Marianna.

The Japanese plums (*Prunus salicina*, formerly called *P. triflora*) are worked on peach, common plum, natives, or Marianna. Peach and Marianna are mostly used, but seedlings of the Japanese kinds should be preferable. Peach is probably preferable to Marianna.

Prunus Simonii works on peach, common plum, myrobalan and Marianna, chiefly on the first.

The ornamental plums are worked on the same stocks as the fruit-bearing sorts. See *Prunus*.

Plums (like cherries) can be top-grafted the same as apples, but the cions must be kept completely dormant. It is preferable to graft very early in the spring.

Plumbago (Leadwort). *Plumbaginaceæ*.

Propagated by seeds, division and cuttings. The cuttings are made from nearly mature wood, taken either in autumn from plants growing in the open or in the spring from stock plants.

Plumeria. *Apocynaceæ.*

Propagated by cuttings, under glass, usually taken in February or March.

Podocarpus. *Taxaceæ.*

Grown from cuttings of firm wood under cover; also from seeds; sometimes grafted on the related species.

Podolepis. *Compositæ.*

Raised from seed, either in April under glass or later outdoors.

Poinciana. *Leguminosæ.*

Propagated by seeds.

Poinsettia (*Euphorbia pulcherrima*). *Euphorbiaceæ.*

Propagated by cuttings of growing shoots, of two or three buds each, handled on a cutting-bench or in a frame. Many propagators prefer to let the cuttings lie exposed two or three days before setting them. Cuttings of ripened wood can be used to good advantage when the heat is rather low; immerse cuttings in water as soon as cut from the old plants; then put them in thoroughly wet sand and keep wet until rooted. Many propagators prefer to cut to a heel. Cuttings taken early in July should make good midwinter plant.

Polemonium. *Polemoniaceæ.*

Propagated by seeds, which may be sown in fall, and by division.

Polianthes (Tuberose). *Amaryllidaceæ.*

Increased by bulbels or offsets. Remove these from the parent bulb in the fall, and keep in a warm dry place until the following spring. The soil should be light, rich and moist throughout the summer. Before frost comes in the fall, take the bulbs up, and when dry, cut off the leaves. The bulbs should be kept as during the preceding winter, and the culture throughout the following year is the same as during the first. The bulbs usually flower the second or third summer.

Polygala (Milkwort). *Polygalaceæ.*

Propagated by seeds sown in fall or early spring; tropical species also by division, and by cuttings of young shoots under cover.

Polygonum. *Polygonaceæ.*

Raised from seeds. The perennials are also easily increased by division of the rootstocks, and by cuttings.

Polypodium (Polypody). *Polypodiaceæ*.

Propagation by division usually. See *Ferns*, page 312.

Polyscias. *Araliaceæ*.

To this genus are now referred many of the glasshouse plants commonly known as aralias, others going to the genus *Dizygotheca*. They do not seed under cultivation. Propagated by cuttings, eyes, pieces of the root and grafts, usually by cuttings of firm wood. The cleft or wedge methods of grafting are usually employed; they must be kept in a night temperature of not less than 70°, in a tight moist case. Eye-cuttings should be placed in brisk heat in a propagating-bed. If the old stools are put in bottom heat, they will throw out cuttings which may be removed with a heel and started in heat.

Polystichum. *Polypodiaceæ*.

Propagated by spores, or by pinning down the fronds on porous surface until small buds are rooted, then detached.

Pomegranate (*Punica Granatum*). *Punicaceæ*.

Multiplied largely by seeds, and all varieties are increased by hardwood cuttings planted in open ground during February, by softwood cuttings in summer, suckers, layers, and scarce kinds by grafting on a common sort.

Poncirus (commonly known as *Citrus trifoliata*). *Rutaceæ*.

Propagated by seeds. See *Citrus* and *Orange*.

Populus (Poplar. Aspen. Cottonwood). *Salicaceæ*.

Raised from seeds, sown as soon as ripe and raked in, on light soil. Suckers are also used. Most often increased by cuttings of ripe wood, taken in fall and spring, as for willows. The weeping forms are stock-grafted on upright sorts, as on *P. grandidentata*.

Portulaca (Purslane. Rose Moss). *Portulacaceæ*.

The annuals are raised from seed. Varieties are sometimes propagated by cuttings. The common rose moss (*P. grandiflora*) is grown from seed sown where the plants are to bloom.

Potato (*Solanum tuberosum*). *Solanaceæ*.

Propagated by tubers, either whole or variously divided. From 8 to 20 bushels of tubers are required to plant an acre, depending on how they are cut and the distance of planting. Seed grows readily (when seed-balls are produced). It is sown the following spring, and small tubers will result, which should be regularly planted the following year, when still larger tubers will result; these in turn planted

should produce full-sized tubers. Potatoes are grown from seed only for the production of new varieties. Potatoes may be grown from stem-cuttings, taken as for geraniums. The cutting will produce one or more small tubers underground, and these may be grown the same as the small tubers raised from seeds, but new varieties are not produced this way. Figs. 101, 102.

If the seed is sown by April 1 following maturity, in a hotbed or greenhouse, and pricked out or potted off when the first true leaf is developed, and transplanted to the open field in the latter part of May or early June, many of the seedlings will produce full-sized tubers the first season, thereby saving at least one year's time as it is then possible to determine whether they are promising or not.—*William Stuart.*

Potentilla (Cinquefoil. Five-Finger). *Rosaceæ.*

Propagated by seeds, layers, division, rarely by green cuttings.

Pothos. *Araceæ.*

Propagation as for philodendron, by dividing the rooting stems.

Primula, Polyanthus (Primrose. Cowslip). *Primulaceæ.*

Grown from seeds, sown carefully in very fine soil, under glass. They may be sown in February in pans or flats in a mixture of loam, leaf-mold and sand, placed in a warm greenhouse. Seeds may also be sown in a coldframe in April or May. The seeds should be fresh; old ones often lie dormant a year. Many hardy kinds are increased by division, in September. See *Auricula.*

Pritchardia. *Palmaceæ.*

Grown from imported seeds. See *Palms*, page 377.

Protea. *Proteaceæ.*

Propagated by imported seeds.

Prune (*Prunus domestica*). *Rosaceæ.*

Prunes are plums. The commercial product is a dried plum. Propagation in all ways as for other kinds of plums.

Prunus (Almond. Apricot. Cherry. Peach. Plum). *Rosaceæ.*

The dwarf almonds (*Amygdalus*) are increased by seeds, division, cuttings, and by budding on seedling plum or peach stocks; also by root-cuttings. Peach stocks give larger trees at first than plum stocks, but the trees are not so long-lived. Perhaps ten years may be considered the average life of most ornamental almonds upon the

peach, while on the plum they may persist twenty-five years or more. See *Almond*.

The ornamental cherries, peaches, and the like, are propagated in essentially the same way as the fruit-bearing varieties. *P. Lauro-cerasus* and *P. lusitanica*, the cherry laurel and Portugal laurel, may be propagated by short cuttings of ripened wood, in a cool greenhouse in autumn. *P. Pissardii* propagates by cuttings of the soft wood and, with more difficulty, from cuttings of dormant wood. Soft cuttings succeed well with many of the double-flowering plums and cherries, if the wood is grown under glass. See *Apricot, Cherry, Peach, Plum*.

Pseuderanthemum. *Acanthaceæ.*

Propagated by greenwood cuttings any time from March to June. To this genus are now referred the plants commonly known as *Eranthemum*.

Pseudolarix (Golden Larch). *Pinaceæ.*

Should be raised only from seeds; if grafted on its own roots or on common larch, it rarely grows into a symmetrical tree.

Pseudotsuga. *Pinaceæ.*

Propagated by seeds, as for *abies* and *pinus*; varieties may be grafted on the type.

Psidium: *Guava.*

Psoralea. *Leguminosæ.*

Propagated by seeds, divisions and cuttings of growing shoots under glass. The tuberiferous species, as the "pomme blanche" or Indian potato (*P. esculenta*), are increased by the tubers or divisions of them.

Ptelea (Hop Tree). *Rutaceæ.*

Multiplied by seeds, sown in autumn or stratified, and also by layers. The varieties may be grafted on the common forms in spring under glass or budded in summer on seedlings of the type.

Pteris (Brake. Bracken). *Polypodiaceæ.*

Easily grown from spores and by division of the rhizomes. See *Ferns*, page 312.

Pterocarya. *Juglandaceæ.*

Handled by seeds sown in autumn or stratified, and by suckers and layers.

Pterostyrax. *Styracaceæ.*

Propagated by seeds, layers, and greenwood cuttings under glass.

Ptychosperma: *Archontophœnix.***Pueraria.** *Leguminosæ.*

Propagated by seeds when procurable, division of the roots, and cuttings. The kudzu vine (*P. hirsuta*, known in the trade as *P. Thunbergiana* and *Dolichos japonicus*) grows readily from seed and may be multiplied by division of the great root.

Pumpkin (Cucurbita, three species). *Cucurbitaceæ.*

Propagated by seeds, when the weather is settled; frost-tender.

Punica: *Pomegranate.***Puschkinia, Adamsia.** *Liliaceæ.*

Propagation by bulbels and seeds.

Puya. *Bromeliaceæ.*

Propagation as for billbergia, which see.

Pyracantha (often included in *Cratægus*). *Rosaceæ.*

Propagated by seeds, by cuttings of ripened wood in fall under glass, kept in winter in a temperate greenhouse, by layers, and by grafting on hawthorn or cotoneaster. Seeds should be treated as for *cratægus* and may not germinate the first year.

Pyrethrum. *Compositæ.*

The pyrethrums are chrysanthemums and are propagated as are other cultivated members of that genus, by seeds and cuttings. The common garden pyrethrums grow readily from seeds, blooming the second year or sometimes the first year if started early under glass. Increased also by division.

Pyrola (Shin Leaf. Wintergreen). *Pyrolaceæ.*

Multiplied by division; very rarely from seeds and with difficulty.

Pyrostegia (*Bignonia venusta*). *Bignoniaceæ.*

Propagation by seeds and cuttings as for *bignonia*, which see.

Pyrus (Apple. Pear). *Rosaceæ.*

The ornamental species and varieties of apples and crabs are budded or grafted on common apple seedling stocks. Layers and green cuttings are occasionally employed for various species and varieties of *Pyrus*. See also *Apple, Pear*. It is a good plan to obtain

stocks as nearly related to the plant which is to be propagated as possible; *e.g.*, Parkman's pyrus does better on *P. pulcherrima* (*P. floribunda*) than on the common apple stock. The wild crabs can be worked on the apple when stocks of their own species cannot be secured.

Quamoclit. *Convolvulacæ.*

Propagation as for ipomœa, which see. The cypress-vine (*Q. pinnata*) grows readily from seeds if they are first soaked in water.

Quercus (Oak). *Fagacæ.*

Stocks are grown readily from seeds, which may be sown in the fall without stratification. Take care that vermin do not dig up the acorns. Some acorns germinate in fall, sending down a root but producing no top till spring. The evergreen species are sometimes grown from cuttings and layers. Varieties are grafted on stocks grown from wild acorns. The stocks are potted in the fall, and the grafting (generally the veneer-graft) is performed in January and February, or sometimes in August. In choosing stocks, care should be taken to get related species.

Quince (*Cydonia oblonga*, and species of *Chænomeles*). *Rosacæ.*

All quinces can be grown from seeds, the same as apples and pears; but seeds are not common in the market, and are, therefore, little used. The fruit-bearing quinces (*Cydonia oblonga*) are propagated most cheaply by means of cuttings of mature wood or by mound-layering. Cuttings are taken in the fall, and are stored in sand, moss or sawdust until spring, when they are planted outdoors. Long cuttings — 10 to 12 inches — are usually most successful, as they reach into uniformly moist earth. Cuttings are usually made of the recent wood, and preferably with a heel, but wood two or three years old will usually grow. With some varieties and upon some soils, there is considerable uncertainty, and layerage is therefore often employed. Mound-layering (see page 74) is practiced when extra strong plants are required. Long root-cuttings, treated like those of the blackberry and raspberry, will also grow.

Many nurserymen bud- or root-graft the better varieties on stocks of Angers or other strong kinds. These stocks are imported from Europe (and are the same as those used for dwarf pears). These imported plants are grown both from cuttings and mound-layers,

the greater part of them from the latter, but seeds are occasionally employed. These stocks are two years old when imported, having been transplanted the first year from the cutting-bed or the stool-yard. To secure extra strong plants and a uniform stand, some growers graft quince cuttings on pieces of apple or pear roots. In such cases the plants should be taken up in the fall, when the quince will be found to have sent out roots of its own; the apple sprouts (or even the entire root) should be removed, and the quince replanted the following spring in the nursery row, otherwise suckers frequently spring from the stock and interfere with the growth of the quince. The union is sufficient to nurse the cion for two or three years.

The flowering or Japanese quince (*Chaenomeles lagenaria*) is best propagated by short root-cuttings, which are usually made in the fall, and scattered in drills in frames or in a well-prepared border in spring. Cuttings of firm, nearly mature wood, handled in frames, will grow, but they are not often used. The double varieties are root-grafted on common stocks of *C. lagenaria* in winter. The plants are then grown on in pots. Common quince (*Cydonia oblonga*) stocks are occasionally used, but they are not in favor. The Chinese quince (*Chaenomeles sinensis*) is worked on the common quince.

Quisqualis. *Combretaceæ.*

Propagated by softwood cuttings in sand with bottom heat; by seeds when obtainable.

Radicula: *Horse-Radish, Water-Cress.*

Radish (*Raphanus sativus*). *Cruciferæ.*

Raised from seeds, usually sown where the plants are to grow. In forcing-houses, the young seedlings are often transplanted into the beds.

Ramondia. *Gesneriaceæ.*

Increased by seeds in spring, or old plants by division.

Rampion (*Campanula Rapunculus*). *Campanulaceæ.*

Grown from seeds, sown where the plants are to stand; good roots are obtained the second year, although if early sown it may run to seed the first year.

Randia. *Rubiaceæ.*

Cuttings of the young shoots in spring in sandy soil in heat.

Ranunculus (Buttercup. Crowfoot). *Ranunculaceæ*.

Propagated by seeds, and by division of the plants in spring. The thick-rooted species are propagated by the natural division of the tuberous parts. After flowering and the herbage dies down, the tuberous roots may be taken up, dried, and kept cool and dry until spring; or the plants may be left in the ground where the winters are not too severe.

Raphia. *Palmaceæ*.

Propagated by seeds. See *Palms*, page 377.

Raspberry (*Rubus strigosus*, *R. occidentalis*, etc.). *Rosaceæ*.

New varieties are originated from seeds, which are washed from the pulp and sown immediately, or stratified. Bearing plants should be had the second growing season, or perhaps the third season far North.

The black-cap varieties are grown mostly from root-tips, as described on page 71. If the ground is loose and mellow, the tips will commonly take root themselves, but on hard ground the tip may have to be held in place by a stone or clod. Some strong-growing varieties, as the Gregg, especially in windy localities, have to be held down. Commercial growers commonly bury the tips in early fall. Blackcaps may also be propagated by layers and by root-cuttings. These cuttings are best handled in warm coldframes or mild hotbeds, being planted very early in spring. By the time the weather is settled, they will be large enough to plant in nursery rows.

The red varieties increase rapidly by means of suckers which spring from the roots. Better plants are obtained by means of root-cuttings, however, as described under blackberry (see also Fig. 103). Commercial men propagate the reds by the sucker method.

Rehmannia. *Scrophulariaceæ*.

Propagated by cuttings of growing wood; also by seeds, giving bloom the second season.

Reinwardtia (Linum, in part, of gardeners). *Linaceæ*.

Propagated by seeds, cuttings of strong shoots in heat and divisions of old plants.

Reseda: *Mignonette*.

Retinospora, species of *Chamæcyparis* and *Thuja* (Japanese Arbor-Vitæ). *Pinaceæ*.

The retinosporas do not constitute a distinct group of plants, but are juvenile forms in other genera. They are grown sometimes from seeds, which should be denuded of pulp. Layers of tender branches are sometimes employed. Most commonly grown from cuttings. These are made from tips of growing or ripened shoots, and are 2 or 3 inches long, with all the leaves left on. They are usually, from necessity, variously branched. The soft cuttings are usually taken from forced plants, and are handled in a close frame or under a bell-glass, with bottom heat. In commercial establishments the cuttings of ripe wood are preferred. Following is the practice of one of the oldest nurseries in the country: Cuttings of the entire season's growth, cut to a heel, are taken in October and November, and are placed in sand in boxes in gentle heat, as in a propagating-house. By February the roots will be formed, and the boxes are then placed in a cool house where the temperature is about 50°. Early in spring (about April 1st) the boxes are placed outdoors in coldframes, where they remain until May, until frost is over. The boxes are then removed from the frames and are set on boards in a shady place, where they are left until fall. In the fall — having been nearly a year in the boxes — the plants are shaken out and are heeled-in in a cellar. The next spring they are planted out in beds, and during the following summer and winter they are given some protection from sun and cold. Yews and arbor-vitæ are handled in the same way. Usually the retinosporas propagate easily from cuttings taken in autumn if given shade; good-sized pieces root in ordinary soil.

Retinosporas are often grafted on retinospora or common arbor-vitæ stocks. This operation is usually performed on potted plants in winter by the veneer method.

Rhamnus (Buckthorn). *Rhamnaceæ*.

The hardy kinds may be increased by means of seeds or by layers. The greenhouse species may be multiplied by cuttings of growing parts in summer. Seeds should be stratified or sown in fall. Rarer kinds are sometimes grafted on related species, *R. Frangula* and *R. cathartica* being mostly used as stocks.

Rhapis. *Palmaceæ*.

Propagated by suckers which are produced freely, or by imported seeds. See *Palms*, page 377.

Rheum (Rhubarb. Pie-Plant. Wine-Plant). *Polygonaceæ*.

Propagated by seeds and by division. Each division should contain at least one bud or eye, with as much rhizome and root as possible. Seeds may be sown where the plants are to stand, but will not reproduce the varieties, and three years are required for the plants to mature.

Rhipsalis. *Cactaceæ*.

Cuttings, after having been dried a few days, should be inserted in coarse sand. See *Cacti*, page 261.

Rhododendron. *Ericaceæ*.

Seeds are largely employed, but they are small and light, and must be carefully handled. They are sown in spring in pans or boxes in a soil of sandy peat, care being taken to cover them very lightly and not to dislodge them when applying water. They are handled in coldframes or in a cool house, and the young plants must be shaded. The plants are commonly allowed to remain a year in the boxes.

The seeds should be sown in prepared boxes, half filled with rocks or ashes, on which is placed a mixture of peat, leaf soil and sand; on top place a thin layer, about one-eighth inch, of finely sifted moss. Water well and sow the seed on the top of the moss. If kept shaded and the moss never allowed to become dry, the seeds germinate readily in about five weeks. Sown the third week in January they are ready to transplant in a peaty mixture by June. Transplant about one inch apart in boxes four inches deep, with a slight drainage at the bottom. These plants will be ready to plant out-of-doors in frames the following May. Three inches of growth are obtained with some species eight months after the seed is sown.

Low-growing plants are often layered. Cuttings of growing wood, cut to a heel, are sometimes employed, being made in summer and handled in a frame, but the percentage of rooted plants is often small.

Rhododendrons are extensively grafted, the veneer method being most used. The operation is performed on potted plants in late summer or early fall, or sometimes in a cool house in early spring. Most of the leaves are allowed to remain on the cion. The plants are then placed in densely shaded cool frames (Fig. 47), and are nearly covered with sphagnum. Various stocks are employed, but for severe climates the hardy species, like *R. catawbiense* and *R. maximum*, are probably best. *R. ponticum* is extensively used in Europe,

but it is not hardy enough for the North, unless worked low and planted deep. See also *Azalea*.

Rhodotypos. *Rosaceæ.*

Propagated by seeds, by greenwood cuttings under glass in early summer, and by hardwood cuttings.

Rhubarb: *Rheum.*

Rhus (Sumac). *Anacardiaceæ.*

Propagated by seeds sown in fall or stratified, layers, suckers, root-cuttings and cuttings of green or ripe wood. Suckers are generally used.

Rhynchospermum: *Trachelospermum.*

Ribes (Currant. Gooseberry). *Saxifragaceæ.*

Propagated by seeds, which should be sown as soon as ripe, or else stratified for new varieties; also by hardwood cuttings in fall and by greenwood cuttings in summer under glass. Mound-layering in summer is sometimes practiced. Budding or grafting is employed for quick propagation of rare varieties, the common available stocks being used. See *Currant* and *Gooseberry*.

Richardia: *Zantedeschia.*

Ricinus (Castor Bean). *Euphorbiaceæ.*

Propagated by seeds, which in the North are started indoors in early spring.

Rivina. *Phytolaccaceæ.*

Propagated readily by seeds, which are produced freely; also by cuttings in spring in heat.

Robinia (Locust. Rose Acacia). *Leguminosæ.*

Increased by seeds, sown in fall or spring, and which usually germinate better if soaked in hot water previous to sowing. Also grown from layers, suckers and root-cuttings. Named varieties are grafted or budded, the common locust stock (*R. Pseudacacia*) being preferred, even for the rose acacia (*R. hispida*). Dwarf forms are propagated by division and other varieties by cuttings of mature wood in fall.

Rocambole (*Allium Scorodoprasum*). *Liliaceæ.*

Propagated by "cloves," which are divisions of the bulb.

Rochea. *Crassulaceæ.*

Increased by cuttings taken in March, placed in sandy peat in a night temperature of about 50°.

Rodgersia. *Saxifragaceæ.*

Multiplied by division of the plant; also by seeds when obtainable.

Rodriguezia. *Orchidaceæ.*

Increased by dividing the plant. See *Orchids*, page 372.

Rohdea. *Liliaceæ.*

Propagated by division, and by seeds if they can be had.

Romneya. *Papaveraceæ.*

Propagated by suckers; also by seeds, but a long time is required.

Rondeletia. *Rubiaceæ.*

Propagated by cuttings of the young points of the shoots, placed in sand in a warm house; cuttings of half-ripened wood do well.

Rosa (Rose). *Rosaceæ.*

New varieties, and sometimes stocks, are grown from seeds, which are sown as soon as ripe, or kept in the hips until spring. The hardy kinds are usually sown in well-prepared beds outdoors.

Roses are sometimes grown from layers, and often from root-cuttings, after the manner of blackberries.

The common way of propagating roses, however, is by means of short cuttings of firm or nearly mature wood, handled under glass, with a mild bottom heat (65° or 70°). They are commonly made in February or March from forced plants. The cuttings are made in various fashions, some persons allowing most of the leaves to remain, and some preferring to cut most of them off, as in Fig. 123. They are commonly cut to one-bud lengths, like Fig. 125. Long cuttings of ripened wood, handled in a cool greenhouse or in frames, may also be employed for the various perpetual and climbing roses. For forcing under glass, cuttings of growing wood (either of the "blind" wood or of the harder flower stems) are taken in late winter or very early spring, struck in sand on benches, transferred to pots, later planted on the benches and grown continuously in summer and fall for the winter bloom.

Most growers feel that the best plants are obtained from cuttings, but most varieties do well when budded on congenial and strong stocks. Budding by the common shield method is considerably employed, and veneer-grafting is sometimes used (Fig. 128). The

stocks are grown either from seeds or cuttings. A common stock is the manetti, which is a strong and hardy type, and the resulting budded plant may be used for regular garden work or for forcing under glass. The eyes should be cut out of the manetti stock below the bud, to avoid sprouting. Because the manetti suckers badly, various wild briars are much used in Europe. The bud is often inserted 2 to 4 feet high, making "standard" roses (Fig. 127). These are practically unknown in this country, except as sparingly imported. The multiflora rose is also a good stock, especially for early results. These manetti and multiflora stocks (and some others) are imported from Europe as yearling cuttings. For outdoor propagating, they are "dressed" much like apple stocks (Fig. 132), and are budded the year in which they are planted in the nursery row. The gardener may grow his own stocks of these (particularly of multiflora) from hardwood cuttings made in spring, and these cuttings should be fit for working in the following fall and winter. Home-grown seedlings should be two years old (unless very strong) before they are budded. Hybrid perpetual roses make excellent pot plants in a short time when winter grafted, with dormant wood, upon multiflora stocks. A stock somewhat used for some of the hybrid perpetuals, with excellent results, is *Rosa Watsoniana*, a Japanese species. This is a slender stock, and is grafted, not budded. "Worked" roses are in greater favor in Europe than in this country, and our various native roses have, therefore, received little attention as stocks. The common sweet briar of the roadsides (which is an introduced species) is sometimes used for stocks. *R. Wichuraiana* is easily propagated by long cuttings of year-old wood in the open air.

Rosmarinus (Rosemary). *Labiatae*.

Increased by seeds and division.

Roystonea: *Oreodoxa*.

Rubiaceae. Rubiads.

Propagation of most of the genera is by cuttings of the partially ripened young wood in good bottom heat; also by seed and a few by root-cuttings. The herbaceous kinds are increased by division and seeds. As well as ornamental garden subjects, many of the rubiads are most important economic plants.

Rubus (Bramble). *Rosaceae*.

Increased by seeds, which should be stratified or sown as soon as ripe. Divisions of the clump, natural stolons, root-cuttings and

suckers are mostly employed. The seeds of *R. deliciosus* and probably others require two years for germination. See *Blackberry*, *Dewberry*, *Raspberry*, *Wineberry*.

Rudbeckia (Cone-Flower). *Compositæ*.

Handled by seeds, division or cuttings.

Ruellia. *Acanthaceæ*.

Propagated by cuttings, in light rich soil under glass, whenever the shoots are firm enough.

Ruscus. *Liliacæ*.

Increased by root suckers; also by seeds, when obtainable.

Russelia. *Scrophulariaceæ*.

Green cuttings under glass is the common method of propagation; seeds may be used, if to be obtained.

Ruta (Rue). *Rutacæ*.

Propagated readily by seeds; also handled by division and cuttings. For meadow rue, see *Thalictrum*.

Sabal (Palmetto). *Palmaceæ*.

Handled by seeds; also by suckers, which should be taken when about one foot long. If suckers have no roots, they must be carefully handled. See *Palms*, page 377.

Sabatia (American Centaury). *Gentianaceæ*.

Raised from seeds, which should be sown thinly in pans, or in a shady border in fall or early spring; also division of old plants.

Saccharum: *Sugar-Cane*.

Saccolabium. *Orchidaceæ*.

Propagation as for *ærides*. See also *Orchids*, page 372.

Sage (*Salvia officinalis*). *Labiata*.

Grown from seeds, sown in spring where the plants are to stand; also by division or layers, but seeds give better plants. Plantations of the common aromatic sweet-herb sage should be renewed every two or three years. Good plants may be grown from cuttings. See *Salvia*.

Sagittaria (Arrowhead). *Alismaceæ*.

Propagated by division, and sometimes by seeds. Some of the species produce underground tubers that may be used for propagation.

Saintpaulia. *Gesneriaceæ*.

Grown easily from seeds. Also from leaf-cuttings taken the end of March and inserted in sand bed, covering only small part of leaf-blade. Sand should not be kept too wet. Handled like sinningia (gloxinia) except that it is not tuber-bearing. See *Gesneriaceæ*, page 318.

Salix (Willow. Osier). *Salicaceæ*.

All the willows grow readily from cuttings of ripe wood of almost any age. Cuttings are usually taken in autumn; they may be put in the ground at once or cellared until spring. The low and weeping varieties are top-worked on any common upright stocks. Kilmarnock (weeping form of *Salix Caprea*), Rosmarinifolia (*S. incana*), and other named varieties are worked on cutting-grown stocks of *S. Caprea*. Seeds planted as soon as the capsule opens may also be employed; if sown on moss in pans or boxes and not covered, they germinate readily and soon make good plants.

Salpichroa. *Solanaceæ*.

Increased by cuttings of half-ripened shoots in sand, under bell-glass; also by seeds when obtainable.

Salpiglossis. *Solanaceæ*.

Propagated by seeds in open air, or in the North they should be started under glass in spring.

Salsify (Vegetable Oyster), *Tragopogon porrifolius*. *Compositæ*.

Raised from seeds, sown in spring where the plants are to remain; hardy; plants may remain in ground all winter. See also *Scolymus*, *Scorzonera*.

Salvia. *Labiataæ*.

Increased by seeds, usually started indoors; also by soft cuttings under glass. The common scarlet sage (*S. splendens*) although perennial is treated as annual; seeds started under glass or in a window in spring produce fine subjects for late summer and fall. Some of the salvias are annuals. For *S. officinalis*, see *Sage*.

Sambucus (Elder). *Caprifoliaceæ.*

Increased by seeds, handled like those of raspberries and blackberries. Named kinds are grown from cuttings of mature wood, greenwood or root-cuttings, and by layers or suckers.

Samphire (*Crithmum maritimum*). *Umbelliferæ.*

Propagated by seed sown as soon as ripe, and by root-division.

Sanchezia. *Acanthaceæ.*

Cuttings of green wood.

Sanguisorba (Burnet). *Rosaceæ.*

Increased by seeds and division.

Sansevieria. *Liliaceæ.*

Propagated by division ; also by leaf-cuttings about 3 inches long, and by suckers.

Sapindus (Soapberry). *Sapindaceæ.*

Multiplied by seeds, and by hardwood cuttings in early spring.

Sapium. *Euphorbiaceæ.*

Propagated by seeds or cuttings ; the various varieties may be top-grafted on seedling stocks.

Sapodilla (*Achras Sapota*). *Sapotaceæ.*

Propagated by seeds planted in shallow flats of light sandy soil, covering to a depth of one-half inch. Shield-budding is also practiced, to perpetuate the best varieties on common seedling stocks, May being the best time for the work in Florida.

Saponaria (Bouncing Bet. Soapwort). *Caryophyllaceæ.*

Propagated by seeds and by division. The hardy annual and biennial kinds may be sown in the open where the plants are to bloom.

Sarracenia (Pitcher-Plant. Side-Saddle Flower). *Sarraceniaceæ.*

Multiplied by dividing the crowns ; also by seeds, sown with chopped sphagnum on moist sandy muck.

Sassafras. *Lauraceæ.*

Handled by seeds sown as soon as ripe, by the abundant suckers and by root-cuttings.

Satureia (Savory). *Labiataæ.*

Propagated by seeds, sown where the plants are to remain ; also by division and cuttings of the young growths.

Satyrium. *Orchidaceæ.*

Division of the plants or roots as new growth begins. See *Orchids*.

Sauromatum. *Araceæ.*

Increased by offsets. See *Araceæ*, page 239.

Saxifraga (Saxifrage. Rockfoil). *Saxifragaceæ.*

Propagated by seeds, division and in some species (as *S. sarmen-tosa*, the "strawberry geranium") by runners. Certain species make bulblets, which propagate the plant.

Scabiosa (Mourning Bride. Pin-Cushion Flower). *Dipsacaceæ.*

Annuals and perennials increased by seeds, usually sown in the open, and sometimes by division. The common annual flower-garden scabious (*S. atropurpurea*) is sometimes started indoors although good results are had by sowing out-of-doors.

Schaueria. *Acanthaceæ.*

Propagated by cuttings, as for jacobinia.

Schinus (California Pepper-Tree). *Anacardiaceæ.*

Grown from seeds, which are freely produced. In greenhouses, cuttings of firm wood may be used.

Schismatoglottis. *Araceæ.*

Increased by division. See *Araceæ*, page 239.

Schizandra. *Magnoliaceæ.*

Propagation is by layers; by ripened cuttings, which should be inserted in sand under glass; by root-cuttings and suckers; also by seeds when procurable.

Schizanthus. *Solanaceæ.*

Annuals, increased by seeds sown indoors in spring. For winter and spring flowering under glass, seed may be sown in fall and plants kept in a light house.

Schizophragma. *Saxifragaceæ.*

Propagated by seeds, greenwood cuttings under glass, and layers.

Schizostylis. *Iridaceæ.*

Multiplied by seeds and by division.

Schlumbergera. *Cactaceæ.*

Propagation as for zygocactus, which see.

Schomburgkia. *Orchidaceæ.*

Propagated by parting or dividing the stems. See *Orchids*, page 372.

Sciadopitys (Umbrella Pine). *Pinaceæ.*

Propagated by seeds and layers. Cuttings of the half-ripened shoots, taken in summer and inserted in sand, in heat, root readily. Seeds, if obtainable, give best results.

Scilla (Squill). *Liliaceæ.*

Slowly increased by seeds, but usually by bulbels or offsets, taken after the foliage has matured. See *Liliaceæ*, page 349.

Scirpus. *Cyperaceæ.*

Increased by seeds, suckers and divisions.

Scolymus (Spanish Salsify). *Compositæ.*

Raised from seed sown in spring where plants are to stand.

Scorzonera (Black Salsify). *Compositæ.*

Grown from seeds, sown where the plants are to stand.

Scutellaria (Skullcap). *Labiataæ.*

The herbaceous species are increased by seeds and division, and the shrubby kinds by cuttings of half-ripened shoots in spring.

Seaforthia elegans: *Archontophænix.***Sea-Kale** (*Crambe maritima*). *Cruciferaæ.*

Raised from seeds (globular pods) sown without being shelled, usually in a seed-bed. When the young plants have made three or four leaves, they should be removed to permanent quarters. Seedlings should furnish crops in three years. Increased also by root-cuttings, 4 or 5 inches long, taken from well-established plants. These should give plants strong enough for cutting in two years.

Sechium (Chayote). *Cucurbitaceæ.*

The entire fruit is planted in early spring; it contains one large seed.

Sedum (Orpine. Stonecrop). *Crassulaceæ.*

Handled by seeds, by division of the tufts, by cuttings of stems or leaves in spring. Pieces of the plant usually grow readily, as cuttings. Some of the kinds produce offsets.

Selaginella. *Selaginellaceæ.*

Propagated by spores, as for ferns (which see) and by short cuttings, inserted in early spring, in pots or pans. The cuttings of

S. Emmeliana (one of the best kinds) should be scattered thinly over the surface of the soil, covered with glass and kept in temperature of 70°; they will soon form roots and little plants at almost every joint.

Selenicereus. *Cactaceæ.*

For propagation, see *Cacti*, page 261.

Selenipedium: *Phragmopedilum*; see *Orchids*, page 372.

Sempervivum (Houseleek). *Crassulaceæ.*

Readily increased by seeds, and by the young plants (offsets) that cluster around the base.

Senecio (Groundsel. Ragweed). *Compositæ.*

A multifarious group of annual and perennial herbs and subshrubs. Seeds usually are freely produced and grow readily. The perennials may be divided. Stem-cuttings and root-cuttings may be used. German ivy (*Senecio mikanioides*) is easily multiplied by cuttings of the running shoots.

Sequoia, Wellingtonia (Redwood). *Pinaceæ.*

Propagated by seeds handled in a frame or half-shady place or by layers, and cuttings treated like those of retinospora and yew. The redwood (*S. sempervirens*) reproduces itself in nature by stump-sprouts as well as by seeds; the big tree (*S. gigantea*) only by seeds.

Serissa. *Rubiaceæ.*

Handled by cuttings, under glass; by seeds, when procurable.

Sesamum (Bene). *Pedaliaceæ.*

Grown from seeds, sown under glass, or in the South in the open border.

Sesbania. *Leguminosæ.*

The annuals increased by seeds; the shrubby kinds by firm cuttings under glass.

Shallot (*Allium ascalonicum*). *Liliaceæ.*

Grown from "cloves," formed by the breaking up of the main bulb.

Shepherdia. *Elæagnaceæ.*

Propagated by seeds sown in the fall or stratified until spring. See *Buffalo-berry*.

Shortia. *Diapensiaceæ.*

Propagated by seeds when they can be collected, by division and runners.

Sibiræa. *Rosaceæ.*

As for spiræa, with which it is frequently united: seeds and layers.

Sicana. *Cucurbitaceæ.*

Annual frost-tender vines, grown from seeds.

Silene (Campion. Catchfly). *Caryophyllaceæ.*

Propagated by seeds, division and cuttings. Seeds are sometimes sown in autumn, of the annual kinds, to insure early bloom.

Silphium (Rosin Plant. Compass Plant). *Compositæ.*

Multiplied readily by seeds and by division.

Sinningia. *Gesneriaceæ.*

The only well-known member of the group is the gloxinia of horticulturists, which see.

Sisyrinchium (Blue-Eyed Grass). *Iridaceæ.*

Increased in spring by seeds and by division.

Skimmia. *Rutaceæ.*

Increased by seeds, sown in fall or stratified, in a frame; also by layers, and by firm cuttings in heat.

Skirret (*Sium Sisarum*). *Umbelliferæ.*

Increased by seeds, sown in spring or fall, offsets, or division of the plants.

Smilax (Green-Briar). *Liliaceæ.*

Young plants are obtained by seeds, by layers, and by division. For "smilax" or Boston-vine of florists, see *Asparagus*, page 244.

Snapdragon: *Antirrhinum.***Sobralia.** *Orchidaceæ.*

Grown by division of strong plants when repotting. See *Orchids*.

Solandra. *Solanaceæ.*

Multiplied by seeds sown in spring; by cuttings of firm young shoots taken with a heel and placed in slight bottom heat.

Solanum. *Solanaceæ.*

The annuals, and most of the other species, are raised from seeds sown where plants are to stand, or the foliage kinds started indoors. The Jerusalem cherry (*S. Pseudo-capsicum*) is grown readily from seeds; also from cuttings. The tuberous kinds may be increased by tubers, or division of them. The greenhouse shrubby plants may be propagated by softwood cuttings in a frame. See *Potato, Eggplant.*

Soldanella. *Primulaceæ.*

Propagated by seed and division.

Solidago (Goldenrod). *Compositæ.*

Readily grown from seed, blooming the second year. Mature plants may be divided in fall or spring.

Sollya. *Pittosporaceæ.*

Propagated freely by seeds, and by cuttings in sand under glass.

Sonerila. *Melastomaceæ.*

Multiplied by seeds; also by cuttings in a frame in a house. Also increased by leaves, giving the same treatment as for bertolonia.

Sophora. *Leguminosæ.*

Increased by seeds, layers and cuttings of either ripened or green wood. The named varieties are grafted on common stocks.

Sophronitis. *Orchidaceæ.*

Propagated by division, just as growth begins. See *Orchids*, page 372.

Sorbaria. *Rosaceæ.*

Propagated by hardwood cuttings, root-cuttings, suckers and seeds, as for spiræa, with which the group is sometimes united.

Sorbus. *Rosaceæ.*

Propagated by seeds sown in fall or stratified, and by layers. Varieties are budded or grafted on allied species, usually *S. Aucuparia*, *S. americana*, and even on hawthorn. Sorbus is a polymorphous group, including the mountain ashes and service trees.

Sorghum: *Holcus.***Sorrel** (*Rumex*, several species). *Polygonaceæ.*

Multiplied by seeds and division. The cultivated kinds are grown as pot-herbs.

Soybean (*Glycine Soja*). *Leguminosæ*.

Grown from seeds sown where the plants are to stand; frost-tender. Two to three pecks of seed are required for an acre in drills, and a bushel or more broadcast.

Sparaxis. *Iridaceæ*.

Propagation is usually by offsets; also by seeds.

Sparmannia. *Tiliaceæ*.

Handled by cuttings of half-ripened wood, as tips of young shoots, in spring.

Spartium. *Leguminosæ*.

Propagated by seeds and by greenwood cuttings under glass.

Spathiphyllum. *Araceæ*.

Propagated mostly by division of the rootstocks; also by seeds when procurable. See *Araceæ*, page 239.

Specularia (Venus' Looking-Glass). *Campanulaceæ*.

The common annual specularias are easily grown from seeds sown where the plants are to bloom, or they may be started indoors.

Sphæralcea (Globe Mallow). *Malvaceæ*.

Propagated by seeds; by greenwood cuttings.

Sphærogyne: *Tococa*.**Spinach** (*Spinacia oleracea*). *Chenopodiaceæ*.

Raised from seeds, sown usually where the crop is to stand, either in fall or spring. Sometimes started in hotbeds for early crop, and transplanted to field or allowed to mature in the frame. The plant is hardy, and in the intermediate climates will stand in field over winter if six to nine weeks old when freezing weather sets in.

Spiræa. *Rosaceæ*.

Propagated by seeds, sown as soon as ripe or stratified till spring. Commonly increased by cuttings, either of mature or green wood. Green cuttings usually make the best plants. These are made in summer and handled in frames. Some sorts are grown from layers in spring. The herbaceous kinds are often increased by division, but these kinds are now referred to other genera, as *Filipendula* and *Aruncus*. Plants forced in winter give excellent cutting-wood, which should be taken when the growth is completed. Genera formerly included in *Spiræa* are *Chamæbatia*, *Holodiscus*, *Physocarpus*, *Sibiræa*, *Sorbaria*, and others.

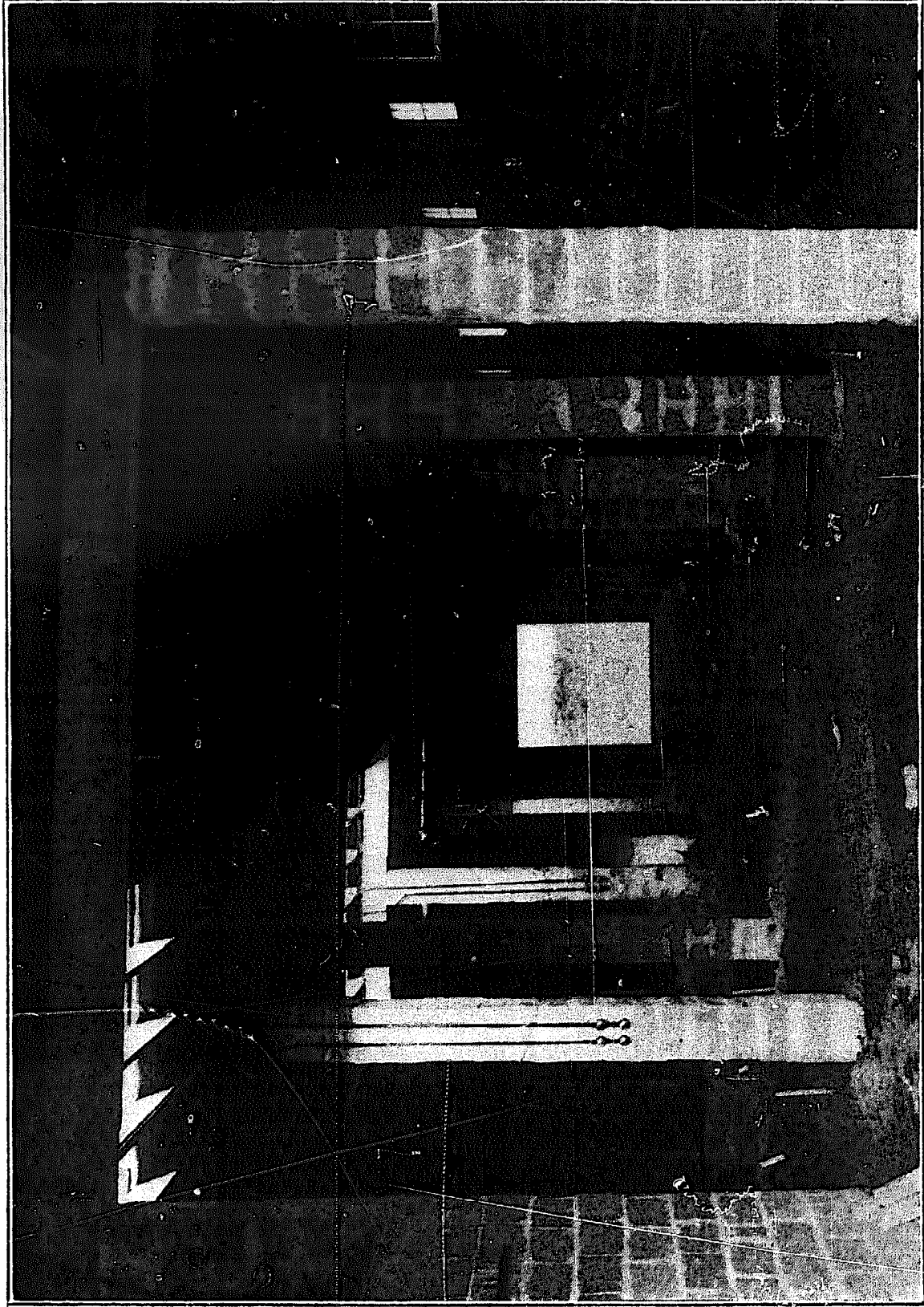

PLATE XII. Nursery packing-room, ready for equipment.

Spondias (Hog-Plum. Otaheite-Apple or -Plum). *Anacardiaceæ*.

Propagated by seeds sown in flats of light soil, covering to a depth of 1 inch; by cuttings of growing wood.

Sprekelia. *Amaryllidaceæ*.

By offsets from the bulbs; also by seeds when obtainable, as for amaryllis, which see.

Spurry (*Spergula sativa*). *Caryophyllaceæ*.

Seeds, sown where plants are to grow; for broadcast field cultivation, 6 to 8 quarts are sown to the acre; annual, tending to become a weed.

Squash (*Cucurbita*, three species). *Cucurbitaceæ*.

Propagated by seeds, when the weather becomes warm.

Stachys, Betonica (Hedge Nettle. Woundwort). *Labiataæ*.

Multiplied by seeds, divisions or cuttings; some species (as the crosnes, chorogi, *S. Sieboldii*) increased by subterranean tubers.

Stanhopea. *Orchidaceæ*.

Increased by division of the old roots. See also *Orchids*, page 372.

Stapelia (Carrion Flower). *Aselepiadaceæ*.

Propagated by seeds when procurable; commonly by cuttings in heat.

Staphylea (Bladder-Nut). *Staphyleaceæ*.

Increased by seeds, sown as soon as ripe or stratified until spring; by suckers, layers, and cuttings of roots and of mature wood; also by greenwood cuttings from pot-grown plants.

Statice (Sea-Lavender. Sea-Pink). *Plumbaginaceæ*.

The limoniums are now included in Statice. The genus comprises annual, biennial and perennial herbs. All are grown from seeds, and the perennials also by division of the clumps. Certain showy species are sometimes grown under glass, and these may be increased by cuttings. Recent writers define Statice as comprising *Armeria*, while the statices of gardens (with open inflorescence) become *Limoniums*; propagation similar for all.

Staurostigma (*Asteriostigma*). *Araceæ*.

Raised from seeds in heat; also by division of tubers. See *Araceæ*.

Stenotaphrum (St. Augustine Grass). *Gramineæ*.

Propagation is mostly by cuttings or parts of the creeping rhizomes.

Stephanotis. *Asclepiadaceæ*.

Multiplied by seeds when obtainable; also by cuttings of half-ripe wood in spring or at other times under a frame in the greenhouse.

Sterculia. *Sterculiaceæ*.

Increased by seeds and by ripened cuttings. The commonest species, *S. platanifolia* but preferably to be called *Firmiana simplex*, seeds freely in the southern states; it is the Japanese varnish tree.

Sternbergia. *Amaryllidaceæ*.

Increased by offsets; also by seeds when they can be obtained.

Stewartia (Stuartia). *Ternstræmiaceæ*.

Grown by seeds sown soon after maturity; also by layers, and by cuttings of various degrees of maturity under cover in summer.

Stigmaphyllon. *Malpighiaceæ*.

Propagates well by means of firm cuttings in autumn; seeds may be employed, if obtainable.

Stillingia. *Euphorbiaceæ*.

Easily handled by imported seeds or by cuttings placed in sand in heat.

Stipa. *Gramineæ*.

Propagated by seeds, or by division of established plants.

Stizolobium: *Velvet Bean*.**Stocks:** *Matthiola*.**Stokesia.** *Compositæ*.

Grown from seeds and by division; blooms second year from seed.

Strawberry (*Fragaria*). *Rosaceæ*.

New kinds are produced from seeds, which are usually sown as soon as the berries are dead ripe. The berries are crushed and the seeds separated by rubbing the pulp in dry sand, which is then sown with the seeds.

Varieties are commonly increased by offsets, or plants formed at the joints of runners. These runners appear after the fruit is off (Fig. 58). The ground should be soft and somewhat moist, to enable

the young plants to obtain a foothold. Plants strong enough for setting are obtained in August and September of the same year in which they start. Ordinarily, the runners will take root without artificial aid; but in hard soils, or with new or scarce varieties, the joints are sometimes held down with a pebble or bit of earth, or are bedded in — the tips inserted into the ground — with a trowel. The runners from a bed that has borne fruit are not likely to be as vigorous and desirable as runners from maiden plants — those that have not yet fruited. New varieties are often propagated throughout the season from plants that are highly cultivated, and which are not allowed to fruit. In commercial propagation, the ratio of increase of different varieties is from fifteen to forty strong runners from one plant set in the spring. Very strong plants are obtained by growing them in pots. A 3-inch pot is sunk below the runner, preferably one from a maiden plant, and the joint is held upon it by a stone or clod. The runner is then pinched off, to prevent further growth, and to throw all its energy into the one plant. The pot should be filled with soft rich earth. Shouldered pots are best, because they can be raised more easily than others, by catching the spade or trowel under the shoulder. The plants will fill the pots in three or four weeks, if the weather is favorable. Old tin fruit-cans, which have been heated to remove the bottoms, old berry boxes and small squares of inverted sod can also be used.

Cuttings of the tips of runners are sometimes made and handled in a frame, as an additional means of rapidly increasing new kinds. These cuttings may be the cast-away tips left from the heading-in or checking of the runners.

Propagation by division of the old crown is practiced only to save the stock of a rare variety that is threatened with extinction and with varieties that make few or no runners, as the bush Alpines and Pan-American.

For forcing strawberries under glass, the first strong runners of the season are rooted in 2-inch or 3-inch pots plunged under them, being sure that the pots contain soil of prime quality. As soon as the pots are filled with roots they are lifted, and the plants are transferred to the 6-inch pots in which they are to fruit. These fruiting pots are then plunged to the rim in coal ashes or other material that will maintain uniform conditions in the pot and yet not allow the plants to root through the bottom. The plants should be well rooted in the pots, and with strong crowns, when ripened in fall, preparatory to the winter forcing.

Strelitzia (Bird-of-Paradise Flower). *Musaceæ*.

Grown by seeds, which usually are produced only when flowers are artificially pollinated; more commonly by suckers, and sometimes by division of the plant.

Streptocarpus (Cape Primrose). *Gesneriaceæ*.

Readily propagated by seeds and by division; also by leaf-cuttings. Seeds should not be covered too deep, and put in open sunny place in intermediate temperature. See *Gesneriaceæ*, page 318.

Streptosolen. *Solanaceæ*.

Propagated by cuttings, much as for geraniums.

Strobilanthes, including Goldfussia. *Acanthaceæ*.

Increased by seeds and cuttings, the latter taken of green wood and started under glass.

Styrax (Storax). *Styracaceæ*.

Raised from seeds, which must be stratified, or else sown as soon as ripe. They usually lie dormant the first year. Also increased by layers and some species by cuttings of green wood. They can be grafted on other storaxes, or on *Halesia carolina*.

Sugar-Cane (*Saccharum officinarum*). *Gramineæ*.

Increased by cuttings of the stems. The cuttings should have a node or joint which bears one or more good buds. These cuttings are planted directly in the field, and the plants will reach maturity in two or three months. Propagation by seeds was once supposed to be impossible, but it is now so raised in Cuba, and in the British West Indies, where the plant produces seed.

Sunflower (*Helianthus* sp.). *Compositæ*.

The common garden and field sunflower is raised from seeds planted where the plant is to grow. Perennials are also grown from seeds as well as by division. Some species increase naturally by rhizomes and tubers. See *Helianthus*; also *Artichoke* (*Jerusalem*).

Swainsona. *Leguminosæ*.

Propagated by cuttings; those taken in late winter bloom in summer; for winter bloom cuttings may be made in spring and summer.

Sweet Pea (*Lathyrus odoratus*). *Leguminosæ*.

Raised from seed, sown either in fall or spring where the plants are to be grown, or rarely in pots and transplanted to the open for early bloom or special varieties. For winter blooming under glass a

special strain or race has been developed; seeds started in September give blooming plants before Christmas if the growing conditions are right. See *Lathyrus*.

Sweet Potato (*Ipomoea Batatas*). *Convolvulaceæ*.

Sweet potato plants do not seed; they are grown in hotbeds, coldframes or forcing-houses (depending on the latitude) from sound tubers of medium size. The tuber is laid on a sandy or other loose bed, and is then covered with sand or sandy loam to a depth of 1 or 2 inches. Sometimes, to guard against rot, the tubers are not covered until the sprouts begin to appear. The tubers may be laid thickly on the bed, but they are less likely to rot if they do not touch each other. Sometimes the tubers are cut in two lengthwise, the cut surface being placed down, in order to place all the plant-giving surface uppermost. In four or five weeks the young plants — 3 to 5 inches high — are pulled off and planted, and others soon arise to take their places. One hand should be held firmly on the soil over the tuber, while the sprout is pulled off, to keep it in place. Three or four crops of sprouts may be obtained from each tuber.

Sweet William (*Dianthus barbatus*). *Caryophyllaceæ*.

Raised from seeds, sown indoors or in the border, and by division of the plants. Best results are obtained by starting new seedlings every other year.

Symphoricarpos (Snowberry. Indian Currant). *Caprifoliaceæ*.

Propagated by seeds, handled like those of blackberries; also by suckers, divisions and both hardwood and greenwood cuttings.

Symphytum (Comfrey). *Boraginaceæ*.

Increased by seeds and by division; also easily by root-cuttings.

Symplocos. *Symplocaceæ*.

Propagated by seeds, cuttings of green wood under glass, and layers. Seeds usually germinate the second year.

Syringa (Lilac). *Oleaceæ*.

New varieties and stocks are grown from seeds, which are usually stratified until spring; and the main specific types are sometimes grown in quantity this way. Green cuttings, handled in frames in spring and summer, are largely used. Cuttings of mature wood will grow; also cuttings of the roots. Layers and suckers are often employed. Varieties are extensively grafted or budded on privet (*Ligustrum*) and common lilacs. Flute-budding is occasionally

employed. Lilacs will grow for a time when worked on the ash. Grafting succeeds when performed in the open air. Grafting (vener method) is usually a spring operation and budding a summer operation. The "syringa" of common speech is *Philadelphus*.

Tabernæmontana. *Apocynaceæ.*

Propagated by greenwood cuttings.

Tagetes (Marigold). *Compositæ.*

Grown from seeds, sown either indoors or out; hardy annuals as known in flower-gardens. The pot marigold is *Calendula*.

Tamarindus (Tamarind). *Leguminosæ.*

Commonly grown from seeds. Varieties may be layered by the so-called Chinese or gootee method (air-layering), and probably by shield-budding on common seedling stocks.

Tamarix (Tamarisk). *Tamaricaceæ.*

Generally increased by ripe cuttings in the open or by greenwood cuttings under glass; also by seeds, which should be only slightly covered.

Tangelo. *Rutaceæ.*

Hybrids of tangerine and pummello, propagated as for citrus.

Tansy (*Tanacetum*). *Compositæ.*

Propagated readily by dividing the old clumps.

Taro: *Colocasia.*

Tarragon (*Artemisia Dracunculus*). *Compositæ.*

An aromatic perennial herb, multiplied chiefly by division or cuttings of old and green wood. Seeds may be used, but are not often produced.

Taxodium (Bald Cypress). *Pinaceæ.*

Seeds sown in spring are usually employed. Layers and cuttings of young wood in wet sand, or even water, under cover, are also used. The varieties may be veneer-grafted in spring on *T. distichum*.

Taxus (Yew). *Taxaceæ.*

Propagated by seeds, sown when gathered or else stratified (germinating second year); also by layers and cuttings of green wood under glass in summer, or of mature wood, as recommended

for retinospora (*chamæcyparis*). The named varieties are veneer-grafted in winter under glass or sometimes in spring or early fall on the upright kinds. Cuttings usually produce shrubby rather than arboreous forms. Fig. 96.

Tea: *Thea*.

Tecoma. *Bignoniaceæ*.

Propagated by seeds and greenwood cuttings under glass. See *Campsis*, to which the trumpet-creeper is now referred by many authors.

Tecomaria. *Bignoniaceæ*.

Propagated by seeds and cuttings under glass in spring or mid-summer, as for bignonia and campsis.

Telanthera: *Alternanthera*.

Terminalia (Tropical Almond). *Combretaceæ*.

Propagated by the large seeds.

Ternstrœmia. *Ternstrœmiaceæ*.

Grown from seeds, and from partially ripe cuttings.

Testudinaria (Elephant's Foot). *Dioscoreaceæ*.

Grown from imported roots or seeds. A long time is required to grow plants of any size from seeds.

Tetragonia (New Zealand Spinach). *Aizoaceæ*.

Grown from seed; for outdoor planting started in January or February indoors; for a forcing-house crop sown in July. Sometimes sows itself in the South.

Tetrapanax. *Araliaceæ*.

The plant usually known as *Fatsia papyrifera* is better called *Tetrapanax papyrifera*: propagated by seeds when these can be obtained, and by greenwood cuttings under glass.

Teucrium (Germander). *Labiataæ*.

Grown from seed as are other herbaceous perennials; also by division of the plants or of slender rhizomes.

Thalictrum (Meadow Rue). *Ranunculaceæ*.

Propagated by seeds, and more commonly division of the roots in early spring.

Thea (Tea). *Ternstræmiaceæ* or *Theaceæ*.

Propagation as for camellia, which see. As grown in the southern United States, the tea plant of commerce is raised from seeds sown in late winter or early spring in nursery rows, the plants being transferred to the plantation when a foot or more high.

Thelesperma. *Compositæ*.

One flower-garden annual is commonly grown, as *Cosmidium Burridgeanum*, supposed to be a hybrid of *T. trifidum* and a coreopsis: readily raised from seeds sown directly in the open or indoors and transplanted.

Theobroma (Chocolate-Tree). *Sterculiaceæ*.

Chiefly important as including *T. Cacao*, the source of cocoa and chocolate; propagated by seeds sown before being dried.

Thespesia. *Malvaceæ*.

Grown from the seeds.

Thevetia. *Apocynaceæ*.

Propagated by seed, or in the greenhouse by cuttings. *T. nereifolia* is the "yellow oleander" of Florida.

Thrinax. *Palmaceæ*.

Propagation by seeds in heat. See *Palms*, page 377.

Thuja, including *Biota* (Arbor-Vitæ. White Cedar, erroneously). *Pinaceæ*.

Propagated by seeds, which should be gathered as soon as ripe (in the fall) and stratified or sown at once; shade the seedlings the first year. Also increased by layers, cuttings of green shoots in summer in a cool frame and cuttings of ripe wood, as recommended for *retinospora*. The named varieties are often grafted on potted common stocks in winter or early fall.

Thujopsis. *Pinaceæ*.

Propagated by seeds, cuttings and grafting, as for thuja.

Thunbergia. *Acanthaceæ*.

The flower-garden plant usually treated as an annual (*T. alata*) grows readily from seeds. It is also grown under glass, as are other species, from seeds and by cuttings taken from shoots after the plant has been cut back in winter, as for allamanda.

Thunia. *Orchidaceæ.*

As the form of the pseudobulbs suggests, this genus is easily propagated by cuttings. These are made about 6 inches long and inserted in pots of sand. After standing in an ordinary propagating-frame or moist greenhouse for a short time, young growths will appear at the nodes. When large enough, they are taken up and potted in ordinary compost. Two years, at least, are needed for them to attain to flowering size, but this is the best method when a large number of plants are wanted. See also *Orchids*, page 372.

Thymus (Thyme). *Labiataæ.*

Increased by seeds and division.

Thyrsacanthus (properly *Odontonema*). *Acanthaceæ.*

Increased by seeds; also by greenwood cuttings under a frame.

Tibouchina. *Melastomaceæ.*

Handled by cuttings of the growing wood under glass.

Tigridia (Tiger Flower). *Iridaceæ.*

Increased by seeds, but generally by offsets from the corms.

Tilia (Basswood. Linden). *Tiliaceæ.*

Grown from seeds planted as soon as ripe or stratified and sown in spring; if kept dry over winter they will remain dormant till the second year. Layers may be made, and cuttings employed, but the named sorts are usually grafted in spring or budded in summer on common stocks. Mound-layering is sometimes practiced.

Tillandsia. *Bromeliaceæ.*

Propagated mostly by suckers (offsets); sometimes by seeds. *T. usneoides* is the "Spanish moss" of the South; rarely propagated, but may be grown from seeds or division of the moss.

Tobacco. *Solanaceæ.*

Grown from seeds started in beds; page 366.

Tococa (usually known as *Sphærogyne*). *Melastomaceæ.*

Propagation by single-eye cuttings in January is a good method. Split the stems, make single-eye cuttings; shorten back the leaves to within about 2 inches of the leaf-stalk; leave about $2\frac{1}{2}$ inches of woody stem; place firmly in sand of propagating-bed and cover with glass; pot in thumb-pots and keep close for a time. May also be propagated by taking the base of the shoot with a piece of the stem attached, rooting in a high moist temperature with shade.

Tomato (*Lycopersicum esculentum*). *Solanaceæ*.

Raised from seeds, usually started under glass. Cuttings of growing shoots, rooted under glass, like fuchsias, may be employed for special purposes.

Torenia. *Scrophulariaceæ*.

Grown from seeds, sown indoors or in the open, and from cuttings in a frame.

Torreya. *Taxaceæ*.

Increased by seeds, cuttings and by grafting on cephalotaxus; cuttings root readily, so that there is little necessity for grafting.

Trachelium (Throatwort). *Campanulaceæ*.

Propagated by seeds sown in spring and by cuttings.

Trachelospermum, Rhynchospermum. *Apocynaceæ*.

Propagation by seeds, and usually by cuttings of half-ripened wood taken with a heel in spring.

Trachycarpus. *Palmaceæ*.

Propagated by seeds and suckers. See *Palms*, page 377.

Tradescantia. *Commelinaceæ*.

Increased usually by cuttings of the growing shoots; also by seeds and division. See *Zebrina*.

Tragopogon: *Salsify*.

Trapa (Water Caltrops). *Trapaceæ* or *Onagraceæ*.

Increased by seeds which must be kept moist to retain their vitality.

Trichopilia. *Orchidaceæ*.

Increased by division of the plants. See also *Orchids*, page 372.

Trichosanthes (Snake Gourd). *Cucurbitaceæ*.

Propagated by seeds, either indoors or out, sown in March; frost-tender.

Trichosporum, Æschynanthes. *Gesneriaceæ*.

Handled by cuttings of the firm partially ripened shoots of the season, cut to two or three joints and with two leaves attached; place in close frame with temperature of about 70°.

Tricyrtis. *Liliaceæ.*

Seeds rarely; increased mostly by offsets and division. These plants may now be known as *Compsoa*.

Trifolium. *Leguminosæ.*

The clovers are grown from seeds sown where the plants are to stand. See *Clover*.

Trillium (Birthwort. Wake-Robin). *Liliaceæ.*

Seeds sown as soon as ripe should give flowering plants in two or three years. Usually multiplied by the natural increase of the rhizomes.

Triteleia: *Brodiaea.***Tritoma:** *Kniphofia.***Tritonia**, including *Montbretia.* *Iridaceæ.*

Raised from seeds, but generally increased by division of the plants.

Trollius (Globe-Flower). *Ranunculaceæ.*

Propagated by fresh seed, which should give blooming plants the following year; also by division of the clumps.

Tropæolum (*Nasturtium.* Canary-bird Flower). *Tropæolaceæ.*

Increased by seeds, started indoors or sown in the garden; tuberiferous species by tubers or division of roots; perennials sometimes by cuttings under glass.

Tsuga (Hemlock). *Pinaceæ.*

Propagated by seeds sown in spring and by grafting on *T. canadensis*. The varieties and Japanese species may also be raised from cuttings.

Tulipa (Tulip). *Liliaceæ.*

Seeds may be sown in boxes of light sandy soil, in late winter, and placed in a coldframe. The next season the young bulbs should be planted in a prepared bed outside, and the following season bloom should be had although a longer period is required before maturity is reached and the full character of the flower develops. Bulbels may be detached from established bulbs when they are lifted, and grown by themselves; this is the usual method. Fig. 43.

Tunica. *Caryophyllaceæ.*

Propagated by seeds and by division.

Turnip (*Brassica Rapa*). *Cruciferae*.

Raised from seeds, where the plants are to remain. For summer use, seeds may be sown very early in spring; but for the main crop sowing is made in July in the northern states.

Typha (Bulrush. Cat-tail. Reed Mace). *Typhaceae*.

Propagated by division of the colonies. They may be grown from seeds in a pot or box of earth set in water.

Udo (*Aralia cordata*). *Araliaceae*.

This Japanese vegetable, consisting of the blanched young shoots, is readily propagated by seeds started in spring under glass, the plants being transferred to the open when 3 or 4 inches high; the following spring they should supply a cutting. Special strains are perpetuated by cuttings of the green shoots, cut to a joint.

Ulex (Furze. Gorse. Whin). *Leguminosae*.

Propagated by seeds sown in spring; by greenwood cuttings under glass, and by cuttings of nearly mature wood in early summer in a coldframe under glass. Varieties are sometimes grafted in spring in the greenhouse on *U. europaeus*.

Ulmus (Elm). *Ulmaceae*.

Commonly propagated by seeds. The seeds of most elms germinate the year they mature (they ripen in spring), and they may be sown at once. The slippery elm (*U. fulva*), however, generally germinates the following year, and the seeds should be stratified. Layers are sometimes put down in autumn in moist, rather light soil, and suckers may be taken. Some species may be raised from greenwood cuttings under glass. The varieties are grafted on common stocks, either by budding in summer or by whip- or splice-grafting in spring outdoors or on potted stock in the greenhouse.

Ursinia. *Compositae*.

A hardy flower-garden annual raised from seeds, started indoors or directly in the open.

Utricularia (Bladderwort). *Lentibulariaceae*.

The floating bladderworts, used in pools and aquaria, are multiplied by division of the plants and by utilizing the winter-buds that fall to the bottom in autumn. The terrestrial tropical kinds usually produce little tubers by which they may be propagated.

Vaccinium (Swamp Huckleberry. Whortleberry. Blueberry. Cranberry). *Ericaceæ*.

Propagated by seeds, layers, root-cuttings, and divisions of the old plants. Some species by hardwood cuttings, for which see cranberry. Huckleberry seeds are small and somewhat difficult to grow. The seeds should be washed from the fruits and stored in sand in a cool place until late in winter. They are then sown in pans or flats on the surface of a soil made of equal parts sand and loam. Cover with fine sphagnum and keep in a cool house or frame, always keeping the seeds moist. Seeds treated in this way may be expected to germinate in a month or two, although they may lie dormant a year. Transplant frequently and keep shaded until large enough to shift for themselves. Layers should be tongued. Cuttings, 2 or 3 inches long, of the best roots, made in fall and placed in mild bottom heat in early spring, often give fair satisfaction. Native plants can be obtained from the woods and fields which will give good satisfaction if small specimens are taken. Gaylussacias are handled in the same way as vacciniums. For the most recent methods of handling this class of plants, see *Blueberry*.

Valeriana (Valerian). *Valerianaceæ*.

Increased by seeds and division.

Valerianella: *Corn-Salad*.

Vallisneria (Eel-Grass). *Hydrocharitaceæ*.

Propagated by the runners at the base of the leaf-tuft.

Vallota (Scarborough Lily). *Amaryllidaceæ*.

Increased by bulbels, which usually appear above the surface of the pot; also by division of the bulbs.

Vanda. *Orchidaceæ*.

The larger number of vandas are propagated in the same way as described for ærides, but two species — *V. teres* and *V. Hookeriana* — both tall and quick growing, may be cut into lengths of a few inches. The practice of the most successful cultivators is to start them every year as cuttings about a foot long. See also *Orchids*, page 372.

Vanilla. *Orchidaceæ*.

Propagation by division and cuttings. The vanilla of commerce (*V. planifolia*) is propagated from long cuttings (from 2 feet to 12

feet long) planted at the base of trees, upon which the plant climbs. See also *Orchids*, page 372.

Velvet Bean (species of *Stizolobium*). *Leguminosæ*.

Frost-tender and requiring a long season, grown only far South; raised from seed sown where the crop is to grow; often planted with Indian corn. Formerly included in the genus *Mucuna*.

Venidium. *Compositæ*.

Increased by seeds, the plants usually being treated as annuals.

Veratrum (False or White Hellebore). *Liliaceæ*.

Grown by seeds and by division.

Verbascum (Mullein). *Scrophulariaceæ*.

Grown readily from seeds sown in the ordinary way; also by greenwood cuttings and division.

Verbena (Vervain). *Verbenaceæ*.

Propagated by seeds sown indoors or in the open; also by cuttings of vigorous shoots; some species by division. The common garden verbena is usually treated as an annual, although often carried over winter by cuttings. Outdoor plants may be cut back in early fall and new growths suitable for cuttings will arise; in this way the particular varieties may be perpetuated.

Vernonia (Ironweed). *Compositæ*.

Raised from seeds, division and cuttings, mostly by division.

Veronica (Speedwell). *Scrophulariaceæ*.

Propagated by seeds and division; shrubby sorts often by cuttings in spring or summer.

Verschaffeltia. *Palmaceæ*.

Grown from imported seeds.

Vesicaria. *Cruciferaæ*.

Annuals propagated by seeds; perennials by division.

Vetch: *Vicia*.

Viburnum. *Caprifoliaceæ*.

Increased by seeds, which should be stratified or sown in fall. They usually remain dormant the first year. Layers usually make excellent plants (Fig. 61). Green cuttings made in summer and

handled in frames give excellent results. *V. tomentosum* (*V. plicatum* of nurseries) is propagated by cuttings. Ripe cuttings are sometimes used for the soft-wooded species. The snowball or guelder-rose (*V. Opulus*) is rapidly increased by layers, and it propagates well by mature cuttings in summer in a frame or propagating-house (Fig. 124). It is also a good stock for closely related species. *V. Lantana*, *V. dentatum* and *V. Opulus* are good stocks on which varieties difficult to handle can be worked by the veneer-graft in winter.

Vicia (Vetch). *Leguminosæ*.

Propagated by seeds sown where plants are to grow. *V. Faba* is the broad or Windsor bean, which is hardy and a cool-season plant, and the large seeds should be planted early in the season. The forage and cover-crop vetches are sown at the rate of 40 to 100 pounds and more to the acre. As a cover-crop in orchards, 30 to 50 pounds are usually advised.

Victoria (Royal Water-Lily). *Nymphæaceæ*.

Grown from seeds. There are two species, one (*V. regia*) requiring a water temperature of 85° to 90° for germination, and the other (*V. Cruziana* or *Trickeri*) a temperature of 65° to 70°. The seed is usually sown in February or March in pots or seed-pans that are set in shallow water. Young seedlings are transferred to small pots, and kept growing continuously until large enough and weather is warm enough for transfer to the tanks for blooming. The victorias are annuals and do not form tubers.

Vigna. *Leguminosæ*.

Increased by seeds; the cow-pea or black-pea (*Vigna sinensis*) by seeds when danger of frost is past.

Vinca (Periwinkle). *Apocynaceæ*.

Increased chiefly by division and by cuttings, also by seeds. *V. rosea* may be propagated annually by seeds.

Viola (Violet. Heartsease. Pansy). *Violaceæ*.

The wild violets may be grown easily from seeds sown in autumn in protected boxes, germination taking place in the spring, the boxes having been exposed to freezing. Dividing the plants is a common method of increase. Some species propagate themselves by runners.

The florist's violet is readily propagated by offsets or separable parts that form in late winter; these are removed and treated as

independent plants, making blooming stock for the following winter. Sometimes the old plant is divided when plants are lifted in spring; this may produce good results, but care must be taken that hard and weak parts are not saved.

Vitex (Chaste-Tree). *Verbenaceæ*.

Propagated by seeds, by suckers, layers, cuttings of green or ripened wood under glass. Cuttings grow with difficulty.

Vitis. *Vitaceæ*.

Propagated by seeds and hardwood cuttings. See *Grape*.

Vittaria. *Polypodiaceæ*.

Propagation by division and spores. See *Ferns*, page 312.

Vriesia. *Bromeliaceæ*.

Propagation as for tillandsia (which see), mostly by offsets or separable parts.

Wahlenbergia. *Campanulaceæ*.

Propagation as for campanula (which see), the annuals by seeds and the others also by division.

Wallflower: *Cheiranthus*.

Wallichia. *Palmaceæ*.

By imported seeds and by suckers. See *Palms*, page 377.

Walnut.

The walnuts are species of *Juglans*, and the propagation is detailed under that entry. The so-called English walnut is *Juglans regia*, much grown in California. Most of the walnut orchards are of seedling trees, grown from selected seeds (or nuts). The introduction of improved varieties, however, has made budding and grafting necessary. The black walnut and butternut (*J. nigra* and *J. cinerea*) are grown mostly as seedlings, but graftage may be employed. See *Juglans*.

Wandering Jew: *Tradescantia*, *Zebrina*.

Washingtonia. *Palmaceæ*.

Propagated readily by seeds. See *Palms*, page 377.

Water-Cress (*Roripa Nasturtium*). *Cruciferae*.

Propagated by cuttings of the young stems, which root in mud with great readiness, or seeds scattered in the water or mud.

Watermelon (*Citrullus vulgaris*). *Cucurbitaceae*.

Propagated by seeds, usually sown where the plants are to remain, after the weather is warm and settled; frost-tender.

Watsonia. *Iridaceae*.

Multiplied by seeds and by offsets

Wigandia. *Hydrophyllaceae*.

Propagated by seeds started indoors in January, and also by root-cuttings.

Wineberry (*Rubus pharicolasius*). *Rosaceae*.

Increases readily by "tips," the same as the black raspberry (see *Raspberry*); also by root-cuttings.

Wisteria (often spelled *Wistaria*). *Leguminosae*.

Readily grown from seeds; sometimes increased by division; also cuttings of ripened wood, usually handled under glass. The common purple and white kinds are largely grown from root-cuttings an inch or two long, placed in bottom heat, when they will start in four or five weeks. Many of the fancy kinds, especially when wood is scarce, are root- or crown-grafted on *W. sinensis*. A good method of propagation is by layers, to which the plants are well adapted.

Witloof (*Cichorium Intybus*). *Compositae*.

A form of chicory, grown for the blanched young shoots. To produce roots for winter and spring forcing, the seed is sown in the open ground in spring as soon as the weather is warm. The roots are lifted before freezing weather in fall, the leaves trimmed to a crown 2 inches long, and stored till wanted.

Wormwood (*Artemisia Absinthium*). *Compositae*.

Hardy perennial, grown from seeds sown as soon as ripe or the following spring; old plants may be divided. See *Artemisia*, *Tarragon*.

Xanthoceras. *Sapindaceae*.

Commonly multiplied by seeds, stratified and sown in spring; root-cuttings in moderate bottom heat are sometimes used.

Xanthosoma. *Araceæ.*

Handled by offsets and by dividing the root-stock. See *Araceæ*.

Xeranthemum. *Compositæ.*

Annuals propagated by seeds, usually sown in the open.

Yucca (Spanish Bayonet). *Liliaceæ.*

Multiplied by seeds and offsets; also by cuttings of stem and rhizome.

Zaluzianskya (Nycterinia). *Scrophulariaceæ.*

Grown from seeds sown indoors in spring or in autumn and plants wintered in a coldframe.

Zamia. *Cycadaceæ.*

Increased by division of the crowns when possible; or by seeds and suckers (offsets). The plants are oftenest imported directly from the tropics. See *Cycas*.

Zantedeschia (Calla of florists). *Araceæ.*

Propagated by offsets, which should be removed and potted when plants are at rest; old crowns may be divided. This is the plant known as *Calla æthiopica* and *Richardia africana*. Some of the zantedeschias are grown from seed. See *Araceæ*, page 239.

Zanthoxylum (Prickly Ash). *Rutaceæ.*

Multiplied by seeds, suckers, but more often by root-cuttings.

Zea: *Maize.***Zebrina** (Wandering Jew). *Commelinaceæ.*

Very easily multiplied by single-joint cuttings of the trailing shoots. These shoots root at the joints if allowed to run on moist earth. This is the wandering jew with reddish foliage and flowers; the green-foliaged and white-flowered one is a tradescantia.

Zenobia. *Ericaceæ.*

Propagated by seeds and layers; also by cuttings of half-ripened wood in July, placed in gentle heat, or by greenwood cuttings from forced plants.

Zephyranthes (Zephyr Flower). *Amaryllidaceæ.*

Multiplied by seeds and by the bulbels or offsets.

Zingiber (Ginger). *Zingiberaceæ*.

Propagated by division of rhizomes in spring.

Zinnia. *Compositæ*.

Annuals, grown from seeds, sown either indoors or out when the weather is settled.

Zizania (Wild or Indian Rice). *Gramineæ*.

Propagated by seeds, sown in water with a soft mud bottom. It is well to place seed in coarse cotton bags and sink them in water for twenty-four hours before planting.

Zizyphus (Jujube). *Rhamnaceæ*.

Propagated by seeds, greenwood cuttings under glass, root-cuttings and offsets (suckers).

Zygadenus. *Liliaceæ*.

Handled by division of rhizomes, and also by seeds.

Zygocactus (Epiphyllum of horticulturists). *Cactaceæ*.

The crab cactus or Christmas cactus (*Z. truncatus* but mostly known as *Epiphyllum truncatum*) is readily grown from cuttings. Pieces of the branches 4 to 6 inches long are placed in sandy soil in gentle heat and kept moderately dry. Zygocactuses are often grafted on strong stocks of pereskia (*Pereskia aculeata* is commonly used, but *P. grandifolia* is equally as good), for the purpose of getting high or rafter plants. A young shoot is cleft- or side-grafted into any part of the pereskia which has become hard, and the cion is held in place by a cactus spine passed through it. Several cions may be inserted along the sides of the stock. See *Cacti*, page 261.

Zygopetalum. *Orchidaceæ*.

Propagated by cutting through rhizomes between old pseudo-bulbs at a good eye. See *Orchids*, page 372.

INDEX

The regular caption-entries in Part II (The Nursery-List) are not indexed here, as they are alphabetic; but all the secondary and non-alphabetic names in the List are included. Sometimes it is an advantage to the propagator to be able to look up all the members of a natural family, to note how they agree and differ among themselves; therefore all the names of families in the Nursery-List are brought together in paragraphs in this index.

- Abutilon Avicennæ*, 23
Acacia diffusa, 23; *pennicervis*, 23;
Rose, 411
Acanthaceæ, 221, 234, 296, 307,
314, 340, 342, 389, 404, 414, 416,
417, 426, 430, 431
Aceraceæ, 221, 365
Achras Sapota, 416
Achyranthes, 339
Acidity, 3
Aconite, Winter, 307
Adamsia, 405
Adder's-Tongue, 309
African Lily, 224
Agaricaceæ, 363
Agaricus campestris, 363
Agathæa, 312
Agrostemma, 353
Air-layering, 76
Aizoaceæ, 360, 429
Akebia quinata, 111
Alcoholic waxes, 171
Alder, 226; White, 283
Alismaceæ, 415
Alkalinity, 3
Allegheny Vine, 223
Allium ascalonicum, 419; *Porrum*, 346;
sativum, 317; *Schænoprasum*, 279;
Scorodoprasum, 411
Allspice, Carolina, 267
Almond, stocks for, 183; Tropical,
429
Alum Root, 332
Amaranthaceæ, 227, 228, 272, 321,
339
Amaranth, Globe, 321
Amaranthus retroflexus, 22
Amaryllidaceæ, 228; 224, 227, 257,
259, 266, 284, 292, 294, 303, 309,
316, 329, 334, 337, 340, 348, 353,
356, 365, 366, 378, 401, 423, 424,
435, 440
Amazon Lily, 309
American Centaury, 414
Anacardiaceæ, 229, 290, 356, 397, 411,
417, 423
Anemone coronaria, 63
Anethum graveolens, 301
Annals of Horticulture, quoted, 28
Annonaceæ, 231, 242, 243
Annular-budding, 136
Anthracnose, 200, 207
Anthriscus Cerefolium, 278
Aphids in nurseries, 209, 210
Aphis pomi, 210; *sorbi*, 210
Apium graveolens, 272
Apocynaceæ, 234; 222, 225, 248, 269,
302, 356, 366, 401, 428, 430, 432, 437
Aponogetonaceæ, 234
Apple, Custard-, 231; leaf-hopper,
213; Mammee-, 356; Otaheite-,
423; powdery-mildew, 197; scab,
196; Star, 281; stocks for, 183
Approach grafting, 119, 166
Apricot, St. Domingo, 356; stocks for,
183

- Aquifoliaceæ, 338, 365
 Araceæ, 239; 222, 224, 226, 229,
 233, 234, 242, 243, 265, 287, 301,
 303, 331, 362, 376, 387, 392, 397,
 403, 417, 422, 423, 440
 Araliaceæ, 221, 240, 302, 311, 319,
 330, 375, 402, 429, 434
Aralia cordata, 434; *quinquefolium*,
 319
 Arbor-Vitæ, 430; Japanese, 409
 Arbutus, Trailing, 306
 Aristolochiaceæ, 242
 Arrowhead, 415
Artemisia Absinthium, 439; *Dracunculus*, 428
 Arthur, J. C., quoted, 27
 Artillery Plant, 394
 Asclepiadaceæ, 243, 274, 336, 357,
 389, 423, 424
 Ash, 315; Prickly, 440
 Aspen, 402
Aspidiotus perniciosus, 213
 Asteriostigma, 423
Atriplex hortensis, 370
 Austria, seeds from, 9
 Autumn Crocus, 286

Bacillus amylovorus, 192
 Bacteria and disease, 192
Bacterium tumefaciens, 194
 Bailey, quoted, 4
 Bald Cypress, 428
 Balloon-Vine, 269
 Balsaminaceæ, 247, 338
 Baltet, quoted, 118
 Barbados Gooseberry, 389
 Barberry, 251
 Bark-grafting, 160
 Barnard's tank, 83, 84
 Barrenwort, 306
 Basellaceæ, 248, 258
 Basswood, 431
 Bastard Cedar, 272
 Bayberry, 364
 Bead-Plant, 366
 Beal, mentioned, 114
 Bean, 391; Castor, 411; Water, 365
 Beard-Tongue, 387
 Bear's Breech, 221
 Beech, 311; Blue, 270
 Beefwood, 271
 Begoniaceæ, 249
 Beinhart, E. G., quoted, 41
 Bell-flower, 267
 Bell-glass, 16, 81
 Bellwort, Giant, 376
 Bene, 419
 Bent-Grass, 224
 Berberidaceæ, 251, 306, 347, 355,
 365
 Betonica, 423
 Betulaceæ, 226, 251, 270, 289, 376
 Bignoniaceæ, 251, 268, 271, 279, 285,
 304, 338, 340, 378, 391, 397, 405,
 429
Bignonia venusta, 405
 Bindweed, 288
 Biota, 430
 Birch, 251
 Bird-of-Paradise Flower, 426
 Birthwort, 242, 433
 Bitter-sweet, 272
 Blackberry anthracnose, 207; Lily,
 250
 Black Hellebore, 332; Salsify, 418;
 spot of rose, 207
 Bladder-Nut, 423; Senna, 287
 Bladderwort, 434
 Blazing Star, 348
 Bleeding-Heart, 300
 Blight, 192
 Blood Flower, 329
 Blue Becch, 270; -Eyed Grass, 420
 Boraginaceæ, 230, 242, 257, 274,
 288, 305, 331, 360, 364, 369, 427
 Boring seeds, 38
 Bottle-Brush, 360
 Bottle-grafting, 144, 164
 Bottom heat, 87
 Bouncing Bet, 416
 Box, 261; Elder, 222, 365; Jasmine,
 391; Thorn, 353
 Boxberry, 317
 Bracken, 404
 Bragg tree-digger, 172
 Brake, 404; Cliff, 387
 Bramble, 413
Brassica alba, 23; *oleracea*, 261; *oleracea*
 var. *acephala*, 286, 343; *oleracea*
 var. *botrytis*, 271; *oleracea* var.
CaULO-Rapa, 344; *oleracea* var. *gem-*
mifera, 260; *Rapa*, 434

- Brazilian Rubber-Tree, 332
 Bread-Fruit, 243
 Bridge-grafting, 160
 Bromeliaceæ, 259; 223, 241, 252, 268,
 293, 304, 329, 334, 367, 394, 397,
 405, 431, 438
Bromus mollis, 23
 Brown, B. S., quoted, 135
 Brugmansia, 299
Bryobia pratensis, 211
 Buckeye, 224
 Buckthorn, 409; Sea, 334
 Budding defined, 113; practice, 121
 Bud-grafting, 118; selection, 186
 Bugbane, 281
 Bugle, 224
 Bulbel, 57
 Bulblet, 61
 Bulbs, described, 56
 Bulrush, 342, 434
 Bureau of Markets, 10
 Burnet, 416
 Burying seeds, 35
 Butomaceæ, 260, 337, 350
 Buttercup, 408
 Butterfly-Pea, 284
 Butternut, 341
 Butterwort, 396
 Button-Bush, 273; Snake-Root, 348
 Buttonwood, 398
 Buxaceæ, 261

 Cabbage Palm, 241
 Cacalia, 305
 Cactaceæ, 261, 273, 274, 304, 305, 307,
 330, 337, 356, 367, 370, 375, 386,
 389, 410, 417, 419, 441
 Cactus, Hatchet, 386
 Calampelis, 304
 Calico Bush, 343
 California Pepper-Tree, 417; Poppy,
 309
 Calipers, 180
 Calliopsis, 288
 Callus, 95
 Calycanthaceæ, 267, 359
 Cameron, Robt., mentioned, 219
 Campanulaceæ, 267, 351, 376, 393,
 398, 407, 422, 432, 438
Campanula Rapunculus, 407
 Champion, 420

 Canary-bird Flower, 433
 Candleberry, 364
 Candytuft, 338
 Cane, Wild, 243
 Cannaceæ, 268
 Cape Marigold, 302; Primrose, 426
 Caper, 268
 Capparidaceæ, 268, 283, 329
 Caprifoliaceæ, 219, 301, 352, 416,
 427, 436
 Cardamom, 305
 Carob, 273
 Carolina Allspice, 267
 Carrion-Flower, 423
 Carrot, record of, 26
 Carya, 333
 Caryophyllaceæ, 241, 269, 273, 300,
 329, 332, 353, 416, 420, 423, 427, 433
 Cashew, 229
 Castalia, 367
 Castor Bean, 411
 Casuarinaceæ, 271
 Catchfly, 420
 Cat-tail, 434
 Cayenne Pepper, 387
Ceanothus americanus, 23
 Cedar, White, 430
 Celastraceæ, 272, 310
 Celery, record of, 26
 Centaury, American, 414
 Ceratopteridaceæ, 273
Cercis japonica, 111
Cherophyllum bulbosum, 278
 Chætochloa, 361
 Chaste-Tree, 438
 Chayote, 418
 Chemicals for germination, 38
 Chenopodiaceæ, 245, 248, 343, 370,
 422
 Cherries, stocks for, 183
 Cherry, Ground, 393; powdery-mil-
 dew, 199; Winter, 393; yellow-leaf,
 198
 Chestnut, Horse-, 224; stocks for, 183
 Chick-Pea, 281
 Chickweed, Mouse-Ear, 273
 Chicory, mentioned, 23
 Chimonanthus, 359
 China Aster, 266; -Berry, 359
 Chinese laving, 76, 78; Sacred Lily,
 365

- Chinkapin, Water, 365
 Chip-budding, 136
 Chocolate-Tree, 430
 Chokeberry, 242
 Christmas Rose, 332
 Christ's Thorn, 377
Cichorium Endivia, 306; *Intybus*,
 23, 279, 439
 Cinquefoil, 403
 Cion, defined, 113
 Circumposition, 76
 Cistaceæ, 282, 331
Citrullus vulgaris, 439
 Cives, 279
 Cleft-grafting, 119, 146
 Clethraceæ, 283
 Cliff Brake, 387
 Climbing Fern, 354
 Clintonia, 303
 Cloche, 16
 Cloth, waxed, 171
 Clover, Prairie, 390
 Club-Moss, 353
 Cobnut, 289
Coccomyces hiemalis, 199
 Cockscomb, 272
 Cocoa-Plum, 281
 Coffee Tree, Kentucky, 329
 Columbine, 239
 Combretaceæ, 407, 429
 Comfrey, 427
 Commelinaceæ, 285, 287, 300, 432, 440
 Commerce in seeds, 5
 Compass Plant, 420
 Compositæ, 222, 224, 233, 241, 242,
 243, 245, 247, 250, 257, 258, 266,
 269, 270, 271, 273, 275, 279, 280,
 282, 288, 290, 296, 297, 302, 303,
 304, 305, 306, 308, 310, 312, 316,
 317, 318, 328, 329, 331, 332, 333,
 334, 338, 344, 346, 347, 348, 354,
 357, 376, 390, 397, 401, 405, 414,
 415, 418, 419, 420, 421, 424, 426,
 428, 430, 434, 436, 439, 440, 441
 Cone-Flower, 414
 Convolvulaceæ, 241, 267, 288, 339,
 340, 406, 427
 Coquito Palm, 341
 Corallita, 233
 Coral-Tree, 308
 Cork Tree, 391
 Cornel, 62
 Corms, described, 61
 Cornaceæ, 245, 289
 Cornell Experiment Station, 25
Cornus stolonifera, 70
 Cotton, mentioned, 23
 Cottonwood, 402
 Cover-crops for nurseries, 178
 Coville, F. V., quoted, 254
 Cow-Parsley, 332; -Parsnip, 332
 Cowslip, 267, 403
 Crakeberry, 306
Crambe maritima, 418
 Crape Myrtle, 344
 Crassulaceæ, 260, 290, 292, 304, 343,
 412, 418, 419
 Cress, Rock-, 239; Wall-, 239
Crithmum maritimum, 416
 Crocus, Autumn, 286
 Crosswort, 293
 Crowberry, 306
 Crowfoot, 408
 Crown, 66; gall, 194; -grafting, 118,
 119, 136
 Cruciferæ, 228; 230, 239, 245, 260,
 261, 269, 271, 275, 286, 291, 292,
 303, 308, 332, 335, 338, 343, 344,
 353, 355, 358, 364, 407, 418, 434,
 436, 439
Cryptomeria japonica, 106
 Cubeb, 397
 Cucumber, Squirting, 304; Tree, 355
Cucumis Anguria, 318
 Cucurbitaceæ, 293; 220, 250, 260,
 285, 304, 318, 322, 344, 353, 359,
 361, 405, 418, 420, 423, 432, 439;
 seeds of, 23
 Currant anthracnose, 200; Indian,
 427; leaf-spot, 200; worms, 215
 Custard-Apple, 231
 Cuttage, 80
 Cutting-bench, 89, 90
 Cutting-grafting, 164
 Cuttings, chapter on, 80
 Cyanophyllum, 360
 Cyatheaceæ, 227, 295, 301
 Cycadaceæ, 274, 295, 302, 306, 440
 Cyclanthaceæ, 269
Cynara Cardunculus, 269; *Scolymus*,
 242
 Cyperaceæ, 269, 281, 296, 379, 418

- Cyperus esculentus*, 281
 Cypress, 294; Bald, 428; Summer, 343; -Vine, 406
Cytisus albus, 23
 Daffodil, 365
 Daisy, English, 250; Michaelmas, 245; Paris, 357; Swan River, 258
 Dame's Violet, 332
 Daniel, L., mentioned, 117
 Datisceae, 299
Daucus Carota, 270
 Davis, R. A., mentioned, 133
 Day Lily, 332
 Delayed germination, 21
 Denmark, seeds from, 10
 Desert Willow, 279
Dianthus Caryophyllus, 269
 Diapensiaceae, 316, 420
 Dielytra, 300
 Diggers, for trees, 172
 Dilleniaceae, 223, 302
 Diosoreaceae, 302, 429
Diospyros Kaki, 184; *Lotus*, 184; *virginiana*, 184
Diplocarpon rosa, 208
 Dipsacaceae, 417
 Diseases of nursery stock, 192; of soils, 40
 Dish-cloth Gourd, 353
 Dissemination, 1
 Dittany, 301
 Division, 62
 Dog's-tooth Violet, 309
 Dogwood, 289
 Double-working, 167
 Dragon's Head, 303
 Droseraceae, 302, 304
 Dwarfing fruit-trees, 184
 Ebenaceae, 390
 Ebony, Mountain, 248
 Edelweiss, 347
 Eel-Grass, 435
 Egg-nucleus, 1
 Egypt, seeds from, 22
 Elaeagnaceae, 260, 305, 334, 419
 Elder, 416; Box, 222, 365
 Elephant's Foot, 429
 Elichrysum, 331
 Elm, 434; Water-, 397
 Empetraceae, 306
Empoasca mali, 213
 Endive, record of, 26
 English advice, 48; Daisy, 250
 Epacridaceae, 306
 Equestrian Star, 334
 Ericaceae, 307; 230, 240, 246, 254, 266, 275, 291, 306, 307, 317, 343, 346, 348, 352, 354, 376, 389, 393, 410, 435, 440
Eriocampoides limacina, 214
 Erythroxyloaceae, 309
 Etherization, 3, 68
 Euphorbiaceae, 310; 221, 225, 270, 286, 332, 341, 357, 392, 401, 411, 416, 424
Euphorbia pulcherrima, 401
 Eutoca, 390
 Evening Primrose, 368
 Everlasting, 331
 Ewart, quoted, 22
Exoascus deformans, 204
Fabræa maculata, 205
 Fadyenia, 317
 Fagaceae, 278, 311, 406
 False Hellebore, 436
 Fennel-Flower, 367
 Fenzlia, 318
 Fern, Climbing, 354; Filmy, 337; Flowering, 376; Hartford, 354; Maidenhair, 223; Stag's-Horn, 398; Sweet, 287; Tree, 227
 Fertilizing for nurseries, 175
Ficus elastica, 76
 Fig, Indian, 370; -Marigold, 360
 Filbert, 289
 Filices, 312
 Filing seeds, 38
 Filmy Fern, 337
 Fir, 219
 Fire-blight, 192
 Firmwood cuttings, 110
 Five-Finger, 403
 Flacourtiaceae, 250
 Flax, 350; New Zealand, 392
 Fleabane, 308
 Floating-Heart, 368
 Flowering Fern, 376; Maple, 220; Rush, 260
 Flute-budding, 135; -grafting, 118

- Forestry seed-sowing, 51
 Forget-me-not, 364
 Forsyth's pot, 88
 Four-O'clock, 361
 Foxglove, 301
 France, seeds from, 10
 Franciscea, 259
 Fraxinella, 301
 French Bean, 391; Mulberry, 266
 Frenela, 266
 Fringe Tree, 279
 Fruit-grafting, 166
 Fumariaceæ, 223, 289, 300
 Fungi and disease, 192
 Fungicides for nursery stock, 191
 Furze, 434

 Gages for trees, 180, 181
 Gale, Sweet, 364
 Garbanza, 281
 Garden, The, quoted, 48
 Garland Flower, 330
 Garryaceæ, 317
 Geneva Station, 27, 176; tester, 27
 Genip, 359
 Gentianaceæ, 311, 317, 368, 414
 Geraniaceæ, 308, 318, 386
 Germander, 429
 Germany, seeds from, 9
 Germination, definition, 11
 Germinators, 38
 Germ-nucleus, 1
 Gesneriaceæ, 318; 222, 225, 301, 307,
 320, 340, 364, 407, 415, 420, 426, 432
 Giant Bellwort, 376
 Ginger, 441
 Ginkgoaceæ, 319
 Gleicheniaceæ, 320
 Globe Amaranth, 321; -Flower, 433;
 Mallow, 422; Thistle, 304
 Globulariaceæ, 320
 Glory-Pea, 284
Glycine Soja, 422
 Golden-Bell, 314; -Chain, 344; Larch,
 404
 Goldenrod, 421
 Goldenseal, 337
 Goldfussia, 426
 Goober, 383
 Gooseberry anthracnose, 200; Bar-
 bados, 389; -spot, 200; mildew, 202

 Gootee, 78
 Gorse, 434
 Gossypium, 290; *herbaceum*, 23
 Gould, H. P., quoted, 380
 Gourd, Snake, 432
 Grades of trees, 179
 Graftage, defined, 113
 Grafting, 136; by approach, 119,
 166; defined, 115; -waxes, 169
 Gramineæ, 328; 224, 229, 243, 247,
 259, 265, 279, 286, 289, 307, 309,
 334, 342, 344, 345, 355, 361, 370,
 387, 391, 424, 426, 441
 Grape, cuttings, 94, 95, 105; Hyacinth,
 363; -Seaside, 285; stocks, 183
 Grass, Bent-, 224; Blue-Eyed, 420;
 Eel-, 435; Love-, 307; Pampas-,
 289; Plume-, 307; Quaking, 259;
 St. Augustine, 424; Whitlow-, 303
 Green-Briar, 420
 Greenwood cuttings, 107
 Ground Cherry, 393
 Groundsel, 419; Tree, 247
 Guernsey Lily, 366
 Gum, 368; Sweet, 350; -Tree, 309
 Gumbo, 368
 Gumi, 305
 Guttiferæ, 316, 356, 357
Gymnonychus appendiculatus, 215

 Habrothamnus, 274
 Haloragidaceæ, 329, 364
 Hamamelidaceæ, 289, 315, 330, 350,
 379
 Hand-glass, 81
 Hardening-off, 17
 Hardwood cuttings, 104
 Hartford Fern, 354
 Hatchet Cactus, 386
 Hatton, cited, 238
 Haw, 292
 Hawk-Weed, 334
 Hawthorn, 292
 Hazel, 289
 H-budding, 135
 Heartsease, 437
 Heater for wax, 151
 Heat for cuttings, 80
 Heath, 307, 308
 Heather, 266
 Hedge Nettle, 423

- Heel cutting, 94
 Heeling-in, 187
 Heikes' tree gage, 180
Helianthus annuus, 23; *tuberosus*, 243
 Hellebore, False, 436; White, 436
 Hemlock, 433
 Hemp, 268
 Herbaceous-grafting, 165
 Heron's-Bill, 308
 Hesler and Whetzel, book by, 190
Hibiscus esculentus, 368; *Trionum*, 23
 Himalaya Berry, 253
 Hippocastanaceæ, 224
 Hog-Plum, 423
 Hoit's grafting-knife, 148
 Hoitzia, 352
 Holly, Japan, 376; Mountain, 365
 Honesty, 353
 Honey Locust, 320
 Honeysuckle, 352
 Hookera, 259
 Hop Hornbeam, 376; Tree, 404
 Horehound, 357
 Hornbeam, 270; Hop, 376
 Horned Poppy, 319
 Horse-Chestnut, 224
 Hortensia, 337
 Houseleek, 419
 Huckleberry, 317; Swamp, 435
 Hume, H. H., quoted, 346, 350, 370, 390
 Husk Tomato, 393
 Husmann, Geo., quoted, 325
Hydrangea paniculata, 111
 Hydrocharitaceæ, 350, 435
 Hydrophyllaceæ, 366, 390, 439
 Hymenophyllaceæ, 337
 Hypericaceæ, 337

 Ice-Plant, 360
 Imantophyllum, 284
Impatiens Balsamina, 247
 Inarching, 119, 166
 Indian Currant, 427; Fig, 370; Rice, 441; Turnip, 242
 Indigo, 338
 Inlaying, 163
 Insecticides for nursery stock, 191
 Insects of nursery stock, 209
 Iridaceæ, 339; 222, 233, 247, 250, 292, 293, 296, 315, 319, 340, 345, 357, 362, 365, 417, 420, 422, 431, 433, 439
 Ironweed, 436
 Ivy, 330

 Japan Cedar, 293; Holly, 376; Quince, 274; seeds from, 10
 Japanese Arbor-Vitæ, 409
 Jasmine Box, 391
 Jennings, J., mentioned, 219
 Jessamine, 341
 Job's Tears, 286
 Jonquil, 365
 Judas Tree, 274
 Judd, W. H., mentioned, 219
 Juglandaceæ, 333, 341, 385, 404
Juglans Hindsii, 184; *nigra*, 184
 Jujube, 441
 Juncaceæ, 342
 Jute, 288

 Kains, M. G., quoted, 178
 Kaki, stock for, 184
 Keeping seeds, 23
 Kentucky Coffee Tree, 329
 Kidney Bean, 391; Vetch, 233
 Kier's layering-boxes, 77
 King and Pammel, quoted, 22
 Knight, Thos Andrew, 13
 Knives, for budding, 125; for grafting, 140, 148
 Kohleria, 340

 Labiatae, 224, 247, 248, 272, 286, 303, 305, 338, 346, 347, 357, 359, 361, 366, 375, 389, 392, 393, 413, 414, 415, 416, 418, 423, 429, 431
 Labrador Tea, 346
 Ladies' Ear-Drop, 315
 Lady's Mantle, 225; Smock, 269
 Lands for nurseries, 173
 Larch, 345; Golden, 404
 Lardizabalaceæ, 225
 Larkspur, 299
 Lath screen, 17
 Lauraceæ, 246, 282, 346, 389, 416
 Laurel, 346; Mountain, 343
 Lavender, 346; Sea-, 423
 Layerage, 70
 Layers, 69, 70
 Lead-Plant, 229

- Leadwort, 400
 Leaf-blight, pear and quince, 204;
 -curl, 203; hopper, 213
 Leather Leaf, 275
 Leaves, cuttings of, 101
 Lefort's wax, 171
 Leguminosæ, 220, 221, 225, 229,
 233, 245, 248, 264, 266, 268, 271,
 273, 274, 280, 281, 283, 284, 287,
 289, 291, 293, 296, 297, 303, 308,
 312, 317, 320, 329, 330, 331, 338,
 343, 344, 345, 347, 352, 353, 358,
 361, 379, 380, 383, 390, 391, 401,
 404, 405, 411, 421, 422, 426, 428,
 433, 434, 436, 437, 439
Lens esculenta, 347
 Lentibulariaceæ, 396, 434
 Leopard's Bane, 303
Lepidium sativum, 292
 Lilac, 427
 Liliaceæ, 349; 224, 225, 227, 233,
 244, 251, 254, 258, 259, 260, 267,
 279, 284, 286, 288, 298, 303, 307,
 309, 315, 316, 317, 320, 330, 332,
 335, 343, 344, 345, 346, 361, 363,
 367, 369, 370, 376, 379, 392, 405,
 411, 412, 414, 416, 418, 419, 420,
 433, 436, 440, 441
Lilium auratum, 58; *candidum*, 58;
 pardalinum, 58; *speciosum*, 58
 Lily, African, 224; Amazon, 309;
 Blackberry, 250; Chinese Sacred,
 365; Day, 332; Guernsey, 366;
 Mariposa, 267; Plantain, 335;
 Royal Water-, 437; St. Bruno's,
 379; Scarborough, 435; Water,
 367
 Lima Bean, 391
 Lime, Spanish, 359
 Limnanthemum, 368
 Linaceæ, 350, 408
 Linden, 431
 Lion's Foot, 347
 Liquorice, 320
 Loasaceæ, 351, 359
 Lobeliaceæ, 303
 Locust, 411; Honey, 320
 Loganiaceæ, 260, 317
 Loosestrife, 354
 Loquat, 308
 Lotus, 365, 367
 Lovage, 348
 Love-Grass, 307; -in-a-Mist, 367
 Lucerne, 358
 Lungwort, 360
 Lycopodiaceæ, 353
 Lygistum, 356
Lygus pratensis, 212
 Lythraceæ, 294, 344, 354

Macleaya cordata, 257
 Madeira Vine, 258
 Magnoliaceæ, 338, 342, 351, 354, 360,
 417
 Maidenhair Fern, 223; Tree, 319
 Maize, mentioned, 23
 Mallet cutting, 95
 Mallow, 355; Globe, 422; Marsh,
 228; Poppy-, 266
 Malpighiaceæ, 355, 424
 Malvaceæ, 220, 228, 266, 290, 332,
 334, 346, 355, 356, 368, 380, 422,
 430
 Mammee-Apple, 356
 Mandrake, 356
Mangifera indica, 356
Manihot dulcis var. *Aipi*, 270
 Maple, 221; Flowering, 220
 Marantaceæ, 265, 357
 Marattiaceæ, 231
 Marigold, 428; Cape, 302; Fig-, 360;
 Marsh, 267; Pot, 266
 Mariposa Lily, 267
 Marjoram, 375
 Marsh Mallow, 228; Marigold, 267
 Martyniaceæ, 357
 Marvel of Peru, 361
 Matrimony-Vine, 353
 Meadow Rue, 429; -Sweet, 314
 Medick, 358
 Medlar, 360
 Melastomaceæ, 358; 251, 273, 332,
 360, 421, 431
 Meliaceæ, 272, 359
 Melianthaceæ, 359
Melilotus albus, 23
Melissa officinalis, 247
 Menispermaceæ, 285, 359
 Michaelmas Daisy, 245
 Mildew, gooseberry, 202; peach, 208;
 rose, 208
 Milfoil, 222

- Milk Vetch, 245
 Milkweed, 243
 Milkwort, 401
 Mint, 359
 Mock Orange, 391; Privet, 391
 Modified whip-grafts, 143
 Moisture for cuttings, 80; for germination, 12
 Monkey-Flower, 361
 Monk's Hood, 222
 Montana Experiment Station, 30
 Montbretia, 433
 Moonflower, 267, 339
 Moonseed, 359
 Moraceæ, 243, 259, 268, 303, 313, 335, 354, 362
 Morning-Glory, 339
Morus alba, 141; *rubra*, 141
 Moss, Club-, 353; Rose, 402
 Motlet, mentioned, 47
 Mound-layering, 74
 Mountain Ebony, 248; Fringe, 223; Holly, 365; Laurel, 343; Rose, 233
 Mourning Bride, 417
 Mouse-Ear Chickweed, 273
 Mugwort, 242
 Mulberry, 259; French, 266
 Mulford, mentioned, 81
 Mullein, 436
 Mummy seeds, 22
 Musaceæ, 247, 331, 362, 426
Musa paradisiaca, 247; *sapientum*, 247
 Musk-Plant, 361
 Mustard, mentioned, 23
Mycosphærella grossulariæ, 201; *sentina*, 206
 Myricaceæ, 364
Myrica Gale, 90
 Myristicaceæ, 364
 Myrsinaceæ, 241, 283
 Myrtaceæ, 266, 309, 310, 311, 328, 347, 358, 360, 364
 Myrtle, 364; Crape, 344; Sand, 346; Wax, 364
Myzus cerasi, 210
 Nasturtium, 433; *A Armoracia*, 335
 Navelwort, 290
Nelumbium luteum, 23
 Nepenthaceæ, 366
Nephelium Litchi, 351
 Nettle, Hedge, 423; -Tree, 273
 Neumann's pot, 89
 New Hampshire, Comr. Agric., 33, 34
 New York Experiment Station, 27, 176
 New Zealand Flax, 392; Spinach, 429
 Ninebark, 393
 Nolanaceæ, 367
 Nursery lands, 173
 Nutmeg, 364
 Nut, Queensland, 354
 Nuttalia, 376
 Nyctaginaceæ, 220, 258, 361
 Nycterinia, 440
 Nymphæaceæ, 367; 261, 365, 437
 Oak, 406
 Oakley, R. A., quoted, 10
 Ochnaceæ, 368
Ocimum basilicum, 248; *minimum*, 248
 Odontonema, 431
 Offset, 64
 Oleaceæ, 279, 314, 315, 341, 349, 368, 376, 391, 427
 Oleander, 366
 Oleaster, 305
 Olive, Wild, 305
 Oliver, mentioned, 135, 219
 Onagraceæ, 283, 309, 315, 321, 342, 352, 368, 432
 Onion, record of, 26
 Orange, Mock, 391; Osage, 354; stocks for, 183
 Orchidaceæ, 372; 223, 224, 231, 233, 252, 254, 258, 259, 260, 265, 271, 286, 295, 299, 306, 321, 322, 344, 353, 358, 361, 368, 369, 379, 389, 391, 392, 398, 412, 414, 417, 418, 420, 421, 423, 431, 432, 435, 441
 Orpine, 418
 Osage Orange, 354
 Osier, 289, 415
 Osmundaceæ, 376
 Otaheite-Apple, 423; -Plum, 423
 Oxalidaceæ, 246, 376
 Oxygen for germination, 12
 Palmaceæ, 377; 221, 222, 240, 241, 245, 247, 257, 258, 265, 270, 275, 280, 285, 290, 298, 301, 302, 308, 310,

- 317, 331, 336, 337, 341, 345, 348, 351, 375, 392, 394, 403, 408, 409, 414, 430, 432, 436, 438
- Palm, Cabbage, 241; Coquito, 341
- Palmer, M. A., mentioned, 211
- Palmetto, 414
- Pammel and King, quoted, 22
- Pampas-Grass, 289
- Panax quinquefolium*, 319
- Pandanaceæ, 378
- Panicum, 361
- Papaveraceæ, 223, 241, 257, 306, 309, 319, 336, 358, 378, 412
- Papayaceæ, 379
- Paper Mulberry, 259
- Pardanthus, 250
- Paris Daisy, 357
- Parrot's Feather, 364
- Parsley, Cow-, 332
- Parsnip, Cow-, 332
- Passifloraceæ, 380
- Passion-Flower, 380
- Pastinacia sativa*, 380
- Patch-bud, 135
- Pea, Butterfly-, 284; Chick-, 281; Glory, 284; Pigeon, 264; record of, 26; Tree, Siberian, 268
- Peach, leaf-curl, 203; mildew, 208; stocks for, 183
- Pear, leaf-blight, 204; Prickly, 370; psylla, 212; scab, 196; septoria, 206; slug, 214; stocks for, 183
- Pecan, stocks for, 183
- Peck, mentioned, 143, 151; quoted, 161, 170
- Pedaliaceæ, 419
- Pedigree trees, 185
- Pennywort, Water, 337
- Peony, 377
- Pepperidge, 368
- Pepper-Tree, California, 417
- Periwinkle, 437
- Persea americana*, 246
- Persimmon, stock for, 184
- Peruvian Bark, 281
- Petroselinum hortense*, 379
- Phoenix dactylifera, 298
- Phytolaccaceæ, 393, 411
- Phyton, 3
- Pigeon Pea, 264
- Pimpernel, 229
- Pimpinella Anisum*, 231
- Pinaceæ, 219, 240, 266, 272, 275, 293, 294, 342, 345, 348, 393, 396, 404, 409, 418, 419, 428, 430, 433
- Pin-Cushion Flower, 417
- Pine, 396; -Plant, 410; Screw-, 378; Umbrella, 418
- Piney, 377
- Pink, 300; Sea, 242, 423
- Piperaceæ, 387, 397
- Pitcher-Plant, 366, 416
- Pittosporaceæ, 397, 421
- Plane-Tree, 398
- Plantain Lily, 335; -Tree, 362
- Plant-bug, 212; -lice in nurseries, 209
- Platanaceæ, 398
- Plate-budding, 134
- Plectodiscella veneta*, 207
- Plumbaginaceæ, 242, 274, 400, 423
- Plum, Cocoa-, 281; Hog-, 423; Otaheite-, 423; stocks for, 184; yellow-leaf, 198
- Plume-Grass, 307
- Podosphæra leucotricha*, 197; *oxycantha*, 199
- Poke, 393
- Poker Plant, 343
- Pole Bean, 391
- Polemoniaceæ, 268, 285, 318, 352, 392, 401
- Pollen-grains, 1
- Polyanthus, 403
- Polygalaceæ, 401
- Polygonaceæ, 233, 285, 362, 401, 410, 421
- Polypodiaceæ, 223, 244, 254, 274, 299, 301, 302, 303, 305, 366, 387, 393, 398, 402, 404, 438
- Polypody, 402
- Pomelo, 328
- Pontederiaceæ, 305
- Pontederia azurea*, 305; *crassipes*, 305
- Poplar, 402
- Poppy, 378; California, 309; Horned, 319; Mallow, 266; Water-, 337
- Portulacaceæ, 265, 348, 362, 402
- Pot, for wax, 151; layering, 76; Mari-gold, 266
- Powdery mildew, 197, 199
- Powell, mentioned, 154
- Prairie Clover, 390

- Prickly Ash, 440; Pear, 370
 Pride of India, 359
 Prim, 349
 Primrose, 403; Cape, 426; Evening, 368
 Primulaceæ, 229, 230, 246, 295, 303, 335, 354, 403, 421
Primula Auricula, 246
 Privet, 349; Mock, 391
 Prong-budding, 134
 Propagating-box, 82, 85; -frame, 82, 86; -house, 86; -oven, 83
 Proteaceæ, 328, 329, 348, 354, 403
Prunus avium, 183; *cerasifera*, 184; *Davidiana*, 183; *domestica*, 184; *Mahaleb*, 183; *salicina*, 184
 Psedera, 380
 Pseudobulb, 63
Pseudopeziza ribis, 200
 Psidium, 328
 Psylla, 212; *pyricola*, 212
Pteronius ribesii, 215
 Punicaceæ, 402
 Purity, testing for, 31
 Purslane, 402
 Pyrolaceæ, 405
Pyrus communis, 183; *Malus*, 183; *ovoides*, 183; *serotina*, 183

 Quaking Grass, 259
 Quamas, 267
 Queensland Nut, 354
 Quince, Japan, 274; leaf-blight, 204; stocks for, 184

 Raffia, 128
 Rag-doll tester, 30
 Ragweed, 419
 Rankin, book by, 190
 Ranunculaceæ, 222, 223, 230, 239, 267, 281, 283, 299, 307, 332, 337, 367, 377, 408, 429, 433
Raphanus sativus, 407
Raphia Ruffia, 128
 Raspberry anthracnose, 207; yellows, 206
 Rattle-Box, 263
 Red-Bud, 274; Cedar, 342; Pepper, -387; spider, 211
 Redwood, 419
 Reed, 243; Mace, 434
 Reed, C. A., quoted, 385
 Regermination, 21
 Resedaceæ, 360
 Resurrection Plant, 230
 Rhamnaceæ, 251, 272, 336, 377, 409, 441
 Rhodanthe, 332
 Rhode Island Experiment Station, 29
 Rice, Indian, 441; Wild, 441
 Ring-budding, 136
 Roberts, quoted, 175
 Rock-Cress, 239
 Rocket, 332
 Rockfoil, 417
 Rock Rose, 282, 331
 Rolfs, P. H., quoted, 394
 Root, cuttings of, 99
 Root-grafting, 119, 136, 138
 Root-grafts *vs.* buds, 141
 Rootstocks, 67
Roripa Armoracia, 335; *Nasturtium*, 439
 Rosaceæ, 225, 228, 234, 238, 242, 253, 274, 275, 281, 290, 300, 308, 311, 314, 318, 319, 335, 342, 343, 352, 355, 360, 376, 380, 383, 392, 393, 398, 403, 405, 406, 408, 411, 412, 413, 416, 420, 421, 422, 424, 439
 Rose Acacia, 411; black-spot, 207; Christmas, 332; mildew, 208; Moss, 402; Mountain, 233; of Jericho, 230; Rock, 282, 331; Sun, 331
 Rosemary, 413
 Rosin Plant, 420
 Rotation in nursery lands, 178
 Royal Water-Lily, 437
 Rubber-Tree, Brazilian, 332
 Rubiaceæ, 413; 244, 258, 273, 281, 286, 293, 316, 330, 334, 340, 352, 356, 364, 366, 380, 387, 402, 407, 412, 419
 Rue, 414; Meadow, 429
 Rumex, 421
 Runner, 69
 Rush, 342; Flowering, 260
 Rutaceæ, 245, 257, 282, 301, 302, 310, 320, 328, 344, 346, 350, 370, 391, 404, 414, 420, 428, 440

 Sabiaceæ, 359
 Saddle-grafting, 119, 144, 158

- Safflower, 270
 St. Augustine Grass, 424; Bruno's
 Lily, 379; Domingo Apricot, 356;
 John's-Wort, 337
 Salicaceæ, 402, 415
 Salisburya, 319
 Salsify, Black, 418; Spanish, 418
 Salt Tree, 330
 Sand Myrtle, 346; Verbena, 220
 Sandwort, 241
 San José scale, 213
 Sapindaceæ, 269, 344, 351, 359, 380,
 416, 439
 Sapotaceæ, 281, 353, 416
 Sarraceniaceæ, 298, 416
 Savin, 342
 Savory, 416
 Saxifragaceæ, 245, 248, 294, 299, 300,
 309, 315, 321, 332, 337, 340, 391,
 411, 412, 417
 Scab, apple and pear, 196
 Scale, 213
 Scarborough Lily, 435
 Schizaceæ, 230, 354
Schizobasopsis (Bowica) volubilis, 258
Schizoneura lanigera, 211
 Scion, 113
 Seoke, 393
 Screens, for seeds, 18
 Screw-Pine, 378
 Scrophulariaceæ, 227, 230, 234, 265,
 272, 287, 301, 308, 318, 350, 358,
 361, 365, 380, 387, 392, 408, 414,
 432, 436, 440
 Sea Buckthorn, 334; -Kale, 291;
 -Lavender, 423; Pink, 242, 423
 Seaside-Grape, 285
 Sedge, 269
 Seedage, definition 12
 Seed, definition, 11; testing, 24
 Seed-grafting, 166
 Seedling, definition, 12
 Seeds, propagation by, 11
 Selaginellaceæ, 418
Senecio cruentus, 282
 Senna, Bladder, 287
 Sensitive Plant, 361
 Separation, 56
 Septoria leaf-spot, 200, 206
 Serpentine layering, 72
 Service-berry, 228
 Setaria, 361
 Shad-bush, 228
 Shaddock, 328
 Shamel, mentioned, 186
Shepherdia argentea, 260
 Shield-budding, 122; -grafting, 159
 Shin Leaf, 405
 Shooting-Star, 303
 Siberian Pea Tree, 268
 Side-grafting, 118, 145, 159
 Side-Saddle Flower, 416
 Silkweed, 243
 Silver-Bell, 329; Tree, 348; Weed,
 241
 Simarubaceæ, 224
Sinningia speciosa, 320
Sium Sisarum, 420
 Skullcap, 418
 Slingerland and Crosby, book by, 190
 Slipperwort, 265
 Slug on pear, 214
 Smith, E. F., cited, 112, 190
 Smoke-Tree, 290; Vine, 223
 Snake Gourd, 432; -Root, Button,
 348
 Snowberry, 427
 Snowdrop, 316; -Tree, 329
 Snowflake, 348
 Soaking seeds, 14
 Soapberry, 416
 Soapwort, 416
 Softwood cuttings, 108
 Soil diseases, 40; for cuttings, 91;
 sterilizing, 40
 Solanaceæ, 259, 274, 296, 299, 305,
 339, 353, 356, 366, 367, 387, 390,
 393, 402, 415, 417, 420, 421, 426,
 431, 432
Solanum Melongena, 305
 Sorrel-Tree, 376
 Sour Gum, 368; soils, 15, 44
 Southernwood, 242
 Spanish Bayonet, 440; Lime, 359;
 Salsify, 418
 Spawn or cormels, 62
 Speedwell, 436
Spergula sativa, 423
 Sphærogyne, 431
Sphærotheca mors-uvæ, 202; *pannosa*,
 209
 Spider Plant, 283

- Spinacia oleracea*, 422
 Spinach, New Zealand, 429
Spiraea blanda, 111; *cantonensis*, 111;
Reevesii, 111; *rotundifolia*, 111;
trilobata, 111
 Splice-grafting, 158
 Spore, definition, 11
 Sporeling, 12
 Spores, propagation by, 11
 Spraying nursery stock, 191
 Spruce, 393
 Spurge, 310
 Squill, 418
 Squirting Cucumber, 304
 Staff-tree, 272
 Stag's-Horn Fern, 398
 Staphyleaceæ, 423
 Star-Apple, 281; of Bethlehem, 376
 Stark tree-digger, 173
 Starwort, 245
 Statistics of seed-production, 5
 Stem, cuttings of, 104; -grafting, 136
 Sterculiaceæ, 315, 355, 424, 430
 Sterilizing soil, 40
 Stewart, Geo., quoted, 31; V. B.,
 quoted, 190
 Stock defined, 113; florist's, 358
 Stocks for trees, 182
 Stolon, 69
 Stonecrop, 418
 Stools, 74
 Storage for cuttings, 92; for nursery
 stock, 187
 Storax, 426
 Stork's Bill, 386
 Stratification, 35
 Strawberry Tomato, 393; Tree, 240
 Striking of cuttings, 93
 String Bean, 391; waxed, 171
 Sturtia, 424
 Stuart, William, quoted, 403
 Styracaceæ, 329, 405, 426
 Sumac, 411
 Summer Cypress, 343
 Sundrop, 368
 Sundew, 304
 Sunflower, 23, 331
 Sun Rose, 331
 Survival of the Unlike, quoted, 4
 Swamp Huckleberry, 435
 Swan River Daisy, 258
 Sweet Cicely, 364; clover, mentioned,
 23; Fern, 287; Gale, 364; Gum,
 350; -scented Shrub, 267
 Sycamore, 398
 Symplocaceæ, 427
 Tamarack, 345
 Tamaricaceæ, 428
 Tanacetum, 428
Taraxacum officinale, 297
 Tarnished plant-bug, 212
 Taxaceæ, 401, 428, 432
 Tea, Labrador, 246
 Teosinte, 309
 Ternstroemiaceæ, 424, 429, 430
 Tester, Geneva, 27
 Testing of seeds, 24
Tetranychus bimaculatus, 211
 Theaceæ, 321, 430
 Thistle, Globe, 304
 Thompson, C. H., quoted, 264
 Thorn, Box-, 353; Christ's, 377
 Thrift, 242
 Throatwort, 432
 Thyme, 431
 Thymelæaceæ, 297, 305, 394
 Tiger Flower, 431
 Tiliaceæ, 288, 422, 431
 Tillotson, C. R., quoted, 51
 Tomato, Husk, 393; record of, 26;
 Strawberry, 393; tree, 296
 Top-grafting, 136, 151
 Toumey, mentioned, 51
 Toxylon, 354
 Tracy seed-planter, 47
 Trailing Arbutus, 306
 Transportation of seeds, 38
 Trapaceæ, 432
 Tree-diggers, 172; Fern, 227; of
 Heaven, 224; Tomato, 296
Trigonella Fœnum-Græcum, 312
 Trimming in nursery, 186
Triticum vulgare, 23
 Trochodendraceæ, 274
 Tropæolaceæ, 433
 Tropical Almond, 429
 Trumpet-Creeper, 268
 Tuber, 63
 Tuberose, 401
 Tubers, cuttings of, 98
 Tubular-budding, 136

- Tulip Tree, 351
 Tupelo, 368
 Turnip, Indian, 242; record of, 26
 Typhaceæ, 434

 Ulmaceæ, 273, 434
 Umbelliferæ, 231, 240, 270, 272, 278, 288, 301, 308, 312, 313, 332, 337, 348, 364, 379, 380, 416, 420; seeds of, 23
 Umbrella Pine, 418; Tree, 355
 Unicorn Plant, 357
 Urticaceæ, 257, 394, 397
 Utah Experiment Station, 31, 32

Vaccinium corymbosum, 254; *macrocarpon*, 291
 Valerianaceæ, 273, 289, 435
Valerianella olitoria, 289
 Vegetable Oyster, 415; Sponge, 353
 Vegetation, definition, 12
 Veneer-budding, 136; -graft, 144
 Veneering, 118
Venturia inæqualis, 196; *pyrina*, 196
 Venus' Looking-Glass, 422
 Verbenaceæ, 266, 270, 283, 304, 345, 350, 390, 436, 438
 Verbena, Sand, 220
 Vervain, 436
 Vetch, Kidney, 233; Milk, 245
 Vetchling, 345
 Viability of seeds, 24
Viburnum plicatum, 97; *tomentosum*, 97
Vigna sinensis, 291
 Violaceæ, 378, 437
Viola tricolor, 378
 Violet, Dame's, 332; Dog's-tooth, 309
 Virgilia, 283
 Virgin's Bower, 283
 Viscaria, 353
 Vitaceæ, 229, 282, 322, 380, 438
Vitis riparia, 183; *vinifera*, 183; *vulpina*, 183

 Wahlenbergia, 398
 Wake-Robin, 433
 Wall-Cress, 239

 Walnut, stocks for, 184
 Wardian case, 40
 Water Bean, 365; Caltrops, 432; Chinkapin, 365; -Elm, 397; -Lily, 367; -Lily, Royal, 437; Pennywort, 337; -Poppy, 337
 Wax for grafting, 169; Myrtle, 364; -Plant, 336
 Weigela, 301
 Wellingtonia, 419
 Wheat, mentioned, 23
 Whin, 434
 Whip-graft, double, 144; modified, 143
 Whip-grafting, 119, 138
 Whistle-budding, 136
 White Alder, 283; Cedar, 275, 430; Hellebore, 436; -wood, 351
 White, Elizabeth C., quoted, 291
 Whitlavia, 390
 Whitlow-Grass, 303
 Whortleberry, 435
 Wild Cane, 243; Olive, 305; Rice, 441
 Willow, 415; Desert, 279
 Windflower, 230
 Wine-Plant, 410
 Winter Aconite, 307; Cherry, 393
 Wintergreen, 317, 405
 Witch-hazel, 330
 Wolf's Bane, 222
 Woodbine, 352
 Woodruff, 244
 Woolly aphid, 210
 Wormwood, 242
 Woundwort, 423

 Yam, 302
 Yarrow, 222
 Yellow-leaf, 198
 Yellow-wood, 283
 Yellows, raspberry, 206
 Yew, 428

Zea Mays, 23
 Zephyr Flower, 440
 Zingiberaceæ, 227, 229, 290, 294, 305, 330, 441

I swear to break all bonds of nature
- to whom I have promised faith, obedience,
gratitude, service

I swear to reveal all to the chief all I
see, read etc

I will know poison, steel & fire as a
means of ridding the world by death or
deceit of the enemies of truth & liberty

page 536
474

Memories of a Physician

We fear how do you under-
stand that

My sister as power, D'acquellon as au-
thority, you as advice, and I as vigilance