

AT MICROFICHE REFERENCE LIBRARY

A project of Volunteers in Asia

How to Build an Oil Barrel Stove

by: Ole Wik

Published by:

Alaska Northwest Publishing Company
Box 4-EEE
Anchorage, AK 99509 USA

Paper copies are \$ 1.95.

Available from:

Alaska Northwest Publishing Company
Box 4-EEE
Anchorage, AK 99509 USA

Reproduced by permission of the author.

Reproduction of this microfiche document in any form is subject to the same restrictions as those of the original document.

\$1.95

HOW TO BUILD AN OIL BARREL STOVE OLE WIK

ADAPTED FROM THE PAGES OF ALASKA® magazine



Ole Wik's oil barrel stove is small and compact, good for both heating and cooking, and nice looking. Making it requires shaping and assembling 12 pieces of metal cut from a discarded oil barrel.

The author has provided simple directions for making the stove—entirely without welding equipment or power tools. Wik made this last of his stoves at a bush camp!

Author Wik, a sometime surveyor, free-lance writer and bookkeeper at a Native store, has lived in the Alaskan bush for 11 years, and he has always relied on homemade wood-burning stoves for heating his house—or cabin, or tent—and cooking his food. He could use some other kind of heater, one supposes, but Wik likes wood stoves. They're simple, they "work good" and they're comfortable to live with. How many purchased gadgets will do all that?

The easy friendship that Ole Wik has with wood stoves is something that he is happy to share with others. He calls out encouragement to the timid, urges on the hesitant one who would shrink—fascinated—from the prospect of beating a barrel into a stove. He says, "The most important thing I can offer a potential stove-builder is an attitude—one of optimistic confidence. Other human beings build stoves, so why not you and me? Go ahead and tackle a project. If you meet discouragement, remind yourself that you're not trying to build a concert violin or an artificial heart—you're only making a simple container for burning wood."

More coming!

Ole Wik's new book on **WOOD STOVES**. A new big book on every kind of wood stove in creation is on the way. It's by Ole Wik and Alaska Northwest Publishing Company.

Watch for it.



HOW TO BUILD

**AN OIL
BARREL
STOVE**

OLE WIK

Photographs by Many Wik



ALASKA NORTHWEST PUBLISHING COMPANY
Anchorage, Alaska



RICHARD HARRINGTON

Copyright ©1976 Ole Wik.
All rights reserved. No part of this book
may be reproduced or transmitted in any
form or by any means, electronic or
mechanical, including photocopying,
recording or by any information storage
and retrieval system, without written
permission of Alaska Northwest
Publishing Company.

Library of Congress Cataloging in
Publication Data.
Wik, Ole, 1939-
How to build an oil barrel stove.
1. Stoves; Wood—Design and construction.
2. Barrels. I. Title.
TH7438.W54 697'.22 76-3768
ISBN 0-88240-077-0

Design by Hilber Nelson
Illustrations by Jon Hersh

Alaska Northwest Publishing Company
Box 4-EEE, Anchorage, Alaska 99509

Printed in U. S. A.

'Tundra Daisies,' Cheap and Good

Ah, the oil barrel! Tens of thousands, perhaps hundreds of thousands of the 55-gallon steel drums have made the trip to Alaska over the years, many of them one-way. World War II and the early oil exploration programs resulted in so many abandoned drums that they came to be called "tundra daisies."

But one man's pollution is another man's solution, and the drums have been a genuine boon to people in the bush. Here was a source of cheap, easily worked sheet steel that could be made into such useful things as rain-water catchments, roofing, dog food cookers,

laundry tubs, gutter pipes, sleds, fish smokers, and—above all—wood stoves. Anybody who has traveled much in the Alaskan bush has seen dozens of different designs of homemade oil barrel stoves, and indeed one wonders what the villagers would have used for heating had no old oil drums been available.

With such a variety of designs to choose from, how does one decide what shape to make his stove? Circumstances dictated some rather rigid limits when I made my first stove more than 10 years ago. The stove had to be compact, and it had to be good for both cooking and heating. It had

Left—The three-way oil barrel stove can be made from a single drum. There are plenty around if you look.



Figure 1

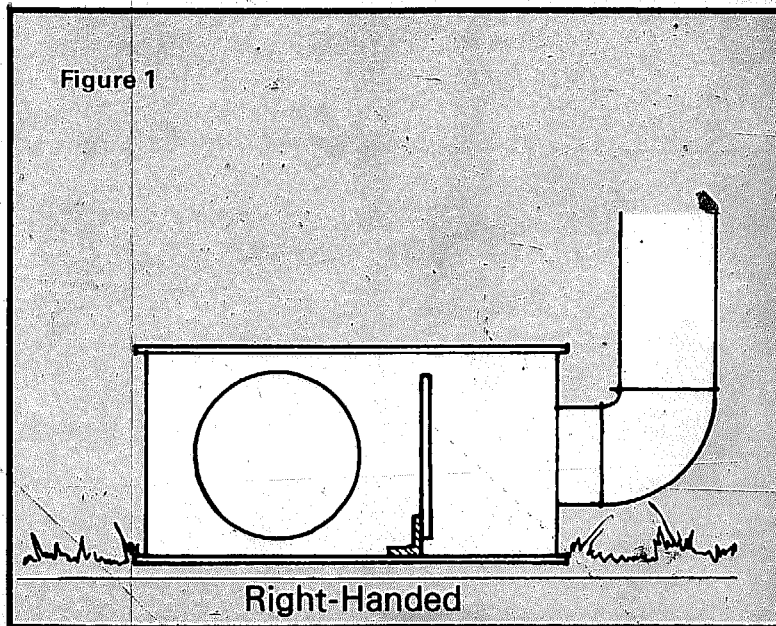

Left—The first light-up—a special occasion. The author's son, Kalle, looks on.

to be made from a single drum, with no other metal besides the fastenings. And it had to be simple enough that I could build it under primitive conditions, using nothing but ordinary hand tools—no welding or power equipment.

I settled on a little square design and went to work. In spite of a blunder or two, the stove held together—in fact, it did all of my heating and cooking for two winters. At that point it was displaced by a more advanced design, but it still did several more years' service as an outdoor laundry-water heater.

Partly out of nostalgia and partly to have a spare tent stove, I recently built another one on the same basic design. It is essentially a rectangular box with a baffle across the middle to force the flames up against the cooking surface (Figure 1). The design is such that the stove can be used with either cooking surface up; a special baffle sealer closes

off the opening between the baffle and the stove bottom in either position. The stove can also be used as a heater, in the upright position, by removing the baffle sealer altogether. That's why I call this model the Three-Way Stove.

I can guarantee that in building it you'll get a good feeling for oil barrel steel and its properties. Even if you choose a different design, many of the construction details and techniques may be applicable to your stove.

Aside from the specific instructions, the most important thing I can offer a potential stove-builder is an attitude—one of optimistic confidence. Other human beings build stoves, so why not you and me? Go ahead and tackle a project. If you meet discouragement, remind yourself that you're not trying to build a concert violin or an artificial heart—you're only making a simple container for burning wood.

Three ways to use the stove. A removable baffle sealer closes off the bottom of the baffle for the horizontal positions.

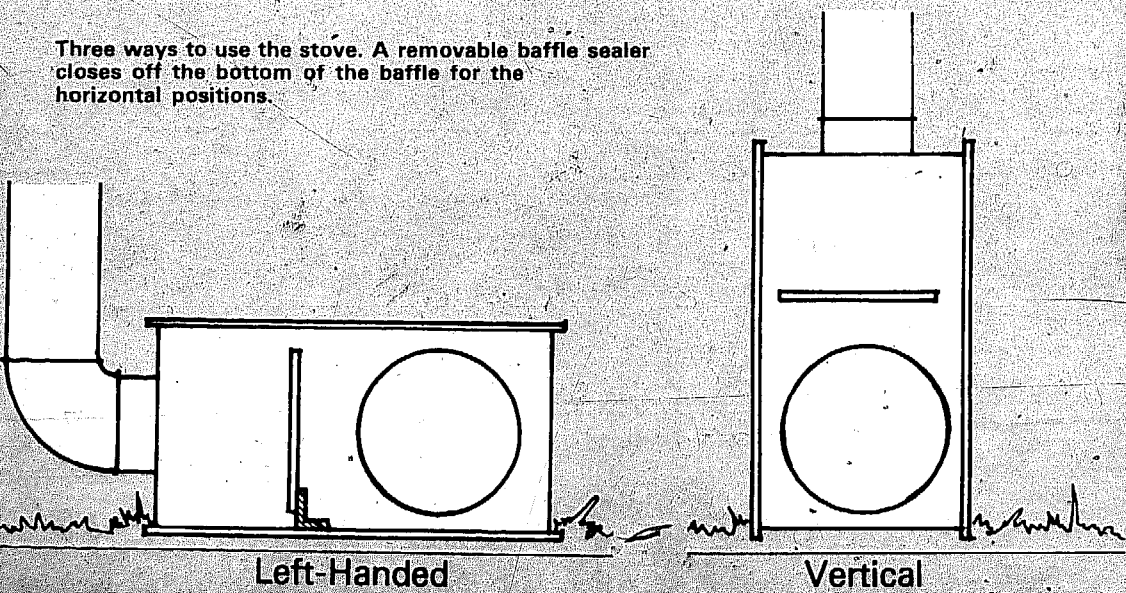

A Few Tools...





and
watch
your
ears

First, the oil barrel: There are two kinds of 55-gallon drums. The older kind has a round rim and is made of fairly heavy-gauge steel. The newer kind has a square rim and is made of lighter gauge metal. The older, heavier drums make more durable stoves, but the metal is far harder to work. For a first stove, I recommend the square-rimmed variety. Your stove will still be substantial.

Obtain a reasonably sound drum (I always hold out for a leaker—they're cheaper) and assemble your tools. Here is what I used:

1. Cutting tools (old snowmobile spring, file, ax to hammer with)
2. Tin snips
3. Anvil
4. Punch
5. Cold chisel
6. Hammer
7. Vise-grip pliers
8. C clamps
9. Drill and bits
10. Gloves
11. Ear protectors
12. Large screwdriver
13. Slip-joint pliers
14. Steel measuring tape
15. Felt-tipped pen
16. Carpenter's square
17. Hacksaw (not pictured)

Note I include ear protectors on the list. There's no way you can make an oil barrel stove without an awful lot of pounding, and there's no way you can do all that pounding without damaging your hearing.

Figure 2 Front View

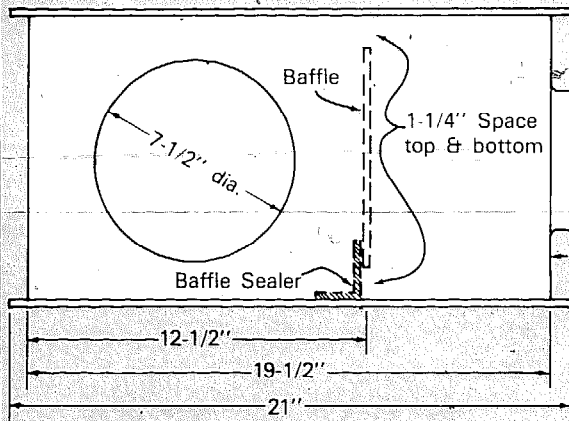

Figure 3 Side View

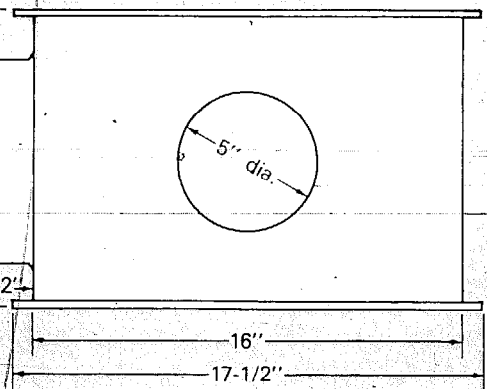

Figure 4 Plan View

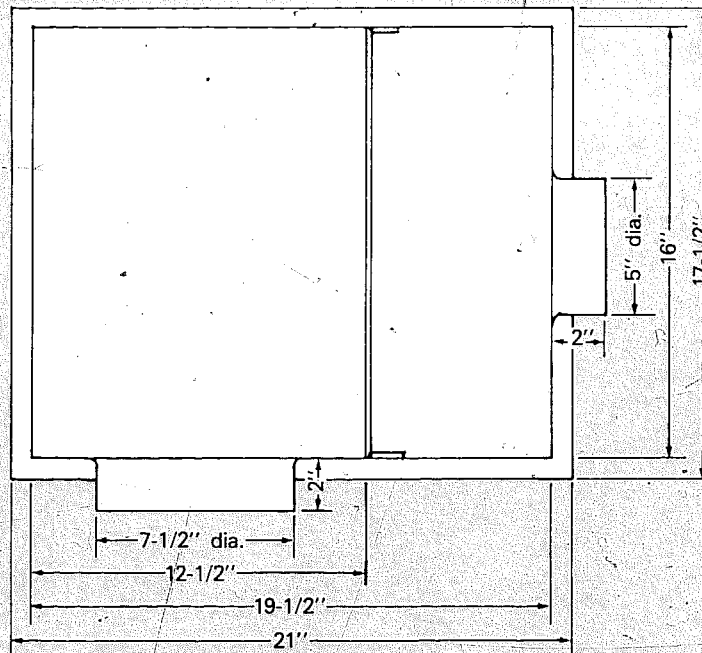
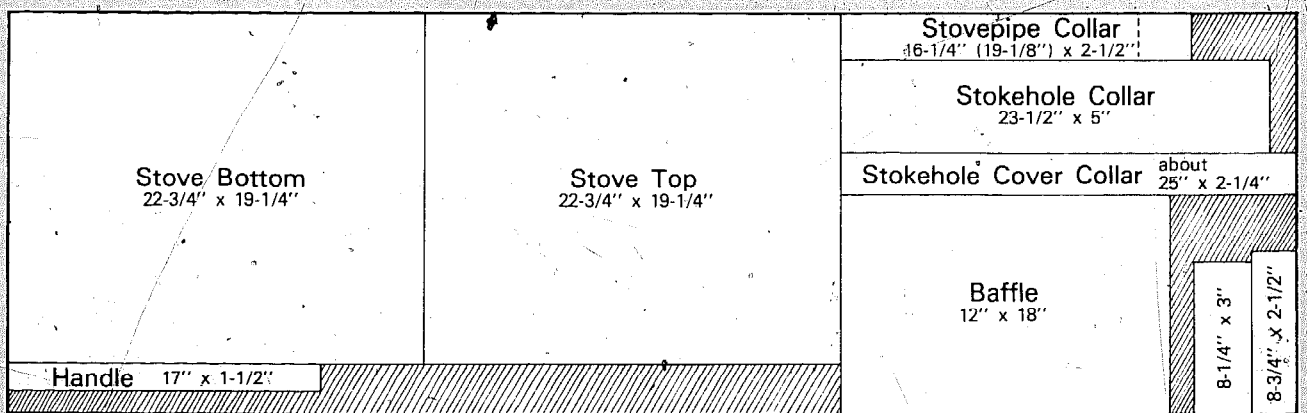

Figure 5 Cutting Diagram



The two-thirds barrel remaining after the third for the body has been removed, shown flattened out. Dimensions shown are for my stove—yours may be a bit different.

Inner Draft Sleeve
Outer Draft Sleeve

Once you have your drum, flush out any explosive fuels inside. Study the plans and cutting diagram (Figures 2 through 5) and budget your materials carefully. Then proceed as follows:

1. Draw reference lines. Draw two lines around the circumference of the drum, 4 inches from each rim. These aid in keeping the work square later.

2. Open the drum. Mark a line along the crest of one of the ribs that divide the barrel into thirds, measuring from the rim to keep it even. Cut along this line to divide the barrel into two parts.

How does one cut a barrel? Lacking anything more sophisticated, I made a barrel-opening tool out of an old snowmobile spring by filing an edge on one corner (Figure 6). With this system I could cut the top off my drum in just under 15 minutes. If you have access to an electric handsaw, you can make a faster, cleaner job of it either by using a special metal-cutting blade or by turning an old wood-cutting blade around backwards.

If you have access to an oxyacetylene cutting torch, flush your drum with hot, soapy water, then fill with more soapy

water to within 1 inch of the top. This will virtually eliminate the danger of explosion. Cut the top off according to Step 3, spill the water out, and cut along the rib as described.

3. Remove the top and bottom of the drum. Mark and cut around the side of the drum 1/2 inch below the top and bottom rims. (The rims stay with the top and bottom.)



Cutting the drum with homemade tool and ax.

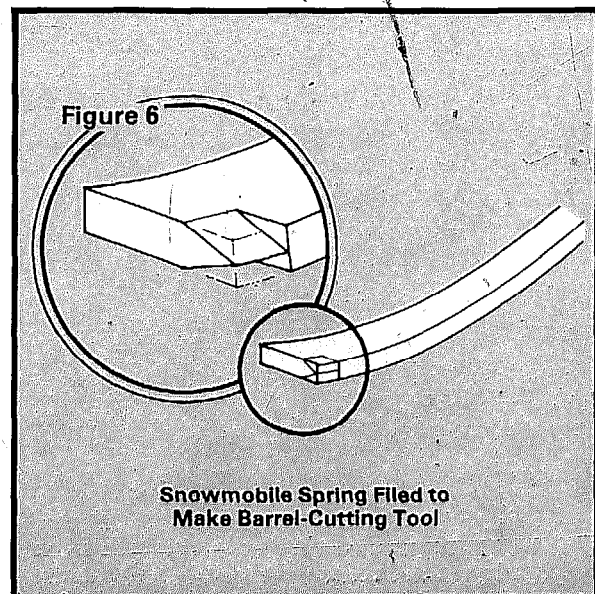
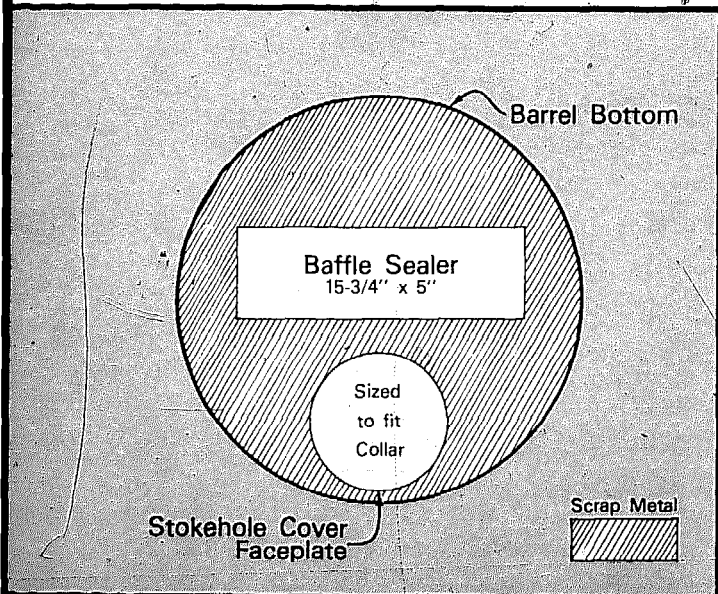

**Forming the
stove body on
a squared log.**



4. Form the stove body. The one-third barrel will be your stove body. Hammer off the rough edges and file or cut away uneven or jagged projections. Form into a rectangle as shown in Figure 7: Mark a

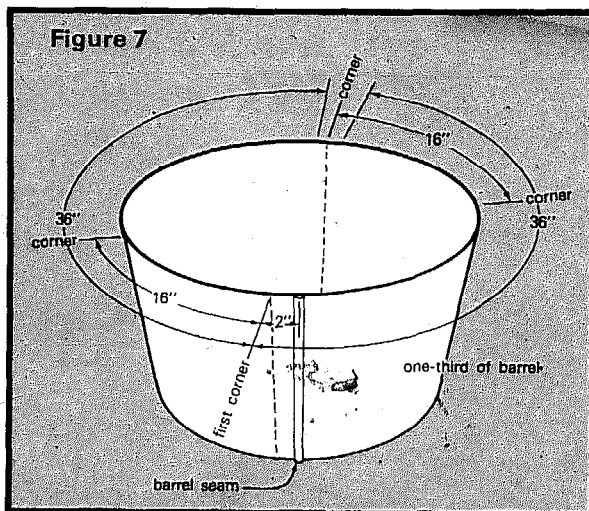

line parallel to the barrel seam and 2 inches away from it. This is your first corner. From this line measure around the drum 36 inches and make a mark. Then measure 36 inches the other way and make a second mark. A point directly between these two marks establishes the

location of the diagonally opposite corner; draw the line. Measure 16 inches around the drum from one of these corners, and then 16 inches in the same direction from the other to locate the remaining two corners. Draw the lines.

Transfer the four corner lines to the inside of the barrel, and score lightly with the cold chisel. Be very careful not to score too deeply, or the metal may break when you bend it. Now give the barrel a bear hug to begin squaring it up, and finish off by pounding on a squared log or other timber. Spare no effort in getting the body as square as you can, especially at the corners. What residual roundness you can't get out at this stage will be removed in the next step.

5. Form the body flanges. Fold a 1/2-inch flange outward at the top and bottom of the stove body. Since your cut will no doubt be a bit wavy, use the reference line as a guide in marking a fold line that averages 1/2 inch from the edge. Then cut inward along the corner lines until you just intersect the fold line.

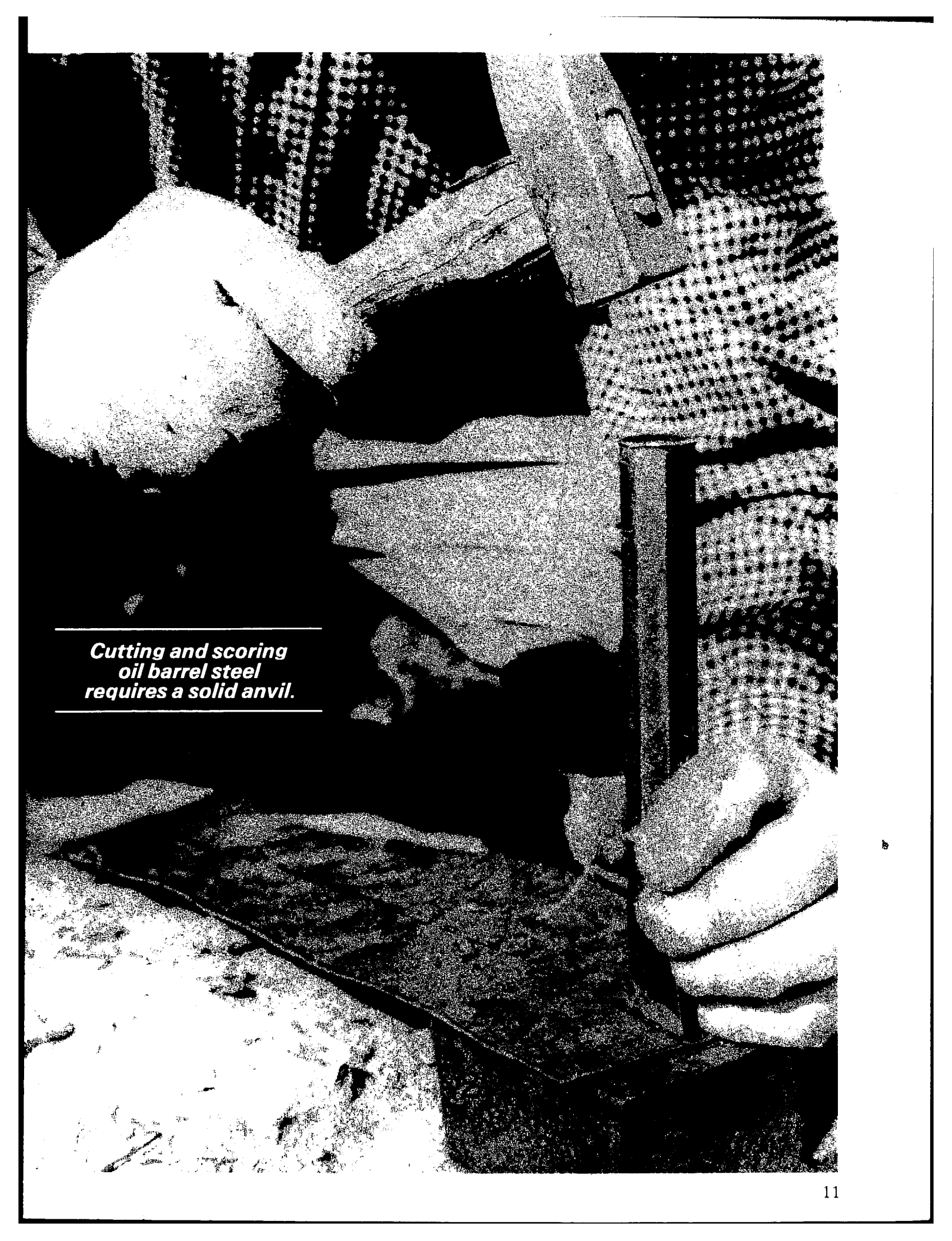

*Cutting and scoring
oil barrel steel
requires a solid anvil.*

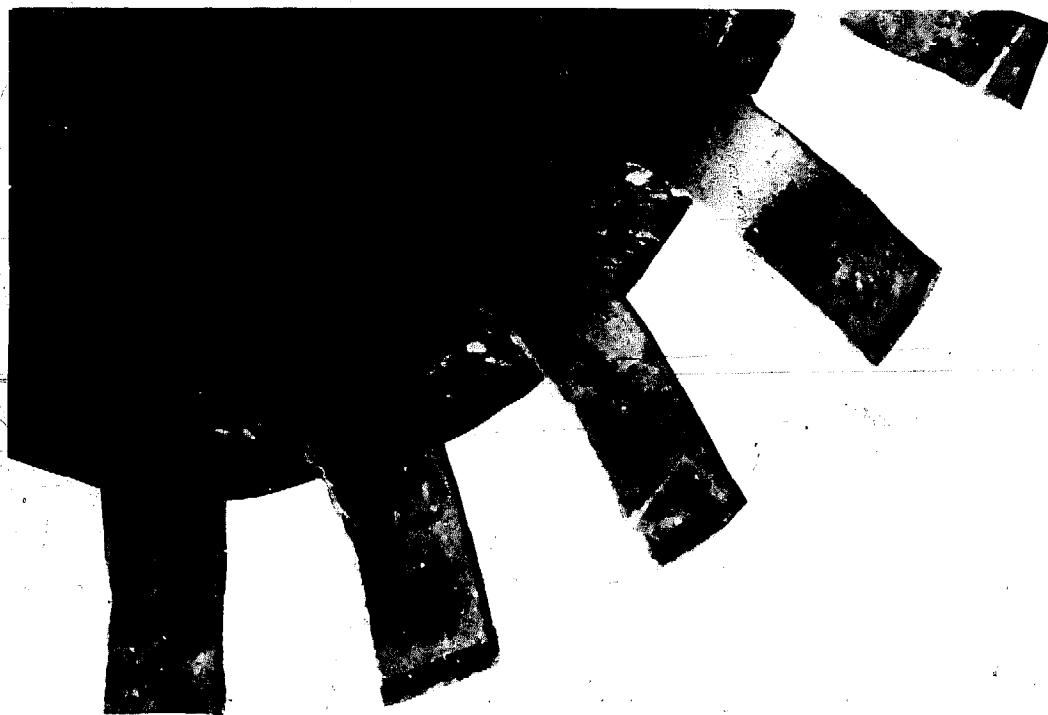

Now comes a careful operation, in which you form the flanges while simultaneously eliminating any residual roundness from the body. Using the pliers, fold one flange outward along the line. On this first pass, bend only about 15° . The bend will stiffen the side somewhat, but not so much that you can't push the side of the body inward wherever it is still bowed out with the original barrel curve. When you push inward to straighten the side, your flange will buckle, forming a wave. Bend this wave back down while holding the side in. This will lock the metal in the newly straightened position. When you have worked all along the length of the flange and it is as straight as you can get it, make another pass with the pliers, folding another 15° or so. After this pass, you will be able to do more straightening. Continue in this way until you have bent the flange a full 90° , and then treat the other flanges similarly. You'll be amazed at how straight and boxlike the sides have become.

6. *Cut out the stove bottom.* Now return to the other two-thirds of your barrel and cut it along the seam. This can be done easily with a cold chisel and a hammer, working from the inside of the drum and pounding against a good, solid anvil of

some kind. Measure the length of your stove body, without the flanges, and add 3 inches to determine the length of the bottom. Draw a line this distance from the cut you just made, and parallel to it. Transfer the line to the inside of the barrel (which is still in the round), cut out the sheet, and flatten it by pounding and tromping. This sheet will be the proper length for the stove bottom, but it will have excess material at the sides, giving you a chance to cut off the ragged edges left from the barrel-opening operation.

To determine the width of the bottom, measure the width of the stove body, without the flanges, and add 3 inches. Lay off the appropriate lines on the sheet and cut-off the excess. By cutting close to one of the original edges, you should have enough metal at the other to form the stove handle.

The bottom sheet will be $1\frac{1}{2}$ inches larger all around than your stove body. This allows you to fold a $\frac{3}{4}$ -inch flap all the way around the bottom to grasp the $\frac{1}{2}$ -inch flange on the stove body, leaving an extra $\frac{1}{4}$ inch to account for irregularities in the flange and any curve that may remain in the stove walls.

Now cut notches in the corners of the stove bottom as shown in Figure 8. With the pliers, fold up the flanges at a right angle, as if you were making a cookie

Figure 8 Cutting Notches at Corners of Stove Bottom

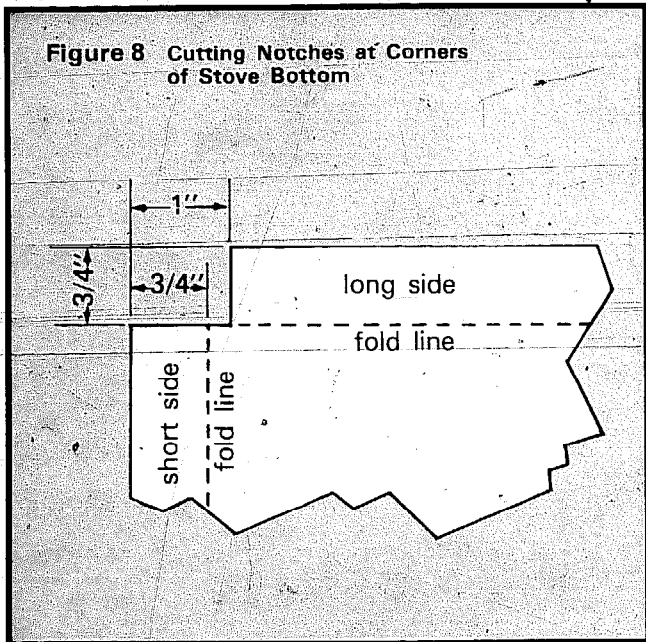

sheet with 3/4-inch sides. Work slowly; make about six passes to complete each edge.

Repeat this whole process to form the stove top. Set both pieces aside for now. The sheet of metal remaining from the two-thirds barrel will provide almost all of the material you'll need for the rest of the stove components, with the balance coming from one end of the drum.

7. Form the stovepipe collar. There are at least four ways to fasten a collar to a stove body without welding, as shown in Figure 9. In every case you form the collar first, since it is far easier to cut a hole to fit an existing collar than it is to make a collar fit an existing hole. Then you cut a hole, somewhat smaller than the collar, and turn up its edge to form a shallow, volcanolike rim. Part of the collar metal grasps the inside of this rim, and part grasps the outside, so that the finished collar can't slip either in or out.

For purposes of illustration, I've used three different collar systems in this stove. You may wish to follow the directions and gain experience with all three methods, or you may wish to select one method and make all three collars the same way.

Figure 9 Four Ways of Attaching a Collar to a Sheet

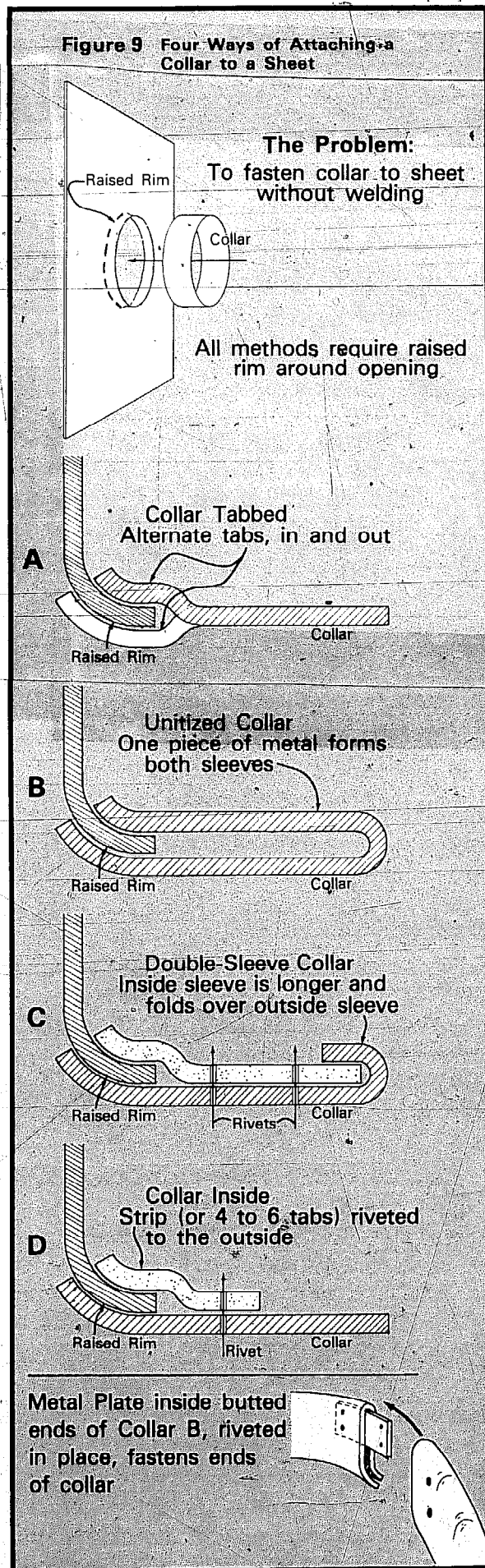

Right— Stovepipe collar after mounting, inside view.
Middle— Stokehole collar prior to mounting. Note "volcano" rim on stove body.
Far right— Stokehole collar after mounting, inside view. (The gap at the bottom was caused by an error.)



Whatever method you choose, always form your stovepipe collar so that the crimped end of the pipe fits inside. Then, when sooty water condenses inside the stovepipe in cold weather, it will run back down into the stove, where it will eventually evaporate. If you were to place the crimped end of the stovepipe up (which may seem more logical), the condensate would run down the outside of your pipe. The resulting stains would look pretty bad, and they would give off an odor the next time the pipe heated up.

To build the stovepipe collar by the method shown in Figure 9A, form a 2-1/2-inch-wide strip of metal around the crimped end of your stovepipe, allowing a 1/2-inch overlap. (Use either 5-inch or 6-inch pipe.) For the best fit, arrange the overlap to nest with the seam of the pipe. Mark the strip and rivet twice. (A six- or eight-penny nail with most of the shank removed makes a fine rivet.)

Center the collar exactly on one of the short sides of the stove body. Trace a line

around the inside of the collar. Before moving anything, make a mark on the circle where the collar seam is, so that you can always line the two parts up later. Cut out the circle, being a bit generous; leave enough metal to form a 1/4-inch rim all around. The metal has plenty of stretch.

Bend the edge of the circular hole outward with pliers to form the little "volcano" rim, sloping upward at about 45°. Slip the collar inside the rim with the marks lined up and tap the rim down to close any gaps. Now position the collar so 1/2 inch sticks inside the rim and mark a line around the collar at the junction. Remove the collar and cut from the near edge to this line to form a series of tabs about 1/2-inch wide. Fold every other tab outward to match the flare of the rim. Slip the collar inside the rim. Pound the inside tabs down against the inside of the rim, then pound the outside tabs down. Keep the collar pressed tightly against the stove body while pounding the tabs over.

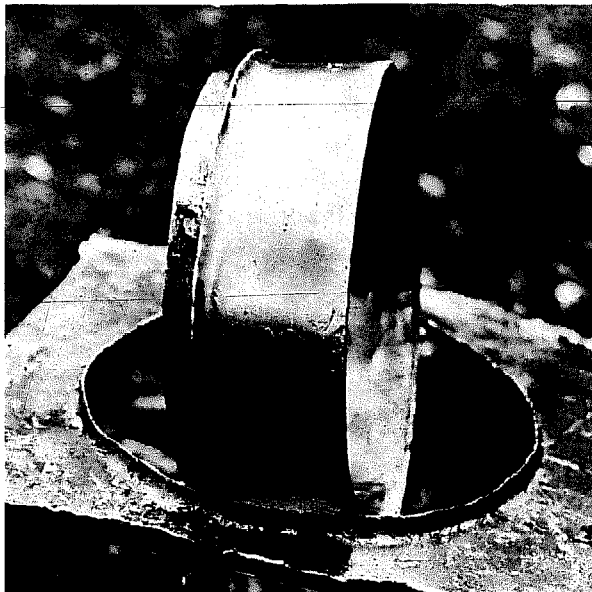

(Although this is the quickest and easiest way to attach a collar to the stove body, it is also the least airtight and the most likely to drip when condensate runs down the pipe. Unless you're pressed for time, I'd suggest one of the other methods shown in Figure 9.)

8. Form and mount the stokehole collar.

Here we'll use the method shown in Figure 9B. This type of collar is the most airtight, the tidiest, and to my mind, the most elegant of the bunch. Cut a strip of metal 23-1/2 by 5 inches. Draw a line along the length of the strip on the painted side, 2-3/8 inches from one edge. Score lightly and fold over to form a doubled strip. Carefully form this into a circle, leaving the shorter side of the fold out.

(This collar should be as nearly circular as you can possibly make it, since the stokehole cover should be able to fit over this collar in three different positions, depending on which side of the stove is

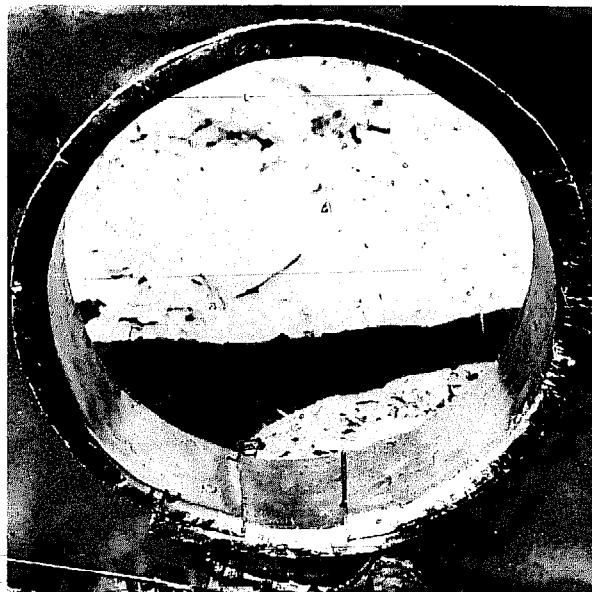

up. You might consider making a circular wooden form 7-1/2 inches in diameter for forming your collar. The danger is that your collar will be enough out of round that you'll have to make a separate stokehole cover for use when the stove is in the other horizontal position. Either cover would then work for the vertical position.)

Butt the two edges of the collar together and insert a 2- by 2-inch piece of metal between the two layers to span the junction. Rivet the insert in place, fastening the ends of the collar together (Figure 9). Be sure that the insert lies well up inside the inner and outer sleeves of the collar so that it will not interfere with the lower edges when you fasten them to the stove body rim.

*Folding over the bottom flange.
Note the newly installed
stokehole collar.*



Lay the collar on the side of the stove, positioned as shown in Figure 2, and trace a circle inside the collar. Cut the hole and form the rim, just as for the stovepipe port (Step 7). Now pry up a lip on the shorter, outer sleeve of the collar, using a large screwdriver. Make an index mark across the screwdriver $\frac{3}{8}$ inch from the tip as a depth guide for inserting the blade. Take very small "bites," bend a small angle at each pass and work all around the collar evenly. Slip the collar into the hole and bend the lip of the collar and the rim of the hole until the lip fits nicely against the rim. When satisfied with the fit, pound the longer, inner sleeve of the collar over the inside of the rim, making sure that the collar is pressed firmly into position. Then tap the collar lip down against the outside of the rim to complete the seal.

9. *Mount the stove bottom.* Continue folding over one of the flanges on the long side of the stove bottom until it is almost flat. Slide the body of the stove into position so that this flap grasps the body flange nearest the stokehole. (The stokehole collar will interfere with the flattening of this one flange, so that is why we prefold it most of the way.) Hammer the stove bottom flaps over to clasp the stove body flanges, working all sides down evenly and gradually. When the flanges are folded over enough to hold the body in position, turn the stove upside down so that you can kneel on the bottom to press it down firmly against the flanges. Pound the flaps over from underneath and finish them off on the anvil.

Your stove body may now have a crazy warp to it, but don't worry—it will come out when you install the stove top.



. Mounting the stove bottom.

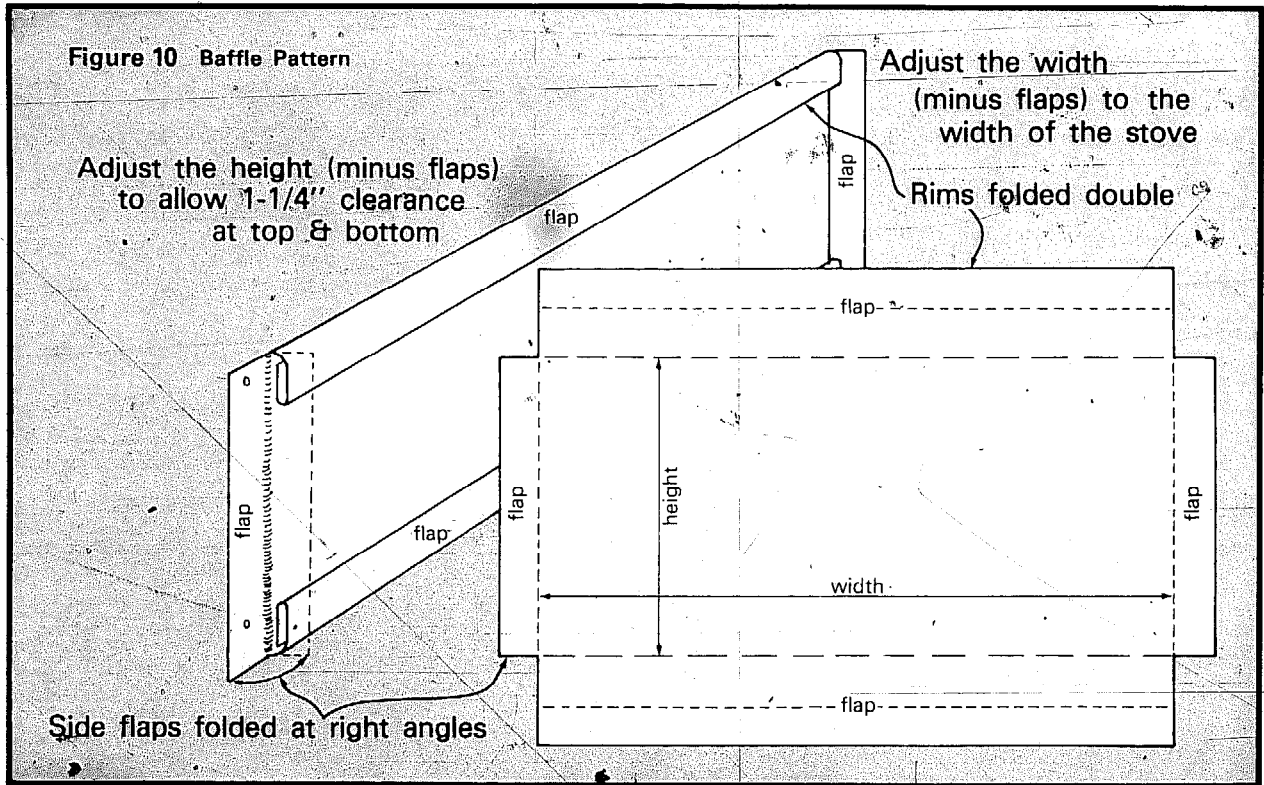

10. Make and install the baffle. Measure the width and depth of your stove at a point 12-1/2 inches from the end opposite the stovepipe port. Cut a piece of metal 12 by 18 inches and fold as shown in Figure 10. Install in the position indicated in Figures 2 and 4, leaving 1-1/4 inches of clearance between the top and bottom of the stove. Rivet four times.

11. Install the stove top. Repeat Step 9.

12. Rivet the stove top and bottom to the body flanges. To prevent the stove sides from buckling and pulling out of the flanges under the stresses of repeated heating and cooling, rivet through the top and bottom and the body flanges as shown in Figure 11. Allow 3 rivets for

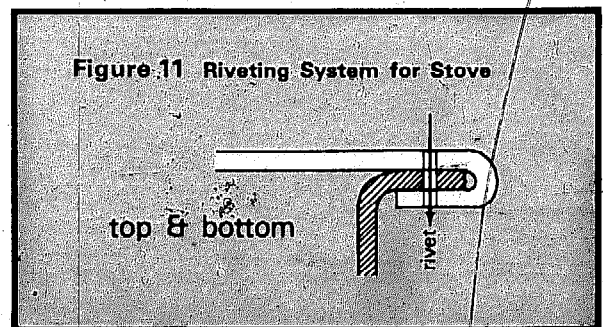

each long side and 2 for each short side, evenly spaced—20 in all. Resist the temptation to omit these rivets; your stove really will cave in without them.

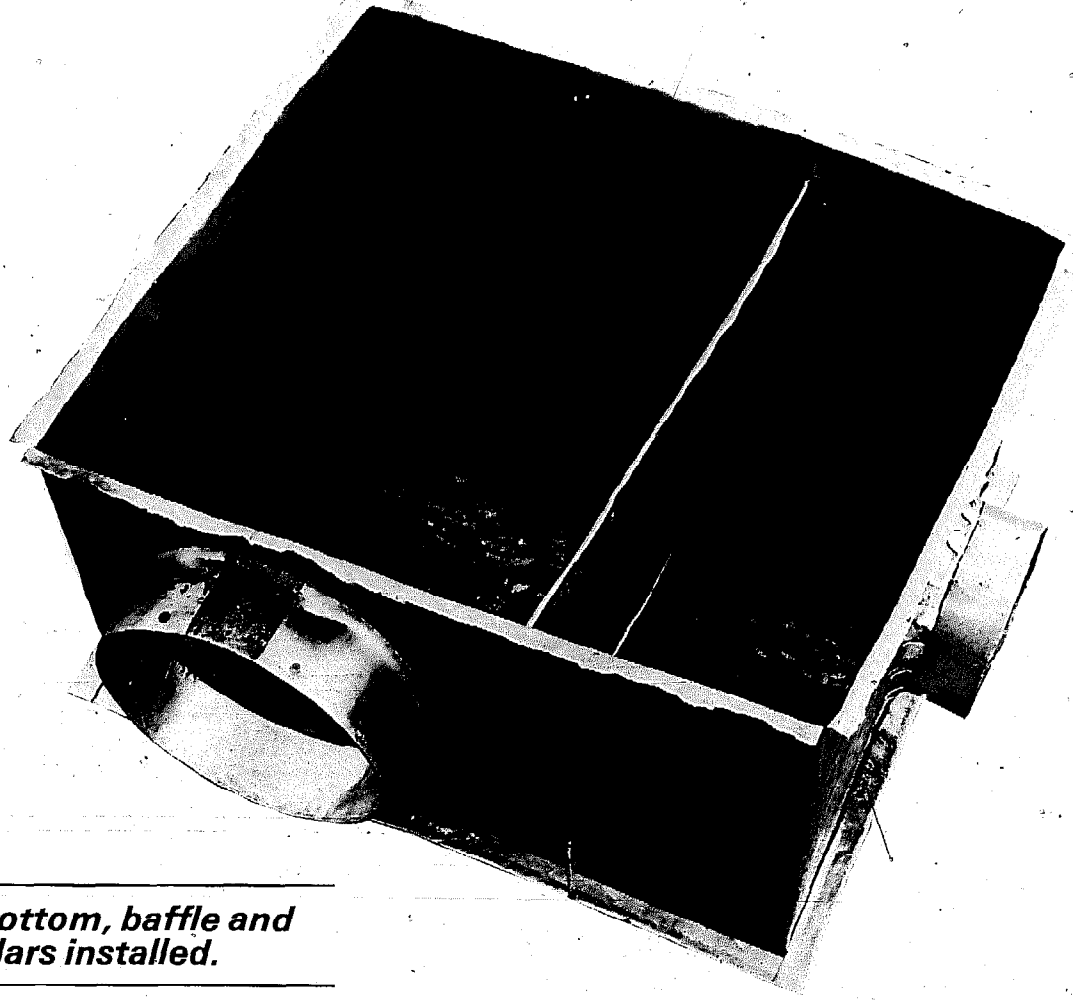

Stove with bottom, baffle and both collars installed.

13. Make the stokehole cover collar (see Figure 12). Measure around the outside of the stokehole collar to get the length of the strip you need, allowing 1/2 inch for overlap. Make the strip 2-1/4 inches wide and mold it to the stokehole collar so that it slides on and off with a smooth, gentle friction fit. (A collar that is too tight makes it hard to get the cover on and off, and one that is too loose admits too much air for best control of the fire.) Rivet twice. Make a mark on both collars so that you can always line them up the same way. With the new collar in place on the stokehole collar, bend a 1/4-inch flange outward on the cover collar, working slowly so as not to distort it. When finished, hammer the collar as necessary to correct the fit.

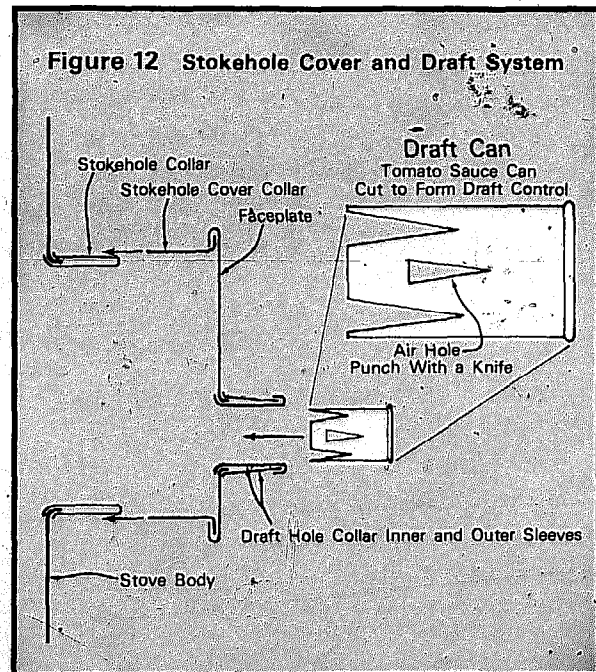

*Faceplate and
draft hole collar.*

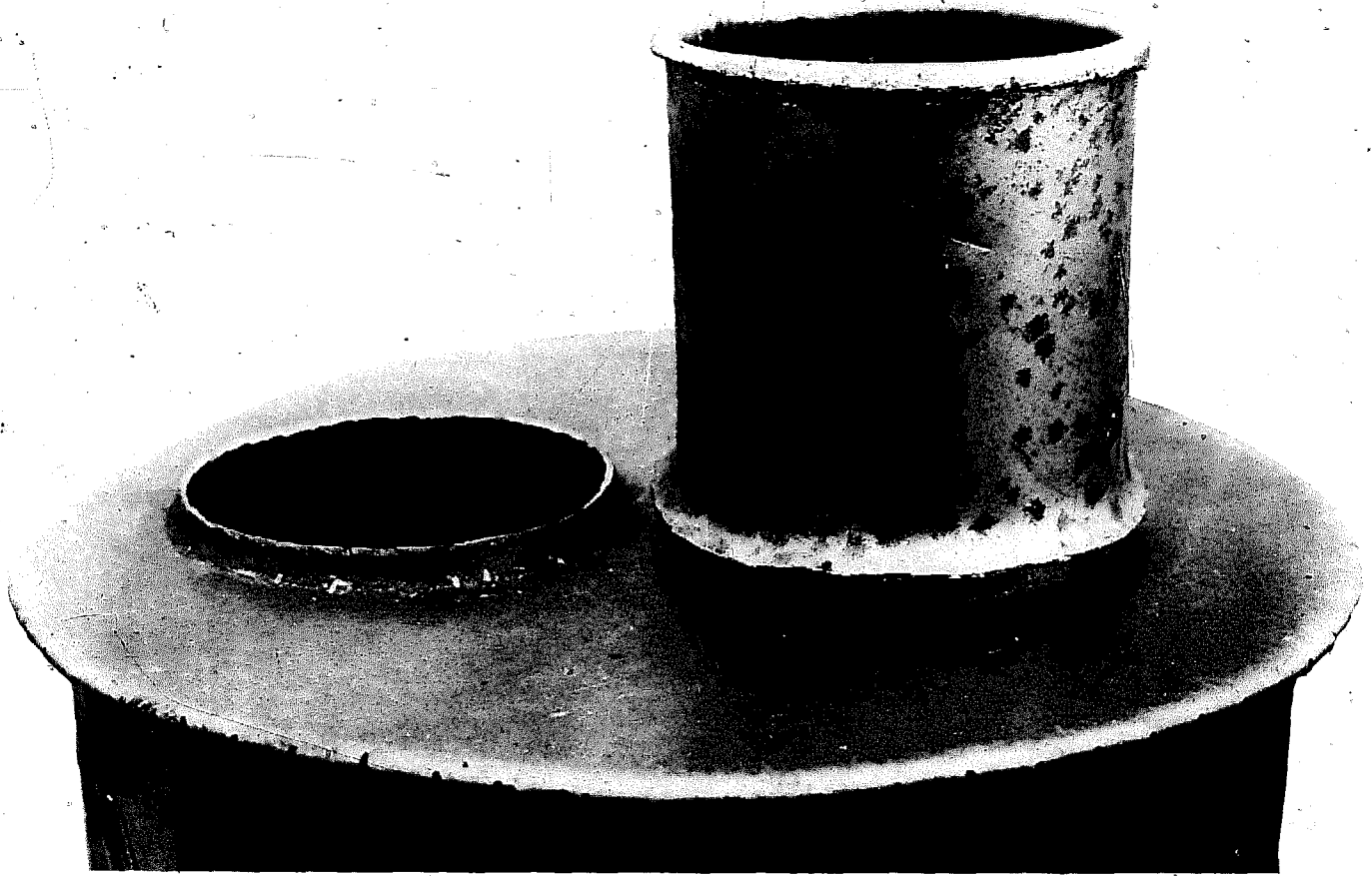

14. *Make the stokehole cover faceplate.* Lay the flanged stokehole cover collar on your oil drum top, with the flanges against the painted side. Trace a circle around the flanges to establish the fold line. Draw another circle 1/4 inch outside this line to establish the edge line. Before moving the collar, make marks on it and on the drum top so that you can always align the two pieces the same way. Cut along the edge line, file off rough edges, and pound the plate out flat.

15. *Form the draft hole collar.* The draft system is shown in Figure 12. A tin can, with air holes cut as shown, slides inside a small collar to admit varying amounts of air to the firebox. This collar is constructed according to the method shown in Figure 9C. First, obtain a soup or tomato sauce can to use as a form in rolling the strips. Carefully measure the circumference of the can and cut a sheet

of metal just a shade longer and 3 inches wide. You want the sheet to go all the way around the can and just butt up edge to edge, with a gently snug fit. Mold this sheet to fit around the can, thus forming the inner sleeve of the collar. Now cut another sheet of metal a shade longer than the inner sleeve and 1/2-inch narrower. Form it around the inner sleeve, with the seams offset 180°. Take care to get both sleeves as round as possible, and check the fit against your can. Clamp the sleeves together so that 1/4 inch of the inner sleeve protrudes at each end of the outer sleeve and rivet twice on each side of each seam—eight rivets in all.

Fold the top of the longer, inner sleeve outward over the lip of the shorter, outer sleeve. Then, using the techniques in Step 8, cut the draft hole in the faceplate (1 inch from the bottom edge) and mount the collar onto it.



Alternative: A simpler way to form the draft is to cut the stokehole cover faceplate (Step 14) in such a way that the large bung hole of the drum falls where you want the draft hole to be. With the bung in place, your stove is shut down all the way, and with the bung out, the stove is wide open. For intermediate settings, get two tomato paste (not sauce) cans. Flatten the open end of one to make it easier to hold and slide the closed end into the draft hole; the loose fit gives a low intermediate setting. Cut a 1/2-inch-square hole in the bottom of the other can, flatten the open end, and stick it into the draft hole for a high intermediate setting. These four positions, combined with the stovepipe damper, will give you the full range of stove control.

16. *Cut the draft can.* After removing the rim, cut the draft can to the pattern shown in Figure 12. Pushing the can all

Mounting the draft hole collar.

the way into the draft hole collar closes the draft completely; pulling it out various distances gives varying amounts of air to the fire; removing it from the collar completely allows a strong blast of air to rush down the tube onto the coals. A simple handle can be riveted onto the bottom of the can to aid in manipulating it.

17. *Mount the stokehole cover faceplate.* With the pliers, slowly fold down a flange around the faceplate, following the fold line. When you have completed a right-angle bend, cut shallow grooves into the outside of this flange with a hacksaw at

**Right—Detail of stokehole cover
and draft system.**

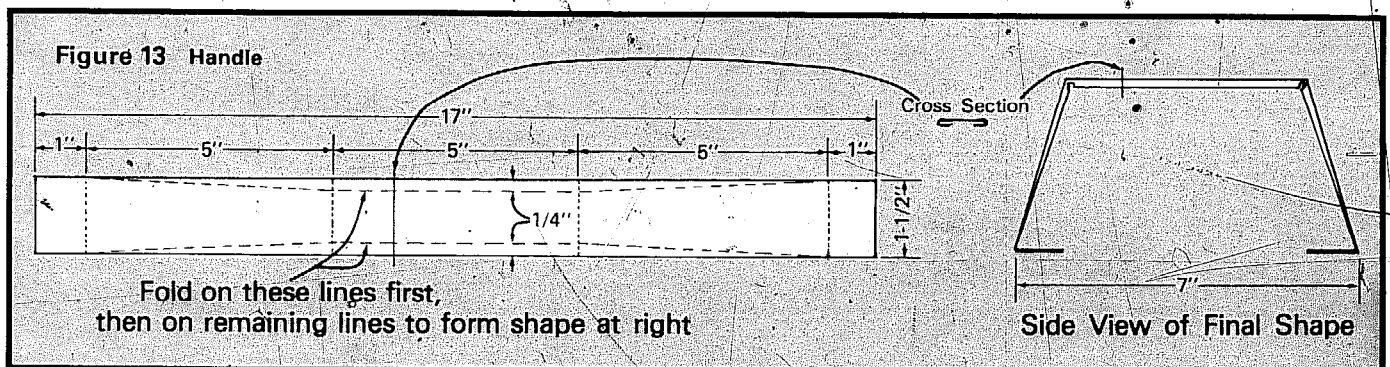

1/4-inch intervals. Cut only about halfway through the metal. Cutting these kerfs removes enough material that the remaining metal can compress easily as you fold the flange over the rest of the way.

Place the stokehole cover collar from Step 13 onto the faceplate, being certain to line up the marks so that the draft hole will be at the bottom of the faceplate when the completed cover is mounted onto the stokehole collar. Hammer the faceplate flange over so that it grips the flange on the collar. When finished, slip the whole assembly onto the stokehole

collar and pound as necessary to correct the fit.

18. Mount the handle. Cut and mark the handle strip according to Figure 13. Drill the holes, then fold along the dashed lines until you have right-angle flanges petering out toward the ends. Starting at the center, pound the flanges over nearly flat—just enough so that the handle is pleasant to the touch. Then fold on the dotted lines to the shape shown. Position the handle on the faceplate high enough to clear the draft system and rivet twice at both ends.

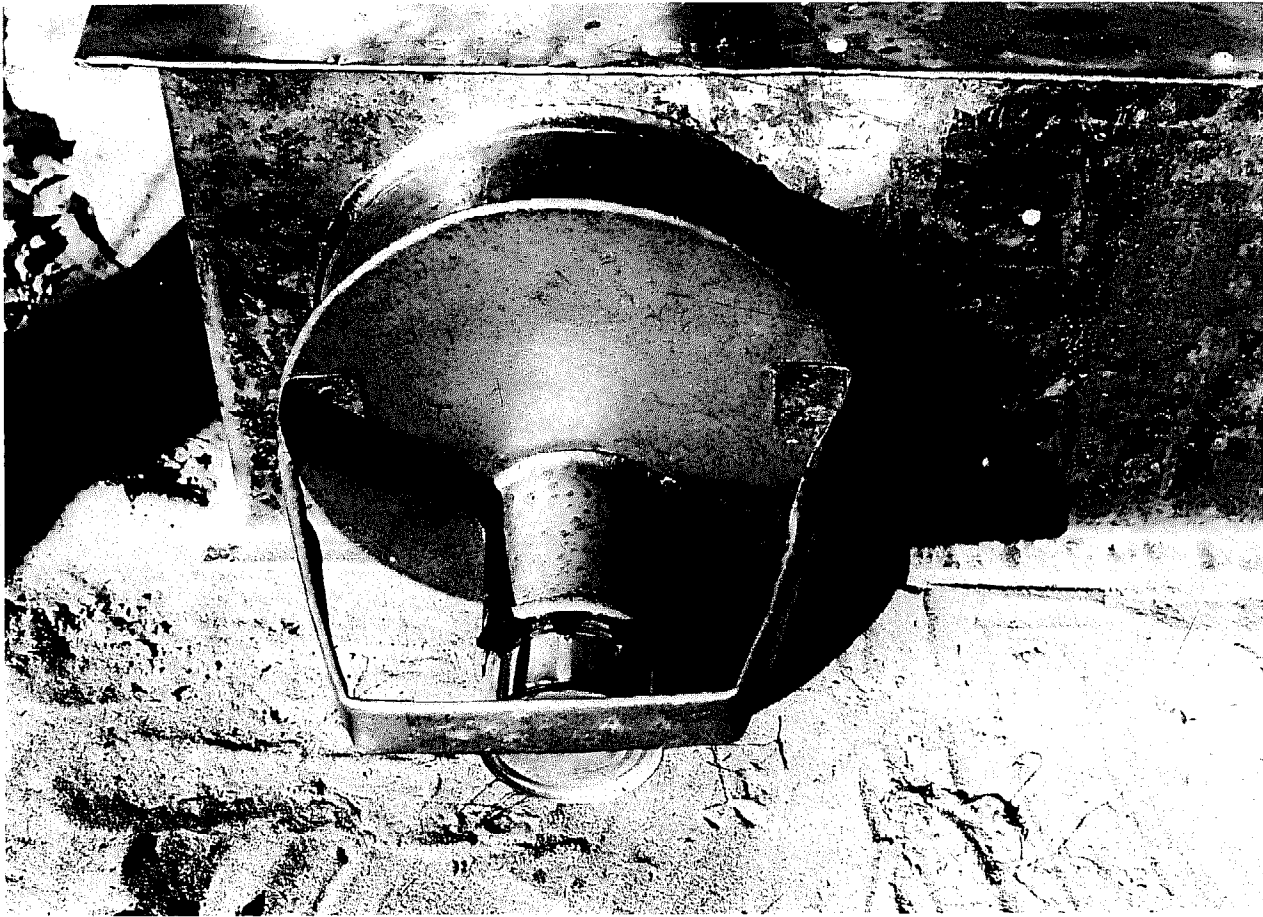

19. *Form the baffle sealer.* Cut a strip 5 inches wide and 1/4 inch shorter than the width of your stove body and fold it according to Figure 14.

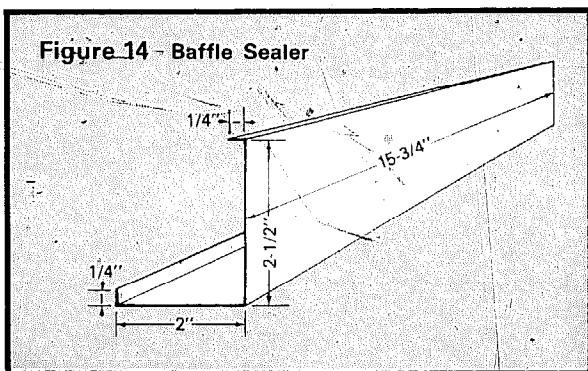

20. *Paint the stove.* If you wish, you can add a coat or two of stove enamel to improve looks and retard rust. Be sure to remove the original barrel paint completely first, since it is not designed for high-temperature use and will flake off after the first few fires, taking your stove enamel with it. Your first fire will drive the volatiles off the enamel, causing an odor, so make sure you have adequate ventilation or else make your first setup outdoors.

21. *Make a trivet.* Take the circle you cut out to form the stokehole and cut four tabs at 90° intervals, 1-inch wide and 3/4-inch deep. Bend the tabs over at right angles to form legs, adjusting the angle of the bend so that the trivet sits flat on the stove top. The trivet will be handy to keep pots up off the cooking surface when they need gentle heat.

Your stove is now complete. Make your first fire a gentle one, both to give the metal a chance to adjust to its new configuration and to cure the enamel. And make your first fire a time for ceremony. Invite some friends over for the stove warming, and put the kettle on. I

think you'll be warmed two ways—by the heat of the burning wood, and by the satisfaction that always comes when you've made something really nice with your hands.



Stove can be used in vertical position with baffle sealer removed.
