

# **AT** MICROFICHE REFERENCE LIBRARY

A project of Volunteers in Asia

Energy for Rural Development: Renewable Resources  
and Alternative Technologies for Developing  
Countries

by: Advisory Committee on Technology Innovation,  
National Academy of Sciences

Published by:  
National Academy of Sciences  
Commission on International Relations  
2101 Constitution Avenue, N.W.  
Washington, DC 20418 USA

Available from:  
National Academy of Sciences  
Commission on International Relations  
2101 Constitution Avenue, N.W.  
Washington, DC 20418 USA

Reproduction of this microfiche document in any  
form is subject to the same restrictions as those  
of the original document.

# *Energy for Rural Development*

Renewable Resources and  
Alternative Technologies for  
Developing Countries

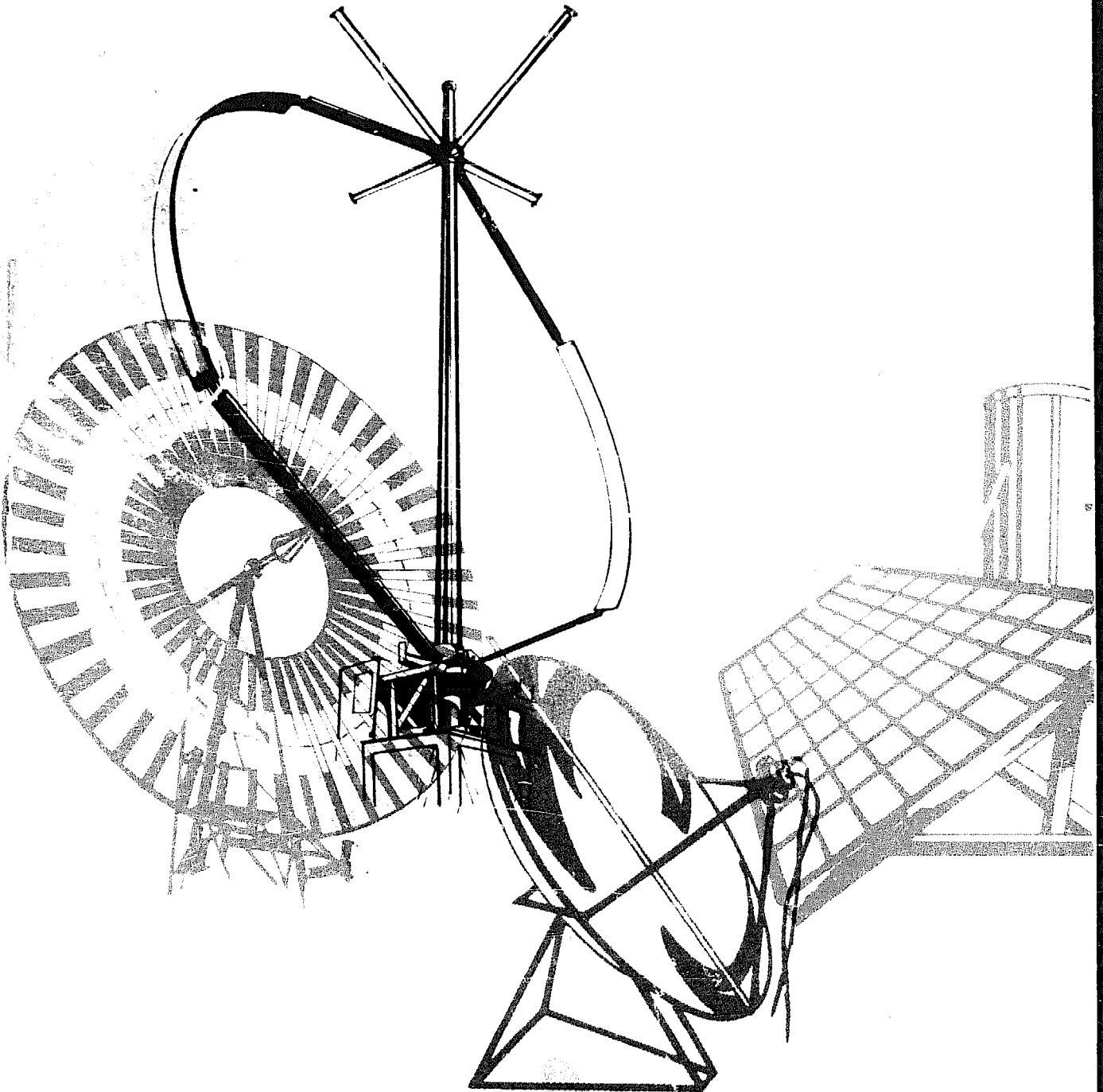

NATIONAL ACADEMY OF SCIENCES

# *Energy for Rural Development*

## Renewable Resources and Alternative Technologies for Developing Countries

Report of an Ad Hoc Panel of the Advisory  
Committee on Technology Innovation  
Board on Science and Technology for  
International Development  
Commission on International Relations

NATIONAL ACADEMY OF SCIENCES  
Washington, D.C. 1976

This publication has been prepared by the Panel on Renewable Energy Resources of the Advisory Committee on Technology Innovation of the Board on Science and Technology for International Development, Commission on International Relations, National Academy of Sciences—National Research Council, for the Office of Science and Technology, Bureau for Technical Assistance, Agency for International Development, Washington, D.C., under Contract AID/csd-2584, Task Order No. 1.

**NOTICE:** The project that is the subject of this report was approved by the Governing Board of the National Research Council, whose members are drawn from the Councils of the National Academy of Sciences, the National Academy of Engineering, and the Institute of Medicine. The members of the Committee responsible for the report were chosen for their special competences and with regard for appropriate balance.

This report has been reviewed by a group other than the authors according to procedures approved by a Report Review Committee consisting of members of the National Academy of Sciences, the National Academy of Engineering, and the Institute of Medicine.

**A French-language edition of this report will be published in early 1977 and single copies will be available on request from:**

**Agency for International Development  
Technical Assistance Bureau  
Office of Science and Technology  
Washington, D.C. 20523**



## PANEL ON RENEWABLE ENERGY RESOURCES

WILLIAM L. HUGHES, Head, School of Electrical Engineering, Oklahoma State University, Stillwater, Oklahoma 74075, USA, *Chairman*

CLANTON C. BLACK, JR., Chairman, Department of Botany, University of Georgia, Athens, Georgia 30601, USA

JAMES A. CRUTCHFIELD, JR., Department of Economics, University of Washington, Seattle, Washington 98105, USA

JESSE C. DENTON, Dean, School of Energy, American Technological University, Killeen, Texas 76541, USA

JOHN A. DUFFIE, Director, Solar Energy Laboratory, University of Wisconsin, Madison, Wisconsin 53706, USA

JOSEPH J. ERMENC, Thayer School of Engineering, Dartmouth College, Hanover, New Hampshire 03755, USA

THOMAS A. LAWAND, Director of Field Operations, Brace Research Institute, Macdonald College, McGill University, Ste. Anne de Bellevue, Quebec, Canada

GEORGE O. G. LÖF, Solar Energy Applications Laboratory, Engineering Research Center, Colorado State University, Denver, Colorado 80521, USA

DALE N. MOSS, Department of Agronomy and Plant Genetics, University of Minnesota, St. Paul, Minnesota 55101, USA

ROBERT W. REX, President, Republic Geothermal, Inc., 11848 E. Washington Boulevard, Whittier, California 90606, USA

GEOFFREY R. ROBSON, Chief, Minerals Section, Energy and Mineral Development Branch, Centre for Natural Resources, Energy and Transport, United Nations, New York 10017, USA

DANIEL I-c. WANG, Department of Nutrition and Food Science, Massachusetts Institute of Technology, Cambridge, Massachusetts 02139, USA

JEROME M. WEINGART, International Institute for Applied Systems Analysis, 2361 Laxenburg, Austria

NORMAN L. BROWN, Board on Science and Technology for International Development, Commission on International Relations, National Academy of Sciences—National Research Council, 2101 Constitution Avenue, Washington, D.C. 20418, USA, *Staff Study Director*

JULIEN ENGEL, Board on Science and Technology for International Development, Commission on International Relations, National Academy of Sciences—National Research Council, *Head, Special Studies*

# *Preface*

Five years ago, the Advisory Committee on Technology Innovation (ACTI) was established by the Board on Science and Technology for International Development of the National Research Council. Its objective was threefold:

- To screen technologies in use in industrialized nations;
- To examine technologies available but not in use; and
- To determine which of these might be successfully applied in developing nations.

Further, ACTI's aim was to determine the direction of research and development of these technologies and encourage any new approaches necessary to adapt them.

In line with these purposes, ACTI began a study of low-power sources of electrical energy for developing countries. The original intent was to concentrate on sources that could provide power of the order of 100 watts for use primarily, but not exclusively, with small communications devices (including village television receivers). A preliminary engineering survey was conducted in 1973 to assess the then-current availability and cost of suitable devices. While the survey recognized the potential applications of solar devices and wind-driven generators, it assumed the continued availability of fossil fuels (e.g., kerosene) in most rural areas of developing countries. This assumption accounted for the emphasis on the economic and mechanical advantages of small, inexpensive, internal-combustion engines.

It soon became apparent, however, that fuel for conventional energy

devices was becoming more expensive and, in many cases, less available. Therefore (and at the request of the Agency for International Development), ACTI broadened the scope of its study to consider other energy sources potentially available to developing countries for low-cost exploitation. A panel was appointed to examine energy technologies applicable at the village or rural level—technologies with power capabilities in the range of 10-100 kilowatts maximum. This report is the result of that examination. Each technology was to be discussed in terms of current or short-term (i.e., within 5 years) and intermediate-term (5-10 years) availability. The panel also was asked to identify the specific research and development efforts needed to make intermediate-term applications feasible in those areas in which such advances offered realistic promise.

With nuclear energy excluded from consideration, the technologies considered by the panel fall into two categories: direct and indirect uses of solar energy. Direct uses of solar energy include cookers, stills for potable water, heating and cooling of buildings, refrigeration, heating of water, crop drying, salt production, and photovoltaics. Indirect uses include photosynthesis, microbial conversion of plant materials to fuel, wind devices, and water devices. Finally, falling into neither of these major categories, there are discussions of geothermal energy and the general problem of energy storage. There were some early doubts about including geothermal sources in this study because of the magnitude of their power capabilities (megawatts) and the cost of exploration and exploitation. The panel felt, nevertheless, that special circumstances could make geothermal wells a practical source of energy for some rural areas in some developing countries. The benefit to those regions in which the technology is applicable was considered sufficient to justify its inclusion.

To maximize its usefulness to two distinct audiences, this report is divided into two sections. The first contains a series of nontechnical summaries in which each technology is described and its potential application outlined. This section is directed to the decision maker and planner who must evaluate technical proposals on the basis of a country's needs and prevailing constraints. The second portion of the report—the technical section—is directed to the specialist who may be familiar with the basic principles involved in given technologies but not with local problems, recent developments, or available information sources.

Technologies available within the next 5 years are variously referred to in the text as having "current," "short-term," or "near-term" availability. These are characterized by devices that either are on the market as manufactured commercial articles or have passed the stages of development and testing and can reasonably be expected to be on the market within 5 years. Technologies likely to become available within 5-10 years are designated "intermediate-

term" technologies, or technologies "soon to be available." For these, devices for their exploitation are only just emerging from the experimental stage and are being tested as prototypes, but have not yet reached the stage where commercial manufacture is imminent.

The panel recognizes that this report is but one step toward the adoption of the technologies discussed, and that application of these technologies to rural development will entail many individual efforts. With this in mind, the panel members have agreed to respond individually to questions that may arise that cannot be answered by information sources listed in the report--within realistic limits imposed by time and geography. Assistance of a similar nature and, especially, on practical matters of construction and operation, may be obtained from other sources, such as VITA\* (Volunteers in Technical Assistance), an organization with long experience in practical applications of technology in the field.

\*Inquiries may be addressed to: VITA, 3706 Rhode Island Avenue, Mt.Rainier, Maryland 20822, USA.

## LIST OF SYMBOLS

a	acre	km	kilometer
AC	alternating current	kW	kilowatt
amp-hr	ampere-hour	kWe	kilowatt electrical
Btu	British thermal unit	kWh	kilowatt-hour
bu	bushel	l	liter
°C	degrees Celsius	lb	pound
cm	centimeter	m	meter
DC	direct current	μ	micron
°F	degrees Fahrenheit	mA	milliamper
ft	foot	mi	mile
g	gram	MHz	megahertz
gal	gallon (U.S.)	mph	miles per hour
Gcal	gigacalorie	m/sec	meters per second
ha	hectare	MW	megawatt
hl	hectoliter	mV	millivolt
hp	horsepower	Ω-cm	ohm-centimeter
hr	hour	psig	pounds per square inch, gauge
Hz	Hertz	W	watt
in.	inch	Wh	watt-hour
kcal	kilocalorie	Whe	watt-hour electrical
kg	kilogram		

# Contents

Introduction	1
Energy Technology and Economic Development—An Overview	3
Conclusions and Proposals	11
NONTECHNICAL SECTION	
PART I DIRECT USES OF SOLAR ENERGY	21
Heating, Cooling, Distillation, Crop Drying, and Power Generation	23
Photovoltaic Devices	27
PART II INDIRECT USES OF SOLAR ENERGY	31
Wind Energy	33
Hydropower	37
Photosynthesis as an Energy Source	41
Microbiological Conversion of Plant Materials to Liquid Fuels	44

# *Acknowledgments*

It is only appropriate that the members of the steering group who originally recommended this study and suggested its form be thanked for their efforts. In addition to Jesse C. Denton and Clanton C. Black, Jr., who were also members of the study panel, the group included Charles A. Rosen (who served as chairman), Irma M. Adelman, Charles A. Berg, Lloyd O. Herwig, and Thomas F. Malone. The panel members found their suggestions most useful.

Thanks are also due to Kudret Selçuk, Marshal F. Merriam, William T. Beale, W. P. Teagen, and Sohrab K. Ghandhi for their assistance with the sections on crop drying, windpower, Stirling engines, Rankine engines, and photovoltaics, respectively. The editorial assistance of Warren Kornberg is acknowledged with thanks, and the major contribution of F. R. Ruskin, who prepared the manuscript for publication, is particularly appreciated.

Finally, special thanks are due the panel members and the National Academy of Sciences Staff Project Director, Norman L. Brown, for their efforts. The panel members labored long and hard to meet their objectives; Dr. Brown labored even longer and harder in editing and providing interfaces among the specialty groups in each of the technologies examined. Coherence in this report should be attributed to his untiring efforts and insistence.

WILLIAM L. HUGHES, *Chairman*  
Ad Hoc Panel on Alternative Energy  
Sources for Developing Countries

PART III	OTHER TECHNOLOGIES	47
	Geothermal Energy	49
	Energy Storage	53
TECHNICAL SECTION		
PART I	DIRECT USES OF SOLAR ENERGY	59
	Heating, Cooling, Distillation, Crop Drying, and Power Generation	61
	Photovoltaic Devices	87
PART II	INDIRECT USES OF SOLAR ENERGY	111
	Wind Energy	113
	Hydropower	137
	Photosynthesis	165
	Microbiological Conversion of Plant Materials to Liquid Fuels	180
PART III	OTHER TECHNOLOGIES	191
	Geothermal Energy	193
	Energy Storage	202
APPENDIXES		
1.	Energy Research and Development with Potential for Small-Scale Application	211
2.	Manufacturers of Solar Heating and Cooling Devices	234
3.	Manufacturers of Terrestrial Solar Photovoltaic Devices	242



4. External Combustion Engines--Rankine and Stirling Engines as Small-Scale Power Sources for Developing Countries	246
5. Currently Manufactured Windmill Pumps and Generators	270
6. Commercial Developers of Wind Machines	278
7. Windmill Towers for Construction on the Farm	280
3. Currently Manufactured Small-Scale Hydropower Machinery	288
9. The Helical Rotary Screw Expander and Its Potential for Geothermal Application	299

# *Introduction*

Energy plays a larger role in man's struggle with the vagaries of nature than merely sustaining life. In *The Economic History of World Population*, Cipolla has said that the more successfully man can use his own energy output to control and put to use other forms of energy, "the more he acquires control over his environment and achieves goals other than those strictly related to animal existence." He then adds what is certainly obvious but does not suffer from repetition—that fundamental to the utilization of nonmuscular energy is the problem of transforming it into the needed form "at a selected time and place and at convenient cost."<sup>1</sup>

That is the theme of this report. It is not the first such study; earlier, related efforts by competent groups and individuals have contributed in many ways to the thinking of the members of this panel.<sup>2</sup> This report focuses, however, as few others have done, on those small-scale energy technologies, not based on conventional fuels, that seem to be candidates for rural and village use in developing countries. It also examines the ways in which their candidacy may be affected by technological and economic constraints, present and future. In undertaking this assignment, the panel recognized from the start that the nature of its charge (contained in the key terms "renewable resources," "small-scale technologies," "rural environment") required that it consider only those technologies that could not be expected to have direct impact on the energy economy of a country. Rather, the technologies would be expected to contribute to the improvement of the quality of rural and village life in situations where conventional fuels and power systems have not yet penetrated or are too expensive to become a significant factor in the foreseeable future. Indirectly, however, the energy economy of some countries is likely to improve as adoption of these small-scale technologies

becomes more widespread (if only to slow the growth of dependence on conventional power systems).

This report provides a summary of the state of the art of alternative (or "appropriate" or "soft") technologies frequently suggested as solutions to rural or individual-family energy needs. Moreover, it informs both the technologist and the planner where to go for more detailed information and what kinds of research and development are needed before a particular device or process is ready for use. Thus, it should be of considerable assistance in evaluating the potential of each energy source in each candidate situation. Indeed, that was the original purpose of the study. It is not, and could not be, a detailed "how to do it" book: that would not be a book but a substantial library.

## REFERENCES

1. Cipolla, Carlo M. 1962. Sources of energy. Conversion of energy. In *The Economic history of world population*. pp. 35-36. Baltimore, Maryland: Penguin Books.
2. See, for example:
  - General Electric Co. March 1963. *Small-scale power supplies for rural communities in developing countries: Report to U.S. Agency for International Development*. Syracuse, New York: General Electric Co.
  - Johnson, A. L. 1974. Non-conventional sources of energy for developing countries. Paper prepared for the United Nations Advisory Committee on the Application of Science and Technology to Development. U.N. Document No. E/AC.52/XX/CRP.T/Annex. New York: United Nations.
  - United Nations. Economic and Social Affairs. 1967. *Small-scale power generation. A study for pioneer electrification work*. U.N. Document No. ST/ECA/94. New York: United Nations.
  - Little, Arthur D., Inc. 1974. *An overview of alternative energy sources for LDCs*. Report to U.S. Agency for International Development, Technical Assistance Bureau, Office of Science and Technology. Cambridge, Mass.: Arthur D. Little, Inc.

Among the more specialized surveys are:

  - Golding, E. W. n.d. *Windmills for water lifting and generation of electricity on the farm*. Agricultural Engineering Branch, Land and Water Development Division, Informal Working Bulletin No. 17. Rome: Food and Agriculture Organization.
  - Heronemus, W. E. 1974. *A survey of the possible uses of windpower in Thailand and the Philippines*. Prepared for the U.S. Agency for International Development, Office of Science and Technology. Amherst, Mass.: University of Massachusetts, Department of Civil Engineering.
  - Lustig, H. 15 February 1974. *Solar energy: The state of the art and the art of the states*. UNESCO Document No. SC/WS/575. Paris: United Nations Educational, Scientific, and Cultural Organization.

An interesting collection of nontechnical articles reviewing the status of solar energy utilization and implications for developing countries appeared in the *UNESCO Courier* 1974 (January).

# *Energy Technology and Economic Development — An Overview*

The relationship between energy and economic development is as crucial in the less-developed countries (LDCs) as it was and continues to be in the industrialized nations. The process of economic growth is traceable in large part to the substitution of energy for muscle in the performance of every type of agricultural, industrial, and domestic task. Moreover, many of the pesticides, herbicides, and fertilizers on which successful agriculture in industrialized nations traditionally depends are also derived from energy (fossil fuel) sources. It is hardly surprising, then, that prospects for growth in critical sectors of the less-developed economies are linked, at least in part, to the development and exploitation of energy resources available to them.

No one familiar with the problems of accelerating economic development has any illusions about the speed with which innovation can be achieved and made economically viable; learning to use energy in new forms and new ways may require years—perhaps even a generation or more—to break down the economic, cultural, social, and institutional barriers that impede technical change in developing countries. But although the development of reasonably priced, scaled-down, and diversified sources of energy, adaptable to a range of needs and a range of physical and cultural environments, is necessary, it is not sufficient for accelerated economic progress.

Decisions that have high payoff potential often center on the economics of energy supply and demand in the developing countries; as in any country, the first step in the appraisal of economic feasibility must be a thorough assessment of present and potential technical capabilities and of the human and material resources required to realize these capabilities. The technical

sections of this report present assessments of the state of the art of a number of conventional and unconventional energy technologies. These are accompanied, in most cases, by an evaluation of their adaptability to the diverse circumstances of underdeveloped economies.

Two additional steps are required, however, before sensible research policies and longer-term programs for the exploitation of energy technologies can be formulated. First, it is essential to link energy programs with other elements of factor supply in the nations involved. (See the discussion of the second proposal in the chapter on Conclusions and Proposals.) Analysis of the economics of development of any of the technologies cannot, by itself, produce all the necessary information, nor can the manufacture of any of the devices discussed in this report generate an information base sufficient for the evaluation of energy programs. Using either approach alone would underestimate the interrelationships of new types of energy production with other components of the economy, particularly the natural-resource systems and the reservoirs of scarce capital and skilled labor that must also be taken into account. Further, available or potentially available foreign exchange—based upon many complex political and economic functions—must be carefully assessed. The availability of foreign exchange is particularly important, since the “shadow prices” of imports in countries with severe exchange restrictions are usually far above nominal money prices, and except for the most rudimentary energy development, dependence on foreign sources of materials and technology almost inevitably will be involved.

Second, and less obvious but often critical, are the costs associated with dissemination of new technology and step-by-step guidance to its application. Being careful not to confuse illiteracy with incapability, one must be aware of the formidable obstacles that impede the dissemination of any new technology in tradition-dominated rural societies, geared as they often are to subsistence or semi-subsistence living and imperfectly linked to imperfectly organized markets and cultural centers. Information costs in this context may often loom larger than those associated more directly with development and application of the technology.

Except for a few approaches—e.g., small, homemade windmills and waterwheels, solar driers, hydraulic rams—with power capabilities near the bottom of the range considered, near-term (1- to 5-year) prospects for effective utilization of the energy sources examined in this report are not encouraging. While the necessary exercises have not been carried out here, an economic evaluation in the dimensions outlined above is likely to paint an even bleaker picture. In short, the developing countries, like the rest of the world, seem condemned to a continuing struggle with increasingly high relative prices for energy from conventional sources. The “energy crisis” will

continue to be, in essence, a fossil-fuel crisis (specifically, an oil crisis). This conclusion should not be surprising; even in the industrialized nations, with their infinitely greater capacity for research and development, capital accumulation, skilled manpower, and ability to take risks, at least a decade or two must pass before any of what are now regarded as promising "unconventional" energy sources will play an important role in the energy-supply picture. Even where a particular energy technology holds promise, the prospect of short-term benefits to developing countries is doubtful; promising sources do not match well with the demands of energy users in developing nations. Again, this is to be expected, since the more promising prospects on the supply side are likely to reflect the pattern of energy demand in the industrialized countries where the research is taking place. That pattern is very different from energy usage or need in the developing countries. While generalizations about these diverse requirements should be made with caution, it is probably safe to say that the major demands for energy in developing countries relate to transportation and the variety of activities associated with food production.

As a recent report\* stated, examination of the energy demands of agriculture reveals a much higher degree of net energy usage and a closer correlation of energy application to productivity than had been anticipated. Much of the phenomenal output of agriculture in the United States and other major food-exporting countries can be traced in large part to the massive application of power and fertilizer to land; labor inputs per unit of output diminished very rapidly as the pull of higher wages in manufacturing and services increased.

Since agricultural expansion in the LDCs is likely to take place in environments most unfriendly to agriculture—tropical forests, poorly or infrequently watered savannahs, or desert lands—energy inputs to achieve the increases of food production required to satisfy rural needs and an expanding rural population will be even more important than they were in the fertile, temperate plains.

More to the point, those inputs will continue to depend largely on petroleum and petroleum-based products. Although the world as a whole must find substitutes for petroleum-based fertilizers in the not-too-distant future, it will require these products in increasing quantities for some decades. Indeed, it is becoming increasingly apparent that the consumption of petroleum products in lower-valued uses (such as space heating) must be curtailed to ensure a continued supply of feed stocks for petrochemical

\*Pimentel, David, *et al.* 1973. Food production and the energy crisis. *Science* 182: 443-449.

industries as a group. At present, the industrialized nations are experiencing difficulty in finding or converting to substitutes for petroleum to achieve this end. Since technological progress in the LDCs, with only minor exceptions, takes place because of a "trickling down" and adaptation of developments elsewhere, one should not expect the LDCs to experience less difficulty. The high cost of capital and the inherent inability, on both political and economic grounds, to take major development risks impose severe constraints on the freedom of developing nations, some balanced precariously on the edge of starvation, to experiment with new energy sources.

Transportation and communication, for example, are the keys to more effective market organization, to more efficient division of labor, and to improved access to natural resources. These are services a nation must buy with its investment in energy sources. But none of the energy sources discussed in this report, indeed none on any visible horizon (considering the constraints that in virtually all cases accompany the need), seems likely to make any significant contribution to transportation of the types and at the levels required to achieve transformation of an economic structure.

In short, the major contribution of energy to economic growth in the LDCs lies in areas that require conventional kinds of energy, and this will probably continue to be the case for at least the next few decades with no easy relief in sight on the side of supply. One cannot reasonably expect those developing nations with exportable supplies of fossil fuels to share them with their neighbors-in-need on any altruistic basis.

The more promising energy technologies discussed in this report involve conversion of the energy in wind and water to electricity, and the use of solar energy for heating and perhaps cooling. To the extent that these technologies relate to demands that are matters of comfort—light, radio, television, space heating, cooling—they will not contribute significantly or immediately to improvement in national economic productivity. Unless a development improves agricultural productivity, moves cash crops to market more efficiently, or brings in manufactured consumer goods at lower costs, it is not likely to have a significant effect on the overall growth potential of an economy emerging from the semi-subsistence straightjacket.

But there are applications of technologies that can indeed contribute to that overall economic growth. Improved communication, for instance, stemming from the availability of modest amounts of electricity, can make possible the dissemination of vital information on agricultural problems, public health, nutrition, and family planning. Solar crop driers can play a significant role in improvement of crop storage, increasing both the quantity and quality of the usable crop at the end of the storage period. The use of dung as fuel to replace the declining supply of firewood in many developing countries has seriously affected agricultural productivity by eliminating its

use as fertilizer.\* An approach to this problem—providing a fuel while preserving the fertilizer potential of dung—is the subject of a separate study.† An array of such small improvements, by relieving pressures on other energy sources that directly influence productivity, could have a long-term cumulative effect on a national economy and should not be discounted.

It needs saying, however, that there is a general high-capital intensity that is characteristic of economically significant energy supplies and that reflects the development pattern of the industrialized nations, which most LDCs appear to have been persuaded is the proper route to follow. This constitutes the chief barrier to unconventional approaches to the use of energy technologies in the LDCs. Thus, where capital and the skills to employ it profitably are scarce, governments are likely to confine major investments in energy to larger-scale projects that promise to contribute substantially to the economic productivity of a whole region or a nation. In its evaluation of the potential of a small-scale approach, given suitable technology, the panel was fully aware of this reality.

Electricity, for example, simply will not profoundly affect the economies of developing nations unless it is extremely cheap, and that means hydroelectric developments on a massive scale where topography and water supplies permit. Yet, relatively small projects using water flow as a direct source of energy or to generate electricity can be attractive in economic terms, even where there is no possibility of large-scale development, as is pointed out in the discussion of hydropower. Small dams can be constructed by local labor with local materials, and they combine long life with minimal maintenance over a considerable range of scales of construction.

Even so, it does not seem likely that significant changes in the use of hydropower will occur in the developing countries over the next 5 years. Most of the small-scale uses of hydropower have been known for centuries, and except for the benefit gained by introducing this ancient technology to areas where it may not be currently used, the most we really expect in the near-term future is a concerted effort to produce incremental gains in reliability and cost. Such gains are not trivial, but they do not suggest major opportunities to substitute local hydropower for imported fossil fuels.

Much the same comment can be made about the use of energy from wind. Wind is more readily available than falling water. For this reason, the LDCs

\*Exacerbating the problem of fuel in rural areas is the growing shortage of firewood, a shortage that is reaching critical proportions in many countries. This problem is discussed in a recent publication: *The Energy Crisis: Firewood* by Erik P. Eckholm, Worldwatch Paper 1, Worldwatch Institute, Washington, D.C., September 1975.

†*Methane Generation from Human, Animal, and Agricultural Wastes*. In preparation. See p. 506.



may well find considerable overall benefit in the use of wind power as a prime source of mechanical power, as well as in the generation of electricity, by harking back to small-unit technologies that proved so useful in rural Europe and America not too long ago. The ability to build structures of proven characteristics at relatively low capital and operating costs, using local materials and manpower, still carries the same rural appeal. Wind power, used directly for large-scale generation of electricity, does not, however, appear any more economically attractive in the LDCs than in the industrialized countries, given the current state of the art. This is true not only because of the storage problem, but also because such a program would involve both capital costs and more elaborate power transmission and integration technology than LDCs can afford at projected costs for such systems.

The discussion of direct uses of solar energy suggests again that short-term gains appear limited to those obtainable from marginal improvements in processes already well known and long established throughout the world. Unfortunately, the fairly optimistic prospect for cost-competitive space heating (and, at higher cost, for air cooling) is of far less interest in the LDCs than in the industrialized nations. There are, after all, a good many cheap substitutes for space heating in the developing countries in temperate and northerly latitudes (e.g., traditional building and clothing design); and in the tropics the problem is obviously not very important. The use of direct solar energy in cooling might be attractive economically, as fossil-fuel costs continue to rise, in the major cities and in tourist-oriented facilities. But at prospective cost levels it certainly is not likely to affect the rural poor (who, in some parts of the developing world, constitute up to 90 percent of the population).

Despite the widespread occurrence of promising geothermal formations, the cost of exploration and development remains formidable, except in units too large to be suitable for the village economy. It does not seem likely that even the best of these fields can offer large amounts of electrical energy at costs comparable to those of prime hydroelectrical sites. That conclusion might well be altered, however, if the development of geothermal energy resources could be combined with the search for oil or the production of fresh water for municipal or irrigation use.

The major environmental obstacles to the development of geothermal energy in the industrialized countries--principally the problem of water residues that are very dirty indeed--may be less immediately pressing in some developing countries. However, even if the scale of the operation were large enough to reduce the unit-cost burden of heavy exploratory and developmental costs, geothermal energy could only be useful in supplying major cities and/or industrial enterprises requiring large amounts of cheap electrical energy. On such a scale, the management of residual waste waters could become a serious problem.

It is difficult to evaluate, in economic terms, the significance of the potential for energy produced by photosynthesis in the LDCs. The original aim of the panel's study in this regard was to concentrate on the production of combustible materials. Consequently, the panel did not include members with the expertise necessary for a discussion of engineering problems involved in technologies of exploitation, such as the destructive distillation of wood.

The economic issues involved in the utilization of plant materials as fuel are regrettably not dealt with in this report—with the exception of the microbiological production of fuels. Nevertheless, it should be pointed out that there are few places in the world where significant quantities of combustible or otherwise convertible materials could be grown that would not compete, directly or indirectly, with vitally needed food production. Direct competition with food production in the use of land is obvious. If, in addition, successful production of materials in sufficiently large quantities to make them desirable as a source of energy requires large amounts of fertilizer, the prospect will not be attractive, in view of the present situation of world food and fertilizer production.

The technology of utilization raises another question: Under what circumstances would it really be worthwhile to convert plant biomass into processed energy such as electricity or even as a primary heat source for manufacturing activities? Why not simply utilize it, as wood and vegetable fibers have been used since time immemorial, for local, small-scale, household fuel supplies, recognizing that a very high proportion of household fuel consumption in developing nations is for basic cooking, smoking, and drying processes? This question has been addressed in a recent report\* that points out the dimensions of the problem of rapidly increasing scarcity of firewood in parts of Asia, Africa, and Central and South America—a scarcity of such proportion that it is intimately bound up with major deforestations and expansion of desert areas. This growing scarcity clearly indicates that expanded cultivation of trees and other combustible plant materials for direct use as fuel by households has not proved practical, and it seems unlikely that the “energy farm” approach would contribute as much to rural development as would expanded cultivation for direct use by households.

The section on photovoltaic production of electricity provides a review of the state of the art in this rapidly moving field, and a look into the future—but not the near-term future—of interest to the LDCs; for them the utilization of this technology is a distinctly remote prospect. Dramatic reductions in the capital costs of photovoltaic generation of electricity would admittedly bring the process within range of the rapidly rising fossil-fuel costs, without the problems that nuclear energy seems destined to generate

\*Eckholm, *op. cit.*

for a number of years. Economies in manufacturing are certainly possible; nevertheless, the investment in photovoltaic research and development on the scale necessary to bring this technology within reach of the LDCs (to whom present fossil-fuel costs are still out of range) seems more easily justified if it is coupled to a mass market in the industrialized countries as well.

Science and technology have distinguished records of outrunning forecasts of progress. In the case of photovoltaics, however, it is certain that the major impetus will come from the developed countries, and the targets for application will be selected by them. The issue, then, becomes the relative rate of return from adapting to the needs of the LDCs a technology likely to be in a state of flux for some time, compared with the rates of return that might be earned in alternative energy investments. In this comparison, the near-term prospects for photovoltaic generation of electric power in developing countries do not appear favorable.

This study of the technological prospects for meeting the rural energy needs of the developing countries suggests that we are unlikely to see any really dramatic change in the definition and relative importance of "conventional" and "unconventional" sources in the next 10-15 years. In addition, technological changes that may occur toward the end of this period will not have significant effect upon the economies of developing countries for yet another decade or two unless a concerted effort is made to shorten the "trickling down" process (mentioned earlier). Therefore, we cannot escape the conclusion that there will continue to be an urgent need for more effective utilization of all energy sources for some time to come.

# *Conclusions and Proposals*

This report provides information on the technologies necessary to exploit renewable energy resources. However, in the view of the panel, it serves a larger purpose. The report provides an examination of the technical and economic constraints that make the prospects for large-scale adoption of most of these technologies in the near future discouraging. The panel's work in connection with this study resulted in three fundamental and inescapable conclusions:

1. A variety of energy sources and technologies is indeed available as alternatives to conventional power systems.
2. With the exception of a few devices (e.g., homemade windmills, solar driers), there are no cheap alternative technologies of significance for either industrialized or developing nations, and there probably will not be any in the near future.
3. It is not enough that an energy source be available; the technology to put it to use must also be available. The benefits of any one of the suggested alternatives for producing energy could be multiplied many times if even a small amount of capital were invested (a) in developing the technology needed to use the energy and (b) in ensuring that the technology is properly integrated into the economy and the culture.

With this in mind, the panel concludes that certain actions might hasten the adoption of technologies that will make possible efficient and economic exploitation of at least some renewable energy resources in rural areas of the

developing world. Since this study was intended to be primarily a technical assessment of certain energy technologies, the panel will not present firm recommendations on the subject, but rather proposals for further consideration.

The following activities are proposed as steps toward a solution of the problems of (a) interdependence of energy and economic development and (b) the consequences of pegging that development to conventional central-source power systems:

- Organization of workshops to evaluate the potential role of decentralized power systems for rural areas in developing countries;
- Organization of a pilot energy-oriented development program to assist rural areas in acquiring the needed energy technology and the means to exploit it usefully; and
- Establishment of regional institutes for research and development on technologies for exploitation of renewable energy resources.

## WORKSHOPS

As a first step, a series of workshops should be held in Asia, Africa, and Latin America to discuss the potential economic and social benefits of developing and adapting small-scale decentralized power supplies that utilize renewable energy resources and that are aimed at rural communities. The workshops should give particular consideration to the two proposals that follow and should be structured to deal with specific country needs (giving full attention to cultural sensibilities). In addition to appropriate government officials and representatives from international and private funding agencies, the workshops should include people from the academic community—particularly from engineering faculties—and others who are responsible for project implementation in the field, including, when possible, village leaders known to be receptive to new ideas.

The panel members know that reports such as this, while perhaps interesting to those with related technical interests and useful as source material for other studies, generally are of no consequence to the people they are designed to help—certainly not in the short run. They are also painfully aware of the failures that have met previous attempts to introduce new energy technologies—such as solar cookers—into developing countries. If serious efforts to help LDCs acquire technologies to exploit their energy resources are to be attempted again, they should be undertaken with the participation at the outset of appropriate representatives of the proposed beneficiary communities.

In the panel's judgment, this proposal is the most important of the three and a necessary preliminary to the consideration of the two below.

## PILOT ENERGY-ORIENTED VILLAGE DEVELOPMENT PROGRAM

A specific rural area (e.g., a village or group of villages) should be selected for study, as an economic unit, by a small team of technologists and rural-development economists. The purpose of this on-site study would be to identify methods—and to devise an appropriate scheme—consistent with national development objectives, to enable the chosen area to adopt appropriate alternative energy systems, including the importation of essential components not locally available. The team would accomplish this by providing information and training that would enable the community to make more efficient use of its own human and natural resources, or by providing capital equipment, as may be necessary.

This suggestion results from the panel's conviction that, when properly used, small—perhaps intermittent—amounts of power can be of critical value to a rural economy. The inability of developing countries to produce relatively small increments of energy is a major bottleneck to development progress in many places. Although provision of such amounts of energy is not a sufficient condition for improvement in economic and social well-being, it is a necessary condition.<sup>1</sup> Its efficacy, of course, is bound intimately to other economic, social, and political changes that must take place concomitantly. The panel believes the interdependence of these changes and energy supply to be so important that provision of energy technology presents a singularly opportune "point of entry" for a rural-development scheme.

The cumulative impact of the effective use of even small amounts of energy in a rural area can be considerable. Agricultural productivity, public health, communications, educational opportunities—all leading perhaps to a slowing down of the rural exodus—could benefit from the availability of even low-power devices.<sup>2</sup> For example, 100 watts available to run a small pump will, with reasonable efficiency, provide irrigation water at the rate of about 20 gallons per minute from a depth of 20 feet.\* It could also provide safe drinking water from an aquifer hitherto impractical to tap, or permit treatment of an unsafe water supply. The communications equipment it could easily power might make emergency medical services available to an

\*This is the equivalent of covering one hectare with one centimeter of water in about 24 hours. For a lift of one meter, however, a one-hectare rice paddy could be covered with water to a depth of two centimeters in about 8 hours.

otherwise isolated community. By powering a village television receiver, as was done until recently in India (Project SITE—Satellite Instructional Television Experiment), it could provide vital information on agriculture, health, nutrition, and family planning. It certainly could provide adequate light for a household; a village of 200 families would require only 20 kilowatts, for example, to provide 100 watts of lighting per family.

None of the devices capable of providing modest amounts of power—with the possible exception of photovoltaics (solar cells)—nor the machines they could operate, need be considered high technology by today's standards. Nevertheless, they do represent a technological level usually beyond reach of a community that has little or no trade with the outside world and must make everything itself. Most of the alternative energy technologies discussed in this report (with the exception of homemade windmills, waterwheels, or solar crop driers, and perhaps the hydraulic ram) are probably inaccessible to most rural communities in developing countries. They are beyond reach, however, not because of lack of skill in the village, but because of the lack of capital to acquire the necessary materials and tools. Education may be wanting, but there is no dearth of capability. The lack of formal education or training has seldom been a barrier to the use of technology at this moderate level, if the community is shown how. Indeed, the village or farm dweller usually understands his problems better than others do, and if given the necessary financial and material resources, can adapt technology to those problems more effectively than most outsiders are willing to believe.

Rural mechanical genius is not an exclusive western characteristic; remarkable technical skills were manifest long before western science developed.<sup>3</sup> Good electric motors are being assembled by illiterate workers in surroundings that are relatively primitive by the standards of an industrialized country, but only because such components as copper wire, silicon-steel laminations, machined castings, bearings, and the like are available. Knowledge can be transmitted and skills transferred, but acquisition of a technology is almost impossible unless critical material bits and pieces can be obtained. There is no reason for self-sufficiency to be a goal in a situation where trade with outside sources of these materials exists or can be generated.

The panel is convinced that a developing country's rural economy will be helped by the creation or acquisition of sufficient capital to obtain the technology that, in turn, will allow the country to put its own human capabilities and natural resources to work. Its economic development will be further enhanced if the country can exploit its renewable energy sources in a manner appropriate to local requirements and consonant with local customs. The panel submits that if energy—and its use—is the one factor basic to economic development, then consideration of a development scheme focused on indigenous energy resources is more than warranted. In the absence of new

means for providing energy, the situation for the energy-poor rural areas will not improve significantly; in the face of increasingly costly conventional energy sources, it will surely deteriorate.

Generalized economic studies and models of rural areas are no more useful in real situations than are purely technological studies. A village on the Mediterranean coast where there is wind, solar energy, and perhaps abundant rain, is radically different from a village in the rain forest that has water but little wind, or a village in India that at certain times of the year may have neither. Any attempt to find a universal model for all these situations will be so full of theoretical generalities as to be of little value to the specific microeconomies to which solutions must be applied. A microeconomy, however, can be effectively studied by specialists in rural economics and related disciplines working in tandem with technologists who know what can be done by capital infusion, by human labor, or by both. The proposal set forth here would test the hypothesis that if the means of adopting appropriate alternative energy systems are available, a rural economic unit can achieve a permanent improvement in its general standard of living and economic well-being. If the experiment is successful, the approach might be replicated elsewhere, in other rural economic units of varying characteristics, to permit a more conclusive assessment of the value of this approach in rural development strategy.

## REGIONAL ENERGY RESEARCH AND DEVELOPMENT INSTITUTES

Regional energy research and development centers should be established to take the lead in development and adaptation of renewable energy-resource technologies appropriate to the region. We urge that these centers be staffed with indigenous personnel to the fullest extent possible and that the staffs include social scientists. Without such people, the panel fears that unfortunate experiences of the past, such as unsuccessful attempts to introduce solar energy devices (e.g., cookers), will be repeated and that the technologies discussed here will be rejected.

The final proposal stems from the panel's recognition of the need to adapt to local constraints both the technologies discussed and the devices available for their exploitation. In the course of the panel's discussions, the concept of international regional research institutes was advanced. This is not a new concept; it has been proposed in various forms in the past—first, perhaps, in 1951 by M. S. Thacker in a paper commissioned for UNESCO.<sup>4</sup> This proposal was for a World Power Commission whose function would be to oversee worldwide energy development. Concerned primarily with large-scale power,



the commission was to be controlled by the industrialized nations. The idea was modified slightly in 1955 with the suggestion that the proposed international body include energy groups dedicated to assisting developing nations. In 1961, it was proposed that an international institute—the International Research Center of Solar and Aeolian Energy—to concentrate on nonconventional energy sources be established in Greece.<sup>5</sup>

In 1972, an NAS panel, in a report on solar energy in developing countries, revived the idea and recommended “the establishment of regional energy R and D centers” assigned the following functions:

- “1. To help generate an information base on energy needs in the region;
2. To carry out the needed research and development to meet regional energy needs;
3. To field-test and provide feedback from users to the centers in order to improve energy processes and evolve useful solar (or other) processes;
4. To act as information, education, and training centers in cooperation with local universities; and
5. To maintain close contact with scientific and engineering developments and energy applications in other centers and in industrialized countries.”<sup>6</sup>

In 1973, an International Working Party organized by UNESCO proposed the creation of an International Solar Energy Commission<sup>7</sup> that presupposed the creation of a network of regional international solar energy centers, and in 1974 the U.N.’s Advisory Committee on the Application of Science and Technology to Development proposed that the United Nations Environment Program (UNEP) “take the lead in initiating an energy institute which could . . . work with various governments, organizations, and individuals in the developing world. . . .”<sup>8</sup>

In the fall of 1975, the United States formally proposed the establishment of an International Energy Institute to help developing countries solve their energy problems.<sup>9</sup> The United States suggested that the institute might identify “current or new technologies most relevant [to the special needs of developing countries] and could help assess all countries’ energy resources and requirements.” Staffed by experts drawn from government, industry, and academic life in both industrialized and developing countries, it could provide training for local and regional technicians or specialists in energy problems. It could become a central point of contact where policymakers and experts could exchange ideas on plans and programs. Further, the institute could become a “first bridge between the massive effort the industrialized countries have now launched to develop alternative sources of energy, and the effort which the developing countries must now undertake.”<sup>10</sup>

No significant move was made to implement any of the earlier recom-

mentations, and the most recent proposal is still a matter of discussion within the U.S. Government. It is therefore timely, the panel believes, to emphasize the necessity for decentralizing not only the power supply systems, but also the proposed International Energy Institute. This decentralization is essential if a country is to take advantage of alternative technologies for exploiting renewable energy resources. An International Energy Institute would undoubtedly serve a valuable function as "a central point of contact" for coordination of research, energy-policy studies, analysis of energy systems, and training of developing country personnel in these and energy management skills. But development and local adaptation of alternative energy technologies are not likely to be accomplished in such a setting. Rather, the central institute should be associated with a series of regional institutes devoted to these ends. Successful local adaptation of new technologies is dependent on practical local input, which is likely to be obtained only under circumstances conducive to field testing and training in technical skills.

The work of these regional institutes should be directed toward lowering the cost of these technologies (so that they become financially accessible to developing countries) and using indigenous material and manufacturing capabilities whenever possible. The panel emphasizes once again that social scientists should be included on the staffs of such centers to give appropriate attention to economic and social factors in the cultural settings in which new technologies are being introduced.

The present cost of current technologies for exploitation of renewable energy resources is, in most cases, beyond the reach of rural communities in developing countries. The role played by energy in rural development is so important, however—particularly in improving the standard of living of rural populations—that the panel feels strongly that this situation should not be permitted to continue. A concerted attempt should be made to bring these technologies within reach of these populations, particularly in energy-poor countries, by increasing production, distribution, and appropriate adaptation and use. To this end, the panel offers these proposals in the hope that they may be usefully applied.

## REFERENCES

1. Although awareness of this interdependence is only recently becoming widespread as a result of the "energy crisis," it is not a new concept. See, for example: Millikan, Robert A. 1939. Science and the world tomorrow. *Vital Speeches* 5:446-468. Also MacCurdy, George G. 1924. *Human origins: A manual of prehistory*. 2 vols. New York: Holt, reprinted by Johnson Reprint Corporation.
2. Merriam, M. F. 1974. *Engineering research for decentralized power: A plan for action*. Honolulu: East-West Center, Technology and Development Institute.

3. See, for example: Brown, N. L., and Pariser, E. R. 1975. Food science in developing countries. *Science* 188:589-593.
4. Thacker, M. S. 24 May 1951. *The role of energy in underdeveloped areas*. UNESCO Discussion Theme 1951 Energy in the Service of Man. Paris: United Nations Educational, Scientific, and Cultural Organization.  
See also Johnson, Reference 2 (Introduction) for a review of the history of this idea.
5. Golding, E. W. 1964. Methods of assessing the potentialities of wind power on different scales of utilization. In *Solar and aeolian energy*. Proceedings of the International Seminar on Solar and Aeolian Energy, 4-15 September 1961, Sounion, Greece. Athens: North Atlantic Treaty Organization. Distributed by Plenum Press, New York.
6. National Academy of Sciences/National Research Council. 1972. *Solar energy in developing countries: Perspectives and prospects*. Report of an *ad hoc* advisory panel of the Board on Science and Technology for International Development, Office of the Foreign Secretary. Washington, D.C.: National Academy of Sciences.
7. *Bulletin of the UNESCO Regional Office of Science and Technology for Africa*. 1974. IX(3) (July-September).
8. Billings, B. H. 1974. *A proposal to the United Nations Environment Programme for a programme in non-polluting energy*. Advisory Committee on the Application of Science and Technology to Development. U.N. Document No. E/AC.52/XX/CRP.7, 11 September. New York: United Nations.
9. Kissinger, Henry. 1975. Global consensus and economic development. Speech before the United Nations General Assembly, Seventh Special Session, September 1. Washington, D.C.: U.S. Department of State, Bureau of Public Affairs, Office of Media Services.
10. Kissinger, Henry. 1975. Energy, raw materials, and development: The search for common ground. Speech before the Conference on International Economic Cooperation, 16 December. Washington, D.C.: U.S. Department of State, Bureau of Public Affairs, Office of Media Services.

**NONTECHNICAL  
SECTION**

*PART I*

***DIRECT USES OF  
SOLAR ENERGY***

---

# *Heating, Cooling, Distillation, Crop Drying, and Power Generation*

Current applications of solar energy that seem appropriate for use in rural areas, depending of course on local conditions, include:

- Heating of water (for domestic and commercial use);
- Heating of buildings;
- Cooling of buildings;
- Drying of agricultural and animal products; and
- Salt production by evaporation of seawater or inland brines.

From the technological standpoint, many other solar energy applications are possible. These include electricity generation, food refrigeration, cooking, production of pure water from salt water, and chemical manufacture. Their economic status is such, however, that near-term use cannot be expected; either the cost of conventional energy sources for these applications is well below solar costs, or there is very little need for such substitution in the economy of developing countries.

The applications listed are in use in various parts of the world today, but this is not to say that the technology does not need further development. It means simply that some equipment is commercially available, and applications in developing nations during the next 5 years can be expected to involve currently available equipment. Conversely, not every application for which commercial equipment is currently available can be expected to be adopted in rural communities in developing nations within the next 5 years without further significant research and development.

## TECHNOLOGY CURRENTLY AVAILABLE

Within the next 5 years, only four of the applications listed can be reasonably expected to be adopted in rural areas of LDCs.

*Agricultural uses of solar energy* include the drying of various crops, employing both direct exposure to sunlight and the use of heated air passed through or over the material to be dried. These processes are available for immediate application, using locally available materials, labor, and expertise. Further, the reliability of the technology is proven, and recent research has resulted in design improvements. The costs of drying grains, fruits, lumber, and other products by solar-heated air have not yet been reliably appraised. Although they appear to be slightly more costly than conventional heating schemes, they are within economic reach.

*Solar energy to produce hot water* has long been used successfully for domestic hot-water supply. Since such systems are often economically competitive with others, the economic advantage of this system compared to those using fossil fuels will increase as the price of fuels rises. Where fuels such as wood or peat are locally available at little or no cost—though such supplies are diminishing—the capital cost of a solar-heated domestic hot-water supply cannot be justified.

*Residential heating by solar energy* often suffers economically wherever fossil fuel supplies are cheap and plentiful, a situation that appears to be vanishing rapidly. In the case of residential heating, hot-air systems have been used successfully instead of hot water. These systems are technologically unsophisticated, generally reliable, and can often be implemented with locally available materials, labor, and expertise.

*The production of salt by evaporation of seawater or inland brines* is an ancient practice sufficiently well known that it will not be treated extensively here. Suffice it to say that it is a current direct use of solar energy that is immediately available for use wherever salt-containing water occurs in conjunction with appropriate climate; the practical and economical use of this method does not depend significantly on technological improvements.

For the most part, these four applications appear to exhaust the available direct uses of solar energy that could be adopted by developing countries within the next 5 years. There is, perhaps, one other application that might be available toward the end of this period—the solar-driven cooling system employing the absorption cycle. About the only technology that will be available during this time, however, will be a redesigned lithium bromide water system. The reliability of the equipment is expected to become adequate within about 5 years, but the cost competitiveness is still open to question; depending upon local conditions, it may not be possible for LDCs in

this time period to rely on local materials, industry, labor, and expertise. If the technology is found to be applicable, however, units of this type will probably make sense economically only if used in fairly large buildings where commercial activity provides the capital for defraying the high investment cost.

## TECHNOLOGY SOON TO BE AVAILABLE

In the period from 5 to 10 years, one can expect the development of improved cooling systems both of the absorption type and the compression type. In the compression-type system, improvements and economies in the organic Rankine cycle and possibly in the Stirling cycle can be expected. With respect to absorption processes, research should include multistage systems and new working fluids. Some new modifications of absorption cycles will have to be proven, and there may also be success in developing desiccant systems suitable for regeneration by use of solar energy. Research and development in all these areas are needed.

It is possible that near the end of this period small solar-powered electrical generators may become practical. (This subject is more thoroughly discussed in the section on photovoltaics.) Especially for communities remote from electric networks, pumping of water, cooling, and perhaps lighting and communications may be solar operated. In areas of exceptionally high fuel price and abundant solar energy, this technology could be introduced if capital is available.

With respect to the large-scale generation of electrical power, there is little that can be accomplished in terms of in-place power in the next 10 years in the developing countries. This may not be the fault of the rate of technological progress so much as the fact that the very sophisticated industrial infrastructure and the considerable capital requirements may militate against successful implementation within this period. With respect to the technology for solar-driven electrical generating systems, there are numerous approaches in the research and development stage at present: Stirling, organic Rankine, and other cycles, as well as photovoltaic, thermionic, and thermoelectric systems. It is too early to single out one approach that is clearly superior, although some indications favor the "power-tower" approach. These approaches need further sorting out before a clear direction emerges. During the next 5-10 years, it is not expected that there will be sufficient agreement in the field to permit successful implementation of a single approach on a significant scale, even in the industrialized countries.



## RESEARCH AND DEVELOPMENT

In the 0- to 5-year period, viable solar-energy applications in the LDCs can be implemented by the introduction of capital and the exploitation of local materials. Some materials will have to be imported, but the bulk of the material would be available in most countries. Capital availability is unquestionably the major factor in the near-term application of solar energy in the LDCs.

For the 5- to 10-year period, capital again is the limiting factor. But research and development on promising new applications and on improving and reducing the cost of solar systems already in use will also be needed. Support of these programs by the local governments, by intergovernmental organizations such as the United Nations and UNESCO, and by the international banking community can be effective. In addition to research on these systems in the technologically advanced countries, practical development projects in the LDCs should be of greatest benefit to the introduction of the technology. Monitoring of results by the sponsoring agencies and dissemination of these results through the existing technical and international reporting channels are necessary concomitants of any program of this kind.

# *Photovoltaic Devices*

Direct conversion of the visible part of the solar spectrum—sunlight—to electricity is perhaps the neatest and most aesthetically pleasing of all schemes for the exploitation of solar energy. It is also, unfortunately, among the farthest from feasibility for widespread application in the developing nations.

Direct photovoltaic conversion can be achieved with basically simple devices that involve no moving parts, no additional sources of energy, and little if any maintenance. These photovoltaic devices, which have become known as solar cells, are based on the properties of certain crystalline solids that enable these materials to supply an electric current capable of performing useful work when the material is exposed to sunlight. Although the devices are indeed basically simple—consisting of a wafer of crystalline material to which two metal contacts are fastened—their fabrication requires the sophisticated technological capabilities of the industrialized nations. In fact, it is this very technology that is now developing methods that may (by reducing the cost of the product) make it economically feasible and justifiable for rural areas to make use of solar cells. Thus, with very few exceptions, developing countries can avail themselves of this technology only by acquiring its products through international trade. This will continue to be the case until more of the third-world nations develop the necessary technological and industrial infrastructure, and the industrial fabrication processes are sufficiently developed through large-scale production, to make transfer of the fabrication technologies themselves economically justified.

Solar cells were first used commercially in 1955. Their development since

then has been primarily a by-product of space research. The very properties that make them attractive for use in developing countries—simplicity, low weight, efficiency, reliability, lack of moving parts—have made them indispensable in supplying power needs of spacecraft. Unfortunately, mass-production techniques (geared to high-volume demand and economic competition) have not yet been implemented in the manufacture of these devices. It is not surprising, therefore, that solar cells have remained so costly. The current concern over the availability and price of fossil fuels and the massive infusion of R and D funds into energy research may provide added stimulus to the recent trends toward cost-cutting, mass-production techniques for solar cells.

### TECHNOLOGY CURRENTLY AVAILABLE

Photovoltaic systems with 10 percent solar-conversion efficiency and with peak power capacities from 1 watt to tens of kilowatts are available from manufacturers in Japan, the United States, England, France, and the Federal Republic of Germany (West Germany). Packaged systems for use in remote applications, such as navigational buoys and lighthouses, environmental monitoring stations, microwave relay stations, and forest ranger communications, are available as commercial products in the range of a few watts to a kilowatt; larger systems are available on a custom basis. Costs of a complete system are dominated by the photovoltaic array; prices of \$20-\$30 per peak watt, corresponding to \$100,000-\$150,000 per average kilowatt installed capacity, are now being quoted, though these costs are expected to decrease by as much as a factor of four within the next few years. These systems all incorporate silicon solar cells produced by modifications of the technology used to produce spacecraft solar cells and include batteries, voltage and current regulation, and other components such as DC/AC inverters as options.

During the coming 5 years, over \$100 million will be spent by industry and government in the United States, Japan, West Germany, France, and England on the development of lower-cost terrestrial photovoltaic power systems. During this period the emphasis will be on the research and development of new processes for mass production of integrated solar modules and, by 1980, of integrated solar-cell arrays using cells made from mass-produced silicon ribbon. Arrays incorporating wide-aperture concentrators without diurnal tracking requirements will probably also be on the market. As a result of the intense research and development effort currently under way on these terrestrial systems, even greater cost reductions can be expected; solar cell modules with a cost of a few thousand dollars per average

kilowatt (down by a factor of about 50), and having conversion efficiencies approaching 15 percent, could be available by 1980.

### TECHNOLOGY SOON TO BE AVAILABLE

If the economic stimulus of fuel shortages and high prices continues, there is a good chance that commercial photovoltaic conversion arrays at costs of a few hundred dollars per average kilowatt will be available by 1985 or sooner. The integration of such arrays into a complete system incorporating energy storage, power conditioning, and transmission and distribution will be required before these are useful on any substantial scale for power generation greater than a few kilowatts per system. In this regard, availability of economically interesting storage systems (see chapters on storage) will be a crucial factor in determining the extent to which such technology is used.

In this price range there would be great interest in the potential use of such technology, perhaps in the establishment of local (village and community-size) "minigrids" with the eventual growth and interlinking of these into larger and more diverse electrical networks. However, if this technology is to be transformed into something that can meet the special technical, economic, and cultural constraints and needs of various developing countries, a deliberate and specific effort will be required; otherwise, the direct "transfer" to the remote village level of photovoltaic systems developed for integration into modern utility grids is unlikely.

*PART II*  
*INDIRECT USES OF  
SOLAR ENERGY*

---

# *Wind Energy*

The exploitation of “free” wind energy is as attractive in its way as photovoltaics are in theirs. It, too, is not free of problems, though for LDCs the problems may be more manageable. Wind was one of the earliest sources of power used to multiply the productive capacity of muscle. On the seas it has been used to propel ships, and on land it has served a variety of purposes on a village scale. These include:

- Pumping fresh water for domestic livestock and agricultural needs;
- Irrigating fields;
- Powering agricultural tasks, such as grinding corn, wheat, and sugarcane, and threshing, chaff cutting, and winnowing;
- Cutting wood;
- Pumping saline water in saltworks; and
- Generating electricity for a variety of purposes.

This chapter concentrates on small-scale wind machines producing up to 10-20 hp (7.5-15 kW).

## **TECHNOLOGY CURRENTLY AVAILABLE**

A variety of windmills is currently available, either commercially or in the form of working prototypes that could be readily manufactured as a market

developed. These include both vertical- and horizontal-axis rotational machines. Among the vertical machines are the Savonius rotor—particularly well suited to local construction—the Darrieus rotor, and the vertical sailmill. Horizontal-axis machines most common are 2-, 3-, and 4-bladed propellers usually associated with wind-powered electrical generators, the multiblade fanmill commonly used for pumping water, and the horizontal version of the sailmill characteristic of the well-known windmill of the Greek islands. In addition, simple windmills of the paddlewheel type, with either horizontal or vertical rotational axes, are used.

In terms of assessing the availability of this technology within the next 5 years, there are enough commercially built units currently available to permit immediate application, whether it be for pumping water, compressing air, or generating electricity.

The water-pumping units vary significantly in price from \$4,000 to \$8,000/hp (\$5,000 to \$10,000/kW) for fractional size units, to \$1,000 to \$2,000/hp (\$1,300 to \$2,600/kW) for units of 5-15 hp (7-20 kW). Few larger-scale pumping units are commercially available today.

Electrical generating units cost from \$3,000 to \$6,000/kW for fractional-kW generators or from \$1,000 to \$2,000/kW for units in the 5- to 15-kW range. One unit just going into production in the United States is expected to sell for about \$500/kW. No larger-scale commercial units are currently being sold.

Most commercially available windmill units sold today are safe, dependable, require little maintenance, and are built with an expected life of 10-20 years (sometimes more), with proper maintenance.

In addition, a number of windmill designs are available that villagers themselves can construct, often utilizing locally available materials.\* In small sizes, these units will produce mechanical shaft power at a cost of \$1,000-\$1,500/hp (\$1,300-\$2,000/kW). In general, however, they will be characterized by slightly higher maintenance and operational requirements—principally labor—than most commercially available units.

In developing areas, classical windmills will often cost much less than the figures quoted above, because a considerable amount can be done with locally available technologies.

\*For example: "How To Construct a Cheap Wind Machine for Pumping Water." Leaflet No. L-5. Brace Research Institute, MacDonald College, McGill University, Ste. Anne de Bellevue 800, Quebec, Canada. (\$1.00) Also: "Low Cost Windmill for Developing Nations" by Hartmut Bossel. Available from VITA (Volunteers in Technical Assistance), 3706 Rhode Island Avenue, Mt. Rainier, Maryland 20822, USA (\$2.00)

## RESEARCH AND DEVELOPMENT

Technological and economic improvements could be expected in 5-10 years if research and development can be encouraged. Such a program should include the following:

- Materials-engineering studies of existing commercial windmills, designed to improve production techniques and reduce costs;
- Development of windmill systems for the production of mechanical shaft power and the generation of electricity, utilizing as many indigenous or locally available materials and technologies as possible;
- Investigation and redesign, where necessary, of equipment to be powered by windmills to carry out the required unit operations—such as pumping, agricultural tasks (milling, threshing, grading), and electrical generation—with a view to their fabrication in local workshops;
- Development of decentralized power systems that are simple, reliable, and that may be serviced—if not fabricated—in village areas;
- Application of known technologies to adapt windmill systems to a variety of environmental conditions (such as winds, rainfall, snow, ice, temperature extremes), which may include development of new forms of rotors for small-scale applications (although significantly improved efficiency in this area should not be expected); and
- A program of public education in rural areas to show what windpower can do.

Such a program could be expected to result in the development and use of equipment capable of delivering 1-15 hp (750 W-11 kW) in a 10-mph (16-kmph) wind, from improvements in existing equipment.

The development of units in the 25- to 50-hp (20- to 40-kW) range would be more costly, but needs attention nonetheless. Considerable spinoff advantage can be expected from development programs currently under way in industrialized nations.

The research and development program outline would most efficiently be undertaken by a central organization, supported by multilateral funding and having an international staff. At present, there are several groups engaged in windpower research in the developed countries, all with different purposes and financing. Among them are academic groups, such as those at Oklahoma State University at Stillwater, Oklahoma, and at the Technische Hogeschool Eindhoven in the Netherlands; the nonprofit Brace Research Institute at McGill University, Montreal; the commercially supported group, Windworks, in Mukwonago, Wisconsin; and the Swedish Technical Board in Stockholm, a



government body. In the developing countries, the Institute of Technology Bandung in Indonesia, for example, has done some development and field work on windpower devices.

The panel feels that the work of all these groups could be coordinated to the best advantage for windpower applications in developing countries only by the creation of a central research and development organization having this as a specific objective, working through regional energy research and development institutes; this is suggested in the section on the panel's conclusions. This organization would be in a position to develop coordinated collaborative design and testing programs with groups such as the Appropriate Technology Development Unit at the Gandian Institute of Studies in Rajghat, Varanasi, India; the Solar Energy Laboratories in Karachi, Pakistan; the National Physical Laboratory in Jerusalem, Israel; and the Ministry of Electricity in Cairo, Egypt.

Such an organization would function with the collaboration of the Advisory Council for the Application of Science and Technology to Development (ACAST) of the United Nations, as well as with national, bilateral, and multilateral donor agencies, to facilitate the exchange of information on work in progress and ensure widest dissemination of results achieved.

# *Hydropower*

## THE HYDRAULIC TURBINE

The first power source extensively used (other than that available from the muscles of men and animals) was that derived from flowing water, either impinging directly upon paddles attached to a wheel or filling buckets attached to a wheel. These are the waterwheels, the precursors of the water turbine, whose origins can be traced to ancient Egypt, China, and Persia.

Waterwheels took over many laborious and monotonous tasks such as grinding grain for flour and animal feed, raising water for irrigation and water supply, textile manufacture, and metallurgical processing.

As the demands for power increased over the centuries, the simple waterwheel became larger. By the middle of the 19th century, the revolutionary development of the water turbine by Fourneyron in France began to displace the waterwheel as a power source; in fact, the steam engine had begun this displacement process a half century earlier.

The water turbine was vastly superior to the waterwheel from almost any practical point of view. It could generate much more power than the largest waterwheel in a much smaller volume or apparatus. It could perform adequately at high or low heads that could not be handled by waterwheels. It also could operate at a greater number of revolutions per minute than the waterwheel, principally by virtue of its smaller diameter.

In New England, during the last half of the 19th century, there were more than 50 manufacturers of water turbines supplying the needs of small, rural mill owners. It was not unusual, however, for a millwright to design and build

his own water turbine; indeed there are a few "homemade" installations still in existence. By the end of the 19th century, the small water turbine in a mill was often belt-connected to an electric generator, principally for lighting purposes.

With the development of large-scale hydro- and thermal-electric central generating stations and the extension of electric power lines to rural areas, the manufacture of small water turbines began to decline rapidly. In recent years, however, no doubt because of the energy crisis, there is renewed international interest in the small-scale hydroelectric unit. Such units are currently available for use in developing nations.

By small-scale, low-head hydroelectric units, we refer to those capable of generating 5-15 kW at heads of 10-20 ft (3-6 m). While the discussion will be primarily in terms of generation of electricity, it must be recognized that the same apparatus can perform useful mechanical tasks directly; it may be connected via belts or gears to grain mills, pumps, wood- and metal-working machinery, and other machines of production.

### Technology Currently Available

For use with low water heads, the fixed-propeller type of turbine or the more familiar Francis type\* is more suitable than the more complicated types such as the Kaplan, which adjust themselves to the electrical load. Small hydroelectric generators are currently available from several manufacturers in the United States and Europe. Also, there appears to be vigorous manufacture and use of such turbines in the People's Republic of China, but this panel has no information regarding their availability for export.

Because of the limited production of such small hydroelectric units, their cost per kilowatt is quite high. Units capable of generating 10 kW cost about \$1,000/kW. The cost per kilowatt rises for smaller capacity units. These costs do not include the cost of other necessary parts of the system, such as the dam, the piping connection (penstock) between the dam and the turbine, and the housing. With all costs considered, the cost of electricity at the generator would probably range from 8¢ to 10¢ per kilowatt-hour.

### Research and Development

Significant cost reductions could probably be achieved in developing countries through the construction of propeller-type turbines from wood. (The more complicated Francis turbine does not lend itself easily to wood

\*See p. 141 for description.

construction.) Reports from China, the Soviet Union, and Rumania indicate that this approach has been used successfully in these countries.

The propeller and the Francis turbines are a mature, time-tested technology; further advances can be expected to be limited to cheaper manufacturing methods and materials and to the incorporation of new technology (solid-state devices) in the electrical controls.

The study of hydropower developments of the past may also be helpful to LDCs. Actual small-scale mills using turbines for many rural needs may still be seen in the United States (New England), China, Switzerland, the Balkans, Norway, and Sweden.

## THE HYDRAULIC RAM

The hydraulic ram is a simple, ingenious pump, operated solely by flowing water, that was developed in Europe at the end of the 18th century. Like the waterwheel, it experienced a period of popularity in the industrialized countries and then a decline coincident with the surge in production and distribution of economical electrical energy. There is still one hydraulic ram manufacturer in the United States who does business on an international scale.

The hydraulic ram can be described as a completely automated device that uses the energy in flowing water to pump part of that water to a height above that of the source. It can also be used to compress air for operating machinery. It is a simple device that contains only two moving parts.

### Technology Currently Available

Manufactured hydraulic rams are currently available at costs ranging from \$159 to about \$2,700, depending on size.

Hydraulic rams can operate 24 hours a day for many months with no maintenance. No significant improvements are anticipated for the next 5 years.

Construction plans for making a hydraulic ram are available from USAID or from Volunteers in Technical Assistance.\*

Additional research and development are suggested for the adaptation of the hydraulic ram to air compression for use in reciprocating engines and turbines.

\*See p. vii for details.

## THE HYDRAULIC AIR COMPRESSOR OR TROMPE

The trompe, or hydraulic air compressor, is a simpler device than the hydraulic ram. It has no moving parts, but utilizes hydraulic potential energy very effectively in the compression of air. This system, which would operate continuously, day and night, without attendance, could store energy in the form of compressed air that can be used to drive turbines and reciprocating engines that, in turn, can drive production machinery or electric generators.

It is suggested that large-scale studies of this simple, low-cost device be undertaken to verify the scant but impressive performance data available from the literature.

# *Photosynthesis as an Energy Source*

The one renewable energy source on which mankind has relied since the discovery of fire is photosynthesis. Even though nature performs the initial function in the conversion of solar energy to an energy-rich biomass, the photosynthetic process is subject to technological advances as sophisticated in their own way as those that apply to photovoltaics.

Mankind has long found important and diverse uses for the by-products of the photosynthetic process—food, fiber, fuel, and shelter. In terms of the concerns of this panel, the exploitation of the by-products of the photosynthetic process is, in effect, a long-established technology for energy conversion and storage. The deliberate development of an agronomic energy resource, however, is not. The emphasis in this report is placed, therefore, on energy resources that can be developed by supplementing current agricultural practices in rural areas.

The space available to a village can be divided into arable and nonarable land; we are concerned here primarily, but not exclusively, with the more efficient use of the former. Although the panel concerned itself with culturing of plants as an energy feedstock, the terms of reference for this study did not permit considerations of the end use of the plant material produced. That final use clearly will depend upon the needs of the population and the methods available to convert the plant material to more useful energy forms, and will dictate many aspects of the specific research, development, and exploitation schemes pursued. (One conversion technology, however, is discussed in the section on microbial conversion.)

When agriculture is viewed from the point of view of human utilization of

sunlight as an energy source, the criteria for choice and timing of crops differ from those conventionally used; factors commonly ignored now become very important. One of the first that should be considered is the energy content of the plant material. This is particularly important where there is a choice among alternative food or fiber crops having differing amounts of residue whose energy content can be exploited.

A second factor that should be considered is that maximum use of available sunlight requires that farmland be kept covered with green plants throughout as much of the year as possible. This involves, for example, multiple cropping, intercropping, nurse crops (i.e., later-maturing crops planted with early-maturing crops so that the former will have a substantial start when the latter are harvested), and the use of cool-, warm-, wet-, and dry-season plants in those seasons when traditional crops may not be planted. Of course, water supply or some other environmental factor may prevent year-round coverage, but bare ground must be covered with green plants—where there are no green plants, no photosynthesis occurs.

A third concept has recently emerged on a sound experimental basis. Most agricultural schemes convert into plant material less than 1 percent of the solar energy available during a growing season. However, some plants, because of an efficient photosynthetic system, can convert 2-3 percent of the incident solar energy. These plants, known as "C<sub>4</sub>" plants,\* require warm growing seasons and high levels of solar radiation. They are already widely grown in many developing countries, but in appropriate climates where they are not grown, they should be given serious consideration as crops, especially during periods of high insolation. These species have the added feature of being able to use water more efficiently and thus are more tolerant of drought than many common crop species.

Finally, there exists another group of plants known as CAM plants\* that, by virtue of a genetically controlled metabolic characteristic, are among the plant world's most efficient water users and therefore do well in semiarid regions. They are slow-growing plants, but in dry areas, where plants could be harvested on long-term rotation (2-6 years), they could make the land more productive and utilize the available water more efficiently.

The choice of food and fiber plants to be grown is usually governed by tradition, which in turn is usually based on generations of experience with local environmental conditions. However, a careful reassessment of these factors, including such fundamental aspects as water supply, temperature, light intensity, and nutrient supply, should be made if maximum capture and storage of solar energy by plants is to be included among the goals of

\*Examples are given in Part II of the Technical Section, chapter on photosynthesis.

agriculture. The ideas that have been briefly described are based on current practice and investigations of plants that are available now. These plants would need to be tested in given areas over several growing seasons, but well-known procedures for introducing new plants could be initiated now. In each area, the procedures to maximize energy capture would have to be worked out over a 2- to 5-year period, with a variety of plants and management techniques.



# *Microbiological Conversion of Plant Materials to Liquid Fuels*

Another process in which biological phenomena are responsible for useful energy production involves the action of microorganisms on plant material substrates and the gathering of the fuel products that result.

Consideration, for example, of the ancient and honored art of fermentation of a variety of plant products to produce alcoholic beverages naturally leads to the idea that the alcohol could be oxidized outside, rather than inside, the body—thereby providing a useful source of sensible heat. Indeed, the single major obstacle to utilizing this idea in rural areas of developing countries is the technological difficulty in separating the alcohol—or other combustible liquids produced by fermentation—in sufficiently pure form to be used as a liquid fuel.

Production of ethyl alcohol by fermentation, as a chemical process, is quite similar to the microbial production of acetone, butyl alcohol, and isopropyl alcohol—all of which are flammable liquids. The processes all involve the growth of microbial populations under anaerobic conditions—i.e., not in contact with air—utilizing the nutrients found in various plant sources, and converting the carbohydrates (sugars and starches) of those plant sources to product systems such as: 1) ethyl alcohol; 2) acetone, butyl alcohol, hydrogen; 3) butyl alcohol, isopropyl alcohol, hydrogen; and 4) acetone, ethyl alcohol, hydrogen.

In three of the cases shown, a gaseous fuel is also produced as a by-product, although not in very large quantities. A similar anaerobic fermentation process does produce large quantities of methane, another

gaseous fuel, but this process is the subject of a separate study and is not discussed in this report.\*

All of the materials listed above have been produced by microbial systems on a commercial scale, particularly during the critical years of materials needs of the 1940s and, to some extent, in the early 1950s. However, with the possible exception of ethyl alcohol, they are now produced industrially, by nonmicrobial means, from petrochemical sources, and even the major part of the world production of ethyl alcohol is manufactured in this way.

### TECHNOLOGY CURRENTLY AVAILABLE

While the chemicals listed can indeed be used as liquid fuels, that use depends on their availability in a sufficiently concentrated form; otherwise the water present will interfere with the combustion process (e.g., within an internal combustion engine) or simply dilute the energy density—the heat available from a given weight—to such an extent as to diminish the economic value of the material. Since the microbial processes produce these chemicals in water solution, mixed with a variety of other suspended and dissolved materials, recovery in a sufficiently concentrated form becomes the critical issue in evaluating the usefulness of the process. Because the technology required to effect the necessary separation is not likely to be available in rural areas, the panel does not feel that microbial processes can be considered for such use at the village level in developing countries within the next 5 years.

### TECHNOLOGY SOON TO BE AVAILABLE

For fuel production utilizing microbiological processes to become realistic in rural areas of developing nations, research and development are needed on materials, equipment, and processing. To reduce capital investment and the need for sophisticated technical skills currently required, it will be necessary to explore the availability of local raw materials, to investigate the microbiology and physical chemistry of the fermentation systems, and to examine recovery operations and equipment.

\**Methane Generation from Human, Animal, and Agricultural Wastes*. In preparation. See p. 306.

*PART III*

***OTHER  
TECHNOLOGIES***

---

# *Geothermal Energy*

Geothermal energy, the natural heat contained within the earth, is generally too deeply buried to be of use. However, in areas of the world that have experienced recent volcanic activity, geothermal resources may exist that can be exploited economically. These are usually found in regions of hot springs or areas where the deep hot rock is known to be fractured or to have pore space that permit water or steam to be circulated to carry heat to the surface.

Geothermal energy is distributed widely over the world, but localized geographically; it is a resource that can be used only near natural occurrences. When it is present, however, it provides a source of energy for electricity generation, space heat, drying, and refrigeration that is competitive with other technologies.

Present technology for electricity generation depends on production and separation of steam from any associated hot water and utilization of the steam to drive turbines or for other direct uses. Hot water may also be utilized directly for space heat.

## TECHNOLOGY CURRENTLY AVAILABLE

Technology for exploiting geothermal sources is in use in many countries.\* Geothermal turbine systems appear to have lifetimes of about 30 years or more. The lifetime of wells appears to be at least 10-15 years—longer in the case of the hot-water wells used in conjunction with space-heating systems.

The power-plant costs range from \$150 to \$500 per kW capacity and from about \$70 to \$100 per kW for the wells. A minimum exploration program may cost about \$100,000, but costs can easily reach \$1 million if much exploratory drilling is required.

Geothermal power projects have proved to be reliable. Hot-water systems and dry-steam systems are in operation in Japan, New Zealand, Mexico, and the United States. Experience has shown that geothermal energy functions reliably 80-95 percent of the time.

Local fabrication of geothermal turbines and generators will depend on the existence of a moderately sophisticated manufacturing capability.

Drilling technology is relatively simple for shallow hot-water wells, but is much more complex for hot wells capable of producing boiling water and steam. Since oil- and gas-well-drilling equipment is universally available and is directly adaptable for geothermal drilling, this means that geothermal drilling is equally available. Some shallow geothermal drilling for hot water can be done with relatively simple cable-tool drilling rigs that are likely to be in use in many developing nations.

## TECHNOLOGY SOON TO BE AVAILABLE

New geothermal technology is being developed mainly in the United States. A new device for hot-water or steam systems is the screw expander. This device employs two counter-rotating screws to serve as a positive displacement

\*Reviews of the technology are available from several sources, including two major international symposia. A series of geothermal review papers has been issued as part of the proceedings of the United Nations Symposium on the Development and Utilization of Geothermal Resources, held in Pisa in 1970 and published as Special Issue 2, Volume 1, of the journal *Geothermics*. (Special Issue 2, Volume 2, Parts 1 and 2 of *Geothermics*, contains all the technical papers presented at the symposium.) The Second Symposium on the Development and Use of Geothermal Resources was held in San Francisco in May 1975, and abstracts of the 358 papers presented have been published by the Lawrence Berkeley Laboratory of the University of California, with the full proceedings to be published early in 1976. In addition, the UNESCO publication *Geothermal Energy* (1973) contains a useful collection of geothermal review papers.

device within which hot geothermal water boils; the steam expands, thereby rotating the screws, which may provide a source of mechanical or, by use of a generator, electrical power. A test program on a 1.25-megawatt device, sponsored by the U.S. National Science Foundation, is under way at the Jet Propulsion Laboratory of the California Institute of Technology.

# *Energy Storage*

None of the intermittent energy sources discussed so far—certainly not those dependent on the vagaries of wind and sunshine—is well considered without the inclusion of storage technologies to hold energy, for instance, when the wind or the sun is down. Storage in those instances is vital; techniques of storage vary.

Energy can be stored in mechanical, electrical, chemical, and thermal forms, the last named being a special form of mechanical energy. We have excluded nuclear forms of energy storage because our concern is confined to applications in rural areas in developing countries.

There are few effective energy storage systems for near-term application in rural communities of developing nations. Stored solar heat for direct use as thermal energy is possible now and is, in fact, being used in water-heating and related systems (see the chapter on heating, cooling, etc.). In favorable geological situations, small hydroelectric pump-back storage is a possibility. Electrolysis to provide a simple fuel for small tractors, small short-range vehicles, refrigeration, etc., might provide the next step up if appropriate development is stimulated and if electricity is available from wind or other sources. Alternatively, batteries—probably lead-acid at least for the foreseeable future—can provide essential electricity for lights, radios, etc. A fundamental point to note is that electricity is often used for convenience in industrialized nations, whereas in rural communities of developing nations, for economic reasons, some other form of energy might be more useful. Compressed-air storage may be useful, but more exploration is needed to be sure. More specifically, mechanical energy can be stored in the form of kinetic

energy (flywheel's) or potential energy (hydraulic systems, compressed air, etc.). Hydraulic storage generally takes the form of hydroelectric pump-back systems, where water is pumped to a higher level during periods of excess generating capacity and, in turn, generates electricity in its downward flow during periods of short supply. It is feasible where 1) construction labor is cheap and 2) land is plentiful enough to be effectively used this way. Energy stored as compressed air usually involves the use of ordinary compressors but may be achieved with isothermal hydraulic compression systems. The latter tend to be much more efficient and are probably more applicable in developing nations because of their simplicity and lack of machinery with moving parts.

Electrical energy can be stored only in the form of electric or magnetic fields (batteries are chemical storage), but the technological requirements are extremely high.

Besides batteries, which convert to electricity the energy in chemical reactions, energy may be stored chemically 1) by electrolysis (or biochemical means discussed elsewhere), which produces hydrogen for direct combustion or for use indirectly in electricity-producing fuel cells, and 2) in the form of fuels produced by techniques such as bacterial processes or high-pressure, high-temperature, hydrocarbon synthesis processes.

## TECHNOLOGY CURRENTLY AVAILABLE

Where economically feasible, hydroelectric storage systems are technically practical now. Although the generating components are available commercially, they are rather expensive for small systems. Making the systems less expensive is a combined function of increasing the volume of production of standard generating units and of using sites for storage dams where land and labor costs make reservoir construction feasible. Additional research and development are not likely to reduce costs significantly. (These generators are discussed more thoroughly in the chapter on hydropower.)

Compressed air systems for energy storage might well be practical for developing countries, and isothermal compression systems provide interesting possibilities. Isothermal hydraulic compression for energy storage died out around 1900, though there has been recent renewal of interest. Air turbines are available and the theory of isothermal compression is adequately known, so that working systems can be engineered now. They would be considerably more costly than diesel electric generators (perhaps two or three times as expensive), but of course would have no fuel costs.

Their application awaits the careful examination of needs for energy storage and the recognition, by those concerned with energy storage, that such



systems can actually be built. These systems should have extremely long life when properly maintained—perhaps 50 years or more—and should be easily and inexpensively operated. Little research and development is needed on the technology, but some systems should be built to prove economic feasibility.

Whenever surplus electricity is available, and whenever hydrogen as a direct fuel can be used, high-pressure electrolysis should be considered. Electrolysis at pressures up to 300 atmospheres and at temperatures up to 250°C has been performed at extremely high efficiencies. The required pressure can be supplied by the gas generated, with no need for mechanical pumps; the elevated temperature can generally be achieved by using the heat developed within the system. In rural areas of developing nations, wind electric systems can be used to provide the electricity needed to make the hydrogen. Where fuel oil is not available, or where it costs a dollar or more per U.S. gallon delivered to the site where it is used, a combination of wind generators and electrolysis units should be seriously considered. Systems are technically feasible now to generate the hydrogen and could be available very shortly if the market appears promising.

Using the resulting hydrogen is another matter. Much experimental work has been done on operating internal-combustion engines with hydrogen fuel. Engines would be available if the market existed. Even now, short-term feasibility (within 5 years) could be a significant possibility. Such an industry could be stimulated into existence quickly by another more potential worldwide oil shortage of even moderate proportions. This total technology is “waiting in the wings.” While it could be available to developing nations within 5 years, the developmental effort will have to take place in technically advanced countries. Considerable research and development—particularly development—are still needed. Heaters, grain dryers, and the like, should be engineered for this fuel in the near future. “Mini” tractors and “mini” trucks should also be developed to a prototype stage fairly soon.

Finally, energy stored in thermal form is, in fact, being used in developing countries now, generally for heating water or homes. This subject is discussed in the section dealing with heating, cooling, distillation, crop drying, and power generation with solar energy.

## TECHNOLOGY SOON TO BE AVAILABLE

Apart from the prospective availability of technologies already mentioned, other energy storage systems show little prospect of becoming available within

5 years or so, for use in developing countries, as a result of current or suggested research and development.

Storage of energy in electrical form (that is, in the form of electric or magnetic fields) is probably not practical now or in the foreseeable future for either developing or industrialized countries. Even if perfect dielectrics and perfect superconductors were assumed available, energy storage densities are simply too low. Economic projections are so discouraging as to preclude any suggestion here that the matter should be considered further.

In recent years, millions of dollars have been spent in the development of special types of batteries. Although most of this effort has been directed toward application in electric vehicles, if an economical new battery were developed it would have general applicability as an energy storage device. No such economical battery has yet grown out of this research, and it is difficult to see applicability in developing countries, within 10 years, of anything now on the horizon.

It is also possible to synthesize hydrocarbons through the technique of hydrogenating organic materials naturally available. This can be done at high temperatures (around 500°C) and high pressures (around 600 atmospheres), but such technology probably does not make sense in the context considered here, and applicability is probably more than 10 years away.

The use of flywheels for energy storage of more than a few seconds' duration awaits development of some of the super-flywheels that have appeared in the literature as technical proposals. Until someone builds one, we really will not know if they are feasible or not. At any rate, applicability probably is more than 5 years away, especially in developing countries.

## RESEARCH AND DEVELOPMENT

Suggestions of areas where research and development would be expected to have a significant effect on availability have been mentioned in discussions of the specific technologies. Some general comments can be made here, however.

As is pointed out in the chapter on hydropower, materials research and development can be expected to cut costs of small hydroelectric generators to some extent. Although technically feasible now, production of hydrogen by high-pressure/high-temperature electrolysis on a small scale can likely be made more attractive in developing countries only by developments directed toward simplifying the technology involved in manufacturing these generators. The use of hydrogen in internal-combustion engines certainly depends on continued research and development in that field, and some engineering

development is needed in heaters and grain dryers to adapt them conveniently to efficient use of this fuel.

Finally, although significant research and development are needed before flywheel storage, hydrocarbon synthesis, batteries, or electrical storage can be put to practical use, none of these technologies is expected to be available for application in rural areas in developing countries within 10 years.

# TECHNICAL SECTION

*PART I*

***DIRECT USES OF  
SOLAR ENERGY***

---

# *Heating, Cooling, Distillation, Crop Drying, and Power Generation*

Solar energy represents a vast energy source that is most available in many areas where population density is often low and where conventional energy resources may be expensive. Other than in agriculture, and in a limited amount of salt production by brine evaporation, there is no significant direct use in the developing countries. This is also generally true in industrialized countries. The additional applications in countries with advanced technological capabilities are for domestic water heating and for electricity generation in very small units, mainly through photovoltaic devices on space vehicles.

In contrast to the few useful applications of solar devices, there are many experimental and developmental solar energy utilization systems. These are being pursued in several of the industrialized countries, particularly the United States, the Soviet Union, Australia, Japan, France, Italy, Israel, India, and Canada. Experiments in these countries cover a broad range of potential uses of solar energy, including electric-power generation on a small scale, heating and cooling of buildings, water desalting by evaporation, cooking, food refrigeration, high-temperature materials processing, specialized solar drying and certain combinations of uses.

Of the two current commercial uses of solar energy in the industrialized countries, i.e., in domestic and institutional water heating and in miniature power systems employing photovoltaic cells, only the water heaters can be considered commercially feasible at this time. The extremely high cost of photovoltaic converters precludes their use for generation of electricity in terrestrial applications requiring more than a very few watts of power.

However, the possibility of substantial cost reduction of these systems may have a significant effect on their utilization in the near future. (This is discussed in the chapter on photovoltaic devices.)

Although not yet in general use, solar heating of buildings—particularly residences—in the United States is rapidly approaching commercial status. Solar heating systems are currently being installed, and several manufacturers are test marketing solar heating components and complete systems. This application can be expected to increase rapidly in favorable climates and should be considered a practical alternative to fuel heat in developing countries requiring space heating. Because of the current and imminent commercial availability of a variety of solar heating devices, manufacturers are listed in Appendix 2 to provide the interested reader with commercial sources of information. While the list is certainly not complete (solar energy is a field that seems to invite new commercial ventures of all sizes), it represents the variety of manufacturers and developers who have come to the panel's attention. It must be pointed out, however, that standard methods of evaluating performance have not been established—for instance, the U.S. National Bureau of Standards has not yet completed its work on standard methods for use by U.S. industry; consequently, specification details are not listed.

Because electric-power generation by photovoltaic devices is a subject that has accumulated extensive literature and experience, it is discussed in a separate chapter of this report.

## SOLAR WATER HEATERS

Solar water heaters constitute a fairly recent development based on a common natural phenomenon: cold water in a container exposed to the sun undergoes a rise in temperature. In its modern form, the solar water heater is basically a flat-plate collector and an insulated storage tank. The collector is commonly a blackened metal plate with attached metal tubing and is usually provided with a glass cover and a layer of insulation beneath the plate. The collector tubing is connected by piping to a tank that stores hot water for use during non-sunny periods. When mounted on a roof or other suitable support, the collector absorbs solar radiation; by transfer of the resulting heat to water circulating through the tubing, hot water is supplied to the storage tank. In the most common designs, the storage tank is located above the top of the collector. The elevated position of the tank results in natural convection: water circulates from the collector to the tank and no pump is required. A typical arrangement is illustrated in Figure 1. Figure 2 shows how the system is modified when natural convection circulation ("thermosiphon") is not

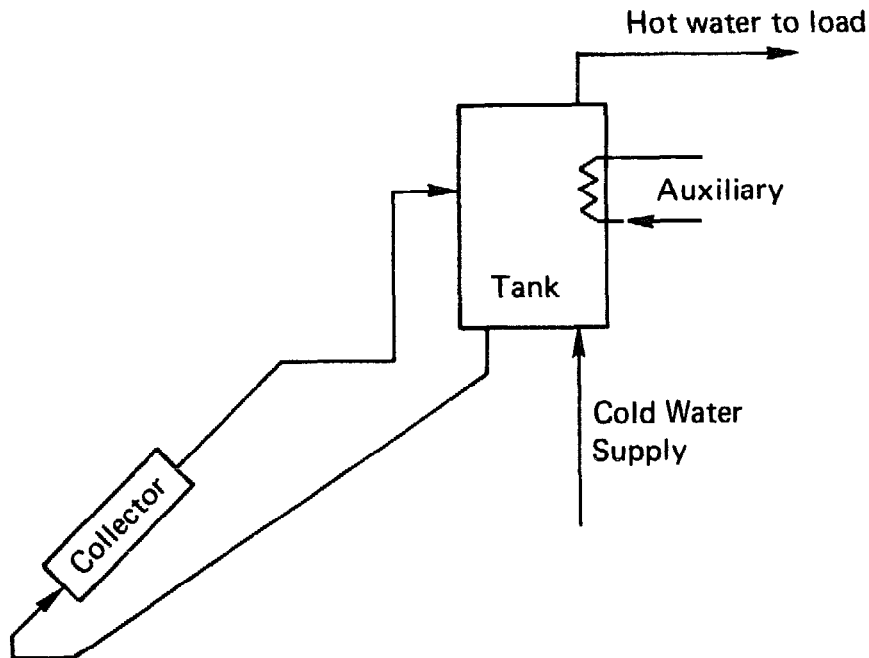

FIGURE 1 Schematic of a natural circulation solar water heater, with auxiliary energy added to the storage tank. Ref. 2 [Courtesy John Wiley & Sons, Inc.]

available. A solar collector area of 30-40 ft<sup>2</sup> (3-4 m<sup>2</sup>) in combination with an insulated tank of 50-100 gal (200-400 l) capacity can provide 50-80 gal (200-300 l) of hot water at about 140°F (60°C) per average sunny day in a favorable climate. (This is normally sufficient for a family of four in the United States.) A useful summary of this technology has been provided from Australia.<sup>1</sup>

### Past and Current Uses

Several countries have used solar water heaters for many years. They were first used extensively in the United States; thousands were made and put to use in southern California between 1900 and 1920 and in southern Florida between 1920 and 1940. New installations declined when the availability of natural gas provided a means of heating domestic water at lower cost. With the change in the price structure of fossil fuels, however, solar water heaters are again being manufactured in the United States on a small scale.

After 1950, water heater designs were greatly improved in Israel, Australia, and Japan. The general type described above was improved by incorporating better thermal contact between the black metal plate and the tubing through which water circulates, as well as by the development of black surfaces that provided greater net energy recovery from the sun. The basic collector and



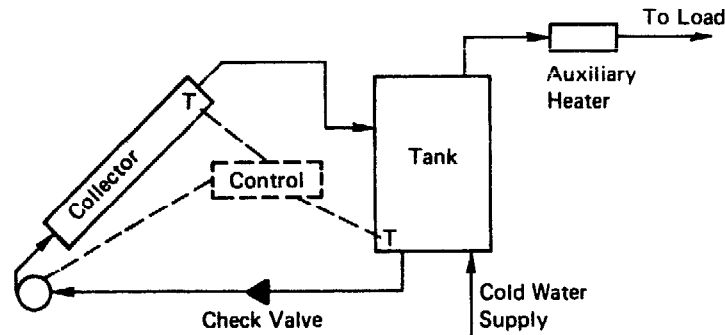

FIGURE 2 Schematic of a forced circulation solar water heater, with auxiliary on line to load. Ref. 2 [Courtesy John Wiley & Sons, Inc.]

system technology is reviewed by Duffie.<sup>2</sup> Commercial firms in Israel began manufacturing and marketing solar water heaters for local and foreign use; sales have been in the range of 10,000-15,000 units per year. At present, about 20 percent of the households in Israel have solar water heaters.

In Australia, solar water heaters were further improved (see below) by development studies in the 1950s and early 1960s, and several manufacturers went into production. They now have an established industry there and produce about 1.5 million units per year. In some districts, particularly in northern Australia, domestic water is heated almost exclusively by solar energy.

### Current Technology (Available within 5 Years)

In Australian practice, the absorbers (collectors) for household-scale use typically measure 8.6-17.2 ft<sup>2</sup> (0.8-1.6 m<sup>2</sup>), with an 80-gal (300-l) water storage tank, optionally fitted with a thermostatically controlled 1-kW electric booster, producing about 50 gal (180 l) of hot water on a good day. Domestic installations employ thermosiphon circulation, which allows the water to recycle through the absorber without pumps, but large commercial and industrial plants delivering some thousands of liters of hot water per day use forced circulation with thermostatic control. One group of residential structures in Darwin has nine separate banks of solar water heaters with a combined hot-water output of about 3,400 gal (13,000 l) per day. Solar water heaters are proving to be the most economical way of providing hot water in many parts of Australia, particularly in the Northern Territory where it is government policy to install solar water heaters in all government houses.

In Japan, hundreds of thousands of solar water heaters have been manufactured and sold, many of a design that combines the collector and storage functions to produce hot water for use at the day's end. By use of

large-diameter plastic tubes—4 in. (10 cm), for example—laid side by side under a glass cover, water is heated and stored in the same containers.<sup>3</sup> In normal use, 20-50 gal (75-200 l) of cold water supplied to the unit in the morning are heated by the sun during the day so that by late afternoon the water in the solar heater has reached temperatures above 100°F (40°C). The hot water is normally fully used in the early evening for bathing and other purposes. These units generally operate without water pressure from the pipeline, whereas the type involving metal collectors and separate storage tanks may be operated at line pressure if so designed.

Experiments with solar water heaters have been undertaken in many countries, but to the best of the panel's knowledge, use in countries other than the United States, Israel, Australia, and Japan has, to date, been quite limited. Production of solar water heaters has commenced in Niger (Figure 3), and it is possible that small-scale manufacture is being undertaken in several other countries.

### Cost

The cost of solar water heaters varies considerably with the quality of construction, but in general the better metal/glass collector units with insulated storage tanks involve a price for the collector of about \$10-\$12 per

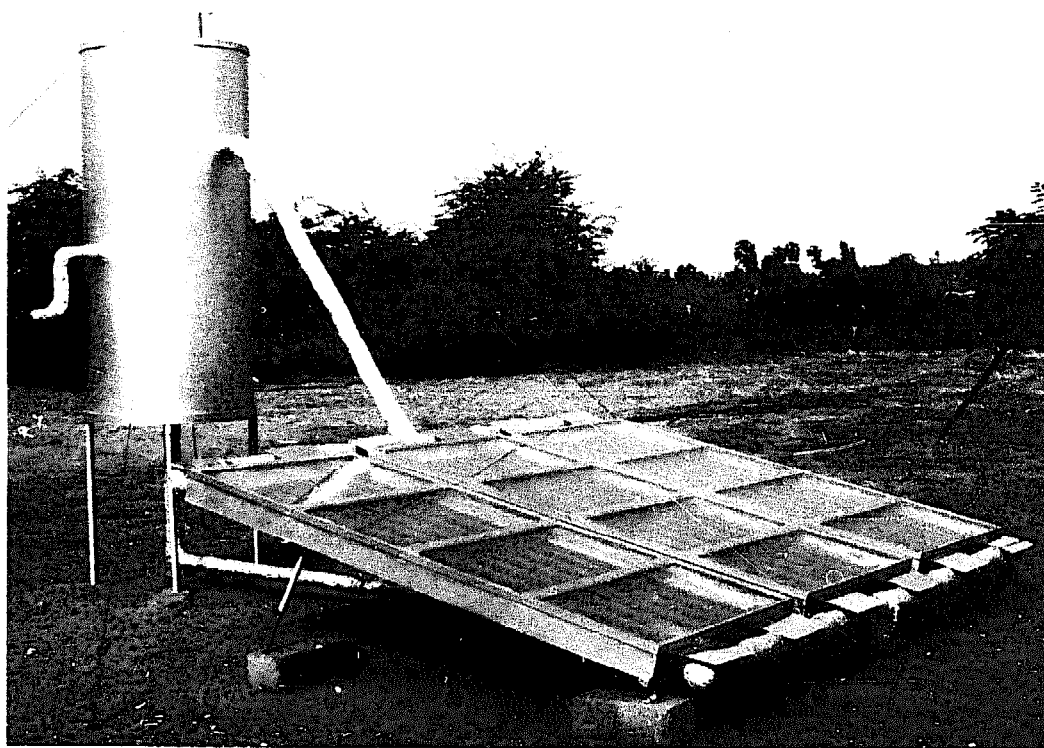

FIGURE 3 Solar water heater, Niamey, Niger.

ft<sup>2</sup> (\$100 per m<sup>2</sup>) in the United States. For a typical, family-sized installation of 30 ft<sup>2</sup> (3 m<sup>2</sup>) and 50-gal (200-l) storage, a total installed cost of about \$300 can be assumed. The type of solar water heater in common use in Japan, providing hot water only in the latter part of the day and combining collector and storage, commands a price of \$100-\$150.

### Reliability (Lifetime and Maintenance)

In its simplest form, the solar water heater is free of moving parts and requires a minimum of maintenance. It is essentially a trouble-free plumbing system with an expected life of 10 years or more; maintenance depends largely on the rate of corrosion or mineral deposits caused by materials dissolved in the water.

### Research and Development

Water-heater technology is well established, and the needed development is principally to adapt the technology to the materials and manufacturing capabilities of the country in question. Hot water for hospitals, schools, industries, and other institutions, as well as for families, could become much more widely available. The nature of the equipment is such that it can be manufactured in developing countries and adapted to their conditions without difficulty.

## HEATING AND COOLING OF BUILDINGS—SOLAR SPACE HEATING

Although residential heating is not a primary problem in most developing countries, comfort heating in some areas would certainly improve living conditions. Much traditional architecture has evolved, in part, to control or minimize temperature fluctuations in the structure. This has been done by designing openings to control admission of sunlight and designing the heat capacity of the structures to minimize undesirable (low or high) temperatures. Traditional building methods, however, have not always been followed in times of rapid population growth. Space heating in developing countries, particularly in buildings of nontraditional architecture, represents a limited problem, but one that can be solved by applying well-established principles. Modern scientific developments can be applied to building design to control all temperature extremes. These include reflective surfaces, controlled overhangs, use of insulating materials, and roof design.

## Past and Current Uses

The technology of solar space heating where water is the medium is essentially an extension of the technology employed in solar water heating, except that energy has to be recovered from the tank through a heat-exchange surface (Figure 4). Reviews of the technology and its applications are available.<sup>2,4</sup> Although commercial solar heating has barely started, a substantial number of successful experimental installations have been made and operated for several years.<sup>5</sup> Collectors and storage units much larger than those employed in solar water heaters are necessary to provide a substantial portion of the heat requirement in a typical residence in a sunny climate.

In addition to the solar heating system, conventional energy systems are necessary for a high degree of reliability. In climates where low temperatures may be encountered, the conventional source should have the capacity to meet the residual energy need. A primary economic issue, then, is balancing the fuel savings made possible by the solar energy system against the capital costs. (Note that in developing countries another important economic factor may be the availability of capital.)

Systems employing air as the heat-transfer medium between the collector and a storage bin containing small rocks (Figure 5) have been used successfully. Solar heat is stored as sensible heat in the rocks and recovered, when needed, by passage of air over the rocks and thence to the rooms.

Several dozen experimental solar houses have been built and operated with the heating system comprising the collector, a heat-storage unit, an auxiliary heater, and appropriate heat-distribution-and-control systems. Many of these have been carefully engineered and their performance measured and reported; others have been put together by well-meaning enthusiasts. There has been notable diversity in concept and design.<sup>6-10</sup> Extensive economic studies have also been made that are applicable to industrial economies<sup>11,12</sup> and that indicate that solar heating should be able to provide energy at costs

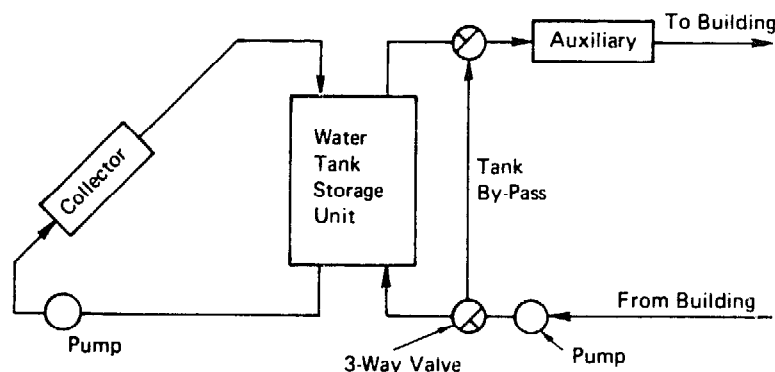

FIGURE 4 Schematic of basic hot water system. Ref. 2  
[Courtesy John Wiley & Sons, Inc.]

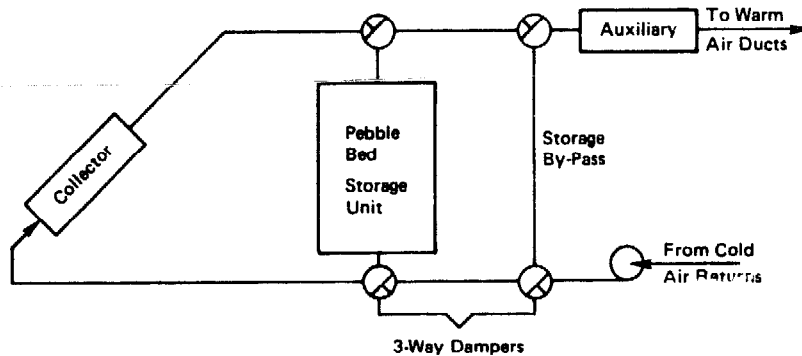

FIGURE 5 Schematic of basic hot air system. Ref. 2 [Courtesy John Wiley & Sons, Inc.]

competitive with other heating methods in many areas. A feasibility study of solar heating in Iran,<sup>13</sup> for instance, indicates that it may be economically practical in that country.

### Current Technology (Available within 5 Years)

Several conclusions have been reached relating to application of solar energy in the United States that are useful in evaluating potential application in developing countries. First, solar heating systems have been built and routinely operated over many years, helping to meet the heating loads of houses. Second, the design principles of several systems are well established, and their performance can be predicted with a certainty limited more by variability of weather than anything else. Third, as fuel costs rise, solar heating becomes competitive with heating by fuels or electric heating in many areas of the United States. Indeed, hundreds of such residential systems have already been installed.

### Cost

The main deterrent to widespread use of solar heating is the cost of the system compared with the value of the fuel saved by use of the solar facilities. In the industrialized countries, solar heating could not compete with conventional methods of heating with fuels such as petroleum, natural gas, and liquified petroleum gases. Only electricity has been sufficiently costly for solar energy to be competitive. During the past two years, however, the price of liquid and gaseous fossil fuels has climbed so rapidly that it now appears that solar heating of buildings will become competitive with these fuels in the near future.

Most studies indicate that in temperate climates it is not practical to

provide 100 percent of the space-heating requirement by solar energy. Systems designed to provide large fractions of annual heating needs in locations with variable weather would be oversized much of the time, and interest and carrying charges on the oversized equipment would make the systems too costly. The primary reason solar water heaters have been competitive and solar space heaters have not, is the difference in load factor on the two systems. The solar water heater is used all year, whenever solar energy is available, whereas the space-heating system is used only during the winter months. The net useful output of the solar water heater, therefore, is 2-3 times greater for the water heater than for the space heater, per unit of collector surface—that is, per unit of capital cost. Because of this, as well as the several-thousand-dollar cost of a complete solar space-heating system, there has been very little application in industrialized countries and even less in developing countries. The recent severe increases in fuel prices have altered this situation in the United States, Japan, and elsewhere, where solar heating is now under rapid commercial development.

The fact that it is impractical to design a solar heating system as the sole heat source of a building may further limit its usefulness for space heating in the developing cold-climate countries. Whereas solar water heaters can be used on an “as available” basis—no hot water available at times—space heating is required virtually without interruption during cold seasons. Since it is possible that the greatest demand for heat will occur during periods of no sunshine, any solar heating system must include a conventional heating system of adequate capacity to keep the structure habitable. Since fuel of some sort must therefore be available wherever solar space heating is applied, its use in the developing countries may be limited.

It is clear that a major design problem is to achieve the most economical combination of solar energy and conventional fuels; studies indicate that optimum solar heating systems will provide perhaps two-thirds or three-fourths of annual heating at current fuel prices. Further escalation of fuel costs will push these fractions upward, possibly as high as 90 percent under some conditions.

## Research and Development

Research and development efforts in solar heating have been aimed almost entirely at applications in the temperate climates of industrialized countries. Because of increasing fuel costs, rapidly expanding research and development activities are under way in the United States and other industrialized countries. Most attention has been given to applying solar heating to single-family residences; attention is now turning to problems of solar heating of multifamily dwellings and institutional buildings. A notable

development of the past year or two is the emergence of industrial interest in manufacture and sale of equipment for solar heating. This is a prerequisite to widespread application; until local heating contractors can buy and install the equipment, the concept remains largely academic.

Solar heating in developing areas presents a set of problems that has received relatively little attention. Of several possible approaches, the first involves design of the structure to utilize such elements as fenestration, shading, insulation, building thermal mass, and selective paints to minimize heat needs. A second approach is to devise heating systems that can operate with no mechanical energy for fluid circulation. Systems have been proposed and studied (e.g., the Altenkirch solar house<sup>14</sup> and the dwellings at Odeillo, France<sup>15</sup>) using only natural circulation; there may be other possibilities worth considering for use in small residences (one such experimental house is shown in Figure 6). A third approach is to adapt solar heating systems (with mechanical circulation) that have been developed for use in industrialized nations, perhaps in larger buildings in urban areas where there are significant annual heating loads to be met.

The extent of space-heating needs in developing countries is virtually unknown. To gauge the potential role of solar energy, therefore, a region-by-region assessment of these needs, including studies of climate, fuel use, typical building designs, and other factors, should be undertaken.

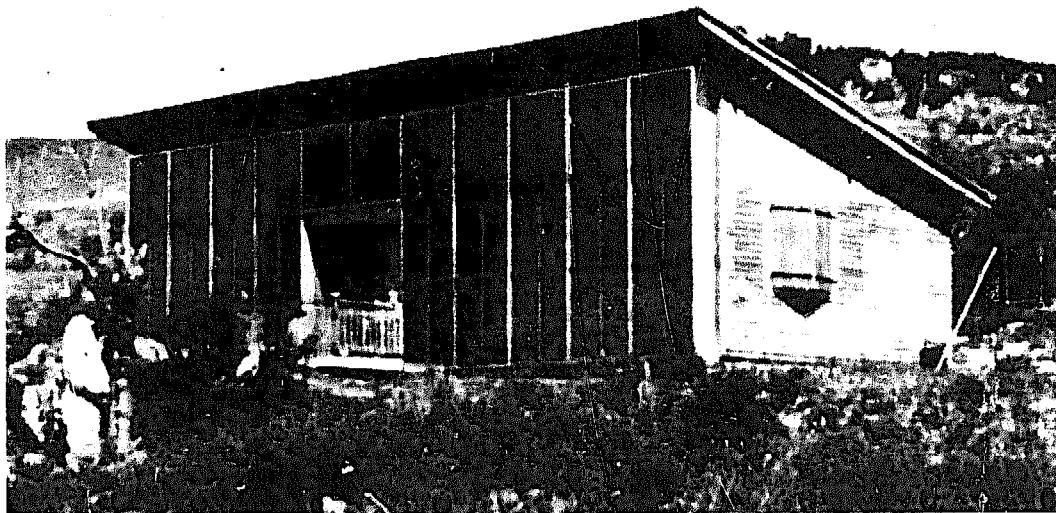

FIGURE 6 Solar-heated house, Odeillo, France.

## HEATING AND COOLING OF BUILDINGS—SOLAR AIR CONDITIONING

Conventional air conditioning involves compression of a vapor, its cooling and condensation to a liquid, and subsequent vaporization by expansion into a region of lower pressure. Heat is withdrawn from the air to be cooled by drawing from it the heat needed for vaporization of the liquid; the cycle is repeated by a return of the vapor to a pressure at which it can be condensed, rejecting the heat of vaporization at a temperature higher than that of the cooled region. The heat of vaporization is rejected to either the outside air or a stream of water.

Solar air conditioning can be accomplished in the same manner by conversion of solar energy to the mechanical form needed to operate a compressor. The need for mechanical power and its relatively high cost from solar energy can be avoided by use of the absorption refrigeration cycle.<sup>2,16</sup> In this process, the pressure of the refrigerant vapor is raised by heating instead of by mechanical compression; the vaporized refrigerant is recovered for recycling by absorption in a solution of the refrigerant and a salt. The low pressure of the expansion/vaporization region is maintained by the reduced vapor pressure of the refrigerant above the absorbent (solution), and the vapor is regenerated by allowing the solution of refrigerant and absorbent to flow into the generator where solar heat is applied.

This process has received some attention for application in temperate climates; other methods, such as air drying with desiccants regenerated by solar heat, are also possible. Technological feasibility seems assured, and economic feasibility appears promising. As with space heating, there are opportunities to use building design to increase comfort and reduce energy requirements.

Solar cooling has not been developed to the same extent as solar heating. Only two or three full-scale experiments have been carried out (e.g., the Colorado State University House<sup>17</sup>) and although they have been generally successful, their results indicate comparatively high costs as against conventional compression cooling. These studies, aimed primarily at applications in the United States, Australia, and Japan, are still at an early stage.

Most development efforts have been associated with supply of a solar-heated fluid to an absorption refrigeration cycle of the type described, generally using the lithium bromide/water system as the absorbent-refrigerant mixture. Temperatures of operation are compatible with efficient flat-plate solar collectors, so a commercial air conditioner can be adapted to a solar heat supply by substituting the solar-heated fluid for the conventional heat source.



In areas where capital is difficult to obtain—and then at high interest—solar cooling appears to have limited prospects except in commercial and public buildings where money may be more available. There is reason to expect that costs of solar cooling systems can be substantially reduced when further information and experience are at hand.

It is particularly important to note that solar air conditioning uses the same collector and storage system for cooling as for winter heating. Thus, the system in combination with solar heating, assuming climate conditions that require both heating and cooling during alternate times of the year, makes possible a considerably higher load factor on the expensive solar equipment.<sup>18</sup> This makes the economic picture more nearly like that of the solar water heater situation. However, the cost of absorption cooling is substantially higher than the cost of compression cooling.

### Application in Developing Countries

Designing air-conditioning systems for use in developing nations presents problems of design and potential utility that may be difficult to address in terms used in industrialized nations. It has been suggested that air conditioning factories and offices would significantly improve the productivity of personnel. Air conditioning could be utilized by residences and community buildings as well. There are also technological problems of system design for operation without mechanical power. In addition to solar operation of mechanical or closed-cycle absorption coolers as noted above, there are other possible cooling methods, including open-cycle humidification-dehumidification,<sup>19</sup> cycles based on solar concentration of LiCl solutions by open evaporation,<sup>20</sup> intermittent cycles that can be adapted to air conditioning,<sup>21</sup> and cooling by nocturnal radiation.<sup>8, 9, 22, 23</sup>

Building designs to minimize needs for cooling may be the most productive approach, particularly for small residential buildings.

The best methods of obtaining cooling with solar energy in developing countries are far from clear at this time, and the immediacy and extent of needs for air conditioning are not known. The importance of obtaining such information is evident.

### SOLAR REFRIGERATION

Closely related to air conditioning, solar refrigeration is generally intended for food preservation or for storage of biological and medical materials. There have been experiments in several countries including the United States,<sup>24, 25</sup> Sri Lanka,<sup>21</sup> France,<sup>26</sup> and the Soviet Union<sup>27</sup> on solar-operated coolers,

using absorption cooling cycles. Most of these are aimed at household-scale food coolers or small-scale ice manufacture. A single experiment in Mexico with a solar-operated, household-scale cooler was unsuccessful. Although the machine was simple in design, it was too complicated to operate and therefore was not usable by the people for whom it was intended. In the Soviet Union, a household refrigerator employing an ammonia-absorption cycle and a pressurized solar collector is under development.

### Research and Development

There are many possible refrigeration cycles and systems, such as intermittent absorption cycles, that can be considered for solar-powered refrigeration. Nevertheless, even so basic a question as the best scale on which to operate solar refrigeration for developing countries has yet to be established; community-scale systems may offer advantages of larger-scale, reduced-educational requirements for users, and (if appropriate) the possibility of distributing ice to smaller users (i.e., households). However, they require a substantial investment in capital and organization of community training and maintenance programs.

There are a number of open questions regarding solar refrigeration. Nevertheless, its application has the attractive possibility of increased utilization of available foodstuffs if refrigeration could be successfully provided. Research and development are needed because of the lack of a practical solar refrigerator at any price and of any understanding of the cost of systems that could be developed. An objective and critical analysis of the need for, and the prospect of, practical solar refrigeration should be the first step in any development effort.

### SOLAR STILLS AND DESALINATION

The use of solar energy for desalting seawater and brackish well water has been demonstrated in several moderate-sized pilot plants in the United States, Greece, Australia, the Soviet Union, and several other countries. This century-old process—the basin-type still—has been modified and adapted to modern materials. It consists of a shallow pool of brine from which a slow evaporation of water takes place. In its modern form it is covered by sloping sheets of glass; water condensing on the underside of the cooler glass covers runs to troughs at the lower edges and to storage. Excess brine that has not evaporated is run to waste as salt water is supplied to the basin. The idea was first applied in 1892 at Las Salinas, Chile, in a plant supplying drinking water for animals working in nitrate mining and transport. The Las Salinas plant

reportedly operated for 30 years. Modern developments in solar distillation have been directed to the use of materials and designs for economical and durable construction, to reduce product-water cost. A complete review of solar distillation is available,<sup>28</sup> and the United Nations has published a less detailed, but useful, state-of-the-art report.<sup>29</sup>

### Current Technology (Available within 5 Years)

Solar distillation is used on a small commercial scale to supply small towns and motels in isolated areas in Australia (Figure 7) and small communities in the Mediterranean basin (Figure 8) and the Caribbean. These are areas where either an adequate source of fresh water is unavailable or the cost of fresh water brought in by transport is too high. Although small community-scale solar stills are nearly competitive with other desalination systems, the process must be regarded as experimental. Still under study are problems of construction materials, energy and material flow, and physical design to maximize output and minimize cost.

Some designs have been rather well standardized, and considerable operating experience is available upon which to judge their utility and costs.

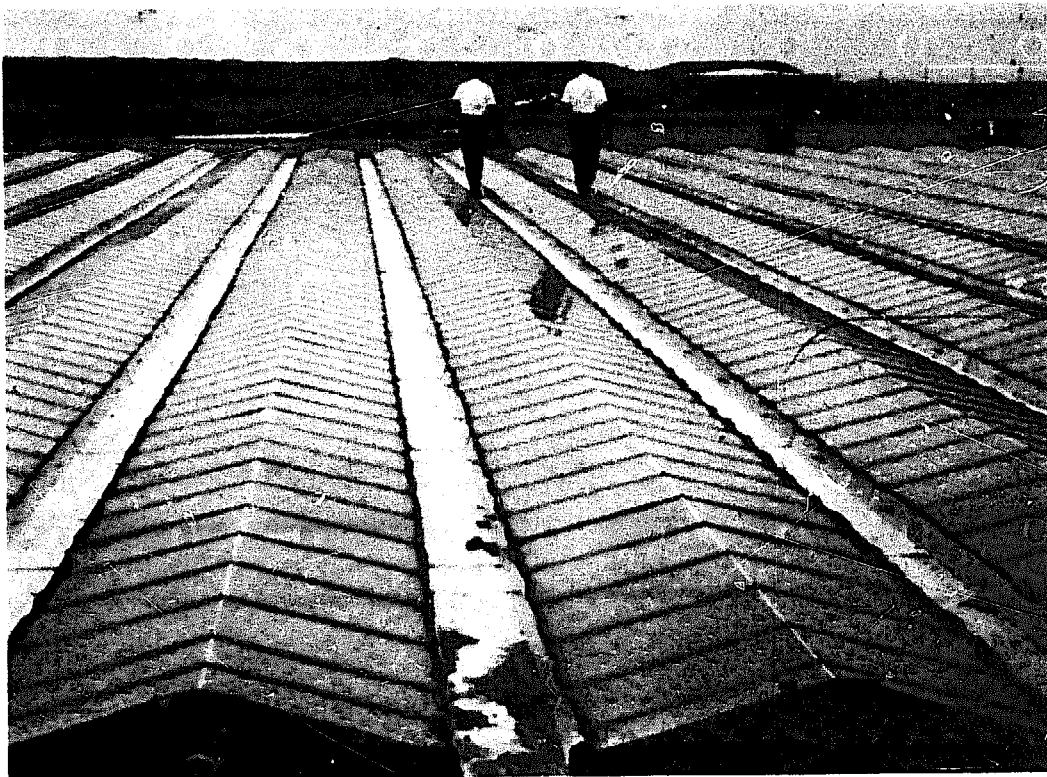

FIGURE 7 Glass-covered solar still, Coober Pedy, Australia. (Constructed in 1966; total area 38,000 ft<sup>2</sup> [3,530m<sup>2</sup> ])



FIGURE 8 Solar still on the island of Patmos, Greece. (Constructed in 1967; total area 95,000 ft<sup>2</sup> [8,826m<sup>2</sup>])

### Cost

Solar distillation requires relatively large capital investment per unit of capacity and, in properly designed and constructed systems, a minimum of operating and maintenance costs. Product-water costs, therefore, depend primarily upon still productivity, service life, capital cost of the installation, and amortization and interest rates.

Since productivity of a solar still is dependent on the intensity and duration of the insolation it receives, it is subject to both diurnal and seasonal variations, which must be taken into account in any analysis of needs and costs. Solar-still productivity is conveniently referred to, in round numbers, as being typically 0.1 gal/ft<sup>2</sup>/day (40 l/m<sup>2</sup>/day) for a clear summer day, with seasonal fluctuations expected to range down to half that on clear days in mid-latitudes (15°-45°). Thus, experience shows that a still will yield about 25 gal/ft<sup>2</sup> (10,000 l/m<sup>2</sup>) annually, with some variations dependent on climate and design. A typical lifetime for a still constructed of concrete, glass, and other durable materials is 20 years or more, although other still designs involve less durable materials that must be renewed periodically.

The lack of more general use of solar stills is almost entirely the consequence of the high capital investment required and the resulting high cost of water produced. In recent years, durable solar stills have been built for a unit cost of \$1.50-\$3/ft<sup>2</sup> (\$16-\$32/m<sup>2</sup>). If a durable solar still can be

constructed for \$1/ft<sup>2</sup> (\$10.75/m<sup>2</sup>), including materials and labor, typical yields would produce water at a cost of about \$3-\$4 per 1,000 gal (80¢-\$1.05 per 1,000 l).

These figures may be compared with typical freshwater costs of 5¢-25¢ per 1,000 gal (1¢-5¢ per 1,000 l), and costs of desalted water from large fuel-fired evaporation plants in the vicinity of \$1-\$1.50 per 1,000 gal (25¢ per 1,000 l). There seems to be little prospect, therefore, that large solar distillers will be competitive with large desalting plants supplied with conventional energy sources unless fuel prices escalate greatly.

Nevertheless, a significant advantage of the solar still is the flexibility it offers in choice of size (capacity). In situations where a community or an industry requires small quantities of water—say, less than 50,000 gal (200,000 l) per day—the solar still may be more economical than the conventional desalting plant. The latter, operating at this low rate rather than at millions of gallons per day, requires a heavy investment per unit of output, with the result that the cost of water produced from it can be several dollars per 1,000 gal. Thus, since cost of the solar desalting plant appears to be competitive in small installations, there is the opportunity to use such plants a) in small communities where potable water is unobtainable except at very high cost; b) in certain industrial and commercial applications where materials must be processed in a region where all available water is brackish; or c) for watering of livestock in areas where grazing is possible if water is supplied. It is for these moderate-volume requirements that solar stills have been built.<sup>30</sup>

### Reliability (~~Lifetime and~~ Maintenance)

Distiller productivity can be predicted<sup>29</sup> for those designs in which problems of mechanical failure or corrosion are minimal. Proven designs are those that use standard, durable construction materials such as glass, concrete, asphalt, and corrosion-resistant metals,<sup>26</sup> although designs that rely in part on new plastic materials are also being investigated.<sup>31</sup> Construction, maintenance, and operation do not require high levels of skill in working with complex machinery, and little day-to-day attention is needed. In short, designs are now available for serviceable solar stills that can be used with reasonable confidence.

With most designs it is possible, to some degree, to use locally available materials and labor in construction.<sup>32</sup>

### Research and Development

The basin-type solar still combines the solar energy collection function and the distillation function in a single unit. Separation of these functions would

allow regenerative, or multistage processes, to be solar operated. This development is dependent upon significant progress in solar-collector technology (i.e., a "breakthrough"). Notable improvement in performance and cost production may result from refinements in basin-still design. In this area particularly, the use of new materials with unique properties, locally available materials, and new designs is potentially important.

Combined energy-source systems, in which solar energy to the still is augmented by waste heat from, for example, intermittently operated diesel or gasoline engines, may reduce the cost of product water from the still.<sup>33</sup> Multiple-function plants, in which water production is integrated with water use, are also being considered, for example, in an integrated system for energy, water, and food production.<sup>34</sup>

Finally, multipurpose systems, producing some combination of water, salt, and possibly power, can be conceived. Within the limits set by relative markets for these commodities, such systems could be significant, but only after considerable research and development.

## Evaluating Solar Distillation

The following checklist is presented as an aid in assessing the relative value of solar distillation as a method of meeting a particular water need.

*Climate.* If the solar radiation climate is good, i.e., skies are generally clear, a solar distillation plant may be feasible. Productivity of stills is a direct function of solar radiation received on a horizontal surface.

*Scale of need.* Solar distillation now appears suited to water requirements on a relatively small scale, i.e., less than about 50,000 gal (200 m<sup>3</sup>) per day. For larger demands, or demands that are anticipated to increase in the near future, other desalination methods are now more economical.

*Site.* The site for the still installation, besides having unobscured solar radiation, should be near the water users. Brackish surface water, groundwater, or seawater must be available nearby. Competing uses for sites should also be considered.

*Estimate of still size.* A well-designed, well-constructed still in a good climate should produce about 25 gal per ft<sup>2</sup> of still (1,000 l per m<sup>2</sup>) per year. This yield, compared with annual water needs, will give a first approximation of the required solar-still area.

*Design.* One or more designs can be selected or developed consistent with local conditions, available materials, and skills of the local work force.

*Estimate of monthly yield.* Based on the selected design, monthly yields of distilled water can be estimated either from experimental data on similar stills in other locations or through the use of estimation methods such as those outlined in the *Manual of Solar Distillation*.<sup>28</sup> These yields should be based

on monthly mean radiation levels and temperatures (the most widely available form of the pertinent meteorological data) such as those available in *World Distribution of Solar Radiation*.<sup>35</sup>

*Rainfall contribution.* If local conditions and regulations permit, rainfall runoff from the glass covers of the still can be recovered. This can be estimated from average monthly rainfall data (if rainfall is not highly variable) or minimum monthly rainfall (if it is variable), applying a reasonable recovery factor. Useful monthly rainfall collected can then be added to still yield to provide an estimate of month-to-month production of useful water from the still.

*Monthly needs versus production.* A comparison of month-to-month distribution of water production and water needs will indicate water-storage requirements, modifications in still size, or possible uses of supplementary sources.

*Estimate of cost.* With the foregoing information, the appropriate data on still designs, first costs, service life, maintenance and operating requirements, and local information on interest rates and other economic factors, the cost of delivering water from the solar stills can be estimated and compared with alternatives.

*Other considerations.* Considerations not directly quantifiable in terms of cost may also be important. These could include, for example, sociological and personal factors, resistance to change, distance of users from the potable-water supply, protection of the still from vandalism, sales methods or other costs of distributing the water, subsidies, and/or fuel savings.

In general, additional research and development would involve further adaptation of existing technology to the specific needs of developing countries. Adaptations would include design modifications that allow use of locally available materials and locally manufactured components. Studies of this type could improve the economics of solar distillation, widen the areas in which it might be useful, and thereby contribute to the solution of water-supply problems, at least for small communities in appropriate climates.

## SALT PRODUCTION

Solar evaporation of seawater or brines has been a traditional method of obtaining salt. It remains important today—on both a small and large scale—in many nations. The basic concept is simple: in areas where evaporation exceeds rainfall, a shallow pond of brine is exposed, which results in evaporation of water and ultimately in crystallization of salt. Solar evaporation is used in many developing countries, for instance, India,

Pakistan, Mexico, Colombia, and Chile. It is also an important industrial process in the United States, Israel, and elsewhere.<sup>36</sup> Modern developments have been concerned with improved pond construction and salt-harvesting techniques.

There appears to be little further research on traditional solar evaporation processes that cannot be done by the industries using the process. The suggestion has been made, however, that further studies of "solar ponds" might lead to improved salt production and by-products of power or distilled water.<sup>37</sup> Solar ponds are large-area brine ponds approximately 1 m deep, in which vertical gradients of salt concentrations are maintained so that the most concentrated and most dense solutions are at the bottom of the pond. Heat is generated at the bottom of the pond by absorption of solar radiation—transmitted by the water—by the pond's black bottom. In spite of the temperature rise of the brine at the bottom, its specific gravity remains higher than that at the top if a sufficiently large concentration gradient is maintained. Under these conditions, convection mixing is minimized and the bottom layers of brine, which may reach 80°-90°C (175°-195°F) while the top remains at 25°C, may then be withdrawn from the pond and used for power generation, salt production by multiple-effect evaporation of brine, water distillation, and so on. To maintain the concentration gradient against the slow upward diffusion of salt, the surface must be slightly "washed" with fresh water, and concentrated brine supplied at the bottom.

It must be recognized that a "solar pond" multipurpose facility would involve high capital cost and that the development of the process and its potential application are probably less attractive in the developing countries than in industrialized nations.

## SOLAR CROP-DRYING

Of all the direct uses of solar energy, sun drying of crops is perhaps the most ancient and widespread. The customary technique involves spreading the material to be dried in a thin layer on the ground to expose it to sun and wind. Copra, grain, hay, and fruits and vegetables are still dried in this manner in many parts of the world, including the industrialized countries. In recent years, innovations have been adopted, particularly for fruit drying, in which fruit is placed in carefully designed racks to provide controlled exposure to solar radiation and wind and to improve material handling. Improved process control and product quality have resulted.

In recent years, the term "solar drying" also has come to mean the process whereby agricultural materials are dried not by direct exposure to the sun—and wind, rain, insects, vermin, and birds—but by means of solar-heated



air in more protected surroundings. The process is of special interest in the case of the soft fruits; these are particularly vulnerable to attack by insects, as the sugar concentration increases during drying.

A large portion of the world's supply of dried fruits and vegetables continues to be prepared by sun drying. Doubtless this process is the cheapest and simplest way to dry crops in regions having abundant sunshine and where the post-harvest season is characterized by low relative humidity and little or no rainfall. In the case of green lumber—where direct exposure to the sun tends to produce curling and warping in many woods—and in the humid tropics, kiln-drying can be accomplished with solar-heated air. The cost of this process is not yet well established.

To remain stable in storage, agricultural crops should be dried to a moisture content of 12-15 percent by weight. The relative humidity of the air that will be in equilibrium with crops of that moisture level varies from crop to crop and ranges from about 48-60 percent for fruits,<sup>38</sup> grain, and hay.<sup>39</sup> Marked decreases in relative humidity (RH) can be achieved with rather minimal increases in air temperature, and the temperature change needed to produce any desired change in RH can be ascertained from standard psychrometric charts. Adequate drying of crops can therefore be achieved in humid climates by raising the temperature of the air circulating among the items to be dried.

### Current Technology (Available within 5 Years)

Although there is no significant commercial manufacture of solar crop dryers, experimentation over the past 20 years has produced a number of designs. These range from the use of solar-heated air in more or less conventional air dryers to a combination of direct drying and air drying by placing the materials to be dried in flat-plate collector-dryers. Among the former are various designs developed in the United States,<sup>39</sup> Turkey,<sup>40,41,42</sup> Canada,<sup>43,44,45</sup> Brazil,<sup>46</sup> and Australia.<sup>47</sup> Combination collector-dryers have been designed and used successfully in India<sup>48</sup> and Trinidad.<sup>49,50</sup>

In the developing countries, solar dryers should be usable by farmers with limited technical skill and small capital resources. The equipment should be as simple and cheap as possible. Locally available materials and relatively unskilled labor may be adequate for constructing "do-it-yourself" dryers of some types. Because of seasonal, short-term use, crop dryers may have to be designed so that a variety of crops, maturing at different times, can be dried in sequence by use of the same equipment. If made and sold commercially, solar dryers will have to be made available at prices well below those of typical solar collectors so that the cost can be recouped in relatively short periods of use.

Because of the wide variety of circumstances encountered, the potential economic advantages of solar crop-drying must be assessed on an individual basis. This will depend principally on the size of the crop to be dried and the prevailing weather conditions. It has been shown that the addition of a solar air heater to an unheated air-drying system can shorten drying time by 50-75 percent. Where the choice is between these two systems, the cost of the solar dryer will be largely offset by the saving in cost of the circulating fan as a consequence of the lower power requirement. In the case of lumber drying in Australia, economic analysis based on current designs and materials has shown solar heating to be slightly more costly than conventional heating systems.

### Research and Development

Development of solar drying can conceivably benefit from further development of collector-dryer combinations and flat-plate air heaters and energy-storage systems to supply hot air to dryers. Research in design and control of these processes, for the particular crops or other materials to be dried, could lead, in developing countries, to other practical applications that could result in improved utilization of food supplies.

## POWER GENERATION

Solar energy for power generation, either in the form of electricity or mechanical work, has been the subject of extensive research in the Soviet Union, United States, France, Italy, and Israel.<sup>51</sup> In addition to the photovoltaic approach to be discussed in the following chapter, efforts to generate power by use of heat engines have been the most numerous. All of these efforts have been more or less dependent on means of collecting and/or concentrating incident solar energy. A large assortment of solar collectors has been operated in numerous experimental assemblies to produce steam or other vapor, which then has been employed in engines of various types to generate electricity or mechanical power. The largest such unit was a plant built in Egypt in 1913, which developed about 50 hp (37 kW).<sup>52</sup>

Most of the work has been directed toward the use of reflecting surfaces to concentrate the solar energy onto a small receiver/boiler, which permits the development of much higher temperatures than is possible with a flat-plate collector. High-pressure steam for electric-power generation or, with precise equipment, extremely high-temperature heat for chemical and metallurgical processing can thus be produced. Concentrators in the form of paraboloids (dishes), parabolic cylinders (troughs), and other shapes have been investi-

gated.<sup>53</sup> A design first studied in the Soviet Union and now being investigated in the United States, involves a large array of flat mirrors mounted on the ground and continually oriented to reflect the sun onto a high-pressure steam boiler. The boiler is located at the top of a high tower having a turbogenerator at its base.<sup>54</sup>

Research and development specifically aimed at solar power generation in the less industrialized regions has been carried on in the Soviet Union, Africa, and, to a limited extent, in Israel. Notable among these efforts are several small solar pumping units of French manufacture in West Africa, based on a design by Girardier,<sup>55</sup> and a similar installation in Mexico. An example of one of these installations is shown in Figure 9. Flat-plate water heaters supply hot water to a boiler in which propane is vaporized and from which this vapor is supplied to a reciprocating engine. Several installations of 1- to 3-kW capacity are in service. Present overall efficiencies of less than 1 percent could be substantially increased by design improvements. Although costs of power produced by this system are high, comparison with diesel units does not show a large difference when diesel engine life is assumed shortened by the lack of maintenance and repair personnel customary in remote areas.

The Soviet program has provided numerous types of experimental solar concentrators up to 5 m (16.5 ft) in diameter, and electric-power units of 1- to 3-kW peak output.<sup>56</sup> Rankine engines operated by steam and a pressurized

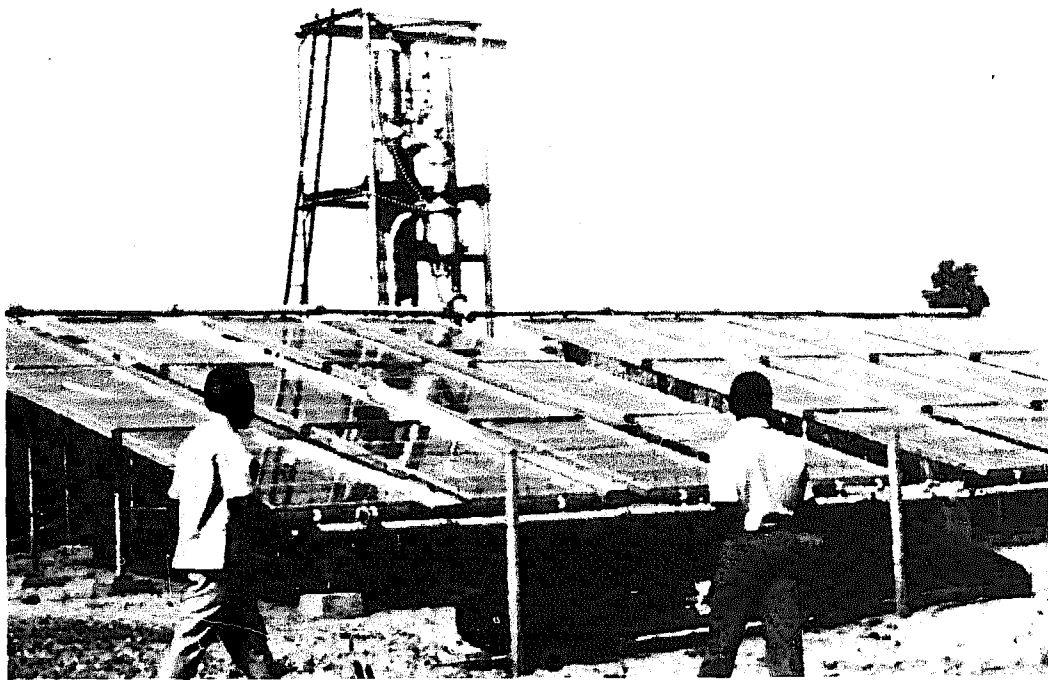

FIGURE 9 Solar pumping station in Africa. (Flat-plate collector, organic-fluid Rankine engine; one of several built in the early 1970s) [Girardier, Ref. 55]

Stirling engine have been used experimentally in conjunction with these concentrators. Comparatively high technical skill would normally be required in the installation and maintenance of these systems.

Costs of solar power units are a major deterrent to their use; economic application would require major design and material savings or usage in situations where the only alternatives are high-priced and short-lived small generators requiring costly fuel.

Other developments in this field will be treated in Appendix 4.

## REFERENCES

1. Commonwealth Scientific and Industrial Research Organization. 1964. *Solar water heaters, principles of design, construction and installation*. Division of Mechanical Engineering, Circular No. 2. Victoria, Australia: Commonwealth Scientific and Industrial Research Organization.
2. Duffie, J. A., and Beckman, W. A. 1974. *Solar energy thermal processes*. New York: John Wiley and Sons.
3. Tanishita, I. 1970. Present situation of commercial solar water heaters in Japan. Paper presented at International Solar Energy Society Conference, 2-6 March 1970, Melbourne, Australia.
4. Beckman, W. A., and Duffie, J. A. 1974. Solar heating and cooling of buildings. In *The energy crisis and energy from the sun*. Symposium on Solar Energy Utilization, 20th Annual Meeting, Institute of Environmental Sciences, 30 April 1974, Washington, D.C. Mt. Prospect, Illinois: Institute of Environmental Sciences.
5. Löf, G. O. G. 1964. Use of solar energy for heating purposes: Space-heating. In *Proceedings of the United Nations Conference on New Sources of Energy: Solar Energy, Wind Power and Geothermal Energy, 21-31 August 1961, Rome, Italy*. Vol. 5: *Solar energy II*, pp. 114-139. U.N. Document No. E/Conf.35/6. New York: United Nations.
6. Engebretson, C. D. 1964. The use of solar energy for space heating: MIT solar house IV. In *Proceedings of the United Nations Conference on New Sources of Energy: Solar Energy, Wind Power and Geothermal Energy, 21-31 August 1961, Rome, Italy*. Vol. 5: *Solar energy II*, pp. 159-177. U.N. Document No. E/Conf.35/6. New York: United Nations.
7. Löf, G. O. G.; El Wakil, M. M.; and Chiou, J. P. 1964. Design and performance of domestic heating system employing solar heated air—the Colorado solar house. In *Proceedings of the United Nations Conference on New Sources of Energy: Solar Energy, Wind Power and Geothermal Energy, 21-31 August 1961, Rome, Italy*. Vol. 5: *Solar energy II*, pp. 185-197. U.N. Document No. E/Conf.35/6. New York: United Nations.
8. Yanagimachi, M. 1964. Report on two and a half years' experimental living in Yanagimachi solar house II. In *Proceedings of the United Nations Conference on New Sources of Energy: Solar Energy, Wind Power and Geothermal Energy, 21-31 August 1961, Rome, Italy*. Vol. 5: *Solar energy II*, pp. 233-247. U.N. Document No. E/Conf.35/6. New York: United Nations.
9. Bliss, R. W. 1964. The performance of an experimental system using solar energy for heating, and night radiation for cooling a building. In *Proceedings of the United*

- Nations Conference on New Sources of Energy: Solar Energy, Wind Power and Geothermal Energy, 21-31 August 1961, Rome, Italy. Vol. 5: Solar energy II, pp. 148-158. U.N. Document No. E/Conf.35/6. New York: United Nations.*
10. Hay, H. R. 1973. Energy technology and solarchitecture. *Mechanical Engineering* 95(11):18-22.
  11. Tybout, R. A., and Löf, G. O. G. 1970. Solar house heating. *Natural Resources Journal* 10(2):268.
  12. Löf, G. O. G., and Tybout, R. A. 1973. Cost of house heating with solar energy. *Solar Energy* 14:253-278.
  13. Bahadori, Mehdi N. 1973. A feasibility study of solar heating in Iran. *Solar Energy* 15:3-26.
  14. Adler, S.; Levite, G.; and Tabor, H. 1964. The Altenkirch solar-cooled house. In *Proceedings of the United Nations Conference on New Sources of Energy: Solar Energy, Wind Power and Geothermal Energy, 21-31 August 1961, Rome, Italy. Vol. 6: Solar energy III, pp. 60-65. U.N. Document No. E/Conf.35/7. New York: United Nations.*
  15. Trombe, F.; Robert, J. F.; Cabanet, M.; and Sesolis, B. 1975. Some performance characteristics of the CNRS solar houses. Paper presented at the International Solar Energy Society Conference, July 28-August 1, Los Angeles, California.
  16. Chung, R.; Duffie, J. A.; and Löf, G. O. G. 1963. A study of a solar air conditioner. *Mechanical Engineering* 85:31.
  17. Ward, D. S., and Löf, G. O. G. 1975. Design and construction of a residential solar heating and cooling system. *Solar Energy* 17:13.
  18. Löf, G. O. G., and Tybout, R. A. 1974. The design and cost of optimized systems for residential heating and cooling by solar energy. *Solar Energy* 16:9-18.
  19. Dunkle, R. V. 1965. A method of solar air-conditioning. *Mechanical and Chemical Engineering Transactions*, Institute of Engineers, Sydney, Australia MC1(1):73-78.
  20. Baum, V. A.; Kakabaev, A.; Khandurdiev, A.; Klychiaeva, O.; and Rakhmanov, A. 1973. Utilisation de l'énergie solaire dans les conditions particulières des régions à climat torride et aride pour la climatisation en été. In *Proceedings of the International Congress. The Sun in the Service of Mankind, 2-6 July 1973, UNESCO House, Paris, pp. EH-96:1-13. Washington, D.C.: Research Applications Directorate, U.S. National Science Foundation.*
  21. Chinnappa, J. C. V. 1962. Performance of an intermittent refrigerator operated by a flat-plate collector. *Solar Energy* 6(4):143.
  22. Hay, H. R., and Yellott, J. I. 1969. Natural air conditioning with roof ponds and movable insulation. *American Society of Heating, Refrigerating and Air-Conditioning Engineers Transactions* 75 (Part I):165-177.
  23. \_\_\_\_\_. 1970. A naturally air conditioned building. *Mechanical Engineering* 92(1):19-25.
  24. Williams, D. A.; Chung, R.; Löf, G. O. G.; Fester, D. A.; and Duffie, J. A. 1958. Cooling systems based on solar refrigeration. *Refrigeration Engineering* 66:33.
  25. Sargent, S. L., and Beckman, W. A. 1968. Theoretical performance of an ammonia-sodium thiocyanate intermittent absorption refrigeration cycle. *Solar Energy* 12:137.
  26. Trombe, F., and Foex, M. 1961. Production de glace à l'aide de l'énergie solaire. In *Applications thermiques de l'énergie solaire dans le domaine de la recherche et de l'industrie. Les Comptes-rendus des Colloques Internationaux du Centre National de la Recherche Scientifique, Montlouis, 23-28 June 1958. Paris: Centre National de la Recherche Scientifique.*

27. Kakabaev, A.; Klychiaeva, O.; and Khandurdiev, A. 1972. Refrigeration capacity of an absorption solar refrigerator plant with flat glazed solution regenerator. *Applied Solar Energy (English translation of "Geliotekhnika")* 8(1-2):90.
28. Talbert, S. G.; Eibling, J. A.; and Löf, G. O. G. 1970. *Manual on solar distillation of saline water*. Office of Saline Water, Research and Development Progress Report No. 546. Washington, D.C.: U.S. Department of the Interior.
29. United Nations Economic and Social Affairs. 1970. *Solar distillation*. U.N. Document No. ST/ECA/121. New York: United Nations.
30. Morse, R. N., and Read, W. R. W. 1968. A rational basis for the engineering development of a solar still. *Solar Energy* 12:5.
31. Hay, H. R. 1973. Plastic solar stills: Past, present, and future. *Solar Energy* 14:393-404.
32. Lawand, T. A. 1968. *Engineering and economic evaluation of solar distillation for small communities*. Technical Report No. MT-6. Ste. Anne de Bellevue, Quebec, Canada: Brace Research Institute, McGill University.
33. Proctor, D. 1973. The use of waste heat in a solar still. *Solar Energy* 14(4):433-449.
34. Jensen, Merle H., and Eisa, Hamdy M. 1972. Controlled-environment vegetable production; results of trials in Puerto Peñasco, Mexico, 1968-1970. Tucson: University of Arizona, Environmental Research Laboratory.
35. Löf, G. O. G.; Duffie, J. A.; and Smith, C. O. 1966. *World distribution of solar radiation*. Engineering Experiment Station, Report No. 21. Madison: University of Wisconsin.
36. Spiegler, K. S. 1955. Solar evaporation of salt brines in open pans. In *Solar energy research*, F. Daniels and J. A. Duffie, eds., p. 119. Madison: University of Wisconsin Press.
37. Tabor, H., and Matz, R. 1965. Solar pond status report. *Solar Energy* 9:177.
38. Szulmayer, W. 1973. Thermodynamics of sun-drying. In *Proceedings of the International Congress. The Sun in the Service of Mankind, 2-6 July 1973, UNESCO House, Paris*, pp. V-24:1-10. Washington, D.C.: Research Applications Directorate, U.S. National Science Foundation.
39. Buelow, Frederick H. 1964. Drying crops with solar heated air. In *Proceedings of the United Nations Conference on New Sources of Energy: Solar Energy, Wind Power and Geothermal Energy, 21-31 August 1961, Rome, Italy*. Vol. 5: *Solar energy II*, pp. 267-272. U.N. Document No. E/Conf.35/6. New York: United Nations.
40. Akyurt, M., and Selçuk, M. K. 1973. A solar drier supplemented with auxiliary heating systems for continuous operation. *Solar Energy* 14:313-320.
41. Selçuk, M. K. 1967. The final report of the solar fruit drier. *COMPLES Bulletin (Cooperation Méditerranéenne pour l'Energie Solaire, Marseilles)* (12):91-101.
42. Selçuk, M. K.; Ersay, Ö.; and Akyurt, Mehmet. 1973. Development, theoretical analysis and performance evaluation of shelf type solar driers. Paper presented at the Winter Annual Meeting of the American Society of Mechanical Engineers, 11-15 November 1973, Detroit, Michigan.
43. Lawand, T. A. 1965. A description of two simple solar agricultural dryers. *COMPLES Bulletin (Cooperation Méditerranéenne pour l'Energie Solaire, Marseilles)* (9):51-56.
44. ———. 1966. A solar-cabinet dryer. *Solar Energy* 10(4):158-164.
45. ———. 1966. *How to make a solar cabinet dryer for agricultural produce*. Leaflet L.6. Ste. Anne de Bellevue, Quebec, Canada: Brace Research Institute, McGill University.

Also available in Arabic (Leaflet L.7) and Spanish (Leaflet L.8) translations.

46. Ghosh, B. N. 1973. A new glass-roof dryer for cocoa beans and other crops. In *Proceedings of the International Congress. The Sun in the Service of Mankind, 2-6 July 1973, UNESCO House, Paris*, pp. V-30:1-17. Washington, D.C.: Research Applications Directorate, U.S. National Science Foundation.
47. Read, W. R. W.; Choda, A.; and Cooper, P. I. 1973. A solar timber kiln. In *Proceedings of the International Congress. The Sun in the Service of Mankind, 2-6 July 1973, UNESCO House, Paris*, pp. V-28:1-10. Washington, D.C.: Research Applications Directorate, U.S. National Science Foundation.
48. Kapoor, S. G., and Agrawal, H. C. 1973. Solar dryers for Indian conditions. In *Proceedings of the International Congress. The Sun in the Service of Mankind, 2-6 July 1973, UNESCO House, Paris*, pp. V-29:1-11. Washington, D.C.: Research Applications Directorate, U.S. National Science Foundation.
49. Headley, O. St. C., and Springer, G. F. B. 1973. A natural convection solar crop drier. In *Proceedings of the International Congress. The Sun in the Service of Mankind, 2-6 July 1973, UNESCO House, Paris*, pp. V-26:1-10. Washington, D.C.: Research Applications Directorate, U.S. National Science Foundation.
50. Satcunanathan, Suppramaniam. 1973. A crop drier utilizing a two pass solar air heater. In *Proceedings of the International Congress. The Sun in the Service of Mankind, 2-6 July 1973, UNESCO House, Paris*, pp. V-27:1-17. Washington, D.C.: Research Applications Directorate, U.S. National Science Foundation.
51. Tabor, H., and Bronicki, L. 1954. Small turbines for solar energy power package. In *Proceedings of the United Nations Conference on New Sources of Energy: Solar Energy, Wind Power and Geothermal Energy, 21-31 August 1961, Rome, Italy*. Vol. 4:68-81. U.N. Document No. E/Conf.35/5. New York: United Nations.
52. Jordan, R. C., and Ibele, W. C. 1955. Mechanical energy from solar energy. In *Proceedings of the World Symposium on Applied Solar Energy, 2-5 November 1955, Phoenix, Arizona*, pp. 81-101. Menlo Park, California: Stanford Research Institute.
53. Zarem, A., and Erway, D. 1963. *Introduction to the utilization of solar energy*. New York: McGraw Hill Book Co.
54. Baum, V. A.; Aparisi, R. R.; and Garf, B. A. 1956. High-power solar installations. *Teploenergetika* 3(6):31-39. (In Russian)
55. Girardier, Jean-Pierre; Alexandroff, M. G.; and Alexandroff, J. M. 1973. Les moteurs solaires et l'habitat pour les zones arides: Realisations actuelles et perspectives. In *Proceedings of the International Congress. The Sun in the Service of Mankind, 2-6 July 1973, UNESCO House, Paris*, pp. E-82:1-10. Washington, D.C.: Research Applications Directorate, U.S. National Science Foundation.
56. Starodubtsev, S. V.; Umarov, G. Ya.; and Kordub, N. V. 1965. A 2.7 meter diameter vacuum film solar concentrator. *Applied Solar Energy (English translation of "Geliotekhnika")* 1(1):16.

# *Photovoltaic Devices*

Solar cells, usually in the form of thin films or wafers, are semi-conductor devices that convert from 3 percent to somewhat under 30 percent of incident solar energy into DC electricity, with efficiencies depending on illumination-spectrum intensity, solar-cell design and materials, and temperature. A solar cell behaves very much like a low-voltage ( $\approx 0.5$ -volt) battery whose charge is continuously replenished at a rate proportional to incident illumination. Connection of such cells into series-parallel configurations permits the design of solar "panels" with high currents and voltages as high as several kilovolts. Combined with energy-storage and power-conditioning equipment, these cells can be used as an integral part of a complete solar electric conversion system. Following their invention as practical devices in 1955, they have been used primarily for providing electrical power to spacecraft, though there have been some specialized terrestrial applications.

The extraordinary simplicity of a solar-photovoltaic system (Figures 10 and 11) would make it appear a highly desirable energy system for terrestrial purposes, both in industrialized and developing nations. The attractive attributes of photovoltaic arrays include the absence of moving parts, very slow degradation of properly sealed cells, possibility for modular systems at sizes from a few watts to megawatts, and extreme simplicity of use. The exceedingly high costs of development and fabrication of spacecraft solar arrays, however, have discouraged any serious thought of widespread terrestrial use of such a technology at the present time, in spite of the potentially attractive characteristics of such systems. A complete spacecraft solar-cell array costs anywhere from \$500,000/kWe (average) for the Skylab



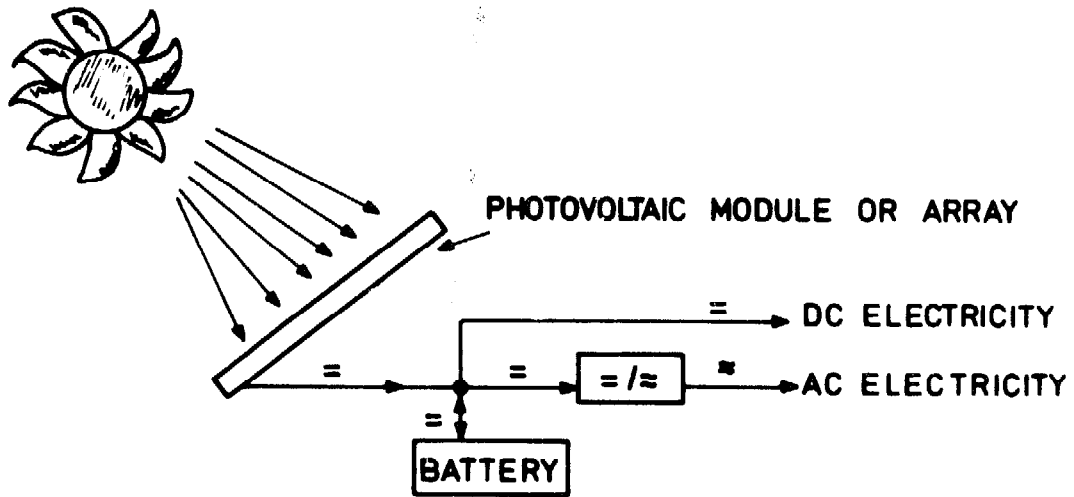

FIGURE 10 Simplified photovoltaic system.

arrays (10 kWe) to several million dollars per average kilowatt for early Mariner spacecraft arrays. An example of such an array is illustrated in Figure 12, where a Mariner IX spacecraft is shown with four large panels designed to deliver 400 W (total) of DC electrical power with an incident solar illumination of  $690 \text{ W/m}^2$  (Mars orbit).

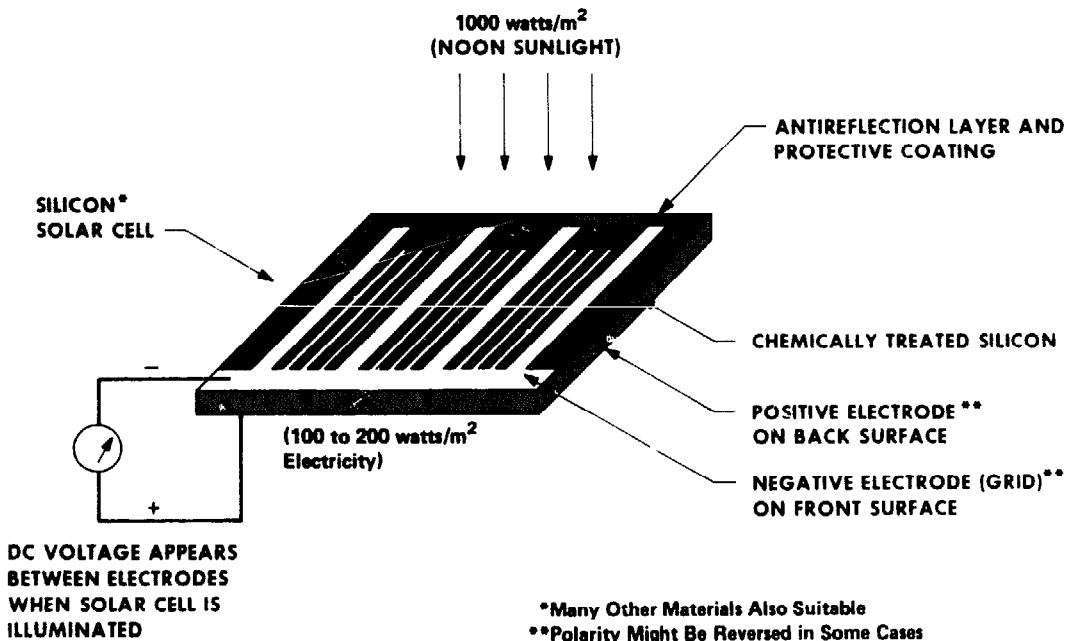

FIGURE 11 Direct conversion of sunlight into electricity—simplified representation of solar-cell operation.

There is now good evidence that, with appropriate technological developments and mass-production techniques, the cost of such solar arrays can be lowered (perhaps as early as the mid-1980s) to the point where a complete system—solar conversion, storage, power conditioning and transmission/distribution—can compete on a life-cycle cost basis with other large-scale energy-system alternatives, and perhaps be useful even in small-scale applications in remote rural areas.

Substantial programs for the development of commercially interesting photovoltaic systems in the United States, West Germany, Japan, and elsewhere have recently been initiated and, coupled with important developments in the past few years, now provide some concrete basis for such a prognosis. Important recent events include the development of continuous production of ribbon silicon suitable for solar cells, improvements in efficiency and stability of CdS solar cells, and the development of inexpensive, wide-aperture concentrators (Winston collector).<sup>1</sup>

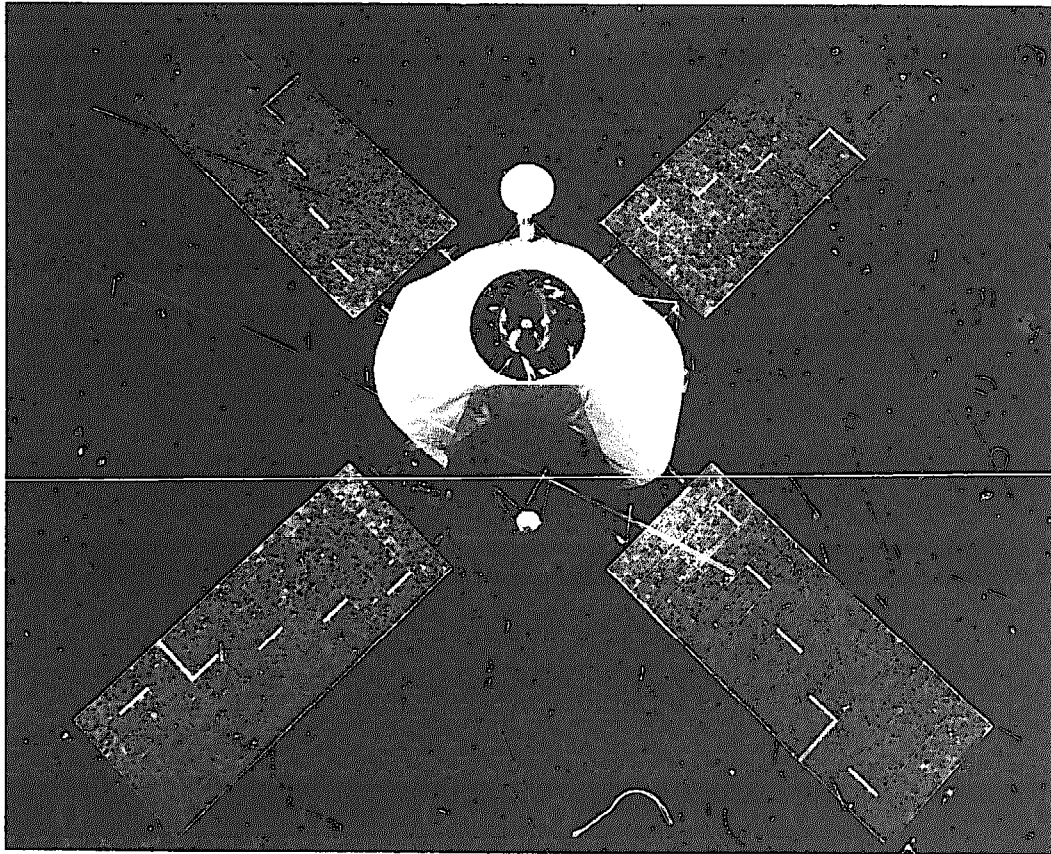

FIGURE 12 Mariner IX spacecraft, showing four silicon solar-cell panels.

## PRINCIPLE OF OPERATION

The operation of the solar cell is based on the photovoltaic effect—the creation of charge carriers within a material by the absorption of energy from incident ionizing radiation. The materials within which this occurs most usefully are the semiconductors—those materials whose properties are somewhere between those of conductors and insulators. They are characterized by the fact that their valence electrons are not free to move about and conduct current as is the case in metals, but are normally confined to electron-pair bonds between the atoms in the crystal. In semiconductors, however, the band of energy levels normally occupied by valence electrons is sufficiently close to the band of energy levels available to conduction electrons that, by absorption of the energy of a photon, an electron can jump the gap between the valence band and the conduction band and become a carrier of electric current. The resultant vacancy (“hole”) created in the residual electron-pair bond can be filled by an electron from a neighboring bond, which has the effect of a positive charge or “hole” migrating in a direction opposite to that of the electron flow.

In order for the conduction of electricity made possible by the creation of hole-electron pairs by ionizing radiation to provide useful work, three conditions must be met. First, the number of pairs of charge carriers created must exceed the number normally present at a given temperature. Second, the material must contain an internal inhomogeneity that keeps opposite charges separate until they are permitted to recombine by flowing through an external circuit. Third, the mean diffusion distance (lifetime) for holes and electrons before they recombine must be greater than the distance to the “collection point,” i.e., the inhomogeneity.

The inhomogeneity is a region within the device separating materials that differ as to the type of charge carrier that predominates in the conduction of electricity: n-type semiconductors if the predominant carrier is negative (electrons) and p-type if it is positive (holes). The p or n characteristic can be imparted to a semiconductor by incorporating into the crystal lattice minute quantities of an atom with one less or one more electron than each matrix atom contributes to the electron-pair bonds with its neighbors.\* In the case of silicon, for example, four valence electrons participate in these bonds. If it is “doped” with atoms having three valence electrons, such as boron or gallium, at any given lattice site the “dopant” becomes an acceptor of an electron in order to complete the bonds to its neighbors, thus providing a hole as a charge carrier and creating a p-type region. On the other hand,

\*This is generally accomplished by diffusion from the surface at an elevated temperature or by ion implantation at low temperatures.

phosphorus, arsenic, or antimony, for example, with five valence electrons, will act as electron donors in silicon and form an n-type region.

The three types of p-n junction encountered in semiconductor devices are the metal-semiconductor barrier, the homojunction, and the heterojunction. An example of the former is the galena-“cat’s whisker” arrangement used in early crystal-set radio receivers; the homojunction is a p-n junction within a semiconductor, and the heterojunction is a p-n junction between two different semiconductors.

Although they are rather easily fabricated, metal-semiconductor junction (“Schottky barrier”) devices (Figure 13) have not, in the past, been particularly interesting as solar cells because their efficiencies are low, they do not utilize as much of the solar spectrum as other types, and they suffer from the inherent problem that any radiation impinging on the metal serves only to raise its temperature. Improved efficiency (10-15 percent), as the result of recent experimental work with these devices, has rekindled interest in them, however, because of their low cost.

Most solar-cell development has taken place with homojunction and heterojunction devices. Figure 14 illustrates some typical characteristics of solar cells.

### Candidate Materials and Configurations

Literally dozens of materials, alone or in combination, possess the semiconductor properties required for high-efficiency ( $>.10$ ) conversion of solar radiation to electricity. A number of these have been investigated as possible commercial solar-cell materials, and three of these—silicon, cadmium sulfide,

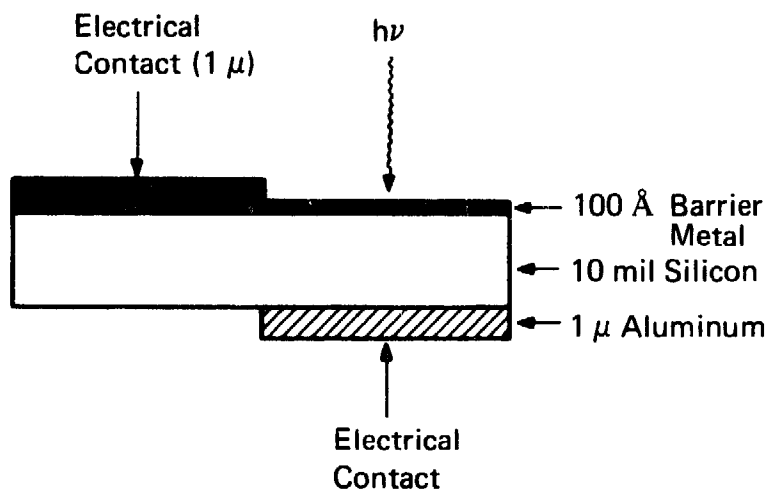

FIGURE 13 Structure of a Schottky barrier solar cell (not drawn to scale).

and gallium arsenide—have all been successfully used in spacecraft applications. Others are in experimental states of investigation. Still others, though known theoretically to be potentially interesting candidates, have yet to be thoroughly studied for these applications. Table 1 includes a brief partial summary of these and their status.

In addition to the possible materials and combinations, there are many possible configurations and processes for achieving them. Configurations

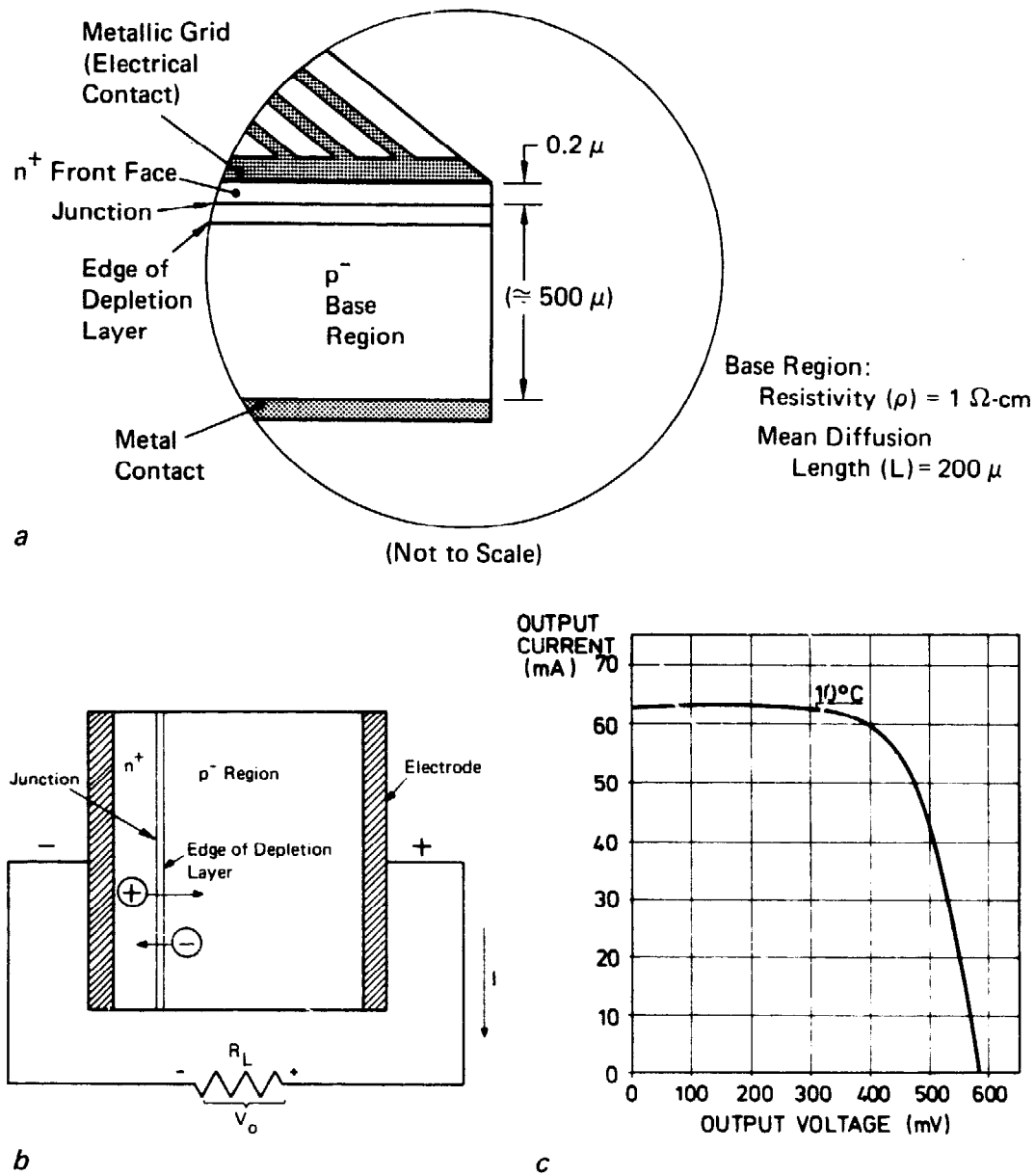

FIGURE 14 Typical characteristics of junction solar cells. *a*, Physical characteristics of a typical  $n^+/p$  solar cell. *b*, Illuminated solar cell with an external load. *c*, Typical solar cell I-V characteristics.

include the use of elemental material in thick and thin films (silicon and selenium), variations in junction design including the possibility of "vertical" junction cells to permit high-voltage operation, ternary compound materials such as GaAlAs for increased efficiency, and the use of graded bandgap materials also to increase the potential efficiency above that possible with constant bandgap materials. The various possibilities are discussed in detail in the current literature.<sup>2</sup>

Processes for forming the semiconductor junction include diffusion at high temperatures, evaporation to form a Schottky barrier layer on the surface of a semiconductor (such as silicon), and chemical epitaxial growth of layers (silicon, GaAs, or GaAlAs), as well as ion implantation. Base materials can be formed through single-crystal growth by various methods including dendritic web growth, Czochralski growth, and a ribbon generating method called EFG (edge-defined film growth). (See "Current Technology" below.) Thin films can be formed by sputtering, evaporation, vapor deposition, and other techniques. Electrodes can be attached by evaporation, silk screening, and application of metal "lace."

These examples merely illustrate the many combinations of materials, cell designs, and fabrication processes possible. Although theoretical investigation indicates that over a dozen possible material combinations can yield high conversion efficiencies, and that certain fabrication processes (such as EFG and thin-film formation) can lead to economically interesting cells in principle, the search for a practical near-optimum combination of these will probably take the better part of a decade and perhaps \$100 million or more in funding; indeed, development costs may be as much as \$1 billion. However, if an adequate level of funding is sustained, and outstanding people from industry, universities, and other centers continue to be involved, the achievement of an economically interesting terrestrial solar-cell system seems inevitable.

## PAST AND CURRENT USES OF TERRESTRIAL PHOTOVOLTAIC SYSTEMS

Since the invention of the silicon solar cell in 1955, there have been roughly a hundred different terrestrial applications of photovoltaic solar energy conversion systems, ranging from scientific experiments to operational applications by industry and government. Installations from a few watts to over a kilowatt peak power have been made in Africa, South America, Mexico, the United States, Canada, Europe, Japan, Southeast Asia, and the Middle East. These have provided power for lighthouse navigational and warning lights; radio, microwave, and television relay stations; aids to

TABLE 1. Some Candidate Materials for Terrestrial Solar Cell Fabrication

Material	Efficiency <sup>(a)</sup>	Status <sup>(b)</sup>	Type <sup>(c)</sup>	Commercial Availability <sup>(d)</sup>	
				0-5 years	5-10 years
AlSb	(e)	experimental	III-V	no	perhaps
InP	.05	experimental	III-V	no	perhaps
GaP	.03	experimental	III-V	no	perhaps
GaAs (Al)	.16	experimental	III-V	perhaps	perhaps
GaAs (Ga <sub>x</sub> Al <sub>1-x</sub> As) $\approx 0.25$		experimental	III-V	no	perhaps
CdS(Cu <sub>2</sub> S)	.05-.08	advanced <sup>(f)</sup> development	II-VI	perhaps	perhaps
CdTe	.05-.06	advanced development	II-VI	no	perhaps
SiC	.03	experimental	IV-IV	no	unlikely
Si	.15-.18	commercial	elemental	yes	
ZnSe	(e)	theoretical possibility	II-VI	no	perhaps
CuInS <sub>2</sub>	(e)	theoretical possibility	II-III-VI <sub>2</sub>	no	unlikely
CuInSe <sub>2</sub>	(e)	theoretical possibility	II-III-VI <sub>2</sub>	no	unlikely
AlInS <sub>2</sub>	(e)	theoretical possibility	III-III-VI <sub>2</sub>	no	unlikely
Zn <sub>3</sub> P <sub>2</sub>	(e)	theoretical possibility	II <sub>3</sub> -V <sub>2</sub>	no	perhaps
Cu <sub>2</sub> O	(e)	theoretical possibility	II <sub>2</sub> -VI	no	perhaps

(a) Efficiency of devices as measured under Air Mass Zero (AM0—see footnote, page 99) conditions of 1,400 W/m<sup>2</sup> incident solar radiation (i.e., with spectral distribution unmodified by atmospheric absorption or scattering—the characteristics of a space environment) and cell temperature approximately 23°C.

(b) "Experimental" refers to cells that have been fabricated in very small numbers under research laboratory conditions. "Advanced development" refers to devices that have been fabricated on a larger scale (many thousands of devices) under conditions that more or less simulate industrial production. "Commercial" refers to devices that are commercially available and technically suitable for use in rural communities.

(c) Roman numerals refer to the group in the periodic table to which each of the elements in the material belongs.

(d) The estimates of commercial availability reflect the opinions of a number of experts as reported in the recent open literature. As a result of the recent acceleration in funding for commercial development on such devices (mainly supported in the United States by the Energy Research and Development Administration [ERDA]), these estimates may prove to be conservative.

(e) Theoretical efficiencies of these devices are in the range of 10-20 percent under AM0

navigation on offshore oil platforms; weather-monitoring stations; remote educational-television sets; highway-emergency call boxes; aircraft-warning lights at airports; and remote communications stations for forest management. (Some examples are shown in Figures 15 and 16.) The present annual commercial market for photovoltaic arrays is perhaps 100 kWe (peak), and is divided among Japanese, American, and European (French, British, and West German) manufacturers (Appendix 3).

### Experimental and Prototype Systems

The categories of application of photovoltaic systems for terrestrial use include scientific tests and demonstrations, quasi-commercial or prototype commercial applications, and fully commercial applications.

Experimental or demonstration uses of solar cells began in 1955 when Bell Laboratories and the Bell Telephone Company installed a solar-powered, rural-telephone carrier system in Americus, Georgia.<sup>4</sup> The system was operated for about 6 months—as a technical demonstration and publicity effort. In 1973, combined photovoltaic (CdS) and thermal collectors were integrated into a laboratory/house at the University of Delaware<sup>5</sup> to explore the nature of residential solar electric/thermal systems connected to a local electric-utility grid. At the California Institute of Technology, scientists from the geology department are using surplus spacecraft solar panels (from Ranger and Mariner spacecraft), suitably modified for protection against weather, to power remote scientific geological stations in California and Mexico.<sup>6</sup> And the Mitre Corporation (McLean, Virginia) is developing a 1-kW solar electric/hydrogen system to demonstrate the use of solar-generated electricity combined with electrolytic hydrogen as a secondary energy carrier.<sup>7</sup> All of these applications have been largely scientific in nature; they have not involved exploration of near-term markets for photovoltaic applications, although the work at the University of Delaware will eventually lead to an evaluation of combined photovoltaic/thermal solar collectors for building applications.

Other experimental systems have been installed in the Chilean desert as a joint University of Chile/RTC (la RTC Radiotechnique-Compelec, France) project, in Iran (at Pahlavi University in Shiraz), as well as in France, Africa, the Soviet Union, India, Japan, England, and West Germany.

---

conditions at 23°C. These materials have been suggested by Loferski<sup>3</sup> as the prime candidates for further research for high-efficiency photovoltaic conversion.

(f) Although cadmium sulfide cells are actually commercially available, their operation is so unreliable and so poorly understood that in terms of rural use they should be considered to be in a state of advanced development.



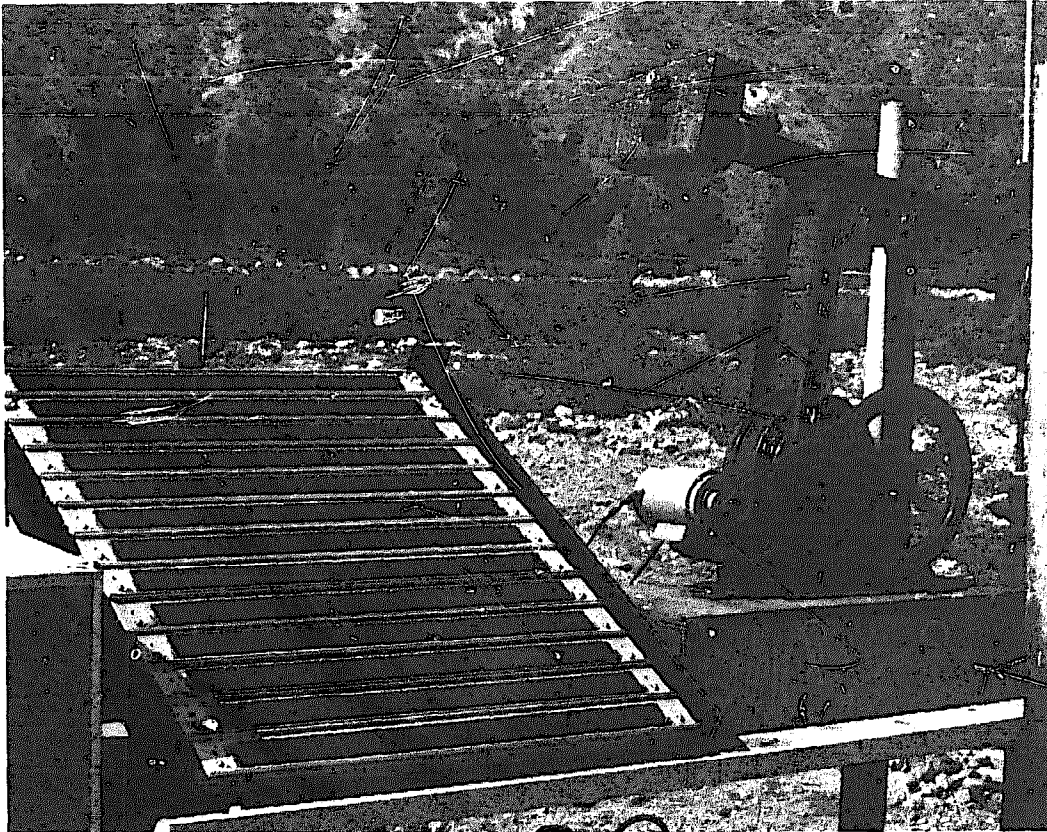

FIGURE 15 Water pump powered by silicon solar-cell array. Illustration shows one of four panels required to power the  $\frac{1}{4}$ -horsepower motor that operates the pump. The array size is 36 X 39 in. (91.4 X 99 cm) and it produces 4 amperes at 12 volts DC. [Courtesy Spectrolab, Inc.]

Quasi-commercial or commercial prototype systems are those in which the initial installation was made in order to determine the operating economics of the system and to make a comparison with other available energy systems. Such applications have generally been in situations where there has been a need for remote power in the 1- to 100-W range and where the cost of replacement of batteries, transportation of fuel, or remote power lines was prohibitive. Such applications include, for example, remote radio beacons; radio, television, and microwave booster and repeater stations; and warning and navigational lighting on offshore oil platforms. A number of installations made on a prototype basis have led to commercial installations, following successful operation of the prototype.

Examples include the first remote solar-cell application in Japan, which provides power for a 150-MHz VHF repeater station on Mt. Shinobu,<sup>8</sup> and the installations of Motorola solar-cell-powered telecommunications equipment by the California Department of Forestry in the late 1960s.<sup>6</sup> In both

cases, commercial installation followed the economic and technical success of the initial installations.

### CURRENT TECHNOLOGY (AVAILABLE WITHIN 5 YEARS)

For purposes of this report, commercial systems are those that are produced as a regular product line by a company, and commercial applications are those in which such products have been purchased by some organization because the solar option was the most economical on an annual cost basis. The current commercial market for terrestrial photovoltaic systems could be characterized as one in which some combination of high reliability, low or no maintenance, zero fuel requirements, and noiseless operation, at power levels below 1 kWe (peak), justify, on an economic basis, the use of photovoltaic systems.

These characteristics of photovoltaic systems are not necessarily advantages over conventional power systems if transportation on foot, or by horseback, Jeep, helicopter, etc., for fueling and maintenance purposes to remote locations is easily available, if batteries can be purchased and installed

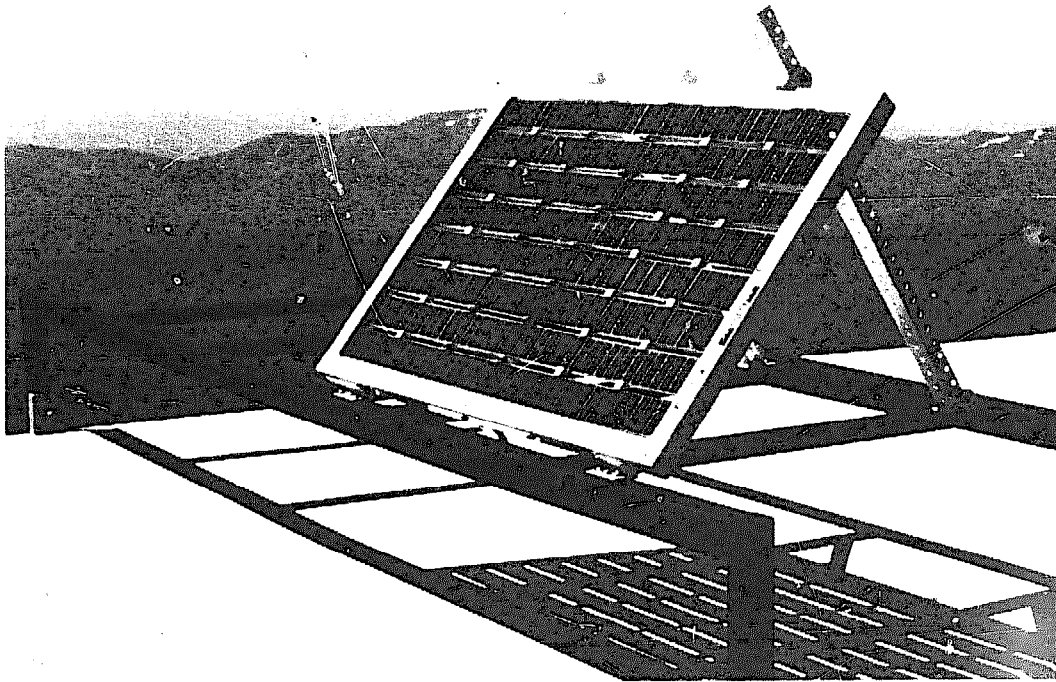

FIGURE 16 Silicon solar cells used for communications. (Photovoltaic panel used by the U.S. Bureau of Land Management to power a VHF radio repeater atop Jack's Peak, Nevada. The array size is 36 X 24 in. (91.4 X 61 cm) and it produces 2.5 amperes at 12 volts DC.) [Courtesy Spectrolab, Inc.]

each year, power lines can be laid, or noise insulation installed where required. Each of these has some specific cost for a given application and a geographic location. Hence, there are situations where the characteristics of photovoltaic systems translate directly into economic advantages. (An economist would say that in these cases the market is operating normally.)

In 1961, Kobayashi<sup>8</sup> reported that it was more economical, on a life-cycle cost basis, to provide remote power at levels up to 50 W by a solar cell/storage battery combination costing \$130/peak watt than to run a power line 1 km. Today, Spectrolab, Inc., has sold over 100 systems for remote power for navigational and warning lights on offshore oil rigs in the United States.<sup>9</sup> Several states in the United States, including California, Nevada, and Oregon, are purchasing photovoltaic power systems for remote radio repeater stations and other similar applications; sailboat owners are purchasing solar arrays to keep batteries charged during long voyages; and the French are providing solar television sets in Niger (see below) for educational purposes. Small solar-powered radios were marketed by Motorola in the early 1960s and, at the extreme end of the luxury market, a West German company has recently introduced a solar-power (trickle-charged battery) electronic cigarette lighter for several hundred dollars! As mentioned earlier, the total world market for diverse commercial and spacecraft applications is roughly 100 kWe (peak) per year and, at present prices for photovoltaic arrays, it is expected to grow to perhaps 3 times that within 3 years.<sup>10</sup>

Of the various types of photovoltaic devices that have been manufactured, only silicon solar cells have become an established commercial product (Table 1). CdS cells have been used in space applications by the United States and France; GaAs cells were used by the Soviet Union in near-sun deep space probes. Nevertheless, silicon cells are the only devices that can be made reliably in quantity, are stable with time, and whose operation is sufficiently well understood to enable properties to be predicted and electrical characteristics to be designed in.

Commercial systems discussed in this section are available from manufacturers in the United States, Japan, West Germany, France, and England. Manufacturers will provide either individual silicon solar-cell modules appropriately encapsulated in rugged supports or complete systems including batteries and power-conditioning equipment.

Most of the devices and systems currently available have been developed and used for specific applications where conventional energy sources are not available, but the need for modest amounts of power is critical in terms of commercial or military operations. Thus, they are too costly for applications in rural areas of developing countries except where a specific and critical need might occur. A summary of some current manufacturers of photovoltaic arrays and an example of typical product data available are listed in Appendix

3 for the benefit of those concerned with use of such systems. Only a few typical examples will be mentioned here; the manufacturers themselves are probably the best source of information regarding practical applications in various locales.

*Solar-powered signaling from remote stations in the United States.* In 1973, the Tidelands Signal Corporation of Houston, Texas, fabricated a complete aid-to-navigation, warning-light system, including silicon solar arrays fabricated by Solar Power Corporation (Massachusetts), and installed the system on an offshore oil platform on the Texas Gulf coast. The lighting system consists of 1 2-mi fog signal and 4 5-mi lamps. Energy consumption is about 25 amp-hr/day x 12 volts = 300 Whe/day. Previously, this lighting system was powered by 40 1.2-volt, 3,300 amp-hr primary batteries. The total weight was 2,000 lb and these were replaced annually. The solar generator system incorporates 80 photovoltaic modules (1.5 W peak under AM1\* illumination, 25°C) in a 4 x 5-ft (1.22 x 1.52-m) array. The information available implies a retail cost of roughly \$20/peak watt and indicates that at such prices for a terrestrial array (sealed, ready to install), such arrays begin to compete with primary and secondary batteries in markets traditionally served by this hardware.<sup>11</sup> The report on this system claims that "solar cell/secondary battery systems clearly compete on a life-cycle cost basis, although the specific numerical details are not discussed."

The National Aeronautics and Space Administration (NASA) Lewis Research Center and the National Oceanic and Atmospheric Administration (NOAA) are cooperating on a project to design, fabricate, and install a number of solar power systems for remote atmospheric monitoring stations.<sup>12,13</sup> Two installations, one in Virginia (Sterling) and one in California (Mammoth Mountain), were built in 1973 and further installations are expected. As a precommercial application, solar arrays have been fabricated by NASA/Lewis using commercial solar cells in arrays made of modules containing 48 (6 x 8) circular silicon solar cells each and supplying 3 W (AM1) per module. The arrays at each installation contain 20 modules, for a peak power of 60 W, and are encapsulated in fluorinated ethylene propylene (FEP) sheets.

*Solar-powered educational television sets in Niger.* This example is one of the very few documented applications of photovoltaics in a developing country.<sup>13</sup> Although similar programs of educational television for use in outlying rural schools have been or are being instituted in other developing

\*The air mass ratio is the ratio of the distance light travels through the atmosphere to the length of the atmospheric path if the source were at the zenith. Thus, in this case, Air Mass One (AMI) implies that the sun is directly overhead.

countries (e.g., Ivory Coast, Brazil, India), none of these seems to have involved the use of solar cells as a power source.

Télévision Scolaire du Niger (TVSN) was created in 1966 as part of a program to upgrade the level of primary education in the country. This educational television system is intended principally for primary schools located in regions without electricity. Reception is assured through the use of television receivers especially designed to operate in climates of extreme heat or cold. These sets are transistorized, will receive at a wavelength of 61 cm (492 MHz), and are designed to operate on batteries supplying 35 W at 34 volts DC ( $\pm 15$  percent). With average battery life of 2,000 hours, it was calculated that one hour of television reception cost 1.38 francs per receiver.

In order to develop a more economical source of energy, the technical services of TVSN and the Office de la Recherche Solaire (Niamey) in 1968 installed an experimental solar panel to power the television set at a school near Niamey. The experiment demonstrated the practicality of providing solar-powered television reception in Niamey during the entire school year (October to June). After an applications study by the ORTF (Office National de la Radio-Télévision Française), six installations followed in 1972, and by 1973 some 800 students in 22 classes were receiving instruction via solar-powered television reception of broadcasts from the production center in Niamey.

As a consequence of the encouraging results of this experiment, the Government of Niger decided on the progressive establishment of a network of solar-powered television sets, with plans to reach 80 percent of the population with educational programs by 1985.<sup>13</sup>

### Reliability (Lifetime and Maintenance)

Photovoltaic arrays have no moving parts, and the basic physical mechanism that accounts for the photovoltaic property has a lifetime measured in thousands of years for silicon. (That is, it is basically related to the rate at which impurity atoms, which form the p-n junction, diffuse through the crystal lattice, degrading the junction.) Techniques have been developed to encapsulate silicon solar cells in a clear silicone material that provides excellent shock insulation and protection from environmental effects. The closer such encapsulation approaches true hermetic sealing, the closer the lifetime of the device will approach that of the base material.

Such reliability may be critical if such systems, when they appear economically attractive, are to be rapidly and widely adopted. People are slow to put total reliance on innovations until a long period of testing and experience has gone by.<sup>14</sup>

In the case of suitably designed solar-cell arrays, the level of maintenance

required to provide very high reliability (on the order of one failure per 10 years of operation) is probably both low and inexpensive. It principally involves protection of the transparent surfaces from extreme abrasion and periodic cleaning of the surface and perhaps the electrical connections. Modules could conceivably be developed for which maintenance would consist of only occasional cleaning. A number of photovoltaic systems have operated for close to a decade with no cleaning and with no observable degradation, despite such relatively dirty industrial atmospheres as the Cleveland Airport, for example.

Little labor is required for upkeep because of the low maintenance requirements of solar cells. Apart from skills and materials normally needed for battery maintenance, only a periodic cleaning of the solar array's surface with water—and perhaps soap and a cloth—is needed to maintain a solar-cell installation. Thus, there is no need for a supportive infrastructure for maintenance and repair, specialized training of maintenance personnel, or special tools, etc. (Compare this with the minimum tools, training, and access to spare parts required for the simplest internal-combustion engine/generator combination.)

### Cost

The economics of the large-scale energy systems currently used in the industrialized nations (and to a considerably lesser extent in developing countries) differ substantially from the economics of small-scale energy systems that might be used in developing countries. In both sets of circumstances, however, the basic capital costs of various system alternatives must be established before any procedure to calculate final costs of energy delivered to the ultimate user can be employed. The costs of energy from a solar-energy conversion system include many factors beyond the capital cost of the solar conversion module. Capital or initial costs include, of course, the costs of the array modules, with support and orientation structures, plumbing (if forced cooling is used), and other elements such as batteries, inverters and other power-conditioning equipment, and hardware for local distribution of electricity. Additional capital investment costs include provisions for replacement parts, tools, materials for cleaning surfaces and inhibiting corrosion (where necessary), and possibly backup systems such as inexpensive internal-combustion engines plus generators, and occasional use of fuel. Other costs will of course include packaging and transporting the system elements to site, fees and tariffs for importation, and labor costs for assembly and operation of the system. Still additional costs include the development of a local infrastructure to handle replacements, training personnel to use the equipment, development and printing of instruction manuals, and possible

additional costs associated with local institutional factors such as the need to monitor how much electricity each member of a settlement is drawing from the system. Other social costs might include payment to, or redirection of, people who make their living delivering kerosene or other fuels that are totally or partially displaced by the solar systems. A partial list of such cost elements is shown in Table 2.

Finally, as with any other proposed investment, the cost of capital and fixed charges will be an important factor in determining the cost of energy. In a photovoltaic system where the costs of the system operation depend primarily on the total capital investment in the delivered system, the interest rates applied to the loans will be particularly important, since the amortized cost of electricity will be almost linearly proportional to the interest rate.

The cost of a cell can be unambiguously expressed in terms of the cost per unit area of the finished device. The actual cost of energy produced in a working environment will depend on such factors as the efficiency of the cell as a function of temperature and of illumination intensity and wavelength, insolation patterns, and other environmental factors. Since the realistic applications of such cells will be in integrated modules, the final costs must be determined in terms of the performance of these modules and not of the cells alone. The current price for individual silicon solar cells is approximately \$10,000 per peak kWe (\$40,000-\$60,000 per average kWe) and the cost of a completed array (with or without batteries and power conditioning, since these are relatively cheap) is \$30,000-\$70,000 per peak kWe (\$120,000 and up for average power). Production of solar arrays or modules at prices more interesting in terms of rural use in developing countries (under \$1,000 per average kWe) will depend on major cost reductions in the production of the semiconductor "blank" and its conversion to the finished cell, and in techniques for combining the cell and all of the necessary supports, contacts, connections, covers, etc., into the final module or array.

Of the various techniques currently under development, only one seems likely soon to result in cost reductions, in the cell blanks and finished cells, of sufficient magnitude to bring total costs below \$1,000/kWe within 5 years. This is a technique, currently undergoing commercial development by Mobil Tyco Solar Energy Corporation (Waltham, Massachusetts), for the production of continuous silicon ribbon of high-enough quality (i.e., purity and freedom from lattice imperfections) to produce solar cells with conversion efficiencies in excess of 10 percent under standard conditions. The process is known as the EFG or Edge-defined Film-Growth technique. In this technique, a "seed" crystal of silicon is dipped in a bath of molten silicon and a film is pulled through a capillary die (Figure 17) to produce a ribbon. (A prototype array of cells fabricated from this material is shown in Figure 18.) Ribbons of 1-in. (2.54-cm) width with thicknesses down to .008 in. (0.2 mm) have been

TABLE 2. Cost Components for a Photovoltaic System

Capital Cost	Continuing Costs
<i>Equipment</i>	<i>Equipment</i>
Solar conversion modules including mechanical supports, heat transfer (active or passive), orientation mechanisms, concentrators, etc.	Replacement components for damaged system elements
Batteries	Replacement of batteries (3 to 5 years) and other elements due to corrosion and other forms of degradation, engines after 3 years
Power conditioning (inverters, voltage regulation, current stabilization, transformers, etc.)	Tools, manuals, etc., which are needed continuously and which break or wear out (or are stolen, sold, or otherwise made unavailable)
Local transmission and distribution components, including cables, plugs, and connections, switches and relays, etc.	
<i>Transportation</i>	<i>Maintenance and Operation</i>
Packaging for shipment	Labor for maintaining equipment, possible costs for night-time protection
Transport from sources to LDCs; (for those components not produced locally)	Labor for operating systems, including handling billings or other techniques for dividing up local support of the system
Internal transport	
<i>Fees</i>	<i>Capital Costs</i>
Import duties	Interest on capital borrowed to purchase systems
Taxes	
Hidden costs	
<i>Local Support</i>	<i>Local Taxes and Other Fees</i>
Spare parts	Possibility of taxes or fees of various kinds imposed locally
Tools	
Manuals	
Training	
<i>Array Deployment</i>	<i>Fuel</i>
Cost of land	
Labor and materials for deployment	Fuel costs for backup system(s) that may be required to reduce risk of solar-system outages to acceptable levels
On-site structures for housing storage batteries, power-conditioning equipment, etc.	



continuously pulled at rates of 1-1½ in. (2.5-3.7 cm) per minute, and with continuous lengths of up to 80 ft (24 m). It has been estimated that finished solar cells could be produced for the cost of \$165/kWe (peak, AM1, 10 percent efficiency, .004 in. or 0.1 mm thick) or between \$500 and \$825 per kW average.<sup>15</sup> These estimates are based on anticipated reduction in loss of silicon during fabrication by a factor of 2, a further reduction—by a factor of 3—in the amount of silicon used (as a consequence of the reduced thickness of the wafer), and a factor of 3 reduction in the cost of the silicon itself as a consequence of the processing technique. In addition, the possibility exists of further significant reductions in cost by the use of solar collectors that would concentrate the light of a larger area onto the cell, thus effectively increasing the area of the solar cell. Figure 18 shows a prototype array of silicon-ribbon solar cells of the type being developed for commercial production.

It should be noted that at the current stage of development, because of the concentration of lattice dislocations in the ribbon, it is not yet possible to obtain these hoped-for efficiencies (10-20 percent) under standard conditions in solar cells made, by direct diffusion, with silicon ribbon. Such efficiencies

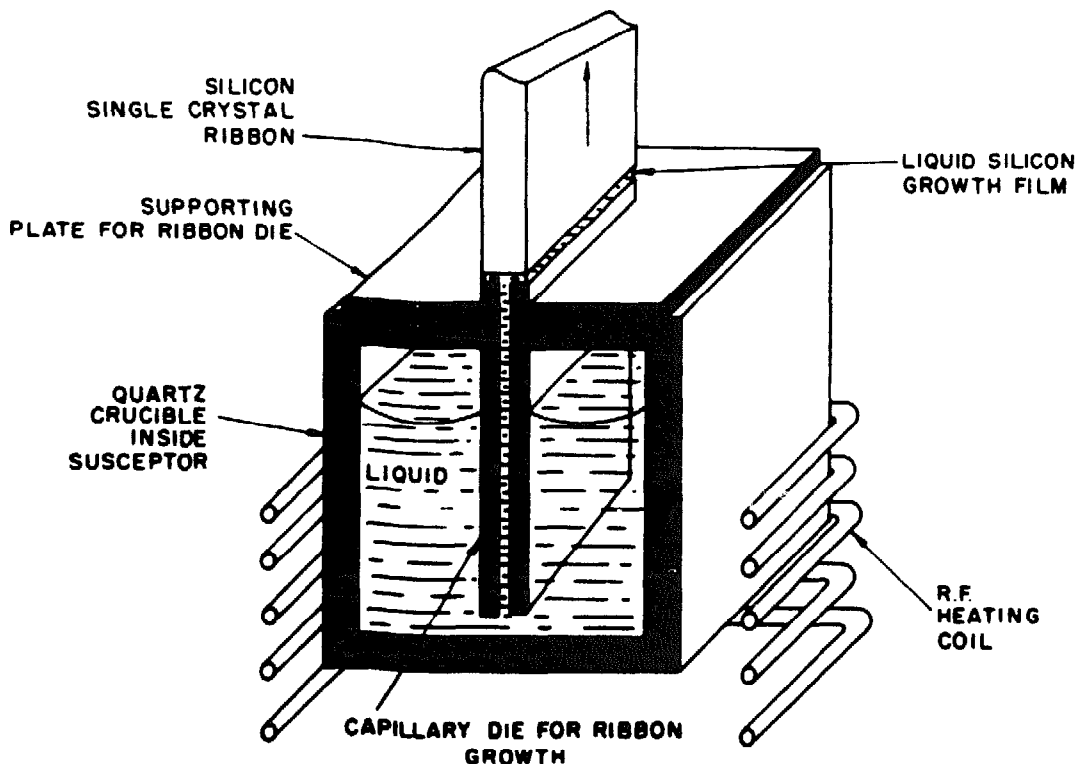

FIGURE 17 Schematic of solar-cell silicon ribbon growth (EFG—"Edge-defined Film Growth") from capillary die. [Courtesy Mobil Tyco Solar Energy Corporation]

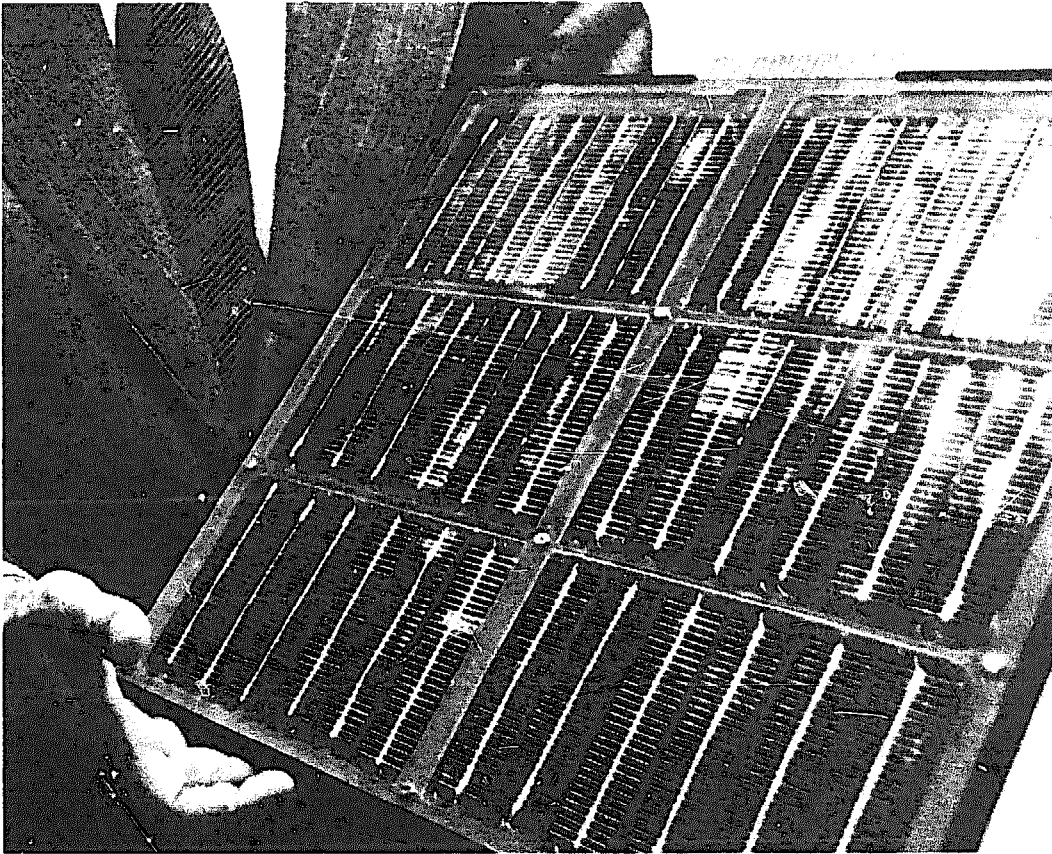

FIGURE 18 Terrestrial photovoltaic array (prototype) fabricated from EFG ribbon silicon. [Courtesy Mobil Tyco Solar Energy Corporation]

have been obtained, however, when an epitaxial layer of silicon is grown on EFG ribbon and the junction is then formed in this layer.\*

Other techniques for the development of low-cost manufacturing processes for production of silicon solar-cell arrays have been explored in considerable detail by Wolf.<sup>17</sup> Among those being examined, for example, is generation of polycrystalline silicon sheet by rolling or extrusion followed by sheet recrystallization by floating zone regrowth.

## RESEARCH AND DEVELOPMENT

Although the development of silicon-cell solar arrays at prices under \$1,000/kWe average was discussed in the previous section, it is really difficult

\*In work recently reported, for example, a conversion efficiency of 10 percent was obtained with an EFG-ribbon cell on which a 30- $\mu$  layer of silicon had been epitaxially grown, while a conversion efficiency of only 6.2 percent was obtained with a cell made from ribbon alone.<sup>16</sup>

to predict whether such a price breakthrough will occur within the next 5 or 10 years. It seems likely that by 1985 such arrays will be available for about \$500/kWe average, but the likelihood of their availability any sooner depends on worldwide interest in, and commercial demand for, such systems.

Integration of solar cells and optical concentrators has been explored in the past. The potential advantage resulting from the reduced cell area needed for a given electrical output might mean a reduction in cell needs by a factor of 4-10; it seems, therefore, that work in this field might usefully be encouraged to compound the savings from new fabrication techniques. This would be the case especially in situations where cooling water is available to keep the silicon temperature from rising beyond the point where the cell efficiency is seriously impaired. (At 200°C the theoretical maximum efficiency is reduced to about 5 percent from a theoretical limit of about 22 percent at 25°C.)

In the case of materials other than silicon, there are some interesting candidates from which highly efficient solar cells might be commercially manufactured within 10 years (Table 1) but, again, whether a sufficient price breakthrough will occur to make them reasonable power sources for developing countries is hard to say. Gallium arsenide is particularly interesting in that, because of the nature of its bandgap, incident sunlight is absorbed at a depth of about 1-2  $\mu$  (compared to 100-200  $\mu$  for silicon), which makes it possible to use much less material per device than with silicon, thus perhaps compensating for its higher cost. Furthermore, because of its electronic properties, GaAs has a higher theoretical efficiency than silicon, its bandgap (1.35 eV) is closer to the optimum for sunlight (average photon energy  $\approx$  1.5 eV) than is silicon's (1.1 eV), and it can operate efficiently at higher temperatures, thereby making the potential use of concentrators more promising.\* Thus, the combination of factors—thinner wafers, smaller areas, and higher efficiencies (as high as 19.1 percent with a concentration factor of 1735)<sup>18</sup>—makes gallium arsenide a material that could compete with silicon as a source of efficient solar cells. However, its accessibility in terms of cost depends strongly on how much further research and development are stimulated by worldwide demand.

## PHOTOVOLTAIC SYSTEMS IN DEVELOPING COUNTRIES

The attractiveness of a photovoltaic system to a developing country will depend on the economic significance of that application to those who have to

\*Although there are many other direct bandgap materials, besides GaAs, that could be considered as candidates for similar reasons, more industrial effort has already been devoted to investigations of gallium arsenide than to any of the others.

pay for and maintain it. In some cases, this may be some agency of government, a donor agency such as the U.S. Agency for International Development (AID), or an international agency such as the United Nations Development Program (UNDP) or the International Bank for Reconstruction and Development (World Bank). In others, it will be the local inhabitants themselves. A detailed analysis of the value of various energy-related or energy-derived (specifically electrical energy) services in various cultural and geographic environments is required before a useful assessment of the potential market for solar power systems can be made (unless the cost of these systems drops to the point where it is the cheapest alternative available for large-scale power generation). The nature and size of various markets in developing countries will depend on the delivered cost of the photovoltaic systems as well as on the value of electricity-derived services. Part of the required analysis would be an economic assessment of the value associated with the following features of photovoltaic systems:

- High reliability;
  - Low maintenance requirements;
  - Zero fuel requirements;
  - Intermittent output without storage, continuous output with storage;
- and
- Modularity (when one piece of the system goes out, the rest can continue to function, which is not the case with generators).

Reliability and maintenance have already been discussed. Photovoltaic systems share total independence of fuel requirements with all other alternative-energy technologies discussed in this report; the intermittent nature of their output—without storage—is another characteristic shared with many of these technologies. The modularity of photovoltaic systems, however, is unusual and worth special attention.

The modular nature of photovoltaic systems permits the users to gain experience with a relatively small investment. This is a crucial aspect of rapid diffusion of an innovation.<sup>14</sup> When large investments in innovations are required, they may never be adopted due to the lack of opportunity to test them at an acceptable level of financial risk. Systems can grow as the affluence of the local community grows, and system elements could be designed to permit the development of local “grids” as neighboring systems grow and eventually become contiguous. Loads can grow with supply, meaning essentially full amortization of the investment. Finally, a modular power system means that one or a few photovoltaic elements can fail and the system can continue to operate. Replacements can be obtained at the most convenient and least expensive time.

## REFERENCES

1. Winston, Roland. 1974. Principles of solar concentrators of a novel design. *Solar Energy* 16:89-95.
2. See, for example:
  - a. *Photovoltaics specialists conference: Conference records*. 1972-1975 eds. New York: Institute of Electrical and Electronic Engineers.
  - b. *The Photovoltaic power and its applications in space and on earth*. 1973. Special volume of the *Proceedings. International Congress of The Sun in the Service of Mankind, 2-6 July 1973, UNESCO House, Paris*. Bretigny-Sur-Orge, France: Centre National d'Etudes Spatiales.
  - c. *Proceedings of the Symposium on the Material Science Aspects of Thin Film Systems for Solar Energy Conversion, 20-22 May 1974, Tucson, Arizona*. U.S. National Science Foundation, RANN—Research Applied to National Needs, Document No. NSF-RA-N-74-124. Tucson: University of Arizona, Optical Science Center.
  - d. *Workshop proceedings. Photovoltaic Conversion of Solar Energy for Terrestrial Application, 23-25 October 1973, Cherry Hill, New Jersey*. 2 vols. U.S. National Science Foundation, RANN—Research Applied to National Needs, Document Nos. Vol. I: NSF-RA-N-74-013A, Vol. II: NSF-RA-N-74-013B. Pasadena: California Institute of Technology, Jet Propulsion Laboratory.
3. Loferski, J. 1974. Some problems associated with semiconductor materials for large scale solar energy conversion. In *Proceedings of the Symposium on the Material Science Aspects of Thin Film Systems for Solar Energy Conversion, 20-22 May 1974, Tucson, Arizona*, p. 237. U.S. National Science Foundation, RANN—Research Applied to National Needs, Document No. NSF-RA-N-74-124. Tucson: University of Arizona, Optical Science Center.
4. Pearson, G. 1964. Applications of photovoltaic cells in communications. In *Proceedings of the United Nations Conference on New Sources of Energy: Solar Energy, Wind Power and Geothermal Energy, 21-31 August 1961, Rome, Italy*, Vol. 4:236-241. U.N. Document No. E/Conf.35/5. New York: United Nations.
5. Böer, K. W. 1973. The solar house and its portent. *Chemical Technology* (July): 394-400.
6. Costoque, E., and Vivian, H. 1969. *Solar energy rechargeable power systems*. Jet Propulsion Laboratory Document No. 650-681. Pasadena: California Institute of Technology, Jet Propulsion Laboratory.
7. Johnson, Augustus. 1975. Personal communication.
8. Kobayashi, M. 1964. Utilization of silicon solar batteries. In *Proceedings of the United Nations Conference on New Sources of Energy: Solar Energy, Wind Power and Geothermal Energy, 21-31 August 1961, Rome, Italy*, Vol. 4:229-235. U.N. Document No. E/Conf.35/5. New York: United Nations.
9. Rosenblatt, A. I. 1974. Energy crisis spurs development of photovoltaic power sources. *Electronics* 47(7):99-111.
10. Ralph, E., and Wolf, M. 1975. Personal communications.
11. Kelly, B. P.; Eckert, J. A.; and Berman, E. 1973. Investigation of photovoltaic applications. In *The photovoltaic power and its applications in space and on earth*, pp. 511-518. Special volume of the *Proceedings. International Congress of the Sun in the Services of Mankind, 2-6 July 1973, UNESCO House, Paris*. Bretigny-Sur-Orge, France: Centre National d'Etudes Spatiales.
12. Forestieri, A. F. 1973. Photovoltaic terrestrial applications. *Workshop Proceedings*.

- Photovoltaic Conversion of Solar Energy for Terrestrial Application, 23-25 October 1973, Cherry Hill, New Jersey, Vol. II: 150-152. 2 vols. U.S. National Science Foundation, RANN-Research Applied to National Needs, Document No. NSF-RA-N-74-013 B(Vol. II). Pasadena: California Institute of Technology, Jet Propulsion Laboratory.*
13. Polgar, S. 1973. Alimentation de téléviseurs par photopiles pour la télévision scolaire du Niger. Paper presented at the International Solar Energy Society Conference, 2-6 July 1973, Paris.
  14. Rogers, Everett M., and Shoemaker, F. Floyd. 1971. *Communication of innovations—a cross cultural approach*. 2d ed. New York: Free Press.
  15. Mlavsky, A. I. 1974. Ribbon growth of silicon. In *Proceedings of the Symposium on the Material Science Aspects of Thin Film Systems for Solar Energy Conversion, 20-22 May 1974, Tucson, Arizona*, pp. 71-83. U.S. National Science Foundation, RANN-Research Applied to National Needs, Document No. NSF-RA-N-74-124. Tucson: University of Arizona, Optical Science Center.
  16. D'Aiello, R. V.; Robinson, P. H.; and Kressel, H. 1975. Epitaxial silicon solar cells. *Technical digest*. Abstract of papers presented at the Annual Meeting of International Electron Devices, 1-3 December 1975, Washington, D.C., pp. 335-338. New York: Institute of Electrical and Electronic Engineers.
  17. Wolf, M. 1974. Methods for low cost manufacture of silicon solar arrays. Paper 74-WA/Ener-4. New York: American Society of Mechanical Engineers.  
———. 1975. Cost goals for silicon solar arrays for large scale terrestrial applications—update 1974. *Energy Conversion*, Oxford, England 14:49-60.  
———. n.d. Progress in new low cost processing methods. Philadelphia: University of Pennsylvania.
  18. James, Lawrence W. 1975. III-V compound heterojunction solar cells. *Technical digest*. Abstract of papers presented at the Annual Meeting of International Electron Devices, 1-3 December 1975, Washington, D.C., pp. 87-93. New York: Institute of Electrical and Electronic Engineers.

*PART II*

*INDIRECT USES OF  
SOLAR ENERGY*

---

# *Wind Energy*

Wind has been described as “the greatest terrestrial medium for harvesting, harnessing, and conserving solar energy.”<sup>1</sup> The source of wind is, of course, in the atmospheric temperature differences generated by the sun, which, in turn, give rise to pressure differentials. The wind is a mechanism for dissipating, as kinetic energy, the potential energy accumulated in those pressure differences.

Wind energy has been used for thousands of years to propel boats and ships and to provide rotary windmill power to reduce the physical burdens of man. The windmill is an invention that dates from the earliest times of recorded history.<sup>2</sup> There is evidence that the ancient Egyptians used windmills as early as 3600 B.C. to pump water to irrigate their arid fields and to grind grain. The early Persians ground grain with a vertical-axis sailmill. Europeans imported the technology from the East and were probably the first to introduce the horizontal-axis mill around the 12th century. Almost all subsequent development has been with this latter type, primarily because of the low rotational speeds and greater efficiency of the horizontal-shaft mill. Up to the 19th century, the millwright’s craft in Europe was esteemed, and mills were built that would work without fail for centuries, although their sails had to be replaced every 15-20 years.

Traditionally, rural populations used windmills principally for the following applications:

- To pump water for domestic use such as watering livestock and irrigating crops;



- To perform agricultural tasks such as grinding corn, crushing sugarcane, threshing, and wood cutting;
- For specialty applications such as moving saline water in salt works; and
- For the generation of electricity (in more recent times).

At the village level in many cultures, classical, traditional forms of windmills are a familiar and established technology. In recent years, there have been attempts by organizations in both industrialized and developing regions to meld wind energy and more advanced technologies into forms that can be used by rural communities. The work of several organizations in the United States and Canada is elaborated upon in this report, but the list is by no means exhaustive; these examples are cited only to illustrate the type of work that has been carried on in these fields.

The Asian experience with windmills dates to ancient times; only a few characteristic examples will be mentioned. The horizontal windmill seems to have been introduced into China during the Sung period (960-1280).<sup>3</sup> Eventually it evolved into something quite different from the Persian type, using the principle of the luffing sail adapted from the junk for its vanes. In the People's Republic of China, windmills are currently used for irrigation on small holdings, using windmill-driven, scoop-bucket systems. The windmills are always constructed of locally available materials—bamboo and wood—and are generally built by the user, although perhaps at one time they were produced by craftsmen for distribution to others. With minor modifications, the same device is used to grind beans and rice and for shelling crops, as well as for pumping.

In Thailand, simple windmills constructed locally, using wooden or bamboo poles with cloth sails, have been used for many years to move water; more recently, a two-bladed, wooden-propeller type of windmill has been introduced. Here, the water is lifted by scoop-buckets attached to an endless belt, or by "water ladder." The buckets scoop water from shallow wells and raise it to the top of the rotating wheel. Each bucket, in turn, turns over on its downward journey, discharging its water into a wooden chute. The water is then lifted up the "water ladder" to a point well above ground level and flows to channels dug in the ground to water crops. The "ladder" consists of a series of wooden flights fitted to an endless chain driven by mechanical linkage to the windmill. The flights are closely fitted to an inclined wooden trough and are able to "scrape" water up the trough, elevating it about 1 m (Figure 19).

The windmill as we know it in the West was derived from watermills—the mechanism is basically that of a watermill turned upside down. Unfortunately, no early designs have survived, for in the earliest days parts were set out full size on the workshop floor and made to templates, much as is done

today. The shaft horsepower of these windmills was around 55 (41 kW) at a wind speed of 17.5 mph (28 km/hr).<sup>4</sup> It is interesting to note that with the four-blade type of construction commonly used, the ratio of tip speed to wind velocity was usually very low.

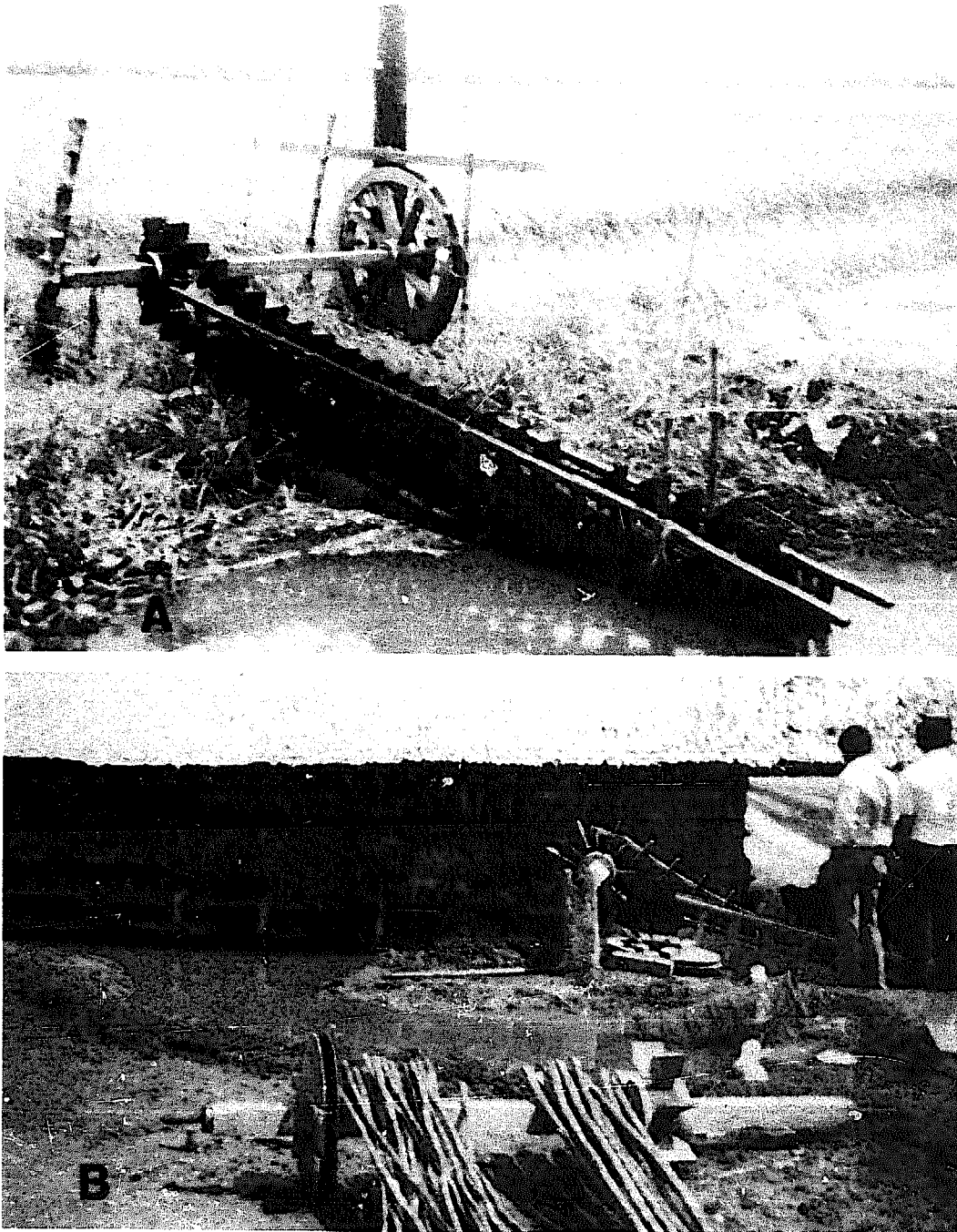

FIGURE 19 Windmill-driven water ladder—Thailand. [Courtesy W. Heronemus]  
*a*, Drive shaft and gear of a Thai water ladder in use in the salt works near Samut Songkhram. *b*, Thai water ladder driven by a two-bladed windmill.

In Europe, the earliest machines made to utilize the wind, dating back to the 12th and 13th centuries, were made in Holland and England. Constructed of wood, iron, and stone, these machines were made by unknown millwrights who, for the most part, designed the mills they built empirically, yet did excellent jobs of design and execution. Subsequently, well-known engineers, including John Smeaton, Sir William Cubitt, and Sir William Fairbairn, became interested in the practical use of windmills. These early windmills in England were used for grinding corn, whereas the Dutch machines were used for pumping to reclaim land. Later, in England, windmills for pumping water in the Fens—Norfolk and Suffolk—came into general use. Farmers have used similar windmills in Russia for hundreds of years; in more recent years the Soviet Union has been devoting much effort to developing large windmills to produce electricity.

Simple sail windmills have been used for centuries on many Greek islands such as Crete and Rhodes, where the primary use is for pumping water. (A modern version of this device is shown in Figure 20.)

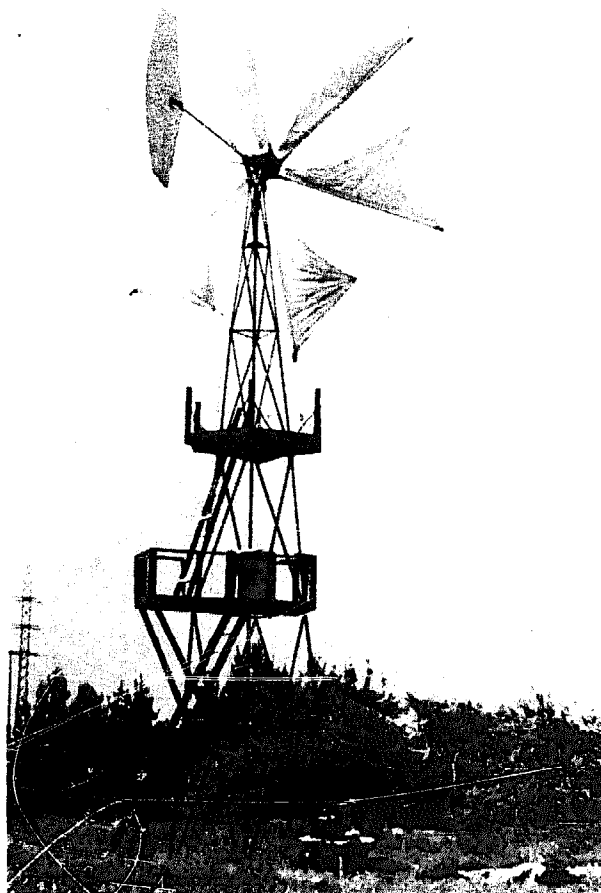

FIGURE 20 Sail windmill.  
[Photo courtesy Brace  
Research Institute. Windmill  
and tower designed by  
Windworks]

Small windmills traditionally have been used in Portugal to irrigate small holdings. The windmills themselves, about 15 ft (4.9 m) in diameter, may be made of metal and are often mounted on very small towers. In the rural areas, a scoop-bucket is used for irrigating. In the cities, windmills are frequently fixed to the roofs of houses to raise water from a sump at ground level to storage on the roofs, when there is insufficient pressure from the community supply to raise the water to a convenient height. The pumps used for this purpose are simple, compact, diaphragm pumps.

In the United States, homemade windmills were a common sight, particularly in the semiarid Midwest, at the turn of the century.<sup>5</sup> They were generally built by people with limited economic means and little or no access to the technological and industrial infrastructure that was already well on the way to development in the United States by that time. Because they represent a technology indigenous to rural areas, depending on inexpensive, locally available materials, and are typical of the ingenuity and inventiveness of farmers the world over, it may be useful to devote some space to their description; the technology remains appropriate.

Among the windmills constructed by farmers for their own use, the following types were the most common:

*Jumbo windmill.* The jumbo windmill was a kind of paddlewheel operated by the wind in much the same way that the overshot waterwheel is driven by water. (See "Hydropower," p. 137) Its operation and construction are apparent from the illustration in Figure 21. Its efficiency varied from 15 to 40 percent, depending on the design, and a typical design delivered up to 1 hp (750 W), depending on the wind speed. Variations in design included the number of blades ("paddles"), adaptation to use with existing buildings to eliminate construction of the shielding box (Figure 22), and use of canvas sails to form the "screw jumbo" (Figure 23).

*Merry-go-round windmill.* Representing an attempt to increase the size—and therefore the power capabilities—of windmills constructed of wood, the merry-go-round windmill was a vertical-axis paddlewheel. It relied on a series of movable shutters surrounding the wheel that could be positioned to shield the blades from the wind on the "return" half of the wheel's rotation. When the shutters were closed, the mill resembled a closed circular cylinder. Figure 24 illustrates a version with a shutter able to accommodate itself automatically to shifting wind direction by virtue of the attached "rudder." The larger merry-go-round windmills were generally mounted on the ground; smaller models were mounted on simple wooden towers (Figure 25).

*Battle-ax windmill.* This mill, mounted on a wooden tower, consisted of four, six, eight, or more arms, each with a fan-like blade, fastened to a horizontal axis. When viewed edge-on while rotating, the assembly resembled



FIGURE 21 Model of a jumbo windmill with wind guard or cut-off. [Source: Barbour, Ref. 5]

a series of battle-axes slashing in opposite directions—hence the name. Again, the construction was inexpensive and simple, as illustrated in Figure 26. Figure 27 illustrates a battle-ax windmill arranged to drive a crosscut saw and equipped with a hand-operated brake to control the speed. Battle-ax windmills are rugged mechanisms capable of performing useful work with a minimum of maintenance. For example, the mill illustrated in Figure 28, built by a farmer in Nebraska, was capable of pumping 930 gal (3,520 l) per hour from a well 42 ft (13 m) deep, when driven by a 13.5-mph (21.7-km/hr) wind. This is an output of 125 W (0.17 hp) of useful work.

*Holland windmill.* As is obvious from the name, this is a version of the familiar Dutch windmill that, in its traditional form, consisted of four slatted fans covered with cloth and fastened to a horizontal axis mounted in a rotatable structure that allowed the direction of the axis to change with the wind direction. In the modifications that were developed in the American Midwest, however, the number of fans was increased to six or eight, the cloth sails were replaced by wood, and the mills were generally mounted on existing farm buildings.

In addition to the types described, several types of turbines were built having greater sophistication of design—for instance, variable-pitch blades—and using many materials that had to be purchased.

While these homemade mills were indeed common, the ubiquitous, commercially manufactured fan-mill was very popular for pumping water and generating electricity, and rapidly became a familiar sight throughout rural America. Thousands of these fan mills are still being used for pumping water on farms, primarily for watering livestock. Wind-powered electric generators such as the Jacobs Wind Electric Plant were made and sold by the thousands. This equipment obviously fulfilled a need in rural communities and is currently experiencing a revival in the United States.

### CURRENT TECHNOLOGY (AVAILABLE WITHIN 5 YEARS)

Windmills as a source of mechanical power continue to be an appropriate technology for rural applications. For their construction and installation, they use locally available materials and labor and utilize local energy sources. The village craftsmen who built them and the local inhabitants who used them had the process entirely under control. When use of the windmill to generate

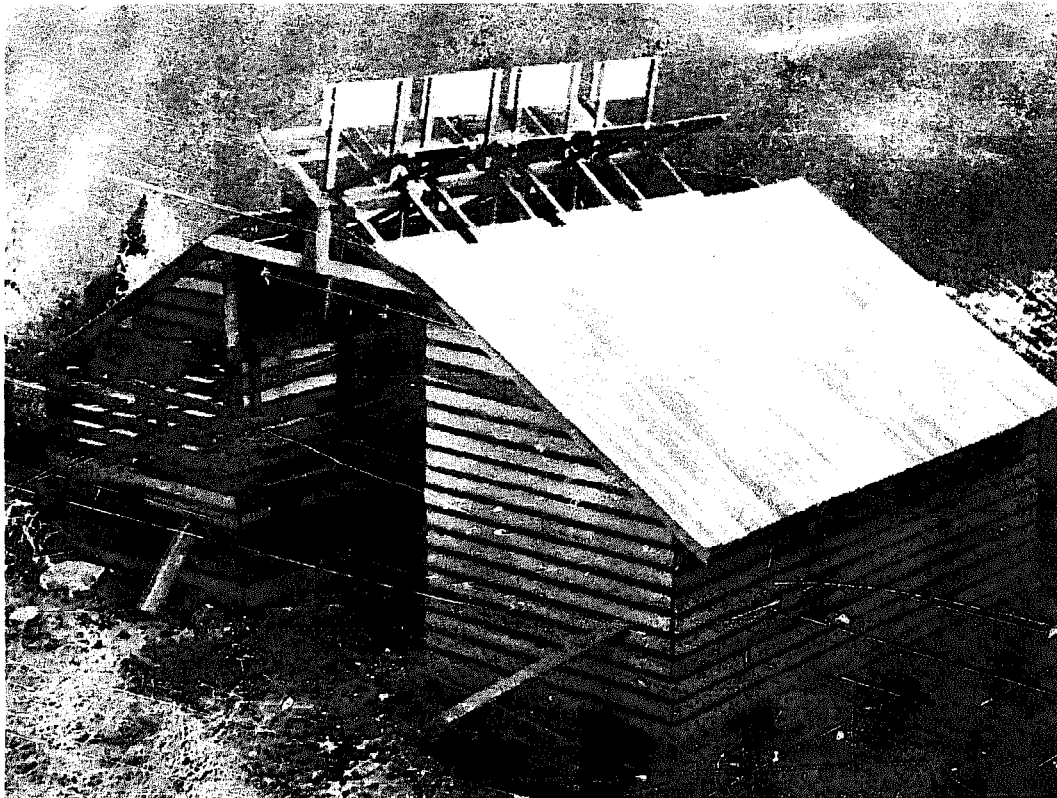

FIGURE 22 Gang of jumbo windmills erected above corncribs or sheds. [Photograph of model. Source: Barbour, Ref. 5]

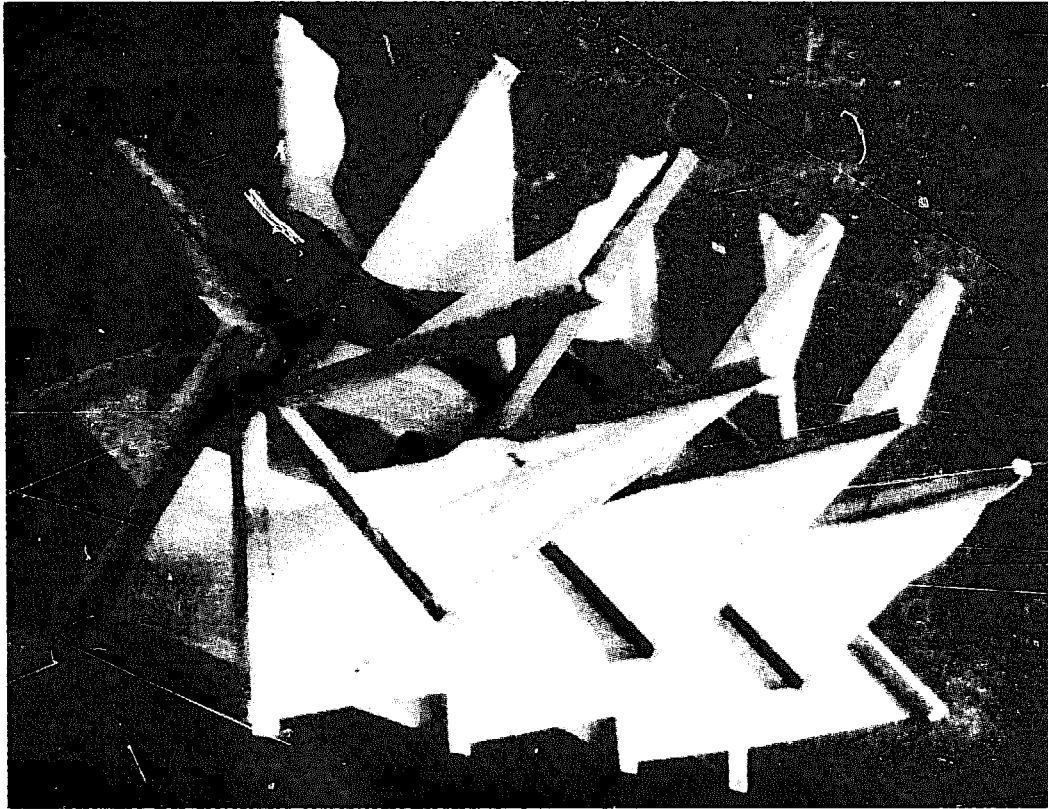

FIGURE 23 Model of screw jumbo windmill, with canvas sails and arms braced with twisted wire. [Source: Barbour, Ref. 5]

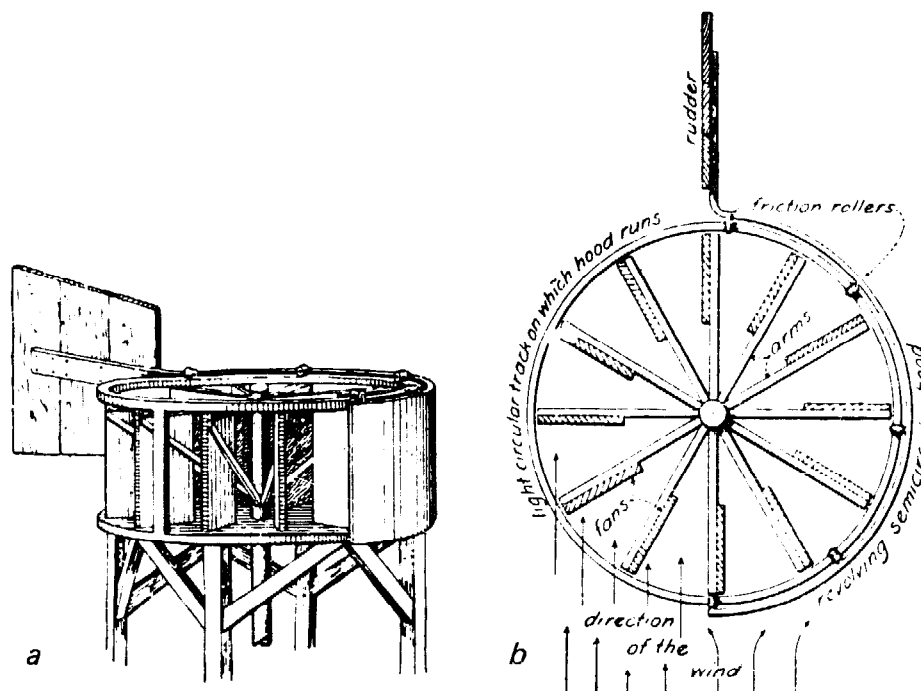

FIGURE 24 Hooded merry-go-round windmill. [Source: Barbour, Ref. 5] *a*, View showing semi-circular hood on rollers guided by large rudder. *b*, Plan view.

FIGURE 25 Small mounted merry-go-round windmill near Lincoln, Nebraska. [Source: Barbour, Ref. 5]

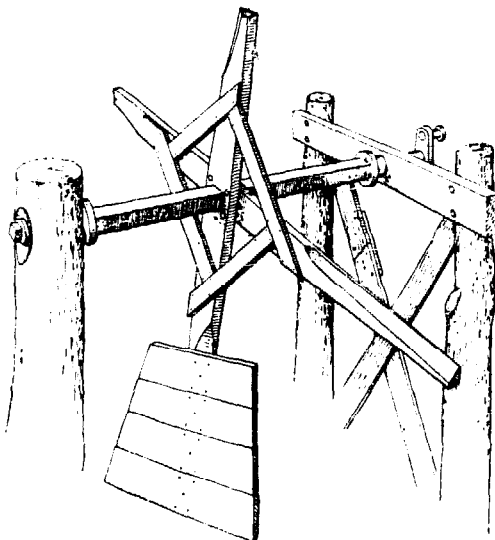

FIGURE 26 Working parts of a four-fan battle-ax windmill on the farm of Matthew Wilson, Overton, Nebraska. [Source: Barbour, Ref. 5]

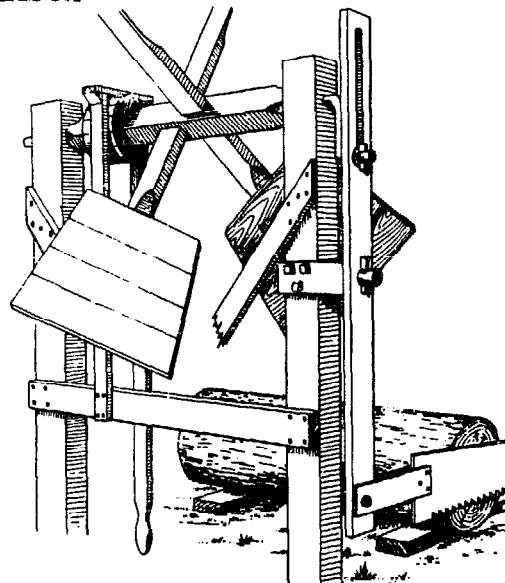

FIGURE 27 Battle-ax windmill driving cross-cut saw, built by A. G. Tingley, Verdon, Nebraska. [Source: Barbour, Ref. 5]



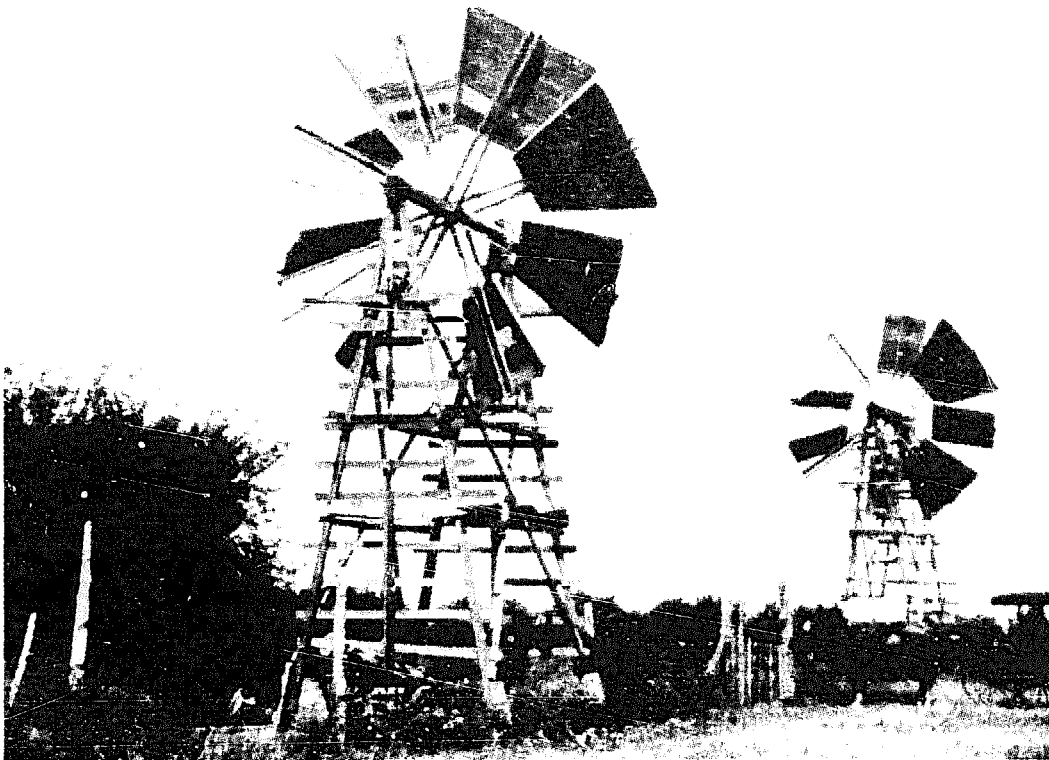

FIGURE 28 Battle-ax windmill pumps. [Source: Barbour, Ref. 5]

electricity is contemplated, however, the technology required is somewhat more than can be assumed to be available in all rural areas. Not only is equipment required to generate, control, and distribute the electricity, but the necessary details of matching the operating characteristics of the generator to the properties of the windmill require some engineering expertise. Although these skills are certainly available in many localities, in some cases it may be useful to consider systems already available. For this reason, a survey of current technology in forms commercially available is included here.

*Technology available in the United States.* Prior to the advent of rural electrification, there were dozens of manufacturers of wind-powered pumps and electric generators in the United States. As far as can be determined, only two continue to make windmill pumps, and both manufacture the typical, multiblade, "American" fanwheel. These pumps are primarily used on open cattle ranges in the West to provide water for livestock. The Heller-Aller Company\* makes systems using fanwheels from 6 ft (1.83 m) to 12 ft (3.66 m) in diameter, in increments of 2 ft (.61 m), and Dempster Industries makes 6- and 8-ft (1.83-m and 2.44-m) fanwheels (Figure 29). Both systems include

\*Details on currently manufactured windmills are given in Appendix 5.

a reciprocating cylinder pump that will deliver up to several hundred gallons per hour, depending on the depth of the well, the diameter of the pump cylinder, and the wind velocity. The Heller-Aller machines range in price (in the United States) from about \$400 to almost \$1,200, exclusive of tower; Dempster's prices on a similar basis for windmills of the same size range from about \$460 to \$2,000.

Until recently, only one company in the United States continued to make a wind-powered electrical generator. The "Wincharger," for many years a familiar sight in the countryside (Figure 30), is still manufactured by Dyna Technology, whose normal production is a 12-volt model designed for use with storage batteries. Typical cost for such a system, including the windmill, generator, governor assembly, electrical controls, handbrake, and 10-ft (3-m) tower, but without battery, is about \$450 in the United States. This system will produce 200 W at maximum wind velocity (23 mph) and thus represents an initial cost of about \$2,200/kW.

Recently, as a result of the increasing concern about fuel consumption, several other U.S. companies have begun offering windmill generator systems. Most of these companies seem to be distributing machines manufactured in Europe or Australia, though others are producing prototype machines, in relatively small quantities, based on variations in design of propellers and generators or alternators. Although in most cases prices of these systems make them questionable on economic grounds for village use in developing

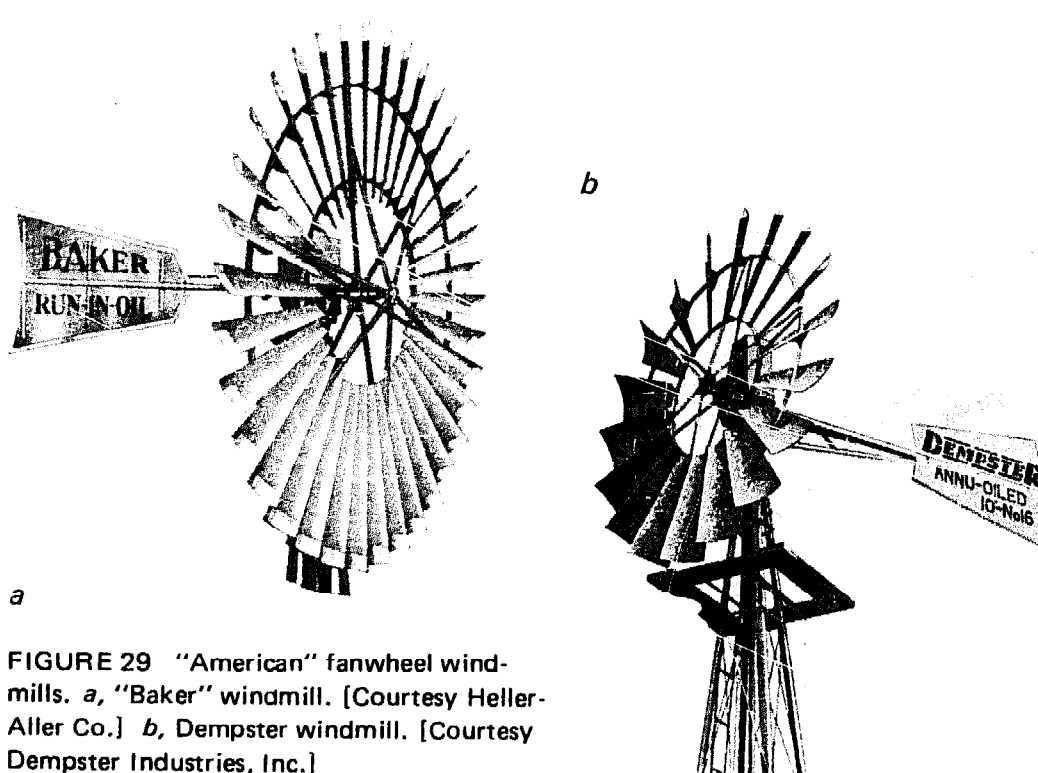

FIGURE 29 "American" fanwheel windmills. *a*, "Baker" windmill. [Courtesy Heller-Aller Co.] *b*, Dempster windmill. [Courtesy Dempster Industries, Inc.]

countries—not to mention problems of replacement parts, maintenance, and repair—the possibility of cost reduction and manufacturing simplification that may result from increased demand makes listing them potentially useful. Appendix 6 lists as much information as we have been able to gather at this time.

One development likely to be available commercially within 5 years represents a departure in design of both the windmill and the electrical system. Moreover, the system is designed to permit construction of most components in LDCs. A multiple-blade fanwheel (Figure 31) has been developed, based on the principle of the bicycle wheel, in which the outer rim and the central hub are held in place by tension members, i.e., wire spokes. The blades, of airfoil design, are aluminum sheets wrapped around pairs of adjacent spokes, with their pitch determined by the placement of the ends of



FIGURE 30 "Wincharger"  
[Courtesy Dyna Technology, Inc.]

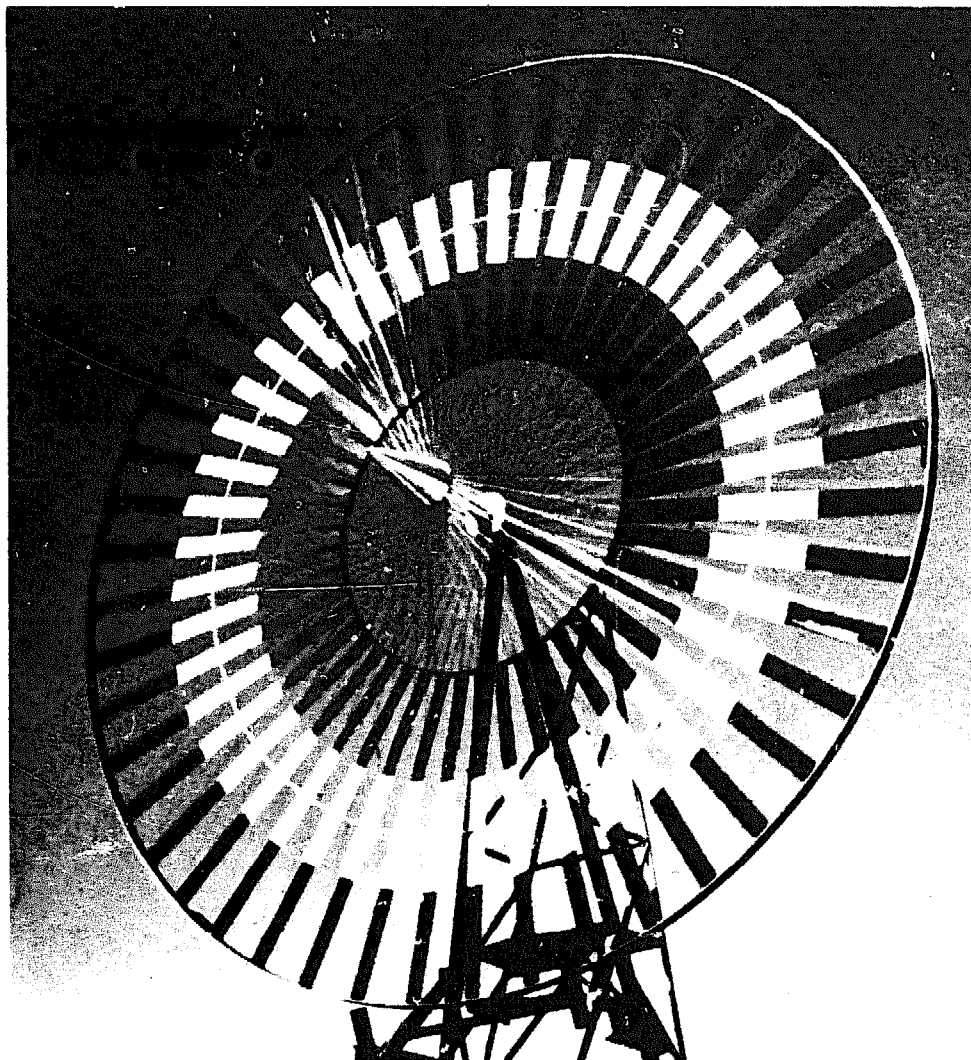

FIGURE 31 Bicycle-wheel turbine. [Courtesy *Popular Science*, © 1974, Times-Mirror Magazines, Inc.]

the spokes on the rim. The result is a great saving in weight compared to conventional construction, and two companies are embarking on production of this fanwheel as part of electrical generating systems. The American Wind Turbine Co.\* will be producing a mill coupled to a rim drive instead of a gear box; by this arrangement efficiencies greater than 40 percent have been obtained. This system can supply either DC or AC of arbitrary, constant frequency, independent of the wind velocity or the shaft speed of the generator. The result is achieved by modulating the field excitation of a small high-frequency (i.e., high-speed) alternator and converting the modulated

\*Details on windmills under development are listed in Appendix 6.

output to DC or AC with simple solid-state circuitry. The operation of the system is analogous to "detection" of conventional audio-frequency amplitude modulation of a radio-frequency carrier. In this case, the carrier varies in frequency as the alternator shaft speed varies, but so long as the wind speed remains above a certain minimum, the filtering circuit will remove the high-frequency components and provide an output dependent only on modulation frequency.<sup>6</sup> Use of a high-speed alternator provides the added advantage of greater power output for a given size and becomes practical with the rim-drive arrangement that the new fanwheel design makes possible. Cost figures for this system are not yet available.

A more conventional use of this turbine is being made by American Energy Alternatives, Inc., in a prototype DC system with models capable of supplying 1,500-5,000 W. Costs per kilowatt (in the United States) are expected to vary from about \$1,500 for the 1.5-kW model to about \$600 for the largest (5-kW) system.

Another system in the prototype stage, planned for production by Independent Power Developers, has a three-blade propeller windmill with DC output at voltages from 24 to 240 volts and rated at 15-18 kW. Cost estimate of the complete system, less tower, is about \$8,500, or between \$500 and \$600/kW.

*Technology available in Europe.* Windmill-operated generators and pumps

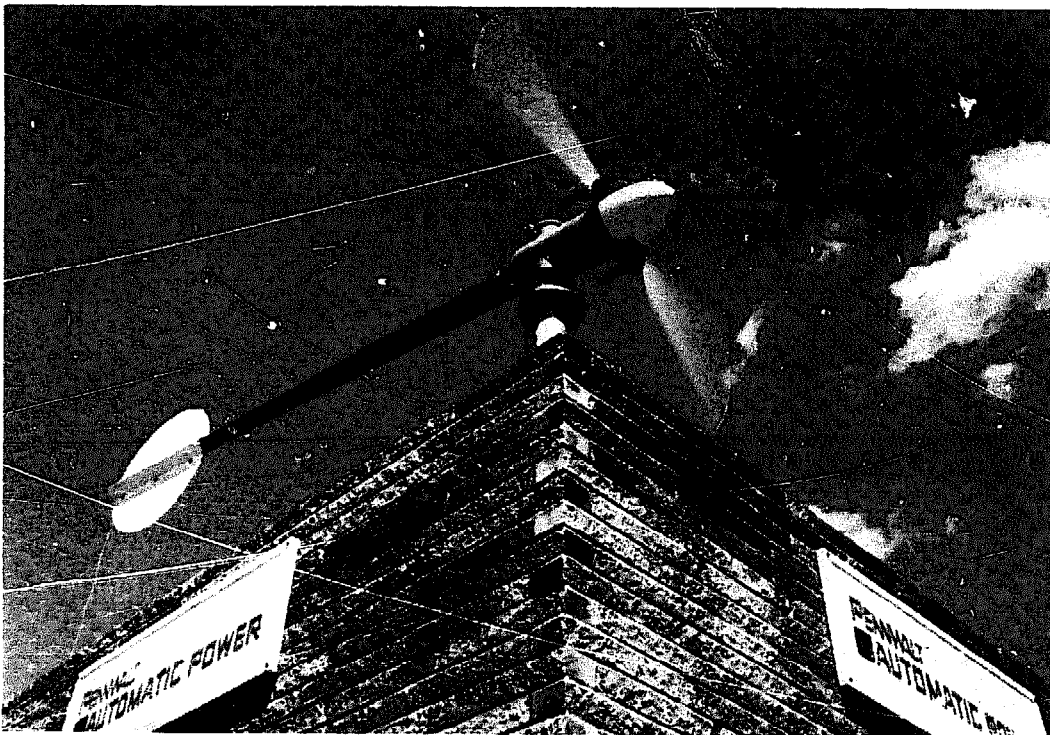

FIGURE 32 Aerowatt generator. [Courtesy Pennwalt/Automatic Power]



FIGURE 33 Elektro generator. [Courtesy Elektro GmbH]

are currently available in Europe from several manufacturers. The French firm, Aerowatt, produces five models of generators (Figure 32), ranging from 24 W to 4.1 kW in capacity, at a wind speed of 16 mph (26 km/hr). Their equipment, while capable of providing maximum output at reasonable wind speeds, is nonetheless quite expensive, ranging from \$2,000 for the smallest to \$20,000 for the largest (in the United States). The Italian firm of Domenico Sperandio is reported to be manufacturing seven models of wind-powered generators, ranging from 100 to 1,000 W, but no further details were available at the time of writing. Wind-driven alternators in single- and three-phase models are manufactured by Elektro GmbH in Switzerland, in sizes ranging from 50 W to 5 kW (Figure 33). At costs ranging from \$1,020 to \$3,840 (in the United States) for the basic system, they seem less expensive than the Aerowatt machines, but still represent a capital investment beyond the means of most villages. Finally, the West German firm Maschinenfabrik Ludwig Bening manufactures three models of propeller-type windmills designed to operate reciprocating pumps. Three-, four-, and five-bladed mills can be connected to a variety of pumps to supply water in amounts ranging from 686 gal (2,600 l) per day from 52.5 ft (16 m) at a wind speed of 6.7

mph (10.5 km/hr), to 3,800 gal (14,500 l) per day from 23 ft (7 m) at a wind speed of 17.9 mph (54.5 km/hr). (On a 24-hour basis, this is the equivalent power output range of about 5-12 W.) Prices average about \$2,530 for the complete assembly, including pump and guyed tower. This firm also makes a wind-powered generator supplying 24-400 W, depending on the wind speed, at 24 volts DC, with costs ranging from about \$200 to \$3,300 (at German port of export) depending on the tower.

*Technology available in Australia.* Wind-driven generators manufactured by the Dunlite Electrical Co. are of two sizes, 1,000 W and 2,000 W (Figure 34). The smaller model uses a 12-volt DC generator and the larger a 115-volt DC generator; both models include an inverter to supply 115 volts AC (60 Hz). Without tower and batteries, prices are \$1,729 and \$2,805 (in the United States) respectively.

*Technology available in Latin America.* In Argentina, the Fabrica de Implementos Agricolas manufactures a fanwheel-powered reciprocating cylinder pump of a type formerly made in the United States (Figure 35). This company is, in fact, the licensee of the U.S. firm (Aermoter) that still distributes the finished package but no longer manufactures either the windmill or the pump. The fanwheels vary in size from 6 ft (1.83 m) to 16 ft (4.88 m) in diameter, at prices in the United States ranging from \$465 to \$4,235 (excluding the cost of the tower). Pumping capacities are similar to those of the Dempster windmills.



FIGURE 34 Dunlite generator.  
[Courtesy Dunlite Electrical Co.  
Pty. Ltd.]

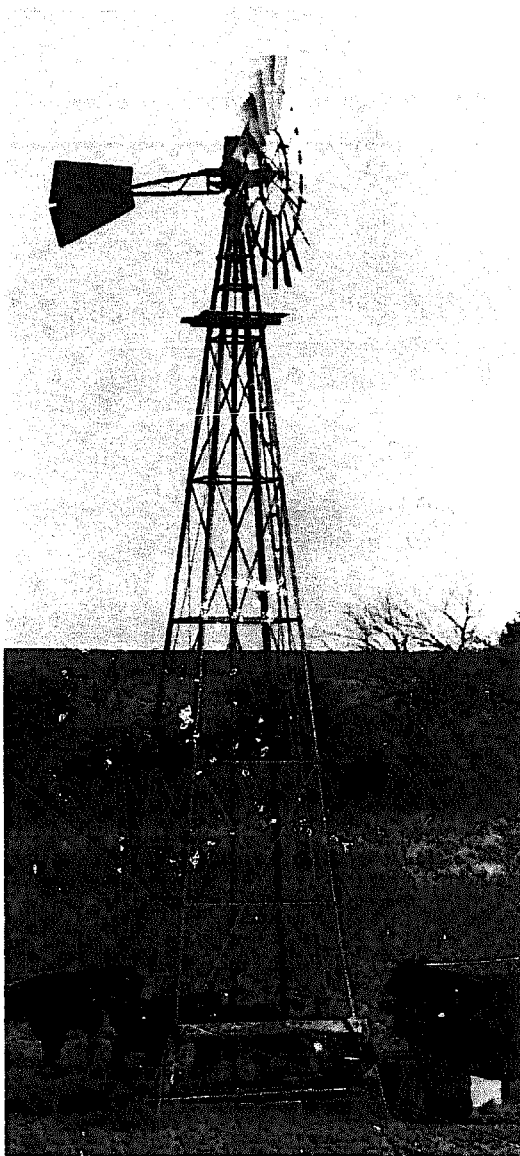

FIGURE 35 Aermotor windmill pump.  
[Courtesy Aermotor/Braden Industries,  
Inc.]

*Technology available in South Africa.* P. Andrag and Sons., Ltd., are the South African licensee of Aermotor and manufacture the Aermotor 8- and 10-ft (2.5-m and 3-m) fanwheel windmill heads for use with water pumps. These are sold in South Africa for \$620 and \$950 respectively, for the windmill head, gear box, and 4-post stub tower.

### Reliability and Cost

Technology provides only part of the answer to the question of how reliably power can be extracted from the wind, and at what cost. In the first place, not all of the power in a wind stream can be extracted by a windmill. The



power in a stream of moving air is proportional to the product of the cross-sectional area of that stream and the cube of its velocity, and it can be shown that the maximum fraction of that power that can be extracted by a windmill is 59.3 percent. As a practical matter, horizontal-axis wind devices achieve less than 70 percent of this theoretical maximum; that is, they are able to extract somewhat less than 42 percent of the power in the wind, and vertical-axis machines are significantly less efficient.

Second, although the wind is a free and inexhaustible source of energy, it does not always blow, and when it does, the velocity may be too low to allow the windmill to begin producing power, or too high for the mechanical design that is practical for average wind speeds. In a review prepared for the Food and Agriculture Organization (FAO) Golding described the problem as follows: "At any specified point on the earth's surface the wind, at a given instant of time, can have a speed ranging from zero to as much as 125 miles per hour (50 m/sec) or more. Even the windiest places have their calm spells while the least windy are occasionally subjected to storms which bring high winds. One cannot, therefore, rely absolutely on power from the wind at a given moment however windy the chosen site may be and, on the other hand, one cannot safely reduce the mechanical strength of a windmill, destined for a relatively calm area, to any great degree. Nevertheless, the probability of there being power available at a particular time is much greater at the windy site [than] is the probability of a machine, erected there, having to withstand severe mechanical stresses fairly frequently."<sup>7</sup>

Finally, the cost of a windmill, whether operating a pump, a generator, or used to grind grain or perform other mechanical tasks, can be evaluated either in terms of the capital cost of the components or—usually more realistically—in terms of the amount of useful power produced. This evaluation depends strongly on the average wind speed over the year and, of course, on the minimum wind speed at which the device starts producing useful power. Generally, the minimum speed is about 6 mph (2.4-3 m/sec). Manufacturers usually list outputs at the "rated" wind speed, which is generally about 15 mph (6.5-7 m/sec) although some large generators may be rated at higher speeds. The amount of useful power produced also depends on the ability of the user to use it when it is produced. In most parts of the world the wind blows at random times, and if the energy cannot be used when the wind provides it and cannot be stored against the time that it is actually needed—as electrical energy in storage batteries or as water pumped to an elevated reservoir, for example—the usefulness of even an elegant wind device is severely compromised. Therefore, one of the essential first steps is to obtain information on average wind speeds at the site contemplated, including data on the length of time during the year that the wind blows with a speed greater than a given minimum. Velocity-duration curves drawn from these

data are useful in calculating the amount of power actually in the wind at a given site and, if necessary, the annual energy output. Such wind data may have to be measured at the proposed site, but more often than not, sufficient information to judge the reliability of the wind may be obtained either from the national meteorological service or the World Meteorological Organization. Details on the calculations may be obtained from standard references such as Golding (References 4 and 7).

Mechanically, the windmills discussed in this chapter are far superior to fossil-fuel-powered engines in terms of reliability. Apart from their independence of fuel supply, they require minimum maintenance (usually an annual inspection and lubrication suffice) and seldom require repair. Some designs are self-regulating and even under the most adverse wind conditions require no care or attention.

The cost of a wind system is closely linked to the type and height of the tower on which the machine is mounted. A large part of that cost is the cost of the tower, which is dependent on its design and the materials of construction. Because tower requirements—and hence permissible designs and materials—are so much a function of local circumstances, the cost of such a system cannot be comprehensively discussed here; it must be evaluated for each situation, based on requirements specified by the manufacturers of the various wind machines.

## LOCAL IMPLEMENTATION

The use of local technology in design, construction, and installation of windmills depends on the knowledge, skills, and materials available to the local community. Aside from the simpler—and less efficient—home-built machines described earlier, and locally devised improvements in assembly of purchased systems, other contributions to reducing the cost of wind systems could certainly be made.

Detailed technical information on a variety of home-built windmills is available from several sources in the United States and Canada. Some of these plans were specifically developed for local construction in developing countries. Others, although not designed with that specific purpose in mind, might be adapted to such a situation in certain cases.

Information in the first category is available principally from two sources: Volunteers in Technical Assistance (VITA) in the United States, and the Brace Research Institute in Canada.\* VITA will supply plans for several types

\*VITA, 3706 Rhode Island Avenue, Mt. Rainier, Maryland 20822, USA; Brace Research Institute, Macdonald College, McGill University, Ste. Anne de Bellevue, Quebec, Canada.

of windmills; for example, one built from scrap automobile parts including a rear axle, voltage regulator, and generator or alternator. The mill itself is a modified fanwheel, the blades of which feather automatically as wind speed increases, and is designed for local fabrication. With several options, the entire unit will supply from 500 W to 3 kW; the cost of materials will vary with the value and availability of scrap automobile parts on the local market. All labor for fabrication, assembly, and installation can be supplied locally.

Brace Research Institute has a number of publications available that are aimed at windmill construction in developing countries. They will supply details for a 10-hp (7.5-kW) system based on a 32-ft (9.8-m) diameter, three-blade rotor connected to a truck rear axle. The entire assembly, including the tower, is designed for local construction, using as many local resources as possible. Brace will also supply details for the construction of a 25-ft (7.6-m) diameter canvas sailmill, a 42-ft (12.8-m) tower built of timber, and plans for the Savonius rotor windmill, a vertical-axis device with an S-shaped cross section developed in the 1920s by S. J. Savonius, a Finnish

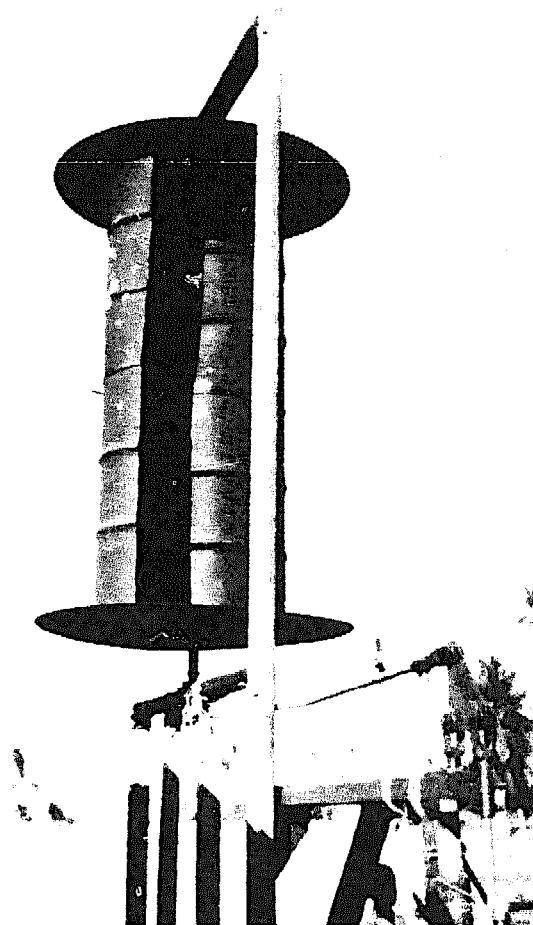

FIGURE 36 Savonius rotor windmill, Sri Lanka. [Courtesy Brace Research Institute]

engineer. The Savonius rotor has proved to be a popular design for local construction, since it can be built from an oil drum that is cut in half lengthwise\* (Figure 36).

Information in the second category—that is, developed for home construction in the United States—is becoming available from a number of sources, primarily as a result of a growing concern about consumption of fossil fuels; detailed plans for some of these designs are available.\*\* The panel has not examined these plans to evaluate them for their appropriateness to materials easily available in developing countries; they are mentioned because they may be a source of ideas for the interested technologist.

It should be emphasized that the materials and skills needed for tower construction would be available in most rural communities. In rural United States, for example, it was long assumed that even though a farmer might purchase a wind machine, he would probably build his own tower. Manufacturers' catalogs often included detailed plans for tower construction, examples of which are given in Appendix 7. It should be borne in mind, however, that production of wind machines requires access to suppliers of many parts—control equipment, alternators, generators, and a host of incidentals such as bearings and brushes—not manufactured in many developing countries, but needed to make a finished product.

## RESEARCH AND DEVELOPMENT

With the renewed interest in this ancient technology, ideas that have not been exploited, such as the vertical-axis Darrieus rotor† (Figure 37), are being revived. In addition, many new ideas are being generated, along with prototypes of machines that represent attempts to put these ideas into practice.<sup>8</sup>

\*An interesting use of the Savonius rotor is the centrifugal windmill pump designed by Professor John D. Isaacs (Scripps Institution of Oceanography), which uses as a pump a rotating vertical pipe with a horizontal arm.

\*\*For example: (1) Plans for a 12- or 16-ft, 3-blade downwind windmill, coupled to an automotive alternator, are available from Helion, Box 4301, Sylmar, California 91342, USA; (2) plans for a three-bladed variable-pitch windmill coupled to an automobile generator, battery, and inverter are available from Sencenbaugh Wind Electric, P.O. Box 11174, Palo Alto, California 94306, USA.

†Invented by J.G.J.M. Darrieus and originally patented by him in 1927, the catenary rotor was subsequently patented in the United States in 1931 (US 1,935,018, Dec.8).

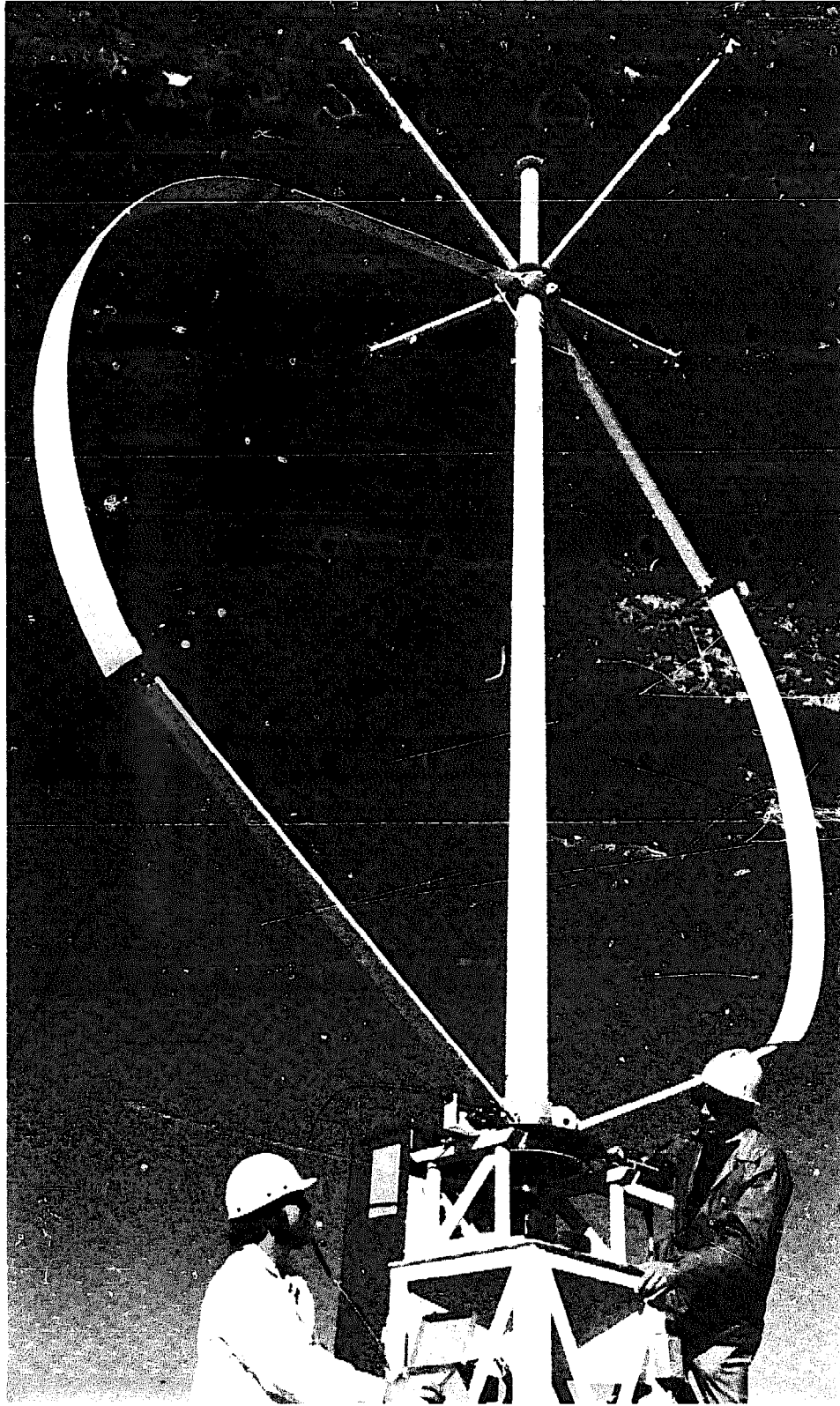

FIGURE 37 Vertical-axis wind turbine (Darrieus rotor). [Courtesy of Sandia Laboratories/ERDA]

Although a new organization has recently been formed\* to coordinate some of these activities, it is primarily a trade organization concerned with manufacture in the United States. Because of the significant potential usefulness of this technology to rural areas in developing countries, a central research and development organization should be formed. With multilateral support, an international staff, and working through regional institutes, this organization would keep abreast of new theories and developments and test prototype machines developed anywhere in the world that show promise for use in developing countries. The staff of such an organization, supplemented by expert consultants, should be able to produce a coordinated and rational program of wind-power exploitation based not only on assessment of new developments, but also on their own original research and development. (At present, there is little coordination of most relevant material in the entire field of alternative energy sources.)

An excellent example of the kind of work such an international organization could do for developing countries is provided by a study of wind power in Thailand recently produced for the U.S. Agency for International Development.<sup>9</sup> The result of an on-the-spot survey by an expert in wind technology, this report details two proposed windmill designs that fit the needs of the Thai farmer and represent a significant increase in agricultural production (through improved irrigation). The proposed fanwheel systems, 6 and 12 m (20 and 40 ft) in diameter, are designed to fit existing indigenous manufacturing capabilities. They are also essentially independent of foreign imports for materials or parts—including the pump—and could be sold at a cost well within the reach of a typical Thai farm family.

Maintaining and encouraging development of the ancient art of the wind machine can result in some revolutionary ideas for supplying the energy needs of rural areas. Parallel with new design concepts for rotors, design of towers that can be built economically must form part of overall wind-system design; otherwise, on the basis of cost, rotor-design improvements may be nullified. A central organization with a competent, development-oriented staff working through regional research and development institutes, entrusted with the capacity to develop new equipment suited to local needs, seems a necessary first step.

## REFERENCES

1. Fuller, R. Buckminster. 1974. Energy through wind power. *The New York Times* January 17.
2. Lanoy, H. 1944. *Les aeromoteurs modernes*. Paris: Girardot & Co.

\*American Wind Energy Association, 21243 Grand River, Detroit, Michigan 48219, USA.

3. Needham, J. 1965. "Power-sources and their employment (III), wind force; the windmill in east and west." In *Science and Civilization in China. Vol 4: Physics and physical technology, part II: Mechanical Engineering*, pp. 55-568. London: Cambridge University Press.
4. Golding, E. W. 1956. *Generation of electricity by windpower*. New York: Philosophical Library.
5. Barbour, E.H. 1899. *Wells and windmills in Nebraska*. Water-supply paper, No. 29. Washington, D.C.: U.S. Geological Survey.

An excellent review of U.S. windmill technology at the turn of the century—unfortunately out of print. Much of the material on farm windmills in the United States was drawn from this source. See also Davidson, J. B., and Chase, L. W. 1908. *Farm machinery and farm motors*. New York: Orange Judd Co.

6. Allison, H. J.; Ramakumar, R.; and Hughes, W. L. 1972. A field modulated frequency down conversion power system. Paper presented at the 1972 meeting, IEEE (Institute of Electrical and Electronic Engineers). *Transaction on Industry Applications* IA9(2):220-226.
7. Golding, E. W. n.d. *Windmills for water lifting and the generation of electricity on the farm*. Agricultural Engineering Branch, Land and Water Development Division, Informal Working Bulletin, No. 17. Rome: Food and Agriculture Organization.
8. One of the more interesting approaches currently under development is the vortex augmentor concept. In this approach a delta-type surface is interposed between the windmill and the wind, with an angle of attack between  $10^\circ$  and  $15^\circ$ . In the vortices created as a "tail wind" the total wind velocity can be increased by as much as a factor of two. This effect can be used advantageously in three ways: (a) to increase the power output of a given windmill at a given velocity (the power varies as the cube of the wind velocity); (b) to decrease the size of the rotor needed to provide a given power at a given wind velocity; or (c) to utilize wind at velocities lower than those at which standard wind-operated generators normally begin supplying energy. Sforza, Pasquale M. 1975. Vortex augmentor concepts for wind energy conversion. In *Proceedings of the Second Workshop on Wind Energy Conversion Systems, 9-11 June 1975, Washington, D.C.*, Frank R. Eldridge, ed., pp. 433-442. U.S. National Science Foundation, RANN-Research Applied to National Needs, Document No. NSF-RA-N-75-050. McLean, Virginia: The Mitre Corporation.
9. Heronemeus, W. E. 1974. *A survey of the possible uses of windpower in Thailand and the Philippines*. Prepared for the U.S. Agency for International Development, Office of Science and Technology. Amherst, Massachusetts: University of Massachusetts, Department of Civil Engineering.
10. Merriam, Marshall F. 1972. Windmills for less developed countries. *Technos* (April-June) 9-23.

Also available as: *Is there a place for the windmill in the less developed countries?* Technology and Development Institute Working Paper Series, No. 20. Honolulu: East-West Center.

This paper contains a good general discussion of windmills and a useful economic analysis.

# *Hydropower*

Although hydropower can be used to perform mechanical work directly, or indirectly through hydroelectricity, the discussion in this section focuses primarily on hydroelectric applications—reflecting major use worldwide. Direct mechanical applications are included in the discussion where appropriate, and are treated separately.

Hydropower has as its energy source the potential energy of a supply of water at some superior elevation. This energy is converted within a turbine into mechanical energy that, in turn, is converted into electrical energy within a rotational electric generator.

The power theoretically available from a waterpower site is equal to the weight of water flowing in a given time multiplied by the drop in elevation (the “head”) of the water. This may be considered as either horsepower or kilowatts, depending on the mathematical constants employed.

The actual power obtained is of course less than the theoretical power. It is calculated by multiplying the theoretical power by various factors that represent the efficiency of each element of the hydroelectric system. These elements include:

- The apparatus conveying water to the turbine (canal, penstock, fittings, and valves);
- The turbine and its discharge piping (draft tube);
- The electrical generator; and
- Any indirect connection between the turbine and generator (gears or a belt).



The overall effect of these efficiencies is to reduce the theoretical power by a factor of 0.6-0.8.

These energy-conversion processes and the means of carrying them out represent a mature technology with established paradigms within which no major surprises have occurred for over 50 years.

At the beginning of this century, there were several hundred manufacturers of small water turbines in the United States. Today, only one remains in business offering a full line of small turbines "off the shelf." This situation may be attributed to the fact that small-scale water power has been superseded by 1) the internal-combustion engine, 2) the steam engine, and 3) the extension of the distribution systems of large central power plants into rural areas.

In several European countries and China, however, the manufacture of low-head, low-power hydroelectric sets appears to be a vigorous, though limited, activity. Indeed, in the book *Water Power Development* by Mosonyi (1960) there is a chapter devoted to midget water power stations in which the power output is less than 100 kW.<sup>1</sup>

## HYDRAULIC ROTATING PRIME MOVERS

In their historical or evolutionary sequence the rotational hydraulic prime movers are:

- Waterwheel (overshot, undershot, and breast);
- Tub wheel/flutter wheel/roue à cuve; and
- Turbines.

*Waterwheels* generally rotate in a vertical plane and are distinguishable from turbines by the fact that no changes in water pressure occur across the vanes of the undershot wheel or the buckets of the overshot and breast wheels.

The *overshot wheel* (Figure 38) has "buckets" at its periphery that are filled with water at the top of their rotation and empty as they approach their lowest position. Although efficiencies of 80 percent were obtained with these wheels, their speed was slow, they generated little power for their size, and they were incapable of operating with rising tailwater. Therefore, along with the less-efficient breast and undershot wheels, they became obsolete. There appears to be only one commercially operating overshot water wheel in New England. It is used to grind grain, make cider, and generate electricity, and was manufactured by the now-defunct Fitz Water Wheel Company of Hanover, Pennsylvania. It is 13 ft (3.96 m) in diameter, 6 ft (1.83 m) wide,

and is said to be capable of developing 30 hp (22.4 kW) at 8 rpm.

The *breast wheel* operates with "buckets" as does the overshot wheel, except that it receives water at about radial height. Its efficiency is around 60 percent.

The *undershot wheel* (Figure 39) is sometimes called a current wheel, since it receives its energy from the impact of a flowing stream of water on its flat or curved radial vanes. Its maximum efficiency is about 20 percent, but this level of efficiency requires that the wheels be built with sides or shrouds to minimize the effects of turbulence, or that the wheel receive water via a channel slightly wider than the wheel itself (a Roman improvement dating to about the third century A.D.).

The *tub wheel* or *roue à cuve* is a variant of the undershot wheel in which the wheel operates in a horizontal plane. An inclined open or closed channel conveys water to it from an elevation of up to about 10 ft (3 m) so as to impinge at right angles on inclined straight blades. It was widely used in mountainous regions of Europe (Scandinavian, Alpine, and Balkan areas) for the grinding of grain. In the Shetland Islands, tub-wheel-powered grist mills were a communal facility. They were often made entirely of wood; their efficiency was about 20 percent.

A tub wheel was in operation in Cilleyville, New Hampshire, from about 1910 to 1960 and was used to grind grain for chicken feed. Its wheel, 7 ft

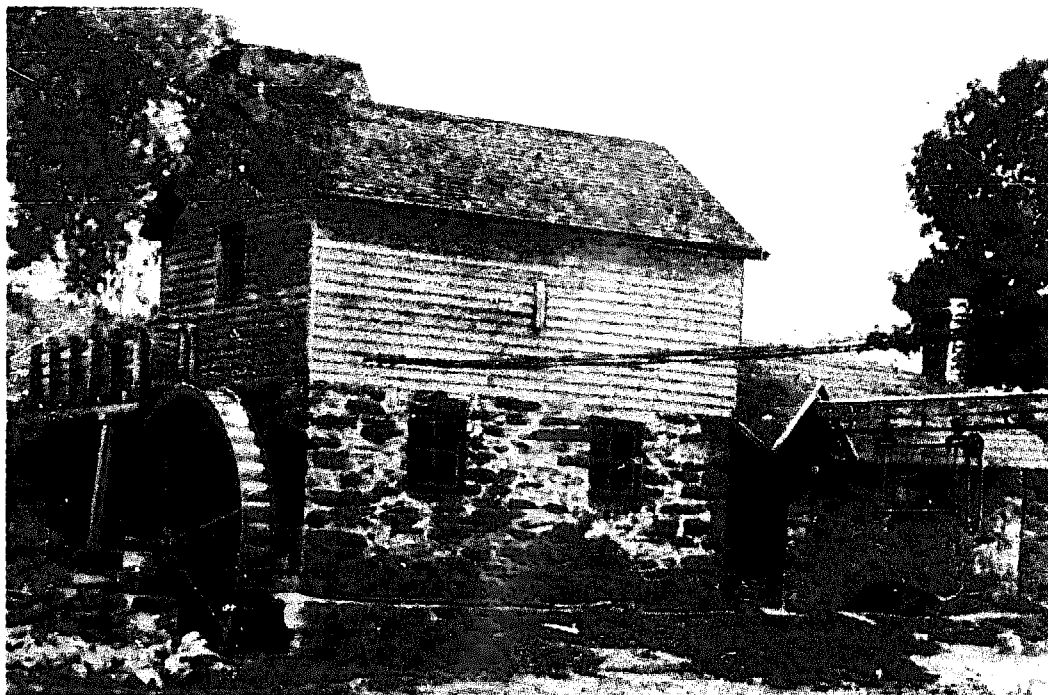

FIGURE 38 Overshot wheel. [From: "Water Power on the Farm," Bulletin No. 60, Fitz Water Wheel Co., Hanover, Pennsylvania, 1923]

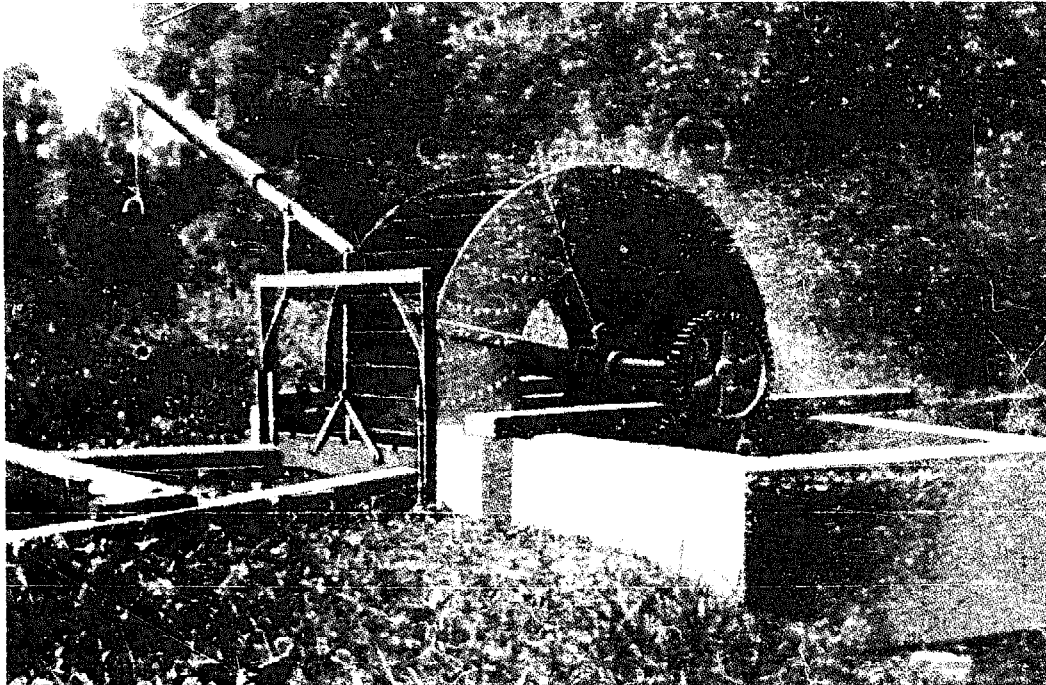

FIGURE 39 Undershot wheel. [From: "Water Power on the Farm," Bulletin No. 60, Fitz Water Wheel Co., Hanover, Pennsylvania, 1923]

(2.14 m) in diameter, rotates on a 5-in. (12.7-cm) steel shaft and receives water under a head of 6 ft (1.83 m) through a 2-ft (0.61-m) closed, square, wooden channel or penstock bound with iron straps. A modern version of the tub wheel is manufactured by the Ganz Company of Budapest.<sup>1</sup>

The *water turbine* differs from the waterwheel in that there is a contrived steady flow of water through passages created by the turbine blades or buckets. The blades are so designed that water enters the passages smoothly and leaves with minimum velocity and energy, having transmitted most of its available kinetic energy to the rotor.

There are three well-established classes of turbines generally classified according to the names of their developers and promoters. They are, in chronological order of their appearance:

1. Francis (reaction, full admission)
2. Pelton (impulse, partial admission)
3. Propeller (reaction, full admission)
  - a. Nagler (fixed propeller blades)
  - b. Kaplan (variable pitch propeller)

Each class dominates a range of heads and speeds, and each has a unique form of runner or rotor.

Essentially, the Francis, Nagler, and Kaplan turbines are linear descendants of the simple reaction turbine of Hero of Alexandria, dating from about 100 B.C. Their development represents the efforts of inventors to create more power from a given space.

The Pelton turbine may be seen as the direct descendant of the undershot waterwheel or the tub wheel (Figure 40).

The *Francis turbine* has water entering the rotor around its complete circumference (Figure 41) and is therefore called a full-admission turbine. It is also sometimes called a "pressure" turbine, which highlights the fact that there is a pressure change across the rotor of the turbine; the pressure/potential energy is converted to kinetic (i.e., mechanical) energy across the runner/blade/rotor. The direction of the water at the entrance to the turbine rotor is tangential (at the circumference of the runner) and at discharge it is parallel to the axis of rotation; this complex directional flow is the reason the Francis turbine is often called a "mixed flow" turbine. Despite its complex runner/rotor structure, its development was an empirical response to the need in rural areas of the 19th-century United States for higher speeds, greater power, and greater economy.

The *Nagler fixed-blade propeller turbine* is a full-admission reaction turbine with a direction of flow described as "axial," that is, parallel to the axis of rotation (Figure 42). It resembles a ship's propeller and indeed may be considered as the inversion of it; its rotor is therefore a much simpler structure than that of the Francis turbine. The low-head, high-speed characteristics of the Nagler turbine often make it possible to connect it directly to electrical generators. The Russian and American hydroelectric units mentioned later as available for developing countries use propeller turbines directly connected to electric generators.

The *Kaplan turbine* has propeller blades whose pitch can be varied during operation to keep the speed of the turbine constant, despite variations in load, so that the turbine will operate at maximum efficiency.

The *Pelton turbine/wheel* is often called an "impulse" turbine, though the principle of "reaction" plays an equally important role in its energy transformations. The Germans often designate it as a "pressureless" turbine, meaning that there is no pressure change across the runner. The pressure/potential energy of the water is converted completely to kinetic energy in a nozzle. The high-velocity stream of water is then directed onto hemispherical buckets to overcome the resistance of the load and transfer energy to the rotating turbine.

The Pelton turbine is usually found in mountainous areas where heads of hundreds of feet are available. The high heads compensate for the design's partial-admission limitation. In the New England area, there appears to be only one Pelton turbine still in place: a homemade unit used until 1972 to operate a woodworking mill. It operated under a head of 124 ft (36.8 m) and

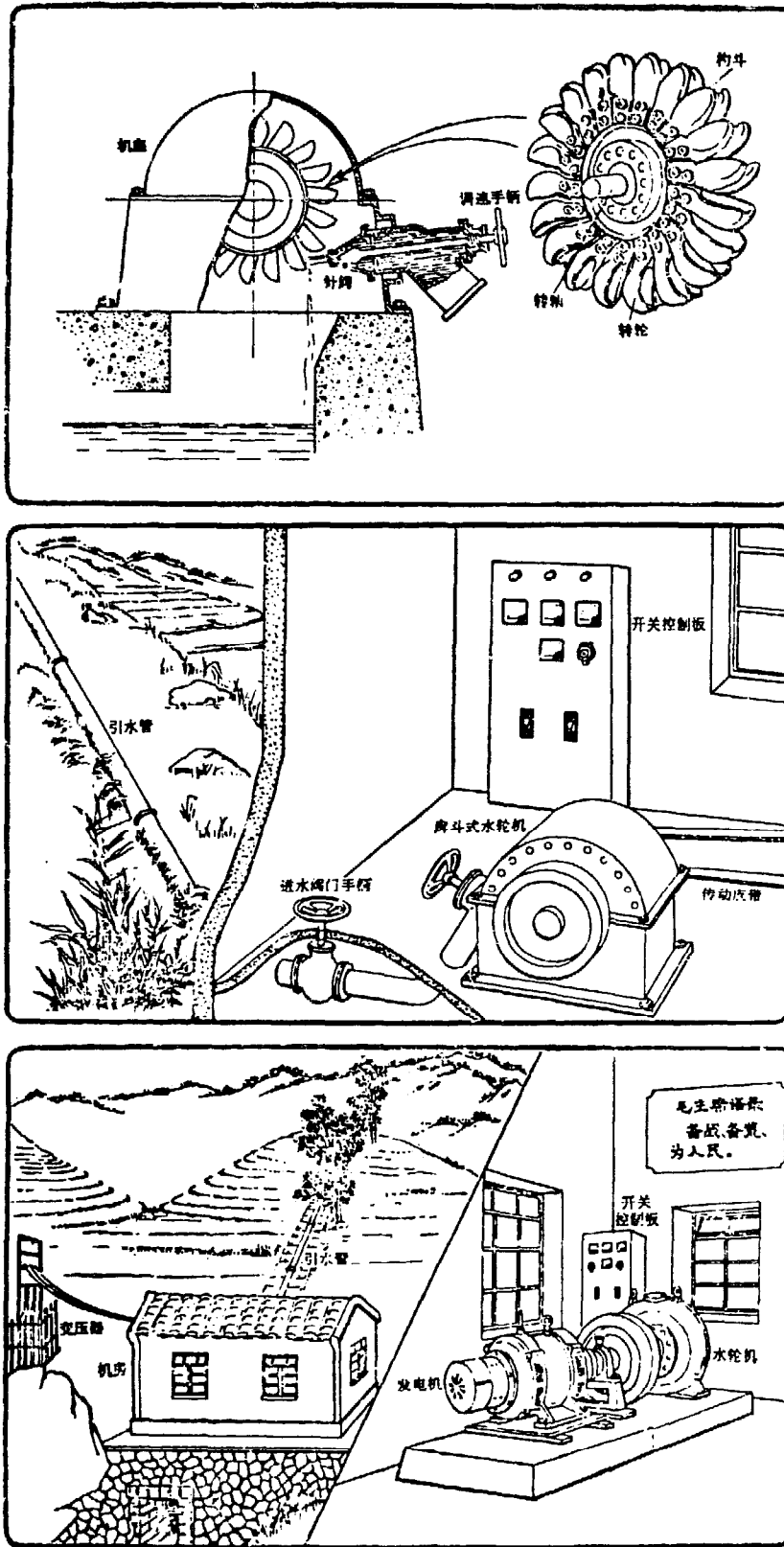

FIGURE 40 Pelton plant and details. [Source: see Ref. 2]

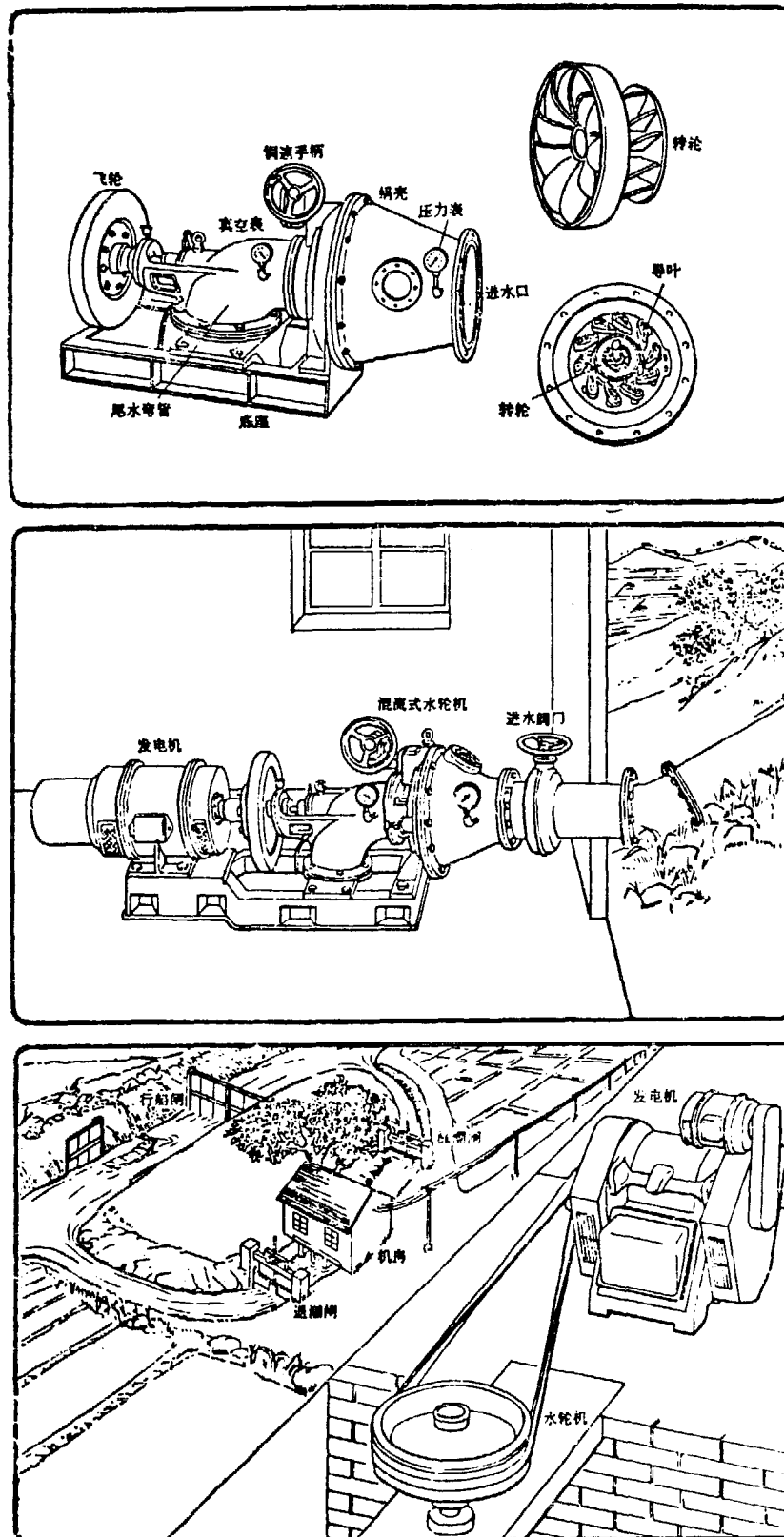

FIGURE 41 Francis turbine plant and details. [Source: see Ref. 2]

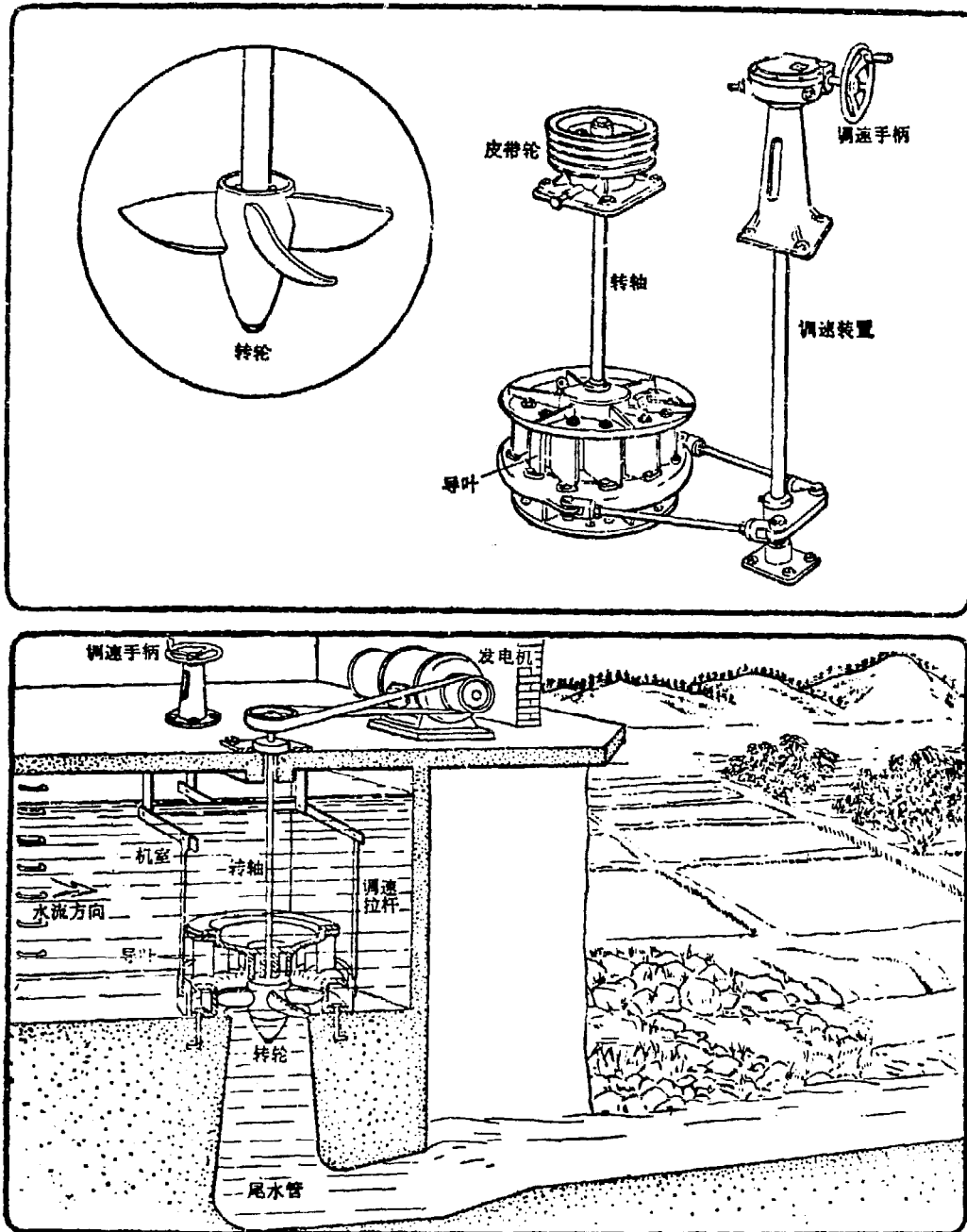

FIGURE 42 Fixed propeller (Nagler) plant and details. [Source: see Ref. 2]

was connected directly to a 5-kW generator operating at a speed of over 1,000 rpm.

The Pelton turbine may be considered the high-speed version of the undershot waterwheel or the tub wheel.

## Water Supply

All turbines require that water be conveyed to them, under pressure, in large pipes or penstocks, from a source at some elevation above the turbine. The drop in elevation from the source to the turbine may be the result of natural conditions or may be artificially created by means of a dam. The dam not only serves to create the elevation difference (head), it also makes possible the storage of water to smooth out variations in stream flow. Ideally, the dam should be located at the point where a substantial drop in the stream bed allows maximum power to be developed with minimum conveyance of water to the turbine. However, for reasons of economy and structural simplicity, the most desirable dam of minimum length and height may have to be located upstream of this point and a long penstock used to convey water to the turbine. In New England, penstocks a mile (1.6 km) long or longer and 5 or 6 ft (1.53 or 1.83 m) in diameter, made of California redwood, have been a common sight for many years.

The selection of sites for hydropower development is dependent on the following factors:

- Topography (slopes, storage, evaporation);
- Geology (dam location, run-off); and
- Stream-flow (rainfall, watershed area).

Figures 43-48 illustrate some typical arrangements of small-scale hydroelectric plants.

The means of securing the necessary data for evaluating a site is a formalized procedure covered by engineering textbooks, some of which are listed later; the same is true of the power machinery.

## Current Technology (Available within 5 Years)

A brief survey of turbine manufacturers in the United States has shown that there is only one, The James Leffel & Co. of Springfield, Ohio, offering suitable "packaged" hydroelectric units off the shelf. Electrical outputs (AC or DC) of 0.5, 1, 2, 3, 5, 7.5, and 10 kW (Figure 49) are available. For each power output, several turbine designs are offered, accommodating to variations in head requirements between 8 and 25 ft (2.5 and 7.6 m). (Details of the Leffel turbines and those of other manufacturers will be found in Appendix 8.)

The cost of these units ranges from \$3,600 for the 0.5-kW unit to about \$10,000 for the 10-kW size. A 10-kW unit developing 100-kWh/day, 350 days/year, with annual fixed and operating charges of 20 percent, would



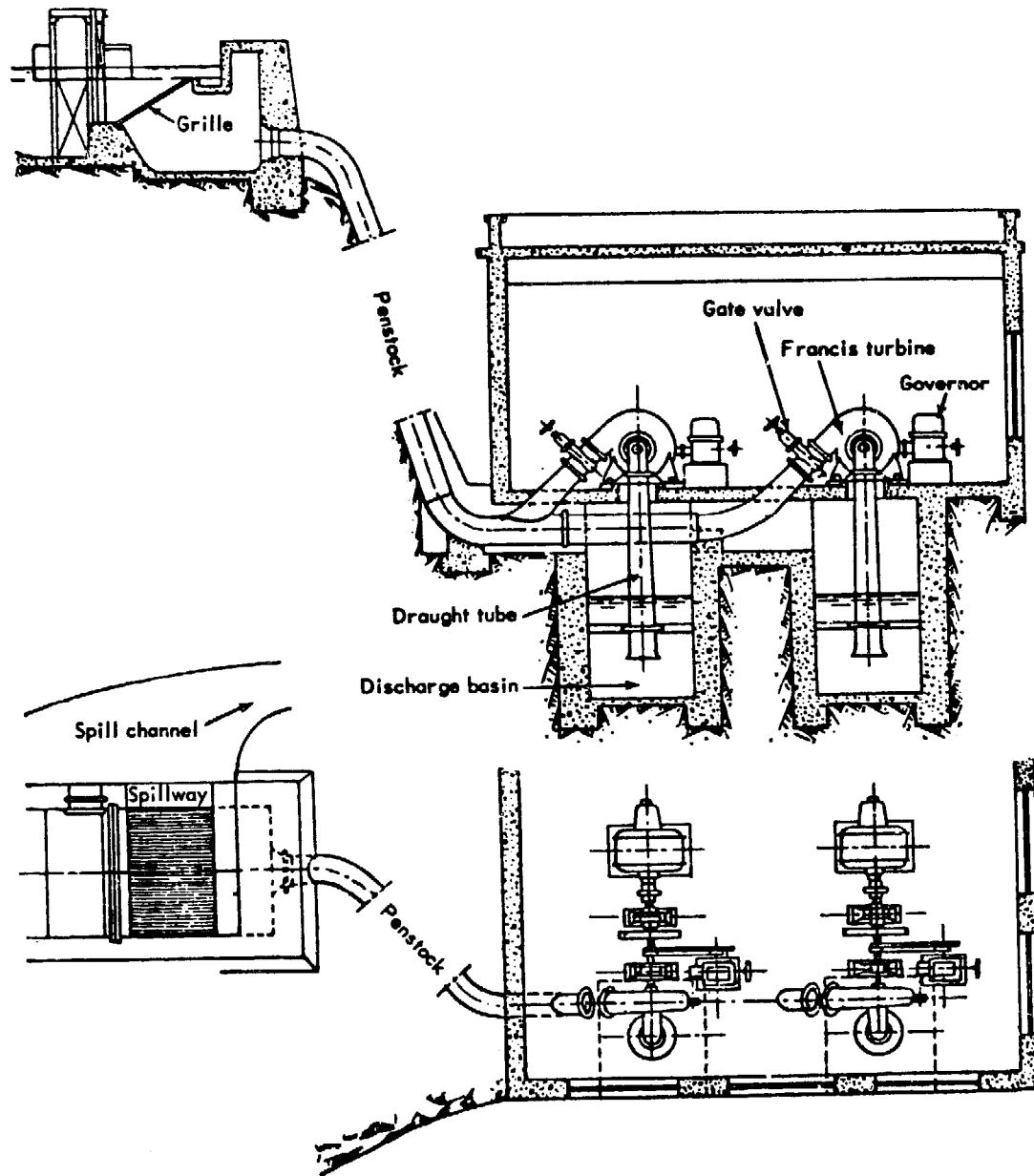

FIGURE 43 Typical layout of small hydro-plant with medium-head Francis turbine.  
 [From: *Small-Scale Power Generation*, United Nations, New York, 1967. UN Publication Sales No. 67.II.B.7.]

supply power at a unit cost of about 6¢/kWh. This does not include the cost of the dam and penstock.

The packaged Leffel units employ propeller-type turbines with fixed blades and are connected directly to the electric generator, doing away with the inconvenience, expense, and reduced efficiencies of using belts or gears.

In addition to these packaged units, Leffel offers its traditional line of

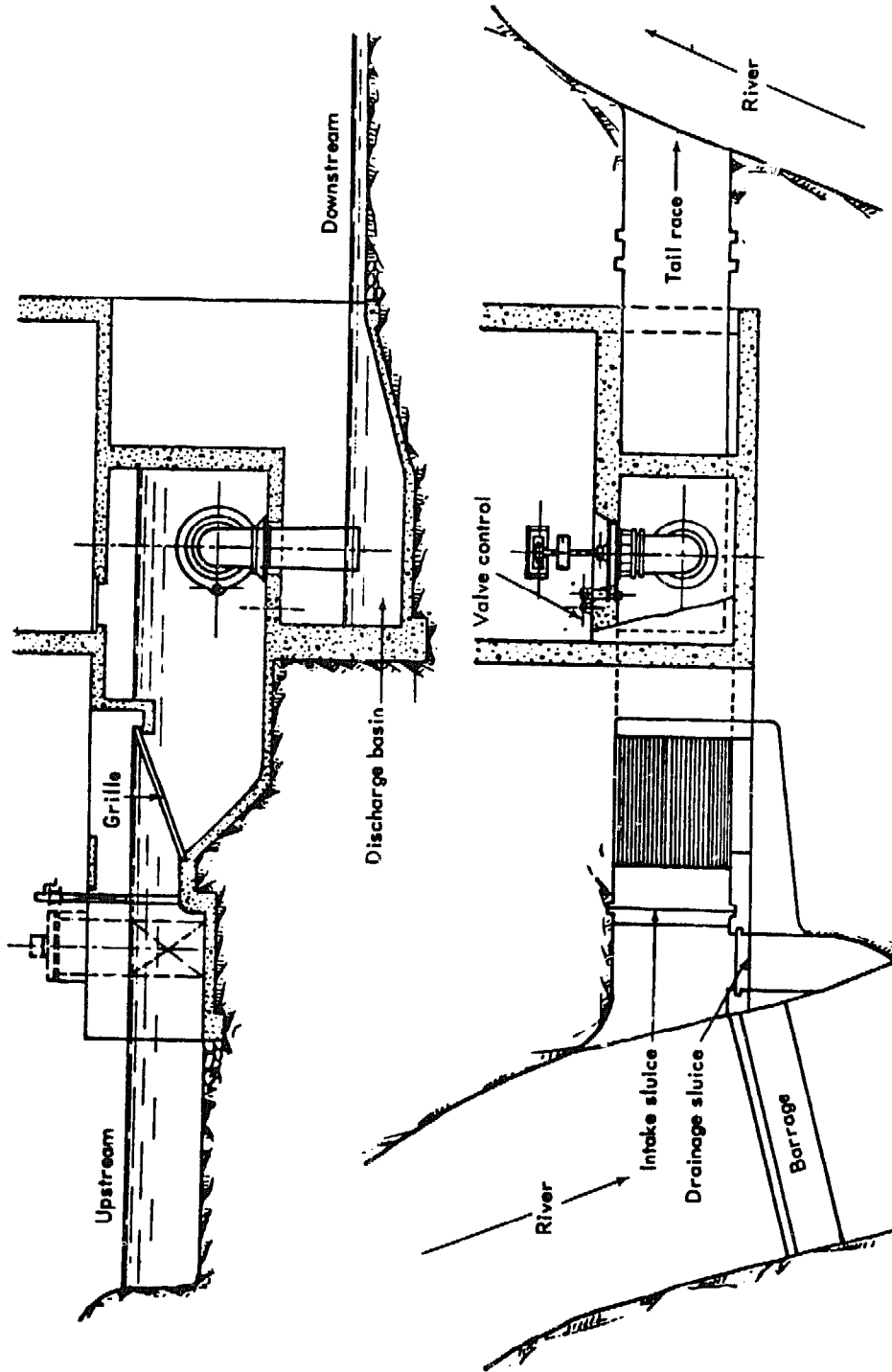

FIGURE 44 Typical layout of small hydro-plant with low-head Francis turbine. [From: *Small-Scale Power Generation*, United Nations, New York, 1967. UN Publication Sales No. 67.II.B.7.]

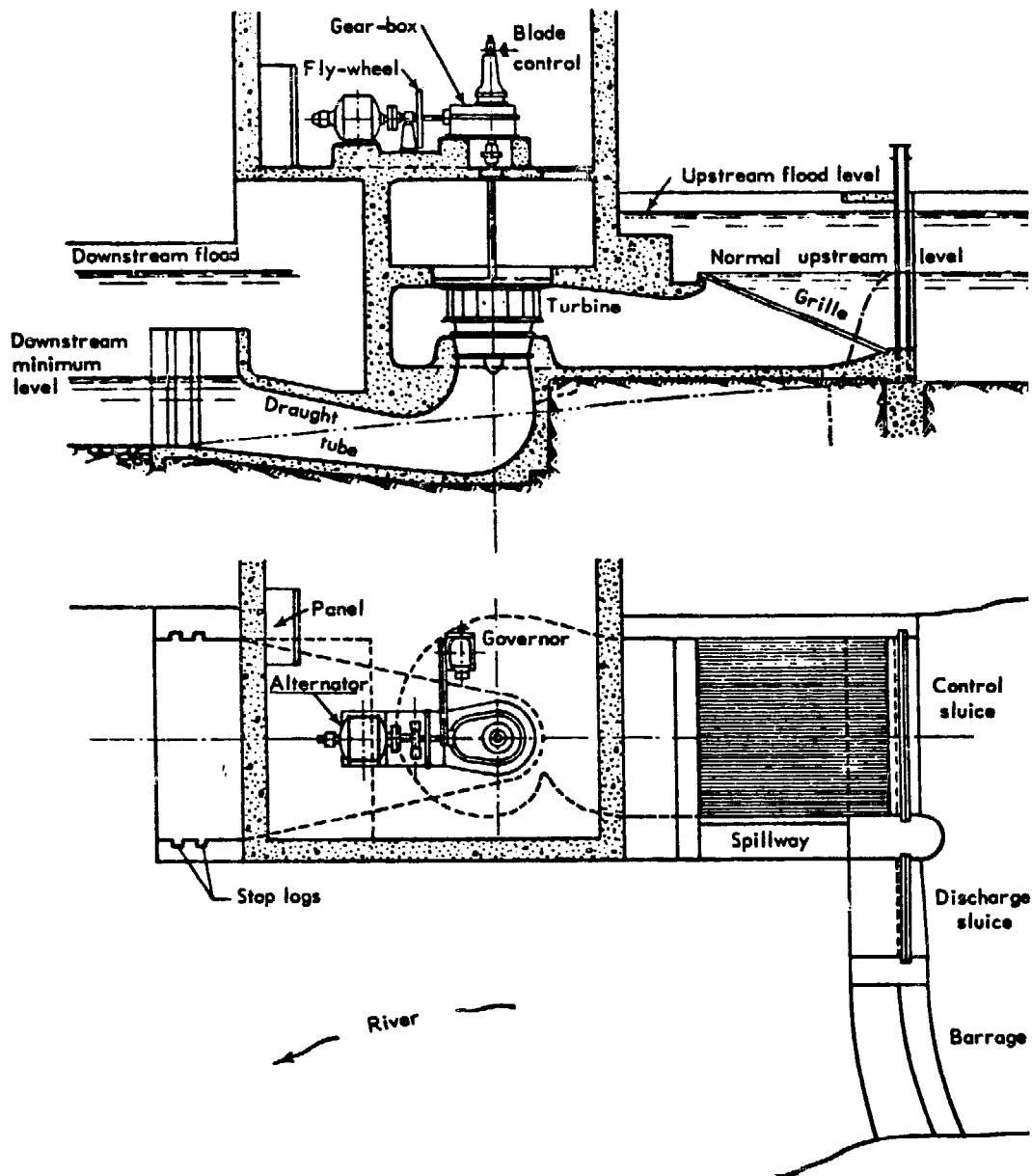

FIGURE 45 Typical layout of small hydro-plant with very low-head Kaplan turbine.  
 [From: *Small-Scale Power Generation*, United Nations, New York, 1967. UN Publication Sales No. 67.II.B.7.]

Francis turbines. The cost of a Francis turbine having a 17-in. (43-cm) diameter runner and developing 20 hp (15 kW) at 294 rpm under a head of 10 ft (3 m) would be \$7,900. Its low speed would require a belt or gear connection to an electrical generator.

The Soviet Union builds a fixed-propeller unit almost identical in size and form to the Leffel fixed-blade unit. It is called "Mikroges" and was designed by V. I. Gromov and Y. N. Fleksuer.

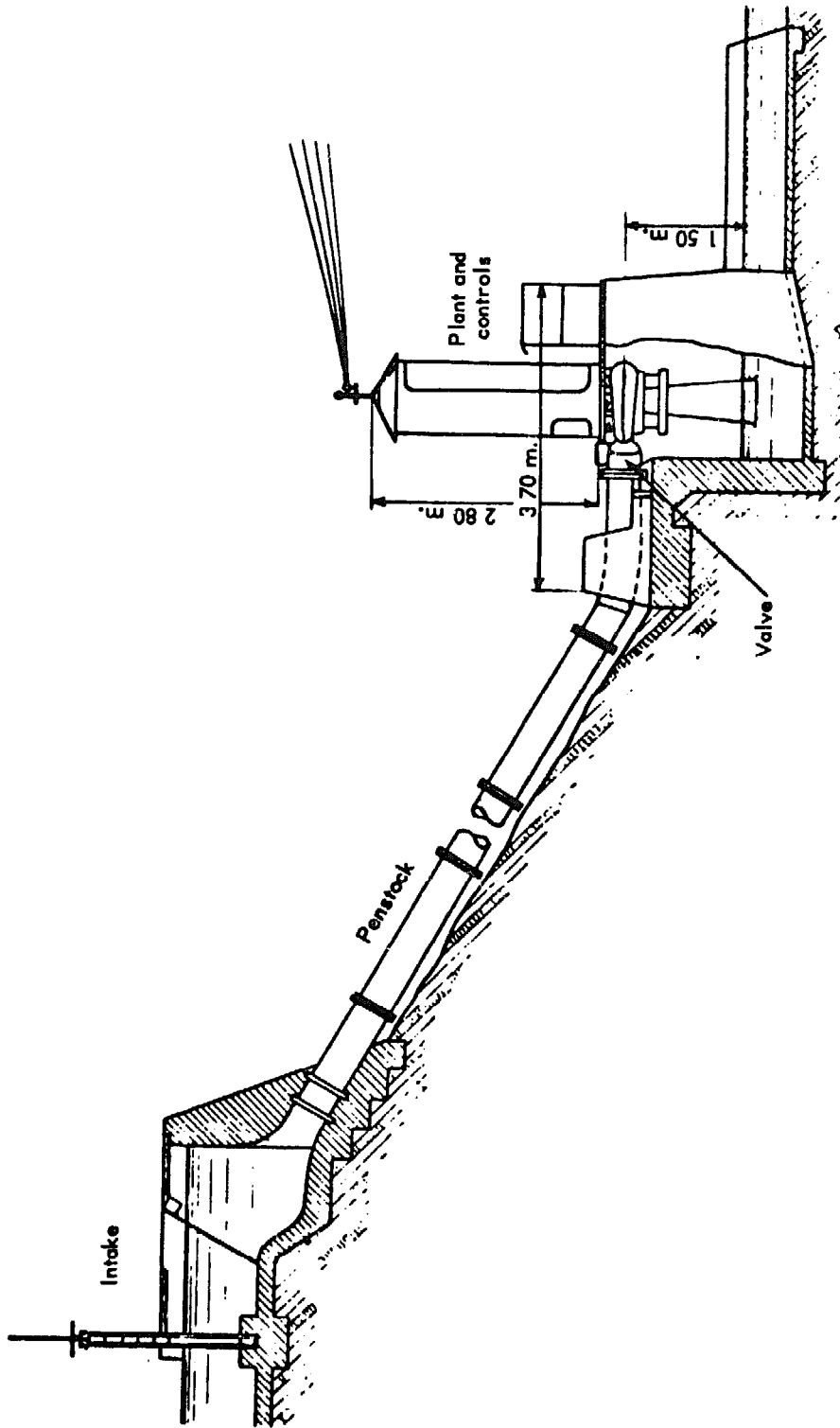

FIGURE 46 Typical layout of micro hydro-plant. [From: *Small-Scale Power Generation*, United Nations, New York, 1967. UN Publication Sales No. 67.II.B.7.]

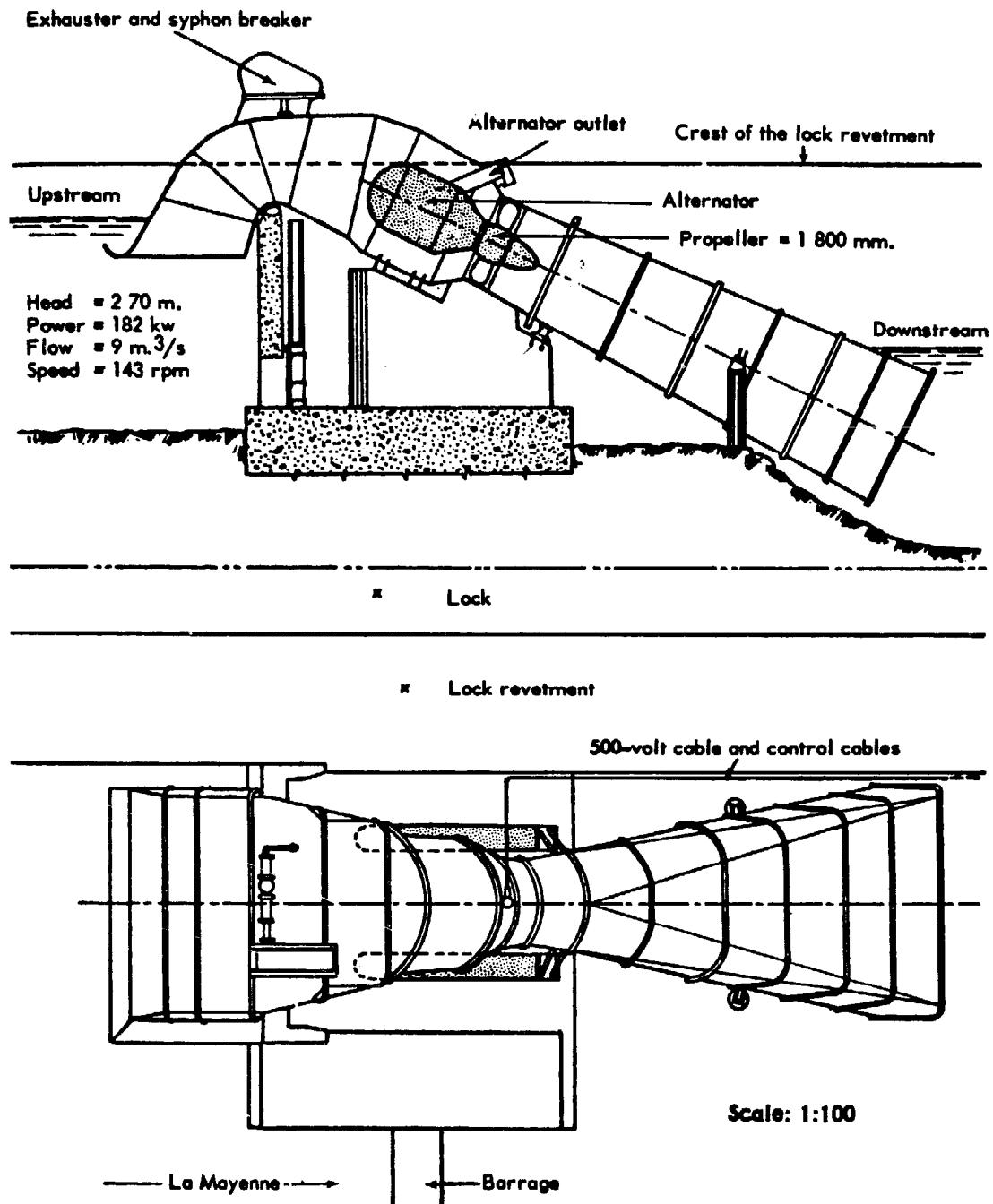

FIGURE 47 Syphon arrangement with bulb propeller turbine: La Mayenne, France.  
[From: *Small-Scale Power Generation*, United Nations, New York, 1967. UN Publication Sales No. 67.II.B.7.]

Gilbert Gilkes & Gordon Ltd., of Kendal, Westmorland, England, offers to design small 10- to 20-kW hydroelectric units for particular heads and flows. Their rough estimate of the cost of such hydroelectric units operating under a 10-ft (3-m) head would be about £17,000 (\$34,000) and for a 15-ft (4.5-m)

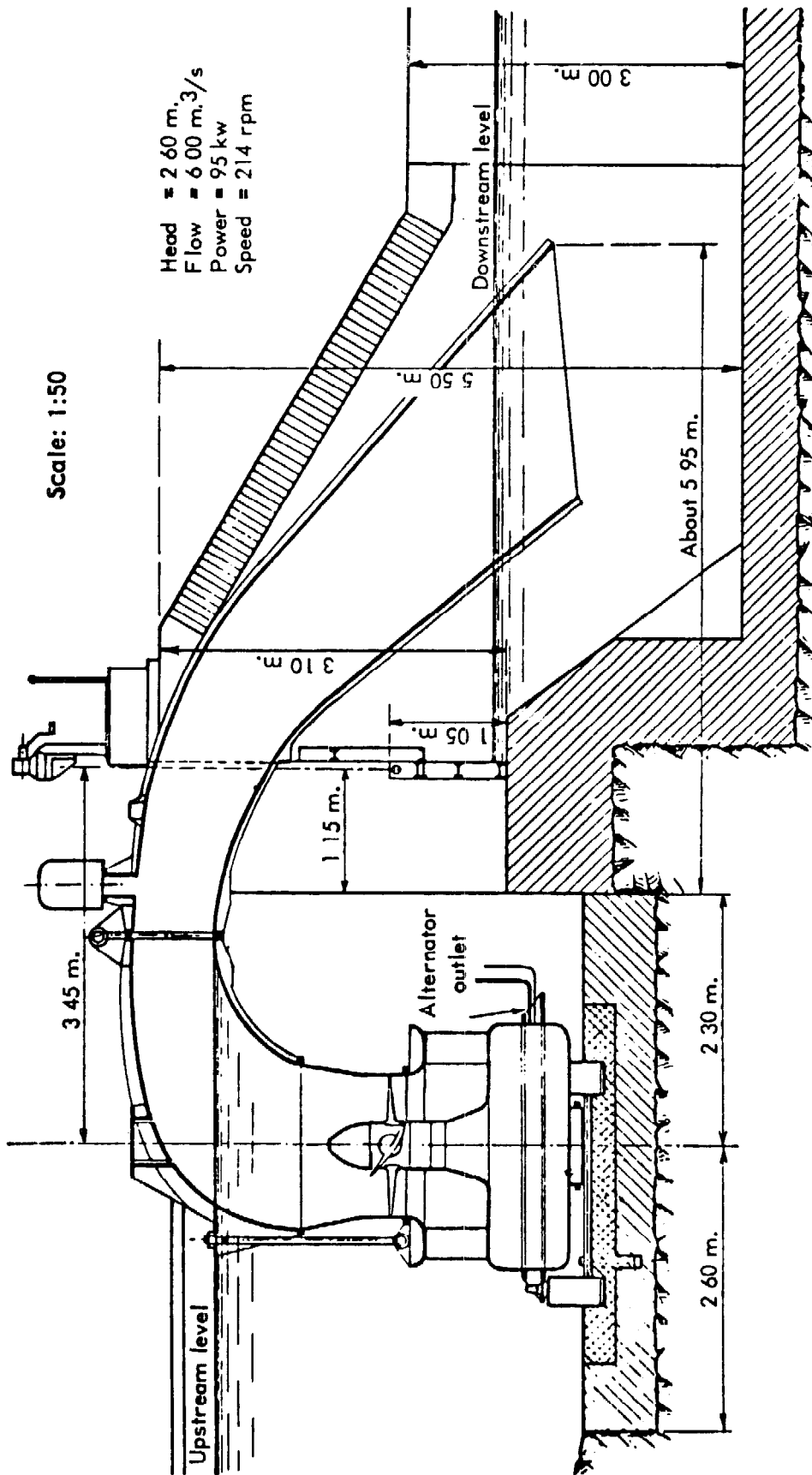

FIGURE 48 Submerged, upward flow micro turbine installation (sectional view): La Garonne, France. [From: *Small-Scale Power Generation*, United Nations, New York, 1967. UN Publication Sales No. 67.11.B.7.]

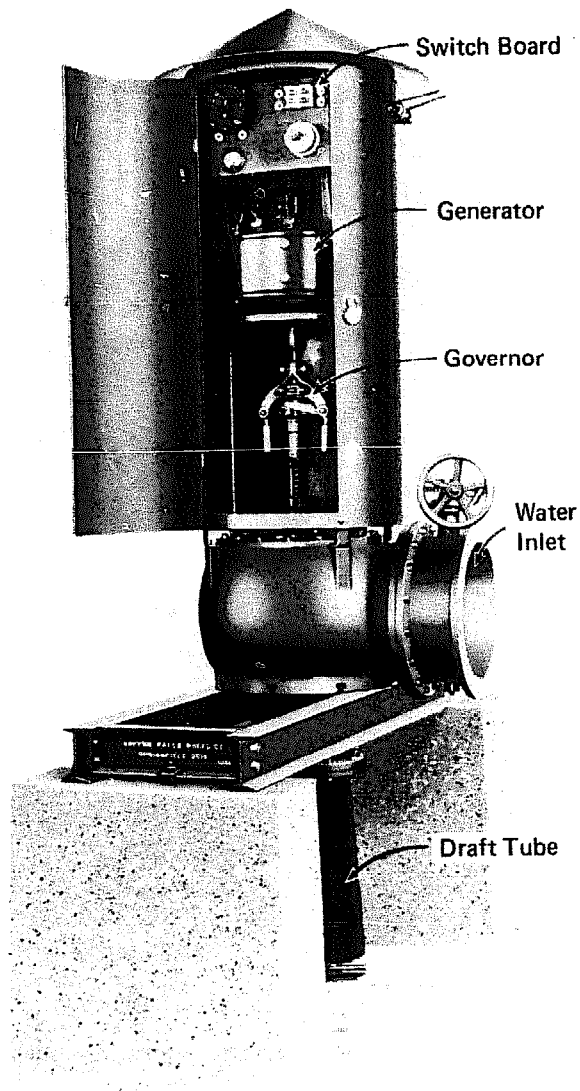

FIGURE 49 A 1-kW Leffel unit on a farm in Ohio. *a*, The 1-kW unit. *b*, Installation of the 1-kW unit. [Courtesy The James Leffel & Co.]



head about £14,000 (\$28,000); this cost is exclusive of such factors as the cost of the dam, penstock, valves, and building.

The Canadian company Barber Hydraulic Turbine Ltd., Port Colborne, Ontario, has designed a small 18.5-kW (20-hp) hydroelectric unit for operational testing in 1976. The turbine is a fixed-blade type, with five blades, and a diameter of 10 in. (25 cm). This project is being partially financed by the Canadian Government.

The Drees Company of Werl, Westphalia, West Germany, manufactures a "micro" hydropower package power plant of about 20-kW capacity. In appearance it resembles the Leffel unit.

In Budapest, Hungary, the Ganz Company manufactures a "Mignon" hydroelectric package plant that develops 15 kW at heads ranging from 7 to 12 m (23 to 39 ft). It weighs about 1,300 kg (2,900 lb) and utilizes a propeller turbine of the Kaplan type.

The Ossberger-Turbinenfabrik of Weissenberg, Bavaria, West Germany, manufactures a hydroelectric package called the Hydro-light. It utilizes a turbine described as a "radial impulse" type, and is made in two sizes: the 3-kVa unit for heads ranging from 4 to 6 m (13 to 20 ft) and the 5-kVa unit for 6- to 9-m (20- to 29-ft) heads of water. These units have reportedly been installed in many developing countries.

Published information and news reports indicate that a rather widespread and reliable technology of small-scale, low-head hydroelectric devices exists in the People's Republic of China.<sup>2,3,4,5</sup> The available literature (in Chinese) describes the use of small hydroelectric units, including Pelton, Francis, and Kaplan turbines. News reports indicate their growing popularity in rural areas and describe the construction and installation of thousands of units of less than 100-kW capacity, including one wooden turbine for a 20-kW hydroelectric plant.<sup>6</sup> Information is also available on details of construction of wooden and reinforced-concrete turbines for small-scale hydroelectric units.<sup>5</sup> However, no details are available to this panel on either the specifications of such units or their commercial availability.

A particularly interesting use of an irrigation canal has been made in Lin Hsien, where a series of small hydroelectric plants has been built along the canal, taking advantage of the progressive drop in elevation. The first such plant, capable of generating 250 kW, is located at the bottom of a 15-m (50-ft) drop, at the top of which is a sedimentation basin to remove the sand and silt that would cause considerable erosion of the metal parts. Thereafter, at every 5-m drop in elevation a 40-kW turbine has been installed, each one preceded by a sedimentation basin. Figure 50 shows one of these 40-kW plants.

Wooden turbines for small hydroelectric units are also being manufactured in the Soviet Union, but again, the panel has been unable to obtain any details.<sup>7</sup>



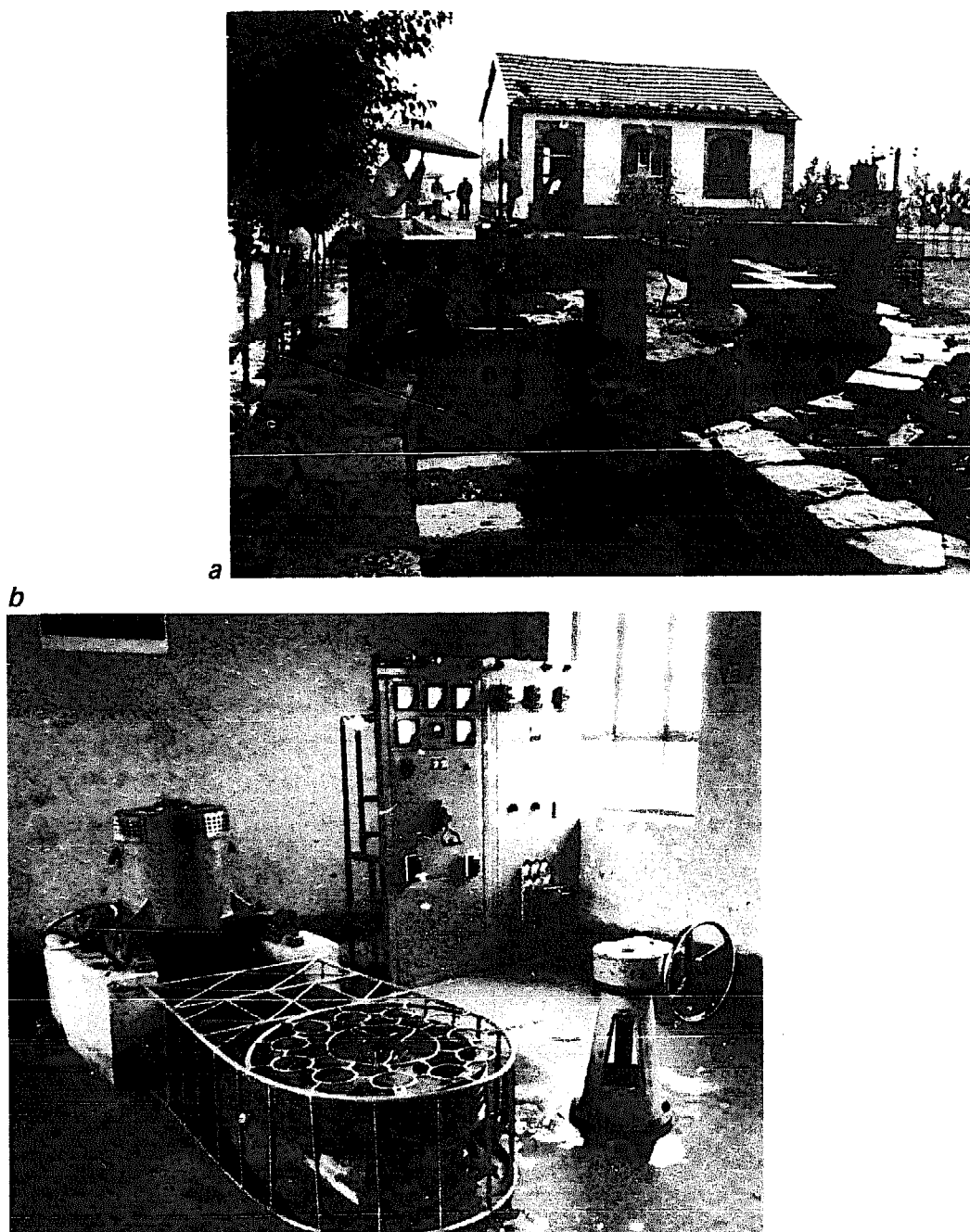

**FIGURE 50** Forty-kilowatt hydroelectric power station in Lin Hsien, People's Republic of China. This installation is one of a series of 26 placed at every 5-meter drop in elevation along the 12th channel of the No. 1 Branch Canal of the Red Flag Canal irrigation system. [These photographs courtesy of Amir U. Khan of the International Rice Research Institute. Dr. Khan visited these stations as a member of a delegation sponsored by the Committee on Scholarly Communication with the People's Republic of China, of the National Academy of Sciences' Commission on International Relations.] *a*, Housing and sluiceways. *b*, Generator and control mechanisms. (The generator is driven by multiple V-belts from the pulley on the turbine shaft.)

## Reliability

Small units of the types described may be expected to have a useful life of about 25 years with minimal maintenance.

## Local Implementation

Although most of the discussion has centered on manufactured devices, small-scale hydroelectric systems lend themselves to significant cost reductions through local enterprise.

- The dams may be made of earth, stone, or logs. Hundreds of such dams have been used in New England and last 25 years and more. Leffel's book on mill dams is excellent on the building of small dams for heads up to 15 ft (4.5 m).<sup>8</sup> (See also Figure 51.)

- Penstocks may be made of reinforced concrete or of wood planks strengthened by iron straps.

- Turbines may be made of wood, though if there is a rudimentary iron and steel industry, these more enduring materials may be used.

The units now available should be examined with the aim of making them simpler and cheaper. It may be possible to eliminate the governor and much of the switchboard equipment. The general problem of simplification should be explored with the companies mentioned above.

As mentioned previously, it has been reported that small wooden turbines are being made in the Soviet Union and China, although no firm information has been obtained from the Soviet Union. It may be worthwhile to pursue the idea of a wooden turbine design. This could become the subject of engineering theses at technical institutes or engineering colleges, preferably within a developing country, with funds provided for students to construct turbines for testing and demonstration. This could serve as a stepping-stone to formal instruction in wooden turbine building for artisans in developing nations.

## HYDRAULIC RAMS

The hydraulic ram, the ingenious, automated water-pumping machine developed by Montgolfier in 1796, is largely forgotten today; at one time water was supplied to the fountains and lakes of the Taj Mahal by these simple devices.<sup>9</sup> Present listings of manufacturers making "hydraulic rams" refer to manufacturers of hydraulic pistons and not Montgolfier's ingenious pump.

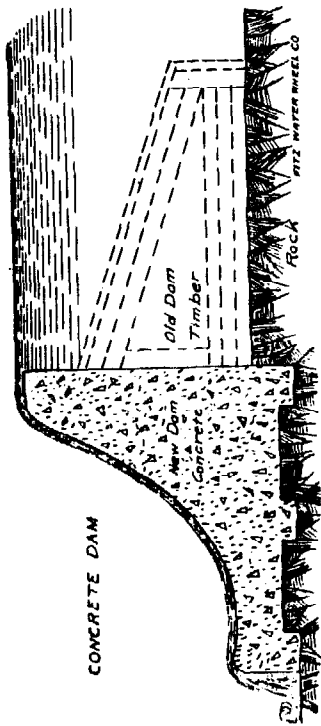

a To anyone familiar with the handling of concrete, this makes a very neat and permanent means of obtaining water storage. It is possibly the best and most shapely structure which can be used. The old wood dam need not be removed.

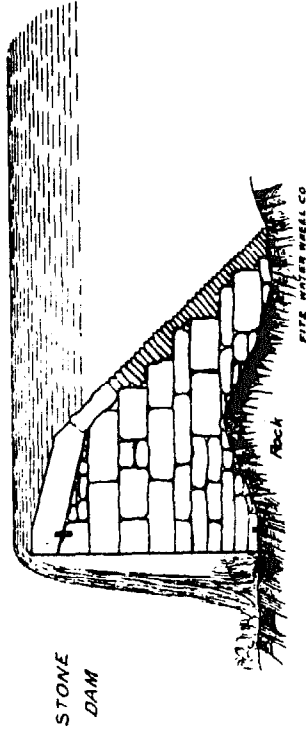

b A very good type of dam made from stone. The outer layers should be bound with concrete or concrete mortar to render it perfectly tight.

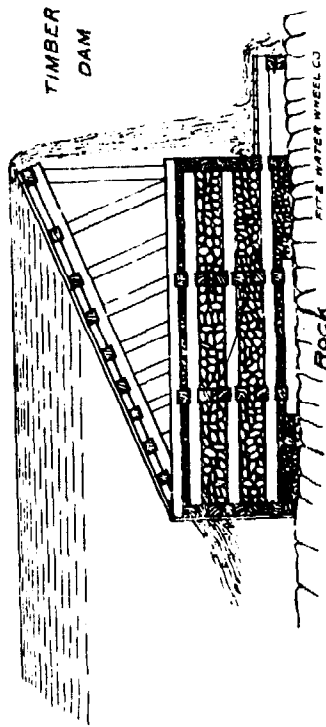

c Another method of building a wood dam where greater height is desired.

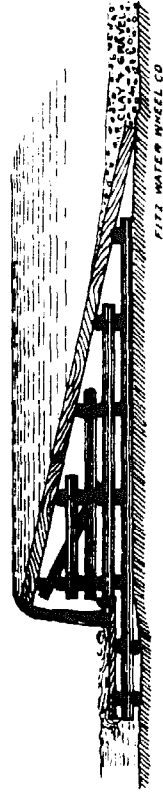

d In sections of the country where timber is easily obtained, this is a very inexpensive dam to build. Easy to construct and very satisfactory where only a small dam is required.

FIGURE 51 Dams for use with small heads. [Drawings and captions reprinted from: "Electric Light Plants Driven by Small Water Powers," Bulletin No. 16, Fitz Water Wheel Company, Hanover, Pennsylvania, 1916]

The basic principle of the hydraulic ram is that of "water hammer." In fact, it was the problem of water hammer that was responsible for its re-invention in England during the early part of the 19th century. What happened was this: a water line was installed in a multistory building for use at its lowest level, the head available being inadequate to serve the upper floors of the building. Whenever the faucet was closed quickly, however, the pipe would rupture near the faucet. A resourceful plumber solved the problem by connecting to the water pipe, just before the faucet, a vertical pipe connected to an open tank a floor or so above to relieve the sudden hammering pressure buildup. Eventually, it was necessary to locate the tank on the top floor, and it soon became obvious that with the supply of water reaching the top floor, a limited amount of water could be supplied to all floors. The idea then blossomed into the English version of the hydraulic ram.

The hydraulic ram, via the phenomenon of water hammer, uses the kinetic energy of water flowing in a pipe to elevate part of this water to a height greater than that causing the flow, with an efficiency of about 60 percent. Figure 52 shows a hydraulic ram and some typical installations. The principle of operation is illustrated in Figure 53. Water flows through the supply pipe D, and through the opening of outside valve F. As the water velocity increases, the dynamic pressure on the underside of the check valve F increases until it overcomes the weight of the valve. Then F moves rapidly upward, closing the opening. The pressure of the moving water causes valve B to open and water is driven into the air-cushion chamber A, increasing the air pressure and discharging through the delivery pipe I. As the momentum of the water in the ram decreases, valve B drops down and closes and the water rebounds somewhat. This creates a sudden drop in pressure under valve F, causing it to drop down and open quickly and the cycle begins again. When valve B is closed, of course, the pressure in A is determined by the head of water in the storage tank and delivery line. Thus, the incremental additions of water to the storage system are the result of the momentary increases in air pressure in A at each cycle. The frequency with which the cycle is repeated is regulated by adjustment of the counterweight C.

A ram using a vertical fall of water of 12 ft (3.7 m), for example, will deliver 5 or 6 percent of the flow to an elevation of 125 ft (38 m); if the lift is to be only 25 ft (7.6 m), about 22 percent of the water flowing will be elevated.

Though the hydraulic ram is customarily a device for pumping water, it has also been used to compress air for rock drills—during the building of the Mont Cenis Tunnel in Switzerland, for instance.<sup>10</sup> The surge of water into the chamber at A can act as a piston to compress the air normally used as an air cushion when the device is used for pumping water. The suction part of the cycle becomes the air-intake cycle in this application.

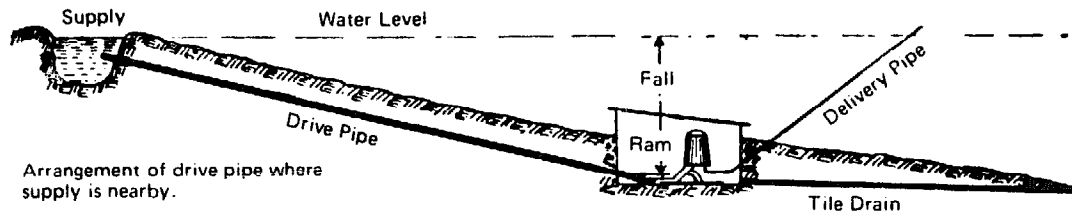

Arrangement of drive pipe where supply is nearby.

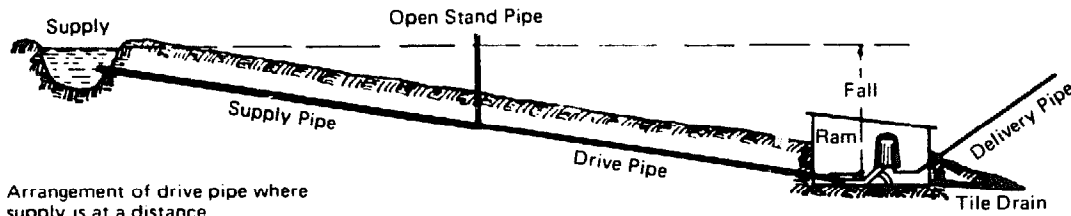

Arrangement of drive pipe where supply is at a distance.

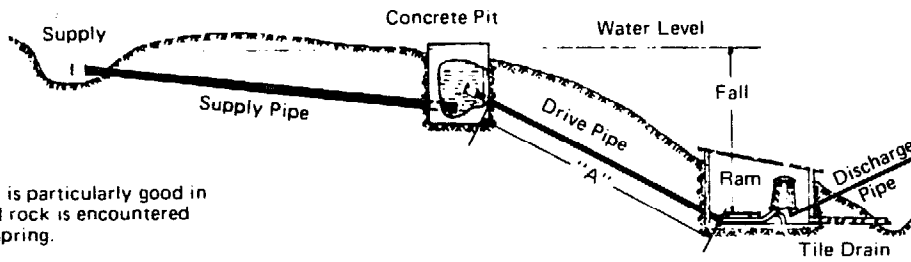

This plan is particularly good in case solid rock is encountered close to spring.

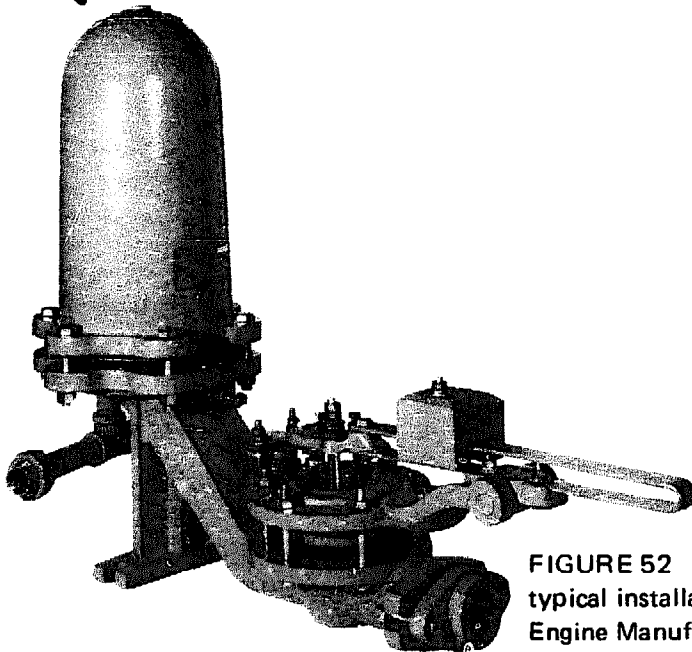
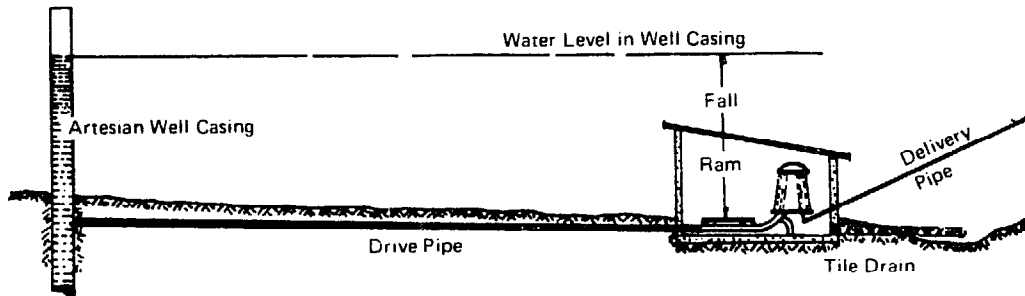

FIGURE 52 Hydraulic ram and examples of typical installations. [Courtesy Rife Hydraulic Engine Manufacturing Co.]

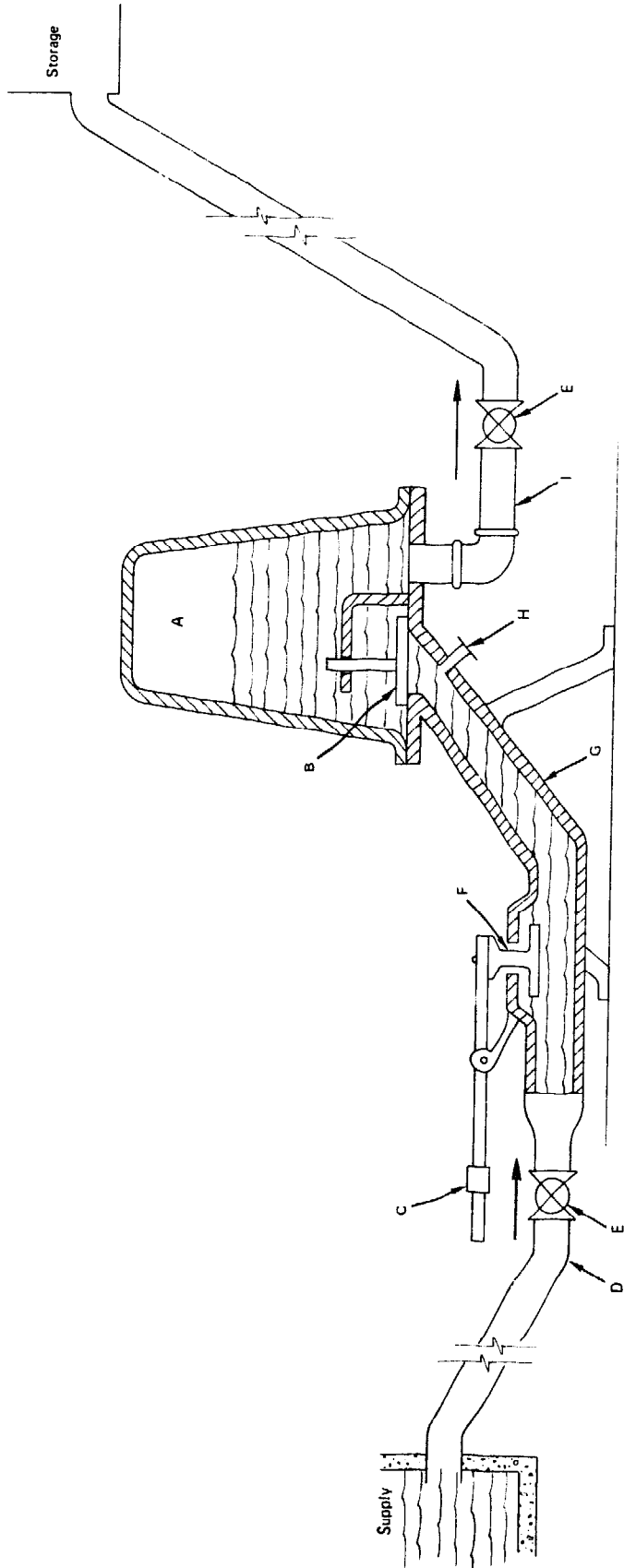

FIGURE 53 The hydraulic ram [Source: *Village Technology Handbook*, VITA, Mt. Rainier, Maryland, USA, 1970]

### Current Technology (Available within 5 Years)

A canvass of about 20 hydraulic ram manufacturers in the United States has turned up only one that manufactures the pump: the Rife Hydraulic Engine Manufacturing Co. of Millburn, New Jersey 07041. This company supplies rams requiring minimal falls—about 2-4 ft (0.6-1.2 m)—ranging in cost, according to pumping capacity, from about \$300 to about \$2,600. (See Appendix 8 for details.)

### Reliability

Rams are completely automated, will operate 24 hours a day with minimum attention for months, and may be used to pump water for irrigation and water supply.

### Local Implementation

In areas where iron pipe and pipe fittings are available, hydraulic rams could be constructed with local materials and utilizing local skills. Complete details for constructing these devices are available from VITA.<sup>11, 12</sup> (See p. vii)

### Research and Development

The hydraulic ram is so reliable and effective in its performance for the pumping of water that it does not require further development for this purpose. It would be worthwhile, however, to support research and development of the hydraulic ram as an air compressor. Such compressed air would be produced continuously and stored in tanks for use in reciprocating engines or turbines driving machines or electric generators.

## HYDRAULIC AIR COMPRESSOR

In medieval Europe this machine with no moving parts was known as the "trompe" and it supplied compressed air to aid combustion in Catalan iron furnaces. At the beginning of the 20th century it enjoyed a brief vogue in the United States as the "hydraulic air compressor."

Basically, the hydraulic air compressor is the inversion of the air-lift pump. It is a simple device in which water at some elevation is allowed to flow into a vertical pipe through a circumferential Venturi (convergent-divergent) entrance. At the minimum areas of the Venturi section, openings are provided

so that the water flowing past these openings will induce air to be sucked into them and become entrained in the water stream (Figure 54). If the water velocity is high enough, the entrained air will be carried to the bottom of the

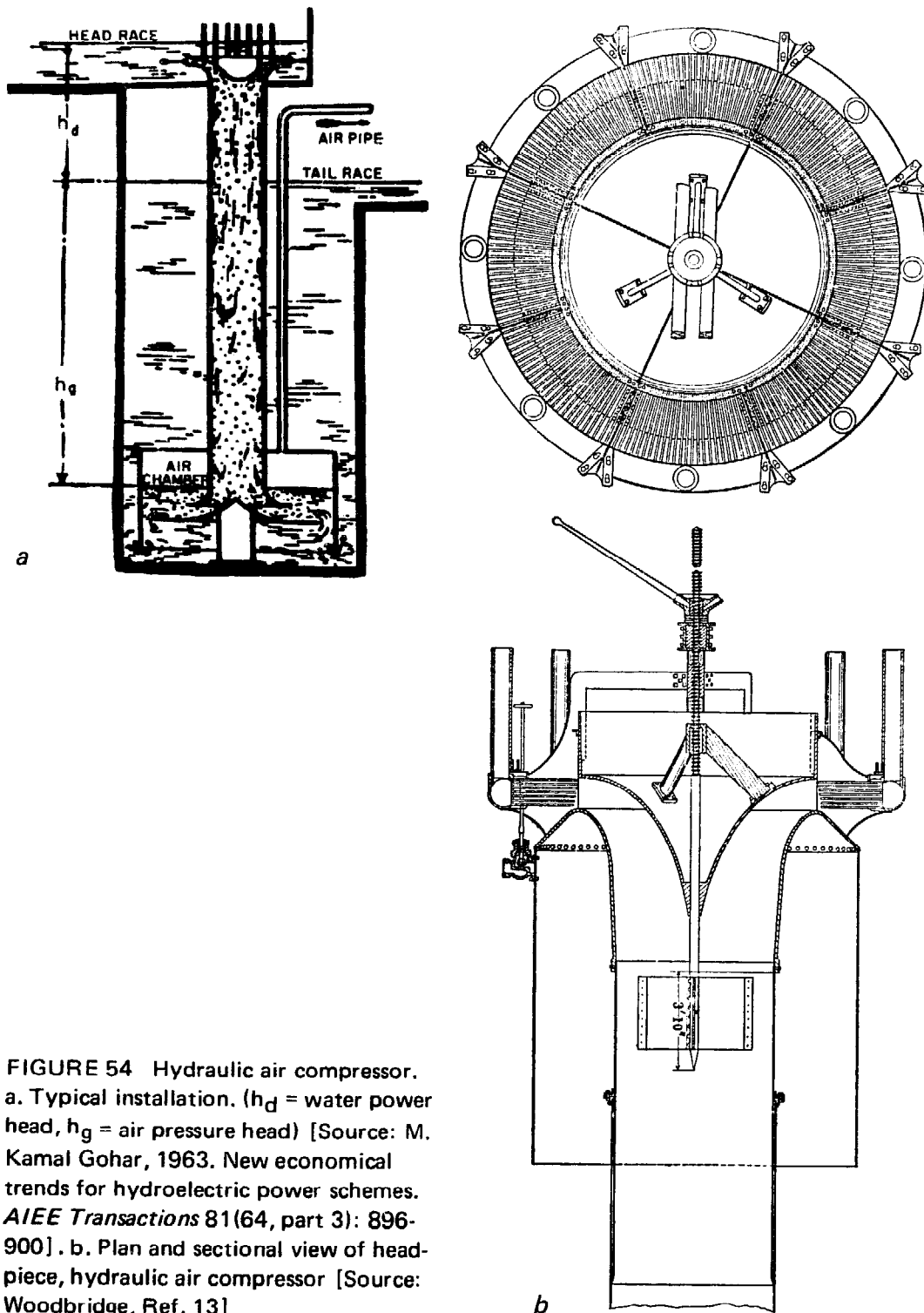

FIGURE 54 Hydraulic air compressor.  
 a. Typical installation. ( $h_d$  = water power head,  $h_g$  = air pressure head) [Source: M. Kamal Gohar, 1963. New economical trends for hydroelectric power schemes. *AIEE Transactions* 81(64, part 3): 896-900].  
 b. Plan and sectional view of head-piece, hydraulic air compressor [Source: Woodbridge, Ref. 13]



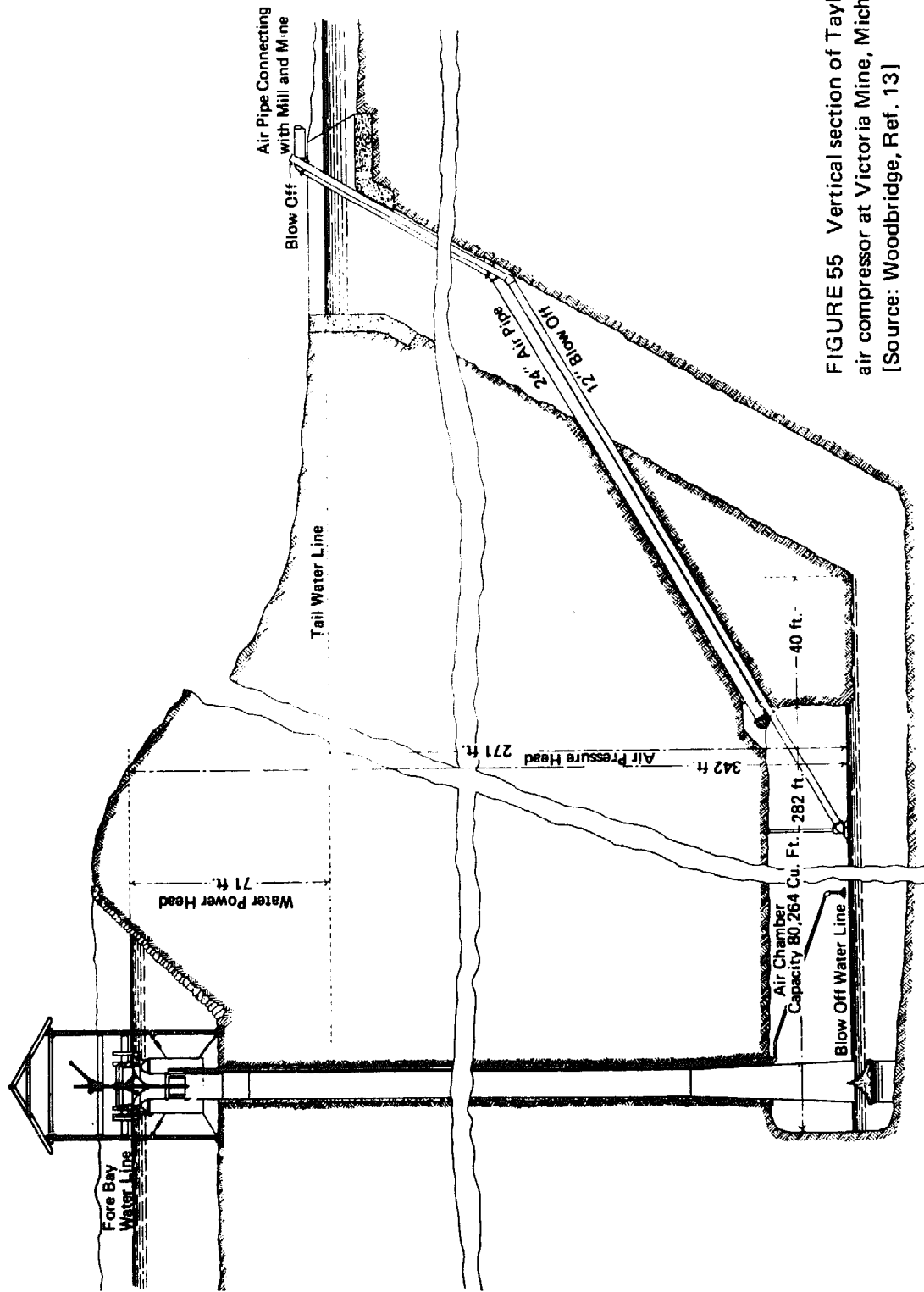

FIGURE 55 Vertical section of Taylor hydraulic air compressor at Victoria Mine, Michigan. [Source: Woodbridge, Ref. 13]

pipe and into a chamber where the air is trapped and compressed by the conversion of its kinetic energy to potential energy.

It has been reported that an installation utilizing a fall of water of 71 ft (21.6 m) with a pipe 5 ft (1.53 m) in diameter compressed enough air to a pressure of 117 lb per square in. (8.05 atmospheres) to develop about 1,000 hp (750 kW).<sup>13</sup> The efficiency of this installation was reported as 82 percent (Figure 55).

### Current Technology (Available within 5 Years)

This is a technology that could be available now. But because it seems to have been forgotten for almost 70 years, there are no known operating installations or available manufactured Venturi devices designed for this application.

### Research and Development

The simplicity of this device and its high performance suggest that it should be resurrected for further study and possible use in hilly terrain where ample water is available. The ability of the device to operate continually day and night, with its simple storage of energy in the form of compressed air in tanks or caves, makes it an interesting and potentially fruitful problem to investigate. The compressed air could be piped to sites to drive reciprocating engines or turbines that, in turn, could power production machines or electric generators.

### REFERENCES

1. Mosonyi, E. 1960. *Water power development*, Vol. 2, pp. 837-886. 2 vols. Budapest: Hungarian Academy of Sciences.
2. *How to run small power stations efficiently*. 1971. People's Republic of China: Shanghai People's Press. (In Chinese)
3. Editorial Publishing Group, East China College of Water Conservancy, Nanking. 1973. *Rural small-scale hydro-electric stations*. People's Republic of China: Shanghai People's Press. (In Chinese)  
See especially Chapters 6 and 11. Chapter 6, "Self-made Turbines," is devoted to construction, in the village, of wooden, ferrocement, and welded turbines. Subheadings include: "Self-made wooden turbines," "Self-made ferrocement turbines," "Self-made steel plate welded turbines," "Self-made partial-admission ferrocement turbines," "Self-made axial-flow full-admission water turbines." Chapter 11 is devoted to construction of dams.
4. Canton Bureau of Water Conservancy and Electric Power. 1973. *Rural small-scale hydroelectric stations*. People's Republic of China: Canton People's Press. (In Chinese)

5. Editorial Publishing Group on Rural Small-Scale Hydropower Stations, Bureau of Water Conservancy and Electric Power, Revolutionary Committee of Hunan Province. 1974. *Rural Hydroelectric Stations*. 2 vols. People's Republic of China: Hunan People's Press. (In Chinese)

This book is concerned with installations of less than 400-kW capacity, using water heads under 30 meters. Part 2 of Volume I discusses construction of earth and stone dams, sluices, and penstocks (reinforced concrete, wood, ferrocement).

6. New China News Agency. 1970. Radio broadcast in English, 6:38 A.M., GMT, 11 August. *BBC Summary of World Broadcasts*, Part 3: The Far East weekly economic report. London: British Broadcasting Company.
7. Mosonyi, E. 1960. *Water power development*, Vol. 2, p. 869. Budapest: Hungarian Academy of Sciences.
8. *The construction of mill dams*. 1874. 1970 reprint. Springfield, Ohio: The James Leffel and Co.
9. Reeves, W. J. 1961. Country workshop. *Australian Country*, September: 32-33. Sydney, Australia.
10. Peele, Robert. 1930. *Compressed air plant*. 5th ed. New York: John Wiley & Sons.
11. *Hydraulic rams for village use*. 1970. Mt. Rainier, Maryland: VITA (Volunteers in Technical Assistance).
12. *Village technology handbook*. 1970. Mt. Rainier, Maryland: VITA (Volunteers in Technical Assistance).
13. Woodbridge, D. E. 1907. The hydraulic compressed-air power plant at the Victoria Mine. *Engineering and Mining Journal* 83(3):125-130.

## SUGGESTED READING

### HYDROELECTRIC PLANTS

- Frizell, J. P. 1905. *Water power*. New York: John Wiley & Sons.
- Koester, F. 1909. *Hydro-electric developments and engineering*. New York: Van Nostrand.
- Daugherty, R. L. 1937. *Hydraulics: a text on practical fluid mechanics*, Chapters XIV-XVIII, pp. 343-418. 4th ed. New York: McGraw-Hill.
- Reports on water power of the U.S.* 1880. Washington, D.C.: U.S. Department of the Interior, Census Office.
- Mead, D. W. 1950. *Hydrology*. New York: McGraw-Hill.
- Wagner, E. G., and Lanoix, J. N. 1959. *Water supply for rural areas and small communities*. Geneva, Switzerland: World Health Organization.

### HYDRAULIC RAM

- Gibson, A. H. 1970. *Hydraulics and its application*, pp. 683-693. London: Constable.
- Meade, D. 1933. *Hydraulic machinery*, pp. 358-383. New York: McGraw-Hill.

### HYDRAULIC AIR COMPRESSOR

- Gibson, A. H. 1970. *Hydraulics and its application*. London: Constable.
- Schulze, Leroy E. 1954. *Hydraulic air compressors*. U.S. Bureau of Mines Information Circular, No. 7683. Washington, D.C.: Department of the Interior.

# *Photosynthesis*

## THE TERRESTRIAL BIOMASS AS A RESERVOIR

In the process of photosynthesis, solar energy absorbed by green plant tissue provides energy to reduce  $\text{CO}_2$  and form carbohydrates, which are then utilized as energy sources and raw materials for all other synthetic reactions in the plant. Thus, solar energy is captured and stored in the form of chemical energy. Cellulosic plant material presents a vast, untapped supply of energy. It is renewable, has a low content of sulphur and other pollutants, and storage of energy from the season in which it is produced until it is needed is simple and inexpensive. When fossil fuels were abundant and low priced, there was little incentive to develop methods to utilize this ready energy supply. Now that traditional fuels are scarce and expensive, however, the vast potential of plants as an energy source merits serious and immediate attention.

Stored plant energy may be released by drying the material and burning it directly, or various processes may be utilized to obtain potential fuels such as ethanol, methane, or other gaseous or liquid fuels. The processes used to derive these fuels, however, may require different forms of the plant material. This section will deal only with the amount of energy involved and with factors that may affect the efficiency of energy capture, not with the processes by which the energy might be extracted or converted to use. (One energy-extraction technology, however—by microbial action—is considered in the next chapter.)

## ENERGY CONTENT OF PLANT MATERIALS

The energy content of several different plant materials is shown in Table 1 as compiled by Alich and Hinman, 1974.<sup>1</sup> All of the materials listed were air- or oven-dry with the exception of the wet sugarcane bagasse. On a dry-weight (moisture-free) basis these materials have an average energy content of 8,700 Btu/lb (4,800 kcal/kg). Obviously, if combustible material is required for the energy-recovery process, the amount of water in the plant material will affect the recoverable energy; fresh leaves may contain 95 percent water. Thus, correction for water content must be made and the energy cost of drying must be considered when plant materials are evaluated as energy sources for combustion. All energy estimates and calculations in this report are based on dry weights.

Szego and Kemp, 1973,<sup>6</sup> discuss the problem of water in plant-energy conversion and use 6,500 Btu/lb (3,600 kcal/kg) as an average energy content for many different air-dry plant materials (10-15 percent moisture) which, on a moisture-free basis, would be about 7,500 Btu/lb (4,200 kcal/kg). As a rule of thumb, 7,500 seems a reasonable and conservative figure for dry plant material.

TABLE 1 Energy Content (Btu/lb) of Plant Biomass (Table Adapted from Alich and Hinman, 1974)<sup>1</sup>

	Plant Part	Percent H <sub>2</sub> O	Btu/lb	kcal/kg
Sugarcane ( <i>Saccharum officinarum</i> ) <sup>2</sup>	Bagasse	12	7,281	3,860
Sugarcane ( <i>Saccharum officinarum</i> ) <sup>3</sup>	Bagasse	52	4,000	2,220
Bamboo ( <i>Phyllostachys</i> spp.) <sup>2</sup>	Cane	10.5	7,398	3,925
Buckwheat ( <i>Fagopyrum esculentum</i> ) <sup>2</sup>	Hulls	10	7,594	4,030
Chamise ( <i>Adenostoma fasciculatum</i> ) <sup>4</sup>	Leaves	0	9,750	5,160
Chamise ( <i>Adenostoma fasciculatum</i> ) <sup>4</sup>	Stems	0	9,450	5,015
Coconut ( <i>Cocos nucifera</i> ) <sup>2</sup>	Shells	13	7,560	4,010
Beech ( <i>Fagus</i> sp.) <sup>2</sup>	Wood	13	7,506	3,990
Birch ( <i>Betula</i> sp.) <sup>2</sup>	Wood	12	7,578	4,015
Oak ( <i>Quercus</i> sp.) <sup>2</sup>	Wood	13	7,182	3,810
Oak ( <i>Quercus</i> sp.) <sup>2</sup>	Bark	7	8,139	4,310
Oak ( <i>Quercus</i> sp.) <sup>3</sup>	Bark	0	8,370	4,450
Pine ( <i>Pinus</i> sp.) <sup>2</sup>	Wood	12	7,956	4,230
Pine ( <i>Pinus</i> sp.) <sup>3</sup>	Bark	0	9,030	4,790
Fir ( <i>Abies</i> sp.) <sup>3</sup>	Bark	0	8,810	4,675
Spruce ( <i>Picea</i> sp.) <sup>3</sup>	Bark	0	8,740	4,640
Redwood ( <i>Sequoia sempervirens</i> ) <sup>3</sup>	Bark	0	8,350	4,425
Oilseed crop <sup>5</sup>	Seed	-	9,000	4,775

## ENERGY PRODUCTION BY PLANTS

Examples of the annual biomass yields and energy equivalents of above-ground dry matter from several types of plants are given in Table 2 (adapted from Table 1). The yields given in Table 2 show much variability within and among species. They are not intended to indicate the yield potential of the species; rather, they are examples of yields from various sites and under varying systems of management. Other examples are found in references 2, 6, 7, 8, and 9. Obviously, the energy accumulated by highly productive plants is massive.

We do not have the climatic data to permit us to estimate the efficiency of capture of solar energy represented by the yields in Table 2. For certain agricultural situations, however, sufficient climatic and yield information is available to make that calculation. For example, an Iowa maize field planted May 1 and harvested October 1 may produce 200 bu/a (180 hl/ha) of shelled grain (4,325 kg dry weight). This would be a high, but not unreasonable, yield for Iowa. Above ground, this crop would have an equal weight of plant material other than grain, giving a total yield of dry plant material of 21,400 kg/ha. This represents the capture of  $9 \times 10^7$  kcal/ha. Between May 1 and October 1, a central Iowa maize field will receive about  $7.4 \times 10^9$  kcal per ha insolation. Thus, a 180-hl/ha (200-bu/a) crop has captured 1.2 percent of the total incident insolation it receives from planting until harvest. When the seeds were germinating and when the plants were small and intercepting little radiation, however, the capture of solar energy would have been essentially 0. Thus, the figure of 1.2-percent capture is an average over the lifetime of this seeded annual crop. Energy capture would be greater if a ground cover of leaves could be attained more quickly. Such could be the case if species could be used that would regrow from root systems after harvest. Some highly productive species such as sugarcane and sorghum do produce successive crops from root systems and, in tropical or subtropical climates where year-round growth is possible, they appear to be very promising species to use for energy capture.

The daily growth rate of a 180-hl/ha (200-bu/a) Iowa maize crop averages  $14 \text{ g/m}^2$  per day for the season. Under favorable conditions, growth rates of 15-25 g dry matter per  $\text{m}^2$  per day have been observed for a number of crops,<sup>1,7,8,9</sup> and under ideal conditions sorghum, maize, sugarcane, and bullrush millet have produced 50 g dry matter per  $\text{m}^2$  per day for a significant part of their growing season. This latter production rate represents a capture of about 3 percent of the incident solar radiation.

It is not realistic to expect to maintain a 3-percent capture rate over long periods of time, although fertile sites under ideal conditions may be able to approach that figure on a sustained basis. For the majority of situations,

TABLE 2 Aboveground, Dry Biomass Yields and Energy Equivalents of Selected Plant Species or Complexes (Adapted from Alich and Hinman, 1974)<sup>1</sup>

Species	Location	(metric tons/ hectare-year)	(10 <sup>7</sup> Btu/ acre-year*)	(10 <sup>7</sup> kcal/ hectare-year*)
<b>Annuals</b>				
Sunflower x Jerusalem artichoke	Russia	13.5	30.0	12.6
Sunflower hybrids (seeds only)	California	1.5	3.4	1.4
Exotic forage sorghum	Puerto Rico	30.6	68.7	29
Forage sorghum (irrigated)	New Mexico	10	22	9
Forage sorghum (irrigated)	Kansas	12	27	11
Sweet sorghum	Mississippi	9	20	8
Exotic corn (137-day season)	North Carolina	7.5	17	7
Silage corn	Georgia	7	16	7
Hybrid corn	Mississippi	6	13	6
Kenaf	Florida	20	45	19
Kenaf	Georgia	8	18	7
<b>Perennials</b>				
Water hyacinth	Florida	16	36	15
Sugarcane	Mississippi	20	45	19
Sugarcane (state average)	Florida	17.5	39.3	16.3
Sugarcane (best case)	Texas (south)	50	112	47
Sugarcane (10-year average)	Hawaii	26	58	24
Sugarcane (5-year average)	Louisiana	12.5	28.1	11.7
Sugarcane (5-year average)	Puerto Rico	15.3	34.3	14.3
Sugarcane (6-year average)	Philippines	12.1	27.2	11.3
Sugarcane (experimental)	California	32	72	30
Sugarcane (experimental)	California	30.5	68.5	28.5
Sudangrass	California	16	36	15
Alfalfa (surface irrigated)	New Mexico	6.5	15	6.1
Alfalfa	New Mexico	8	18	7
Bamboo	South East Asia	5	11	5
Bamboo (4-year stand)	Alabama	7	16	7
<i>Abies saccharinensis</i> (dominant species) & other species	Japan	6	13	6
<i>Cinnamomum camphora</i> (dominant species) & other species	Japan	6.8	15	6.3
<i>Fagus sylvatica</i>	Switzerland	4.3	9.7	4.0

<i>Larix decidua</i>	Switzerland	2.2	4.9	3	2.1
<i>Picea abies</i> (dominant species) & other species	Japan	5.5	12	8	5.1
<i>Picea omorika</i> (dominant species) & other species	Japan	6.4	14	10	6.0
<i>Picea densiflora</i> (dominant species) & other species	Japan	6.1	14	9	5.7
<i>Castanopsis japonica</i> (dominant species) & other species	Japan	8.3	19	12	7.7
<i>Betula maximowicziana</i> (dominant species) & other species	Japan	3	7	4	3
<i>Populus davidiana</i> (dominant species) & other species	Japan	5.5	12	8	5.1
Hybrid poplar (short-rotation)	Pennsylvania	4	9	6	4
Seedling crop (1 year old)	Pennsylvania	8	18	12	7
Stubble crop (1 year old)	Pennsylvania	8	18	12	7
Stubble crop (2 years old)	Pennsylvania	8.7	20	13	8.1
Stubble crop (3 years old)					
American sycamore (short-rotation)					
Seedlings (2 years old)	Georgia	2.2	4.9	3	2.1
Seedlings (2 years old)	Georgia	4.1	9.2	6	3.8
Coppice crop (2 years old)	Georgia	3.7	8.3	6	3.5
Black cottonwood (2 years old)	Washington	4.5	10	7	4.2
Red alder (1-14 years old)	Washington	10	22	15	9.3
Eastern cottonwood (8 years old)		3	7	4	3
<i>Eucalyptus</i> sp.	California	13.4	30.1	20	12.5
<i>Eucalyptus</i> sp.	California	20.1	45.1	30	18.8
<i>Eucalyptus</i> sp.	Spain	8.9	20	13	8.3
<i>Eucalyptus</i> sp.	India	17.4	39.1	26	16.2
<i>Eucalyptus</i> sp.	Ethiopia	21.4	48.1	32	16.9
<i>Eucalyptus</i> sp.	Kenya	8.7	20	13	8.1
<i>Eucalyptus</i> sp.	South Africa	12.5	28.1	19	11.7
<i>Eucalyptus</i> sp.	Portugal	17.9	40.2	27	16.7
Miscellaneous					
Algae (fresh-water pond culture)	California	39	88	58	36
Tropical rainforest complex (average)		18.3	41.2	27	17.1
Subtropical deciduous forest complex (average)		10.9	24.5	16	10.2
Puckerbrush complexes (average)	North Carolina	2.2	4.9	3	2.1
Puckerbrush complexes (average)	Maine	4.4	9.9	7	4.1
World's oceans (primary productivity)		6	13	9	6

\* Assuming 7500 Btu/lb.



however, it is probable that managed, productive sites could maintain production rates equivalent to the capture of 1 percent of the incident solar radiation during the crop-growing season. Thus, 1-percent capture of solar energy incident during a growing season could be used to estimate the potential energy supply obtainable by a plant system used as a solar collector. Obviously, in temperate climates this production would occur only during the warm months, but it could be continuous in fertile tropical and subtropical areas.

## SOURCES OF PLANT MATERIAL

Plants that may be useful as energy sources may be found in one of three cultural schemes. First, the least disruptive source would be to utilize crop residues from land being used to grow food.\* Only a part of the above-ground portions of plants is utilized as food. (As stated earlier, for many cereal crops only half of the above-ground dry weight is in the grain.) The energy in the crop residue is generally wasted. Even for plants that are fed to livestock, most of the energy is found in the animal wastes. Thus, crop residues and animal wastes are potential sources of energy for man.

The second source of plant material that could be utilized in an energy-recovery scheme is the native vegetation on non-farm lands. Most of this land will be untilled, but for good reason; it may have low productivity or be too rough or too wet to farm, or the yield per unit area may be low. Therefore, there are likely to be serious problems in gathering much plant material. Nevertheless, much uncultivated land could be a source of an occasional harvest of plants to be used for energy generation.

The third possibility could be the growing of special crops intended for use as energy sources—the so-called energy farm—which would allow the utilization of rapidly growing species without regard to the stringent quality requirements that often limit yields in food or fiber crops. The use of land for energy crops would compete, however, with the need for land on which to grow food. This may be a serious limitation to the establishment of energy farms, and decisions on how to use land must be made by the community involved. Here, we will consider factors that affect the productivity of plants, wherever they are grown.

\*While not likely to be found in rural areas in developing countries, feed lots would be a source of residues that would belong in this category.

## ENERGY YIELD

There are many factors that affect the energy yield of plant materials. These include climate, morphology (ground cover), insolation, availability of nutrients, soil conditions, and the efficiency of the photosynthetic reaction.

### Climate

The climate of a region will exert a major controlling influence on the possibility of utilizing plants as a source of energy. In many developing countries the meager rainfall seriously inhibits plant growth. Dry countries have a limited capacity to produce plants that could be used as energy sources. Furthermore, the crops that traditionally supply the food in dry climates have little residue, and the potential for a significant source of energy from plants is nil.

Temperate-zone climates, with their seasonal variation, do not impose serious limitations on production to the point that it is unreasonable to think of plants as energy sources; rather the constraint in temperate climates is simply that production is seasonal. This seasonal constraint is compensated for in some cases, however, by the fact that high-latitude areas have long days during their summers, and the daily plant production per unit land area can be great.

In the tropics, the potential exists for a constant rate of production the year round; therefore, energy-recovery schemes could operate continuously, utilizing plant material in an identical form at all times. Even so, local rainfall patterns are likely to place constraints on the choice of plant species that could be utilized as energy sources at various times of year. Consequently, there is need to match the plant species to the climatic constraints of specific localities in order to provide a continuous supply of plant material for utilization as an energy source.

### Ground Cover and Morphology

Apart from the obvious considerations of climate and soil, a primary condition that must be met before sizable productivity can be realized is that a large percentage of the available insolation must be absorbed by green plant tissue. This involves a number of considerations. First, harvests that leave only bare soil must be followed by rapid revegetation. Generally, plants growing from seed will be slow to provide an adequate ground cover compared to those that regrow from an established root system. Perennial species, or those that may regrow after harvest for several harvests, appear to have definite advantages over species that must be seeded. Thus, to maximize

production, a species must be selected carefully. Several species that have a regrowth potential—and also possess the highly productive C<sub>4</sub> photosynthetic system (see below)—are adapted to the climate of the humid tropics.

The shape of the leaves and their orientation with respect to the sun are also important in determining the potential productivity of a species. Not only are there diverse genotypes from which to choose, but there is also the possibility of breeding specific morphological types to take best advantage of solar radiation. Thus, as far as plant morphology is concerned, there are both short-term and long-term possibilities.

### Insolation

Plant productivity on a daily basis is highly correlated with the total daily insolation.<sup>10</sup> The long days in temperate climates or the cloudless days in semiarid tropics present unique possibilities in terms of daily production per unit land area. In estimating the local productivity potential, local insolation information would be essential.

### Nutrient Elements

Plants as biological entities require large amounts of potassium, phosphorus, and especially nitrogen. Systems that recycle these elements as much as possible, by returning to the soil the sludge from anaerobic digestion or the ash residues from combustion schemes, would be highly desirable for minimizing the need for additional fertilizer. Where recycling is impractical, it is essential that a developing country, in order to maintain high plant productivity, have an economic system that will permit the manufacture or importation of fertilizer containing these elements. The problem will be exacerbated in areas of high rainfall where leaching by drainage water often depletes the soils of these elements.

A high rate of plant productivity is possible only if the soil has good tilth and water-holding capacity and is free of toxic substances. Generally, any soils meeting these requirements will already have been discovered and will be in use for agricultural crops. However, some areas having desirable soils may not be utilized in agriculture because they are virtually inaccessible or difficult to manage (they may be too steep or too wet, for example). These areas will have little value as energy-crop sites for the same reasons they are not being utilized by agriculture. It is likely, therefore, that energy farms will compete with food production. The need for food may preclude their utilization as sites for energy crops, and the utilization of crop or animal wastes may be the only practical way that agricultural land can provide alternative energy sources.

## Photosynthetic Efficiency

In recent years, it has been discovered that plants utilize three different biochemical systems to convert sunlight to chemical energy.<sup>11</sup> All higher plant species utilize a biochemical system for the capture of light by chlorophyll and the transfer of this energy to stable chemical compounds. In some species, however, CO<sub>2</sub> is reduced to form a three-carbon compound and the biochemical system in which this is done is now referred to as the C<sub>3</sub> system for photosynthesis.

Other species that are especially adapted to high temperatures fix CO<sub>2</sub> in the light to form a four-carbon compound and are referred to as C<sub>4</sub> plants. Plant species that have the C<sub>4</sub> system are capable of high rates of CO<sub>2</sub> fixation and are generally more tolerant of high temperatures than are C<sub>3</sub> plants. They do poorly at cool temperatures, however.

Many species native to deserts have evolved a third system for fixing CO<sub>2</sub> at night, known as Crassulacean Acid Metabolism (CAM) from the fact that the system was discovered and studied in the *Crassulaceae*. The advantage of this system is that CAM plants can keep their stomata closed during periods of high temperatures and insolation and thereby drastically reduce their water loss. Therefore, they are particularly well adapted to arid climates. The system requires a large acid-storage capacity and all CAM plants have large, fleshy, photosynthetic organs. Unfortunately, most CAM species grow very slowly and their use in energy-recovery schemes would be confined to occasional harvests. In Table 3 are listed examples of C<sub>3</sub>, C<sub>4</sub>, and CAM species. In Table 4 we have listed some general environmental conditions and the plant type that is likely to display the greatest productivity under given conditions. An understanding of a species' photosynthetic system can be helpful in evaluating whether it should be used in a particular cropping situation. In some instances, productive energy schemes may well entail the importation of desirable non-native species suited to particular environmental conditions. Only a few of the world's plant species have been characterized as to their photosynthetic systems, however, and more work in characterization is needed.

## MULTIPLE CROPPING AND INTERCROPPING

Because species differ in their reaction to light, temperature, and water stress, the highest yearly production in many climates will be obtained from a combination of species assembled to conform to seasonal weather. However, multiple crops present the problem of minimizing the inevitable periods of low productivity between the harvest of one crop and the establishment of an

adequate leaf area on a succeeding crop. The most rapid establishment of a new ground cover after harvest would appear to be one of the criteria that should help define the optimum energy-crop sequence for a particular area.

Even in temperate zones, where often only a single crop is grown per year, it may be feasible to fit an energy crop into time slots not now being utilized. In Minnesota, for example, it is possible to plant winter rye late in the fall and raise it as an early spring crop, suitable as an energy feed stock, on farmland that will be seeded to maize in May. The rye germinates in the fall and develops a leaf cover that carries over into spring. The winter rye grows rapidly in cool spring weather and a harvest of 3 tons per a (7 metric tons per ha) or more of dry matter can be taken off the land before it is seeded to maize. The rye is of little value for forage and produces no grain, but it does contain energy that, presumably, could be recovered. Thus, an energy crop offers the potential of utilizing a part of the season now wasted for the 6 million acres on which maize is grown in Minnesota each year. Another example for Minnesota agriculture would be the possibility of utilizing land for an energy crop on which oats, barley, and wheat are grown after these crops are harvested in late July. Millions of acres lie idle in Minnesota during August and September after small grains are harvested.

These examples for an area in which there is strong tradition that a short

TABLE 3 List of some common C<sub>3</sub>, C<sub>4</sub>, and CAM species.

Typical C <sub>3</sub> plants	Typical C <sub>4</sub> plants	Typical CAM plants
<i>Avena sativa</i> L. (oats)	<i>Sorghum vulgare</i> pers. (sorghum)	<i>Agave americana</i> L. (century plant)
<i>Oryza sativa</i> L. (rice)	<i>Panicum miliaceum</i> L. (proso millet)	<i>Ananas comosus</i> Merr. (pineapple)
<i>Hordeum vulgare</i> L. (barley)	<i>Saccharum officinarum</i> L. (sugarcane)	<i>Aloe</i> sp.
<i>Triticum aestivum</i> L. (wheat)	<i>Zea Mays</i> (maize)	<i>Cactaceae</i> sp.
<i>Gossypium hirsutum</i> L. (cotton)	<i>Amaranthus retroflexus</i> L. (redroot pigweed)	
<i>Medicago sativa</i> L. (alfalfa)	<i>Cynodon dactylon</i> (L.) pers. (bermudagrass)	
<i>Glycine max</i> (L.) merr. (soybeans)	<i>Digitaria sanguinalis</i> (L.) (crabgrass)	
<i>Arachis hypogaeae</i> L. (peanuts)		
<i>Helianthus annuus</i> L. (sunflower)		
<i>Dactylis glomerata</i> L. (orchardgrass)		

TABLE 4 General Environmental Features That Favor Growth of Certain Plant Types.

General Environmental Conditions	Favored plant type
High light intensity and high day and night temperatures	C <sub>4</sub>
Low (25°C) day temperatures	C <sub>3</sub>
High to medium light intensity low night temperature (20°C)	CAM
High light intensity and temperature, low fertility	C <sub>4</sub>
Low and/or sporadic rainfall	CAM
Low annual rainfall, but seasonal high light, high temperature	C <sub>4</sub>

growing season permits only a single crop illustrate the adaptability of "energy" crops (if energy recovery is the principal criterion and the quality or form of the product is unimportant). It is highly probable that similar seasonal niches will be found and could be utilized in most agricultural systems.

In addition, since individual crop species often make unique demands on space and the environment, two carefully selected productive species grown simultaneously not only will not interfere with each other, but can give greater yields from a plot they share than either species would if grown in isolation.<sup>1,2</sup> This is especially true in less intensively managed situations.<sup>1,3,14,15</sup> Relatively little experimental work has been done on intercropping, but it is a practice that should be evaluated in greater depth as part of the attempt to utilize plants to capture solar energy.

## TECHNOLOGY OF PLANT PRODUCTION

The production of the base biomass for the capture of solar energy involves many of the same plant-production techniques and many of the same problems that are encountered in present-day agriculture.

### Cost

The cost of producing biomass for energy capture will approximate the costs of crop production. To this must be added the cost of delivery of the plant material to the energy generator sites and the handling of the material during

conversion. These costs will depend to some extent on the conversion scheme selected to recover the energy from the plant material.

High energy yields per acre may well depend on the availability of an ample supply of fertilizer. This will always represent a direct cost for energy production. Some saving can be made by recycling residues from the energy recovery facilities. Nevertheless, distribution problems and fluctuations in fertilizer production (witness the recent worldwide shortage) may present serious problems of supply and foreign exchange that could limit energy farming in some countries. Even so, the available agricultural residues alone present an attractive source of potential energy in most humid climates.

Another major "cost" that must be considered is that energy crops or energy farms may compete directly with food production for both land and fertilizer. The need for food may limit the use of choice land for energy farms. Perhaps crop residues and occasional harvests from untilled land may be the only practical sources of plant material for energy feed stocks. These materials will often be available to communities without direct cost other than that of collection and handling.

### Reliability

The knowledge and experience for growing plants is available in all countries. On-site advisors may be able to increase the efficiency of the production process, but the reliability has been established, over many centuries, for nearly all local environments. In general, the reliability will depend more on water supply than on any other factor.

### Local Implementation

The work involved in growing, harvesting, and collecting plant material and even conducting necessary short-term research can be done locally with local technology (except, perhaps, for providing chemical fertilizers in situations where they are needed). The choice of management practices and of species to be used in energy-capture systems will probably require, at the start, the availability of trained consultants, not to mention the personnel needs that will ultimately arise in connection with the energy-conversion factory.

## RESEARCH AND DEVELOPMENT

An engineering plan for recovering energy from plant material has not been specified. Once that is done and the acceptable form of the plant material has been specified, the general limits on production schemes can be established

and local areas can be classified as to their acceptability for use in producing energy. Factors such as distance from the recovery plant, suitability for different cropping schemes, and the decision on the need to use land to grow food or to collect solar energy must be made. Trained personnel will likely be needed to advise the local inhabitants.

On-site research will be required to determine the species to be used and how they are to be managed. Non-native species may be required to maintain the highest productivity. Agronomic advisors will be necessary to suggest efficient plants for capturing energy. Local people could be trained as technical assistants. Important aspects of this research will include the efficient use of fertilizer and an analysis of the energy consumed in growing, harvesting, drying, and handling as against the energy produced.

## POTENTIAL FROM UNTILLED LAND

Many communities have land, not now used for farming, that could be used for energy crops. Scrub woodland, swampy areas, and land too steep or too infertile for agricultural use may support plants that could be used as fuel for energy-recovery schemes. Some of these sites, such as swamp land, may be highly productive. Others may support an occasional harvest of an energy crop. Every community would need to conduct a local survey of such areas to evaluate the potential of local energy sources. Trained personnel should be involved in those local surveys. Care must be exercised in utilizing such areas to prevent possible long-lasting ecological damage. Some local experimentation may be required to determine the effects of harvesting plants from wasteland.

## TIME SCALE OF RESULTS

Four types of research are involved in establishing energy-crop schemes. First, the principles of maintaining highly productive systems should be outlined in a detailed training manual. The information is available in current literature and the task could be completed within 6 months after being commissioned. The principles that have been touched on in this report should be included, as well as directions for conducting field experiments, sampling populations, and evaluating results. This manual would be useful for on-site agronomic advisors (who perhaps may be familiar only with food crops, but should not exclude any species from consideration) and in training technical people to assist with the research.

The second type of research would involve inventories of local resources



including crop residues and potential harvests from untilled land. This should take no longer than about 2 weeks for each community. It will require trained agronomists who are good botanists and ecologists as well, or small, mobile, interdisciplinary teams.

The third area involves local or regional research on cropping schemes. This will take a minimum of 2 years and should be relatively complete in 5. It will involve factors such as the identification of optimum species, selection of combinations for multiple-cropping schemes, evolution of management schemes for maximum productivity and efficient use of fertilizers, and determination of energy and food crop combinations. However, it need not be completed in order to begin utilizing plant materials readily available in many communities.

The fourth type of research will address long-term agronomic questions and such questions as the ecological management of waste lands. Management of low-fertility sites for energy crops, adaptation of major technological developments, and long-term questions such as development of irrigation potential should be investigated. Results are unlikely before 10 years at the earliest.

The basic research to support these suggested applications cannot be divorced from the plans for energy recovery from plant material; therefore, it should involve both engineers and ecologically oriented agronomists. Appropriate research groups could be assembled from personnel at a few universities and institutes that have specialized in agricultural research. The research could be supported by foundations or governments as independent efforts. The problem will be to identify groups who have an interest in addressing these questions. Announced availability of support from foundations, governments, or international agencies, on a contract or grant basis, should help draw responses from interested and qualified groups.

## REFERENCES

1. Ahlich, J. A., Jr., and Hinman, Robert E. 1974. *Effective utilization of solar energy to produce clean fuel*. Report to the National Science Foundation. Menlo Park, California: Stanford Research Institute.
2. Hodgman, C. D., ed. 1945. *Handbook of chemistry and physics*. 29th ed. Cleveland, Ohio: The Chemical Rubber Publishing Co.
3. *Steam: its generation and use*. 1963. New York: Babcock and Wilcox Co.
4. Rothermel, R. C., and Philpot, C. W. 1973. Predicting changes in chaparral flammability. *Journal of Forestry* 71(10):640-643.
5. Loomis, R. S. et al. 1971. Agricultural productivity. *Annual Review of Plant Physiology* 22:431-468.
6. Szego, G. C., and Kemp, C. C. 1973. Energy forests and fuel plantations. *Chemical Technology (May)*: 275-284.

7. Loomis, R. S., and Williams, W. A. 1963. Maximum crop productivity: an estimate. *Crop Science* 3:67-72.
8. deWit, C. T. 1959. Potential photosynthesis of crop surfaces. Reprint. Wageningen, Holland: Institute of Biological and Chemical Research on Field Crops and Herbage.
9. Zelitch, I. 1971. *Photosynthesis, photorespiration and plant productivity*. New York: Academic Press.
10. Moss, D. N.; Musgrave, R. B.; and Lemon, E. R. 1961. Photosynthesis under field conditions. III. Some effects of light, carbon dioxide, temperature, and soil moisture on photosynthesis, respiration and transpiration of corn. *Crop Science* 1:83-87.
11. Hatch, M. D. 1971. Mechanism and function of the C<sub>4</sub> pathway of photosynthesis. In *Photosynthesis and photorespiration*, Hatch et al., eds., pp. 139-152. New York: Wiley-Interscience.
12. Sprague, H. B. 1936. *Bulletin. New Jersey. Agricultural Experiment Station* 609:1.
13. Andrews, D. J. 1972. Intercropping with sorghum in Nigeria. *Experimental Agriculture*, London 8:139-150.
14. Multiple cropping. 1974. In *IRRI 1974: annual report for 1973*, pp. 15-34. Los Baños, Philippines: IRRI (International Rice Research Institute).
15. Kelly, Isabel T., and Palerm, Angel. 1952. *Tajin Totonac: history, subsistence, shelter and technology*. Institute of Social Anthropology, Publication No. 13, pp. 99-149. Washington, D.C.: Smithsonian Institution.

### SUGGESTED READING:

- Begg, J. E. 1965. High photosynthetic efficiency in a low-latitude environment. *Nature* 105:1025-1026.
- , and Jarvis, P. G. 1968. Photosynthesis in Townsville lucerne (*Stylosanthes humilis*). *Agricultural Meteorology*, Amsterdam 5:91-109.
- Black, C. C.; Chen, T. M.; and Brown, R. H. 1969. Biochemical basis for plant competition. *Weed Science* 17(3):338-344.
- Bonner, J. 1962. The upper limit of crop yield. *Science* 137:11-15.
- Chandler, R. F., Jr. 1969. Plant morphology and stand geometry in relation to nitrogen. In *Physiological aspects of crop yield*, J. D. Eastin et al., eds., pp. 265-285. Madison, Wisconsin: American Society of Agronomy (ASA) and Crop Science Society of America (CSSA).
- Field crops*. 1974. Washington, D.C.: U.S. Department of Agriculture, Crop Reporting Board, Statistical Reporting Service.
- Heichel, G. H. 1973. Comparative efficiency of energy use in crop production. *Bulletin of the Connecticut Agricultural Experiment Station*, New Haven, Connecticut 739:1-26.
- Pimentel, David et al. 1973. Food production and the energy crisis. *Science* 182:443-449.
- Monteith, J. L. 1965. Light distribution and photosynthesis in field crops. *Annals of Botany New Series*, London 29:(113)17-38.
- Moss, D. N. 1965. Capture of radiant energy by plants. *Meteorological Monographs* 6:90-108.
- . 1967. Solar energy in photosynthesis. *Solar Energy* 11:173-179.
- Westlake, D. F. 1963. Comparison of plant productivity. *Biological Reviews of the Cambridge Philosophical Society* 38:385-425.

# *Microbiological Conversion of Plant Materials to Liquid Fuels*

The microbiological approach to the identification of alternative energy sources falls into two categories, gaseous- and liquid-fuel generating systems, both of which, in general, utilize anaerobic microbial populations. The generation of methane fuel gas by means of the classical "anaerobic digestion," the best known of these anaerobic processes, is the subject of a separate, concurrent study and will not be discussed here.<sup>1</sup> The focus in this chapter is on the microbiological production of other gaseous and liquid fuels—more specifically, production by microbial action of the following fuels and fuel systems:

- ethanol;
- acetone/butanol + hydrogen;
- butanol/isopropanol + hydrogen; and
- acetone/ethanol + hydrogen.

In addition, the raw materials for the production of these fuel systems will be discussed, as will the present technology and the requirements for the translation of this technology to developing countries.

## **A TYPICAL PROCESS TECHNOLOGY**

Virtually all of the chemicals that can be considered as potential sources of energy have been produced microbiologically in commercial-scale operations

in the past. Most of these materials were produced during the critical years of the 1940s, when nations on both sides in World War II were seeking supplementary fuel sources, and to a lesser extent in the early 1950s.

From a chemical-process point of view, the methods of microbiological production of the variety of fuel systems outlined above are quite like one another. Since current industrial production relies on synthesis from petrochemical sources, however, with the exception of ethanol none of these chemicals is being commercially produced by microbiological processes at the present time. (A typical schematic flow diagram, in this case illustrating the production of a mixture of acetone, ethanol, and butanol, with minor amounts of ethanol and hydrogen, is shown in Figure 56.)

The proper selection of the raw material (substrate) is critical to the economic viability of all microbiological processes. The example in Figure 56 is based on the uses of molasses as the raw material, though we shall discuss other raw materials as well in considering the transferability of this technology to developing nations.

In the industrial process for solvent production by microbial action, the general procedure calls for the sequential development of inoculum necessary for the final production fermentor. The inoculum buildup is shown in the upper left quadrant in Figure 56; required quantities of the desired microbial cultures are produced, starting with test-tube batches and moving to successively larger culture vessels.

The final fermentors for the production of chemicals may vary in size; this example employs fermentors ranging from 60,000 to 500,000 gal (227 to 1,900 m<sup>3</sup>). As the nutrients for the production fermentors undergo processing, the medium must be sterilized to eliminate interfering or otherwise undesirable organisms. The nutrient needs of the microorganisms must also be defined.

The conversion of the raw materials (carbon, nitrogen, salts, etc.) into the microbial biomass takes place in the fermentor. The organisms act here as "bio-catalysts" capable, generally in the absence of oxygen (anaerobically), of producing the desired products during the conversion process. Sufficient stirring is required to maintain a homogeneous suspension as well as to facilitate the transport of nutrients to the microorganisms and residual and metabolic products away from the microorganisms. In addition, since in these processes the overall reaction is exothermic, the liberated heat must be removed through convective heat transfer. The growth of the microorganisms and the subsequent production of chemicals are generally performed in batch-wise fashion; typical times of operation for this segment of the process range from 40 to 60 hours.

The main products from the example cited are acetone, ethanol, and butanol. These materials are produced extracellularly and are recovered from

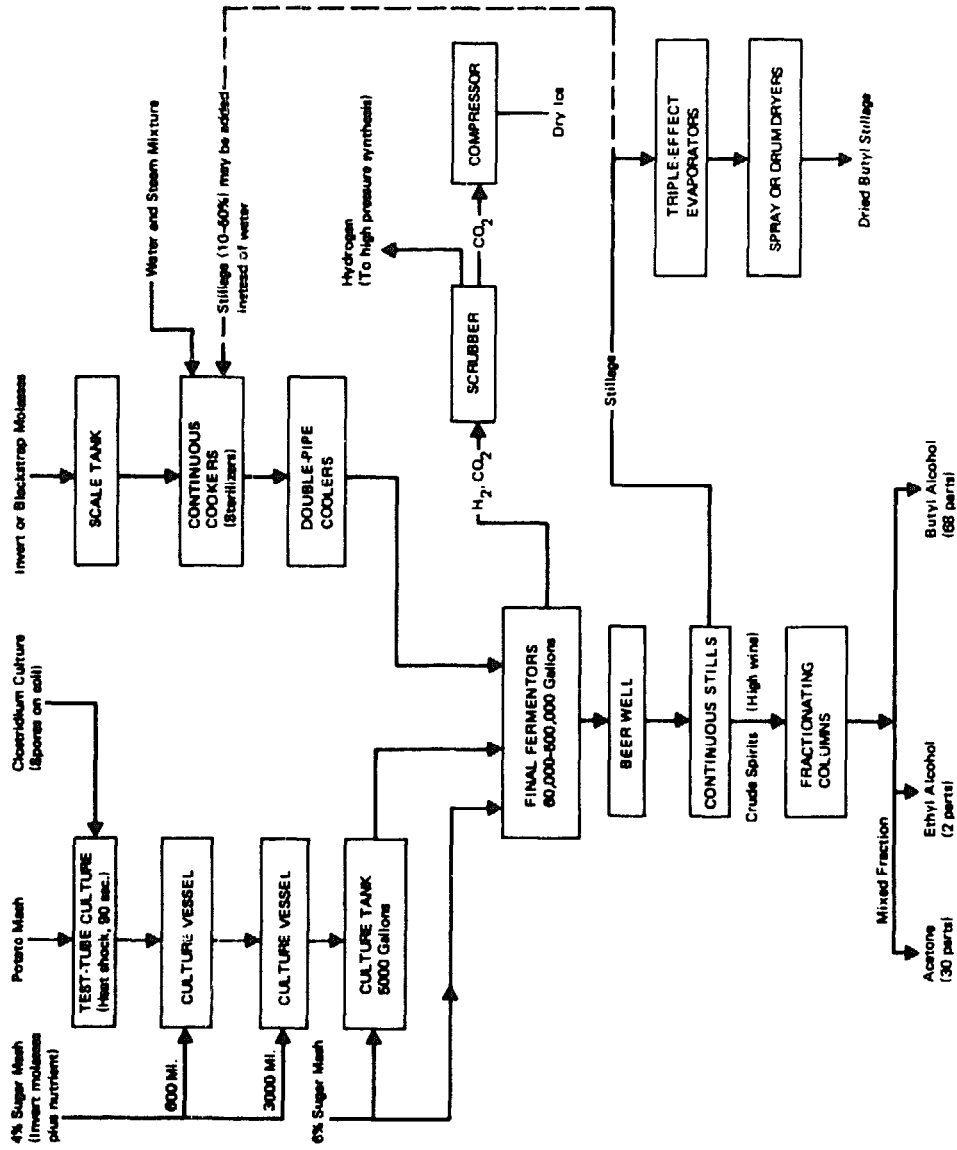

FIGURE 56 Flow diagram of typical modern acetone-butanol fermentation using sugar products. [Source: Beesch, Ref. 2. Reprinted with permission from *Industrial and Engineering Chemistry*. Copy-right by the American Chemical Society.]

the reaction mixture by conventional distillation. In addition, there are several by-products that have potential value. During fermentation, for instance, hydrogen and carbon dioxide are formed as gaseous by-products. The carbon dioxide can be removed by scrubbing and recovered as dry ice. The hydrogen gas can also be recovered as a raw material for other syntheses or, alternatively, as an energy source. The stillage (or bottoms) from the distillation is composed of the microbial biomass as well as nonvolatile products formed during fermentation. Portions of these materials can be recycled directly to the fermentor as nutrients for microbial growth, or, dewatered by evaporation and then dried, these materials can become an excellent animal-feed supplement or fertilizer.

The production of chemicals that might be considered as energy sources must be evaluated from the point of view of material and energy balances. In Table 1 are shown the results of this analysis with energy balance estimated for the purpose of this report, based on materials balance information obtained from Beesch, 1952<sup>2</sup> (Figure 56). The material balance was based on raw-material input of 100 kg of molasses containing 57 kg of fermentable sugars, 3.1 kg of protein, and 6.2 kg of ash. The other material added (15.2 kg) was presumably recycled stillage. The caloric values associated with the different raw materials are calculated on the basis of average values of heats

TABLE 1 Typical Material and Energy Balances of Acetone-Butanol-Ethanol Fermentation

Starting Material—100 kg Blackstrap Molasses		
Component	Quantity (kg)	Energy (kcal. $\times 10^{-3}$ )
<i>Materials and Energy Input:</i>		
Sucrose and Invert Sugar	57.0	212
Protein	3.1	12
Ash	6.2	0
Other	15.2	56
<hr/>	<hr/>	<hr/>
Total	81.5	280
<i>Materials and Energy Output:</i>		
Butanol	11.5	100
Acetone	4.9	36
Ethanol	0.5	3
Carbon Dioxide	32.1	0
Hydrogen	0.8	24
Dry Feed (6 kg prot/6 kg ash)	28.6	106
<hr/>	<hr/>	<hr/>
Total	78.4	269

of combustion. The primary products were butanol, acetone, and ethanol. By-products included carbon dioxide, hydrogen, and animal-feed proteins.

In terms of the energy available from the combustible products (i.e., the solvents and the gaseous hydrogen), this system achieves a conversion of 77 percent of the input sugars. Although in this example the primary product was butanol, it is technically feasible to manipulate the product solvent mixture to any desired ratio, without altering significantly the conversion efficiency.

### CURRENT TECHNOLOGY (AVAILABLE WITHIN 5 YEARS)

The usefulness of microbiological production of energy in developing nations must be considered in the light of the technical and economic constraints facing those nations. These constraints are quite different from those operating in an industrialized nation, and include:

- The availability and appropriateness of raw materials for energy conversion;
- The technical challenge—village-scale concept; and
- The type of research and development required and projected outcome.

### RAW MATERIALS FOR ENERGY CONVERSION

It has been stated previously that the selection of the raw material for the production of chemicals is extremely important. In an industrialized country this selection is generally based on economics. In rural areas where a cash economy may not even exist, the raw materials needed for production must be freely available. Furthermore, the types of raw materials available frequently differ from one locality to another. The raw material requirements of the microbiological production process are somewhat less critical than those of most chemical processes, since a variety of primary raw materials can be considered.

Table 2 lists various primary raw materials that can serve as carbon and energy sources for the production of the various output chemicals. In general, the soluble carbohydrates can be used directly for fermentation. However, waste products and the cellulosic type of substrates including wood, hulls, and citrus waste, are likely to be more abundant and less important to the economy of developing nations. Unfortunately, the technology for their utilization is less advanced than for soluble and easily fermentable substrates such as molasses, sugars, and starches.

In addition to the energy or carbon source needed for the microbial process, there are other raw-materials needs. The most important of these are the inorganic nutrients such as ammonia, phosphorus, magnesium, and other minerals in trace amounts. The fact that these necessary chemicals must be purchased could constitute an economic barrier to use of the microbial process in some places.

## THE TECHNICAL CHALLENGE: VILLAGE-SCALE CONCEPT

There is also a serious question as to whether, even with suitable raw materials available, the technology exists at the village level in a developing country to make the microbiological production of energy practical; the developments in this technology have been achieved mainly in industrialized nations, where all of the necessary advanced technological capabilities are readily available. The degree of technological advancement necessary for success will be illustrated by considering the various segments of the microbial conversion process.

### Microbial Culture Maintenance and Inoculum Preparation

The microbial cultures that are potent producers of the desired chemicals must be maintained according to established procedures. In the industrialized nations, this involves the availability of trained technical personnel and proper physical facilities. However, the usual criterion of maximum product yield, on the basis of which high-technology industries operate, may not be

TABLE 2 Types of Raw Materials Potentially Useful for Microbial Conversion to Fuels in LDCs\*

Ethanol	Acetone-Butanol	Butanol-Isopropanol	Acetone-Ethanol
Molasses	Molasses	Molasses	Molasses
Sulfite Liquors	Sulfite Liquors	Sugar Cane	Potatoes
Cellulose Pulp	Corn Cobs	Raw Sugar	Corn
Pineapple Juice	Wood Sugars	Wood Sugars	Peanut Hulls
Potatoes and Potato Products	Cassava	Sulfite Liquors	Oat Hulls
Citrus Waste		Starchy Products	Corn Cobs
Sweet Potato			Wood Sugars
Manioca Meal			

\*Production of the chemicals listed has been demonstrated from all of the raw materials listed under each chemical.



essential in a village operation. One could therefore relax the stringent culture maintenance and development programs that commercial competition necessitates.

At the same time, since the general practice for the microbiological production of chemicals has been to employ batch rather than continuous operations, the preparation of inoculum for seeding subsequent fermentors becomes an integral part of the overall scheme. This would require laboratory-scale and pilot-scale inoculation fermentors as well as trained personnel for their successful operation. It is difficult to conceive that technical talents of this nature are readily available at the village level.

### Production Fermentor Operations

The heart of the process for solvent production is the fermentor, in which microbial propagation and fermentation of the raw materials take place. These involve sterilization of nutrients as well as maintenance of aseptic conditions during fermentation. The process control for such operations is minimal, but it must be reliable. On the other hand, it is probable that in most villages—certainly within village clusters—some kind of beer is routinely brewed, which surely indicates some degree of technical competence.

### Product Recovery

The other critical technical challenge for the village would involve the unit operations for product recovery that are necessary if the solvents produced are to be used as fuel. Recovery of gaseous products from fermentors has become a common and routine practice at the farm and village level in many developing countries<sup>1</sup> and, apart from considerations of safety, the low-pressure storage of a combustible fuel such as hydrogen might be useful in this situation. In a typical example, off-gas from a fermentor might contain 40 percent H<sub>2</sub> and 60 percent CO<sub>2</sub>. The utility of this type of fuel must first be determined, however.

The most critical aspects of the product recovery process lie in the distillation requirement to recover a useful solvent. To be useful as a fuel to operate machinery—or even to use as a heat source for cooking or other processes—the solvent must be recovered in a sufficiently pure form that the concentration of water will not be high enough either to interfere with combustion or to reduce the heat value (Btu/lb or kcal/kg) to an uneconomic level. To do this for the solvents involved requires distillation equipment and modes of operation easily available in an industrial complex, but not within the capabilities of even the village producers of distilled alcoholic liquors. Lastly, the recovery of stillage as a potential animal feed or fertilizer would

require dewatering technology. Here again, one would have some reservation as to the capabilities of achieving this successfully at the village level.

All of these considerations, then, from availability of raw materials to the technological prerequisites, appear to dictate the following conclusion: the present state of technology in the microbiological production of fuels from agricultural products does not make this a practical approach.

## RESEARCH AND DEVELOPMENT

The probability of microbiological production of fuels at a village level could be enhanced provided research and development efforts are initiated. Research needs include:

- Examination of the type and nature of available raw materials, e.g., starches, soluble carbohydrates, waste products (cellulosics) in candidate locales (see chapter on photosynthesis);
- Exploration of the potential of microorganisms known to perform the desired conversions, with raw materials already proven useful;
- Isolation and screening programs for new microorganisms capable of performing the desired conversion using either known or new and unproven raw materials, e.g., indigenous carbohydrate wastes and cellulosics;
- Development of fermentation systems and product recovery schemes in which minimum technical skills will not prevent high probability of success, e.g., non-aseptic fermentations, minimum process-control requirements, reliable operations;
- Development of equipment for fermentation and recovery operations that is less capital-intensive (e.g., economical and reliable dewatering techniques, non-metallic fermentors made with cheap materials and construction techniques\*); and
- Delineation of the exact requirements and specifications of the microbial products sought from locale to locale or application to application.

These suggestions are all directed to adapting a known technology to the constraints characteristic of rural areas in a developing country. The potential

\*For example, the report, *Ferrocement: Application in Developing Countries* (National Academy of Sciences, Washington, D.C., February 1973), recommended that consideration be given to "the use of ferrocement to replace steel—particularly stainless steel—in manufacturing at least some units of basic food-processing equipment." Among the possibilities suggested were fermentation vats, storage vats or tanks, and driers of various sorts.

already exists for much of this research and development to be performed by institutions in developing countries. For example, for countries located in Central America, the Institute for Central America Industries and Technology (ICAITI) located in Guatemala City has the equipment, the scientific personnel, and the perspective for the task. When research is conducted using equipment and physical facilities incompatible with situations in developing countries, the results are often totally irrelevant or unacceptable for other, less-tangible reasons; therefore it is important that research institutes in industrialized nations play a limited—perhaps only a consulting—role. Other research institutes similar to ICAITI in other parts of the world (such as the Central Food Technology Research Institute in Mysore, India) should also be considered.

The funding of these activities could be part of the programs of the aid-donor nations, international agencies, or perhaps private foundations. Although it would be useful to make one agency, e.g., AID, responsible for technical coordination and monitoring of progress, it is strongly recommended that scientific personnel from universities and industry play an active role.

## REFERENCES

1. National Academy of Sciences. *Methane generation from human, animal, and agricultural wastes*. Report of an *ad hoc* panel of the Advisory Committee on Technology Innovation, Board on Science and Technology for International Development, Commission on International Relations. (In preparation. See p. 306.)
2. Beesch, S. C. 1952. Acetone-butanol fermentation of sugars. *Industrial and Engineering Chemistry* 44(7):1677-1682.

## SUGGESTED READING

### Ethanol Production

- Agar, H. D., and McCarthy, J. L. 1951. Fermentation to alcohol of concentrated calcium, magnesium, and ammonium sulfite waste liquors. *TAPPI* (Technical Association of the Pulp and Paper Industry) 34(3):126-131.
- Barron, H. 1944. *Distillation of alcohol*. Louisville, Kentucky: Joseph E. Seagram and Sons, Inc., Division of Education.
- Bilford, H. B.; Scalf, R. E.; Stark, W. H.; and Kolachov, P. J. 1942. Alcoholic fermentation of molasses, rapid continuous fermentation process. *Industrial and Engineering Chemistry* 34:1406-1410.
- Boruff, C. S., and Van Lanen, J. M. 1947. The fermentation industry during World War II. *Industrial and Engineering Chemistry* 39:934-937.

- Borzani, W., and Falcone, M. 1953. Control of starter preparation in fermentation of molasses. *Journal of Agricultural and Food Chemistry* 1:1070-1071.
- Dunn, P. M. 1945. Industrial alcohol from wood waste. *Chemical Products and the Chemical News* 9(1/2):15-17.
- Jacobs, P. B. 1947. *Alcohol from agricultural commodities*. U.S. Department of Agriculture, Report AIC-95. Washington, D.C.: U.S. Department of Agriculture.
- Joseph, H. G. 1947. Industrial alcohol production from sulfite waste liquor by the Ontario Paper Co., Ltd. *Sewage and Industrial Wastes* 19(1):60-69.
- Leonard, R. H., and Hajny, G. J. 1945. Fermentation of wood sugars to ethyl alcohol. *Industrial and Engineering Chemistry* 37:390-395.
- Lichty, L. C., and Phelps, C. W. 1938. Gasoline-alcohol blends in internal-combustion engines. *Industrial and Engineering Chemistry* 20:222.
- Liebmann, A. J. 1942. Alcohol in war. *Wallerstein Laboratories Communications* 5(15):131-137.
- Miller, E. S. 1943. Industrial alcohol from wheat. *American Miller* 71:39-42.
- Thorne, C. B.; Emerson, R. L.; Olson, W. J.; and Peterson, W. H. 1945. Evaluation of malts for production of alcohol from wheat. *Industrial and Engineering Chemistry* 37:1142-1144.

### Acetone-Butanol Production

- Arzberger, C. F.; Peterson, W. H.; and Fred, E. B. 1920. Certain factors that influence acetone production by *Bacillus acetoethylicum*. *Journal of Biological Chemistry* 44:465-479.
- Banzon, J. R. 1941. Fermentative utilization of cassava. *Iowa State College Journal of Science* 16:15-18.
- Beesch, S. C. 1952. Acetone-butanol fermentation of sugars. *Industrial and Engineering Chemistry* 44:1677-1682.
- . 1953. Acetone-butanol fermentation of starches. *Applied Microbiology* 1(2):85-95.
- Bryner, L. C.; Christensen, L. M.; and Fulmer, E. I. 1936. Hydrolysis of oat hulls with hydrochloric acid. *Industrial and Engineering Chemistry* 28:206-208.
- Fred, E. B.; Peterson, W. H.; and Anderson, J. A. 1923. Production of acetone, alcohol and acids from oat and peanut hulls. *Industrial and Engineering Chemistry* 15:126.
- Gabriel, C. L. 1928. Butanol fermentation process. *Industrial and Engineering Chemistry* 20:1063-1067.
- , and Crawford, F. M. 1930. Development of the butyl-acetone fermentation industry. *Industrial and Engineering Chemistry* 22:1163-1165.
- Gill, A. 1919. The production of normal butyl alcohol and acetone by fermentation of horse chestnuts. *Society of Chemical Industry Journal*, London 38:411-412T.
- Leonard, R. H.; Peterson, W. H.; and Ritter, G. J. 1947. Butanol-acetone fermentation of wood sugar. *Industrial and Engineering Chemistry* 39:1443-1445.
- Morikawa, K., and Prescott, S. C. 1928. A new fermentation yielding butyl and isopropyl alcohols. *Journal of Bacteriology* 13:58.
- Nathan, F. 1919. The manufacture of acetone. *Society of Chemical Industry Journal*, London 38:271-273T.
- Peterson, W. H., and Fred, E. B. 1932. Butyl-acetone fermentation of corn meal. *Industrial and Engineering Chemistry* 24:237.
- Prescott, S. C., and Morikawa, K. Production of butyl and isopropyl alcohols. U.S. Patent 1,933,683 (Cl. 195-20), 7 November 1933, Appl. 26 January 1927; 3 pp.

- Robinson, G. C. 1922. A study of the acetone and butyl alcohol fermentation of various carbohydrates. *Journal of Biological Chemistry* 53:125-154.
- Waksman, S., and Kirsh, D. 1933. Butyric acid and butyl alcohol fermentation of hemicellulose- and starch-rich materials. *Industrial and Engineering Chemistry* 25:1036-1041.
- Wendland, R. T.; Fulmer, E. I.; and Underkofler, L. A. 1941. Butyl-acetonic fermentation of Jerusalem artichokes. *Industrial and Engineering Chemistry* 33:1078-1081.
- Wiley, A. J.; Johnson, M. J.; McCoy, E.; and Peterson, W. H. 1941. Acetone-butyl alcohol fermentation of waste sulfite liquor. *Industrial and Engineering Chemistry* 35:606-610.

### Butanol—Isopropanol Production

- Baba, T. 1952. On the industrial production of butanol, isopropanol, and acetone by a fermentation process. *Bulletin. Faculty of Engineering, Hiroshima University* 1:101-110.
- Osburn, Oiven Lloyd. 1935. The production of butyl and isopropyl alcohols by fermentative processes. *Iowa State College Journal of Science* 10:97-98.
- \_\_\_\_\_; Brown, R. W.; and Werkman, C. H. 1937. The butyl alcohol-isopropyl alcohol fermentation. *Journal of Biological Chemistry* 121:685-695.
- \_\_\_\_\_; \_\_\_\_\_; and, \_\_\_\_\_. 1938. Dissimilation of intermediary compounds in the butyl-isopropyl alcohol fermentation. *Iowa State College Journal of Science* 12:275-284.
- \_\_\_\_\_, and Werkman, C. H. 1935. Utilization of agricultural wastes. II. Influence of nitrogenous substrate on production of butyl and isopropyl alcohols by *Clostridium butylicum*. *Industrial and Engineering Chemistry* 27:416-419.

*PART III*

*OTHER  
TECHNOLOGIES*

---

# *Geothermal Energy*

Geothermal resources have been known since ancient times when they were widely utilized to support establishments for therapeutic hot bathing. For hundreds of years this was their only use, particularly in Europe, where cities grew up as spas based upon the therapeutic use of hot springs. At the beginning of the 20th century, a new application of geothermal energy was found at Larderello, in Italy, where geothermal steam was used for the generation of electricity.

Exploitable geothermal resources are most likely to exist in those parts of the world that have experienced geologically recent volcanism (in the past million years), though they may exist in other areas also. Known geothermal areas include the circum-Pacific "circle of fire," which is a region of active earthquakes and volcanoes. This comprises the western part of South America and the Andes, most of Central America, large parts of the western United States and the Rocky Mountains, the Aleutian Islands, the Kamchatka peninsula, Japan, Taiwan, Indonesia, the Phillipines, New Zealand, and many South Pacific Islands. A large part of East Africa, associated with the Rift Valley System, also has geothermal activity in Ethiopia, Kenya, Uganda, Tanzania, and Zaire. In Asia and Europe hot springs extend from Nepal, India, Afghanistan, Iran, and Turkey to Greece and Italy.

Many other countries and geological provinces possess geothermal resources, although they are devoid of hot springs or other evidence of hot water at depth. For example, it has been estimated that as much as one-third of the Soviet Union is underlain by exploitable geothermal energy.

Geothermal energy is the natural heat contained within the earth.

Temperatures in the earth increase with depth. At a depth of 20 km the temperature is close to 750°C. However, most of this heat is too deeply buried to be exploited. The depth from which heat may be extracted economically is unlikely to exceed 10 km; even in this outer 10 km most natural geothermal heat cannot easily be extracted and put to practical use. Geothermal energy does, however, have economic significance where the hot rock at depth is fractured or has pore spaces that permit water or steam to circulate and carry heat from the rock to the surface if a natural channel exists or if a geothermal well is drilled. It has been proposed that in order to exploit the heat contained in rocks that are not penetrated by fractures or pore spaces, fractures could be induced artificially, using explosives or hydraulic fracturing techniques. These proposals are now under active practical investigation in the United States, but it seems unlikely that this technology will be available for practical use in the near future.

## PAST AND CURRENT USES

The main uses of geothermal energy have been to generate electricity and to heat buildings and greenhouses. Geothermal energy is used for space heating and in greenhouses in Iceland, Hungary, the Soviet Union, and the United States. It is used for air-conditioning buildings, product-processing in a paper-pulp plant in New Zealand, drying diatomite in Iceland, recovering salt from sea water in Japan, and for heating soil for agriculture in Israel. Some chemical products may be associated with geothermal energy utilization, such as the production of dry ice from geothermal carbon dioxide in the United States, the production of borax associated with geothermal steam in Italy, and the production of calcium chloride from geothermal brines in the Imperial Valley, California.

## CURRENT TECHNOLOGY (AVAILABLE WITHIN 5 YEARS)

Applications of current technology to exploit geothermal sources are relatively simple or complex, depending on the temperature of the source—hot water sources that are below the normal boiling point, or sources of steam or superheated water.

### Simple Applications

Applications involving water at a temperature below the boiling point—in general, those using water for heating or bathing—do not involve a complex



technology. All that is required is an ability to dig shallow wells, to lift water through small vertical distances and to construct channels or pipes to conduct water to the point of use. When applied on a small scale where hot springs occur naturally, this type of thermal energy use can be had at virtually zero cost. There are few locations in the world, however, where opportunities for this type of development occur that have not already been exploited.

The development of geothermal resources in other circumstances (where high-temperature water and steam are required or where the resource lies at a considerable depth) presents special problems in technology and finance.

### Complex Applications

Geothermal resources have attracted considerable interest among energy users in the recent past as a possible substitute for oil in the generation of electricity and heat.

In many places in the world, there is high probability of finding hot water for space heating and process heating. High-temperature geothermal water and steam have been exploited in countries such as Iceland, Italy, Indonesia, Japan, the Philippines, South America, the western United States, and Central America, where volcanic activity has occurred within the geologically recent past. In general, high-temperature geothermal water and steam are suitable for electricity production at delivered costs that are significantly lower than those for electricity produced from fuel oil at current prices. Plant requirements are similar to those of standard thermal power stations, with the difference being that neither boiler nor fuel is required to produce the steam. The capital cost of a geothermal electricity-generating plant, therefore, is lower than that of a fossil-fueled thermal plant, and there are, of course, no fuel costs. There is, however, an element of financial risk and expense in exploring and drilling for water and steam, since it cannot be guaranteed that they will be found in adequate quantity and quality for electricity generation. This must be considered part of the total cost of production.

Some high-temperature geothermal water contains dissolved mineral salts that, when present in high concentration, make it difficult to discard necessarily substantial quantities of geothermal water without causing unacceptable pollution of surface or ground water. Disposal by channel to the sea has been adopted in the Ahuachapan Field in El Salvador, where alternative reinjection beneath the surface has also been tested. Apart from being an environmental problem, this is also a cost item.

Geothermal exploration makes use of advanced technology; geothermal drilling requires the use of equipment and techniques similar to those in use in the oil and gas industry, though it requires the use of drilling personnel with geothermal experience. It follows, therefore, that there is a minimum

scale of activity and investment of risk capital that is required if geothermal exploration is to be carried out with good prospects of success. Exploration that is economically and technically justified normally must be undertaken where there is a requirement for electricity production of several megawatts or several tens of megawatts. When the requirement for electricity is in the kilowatt range—as, for example, in some rural applications—geothermal sources will not be economically viable unless steam-production costs can be shared among several communities.

## EXPLORATION

Exploration and prospecting are field activities that must be carried out before drilling if the risk of unproductive drilling is to be minimized. Exploration for geothermal resources in many countries is likely to take place in at least two phases: an initial phase of reconnaissance, and a second phase of more-detailed investigations and possibly exploratory drilling.

Surveys commonly undertaken as part of the reconnaissance phase include: a) airborne infra-red scanning surveys, in situations where little information on the location of hot springs is available; b) regional studies of the hydrogeochemistry of known hot springs and associated cold-water springs; and c) studies of the regional geology, particularly of the principal tectonic features and the relation of these to known hydrothermal activity.

A variety of surveys is undertaken during the second phase of investigation. Detailed hydrogeochemical investigations of the prospect area are conducted to locate and evaluate those anomalies in mineral or gas content that may be related to the existence of hot water or steam beneath the surface. Geophysical surveys—most commonly electrical resistivity surveys—are used to determine the sites of the initial “wild-cat” or exploration wells. Exploration experience indicates that steam-producing areas are commonly associated with indications of low electrical resistivity at a depth of several hundred meters beneath the surface. Other geophysical exploration techniques, such as micro earthquake or ground-noise surveys, are still in the process of evaluation. Still others, such as seismic reflection surveys and gravity surveys, may be useful where previous experience indicates an association of the geothermal resource with a structural feature exhibiting a contrast in seismic velocity or in density.

### Cost of Exploration Using Current Technology

The cost of geothermal reconnaissance surveys ranges between several cents and several dollars per square kilometer; the actual cost depends on whether

airborne infra-red, hydrochemical, and reconnaissance geological surveys are all carried out and whether the survey covers all potentially productive areas. Costs can be minimized in the case of rural projects if financial considerations require that some limit be set to the distance over which any electricity developed may be transmitted. If this distance is, say, 50 km, then the reconnaissance can be limited to an area within a 50-km radius of the communities to be served.

Detailed geophysical and geochemical surveys each may cost up to \$1,000-\$2,000 per day. Typical expenditures for detailed investigations of a prospect several tens of square kilometers in area may amount to \$100,000.

## AVAILABILITY OF TURBO-GENERATING EQUIPMENT

Steam turbines in sizes suitable for use in rural geothermal applications are readily available. Single-stage back-pressure turbines are available in power ranges up to 400 kW and small turbines with 2 or 3 stages, usable as back-pressure or as condensing machines, are available in power ranges up to 4 or 5 MW.

## Cost of Geothermal Development Using Current Technology

A geothermal plant using a condensing turbo-generator of 30-MW capacity was commissioned in El Salvador in 1975. Installed costs, estimated at \$257/kW in 1972, actually were approximately \$500/kW; however, almost one-half of this figure represents the cost of installing the plant for disposal of the geothermal brine produced.

The cost of steam in geothermal electricity-generating plants is a function of the ratio of dry wells to productive wells drilled and of the productivity of the wells. If, for example, each well costs \$300,000, if 4 dry wells are drilled for each productive well, if the productive well yields steam equivalent to 5 MW, if the life of the well is 10 years and the interest is 10 percent, then the cost of steam will be \$0.006/kWh at a load factor of 0.9. Analysis of operating-plant economics indicates that if the life of the generating plant is 25 years and a 10-percent interest rate is used, then fixed charges, including maintenance, will be \$0.004/kWh and the total generating cost (that is, steam charges plus fixed charges) will be \$0.010/kWh for geothermal-generated electricity when the plant is used for base-load operation (at a load factor of 0.9).

This kind of installation—consisting of a condensing turbo-generator of a few megawatts capacity—would seem to be economically feasible in rural applications only where a number of sizable rural communities cluster around

a geothermal field so that electricity generated at a central location near the geothermal field could be distributed to the surrounding communities by relatively short transmission lines. In rural communities the load factor would not usually be 90 percent; costs in rural applications would, therefore, be higher than \$0.010/kWh, depending on the load factor.

An alternative approach that may be economically feasible where geothermal resources are located in areas with few and relatively small communities, would be to make use of non-condensing turbo-generators. These would minimize capital costs as well as maintenance and operating costs. Communities in such an area might also rely upon some central organization, external to the rural community being served, to provide the steam wells required. This organization could, of course, be financed either from public funds or from private venture capital.

Geothermal wells drilled in such scattered rural areas would be more expensive than wells drilled within a geothermal field. If the cost per well in a rural area is, therefore, taken to be \$300,000, the steam produced is equivalent to 2 MW, and other factors are the same as those given above, then the cost of steam will be \$0.015/kWh. If, as a reasonable approximation, we take the installed cost of a rural non-condensing generating plant at 50 percent of a condensing turbo-generator, then fixed charges will be roughly \$0.002/kWh and the total cost of electricity \$0.017/kWh if the load factor is 0.9. This cost is still significantly lower than the cost of electricity generated using oil-fired thermal or diesel generators that would range from \$0.02/kWh to much higher values in a rural area in a developing country, but two factors must be considered. First, the costs depend on the actual costs of fuel transport and maintenance. The additional costs that may be involved in transporting the fuel from the port to the point of use in a rural area in a developing country may result in very high fuel costs at the point of use. Second, at lower load factors the cost would rise in inverse proportion to the load factor; for example, in rural areas and in small communities where the main use of electricity is for lighting, load factors may be in the range of 0.2-0.5.

## DIRECT APPLICATION OF GEOTHERMAL ENERGY FOR HEATING

Lower-temperature geothermal water resources that are less suitable for electricity production are highly suitable for many applications requiring thermal energy, such as district heating and greenhouse heating. Such resources are found not only in volcanic areas, but also in areas with thick accumulations of permeable sediments, for example, the Gulf of Mexico in the United States, and the Paris Basin and the Hungarian Basin in Europe, all

of which are areas without recent volcanic activity. Geothermal water is already in use in district-heating and greenhouse-heating applications in Iceland, Hungary, Japan, New Zealand, and the Soviet Union, and on a somewhat smaller scale in the United States, France, Czechoslovakia, and Rumania.

In rural areas, the use of low-temperature geothermal water as a source of heat in agricultural applications appears to be promising in those developing countries with a cold season that ordinarily prevents crop production and processing. Experiments are taking place in Israel, for example.

The cost of thermal energy from geothermal wells producing water below the boiling point at atmospheric pressure depends upon such factors as seasonal variation in demand and the actual temperatures of the water before and after use, as well as upon the productivity of the wells. Representative costs in Europe fall within the range of \$1 to \$4/Gcal, which is about one-half to one-eighth the cost of such thermal energy at current (1976) local prices for imported oil. Furthermore, low-temperature geothermal waters are less commonly highly charged with mineral salts and therefore present fewer problems of disposal of waste water. The deposition of carbonate scale in pipes carrying low-temperature geothermal water has occurred in some cases, but control measures have proved effective in dealing with the problem.

In situations where information on the presence of geothermal waters is available as a by-product of the search for oil and gas, the element of financial risk is largely absent from subsequent geothermal development. This will occur where low-temperature geothermal waters occur in deep sedimentary basins that have been investigated for the presence of petroleum.

## CURRENT RESEARCH AND DEVELOPMENT

Geothermal energy can be used in many places in the world where power requirements are small. This is true provided adequate equipment is available for utilizing hot water/steam mixtures directly from one or two hot-water wells of moderate size capable of producing mixtures of steam and hot water. However, conventional steam/water separators and steam turbines of the type available at present may not function efficiently when used in conjunction with geothermal water that deposits mineral scale, because of the mechanical and thermal problems caused by these deposits. During the past 3 years, engineering tests have been made on new equipment that has been proposed as a possible way to overcome these problems.<sup>1</sup> Tests performed in Mexico on brine from a well at the Cerro Prieto field, using a helical rotary screw expander as a prime mover, demonstrated that this device can operate with such brines and produce power at reasonable efficiencies. These results have

been supplemented by further tests, with larger units, using brine from a well in the East Mesa field of the Imperial Valley, California. Appendix 9 contains a description of the helical rotary screw expander, a discussion of its efficiency, and details of the tests referred to above.

## GEOTHERMAL RESOURCES DEVELOPMENT POLICY

Those countries that have not yet begun to evaluate or develop their geothermal-resource potential may be assisted in determining policy if they take the following points into consideration:

- Base-load electricity produced from high-temperature geothermal resources is likely to be substantially cheaper than electricity produced at solid-fuel-fired or oil-fired thermal generating stations, considering the present world prices of oil and coal;
- Most countries having geologically recent volcanic activity are likely to possess high-temperature geothermal resources;
- Exceptionally great thicknesses of sediment and an exceptionally high regional heat flux are not necessary for these geothermal resources to be exploitable economically;
- Exploration and development of high-temperature geothermal resources involve an element of financial risk;
- Low-temperature geothermal sources can be developed to satisfy a need for heating in winter, for example, and thus substitute for oil or coal; and
- In many locations, where petroleum exploration has taken place, low-temperature geothermal resources can be developed at less financial risk.

## REFERENCE

1. McKay, R. A., and Sprankle, R. S. 1974. Helical rotary screw expander power system. In *Proceedings of the Conference on Research for the Development of Geothermal Energy Resources, Pasadena, California, 23-25 September*, pp. 301-307. Pasadena: California Institute of Technology, Jet Propulsion Laboratory.

## SUGGESTED READING

1. *Proceedings of the United Nations Symposium on the Development and Utilization of Geothermal Resources, 1970, Pisa, Italy. Geothermics, Special Issue 2, 2 vols.* Vol. 1 contains the rapporteurs' summaries. Vol. 2, in two parts, contains all the technical papers presented at the symposium.

2. *Abstracts, Second United Nations Symposium on the Development and Use of Geothermal Resources, San Francisco, California 20-29 May 1975.* Berkeley, California: University of California, Lawrence Berkeley Laboratory.

The abstract volume, in English, French, and Spanish, was distributed at the conference. The full proceedings are to be published in 1976.

3. Armstead, H. C., ed. 1973. *Geothermal energy: a review of research and development.* Paris: United Nations Educational, Scientific, and Cultural Organization.

# *Energy Storage*

The use of intermittent or variable sources of energy, such as solar and wind energy and some of the forms derived from moving water, often becomes practical only if some means of energy storage is possible. Specifically, we are concerned with storage methods feasible within the constraints under which rural communities in developing nations operate: there must be minimal requirements for capital investment, sophisticated equipment, or complicated maintenance.

## TECHNOLOGY OF STORAGE

There are numerous ways to store energy in almost any form; some are more attractive economically in particular situations than others. Many are well known, particularly in industrialized nations. Their suitability to village applications in developing nations will vary with local conditions.

Energy is manifested in several important forms, including mechanical, electrical, chemical, and thermal—the latter being a special form of mechanical energy. Energy may be converted from any of these forms to any other form by one or more intermediate processes, always, however, entailing some loss of energy. The loss usually, but not always, manifests itself as heat. For example, chemical energy is converted to electrical energy in an ordinary power plant. Fuel (chemical energy) is burned (thermal energy) to produce steam that turns a turbine (mechanical energy) coupled to an electrical



generator (electrical energy). The overall process is, on the average, about 33 percent efficient. There are ways, using fuel cells, to turn fuel (chemical energy) directly into electricity (electrical energy) without all the intermediate steps. Theoretically, this latter technique should be more efficient and less costly than the chemical-thermal-mechanical-electrical route; for several practical reasons, mostly having to do with materials problems, this is not yet true.

The important point is that conventional fuels are simply cases of sun-derived energy converted to, and stored in, chemical form. It is true that for oil, natural gas, and coal, nature has done the storage for us. But the fact remains that they are merely chemically stored energy forms, and that we shall have to devise shorter processes to obtain the same results if we are to make the use of intermittent energy sources practical.

The basic energy-storage problem is to devise ways to take energy, whenever and in whatever form available, convert it (if necessary) to forms best suited for storage, and then reconvert it, with minimal loss, to a useful form at the time it is needed. The principal physical possibilities include mechanical, chemical, and thermal storage.

## CURRENT TECHNOLOGY (AVAILABLE WITHIN 5 YEARS)

With current technology there are practical ways to store energy in mechanical, chemical, and thermal forms.

### Storage of Energy in Mechanical Form

Mechanical energy may be stored in the form of kinetic or potential energy. Although the use of the flywheel as a kinetic-energy storage device is well known, there is little prospect that this technique would find significant use in the immediate future in rural situations at power levels that would be useful; it depends too heavily on sophisticated materials and maintenance capabilities.

Mechanical energy may be stored in the form of potential energy by pumping water to a reservoir at a higher level and allowing it to flow down to a lower reservoir whenever the energy is required. This is conventionally called a pump-back system. The kinetic energy of the flowing water is usually converted to electrical energy, although it could, of course, be used directly as mechanical energy. Simple water wheels provide direct mechanical energy whenever stationary mechanical power can be used; when the energy must be moved from place to place, electric generators are probably the best possibility.

A difficulty of the pump-back storage system is that relatively large reservoirs are required. Generally, the best possibility in developing areas is to try to find a reasonably large basin for an upper reservoir located near an existing lake or river. The latter then becomes the lower reservoir. With current technology in pump-back systems, generally about two-thirds of the energy is available for reuse after storage. The feasibility of such a system, however, usually depends on an energy market sufficient to justify the installation of the primary pumping system and its energy supply. Then the pumping from lower to upper reservoir can be accomplished economically during off-peak periods, making supplementary energy available during periods of peak demand. Wind-energy systems providing electricity and/or mechanical services during the day and pumping at night might be one example.

Still another method for storing mechanical energy is through compressed air. Two basic methods are of interest: direct compression and isothermal hydraulic compression. Direct compression, to be practical, requires the availability of natural or man-made underground caverns that can be sealed and pressurized. Reuse of the stored energy requires the availability of low-pressure turbines or piston engines similar to the old-style steam engines. Generally, such systems provide a relatively low overall efficiency. About one-third of the initial energy can finally be reutilized. This figure can be improved considerably when compressed-air systems are combined with gas-turbine cycles or with refrigeration cycles, but the latter are probably not immediately applicable to our major interest.

Of much greater interest to small communities and rural areas in developing nations is isothermal hydraulic compression. In this process (which is at least 3,000 years old), a vertical tube is placed in front of a dam that is creating a head of water, typically 5-10 m (15-30 ft) or more. Water flowing into the inlet entraps air bubbles that are carried to the bottom with the water. The water then passes through the bottom of a sealed tank or cavern where the air bubbles rise. Ultimately, the air in the tank or cavern will be compressed to a pressure slightly less than that of the hydraulic head of the vertical (Venturi) tube. That compressed air can then be used in a simple turbine or other suitable expander to obtain usable mechanical energy.

Such isothermal hydraulic compressors were used from ancient times until the latter part of the 19th century when they were gradually replaced by electrical, steam, or internal-combustion devices. (See chapter on hydropower.)

### Storage of Energy in Chemical Form

Although the input and output energy for a battery is electrical, the actual energy storage is in chemical form. The most widely known device is the

conventional lead-acid battery; the technology is mature and the costs are fairly well known. The storage efficiency is about two-thirds, or roughly the same as for pump-back storage. The battery life is fairly long, perhaps 10 years or more when properly maintained, but the cost is high if one wishes to store enough energy for significant use. In some cases, however, it is the only thing available. In such circumstances, it may be used to operate a few lights, television sets, and similar low-demand devices, but it will be too expensive for light industrial or vehicular applications.

Electrolysis of water represents another technique for storing energy in chemical form. The stored product is hydrogen, which then can be used as a simple fuel. To minimize storage requirements, it must be stored at relatively high pressures; even so, the energy density is fairly low. (Greater energy densities could be achieved by liquefaction, but the mechanical and cryogenic technologies required seem out of place in this discussion.) Nevertheless, one of the major attractions of this approach is that the basic raw material is distilled water, and it is possible to develop simple devices to run on hydrogen directly. These include simple heaters and internal-combustion engines. The former could be used for space heat, grain drying, cooking, etc.; the latter could be adapted to small, rather short-range vehicles such as "mini" tractors and "mini" trucks. In a rural, small-village situation, these devices could be extremely useful and would not require imported fuel. Development of simple electrolysis systems, and simple heaters and engines using hydrogen as a fuel, should have high priority.

One interesting facet of electrolysis is that it can be performed with very high efficiency at very high pressures, provided the temperature is elevated to about 200°C. Efficiencies of 92-93 percent can be achieved at pressures of 150-250 atmospheres at these temperatures. These pressures can be created by the gas generated, if the system is properly designed, and this would eliminate the need for compressor pumps. Generally, the elevated temperatures can be achieved by insulating the pressure vessels and using the internal ( $I^2R$ ) losses to supply the necessary heat. Thus, the whole electrolysis system is essentially a static (no moving parts) system with the exception of manual valves. The input energy must be electricity, which for the time being could be obtained from wind-generation systems (Figure 57).

Energy can also be stored chemically in the form of combustible hydrocarbons and alcohols synthesized from hydrogen and organic materials. Many such processes are under study throughout the world, but none is yet known to have short-term applicability to the rural community in a developing nation. Anaerobic bacterial processes may be an important exception to this statement; this subject is covered in the chapter on microbial conversion of plant materials to liquid fuels, and is treated in detail, with respect to generation of methane, in a separate Academy study.<sup>1</sup>

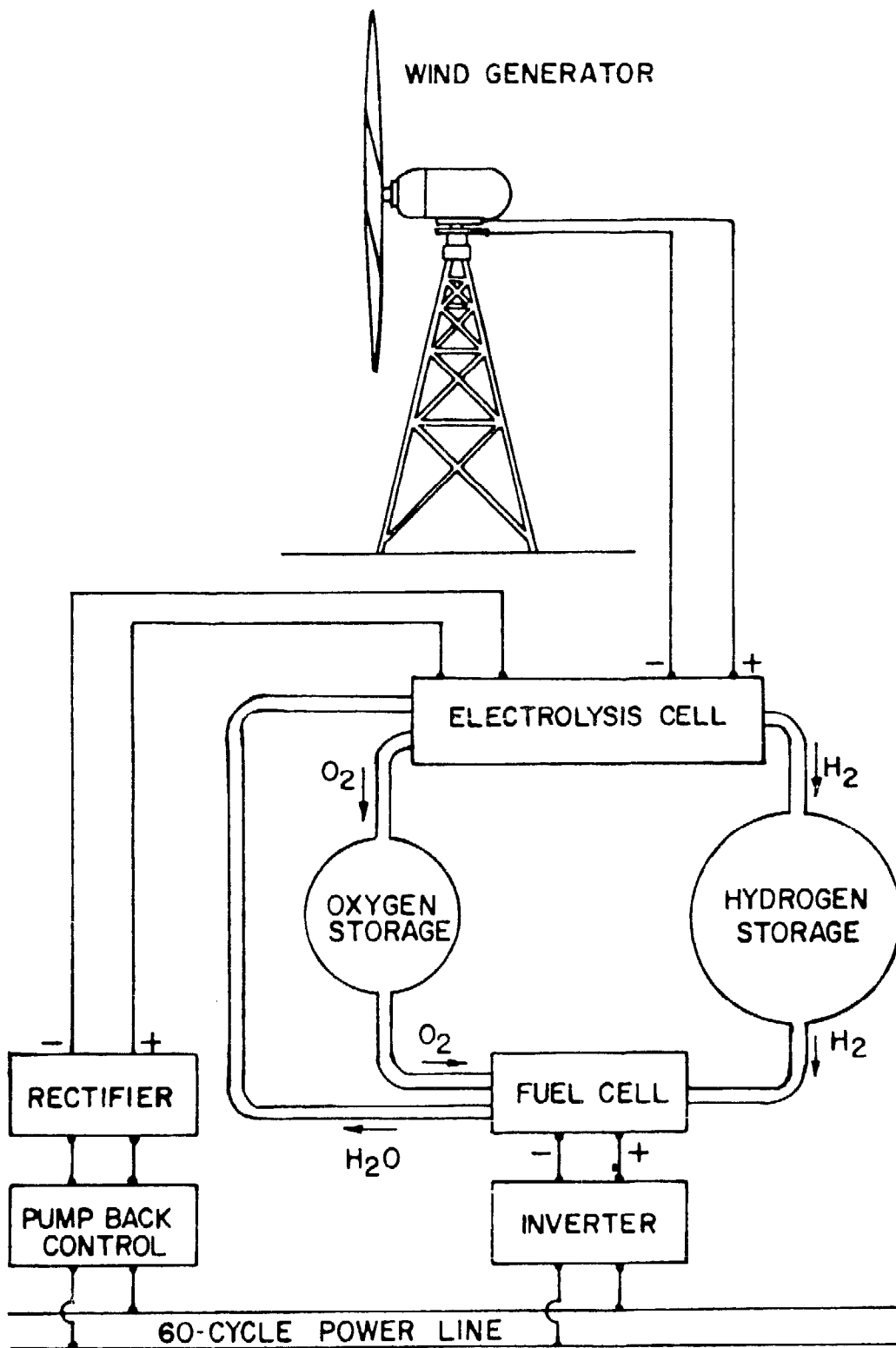

FIGURE 57 Wind as power source. [Source: Utilization of Resources. The Role of Energy in the Development of Human Settlements in Africa. United Nations Economic and Social Council, Document E/CN.14/HUS/6, 17 April 1975.]

### Storage of Energy in Thermal Form

Energy can obviously be stored as heat in appropriate materials, provided suitable thermal insulation surrounds the storage substance. Water and rocks, materials of high-heat capacity that are generally available, are commonly used as storage media. Sources of energy such as solar heaters or wind generators can be used. The major difficulty is that the energy can be effectively reutilized only as heat; reconvertng the heat energy to electrical or mechanical energy always involves significant losses because of fundamental thermodynamic limitations. Storage temperatures generally would be low, and maximum reversion efficiency (to mechanical or electrical form) would be on the order of a few percent. Nevertheless, direct reuse as heat can be practical, and this is done in some places; more information on this point is provided in the chapter on heating, cooling, distillation, crop drying, and power generation.

### RESEARCH AND DEVELOPMENT

Although other means of storing energy have been suggested, they require further research and development before they can be put to practical use.

### Storage of Energy in Mechanical Form

There is much current interest in the development of "super flywheels," which are proposed devices constructed from exotic materials of high tensile strength. Long-term development possibilities look rather good, but because the manufacture of the required sophisticated materials will call for high technological capability and large capital investments, the applicability of this technology to rural areas in developing nations is really a long way off.

The possible use of isothermal hydraulic compression, while not appearing to depend significantly on technical research and development, would benefit from construction and operation of a few prototypical installations to determine economic feasibility.

### Storage of Energy in Chemical Form

Much research has been conducted on batteries other than the conventional lead-acid battery, and that research is continuing. It is primarily directed at reducing the weight per unit of energy stored so that electrically driven vehicles might become practical. The most promising work has been with batteries operating at rather high temperatures, or with batteries using expensive materials such as silver. As far as we know, there is no new battery

on the horizon that shows more promise for rural areas than the conventional lead-acid cell. The use of hydrogen as a fuel will depend on results of further research on storage and transportation as well as on developments leading to simplification of the electrolysis process. However, there is little prospect that this process will become practical for use in rural areas of developing countries within 10 years or so. For similar reasons, current research and development on fuel cells should not be counted on to make these devices available in villages any time soon.

### Storage of Energy in Electromagnetic Form

The only known techniques of storing electrical energy directly without changing form are in very high-intensity electric fields or very high magnetic fields. While some work is being done with these techniques, the technology requirements and costs are extremely high, and the possible energy densities achievable are, so far, very low. Unless some breakthrough occurs in techniques or materials not now foreseen, these methods will probably not be useful for long-term storage in either industrialized or developing nations in the foreseeable future.

### REFERENCE

1. National Academy of Sciences. *Methane generation from human, animal, and agricultural wastes*. Report of an *ad hoc* panel of the Advisory Committee on Technology Innovation, Board on Science and Technology for International Development, Commission on International Relations. (In preparation. See p. 306.)

# *APPENDIXES*

---

APPENDIX 1

*Energy Research and  
Development with  
Potential for  
Small-Scale Application*

[The information in this list was compiled by NAS staff, primarily from responses to inquiries sent to organizations and individuals in the countries listed. It is not necessarily complete, but represents the best information available as of early 1976.] \*

\*Since the compilation of this material, a report prepared for the U.S. Energy Research and Development Administration has been published that supplements the information in this appendix: de Winter, F., and de Winter, J. W., eds. 1976. *Description of the Solar Energy R&D Programs in Many Nations*. Available from the National Technical Information Service, U.S. Department of Commerce, Springfield, Virginia 22161 U.S.A.



Country	Institution/Organization (Location)	Contact	Activities	
Argentina	Observatorio Nacional de Física Cósmica	Lic. Jorge Luis Guerrero	Thermal conversion of solar energy; solar distillation; solar heating of fluids	
	Comisión Nacional de Estudios Geoheliofísicos Departamento de Radiación Solar Programa de Helioenergética Av. Mitre 3100, San Miguel, Pcia. de Buenos Aires	Ing. Alfredo Tomás Rapallini		
	Observatorio Nacional de Física Cósmica Departamento de Radiación Solar Meteorología Av. Mitre 3100, San Miguel, Pcia. de Buenos Aires	Lic. Ernesto Santino Crivelli Lic. Manuel Agustin Rela	Radiation measurements and calibration of instruments; radiation climatology	
	Universidad Nacional de Salta Departamento de Ciencias Exactas Buenos Aires 177, Salta	Dr. Luis Saravia	Solar crop dryers, heaters, collectors; selective surfaces	
	Universidad Nacional de San Luis Departamento de Física y Química Chacabuco y Pedemera San Luis	Lic. Mario Diaz	Solar water heating; solar distillation	
	Universidad Nacional de Rosario Departamento Física Av. Pellegrini 250 Rosario, Pcia. Santa Fe	Dr. Carlos Garibotti	Low-loss structures; thermal conversion of solar energy	
	Universidad Nacional de La Pampa Instituto de Estudios Regionales Mansilla 178, Santa Rosa, La Pampa	Prof. Juan Elias Zabala	Solar stills for local communities	
	Australia	CSIRO [Commonwealth Scientific and Industrial Research Organization] Division of Mechanical Engineering P.O. Box 26, Highett, Melbourne	Dr. B. Rawlings, Chief of Division	Thermal conversion; collector design and development; water heating and low-pressure-steam generation; building heating and cooling
		Division of Mechanical Engineering Highett, Victoria 3190	P.I. Cooper, Research Scientist W.R.W. Read, Principal Research Scientist	Stills; timber kiln

CSIRO Solar Energy Studies P.O. Box 89, East Melbourne, Victoria 3002	Mr. Roger N. Morse, Director of Solar Energy Studies	Solar energy feasibility studies; energy utilization in industry; con- tact with solar-energy research work- ers in Australia and overseas.
CSIRO Division of Atmospheric Physics Melbourne [Radiation Centre for Region V, World Meteorological Organization]	G. W. Paltridge	Radiation measurements
CSIRO Division of Building Research Melbourne		Radiation measurements in Papua
CSIRO Division of Irrigation Research Griffith	K. V. Garzoli	Thermal characteristics of glass and plastic greenhouses
CSIRO Division of Land Use Research P.O. Box 1666 Canberra City, A.C.T. 2601	Dr. J. D. Kalma Dr. R. J. Millington	Radiation measurements; insolation; energy use in agriculture and in urban environments; climatological/meteo- rological aspects of energy use
CSIRO Division of Food Research P.O. Box 52, North Ryde, Sydney, N.S.W. 2113	Mrs. W. Szulmayer	Sun-drying of fruit
University of Melbourne Department of Mechanical Engineering Melbourne	W. W. S. Charters, Reader in Thermo- dynamics, Chairman of Department	Thermal properties of solar air heaters; solar water heaters, collector surfaces; solar dwellings; solar col- lectors, system performance
University of Queensland Department of Mechanical Engineering St. Lucia, Brisbane, 4067	Norman R. Sheridan, Reader in Mechanical Engineering	Heating and cooling of buildings; photovoltaic conversion; heat engines; energy storage and trans- mission; publishes "Solar Research Notes"

Country	Institution/Organization (Location)	Contact	Activities
	University of New South Wales School of Mechanical and Industrial Engineering P.O. Box 1, Kensington 2033, New South Wales	C. M. Sapsford	Radiation measurements; residential heating and cooling; performance of flat-plate collectors
	International Solar Energy Society Australian and New Zealand Section c/o CSIRO Division of Mechanical Engineering P.O. Box 26, Highett, Victoria 3190	Robert V. Dunkle, Editor Progress in Australia and New Zealand"	Publishes annually the "Solar Energy Progress in Australia and New Zealand"
	The University of Western Australia Department of Mechanical Engineering Nedlands, W. A. 6009	R. S. Minchin, Senior Lecturer	Low-cost heater—design, construction, installation (total materials cost A\$15)
		J. A. Appleyard, Senior Lecturer	Cylindrical solar water heater combining absorber and storage tank in one unit—design, construction, testing
Belgium	Ministère de l'Agriculture Bruxelles 1000	J. F. M. Ronchaine, Ingénieur Agronome	Greenhouses, stills
	Université Catholique de Louvain Faculté des Sciences Appliquées Laboratoire de Physico-Chimie et de Physique de l'État solide Batiment Boltzmann Place Croix du Sud, 1 B 1348 Louvain-La-Neuve	Prof. J. P. Issi J. P. Michenaud	Thermoelectric conversion
Brazil	Universidade Federal da Paraíba Laboratório de Energia Solar João Pessoa, 58.000 Paraíba	Cleantho Torres, Head Antonio MacDowell Pio Caetano Lobo Julio Goldfarb Rogério Klüppel	Water distillation; drying of fruits; solar furnaces; solar engines for irrigation. Publishes a biannual bulletin (in Portuguese).

Instituto Tecnológico de Aeronáutica  
 Division of Mechanical Engineering  
 12.200 São José dos Campos, São Paulo  
 Centro de Pesquisas do Cacau  
 Agricultural Engineering Division  
 Caixa Postal 7, Itabuna - B.A.

Dr. Sérgio Nelo Vannucci, Sea water distillation  
 Assistant Professor

Dr. Biswa Nath Ghosh, Crop dryer  
 Head [Current Address:  
 Gulf and Western Ad-  
 vanced Development and  
 Engineering Center, 101  
 Chester Road, Swarth-  
 more, Pa. 19081,  
 U.S.A.]

Burma	Central Research Organization Rangoon	U Maung Maung	Solar cookers; stills; hot-water heaters; crop drying; salt production
Canada	The University of Western Ontario Faculty of Engineering Science London 72, Ontario  Brace Research Institute Macdonald College McGill University Ste. Anne de Bellevue Quebec	Prof. R. K. Swartman  Thomas A. Lawand, Director of Field Operations	Solar collectors; solar-powered refrigeration and ice making  Radiation measurements; crop drying; cookers; distillation; hot-water heaters; solar still/greenhouse combinations; environmentally adapted greenhouses; solar-powered engines; solar ponds; windmills for electrical generation and water pumping; use of solar and wind energy in heating buildings, etc. (A variety of practical publications available.)
Chile	Universidad del Norte Solar Energy Laboratory Antofagasta	Prof. Carlos Espinosa	Radiation measurements; hot-water heaters

Country	Institution/Organization (Location)	Contact	Activities
	Universidad de Chile Department of Mechanical Engineering Casilla 2777, Santiago	Sergio Alvarado Felipe Wainer	Radiation cooling
	Universidad Técnica Federico Santa María Solar Energy Research Center Casillas 110-V. - 132-V., Valparaíso	Dr. Julio R. Hirschmann Director, Solar Energy Research Center Dr. Bernardo Seifert, Director, Solar Energy Laboratory Prof. Germán Frick, Director, Lab. for Horticulture Technol- ogy	Radiation measurements; cookers; hot water heaters; stills; solar ponds; publishes Revista "Scientia"; evapo- rative cooling of greenhouses
	Universidad Técnica Federico Santa María Solar Energy Research Center Viña del Mar	Dr. Arnold Keller Dr. Bernardo Seifert	Solar collectors; surface treatments Experimental station for hot-water heaters, stills, solar furnaces
	Universidad Técnica Federico Santa María Solar Energy Research Center Calama	Prof. Germán Frick, Director	Experimental station for solar ponds and for horticulture in controlled environment (plastic greenhouses)
	Universidad Técnica Federico Santa María Solar Energy Research Center Quillagua	-	Experimental station with solar saline water distillation plant
Egypt	Ain Shams University Heliopolis, Cairo	M. K. Elnesr	Radiation measurements; solar col- lectors; stills

National Research Centre Solar Energy Laboratory Dokki, Cairo	Dr. Ing. Ibrahim A. Sakr, Dir.	Solar cookers; stills
France Université de Nancy Faculté des Sciences Laboratoire de Physique de Dépôts Métalliques Boulevard des Aiguillettes 54 - Nancy	Prof. Jean Fléchon	Solar refrigeration; air conditioning; photovoltaics
Centre National de la Recherche Scientifique [CNRS] Laboratoire de l'Énergie Solaire Odeillo	Dr. Felix Trombe, Director	Solar furnace; refrigeration; residen- tial heating; radiation measurements
Université de Provence Centre de Saint Jerome Département d'Héliophysique Marseille	J. Millet, Maître Assistant M. Bazan, Assistant B. Imbert, Assistant J. P. Legre, Assistant J. Gervais, Assistant	Radiation measurements
Société Française d'Études Thermiques et d'Énergie Solaire [SOFRETES] Zone Industrielle d'Amilly B.P. 163, 45203 Montargis	L. Aiache, Assistant G. Durr, Chercheur J. Le Troquer, Chercheur B. Imbert, Assistant J. P. Girardier	Helio-electrochemical conversion
PROMETHEE (joint venture between SOFRETES and French Atomic Energy Agency) Zone Industrielle d'Amilly B. P. 163, 45203 Montargis	M. Clemot J. P. Girardier	Heat engines using solar energy for water pumping
Coopération Méditerranéenne pour l'Énergie Solaire (COMPLES) Siège Social: Palais de la Bourse 13001 Marseille	Prof. M. Perrot, President	R and D in solar energy. First appli- cation: solar pumps for irrigation purposes
		Publishes semiannual bulletin, "Revue Internationale d'Héliotech- nique"

Country	Institution/Organization (Location)	Contact	Activities
	Association Française pour l'Étude et le Développement des Applications de l'Énergie Solaire (A.F.E.D.E.S.) 28, rue de la Source, 75016 Paris	P. Girard, Délégué General	Publishes <i>Cahiers A.F.E.D.E.S.</i> ; organizes study meetings with the reports sent to members; documentation center for members' use
Germany (Federal Republic of)	Forschungsinstitut für Energietechnik 7441 Wolfsschlagen Hauffstr. 14	Prof. Dr.-Ing. G. Schöll	Solar collectors
	Forschungsinstitut für Windenergie-technik 7 Stuttgart 80 Pfaffenwaldring 31	Prof. Dr. V. Hütter	Wind energy
	Technische Universität Braunschweig 33 Braunschweig Mendelssohnstr. 16	Prof. E. W. Justi	Solar cells
	Institut für Systemtechnik und Innovationsforschung (ISI) 75 Karlsruhe Breslauerstr. 98	—	Solar energy
	Institut für Wasserbau und Wasserwirtschaft TH Aachen 51 Aachen Mies-van-der-Rohe-Strasse	—	Hydropower
	Rheinische-Westfälische Technische Hochschule Institute for Applied Thermodynamics Aachen	Dr. Ing. A. Beckers	Bilateral program with Universidad Técnica Federico Santa Maria Chile
	Kernforschungsanlage Jülich 517 Jülich	Dipl.-Ing. F. J. Friedrich	Collectors, solar cells, solar thermal gas processes
	Deutsche Forschungs- und Versuchsanstalt für Luft- und Raumfahrt E. V.	—	Solar and wind energy

Greece	Philips Forschungslaboratorium 51 Aachen Postfach 1980, Weisshausstrasse	Dr. Hörster	Solar energy
	Hellenic Industrial Development Bank Amalias Ave. 20, Athens 118	P.P. Kokkaliaris, Chemical Engineer	Solar distillation; desalination
	Greek Atomic Energy Commission Nuclear Research Center "Demokritos" Aghia Paraskevi - Attiki	Dr. Argyrios-Demetrios Spyridonos Dr. (Mrs.) E. Delyannis	Solar stills; water heaters; collectors; concentrators; space-heating
India	Regional Engineering College Warangal (A.P.) 506004	Dr. T. L. Sitharama Rao Mr. S. Subramanyam	Solar water heater; multipurpose solar collector
	Aurobindo Centre for Environmental Studies Pondicherry	Dr. C. L. Gupta	Solar water heaters
	Central Arid Zone Research Institute Division of Wind Power and Solar Energy Utilization Jodhpur, Rajasthan	H. P. Garg Dr. A. Krishnan	Radiation measurements; flat-plate collector design; wind power
	Birla Institute of Technology and Science Pilani, Rajasthan	A. K. Jain T.L.S. Rao, Assistant Prof.	Solar water heaters
	National Physical Laboratory Hillside Road, New Delhi	Dr. G. D. Sootha Dr. V. G. Bhide	Has developed solar cookers, solar water heaters, solar-heated Stirling engine, solar-distillation systems; current activity not certain
	Indian Meteorological Department New Delhi	Dr. A. Mani, Deputy Director	Radiation measurements
	Ghandian Institute of Studies Appropriate Technology Development Unit P.O. Box 116 Rajghat, Varanasi 221001	M. M. Hoda, Head of Unit	Appropriate technology documenta- tion directory; encouraging research on appropriate technology in rural areas and its adoption in India



Country	Institution/Organization (Location)	Contact	Activities
	Defence Research Laboratory Jodhpur	Dr. J.P. Gupta, Senior Scientific Officer	Solar space heating
	Central Building Research Institute Roorkee	R. K. Chopra, Jr., Sci- entific Officer R. Ganguli J. S. Puri	Radiation measurements; flat-plate collectors; water heaters; residential heating
	Central Salt and Marine Chemical Research Institute Bhavnagar, Gujarat	Dr. R. L. Datta, Assistant Director	Radiation measurements; stills
	Indian Institute of Technology Department of Mechanical Engineering Kanpur 208016, U.P.	Prof. H. C. Agrawal	Solar collectors for rural use; solar drying of agricultural products; water heaters
	Department of Chemical Engineering	Dr. C. V. Sheshadri Dr. A. V. S. Prabhakara Rao Dr. G. D. Agrawal	Cultivation and use of algae for cattle feed and digestion to produce biogas.
	Department of Civil Engineering	Dr. S. Ramaseshan	Effects of solar energy on water re- sources (temperature, precipitation, use)
	Indian Institute of Technology Department of Mechanical Engineering Madras 600036	Dr. G. D. Agrawal Dr. Y. C. Das	Solar-radiation measurements as possible index of environmental de- terioration; solar thermal stresses in structures
	Motilal Nehru Regional Engineering College Mechanical Engineering Department Allahabad 211004	Dr. M. C. Gupta, Head, Solar Energy Lab Dr. B. K. Gupta	Solar space cooling; solar drying; solar water heaters Cooling of industrial and public buildings; flat-plate collectors; Fresnel lenses

<p>All India Solar Energy Working Group c/o R. L. Datta, Central Salt and Marine Chemical Research Institute Bhavnagar, Gujarat</p>	<p>R. K. Bhardwaj, Reader in Mechanical Engineering</p> <p>Dr. R. L. Datta, Chairman</p>	<p>Solar water heaters</p> <p>Publishes proceedings; devoted to promotion of solar energy research and development and dissemination of knowledge in field of solar energy</p>
<p>Pahlavi University Department of Mechanical Engineering Shiraz</p> <p>Institute of Natural Resources Karaj</p> <p>Teheran University Agricultural Engineering Department Karaj</p>	<p>Prof. Mehdi N. Bahadori</p> <p>-</p> <p>Dr. Javed Maghsood</p>	<p>Solar residential heating; solar cook- ing; solar sterilization; solar desali- nation; solar dehydration of fruits and vegetables</p> <p>Hot-water heaters</p> <p>Greenhouses</p>
<p>Building Research Center Scientific Research Foundation Baghdad</p> <p>Mustansiriya University Faculty of Science Physics Department Baghdad</p>	<p>A.E.A. Almaini, Re- search Asst.</p> <p>A.E.A. Alhadithi, Re- search Asst.</p> <p>M. A. Abbas</p>	<p>Solar water heaters; space heating</p> <p>Radiation measurements</p>
<p>Scientific Research Foundation Dan Danziger Building Hebrew University Campus P.O. Box 3745, Jerusalem</p>	<p>Dr. Harry Z. Tabor, Scientific Director</p>	<p>Solar-energy systems; collectors and materials; climatic control of buildings, including fenestration studies; energy recovery; solar ponds for heat and power; power units</p>

Country	Institution/Organization (Location)	Contact	Activities
	The National Physical Laboratory of Israel Hebrew University Campus Danziger Building A Jerusalem	Avram Kalisky, Director	Hot-water heaters; hot-water heating systems; solar ponds; photovoltaics; research on materials and design to maximize natural heating and cooling of buildings; radiation measurements; heat exchangers
	The Hebrew University of Jerusalem Human Sciences Laboratory School of Applied Science and Technology Jerusalem	Prof. Hillel I. Shuval Dr. Georges Belfort Dr. Inka Dor	Use of solar energy to grow algae in wastewater as a low-cost protein animal feed; anaerobic fermentation of agricultural wastes for methane production
	The Hebrew University of Jerusalem Authority for Research and Development Department of Physics Mount Scopus P.O. Box 24100, Jerusalem	Prof. E. Harnik Prof. M. Schieber Prof. D. Shaltiel Prof. Y. Jacoby	Solar cell materials and fabrication technology Hydrogen storage; use of light guides for the transport of solar energy
	Department of Physical Chemistry	Prof. G. Stein	Photochemical fuel production; hydrogen evolution; hydrogen storage
	Department of Botany	Prof. B. Z. Ginzburg Dr. B. Z. Dorfman	Algae/microbial conversion to liquid fuels
	Department of Organic Chemistry	Prof. S. Patai Dr. S. Brenner Prof. J. Klein Prof. J. Klein Prof. M. Rabinowitz Prof. J. Blum Prof. I. Agranat	Pyrolysis of cellulose and wastes Hydrogenation of cellulose and agricultural wastes Coal liquefaction; coal reactions
	The Hebrew University of Jerusalem Center for Research in Energy, Fuel and Petrochemistry		

Ben-Gurion University of the Negev  
 Research and Development Authority  
 P.O. Box 1025  
 Beer-Sheva, 84110

Dr. D. Pasternak  
 Dr. M. Twersky

Geothermal heating of soil (growing crops in cold season, protection from freezing, accelerating growth); geothermal heating of greenhouses, nurseries, and poultry and other small-animal facilities

E. Rappaport  
 Dr. D. Pasternak  
 Dr. A. Richmond

Controlled environmental systems--greenhouses and algae-producing units

Dr. I. Yaron  
 Dr. I. Borde

Solar cookers; absorption refrigeration for preserving agricultural produce

Dr. C. Forgacs

Desalination of brackish water; design of small field units for drinking water

Department of Mechanical Engineering

Dr. O. Igra

Shrouded windmills for water pumping and generating electricity

Dr. A. Bar-Cohen  
 Dr. K. Preiss

Solar heating; hot-water heaters

Italy

European Community Joint Research Centre  
 21020 Centro Euratom di Ispra  
 Varese

Dr. Joachim Greiz,  
 Scientific Directorate

Collectors for residential heating; quantum conversion problems; large-scale electricity production

Istituto Chimico "G. Ciamician" dell' Università  
 Bologna

V. Balzani  
 F. Bolletta  
 L. Moggi

Photochemical conversion

Laboratorio Fotochimica e Radiazione d'Alta  
 Energia del CNR  
 Bologna

Photochemical conversion

Japan

Keio University  
 Tokyo

Prof. I. Tanishita

Hot-water heaters

Country	Institution/Organization (Location)	Contact	Activities
	Waseda University Department of Architecture Nishiokubo, Shinjuku-ku, Tokyo 160	Prof. K. Kimura M. Udagawa, Research Engineer	Experimental solar house; solar space-heating; hot water; solar col- lectors (theory and experiment); absorption cooling; calculation of heating and cooling loads of build- ings
	Tokai University	Prof. I. Tanishita	Hot-water heaters
	Tokai University Department of Architecture Shibuya-ku, Tokyo	Prof. S. Tanaka	Basic study on solar heating and cooling systems
	Kogakuin University Department of Architecture Shinjuku-ku, Tokyo	Prof. Y. Nakajima	Heat storage tank, theory and experiment
	Osaka Institute of Technology Department of Mechanical Engineering Asahi-ku, Osaka	Prof. Y. Saito	Experimental combined flat-plate and focusing collector
	Tokyo Metropolitan University Department of Architectural Engineering Setagaya-ku, Tokyo	Prof. N. Ito	Bibliography on solar heating, cooling and hot-water supply
	University of Tokyo Sogoshikenjo School of Engineering Bunkyo-ku, Tokyo	Prof. Y. Matsuo	Solar-radiation measurements; measurement and theory of heating and cooling loads of buildings
Netherlands	Eindhoven University of Technology Laboratory for Fluid Mechanics Eindhoven	Ir. P. T. Smulders	Windpower for developing countries

Mechanical Engineering Department	Prof. Ir. C. W. J. von Koppen	Production of hydroelectric power by means of Banki-type radial-flow turbine generators for small head, for developing countries; solar cooling
Chemical Engineering Department	Ir. S. P. Bertram	Fermentation of organic materials to produce methane (for developing countries)
Koninklijk Instituut voor de Tropen Department of Product Research Mauritskade Amsterdam	Ir. F. W. Korthals Altes	Solar dryers
Ingenieurbureau Dwars Hederick en Verhey Laan 1914 35, Amersfoort	Ir. H. Deibel	Solar stills
Organization for Industrial Research TNO P.O. Box 406 Delft	Ir. P. van Staveren	Utilization of windpower
University of Technology Enschede	E. Odijk	Windpower, solar energy
Foundation TOOL (Technische Ontwikkeling Ontwikkelingslanden) P.O. Box 525 Eindhoven	Prof. Dr. Ir. W. P. M. van Swaay	Wood gasification
	-	Coordination of projects involving development of small-scale energy technology for developing countries
New Zealand	Dr. R. F. Benseman	Water heaters and solar-radiation distribution
Dominion Physical Laboratory Department of Scientific and Industrial Research Physics and Engineering Laboratory Private Bag, Lower Hutt		

Country	Institution/Organization (Location)	Contact
Niger	Office de l'Énergie Solaire Organization Nigerienne de l'Énergie Solaire Niamey	Dr. Abdou Moumouni, Directeur Abdoulaye Hima, Technicien
Nigeria	University of Ife Ife-Ife	Dr. V. A. Williams
	University of Lagos Department of Mechanical Engineering Lagos	Dr. S. O. Adenubi Dr. V. A. Akinsete
Pakistan	Pakistan Council of Scientific and Industrial Research (P.C.S.I.R.) Labs. Kernal Ataturk Road, PPI Building Karachi	Director, Solar and Wind Energy Program
Papua New Guinea	The Papua New Guinea University of Technology Department of Electrical Engineering Faculty of Engineering P.O. Box 793 Lae	Prof. J. L. Woodward
Peru	Instituto de Investigaciones de Aplicaciones de la Energía Solar (INAES)	Prof. J.C.V. Chinappa Dr. Maximiliano Duran Dr. Casio Ore Ing. Alfredo Oliveros Prof. Alejandro Duran
Republic of China (Taiwan)	National Tsing Hua University Power Mechanical Engineering Department 855 Kuang Fu Road Hsinchu, Taiwan 300	Dr. Ching-Kwei Kang

Solar Energy Laboratory Dakar	I. Toure, Director	Radiation measurements; absorption cooling
College of Petroleum and Minerals Dahran	Prof. M. Ali Kettani Hussein K. Abdel-Aal	Solar-radiation measurements; helio- hydroelectricity; direct energy con- version; hydrogen production: min- eral production from the sea
University of Riyadh College of Engineering Riyadh	Dr. J. A. Sabbagh, Dean Dr. A. A. M. Sayigh, Dr. E. M. A. El-Salam	Solar water heaters, stills, boilers; solar house; effect of radiation on the habitat
Université de Dakar Institut de Physique Météorologique H. MASSON Faculté des Sciences Dakar-Fann	Prof. Djibril Fall	Flat-plate collector; solar motor; water heater; dryer
Centre National de la Planification de la Recherche Scientifique et Technologique Dakar	Dr. Assad Takla	Solar pumps; cost reduction
Nuclear Atomic Energy Institute Dhaka	Dr. Jong Hee Cha	Flat-plate collector
University of Ceylon Peradeniya	Dr. N.S. Wijesundera, Lecturer in Mechanical Engineering	Solar water heaters
Central Electricity Board University of Ceylon Colombo Campus 11 Abdul Caffoor, Kawatha, Colombo-3	Dr. K. Ghanalingam Prof. K. Kularatnam	CdS cells for water pumping Salt and minerals from the sea
Lambers Institute of Technology Department of Geology P.O. Box S-402 20 Copenhagen 5	Prof. K. G. Eriksson	Geothermal heating



Country	Institution/Organization (Location)	Contact	Activities
	The Lund Institute of Technology Division for Building Construction Fack S-220 07 Lund	Prof. Bo Adamson	Solar heating and cooling
	State Power Board Fack S-162 87 Vaellingby	Benat Nordstroem	Hydroelectric power generation; windpower generation
	Swedish Board for Technical Development Fack S-100 72 Stockholm 43	Olle Ljungstroem	Windpower generation
	Svensk Kaernbraenslefoersoerjnings AB Fack S-102 40 Stockholm	Ingemar Lindholm	Solar heating and cooling
	Royal Institute of Technology Department of Building Technology Fack S-100 44 Stockholm 70	Prof. Ingemar Hoeglund	Solar heating and cooling
	Department of Chemical Technology	Prof. Olle Lindstroem	Pyrolysis of waste and production of methanol as a fuel
Thailand	Asian Institute of Technology Division of Community and Regional Development P.O. Box 2754 Bangkok	Dr. R.H.B. Exell	Solar radiation in Thailand, solar distillation of water; solar-powered water pump; solar refrigeration
	Division of Environmental Engineering	Dr. P. A. Cowell	Solar-powered water pump
	King Mongkut Institute of Technology Mechanical Engineering Department 91 Pracha Uthit Road, Rachaburana	Dr. Maung Nay Htun Dr. Prida Wibulsas Ken Cooper	Solar distillation Solar water heater

Trinidad	University of the West Indies Department of Mechanical Engineering Faculty of Engineering St. Augustine	Dr. Supramaniam Sateunanathan, Head of Department	Solar stills; air heaters; water heaters; crop drying; refrigeration/air conditioning
	University of the West Indies St. Augustine	Oliver St. C. Headley, Dept. of Chemistry	Solar crop dryers; flat-plate collectors; solar stills
Turkey	Middle East Technical University Ismet Inonu Bulvari Ankara	Dr. M. Kudret Selçuk (current address: Jet Propulsion Laboratory, Bldg. 277, Rm. 202, Pasadena, Calif. 91103, U.S.A.) Prof. M. Akyurt	Radiation measurements; thermal properties of controlled-environment greenhouses; heat engines; crop drying
United Kingdom	University College Solar Energy Unit Department of Mechanical Engineering P.O. Box 97 Cardiff	Dr. B. J. Brinkworth	Utilization of solar energy for domestic, commercial, agricultural and industrial purposes
	College of Technology Department of Mechanical Engineering Brighton, Sussex	Dr. J. C. McVeigh	Flat-plate collectors
	Electrical Research Association Cleve Road Leatherhead, Surrey KT22 7SA	A. H. Stodart, General Mgr., Industrial Services Division	Wind power
	University of Reading Department of Engineering and Cybernetics Whiteknights, Reading RG6 2AY	Prof. P. D. Dunn	Water-piston pumps; Stirling engines; vertical-axis windmills; solar heaters; methane generation
	University of Sheffield Department of Building Science Sheffield	Prof. J. K. Page, Head of Department	Estimation of direct and diffuse insolation on vertical and inclined surfaces from radiation received on horizontal surfaces.

Country	Institution/Organization (Location)	Contact	Activities
	Intermediate Technology Development Group Ltd. Parnell House, 25 Wilton Road London SW1V 1JS	George McRobie, Director (Com- munication)	Source of information on water, wind & solar power; publishes <i>Appropriate Technology</i> quarterly.
Union of Soviet Socialist Repub- lics	Ministry of the Electrical Engineering Industry Moscow	A. P. Landsmann	Photoelectric generators
	Power Engineering Institute <i>imeni G.M. Krzhizhanovskiy</i> Solar Energy Laboratory Leninskiy Prospekt 19, Moscow	Dr. Yuriy Nikolayevich Malevskiy, Director Dr. Sergey M. Lukomskiy Dr. Rafael Rafaelevich Aparisi Dr. Dmitriy Ivanovich Teplyakov Dr. Boris Arnol'dovich Garf	Solar stills; absorption cooling; thermoelectric generators; heat pumps; collectors and concentrators; cookers
	All Union Institute for Research in Solar Technology Leninskiy Prospekt 19, Moscow	Dr. B. V. Petukhov	Solar pumps
	All Union Scientific Research Institute of Sources of Current Solar Energy Laboratory Moscow	Dr. Nikolay Stepanovich Lidorenko, Director Dr. B. V. Tarnizhevskiy	Solar pumps; photovoltaics; surface coatings
	Turkmen Physico-Technical Institute Ashkhabad, Turkmen SSR	Dr. Aman Kh. Khanberdiyev Dr. R. Bairamov	Solar stills; refrigeration; thermo- electric generators; photovoltaics
United States	University of California (Berkeley) Sea Water Conversion Laboratory 1301 South 46th Street Richmond, California 94804	Prof. Alan D. K. Laird, Director Badawi W. Tleimat, Sr. Development Engr. Prof. Everett D. Howe, Emeritus Director	Solar stills; desalination

University of California (Richmond) Sanitary Engineering Research Laboratory Richmond Field Station 1301 South 46th Street Richmond, California 94804	Prof. William J. Oswald Prof. Clarence G. Golueke	Waste-water treatment; algae; methane generation
University of Delaware Institute of Energy Conversion Newark, Delaware 19711	Dr. Allen M. Barnett, Director	Photovoltaics (CdS/Cu <sub>2</sub> S solar cells); solar heating and cooling of build- ings; solar collectors; heat storage; energy management; distributed con- version systems in conjunction with utility grid; techno-economical analysis
University of California Los Angeles, California	Prof. Richard Schoen	Heating of buildings
Colorado State University Fort Collins, Colorado	Prof. George O. G. Löf	Cookers; residential heating and cool- ing; water heaters
Southern Methodist University Institute of Technology Dallas, Texas	Prof. Harold A. Blum	Flat-plate collectors—design
Oklahoma State University School of Engineering Stillwater, Oklahoma 74075	Prof. William L. Hughes, Prof. H. J. Allison Prof. R. Ramakumar	Windmill turbines, pumps, generators (variable speed, constant frequency); energy storage (hydrogen from elec- trolysis of water)
University of Wisconsin Solar Energy Laboratory Engineering Research Laboratory 1500 Johnson Drive Madison, Wisconsin 53706	Dr. John A. Duffie, Director	Collectors; residential heating; refrigeration
Battelle Memorial Institute Columbus Laboratories 505 King Avenue Columbus, Ohio 43201	Dr. James A. Eibling	Solar heating and cooling; solar stills; Stirling engines; energy storage; flat- plate collectors; concentrators

Country	Institution/Organization (Location)	Contact	Activities
	University of Minnesota Department of Mechanical Engineering 125 Mechanical Engineering Building Minneapolis, Minnesota 55455	Dr. Richard C. Jordan, Head Dr. Ernst Eckert Dr. Ephraim Sparrow Floyd Larsen	Solar thermal electric power; heating and air conditioning; flat-plate collectors; energy storage and heat- pump systems; selective surfaces
	University of Massachusetts Department of Civil Engineering Amherst, Massachusetts 01002	Prof. William Heronemus	Wind energy conversion
	University of Maryland Department of Mechanical Engineering College of Engineering College Park, Maryland 20742	Prof. Stephen L. Sargent Prof. Redfield Allen	Organic Rankine-cycle engines; absorption cooling
	National Aeronautics and Space Administration (NASA) Goddard Space Flight Center Greenbelt, Maryland	Dr. M. P. Thekaekara, Code 912	Radiation measurements
	Arizona State University College of Architecture Tempe, Arizona	Prof. John I. Yellott, Chairman, Solar Energy Program	Residential and institutional heating and cooling
	Energy Research and Development Administration (ERDA) Division of Solar Energy 20 Massachusetts Avenue, N.W. Washington, D.C. 20545	Dr. Lloyd O. Herwig, Scientific Advisor Dr. Frederick H. Morse, (Heating and Cooling) Louis V. Divone, (Wind Energy Conversion) W. R. Cherry, (Crop Drying)	Supports and coordinates research on solar energy in U.S. institutions and development of commercial tech- nology

Volunteers in Technical Assistance (VITA)  
3706 Rhode Island Avenue  
Mt. Rainier, Maryland 20822

Dr. Michael P. Greene

Technical inquiry service provides assistance on request in most areas; publishes plans and booklets on devices and implements; participates in projects on appropriate technology

Route 4, Box 258  
Mt. Airy, Maryland 21771

C. J. Swet

Solar cooker, pump; liquid heating solar collectors; decentralized hydrogen production from sunlight and water; decentralized ammonia fertilizer production from sunlight, water and air

University of Florida  
Department of Mechanical Engineering  
Solar Energy and Conversion Laboratory  
Gainesville, Florida 32611

Prof. E. A. Farber,  
Director

Residential heating and cooling; distillation; refrigeration; cookers; heat engines; solar-powered automobile

University of California  
Department of Materials Science and Engineering  
Hearst Mining Building  
Berkeley, California 94720

Prof. Marshall F.  
Merriam

Low-cost pyranometer; solar ponds; low-cost collectors; low-pressure solar steam

Ohio University  
Mechanical Engineering Department  
Athens, Ohio 45701

Prof. William T. Beale

Low- and high-temperature Stirling engines; flat-plate collectors; windmills

Zambia

University of Zambia  
P.O. Box 2379  
Lusaka

Prof. J.M.K. Dake

Solar ponds

APPENDIX 2

*Manufacturers of  
Solar Heating and  
Cooling Devices*

[This compilation is not necessarily complete, but represents the best information available to NAS staff at the time of publication. Although the list is meant to include only those organizations currently engaged in commercial marketing of solar devices, it is possible that some of those listed are not yet at that stage.]

Country	Company (Location)	Contact	Product or Activity	
Australia	Braemar Engineering Co., Ltd. Bilsen and Zillmere Roads Geebung 4034 Queensland	—	Flat-plate copper collector and water-heater systems	
	Carbon Engineering Pty. Ltd. 12 Bailey Street West End, Brisbane 4101 Queensland	—	Flat-plate copper collector and water-heater systems	
	Sola-ray Appliances 6 Boag Road Morley 6062 Perth	—	Flat-plate copper collector and water-heater systems	
	S. W. Hart and Co., Pty., Ltd. 112 Pilbara Street Welshpool, W.A. 6106	—	Flat-plate copper collector and water-heater systems	
	Smalls Sola Heeta Co., Pty., Ltd. 10 Goongarrie Street Bayswater, W.A. 6053	—	Flat-plate copper collector and water-heater systems	
	Beasley Industries Pty., Limited Bolton Avenue Devon Park, South Australia 5008	—	Flat-plate copper collector and water-heater systems	
	Chile	Compañía Química y Minera de Chile Departamento de Investigaciones Científicas Santiago	—	Solar evaporation ponds
		Compañía Anglo-Lautaro Santiago	—	Solar evaporation ponds; production of sodium sulfate



Country	Company (Location)	Contact	Product or Activity
Germany (Federal Republic of)	Dornier System GmbH Postfach 1360 7990 Friedrichshafen	K. Kögler, Head Thermodynamics Dept. Dr. H. Rieche, Head Marketing	Stills for sea-water desalination by solar-heated heat pipes; heating and cooling hot water; electricity generation
	AEG-Telefunken Abteilung Raumfahrttechnik und Neue Technologien 2000 Wedel, Industriestrasse	S. Korius H. Manthey	Small solar batteries
India	The Tata Iron and Steel Co., Ltd. 220 Outer Circle Road Jamshedpur	M. K. Ghosh	Solar cooker
Japan	Yazaki Buhin Co., Ltd. Kosai-shi, Shizuoka-ken	T. Ishibashi, Technical Director	Solar absorption-refrigeration; Yazaki solar house-cooling, heating hot water; selective surface manufacture
	Yanagimachi Laboratory Meguro-ku, Tokyo	M. Yanagimachi, President	Heat-pump-assisted solar heating system; heat-storage tank
	Nihon Kogyo Co., Ltd. Minato-ku, Tokyo	H. Igarashi, Technical Director	Selective copper absorber
	Toshiba Electric Co., Ltd. Kaden Research Laboratory Kawasaki-shi, Kanagawa-ken	M. Sakamoto, Chief Res. Engineer H. Koizumi, Chief Res. Engineer	Domestic hot-water unit
	Showa Aluminum Co., Ltd. 480 Imuzuka, Oyama City	Y. Asano, Technical Director	Solar hot-water heater, Roll- Bond® absorber
	Kawasaki Juko Co., Ltd. Minato-ku, Tokyo	S. Fijidai, Research Engr.	Double-effect absorption-refrigera- tion machine
	Ishikawajima-Harima Juko Co., Ltd. Chiyoda-ku, Tokyo	S. Ichikawa, Solar Energy Project, Manager	Freon turbine solar refrigerating machine

	Sanyo Electric Co., Ltd. Hirakata-shi, Osaka	K. Finotani, Chief Res. Engineer	Solar absorption-refrigerating unit; selective surfaces
	Takenaka Research Laboratory Koto-ku, Tokyo	K. Maekawa, Technical Dir. Y. Tanaka, Chief Res. Engr.	Solar collectors for heating and cooling
Mexico	Circuito Novelistas A. Cd-Satelite (Ed. de Mexico)	Maximo Chauvet, Ingenieur E.C.P.	Heaters
United Kingdom	Alcoa Ltd. Gowerton, Swansea	-	Roll-Bond® heat exchangers
	Air Distribution Equipment (Midlands and West) Ltd. 64 Whitebarn Road Llanishan, Cardiff Wales	-	Collectors, control equipment
	Commercial Solar Energy 163 Pelham Road Sherwood, Nottingham	-	Collectors
	A. T. Marston & Co., Ltd. Lancaster Road Shrewsbury, Salop	-	"Calorsol" collectors
	Pilkingon Brothers, Limited Latham, Ormskirk, Lancashire	H. C. Agrawal, Senior Technologist, R&D Labs	Solar dryers
	Production Methods, Ltd. West Arthurlie Works Barrhead, Glasgow Scotland	-	"Raystore" collectors
	Rolls-Royce Technical Institute Derby Engines Division Rolls-Royce Anti-Poverty Group P. O. Box 31 Derby	-	Low-cost water heater

Country	Company (Location)	Contact	Product or Activity
	Solar Centre 171 Ifidel Road, Chelsea London, SW10 9AF	-	"Sunstore" collectors
	Solar Heat, Ltd. 99 Middleton Hall Road Kings Norton Birmingham B30 1AG	-	"Suntrap" collectors
	Solar Water Heaters, Ltd. Pillar House 21 South Parade Doncaster, York	-	Collectors
	Stellar Heat Systems, Ltd. Upper York House 30 Upper York Street Bristol BS2 8Q3	-	Collectors; consultancy services
United States	Thermo Electron Corporation Waltham, Massachusetts	Jerry P. Davis	Organic Rankine cycle engine for low-temperature heat sources
	Sunwater Company 1112 Pioneer Way El Cajon, California 92020	Horace McCracken, Pres. Ed Smith	Solar water heaters, stills, space heaters
	SES, Inc. 70 South Chapel Street Newark, Delaware	Dr. Steven DiZio, Pres.	CdS/Cu <sub>2</sub> S solar cells
	PPG Industries, Inc. One Gateway Center Pittsburgh, Pennsylvania 15222	-	Flat-plate collector. Double-glazed with aluminum Roll-Bond® panel.
	Kalwall Corporation 1111 Candia Road	-	Flat-plate collector with fiberglass- reinforced plastic covers

P. O. Box 237 Manchester, New Hampshire 03105	-	Flat-plate aluminum alloy absorber for use in collectors
Oilin Brass/Roll-Bond Products East Alton, Illinois 62024	-	"Econocoil," a heat exchanger cur- rently being sold as absorber for flat-plate collector
Tranter Manufacturing, Inc. 735 East Hazel Street Lansing, Michigan 48909	-	Copper flat-plate collectors
Energex Corporation 5115 South Industrial Road Suite 513 Las Vegas, Nevada 89118	-	Copper flat-plate collectors
U. S. Solar Corporation 6407 Ager Road West Hyattsville, Maryland 20782	-	Copper flat-plate collectors
Solaron Corporation 4850 Olive Street Commerce City, Colorado 80022	John Bayless	Complete solar heating and cooling systems
Copper Development Associates 405 Lexington Avenue New York, New York 10017	Paul Anderson	Collectors
Sunworks, Inc. 669 Boston Post Road Guilford, Connecticut 06437	Everett M. Barber, Jr.	Copper flat-plate collectors
E & K Service Co. 16824 74th Avenue, N.E. Bothell, Washington 98011	-	Flat-plate collector and home space- heating system
Free Heat P. O. Box 8934 Boston, Massachusetts 02114	-	Flat-plate collector and home space- heating system

Country	Company (Location)	Contact	Product or Activity
	Garden Way Laboratories Charlotte, Vermont 05445	-	Water-heating system
	Hitachi America Ltd. 437 Madison Avenue New York, New York 10022	-	Collector for domestic hot water
	Reynolds Metals Co. Building E-A 2315 Dominguez Street Torrance, California 90509	Plant Engineer	Flat-plate collectors, heat exchangers, header systems
	Solar Power Corporation 930 Clocktower Parkway Village Square New Port Richey, Florida 33552	-	Flat-plate collector
	Sunsource 9606 Santa Monica Boulevard Beverly Hills, California 90210	-	Flat-plate collector
	CSI Solar Systems Division 12400 49th Street North St. Petersburg, Florida 33730	-	Domestic hot-water-heating systems
	Energy Systems, Inc. 634 Crest Drive El Cajon, California 92021	-	Flat-plate collector
	Helio-Dynamics Inc. 518 South VanNess Avenue Los Angeles, California 90020	-	Flat-plate collectors, domestic hot- water, space-heating, air-conditioning systems; solar refrigeration and freezing
	Raypak, Inc. 31111 Agoura Road West Lake Village, California 91360	-	Flat-plate collectors

<p>Piper Hydro 2895 East La Palma Ave Anaheim, California 92806</p> <p>Rodgers and MacDonald 3003 N.E. 19th Drive Gainesville, Florida 32601</p> <p>Solar Water Heater Co. P. O. Box 341872 Coral Gables, Florida 33134</p> <p>Wilcon Corporation 3310 S.W. 7th Street Ocala, Florida 32670</p> <p>W. R. Robbins and Son 1401 N.W. 20th Street Miami, Florida 33142</p> <p>Youngblood Co., Inc. 1085 N.W. 36th Street Miami, Florida 33127</p>	<p>— Flat-plate collectors, domestic hot-water and space-heating systems; heat pumps</p> <p>— Flat-plate collectors, domestic hot-water systems</p> <p>— Domestic water heaters, space-heating systems</p> <p>— Hot-water heating systems using collector of vinyl tubing with dyed heat-transfer fluid</p> <p>— Flat-plate collectors</p> <p>— Flat-plate collectors for domestic hot water</p>
--	--

NOTE: The United States Energy Research and Development Administration and the Department of Housing and Urban Development are currently compiling information for a forthcoming catalog of solar-energy products. The catalog is designed to:

- Disseminate information to the general public and to the solar industry about the types of hardware available under development.
- Provide a general reference base of "state-of-the-art" technology immediately available through commercial suppliers.
- Enhance capabilities of individuals and organizations to collaborate in the assembly, development, and marketing of complete systems and subsystems.
- Establish a standard basis for collection and dissemination of information within the solar energy industry."

Information about this project may be obtained from either of the following addresses:

<p>ERDA Technical Information Center P. O. Box 62 Oak Ridge, Tennessee 37830</p>	<p>or Division of Energy, Building Technology and Standards Room 8158, Department of Housing and Urban Development Washington, D.C. 20410</p>
--	---

**APPENDIX 3**

***Manufacturers of  
Terrestrial Solar  
Photovoltaic Devices***

[This list includes only those manufacturers known to be producing commercially available terrestrial solar arrays at the time of writing. It may not be complete, but it represents the best information available to the panel at this time.]

Manufacturer	Cable, TWX, or Telex Address	Telephone
SOLAREX 1335 Piccard Drive Rockville, Maryland 20850 U.S.A.	TWX: 710 828 7909 Cable Address: SOLAREX	(301) 948-0202
Spectrolab, Inc. Division of Hughes Corporation 12484 Gladstone Avenue Sylmar, California 91342 U.S.A.	TWX: 910 496 1488	(213) 365-4611
Iran Solar Energy Company (Affiliate of Spectrolab, Inc.) 100 Hafez Avenue, Ehansi Building Teheran IRAN	Telex: 2516 Cable Address: 668 Teheran	43530-669775-8
Ferranti Limited Electronic Components Division Gem Mill Chadderton, Oldham OL9 8NP ENGLAND	Telex: 668038	061-624-6661
Centralab Semiconductor Division 4501 Arden Drive El Monte, California 91734 U.S.A.	TWX: 910 587 3429	(213) 448-4001
Solar Power Corporation 23 North Avenue Wakefield, Massachusetts 02185 U.S.A.	TWX: 710 348 7674	(617) 246-2355
Sharp Corporation Industrial Instruments Group Yamatokooryama, Nara 639-11 JAPAN	Telex: J63428 or J63429 Cable Address: LABOMETSANKI OSAKA	
R.T.C. La Radiotechnique-Compelec 130, Avenue Ledru-Rollin 75540 Paris FRANCE	Telex: 68495	355-44-99



#### APPENDIX 4

# *External-Combustion Engines — Rankine and Stirling Engines as Small-Scale Power Sources for Developing Countries*

Two types of external-combustion engines adaptable to a variety of heat sources are the Stirling- and Rankine-cycle engines. Both are based on modifications of the Carnot cycle, as illustrated in Figures 59 and 64, but thermal efficiencies are such that for operating temperatures below about 300-350°C, the Rankine engine is more efficient.

#### RANKINE ENGINES

The traditional example of a Rankine engine is the familiar steam engine, with thermal efficiencies of some 5-15 percent. This discussion, however, will be restricted to engines that are more useful on a smaller scale and that operate at temperatures in the range that can be achieved with solar collectors. For these lower temperatures, Rankine-cycle engines have been designed that use organic materials instead of water as the working fluid. The analysis that follows illustrates the type of system that would be associated with a solar-powered Rankine-engine-operated electric power plant.<sup>1,2</sup> It is based on current manufacturing capabilities for the individual components.

Introduction

Figure 60 shows a schematic of a solar-powered organic Rankine-cycle engine loop. The system of the schematic indicates the engine driving an electric generator. However, the engine could just as well be driving a water pump or the compressor of a cooling system.

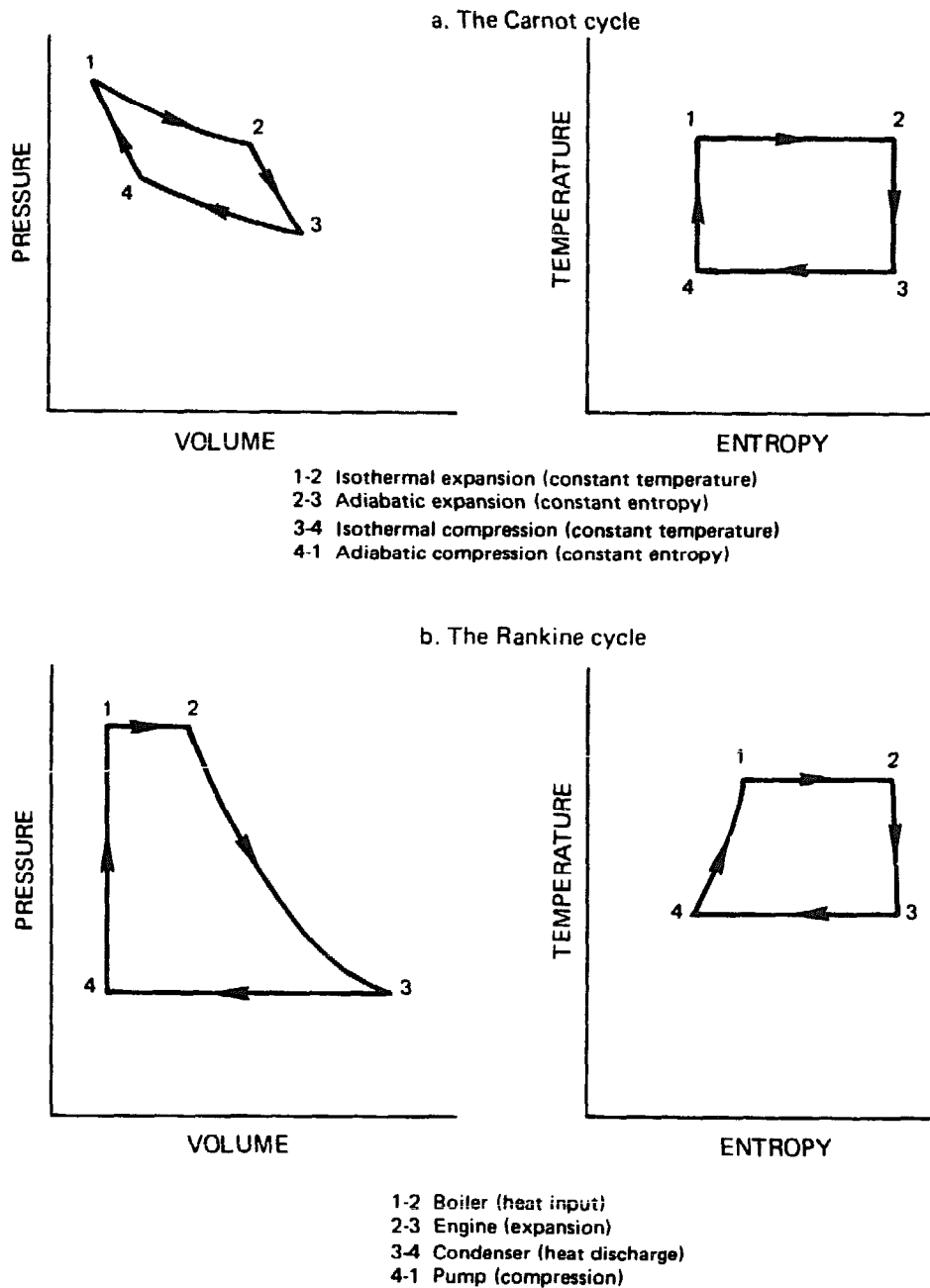

FIGURE 59 The Carnot and Rankine cycles.

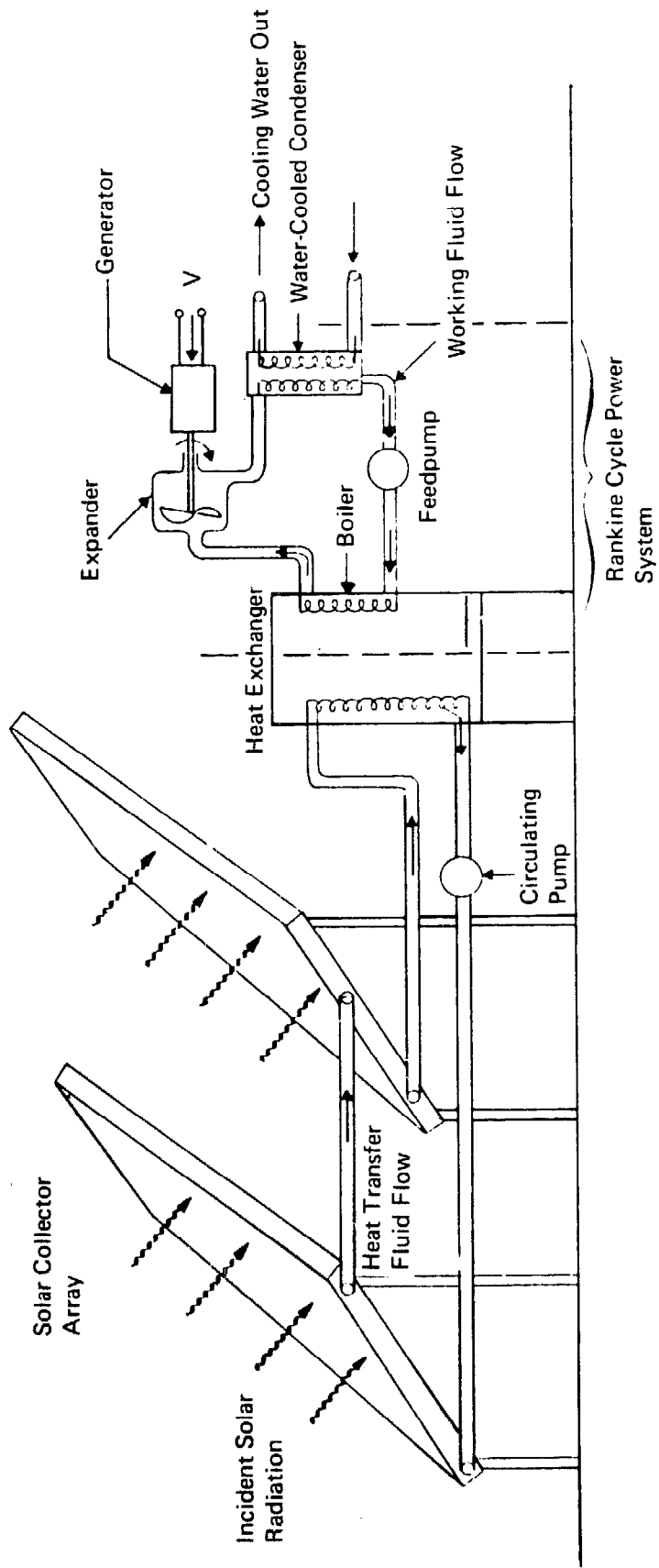

FIGURE 60 Solar-powered electric power plant. [Courtesy Arthur D. Little, Inc.]

Organic Rankine-cycle engines are particularly well suited for solar power application for a number of reasons:

- They have high thermal efficiency\* even when operating with the low to moderate temperatures (180-400°F [80-200°C]) achievable with flat-plate collectors or collectors using low levels of focusing.
- The cost of components is low because of the use of common materials of construction (mostly carbon steel) and relatively uncomplicated mechanical components. This is potentially very important to developing countries because of the possibility of using local materials and labor.
- Organic Rankine-cycle engines have high reliability as a result of their sealed construction that protects them from the harmful effects of the surrounding environment (dust, moisture, etc.).
- Since the organic working fluids have very low freezing points, there are no problems associated with freezing.
- Finally, they are adaptable for use over a wide power range from 1-kW pumping systems to multimegawatt power stations.

### System Description and Operation

The engine consists of four major components:

- expander
- boiler
- feedpump
- condenser.

During operation, a heat-transfer fluid (typically pressurized water) flows through the collector array and is heated to a temperature in the 200-400°F (100-200°C) range depending on solar-collector configuration, solar flux, and engine operating conditions. (This would entail a system capable of operating at about 235 psig [16.5 kg/cm<sup>2</sup> gauge].)

This hot fluid is then used to vaporize the working fluid of the engine in a heat exchanger; a number of common refrigeration fluids are appropriate for use in the engine loop. The hot, high-pressure, working fluid is then used to drive the expander of the Rankine-cycle engine. For higher-power-output applications (>100 kW) the expander will be a turbine. Lower-power systems can use positive displacement configurations such as reciprocating or vane-type expanders. After leaving the expander, the working-fluid vapor is

\*60-70 percent of the ideal cycle efficiency, given the heat input and rejection temperatures.

condensed and the liquid is then pumped back into the solar-collector heat exchanger, completing the cycle.

### System Performance Estimates

An estimate of overall system efficiency depends on analysis of the efficiency of the major components.

#### ENGINE EFFICIENCY

The efficiency of the engine depends on both the ideal efficiency of the cycle under consideration (assuming 100-percent expander efficiency, etc.) and the actual efficiency of the major system components, such as the expander and feedpump. Tests by a number of firms for a range of component configurations indicate that with existing technology the following component efficiencies are obtainable:

- expander—70-85 percent
- feedpump—70-93 percent.

Engine performance calculated on the basis of an expander efficiency of 80 percent and a feedpump efficiency of 80 percent indicates that it is possible to achieve about 65 percent of the ideal Carnot efficiency when the engine is operated in its appropriate temperature range. The corresponding engine efficiencies, as a function of both heat-input and heat-rejection temperatures, are shown in Figure 61. As this figure indicates, heat-engine efficiency increases with increasing heat-input temperature and with decreasing heat-rejection temperature. The 120°F (~50°C) heat rejection temperature is considered to be typical of air cooling, 100°F (~40°C) of evaporative cooling, and 80°F (~30°C) of water cooling. The effect of condenser temperature is quite significant—particularly for systems operating with lower (200°F [~95°C]) heat-input temperatures—thus providing a strong incentive to use water cooling if water is available (such as for water-pumping applications).

#### ANNUAL COLLECTOR EFFICIENCY

Both focusing and non-focusing collectors can be used as the heat source for organic Rankine-cycle engines. Flat-plate (non-focusing) collectors are used here to illustrate the effect of thermal collector characteristics on overall system performance for the following reasons:

- Flat-plate collectors have the advantage of being capable of effective

operation mounted in a fixed position. The collectors and their mounting structure are, therefore, structurally simple—an advantage for use in remote areas.

- Flat-plate collectors can utilize diffuse as well as direct radiation, making such a system appropriate over a wide range of geographical areas and varying climatic conditions.

- The technology of flat-plate collectors is advancing as a result of industry and government programs to develop solar heating and cooling systems (particularly in the United States).

- Organic Rankine-cycle engines can effectively use the low to moderate temperatures achievable with flat-plate collectors.

For estimating the performance of the collector/engine combination it is most realistic to use the *average annual* collector efficiency as a measure of collector performance rather than the efficiency at midday (i.e., high solar flux conditions) often referred to in the literature.

Calculated curves<sup>2</sup> for the annual collector efficiency in an arid region at 32.5° north latitude for a variety of solar collectors tilted in a fixed position (32.5° relative to horizontal) show that the collection efficiency can vary widely, depending on the collector configuration (Figure 62). All the curves assume selective coatings on the absorber plate. (A collector with a flat black

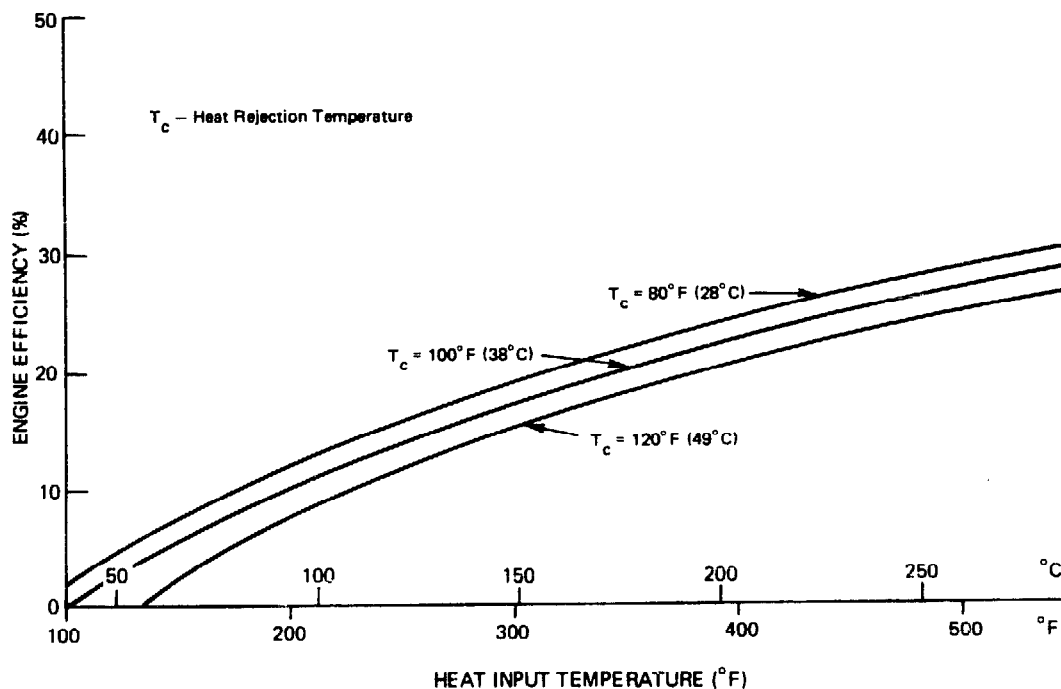

FIGURE 61 Heat engine efficiency as a function of temperature for an engine operating at 65 percent of Carnot efficiency. [Courtesy Arthur D. Little, Inc.]

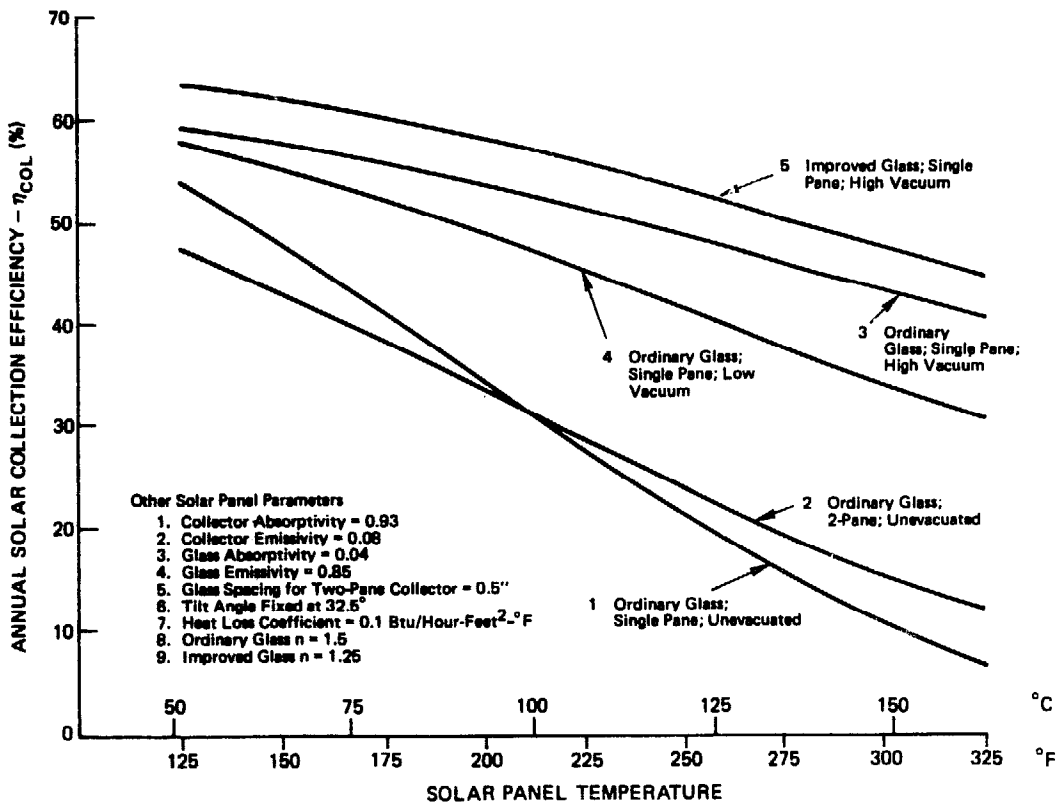

FIGURE 62 Annual solar collector performance as a function of collector temperature (for Yuma, Arizona). [Source: Bartoszek, *et al.*, Ref. 2]

coating and on two cover plates would have an efficiency level lower by approximately 10 percent than that indicated by Curve 1.)

As indicated, a large improvement in collector performance is achieved by using some form of convection suppression between the absorber plate and the cover plate(s) to eliminate heat transfer losses by convection. Figure 62 indicates the use of partial vacuum; similar results, however, may be obtained by using cellular structures (honeycombs).

Curve 5 indicates the improvement that would be achieved by using anti-reflective coatings or surface treatments on the glazing to reduce transmission losses. The benefits of anti-reflective coating would be even more pronounced for the lower-performance collectors typified by Curves 1 and 2.

#### SYSTEM EFFICIENCY

The overall system efficiency, which to a great extent determines the collector area requirements, is defined as:

$$\eta_s = \eta_e \times \eta_c$$

where:

$\eta_s$  = overall system thermal efficiency

$\eta_e$  = engine thermal efficiency

$\eta_c$  = collector efficiency

Since increased collector temperature results in increased engine efficiency and decreased collector efficiency, there is an optimum operating temperature range for each engine/collector configuration. The variation in annual system efficiency is shown in Figure 63 for the collectors of Figure 62. The engine efficiency used in calculating these curves corresponds to the curve of Figure 61 with a condenser operating at 100°F (38°C).

As indicated, annual average efficiency levels are about 3.5 percent for collectors without some form of vacuum suppression and 6.5 percent to 9 percent if collectors using vacuum suppression are utilized. It should be noted that the peak efficiency of these systems under high flux conditions at solar

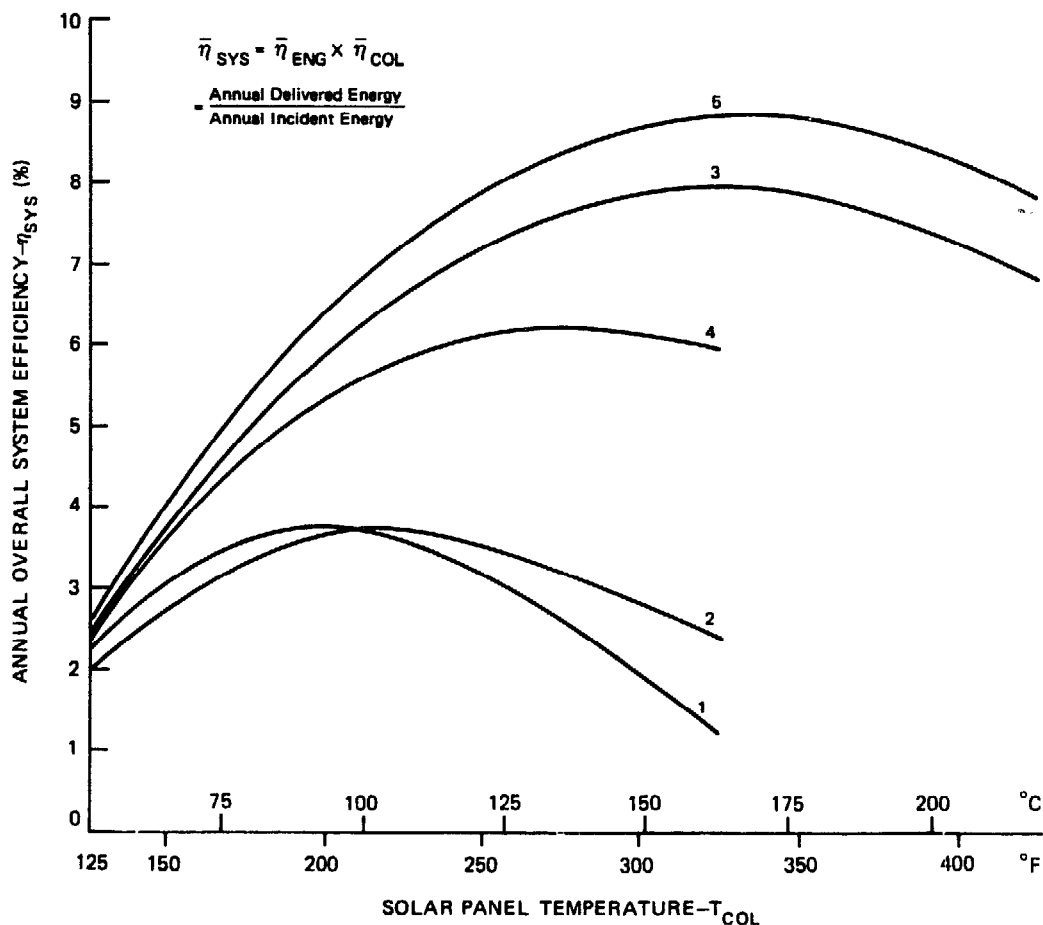

FIGURE 63 Annual overall system efficiency variation with collection temperature. [Source: Bartoszek, *et al.*, Ref. 2]



noon would be significantly (~50 percent) higher than those indicated in Figure 63. (These numbers are approximate; for a given design and application, it is possible to calculate more exactly what output can be expected.)

### Comparison with Other Cycles

The heat generated in the solar collector array can, in principle, be used to operate any form of heat engine, including:

- Stirling cycle
- Rankine cycle (using water)
- Rankine cycle (using organic fluids)
- Ericsson cycle
- Closed cycle Brayton
- Hybrid cycle.

All of these engines have been suggested for use in solar thermal power systems. However, it is very difficult to operate gas-cycle engines (Stirling, Ericsson, Brayton) efficiently at the low temperatures (200-350°F [100-180°C]) associated with arrays of flat-plate solar collectors using low-level concentration, even though the ideal efficiency of the Stirling and Ericsson engines would be the Carnot efficiency. At these relatively low heat-input temperatures, the compression work in the gas cycle approaches the expansion work so that the net work output becomes very sensitive to the efficiency of the compression and expansion processes. Even with low operating temperature differences, the efficiency of the Rankine-cycle engines remains high (60-70 percent of the ideal Carnot efficiency). This is due to the fact that the pump work is a relatively small percentage of the expansion work.

If collector arrangements are used that can operate at elevated temperature levels (1,000°F [550°C] or higher) the engines based on gas cycles could, however, be very attractive and would merit serious consideration.

### STIRLING ENGINES

Unlike the Rankine engines, Stirling engines are external-combustion heat engines that usually utilize air or other gases as working fluid. They are capable of operating on any source of heat such as sun, wood, coal, or field waste. Invented in 1816 by Robert Stirling, they were competitive with steam engines of the day, particularly with regard to fuel efficiency and safety.

(Figure 64 shows the basic Stirling cycle.) In the early 1900s thousands were sold as coal-burning water-pumping machines that produced from 50 to 500 watts of delivered power at about 2 percent overall thermal efficiency.<sup>3</sup> These pumping engines used air at atmospheric pressure for a working fluid, and a cast-iron hot end. As a result, they were very large and heavy for their power. However, they were exceptionally quiet, durable, and easy to operate and maintain; they were displaced only by the advent of widely distributed electric power in the 1920s.<sup>4</sup>

Toward the end of the Second World War there was launched an intensive development effort that has resulted in today's powerful, efficient, and quiet Stirling engines (Figures 65 and 66) intended for automotive use. In order for these large crank-type engines to come into commercial use, a number of very difficult design problems must still be solved.

As a result, and because of the nearly universal availability and very low cost of internal-combustion engines, the traditional crank-type Stirling engine remains in the development labs instead of on the road or in the field. No such engines producing more than a few watts of power are at present available on the market.

### Free-Piston Stirling Engines

The practical difficulties of producing crank-type Stirling engines have led to the development of a great variety of free-piston linear-motion Stirling engines that, while they operate on exactly the same cycle as the crank machines (Figure 67), avoid many of their problems. Furthermore, their design makes the construction of small engines more easily achieved. Power is removed from these engines by various linear-motion pumps or alternators.<sup>5</sup> It should be emphasized that *all of these engines are under development* and are not yet commercially available in production quantities that would reflect a realistic manufacturing cost. These engines are under development in the United States under the sponsorship of the Energy Research and Development Administration (space power plant), the National Institutes of Health (artificial heart), and the American Gas Association (gas-fired air conditioner). Private groups are also involved in developing some of these devices.

Figures 68 through 71 show several means of power extraction that are useful with linear motion engines. All of these have been built in prototype quantity and operated successfully. The inertia pump (Figure 68) is being developed in the United States for commercial use in a gas-fired air-conditioner system in which the free-piston Stirling engine (FPSE) drives an inertia pump that pumps Freon-12 around a conventional cooling cycle. When lower temperatures for food freezing are required, an even simpler machine can be used. In this, an FPSE heat engine drives an FPSE heat pump;

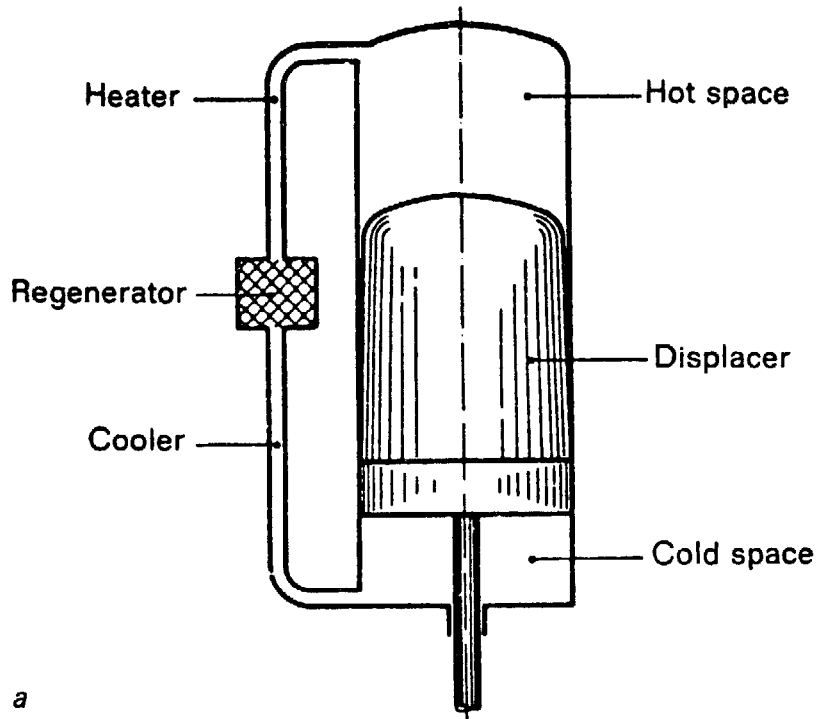

a

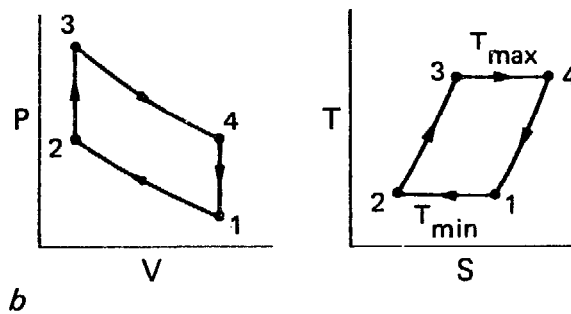

b

- 1-2 Isothermal compression at the lower temperature.
- 2-3 Heat input at constant volume, raising gas to upper temperature, increases pressure still further.
- 3-4 Isothermal expansion at upper temperature.
- 4-1 Gas cooled to lower temperature at constant volume.

FIGURE 64 The Stirling Cycle. [Courtesy Philips Research Laboratories, Eindhoven]

- a. Principle of the displacer system.
- b. The thermodynamic cycle.
- c. Diagram of the cycle.

c

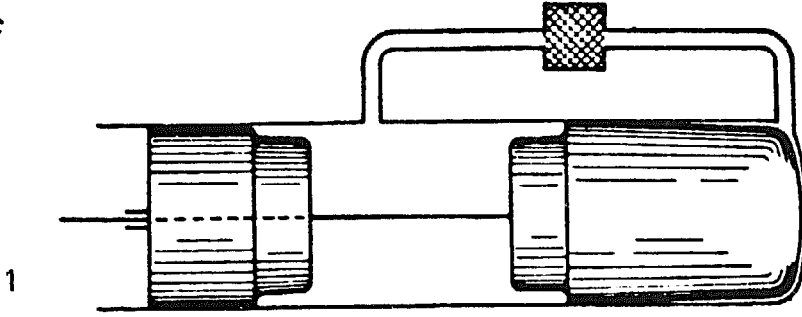

1

*Piston at bottom dead centre. Displacer at top dead centre. All gas in cold space.*

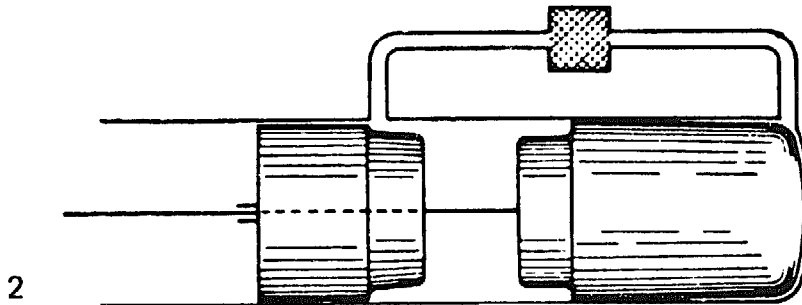

2

*Displacer remaining at top dead centre. Piston has compressed gas at lower temperature.*

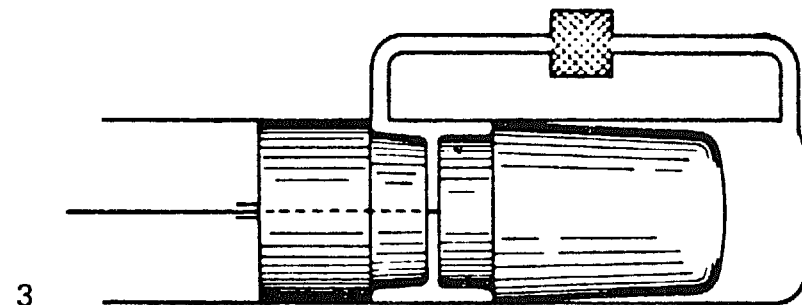

3

*Piston remaining at top dead centre. Displacer has shifted gas through cooler, regenerator and heater into hot space.*

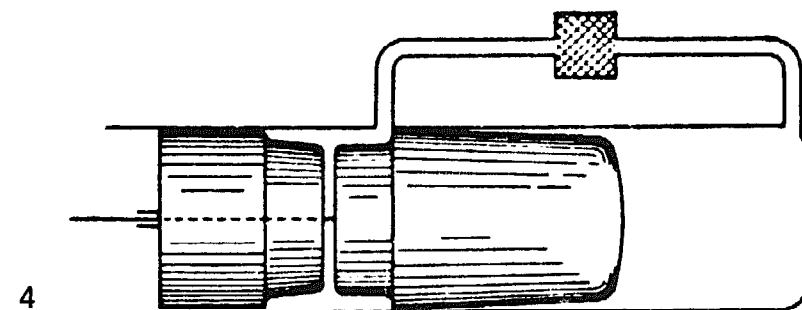

4

*Hot gas expanded. Displacer and piston have reached bottom dead centre together. With piston stationary, displacer now forces gas through heater, regenerator and cooler into cold space, thus re-attaining situation 1.*

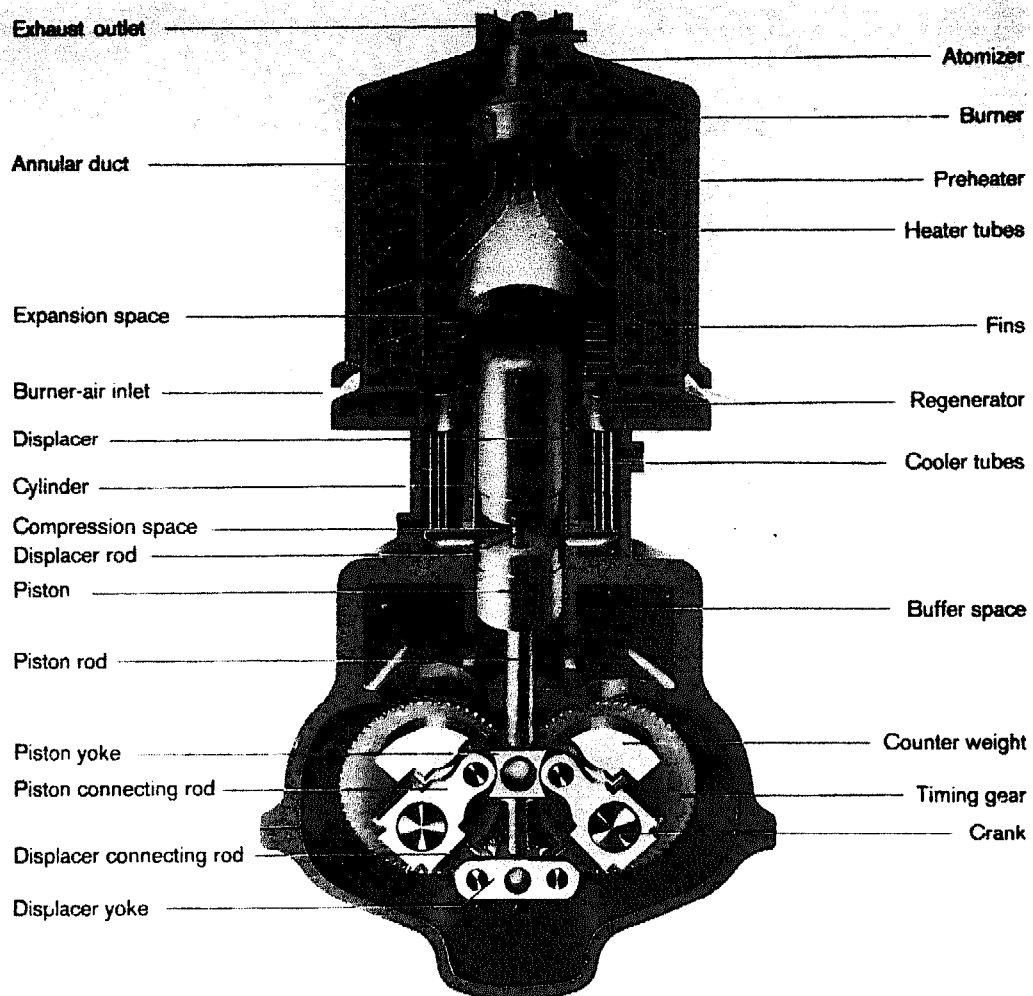

FIGURE 65 The Philips rhombic engine. [From: R. J. Meijer: 1970. *Philips Technical Review* 31:168-85]

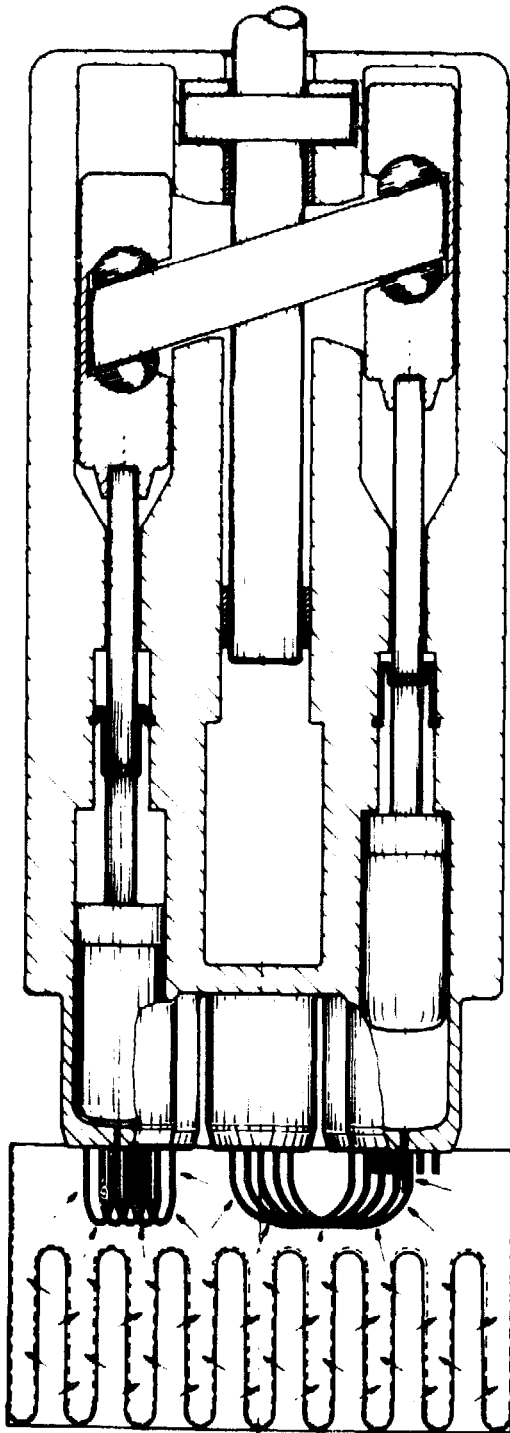
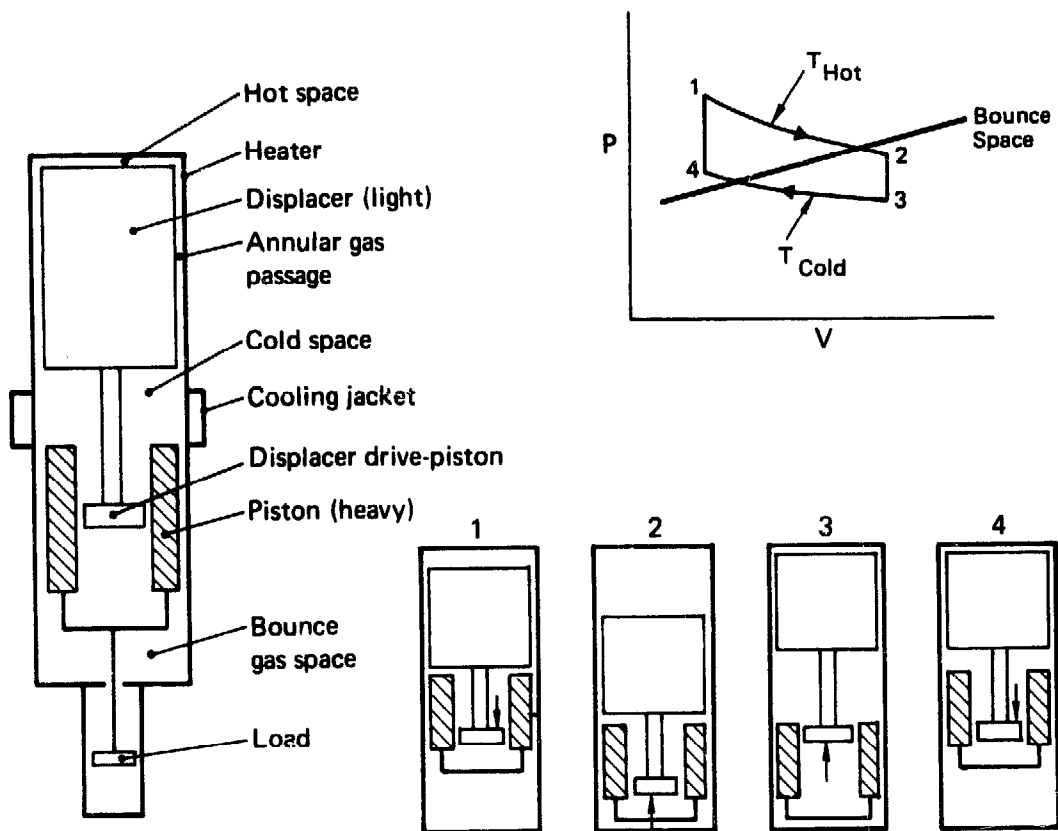

FIGURE 66 Swashplate Stirling engine. [From: R. J. Meijer. 1970. *Philips Technical Review* 31:168-85]

this combination is dynamically balanced and hermetically sealed, and as a result of its very simple construction, would probably be more reliable and less expensive than the engine/inertia pump combination.

A variant of the FPSE is the free-cylinder engine, illustrated in Figure 69, that operates from solar energy concentrated by a Fresnel lens.

A free-piston/linear-alternator engine is under development in the United



- 1-2 Working gas in hot space, working-gas pressure higher than bounce-gas pressure. Expanding gas drives displacer and piston down. With a lower mass than the piston, the displacer accelerates more rapidly and soon contacts the piston and both move together, compressing bounce gas.
- 2-3 Bounce-gas pressure greater than working-gas pressure. Pressure differential acting on displacer drive-piston, while bounce gas is still being compressed by piston, moves displacer up, shuttling working gas into cold space. Working-gas pressure drops rapidly.
- 3-4 Bounce-gas pressure drives piston up, compressing cold working gas.
- 4-1 Rise in working-gas pressure drives displacer down, shuttling cold gas into hot space. Working-space pressure rises rapidly.

FIGURE 67 Free-piston Stirling engine—principle of operation. [Adapted from Beale, *et al.*, Ref. 8]

States in a project supported by the Energy Research and Development Administration, intended to result in a very long-life 1-kW space power plant heated by a radio isotope. The linear-alternator machine may be made to operate on solar power, using either high temperature with a concentrating collector, or low temperature such as is available from a flat-plate collector. The use of a flat-plate collector to operate an FPSE diaphragm pump is

illustrated in Figure 70. If the flat plate is used, condensing working fluids rather than an ideal gas might be more appropriate, since they produce much more work per cycle.<sup>6</sup>

### Diaphragm Engine

A particularly attractive variation for electric-power generation is shown in Figure 71.<sup>7</sup> This machine uses flexing diaphragms and springs, without any sliding fits or seals. The displacer is driven by the force transmitted from the cylinder to the displacer through the displacer support-spring, as the displacer oscillates at a resonant frequency determined by its mass and support-spring stiffness. Since the motion of the cylinder is  $180^\circ$  out of phase with the

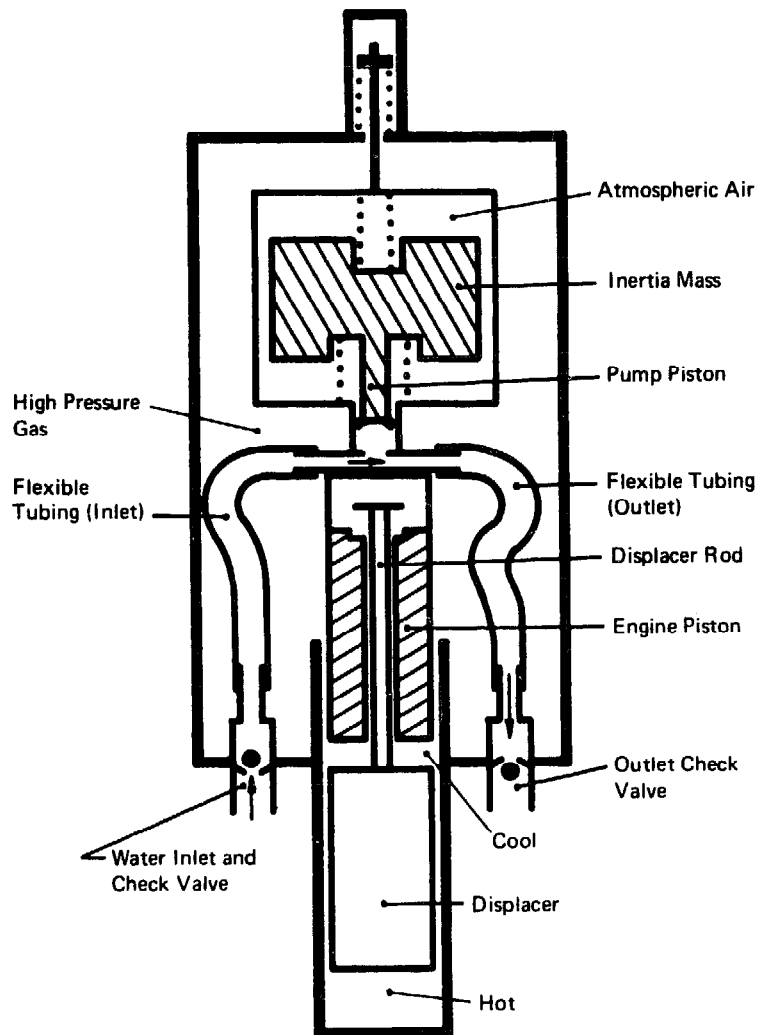

FIGURE 68 Free-piston Stirling engine inertia pump.  
[Source: Beale *et al.*, Ref. 8]



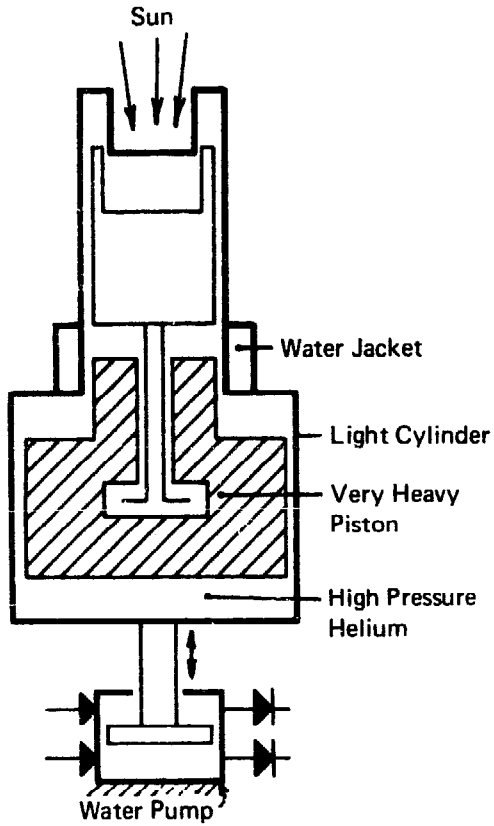

FIGURE 69 Free-cylinder Stirling engine. Power is taken from the cylinder, which moves in reaction to the motion of the heavy piston. [Source: Beale *et al.*, Ref. 8]

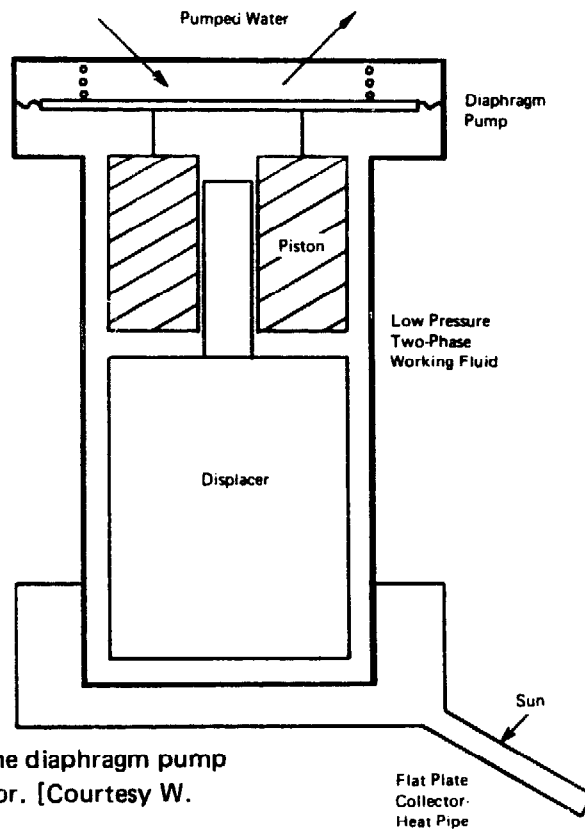

FIGURE 70 Free-piston Stirling engine diaphragm pump operated from a flat-plate solar collector. [Courtesy W. Beale]

diaphragm, a net energy input to the displacer is achieved. The present experimental models run at 110 Hz and produce about 25 W. Larger sizes are possible. Propane-heated and radioisotope-heated versions are operating. A propane-heated field-trial prototype is providing the electrical power for the UK National Data Buoy, and a similar machine powering a large marine light has been demonstrated commercially at the International Association of Lighthouse Authorities Exhibition at Ottawa in August 1975. This machine is being actively developed at the Atomic Energy Research Establishment, Harwell, England, and is now being offered commercially by two UK firms.<sup>8</sup>

### Fluidyne Engine

One of the more recent variants of the free-piston Stirling engine is the "Fluidyne" pump being developed at Harwell.<sup>1,2</sup> This engine, illustrated in Figure 72, uses columns of fluid in tubes to displace the working gas (air) between the hot and cold regions, and also for extracting output power. This lends itself to direct integration in water-pumping systems.

At present, the following results have been achieved with some of the experimental Stirling engines of the type discussed here; better performance is expected with development.

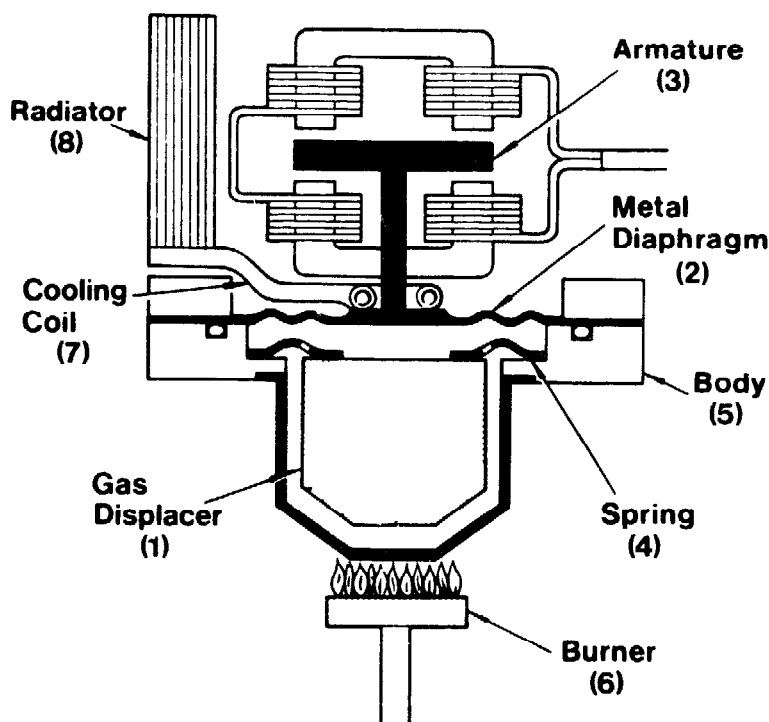

FIGURE 71 Harwell diaphragm engine. [Source: Harwell Bulletin No. 74/26]

Type of Load and Working Gas	Heat Source	Hot-End Temperature degrees C	Power Out	Thermal Efficiency	Reference
inertia Freon compressor (helium)	electric	650	2 kW	30%	9
inertia water pump (air)	electric	550	3 W	3%	9
linear alternator (helium)	electric	600	34 W	12%	9
linear alternator (air)	electric	500	3.6 W	4%	9
free cylinder water pump (helium)	sun (Fresnel lens)	450	6 W	3.5%	9
free cylinder water pump (helium)	electric	600	70 W	14%	9
Harwell diaphragm engine alternator (helium)	electric	594	37.5 W	16.9%	10
Harwell diaphragm engine alternator (helium)	propane	450	31.8 W	10%	11
Harwell diaphragm engine alternator (helium)	Sr <sup>90</sup>	280	10.7 W	7.8%	10

A demonstration FPSE as shown in Figure 68 has operated for 2,600 hours without wear or performance degradation.<sup>9</sup> Critical components of the Harwell diaphragm engines have been operated for 2½ years without failure.<sup>6</sup> Two of these engines, one propane-heated and one radioisotope-heated, have each operated for more than 7,000 hours without wear or performance degradation.<sup>8</sup>

## THE STATUS OF CURRENT TECHNOLOGY

There is as yet no significant commercial manufacture of Stirling engines. It is possible, however, to construct a 150-W output, free-piston Stirling engine

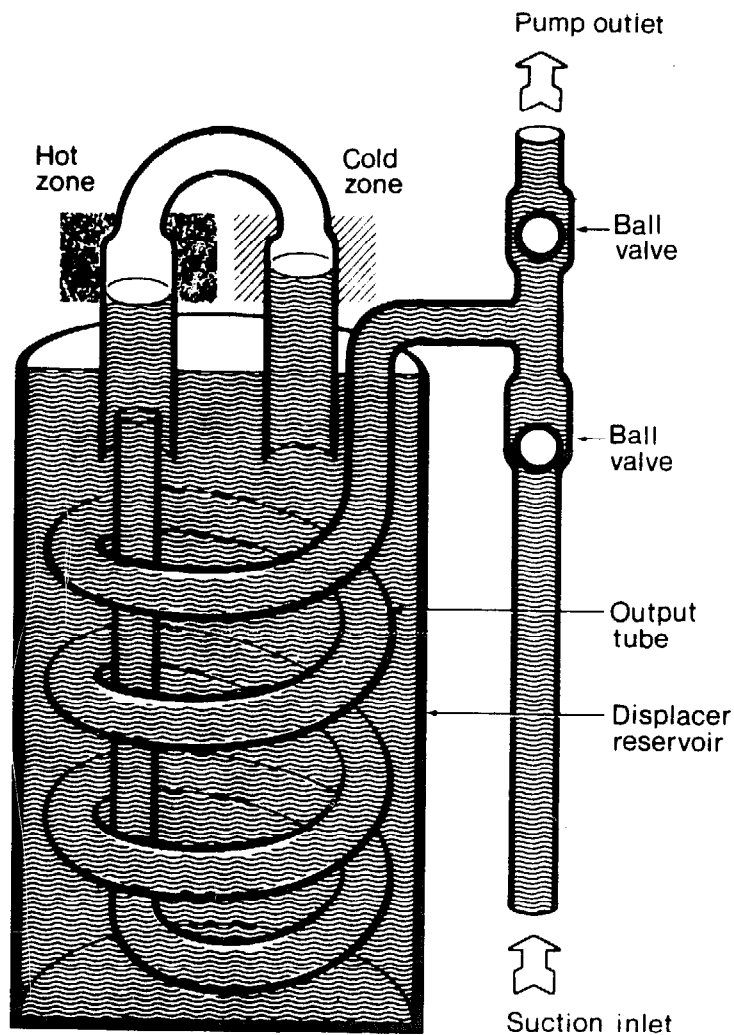

FIGURE 72 The Harwell "Fluidyne" pump. In operation, air is displaced between the hot and cold zones and the resulting changes in pressure force water up and through the pump, at the same time maintaining the rhythmic movement of the air. [Courtesy AERE Harwell]

weighing about 20 kg with all accessories, including power-output device (pump or alternator) and cooling system, with an overall efficiency of about 5 percent operating on solid fuels—or as high as 20 percent operating on bright sun with a Fresnel lens<sup>9</sup>—and costing approximately \$100 as made in the United States. The performances and costs are approximations from present experience, and the costs may be lower if large numbers of engines are produced. The cost of the collector and tracker is not included, and is likely to be quite high (say \$200 for a 100-W engine).

This machine could be expected to have a life of at least 4,000 hours and probably much more. The most likely failure modes would be corrosion of the hot end, and/or leakage of pressurized working fluid. It would be possible to repair it only at a central shop, but repair would be simple and cheap, probably requiring only replacement of the hot end and recharging. Internal moving components would operate on a gas film and should have no appreciable wear. Internal springs would be stressed only briefly during startup.

Whether the FPSE could be manufactured locally would depend on details of design. The only difficult operation is the very close fitting required on piston/cylinder and displacer rod. These might be designed for a hand-lapped fit, resulting in non-interchangeable matching pairs. Material throughout could be cast iron or steel if a low-temperature hot end is tolerated. Possibly a more desirable solution would be to use a relatively small amount of stainless steel for the hot end. This would greatly increase durability and might be less costly in the long run.

The diaphragm-type machine avoids the need for any sliding surfaces, so there is no wear and no close fits are required. Nevertheless, the present manufacturing costs of these machines in Great Britain are more than 100 times greater than the \$100 estimate given for the 150-W FPSE. Furthermore, the diaphragm machines are much heavier for a given output than the FPSE machines. As with some thermoelectric and photovoltaic systems available commercially, the main present application of the diaphragm-type machine would be in situations where the ability to provide a few tens of watts of electric power, for a year or more without attention or refueling, is of great value.

## RESEARCH AND DEVELOPMENT

Given the state of development of the free-piston Stirling engine, one would expect it to be commercially available in 5-10 years, if the demand warrants further commercial interest.

Further development of the diaphragm engine might also result in a

device that would be available in 5-10 years. It is not only intrinsically extremely durable if properly designed and constructed, but also potentially very inexpensive in power levels below 100 W; the major cost is the alternator itself and the power diaphragm, which must be free of any flaws. It could be very largely assembled from pressings. Thus, if the potential market justified a substantial investment in design and tooling, there seems no reason why the cost should not be reduced to that of a small gasoline engine, if manufactured in equally large numbers.

The presently known technology would be adequate for power plants on the order of 100 W. For kilowatt levels of power, some work is needed to find designs of hot ends, solid-fuel burners, lenses, tracking mechanisms, and pumps appropriate for local manufacture in developing countries.

As a result of the active development programs being carried on for automotive, air-conditioning, artificial-heart, and space applications, rapid improvements in efficiency and durability of the Stirling engine can be expected, along with a reduction in costs.

## USES OF THE STIRLING ENGINE IN DEVELOPING COUNTRIES

In view of the current state of development, there is little likelihood that Stirling engines will be used in developing countries to any great extent in the next 5 years. (The one possible exception is use of the large, slow, 1908-style engines discussed earlier, that could certainly be manufactured today in many developing countries.) If interest and demand in the industrialized countries result in manufacturing economies for the machines that exist in prototype form, some applications in developing countries may be possible in 5-10 years.

Stirling engines can be made to operate with either high-temperature sun-tracking collectors or with lower-temperature fixed collectors. The free-cylinder water pumps and the diaphragm linear alternator seem the most likely candidates for solar power.

Any of the Stirling engines mentioned could be designed to operate on solid fuel with power/volume ratio and efficiency dependent on the design of the heat exchangers. Solid-fuel stove/engine combinations can be devised to serve as heating or cooking units while providing electric power (Figure 73). These stoves could burn straw, dung, coal or any locally available fuel.

The free-cylinder engine with induction pump would have all its high-mortality components easily available, and its precision components completely protected from any possible contamination.

Another possibility would be to use an electric motor to drive a pump, and

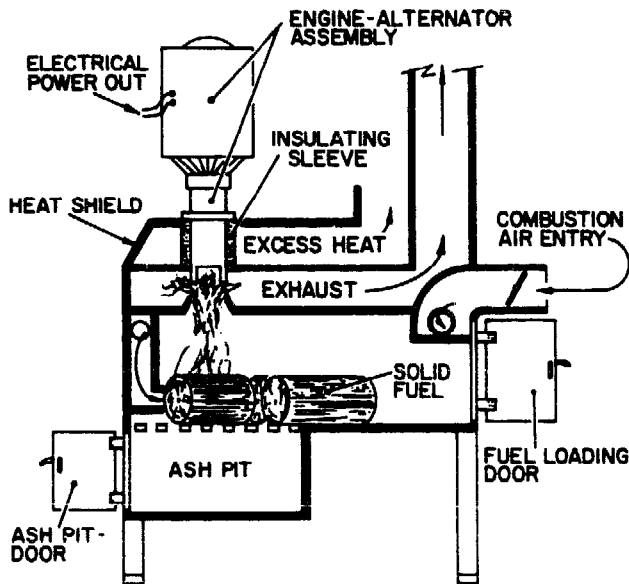

FIGURE 73 Combination wood stove/solid-fuel Stirling engine. [Courtesy W. Beale.]

use a Stirling engine, windmill, or other power source to maintain charge in a battery. This is a complex arrangement, but it has the advantage that many power sources can be used in parallel, and many uses can be made of the stored electric energy.

A third water-pumping alternative would be to use the 1908-style, large, slow, atmospheric engines. A modern design of these would have performance not less than the early 500-W 1-percent achievement. A possible advantage of this large and simple machine is that it requires lower tolerances and is more easily adapted to local foundry and machining capabilities than the more precisely finished high-pressure engines. It does, however, require far more metal for the same power. Another advantage of this rather primitive but appealing engine is its educational value. Its workings are obvious to the interested observer, which is not the case with the free-piston machines.

## REFERENCES

1. Prigmore, Daryl R., and Barber, Robert F. 1974. A prototype solar powered, Rankine cycle system providing residential air conditioning and electricity. Paper No. 749026. *Ninth Intersociety Energy Conversion Engineering Conference Proceedings*. 26-30 August, San Francisco, California. pp. 326-333. New York: American Society of Mechanical Engineers.
2. Bartoszec, J. T.; Swanson, J. L.; and Teagan, W. P. 1975. A solar-powered water pumping system for the Yuma (Arizona) desalination plant. Paper No. 759114. *Record of the Tenth Intersociety Energy Conversion Engineering Conference*. 18-22 August, University of Delaware, Newark, pp. 765-771. New York: Institute of Electrical and Electronic Engineers.

3. Rider-Ericsson Engine Company. *Hot air pumping engines catalog-1908*. Lansing, Michigan: Robert Huxtable Company, Box No. 1107, Zip Code 48904.
4. Walker, Graham. 1973. *Stirling-cycle machines*. New York: Oxford University Press.
5. Beale, W. 1969. Free piston Stirling engine—some model tests and simulations. Paper 690230. Presented at the Society of Automotive Engineers Automotive Engineering Congress, 13-17 January, Detroit, Michigan.
6. Walker, Graham. 1974. Personal communication. University of Calgary, Mechanical Engineering Department, Alberta, Canada.
7. Cooke-Yarborough, E. H.; Franklin, E.; Geisow, J.; Howlett, R.; and West, D. D. 1974. Thermomechanical generator: an efficient means of converting heat to electricity at low power level. *Institute of Electrical Engineers, London, Proceedings* 121(7):749-751.  
Also Atomic Energy Research Establishment (of United Kingdom Atomic Energy Authority), Harwell, England (referred to after this as AERE), Report AERE-R7645.
8. Harrison, J. D. L. 1975. Personal communication. AERE Harwell, Energy Technology Support Unit.
9. Beale, W.; Holmes, W.; Lewis, S.; and Cheng, E. 1973. Free piston Stirling engines—a progress report. Paper 730647. Presented at the Society of Automotive Engineers Automotive Engineering Conference, 18-22 June, Chicago, Illinois.
10. Cooke-Yarborough, E. H., and Yeats, F. W. 1975. Efficient thermo-mechanical generation of electricity from the heat of radioisotopes. *Record of the Tenth Intersociety Energy Conversion Engineering Conference, 18-22 August, University of Delaware, Newark*, pp. 1003-1011. New York: Institute of Electrical and Electronic Engineers.  
Also Harwell Report AERE-R8036.
11. *Ocean '74: IEEE International Conference on Engineering in the Ocean Environment Record*. Vol. 1. 21-23 August, Halifax, Nova Scotia, pp. 226-231. New York: Institute of Electrical and Electronic Engineers.  
Also Harwell Report AERE-R7753.
12. West, C. D. 1974. Fluidyne heat engine. Paper No. 5. *Record of the International Solar Energy Society (UK Section) Conference on Solar Energy Utilization*, 9 July, Brighton Polytechnic, England, pp. 54-79. London: International Solar Energy Society, UK Section.  
Also Harwell Report AERE-R6775.

## SUGGESTED READING

- Martini, W. R. 1972. Developments in Stirling Engines. ASME Paper 72-WA/ENER-9. New York: American Society of Mechanical Engineers.
- Zarinchang, Jafar. 1972. *The Stirling engine: a bibliography*. London: Intermediate Technology Development Group.
- Walker, Graham. 1973. The Stirling engine. *Scientific American* 229(2):80-87. An excellent general summary of Stirling engine development. For a technical summary and comprehensive bibliography, see Ref. 4.



APPENDIX 5

*Currently Manufactured  
Windmill Pumps and  
Generators*

[This list is not necessarily complete but it has been compiled from the best information available to NAS staff. The information has been supplied by the developers; thus, neither the panel nor the NAS/NRC can assume responsibility for its accuracy.]

**Manufacturer**

**Aermotor**  
 Division of Braden Industries, Inc.  
 Industrial Park  
 P. O. Box 1364  
 Conway, Arkansas 72032  
 U.S.A.

[Note: Manufacture of the fanwheel is done by licensee in Argentina, for units sold by Aermotor. Windmill heads are also manufactured by South African licensee.]

**Equipment**

"Aermotor" water pumping windmill, multi-blade (18) fanwheel coupled to reciprocating cylinder pump.

**Wheel Diam. (feet)**      **Stroke (inches)**      **Cost (windmill alone) (F.O.B. branch warehouse in U.S.)**

6                              5½ & 3                      \$ 465.

8                              8 & 6                              690.

10                             10 & 7½                     1165.

12                             12 & 9                        1945.

14                             14 & 10                     3125.

16                             16 & 12                     4235.

Stub towers, for mounting Aermotor windmill on owner-supplied tower, are available in heights from 3 feet to 14 feet, at prices ranging from \$44 to \$965, depending on the size of the fanwheel. Standard four-post towers are also available from 21 feet to 47 feet high, and costing from \$535 to \$3175, depending on the size of the fanwheel. (Costs F.O.B. branch warehouse in U.S.)

A E R M O T O R P U M P I N G C A P A C I T Y									
Diameter of Cylinder (Inches)	Capacity per Hour, Gallons		Total Elevation in Feet						
	8-15 Ft		S I Z E O F A E R M O T O R						
	6 Ft	8 Ft	6 Ft	8 Ft	10 Ft	12 Ft	14 Ft	16 Ft	
1½	105	150	130	185	280	420	600	1,000	
1¾	125	180	120	175	260	390	560	920	
2	130	190	95	140	215	320	460	750	
2¼	180	260	77	112	170	250	360	590	
2½	225	325	65	94	140	210	300	490	
2¾	265	385	56	80	120	180	260	425	
3	320	470	47	68	100	155	220	360	
3¼	440	550	35	50	75	115	160	265	
3½	—	730	—	—	65	98	143	230	
4	570	830	27	39	58	86	125	200	
4½	—	940	—	—	51	76	110	180	
4¾	725	1,050	21	30	46	68	98	160	
5	—	1,170	—	—	—	—	—	—	
5¼	900	1,300	17	25	37	55	80	130	
5¾	—	1,700	—	—	—	—	—	—	
6	—	1,875	—	—	17	25	38	55	85
7	—	2,550	—	—	—	19	28	41	65
8	—	3,300	—	—	—	14	22	31	50

Capacities shown in the above table are approximate, based on the motor on the 1000 stroke, operating on a 15 to 20 mi.-an-hour wind. The short stroke increases elevation by one-third and reduces pumping capacity one-fourth.

Manufacturer	Equipment																								
Aerowatt 37, Rue Chanzy 75011 Paris France [Information supplied by U.S. representative: Automatic Power, Inc. P.O. Box 18738 Houston, Texas 77023]	"Aerowatt" wind-driven electric generator [battery charger]. Two-blade variable-pitch propeller, three-phase AC generator with 12- or 24-volt DC output from solid-state controller [rectifier/regulator]. Electrical brake.																								
	<table border="1"> <thead> <tr> <th>Model No.</th> <th>Propeller Diam. (feet) (meters)</th> <th>Power Generated at 16 mph [7.15 m/s] (kW)</th> <th>Average produced in one year with average annual wind velocity of 16 mph [7.2 m/s]</th> </tr> </thead> <tbody> <tr> <td>24FP7</td> <td>3.3 1.0</td> <td>28</td> <td>Power (kW) 14 Energy (kW-hrs) 126</td> </tr> <tr> <td>150FP7</td> <td>6.7 2.04</td> <td>130</td> <td>72 628</td> </tr> <tr> <td>300FP7</td> <td>10.7 3.16</td> <td>350</td> <td>184 1600</td> </tr> <tr> <td>1100FP7</td> <td>16.7 5.09</td> <td>1125 volt-amps</td> <td>450 3900</td> </tr> <tr> <td>4100FP7</td> <td>30.7 9.34</td> <td>4100 volt-amps</td> <td>1500 13,100</td> </tr> </tbody> </table>	Model No.	Propeller Diam. (feet) (meters)	Power Generated at 16 mph [7.15 m/s] (kW)	Average produced in one year with average annual wind velocity of 16 mph [7.2 m/s]	24FP7	3.3 1.0	28	Power (kW) 14 Energy (kW-hrs) 126	150FP7	6.7 2.04	130	72 628	300FP7	10.7 3.16	350	184 1600	1100FP7	16.7 5.09	1125 volt-amps	450 3900	4100FP7	30.7 9.34	4100 volt-amps	1500 13,100
Model No.	Propeller Diam. (feet) (meters)	Power Generated at 16 mph [7.15 m/s] (kW)	Average produced in one year with average annual wind velocity of 16 mph [7.2 m/s]																						
24FP7	3.3 1.0	28	Power (kW) 14 Energy (kW-hrs) 126																						
150FP7	6.7 2.04	130	72 628																						
300FP7	10.7 3.16	350	184 1600																						
1100FP7	16.7 5.09	1125 volt-amps	450 3900																						
4100FP7	30.7 9.34	4100 volt-amps	1500 13,100																						
	<table border="1"> <thead> <tr> <th>Windmill Generator*</th> <th>Controller</th> </tr> </thead> <tbody> <tr> <td>27FP7 \$2,380.</td> <td>24FP12 (12-volt) \$ 462.</td> </tr> <tr> <td>150FP7 3,865.</td> <td>150FP12 (12-volt) 1,070.</td> </tr> <tr> <td>300FP7 5,680.</td> <td>150FP24 (24-volt) 1,070.</td> </tr> <tr> <td>1100FP7 9,740.</td> <td>300FP24 (24-volt) 1,120.</td> </tr> <tr> <td>4100FP7 22,360.</td> <td></td> </tr> </tbody> </table>	Windmill Generator*	Controller	27FP7 \$2,380.	24FP12 (12-volt) \$ 462.	150FP7 3,865.	150FP12 (12-volt) 1,070.	300FP7 5,680.	150FP24 (24-volt) 1,070.	1100FP7 9,740.	300FP24 (24-volt) 1,120.	4100FP7 22,360.													
Windmill Generator*	Controller																								
27FP7 \$2,380.	24FP12 (12-volt) \$ 462.																								
150FP7 3,865.	150FP12 (12-volt) 1,070.																								
300FP7 5,680.	150FP24 (24-volt) 1,070.																								
1100FP7 9,740.	300FP24 (24-volt) 1,120.																								
4100FP7 22,360.																									
	Cost (F.O.B. Houston, Texas)																								

\*For standard machine with urethane-painted machined hardwood blades. Does not include tower or batteries.

P. Andrag and Sons (Pty.) Ltd.  
P.O. Box 364  
Belleville, Cape Province  
Republic of South Africa

Manufactures 8- and 10-foot fanwheels under license from Aermotor (U.S.). See entry under Aermotor for details.

Dempster Industries  
 P.O. Box 848  
 Beatrice, Nebraska 68310  
 U.S.A.

Water-pumping windmill, multi-blade fanwheel coupled to reciprocating cylinder pump.

Wheel Diam. (feet)      List Price\*      Typical pumping capacities, 18-mile-per-hour wind, 2-inch cylinder pump:

Wheel Diam. (feet)	List Price*	Wheel Diam. (feet)	Total Elevation (feet)	U.S. gallons per hour
6	465.	6	95	130
8	670.	8	135	195
10	1150.			
12	1900.			
14	2970.			

\* F.O.B. shipping-point

Dunlite Electrical Co. Pty. Ltd.  
 21-27 Frome Street  
 Adelaide, S. A.  
 Australia

Wind-driven electric battery charger. Three-blade, 13-foot diameter variable-pitch propeller (automatically controlled by centrifugal governor) supplied in two basic models:

- 1000 watts, 12 volts DC
- 2000 watts, 115 volts DC

Manufacturer	Equipment	Wind-driven AC generators, for use as battery charger or as direct source of single- or three-phase AC power. Variable-pitch 2- or 3-blade propeller (except as noted) with manually adjusted tail fin.									
Model	Rated Windspeed <sup>a</sup> (mph)	Output Watts	Volts <sup>b</sup>	Diam. (meters)	No. of Blades	Cost (F.O.B. Factory Swiss Fr.) Generator <sup>c</sup>	Control Panel	Voltage Regulator			
Electro GmbH Winterthur St. Gallerstrasse 27 CH-8400 Winterthur Switzerland	W50	40	18	50	DC	6/12/24	0.45 x 1 m high <sup>d</sup>	2	2400.	310.	350.
	W250	40	18	250	DC	12/24	0.66 x 1.3 m high <sup>d</sup>	2	3100.	330.	380.
	WV05	20	9	600	DC	25/36	2.5	2	3350.	330.	400.
	WV15G	23	10	1200	DC	24/36/48/65/110	3.0	2	4100.	400.	150.
	WV25G	24	11	2200	DC	36/48/65/110	3.6	2	5150.	500.	150.
	WV35G	24	11	4000	DC	48/65/110	4.4	3	6850.	580.	150.
	WVG50G	26	12	5/6000	DC	65/110	5.0	3	7900.	680.	150.
	WV15W	23	10	1200	AC	110, 1-phase (30-70Hz)	3.0	2	4750.	900.	included
	WV25D	25	11	2000	AC	110, 3-phase (40-70Hz)	3.6	2	5850.	1200.	included
	WV35D	23	10	3500	AC	110/220, 3 phase (35-60Hz)	4.4	3	7600.	1550.	included
	WVG50D	23	10	5000	AC	110/220, 3 phase (50-80Hz)	5.0	3	8700.	1550.	included

Automatic control for generators WV15-WVG50:

274-212 DC 24/36 for attended operation S Fr. 1650. } F.O.B. Factory  
 266-213 DC 24/36 for unattended operation S Fr. 2200. }

- Notes:
- a. Speed at which wind plant develops maximum rated output.
  - b. WV05 and WV15G available with optional 12-volt output for 5% surcharge; WV25G available with optional 24-volt output for 5% surcharge.
  - c. Cost does not include tower, control panel, or regulator (except as noted).
  - d. Vertical-axis turbine.
  - e. Only with automatic control.
  - f. A 10-kW generator will soon be available.

The Heller-Aller Co.  
 Perry and Oakwood Streets  
 Napoleon, Ohio 43545  
 U.S.A.

"Baker" water pumping windmill, multi-blade fanwheel coupled to reciprocating cylinder pump.  
 Wheel Diam. (feet) No. Fan Blades Cost (windmill alone)  
 (F.O.B. Napoleon, Ohio)

6	20	\$ 401.20
8	36	522.90
10	30	712.70
12	32	1145.00

### Pumping Capacities of Back-Geared "Baker" Windmills (in 15-mile-per-hour wind)

Total Elevation in Feet	6 FOOT BAKER		8 FOOT BAKER		10 FOOT BAKER		12 FOOT BAKER	
	Diameter of Cylinder Inches	U. S. Gallons Per Hour	Diameter of Cylinder Inches	U. S. Gallons Per Hour	Diameter of Cylinder Inches	U. S. Gallons Per Hour	Diameter of Cylinder Inches	U. S. Gallons Per Hour
25	3	350	3 1/2	900	4	1250	6	2400
35	2 1/2	240	3	720	3 1/2	925	5	1625
50	2 1/4	200	2 1/2	450	3	700	4 1/2	1425
75	2	160	2 1/4	350	2 1/2	475	4	1125
100	2	150	2	250	2 1/2	460	3	600
125	1 5/8	120	1 7/8	240	2	280	2 1/2	525
150	.....	.....	1 3/4	220	2	280	2 1/2	525
200	.....	.....	.....	.....	1 7/8	260	2	325
250	.....	.....	.....	.....	1 3/4	215	2	325
300	.....	.....	.....	.....	.....	.....	1 3/4	200

The above capacities are approximate. By the total elevation in feet we do not mean the depth of the well, but the distance to the cylinder. Do not use pipe smaller than that for which cylinders are fitted.  
 While we recommend the above table larger cylinders may in many circumstances be used with satisfaction.

Manufacturer	Equipment		
Maschinenfabrik Ludwig Bening 2847 Barnstorf Postfach 171 Federal Republic of Germany	"Lubing" wind-driven generator [battery charger], 24-volt output, 3-blade variable-pitch (centrifugal governor) propeller with blades of fiberglass-reinforced plastic.		
	Model	Diameter (meters)	Cost (F.O.B. Factory) (DM)
	M 022-3	2.2	\$5224.
	M 022-3-6	2.2	7058.
	M 022-3-9	2.2	7448.
	M 022-3-12	2.2	7858.
	"Lubing" wind-power pumps, 3-, 4-, and 6-blade rotors coupled to reciprocating brass pump, capable of maximum lifts of 23 to 52.5 feet (7 to 16 meters). Rotor blades aerodynamically shaped of molded plastic. 6-blade rotor equipped with centrifugal speed control on three blades, remaining three fixed. Prices not given.		
Also available is a variety of pumps coupled to model M 022-3-6 (3-blade rotor mounted on 6-meter tower) for approximately DM 6500, F.O.B. factory, depending on the pump selected.			

Winco Division  
Dyna Technology, Inc.  
P.O. Box 3263  
Sioux City, Iowa 51102  
U.S.A.

- “Wincharger” Model No. 1222H wind-driven electric battery charger
- 6-foot diameter 2-blade propeller (wood) with centrifugally operated air-brake governor set to cut in at wind speeds above 23 miles per hour (11.8 meters per second)
  - 200-watt, 12-volt DC generator
    - starts charging in winds of 7 miles per hour (3.6 meters per second)
    - maximum charging current 14 amperes at 23 miles per hour (11.8 meters per second)
    - maximum voltage 15 volts
  - 10-foot 4-leg tower (angle iron)
  - control box complete with ammeter
- Cost, complete—\$445. F.O.B. factory.



## APPENDIX 6

# *Commercial Developers of Wind Machines*

[This list is not necessarily complete but it has been compiled from the best information available to NAS staff. The information has been supplied by the developers; thus, neither the panel nor the NAS/NRC can assume responsibility for its accuracy.]

1. American Energy Alternatives, Inc.  
P.O. Box 905  
Boulder, Colorado 80302  
U.S.A.

Prototype wind-driven generator based on "bicycle-wheel" turbine (see Figure 31) 8 feet in diameter, direct-drive alternator with rectifier supplying 12, 24, 48, etc. volts DC. Plans call for following models:

output	Rated Windspeed (mph)	Projected Cost (F.O.B. Boulder)
1.5	?	\$2100-2200
2.5	33 (at 5000' alt.)	\$2650
5	42 (at 5000' alt.)	\$2900-3000

2. American Wind Turbine Co.  
1016 East Airport Road  
Stillwater, Oklahoma 74074  
U.S.A.

"Bicycle-wheel" turbine (see Figure 31) coupled to direct-drive, high-speed alternator, with solid-state field-modulated frequency conversion to supply constant frequency AC. Prototype system built, with plans for turbines 15 to 30 feet in diameter, including pumping systems using electric motor pumps. Plans include "tooling package" for manufacture by developing countries.

3. Windworks  
Box 329, Route 3  
Mukwonago, Wisconsin 53149  
U.S.A.

Nonprofit company, designs wind-driven generator systems, including synchronous inverters and towers, and provides design information on a consulting basis.

4. Noah Energy Systems GmbH  
Wippenhohner Str. 32  
D-5202 Hennef 1  
Switzerland

Prototype wind-driven generator providing 30 kW (variable frequency) at wind speeds of 10 meters/second and 90 kW maximum (in gusts). Rotor 12 meters in diameter, 6 fixed airfoil blades. Reportedly developed for application in developing countries, with local servicing. Projected cost is Fr. 75,000, FOB factory.

5. Jacobs Wind Electric Company, Inc.  
Box 722, Route 11  
Fort Myers, Florida 33901  
U.S.A.

Formerly manufactured the Jacobs Wind Electric Plant, 1930-1960. Currently designing a new wind-driven electric plant—no details available.

6. Grumman Aerospace Corp.  
Bethpage, New York 11714  
U.S.A.

Commercial development of sail-wind windmill developed at Princeton University. Grumman's version has three blades made of aluminum spars and Dacron sails, 12.5 feet in diameter, coupled to automobile alternator producing about 1 kW in 20-mph winds. Windmill also intended to be sold for pumping and as a heat generator by coupling to a gear pump with restricted supply of water. Prices not available. Grumman also is developing a controlled-pitch 3-blade 25-foot diameter 15-kW wind-driven generator with extruded aluminum blades and standard ("off the shelf") generator. Machine is expected to produce 35,000 kWh annually for average wind speeds of 14 mph. Price not available.

7. Dornier-System GmbH  
Postfach 1360  
7990 Friederichshafen  
Federal Republic of Germany

Prototype Darrieus windmill-generator, 10-kW capacity. Rotor fabrication designed for manufacture in developing countries.

**APPENDIX 7**

***Windmill Towers  
for Construction  
on the Farm***

(Reprinted from the catalog of Smith & Thayer Co., Boston, Massachusetts.)

For information on light-weight, low-cost tower of modern design, contact:

Windworks  
Box 329  
Route 3  
Mukwonago, Wisconsin 53149  
U.S.A.

**DIRECTIONS**  
**FOR BUILDING**  
**36-FOOT DERRICK**  
**FOR 8½ OR 10-FOOT**  
**BACK GEARED IRON TURBINE WIND ENGINE.**

**LIST OF MATERIALS FOR 36-FOOT DERRICK FOR 8½ AND 10-FOOT ENGINES.**

- 4 Pieces, 4x4, 18 feet long, for Main Post.
- 4 Pieces, 4x4, 20 " " " " "
- 1 Piece, 2x6, 12 feet long, for Lookout on which to build Platform.
- 2 Pieces, 2x4, 16 feet long, for Ladder.
- 2 Pieces, 2x4, 12 feet long, for Platform.
- 2 Pieces, 1x4, 12 feet long, for Ladder.
- 24 Pieces, 1x6, 16 feet long, for Braces, Collars and Girts.
- 4 Anchor Posts, 8 feet long, should be of solid stuff not less than 6x6.
- 4 Cross Anchors.
- 5 Pounds of 20d nails for Platform.
- 15 Pounds rod nails for Braces.
- 8 4½x½ Bolts and Washers for Splicing Main Post.
- 8 10½x½ Bolts and Washers for bolting Main Posts to Anchor Posts.

The cost of above material will not exceed \$12, and the cost of labor, building derrick and erecting mill will be from \$8 to \$12, as it requires the labor of two men two days. We do not furnish derricks, except on special agreement, as they are inconvenient and expensive to ship, and they can be made on the ground cheaper. They are usually furnished by the purchaser, or by the agent erecting the mill. Any ordinary carpenter can, from our specifications, give an estimate of its cost, and by following our description erect one without trouble.

SPRINGFIELD, OHIO.

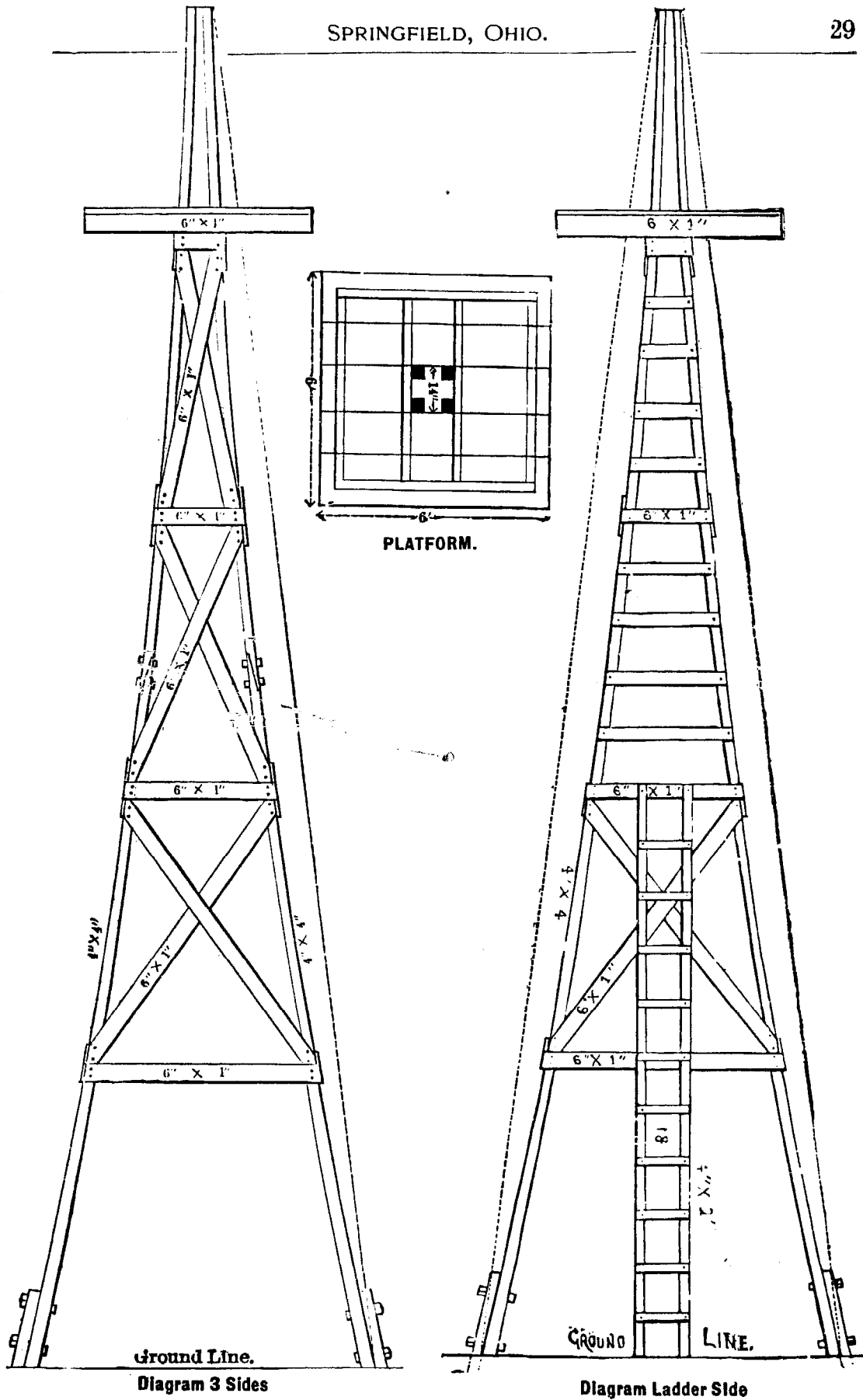

## DIRECTIONS FOR

36-Foot Derrick for  $8\frac{1}{2}$  and 10-Foot Engines.

Select the four posts, 4x4, for top of derrick, and cut out the inside corners of each post 2 inches at the top, tapering to a point or nothing in 4 feet. Splice the 4x4 posts together with a 2 foot splice, in the manner indicated in the cut, saw the ends square and see that the four posts are exactly the same length; lay them side by side and space off for the girts, making square across the four posts at once (as shown by illustration on page 31.) The top edge of the first girt should be 68 inches from top of derrick. The top edge of lower girt should be 90 inches from the lower end of posts; divide the distance between the upper and the lower girt equally for two other girts. Lay two posts side by side with their ends exactly even, insert a piece 1 inch thick, 2 inches wide, and 4 inches long, between the top ends, which will make the posts measure 9 inches across at the top, from outside to outside. Spread the posts so that they will measure 14 inches across from outside to outside, 62 inches from the top. Nail on the top collar, using the first one for a pattern by which to cut the remaining three, two of which should be 2 inches longer than the first to allow for lap. Observe the same rule in cutting all the girts. Nail on the first girt 9 inches from the top and second 68 inches from the top as marked. Go to the bottom of the posts and spread the ends 9 feet apart. (The rule is 1 foot spread for every 4 feet in height.) Nail a temporary stay on both to hold them there, then draw a chalk line from the bottom of one post to the top and around to the bottom of the other post. Measure from the line to the outside edge of each post and move the posts back and forth until the distance from the line to the outside edge of each post is the same at each girt; this will give you the correct spring of the posts (These directions should be strictly observed.) Nail on lower girt 90 inches from bottom, and remaining 2 at equal distances, as marked. Nail on diagonal braces across from each girt to the one above each way, and see that inside corner of each brace is even with inside of post, and trim outside corner even with outside edge of post; use first brace for a pattern to cut remaining 7 in that section by allowing 2 inches for lap on 4, as in the girts. Nail on lookout as sill for platform (2x6x6), let its lower edge rest on the upper edge of first girt. When this side of derrick is complete turn it upside down with girts and braces on ground, lay the remaining posts on top of the first and build that side of the derrick exactly like the first, being careful to nail the girts on exactly opposite the first. Insert the 1-inch strips between the upper and lower posts and nail on the two remaining collars at the top and the first girts, then block up under the lower posts until the posts have the same



SPRINGFIELD, OHIO.

31

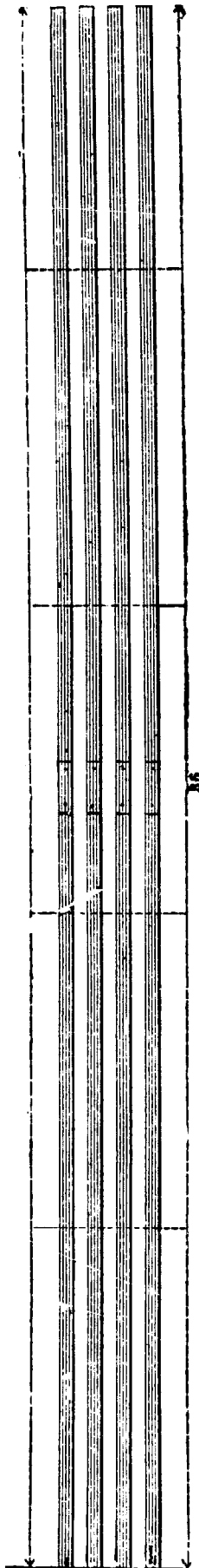

spring at each girt as they have the other way. Nail on the remaining girts on two sides, and braces on side and complete ladder side as shown in cut. Raise the derrick with pike poles. A rope fastened near the top will greatly facilitate the work of raising when the derrick is about half-way up. Drop a plumb line from the center of the derrick at the top, and when the derrick stands perfectly plumb bolt to the anchor posts, which should be not less than 6 inches square and 4 feet in the ground, with a cross anchor near the bottom of each anchor post. Complete platform as shown in cut on page 29.

## DIRECTIONS FOR

## 36 foot Derrick for 12 foot Engine.

Select the four posts, 4x6, for top of derrick, and cut off the inside of each post at the top, tapering to a point or nothing in sixteen feet, making posts at top four inches square. Cut out the inside corners of each post 2 inches at the top, tapering to a point or nothing in 5 feet. Splice the 4x6 posts together with a 2 foot splice,

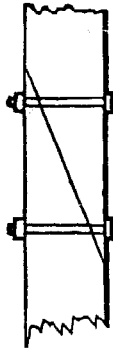

in the manner indicated in the cut, saw the ends square and see that the posts are exactly the same length; lay them side by side and space off for the girts, marking square across the four posts at once (as shown by illustration on page 37.)

The top edge of the first girt should be 80 inches from top of derrick. The top edge of lower girt should be 96 inches from the lower end of posts; divide the distance between the upper and the lower girt equally for two other girts. Lay two posts side by side with their ends exactly even, insert a piece 2 inches thick, 2 inches wide, and 4 inches long, between the top ends, which will make the posts measure 10 inches across at the top from outside to outside. Spread the posts so that they will measure 16 inches across from outside to outside, 72 inches from the top. Nail on the top collar, using the first one for a pattern by which to cut the remaining three, two of which should be 2 inches longer than the first to allow for lap. Observe the same rule in cutting all the girts. Nail on the collar 9 inches from the top and first girt 80 inches from the top as marked. Go the bottom of the posts and spread the ends 9 feet apart. (The rule is 1 foot spread for every 4 feet in height). Nail a temporary stay on both to hold them there, then draw a chalk line from the bottom of one post to the top and around to the bottom of the other post. Measure from the line to the outside edge of each post and move the posts back and forth until the distance from the line to the outside edge of each post is the same at each girt; this will give you the correct spring of the posts. (These directions should be strictly observed.) Nail on lower girt 96 inches from bottom, and remaining 2 at equal distances, as marked. Nail on diagonal braces across from each girt to the one above each way, and see that inside corner of each brace is even with inside of post, and trim outside corner even with outside edge of post; use first brace for a pattern to cut remaining 7 in that section by allowing 2 inches for lap on 4, as in the girts. Nail on lookout as sill for platform (2x6x6,) let its lower edge rest on the upper edge of first girt. When this side of derrick is complete turn it upside down with girts and braces on ground, lay the remaining posts on top of the first and build that side of the derrick exactly like the first, being careful to nail the girts on exactly opposite the first. Insert the two-inch strips between the upper and lower posts and nail on the two remaining collars at the top and the first girts then block up under the lower posts until the posts have the same



## SPRINGFIELD, OHIO.

37

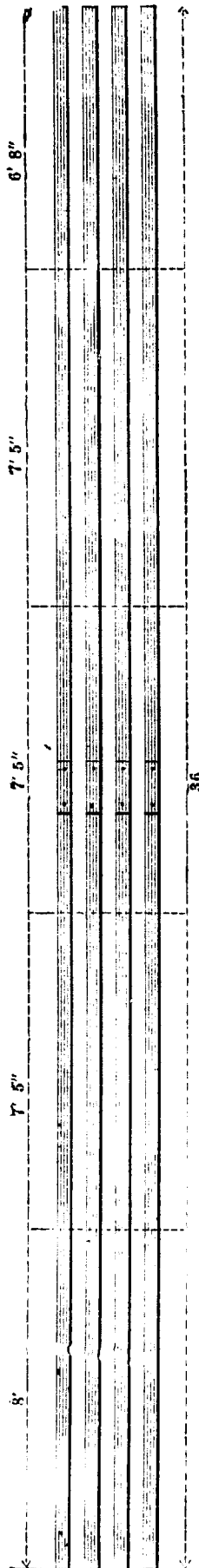

spring at each girt as they have the other way. Nail on the remaining girts on two sides, and braces on one side and complete ladder side as shown in cut. Raise the derrick with pike poles. A rope fastened near the top will greatly facilitate the work of raising when the derrick is about half way up. Drop a plump line from the center of the derrick at the top, and when the derrick stands perfectly plumb bolt to the anchor posts, which should be not less than 6x8 inches square and 5 feet in the ground, with a cross anchor near the bottom of each anchor post. Complete platform as shown in cut on page 29.

## QUADRANTS FOR TRANSMITTING POWER.

FROM WIND ENGINES.

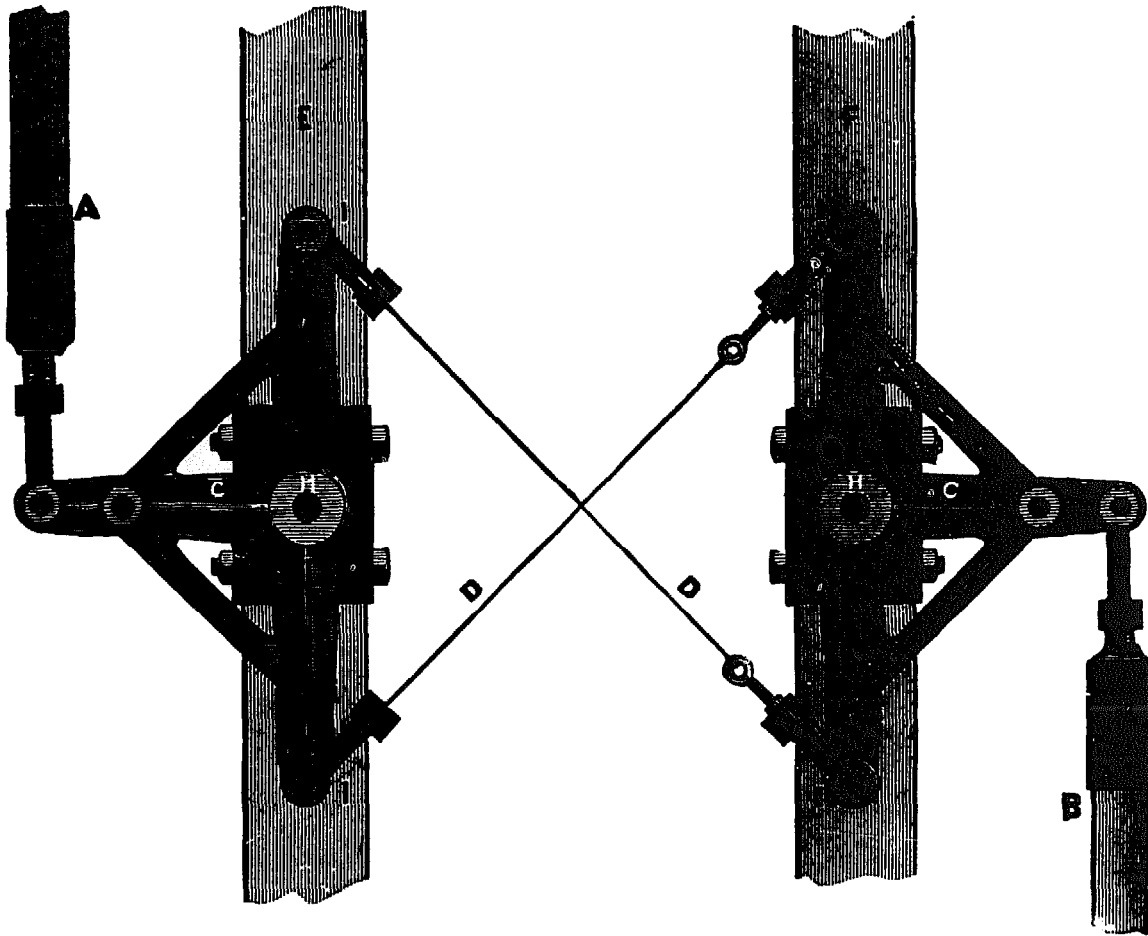

It is often desirable, in order that the wind may have an unobstructed passage to the wheel, to place the engine at some distance from the pump and well. The above cut represents our Quadrant, especially designed for this purpose. A represents the actuating rod of the Engine; B the plunger rod of the Pump. E and F are two posts which should be not less than 4x4. Post E is set in the derrick, its center 9 inches from the center of the actuating rod A, the top, braced to the derrick, and bottom of post firmly imbedded in the ground. Post F is securely fastened to the platform of well, its center 9 inches from center of plunger rod of Pump B. The two Quadrants C are placed on stud H, on casting bolted to posts E and F, and are connected together by wires D D, crossing each other. By this arrangement we obtain the same motion on the pump as if it was placed directly under the derrick, the down stroke of actuating rod of Engine giving a down stroke of plunger rod of Pump with very little loss of power.

APPENDIX 8

*Currently Manufactured  
Small-Scale Hydropower  
Machinery*

[Information included in this appendix has been supplied by the manufacturers. It is not presented as complete but is meant to serve as a convenience to readers who might wish to request further details from the manufacturer.]

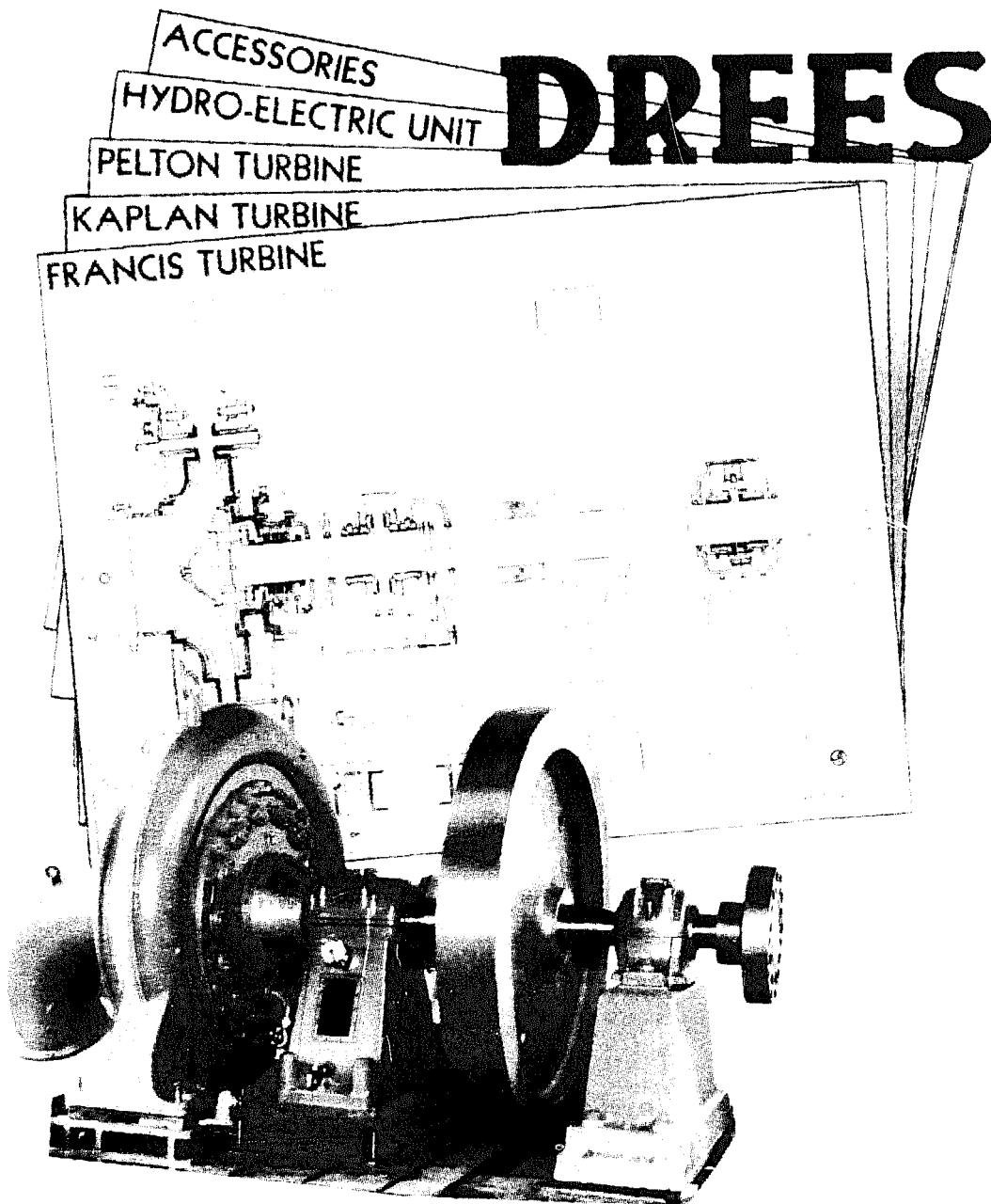

**Francis-Spiralturbine**  
**Francis Spiral Turbine**  
**Turbine a Bâche Spirale Francis**  
**Turbina Espiral Francis**

DREES & CO GMBH · 476 WERL i. WESTF.

MASCHINENFABRIK UND EISENGIESSEREI · ABT.: WASSERTURBINENBAU

Schützenstraße 36-38 · Telefon 02922 5071/5072 · Telegramme: Dreesco Werl ·

Telex: 8421404 dres d

KLEINKRAFTWERK  
MICRO WATER  
POWER PLANTS

# DREES

MICROCENTRALES  
HIDROELECTRICAS  
MICROCENTRALES  
HYDRAULIQUES

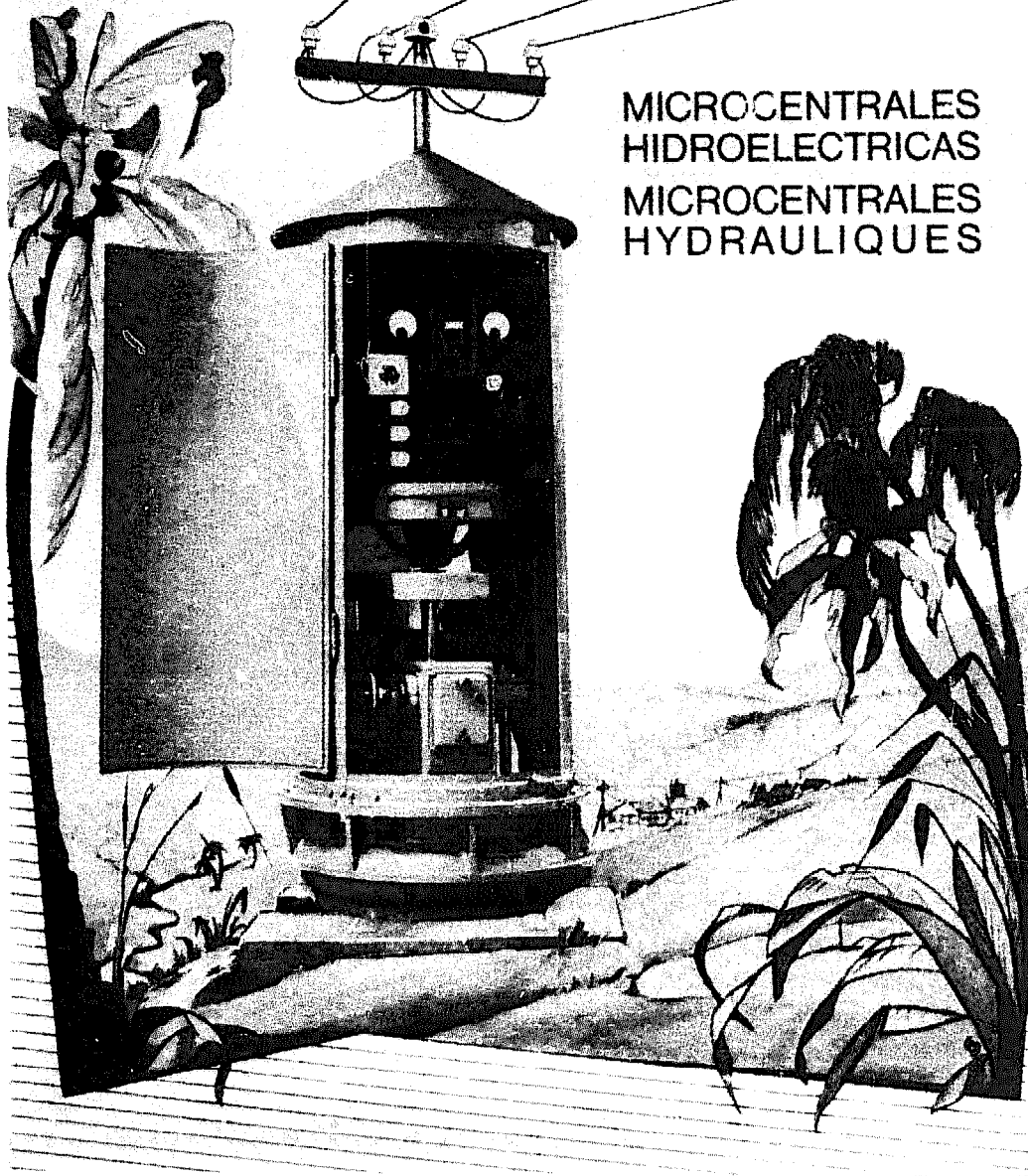

**GILBERT GILKES & GORDON LTD**  
**WATER TURBINE & PUMP MANUFACTURERS**

Kendal - England - Telephone: KENDAL 20028 - Telex: 65125

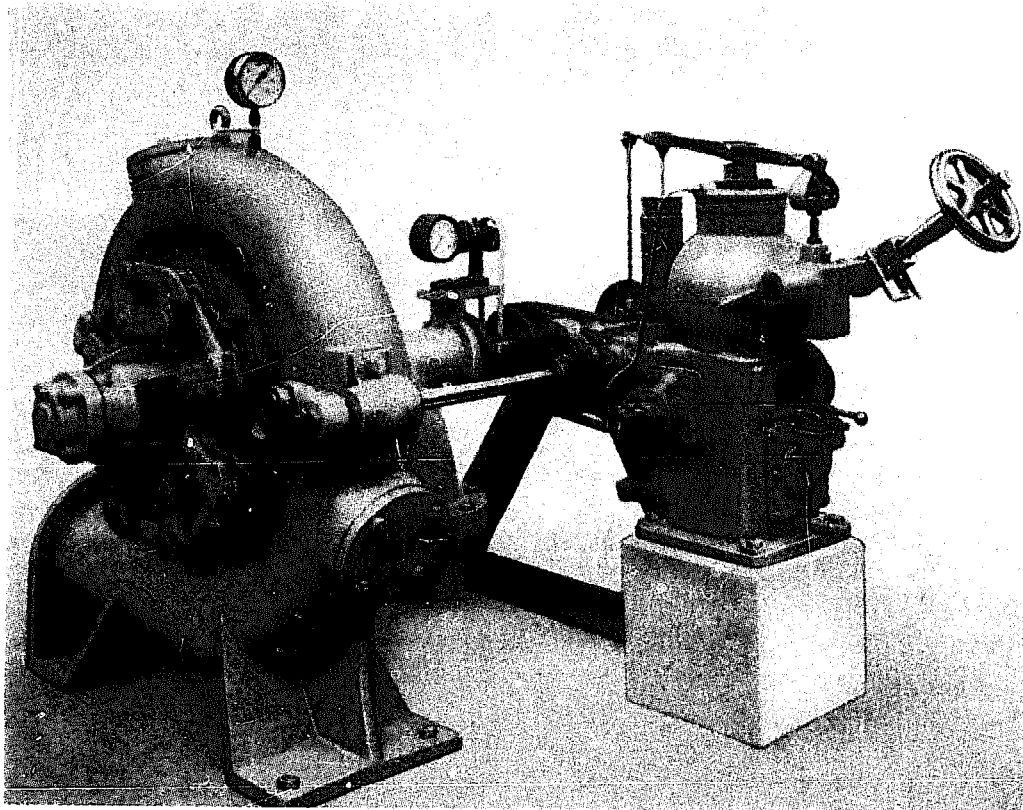

Turgo Impulse Wheel—suitable for heads of water between 50 and 400 feet (15 and 120 meters) with outputs up to 500 B.H.P.

Examples of turbine capacities and prices, supplied by the manufacturer:

kW	<u>Head</u> (ft)	<u>Flow</u> (ft <sup>3</sup> /min)	Type	Price
10	50	376	Francis	£6,300
10	100	106.5	Turgo	£4,500
25	50	512	Francis	£7,800
10	200	45.5	Pelton	£4,200

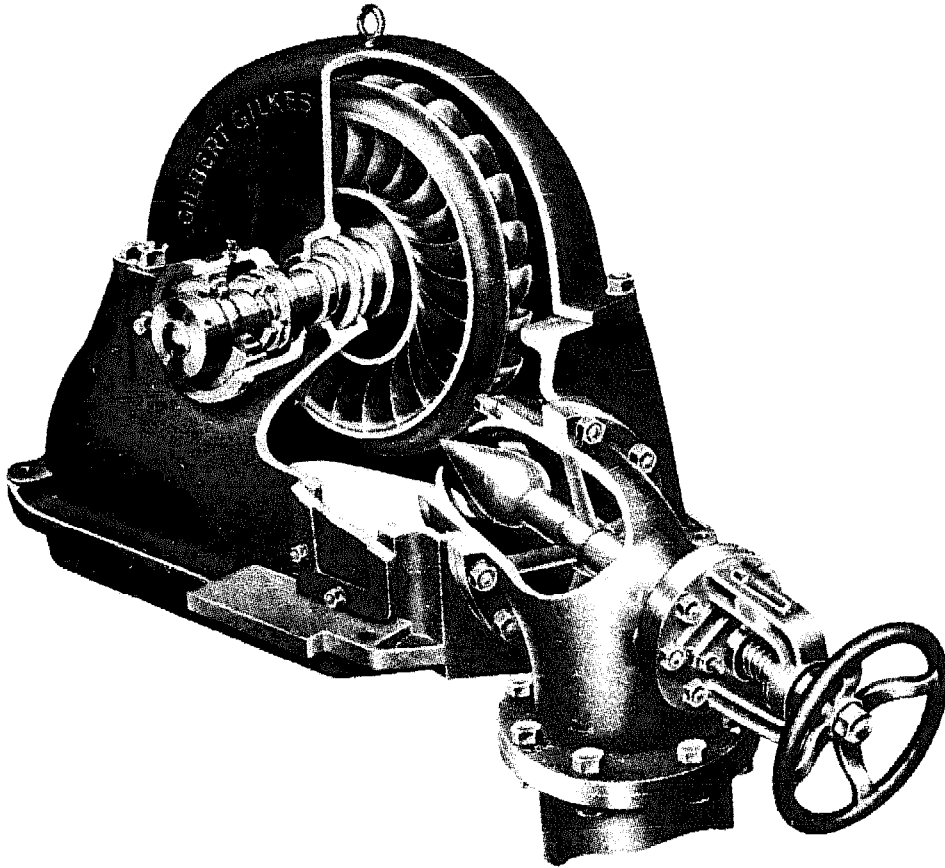

Small spiral cased Francis turbines—suitable for water heads of 25 to 200 feet (7.5 to 60 meters) with outputs up to 100 or 150 horsepower.

THE JAMES LEFFEL & CO.  
 SPRINGFIELD, OHIO, U. S. A.

Rating Tables of Hoppes Hydro-Electric Units

ELECTRICAL CAPACITY	Head in Feet	Style	Water in Cubic Feet Per Minute	ELECTRICAL CAPACITY	Head in Feet	Style	Water in Cubic Feet Per Minute	
½ KILOWATT OR 500 WATTS	• 8	HL	104	5 KILOWATTS OR 5000 WATTS	8	OT	760	
	• 9	HJ	92		9	OT	600	
	• 10	HJ	82		10	LR	590	
	• 11	F	74		11	LR	535	
	• 12	F	68		12	LR	490	
1 KILOWATT OR 1000 WATTS	• 8	IL	190		13	JP	470	
	• 9	HL	175		14	JP	435	
	• 10	HL	155		15	JP	400	
	• 11	HL	140		16	JP	365	
	• 12	HJ	127		17	JP	340	
	• 13	HJ	118		18	JP	330	
	• 14	HJ	110		19	JP	320	
	• 15	HJ	105		20	JP	315	
	• 16	HJ	100		21	HL	300	
	• 17	HJ	94		22	HL	290	
	• 18	HJ	90		23	HL	285	
	• 19	F	84		24	HL	275	
	• 20	F	80		25	HL	260	
	• 21	F	76					
	• 22	F	74					
• 23	F	72						
• 24	F	70						
• 25	F	68						
2 KILOWATTS OR 2000 WATTS	• 8	JP	330		7½ KILOWATTS OR 7500 WATTS	11	OT	800
	• 9	JP	290			12	OT	740
	• 10	JP	260	13		LR	680	
	• 11	HL	245	14		LR	630	
	• 12	HL	225	15		LR	590	
	• 13	HL	215	16		JP	550	
	• 14	HL	190	17		JP	515	
	• 15	HL	178	18		JP	490	
	• 16	HL	166	19		JP	480	
	• 17	HL	156	20		JP	450	
	• 18	HJ	153	21		JP	430	
	• 19	HJ	148	22		JP	410	
	• 20	HJ	140	23		JP	400	
	• 21	HJ	133	24		JP	390	
	• 22	HJ	127	25		JP	380	
• 23	HJ	120						
• 24	F	116						
• 25	F	110						
3 KILOWATTS OR 3000 WATTS	8	LR	470	10 KILOWATTS OR 10000 WATTS	12	OT	980	
	9	JP	415		13	OT	900	
	10	JP	370		14	OT	840	
	11	JP	340		15	OT	780	
	12	JP	310		16	LR	715	
	13	JP	280		17	LR	670	
	14	JP	260		18	LR	650	
	15	IL	250		19	JP	610	
	16	IL	240		20	JP	580	
	17	HL	225		21	JP	550	
	18	HL	210		22	JP	525	
	19	HL	200		23	JP	500	
	20	HL	190		24	JP	490	
	21	HL	180		25	JP	480	
	22	HL	170					
23	HL	165						
24	HJ	162						
25	HJ	158						

Head in feet referred to above is illustrated on page 294.

Style refers to various sizes of Hoppes Hydro-Electric Units. See dimensions on 294.

Quantity of water the unit will use at full rated capacity is listed above in cubic feet per minute.

\*Units marked with \* furnished in direct current only.

Standard rating for alternating current units is 3 phase 60 cycle and either 120 or 240 or 480 volts. These Hoppes Hydro-Electric Units may also be furnished for 50 cycle current.

When you write us, please give full particulars on your electrical requirements.



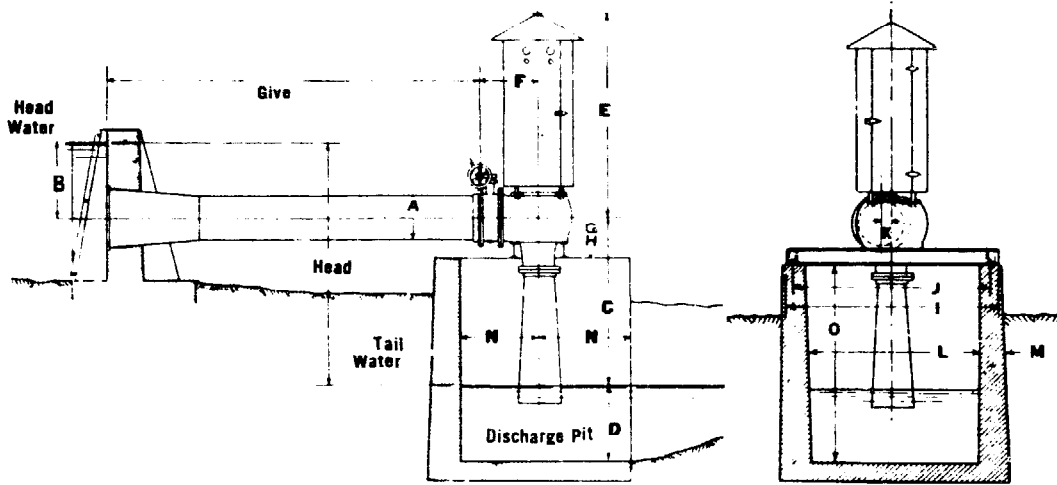

Style	Flow (cfm)	Price
HJ	82	\$ 3,850.00
F	68	3,550.00
HL	155	5,200.00
HJ	105	4,525.00
F	68	4,150.00
JP	260	5,300.00
HL	178	4,850.00
JP	370	6,750.00
IL	250	5,950.00
HJ	158	5,200.00
LR	590	9,950.00
JP	400	8,950.00
HL	260	5,400.00
OT	800	11,950.00
LR	590	9,375.00
OT	980	12,550.00
LR	715	10,250.00
JP	610	7,300.00
JP	480	7,300.00

GENERAL DIMENSIONS						
Style Sizes						
	F	HJ	HL IL	JP	LR	OT
A	6"	10"	12"	16"	18"	20"
B	18"	24"	24"	36"	36"	36"
C	60"	60"	60"	60"	60"	60"
D	24"	30"	30"	36"	42"	48"
E	58"	72"	72"	88"	90"	90"
F	20 <sup>1</sup> / <sub>2</sub> "	18"	18"	22"	23"	27"
G	5 <sup>1</sup> / <sub>2</sub> "	8 <sup>5</sup> / <sub>8</sub> "	9 <sup>5</sup> / <sub>8</sub> "	11 <sup>1</sup> / <sub>8</sub> "	11 <sup>7</sup> / <sub>8</sub> "	14 <sup>1</sup> / <sub>4</sub> "
H	5"	5"	5"	6"	6"	7"
I	72"	72"	72"	84"	84"	96"
J	66"	66"	66"	78"	78"	90"
K	3 <sup>1</sup> / <sub>8</sub> "	4 <sup>3</sup> / <sub>4</sub> "	4"	4"	4"	4 <sup>1</sup> / <sub>2</sub> "
L	60"	60"	60"	72"	72"	84"
M	8"	8"	8"	9"	10"	10"
N	30"	30"	30"	36"	42"	48"
O	73 <sup>1</sup> / <sub>2</sub> "	73 <sup>3</sup> / <sub>8</sub> "	75 <sup>3</sup> / <sub>8</sub> "	78 <sup>7</sup> / <sub>8</sub> "	84 <sup>1</sup> / <sub>8</sub> "	86 <sup>3</sup> / <sub>4</sub> "

## OSSBERGER-TURBINENFABRIK

WEISSENBURG/BAYERN

Germany - Allemagne - Alemania

Schliessfach - P.O. Box - 8 P - Apartado 32 - Telefon 23 62

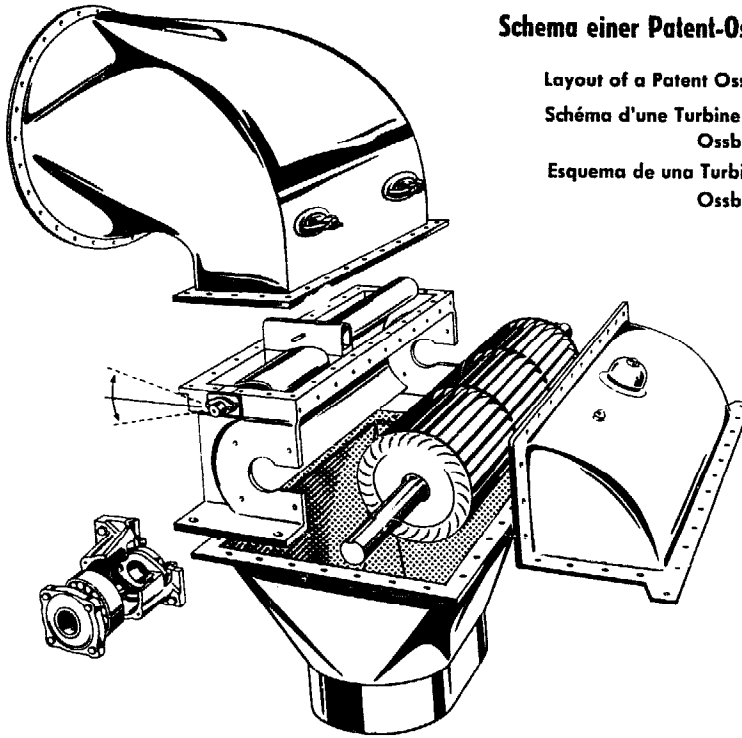

### Schema einer Patent-Ossberger-Wasserturbine

Layout of a Patent Ossberger Water Turbine

Schéma d'une Turbine Hydraulique Brevetée  
Ossberger

Esquema de una Turbina Hidráulica Patente  
Ossberger

#### Charakteristiken:

- 2-Zellen-Bauweise
- Ganzstahlbauweise
- Wenig drehende Teile
- Leitapparat bestehend aus einer Dreipunktschaufel im Dreipunktsystem
- Wasserzu- und Abführung durch Rohrleitungen
- Nur 5 Schmierstellen
- Unempfindlich gegen verschmutztes Triebwasser
- Garantie für günstigsten Wirkungsgrad ab  $\frac{1}{8}$  Q
- Garantie für geringen Verschleiß und große Lebensdauer
- Garantie für unkomplizierten Einbau an ungefähertem Standort, anspruchstose Wartung und Pflege

#### Caractéristiques:

- Construction à double compartiment
- Construction tout acier
- Peu de pièces tournantes
- Directrice se composant d'une palette rotative en un système à trois points
- Aménée et évacuation des eaux par conduites
- Cinq points de graissage seulement
- Insensible aux eaux polluées ou chargées de feuilles
- Garantie d'un degré d'efficacité le plus favorable à partir de  $\frac{1}{8}$  Q
- Garantie d'une usure minimum et d'une longévité maximum
- Simplicité d'installation garantie. Entretien et soins quasi nuls

#### Salient features:

- 2-cell construction
- All steel construction
- Few rotating parts
- Guide equipment consists of one rotary blade with a 3 point contact
- Water supply and discharge through piping
- Only 5 lubricating points
- Unaffected by polluted propellant water
- Guarantees highest efficiency from  $\frac{1}{8}$  Q upwards
- Guarantees low wear and long life
- Guarantees trouble-free installation on a safe site, undemanding in maintenance or servicing

#### Características:

- Tipo de dos celdas
- Modelo totalmente de acero
- Menos piezas giratorias
- El órgano de conducción consta de una paleta directriz con el sistema de tres puntos
- Conducciones de entrada y salida de agua por tuberías
- Solamente cinco puntos de engrase
- Insensible para aguas motrices ensuciadas
- Garantía para rendimientos favorables a partir de  $\frac{1}{8}$  Q
- Garantía de un desgaste mínimo y gran duración
- Garantía para sencilla instalación en lugares fuera de peligro, modesta vigilancia y conservación

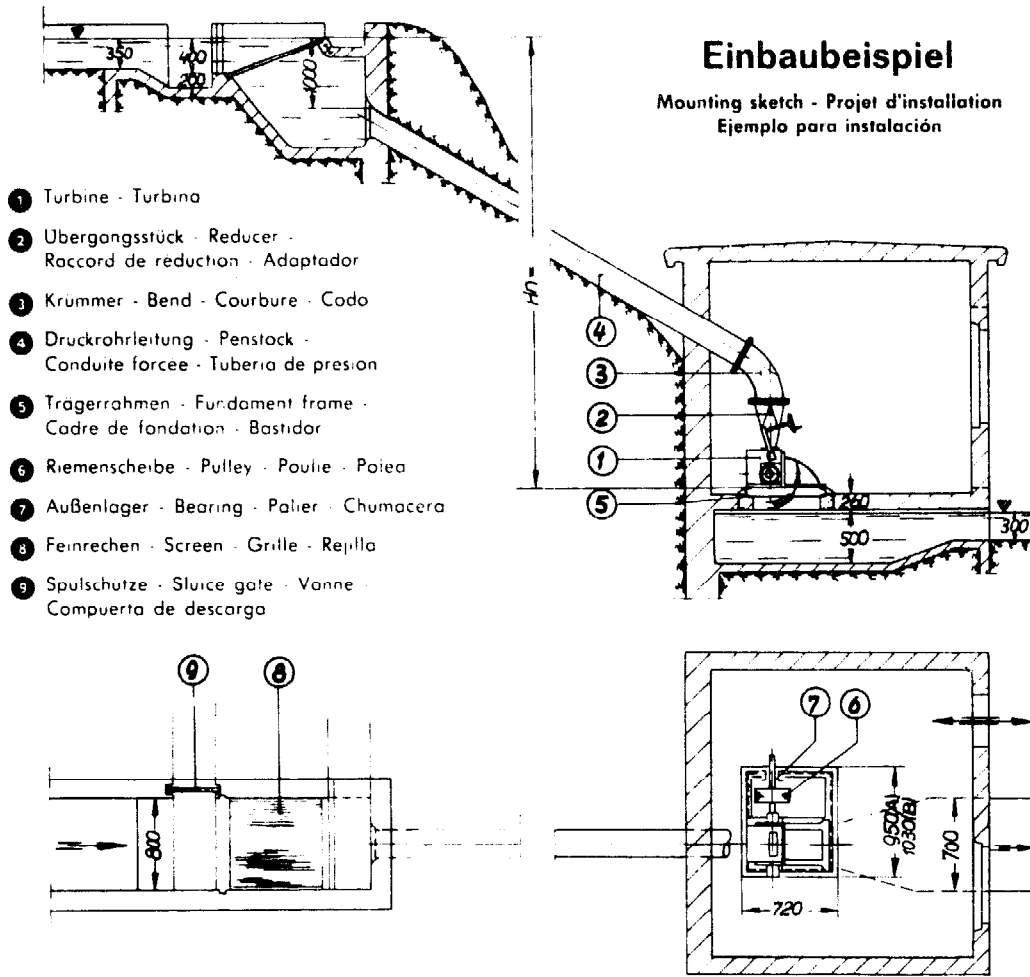

**PATENT-OSSBERGER-WASSERTURBINE TYPE: UNIVERSAL A**

H m	Gefälle	Head	Chute	Caida						Maße Measures Dimensions Medidas 1030 x 750 x 950 mm Gewicht Weight Poids Pesos 370 kg	Preis Price Prix Precio		
	4	5	6	7	8	9	10						
Q Litr sec	Wassermenge Supply		Debit Caudal										
	49	55	60	66	70	75	80						
N PS HP CV HP	Leistung Output		Pissance Potencia										
	2,1	2,9	3,8	4,9	6,0	7,2	8,5						
n U/min r.p.m. t.min	Drehzahl Speed		Vitesse Velocidad										
	380	430	470	510	550	580	615						
mm	Rohrleitung Penstock		Conduite forcee Tuberia										
	250	250	250	250	250	250	250						

**PATENT-OSSBERGER-WASSERTURBINE TYPE: UNIVERSAL B**

H m		10	15	20	25	30	Maße Measures Dimensions Medidas 950 x 750 x 950 mm Gewicht Weight Poids Pesos 340 kg	Preis Price Prix Precio		
Q Litr sec		22	27	31	35	37,5				
N PS HP CV		2,3	4,3	6,6	9,3	12				
n U/min r.p.m. t.min		615	755	870	980	1070				
mm		200	200	200	200	200				

Im Lieferumfang enthalten - Parts of delivery - Le prix de livraison comprend - El precio contiene - Pos. 1, 2, 3, 5, 6, 7, 8

RIFE RAM AND PUMP WORKS  
RIFE HYDRAULIC ENGINE MANUFACTURING CO.  
Box 367, Millburn, New Jersey 07041

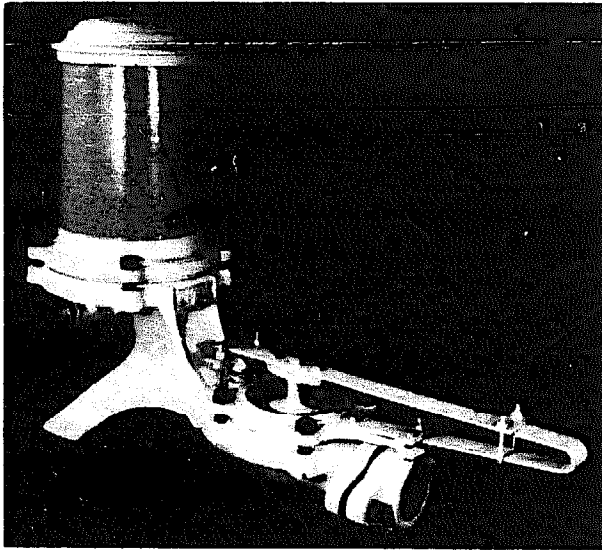

RIFE "Series B" Ram

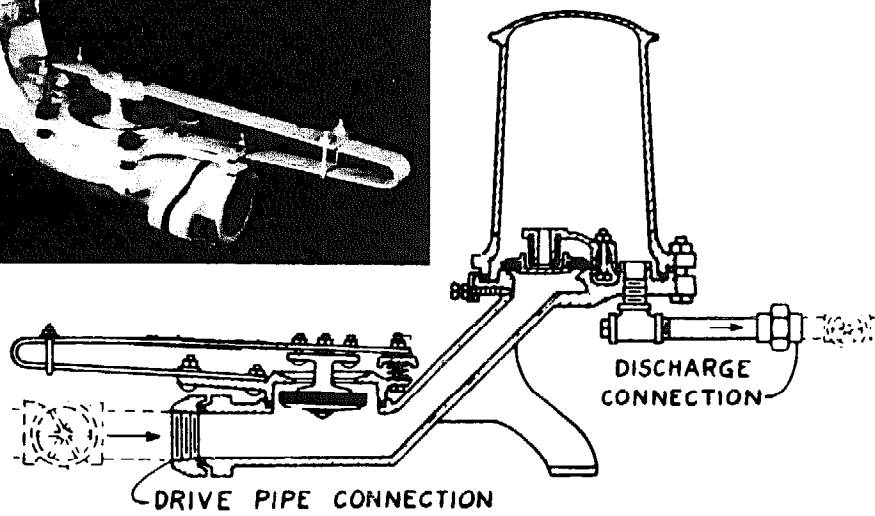

RIFE "Everlasting" Standard Ram

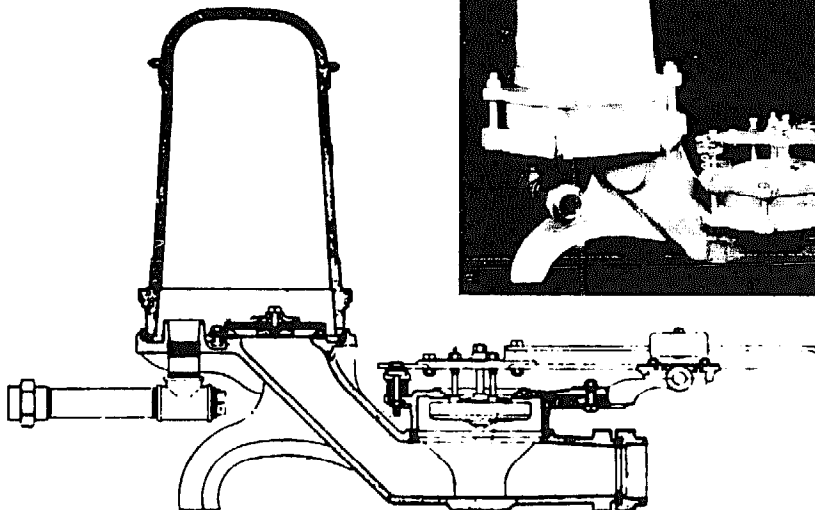
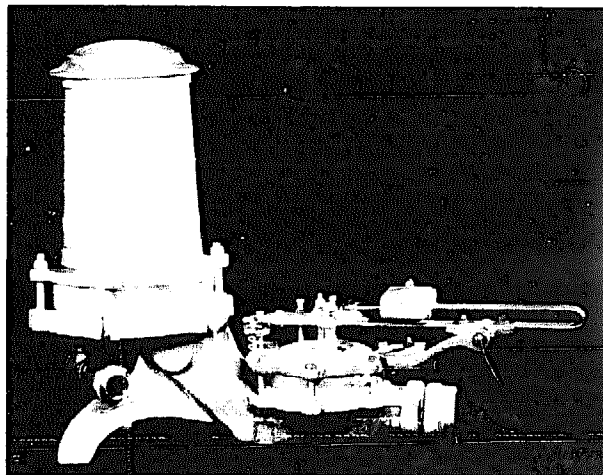

**SPECIFICATIONS OF RIFE HYDRAULIC RAMS**  
New High Capacity Models

RAM NO.	INTAKE (drive) PIPE SIZE	DISCHARGE (delivery) PIPE SIZE	INTAKE CAPACITY (Gals. per min. used)			MINIMUM VERTICAL FALL required in feet	CRATED WEIGHT (SINGLE-ACTING) in pounds (approx.)
			Min.	Normal	Max.		
<i>RIFE "NEW MODEL" SERIES B RAMS (4 Bolt Design)</i>							
<i>Maximum Vertical Fall 15 ft. - Maximum Vertical Lift 150 ft.</i>							
<i>Unit includes iron gate strainer for intake end of drivepipe</i>							
10B	1-1/4"	3/4"	1½	6	7	2	94
15B	1-1/2"	3/4"	6	10	13	2	102
20B	2"	1"	8	18	20	2½	150
25B	2-1/2"	1"	12	28	35	2½	202
30B	3"	1-1/4"	20	40	55	3	263

**RIFE "EVERLASTING" STANDARD RAMS**  
*A more rugged development of the previous Series "A" 6 Bolt Design*  
*Maximum Vertical Fall 25 ft. - Maximum Vertical Lift 250 ft.*  
*All steel and iron parts zinc coated or plated*  
*Unit includes special steel strainer for intake end of drivepipe*

10S	1-1/4"	3/4"	3	7	10	3	160	
15S	1-1/2"	3/4"	5	11	15	3	171	
20S	2"	1"	10	20	25	3½	249	
25S	2-1/2"	1"	15	30	45	3½	273	
30S	3"	1-1/4"	25	45	70	4	339	
40S*	4"	2"	35	90	125	4	565	
60S*	6"	3"	75	225	350	4	1325	
80S	8"	4"	Repair parts only . . . . .					

\*#40S and #60S equipped with steel air chamber. #60S includes special welded pipe nipple to assemble inclined drivepipe to level ram.

## APPENDIX 9

# *The Helical Rotary Screw Expander and Its Potential for Geothermal Application*

The helical screw expander basically consists of a pair of counter-rotating tapered screws, as shown in the accompanying drawing. These screws have been utilized as pumping devices for many years and have proved to be long-lived and reliable. The original pump design, developed in Sweden in the 1930s, is known as the Lysholm screw. This device gradually came to be used as a gas compressor in commercial installations until, by the 1950s, its use was rather extensive. Experimental use of this device—in the reverse application as gas expander—as a prime mover with geothermal sources began in 1971.<sup>1</sup>

The construction, and hence the operation, of the machine are illustrated in the drawing. The channels formed by the meshing rotating screws provide a path for the liquid, which permits continuous flashing of steam as the pressure decreases, and all of the fluid—liquid plus vapor—is carried through the prime mover throughout the entire expansion process. As described by MacKay and Sprankle, “The geothermal fluid flows through the internal nozzle control valve and at high velocity enters the high-pressure pocket formed by the meshed rotors, the rotor case bore surfaces, and the case end face, designated by A in the two figures. As the rotors turn, the pocket elongates, splits into a V, and moves away from the inlet port to form the region designated by B. With continued rotation, the V lengthens, expanding successively to C, D, and E as the point of meshing of the screws appears to retreat axially from the expanding fluid. The expanded fluid at low pressure is then discharged into the exhaust port.”<sup>1</sup>

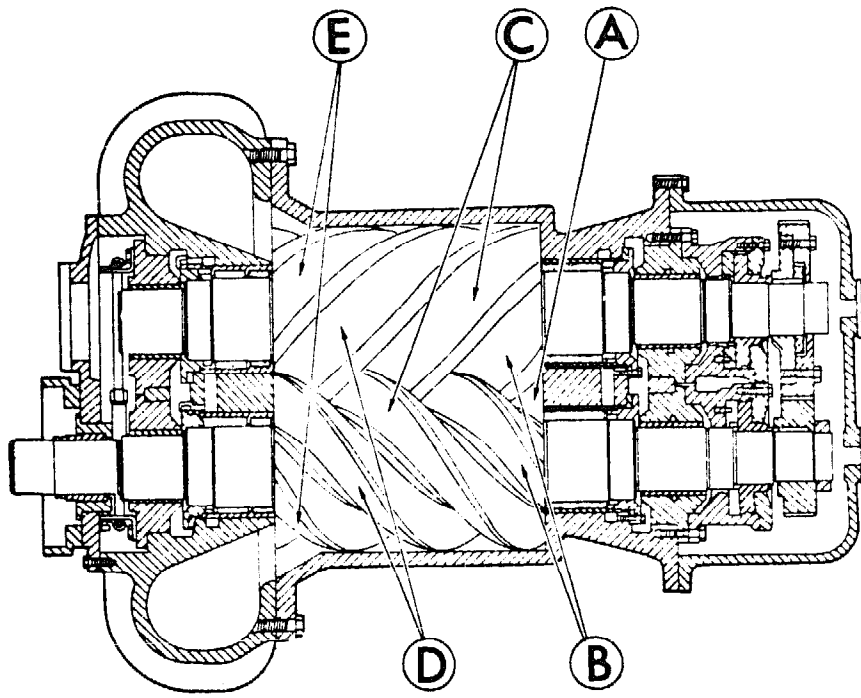

PLAN SECTION VIEW

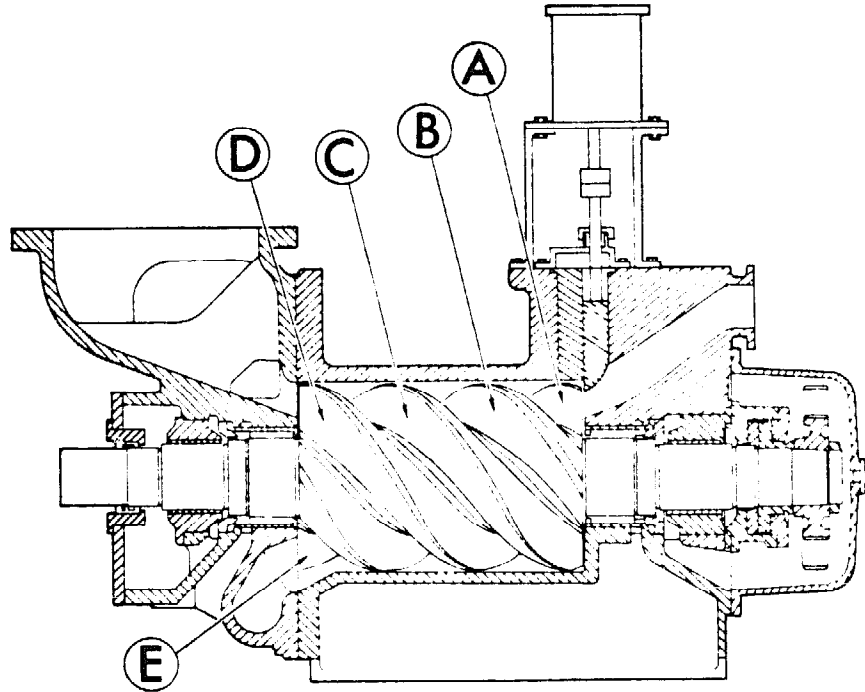

SIDE SECTION VIEW

The potential advantages of the helical rotary screw expander lie in possible economies of operation when certain mineral-rich brines are used to generate electric power. Mineral deposition on the screw surfaces may be beneficial by eliminating the need for close machining tolerances. As deposits build up, clearances disappear and better seals are formed between the counter-rotating screws and between the screws and the case. This continual lapping action, as scale grinds against scale, also serves to prevent total encrustation and may provide a "self-healing" mechanism if the case or the rotors should be scarred, by permitting mineral deposits to fill the depression.

Tests show that the device is tolerant of a wide range of geothermal fluids. It is capable of running on geothermal brines that have the ability to deposit silica and carbonate scale in conventional systems, and also seems to be very tolerant of geothermal fluids containing clay, silt, and sand without significant interference with its operation as a prime mover. Tests indicate that it is also tolerant of a wide range of enthalpy of the geothermal fluid. The low-enthalpy fluids produce less electrical power than do the high-enthalpy ones, but in tests the system has shown itself capable of operating with a remarkable degree of effectiveness over significant enthalpy ranges.

This expander can be manufactured by any of the helical rotary screw compressor manufacturers. With international capability for manufacturing, the lead time for producing small electrical power generators of this type would be relatively short, and standardization would permit more easy maintenance. As with conventional equipment, these power generating units could be readily mobile<sup>1</sup> and their portability would make for flexibility in utilization.

If further development and field use of the helical rotary screw expander should bear out the test results, geothermal sources not exploitable with current techniques might become economically exploitable. Its thermodynamic efficiency is somewhat lower than that of conventional gas turbines, but energy efficiency will be less important than flexibility and reliability in rural applications. Projected costs for complete generator systems are of the order of \$100 to \$200 per kilowatt. These capital costs, inherent simplicity, and potential reliability in a technologically adverse environment make it of considerable potential value for rural applications in developing countries.

## REFERENCE

1. McKay, R. A., and Sprankle, R. S. 1974. Helical rotary screw expander power system. In *Proceedings of the Conference on Research for the Development of Geothermal Energy Resources, Pasadena, California, 23-25 September*, pp. 301-307. Pasadena: California Institute of Technology, Jet Propulsion Laboratory.



## ADVISORY COMMITTEE ON TECHNOLOGY INNOVATION

### MEMBERS

- GEORGE BUGLIARELLO, President, Polytechnic Institute of New York, Brooklyn, New York, *Chairman*
- E. R. PARISER, Senior Research Scientist, Department of Nutrition and Food Science, Massachusetts Institute of Technology, Cambridge, Massachusetts
- LEWIS PERINBAM, Vice President Special Programs, Canadian International Development Agency, Ottawa, Canada
- CHARLES A. ROSEN, Staff Scientist, Stanford Research Institute, Menlo Park, California
- VIRGINIA WALBOT, Department of Biology, Washington University, St. Louis, Missouri

## BOARD ON SCIENCE AND TECHNOLOGY FOR INTERNATIONAL DEVELOPMENT

- DAVID PIMENTEL, professor, Department of Entomology and Section of Ecology and Systematics, Cornell University, Ithaca, New York, *Chairman*
- CARL DJERASSI, Department of Chemistry, Stanford University, Stanford, California, *Chairman, 1973-1975*

### MEMBERS

- GEORGE S. HAMMOND, Foreign Secretary, National Academy of Sciences
- RUTH ADAMS, American Academy of Arts and Sciences, Boston, Massachusetts
- EDWARD S. AYENSU, Director, Department of Botany, Smithsonian Institution, Washington, D.C.
- JOHN D. BALDESCHWIELER, Division of Chemistry and Chemical Engineering, California Institute of Technology, Pasadena, California
- IVAN L. BENNETT, JR., Dean, School of Medicine, New York University Medical Center, New York, New York
- DWIGHT S. BROTHERS, International Agricultural Development Service, The Rockefeller Foundation, New York, New York
- GEORGE BUGLIARELLO, President, Polytechnic Institute of New York, Brooklyn, New York
- CHARLES DENNISON, Former Vice President, International Minerals and Chemicals Corporation, New York, New York

WILLIAM A. W. KREBS, Vice President, Arthur D. Little, Inc., Cambridge, Massachusetts

FRANKLIN A. LONG, Program on Science, Technology, and Society, Cornell University, Ithaca, New York

FREDERICK T. MOORE, Economic Advisor, International Bank for Reconstruction and Development, Washington, D.C.

JOSEPH PETTIT, President, Georgia Institute of Technology, Atlanta, Georgia

JOSEPH B. PLATT, President, Harvey Mudd College, Claremont, California

HELEN RANNEY, Chairman, Department of Medicine, University Hospital, San Diego, California

ROBERT M. WALKER, McDonnell Professor of Physics, Director, Laboratory of Space Physics, Washington University, St. Louis, Missouri

STERLING WORTMAN, Vice President, The Rockefeller Foundation, New York, New York

#### STAFF

VICTOR RABINOWITCH, Director

JULIEN ENGEL, Deputy Director, *Head, Special Studies*

Board on Science and Technology for International Development  
Commission on International Relations  
National Academy of Sciences—National Research Council  
2101 Constitution Avenue, Washington, D.C. 20418, USA

### Advisory Studies and Special Reports

Single copies of published reports listed below are available free on request to the Board on Science and Technology for International Development while supplies last.

7. **U.S. International Firms and R, D, & E in Developing Countries.** 1973. 92 p. Discusses aims and interests of international firms and developing-country hosts and suggests that differences could be mitigated by sustained efforts by the firms to strengthen local R, D, & E capabilities.
10. **Food Science in Developing Countries: A Selection of Unsolved Problems.** 1974. 81 p. Describes 42 unsolved technical problems with background information, possible approaches to a solution, and information sources.
11. **Aquatic Weed Management: Some Perspectives for Guyana.** 1973. 44 p. Report of workshop with the National Science Research Council of Guyana describes new methods of aquatic weed control suitable for tropical developing countries.
14. **More Water for Arid Lands: Promising Technologies and Research Opportunities.** 1974. 153 p. Outlines little-known but promising technologies to supply and conserve water in arid areas. (This publication will also be available in French in early 1977.)
15. **International Development Programs of the Office of the Foreign Secretary,** by Harrison Brown and Theresa Tellez. 1973. 68 p. History and analysis, 1963-1972; lists staff, participants and publications.
16. **Underexploited Tropical Plants with Promising Economic Value.** 1975. 187 p. Describes 36 little-known tropical plants that, with research, could become important cash and food crops in the future. Includes cereals, roots and tubers, vegetables, fruits, oilseeds, forage plants, etc.
17. **The Winged Bean: A High Protein Crop for the Tropics.** 1975. 43 p. Describes a neglected tropical legume from Southeast Asia and Papua-New Guinea that appears to have promise for combatting malnutrition worldwide.
18. **Energy for Rural Development: Renewable Resources and Alternative Technologies for Developing Countries.** 1976. (This publication will also be available in French in early 1977.)

20. **Systems Analysis and Operations Research: A Tool for Policy and Program Planning for Developing Countries.** 1976. 98 p. Examines utility and limitations of SA/OR methodology for LDC application and means for acquiring indigenous capabilities.

Another report (prepared in cooperation with BOSTID) available from the above address is:

**An International Centre for Manatee Research.** 1975. 34 p. Describes the use of the manatee, a large, almost extinct, marine mammal, to clear aquatic weeds from canals. Proposes a research laboratory to develop manatee reproduction and husbandry. Published by the National Science Research Council of Guyana.

The following out-of-print BOSTID reports are available **only** from the National Technical Information Service. To order, send report title, NTIS Accession Number, and amount indicated. Pay by NTIS Deposit Account, check, or money order. U.S. orders without prepayment are billed within 15 days; a 50¢ charge is added. Foreign buyers must enclose payment plus U.S. \$2.50 handling charge per item. Send order to:

National Technical Information Service  
Springfield, Virginia 22161, USA

1. **East Pakistan Land and Water Development as Related to Agriculture.** January 1971. Reviews World Bank proposed action program in land and water management. NTIS Accession No. PB 203-328. \$4.25.
2. **The International Development Institute.** July 1971. 57 p. Endorses concept of new science-based technical assistance agency as successor to AID; examines its character, purposes, and functions. NTIS Accession No. PB 203-331. \$4.25.
3. **Solar Energy in Developing Countries: Perspectives and Prospects.** March 1972. 49 p. Assesses state of the art, identifies promising areas for R & D, and proposes multipurpose regional energy research institute for developing world. NTIS Accession No. PB 208-550. \$4.25.
4. **Scientific and Technical Information for Developing Countries.** April 1972. 80 p. Examines problem of developing world's access to scientific and technical information sources, provides rationale for assistance in this field, and suggests programs for strengthening information infrastructure and promoting information transfer. NTIS Accession No. PB 210-107. \$4.75.

6. **Research Management and Technical Entrepreneurship: A U.S. Role in Improving Skills in Developing Countries.** 1973. 40 p. Recommends initiation of a systematic program and indicates priority elements. NTIS Accession No. PB225-129/6AS. \$3.75.
8. **Ferrocement: Applications in Developing Countries.** 1973. 89 p. Assesses state of the art and cites applications of particular interest to developing countries—boat-building, construction, food- and water-storage facilities, etc. NTIS Accession No. PB 220-825. \$5.25.
9. **Mosquito Control: Some Perspectives for Developing Countries.** 1973. 63 p. Examines biological-control alternatives to conventional pesticides; evaluates state of knowledge and research potential of several approaches. NTIS Accession No. PB 224-749/AS. \$4.25.
12. **Roofing in Developing Countries: Research for New Technologies.** 1974. 74 p. Emphasizes the need for research on low-cost roofs, particularly using materials available in developing countries. NTIS Accession No. PB 234-503/AS. \$4.75.
13. **Meeting the Challenge of Industrialization: A Feasibility Study for an International Industrialization Institute.** 1973. 133 p. Advances concept of an independent, interdisciplinary research institute to illuminate new policy options confronting all nations. NTIS Accession No. PB 228-348. \$5.75.

### Related Publication

Another out-of-print report (prepared in cooperation with BOSTID) available from the National Technical Information Service is:

**Products from Jojoba: A Promising New Crop for Arid Lands.** 1975. 30 p. Describes the chemistry of the oil obtained from the North American desert shrub *Simmondsia chinensis*. NTIS Accession No. PB 253-126/AS. \$3.75.

### Reports in preparation (working titles)

BOSTID will fill requests for single copies of reports in preparation upon publication.

5. **The Role of U.S. Engineering Schools in Foreign Assistance Activities.**
19. **Methane Generation from Human, Animal, and Agricultural Wastes.**
21. **Making Aquatic Weeds Useful: Some Perspectives for Developing Countries.**
22. **Guayule: An Alternative Source of Natural Rubber.**
23. **Remote Sensing for Development.**
24. **Appropriate Technologies for Developing Economies.**
25. **Little-Known Legumes with Promising Economic Potential.**
26. ***Leucaena leucocephala*: New Forage and Tree Crop for the Tropics.**