

GREAT GARDEN FORMULAS

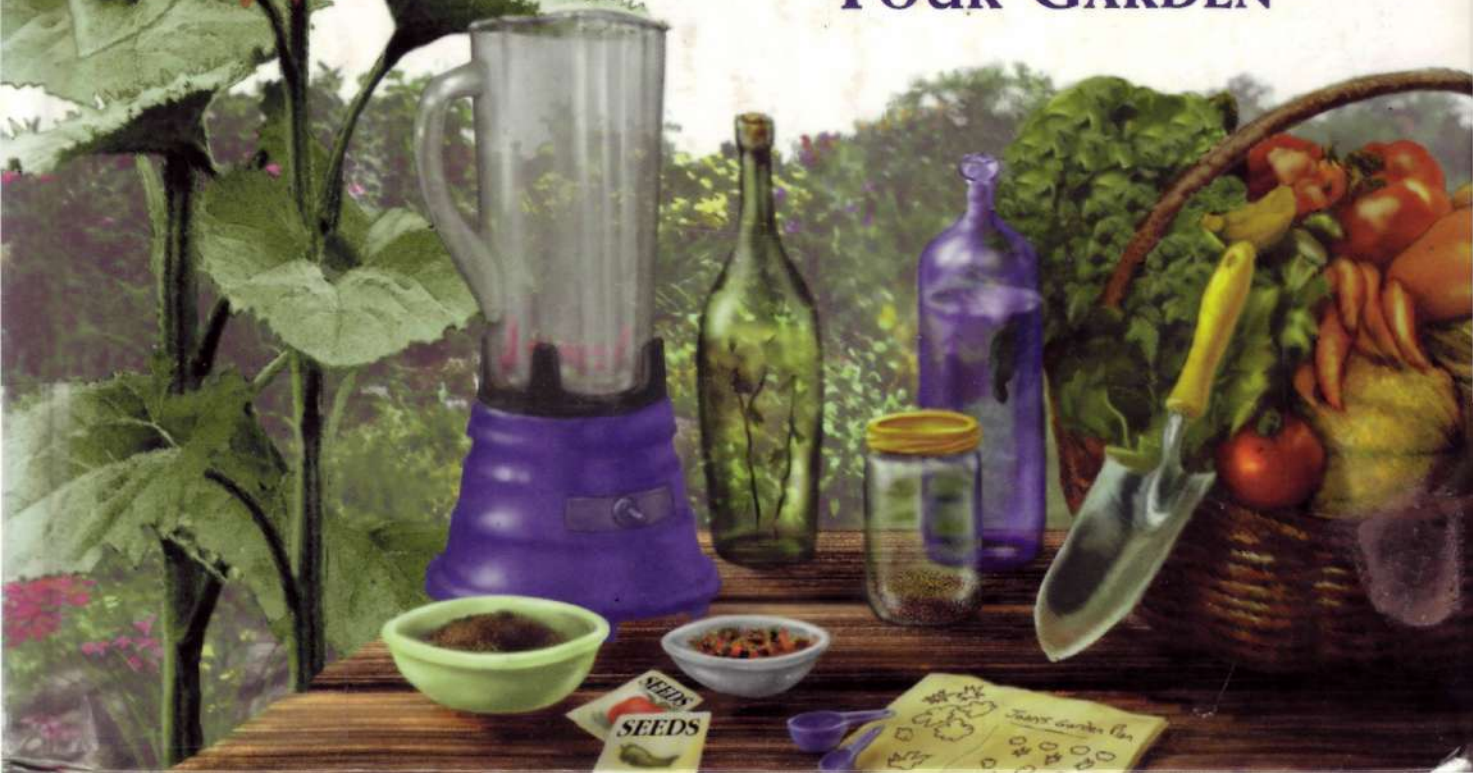

The **ULTIMATE** BOOK
of **MIX-IT-YOURSELF**
CONCOCTIONS for
YOUR GARDEN



Fast, Fun, and Fabulous Fertilizer Quick-Fixes

Feed the soil, and the soil will feed your plants. That's one of the basic tenets of organic gardening. In most cases, an annual application of rich compost or well-aged manure will provide enough nutrients and organic matter to sustain your plants all through the growing season. Even so, your garden will probably need a quick pick-me-up from time to time. That doesn't mean that you have to run out to the garden center and drop some cash on an expensive fertilizer. Chances are you have the ingredients for making your own inexpensive, earth-friendly plant food right at hand.

We've polled garden experts from around the country for their favorite fertilizer formulas. Many of these fertilizer mixes, blends, and solutions provide more than the big three nutrients of nitrogen, phosphorus, and potassium. They also include vital micronutrients, plant growth hormones, soil conditioners, and even disease and insect fighters. Some of these time-tested fertilizer formulas include traditional, easy-to-find materials, like fish emulsion and manure. Others make use of more unusual ingredients, like Epsom salts and vinegar. Still others make the most of kitchen and garden wastes, including coffee grounds and weeds.

We hope these gardener-to-gardener formulas will inspire you to cook up some of your own creative mixes by making use of

locally available materials for fertilizer. Collect wastes from local breweries, manure from zoos or local farms, leaves from curbsides, and kitchen scraps from restaurants or grocery stores. Many establishments will be glad to have your haul away their wastes for free.

KNOW YOUR INGREDIENTS

Some of the recipes in this chapter include fertilizer products that you'll need to buy at a garden center or through a mail-order supply company. If you're new to using organic fertilizers, you may not know the names of some of these products. Here's a rundown of some products you'll use:

- Blood meal:** dried blood produced as a by-product of the meat industry; contains about 13 percent nitrogen
- Colloidal phosphate:** clay washed from rock phosphate when the rock phosphate is mined; good source of phosphorus
- Cottonseed meal:** a waste product left after cottonseed oil is pressed out of cottonseed; may contain chemical residues
- Fish emulsion:** a liquid by-product of the animal feed industry, made from fish; good source of nitrogen
- Greensand:** mined mineral deposits; good source of potassium and other minerals
- Guano:** aged, dried bird or bat droppings; high in nitrogen and phosphate

RECIPE: GARDEN FERTILIZER FORMULAS
1 CUP GREEN SAND
3 CLOVES GARLIC, CRUSHED
1 TEASPOON CHILI POWDER

harvests of vegetables and fruit will require more frequent fertilizer applications, particularly before and immediately after flowering.

Pick Your Mix

You'll find both dry and liquid fertilizer formulas in this chapter. Dry fertilizers, such as long-lasting granular or powdered mixes, are great for sidedressing actively growing plants. These power-packed organic fertilizers not only supply nutrients, but also improve the texture and moisture retention of the soil by feeding a vast army of beneficial microbes (as many as 900 billion in 1 pound of soil). And these fertilizers will keep on working for weeks, even months.

In most cases, you can just spread dry fertilizer on the soil around individual plants and lightly scratch them into the soil. If your soil is low on any of the major nutrients (nitrogen is especially soluble, so it leaches out quickly from the soil), these

dry fertilizers may be the best way to provide them.

The liquid fertilizer formulas we've collected take the form of fast-acting teas and mixtures for foliar feeding (spraying the leaves of a plant) and soil drenches. While it's no substitute for a balanced soil, foliar feeding can be the best way to supplement your plants' diets. Like the vitamin and mineral supplements we humans take to combat high stress levels or to make up for poor eating habits, foliar feedings don't replace good soil fertilizers, they merely supplement them. If major nutrients or trace minerals are missing from the soil, these liquid fertilizers, sprayed directly on the leaves, will provide them fast! Plants will immediately absorb the micronutrients from liquid fertilizers like manure tea, compost tea, and seaweed solutions. Since plants can't store excess nutrients in their leaves and draw on them later, you'll have to repeat foliar feedings at regular intervals.

BUCKETS BEAT BAGS

It's cheaper to buy fertilizer ingredients in bulk and split the costs and the resulting mix with a gardening friend or neighbor. But splitting a batch isn't always possible, and it's a good idea to be prepared in case there are leftovers.

You'll need containers, of course, but labels are just as important. Always label fertilizer containers before you fill them so there's no chance of forgetting a label or

confusing the contents with another garden product.

Store homemade fertilizer in 5-gallon plastic buckets with lids. That way, moisture (and pests) can't get into the mix and spoil it. You can get buckets for free—or for a small fee—from grocery stores and restaurants. Attach your labels, or use a permanent marking pen to write the date and ingredients on each bucket. ♻️

Mix and Match Organic Fertilizer

"Make your own custom organic fertilizer for almost any plant," says Bill Wolf, co-author of *Rodale's Chemical-Free Yard and Garden*. In general terms, there are three basic nutrients that a good general organic fertilizer should supply: nitrogen, phosphorus, and potassium. You can save money by buying organic amendments that supply these nutrients and mixing them yourself in the proportions Bill recommends. The specific quantities of each nutrient will vary according to the materials you use, but all will give a balanced supply of nutrients.

Ingredients and Supplies

- 2 parts blood meal or 3 parts fish meal
(nitrogen source)
- 3 parts bonemeal, 6 parts rock phosphate, or 6 parts colloidal phosphate
(phosphorus source)
- 1 part kelp meal or 6 parts greensand
(potassium source)
- Dust mask
- Gloves
- Safety goggles

Directions

1. Choose 1 nitrogen source, 1 phosphorus source, and 1 potassium source from the materials listed above. For example, you could select blood meal for nitrogen, rock phosphate for phosphorus, and greensand for potassium.
2. Mix the 3 materials you've chosen in the proper proportions. Be sure to wear a dust mask, gloves, and safety goggles while mixing the ingredients.

KELP HELPS YOUR PLANTS

Kelp meal is the single product that Bill Wolf uses most to fertilize plants because it is such a complete source of the minerals that plants need. He advises applying 10 pounds of kelp per 1,000 square feet for fruit crops, vegetables, lawns, or ornamentals. Adding 1 teaspoon of kelp meal to the potting soil in a 6-inch pot will keep container plants looking their best.

Bill also says that if you can get fresh kelp or seaweed, by all means use it! He recommends rinsing the seaweed to remove salt, then applying it as a mulch or adding it to your compost pile. It decays quickly and is weed and seed free! 🌱

3. Apply the custom fertilizer around the base of established perennials, fruit trees, or roses. You can also mix some of the fertilizer into the soil of a bed before planting vegetable or flower transplants.

1 teaspoon chili powder

FERTILIZER FORMULAS

FERTILIZER FORMULAS

Spring-Planting Special Organic Fertilizer

If you really want to know what kind of organic fertilizer you're putting on your flower and vegetable gardens, quit buying prebagged mixes. Make your own homemade fertilizer and you won't have to wonder about those "extra" ingredients that tend to show up in commercial fertilizers. This mix will give you the "grow power" of a 25-pound bag of 5-10-10 fertilizer—that's 5 percent nitrogen, 10 percent phosphorus, and 10 percent potassium—with no unnecessary additives.

Ingredients and Supplies

- 17 pounds cottonseed meal
- 8 pounds colloidal phosphate
- 45 pounds granite dust
- Respirator
- Gloves
- Safety goggles
- Large wheelbarrow or plastic drop cloth
- Shovel

Directions

1. Find out what your garden needs before you apply fertilizer. Send a soil sample to a testing lab and ask them for organic recommendations. (See "Organic Soil Testing" on page 57 for labs that offer this service.)
2. Put on the respirator (a more effective form of dust mask), gloves, and goggles, then place all the ingredients in the wheelbarrow or on the drop cloth and mix with the shovel.
3. Before planting in spring, spread the fertilizer over the garden area—the amount

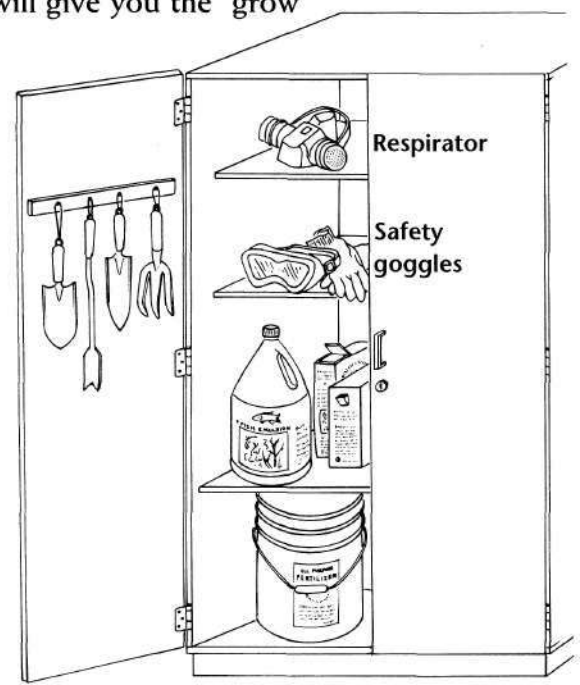

Store fertilizer in a dry place that's out of the sun, like a storage shed or garage. Keep it in a locked cabinet or other secure place so that it's out of reach of children and pets.

you'll need to use depends on your soil test. (Wear gloves, goggles, and a respirator when you work.) Hoe or rake the fertilizer into the top 4 to 6 inches of soil.

Yield: The equivalent of 25 pounds of 5-10-10 commercial organic fertilizer

Fantastic Foliar Feeding Formula

"Foliar (or leaf) feeding is the most efficient way to fertilize," says John Dromgoole, owner of Garden-Ville nursery in Austin, Texas, and host of the "Gardening Naturally" radio program. "When you apply fertilizer to the soil, the roots may take up as little as 10 percent of the nutrients," he explains, "but when fertilizer is applied to the leaves, 90 percent of the material is absorbed." John regularly foliar-feeds all of the nursery stock at Garden-Ville, as well as the plants in his home landscape. His formula includes fish emulsion for nitrogen and seaweed for trace minerals, growth stimulants, and plant hormones. One of John's secret ingredients is blackstrap molasses, which contains iron and sulfur as well as simple sugars that nourish the plants.

Ingredients and Supplies

- 2 tablespoons fish emulsion
- 1 tablespoon liquid seaweed
- 1 teaspoon blackstrap or horticultural-grade molasses
- 1 tablespoon Medina or other biostimulant (if available)
- 1 gallon water (rainwater, if possible)
- Pump spray bottle

Directions

1. Mix all ingredients well.
2. Pour the mixture into a pump sprayer and spray on plants, especially the undersides of the leaves, until the liquid drips off.

Yield: About 1 gallon of liquid fertilizer

Note: You can use this solution on annuals, perennials, roses, vegetables, and fruit trees. Start weekly applications as

MONEY-SAVING TIP

Instead of using liquid seaweed, buy seaweed powder and mix it with water at home to make your own concentrate. Not only can you mix small amounts as needed, you'll also save up to 30 percent of the cost. 🌱

seedlings develop their first set of true leaves and continue until blooming begins. For vegetables, make one final application when your plants set fruit. Apply to fruit trees as blossoms drop and leaves begin developing. To use as a transplant starter, mix the solution at half strength and apply as a soil drench.

REAR THE GARDEN FORMULAS
FERTILIZER FORMULAS
1 teaspoon chili powder

Seedling Starter Solution

It's tough being a transplant. If you've ever moved to a new house or a new town, you know how stressful relocation can be. Moving is just as tough for your plants as it is for you.

So give your transplants a break on moving day by serving them a sip of weak "starter solution." Your young plants will recover quickly from the shock of transplanting with this nutrient boost.

Ingredients and Supplies

- ½ cup fish emulsion
- ½ cup seaweed extract
- Small disposable container, like a coffee can
- 8-ounce jar or bottle with lid

Directions

1. Mix the fish emulsion and seaweed extract together in the container.
2. Pour the mix into a jar or bottle. Seal it tightly, label it, and store it in a cool, dark place, like a basement storage cabinet.
3. To use, add 3 tablespoons of starter solution to 1 gallon of water. Use as a soil

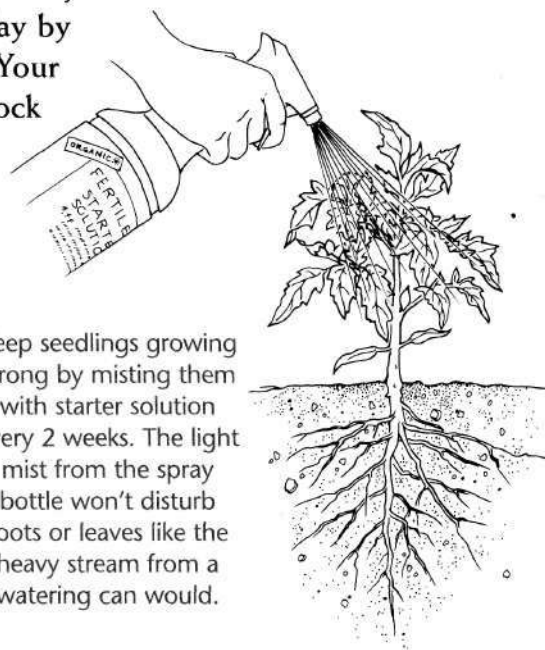

Keep seedlings growing strong by misting them with starter solution every 2 weeks. The light mist from the spray bottle won't disturb roots or leaves like the heavy stream from a watering can would.

drench at transplanting time or as a spray for foliar (leaf) feeding.

Yield: 1 cup of fertilizer concentrate

MORE STARTER SOLUTIONS

If you don't have the ingredients to make a fish emulsion-seaweed extract starter solution, you can substitute compost or manure. Don't use manure tea or manure-based compost tea to provide a nutrient boost for your fruit or vegetable crops, since there's a chance manure can carry *E. coli* bacteria.

To make compost or manure tea, fill a large trash can or other waterproof

container one-eighth full of compost or manure. Then fill the container to the top with water. Allow the mixture to steep for a day or two, stirring several times during this period. Dip off the liquid and dilute it with water to a light amber color.

Water each transplant with clear water, then pour about a cup of this solution around the base of each plant. Repeat at 10- to 14-day intervals. 🌱

Plant Help from Kelp

Looking for the perfect all-purpose food for your perennials, herbs, shrubs, roses, and fruit trees? Phil Boise of Goleta, California, has concocted an organic mix that keeps his plants healthy and productive all year. Phil and his wife, Ellen McLaughlin, sell organically grown plants, organic pest controls, fertilizers, and seeds at Island Seed and Feed in Goleta.

"Don't skimp on the kelp," Phil says. He uses only cold-water-harvested kelp. "It has a lower salt content and a better nutrient, hormone, and mineral percentage." He's found that kelp also helps to improve the pest and disease resistance of his plants.

Ingredients and Supplies

- 1 part kelp meal
- 2 parts alfalfa meal
- 4 parts any combination cottonseed meal, fish meal, and/or soybean meal
- 1 part rock phosphate
- Dust mask
- Gloves
- Safety goggles

Directions

1. Mix all ingredients thoroughly while wearing a dust mask, gloves, and safety goggles.
2. Use up to 3 cups for each mature rose-bush, perennial, or shrub. For annuals and herbs, use only up to 1½ cups. For midsize fruit trees, you can apply up to 6 cups.
3. Apply 2 or 3 times a year.

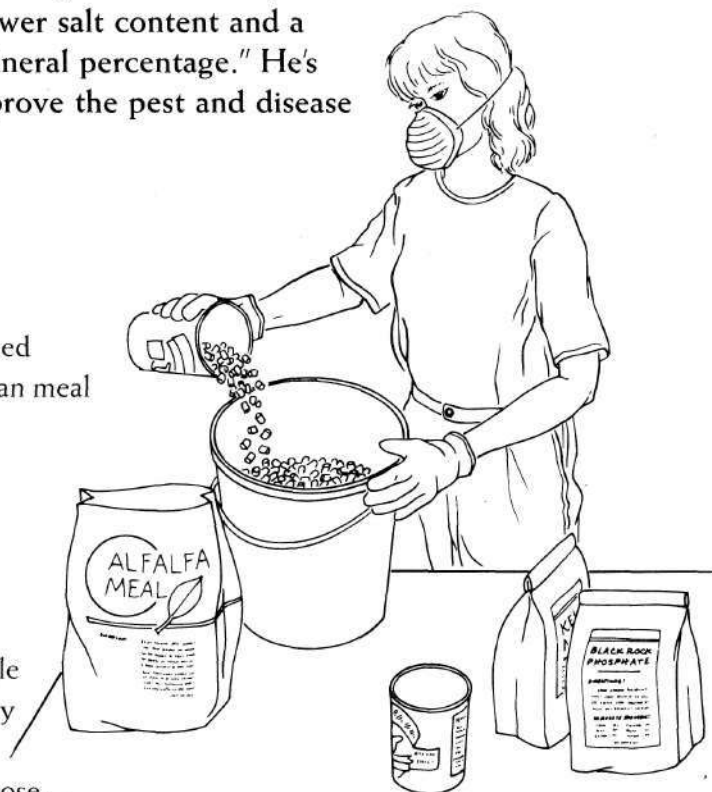

Recycled plastic containers like yogurt cups make perfect scoops for measuring fertilizer ingredients in "parts." When mixing fertilizers, wear gloves and a dust mask to protect your skin and to avoid inhaling fine dust particles.

Give Your Plants a Weed Feed

If you can't beat 'em, feed with 'em. That could be the motto of Neil Strickland of Raymond, Mississippi. Neil fertilizes his entire vegetable garden and 3-acre orchard exclusively with a homemade weed tea. Just like cover crops, weeds contain traces of the "big three" nutrients: nitrogen, phosphorus, and potassium. "And fast-growing weeds have many growth hormones and trace minerals," Neil says. He uses whatever is on hand for his brew, including horsetail (*Equisetum arvense*), chickweed, comfrey, nettles, and even willow branches and grass clippings. "If you can use only one plant, make it willow branches," he says, "because they contain many growth hormones that are especially beneficial for transplants."

Ingredients and Supplies

- 55-gallon drum or several 5-gallon buckets
- Silica-rich plants, like stinging or false nettles, or horsetail
- Any type of willow branch (watersprouts are especially good)
- Green matter, such as fresh lawn clippings, chickweed, and comfrey
- Rainwater or chlorine-free water

Directions

1. Coarsely chop some silica-rich plants, willow, and green matter, and fill the drum or buckets $\frac{1}{3}$ to $\frac{1}{2}$ full of plant material.
2. Fill the drum or buckets with rainwater or chlorine-free water. It's important to use water that hasn't been chlorinated, because chlorine may kill the microbes that break down the plant matter.
3. Let the mixture stand in the sun for several days (preferably not too close to the house—this is a pretty fragrant fertilizer!).
4. Pour or drain the liquid off the top into a separate container.
5. To use, mix 1 quart of the fertilizer liquid in 5 gallons of water. Spray on plant leaves as a foliar fertilizer, or use as a soil drench



Stinging nettle

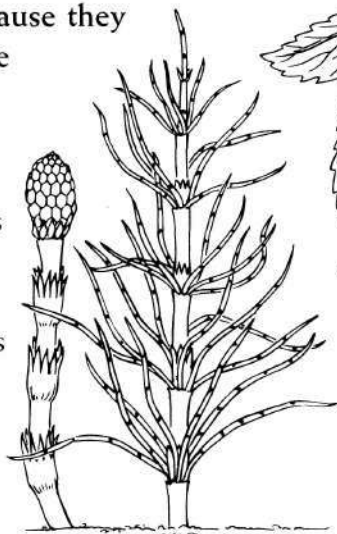

Field horsetail

for vegetables, fruit trees, and ornamentals. (Neil often uses the liquid full strength on established plants and has not experienced any burning.)

Yield: About 30 gallons of nutrient tea

Note: Add more water and new weed material to the drum or buckets as you use the fertilizer and you'll have a continuous source of plant

food. "It's like sourdough starter," explains Neil's friend, Kathleen Chapman, also of Raymond, Mississippi. "You have to keep it going by continuing to add fresh plants and more water. The sludge that remains in the bottom of the container contains microbes that keep the fertilizer cooking." Kathleen says that this weed tea keeps her flower and herb gardens lush and green all season long.

SKEETER BEATER

As the weed fibers begin to break down, and the water becomes brown and thickens, algae may grow on the top of your weed-tea container. That's fine. "But mosquitoes can be a problem in the barrels," warns Neil Strickland. He adds minnows to his barrels to feed on mosquito larvae, but suggests that if you don't want to fool with fish, you can cover the containers with screens or light-weight row cover fabric to prevent mosquitoes from laying eggs in the water. Use a transparent or translucent cover and don't seal the top, because the process that breaks down the plant matter requires oxygen and sunlight. Don't use both a cover over your weed barrel and minnows inside it—the poor minnows won't have anything to eat!

If cold weather forces you to shut down your weed tea preparations for the winter, make good use of the rich sludge at the bottom of the barrel. Add the sludge to your compost pile to get even more benefit from the microbes and nutrients in it. Start a new barrel with fresh weeds when spring arrives. 🌱

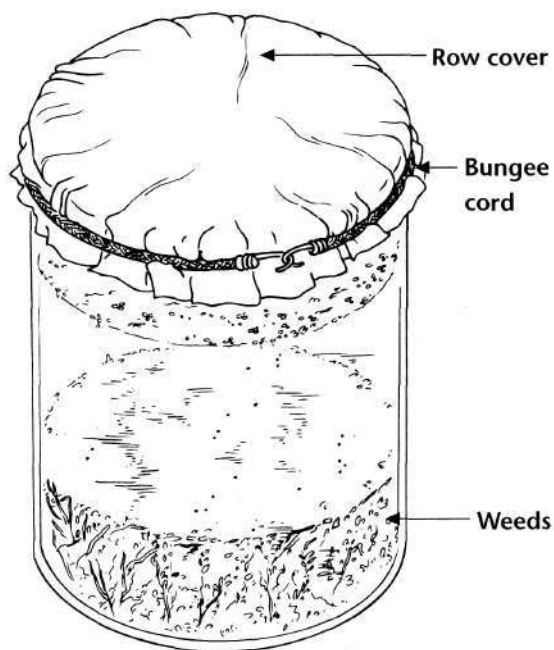

Soak weeds like chopped willow suckers, stinging nettles, and chickweed in water for a few days to make a nourishing tea for plants. A covering of window screen or row cover helps to keep mosquitoes from making a home in your weed-tea barrel.

cup
tea
EXPEND
FORMULAS
FERTILIZER FORMULAS
1 teaspoon chili powder

Swiss Chard Cocktail

Did you go overboard on sowing Swiss chard? Or maybe you're looking for a fast-growing fertilizer source to fill in some empty garden space? You can solve your problems and satisfy your plants' hunger by serving them Swiss chard tea for a quick pick-me-up. Fantastic in salads, stir-fries or just steamed, Swiss chard is great for plants, too. "A happy hour for sad-looking plants" is how Dominique Inge, a self-described "passionate gardener," characterizes her recipe. She uses it regularly on the plants in her organic gardens in Granbury, Texas.

Ingredients and Supplies

- 2 cups red or green Swiss chard leaves, coarsely chopped
- Blender
- Cheesecloth or colander

Directions

1. Place the chopped leaves in the blender.
2. Add enough hot water to fill the blender jar and blend thoroughly.
3. Strain the mixture through cheesecloth or a colander and apply the cooked leaves around the base of plants.
4. After the liquid cools, use it as a soil drench around plants.

Yield: About 8 cups of Swiss chard tea

Note: Swiss chard leaves that are longer than 10 inches are best added to the compost pile or used in this tonic tea. You can also use the liquid that's left after cooking Swiss chard in the same way.

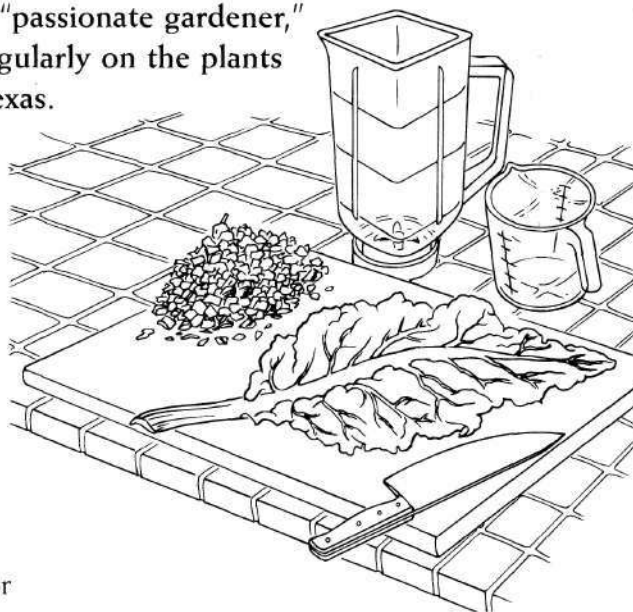

Chop your overgrown Swiss chard leaves and process them with hot water in a blender. The cooled cocktail is a great pick-me-up for woebegone plants.

Variation: If all of your chard winds up on the dinner table, you can substitute comfrey in this recipe. Its leaves are high in calcium, phosphorus, potassium, trace minerals, and vitamins A, B-12, and C.

Let Those Grass Clippings Lie!

Grass clippings make great fertilizer, according to Cyane Gresham, compost specialist at the Rodale Institute Experimental Farm in Kutztown, Pennsylvania. Cyane says that it's a crime to waste grass clippings by bagging them up for disposal with household trash because they're such a terrific organic source of nitrogen and other nutrients. "Grass clippings should never leave your property. They are too valuable as a mulch and fertilizer for the lawn, gardens, and landscape," Cyane explains.

Ingredients and Supplies

- Lawn mower
- Rake
- Wheelbarrow or 5-gallon bucket

Directions

1. Mow your lawn.
2. To fertilize the lawn, leave the grass clippings in place. They will break down and add organic matter and nutrients to the soil. To fertilize other areas, rake up some of the clippings (especially in areas where the clippings are dense and might choke out the grass growing underneath them).
3. Put the clippings in a wheelbarrow or bucket and transport them to your garden.
4. Apply the clippings lightly around garden plants. Avoid dense mats of clippings—these can keep water from penetrating the soil. If necessary, mix some fallen leaves into the clippings to create a looser mulch.

MOW IT RIGHT

Some gardeners like to give the lawn a buzz cut when they mow so they won't have to mow as often. But cutting your lawn short is tough on the grass, and it also makes it easier for weeds to grow in your lawn. Ideally, you should remove only one-third of the height of your grass when you mow. For example, if your lawn is 3 inches long at mowing time, you should cut off 1 inch of grass, at most. Mowing high means you can leave your grass clippings in place, which is good for your lawn and less work for you.

If you've missed a mowing or two and have to remove more than one-third of the grass, don't panic. Just rake up the clippings and use them as mulch around your perennials, herbs, or roses. ♻️

RECIPE FOR CHILI POWDER
GARDEN FERTILIZER FORMULAS
1 teaspoon chili powder

Feed Your Garden with Cover Crops

Fifth generation farmer Dean Berden of Snover, Michigan, uses cover crops for fertilizer in his farm fields and his family vegetable garden. Dean produces dry beans, soybeans, wheat, oats, and organically certified cover crop seeds on his 500-acre Thistle Down Farms without using any commercial fertilizer supplements.

In his home garden, Dean also depends on cover crops to build soil fertility. He uses a three-year rotation program, planting a cover crop the first year to build fertility, followed by a "light-feeding" vegetable crop, like peas or beans, in the second year and a "heavy-feeding" crop, like corn or tomatoes, in the third year.

"The microbes in the soil thrive on the habitat created by cover crops," Dean explains. "When the cover crops are cut and tilled under, the microbes greatly increase in numbers and feed themselves on the plant residues." In turn, the microbes generate nutrients in forms that plant roots can absorb.

Ingredients and Supplies

2 pounds per 100 square feet cover crop seed (soybean, oat, and medium red clover seed)

Rotary tiller or digging fork

Directions

1. In the spring, sow $\frac{1}{3}$ of your vegetable garden with cover crop seed, spreading the seed lightly by hand and raking it in after planting. Dean recommends combining 2 or even all 3 kinds of cover crops in the same planting.
2. Water the seeded plot well.
3. When the seed has germinated and the cover crop plants are 10 to 12 inches tall, till the plants into the soil. You can also cut the plants to the ground and dig them in by hand, but be forewarned—digging in a

HOW'S THAT VEGGIE'S APPETITE?

To use Dean Berden's soil-building rotation program, you need to know which vegetable crops are heavy feeders and which are light feeders. Here's a rundown of the most common crops by their feeding habits:

Heavy Feeders

Broccoli
Cabbage
Cauliflower
Cucumbers
Eggplant
Lettuce
Melons
Peppers
Pumpkins
Spinach
Squash
Tomatoes

Light Feeders

Beans
Beets
Carrots
Garlic
Onions
Peas
Potatoes
Radishes
Turnips

cover crop by hand can be a tough job! You may want to rent or borrow a tiller instead.

4. At the end of August or in September, reseed the plot with more cover crops as before. Dean says that, for the second seeding, a combination of oats and red clover is best.

5. Allow this crop to remain in place through the fall and winter. The crop will be killed by frost, but leave the dead plants in place to protect the soil from erosion during the winter.

6. The following spring, till the cover crop under. Allow 2 or 3 weeks for the crop

residues to break down, and the plot will be ready to plant. You may want to work the soil lightly again just before planting.

7. Sow seeds or plant transplants of light-feeding vegetable crops (see "How's That Veggie's Appetite?" on the facing page for a list of light-feeding and heavy-feeding crops).

8. Tend and harvest the crops.

9. The following spring, sow seeds or plant transplants of heavy-feeding vegetable crops.

10. Tend and harvest the crops. The following spring, it's time to start again with a year of soil-building cover crops.

Year 1	Cover crops	Heavy feeders	Light feeders
Year 2	Light feeders	Cover crops	Heavy feeders
Year 3	Heavy feeders	Light feeders	Cover crops

A 3-year crop rotation that alternates heavy feeding garden crops like tomatoes with cover crops and then lighter feeders like beans builds and maintains healthy soil, which means more homegrown food for dinner!

RECIPE EXTENSION FORMULAS
FERTILIZER FORMULAS
1 teaspoon chili powder

Hay Gives Plants Horsepower

Want great performance from your perennials? "Fuel them with high-octane alfalfa hay tea," says John Dromgoole, owner of Garden-Ville nursery in Austin, Texas, and host of the "Gardening Naturally" radio program. Alfalfa has been used for centuries as livestock feed. But John says that everything that makes it a valuable feed—high nitrogen, vitamin A, folic acid, potassium, calcium, and trace minerals—also makes it a great foliar plant food. John says alfalfa tea is especially good for roses and long-blooming ornamentals. You can also substitute bagged alfalfa meal for the hay.

Ingredients and Supplies

- 5-gallon bucket
- 1 bale organically grown alfalfa hay, coarsely chopped, or 1 bag alfalfa meal
- Panty hose or cheesecloth

Directions

1. Fill the bucket $\frac{1}{4}$ full with alfalfa hay or alfalfa meal.
2. Add water (preferably rainwater) to fill the bucket.
3. Allow the tea to brew for 1 week to 10 days. (This tea smells pretty strong, so don't mix it too near the house!)
4. To make a foliar (leaf) spray or a soil drench, strain the mixture through cheesecloth or a piece of old panty hose. Dilute with water at a ratio of 1 cup of mixture per gallon of water. The final result should look like light transparent tea.

Yield: About 4 gallons of concentrated nutrient tea

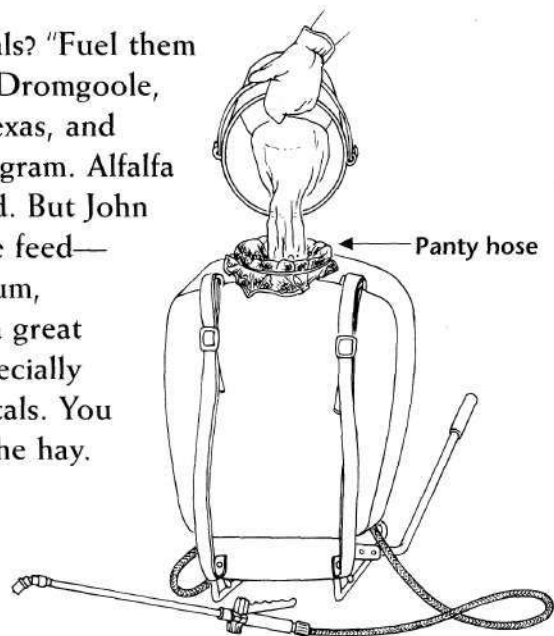

Strain fertilizer mixes like alfalfa tea through cheesecloth or a piece of panty hose to catch plant debris so that it won't clog your sprayer.

BALE BARN

One bale of hay should feed your garden for an entire gardening year. (Or you may be able to collect loose hay from the floor of a local feed store—for free!) Chop and mix the alfalfa as needed. Store the remaining hay under cover to prevent leaching and loss of nutrients. You can keep the hay in a garage or garden shed, or cover it with a tarp in a shady spot. 🌱

Note: To replenish the mix, just add more hay and more water to the bucket as needed. When the bucket is full of "used" alfalfa, you can use the dregs to sidedress established plants in the garden.

The Worms' Turn

Jay Mertz always makes room for earthworms at Rabbit Hill Farm in Corsicana, Texas, where he and his wife, Joanne, raise earthworms and sell castings, potting soil, and organically grown plants. He knows that earthworms not only aerate the soil to a depth of 6 feet and make minerals more available in the process, but each earthworm also produces rich fertile castings, or manure, and lots of it—up to its body weight each day! The castings contain several vital nutrients as well as an enzyme that increases the moisture holding capacity of the soil.

"Earthworm castings are the world's best fertilizer," Jay claims. Castings contain all the nutrients plants need for a terrific start, and the additional Epsom salts in his formula provide magnesium for sweet, juicy tomatoes and melons.

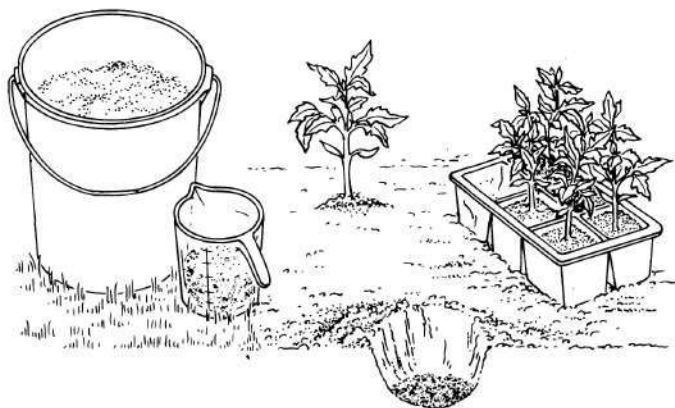

A cup of earthworm castings and a teaspoon of Epsom salts sprinkled in the planting hole are all you need to give your tomatoes and melons a great start.

Ingredients and Supplies

- 12 cups earthworm castings
- $\frac{1}{4}$ cup Epsom salts
- Plastic measuring cup or empty 8-ounce yogurt container

Directions

1. Put earthworm castings in a bucket or other container and add the Epsom salts. Mix well.
2. Put 1 cup of the mixture in the bottom of each transplant hole as you plant tomatoes and melons.

Yield: 12 $\frac{1}{4}$ cups of organic fertilizer mix

YOUR OWN EARTHWORM FARM

You can buy earthworm castings from a garden supply catalog. But it's more fun to build a worm composter to produce a free supply of castings. Earthworms make composting easy—even indoors! Just use a small box to hold earthworms, soil, and kitchen waste. These polite houseguests will consume your kitchen food wastes and shredded newspapers and give you earthworm castings, the world's greatest fertilizer. All they ask for is a nice warm, dark bed and steady meals. To learn more about earthworms and worm bins, see pages 20–21. 🐛

Fabulous Fertilizer Fix for Bulbs

Bulbs need more than bonemeal to do their best. Bonemeal does supply daffodils, tulips, and other bulbs with the phosphorus and calcium they crave, but this fertilizer mix offers more. To give your bulbs a more complete diet this fall, add nitrogen (from blood meal) and potash (from greensand or ashes) to your bulbs' bonemeal meal.

Ingredients and Supplies

- 2–3 pounds blood meal
- 2–3 pounds bonemeal
- 2–3 pounds greensand or wood ashes
(use greensand if your soil's pH is near neutral; use wood ashes to raise the pH if your soil is acidic)
- Dust mask or respirator
- Gloves
- Safety goggles
- Bucket, washtub, or plastic drop cloth
- Shovel

Directions

1. Put on a dust mask or respirator, gloves, and safety goggles (fertilizer materials are dusty), then mix all the ingredients in the bucket or washtub or on the drop cloth, stirring them together with a shovel.
2. Topdress established bulb beds with the mixture in early spring when the foliage starts to emerge from the ground. Broadcast the fertilizer over the soil surface without working it into the soil. Wear your dust mask or respirator, goggles, and gloves for this step, too.

FREE FERTILIZER MIX

If you have horses or cows—or access to a stable or farm—you can substitute dry manure for the Fabulous Fertilizer mix. (Store-bought manure will work as well.) Use 16 gallons of dry manure, or a ¼-inch layer per 100 square feet of bed. Reapply each spring.

Compost is another great free fertilizer option. Rather than making the Fabulous Fertilizer mix, you can apply 16 gallons (or a ¼-inch layer) of compost per 100 square feet of bulb bed in fall and 2 pounds of blood meal in spring each year. 🌱

Digging around the emerging bulbs can damage roots, so let spring rains wash the fertilizer into the ground.

Yield: Enough fertilizer for 100 square feet

Variation: Substitute 2 pounds colloidal phosphate for the bonemeal. Colloidal phosphate breaks down gradually over about 5 years, so test your soil to see what it needs before fertilizing again.

Super Food for Roses

"Roses really respond to organic fertilizers," says Judy McKeon, chief horticulturist and rosarian for the Morris Arboretum of the University of Pennsylvania in Philadelphia. "We fertilize all of our roses with this organic blend in early spring and give repeat-bloomers a second application in early summer," she says. "They respond with fantastic foliage and flowers."

Ingredients and Supplies

- 2-gallon bucket
- 1 cup alfalfa meal
- 1 cup fish meal
- 1 cup greensand
- ½ cup bonemeal
- 1 cup gypsum
- Dust mask

Directions

1. Mix all ingredients together in the bucket. Wear a dust mask while you work.
2. Pull back mulch and work the mix gently into the soil.
3. Reapply mulch and water well.

Yield: 4½ cups of natural rose food

Note: This formula makes enough fertilizer to feed 1 large rose bush or several small ones. If you prefer, you can triple or quadruple the recipe and store the extra rose food in a sealed, labeled container in a dry, cool place.

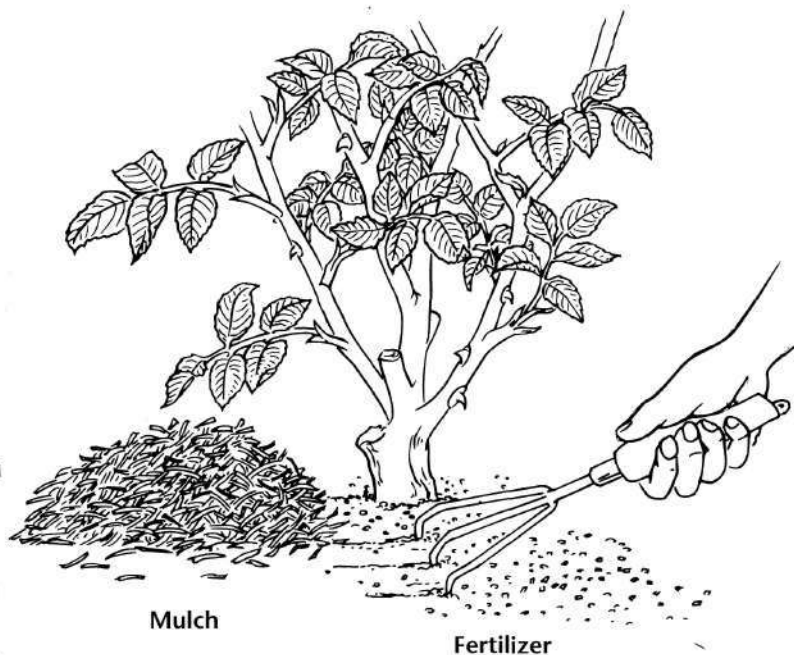

In early spring, push back the mulch around your rose bushes and work organic fertilizer into the top inch of soil. Then remulch the soil and water well. Results—robust roses!

1 cup alfalfa meal
1 cup fish meal
1 cup greensand
½ cup bonemeal
1 cup gypsum
Dust mask
FERTILIZER FORMULAS
1 teaspoon chili powder

A Quick Pick-Me-Up for Plants

The caffeine in coffee gives us a quick pick-me-up, but coffee and coffee grounds contain nutrients that can give plants a gentle jolt. They're a rich source of nitrogen, tannic acids, and other nutrients. Acid-loving plants, especially, respond to coffee grounds and leftover coffee. (For a list of plants that will benefit from a coffee pick-me-up, see "Acid-Loving Plants" on the facing page.)

Ingredients and Supplies

Coffee grounds
Newspaper

Directions

1. Air-dry coffee grounds in a thin layer on newspaper outdoors.
2. Work the grounds directly around the base of acid-loving plants, or, for container plants, sprinkle the surface of the soil lightly with grounds.
3. Repeat monthly.

Note: You can skip the drying step by putting wet grounds directly into your compost pile. If you don't have enough coffee grounds to go around, stop by the local coffee shop or diner and load up. Most are happy to let you take all you can carry. You can also water plants with diluted leftover coffee in water for a quick green-up. For outdoor garden plants, use a 1:2 dilution of coffee in water. For tender or indoor plants, use a 1:4 dilution.

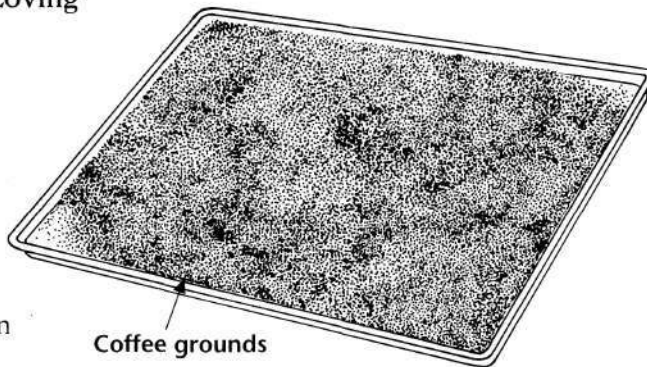

Coffee grounds

Don't throw away those coffee grounds! Instead, spread them out in a ¼" layer on a metal tray to dry. They'll make excellent fertilizer for your acid-loving plants.

SAVE YOUR EGGSHELLS TOO

When you set aside the coffee grounds from your morning coffee, make sure you save the eggshells from your breakfast eggs as well. Sprinkle the eggshells in your compost pile. Eggshells supply calcium, and the beneficial microbes that break down organic material in your compost pile will work faster and better if you put a little calcium in their diet. 🐣

RENT EXPENSE FORMULAS
1 cup greens and
1 cup greens and
FERTILIZER FORMULAS
1 teaspoon chili powder

Fruitful Fruit Tree Fertilizer

With plant food—as with people food—moderation is the key. Fruit trees need nitrogen to bear good crops, but too much nitrogen makes them grow too many leaves at the expense of flowers and fruit. Fish emulsion is an excellent source of nitrogen for fruit trees. By following a three-times-a-year fertilization program, you can bring young fruit trees to bear without a hitch.

Ingredients and Supplies

- 1 teaspoon fish emulsion
- 5 gallons water
- 5-gallon bucket

Directions

1. To fertilize newly planted fruit trees, mix the fish emulsion and water in the bucket and apply. Soak the feeder root area (see the illustration at the right) with the full 5 gallons of formula 3 times: once in early spring while trees are still dormant, once after blossoms fall, and again in early summer.
2. Every year after the first year, increase the concentration of fish emulsion by 1 teaspoon, until the trees reach maturity. Apply the full 5 gallons to the feeder root area 3 times per year, just as described above. By the time the tree is full-size, you'll probably be using 10 teaspoons of concentrated liquid fish fertilizer with every 5 gallons of water for a semi-dwarf (12- to 15-foot-tall) tree.

Yield: 5 gallons of fruit tree fertilizer

Variation: Another good way to fertilize is to mulch your fruit trees early in the spring with 2 or 3 inches of compost or hay that's



When you fertilize young fruit trees, pour the mix around each tree in a band that extends 1' inside the drip line to 3' outside the drip line. This way, you'll reach most of the young tree's feeder roots.

been fortified with a high-nitrogen organic material like manure. Simply sprinkle 2 shovelfuls of dried manure over the ground before you apply the mulch.

cup
of
expensive
formulas
CUP
FERTILIZER FORMULAS
1
teaspoon
chili
powder

Flowering Houseplant Fertilizer

Foliage plants will put on plenty of leaf growth if you feed them with a high-nitrogen fertilizer, like fish emulsion. But flowering houseplants need more potassium and phosphorus to put on a blooming big show. Go ahead and give flowering plants fish emulsion when you fertilize your foliage plants, but supplement their diet with this mix, which has an NPK (nitrogen–phosphorus–potassium) ratio of 5–6–4.

Ingredients and Supplies

- 2 parts cottonseed meal
- 2 parts bonemeal
- 2 parts wood ashes
- Bowl or bucket for mixing

Directions

1. Mix all ingredients together in a bowl.
2. Using a fork, work the fertilizer into the top layer of soil, applying every 6 to 8 weeks at a rate of 1 teaspoon per 6-inch pot.
3. Store unused fertilizer in a sealed, labeled container for future feedings.



Be gentle when you work fertilizer into houseplants' soil—you don't want to tear up the plant's roots. Use an old fork or a chopstick to mix the fertilizer into the soil without injuring the plant.

Raise Your Beds and Lower Your Labor

Improve your soil with NO digging, using this nifty raised bed recipe from landscape designer Pat Lanza of Wurtsboro, New York. You just layer the ingredients for these "lasagna" beds right on top of the existing sod or soil. Pat says that her recipe will give you a raised garden bed "in half the time and with a third the work" of conventional bed-preparation methods! Pat's "lasagna" recipe is for a 4 × 12-foot garden bed.

Ingredients and Supplies

- Newspapers, wet (no glossy colored sections)
- 4-cubic-foot bale peat moss, moistened
- 3 bushels grass clippings
- 3 bushels shredded leaves
- 3 bushels compost
- 4 bags dehydrated manure or 4 wheelbarrows full of aged barnyard manure
- 1 bucket wood ashes or 4 cups limestone
- Plastic sheet (to cover bed)
- Stones or bricks

Directions

1. Measure the bed and mark the corners, then stomp down any tall weeds or grass.
2. Lay wet newspaper—about 10 to 12 sheets thick—over the sod, overlapping the edges.
3. Now make your "lasagna": Cover the paper with a 2-inch layer of moistened peat

moss, then 4 inches of grass clippings, 2 more inches of peat, then 4 inches of shredded leaves, 2 inches of peat, 4 inches of compost, 2 inches of peat, and 4 inches of manure. (You can substitute other organic materials, such as hay or straw, for the peat moss, grass, leaves, compost, and manure.)

4. Moisten each layer thoroughly as you go, repeating the layers until all the ingredients are used. Sprinkle the ashes or lime over the top of the bed.
5. Cover this "lasagna" with plastic, using rocks or bricks to secure the edges, and let it "bake" for at least a few weeks—the longer the better.
6. When you're ready to start planting, remove the plastic, and stir all the ingredients together with a garden fork. Then pop in your plants, water, and mulch.

Yield: One 4 × 12-foot raised bed that can provide fresh herbs, vegetables, and flowers for 1 to 4 people all season

Note: Pat says this recipe gives you a rich, raised bed with delicious soil and without any digging. "It's so easy, and it takes little time and little money," she adds. And, just one season after you build your bed, you'll find that even the hardest clay soil under it

will be looser due to the magic worked by the composted materials in the bed (and the earthworms they attract).

(Learn more about Pat's time-saving gardening techniques in her book, *Lasagna Gardening*, due out in bookstores in 1998.)

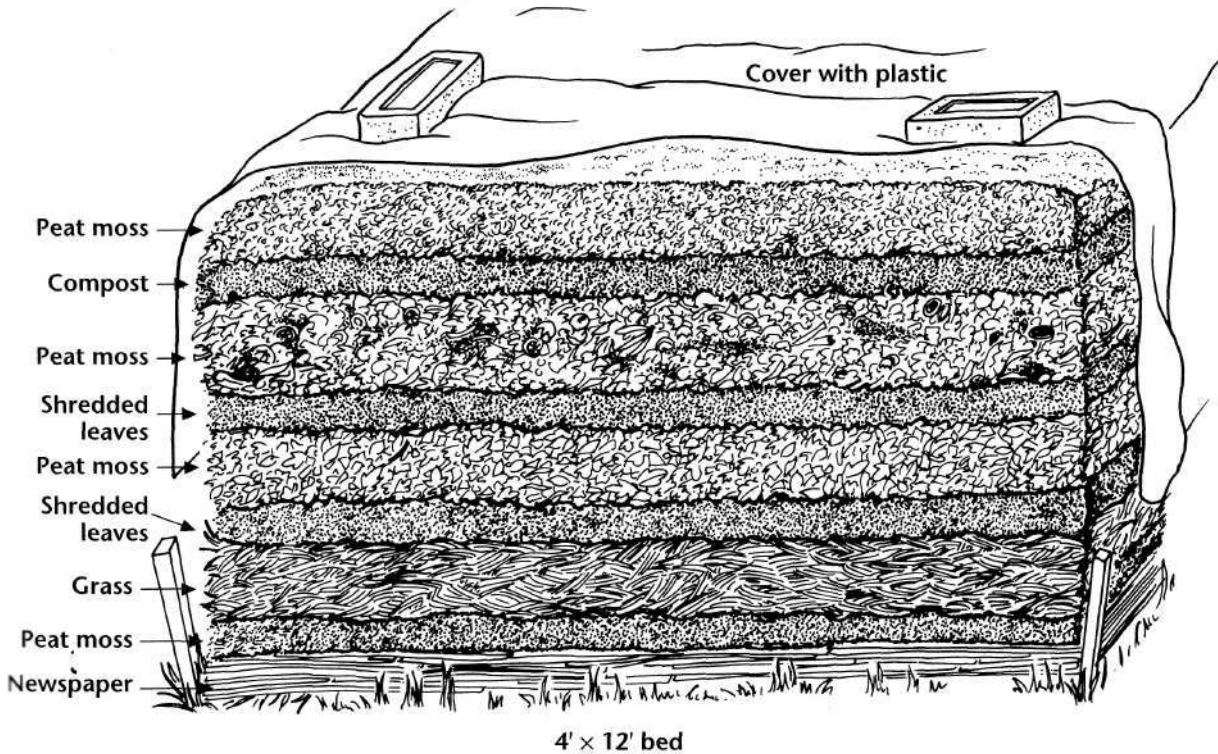

Create the perfect soil for raised beds! After covering the top of the pile with plastic, sun-bake lasagna-like layers of organic ingredients for a few weeks. The materials will break down over time to create rich, crumbly compost you can grow your plants in.

1/2 cup
pat's
peat moss
gardening
SOIL IMPROVEMENT
with water
AND SOIL MIX
FOR PLANTS
pat's
powder

Super-Simple Potting Mix

What could possibly be simpler than this two-ingredient container mix recipe from Connie Beck, who teaches vocational horticulture in San Diego County, California. You can buy perlite—a very lightweight natural mineral—at garden centers.

Ingredients and Supplies

- 1 part perlite
- 1 part compost (sifted)

Directions

1. Moisten the perlite before you start mixing—it's usually very dusty.
2. Mix the perlite into the compost, and you're ready to plant!

Note: Connie says that this mix is so good at preventing diseases that she lacks examples of plant problems to show her students.

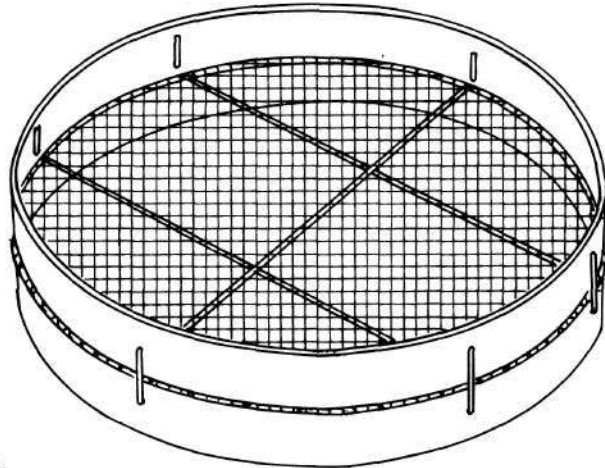

Use a compost sifter to filter out lumps, sticks, and other debris from your compost, leaving fine-textured organic matter to add to your potting mix.

Super-Simple Seed-Starting Mix

This variation on Connie Beck's mix (above) substitutes vermiculite (moisture-holding bits of expanded mica), guaranteeing that transplants get off to a good start.

Ingredients and Supplies

- 1 part vermiculite
- 1 part compost (sifted)
- Milled sphagnum peat moss, or clean, fine sand

Directions

1. Blend vermiculite into compost and fill flats or small (4-inch) pots with the mix.
2. Sow your seeds as directed on the package.
3. Sprinkle a fine dusting of moss or sand on the surface of the mix to discourage the fatal disease called "damping-off" that can infect seedlings at ground level in moist conditions.

BECK'S SUPER-SIMPLE SEED-STARTING MIX FOR PLANTS AND POTTING MIX FOR IMPROVING SOIL

Deluxe Seed-Starting and Soil-Block Mix

Your seedlings will get off to a great start in a loose, light planting mix like this recipe from Maine's master organic grower Eliot Coleman, author of *The New Organic Grower*. Use the mix in traditional plastic seedling flats, recycled yogurt cups, or other containers, or try making soil blocks—lightly compressed cubes of potting soil made with a special tool called a soil block-maker (see "Sources," beginning on page 308). Eliot says that the advantage of starting your seedlings in soil blocks is that "roots grow throughout the block of the soil up to the edges and then wait, poised to continue growing as soon as they're set into the garden, instead of circling around the walls and becoming rootbound as they do if grown in regular containers."

Ingredients and Supplies

10-quart bucket (for measuring)	1 cup colloidal phosphate
½ cup lime	1 cup greensand
40 quarts peat moss	1 cup blood meal (if you plan to use the mix for growing larger transplants)
Dust mask	1 bucket soil
Wheelbarrow	2 buckets very well-aged compost, sifted
2 buckets coarse sand or perlite	

Directions

1. Mix the lime into the peat moss. Wear a dust mask to avoid breathing dust from dry ingredients. A wheelbarrow is a good mixing container.
2. Combine the peat-lime mixture with the coarse sand or perlite, the colloidal phosphate, and the greensand, which provides potassium and trace elements. If you're making this mix for growing larger transplants, add the blood meal, too. Leave out the blood meal if you're making small soil blocks for germinating seeds—they don't need the extra nourishment.
3. Mix in the soil and the compost and stir all ingredients together thoroughly.
4. Fill your containers with the mix and tap them to eliminate any large air pockets. Then plant your seeds according to the packet directions and loosely cover the containers with plastic to keep the mix moist until they sprout.

Yield: About 2 bushels of planting mix

Note: To make soil blocks, Eliot recommends moistening the mix with about 1 part water to 3 parts mix. Spread the moistened mix on

GARDEN SOIL IMPROVEMENT AND SOIL MIX FOR PLANTS AND POWDER

a hard surface at a depth that is thicker than the blocks you're making. Press the block-maker into the mix with a quick push, followed by a twisting motion when it hits the table surface. Then lift the block-maker, set it

into your tray and eject the blocks with the plunger. You can set your finished soil blocks in regular plastic seedling flats or, Eliot suggests, try using plastic bread trays from a commercial bakery.

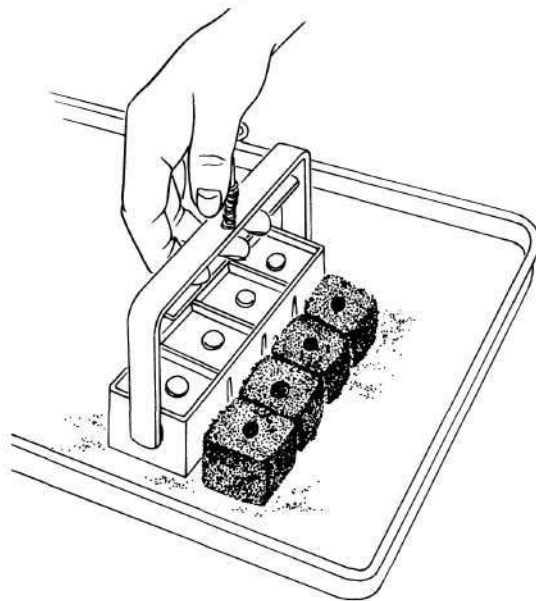

For large potting jobs, you'll need to mix *a lot* of soil. A wheelbarrow is the perfect container for combining ingredients to make planting mixes.

Moisten your planting mix before using a soil block maker—moist mix makes it easier to form blocks that will hold together.

WARD OFF DAMPING-OFF

The compost in Eliot Coleman's seed-starting mix will help prevent damping-off, a fungal disease that infects seedling stems and causes the young plants to fall over and die. Other steps to prevent damping-off include:

- Providing good air circulation. Run a small fan near the pots and don't plant seeds too thickly.
- Cover seeds with a layer of milled light sphagnum moss (often sold as "No Damp Off"). Studies have shown the moss contains compounds that inhibit damping-off.
- Give seedlings the brightest light you can. If you don't have a greenhouse or large south-facing window, use fluorescent shop lights and keep your plants just an inch or so below the tubes. 🌱

SOIL IMPROVEMENT AND SOIL MIX FOR PLANTS powder

Satisfy Acid-Loving Plants with Sulfur

Even if your soil isn't naturally acidic, you can grow acid-loving plants like azaleas, rhododendrons, or blueberries, says Dan Hartmann, general manager of Hartmann's Plantation in Grand Junction, Michigan. The secret is to add the right amount of sulfur to the soil to lower the pH. Dan explains how to figure out "the right amount."

Ingredients and Supplies

- Soil pH test results
- Granular or powdered sulfur
- Peat moss or acidic compost

Directions

1. Before you can determine how much sulfur to add, you need to get your soil tested to find out the pH. Check with your garden center or local extension office for information on testing services; home test kits are also available.
2. Use the chart on the facing page to determine how much sulfur to add to lower the pH to about 5.5, which is low enough for blueberries and many other acid-lovers.
3. "If possible, apply the sulfur to the planting area in the fall," Dan advises, "or at the very least 1 month before you plant in the spring."
4. If you absolutely have to plant immediately, amend the soil *in the planting hole* with up to 50 percent peat moss. Then apply the sulfur to the top of the soil just beyond the planting hole. The naturally acidic peat

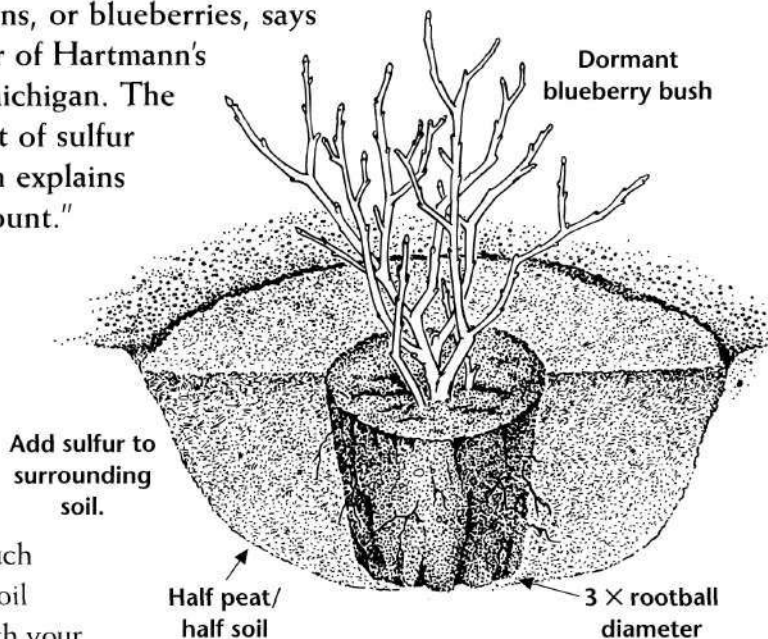

Appease your acid-loving transplant in less-than-acidic conditions by mixing 1 part peat moss (which is naturally acidic) to 1 part garden soil in the planting hole, then applying sulfur to the top of the soil just beyond the hole.

moss will get the plants started and by the time their roots reach into the soil outside the peaty area, the sulfur will have had time to lower the pH.

5. Dan says you'll also need to add more sulfur in the future. "Probably every year if you started with a pH 7 soil; every other year for pH 6.5; and every 3 to 4 years if your soil was pH 6." He cautions that you should apply sulfur only in the winter when the plants are dormant.

HOW MUCH SULFUR TO ADD

The amount of sulfur you need to add to your soil to keep acid-loving plants like blueberries happy depends on the type of soil in your garden, as well as the pH you start with. Sandy soils typically need less sulfur to lower pH levels, while loam and clay soils take more sulfur to change their pH. If you're

not sure what kind of soil you have, see "Soil Texture Tips" on page 65. Then use the results of a soil pH test to find your soil's current pH and the pounds of sulfur you need to add, per 100 square feet of garden space, to acidify the soil to a pH of about 5.5.

CURRENT pH	SANDY SOIL (LBS.)	LOAMY SOIL (LBS.)	CLAY SOIL (LBS.)
6.0	0.4	1.2	1.4
6.5	0.8	2.4	2.6
7.0	1.2	3.5	3.7
7.5	1.5	4.6	4.9

PLANTS THAT PREFER A LOW pH

The plants listed below will thrive in soil acidified with Dan Hartmann's methods, as well as in naturally acidic soil (below pH 7). Most acid-loving plants, including many of these, will also tolerate neutral soil.

Flowers

Bleeding hearts (*Dicentra* spp.)
 Butterfly weed (*Asclepias tuberosa*)
 Candytufts (*Iberis* spp.)
 Cardinal flower (*Lobelia cardinalis*)
 Creeping phlox (*Phlox stolonifera*)
 Euphorbias (*Euphorbia* spp.)
 Heather (*Calluna vulgaris*)
 Japanese iris (*Iris ensata*)
 Lilies (*Lilium* spp.)
 Lupines (*Lupinus* spp.)

Trees and Shrubs

Azaleas (*Rhododendron* spp.)
 Birches (*Betula* spp.)
 Camellia (*Camellia japonica*)
 Dogwoods (*Cornus* spp.)
 Gardenia (*Gardenia jasminoides*)
 Hollies (*Ilex* spp.)

Hydrangeas (*Hydrangea* spp.)
 Junipers (*Juniperus* spp.)
 Magnolias (*Magnolia* spp.)
 Mountain ash (*Sorbus* spp.)
 Mountain laurel (*Kalmia latifolia*)
 Pines (*Pinus* spp.)
 Rhododendrons (*Rhododendron* spp.)

Herbs

Parsley (*Petroselinum crispum*)

Fruits and Vegetables

Apples
 Blackberries and raspberries
 Blueberries
 Carrots
 Eggplant
 Gooseberries
 Huckleberries
 Lima beans
 Potatoes
 Pumpkins
 Strawberries
 Sweet potatoes
 Tomatoes

1/2 CUP
 1 Tbsp
 1 Tbsp
 SOIL IMPROVEMENT AND SOIL MIX FOR PLANTS powder

Potions and Practices for Organic Pest Control

On any warm summer day, your garden is filled with flying, crawling, and jumping insects. But very few of these creatures are plant pests. Most of them—including spiders, lady beetles, and many wasps and flies—are more interested in capturing other insects than in aggravating gardeners. So controlling the few insects that are pests really isn't hard. Organic gardeners have devised lots of useful sprays, barriers, and traps for controlling pests without chemical pesticides.

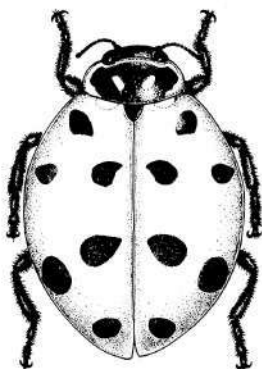

Ladybug

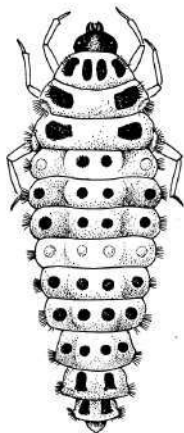

Ladybug larva

Ladybugs, lacewings, ichneumon wasps, and many other beneficial insects are hard at work in your garden destroying plant-eating pests.

Pest insects usually have specific food requirements. Many of the pest control formulas in this chapter work by tricking pests into thinking that they are on the wrong plant or making them eat something that they can't digest.

You'll also find formulas in this chapter for bigger pests, like squirrels, deer, cats, and dogs. These pesky animals can frustrate gardeners by

eating or trampling plants. But, although we don't want animals to hurt our gardens, we also don't want to hurt the animals, so all of the formulas you'll find here are strictly nonpoisonous. They work by conditioning animals to look elsewhere for dinner.

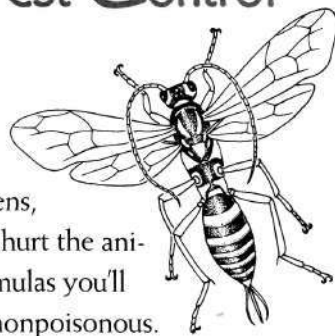

Ichneumon wasp

Use these same approaches when developing your own formulas to solve unusual pest problems in your garden. For example, if you have a problem with an insect that eats one type of plant but is never seen on another, try planting the two types of plants close to each other to confuse the pest and lessen the damage. Or you might brew a tea from leaves of the plant the pest ignores and use it to drench the plant that the pest likes. It just might fool them!

YOUR FIRST DEFENSE AGAINST PESTS

If you spot insect pests on a plant, simply pick them off! Then dispense with the pests using two flat rocks or whatever squashing method you can think up.

If the pests are too small, fast, or numerous for hand-picking, take action right away with an appropriate pest control formula. Pest populations tend to build up very quickly, and it's always easier to control a pest problem the day you discover it than to wait for another day—by then, you may face double the problem. 🌿

1/2 cup chili powder
1 teaspoon chili powder
REAR GARDEN FORMULAS PEST CONTROL FORMULAS

Paralyzing Pest Salsa

Paralyze pests with salsa that's only a little stronger than you might eat on your chips. The creator of this formula, Santa Barbara gardener and author Kathleen Yeomans, uses it to control pests ranging from ants to black widow spiders.

"This is my favorite all-purpose insect spray," Kathleen says. According to Kathleen, the spray will make ants pass out cold, and it has actually killed a black widow spider.

Ingredients and Supplies

- 2 pounds ripe, blemished tomatoes
- 1 large onion
- 1 pound fresh chili peppers
- 2 cloves garlic
- Food processor or blender
- 1 cup vinegar
- ½ teaspoon pepper
- Cheesecloth or coffee filter
- Pump spray bottle

Directions

1. Roughly chop the tomatoes, onion, peppers, and garlic.
2. Place the chopped vegetables in a food processor or blender and blend until liquefied.
3. Add vinegar and pepper to the mixture.
4. Strain the mixture through several layers of cheesecloth or a disposable coffee filter.
5. Pour the strained liquid into the pump spray bottle.
6. Spray the liquid directly on pests that you spot in your garden.

Yield: About 3 cups of insect-knockout salsa

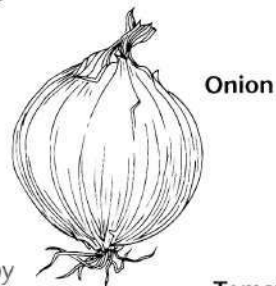

Get rid of pests fast by spraying your plants with this wicked salsa! Combine tomatoes, onions, chili peppers, and garlic with vinegar and black pepper to make the spray.

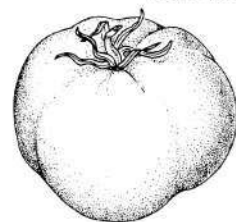

Note: Crushed garlic contains allicin, the smelly compound that confounds the sensory receptors of insects in search of a tasty plant feast. Hot peppers are loaded with fiery capsaicin, which gives a chemical burn to marauding mammals and some soft-bodied insects. Onions help give the salsa an extra aromatic kick, and the sulfur in them may suppress some fungal diseases. Many pests avoid tomatoes, so the unmistakable tomato odor signals them to look elsewhere.

Caution: This salsa can be highly irritating if it gets in your eyes or mouth, so spray it only on a windless day.

Pest-Puzzling Garlic Extract

Garlic has a perplexing effect on a wide range of garden pests, from aphids to Mexican bean beetles. This formula for garlic extract comes from David Stern, an organic farmer and director of the Garlic Seed Foundation in Rose, New York. Garlic extract probably works by confusing insects in search of their favorite host plants, so for maximum effectiveness, spray before any pests have become a serious problem.

Ingredients and Supplies

- ¼ pound garlic (2–3 whole garlic bulbs)
- 1 quart water
- 4–5 drops dishwashing liquid
- Blender or food processor
- Cheesecloth
- 1-quart glass jar

Directions

1. Separate the garlic bulbs into cloves but do not peel them.
2. Place the whole garlic cloves in a blender or food processor with 1 cup of the water. Chop well. If you have lots of garlic plants, you can use garlic leaves instead of cloves. The chopped leaves also contain allicin, one of the pest-repelling ingredients in garlic.
3. Add the rest of the water and the dishwashing liquid. Blend until liquefied. (This usually takes several minutes.)
4. Strain the mixture through cheesecloth to remove bits of garlic that might clog the sprayer. It's a good idea to strain a second time if any debris remains in the concentrate.
5. Store the strained concentrate in a glass jar with a tight fitting lid until you are ready to use it.

GOOD BUGS DON'T LIKE GARLIC

Be selective when you spray your plants with garlic extract. Even though it's organic, it can disrupt or even kill helpful insects like syrphid flies and lacewings which prey on pest insects. 🐛



Yield: About 1 quart of concentrated garlic extract

Note: To make a spray from the concentrated extract, dilute 1 part extract with 10 parts water (¼ cup concentrate to 2½ cups water). Put the diluted extract in a pump spray bottle or pressure sprayer and apply to plants that are under pest attack or that you suspect are likely targets, like young bean and potato plants. David points out that you can also apply the garlic extract to the soil to discourage nematodes.

Citrus Killer for Aphids

Pesky insects go into convulsions when doused with citrus oil extract. This mixture quickly neutralizes aphids and other soft-bodied insects in the California garden of Kathleen Yeomans, author of *The Able Gardener*. She also uses it to deter ants. "The spray will keep ants away for a while, but they may come back," Kathleen observes. But since this mixture has such a refreshing smell, you'll probably enjoy using it often.

Ingredients and Supplies

- 1 pint water
- Rind from 1 lemon, grated
- Cheesecloth
- Pump spray bottle

Directions

1. Bring the water to a boil. Remove from heat and add the grated lemon rind.
2. Allow the mixture to steep overnight.
3. Strain the mixture through cheesecloth, and pour into the pump spray bottle.
4. Apply the mixture to plant leaves that are under attack by aphids or other soft-bodied insects. The mixture must come in contact with the insects' bodies to be effective.

Yield: About 1 pint of citrus oil extract

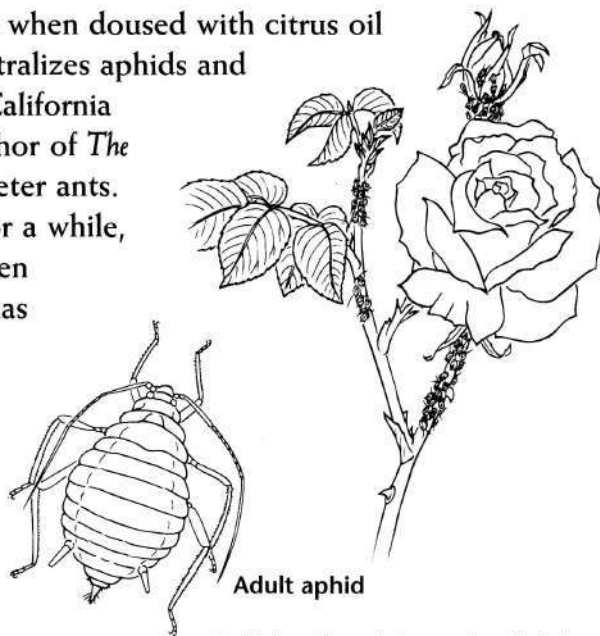

Adult aphid

Aphids will suck your plant's juices and can cause considerable damage if you don't control them. A safe and simple spray, made with lemon rind and water, is all you need to stop aphids in their tracks.

CITRUS SUBSTITUTES

Lemon isn't the only source for a citrus spray. You can make a similar spray using orange or grapefruit rinds. Richard Merrill, Director of Horticulture at Cabrillo Community College in Santa Cruz, California, has tried several kinds of citrus sprays on aphids. "Citrus fruits with pungent rinds work best, since they probably include more limonene and linalool, which are the active ingredients," he says. For example, a navel orange with a mild, sweet rind would probably not carry the punch of a spray made from the rind of a sour orange, grapefruit, or lemon. ♣

KATHLEEN YEOMANS' PEST CONTROL FORMULAS 1 teaspoon chili powder

3 cloves garlic, crushed

1 teaspoon chili powder

1 cup greens and

PEST CONTROL FORMULAS

Ailing Slug "Ale"

If there's one pest that every gardener loves to hate, it's a slug. Slugs can ruin tender young vegetables and beautiful flower gardens in just a few nights' feedings. But slimy slugs will drink themselves to death when you offer them this aromatic brew concocted by Carl Elliot, garden coordinator for Seattle Tilth's demonstration garden.

Any time is a good time to get rid of garden slugs, but Carl says to be especially vigilant in the fall. That way, there will be fewer slugs around in the spring, when your garden is brimming with the young, tender plants that slugs like best.

Ingredients and Supplies

- 1 quart unpasteurized beer
- 1 tablespoon sugar
- 1 teaspoon baking yeast
- Plastic milk jug or large glass jar
- 15 1-quart plastic yogurt containers

Directions

1. Mix ingredients together in the milk jug or jar. If you're not sure whether the beer you have is unpasteurized, check the bottle label.
2. Let the mixture sit in a warm (70°F) place for a few days, until you see bubbles form.
3. While the mixture is brewing, make some of Carl's Seattle-style slug traps by cutting openings 1 inch high × 2 inches wide in the sides of the yogurt containers, as shown in the illustration at right.
4. Pour the beery brew about ½ inch deep into the yogurt containers and replace the lids.
5. Bury the yogurt containers around your garden so that the openings in the sides are about ¼ inch above the soil line.

Yield: Enough brew to fill about 15 slug traps

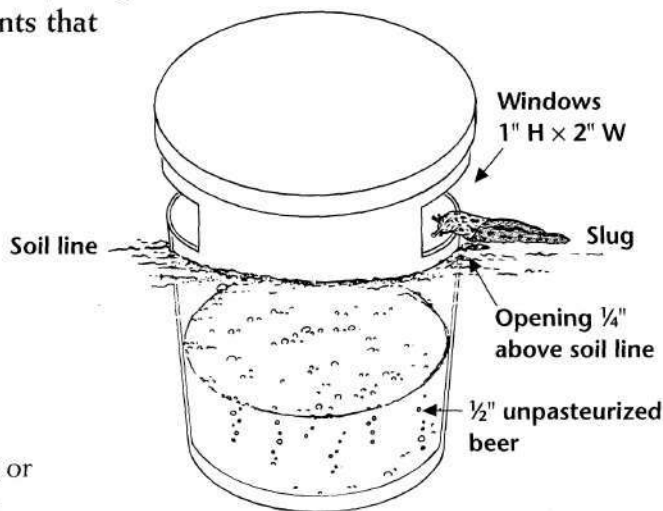

To make a slug trap, take a 1-quart yogurt container and cut entrance holes near the rim. Bury the container in your garden so that the holes are ¼ above the ground, pour in ½ of beer, then replace the lid.

Note: When setting the traps, make sure that the windows in the traps are just a little higher than ground level to keep ground beetles from falling in. Ground beetles eat slug eggs, so the more of them you have, the better. Empty, clean, and refill the traps every 3 days, Carl advises. "Slugs like fresh beer. They won't go in there if it smells like bacteria," he says.

A LOW-PROFILE SLUG TRAP

Here's an inconspicuous beer-baited slug trap that's perfect for high-visibility flower beds. Save some 1-liter soda bottles. Cut the bottles in half, and insert the top half of the bottle upside down into the bottom half. This will create a funnel effect. Pour $\frac{1}{2}$ cup of beer into each funnel and sink the bottles partway into the soil. The slugs will crawl in and drown. To clean out the traps, remove the funnel part, and pour the contents of the traps on your compost pile. Then you can add fresh beer, put the funnels in place again, and put the traps back in the garden. 🐌

A 1-liter plastic soda bottle makes a cheap, effective slug trap that practically disappears amid your flowers. Just add beer—a slug favorite—and watch the slimy pests slide down the funnel to meet their fate.



Slug-Dissolving Spray

Fry baby slugs alive when they're hiding in the crowns of daylilies and other perennials in the spring. For slugs that are too small to handpick or be attracted to traps, Marianne Binetti uses this recipe in her Washington State garden.

Ingredients and Supplies

- 1½ cups nonsudsing ammonia
- 1½ cups water
- 1-quart pump spray bottle

Directions

1. Pour the ammonia and water into the spray bottle.
2. Shake gently to mix.

3. Spray the mixture in areas where small slugs appear to be active.

Note: "It fries the skin off the slugs, but it doesn't hurt the plants, and the ammonia breaks down into nitrogen," Marianne says. She keeps a spray bottle filled with this solution by the back door so that it's always ready to use when she discovers slimy slugs slinking around in her garden.

EXPANDED PERENNIALS PEST CONTROL FORMULAS 1 teaspoon chili powder

Mealybug Death Drench

Melt mealybugs from the stems of orchids and sensitive tropical houseplants with this cheap and easy spray. Bob Thompson, an orchid hobbyist who lives near Daytona Beach, Florida, says this formula will control mealybugs on any plant, including citrus and poinsettias. The soap kills some of the mealybugs right away as it penetrates their protective coating, Bob says. Survivors are then suffocated by the thin coating of corn oil. "It's horribly effective," Bob reports. "Within days, every mealybug is gone."

Ingredients and Supplies

- 1 gallon water
- Pressure sprayer
- 2 tablespoons corn oil
- 2 tablespoons dishwashing liquid

Directions

1. Place the water in a clean pressure sprayer.
2. Mix in oil and dishwashing liquid.
3. Apply thoroughly to plants infested with mealybugs. Make sure the mixture coats the insects well. The mixture will not harm sensitive orchid foliage, but to be effective, it must contact the insects directly.

Yield: 1 gallon of mealybug-killing drench

Note: Bob usually makes a gallon-size batch of drench for his greenhouse full of orchids. For smaller jobs, just make a quart of drench and use a pump spray bottle.

Recheck your plants about 2 weeks after treatment because some mealybug eggs may have survived. If you find only a few mealybugs, either repeat the treatment or follow up with an alcohol spray (see "Massacre Mealybugs with Rubbing Alcohol" at right).

MASSACRE MEALYBUGS WITH RUBBING ALCOHOL

If you have only one plant infested with mealybugs, don't mess with a soap spray. Just spritz the mealybugs with rubbing alcohol. Bob Thompson keeps a small spray bottle filled with alcohol in his orchid greenhouse and uses it to neutralize any mealybugs he finds on isolated plants. Bob uses rubbing alcohol straight from the bottle (it's usually a mixture of 70 percent alcohol and 30 percent water). 🐜



Get rid of sap-sucking mealybugs by spraying them with rubbing alcohol. Your houseplants will thank you!

Tomato Stake Whitefly Trap

Trick whiteflies with the color yellow. Whiteflies are attracted to yellow surfaces, and you can buy commercially produced traps that have sticky yellow surfaces where whiteflies land and get fatally stuck. In Brooklyn, Ohio, tomato lover Katherine Jarmusik came up with a nifty way to recycle some household items into a sticky whitefly trap at a cost that is much lower than the price of commercial traps.

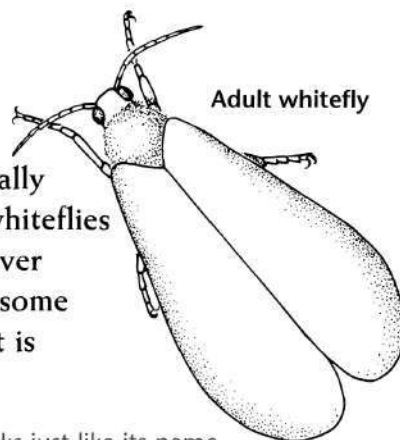

Ingredients and Supplies

- 4 6-foot-long tomato stakes
- 4 48-ounce juice cans, each with 1 end removed
- Yellow paint
- Paintbrush
- 12 yellow or clear plastic bags (like the ones used to cover newspapers on rainy days)
- Petroleum jelly

Directions

1. Use the stakes to support growing tomatoes. Or, if you're already using another type of support for your tomatoes, pound in the stakes alongside the plants. Four stakes set every 2 feet will protect a row of 10 tomatoes.
2. Paint the juice cans yellow.
3. Place the painted cans over the tops of the tomato stakes.
4. Cover each can with a yellow or clear plastic bag.
5. Smear petroleum jelly on the outside of the bags.

Yield: 4 super-sticky whitefly traps

A whitefly looks just like its name suggests—a flying white blur.

These pests feed on sap, gathering in large swarms on leaf undersides. If you shake an infested plant, a cloud of tiny whiteflies will take to the air.



Trap whiteflies by placing a plastic bag over an inverted can and coating the bag with petroleum jelly. Put the can on top of a stake in the midst of your tomatoes.

Confuse Cuke Beetles with Rattails

Confuse cucumber beetles and other garden pests by planting rattail radishes in and around your vegetables. After Master Gardener Carol Kelly of Saltsburg, Pennsylvania, heard other gardeners talking about interplanting radishes with pest-plagued crops, she decided to try rattail radishes, a special variety of radishes that have edible pods. She especially recommends planting this tasty deterrent around your summer squash plants to repel cucumber beetles.

Carol thinks that regular radishes will discourage cucumber beetles, too, but the rattail radish plants grow bigger—often 18 inches tall—and she likes the flavor of the edible pods, which appear after the flowers. “I pick them when they’re still young and tender and chop them into salads,” Carol says. Rattail radishes develop a thick taproot, but it’s not edible like other kinds of radishes.

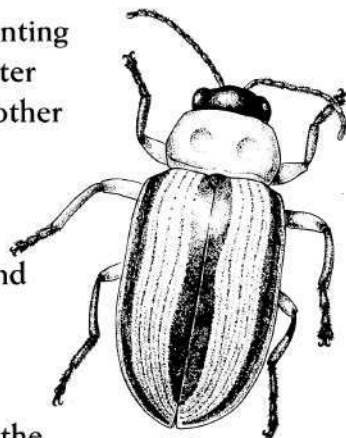

Striped cucumber beetles often eat squash family crops, beans, peas, and other plants. Besides consuming your crops, they can also transmit plant diseases.

Ingredients and Supplies

- 1 packet summer squash seeds
- 1 packet rattail radish seeds

Directions

1. After danger of frost has passed, plant squash seeds or transplants directly in the garden.
2. Sow a few rattail radish seeds in between the rows or around the hills of squash and at the ends of the rows. Rattail radish seeds are available in seed catalogs—check the listings for oriental vegetables. (One source is Pine-tree Garden Seeds; see “Sources,” beginning on page 308.)



If you’re planting different types of summer squash together, such as pattypan squash and zucchini, plant extra rattail radishes between them. The radishes will confuse pests and serve as row markers at the same time.

Onion Rings for Cabbage Loopers

Confuse cabbage loopers and cabbageworms by surrounding your broccoli, cabbage, and cauliflower plants with onions. In both spring and fall, Charlotte, North Carolina, gardener Jeff Davis sees very few loopers when he uses this easy companion planting method.

Ingredients and Supplies

- 20 assorted cabbage, cauliflower, broccoli, kohlrabi, or brussels sprout seedlings
- 100 onion sets

Directions

1. In the spring, set out the seedlings in the normal manner, spacing them at least 18 inches apart.
2. As you settle in each plant, surround it with a ring of onion sets, spacing them 4 inches apart. The idea, Jeff says, is to encircle the cabbage family plants so that they're hidden by a screen of onions.

Note: Jeff inspects his plants often in search of cabbage loopers, but rarely finds one of the leaf-eating visitors. On 20 cabbage plants surrounded by onions, he may find 3 loopers at the peak of their season.

Some of the onions eventually grow into bulbs, but Jeff harvests most of them for use as green onions.

Cabbage looper

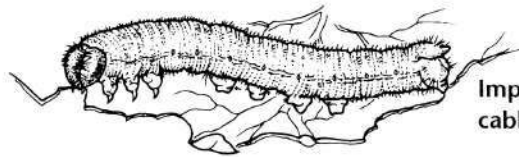
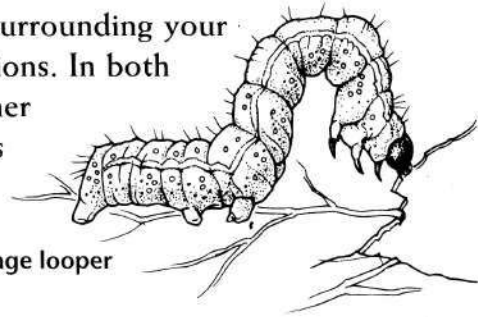

Imported cabbageworm

Imported cabbageworms and cabbage loopers feed on leaves in the cabbage family. Imported cabbageworm adults are white butterflies, whereas cabbage looper adults are gray mottled moths.

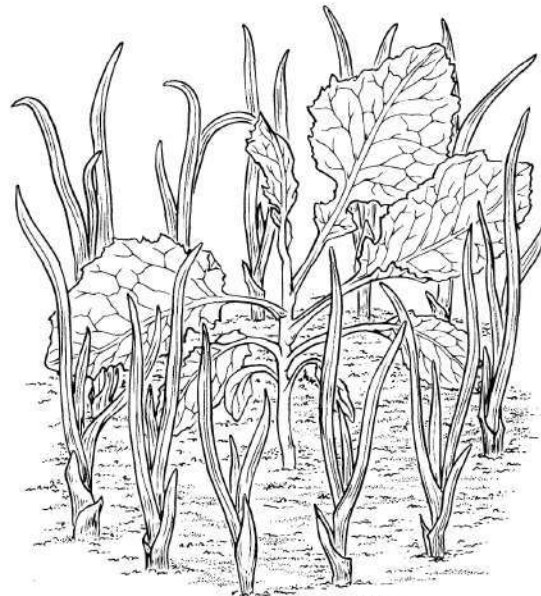

Discourage the adult moths of cabbageworms and cabbage loopers from laying eggs on cabbage-family plants by planting a ring of onion sets around each seedling.

Skip-a-Season Planting

To whip chronic pest problems, starve them out. Dr. Judy Hough-Goldstein, a professor of entomology and applied ecology at the University of Delaware, recommends a special strategy that discourages pests by denying them their favorite foods. With this technique, you'll have to forego planting certain crops for a season, but you'll reduce pest problems without the expense and trouble of buying or making barriers, traps, sprays, or dusts.

Ingredients and Supplies

- An established vegetable garden
- 2 crops that have chronic pest problems
- Notebook (for keeping garden records)

Directions

1. Choose 2 crops that have suffered from pest problems in your garden in the past. Judy suggests 2 likely subjects: potatoes (subject to attack by Colorado potato beetles) and onions (which can be seriously damaged by onion root maggots). Designate one of your problem crops as crop #1 and the other as crop #2.
2. Plant your garden as you usually would, with one exception. Don't plant any seeds, sets, or plants of crop #1. (It's okay to plant crop #2.)
3. The following year when you plant your garden, plant crop #1, but don't plant any seeds, sets, or plants of crop #2, the second pest-troubled crop.
4. During the season, keep records of the number of pests on crop #1 and the severity of damage they cause.

5. The third year, plant crop #2, and skip crop #1. Keep notes again on damage.
6. For the fourth year, start again with step #3.

Note: "Many people have the experience of starting a new garden and having no pest problems, and then insects get worse and worse every year," Judy observes. That's because the insects become established local residents when they are provided with their favorite foods year after year. The starvation strategy will be most effective if your garden is isolated from others, so that the pests can't find an alternate source of food easily. It also works best for pests that feed on only one type of crop, such as Mexican bean beetles and squash bugs.

Skip-a-season planting may not reduce pest problems in an area where there are a lot of gardens or in a community garden setting.

1 teaspoon chili powder
GARDEN FORMULAS PEST CONTROL FORMULAS

ANOTHER STARVATION STRATEGY

There is a way to plant your crop and keep pests from eating it, too. Cover the crops with row covers—lightweight synthetic fabric that lets air and water through but keeps pests out. When properly used, row covers are an impenetrable barrier between insects and the crops they seek. To protect crops from pests, you need to cover the crop as soon as you plant it and securely weigh down the sides of the row covers by covering them with boards or burying them in the soil. Check under row covers from time to time to make sure that no insects have sneaked inside. Otherwise, they'll be free to feast to their heart's content.

There's another special barrier that's useful for starving cutworms, a pest that

isn't stopped by row covers. Cutworms are soil-dwelling insect larvae that like to chew on the stems of plants. Cutworms travel just below the surface of the soil searching for tender transplant stems. When they find a tasty stem, they dig in, sometimes cutting right through the stem and killing the plant.

To foil cutworms, just collect the cardboard tubes from rolls of toilet paper or paper towels and cut the tubes into 2-inch sections. Nestle one "cutworm collar" around the stem of each young vegetable and flower transplant (cutworms will attack a wide variety of plants) right after planting, pushing the collar about 1 inch into the soil. The collar will block the traveling pests and save your plants' stems from becoming cutworm snacks. 🐛

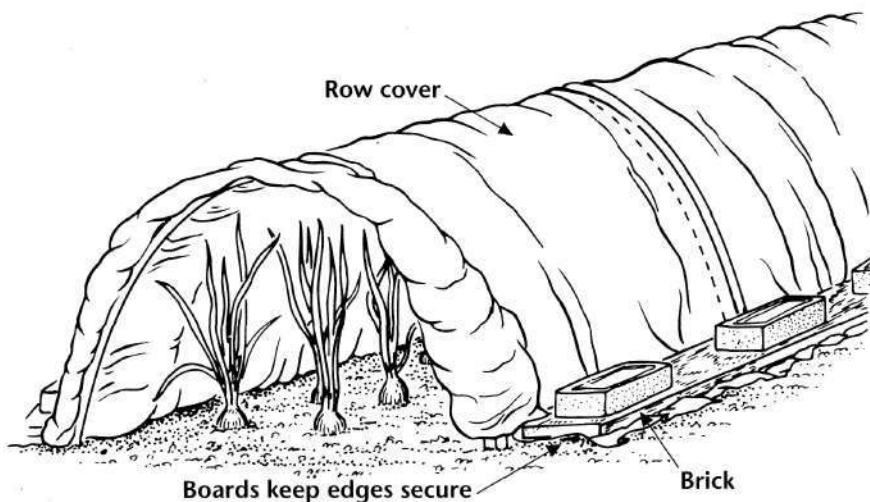

You can protect crops like broccoli, cabbage, and cauliflower that don't need insect pollination by keeping them under a row cover from planting until harvest. This is a great way to prevent problems with imported cabbageworms or cabbage loopers that often plague these cabbage family crops. For crops like squash and melons that need insect pollination to produce a harvest, remove row covers when the flowers open.

Squirrel Solution

Stop squirrels from decapitating tulips or chewing up other flower buds with this spicy mixture invented by Diana Jones of Baltimore, Maryland. Diana's neighbor has used it to protect her rhododendron buds from squirrels, too.

Ingredients and Supplies

- 2 tablespoons cayenne pepper
- 1 quart very hot water
- Cheesecloth
- Pump spray bottle
- 1 teaspoon horticultural oil

Directions

1. Mix the cayenne pepper with very hot water.
2. Allow the mixture to steep until cool.
3. Strain the mixture through cheesecloth and pour it into a pump spray bottle.
4. Add the horticultural oil and shake well to mix.
5. Spray the mixture on tulips as soon as the plants begin producing buds in the spring.

Yield: 1 quart of squirrel-stopping solution

Note: "The squirrels used to decapitate my tulips as soon as the buds began to color up and then leave them lying on the ground," Diana says. As long as she sprays the tulips well when the buds are still green, the squirrels leave them alone. Unless the season is unusually rainy, Diana finds that spraying only one time usually does the trick.

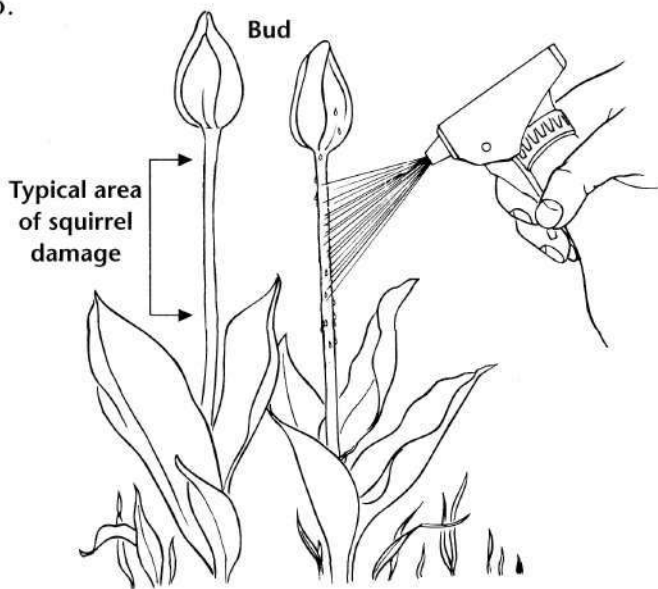

Imagine a squirrel's surprise when it bites down on a tulip bud sprayed with a hot cayenne pepper solution! It'll think twice before nibbling another bud.

ANOTHER WAY TO WARD OFF SQUIRRELS

If squirrels—or chipmunks—use blooming tulip tops as a way to find the tasty bulbs belowground, turn them away with this simple trick: Apply a light sprinkling (about 1 tablespoon) of used cat box litter around the base of your flower plants (don't use the litter for food crops). It takes only a little bit of litter to convince squirrels that a hungry cat is lurking nearby and that they should look elsewhere for their meal. 🐾

1 teaspoon chili powder

ADDITIONAL PEST CONTROL FORMULAS

Fishy Deer Deterrent

When deer come after his flowers, Frank Arnosky frustrates them with this aromatic recipe made with ingredients that are good for his plants' health. Halfway between San Antonio and Austin, Texas, Frank and Pamela Arnosky battle deer all year on their 5-acre cut-flower farm.

Ingredients and Supplies

- 3 tablespoons kelp
- 1 cup fish emulsion
- 3 tablespoons liquid hand soap
- 3-gallon backpack or pump sprayer

Directions

1. Mix ingredients together in the sprayer tank. Frank uses liquid Dial and notes that he doesn't always measure the liquid soap—he just adds “one good squirt.”
2. Fill the sprayer to the fill line with water.
3. Apply the spray to any plant that is being eaten by deer. Spray until the mixture drips off the leaves.
4. Reapply every 7 to 10 days or following any heavy rain that washes the mixture off plant leaves.

Yield: 3 gallons of deer deterrent spray

Note: Frank thinks that deer are repelled by the smell of the fish emulsion, and if they do take a bite, they don't like the taste of the soap. To further offend the deer, Frank hangs his dirty work shirt on a pitchfork at the end of a row and leaves it there for a couple of

WHAT'S THAT SMELL?

In addition to soap and fish, the stench of rotten eggs disgusts deer. Dr. Larry Clark, project leader for repellents at the National Wildlife Research Center in Fort Collins, Colorado, says that his father tried to cook up a rotten egg deer deterrent in his garage, “but it was really potent—and it really stinks.” Dr. Clark thinks that gardeners with deer problems are better off using Deer-Away, a commercial product that contains the sulfurous compounds that give putrefied eggs their deer-detering punch. Unlike rotten eggs, which wash away quickly when it rains, Deer-Away is effective for several weeks. 🌱

days. Pamela thinks that a smelly blanket from the doghouse is a good addition to the deer war aroma arsenal. The occasional presence of a dog in and around the garden also helps keep pesky deer at bay.

Caution: Limit the use of this smelly spray to the ornamental plants in your garden to avoid getting a mouthful of fishy-soapy flavor in your next salad!

Castor Oil Mole Repellent

Moles make a U-turn when they encounter the smell of castor oil, the magic ingredient in this formula. Seattle area gardener Don North tried many other mole remedies and finally got great results with this mixture.

Ingredients and Supplies

- 1 cup warm water, divided in half
- 4 tablespoons dishwashing liquid
- Blender
- 3 ounces castor oil
- 1-quart glass jar with lid (for storage)
- Rubber spatula

Directions

1. Place $\frac{1}{2}$ cup warm water and dishwashing liquid in a blender.
2. Blend on low speed a few seconds.
3. With blender on, pour castor oil into the foamy mixture, and blend for 30 seconds or until well mixed.
4. Pour mixture into the glass jar.
5. Place remaining $\frac{1}{2}$ cup warm water into the empty blender, scrape castor oil mixture from the sides of the blender with a rubber spatula, and blend again for 30 seconds.
6. Pour second mixture into the jar, screw on the lid, and shake to mix.

Yield: About 12 ounces of mole repellent

Note: To use the mole repellent, mix 2 tablespoons in a gallon of warm water. If you have a severe mole problem, you can spray the diluted mixture all over your yard.

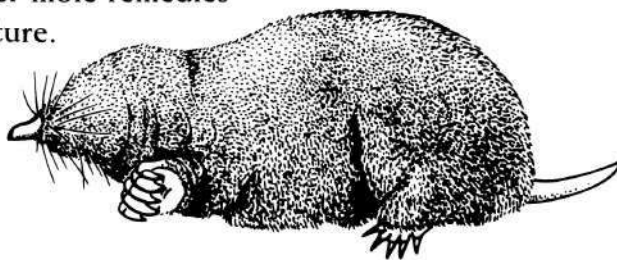

Although moles eat grubs and other insects, they can ruin a lawn's looks and damage young plant roots with their tunneling.

"Instead of spraying it, I find a mole mound or tunnel, make an opening in it with a stick, and pour in about a cup of the diluted mixture," Don says. Then he stomps on the mound or tunnel. With over an acre of yard to keep mole-free, Don's seek-and-pour method is much quicker and easier than spraying.

If you'd rather not make up your own mixture, Don has also gotten excellent results with a commercial product called Mole-Med, which is made from ingredients similar to the ones in this homemade formula. Mole-Med is available from mail-order garden suppliers. You may also find castor oil sprays useful in chasing away chipmunks, squirrels, and gophers that are damaging your garden with their digging. For these pests, spray castor oil solution directly on the areas where damage occurs.

Scented Soap Deer Deterrent

Disgust deer with the flowery scent of soap. Like many wild animals, deer have a highly developed sense of smell. Eric Sideman, director of technical services for the Maine Organic Farmers and Gardeners Association, recommends using scented deodorant soap to keep deer from bothering your garden. Any brand of soap will do, but the smellier the soap, the better it seems to work, Eric says.

Ingredients and Supplies

- Several small bars scented soap
- An ice pick
- String, cut into 14-inch pieces

Directions

1. Unwrap the bars of soap.
2. Use the ice pick to bore a small hole in the middle of each bar. Watch your fingers!
3. Run a string through the hole.
4. Tie the ends together securely.
5. Hang the soap at waist level from trees and bushes outside your garden, spacing them 20 to 25 feet apart.

Note: Eric emphasizes the importance of hanging your scented soap barrier long before you actually need the protection. Put the soap up when you first plant your crop. If you wait until deer damage has already started, the soap bars may not do much good.

Variation: If you need to protect several plants for just a few weeks when deer browsing is severe, or if your plants are so large that they'll require many bars of soap, commercial repellent sprays are a good

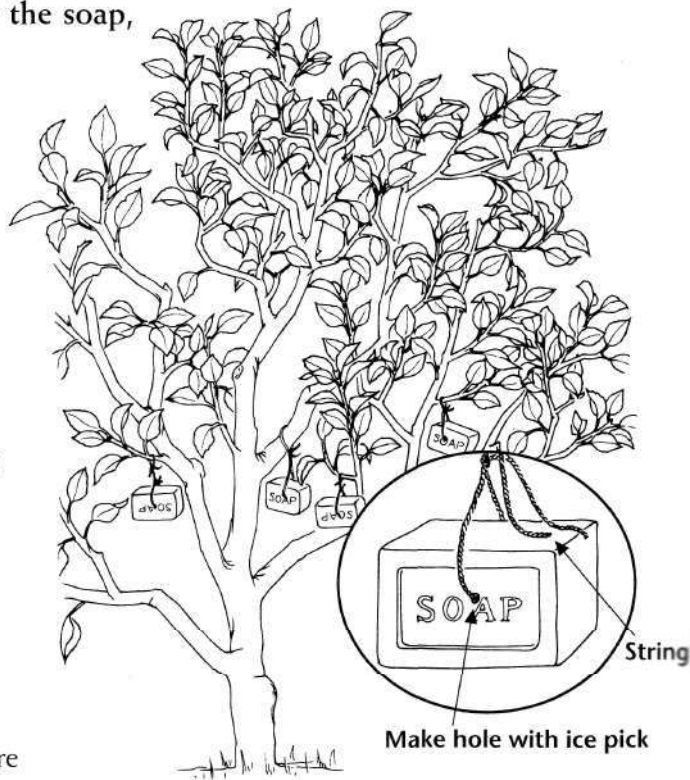

Keep deer from munching your plants by hanging a few deodorant soap bars in your bushes and trees at waist height. Deer will wrinkle their noses at the perfumed soap and search elsewhere for food.

alternative. Products that have soaps or rotted egg solids as their active ingredients are very effective when applied according to label instructions.

Deter Deer with Smelly Plants

Deer delight in devouring a wide range of garden plants, from vegetables to shrubs. Deer favorites seem to vary from region to region, but there are some plants that deer dislike fairly reliably. Patti Simons, a former deer rehabilitator in Austin, Texas, suggests that you protect your garden from deer damage by interplanting these strongly scented herbs and other deer-discouraging plants throughout your garden.

Ingredients and Supplies

- Highly aromatic herbs
- Strongly scented, poisonous, prickly, or unappetizing (to deer) plants
- Rampantly spreading plants
- Vining plants

Directions

1. Plant a generous mix of the 4 types of plants listed above around the boundaries of your yard. When deer brush against these aromatic plants, the scent rubs off on their fur. The deer end up enveloped in a cloud of strong scents that confuses their senses and tends to discourage them from eating.
2. As you notice plants that deer seem to prefer, try hiding them from the deer by planting a non-preferred plant very close by.

Create a "deer-stopper" garden of strong-scented and prickly plants around the area where deer enter your yard. With no tasty morsels to draw them into your garden, deer are likely to bypass your yard in search of plants they prefer. This plan shows one example of an attractive combination of plants that deer find unappealing and even repellent. The numbers in parentheses show the quantity of each plant used in this plan.

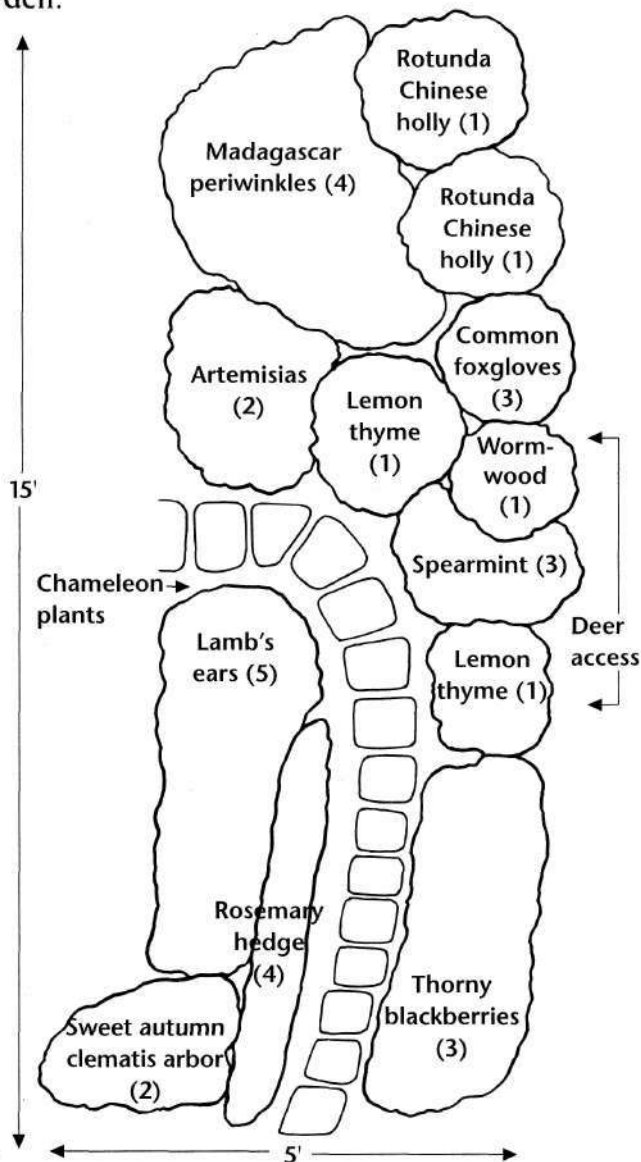

















PEST CONTROL FORMULAS 1 teaspoon chili powder

PLANTS THAT DEER DON'T DESIRE

While deer's tastes for your landscape plants may vary, depending on where you live and how hungry the deer are, there are some plants that

Bambi is less likely to eat. The plants in this table are among those that deer rarely—if ever—dine on; you may discover others that are effective in your area.

PLANT	DESCRIPTION
	HARDINESS ZONES
Artemisias (<i>Artemisia</i> spp.)	 Gray to silvery gray plants grown for their attractive foliage rather than their flowers; most species are perennial, from 1 to 3 feet tall  Zones 3 to 9
Mexican oregano (<i>Lippia graveolens</i>)	 3- to 6-foot-tall shrub with dark green leaves and small pale flowers  Hardy to Zone 8
Mints (<i>Mentha</i> spp.)	 Up to 30-inch-tall perennials with small purple or pink spike flowers in midsummer; may spread rampantly  Zones 5 to 9
Rosemary (<i>Rosmarinus officinalis</i>)	 2- to 6-foot-tall upright tender perennial with needlelike leaves and small blue, lilac, or pink flowers; also prostrate and creeping forms  Zones 8 to 10
Lemon thyme (<i>Thymus</i> × <i>citriodorus</i>)	 6 to 12 inches tall and 18 to 24 inches wide with dark green or variegated foliage with lemony scent; purple flowers in early summer (but doesn't set seed)  Zones 5 to 9
Wormwood (<i>Artemisia absinthium</i>)	 3- to 5-foot-tall bushy perennial with 2- to 5-inch-long gray-green leaves; small yellow flowers in summer  Zones 5 to 9
Chameleon plant (<i>Houttuynia cordata</i> 'Chameleon')	 Perennial groundcover with showy green, red, and yellow 2- to 3-inch heart shaped leaves and small white flowers in summer; likes moist soil conditions  Zones 5 to 8
Obedient plant (<i>Physostegia virginiana</i>)	 Also called Virginia false dragonhead; 3- to 4-foot-tall perennial with 5-inch-long leaves and spikes of 1- to 1½-inch purple, pink, or white flowers that bloom in summer  Zones 3 to 9
Queen-Anne's-lace (<i>Daucus carota</i>)	 Biennial; 1 to 3 feet tall with ferny foliage and clusters of tiny lacy white flowers in midsummer





















HIGHLY AROMATIC HERBS

RAMPANT SPREADERS

1 teaspoon chili powder

PEST CONTROL FORMULAS

RAMPANT SPREADERS

PLANT	 DESCRIPTION  HARDINESS ZONES
VINING PLANTS Sweet autumn clematis (<i>Clematis maximowicziana</i>) Wisterias (<i>Wisteria</i> spp.)	 Vigorous perennial vine with dark green 4-inch-long leaves, covered with small white blooms in late summer and fall  Zones 5 to 9
	 Very vigorous woody vines, can grow over 10 feet a year; drooping clusters of fragrant violet flowers bloom in spring  Zones 4 or 5 to 10
POISONOUS, PRICKLY, UNAPPETIZING PLANTS Blackberries (<i>Rubus</i> spp.) Butterfly weed (<i>Asclepias tuberosa</i>) Foxgloves (<i>Digitalis</i> spp.) 'Rotunda' Chinese holly (<i>Ilex cornuta</i> 'Rotunda') Lamb's-ears (<i>Stachys byzantina</i>) Madagascar periwinkle (<i>Catharanthus roseus</i>) Spurge (<i>Euphorbia</i> spp.)	 Perennial vines with luscious black berries form an impenetrable hedge; choose a thorny variety that is best suited for your area; plant 3 to 4 feet apart  Zones 5 to 9
	 1- to 3-foot-tall perennial with 2- to 5-inch clusters of waxy bright orange, red, or yellow ½-inch flowers in midsummer  Zones 3 to 9
	 2- to 5-feet tall biennial or short-lived perennials with tall spikes of pink, white, yellow, or brown flowers  Zones 4 to 8
	 Compact, dense, spiny-leaved shrub that does not fruit; 3 to 4 feet tall and 6 to 8 feet wide; can be grown as a thick dense hedge  Zones 7 to 9
	 Perennial with soft, wooly gray-white leaves and fuzzy 6- to 15-inch-long spikes of purple blossoms  Zones 4 to 8
	 Also called annual vinca; annual with dark green leaves with white central veins and 2-inch, 5-petaled white, rose, or pink flowers; 12 to 18 inches tall  Annual
	 Most species are 1 to 3 feet tall and bloom in spring, with 2- to 3-inch flower clusters surrounded by showy yellow bracts (modified leaves)  Perennial, hardiness varies with species

Dog-Gone Potion

Deter digging dogs by dousing their favorite digging holes with this pungent potion. Toronto gardener Mary Perlmutter also recommends this mixture for treating the soil where you don't want dogs to nap.

Ingredients and Supplies

- 1 clove garlic, chopped
- 1 pungent onion, chopped
- 1 quart warm water
- 1 teaspoon Tabasco sauce
- 1 tablespoon cayenne pepper
- 1 large plastic or metal pail

Directions

1. Mix all ingredients together in the pail.
2. Allow to steep overnight.
3. Use a metal can to scoop up the mix and dribble it onto soil where dogs are likely to dig or lie. You can also use this formula to discourage dogs that are intent on rearranging your compost heap. When the compost is turned and you want it left alone, sprinkle it thoroughly with Dog-Gone Potion.

Yield: About 1 quart of Dog-Gone Potion

SNEAKY SCAT TACTICS

Nobody wants to hurt a pet, but when pets are pestering the plants in your garden, it's time to show them the door. Here are some sneaky ways to lure them away from your garden and keep them otherwise occupied.

- Kitties love catnip (*Nepeta cataria*)—they'll frazzle themselves and the plant by eating it, batting it around, and rolling on it. You can capitalize on their catnip compulsion by planting kitty "trap crops" of catnip to keep them out of your garden. Simply dig up a small plot at the edge of your property, far away from your garden and your bird feeders. Plant a patch of catnip, and nearby, dig up the soil and mix in some sand, so they'll have a place where they can dig, roll, and munch catnip to their heart's content. They'll never give your garden a second thought.
- If your dog is digging in your garden, you may not be able to change its pesky habit, but you can redirect it! Give the dog its own sandbox—you can make an inexpensive one by filling a kiddie swimming pool with sand. Put the sandbox far away from your garden and bury treats, like dog biscuits and chew toys, in the sand for Fido to dig up. Pretty soon, your pooch will look forward to digging for buried treasures in its sandbox and will forget all about digging in your garden. 🐾

Cat-Away Solution

Cats generally don't eat garden plants (except catnip), but they can be a problem when they dig into the soft soil of garden beds. To discourage them before they get in the habit, try this peppery mixture. Toronto master gardener and author of *How Does Your Garden Grow...Organically?* Mary Perlmutter suggests using this soupy repellent outside on freshly cultivated beds or along fences that surround the garden.

Ingredients and Supplies

- 2 tablespoons cayenne pepper
- 3 tablespoons powdered mustard
- 5 tablespoons plain flour
- Large bowl (for mixing)
- 2 quarts water
- Funnel
- Plastic squirt bottle

Directions

1. Mix pepper, mustard, and flour together in a large bowl.
2. Add the water gradually, mixing all ingredients thoroughly as you go.
3. Pour the mixture through the funnel into the plastic squirt bottle.
4. Squirt the mixture where cats are likely to walk on their way to garden beds.

Yield: About 2 quarts of cat-repelling solution

Vinegar Spray Keeps Cats Away

Use vinegar to chase away wandering tomcats and neutralize the smell that they leave behind. "The cats can smell the vinegar but I can't," says Victoria Price of Silver Spring, Maryland. She puts vinegar around the base of her birdbath, on her patio wall, and on the trunk of a cedar tree that's a popular gathering place for cats. As long as the cats can smell the vinegar, it works like a scent fence to keep them away.

Ingredients and Supplies

- White vinegar
- Small plastic squirt bottle

Directions

1. Fill the bottle with the vinegar.
2. Squirt 1 to 2 ounces of vinegar where cats have sprayed and onto stone or concrete surfaces where they are likely to visit.

Defeating Plant Diseases the Organic Way

Whether it's rust on your roses or powdery mildew on your pumpkins, the ugly symptoms and disappointing crops caused by plant diseases have no doubt resulted in suffering for you (or rather, your plants). All kinds of plants, from mighty oaks to dainty annual flowers, are susceptible to the bacteria, fungi, and viruses that cause plant diseases. But that doesn't mean that you're doomed to diseased plants. You have lots of solutions, from disease-prevention planting plans to homemade remedies that can help you keep your vegetables, flowers, lawn, trees, and shrubs healthy.

Prevention is the best defense. It's easier to keep your plants disease-free than to try to cure them once they're infected. The best way to ensure your plants' health is to provide a healthy, fast-draining soil and appropriate growing conditions. Organic matter is the key to soil health and good drainage, so make sure that your soil has plenty. (See "Soil Improvement and Soil Mix Formulas," beginning on page 56, for recipes for building healthy soil.)

The right plants can make disease prevention much easier. Choose disease resistant varieties whenever possible and match plants to the conditions in your garden.

Adopt a disease prevention routine. When you walk through your garden, always be on the lookout for discolored leaves or other symptoms that just don't look right. If you see diseased leaves, pluck them off of your plants to prevent the disease from spreading. If necessary, remove a sickly plant before it infects its neighbors.

If you're growing fruits and vegetables, be sure to clear out plant debris after your harvest so that you don't give diseases a place to camp out, waiting for spring to strike again. (Don't work in the garden when plants are wet because water is a great disease conductor.) Compost any healthy material you remove from your plants, but be sure to throw any diseased leaves or stems into the garbage.

Doctor plants with care. In some cases, you can use sprays, powders, and other treatments to discourage disease or prevent it from spreading. When treating plants with a spray or powder, keep these simple rules in mind:

- **Test your treatments.** Try both homemade and store-bought cures on one leaf first to test your plant's sensitivity. It's like trying out a stain removal product on a small area before going whole hog. Wait a day to see if any problems turn up before you treat the entire plant.

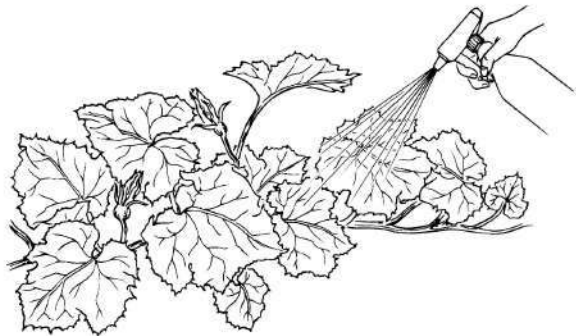

Proceed with caution: Before treating a whole plant, apply a disease-fighting spray or powder to just one leaf to gauge a plant's sensitivity. If you see signs of damage after a day, dilute the spray and test again or find an alternative method.

Seedling-Ease Chamomile Tea

It's sad to watch beautiful little seedlings suddenly wilt and die—cut down before their time by a disease called damping-off. There is no cure for this soil-dwelling fungal disease, but according to Penny King, an herbal educator, you can prevent damping-off with chamomile tea. Penny saw her share of damping-off when she grew herbs commercially as the owner of Pennyroyal Herbs in Georgetown, Texas. She found that she could prevent damping-off losses simply by watering her seedlings with chamomile tea.

Ingredients and Supplies

- 1 cup water
- 2 teaspoons dried chamomile flowers
- Strainer

Directions

1. Bring the water to a boil, then remove from heat and stir in the chamomile flowers. Cover and allow the mixture to come to room temperature.
2. Strain the liquid and use full strength. Dampen potting soil mixtures with the tea before you plant your seeds. And then water with the tea blend, spraying the soil lightly each day with the chamomile tea instead of water.

Yield: About 1 cup of Seedling-Ease tea

Note: You can also use chamomile tea to water cuttings and to soak seeds prior to planting.

Variations: For a slightly stronger antifungal tea, add 2 teaspoons of dried horsetail (*Equisetum arvense*) to the water and chamomile flowers. (You can buy dried horsetail from many mail-order herb suppliers.)

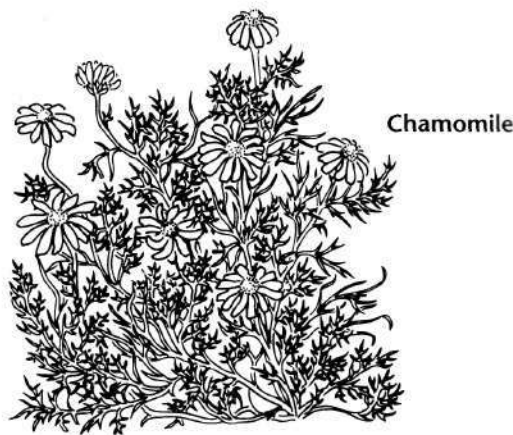
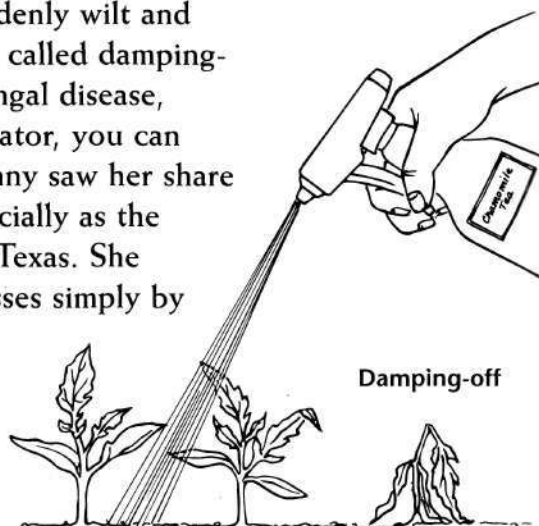

Chamomile's daisies hold health benefits for people *and* plants! Long hailed for its soothing effects on humans, a simple chamomile tea solution is also an effective way to protect seedlings from damping-off disease.

Use this stronger tea solution on established plants that exhibit signs of fungal disease. Repeated applications of the tea can cure many fungal problems. Be sure to spray both sides of the leaves thoroughly.

Rhubarb Spray to the Rescue

For a garden rescue straight from the garden, try Mary Perlmutter's recipe for a rhubarb spray that destroys fungal diseases as well as aphids and June bugs. "If I see signs of a disease that's just starting, I give it a shot of the rhubarb mixture," says author and organic gardener Mary, who has experimented for years with using plants like rhubarb and garlic for solving disease problems in her rural Canadian garden.

Ingredients and Supplies

½ cup rhubarb leaves (about 6 leaves),
crushed
3 quarts water
Pot (for boiling)

Blender (optional)
Cheesecloth or fine-mesh sieve
Pump spray bottle

Directions

1. Cut or tear rhubarb leaves into small pieces. Mary uses rhubarb from her garden, but if you need to buy some, you may find rhubarb with its leaves intact at a farmer's market. Most supermarkets sell it with the leaves removed.
2. Place the leaves in the water and bring it to a rolling boil.
3. Steep the leaves for at least an hour. Mary says she likes to steep them overnight.
4. Shred the boiled leaves further in a blender, if desired. Strain the solution through the cheesecloth or sieve and pour it into a spray bottle. Add the leaf residue to your compost pile.

5. Spray affected plants thoroughly.

Yield: About 3 quarts of rhubarb-leaf spray

Note: Mary suggests making a new batch of rhubarb spray each time you want to spray. "I have been known to strain it and put it in the freezer," she says, "but I prefer a fresh mixture." She adds that you can also keep leftover spray—carefully labeled—in the refrigerator; for a freshness check, be sure that it doesn't have an off odor. Or, if you have a spot where you'd like to lower the pH in your garden, just pour the excess rhubarb spray into your compost or soil for a slightly acidic boost.

Hello Jell-O Seed Starter

To get her flower and vegetable seeds off to a disease-free start, organic gardener Marion Hess of Northville, Michigan, believes in a sweet approach. She sprinkles her seeds with Jell-O powder. She also feeds her young plants with Jell-O as they grow.

Ingredients and Supplies

- Peat pots
- Potting soil
- Seeds
- 1 package Jell-O powder, any flavor with sugar
- Powdered skim milk, in amount equal to Jell-O (optional)
- Salt shaker or other sprinkling device
- Newspaper

Directions

1. Fill the peat pots with potting soil and place 2 seeds in each pot.
2. Fill the salt shaker with the Jell-O powder (and powdered skim milk, if desired, for extra calcium) and sprinkle the powder lightly on top. Gently press down the powder and cover lightly with soil.
3. Moisten the soil and cover it with damp newspaper.
4. After 4 days, remove the newspaper and keep the seeds in a warm area with temperatures of 55° to 65°F.

Note: Should your friends snicker about your plant's snacking habits, just tell them that it makes sense when you think about what's in Jell-O, Marion says. "The gelatin helps the plant hold water, and the sugar feeds the organisms in the soil."

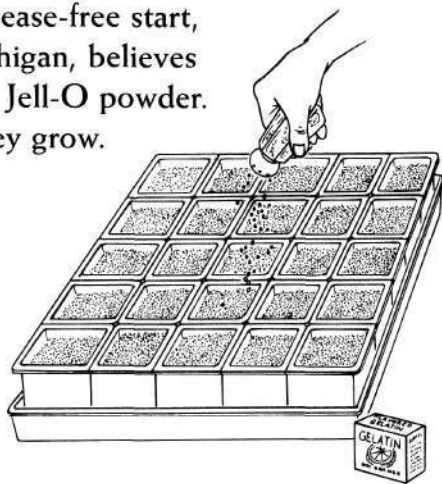

Sprinkle seeds or seedlings with flavored gelatin powder. The nitrogen in the gelatin speeds sprouting and boosts plant growth, and the sugar feeds beneficial soil microbes.

JELL-O DIET PLAN FOR PLANTS

Even after your plants are up and running, Jell-O can still help keep them healthy, Marion Hess says. "In any organic, liquid fertilizer, such as compost tea, I always add Jell-O," she reveals. Add ½ to 1 teaspoon of Jell-O powder to 1 gallon of fertilizer in a bucket. Mix well and use the mixture immediately to prevent thickening. Pour directly on the soil. Because of possible thickening, you don't want to use a spray bottle with this mixture, Marion warns.

Many adventurous gardeners use Jell-O for their houseplants, but Marion says it's just as great at fighting off fungal diseases in outdoor plants. And, she adds, while any flavor will do, lemon's her top choice, because she thinks the citrusy odor repels some bugs. 🐛

Mighty-Milk Tomato Blight Cure

To ward off common tomato diseases, like early blight, try a sprinkling of powdered milk when you set out the tomato transplants. This simple suggestion comes from organic gardener Marion Hess, who is a special contributor for Prodigy's on-line gardening newsletter *Prodigy Gardens Newsletter*. Marion credits milk with her amazing tomato track record of no diseases, ever. "I have never even had to rotate my crop," she marvels. And the technique is gentle, Marion assures. "It won't hurt anything in your yard."

Ingredients and Supplies

- ¼ cup plus 2 tablespoons powdered nonfat milk
- ¼ cup Epsom salts (optional)
- 1 shovelful of compost (optional)
- Salt shaker or other sprinkling device
- Hand trowel

Directions

1. Prepare your garden site or planting container for planting by digging a hole.
2. Use the shaker or your hand to sprinkle the powdered nonfat milk into the planting hole. Add the Epsom salts and compost or composted manure, if desired. The Epsom salts and compost will boost your plant's overall growth and disease resistance, Marion says.
3. Mix the ingredients into the soil with the hand trowel.
4. Set your tomato plant in place and refill the hole with soil.
5. Sprinkle about 2 tablespoons additional powdered nonfat milk around the plant, then mix the milk into the soil with the trowel.

MULCH TOMATOES IN TO KEEP DISEASE OUT

A layer of mulch doesn't just keep moisture in the soil; it also can protect your tomatoes from diseases, says Dr. Frank Killebrew, extension plant pathologist at Mississippi State University. "The mulch provides a physical barrier between soil and plant surfaces and reduces the amount of disease inoculum that is splashed onto foliage, stems, and fruits during rainy periods," explains Dr. Killebrew. Mulching can prevent tomato (and cucumber) rot diseases. He suggests using black plastic or organic materials such as bark, composted sawdust, oat straw, or pine needles for mulch. ♣

6. Add more powdered milk every few weeks throughout the growing season by sprinkling about 2 tablespoons of the powder on top of the soil. When you use your trowel (or a spade or garden fork) to mix the powder into the soil, take care not to damage roots that are growing near the soil surface.

Wipe Out Black Spot with Tomato Leaf Tonic

When black spot attacks her roses, organic gardener and author Mary Perlmutter uses ingredients that are plentiful all summer long: tomato leaves and onions! Mary steeps the leaves and onion in alcohol. The sharp-smelling solution not only discourages the black spot fungus but aphids, asparagus beetles, and scale insects as well.

Ingredients and Supplies

- 10 tomato leaves
- 1 medium-size onion, finely chopped
- ½ cup rubbing alcohol
- Cotton batting
- Stick, about the size of a chopstick

Directions

1. Pick 10 tomato leaves from a healthy tomato plant and chop them into small pieces.
2. Combine the onion with the tomato leaves in the rubbing alcohol. Steep the mixture overnight.
3. Make a cotton swab by wrapping a piece of the cotton batting around the stick. The idea is to make a swab that is large enough to let you apply the mixture easily.
4. In the morning, remove any diseased leaves from your roses. Dip the swab in the tomato-onion solution and wipe the entire plant, including the tops and undersides of all the leaves.

Yield: About ½ cup of black spot-stopping Tomato Leaf Tonic

BEATING BLACK SPOT

Black spot (*Diplocarpon rosae*) is a disfiguring fungal disease that infects roses during warm, wet weather. The disease causes black spots ringed with yellow on rose leaves. While black spot is rarely fatal, a severely infected plant may drop all of its leaves.

Luckily, you can thwart black spot with good gardening practices. Every time you visit your garden, clean up fallen leaves and organic debris to remove places where black spot spores collect. While you're there, prune off and destroy infected leaves and seriously infected canes.

You can also keep black spot off plants by being careful not to splash spore-laden, muddy water on them when watering. A mulch of disease-fighting compost actually kills spores in the soil and keeps them from splashing onto plants.

Good air circulation also prevents black spot spores from taking hold. To open the center of rose bushes to air and sun, carry pruners on garden visits and cut out any inward-growing shoots. Growing roses in full sun and spacing them far enough apart for adequate air circulation can stop black spot troubles before they start. 🌹

RENT GARDEN FROM THE FORMULAS FOR DISEASE CONTROL
1/2 cup chili powder
1/2 cup rubbing alcohol
1/2 cup water
1/2 cup chili powder

Baking Soda Blitz

For a disease fighter that's cheap, easy, and proven effective, look no further than your kitchen cabinet. This recipe, offered by Dr. Thomas A. Zitter, a professor in the Cornell University Department of Plant Pathology, includes lightweight oil that acts as a spreader-sticker to help the baking soda stay on leaves. By keeping the baking soda on the leaves, the oil makes the spray more effective.

Use this recipe when you have to spray only occasionally—some plants may be injured by repeated applications of oil.

Ingredients and Supplies

- 1 tablespoon baking soda
- 1 tablespoon horticultural oil
- 1 gallon water
- 1-gallon backpack or pump sprayer

Directions

1. Mix the baking soda, oil, and water in the sprayer.
2. Spray each plant completely, including the tough-to-reach spots like the undersides of leaves, says Dr. Zitter. "Some of these things (fungi) do very well on the underside of a leaf. If you spray only the top, you will reduce the population by half—if you're lucky—and you will have a new set of spores."

Yield: About 1 gallon of fungus-fighting spray

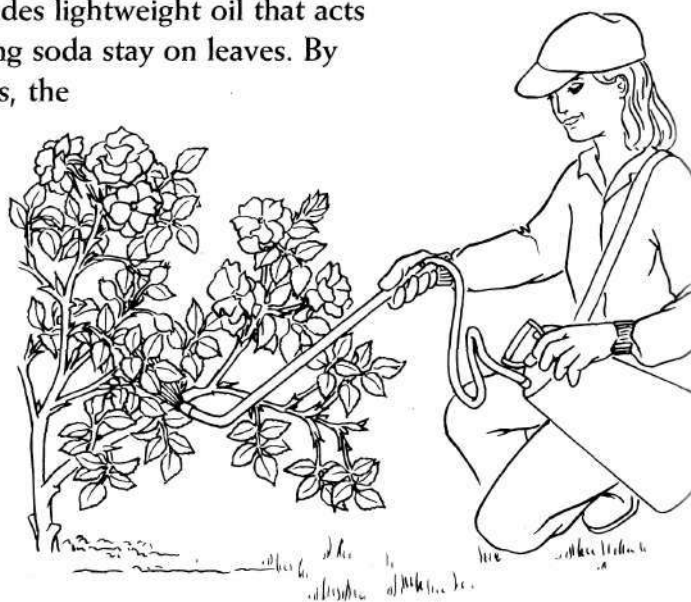

Fight fungal diseases like black spot and powdery mildew with baking soda spray—it's cheap and effective! Be sure to spray the undersides of leaves as well as the tops.

Variation: Dr. Zitter points out that while baking soda is great, its near relation, potassium bicarbonate, performed even better in studies and the Environmental Protection Agency (EPA) has approved it as a commercial home and garden product. (Look for potassium bicarbonate at garden centers.)

GREEN FORMULAS FOR DISEASE CONTROL

1/2 spoon chili powder

1 pint water

Deluxe Baking Soda Spray

Instead of mixing separate sprays for diseases and insects, consider using Dennis Glowniak's deluxe combo spray, which works for both. Spray weekly and it's "good-bye pests!" promises Dennis, president of the California Organic Garden Club.

Ingredients and Supplies

- 1½ tablespoons baking soda
- 1 tablespoon insecticidal soap
- 1 tablespoon canola oil
- 1 cup plus 1 gallon water
- 1 tablespoon vinegar
- Backpack or pump sprayer

Directions

1. Mix the baking soda, soap, and oil with 1 cup of water.
2. Add the vinegar. Don't mix the vinegar in until last or the mixture may bubble over.
3. Pour the mixture into the sprayer and add 1 gallon of water. Shake or stir to combine the ingredients.
4. Spray plants, covering the tops and bottoms of the leaves.

Yield: About 1 gallon of baking soda spray

BAKING SODA'S BEST AS A PROBLEM PREVENTER

You should always keep a simple solution of 1 teaspoon baking soda to a quart of water mixed and ready for action in your garden, states Dorothy Read, editor of *The Garden Sampler* magazine, which is based in Peru, Vermont. The spray stops fungal diseases on everything from roses to pumpkins, Dorothy claims.

Dorothy's recipe is simple and effective at combating fungal diseases such as black spot and powdery mildew, but there are

other versions you can try as well. No matter which recipe you use, be snappy about it, Dorothy urges, because while bi-carbonates stop the spread of fungi, they can't clean up a diseased mess. Dorothy explains that baking soda works best as a preventive—if you've had trouble with fungal diseases in the past, start spraying susceptible plants before disease symptoms start and continue at weekly intervals to prevent the problem. 🌿

RECIPE BY DENISE WILSON FOR GARDEN SAMPLER
FOR FORMULAS FOR DISEASE CONTROL
1/2 cup water
1/2 cup chili powder

Powdery Mildew Solution

Here's a new twist on the popular baking soda-and-oil mix for controlling powdery mildew. Iowa-based garden writer Veronica Fowler offers this version that uses Murphy's Oil Soap. "The baking soda alters the pH of the leaf, making it more difficult for powdery mildew to form," Veronica explains. "The oil soap serves as a spreader-sticker, so that the mix spreads more evenly and doesn't wash off as readily."

Ingredients and Supplies

- 1 gallon warm water
- 3 tablespoons baking soda
- 1 tablespoon Murphy's Oil Soap

Directions

1. Mix all ingredients well.
2. Spray plants when you spot the very first sign of powdery mildew—a grayish coating on leaves. Coat both sides of leaves thoroughly. Spray every 7 to 10 days until daytime temperatures start getting into the 70s.

Yield: About 1 gallon of Powdery Mildew Solution

Note: On plants with chronic powdery mildew problems, use this spray as a preventive. Spray once or twice in very early spring before any sign of disease appears. If you notice powdery mildew, take action to stop its spread. Remove all affected leaves and spray with a baking soda solution. Prune or thin to improve air movement around the foliage. Finally, make sure the plant isn't stressed by drought or other problems; stressed plants seem more susceptible to infection.

PLANTS PESTERED BY POWDERY MILDEW

The fungal disease powdery mildew is ugly but it seldom does serious harm. If you're growing a plant that's susceptible to the fungus—check the list below—and don't like how it looks, keep baking soda and Murphy's Oil Soap handy for a quick preventive spray.

Trees and Shrubs

- Crabapples (*Malus* spp.)
- Crape myrtle (*Lagerstroemia indica*)
- English oak (*Quercus robur*)
- Euonymous (*Euonymous* spp.)
- Hackberries (*Celtis* spp.)
- Honeysuckles (*Lonicera* spp.)
- Lilac (*Syringa vulgaris*)
- Privets (*Ligustrum* spp.)
- Roses (*Rosa* spp.)

Flowers

- Bee balm (*Monarda didyma*)
- Dahlias (*Dahlia* hybrids)
- Delphinium (*Delphinium* × *elatum*)
- Phlox (*Phlox paniculata*)
- Zinnia (*Zinnia elegans*)

Spray Away Brown Patch in Lawns

If your lovely green lawn develops brown or yellow rings or patches that die out, brown patch may be the culprit. A variety of *Rhizoctonia* fungi causes this disease; some species thrive in cool weather, while others affect grasses in warm weather.

If brown patch plagues your lawn, fight back with this formula from John Dromgoole, owner of Garden-Ville in Austin, Texas. Follow up with John's suggestions for correcting water and fertilizer problems or the disease will return.

Ingredients and Supplies

- 1 rounded tablespoon baking soda or potassium bicarbonate
- 1 tablespoon horticultural oil
- 1 gallon water

Directions

1. Mix all ingredients thoroughly.

2. Spray lightly on your lawn. Avoid over-use or drenching the soil with baking soda.
Yield: About 1 gallon of spray for battling brown patch

Note: John says potassium bicarbonate, available in garden centers, is the best choice for this spray. Unlike baking soda, potassium bicarbonate leaves no salt residue in the soil.

COMPOST STOPS BROWN PATCH COLD

How can you tell if your lawn has brown patch? Take a look at your lawn care techniques. John Dromgoole says, "the disease is generally caused by poor drainage, too much rain or irrigation, and/or too much nitrogen fertilizer. Another symptom is that the leaves easily pull loose from the runners."

Aerate to improve the movement of air, nutrients, and water through the soil. And fix drainage problems by filling in low spots or installing drain tiles in your yard. To permanently solve brown patch problems, John suggests applying a half-inch layer of finished compost to your lawn. The microbe trichoderma, which exists in compost, is a powerful deterrent to brown patch. 🍄

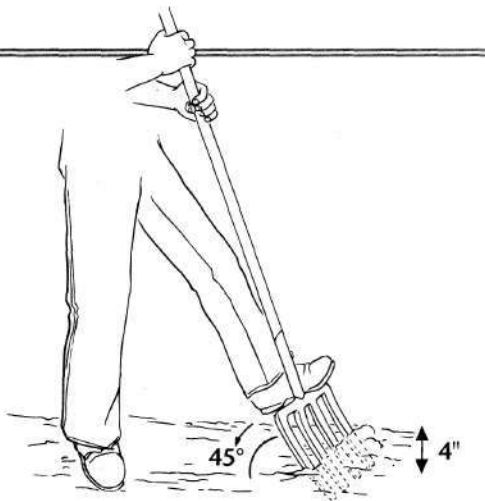

You can aerate your lawn with a spading fork. Insert the tines about 4" into the ground at a 45° angle. Press down lightly to loosen the soil, then pull out the fork. Repeat at 1' intervals.

Dual-Purpose Garden Spray

A garden product that you may already have can help your plants fight off fungal diseases. Antidesiccants (or antitranspirants) are best known as the stuff you spray on Christmas trees or wreaths to hold in moisture and make them last longer. But studies show that the sprays can also fight off rust and powdery mildew, says landscape consultant Mark Whitelaw, a consulting rosarian for the American Rose Society.

Ingredients and Supplies

Antitranspirant or antidesiccant
Backpack or pump sprayer

Directions

1. Antitranspirants are sold at nurseries under various commercial names as a ready-to-use spray or as a concentrate that you'll need to mix up. Buy whichever is most useful to you. And don't let those long words scare you off—antitranspirants are virtually nontoxic and biodegradable. They work by creating a film on a plant's leaves.
2. When you spray, be sure to coat the tops and bottoms of leaves. Application techniques depend on which form you buy, Mark says, so read and follow label directions. By coating the leaves and stems, you block fungi from the leaves and/or give any fungal spores that are already there a coat, which prevents them from spreading. The film will not protect new growth, so reapply as needed, according to the label.

WATER FIRST

Whether you're feeding your plants, using a foliar (leaf) spray, insecticidal soap, or any other man-made interference, getting out your hose or watering can should always be step number one. "Always, always irrigate before applying any chemical, of any sort, for any purpose!" Mark Whitelaw insists. "This puts less stress on the roots and foliage of the plant." If you don't water, you'll create conditions that can injure the leaves. 🌱

Note: Gardeners in cool, humid climates, like the Pacific Northwest and New England, boast success with antidesiccants in fighting the dreaded rose rust which thrives in their area, Mark says. At the same time, antidesiccants are popular with some in southern California's dry inland areas. "Antitranspirants are particularly effective against powdery mildew in areas where hot, dry conditions prevail during the day, but high humidity conditions exist at night and early morning," he explains.

100 BEST FORMULAS FOR DISEASE CONTROL

1/2 spoon chili powder

Fishy Foliar Spray

You can feed your plants and slow the spread of fungal diseases at the same time when you combine two ocean-going ingredients in a foliar (leaf) spray. Rick Estes, president of the New Hampshire chapter of the Northeast Organic Farming Association, uses this nutrient-rich seaweed and fish emulsion "soup" when plants show the first symptom of disease. He also uses it during the growing season and at transplanting time to give plants an energy boost.

Ingredients and Supplies

- 2–4 tablespoons liquid seaweed
- 2–4 tablespoons liquid fish emulsion
(sold at most garden centers and
some discount chain stores)
- 1 gallon water
- Backpack, pump, or hose-end sprayer

Directions

1. Before you get started, take note: You may have to set your alarm clock. "You should get up before the sun hits the leaves to foliar-feed," Rick says. "Then the stomata (pore-like openings) of the leaves are open, taking in their moisture" for the day ahead.
2. Mix the liquids with 1 gallon of water in the sprayer and shake to blend thoroughly.
3. Spray generously, coating tops and bottoms of leaves. Stretch out your treatments. Don't spray more often than every 5 days, Rick suggests, even if plants show symptoms of a fungus or other ailment. "Always give the plants time to put the extra nutrients to work,"

SEAWEED STRAIGHT

For a last-ditch effort, when a treasured plant is nearly dead, Rose Marie Nichols McGee reaches for the liquid seaweed—a magical tip that she cherishes but hesitates to share. "I love liquid seaweed, but I'm always nervous about making too many claims for something. It's a tip we kind of pass on to friends," says the president of Nichols Garden Nursery.

So consider this a tip from a friend: To try to save a dying plant, make a circle of liquid seaweed around the trunk or stem and water it in. "If there's still something there, the seaweed gives it a booster." 🌱

he says. Rick recommends a dose of "nutrient and mineral soup" at transplanting time to help reduce shock and give plants a boost. For the squeamish (or those with curious cats): You can buy odorless fish emulsion.

Yield: About 1 gallon of Fishy Foliar Spray

Oil on the Offense Spray

To prevent fungal diseases from taking hold in late winter and early spring when wet, rainy weather can mean trouble, spray your plants with diluted oil, suggests Andy Lopez, founder of the Invisible Gardeners of America. Andy uses oil on fruit trees, vegetables, roses, and most flowers. However, he cautions, oil benefits only shiny-leaf plants. Do not spray oil on fuzzy-leaf plants, which are vulnerable to burning.

Ingredients and Supplies

- 1 teaspoon oil (plant-based oil such as castor, coconut, or a light salad oil)
- 1 teaspoon liquid soap (any biodegradable dishwashing liquid or Dr. Bronner's Peppermint 18-in-1 Soap)

- 1 gallon water (with chamomile tea or compost tea, optional)
- Backpack or pump sprayer

Directions

1. Mix the oil, soap, and water in the sprayer. Water is easiest, but if you've got it, substitute a few cups of chamomile tea or compost tea, both of which help inhibit disease, Andy suggests.

2. Spray a fine mist on plants as often as needed, "usually daily the first week, then weekly, and, if it holds out, then monthly."

Yield: About 1 gallon of preventive oil spray

Note: Andy is picky about the types of oil he will use in the garden. Plant-based oils, such as castor oil or coconut oil, are his favorites, but he is also fond of fish oils, which have minerals that can help strengthen plants against disease. Because it contains peppermint oil (which acts as an insect repellent), he likes to use Dr. Bronner's peppermint soap when mixing any garden spray with a liquid soap.

Variation: Because it's a cheap, easy, and effective alternative, many gardeners prefer plain old salad oil for disease prevention, says Marion Hess, special contributor for Prodigy's on-line gardening newsletter, *Prodigy Gardens Newsletter*. "You mix 1 teaspoon of a light salad oil, like canola or safflower, and 1 teaspoon of liquid soap in 1 gallon of water. It seems to prevent disease."

Even when they're made with vegetable oil instead of petroleum oil, oil sprays can injure your plants if you don't apply them properly. Avoid using an oil spray when temperatures are expected to go above 85°F or below freezing. It's always best to test an oil spray on a few leaves and then wait and watch for a few days before dousing an entire plant.

Fire-Away Rust Removal

If you're fond of old-fashioned hollyhocks, odds are that you're familiar with rust, the ugly orange fungus that can quickly disfigure an entire garden. "Even if you stayed on it every single day with a chemical, you would not get all of the spores," says Mary Lou Heard, owner of Heard's Country Gardens in Westminster, California. So she devised the "fire method." She just makes a tiny fire beneath the hollyhock (with safety precautions!) to kill spores. It works for roses and snapdragons, too.

Ingredients and Supplies

- ¼ cup shredded paper or paper scraps
- Matches
- Jug of water and/or fire extinguisher

Directions

1. First, remember that you are lighting a fire, although it's small, use precautions. Have a jug of water or a fire extinguisher nearby. Make sure that there is no dry material nearby that could catch a flame and be sure to completely extinguish any remaining sparks.
2. Begin by placing a thin layer of the paper at the base of the plant. "You make a little circle of fire around the stem," Mary Lou says. She explains that the fire makes an instant flash of heat in a full circle around the base of the plant. Mary Lou emphasizes that you want to make sure that the area of heat extends to the outermost leaf, however far away that farthest leaf is. That way, you can be sure that you're hitting all the rust spores.
3. Light the fire. Expect a quick flame for 5 to 10 seconds. It should extinguish on its

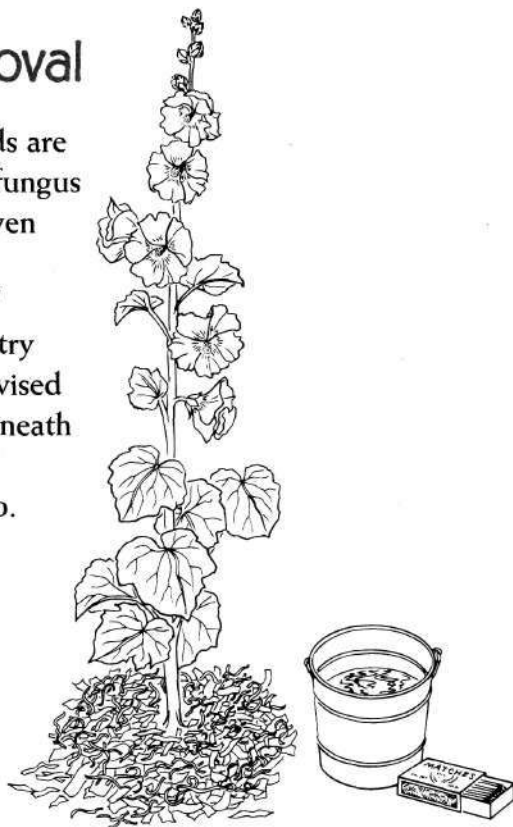

The heat from a small flash fire will help kill the rust spores that often plague hollyhocks. Use a thin layer of paper to encircle the plant stem without touching it, fill a bucket of water and place nearby, then light the paper and fire away.

own; if not, use the water to douse it. You may lose some lower leaves in the process, Mary Lou cautions. But she adds, "When the plant recovers from this little bitty heat, it comes back so gorgeous."

Note: If more than one plant shows symptoms of rust, repeat the process individually, for each plant. In 2 weeks, check to be sure that the plant is clean. If there are any diseased leaves, remove them. If the fungus reappears, treat that plant again. Mary Lou says she's never had any problems past that point.

Deter Disease with Disinfectant Dips for Tools

Clean your tools! You've heard that advice before, but now it's time to take it seriously. Using bleach or another disinfectant for tools is a must, says Dr. Cheryl Smith, a specialist in plant health with the University of New Hampshire Cooperative Extension. "If you're going to do pruning or any type of cutting, cut diseased areas of a plant last, and make sure that cutting tools, even scissors, get thoroughly cleaned prior to next use," Cheryl says. Otherwise, an isolated problem could become a full-scale plague.

Ingredients and Supplies

- 1½ cups household bleach
- 1 gallon water
- Clean bucket
- New steel wool pad
- Motor oil or other oil used to condition tools

Directions

1. Mix the bleach and water to produce a 10 percent solution. This works fine for most cleaning.
2. Dip tools in the disinfectant after each use. For plants or trees that are already suffering symptoms, dip tools as you go along, cautions landscape consultant Mark Whitelaw. "If you are pruning severely diseased shrubs, or shrubs with highly infectious diseases, I recommend dipping the 'business end' of the pruners between making each cut."
3. After disinfecting, your tools need tender loving care to prevent discoloration or corrosion. Rinse thoroughly, then rub them lightly with a clean steel wool pad.

WASH UP

Don't forget to clean your shovel, hand tools, gloves, and even gardening shoes to prevent diseases from spreading, especially if you suspect a soil-borne disease. After you are finished working in the garden, wash your gloves and shoe soles in warm, soapy water and hang them out to dry. 🌱

4. Sharpen the edges if you'd like, and oil the tools before storing them for the next outing.

Yield: About 1 gallon of tool-disinfecting dip
Variation: To destroy fire blight bacteria that afflicts apple and crabapple trees, use 3 cups of bleach in 1 gallon of water (a 20 percent solution), says Dr. H. Arthur Lamey, a plant pathologist with the North Dakota State University Extension Service in Fargo. Or you may use pine cleaner at full strength, he says; just be sure that the label lists 19.9 percent pine oil.

Herbal Soap Spray

Keeping plants clean and disease-free is the backbone of Donna Carrier's job as owner of Organic Plant Care, an interior landscaping company based in East Swanzey, New Hampshire. Soap sprays are a crucial part of her strictly organic regimen, but they don't have to smell bad to work, she says. Donna concocted her own soap spray that's scented with fragrant herbs.

Ingredients and Supplies

- 1 cup wormwood or tansy
- 1 cup lavender
- 1 cup sage
- 1-quart heat-resistant canning jar
- 2 cups water
- 1 teaspoon liquid, nondetergent soap, like castile soap or Murphy's Oil Soap
- Pump spray bottle

Directions

1. Place the wormwood or tansy, lavender, and sage in the canning jar and fill the jar with boiling water.

2. Let the mix sit until it cools to room temperature. Then drain off and reserve the liquid.

3. Combine $\frac{1}{8}$ cup of the herbal liquid with 2 cups water and 1 teaspoon liquid nondetergent soap.

4. Fill the pump spray bottle and spray the mixture on plants. Repeat once a month.

Yield: About 2 cups of herbal soap spray

Note: If your plants are very dirty or dusty, saturate a cotton cloth with the liquid and wipe the leaves clean.

Soapy Indoor Plant Spray

For indoor plants that are exposed to pollutants from heaters or stoves, a cleaning spray can boost health and deter diseases, says Donna Carrier, owner of Organic Plant Care, East Swanzey, New Hampshire. This gentle spray cleans dust and dirt from plants and does not pose any risks to plants or animals, she adds. You can use it in your outdoor garden, too.

Ingredients and Supplies

- 1 tablespoon liquid, nondetergent soap
- 1 tablespoon liquid seaweed (optional)
- 1 quart lukewarm water
- Pump spray bottle
- Clean cloth

Directions

1. Mix soap, seaweed, and water together in the spray bottle.

2. Spray plants liberally and wipe off excess moisture with a clean cloth. Use monthly.

Yield: About 1 quart of soapy plant spray

1 cup green and
herb formulas for disease control
1/2 cup water
1/2 cup chili powder

Plant Mixing Plan

To save cucumbers and squash from one of their greatest enemies—bacterial wilt—try companion planting, suggests Dennis Glowniak, president of the California Organic Garden Club.

Dennis says you can't beat this combination of tansy and radishes for a healthy summer-long feast of cucumbers and squash.

Like many bacterial diseases, wilt is carried by an insect pest. In this case, it's the cucumber beetle, which injects the wilt disease as it feeds. In this planting plan, the pungent aroma of tansy confuses and repels the beetles, while the radishes lure them away from the vine crops.

Ingredients and Supplies

- Squash or cucumber transplants
- Radish seeds
- Tansy plants

Directions

1. Plant the squash or cucumber transplants in your garden, and tuck radish seeds into the soil in a circle around each transplant. The radishes should pop up within a day or two.
2. Check the radishes daily for cucumber beetles and squish any that you find. If you're squeamish about squishing them, drop the beetles into a jar or bag and throw it into the trash.
3. Plant the tansy the same day you plant your vegetable transplants. Tansy can be invasive, so set it in a plastic pot with the bottom cut out and set the plant in the soil, pot and all, to contain it. If you plant tansy directly into the soil, check it regularly and pull up any underground shoots that wander away from the planting area. Plant a 4-inch

ANOTHER FRIENDLY MIX

Some herbs have a reputation for helping their neighbors fight off disease. "Try basil, for tomatoes," for instance, Dennis Glowniak recommends. "People think of basil and tomato as going well together in sauces, but actually a number of tests have shown that when they're planted together, both plants are more vigorous." Dennis explains that a vigorous plant repels diseases and insects more easily than one that's unthrifty. To give your tomatoes the benefits of basil (and vice versa), simply plant one basil plant inside each tomato cage, on the sunny side. 🌱

clump of tansy for every 2 vegetable plants. Anecdotal evidence suggests that the tansy encourages overall healthy growth in cucumbers, Dennis says.

4. Divide unpotted tansy with a shovel at least annually. "You don't walk away from tansy," Dennis warns.

BEANS EXPLORE THEM FOR PLANTING FORMULAS FOR DISEASE CONTROL
CUCUMBER BEETLE
DIPLOMA
DIRTY WARD
SPOON CHILI POWDER

Weed-Busters

Anyone who plants a garden enlists in a never-ending battle with weeds. Some gardeners take the quick-fix, shotgun approach and blast them with chemicals. In fact, home gardeners spend more than \$200 million a year on herbicides. But that's only part of the cost. Chemical herbicides have been implicated in groundwater pollution, soil degradation, and even serious human health problems. In the end, it's a bad bargain, because the weeds keep coming back.

But many enlightened gardeners take a more holistic approach. They say that a weed is just a plant out of place. And, in fact, one person's weed may be another person's flower or even salad green. While one gardener struggles to eliminate violets from a lawn, another will cultivate them in the flower bed, and still others may enjoy their foliage and flowers in salads.

That's not to say that every weed has a good side. Or that we have to learn to live with them. In fact, you can have a weed-free lawn and garden without resorting to dangerous chemicals or spending hours on the back-breaking labor of hoeing or chopping or pulling weeds.

There's a whole slew of natural products that will kill weeds if applied correctly. In fact, you'll be surprised at the number of potent—but safe and environmentally sound—natural weed killers that are already in your cupboard or medicine cabinet.

In this chapter, you'll find some of the best homemade weed-killing recipes from

organic gardeners around the country. But that's not all. You can enlist the power of the sun to burn out weeds. All it takes is a little bit of plastic and a little time. Or you can elbow them out with cover crops—and we've got a list of some surprising, versatile, and good-looking crops that you can use. And, of course, there's mulch. We've got that covered, too, well beyond the common grass clippings and straw. You'll learn how to manage your mulch materials so that they do a good job of smothering weeds and building the soil, while looking good all through the season.

When you put these weed-busting formulas to work in your garden, you'll find that it's not difficult at all to put weeds in their place.

WEEDS AT WORK

Many gardeners say that having a few weeds in the garden isn't such a bad thing. Linda Anne LeBoutillier of Waterloo Gardens in Devon, Pennsylvania, always leaves a few weeds growing so that rabbits can eat their fill of clover and lamb's quarters rather than garden plants. Other weeds, such as Queen-Anne's-lace, serve as a magnet for beneficial bugs. Besides, Linda Anne figures, keeping some areas untouched grants a peaceful, natural touch to her gardening. "I have so many birds and butterflies here," she says. "For the balance of nature, I can live with some weeds." ❁

RENTAL EXPENSE FORMULAS FOR WEED CONTROL (teaspoon chili powder)

Weeds in Hot Water

Instead of scratching and digging and pulling weeds from sidewalk or driveway cracks, you can use boiling water to eliminate them quickly and safely. Boiling water will kill any plant or seed it touches, says Michigan organic gardener Marion Hess, a special contributor to Prodigy's on-line gardening newsletter, *Prodigy Gardens Newsletter*. So be careful not to splash any of it on neighboring garden plants or turf. Though this hot bath will destroy weed seeds that are already in the soil, seeds can be blown or carried in again, so Marion always leaves the dead weeds in place to mulch the soil and discourage germination of more weed seeds.

Ingredients and Supplies

Tea kettle or pan

Directions

1. Boil a full kettle of water.
2. Pour slowly and carefully, dousing both the weeds and the soil immediately surrounding them.

Yield: 1 kettleful of weed-whacking water

Bubble Trouble Soap Spray

A strong dose of soap can kill weeds by burning their leaves and roots, says California gardener Andy Lopez, founder of the Invisible Gardeners of America. "Different weeds require different strengths of soap," Andy says. You'll have to experiment to see how tough your weeds are.

Ingredients and Supplies

5 tablespoons natural liquid soap
1 quart water
Pump spray bottle

Directions

1. Mix the soap and water.
2. Spray leaves and the root area of weeds during the hottest time of day.
3. Check in 24 hours. The weed should appear burned and nearly dead. If not, double the concentration and spray again.

Yield: About a quart of soap solution

HERB FORMULAS FOR WEED CONTROL 1/2 TEASPOON CHILI POWDER

PARK THAT TILLER

The wise gardener trying to eradicate an aggressive weed follows one commandment, says Seattle gardener Barbara Donnette: "Thou shalt not till!" Tilling to remove persistent and perennial weeds or herbs like the ones shown below will produce the opposite effect. It breaks the plant and its roots and rhizomes into tiny stubs

that can multiply into monster plants. At the Seattle P-Patch Community Gardens, where Barbara is program manager, a patch of comfrey that was mistakenly tilled proceeded to infest the entire acre. "Twice a year, for 10 years, we did comfrey combat," she says. "But more comfrey always came up the next spring." 🌱



Comfrey



Mint



Jerusalem
artichokes

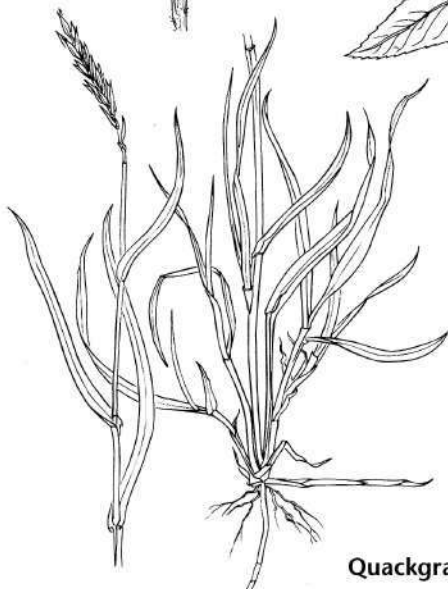

Quackgrass



Tansy

Sorry, Charlie

If creeping Charlie catches hold in your lawn, it can be a recurring nightmare. To solve problems with this low-growing, yellow-flowered weed in your lawn, try borax, the same laundry additive that makes your white socks whiter. When Dr. Micheal Owen, an Iowa State University weed scientist, studied the effect of borax in controlling the shade-loving weed, he found that "the results were comparable to those from commercial herbicides." He notes that borax is most effective as a weed-killer in late spring or early summer, when weeds are growing actively. Be warned though: Borax doesn't work on other weeds (like dandelions) and it may cause a temporary yellowing of nearby grass. If you see some yellowing in surrounding grass, just mow frequently and it should color up within six weeks.

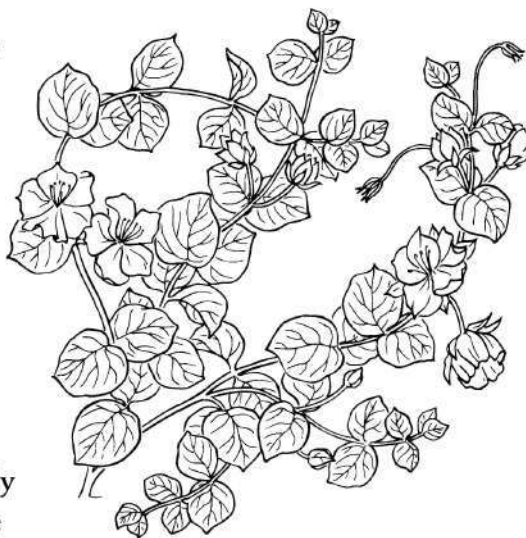

Creeping Charlie is a low-growing perennial weed that can wreak havoc with your lawn's good looks. A treatment of water mixed with borax will help keep Charlie's creeping under control.

Ingredients and Supplies

- 5 teaspoons borax, like 20 Mule Team Borax, for every 25 square feet of lawn
- 1 quart water
- Pump spray bottle

Directions

1. Mix borax in water. (Measure exactly: Too little and you won't get the job done; too much and you could kill your grass, too.)
2. Spray to cover a 25-square-foot area.
3. Water and fertilize your turf after the treatment so that it rapidly fills in the space left by the dead weeds.

Yield: About 1 quart of borax solution

KILLER COLA

Linda Anne LeBoutillier of Waterloo Gardens in Devon, Pennsylvania, has reached back into her childhood memories to resurrect an old, unconventional weed-killer: Coca-Cola. "My grandfather used Coca-Cola on the weeds between the cracks in the sidewalks," says Linda Anne. He would take a drink from that old green bottle, then pour the rest on the weeds." She swears it works. "Just pour it in the center of the leaves, preferably on a hot day when they'll roast." It may take up to a week for the weed to completely keel over, Linda Anne says. ☘

Gluten for (Weed) Punishment

Want to fertilize your lawn and garden and suppress the growth of new weeds at the same time? Believe it or not, corn gluten meal—a filler in many dog foods—does the trick, says Carolyn Ormsbee, staff horticulturist for Gardener's Supply Company in Burlington, Vermont. Available from mail-order garden suppliers, corn gluten prevents the germination of weed seeds, including lamb's quarters, purslane, and dandelion; it won't kill existing weeds or other plants.

Ingredients and Supplies

- 20 pounds corn gluten meal for every 1,000 square feet
- Any garden spreader

Directions

1. Fill spreader with dry gluten meal.
2. Apply evenly at about the time weeds start germinating in your area and again in late summer or early fall. (You can also apply the meal by hand.)
3. In a vegetable garden or flower bed, work the meal into the top 3 inches of soil.
4. Water thoroughly. This starts weed seeds germinating and also activates the gluten.
5. Adjust your fertilizer program. Since corn gluten provides a good dose of nitrogen, be sure to hold off on fertilizing for 2 to 4 weeks.
6. Refrain from sowing seed in the area for 6 months. Though existing flowers, turf, or vegetables won't be affected, corn gluten prevents all seed germination for several months after it's applied.

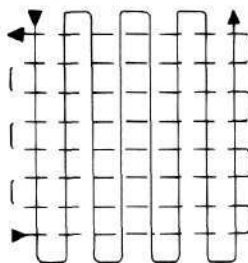

Spread the gluten over your lawn. Then spread it again at right angles.

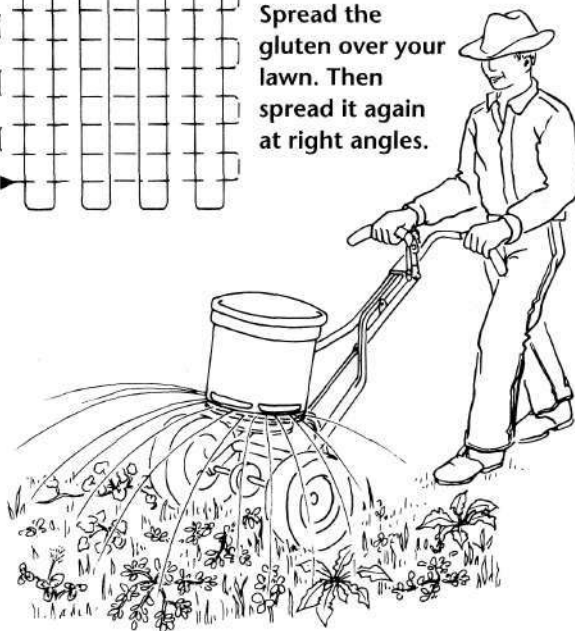

Prevent weed seeds from sprouting in your lawn by applying corn gluten meal, a by-product from milling corn. Spread the meal in a crisscross pattern for best coverage.

7. Reapply every year.
8. Be patient. Weed populations should decrease dramatically over 2 to 3 years.

Bake 'Em in Plastic

To get rid of lingering weeds and their seeds in a new flower or vegetable bed, try trapping the sun's heat to burn them to death. All you need is clear plastic to cover the area and the patience (and space) to leave the area alone while the sun does its work. While this technique, called solarizing, works fastest in hot climates, you can do it during summer's peak heat in northern states, says Michigan organic gardener Marion Hess, a special contributor to Prodigy's on-line gardening newsletter, *Prodigy Gardens Newsletter*.

Ingredients and Supplies

- Tiller or hand shovel
- Enough clear plastic to cover an entire plot
- Rocks
- Clear plastic tape (optional)

Directions

1. Till the soil 5 inches deep.
2. Water soil well, soaking it to a depth of 6 to 12 inches.
3. Cover the area tightly and completely with the plastic sheets, making sure that all the soil is well covered and there are no gaps.
4. Tuck the edges of the plastic into the soil and weigh them down with rocks.
5. Wait. In hot climates, solarization can take as little as 3 weeks or up to 2 months. In cooler climates, leave the plastic cover on for at least 2 months.
6. Inspect the cover frequently for holes. If any develop, patch them with tape.

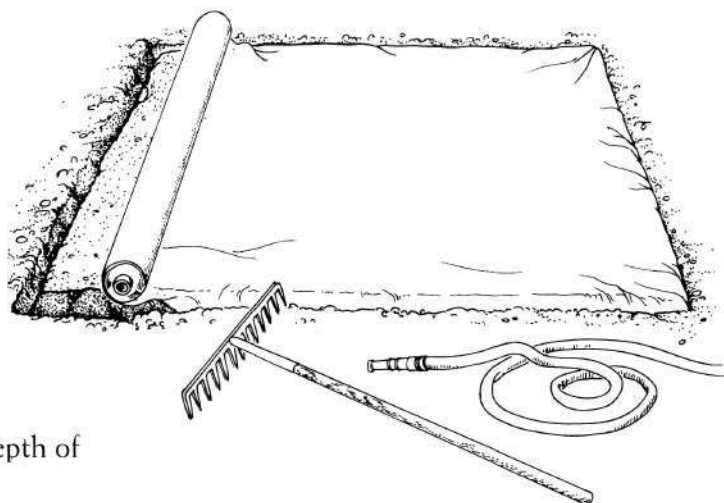

To use the sun's heat to kill weeds and weed seed in a new garden, rake the bed smooth, water it well, and cover it tightly with clear plastic for up to 2 months during the summer.

7. Remove plastic, and pull any remaining weeds from the bed.
8. Plant your garden or take other measures to cover the soil to keep weed seeds from entering this weed-free zone.

Covering the Uglies

Mulching is probably the most common form of weed control—except for yanking! But while everybody does it, no two people seem to do it the same way. Gardeners show their creativity and resourcefulness by recycling all sorts of waste material as mulch. Most of it works to smother weeds, hold moisture, and even improve the soil. But a lot of these materials aren't especially attractive. If you use cardboard, newspaper, or old plastic bags as your mulching medium, you may merit a gold medal for recycling, but you won't win any garden beauty contests.

Don't let that stop you from using these materials, though. It's easy to cover them up with more attractive mulch materials, from wood chips to shredded leaves.

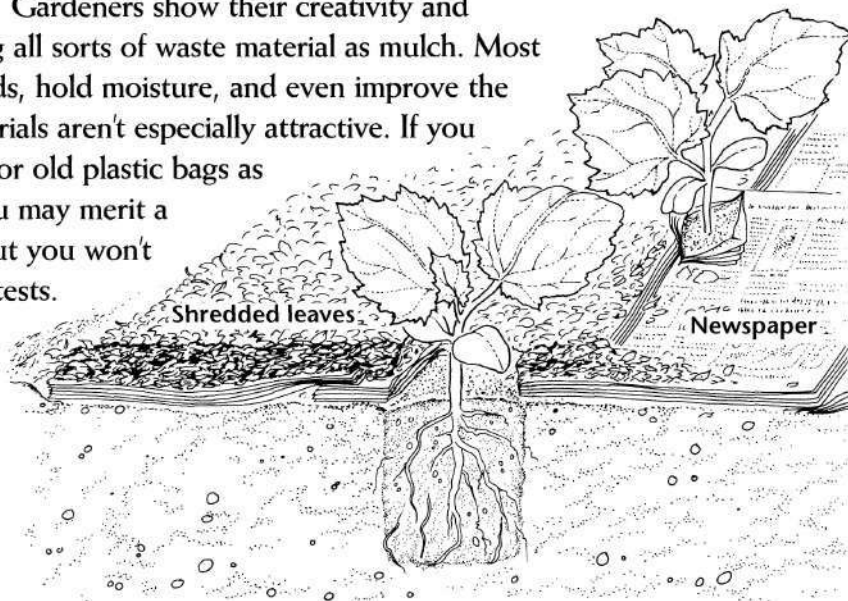

Ingredients and Supplies

- Cardboard, plastic, or newspaper (for the base layer)
- Wood chips, shredded leaves, grass clippings, cocoa mulch, small stones, or gravel (for the top layer)

Directions

1. Lay single sheets of cardboard or plastic, or ½- to 1-inch-thick sections of newspaper, across garden paths or rows.
2. Cover with the top layer of your choice.

A thick layer of newspaper is a great weed-stopping mulch for vegetable beds. To plant through the mulch, just cut a small hole in the paper for each transplant. To make the bed look nicer, top the paper with shredded leaves or grass clippings.

Note: Water your garden well before you mulch. If you poke holes through the mulch for putting in transplants, water them right at their planting holes. Otherwise, your weed-blocking mulch may keep water from reaching your transplants' roots.

CARDBOARD WITH CHIPS

At the Seattle P-Patch Community Gardens, program manager Barbara Donnette has mulching down to a science. "We spread a layer of cardboard between raised beds and cover it with wood chips," she says. Cardboard is her favorite bottom layer because it comes in large pieces that slowly deteriorate after they've done their job of smothering weeds. As the cardboard deteriorates, simply add wood chips to the top to keep new weeds from sprouting, Barbara suggests. Plastic works well, too, but it tears frequently, and pieces work their way to the surface, giving the garden a junky look.

Cardboard is also an excellent base mulch for a garden bed that's infested with tough weeds like thistles, which can sometimes push their way through light mulches like leaves or straw. It's also a good weapon for reclaiming a bed that's too weed-filled to till or even hand-dig.

Just cover the entire bed with sturdy corrugated cardboard and top the cardboard with a more decorative mulch like grass clippings or cocoa mulch. After mulching the bed, let it sit for two weeks or longer. The weeds will begin to die off and decompose under the cardboard. When you plant the bed, simply use a trowel to cut through the mulch and cardboard wherever you want to insert a plant. Set the plant in place, and then push the mulch close to, but not touching, the plant stem.

As the garden grows, check frequently for weeds near your plants' stems. A few may still be alive and find their way through the hole in the cardboard layer. It's easy to pull these escapees. By the following season, the cardboard will have decomposed, and you should have a nearly weed-free garden bed. ♻️

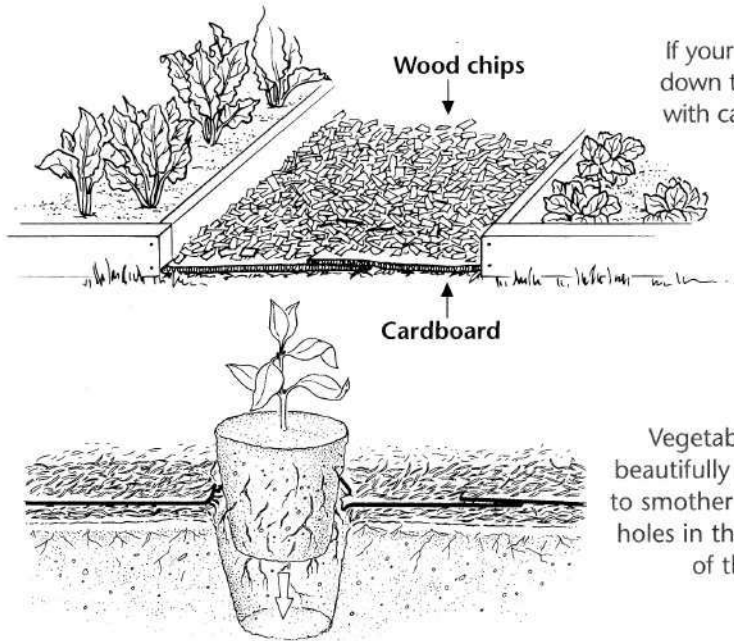

If your garden paths are weedy, just chop down the weedy tops and cover the paths with cardboard. Top off things with wood chips for prettier paths.

Vegetable and flower transplants grow beautifully in a bed mulched with cardboard to smother out competing weeds. Just punch holes in the cardboard and slip the rootballs of the transplants through into the soil underneath.

Basic Spread-It-On-Thick Mulch

You can use a wide variety of organic materials as mulch to smother weeds and improve the soil in the process. Whatever you use, make sure to spread it at least 3 inches thick to prevent sunlight from reaching the soil surface, says Margaret Sharpe, editor of *The Old Texas Rose* newsletter. She often mulches in the fall to prevent late-season weed growth, then tills the mulch under in spring at planting time.

Ingredients and Supplies

Wood chips, shredded bark, grass clippings, shredded leaves, cocoa mulch, compost, straw or hay, coffee chaff, seaweed (rinsed completely to remove salt), and much more!

Directions

Spread mulch ingredients in a 3- to 4-inch-deep layer around plants or on garden paths.

Note: Nearly any organic material can be used as a mulch, but some can have an impact on soil pH and fertility. Leaves, for example, can be either acid or alkaline. Margaret has a good supply of pecan leaves on hand, but she knows that they're alkaline, so she mixes in acidic pine needles to balance the pH. Some mulches are high in carbon and low in nitrogen. Sawdust, for example, will use up nitrogen as it decomposes, so it's a good idea to mix it with a nitrogen-rich material such as grass clippings.

Variations: Rose Marie Nichols McGee, president of Nichols Garden Nursery in Albany,

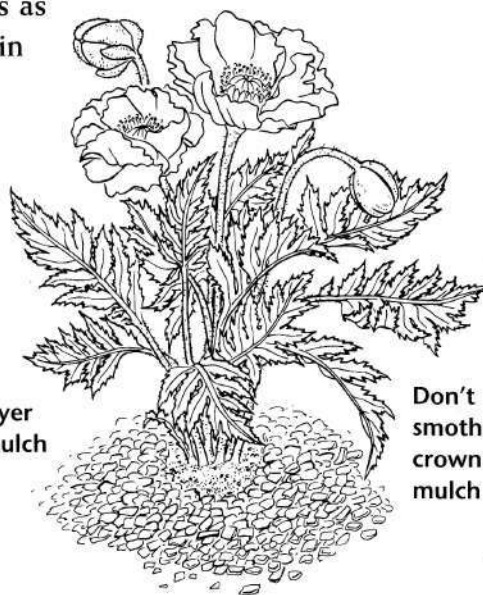

3" layer
of mulch

Don't
smother
crown with
mulch

Stop weeds with mulch! A 3"-thick layer of mulch around your plants keeps the soil too cool for many weed seeds to sprout.

It's also a tough barrier for delicate weed seedlings to push through.

Oregon, collects "mint straw" from local mint-oil producers to use as a mulch in the nursery's herb and vegetable gardens. "It holds down the weeds and improves the tith of our soil," she says. In Seattle, Barbara Donnette turned to local coffee roasters for free coffee chaff, which is produced in the roasting process. "It's acidic and provides a little bit of nitrogen," she says. Mary Lou Heard, owner of Heard's Country Gardens in Westminster, California, likes to mulch with cocoa shells. They're attractive, nicely scented, and they seem to discourage cats from digging in her garden.

HERB FORMULAS FOR WEED CONTROL (teaspoon chili powder)

Sprout 'n' Hoe Is the Way to Go

To protect young seedlings from weed competition, change your timing a tad. When you carefully work up a fine seedbed for sowing seeds, you usually bring weed seeds to the surface as well. You also may be cutting perennial weed roots into small pieces that look harmless but are still capable of resprouting. All too often, a crop of weeds springs up more quickly and aggressively than your precious plants.

Rodale garden book editor Fern Bradley outwits weeds by letting them sprout *before* she plants her seeds. "I welcome weeds to grow in my garden—for a week or two," Fern says. "Then I hoe them down to make way for the seeds I want to grow."

Ingredients and Supplies

- Digging fork or tiller
- Hand cultivator or trowel (optional)
- Soil amendments (optional)
- Rake
- Sprinkler
- Oscillating or scuffle hoe
- Seeds (of your choice)

Directions

1. Use a digging fork or tiller to cultivate the soil in the bed you want to plant.
2. If necessary, work over the bed by hand, using a hand cultivator or trowel to dig out tough perennial weeds and weed roots.
3. Dig or till the bed again, adding any soil amendments (such as compost or bonemeal) that are needed, and rake it smooth.

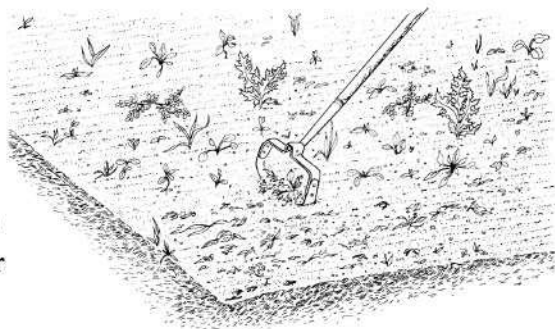
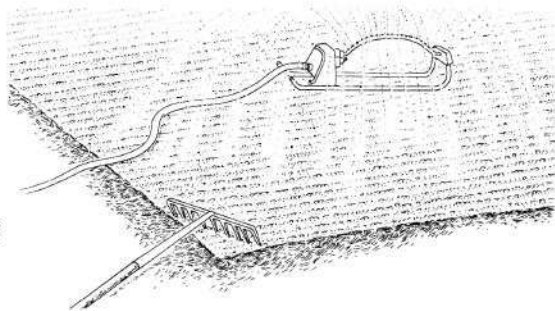

To get the jump on weeds in empty garden beds, prepare the bed just as you would for planting—but don't plant it right away! Instead, water it gently for a week or so to encourage weeds to sprout. Then, hoe the weed seedlings and pull perennial weeds by hand. The result: A nearly weed-free, ready-to-plant garden bed.

4. Water the bed as needed to keep it moist for 7 to 10 days. Weeds should sprout in the bed.
5. When the bed is covered with weeds that are 1 to 2 inches tall, carefully pull out any perennial weeds by hand.
6. Work the bed lightly with an oscillating or scuffle hoe to cut off weed seedlings just below the soil surface. This will kill the weed seedlings, leaving you a weed-free bed.
7. Carefully plant the bed with seeds of garden plants. Disturb the soil as little as possible to avoid bringing up any new weed seeds.

LEARN ABOUT THE NEW FORMULAS FOR WEED CONTROL. LEASPOON CHILI POWDER

Try a Rye Bed

To make a weed-free garden bed from scratch, try smothering the weeds in winter rye, suggests Julie Berbiglia, author of *The Lazy Gardener's Guide to Organic Gardening*. Julie says that she and her coworkers kept an 11 × 11-foot plot in rye all summer at the organic demonstration gardens of the Scarritt-Bennett Center's Organic Garden and Arboretum in Nashville, Tennessee. "By July, the rye was completely dried, and it had smothered out every kind of weed," says Julie. "The roots went down several inches and aerated the soil. When we pulled them up, the soil was very soft, without any digging."

Ingredients and Supplies

About 1 pound winter ryegrass seed for 500 feet

Directions

1. Sow winter rye in the fall.
2. Till it under in the spring, or let it grow out over the summer and till it under in fall.

Variation: You can save yourself a lot of time tilling down rye if you follow Julie's no-dig cover crop technique. When the rye reaches about 3 feet tall, lay cardboard over the rye, breaking and flattening the ryegrass beneath it. Then cover the cardboard with a 1-inch-thick layer of compost. In 1 to 2 months, the

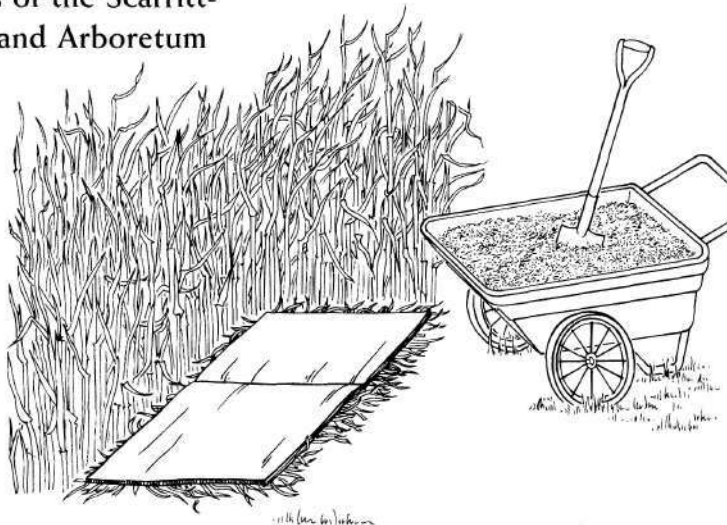

A dense crop of winter rye chokes out competing weeds and improves the soil. To kill the rye before it goes to seed, break the crop stems and lay flattened cardboard boxes on top. Cover the cardboard with an inch of compost. Let the rye decompose for several weeks and then plant straight into the compost.

rye and cardboard should be decomposed. "That created some of our richest plots," Julie says. "We planted our tomatoes in them, and we had tomatoes like I've never seen before."

CREATIVE COVER CROPS

"Using cover crops is probably the most important single aspect of our weed control," says Alan Kapuler, research director for Seeds of Change, an organic seed company in Santa Fe, New Mexico. You can sow seeds of traditional cover crops such as rye, hairy vetch, clovers, and buckwheat to add green matter to your soil and smother weeds. Or you can use your imagination to find other plants to fill space before weeds do. That's the key: no bare ground, Alan says. Along with traditional cover crops, Alan plants flowers, herbs, and even vegetables as cover crops to keep ground covered with desirable rather than pest plants. Here are some of the

more unusual (and effective) cover crops used by Alan.

Anise hyssop provides shelter and nectar for bees.

Bronze fennel offers shelter for beneficial insects.

Lettuce grows quickly and provides green matter that can be turned under the soil.

Marigolds discourage nematodes in the soil.

Peas add nitrogen to the soil.

Poppies provide beauty as well as weed control.

Sunflowers can be cut and left to decompose on the ground, where they act as a mulch and add carbon to the soil. ♡

Compost Your Weeds Away

If you don't want to dig out a weed patch to make way for a garden patch, take a lesson from California organic gardener Carrie Teasdale. She makes an on-site compost pile that not only provides humus for her garden but smothers weeds as well. Choosing a site where weeds are growing makes sense, Carrie says. "If there are weeds growing, that's a good place for a garden." She lets her on-site compost cook for several months, noting that the hotter the weather, the quicker it will break down.

Ingredients and Supplies

Horse manure
Dried leaves, shredded, or straw
Grass clippings
Fish meal or alfalfa meal (optional)

Directions

1. Cut weeds and let them fall in place.
2. Cover weeds with 4-inch-deep layers of horse manure and leaves or straw. If desired, sprinkle fish meal or alfalfa meal between layers to speed the process a bit.
3. Cover with a 2-inch-deep layer of grass clippings.
4. Allow to decompose in place.

Weed-Free Lawn Formula

A thick lawn is a weed-free lawn, says Michael Kaufman, owner of Kaufman Lawn Care, an organic lawn service company in Michigan. "You can't have two plants in the same place. So if you have a nice thick lawn, there's no room for weeds," says Michael. Fertilizing, reseeding (if necessary), and reducing thatch are among the basics of Michael's weed-busting formula. His special fertilizer mix also helps grasses survive drought.

Ingredients and Supplies

- 2 cups fish emulsion
- 2 cups seaweed extract
- 5 gallons water
- Hose-end sprayer

Directions

1. Evaluate the condition of your lawn. If it's relatively weed-free and doesn't have a thatch problem (see "How Thick Is Your Thatch?" on the facing page to learn about thatch), proceed to step 2. If your lawn contains more than 25 percent weeds or has more than ½-inch-deep buildup of thatch, you'll need to reseed or dethatch and reseed before proceeding to step 2.

2. Mix fish emulsion, seaweed extract, and water in the hose-end sprayer. You can also use just one of the fertilizers instead of both of them. In that case, use 2½ cups of fish emulsion, or 4½ to 5 cups of seaweed extract, with the 5 gallons of water.

3. In the spring, apply the fertilizer mixture to your lawn.

4. Repeat the application in fall.

Yield: Enough lawn rejuvenating formula to treat 5,000 square feet of lawn

Note: Especially weedy lawns require more drastic action. If your lawn is more than half weeds, your best bet is to till it under and start from scratch, Michael says. You don't have to sow the same type of grass that was growing there previously. Just ask your local seed supplier for the best types for your area, and make sure that you use disease-resistant hybrid seed.

ADDITIONAL FORMULAS FOR WEED CONTROL: 1 TEASPOON CHILI POWDER PER 5 GALLONS

"Orange" You Fond of Hummingbirds?

This simple formula lures hordes of hummingbirds—especially Anna's and black-chinned types—to Charity Hagen's yard in Wildomar, California. "If you want to *really* attract a lot of hummingbirds," Charity says, "add orange extract to the hummingbird nectar." She explains that you can buy orange extract at the grocery store or just squeeze orange juice into the hummingbird feed mixture.

Ingredients and Supplies

- 1 part sugar
- 3 parts water
- A few drops of
orange extract
or orange juice

Directions

1. Dissolve the sugar in the water.
2. Add the orange extract or orange juice and stir a few times. (Don't add red food coloring, since it's bad for the birds' health.)
3. Pour the mix into a hummingbird feeder, or store it in the refrigerator for up to 2 weeks.

Note: You probably won't have to worry about leftover nectar, since, according to Charity, "it keeps the hummingbirds coming back for more—they just can't resist it, and

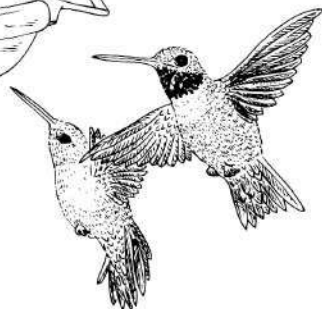
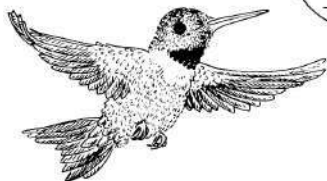
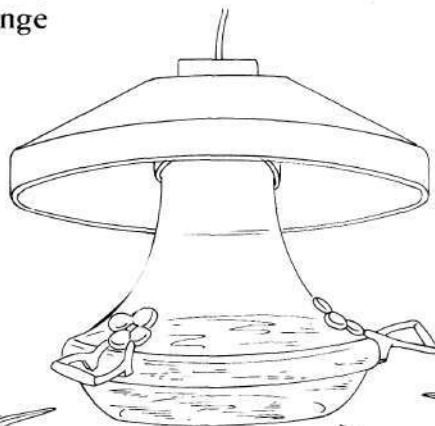

Look for ruby-throated hummingbirds (*right*) in the eastern half of the United States and in southeastern and south central Canada. Keep an eye out for black-chinned hummingbirds (*left*) and other species in the western states.

the orioles love it too!" But if any mix remains in the feeder after a week, discard it and replace it with fresh formula. Wash out the feeder before adding the fresh mix.

Birdsong Granola

This recipe is a "natural" for health-conscious birds! "I always make granola for my family," explains Diane Winslow, an avid birder and the owner of It's About Thyme herb nursery in Austin, Texas. "And as I read about what nutrients birds need, it seemed like a granola-like mix would be good for them, too." Your birds will love it!

Ingredients and Supplies

- 1 cup corn oil or peanut oil
- 1 cup honey
- 2 cups chopped nuts
- 2 cups millet
- 1 cup wheat germ
- 2 cups raisins or other dried fruit, except coconut
- 2 cups hulled sunflower seeds
- 2 cups crumbled dog biscuits

Directions

1. Mix the oil and honey, then heat gently just until they blend together.
2. Mix the other ingredients in a large bowl. Add the warm honey and oil, and stir to combine.
3. Press the mix into a shallow baking pan.
4. Bake at 375°F for 10 minutes.
5. Let cool, then crumble and serve to birds.

Yield: 11 cups of granola

Variations: You can use this recipe as a starting point, then add other ingredients as they become available. Diane adds crumbs from bread, cake, or crackers. "You can use any dried fruit except coconut, which swells in the bird's stomach," Diane cautions. In the winter, combine the granola with suet to supply the extra fat birds need to keep warm.

SERVING SUGGESTIONS

Scatter some Birdsong Granola on the ground and birds will come. But for a really good response from your feathered friends, follow the example of Charity Hagen of Wildomar, California. Charity says that the key to attracting lots of birds is the placement of the feeders.

To attract the greatest variety of birds, place your feeders at different sites and arrange them at different heights. Place several feeding trays or platforms on the ground, then set up one or two feeders a few inches above ground level. Arrange some feeders a foot or two off the ground, and hang other feeders higher up in trees. (Place the ground-feeders in an open area away from bushes and plants so that predators can't sneak up on the birds.)

When you use multiple feeding stations, you give ground-feeding birds all the room they need to eat in comfort. And by adding feeders at several different heights, you provide feeding options for birds that are too shy to feed directly on the ground. 🐦

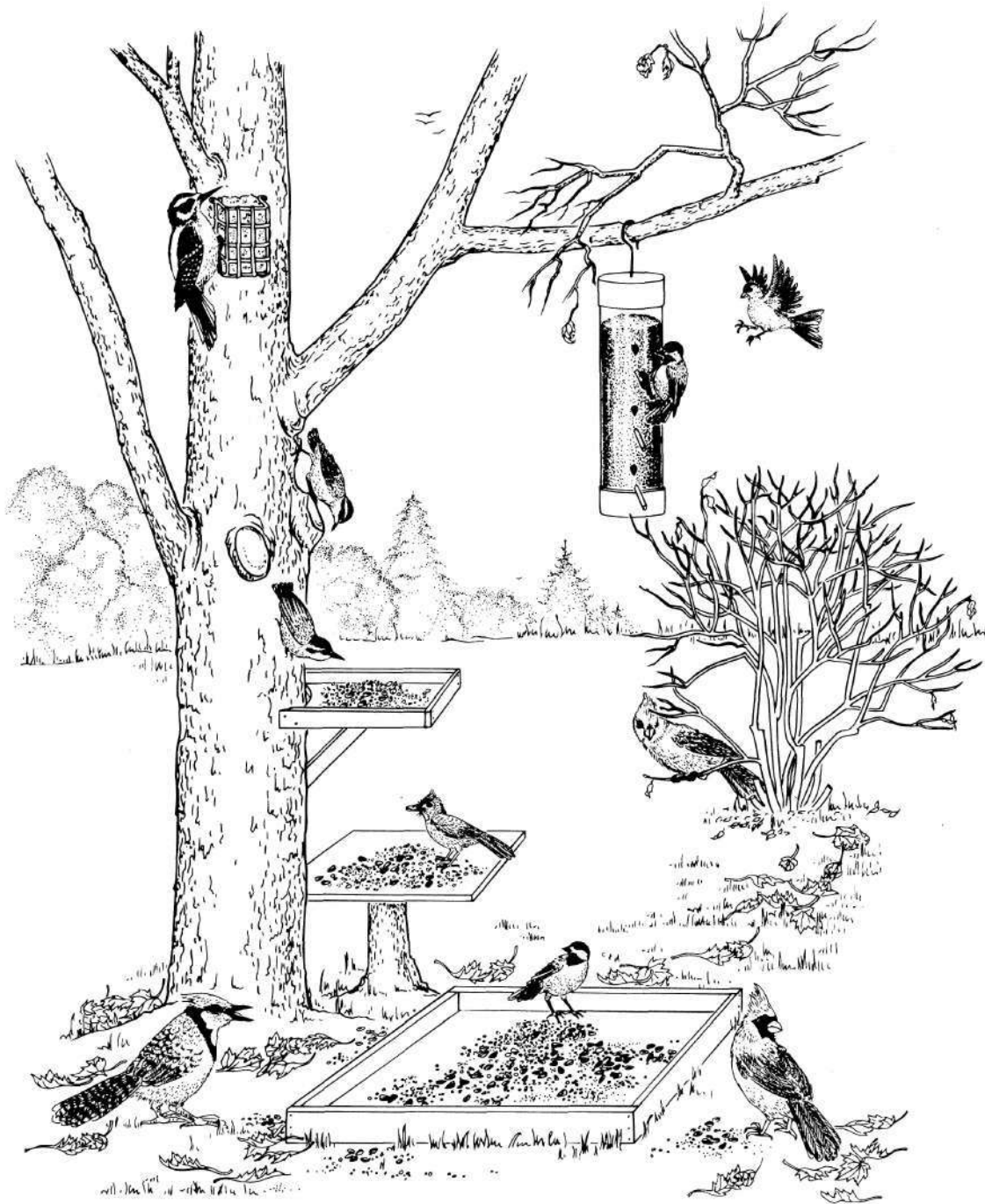

Make dining convenient for your feathered friends. A ground feeder makes eating easy for cardinals, while nuthatches prefer raised platform feeders. Titmice like any feeder that's set off the ground, and chickadees visit all kinds of feeders, including hanging types.

Suet Smorgasbord

Bird enthusiast Robin Guy feeds birds all year long at her home in Lake Forest, Illinois. The birds appreciate her offerings in spring, summer, and fall, but particularly enjoy a special treat she cooks up for them when cold winds blow. "In winter, once we've had a few hard freezes, we give the birds some extra fat in their feed in the form of suet," she says. Cherries and seeds make this mix particularly palatable to birds.

Ingredients and Supplies

- 1–1½ pounds beef fat
- ¼ cup millet (red and white mixed, if possible)
- ⅓ cup cracked corn
- ⅛–¼ cup safflower seeds
- ¾ cup chopped dried cherries
- Small containers, like plastic margarine or cottage cheese tubs
- Waxed paper

Directions

1. Warm the beef fat in a saucepan until it melts. Pour off the liquid as the fat melts to prevent it from burning.
2. Let the liquid fat cool slightly, then stir in the other ingredients. Robin notes, "All measurements are approximate. I never measure—I just add whatever is needed to make it look right!" It looks right, Robin says, when the seeds and fruit are almost touching each other, with the fat acting as a binder.
3. Line the containers with waxed paper and pour in the mix.
4. Refrigerate until cool, then store in the freezer until ready for use. You can put a suet cake out for the birds without thawing it.

FREE INGREDIENTS FOR YOUR SUET SMORGASBORD

You can get fruit and fat for suet mixes without spending a dime! Robin Guy gets the fruit for cherry suet from her cherry trees. She collects imperfect cherries with insect holes or bird damage, cuts up the fruit in halves or quarters, and dries them in her dehydrator. Then Robin stores the dried cherries in the freezer until winter when she makes suet. If you eat meat, follow Robin's example and cut the beef fat from your steaks. Freeze it in labeled packages until you're ready to make suet. Otherwise, you can get fat inexpensively or free from a butcher. 🐦

Pop a suet cake out of its container and hang it in a mesh bag or wire suet cage.

Yield: About 4 cups of suet

Variation: Cracked Corn Suet

Increase cracked corn to 1 cup. Replace cherries with ¼ cup black oil sunflower seeds.

Variation: Sunflower Suet

Decrease cracked corn to ¼ cup. Replace cherries with 1 cup black oil sunflower seeds.

A Bee-ootiful Garden

Be a friend to bees by growing plants that will attract them to your garden. A mixture of perennial herbs and self-sowing annuals attracts bees and adds beauty to your garden too, says Rose Marie Nichols McGee, president of Nichols Garden Nursery in Albany, Oregon. The plants in this mix are so easy to grow that "it's hard to go really wrong with it," she adds. (See "Flowers That Attract Beneficial Insects" on the facing page for plant descriptions.)

Ingredients and Supplies

- 1 seed packet sweet alyssum
- 1 seed packet catmint (or buy small transplants)
- 1 seed packet coriander
- 1 seed packet dill
- 1 seed packet tansy phacelia
- 1 seed packet poached egg flower or meadow foam
- 1 seed packet corn poppies
- 1 seed packet single-flowered sunflowers
- 1 seed packet white yarrow (or buy small transplants)
- Organic fertilizer (optional)

Directions

1. In early spring, prepare planting areas on the borders of your garden. A band of flowers 1 foot wide will bring bees and all kinds of other beneficial insects. Depending on the amount of seed per packet, this mix covers between 100 and 200 feet of border.
2. Sow small amounts of each type of seed on prepared ground that's moderately fertile



How can you tell if your black-and-yellow-striped visitor is a honeybee? Honeybees are hairy and about $\frac{3}{8}$ " long, with black and yellow stripes on their abdomens. When you see them in your yard, you know that they're hard at work pollinating your plants.





















and free of weeds. (In areas with mild winters, you can plant seed in the fall if you prefer.) For more on growing plants from seed, see page 267.

3. Gently water the seeds in and keep the ground evenly moist while the flowers are getting established (the first month or so after planting).
4. Once the seeds are up, water them with a diluted organic fertilizer, such as a weak solution of fish emulsion or liquid seaweed. If your soil is good and fertile, you can skip the additional fertilizer.

FLOWERS THAT ATTRACT BENEFICIAL INSECTS

When you plant this mix of annual and perennial flowers in your yard, you'll provide food for hungry bees who will repay you by pollinating the

plants in your garden. These blooms will also attract other beneficial insects, including hover- or syrphid flies, lacewings, lady beetles, and parasitic wasps.

PLANT	 DESCRIPTION  HARDINESS ZONES
Sweet alyssum <i>(Lobularia maritima)</i>	 Clusters of ¼-inch-wide pink, purple, or white flowers on 4- to 8-inch-tall mounded plants  Annual
Catmint <i>(Nepeta × faassenii)</i>	 Perennial with ½-inch-wide blue-violet flowers on long stems; plants grow 1½ to 2 feet tall  Zones 3 to 8
Coriander <i>(Coriandrum sativum)</i>	 Herb with tiny white flowers on 1- to 3-foot tall plants  Annual
Dill <i>(Anethum graveolens)</i>	 Herb with yellow-green flower heads and feathery foliage; plants grow to 3 feet tall  Annual
Tansy phacelia <i>(Phacelia tanacetifolium)</i>	 Bell-shaped blue to lavender flowers on 1- to 4-foot-tall plants; wear gloves when handling this plant, since it causes some gardeners to break out in a rash  Annual
Poached egg flower or meadow foam <i>(Limnanthes douglasii)</i>	 Flowers that have yellow centers and white edges; spreading plants grow to 1 foot tall  Annual
Corn poppy, Shirley poppy <i>(Papaver rhoeas)</i>	 3- to 4-inch-wide pink, purple, red, or white flowers; plants grow 2 to 3 feet tall  Annual
Single-flowered sunflower <i>(Helianthus annuus)</i>	 Yellow, orange, or maroon flowers with dark centers; flowers are up to 1 foot wide on 1- to 12-foot-tall stems (size depends on variety)  Annual
White yarrow <i>(Achillea millefolium)</i>	 Perennial with 2- to 3-inch-wide flowers on 1- to 2½-foot-tall plants  Zones 3 to 9

BIRD, BUTTERFLY, & BENEFICIAL INSECT FORMULAS

ANNUAL FLOWERS FOR THE BIRDS

These annuals produce seeds that birds like to eat. All of these flowers thrive in full sun, so choose an open spot for your bird-garden planting.

PLANT	DESCRIPTION
Sweet alyssum (<i>Lobularia maritima</i>)	Pink, purple, or white blooms appear in ¾-inch-wide clusters on 6- to 12-inch-tall mounds of foliage
Grain amaranth (<i>Amaranthus hypochondriacus</i>)	Spiked flower heads grow 1 foot tall and are red, green, or marbled red and green; the seed heads are beautiful; plants grow 6 feet tall
China aster (<i>Callistephus chinensis</i>)	Blue, rose, or white blooms are 2½ inches wide; plants grow 2 feet tall
Bachelor's buttons (<i>Centaurea cyanus</i>)	Blue, pink, purple, red, or white blooms grow 1 to 2 inches wide on 12- to 30-inch-tall plants
Black-eyed Susan (<i>Rudbeckia hirta</i>)	Daisylike yellow blooms have brown centers and grow 2 to 3 inches wide; plants grow 1 to 3 feet tall
Cosmos (<i>Cosmos bipinnatus</i> and <i>C. sulphureus</i>)	Blooms are 1 to 2 inches wide; <i>C. bipinnatus</i> has pink, white, or crimson ray flowers with a yellow center; plants grow 4 to 6 feet tall; <i>C. sulphureus</i> has yellow, red, or orange daisylike blooms on 2- to 3-foot-tall stems
Flax (<i>Linum usitatissimum</i>)	Blue or white delicate ½-inch-wide blooms grow on 3- to 4-foot-long stems
Larkspur (<i>Consolida orientalis</i>)	Blue, rose, violet, or white blooms are 1¼ inches long and grow on long spikes; plants grow 1 to 2 feet tall
Pincushion flower (<i>Scabiosa atropurpurea</i>)	Rounded 2-inch-wide blooms come in blue, cream, lavender, maroon, pink, and white; plants grow 2 to 3 feet tall
Corn poppy, Shirley poppy (<i>Papaver rhoeas</i>)	Four-petaled 2-inch-wide blooms come in deep purple, red, or white; plants grow 2 to 3 feet tall
Sunflower (<i>Helianthus annuus</i>)	Yellow, red, and rust-colored blooms grow 3 to 12 inches wide on plants that are 1 to 12 feet tall (size depends on the variety)

A Fluttery Butterfly Garden

Butterflies can't live on nectar alone. If you want to attract lots of butterflies and get them to stick around, try this three-part recipe from LuAnn Craighton, a naturalist with the education department at Callaway Gardens in Pine Mountain, Georgia. LuAnn says the first step is to pick a place with the right living conditions. Next, grow a variety of plants. And third, care for the plants organically.

Ingredients and Supplies

- 10 nectar-producing flowers for adult butterflies (see "Pick the Right Nectar Plants" on page 186)
- 10 host plants for butterfly caterpillars (see "Pick the Right Caterpillar Host Plants" on page 188)
- 1 (or more) 3 × 3-foot sunny garden spots sheltered from strong winds
- 1 or 2 flat stones (for warming spots)
- Shallow puddle or terra-cotta saucer filled with wet sand and laced with a few dashes of Epsom salts
- 1 seat (for butterfly watching)

Directions

1. In a spot that gets at least 6 hours of sun each day, plant a variety of plants that attract butterflies and provide food for their young.
2. Add 1 or 2 flat stones where the butterflies can warm themselves.
3. Provide a puddle or other shallow water source so that your butterflies can drink or search for salts.
4. Site a bench where you can enjoy the show!

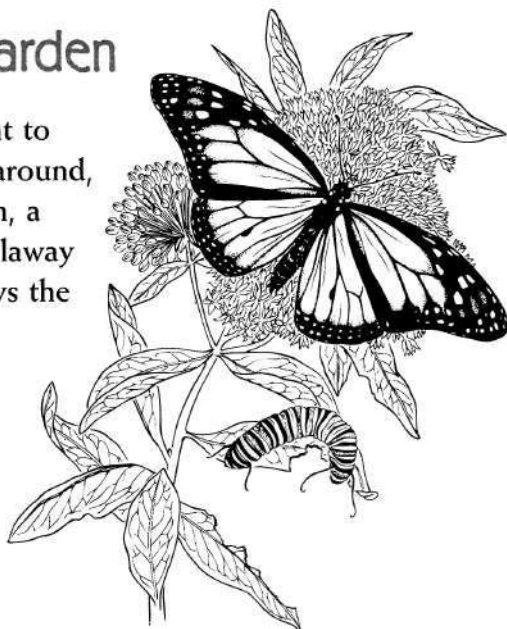

Protect the caterpillars that have yellow, black, and white stripes when you see them on your milkweeds! They'll munch on the milkweed plants, then turn into majestic monarch butterflies.





















FLUTTERY FACTS

- Butterflies are cold-blooded and don't get moving until their body temperature reaches about 80°F.
- When butterflies gather in groups around puddles, they're after salts in the mud, not just the water.
- Larvae chew holes in the leaves of host plants, but seldom harm the plant.
- The organic caterpillar killer BT (*Bacillus thuringiensis*) controls cabbage loopers and other vegetable-eating larvae. But it will also kill butterfly larvae if it drifts to their host plants. Avoid BT and hand-pick problem caterpillars, or be *extremely* careful if you use BT.
- In hot, dry climates, butterflies appreciate dappled shade in the heat of the day. 🦋

PICK THE RIGHT NECTAR PLANTS

You don't have to resort to trial-and-error to find out which plants attract butterflies. Ann Swengel, a vice president of the North American Butterfly Association (NABA), suggests growing

some of these nectar and host plants as a starting point for attracting a variety of butterflies. For a much longer list, write to NABA at 4 Delaware Road, Morristown, NJ 07960.

PLANT	 DESCRIPTION  HARDINESS ZONES
Black-eyed Susan <i>(Rudbeckia hirta)</i>	 Yellow and brown daisylike blooms; 2- to 3-foot-tall hairy-leaved plant  Annual
Purple coneflower <i>(Echinacea purpurea)</i>	 Rose-pink daisylike blooms; 2- to 4-foot-tall perennial  Zones 3 to 8
Yellow cosmos <i>(Cosmos sulphureus)</i>	 Yellow, orange, or red daisylike blooms; 2- to 3-foot-tall bushy plants  Annual
Goldenrods <i>(Solidago spp.)</i>	 Plumelike clusters of golden or yellow blooms; 1- to 5-foot-tall perennial  Zones 3 to 9
Impatiens <i>(Impatiens wallerana)</i>	 Flat, spurred blooms in lavender, pink, red, orange, or white; 6- to 24-inch-tall, neatly mounded plants  Annual
Joe-Pye weeds <i>(Eupatorium spp.)</i>	 Substantial clusters of fuzzy rose-purple flowers; bold 3- to 12-foot-tall perennials  Zones 3 to 8
Lantanas <i>(Lantana spp.)</i>	 Flat-topped clusters of red and yellow or pink blooms; 18-inch- to 4-foot-tall shrubby plant  Zones 8 to 10 (treat as an annual farther north)
Lupines <i>(Lupinus spp.)</i>	 Dense 2-foot-long spikes of pealike flowers in shades of pink, white, blue, purple; bushy perennials grow 2½ to 3½ feet tall  Zones 3 to 6
French marigold <i>(Tagetes patula)</i>	 Daisylike to rounded red and yellow blooms (choose single-flowered cultivars instead of doubles—butterflies can reach the nectar more easily); 6- to 20-inch-tall plant with strongly scented leaves  Annual

FLOWERS

























RECIPE FOR THE BEST BIRD BUTTERFLY & BEANFEEDING INSECT FORMULAS

PLANT		DESCRIPTION	HARDINESS ZONES
FLOWERS	Mints (<i>Mentha</i> spp.)	Spikes of small, 2-lipped purple, pink, or white flowers bloom at top of plants; bushy, spreading perennials grow to 2 feet tall	Zones 5 to 9
	Pineapple sage (<i>Salvia elegans</i>)	Small bright red 2-lipped blooms; 2- to 3-foot-tall herb with fragrant leaves	Annual
	Rose verbena (<i>Verbena canadensis</i>)	Rounded clusters of purple, rose, or white blooms; 8- to 18-inch-tall perennial	Zones 4 to 10 (treat as an annual farther north)
	Brazilian vervain (<i>Verbena bonariensis</i>)	Rounded clusters of tiny violet blooms; 3- to 4-foot-tall perennial	Zones 7 to 9
	Zinnia (<i>Zinnia elegans</i>)	Round, flat, or mounded blooms in every color but blue; 6- to 36-inch-tall plants grow low and mounded or upright and bushy	Annual
SHRUBS	Glossy abelia (<i>Abelia</i> × <i>grandiflora</i>)	Clusters of small pinkish purple or white blooms; 3 to 6 feet tall and wide; rounded, semi-evergreen shrub	Zones 6 to 10
	Azaleas (<i>Rhododendron</i> spp.)	Lavender, orange, pink, red, white, or yellow funnel-shaped blooms; 1 to 20 feet tall (depending on species); evergreen and deciduous shrubs	Zones 4 to 9
	Orange-eye butterfly bush (<i>Buddleia davidii</i>)	Pink, purple, red, or white fragrant lila-like blooms; 5- to 15-foot-tall arching plant that flowers best if cut back to the ground each spring	Zones 5 to 10
	Lilacs (<i>Syringa</i> spp.)	Large, very fragrant blue, lavender, pink, or white bloom clusters; 4- to 20-foot-tall upright plants look loosely rounded over time	Zones 3 to 7

PICK THE RIGHT CATERPILLAR HOST PLANTS





















Butterflies typically lay their eggs on the plants that their caterpillars feed on. If you want to attract a specific butterfly, provide the food plant or plants

that it needs to survive. Caterpillars are always hungry, so don't be surprised when they munch the plant leaves to pieces!

PLANT	 DESCRIPTION  HARDINESS ZONES  BUTTERFLIES ATTRACTED
Asters (<i>Aster</i> spp.)	 Mounds of purple, pink, red, or white daisylike blooms; 1- to 8-foot-tall bushy plants  Zones 2 to 8, depending on the species  Pearl and northern crescents
Clovers (<i>Trifolium</i> spp.)	 White, red, or pink ball-like flowers; plants range from low creeping forms to 2 feet tall  Annual, biennial, or perennial, depending on the species  Clouded sulphurs and acmon blues
Herbs (dill, carrots, fennel, and parsley)	 Yellow, greenish, or white flat-topped or ball-like clusters (called umbels); fragrant feathery foliage for all but parsley, which has flat or curled leaves  Annuals or biennials  Black and anise swallowtails
Hollyhock (<i>Alcea rosea</i>)	 Large white, pink, red, or yellow bowl-shaped blooms; 3- to 6-foot-tall flower stems  Biennial grown as an annual  Painted and west coast ladies and common checkered skippers
Milkweeds (<i>Asclepias</i> spp.)	 Clusters of green, orange, yellow, pink, or purple blooms; 1- to 5-foot-tall flower stems  Zones 3 to 9  Monarchs
Wild petunias (<i>Ruellia</i> spp.)	 Solitary or loose clusters of trumpet-shaped blooms in red, pink, or blue; 1- to 3-foot-tall perennials  Zone 10  White peacocks
Snapdragon (<i>Antirrhinum majus</i>)	 Spikes of tubular 2-lipped flowers in every color but blue; 1- to 4-foot-tall low mounded or tall spiky plants  Annual  Common buckeyes

HERBACEOUS PLANTS

RED BUTTERFLY & BENEFICIAL INSECT FORGOTTEN

	PLANT	 DESCRIPTION  HARDINESS ZONES  BUTTERFLIES ATTRACTED
HERBACEOUS PLANTS	Sunflower <i>(Helianthus annuus)</i>	 Large yellow daisylike blooms; sturdy 2- to 12-foot-tall flower stalks (size depends on the cultivar)  Annual  Gorgone checkerspot (these butterflies are found only in and near the Great Plains, so don't expect to attract them elsewhere)
	Violets <i>(Viola spp.)</i>	 Blue, violet, white, red, orange, or yellow blooms; 1- to 12-inch-tall plants  Zones 3 to 9, depending on the species  Some fritillaries
TREES	Cherries <i>(Prunus spp.)</i>	 Large group of trees and shrubs, many ornamental and others popular for their stone fruits; clusters of white to pink single or double flowers  Zones 2 to 10, depending on the species  Some tiger swallowtails, coral hairstreak, Lorquin's admiral
	Citrus <i>(Citrus spp.)</i>	 Evergreen shrubs to small trees, several popular for their fruits; white or purple flowers produced singly or in clusters  Zones 8 to 10, depending on the species  Some swallowtails
	Oaks <i>(Quercus spp.)</i>	 Large group of deciduous or evergreen trees and some shrubs, with acorn fruit; greenish male flowers in drooping catkins, female flowers single or in small spikes at base of leaves, both male and female on same plant  Zones 3 to 10, depending on the species  Some hairstreaks, some duskywings
	Willows <i>(Salix spp.)</i>	 Large group of shrubs and trees, many grown as ornamentals; tiny yellow or green flowers in catkins, male and female on separate plants  Zones 2 to 9, depending on the species  Some fritillaries, some swallowtails, some tortoiseshells, some admirals, some hairstreaks, faunus anglewing, viceroy, mourning cloak, red-spotted purple

The Pleasures of Herbs

Herbs may be the most versatile plants on earth. Of course, they're unsurpassed for spicing up virtually any dish, but herbs offer much more than seasoning. The seeds, leaves, and even roots of culinary herb plants are power-packed ingredients outside the kitchen, too. Hard-working herbs can be used as natural cleansers and disinfectants. Some herbs can brighten a room with their scent. Others add natural beauty to crafts and gifts.

Part of the appeal of herbs is their intense fragrance and flavor. In many of the formulas in this chapter, a spoonful or two of concentrated herb oil is all that's required. You'll find a rich choice of formulas that will help you get the most from your herb garden. But before you can use them to their best potential, you need to know how to harvest and store herbs.

Harvesting Fresh Herbs

There's nothing like the luxury of knowing that you have a supply of fresh herbs growing just steps away from the kitchen. Because nothing beats the flavor of just-picked herbs, the best time to harvest herbs is when you need them! However, if it's more convenient to plan ahead, early in the day is the best time for harvesting. Head out to the garden with sharp scissors or clippers just after the morning dew has evaporated.

Unless it's time to harvest the whole plant, think of harvesting as pruning the

plant for continued growth. Clip off up to one-fourth of the plant by pruning the tips or cutting off whole stalks that detract from the plant's appearance.

If you won't be using the herbs right away, shake off any surface dirt and submerge the stalks upright in a glass of water. To store for longer than a day, place the glass in a plastic bag, tie it loosely with a twist-tie, and refrigerate. Alternately, you can wrap the cuttings in a damp paper towel and enclose the bundle in a plastic bag. Either way, most herbs will stay fresh for up to three days when refrigerated.

To prepare fresh herbs for cooking, snip the leaves from the stalk with scissors, allowing the leaves to fall onto a cutting board. Then mince the leaves with a sharp knife. You can also roll a small handful of the herb into a ball and use sharp scissors to cut the herbs into fine pieces. You can use a food processor to chop large amounts of herbs, but if you try this method, take care not to over-process the herbs or you'll end up with green mush.

You can use fresh herbs in place of dried herbs in any recipe. Simply increase the amount of dried herb that's called for with two- to three-fold that amount of fresh herb. This takes into consideration the loss of water in dried herbs: As herbs dry, their flavor becomes concentrated. In most recipes, it's best to add either fresh or dried herbs in the last 15 minutes of cooking to retain the most delicate flavor.

Drying Herbs

You can dry herbs throughout the growing season as time allows. For best results, harvest them on a sunny day during a dry spell, and wait until the morning dew has evaporated before harvesting. If evening is the best time for you, harvest before the dew forms again. Harvest the herbs with scissors as described on page 191, and shake off any surface dirt. Then cover the cuttings with a towel as you work to protect them from shriveling in the burning sun.

Don't bother to wash the herbs unless they are very muddy. Just begin drying them as soon as possible using one of the following techniques:

To hang-dry herbs, first lay stalks on a counter and sort by size. Bunch four or five stem ends together and fasten tightly with wet twine, rubber bands, or twist-ties. Hang the herbs out of direct sunlight in a dry area with good air circulation. You can string a clothesline in an unused room of your home and use clothespins to secure bunches of herbs to the line. If there is no available space out of direct sunlight, put the herbs in paper bags with the stem ends coming out of the top of the bag. Cut several holes in the bags to allow for air circulation, and hang them.

For screen drying, set up screens on wood blocks to provide air space. Set them out of direct sunlight. The herbs can be just touching each other, as they'll shrink. Lay herbs in a single layer on each screen. If you don't have a good supply of screen, you can spread out the herbs in a single layer in wicker baskets for drying.



To prepare a cup of chopped herbs quickly, place the leaves in a teacup and snip with scissors until the herbs are uniformly minced.



For quick salad garnishes, roll a handful of fresh herbs into a ball and snip them with scissors, letting the pieces fall into your salad.

Probably the easiest way to dry herbs is with a food dehydrator. Just follow the instructions that come with the dehydrator.

You can also dry herbs in a microwave oven. Spread a cup of herbs in a single layer between paper towels. Microwave on high for 30 seconds. Turn the herbs over and microwave on high for another 30 seconds. Repeat this process until the herbs feel brittle and rattle when you shake the paper towels. Total drying time is about 3 minutes. Take care not to overcook or the herbs will taste scorched.

To dry herbs in direct sunlight, place them stem side up in a paper bag that has several holes cut out for air circulation. Attach the bag to a string or clothesline using clothespins.

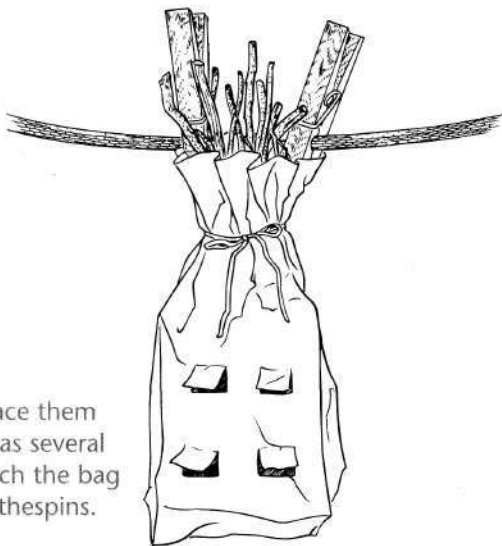

Storing Herbs

Although herbs hanging in the kitchen add a homey touch, leaving them exposed to moisture in the air for too long will eventually degrade their flavor. Therefore, as soon as the herbs are crackly dry, remove the leaves from the stalks. Be careful not to crumble the leaves or you'll lose some of the aromatic oils. Place the leaves in airtight containers. Glass or ceramic containers are your best choice because metal and plastic can affect the flavor of delicate herbs. Store the containers in a cool, dark place away from heat for up to a year.

To use home-dried herbs in recipes, crumble the leaves when measuring to get an accurate measure and then proceed as directed. If you need to buy dried herbs, check for a fresh smell and bright color.

Once herbs are harvested or safely stored, you're ready to unleash their power in our homemade formulas for savory seasonings, like vinegars and herb-flavored oils, in refreshing teas, or in many of their useful guises in cleansers, potpourris, or candles.

HERBAL CUBES

Herbs like parsley and basil have a lot of moisture in their leaves. Although hang drying will work, freezing often gives more flavorful results. To prepare, place 2 cups of herbs in the blender with 4 cups of water, and blend until herbs are well distributed in the water. Then freeze the herbal water in ice cube trays. When frozen, unmold and place in plastic zipper bags, then label. To use, drop an herb cube into sauces, soups, or stews during the last 15 minutes of cooking. If you don't want added water in the recipe, defrost the cubes in a small container and strain out the water.

It's also easy to freeze herbs in oil for recipes such as pesto. To prepare, chop the basil (or other herb of your choice) in a food processor, add just enough olive oil to make a paste, and then freeze in yogurt cups. 🌿

HERBAL FORMULAS FOR COOKING AND GREAT TASTE

Warm and Spicy Tea

Although delicate leaves and flowers are the most common herb tea ingredients, pungent roots, barks, and spicy seeds also make tasty brews. But these tougher plant components need a little boiling for best flavor. "This is my husband's favorite tea," says Mindy Toomay, cookbook writer and author of *A Cozy Book of Herbal Teas*. "This blend is also good iced, but you must double the strength as the melting ice cubes will dilute it."

Ingredients and Supplies

- 3 cups water
- Stainless steel, enamel, or glass saucepan
- 2 slices fresh ginger root, each slice
 $\frac{1}{4}$ inch thick
- 2 teaspoons dried rose hips, crushed
- 1 teaspoon dried aniseed
 (*Pimpinella anisum*), crushed
- Strainer

Directions

1. Bring water to a boil in the saucepan.
2. Pound ginger slices gently with the broad side of a knife to break up the pulp.
3. Place the ginger, rose hips, and aniseed in the boiling water, reduce the heat to medium, and simmer, uncovered, for 5 minutes.
4. Strain and pour the mixture into a warmed teacups.
5. Sweeten with honey, if desired.

Yield: 2 cups of root seed tea

BREWING THE BEST TEA

Most commonly, tea is made by the process of "infusion," which involves pouring boiling water over herbs and allowing the brew to steep before drinking. The French term "tisane" is also used to describe this process. This method is the best for making tea from herb leaves and flowers. "Decoction" is the technical term for boiling plant materials in water to make tea. This is the preferred method for brewing tough plant parts, like barks, seeds, and roots, and coarse leaves, like bay leaves. Some herbal tea recipes combine both delicate and coarse materials. In this case, boil the tough parts first, strain, and pour the liquid over the remaining herbs in a teapot. ☛

Fancy Ice Cubes Dress Up Cold Drinks

For that special touch when serving iced tea or other cold beverages, pour them over floral ice cubes. To create the colorful cubes, just add whole blossoms or individual petals of any edible flower, such as calendula or violets, to ice cube trays. The floral ice is perfect for chilling drinks, including herbal teas, at a summer garden party.

Ingredients and Supplies

Blossoms or petals of borage, calendula, pansies, roses, thyme, or violets
Ice cube trays

Directions

1. Gather edible flower blossoms and rinse them in cold water to remove garden dust or bits of soil. Gather only blossoms from plants that have never been sprayed or treated with any type of insect- or disease-killing sprays.
2. Fill ice cube trays half-full with water.
3. Put 1 blossom (for small-petaled flowers) or 1 individual petal (of large-petaled flowers) in each compartment of the tray.
4. Put the trays in the freezer and freeze the cubes until set.
5. Remove the trays from the freezer and fill them to the top with water.
6. Return the trays to the freezer and let the cubes freeze solid.

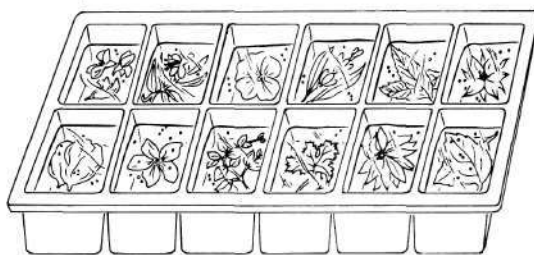

The secret to making ice cubes with flower and herb blossoms in the center is to fill ice cube trays only halfway with water and flowers at first. Freeze the partially-filled trays enough to set, then top the trays with more water and freeze them solid.

Caution: Before using any type of flower to make floral ice cubes, be sure that you've verified that the flower is edible and that you've identified the flower correctly. If you're in doubt, contact your local Cooperative Extension Service for information on edible flowers and for help in identifying particular flowers. Don't use flowers from plants that have been fertilized with manure or manure tea. Also, never make floral ice cubes with flowers that you've bought from a florist or supermarket—the flowers may have been treated with chemical sprays.

All-In-One Herbal Vinegar

Pat Reppert, owner of Shale Hill Farm and Herb Gardens in Saugerties, New York, hosts a daily radio cooking show and makes gourmet herbal specialties, including single-ingredient and combination herbal vinegars. She finds that single-herb vinegars sell best because they're more versatile in cooking and because they add zip to salads and sauces without fat, sugar, or salt.

Ingredients and Supplies

- 1 quart white wine vinegar (5% acidity)
- Stainless steel saucepan
(don't use aluminum or cast iron)
- 1-quart glass jar with tight-fitting lid
- Fresh herbs (like tarragon, basil, salad burnet, dill, or mint)
- Strainer
- Coffee filter
- Funnel
- Glass bottles with caps (vinegar will rust metal caps and lids)

Directions

1. Heat the vinegar in the saucepan until it's almost ready to bubble, but don't let it boil. Meanwhile, wash and rinse the glass jar and fill it with boiling water.
2. Let the jar sit for a minute or two, then pour out the water, and loosely fill the jar $\frac{1}{2}$ full with herbs. (Pat doesn't wash the herbs unless they're dirty.)
3. Pour the hot vinegar over the herbs, filling the jar to the top.
4. Cap the jar and store the mixture in a cool, dark place.

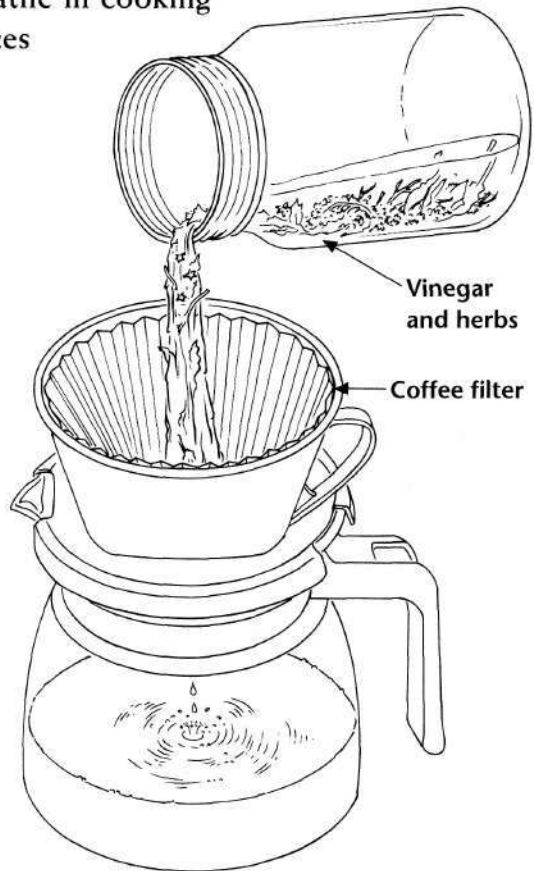

A coffee filter is perfect for straining out herbs when you make herbal vinegar.

5. After 1 month, strain the plant material out of the vinegar.
6. Line the funnel with a coffee filter and pour the vinegar through the filter to strain again.

7. Pour the vinegar into a saucepan and heat it to the simmer stage. (Again, don't let it boil.) Skip this step if you used basil, because basil loses its delicate flavor with heat.
8. Pour the hot vinegar into sterile hot bottles.
9. If desired, add a sprig of the fresh herb for decoration.
10. Cap the bottles with sterile caps.

Yield: 1 quart of herb vinegar

Note: Substitute herbal vinegar for all or part of the vinegar in recipes for salad dressings, marinades, sauces, mustards, baked

beans, pickles, and chutney. Also try adding a splash to soups (especially bean), stir-fries, cooked greens, gravies, and sauces.

Variation: Herbalist Julie Manchester of Woodsong Herbals in Randolph, Vermont, who makes and markets gallons of herbal vinegar each year, says that her best-selling combination is rosemary, shallots, and tarragon in red wine vinegar. A close runner-up, and personal favorite, is opal basil, garlic, and thyme in white wine vinegar. "The color from the opal basil is fabulous!" she says.

MULTI-HERB VINEGARS

When making flavored vinegars, your recipe is limited only by your imagination. In fact, the possible combinations sometimes seem overwhelming. Maggie Oster, author of *Herbal Vinegar*, grows herbs in Louisville, Kentucky, and has experimented with hundreds of flavored vinegars.

Maggie suggests that if you're using spicy ingredients, like hot peppers, garlic, or herb seeds, you should start with 1 scant tablespoon per cup of vinegar. "Check the flavor every week," she advises, "and feel free to make adjustments." For the freshest flavor, use flavored vinegars within 6 months after opening. Unopened, most vinegars will last at least 1 year. Store flavored vinegars in a cool, dark place.

Apple cider vinegar. Try dill, bay, and garlic; horseradish, shallot, and hot red

pepper; or dill, mustard seeds, lemon balm, and garlic.

Champagne or rice vinegar. Flavor with lemon balm, lemon verbena, lemon thyme, lemongrass (*Cymbopogon citratus*), and lemon zest.

Red wine vinegar. Select sage, parsley, and shallots; marjoram, salad burnet (*Sanguisorba minor*), and lemon balm; or cilantro, garlic, and fresh ginger root.

White wine vinegar. Choose tarragon, elder flowers (*Sambucus canadensis* or *S. nigra*), spearmint, lemon balm, shallot, garlic, whole cloves, and peppercorns; orange mint, coriander seeds, garlic, and orange zest; or rosemary, thyme, marjoram, savory (*Satureja* spp.), lavender, bay, garlic, and hot red pepper. 🌿

Invigorating Vinegar Tonic

Herbalist Susun Weed, author of *Wise Woman Herbal* and founder of the Wise Woman Center in Woodstock, New York, uses herbal vinegars to boost the mineral count in her diet. "Many herbs and weeds are extremely high in minerals," she says. "And ordinary apple cider vinegar dissolves the minerals from plant tissues and puts them into a form that your body can assimilate. Many of these plants have excellent nutritive qualities beyond adding minerals to the diet," Susun adds. "For example, purslane contains more omega-3 fatty acids than any other known plant."

Ingredients and Supplies

- 1-quart glass bottle with nonmetal lid
- 1 quart pasteurized apple cider vinegar (5% acidity)
- Fresh herbs and wild plants
- Waxed paper and rubber band (optional)

Directions

1. Fill the jar loosely with any 1 fresh plant material, cut small.
2. Pour vinegar over the herb, filling the jar to the top.
3. Label the jar and cap, or cover with waxed paper attached with a rubber band.
4. Let the vinegar stand in a cool, dark place for at least 6 weeks. "Sometimes I don't bother to strain it," confesses Susun. "I just eat the pickled plant material as well as putting the vinegar on salads, in marinades, and in lentil and bean soups."

Yield: 1 quart of vinegar tonic



Because vinegar will rust metal, it's best to store herbal vinegars in jars with plastic or other nonmetal lids. If you use a metal lid, cover the mouth of the jar with waxed paper before screwing on the lid.

HEALTH-BUILDING HERBS FOR HERBAL VINEGARS

For a zesty way to add bone-building calcium to your diet, herbalist Rosemary Gladstar, author of *Herbal Healing for Women* and founder of Sage Herbal Retreat Center in East Barre, Vermont, recommends a vinegar blend using equal parts of alfalfa, nettle, oat straw, and raspberry leaves.

Herbalist Susun Weed uses a variety of cultivated and wild herbs to make her Invigorating Vinegar Tonic. Here are some of Susun's recommendations:

Cultivated herbs: thyme, catnip, bee balm (also known as bergamot), lemon balm, sage, lavender, and horseradish root

Wild herbs: dandelion root or leaf (*Taraxacum officinale*), chickweed (*Stellaria media*), yarrow, goldenrod flowers (*Solidago* spp.), bugleweed (*Lycopus* sp.), purslane (*Portulaca oleracea*), self-heal (*Prunella vulgaris*), burdock root (*Arctium minus*), and wintergreen (*Gaultheria procumbens*) 🌿

Salt-Free Herbal Seasoning

Herbalist Kathy Lee, founder of Walk in Beauty, a retail herb shop and mail-order supplier in Colfax, California, really enjoys creating recipes that combine high nutrition with good flavor. She says that it's easy because "all of the Mediterranean herbs are high in healthful antioxidants." This tasty seasoning mix adds great flavor to food without adding salt. Toasted sesame seeds add beneficial calcium to this mix.

Ingredients and Supplies

- 1 cup sesame seeds
- Small cast-iron frying pan
- 2 tablespoons garlic powder
- 1 tablespoon dried rosemary
- 1 tablespoon dried marjoram
- 1 tablespoon dried thyme
- 1 tablespoon dried lemon zest
- Blender or food processor
- Airtight storage container

Directions

1. Toast sesame seeds in a cast-iron pan over medium heat until brown, but not burned.
2. Cool toasted seeds slightly, then blend them with remaining ingredients.
3. Store the mixture in an airtight container.

Yield: About 1½ cups of herbal seasoning

Powerhouse Herbal Blend

This unusual blend of kitchen herbs and wild greens is a satisfying salt substitute that's rich in minerals. "My family loves this mix," says herbalist Julie Manchester of Woodsong Herbs in Randolph, Vermont. "Just don't mention that you're seasoning dinner with weeds!"

Ingredients and Supplies

- | | |
|--|---|
| 2 parts dried dandelion leaf
(<i>Taraxacum officinale</i>) | 1 part dried field mustard leaves
(<i>Brassica rapa</i>) |
| 2 parts dried stinging nettle leaf
(<i>Urtica dioica</i>) | Blender or food processor |
| 2 parts dried plantain leaf
(<i>Plantago major</i> or <i>P. lanceolata</i>) | Airtight storage container |
| 2 parts dried cabbage leaf | |
| 1 part dried chives or scallion greens | |
| 1 part dried parsley | |
| 1 part dried watercress leaves | |

Directions

1. Combine ingredients in blender.
2. Process until mixture is finely ground (in blender, pulse on "chop" setting).
3. Store in a labeled airtight container.

Perfect Pizza Seasoning

Homemade pizza is a quick-and-easy meal when you use ready-made pizza crust from the store. You can buy premade pizza sauce too, but for a more authentic flavor, try using plain tomato sauce (perhaps you have canned or frozen sauce made from your garden tomatoes!) and this mix of dried herbs and vegetables.

Ingredients and Supplies

- ¼ cup dried oregano
- 2 tablespoons dried basil
- 2 teaspoons onion powder
- 1½ teaspoons garlic powder
- ¼ teaspoon crushed red pepper flakes
- Small bowl
- Glass jar with airtight lid

Directions

1. Mix ingredients in the bowl.
2. Pour the mixture into the jar, seal it, and store it in a cool, dry place.
3. Sprinkle the mix on top of pizza as desired before baking, or mix 1 tablespoon into 1 quart of sauce before spreading the sauce on the pizza dough.

Yield: 7 tablespoons of pizza seasoning

Basil-Garlic Herbal Oil

Pat Reppert, owner of Shale Hill Farm and Herb Gardens in Saugerties, New York, teaches herb cookery on her daily radio show in Kingston, New York. She reports that herbal oils are the latest trend for dressing up simple dishes, especially vegetables. Use this oil in stir-fries or to baste vegetables before roasting, broiling, or grilling. Just a thin coating imparts a rich flavor while keeping the calories down.

Ingredients and Supplies

½ cup basil leaves or other herbs
(use ⅓ cup if using stronger flavored herbs, like rosemary, thyme, and oregano)
1 cup extra-virgin olive oil
Stainless steel skillet

3 cloves garlic, peeled and cut into matchstick-size pieces
1 teaspoon lemon juice
Strainer (optional)
Sterilized bottle and cap

Directions

1. Swish the basil leaves briefly in cold water to clean them.
2. Spread basil on towels and pat gently to dry them.
3. Remove stems and measure out ½ cup of loosely packed leaves.
4. Heat the olive oil in a skillet.
5. When the oil is hot but not smoking, stir in the garlic and sauté it until the garlic barely begins to brown (stir frequently).
6. Remove the garlic from the heat and stir in the herbs and lemon juice.
7. Let the mixture cool for 1 hour at room temperature.
8. Strain out plant material (or leave it in for stronger flavored oil) and pour the cooled oil into a sterilized bottle. Cap the

jar and label it, including the exact date of preparation.

9. Keep the oil refrigerated and discard any that's unused after 2 weeks.

Yield: Approximately 1 cup of herb-garlic flavored oil

Note: Olive oil congeals in the refrigerator, but you can let the oil stand at room temperature for an hour or so to let it clear before using it. Just make sure to keep it refrigerated at all other times.

Caution: Because oil is highly perishable once it's infused with plant material, make flavored oils in small batches and always keep them refrigerated. Discard any left-over flavored oil after 2 weeks.

One-Pot Roasted Garlic and Garlic Oil

If you love garlic, don't use it just as a seasoning. Roasted whole garlic is a delicious hot side dish. Roasting mellows garlic flavor and brings out a delicious sweetness. You can also mash roasted garlic and use it as a spread on crackers or bread. Roasted garlic oil is a mouth-watering topping for meat or vegetables.

Ingredients and Supplies

- 6–8 garlic bulbs
- Knife
- Small ovenproof baking dish
- 1 cup good-quality olive oil
- Glass bottle
- Funnel
- Small container

Directions

1. Preheat oven (or toaster oven) to 375°F.
2. Slice the tops off of the garlic bulbs.
3. Arrange the garlic in the baking dish and add the olive oil.
4. Cover and bake for 1 hour.
5. Remove the cover and bake for an additional 15 minutes.
6. While the garlic finishes cooking, sterilize the glass bottle.
7. If you're serving the garlic as a side dish, remove it to a serving plate. If you want to save the garlic paste, let the dish and garlic cool first. Then squeeze the garlic paste into a container and cover it with a thin layer of the garlic-flavored oil.

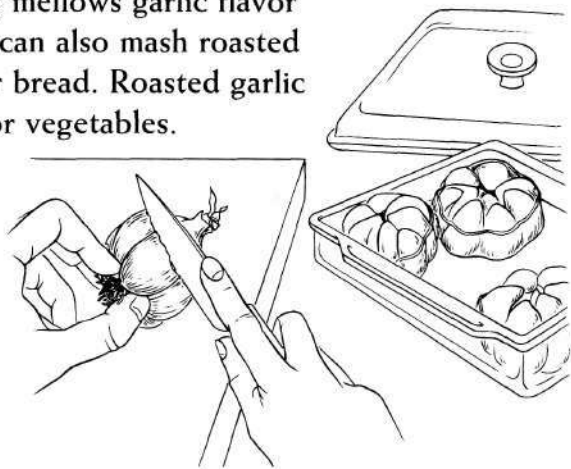

To make delicious roasted garlic, cut the tops off the bulbs, arrange the garlic in a baking dish, and bake it with olive oil.



After baking garlic in olive oil, let the oil cool and pour it into a sterilized jar. You can keep the refrigerated oil for 2 weeks and use it as a dressing for meat or vegetables.

8. Make sure that the oil is cool enough to handle safely. Put the funnel in the mouth of the bottle and pour the oil into the funnel.

Yield: 6 to 8 bulbs of roasted garlic and about $\frac{3}{4}$ cup of roasted garlic oil

Note: You can store garlic paste and garlic oil in the refrigerator for up to 2 weeks.

Discard any paste and oil that is unused after that time.

Caution: When you first remove the baking dish from the oven, handle it with great care. Hot oil can cause serious burns. Always let the oil cool before you try to pour it into a storage bottle.

Double-Roasted Rosemary Vegetables

Hearty roasted vegetables transform root-cellar pickings like potatoes and winter squash into sublime winter treats. Try serving these roasted vegetables as an appetizer or over dressed salad greens as a change of pace.

Ingredients and Supplies

- 12 baby potatoes, scrubbed (cut larger potatoes into 2-inch chunks)
- 1 large sweet potato or peeled winter squash, scrubbed and cut into 2-inch chunks
- 4 small beets, scrubbed (don't cut or they'll bleed)
- Roasted garlic oil (see recipe on the facing page)
- Casserole dish with lid or aluminum foil
- Rosemary sprigs
- Sea salt (optional)

Directions

1. Preheat oven to 375°F.
2. In the casserole dish, toss vegetables with enough roasted garlic oil to coat lightly.
3. Arrange vegetables in a single layer.
4. Place several sprigs of rosemary between and on top of vegetables; add salt, if desired.

5. Cover and bake for 1 hour.
6. Remove lid and bake another 15 minutes until vegetables are fork-tender.
7. Serve hot or at room temperature.

Yield: Serves 4

HEALTHY HERBAL SEASONING

Instead of using butter on steamed vegetables or rice, try this quick no-cholesterol seasoning. Mix 2 tablespoons of canola, sunflower, or olive oil with 1 teaspoon of dried crumbled herbs, like marjoram or thyme, in a small microwave-safe container. Microwave on high for 30 seconds or until oil is hot. Let the mixture stand for 15 minutes before using. You can also use this healthy topping to baste fish or chicken before baking or broiling. 🌿

GO WILD WITH HERBAL SALADS

Garden herbs like thyme, tarragon, and borage will liven up a conventional garden salad, but wild herbs can add an unexpected highlight. Wild herbs like garlic mustard (*Alliaria petiolata*) add spicy flavor and an interesting texture to salads. Plus, wild herbs can be quite nutritious! The leaves and flowers of blue violet (*Viola papilionacea*) are rich in vitamin A, while purslane (*Portulaca oleracea*) leaves and

stems score high in omega-3 fatty acids. Dandelion (*Taraxacum officinale*) leaves are highly nutritious, and chickweed (*Stellaria media*) leaves are rich in minerals. Before you harvest any wild plants for salads, be sure you've identified the plant correctly and that it is safe to eat. If you're in doubt, consult your local Cooperative Extension office for recommendations on edible wild plants and for help in identifying plants. 🌿

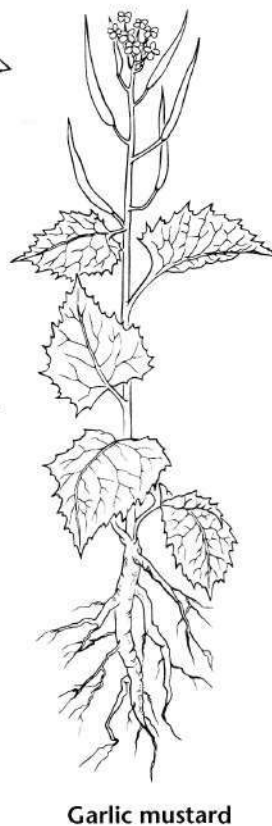
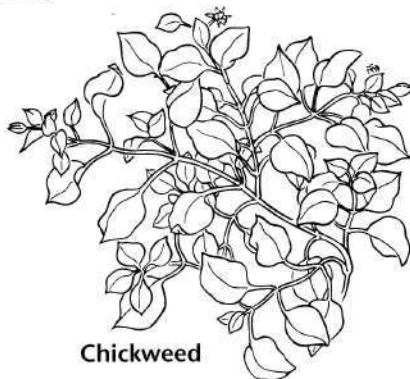
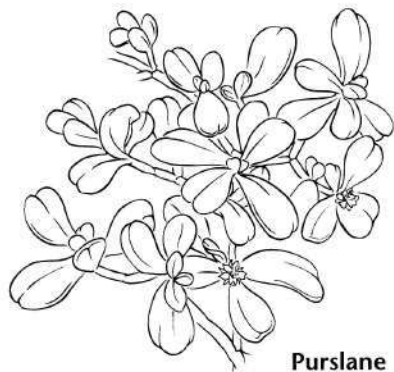
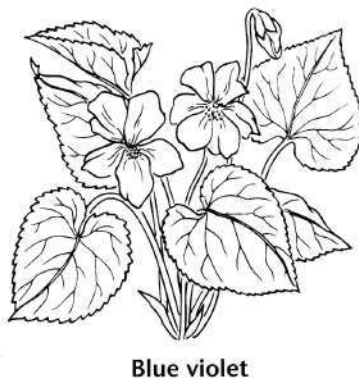
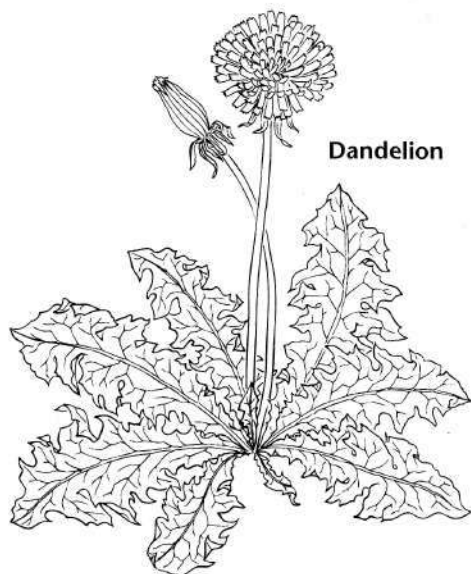

Potpourri of Christmas Legends

Herbalist and floral designer Betsy Williams of Andover, Massachusetts, author of *Potpourri and Fragrant Projects*, uses plant materials linked to Christmas in her potpourri. Betsy suggests using the language of flowers to create a "message mix" for the occasion. For example, thyme represents courage and sweet woodruff means humility. It is said that Joseph gathered these herbs to mix with the straw in the manger.

Ingredients and Supplies

- Small glass jar with tight-fitting lid
- ½ cup frankincense tears
- ¼ cup orris root, cut and peeled (or buy orris root chunks)
- 20 drops lavender oil
- 10 drops rosemary oil
- 4–6 cups Christmas herbs, like thyme and sweet woodruff
- ⅛ cup myrrh powder
- ½ cup chamomile and lavender flowers
- Large ceramic, stainless steel, or glass mixing bowl
- 1-gallon glass jar with tight-fitting lid
- Gold metallic ribbon, cut into small snips
- Citrus peel, cut into stars and dried

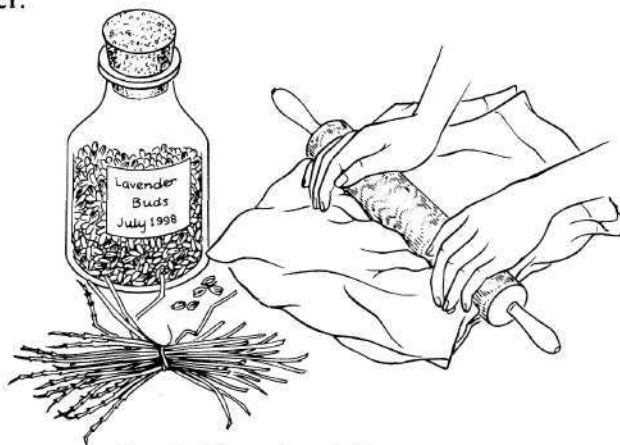

Bundled lavender stalks

To strip lavender flower buds quickly, put the stalks in a pillowcase. Roll the encased lavender with a rolling pin to separate the buds from the stalks. Store the flowers in a jar to use in potpourri. Tie together the bare stalks to make fragrant fire starters.

Directions

1. Measure frankincense (check mail-order herb suppliers) and orris root into small jar.
 2. Drip the oils over the mixture, tighten the lid, and shake the jar to distribute the oils.
 3. Set aside for at least 3 days to allow the oils to blend with the plant material.
 4. Put the mixed Christmas herbs, myrrh powder, and chamomile and lavender flowers into the mixing bowl.
 5. Add oil, frankincense, and orris root to the herbs; mix well without crumbling the herbs.
 6. Transfer the mix to the 1-gallon jar. Shake the jar gently to blend the ingredients.
 7. Allow the mix to age for at least 6 weeks, shaking often.
 8. Add the ribbon snips and citrus peel to the potpourri as you package it for gifts.
- Yield: 4 to 6 cups of potpourri

Garden Harvest Potpourri

The fragrance of an ideal potpourri is a mix of many scents that's not dominated by any one ingredient. Potpourri blends should also look as nice as they smell, with distinct leaves and flowers.

"Fragrance-crafting isn't an exact science," says herbalist and artist Terry Whye of the Whye Clay Works Pottery Studio in Finksburg, Maryland. "Keep playing until you achieve a blend that you really like. And don't forget to take notes so that you can make it again!"

Terry gathers material for her best-selling potpourri blend throughout the year. It includes evergreen needles from the holiday tree, flowers and herbs, and spicy bay leaves and juniper berries. Terry fine-tunes the blend with essential oils and a fixative to preserve the scent. "The mix changes every year because my garden changes," says Terry.

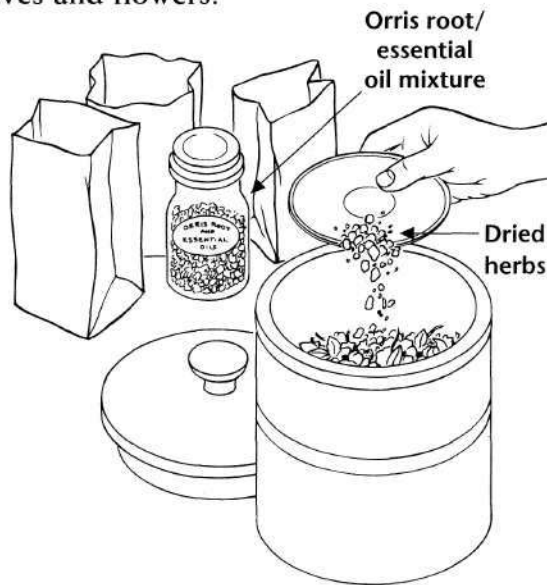

For pleasing potpourri, experiment with different blends of herbs, flowers, berries, pods, and other plant material, along with essential oils and a fixative like orris root.

Ingredients and Supplies

- 1 teaspoon essential oil or oil blend
(Terry uses rosemary, lavender, geranium, clary sage, and citrus oils)
- 3 tablespoons orris root pieces per quart of plant material
- Glass jar with lid
- 1 quart dried leaves, flowers, bark, and berries
- Ceramic crock with lid or a large glass jar with lid

Directions

1. Mix the essential oil and orris root in the glass jar.
2. Cap the jar and let it mellow in a cool dark place for a day to a week.

3. Mix the dried materials in the crock, stirring gently with your hands. Sprinkle in the orris root mix as you go along.
4. Let it sit overnight, take a whiff, and adjust the formula as desired.
5. Let the potpourri mellow for 2 weeks. Check the scent again, and make any needed adjustments.
6. Allow the mix to sit for 2 more weeks.
7. To use the potpourri, open the lid to perfume a room. Close the container after several hours to preserve the scent.

Yield: 1 quart of colorful potpourri

SEASONAL POTPOURRI INGREDIENTS

The beauty of making your own potpourri mixes is that you can adjust the way they look and the way they smell to match the changing seasons.

In winter. Use bay leaves, sweet birch bark (*Betula lenta*), wild black cherry bark (*Prunus serotina*), dried citrus peel, evergreen needles, small pine cones, sassafras roots (*Sassafras albidum*), and wintergreen leaves (*Gaultheria procumbens*).

For spring and summer. Gather scented flowers, like basil, bee balm (also known as bergamot), borage, burnet (*Sanguisorba minor*), calendula, chamomile, red clover (*Trifolium pratense*), daffodil, honeysuckle, jasmine, lavender, lily-of-the-valley, marjoram, mint, mock orange (*Philadelphus × virginalis*), pansy, rose, flowering tobacco (*Nicotiana glauca*), violet, wisteria, and sweet woodruff. Add fragrant leaves, like bee balm, citrus, eucalyptus, scented geranium, lemon balm, lemongrass (*Cymbopogon citratus*), lemon verbena, lavender, mints, patchouli (*Pogostemon cablin*), rosemary, sage, sweet grass (*Hierochloa odorata*), thyme, violet, and sweet woodruff. Also use everlasting flowers, such as globe amaranth (*Gomphrena globosa*), bells of Ireland (*Moluccella laevis*), hydrangea, rocket larkspur (*Consolida ambigua*), Lenten rose (*Helleborus orientalis*), red or pink peony petals, poppy flower heads, statice,

winged everlasting (*Ammobium alatum*), and yarrow.

In autumn. Include bayberries (*Myrica pennsylvanica*), coriander seeds, fennel seeds, hawthorn berries (*Crataegus* spp.), juniper berries, nigella seed pods (*Nigella damascena*), rose hips, and smooth sumac berries (*Rhus glabra*). Terry likes to use seeds and pods that look interesting, like milkweed, acorns, and dried grass seedheads.

Dry ingredients and store in individual airtight containers until ready to prepare the mix. Terry dries her materials on screens and in baskets and paper bags in a warm dry room. "Don't dry or store everything together," she cautions. "You'll lose the individual fragrances."

If your potpourri seems to have lost some fragrance, refresh it by mixing in 1 teaspoon of brandy or essential herbal oil. Experiment with these fragrant formulas to create or refresh potpourri.

Citrus: 1 part each bee balm (also known as bergamot), lemon, and tangerine

Floral: 3 parts rose, 2 parts jasmine, and 1 part carnation

Garden: 2 parts rose and 1 part each thyme, sandalwood, caraway, cloves, and lavender

Herb: 4 parts lavender, 2 parts rosemary, 1 part marjoram, and 1 part bay

Spice: 2 parts allspice and 1 part each cinnamon, clove, and tangerine 🌿

Homemade Herbal Beeswax Candles

Beeswax candles decorated with herbs and flowers are a precious commodity. "A bee consumes an average of 17 pounds of honey to make 1 pound of beeswax," says Kathy McQuade-Sedler, herbalist and owner of Sedler's Mother Earth Herbs in Grass Valley, California. "Beeswax has a lovely fragrance all its own and burns much longer than paraffin."

Ingredients and Supplies

- Vegetable grater or heavy flat-bladed knife
- 1–1½ pounds beeswax (the lightest color available)
- Clean recycled metal can
- Double boiler
- 30-ply flat braid candle wicking
- Muffin tin
- Nonstick vegetable-oil spray
- Chopsticks
- Dried herbs and flowers, like slivered rose petals, calendula petals, and lavender buds

Directions

1. Cover your work area with newspaper, old towels, or plastic.
2. Grate the beeswax, or slice it into thin shavings. Place the wax in the can.
3. Fill the bottom of the double boiler about half full with water. Bring water to a low boil over medium-low heat.
4. Place the metal can in the double boiler and melt the wax slowly.
5. Cut the wicking into 5-inch-long pieces.
6. Coat the muffin tin with the vegetable-oil spray. Dot melted wax into each cup.

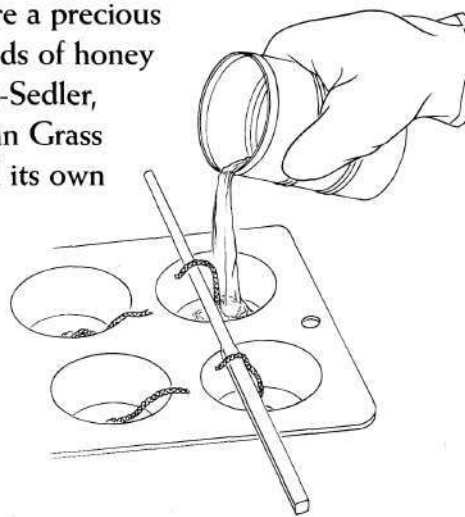

To keep candle wicks upright while making molded beeswax candles, drape the wicks over chopsticks laid across the mold—in this case, a muffin tin.

7. Lay chopsticks across the muffin tins. Press the wicks into the soft wax, and drape the wicks over the chopsticks.
8. Pour the wax into the cups slowly, filling $\frac{1}{4}$ full. Allow to set for 10 minutes.
9. Finish filling the muffin cups, sprinkling in the dried herbs and flowers little by little as you pour the wax.
10. Allow the wax to harden. The candles will pull away from the pan the same way a cake does when it's ready.
11. Pop the candles out onto a towel, and let them sit out for at least 24 hours before using.
12. Before burning the candles, trim the wicks to between $\frac{1}{4}$ and $\frac{1}{2}$ inch.

Yield: 12 herbal beeswax candles

Fancy Herbal-Scented Flames

When making your own candles, you can add excitement with the scents and colors of fragrant oils and herbs. For fragrance, you don't need to use the more expensive pure essential oils; fragrance oils and perfume work well. For natural color, use powdered alkanet root (red), powdered curry, saffron or turmeric (yellow), cinnamon or cosmetic red clay (reddish brown), powdered stinging nettle or parsley leaves (green), or paprika (orange).

Ingredients and Supplies

Vegetable grater or heavy flat-bladed knife

Clean recycled metal can

Double boiler

30-ply flat braid candle wicking

Muffin tin

Nonstick vegetable-oil spray

Chopsticks

1–1½ pounds beeswax

Teabags made of muslin

For fragrant candles

½–1 teaspoon perfume or fragrant oils per pound of wax

For natural color candles

Herbs for natural color (1 teaspoon at a time until desired color is reached)

Directions

1. Follow steps 1 through 5 from "Homemade Herbal Beeswax Candles" on the facing page.
2. For fragrance: Add perfume or fragrant oil to the melted beeswax. Mix well and stir as you pour to keep the oils in suspension. You can also dip the wicks into the oils.

CANDLE SAFETY TIPS

- When making candles, keep in mind that hot wax can cause serious burns. Wear eye protection and work slowly to avoid splatters.
- Wax is highly flammable—always heat at the recommended temperature with a double boiler, never directly on a burner.
- Adding plant materials and essential oils to candles may cause them to sputter while burning. Be sure to place candles a safe distance away from flammable objects. Never let any candle burn unattended. 🕯️

For natural color: Enclose 1 teaspoon of coloring herbs in a muslin teabag and steep in wax for 10 minutes; remove bag and mix wax well. To test color, pour a drop onto white paper. Repeat the process with a new muslin teabag of herbs until you reach the desired color.

3. Continue with steps 6 through 12 from "Homemade Herbal Beeswax Candles." (In step 9, add decorative dried herbs to the candles, if desired.)

Pinecone Fire Starters

For a delightful forest fragrance from your home hearth, try pinecone fire starters. Artist JoAnn Stak of Dandelion Designs in Burlington, Vermont, enjoys making these simple, but ingenious crafts. A small basket of pinecone fire starters makes a nice holiday gift.

Ingredients and Supplies

- Vegetable grater or heavy flat-bladed knife
- Beeswax
- Clean recycled metal can (wide enough for pinecones to fit into)
- Double boiler
- Pinecones
- Tongs
- 1-inch pieces of candle wicking

Directions

1. Grate the beeswax or use the flat-bladed knife to slice the wax into thin shavings. Place the beeswax in the metal can.
2. Fill the bottom of the double boiler about half full with water. Bring water to a low boil over medium-high heat.
3. Place the metal can in water in the top of the double boiler and melt the wax slowly.
4. Hold a pinecone with the tongs, and dip it into the melted wax for a few seconds.
5. Lift the pinecone out of the wax, and hold it above the can while excess wax drips off.
6. Let the wax cool partially. Press a piece of candle wicking into the soft wax, and set the cone aside to let the wax harden.

Note: You can add fragrant oil to the beeswax when making these fire starters. See "Fancy Herbal-Scented Flames" on page 217 for directions for adding oil to melted beeswax.

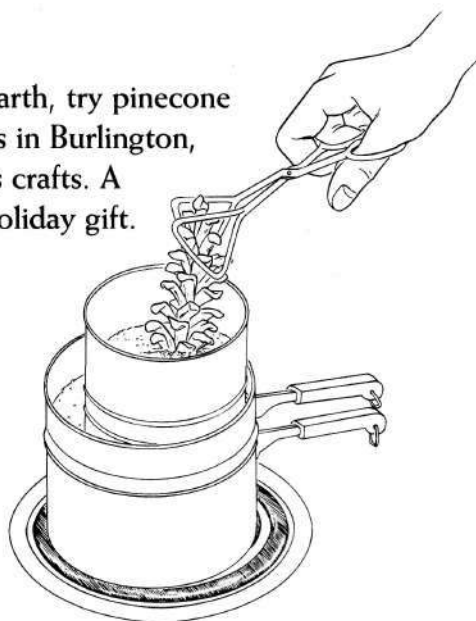

To make a pinecone fire starter, dip one end of a pinecone into a metal can that contains melted beeswax.

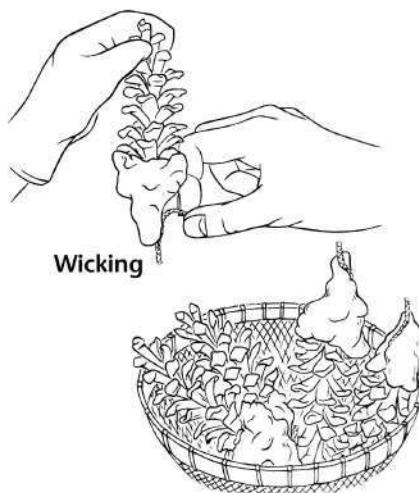

Wicking

After the wax cools and hardens partway, press a piece of candle wicking into the soft wax.

Caution: Hot wax can cause serious burns. Wear protective gloves when attaching the wick to the soft, warm wax.

All-Purpose Herbal Soap Concentrate

"The National Research Council has estimated that hypersensitivity to chemicals in common household products results in acute or chronic health problems for about 15 percent of the population," says herbalist and educator Louise Gruenberg of Oak Park, Illinois. She has spent 20 years developing safe and effective natural cleaning formulas. "For the sake of my family's health, I don't mind the extra time it takes to make my own cleaning products," says Louise. This formula is great for tough jobs like vinyl floors, walls, woodwork, and furniture.

Ingredients and Supplies

- ½ cup (or more) concentrated oil soap, such as Murphy's Oil Soap Paste
- Glass measuring cup
- 1 tablespoon orange or lemon essential oil or combination of both
- Wide-mouth glass jar with lid for storage
- 1 cup antibacterial herbs, like lavender, mint, or thyme
- Saucepan

Directions

1. Place the paste in the measuring cup and stir in the essential oils.
2. Tilt the cup to the side. If the oil separates from the mixture around the edges, add more paste and stir.
3. Store the concentrate in a wide-mouth glass jar. (Label it well—it looks like apple jelly!)
4. To use, first make an herbal infusion by placing 1 cup of antibacterial herbs in a saucepan. Pour 4 cups of boiling water over the herbs and let the mixture steep for 2 hours. Then add 1 to 3 teaspoons of

VERSATILE VINEGAR

Vinegar is one of the best safe and natural cleansers. You can use it to clean windows, baseboards, wood floors, ceramic tile, plastic, linoleum, and many other surfaces. (Just don't use vinegar on iron or other metal surfaces that rust.) To use, mix 2 cups of vinegar (either white or apple cider) with 2 gallons of hot water in a bucket. Vinegar also has natural antibacterial properties, but for even greater disinfectant power, replace 4 cups of the water with a strong infusion of lavender, rosemary, mint, or thyme. Make the infusion by steeping 1 cup of the herbs in 4 cups of boiling water for two hours. 🌿

concentrate to the 4 cups of herbal infusion. Wipe the cleanser on the surface to be cleaned with a sponge or mop, then rinse quickly. A little vinegar in the rinse water helps remove the soap and also discourages bacterial growth.

Yield: About 1 cup of soap concentrate

Refreshing Herbal Spray Disinfectant

Herbalist and artist Terry Whye of Whye Clay Works Pottery Studio in Finksburg, Maryland, uses essential oils to make a stimulating air freshener. She says that it has natural anti-bacterial and antiviral properties, so it's good for general disinfecting and also clears the air around people with colds. Most high-quality essential oils won't stain, but use with care on painted and wooden surfaces as well as on light-colored fabrics.

Ingredients and Supplies

- Glass hand-held misting bottle
- 2 ounces water (distilled or spring water is best)
- 1 teaspoon each rosemary, eucalyptus, lavender, clary, and lemon essential oils
- ½ teaspoon peppermint, tea tree, and cedarwood essential oils
- ⅛ teaspoon (or less) clove bud essential oil

Directions

1. Mix the water and the essential oils in the misting bottle.
2. Shake well.
3. Spray as needed around the perimeter of rooms, in trash cans, closets, drawers, and shoes, under cushions, and inside bedclothes and suitcases.

Yield: About 2 ounces of herbal disinfectant

PUT HERBS IN A VACUUM

Put herbs in a vacuum cleaner, that is! To make vacuuming more of a pleasure than a chore, sprinkle ½ cup of fresh-smelling dried herb leaves, like lemon verbena or rosemary, on the carpet. Run the vacuum over the leaves, and then continue vacuuming the rest of the room. The pleasant fragrance will travel with you as you work. 🌿



Lemon verbena

CLEARING THE AIR

Many herbs have natural disinfectant properties. You can custom-blend your own disinfecting air fresheners with any of these essential oils: basil, bay, bee balm (also known as bergamot), camphor, cardamon, chamomile, cinnamon, clary, clove, eucalyptus, fir, ginger, grapefruit, juniper, lavender, lemon balm, meadow-sweet, myrrh, myrtle, nutmeg, orange, oregano, patchouli, peppermint, Peru balsam, pine, rose-scented geranium, rosemary, sage, sandalwood, savory, spearmint, spruce, tea tree, and thyme.

When making herbal air fresheners, be sure to handle the essential oils with care. Some, such as Peru balsam, can irritate your skin. Also, test the fragrance of essential oils before you set out air fresheners that contain them. You may not like certain fragrances, or you may find a fragrance irritating when you inhale it.

One easy way to make an herbal air freshener is to dip a cotton ball in one of the essential oils listed above and place the cotton on a saucer.

For a long-lasting bathroom freshener, try custom-made incense. Buy unscented incense sticks (called punks) from a craft supplier. Pour a small amount of essential oil into a dish. Use a small brush to paint the incense sticks with the oil. Apply two or three coats to ensure that the essential oils are absorbed. (It helps to thin the essential oils with a little rubbing alcohol.)

To make a holder for the incense sticks, pour some sand into the opening in a seashell, or put some sand in a decorative dish. Stick the uncoated end of the burning incense stick into the sand. To make the

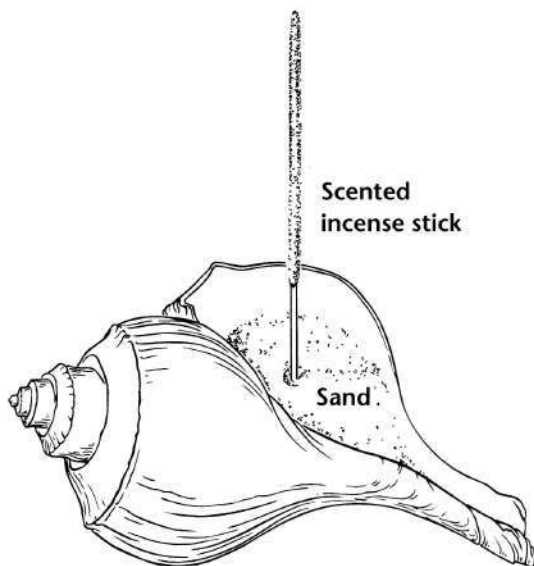
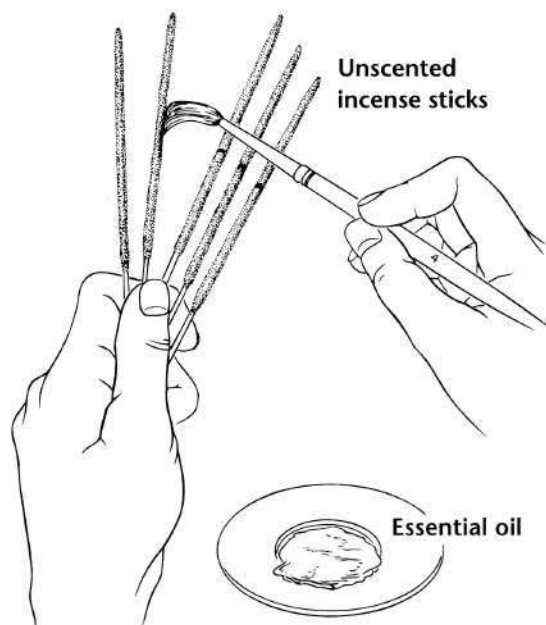

incense stick last longer, just let it burn for a minute or two, then upend the stick and extinguish the lit portion in the sand. That way, you can reuse each stick several times. ♣

Moth-Chasing Marvels

Looking for a moth-repellent without that horrible mothball smell? Barbara Steele, co-owner of Alloway Gardens in Littlestown, Pennsylvania, created this moth-chasing recipe for her customers' suitcases, garment bags, sweater boxes, drawers, and shoes. Barbara says that this blend also has good disinfectant properties. She suggests "If you don't want to make sachet bags, just stuff the mix in old socks or tie it in a handkerchief." Barbara tucks some of these insect-repellent sachets inside pet beds as well.

Ingredients and Supplies

3 cups herbs (in any proportion, any 4 of these dried herbs: lavender, lavender cotton, mint, rosemary, southernwood, tansy, wormwood, or yarrow)

Large brown bag

4 teaspoons orris root powder

Small mixing bowl

8–10 drops clove oil

Stainless steel fork

1 cup cedar chips

1 rounded tablespoon whole cloves

10–12 bay leaves

2 or 3 clothespins

Directions

1. Place herbs in the brown bag.
2. Measure orris root powder into the bowl.
3. Add clove oil to the orris root and mix well with a stainless steel fork, smoothing out any lumps.

TIME-SAVING SACHET TIP

For no-sew sachet bags for herbal moth repellent or other fragrant herbal mixes, simply stuff the mix into muslin tea bags or recycled paper coin envelopes. To make fun and unusual gift sachets, use "Garden Harvest Potpourri" on page 214 to fill vintage cotton gloves and fancy handkerchiefs tied with a ribbon. 🌿

4. Sprinkle the powder over the herbs and shake the bag to mix.
5. Add the remaining ingredients and shake well again.
6. Close the bag tightly and clip with clothespins to hold in place.
7. Let the mix mellow for 2 weeks before you use it.

Yield: About 4 cups of moth-chasing mix

Pantry Protection Herbal Blend

Here's an old-time remedy for roaches and other kitchen pests, from herbalist and garden writer Tina James in Reisterstown, Maryland. "I had never seen a roach until I moved to the city after graduation. Someone told me to sprinkle borax in my cupboards and it really worked!"

Ingredients and Supplies

- 1 cup borax
- ¼ cup black pepper
- Small glass mixing bowl
- ¼ cup bay leaves
- Scissors

Directions

1. Mix borax and pepper in the bowl.
2. Cut each bay leaf into 4 or 5 pieces and add them to the bowl.
3. Stir to mix.
4. To use, sprinkle a small amount in the corners of cupboards and pantry shelves.

Yield: 1½ cups of pantry-protecting blend



Ants on the march in your home? To repel them, find where they're entering the house and sprinkle the area with fresh or dried tansy.

REPEL THEM WITH CANDLES

Insects bugging you at your picnic? You can make your own bug-repellent candle by placing a few drops of pest-proofing essential oils in the well of a votive candle before lighting it, suggests herbalist Sue-Ryn Burns of Hill Woman Productions on Wellesley Island, New York. Sue-Ryn's

favorite insect-repelling combination of essential oils is: 3 parts citronella, 2 parts lavender, 1 part eucalyptus, and 1 part vetiver. Or make some custom-scented incense sticks (see the illustration on page 223), and take them along on your next picnic. 🐛

HERBAL FORMULAS FOR COOKING AND CRAFTS

Here's to Your Herbal Health

Since the beginning of time, herbalists and physicians have turned to herbs for their almost magical soothing and healing properties. For centuries, herbs were the only medicines available. But the power of herbs is more than the stuff of superstition and old wives' tales. Many of today's prescription drugs are still made from common and not-so-common herbs. Using plants as partners for beauty, comfort, and health is an ancient art now enjoying a much deserved resurgence. And we don't need medical studies to tell us that spending time in a steaming herbal bath refreshes the body as well as the spirit.

Like all work with living things, herbcrafting is an art as well as a science. Although there are standard procedures for making herbal products, you'll find variations among the herbalists who have shared their recipes. One practitioner may like to infuse herbal oils in the sun, another may use a Crock-Pot and achieve equally good results. Similarly, most herbs have a wide range of healing properties. It's not unusual, for example, to find dandelion leaves used as a diuretic as well as a cure for skin blemishes.

Exercise caution when trying an herbal formula, especially if it's meant to be taken internally. If you're pregnant, ingesting some herbs may increase the risk of miscarriage. These include comfrey, feverfew, mugwort, southernwood, tansy, and wormwood. If you're pregnant or undergoing medical treatment, consult a physician before trying any herbal formula.

Keep Things Clean

There is one hard-and-fast rule in making herbal products for both internal and external use: Be sure that all of your equipment and ingredients are *clean*. Sterilize storage containers or wash them well with hot, soapy water. When a recipe calls for cookware, use glass or stainless steel pans. Aluminum can react with some herbs and with ingredients like vinegar.

Most herbalists prefer to use ceramic or glass containers to mix and store herbal products. However, it's fine to put a monthly supply of your homemade cosmetics in plastic containers to avoid the chance of broken glass. Be sure to label your homemade herbal products, including both the date and contents.

Some Herbal Terms

Before you can begin your journey to herbal health, it's important to understand the language of herbal preparations. So here's a thumbnail glossary of important herbal terms.

Infusion. An infusion is simply another word for tea. Herbal infusions are used to enhance body care products and to make healing herbal washes or baths. Infusions are best when prepared fresh for daily use, although they will keep for a few days in the refrigerator.

Tinctures. Also called herbal extracts, tinctures are a concentrated liquid form of

herbal medicine made by steeping fresh or dried herbs in a solvent, typically alcohol. Because they are concentrated, tinctures are convenient to use and easy to consume. You'll use them by the drop rather than by the quart or the cup. Tinctures also store well—they'll keep for five years or more in a cool, dark place.

Herb-infused oils. To make an herb-infused oil, you'll steep the herbs in the oil, which imbues the oil with the herbs' healing properties. You can use the resulting oil directly on your skin or combined with other ingredients to make salves and creams. Extra-virgin olive oil is the most

commonly used oil for herbal skin preparations because it resists rancidity. The infused herbal oils discussed in this chapter are intended for external use. To learn about herbal oils for cooking, see "Basil-Garlic Herbal Oil" on page 205.

Salves. Salves are a thickened oil usually created by melting beeswax into an infused herbal oil. Used externally to treat skin problems, they keep the healing properties of the herbs in place longer than alcohol or water-based products. Salves can be stored for many years in a cool, dark place. They are quick and easy to make once the herbal oil is prepared.

Essential oils. It takes sophisticated equipment to make essential oils, which are highly concentrated, pure plant distillates extracted from various parts of plants. Also, a huge volume of plant material is required to make even a small amount of pure oil, so it's nearly impossible to make essential oils at home. However, you can buy herbal oils at herb shops and pharmacies. When shopping

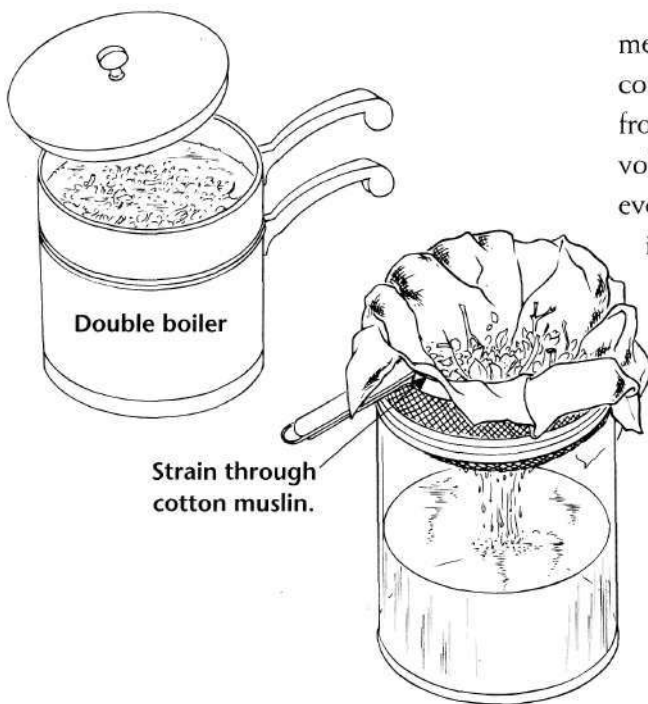

Use a double boiler to gently warm extra-virgin olive oil and herbs to make an infused oil. Once the oil has cooled, strain it through a piece of cotton muslin to remove the herbs. Twist the muslin to remove as much oil as possible. See "Basic Herb-Infused Oil" on page 231 for complete instructions.

for essential oils, look for pure essential oils packaged in dark-colored bottles. Synthetic oils, although far less expensive, cannot be safely or effectively used in therapeutic recipes. Due to variations in the oil content of various plants, you'll find a wide range in the cost of essential oils. Pure rose oil, for example, costs \$45 for 1/8 ounce, whereas the same amount of lavender oil costs \$5.

Essential oils are almost always intended for external use. In addition, most essential oils are too strong to use directly on the skin; they must first be mixed into an oil or cream. Store essential oils in a cool, dark place out of the reach of children. Don't use essential oils if you're pregnant or are undergoing medical treatment. If in doubt, consult with a competent health provider.

It's always a good idea to perform a patch test before using a new essential oil. Dilute a drop or two of the oil in vegetable oil and

apply a small amount of the diluted oil to your inner arm. After 30 minutes, remove the test oil and check for any irritation.

To keep essential oils clean, apply with an eyedropper or cotton swab. Also be sure to keep the outside of the bottle clean by wiping the bottom of the bottle after use. Essential oils can mar surfaces, especially plastic ones. Be sure to twist bottle caps on tightly as well.

In addition to using essential oils for creating body care products, you can use the healing power of fragrance in other ways, such as placing a few drops in a scent ring around light bulbs, adding to a diffuser, mixing with potpourri and simmering scents, and adding to cleaning products.

Once you learn how to get the most out of herbs, you'll find that you've opened the door to the time-honored practice of herbal healing and joined centuries of herbalists who have tapped the magic of herbs.

POPULAR ESSENTIAL OILS

Here's a list of the qualities of some of the most useful and enjoyable essential oils for salves, balms, and home remedies.

Bee balm (also known as bergamot): uplifting, clean, antidepressant

Eucalyptus: invigorating, uplifting, antiseptic, decongestant, analgesic

Zonal geranium: uplifting, balancing, relaxing, astringent

Grapefruit: bright, uplifting, clean, cleansing, stimulating

Lavender: antifungal, antiseptic, antidepressant, calming, deodorizing, anti-inflammatory, antibacterial

Lemon: energizing, antiseptic, astringent, antibacterial

Sweet orange: uplifting, antispasmodic, balancing, antiseptic

Peppermint: stimulating, refreshing, uplifting, cooling, antiseptic, expectorant

Rose: sensual, antidepressant, tonic, astringent, antispasmodic, sedative

Rosemary: warming, stimulating, analgesic, antiseptic, antispasmodic, astringent

Sandalwood: soothing, sensual, centering, antiseptic, sedative, warming

Thyme: antibacterial, warming, stimulating, expectorant

Quick and Easy Herbal Soap

Making soap from scratch is a time-consuming challenge, but you don't have to start from scratch to create lovely personalized soap products. Artist JoAnn Stak, owner of Dandelion Designs in Burlington, Vermont, melts bars of purchased glycerin soap, adds her own herbs, and then remolds the soap. Remaking soap is fun and those with sensitive skin can make sure nothing harmful is added. And, as JoAnn points out, cleanup is easy. After all, it's soap!

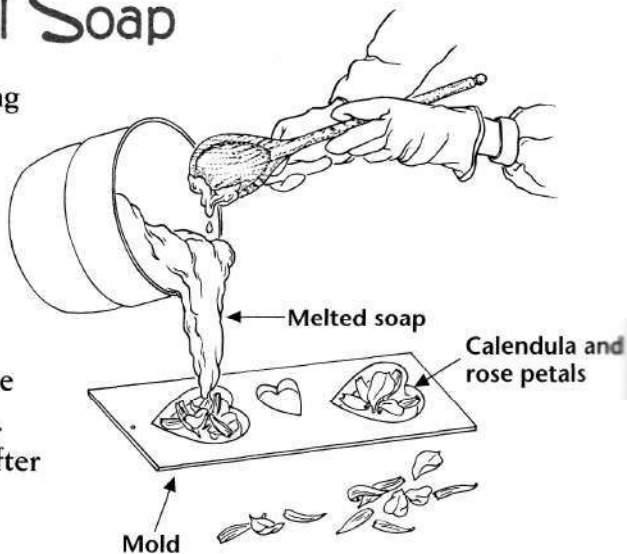

Ingredients and Supplies

- 2 cups glycerine soap bars, cut into chunks
- Double boiler
- 10–20 drops essential oils of herbs or flowers from the list on the facing page (optional)
- 2 tablespoons exfoliating agents from the list (optional)
- 2 teaspoons or 2 gel caps nutritive agents from the list (optional)
- 2 tablespoons dried herbs or flowers from the list (optional)
- Soap or candy molds (or shallow plastic containers, wider at the top than the bottom)
- Towel
- Plastic wrap or plastic zipper bags

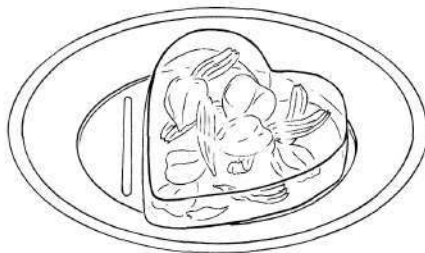

For a designer touch, arrange dried flowers and herbs on melted soap after it has set for a few minutes. Let it set until firm. Pour a thin layer of melted soap over the dried materials, creating a transparent window effect. Allow it to harden again before unmolding.

Directions

1. Melt soap chunks in a double boiler over medium-low heat.
2. Stir in pure essential oils and/or exfoliating or nutritive agents.

3. Pour mix into molds. If desired, sprinkle dried herbs and flowers into the mix as you pour so they don't settle to the bottom.
4. Allow to harden for about ½ hour.
5. Pop out soap onto a towel.
6. Let bars sit overnight to harden completely.
7. Wrap bars in plastic or put in plastic zipper bags to preserve scent.

Yield: 2 bars of herbal glycerine soap

HERBAL EXTRAS FOR CUSTOM-MADE SOAP

Add herbs and other ingredients to your homemade soap to create just the type you need—a facial soap, body soap, a gritty soap to help renew your skin, or an enriched soap.

Pure essential oils for facial soap:

chamomile, lemon, lavender, neroli, geranium, grapefruit, frankincense, rose attar

Pure essential oils for body soap: rosemary, grapefruit, lavender, bee balm (also known as bergamot), orange, pine, peppermint

Dried herbs and flowers (ground or whole): calendula, rose petal, lavender buds, violet flowers

Exfoliating agents: finely ground oatmeal, finely ground corn meal, finely ground almond kernels, white clay (kaolin), green clay (bentonite)

Nutritive agents: cold-pressed oils, like jojoba, apricot kernel, avocado, evening primrose oil, vitamin E, vitamin A

Test the ingredients on your skin before adding them to soap: Mix a small amount of the herbs and other ingredients in pure vegetable oil and rub the mixture on the inside of your arm. Check in half an hour to make sure that there is no irritation. 🌿

Basic Herb-Infused Oil

Many herbal salves and creams start with herb-infused oils. Use this formula from herbalist Pat Carrigan of Shepherdstown, West Virginia, to create herbal oils that you can use directly on your skin or as the basis for other herbal concoctions.

Ingredients and Supplies

Dried or fresh wilted herbs (see page 232 for instructions on wilting fresh herbs)

Double boiler or Crock-Pot

Extra-virgin olive oil

Fine-mesh strainer

Cotton muslin to line strainer

Large glass container or bowl

Sterilized glass jars with lids

Directions

1. Place desired herb or herbs in the double boiler or Crock-Pot. (If you're using roots,

chop and infuse them in the oil for at least 2 hours before adding leaves or flowers.)

2. Pour in enough extra-virgin olive oil to cover the herbs with 1 to 2 inches of oil.

3. Gently heat the herbs at about 180°F for 2 to 4 hours. Keep the pot or boiler covered, and stir occasionally.

4. Remove from heat and let the oil cool.

5. Strain the oil through a fine-mesh strainer lined with cotton muslin.

6. Squeeze out any excess oil remaining in the muslin.

7. Pour the oil into sterilized glass jars to store.

Gardeners' Hand Cream

Do your hands throb and ache after a day of weeding? Don't give up on gardening! Instead, try this multipurpose hand cream from herbalist Margi Flint of Earthsong Herbals in Marblehead, Massachusetts. It contains black cohosh to ease arthritic pain, St.-John's-wort to help reconnect nerve tissue, and plantain and calendula to heal nicks and scratches.

Ingredients and Supplies

2 handfuls each of fresh plantain leaf, calendula flowers (*Calendula officinalis*), St.-John's-wort flowers (*Hypericum perforatum*), and black cohosh leaf (*Cimicifuga racemosa*)

Double boiler

Extra-virgin olive oil

Strainer

Linen towel, fine cotton handkerchief, or cheesecloth

Bowl

Glass jar

4-inch piece of Solomon's seal root (*Polygonatum biflorum*) (optional; see "Use Solomon's Seal Sparingly" on the facing page)

1 tablespoon hexane-free castor oil

1 tablespoon coconut oil

½ ounce (or more) beeswax, grated

Blender

¼ cup floral water (lavender, lilac, or rose water)

¼ cup aloe vera gel

Glass wide-mouth jar

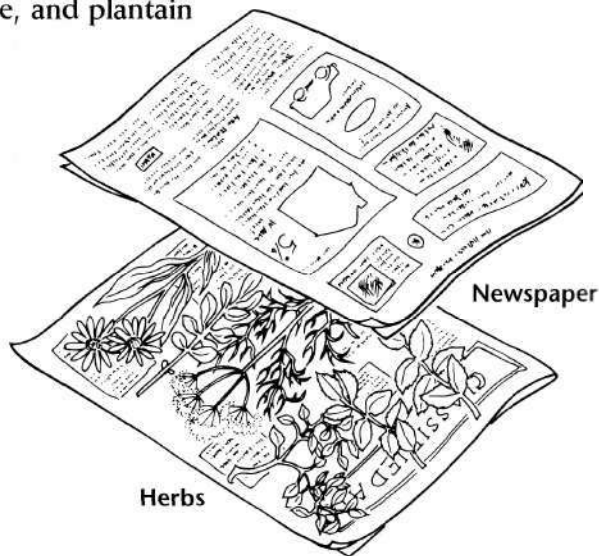

Wilt your herbs overnight by spreading them out between sheets of newspaper. The next day, they'll be ready to use in the Gardeners' Hand Cream recipe or in any formula that calls for herb-infused oil.

Directions

1. Let the herbs wilt overnight to reduce their water content.
2. Place the herbs in the double boiler. Pour olive oil over the herbs until there are 2 to 3 inches of oil topping the herbs.
3. Heat the herbs and oil for about 2 hours with the lid of the pot slightly askew.
4. Allow the oil to cool to room temperature.

5. Line the strainer with the towel, handkerchief, or cheesecloth and pour the herb mixture into the strainer.
6. Let the oil drain into a clean bowl for several hours; squeeze out any excess oil.
7. Pour the oil into a glass jar, and label and date it. Set it on a windowsill at eye level.
8. After a day or two, check for any water droplets in the bottom of the jar. If water is evident, pour off the oil into another glass jar, leaving the watery oil at the bottom. "Water will cause the oil to turn rancid, so don't forget this step," cautions Margi. "But don't waste the watery oil. Mix it with some sea salt to make herbal salts for a soothing bath." Margi recommends mixing 3 tablespoons of the oil with 1 cup of sea salt and adding ¼ cup of herbal salt per tubful of bathwater.

9. Place ½ cup of infused oil in the double boiler. (Also include 3 tablespoons of Solomon's seal, if desired.)
10. Add castor and coconut oils and beeswax. Heat just until the wax has melted.
11. Let the wax and oil mixture cool to room temperature. While it cools, put the aloe vera and floral water into a blender.
12. Turn on the blender to its highest speed and slowly pour the oil-wax mixture into the blender.
13. Pour the finished cream into sterile wide-mouth jars.
14. To use the cream, dab some of it onto the backs of your hands and rub it into your hands and fingers until it is well absorbed.

USE SOLOMON'S SEAL SPARINGLY

Another plant with healing qualities is Solomon's seal, says Margi Flint. She also extracts oil from its roots to add to her hand cream, especially for clients with tendon problems.

However, she cautions: "Solomon's seal is abundant where I live but endangered in other areas. Because you destroy the plant by harvesting the root, only harvest from a prolific stand on your own property. And say lots of prayers of gratitude!" When you're gathering herbs for infusions or other formulas, make a habit of taking them only from your own property. That way, you know they're 100 percent

organic and you don't deplete wild plant populations.

To infuse oil with Solomon's seal root, repeat steps 2 through 9 of the directions for "Gardeners' Hand Cream," using a 4-inch piece of root, cut into small pieces, and 1 cup of extra-virgin olive oil.

Margi makes the Solomon's seal root oil in a separate batch and uses it in her hand cream only when needed. "Remember to compost any remaining plant material—even the herbs strained from the oil," she adds. "As the Cherokees say, you don't get the medicine until everything goes back to the earth." ❀

Take a Bath with Herbs and Flowers

Herbalist Sue-Ryn Burns of Hill Woman Productions on Wellesley Island, New York, employs the ancient art of salt-drying to preserve the delicate fragrances of herbs and flowers. "Some scents, like lily-of-the-valley and peony, are almost impossible to preserve through any other means," says Sue-Ryn. She prefers to make single-scent salts, but it's fine to mix them if you don't have enough of any one plant. "Moist flowers, like peonies, may cause the salt to cake, so I cover the jar with cheesecloth for a few days to allow some of the moisture to escape before closing it up," says Sue-Ryn. "The extra trouble is worth it for the scent."

Ingredients and Supplies

- Sea salt
- Large glass jar or crock with lid
- Fragrant flowers and herbs
- Large mesh strainer
- Wooden spoon

Directions

1. Put an inch of salt in the bottom of the jar.
2. Add a layer of flowers and herbs.
3. Sprinkle salt over the flowers and herbs until they are covered.
4. Add another layer of flowers and herbs, cover with salt, and continue until the jar is full or you run out of blossoms. The last layer should be an inch of salt.
5. Cover the container and let it sit in a cool, dark place until the salt is pleasantly scented—about 3 weeks. It's fine to leave the flowers and herbs in longer, but Sue-Ryn suggests removing them after 3 months to keep the scent fresh.
6. To separate the flowers and herbs from the salt, pour the mix into the strainer gradually and work it through the mesh. Use the spoon to break up any lumps. It won't hurt to leave a few petals in the salt.
7. Store the salt in airtight containers. The salt will keep indefinitely.
8. Put a few petals on top as a decorative identification.
9. To use, add 1 to 2 cups of salt under running water while filling the tub.

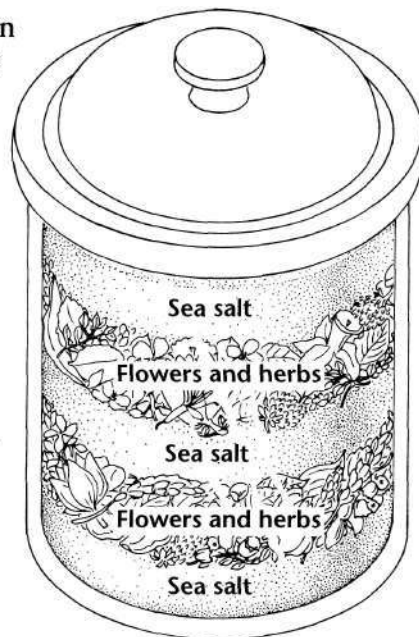

Treat yourself—or a friend—to fragrant bath salts scented with herbs or flowers. This simple and soothing bath additive is easy to make, too—just layer sea salt with fresh-picked flowers or herbs from your garden.

FLOWERS AND HERBS FOR SALT-DRYING

Use sea salt to capture the sweet scents of herbs and flowers from your garden. Here are some of the plants Sue-Ryn Burns uses to make soothing bath salts; try these or experiment with your own favorite garden fragrances.

Sweet clover (*Melilotus officinalis*)
Daffodil
Heliotrope (*Heliotropium arborescens*)
Honeysuckle
Hyacinth

Lavender
Lemon balm
Lilac
Lily-of-the-valley
Marjoram
Peonies
Roses
Thyme
Tulip
Violet
Wisteria

Fantastic Fragrant Bath Powder

Make a luxurious yet inexpensive bath powder by combining common pantry ingredients with ground herbs. This recipe is from herbalist Mariam Massaro of Wise Ways Herbals in Worthington, Massachusetts, a mail-order company offering handcrafted natural body care products. A coffee grinder works well to grind the herbs.

Ingredients and Supplies

4 cups arrowroot powder
4 cups cornstarch
2 cups fine sea salt
1 cup powdered white clay (kaolin)
½ cup powdered herbs, like lavender buds, calendula petals (*Calendula officinalis*), orange flower petals, sage leaves, and slippery elm root (*Ulmus rubra*)
Ceramic bowl

Wooden spoon
3 teaspoons essential oils, like lemon, rose, and lavender for a floral scent; peppermint, lavender, and chamomile for a cooling summer powder, or tea tree for antifungal powder
Storage container
Recycled shaker container or powder box

Directions

1. Combine dry ingredients in the bowl and stir well with the wooden spoon.
2. Add the essential oils.
3. Pour the mixture into a storage

container and label it. The powder will keep indefinitely.

4. Fill shakers or powder boxes as needed.

Yield: About 3 quarts of herbal body powder

HEALTHY LIVING FOR SALVES, BALMS, & HOME REMEDIES

Tension-Taming Bath Tea

Herb tea is good for body and soul—and for a bath! Many of the healing properties of herbs can be absorbed directly through the skin to ease tension, draw out impurities, and stimulate circulation. Herbalist Tina James of Reisterstown, Maryland, says she picks herbs for the evening bath while she's harvesting greens and veggies for dinner. "Regular clipping keeps herbs looking good and growing vigorously," says Tina. "But what to do with all the trimmings? Bath tea is one way to make use of the surplus."

Ingredients and Supplies

- 4 cups fragrant herbs, coarsely chopped
- Large heat-proof glass container
- Boiling water (to cover herbs)
- Strainer

Directions

1. Place herbs in the glass container.
2. Pour boiling water over the herbs.
3. Cover the brew with a dish or towel to capture the essential oils.
4. Let sit for at least an hour, then strain.
5. To use, draw bath and pour herb tea into the bath water.
6. Relax and enjoy.

Note: Tina recommends turning any of these herbs into tea for your tub: alfalfa, basil, chamomile, comfrey (*Symphytum officinale*), scented geraniums (*Pelargonium* spp.), lavender, lemon balm, mint, mugwort (*Artemisia* spp.), parsley, plantain (*Plantago major*), sage, strawberry, thyme, or violet.

PUT A TEA BAG IN YOUR TUB

Make a bath "tea bag" by enclosing dried herbs in a washcloth (a dark-colored washcloth won't show stains). Tie the "tea bag" tightly with string. Hang from the faucet while filling the bath to release the scent and healing properties of the herbs. When bathing, squeeze the bag to release its fragrance. Each bag brews several baths. 🌿

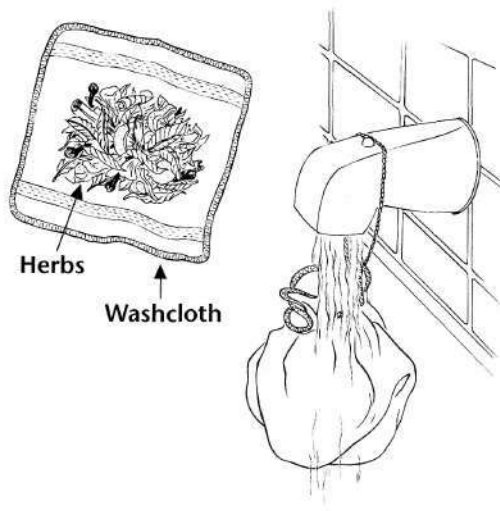

Herbal Hair Rinses

"Natural hair care products are a great place to begin an herbal body care program," says herbalist Julie Bailey, owner of Mountain Rose Herbs, a mail-order supplier of herbs and herbal products in North San Juan, California. "They're a snap to make and inexpensive as well," Julie says. The vinegar in this recipe not only smooths out tangles, it also restores your hair's acid balance.

Ingredients and Supplies

Large glass jar with rustproof lid for steeping
4 cups raw apple cider vinegar
Plastic squeeze bottle
Distilled or spring water

Herbs for dark hair

2 parts stinging nettle leaves
(*Urtica dioica*)
1 part chamomile flowers
1 part rosemary leaves

Herbs for light hair

2 parts stinging nettle leaves
1 part chamomile flowers
1 part calendula flowers
(*Calendula officinalis*)

Herbs for red hair

2 parts stinging nettle leaves
1 part hibiscus flowers
1 part safflower flowers
(*Carthamus tinctorius*)

Directions

1. Decide which blend of herbs you want to use: herbs for dark hair, light hair, or red hair. Place 1 cup of the appropriate herb blend in the glass jar.
2. Pour enough vinegar over the herbs to cover them completely. (In winter, Julie heats the vinegar in a non-aluminum pan until it's almost ready to boil. Then she pours the hot vinegar over the herbs into a heat-proof glass jar.)
3. Cap the jar.
4. Let the jar sit in the sun for 2 weeks.

5. Strain, label, and date. Store in a cool, dark place. The herbal vinegar will keep at least several years.
6. To use, dilute the herbal vinegar with an equal amount of water to fill the squeeze bottle.
7. After shampooing, squeeze about ½ cup of the vinegar rinse over your hair. Keep your eyes closed as you massage the mixture into your scalp for a few minutes, then rinse.

Yield: 1 quart of herbal hair rinse

Custom-Blended Herbal Shampoo

If you already have a favorite shampoo, you can enhance and personalize it by mixing in a homemade herb infusion. It will also help to stretch your shampoo supply.

Ingredients and Supplies

- 1 tablespoon dried or 3 tablespoons fresh herbs (use blends specified in "Herbal Hair Rinses" on page 237)
- Heat-proof measuring cup
- $\frac{3}{4}$ cup boiling water
- Tea towel
- Strainer
- Plastic yogurt cup with lid
- Shampoo (try unscented castile or natural baby shampoo)
- 1 teaspoon jojoba or vitamin E oil
- 5 drops essential oil, like lavender, rosemary, or basil (optional)

Directions

1. Place herbs in the measuring cup, and pour the boiling water over them.
2. Cover with a tea towel.
3. Cool to room temperature.
4. Strain infusion into the plastic cup.
5. Add 2 tablespoons of shampoo and the jojoba or vitamin E oil to the herbal infusion. Add 5 drops of essential oil, if desired, and shake to mix.
6. To use, shake the mix and shampoo as normal. This diluted shampoo will keep for 2 to 3 days in the shower and up to a week in the refrigerator.

Yield: About 1 cup of herbal shampoo

BAD HAIR DAY? HERBS TO THE RESCUE!

Rosemary will remove that lingering chemical smell from a new perm and fight dandruff as well. Make a cup of strong rosemary tea by pouring 1 cup of boiling water over 1 tablespoon of dried herb. Let the mixture steep until cool. Strain out the herb and rub the tea into your hair or use it as a rinse after shampooing. A few drops of rosemary essential oil mixed into a cup of water to make a rinse will also do the trick.

Essential oils are great for styling and freshening hair as well. Add about 10 drops of lavender, basil, lemon, clary sage, or sandalwood essential oil to 1 cup of distilled or spring water. Shake well, mist your hair, and use your fingers to style your hair. Shake the mister before each use to disperse the oils in the water. ♡

Conditioning Hair Oil

To improve your hair texture and condition your scalp, try this simple herb-infused oil from Mariam Massaro, herbalist and owner of Wise Ways Herbals, a mail-order supplier of natural body care products in Worthington, Massachusetts. "This treatment cleans and stimulates the scalp," she explains. "You'll reap lustrous results after just two or three weeks."

Mariam recommends using dried or wilted herbs when making an infused oil to reduce excess moisture. To wilt fresh herbs, dry them on a screen or between newspaper for a day or two, as shown on page 232. In the summer months, Mariam saves time and energy by using the sun to infuse the oil: Simply pour the oil over the herbs and let it sit outside for two weeks. There's no need to heat the oil first.

Ingredients and Supplies

- 3 cups good quality olive oil
- 1 tablespoon dried basil leaf
- 1 tablespoon dried burdock root
(*Arctium lappa*)
- 1 tablespoon dried sage leaf
- 1 tablespoon dried stinging nettle leaf
(*Urtica dioica*)
- 1 tablespoon dried lavender buds

- Stainless steel or enamel pan
- Heat-proof glass jar with a lid
- Strainer lined with muslin
- A few drops essential oils, like basil, rosemary, and/or lavender (optional)
- Glass storage jar with lid
- Plastic storage bottle with lid

Directions

1. Heat the olive oil and herbs in the pan until the oil comes to a light simmer and the mix smells nice and strong.
 2. Pour oil and herbs in the heat-proof glass jar and cap the jar.
 3. Let the mixture sit at room temperature for 4 or 5 days.
 4. Strain until the oil is clear.
 5. Pour into a glass storage jar and cap tightly. The oil will keep at least a year in a cool, dark place.
 6. To use, pour $\frac{1}{2}$ cup of the herb-infused oil into a plastic storage bottle. Add essential oils, if desired. Shake well.
 7. Pour a teaspoon or so of the oil in the palms of your hands and massage it into your scalp.
 8. Bend over and brush your hair from the nape of your neck to the crown of your head 100 times.
- Yield: 3 cups of conditioning hair oil

Corny Cleanser for Oily Skin

Save your face from soap with this herbal cleanser from herbalist Sue-Ryn Burns of Hill Woman Productions on Wellesley Island, New York. Sue-Ryn's mixture of cornmeal, oatmeal, lavender, kelp, and other herbs is great for giving oily skin a deep-yet-gentle cleansing. For a quick face mask, just let the paste dry on your face and then gently brush it off.

Ingredients and Supplies

- Blender
- 6 ounces oatmeal
- 1½ ounces rose petals
- 1 ounce lavender buds
- Mixing bowl
- 6 ounces cornmeal
- 1 ounce Irish moss powder
- ½ ounce kelp granules
- ½ ounce comfrey root powder
- Storage containers

Directions

1. Blenderize oatmeal with rose petals and lavender buds.
2. Pour the mixture into a clean mixing bowl.
3. Add cornmeal, Irish moss powder, kelp granules, and comfrey root powder, and mix well.
4. Put a small amount into a container for daily use.
5. Store remainder in an airtight container. It will keep indefinitely, although it's best if used within 6 months.
6. To use, rinse your face with water first.
7. Put a small amount of the cleansing powder in your hands and add enough water to make a paste.



Before making an herbal face cleanser, use a blender to chop up ingredients like oatmeal, rose petals, or lavender buds.

8. Rub your face gently, making little circles with your hands.
9. Rinse your face with warm water, ending with a cold splash to close the pores.

Yield: About 1 cup of cleansing grains

Caution: If you are pregnant, consult with a physician before using any formula that contains comfrey root powder.

Corny Cleanser for Dry Skin

If soap makes your skin uncomfortably dry, try this gentle herbal mixture from herbalist Sue-Ryn Burns of Hill Woman Productions on Wellesley Island, New York. Her combination of cornmeal, oatmeal, slippery elm powder, chamomile flowers, and other herbs will leave your skin feeling fresh and smooth. You can use this cleanser as a face mask, too—just leave the paste on your face until it dries, then gently brush it away.

Ingredients and Supplies

Blender

6 ounces oatmeal

1 ounce chamomile flowers

½ ounce elder flowers

½ ounce orange blossoms

Mixing bowl

6 ounces cornmeal

1 ounce Irish moss powder

1 ounce slippery elm powder

½ ounce comfrey root powder

Storage containers

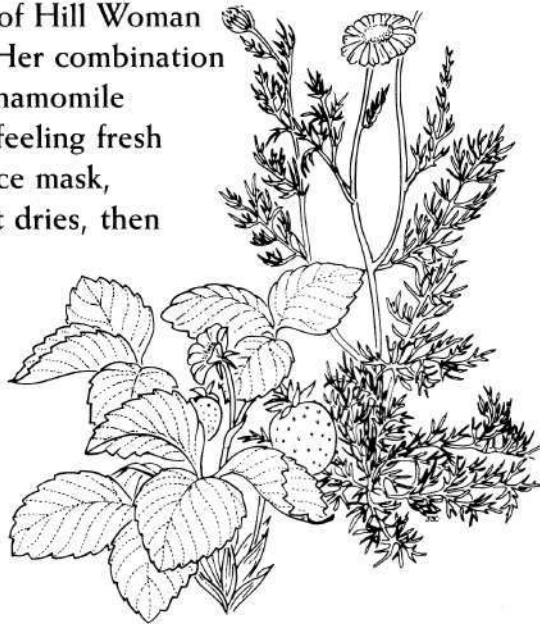

Roman chamomile is an easy-growing perennial herb that makes a great companion for perennial crops such as strawberries. Use the daisy flowers of this handy herb to make homemade chamomile tea, as well as in herbal products like Corny Cleanser for Dry Skin.

Directions

1. Blenderize oatmeal with chamomile flowers, elder flowers, and orange blossoms.
2. Pour the mixture into a clean mixing bowl.
3. Add cornmeal, Irish moss powder, slippery elm powder, and comfrey root powder, and mix well.
4. Put a small amount into a container for daily use.
5. Store remainder in an airtight container. It will keep indefinitely, although it's best if used within 6 months.
6. To use, rinse your face with water first.

7. Put a small amount of the cleansing powder in your hands and add enough water to make a paste.
8. Rub your face gently, making little circles with your hands.
9. Rinse your face with warm water, ending with a cold splash to close the pores.

Yield: About 1 cup of cleansing grains

Caution: If you are pregnant, consult with a physician before using any formula that contains comfrey root powder.

Fluffy Herbal Face Cream

You can make your own luxurious, fluffy, white face cream and customize it with the herbs and essential oils that you like best. Herbalist Rosemary Gladstar, founder of Sage Mountain in East Barre, Vermont, and author of *Herbal Healing for Women*, has trained hundreds of apprentices, many of whom have developed entire natural body care product lines based on her recipes. Here's Rosemary's original face cream recipe:

Ingredients and Supplies

- ¾ cup grapeseed oil
- ⅓ cup coconut oil and/or cocoa butter
(Rosemary uses both)
- 1 teaspoon lanolin
- ½ ounce beeswax, grated
- Double boiler
- ⅔ cup distilled water or rosewater
- ⅓ cup aloe vera gel (don't use fresh aloe juice, as bacteria can grow in it)
- Blender (very clean!)
- 10,000 units vitamin A (optional)
- 20,000 units vitamin E (optional)

- 1 teaspoon black currant seed oil or evening primrose seed oil (optional)
- 1 tablespoon herbal tinctures from herbs listed in "Steam Your Cares Away" on page 246 (optional) (Note: See "Fight Allergies with Herbs" on page 262 for information on how to make an herbal tincture)
- 1 teaspoon essential oil of lavender, sandalwood, geranium, chamomile, ylang ylang, or helichrysum (optional)
- Wide-mouth jar

Directions

1. Heat the grapeseed and coconut oil, cocoa butter, lanolin, and beeswax in a double boiler until just melted.
2. Remove from heat and let cool to room temperature. (The oils are easier to work with if you do not let them solidify.)
3. Place water and aloe vera gel in the blender.
4. Add optional ingredients to the blender.
5. Turn on the blender to the highest speed and add in the oil mixture in a slow, thin drizzle. ("It's just like making mayonnaise," notes Rosemary.)
6. When the blender starts to cough and choke, turn it off. "Do not overbeat," cautions Rosemary. "Don't give up if it doesn't turn out perfectly the first time," she adds.

"The key is finding the right temperature for the ingredients to blend well."

7. Put a week's supply of face cream in a small clean container for use in the bathroom. Store the remainder in the refrigerator until needed.

8. Apply face cream to the face and neck with clean hands, and smooth the cream into your skin until it's absorbed.

Yield: About 2 cups of herbal face cream

FOR CREAMIER CREAM

Herbalist Terry Whye of Whye Clayworks and Pottery Studio in Finksburg, Maryland, makes Rosemary's herbal face cream for holiday gifts. "I've found that dissolving 1 teaspoon of borax into the water guarantees that the cream sets up for me," Terry says. 🌿

Fennel Face Soother

For a refreshing herbal splash, herbalist and licensed aesthetician Stephanie Tourles, author of *The Herbal Body Book* and owner of September's Sun Herbal Soap Company, takes advantage of the skin-softening properties of fennel. "Fennel creates a slipperiness that feels wonderful on the face and body," Stephanie says. "I use this as a hair rinse as well. It restores the natural pH balance of your skin and scalp."

Ingredients and Supplies

2 cups distilled water

1 tablespoon crushed fennel seeds

¼ cup apple cider vinegar

2 teaspoons glycerin (available from a pharmacy)

Storage container or pump spray bottle

Directions

1. Boil water.
2. Remove water from heat and add crushed fennel seeds.
3. Cover, steep for 45 minutes, and strain out fennel seeds.
4. Stir vinegar and glycerin into fennel-infused water.

5. Pour into storage container, label and date. Herbal splash will keep for 30 days.
6. Splash or spray on as desired.

Yield: About 2 cups of fennel face soother

Caution: Fennel can cause an allergic reaction in some individuals.

7 cups
FOR CREAMIER CREAM
FOR SALVES, BALMS, & HOME REMEDIES

Best-Selling Herbal Massage Oils

Oils infused with healing herbs are among the most versatile homemade body care products. Using an herbal oil as a base, it's easy to create custom-scented massage and bath oils as well as skin softeners for face and body. You can also use the oil as a base for making salves and creams.

This massage oil recipe is a favorite of Julie Bailey, owner of Mountain Rose Herbs, a mail-order supplier of herbs and herbal products in North San Juan, California. Julie makes herbal oil blends for her best-selling massage oils. To reduce the moisture, Julie wilts the herbs for 24 hours by laying them out on screens.

Ingredients and Supplies

- 2 or 3 clean glass jars
- Extra-virgin olive oil
- Strainer
- Cheesecloth
- Glass storage container

Fragrant, relaxing blend

- 1 part calendula (*Calendula officinalis*)
- 1 part damiana leaves (*Turnera diffusa*)
- 1 part lavender buds
- 1 part red rose petals or rose geranium leaves (*Pelargonium graveolens*)
- ½ part rosemary leaves
- ½ part self heal leaves and flowers (*Prunella vulgaris*)

Directions

1. Decide whether you want to make the fragrant, relaxing oil or the oil to soothe sore muscles. Wilt the appropriate herbs and flowers overnight.
2. Place the wilted herbs and flowers in a glass jar.

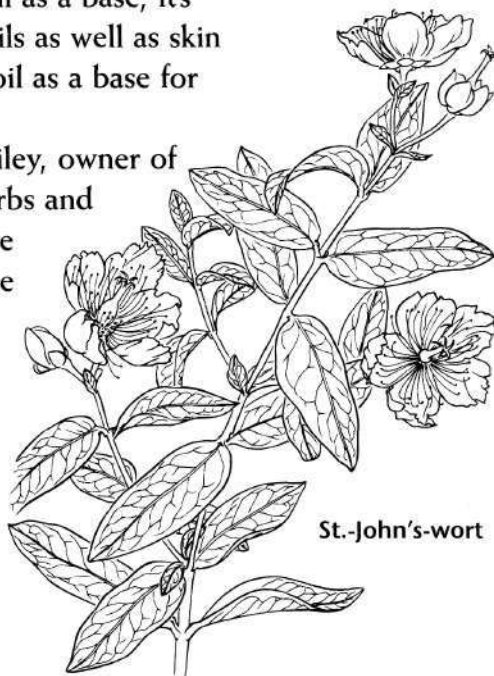

St.-John's-wort

Blend for soothing sore muscles

- 2 parts calendula petals (*Calendula officinalis*)
- 1 part chamomile flowers
- ¾ part ginger root (*Zingiber officinale*)
- Rose and lavender essential oils
- 1 part mugwort leaves and flowers (*Artemisia* spp.)

3. Cover them with oil and cap tightly.
4. Let sit in the sun for 3 to 4 weeks, shaking every few days.
5. Add more oil as necessary to keep the plant material covered.
6. Line the strainer with cheesecloth.

7. Strain the oil into a clean glass jar, squeezing as much oil out of the cheesecloth as possible.
8. Let the oil sit for 1 to 2 weeks in a cool, dark place.
9. If sediment or water settles to the bottom of the jar, pour off the oil into a clean glass storage jar, being careful not to include the impurities.
10. Store the finished oils in a cool, dark place, where they will keep for at least 1 year.
11. To use, pour a cup of the oil into a small container. Scent with essential oils, if desired.

Note: "I like to pick the plants on the new moon and strain the oil on the next new moon," Julie says. "This gives a natural rhythm to my work."

Variation: To soothe pain, try a massage oil made with St.-John's-wort (*Hypericum perforatum*). "St.-John's-wort oil is a good remedy of choice for inflamed muscle and nerve pain. It's effective for bruises, contusions, inflamed arthritic joints, and even sunburn," says pharmacist and herbalist Lynn Shumake of Blue Mountain Herbal Apothecary in Glenelg, Maryland.

"The oil is especially fun to make because it turns a beautiful rich burgundy color after 2 to 3 months," Lynn adds. "That's when you know it's ready." Lynn uses sesame oil for his herb-infused oils. "Sesame oil may be more expensive, but it won't turn rancid. In India, where it is considered a sacred oil, it's been used for centuries without refrigeration."

QUICK ESSENTIAL MASSAGE OILS

Herbalist Rita C. Karydas, owner of Lunar Farms Herbal Specialist and Learning Center in Gilmer, Texas, makes quick massage oils using grapeseed oil, sweet almond oil, olive oil, and vitamin E oil. "Grapeseed oil is great for massage, since it's absorbed quickly and doesn't leave a sticky film," says Rita. "A combination of sweet almond oil and olive oil has therapeutic properties, soothes, moisturizes, and is good for most skin types. Try 3 parts almond oil to 1 part olive oil. Add ¼ teaspoon of vitamin E as an antioxidant to extend the shelf life of your massage oil blend."

Twenty-five drops of essential oils is enough for a 2-ounce bottle. After you add and mix your essential oils, let the bottle sit for an hour or longer; then smell and adjust the fragrance blend to suit your taste. Try the following essential oils to make special massage blends.

Congestion blend: eucalyptus, lemon, tea tree

Sore muscle blend: lavender, rosemary, peppermint

Sports blend (cooling, stimulating, and relieves muscle pain): sweet birch, peppermint, spearmint 🌿

"Gently massage the oil onto affected areas," Lynn says. "You may apply warm, moist heat with a washcloth. Repeat 2 to 3 times daily." St.-John's-wort may cause sun sensitivity on long exposure. As a precaution, use a good sunscreen lotion.

Herbal Sleep Pillows

Having trouble sleeping? Maybe you need a soporific pillow. Herbs like hops and mugwort induce sleep; rosemary and lavender are soothing; and thyme is good for the respiratory system. "This pillow works like a charm for my wife, Lucy," claims herbalist Rob Wood of Spoutwood Farm in Glen Rock, Pennsylvania. Rob created this blend from dried herbs, enclosed it in a pillowcase, and then inserted the herbal pillow into another pillowcase. He simply removes the herbal sack and washes the outer pillowcase as needed.

Ingredients and Supplies

- 2 cups lavender buds
- 1 cup hops flowers (*Humulus lupulus*)
- 1 cup oak moss
- $\frac{2}{3}$ cup rose geranium leaves
(*Pelargonium graveolens*)
- $\frac{2}{3}$ cup rosemary leaves
- $\frac{2}{3}$ cup lemon balm leaves
- $\frac{2}{3}$ cup chamomile flowers
- $\frac{1}{3}$ cup thyme leaves and flowers
- $\frac{1}{3}$ cup mugwort leaves and flowers
(*Artemisia* spp.)
- Large ceramic bowl
- 2 10 × 12-inch pillowcases
- Sewing machine or needle and thread

Directions

1. Mix the herbs in the bowl.
2. Stuff the herbs into one pillowcase and sew it shut.

MAKING YOUR OWN CASES

If you do any home sewing, you may enjoy making your own pillowcases to fill with sleep-enhancing herbs. To make one case, cut two pieces of plain fabric 12 × 14 inches. Put the right sides of the fabric together and sew the two pieces together on three sides, 1 inch from the outside edge. Turn the fabric right-side-out, stuff the pillow with the herbs and sew the remaining edge shut. Follow the same procedure to make the outer case, using decorative fabric. Stuff the plain filled pillow inside the decorative case and sew the decorative case shut. 🌿

3. Put the herb pillow inside another pillowcase. Sweet dreams!

Yield: 1 Herbal Sleep Pillow

RECIPE FOR PILLOWS FOR SALVES, BALMS, & HOME REMEDIES

Simply Wonderful Herbal Cream

This silky smooth cream, created by California herbalist Shatoiya de la Tour of Dry Creek Herb Farm and Learning Center, is a snap to make and very nourishing for all types of skin. Use a very clean food processor or blender to whip up a batch for yourself or as a gift for a friend.

Ingredients and Supplies

- 1 cup grapeseed oil
- 4 ounces grated beeswax
- Double boiler
- 1¼ cup distilled water or rosewater
- ½ cup aloe vera gel
- ¼ cup herb tincture of your choice
(calendula is one good choice)
- Food processor or blender (very clean)
- 2 teaspoons lavender essential oil
- Sterilized storage jars

Directions

1. Heat the oil and the beeswax gently in the double boiler just until the beeswax melts.
2. Place the water, aloe vera gel, and herb tincture in the food processor.
3. Process on high speed.
4. Pour the oil mixture in a thin stream through the feeding tube, adding the essential oil last. Stop the machine and scrape the sides as needed.
5. When the cream is smooth, pour it into jars. Stored in a cool, dry place, this cream will keep well for at least 6 months.

Yield: About 2 cups of herbal body cream

A DANDY DANDELION CURE

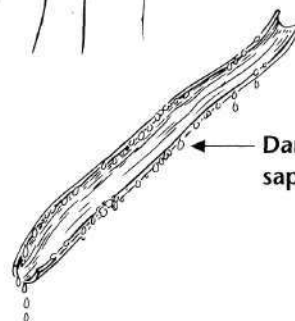

You can help pimples clear up with dandelion sap! Slit open the stem of a dandelion flower stalk and dab on some of the sticky white sap. Repeat every several hours. Often, the spots will disappear overnight. ♡

Herbal Cream Aids Aching Feet

When you have tired feet after spending a day touring gardens or plant shopping, try this foot cream formulated to help runners who suffer from tired, sore feet. Created by Aubrey Hampton of Aubrey Organics in Tampa, Florida, this cream softens and soothes the skin and increases circulation. Here's how you can make Feet Relief at home.

Ingredients and Supplies

1 package (10.5 ounces) firm silken tofu
Small mixing bowl
Whisk
3 tablespoons fresh aloe vera flesh or
organic aloe vera gel
4 tablespoons shea butter
Blender

3 tablespoons grain alcohol or vodka
3 tablespoons jojoba oil
½ cup olive oil
1 cayenne pepper
2 drops each essential oils of eucalyptus,
ginger, peppermint, tea tree,
camphor, and wintergreen
Clean storage jar

Directions

1. Place the tofu in a small mixing bowl and whisk until it breaks up.
2. Put the tofu, aloe vera, and shea butter (found in health food stores) in the blender and mix for 1 minute.
3. Turn off blender and stir lightly.
4. Add alcohol and continue to alternate blending with stirring until the mixture is uniform in texture.
5. Add the jojoba oil and blend.
6. Use the cayenne pepper and olive oil to make an infused oil, following the procedure described in "Basic Herb-Infused Oil" on page 231.
7. Add 3 tablespoons of the cayenne pepper oil to the mixture and blend.
8. Add essential oils and continue blending until the cream is smooth.

9. Pour the cream into a clean jar, and store it in the refrigerator for up to 2 weeks.
10. To use, apply the cream to your feet at night after washing them. Be sure to wash your hands after using the cream. Do not get the cream on your face or near your eyes—it will burn. Also avoid getting the cream into any open wounds.

Yield: About 1 pint of foot massage cream

Note: Shea butter is made from the seeds of the shea tree, a tree native to tropical Africa. It is nonallergenic and excellent for dry skin.

Although cayenne pepper oil creates an initial burning sensation, it ultimately relieves pain by blocking the activity of substance P, which is necessary for the transmission of pain impulses to the central nervous system.

Herb-Scented Foot and Body Warmers

What's stuffed with grain, applied hot or cold, and comforts aching muscles and cold feet? A pillow. But not just any pillow! This one is filled with flaxseed and rice and can be heated in the microwave to provide fragrant, warm heat or chilled in the freezer to cool a fever or over-extended muscles.

"I discovered these in a specialty gift shop a few years ago," says Alison Melotti-Cormack, an artist in Chambersburg, Pennsylvania. Alison toyed with the design, creating a prototype that she likes even better than the original inspiration. "It's important to use all-cotton fabrics," cautions Alison. "You don't know what will happen if you heat synthetics in a microwave."

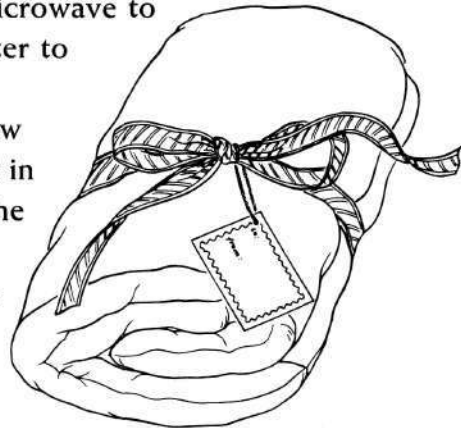

Herb-scented foot and body warmers make the perfect holiday gift for cold winter days.

Ingredients and Supplies

- 1/3 yard 100% cotton muslin
- 1/3 yard 100% cotton flannel
- 9 x 9 1/2 inches paper pattern piece
(to be cut on the fold)
- 9 1/2 x 10 1/2 inches paper pattern piece
- Thread
- Sewing machine
- 3 1/2 cups long-grain white rice
- 2 cups flaxseed
- Herb sachet (lavender is Alison's favorite)

Directions

To make the inner muslin pillow:

1. Using the smaller pattern, cut 2 rectangles, both on the fold of the muslin.
2. Stitch all sides together using 1/2-inch seam allowances and leaving a 2- to 3-inch opening on one short side. Reinforce the corners by sewing over them several times.

HERBAL EYE PILLOW EASES HEADACHES

To make a soothing eye pillow, make a 7 1/2 x 3 1/2-inch pillowcase from a woven soft fabric such as silk, suede, or flannel. Fill with flaxseed mixed with a few tablespoons of lavender buds and sew shut. To use, chill in the freezer and lay over forehead and eyes for sweet relief. 🌿

3. Turn the muslin sack so that the seam allowances are on the inside.
4. Fill the sack with the rice and flaxseed. (Make a funnel from a piece of paper for easier filling.)
5. Stitch the opening shut.
6. Check for any leaks by tipping the sack from hand to hand, mixing the rice and flaxseed at the same time.

To make the outer flannel pillowcase:

- Using the smaller pattern, cut 1 rectangle of flannel on the fold.

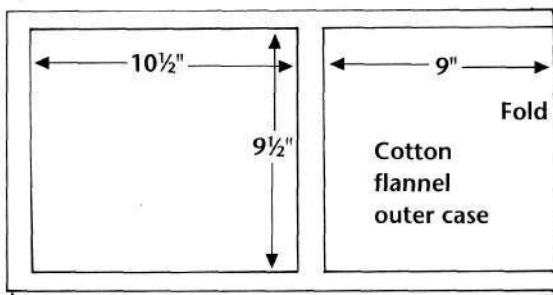

Cut on fold 9" x 9 1/2"

- Using the larger pattern, cut 2 rectangles of flannel.
- Hem one of the short seams on each of the 2 flaps of flannel.
- Lay out the long side of the flannel with right sides up. Overlap the 2 flaps with hemmed sides in the middle and right sides facing downward.

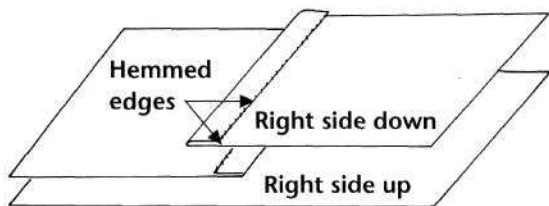

- Stitch around the periphery of the flannel sack again, reinforcing the corners and double-stitching over the overlaps.

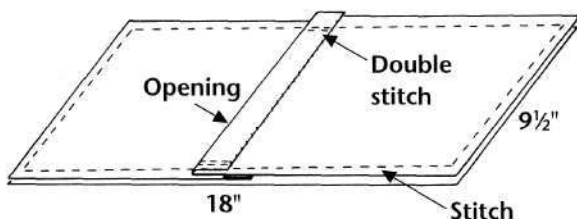

- Trim seams and corners and turn right sides out. Insert the grain sack through the opening in the middle. Shake and flatten out the grain sack evenly.

- For warm applications, heat the pillow in the microwave for 2 to 3 minutes. Warm your hands by placing them inside the flap, wrap the pillow around tired shoulders, lay it over cold feet, or place it in the back of your chair or car seat to ease back pain.

For moist heat, place a cup of water in the microwave when heating the pillow. Then lay the pillow over your eyes, nose, and cheeks to ease sinus congestion.

- For cold applications, such as reducing swelling, freeze the pillow until it is cold.
- Be sure to remove the grain sack before washing the flannel pillowcase.

Yield: 1 Herb-Scented Foot and Body Warmer

Note: It's easy to enhance the healing properties of this pillow with herbs. Just drop a small herb sachet into the outer pillow case along with the grain sack. Remove the herbs when heating or chilling the pillow. "I don't add the herbs to the grain sack because they'll need to be refreshed long before the pillow wears out," explains Alison. "And I don't use essential oils, as the scent will remain in the pillow for longer than you may like." By the way, the rice smells wonderful when it's heated.

Herbal Powder Keeps Feet Fresh

Have you been looking for a simple powder to keep feet and footwear fresh? Herbalist Gail Ulrich, author of *Herbs to Enhance Immunity* and founding director of Blazing Star Herbal School in Shelburne Falls, Massachusetts, has this easy recipe to share.

"Mix in a few drops of tea tree oil to the powder if foot fungus is a problem," Gail says.

Ingredients and Supplies

- ½ cup cornstarch
- ½ cup arrowroot powder
- ¼ cup powdered calendula petals
(*Calendula officinalis*)
- 1 tablespoon black walnut hull or chaparral leaf powder
- Small mixing bowl
- Yogurt cup with lid
- ½ teaspoon essential oils such as lavender, lemon, peppermint, and/or tea tree
- Shaker container

Directions

1. Mix together all dry ingredients in a bowl.
2. Put a small amount of the mix in the yogurt cup, and add the essential oils.
3. Shake well to mix.
4. Return the mix to the bowl and mix again.
5. Pour the mix into a shaker container. It will keep indefinitely.

Yield: About 1 cup of herbal foot powder

YARROW FIRST-AID TINCTURE

It's great to feel the warm earth between your toes while you garden. But it's no fun when your bare feet meet with sharp or hard objects in the soil. Keep this simple yarrow tincture on hand for times when your feet (or other parts) need a little first aid.

"Yarrow is my all-purpose remedy for cuts, scrapes, and bruises," says herbalist Margi Flint of Earthsong Herbals in Marblehead, Massachusetts. Margi makes yarrow tincture from the white flowers of the plant and keeps it handy in a plastic spray bottle.

Fill a 1-quart glass jar loosely with fresh yarrow flowers, then add vodka (the cheapest you can buy) to the jar to cover them, allowing for 2 inches of clear alcohol at the top. Let the jar sit for two to three weeks at room temperature, then strain out the yarrow. Fill a quart-size spray bottle with the yarrow tincture and add 20 drops of lavender essential oil. To use, shake the bottle well and spray directly on bruises, cuts, and scrapes. Repeat every several hours until healing is evident. This tincture will keep for at least five years. 🌿

Soak Your Feet in Soothing Herbs

So you think you have tired, aching feet? "This recipe gets a lot of use on the days we're parading around the Sterling Renaissance Festival in period footwear," says Sue-Ryn Burns, herbalist at Hill Woman Productions on Wellesley Island, New York. The herbs in this dried blend are soothing and cleansing and may even help protect your feet against fungal disease.

Ingredients and Supplies

- 2 parts red clover flowers (*Trifolium pratense*)
- 2 parts violet leaves and flowers
- 1 part clary sage leaves (*Salvia sclarea*)
- 1 part calendula flowers (*Calendula officinalis*)
- 1 part lavender buds and leaves
- 1 part thyme leaves
- Mixing bowl
- Airtight storage container
- Nonreactive glass or stainless steel
saucepan
- Strainer
- Plastic wash basin or other footbath pan
- Essential oils (optional)

Directions

1. Mix all of the herbs together in the mixing bowl.
2. Place the mixture in an airtight container and store it in a cool, dry place—it will stay fresh for up to 1 year.



Nurture your soil and your soles with a garden cover crop of red clover. Sow this clover between the rows of your garden in late summer and let it protect the soil over the winter. When the clover blooms next summer, gather its flowers to use in this soothing foot soak.

3. To use, simmer 3 tablespoons of the herb mix in 2 cups of water in the saucepan for 15 minutes.
4. Strain the mixture into a pan that is big enough to accommodate both feet.
5. Add enough lukewarm water to cover your feet. (Add essential oils, if desired.)
6. Relax for at least 15 minutes.

Refreshing Rosewater

Remember the rosewater your grandmother used? "Although rosewater is usually produced by distilling fresh rose petals," says herbalist Rosemary Gladstar, founder of Sage Mountain in East Barre, Vermont, and author of *Herbal Healing for Women*, "the following recipe is easy to make and just as effective." The more fragrant the petals, the stronger the scent of the lotion.

Ingredients and Supplies

- 3 cups fresh rose petals
- Glass quart jar
- 3 cups distilled witch hazel extract
- 1 cup distilled water
- Strainer
- Linen towel, muslin, or cheesecloth

Directions

1. Place the rose petals in the glass jar, filling it to 3 inches from the top.
2. Mix the witch hazel extract with the distilled water.
3. Fill the jar to the top with the liquid mixture.
4. Cover tightly, label and date, and place in a warm shaded area. Let the mixture sit for 2 to 3 weeks.
5. Strain the rose petals from the liquid by pouring it through linen towel, muslin, or cheesecloth. Wring out the cloth to remove extra rosewater.

BLACK EYE BLUES?

Poked your eye on a tomato stake? To soothe a black eye, Matthew Wood, author of *The Book of Herbal Wisdom*, recommends a comfrey poultice. Simply bruise a few comfrey leaves (*Symphytum officinale*) and lay them over the affected area. That ugly bruise will fade in a twinkle. If you're pregnant, don't try this without consulting a doctor first. 🍀

6. Store the rosewater in a covered bottle. The rosewater will keep indefinitely, but the fragrance is best within the first year after you make this soothing lotion.
7. To use, apply with a piece of cotton or spray lightly on your face. Rosewater is gentle enough to use around the eyes and can actually be used as a compress to refresh tired eyes.

Yield: 1 quart of rosewater

Cloves Add Taste to Paste

Brushing your teeth with baking soda or salt still makes for good daily hygiene. Herbalist Stephanie Tourles, author of *The Herbal Body Book* and owner of September's Sun Herbal Soap Company, recommends adding a touch of cloves.

Ingredients and Supplies

- 1 teaspoon baking soda or fine sea salt
- 1 drop peppermint, clove, cinnamon, or spearmint essential oil
- Chopstick or other utensil (for stirring)

Directions

1. Combine the baking soda or salt with the essential oil in a small dish.
2. Use a chopstick or other utensil to mix the ingredients together until they form a smooth, thick paste. If the mixture is runny, add a little more baking soda or salt—a runny powder won't stay on your toothbrush.
3. Put some of the mixture on a toothbrush, and brush your teeth as you would with any commercial toothpaste. Rinse thoroughly.

Spicy Herbal Mouthwash

For naturally fresh breath, use homemade mouthwash with fresh herbs and spices, says herbalist Tina James of Reisterstown, Maryland. If you are using fresh herbs, triple the amount of herbs in the recipe.

Ingredients and Supplies

- 1 tablespoon dried blackberry leaves
- 1 tablespoon dried thyme
- 1 tablespoon dried peppermint
- 1 tablespoon cloves, crushed
- 1 tablespoon nutmeg, freshly grated
- Clean glass jar with lid
- 2 cups vodka (the cheapest you can buy)
- Strainer
- Storage container
- Essential oil of peppermint (optional)

Directions

1. Combine herbs and spices in the jar.
 2. Add vodka and stir or shake to make sure that the herbs are covered.
 3. Steep at room temperature for 2 weeks.
 4. Strain liquid into storage container. It will keep indefinitely.
 5. To use, add 2 tablespoons of mouthwash concentrate to $\frac{1}{2}$ cup water. Swish a comfortable amount in your mouth, then spit it out. Repeat until your mouth feels fresh.
- Yield: About 2 cups of spicy mouthwash

1 cup greensand
RECIPE FOR PHILAS FOR SALVES, BALMS, & HOME REMEDIES
5 CLOVES GARLIC CRUSHER

Comfrey Poultice

Comfrey is a time-honored and effective remedy for bruises, sprains, and even broken bones. "In fact," says herbalist Laurieann Quiry, who practices at Mount Lebanon Herbals in New Lebanon, New York, "comfrey's common name is 'knit bone.'" You can make a poultice from fresh leaves and apply it directly to the affected area.

Whole dried leaves can also be used for poultices. If the leaves are chopped, use warm water to make them into a paste. Wrap the wound with gauze to hold the paste in place.

Ingredients and Supplies

- Saucepan
- Tongs
- Fresh comfrey leaves (*Symphytum officinale*)
- Bandage (optional)

Directions

1. Boil water in the saucepan.
2. Using tongs, dip comfrey leaves into the boiling water.
3. Remove the leaves and let them cool until they are cool enough to touch.
4. Wrap the leaves around the wound, holding them in place with a bandage, if necessary.
5. Repeat with freshly heated leaves every 30 minutes.

Note: This poultice is for external use only; do not apply to cuts or open wounds.

GARDENER'S BAND-AID

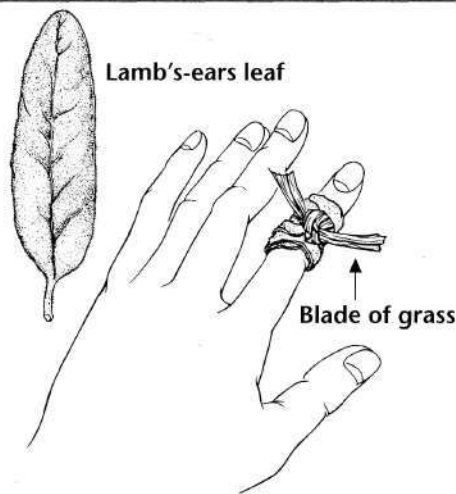

"Here's a wonderful remedy I teach all the kids who visit us at Heart's Ease Herb Shop & Gardens in Cambria, California," says Sharon Lovejoy, author of the children's classic *Sunflower Houses*. For minor cuts and scratches, wash the wound, then open an aloe vera leaf and squeeze some of the gel onto the hurt. Next, find a lamb's-ears (*Stachys byzantina*) leaf to wrap around the cut. Tie it in place with a piece of grass. Voilà! An emergency Band-Aid! 🌿

Poison Ivy Liniment

Herbalist Paul Carmichael, owner of Lily of the Valley Herbs, a retail and mail-order herb shop in Minerva, Ohio, suggests using this goldenseal liniment to soothe not only poison ivy rash, but also clean abrasions, insect bites, ringworm, and other skin rashes. His kids dubbed Paul's best-selling recipe "boo-boo juice."

Ingredients and Supplies

- 1 tablespoon goldenseal root powder
(*Hydrastis canadensis*)
- 1 tablespoon myrrh powder
- 1 tablespoon white oak bark powder
- Glass jar
- 2 cups isopropyl alcohol
- Strainer lined with muslin
- 16-ounce bottle with cap

Directions

1. Place herbs in the jar and pour in alcohol.
2. Shake well daily.
3. Let the mixture sit for 2 weeks, then strain it into a bottle.
4. To use, dab the liniment on rashes, insect bites, or abrasions.

Yield: 2 cups of "boo-boo juice"

Note: This liniment keeps indefinitely

A JEWEL OF A CURE

Nature usually offers amends for her plagues. Quite often, the cause and cure are neighbors. Such is the case with jewelweed (*Impatiens capensis*), which grows abundantly at the edges of streams and moist woodlands right alongside that troublesome poison ivy vine. For quick relief from poison ivy, pinch off a piece of jewelweed, slit the stem, and rub the juice on affected areas. To make an emergency stash, cover a pot of jewelweed (leaves, stems, and flowers) with water, simmer until reduced by half, and freeze into cubes. Use the cubes directly on the skin or melt them and make a compress with the liquid. Jewelweed also eases the itch and sting of stinging nettle and insect bites. 🌿

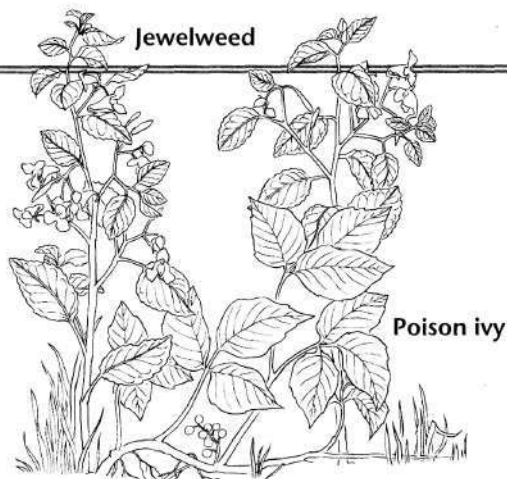

When you need relief from the itching caused by poison ivy, jewelweed is a gem. Simply split the stem of the jewelweed and apply the juice to affected areas. As luck would have it, jewelweed often grows right beside the irritating ivy.

Invincible Herbal Insect Repellent

"Gardeners and hikers need powerful insect protection up in these hills," says Tina Wilcox, head gardener at the Ozark Folk Center in Mountain View, Arkansas. "So before heading outdoors, I douse myself with an incredible repellent that my friend Marion Spear and I concocted," Tina says. "It renders me almost invincible to both insects and poison ivy!"

Ingredients and Supplies

- Large handful fresh jewelweed
(*Impatiens capensis*)
- Large glass jar with plastic lid (vinegar
corrodes metal)
- Strainer
- 1 quart apple cider vinegar
- ½ teaspoon pennyroyal oil
- 1 teaspoon eucalyptus oil
- 1 teaspoon orange oil
- 1 teaspoon citronella oil
- Plastic spray bottle

Directions

1. Crush jewelweed in the jar and cover with vinegar.
2. Let steep for several days.
3. Strain out the jewelweed and mix essential oils into the vinegar.
4. Before applying all over, spray a small amount on the inside of your arm and monitor for 15 minutes for any allergic reaction.
5. To use, spray thoroughly on clothing and lightly on any exposed skin except your face. Reapply every ½ hour or so. (To keep

CHASE AWAY PESTS WITH PENNYROYAL

You can grow your own pest repellent and save a bundle on commercial sprays with a small patch of pennyroyal (either *Mentha pulegium* or *Hedeoma pulegioides*). Plant this pest-repelling herb near your garden or back door. When you head out to do gardening or yard work, grab a handful of leaves, crush them, and rub them on your skin. The oil from the foliage will leave a pleasant minty fragrance on your skin while keeping away flies, mosquitoes, gnats, ticks, and chiggers. It really does work at keeping pests at bay; in fact, many commercial repellents contain pennyroyal oil. 🌿

insects away from your face, spray your hat or bandanna.)

Yield: About 1 quart of invincible spray

Note: This formula will keep indefinitely.

Caution: If you are pregnant, don't use pennyroyal, even topically, as it may increase the risk of miscarriage.

INSTANT FIRST AID FOR GARDENERS

Here's a potpourri of quick herbal fixes for minor health woes ranging from allergies to toothaches. Keep in mind that if you have any injury that's potentially serious, you should seek professional medical assistance.

Allergy attack. Sneezing while you're out walking? "No problem," says Minnesota herbalist Matthew Wood, author of *The Book of Herbal Wisdom*. "Look for some ragweed (*Ambrosia artemisiifolia*) and nibble on the leaf. This can clear up your symptoms, but if it doesn't work instantly, it's not going to help. Ragweed causes allergies because its pollen grains lodge in the nasal passages and irritate the tissues. The leaves are safe. This shows that the plant can cure what it causes!"



Echinacea

Yarrow

Bee sting. Grab a plantain leaf (*Plantago major*), chew it up, and smack it on the skin. It offers quick relief that even little kids can use. In fact, herbalist Margi Flint of Earthsong Herbs in Marblehead, Massachusetts, reports that when a visiting friend who is extremely allergic to bee stings was stung, "I gave her a plantain leaf to chew on while I dialed 9-1-1. Before the emergency crew arrived, her symptoms had disappeared. Now she carries plantain with her wherever she goes!" (Note: If you're allergic to bee stings, don't rely on plantain alone to relieve your reaction. Get medical help to be sure you recover safely.)

Bleeding. Apply fresh yarrow flowers or leaves to the wound. Periwinkle leaves (*Vinca major*) are also great styptics—just crush the leaf and press it into the wound (or in your nose for a nosebleed.) To help fend off infection, try chewing on some echinacea root (*Echinacea angustifolia*) or take a dose of echinacea tincture. Herbalist Laurieann Quiry of New Lebanon, New York, says, "Echinacea has powerful anti-septic and antibacterial qualities."

Boils. Use a rolling pin to bruise a cabbage leaf. Tie the cabbage leaf around the boil with a bandage. Change every 30 minutes.

Coughs and colds. "Here's an old-fashioned remedy," says herbalist Tina James of Reisterstown, Maryland. Grate an onion and place it in a heat-proof container with 2 tablespoons of thyme leaves. Add 2 cups of boiling water, cover, and let steep for at least 20 minutes. Strain into a teacup, add lemon and honey, and drink.

Earache. "Chop plantain leaves finely and squeeze out the juice through gauze, or

bruise some plantain leaves in your hands until you extract a few drops of juice," advises medical herbalist Claudia Wingo.

"Then put a couple of drops in your ear." If you suspect that your eardrum has been perforated, do not use herbal ear drops.

Gas pains. Crush fennel seeds with a mortar and pestle and brew them into a tea. Fennel seed tea also gives quick yet gentle relief to colicky babies. Caution: Some individuals may have an allergic reaction to fennel.

Headache. Simply chew on a leaf of feverfew (*Chrysanthemum parthenium*); some migraine sufferers eat a single feverfew leaf each day to ward off these severe headaches. Feverfew-flower or lavender-flower tea is also effective. (Caution: If you are pregnant, consult with a physician before using any formula that contains feverfew.) Also try rubbing lavender essential oil into the painful areas. (Lavender is one of the few essential oils that can be used directly on the skin.)

Sticker in your finger. Plantain comes to the rescue again. Chew on the leaf and place it on the problem. Tie it in place with a piece of grass or vine, if needed. Replace the leaf every 30 minutes. Within a few hours, you should be able to squeeze the splinter out.

Stomachache. Chew on some mint leaves or make a cup of mint tea. Ginger root (*Zingiber officinale*) tea is also excellent for relieving nausea and motion sickness.

Sunburn. Ouch! Aloe vera soothes the burn. If your aloe vera plant is too small to provide enough to swab all of the affected skin, use purchased aloe vera gel or take the plantain poison ivy bath described on page 257. Or simply add 2 cups of apple cider vinegar to

Purslane

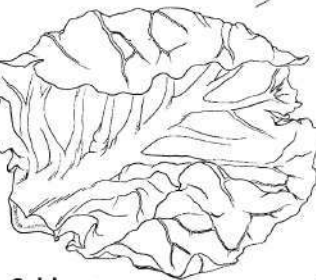
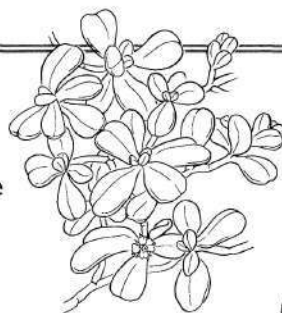

Cabbage

Periwinkle



the tub. St.-John's-wort oil applied directly to the skin also gives quick relief for sunburn pain. Avoid additional sun exposure after applying St.-John's-wort oil, as it can make your skin more sensitive to sunlight.

Sun-weary. If too much time in the garden leaves you feeling hot and dry, "Look around for some purslane (*Portulaca oleracea*)," advises Richo Cech of Horizon Herbs in Williams, Oregon. "Munch on the vitamin-rich leaves to rehydrate and re-mineralize your body. You can also chew some of the leaves and lay them over your eyes for quick cooling relief."

Toothache. Essential oil of cloves is an age-old remedy for numbing tooth pain. Put a dab of the oil on a cotton swab and dot the painful area, avoiding the lips and tongue.

Plantain leaf is also great for a toothache. Chew up the leaf and wad it around the painful tooth. 🌿

Fight Allergies with Herbs

Are pollen allergies keeping you out of the garden? "When allergy season arrives, we have people standing in line at the shop for this remedy," says Claudia Wingo, a registered nurse and medical herbalist who practices at the Smile Herb Shop in College Park, Maryland. "Start taking this herbal tincture about two weeks before the pollen gets thick," Claudia advises. "The results are truly miraculous."

Ingredients and Supplies

Equal parts fresh leaves of ground ivy (*Glechoma hederacea*), plantain (*Plantago major* or *P. lanceolata*), and stinging nettle (*Urtica dioica*)

Quart glass jar

1 quart vodka

Strainer lined with linen handkerchief or cheesecloth

Eyedropper bottle

Directions

1. Fill jar about $\frac{1}{3}$ full with fresh herbs. If you use stinging nettle, be sure to gather the leaves before the plants begin to flower.
2. Fill the jar with vodka.
3. Let the mixture steep for 2 to 3 weeks at room temperature.
4. Strain. Fill an eyedropper bottle with the tincture for daily use.
5. To use, put 20 to 25 drops of the tincture into a small glass of water and drink. Repeat 3 or 4 times a day. For best results, begin

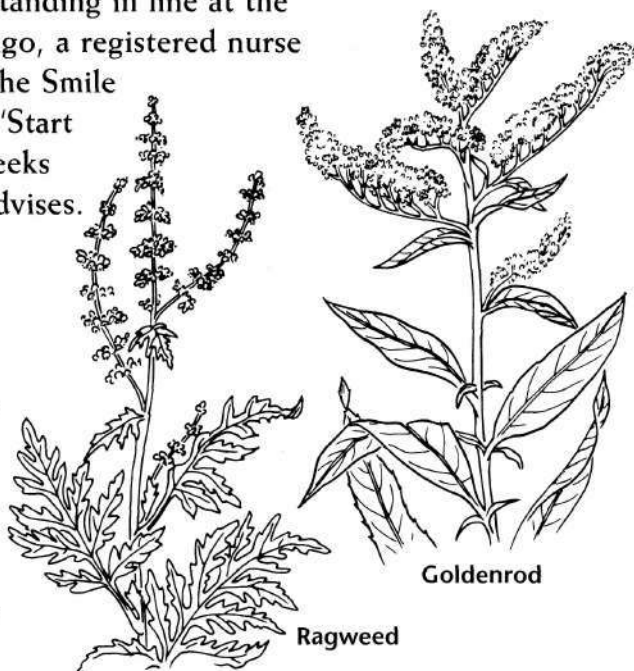

Don't blame goldenrod (*Solidago* spp.) when seasonal allergies make you sneeze. Although this showy native plant is highly visible at the height of the allergy season, it's not the cause of your woes. The real culprit is ragweed (*Ambrosia artemisiifolia*), an introduced species that raises its inconspicuous flowers in many of the same sites where goldenrod blooms.

taking drops 2 weeks before allergy season and continue until the air clears.

6. Store remainder in a glass jar in a cool, dark place. The tincture will keep for up to 5 years in these conditions.

Yield: About 1 quart of allergy-fighting tincture

FORMULAS FOR SALVES, BALMS, & HOME REMEDIES

Soothing Flea-Bite Wash

To soothe your pet's flea-bitten skin, swab on this herbal infusion created by Maine herbalist Deb Soule of Avena Botanicals, author of *The Roots of Healing: A Woman's Book of Herbs*. Because this formula calls for dried herbs, the mix can be stored for long-term use. If you use fresh herbs, triple the amount of each.

Deb says it helps to apply a healing balm after washing the sore areas. She recommends calendula oil or salve. (Also try "Jack the Dog's Herbal Skin Oil" on page 264.)

Ingredients and Supplies

- ½ cup dried rosemary leaf
- ½ cup dried calendula flowers
(*Calendula officinalis*)
- ¼ cup dried stinging nettle leaf
(*Urtica dioica*)
- ¼ cup dried comfrey leaf
(*Symphytum officinale*)
- ¼ cup dried red clover flowers
(*Trifolium pratense*)

Mixing bowl

Airtight storage container

Non-aluminum saucepan with lid

Strainer

Directions

1. Mix the dried herbs. Store them in an airtight storage container in a cool, dry place for up to 6 months.
2. To make the herbal wash, boil 1 quart of water and stir in 6 tablespoons of the dried herb blend.

GIVE FLEAS A SALTY SEND-OFF

After bathing your pet to rid it of fleas, sprinkle salt around areas where animals lie, advises Deb Soule. "Salt dehydrates the fleas and they die." 🐾

3. Turn off heat, cover, and let the infusion steep overnight.
4. The next day, strain the herbs.
5. With a clean cloth, rinse sore areas with the infusion.
6. Repeat several times a day.

Yield: 1¾ cups of dried herb mix (enough to make about 6 quarts of soothing herbal wash)

Note: Comfrey is considered unsafe for internal use by humans. Make sure your pet doesn't lap up this soothing wash while you're applying it.

HERBS FOR SALVES, OILS, & HOME REMEDIES

Piney Flea Shampoo

Here's a safe, effective flea shampoo from herbalist Deb Soule, author of *The Roots of Healing: A Woman's Book of Herbs* and proprietor of Avena Botanicals, an herbal apothecary in Rockport, Maine.

Ingredients and Supplies

- 1 cup liquid castile soap
- 1/8 ounce essential oil of pine
- Plastic squeeze bottle

Directions

1. Measure soap and pine oil into the plastic bottle and shake well.
2. Add the full amount to your pet's bath water.

Yield: 1 cup of herbal flea shampoo

Jack the Dog's Herbal Skin Oil

To heal sores and "hot spots" that animals can't seem to leave alone, animal herbalist Barb Dawson of Atlanta, Georgia, created this soothing skin oil. "Jack is an Afghan hound I helped rescue," explains Barb. "He was so anxious that he chewed on himself if I left him alone for a minute. That's how this skin oil came about." The story has a happy ending: Jack's sores healed, and he has a wonderful new home.

Ingredients and Supplies

- 1 part fresh calendula flowers
(*Calendula officinalis*)
- 1 part fresh sweet fern leaves
(*Comptonia peregrina*)
- 2 1-pint glass jars with straight sides and tight-fitting lids
- 1 part fresh comfrey leaves
(*Symphytum officinale*)
- Almond oil (the best quality you can afford)

- Chopstick
- Strainer lined with muslin or linen
- Sterilized glass jars for storage
- Goldenseal root tincture
(*Hydrastis canadensis*)
- Lavender essential oil
- Rosemary essential oil
- Eyedropper bottle
- Gauze

Directions

1. Place equal amounts of calendula flowers and sweet fern leaves in one glass jar.
2. Place comfrey leaves in the other glass jar.
3. Pour enough almond oil in each jar to cover the herbs.
4. Slide a chopstick into the oil to release any air bubbles, then cap jars tightly.
5. Place jars in a sunny window.
6. Wipe the inside of each jar and lid occasionally to remove any moisture.
7. After 2 weeks, strain out plant parts.
8. Store oils in separate sterilized glass jars.
9. Before applying, pour equal amounts of the calendula/sweet fern oil and the comfrey oil into a clean bottle.

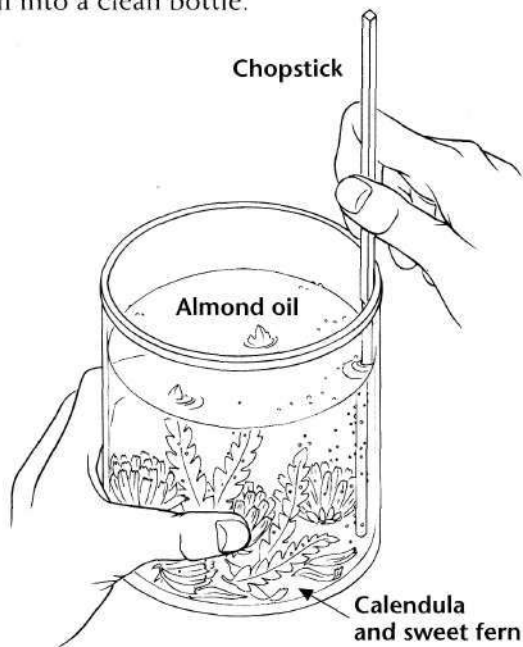

It's important to prevent mold from developing while infusing oil with herbs. Air bubbles are possible troublemakers because they can trap water vapors from the herbs and the vapors may promote mold. Get rid of any air bubbles in the herb and oil mixture by occasionally stirring it with a chopstick.

10. For each 8 ounces of almond oil, add 4 droppersful of goldenseal tincture and 1 capful of each of the essential oils; shake well.
11. Label and date the bottle. This formula will keep for up to a year if stored in a cool, dark location.
12. To apply, shake the bottle well before each use. Apply liberally to damaged skin using a piece of gauze to dab the oil in place. Try not to rub the sore skin.

Note: Comfrey is considered unsafe for internal use by humans. Make sure your pet doesn't lap up this herbal skin oil while you're applying it.

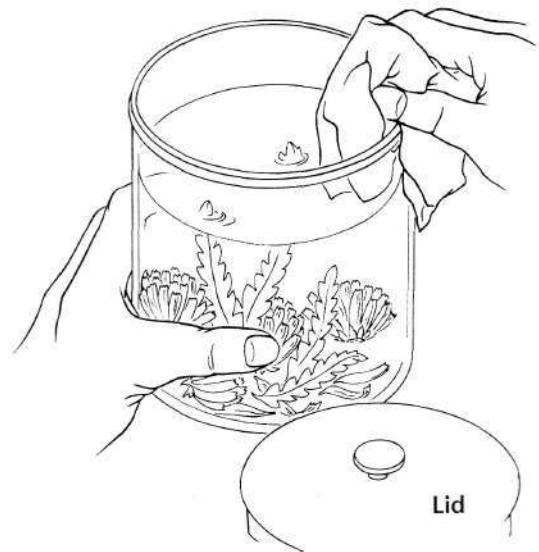

Moisture under the lid and around the insides of the jar can also encourage mold. Occasionally wipe these areas while the oil-and-herb mixture is setting.

Metric Conversion Tables

LIQUID AND HOUSEHOLD MEASUREMENTS

TO CONVERT	To	FROM	USE
	milliliters	teaspoons	___ teaspoons \times 5 = ___ milliliters
	teaspoons	milliliters	___ milliliters \times 0.201 = ___ teaspoons
	liters	cups	___ cups \times 0.24 = ___ liters
	cups	liters	___ liters \times 4.17 = ___ cups

COMMON EQUIVALENTS	U.S.	METRIC
	¼ teaspoon	1.25 milliliters
	½ teaspoon	2.5 milliliters
	1 teaspoon	5 milliliters
	1 tablespoon (3 teaspoons)	15 milliliters
	2 tablespoons (1 fluid ounce)	30 milliliters
	¼ cup (2 fluid ounces)	60 milliliters
	⅓ cup (2.67 fluid ounces)	80 milliliters
	½ cup (4 fluid ounces)	120 milliliters
	⅔ cup (5.33 fluid ounces)	160 milliliters
	¾ cup (6 fluid ounces)	180 milliliters
	1 cup (8 fluid ounces)	240 milliliters
	1 pint (2 cups)	480 milliliters
1 quart (2 pints or 4 cups)	960 milliliters (0.96 liters)	
1 gallon (4 quarts, 8 pints, or 16 cups)	3,840 milliliters (3.84 liters)	

WEIGHTS

TO CONVERT	To	FROM	USE
	grams	ounces	___ ounces \times 28.35 = ___ grams
	ounces	grams	___ grams \times 0.035 = ___ ounces
	kilograms	pounds	___ pounds \times 0.454 = ___ kilograms
pounds	kilograms	___ kilograms \times 2.2 = ___ pounds	

1 teaspoon chili powder

GREAT GARDEN FORMULAS

GREAT GARDEN FORMULAS

WEIGHTS — CONTINUED

COMMON EQUIVALENTS	U.S.	METRIC
	1 ounce	28 grams
	2 ounces	57 grams
	4 ounces (¼ pound)	113 grams
	5 ounces (⅓ pound)	142 grams
	6 ounces	170 grams
	7 ounces	198 grams
	8 ounces (½ pound)	227 grams
	10 ounces	284 grams
	12 ounces (¾ pound)	340 grams
14 ounces	397 grams	
16 ounces (1 pound)	454 grams	
32 ounces (2 pounds)	908 grams (.908 kilogram)	

LENGTH

TO CONVERT	TO	FROM	USE
	inches	centimeters	___ centimeters × 0.394 = ___ inches
	centimeters	inches	___ inches × 0.254 = ___ centimeters
	feet	centimeters	___ centimeters × 0.033 = ___ feet
	centimeters	feet	___ feet × 30.48 = ___ centimeters

COMMON EQUIVALENTS	U.S.	METRIC
	1 inch	2.54 centimeters
	6 inches	15.24 centimeters
	12 inches (1 foot)	30.48 centimeters
	18 inches (1½ feet)	45.72 centimeters
	24 inches (2 feet)	60.96 centimeters
	36 inches (3 feet or 1 yard)	91.44 centimeters
	60 inches (5 feet)	152.4 centimeters (1.524 meters)
72 inches (6 feet or 2 yards)	182.88 centimeters (1.829 meters)	

1/4 cup hot oil
 GREAT GARDEN FORMULAS
 1 teaspoon chili powder

USDA Plant Hardiness Zone Map

This map was revised in 1990 to reflect changes in climate since the original USDA map, done in 1965. It is now recognized as the best estimator of minimum temperatures available. Look at the map to find your area, then match its pattern to the key on the right. When you've found your pattern, the key will tell you what hardiness zone you live in. Remember that the map is a general guide; your particular conditions may vary.

