

**HOW TO
BUILD YOUR OWN
UNDERGROUND
HOME**

2ND EDITION

RAY G. SCOTT

Contents

Introduction	ix
1 Definition and Objectives Mental and Physical Preparation—Benefits—Alternatives	1
2 Design and Land Must Work Together Well Depths—Excavating—Water Problems—County Regulations—Financing—Restrictions—Lot Size—Into-the-Hill Approach—Level Ground—Below Grade Level—Half-and-Half Construction—Basic Necessities—Extreme Conditions	10
3 How to Get Work Done Insurance—Best Working Hours—Right Tool for the Job—Rental Equipment—Borrowing Tools	24
4 When to Hire a Professional Property Layout—Lawyer's Fees—Sample Purchase—Real Cost—Excavating—Building Materials—Concrete—Masonry—Floor Slab—Interior Walls—More Necessary Purchases—Repeating Work	29
5 Codes and Regulations Means of Egress—Sprinkler System—Smoke Detectors—Series of Corridors—Retaining Walls—Hand Railings—Air Circulation—Potential Electrical Code Problems—Helpful Reminders—Plumbing—Stairs—Door Openings—Building Code Appeals Board—Professional Engineers	41
6 Site Preparation Driveway—Setback—Septic-Sewer System—Surveying—Landscaping—Property Lines	54

7	Preparing and Pouring the Footers The Concrete—Placing Cast-Iron Sewer Pipe—Monolithic Pour	64
8	Walls Formed and Poured Walls—Block Walls—Why All-Block Interior Walls?	73
9	Roof Design and Preparation Block Stuffing—Rebar—Wire Mesh—Steel Placement—Precast Concrete—Chimneys	81
10	Alternate Design Problems—Advantages—Yet Another Approach	103
11	Waterproofing and Insulation Moisture Treatments—Roof Insulation—Potential Pitfalls	113
12	What About Moisture? Grading—Condensation—Sponge Effect—Polyethylene Sheets—Air Pockets—Humidity	122
13	Backfilling and Grading Overlapping Method—Backfilling—Insulation Board—Using a Tractor—Using a Crane—Final Grading—Backhoe Removal—Grass Seed	130
14	Utilities Plumbing—Water Pipes—Cleaning New Water Lines—Maintenance—Electric Wiring	143
15	Woodworking Nails, Nails, Nails—Hanging Doors—Wooden Walls	148
16	Adding Trim and Fixtures Decoration and Layout—Bedrooms—Kitchen—Appliances—Recycled Materials—Furniture—Carpet and Padding—Paint—Interior Garden—Lighting—Ideas	154
17	Heating and Ventilation Heating—Fan System—Cooling—Fresh Air	165
18	Domes and Skylights Indoor Garden—Cost of a Dome—Constructing Your Dome	169
19	Underground Home Ceiling The Roof Slab—Creative Ceilings—Ceiling Space—Painting Your Ceiling	180
20	After the Basics The Entrance—Getting Used to Living Underground—No Windows—Strange Sensations—Radio and Television Reception—Door Bells	184
21	Would I Do It Again?	188
22	Alternate Sources of Energy Heat—Wood Stoves—Coal—Solar Heat—Solar/Electric—Workable Electric Source—Wind Power—Other Fuels	189
23	Underground Home Publicity Positive Attention—Negative Attention—Public Attention—Private Attention	193

24	Years Later	195
	Dome Alignment—Skylight Foundation—Skylight Repair—Heat from the Sun—Crickets—Snow—Visitors—Utility Bills—Lack of Light—Problem Neighbors	
25	“The Day After”	199
	Better Odds—Other Designs—How to Choose Slope Direction	
	Index	205

Introduction

As you browse through this second edition of *How to Build Your Own Underground Home*, you must be asking yourself, "What more can he find to write about after three previous books on the subject of underground homes."

The answer is basic. Like many subjects that are surrounded by good old yankee ingenuity, improvements and advancements are constantly being made. This second edition includes the pertinent information that has come to light since 1978 in the field of earth-sheltered living.

Consider that when the first edition was writ-

ten energy was the predominate word of the day. Today earth-sheltered homes are being built more for a preferred architectural style than for the energy-savings factor. As you read on you will definitely notice the influence the 1980s are having on design and materials.

Earth-sheltered homes are now being accepted as a modern style of home as compared to the sideshow they once were. To repeat a phrase I have used in my previous books, earth-sheltered living is an idea whose time has come.

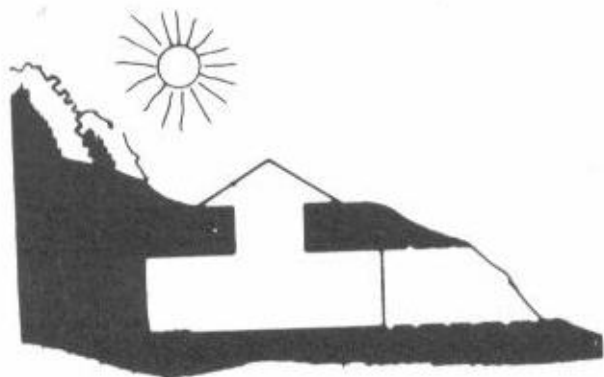

Definition and Objectives

The definition of an underground house at first seems totally self-explanatory, but if you consider the limitless variations of terrain, weather, and human nature, you can imagine the extremes that are possible. Therefore, a clarification, along with my definition, is in order here at the beginning of this book. You can imagine the extremes that might occur when somewhere, sometime, someone has set up a permanent residence in a cavern or cave 100 feet or more below grade surface. On the other hand, there are homes, particularly in California, with approximately 4 inches of soil or sod growing on the roof only to act as an insulator against extreme hot and cold temperatures. These two conditions should definitely be considered the extremes of engineering ease and difficulty.

Therefore, to avoid covering problems and methods of construction that would probably never be encountered by a potential underground home builder reading this book, I have established my parameters of a typical (if there is such a thing) underground home to be 2 to 5 feet under the earth's surface. The biggest reason I have for suggesting 5

feet of earth over the roof of an underground home is that this is the point of best compromise.

By compromise, I mean that 4 or 5 feet of earth gives you the most insulation for the least amount of weight. If you consider that earth, with an average amount of small rocks and dampness from rain, weighs around 100 pounds per cubic foot, it is easy to calculate how many cubic feet of dirt you will have over your head. Multiply the number of cubic feet by 90 pounds. This will give you an estimated total weight that your concrete roof slab will have to support. The more weight overhead, the more reinforced concrete you will need, and the more it will cost.

According to my personal tests and calculations, 5 feet of earth will give approximately 90 percent of the insulation value that 10 feet of earth will give you. The cost and strength of the roof slab to hold up 10 feet of earth, however, would be unreasonable, probably three or four times more expensive than a slab of concrete capable of holding 5 feet of earth. Figure 1-1 shows a bar graph, for estimating the percent of insulation value in rela-

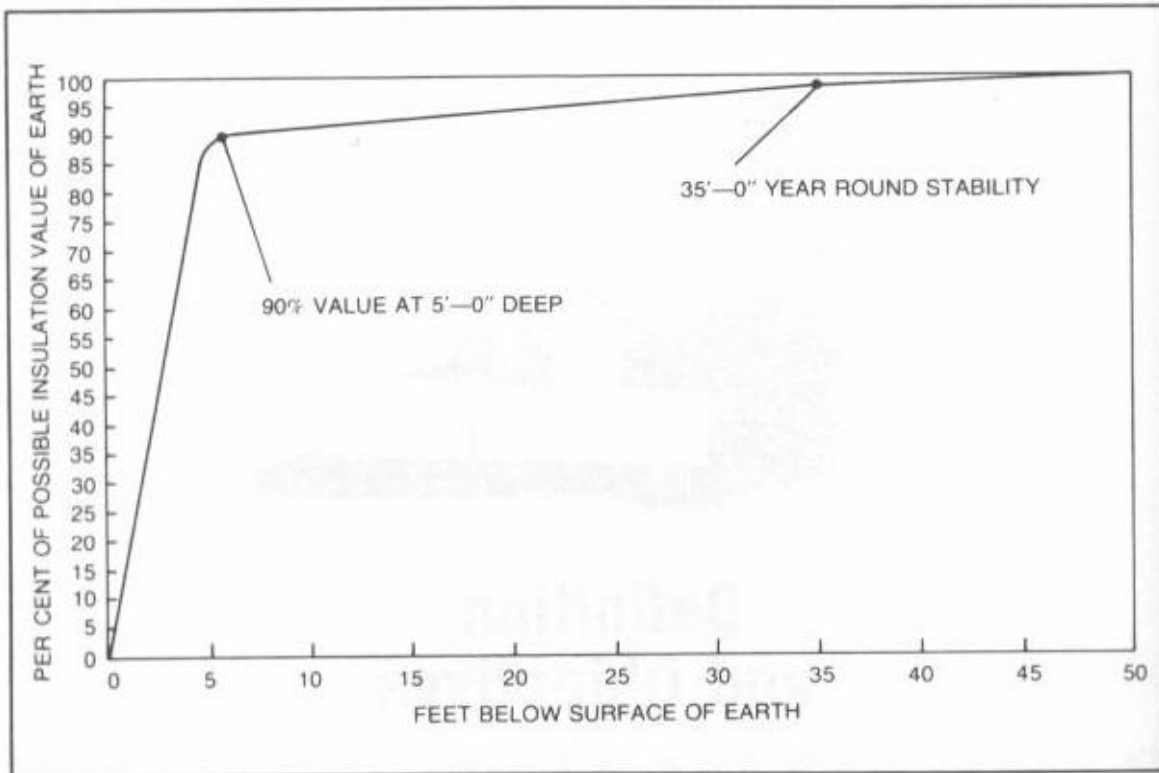

Fig. 1-1. Graph showing relationship of earth depth to insulating value.

tion to depth of soil.

Just as the depth into the ground could be varied, the amount of vertical exterior wall surfaces covered by dirt is likewise varied. The previously mentioned sod-roofed homes have no exterior walls covered by dirt. All the walls are built conventionally constructed. But the home which I have built and now live in has three-and-one-half vertical sides covered by a minimum of 4 feet of earth. In all fairness, I've seen a few good designs with only three walls covered by earth.

So now having mentioned the extremes for exposed exterior wall surfaces, I'll make this suggestion: If you are really interested in building underground, go all the way. The engineering problems are basically the same regardless of whether you have one side, two sides, or all four sides plus the roof covered by earth. Nevertheless, the benefits are substantially increased in direct proportion to the more exterior vertical wall sur-

faces covered.

MENTAL AND PHYSICAL PREPARATION

If the preceding definition doesn't scare you, consider one more thing. Before you make the final decision to build underground, you will want to be prepared mentally, as well as physically, to handle a project that is different from the normal. When I say physically and mentally, I mean exactly that. Building a house of any kind will test a person's physical stamina. This is especially true when you try to do most of the work yourself. Remember that a concrete block soaked by rain can weigh nearly 100 pounds, that a shovel of wet dirt can weigh over 25 pounds, that a cubic foot of wet concrete can weigh 100 pounds a cubic foot, a sheet of plywood can weigh 80 pounds, and that Sheetrock might weigh 120 pounds. These are just a few examples of material weight.

Family Involvement

If you have a family, particularly a wife, I suggest you discuss this idea in great depth with her. She will have to be part of this project and you'll need all the support you can get; so it's best to start with your wife. It's one thing if your friends and neighbors think you're foolish to begin building underground, but if the family thinks you have one oar out of the water, then you're at a tremendous psychological disadvantage going into such a project. Check it out with anyone who will be effected should things go wrong.

Friends

So now you can just imagine the kick-in-the-head when some stranger (or friend) comes along and verbally tears your plans apart with inaccurate and incomplete knowledge or facts, or a distant relative drops in after a hard day's work and proceeds to tell you that you have a screw loose (and probably means it). This is an example of the mental harassment you must be prepared to handle.

Sometimes people can unintentionally be downright demoralizing. But then there's always a friend to come by and lift your spirits by telling you that you are doing a good job and how much he likes the idea of building underground. This is the type of friend you need. He is also most likely the same friend you can call on for a helping hand. The person who knocks your project probably won't hang around long enough to get involved or help out.

Contrary to popular belief, most people are not innovators or experimenters, and they don't know how to handle anyone who attempts to be one—except by criticizing. This is probably the truest statement you'll read in this book. In my short life of 44 years, I have so far done quite a few unconventional things. Building an underground home is definitely the biggest risk from a financial viewpoint, but it probably won't be my last project. If I've learned one thing by my experiences, it is simply that the overwhelming majority of the population only wants to take a look at the unconventional.

Many people will say they would like to do this and that, or someday they'll do such and such, but

they really can't come up with a reason for not starting their dream projects immediately. They just procrastinate until it's too late in life to accomplish anything (an underground house, sailboat, a trip, or a job change). Since this project was conceived in August of 1977 I have discussed the idea with thousands of people. Over 5000 people have visited my house in person. I have talked to another 500 people on the phone from Maine to California. I've answered uncounted letters to potential builders.

My books have sold extremely well so I know the interest is out there, but to this date only one person has later contacted me and said: You know that underground house I told you I was going to build, well here's a picture of it finished (see Chapter 10).

I do know of many who were very interested but were afraid, for whatever reason, and are now living in a three-bedroom rancher—of which there are hundreds more exactly like in our small town. Talk is cheap and so some people give it away. Don't waste your time on idle talk; time is still money. As you read this paragraph, I'm sure you will recognize yourself, friends, and family. I hope you are daring enough to be innovative whether you decide to build an underground house or not.

I am fortunate that most of my neighbors were and are kind people and seem to be sincere in their friendship and interest. But don't count on this attitude of acceptance of your endeavor. Expect to be called foolish, dumb, and worse. If you are lucky, and you have nice neighbors, things should go well. Consider yourself fortunate. But I will bet you my last dollar that there will be one joker in your neighborhood, just as there was in mine. This one neighbor who was furious at having an underground house next door wasted a lot of his time and money taking me to court for minor infractions. He tried to stop my construction on every front you could imagine—from causing rain runoff to flow over his property to claiming smoke from my construction site filtered into his house and damaged his property. He even tried to put pressure on the bank to cancel my loan by claiming my house was a safety hazard to the community. Needless to say, he



Fig. 1-2. Typical view of my skylight after a snow storm.

failed on all attempts and my project turned out successful. He has since moved out of state with an ulcer I hope I gave him. My new neighbors are just great and like the idea of living next door to an underground house. They now have open space to view. See Figs. 1-2 through 1-6.

BENEFITS

Now that you know what I consider an underground house to be, and you have been warned of the mental harassments (I'll tell you of more physical problems and legal pitfalls in subsequent chapters), let me now tell you of the benefits you can expect to find.

Fuel Savings

Because temperature, rainfall, winds, and storms vary from coast to coast, some of your major objectives will probably be different from mine. The reason I decided to build my geothermic (sounds more technical than underground) home was defi-

nately the cold winters and the hot summers of Maryland. In the winter, the fuel bill in my previous conventional-style home was doubling almost every year. And the electricity needed to run air conditioners in the summer wasn't doing any better.

Nature's Gifts

If you have ever taken a tour of any of the commercially operated underground caverns, you'll remember seeing a sign somewhere near the beginning stating that the temperature at this point never varies from a specific range, usually 54° or 55° F, winter or summer. This is one of the great gifts of nature that few of us take advantage of.

As you are probably aware, windmills and wind generators are enjoying a rejuvenated popularity since the fuel shortage of 1973. This is one way of taking advantage of nature's free gifts. Another, of course, is using water power to turn a similar generating system. And don't forget that a few of the real back-to-earth folks (who deserve a great deal of

credit) are using block ice frozen in the winter to keep cold storage areas cool through summer. As for solar power, I'll only mention it and suggest that you read up on the subject before building your underground house. There are millions of words written on solar energy. It's here and now and forever, and it's practical to use.

These gifts of nature, along with many others, are used by only a small segment of the population because it's just not as convenient as they would like it to be. Geothermic heat and earth insulation are just as free, but only tested and used by a minute few. I feel, however, that this will be changing in the near future simply because the cost of all fuels will continue to climb at an unreasonable rate.

Once you are closed in 4 or 5 feet underground with average exterior exposure, you can expect to find year-round temperatures stabilizing. Actually, the temperature does not stabilize year round until you are between 30 and 35 feet below the earth's

surface, but the interesting fact is that after only 4 feet of dirt and 10 inches of concrete the lowest temperature I have recorded inside my home while under construction during the winter of 1977 was 46° F. This was without man-made heat of any kind.

Instead of paying to heat your house in the winter from the mid-teens to a comfortable temperature near 72° F, your additional heat requirement will be minimal. Remember, the constant temperature referred to underground is only when there is no life activity. Once you add light bulbs, cooking heat, body heat, and appliance heat, the temperature will be much higher and thus leave only a few degrees to be raised by conventional or experimental means.

Also note that in the summer these same heat additions are not great enough to require air-conditioning. The highest temperature recorded in our home since 1978 was 79° F. You must realize that every building and every location is as different



Fig. 1-3. There is a house under there but no windows.

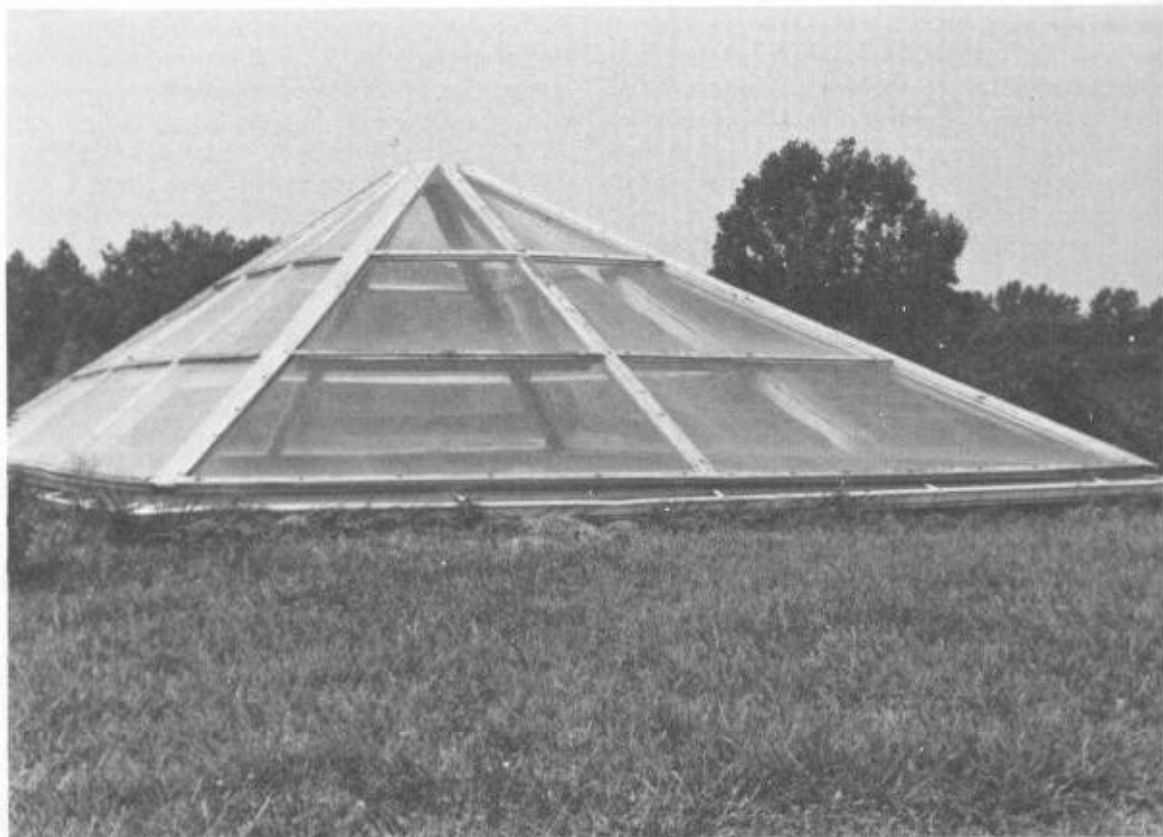

Fig. 1-4. A typical skylight.

as the people who build them. You can expect some of these examples to be more in your favor or less in your favor depending on your situation. I am only quoting from my own personal experience.

Maintenance

During the time my working design was being formed, I nearly overlooked the other major advantages. Consider exterior maintenance. Because an underground home has no trim or paint, no windows to wash, no shingles to blow off, and the exposed walls are stone, you do not have to put many hours into constant outside work. The only thing you really need is a good riding lawn mower and a small push power mower.

One problem I didn't count on was the difficulty in keeping a skylight from leaking. The extreme

temperature of winter to summer, day to night, cause expansion of materials constantly. This always made the joints and seams leak. The leaks never caused a major problem, but the rain droplets falling 18 feet below always kept the glass doors dirty. This problem has since been eliminated by better caulking as of 1984 and all is well with the skylight (remember, it's not a factory-made unit).

Permanency

Don't forget that all exterior walls are concrete—as are the ceiling and floor. If they are designed and constructed correctly, they are impervious to nearly everything. Nothing—insects, fire or water—deteriorates the basic structure. So you can forget the annual termite inspection, rotting beams, etc.



Fig. 1-5. An indoor garden.

Equally important is the elimination of a major fire potential. If you build your house as I did mine, it is nearly impossible for a fire to get a foothold unless you are a pack rat and cram your storage areas with combustible items. Of course, even an

underground home would be vulnerable to this type of carelessness.

Theft Factor

By eliminating all windows, you remove the temp-

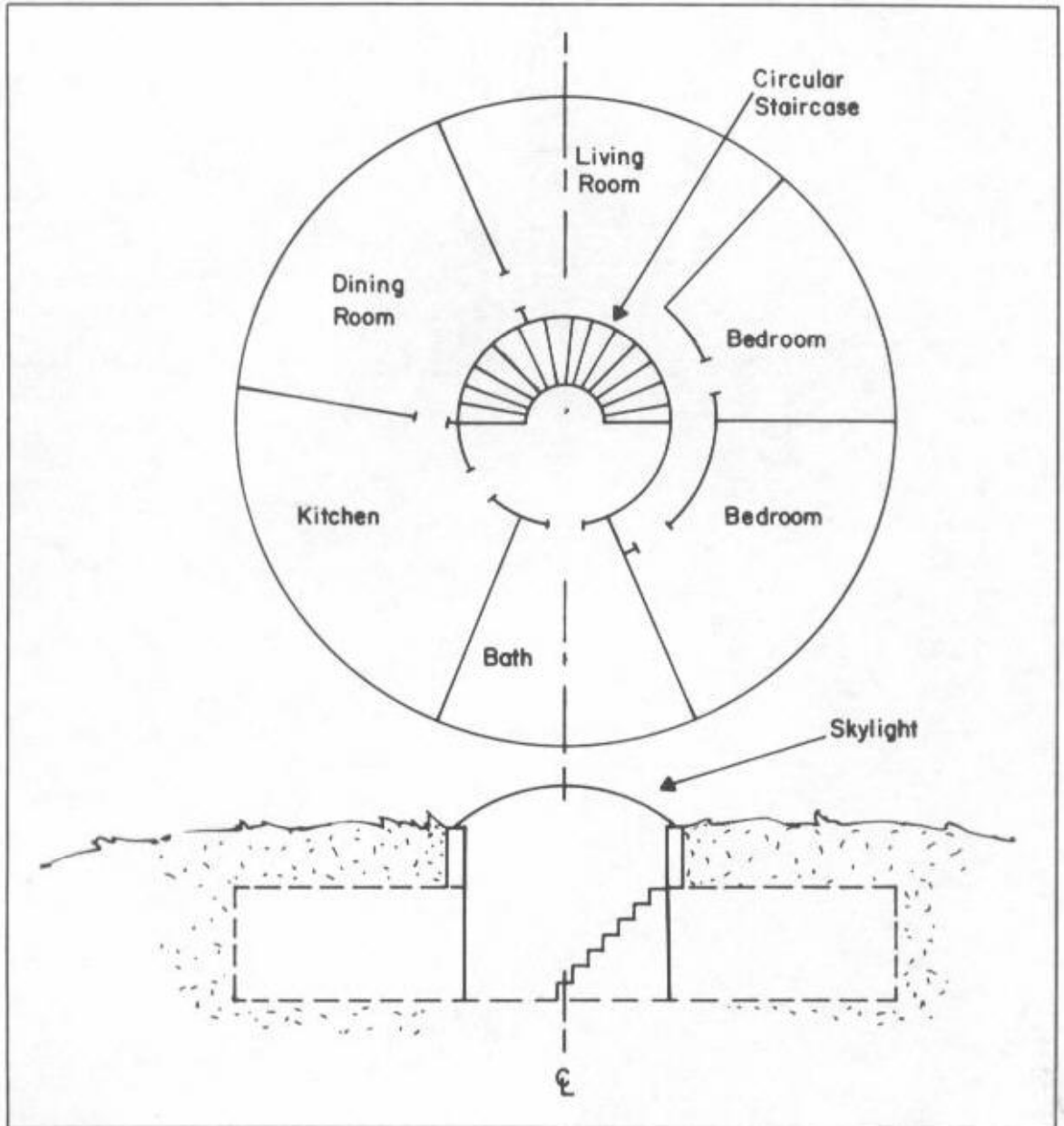

Fig. 1-6. Sketch of the circular design.

tation of vulnerable openings to a petty thief even though we know that the professional is going to find a way to steal regardless of the type of house you have. Nevertheless, an underground house definitely gives you a feeling of security and stability.

For the Lady of the House

When you don't have windows on every wall, you can arrange furniture in an endless combination because you never block a window. This should be particularly interesting to the woman of the household. She will delight in the fact that she will not have to wash windows or buy as many curtains as in a conventional home.

Property Conservation

Last, but not least, is one of my favorite reasons. I bought approximately 2½ acres of rolling hillside in beautiful Harford County, Maryland. After building a 3600-square-foot house, including the garage, I still have 99 percent of the acreage usable and unobstructed by any man-made objects. Besides, the children can't knock a baseball through my windows.

Now that you know all the good points and are thinking seriously about a subterranean home, I'll tell you a few of the alternatives you can begin to think about.

ALTERNATIVES

The alternatives are unlimited; just let your imagination take over. For example, these houses can be circular, rectangular, or square. There are one-story, split-level, and probably two-story houses. They are as small as one or two rooms, or as big as my 40-x-90-foot, two-level house. Size and shape

are only the first of many major decisions you will have to make.

Skylights or domes are usually necessary. Sometimes they cover indoor gardens and sometimes they only provide light to rooms. You could have one dome or six skylights or anything in between. One underground house I know of has the main entrance by a staircase to the center of a circular layout. I consider this an unconventional underground house because of the irregular room shapes. Room locations and exits are your personal choice. The method of construction is what is crucial. The most important thing to consider is that room location will have to meet building codes for your locale.

Another factor that enters into alternatives regarding your house design is the land or site where you select to build. Does your design fit the land? Remember, you can build an underground home almost anywhere except a swamp. Once the exact location is established, you eliminate many of your alternatives. For example, if the land you decide on is rocky, you will not be excavating as deep as you would if it were a sandy soil with no rocks.

And if the land faces north instead of south, you certainly would not want to build the open side using glass. You shouldn't excavate very deep if standing water is close by.

As your plans begin to progress and by the time you meet building codes, zoning regulations, neighborhood restrictions, and avoid the natural pitfalls, you won't have the limitless possibilities you first pictured. Nevertheless, even after meeting all these regulations, an underground house will still be a challenge to the imagination.

Keep tossing over in your mind all the things you could add to make your home interesting and individualistic.

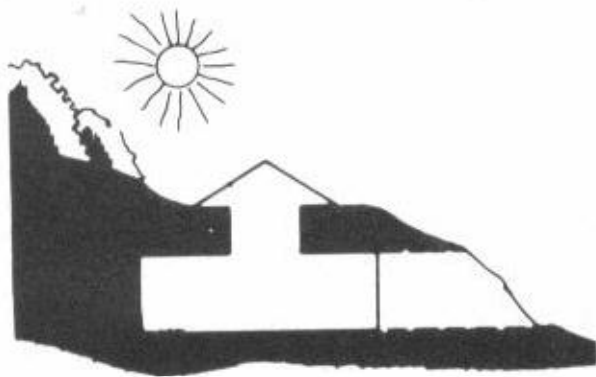

Design and Land Must Work Together

The design of your house and the contour of the land must work together. See Fig. 2-1. This is true regardless of what type of home you are building, but never more true than when designing an underground house. Any land with a water table low enough to build a conventional home could be used to build an underground home, but a water table varies from site to site. The water table is the depth underground at which you first come in contact with standing water under normal prevailing conditions. It is also a fact that the drier the land, the easier your underground endeavor.

Whatever you do, don't buy the first piece of ground you come across. Look around until you have found a couple of acres you really like. If there is such a thing as the ideal location for an underground house, it would be the top of a knoll or hill in the high section or your locale. It is also obvious that you can't always get the best location. Because this is one of the most important decisions in your life, make it the best possible. Look very carefully at the drainage adjacent to your potential house location. Pretend that it has been raining for a week

and imagine where the run off would be going. This is the first step to judging the usability of the land.

WELL DEPTHS

Check the depth of some of the wells drilled in recent years adjacent to your choice of property. You will be looking for places where well depths are 200 feet or deeper. This tells you that water is not near the surface of the land you will be building on. This is not to say that if the neighbors have a well only 100 feet deep that you can't build an underground home nearby. It's only an indication that moisture is closer to the surface—thus nearer your potential house.

EXCAVATING

The type of excavation problem you could run into is this. If by chance, you started excavating in mid-summer when most sections of the country are entering their driest months, you could be deceived into thinking the land is really ideal. When the following spring rains begin (as they always do), the



Fig. 2-1. My house under construction. The black line indicates the property line.

land around could turn into a big swamp, holding water like a sponge. If this would happen, of course, water would try to seep through the concrete wall, floor, or roof.

WATER PROBLEMS

The action of water coming through a concrete floor of any house is hydrostatic pressure. Briefly, this is when the soil around the concrete block cannot absorb any more water and the excess water cannot run off because it is surrounded by a less porous soil or a rock formation.

At this point, the water has no where to go but through the path of least resistance (usually your concrete floor or block walls). More water is seeping through because of gravity and this water has weight. The weight causes pressure at lower levels and therefore water is forced through any minute opening (see Fig. 2-2). This is a condition you must

avoid at all costs when locating your underground house.

If possible wait until you have a rainy period. The greater the rainfall the better. A positive way to see what the conditions would be around your house if it were already built would be to dig a hole 20 to 25 feet deep. It should be big enough to climb down into, but be extremely careful of caving walls. Examine the soil closely under actual conditions. If you don't have time to do all this investigating or it is not feasible for some reason, or you would prefer to have a professional give you advice, look in your local telephone book under engineers—soil testing or engineering—soil. Every community of a reasonable size will have one or more listed.

Anywhere there is a major construction going on, especially road work, there will be soil testing facilities close by. This will cost you, but it is definitely worth the expense if the land you're

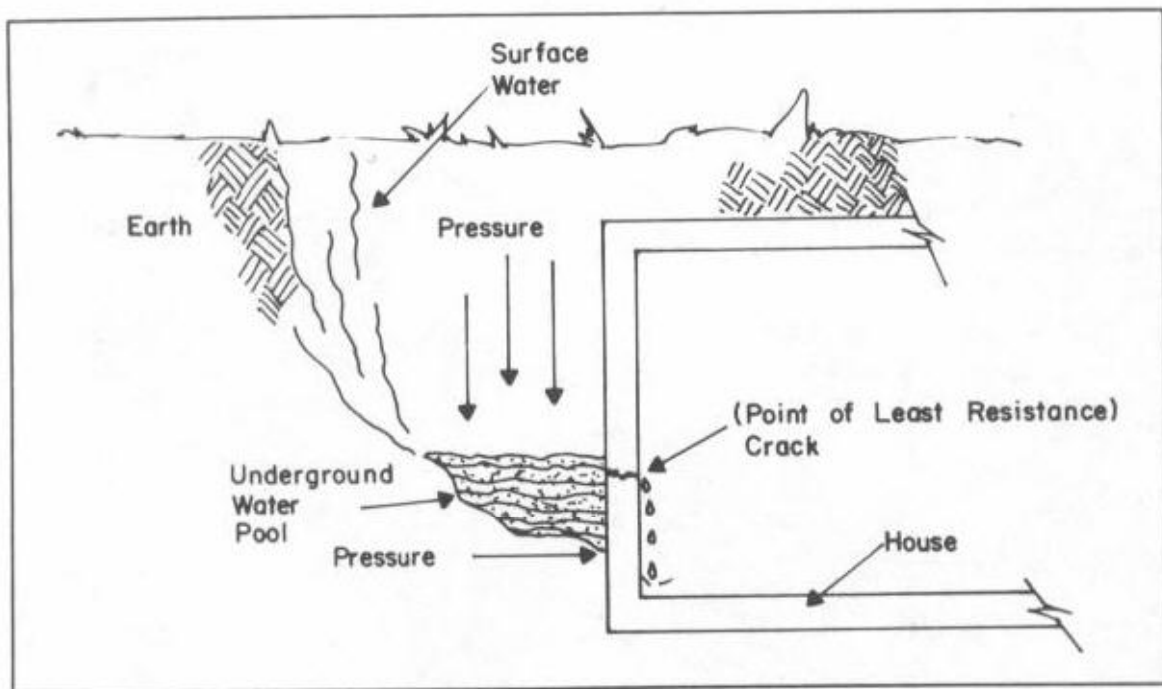

Fig. 2-2. Pockets of water cause pressure below.

thinking of buying is questionable. Remember, water leaking in your underground home could make it useless, and you would lose everything that you have invested.

COUNTY REGULATIONS

Your county probably has a department called "Land Use Soil Bank" or some similar title. These local offices are usually a good source to check once you have limited your search for the land to one or two parcels.

Another local government department to check out would be the Health Department, Well and Water Division. The state of Maryland, as with most other states has offices in each county or township. Each office should have complete topography maps, charts, and documental testing of the soil and earth conditions in the area where you are contemplating building an underground house.

Also, farm-related agencies such as the state farm bureau and the department of agriculture should have up-to-date soil testing results for com-

mercial farming in your area.

Any and all this information is valuable when trying to make up your mind which piece of property to buy. Be prepared to meet resistance or limited cooperation if these local officials know you are contemplating building underground. My suggestion to you, at this stage, would be to keep your plans to yourself. Remember, this is the voice of experience talking. Use all these sources to their fullest, combine them with good judgement, and you shouldn't go wrong.

I strongly suggest that you make the final decision on exact location and get the deed in your name before beginning the design of your building. The reason I say this is that many things can happen on the way to the lawyer's office for final settlement and the best laid plans of mice and men often go astray.

FINANCING

You might not get financing at a reasonable rate or you might not get financing at all. Let me tell you

what happened to me because it may very well happen to you and you can plan accordingly. Because I built my house in the community that I was born and lived in all my life, as did my parents and relatives before me, you can see that the local banks were definitely on a first-name basis with me. Aside from my life-long residence, my credit was flawless.

When I decided to build a new house (my underground intentions as of yet were unannounced). I stopped by to see my friendly banker. After a short discussion on houses in general, he asked me how much I needed. I gave him my figure and he said, no problem. Within a few days a letter came in the mail stating that I could have the amount I requested—just stop in when I was ready to finalize the loan. It was just that easy even though I was going to be my own contractor. This fact will bother some banks, and especially if you don't have the credentials similar to mine. I had 15 years engineering background, professional registry, and the experience of building previous homes.

Remember that to this point they know nothing of an underground home. So I have the letter of loan approval, but—as I am a basically honest individual—I decided to tell the bank of my plans to build underground. As a matter of fact, I even built a scale model of my house.

He was impressed all right! So impressed that he said he couldn't possibly approve a loan for a far-out venture like an underground home. At this point, the negotiations began. After a great deal of pleading and promising my life away, they changed their minds and approved my loan. But this was only because of my life-long ties to this particular bank.

If a stranger or a younger, less-proven individual approach my bank or any other loaning institution for money to build underground, I'm afraid the answer would be short and sweet. No, no, no. This story is not meant to discourage you, but only to emphasize what you are up against.

As for V.H.A. and F.H.A. loans, they are even more difficult to obtain. If you qualify, check into them to see if they will loan money for building underground. I've read articles claiming that F.H.A. and V.H.A. are really interested in an energy-

efficient construction, but I believe this to be good public relations. To qualify, a design would have to be approved by their review boards and I know how that goes. Paper work, paper work, delays, delays and more paper work. If you can obtain a commercial loan, by all means do it, even if it is at a higher interest. The aggravation isn't worth a few dollars. Don't waste time begging or waiting for government assistance.

RESTRICTIONS

Another problem could be that restrictions do not allow an underground home to be built in the area of your choice because the soil is unsuitable. These are just a few of the potential roadblocks to actually getting a deed in your name. If you invest your valuable time and money designing and building for a particular site and the deal falls through, it would be unfortunate and costly. If a professional draws up your blueprints, he will adapt to a particular piece of ground. If you change locations, the prints would have to be revised to suit the new location. This is not necessarily true for a conventional home, but most likely true for an underground home.

LOT SIZE

I also suggest that the size of your lot be no smaller than 2 acres. The reason behind this statement is purely cosmetic. Conventional homes can be designed to be attractive side by side on small plots of ground (such as many developments are), but in my opinion an underground home loses much of its appeal when crowded by conventional homes.

Now let's assume that your dream location is a reality. The deed is in your name. If you have picked out a good piece of land, 50 percent of your potential problems will be eliminated. See Fig. 2-3 and locate the lay of the land that most resembles yours. Note the house location in each situation. I will explain the pros and cons of each as I see it.

INTO-THE-HILL APPROACH

Into-the-hill construction is the most popular approach to building underground (Fig. 2-4). This method is by far the easiest to build, especially from

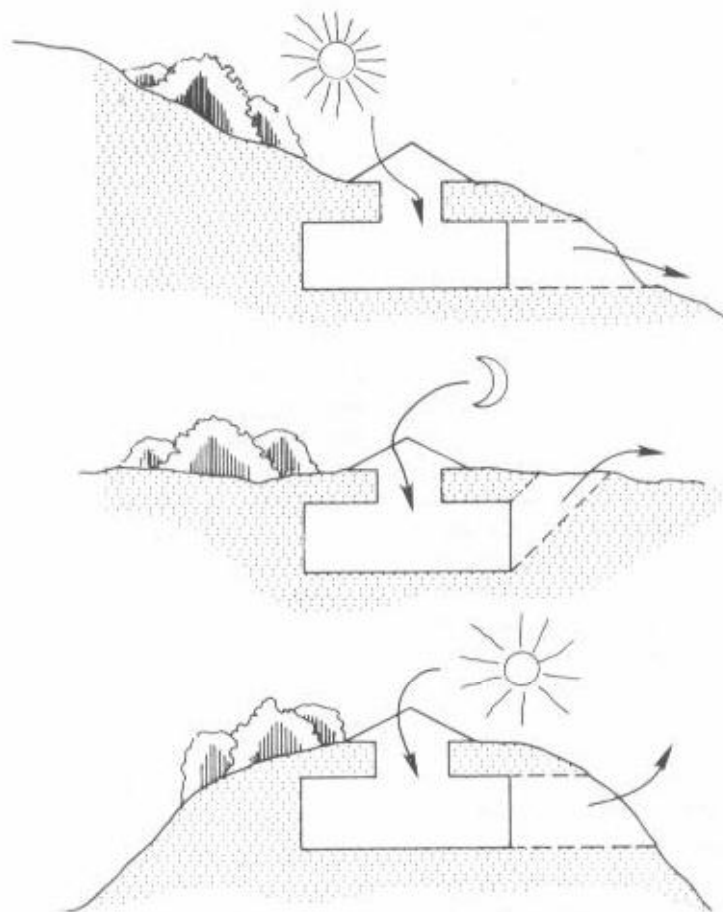

Fig. 2-3. Three basic possibilities for an underground house location.

a grading viewpoint, because approximately 65 percent of the cubic footage has to be excavated. The reason this is ideal is that you will need tons and tons of dirt to backfill and complete final grading.

The into-the-hill method provides a natural method of moving building materials around by an ordinary truck. The upper part of the hill allows you to work at roof level. At the same time, the natural slope will give you access to the lower level by normal vehicles. If it were not for the ability to deliver building material to the lower level by truck, you would have to keep a crane of some type on the site to lower the heavier building material.

Cranes are expensive to rent.

LEVEL GROUND

The level-ground method is to be used as a second choice for quite a few reasons (Fig. 2-5). First, backfilling is much more expensive and difficult because the structure is above ground and, because you did not excavate, you have to obtain fill dirt from somewhere to cover it with. This is definitely a course to take as a last resort. I had to buy some extra dirt for my final grading. I called every possible source to check prices of a dump-truck load (approximately 14 tons) and I found the prices (in

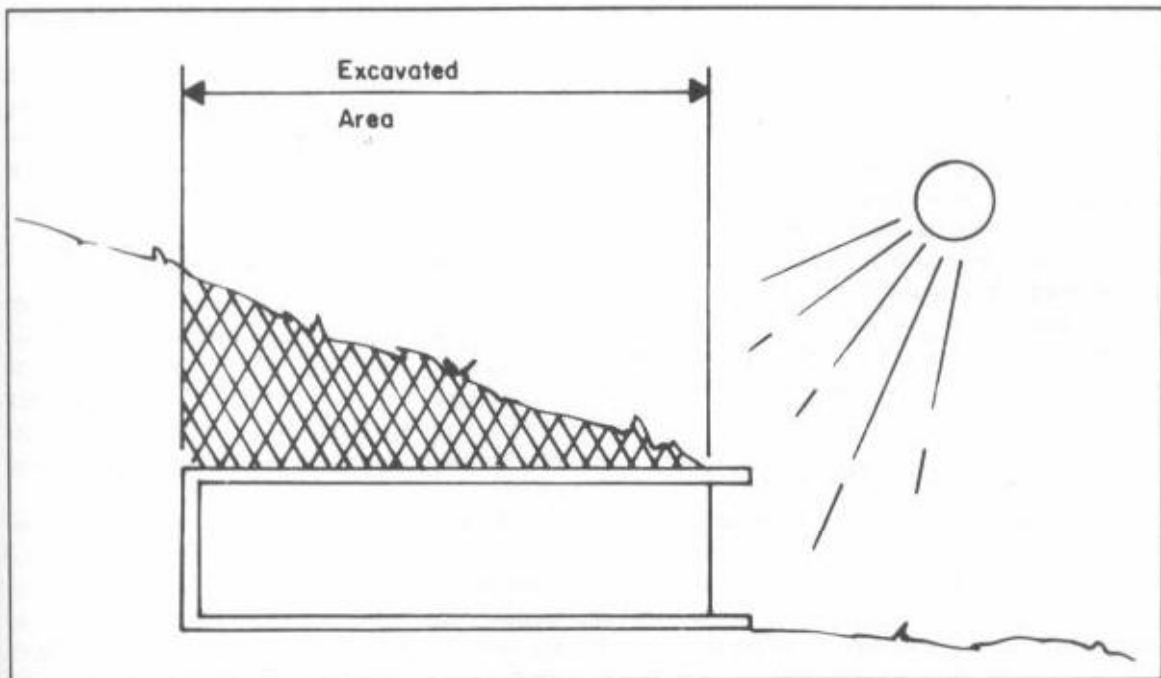

Fig. 2-4. The into-the-hill method is ideal from a material-handling standpoint.

1978) ranged from \$3 per ton to \$10 per ton for the best quality topsoil.

So you see, buying the good earth isn't an inexpensive approach. Even if you could get dirt for

free, you would have to rent a crane and bucket to put the dirt on top. It would be unwise to take a bulldozer on your top roof slab regardless of its designed strength. This would be expensive and

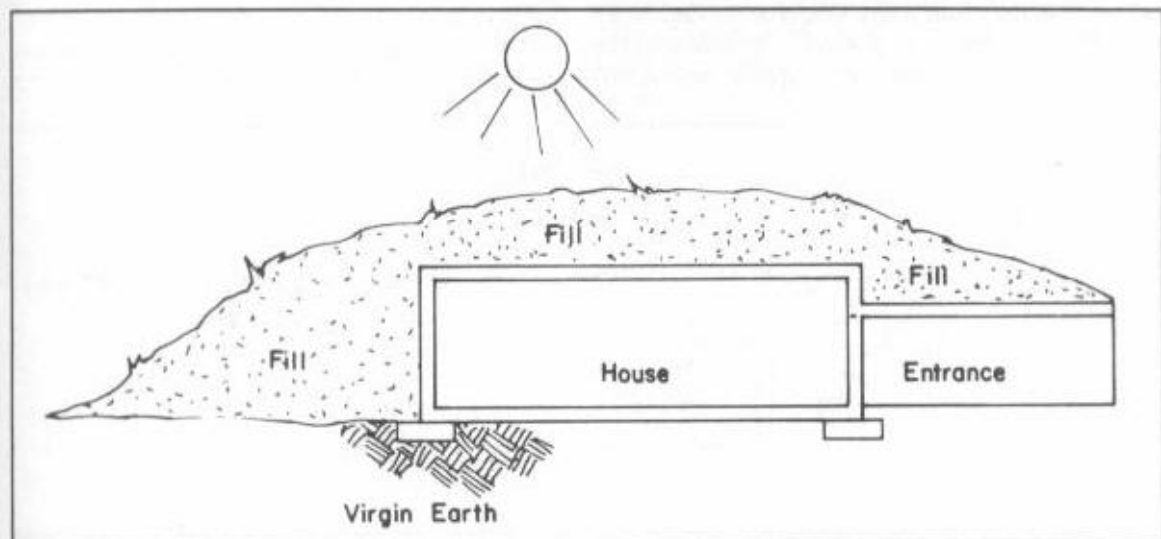

Fig. 2-5. Backfilling and extra earth get to be cost prohibitive when building underground above natural grade.

time-consuming. The extra equipment combined with the cost of buying and hauling soil will make the style more expensive than you probably want to get involved with.

A second point to consider when looking at the ground-level style is that the heat loss and heat absorption is greater when a mass of earth is less in volume and above the natural terrain.

There is one positive aspect of this type. It might be easier to comply with local building codes simply because you would be able to exit from each exterior wall with limited trouble and cost. Also, you eliminate the cost of the initial major excavation.

BELOW GRADE LEVEL

The below-grade-level is, in my opinion, the least desirable approach (Fig. 2-6). The major reason is that exit and entrance would have to be up and down a set of steps, and a garage entrance would be at the bottom of a hill. Unless a well-designed drain system is installed, this presents a drainage problem. In many cases, an auxiliary sump pump would be required to pump storm drains up to a natural drain level. In almost any situation where the house is built below a level grade, the drainage system becomes a major endeavor and also very expensive.

Consider the possibility of a clogged drain or power blackout. Your house would be flooded. Not a nice thought, but it is possible. In addition, the pump on this system will require occasional

maintenance. If these features don't bother you, then go ahead and use this method.

The construction is basically the same in methods one and two. If there is one benefit to the below-grade-level house, it is that you will not have to haul in additional fill dirt when you are doing the final grading.

HALF-AND-HALF CONSTRUCTION

Half-and-half is a term I've given to the many homes built, as the term indicates, half underground and half above ground (Fig. 2-7). At first thought, you could argue that there is no difference between these homes and thousands of conventional homes that have used their club basements as a daily living center.

I guess this is technically true, but if you look closely you will have to agree that there is a real difference. Figure 2-7 shows the major feature that qualifies the half-and-half house to be called an underground home. Usually the structure above grade level is used for a garage, storage, an area for solar heat-storage tanks or possibly a workshop. In all fairness, the half-and-half homes researched for this book had less than 20 percent of the actual floor space above ground, and that 20 percent was always a nonliving area. One of the advantages of this style is that exits and entrances are more conventional, and thus it is easier to meet building codes on local restrictions. If there are disadvantages, it would be the extra cost of working on two levels and extra

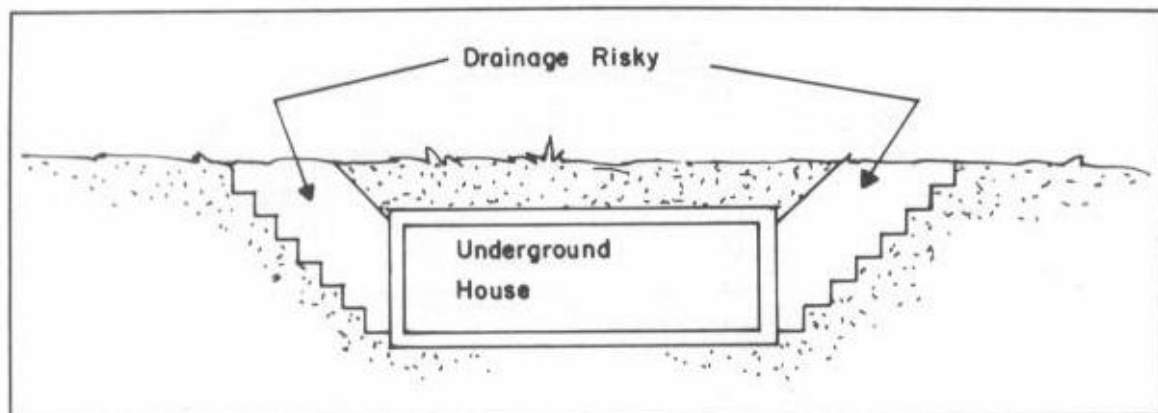

Fig. 2-6. Below-level grade presents major problems.

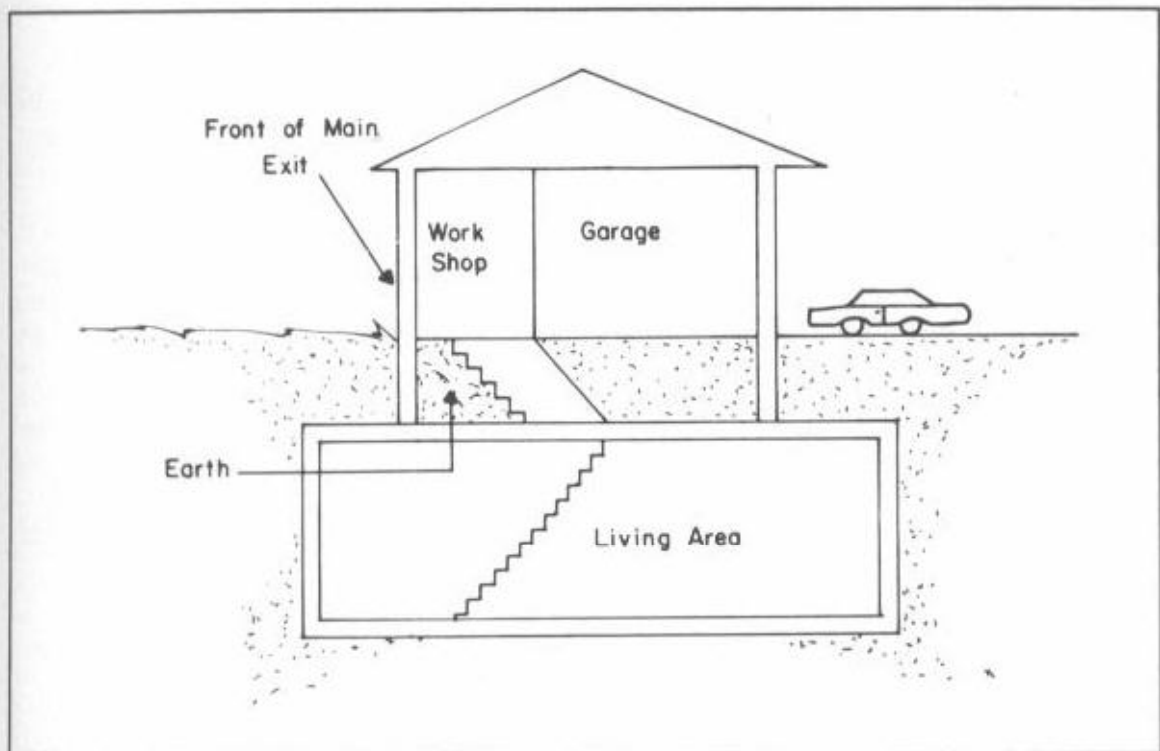

Fig. 2-7. Half and half is a good idea from an engineering viewpoint.

precaution that would have to be taken to ensure against water seeping along the first level into the lower level.

BASIC NECESSITIES

Now that you're getting down to serious business with this earth-sheltered home idea, don't overlook the forest for the trees. You should be expecting some unusual problems to show up when you do something as different as this, but don't forget the basic necessities that should be considered regardless of this type of house you are building.

The accessibility to good roads in winter or rainy seasons should be considered seriously. It's easy to say you like remoteness and getting back to the wilderness, especially when the weather is good and you're excited about a new project and are physically active, but this house will be there a long time and so will the mortgage payments. Stop and think how you will feel about a specific location in 10 years. You've settled down a little, probably have a

few more gray hairs and the children are growing like weeds. That beautiful picturesque, four-acre tract of land you got real cheap 10 years ago because it was 5 miles to the nearest paved road now presents the problems of daily trips to the store and children walking to meet the bus. It might not be the ideal location you first thought it was.

Also check into the cost of running telephone cables from the road to your house. The cost varies from location to location, as does the method by which the electric company charges you to bring power to your house. The way it works in Harford County, Maryland is like this: the electric company will install service lines to the meter, regardless of the distance from the existing power source, at a charge of approximately 50 cents per foot (1983 prices). The cable will be placed in a ditch 22 to 24 inches deep to the corner of your house nearest the electric company's service line (see Fig. 2-8). If you want the meter on a wall or post farther away than the nearest point, you have to pay the Electric

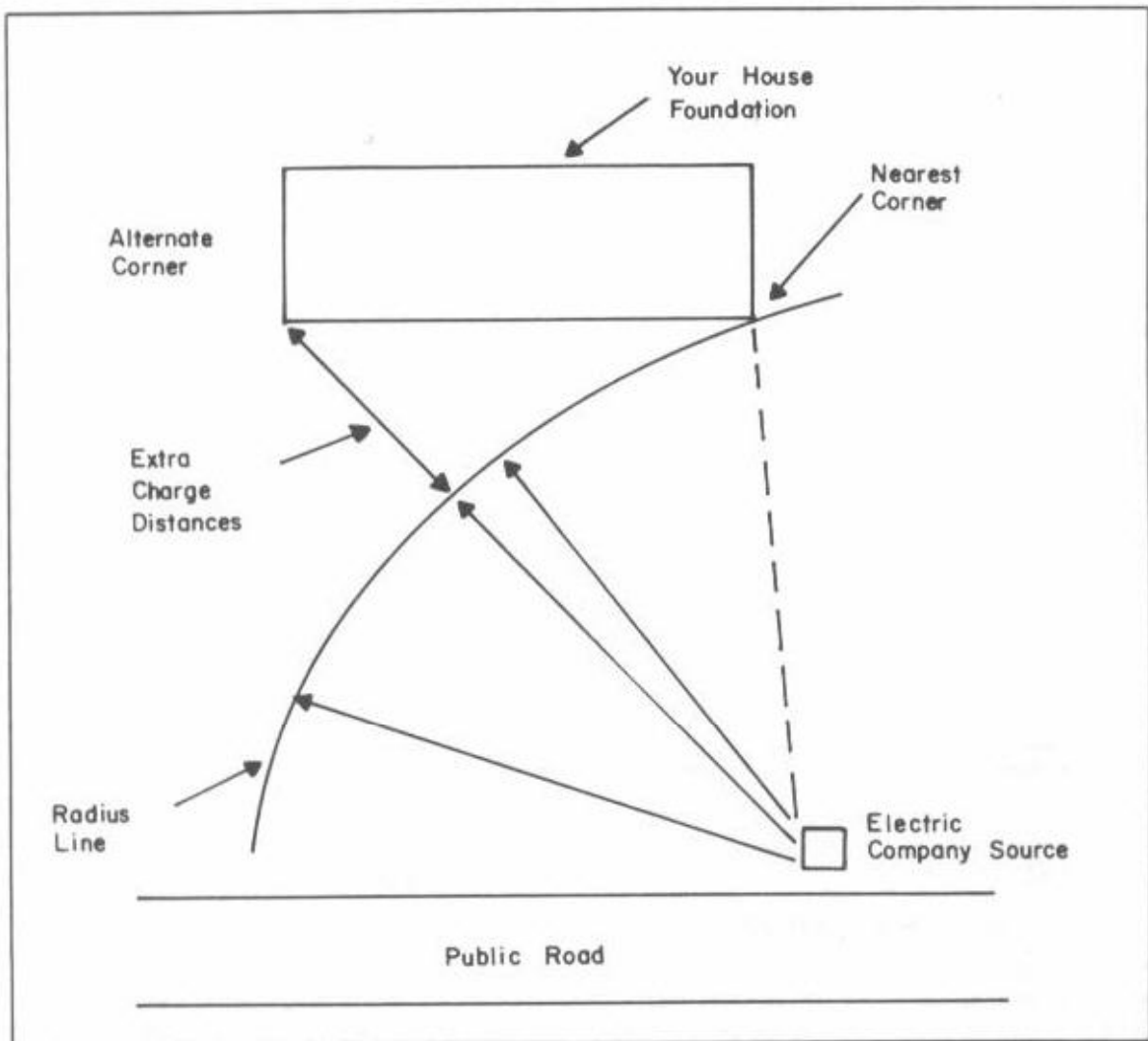

Fig. 2-8. Install your electric line at the nearest corner of your house to their source.

Company so much per additional foot of power line required. That cost is approximately \$10 per foot. Quite a difference and quite an incentive to install the meter on the nearest corner to their (electric company) source of power.

Ask precisely what the charges will be. You will find the telephone and electric companies very cooperative organizations when planning the location of lines, meters, and the place of line entry into your underground house. I won't go into gas lines because I emphatically recommend that you don't

even think about liquid gas, propane, or natural gas as a fuel.

As you know, a leak in a gas line is a serious problem anywhere, but in an underground house, it's more of a concern because of the air tightness of the structure. Don't ask for trouble with these fuels; building underground will present more than enough problems. If you stick strictly to electricity as the utility and a wood- or coal-burning stove for heating assistance, you'll be safer and happier.

Before signing your life away for a parcel of

land, make sure water is available. Most likely you will drill a well deep if you have a good piece of ground. One of the regulations in Harford County, Maryland is that an approved well usually must be drilled before construction can begin. You would be in sad shape to get your money invested in construction and find out there is no water down below.

Well drillers are usually full of valuable information. They can probably predict the depth, quality, and quantity of water you will find fairly accurate. Experience has taught them a great deal. So have faith in your well driller. You have the final say as to the location of your well (after the health department suggests a particular area). Make sure the well driller agrees with your choice.

One important phase of drilling a well is to

discuss before hand with the driller the method of payment. Most drillers have a set fee per foot for soft dirt, another for hitting rock, or they will quote you an average of the two prices, regardless of what they strike on their way to water. Also ask them about drilling a second or third hole, if the first or second turn out to be dry. Some drillers do the second drilling for half price. Some have other arrangements. Find out *before* you start drilling and not after you hit rock.

Once you get a good well, you have to get rid of the waste it creates. Sewage disposal is just as important as finding water. Once again the local regulations dictate your septic system's location, size, and configuration. Make sure your land is approved for a satisfactory system before you build

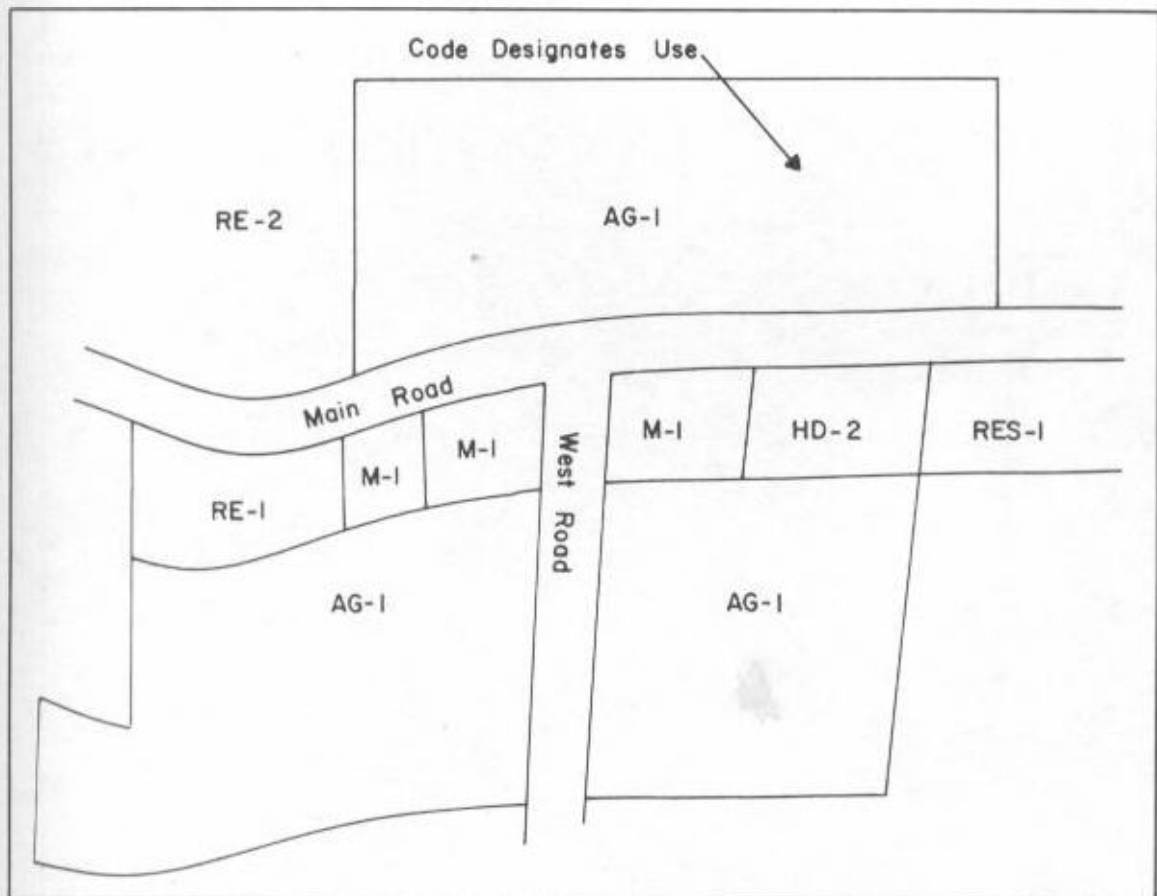

Fig. 2-9. A typical zoning map will have each plot of land identified by a code number indicating its possible use.

(even if it is not a standard requirement). If public sewers aren't close enough to hook into, ask for a perc test before buying a piece of ground for a private home. If the soil is not suitable for a good sewer system, it most likely is not going to give good drainage for your house.

Don't buy property because it's inexpensive. If you do, it will come back to haunt you. Sooner or later you'll pay for buying a marginally acceptable piece of ground. Remember, you don't get something for nothing. Check out all codes, regulations, ordinances, and zoning laws that might apply to your choice of property to see if they will cause you a problem building underground.

Some land has restrictions attached to the deed from previous owners. For example, years ago a dedicated farmer could have stipulated in his will that his farmland never be used for anything but farming. This can be done legally, and all of a sudden

you could find yourself raising a herd of cattle instead of building an underground home.

Another source of restrictions comes from development preferences. If a housing development has a set of restrictions drawn up, they might include the size of the house, material used, and style. I have never heard of one that allowed underground homes. So watch out. Zoning laws will be the easiest to comply with. They simply control things like multifamily dwellings, commercial ventures, or farming.

It's very easy to find out if a particular piece of land is zoned for a single-family underground house (Fig. 2-9). Just stop by the county zoning department and look at their zoning map. I think every county in the nation has one. Now I'll assume your dream location is a reality and the deed is in your name.

If you are not discouraged by now, continue



Fig. 2-10. David and Debbie Greenlaw are actually building above ground and then covering the home with earth.



Fig. 2-11. Notice that there is no mortar between block—only surface bonding.

reading into Chapter 3. Remember, I'm trying to save you aggravation, trouble, and money—not discourage you.

EXTREME CONDITIONS

I met a man from Preston, Maryland who tackled underground living in a way most people never think of. He is building underground above grade level. Why you might ask? Because southern Maryland is close to sea level and the sand soil has a water table close to the surface. It has been said that if you dig a hole to place a mailbox post you'll probably strike water in that area of the country. Mr. David Greenlaw and wife, Debbie, are actually building 18 inches above the virgin surface on fill dirt. They plan to bring in additional earth to cover the structure.

Mr. Greenlaw is practicing what I've stated before. He is building on a 4-acre tract of land. In his case he is building a man-made pond on the property and using the excavated earth to cover his house. He is also using the technique of surface building to erect the structure rather than the conventional



Fig. 2-12. Surface bond on both sides of the block.

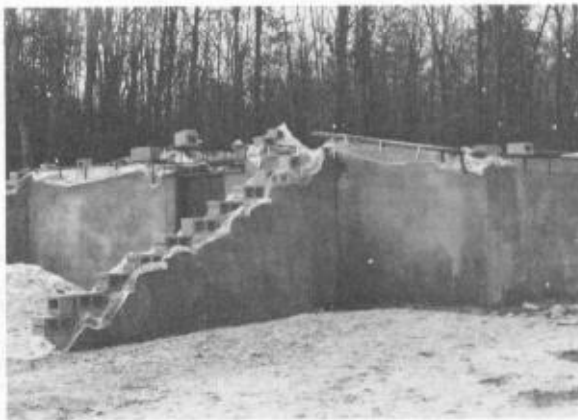

Fig. 2-13. Underground construction above virgin grade.

mortar between block as I used as shown in Fig. 2-10 and Fig. 2-11.

Surface bonding is the latest innovation to become popular with underground home builders. The object is to stack concrete block exactly as if they were being mortared together—except they are stacked dry (mortarless). A coating is applied to the exterior of their block forming a membrane that the manufacturer claims is stronger than mortared block. My expertise is with poured concrete and

mortared block. My expertise is with poured concrete and mortared block, I can say is time will tell. To date (spring '83) I've heard nothing but favorable results from surface bonding. Most people surface bond exterior and interior; that is the accepted method. See Fig. 2-12.

Mr. Greenlaw's six-room, 1200-square-foot house is definitely an unusual underground home. It is the only one I know of that is underground above the grade surface. See Fig. 2-13.

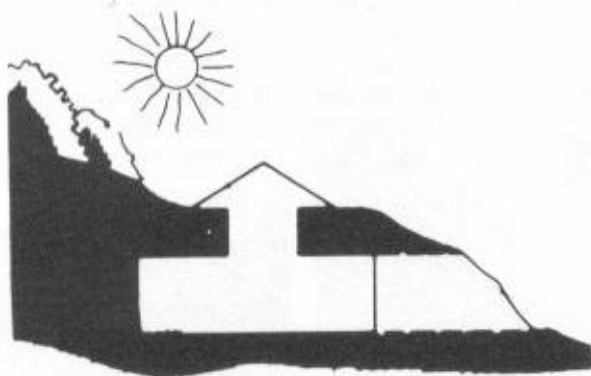

How To Get Work Done

Because you are building your house yourself, you certainly don't lack energy or interest. There are only a few things that can slow you down. These include the weather, a lack of money, or poor planning. The first you have no control over. Money is a personal thing between you and your bank, you know how much you have to work with and how careful you must be with it. This leaves planning, and you have total control over it. Whatever you do, don't confuse planning with designing. Designing is expanding an idea. Planning is the art of allocating your time.

Design will be settled long before you actually begin to build, and you really can't do much changing after you have actually begun pouring concrete and laying block. Once your plans are approved by all appropriate authorities and a building permit has been issued, you can consider the design phase of your project final (except in minor instances). You are asking for real delays if you make major design changes once construction has begun.

Time allocation will continue from day one of construction to the time you use the last paint

brush. This is the important part of building that you have control over. Time is as important as money. Sometimes it is more important because money can't buy time, but in time you can make money.

Once you're committed to building an underground house, figure on one year of continuous work on your part—maybe even more—depending on your desire to get the job done and nature's cooperation.

First of all, don't get behind before you start. Break ground in the early spring. If you wait until midsummer, you will be in a race with mother nature to beat cold weather. Of course, I'm assuming that you're building the underground house in a region with extreme seasons (such as in Maryland). If you happen to be in the deep South or Southwest, you just have to appreciate our problems of changing seasons.

The reason it is imperative to complete all concrete work and get it covered with earth is simple. Concrete expands and contracts like anything else with heat and cold. The expansion and contraction cause cracking, and that is a condition

you need to avoid at any cost. This is why I suggest you plan carefully to be able to pour your roof slab during a time period where the temperature doesn't get below freezing or vary to extremes of hot and cold.

You must realize that that if your building were being built in a locale where the temperature might reach 100° F during a day in September, but fall to 40° F at night, causing a 60° F differential, cracking could develop. This condition would probably do more damage than actually pouring concrete at 50° F and having the temperature drop to 32° F at night. The extreme differential is what causes the cracking problem. How's that for a planning problem?

I can't begin to tell you how to plan well personally. I don't think any book can. You are born with that ability. It's almost a talent—like singing. Fortunately, I was born with a planning ability a little above average. I know, however, that if I had been even better at planning my job would have been much easier. Just think a little bit ahead. Don't overlook the little things such as small tools, nails, or a water cooler.

The following is a good example of something that happened to me. I had a gas generator on the site to use while building the scaffolding for the roof. I rushed to the site early in the morning with my power saw, starting the generator and, lo and behold, I'd forgotten my extension cord. For the want of an extension cord, hours of work were lost until I left the site and picked one up.

Now I was ready to cut boards, and I did—for about 15 minutes. Then the generator ran out of gas. As if this wasn't bad enough, I didn't have a container for the gas. So by the time I got a can out to the gas station, back to the site, started the generator and was ready to work, I was starved and ready for lunch.

Of course, I didn't brown bag a lunch at first because I didn't realize how much time it takes to drive 3 miles, get a sandwich and a soda, and get back to work. I soon learned to brown bag a sandwich on those days when I planned to put in a full day's work. If there is food and drink on the site, I found I could get an average of two more hours a day of working time. This really adds up in a year.

I have to admit that the day I described was unusual for me, but it is an example of what good planning and a little thought can prevent.

How to get additional working time is the eternal problem for do-it-yourselfers. I presume you are working a regular 40-hour week to pay for the other 128 hours and the house. Let's also assume that you use 10 hours a week traveling to and from work and to and from the building site. You probably need seven hours of sleep a night and time to eat. Let's say that is 10 hours a week. This gives you a total of 109 hours just to eat, sleep, and work at your regular occupation. That leaves 59 hours to take care of personal business, see your family, socialize, and build a house. So you see, there's really no time to waste in idle talk. You cannot waste effort of any kind.

One of the fine lines you will have to walk when building an underground house is tactfully dealing with and handling friendly, inquisitive people. This sounds like an unfriendly gesture but it is not. Here's what I mean. Naturally an underground house is interesting. Maybe some day there will be enough underground homes around so that the majority of the public will have seen one or possibly have been inside of one. Once this happens, of course, the novelty will be missing and the curiosity seekers will not visit you. This is definitely in the future.

Be prepared for the present because, as the word of your innovative project spreads, your friends and neighbors will stop by to talk with you about your house. This is the problem. How do you politely keep on working while they are asking you basic questions? Remember, after a while, you have answered every question many times and explained the details to many people. But each time the questions are asked, it is the first time for your friend. Soon you will find yourself talking more than working. Nevertheless, it is good to know that people are interested, so you just do your best to work and talk, talk, and work. Most people will volunteer a helping hand and that is something you can always use.

INSURANCE

With all the visitors you will have on your property

from beginning to end, I suggest you obtain a good insurance policy covering personal liability. As I'm sure you are aware, it's awfully easy to have an injury on a construction site. This is especially true in the early stages when the terrain is full of ditches, rubble, nails, loose timber, and so on.

Ask your lawyer about posting the property as a means of liability protection, but don't count on a no-trespassing sign to protect you against a lawsuit if someone would get hurt. It would be voided by your personal invitation to visitors or workers. You are still liable for these people. Anyway you slice it, you need a good insurance policy.

Explain in detail what you are building to your insurance agent. Consider that building underground requires deeper excavation and higher scaffolding and movement of tons of concrete and steel. I can't reiterate enough to be well covered with insurance from the day you buy the land. Don't forget to ask about the possible theft of construction materials. Plywood and 2 × 4s have been known to grow legs and walk away from a building site after dark—more than once.

BEST WORKING HOURS

I found the best time to work uninterrupted was to start at sunrise. I don't mean just early; I mean exactly at sunup. Once you get used to these early hours, you'll find work progresses much faster than evening work. It's also invigorating and the sunrises seem to be good for the mind. To be honest with you, I found the weekends, holidays, and vacation days to be the time to get the big jobs done. You'll find that the larger phases of construction need to be completed by continued hours of working.

You can never get a big job done (for example, plumbing) if you do it 15 minutes at a time, one day at a time. It will take 15 minutes to get the necessary tools and supplies together and ready for work, whether that work period is to be for 10 minutes or 10 hours. This is another way to save valuable time by planning. If you have only a few minutes to work, do something that can be *completed* in that time, if at all possible. One such job would be hanging a door. Or use the time to prepare a particular area for a

bigger job. Keep this train of thought in mind and you will find you have saved days by the time you're finished building.

During early mornings and evenings, I used to take care of small things. If you can arrange to take a vacation at times when a big job needs to be completed, then you are fortunate. There's nothing worse than having a complete week off from your normal job, have it pass, and accomplish nothing significant. It can really demoralize and frustrate you if it happens.

Still another phase of getting work done is affected by availability of material. This is where planning far ahead on your part can prevent a problem. When ordering material, be sure to give the supplier long enough advance notice to deliver supplies by the time you need them. Don't wait until the last minute and then waste time because you are missing a 2 × 4 or one concrete block. Don't forget that you're not the only one ordering supplies. Don't expect the vendor to jump at your request for immediate delivery.

If there is one way above all others to save time, it is to complete one craft throughout the house. For example, if you are putting furring strips on the block walls, start in one room and continue throughout the house. The same goes for plumbing, electric, Sheetrock, painting, or whatever. If you try to complete one room at a time—from scratch to final trim—and then move on to the next room, you will spend most of your time putting tools away and getting new ones out.

Also by completing one job throughout the house, you become skilled at the particular job. The only thing to be said against this method is that it gets boring. For example, hammering nails for three days and then painting for three days becomes very monotonous. Jumping around can break this monotony, but it wastes valuable time. Mix and match these theories of getting work done as they fit your situation.

Probably the most effective time-saving idea that I will mention is the following: When you have help available, whether it's a friend, relative, paid worker, young or old, male or female, don't overlook the fact that everyone can do some type of work. If you ask the wrong person to do the wrong

job, you either have to hold their hand or do the job over. Don't ask a child to do a man's work and vice versa. This way neither person will become frustrated by being asked to do a job they can't handle. Use your labor effectively.

Don't take for granted, however, that your life-long buddy knows how to solder pipes together just because he says he can. It would be a mistake on your part to let this friend go off to one end of the house to do plumbing while you worked at the other, thinking you were getting twice the work done only to find out weeks later that every joint he connected leaks. Now you have double labor and possible material expense. Let a helper work up gradually until you have confidence in his ability. Your eyes must be the final judge.

About the only other thing which is really important as far as saving time and making work easier is to have work that needs to be completed inside and outside even after you are under roof. In Harford County, Maryland, just as in most other locales, the weather varies considerably. Even in mid winter, we have occasional time periods of warmer-than-usual temperature. When this happens, get something done outside that can't be completed in bad weather. In the warm weather, there are surely going to be days that rain prevents outside work. I know of people who would just cancel that day's work. But if you're really anxious to complete your house, you can always find something constructive to do whether it's winter, summer, night, day, rain, snow, or clear weather.

RIGHT TOOL FOR THE JOB

One of the biggest mistakes do-it-yourselfers do is try to move a mountain with a teaspoon. If you need a jackhammer to break concrete, don't stall. If it can't be broken easily with a sledgehammer, rent a jackhammer. The cost might seem expensive, but you get the job done and go on to other things. Don't waste energy and time cutting wood with a dull saw blade. Keep it sharp. Buy a new blade. If you have three acres to get into lawn, don't try to do it by hand. Rent or borrow a tractor. If you have piece of white pine trim wood $\frac{1}{4} \times \frac{3}{4}$ inches, don't try to cut it with a coarse-tooth, 10-inch circular saw.

Now you see what I mean by getting the right

tool for the job. Too many people spend valuable time and energy using the wrong tool for a job. They end up ruining the tool or the material. They hurt themselves physically or at minimum become frustrated with their ability which soon leads to bigger mistakes. Rent or buy the right tool. It's just as wrong to use an oversized tool for a small job as it is to use a small tool for a big job.

RENTAL EQUIPMENT

Rental equipment doesn't pertain any differently to underground homes than conventional homes. As with any other business, prices vary. Shop around if you have the opportunity, but don't be fooled into thinking you're saving money to rent an air compressor (for example) \$3 cheaper per day but you have to drive 50 miles to get it.

There are businesses that rent anything, and most times they are the place to go. But don't forget that the specialty business sometimes rent equipment. For example, a lumberyard might have an insulation blower to place loose insulation. Buy the insulation and sometimes you get the use of a machine free or at a reduced cost.

If you are using a lot of steel in your underground house, maybe the steel company will loan you a torch outfit (if you can use it safely).

It wouldn't be unusual for a lumberyard to loan or rent automatic nailing guns or the guns that shoot nails into concrete. Ask around and you might be surprised at what you find for rent.

BORROWING TOOLS

Never a tool borrower be are words my dad used to constantly repeat to me. He was an auto mechanic and he had many expensive tools. He said the way to keep a friend is to refuse to loan him your tools.

These words of wisdom proved true once again while I was building my underground house. Example: I loaned a neighborhood friend my new 10-pound sledgehammer. He took one swing at a chunk of concrete and broke the handle. He said the handle was already cracked. I didn't argue. I just took the pieces home, took my \$15 loss, and the friendship has never been the same since.

This example is repeated thousands of times a day, but neighbors, friends and relatives keep on

lending and borrowing tools. This little example may sound petty, and it shouldn't be taken out of proportion to its value as advice.

A good rule of thumb would be to pay particular attention to lending or borrowing any tool that is complicated (such as electric drills, saw, etc.). Measuring devices such as micrometer, transits, cameras, fit into the technical equipment category. Common sense tells you the odds of someones

else's tool breaking while you have it and vice versa in direct proportion to its complexity. Don't dwell on this subject; simply give it some thought.

The important factor in making a decision about borrowing or lending tools is time and distance. It's one thing to loan a friend your hammer for five minutes while he's working with you on a job. It's another thing to loan a casual acquaintance—who lives in the next county—your new power saw.

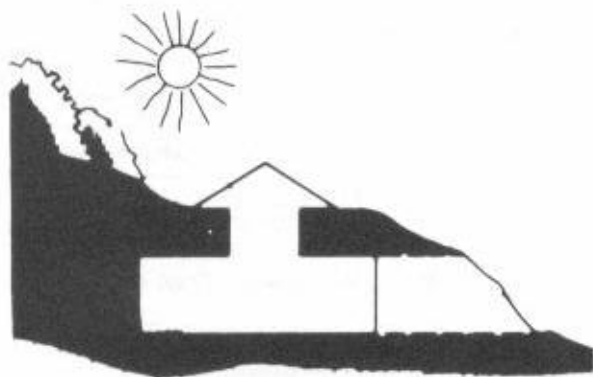

When to Hire a Professional

It is easy for me to sit here in my office writing a book and tell you to plan ahead and save money when this was something I found most difficult to do successfully. Because you are reading this book, I have to assume that, if you build, you are planning to do some of the work yourself. Should you decide not to build underground, this chapter will be a help regardless of the style of house you decide on, as long as you do 50 percent of the buying and building yourself.

As we all know, there is always more than one way to do anything. This is never more true than when building a house. The crafts that I found easy you may not, and vice versa. As you read on, keep this in mind and pick the subjects you feel comfortable with.

PROPERTY LAYOUT

One of the easiest ways to begin your project and save a few dollars right from the start is to locate and lay out your house corners on your property—once you own it. All you need is approximately 30

wooden stakes about 1 × 3 × 48 inches, roughly 400 feet of surveyor's string, a surveyor's transit, a plumb bob, and a 100-foot steel tape measure. Most likely, a local rental company will rent a transit to you and they can show you how to use it.

There is no need to buy a transit. They are expensive, and you will only need this instrument in the beginning phase of building layout. It is one of the few items that I suggest you rent as a method of saving money. In addition, transits around construction sites have been known to grow legs and walk away from their owners, never to be seen again. After a short lesson with your transit and a few practice readings, you can lay out the corners of your house as well as anyone. Just go slow and double check yourself. Be sure to check local regulations regarding side clearances to your property line. Your house usually has to be at least 10 feet from your side boundary, but check the code to be sure.

Underground structures do not necessarily have to be kept 15 feet from your boundary (see Fig. 4-1). The original reason for the 15-foot, side-

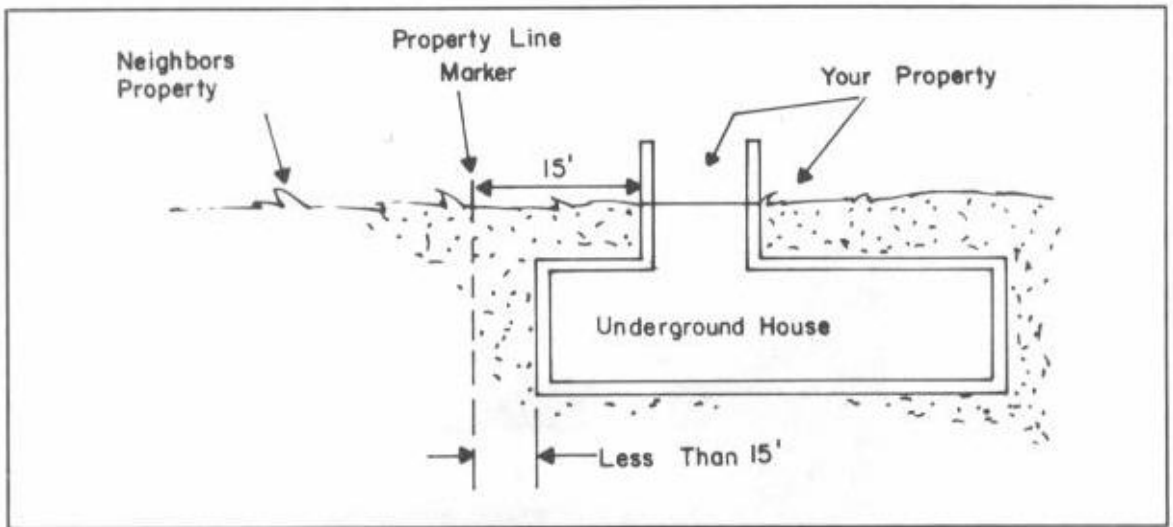

Fig. 4-1. What's above the ground isn't necessarily below the ground.

clearance ruling was so that a fire truck could pass between your property line and your structure. If you build underground, you possibly could build closer than 15 feet to the property line (especially if

the terrain were kept level). This is one question that must be settled by local officials. It's better to be safe than sorry. I hope no one considers building an underground house under these crowded condi-

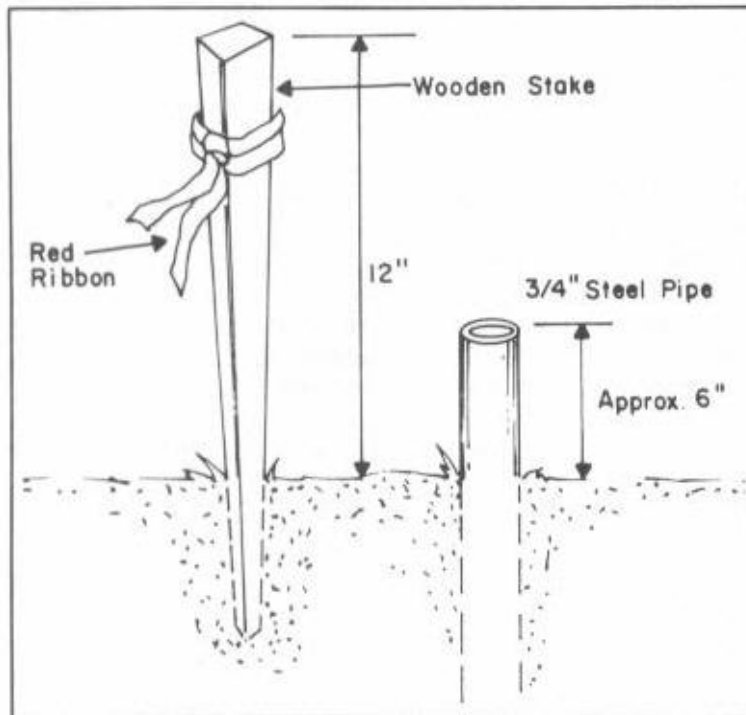

Fig. 4-2. Sometimes a temporary wooden stake is placed near a steel post.

tions, but if you must, you must.

By telling you to locate your house corners, I am not suggesting that you try to locate permanent boundary survey markers. These are two different jobs, and this is a job for a professional surveyor. Also, most localities require a certified surveyor to check these boundaries and a practicing lawyer to record the deed.

If, however, your locality does not require property to be re-surveyed when changing owners

and you can locate at least one of the original (steel pipe) markers (Fig. 4-2) and you're sure it's a good marker, then you can proceed to check all the corners of the property. This can be done by the amateur if the property in question isn't too big or doesn't have many complicated measurements. See Fig. 4-3.

LAWYER'S FEES

Lawyer's fees connected with buying property or

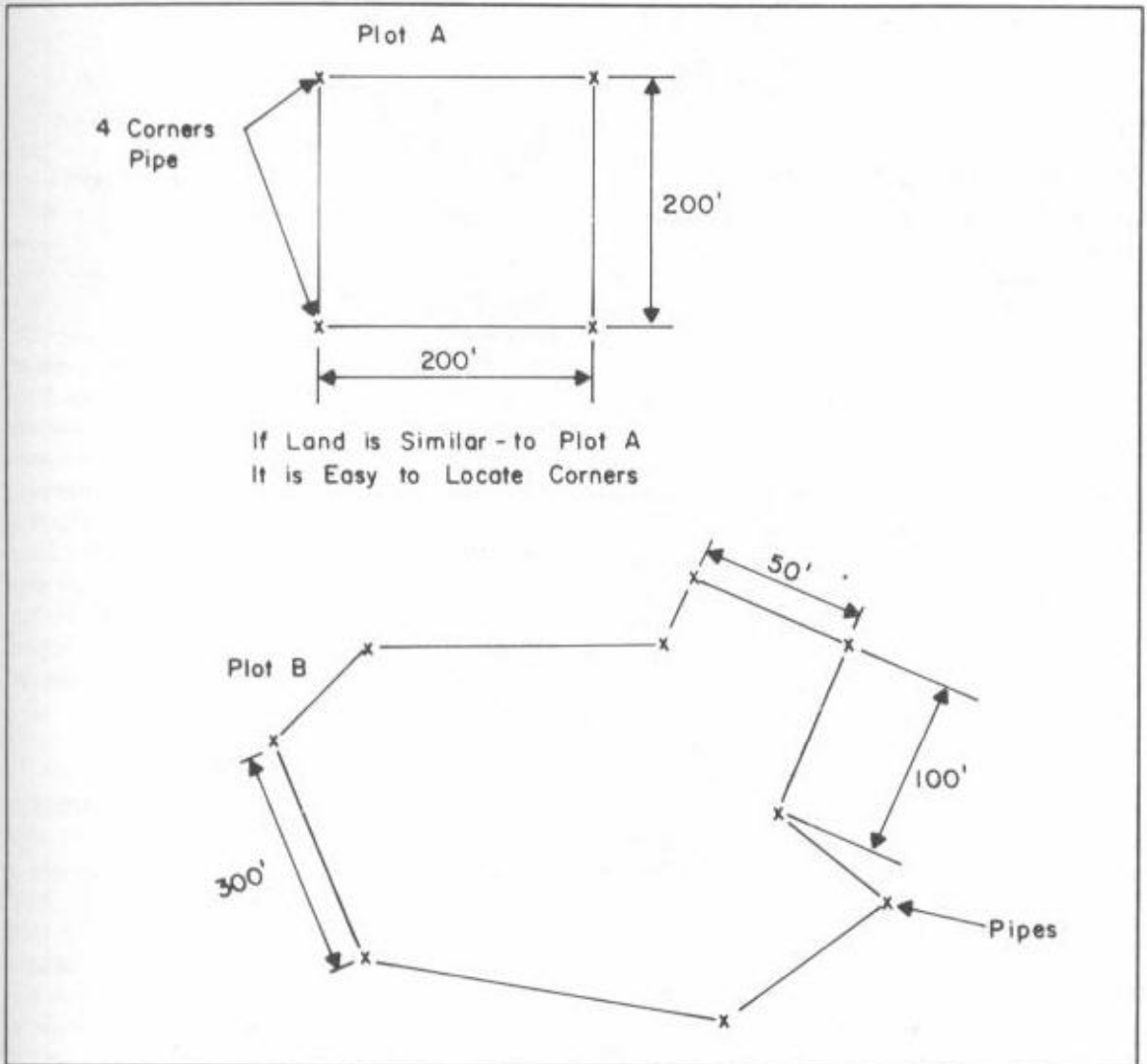

Fig. 4-3. If your plot has many sides, use a professional surveyor.

recording mortgages are occasionally a rip-off. Ask friends who have recently purchased land or a house what their charges were. One of the biggest surprises connected with home building or buying that everyone encounters is that the actual cost of the property that is asked by the seller is only the top of the iceberg as far as cost goes. If anyone you know has recently purchased real estate, they will attest to this. I'm relaying this warning especially to the younger person buying his first property. Here is a totally hypothetical example only to show the progression of dollars required to buy a parcel of land to build on. Remember the figures and items are estimated because they vary drastically from locale to locale.

SAMPLE PURCHASE

Here is an example ad in a newspaper: Two-acre lot, 1/2 wooded; nice view, \$20,000. The sum advertised might seem reasonable to you, but don't relax and write a check yet. At the very beginning, a percolation test is required to ensure the health department that a septic system will work well on this level. If that is required, add \$100 to \$200 depending on how easily accessible the land is.

Once you actually agree to buy the land, it might have to be surveyed. Add \$200 to \$500 depending on how complex the shape is. Next you need a lawyer for the title search. This covers hidden ownerships or liens placed against this property by previous owners. Add about \$500 for a normal search. Of course there is a tax. The tax is usually real estate tax (not sales tax). Real estate taxes are paid a year in advance so you must reimburse the previous owner his share of that year's tax. Suppose the real estate tax for said property was \$800 a year. If you bought the property three months into the tax year (or 1/4 year), you would have to reimburse the previous owner for 3/4 of the year tax or \$600. That's the law. So a piece of land of yours may be higher or lower.

Now you have a registering fee. This is for recording your ownership on the courthouse records and everywhere else the law requires. This could run over \$200 depending on where you are. Then there is a stamp tax. This is exactly what it

implies. A little seal is attached to the documents as they go through the legal channels. This is a local tax as opposed to the state sales tax. Add \$50 to \$150.

Now you see how the price of buying land goes up. If the property has a building on it, you might have to pay for a termite inspection. Sometimes the seller or sometimes the buyer picks up the bug tab. Don't be surprised if you also get asked to help with the financing expenses. There are many plans and systems you could get involved in, but the results are the same—it cost you money.

REAL COST

Already this \$20,000 piece of ground could be as high as \$22,500, and you could continue to add little hidden costs that you might encounter. When I say hidden costs, I'm not indicating that the system is trying to deceive you. I only mean that these costs are not spelled out in big black letters to a first-time property buyer. Because most people don't buy homes and property on a frequent basis, I'm sure many people tend to forget what was involved in buying their property. Also, the cost changes from year to year. These costs do not include the hook-up of utility, highway access costs, permits, or anything other than getting the deed in your name.

Fortunately, I have a reliable friend who is a lawyer and another who is a banker; so I feel comfortable buying and selling. I can't caution you enough to check for undisclosed costs. As for tax stamps, local taxes, fees, etc., you're stuck. They're everywhere and inescapable. So for now accept them. At least most are one-time costs.

EXCAVATING

Now that you have your land, are happy with it, and are ready to break ground, let a local excavator with a good bulldozer (Fig. 4-4) do the heavy digging and grading. Even if you could afford a dozer, you'd probably waste days learning how to use one well enough to dig a foundation. A professional can usually do a foundation in one or two days. Once the foundation excavation is complete, you can begin to do work yourself.

If you're dexterious enough to operate a back-



Fig. 4-4. A 450 Case bulldozer is not too small and it's not too large.

hoe, you can invest some of your money for a good return. For clarification, a backhoe is a rubber-tired tractor with a scooping bucket on the rear and a bigger scooping bucket on the front. Both are hydraulically operated and easy to operate with a little help from an experienced operator.

These mechanical workhorses are invaluable around a construction site. For example, after the dozer digs the hole and cuts a driveway, you can dig your own footers, spread your own gravel base in the driveway, and move or drag anything that needs moving. See Fig. 4-5. These used backhoes are available (as of 1972) through dealers or private sales. It really makes no difference what the price is as long as it's a good value. The point is that, if you service it regularly and don't misuse it, you can get your full price back when you sell it after your home is complete.

Remember that this same tractor will most likely do all of your fine grading, leaving only hand manicuring to complete your lawn. The most important thing is that these vehicles can work close to

your underground home and in many cases can work and grade even on the roof. Grade the roof only if your advising engineer says it is safe to do so. The uses you will find for this tractor are unlimited. Remember, shop carefully to find a good buy. Take an expert with you as you buy a backhoe. Then don't panic to sell this vehicle immediately when you are finished because it will retain resale value. You might even pick up a few extra dollars doing small digging jobs in the neighborhood.

BUILDING MATERIALS

Now that you've rented a transit and bought a backhoe, you're ready to buy building material. By building an underground home using my method, poured concrete and concrete block are the two biggest single purchases you'll make. Check supplier prices carefully. For example, my house required nearly 8000 concrete blocks. When checking prices with the four major suppliers in my area, I found delivered price of a standard 12-inch concrete block to vary as much as 15 cents a block.



Fig. 4-5. A backhoe in the digging position.

It doesn't take a genius to figure the savings here.

If you have a method of hauling and unloading these blocks, you can save a bundle more. But most people don't have access to the equipment to move pallets of block (you need a heavy-duty forklift) so leave the job of delivery to the block company. Don't make plans to lay these blocks until you actually see them on your site. Block companies are famous for missing their delivery date by days, and especially to a first-time or private home builder. The reason is simple. They have good intentions when the dispatcher says he will deliver on a particular day and time, but he knows you are an individual. Then a large contractor who is a regular customer calls an hour after you do and wants 5000 blocks delivered the next day. You can easily figure out who is going to get their blocks on schedule. It's not you.

By the way, most block companies have seconds. These are blocks with cracks or chips. They are just as good as the first grade once mortar is

applied. Ask about them. They could be used for interior walls at an additional savings. Don't use them on the exterior walls.

CONCRETE

Now for the concrete—remember you have to pour footers before you can lay block. Refer to Chapter 8 for details on how to prepare footers. Once your footers are ready for concrete, don't even consider mixing your own. Buy from a local concrete delivery company. There are two standard methods that concrete companies use to deliver concrete to your site.

Cement Mixer

One way is the conventional rotating barrel-on-the-back type that you commonly know as a cement mixer (Fig. 4-6). This type mixes cement, gravel, sand, and water as they drive down the road or on your site. The only problem is that they are batch

mixed. This means that if you order 6 yards of concrete, they load the cylinder with the appropriate amount of cement, sand, and gravel. The only thing left out is the water. This is added when it reaches your site. The catch is that you now own and pay for all 6 cubic yards of concrete even if you over estimated and can only use 4 cubic yards.

Square Back

The second method of delivering concrete is the newer, rectangular-box type. This type of concrete truck carries all of the ingredients—cement, sand, gravel, and water—in separate containers. Once you are ready to pour, they begin to blend these components together, forming a slurry mix of concrete only seconds before it comes out of the truck.

With this method you only pay for what you use. Because everything is unmixed until immediately prior to pouring, the truck can stop pouring at anytime you designate and return to its home plant without wasting anything.

They do, however, charge a fee if you order a

small amount, (usually an additional 10 percent). You will have to pay this fee if the total yards used from one truck is less than about 5 cubic yards. This second method also avoids any panic rush to pour if a problem arises. The first method requires dumping to begin immediately after the water is added and continued pouring until the truck is completely empty (even if the excess is dumped in your driveway).

Because most companies in a given area will charge the same per cubic yard, the only other advantage you gain is service. If you are pouring your footers yourself, try to be ready for the first load of the morning from the concrete company. The reasoning is that this is the only load that will be on a known time schedule. After delivery of the first load, the driver returns to the company and loads up to begin his next assigned delivery. The later in the day the more delays he has encountered on previous assignments. Therefore, you could wait for hours for a load to be delivered. In all fairness to the concrete companies, it is difficult to stay on a schedule. Once I had a crew of friends over to help



Fig. 4-6. A typical barrel type of concrete truck.

and the truck was three hours late; we just stood around wasting time.

If you have a choice, definitely buy from a company that mixes concrete on the site because you'll only pay for what you use. This is better than a premix company because you order in advance and have to pay for the full load whether you use it or not. Contrary to what you estimated your concrete usage would be, you'll probably miss by at least a half yard due to inexperience and possibly an uneven pouring surface.

MASONRY

Now that your footers have been poured and your blocks have been delivered, let an experienced block mason lay your block. Here's your chance to save again. Get a price to lay the block from at least three different small block laying companies with good reputations. Check their work and reliability

in advance, and don't pay for anything until the job is done to your satisfaction. It should take about three successive days of good working weather to finish the exterior walls of a standard underground house (if there is such a thing).

Anytime you're working with a small contractor, ask his price. Once the work is done and you're ready to pay the bill, ask if he gives a discount for paying cash. Sometimes they will give you a good discount for paying cash because they avoid the risk of a bad check. Also when dealing with a small contractor, get a clear understanding as to who is ordering and paying for sand, mortar, and water. The total price is usually the same whether you take care of these items or the block layer does.

It's a serious delay to have block and workers, but no sand. If you can work with your block layer and have him agree to lay one day's worth of block around the total perimeter of your house—maybe three, four or five blocks high (Fig. 4-7)—and then

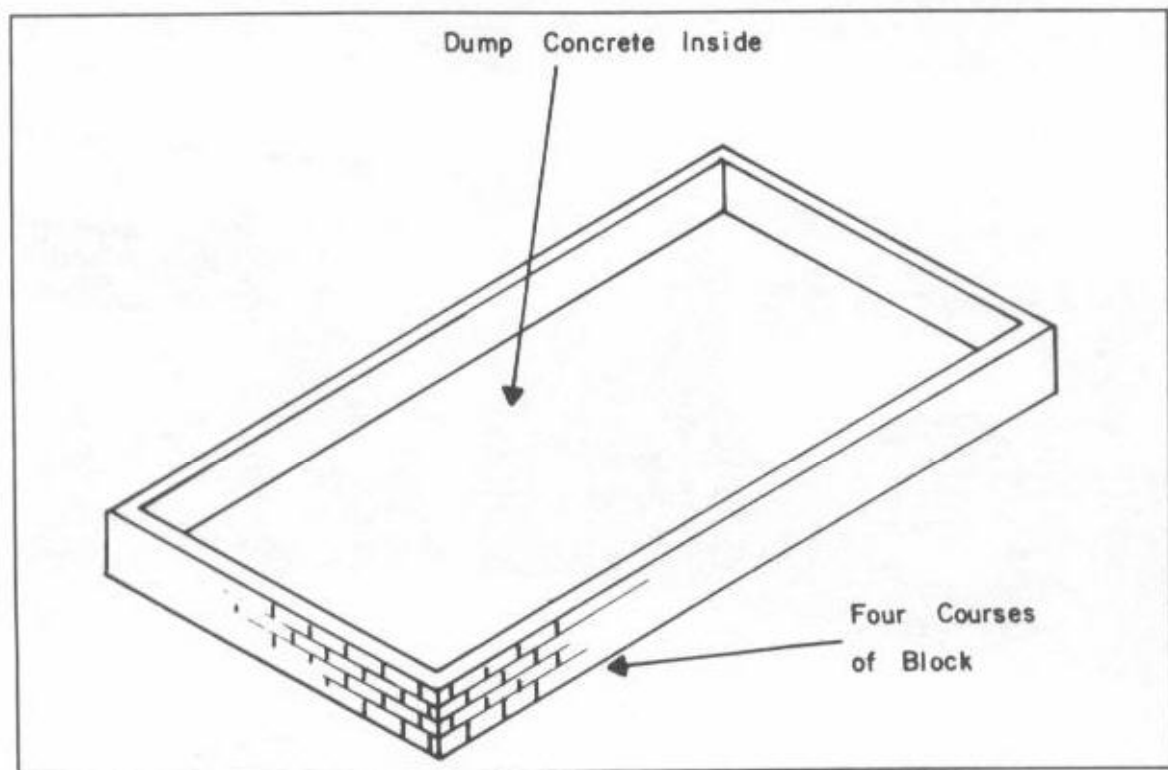

Fig. 4-7. The floor can be poured without forms. The concrete truck will have easy access to the dump area.

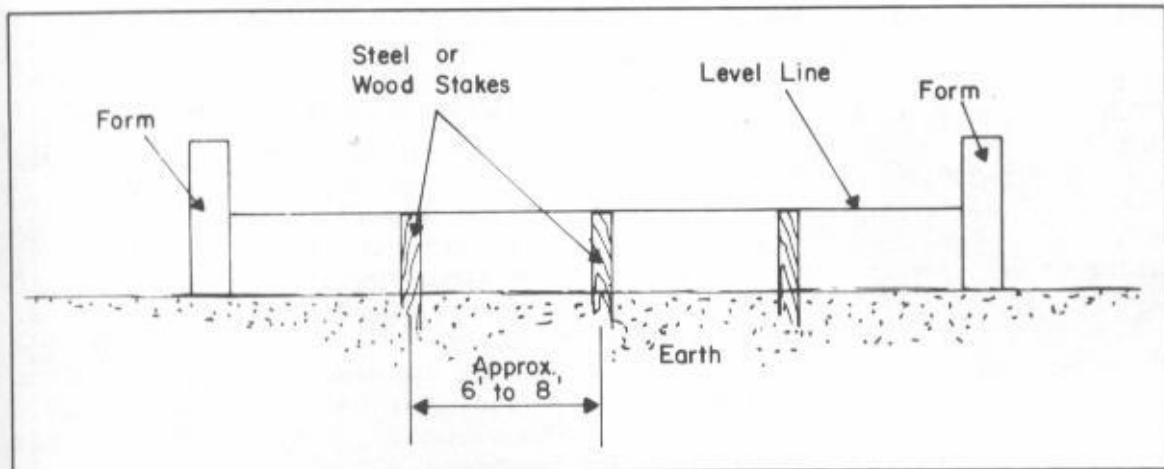

Fig. 4-8. Pave the concrete to the top of each stake.

leave the site and come back at a later date at no extra charge, it will be easier to pour the concrete floor. If your mason has to continue laying block until the walls are at their maximum height, it only makes it harder to move men and equipment around to pour the concrete floor.

FLOOR SLAB

Back to saving money. Hire a concrete finisher to pour the smooth floor slab. This is one of the most important jobs in building your underground house. If the floor sets up uneven, or rough, or cracked, it's a major problem because you will most likely be putting carpet and tile directly over the concrete. A smooth level surface is absolutely necessary. Find out who the contractors prefer.

A good way to find the best people in the trades of plumbing, block laying, concrete finishing, etc., is to look for the one that can't give you immediate service. He's naturally in demand. The guy who is sitting by his phone and can start tomorrow is not busy for a reason. Find out why. I found it was better to wait for the busy man than hire an idle contractor. I'm not telling you not to give a new man a chance, but be careful. The concrete finishers will give you a price in cents per square foot. Once again, find out what this covers. How smooth should the pouring bed be? What about level pegs?

For clarification, level pegs are wooden or

steel pegs (Fig. 4-8) driven in the ground so that the top of each peg is level with the others and to the grade level that you want your finished concrete to be. As your concrete flows and you work it smooth, it should end up level with the tops of these pegs. This way you don't have to use any type of leveling device to ensure a level floor or footer. If the pegs were put in accurately, then the floor should be level.

Pouring a slab of concrete is another way to save a few dollars. If your area is unlevel, fill low spots with gravel. Gravel is much less expensive than filling these holes with concrete. For example, a cubic yard of concrete (as of 1982) was approximately \$49 delivered. A cubic yard of small stone would be approximately \$4 delivered. This is quite a difference in cost if you're only filling a hole.

INTERIOR WALLS

A second reason for pouring the floor after a couple of courses of exterior wall block are laid and before the interior walls are started is because of the difficulty of leveling and smoothing concrete one room at a time. There is absolutely nothing to be gained by pouring concrete after interior walls are up. Don't even consider this method.

A third reason to put interior walls up after floor slab is complete is that it is very easy to lay out the walls in their actual position. This is how I

located my interior walls (Fig. 4-9).

Once your floor is finished, take the width of your interior wall block and cut a board that width. Usually in an underground home you can use 6-inch concrete block for interior walls (unless your engineer says otherwise). This board should be approximately 8 feet long for ease of handling. Now with a 100-foot tape measure and a can of bright spray paint (why not red) and a chalk line, begin to lay the entire floor plan on the concrete floor. Spray along both edges of the board, leaving a wall location mark (Fig. 4-9).

This system is good because it gives you a chance to check actual sizes of rooms rather than looking at a blueprint. By this time you need psychological lift and you will feel a sense of accomplishment seeing your rooms in full scale. Also, now is the time to make a change in wall location—not later. Walk through the make-believe rooms.

Check out door locations, openings, closets, room sizes and anything else you can think of.

MORE NECESSARY PURCHASES

Now that you have things started, there's no turning back. There are a few more things to buy (preferably used). Watch for a bargain on an acetylene cutting-torch outfit. They are easy to use, and you'll need it to cut the metal rebar that you'll be putting in the concrete roof and retaining walls. They are hard to find, but you will need one, and renting it is expensive. If you rent by the day, you are rushed to get your cutting done and return the torch outfit. This is a good way to have an accident or make a stupid mistake.

Buy a good radial-arm saw new or used. It will be one of the most valuable tools you acquire, and you'll probably keep it forever. Check prices closely and watch motor and blade sizes. Ask your

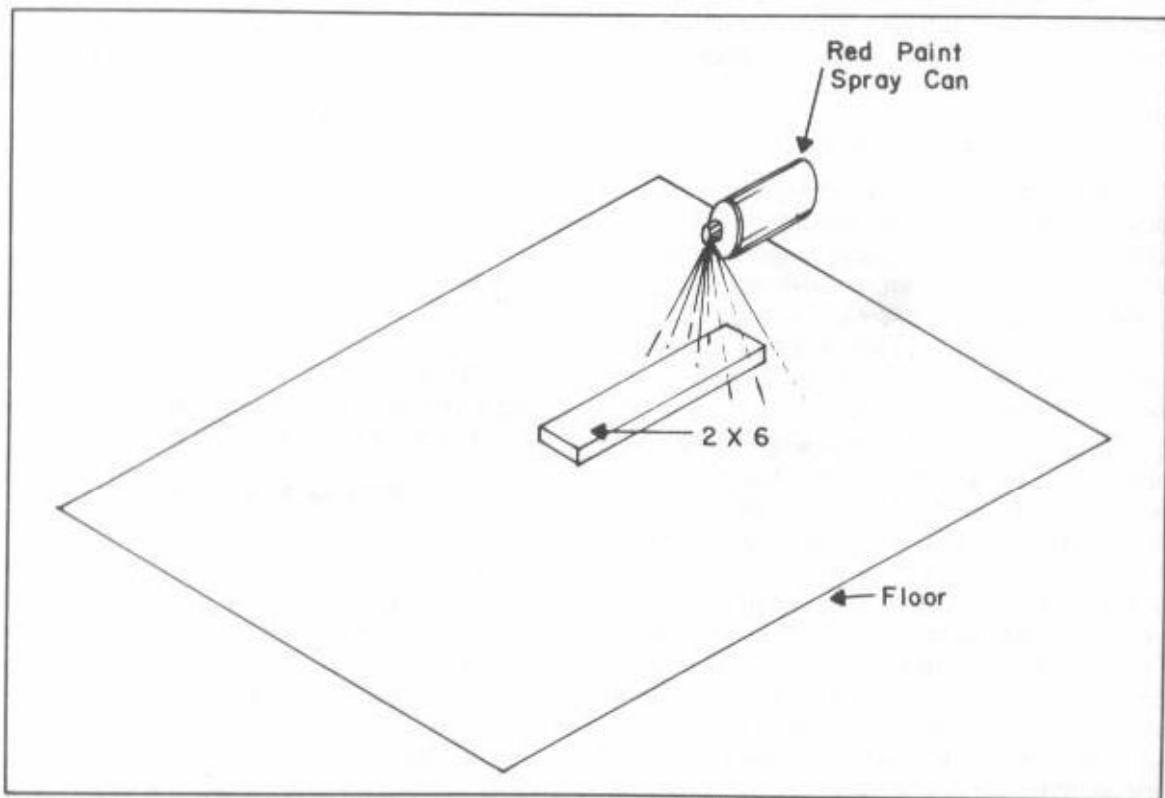

Fig. 4-9. Spray around a 2 x 6 or a 2 x 8 to leave a pattern on the concrete. Changes can be covered with gray spray paint.



Fig. 4-10. An old station wagon can be used to haul materials while you are building the house.

friends and experts about sizes and brand names. Remember you're not a professional carpenter so don't buy the super contractor's model. Just buy the size you need.

Another thing I bought that has proved to be a lifesaver is an old station wagon. I recently found a 1969 Rambler. The body was shot but the motor and transmission were in good shape (Fig. 4-10). I have come to call it my "poor man's pick-up." If you price pick-up trucks you'll know why. An old station wagon can haul (one way or another) 90 percent of the supplies a pick-up truck can. I loaded block sand, wood, steel concrete, and anything and everything in it. If it has to go to the junkyard it was money well spent to have an "almost pick-up truck" for building this house without paying for and destroying a good truck. Give it thought.

REPEATING WORK

There is an old saying that goes "There is never time to do work right the first time, but always time to do it over." This fits home construction very

well. Doing a job twice will waste both time and money.

When building the underground home described in this book, I was in a hurry to pour the small roof. I didn't brace the supports as good as I should have. The forms fell after 1500 pounds of wet concrete was in place. This little accident took a day to clean up, plus the loss of a yard of concrete, broken forms, plus the time and material to rebuild the forms. For the chance to save an hour and \$10, it actually cost me \$250 more, plus additional 10 hours' work. Haste makes waste.

The preceding example is one of getting in a hurry or being careless. Here is an example of bad planning. I know someone who started building an underground house and, after the walls were up, he figured it was time to grade the lawn. He wanted to let the grass get a good start. After hours of work grading and raking, he planted 200 pounds of grass seed. A beautiful job. So now back to building his underground house.

The next day a concrete truck got stuck in his

newly planted lawn. The electricians parked their cars on the lawn, scrap building material got stacked around, inspectors, visitors and others walked all around the property. By the time the house was done, he had to grade 98 percent of the lawn over again. A waste of about 10 hours. Don't plant grass seed or do the final grade until the house is complete.

Yet another cost because of bad planning was the man who paid a backhoe operator to come in and dig a ditch for his water line. This cost \$35 per hour from the time he left his (the operator's) shop. The ditch was dug and the backhoe left. My friend now went and bought pipe, placed it in the ditch, and called the backhoe contractor back again; \$35 per hour from the time he leaves his shop. If my friend would have bought his pipe beforehand, digging and covering could have been done on the same day, eliminating a couple of hours of travel time.

And then this one I'm guilty of. I decided to hurry up and get the carpet installed once I got the walls built. All I had to do was paint. I didn't realize how much trouble it was to keep the carpet covered. This extra effort caused me six or eight hours simply protecting the carpet against paint. Paint before you install carpet.

And then there is the waste of not knowing. I saw a man finish his house about July 4. He planted dozens of little expensive bushes, trees, and shrub-

bery. A hot spell set in for about 10 days and most of his landscape work turned brown even though he watered the plants. Ask your plant nursery people when to plant in your locale. You'll find midsummer usually is not the time.

One last example of waste is not buying wisely. Most lumberyards sell 2- \times 4-inch- \times 8-foot lumber best (grade A), good (standard), and economy grades. As of January 1983, in Maryland, the prices ranged from \$.89 to \$1.90 per 8-foot, 2 \times 4. So you see a real saving is possible when buying any quantity. A friend of mine bought the best grade 2 \times 4s because some were to be used where they would show. The result was that he only used about ten 2 \times 4s in places that were visible. The remaining 190 were used inside walls on places that would never be seen again. He should have bought ten grade-A 2 \times 4s and 190 economy-grade 2 \times 4s. This little oversight cost him about \$185. Mistakes like these soon add up.

One last example of poor planning is shown by the man who rents a big commercial air compressor and jackhammer assembly to break up concrete at a rate of \$150 per day, and then takes a two-hour lunch break and has to keep the equipment for two days. Not a smart move. I hope these examples will at least make you realize that, if you don't plan well, you could waste as much as 50 percent of your money. Time is also money.

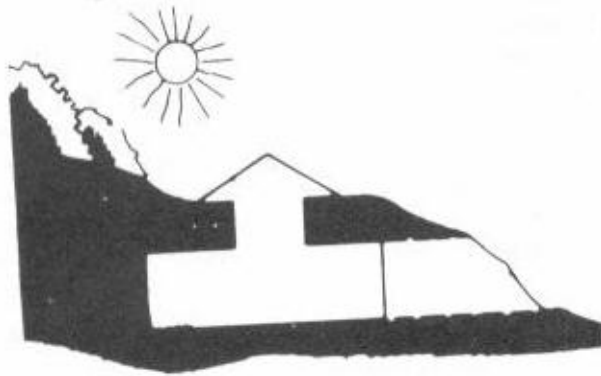

Codes and Regulations

Probably the largest single stumbling block you are going to face is how to comply with the local building codes. Once you face the facts that most building inspectors are long-term government employees and must constantly justify their careers you can easily understand why the mention of an underground house might start a panic. If they inspect and approve any phase of your building project, and— heaven forbid—something drastic happened like a fire or a collapsing wall, they are a possible link in the responsibility chain. They will take no chances of looking bad in their job performance.

Consequently, they usually just overdo everything. They will stick strictly to the book. If it's mentioned in their code book, they aren't interested because they are not liable. To prove my point, one regulation in our local codes covers hand railings. I have a set of four steps leading from the interior area down to the garage level. A hand rail is a must by codes for safety reasons. Any time you have three or more steps there must be a railing. Of course, I can't really say anything against the hand-

rail regulation except that it seems to be more of a nitpicking, harassing technique than of any real physical value. This code is now enforced diligently in our county.

In Chapter 9, I described how I built the support structure for pouring the concrete roof slab. In my roof alone, there are more than 146 tons of concrete, 20 tons of steel, 800 tons of dirt, plus a 2-ton dome. But to this day, no official or inspector has questioned the strength or method of construction because it's not mentioned in their code books to do so. Pouring this roof alone could have killed as many as 15 people if it had collapsed in mid-construction, but officially no one cares. I say officially because all the inspectors are local people and I know that they personally do not want to see a tragedy happen.

To verify this fact, I can tell you that on the day I poured 3 yards of concrete in a footer, I had two separate visits from official sources, just to see if I was doing it right. Quite a paradox, but I'm sure you'll see it as you build. They are geared to con-

ventional home building and not underground homes. I should also like to add that this is truer the more rural your location. If you were to build a strange structure in a district where high-rise office buildings, large industrial complexes and big apartment complexes are constantly under construction, the inspectors there have seen and are familiar with practically any type of construction problem.

On the other extreme, at the present time, there are still some area of the United States that have no building codes at all. God bless their non-meddling souls. It's a pleasure to realize that some communities still believe that the best government is the least governing.

If you intend to build in a community that has a complete set of building codes and zoning regulations, I'll remind you of a few things that will give you and them concern.

MEANS OF EGRESS

Probably the most difficult to comply with is a term called means of egress. This meaning exits. This covers doors, windows, holes, or anything else that could be used as fire escapes. Usually the codes require two exits from each room except the bathroom.

When you build underground, the windows are the first to go—thus a problem. Not only must you have a window leading to the exterior in each bedroom but that window must meet very specific dimensions. In the case of a fire, exit windows and not just any old window will do. Follow these specifications. A bedroom window must have a clear opening of not less than 5.7 square feet, when the window is open, but the width cannot be less than 20 inches nor can the height be less than 24 inches. This window also must be opened without tools of any kind. Inspectors prefer these windows to be double hung (standard window), but they will accept a sliding or swing out type provided they meet dimensional statistics of their own. You now see that installing a window isn't as simple as it at first seems. The same type of regulation applies to doors, insulation, framing, and all other phases of home construction.

SPRINKLER SYSTEM

The solution that was proposed to me was to use a commercial sprinkler system in place of the missing windows. If you could price their systems, you'll soon find it unreasonable from a cost viewpoint. In my house, an acceptable sprinkler system would have cost approximately \$10,000. Needless to say, I couldn't accept that alternative. You might find that designing around the missing windows present some design problems, but they can be worked out. Sprinkler systems were not intended to be installed in homes. The mention of this as a solution shouldn't be considered seriously until there is no other possible solution such as smoke detectors.

SMOKE DETECTORS

After much negotiations, conflict, and letter writing, we (the inspectors and I) agreed that a smoke detector in each room would be adequate. Even on our compromises we ran into a snag. My idea of a good smoke detector was a battery-operated model made by any of the major smoke-detector manufacturers. When I say battery-operated, I mean the type that doesn't require hook-up to the 120-volt house electricity. They only require small-voltage batteries (usually one 9-volt battery that lasts for over a year).

My logic for this type is understandable I think. If the house electricity is out of order because of a storm or if a fire starts in the electrical circuit it usually blows the fuse or breaker, thus shutting down the power to the detector that is supposed to be on guard. But a battery-operated model is on guard at all times. These battery models usually have a warning system that would sound when the battery is wearing down and ready for replacement.

County inspectors, as usual, had a different view of the same subject. They say that human nature, more often than not, will allow you to forget to replace the run-down battery so that the detector system will most likely be inoperative after the first battery wears down.

I felt I was right, but I admit that it's all in how you analyze the problem. The solution to this dispute was to install a dual-voltage smoke detector. There are a few on the market, but they are more

expensive than a single-voltage detector. A dc voltage detector will be in the \$5 to \$12 range, an ac voltage detector will run around \$15 to \$20 and a dual-voltage (ac-dc) will be around \$25 (1983 prices). I strongly suggest several detectors; one in each room would be my preference, underground or conventional.

SERIES OF CORRIDORS

There is another alternative to meeting egress (fire-escape routes) regulations. That is by a series of corridors leading from each room (Fig. 5-1). The reason a corridor or hallway is required is because most local codes say you must be able to escape to the exterior by means of a window or door—without going through another room.

For example, you cannot escape from your bedroom into the living room to get to the nearest door or window. Your bedroom must have a window that leads to the outside and a doorway that leads to a corridor. Corridors are not considered rooms by definition.

Now you can easily see why underground homes get into conflict when you eliminate all of the exterior windows. To meet all codes by the corridor

system, you would have to waste a lot of square feet of expensive floor space, plus isolate some living areas. Corridors are not my idea of a solution but you might be able to work out an acceptable arrangement. In summary of this fire escape problem, you have basically four choices to consider before you finalize your plans:

- Provide a corridor to each room.
- Provide an approved sprinkler system.
- Provide approved smoke detectors in each room.
- Provide escape from each room through the roof.
- Provide a window penetration through the earth, thus defeating the purpose of an underground house. See Fig. 5-2.

It is my opinion that the third solution is a very economical and logical approach. That is the way I solved the problem, and I am confident that your local inspectors will work out this solution with you. If not, contact the state authorities such as state fire marshall or state health department. They can sometimes act as mediators in local disputes.

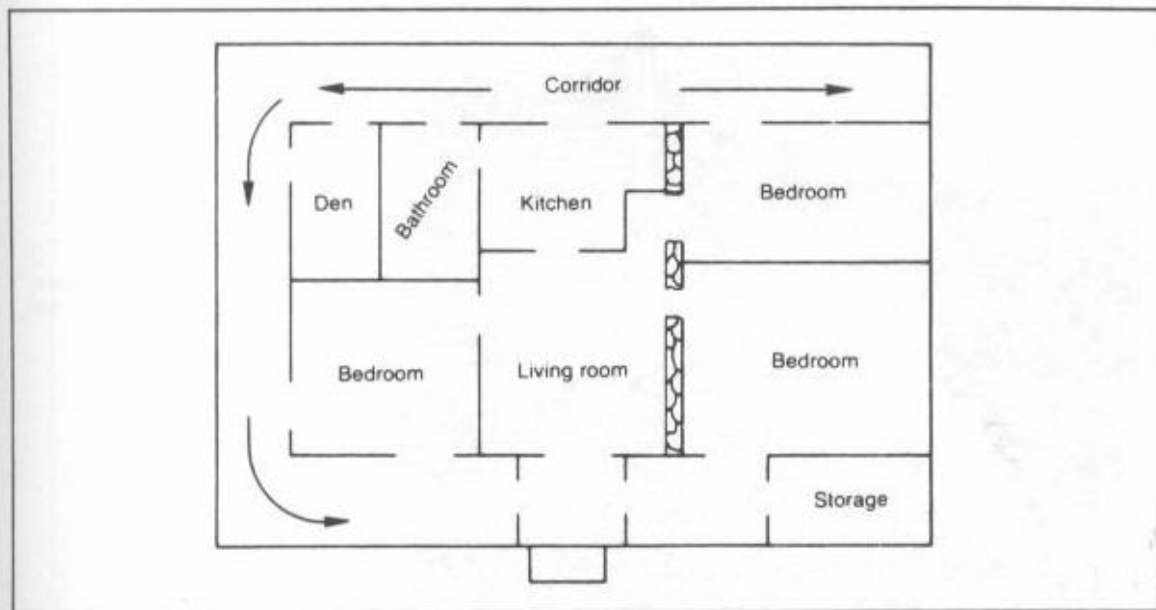

Fig. 5-1. The outside corridor design is an alternative.

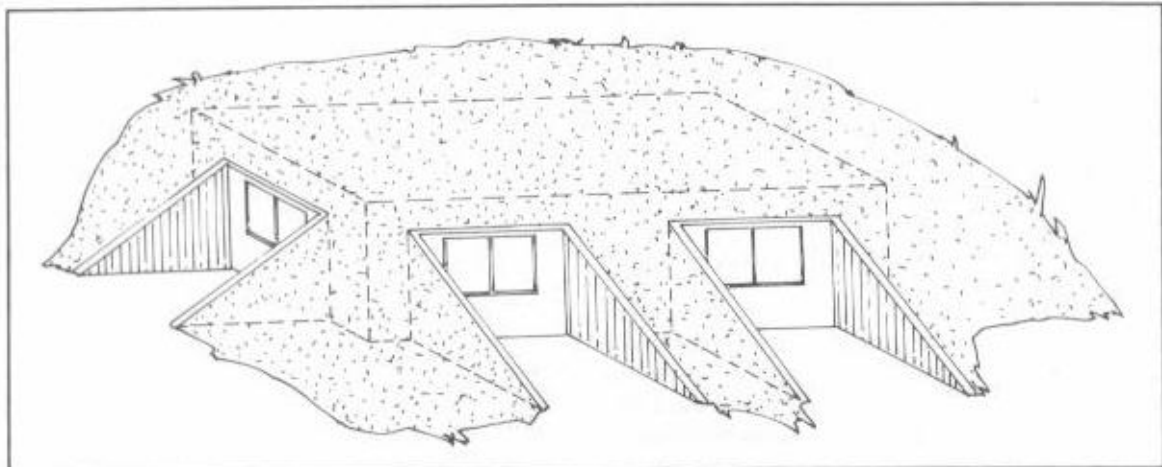

Fig. 5-2. Cutting openings for numerous windows soon defeats the logic of underground homes.

Most building codes are geared to protect against fire and ensure your health.

The fourth and fifth solutions are listed more in jest than for serious consideration. It should be obvious that the more holes you have in your roof the more problems you potentially have (such as leaks or heat loss or gain through these openings). If anyone is telling you (officially or unofficially) that

you need more than two exit corridors out of an underground house, challenge their source and credentials.

RETAINING WALLS

Another area that could cause you some trouble when trying to meet codes is retaining walls. See Fig. 5-3. Most underground homes have more than

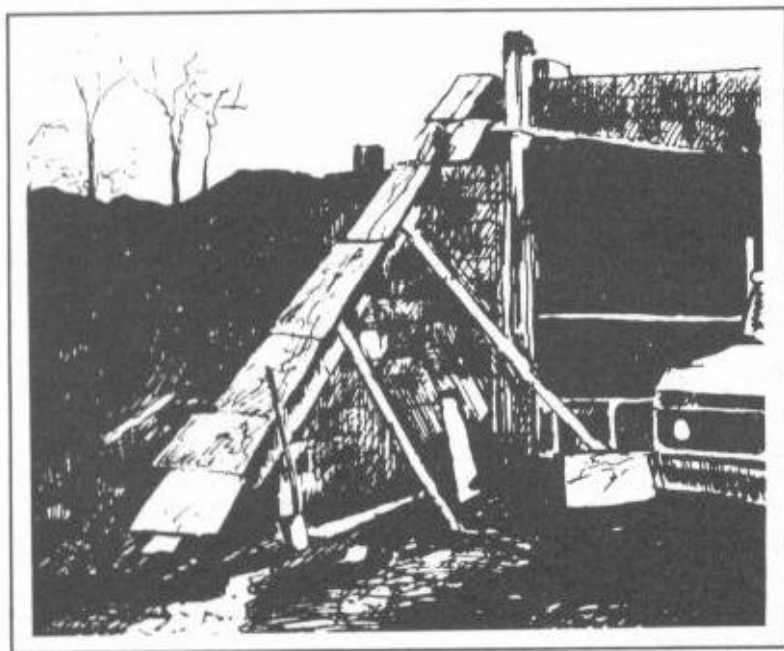

Fig. 5-3. Artist sketch of a typical underground house retaining wall.

their share of retaining walls (depending on the design, of course). Most localities have regulations as to maximum height and method of construction. Try to arrange your design to eliminate exterior retaining walls—if at all possible. If you can't, figure the cost closely. They are extremely expensive to build if they meet the code.

If you expect a retaining wall to easily stand on its own when the force of mother nature, by means of freezing and thawing the soil combined with the weight of the soil, is trying to push it over, then you are naive (Fig. 5-4). You can reinforce the wall with enough steel and enough concrete to ensure that it will stand and not crack against any of the elements, but it is difficult and costly. One of my solutions to retaining walls is to always brace one against another with steel-reinforced concrete (Fig. 5-4). If

you have only one retaining wall, you can always tie it to an anchor post of some type (Fig. 5-5).

Additional suggestions on how to tie a retaining wall back could be lengthy and it is a subject that has been written about in detail. Ask a good contractor or engineer or search the library for books on this subject. It will be worth your time to particularly look into the use of railroad ties. Most railroad ties that you can buy now have never been used on a railroad and they aren't really the same thing. The old-time railroad ties were pressure cooked in creosote (a preservative) to prevent rotting. The new so-called ties have only been dipped in a preservative and will not last as long as a real tie. Building retaining walls of ties is a difficult, back-breaking job. Use something that will stay in place as long as possible. See Fig. 5-6.

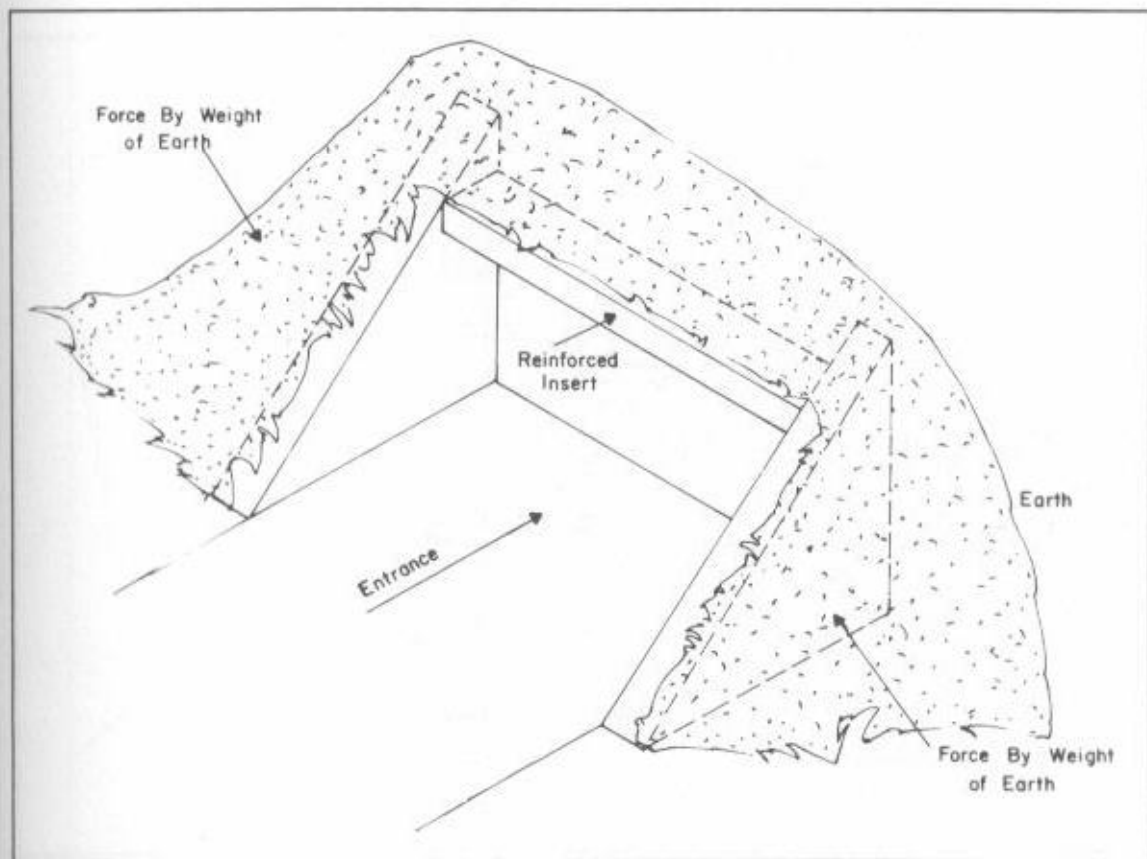

Fig. 5-4. A reinforced section between two walls keeps them upright and stable.

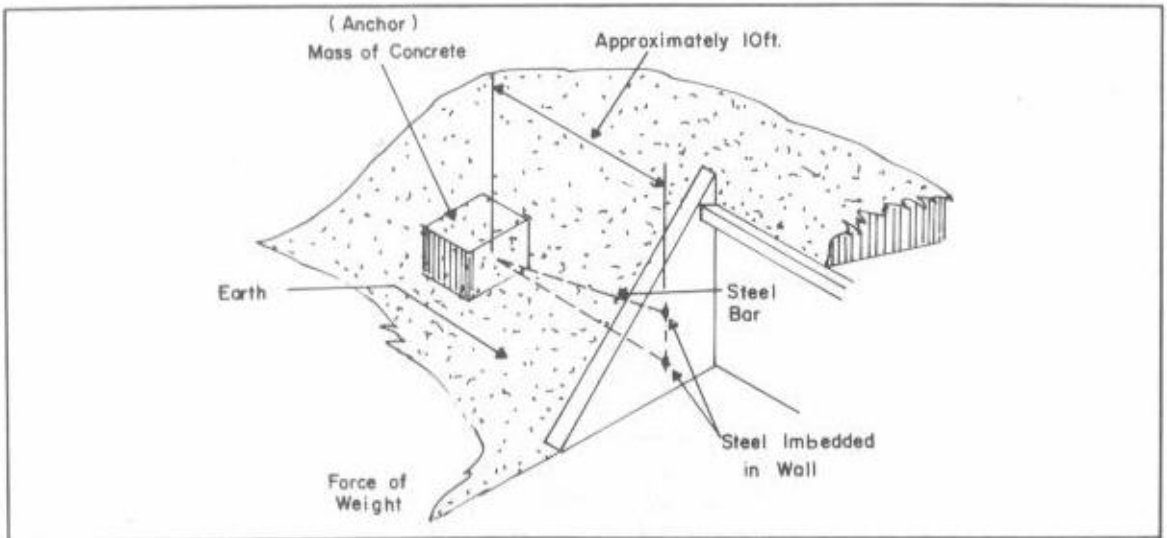

Fig. 5-5. Anchor a wall to a solid mass such as concrete.

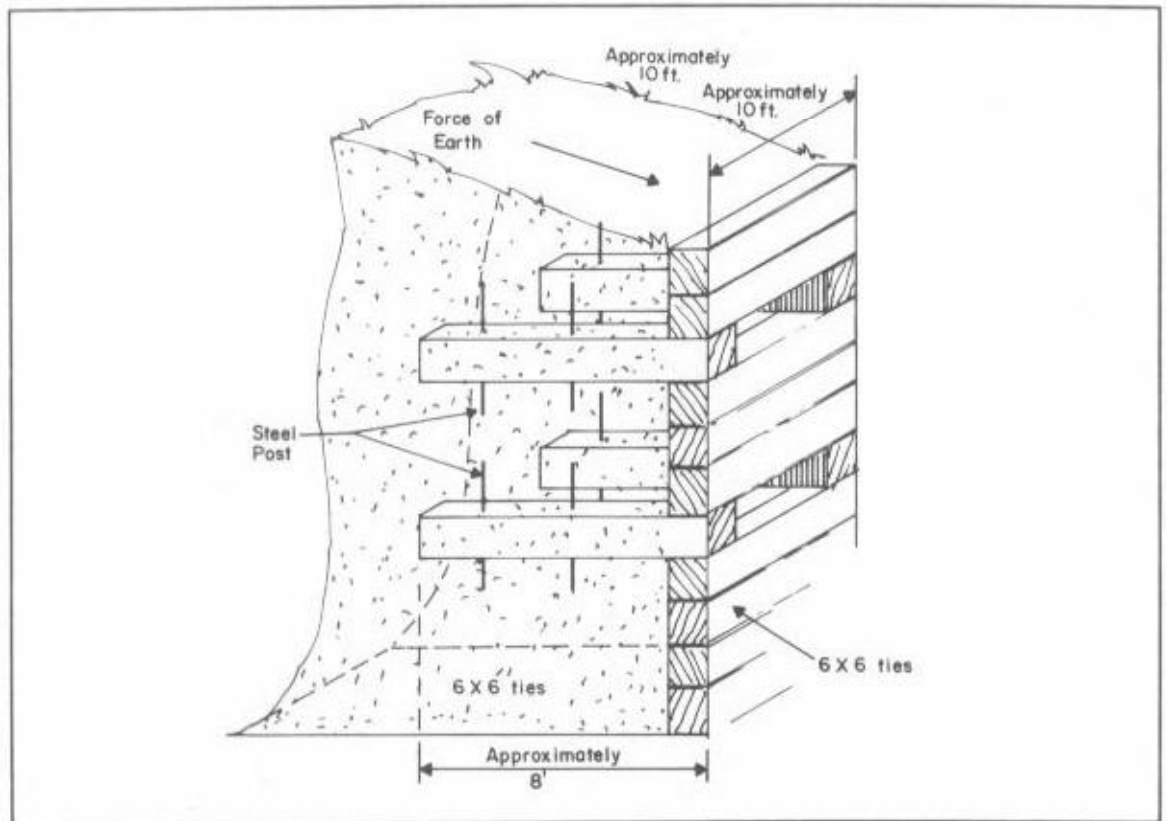

Fig. 5-6. Laying wooden ties for a retaining wall is tricky; use an anchor tie as shown.

HAND RAILINGS

Another subject that will require close attention to complete your house is hand railings. There is usually a difference between safe conditions and meeting the codes. I ran into a problem with my interior garden (Figs. 5-7 and 5-8). When a garden is

covered by a skylight, it is a personal judgement as to whether it is considered exterior or interior.

If indeed the inspector feels it is exterior, then handrail, doors and electrical boxes must meet one segment of the code. If he decides it is interior, then he will turn to another page in his book. As I men-

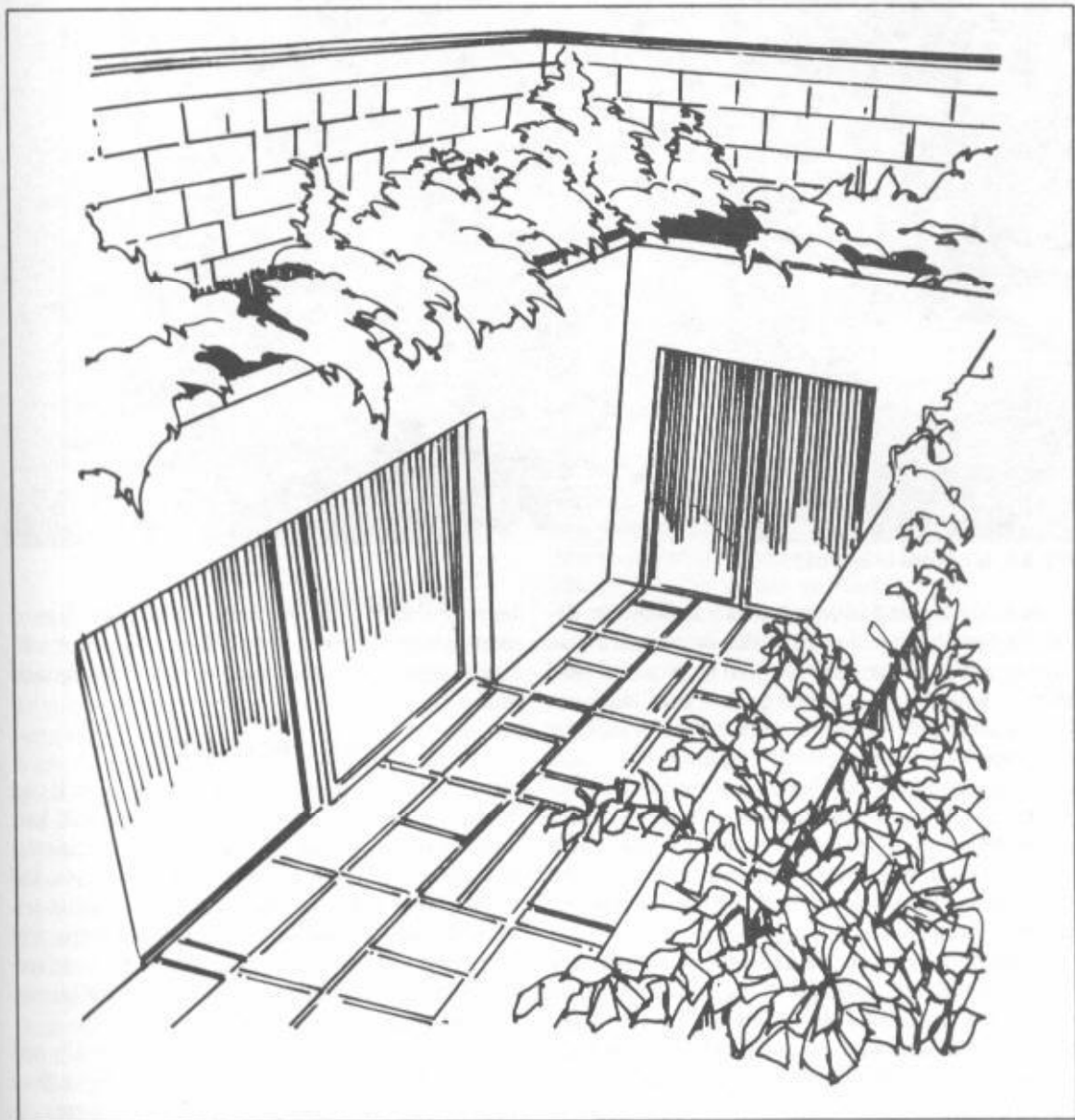

Fig. 5-7. Typical view of an indoor garden.



Fig. 5-8. Is it inside or outside?

tioned, handrailing requirements are different depending on the use of your garden or atrium. If you plan to use an above-floor level to grow year-round plants, then you are required to have a railing (even if you only use it once a year). If it is just for decoration, then no railing is required.

Still another problem area could be glass doors. The codes sometimes say sliding glass doors are not allowed as a principal means of egress. This becomes particularly complicated when these doors enter into your garden. Is it exterior space or interior space?

Most local building codes were patterned after a basic set of national regulations and sometime in the past these codes have been adopted as the gospel truth. In addition, many subdivisions have drawn up a few amendments to the national codes. Most of these amendments are pets of some local developer and in no way are intended to serve your

benefit—only your expense. For this reason, everywhere in this country will probably take a different approach to the building of an underground house.

AIR CIRCULATION

Air circulation is one area that is important. If your house is like mine when complete, you will have only a wood stove for heat. I'm not suggesting that you don't put conventional heating in if you feel comfortable doing it, but the majority of underground home owners find wood heating is the most satisfying (even over solar heat). If you use conventional heat with a duct system, then all air circulation problems will be easily met.

Just because you heat one room easily and quickly doesn't mean the hot air will move from room to room. You need a circulation system. A wood stove needs oxygen to breath. As the fire

burns, oxygen must be replenished. So you do need a duct to the outside world. Here is where the codes will conflict with your good judgement about the size and location of the fresh air intake supply.

The inspector's logic here is that in a conventional home fresh air is drawn in around windows, under doors, etc., regardless of the new caulking and installed insulation strips. I know from experience that all you need to do is circulate the air inside the house. The exterior doors would have to be opened approximately once a day to provide all the fresh air necessary to live comfortably. This is particularly true if you have a large dome or breathing skylight.

If you keep bringing in outside air in the winter when it's not required, you defeat the purpose of underground living. Of course, the same is true in the summer. I like and need fresh air as much as anyone, but enough is enough. Don't change air more frequently than necessary. By that statement, I don't mean to defy the building codes. Ask for a deviation from the building code if you think they are unreasonable. Deviations are often given if the exception is noted on the building permit and there are attached drawings.

POTENTIAL ELECTRICAL-CODE PROBLEMS

The National Electric Code covers everything from door bells to flood lights, dryers, and bathroom fans. As you might suspect, building underground presents very few problems electrically. Wires can run in any direction, any place, and take up very little space. The one phase of underground construction that should get your electrician's undivided attention is running conduit through the concrete roof slab. The size and placement of this conduit is crucial prior to pouring concrete. This conduit is primarily used for ceiling lights, outlets and fans, any other electrical service can run around or through walls. Do not attempt to place wires inside the conduit prior to pouring concrete. Movement of the wet concrete as it is poured might move the conduit a few inches and could break a wire inside the conduit. It is easy to thread wire through conduit with a tool all electricians have; it's called a

"fish tape."

When you build a new house underground or not, you will most likely be required to have that house wired by a licensed electrician. Even localities that do not have comprehensive building codes usually have adapted an electrical code. Check your local codes if you plan to act as your own electrician.

HELPFUL REMINDERS

Because an underground home usually has many walls of block, it's likely that a wire will go around a corner from time to time. The safe way to do this is by breaking a hole in the wall of the concrete block (see Fig. 5-9). This is done to prevent the wire from bending over a sharp edge that could become a chaffing point.

When boxes are mounted to block walls by a furring strip (Fig. 5-10), a hole must be broken into the block to allow the box to protrude into the wall. The codes don't mention closing up the broken area with cement before Sheetrock is applied, but I suggest you do it because it creates a passageway for mice or bugs. In the event of a fire in one room, any opening allows oxygen to get into the fire and smoke to escape to other rooms. It is very easy to place mortar in around an electrical box.

Because most underground homes sprawl over one level rather than two levels, they are usually long (50 to 100 feet). If you only install one main breaker box and panel (200-amp service) to wire the extreme ends of the house it would require many runs of expensive, electrical plus labor. If you install a separate 100-amp breaker box at the opposite end of the house, the distances will not be as great. Discuss this with your electrician. It may be more expensive but definitely a better arrangement.

I also suggest that you place the wires in the walls for individual electric heat even if you initially do not install the heaters themselves. The cost of the wire and labor is minute as the house is wired compared to what it would be once the walls are complete. I say this because many underground home owners intend to heat with wood stoves or solar panels, and they find two years later that the wood is too much trouble or the sun doesn't shine as

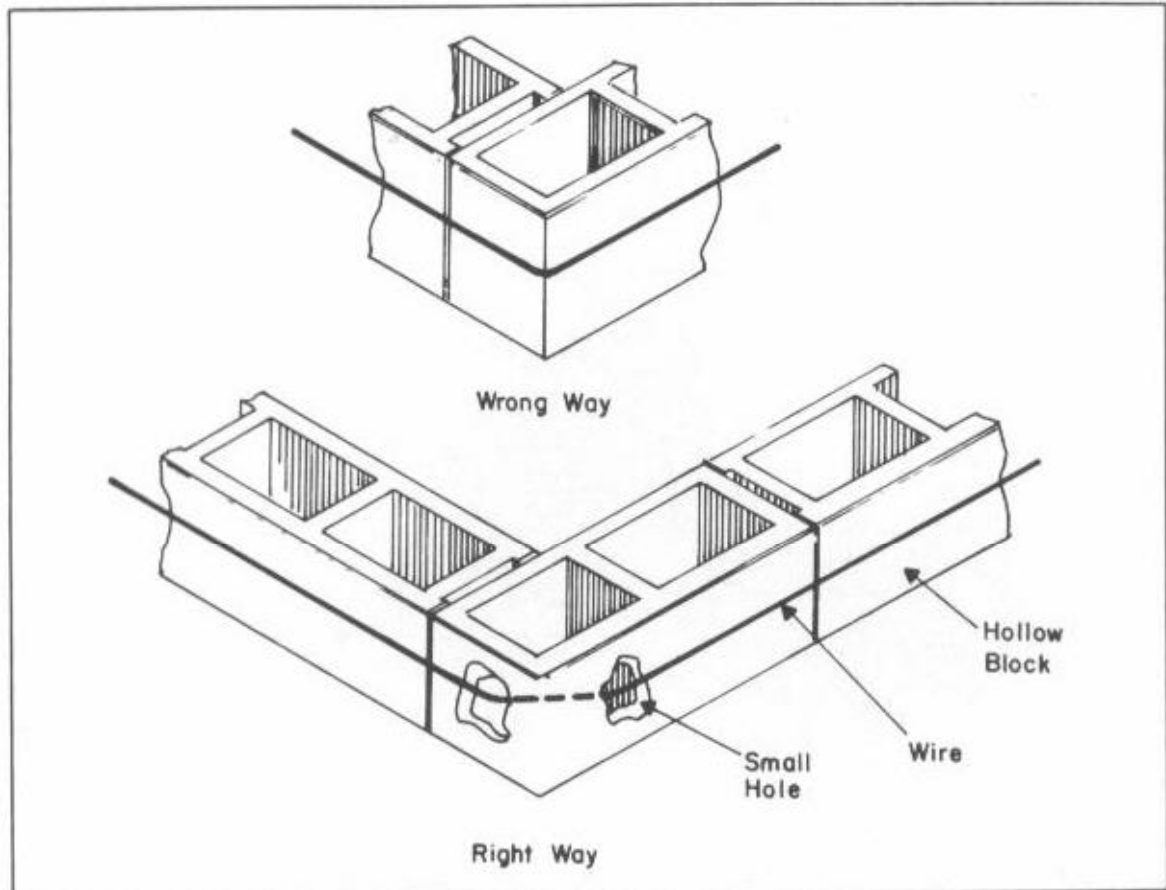

Fig. 5-9. Run a wire through block (not around the outside corners).

much as they thought. This is a case where a little thought and cost up front could save trouble and dollars later. This is especially important if you sold this underground house and the new owner wanted conventional heat.

It's difficult for a nonelectrician to save on electrical costs. The best bet is to have two or three small electrical companies give you quotes. You cannot easily shop for prices on the components because the specifications of wire switches, etc., are described in electricians lingo that you might not understand fully. Nothing is more dangerous or frustrating than knowing a little bit about a subject. I suggest you contract the complete electrical phase of your underground house to a competent electrician.

PLUMBING

The plumbing phase of an underground house does require special attention. The following are a few examples:

The cast-iron drain lines under the concrete floor should be checked and double checked because once the concrete floor is poured (Fig. 5-11) those drain pipes are covered out of sight forever (unless you have a jackhammer and shovel at hand). They are laid in place the same as in a conventional house, but most times the drain pipes travel longer distances under more weight and concrete than a standard house.

I suggest that you install "clean-out" pipes more often. A clean-out is the term for the pipe fitting that allows access to the drain for Roto-

Router equipment (Fig. 5-12). Why not place a clean-out behind the bathtub, in the laundry room, in the closet, and anywhere else you can. They cost little to install at construction and can save a lot of time and money should the under-floor drains become clogged.

A simple suggestion that is worth its weight in gold is to use PVC (plastic) pipe everywhere you possibly can and anywhere the code allows. Don't be fooled by the old school of thought that copper or steel is better. Remember that it takes years to build a good business. Many plumbers are "old-timers" and sometimes are non-receptive to

change. The change from copper to PVC and plastic PVC (polyvinyl chloride) has done to the plumbing trade what small computers have done to the businessman.

You can do your own plumbing. Don't be afraid to tackle your own plumbing work. You can easily get a permit to do your own plumbing work on your own house.

Many amateur electricians have been hurt or killed by their mistakes. Very few amateur plumbers have drowned from their plumbing mistakes.

Unlike electrical components, plumbing components are easy to compare prices. One of the best

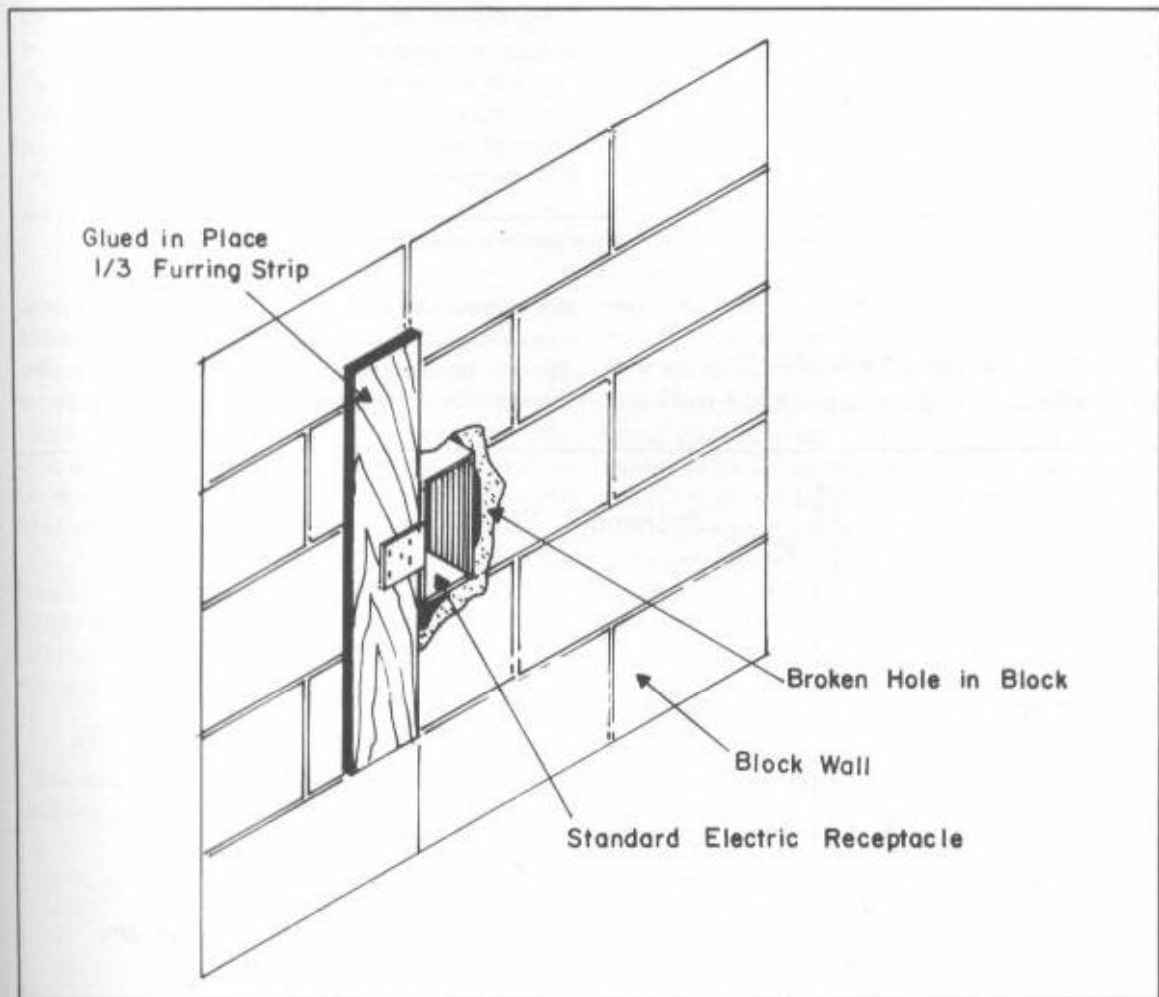

Fig. 5-10. The electrical wiring receptacle must be recessed in block cavity in order to be flush with Sheetrock surface.

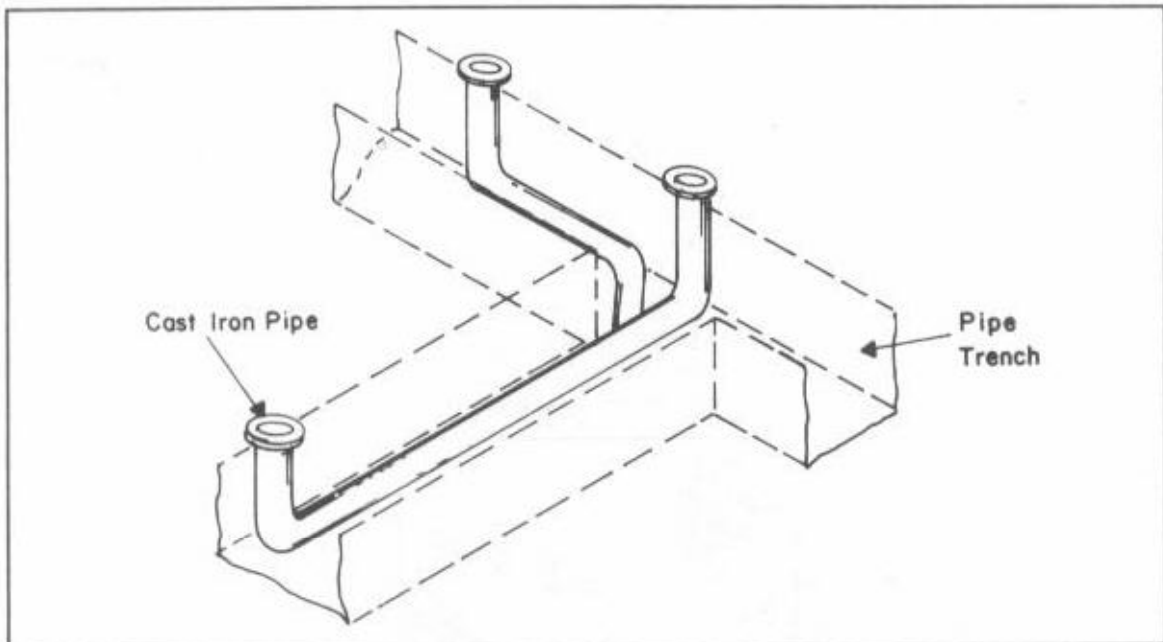

Fig. 5-11. Check cast-iron pipes in trenches very carefully just before concrete floor is to be poured.

places to become familiar with the plumbing system, names, and prices is a Sears or Montgomery Ward catalog. The prices in these catalogs are very competitive. The only places you might find lower

prices would be at the large chain hardware stores.

This is the place for me to comment on one of my pet peeves with the building industry. Remember I'm not a contractor. First, I'm an engineer

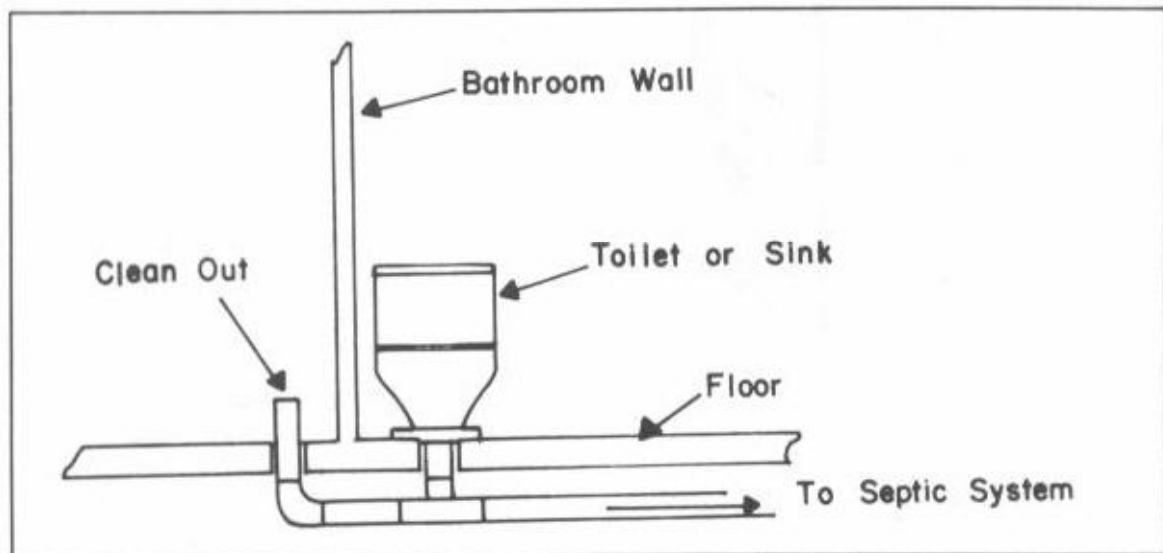

Fig. 5-12. A clean-out pipe is usually installed at the beginning of a septic line.

and then a builder. All communities have their wholesale plumbing supply house where the professional plumbers buy, but the kicker is that their wholesale prices aren't as low as the chain stores. Plumbers buy from these plumbing houses because they carry all the odd fittings, and hard to get parts that a chain store wouldn't have. Your new house won't have the unusual items. Every plumbing fitting in a new house is common as dirt. Shop and save money on fittings as well as tubs, sinks, spigots, etc.

STAIRS

Still another area that you might watch out for and design around is the steps. The reason to avoid steps in an underground house is, once again, written in the sacred scrolls of building codes. A principal means of egress cannot contain steps upward—only downward. Because you are already down, you can't continue in that direction. This is a code rule that varies from locale to locale.

DOOR OPENINGS

Most likely all doors opening to all living areas from utility rooms, storage rooms, garages, laundry rooms, or furnace rooms must be made of solid wood approximately 1½ inches thick with no windows. They also must have an approved burn rate. The reasoning is that it will contain a fire in these work areas long enough for you to escape past (not through) the door.

As you go through these trials and tribulations, you'll find you cannot meet certain codes or that it is really impractical to do so. If that is the case, there is a means of appeal if the building inspector will not suggest an alternative to your problem.

BUILDING CODE APPEALS BOARD

Your course of action is usually to refer to the building codes appeals board. The members are

usually politically appointed for a specific term. They have absolutely no power to change a regulation. For example, they cannot give you approval to eliminate a door if a door is called for by code.

Most codes make use of the overworked and all-encompassing word *approved*. If you put a hand railing along a stairway and use a piece of wood 2 × 2 inches thick, the inspector may disapprove the railing. You can ask for an appeal to the appeals board saying that 2 × 2 is strong enough and should be accepted. Then they will rule either for you or against you. They will never say a 2-inch board is not okay but 2-×-3-inch board is okay. They will not suggest what is acceptable. They will give you a yes or no answer to your specific question.

If you do not receive a satisfactory answer from this appeal board, then you may also proceed through the courts. I don't suggest getting involved in the courts for a decision that is minor (such as the hand railing example). If you have an underground house design that violates present regulations, but it has sound engineer principles behind it, by all means explore every avenue possible. That's how rules are changed.

PROFESSIONAL ENGINEERS

The official stance that my local inspection department took was that I had to get a professional engineer to put his stamp or seal on my drawing. Such a seal is a legal signature that indicates that the signing engineer has checked strength and material and agrees that the architectural drawing is satisfactory. This type of engineer is tested by the state for proof of his ability. Then he is given permission to charge a fee for checking the drawings (thus taking a share of the responsibility). As long as the engineer had his name on the drawing, the county inspection department could say that they were not responsible should something go wrong if the design was found to be defective.

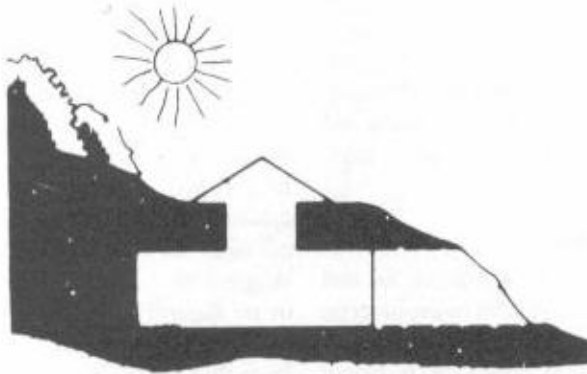

Site Preparation

Site preparation for an underground house is definitely crucial. It is much more important than that of a conventional home because most underground homes are into the side of a hill.

Chapter 2 explains what to look for and what to avoid when finding your ideal location. There is an interrelation between these two chapters. As you read on, you will notice that I am explaining location to you as if your land were in the two- to three-acre range. I think of this as the minimum size for an underground house. It is obvious that if you have 10 or 15 acres you should have little trouble locating the ideal spot for everything. Therefore, I will only point out the things to watch for if your land is in the two- to three-acre range (Figs. 6-1 and 6-2).

Once your boundaries are clearly and accurately marked by surveyors stakes, find an observation point where you can observe most of your property and study the contour.

DRIVEWAY

When building an underground house, you have to

give a lot of thought to where you are going to cut your driveway. This is the first excavation that usually takes place. I suggest you put your driveway on one side or the other as opposed to down the middle of your property (Figs. 6-3 and 6-4). If your driveway is in the center of your yard, you split the lawn into two parcels, and either of them might not be big enough to use for recreation areas.

SETBACK

What is a setback? What are the restrictions on a setback? Setback is a term established to name a suitable distance from the nearest public roadway where you can build your house. This distance is different for each piece of land. The reason for this type of local regulation is to prevent someone from setting a new house right up against the roadside. Figure 6-5 shows a typical plot layout eliminating where you can't build.

It is imperative that the state, county or whatever local government is maintaining the road past your property have access to additional land, should



Fig. 6-1. Not a bad view for an earth-sheltered home.



Fig. 6-2. Your view might look like this.



Fig. 6-3. Preparing your site.



Fig. 6-4. Cutting the driveway on a new building site.

the road ever need to be widened. The local utility company, even though not a part of a government agency, also must have a place to lay pipe or wires or set poles, transformers, etc.

If this setback distance causes you a problem, ask for a variance from the established dimension. The variance will usually be granted if you are only asking for a few feet.

When building underground, the setback dimension becomes a clouded issue. The setback dimension has always referred to construction above ground. With the coming of the underground home, it was only natural that conflict developed. See Fig. 6-6. In most areas, it is legal to ignore the setback dimensions as long as you're over 3 feet below the surface (see Fig. 6-6). The logic is that the utility could still use the land above your house without disturbing it.

Some locations have taken this issue to the courts. To date I know of no case where the locality could enforce a set back line 5 feet underground. Remember that a setback line is not only required

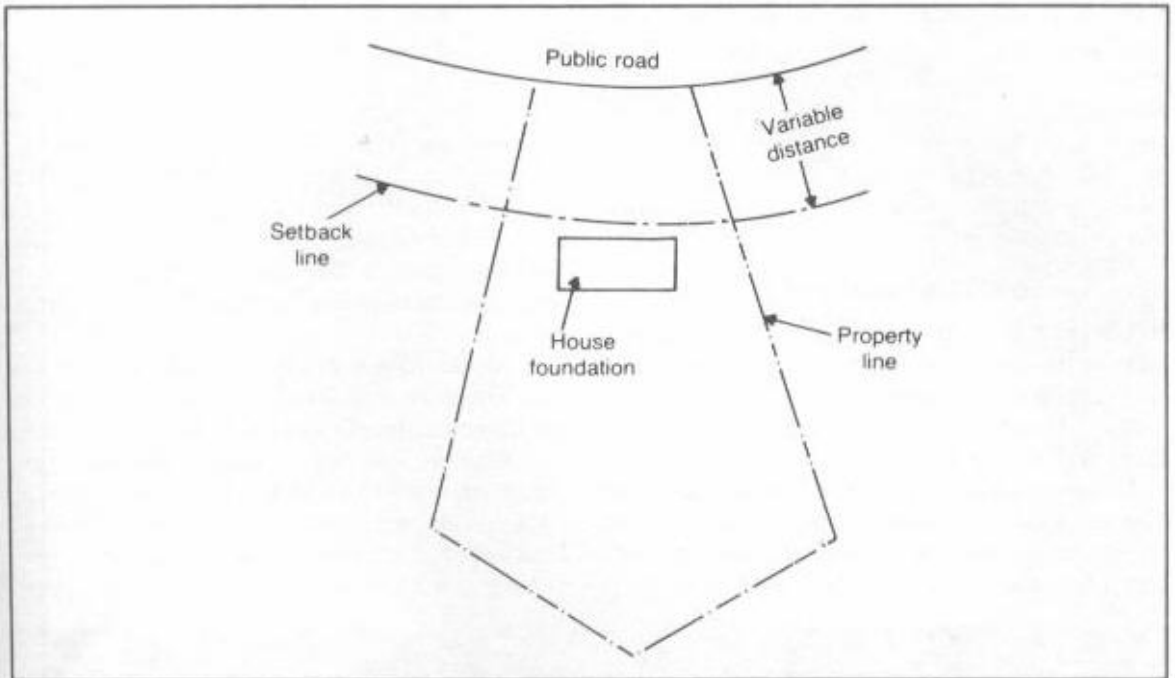

Fig. 6-5. Setback levees are established by local governments to ensure space for future expansion.

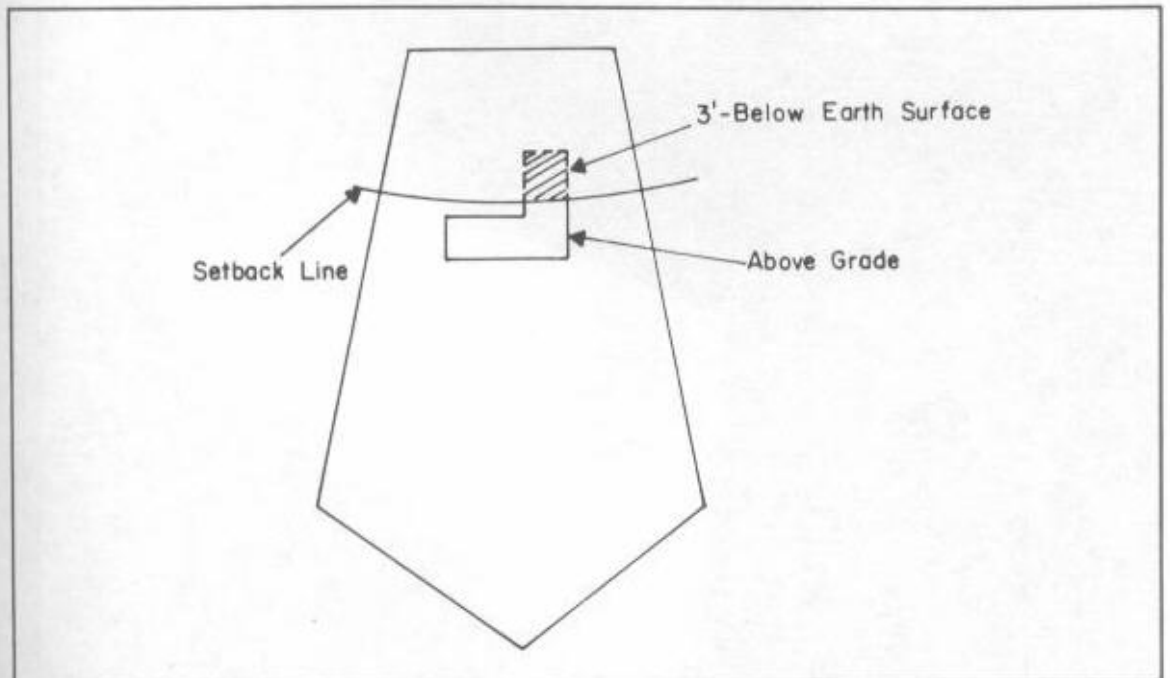

Fig. 6-6. Setback lines may not apply underground. Check local restrictions.

from the road frontage, there is also a regulation controlling how closely you can build to your neighbor's property line. This dimension is usually 10 to 20 feet. If you have a three-acre tract to build on, and you follow all of the possible regulations, you will soon notice that you don't have as much choice as you first thought concerning the location of your house.

SEPTIC-SEWER SYSTEM

Before you start driving markers in the ground locating the corners of your house, have you cleared the location of your septic-sewer system with the health department? If not, be sure to check with them. And don't forget the well is also covered by regulations. Usually the local health department handles this. Of course, I'm assuming that your land is covered by codes because most land near major population centers is heavily regulated. This is

especially true if it's a small parcel.

Let me mention a few things to consider when installing a septic system. First there is the conventional septic tank, a commercially manufactured concrete box about $5 \times 6 \times 8$ feet in size. See Fig. 6-7. It is the standard method used nationwide today. What varies with this system is the length and layout of the drain field extending from the tank. Each installation is different and designed to fit your land. The local health department will assist in design.

An alternate sewer system could be a dry well (see Fig. 6-8). A dry well is a big deep hole lined with concrete blocks and no drain field.

Whatever you and the local health department decide on, don't do a slipshod job. This is a messy, back-breaking job when it's constructed new. Imagine what it would be like to dig up a sewer system after it has been used for two or three years.



Fig. 6-7. Concrete septic tank in place.

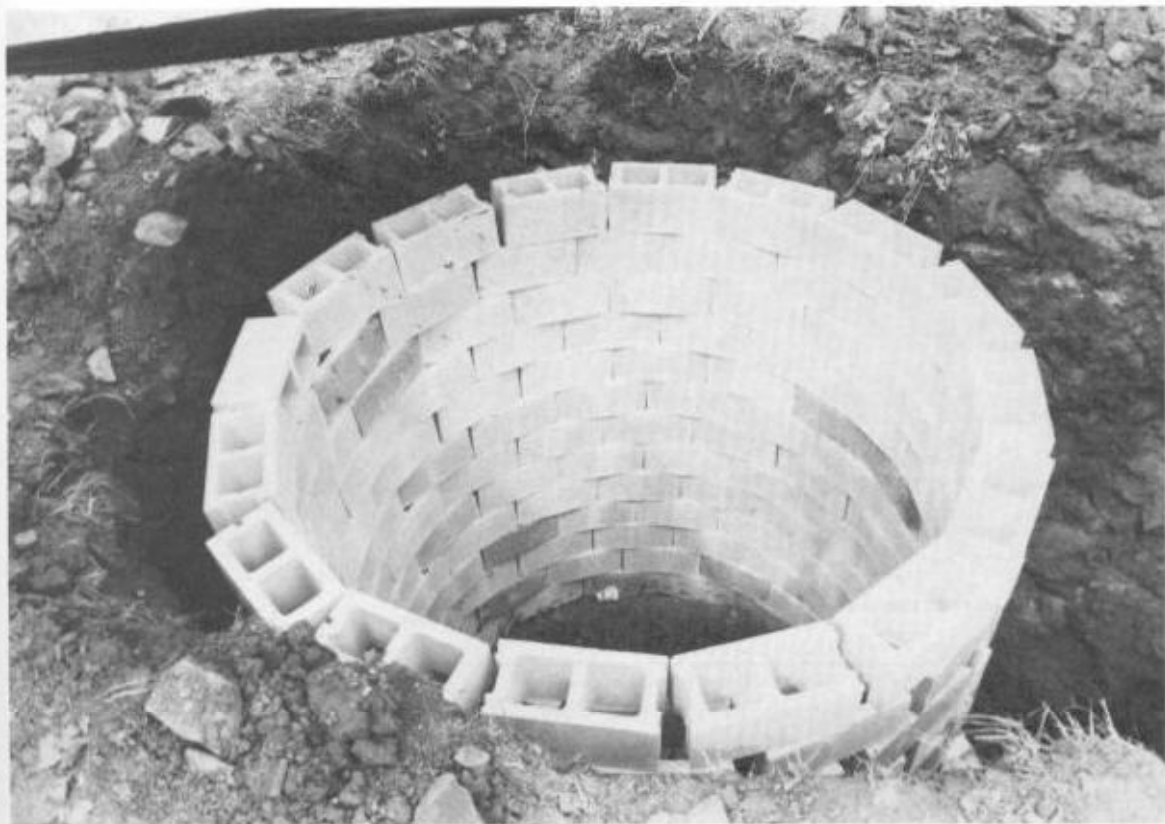

Fig. 6-8. A dry well is made of stacked concrete block.

Not a pleasant thought. If you take a shortcut, that's what will happen.

The local health department also regulates this well-digging procedure. Your well must be uphill from yours or any neighboring septic system. Needless to say that's a good idea. A well must also be located a specific distance from property lines and house foundations.

In some localities (Maryland is one), the homeowner can't ever install your own well pump. Let a professional plumber do the job. More and more localities are adopting to these procedures because homeowners in the past have taken shortcuts or in some way contaminated water to be used for drinking. Thus a health hazzard.

I guess well drilling is something that must be regulated but it does make the job very expensive. You'll be surprised at how many problems you can

run into simply drilling a well. How did the pioneers of this land ever survive without modern technology (and regulations)!

SURVEYING

Now back to site preparation (Fig. 6-9). It's time to begin putting stakes in the ground. You can locate the corners of your house yourself with a transit or you can hire a professional surveyor. If you do it yourself, follow this method. You must have a set of drawings of your house by now. Add 4 feet to the overall width and length. The reason for this is that the stakes you drive into the ground when laying a house do not indicate the actual exterior wall corners but the corners of excavation (Fig. 6-10).

The bulldozer operator will use these stakes as a guide to dig the foundation. The purpose of the extra 4 feet on the length and width is that the



Fig. 6-9. You can learn to use a transit in a few minutes.

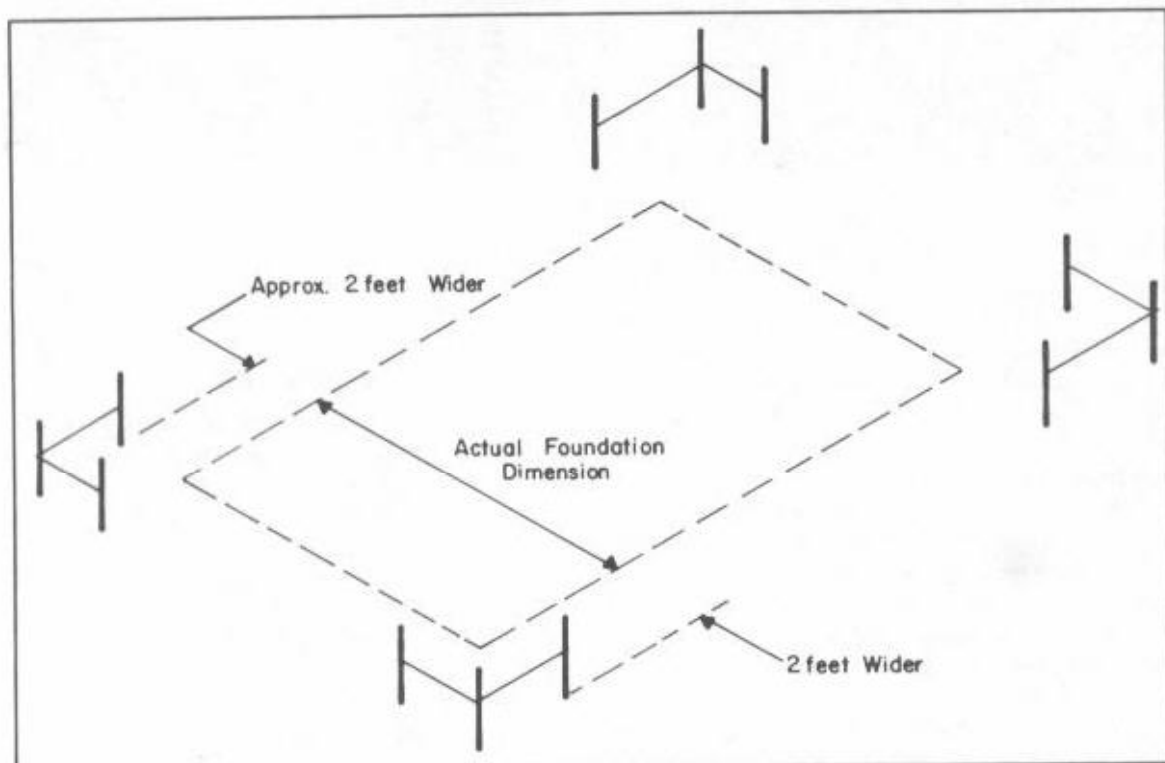

Fig. 6-10. The stakes are located away from the final foundation. This is to allow room for the blocklayers to get on both sides of the wall.

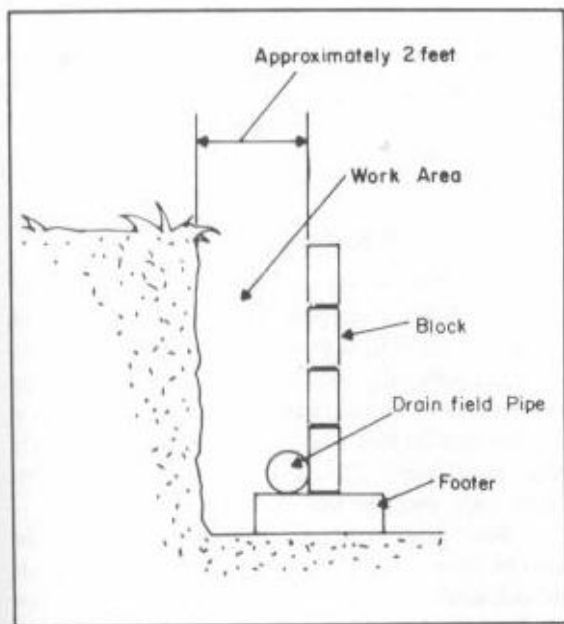

Fig. 6-11. A work area is required by the blocklayer.

blocklayer or form builders need room to walk and work around the actual wall once they are started (Fig. 6-11). Also the drain field is laid in this same space once the walls are erected.

It should be noted that the additional 4 feet is

actually 2 feet on either side of the house (see Fig. 6-12). Don't overlook the location of the actual corners of the house because it will set in the excavated hole.

As soon as this dozer cuts your driveway and you agree that it's the right location, bring in gravel for a driveway bed. Look in the local telephone directory under gravel or quarries. Common terminology around Maryland for the appropriate gravel is crusher run or #2 stone. This is a gravel and dust mixture that is as inexpensive as any gravel, and it packs to make a good road bed.

You can't blame them for that because their trucks are expensive and serve as their basic means of livelihood. Besides, you could be liable for towing bills or damage to the trucks. Think about it this way. If you spread the gravel in the beginning it all gets packed down for free by workers and delivery trucks. That's probably the only free assistance you'll receive.

Whatever you do, don't let anyone talk you into paving your driveway with blacktop or macadam the first year. Let the gravel pack and settle for at least one year.

If you are going to concrete your driveway, that's a different story. Concrete could be poured as soon as the house is complete, as long as it's not

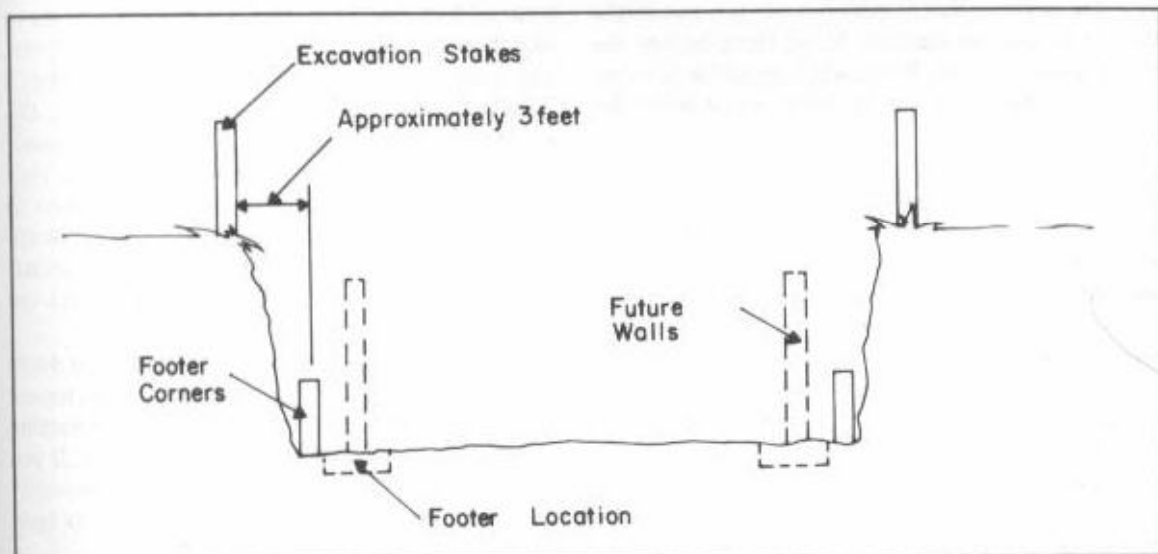

Fig. 6-12. Don't confuse the difficult points of measurement.

over loose fill dirt. Don't concrete or macadam your driveway and let heavy delivery trucks drive over it the first month it has been poured. Give it a chance to cure. A couple of months should be sufficient. If it cracks after two months, it wasn't put down or reinforced properly in the first place. Then your problems are just beginning as far as driveways go.

Give some more thought to putting anything down on your driveway other than gravel. The tax assessors love people who improve their property with a hard driveway. It's not fair but it's the system of tax assessment. A hardtop driveway, just as swimming pools or tennis courts, add real value to your home (therefore raising its taxable base). You not only pay for the driveway, but you keep on paying for it by yearly taxation.

LANDSCAPING

If your land is grown over with weeds or undergrowth, find a way to mow it to grass length while the excavation is going on. Nearly every neighborhood has someone with a big field mower behind a farm tractor who will do this for a reasonable price. You'll want to actually see the surface of the land that will become your future lawn. If it is overgrown with brush, I don't care how many times you walk over a piece of land, you never see everything.

Large rocks that require a dozer to move might be just below the surface. Move them before the dozer leaves the site. It's nearly impossible to move a rock as big as a refrigerator even with the backhoe.

Another reason for mowing the land is to eliminate rodents, insects, and allergenic weeds. It will also allow the land to dry out. If you have a wooded area on your property, try to cut down underbrush, dead trees, and unhealthy trees to allow the stronger trees to develop into good shade trees. Talk to a professional regarding the selection of the trees you save as opposed to the ones that get the axe. Some trees might be rare or otherwise valuable. Some might be dying, and some may be thorny or have poison berries or leaves. Don't go in and methodically cut down all the living trees and bushes on the premise that you will have to buy

from a nursery anyway when the house is complete. It's usually a waste of natural beauty. Nursery plants are expensive and very difficult to start. Keep your underground house surrounded by a natural setting as much as possible. You'll be happier in the long run and so will your neighbors.

PROPERTY LINES

Another thing to do regarding site preparation, which I strongly suggest, is that once the official survey is made by a professional and the property markers officially are set, remove any wooden posts and drive steel pipes in their place. Do this at least every 50 feet along your neighbor's property line on all sides. Drive them to grade level, but make sure you can find them if you need to.

Some wise man once said, "Fences make the best neighbors." This at first might sound like a cold or unfriendly attitude, but it is not. Personalities change, situations change, and neighbors change. There's nothing that will cause hard feelings faster than two people who think they both own the same rose bush on a common boundary. I don't necessarily agree with the fence theory, but at least make sure it's obvious where the property lines are—right from the start.

The reason I point this out is that with both homes I have built the question has come up as to who is using whose property to plant those proverbial rose bushes. Because you are building a "strange" home in the eyes of most people, the world you live in might not be ready to jump on your bandwagon or beat a path to your door. In fact, they could be downright nasty once your intentions to live underground are made public. Cover all possible sources of contention, especially those boundaries. There's no use in asking for any extra unfavorable reaction.

As site preparation continues, have your dozer operator grade off approximately 6 inches of topsoil to form a mound. This method will prevent wasting topsoil that you will need for final grading. If you don't pile your topsoil aside, it will be covered by the lesser-grade soil dug while installing footers, the foundation or the driveway.

If you think the extra grading effort to save topsoil isn't worth the extra money you might have to pay a dozer operator, you'd better check the price

of a truckload of good topsoil. You'll agree that it's easier and more economical to save good soil rather than pay to haul it in at final-grading time.

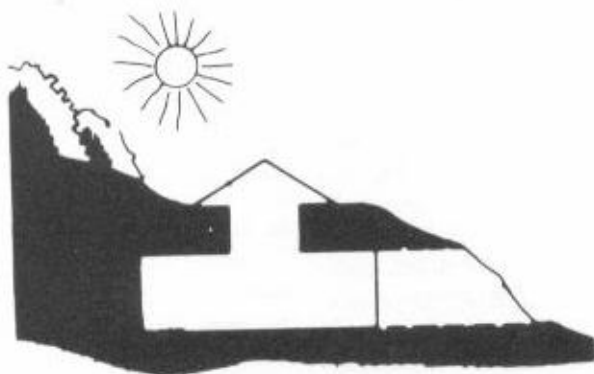

Preparing and Pouring the Footers

Preparing footers for an underground house is much more crucial than for a conventional home because of the excessive weight bearing on them. The consequences also crucial. Cracking walls will lead to leaks. Dig your footers correctly and accurately and it will be time well spent.

To begin with, a conventional house footer is usually required by code to be 16 inches wide by 8 inches deep. I recommend that for an underground house over 2000 square feet that you increase the width to 24 inches wide and 12 inches deep. Use reinforcing steel rods as an added safety factor against settling cracks. The amount of steel rod added to the footer is immaterial. The more the better but it is expensive. Use good judgement and ask for advice. In my opinion, four pieces of steel rebar, $\frac{3}{4}$ of an inch in diameter, would be a good idea (Fig. 7-1).

The important thing about preparing and digging footers is that they are level and square. Also the corners are at right angles. The reason to keep the corners square is because weight is trying to push everything further into the ground (Fig. 7-2).

To exaggerate this point, suppose the footers were only 1 inch wide and pointed on the bottom. They would act as a knife edge and would keep settling deeper and deeper. It's the wide, flat surface that stops settling in the same way that snowshoes stop you from settling in the snow.

The footer will be dug by a backhoe driven by a professional or by you. Either way the footers will be dug by a backhoe and cleaned up by hand labor and a square-tipped shovel. In preparation for the backhoe to begin digging, you have to place guide lines on the dirt for the operator to follow. Use a common field line that can be bought at any hardware store. Lay out the location of each footer edge (not center line) in the same way the football field stripes are applied. The backhoe operator will then dig beside this white line you put down.

Notice I said mark the edges of the footer. If your addition and subtraction is not accurate, you will be digging footers where there are not walls and vice versa. See Fig. 7-3. Now that these white lines of lime are in place and the machine is digging, you need two additional helpers and a good transit.

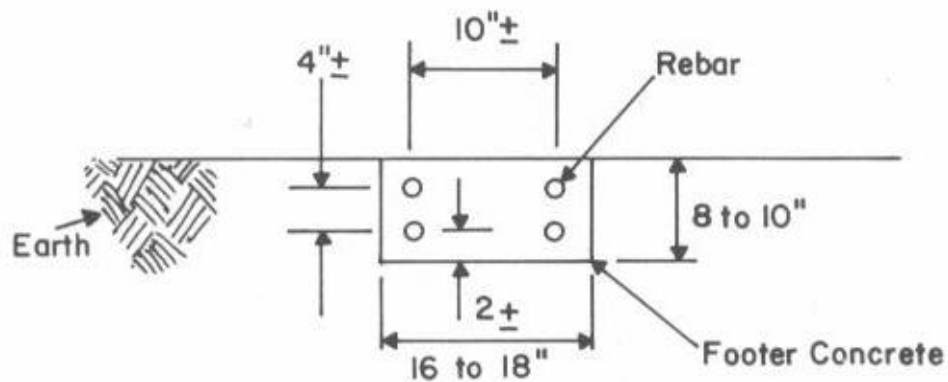

Fig. 7-1. Typical placement of rebar in normal footers.

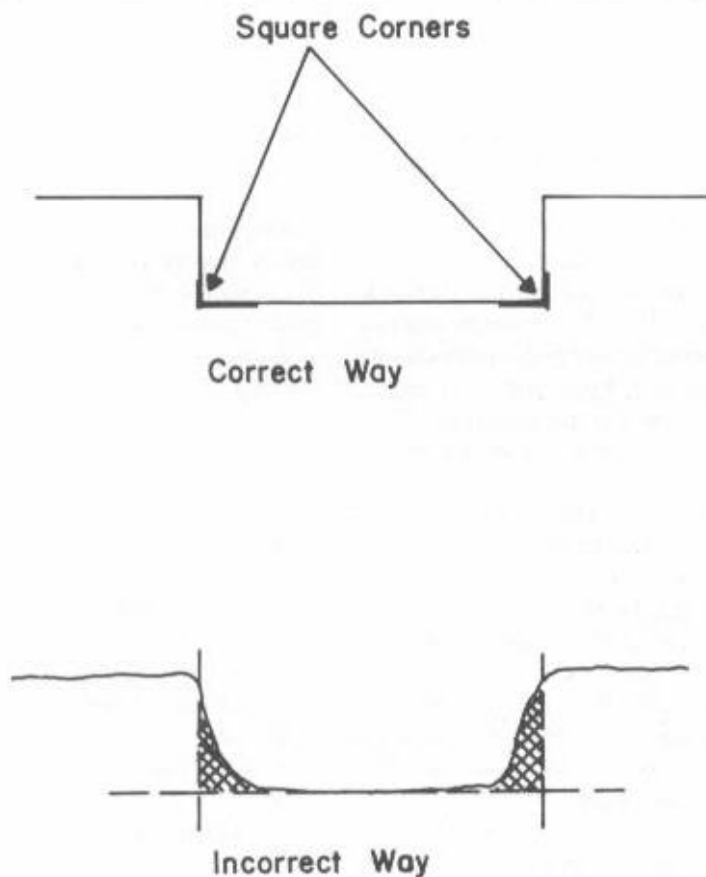

Fig. 7-2. Always keep corners of footers square and clean.

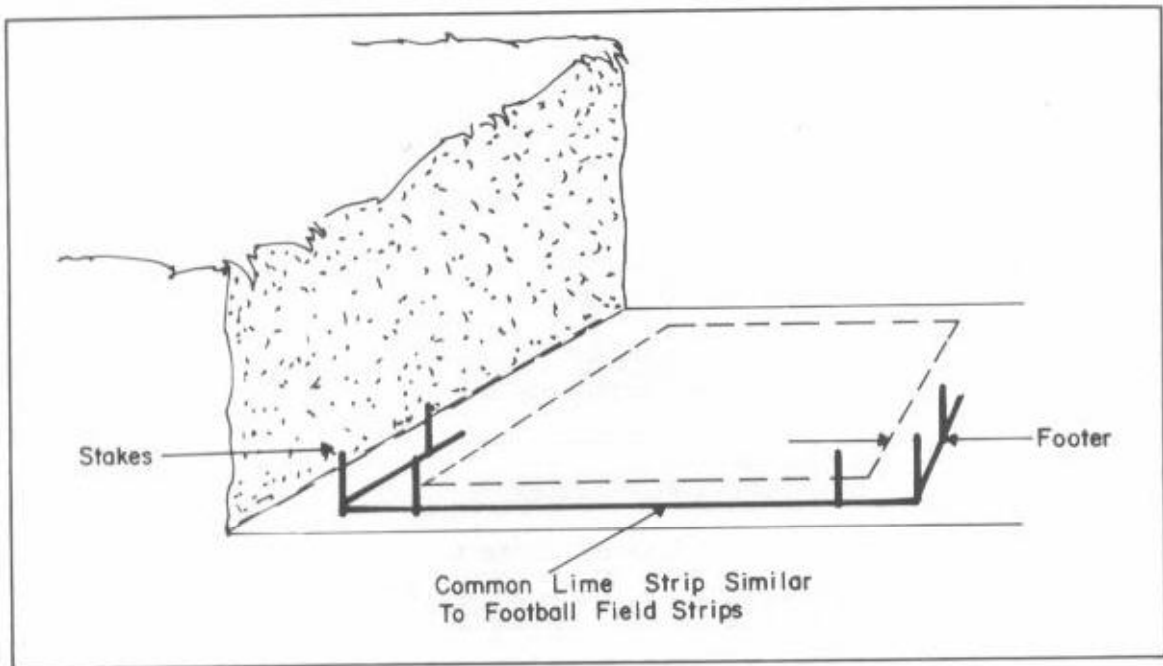

Fig. 7-3. Stakes are placed to the outside of the footers.

Set the transit up totally outside the perimeter of the house foundation by at least 25 feet. This will prevent having to relocate the transit as the backhoe maneuvers closer. How do you set up a transit you ask? When do you get one? Both questions are relatively easy to answer. First, you must rent or borrow a transit; don't buy one just for one job. They are expensive and have very little use to you once your home is built. It will cost about \$25 a day, and the renting store people should be able to show you how to use it for your purposes.

Briefly, a transit is a rotating level with a telescope on top of it. The principle, once understood, will make it very easy to use a transit. A transit pivots atop a tripod. Once this tripod is set firmly on the solid ground, the telescope is adjusted until it maintains a level condition as it rotates 360 degrees. Adjustment knobs are the means to which you obtain the level condition.

You can figure that if you take a common 36-inch yardstick, move 50 feet or so away from the transit. Have someone hold it in a vertical position, and as you sight through the telescope you will see

some figure on the yardstick (See Fig. 7-4). If the holder moves to another place and repeats the placement of the yardstick and you pivot the transit (making sure not to move or bump the tripod) you will now see a different number. By adding or subtracting these numbers, it is easy to figure if the setting point of the yardstick is rising, falling, or staying level. It's simple once you do it the first time.

As the backhoe is digging, you and a helper will continually measure the depth of his diggings to maintain a uniform ditch. Approximately every 4 feet, drive a wooden or steel stake in the center of the footer. These stakes are driven in the ground until the tops of all the stakes are level with each other, as established by the transit reading. The stakes are spaced equally as the machine digs, and your helper takes readings on the transit. This continues until all the footers are complete.

Up to this point, the footer preparation is the same as in a conventional building. The big difference is that every wall is a bearing wall. Therefore every wall requires a footer underneath. This might

not sound like a major point, but consider that, by putting footers under every interior wall, the amount of digging, hand shoveling, concrete, steel and so forth is approximately two and a half times as much as for a conventional house.

My house, above the ground, would have required 260 feet of footer. So you see how the cost and labor can add up fast. This coupled with the extra width and depth I suggested earlier could cause your underground house footers to actually cost over four times that of a conventional house.

Do not take these footers lightly. If you do, you will not only waste time and money, but you could endanger the complete integrity of the structure.

THE CONCRETE

Pouring fresh concrete is a job you can handle with a little help from your friends. This is true whether it's footers, sidewalks or your roof. First of all, all concrete companies sell concrete by the cubic yard delivered. You are responsible for telling them how much to deliver, and you are responsible for the distribution of this concrete. To figure how much you will need for a specific pour, you simply figure the cubic yards of the area to be filled (length times width times height).

These dimensions are usually discussed in feet and inches so be careful when converting to cubic

yards. There are 27 cubic feet in a cubic yard. I have heard stories from the concrete truck drivers about do-it-yourselfers who forgot that they were buying a cubic yard instead of a square yard. Remember, that, when you are talking to the concrete company on the telephone, the dispatcher has no idea what you're doing. So he takes your request whether you ask for 1 yard or 100 yards. Be careful with the simple arithmetic. It could be costly if you make a mistake.

Also remember that once the truck arrives with your order, it's your concrete. Concrete does not make round trips. If you have a footer to be filled that actually requires 5 yards, but through your mistake in ordering the truck arrives with 6 yards, you pay for your order and the excess gets dumped on your property for you to clean up later.

Once the truck arrives, the driver will know how close to get to your diggings. Let this decision be his. Most drivers are experienced and are responsible for their trucks. I happened to get a driver who was a little more of a cowboy than a truck driver. Figures 7-5 and 7-6 illustrate the results of carelessness and poor judgement. This time the driver was only severely shaken. It's a miracle that this accident was not fatal, but the truck was totally destroyed.

Let the driver make the decision as to how and

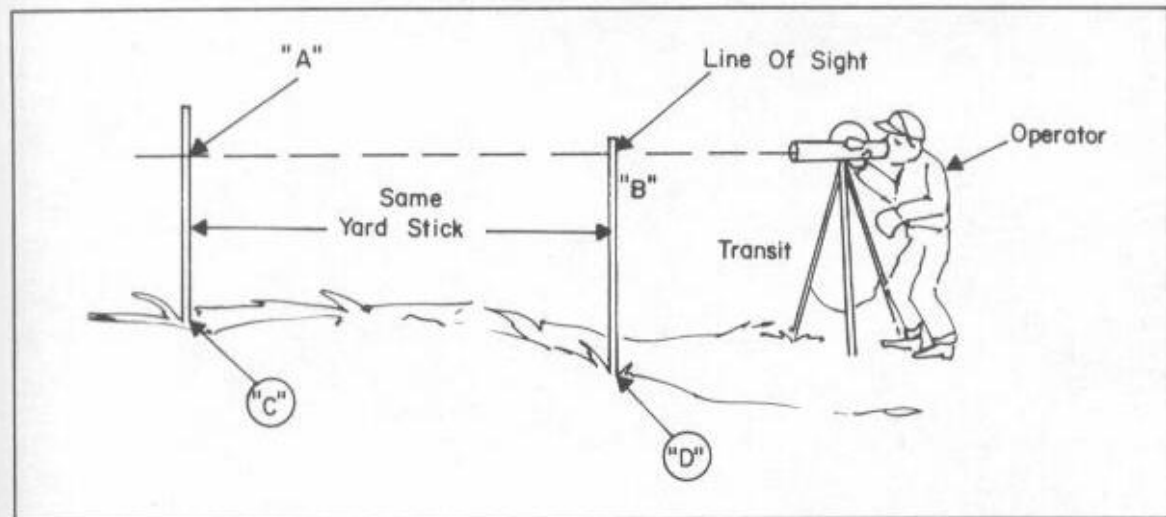

Fig. 7-4. Subtract the difference between Point A and Point B to figure the difference in the height of Point C and D.



Fig. 7-5. Poor judgment caused this truck to be destroyed.



Fig. 7-6. Accidents are caused by carelessness.

where he will dump the concrete. When pouring concrete down a hole, the risks can be very great at times. This is especially true for building an underground house.

Once the concrete truck starts pouring wet concrete in your footer, all you need is a good rake and shovel. The driver will ask you whether you want it wet or dry. He only means with more or less water added. If the concrete flows along the footer easily by raking, then keep the consistency. Put the stakes in the footer to ensure the proper level for the concrete.

Don't forget to watch them closely as the concrete flows. They are now the only guide you have to keep the concrete level enough to lay the block on. I'll remind you right here that the interior footers of an underground house need not be as level as you might think. See Fig. 7-7. A 4- \times -6-inch slab of concrete gets poured over these interior footers.

Don't try to pour footers and slab at the same time. It's a big job and there's no advantage to be gained except very little time. The best reason for not pouring footers and a slab at one time is that if you have good drainage soil it will be a sandy, mica soil and very loosely packed as opposed to a clay soil. It is often very difficult to keep footer ditches from caving in along the edges.

If the side of your footer ditch does cave in, you either lose strength or waste concrete. If you pour

the footer and continue pouring more concrete to make the floor slab, the edges will most likely collapse. This is my opinion, and I'm sure some people reading this will disagree. Remember that I'm living in my house and everything is working well. I'll cover monolithic pouring later in this chapter.

Now back to the footers you are pouring. In most cases, the concrete will flow freely 10 or 15 feet with little raking and shoveling. Once the raking becomes difficult, ask the driver to move to another spot, if he thinks he can do so safely, and continue to dump until all the footers are filled to the top of the leveling pegs. There is no need to use a trowel on the footers. The surface, as it settles and hardens, is smooth enough as long as it is level to plus or minus a half inch. If you misjudge and the footers set up out of level, the block layer can correct the mistake. It is a slow procedure and most blocklayers hate to begin laying block on footers that are unlevel or out of square.

The principle of right (90°) angle corners is the foundation of basic building construction. The entire weight of your house plus the earth covering it rest on these footers. If by chance you poured them out of square, then the blocklayer will have to shift his first course of block to the edge of the footer to compensate for your error (Fig. 7-8). Once he does this, the weight is not distributed evenly and a crack

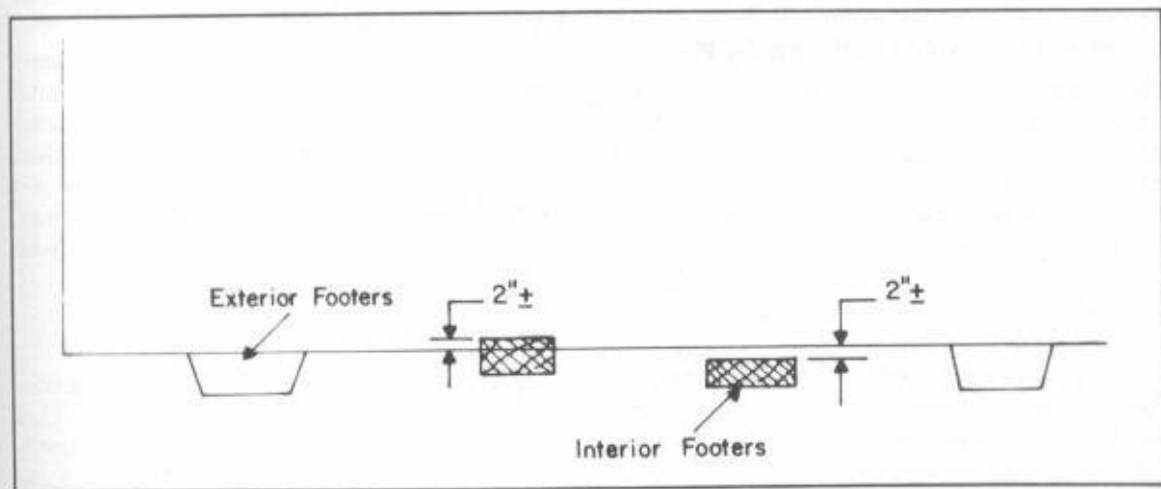

Fig. 7-7. Interior and exterior footers need not be exactly level with each other.

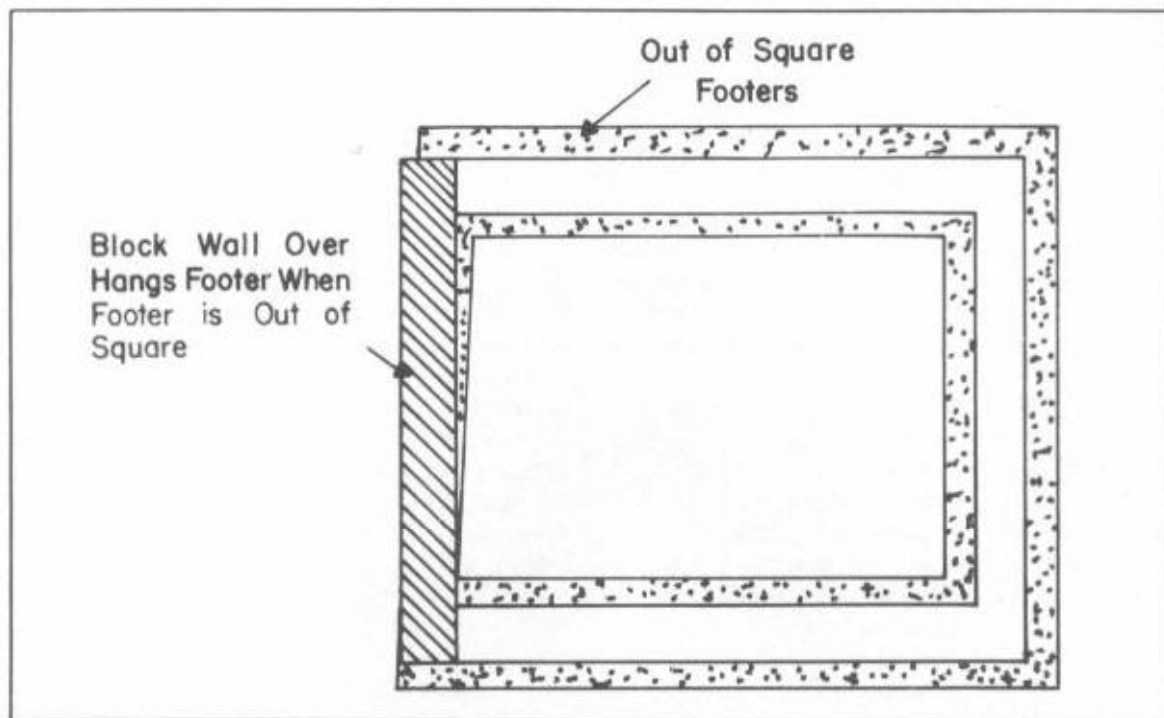

Fig. 7-8. Exaggerated conditions to illustrate the problems out-of-square footers can cause. They are usually not this extreme.

in the footer, wall, or even roof is likely to happen in the future. If you are not confident in your ability to keep the footers accurate and square, hire someone to help you. You can't end up with a successful underground house if the foundation is a weak link.

PLACING CAST-IRON SEWER PIPE

The placement of sewer drain pipe is a very artistic procedure, especially when building underground. You might never be able to correct a mistake without digging up the floor with a jackhammer, thus breaking the integrity of the floor area.

Cast-iron pipe used for these main drain lines is 4 inches in diameter and standard in the building material industry. The connections are also universal. Any amateur laying this pipe will have little difficulty as long as he follows the plumbing code. You must always have this 4-inch-diameter drain pipe falling at the rate of $\frac{1}{4}$ inch per foot. See Fig. 7-9. The inspectors have the last word on how you place this pipe. Follow their directions and sugges-

tions. Once this drain line is above the floor level the diameter drops to a smaller size.

Once the footers are poured and set up, check all the cast-iron sewer pipe you placed (Fig. 7-10). This is the only time you will get a chance to do anything about mistakes or damaged pipes. The plumbing inspector has approved your system (most likely), but that doesn't stop accidental breaking or movement as final footer preparation takes place. The next chance you will get to correct a drain pipe will be at great expense because you will be using a jackhammer to break the floor apart. Check the pipe carefully; it will be a load off your mind later on.

MONOLITHIC POUR

Monolithic means nothing more than pouring floor and footers all at the same time. See Fig. 7-11. I know I suggested not to do it that way mainly because this book is written for the private home builder, usually working with one or fewer helpers.

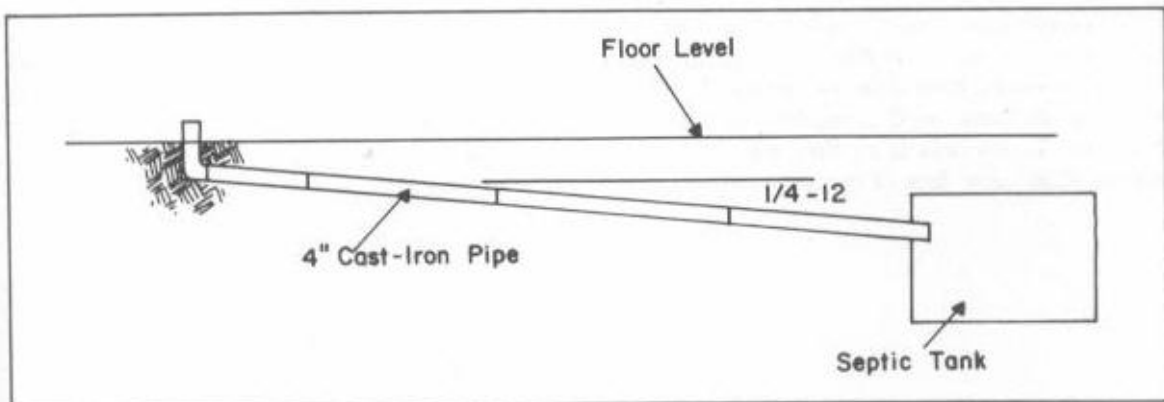

Fig. 7-9. Drain pipe should fall 1/4 inch for an even foot in length.

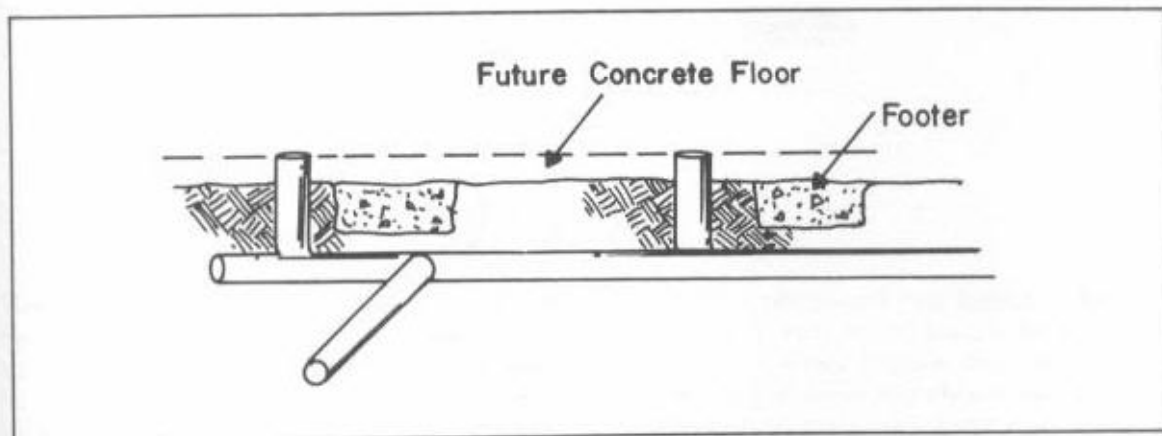

Fig. 7-10. Once the floor is poured, pipes are hidden.

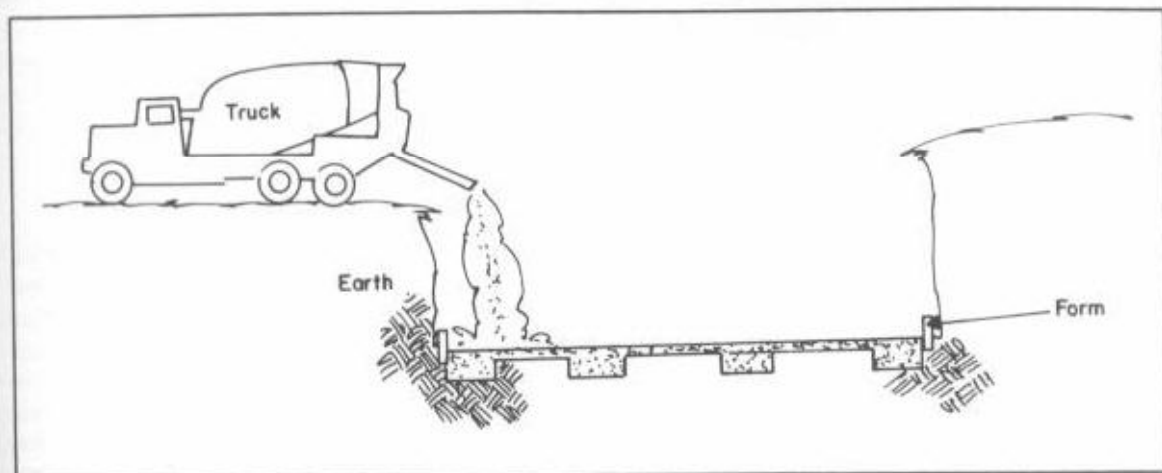

Fig. 7-11. A monolithic pour means the footer and floor is poured all at once.

It is my experience that, if you keep a job small and basic, you stay out of trouble.

A monolithic pour of the footers and floor in my house would have used about 90 cubic yards of concrete. To express it another way, you would spread 4230 cubic feet of concrete almost a mile

long (that's typical house sidewalk). That's an enormous amount of concrete to move around in two hours. If you have access to extra labor, then by all means pour footers and floor in one pour.

I can't stress enough to watch out for movement of the cast-iron sewer pipe.

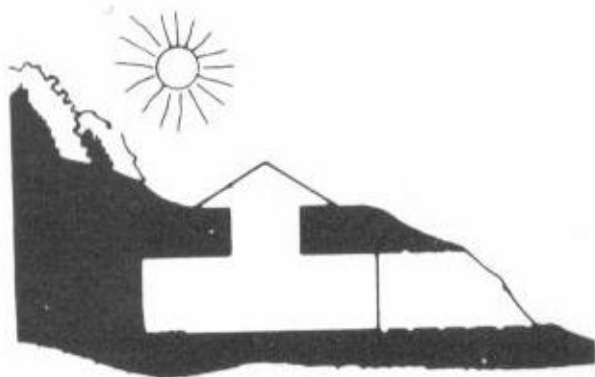

Walls

There are only two basic methods for constructing the concrete walls of an underground house. There are nearly endless methods and materials available for constructing conventional, above-ground homes. Above-ground construction lends itself to plastic, wood, glass, stone, brick, metal, concrete, and any combination of the above. For underground construction, the material is best limited to two types: concrete or wood. The two possible ways of erecting concrete are pouring concrete in forms or laying concrete block.

FORMED AND POURED WALLS

Using formed and poured walls is the strongest, most difficult, and most expensive method. Needless to say, any advantage you gain you pay for. I'm sure you are aware that there is always more than one way to do any job. The same goes for pouring concrete walls. Insert a section of steel into the poured footers immediately after they are all leveled out. These pieces of steel should stick out of the center of the concrete about 12 inches (see

Fig. 8-1). So if you poured your footers 12 inches deep, the steel rebar would have to be cut into approximately 24-inch lengths. Put these steel pieces on 2-foot centers everywhere a wall will be.

Remember to skip putting a post in the section of footer where a doorway will be. If you forget or misjudge, you can simply cut it off later. It's not that big of a deal. The reason for these steel posts is to tie the walls solidly to the footer to prevent any possible movement. This method definitely increases strength. This is the type of construction you would use if cost were not a major factor.

The alternative to tying the walls to the footers is simply to set the wall on top of the footer and rely on the actual bonding of concrete to concrete, rather than a steel connection. See Fig. 8-2 from the groove method.

Once you decide on the method of setting the poured concrete wall on the footer, the actual wall-forming preparation is the same. You can locate form builders or renters in the telephone directories of most major cities. Renting forms will be the easiest and the most economical method. You

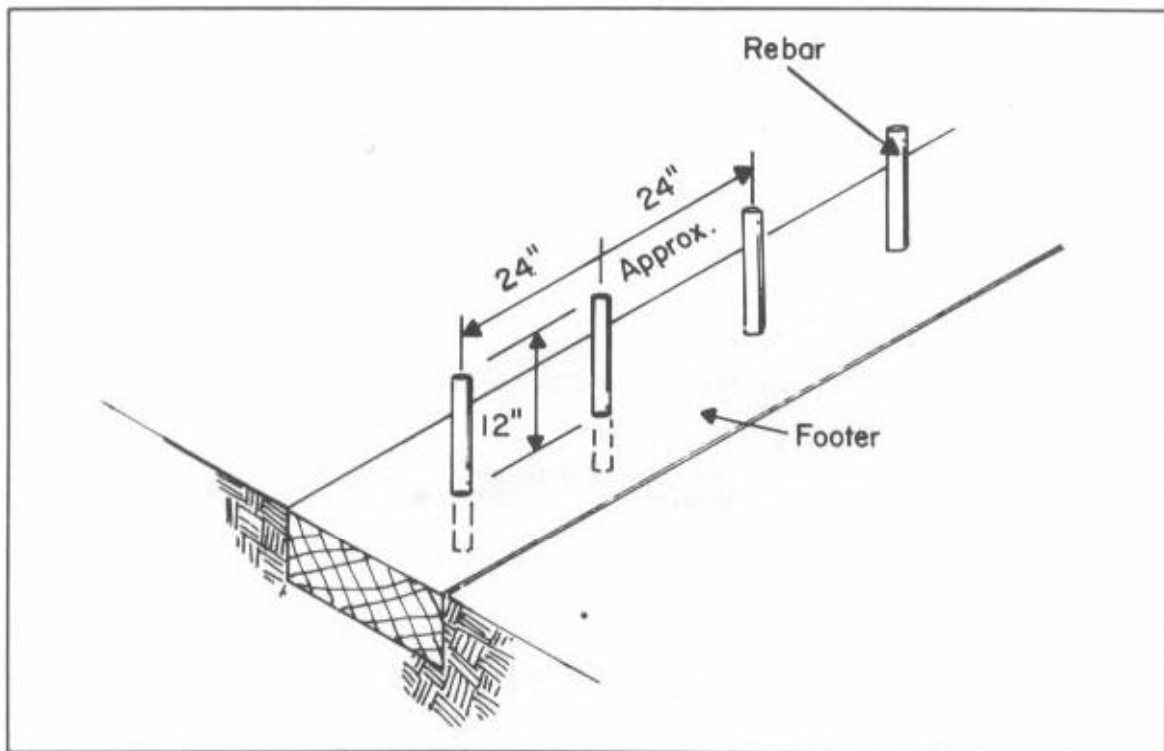

Fig. 8-1. Rebar to anchor walls to footers should be spaced as shown.

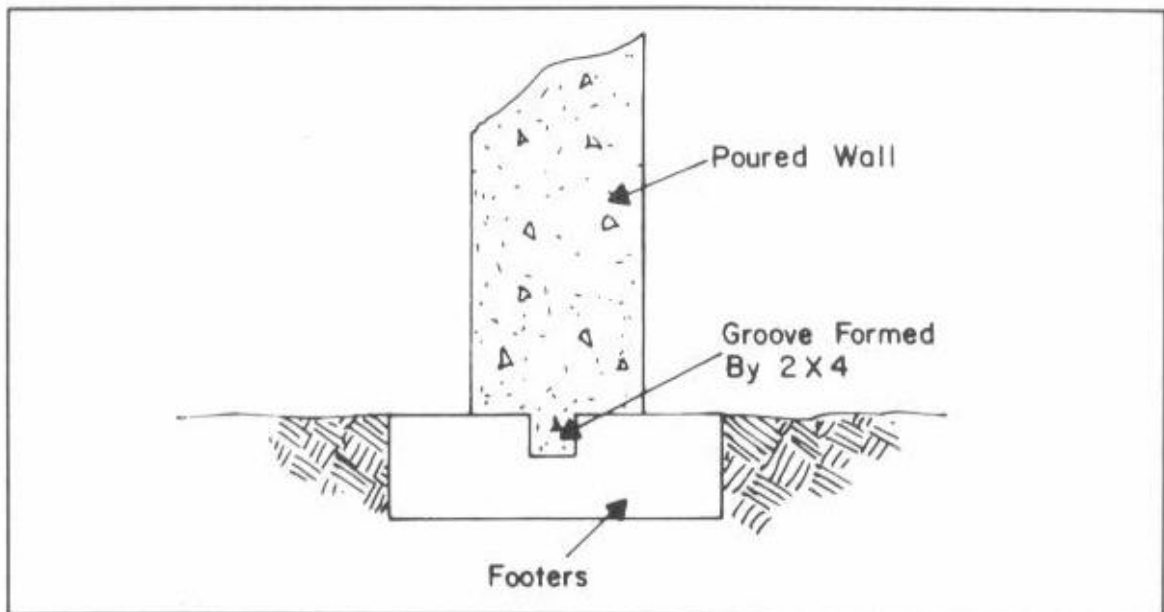

Fig. 8-2. A groove formed by a length of 2 x 4 provides a groove to seat a poured concrete wall.

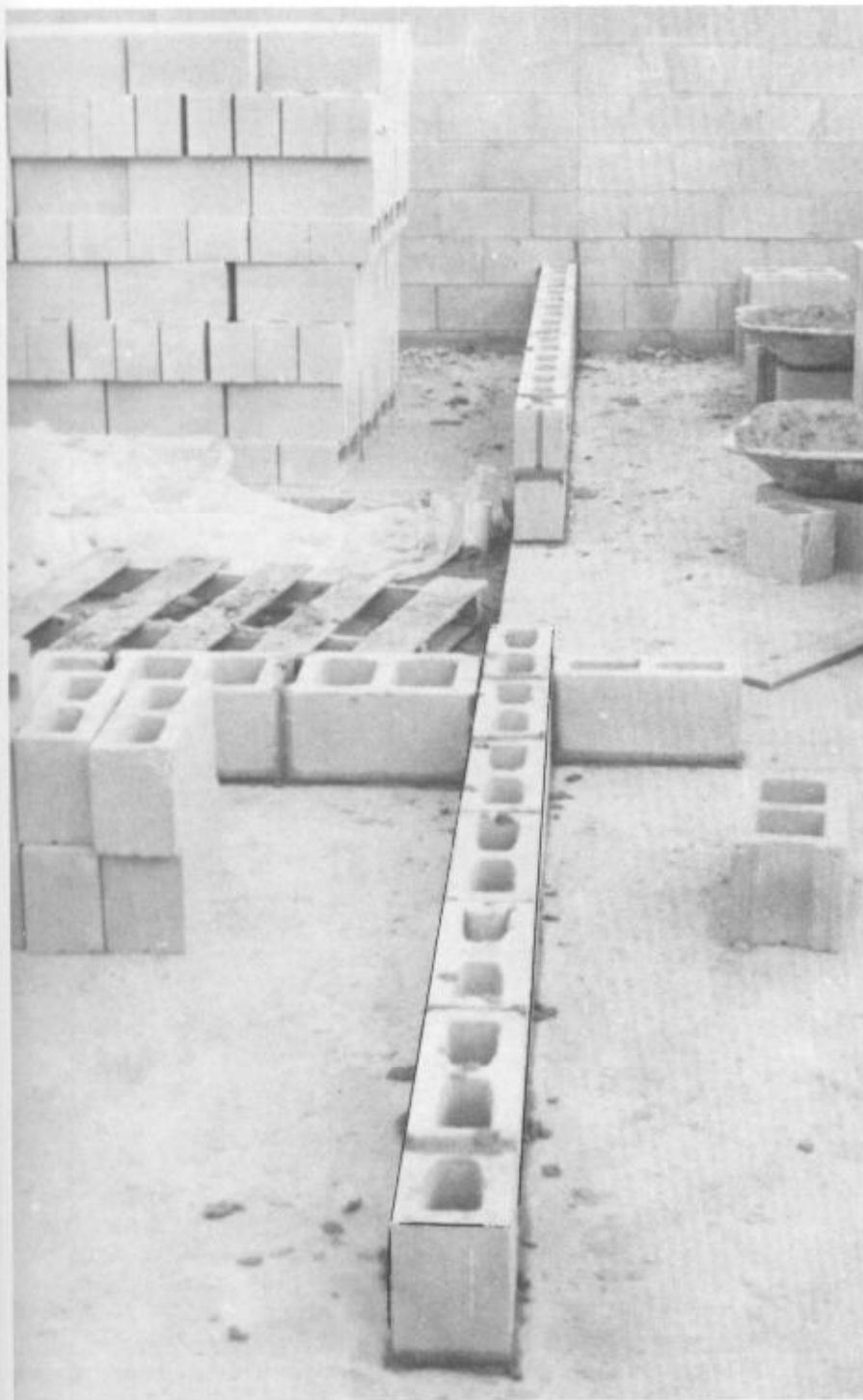

Fig. 8-3. First stages of interior walls.

should have someone experienced in form erecting to assist you. If you rent the forms, remember that you are responsible for any pieces that you damage or intentionally modify. Also there is always the chance of collapsing forms and the extra labor and expense used to clean up the mess.

A collapsed form could dump 15 or 20 yards of concrete all over your floor, foundation, and equipment. The only way to clean up this mess is to let it set up a day or so, then use a jackhammer to break up the concrete, haul it away, repair, and then rebuild the form. You might easily find that the extra labor, rental of equipment, lost time, damaged forms and lost concrete could cost you thousands of dollars you could put to good use elsewhere in the underground house. Over the years, I've had concrete-filled forms collapse on the job on three different occasions. Be extra careful when handling concrete above ground level. See Fig. 8-3.

BLOCK WALLS

I'll state right now that it is my preference to use concrete block for all walls, exterior and interior, instead of poured concrete. Think about the pouring method, analyze it, and consider the alternatives.

Check around and get a respectable blocklayer and contract price for the complete job. This is where your good judgement comes in. No one can help you make a choice. Only you have the facts and you have to live with them.

A good blocklaying crew will take about 10 working days to put up an average underground house. It will then be ready for you to begin preparation for the roof. Figures 8-3, 8-4, and 8-5 illustrate the different stages of block work. Construct all walls (even closets) out of block. Exterior walls should never be less than 12 inches thick. They are just right at that width to put rebar in and fill with concrete for strength. A post of rebar and filled



Fig. 8-4. Mid stages of blocklaying.



Fig. 8-5. Final stage of blocklaying.

concrete should be created any place that an interior wall does not intersect with an exterior wall. For a distance exceeding 10 feet, these posts should be approximately 4 feet long or three blocks (Fig. 8-6).

Use rebar about $\frac{3}{4}$ of an inch in diameter and insert a length down each hole in the block all the way to the footer if possible. The interior wall can be 6-inch concrete block and doesn't need to be filled with concrete except in rare conditions.

There are several reasons why you don't fill interior block with concrete. The cost is prohibitive, and your electrician will use the hollow block to feed some of his wire through to meet certain codes. The wires can only be fed to the receptacle box by way of the hollow concrete block (Fig. 8-7). Most importantly, you'll probably have to knock at least one hole in the interior wall due to oversight of some trivial dimension. Have you ever tried to knock a hole in solid concrete? Forget it unless you

have a jackhammer.

I forgot to leave openings to the back of the bathtubs to allow access to the plumbing (Fig. 8-8). Also, there had to be a hole for a vent pipe out of each bathroom. This I didn't forget. I planned to locate this as the construction progressed.

Don't forget that the water pipes have to go through the walls to the kitchen and bath. In my house the copper pipes pass through the walls at approximately eight different places. This would be a major job if the walls were solid concrete. Another place that I had to chip away the block was where I tried to install my one-piece fiberglass tub and shower unit. I found the unit to be $\frac{1}{2}$ inch wider than my door opening. This was an oversight that didn't cause a real problem because we just broke away the block as needed.

Instead of knocking block out for everything you should plan better than I did and install vents

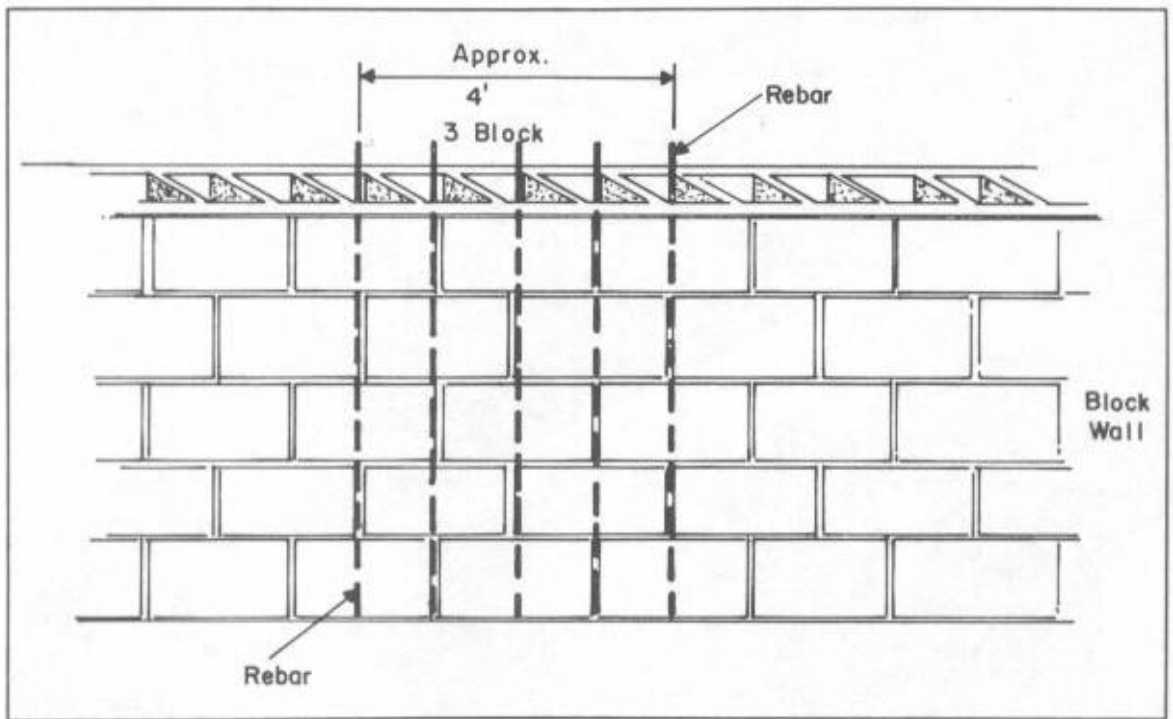

Fig. 8-6. Place rebar in the block and fill with concrete to form a solid post approximately 4 feet.

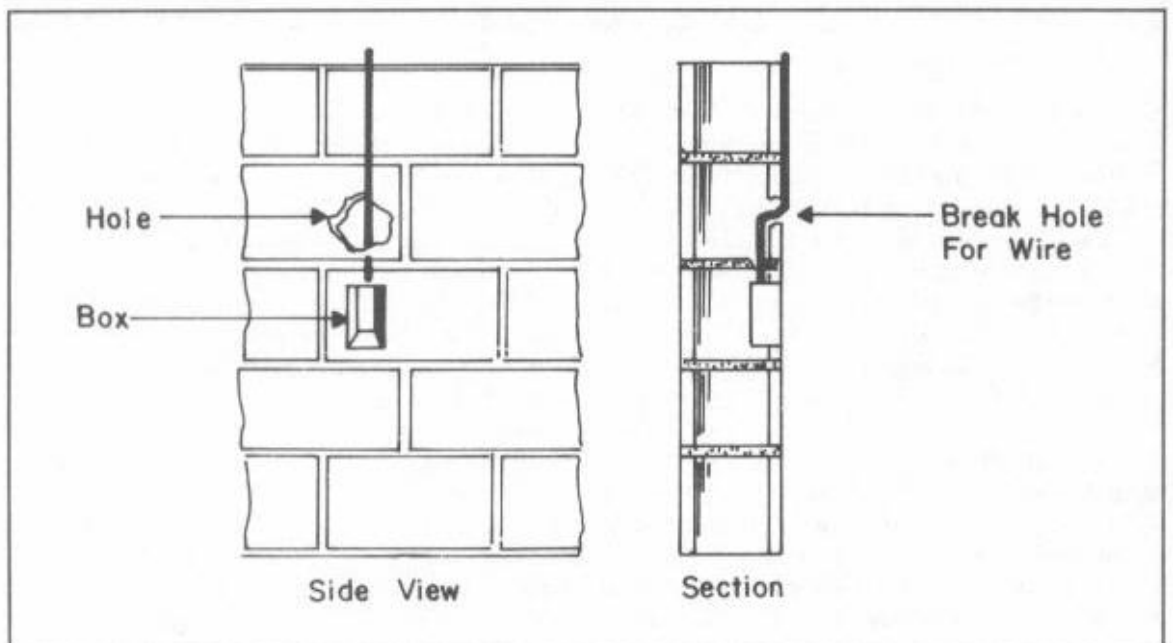

Fig. 8-7. Break a hole in the block for wire to reach the receptacle box.

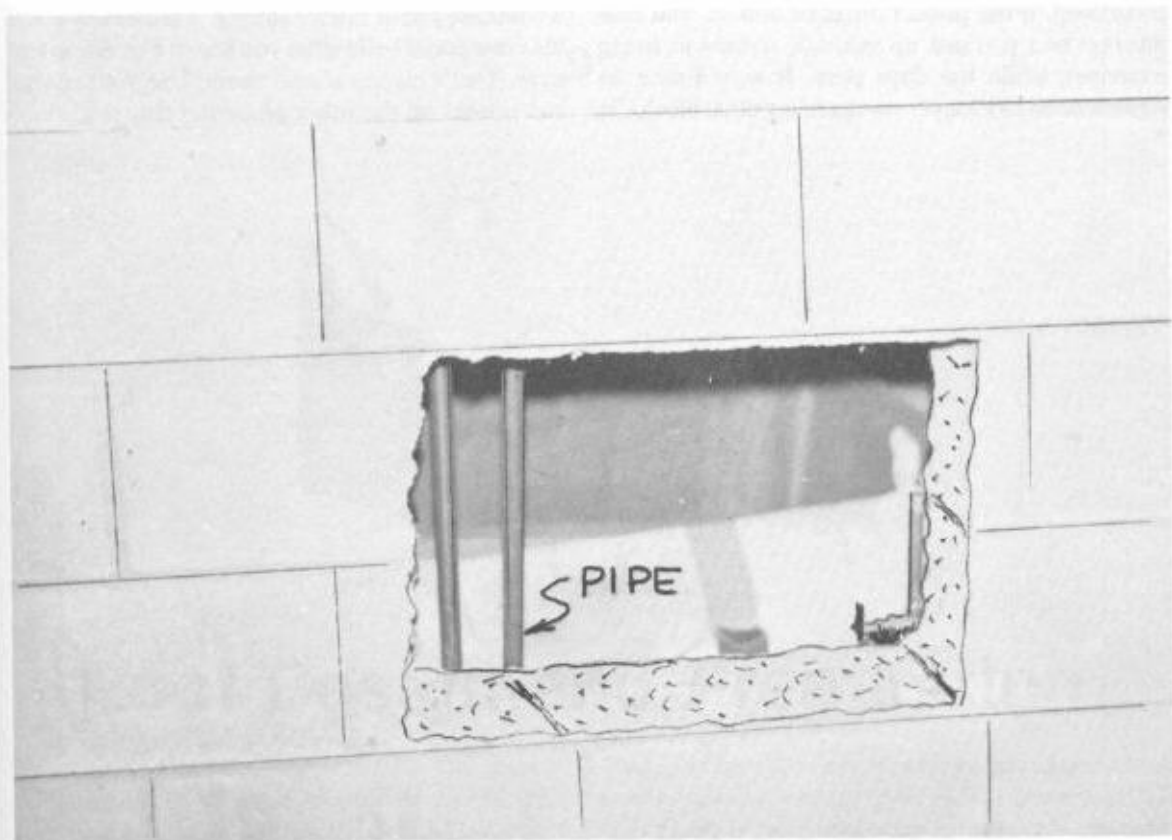

Fig. 8-8. Leave an opening to access pipes for both tubs.

and heat ducts as the block is laid. This sounds easier than it is. Vent and air ducts sometimes have to be relocated because natural air currents are drastically affected by being underground. I found that where I thought air would circulate naturally it didn't (and vice-versa). Thus I had to relocate numerous openings in the concrete block.

I suggest you try to locate the vent openings as the block goes up, but don't be surprised if you miss a few. One point I want to expand on is the allowance of the opening for steel duct work (heating and cooling) to pass through walls. It's easy to say I'll knock a hole later but it's difficult and time consuming. In my first underground house I didn't do as I'm telling you, and that's why I know about the extra work involved.

As your block work progresses day by day, you will—for the first time—see a house developing

before your eyes and realize you're really undertaking an enormous project. There's no turning back at this point; you had better like what you see so far.

WHY ALL-BLOCK INTERIOR WALLS?

Block walls throughout give a solid, sound-proof construction while adding only 1 percent to the total cost. I feel this is money well spent. Once again the absence of wood from studded walls eliminate a fire hazard. When building underground that's a real consideration.

The only reason I didn't lay my own block was time. I'm as good as most blocklayers, but I'm only one person and, at my best, I'm slow. The old saying "time is money" fits this phase of construction. If you try to lay 6000 concrete block yourself with the help of a brother-in-law, you're asking for disap-

pointment. If the project drags on and on, you lose interest and you use up valuable dollars in living expenses while the days pass. It would take an experienced blocklayer weeks to lay 6000 blocks. It

would take you or I twice as long. A professional and his crew could build what you see in Fig. 8-5 in two days. That's money wisely spent. Use your energy and talents on the other phases of construction.

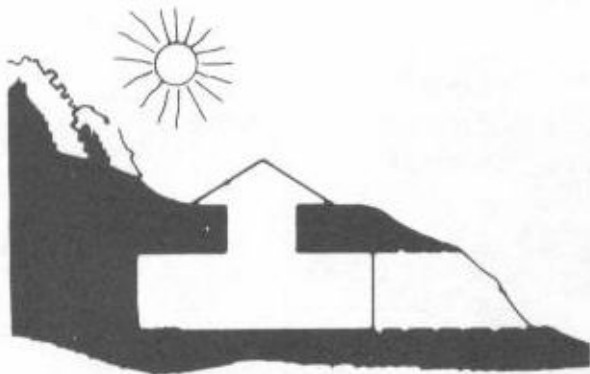

Roof Design and Preparation

Now that you have all the walls up and level at ceiling height, you come to another crucial part: preparing the shoring (Figs. 9-1 and 9-2), the substructure and braces for pouring concrete. What you are actually doing is building a platform capable of holding as much as 250 pounds per square foot. This includes steel, approximately 10 inches of wet concrete, and a worker smoothing this concrete.

Holding wet concrete until it sets is like holding onto the proverbial burlap bag full of bobcats. Wet concrete wants to go everywhere except where you want it. If it finds a small hole, it will make the hole bigger and bigger until it breaks through. This method completes the roof in one pouring with no joints. Then there are no seams and no leaks. This is also the method that you can do yourself with a little luck and some help from your friends.

Be realistic when evaluating your abilities to build your own shoring and substructure and pouring the slab. You might want to have a contractor do it. Doing it yourself is a back-breaking job, but you can save approximately \$3 per square foot of roof.

That adds up fast to a real savings, and especially if you're building a house over 3000 square feet.

There is more than one way to pour a concrete roof. The only thing different from pouring a concrete floor is that it is suspended 8 feet in the air. And that's a major difference.

I did my shoring (Fig. 9-3) by laying rough-cut lumber down on the concrete floor, wall to wall, every 18 inches. You can get this type of inexpensive lumber at saw mills. It's the strips that are cut from a log before they get to the center where the good boards are cut from.

I did not glue or nail this rough lumber to the concrete floor (Figs. 9-4 and 9-5). It is not necessary to go to that extra time and cost. Check around for this wood. You'll find it. Later, when you're finished your house, cut this wood up and use it in your fireplace. I paid 2 cents a foot for random length over 8 feet long. I picked this wood up to save money, rather than pay a delivery cost, because every little bit helps.

Lay the rough-cut lumber down on the floor in a pattern similar to Fig. 9-6. For this step, you will



Fig. 9-1. Once interior walls are complete, the wooden shoring structure is started.

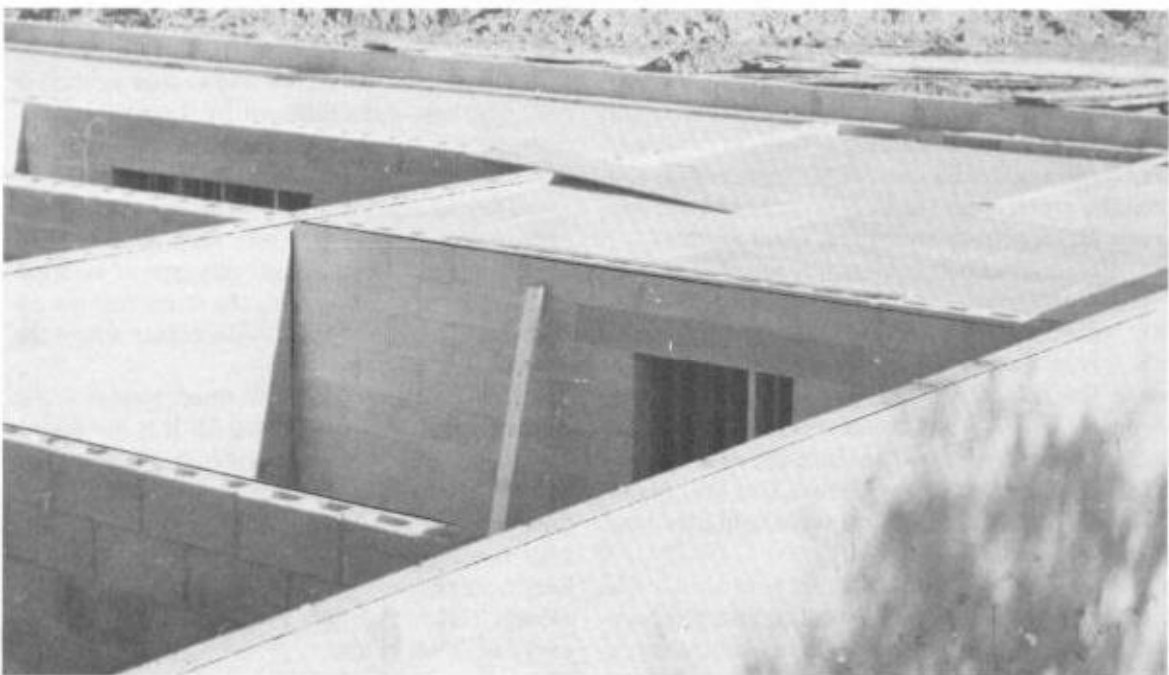

Fig. 9-2. This is how shoring looks once underway.

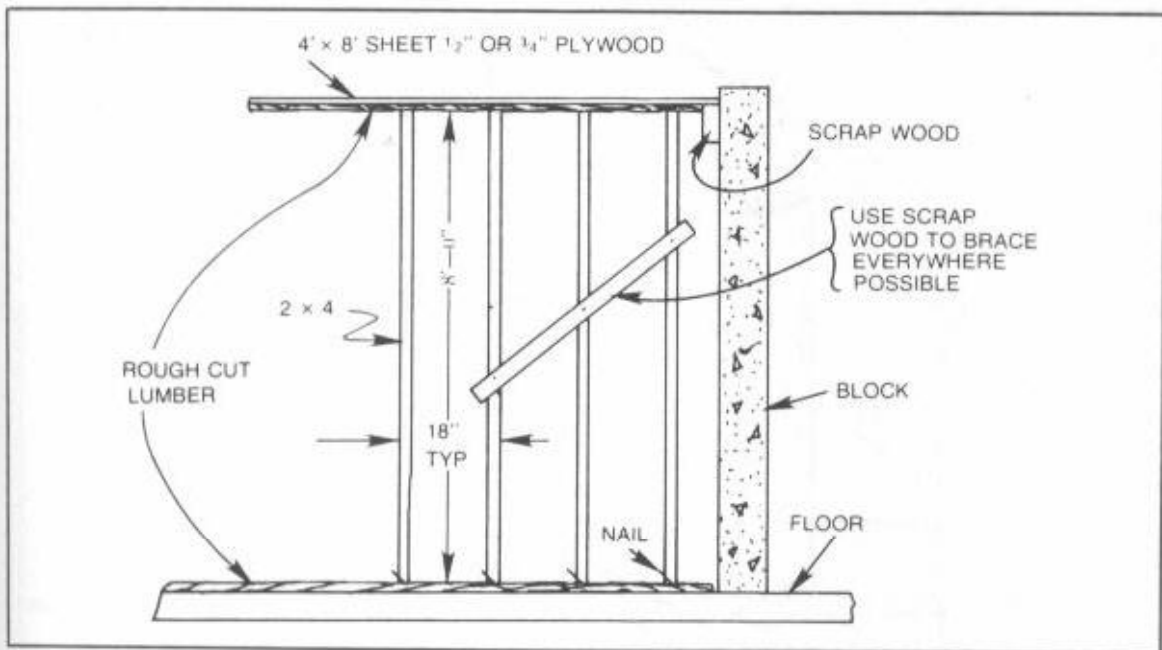

Fig. 9-3. A typical arrangement for storing materials.



Fig. 9-4. Wood against the floor is not glued in place.

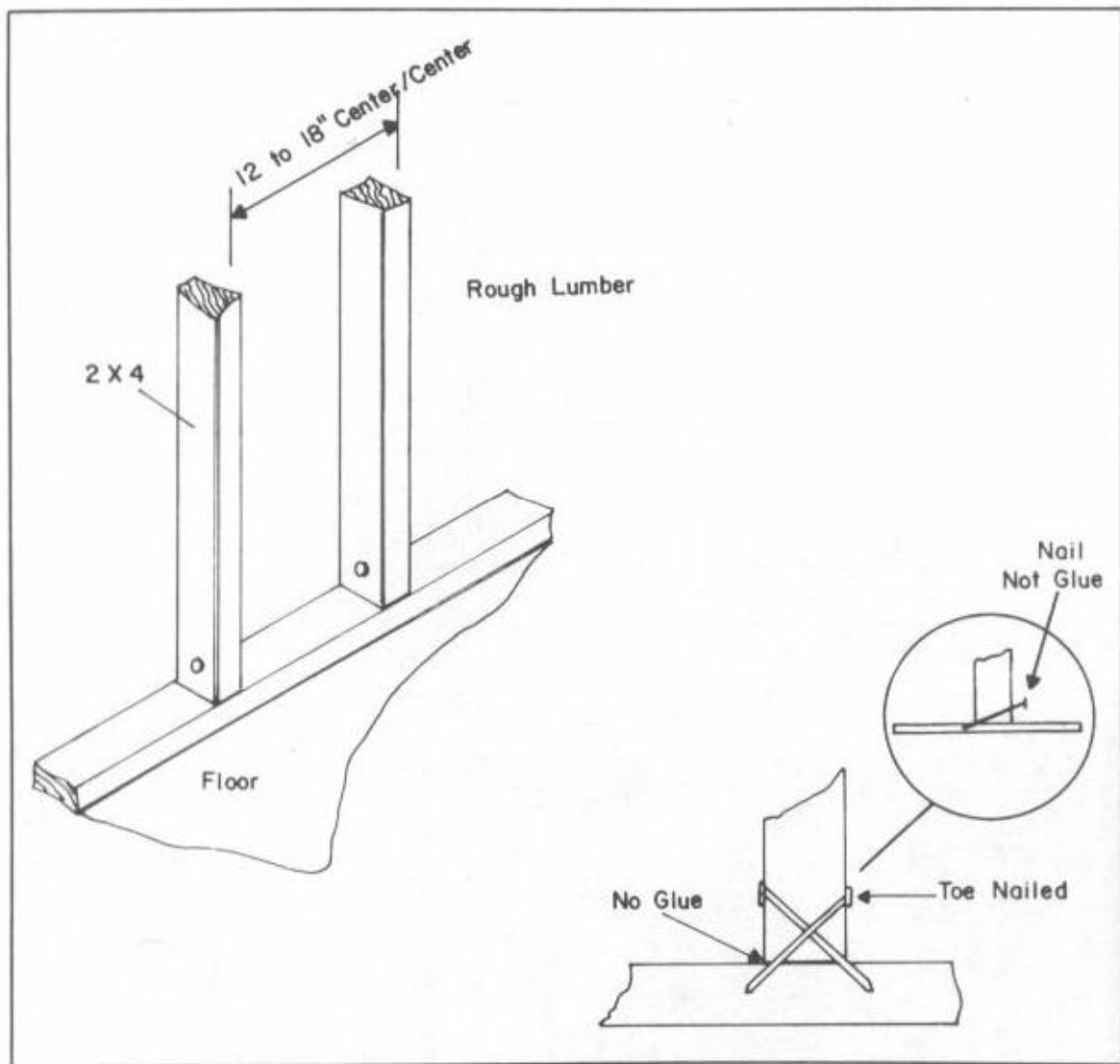

Fig. 9-5. Don't glue wood together onto concrete floor.

definitely need two or three people willing to work. Don't try to erect scaffolding by my method without sufficient labor (free or otherwise).

Once you have laid rough lumber on the floor and nailed a section of 2 x 4s along the ceiling height, stand a 2 x 4 upright under the first piece of rough lumber. Try to start in a corner. See Fig. 9-7.

With a few more 2 x 4s nailed between the top and bottom rough lumber, you can lay a sheet of

½-inch, sheeting-grade exterior plywood on the top. As your helpers hold this arrangement together, you climb up to the top of the block wall and nail through the plywood and the rough lumber into one of the upright 2 x 4s. You now have the beginning of your support. Your supports will be the same throughout the rest of the house.

Once you actually erect that first sheet of plywood in a particular area, the remainder is rather

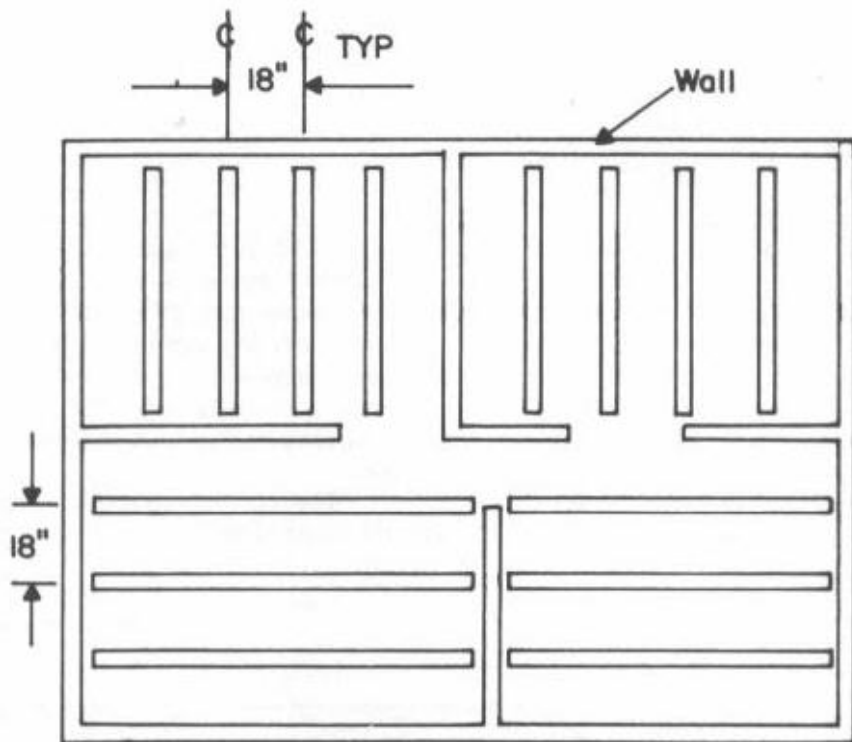

Fig. 9-6. Rough lumber should be laid in a pattern similar to this in any direction as long as 18-inch centers are maintained.

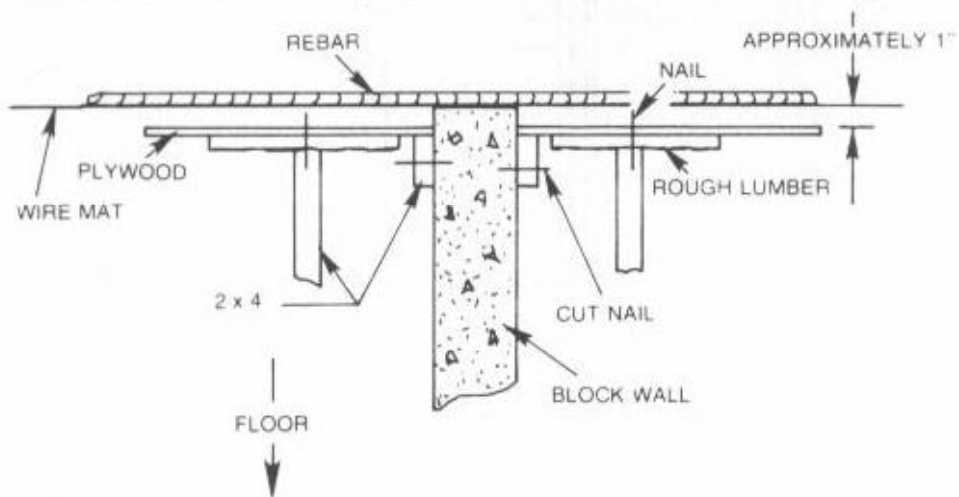

Fig. 9-7. This wood should not go over the top of the block wall.

easy. Once you get one section secure you can climb out on it to assemble the next section. See Figs. 9-8 and 9-9.

If, at this point, you are considering leaving out the rough cut lumber, please don't because the results could be catastrophic. The rough lumber prevents the extreme weight of the concrete from punching a hole through the concrete floor or through the ½-inch plywood. It is a must if the job is to be safe.

Continue to set 2 × 4s upright, watching closely to keep them at 16-inch centers (maximum). If your centers are a little less than 16 inches, that will be acceptable.

Continue this method until one room is complete. Be sure to have a good piece of rough lumber at each joint of the plywood, because this is the weakest point of the plywood structure. The sad

thing about this method is that you are constantly cutting plywood sheets. Therefore they can't be sold later. Don't waste the plywood; save all the small pieces. See Fig. 9-10. They will fit somewhere as things progress.

Two good things in your favor now are that you can climb up and walk around on this plywood platform that you're building and the assembly begins to take stability. It doesn't require as much physical labor to maneuver in place.

Before you buy 2 × 4 × 8s, I suggest you try to keep the ceiling very close to 8 feet. Sheetrock and paneling come in 4-×-8 foot sheets. If your ceiling ends up 7 feet, 11 inches high, you will have to cut each piece of Sheetrock or paneling. That's quite a job.

The way you control your ceiling height is by the length of the 2 × 4s. If you buy standard 2 × 4 ×

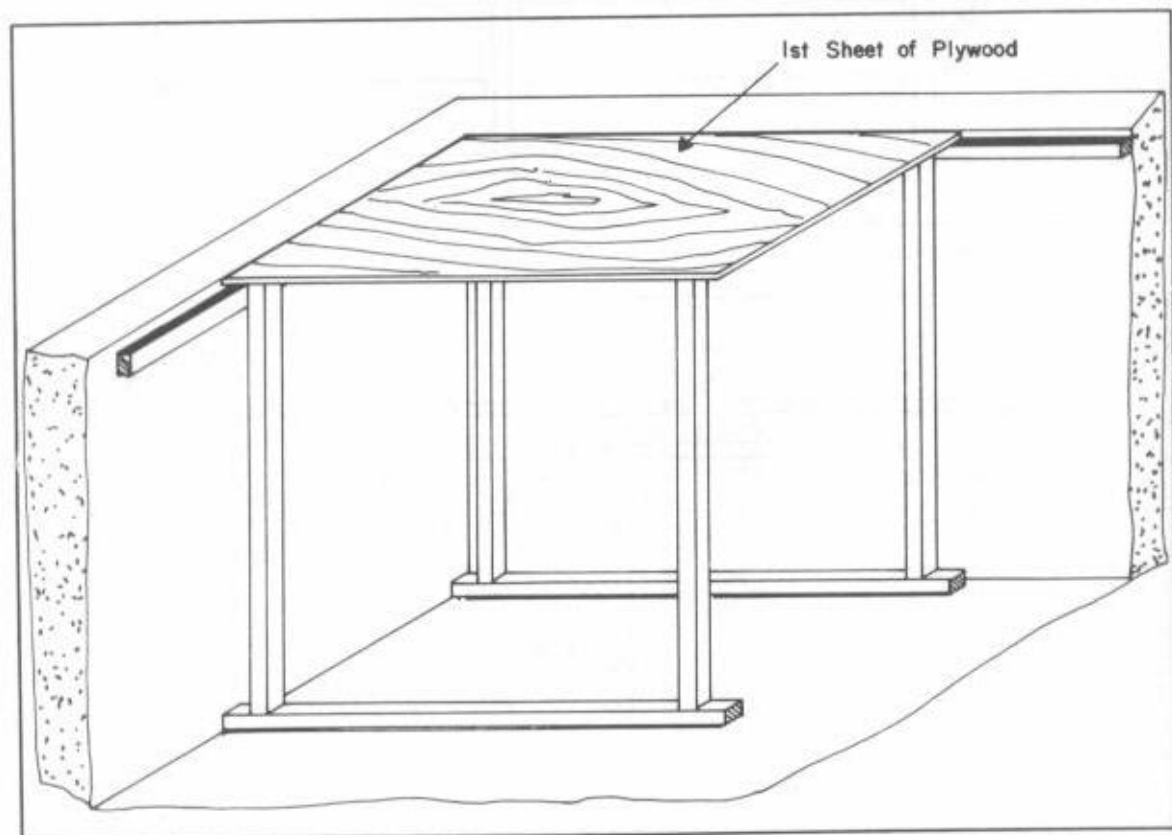

Fig. 9-8. Once the first sheet of plywood is in place, you can climb out on it to connect the next one, and so on.

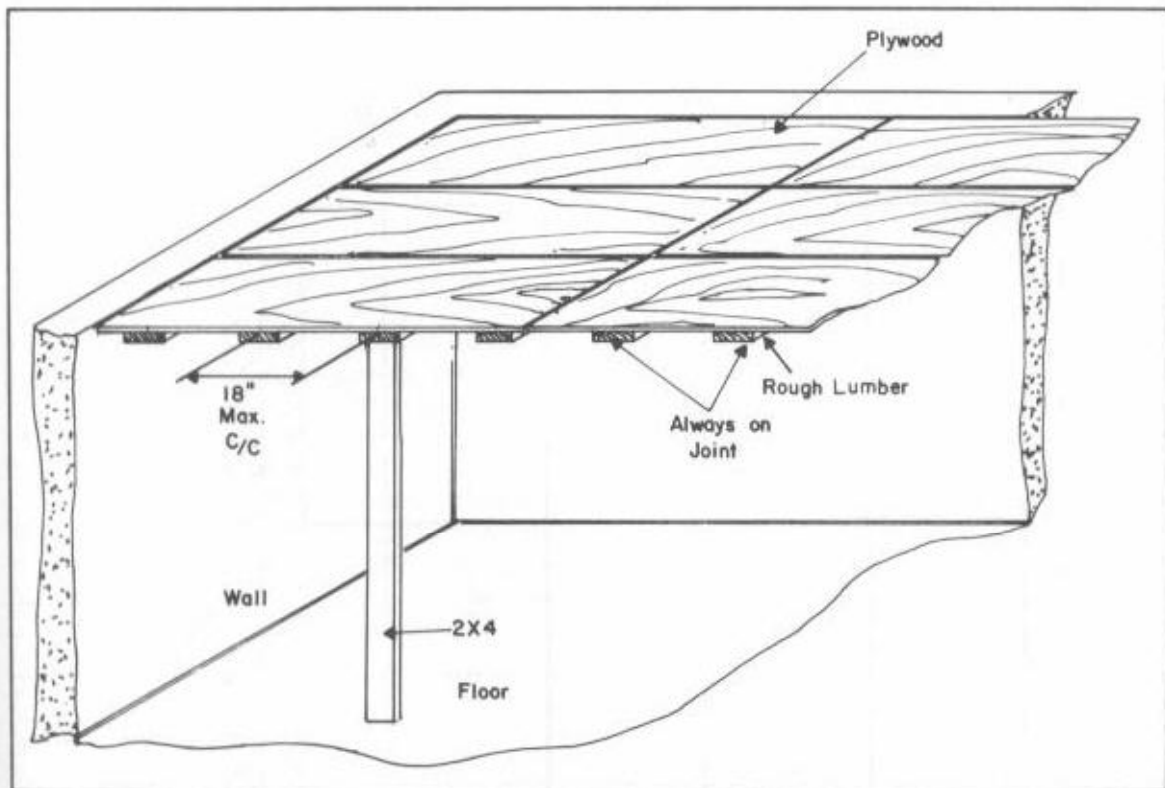

Fig. 9-9. Work from the first sheet to second sheet and so on. Always keep rough lumber spaced as described.

8s and set them on rough lumber, add another rough board on top—both of which are approximately 1 inch thick—and then set a sheet of $\frac{1}{2}$ -inch plywood on that, it's easy to figure that your ceiling will then be 8 feet, $2\frac{1}{2}$ inches tall when these are removed. That's too tall.

Cut 2 inches off each $2 \times 4 \times 8$ before you use it. If you do, you will end up with a ceiling approximately 8 feet in height. Whatever you do, don't try to use precut 2×4 s. Precut 2×4 s are approximately 7 feet, $8\frac{3}{4}$ inches long. This would make the ceiling too low (Fig. 9-11).

The reason I stress this 8-foot ceiling height is because it is relatively simple to maintain an 8-foot ceiling height at construction, but it is extremely time consuming to cut wallboard or paneling to make the walls less than 8 feet high.

Even more important is that the lending institutions and government agencies such as the

FHA or VHA, require certain dimensions to be used. An inch or two one way or the other will only cause you extra time and work, but should you drift 6 or 8 inches of the standard 8-foot ceiling height you might have trouble getting the house financed (or sold years later). An additional reason is that it just won't look right. Everyone is familiar with 8-foot ceilings. If you lower or raise yours, people will figure something must be wrong, especially in an underground house. Don't give outsiders anything to pick out when discussing your house.

Each room is shored up and braced individually. Do not let the wood go over the top of the block wall (Fig. 9-7). This method locks all the walls in place with concrete. In addition, it holds all of your shoring secure from moving left, right, forward, or backward. Most importantly, the rebar lays on the top of the block, and this avoids an extreme load on the shoring. Once the shoring is up in all rooms, go

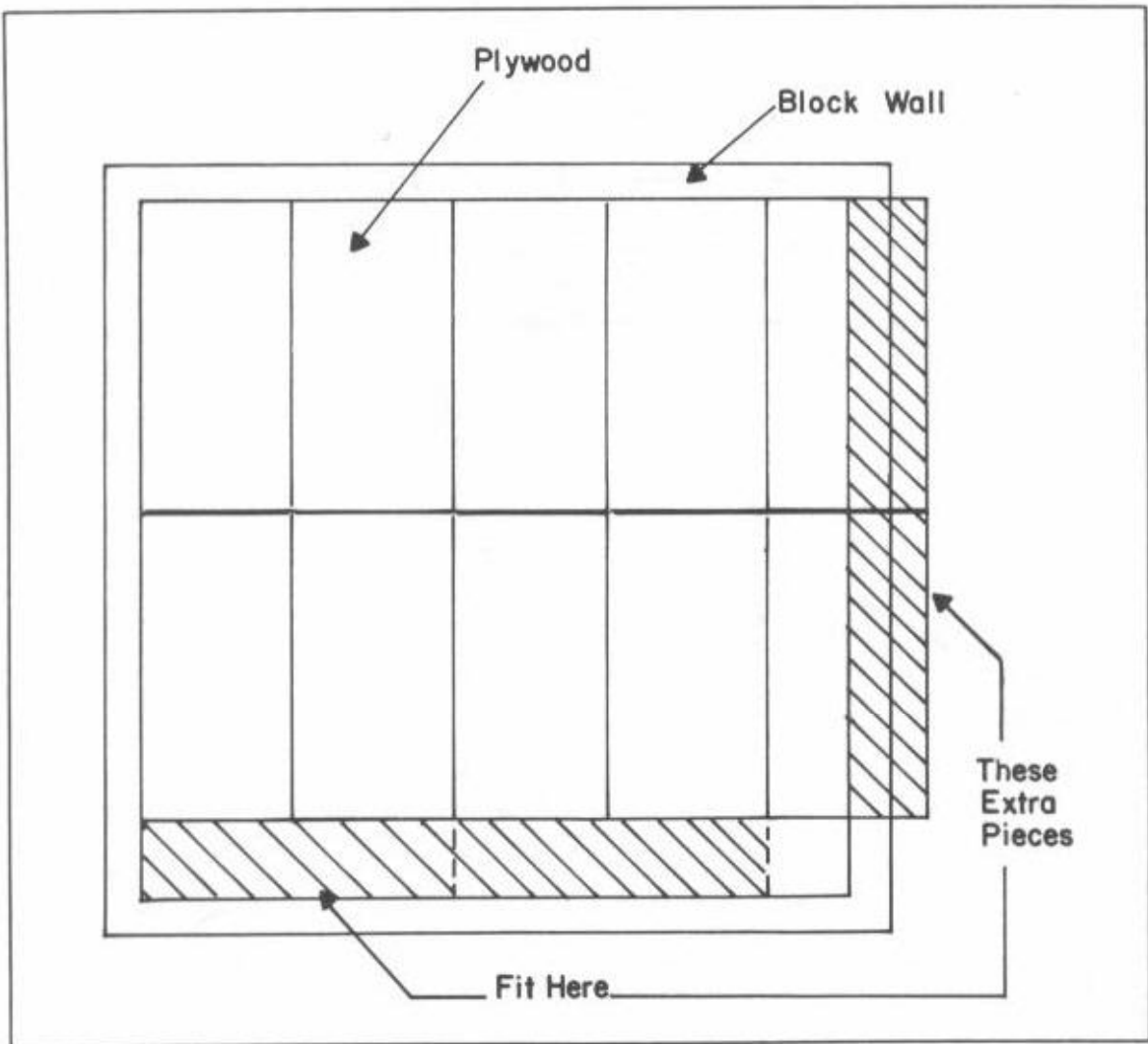

Fig. 9-10. Save plywood pieces because they always fit somewhere.

back and check each 2×4 to make sure it is plumb and toenailed with at least two 10-penny nails, top and bottom.

Remember, one slip of a 2×4 and down comes the wet concrete. I can't warn you enough about this. A slip could bankrupt you. If you add the cost of the concrete, the cost of the lumber, your labor, and the cost of cleaning up wet concrete once it has fallen, you can easily see why this could be the only mistake you'll make—because it will also be the last.

Once you have 2×4 s spotted on 18-inch centers throughout the structure (as in Fig. 9-12), you should cross brace or tie together these 2×4 posts. See Fig. 9-13. It really doesn't matter how you cross brace this timber as long as the 2×4 braces are at a slight angle of about 30 degrees.

The more you tie together the better and stronger the construction. This cross bracing will prevent vibration as the weight of the wet concrete is placed on top of the plywood. It is also not necessary to catch each and every 2×4 , but the more you

brace the stronger the structure.

Now that all the supports are moving toward completion and you can walk around on this platform, you're ready for the next step.

BLOCK STUFFING

Stuff each open concrete block with paper see Fig. 9-14. Save the concrete mortar bags from the blocklayer work. Tear them in half and put half in each hole of the concrete block to prevent concrete from flowing down the block. Filled block are too expensive and unnecessary strength. Make sure your engineer agrees that all walls do not need to be filled with concrete. Some walls probably will, but don't fill any walls unnecessarily.

Now that your shoring is up completely, and all the holes are stuffed with paper, and you are ready to spread plastic. Plastic is used to prevent the concrete from sticking to the plywood so that it will come down easily and will be resalable.

Use construction-grade plastic that comes in big rolls and can be purchased from any building supply store. This plastic is really polyethylene sheeting. It is sold in 100-foot rolls with widths of 20 to 50 feet. The thickness is usually 4 mil but 6 mil and thicker is available (4 mil is about the thickness of a sheet of paper). This polyethylene cost about 6 cents per square foot.

Cover all the plywood with one sheet of plastic. If you tear a small hole in the plastic, don't worry because a little concrete on the wood won't hurt anything.

There is no doubt that the crucial part of your underground house will be the roof. Put your time and money into the design of the slab. It will be money well spent. A good professional engineer should look your plans over, make suggestions, and lay out a steel reinforcement bar pattern for you for a small fee. About \$250 would be fair.

When working up the original floor plan, be

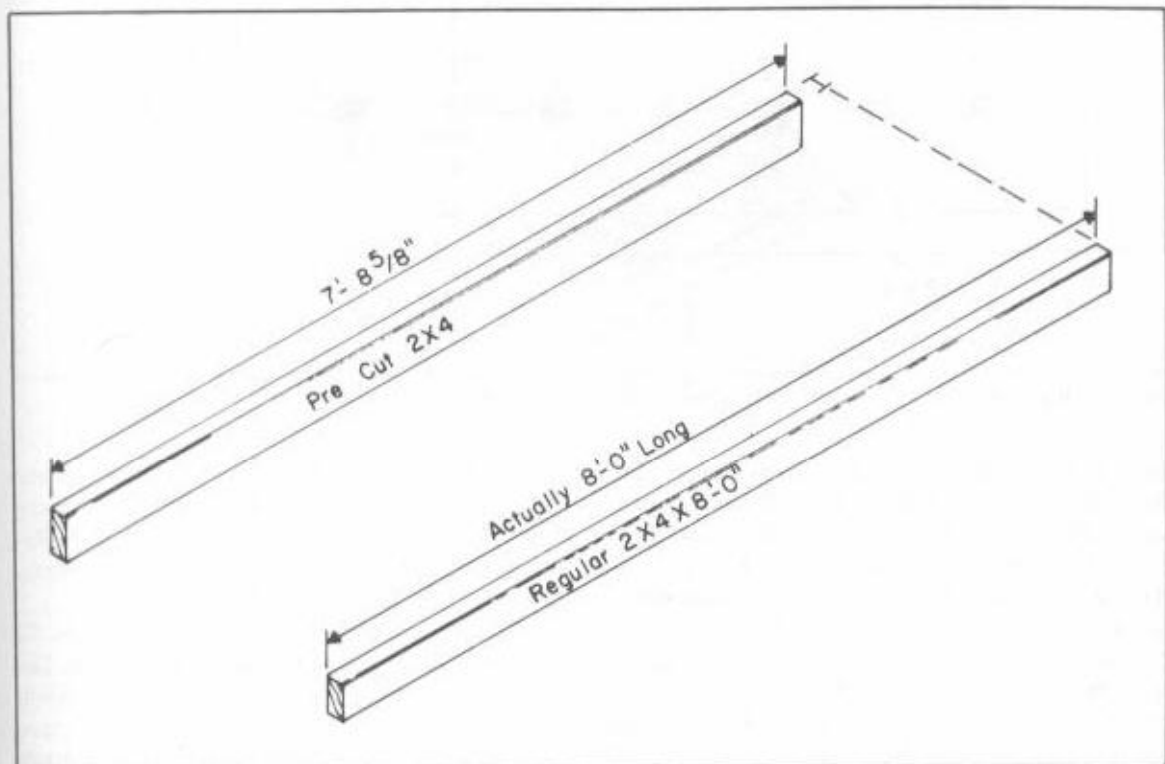

Fig. 9-11. Cut 2 x 4s are sold by many suppliers.

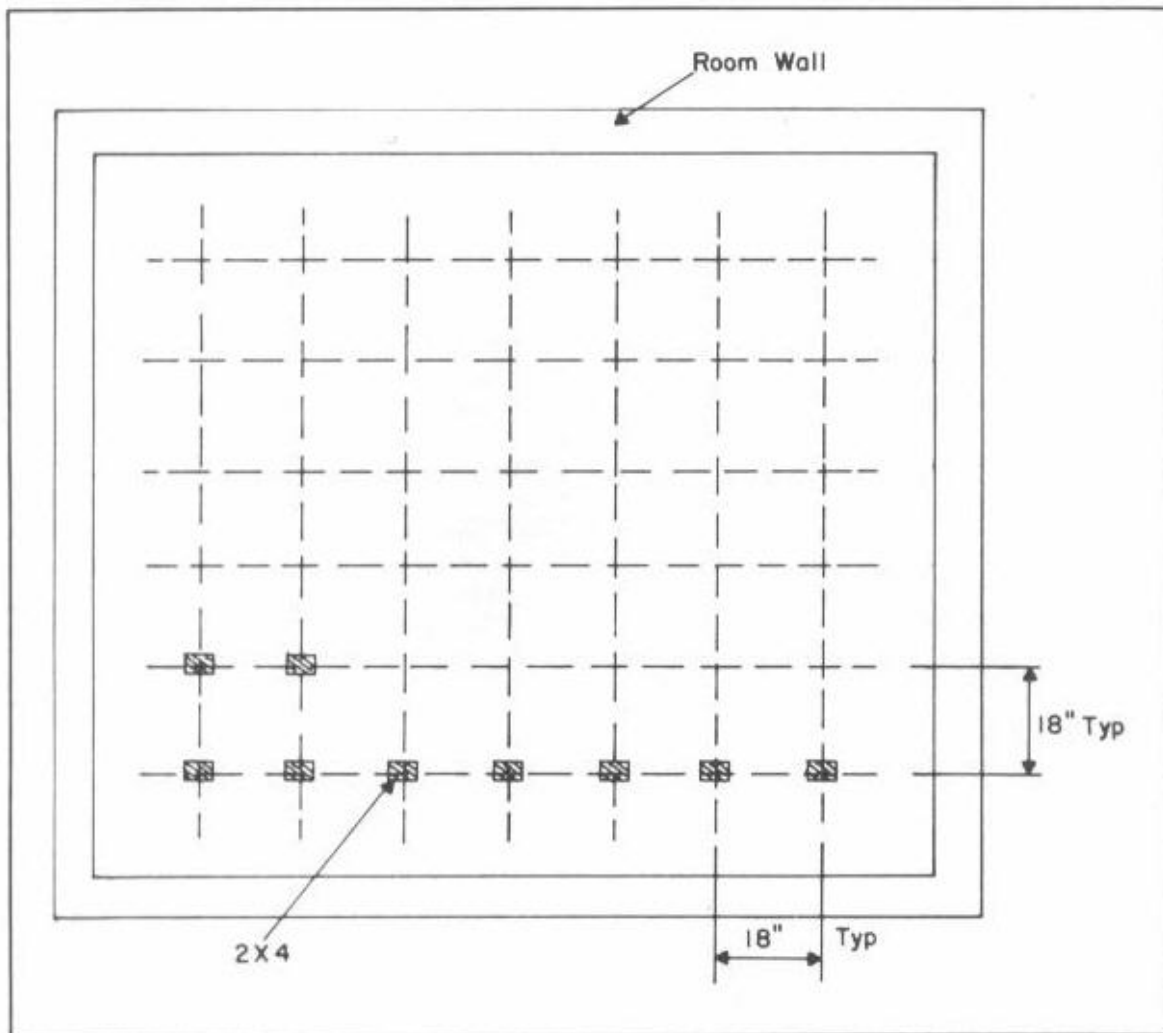

Fig. 9-12. If you use 2 x 4s, then the 18-inch C-to-C pattern is essential.

sure to keep the rooms near conventional size. Because your interior walls are bearing walls and physically holding up the roof and dirt, you want to avoid spanning a long distance. The method of construction, cost, and the reinforcement involved then becomes crucial and a bigger job than the average person can handle or afford. The widest span I recommend is 20 feet (Fig. 9-15).

A rule of common sense I would suggest for you to follow is that, when laying out a floor plan, add the length and the width. The total should not

exceed 38 feet. For example, a room that is 16 feet by 20 feet would equal 36 feet, or a utility room could be 25 feet by 8 feet to equal 33 feet. Remember that this is only my rule of thumb. Trust your engineer as a final authority.

If your living requirements are average, 20 feet is as wide as any room usually needs to be. The engineers designing the strength of your roof will need an exact layout of your floor plan. If you have ever had a course in high school drafting, you should be able to make all the drawings necessary to build

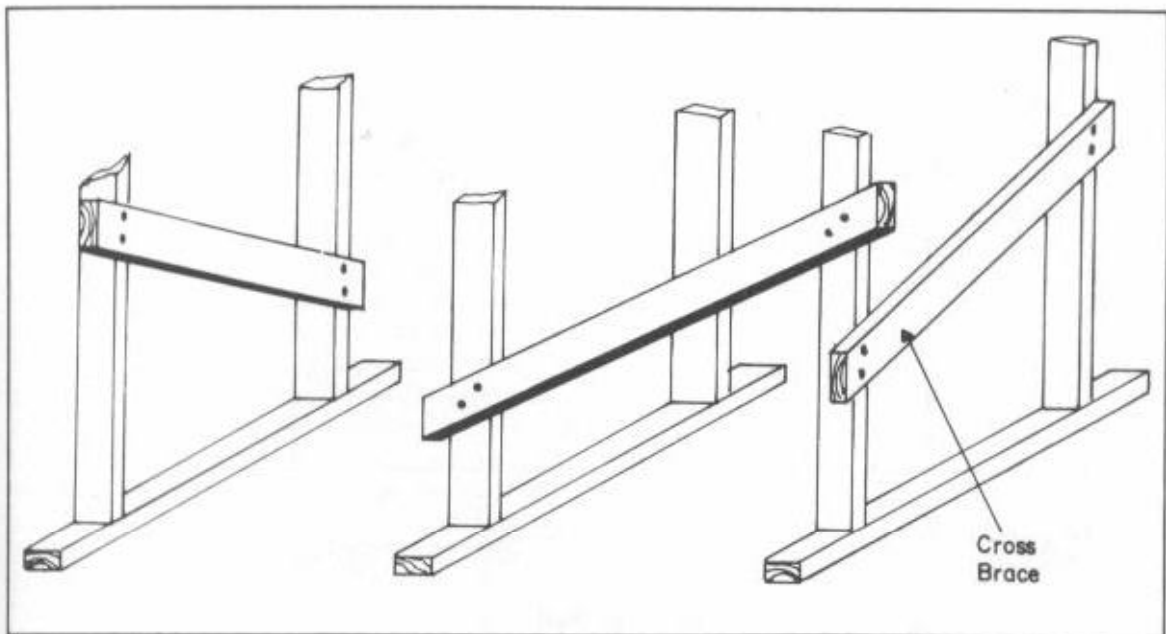

Fig. 9-13. Cross bracing can be done with scrap lumber. One nail is sufficient at each end. This is to prevent vibration when under pressure.

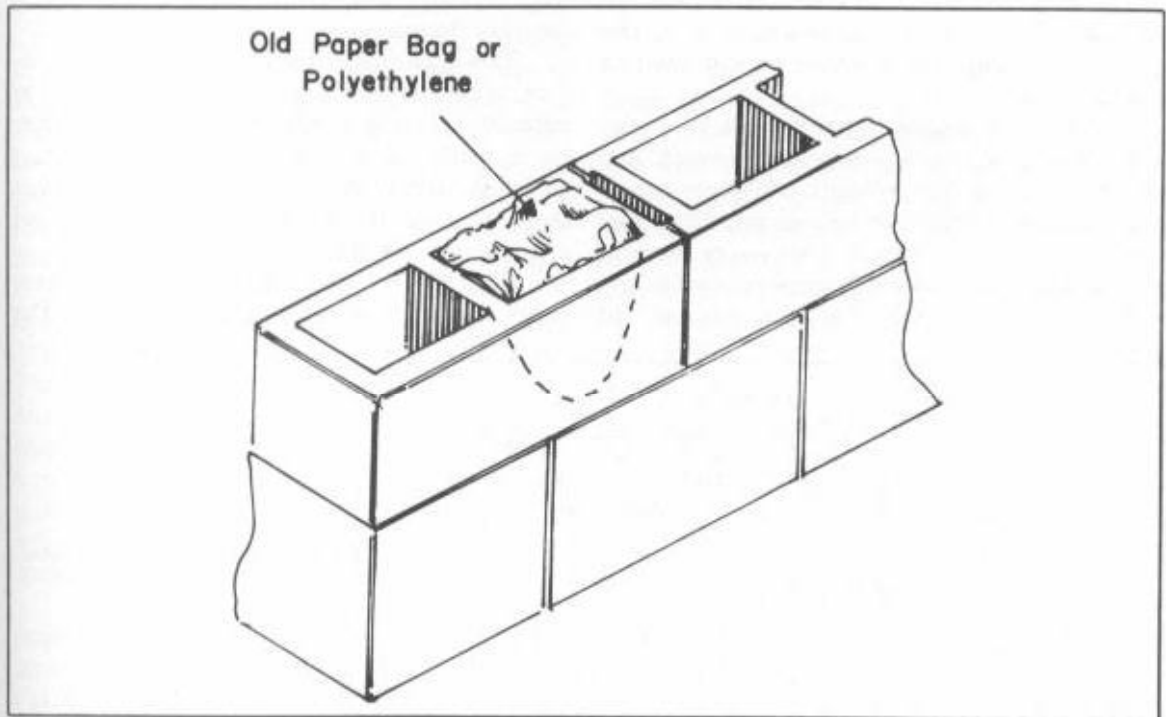

Fig. 9-14. Block stuffing could be anything, even newspaper, but old concrete bags make the best stuffers.

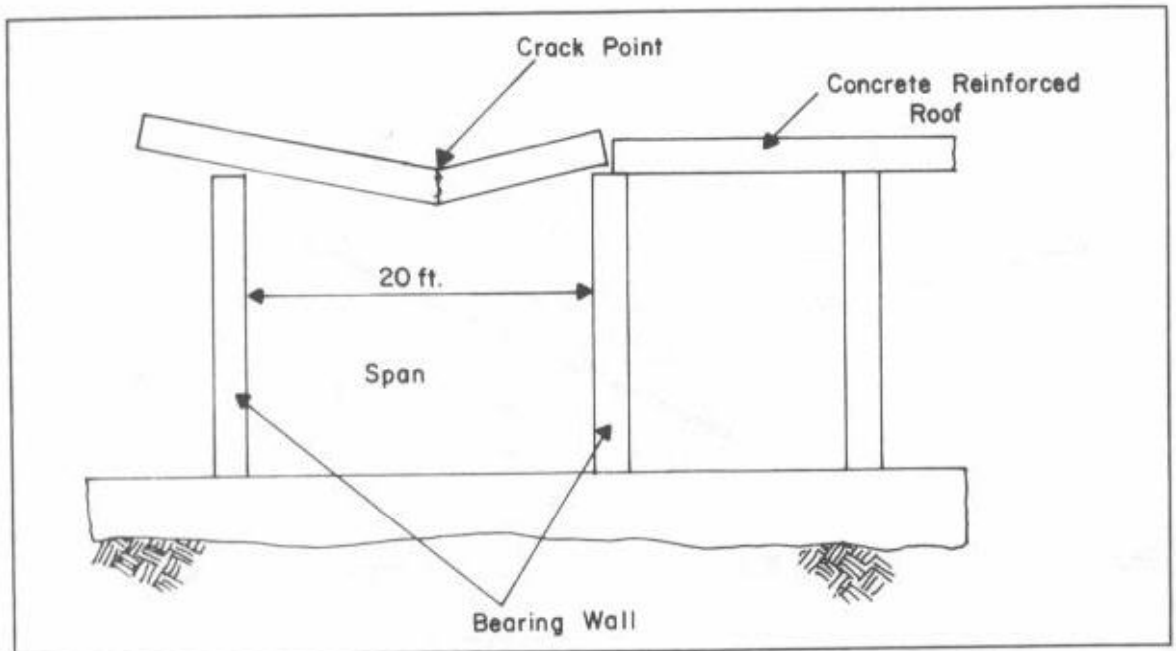

Fig. 9-15. This is the condition you will cause the wider the span gets.

your house. If you don't feel comfortable doing this drawing, your engineer will have someone make a reliable set for you.

To locate an engineer, look in your local telephone directory under *construction engineer*. Any city of reasonable size will have a listing of one or more engineers capable of helping you. When you contact him, tell him exactly what you're planning and ask him what he would charge to provide you with a drawing showing rebar size, location, and

concrete thickness.

Talk with this engineer at great length concerning the facts and details of your house. All the information you give him must be very accurate. For example, you can't tell him that you're planning on 5 feet of dirt over the roof when, indeed, this depth might be 10 feet. You must be specific and accurate with information.

Figure 9-16 is a sample drawing. Once again, check around for rates if you have the choice. The

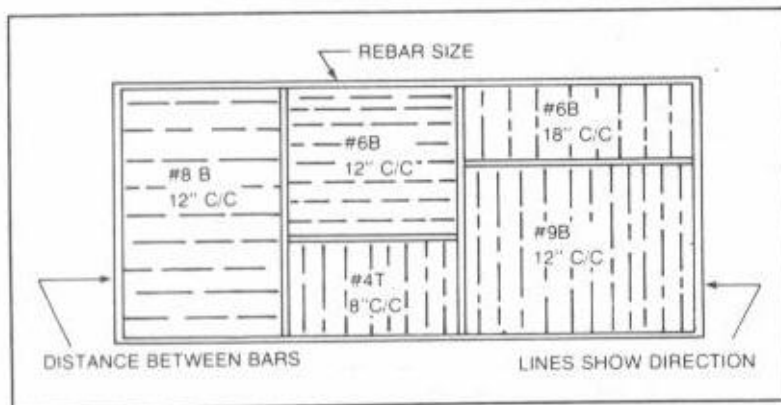

Fig. 9-16. Size and location of rebar.

price will vary quite a bit from engineer to engineer, depending on his interest in unusual dwellings, ecology energy savings, or your plans in general. These are professionals and if they can possibly give you a break on price, they will, and especially if they know you plan on building this structure yourself. They make up any financial break they give you on the next multimillion dollar project they design.

Another place to check for a good engineer is your local college. Some of those professors are sure to be engineers or have an engineering background. Before making a commitment to any engineer, check with the building code department to determine if you need a professional engineer's stamp or seal on your drawings. The seal means he is legally responsible for the design. Just make sure the person figuring the strength of materials in your roof is qualified and interested in underground homes.

REBAR

Rebar is steel rod approximately 40 feet long and comes in diameters from $\frac{3}{8}$ of an inch to 1 inch. These bars or rods are for strengthening concrete and nothing more. Your roof will probably use all diameters and lengths, depending on room widths. This is where your cutting torch comes in handy.

The cutting torch is by far the easiest and most universal method for placing, bending, and cutting rebar. By heating the steel, you can make the bends that will be required in some places.

There are other methods for cutting rebar. You could use a circular saw with a metal cutting blade. This method is slower but still gets the job done. The bending, however, will now have to be done by brute strength—yours. When large companies lay rebar, they have long-handled shears or cutters like a pair of bit-cutting pliers that will actually shear through some thicknesses. You, as a small contractor, might have a hard time locating this tool at a reasonable price.

The rebar will be delivered to your site in long lengths. You will have to cut and bend the lengths to form the pattern designed by the engineer. Rebar can be bought from a used steel dealer listed in your local telephone directory. The term "used" is mis-

leading; it was simply previously owned and left over from a large construction project. Buy it if possible. Used rebar is about half the price of a new rebar.

WIRE MESH

Another type of steel used for added strength in concrete is called concrete mat or wire mesh. It's a roll of heavy steel screen resembling a roll of fencing. It is manufactured in many sizes. This wire mesh adds additional strength to prevent cracking. I covered my entire roof with steel mat (Figs. 9-17 and 9-18) and then the rebar was put in place.

Discuss wire mesh and rebar with a couple of experts, (especially the technique of tying rebar and steel together). When rebar is laid in a criss cross pattern, it must be tied together with a piece of wire to prevent the steel from rolling and shifting as you walk on it (Fig. 9-19). Common stovepipe wire is often used. You must consider that wet concrete will be dropped on this steel from approximately 4 feet above. That's a great deal of weight trying to move your rebar around.

It is crucial that the rebar does not move. Take your time and do it right. As the rebar is being laid in place, it cannot be touching the wood scaffolding. It must be raised off of the wood by at least an inch. See your engineered roof design for the exact height. This is so that the concrete flows easily under and completely surrounds the steel. There are wire pegs sold for this purpose or you can use pieces of concrete block. Either way works fine.

Again, placing this rebar is crucial. It is physically impossible for one person to drag a 40-foot length, $\frac{5}{8}$ -inch-in-diameter piece of rebar around on top of the scaffolding. You will need an extra person to control the steel. Once you have maneuvered just one piece of this rebar around, you will know what I mean by it being difficult to handle. Only experience will make it easier.

Be careful as you cut through a length of steel. If it happens to be laying on an uneven surface—such as the ground, and you cut through the steel—one piece or the other could spring up and hit you in the face. This is exactly what happened on my job. The steel looked very relaxed, but when the

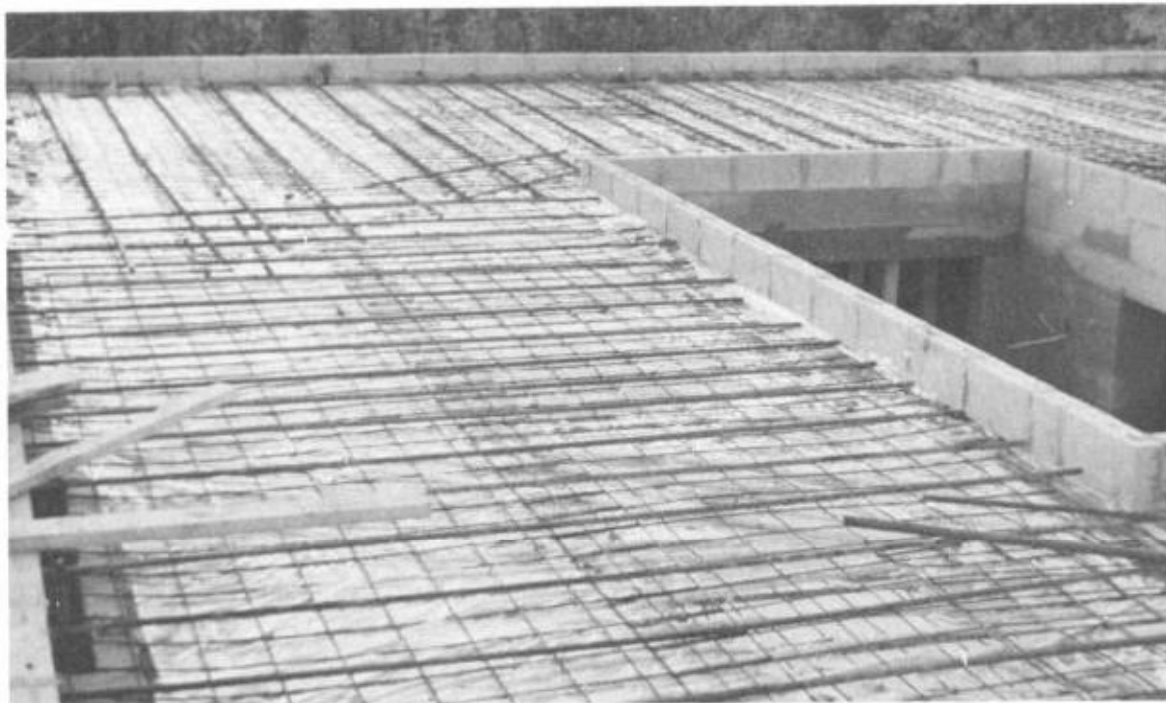

Fig. 9-17. Wire mesh gives real strength to the roof structure.

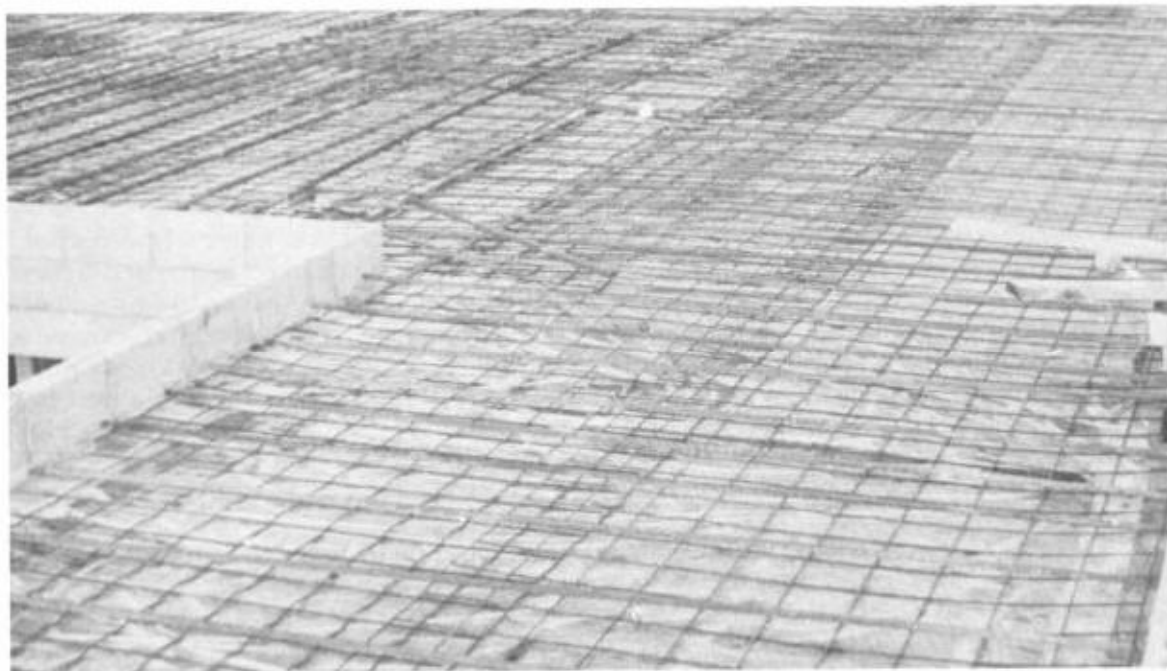

Fig. 9-18. This wire mesh is $\frac{1}{4}$ of an inch in diameter. Other sizes are available.

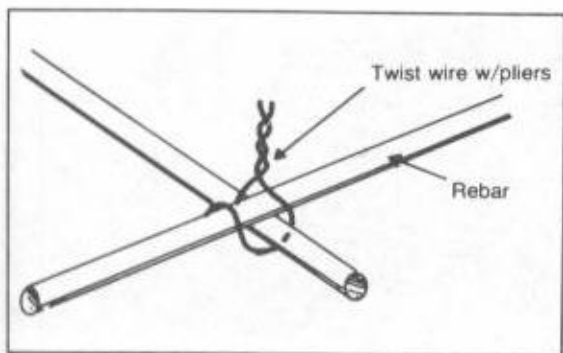

Fig. 9-19. Tie rebar together with stove pipe wire.

cut was made one end sprang up and caught me in the face. It could have been serious but I was lucky; you might not be. Steel under tension does strange things when that tension is released by a cutting torch.

STEEL PLACEMENT

Now you have worked your way to the steel placement phase. Anyone can do this just by using common sense and following the instructions of your engineer or concrete expert. I fenced in the perimeter of my roof with block to form a totally closed area for pouring concrete. Once you get this far, you're at the crucial point of your project. Don't let your wood frame work become exposed to rain, wind, etc., for a long period of time. Constant wetting of the plywood will cause it to separate and buckle, thus losing some of its strength. The sooner you pour concrete on the erected shoring the better.

At this point you'll have all shoring in place, all holes filled, plastic in place, and steel in place and raised off the plywood by at least 1 inch. It will also be laying on the blockwork. Finally, you must have a solid level spot that is an easily accessible immediately adjacent to the building for the concrete trucks and the crane to set up.

This might not seem like a big deal, but the following is a true story. At 8 A.M. the crane arrived, at 8:05 the concrete trucks begin to arrive, and my helpers are all ready to go. The crane, big and awkward as it was, kept spinning wheels in the mud and couldn't get into place. Everyone was standing

around waiting helplessly for half an hour when someone decided to get my backhoe and push the big crane. The extra effort was just enough to allow the crane to roll into his preferred position. If that had not worked, the day could have been lost and I would have been charged for unused concrete. You might not be so lucky.

There is more than one way to get concrete from truck to roof. One way is to use a concrete pump. You can rent this equipment for about \$300 a day. A concrete pump is just that. It pumps liquid concrete over distances up to 100 feet away. The problem with a pump is that it's slow and you need someone to hold a hose constantly at approximately every 10 feet of length because the throbbing effect of the pump tends to make the line uncontrollable.

Some of the newer concrete pumps are really another vehicle with a pump mounted on the frame. These modern pumping units (naturally) are more expensive to rent, and are usually only required on commercial or industrial construction. They might rent for \$600 to \$800 per day depending on size. Check around for pump rental, but don't be surprised if it's difficult to set up a pump at a reasonable cost.

Another method, which is the recommended one, is to use a crane. They rent for about \$500 a day, with one operator. Discuss the methods with local experts (especially the concrete finishers in your area).

If you use a crane, it will take approximately six hours from start to finish for an average house. The crane will have two buckets. The concrete truck backs up to one bucket and fills it. Then the crane lifts that bucket to the farthest corner and dumps it. While this is happening, the truck is loading the second bucket. By the time it is full, the crane will be returning with the first bucket (now empty). Keep repeating this sequence until the roof is covered to the depth you require (Figs. 9-20 through 9-23).

As the concrete is dumped, you need labor (and lots of it) to level it and a finisher to smooth it. The smoother the surface, the less moisture the concrete will absorb when covered with dirt. Don't use a trowling machine such as you will use on your

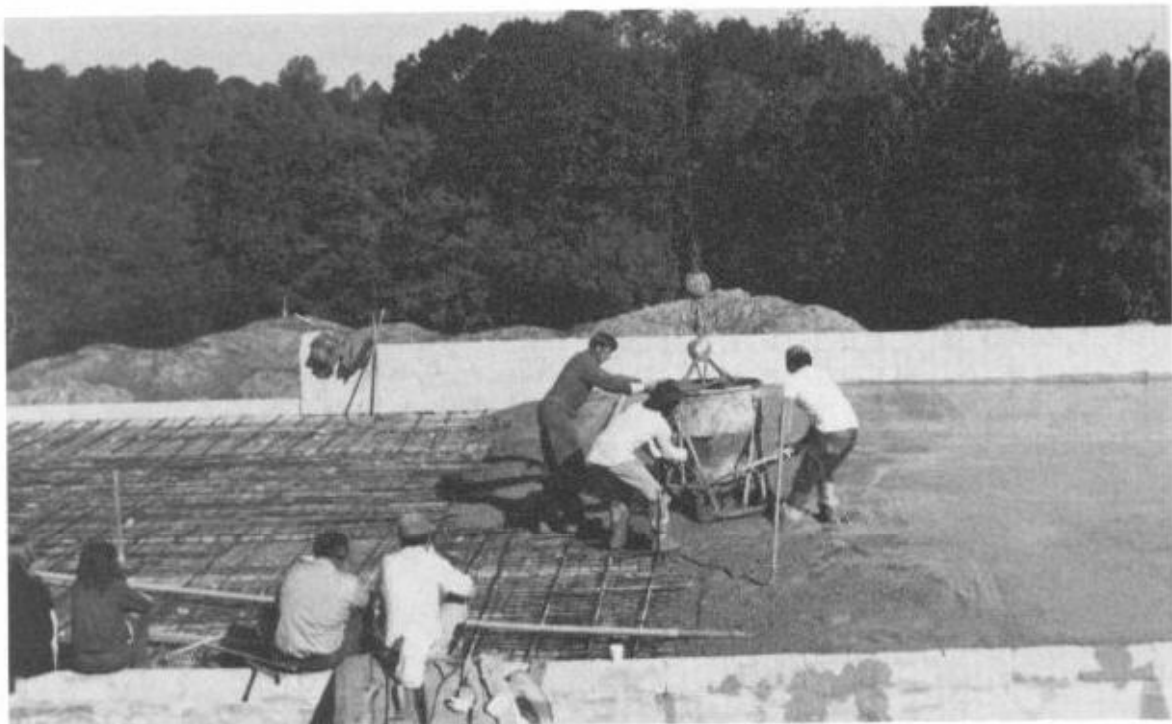

Fig. 9-20. A crane is moving a bucket of concrete in place.

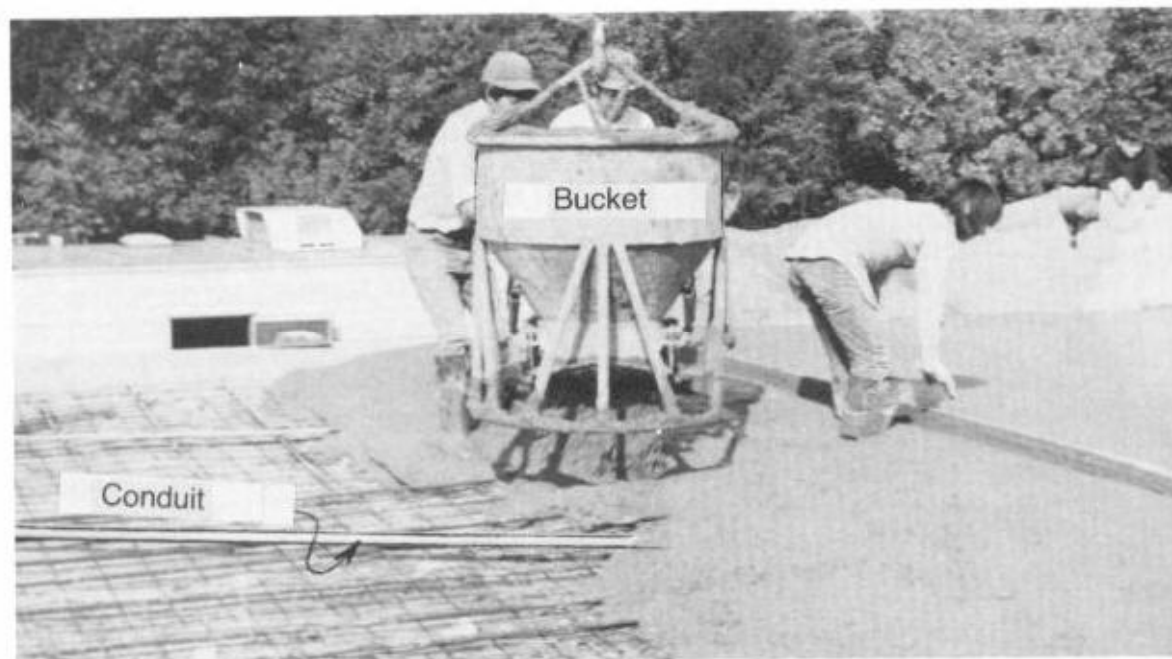

Fig. 9-21. Notice the concrete is being spread with a section of 2 x 4.

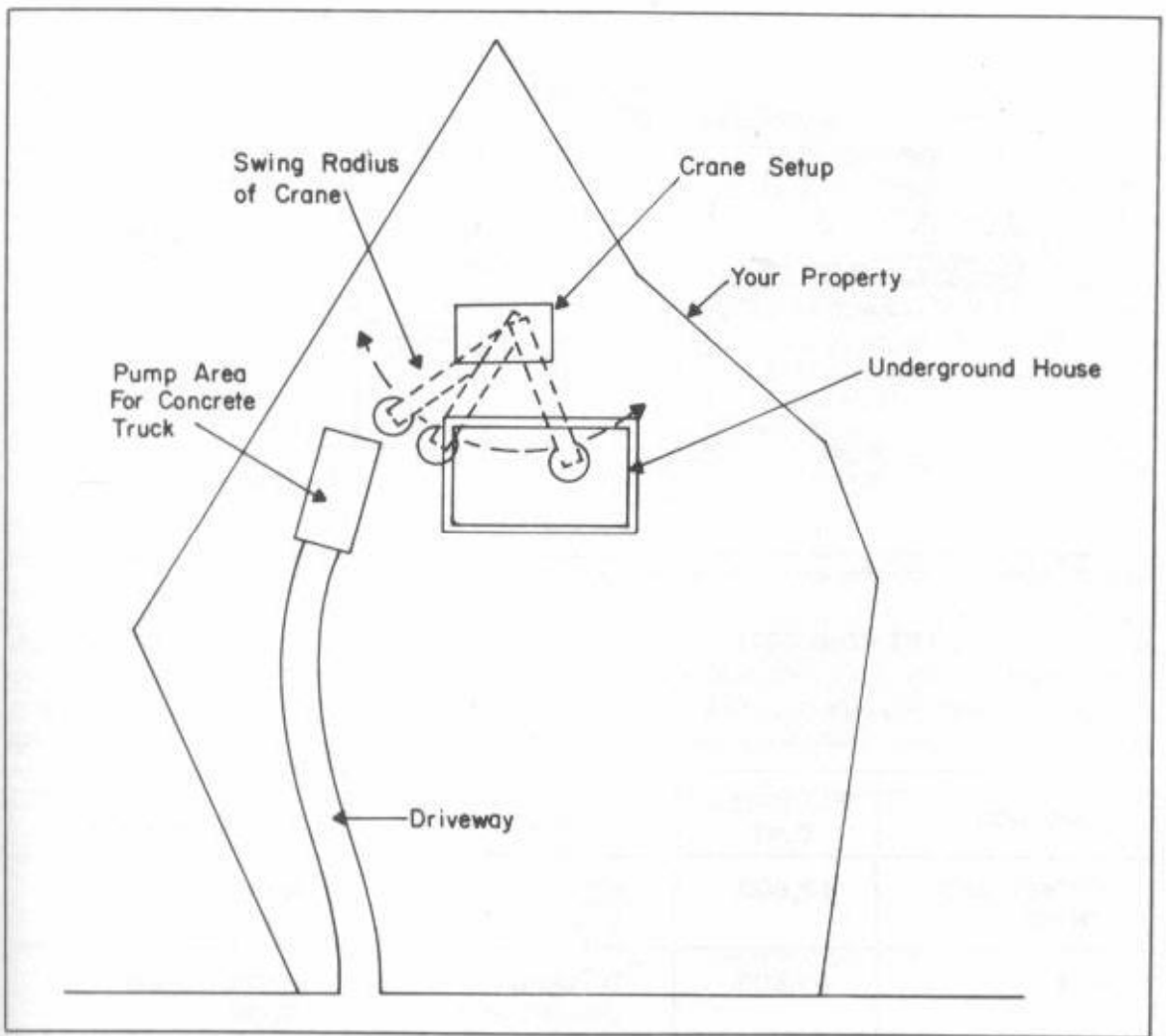

Fig. 9-22. The crane must set up so that the concrete trucks can deliver to the crane swing radius.

floor. There is no advantage in getting the roof as smooth as your floor.

One other thing to remember is to have someone shake the steel lightly by any method possible. You could use a pick as the concrete flows across your steel network. This ensures that the concrete reaches all cracks and crevices and completely surrounds the steel. Concrete must totally surround all steel. The minimum thickness under the steel should be 1 inch. Do *not* use an electric or hydraulic vibrator to settle the concrete. Unless the shoring

and framework is professionally installed and approved by a professional engineer, a vibrator will shake most constructed shoring apart. It's not necessary to cause this tremendous stress on the shoring. If your experts suggest a vibrator, get a second and a third opinion. I can't stress this vibration danger enough. Falling concrete can be fatal.

One hour after the last bucket is dumped and raked, you can relax. If it hasn't collapsed by then, it will be there until doomsday. You are now halfway to completion of your underground house!

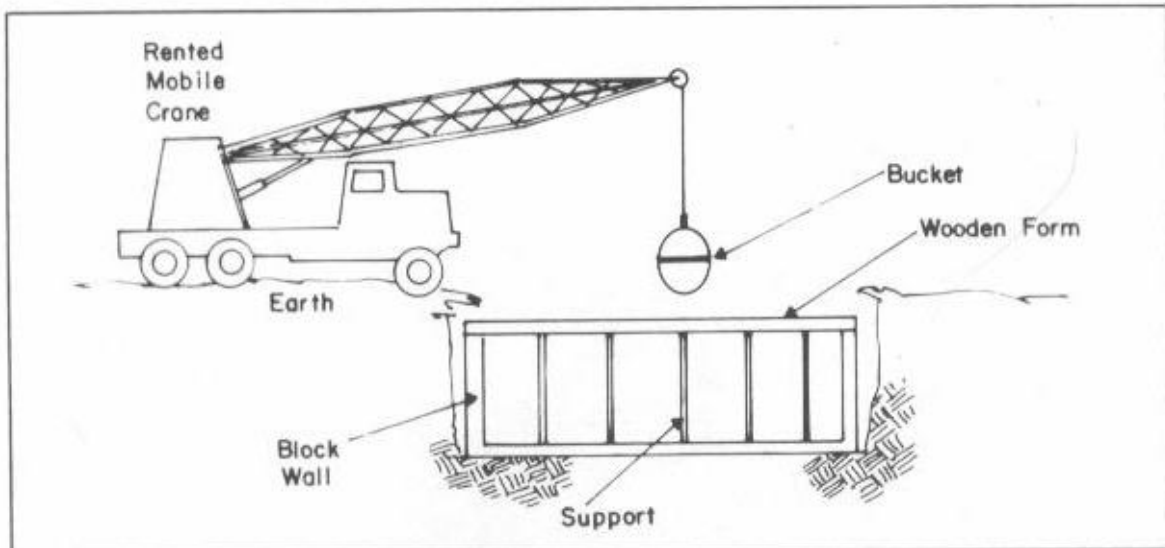

Fig. 9-23. Mobile crane operation and bucket can easily be rented.

PRECAST CONCRETE

If once again you will check your local telephone directory under *concrete products*, you'll find precast or prestressed concrete. There are companies that

make slabs of concrete designed to carry any weight you require. These slabs usually have a maximum length and width somewhere around 20 feet long by 4 feet wide. This gives you quite a few joints that

METHOD	*ESTIMATED COST	ADVANTAGE	DISADVANTAGE
BUCKET AND CRANE	\$9,600.	FAST	NONE
PUMP	\$9,600.	IF CRANE UNAVAILABLE	EXTRA LABOR; SLOW
PRE-CAST	\$16,800.	ONE-DAY INSTALLATION LESS LABOR	EXPENSIVE; SEAMS TO PATCH, POSSIBLE LEAKS
DIRECT DUMP	\$9,360.	NO RENT OF CRANE OR PUMP	LOTS OF LABOR AND WHEELBARROW; SLOW
CONTRACTOR EVERYTHING	\$24,000.	NO RESPONSIBILITY TO YOU	COST

* ESTIMATED COST FOR 3,600 SQUARE FEET INCLUDING ALL FORMING, PREPARATIONS, ETC.

Fig. 9-24. Chart comparing the cost to building a roof slab.

are sealed in a variety of ways, but they are almost always covered with a second layer of poured concrete or sprayed insulation such as foam. These companies will set these precast pieces in place of your walls for a price. The advantages of this system is that there is no scaffolding to erect, it is rigid, and it can be placed in one day. Of course, the disadvantages to this method is cost and the possibility of leaks.

Discuss all aspects of your roof with professionals. Talk to more than one person in each trade. They can all give you valuable information. In the end, you have to make the final decisions as to how and who.

CHIMNEYS

As for building a chimney, in my opinion there is only one method that is solid and practical. Buy a length of approximately 8-inch-diameter steel pipe however high you want your chimney to be and weld bars to the sides (Fig. 9-24). These bars rest on the concrete and hold the pipe upright until you fill around the pipe with concrete and tar it over this new seam. It's that simple and works well.

Standard chimneys will crack immediately after the first freeze because the block above ground level freezes solid and is forced to shift. The block 4 feet underground does not freeze and is mortared stationary to the roof which doesn't move, thus causing cracking. Watch this chimney phase closely. You can't live underground without one or two chimneys.

Do not put any holes in the roof except for the chimney. Holes are just too hard to keep waterproof. Any venting can be put through the exterior walls just as easily as through the roof.

It is a very good idea to lay down PVC conduit (approximately 2" diameter) on the steel before the concrete is poured (Fig. 9-25). This is for the main runs of your electrical wires. Be sure to let the electrician that is working with you locate and install this conduit. The codes are once again very tricky.

If your house is small, say 40 feet by 25 feet, the cost of putting pipe in the ceiling concrete would probably be more expensive than running wire around the walls. If you want hanging ceiling lights, you should definitely give the conduit considera-

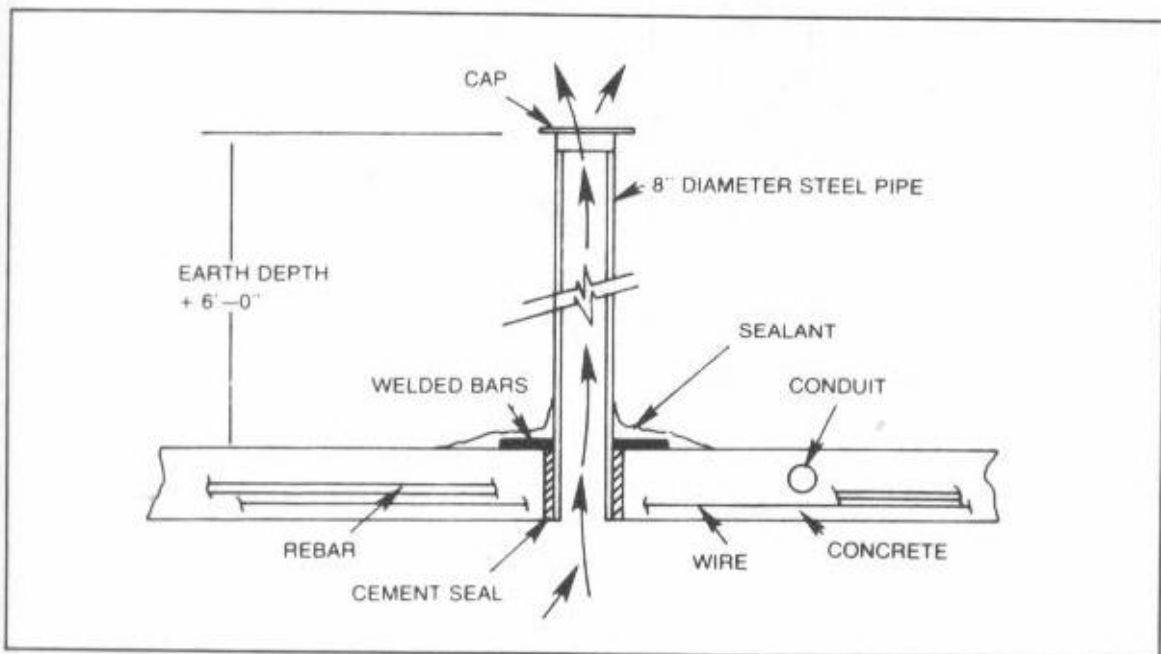

Fig. 9-25. Notice the electrical conduit in place in the concrete.

tion. I put conduit in the concrete because my house is 90 feet long and 40 feet wide, and I wanted ceiling lights in some rooms. This installation is not hard to do.

After all rebars and shoring are in place, locate exactly where you want the chimney hole to be. Secure to the plywood anything you find that is 8 inches to 9 inches in diameter (maybe an old bucket or can). This will leave a hole in the roof for your chimney. It is ridiculous to jackhammer a hole in the roof after the concrete is poured and set.

Even though my design required the chimney to penetrate the roof (because my fireplaces were more than 10 feet from the exterior walls), I recommend placing the chimney outlet on an exterior wall (Fig. 9-26), if possible. It is much easier to waterproof an opening on a vertical surface than a horizontal one.

Should you be forced to place the hole in the roof section, I suggest a little additional safety measure that you could construct as the roof is being poured. Figure 9-27 shows a raised lip approxi-

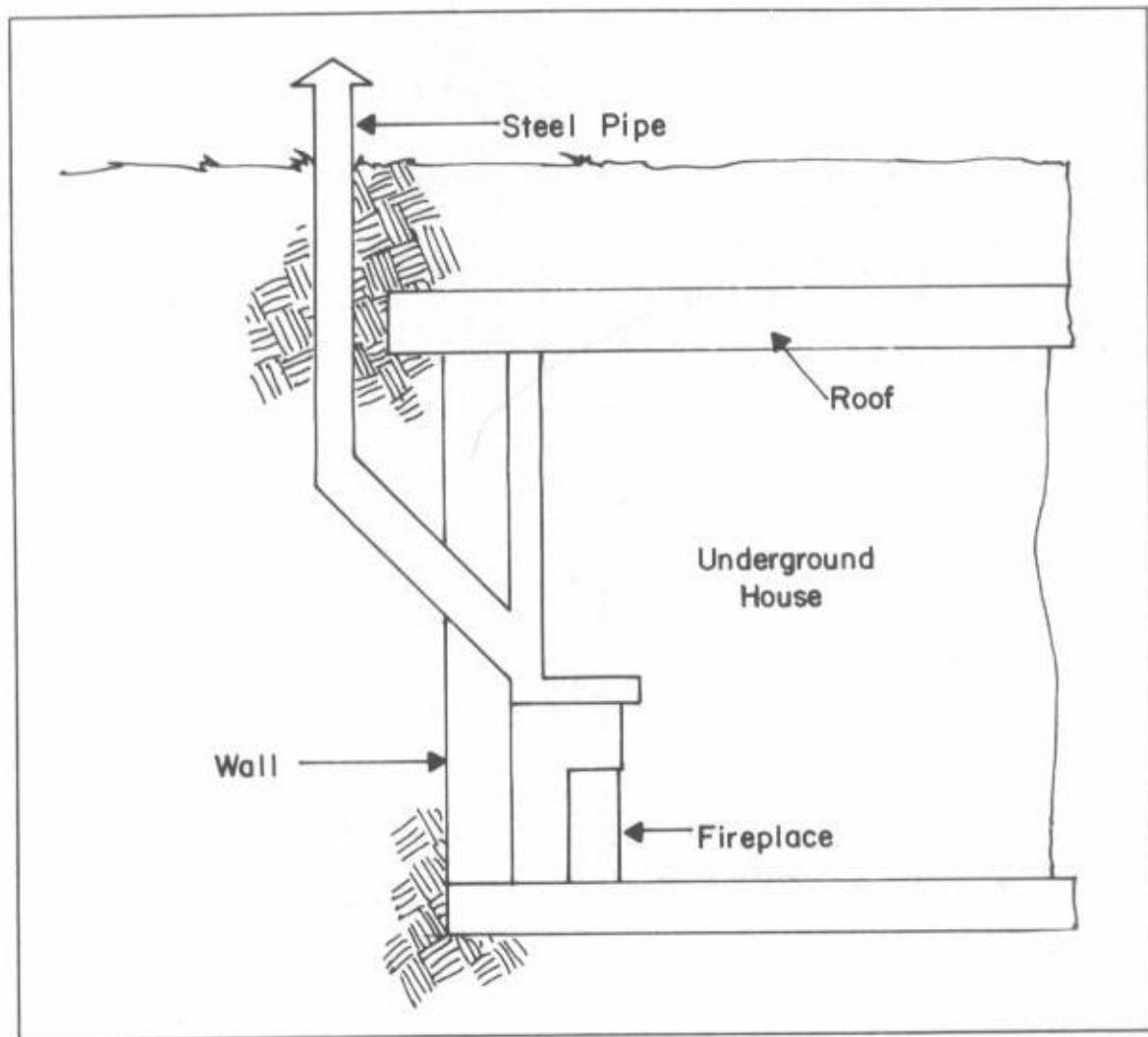

Fig. 9-26. Preferred way to place chimney.

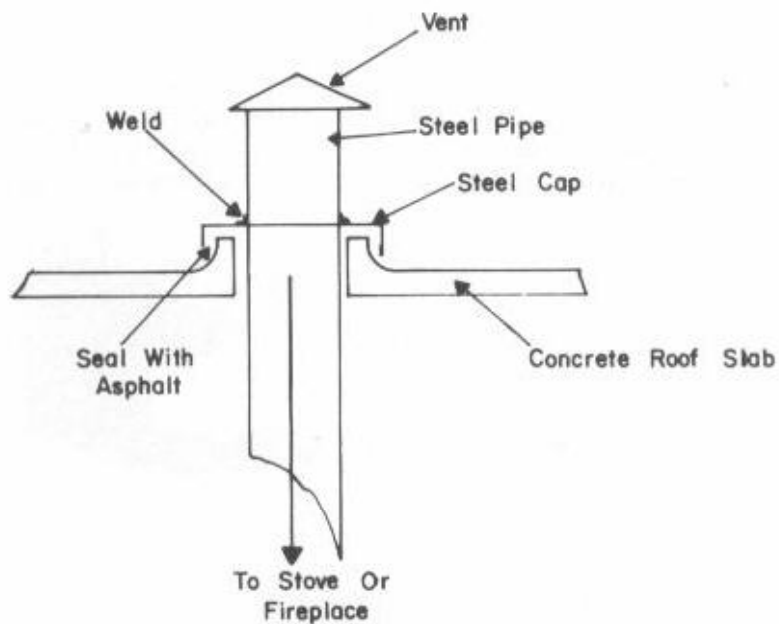

Fig. 9-27. Build a column of concrete as the roof is being poured at least 6 inches high.

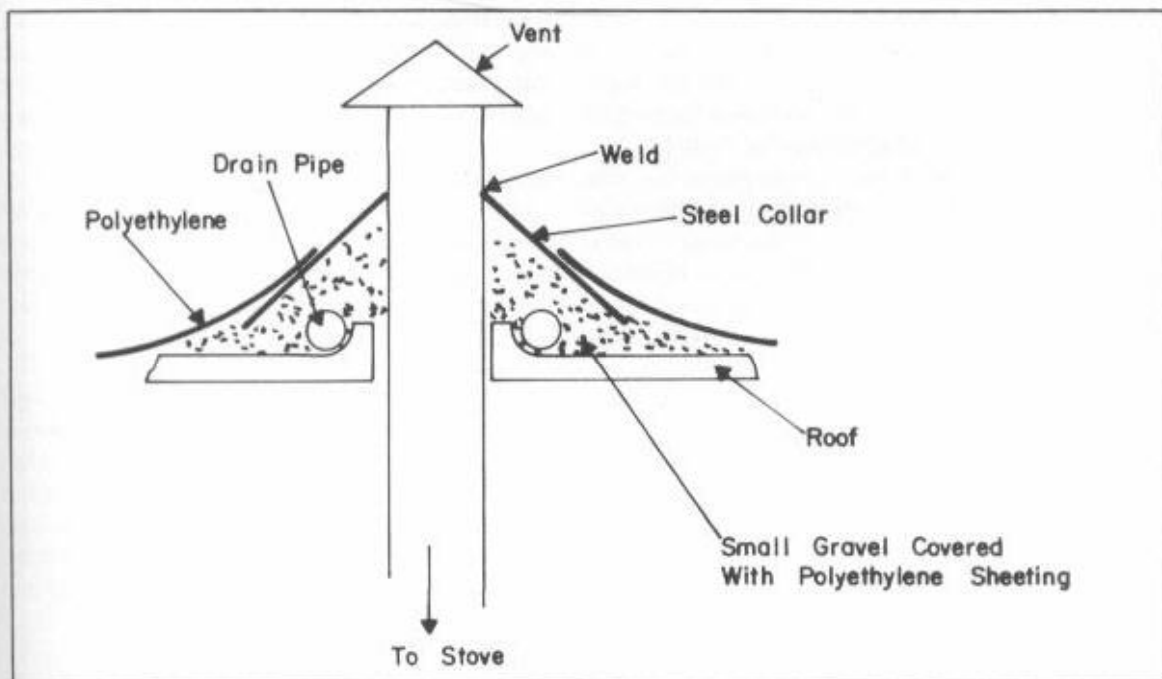
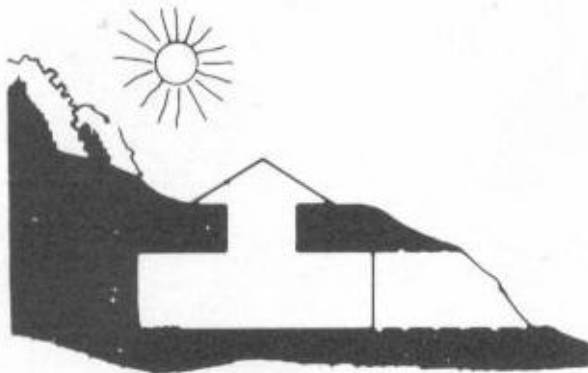

Fig. 9-28. Install the drain system away from the chimney as a safety precaution.

mately 1 foot from the chimney pipe. This lip is raised about 3 inches and is overlapped by a shroud. See Fig. 9-27.

Yet an additional safety measure could be to place a perforated drain pipe in a bed of gravel that vents to the downhill side of your property. (See Fig. 9-28). The reason for pointing out these things

is that this is a weak link in the waterproofing system. I had to rebuild my chimney after two years because of a very small, aggravating leak. A little extra effort and design in the beginning is far better than saying, "I wished I *had* done it another way, as the water runs down the chimney pipe." Once again you should consult with the professionals.



Alternate Design

The state of earth-sheltered living has taken a few giant steps since 1978. For example, would you believe an underground house not under the earth's natural grade. Of course, this is truly an earth-sheltered home.

The reason David Greenlaw built under earth, but above ground level is because southern Maryland is only a few feet above sea level. In southern Maryland, you often strike water digging a post hole.

PROBLEMS

This method presents one major problem: finding enough earth to cover the finished structure. If you had to have soil trucked to the site, the cost of the soil might exceed the cost of the structure. The second major problem is placement of the earth. Naturally, a crane and bucket will be required. See Fig. 10-1.

ADVANTAGES

The other side of the coin is that working on ground

level is naturally easier. How do you make a mound of dirt appealing? A little imagination and landscaping will do the trick. Figures 10-2 and 10-3 show the beginning stages of building above ground.

Another unusual characteristic of this house is that it is mountainless construction. The blocks are stacked in the usual pattern but without mountains. Then a layer of special sealer is applied to the extension sides of the block. See Fig. 10-4. The roof is made of wood with layered sealing arrangement (Fig. 10-5).

Builder-designer David Greenlaw deserves real credit for tackling new and innovative methods of construction. (Fig. 10-6). Figure 10-7 shows an internal view of walls that are made of concrete block. Notice the slope of the rafters. This is to ensure water runoff on the wooden-layered roof. Figure 10-8 is another view of the early steps of construction.

Should everything go as planned Mr. Greenlaw's home will look like Fig. 10-9 when completed. Not bad for an owner-built project.

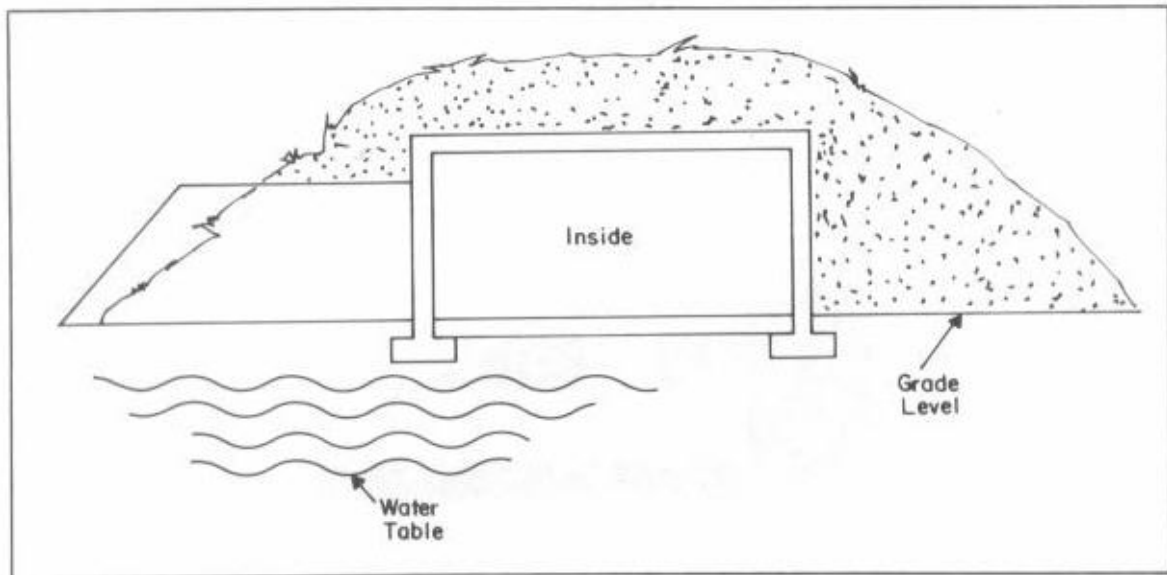

Fig. 10-1. The above-grade-level, earth-sheltered home.



Fig. 10-2. Early stages of blocklaying for this typical home.

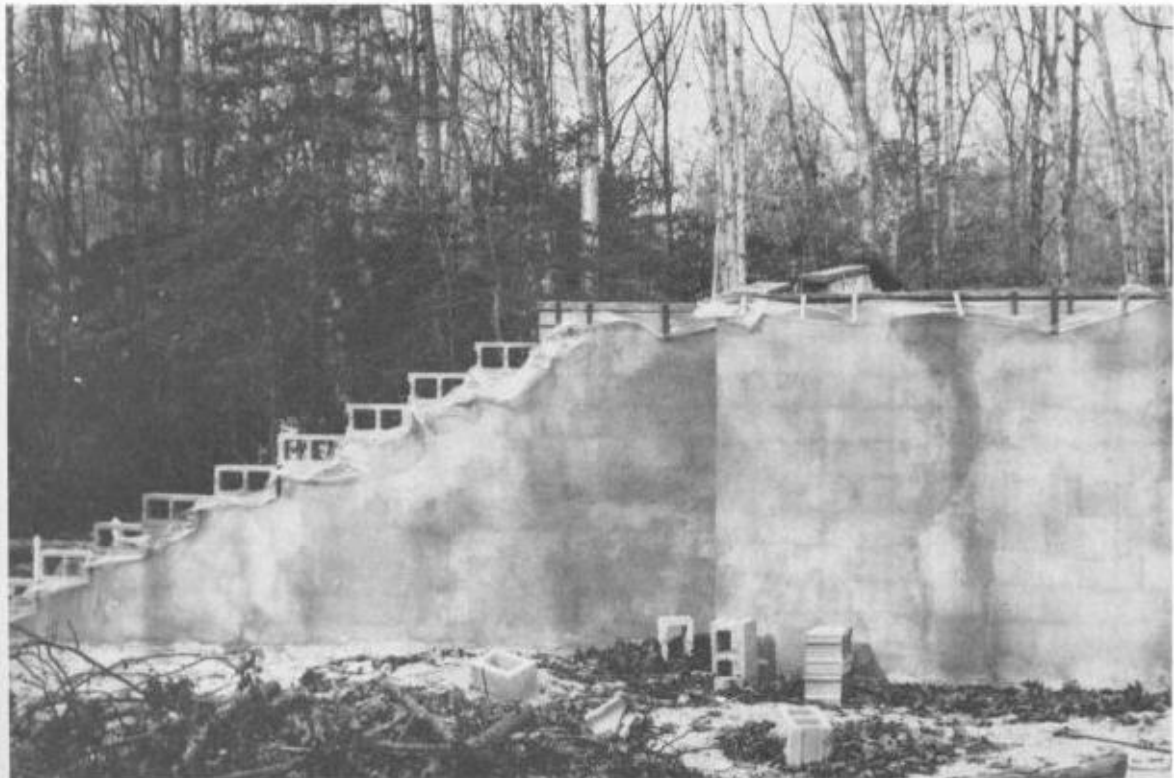

Fig. 10-3. Another view of the same structure.

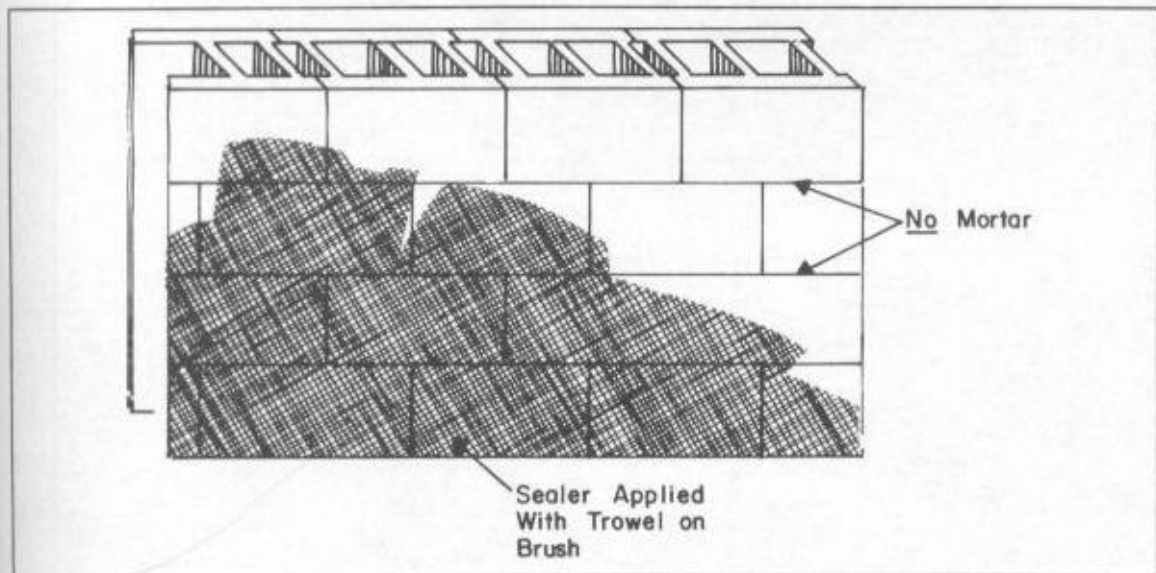

Fig. 10-4. Sealer-adhesive holds block together without mortar.

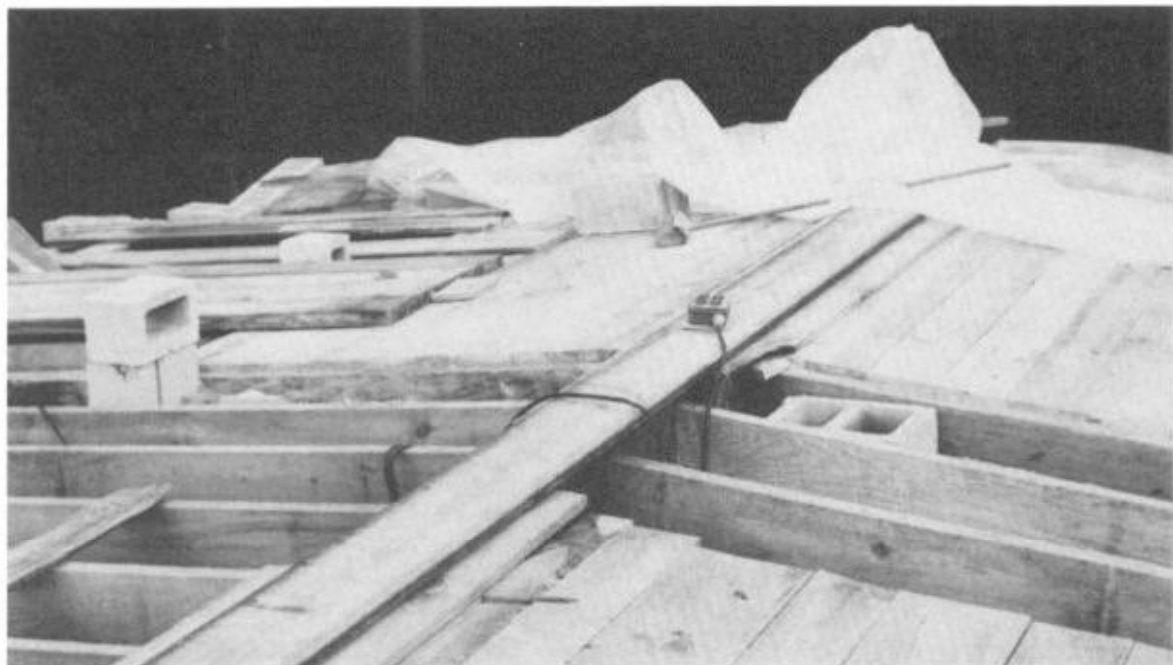

Fig. 10-5. Notice plank wood roof arrangement.



Fig. 10-6. Mr. Greenlaw using a home-made concrete mixer.

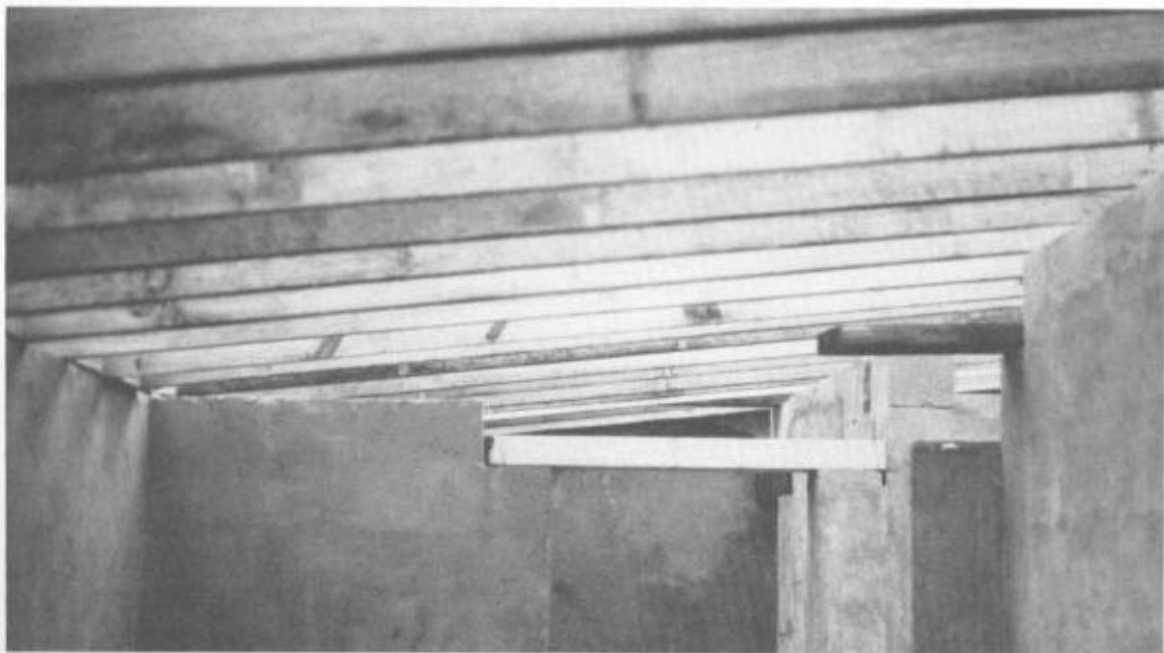

Fig. 10-7. Notice block interior walls and sloped rafting.



Fig. 10-8. Front view of block construction.

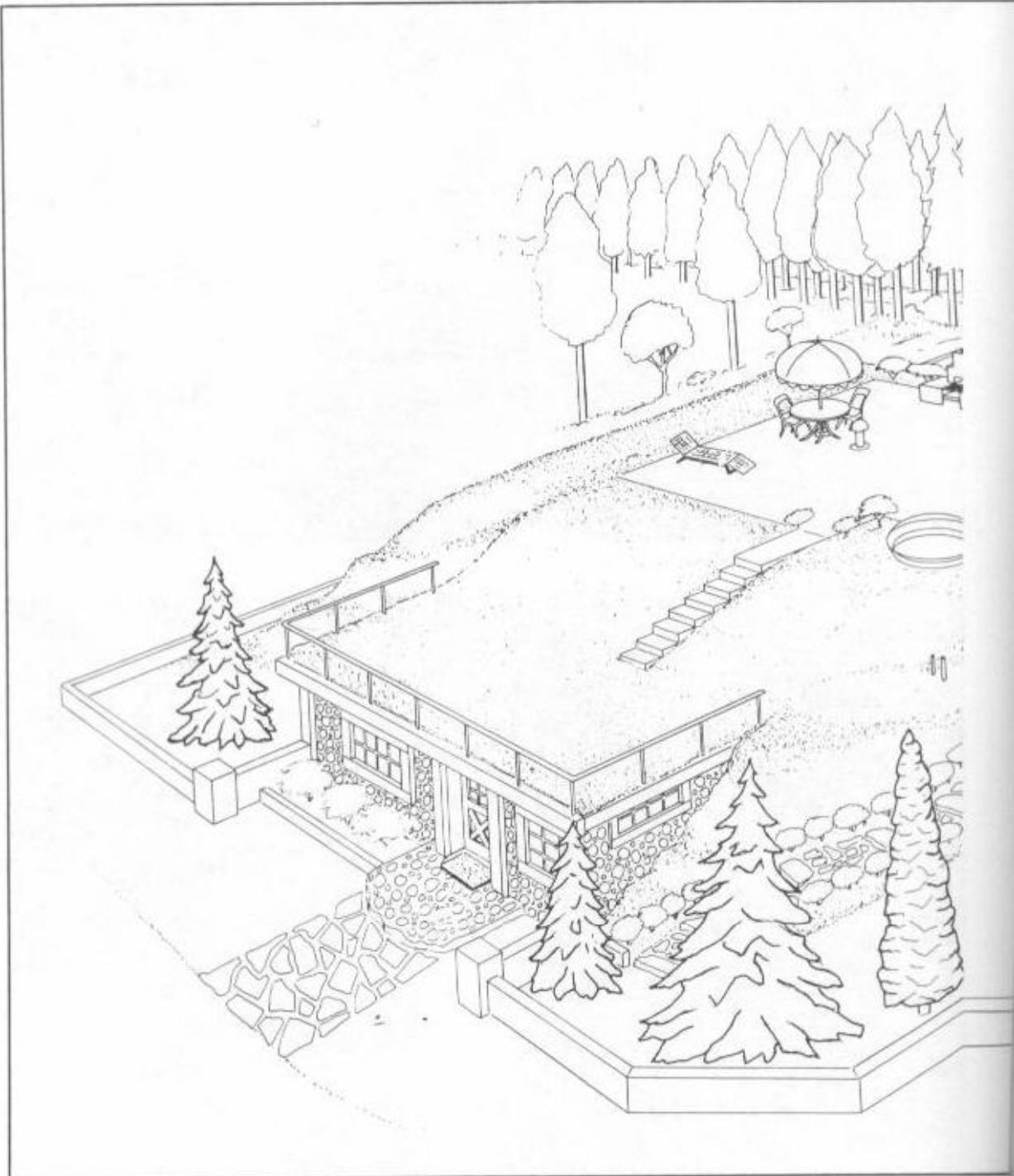

Fig. 10-9. Artist conception of finished project near Preston, Missouri.

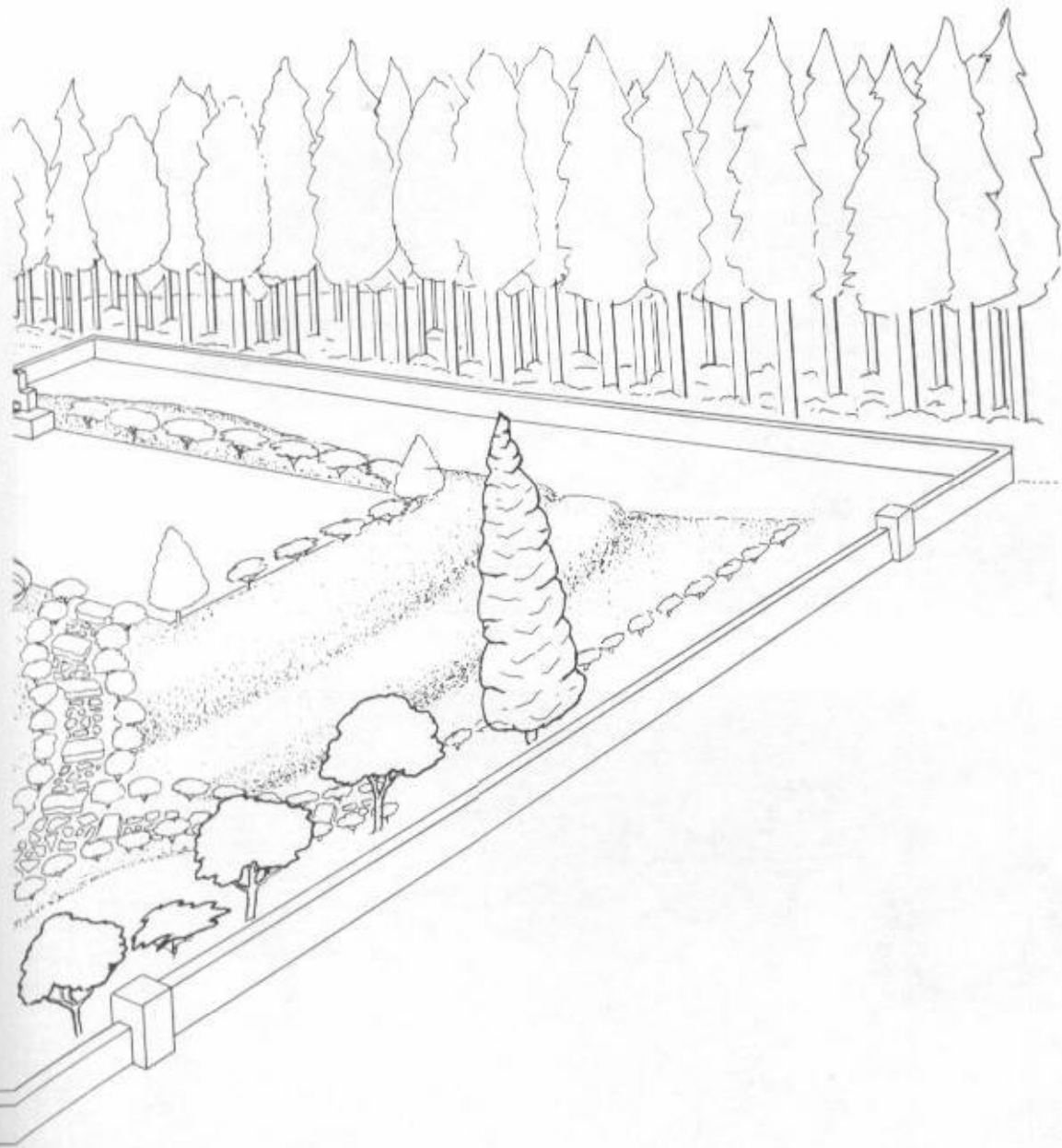



Fig. 10-10. One of the largest earth-sheltered homes in the country under construction.

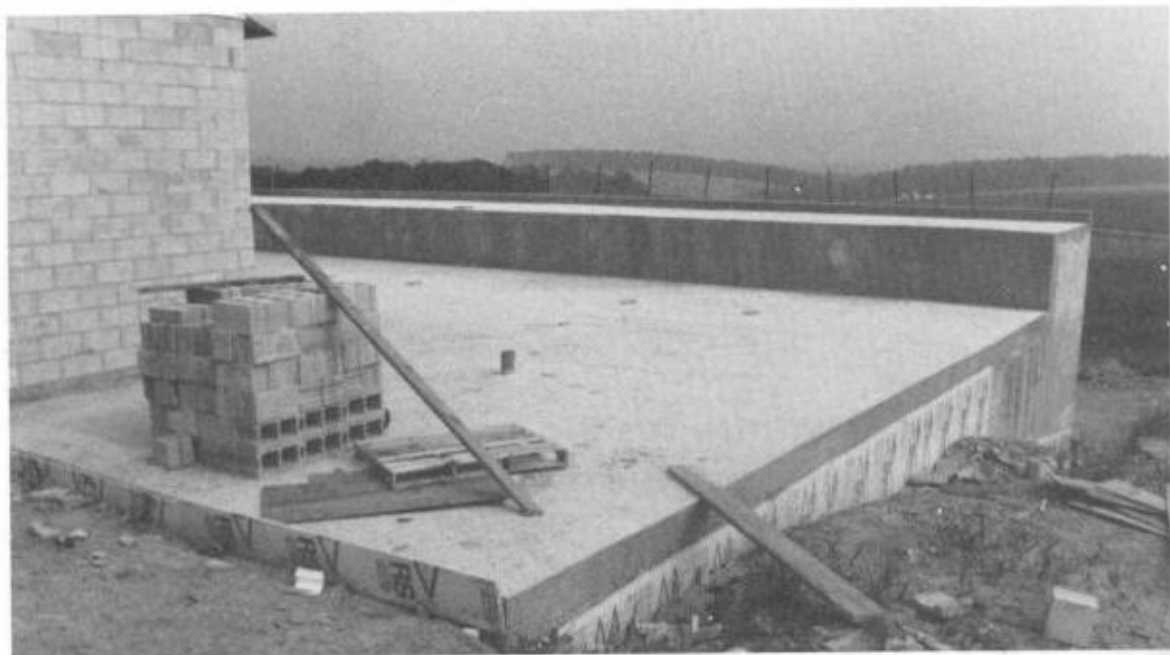

Fig. 10-11. Two-story underground garage.

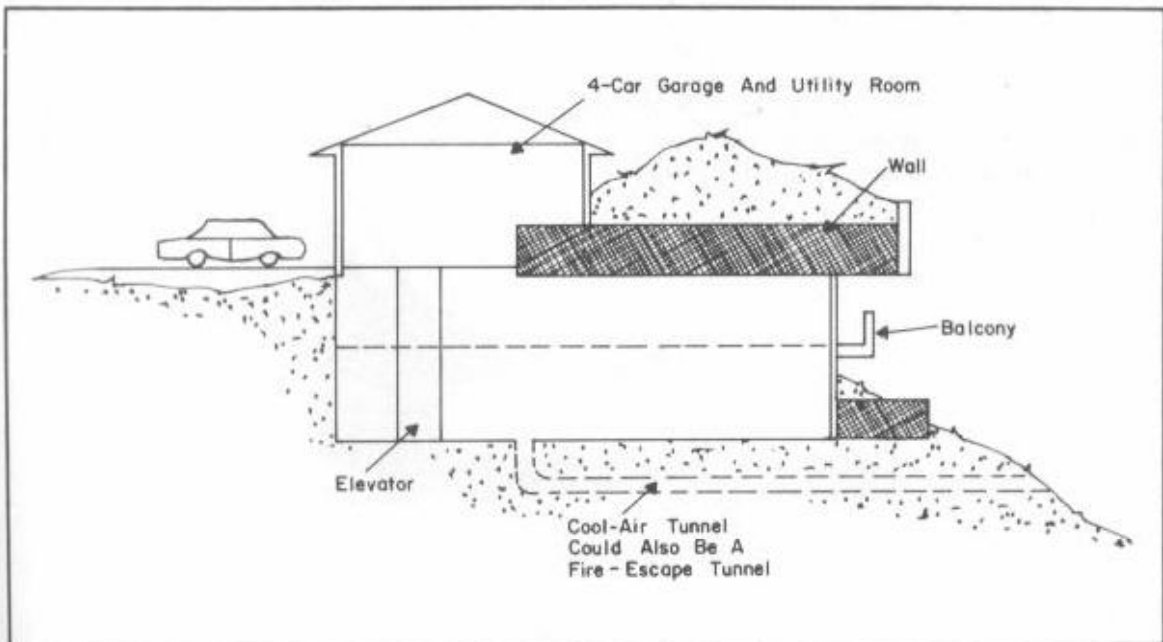

Fig. 10-12. Sectional view of a house in southeastern Pennsylvania.

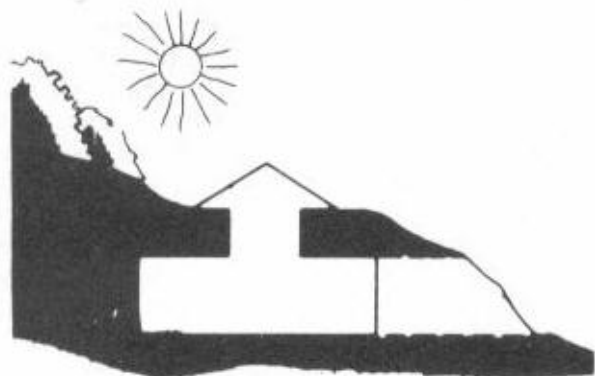

Fig. 10-13. One last view of this earth-sheltered home.

YET ANOTHER APPROACH

The house shown under construction in Figs. 10-10 and 10-11 is the extreme opposite as far as size goes. This house is technically an earth-sheltered house, yet it doesn't appear so in these early pictures. The builder of this house has taken more than

two years, and progress was still slow as of this writing. How would you like to live in a 6000-square-foot house? This doesn't count the four-car garage and utility rooms. When completed it certainly will be a fantastic building. See Figs. 10-12 and 10-13.



Waterproofing and Insulation

When you mention underground homes or subterranean structures of any kind, people immediately and always think of a damp and dark hole. I'm sure their experience with older buildings, used for storage or warehousing, and unfinished house basements with inefficient drainage and lighting are the culprit for this bad reputation. This is rightly so because many times the drainage is inadequate due to poor grading or planning.

Just as almost everything in the world has changed in the past 25 years, so have building materials, methods, and equipment. For one example, urethane foam used for insulation was unavailable to the general public as recently as five years ago. Polyethylene and Styrofoam have become commonplace for home construction.

Before going any further, I'll give my definition of waterproofing. It's simply preventing excessive (damaging) moisture from reaching the interior of your home. This can be done in a variety of ways with a variety of building materials. First, I'll give some examples of extreme methods to ensure a moisture-free house. Remember that no matter

what you do or how well you do it, there's always the possibility of a moisture problem requiring mechanical assistance such as pumps or at least dehumidifiers. I just want you to be aware of the potential problems. It's a risk you will have to take when building underground.

MOISTURE TREATMENTS

Once you have excavated the land to the level you want, poured your footers, and are ready for the walls, you might realize that you could have poured solid-cement reinforced walls instead of concrete block walls. Solid concrete is a superior barrier against running water only. Whatever your exterior walls are, they should now be treated to prevent moisture from touching the exterior surface. When I say touching I mean exactly that. If you keep water away from the exterior, naturally it will not reach the interior.

This keeping away phase might be next to impossible 100 percent of the time. The trick is to keep as much moisture as possible away as much of the time that you can. There are numerous ways to

keep water and moisture away from an underground house. For example, there is drainage, natural shelter, tar or asphalt, parging, polyethylene sheeting, and plastic panels—to mention a few. I used hot tar (asphalt) and a layer of 6-mil polyethylene. See Fig. 11-1. Depending on your situation, you could use any or all of these methods in your construction.

Parging

Parging is mortar mixed with a greater-amount-of-cement-than-normal mortar mix. To the laymen mortar is simply cement. The block mason will spread a heavy layer of the mixture over the entire surface of the block work. The cement fills the pores of the block and is the beginning of a waterproof wall. Do not pass over the parging. Do not spray tar directly on the block. Standard concrete blocks are very porous and the tar will not fill up all

the holes. Parge first and then cover with tar. See Fig. 11-2.

Tar (Asphalt by a Tar Baby)

I used two heavy coats of hot tar sprayed on by a commercial tar baby. See your local telephone directory for the entry *waterproofing—tar*. Two coats of tar are sprayed on. The second coat is sprayed on after the first has dried. This method is far superior to one heavy coat. Another reason in favor of the second method is that any high spot or edge will only absorb a thin layer of tar. Additional tar will only settle to the low spots, leaving the high spots only lightly covered. By spraying one average coat everywhere—letting it dry and spraying a second equivalent coat a day or so later—the build-up is uniform. This is the most common method.

The tar method is reasonably inexpensive; it



Fig. 11-1. The structure was coated with two coats of hot tar and then wrapped in 6 mil polysheets.

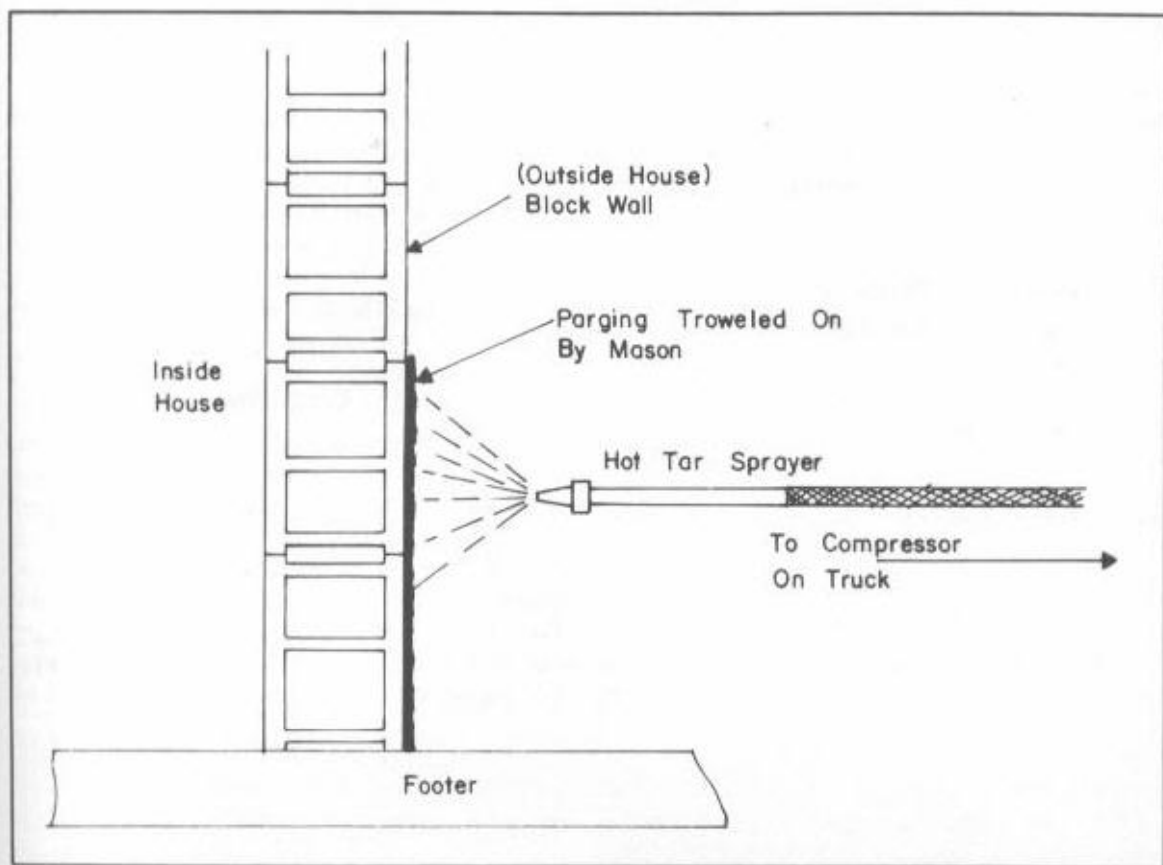

Fig. 11-2. Hot tar is sprayed.

costs about 9 cents a square foot applied. The application goes fast if a commercial spraying unit is used.

This brings me to a very important point. Do not attempt to brush on tar or asphalt yourself. You may think this is a way to save a few bucks, but it's not. A brush doesn't do the job a sprayer will do. If you buy tar by the 5-gallon bucket, you'll end up wasting much of it from dripping and spilling. The most important reason for not doing the job yourself is the mess it creates. You get tar in your hair, on your skin, and it is nearly impossible to remove. The spraying of waterproofing tar is a job you want to avoid. Let a professional do what he does best.

Polyethylene Layers

If you want to go to additional expense, you can

wrap the entire structure with two or three layers of polyethylene. You can buy polyethylene in 100-foot rolls, 20 feet or 40 feet wide and 6 milligrams thick (about the thickness of a sheet of paper), from most building supply stores. Once the tar is on the block and dry to the touch, you can begin to wrap the building, ending with two or three layers over the entire structure. Try to keep the polyethylene smooth and wrinkle free.

Do not attempt to place the plastic while wind is blowing. I used these polyethylene sheeting but found that the wrinkles were a real problem because a mild breeze always seemed to be blowing. This proved to be more trouble than it was worth. Just for information's sake, polyethylene sheeting will not deteriorate underground, but sunlight will deteriorate this material. Tests indicate that

polyethylene that has been underground is still intact after 20 years. The only reason I am reluctant to urge you to use polyethylene is that if you tear one hole in it, as you back fill the dirt, you will lose most of the potential waterproofing value. Rest assured you will tear holes in the polyethylene as the earth is spread.

Crisscross Polyethylene Sheet

If you take the 100-foot rolls and spread the polyethylene one direction, then spread about 6 inches of soft earth—then spread another layer of polyethylene perpendicular to the first layer—you will build a good moisture barrier at a reasonable cost. This polyethylene I've been discussing cost about 6 cents a square foot, depending on the quantity purchased.

Pressed Insulation Board

Following the wrapping of the structure, you can begin to backfill gently (Fig. 11-3). Take care not to

tear the plastic if you do use it. If you want to take another precaution, buy pressed insulation board. They are usually about $\frac{1}{2}$ of an inch thick. It is as inexpensive as any building material you can buy in 4×8 sheets. Line the exterior walls with this material. The only purpose it will serve is to cushion the rock and dirt; if drainage is good this should be all you need. If you want to go to real extremes and you have an indication that your soil isn't as good as it should be, this next method should work for you. But it is expensive.

Drain Pipe

The most common method to keep water away from concrete floors is a series of pipes covered with gravel, leading to a drain line away from the house (Fig. 11-4). These pipes form what is called a drain field. If you place a perforated 4-inch-diameter drain pipe in a bed of 1-inch diameter crushed stone (as in Fig. 11-4) below the surface you want to keep dry, the water will naturally flow to this loose gravel, into the perforated pipe, and then out to wherever



Fig. 11-3. Begin to back fill carefully while watching for large rocks.

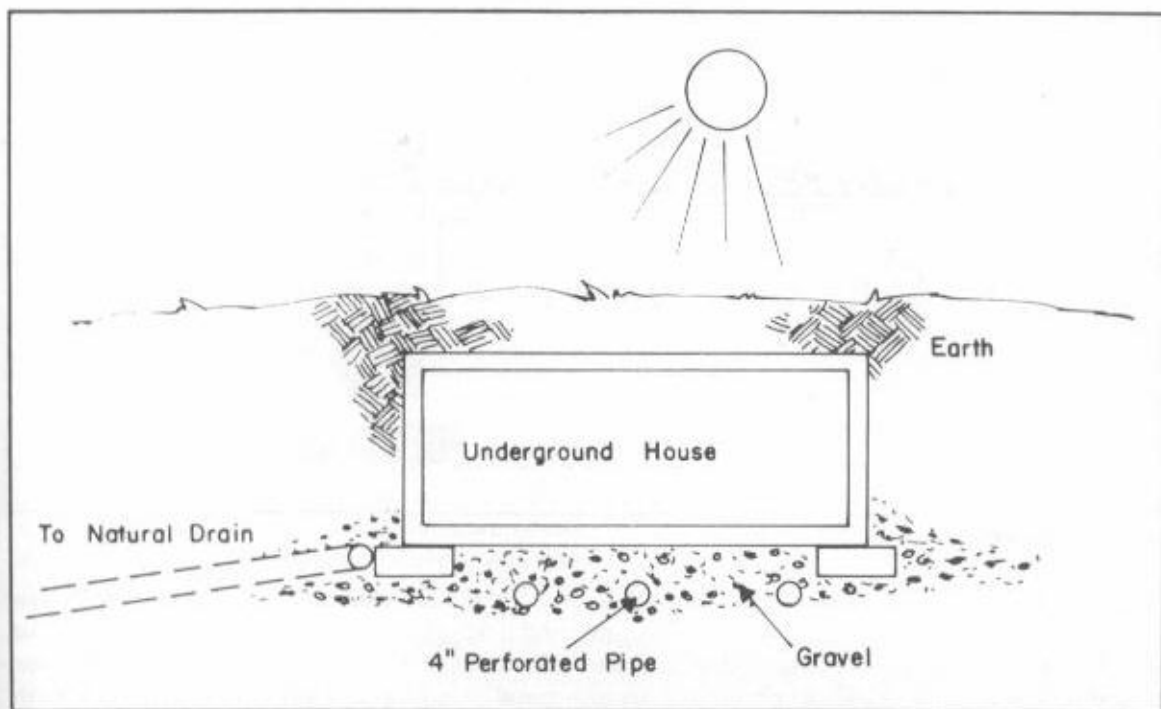

Fig. 11-4. Drain field under floor.

the end of the pipe is placed. This perforated pipe is sold in 50-foot rolls for this exact purpose. Ask your building supply store.

Make sure that the drain field always drops at least $\frac{1}{4}$ -inch per foot of length (Fig. 11-4), and that the entire pipe and gravel stay below the underside of the concrete floor or bottom edge of the exterior walls.

As long as I'm discussing methods of keeping moisture away from the floor, a less costly method is to lay a couple of layers of the polyethylene down before pouring the concrete. These polyethylene sheets were the only prevention I took to stop moisture from penetrating through the floor, and it seems to be doing the job. In reality, I don't think anything would usually be required if the soil is of good drainage quality.

Roof Drain Fields

Even though I didn't place any drain field in the earth over my roof slab, I could have as insurance. The following method is one of the many designs

that would work. After the waterproofing polyethylene sheets are covered with approximately 6 inches of earth, you could lay another layer of polyethylene, place the drain pipe at this level, cover with a course of gravel, then add more earth. Do this at 10-foot intervals across the roof, leaving the ends of the pipe open to a clean draining path. See Fig. 11-5.

Clay as a Water Barrier

One more thing you can do to help ensure the proper runoff of excessive water is to have clay soil trucked to your site, from wherever you can find it, and grade from 6 inches to 1 foot of clay over the roof (Fig. 11-6).

Good-quality clay will have a consistency similar to modeling clay. It should be graded to a peak and another 3 or 4 feet of good topsoil added on top of the clay. If water happens to seep that far down, the clay barrier will cause the water to divert off the roof.

The condition you can create with clay by

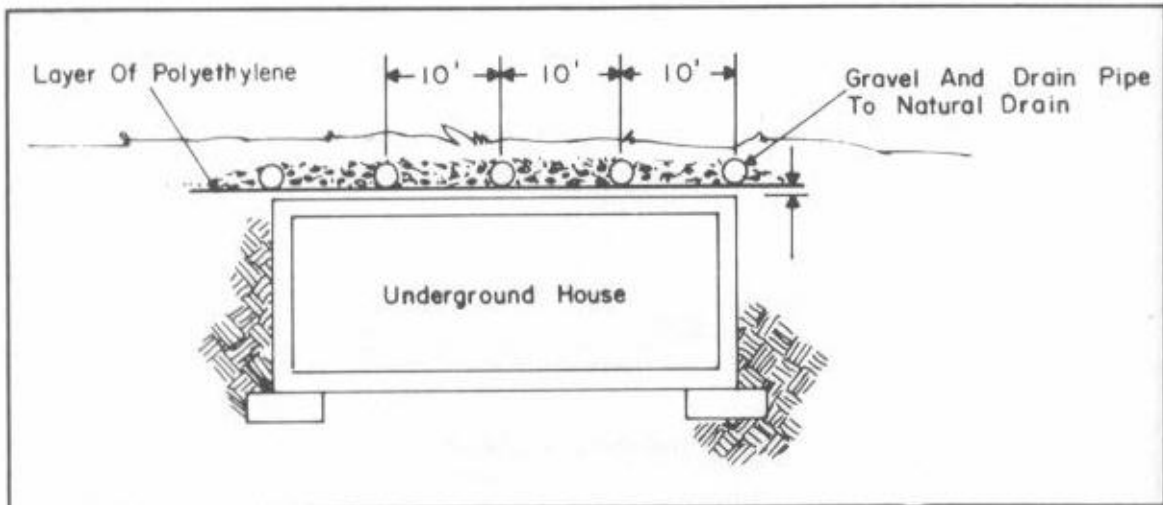

Fig. 11-5. Drain field over roof.

forming a pitch to the top of the concrete roof slab to divert water away from any opening can be formed into the concrete slab as it is poured. It is possible to pour the concrete with a pitch suitable enough to ensure that water cannot flow toward an opening such as your garden or chimney opening. At the same time, you could lay standard perforated drainage pipes in a bed of gravel directly on top of the concrete.

Use whichever system you feel safe with and top it all off with a crop of excellent quality grass. Once a good sod base has developed, keep it manicured smoothly and cut as short as reasonable. Follow your local landscaping expert's advice as to the length you can cut the grass depending on the temperature, rainfall, and other conditions affecting the ability of your grass to survive. I mixed two grass seeds together in a 50/50 ratio. One seed

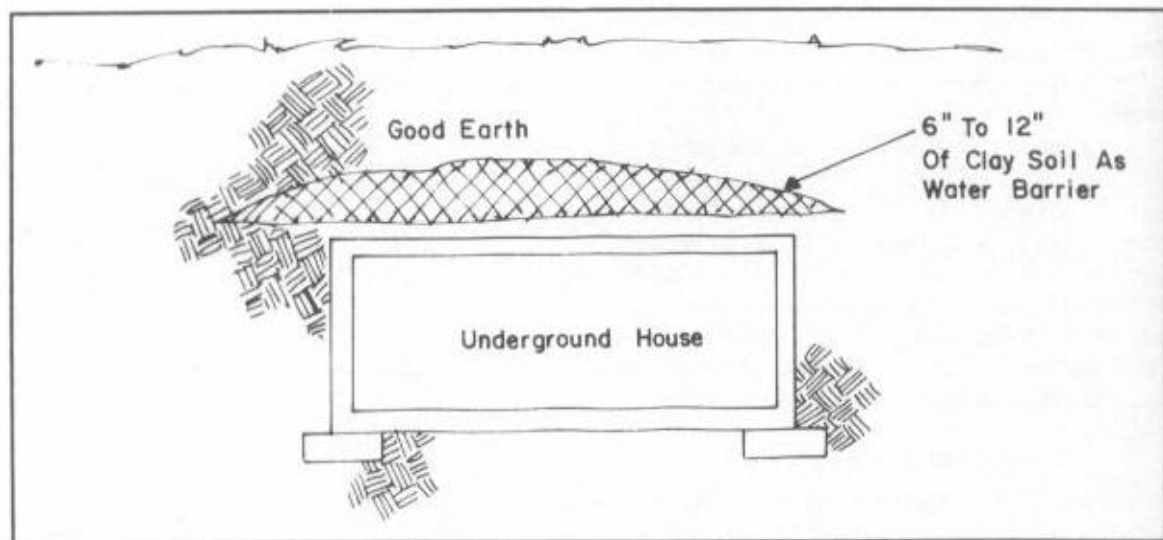

Fig. 11-6. Clay will also act as a water barrier.

sprouted in three days, when watered, but was an annual. This was only to prevent erosion until the permanent seed caught hold.

Smoothness of Roof

One additional fact worth remembering about waterproofing deals with the smoothness of the roof's concrete. The rougher the surface the more moisture the concrete will absorb. If the slab is polished smooth, water will not penetrate the surface. Obviously, there is a happy medium to work for. Refer to Chapter 9.

ROOF INSULATION

Insulating an underground house roof is a good investment. Now that my house is five years old and it has stabilized in performance, I find that about 85 percent of the heat loss is through the ceiling. The

walls and floors only account for 15 percent of my total heat loss. I must point out that the heat loss is still very minimal when compared to a standard above-the-ground house. I recommend at least an R-6 insulation barrier placed on top of the roof slab, after the plastic is in place.

The R-6 factor can be achieved by using pressed, high-density urethane or styrofoam sheets. These are manufactured in 4 × 8 sheets in many thicknesses. To reach an R-6 insulating factor would cost you about 35 cents per square foot. See Fig. 11-7.

Remember the words *high density*; this ensures less water absorption and a stronger panel. There is no need to join these 4 × 8 panels together by a tape or adhesive. Simply lay the panels on a bed of soft earth approximately 1 inch thick, and cover with polyethylene sheets see (Fig. 11-8). If possible, overlap the insulation a few feet as in Fig. 11-9.



Fig. 11-7. Insulation board can be used on the roof. Use high-density, water proof material.

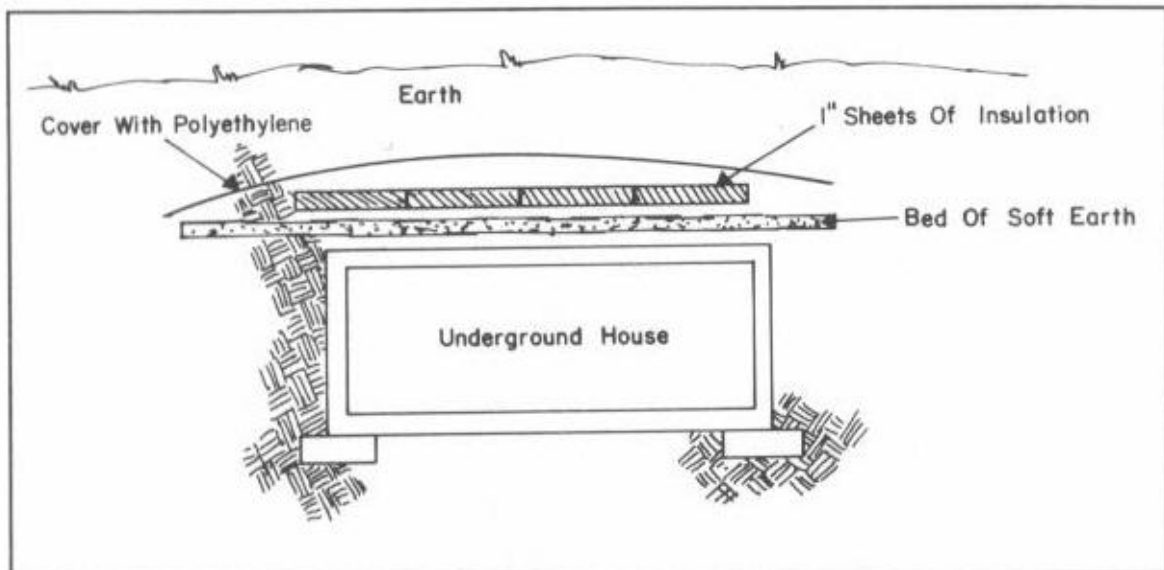

Fig. 11-8. Use at least 1 inch of insulation. While 2 or 3 inches would be better, it's expensive.

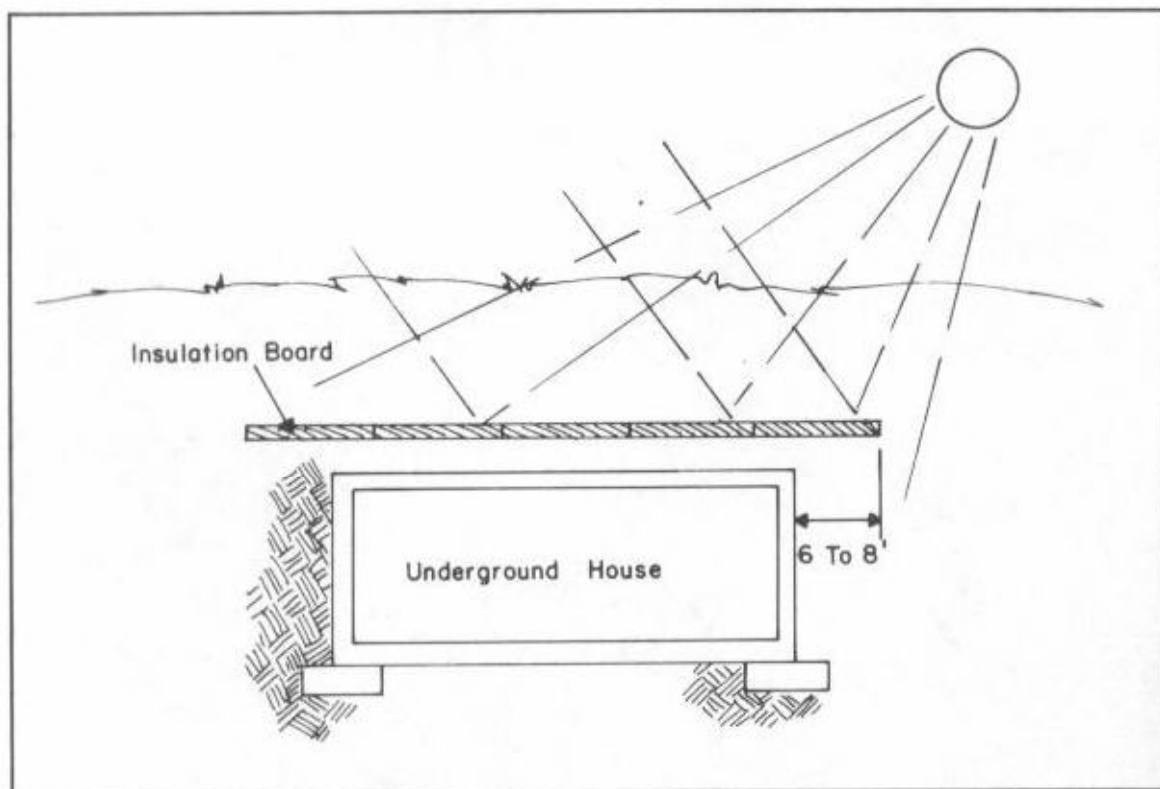

Fig. 11-9. Overlap insulation at the edge of the roof to prevent angular penetration of temperatures.

POTENTIAL PITFALLS

Waterproofing and insulation tend to be subjects that the general public tends to take for granted. For example, I've heard the statement "It can't leak, I covered the roof with 500 gallons of tar." Well, if the 500 gallons of tar were not applied evenly at the correct temperature, the quantity is irrelevant.

Insulation Absorption

If insulation material—be it styrofoam, urethane, or fiberglass—gets wet, the insulation value is eliminated. If this material dried out it would never be the same even if it never got wet again. That's why I've stressed high-density insulation that will not absorb water.

Sloping Door Sills

Anytime you have an opening in an underground

home on the floor level, you must remember to level or slope the poured concrete away from the interior. Just in case droplets of water would leak in over the door, window, skylight, etc., they would flow away from the interior as opposed flowing into the room.

Sloping Overhead Lintels

The opposite is true over each door or window; always slope the edge of the concrete away from the opening. Should moisture reach this level, it will tend to seek another point to escape into a drain rather than drip over the opening. These two conditions can cause an underground homeowner unlimited problems or save a lot of headaches. It's little things like this that make an earth-sheltered home work.

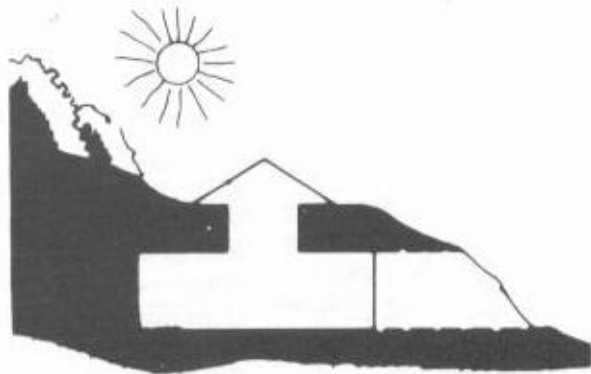

What About Moisture?

Whenever the subject of an underground home comes up in conversation, the same questions consistently pop up. What about moisture? Doesn't the house smell musty? Aren't there drops of water on the ceiling? Why isn't an underground home just like a basement? These questions are definitely logical so I'll try to explain why an underground house has no real moisture problems if it is mechanically water proofed.

Most people have been in an old house with a clammy-feeling basement at one time or another. The waterproofing applied to many conventional home basements is only one step better than nothing at all. Then the grading is quite often done with mainly cosmetic results in mind rather than keeping water away from the foundation. Also, the top of a basement is exposed to a fluctuating temperature. The interior floor and lower walls are always trying to maintain a constant 54° F (plus or minus a few degrees). In addition, the absence of physical activity in a basement causes a lack of the required air circulation. These are all a few reasons why a basement usually smells musty.

The reason my house doesn't have these problems is basic. My grading was given top consideration for maximum water runoff. Then my waterproofing was applied cautiously and generously.

GRADING

I recommend that the earth be graded to a minimum slope of 10 degrees (Fig. 12-1), and that the soil be packed firmly by the heaviest possible equipment that your roof structure will support. If you keep water physically away from the roof, the possibility of a water problem is greatly reduced.

CONDENSATION

Once these physical moisture barriers are complete, the remaining moisture problem is the result of the law of physics. Condensation is the direct result of temperature differential and the percentage of humidity of the outside air or simply the amount of moisture in the atmosphere (air). See Fig. 12-2. Warm air holds more moisture than cold

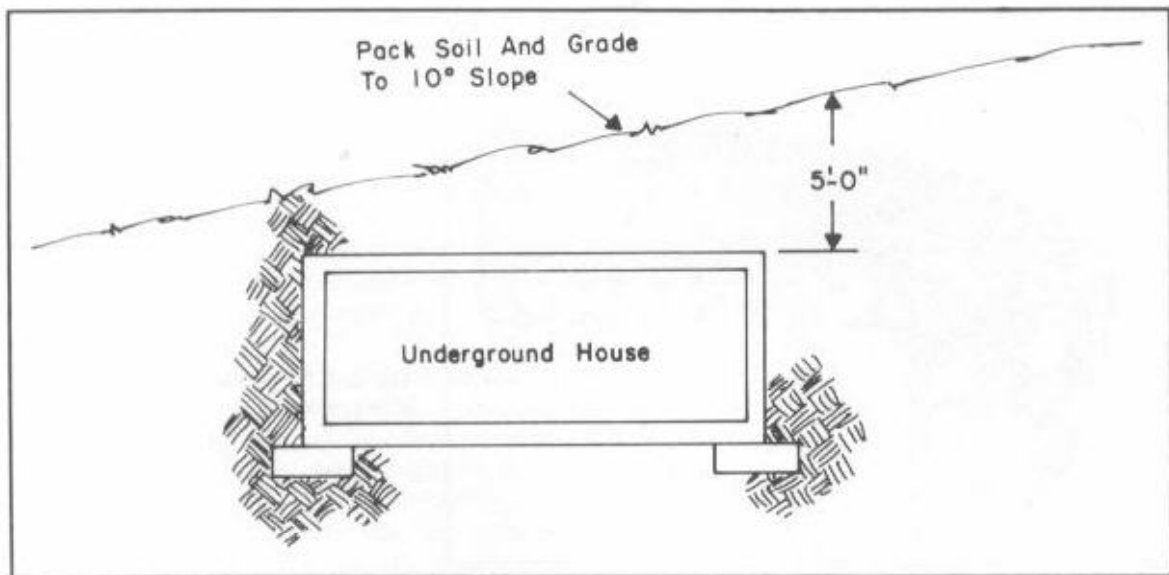

Fig. 12-1. Always maintain at least a 10° slope in grading.

air. The temperature differential I'm referring to is best exemplified by what happens when the windshield of your car fogs up when you first start to drive when it's cold outside.

The reason fog appears on the interior of the glass is that your body heat and breath are warm. Approximately $\frac{1}{4}$ of an inch on the other side of the glass is a temperature of probably 50 degrees or

colder. The $\frac{1}{4}$ -inch-thick glass is the point to consider. Remember hot and cold separated by a thin membrane will cause moisture to form on the warmer side.

The reason my walls do not sweat can easily be illustrated. The temperatures shown in Figs. 12-3 are estimated to help explain the point.

In Fig. 12-3 you will note that the temperature

Fig. 12-2. An example of how condensation forms.

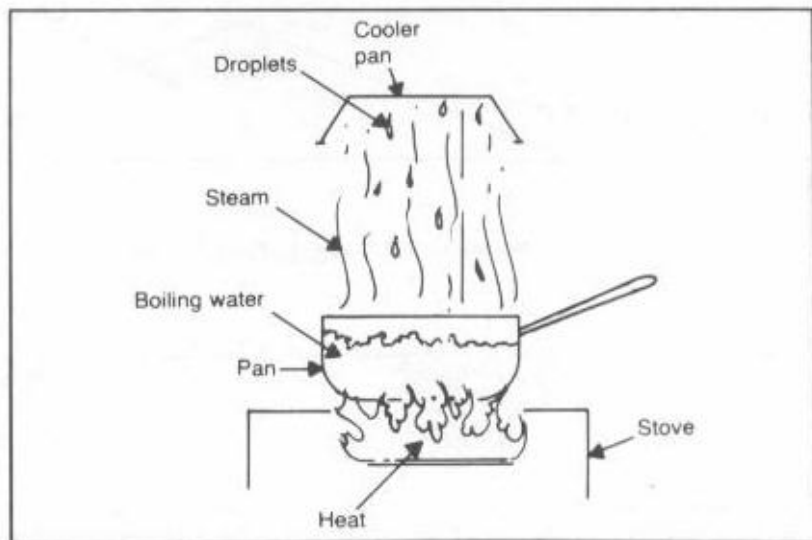

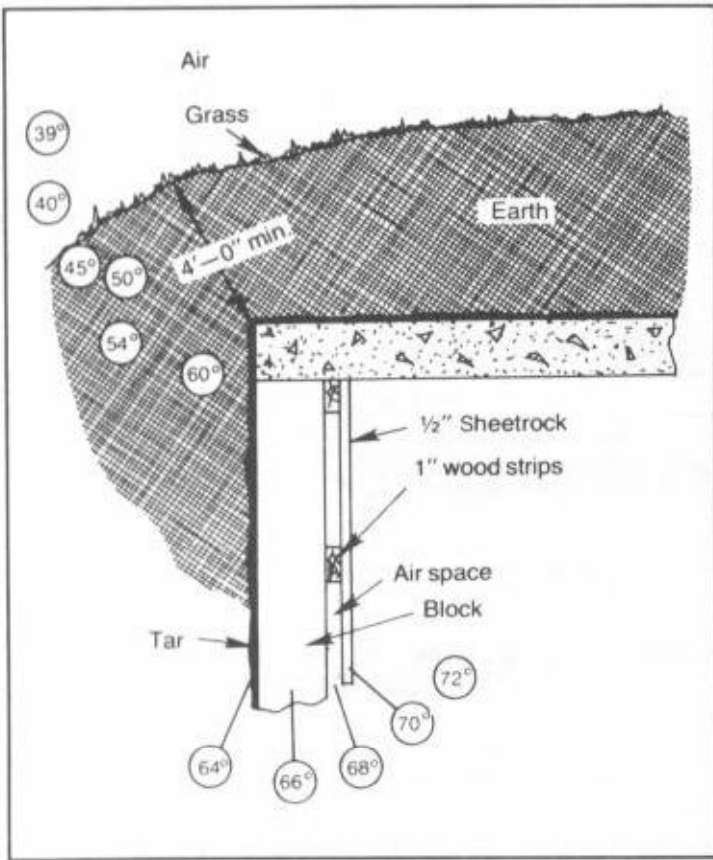

Fig. 12-3. Notice the gradual penetration of temperatures.

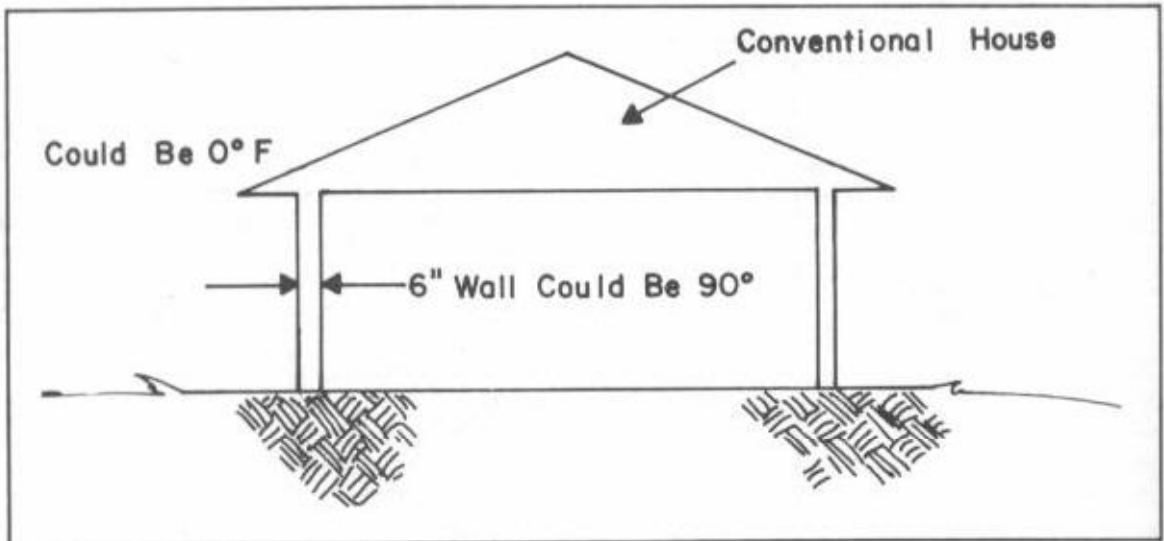

Fig. 12-4. Temperatures could be 90° different, only 6 inches apart in conventional construction.

differential isn't present. Figure 12-4 shows how great the temperature differential could be in a conventional basement. As you see, it is a similar condition to the cold-car example.

In short, if the temperature is similar on each side of the walls, the remaining moisture problem can be handled with a standard room dehumidifier. Therefore, when the walls and roof are surrounded by a thermal mass of concrete and earth, the extreme temperature is some distance away from the living area.

The reason I don't have a problem around my entrance doors is that the living area is separated from the outside temperature by a foyer arrangement (Fig. 12-5). Proof that this arrangement works is seen every springtime in most conventional garages. All winter the concrete floor has absorbed coldness because the garage usually is unheated. Most people get spring fever the first warm spring day. They swing open the garage door, in flows spring air, approximately 70° F, striking the 35-degree concrete floor, and condensation forms im-

mediately. If you live in a conventional home with a detached, unheated garage (anywhere except in the sunbelt), you've seen the phenomenon. This doesn't happen in an underground house unless you intentionally leave the front door open.

SPONGE EFFECT

Just as condensation is a potential problem, there is another moisture problem. It is technically called *capillary draw*, but more commonly it is called the sponge effect (Fig. 12-6). The reason for the name is simple. Just as a dry sponge absorbs water, so does the air inside of your house. The air in your house, however, is absorbing water from the earth because warm air holds more moisture than does cold air.

The sponge effect also refers to the moisture absorbed by carpet, curtains, Sheetrock, furniture, etc. This is precisely why you must take all precautions to ensure that the exterior rainwater is diverted immediately away from the underground structure. If rainwater were to seep against the

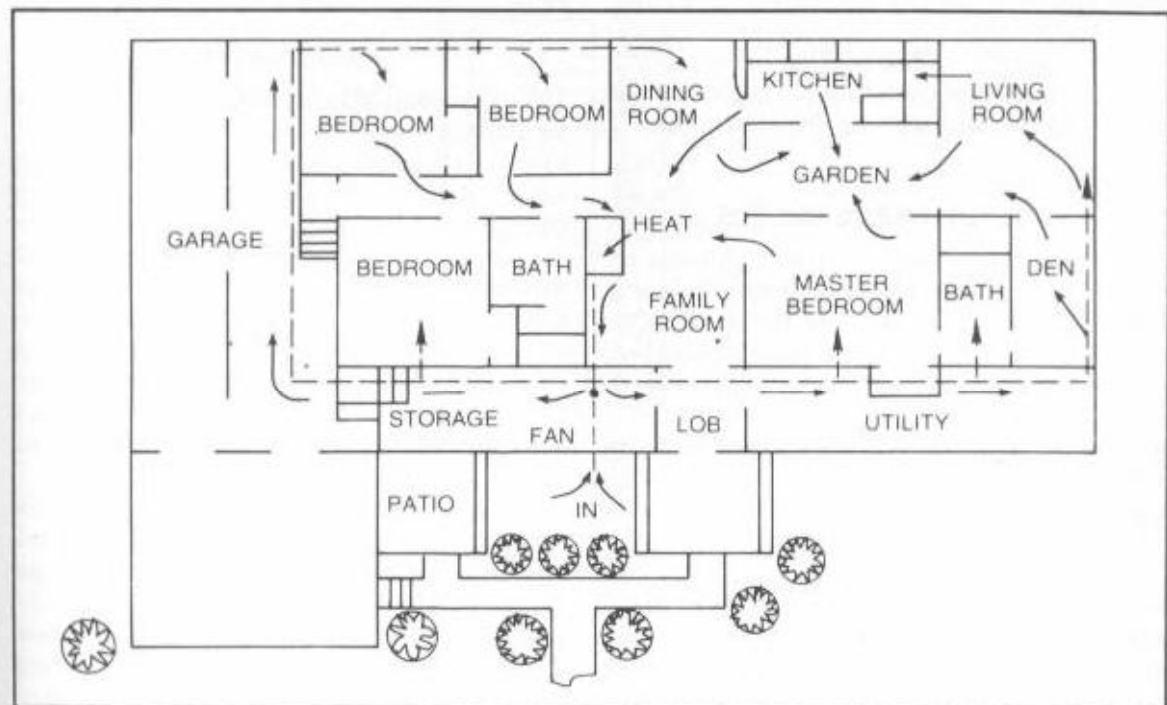

Fig. 12-5. Notice that the foyer and utility rooms separate living areas from outside.

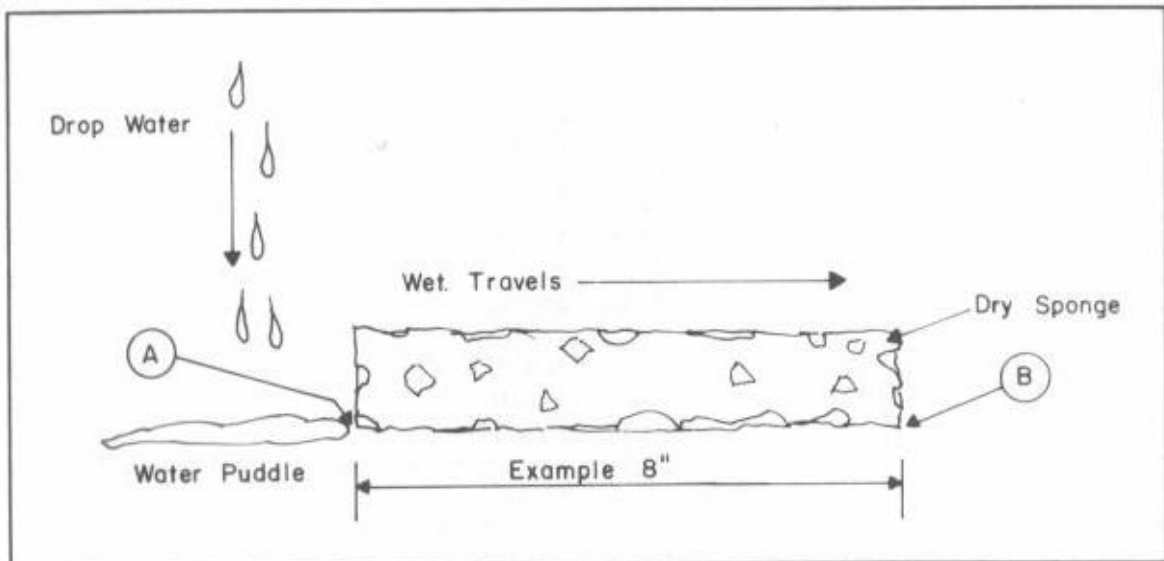

Fig. 12-6. In a short time, the water at point A will travel to point B.

block wall of your underground house (Fig. 12-6), the sponge effect would be immediate, and a simple household dehumidifier would not handle the overload of moisture.

One sure way to deal with the sponge effect is to place sheets of polyethylene between the inside of the exterior wall and the Sheetrock. See Fig. 12-7.

POLYETHYLENE SHEETS

There are a couple other methods to prevent the sponging of humid air (or at least to help slow it down). The first method is one that I employed. Wrapping your house in polyethylene sheets is valued for helping to prevent the sponging effect of moisture coming from the earth to the interior. Remember, however, that once a hole is in this material the water will definitely find it and be trapped inside against the block rather than be absorbed back into the drier earth.

This is why the polyethylene sheet should be kept in the largest single seamless piece available. Polyethylene can be bought most places in 100-foot-by-20-foot rolls, 4 mil thick. This works well and especially if the connecting areas are overlapped and tucked (as in Fig. 12-8). A safe method

would be to cover the exterior with polyethylene as well as hang a poly barrier on the inside. See Fig. 12-8.

AIR POCKETS

The second method is one that, if you have followed my building suggestions up to this point, you will have already included it in your house. This system has a 1-inch air pocket created by the wood furring strips used to hold the Sheetrock up. Air pockets are the best way to prevent sponging of moist air from the earth to the interior. A 2-inch air space would be better, but the cost of furring all the walls with a 2-inch air space would be greater. A 2-inch strip of wood is probably prohibitive from a cost and labor standpoint. There is no value in creating a space greater than 2 inches between the Sheetrock and the block walls.

The construction of my exterior and interior walls, combined with the special air circulation system I installed, are adequate to prevent most major moisture problems as long as the air is exchanged frequently in corners, closets, and behind furniture. This air will move about with the simplest of ventilating systems using a mechanical in-line fan.

Note the description of the in-line fan in

greater detail in Chapter 17. A reminder here that the building codes in different areas affect the air handling system greatly as well as the possible thickness of these air pockets. My book is a thought provoker. The final design is controlled by your local building codes.

HUMIDITY

Humidity and condensation are both moisture problems but they are not the same animal. The

cold air meeting a warm surface (or vice versa) takes place in your underground home. What about the humid air Mother Nature creates. This humid air will be drawn into your house underground or not. Humidity will be a slight problem that you will have to deal with.

A standard, large-room-size dehumidifier will remove the extra humidity. Now don't be shocked by that statement. Remember that anywhere in the United States, except possibly the southwest,

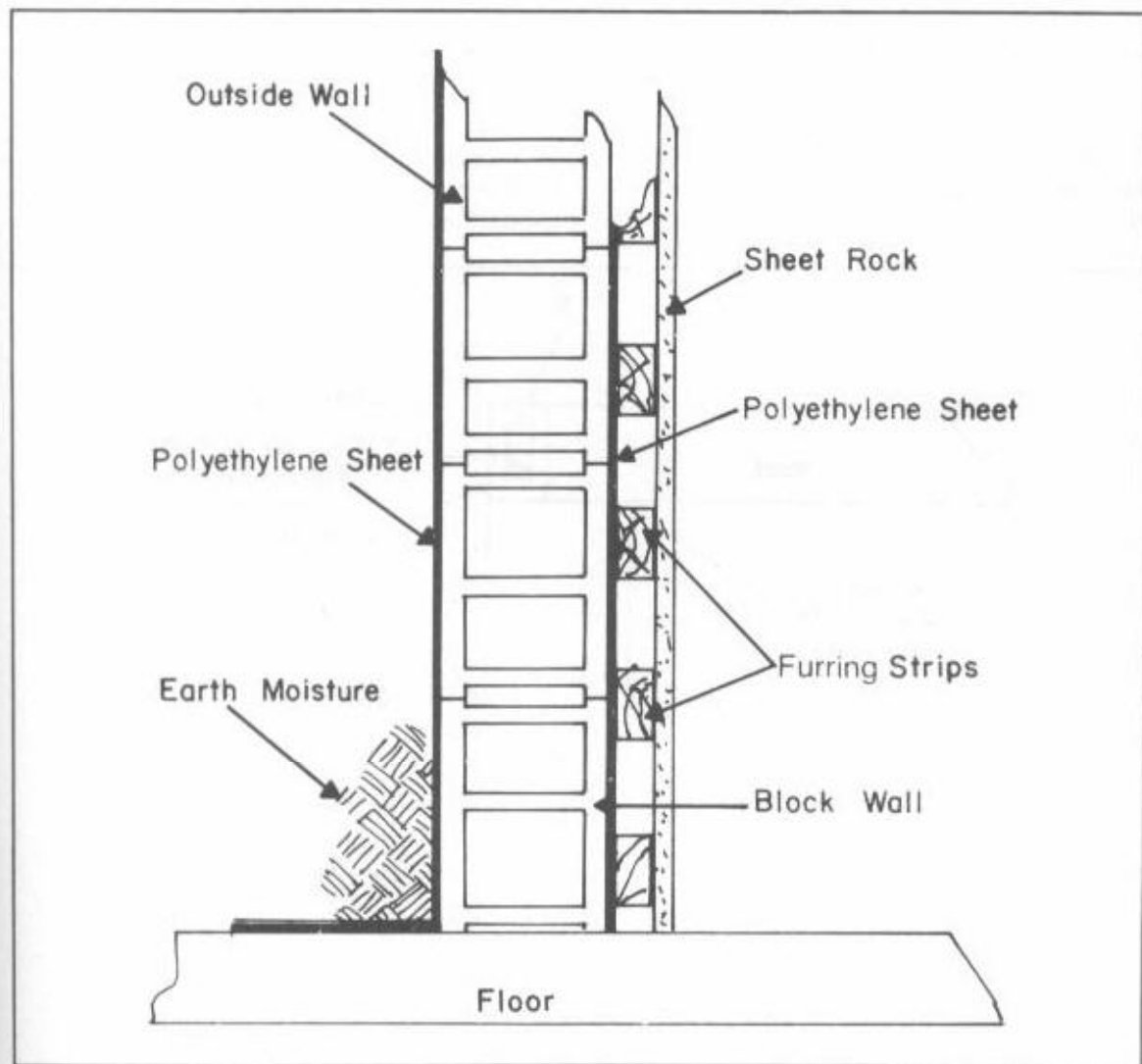

Fig. 12-7. Typical section of exterior wall.

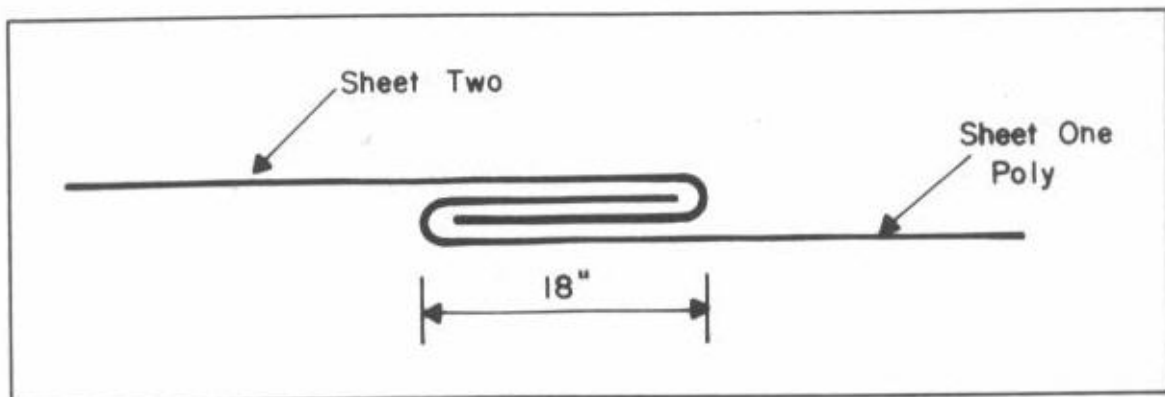

Fig. 12-8. Lopping method of plastic sheets; no glue is necessary.

people use dehumidifiers in their conventional houses. I'm just reminding you that you can expect the same simple humidity problems as in any other house.

Each section of the country has conditions and weather patterns that are specifically their own. For this reason, and due to the long technical calculations, I am not going to go into great detail about

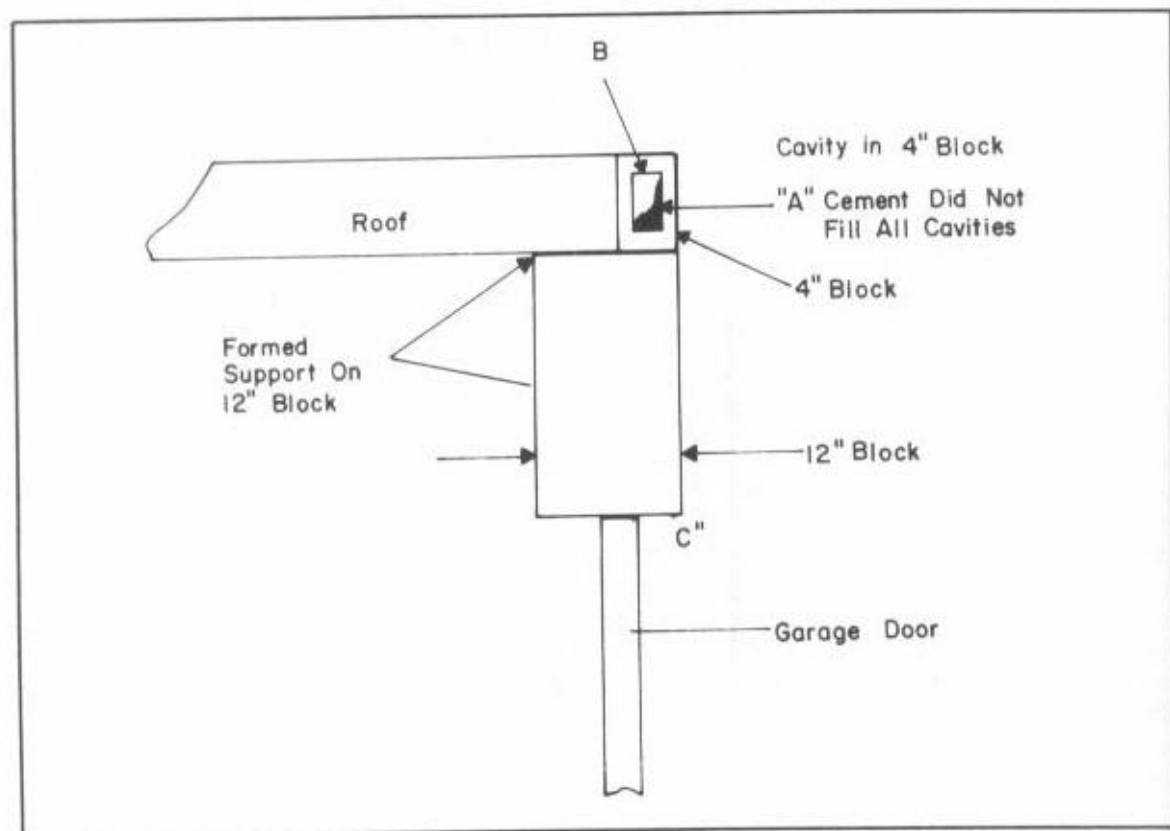

Fig. 12-9. The oversight caused me a problem. Water travels from Point B down cavity Point A to Point C over the garage door.

how to figure heat loads, humidifier sizes, etc. There is one term, however, that should be mentioned. *Dew point* is the temperature at which moisture droplets will form. This is not a constant point. It fluctuates with the percent of humidity in the outside atmosphere.

You learn a great deal about the dew point as you discuss the construction of an underground house. After lengthy discussions with numerous experts in the field of air handling, I proceeded to install an air-handling system. The dew point is another law of physics that applies to warm air holding more moisture in vapor form than colder air. This explains the lessening of a humidity problem in the winter.

Another thing you can do to lessen the possibility of a moisture problem is to insulate hot-water and cold-water pipes. Also insulate the hot water heater.

Moisture is a problem that can be conquered—probably as easy as any other problem connected with an underground house—if you approach it head on instead of pretending it won't be a problem.

As you might recall, I built the walls of my house out of block and the roof out of poured concrete. Figure 12-9 shows how I kept the flowing concrete from flowing off the roof scaffolding. I forgot to make sure that each of the 4-inch blocks became filled with concrete.

Now four years later, I find that at least one block wasn't filled and a small leak developed over the door in my interior atrium. I'm now digging this up and applying a waterproof coating. If I had been observant in 1977, I wouldn't have to excavate this area in 1984. We all get in a hurry to finish a job, and especially on as interesting as an underground house. I hope you learn by my mistake.

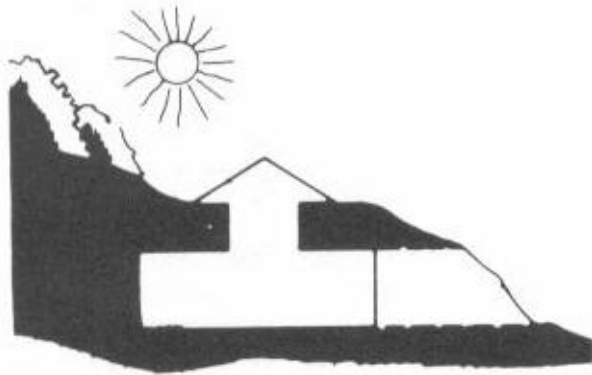

Backfilling and Grading

By the time you get this far, you will have approximately 75 percent of your money invested, listened to plenty of ridicule and put in hundreds of hours of hard work. Don't make a major mistake now. Whatever you do, don't do any grading near the building for at least three weeks after the concrete roof slab has been poured. Even then I suggest you tread softly until the concrete has cured for five weeks.

At this point, I'll tell you of a change I will make on the next underground home I build. I will not try to waterproof the entire structure at one time. As shown in Fig. 13-1, I did not backfill against the exterior walls until the roof slab was complete.

My reasoning for this was to keep the complete surface, four walls, and the roof exposed so that they could be sprayed with hot tar and wrapped in polyethylene sheets all in a continuous application. This proved to be unfeasible because of the difficulty in keeping the area around the walls free of fallen earth and water (from rainfall). Additionally it is very difficult to handle sheets of polyethylene 90 feet long and 30 feet wide. The slightest breeze

creates an uncontrollable flapping in these lightweight sheets of plastic.

The cavity along the block (Fig. 13-1) was approximately 3 feet wide and 15 feet deep. It was constantly falling away and then needed to be hand shoveled out. Try throwing a ton of wet dirt shovel by shovel 15 feet in the air over your shoulder and you will soon see that wrapping the structure in one piece isn't worth the effort. If I had it to do over again, I would complete the exterior walls and spray them with two coats of tar to within 1 foot of the roof-slab line.

After the wrapping of the plastic (Fig. 13-2) and about one day of drying, I would begin pushing dirt against the wall, first checking to see that the drain pipe at the base isn't disturbed by the first load of dirt falling from as high as 15 feet.

By backfilling as I suggest, (not as I did), you will eliminate a couple of the major problems I had throughout early construction. The first problem was the constant collapsing of the dirt before I had the tar sprayed. Second, it was a constant safety

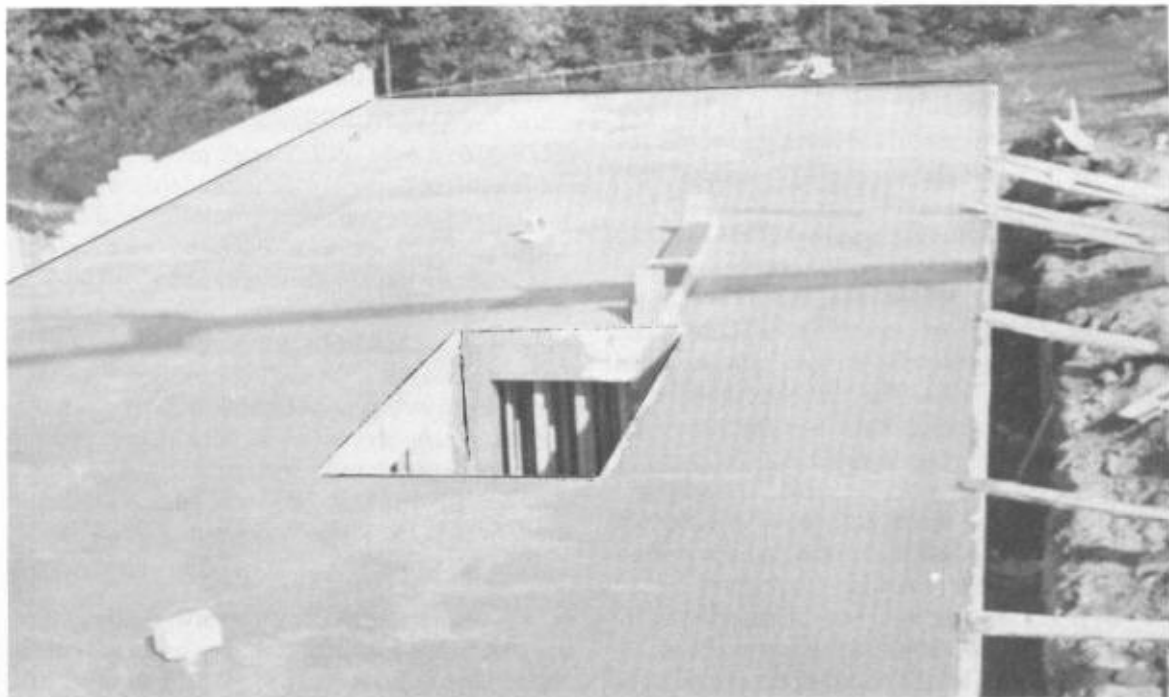

Fig. 13-1. Notice no backfilling is done until the roof slab has been poured.



Fig. 13-2. Polyethylene sheets are difficult to keep smooth.

hazard, and more than once I dropped tools into the hole and had to climb down to retrieve them.

A constant concern was that someone or a neighborhood pet would fall down into the man-made creation (Fig. 13-3), and hurt themselves. As I was grading, an official stopped by to tell me that I needed a barrier of some type to stop soil from washing into a small stream nearby (300 feet away). There was and is a hillside of natural vegetation of underbrush, trees, bushes, etc., but he wanted me to provide a barrier of bales of hay or straw staked to the ground to prevent erosion into the small stream. See Fig. 13-4. The part that irritated me was that this excavation was never mentioned as a safety hazard to human beings.

It bothered me so I eventually put up a makeshift warning fence. But the inspection officials never mentioned it. Another paradox of bureaucracy: holes were not his department.

By doing the grading at two different times, the dirt against the wall has time to settle, especially after a heavy rain. Do not do any of the grading until all interior block walls are tied in place to the exterior walls or these exterior walls will crack or

collapse. If you now fill the dirt against the exterior wall, it will be easier to move around while preparing scaffolding for the roof pouring. See Fig. 13-5.

OVERLAPPING METHOD

If I could do it over again, I would prefer to spray the walls from the bottom to the top and then wrap them with the polyethylene by folding a piece of polyethylene 20 feet wide in half to form a piece 10 feet wide. By the length of your house or 100 feet, whichever is greater, you can rather easily attach the plastic to the wall by brushing on a new layer of tar or asphalt near the ceiling line. See Fig. 13-6. This will allow the polyethylene to hang down as a curtain, all the wrinkles will fall out, and you can easily maneuver it to get it straight and wrap around a corner. Be sure that the plastic folds out over the drain field at the lower wall (as in Fig. 13-7).

BACKFILLING

Now you can begin pushing the earth gently against the wall, making sure that all large rocks and debris are removed. Allow only loose soil to touch the polyethylene. Otherwise rocks will tear holes in the plastic and it will be basically useless.

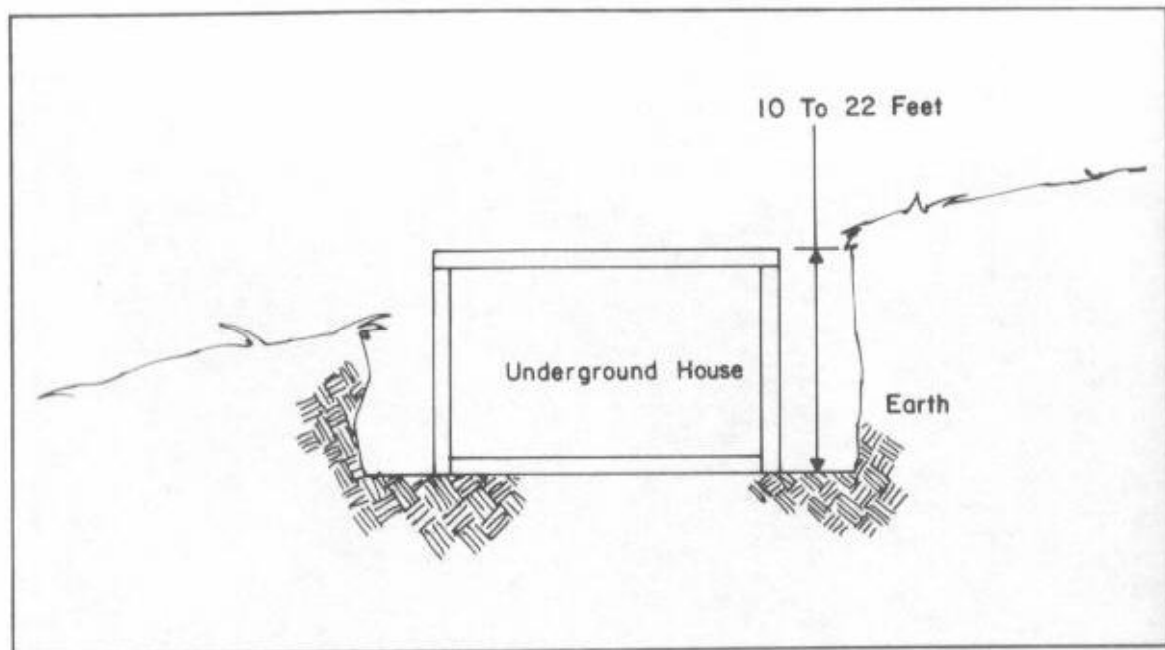

Fig. 13-3. Excavation causes dangerous conditions for visitors.

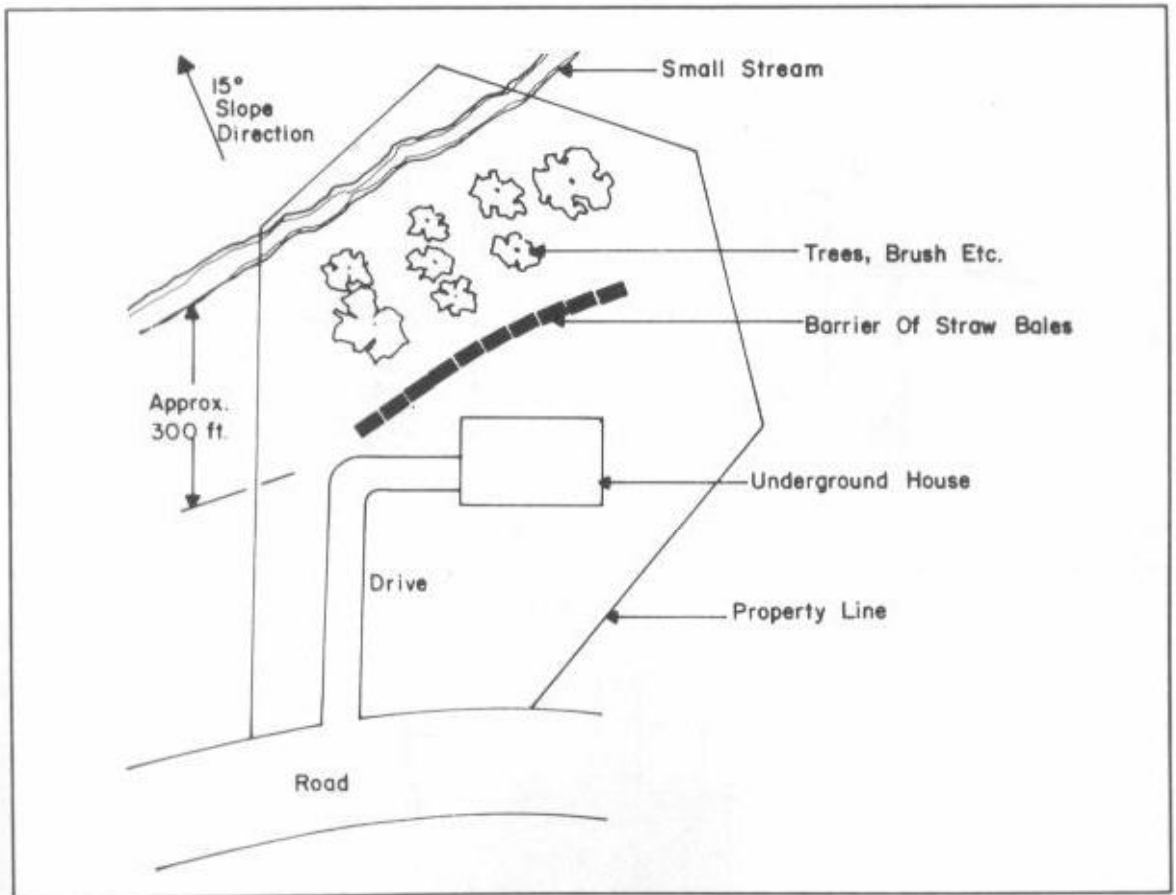

Fig. 13-4. Provide a run of barriers with bales of hay or straw to form a dike.

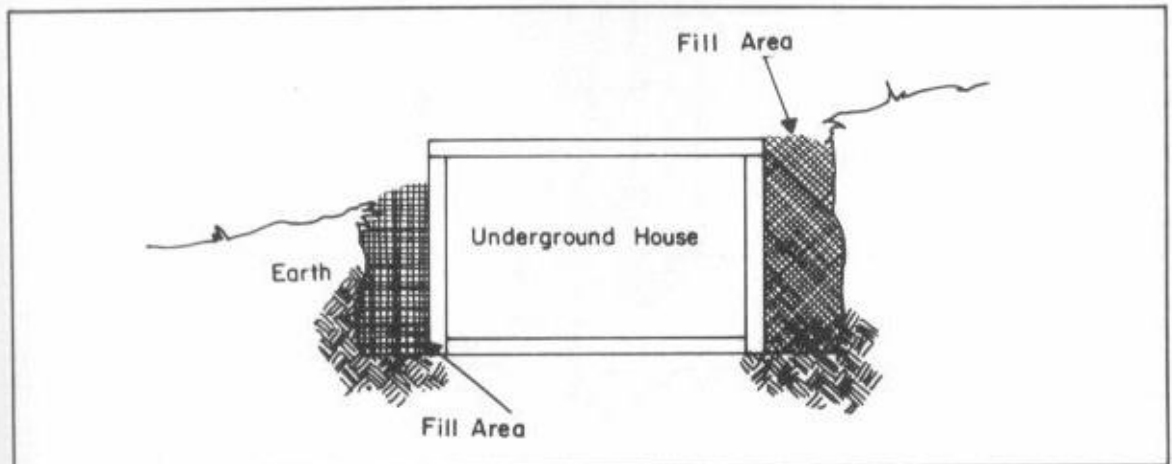

Fig. 13-5. Backfill areas before the roof scaffolding is placed. You need to walk on this space.

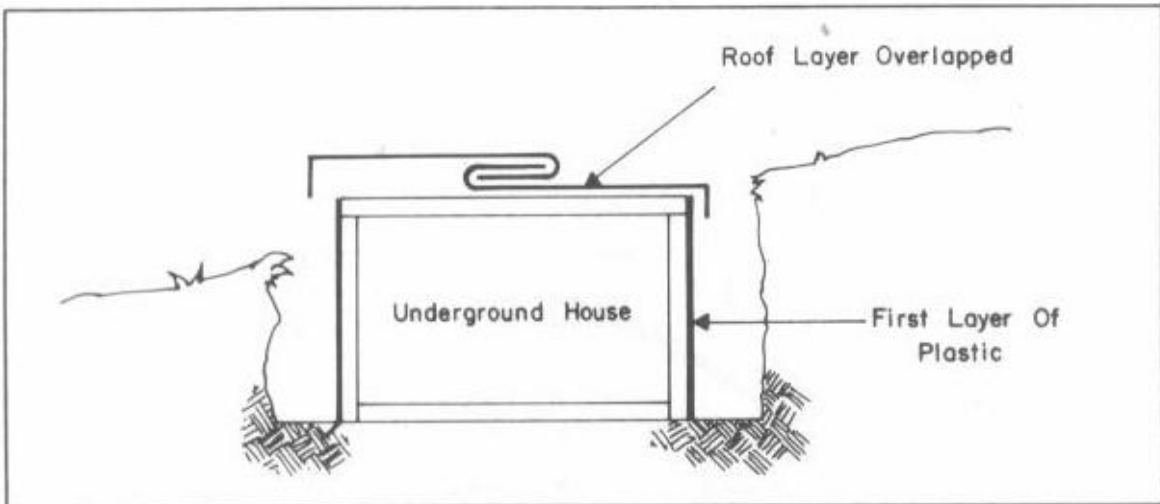

Fig. 13-6. Overlap the roof with plastic against the wall. Be sure to spread tar in between with a brush to form a good bond.

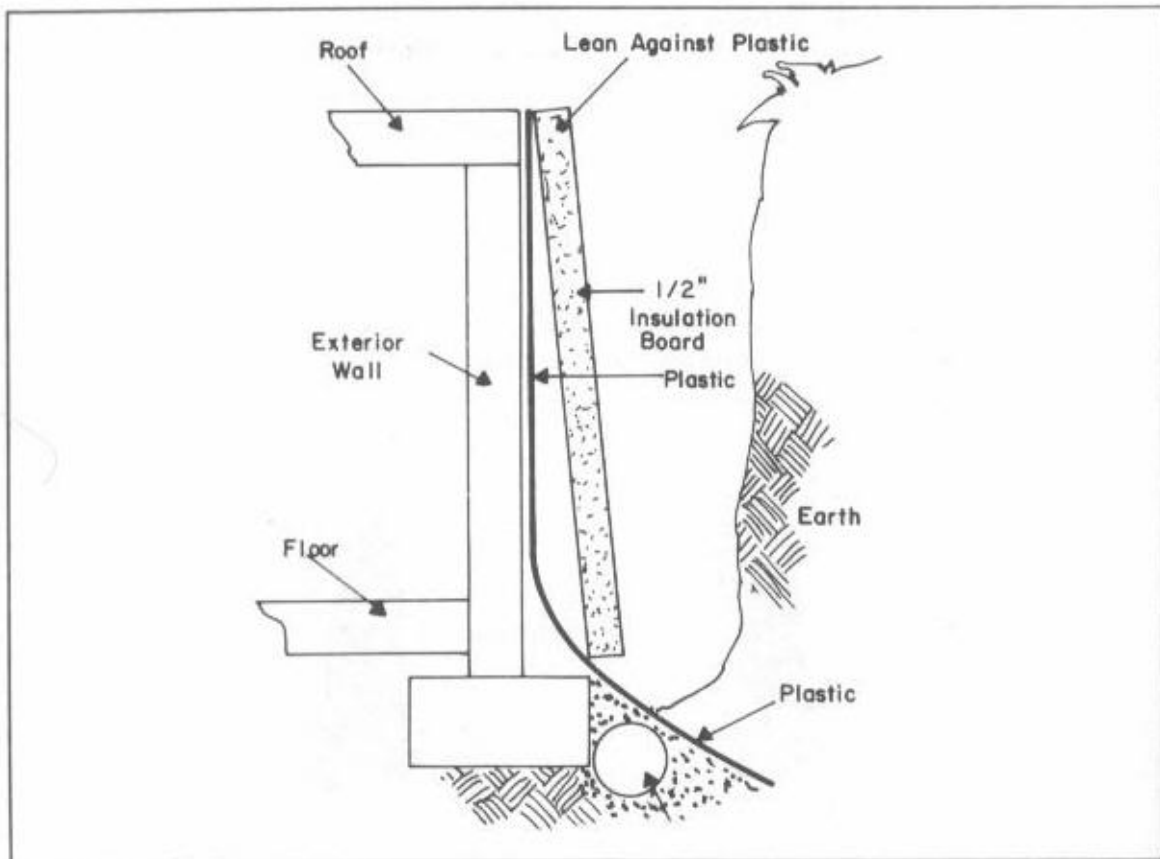

Fig. 13-7. If money is no factor, use insulation on particleboard to shield against rocks tearing the plastic as you backfill.

INSULATION BOARD

If by chance your soil is filled with the small, sharp stones commonly found in some good earth and it is not practical to screen this all out, you could install 4-x-8-foot sheets of any of the pressed insulation board commonly found in building supply stores. The material is about $\frac{3}{4}$ of an inch thick and inexpensive. It goes by many commercial names, but it is commonly referred to as black insulation board (even though its insulation quality is basically useless).

This board does act as a shield against the rocks or stones hitting the plastic. Use your good judgment and decide if this extra precaution is necessary. (Fig. 13-7). Once the walls are covered with plastic insulation board and the earth is backfilled to a level about 18 inches below the roof

top (as in Fig. 13-8), you are ready to go to the next phase.

Time Is Important. I do not recommend that you let a long period of time pass before beginning the backfilling of the roof. Try to avoid a heavy rainfall from running down behind the plastic (as in Fig. 13-7). If it does happen it will cause the water to seep down behind the plastic but in front of the tar. It could take quite a while to dry out thoroughly.

Think of your underground house as a sponge. If you would place a wet sponge in a plastic trash bag and bury it, it would take quite some time to dry out. Bury a dry sponge in a similar manner and it may never get wet. The early success of your home depends on how dry it is as it is covered over. Unlike the wet sponge, you would be able to dry a wet underground house out by turning de-

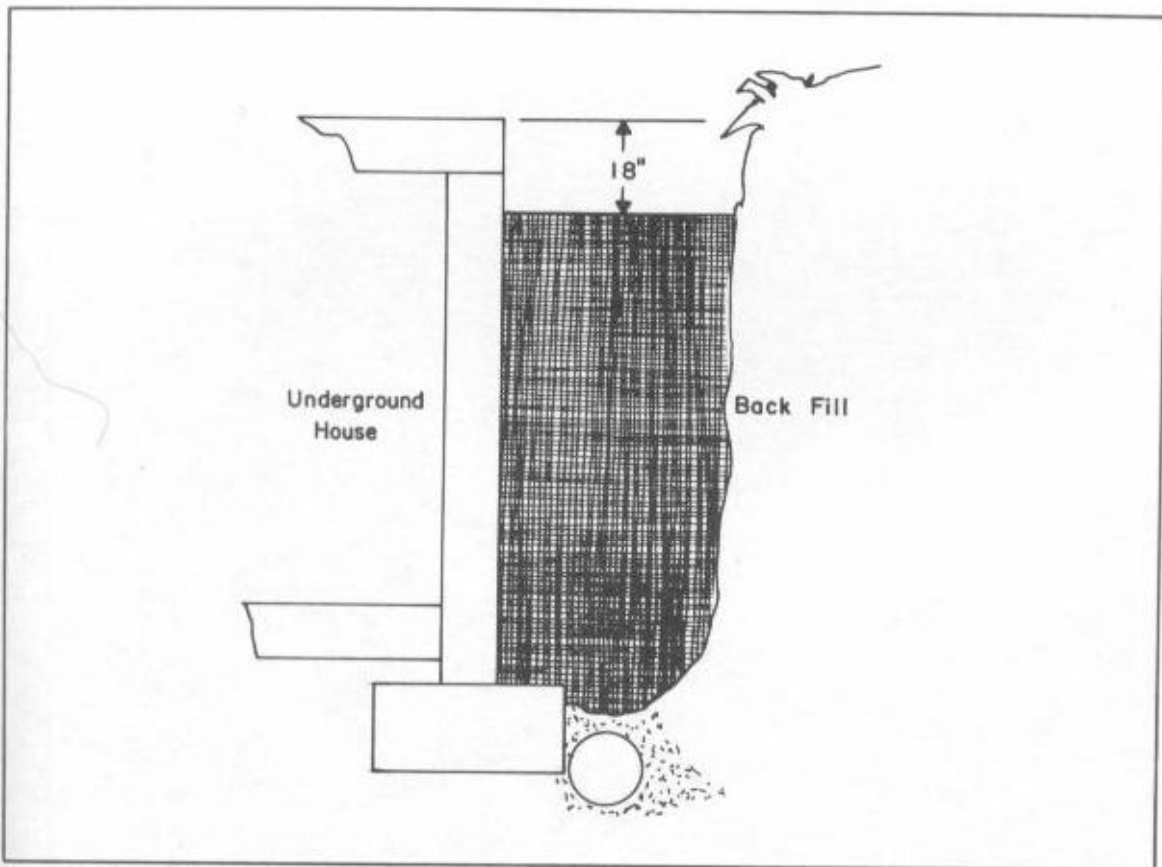

Fig. 13-8. The 18 inches of space will give you room to seal the roof plastic to the side plastic.



Fig. 13-9. A small tractor works well for placing earth on the roof.



Fig. 13-10. A small tractor is very easy to maneuver and it is not too heavy.

humidifiers on the inside until a desired humidity level is reached.

USING A TRACTOR

Now begin to spread the dirt over the roof unless your engineer says otherwise. Leave the underside shoring up until you have at least 3 feet of dirt spread smoothly over the complete structure. Do this with a small tractor, initially, similar to the one shown in Figs. 13-9 and 13-10. One like this can usually be rented by the day or week.

The reason I say a small tractor and 3 feet of dirt is that the dirt transfers the weight of the tractor uniformly downward onto the roof slab as opposed to the weight of the tractor being distributed to only the four wheels of the tractor. Putting the dirt over the slab roof safely is one of the most hazardous phases of building this type of house.

Using the small tractor with a front bucket is one method of moving dirt. It is also the preferred method.

The small, front-end loaders can only haul approximately one-quarter of a yard at a time, but then Rome wasn't built in a day. Do not use a bulldozer on the roof. See Fig. 13-11.

If you have a light, compact car like a Volkswagen or a Datsun and a small utility trailer like the smallest open-bed ones you can rent from rental outfits, you are also ready to move dirt. Pull the empty trailer to the source of dirt. Use common sense as to how full to fill the trailer. Then drive the car and trailer onto the roof, but only after you have spread at least 6 inches to 1 foot of dirt by some other method such as a wheel barrow or bucket.

Whichever method you use, don't drive a tractor, car, or anything else directly over the tar or

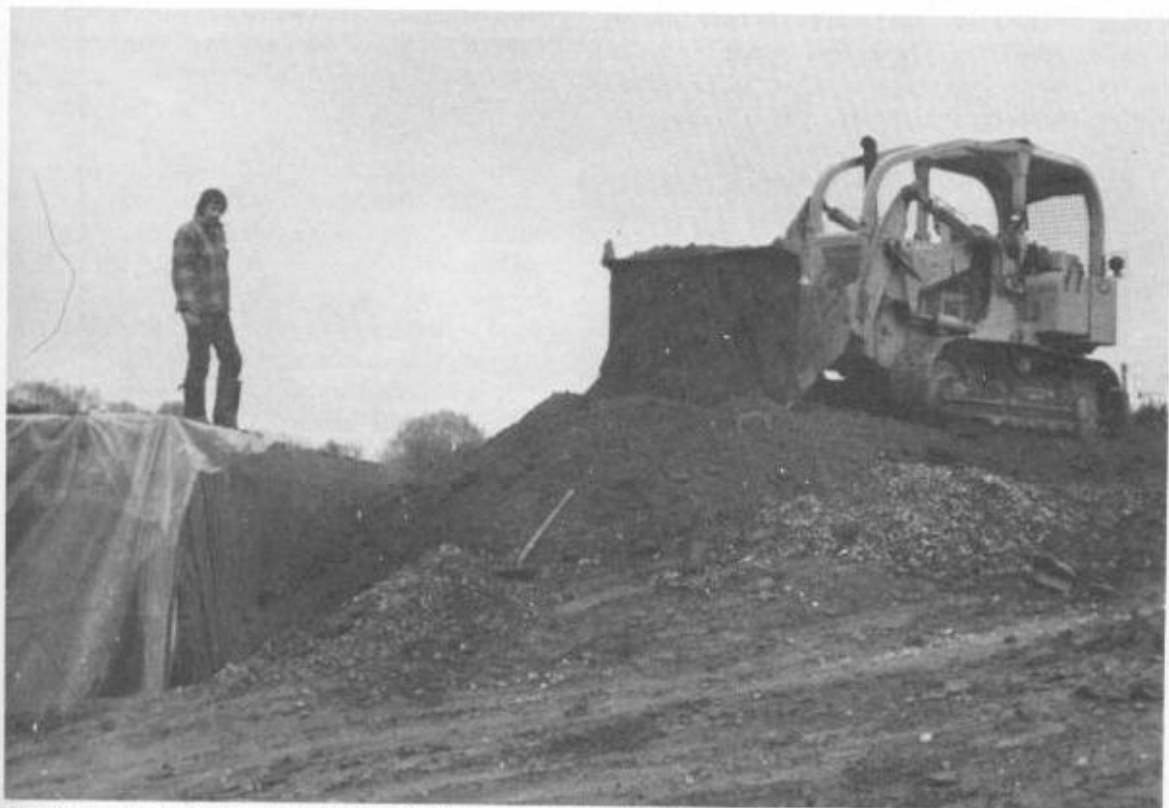

Fig. 13-11. Don't get into a rush and let the bulldozer go on the roof. This is me guarding against possibility. (My neighbors thought I was going to jump, but I fooled them.)

plastic. The tar, as thick as you have on your roof, will never dry hard and any vehicle will slip and slide as if on frozen water. You can get around doing this by hand by backing the trailer to the edge, dumping the first load and spreading it roughly. Then back over that load and dump the next. Keep leap-frogging backward until you have enough dirt spread to drive forward and make a circle. This will cut down on the time it takes you to make a single trip. Naturally, if you are using a small tractor, you dump frontward and continue the same procedure. Just don't drive on plastic or tar until 6 inches of earth is in place. Then it's only a matter of the number of trips you make. Patience will be rewarded in this phase of construction.

USING A CRANE

Still another method that is to be considered, depending on availability and cost to you, is the crane. It could be the same crane you might have used to dump concrete. Use the largest bucket available and fill it with dirt using your backhoe. The crane will then very accurately place the dirt. The only disadvantage is cost.

If the money is available, you can't beat a crane and a bucket for accurately placing the earth over the roof. All you need is a medium-size, front-end loader to load the crane's container as fast as the operator can dump. This crane will cost about \$300 per day for dumping earth. It is less expensive than dumping concrete because there is less of a risk. As opposed to the concrete-dumping phase, the earth-dumping phase requires only two people: the crane operator and the front-end loader operator. The crane operator can trigger the bucket release from inside the crane. An operator is not required on the roof top.

Whatever method you choose to use, be careful when working close to the edge. This dirt is loose and will roll and pack. This can easily upset tractors, cranes, or any other mechanical equipment.

FINAL GRADING

After five weeks, if the 3 feet of dirt and the supports are still in place, it will be safe enough to take

your backhoe on top of the structure. Remove the bucket from the back. This is easily done; don't take a chance carrying all the extra weight of the bucket onto the roof. Only the scoop on the front will be required.

Once you are finished running around up on the roof with your backhoe, then put the aft bucket on and finish up the rest of your grading. The reason you can't continue to use a small tractor or trailer is because that will only move or carry approximately a quarter yard of dirt. A backhoe tractor will carry one-half to three-quarters of a yard at one trip. You'll be thankful for the extra hauling capacity when you start dumping dirt over the edge to build up a sloped wall (if that is your design).

Don't drive on the roof unless you have complete control of the tractor! Next to driving a grading vehicle on the roof, the most dangerous thing you can do is operate a bulldozer or large tractor close to an unsupported wall while pushing soft dirt. The weight of the vehicle pressing down on soft dirt displaces it (Fig. 13-12). This dirt must go somewhere and it will try to push the nearest block or concrete wall away.

As final grading progresses, don't be surprised if you have to haul dirt to your site before you're done. I thought I had enough dirt to cover half the neighborhood, but I found out that I needed another 125 tons of dirt. The need for additional fill dirt will depend on the lay of your land, the amount of dirt you have excavated, and the design.

If it is necessary to bring in additional dirt, check every price in town. I found good, clean fill dirt—not topsoil—ranged from \$1 a ton to \$5 a ton. So you can easily add up the potential savings. If good topsoil is required, the price is much higher. Don't use topsoil for fill and don't use fill for topsoil. Only a few inches of good soil is required to grow grass.

BACKHOE REMOVAL

As the grading and filling phase of your subterranean home draws to a close, you will find that the backhoe I suggested you buy is no longer required. Once the rough driveway is in and all the major grading is complete, begin to look for a buyer for

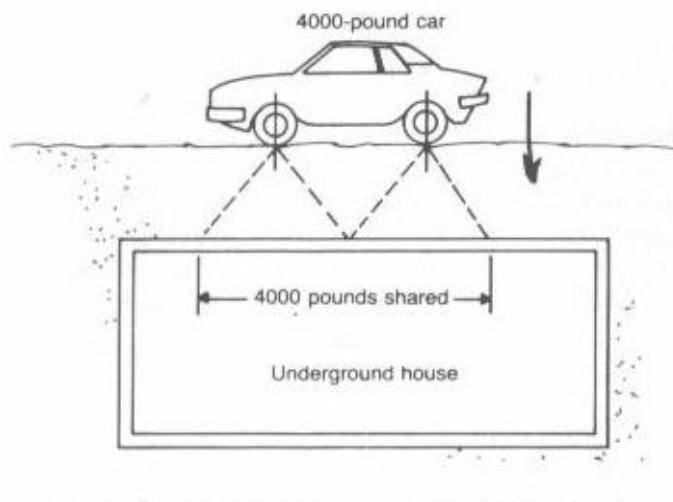

Fig. 13-12. The weight of a vehicle will displace the earth as the wheel presses downward.



Fig. 13-13. Trade your backhoe for a riding garden tractor with attachments.

this heavy equipment. If you made a good buy and didn't misuse your tractor, you will probably make enough profit to buy a large riding lawn mower with a snow blade and a small trailer. See Fig. 13-13.

GRASS SEED

Final grading takes place by hand raking and shoveling. Be sure to plant the best grass seed and fertilize it as recommended by the experts in your area. Even grass seed varies from locale to locale. For final grading, check into the use of sod. I tried to

use it on a steep grade. After the first heavy rain, it came tumbling down under its own weight (Fig. 13-14). I had better luck planting fast-growing grass seed with good grass seed than I did with sod. Use your own good judgement and ask people in your area for advice.

Seeding Sloping

Getting grass to take on any lawn in the springtime in most sections of the country is somewhat of a problem because of heavy rains at times. Getting

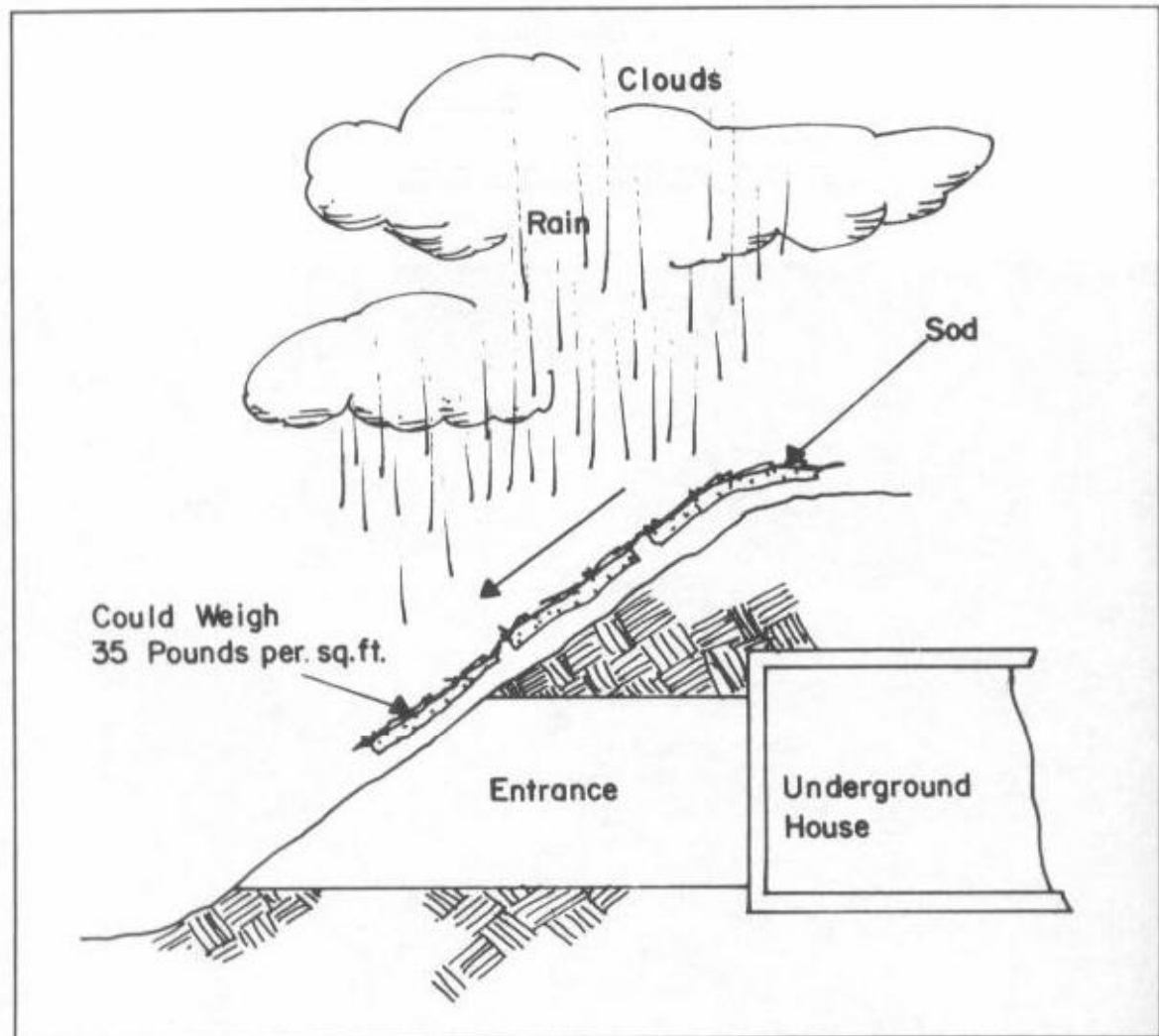

Fig. 13-14. Sod will slide down the hill under its own weight where soaked with rain that could weigh 35 pounds per square foot.

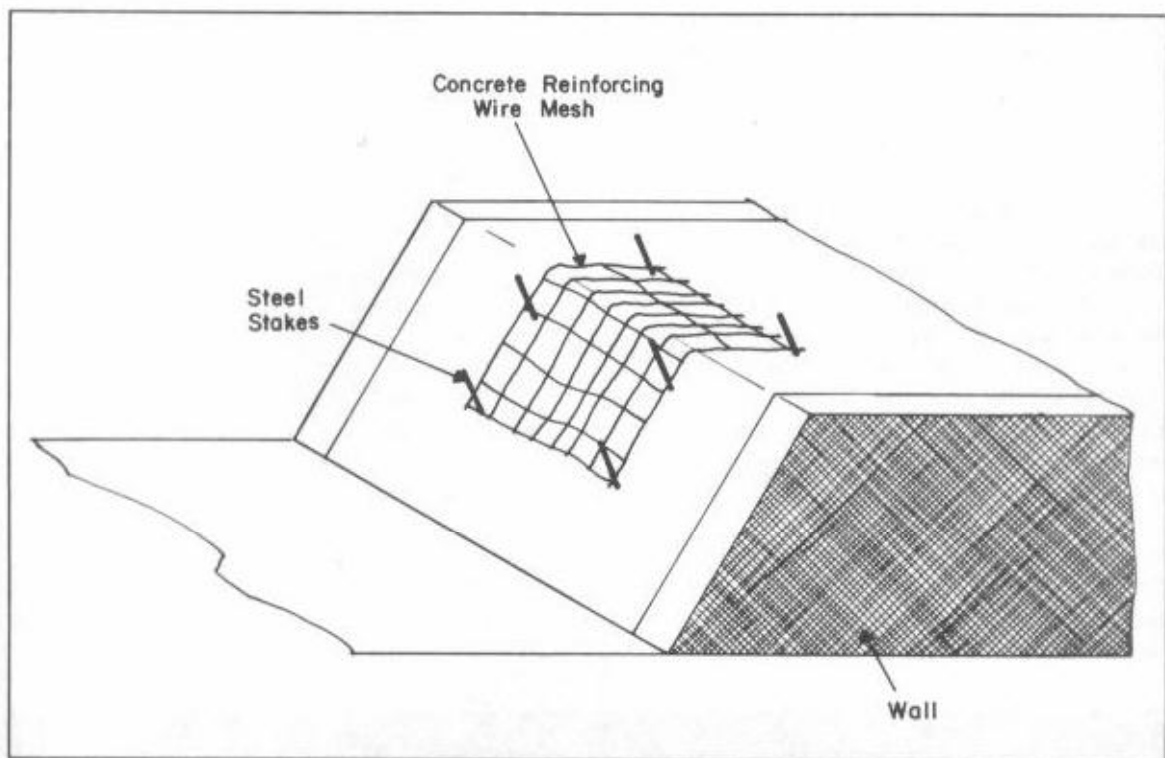

Fig. 13-15. Placing wire mesh on a hillside will hold sod in place easily (a trick of the landscaping trade).

grass seed to hold on a 45 degree slope when 4 inches of rain falls in one day is nearly impossible (or so I thought). In each of the past two planting seasons, part of the banks slid down similar to a small mudslide.

Each summer I would pile the dirt back up, and by fall the grass was growing again. Each spring the dirt slid back down. I was about to agree that the degree of the slope needed to be reduced. That would have required a lot of new work. Plus, the retaining walls would have to be changed to match the new slope.

One of my neighbors said he solved a similar problem by laying lengths of concrete wire reinforcement mesh down and staking them into the ground. Then he laid a couple of inches of topsoil over the mesh. I tried this method and it worked like a charm (Fig. 13-15). I found that if you have a slope of 40 degrees or less, all you need is good soil, good seed, and light rain.

If your slope is 45 degrees or greater, the wire mesh is a must. Don't think that planting sod is the answer. The sod will become soaked with the first rain. Because water weighs over 62 pounds a cubic foot, it adds great weight to the already heavy sod, and then down the slope it slides. Stakes only hold the sod in place immediately adjacent to the stake itself.

I suggest that you ask a local landscaper his opinion on what you should do. Weather conditions in the growing months vary from locale to locale enough that my advice, based on Maryland weather, might not be good advice for your area. But don't forget the wire mesh; it will rust away in a few years (maybe five or so). By then, the grass will have a good root system, and the soil will be as compacted as it's going to get.

Lawn Cutting

If your house is similar to mine and the side slopes

are as you see in Fig. 13-16. There is really only one practical way to cut the grass on this bank. Use a lightweight rotary lawn mower with a rope tied to the back. This might seem awkward to you the first time, but it is very easy, efficient, as well as great exercise.

I can't make this following point strong enough. Do not walk up and down or across the slope with the lawn mower. Stand at the top edge only and let the mower down slowly. Pull it back up the same way. You will soon learn to control the mower easily and also learn to avoid cutting the rope. As for the rope, use ¼-inch or thicker rope. Tie knots every so often to help with the grip required to pull the mower up. Of course, use gloves to avoid rope burns.

For safety's sake, do not let anyone get below to watch what you are doing. This rope has broken a couple of times on me and the mower goes until it hits something, cutting most things in its path. If you think I'm exaggerating the safety aspect of this

lawn mower, don't take it lightly. In the past 20 years, I have had two accidents, one with each foot slipping under a rotary lawn mower on a hill—not at this underground house but at previous locations. I think I've learned my lesson. You should learn by my mistake; it's less painful.

Now that you've thought about the problems of getting grass to grow and then cutting it, you might say, "If it is that much trouble, then I won't plant grass on my banks." If you plant an ivy or green-ground cover, it looks acceptable for a while. As it grows and the roots take hold, the leaves spread out like an umbrella. This kills anything like grass that would try to fill in the spaces between plants. When a heavy rain falls, the water runs under the leaves, washing dirt away. Once erosion starts it is hard to stop.

I have no personal experience on this problem, but I think it should be given thought. The only way you will know is to try it because with each situation is different (slope, climate, etc.).

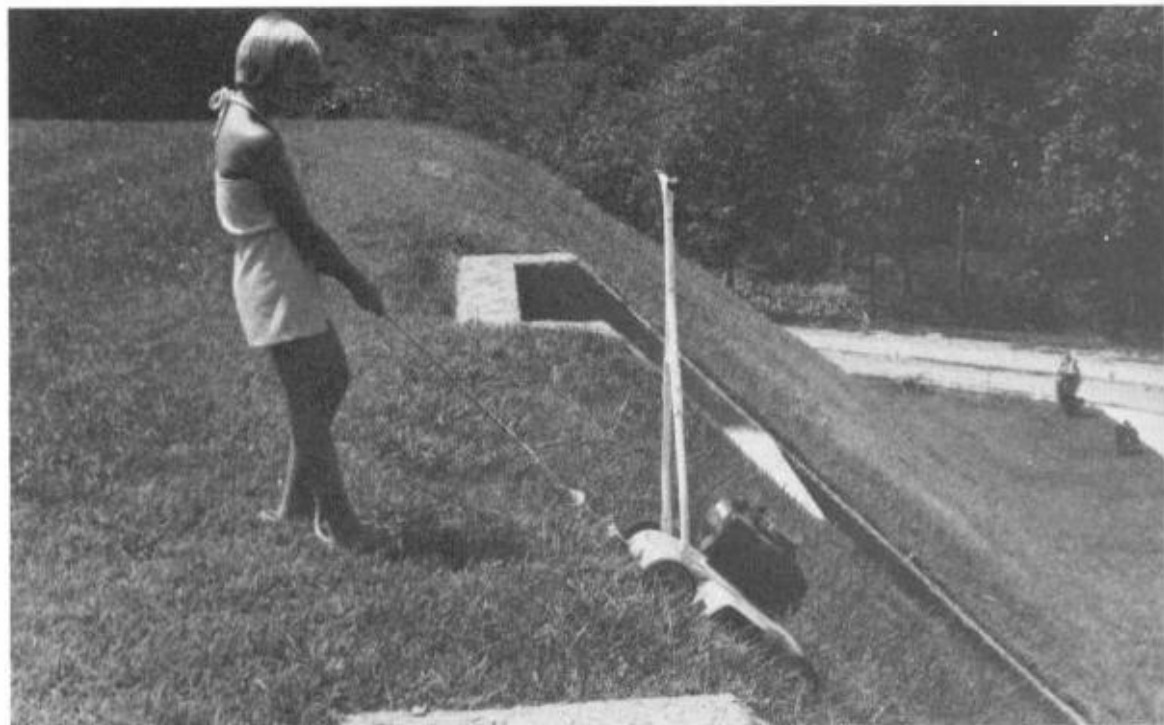
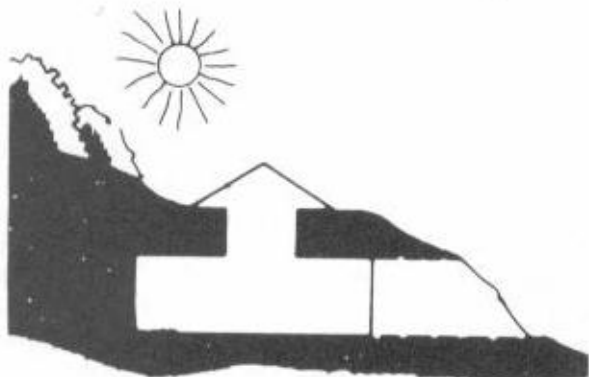

Fig. 13-16. Cutting the lawn is a trick easily mastered.



Utilities

By now you ought to be pleased with your construction ability. You have a solid concrete shell, floor, roof, and block walls. From here on to final completion it will get easier physically, but at times the mental pressure will begin to get to you. If the building inspectors haven't hassled you or some neighbors are not up in arms, you're very lucky. But I'm sure you have all those minor problems under control.

PLUMBING

Plumbing is one of the easiest trades to do yourself. Most local codes will allow the homeowner to do his own plumbing with a special homeowner permit. The best thing about plumbing, both water and drain, is that it's safe for an amateur to work with. Common sense will tell that drains always run downhill.

The codes say that a good drain drops $\frac{1}{4}$ of an inch for every foot of length. Of course, this rate of drop is not always true, especially in drains that are 2 inches in diameter or smaller. If you followed the

codes, you should have 4-inch cast-iron drains under the concrete slab. This is a nationally accepted code. Once above ground, however, the codes are as different as day and night.

Some local codes allow the use of polyvinylchloride pipes (commonly called PVC pipes). Some places require copper or steel. Other places allow common plastic to be used in certain drains. All I can tell you is to check your plumbing codes. They are usually fair and easy to meet, especially the drain phase of plumbing.

One of the things that has changed and improved since my house was built in 1977 is the increased use and acceptance of plastic pipe of all kinds. As you go through the code requirements, you'll notice reference to thin wall plastic, CPVC, and PVC.

Thin Plastic. Thin plastic is a special plastic pipe used for nonpressure drains such as a bathroom sink. It's less expensive than PVC.

CPVC. CPVC can be used for hot or cold water. Use plastic anywhere you can in the plumbing phase of your underground house. Professional

plumbers favor metal pipe (such as copper). Why? Because it takes longer to install and has to be replaced, thus more work for the plumbing trade. Plumbers won't admit to this, but it's true.

WATER PIPES

The same is true for waterlines as for drains. As you read the regulations covering portable water pipes, you will notice that if copper is required it will be either $\frac{1}{2}$ of an inch or $\frac{3}{4}$ of an inch in diameter, depending on how many branch lines are involved.

Regardless of the size required, this pipe is really called hard copper tubing and it is bought in lengths approximately 20 feet long. There is a special copper pipe cutter that is inexpensive and invaluable when doing your own plumbing. Buy one. Do not use a hacksaw.

After the pipes are cut and ready to be soldered into a fitting, they must be cleaned with a wire brush or steel wool. Each part to be soldered must have a bright shiny finish. Once these parts are shiny they are treated with a soldering flux paste. This is an acid base paste—similar to toothpaste—that cuts any trace of oil or grease off of the copper. Solder will not stick to copper if it is coated with grease. This procedure must be followed to ensure a water-tight connection.

Plastic (PVC) pipe can be used in place of copper pipe in most instances. I suggest that you use PVC for cold-water pipes where possible. It is so much easier to work with than copper. PVC won't rust, and it's easy to cut and put together. You will most likely have to use quite a bit of copper pipe to meet the codes. Don't waste it because it is expensive. Another important thing to remember is to always buy the best-quality valves, pipe, fittings, faucets, etc., to install in places that are difficult to get at for repairs. It's one thing to have a leak in an open area that is easily accessible for repairs, but it is a nightmare to get to a leak in some obscure cubbyhole without wall demolition. Quality is equally important when getting the spigots for bath and kitchen. Cheap units will rust away before you know it, and they are difficult, if not impossible, to repair.

CLEANING NEW WATER LINES

After you use cement, glue, solder, flux, and any other substance it takes to assemble a water-pipe system, it's only natural that it's infested with all types of bacteria. To make these pipes clean and the water usable for human consumption, there is a simple operation commonly used to disinfect a water system. Flush the pipes with a mixture of approximately 1 cup of laundry bleach to a 5-gallon bucket of water and pump this solution through the pipes until you're sure it's coming out of all the spigots. Once the strong bleach taste is sampled at each outlet, close off spigots and let the bleach water set for about 12 hours. Then flush the pipes with clean water until no bleach taste is present. The local health department will check your water to ensure it is safe to drink (usually for free). Call them because they are usually helpful.

MAINTENANCE

One of my reasons for going underground was to eliminate as much year-round maintenance as possible. It doesn't make much sense to do away with exterior maintenance problems and build in interior problems. The same theory is even more true when buying your deep-well pump and installing it.

Buy a reputable-brand, submersible deep-well pump. They are easy to hook up, but it is a somewhat physically demanding job to lower that heavy pump and plastic pipe 300 hundred feet down a 6-inch- or 7-inch-diameter steel casing. Once it's down, it should be good for 10 years or more. Follow instructions closely; double check the plastic for leaks.

Check out all phases of wiring before lowering the unit down into the well casing. Be extremely careful because pipe and electric lines slide down the steel casing.

One safety precaution that must be taken is to attach the electric wires to the water pipe with electrical tape (see Fig. 14-1). Do this every 4 feet for the first 50 feet or so. The reason for this is that a submersible pump tends to rotate as it starts much the same as a car engine raises up as you rev the engine. This movement will rub loose wire against

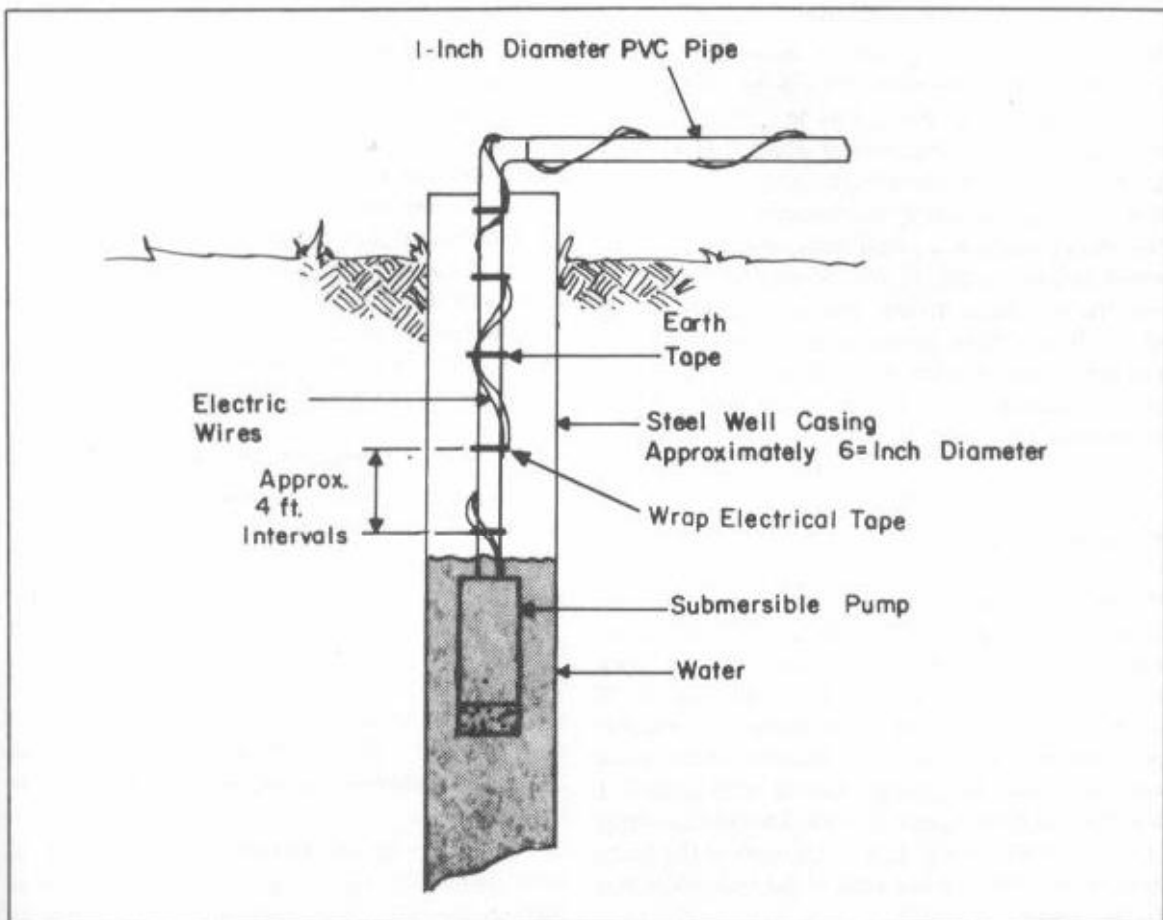

Fig. 14-1. Wrap electrical tape around wires and plastic pipe to keep wires from scraping against the well casing.

the well casing and cause a short. I know because it happened to me after three years. If you pull up all of this pipe with the pump hanging on the end, this time the line is full of water and the water weighs approximately 62 pounds per cubic foot. It won't take you long to realize how heavy this is going to be. It could easily exceed 400 pounds.

ELECTRIC WIRING

If you are careful, you won't waste your valuable time on something as unnecessary as frayed electric wires. Question your wholesale supplies. They are usually very cooperative. If you have a little extra money, I would suggest letting a professional

do the pump installation. It's a gamble doing it yourself.

If you followed my earlier suggestion and installed plastic conduit in the roof slab, your electric wiring runs will be much easier than if you plan to run all wiring around walls. If you are doing your own wiring, I assume you must have some knowledge of the subject or know someone who does.

Most electric codes will allow a homeowner to work on his own house. Some communities even have a test you must pass. If they have a test, it will be on the basics such as which wire is ground, what size for so many amps, etc. If you know nothing about electrical wiring, you'll never pass.

Electricians

If you have the money and are short on electrical experience, I'd suggest you let a registered electrician do the wiring. Electricity is one of the most difficult and most dangerous of all the trades. Many professional electricians work for big companies by day for a high rate of pay and benefits, but will work for you by night at a much reduced rate. I mean a much reduced rate. If you do decide to hire an electrician, check around and get one for a good price. If you do it yourself, go to the wholesale outlets for parts. They will sell to an individual in large quantities. You save a bundle over a small retail outlet.

Wiring

If you're doing the electrical work yourself and you now have all the materials, the runs are made just as if it were the basement of a conventional home. The underground concept does not present any problems with wiring. Wires are clamped to the block wall in straight runs and all turns are made in 90 degrees if possible. When roughing-in receptacle and switch boxes, they are mounted to the block wall by nailing and gluing a furring strip (usually 1 inch by 3 inch) alongside of a hole knocked carefully in the concrete block. Locate the web of the block before you start. Mount ears of the receptacle box to the wood.

Feed wires per code and continue until all the wires are in place. Then go around and cement in all excess areas around the box. If codes allow and non-metallic receptacle boxes are available, try to use them. Even if a wire should short out against the sides of the box, it would not ground out. I used them and they worked great. Once all wire is in place, use a felt-tip marker (black or blue) and identify each wall. You should identify them by name, indicating direction and spelling out any other information you feel might be valuable in the future. Print this information in letters approximately 2 inches high. Then take a clear black and white photograph. This way you can go back years later and locate wiring if necessary for additions or any other reasons.

Be sure to wait until you get all the furring strips in place before you take a photograph; it's good to know where the strips are also. As a rule of thumb, take the photo just before the Sheetrock goes up.

A second precaution could be taken even though it's time consuming. Make sure the pictures are good before closing the wall. Perhaps you could use an instant-picture camera. I recall I closed one room and the film developed totally black. The information is only in my memory (which is known to fade once in a while). Get good pictures; it's well worth the extra effort.

Telephone Wiring

I consider the telephone an important utility. Why not prewire your house for the telephone just as you did for the electricity? This is another area where you can save money. The receptacle boxes used for telephone outlets are the same as the receptacle boxes used for standard electric outlet. The boxes are installed into the concrete block exactly as if they were to be used for electricity. You can make arrangements with the phone company to install these boxes yourself, saving approximately \$10 an outlet.

Once you install the boxes in the locations of your choice, the telephone company will come in and complete the wiring installation. The telephone company will work with you in most cases. Even though I installed a phone outlet in every room, I only installed two phones with jack cords. You can unplug either phone and carry it to any room in the house without paying for extra telephones. Ask the phone company how you can install the boxes and save money.

Don't use any of the liquid fuels on vapor gases. Stick to electricity for everything. Remember, you don't have windows to open in emergencies. All utilities—plumbing, sewers, electric, telephone—are basically the same when building either an underground house or building any standard structure. When all walls are block, it is obvious that you will have a problem moving or changing any utility once the final walls are in place.

The nicest thing about reaching this stage is the convenience factor. For the first time you can plug in a light bulb. Water is now available for washing, mixing cement, or whatever else is required. The bathrooms might even be hooked up by

now. This is your first taste of convenience. Up until this point, you were really roughing it. I remember what it was like to reach this plateau. If you worked as hard as I did to get to this point, it's a good time to celebrate.

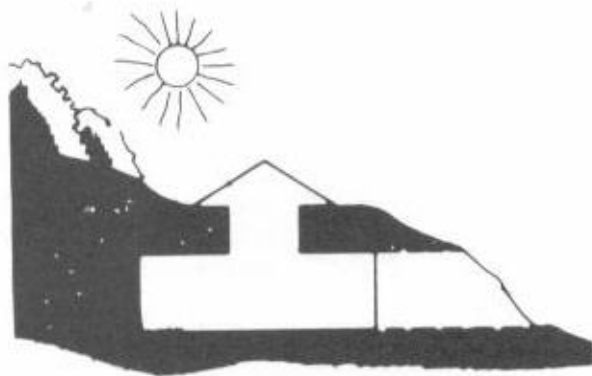

Woodworking

Approximately 80 percent of an underground house is concrete. You might think that your woodworking ability won't be tested. How wrong you are! Your woodworking skills will be put to the test in hanging doors, trim, and baseboard molding. This is where a radial-arm saw will be very valuable. With a few exceptions, the fine trim of an underground house is very similar to that of a conventional home.

NAILS, NAILS, NAILS

Before the trim phase, you will have to pound over 3000 nails into concrete. If you have never driven a nail into a concrete block, you don't know what you're missing. It takes much more force to drive a nail into concrete than into wood. These 3000 nails will be used to attach 1-x-3-inch wood strips to the block wall. The 3-inch strips should be evenly spaced. Whatever you do, don't leave spaces wider than 18 inches. If you do, the Sheetrock will flex or possibly break. See Fig. 15-1.

Before these wood strips are attached to the block wall, you should apply some type of adhesive

designed for gripping wood to concrete. Readily available at any building supply store is adhesive in tubes like caulk. It is applied with a standard caulking gun. This adhesive is commonly called *panel cement*. Apply a bead of panel cement to each board in a similar way toothpaste is applied to a toothbrush. Once these boards are nailed up and the cement hardens, these strips will not fall.

The *masonry nail* is commonly used to attach wood to solid concrete (like a floor slab). The *cut nail* (Fig. 15-2) is rectangular in section. I have found that cut nails are easier to drive into concrete block.

Drive a nail approximately every 2 feet. A rule-of-thumb to go by is that the nail should be $\frac{1}{2}$ inch longer than the board you are attaching.

As you are hammering these boards up, you will notice a technique is required to get this arm-breaking job done. You will soon see that the nails go into the block very tightly. If you give the nail one last hit just to make sure it is tight, then all of a sudden it will pop loose. This is because of the

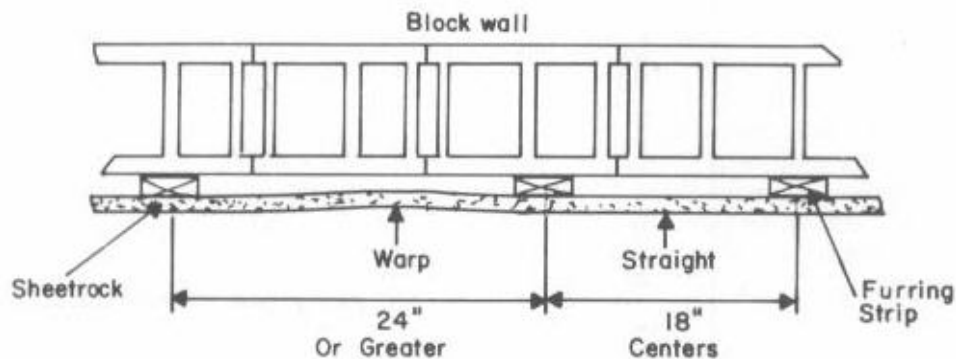

Fig. 15-1. If the span is too great, the Sheetrock will buckle.

vibration caused by the hammer hitting the surface of the board and not the nail.

As the first nail in a particular board is driven in tight, move along about 2 feet and drive another. Once the next nail is started into the wood, hold your free hand on the wood to dampen the vibration. Continue this procedure until you have all the furring strips in place. These furring strips are needed

to hold the Sheetrock or paneling on the wall. The 1-inch air pocket created as the covering goes up serves as a great insulator against temperature change or humidity.

Some builders will place a sheet of polyethylene between the furring strips and the block as a moisture barrier (Fig. 15-3). Unless you feel that your area is going to receive an excessive

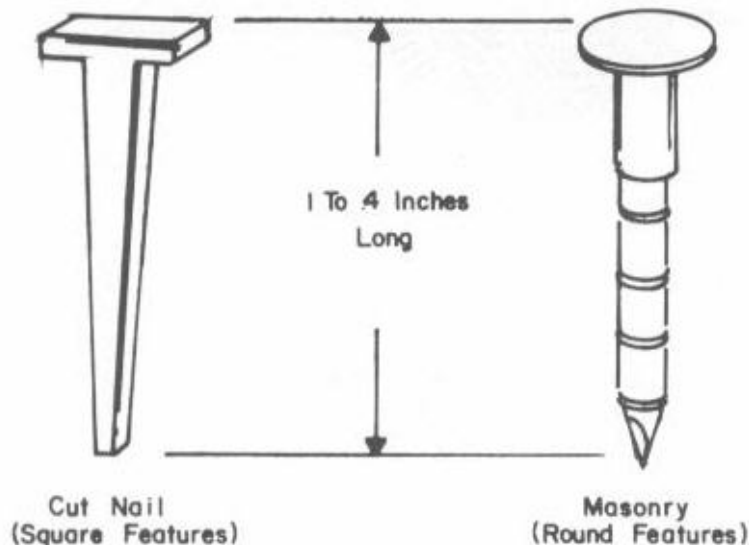

Fig. 15-2. Notice the difference in nails used on concrete.

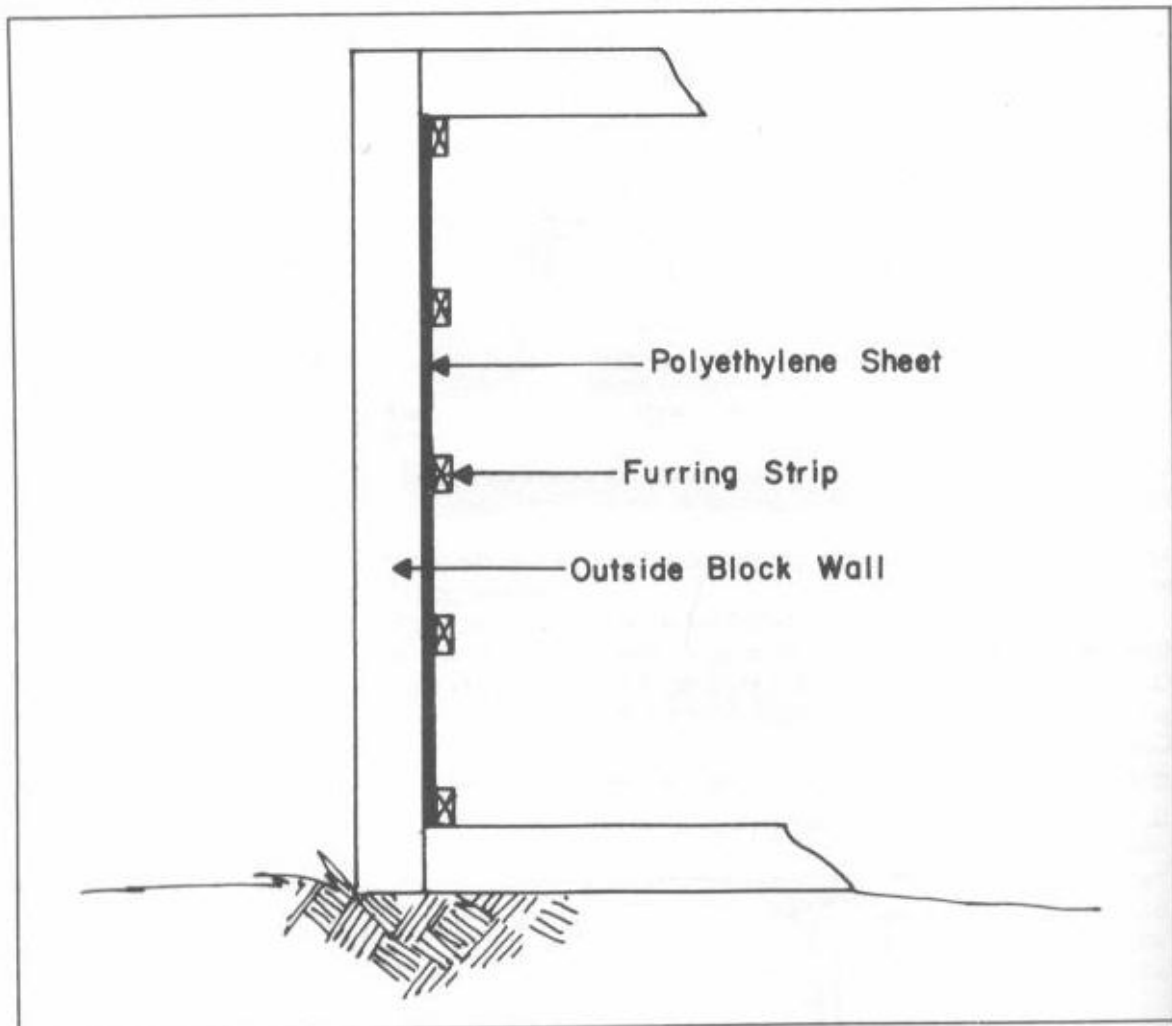

Fig. 15-3. A polyethylene shield could be used as extra precaution.

amount of rain, the plastic will most likely be for naught. The other side of the coin is that this plastic isn't very expensive (approximately 5 cents per square foot); it can't hurt to install it against the walls. I didn't and it hasn't affected my living area. If you are going to have a moisture problem, the plastic on the walls will be of little consequence in the long run. Give it consideration and ask your engineer.

HANGING DOORS

When building a conventional home, it is standard

procedure to use 2- \times -4-inch interior wall studs. Therefore, interior walls always turn out to be approximately 4½ inches thick. Because of this dimensional consistency, some companies manufacture a prehung door assembly. The door is already attached to the frame with hinges and all final trim. The builder just inserts this assembly in place and "presto," the entire doorway is complete. Simple, isn't it?

But if you built an underground house to the specifications I indicated, you now have all of your interior walls at least 8 inches thick. Add it up. The

walls are 5½ inches wide. The furring strips on both sides of the wall are ¾ of an inch thick each. And don't forget the two pieces of ½-inch Sheetrock. This adds up to a thickness of 8 inches.

Because underground homes have not really taken over the building world, no manufacturer makes prehung doors to 8-inch-thick walls. By now you have guessed it. An underground home builder has to completely build his door assembly from blank lumber, even to the point of drilling holes for and attaching door knobs.

This might not seem like a big deal but it is. Hanging a prehung door assembly takes about half an hour. Building a doorway assembly from scratch takes even an expert carpenter 10 times as long to finish. Also, the quality is never as good as the factory-assembled units. Another fact you have to face is that you can't possibly build a door assembly as inexpensively as you could buy one if it were available.

There is a special tool available to ensure that the door-knob hole is in the correct position every time. This drill assembly is expensive and hard to

find, but you must use it to ensure accuracy. See if you can rent or borrow this tool. Buy one only as a last resort because you will probably never use it again.

If you are wondering how to go about building a door frame from scratch, simply examine a conventional house and expand the width by buying wider boards. Use 1-inch boards commonly referred to as shelving boards (Fig. 15-4). These boards come in different grades that are usually referred to as "clean" and "B" grade.

Clean wood is free of knots (maybe a small blemish) and is basically the best grade of wood. I suggest you use B-grade wood because if you're going to stain the wood the "knot" will look good. If you're going to paint this wood the knots will not show. Knot holes and nail holes can be covered with a wood putty or even wallboard joint cement. See Fig. 15-5.

Always use finishing nails, not common nails, to build a door frame. See Fig. 15-6. Never use nails larger than required to make a secure joint.

Missing windows will eliminate some of the

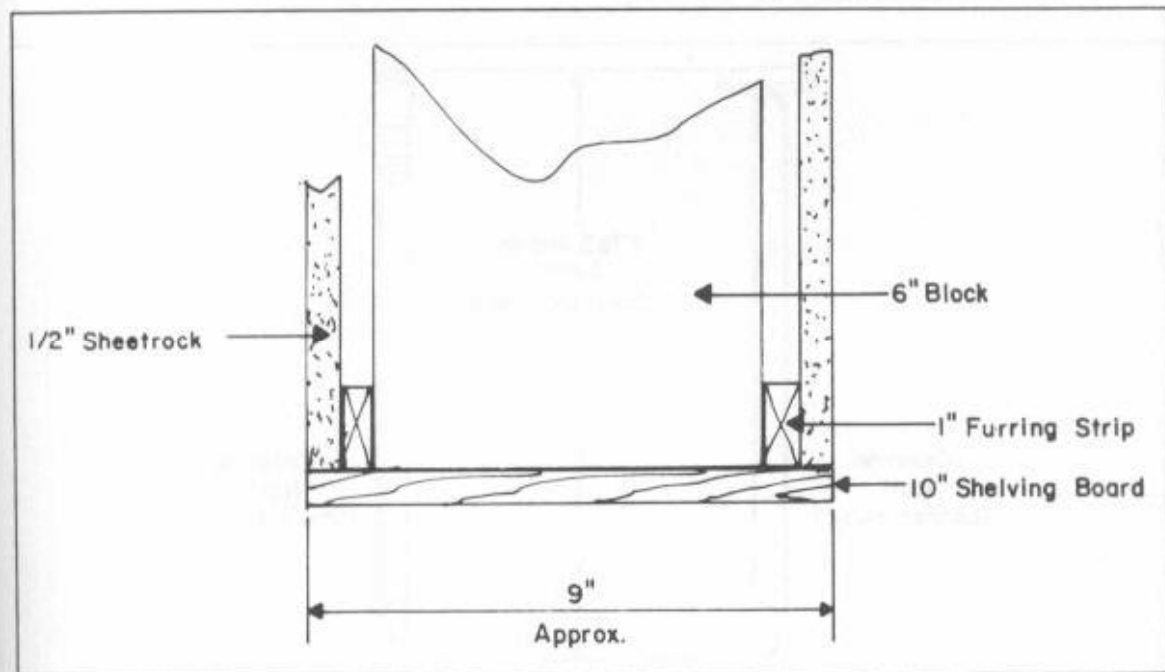

Fig. 15-4. Prehung doors sometimes don't work in an underground house.

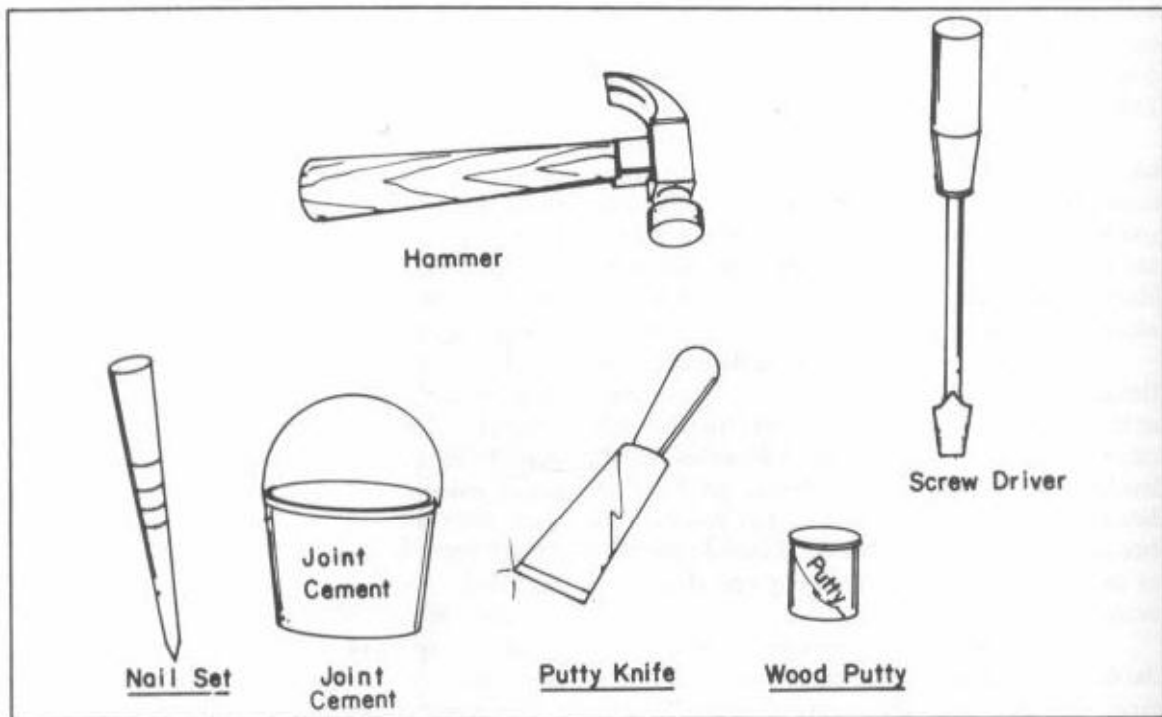

Fig. 15-5. Basic items used to make a door from scratch.

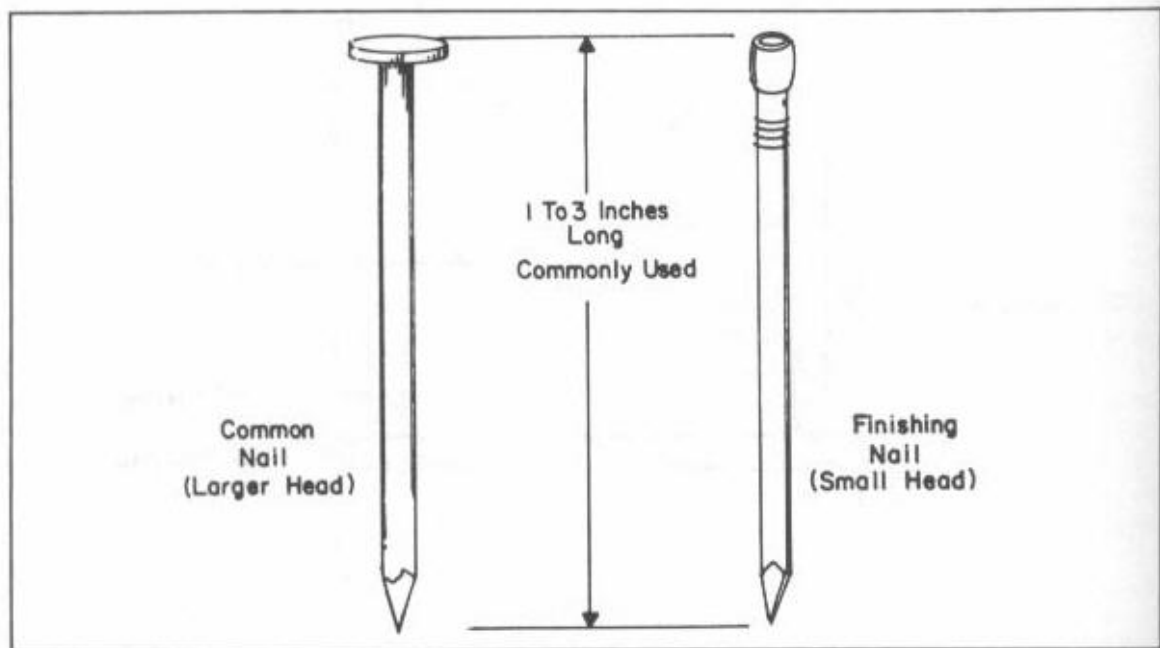

Fig. 15-6. Just a reminder of the difference in the nails used.

fine finishing that is common to a conventional home; you do have a trade off of sorts. It might take longer to hang doors in an underground house, but less time to finish off the trim work (a fair trade).

WOODEN WALLS

Your design might not call for block (masonry) walls

throughout the interior. Many designs have used standard 2-x-4 studding in 16-inch centers with standard ½-inch wallboard (Sheetrock).

If you use this method, the prehung doors could be used. Beware of a design that has no concrete walls or pillars for support between the exterior walls.

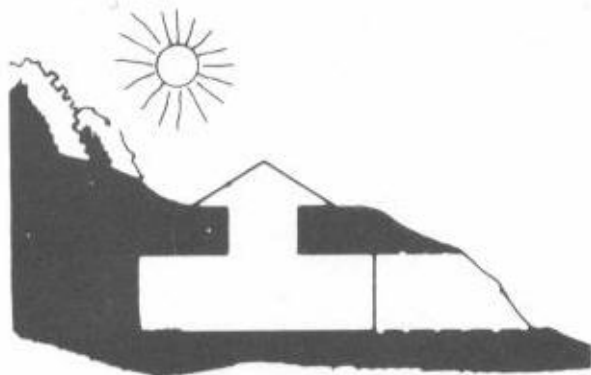

Adding Trim and Fixtures

While reading this book, you've noticed that I'm giving my personal advice and opinions. Remember, I've already lived in my underground house for five years so I know the reaction friends, the general public, neighbors, and the inspectors will have. As for technical advice, any engineer can figure the strength of material, electrical requirements, and other specific sciences. It's the nonexact areas that can make or break the success of your underground home.

DECORATION AND LAYOUT

As you begin to plan interior decoration, do it with an open mind. I suggest you use unusual materials and designs and layouts (Figs. 16-1 through 16-5). Don't forget that an underground home is unusual and it takes a special personality to own, build, and design one. Once you are committed to going underground, you have to face the criticism anyway so you might as well add a few strange colors and designs. Why not have mirrors on the ceiling? Use whatever ideas you have hidden away in the back of

your mind that you thought you could never use.

I mention mirrors because they probably create the greatest difference in a room that anyone single addition can create. Murals run a close second, but mirrors make a room look bigger, brighter, and more exciting. Use mirrors generously in your underground home. I did (Fig. 16-6) and I plan to add more in the near future.

BEDROOMS

We gave an open, warm feeling to each of our bedrooms by the use of special wall murals (Figs. 16-1 and 16-2). These murals are available from major wallpaper suppliers and range in cost from \$20 to \$150. Surely you'll find a design to fit your personality and taste. The mural, such as the woods scene in Fig. 16-2, gives a warm sensation to any room, especially one without windows.

I also suggest that you don't create a reverse condition by hanging a mural that is congested or too busy. These are psychological conditions that you create without being aware of it. Keep murals

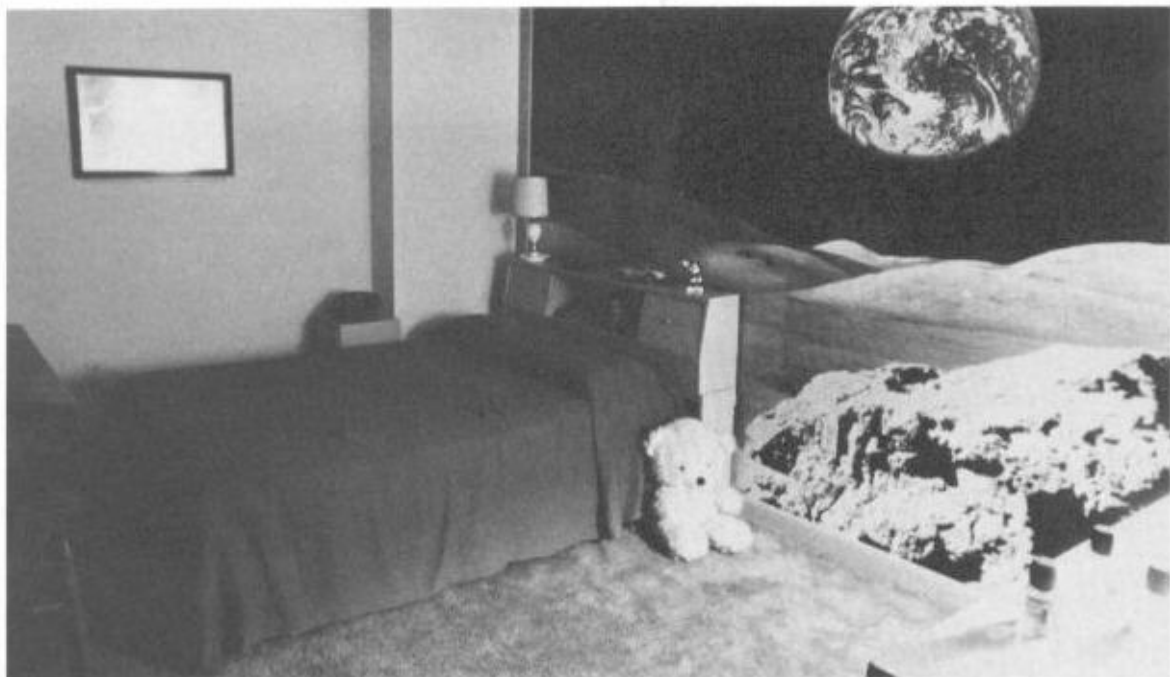

Fig. 16-1. One of four bedrooms. Note the mural of the earth.



Fig. 16-2. The mural on the den wall gives an open feeling.



Fig. 16-3. The TV room also has an open feeling.

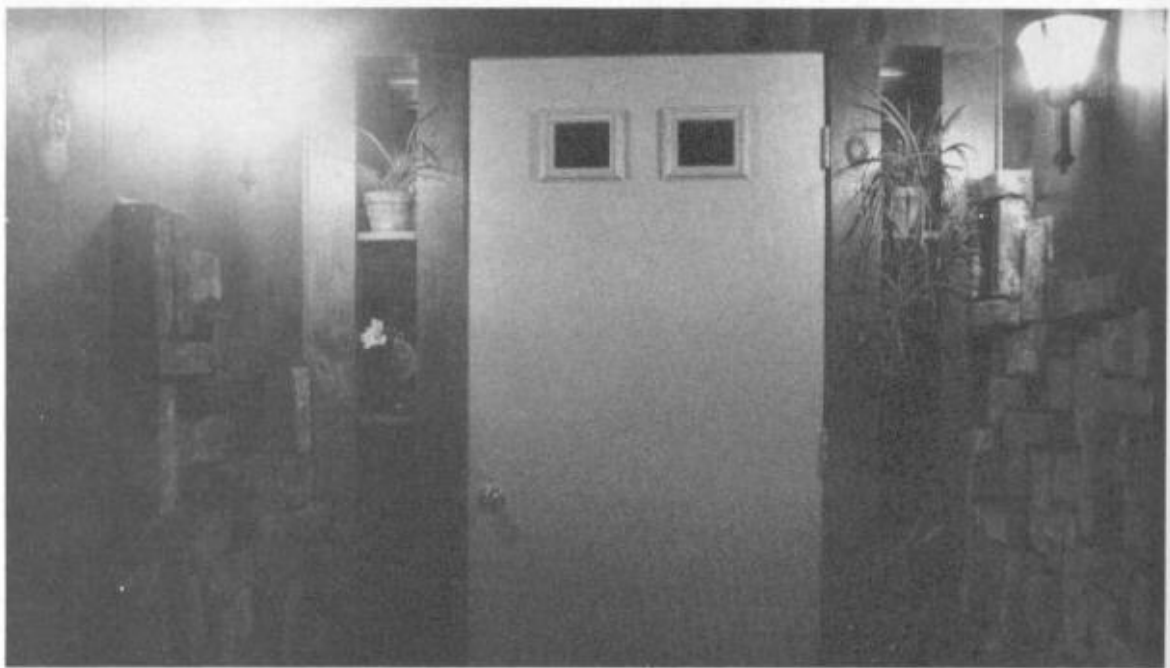

Fig. 16-4. The foyer area (looking to the front door).



Fig. 16-5. Another bedroom done in light colors.

peaceful, gentle, and warm. They work well in creating the atmosphere you prefer.

KITCHEN

Because you don't have windows on any wall, you can really use the unobstructed walls to your advantage. In addition to murals, consider full-wall bookcases or room-length shelves. You'll be surprised at the uses you will find for all of the additional wall space. Figure 16-7 shows our kitchen. We used earth colors. Otherwise, it's very conventional even if it is 6 feet underground.

Now that this kitchen has been in use for nearly five years, I can honestly say that the absence of windows did not cause a depressed atmosphere as some people question years ago.

If you noticed the carpet shown in Fig. 16-7 you will see that it is still in good shape five years later after dozens of spills and mishaps. This is regular

good-grade, living-room carpet installed in the kitchen. It is proof that the longer shag carpet can be successfully used in an area commonly reserved for standard indoor-outdoor carpet.

APPLIANCES

I recommend all-electric appliances in 1977 and now seven years later I can reiterate that was a wise decision. The increase in the electric bill is more than offset by the absence of other fuel bills. The all-electric kitchen is the thing of the future, especially microwave cooking. Use it to your advantage.

RECYCLED MATERIALS

Because most underground homes are built with energy savings in mind, why not carry that theme a little farther? Use Recycled building materials. Authentic old barn wood is a good place to start. It will take some searching of the old farms and coun-

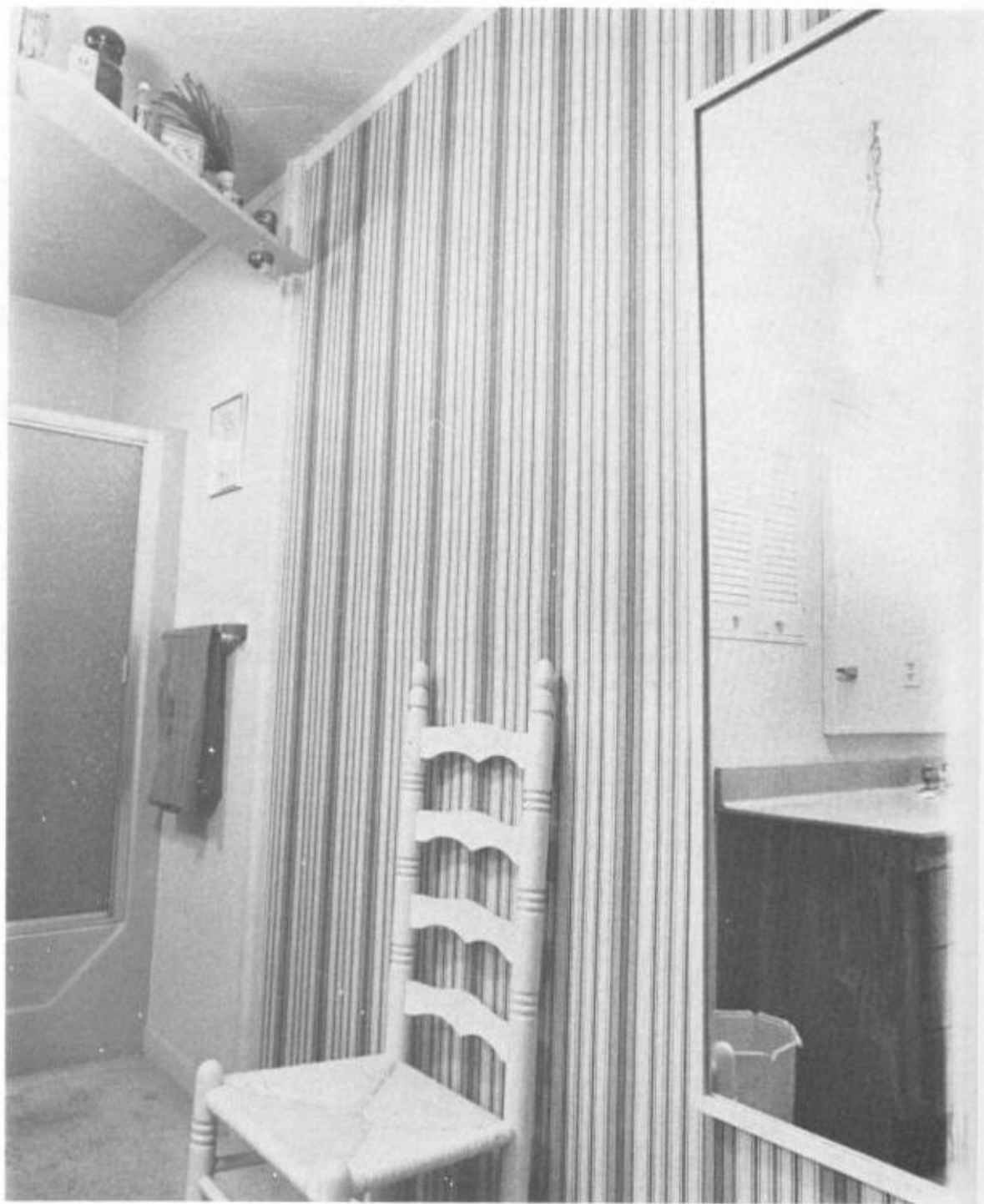

Fig. 16-6. Use mirrors generously as in this bathroom.



Fig. 16-7. An underground kitchen is no different than an above ground kitchen.



Fig. 16-8. Notice the old barr wood that is difficult to find.

tryside to find wood that the owner will let you buy at a reasonable cost (or maybe even give to you). Disinfected, trimmed barn boards in a hallway or family room is a very attractive appearance, complimentary to any underground house (Fig. 16-8). Also, you can find brick from an old building for steps, walls, shelves, floors, etc. Old brick or stone is relatively easy to find (Fig. 16-4).

FURNITURE

Why not refinish old or previously owned furniture to suit your taste? You'll be mentally and financially rewarded if you take the time to salvage some of the past to go with your home of the future.

CARPET AND PADDING

Once you are ready for carpet and padding, shop

around. Prices and quality are as different as day and night. As you probably realize, the carpet will be the single most eyecatching item in your house. Quality carpet just jumps out at you as you enter a home. Also remember that the bright, light colors will reflect light and give a warm, dry feeling to your house. There is no use adding to the stigma of a cave by using drab colors.

The pastel shades are the ones I found to be the brightest and the easiest to match furniture and wall hangings. Off-color or unusual shades only causes a problem with the final touches. This is especially true if you're on a limited budget.

PAINT

Always use light, bright colors. I suggest earthy colors such as greens, yellows and browns, etc.

Another suggestion I think you will find helpful when painting is the use of "sandpaint." This is a commercial product that is nothing more than a sand product added to latex paint. It is thick, like paste, and applied with a sponge. It really gives a different effect to Sheetrock walls. In addition, you do not have to sand the Sheetrock as smooth when sand paint is going to be used.

One disadvantage of this paint is that it can't be washed. Don't use this rough surface where dirt will easily accumulate. This includes TV rooms or small children's bedrooms. Hallways next to the garage always manage to get dirty so use a paint that is very durable when washed.

INTERIOR GARDEN

One of the spots in your house that will receive the most attention, simply because no one else has one, is your interior garden. If you didn't include one, you'll soon wish you had (Fig. 16-9). In our garden area, we used 8-x-16-1-inch-thick concrete cap block. These replaced the original wood stepping block because rotting occurred due to constant watering of the plants. Plants grow quickly under ideal temperature and humidity conditions. The garden or indoor atrium is a must in an underground home like my design. If your design has the exposed souther exposure, then a garden can be eliminated. If no exterior surfaces are open, then a garden is the only way to go.

We also hang many live plants over from the dome (Fig. 16-10). At times, they even form a ceiling of live plants overhead as we walk through. Clinging ivy is another way to cover the block walls in your atrium.

LIGHTING

Another subject that is only as limited as your imagination is lighting. This is especially true in the garden (Fig. 16-11) and Fig. 16-12). Give thought to using dimmer switches, ground-level lights, or hanging or side-mounted fixtures. Regardless of where, how, or the quantity of light fixtures, why not experiment with colored bulbs (especially blues and greens). Any good electrical supply store will have an ample supply to choose from.

Once you start installing lighting outside, why not consider lighting the edges of the driveway with small direct-current exterior lights? Remember, the driveway is one of the few things that is visible from the road. See Fig. 16-13.

One fixture or device that we made use of was the commercial electric timers that are available everywhere. For example, we are experimenting with turning lights on and off in the garden as night falls and morning arrives. Another use for these timers is to turn your hot water heater on and off at times when hot water is required. I realize lighting and timers are not restricted to underground homes, but they do give you another dimension to work with (especially for electrical conservation).

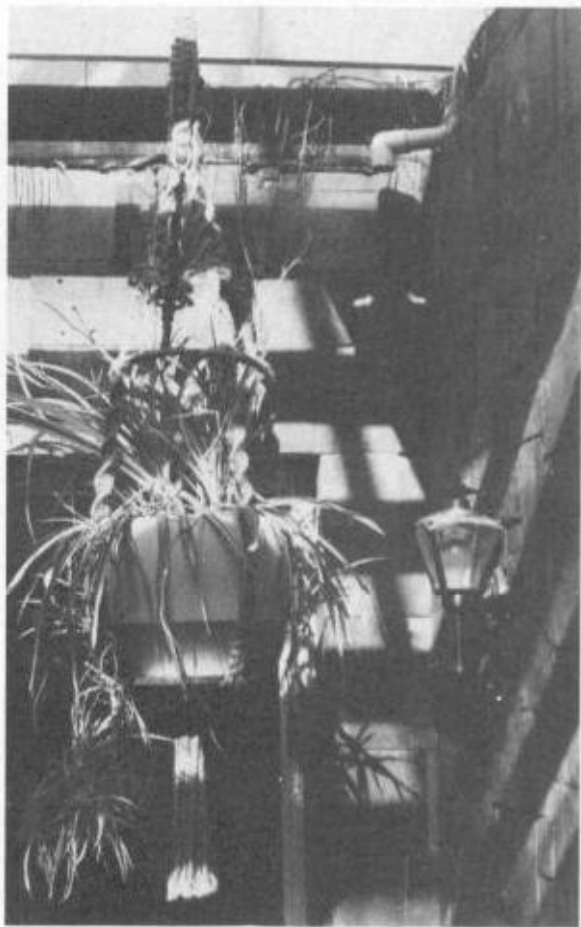

Fig. 16-9. An indoor garden is a real attraction.



Fig. 16-10. At times the garden growth gets out of hand and must be cleaned out and cut back.



Fig. 16-11. Ground level plants give a nice effect.



Fig. 16-12. Wall lighting is necessary.



Fig. 16-13. The driveway is very noticeable to strangers because the house cannot be seen from the road.

IDEAS

You can find interesting ideas for conventional homes in home and garden magazines. We ignored the windows and found that many of the ideas could

be used underground as well as above ground.

If you don't have a collection of pictures, remember that local libraries have back issues of most magazines.

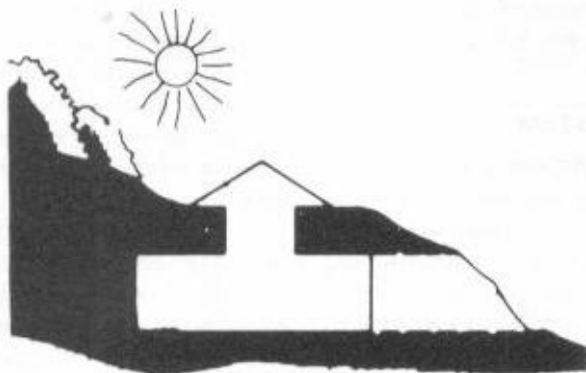

Heating and Ventilation

Heating and ventilation can cost you a fortune if you don't approach it with a great deal of logic. An underground home is virtually airtight so many of the conventional rules of thumb will have to be ignored or changed.

HEATING

Any good heating-ventilation contractor can install conventional sheet-metal duct systems such as the ones you will find in any conventional house. If you examine any house with a forced hot-air system, it has at least two vents per room. One is a return vent and the others are for incoming hot air. These vents are connected to a sheet-metal duct system that comes from and returns to a central heating plant.

Other possible ways of heating include electric or hot-water baseboard heat. Many people use only wood stoves to heat their underground home. The metal duct system is by far the most expensive, most difficult, and most inefficient system to use in an underground house similar to the one in this book. The reason is that the contractor would have

to break through concrete walls at least three times per room unless you construct the openings for the duct work into the wall as you lay the block. That would require considerable construction time.

In my case, with ten heated rooms, that would be at least 30 holes broken by hand in concrete block or solid concrete. It would cost time and money, and it would weaken the structure.

A second negative reason not to use a metal duct system is that the Sheetrock walls would have to be built around the duct to cover it when finishing a room's interior. This in itself is a time-consuming job. Baseboard, hot-water units are commonly used in underground structures because all that is required to pass from room to room is a hole large enough to get a 3/4-inch-diameter pipe through. That's quite a difference.

Electric baseboard heating units are also very popular because they require even less time to install and the wiring can be routed anywhere behind the Sheetrock. The big drawback to either of these systems is that you cannot adapt an air-con-

ditioning-dehumidifier system should you prefer to have this luxury in the future. Remember that an underground house is definitely easier to heat and it stays cooler, but your location, method of construction, and life-style will determine the actual heat loads that must be overcome (either cooling or heating).

FAN SYSTEM

My system is simple but efficient. It cost approximately one-tenth of the cost of a conventional hot-air system, and in many ways it is twice as efficient and flexible. The general idea that I used follows.

Start with the room where your wood stove is located. This should be in a centrally located room. As this room heats up by the radiant heat of the

stove, it is nothing more than a big hot-air plenum, serving the same purpose as a plenum chamber or a furnace. By installing a miniature motor approximately one-hundredth of a horsepower with approximately an 8-inch diameter fan blade into the wall, the fan will draw hot air out of the main room into the next room. By using a variable speed of this fan motor, you control the volume of air that flows through the wall. By repeating this procedure in any adjacent room, you can circulate the air as necessary.

Do not forget that if you draw air into a room there must be a vent to allow the same volume of air to escape. In some cases, I used a small grill for this escaping air. In most rooms the doors were cut to clear the carpet by approximately $\frac{1}{2}$ inch. This

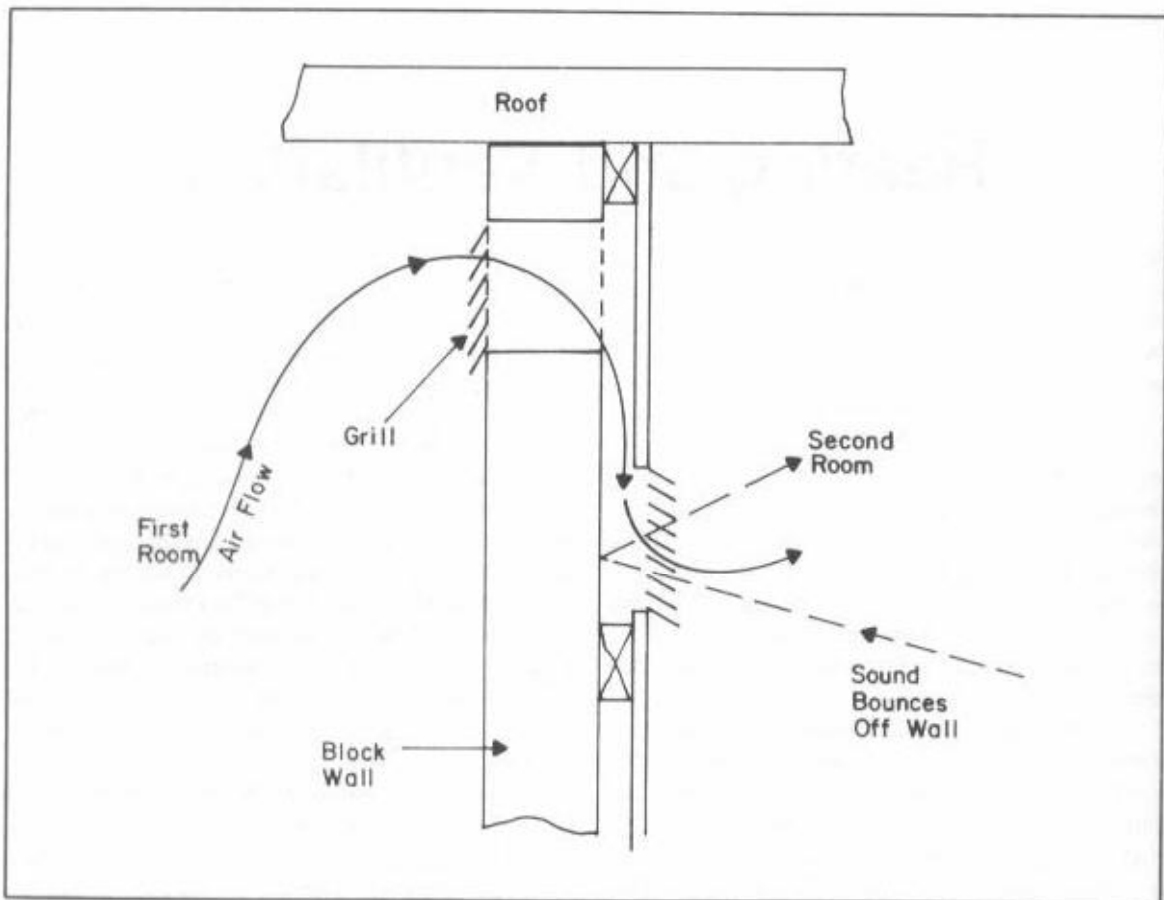

Fig. 17-1. Air vents can be offset to prevent sound from penetrating.

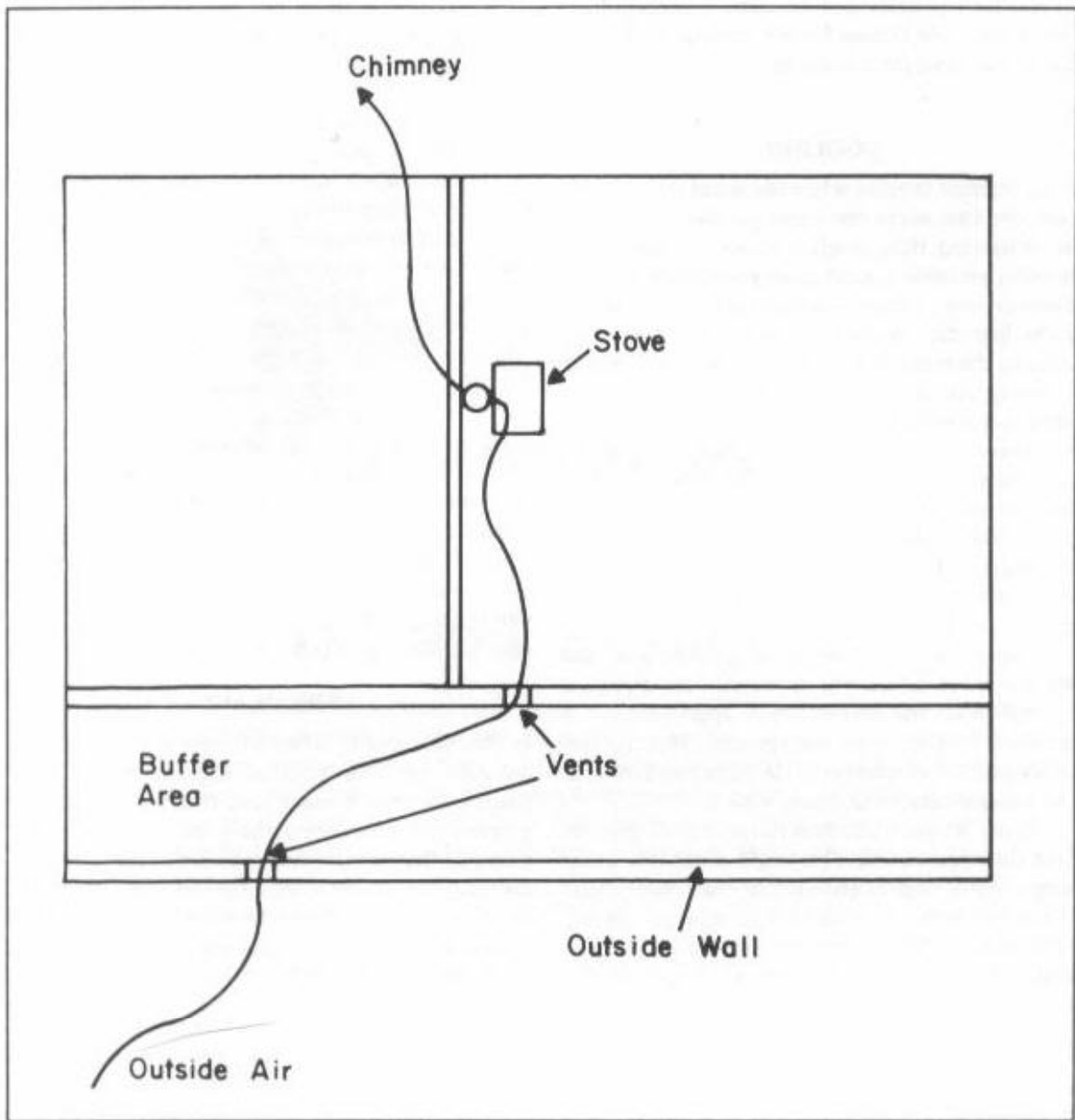

Fig. 17-2: Outside air travels through vents into the stove and up the chimney.

½-inch clearance allows the pressure to escape very satisfactorily.

Of course, if the door is open there is no problem at all. The airflow will continue to circulate by using only this small in-the-wall motor and no duct system. The only additional venting necessary

is to have a clear, unobstructed path for fresh, exterior air to be drawn in as the hot air goes up the chimney.

In my house, as in many others, all that is required is to vent air into the atrium or garden area. If your garden dome is not air tight, as most

are not, further venting in the dome is unnecessary. This is the main reason for not making the foundation of the skylight a loose fit.

COOLING

In the warmer months when the wood stove is not used, the fans serve the same purpose of keeping the air moving, thus avoiding a stale or musty odor. By using a standard, good-quality room dehumidifier in one or more rooms—depending on the severity of the humidity problem—and letting these fans circulate the room air past these dehumidifiers, it is relatively simple to control the humidity in the entire house without a complex system of duct work or expensive central heating-humidifying unit.

The disadvantage of putting a hole in the wall is that now sound can travel very easily from room to room. This condition can be nearly eliminated by sidestepping this air flow with a simple duct system you construct yourself as the wallboard goes up. See Fig. 17-1.

This allows the air to go through the wall, and then travel behind the Sheetrock until the grill vent is installed on the opposite wall approximately 4 feet away from the concrete opening. This method is only a minor adaptation to the direct air flow, but it is a major barrier to sound waves.

In my house, these fans run nearly 75 percent of the time year round. This might sound like we're using a great deal of power, but don't forget that each one is only one-fifth of a horsepower for my entire house. Most conventional furnaces have motors that draw more than twice the power that

these require. This is just another advantage of building underground could give you should you prefer to rely on a somewhat unconventional airflow system.

I want to make it clear that if you are not on a limited budget then by all means have a professional heating contractor install a standard unit such as a heat pump. They obviously work the best because of years of development under any and all conditions. Even if you do install a conventional heating-cooling system (duct work and all), the size of the unit can be approximately half the size required to take care of a home the same size above ground. My method of small fans is the economical way and it is 95 percent satisfactory. The heat pump is much more expensive but 100 percent effective.

Evaluate your situation and make the decision that suits your life-style. Also take into consideration that most current building codes require a new home to have a standard heating system even if other sources (such as solar) are used. A backup unit is a must if the BOCA building code (a national code) is enforced in your area. Check it out.

FRESH AIR

In the cold months, when a fireplace is in use, I do not draw fresh air from the outside mechanically (fan). I do have a small vent that leads from the exterior to the vicinity of the wood stove. The heat rising up the chimney naturally draws fresh air into the main room. This is plenty of fresh air unless a lot of smoking or cooking odors are present, then a mechanical means of replacing fresh air will be required. See Fig. 17-2.



Domes and Skylights

From the data I have collected on underground homes, I figure that about 85 percent of them have either a skylight or a dome. Approximately 75 percent of such homes have some type of interior garden, atrium, or courtyard. I highly recommend that you consider including a garden in your plans due to the absence of windows. You need a method of natural light access to eliminate any trace of a cave like atmosphere.

Because your house is below grade level, a dome is easier to build and install than if you tried to put one on a conventional house roof that is 20 feet off the ground. The only real challenge is to make the system leakproof. This is relatively easy to do if you follow a few simple rules. The first and most important item is to always have an emergency drain in the garden area. In the event of a leak, the water will have a place to escape before it reaches the interior of your underground home. See Fig. 18-1.

INDOOR GARDEN

My garden is approximately 8 feet wide by 16 feet

long. This seems to be the average size. The dome or skylight is another place where a person handy with tools will save money. I built my dome in the shape of a pyramid and covered it with $\frac{1}{4}$ -inch-thick acrylic plastic. It measures 16 feet wide by 24 feet long by 8 feet high. See Figs. 18-2 and 18-3.

To build the super structure of a dome, all you need is a hand circular saw with a special aluminum cutting blade, a square, a tape measure, a good aluminum welder, and a place to work. Don't use any material for structural support but aluminum; it's lightweight, easy to cut, and it won't rust or need painting.

Check at least three or four local suppliers because the price of aluminum varies quite a bit. Aluminum is sold by the pound (the more you buy the less expensive the pound rate). Buy all you need at one time and pick it up if possible. Shipping of irregular shapes is always costly. If you decide to build your own dome, try to stick to a shape similar to my pyramid style (shown near completion in Fig. 18-4). Avoid curves because the bending of plastic covering is very difficult without the proper

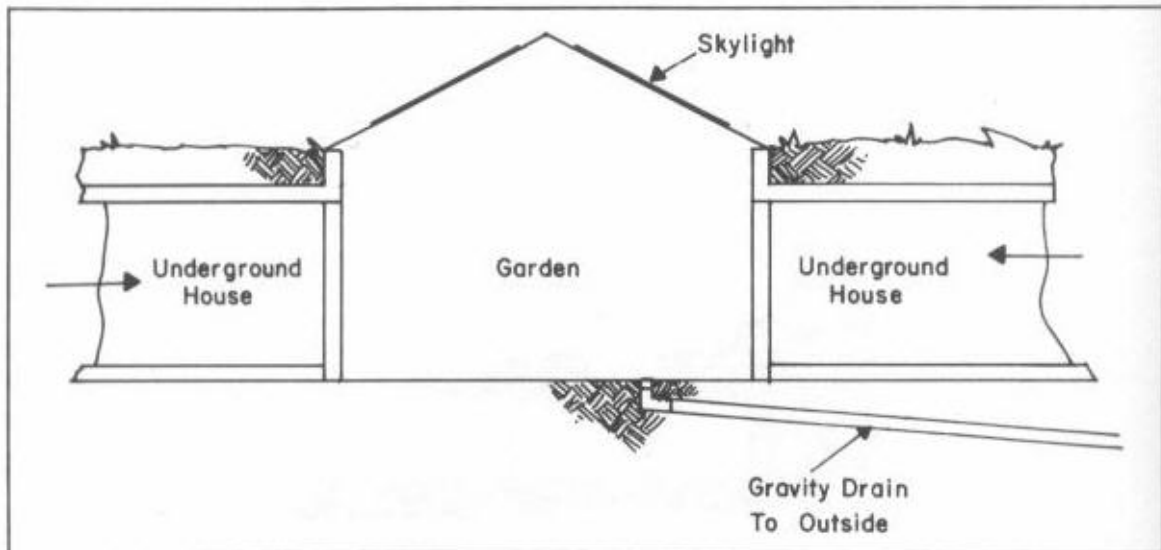

Fig. 18-1. Always install a gravity drain in the garden corner.

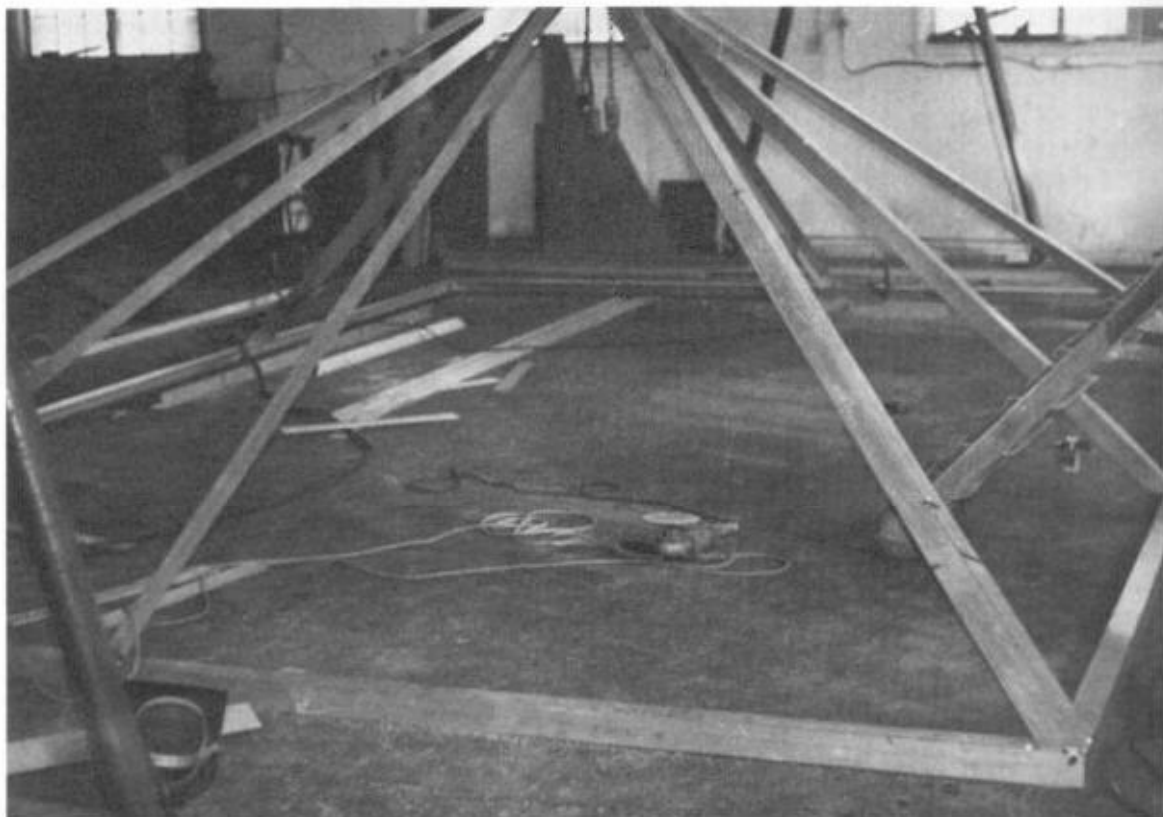

Fig. 18-2. The skylight structure under construction.

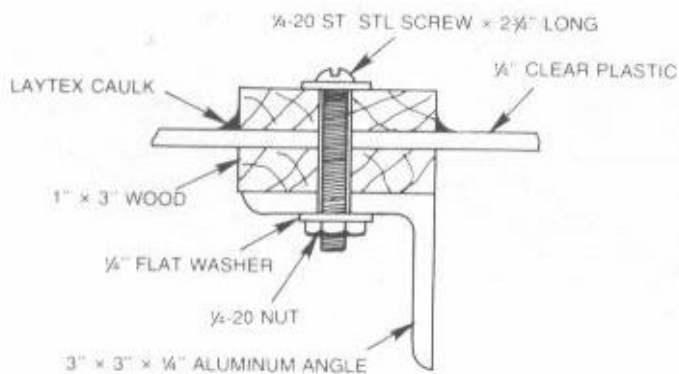

Fig. 18-3. A typical method of assembly.

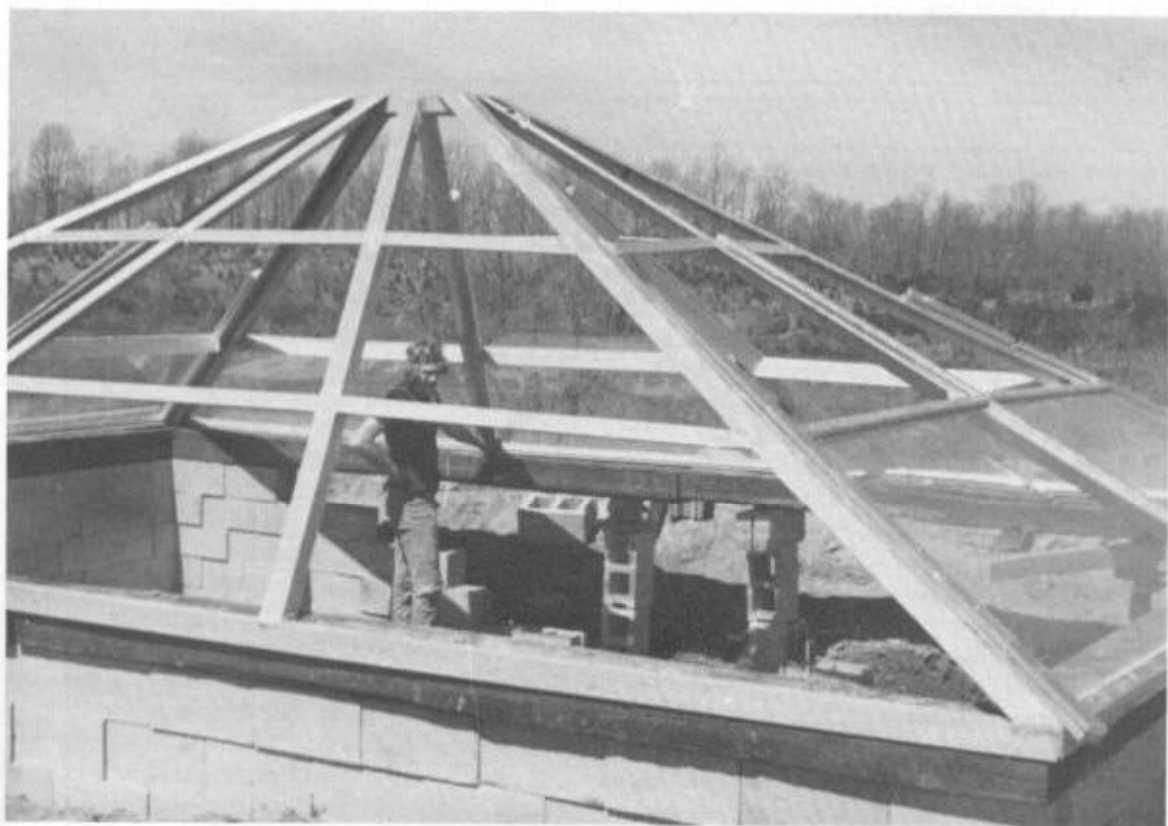

Fig. 18-4. Skylight as it is set in place on the foundation.

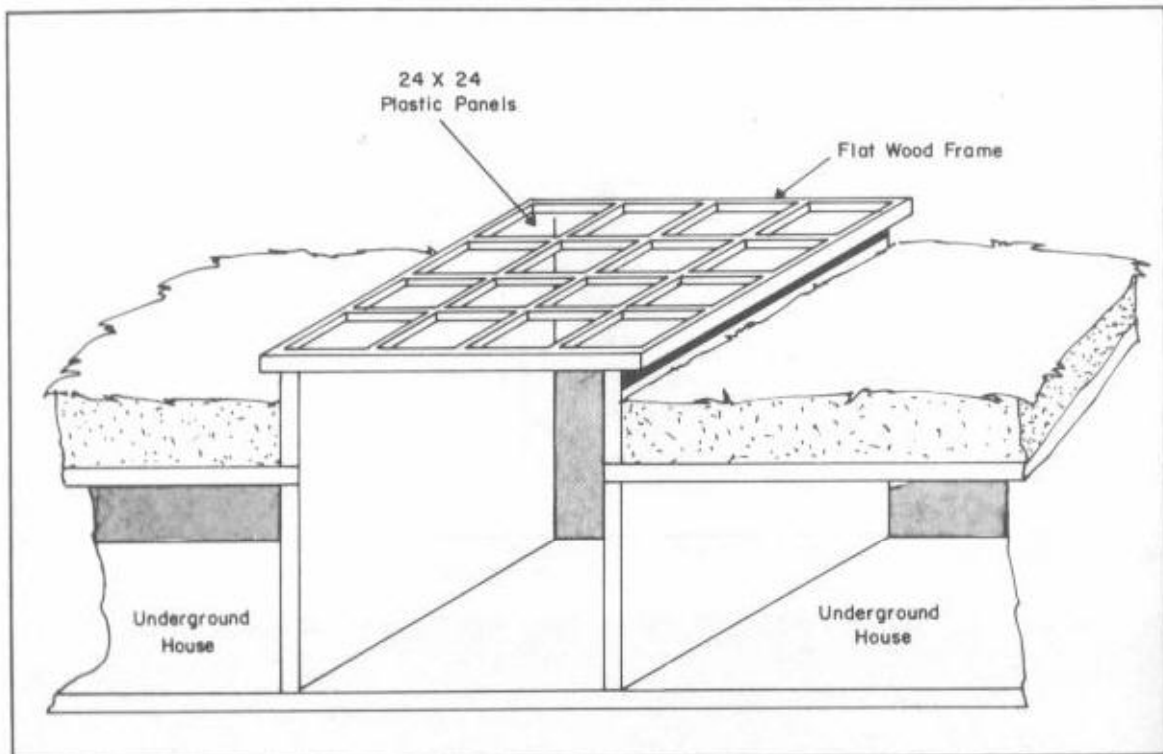

Fig. 18-5. A 2 x 6 or 2 x 8 would make a skylight frame on a single plane.

specialized equipment for heating plastic.

It is possible to build a garden skylight out of wood. This does, however, limit your design to a flat pattern (Fig. 18-5). Using 2 x 6s or 2 x 8s and keeping a square pattern will work well. I suggest that you use a wood glue as well as nails to construct the frame, and that the squares be no greater than 24 inches to a side. Once the framework is constructed, place 1/4-inch-thick acrylic (plexiglass) on the top. Use 4-x-8-foot sheets. You do not have to place many screws to hold the plastic in place. See Fig. 18-6 for a hole pattern.

Once your flat skylight is built, you can slope its foundation slightly to ensure runoff. Also you should attach a rain gutter of some type that leads to a distant drain. Whatever style of skylight you decide to build yourself, you will find out after a year or two that it will leak due to continuous expansion and contraction. A standard silicone caulk will solve this problem.

COST OF A DOME

If you are still undecided about whether to build your own dome or buy a manufactured one, consider these facts: I completed my dome (technically not a dome) at a cost less than \$3,000. The equivalent structure commercially built would have cost more than \$9,000 (not delivered and not totally assembled). I was afraid to ask about a delivery charge. There is another drawback. You'll find only a few dome manufacturers interested in talking to a private home owner because most of their work is with commercial building contractors specializing in shopping malls and office buildings. If by now you are considering doing without a dome or a skylight, however, I'll try again to convince you to include one at any cost. See Fig. 18-7.

Besides the element of natural light, consider the pleasures of a year-round growing area for exotic plants or a small vegetable garden. In addition,

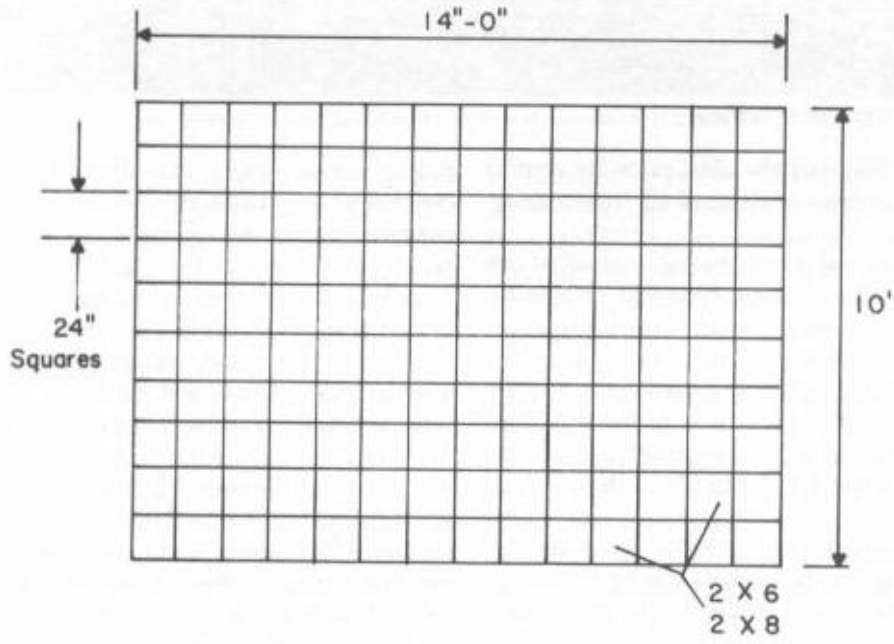
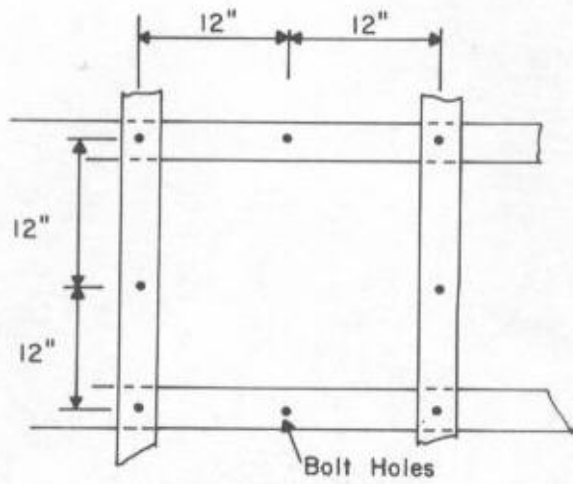

Fig. 18-6. Don't drill too many holes.

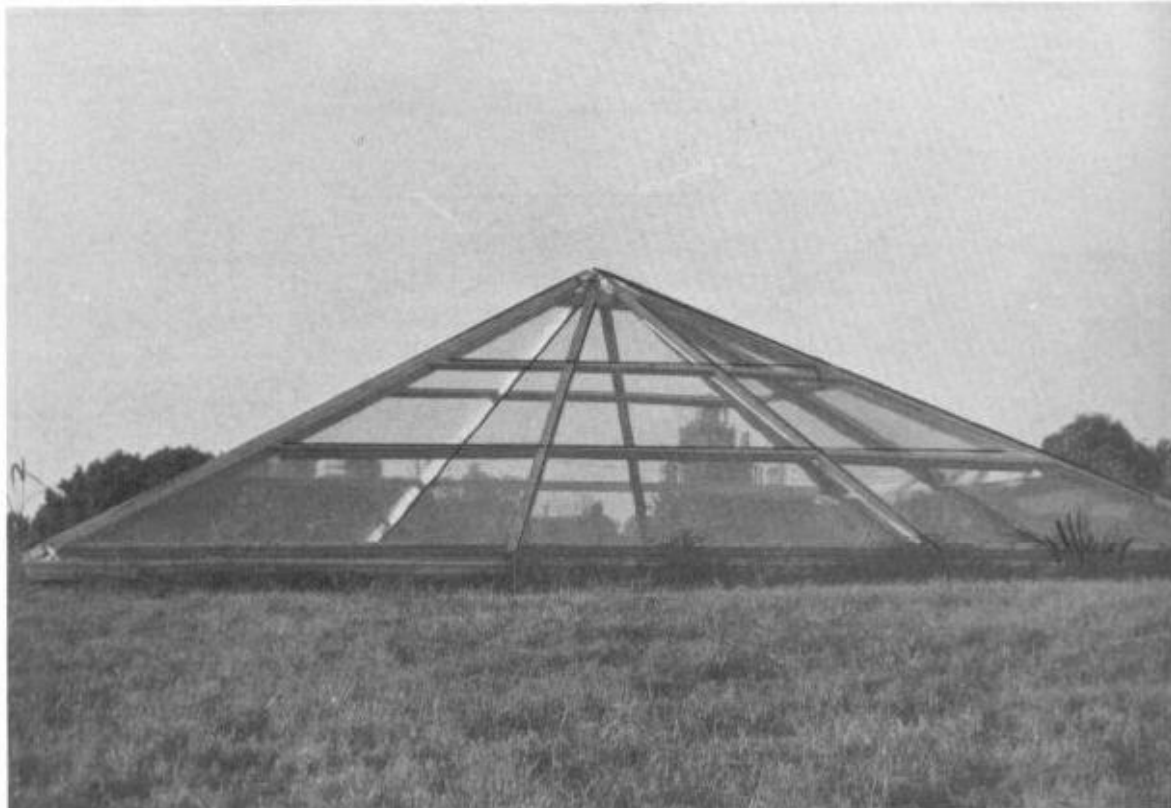

Fig. 18-7. My skylight setting in place.

an atrium will give you the ideal place for natural ventilation or airdraw because of its height above grade level.

Now for the major reason. A garden or atrium covered by a dome of some type will give you a place to provide emergency exits in order to comply with some local building codes. Check codes carefully as you design your garden and dome. Consider all possibilities before locking in on a design. Figures 18-8 and 18-9 show my garden in mid construction, and Figs. 18-10 and 18-11 show it near completion.

Skylight models vary greatly. Some are designed to let light in and others can be opened as well. Check the local building supply stores as a source.

CONSTRUCTING YOUR DOME

If you decide you want an aluminum dome, find a

good aluminum welder who will work with you. If he can't work on your site, then at least be near enough to make moving the welded frame possible (Fig. 18-12). Never install the plastic panes until the dome is in place and set on a stable foundation. The flexing will break the plastic panes every time. Check prices and explain your project to the welder. Keep looking until you find one who is interested in your underground house and not just your cash.

Try to arrange to do the sawing, fitting, holding, and grinding yourself. Let the welder weld. You'll both be satisfied and the finished product will show it. If you are in doubt about strength of the material, return to the engineer who helped with the roof. If he was accurate with the roof strength, the dome will be a breeze.

Once you find this person capable of welding aluminum and he agrees to help you, you have to have all aluminum angle and flat bar delivered.

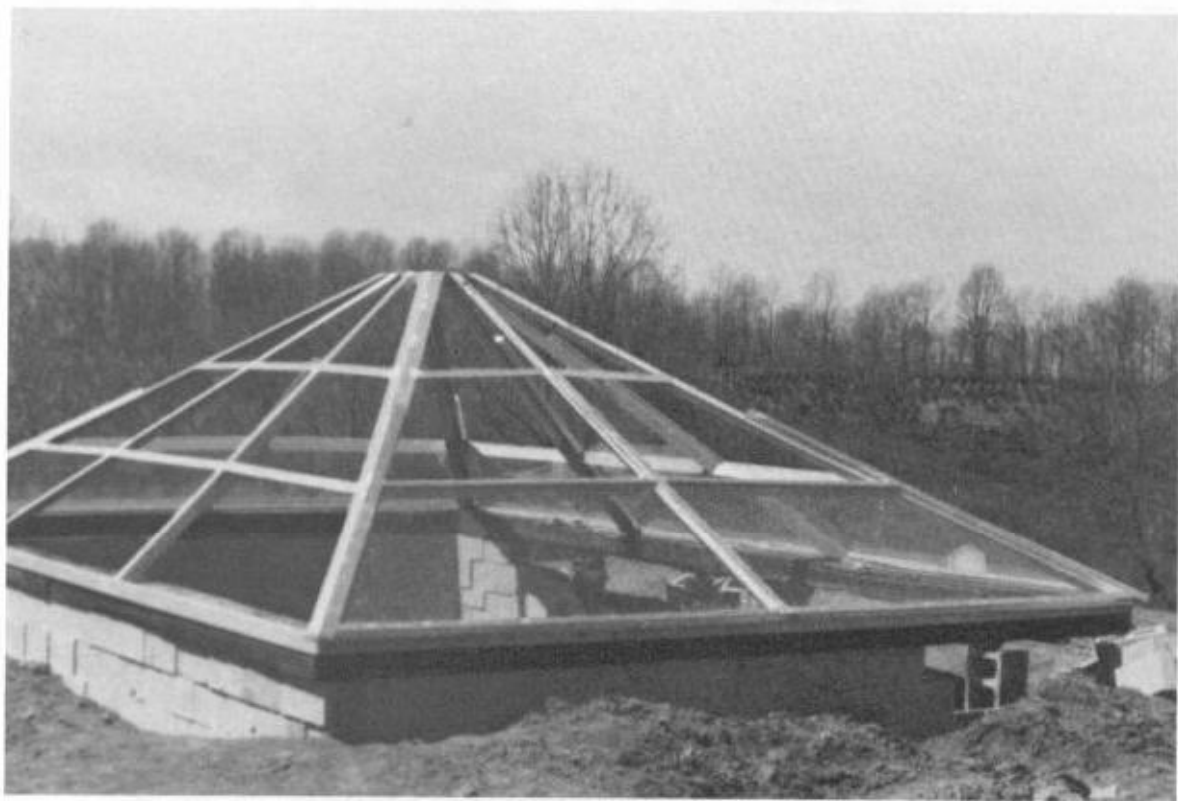

Fig. 18-8. Notice the stacked block in the garden allows moisture to penetrate to plastic.

Aluminum 3-x-3-x-1/4-inch angle and 1/4-x-3-inch aluminum flat bar should be sufficient to build a typical dome. To avoid cutting aluminum at the wrong angle or too short, use cardboard to make a template at the joints.

Use a good tape measure and triple check the dimensions after tack welding and before permanent welding. Continue this procedure until the dome's super structure is complete. Once welding is finished, use a grinder to smooth welded joints so that the plastic and wood will lay flat.

If you are wondering how to cut aluminum at home, it's easy if you have a standard circular saw. Any hardware store sells metal-cutting discs that adapt to circular power saws. Buy a couple; they cost about \$6 each and cut a lot of aluminum. Take it easy as you're getting used to this cutting procedure. The blade will occasionally grab or pinch.

Once your framework is complete and ready

for installation, you need to construct a foundation on which to set this structure. I stacked 8-inch concrete blocks from roof slab to ground level (Fig. 18-9). Then I set 8-x-9-inch railroad ties around the perimeter. Finally, the structure rested on the ties and was bolted down. The reason I stacked block with no mortar was to let the dome "breathe" and to allow some moisture to seep through to the earth inside the dome.

If you're building a dome for the first time the final step is to caulk each seam using an acrylic caulk. Any good-quality caulk will work fine. Finally, the dome must be bolted to the railroad ties by using lag bolts that are approximately 6 inches long.

As a safety reminder, do not watch the welder as he is welding. The light flash will burn your eyes. Even a reflection off of a wall will cause a severe burn or possible blindness. Be very careful if weld-

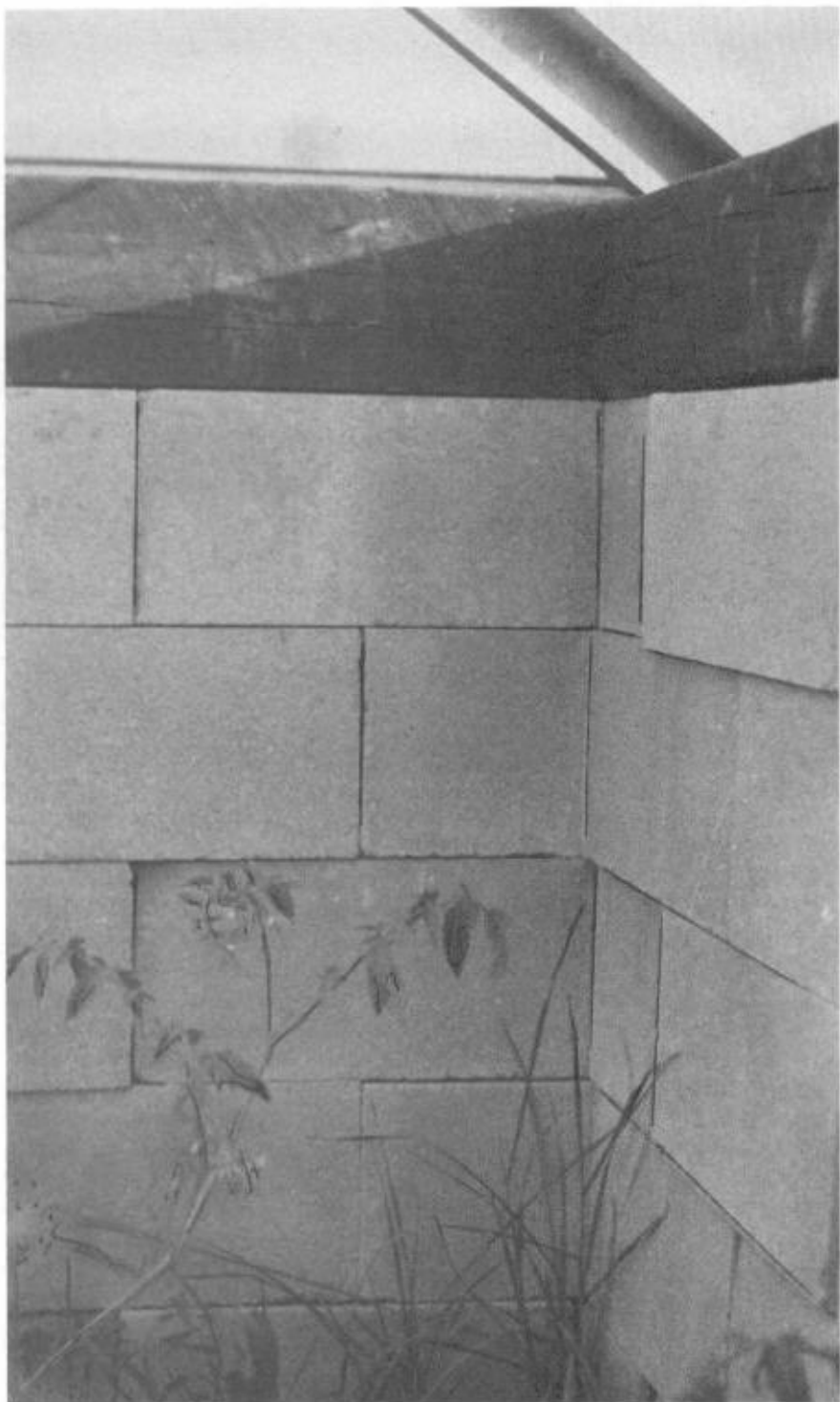

Fig. 18-9. Skylight tentatively in place.



Fig. 18-10. View at ground level.

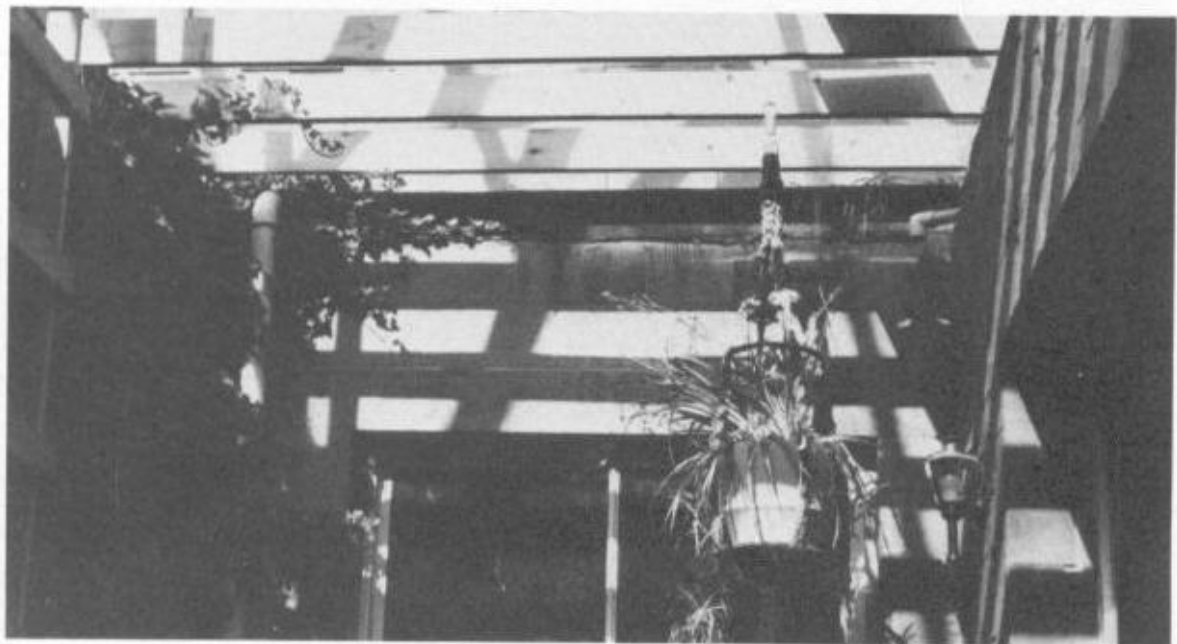

Fig. 18-11. Typical view in garden overhead.



Fig. 18-12. Not the approved way of moving a skylight frame, but it worked.



Fig. 18-13. The dome is still in place after six years; snow, wind, and hail haven't phased it.

ing is a subject with which you are not familiar.

Beware of my construction methods. I understand that it may be against some building codes in some locales. Let me mention something very interesting about the indoor gardens of underground homes. One inspector will say that a garden area like mine is an outdoor area and that exterior building codes apply to electrical outlets, water lines, etc. The next inspector will say that the same area

is definitely an interior room and that interior codes apply. Let them fight it out. I say it's an indoor area.

After a few years of experimenting and changing, you can see by Fig. 18-13 that my dome is still intact and working well. Underneath my dome, anything—cactus next to ivy, lilies next to pine trees and geraniums next to fig trees—will grow nicely. They all get the same temperature, light, and moisture.

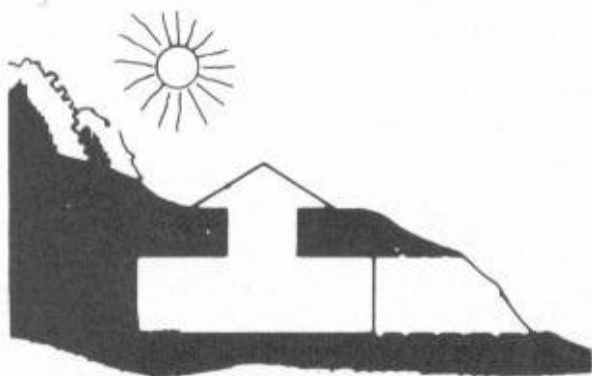

Underground Home Ceiling

Have you ever stopped to think about what your ceiling is going to look like when your house is complete? I realize that, with all the other problems of building about the cosmetic effects of the concrete slab—your roof. If you stop and think about it, you'll discover this 10-inch concrete slab has two sides; one is on the inside of your house. This could possibly be your finished interior ceiling.

THE ROOF SLAB

If you poured your roof slab in one piece over a sheet of plastic and you have removed all the scaffolding, you will notice a pattern formed in the concrete by the plastic. Most likely this will be suitable for a finished ceiling texture. All that is required is to paint the concrete roof with flat, latex paint.

Although there are other ways of finishing your ceiling interior, they are definitely a job to install. With all of your shoring, reinforcing, and other construction involved in pouring the roof, it is not logical to expect the underside of your roof to turn

out smooth and level. It will definitely have high and low spots; this will prevent you from attaching Sheetrock directly to the underside of the concrete.

The uneven surface is not the only determining factor. Probably the biggest problem you will discover is that you cannot drive concrete nails into your ceiling. There are two reasons for this. If the concrete has the proper quality, it will be too hard and brittle to accept nails. The main reason is that it is physically difficult to hammer over your head for any length of time or apply enough hammering leverage.

Another way to get nails into concrete is to use a nail-shooting gun designed especially to shoot nails into concrete, similar to a cartridge in a standard gun. These guns can be rented and are easy to use. I don't recommend shooting nails into the concrete ceiling even though it's commonly done. The reason is that occasionally a chunk of cement will break out. I definitely do not recommend shooting nails into the concrete ceiling even though it's

CREATIVE CEILINGS

commonly done. The reason is that occasionally a chunk of cement will break out. I definitely do not recommend shooting nails into any slab under 8 inches thick.

There is only one way to attach Sheetrock to the ceiling, and it isn't easy. Using a $\frac{1}{4}$ -inch drill bit, drill a hole approximately $1\frac{1}{2}$ inches deep and insert the appropriate part of an anchor-bolt assembly. The anchor bolts are available from almost any hardware supply store. I suggest you use 1-x-3-inch wood strips that are 8 feet long for ease of handling.

You should first place a bead of panel cement on each wood strip and then put anchor bolts every 2 feet for a typical wood-strip installation (Fig. 19-1). Now all you have to do is to continue this procedure throughout the house in each room you want to install Sheetrock.

If you don't like either of these methods of finishing your ceiling, there is yet another alternative to ceiling decoration.

This alternative is the method I have on the ceiling of two of my rooms. All that is involved is a little patience, originality, and time. The pattern is nothing more than pieces of wood cut at random lengths, widths, and thicknesses. The largest piece is approximately 8 inches long. The reason for the short lengths is that panel cement is the only thing holding them in place. No bolts, screws, or nails are used—only glue. Most likely, the smaller pieces will stick without support until the glue sets. This is especially true if you tap it gently with a hammer to force a tight seal.

Experimentation on your part will soon develop a style and approach that will make a super ceiling with a personal touch. An additional value with this method is that wood is an excellent insulator and a little extra insulation never hurt anything.

As in previous chapters, I have tried to be

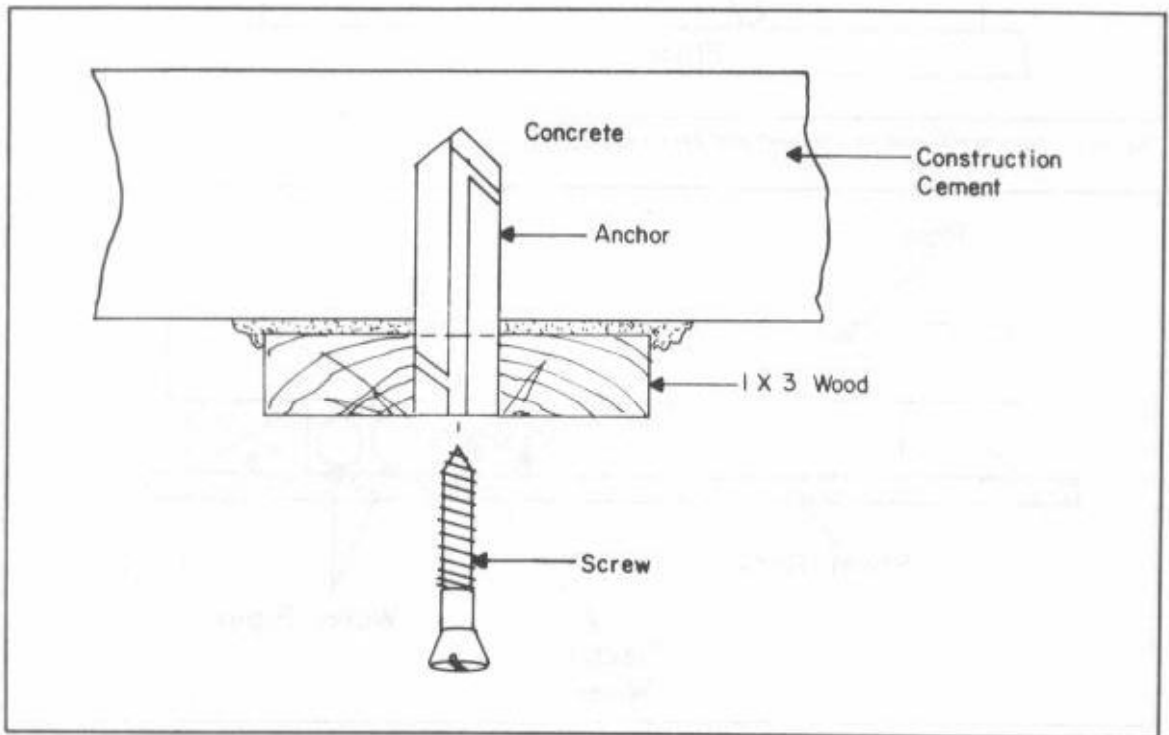

Fig. 19-1. If you use the anchor bolt system, a screw is required approximately 4 feet in length.

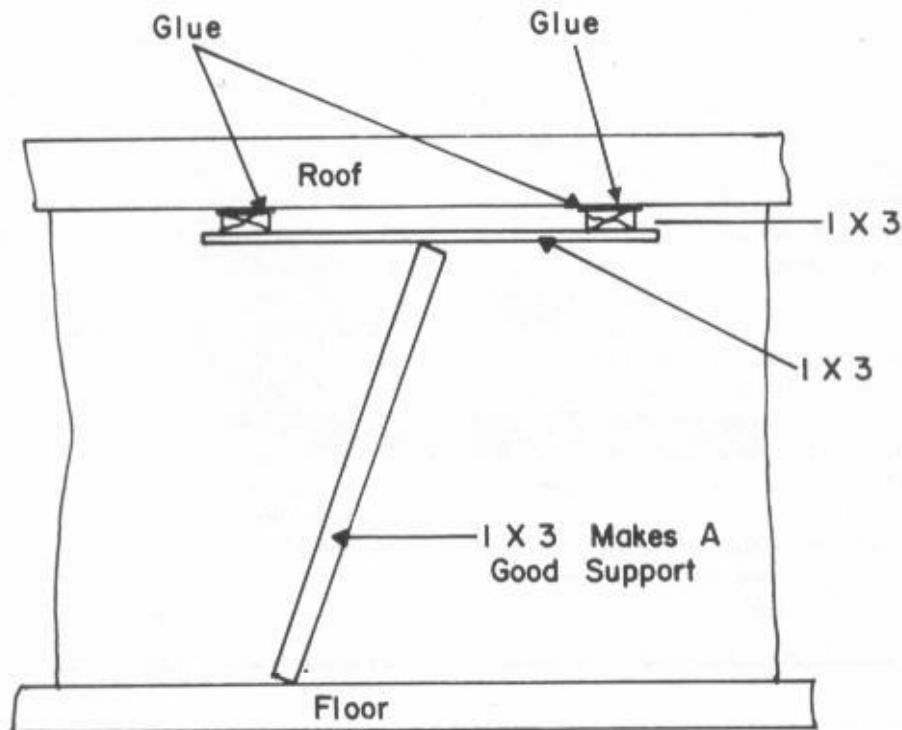

Fig. 19-2. Anything will work as a support until the concrete dries.

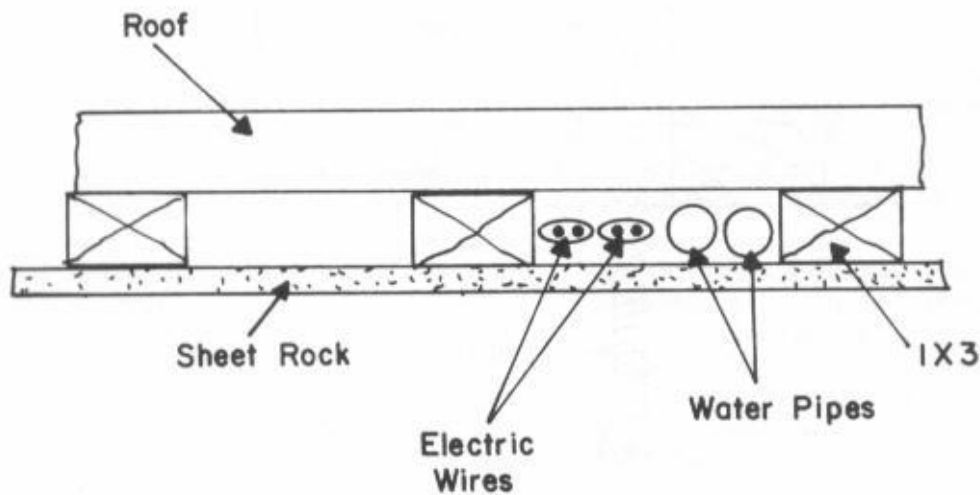

Fig. 19-3. If you create a space on the ceiling, you might as well use it.

honest with you on the pros and cons of each step as I see them. The negative side of this method is the extra wood is looked upon as additional fire hazards by the inspectors. This might cause contention.

If you do glue something to your ceiling, remember that almost anything can be glued there if you use a pole brace until the glue dries. Construction glues are very strong (Fig. 19-2).

If you plan on having a conventionally smooth Sheetrock ceiling, extra effort will be involved in securing the Sheetrock and getting it level. The easiest and most artistic approach would be to glue something directly onto the concrete or apply a stucco or paint of some type. Keep your imagination working and the results will be rewarding.

CEILING SPACE

If you go to all the trouble to mount strips of wood

on the underside of the slab, you might as well create a space that can be used for something such as heat ducts, wiring, or pipes (Fig. 19-3). Remember that you must plan the finished ceiling height before the concrete slab is poured. Always keep the ceiling 8 feet above the floor for cosmetic reasons. You might live with a ceiling 7 feet, 6 inches high, but the person you try and sell your underground house to might not want the lower ceiling. Building underground is difficult enough; don't make matters more difficult.

PAINTING YOUR CEILING

For a different approach, try painting the ceiling a darker color than the wall, make it only a shade or two darker but nevertheless darker. This is against most decorating concepts but it looks good in my house.

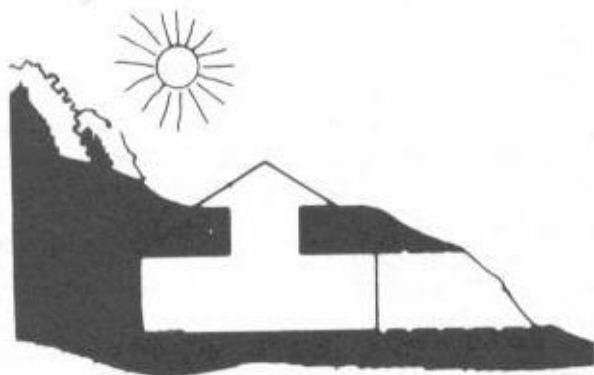

After the Basics

Once the basic construction part of your underground home is complete, you can and should relax for a while before going on to the fine details of finishing. These details include driveway surfacing, other than basic gravel, landscaping, other than grass and standing trees—and so forth.

On the inside, finishing touches might include the shop workbench you've always wanted or storage shelves. These are all things that are nice to have, but they are not essential to a final inspection by the bank or building codes department. As a matter of fact, anything you build is subject to inspection. Therefore, the less there is to inspect, the less chance you have of hitting a snag. Take your time adding these finishing touches.

THE ENTRANCE

Why not give your entrance a distinctive appearance? Perhaps you could have an unusual mailbox or just a nice display of evergreen shrubbery. Unless there is a sudden surge of popularity in building underground, your house will definitely be a

novelty, and the curiosity seekers will drive by to take a look. Even though they might not see much from the outside, they will form a lasting opinion of your home by what they see from the road. See Fig. 20-1 for a front-door view of my home.

GETTING USED TO LIVING UNDERGROUND

There really is an adjustment period to getting used to living underground, really underground, such as in my house. If you build partially underground, the adjustment is lessened.

Building underground is one thing to accomplish, but living underground successfully is definitely another. You must realize, as you are building, that there is no way to see if you will like living underground until you actually are there. Spending a few hours touring and visiting an underground home doesn't give a true indication.

Thousands of people have been inside my home for a short period of time, but they still don't know for sure what it's like living there. The sad thing about this point is that it costs a great deal of



Fig. 20-1. The view approaching the front door is different than most houses.

money to find out. If you don't like what you've built, there is a big question as to its value. If you're lucky, you could sell it at a profit. On the other hand, your potential buyers are few and far between.

To emphasize the point of the 6000 or so people who have toured my home, approximately 1 in 20 say that its always been their dream project to build and live underground. A little calculation will show you that converts to approximately 300 perspective underground home builders in my area of the country. I've personally asked every one of the people to give me a personal tour of their underground homes as I've shown them mine. To date, I haven't had an invitation and I don't know of anyone who has built underground. Talking and doing are two different subjects. A lot of people might like your underground home but buying it is another story.

NO WINDOWS

Probably the first thing you adapt to easily, as we

did, was the absence of windows. Even though you think this will be the most difficult problem, it is really the easiest. Of course my garden area helped eliminate that problem (see Fig. 20-2). You've probably always had a window to look out of or to open. Here is where your dome and indoor garden will save you.

STRANGE SENSATIONS

For the first few months of living in our home, we experienced an odd feeling caused by the absence of noise. In a conventional house after you turn the television off late at night and the children are asleep—if you sit still and listen—you might say things are deathly silent. Well they are in comparison to normal activity. Absolute silence is not obtainable in a home, and that is good because the average person would go bananas in an absolutely soundless room.

An underground house is somewhere in between these two extremes because the block walls

absorb sounds. Noises such as hot water heaters warming up, the presence of car noises on the nearest road, airplanes, or dogs barking are all considered "normal." These are now almost totally eliminated.

The strange thing is that if your daily routine takes you to the outside world, such as shopping or school, your ears become tuned into the sound level around you and your speech level is comparatively higher. When you walk into your underground home, especially for the first few months, you will find yourself talking louder than necessary by force of the habit from trying to be heard normally on the outside. The absence of background noise isn't noticed, and you continue talking as if it were present. This is something you get used to in a short time; it's nothing to get excited about.

The layout and configuration of the rooms make quite a difference as well as the carpet quality and the amount of glass. You must realize that if you have hardwood floors and loads of metal and glass furniture, the sound-absorption factor is diminished.

RADIO AND TELEVISION RECEPTION

Allowing for radio and television reception is something that never crossed my mind as I designed my house. Once we moved in and turned the radios and televisions on, we immediately noticed that in some rooms absolute nothing could be picked up on the radio. The waves could not penetrate the earth and concrete. As you get closer to the doors of your dome (if you have one), the television and radio waves will filter in—giving some reception. Even close to an opening, the reception leaves much to be desired.

Our solution was to use the aluminum structure of the dome as an aerial for both television and radio. The amount of aluminum available and its configuration make quite a difference. You might have to get a serviceman who is good with television and antennas to stop by and show you the best way to attach and run the wiring. Your design must have an outlet or path for the television aerial wire.

Bad reception is easily overcome if you run a master aerial lead to each room as you are finishing

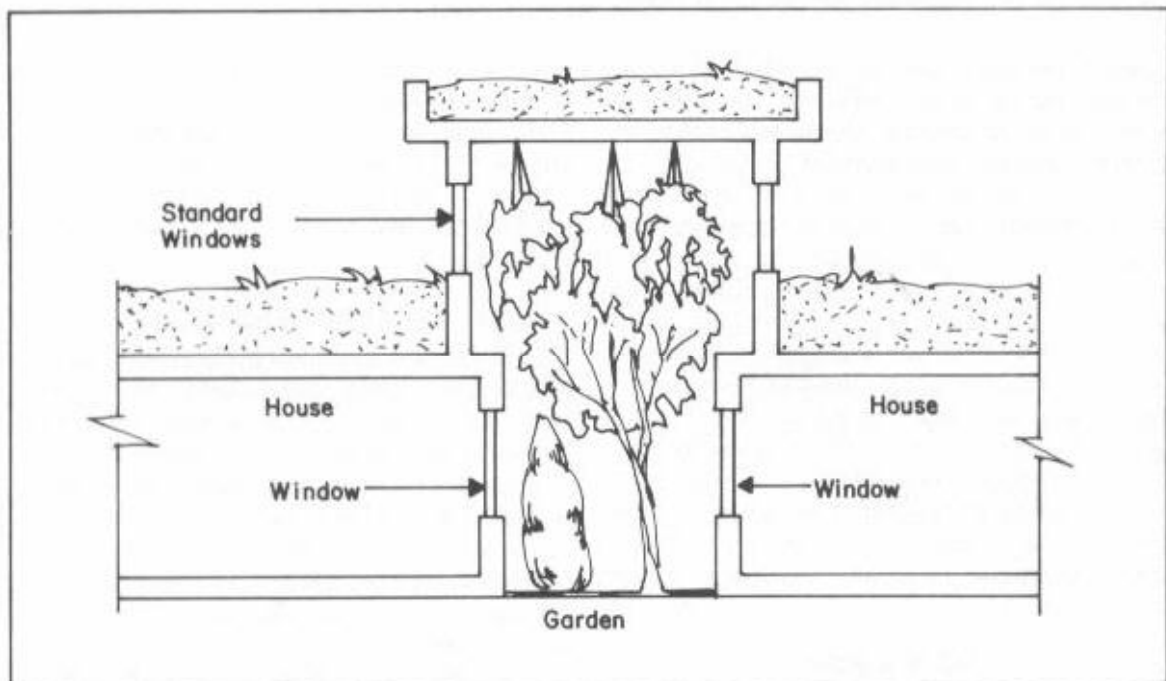

Fig. 20-2. Windows open to the garden area.



Fig. 20-3. Speaking of different—that's me and my car on the roof. (I'm the tall one.)

the walls. Before you finish the interior of your underground house, discuss this with a qualified television repair man. He might have a few good suggestions for your area of the country.

Cable or Satellite TV. If you live in an area where cable or satellite television is available, I would suggest you check into the service.

DOOR BELLS

Something simple as a person at your front door

causes a problem if you don't have a good door-bell system. That means a loud chime in a few different locations throughout the house. If you are in a back bedroom with all walls of concrete block, you'll never hear a knock on the front door or even a centrally located little doorbell chime.

It's easier to plan as you build than after all the walls are up and painted. If your structural design is different than mine, the sound problems will probably be lessened. See Fig. 20-3.

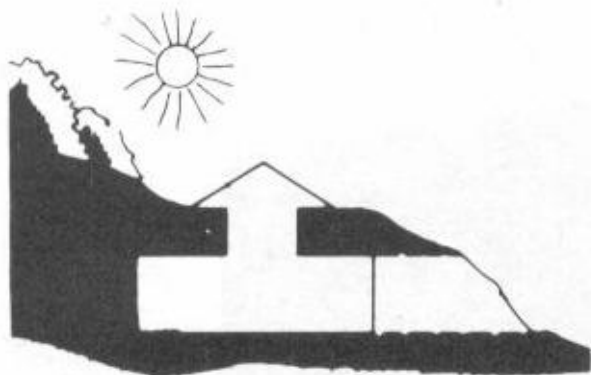

Would I Do It Again?

I am constantly asked if I would build underground again. The answer is emphatically yes! The only thing that has changed since 1977 when I built my underground house is that the nation has gone through an energy scare (or whatever it was). Immediately everyone thought about ways to save energy. Building underground was a natural and it still is today. My house saves energy but I'd build underground for other reasons.

The secure and quiet feeling living underground gives you is really something you look forward to. You don't hear wind blowing and thunder sounds like it's off in the distance. Living under-

ground is a feeling you learn quickly to be comfortable with and soon miss when you visit conventional homes. The absence of windows is a blessing and not a hindrance.

After five years of observing what happens underground, I would do very little different than what you just read about in the preceding chapters. The most important, single design changes I would make would be the roof slab. It would have an overhang over the walls in all directions. This would keep moisture away from the exterior walls. I know the humidity at the interior surface of my exterior walls could be reduced by this change.

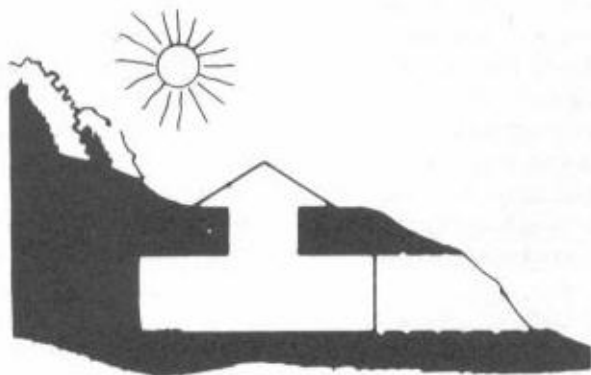

Alternate Sources of Energy

Alternate energy, now there's a catchall phrase! Since I began building my underground house, I have heard more stories about alternate sources of energy than you would believe. There are people with homemade energy-producing systems using methane from decayed plant life and animal waste. Don't forget the water wheel and the old standby the windmill. Then there is hydrogen obtained from everyday drinking water. Not to forget steam from a coal or a wood-fired boiler.

These methods are all fine and dandy, but only rarely do they ever provide a less expensive, more convenient source of energy than the conventional utilities such as, gas, electricity, or fuel oil.

My definition of alternate energy is any energy source for which you don't receive a bill in the mail. Of course, energy is synonymous with utilities when discussing home use. The two basic requirements are heat and electricity. I admire anyone who uses alternate energy—efficient or not.

HEAT

People who have heard unfounded stories about

underground homes not needing a heat source definitely have the wrong impression. Heat most certainly is required. The good thing about building underground is that it only takes about 25 percent of the heat required for a conventional home. As you can figure, it doesn't take long for a 75 percent annual fuel bill savings to add up to a substantial amount.

Sometime in the near future, fossil fuels might become unavailable to heat your house at any cost. So you can look at the underground idea as doing your part to save energy. Now that I have convinced you that some small heat source will be required.

WOOD STOVES

Wood stoves are probably used in over 80 percent of all underground homes. I base this estimate on information given to me by other underground home builders who have contacted me. I've taken no scientific survey, but I'm convinced that wood stoves are the most popular heat sources in underground homes.

Like many commercial products on the mar-

ket, there are stoves of excellent quality and stoves that are outright dangerous to use. You will only get what you pay for in a wood stove; be prepared to buy "quality." Most of the brands are sturdily built and have excellent airflow. You will find quite a few manufacturers of wood stoves that distribute regionally. Therefore, they are not available to everyone, everywhere. There are good books written on wood stoves. I suggest that you make up your mind intelligently by reading up on the subject and by physically examining as many brands as possible until you're satisfied that you know what you are buying.

There are many scientific results available from different manufacturers indicating that one brand burns twice the wood of another brand under similar conditions supplying the same heat. You could end up cutting twice the wood necessary to get through a winter.

I don't have to buy wood, but I do realize that wood could be a costly fuel if you have to buy cords of wood year in and year out. Even if you paid premium prices, it would still be less expensive than the oil-base fuels. Besides, wood is a replenishable natural resource.

If you have to buy wood by the cord over any extended period of time, you're doing something wrong. Wood is everywhere. Some builders will even pay you to clean up the scrap wood after a new house is built. Many people will pay to have a piece of land cleared of the trees and you keep the wood. All you need is a good chain saw, energy, and an old station wagon.

If you must buy all of the wood for your wood stove because of location or physical limitation, I strongly recommend a conventional heating system with a wood stove for cosmetic and atmospheric effects only.

COAL

In some sections of the country, coal is easier and less expensive to obtain than wood. There are problems with the odor and the mess, but it's less expensive and easier to handle than wood.

The important thing to remember if you use a

stove is to locate your heating unit centrally. Your chimney is the main part of your natural heating-ventilation system. Put it near the center of the living area. As your hot air rises up the chimney, it draws air from the point of least resistance. That is out of the living area as long as you provide a method for fresh air to be drawn inside the house.

In an underground house, the hot air rises up the chimney. This draws air out of the adjacent room creating a slight vacuum. This vacuum is filled by fresh, colder air from the outside, thus creating a natural, continuous flow of air.

The airflow might need mechanical assistance such as a small fan or duct system. The exact size and layout of your home will determine this. You could also use vents or lowered panels in doors to create a flow of fresh air. This pattern of airflow will continue as long as the air temperature is warmer inside than outside or a slight breeze is blowing past the chimney.

Your building inspector might ask, "What happens when the wind doesn't blow, it's 100 degrees outside, and you have a fire in your stove?" He is technically correct but not practical. Because this condition will only come up in the summer months, it is safe to say that your doors won't be continually shut for an extended period of time (a week or more). In case your inspector requires additional assurance of ventilation, you can install a small fan and vent from the exterior or you can draw fresh air from the indoor garden that I hope you included.

Air circulation is a subject that your inspector might harp on or not even mention. It depends on your local inspection system. If it's a big deal to your local officials, rely on your engineer. You probably know him pretty well by now.

For your own information, let me tell you that you can take an underground house the size of mine (2800 square feet of living area), close all exterior doors, burn your stove for at least five days, living normally inside, and the atmosphere inside will hardly be stale. Because an underground home is more airtight than a conventional home, some people are scared into thinking they are going to lack fresh air. It just isn't so. Normal traffic opens

and shuts exterior doors numerous times a day.

I do suggest that a vent of some type be installed on the exposed exterior wall, and that if feed directly to the interior only as a safety precaution. This is a subject that your local code will control probably in great detail. If you have a vented dome, you're even better off.

SOLAR HEAT

Solar heat is another catchall phase; it means any heat from sunshine. This includes a very simple system of simply opening curtains as the sun shines and closing them as the sun sets. It could be the complex systems of piping, valves, and pumps used on conventional houses adapted for solar heat.

It is my opinion from my research that complex solar-heat systems will cost much more to build, install, and maintain than you could ever retrieve in heat bill savings in a lifetime. Remember, I'm going on the assumption that your heat requirement will be one-fourth that of a conventional home.

I do encourage you to use solar heat and to do all possible investigation if cost is not a major factor. Solar heating is definitely a subject whose time will come, and everyone should support its use and research. The only drawback is the initial cost.

Notice that I said *will* come. Solar energy in all forms was the in thing of the late 1970s. Americans are very fickle in the long-term acceptance of most things. When I built my house (1977), the world was supposedly on the verge of a solar society, quoting expert after expert.

Well, today solar panels and solar homes are not nearly as popular as five years ago. A recession, of course, hurt building, the price of oil went down, but the real reason is that the public in general has not been able to accept to any type home except the three-bedroom, two-bathroom rancher in suburbia.

The idealists, the back-to-nature people, and the conservationists are all alive and well, even if their numbers have dwindled. They are at the bottom of the economic ladder, and don't constitute a large block of the home-buying public. The professional, corporate, white-collared males with the pinstriped suits make up the mass of new-home

buyers. They want a home to match their image.

SOLAR / ELECTRIC

Please do not be confused with the terms solar heat and solar electric. Solar heat is here today. Solar electric cells for domestic use are probably five or ten years away. Or it's possible a major breakthrough will never be developed in the production of solar electric cells (photovoltaic cells). You can't buy them at the local hardware store yet.

I believe that photovoltaic cells for home use will be made impractical by the large-scale production of synthetic fuels that will power existing power plants. Thus you will always buy your electric from the electric company. In addition, power-using items are becoming more and more efficient. Don't hold your breath waiting for solar electric cells to show up in department-store catalogs.

A WORKABLE ELECTRIC SOURCE

There is a source of electrical power that is less expensive than your local power company. You should be well versed on electricity and mechanically inclined to pursue this method. I'll describe the basic idea and you can take it from there.

The alternate electrical system is to use a small diesel engine, such as a four-cylinder Volvo engine for example, coupled with a direct-current generator that charges heavy-duty storage batteries similar to the ones used with commercial equipment. By a series of regulators and switches, you can keep these batteries fully charged with a minimum use of diesel fuel. The catch is that you will have to wire your house for direct current use instead of the usual alternating current from the power company. Most of your light bulbs and small appliances will operate sufficiently off of dc. Only the big electric appliances require ac. This system would be somewhat expensive to set up, but it would pay for itself in a short time.

WIND POWER

What about a wind generator? A really interesting

source of electrical energy that is free is a wind generator. There are approximately 10 good wind-generator manufacturers in this country. Each claims to be the most efficient. All of the devices work basically the same. Some use storage dc batteries while others use inverters without dc batteries and provide ac.

One thing to be sure of is that your area has the average wind speed needed to turn a windmill. Because the wind blows at different speeds from day to day and each wind generator's conditions are different, it's hard to be specific about what conditions are required. From my research, I have drawn the conclusion that if you had 15 miles per hour winds 50 percent of the time, using batteries and a 5-foot diameter blade on the appropriate generator, you could probably do away with the electric company. Call your local airport for basic wind and information.

A note of caution concerns the advertisements making great claims about the amount of power you can expect. Their claims are in the same category as the advertised gas mileage of new cars (if they claim 30, you'll get 20 mpg).

The distance your windmill is from the house

is all important and so is the height above ground level. Don't forget about the natural obstructions of the wind such as trees and hills.

I researched windmills for my underground house and found it would take \$20,000 to construct a system capable of powering my 2800-square-foot house. And then I'd have to maintain it. I'd never save \$20,000 worth of electricity in my lifetime if you count investment, interest, inconvenience, and repairs.

If you live in the higher mountains, then it may prove to be a practical alternative. Check things closely. The only people I will recommend a windmill to are the lucky ones living near Dodge City, Kansas. Records indicate that Dodge City, Kansas is the windiest city in the continental United States.

OTHER FUELS

As for methane, hydrogen, propane, etc, feel free to experiment with it, but don't get involved in a large-scale operation at the same time you build underground. Conquer the art of living underground first, and then move on to the exotic fuels for powering your house.

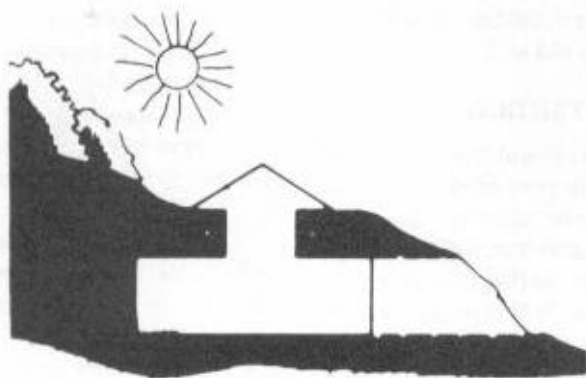

Underground Home Publicity

There is a fact that you must face when getting involved in any project as big as building an underground house. As with most unusual projects, many people will be interested. It seems that with the energy shortage, underground homes are surely a subject to receive attention. Of course, there are many types of attention that you get—negative, positive, private, and public.

POSITIVE ATTENTION

Fortunately for you as the home builder, the people that give you publicity, through their request or yours, are fairly easy to categorize. As you read on you will see what I mean.

I have found one thing to be 99 percent true. The groups of individuals who personally ask to see your house are almost always friendly and not likely to cause you any problems. You very rarely will have a person ask to see your house and then bad-mouth it behind your back. If you build your underground house correctly, visitors will go away impressed. They will also become your best moral

supporters. You will be surprised by the number of friendships you make that will continue after the house building has been completed. This is reason enough to build an underground house; we all need all the friends we can get.

NEGATIVE ATTENTION

Just as the private citizens who ask to see your house are 99 percent friendly, you can rest assured that 99 percent of the public or regulatory personnel who see your house will have a negative opinion. In all fairness to these people, they usually form their opinions through the eyes of their specific jobs: zoning, health, fire, insurance, or building inspectors. Don't be surprised if the dog catcher even gets into the act!

Let me explain what I mean by seeing an underground house through their job titles as opposed to their personal interest. In the course of my complicated maneuverings with the county and state officials, I had one inspector who gave me real problems as he acted in the manner and capacity of

an inspector. As a matter of fact, he was downright uncooperative. A week after the inspection, the same inspector contacted me and wanted to know if he could show my house to his family. This time everyone was as friendly as could be. Once back on the job, he reverted to his old self.

PUBLIC ATTENTION

Public attention is the most critical type of attention you will receive. It can make your adaption into the community smooth, or, if the attention the newspaper, radio and television give you is negative, the neighborhood will be convinced that your house is a black spot in the community. At this point, I will put your mind at ease and tell you to relax.

When a newspaper reporter or television station contacts you for an interview, they are almost always forward-thinking, intelligent individuals who like to see people doing individualistic projects (especially saving energy). The time is right. These reporters can be your best allies if you get into any real hassles with officials. Reporters, by nature, will see that no one pulls the wool over anyone's eyes simply by constant exposure in the media.

I do, however, have some good advice for you as you prepare for your interviews with television or newspaper reporters. Know what you are talking about; don't make dumb, specific statements. First of all, they only want general information that the public can relate to. For example, if a reporter asks you how strong your concrete roof is, don't answer that it will hold exactly 795 pounds per square foot. First of all, no one knows exactly how strong your concrete is and second, someone will begin to question your judgement. Whatever you do, don't pin yourself into a corner by broadcasting specific facts about your house that the public does not need

to know.

If you build underground in a community where you are the first to do so, you're sure to get newspaper coverage. There are few things more frustrating than having your project photographed at a bad angle or a misquote on something you said. One newspaper photographed my house from an angle so that it appeared that one of the neighboring homes was setting on top of my roof. It was really 500 feet in the background, but the picture didn't look that way. Everyone got a laugh except me.

Then one reporter was sure I said 1000 cubic feet of concrete when I really said 100 square feet; quite a difference, embarrassing and there was nothing I could do.

Yet in another article someone drew a cartoon to go with the long-distance telephone interview for a major newspaper. This time the article was great, no misquotes, but the artist drew a cartoon of a bowlegged man with a beard, bermuda shorts, and a shotgun standing on the roof of an underground home trying to shoot gophers that were digging into his underground house.

I got calls from people I hadn't seen in years telling me what a handsome man I had become. Once again, there was nothing I could do once it went to press. And you don't get a chance to approve or disapprove the story. Just one of the problems of stardom you'll have to face.

PRIVATE ATTENTION

The less negative attention you receive publicly, the less private attention you are likely to receive. Accept the fact that building an underground house is an attention-getting project. Use it to your advantage and do not let it cause a problem.

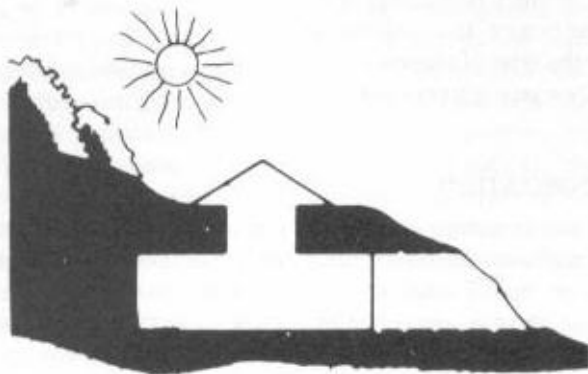

Years Later

My underground home has been completed for over 5 years now. The preceding chapters describe my experiences dealing with day-to-day problems. These years have given me time to collect my thoughts and change my opinions on some things. Some of the things I thought to be insignificant were not, and some of the things I thought to be important or crucial were no problem at all.

DOMES ALIGNMENT

As I located my house on the piece of property I had bought, I centered the structure with the front doors facing the only direction feasible. I thought nothing about this layout at the time because I thought, if I was totally underground, what difference would it make how the house was situated. For the most part there was no problem.

The slight inconvenience I did discover was caused by the way the sunlight comes through the panes of the dome. As it turned out, I had two corners of my garden area under the dome. About 15 percent of the total area was never directly hit by

sunlight. This doesn't affect the garden except for losing a small growing area. Needless to say, a real professional could have figured the path of the sun and the shadow it would cast if he had given it the time and concern.

Another little discovery that I made, once I actually settled down to a daily routine in my house, was that the dome sweats year round. Only in extremely cold temperatures do the droplets freeze to the panes of plastic. Otherwise, the condensation droplets accumulate and cling to the panes. They soon evaporate and dissipate into the air.

These droplets cling to the panes as high as 22 feet overhead. If the wind is blowing slightly, all is well. When the wind velocity nears 40 miles per hour, in gusts, the panes vibrate and thus shaking the droplets loose to fall to the ground.

Still, it is not a big problem unless you are walking through the garden in the early morning around sunrise when the most drastic temperature changes take place. Unfortunately, this is the time we are usually crossing through the garden from the

bedroom to the kitchen for the first cup of coffee. If the time is right and the wind is blowing hard enough, you can get a nice shower.

This only happens once in a while, I consider it a special feature of underground living. I'm not about to do any major construction to eliminate a few drops of water. This is the type of phenomenon that was not expected. Only a year's living experience brought it to light.

SKYLIGHT FOUNDATION

The building codes call for any structure similar to my dome to be anchored solidly to the roof structure. If you recall I did not do this. I stacked concrete blocks on the roof slab, using no mortar. The reason for no mortar was to allow normal water seepage for the indoor garden soil. The inspectors said that this would cause a problem, and I was cited for noncompliance.

This point still has not been resolved. The fact is that the stacked block works extremely well. Only a limited amount of rainwater actually seeps through, and the cracks allow air to filter through into the top of the dome. The suggestion that the earth will settle against these stacked, unmortared block and cause them to cave in is unwarranted. My block are exactly in the same place I put them 18 months ago. Once thing I did do after one year was raise the dome 8 inches higher by placing another row of block around the perimeter. This was to allow a build-up of dirt to create more of a slope for rain to run off.

SKYLIGHT REPAIR

If you noticed by the pictures of my pyramid-shaped skylight, I designed it so that some of the plexiglass panels are quite large. The longest span of acrylic is over 8 feet in its longest direction. This was fine for assembly, but after four years of hot summers the plexiglass actually began to sag. Now five years later I must replace a couple of the longest panels.

This isn't a major crisis but it was still a design oversight. Don't make the same mistake. I suggest that the longest span of acrylic plastic should not exceed 48 inches in any direction; 36 inches would be a safer dimension to work around.

HEAT FROM THE SUN

Another interesting fact I discovered about having an enclosed garden area is the true power of the sun to heat. All of the armchair engineers are telling me, "I told you it would be hot in there." Of course anyone could have predicted that, but I don't believe anyone expected the temperature to get as high as 165° F, which it actually did. Do you know that 165° F fries tomatoes on the vine?

This was a problem that I discovered only after I lost quite a few good yielding tomato and pepper plants. The solution to that problem is simple. If you are in the midst of a hot spell, spread a thin sheet of polyethylene (plastic) over the plants. This is the same type of plastic you used for waterproofing the walls and pouring concrete. It works well. Additionally, during the extreme hot days of August, I used a portable electric household fan directed upward to circulate additional air. It is not practical to install a fan of this size permanently because it will only be used approximately 10 days a year. These are truly little bits of information that only time can reveal.

CRICKETS

Many people ask if I have an insect problem. No, I do not have an insect problem. Specifically, I have a cricket problem. Right! Crickets. I can truthfully say that spiders, ants or bugs of any kind are not present. Not many above ground homes can say that.

I have been told that an indoor garden like mine is the perfect living quarters for crickets. Now, before you get excited and conclude that my house is overrun with crickets, I'll be specific. First, they seem to congregate only in the garden. Occasionally one will venture into another room, but a normal house will have that same problem. Because they stay near the humid, garden-dome area, it makes them easy to control.

Many of the commercial insect sprays do the job. It doesn't eliminate them completely. It only cuts down their population. A week later they are back. So I spray again. I have to admit, I enjoy the chirping sound at night. It sounds like you're sleeping in a tent sometimes. I even feel cruel when I

exterminate these harmless creatures. Nevertheless, I built the house for humans, not crickets, so one of us has to leave—and I'm the one who pays the mortgage.

SNOW

The problem with the snow drifting and blocking the doors was relatively easy to solve. When spring arrived, I planted shrubs and trees to create a natural barrier to block the drifting snow. In my case, as in most other underground homes, a good building location is hard to find for many reasons. Trying to find a satisfactory location with a southern exposure is like being on a treasure hunt. Most of you, however, will probably have to sacrifice that southern exposure for other benefits.

VISITORS

I like to share my project with people who are sincerely interested in saving energy or who are merely curious. The only part about visitors that gets to be unpleasant is that a few, maybe 20 percent, show up at my front door without any warning whatsoever. Not even a phone call. They just show up at the door.

Well this isn't too bad since we try to keep the house presentable most of the time. For the most part, their timing isn't too bad. If I'm really busy, the children have been very efficient about taking visitors on the "grand tour" and explaining the interesting points. Nevertheless, there are a few inconsiderate people who not only show up without warning but do it at 7 o'clock on Sunday morning. It's asking a great deal to be congenial under such circumstances. If you ever build an underground house, you will see that I'm not joking. The timing of some people is really off and their consideration is almost nonexistent. Nevertheless, I have never refused to show anyone through who has asked to see my house and I have answered their questions.

There is another type of person that will show up with or without an invitation. They will bring their children and dogs. If the children are well behaved, fine. More often than not they are renegades. These visitors are few and far between, but rest assured that, if you build the only under-

ground house in your community, you will have all types of visitors. Most are considerate.

UTILITY BILLS

Anyone investigating underground home building has checked on the utility savings—less fuel for heat, etc. Although I don't use a conventional heating system; I use only wood, and a minimum of that. So I have really cut my fuel use by 100 percent. The only negative side to the energy-saving idea of an underground home is that my neighbor's electric bill is running approximately 10 percent lower than mine. He owns a conventional, normal-sized home. I figure that I actually use only 50 to 55 percent of the total amount of energy that I would be using if I actually had a conventional fuel system and a typical electric bill.

This statement, however, is made with a slight reservation. Because all the traffic created by this new project has begun to subside and the constant use of power tools has slacked off, I expected my electricity consumption to drop. The actual electric bill got higher only because of inflation in general and the electric company passes there cost along to me. But the kilowatt hour use per year has constantly dropped year after year, mainly because my family (as with everyone else) became energy conscious and we developed simple methods of saving electricity, such as more use of the microwave oven instead of conventional electric oven.

I connected a few lights to fluorescent bulbs, replaced incandescent bulbs and finally I'm not trying to convince anyone it's as light as a conventional home. The first year I overreacted by leaving extra lights on. Now I accept the extra darkness as a better way of living; maybe its not for everyone, but for us it's fine.

LACK OF LIGHT

Earlier in this book, I said we adapted well to the absence of windows. That, of course, was my first thought, with only limited experience living without them. I can honestly say that one year later the windows aren't even missed—not one bit. I am fully convinced that even conventional homes could do well by eliminating a few windows. With the right

decoration inside, the lack of windows is a blessing.

Don't let anyone try to convince you that windows are a necessary part of comfortable home living. You'll never miss them. Nevertheless, there is one small catch you should be made aware of—oversleeping or losing track of time. This is easy to do. Remember that, once you shut a bedroom door and turn the lights out, it is totally dark. The only help you have in the morning is the alarm clock.

During the first year, we had several occasions to sleep in one of the three bedrooms without natural light. Because it was a weekend, we didn't have to get up for work. All of a sudden the phone rang, I grabbed it and gave the party on the other end a few choice words, not fit for publishing, because I thought it was 4 A.M.. It turns out it was nearly noon. Oversleeping happened more than once, especially to the children on school days.

PROBLEM NEIGHBORS

If by unfortunate necessity you had to build your house close enough to neighbors so that they could see your progress, you probably had at least one neighbor give you static over your choice to go underground. The old saying "time heals all wounds" is true even in underground homes. You

will find, just as I did, that one year later the people opposing your house have become tired of hearing themselves talk, and the neighbors who were questionable have become good friends. The official side mellows just as easily. The building inspectors will be tired of talking to you by now (especially if you haven't let them get you down).

In closing this chapter, I can safely say that the only thing rougher than the actual building construction was the first year of living inside. Things are settling down, and it is almost like living in a conventional house. After five years, my close neighbors, for one reason or another, decide to sell their conventional homes (both within sight of my underground house). Each of their homes sold for top dollar, squelching the idea that an underground home devalues a neighborhood.

I think the real estate agents increased their likelihood of showing these conventional homes by telling the prospective buyers that they could see an underground house in the neighborhood. The novelty attracted traffic and traffic sells homes. To those develop planners and owners who write in the sales contract that underground homes cannot be built in a particular housing development (housing discrimination), what next?

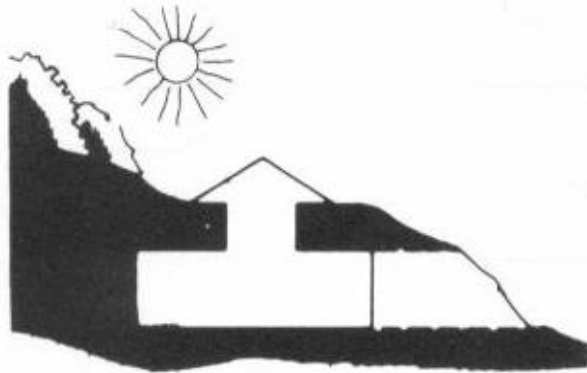

“The Day After”

If the title of this chapter sounds familiar, it's intentional. Once again the future of earth-sheltered homes is on an upward swing. When the first edition of this book was written in 1977, the key word was energy. Everyone was concerned about saving energy because of the Mid-East oil embargo. Slowly the general public (me included) accepted the high cost of oil (energy). When prices slowly began to decline, everyone became complacent about the cost of energy. This also resulted in a lackadaisical attitude toward earth-sheltered homes.

Then came the highly publicized television movie, called “The Day After,” about a nuclear attack on the United States. The movie almost did for the earth-sheltered home what the oil embargo did a few years earlier. Immediately after the showing of “The Day After,” I began to receive calls and letters asking specific questions relating to the durability of a house similar to mine if a nuclear explosion such as the movie depicted actually happened.

By building underground, you reap the same

old energy savings benefits but you also have a structure that is basically impervious to destruction. Whatever your reason for building underground, it still is a good idea whose time has come.

How safe would underground homes be in case of a major explosion? Naturally it depends on how close you are talking about, and how strong the destructive force. No one could calculate exactly what would happen to any structure. Wind direction and velocity, the topography, the temperature, and plant growth are only a few things that would greatly effect your chances of survival. See Fig. 25-1.

My house is 5 feet underground. The ceiling is 10 inches of steel-reinforced concrete. Suppose there was a nuclear explosion at point “0” in Fig. 25-2, and the first conventional structure standing undamaged was 50 miles from point 0. My house would still be inhabitable about 15 miles from point 0. That could be considered 5 times safer than a conventional structure, but this factor must be addressed with considerable clarification.

Surviving the initial shock wave and the heat

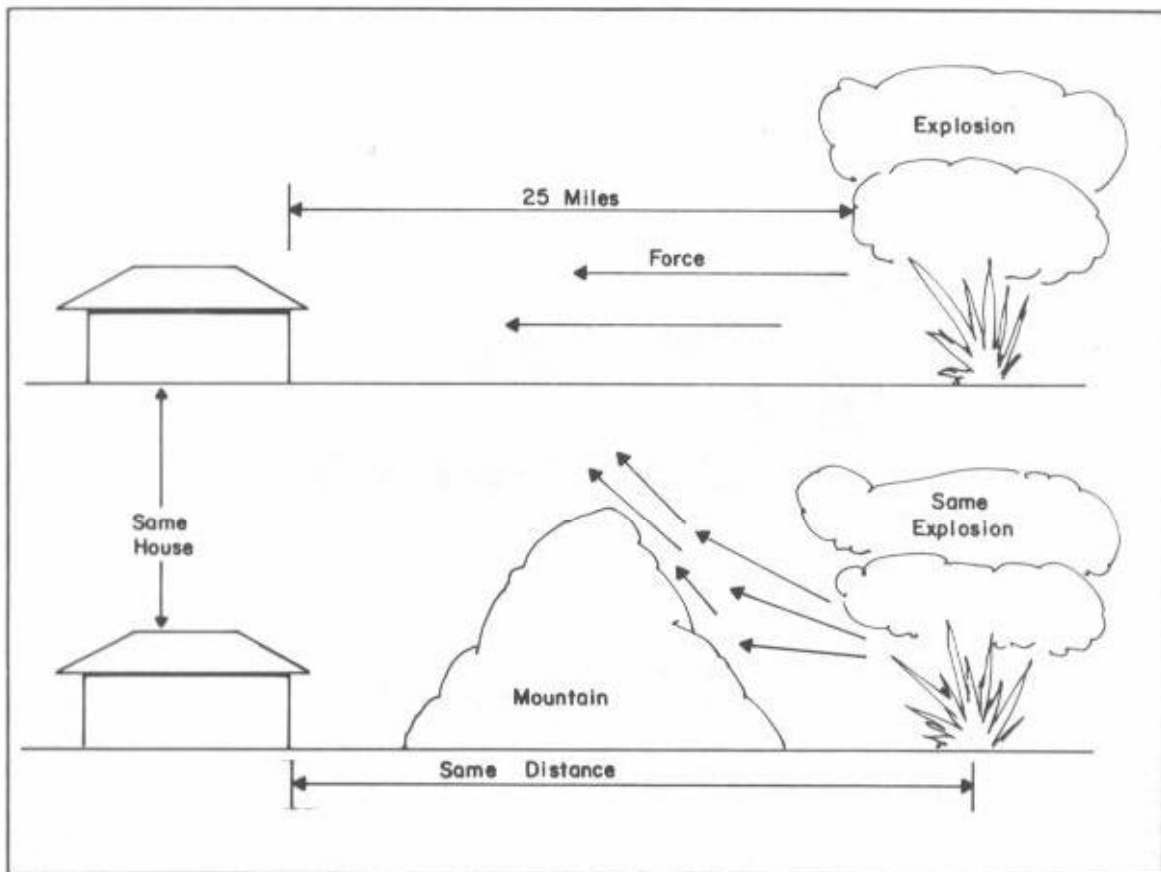

Fig. 25-1. Once you realize the variable that could protect or expose your structure, it is easy to see how precise answers are difficult.

wave is only a fraction of the battle. A major problem that could arise in an underground house would be a vacuum. See Fig. 25-3. A shock wave passing over an underground house designed like mine, with a skylight, would create a tremendous vacuum inside the house. The fast moving air over the skylight would draw the inside air out rapidly, the same as smoke is drawn out of a car going down the road 50 miles per hour with the window open slightly. Just because the underground structure survives a shock wave doesn't mean that the inhabitants would survive as well.

I won't get into the problems of water, food and medical supplies because these are the same problems faced by owners of aboveground, conventional housing.

BETTER ODDS

My conclusion to this basically unanswerable question is that you would be about five or ten times safer in an underground house similar to the one described in this book. The major reason is the roof structure and the fact that the living area is completely surrounded by earth to a minimum depth of 5 feet.

OTHER DESIGNS

Other designs of earth-sheltered homes could actually be less safe than conventional home basements. Figure 25-4 shows an earth-sheltered home that could be extremely vulnerable should it be facing the blast area. The all glass frontal area (a popular de-

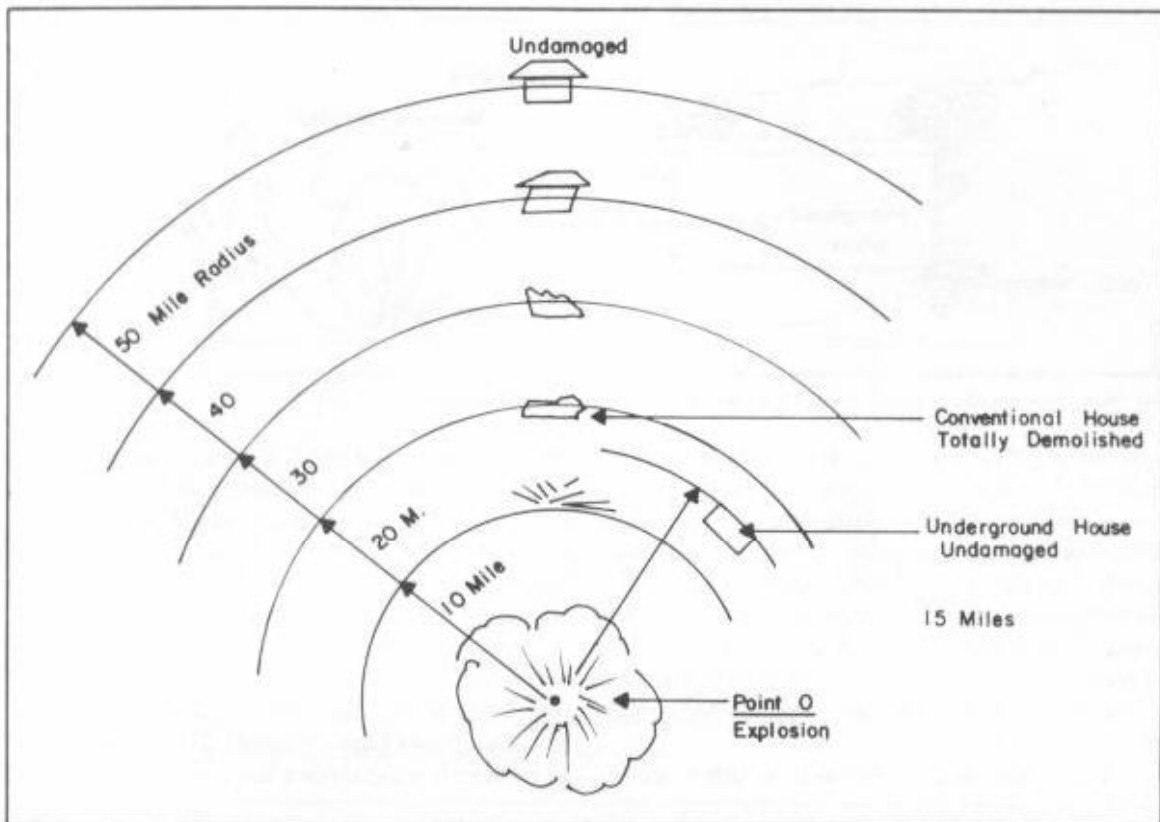

Fig. 25-2. My underground house would have a five to ten times better chance of survival.

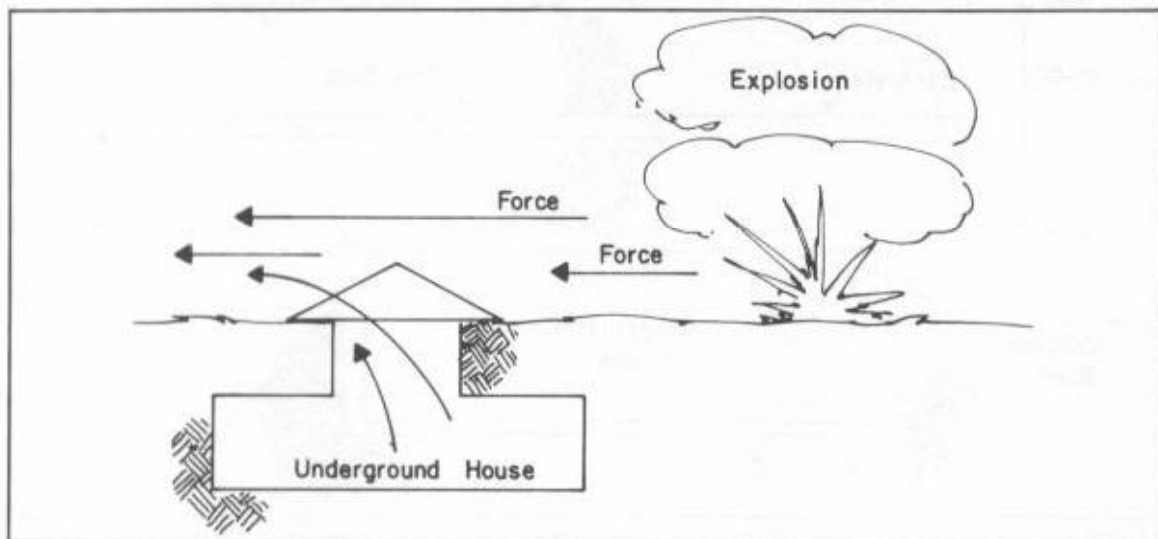

Fig. 25-3. A force (wind) passing over a large dome or skylight would create a vacuum inside the underground house.

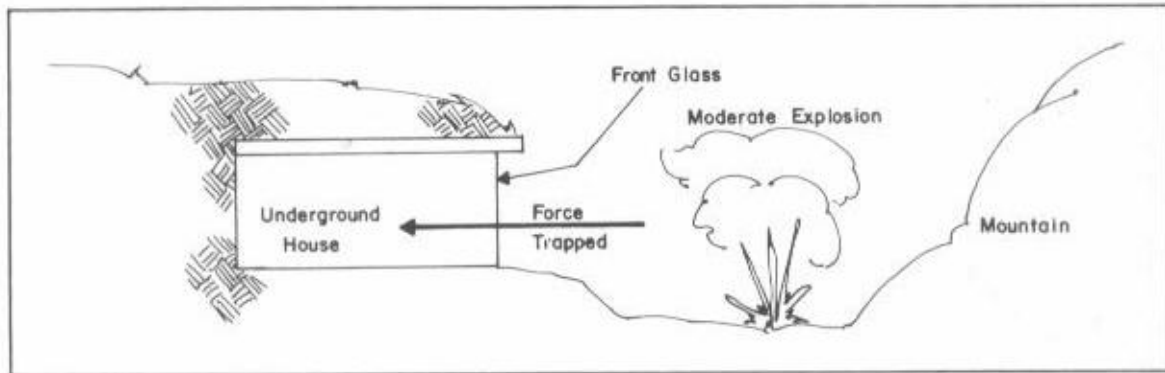

Fig. 25-4. This condition would actually trap the pressure inside the structure.

sign) could prove to be a trap. It is my strong opinion that a nuclear war or an accident isn't likely, and it's not on my list of things to worry about. Nevertheless, I've been wrong before. Should you feel differently, I can understand and I suggest you consider the following design when building your underground house. The design shown in Fig. 25-5 is a variation of mine. Someone asked what I could do to make the design in this book even safer. This is what I would do.

The same idea lends itself to other under-

ground homes. As Fig. 25-5 shows, I would simply add a second layer of reinforced concrete. The second roof or protection shield would be below the frost line (approximately 36 inches below earth surface in Harford County, Maryland). This depth changes around the country.

I would grade away the existing earth over the initial roof and leave an 18-inch depth of earth between layers. Be sure to remove any and all rock of any size greater than a baseball. The reason for the 18 inches of earth between layers of concrete is that

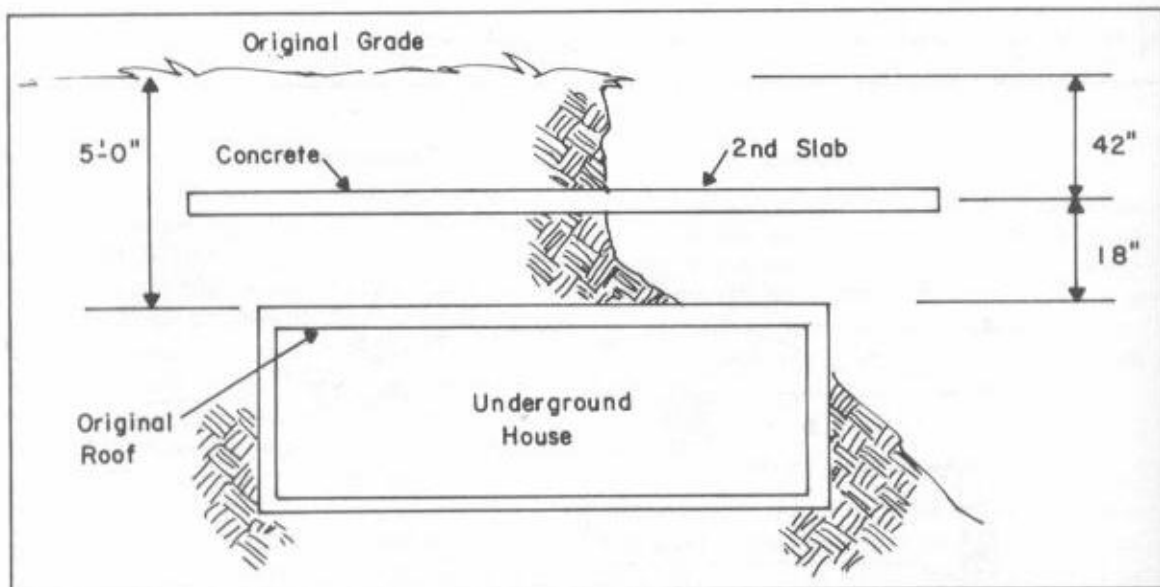

Fig. 25-5. The second steel-reinforced slab of concrete would add tremendously to the safety of an underground house. There are two separate 6-inch slabs of the roof's area between the 12" roof.

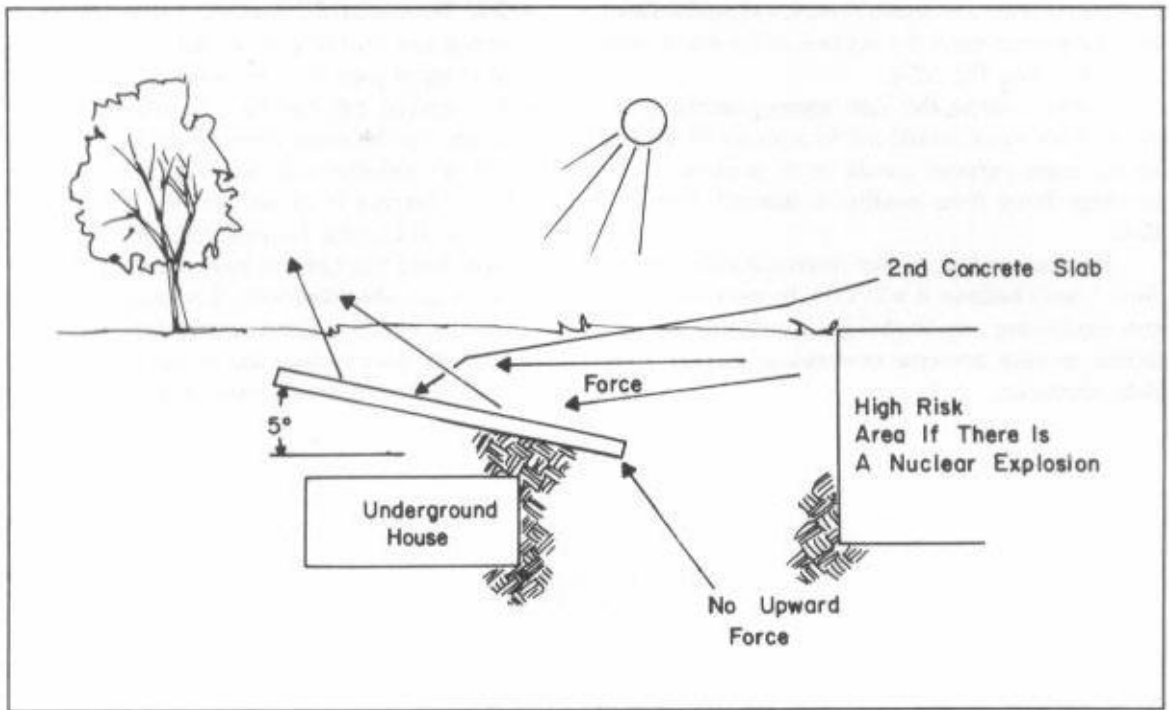

Fig. 25-6. The sloped roof would divert the explosion of the fence.

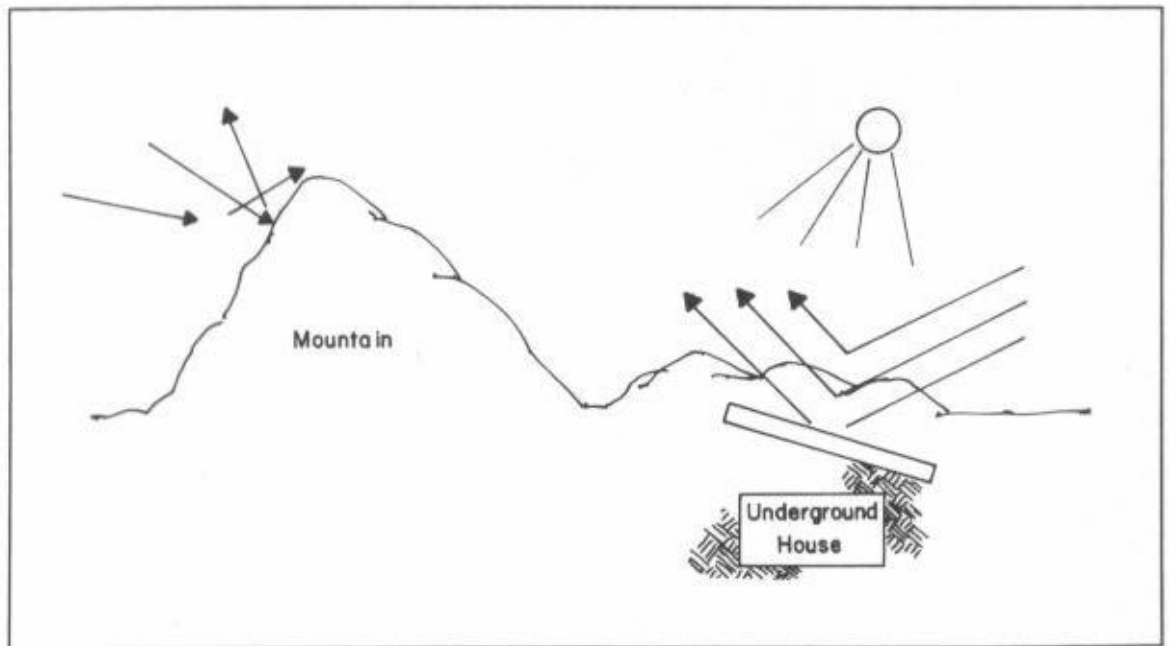

Fig. 25-7. Slope the slab in the most logical direction.

the earth will act as a shock absorber should a direct force be placed upon the surface of the earth over the house. See Fig. 25-6.

I would slope the slab approximately 5 degrees. This slope would act as a water diversion, but its main purpose would be to prevent a tremendous force from peeling it upward. See Fig. 25-6.

Remember that I'm not advocating this procedure. I don't believe it will even be necessary. I'm only explaining a method that I would use should I choose to take extreme precautions against a nuclear explosion.

HOW TO CHOOSE SLOPE DIRECTION

Common sense will help here. All I can say is to look on a map of your area. See what is in the way of an explosive force. See Fig. 25-7. If you're up against a mountain, let the natural terrain do its job. Slope the roof the opposite way. See Fig. 25-7.

If the terrain is of no use, such as in the Washington D.C. area, I suggest that you slope the roof away from the nearest ground-zero target.

Don't get obsessed with this facet of underground home building. Surviving the first day would only open the door to more catastrophic problems. Take your chances. Don't waste money.

Index

A

Air, fresh, 168
Air circulation, 48
Air pockets, 126
Air vents, 166
Appliances, 157

B

Backfilling, 15, 131, 132
Backfilling and grading, 130
Backhoe, 33, 34, 64, 66, 139
Backhoe removal, 138
Bathroom, 158
Bedrooms, 154, 155
Block, building, 21
Block construction, 107
Blocklaying, 76, 77, 104
Block stuffing, 89, 91
Block walls, 76, 79, 107
Bond, surface, 21
Building code appeals board, 53
Building codes, 16
Building materials, 33
Bulldozer, 59, 137

C

Carpet and padding, 160
Cast-iron sewer pipe, 70
Ceiling, 182

Chimneys, 99, 100, 167
Coal, 190
Codes, building, 48
Codes and regulations, 41
Concrete, 6, 23, 24, 34, 35, 36, 46, 50,
52, 61, 67, 74, 81, 91, 95, 96,
141, 182
Concrete, marking changes in, 38
Concrete, nails for use on, 149
Concrete, precast, 98
Concrete delivery, 35
Concrete floor, 84, 125
Concrete pour, 71
Concrete truck, 39, 69, 97
Condensation, 122
Condensation, formation of, 123
Condensation sponge effect, 125
Conservation, property, 9
Construction, above-ground, 73
Construction, half-and-half, 16
Construction, underground, 22
Construction details, planning, 40
Cooling, 168
Corridors, series of, 43
Crane, using a, 138
Crickets, 196

D

Decoration and layout, 154

Design, corridor, 43
Design advantages, 103
Design problems, 103
Design sketch, 8
Designs, other, 200
Dome, 178
Dome, cost of a, 172
Dome alignment, 195
Dome construction, 174
Domes and skylights, 169
Door bells, 187
Door openings, 53
Doors, hanging, 150
Doors, prehung, 150
Door sills, sloping, 121
Drain field, 61
Drain field, roof, 118
Driveway, 54, 56, 163

E

Earth cover, 20
Earth-sheltered home, 104, 111
Egress, means of, 42
Electrical code, 49
Electrical conduit, 99
Electrical wiring, 51, 145
Electricians, 146
Electricity, 18

Electric source, a workable, 191
Energy, alternate sources of, 189
Engineer, construction, 92
Engineers, 90
Engineers, professional, 53
Entrance, the, 184
Equipment, rental, 27
Excavating, 10, 32
Excavation, 132

F

Family involvement, 3
Fan system, 166
Fees, lawyer's, 31
Financing, 12, 13
Fixtures, adding, 154
Floor, 83
Floor slab, 37
Footers, 65, 66, 69
Footers, monolithic pour for, 70
Footers, preparing and pouring, 64
Foyer, 156
Friends, involvement of, 3, 27
Fuels, other, 192
Fuel savings, 4
Furniture, 160

G

Garage, underground, 162
Garden, 175, 177
Garden, indoor, 7, 47, 169
Garden, interior, 161
Grade, below-level, 16
Grading, 122, 123
Grading, final, 138
Grading and backfilling, 130
Grass seed, 140
Gravel, 35
Ground, level, 14

H

Heat, 5, 189
Heat, solar, 191
Heat from the sun, 196
Heating and ventilation, 165
House, for the lady of the, 9
House design, 10
Humidity, 127
Hydrostatic pressure, 11

I

Insulation, 113, 120, 134
Insulation, earth, 5
Insulation, roof, 119
Insulation absorption, 121
Insulation board, 135
Insulation board, pressed, 116
Insulation values, 2
Insurance, 25

K

Kitchen, 157, 159

L

Land, 31
Land, real cost of, 32
Land, sample purchase of, 32
Land contour, 10
Landscaping, 62, 141
Land use, 10
Lawn cutting, 141, 142
Lawyer's fees, 31
Light, lack of, 197
Lighting, 161
Lighting, wall, 163
Lintels, sloping overhead, 121
Lot size, 13
Lumber, rough, 85
Lumberyards, 40

M

Maintenance, 6
Masonry, 36
Materials, building, 33
Materials, hauling, 39
Materials, recycled, 157
Moisture, what about, 122
Moisture treatments, 113
Mortar, 21, 105

N

Nails, 148, 152
Nature's gifts, 4
Necessities, basic, 17
Neighbors, problem, 198

P

Paint, 160
Parging, 114
Pipe, cast-iron sewer, 70
Pipe, drain, 116
Pipes, water, 144
Plumbing, 50, 143
Plywood, 86, 88
Polyethylene layers, 115
Polyethylene sheets, 116, 126, 131, 150
Preparation, mental and physical, 2
Professionals, when to hire, 29
Property, purchase of, 32
Property conservation, 9
Property layout, 29
Property lines, 62
Purchases, necessary, 38

R

Radio reception, 186
Railings, hand, 47
Rain fields, roof, 117
Rebar, 12, 74, 78, 92, 93, 95
Roads, 17
Roof, 2
Roof, earth on the, 136
Roof, sloped, 203
Roof, smoothness of the, 119

Roof design and preparation, 81
Roof drain field, 118
Roof drain fields, 117
Roof insulation, 119
Roof plastic, 98, 135
Roof slab, the, 180, 203

S

Sand, 35
Sealer-adhesive, 105
Septic line, 52
Septic-sewer system, 58
Setback, 54, 57
Sewage disposal, 19
Site preparation, 54, 56
Skylight, 4, 9, 47, 49, 171, 172, 174, 176, 178
Skylight foundation, 196
Skylight repair, 196
Skylights and domes, 169
Skylight structure, 170
Slope direction, how to choose, 204
Smoke detectors, 42
Snow, 197
Soil, 20
Solar/electric heat, 191
Solar heat, 191
Sprinkler system, 42
Stairs, 53
Steel placement, 95
Sun, heat from the, 196
Surveying, 59
Surveyor, use of a professional, 31

T

Tar, 114
Telephone service, 17
Television reception, 186
Television room, 154
Theft factor, 8
Tools, borrowing, 27
Tractor, using a, 137
Trim, adding, 154

U

Underground garage, 110
Underground home, below grade level, 16
Underground home, benefits of a, 4
Underground home, building a, 30
Underground home, definition of, 1
Underground home, designing an, 24
Underground home, hill approach for an, 13
Underground home, loans for an, 13
Underground home, objectives of, 1
Underground home, permanency of a, 6
Underground home ceiling, 180
Underground home design, 103, 125
Underground home living, 199
Underground home location, 14

Underground home lot size, 13
Underground home publicity, 193
Underground home restrictions, 13
Underground house, financing
 your, 12
Underground living, 184, 188
Utilities, 143
Utility bills, 197

V

Ventilation and heating, 165
Visitors, 197

W

Wall, block, 85
Wall, interior, 75

Walls, 2, 6, 45, 46, 64, 73, 74, 82, 107
Walls, block, 76
Walls, formed and poured, 73
Walls, interior, 37, 79
Walls, retaining, 44
Walls, wooden, 153
Water, 35, 117, 128
Water lines, cleaning, 144
Water lines, maintenance, 144
Water pipes, 144
Water, problems with, 12
Water problems, 11
Waterproofing, 113
Waterproofing pitfalls, 121
Well, dry, 59
Well depths, 10

Windows, 5, 8, 44, 150
Wind power, 191
Windows, no, 185
Wire mesh, 93, 94
Wiring, 146
Wiring, telephone, 146
Wood stoves, 189
Woodworking, 148
Work, best hours for, 26
Work, how to get it done, 24
Work, repeating, 39
Work, right tools for the, 27

Z

Zoning laws, 20
Zoning map, typical