



[RDL](#) [Table of](#) [Document](#) [Download](#)

[Homepage](#) [Contents](#) [Information](#) [Instructions](#)

***FM 5-103**

**Headquarters
Department of the Army
Washington, DC
10 June 1985**



Table of Contents

PREFACE

CHAPTER 1 - SURVIVABILITY ON THE BATTLEFIELD

THE AIRLAND BATTLEFIELD

THE THREAT

ROLE OF US FORCES

CHAPTER 2 - SURVIVABILITY ANALYSIS

THE PLANNING PROCESS

DATA COLLECTION

EVALUATION

COMMAND AND CONTROL

CHAPTER 3 - PLANNING POSITIONS

WEAPONS EFFECTS

CONSTRUCTION MATERIALS

POSITION CATEGORIES

CONSTRUCTION METHODS

SPECIAL CONSTRUCTION CONSIDERATIONS

CHAPTER 4 - DESIGNING POSITIONS

BASIC DESIGN REQUIREMENTS

INDIVIDUAL FIGHTING POSITIONS

CREW-SERVED WEAPONS FIGHTING POSITIONS

VEHICLE POSITIONS

TRENCHES

UNIT POSITIONS

SPECIAL DESIGNS

CHAPTER 5 - SPECIAL OPERATIONS AND SITUATIONS

SPECIAL TERRAIN ENVIRONMENTS

COMBINED OPERATIONS

CONTINGENCY OPERATIONS

APPENDIX A - SURVIVABILITY EQUIPMENT

APPENDIX B - BUNKER AND SHELTER ROOF DESIGN

APPENDIX C - POSITION DESIGN DETAILS

[APPENDIX D - CAMOUFLAGE](#)

[GLOSSARY](#)

[REFERENCES](#)

[AUTHORIZATION LETTER](#)

DISTRIBUTION RESTRICTION: Approved for public release; distribution is unlimited.

*This publication supersedes FM 5-15, 27 June 1972 and TB 5-15-1, 16 July 1969.

[RDL](#)[Table of](#)[Document](#)[Download](#)[Homepage](#) [Contents](#) [Information](#) [Instructions](#)

PREFACE

The purpose of this manual is to integrate survivability into the overall AirLand battle structure. Survivability doctrine addresses when, where, and how fighting and protective battlefield positions are prepared for individual soldiers, troop units, vehicles, weapons, and equipment. This manual implements survivability tactics for all branches of the combined arms team.

Battlefield survival critically depends on the quality of protection afforded by the positions. The full spectrum of survivability encompasses planning and locating position sites, designing adequate overhead cover, analyzing terrain conditions and construction materials, selecting excavation methods, and countering the effects of direct and indirect fire weapons.

This manual is intended for engineer commanders, noncommissioned officers, and staff officers who support and advise the combined arms team, as well as combat arms commanders and staff officers who establish priorities, allocate resources, and integrate combat engineer support.

The proponent of this publication is the US Army Engineer School. Submit changes for improving this publication on DA Form 2028 (Recommended Changes to Publications and Blank Forms) and forward it directly to Commandant, US Army Engineer School, ATTN: ATZA-TD-P, Fort Belvoir, VA 22060-5291.

Unless otherwise stated, whenever the masculine or feminine gender is used, both men and women are included.

[RDL](#)[Table of](#)[Document](#)[Download](#)[Homepage](#) [Contents](#) [Information](#) [Instructions](#)

CHAPTER 1

SURVIVABILITY ON THE BATTLEFIELD

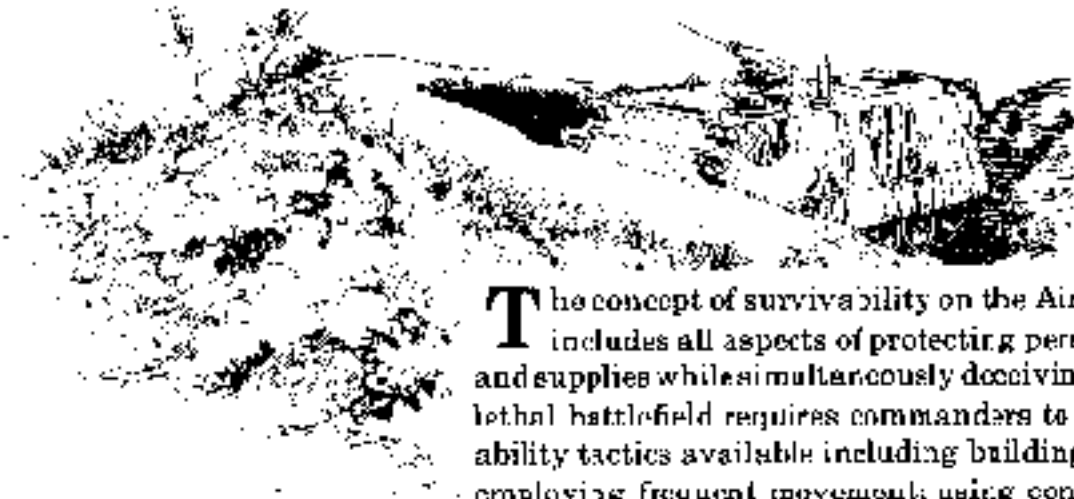

The concept of survivability on the AirLand battlefield includes all aspects of protecting personnel, weapons, and supplies while simultaneously deceiving the enemy. The lethal battlefield requires commanders to know all survivability tactics available including building a good defense; employing frequent movement; using concealment, deception, and camouflage; and constructing fighting and protective positions for both individuals and equipment. The worth of survivability positions has been proven throughout history. Protective construction in the form of fighting and protective positions by itself cannot eliminate vulnerability on the modern battlefield. It can, however, limit personnel and equipment losses by reducing exposure to Threat acquisition, targeting, and engagement. Protective construction also gives confidence to soldiers in fighting positions to use their weapons, or weapons system, more effectively. This chapter discusses basic survivability doctrine, Threat doctrine, and the role of the United States (US) forces on the AirLand battlefield.

THE AIRLAND BATTLEFIELD

The purpose of military operations in the next battle is to win. To achieve success, our forces must gain the initiative, deploy in depth, and stress agility and synchronization of activities and functions. Such an approach will prevent the enemy from freely maneuvering forces in depth to reinforce an attack, build up a defense, or counterattack. In the next fast-paced battle, our forces must protect themselves as never before from a wide range of highly technical weapons systems. Thus, in both the offense and defense, we will have to be ever-conscious of the enemy's ability to detect, engage, and destroy us. Careful planning and diligent work will enhance our ability to survive.

Survivability doctrine addresses five major points significant to the AirLand battlefield:

1. Maneuver units have primary responsibility to develop, position, and begin building their own

positions.

2. The engineer's ultimate role in survivability is set by the maneuver commander controlling engineer resources.
3. Based on those resources, engineer support will supplement units as determined by the supported commander's priorities.
4. Engineer support will concentrate on missions requiring unique engineer skills or equipment.
5. Survivability measures begin with using all available concealment and natural cover, followed by simple digging and constructing fighting and protective positions. As time and the tactical situation permit, these positions are improved.

The following AirLand battle conditions will shape our protection and survivability efforts:

-
- The need to win at the forward line of our own troops (FLOT), conduct deep battle operations, and overcome threats in the rear area.
- The use of effective firepower and decisive maneuver.
- The existence of a nonlinear battlefield resulting from dissolution of battle lines and areas due to maneuvering, and rapid dispersion from areas of nuclear and chemical weapons effects.
- Coordinated air/ground operations involving frequent movement by friendly troops.
- Proliferation of nuclear and chemical tactical weaponry.
- Active reconnaissance, surveillance, and target acquisition efforts through visual, remote sensing radar, and tactical radio direction finding procedures.
- Reliance on electronic warfare as a combat multiplier.

THE THREAT

During the next battle, US forces are likely to encounter or work with nations of widely diverse political systems, economic capabilities, cultures, and armies. Whether the battle is with Warsaw Pact or Third World countries, US forces will be exposed to Soviet-style weaponry and tactics. The following outline of Threat tactics and battle priorities provides a key to understanding survivability requirements for US forces. (See Field Manuals (FMs) [100-2-1](#), [100-2-2](#), and [100-2-3](#) for more detailed information.)

DIRECT FIRE WEAPONS

The opposing Threat is an offensively-oriented force that uses massive amounts of firepower to enhance the maneuverability, mobility, agility, and shock of its weaponry. It seeks to identify and exploit weak points from the front to the rear of enemy formations. The tank is the Threat's primary ground combat weapon, supplemented by armored personnel carriers (APCs) and other armored fighting vehicles. Large mechanized formations are used to attack in echelons, with large amounts of supporting suppressive direct and indirect fire. To achieve surprise, Threat forces train to operate in all types of terrain and during inclement weather. Threat force commanders train for three types of offensive action: the attack against a defending enemy, the meeting engagement, and the pursuit.

The Attack Against a Defending Enemy

Threat forces concentrate their attack at a weak point in the enemy's defensive formation. Threat doctrine emphasizes three basic forms of maneuver when attacking a defending force: envelopment, frontal attack, and flank attack. Penetration of enemy defenses is the ultimate objective in all three operations. The Threat force uses echeloned forces in this effort, and their goal is to fight through to the enemy rear and pursue retreating forces.

Threat attacks of strongly-defended positions will usually have a heavy air and artillery preparation. As this preparation is lifted and shifted to the depths of the enemy, advance guard units conduct operations to test the strength of the remaining defenders. Critical targets are reduced by artillery or by ground attacks conducted by advancing armor-heavy main forces. These forces attack from the march unless they are forced to deploy into attack formations by either the defending force or terrain conditions. The Threat seeks to overwhelm its enemy by simultaneously attacking as many weak points as possible. If weak points cannot be found, the Threat deploys into concentrated attack formations, usually organized into two echelons and a small reserve. These formations are initially dispersed to limit nuclear destruction, but are concentrated enough to meet offensive norms for attack. The Threat attacks defensive positions in a column formation and continues the attack into depths of the defense. Threat regimental artillery directly supports battalions, companies, and platoons for the duration of the engagement.

United States Forces

United States defending forces conduct extensive survivability operations during an enemy attack. Preliminary activities include deliberate position construction and hardening for both weapons and command and supply positions. Alternate and supplementary positions are also located and prepared if time allows. Finally, covered routes between these positions are selected, and camouflage of all structures is accomplished.

The Meeting Engagement

The meeting engagement is the type of offensive action most preferred by Threat forces. It relies on a standard battle drill executed from the march using combined arms forces and attached artillery support. Threat doctrine stresses rapid maneuver of forces and attacking while its enemy is on the march--not when it is in a prepared defense. Attacking a defending enemy requires superiority of forces--a requirement the Threat seeks to avoid.

The meeting engagement begins as the Threat advance guard of a combined arms force makes contact with the enemy advancing force. As soon as contact is made, the Threat battle drill begins. When possible, the main Threat force maneuvers its advance guard to a flank and attacks. This preliminary maneuver is supported by a barrage from the Threat force organic artillery which has deployed at the first sign of contact. The Threat force then makes a quick flank or frontal attack on enemy forces as they advance support their engaged advancing forces.

Upon withdrawal from contact and as the enemy force reacts to the flank attack, the Threat reconnaissance force continues its advance. This tactic then relies on the elements of surprise and shock for success. The Threat seeks to disable the enemy force along the depth of the enemy's formation.

United States Forces

When US forces are involved in a meeting engagement, survivability operations are needed, but not as much as in the deliberate defense. Hastily prepared fighting and protective positions are essential but will

often be prepared without engineer assistance or equipment. Maneuver units must also use natural terrain for fighting and protective positions.

The Pursuit

The pursuit of retreating forces by a Threat advancing force takes place as leading echelons bypass strongpoints and heavy engagements and allow following echelons to take up the fight. After any penetration is achieved, Threat doctrine calls for an aggressive pursuit and drive into the enemy rear area. This often leaves encircled and bypassed units for follow-on echelon forces to destroy.

United States Forces

Survivability in retrograde operations or during pursuit by the Threat force presents a significant challenge to the survivability planner. During retrograde operations, protective positions--both within the delay and fallback locations--are required for the delaying force. Company-size delay and fall back fighting and protective positions are most often prepared. Planning and preparing the positions requires knowledge of withdrawal routes and sequence.

INDIRECT FIRE WEAPONS

Threat commanders want to achieve precise levels of destruction through implementation of the rolling barrage, concentrated fire, or a combination of the two. Combined with tactical air strikes and fires from direct fire weapons, these destruction levels are-

-
- Harassment with 10 percent loss of personnel and equipment; organizational structure is retained.
- Neutralization with 25 to 30 percent destruction of personnel and equipment; effectiveness is seriously limited.
- Total destruction with 50 percent or more destruction of personnel and equipment.

The Threat can plan for the total destruction of a strongpoint by delivering up to 200 rounds of artillery, or 320 rounds from their medium rocket launcher, per 100 meter square. Thus, the Threat force attacks with a full complement of direct and indirect fire weapons when targets of opportunity arise or when the tactical situation permits.

United States Forces

To survive against this tremendous indirect fire threat, US forces must counter the physical effects of indirect fire, such as fragmentation and blast. Protection from these effects creates a large demand for engineer equipment, materials, and personnel. Careful consideration of the time and construction materials available for the desired level of survivability is necessary. Therefore, priorities of construction are necessary. Covered dismounted firing positions and shelters adjacent to large weapons emplacements are constructed by maneuver units, usually without engineer assistance. The maneuver commander must prioritize the construction of overhead cover for command, control, and supply positions.

NUCLEAR WEAPONS

Threat plans and operations for their nuclear systems are ranked in the following order:

-
- Destroy US nuclear delivery systems, nuclear weapons stocks, and the associated command and

control apparatus.

- Destroy US main force groupings.
- Breach US main lines of defense.
- Establish attack corridors within US battlefield boundaries.

Threat nuclear targeting plans are based on the use of massive amounts of supporting conventional direct and indirect fire. These massive artillery barrages enable the use of Threat nuclear weapons systems against targets which conventional weapons cannot destroy or disable.

United States Forces

Due to the multiple effects of a nuclear detonation, survivability operations against nuclear weapons are difficult. Thermal, blast, and radiation effects require separate consideration when designing protection. However, fortifications effective against modern conventional weapons will vary in effectiveness against nuclear weapons.

CHEMICAL WEAPONS

Often, Threat forces may use massive surprise chemical strikes in conjunction with nuclear and conventional attacks. These chemical strikes are aimed at destroying opposing force offensive capability, as well as disrupting logistics and contaminating all vulnerable rear area targets.

United States Forces

United States (US) forces must plan to fight, as well as survive, on a chemical contaminated battlefield. Open or partially open emplacements afford no protection from chemical or biological attack. Personnel in open emplacements or nonprotected vehicles must use proper chemical protective clothing and masks to avoid chemical vapors and biological aerosols.

DEEP ATTACK

Threat doctrine dictates that the attack must advance to the enemy rear area as quickly as possible. To supplement this main attack, the Threat may deploy its airborne, airmobile, or light forces to fight in the enemy rear until relieved by advancing forces. In most cases, smaller airborne/airmobile forces (battalion or regimental sizes) are deployed to strike targets in the enemy rear which are critical to the success of Threat forces. Additionally, covert reconnaissance missions or sabotage and harassment missions are accomplished by small Threat teams deployed in the rear. All of the Threat forces involved in a deep attack are trained and equipped to operate in contaminated environments.

Threat organization in the deep attack normally consists of the airborne/airmobile battalion for missions involving a long-range strike group. Operational maneuver groups will also conduct deep attacks using armor heavy forces. Organization for covert reconnaissance is normally a platoon-or company-size reconnaissance element.

United States Forces

When attacks on rear areas are made by Threat force aircraft, or by covert or overt airborne/airmobile forces, rear area activities are susceptible to many of the weapons encountered in the forward area. Thus, survivability of these rear area activities depends on adequate protective construction before the attack.

[Technical Manual \(TM\) 5-855-1](#) describes permanent protective construction in detail.

ROLE OF US FORCES

COMMANDER'S ROLE

Commanders of all units must know their requirements for protection. They must also understand the principles of fighting positions and protective positions, as well as the level of protection needed, given limited engineer assistance. Survivability measures are subdivided into two main categories: **fighting positions** for protection of personnel and equipment directly involved in combat; and **protective positions** for protection of personnel and equipment not directly involved with fighting the enemy. In order to protect their troops in the combat zone, commanders or leaders must fully understand the importance of fighting positions, both in the offense and in the defense. The initial responsibility for position preparation belongs with the maneuver commander's own troops. Even within the fluid nature of the AirLand battle, every effort to fortify positions is made to ensure greater protection and survivability.

ENGINEER'S ROLE

The engineer's contribution to battlefield success is in the five mission areas of mobility, countermobility, survivability, general engineering, and topographic engineering. Although units are required to develop their own covered and/or concealed positions for individual and dismounted crew-served weapons, available engineer support will assist in performing major survivability tasks beyond the unit's capabilities. While the engineer effort concentrates on developing those facilities to which the equipment is best suited, the engineer also assists supported units to develop other survivability measures within their capabilities. Before the battle begins, training as a combined arms team allows engineers to assist other team members in developing the survivability plan.

Survivability on the modern battlefield, then, depends on progressive development of fighting and protective positions. That is, the field survivability planner must recognize that physical protection begins with the judicious use of available terrain. It is then enhanced through the continual improvement of that terrain.

In the Offense

In the offense of the AirLand battle, fighting and protective position development is minimal for tactical vehicles and weapons systems. The emphasis is on mobility of the force. Protective positions for artillery, air defense, and logistics positions are required in the offense and defense, although more so in the defense. Also, command and control facilities require protection to lessen their vulnerability. During halts in the advance, units should develop as many protective positions as possible for antitank weapons, indirect fire weapons, and critical supplies. For example, expedient earth excavations or parapets are located to make the best use of existing terrain. During the early planning stages, the terrain analysis teams at division, corps, and theater levels can provide information on soil conditions, vegetative concealment, and terrain masking along the routes of march. Each position design should include camouflage from the start, with deception techniques developed as the situation and time permit.

In the Defense

Defensive missions demand the greatest survivability and protective construction effort. Activities in the

defense include constructing protective positions for command and control artillery, air defense, and critical equipment and supplies. They also include preparing individual and crew-served weapons positions and defilade fighting positions for fighting vehicles. Meanwhile, countermobility operations will compete with these survivability activities for engineer assistance. Here again, maneuver commanders must instruct their crews to prepare initial positions without engineer help. As countermobility activities are completed, engineers will help improve those survivability positions.

Two key factors in defensive position fighting development are: proper siting in relation to the surrounding terrain, and proper siting for the most effective employment of key weapons systems such as antitank guided missiles (ATGMs), crew-served weapons, and tanks. Critical elements for protective positions are command and control facilities, supply, and ammunition areas since these will be targeted first by the Threat. The degree of protection for these facilities is determined by the probability of acquisition, and not simply by the general threat. Facilities emitting a strong electromagnetic signal, or substantial thermal and visual signature, require full protection against the Threat. Electronic countermeasures and deception activities are mandatory and an integral part of all activities in the defense.

COMBAT/COMBAT SUPPORT ROLE

The survivability requirements for the following units are shown collectively in the [table](#) on Survivability Requirements.

Survivability Requirements

**LIGHT
INFANTRY**

To Protect	From	Use
Riflemen	Frontal small caliber direct fire, limited fragmentation	Individual hasty and deliberate fighting positions with overhead cover
M-60 and .50 caliber machine gun	Frontal small caliber direct fire, substantial fragmentation	Machine gun fighting position with overhead cover
4.2 in and 81-mm mortar	Small caliber direct fire, limited fragmentation	Mortar position
LAW	Small caliber direct fire, limited fragmentation	Individual and LAW fighting positions with overhead cover
Dragon	Frontal small caliber direct fire, substantial fragmentation	Dragon fighting position with overhead cover
TOW, ground-mounted TOW, jeep-mounted	Frontal small caliber direct fire, limited fragmentation	Dismounted TOW fighting position, vehicle fighting position
Redeye/Stinger	Small caliber direct fire	Individual fighting positions
CP/mortar/FDC/critical supplies	Small caliber direct fire, fragmentation, contact burst bombs	Runkers, deep-cut positions
Air assault aircraft	Small caliber direct fire, limited fragmentation, rockets	Parapets, walls, dispersion
Support vehicles	Small caliber direct fire, limited fragmentation	Terrain positioning, deep-cut positions

**MECHANIZED
INFANTRY**

Dismounted weapons systems	See Light Infantry requirements	See Light Infantry requirements
APCs and mortar carriers	Small caliber direct fire, direct HEAT fire, fragmentation	Terrain positioning, parapets, walls, hull defilade
Lightly armored and thin-skinned support vehicles (CP)	Small caliber direct fire, limited fragmentation	Terrain positioning, deep-cut positions

*Survivability Requirements (Continued)***ARMOR**

To Protect	From	Use
Tanks, ITVs, IFVs	Small caliber direct fire, direct HEAT fire, hyper-velocity, ATGM direct fire, fragmentation	Terrain positioning, hull and turret deflade
Lightly armored and thin-skinned support vehicles (CP)	Small caliber direct fire, fragmentation, ATGM direct fire	Terrain positioning, deep-cut positions
Dismounted activities	See Light Infantry requirements	See Light Infantry requirements
Air Cavalry aircraft	Small caliber direct fire, rockets, fragmentation	Parapets, walls, dispers on
Air Cavalry FARPS	Small caliber direct fire, fragmentation, bombs, rockets	Individual fighting positions, parapets, walls, bunkers

**FIELD
ARTILLERY**

Gun crews, riflemen	Small caliber direct fire, substantial fragmentation	Individual fighting positions with overhead cover
Towed gun position	Small caliber direct fire, direct HEAT fire, limited fragmentation	Parapets, walls, dispersion
Self-propelled gun position	Small caliber direct fire, direct HEAT fire, limited fragmentation	Parapets, walls, dispersion
Command and control, FDC/BOC	Small caliber direct fire, substantial fragmentation, contact burst, bombs	Bunkers, deep-cut positions
Ammunition carriers, support vehicles	Small caliber direct fire, fragmentation	Parapets, walls, deep-cut positions

Note: Small caliber direct fire is considered ball and tracer rounds (5.56 to 14.5 mm) fired from pistols, rifles, and machine guns. The positions mentioned are detailed in chapter 4 of this manual.

*Survivability Requirements (Continued)***COMBAT ENGINEER**

To Protect	From	Use
Dismounted Light Infantry operations	See Light Infantry requirements	See Light Infantry requirements
Mounted Mechanized Infantry and Armor operations	See Mechanized Infantry and Armor requirements	See Mechanized Infantry and Armor requirements
Construction equipment protection	Small caliber direct fire, fragmentation	Parapets, walls, deep-cut positions

AIR**DEFENSE ARTILLERY**

Dismounted Infantry operations	See Light Infantry requirements	See Light Infantry requirements
ADA systems in support of maneuver units	Small caliber direct fire, bombs, ATGM direct fire, contact burst	Frequent movement, dispersion, terrain positioning, parapets
ADA systems in support of fixed installations	Small caliber direct fire, bombs, ATGM direct fire, contact burst	Parapets, walls, shelters

AVIATION

Aircraft parking areas	Small caliber direct fire, limited fragmentation	Parapets, walls, dispersion
FARPS	Small caliber direct fire, fragmentation, bombs, rockets	Parapets, walls, bunkers, individual fighting positions
Command and control facilities	Small caliber direct fire, fragmentation, contact burst, bombs	Shelters

Note: Small caliber direct fire is considered ball and tracer rounds (6.56 to 14.5 mm) fired from pistols, rifles, and machine guns. The positions mentioned are detailed in chapter 4 of this manual.

*Survivability Requirements (Continued)***UNIT****SUPPORT SYSTEMS**

To Protect	From	Use
Communications, power generation equipment	Small caliber direct fire, limited fragmentation	Parapets, deep-cut positions
Supply/support vehicles	Small caliber direct fire, limited fragmentation	Parapets, deep-cut positions
Forward maintenance activity	Small caliber direct fire, fragmentation	Shelters, deep-cut positions
Forward medical activity	Small caliber direct fire, fragmentation, bombs	Shelters
Chemical, radiological, bath decontamination points	Small caliber direct fire, fragmentation	Individual fighting positions, shelters
Water supply points	Small caliber direct fire, fragmentation	Shelters

MAJOR**LOGISTICS****SYSTEMS AND REAR AREA**

POL tank farms	Acquisition/targeting covert strikes	Camouflage, shelters
Supply depot activities	Acquisition/targeting covert strikes	Camouflage, shelters
Depot maintenance activities	Acquisition/targeting covert strikes	Camouflage, shelters
Port/harbor activities	Acquisition/targeting covert strikes	Camouflage, shelters

Note: Small caliber direct fire is considered ball and tracer rounds (5.56 to 14.5 mm) fired from pistols, rifles, and machine guns. The positions mentioned are detailed in chapter 4 of this manual.

Light Infantry

Light infantry units include rifle, airborne, air assault, and ranger units. They are ideally suited for

close-in fighting against a force which has equal mobility or a mobility advantage which is degraded or offset. Difficult terrain, obstacles, and/or weather can degrade a mobility advantage. Surprise or stealth can offset a mobility advantage. In restricted terrain such as cities, forests, or mountains, light infantry units are also a challenge to enemy armor forces.

Due to the lack of substantial armor protection, light infantry units may require extensive fighting positions for individual and crew-served weapons, antitank weapons, and vehicles. Command and control facilities require protective positions. The defense requires fortified positions when terrain use is critical and when covered routes are required between positions.

Light forces readily use local materials to develop fighting positions and bunkers rapidly. Priorities are quickly established for position development—first to antitank and crew-served weapon positions, and then to command and control facilities and vital logistics positions. Artillery positions must have hardening improvements soon after emplacement is complete. In air assault units, aircraft protection is given high priority. Aircraft is dispersed and parapets or walls are constructed when possible.

Mechanized Infantry

Mechanized infantry operations in both the offense and the defense are characterized by rapid location changes and changes from fighting mounted to fighting dismounted. Mechanized infantry units normally fight integrated with tanks, primarily to destroy enemy infantry and antitank defenses. When forced to fight dismounted, such units need support by fire from weapons on board their APCs or infantry fighting vehicles (IFVs). When the terrain is not suitable for tracked vehicles or visibility is severely restricted, mechanized infantry may have to fight dismounted without the support of APCs or IFVs. When mounted, mechanized forces rely heavily on terrain positioning for fighting positions. Fighting positions increase survivability when the situation and time permit construction.

Armor

The tank is the primary offensive weapon in mounted warfare. Its firepower, protection from enemy fire, and speed create the shock effect necessary to disrupt the enemy's operations. Tanks destroy enemy armored vehicles and suppress enemy infantry and ATGMs. Armor and infantry form the nucleus of the combined arms team and both complement and reinforce each other. Infantry assists the advance of tanks in difficult terrain, while armor provides protection in open terrain, thus providing flexibility during combined arms maneuver.

Armor units rely on terrain positioning to decrease vulnerability. When possible, these terrain fighting positions are reinforced (deepened) by excavation. Protective positions for thin-skinned and lightly-armored support vehicles, as well as command posts and critical supplies, require significant hardening. Armor units enhance protection by constructing alternate and supplementary positions and defining routes between them.

Armored and Air Cavalry

Armored cavalry units need minimal fighting and protective positions. They rely almost totally on effective use of maneuver and terrain to reduce the acquisition threat. Air cavalry units, performing the same reconnaissance and security missions as ground armored cavalry, require somewhat more protective construction. Protective revetments and/or parapets are required at forward arming and refueling points (FARPs) and, in some cases, at forward assembly areas. These activities are always time

consuming and supplement the basic survivability enhancement techniques of dispersion and camouflage.

Aviation

Army aviation units, in addition to air cavalry units, consist of attack helicopter and combat support aviation forces. Attack helicopter units are aerial maneuver units which provide highly maneuverable antiarmor firepower. They are ideally suited for employment in situations where rapid reaction time is important, or where terrain restricts ground forces.

Combat support aviation units give dismounted infantry and ground antitank units tactical mobility. This enables them to move rapidly to the enemy's flanks or rear, or to reposition rapidly in the defense. Combat support aviation units can quickly move towed field artillery units and other lighter combined arms team elements as the commander dictates. They also provide critical supplies to forward areas in the defense and attacking formations when groundlines of communications have been interdicted.

Protection for Army aviation units is employed with full consideration to time constraints, logistical constraints, and the tactical situation. The primary means for aircraft protection on the ground is a combination of terrain masking, cover and concealment, effective camouflage, and dispersion. When possible, protective parapets and revetments are built. Aircraft logistics facilities, including FARPs and maintenance facilities, require additional protective construction. The FARPs require some protection of supplies and ordnance through the use of protective parapets and bunkers. They also require fighting positions for occupants of the points.

Field Artillery

Field artillery is the main fire support element in battlefield fire and maneuver. Field artillery is capable of suppressing enemy direct fire forces, attacking enemy artillery and mortars, suppressing enemy air defenses, and delivering scatterable mines to isolate and interdict enemy forces or protect friendly operations. It integrates all means of fire support available to the commander and is often as mobile as any maneuver force it supports. Fighting and protective position use is one of several alternatives the field artillery leader must evaluate. This alternate may be alone or in combination with other survivability operations, such as frequent moves and adequate dispersion.

Counterfire from enemy artillery is the most frequent threat to artillery units. Dug-in positions and/or parapet positions, as well as existing terrain and facilities, can provide protection. Threat acquisition and targeting activities are heavily used against artillery and are supplemented by some covert Threat deep ground attacks. Thus, personnel and equipment need some direct fire protection. Fire direction centers and battery operation centers should be protected with hardened bunkers or positions to defeat counterfire designed to eliminate artillery control.

In urban areas, existing structures offer considerable protection. Preparation for these is minimal compared to the level of protection. The use of self-propelled and towed equipment for positioning and hardening efforts enhance survivability. Some self-propelled units have significant inherent protection and maneuverability which allow more flexibility in protective structure design.

Combat Engineers

Combat engineers contribute to the combined arms team by performing the missions of mobility,

countermobility, survivability, topographic operations, general engineering, and fight as infantry. *Mobility* missions include breaching enemy minefield and obstacles, route improvement and construction, and water-crossing operations. *Countermobility* missions include the enhancement of fire through obstacle and minefield employment. *Survivability* missions enhance the total survivability of the force through fighting and protective position construction. *Topographic operations* engineering missions include detailed terrain analysis, terrain overlays, trafficability studies, evaluation of cover and concealment, soils maps, and other information to base mobility, countermobility, and survivability decisions. *General engineering* missions support theater armies with both vertical and horizontal construction capabilities.

Combat engineer fighting and protective position requirements depend on the type and location of the mission being performed in support of the combined arms team. Personnel and equipment protective positions are used when project sites are located within an area that the Threat can acquire. Engineers have limited inherent protection in vehicles and equipment and will require fighting positions, protective command and control, and critical supply bunkers when under an enemy attack. When time is available and when the mission permits, revetments and parapets can protect construction equipment. Generally, engineers use the same methods of protection used to protect the maneuver force they are supporting.

When engineers *fight as infantry*, they employ protective measures similar to those required by light or mechanized infantry forces.

Air Defense Artillery

Air defense units provide security from enemy air attack by destroying or driving off enemy aircraft and helicopters. Their fire degrades the effectiveness of enemy strike and reconnaissance aircraft by forcing the enemy to evade friendly air defense. Short-range air defense systems normally provide forward air defense protection for maneuver units whether the units are attacking, delaying, withdrawing, or repositioning in the defense. Air defense units also provide security for critical facilities and installations.

The main technique for air defense artillery (ADA) survivability is frequent movement. Because their main mission is to protect divisional and corps assets, ADA units are a high-priority target for suppression or attack by enemy artillery and tactical aircraft. Signature acquisition equipment, smoke, dust, contrails associated with firing, and siting requirements allow them to conduct their mission. Available terrain is generally used for cover and concealment since little time is available for deliberate protective construction. Dummy positions are constructed whenever possible, since they may draw significant enemy artillery fire and aircraft attack.

The ADA equipment used is usually protected by parapets, revetments, or dug-in positions similar to infantry and armor/tracked vehicle positions as long as fields of fire for the systems are maintained. Deliberate protective construction is always done when systems are employed to defend fixed installations, command posts, or logistics systems.

Unit Support Systems

Several types of combat support equipment and their positions are considered unit support systems. These systems include communications and power generation equipment, field trains, forward supply points, decontamination sites, and water points. Protection for each of these positions depends greatly on their battlefield location and on the mission's complexity. Protective measures for both equipment and

organic and supported personnel are normally provided. Initial positioning of these systems takes full advantage of terrain masking, cover and concealment, and terrain use to enhance camouflage activities.

Major Logistics Systems and Rear Areas

Major logistics systems and rear area operations include rear area supply depots; petroleum, oils, and lubricants (POL) tank/bladder farms; rear area/depot level maintenance activities; and so on. Survivability planners are most concerned with denial of acquisition and targeting of these positions by the Threat. A combination of camouflage and deception activities is usually used to conceal major logistics system activities.

Actual survivability measures used to protect large activities depend on the type of threat anticipated and target analysis. The obvious threat to large facilities is conventional or nuclear/chemical artillery, or missile or air attack. These facilities need physical protection and built-in hardening. A less obvious threat is covert activities begun after a Threat insertion of deep-strike ground forces. Measures to counter this type of threat include some fighting and protective positions designed to defeat a ground force or direct fire threat.



[RDL](#) [Table of](#) [Document](#) [Download](#)

[Homepage](#) [Contents](#) [Information](#) [Instructions](#)

References

REQUIRED PUBLICATIONS

Required publications are sources which users must read in order to understand or to comply with FM 5-103.

Field Manual (FM)

FM 5-20 Camouflage

FM 5-25 Explosives and Demolitions

[FM 5-34](#) Engineer Field Data

FM 5-35 Engineer's Reference and Logistical Data

FM 90-2 (HTF) Tactical Deception (How to Fight)

FM 100-2-1 Soviet Army Operations and Tactics

FM 100-2-2 Soviet Army Specialized Warfare and Rear Area Support

FM 100-2-3 The Soviet Army Troops Organization and Equipment

[FM 100-5](#) (HTF) Operations (How to Fight)

RELATED PUBLICATIONS

Related publications are sources of additional information. They are not required in order to understand FM 5-103.

Department of the Army Pamphlet (DA Pam)

DA Pam 50-3 The Effects of Nuclear Weapons

Field Manual (FM)

FM 3-12 Operational Aspects of Radiological Defense

[FM 5-100](#) Engineer Combat Operations

[FM 5-102](#) Countermobility

[FM 6-20](#) (HTF) Fire Support in Combined Arms Operations (How to Fight)

[FM 7-7](#) (HTF) The Mechanized Infantry Platoon and Squad (How to Fight)

[FM 7-8](#) (HTF) The Infantry Platoon and Squad (Infantry, Airborne, Air Assault, Ranger) (How to Fight)

[FM 7-10](#) (HTF) The Infantry Rifle Company (Infantry, Airborne, Air Assault, Ranger) (How to Fight)

[FM 7-20](#) The Infantry Battalion (Infantry, Airborne, and Air Assault)

FM 21-40 NBC (Nuclear, Biological, and Chemical) Defense

[FM 31-71](#) Northern Operations

[FM 71-1](#) (HTF) Tank and Mechanized Infantry Company Team (How to Fight)

[FM 71-2](#) (HTF) The Tank and Mechanized Infantry Battalion Task Force (How to Fight)

[FM 90-3](#) (HTF) Desert Operations (How to Fight)

[FM 90-5](#) (HTF) Jungle Operations (How to Fight)

[FM 90-6](#) (HTF) Mountain Operations (How to Fight)

[FM 90-10](#) (HTF) Military Operations on Urbanized Terrain (MOUT) (How to Fight)

FM 101-10-1 Staff Officers' Field Manual: Organizational, Technical, and Logistic Data (Unclassified Data)

Standardization Agreement (STANAG)

STANAG 2002 NBC Marking of Contaminated or Dangerous Land Areas

STANAG 2074 OP Training in Combat Survival

STANAG 2079 OP Rear Area Security and Rear Area Damage Control

Technical Manual (TM)

TM 3-220 Chemical, Biological, and Radiological (CBR) Decontamination

TM 5-301-1 Army Facilities Components System - Planning (Temperate)

TM 5-301-2 Army Facilities Components System - Planning (Tropical)

TM 5-301-3 Army Facilities Components System - Planning (Frigid)

TM 5-301-4 Army Facilities Components System - Planning (Desert)

- TM 5-302-1** Army Facilities Components System: Designs: Vol 1
- TM 5-302-2** Army Facilities Components System: Designs: Vol 2
- TM 5-302-3** Army Facilities Components System: Designs: Vol 3
- TM 5-302-4** Army Facilities Components System: Designs: Vol 4
- TM 5-302-5** Army Facilities Components System: Designs: Vol 5
- TM 5-303** Army Facilities Components System - Logistic Data and Bills of Materiel
- TM 5-331A** Utilization of Engineer Construction Equipment: Volume A; Earthmoving, Compaction, Grading and Ditching Equipment
- TM 5-331B** Utilization of Engineer Construction Equipment: Volume B; Lifting, Loading, and Handling Equipment
- TM 5-855-1** Protective Design: Fundamentals of Protective Design (Non-Nuclear)

PROJECTED PUBLICATIONS

Projected publications are sources of additional information that are scheduled for printing but not yet available. Upon print, they will be distributed automatically via pinpoint distribution. They may not be obtained from the USA AG Publications Center until indexed in DA Pamphlet 310-1.

Field Manual (FM)

- FM 71-2J** The Tank and Mechanized Infantry Battalion Task Force



[RDL](#)

[Table of](#)

[Document](#)

[Download](#)

[Homepage](#) [Contents](#) [Information](#) [Instructions](#)

[Survivability Requirements](#): Light Infantry/Mechanized Infantry

[Survivability Requirements \(Continued\)](#): Armor/Field Artillery

[Survivability Requirements \(Continued\)](#): Combat Engineer/Air Defense Artillery/Aviation

[Survivability Requirements \(Continued\)](#): Unit Support Systems/Major Logistics Systems and Rear Area

Survivability Requirements

LIGHT INFANTRY

To Protect	From	Use
Riflemen	Frontal small caliber direct fire, limited fragmentation	Individual hasty and deliberate fighting positions with overhead cover
M-60 and .50 caliber machine gun	Frontal small caliber direct fire, substantial fragmentation	Machine gun fighting position with overhead cover
4.2 in and 81-mm mortar	Small caliber direct fire, limited fragmentation	Mortar position
LAW	Small caliber direct fire, limited fragmentation	Individual and LAW fighting positions with overhead cover
Dragon	Frontal small caliber direct fire, substantial fragmentation	Dragon fighting position with overhead cover
TOW, ground-mounted TOW, jeep-mounted	Frontal small caliber direct fire, limited fragmentation	Dismounted TOW fighting position, vehicle fighting positions
Redeye/Attofer	Small caliber direct fire	Individual fighting positions
CP/mortar/FDC/critical supplies	Small caliber direct fire, fragmentation, contact burst bombs	Runkers, deep-cut positions
Air assault aircraft	Small caliber direct fire, limited fragmentation, rockets	Parapets, walls, dispersion
Support vehicles	Small caliber direct fire, limited fragmentation	Terrain positioning, deep-cut positions

MECHANIZED INFANTRY

Dismounted weapons systems	See Light Infantry requirements	See Light Infantry requirements
APCs and mortar carriers	Small caliber direct fire, direct HEAT fire, fragmentation	Terrain positioning, parapets, walls, hull defilade
Lightly armored and thin-skinned support vehicles (OP)	Small caliber direct fire, limited fragmentation	Terrain positioning, deep-cut positions

Survivability Requirements (Continued)

ARMOR

To Protect	From	Use
Tanks, ITVs, IFVs	Small caliber direct fire, direct HEAT fire, hyper-velocity, ATGM direct fire, fragmentation	Terrain positioning, hull and turret deflating
Lightly armored and thin-skinned support vehicles (CP)	Small caliber direct fire, fragmentation, ATGM direct fire	Terrain positioning, deep-cut positions
Dismounted activities	See Light Infantry requirements	See Light Infantry requirements
Air Cavalry aircraft	Small caliber direct fire, rockets, fragmentation	Parapets, walls, dispers on
Air Cavalry FARPS	Small caliber direct fire, fragmentation, bombs, rockets	Individual fighting positions, parapets, walls, bunkers

FIELD ARTILLERY

Gun crews, riflemen	Small caliber direct fire, substantial fragmentation	Individual fighting positions with overhead cover
Towed gun position	Small caliber direct fire, direct HEAT fire, limited fragmentation	Parapets, walls, dispersion
Self-propelled gun position	Small caliber direct fire, direct HEAT fire, limited fragmentation	Parapets, walls, dispersion
Command and control, FDC/BOC	Small caliber direct fire, substantial fragmentation, contact burst, bombs	Bunkers, deep-cut positions
Ammunition carriers, support vehicles	Small caliber direct fire, fragmentation	Parapets, walls, deep-cut positions

Note: Small caliber direct fire is considered ball and tracer rounds (5.56 to 14.5 mm) fired from pistols, rifles, and machine guns. The positions mentioned are detailed in chapter 4 of this manual.

Survivability Requirements (Continued)

COMBAT ENGINEER

To Protect	From	Use
Dismounted Light Infantry operations	See Light Infantry requirements	See Light Infantry requirements
Mounted Mechanized Infantry and Armor operations	See Mechanized Infantry and Armor requirements	See Mechanized Infantry and Armor requirements
Construction equipment protection	Small caliber direct fire, fragmentation	Parapets, walls, deep-cut positions

AIR

DEFENSE ARTILLERY

Dismounted Infantry operations	See Light Infantry requirements	See Light Infantry requirements
ADA systems in support of maneuver units	Small caliber direct fire, bombs, ATGM direct fire, contact burst	Frequent movement, dispersion, terrain positioning, parapets
ADA systems in support of fixed installations	Small caliber direct fire, bombs, ATGM direct fire, contact burst	Parapets, walls, shelters

AVIATION

Aircraft parking areas	Small caliber direct fire, limited fragmentation	Parapets, walls, dispersion
FARPS	Small caliber direct fire, fragmentation, bombs, rockets	Parapets, walls, bunkers, individual fighting positions
Command and control facilities	Small caliber direct fire, fragmentation, contact burst, bombs	Shelters

Note: Small caliber direct fire is considered ball and tracer rounds (5.56 to 14.5 mm) fired from pistols, rifles, and machine guns. The positions mentioned are detailed in chapter 4 of this manual.

Survivability Requirements (Continued)

**UNIT
SUPPORT SYSTEMS**

To Protect	From	Use
Communications, power generation equipment	Small caliber direct fire, limited fragmentation	Parapets, deep-cut positions
Supply/support vehicles	Small caliber direct fire, limited fragmentation	Parapets, deep-cut positions
Forward maintenance activity	Small caliber direct fire, fragmentation	Shelters, deep-cut positions
Forward medical activity	Small caliber direct fire, fragmentation, bombs	Shelters
Chemical, radiological, bath decontamination points	Small caliber direct fire, fragmentation	Individual fighting positions, shelters
Water supply points	Small caliber direct fire, fragmentation	Shelters

**MAJOR
LOGISTICS
SYSTEMS AND REAR AREA**

POL tank farms	Acquisition/targeting covert strikes	Camouflage, shelters
Supply depot activities	Acquisition/targeting covert strikes	Camouflage, shelters
Depot maintenance activities	Acquisition/targeting covert strikes	Camouflage, shelters
Port/harbor activities	Acquisition/targeting covert strikes	Camouflage, shelters

Note: Small caliber direct fire is considered ball and tracer rounds (5.56 to 14.5 mm) fired from pistols, rifles, and machine guns. The positions mentioned are detailed in chapter 4 of this manual.

[RDL](#)[Table of](#)[Document](#)[Download](#)[Homepage](#) [Contents](#) [Information](#) [Instructions](#)

CHAPTER 2

SURVIVABILITY ANALYSIS

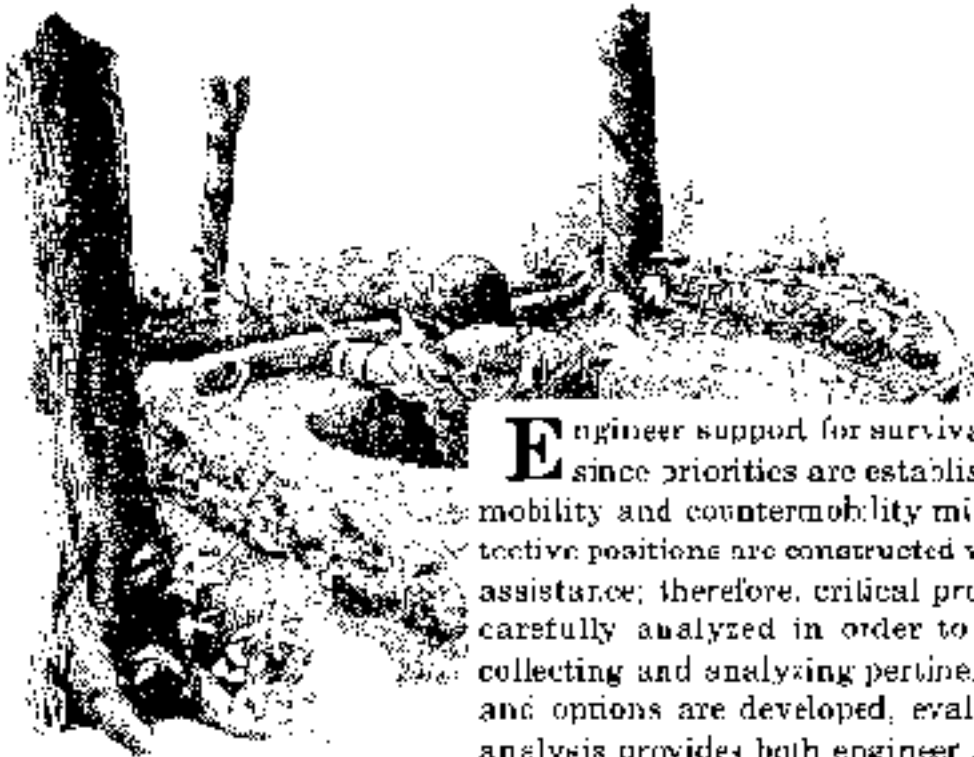

Engineer support for survivability missions is limited since priorities are established in combination with mobility and countermobility missions. Fighting and protective positions are constructed with and without engineer assistance; therefore, critical protection requirements are carefully analyzed in order to establish priorities. By collecting and analyzing pertinent data, courses of action and options are developed, evaluated, and planned. The analysis provides both engineer and maneuver commanders with a clear, mental picture of what is needed to implement the survivability mission. Once priorities are made and engineer support is allocated for survivability tasks, responsibilities of the maneuver commander, engineer commander, and staff are clearly defined.

This chapter outlines the overall planning process, identifies pertinent data to be collected, evaluated, and analyzed, and identifies command and control requirements.

THE PLANNING PROCESS

This section outlines the information needed and the decision-making process required for executing survivability missions. Increased engineer requirements on the AirLand battlefield will limit engineer resources supporting survivability. Mobility, countermobility, survivability (M-CM-S), and general engineering requirements are in competition for the same engineer assets. Survivability requirements are compared with the tactical need and the need for mobility and countermobility operations. The maneuver commander sets the priorities which allow the force to perform critical tasks. The successful force must have enough flexibility to recognize and make immediate necessary changes on the battlefield.

DECISION MAKING

Both the commander and staff are involved in the military decision-making process. It provides courses of action for the commander and, by selecting the best course, enhances survivability. The staff input in the decision-making process for planning survivability missions includes:

- Military intelligence (enemy activity, terrain, weather, and weapon types).
- Operations (tactical maneuver, fire support, and engineer support).
- Administration/logistics (personnel and combat services support activities).
- Civil affairs (civilians possibly affected by military operations).

PLANNING SEQUENCE

The engineer prepares or assists in the preparation of survivability estimates and plans to support the survivability efforts of the entire unit. In organizations without a staff engineer, the operations officer performs the analysis and formulates survivability plans. The following sequence is used to develop survivability support options and plans.

-
- Mission and commander's guidance are received.
- Time available is considered.
- Threat situation and Threat direct and indirect assets are analyzed.
- Friendly situation and survivability support resources are evaluated.
- Survivability data, including terrain analysis results, is evaluated.
- Possible courses of action are developed.
- The Survivability portion of the engineer estimate is prepared.
- Courses of action constraints are compared with actual engineer resources available.
- Plans are prepared, orders are issued, and staff supervision is conducted.

The survivability planning process is completed when the survivability estimates and plans are combined with those for mobility, countermobility, and general engineering. The maneuver commander then has a basis for deciding task priorities and allocating support.

DATA COLLECTION

INFORMATION ON METT-T

Information on mission, enemy, terrain and weather, time, and troops (METT-T) is compiled.

The Mission

Subordinate commanders/leaders must understand the maneuver commander's mission and guidance. The commander/ leader must know what survivability tasks are necessary and how they interface with mobility, countermobility, and other tasks necessary for completing the mission. In addition, the commander/leader implementing survivability tasks must know if any additional support is available.

The Enemy

The maneuver commander and engineer must fully understand the threat to the force. Weapon types, probable number of weapons and rounds, and types of attack to expect are critical in survivability planning. When these factors are known, appropriate fighting and protective positions are designed and constructed.

Terrain and Weather

One of the most important sources of information the maneuver commander and supporting engineer receive is a detailed terrain analysis of the area. This analysis is provided by the division terrain team (DTT) or corps terrain team (CTT). It includes the types of terrain, soil, and weather in the area of operations. A good mental picture of the area of operations enables the commander to evaluate all M-CM-S and general engineering activities to create the best plan for attack or defense.

Time

Every survivability mission has a deadline for reaching a predetermined level of protection. Hardening activities will continue past the deadline and are done as long as the force remains in the position. Survivability time constraints are deeply intertwined with mobility and countermobility time constraints. If the level of protection required cannot be achieved in the time allotted, resources are then committed to mobility or countermobility operations, or as designated by the maneuver commander.

Troops and Resources

The commander must weigh available labor, material constraints, and engineer support before planning an operation. Labor constraints are identified through analysis of the three sources of labor-maneuver unit troops, engineer troops, and indigenous (host nation/local area) personnel. Supply and equipment constraints are identified through analysis of on-hand supplies, naturally-available materials, and supplies available through military and indigenous channels. Careful procurement consideration is given to available civilian engineer equipment to supplement military equipment.

INFORMATION ON INTELLIGENCE

The maneuver force commander and engineer must have access to available intelligence information provided by staff elements. Battalion S2 sections provide the bulk of reconnaissance and terrain information, and experts at the division level and above assist the commander. For example, the DS terrain team, the production section of the division tactical operations center (DTOC) support element, and the corps cartographic company can quickly provide required terrain products. In addition, the commander uses the division intelligence system which provides the Threat order of battle and war-damaged key facilities. When reconnaissance requirements exceed the capability of battalion reconnaissance elements, maneuver or supporting engineer units collect their own information.

EVALUATION

When the engineer or maneuver units have collected all data required for protective construction, the data is analyzed to evaluate possible courses of action. Alternatives are based on the commander's guidance on protection needs, priorities, and planning.

PROTECTION NEEDS

Although the decision on what is to be protected depends on the tactical situation, the following criteria

are used as a guide:

-
- Exposure to direct, indirect, and tactical air fire.
- Vulnerability to discovery and location due to electronic emissions (communications and radar), firing signature, trackable projectiles, and the need to operate in the open.
- Capability to move to avoid detection, or to displace before counterfire arrives.
- Armor suitable to cover direct small caliber fire, indirect artillery and mortar fire, and direct fire antitank weapons.
- Distance from the FLOT which affects the likelihood of acquisition as a target, vulnerability to artillery and air bombardment, and chance of direct contact with the enemy.
- Availability of natural cover.
- Any unique equipment item, the loss of which would make other equipment worthless.
- Enemy's engagement priority to include which forces the Threat most likely will engage first.
- Ability to establish positions with organic equipment.

Using these factors in a vulnerability analysis will show the maneuver commander and the engineer which maneuver, field artillery, and ADA units require the most survivability support. The table [Equipment to be Protected](#) lists weapons systems in these units requiring fighting position/protective position construction.

PROTECTION PRIORITIES

Based on a vulnerability analysis of systems that need protecting in the tactical situation, the maneuver commander develops the priorities for protective activities. *Setting survivability priorities is a maneuver commander's decision based on the engineer's advice.* Using the protection criteria discussed earlier, and an up-to-date detailed terrain analysis portraying the degree of natural protection, a commander develops and ranks a detailed tactical construction plan to support survivability efforts. This detailed plan is usually broken down into several priority groupings or levels of protection. Primary, supplementary, and alternate positions are developed in stages or in increasing increments of protection.

Equipment to be Protected

Type of Unit	Equipment
Air Defense Artillery	Weapons carrier APC Radar* Control system Firing system
Armor and Armored Cavalry	Cavalry fighting vehicle Tank Mortar carrier APC Command post carrier
Field Artillery	Artillery weapons Ammunition carrier APC Command post carrier Target acquisition radar van Other vehicles: Battery executive post Battery command Battery fire direction
Infantry and Mechanized infantry	Infantry fighting vehicle Command vehicle Mortar carrier Command post carrier APC

* Includes FAAR for Vulcan, Chaparral, and Stinger; and PAR, CWAR, and ROR for the Hawk.

The [table below](#) shows example standard survivability levels for maneuver units in defensive positions. The levels and figures developed in the table are usually used by the maneuver commander in developing priorities, and by the engineer in advising the commander on survivability workloads. The number of vehicles or weapons systems in the table is modified after comparing with the actual equipment on hand. The table is used as a general planning guide. Weapon systems, such as missiles and nuclear-capable tube artillery, will require the maximum protection the tactical situation permits, regardless of whether the force is in an offensive or defensive posture.

Standard Survivability Estimates for Maneuver Units

Level	Description of Recommended Priority of Survivability Support		Number of Positions Needed			
			Armor Bn	Mech Inf Bn	Armor Co	Mech Inf Co
1	TOWs Tanks APC (Plt and Co HQ only) TOC	- P - P - 50% P - P	80	100	15	15
2	TOWs Tanks APC (Plt and Co HQ only) TOC	- P and A - P - P P	85	175	15	25
3	TOWs Tanks APC (Plt and Co HQ only) TOC Combat Support	- P and A - P and A - P - P - P	150	180	30	26
4	TOWs Tanks APC (all) TOC Combat Support Combat Train	- P and A - P and A - P - P - F - 50% P	160	190	30	30
5	TOWs Tanks, APC (all) TOC Combat Support Combat Train	- P, A, and S - F and A - P - F - P	185	295	45	40
6	TOWs, Tanks and APC (all) TOC Combat Support Combat Train	- F, A, and S - F and A - F and A - F	265	330	45	45

Notes: P = primary, A = alternate, S = supplementary hull defilade positions.
Numbers are rounded to the nearest 5
Combat Support vehicles comprise mortars, ADA, and so forth.
For Plt and Co HQ, allow four APCs per platoon and two per Co HQ

In the Offense

In offensive operations, fighting and protective positions are developed whenever time is adequate, such as during a temporary halt for regrouping and consolidation. Recommended priorities for protection at a halt in the offense are-

- Antitank weapons.
- Tanks.
- Indirect fire weapons.
- Critical supplies, such as ammunition and POL, as well as ground vehicles and aircraft (rotary winged).

These positions are usually expedient positions having the thickness necessary for frontal and side protection, making maximum use of the terrain.

In the Defense

In defensive operations, substantial effort for fighting and protective position construction is required. General priorities for protective construction in a defensive battle position are-

-
- Antitank weapon protection.
- Tank position development.
- Armored personnel carrier (APC) position development.
- Command post position hardening.
- Combat support position (including field artillery, ADA, mortars, and so on) hardening.
- Crew-served weapons position, individual fighting position, and covered routes between battle positions.

PROTECTION PLANNING

Operations Staff Officer

Priorities of work are recommended by the maneuver operations staff officer with input from the engineer. Survivability requirements for a defensive operation might receive the commander's first priority for engineer work. However, these tasks may require using only 10 percent of the engineer resources, while countermobility tasks may demand 70 percent.

The maneuver commander establishes engineer work priorities and sets priorities for tasks within the functions just mentioned. Using an analysis of what equipment requires protection, what priorities are set for sequential protection of the equipment, and which equipment and personnel require immediate protection, the maneuver commander can set individual priorities for survivability work.

Engineer Staff Officer

Survivability data and recommendations are presented to the commander *or* supported unit through an engineer staff estimate. The engineer estimate includes a recommendation for task organization and mobility, countermobility, survivability, and general engineering task priorities. Instructions for developing the engineer estimate are contained in [FM 5-100](#).

Tasks Organizations

Various command and support relationships under which engineer assets are task-organized can enhance mission accomplishment. The available assets are applied to each original course of action in a manner

best suited to the METT-T factors and the survivability analysis. The [table below](#) lists the different command and support relationships and how they affect the engineer unit. The recommended command relationship for engineers is operational control (OPCON) to the supported unit.

Command and Support Relationships

	Supported Relationships		Command Relationships	
<i>An engineer element with a relationship of:</i>	Direct support (DS)	General support (GS)	OPCON	Attached/assigned
<i>Is commanded by:</i>	Parent unit*	Parent unit*	Supported unit	Supported unit
<i>Maintains liaison and communication with:</i>	Supported and parent units	Supported and parent units	Supported unit and parent units	Supported unit
<i>May be task organized by:</i>	Parent unit	Parent unit	Supported unit	Supported unit
<i>Can be:</i>	Dedicated support to a particular unit. May be given task or area assignments	Used only to support the parent force as a whole. May be given an area/task assignment	Placed OPCON to other engineer units, or made DS to brigades or task forces	Further attached, OPCON, or DS to brigades or task forces, or retained GS
<i>Respond to support requests from:</i>	Supported unit	Parent unit	Supported unit	Supported unit
<i>Work priority established by:</i>	Supported unit	Supported unit	Supported unit	Supported unit
<i>Spare work effort available to:</i>	Parent unit	Parent unit	Supported unit	Supported unit
<i>Requests for additional support forwarded through:</i>	Parent unit	Parent unit	Supported unit	Supported unit
<i>Receives logistical support from:</i>	Parent unit	Parent unit	Parent unit**	Supported unit**

* It is possible that units will receive additional engineer support without a command relationship—the support relationship of DS to the division.

** When placed OPCON, the supporting unit provides support in the common classes of supply to the maximum extent possible.

Note: The supported unit, regardless of command/ support relationship, furnishes engineer materials to support engineer operations.

COMMAND AND CONTROL

COMMANDERS' RESPONSIBILITIES

Operations orders (OPORDs) are used by the commander or leader to carry out decisions made following the estimating and planning process. Survivability missions are usually prescribed in the OPORD for all units, including both engineers and nonengineers. Survivability priorities are specifically defined in the OPORD. [Field Manual 5-100](#) discusses engineer input to OPORDs. It is impossible to divide responsibilities in survivability missions between the maneuver commander and the engineer commander.

Maneuver Commander

The maneuver commander is responsible for organizing, planning, coordinating, and effectively using engineer resources to accomplish the survivability mission. The maneuver commander must rely on the engineer staff officer or supporting engineer commander to provide analyses and recommendations for protective construction and fighting position employment. The commander implements decisions by setting priorities and further defining the constraints of the mission to the engineer.

Engineer Commander

The engineer commander, in addition to fulfilling advisory responsibilities to the maneuver commander, accomplishes tasks in support of the overall survivability mission as follows:

-
- Insures timely reports concerning survivability tasks are made to the engineer staff officer or the operations and plans officer (G3/S3).
- Develops survivability operational plans.
- Insures engineer tasks are supervised, whether or not they are performed using engineer labor.
- Inspects fighting and protective positions for structural soundness.
- Provides advice and repair estimates for fighting and protective positions built or occupied by supported units.
- Recommends and identifies uses for engineer support in survivability operations through the sequence of command and staff actions.
- Evaluates terrain to determine the best areas for construction of survivability systems.

Joint Responsibilities

Based on knowledge of fighting and protective position effectiveness and protection ability, the engineer continues to advise the maneuver commander on survivability matters following the location, construction, and/or repair of these positions. The engineer provides valuable information to aid in decision-making for deployment to alternate and supplementary positions and retrograde operations. The engineer keeps the maneuver commander informed on the level of fighting that the existing fighting and protective positions support, and what protection the covered routes provide when movement between positions occurs.

STAFF OFFICERS' RESPONSIBILITIES

The engineer staff officers' (Brigade Engineer, Assistant Division Engineer) responsibilities include Coordination of mobility, countermobility, survivability, and general engineering tasks on the battlefield. As a special member of the commander's staff, the engineer interacts with other staff personnel. This is accomplished by integrating survivability considerations with plans and actions of the other staff members. Staff responsibilities concerning survivability plans and execution are as follows.

G2/S2

The G2/S2 is the primary staff officer for intelligence matters and has responsibility for collecting information on Threat operations and types and numbers of weapons used. Using all available intelligence sources to predict enemy choices for avenues of approach, the G2/S2 assists in survivability emplacement. It is the responsibility of the G2/S2 to receive survivability emplacement records from the G3/S3, disseminate the information, and forward records to the senior theater Army engineer.

G3/S3

The G3/S3 has primary staff responsibility for all plans and operations, and also develops the defensive and fire support plans considering survivability and other engineering support. The G3/S3 also receives progress/ completion reports for survivability construction and emplacement and records this information in conjunction with mobility and countermobility records (for example, minefield and obstacle records). The G3/S3 works closely with the staff engineer to develop the engineer support plans for the commander.

G4/S4

The G4/S4 is the primary staff coordinator for the logistic support required for survivability tasks. The G4/S4 works closely with the staff engineer to insure that types and quantities of construction materials for survivability emplacements are available. The G4/S4 also coordinates with the engineer to supply additional transportation and equipment in accordance with the commander's priorities for engineer support. Engineers alone do not have the assets to haul all of the class VI material necessary for hardened survivability positions.

Equipment to be Protected

Type of Unit	Equipment
Air Defense Artillery	Weapons carrier APC Radar* Control system Firing system
Armor and Armored Cavalry	Cavalry fighting vehicle Tank Mortar carrier APC Command post carrier
Field Artillery	Artillery weapons Ammunition carrier APC Command post carrier Target acquisition radar van Other vehicles: Battery executive post Battery command Battery fire direction
Infantry and Mechanized infantry	Infantry fighting vehicle Command vehicle Mortar carrier Command post carrier APC

* Includes FAAR for Vulcan, Chaparral, and Stinger; and PAR, CWAR, and ROR for the Hawk.

Standard Survivability Estimates for Maneuver Units

Level	Description of Recommended Priority of Survivability Support		Number of Positions Needed			
			Armor Bn	Mech Inf Bn	Armor Co	Mech Inf Co
1	TOWs Tanks APC (Plt and Co HQ only) TOC	- P - P - 50% P - P	80	100	15	15
2	TOWs Tanks APC (Plt and Co HQ only) TOC	- P and A - P - P P	85	175	15	25
3	TOWs Tanks APC (Plt and Co HQ only) TOC Combat Support	- P and A - P and A - P - P - P	150	180	30	25
4	TOWs Tanks APC (all) TOC Combat Support Combat Train	- P and A - P and A - P - P - F - 50% P	160	190	30	30
5	TOWs Tanks, APC (all) TOC Combat Support Combat Train	- P, A, and S - F and A - P - P - P	185	295	45	40
6	TOWs, Tanks and APC (all) TOC Combat Support Combat Train	- F, A, and S - F and A - P and A - F	265	330	45	45

Notes: P = primary, A – alternate, S = supplementary hull defilade positions.
 Numbers are rounded to the nearest 5
 Combat Support vehicles comprise mortars, ADA, and so forth.
 For Plt and Co HQ, allow four APCs per platoon and two per Co HQ

Command and Support Relationships

	Supported Relationships		Command Relationships	
<i>An engineer element with a relationship of:</i>	Direct support (DS)	General support (GS)	OPCON	Attached/assigned
<i>Is commanded by:</i>	Parent unit*	Parent unit*	Supported unit	Supported unit
<i>Maintains liaison and communication with:</i>	Supported and parent units	Supported and parent units	Supported unit and parent units	Supported unit
<i>May be task organized by:</i>	Parent unit	Parent unit	Supported unit	Supported unit
<i>Can be:</i>	Dedicated support to a particular unit. May be given task or area assignments	Used only to support the parent force as a whole. May be given an area/task assignment	Placed OPCON to other engineer units, or made DS to brigades or task forces	Further attached, OPCON, or DS to brigades or task forces, or retained GS
<i>Respond to support requests from:</i>	Supported unit	Parent unit	Supported unit	Supported unit
<i>Work priority established by:</i>	Supported unit	Supported unit	Supported unit	Supported unit
<i>Spare work effort available to:</i>	Parent unit	Parent unit	Supported unit	Supported unit
<i>Requests for additional support forwarded through:</i>	Parent unit	Parent unit	Supported unit	Supported unit
<i>Receives logistical support from:</i>	Parent unit	Parent unit	Parent unit**	Supported unit**

* It is possible that units will receive additional engineer support without a command relationship—the support relationship of DS to the division.

** When placed OPCON, the supporting unit provides support in the common classes of supply to the maximum extent possible.

Note: The supported unit, regardless of command/support relationship, furnishes engineer materials to support engineer operations.

[RDL](#)[Table of](#)[Document](#)[Download](#)[Homepage](#) [Contents](#) [Information](#) [Instructions](#)

CHAPTER 3

PLANNING POSITIONS

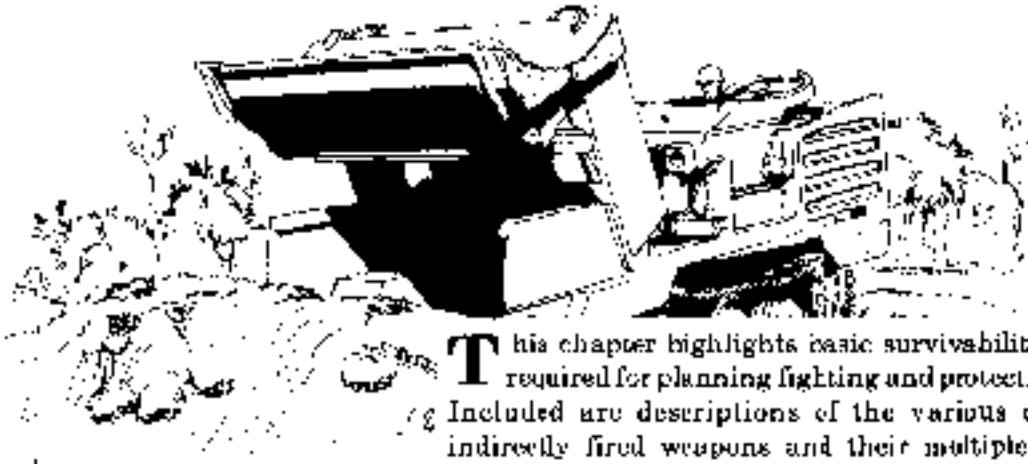

This chapter highlights basic survivability knowledge required for planning fighting and protective positions. Included are descriptions of the various direct and indirectly fired weapons and their multiple penetration capabilities and effects on the positions. Both natural and man-made materials available to construct the positions are identified and ranked according to their protection potential. Positions are then categorized and briefly described. Construction methods, including the use of hand tools as well as explosives, and special overall construction considerations such as camouflage and concealment, are also presented.

WEAPONS EFFECTS

A fighting position is a place on the battlefield from which troops engage the enemy with direct and indirect fire weapons. The positions provide necessary protection for personnel, yet allow for fields of fire and maneuver. A **protective position** protects the personnel and/or material not directly involved with fighting the enemy from attack or environmental extremes. In order to develop plans for fighting and protective positions, five types of weapons, their effects, and their survivability considerations are presented. Air-delivered weapons such as ATGMs, laser-guided missiles, mines, and large bombs require similar survivability considerations.

DIRECT FIRE

Direct fire projectiles are primarily designed to strike a target with a velocity high enough to achieve penetration. The **chemical energy** projectile uses some form of chemical heat and blast to achieve penetration. It detonates either at impact or when maximum penetration is achieved. Chemical energy projectiles carrying impact-detonated or

delayed detonation high-explosive charges are used mainly for direct fire from systems with high accuracy and consistently good target acquisition ability. Tanks, antitank weapons, and automatic cannons usually use these types of projectiles.

The **kinetic energy** projectile uses high velocity and mass (momentum) to penetrate its target. Currently, the hypervelocity projectile causes the most concern in survivability position design. The materials used must dissipate the projectile's energy and thus prevent total penetration. Shielding against direct fire projectiles should initially stop or deform the projectiles in order to prevent or limit penetration.

Direct fire projectiles are further divided into the categories of ball and tracer, armor piercing and armor piercing incendiary, and high explosive (HE) rounds.

Ball and Tracer

Ball and tracer rounds are normally of a relatively small caliber (5.56 to 14.5 millimeters (mm)) and are fired from pistols, rifles, and machine guns. The round's projectile penetrates soft targets on impact at a high velocity. The penetration depends directly on the projectile's velocity, weight, and angle at which it hits.

Armor Piercing and Armor Piercing Incendiary

Armor piercing and armor piercing incendiary rounds are designed to penetrate armor plate and other types of homogeneous steel. Armor piercing projectiles have a special jacket encasing a hard core or penetrating rod which is designed to penetrate when fired with high accuracy at an angle very close to the perpendicular of the target. Incendiary projectiles are used principally to penetrate a target and ignite its contents. They are used effectively against fuel supplies and storage areas.

High Explosive

High explosive rounds include high explosive antitank (HEAT) rounds, recoilless rifle rounds, and antitank rockets. They are designed to detonate a shaped charge on impact. At detonation, an extremely high velocity molten jet is formed. This jet perforates large thicknesses of high-density material, continues along its path, and sets fuel and ammunition on fire. The HEAT rounds generally range in size from 60 to 120 mm.

Survivability Considerations

Direct fire survivability considerations include oblique impact, or

impact of projectiles at other than a perpendicular angle to the structure, which increases the apparent thickness of the structure and decreases the possibility of penetration. The potential for ricochet off a structure increases as the angle of impact from the perpendicular increases. Designers of protective structures should select the proper material and design exposed surfaces with the maximum angle from the perpendicular to the direction of fire. Also, a low structure silhouette design makes a structure harder to engage with direct fire.

INDIRECT FIRE

Indirect fire projectiles used against fighting and protective positions include mortar and artillery shells and rockets which cause blast and fragmentation damage to affected structures.

Blast

Blast, caused by the detonation of the explosive charge, creates a shock wave which knocks apart walls or roof structures. Contact bursts cause excavation cave-in from ground shock, or structure collapse. Overhead bursts can buckle or destroy the roof.

Blasts from high explosive shells or rockets can occur in three ways:

- Overhead burst (fragmentation from an artillery airburst shell).
- Contact burst (blast from an artillery shell exploding on impact).
- Delay fuze burst (blast from an artillery shell designed to detonate after penetration into a target).

The severity of the blast effects increases as the distance from the structure to the point of impact decreases. Delay fuze bursts are the greatest threat to covered structures. Repeated surface or delay fuze bursts further degrade fighting and protective positions by the cratering effect and soil discharge. Indirect fire blast effects also cause concussions. The shock from a high explosive round detonation causes headaches, nosebleeds, and spinal and brain concussions.

Fragmentation

Fragmentation occurs when the projectile disintegrates, producing a mass of high-speed steel fragments which can perforate and become imbedded in fighting and protective positions. The pattern or distribution of fragments greatly affects the design of fighting and protective positions. Airburst of artillery shells provides the greatest unrestricted distribution of fragments. Fragments created by surface and delay bursts are restricted by obstructions on the ground.

Survivability Considerations

Indirect fire survivability from fragmentation requires shielding similar to that needed for direct fire penetration.

NUCLEAR

Nuclear weapons effects are classified as residual and initial. Residual effects (such as fallout) are primarily of long-term concern. However, they may seriously alter the operational plans in the immediate battle area. The [figure below](#) of tactical nuclear weapons shows how the energy released by detonation of a tactical nuclear explosion is divided. Initial effects occur in the immediate area shortly after detonation and are the most tactically significant since they cause personnel casualties and material damage within the immediate time span of any operation. The principal initial casualty producing effects are blast, thermal radiation (burning), and nuclear radiation. Other initial effects, such as electromagnetic pulse (EMP) and transient radiation effects on electronics (TREE), affect electrical and electronic equipment.

Energy distribution of tactical nuclear weapons

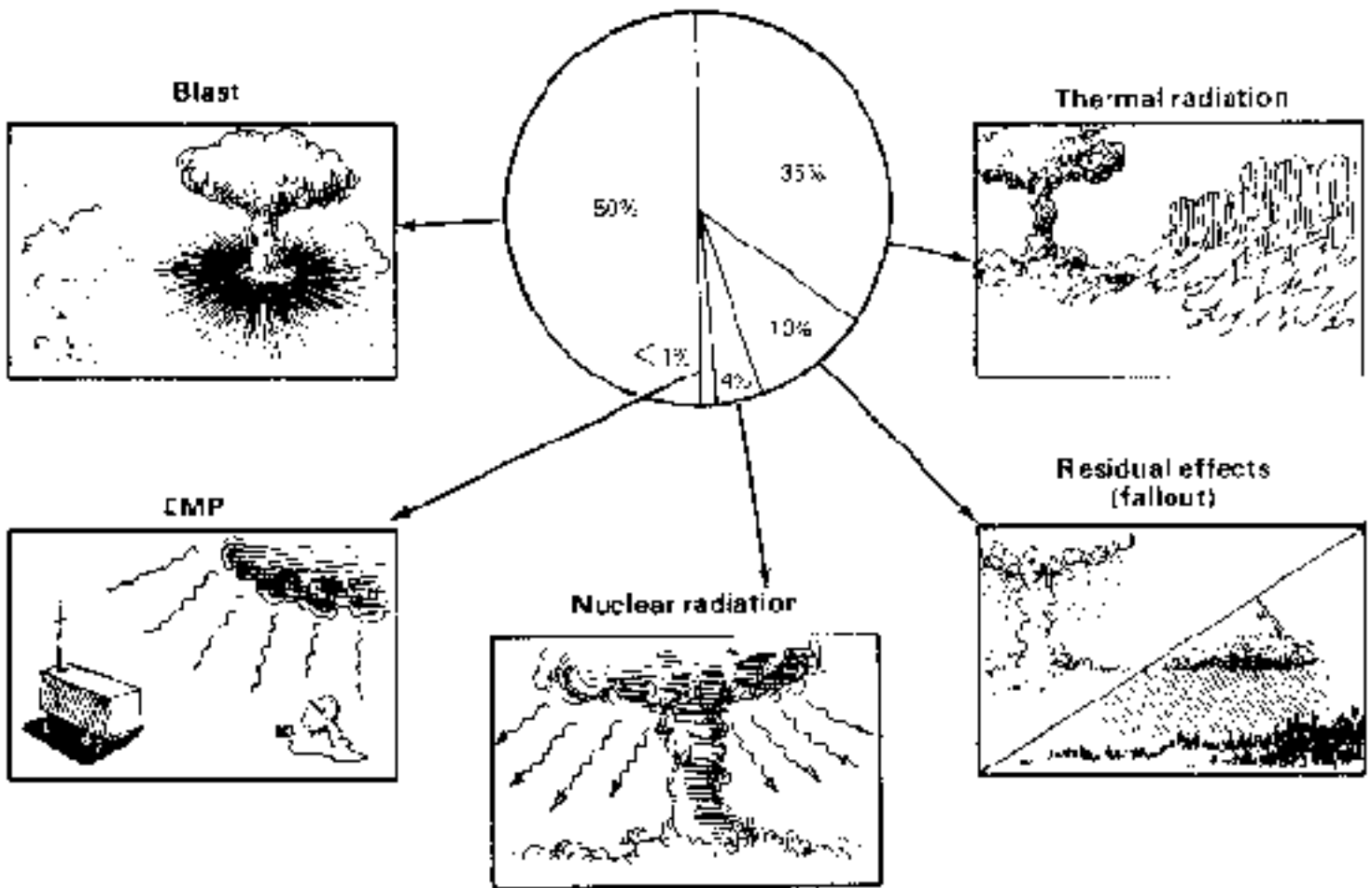

Blast

Blast from nuclear bursts overturns and crushes equipment, collapses lungs, ruptures eardrums, hurls debris and personnel, and collapses positions and structures.

Thermal Radiation

Thermal radiation sets fire to combustible materials, and causes flash blindness or burns in the eyes, as well as personnel casualties from skin burns.

Nuclear Radiation

Nuclear radiation damages cells throughout the body. This radiation damage may cause the headaches, nausea, vomiting, and diarrhea generally called "radiation sickness". The severity of radiation sickness depends on the extent of initial exposure. The [figure below](#) shows the relationship between dose of nuclear radiation and distance from ground zero for a 1-kiloton weapon. Once the dose is known, initial radiation effects on personnel are determined from the [table below](#). Radiation in the body is cumulative.

Relationship of radiation dose to distance from ground zero for a 1-KT weapon

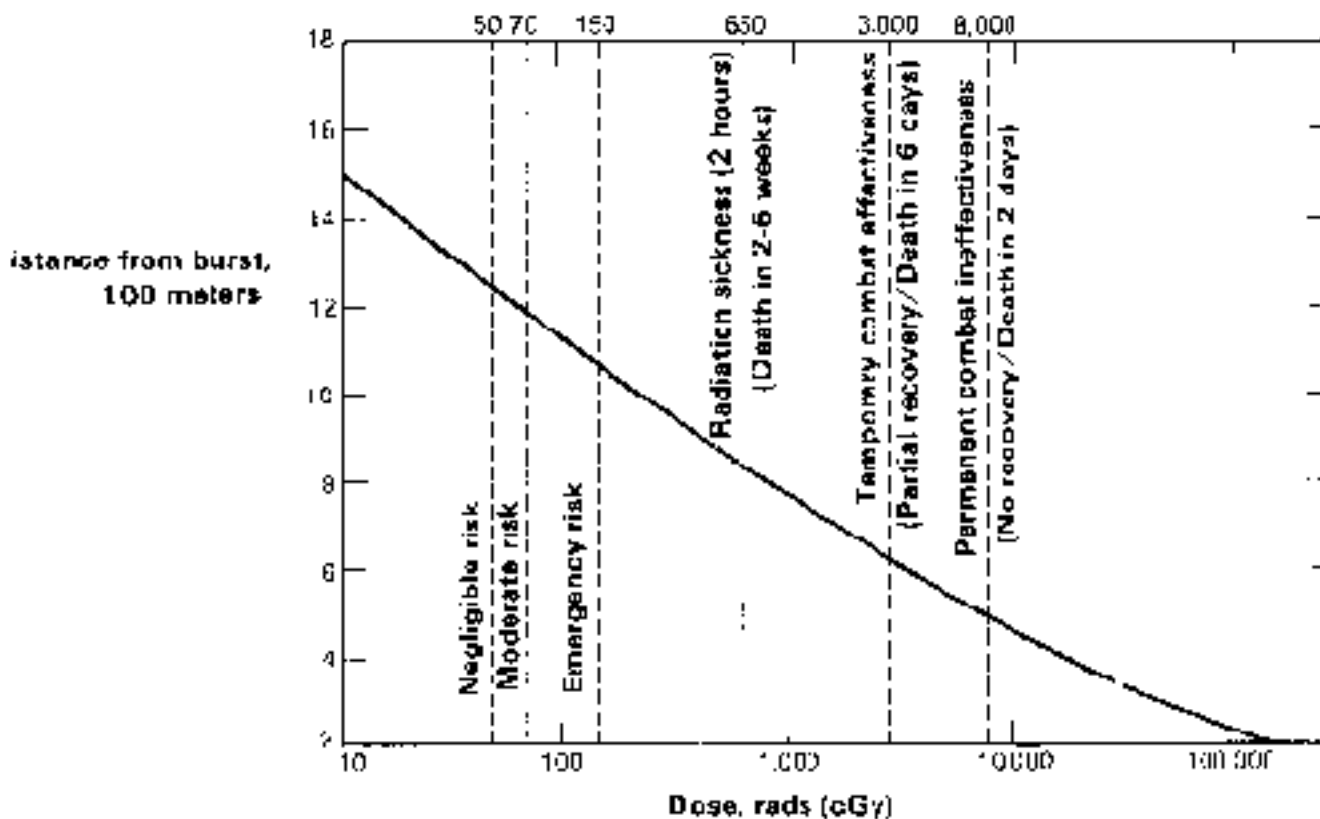

Initial Radiation Effects on Personnel

Early Symptoms*

Dose rads (cGy)	Percent of Personnel	Time to Effect	Combat Effectiveness of Personnel	Fatalities
0 to 70	<5% of personnel require hospitalization		Full	None
150	5%	≤ 6 hours	Effectiveness reduced depending on task. Some hospitalization required.	None
650	100%	≤ 2 hours	Symptoms continue intermittently for next few days. Effectiveness reduced significantly for second to sixth day. Hospitalization required.	More than 50% in about 16 days
2,000 to 3,000	100%	≤ 5 minutes	Immediate, temporary incapacitation for 30 to 40 minutes, followed by recovery period during which efficiency is impaired. No operational capability.	100% in about 7 days
8,000	100%	≤ 5 minutes	Immediate, permanent incapacitation for personnel performing physically demanding tasks. No period of latent recovery.	100% in 1 to 2 days
18,000	100%	Immediate	Permanent incapacitation for personnel performing even undemanding tasks. No operational capability.	100% within 24 hours

* Symptoms include vomiting, diarrhea, "dry heaving," nausea, lethargy, depression, and mental disorientation. At lower dose levels, incapacitation is a simple slow down in performance rate due to a loss of physical mobility and/or mental disorientation. At the high dose levels, shock and coma are sometimes the "early" symptoms.

Nuclear radiation is the dominant casualty producing effect of low-yield tactical nuclear weapons. But other initial effects may produce significant damage and/or casualties depending on the weapon type, yield, burst conditions, and the degree of personnel and

equipment protection. The figure on [Tactical radii](#) shows tactical radii of effects for nominal 1-kiloton weapons.

Tactical radii of effects of 1-KT and 10-KT fission weapons from low airburst

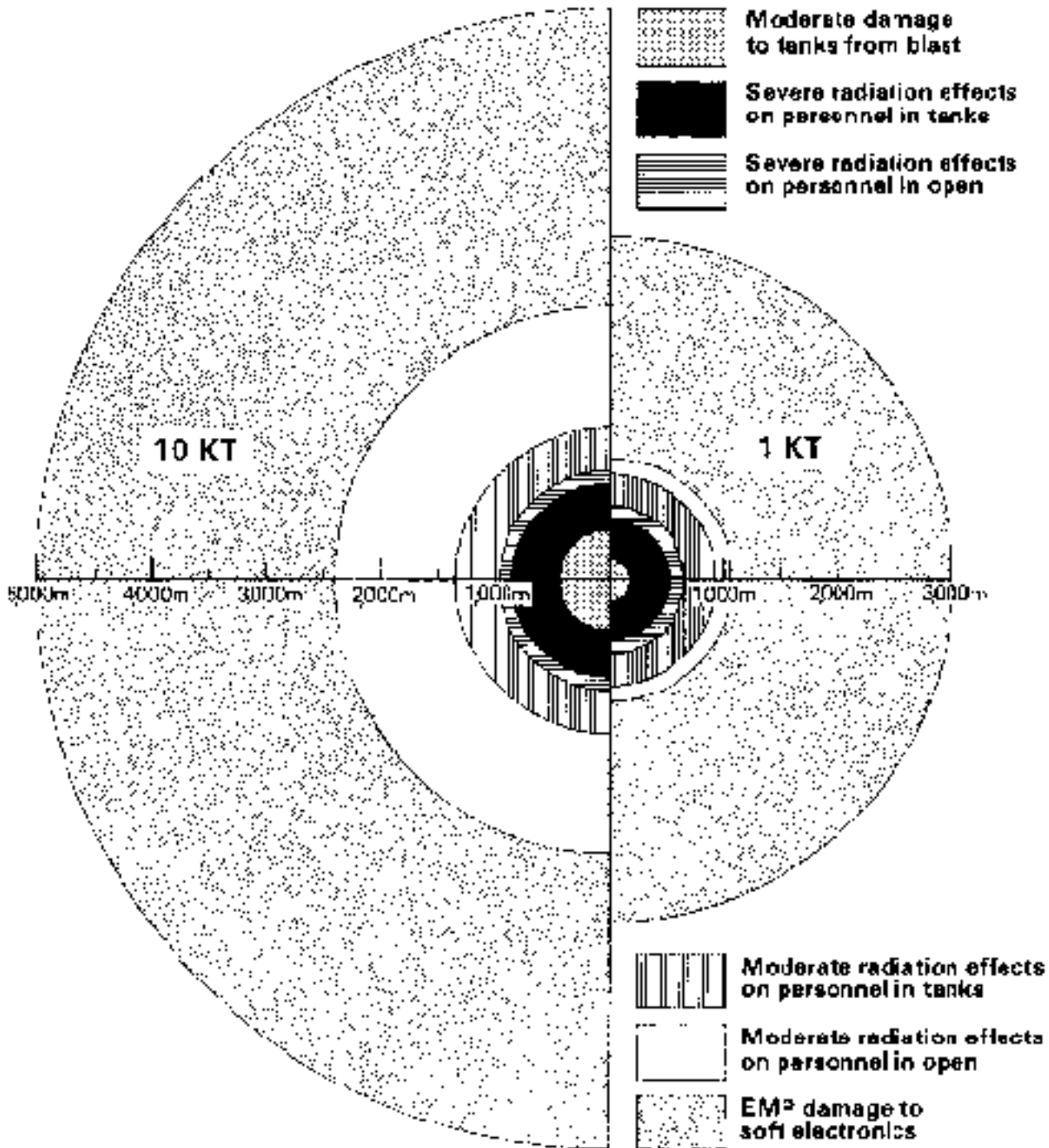

Electromagnetic pulse

Electromagnetic pulse (EMP) damages electrical and electronic equipment. It occurs at distances from the burst where other nuclear weapons effects produce little or no damage, and it lasts for less

than a second after the burst. The pulse also damages vulnerable electrical and electronic equipment at ranges up to 5 kilometers for a 10-kiloton surface burst, and hundreds of kilometers for a similar high-altitude burst.

Survivability Considerations

Nuclear weapons survivability includes dispersion of protective positions within a suspected target area. Deep-covered positions will minimize the danger from blast and thermal radiation. Personnel should habitually wear complete uniforms with hands, face, and neck covered. Nuclear radiation is minimized by avoiding the radioactive fallout area or remaining in deep-covered protective positions. Examples of expedient protective positions against initial nuclear effects are shown on the [chart below](#). Additionally, buttoned-up armor vehicles offer limited protection from nuclear radiation. Removal of antennae and placement of critical electrical equipment into protective positions will reduce the adverse effects of EMP and TREE.

Examples of expedient protective positions against initial nuclear effects

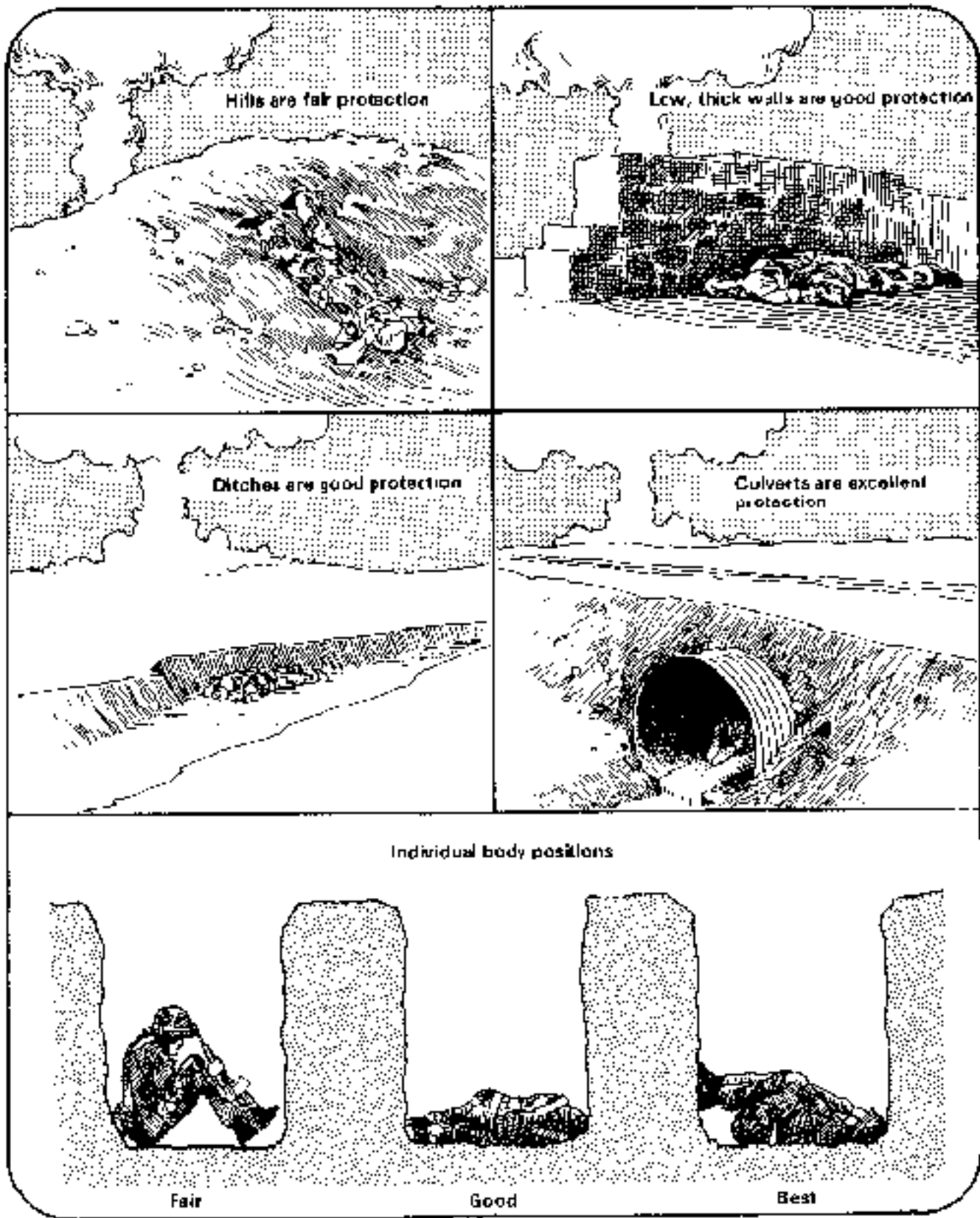

CHEMICAL

Toxic chemical agents are primarily designed for use against personnel and to contaminate terrain and material. Agents do not destroy

material and structures, but make them unusable for periods of time because of chemical contaminant absorption. The duration of chemical agent effectiveness depends on-

- Weather conditions.
- Dispersion methods.
- Terrain conditions.
- Physical properties.
- Quantity used.
- Type used (nerve, blood, or blister).

[Field Manual 21-40](#) provides chemical agent details and characteristics. Since the vapor of toxic chemical agents is heavier than air, it naturally tends to drift to the lowest corners or sections of a structure. Thus, low, unenclosed fighting and protective positions trap chemical vapors or agents. Because chemical agents saturate an area, access to positions without airlock entrance ways is limited during and after an attack, since every entering or exiting soldier brings contamination inside.

Survivability Considerations

Survivability of chemical effects includes overhead cover of any design that delays penetration of chemical vapors and biological aerosols, thereby providing additional masking time and protection against direct liquid contamination. Packing materials and covers are used to protect sensitive equipment. Proper use of protective clothing and equipment, along with simply avoiding the contaminated area, aids greatly in chemical survivability.

SPECIAL PURPOSE

Fuel-air munitions and flamethrowers are considered special-purpose weapons. Fuel-air munitions disperse fuel into the atmosphere forming a fuel-air mixture that is detonated. The fuel is usually contained in a metal canister and is dispersed by detonation of a central burster charge carried within the canister. Upon proper dispersion, the fuel-air mixture is detonated. Peak pressures created within the detonated cloud reach 300 pounds per square inch (psi). Fuel-air munitions create large area loading on a structure as compared to localized loadings caused by an equal weight high explosive charge. High temperatures ignite flammable materials. Flamethrowers and napalm produce intense heat and noxious gases which can neutralize accessible positions. The intense flame may also exhaust the oxygen content of inside air causing respiratory injuries to occupants shielded from the flaming fuel. Flame is effective in penetrating protective positions.

Survivability Considerations

Survivability of special purpose weapons effects includes covered positions with relatively small apertures and closable entrance areas which provide protection from napalm and flamethrowers. Deep-supported tunnels and positions provide protection from other fuel-air munitions and explosives.

CONSTRUCTION MATERIALS

Before designing fighting and protective positions, it is important to know how the previously-described weapons affect and interact with various materials that are fired upon. The materials used in fighting and protective position construction act as either **shielding** for the protected equipment and personnel, **structural components** to hold the shielding in place, or both.

SHIELDING MATERIALS

Shielding provides protection against penetration of both projectiles and fragments, nuclear and thermal radiation, and the effects of fire and chemical agents. Various materials and amounts of materials provide varying degrees of shielding. Some of the more commonly used materials and the effects of both projectile and fragment penetration in these materials, as well as nuclear and thermal radiation suppression, are discussed in the following paragraphs. (Incendiary and chemical effects are generalized from the previous discussion of weapons effects.) The following three tables contain shielding requirements of various materials to protect against direct hits by [direct fire projectiles](#), direct fire high explosive [\(HE\) shaped charges](#), and [indirect fire fragmentation and blast](#). The table below lists nuclear protection factors associated with [earth cover and sandbags](#).

**Material Thickness, in Inches, Required to Protect
Against Direct Hits by Direct Fire Projectiles**

Material	Caliber and Machine Gun (7.62-mm) Fire* at 100 yd	Antitank Rifle (76-mm) Fire at 100 yd	20-mm Antitank Fire at 200 yd	37-mm Antitank Fire at 400 yd	50-mm Antitank Fire at 400 yd	75-mm Direct Fire at 500 to 1,000 yd	Remarks
Solid walls**							
Brick masonry	18	24	30	60			None
Concrete not reinforced***	12	18	24	42	48	54	Pain formed-concrete walls
Concrete reinforced	8	12	18	36	42	48	Structurally reinforced with steel
Stone masonry	12	18	30	42	64	60	Values are guides only
Timber	36	60					Values are guides only
Wood	24	38	48				Values are guides only
Walls of loose material between boards**							
Brick rubble	12	24	30	60	72		None
Clay, dry	36	48					Add 100% to thickness if wet
Gravel/small crushed rock	12	24	30	60	72		None
Loam, dry	24	36	48				Add 50% to thickness if wet
Sand, dry	12	24	30	60	72		Add 100% to thickness if wet
Sandbags, filled with							
Brick rubble	20	30	30	60	70		None
Clay, dry	40	60					Add 100% to thickness if wet
Gravel/small crushed rock	20	30	30	60	70		None
Loam, dry	30	50	60				Add 50% to thickness if wet
Sand, dry	20	30	30	60	70		Add 100% to thickness if wet
Deposits of							
Clay	42	60					Add 100% to thickness if wet
Loam	30	40	60				Add 50% to thickness if wet
Sand	24	36	48				Add 100% to thickness if wet
Snow and ice							
Frozen snow	60	60					None
Frozen soil	24	24					None
Icecrete (ice aggregate)	18	18					None
Tamped snow	72	72					None
Unpacked snow	180	180					None

* One burst of five shots

** Thicknesses to nearest 1/2 in.

*** 3,000 psi concrete.

Note: Except where indicated, protective thicknesses are for a single shot only. Where weapons place five or six direct fire projectiles in the same area, the required protective thickness is approximately twice that indicated. Where no values are given, material is not recommended.

**Material/Thickness, in Inches, Required to Protect
Against Direct Fire HE Shaped-Charge**

Material	73-mm RCLR	82-mm RCLR	85-mm RPG-7	107-mm RCLR	120-mm Sagger
Aluminum	36	24	30	36	36
Concrete	36	24	30	36	36
Granite	30	18	24	30	30
Rock	36	24	24	30	36
Snow, packed	156	156	156	-	-
Soil	100	66	78	96	96
Soil, frozen	50	33	39	48	48
Steel	24	14	18	24	24
Wood, dry	100	72	90	108	108
Wood, green	60	36	48	60	66

Note: Thicknesses assume perpendicular impact.

**Material Thickness, Inches, Required to Protect Against
Indirect Fire Fragmentation and Blast Exploding 50 Feet Away**

Material	Mortars		122-mm Rocket	HE Shells		Bombs				
	82-mm	120-mm		122-mm	152-mm	100-lb	250-lb	500-lb	1,000-lb	
Solid Walls										
Brick masonry	4	6	6	6	8	8	10	13	17	
Concrete	4	6	6	6	8	8	10	13	18	
Concrete, reinforced	3	4	4	4	6	7	9	12	15	
Timber	8	12	12	12	14	15	18	24	30	
Walls of loose material between boards										
Brick rubble	9	12	12	12	12	18	24	28	30	
Earth*	12	12	12	12	16	24	30			
Gravel, small stones	9	12	12	12	12	18	24	28	30	
Sandbags, filled with										
Brick rubble	10	18	18	18	20	20	20	30	40	
Clay*	10	18	18	18	20	30	40	40	50	
Gravel, small stones, soil	10	18	18	18	20	20	20	30	40	
Burnt*	8	16	16	16	18	30	20	40	40	
Loose carpets of										
Clay*	12	20	20	20	30	36	48	60		
Sand*	10	18	18	18	24	24	36	36	48	
Snow										
Tamped	60	60	60	60	60	-	-	-	-	
Unpacked	60	60	60	60	60	-	-	-	-	

* Double values if material is saturated.

Note: Where no values are given, material is not recommended.

**Shielding Values of Earth Cover and Sandbags for a
Hypothetical 2,400-rads (cGy) Free-In-Air Dose**

Type of Protection	Radiation Protection Factor	Resulting Dose rads
Soldier in open	None	2,400
Earth Cover		
Soldier in 4-ft-deep open position	8	300
with 6 in of earth cover	12	200
with 12 in of earth cover	24	100
with 18 in of earth cover	48	50
with 24 in of earth cover	96	25
Sand- and Clay-Filled Sandbags		
Soldier in 4-ft-deep open position	8	300
with 1 layer of sandbags (4 in)	16	150
with 2 layers of sandbags (8 in)	32	75
with 3 layers of sandbags (12 in)	64	38

Soil

Direct fire and indirect fire fragmentation penetration in soil or other similar granular material is based on three considerations: for materials of the same density, the finer the grain the greater the penetration; penetration decreases with increase in density; and penetration increases with increasing water content. Nuclear and thermal radiation protection of soil is governed by the following:

- The more earth cover, the better the shielding. Each layer of sandbags filled with sand or clay reduces transmitted radiation by 50 percent.
- Sand or compacted clay provides better radiation shielding than other soils which are less dense.
- Damp or wet earth or sand provides better protection than dry material.
- Sandbags protected by a top layer of earth survive thermal radiation better than exposed bags. Exposed bags may burn, spill their contents, and become susceptible to the blast wave.

Steel

Steel is the most commonly used material for protection against direct and indirect fire fragmentation. Steel is also more likely to deform a projectile as it penetrates, and is much less likely to splinter than concrete. Steel plates, only $\frac{1}{6}$ the thickness of concrete, afford equal protection against nondeforming projectiles of small and

intermediate calibers. Because of its high density, steel is five times more effective in initial radiation suppression than an equal thickness of concrete. It is also effective against thermal radiation, although it transmits heat rapidly. Many field expedient types of steel are usable for shielding. Steel landing mats, culvert sections, and steel drums, for example, are effectively used in a structure as one of several composite materials. Expedient steel pieces are also used for individual protection against projectile and fragment penetration and nuclear radiation.

Concrete

When reinforcing steel is used in concrete, direct and indirect fire fragmentation protection is excellent. The reinforcing helps the concrete to remain intact even after excessive cracking caused by penetration. When a near miss shell explodes, its fragments travel faster than its blast wave. If these fragments strike the exposed concrete surfaces of a protective position, they can weaken the concrete to such an extent that the blast wave destroys it. When possible, at least one layer of sandbags, placed on their short ends, or 15 inches of soil should cover all exposed concrete surfaces. An additional consequence of concrete penetration is spalling. If a projectile partially penetrates concrete shielding, particles and chunks of concrete often break or scab off the back of the shield at the time of impact. These particles can kill when broken loose. Concrete provides excellent protection against nuclear and thermal radiation.

Rock

Direct and indirect fire fragmentation penetration into rock depends on the rock's physical properties and the number of joints, fractures, and other irregularities contained in the rock. These irregularities weaken rock and can increase penetration. Several layers of irregularly-shaped rock can change the angle of penetration. Hard rock can cause a projectile or fragment to flatten out or break up and stop penetration. Nuclear and thermal radiation protection is limited because of undetectable voids and cracks in rocks. Generally, rock is not as effective against radiation as concrete, since the ability to provide protection depends on the rock's density.

Brick and Masonry

Direct and indirect fire fragmentation penetration into brick and masonry have the same protection limitations as rock. Nuclear and thermal radiation protection by brick and masonry is 1.5 times more effective than the protection afforded by soil. This characteristic is due to the higher compressive strength and hardness properties of

brick and masonry. However, since density determines the degree of protection against initial radiation, unreinforced brick and masonry are not as good as concrete for penetration protection.

Snow and Ice

Although snow and ice are sometimes the only available materials in certain locations, they are used for shielding only. Weather could cause structures made of snow or ice to wear away or even collapse. Shielding composed of frozen materials provides protection from initial radiation, but melts if thermal radiation effects are strong enough.

Wood

Direct and indirect fire fragmentation protection using wood is limited because of its low density and relatively low compressive strengths. Greater thicknesses of wood than of soil are needed for protection from penetration. Wood is generally used as structural support for a survivability position. The low density of wood provides poor protection from nuclear and thermal radiation. Also, with its low ignition point, wood is easily destroyed by fire from thermal radiation.

Other Materials

Expedient materials include steel pickets, landing mats, steel culverts, steel drums, and steel shipping consolidated express (CONEX) containers. [Chapter 4](#) discusses fighting and protective positions constructed with some of these materials.

STRUCTURAL COMPONENTS

The structure of a fighting and protective position depends on the weapon or weapon effect it is designed to defeat. All fighting and protective positions have some configuration of floor, walls, and roof designed to protect material and/or occupants. The floor, walls, and roof support the shielding discussed earlier, or may in themselves make up that shielding. These components must also resist blast and ground shock effects from detonation of high explosive rounds which place greater stress on the structure than the weight of the components and the shielding. Designers must make structural components of the positions stronger, larger, and/or more numerous in order to defeat blast and ground shock. Following is a discussion of materials used to build floors, walls, and roofs of positions.

Floors

Fighting and protective position floors are made from almost any

material, but require resistance to weathering, wear, and trafficability. Soil is most often used, yet is least resistant to water damage and rutting from foot and vehicle traffic. Wood pallets, or other field-available materials are often cut to fit floor areas. Drainage sumps, [shown below](#), or drains are also installed when possible.

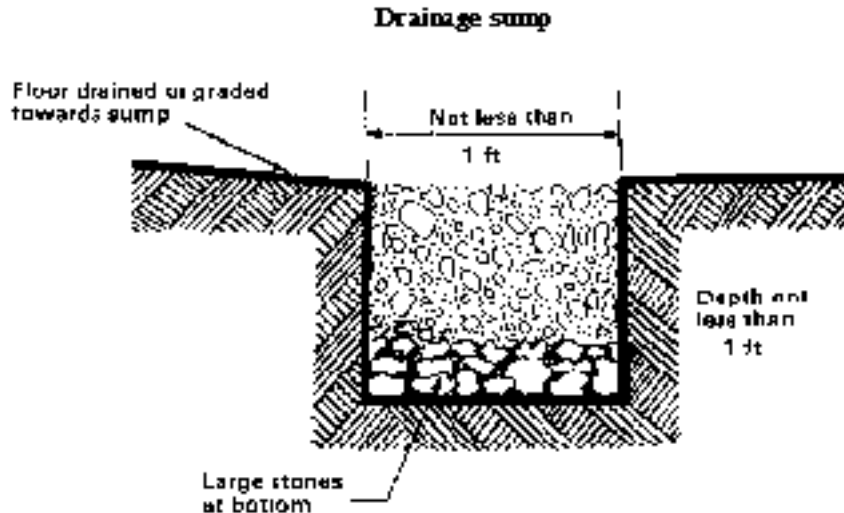

Walls

Walls of fighting and protective positions are of two basic types—below ground (earth or revetted earth) and aboveground. Below ground walls are made of the in-place soil remaining after excavation of the position. This soil may need revetment or support, depending on the soil properties and depth of cut. When used to support roof structures, earth walls must support the roof at points no less than one fourth the depth of cutout from the edges of excavation, [as shown](#).

Earth wall roof support points

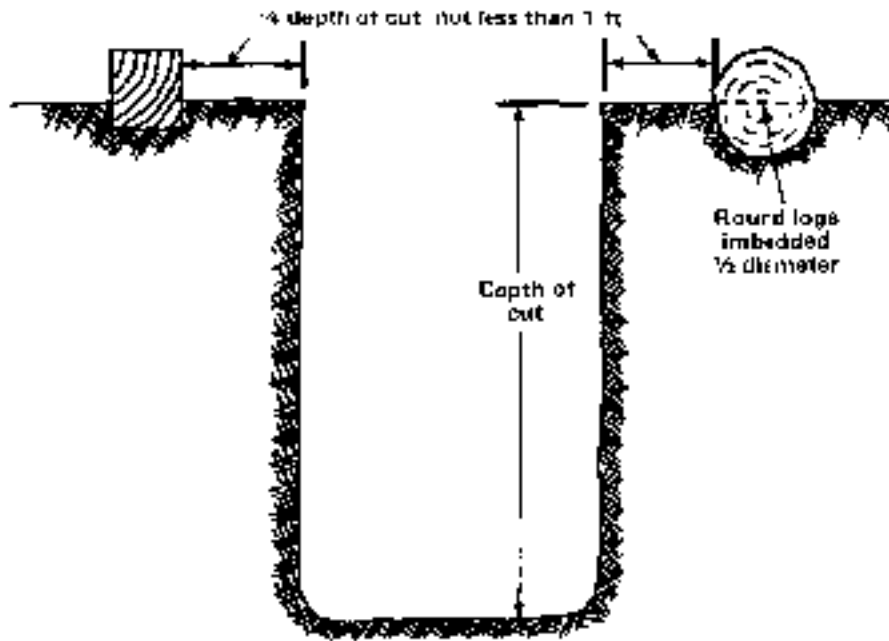

Aboveground walls are normally constructed for shielding from direct fire and fragments. They are usually built of revetted earth, sandbags, concrete, or other materials. When constructed to a thickness adequate for shielding from direct fire and fragments, they are thick and stable enough for roof support. Additional details on wall design are given in [FM 5-35](#).

Roofs

Roofs of fighting and protective positions are easily designed to support earth cover for shielding from fragments and small caliber direct fire. However, contact burst protection requires much stronger roof structures and, therefore, careful design. Roofs for support of earth cover shielding are constructed of almost any material that is usually used as beams or stringers and sheathing. The [first two tables](#) present guidelines for wooden roof structures (for fragment shielding only). A [third table](#) is converting dimensioned to round timber. The tables on [Maximum Span](#) are pertaining to steel pickets and landing mats for roof supports (for fragment shielding only).

Maximum Span of Dimensioned Wood Roof Support for Earth Cover

Thickness of Earth Cover, ft	Span Length, ft					
	2½	3	3½	4	5	6
	Wood Thickness, in					
1½	1	1	2	2	2	2
2	1	2	2	2	2	3
2½	1	2	2	2	2	3
3	2	2	2	2	3	3
3½	2	2	2	2	3	3
4	2	2	2	2	3	4

Maximum Span of Wood Stringer Roof Support for Earth Cover

Thickness of Earth Cover, ft	Span Length, ft					
	2½	3	3½	4	5	6
	Center-to-Center Spacing, in					
1½	40	30	22	16	10	18*
2	33	22	16	12	8/20*	14*
2½	27	18	12	10	16*	10*
3	22	14	10	8/20*	14*	8*
3½	18	12	8/24*	18*	12*	8*
4	16	10	8/20*	10*	10*	7*

Notes: Stringers are 2 x 4s except those marked by an asterisk (*) which are 2 by 6s

Converting Dimensioned Timber to Round Timber

4 x 4	6
6 x 6	7
6 x 8	8
8 x 8	10
8 x 10	11
10 x 10	12
10 x 12	13
12 x 12	14

*Sizes given are nominal and not rough cut timber.

Maximum Span of Steel Picket Roof Supports for Sandbag Layers

Number of Sandbag Layers	Span Length, ft		
	3	6	9
Single-Picket Beams[†]	Center-to-Center Spacing, in		
2	7	7	6
5	6	5	4
10	4	4	3
15	4	3	2
20	3	3	2
Double-Picket Beams^{**}			
2	7	7	7
5	7	7	7
10	7	6	5
15	7	5	4
20	6	5	4

[†] Used with open side down.

^{**} Two pickets are welded together every 6 inches along the span to form box beams.

**Maximum Span of Inverted Landing Mats (MSA1)
for Roof Supports**

Number of Sandbag Layers	Span Length, ft
2	10
5	6 $\frac{1}{2}$
10	6
15	4
10	3 $\frac{1}{2}$

When roof structures are designed to defeat contact bursts of high explosive projectiles, substantial additional roof protection is required. The table on [defeat contact bursts](#) gives basic design criteria for a roof. [Appendix B](#) of this manual describes a procedure for overhead cover design to defeat contact burst of high explosive projectiles.

POSITION CATEGORIES

Seven categories of fighting and protective positions or components of positions that are used together or separately are-

- Holes and simple excavations.
- Trenches.
- Tunnels.
- Earth parapets.
- Overhead cover and roof structures.
- Triggering screens.
- Shelters and bunkers.

HOLES AND SIMPLE EXCAVATIONS

Excavations, when feasible, provide good protection from direct fire and some indirect fire weapons effects. Open excavations have the advantages of-

- Providing good protection from direct fire when the occupant would otherwise be exposed.
- Permitting 360-degree observation and fire.
- Providing good protection from nuclear weapons effects.

Open excavations have the disadvantages of-

- Providing limited protection from direct fire while the occupant is firing a weapon, since frontal and side protection is negligible.
- Providing relatively no protection from fragments from overhead bursts of artillery shells. The larger the open excavation, the less the protection from artillery.
- Providing limited protection from chemical effects. In some cases, chemicals concentrate in low holes and excavations.

TRENCHES

Trenches provide essentially the same protection from conventional, nuclear, and chemical effects as the other excavations described, and are used almost exclusively in defensive areas. They are employed as protective positions and used to connect individual holes, weapons positions, and shelters. They provide protection and concealment for personnel moving between fighting positions or in and out of the area. They are usually open excavations, but sections are sometimes covered to provide additional protection. Trenches are difficult to camouflage and are easily detected from the air.

Trenches, like other positions, are developed progressively. As a general rule, they are excavated deeper than fighting positions to allow movement without exposure to enemy fire. It is usually necessary to provide revetment and drainage for them.

TUNNELS

Tunnels are not frequently constructed in the defense of an area due to the time, effort, and technicalities involved. However, they are usually used to good advantage when the length of time an area is defended justifies the effort, and the ground lends itself to this purpose. The decision to build tunnels also depends greatly on the nature of the soil, which is usually determined by borings or similar means. Tunneling in hard rock is slow and generally impractical. Tunnels in clay or other soft soils are also impractical since builders must line them throughout to prevent collapse. Therefore, construction of tunneled defenses is usually limited to hilly terrain, steep hillsides, and favorable soils including hard chalk, soft sandstone, and other types of hard soil or soft rock.

In the [tunnel system](#) shown, the soil was generally very hard and only the entrances were timbered. The speed of excavation using hand tools varied according to the soil, and seldom exceeded 25 feet per day. In patches of hard rock, as little as 3 feet were excavated per day. Use of power tools did not significantly increase the speed of excavation. Engineer units, assisted by infantry personnel, performed the work. Tunnels of the type shown are excavated up to 30 feet below ground level. They are usually horizontal or nearly so. Entrances are strengthened against collapse under shell fire and ground shock from nuclear weapons. The first 16½ feet from each entrance should have frames using 4 by 4s or larger timber supports.

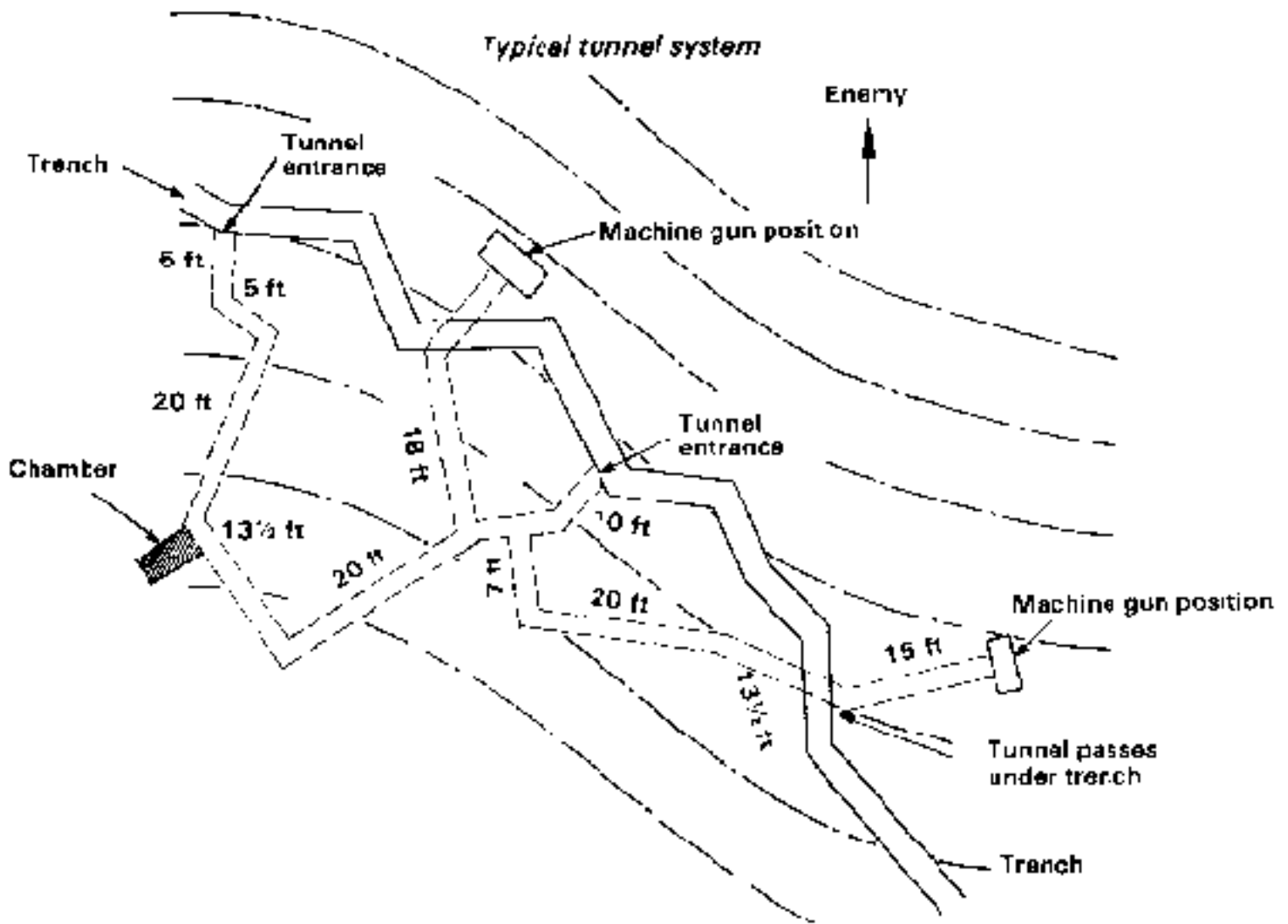

Untimbered tunnels are generally 31½ feet wide and 5 to 6 1/2 feet high. Once beyond the portal or entrance, tunnels of up to this size are unlimbered if they are deep enough and the soil will stand open. Larger tunnels must have shoring. Chambers constructed in rock or extremely hard soil do not need timber supports. If timber is not used, the chamber is not wider than 6½ feet; if timbers are used, the width can increase to 10 feet. The chamber is generally the same height as the tunnel, and up to 13 feet long.

Grenade traps are constructed at the bottom of straight lengths where they slope. This is done by cutting a recess about 3½ feet deep in the wall facing the inclining floor of the tunnel.

Much of the spoil from the excavated area requires disposal and concealment. The volume of spoil is usually estimated as one third greater than the volume of the tunnel. Tunnel entrances need concealment from enemy observation. Also, it is sometimes necessary during construction to transport spoil by hand through a trench. In cold regions, air warmer than outside air may rise from a tunnel entrance thus revealing the position.

The danger that tunnel entrances may become blocked and trap the occupants always exists. Picks and shovels are placed in each tunnel so that trapped personnel can dig their way out. Furthermore, at least two entrances are necessary for ventilation. Whenever possible, one or more emergency exits are provided. These are usually small tunnels with entrances normally closed or concealed. A tunnel is constructed from inside the system to within a few feet of the surface so that an easy breakthrough is possible.

EARTH PARAPETS

Excavations and trenches are usually modified to include front, rear, and side earth parapets. Parapets are constructed using spoil from the excavation or other materials carried to the site. Frontal, side, and rear parapets greatly increase the protection of occupants firing their weapons. Thicknesses required for parapets vary according to the material's ability to deny round penetration.

Parapets are generally positioned as [shown below](#) to allow full frontal protection, thus relying on mutual support of other firing positions. Parapets are also used as a single means of protection, even in the absence of excavations.

Parapets used for frontal protection relying on mutual support



OVERHEAD COVER AND ROOF STRUCTURES

Fighting and protective positions are given overhead cover primarily to defeat indirect fire projectiles landing on or exploding above them. Defeat of an indirect fire attack on a position, then, requires that the three types of burst conditions are considered. (**Note:** Always place a waterproof layer over any soil cover to prevent it from

gaining moisture or weathering.)

Overhead Burst (Fragments)

Protection against fragments from airburst artillery is provided by a thickness of shielding required to defeat a certain size shell fragment, supported by a roof structure adequate for the dead load of the shielding. This type of roof structure is designed using the thicknesses to defeat fragment penetration given in the table on [Indirect Fire Fragmentation and Blast](#). As a general guide, fragment penetration protection always requires at least 1½ feet of soil cover. For example, to defeat fragments from a 120-mm mortar when available cover material is sandbags filled with soil, the cover depth required is 1½ feet. Then, the [Maximum Span](#) table shows that support of the 1½ feet of cover (using 2 by 4 roof stringers over a 4-foot span) requires 16-inch center-to-center spacing of the 2 by 4s. This example is [shown below](#).

Position with overhead cover protection against fragments from a 120-mm mortar

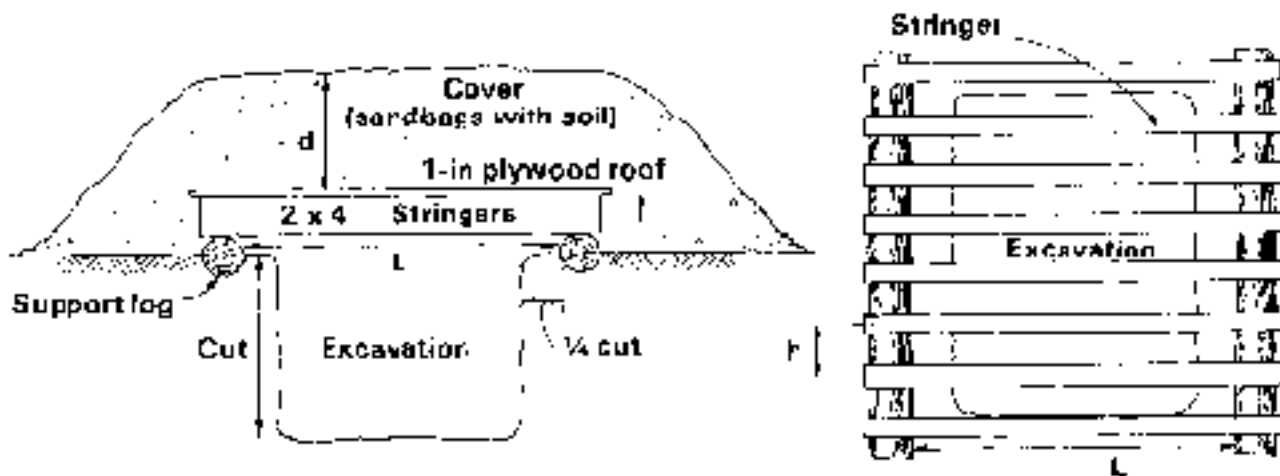

L - Span of stringer (4 ft)
 f - Stringer spacing (16 in)
 d - Depth of cover (1½ ft)

Contact Burst

Protection from contact burst of indirect fire HE shells requires much more cover and roof structure support than does protection from fragmentation. The type of roof structure necessary is given in the following [table](#). For example, if a position must defeat the contact burst of an 82-mm mortar, the [table](#) provides multiple design options. If 4 by 4 stringers are positioned on 9-inch center-to-center spacings over a span of 8 feet, then 2 feet of soil (loose, gravelly sand) is

required to defeat the burst. [Appendix B](#) outlines a step-by-step design and reverse design analysis procedure for cover protection of various materials to defeat contact bursts.

**Center-to-Center Spacing for Wood Supporting
Soil Cover to Defeat Contact Bursts**

Nominal Stringer Size (inches)	Depth of Soil (d) (feet)	Center-to-Center Stringer Spacing (h) (inches), for Cited Span Length (L) (feet)				
		2	4	6	8	10
For Defeat of 82-mm Contact Burst						
2 x 4	2.0	3	4	4	4	3
	3.0	18	12	8	5	3
	4.0	18	14	7	4	3
2 x 6	2.0	4	7	8	8	6
	3.0	18	18	16	12	8
	4.0	18	18	18	11	7
4 x 4	2.0	7	10	10	9	7
	3.0	18	18	18	12	8
	4.0	18	18	18	10	7
4 x 8	1.5	4	5	7	8	8
	2.0	14	18	18	18	18
	3.0	18	18	18	18	18
For Defeat of 120- and 122-mm Contact Bursts						
4 x 8	2.0	-	-	-	-	-
	3.0	-	-	-	-	-
	4.0	3.5	4	5	5	6
	5.0	12	12	12	11	10
	6.0	13	18	18	16	12
6 x 8	2.0	-	-	-	-	-
	3.0	-	-	-	-	-
	4.0	-	-	6.5	6	6
	5.0	14	14	13	12	10
	6.0	18	18	18	16	12
6 x 8	2.0	-	-	-	-	-
	3.0	-	-	-	-	-
	4.0	5.5	6	8	9	10
	5.0	16	8	18	18	17
8 x 8	2.0	-	-	-	-	-
	3.0	-	-	-	-	-
	4.0	7.5	8	11	12	18
	5.0	18	18	18	18	18

**Center-to-Center Spacing for Wood Supporting
Soil Cover to Defeat Contact Bursts (Continued)**

For Defeat of 152-mm Contact Burst						
4 x 8	4.0	-	-	-	-	3.8
	5.0	6	6	7	7	7
	6.0	17	16	14	12	10
	7.0	18	18	18	15	11
6 x 6	4.0	-	-	-	-	-
	5.0	7	8	8	8	7
	6.0	18	18	15	12	10
	7.0	18	18	18	15	11
6 x 8	3.0	-	-	-	-	-
	4.0	-	-	-	-	6
	5.0	10	11	12	12	12
	6.0	18	18	18	18	17
8 x 8	3.0	-	-	-	-	-
	4.0	-	-	-	-	8
	5.0	14	15	16	17	16
	6.0	18	18	18	18	18

Note: The maximum beam spacing listed in the above table is 18 inches. This is to preclude further design for roof material placed over the stringers to hold the earth cover. A maximum of 1 inch wood or plywood should be used over stringers to support the earth cover for 82-mm bursts; 2 inches should be used for 120 mm, 122 mm, and 152-mm bursts.

Delay Fuze Burst

Delay fuze shells are designed to detonate after penetration. Protection provided by over-head cover is dependent on the amount of cover remaining between the structure and the shell at the time of detonation. To defeat penetration of the shell, and thus cause it to detonate with a sufficient cover between it and the structure, materials are added on top of the overhead cover.

If this type of cover is used along with contact burst protection, the additional materials (such as rock or concrete) are added in with the soil unit weight when designing the contact burst cover structure.

TRIGGERING SCREENS

Triggering screens are separately built or added on to existing structures used to activate the fuze of an incoming shell at a "standoff" distance from the structure. The screen initiates detonation at a distance where only fragments reach the structure. A

variety of materials are usually used to detonate both super-quick fuze shells and delay fuze shells up to and including 130 mm. Super-quick shell detonation requires only enough material to activate the fuze. Delay shells require more material to both limit penetration and activate the fuze. Typical [standoff framing](#) is shown below.

Typical standoff framing with dimensioned wood triggering screen

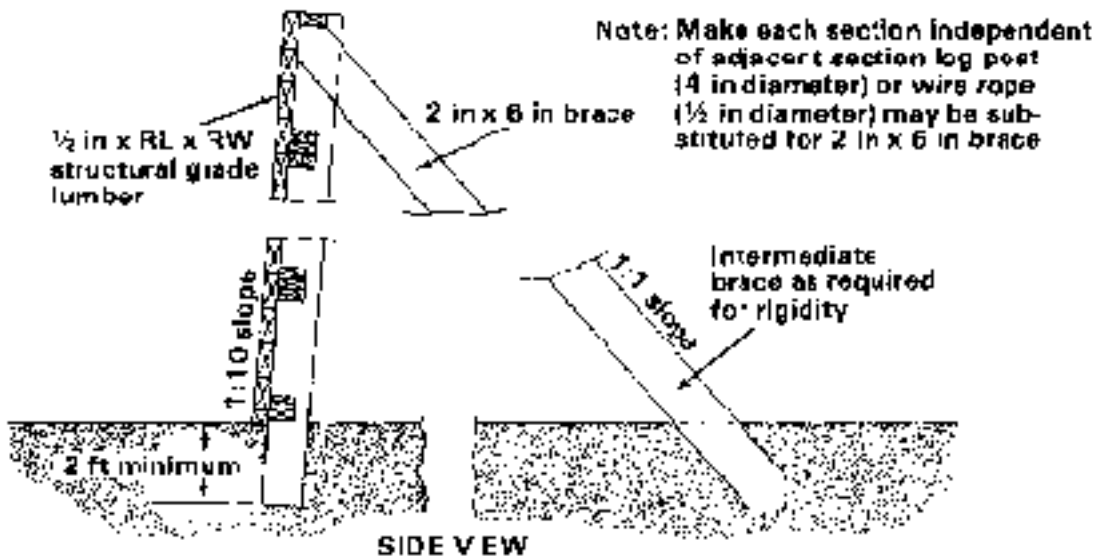
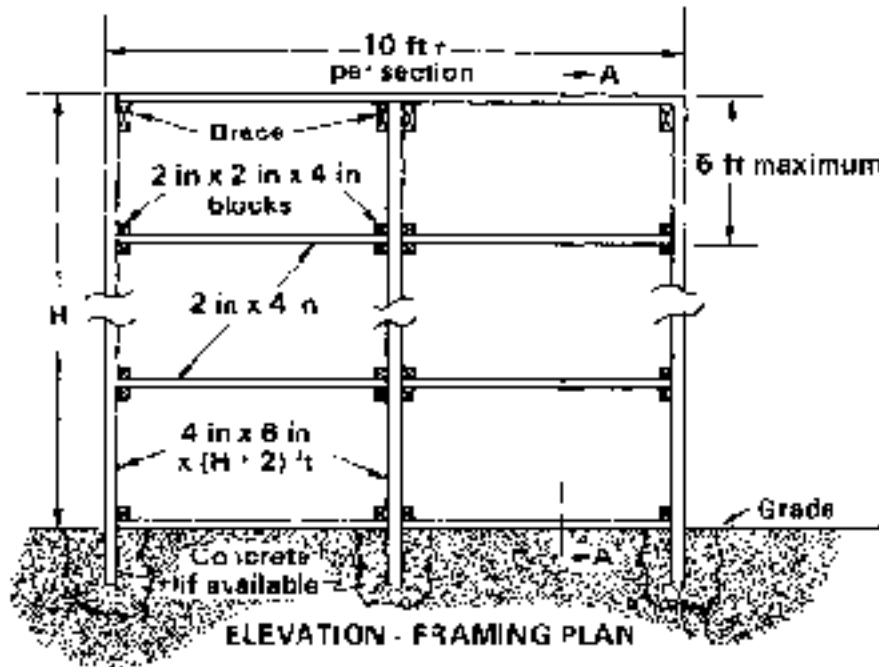

Defeating Super-Quick Fuzes

Incoming shells with super-quick fuzes are defeated at a standoff distance with several types of triggering screen materials. The [first table](#) below lists thicknesses of facing material required for

detonating incoming shells when impacting with the triggering screen. These triggering screens detonate the incoming shell but do not defeat fragments from these shells. Protection from fragments is still necessary for a position. The [second table](#) below lists required thicknesses for various materials to defeat fragments if the triggering screen is 10 feet from the structure.

Triggering Screen Facing Material Requirements

Material	Triggering Requirements*
Plywood, dimensioned timber	1 1/8-in thickness
Soil in sandbags with plywood or metal lacing	1-in thickness (24-gage sheet metal)
Structured steel (corrugated metal)	4-in thickness
Tree limbs	2-in diameter
Ammunition crates	1 layer (1-in-thick wood)
Snow	3 feet

* For detonating projectiles up to and including 120 mm mortar, rocket, and artillery shells.

Triggering Screen Material Thickness, in Inches, Required to Defeat Fragments at a 10-Foot Standoff

Material	Incoming Shell Size		
	82 mm	120 mm	122 mm
Soil	10	18	18
Soil, frozen	5	9	9
Sand	8	16	16
Clay	10	18	18
Steel (corrugated metal)	1/8	1	1
Wood (fir)	5	14	14
Concrete	2	2	3
Snow	60	80	80

Defeating Delay Fuzes

Delay fuzes are defeated by various thicknesses of protective material. The [table](#) below lists type and thickness of materials required to defeat penetration of delay fuze shells and cause their premature detonation. These materials are usually added to positions designed for contact burst protection. One method to defeat penetration and ensure premature shell detonation is to use layers of large stones. The [figure below](#) shows this added delay fuze protection on top of the contact burst protection designed in [appendix B](#). The rocks are placed in at least three layers on top of the required depth of cover for the expected shell size. The rock size is approximately twice the caliber of the expected shell. For example, the rock size required to defeat 82-mm mortar shell penetration is 2 x 82 mm = 164

mm (or 6½ inches).

Required Thickness, in Inches, of Protective Material to Resist Penetration of Different Shells (Delay Fuze)

Shells	Concrete*	Rock**	Rock Size (inches)
82-mm mortar	6	20	6½
120-mm mortar	20	36	9
122-mm rocket	50	40	10
122-mm artillery	68	40	10
130-mm artillery	80	42	10½

* 3,000 psi reinforced concrete.

** Rock must be relatively strong (compressive strength of about 20,000 psi) and in three layers for 82 mm; four layer for others.

Note: Due to the extreme thickness required for protection, materials such as earth, sand, and clay are not recommended.

Stone layer added to typical overhead cover to defeat the delay fuze burst from an 82-mm mortar

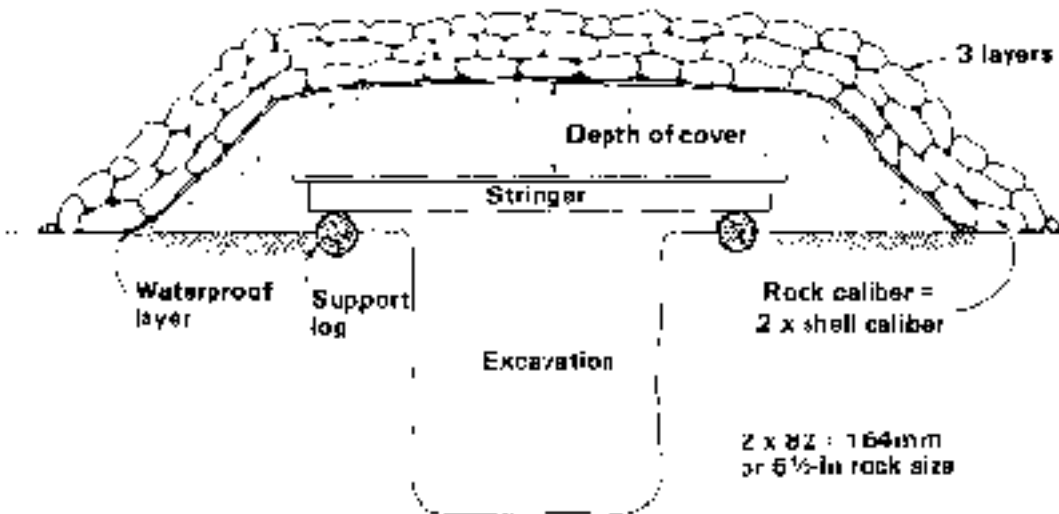

In some cases, [chain link fences](#) also provide some standoff protection when visibility is necessary in front of the standoff and when positioned as shown. However, the fuze of some incoming shells may pass through the fence without initiating the firing mechanism.

SHELTERS AND BUNKERS

Protective shelters and fighting bunkers are usually constructed using a combination of the components of positions mentioned thus far. Protective shelters are primarily used as-

- Command posts.
- Observation posts.

- Medical aid stations.
- Supply and ammunition shelters.
- Sleeping or resting shelters.

Protective shelters are usually constructed aboveground, using cavity wall revetments and earth-covered roof structures, or they are below ground using sections that are airtransportable.

Fighting bunkers are enlarged fighting positions designed for squad-size units or larger. They are built either aboveground or below ground and are usually made of concrete. However, some are prefabricated and transported forward to the battle area by trucks or air.

If shelters and bunkers are properly constructed with appropriate collective protection equipment, they can serve as protection against chemical and biological agents.

Chain link fence used for a standoff

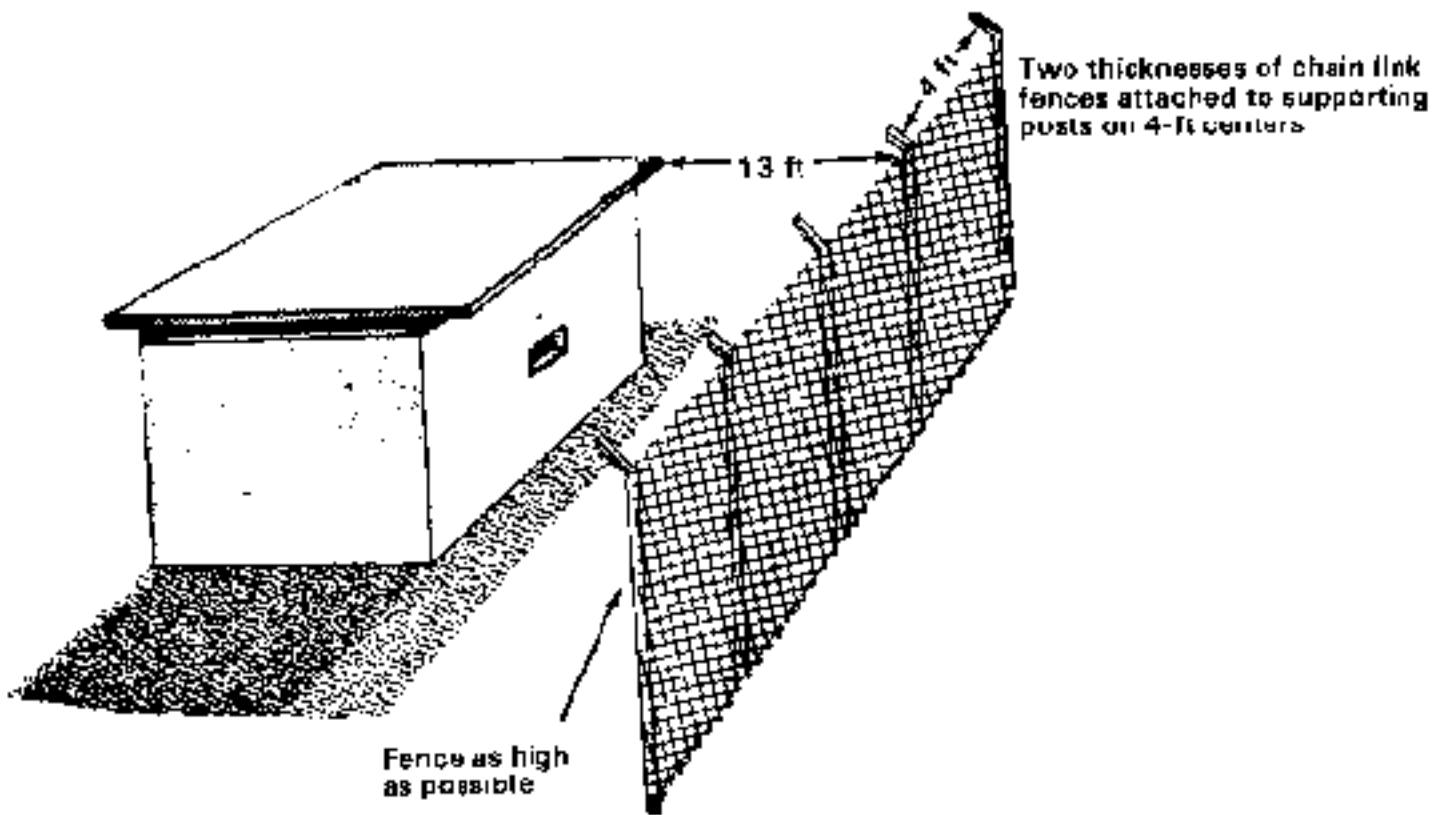

CONSTRUCTION METHODS

For individual and crew-served weapons fighting and protective position construction, hand tools are available. The individual soldier carries an entrenching tool and has access to picks, shovels, machetes, and hand carpentry tools for use in individual excavation and vertical construction work.

Earthmoving equipment and explosives are used for excavating protective positions for vehicles and supplies. Earthmoving equipment, including backhoes, bulldozers, and bucket loaders, are usually used for larger or more rapid excavation when the situation permits. Usually, these machines cannot dig out the exact shape desired or dig the amount of earth necessary. The excavation is usually then completed by hand. Descriptions and capabilities of US survivability equipment are given in [appendix A](#).

Methods of construction include sandbagging, explosive excavation, and excavation revetments.

SANDBAGGING

Walls of fighting and protective positions are built of sandbags in much the same way bricks are used. Sandbags are also useful for retaining wall revetments as shown on the right.

The sandbag is made of an acrylic fabric and is rot and weather resistant. Under all climatic conditions, the bag has a life of at least 2 years with no visible deterioration. (Some older-style cotton bags deteriorate much sooner.) The useful life of sandbags is prolonged by filling them with a mixture of dry earth and portland cement, normally in the ratio of 1 part of cement to 10 parts of dry earth. The cement sets as the bags take on moisture. A 1:6 ratio is

Retaining wall revetment

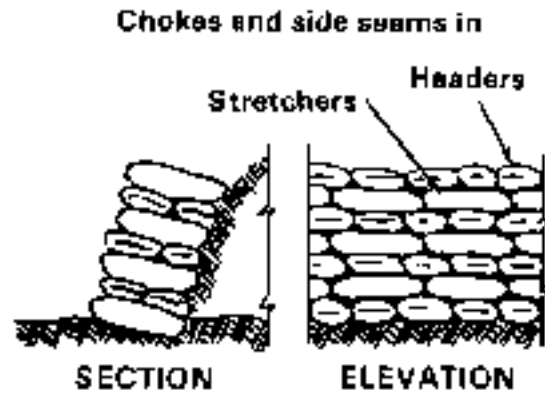

Joints broken

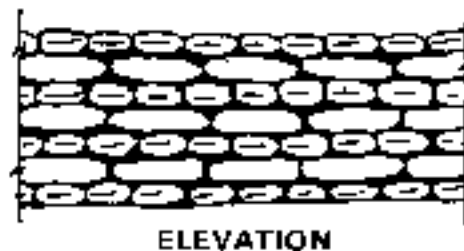

Stretchers and headers

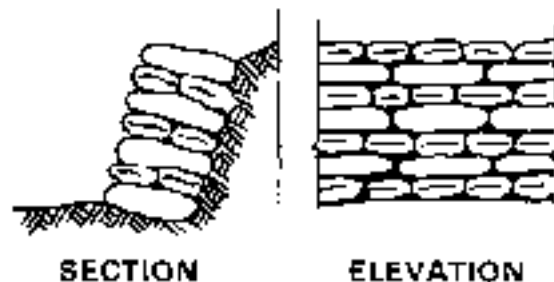

used for sand-gravel mixtures. As an alternative, filled bags are dipped in a cement-water slurry. Each sandbag is then pounded with a flat object, such as a 2 by 4, to make the retaining wall more stable.

As a rule, sandbags are used for revetting walls or repairing trenches when the soil is very loose and requires a retaining wall. A sandbag revetment will not stand with a vertical face. The face must have a slope of 1:4, and lean against the earth it is to hold in place. The base for the revetment must stand on firm ground and dug at a slope of 4:1.

The following steps are used to construct a sandbag revetment wall such as the one [shown](#).

- The bags are filled about three-fourths full with earth or a dry soil-cement mixture and the choke cords are tied.
- The bottom corners of the bags are tucked in after filling.
- The bottom row of the revetment is constructed by placing all bags as headers. The wall is built using alternate rows of stretchers and headers with the joints broken between courses. The top row of the revetment wall consists of headers.
- Sandbags are positioned so that the planes between the layers have the same pitch as the base-at right angles to the slope of the revetment.
- All bags are placed so that side seams on stretchers and choked ends on headers are turned toward the revetted face.
- As the revetment is built, it is backfilled to shape the revetted face to this

Expedient funnel for filling sandbags

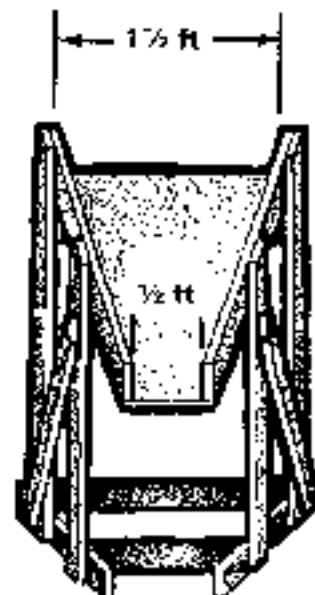
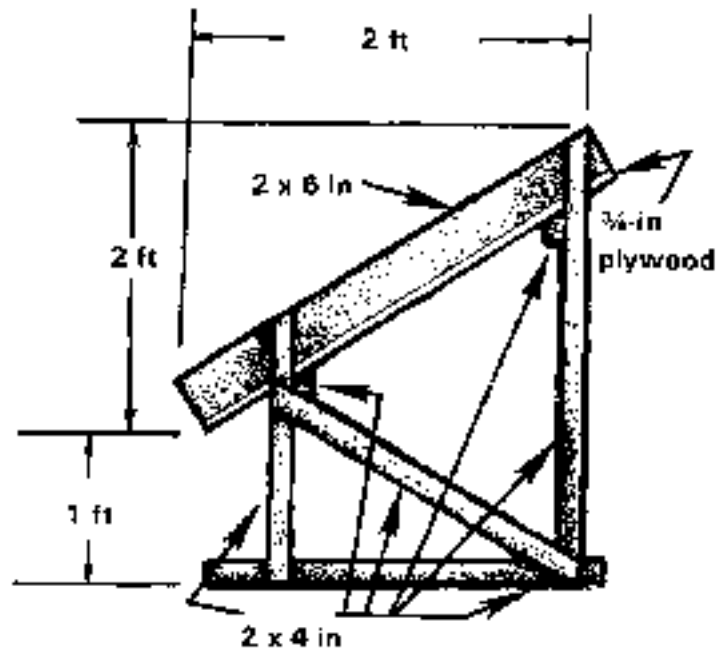

slope.

Often, the requirement for filled sandbags far exceeds the capabilities of soldiers using only shovels. If the bags are filled from a stockpile, the job is performed easier and faster by using a lumber or steel funnel [as shown on the right](#).

EXPLOSIVE EXCAVATION

Explosive excavation is done by placing charges in boreholes in a particular pattern designed to excavate a certain dimensioned hole. Boreholes are dug to a depth two thirds that of desired excavation. The holes are spaced no farther apart than twice their depth, and no closer to the desired perimeter than the depth of the borehole.

The boreholes are dug with posthole diggers, hand augers, or with 15-or 40-pound shaped charges. The holes are backfilled and tamped. Borehole sizes made with shaped charges are listed in the [first table](#) below. Boreholes made with shaped charges may need additional digging or partial filling and tamping to achieve a desired depth. When setting explosives, the charges are placed in the borehole with two thirds of the charge at the bottom and one third halfway down. The charges are then tamped. The [second table](#) below lists the pounds of explosive needed in a sandy clay soil per depth of borehole.

Average Borehole Sizes Made by Shaped Charges

Material	Shaped Charge		Resulting Borehole		
	Distance, in	Depth, ft	Diameter, in	Depth, ft	Diameter, in
Soil: deep-packed snow	30	7	7	-	-
	48	-	-	7	14
Frozen ground	30	6	3	-	-
	50	-	-	6	7
Ice	42	7	4	12	7

Amount of Explosive Required for Blasting Craters

Amount of Explosive Required for Blasting Craters

Depth of Borehole, ft	Pounds of Explosive
2	3
3	5
4	8
5	13

Because soil type and explosive effectiveness vary, the quantity of

explosive required may differ slightly from the amounts given in the previous table. A test hole is detonated to check the accuracy of the table in the specific soil condition. After tamping and detonating the charges, the loose earth is removed and the position is shaped as desired.

Rectangular Positions

Borehole and charge location in rectangular position excavation [shown below](#) in the diagram is as follows:

- The outline of position is marked on the ground.
- Holes are located a borehole's depth inward from each of the four corners.
- Additional holes are spaced along both sides at distances not exceeding two times the depth of the boreholes.
- Inner rows are spaced equal distance from the outer rows at distances not exceeding two times the borehole depth.
- Each row is staggered with respect to adjacent rows.
- The calculated charge weight is doubled in all holes in interior rows.

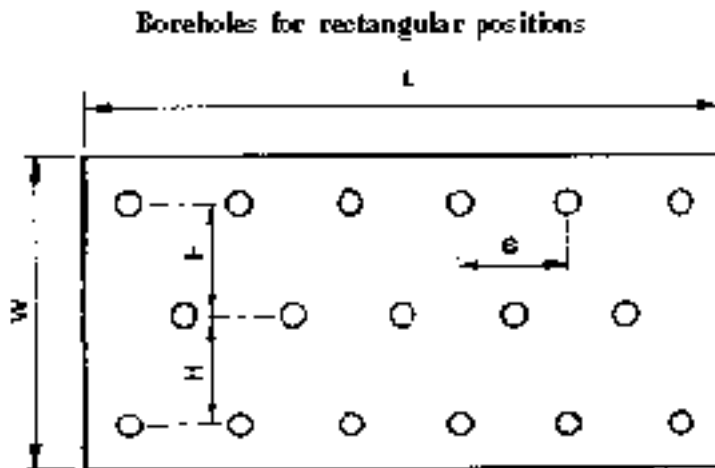

L - Length
W - Width
S - Distance between holes in row
 $2x$ borehole depth
H - Distance between rows
 $2x$ borehole depth

Information concerning the calculation of charge weights and the use of prime cord or blasting caps is contained in [FM 5-34](#) and [FM 5-25](#).

To create ramps for positions in relatively flat terrain using explosives, the lower portion is excavated as a rectangular position, [as shown](#), and the upper end is excavated by hand. Charges are not

placed closer than the borehole depth from the desired edge, and not farther than twice the borehole depth apart. Portions of the position less than 2 feet deep are usually excavated by hand.

Boreholes for positions in flat terrain

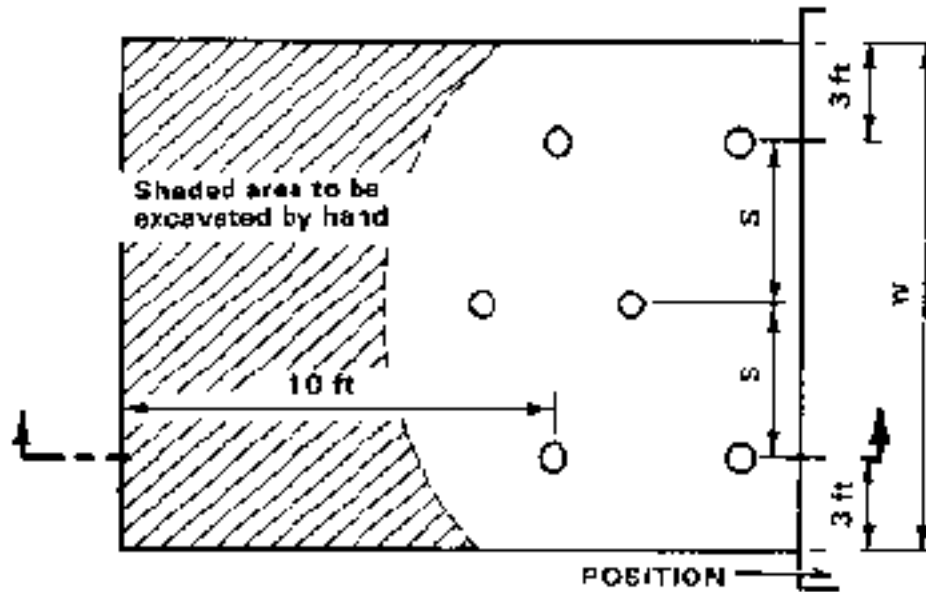

PLAN

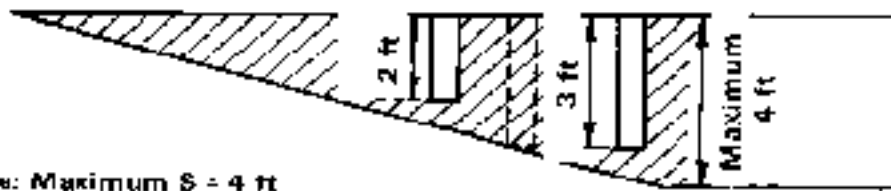

Note: Maximum S = 4 ft

SECTION

Circular Positions

Circular positions are prepared with a circular arrangement of boreholes surrounding a borehole at the center of the position. Several concentric rings of holes are needed for large positions, and one ring or only one charge for small positions. The charge layout [shown on the right](#) is as follows:

- The radius of the desired circular position is determined.
- The borehole depth is subtracted from the radius

and a circle is inscribed on the ground with the new radius length.

- The new radius length is divided by twice the borehole depth to determine the number of rings within the position.
- Each additional ring is positioned at equal distances between the outer ring and the center of the position.
- Boreholes are spaced equal distance along each ring. Each hole should not exceed twice the borehole depth from another hole on the ring.
- The charge weight is doubled in all holes in the interior rings.

Boreholes for circular positions

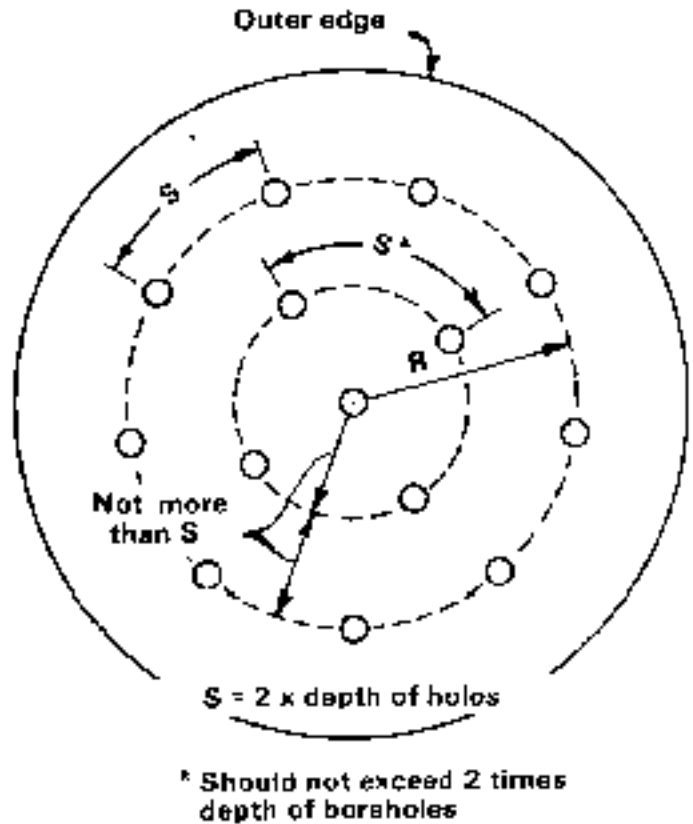

When the position diameter does not exceed twice the borehole depth, a single charge placed at the center of the position is enough. When the position diameter is between two and four times the borehole depth, space three holes equal distance around the ring and omit the center hole.

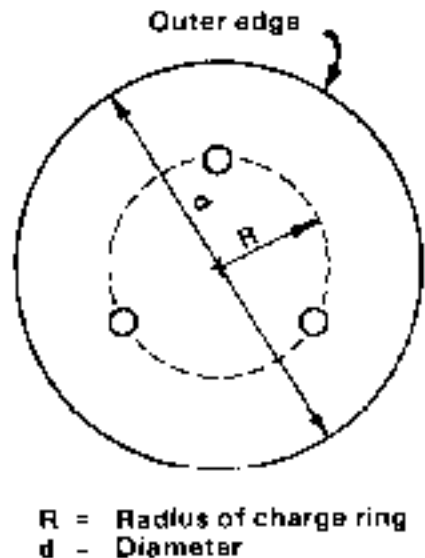

Positions in Frozen Soil

In frozen soil, blasting requires about 1.5 to 2 times the number of boreholes and larger charges than those calculated for moderate

climates. To determine the number of bore-holes needed, testing is performed before extensive excavation is attempted. For frozen soil, hole depth (d) should equal required depth of excavation. The required charge weight (w) is $w = 0.06 d^3$ pounds, where (d) is in feet.

Positions in Rocky Soil

Boulders and rocks are removed by using blasting methods described in [FM 5-25](#) or [FM 5-34](#). These manuals also described similar activities for stump and tree root removal.

EXCAVATION REVETMENTS

Excavations in soil may require revetment to prevent side walls from collapsing. Several methods of excavation revetments are usually used to prevent wall collapse.

Wall Sloping

The need for revetment is sometimes avoided or postponed by sloping the walls of the excavation. In most soils, a slope of 1:3 or 1:4 is sufficient. This method is used temporarily if the soil is loose and no revetting materials are available. The ratio of 1:3, for example, will determine the slope by moving 1 foot horizontally for each 3 feet vertically. When wall sloping is used, the walls are first dug vertically and then sloped.

Facing Revetments

Facing revetments serve mainly to protect revetted surfaces from the effects of weather and occupation. It is used when soils are stable enough to sustain their own weight. This revetment consists of the revetting or facing material and the supports which hold the revetting material in place. The facing material is usually much thinner than that used in a retaining wall. Facing revetments are preferable to wall sloping since less excavation is required. The top of the facing is set below ground level. The facing is constructed of brushwood hurdles, continuous brush, poles, corrugated metal, plywood, or burlap and chicken wire. The following paragraphs describe the method of constructing each type.

Brushwood Hurdle. A brushwood hurdle is a woven revetment unit usually 6½ feet long and as high as the revetted wall. Pieces of brushwood about 1 inch in diameter are weaved on a framework of sharpened pickets driven into the ground at 20-inch intervals. When completed, the 6 ½-foot lengths are carried to the position where the pickets are driven in place. The tops of the pickets are tied back to stakes or holdfasts and the ends of the hurdles are wired together.

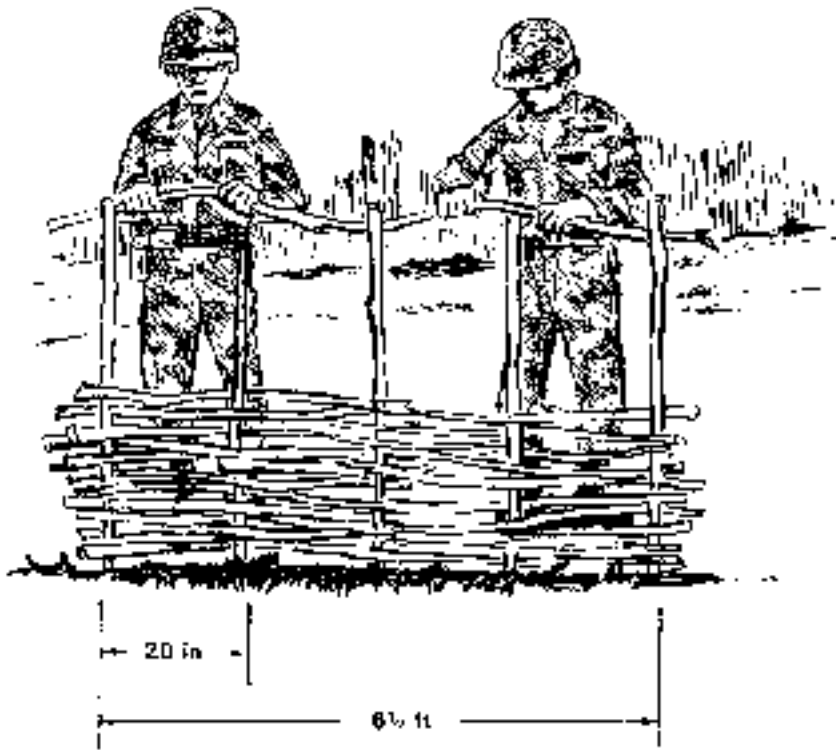
Brush wood bundle

Continuous Brush. A continuous brush revetment is constructed in place. Sharpened pickets 3 inches in diameter are driven into the bottom of the trench at 30-inch intervals and about 4 inches from the revetted earth face. The space behind the pickets is packed with small, straight brushwood laid horizontally. The tops of the pickets are anchored to stakes or holdfasts.

Continuous brush revetment

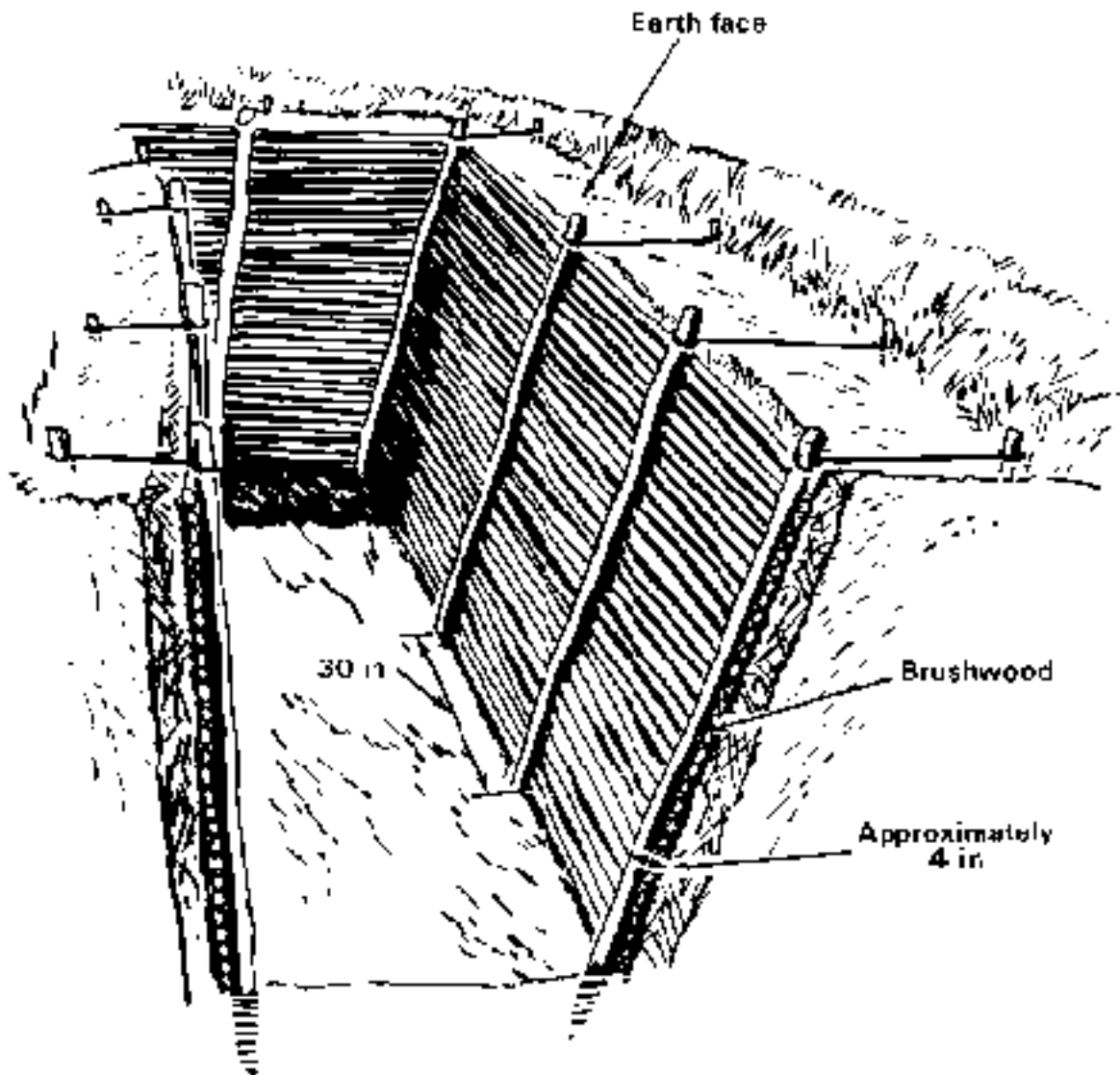

Pole. A pole revetment is similar to the continuous brush revetment except that a layer of small horizontal round poles, cut to the length of the revetted wall, is used instead of brushwood. If available, boards or planks are used instead of poles because of quick installation. Pickets are held in place by holdfasts or struts.

Pole revetment

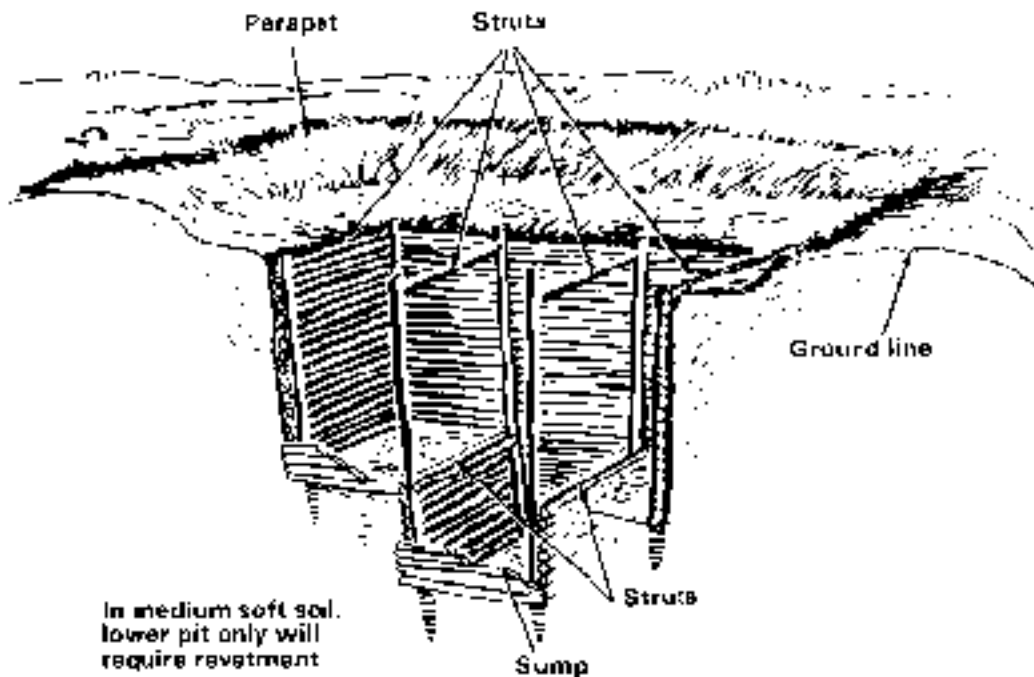

Corrugated Metal Sheets or Plywood. A revetment of corrugated metal sheets or plywood is usually installed rapidly and is strong and durable. It is well adapted to position construction because the edges and ends of sheets or planks are lapped, as required, to produce a revetment of a given height and length. All metal surfaces are smeared with mud to reduce possible reflection of thermal radiation and aid in camouflage. Burlap and chicken wire revetments are similar to revetments made from corrugated metal sheets or plywood. However, burlap and chicken wire does not have the strength or durability of plywood or sheet metal in supporting soil.

Type: of metal revetment

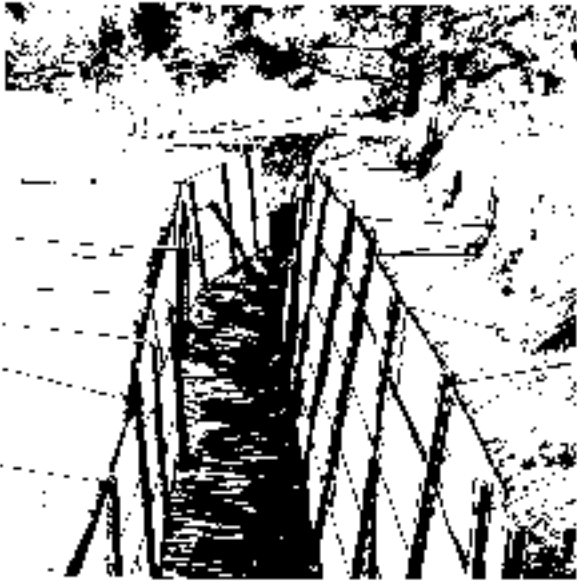

Corrugated metal sheets

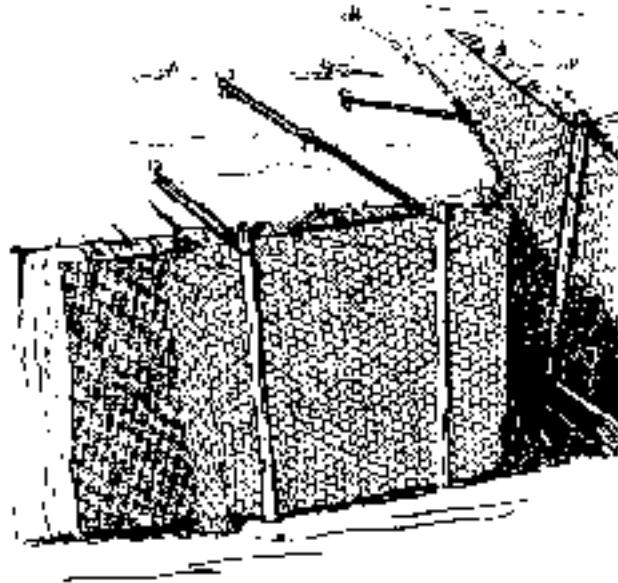

Burlap and chicken wire

Methods to Support Facing

The revetment facing is usually supported by [timber frames](#) or [pickets](#). Frames of dimensioned timber are constructed to fit the bottom and sides of the position and hold the facing material apart over the excavated width.

Facing revetment supported by timber frames

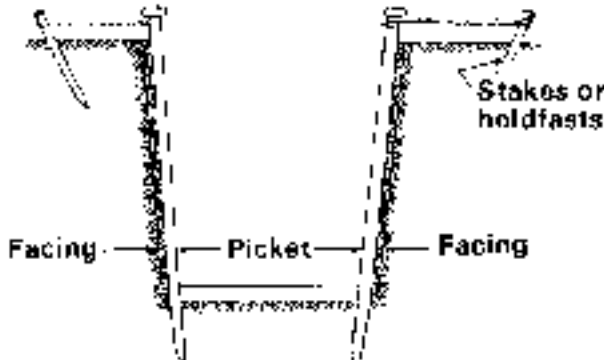
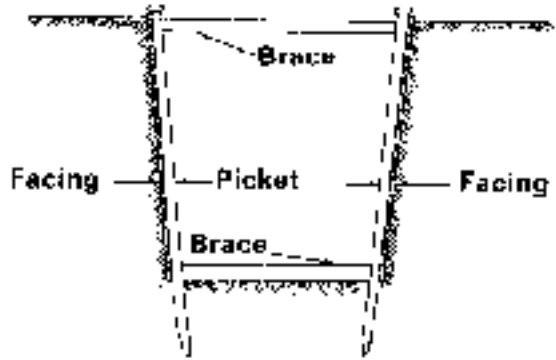

METHOD OF PLACING STAKES

Facing revetment supported by pickets

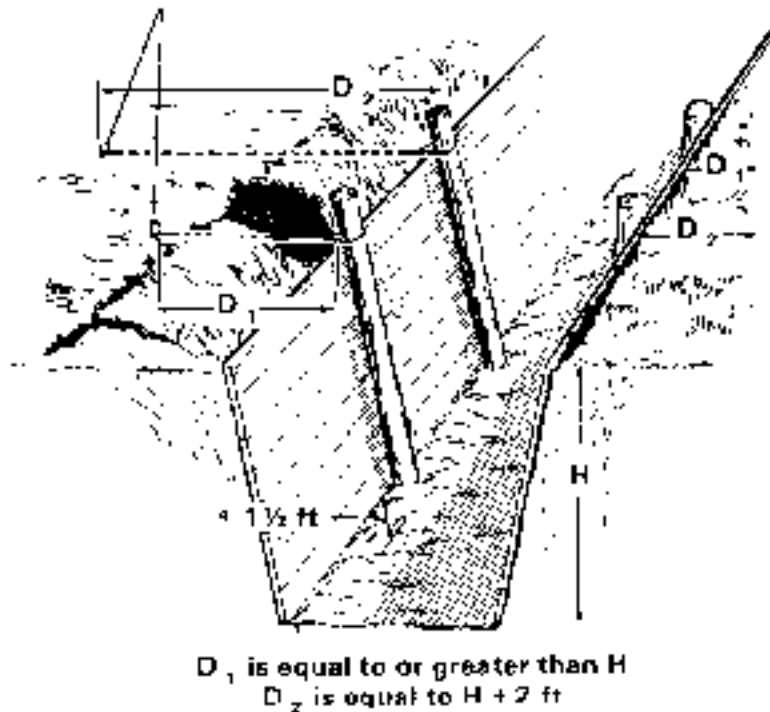

METHOD OF ANCHORING PICKETS

Pickets are driven into the ground on the position side of the facing material. The pickets are held tightly against the facing by bracing them apart across the width of the position. The size of pickets required and their spacing are determined by the soil and type of facing material used. Wooden pickets smaller than 3 inches in diameter are not used. The maximum spacing between pickets is about 6½ feet. The standard pickets used to support barbed wire entanglements are excellent for use in revetting. Pickets are driven at least 1½ feet into the floor of the position. Where the tops of the pickets are anchored, an anchor stake or holdfast is driven into the top of the bank and tied to the top of the picket. The distance between the anchor stake and the facing is at least equal to the height of the revetted face, with alternate anchors staggered and at least 2 feet farther back. Several strands of wire holding the pickets against the emplacement walls are placed straight and taut. A groove or channel is cut in the parapet to pass the wire through.

SPECIAL CONSTRUCTION CONSIDERATIONS

CAMOUFLAGE AND CONCEALMENT

The easiest and most efficient method of preventing the targeting and

destruction of a position or shelter is use of proper camouflage and concealment techniques. Major considerations for camouflage use are discussed in [appendix D](#). Following are some general guidelines for position construction.

Natural concealment and good camouflage materials are used. When construction of a positions begins, natural materials such as vegetation, rotting leaves, scrub brush, and snow are preserved for use as camouflage when construction is completed. If explosive excavation is used, the large area of earth spray created by detonation is camouflaged or removed by first placing tarpaulins or scrap canvas on the ground prior to charge detonation. Also, heavy equipment tracks and impressions are disguised upon completion of construction.

Fields of fire are not overcleared. In fighting position construction, clearing of fields of fire is an important activity for effective engagement of the enemy. Excessive clearing is prevented in order to reduce early enemy acquisition of the position. Procedures for clearing allow for only as much terrain modification as is needed for enemy acquisition and engagement.

Concealment from aircraft is provided. Consideration is usually given to observation from the air. Action is taken to camouflage position interiors or roofs with fresh natural materials, thus preventing contrast with the surroundings.

During construction, the position is evaluated from the enemy side. By far, the most effective means of evaluating concealment and camouflage is to check it from a suspected enemy avenue of approach.

DRAINAGE

Positions and shelters are designed to take advantage of the natural drainage pattern of the ground. They are constructed to provide for-

- Exclusion of surface runoff.
- Disposal of direct rainfall or seepage.
- Bypassing or rerouting natural drainage channels if they are intersected by the position.

In addition to using materials that are durable and resistant to weathering and rot, positions are protected from damage due to surface runoff and direct rainfall, and are repaired quickly when erosion begins. Proper position siting can lessen the problem of surface water runoff. Surface water is excluded by excavating intercepted ditches uphill from a position or shelter. Preventing water from flowing into the excavation is easier than removing it. Positions are located to

direct the runoff water into natural drainage lines. Water within a position or shelter is carried to central points by constructing longitudinal slopes in the bottom of the excavation. A very gradual slope of 1 percent is desirable.

MAINTENANCE

If water is allowed to stand in the bottom of an excavation, the position is eventually undermined and becomes useless. Sumps and drains are kept clean of silt and refuse. Parapets around positions are kept clear and wide enough to prevent parapet soil from falling into the excavation. When wire and pickets are used to support revetment material, the pickets may become loose, especially after rain. Improvised braces are wedged across the excavation, at or near floor level, between two opposite pickets. Anchor wires are tightened by further twisting. Anchor pickets are driven in farther to hold tightened wires. Periodic inspections of sandbags are made.

REPAIRS

If the walls are crumbling in at the top of an excavation (ground level), soil is cut out where it is crumbling (or until firm soil is reached). Sandbags or sod blocks are used to build up the damaged area. If excavation walls are wearing away at the floor level, a plank is placed on its edge or the brushwood is shifted down. The plank is held against the excavation wall with short pickets driven into the floor. If planks are used on both sides of the excavation, a wedge is placed between the planks and earth is placed in the back of the planks. If an entire wall appears ready to collapse, the excavation is completely revetted.

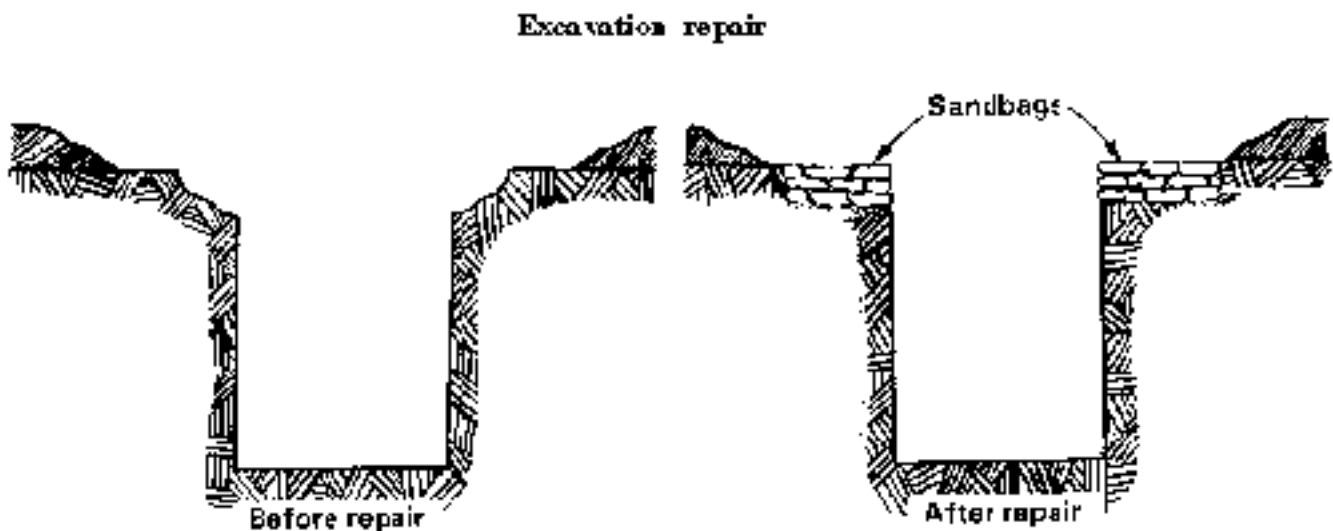

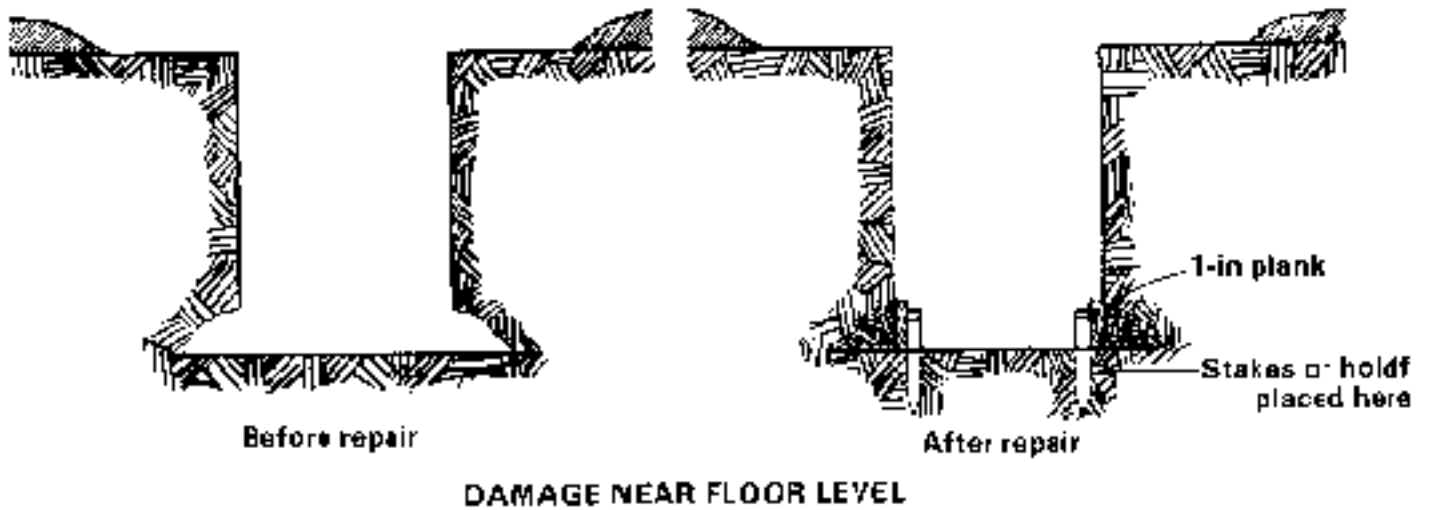

SECURITY

In almost all instances, fighting and protective positions are prepared by teams of at least two personnel. During construction, adequate frontal and perimeter protection and observation are necessary. Additional units are sometimes required to secure an area during position construction. Unit personnel can also take turns with excavating and providing security.

Energy distribution of tactical nuclear weapons

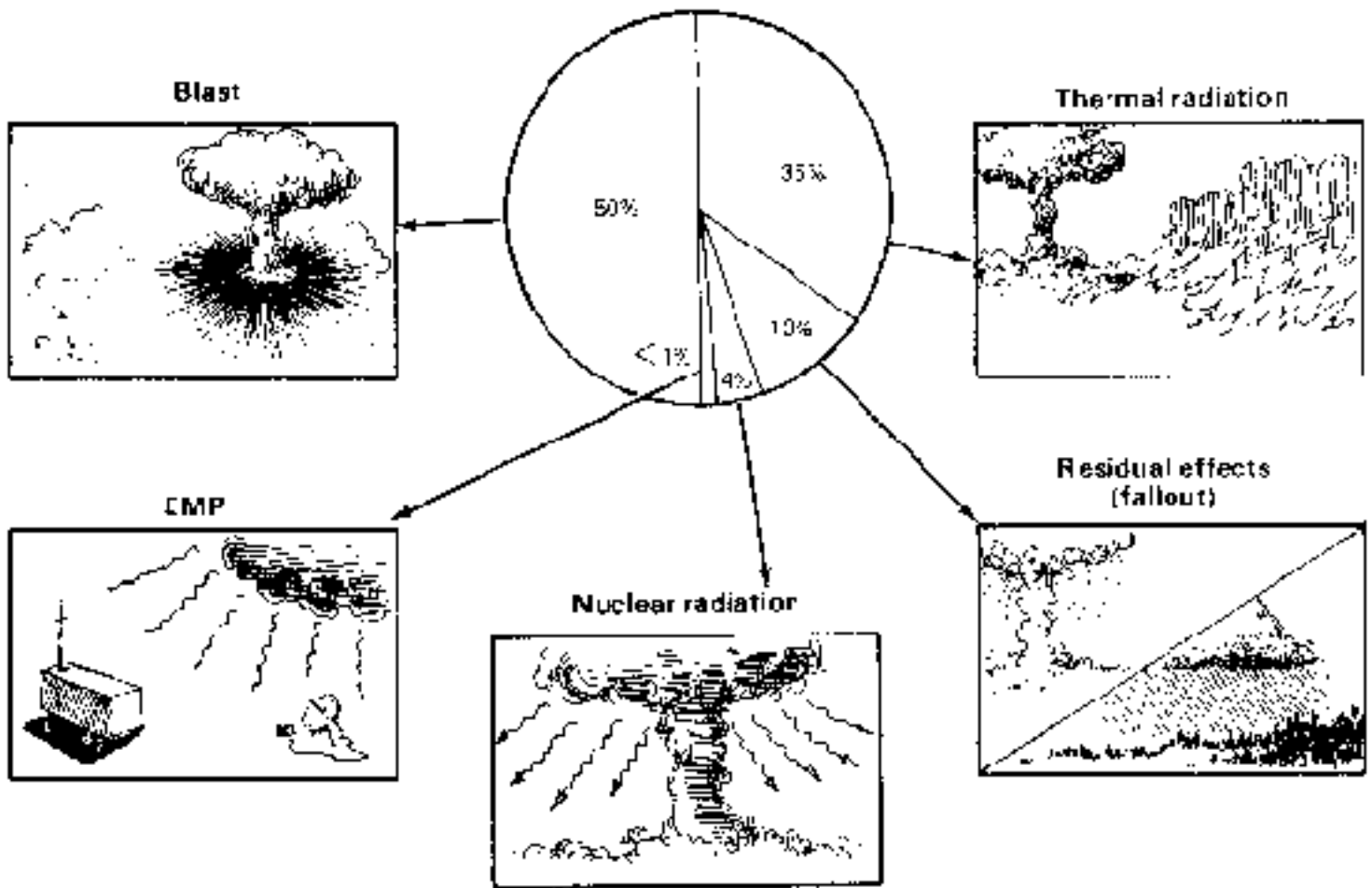

Relationship of radiation dose to distance from ground zero for a 1-KT weapon

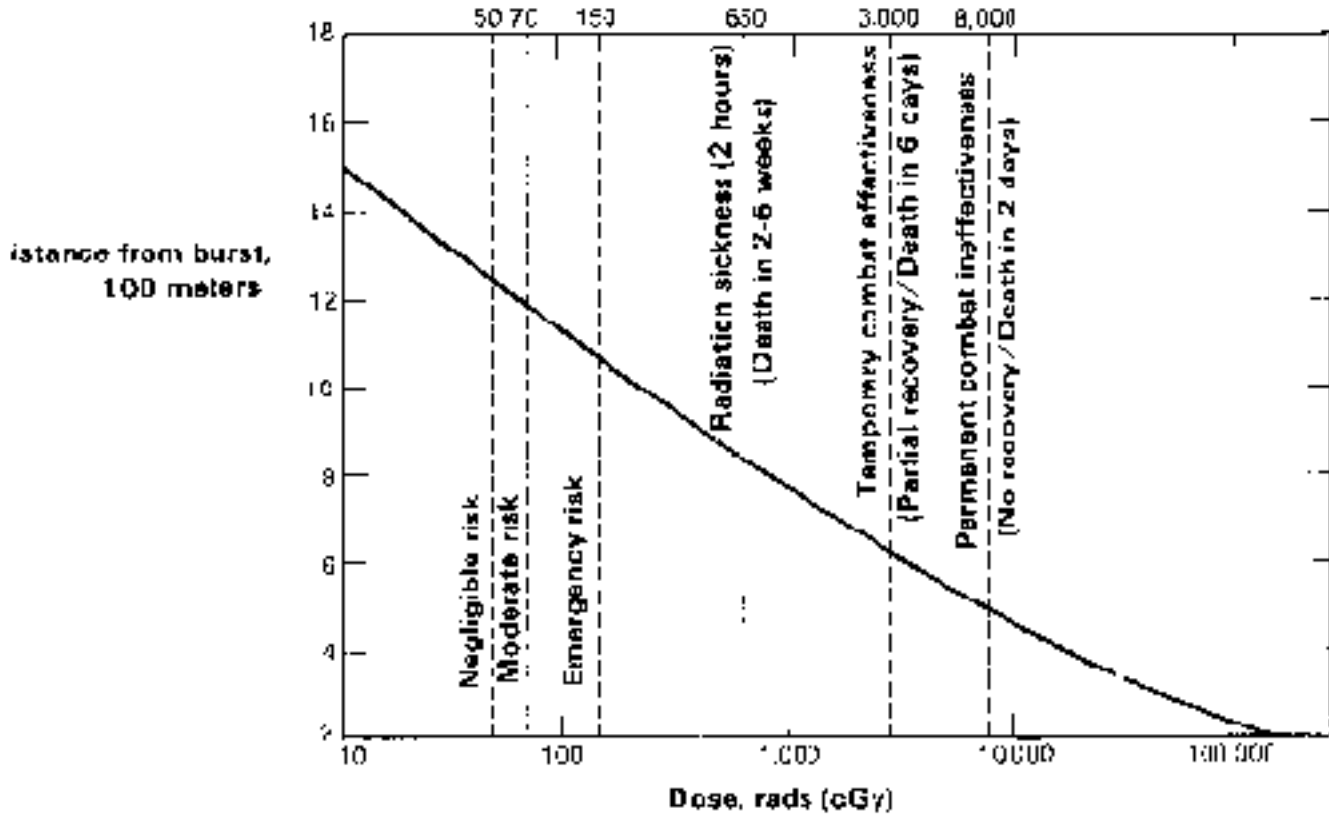

Initial Radiation Effects on Personnel

Early Symptoms*

Dose rate (cGy)	Percent of Personnel	Time to Effect	Combat Effectiveness of Personnel	Fatalities
0 to 70	<5% of personnel require hospitalization		Full	None
150	5%	≤ 6 hours	Effectiveness reduced depending on task. Some hospitalization required.	None
650	100%	≤ 2 hours	Symptoms continue intermittently for next few days. Effectiveness reduced significantly for second to sixth day. Hospitalization required.	More than 50% ill about 16 days
2,000 to 3,000	100%	≤ 5 minutes	Immediate, temporary incapacitation for 30 to 40 minutes, followed by recovery period during which efficiency is impaired. No operational capability.	100% in about 7 days
8,000	100%	≤ 5 minutes	Immediate, permanent incapacitation for personnel performing physically demanding tasks. No period of latent "recovery."	100% in 1 to 2 days
18,000	100%	Immediate	Permanent incapacitation for personnel performing even undemanding tasks. No operational capability.	100% within 24 hours

* Symptoms include vomiting, diarrhea, "dry heaving," nausea, lethargy, depression, and mental disorientation. At lower dose levels, incapacitation is a simple slow down in performance rate due to a loss of physical mobility and/or mental disorientation. At the high dose levels, shock and coma are sometimes the "early" symptoms.

Tactical radii of effects of 1-KT and 10-KT fission weapons from low airburst

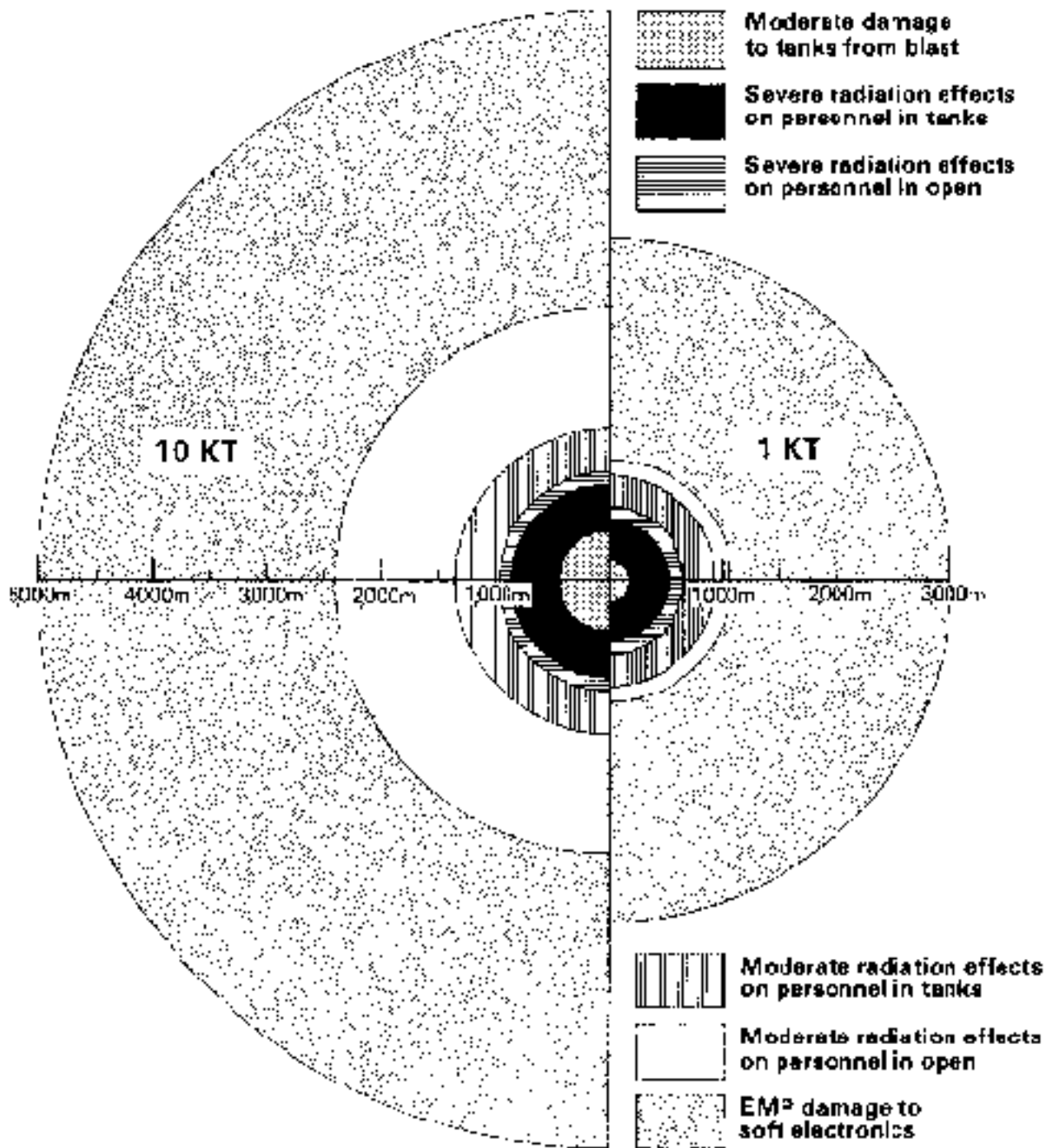

Examples of expedient protective positions against initial nuclear effects

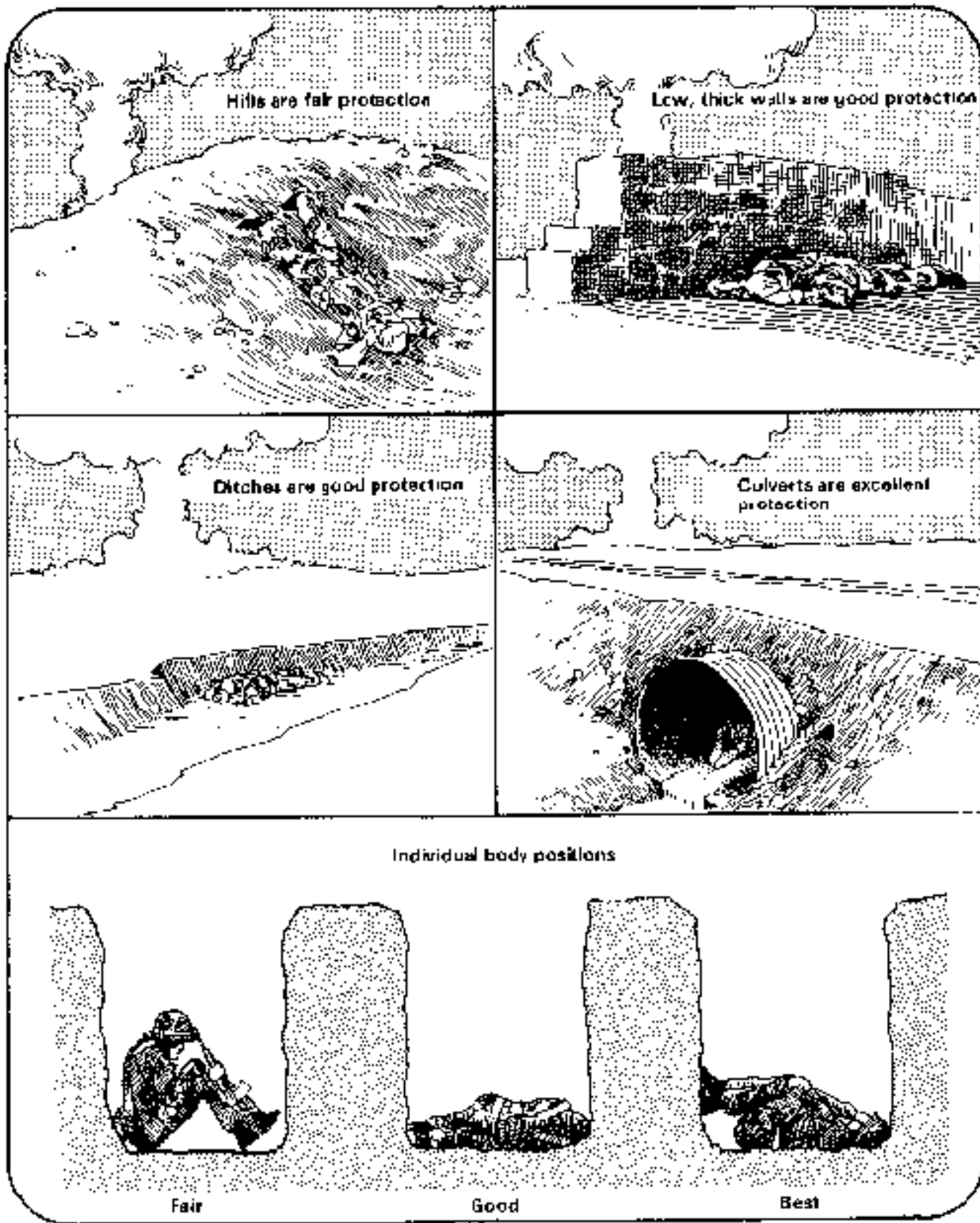

**Material Thickness, in Inches, Required to Protect
Against Direct Hits by Direct Fire Projectiles**

Material	Caliber and Machine Gun (7.62-mm) Fire* at 100 yd	Antitank Rifle (76-mm) Fire at 100 yd	20-mm Antitank Fire at 200 yd	37-mm Antitank Fire at 400 yd	50-mm Antitank Fire at 400 yd	75-mm Direct Fire at 500 to 1,000 yd	Remarks
Solid walls**							
Brick masonry	18	24	30	60			None
Concrete not reinforced***	12	18	24	42	48	54	Pain formed concrete walls
Concrete reinforced	8	12	18	36	42	48	Structurally reinforced with steel
Stone masonry	12	18	30	42	64	60	Values are guides only
Timber	36	60					Values are guides only
Wood	24	38	48				Values are guides only
Walls of loose material between boards**							
Brick rubble	12	24	30	60	72		None
Clay, dry	36	48					Add 100% to thickness if wet
Gravel/small crushed rock	12	24	30	60	72		None
Loam, dry	24	36	48				Add 50% to thickness if wet
Sand, dry	12	24	30	60	72		Add 100% to thickness if wet
Sandbags, filled with							
Brick rubble	20	30	30	60	70		None
Clay, dry	40	60					Add 100% to thickness if wet
Gravel/small crushed rock	20	30	30	60	70		None
Loam, dry	30	50	60				Add 50% to thickness if wet
Sand, dry	20	30	30	60	70		Add 100% to thickness if wet
Parapets of							
Clay	42	60					Add 100% to thickness if wet
Loam	30	40	60				Add 50% to thickness if wet
Sand	24	36	48				Add 100% to thickness if wet
Snow and ice							
Frozen snow	60	60					None
Frozen soil	24	24					None
Icecrete (ice aggregate)	18	18					None
Tamped snow	72	72					None
Unpacked snow	180	180					None

* One burst of five shots

** Thickesses to nearest 1/2 in.

*** 3,000 psi concrete.

Notes: Except where indicated, protection thicknesses are for a single shot only. Where weapons place five or six direct fire projectiles in the same area, the required protective thickness is approximately twice that indicated. Where no values are given, material is not required.

**Material Thickness, in Inches, Required to Protect
Against Direct Fire HE Shaped-Charge**

Material	73-mm RCLF	82-mm RCLF	85-mm RPG-7	107-mm RCLR	120-mm Sagger
Aluminum	36	24	30	36	36
Concrete	36	24	30	36	36
Granite	30	18	24	30	30
Rock	36	24	24	30	36
Snow, packed	156	156	156	-	-
Soil	100	66	78	96	96
Soil, frozen	50	33	39	48	48
Steel	24	14	18	24	24
Wood, dry	100	72	90	108	108
Wood, green	60	36	48	60	66

Note: Thicknesses assume perpendicular impact.

**Material Thickness, Inches, Required to Protect Against
Indirect Fire Fragmentation and Blast Exploding 50 Feet Away**

Material	Mortars		122-mm	HE Shells		Bombs			
	62-mm	120-mm	Rocket	122-mm	152-mm	100-lb	250-lb	500-lb	1,000-lb
Solid Walls									
Brick masonry	4	6	6	6	8	8	10	13	17
Concrete	4	6	6	6	8	8	10	13	18
Concrete, reinforced	3	4	4	4	6	7	9	12	15
Timber	8	12	12	12	14	15	18	24	30
Walls of loose material between boards									
Brick rubble	9	12	12	12	12	18	24	28	30
Earth*	12	12	12	12	16	24	30		
Gravel, small stones	9	12	12	12	12	18	24	28	30
Sandbags, filled with									
Brick rubble	10	18	18	18	20	20	20	30	40
Clay*	10	18	18	18	20	30	40	40	60
Gravel, small stones, soil	10	18	18	18	20	20	20	30	40
Stone*	8	16	16	16	18	30	30	40	40
Loose carpets of									
Clay*	12	20	20	20	30	36	48	60	
Sand*	10	18	18	18	24	24	36	36	48
Snow									
Tamped	60	60	60	60	60	-	-	-	-
Unpacked	60	60	60	60	60	-	-	-	-

* Double values if material is saturated.

Note: Where no values are given, material is not recommended.

**Shielding Values of Earth Cover and Sandbags for a
Hypothetical 2,400-rads (cGy) Free-In-Air Dose**

Type of Protection	Radiation Protection Factor	Resulting Dose rads
Soldier in open	None	2,400
Earth Cover		
Soldier in 4-ft-deep open position	8	300
with 6 in of earth cover	12	200
with 12 in of earth cover	24	100
with 18 in of earth cover	48	50
with 24 in of earth cover	96	25
Sand- and Clay-Filled Sandbags		
Soldier in 4-ft-deep open position	8	300
with 1 layer of sandbags (4 in)	16	150
with 2 layers of sandbags (8 in)	32	75
with 3 layers of sandbags (12 in)	64	38

[RDL](#)[Table of](#)[Document](#)[Download](#)[Homepage](#) [Contents](#) [Information](#) [Instructions](#)

CHAPTER 4

DESIGNING POSITIONS

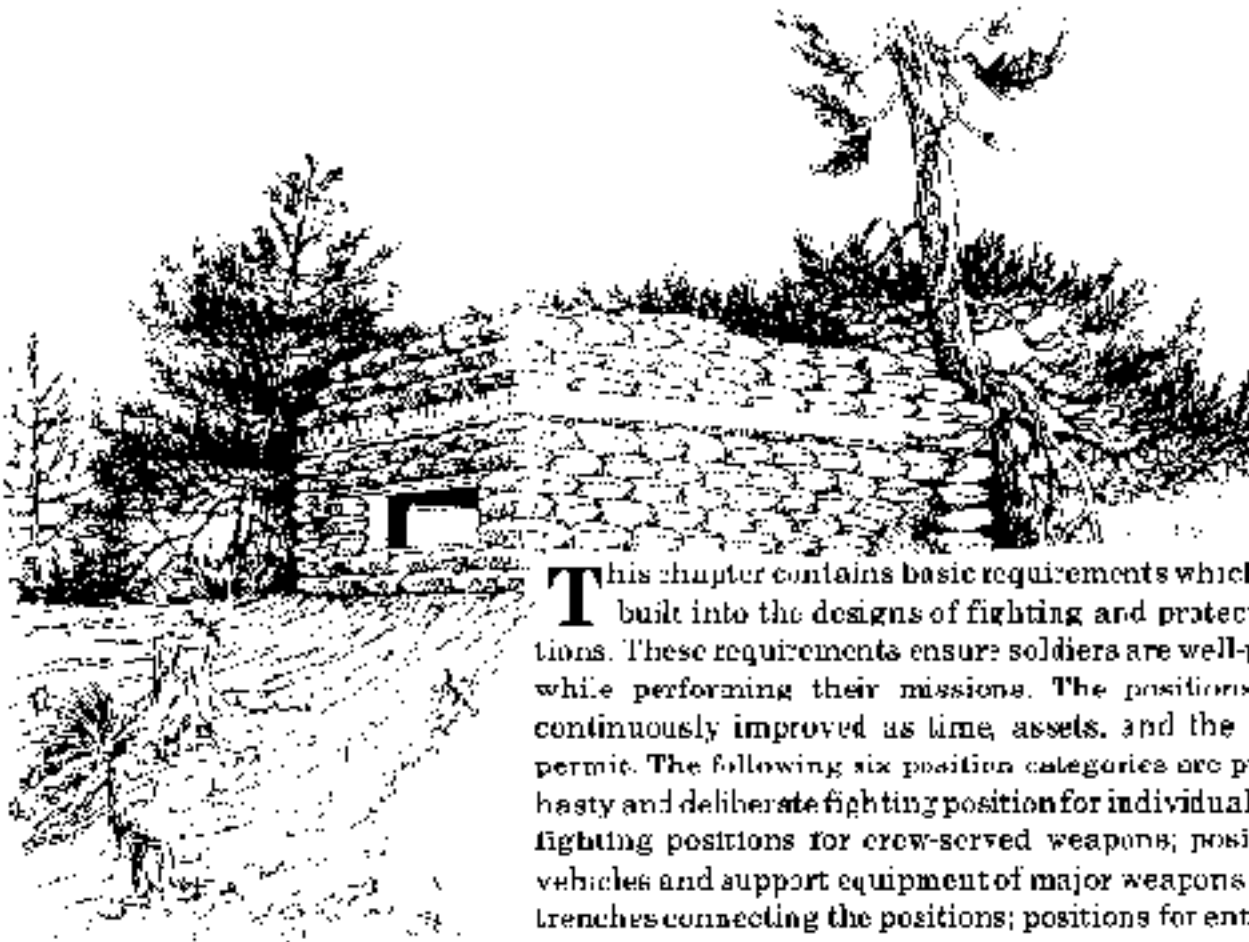

This chapter contains basic requirements which must be built into the designs of fighting and protective positions. These requirements ensure soldiers are well-protected while performing their missions. The positions are all continuously improved as time, assets, and the situation permit. The following six position categories are presented: hasty and deliberate fighting position for individual soldiers; fighting positions for crew-served weapons; positions for vehicles and support equipment of major weapons systems; trenches connecting the positions; positions for entire units; and special designs including shelters and bunkers. The positions in each category are briefly described and accompanied by a typical design illustration. Each category is summarized providing time and equipment estimates and protection factors for each position. Complete detailed construction drawings, and time and material estimates for each position, are contained in appendix 11.

BASIC DESIGN REQUIREMENTS

WEAPON EMPLOYMENT

While it is desirable for a fighting position to give maximum protection to personnel and equipment, primary consideration is always given to effective weapon use. In offensive combat operations, weapons are sited wherever natural or existing positions are available, or where weapon emplacement is made with minimal digging.

COVER

Positions are designed to defeat an anticipated threat. Protection against direct and indirect fire is of primary concern for position design. However, the effects of nuclear and chemical attack are taken into consideration if their use is suspected. Protection design for one type of enemy fire is not necessarily effective against another. The following three types of cover—frontal, overhead, and flank and rear—will have a direct bearing on designing and constructing positions.

Frontal

Frontal cover provides protection from small caliber direct fire. Natural frontal protection such as large trees, rocks, logs, and rubble is best because enemy detection of fighting positions becomes difficult. However, if natural frontal protection is not adequate for proper protection, dirt excavated from the position (hole) is used. Frontal cover requires the position to have the correct length so that soldiers have adequate room; the correct dirt thickness (3 feet) to stop enemy small caliber fire; the correct height for overhead protection; and, for soldiers firing to the oblique, the correct frontal distance for elbow rests and sector stakes. Protection from larger direct fire weapons (for example, tank guns) is achieved by locating the position where the enemy cannot engage it, and concealing it so pinpoint location is not possible. Almost twice as many soldiers are killed or wounded by small caliber fire when their positions do not have frontal cover.

Overhead

Overhead cover provides protection from indirect fire fragmentation. When possible, overhead cover is always constructed to enhance protection against airburst artillery shells. Overhead cover is necessary because soldiers are at least ten times more protected from indirect fire if they are in a hole with overhead cover.

Flank and Rear

Flank and rear cover ensures complete protection for fighting position. Flank and rear cover protects soldiers against the effects of indirect fire bursts to the flanks or rear of the position, and the effects of friendly weapons located in the rear (for example, packing from discarded sabot rounds fired from tanks). Ideally, this protection is provided by natural cover. In its absence, a parapet is constructed as time and circumstances permit.

SIMPLICITY AND ECONOMY

The position is usually uncomplicated and strong, requires as little digging as possible, and is constructed of immediately-available materials.

INGENUITY

A high degree of imagination is essential to assure the best use of available materials. Many different materials existing on the battlefield and prefabricated materials found in industrial and urban areas can be used for position construction.

PROGRESSIVE DEVELOPMENT

Positions should allow for progressive development to insure flexibility, security, and protection in

depth. Hasty positions are continuously improved into deliberate positions to provide maximum protection from enemy fire. Trenches or tunnels connecting fighting positions give ultimate flexibility in fighting from a battle position or strongpoint. Grenade sumps are usually dug at the bottom of a position's front wall where water collects. The sump is about 3 feet long, ½ foot wide, and dug at a 30-degree angle. The slant of the floor channels excess water and grenades into the sump. In larger positions, separate drainage sumps or water drains are constructed to reduce the amount of water collecting at the bottom of the position.

CAMOUFLAGE AND CONCEALMENT

Camouflage and concealment activities are continual during position siting preparation. If the enemy cannot locate a fighting position, then the position offers friendly forces the advantage of firing first before being detected. [Appendix D](#) of this manual contains additional information on camouflage.

INDIVIDUAL FIGHTING POSITIONS

The [table below](#) summarizes the hasty and deliberate individual fighting positions and provides time estimates, equipment requirements, and protection factors.

Characteristics of Individual Fighting Positions

Type of Position	Estimated Construction Time (man-hours)	Equipment Requirements	Direct Small Caliber Fire	Indirect Fire Blast and Fragmentation (Near-Miss)*	Indirect Fire Blast and Fragmentation (Direct Hit)	Nuclear Weapons**	Remarks
HASTY							
Crater	0.2	Hand tools	7.62mm	Better than in open - no overhead protection	None	Fair	
Skirmisher's trench	0.5	Hand tools	7.62mm	Better than in open - no overhead protection	None	Fair	
Front position	1.0	Hand tools	7.62mm	Better than in open - no overhead protection	None	Fair	Provides no around cover
DELIBERATE							
One-soldier position	3.0	Hand tools	12.7mm	Medium artillery no closer than 30 ft - no overhead protection	None	Fair	
One-soldier position with ½ ft overhead cover	8.0	Hand tools	12.7mm	Medium artillery no closer than 30 ft	None	Good	Additional cover provides protection from direct hit small mortar blast
Two-soldier position	6.0	Hand tools	12.7mm	Medium artillery no closer than 30 ft - no overhead protection	None	Fair	
Two-soldier position with ½ ft overhead cover	11.0	Hand tools	12.7mm	Medium artillery no closer than 30 ft	None	Good	Additional cover provides protection from direct hit small mortar blast
Low position	3.0	Hand tools	12.7mm	Medium artillery no closer than 30 ft - no overhead protection	None	Fair	

Note: Chemical protection is assumed because of individual protective masks and clothing.

* Size - small and	Small	Medium
Mortar	82mm	120mm
Artillery	105mm	152mm

** Nuclear protection ratings are rated poor, fair, good, very good, and excellent.

HASTY POSITIONS

When time and materials are limited, troops in contact with the enemy use a hasty fighting position located behind whatever cover is available. It should provide frontal protection from direct fire while allowing fire to the front and oblique. For protection from indirect fire, a hasty fighting position is located in a depression or hole at least 1 ½ feet deep. The following positions provide limited protection and are used when there is little or no natural cover. If the unit remains in the area, the hasty positions are further developed into deliberate positions which provide as much protection as possible.

Crater position (hasty)

A shell or bomb crater, 2 to 3 feet wide, offers immediate cover (except for overhead) and concealment. By digging a steep face on the side toward the enemy, the soldier obtains a hasty fighting position. Troops using a small crater position in a suitable location can later develop it into a deliberate position.



Skirmisher's trench (hasty)

The skirmisher's trench is a shallow position which provides a hasty prone fighting position for the individual soldier. When immediate shelter from enemy fire is needed, and existing defilade firing positions are not available, soldiers lie prone or on their side, scrape the soil with an untrenching tool, and pile the soil in a low parapet between themselves and the enemy. In this manner, a shallow body-length pit is quickly formed in all but the hardest ground. The trench is oriented so it is oblique to enemy fire. A soldier presents a low silhouette in this type of position, and is protected to a limited extent from small caliber fire.

**Prone position (hasty)**

The prone fighting position is a further refinement of the skirmisher's trench. It serves as a good firing position for the soldier, and provides better protection against direct fire weapons than the crater position or skirmisher's trench.

**DELIBERATE POSITIONS**

Deliberate fighting positions are modified hasty positions prepared during periods of relaxed enemy pressure. If the situation permits, the unit leader verifies the sectors of observation before preparing each position. Continued improvements are made to strengthen the position during the period of occupation. Small holes are dug for automatic rifle bipod legs so the rifle is as close to ground level as possible. Improvements include adding overhead cover, digging trenches to adjacent positions, and maintaining camouflage.

One-soldier position (deliberate)

The one-soldier fighting position is the individual soldier's basic defensive position. It allows flexibility in the use of cover, since the hole needs only be long enough for one soldier plus gear. It does not have the security of a two-person position; therefore, it must allow a soldier to shoot to the front or oblique from behind frontal cover.

**One-soldier position with overhead cover (deliberate)**

A significant improvement of the open position previously described, the one-soldier fighting position with overhead cover provides protection from airburst weapon fragments. A good position has overhead cover that allows a soldier to fire from beneath it. Logs 4 to 6 inches in diameter, or 6 by 6-inch timbers, extend at least 1 foot on each side of the position to provide a good bearing surface for overhead cover.



Two-soldier position (deliberate)

Generally, the two-soldier fighting position is preferred over a one-soldier position since one soldier can provide security while the other is digging or resting. In this manner, fighting positions are effectively manned for longer periods of time. If one soldier becomes a casualty, the position is still occupied. Further, the psychological effect of two soldiers together permits occupation of the positions for longer periods.

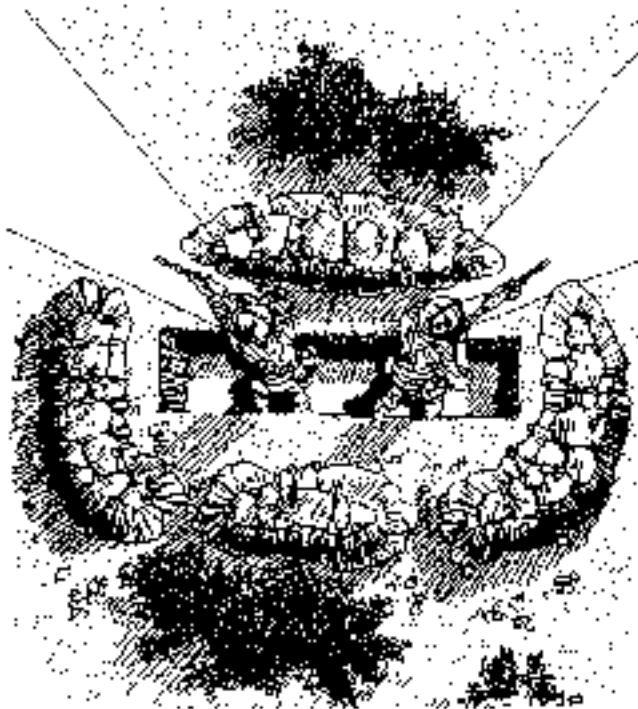

The basic position is usually modified by extending one or both ends of the hole around the sides of the frontal cover. The modification is generally necessary in close terrain when grazing fire and position mutual support extend no farther than to one adjacent position. Modification is also necessary to cover dead space in close terrain immediately in front of the position.



Two-soldier position with overhead cover (deliberate)

The two-soldier fighting position with overhead cover is an improvement of the open two-soldier position. Overhead cover is made as described for the one-soldier position with overhead cover.

**LAW position**

The LAW is fired from the fighting positions previously described. However, backblast may cause friendly casualties of soldiers in the position's backblast area. The gunner should ensure any walls, parapets, large trees, or other objects to the rear will not deflect the backblast. When the LAW is fired from a two-soldier position, the gunner must ensure that other soldiers in the rear are not in the backblast area. The front edge of a fighting position is a good elbow rest to help the gunner steady the weapon and gain accuracy. Stability is better if the gunner's body is leaning against the position's front or side wall.

**CREW-SERVED WEAPONS FIGHTING POSITIONS**

The [table below](#) summarizes crew-served weapons fighting positions and provides time estimates, equipment requirements, and protection factors.

Mortar position

A fighting position for a mortar is a circular-shaped hole. The position is dug to a depth sufficient to shield the weapon and crew, yet not restrict the weapon's operation. An ammunition-ready rack or niche is sometimes built into the side of the position for the gunner's convenience. The bottom of the ammunition rack is elevated from the position's floor. Another ready rack is constructed in one side of the trench leading to the position. Before the parapet is built, the mortar is laid for direction of fire by using an aiming circle or



a alternate means. If a parapet is used, it is limited to 20 inches high and 3 feet wide. An exit trench is

constructed leading to personnel shelters and other mortar positions.

Characteristics of Crew-Served Weapons Fighting Positions

Type of Position	Estimated Construction Time (man-hours)	Equipment Requirements	Direct Small Caliber Fire	Indirect fire Blast and Fragmentation (Near Miss?)	Indirect fire Blast and Fragmentation (Direct Hit)	Nuclear Weapon**
Dragon position	4.0	Hand tools	12.7mm	Medium artillery no closer than 30 ft - no overhead protection	None	Fair
Dismounted TOW position	1.0	Hand tools	12.7mm	Medium artillery no closer than 30 ft - no overhead protection	None	Fair
90mm RCLP position	6.0	Hand tools	12.7mm	Medium artillery no closer than 30 ft - no overhead protection	None	Fair
Machine gun position	7.0	Hand tools	12.7mm	Medium artillery no closer than 30 ft - no overhead protection	None	Fair
Machine gun position with 15-ft overhead cover	12.0	Hand tools	12.7mm	Medium artillery no closer than 30 ft	None	Good
Mortar position	14.0	Hand tools	12.7mm	Medium artillery no closer than 30 ft - no overhead protection	None	Fair

Note: Chemical protection is assumed because of individual protective masks and clothing.

* Shell sizes are

	Small	Medium
Mortar	82mm	120mm
Artillery	105mm	152mm

** Nuclear protection ratings are rated poor, fair, good, very good, and excellent.

Dragon position

The Dragon is also fired from previously-described positions; however, some changes are necessary. The soldier must consider the Dragon's extensive backblast and muzzle blast, as well as cleared fields of fire. When a Dragon is fired, the muzzle end extends 6 inches beyond the front of the position, and the rear of the launcher extends out over the rear of the position. As the missile leaves the launcher, stabilizing fins unfold. Therefore, the soldier keeps the weapon at least 6 inches above the ground when firing to leave room for the fins. A

waist-deep position will allow the gunner to move while tracking a target. Because of the Dragon gunner's aboveground height, soldiers should construct frontal cover high enough to hide the soldier's head and, if possible, the Dragon's backblast. The soldier must dig a hole in front of the position for the bipod legs. If cover is built on the flanks of a Dragon position, it must cover the tracker, missiles, and the gunner. Overhead cover that would allow firing from beneath it is usually built if the backblast area is clear.

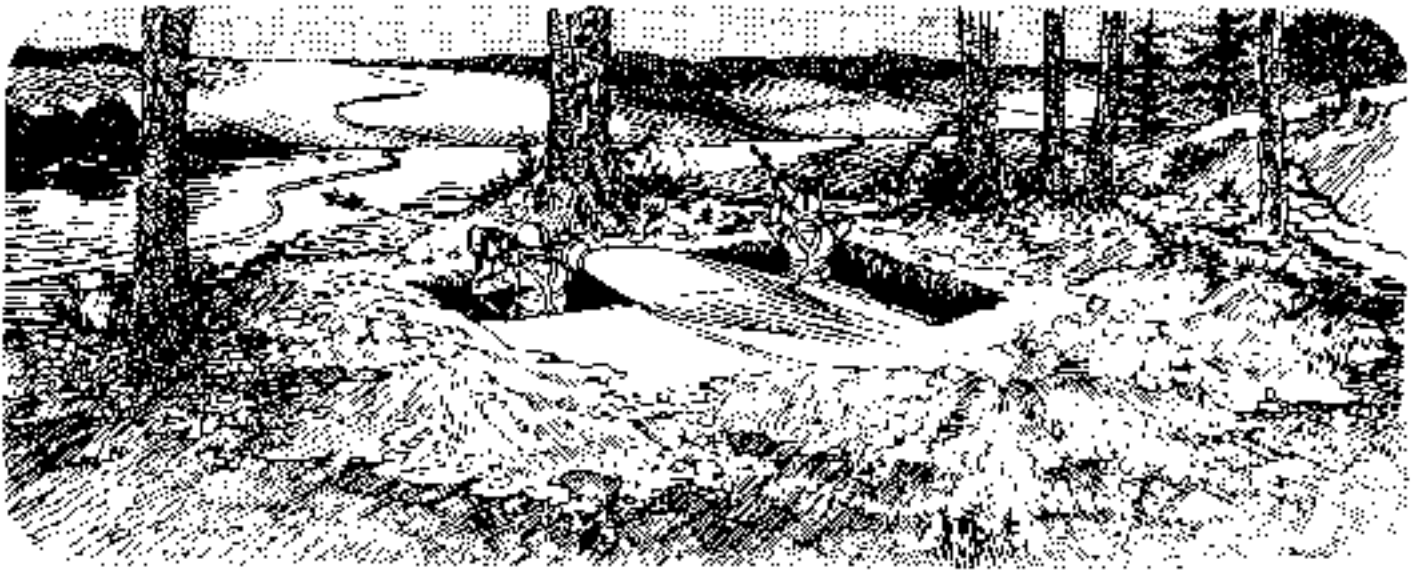

Dismounted TOW position

A fighting position for the dismounted tube-launched, optically tracked, wire-guided (TOW) missile must not interfere with the launch or tracking operations of the weapon. As with the Dragon, allowances for backblast effects are necessary. Backblast and deflection requirements restrict the size of overhead cover for the weapon. Thus, if overhead cover is desired, it should protect only the crew when it is not engaged in a firing operation. The position is excavated to a comfortable depth for a kneeling firing posture. When soldiers are not firing the TOW, the weapon's rear leg is moved back, effectively reducing exposure of the weapon. Crew members then enter their protective holes within the position.

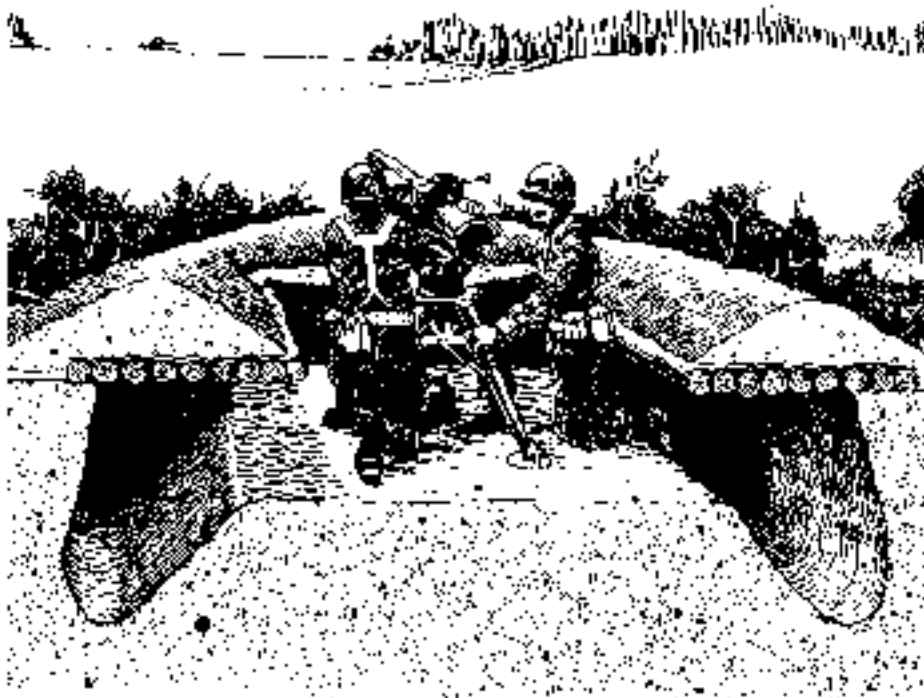

Recoilless rifle position (90 mm)

Positions for the 90-mm recoilless rifle (RCLR) are built like Dragon positions. Since two soldiers operate this weapon, however, the hole is made a little longer to permit firing from the right side of the frontal cover. The extra space positions the assistant to the right side of the RCLR.

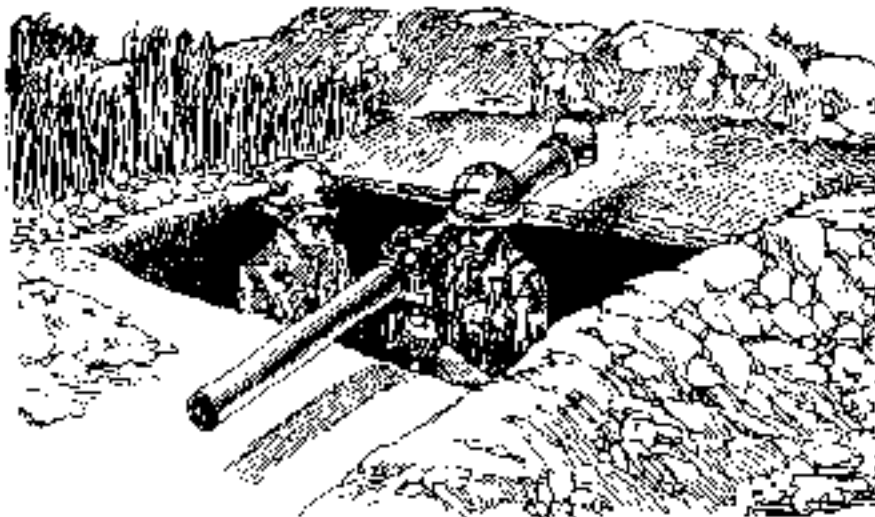

Machine gun position

Fighting positions for machine guns are constructed so the gun fires to the front or oblique. However, the primary sector of fire is usually oblique so the gun can fire across the unit's front. Two soldiers are required to keep the gun firing. Therefore, the hole is shaped so both soldiers (gunner and assistant gunner) can get to the gun and fire it to either side of the frontal protection. The gun's height is reduced by digging the tripod platform down as much as possible. However, the platform is dug to keep the gun transverse across the entire sector of fire. The tripod is used on the side with the primary sector of fire, and the bipod legs are used on the side with the secondary sector. When changing from primary to secondary sectors, the machine gun is moved but the tripod stays in place.



When there is a three-soldier crew for a machine gun, the ammunition bearer digs a one-soldier fighting position to the flank. From this position, the soldier can see and shoot to the front and oblique. The

ammunition bearer's position is connected to the gun position by a crawl trench so the bearer can transport ammunition or replace one of the gunners.

Machine gun position with overhead cover

Overhead cover for a machine gun position is built over the middle of the position. Cover is constructed as described for the one-soldier fighting position with overhead cover.



VEHICLE POSITIONS

This section contains designs for fighting and protective positions for major weapons systems vehicles and their support equipment. Initially, vehicles use the natural cover and concealment in hide positions to increase survivability. As time, assets, and situation permit, positions are prepared using organic excavation equipment or engineer support. Priority is given to those vehicles containing essential

mission-oriented equipment or supplies. Drivers and crews should use these fighting positions for individual protection also.

Parapets positioned at the front of or around major weapons systems will provide improved protection from direct fire and from blast and fragments of indirect fire artillery, mortar, and rocket shells. At its base, the parapet has a thickness of at least 8 feet. Further, the parapet functions as a standoff barrier for impact-detonating direct fire HEAT and ATGM projectiles. The parapet should cause the fuzes to activate, thereby increasing survivability for the protected vehicles. If the expected enemy uses kinetic energy direct fire armor piercing or hypervelocity projectiles, it is impossible to construct parapets thick enough for protection. To protect against these projectiles, deep-cut, hull defilade, or turret defilade positions are prepared. The dimensions for fighting and protective positions for essential vehicles are constructed no larger than operationally necessary.

FIGHTING POSITIONS

Success on the battlefield requires maneuver among fighting positions between main gun firings. Maximum use of wadis, reversed slope hills, and natural concealment is required to conceal fighting vehicles maneuvering among fighting positions. After a major weapon system fires its main gun, the vehicle and gun usually must maneuver concealed to another position before firing again. If the major weapon system immediately reappears in the old position, the enemy will know where to fire their next round. The [table](#) summarizes dimensions of the hasty and deliberate vehicle positions discussed in the following paragraphs. Construction planning factors for vehicle fighting positions are shown in the table.

Dimensions of Vehicle Positions

Vehicle Type	Position Dimension, ft ²			Equipment Hours ³ D7 Dozer/M9 ACI	Minimum Parapet Thickness of Base, ft
	Length	Width	Depth ^{4, 5}		
HASTY¹					
M113 series carrier ³	22	14	3	0.6	8
M577 command post vehicle	22	14	9	0.8	8
M106 and M125 mortar carrier	22	16	7	0.7	8
DELIBERATE (Hull Defilade)					
M113 series carrier ³	22	14	6	0.6	8
M901 improved TOW vehicle	22	14	7	0.6	8
M577 command post vehicle	22	14	9	0.8	8
M106 and M125 mortar carrier	22	16	7	0.7	8
M2 and M3 fighting vehicle	26	16	7	0.8	8
M1 main battle tank	22	18	5	0.9	8
M60 series main battle tank	30	18	6	0.9	8
M48 series battle tank	30	18	6	0.9	8

DELIBERATE (Access Route)

Each access route between positions or hide locations must have the same width as the hull defilade. Clearing times are planned using FM 5-34. Production time is determined by calculating the volume of soil needed to be moved (cubic yards) and dividing by 100 bank cubic yards per 0.5 hour.

DELIBERATE (Hide Location)

Hide locations are made using natural terrain and concealment. Ground clearing times are planned with the use of FM 5-34. The minimum width of the hide location is the same as the deliberate hull defilade. The hide position depth requirement is calculated by increasing the depth given in the deliberate turret defilade position by 15 percent.

DELIBERATE (Turret Defilade)

M113 series carrier ³	22	14	7	0.7
M901 improved TOW vehicle	22	14	9	0.8
M2 and M3 fighting vehicle	26	16	10	0.8
M1 main battle tank	22	18	5	0.9
M60 series main battle tank	30	18	6	0.9
M48 series battle tank	30	18	6	0.9

Notes:

- Hasty positions for tanks, IFVs, and ITVs not recommended.
- Position dimensions provide an approximate 3-foot clearance around vehicle for movement and maintenance and do not include access ramp(s).
- Includes M132 flamethrower and M103 Vulcan.
- Total depth includes any parapet height.
- Production rate of 100 bank cubic yards per 0.5 hour. Divide construction time by 0.35 for rocky or hard soil, night conditions, or paved batch operations (M9). Use of natural terrain features will reduce construction time.
- All depths are approximate and will need adjustment for straddling terrain and fields of fire.

Hasty Positions

Hasty fighting positions for combat vehicles including armored personnel carriers (APCs), combat engineering vehicles (CEVs), and mortar carriers take advantage of natural terrain features or are prepared with a minimum of construction effort. A frontal parapet, as high as practical without interfering with the vehicles' weapon systems, shields from frontal attack and provides limited concealment if properly camouflaged. Protection is improved if the position is made deeper and the parapet extended around the vehicle's sides. Because of the false sense of security provided by parapets against kinetic energy and hypervelocity projectiles, hasty vehicle fighting positions with parapets are not recommended for tanks, infantry fighting vehicles (IFVs), and improved TOW vehicles (ITVs). Hasty fighting positions do offer protection from HEAT projectiles and provide limited concealment if properly camouflaged. As the tactical situation permits, hasty positions are improved to deliberate positions.

Hasty fighting position for APC



Deliberate Positions

Deliberate fighting positions are required to protect a vehicle from kinetic energy hypervelocity projectiles. The position is constructed in four parts: hull defilade, concealed access ramp or route, hide location, and turret defilade. Positions formed by natural terrain are best because of easy modification; however, if preparation is necessary, extensive engineer support is required. Each position is camouflaged with either natural vegetation or a camouflage net, and the spoil is flattened out or hauled away. **All fighting positions for fighting vehicles (tanks, IFVs, ITVs) are planned as deliberate positions.** Since the lack of time usually does not allow the full construction of a deliberate position, then only some parts of the position's construction are prepared. For example, the complete fighting position for a tank requires the construction of a hull defilade, turret defilade, concealed access ramp or route, and hide location all within the same fighting position. The maneuver team commander uses organic and engineer earthmoving assets and usually constructs fighting position parts in the following order:

- Hull defilade.
- Concealed access ramp or route.
- Hide location.
- Turret defilade.

Developing deliberate fighting positions

Digging hide locations and concealed routes between fighting positions is not practical due to the lack of engineer assets and time. Engineer assets are required to dig the hull and turret defilade positions only. The ramps and concealed routes should require only partial clearing and leveling with blade tanks or engineer equipment because natural concealed routes and hide locations are used. If time permits, the commander has the preceding fighting position expanded into a fighting position with all four parts as shown, including a hide and turret defilade location. The access ramp from the hide location to the hull defilade position usually provides turret defilade for a vehicle at some point on the ramp. This location is marked with engineer tape and a chem light so the vehicle driver can see the mark and drive to it. This fighting position affords maximum protection and maneuver for the tank.

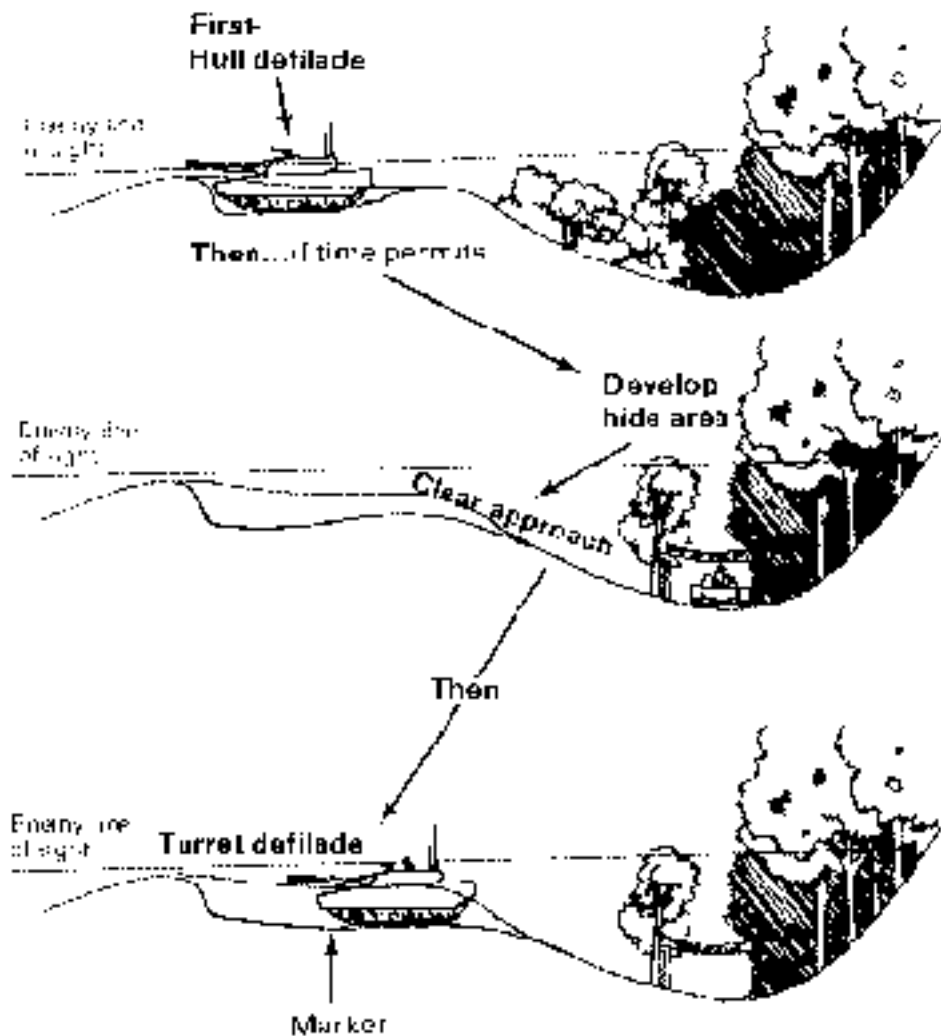

Deliberate fighting position for M1 tank (hull defilade)

In wide-open terrain such as deserts, maneuver between hull defilade positions is camouflaged by organic mortar smoke or vehicle smoke generators.



PROTECTIVE POSITIONS

Vehicle protective positions are constructed for vehicles and weapons systems which do not provide direct fire against the enemy. The positions are neither hasty nor deliberate because they all require extensive engineer assets and construction materials to build. Unless separate overhead cover is constructed, the positions do not provide blast protection from indirect fire super quick, contact, or delay fuze shells. The positions do, however, provide medium artillery shell fragmentation protection from near-miss bursts greater than 5 feet from the position, and from direct fire HEAT projectiles 120mm or

less fired at the base of the position's 8-foot thick parapet.

Artillery firing platform

Artillery firing platforms for towed or self-propelled artillery weapons are necessary on soft ground to preclude weapon relaying after each round is fired. The pad distributes the load over a large area with no significant

settlement and is flexible, level, and strong enough to withstand the turning and movement of self-propelled weapons. The pad allows firing in all directions. Trail logs are anchored outside the pad for towed weapons. For

self-propelled weapons, the recoil spades are set in compacted soil material or in a layer of crushed rock around the pad. These positions provide limited protection with the use of a parapet.

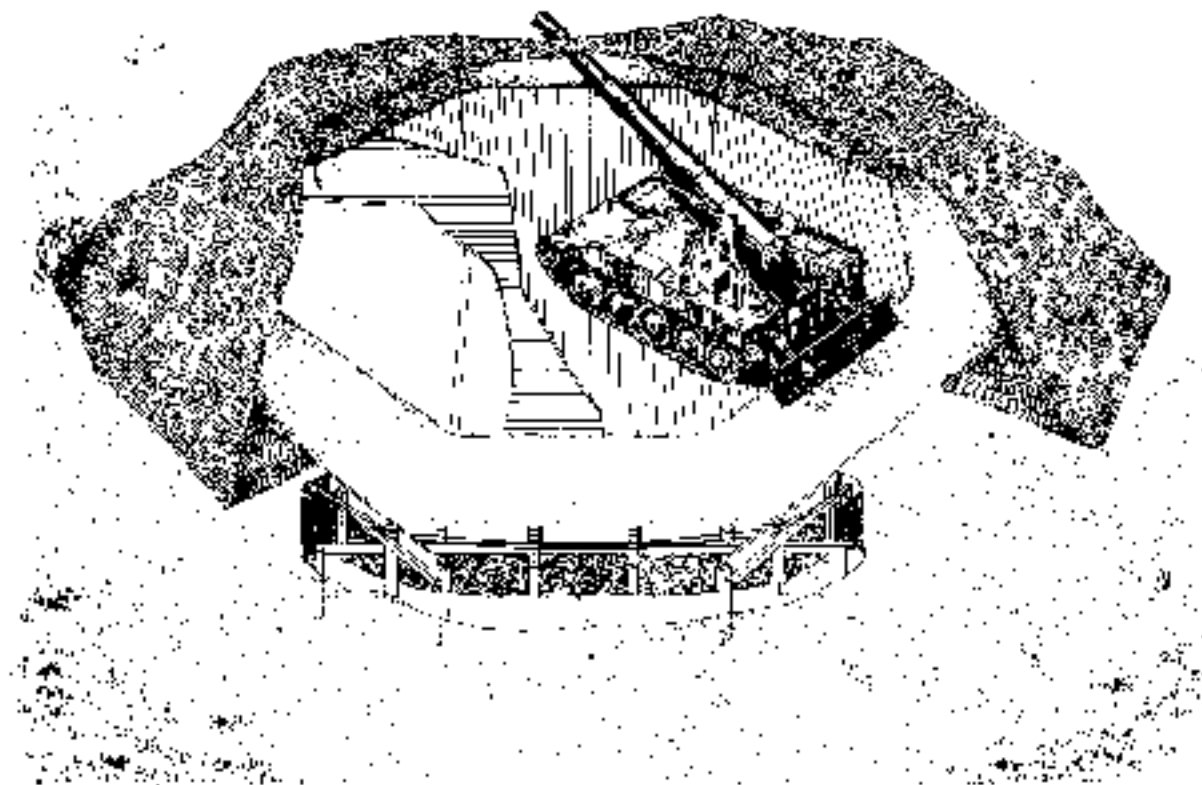

Parapet position for self-propelled howitzer and ammo carrier

A parapet position for field artillery provides improved protection from near-miss indirect fire weapons effects and small caliber direct fire. The parapet is constructed with material removed from the excavation and is built low enough to allow direct howitzer fire. It is usually necessary to stabilize the parapet walls to prevent

deterioration caused by muzzle blast and weather. The position is camouflaged with natural vegetation or camouflage netting. The table on page 4-18 gives dimensions of positions for light artillery vehicles. Shelter construction is necessary to provide adequate protection for the firing crew, fire direction center (FDC), and

tactical operations center (TOC). Separate shelters are necessary to contain an artillery section's basic load of projectiles, fuzes, and propelling charges. If time allows, firing positions, TOCs, and FDCs are connected by trenches. Shown is a typical layout for an 8-inch battery and a light division 155-mm battery.

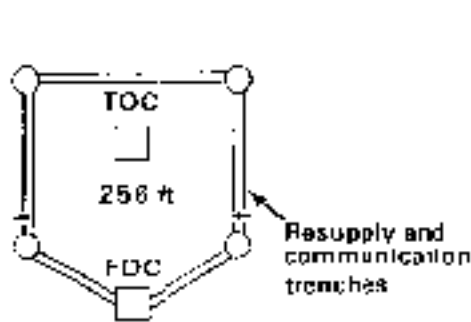

FOUR-GUN POSITION FOR 8-IN BATTERY

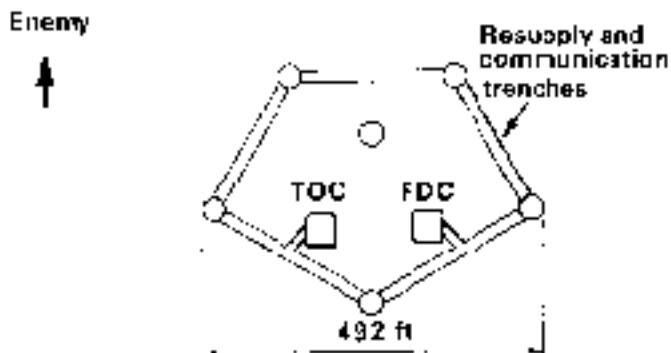

SIX-GUN POSITION FOR LIGHT DIVISION 155MM BATTERY

Parapet position for ADA

A parapet position for air defense artillery provides improved protection for missile launcher equipment, target acquisition equipment

has special operational requirements that make it very difficult to protect. The requirement for acquisition radar to "see" the battlefield

precludes the use of dense protective materials such as soil, concrete, and rock in position construction.

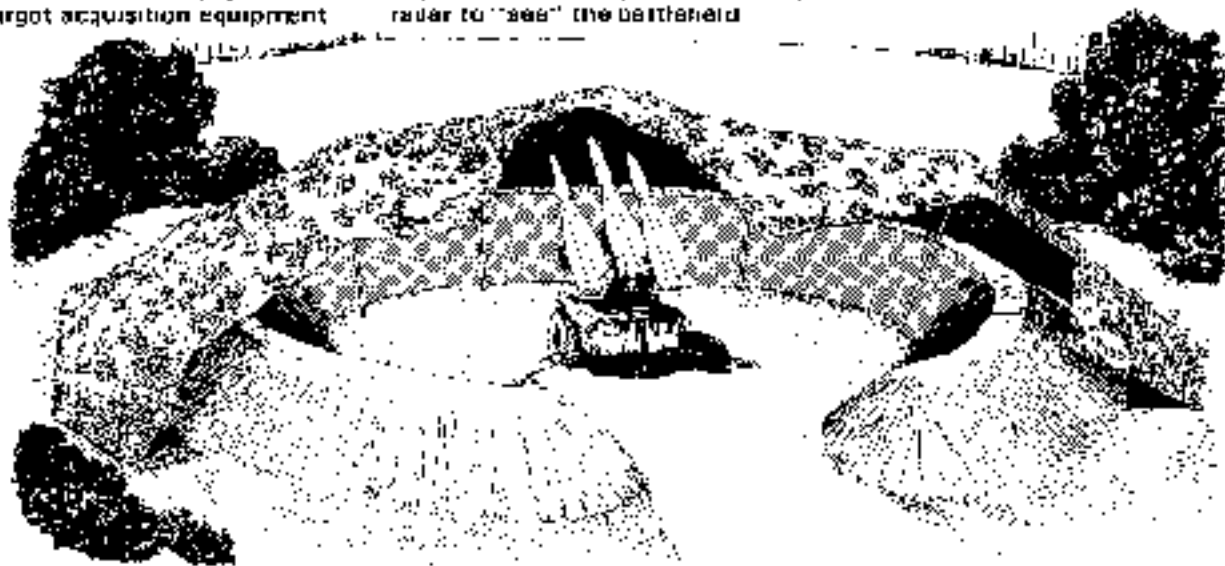

Dimensions of Field Artillery Vehicle Positions

Vehicle Type	Length	Dimension, ft ¹		Equipment Hours ² (07 Doser/M9 ZCF)	Minimum Parapet Thickness at Base, ft	Remarks
		Width	Depth ^{3,4}			
Chaparral (M730) ant self-propelled Hawk	26	15	4	0.5	8	
Eivad	36	18	5	0.9	8	
General support truck/launcher	27	17	3	0.4	8	
155-mm self-propelled howitzer (M109)	107	14	5	1.7	8	Length accommodates ammunition supply vehicle
175-mm self-propelled gun (M107)	105	16	5	1.4	8	Length accommodates ammunition supply vehicle
8-in self-propelled howitzer (M95)	113	14	6	1.6	8	Length accommodates ammunition supply vehicle
8-in self-propelled howitzer (M110)	108	17	5	1.6	8	Length accommodates ammunition supply vehicle

Notes

1. Position dimensions provide an approximate 3-ft clearance around vehicle for movement and maintenance and do not include ramping.
2. Total depth includes any parapet height.
3. Production rate of 100 bunkers per day per shift, 24-hour, divide construction time by 0.65 to allow for late start, night construction, or closed batch operations (MS). Use of natural terrain features will reduce construction time.
4. All depths are approximate and will vary according to surrounding terrain and needs of the unit.

Deep-cut position

A deep-cut vehicle position is prepared to provide protection for support vehicles such as cargo trucks, maintenance and computer vans, communications, decontamination equipment, POL transporters, and earthmoving equipment. The position is usually open on each end for drive-in

access/egress, or prepared with a rear wall having one entranceway only. The position is designed so the tops of vehicles are at least 1 foot below the top of the surrounding walls. Camouflage netting, if available, is placed across the position. The table on page 4-19 shows dimensions for

typical deep-cut positions. The deep-cut vehicle protective position is not used as a fighting position because deep cuts do not provide hull defilade, turret defilade, and concealed routes between positions. However, TOCs can use the deep-cut design with two cuts intersecting for battlefield positions.



Covered deep-cut position

The covered deep-cut vehicle protective position provides greatly improved protection over the deep-cut protective position. In a defensive operation, several deliberate fighting positions are constructed with concealed routes from these positions to the covered deep-cut positions. The weapon remains inside the covered deep-cut position until needed. After firing, the weapon is moved to alternate fighting positions or returned to its covered deep-cut position. This position also provides overhead cover for the protection of essential supplies or equipment.



Dimensions of Typical Deep-Cut Positions

Vehicle Type	Dimension, Ft-			Equipment Hours (M9 ACFT)	Remarks
	Length	Width	Depth		
6-ton truck	18	12	7	0.5	Add 3 ft to length for cargo hoist
1-ton truck	20	13	9	0.7	Add 5 ft to length for porta goal (M56)
2-ton cargo truck	29	13	10	1.1	Add 14 ft to length for cargo or water trailer
2-ton shop van	28	14	12	1.3	
5-ton cargo truck	38	14	10	1.5	
5-ton shop van	36	14	12	1.7	
10-ton cargo truck	34	16	12	1.9	
10-ton tractor w/ van semitrailer	33	16	12	2.3	Dimensions shown are for trailer length of 30 ft. For other trailers, add 23 ft to actual trailer length

Notes:

1. Position dimensions provide an approximate 3-foot clearance around the perimeter and must be used and do not include ramp.
2. Production rate of 100 bank cubic yards per 0.75 hour. Divide construction time by 0.85 to recover material, dig, and load time for closed trench operations (M9). Use of natural terrain features will reduce construction time.

TRENCHES

Trenches are excavated to connect individual fighting positions and weapons positions in the progressive development of a defensive area. They provide protection and concealment for personnel moving between fighting positions or in and out of the area. Trenches are usually included in the overall layout plan for the defense of a position or strongpoint. Excavating trenches involves considerable time, effort, and materials, and is only justified when an area is occupied for a long time. Trenches are usually open excavations, but covered sections provide additional protection if the overhead cover does not interfere with the fire mission of the occupying personnel. Trenches are difficult to camouflage and are easily

detected, especially for the air. Trenches, as other fighting positions, are developed progressively. They are improved by digging deeper, from a minimum of 2 feet to about 5 ½ feet. As a general rule, deeper excavation is desired for other than fighting trenches to provide more protection or allow more headroom. Some trenches may also require widening to accommodate more traffic, including stretchers. It is usually necessary to revet trenches that are more than 5 feet deep in any type of soil. In the deeper trenches, some engineer advice or assistance is usually necessary in providing adequate drainage. Two basic trenches are the crawl trench and the standard fighting trench.

Crawl trench

A crawl trench is used to conceal movement into or within a position and to provide a minimum of protection. A crawl trench is usually dug 2 to 2½ feet deep and as narrow as possible. Trenches need a zigzagging or winding pattern. The spoil is placed on the parapets, normally on each side of the trench. If the trench runs across a forward slope, all the spoil is placed on the enemy side to make the parapet higher. All spoil needs careful concealment from enemy direct observation.

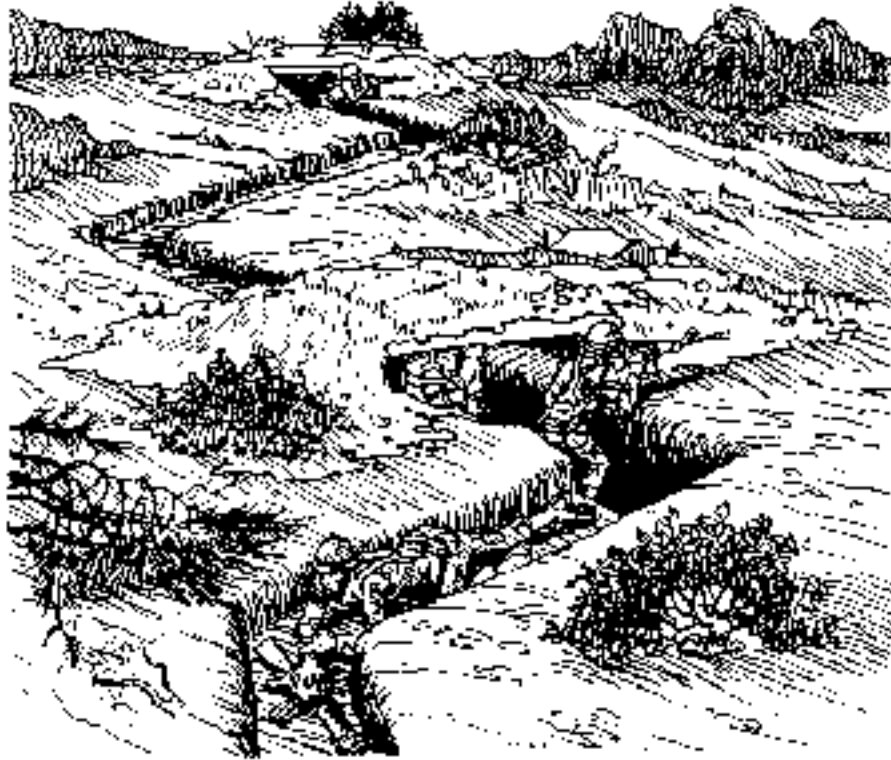

Standard fighting trench

A standard fighting trench is developed from the crawl trench with an increased depth of 5½ feet. It is sometimes constructed with fighting bays or with a fighting step. Fighting positions are constructed on

both sides of the trench to provide alternate positions to fight to the rear, step-off areas for foot traffic in the trench, and protection against lengthwise firing into the trench. Overhead cover also provides additional

protection. Although this trench is primarily a fighting position, it is also used for communication, supply, evacuation, and troop movements.

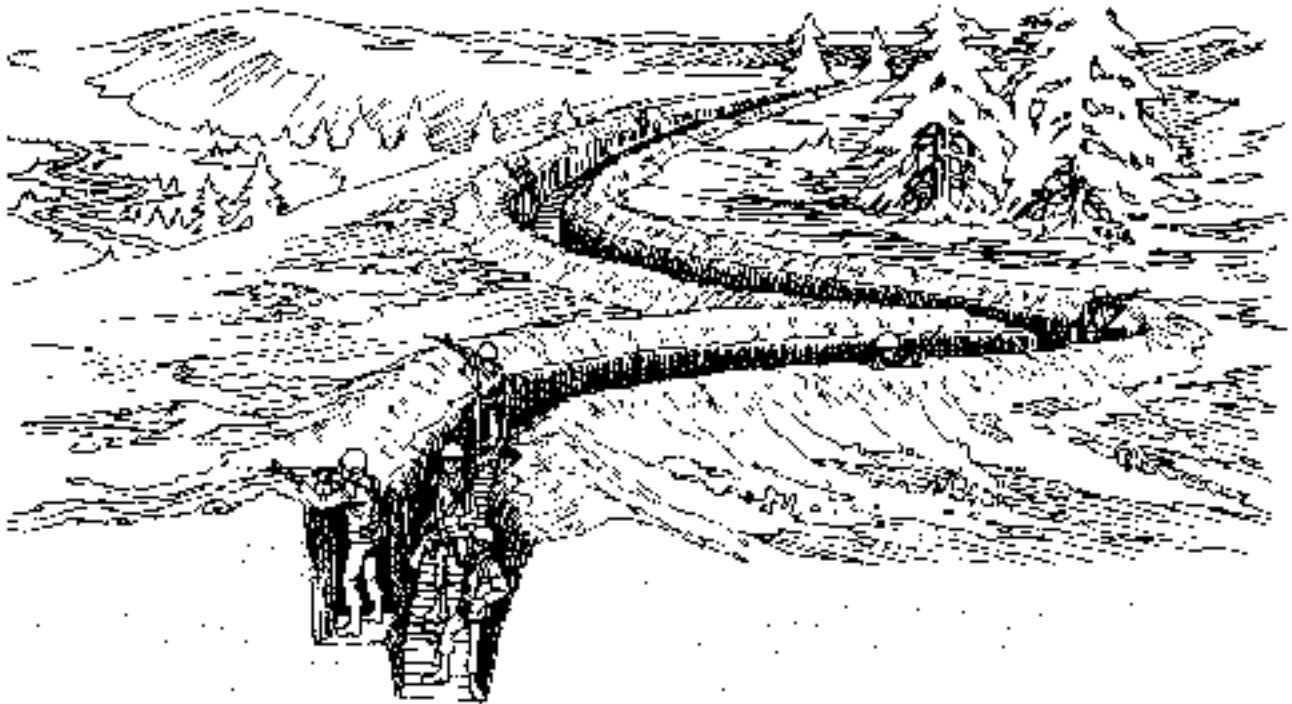

Each trench is constructed to the length required and follows either an octagonal or zigzag trace pattern. Special combinations and modifications are made to meet battlefield demands.

Octagonal trace

The octagonal trace has the advantages of affording easy communication and providing excellent protection while facilitating oblique fire along the front. It is economical to construct, both in labor and material, and can be provided with a continuous fire step.

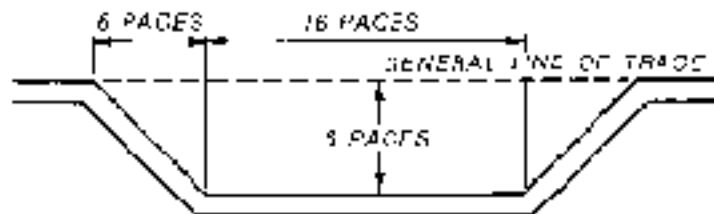

Zigzag trace

A zigzag trace can provide protection from lengthwise fire into the trench and shell bursts by employing short tangents and occupying alternate tangents. The zigzag trace has the advantages of simplicity and ease of constructing, revetting, and maintaining; positioning on the terrain; and permitting both frontal and flanking fire.

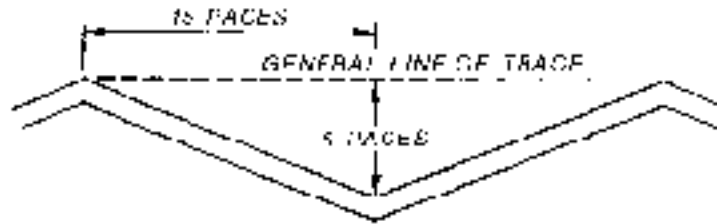

UNIT POSITIONS

Survivability operations are required to support the deployment of units with branch-specific missions, or missions of extreme tactical importance. These units are required to deploy and remain in one location for a considerable amount of time to perform their mission. Thus, they may require substantial protective construction.

FORWARD LOGISTICS

Forward logistics are subdivided into the following areas normally found in the brigade trains area of a mechanized division:

- Field trains (elements of maneuver battalions and companies).
- Forward supply points.
- Forward support maintenance.
- Medical stations.
- Battalion aid stations.
- Miscellaneous activities.

Field Trains

Shelters described in the next section (Special Designs) are adequate for general supply storage. In practice, most of the supplies remain on organic trucks and trailers in forward areas so trains can responsively move to support combat forces. They are protected by deep-cut vehicle positions or walls.

Forward Supply Points

Petroleum, oils, and lubricants (POL) products are a critical supply category in mechanized operations. Tanker trucks of the supply points are protected by natural berms or deep-cut protective positions. Overhead cover is impractical for short periods of occupancy, but maximum use is made of camouflage nets and natural terrain concealment. Class I, II, and IV supplies not kept in vehicles are placed in deep-cut trenches when time permits, but are of low priority for protection since even a direct hit on unprotected items may not completely destroy stocks.

Forward Support Maintenance

In a highly fluid battle situation where frequent displacement of the forward support company is required, the company cannot afford the effort required to construct extensive protective positions and

shelters due to conflicts with basic mission accomplishment. Further, the company base of operations is close to the brigade trains area which is relatively secure from overt ground attack. Also, a large portion of the company is habitually employed away from the company area providing contact teams to supported units. Thus, the basic protection requirements are simple positions for individuals and crew-served weapons. The specific number of positions is determined by the size of the company position perimeter and the number of personnel and crew-served weapons available to protect the perimeter. In the principal company area, individual positions are constructed near their billeting areas and on the periphery of their work sections. Simple cut-and-cover or other expedient shelters are constructed next to principal shop facilities to provide immediate protection from artillery/ air attack. These shelters are usually not larger than 10-person shelters.

Medical Stations

The amount of equipment emplaced at a medical clearing station varies from mission to mission. Protection for a minimum of 40 patients is required as soon as possible. Design and construction of shelters with adequate overhead cover is mandatory so medical care and treatment are not interrupted by hostile action. Enemy air activity may hinder prompt evacuation of patients from the clearing station; thus, adequate shelter for both holding and treating patients becomes paramount. For planning purposes, shelters for protecting 20 personnel on litters or folding cots, and smaller shelters for surgery, X-ray, laboratory, dental, and triage functions are considered. The deliberate shelters are generally well-suited to these activities.

Protection for personnel organic to medical companies is provided by individual and crew-served weapons positions. When the situation permits, shelters are constructed for sleeping or other activities. Ambulances and other vehicles also need protection. Vehicle protection is usually deep-cut type, with maximum advantage taken of protection offered by terrain and vegetation.

Battalion Aid Stations

Battalion aid stations normally operate from a tracked vehicle situated behind natural terrain cover. As time and resources permit, this site is improved with overhead cover and parapets allowing vehicle access and egress. Although the patient-holding capacity of the aid station is extremely limited, some permanent shelters are provided for patients held during periods when enemy activity interrupts evacuation.

Miscellaneous Activities

Miscellaneous activities include forward arming and refueling points (FARPs), water, decontamination, clothing exchange, and bath points. In fast-moving combat situations where established supply points are too distant to provide rapid fuel and ammunition service, FARPs are established. With the anticipated short time of intense operation of the FARP, personnel have little time for protective activities. Prefabricated defensive walls provide the necessary protection within the short time available.

The various activities involved in water, decontamination, clothing exchange, and bath points require protection for both customers and operating personnel. Equipment, such as power sources (generators), needs protection from indirect fire fragmentation and direct fire. Operating personnel need both individual fighting positions and protective positions. Many of the shelters described in the next section (Special Designs) are adapted for aboveground use in decontamination operations, clothing exchange, or bath points.

ARTILLERY FIREBASES

Artillery firebases are of extreme tactical importance and require substantial protective construction. The most frequently constructed firebase houses are an infantry battalion command element, two infantry companies, a 105-mm howitzer battery, and three to six 155-mm howitzer batteries. A firebase housing the above units consists of the following facilities: infantry TOCs, artillery FDCs, ammunition storage positions, garbage dump, command and control helicopter pad, logistics storage area and sling-out pad, artillery firing positions, helicopter parking area and refuel point, and hardened sleeping protective positions. Firebases usually are surrounded by a protective parapet with perimeter fighting positions, two or more bands of tactical wire, hasty protective minefield, and a cleared buffer zone to provide adequate fields of fire for perimeter defense. ([Field Manual 5-102](#) provides detailed information on minefield.) If a local water source is available, an airportable water supply point is setup to provide water for the firebase and the units in the local area.

Firebase construction is divided into three phases: combat assault and initial clearing (Phase I), immediate construction (Phase II), and final construction (Phase III). Dedicated engineer support is a requirement for the construction of a firebase.

Phase I

Combat assault and initial clearing consists of securing the firebase site and clearing an area large enough to accommodate CH-47 and CH-54 helicopters if the site is inaccessible by ground vehicle. The time required to complete this phase depends on the terrain at the firebase site. If the site is free of trees and undergrowth, or if these obstacles were removed by artillery and tactical air fire preparation, combat engineers can move immediately to phase II after the initial combat assault on the site. If the site is covered with foliage and trees, the security force and combat engineers are required to descend into the site from hovering helicopters. Depending on the density of the foliage on the site, completion of the initial clearing phase by combat engineers with demolitions and chain saws may take up to 3 hours.

Phase II

Immediate construction begins as soon as the cleared area can accommodate either ground vehicles or, if the site is inaccessible by ground vehicle, medium or heavy lift helicopters. Two light airmobile dozers are lifted to the site and immediately clear brush and stumps to expand the perimeter and clear and level howitzer positions. Meanwhile, the combat engineers continue to expand the perimeter with chain saws, demolitions, and bangalore torpedoes. If enough area is available, a heavy airmobile dozer is usually committed to clear a logistics storage area and sling-out pad, then expand the perimeter and fields of fire. The backhoes are committed to excavate protective positions for the infantry TOC, artillery FDC, and, as soon as the perimeter trace is established, perimeter fighting positions.

The immediate construction phase is characterized by the coordinated effort of infantry, artillery, and engineer forces to produce a tenable tactical position by nightfall on the first day. A coordinated site plan and list of priorities for transportation and construction are prepared and constantly updated. Priorities and the site plan are established by the tactical commander in coordination with the project engineer.

As soon as a perimeter trace is set up and the site is capable of accepting the logistics and artillery lifts, maximum effort is directed toward the defenses of the firebase. Combat engineers and the heavy dozer continue to push back the undergrowth to permit adequate fields of fire. The two light airmobile dozers

are committed to constructing a 5 to 8 foot thick parapet around the perimeter to protect against direct fire. Infantry troops are committed to constructing perimeter fighting positions at sites previously excavated by the backhoes. With the assistance of combat engineers, the infantry troops also begin placing the first band of tactical wire, usually triple standard concertina. Artillery troops not immediately committed to fire missions prepare ammunition storage protective positions and parapets around each howitzer.

Phase III

Final construction begins when construction forces complete the immediate defensive structures. Combat engineers placing the tactical wire or clearing fields of fire begin construction of the infantry TOG and artillery FDC. Infantry and artillery troops are committed to placing the second band of tactical wire to building personnel sleeping protective positions with overhead cover. Phase III is usually a continuous process, involving constant improvement and maintenance. However, most protective structures, including sandbag protection of the TOC and personnel positions, usually are completed by the end of the fourth day. Time is the controlling parameter in construction of a firebase.

STRONGPOINTS

Strongpoints are another example of unit positions requiring substantial protective construction. A strongpoint is a battle position fortified as strongly as possible within the time constraints to withstand direct assaults from armor and dismounted infantry. It is located on key terrain critical to the defense and controls an enemy main avenue of approach. In some cases, the brigade or division commander may direct that a strongpoint be emplaced by a battalion or company-sized unit. The strongpoint is essentially an antitank "nest" which tanks physically cannot overrun or bypass, and which enemy infantry reduces only with expenditure of much time and overwhelming forces. The strongpoint is the "cork" in a bottleneck formed by terrain, obstacles, units and preplanned fires. The strongpoint is similar to a perimeter defense in that it is developed to defeat an attack from any direction. It is distinguished from other defensive positions by the importance of the terrain on which it is located and also by the time, effort, and resources spent to its development. A strong-point is not setup on a routine basis.

Survivability tasks necessary to develop a strongpoint are divided into developing positions in open areas and in urban or built-up areas. Critical survivability tasks in open areas include preparation of-

- ATGM positions.
- Tank hull defilade positions as a minimum for primary, alternate, and supplementary positions. Turret defilade and hide positions are prepared as time allows.
- Dug-in positions for command, aid stations, and critical storage.
- Covered routes between positions.

Critical survivability tasks in built-up areas include preparation of-

- ATGM positions.
- Covered routes between buildings.

SPECIAL DESIGNS

The [table](#) summarizes construction estimates and levels of protection for the fighting positions, bunkers, shelters, and protective walls presented in this section.

Characteristics of Special Design Positions

Type of Position	Estimated Construction Time (man-hours)	Equipment Requirements	Direct Small Caliber Fire	Indirect Fire Blast and Fragmentation (Near-Miss)**	Indirect Fire Blast and Fragmentation (Direct Hit)	Nuclear Weapons**	Remarks
FIGHTING POSITIONS:							
Wood-frame or steel frame fighting position with 2.0-ft overhead cover	.37	Hand tools	12.7mm	Medium artillery no closer than 30 ft	Small mortar	Good	
Fabric-covered frame fighting position with 1.5-ft overhead cover	.6	Hand tools	12.7mm	Medium artillery no closer than 15 ft	Small mortar	Good	

Note: Chemical protection is assumed because of individual protective masks and clothing.

* Shell sizes are: Small Medium
 Mortar 60mm 120mm
 Artillery 105mm 152mm

** Nuclear protection ratings are listed poor, fair, good, very good, and excellent.

Characteristics of Special Design Positions (Continued)

Type of Position	Estimated Construction Time (man-hours)	Equipment Requirements	Direct Small-Caliber Fire	Indirect Fire Blast and Fragmentation (Near-Miss)*	Indirect Fire Blast and Fragmentation (Direct Hit)	Nuclear Weapons**	Remarks
BUNKERS							
Corrugated metal fighting bunker with 2-ft overhead cover	48	Hand tools, backhoe	7.62mm	Medium artillery no closer than 10 ft	Small mortar	Good	
Plywood perimeter bunker	48	Hand tools, backhoe	7.62mm	Limited protection; no overhead protection	None	Poor	
Concrete log bunker with 2-ft overhead cover	42	Hand tools, backhoe	7.62mm	Medium artillery no closer than 10 ft	Small mortar	Good	Construction time assumes precast logs; protection provided includes one layer of sandbags around walls
Precast concrete side bunker with 2-ft overhead cover	30	Hand tools, backhoe, crane	7.62mm	Medium artillery no closer than 10 ft	Small mortar	Good	Construction time assumes precast concrete slabs; protection provided includes one layer of sandbags around walls
Concrete area bunker with 2-ft overhead cover	28	Hand tools, backhoe, crane	7.62mm	Medium artillery no closer than 10 ft	Small mortar	Good	Construction time assumes precast concrete slabs; protection provided includes one layer of sandbags around walls
SHELTERS							
Two soldier sleeping shelter with 2-ft overhead cover	10	Hand tools	7.62mm	Small mortar on contact	Small mortar	Fair	
Metal culvert shelter with 2-ft overhead cover	48	Hand tools, backhoe	7.62mm	Small mortar no closer than 5 ft	None	Fair	
Inverted metal shipping container shelter with 2-ft overhead cover	28	Hand tools, backhoe	11.7mm	Medium artillery no closer than 10 ft	Small mortar	Good	

Note: Chemical protection is assumed because of individual protective masks and clothing.

* Shot sizes are: Small 82mm, Medium 120mm, Mortar 82mm, 120mm, Artillery 160mm, 152mm

** Nuclear protection ratings are rated: poor, fair, good, very good, and excellent

Characteristics of Special Design Positions (Continued)

Type of Position	Estimated Construction Time (man-hours)	Equipment Requirements	Direct Small Caliber Fire	Indirect Fire Blast and Fragmentation (Near-Miss)*	Indirect Fire Blast and Fragmentation (Direct Hit)	Nuclear Weapons**	Remarks
SHELTERS (Continued)							
Air transportable assault with 2-ft overhead cover	60	Hand tools, backhoe	Cannot engage	Medium artillery no closer than 30 ft	Small mortar	Very good	Construction time assumes prefabricated walls and floor
Timber post buried shelter with 2 1/2-ft overhead cover	48	Hand tools, backhoe	Cannot engage	Medium artillery no closer than 30 ft	Small mortar	Very good	
Modular timber frame shelter with 2 ft overhead cover	96	Hand tools, backhoe	Cannot engage	Medium artillery no closer than 20 ft	Small mortar	Very good	
Timber frame buried shelter with 2 ft overhead cover	64	Hand tools, backhoe	Cannot engage	Medium artillery no closer than 25 ft	Small mortar	Very good	
Aboveground cavity wall shelter with 2-ft overhead cover	700	Hand tools, backhoe, stake	12.7mm	Medium artillery no closer than 20 ft	Small mortar	Good	
Steel frame/fabric covered shelter with 1 1/2 ft overhead cover	35	Hand tools, backhoe	Cannot engage	Medium artillery no closer than 10 ft	Small mortar	Very good	Construction time assumes prefabricated frame
Hardened fabric/fabric shelter with 4 ft overhead cover	45	Hand tools, backhoe	Cannot engage	Medium artillery no closer than 10 ft	Medium artillery	Excellent	Shelter provides improved nuclear protection to 30 psi
Rectangular frame shelter with 2-ft overhead cover	38	Hand tools, backhoe	Cannot engage	Medium artillery no closer than 15 ft	Medium artillery	Very good	Construction time assumes prefabricated frame
Concrete arch shelter with 4 ft overhead cover	64	Hand tools, doper, backhoe, crane	Cannot engage	Medium artillery no closer than 5 ft	Medium artillery	Very good	Construction time assumes prefabricated arches and end walls

Note: Chemical protection is assumed because of individual protective masks and clothing.

* Shell sizes are: Small Medium
Mortar: 82mm 120mm
Artillery: 105mm 152mm

** Nuclear weapons fire effects are listed only for ground units and not for shelters.

** Nuclear protection ratings are rated poor, fair, good, very good, and excellent.

Characteristics of Special Design Positions (Continued)

Type of Position	Estimated Construction Time (man-hours)	Equipment Requirements	Direct Small Caliber Fire	Indirect Fire Blast and Fragmentation (Near Miss)*	Indirect Fire Blast and Fragmentation (Direct Hit)	Nuclear Weapons**	Remarks
SHELTERS (Continued)							
Metal pipe arch shelter with 4 ft overhead cover	58	hand tools, dozer, backhoe, crane	Cannot engage	Medium artillery no closer than 5 ft.	Medium artillery	Very good	Construction time assumes pre-assembled arch and Eric section

Type of Position	Estimated Construction Time (man-hours) per 10-ft section	Equipment Requirements	Direct Small Caliber Fire	Indirect Fire Blast and Fragmentation (Near Miss)*	Direct Fire HEAT	Nuclear Weapons**	Remarks
PROJECTIVE WALLS							
Earth wall	3	Dozer, dump truck, scoop loader	12.7mm	Medium artillery no closer than 5 ft	120mm at wall base	Poor	
Earth wall with levelment	20	Hand tools; scoop loader	12.7mm	Medium artillery no closer than 5 ft	120mm at wall base	Fair	
Soil-cement wall	25	Hand tools; concrete mixer; crane w/concrete bucket	12.7mm	Small artillery no closer than 5 ft	82mm at wall base	Fair	Walls require tamping
Soil bin wall with ng revetment	35	Hand tools; scoop loader	5.45mm	Small artillery no closer than 5 ft	None	Poor	
Soil bin wall with timber revetment	30	Hand tools; scoop loader	5.45mm	Small artillery no closer than 5 ft	None	Fair	
Soil bin wall with plywood revetment	19	Hand tools; scoop loader	12.7mm	Medium artillery no closer than 5 ft	120mm at wall base	Poor	Based on plywood section. Provides nuclear blast protection for dug, concrete targets
Plywood portable wall	5	Hand tools; backhoe	5.45mm	Small nuclear no closer than 5 ft	None	Poor	
Steel landing mat wall	3	Welding; crane	None	Refer to the table on page	None	Poor	M3A1 steel landing mat only

Note: Chemical protection is assumed because of individual protection masks and clothing. All walls are 5 feet high with minimum thickness as specified in construction plans.

* Shell sizes are:

	Small	Medium
Mortar	82mm	120mm
Artillery	105mm	152mm

** Nuclear protection is minimal except as noted.

Characteristics of Special Design Positions (Continued)

Type of Position	Estimated Construction Time (man-hours) per 10-ft section	Equipment Requirements	Direct Small Caliber Fire	Indirect Fire Blast and Fragmentation: (Near-Miss)*	Direct Fire HEAT	Nuclear Weapons**	Remarks
PROTECTIVE WALLS (Continued)							
Portable pre-cast concrete wall	25	Hand tools; concrete mixer; crane	7.62mm	Medium artillery no closer than 5 ft	None	Poor	One layer of sand-bags on outer panel surface improves small caliber protection
Cast in place concrete wall	35	Hand tools; concrete mixer, crane w/concrete bucket	12.7mm	Small artillery no closer than 5 ft	None	Poor	One layer of sand-bags on outer panel surface improves protection to include indirect fire blast and fragmentation from large artillery
Portable asphalt armor panels 2x8x4	15	Hand tools, welding, hot asphalt source	7.62mm	Small artillery no closer than 5 ft	None	Poor	

Note: Chemical protection is assumed because of individual protection masks and clothing. All walls are 5 feet high with minimum thickness as specified in construction plans.

* Shell sizes are: Small Medium
 Mortar 82mm 120mm
 Artillery 105mm 152mm

** Nuclear protection is minimal except as noted

FIGHTING POSITIONS

The following two positions are designed for use by two or more individuals armed with rifles or machine guns. Although these are beyond the construction capabilities of non-engineer troops, certain construction phases can be accomplished with little or no engineer assistance. For example, while engineer assistance may be necessary to build steel frames and cut timbers for the roof of a structure, the excavation, assembly, and installation are all within the capabilities of most units. Adequate support for overhead cover is extremely important. The support system should be strong enough to safely support the roof and soil material and survive the effects of weapon detonations.

Wood-frame fighting position

The wood-frame or steel-frame fighting position consists of prefabricated timber or steel-frame support elements that support a

timber or concrete roof. The position is useful as a two-soldier fighting or observation position in areas where it is dug-in.

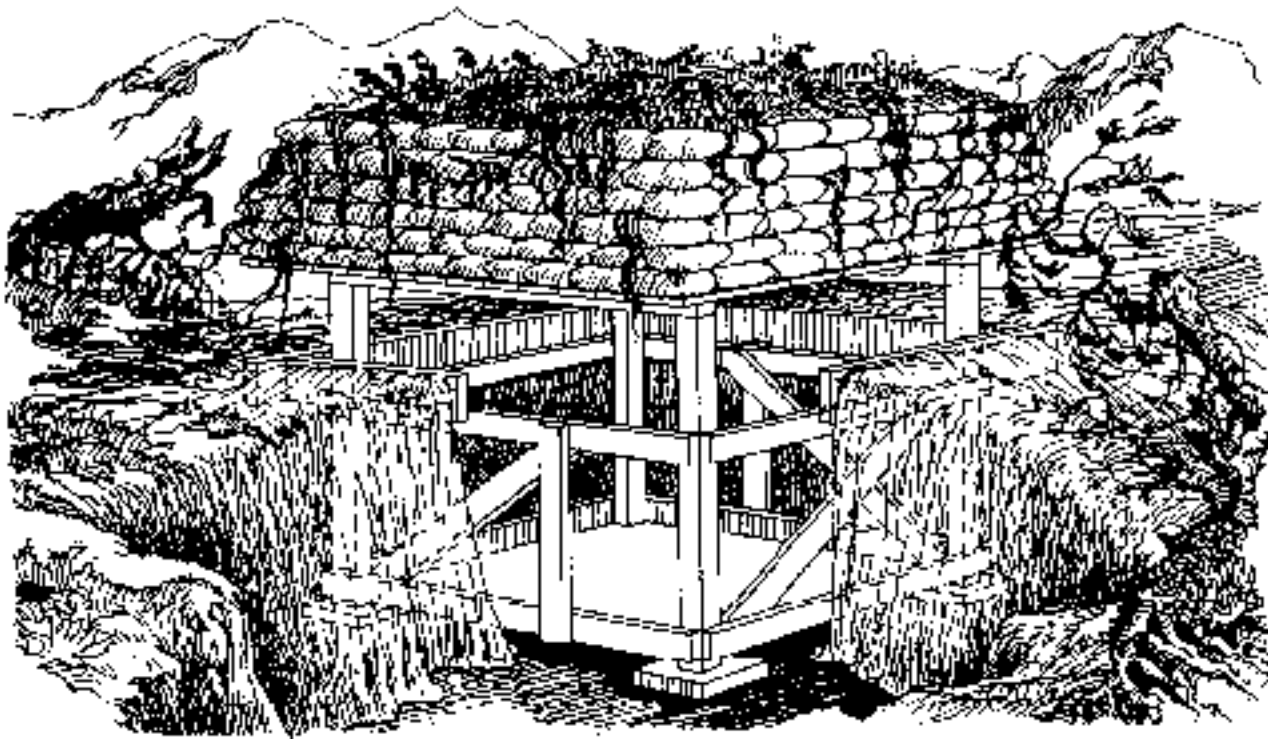

Fabric-covered frame position

A position constructed of a metal support frame covered with a strong fabric material is very effective as a support system for overhead cover. It also provides substantial levels of protection from blast and fragmentation. With 1½ feet of overhead cover, this position survives detonation of a contact burst 32-mm mortar shell on the roof. Similar structures made from harder materials (wood, concrete, landing mat) require 2½ feet of cover material for the same level of protection, due to lack of resilience of the harder materials. The position shown is useful as a one- or two-soldier fighting position. If the rear wall is

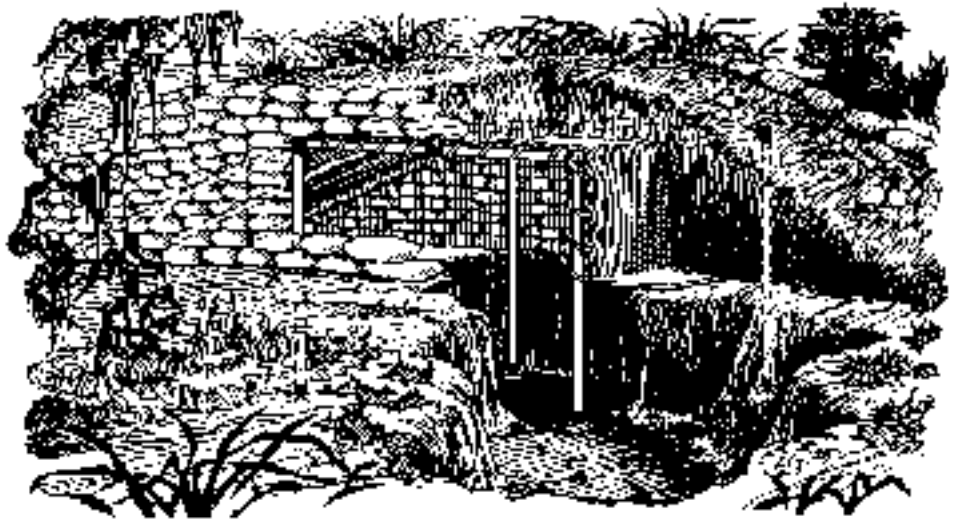

omitted, antitank weapons can be fired from this position.

BUNKERS

Bunkers are larger fighting positions constructed for squad-size units who are required to remain in defensive positions for a longer period of time. They are built either above-ground or below ground and are usually made of reinforced concrete. Because of the extensive engineer effort required to build bunkers, they are usually made during strong-point construction. If time permits, bunkers are connected to other fighting or supply positions by tunnels. Prefabrication of bunker assemblies affords rapid construction and placement flexibility. Bunkers offer excellent protection against direct fire and indirect fire effects and, if properly constructed with appropriate collective protection equipment, they provide protection against chemical and biological agents.

Corrugated metal fighting bunker

A bunker made from corrugated metal walls is very useful in areas where digging is not possible. With 1½ foot thick earth-filled walls and 2½ feet of overhead cover, this position defeats direct fire and blast and fragments from near-miss mortar and artillery shells. For more protection, sandbags are stacked or loose earth is pushed up against the walls. The upper portion of the structure is left open for maximum visibility in all directions. Firing ports are located in the walls near the floor.

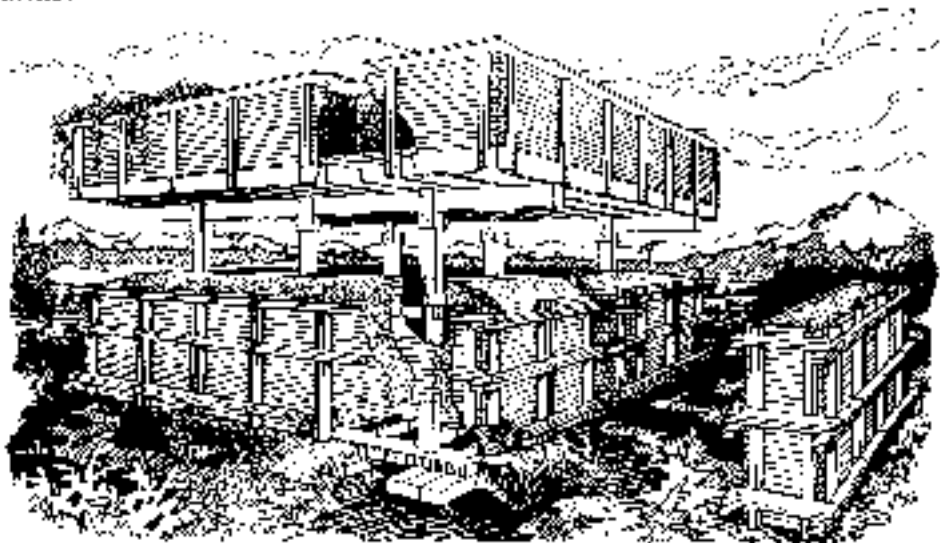

Plywood perimeter bunker

A plywood perimeter bunker is used as an aboveground protective security position. The bunker has a post foundation, as shown, or is constructed directly on the ground with earth-filled walls.

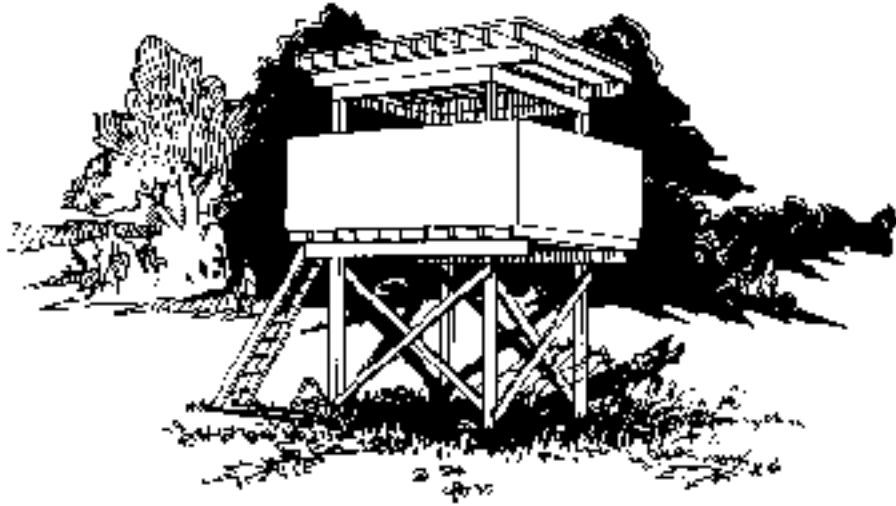

Concrete log bunker

The concrete log bunker is a four-soldier fighting bunker constructed of precast reinforced concrete logs. Each log weighs approximately 50 pounds per foot, and is available in various lengths up to 10 feet. The protection provided by this bunker is significantly improved by the addition of at least one layer of sandbags around each wall. Alternate designs are possible using the various log lengths.

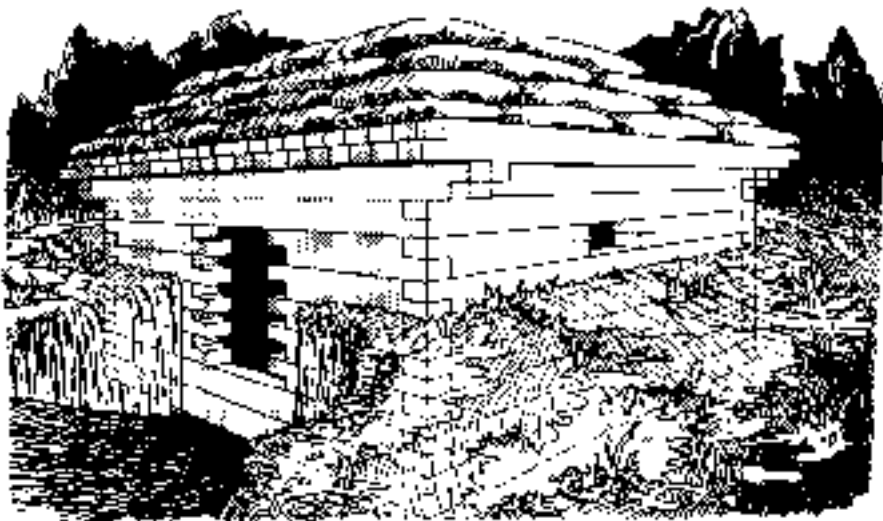

Precast concrete slab bunker

The precast concrete slab bunker is designed for use where aboveground construction is needed, but it is usually placed partially or completely below ground. The rectangular panels are designed for shop fabrication on a large scale basis. Engineer support is required for fabrication and installation. This bunker provides excellent protection, especially if sandbags are stacked or loose earth is pushed up against the walls. When used as an observation bunker, the observation ports are enlarged to include firing ports near the floor.

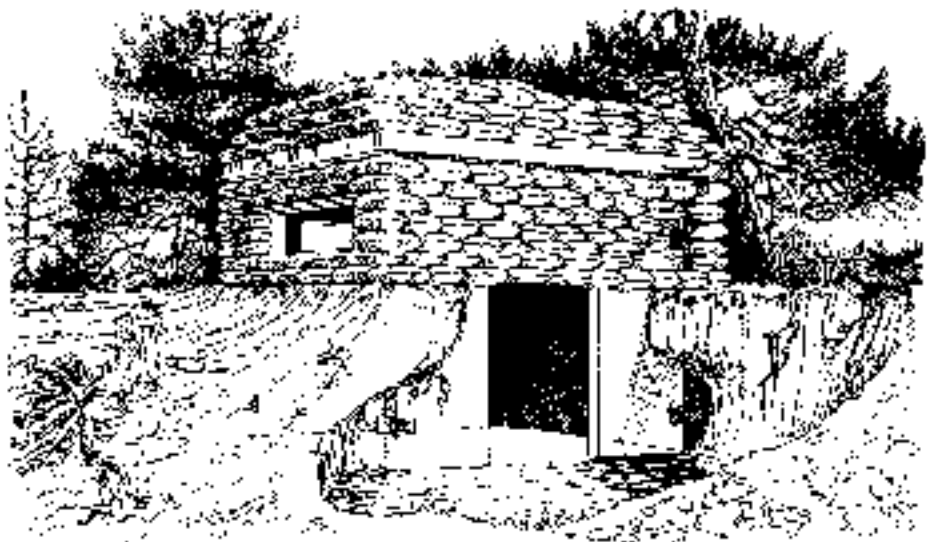

Concrete arch bunker

The concrete arch bunker is a four-soldier fighting position adapted from the concrete arch shelter (refer to page 4-26). The bunker consists of three precast reinforced concrete components: a 6-foot high arch section, a rectangular back wall section, and a semicircular roof section. Significant engineer support is required to construct and emplace this bunker. Fragmentation protection is increased by placing a layer of sandbags against the walls.

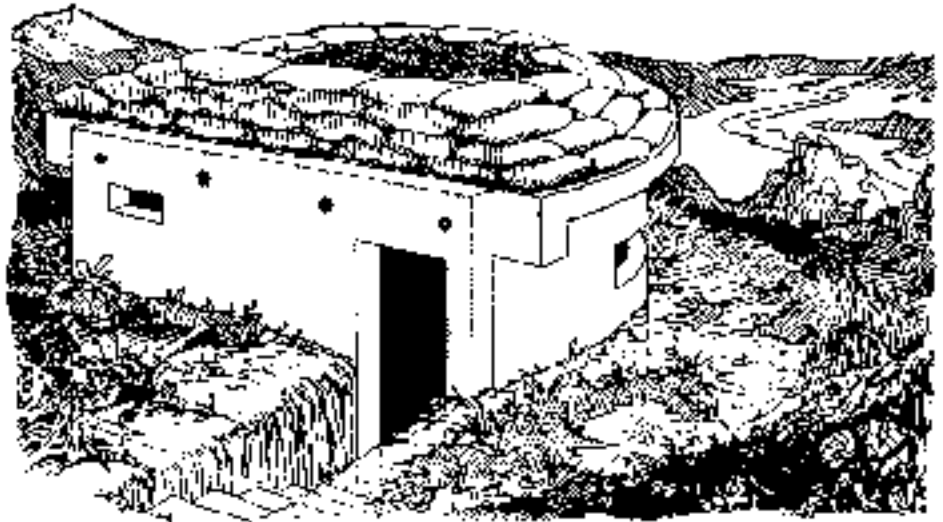

SHELTERS

Shelters are primarily constructed to protect soldiers, equipment, and supplies from enemy action and the weather. Shelters differ from fighting positions because there are usually no provisions for firing weapons from them. However, they are usually constructed near-or to supplement-fighting positions. When available, natural shelters such as caves, mines, or tunnels are used instead of constructing shelters. Engineers are consulted to determine suitability of caves and tunnels. The best shelter is usually one that provides the most protection but requires the least amount of effort to construct. Shelters are frequently prepared by support troops, troops making a temporary halt due to inclement weather, and units in bivouacs, assembly areas, and rest areas. Shelters are constructed with as much overhead cover as possible. They are dispersed and limited to a maximum capacity of about 25 soldiers. Supply shelters are of any size, depending on location, time, and materials available. Large shelters require additional camouflaged entrances and exits.

All three types of shelters-below ground, aboveground, and cut-and-cover-are usually sited on reverse

slopes, in woods, or in some form of natural defilade such as ravines, valleys, wadis, and other hollows or depressions in the terrain. They are not constructed in paths of natural drainage lines. All shelters require camouflage or concealment. As time permits, shelters are continuously improved.

Below ground shelters require the most construction effort but generally provide the highest level of protection from conventional, nuclear, and chemical weapons.

Cut-and-cover shelters are partially dug into the ground and backfilled on top with as thick a layer of cover material as possible. These shelters provide excellent protection from the weather and enemy action.

Above-ground shelters provide the best observation and are easier to enter and exit than below ground shelters. They also require the least amount of labor to construct, but are hard to conceal and require a large amount of cover and revetting material. They provide the least amount of protection from nuclear and conventional weapons; however, they do provide protection against liquid droplets of chemical agents. Aboveground shelters are seldom used for personnel in forward combat positions unless the shelters are concealed in woods, on reverse slopes, or among buildings. Aboveground shelters are used when water levels are close to the ground surface or when the ground is so hard that digging a below ground shelter is impractical.

The following shelters are suitable for a variety of uses where troops and their equipment require protection, whether performing their duties or resting.

Two-soldier sleeping shelter

The design for a two-soldier sleeping shelter is very simple, and is constructed without engineer support. Culvert sections used in the design are delivered in large quantities by truck or helicopter, and then are hand-carried to specific installation sites by intended occupants working in teams of two. These shelters provide good protection from direct fire small caliber mortars (60 and 82 mm), machine guns below 12.7-mm size, indirect fire fragmentation, and grenades. With additional cover, the protection level increases to include larger direct fire projectiles. The low profile of the structure makes it a difficult target to hit.



Metal culvert shelter

A metal culvert shelter, quickly constructed aboveground, is intended for use in areas where personnel are billeted or work in conventional nonprotected buildings but need shelter in case of attack. For example, shelters are placed outside conventional billets, dining facilities, and large areas of living quarters. The shelter is 6 feet high and consists of two rows of 55-gallon drums with about a 4-foot span between rows. Two by four studs, measuring 4 inches higher than the drums, are centered inside each drum. The drums are then filled with soil & 2 by 8 top plates is connected to the 2 by 4 studs lengthwise through the bunker. The 6-foot corrugated metal pipe halves are bolted together and connected to the top plates. A 2-foot layer of sandbags is placed along each

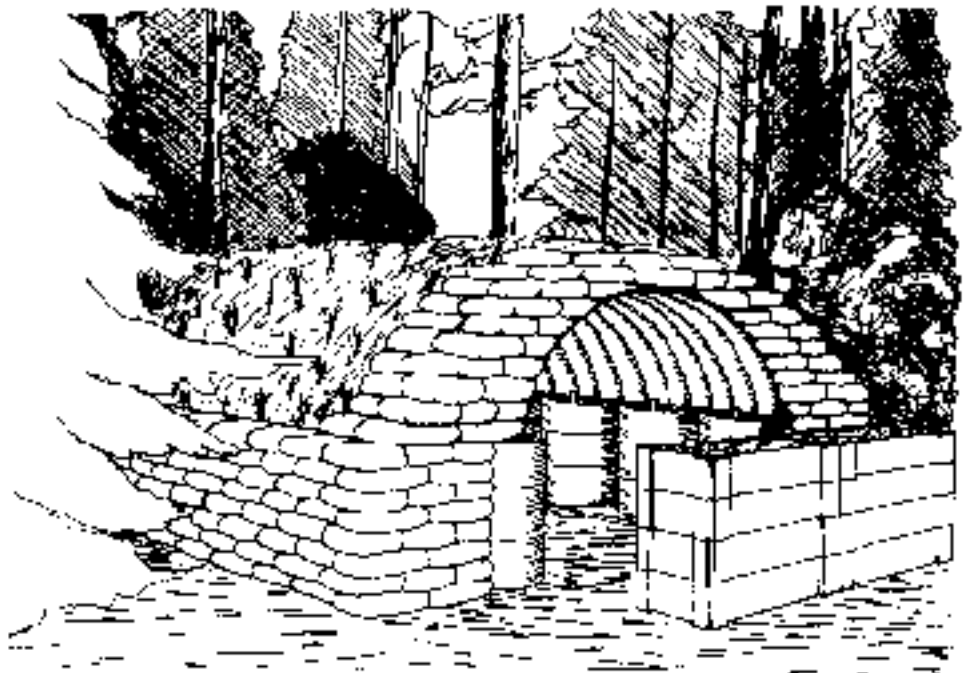

row of drums. To protect the ends of the bunker, barrier walls are erected 2 feet beyond the entrances. Additional protection is provided on the side and end

facing the probable direction of attack by increasing sandbag thickness. This shelter provides protection against mortars and small caliber direct fire weapons.

Metal shipping container shelter

Large metal shipping containers, such as consolidated express (CONEX) containers, are used to make effective shelters. These box-shaped containers, with internal dimensions of 8 feet long, 6 feet wide, and 6 feet high, are easily converted into protective command posts, communication shelters, troop shelters, aid stations, and shelters for critical supplies. Because the CONEX container's floor is stronger than its roof, it is inverted to resist more blast and provide more overhead cover. Although the shelter is sometimes constructed above ground, it is easier to construct it below ground by placing the inverted CONEX container in a hole half its height and then covering its roof with earth.

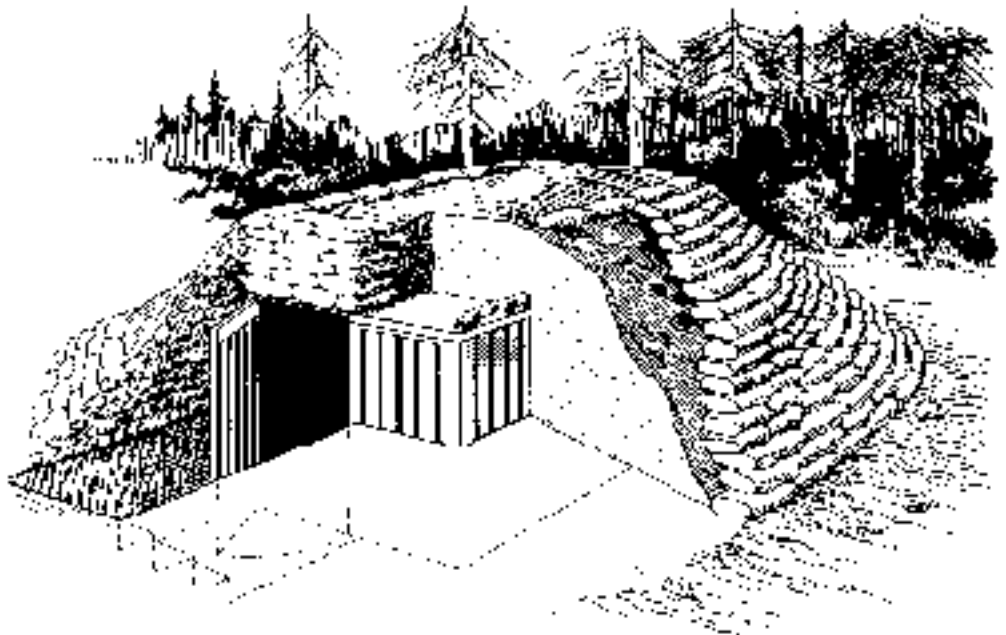

Airtransportable assault shelter

The airtransportable assault shelter is a prefabricated plywood structure suitable for a command post or fire direction center (FDC). It is moved completely assembled (except for the roof) from site to site as the tactical situation demands. Because of its tapered walls, it is easily removed from the ground by helicopter.

The walls and floor are usually prefabricated in rear areas and then trucked or flown, assembled or disassembled, to the site. The below ground site is sometimes excavated with explosives and hand tools. The floor area is excavated 2 feet longer and 2 feet wider than the actual floor area, allowing work space during construction. Fasteners provided along the edges of each wall and the floor allow the shelter's components to lock together into a complete unit. The walls drop below the floor section so the floor acts as a brace for the bottom edge of

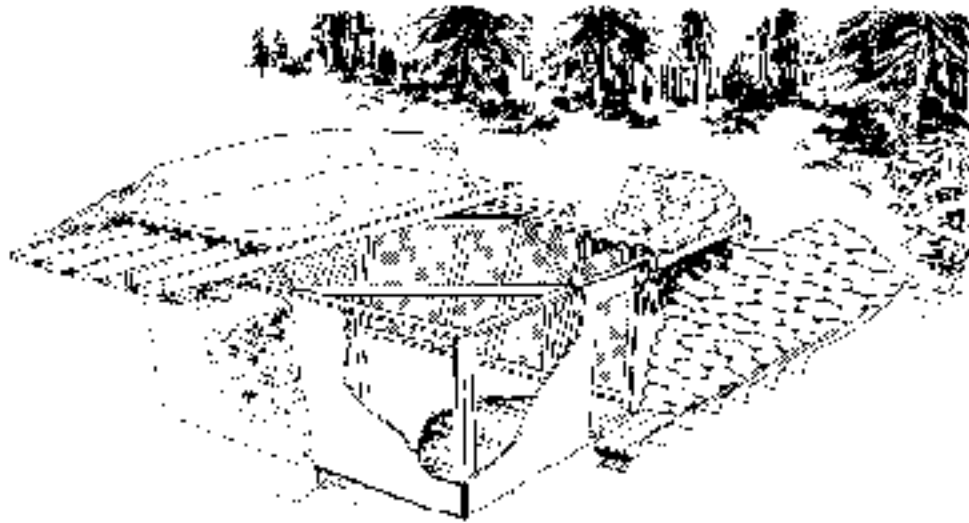

the walls preventing cave-in. Two large straps completely around the structure, placed during construction, are used in attaching the bunker to a helicopter lifting hook for shelter pullout and transport.

The roof is concentric to and larger than the floor section and is fabricated in the rear area or at the erection site. The roof overlaps the walls and supports itself on firm (unexcavated) ground—not on

the shelter walls. The shelter weighs approximately 1,500 pounds without the roof. The shelter is usually no more than 6½ feet high, and the floor space is less than 100 square feet. Excavation, assembly, backfilling, and construction of the roof and entrance are possible in less than 10 hours with a six-member crew.

Timber post buried shelter

The timber post buried shelter is a wood frame support system for overhead cover material. It is used only in soil or rock material which maintains the original vertical excavation in any weather. Because it is below ground, the shelter provides excellent protection from indirect fire fragmentation and direct fire. The greatest threat to this structure is direct hits on the roof from indirect high explosive weapons. However, if the overhead cover is properly constructed, this shelter can sustain direct hits from mortar burst weapons as large as 82 mm. Large

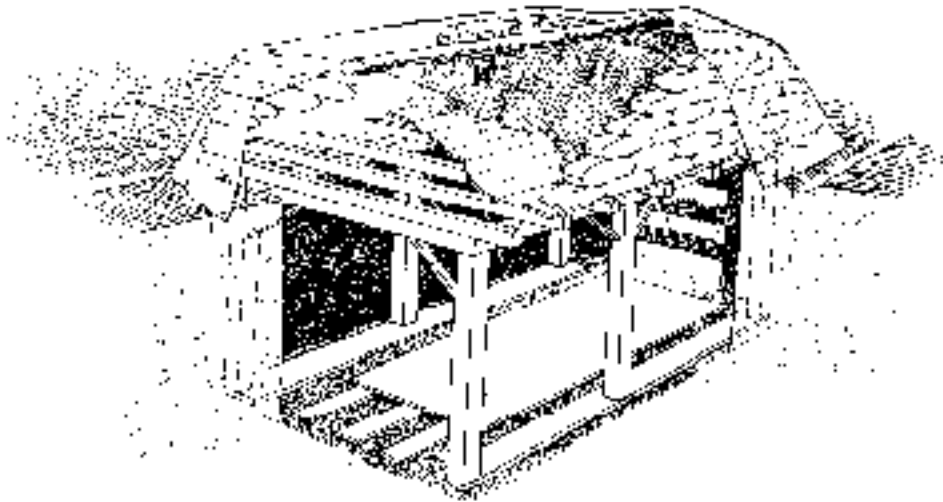

shelters are made by joining several units together. However, the excavation effort required is sizable, and

it is very likely that engineers will have to provide support with power tools and excavation equipment.

Modular timber frame shelter

Modular timber frame shelters are designed so the modular units are assembled for individual use or in combinations of two or more to provide the required shelter area. They are either constructed above ground or partially below ground. The advantage of sectional shelters used for command posts or aid stations is the flexibility of the shelter area that is provided. They also lend themselves to prefabrication and airtransportability by utility helicopter, except for the roof. The principal disadvantage is the degree of skill required in constructing the sections from dimensional lumber or logs of comparable strength, necessitating engineer assistance and supervision.

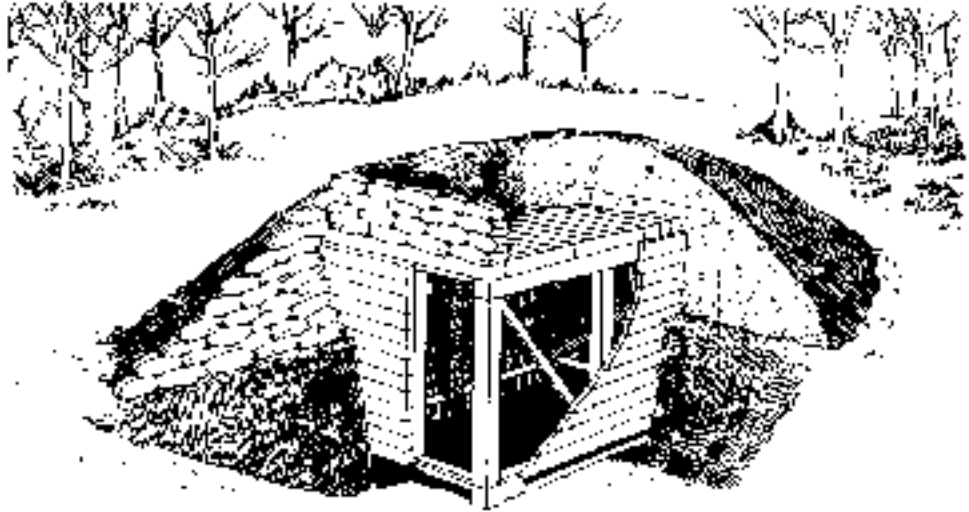

Timber frame buried shelter

The timber frame buried shelter is similar to the modular shelter except for the size of its structural members. It is not airtransportable when assembled. It is installed partially buried or completely below ground, if desired. Below ground, it provides excellent protection against indirect fire fragmentation and direct fire. The overhead cover, when properly constructed, shields against indirect fire contact burst shells up to 82 mm. In most cases, some degree of engineer support is needed for construction and installation.

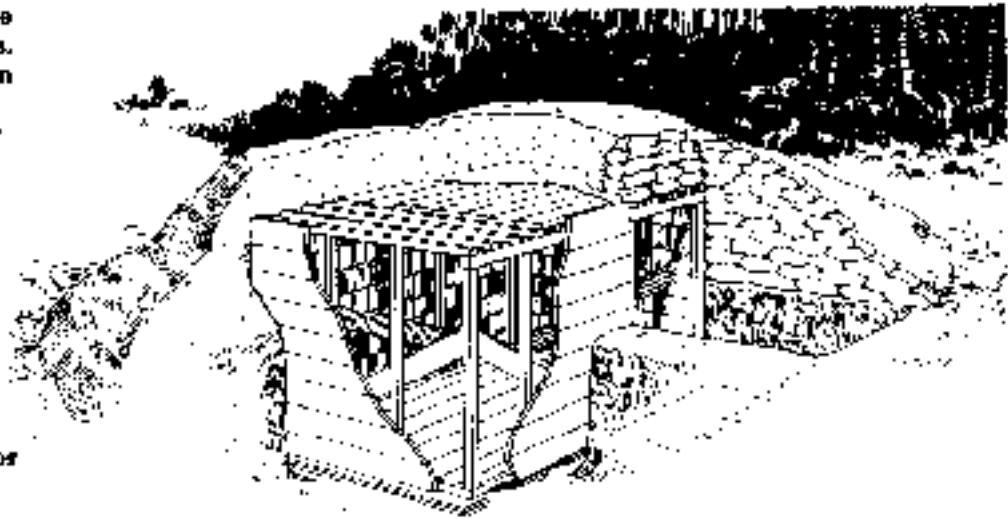

Aboveground cavity wall shelter

An aboveground cavity-wall shelter provides protection quarters for about 12 soldiers where below ground construction is not possible due to high water tables, rocky ground, and other factors. The design is made of a 6-inch thick foundation slab and 3-foot thick earth-filled walls. Overhead cover is provided by layers of sandbags or about 1½ feet of loose earth supported on heavy stringers, beams, and posts. It requires a high degree of engineer effort; but, when properly constructed and camouflaged, the roof provides good protection against all indirect fire projectiles smaller than 162 mm or artillery contact burst attacks.

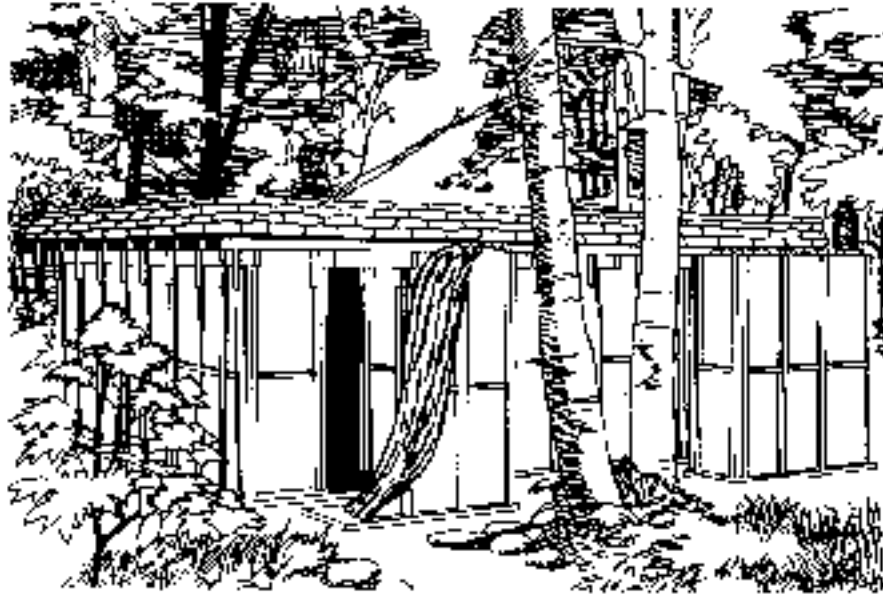

Steel frame/fabric-covered shelter

A steel frame/fabric-covered shelter, because of its flexibility, provides significantly more protection from conventional weapons than structures constructed from timber or concrete materials. The semielliptical-shaped shelter is made of four steel elements—interior frames, end frames, longitudinal braces, and pipe connectors. The frame is covered with a flexible fabric cover. The end and interior frames are fabricated from steel tubing formed into an elliptical arch. A straight section of tubing is welded to each of the two sides at the bottom of the arch.



End frames are braced vertically and horizontally to provide support for the fabric covering at the ends of the shelter. Four longitudinal braces hold the frames in place and prevent the shelter

from collapsing. The flexible fabric cover supporting the soil backfill is a two-ply, neoprene-coated nylon fabric (airfield surface memorandum T-17). If the shelter is buried with at least 1½ feet of soil

cover, it can survive small contact burst mortar shells (82 mm or less), and delay fuzed medium artillery shells (162 mm) exploding in the ground 10 feet from the structure.

Hardened frame/fabric shelter

A hardened frame/fabric shelter provides excellent protection from conventional and nuclear weapons. When equipped with a sealed vertical entryway and buried with at least 4 feet of soil cover, this shelter survives shock and airblast loadings at a 30-pounds per square inch (psi) nuclear overpressure range. In addition, a high level of initial radiation protection is provided. Further, the shelter survives contact bursts of medium artillery shells (152 mm or less).

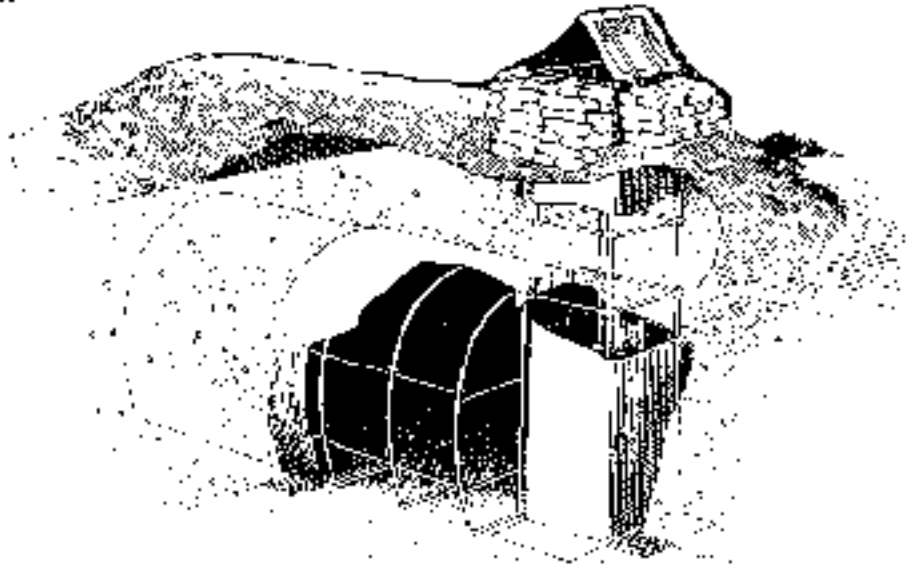

Rectangular fabric/frame shelter

A rectangular fabric/frame shelter is suitable for a command and control center, troop shelter, or medical facility. Aluminum or steel frame members are covered with T-17 airfield surface membrane for supporting at least 1½ feet of soil cover. A partially or fully buried shelter survives small contact burst mortar shells (82 mm or less) and delay fuze medium artillery shells (162 mm or less) exploding in the ground 15 feet from the shelter.

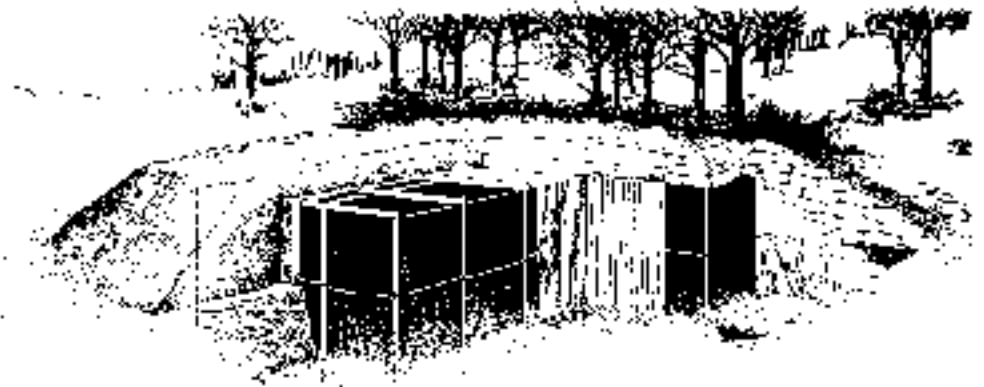

Concrete arch shelter

A concrete arch shelter is prefabricated from 4-foot long arch sections and constructed to any length required. Basic arch or end section components are truck or airtransportable. Engineers are required to fabricate the shelter components, but assembly at the site requires no engineer technical support other than excavation and lifting equipment. The shelter is buried with at least 4 feet of earth overhead cover. It can survive a medium artillery shell (152 mm or less) or a delay fuze shell exploding 5 feet from the structure.

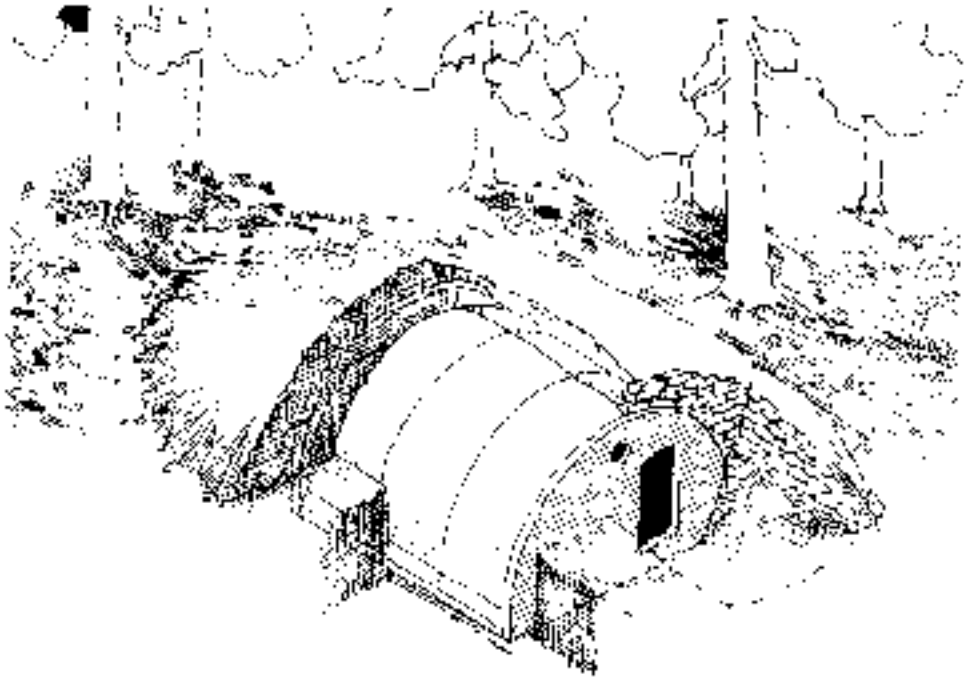

Metal pipe arch shelter

The metal pipe arch shelter is identical in size to the concrete arch shelter and uses the same end walls. The arch section is made of seven 12-foot long corrugated galvanized steel plates of differing curvature bolted together along the longitudinal joints. Protection provided by this shelter is the same as that for the concrete arch except very little protection from fragments and blast is provided until the backfill and cover material are in place.

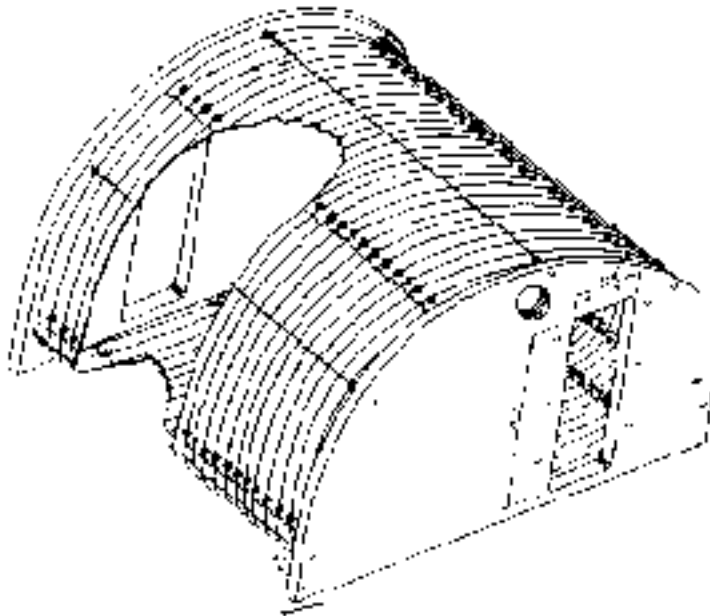

PROTECTIVE WALLS

Several basic types of walls are constructed to satisfy various weather, topographical, tactical, and other military requirements. The walls range from simple ones, constructed with hand tools, to more difficult walls requiring specialized engineering and equipment capabilities.

Protection provided by the walls is restricted to stopping fragment and blast effects from near-miss explosions of mortar, rocket, or artillery shells; some direct fire protection is also provided. Overhead cover is not practical due to the size of the position surrounded by the walls. In some cases, modification

of the designs shown will increase nuclear protection. The wall's effectiveness substantially increases by locating it in adequately-defended areas. The walls need close integration with other forms of protection such as dispersion, concealment, and adjacent fighting positions. The protective walls should have the minimum inside area required to perform operational duties. Further, the walls should have their height as near to the height of the equipment as practical.

Earth walls

Earth walls are constructed entirely of compacted earthfill. The sides have a 1:1 slope (or 45 degrees); therefore, a large area and constant maintenance are required, particularly in locations with high rainfall rates. A waterproof covering or sandbags are recommended to stabilize this type of protective wall.

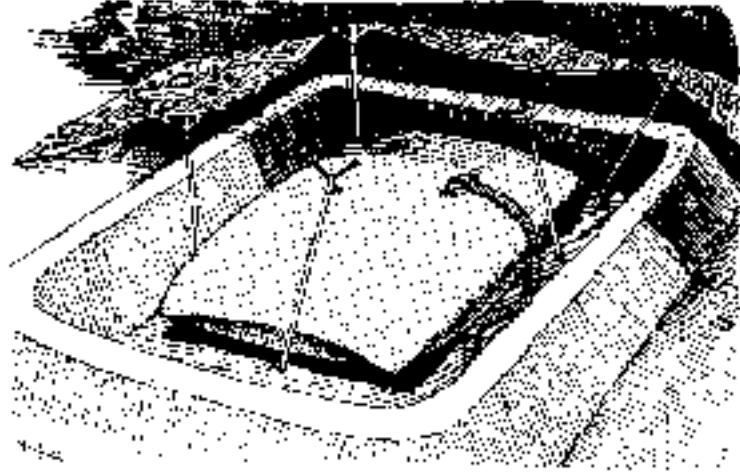

Earth wall with revetment

An earth wall with a revetment is a wall constructed of soil placed at a 1:1 slope against a revetment. Normally, the revetment is located on the inside of the wall as close as possible to the protected equipment. The wall's height should be at least equal to the equipment protected.

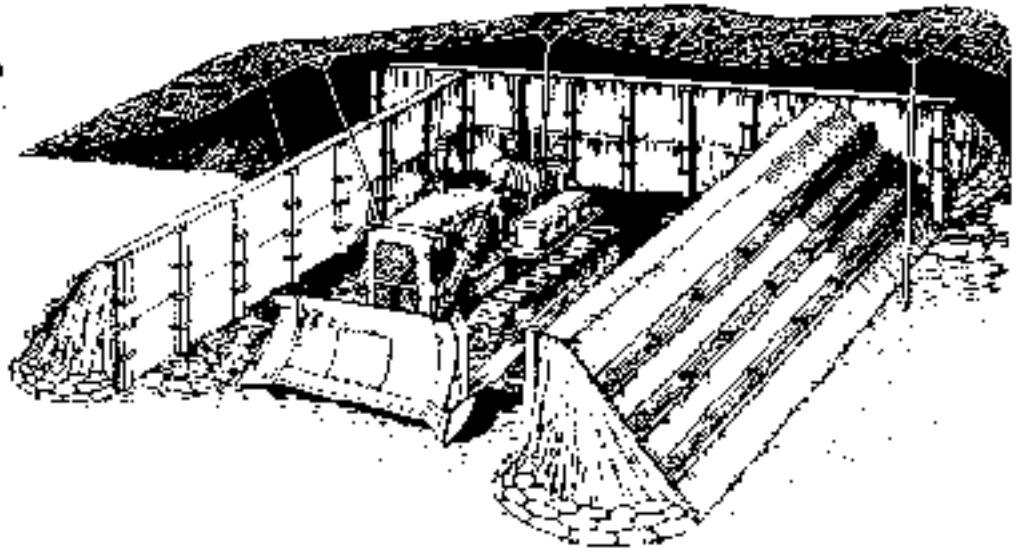

Soil-cement wall

A soil-cement wall provides better protection from fragments, requires less area for the position, and is more permanent than the earth wall. The wall requires special equipment to construct forms and prepare the soil-cement mixture. A free-standing wall with a 1:10 slope is constructed using a mixture of one part portland cement (by weight) with 10 parts of soil (by weight).

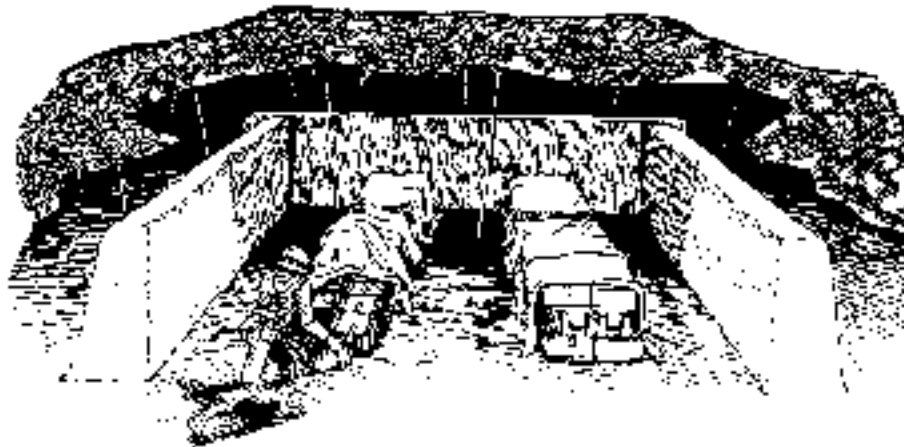

Soil bin wall with log revetment

Soil bin walls with side revetments constructed from logs, dimensioned timber, plywoods, or corrugated metal effectively defeat fragments. With a minimum thickness of 1 foot, the walls stop small size artillery fragments, mortar, and rocket shells exploding as close as 5 feet from the walls.

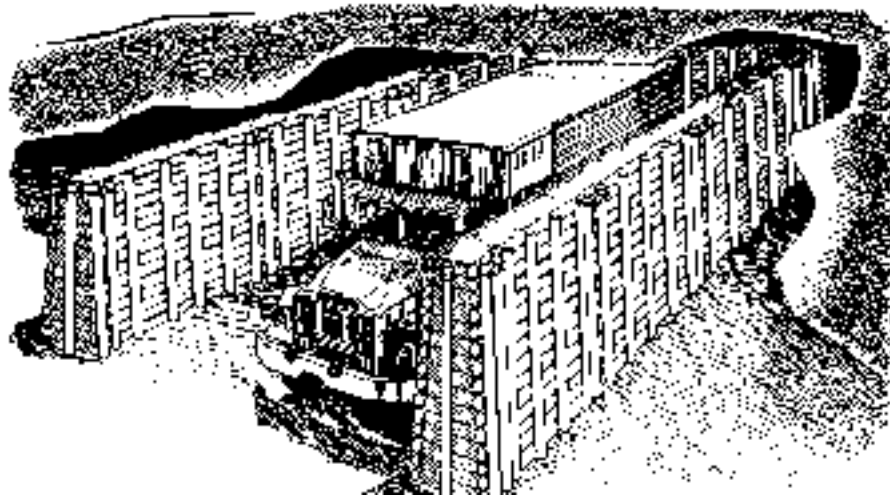

Soil bin wall with timber revetment



Soil bin wall with plywood revetment

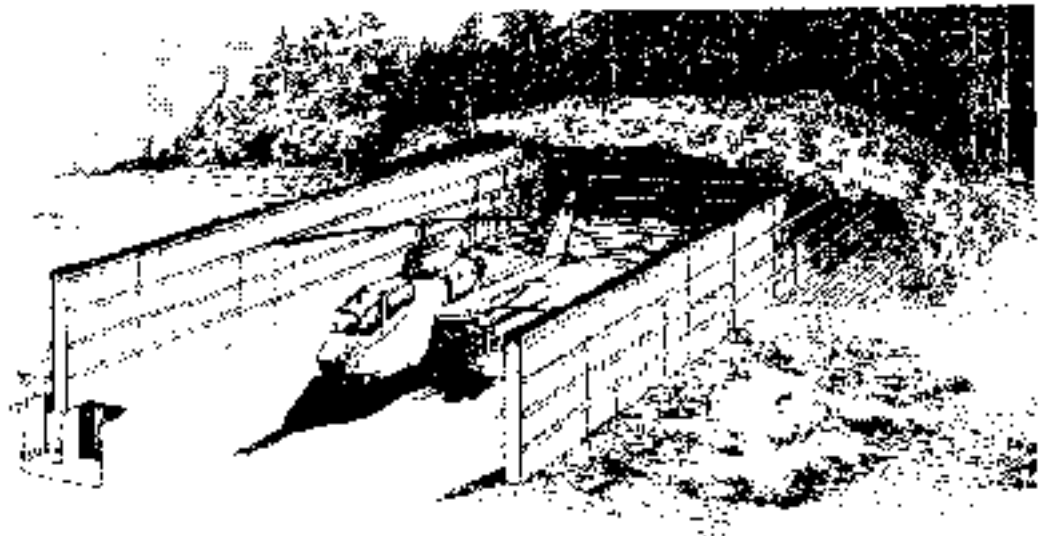

Plywood portable wall

A small portable wall made from plywood or corrugated metal is designed for use around supplies or equipment such as generators, POL, and ammunition. The wall stops mortar shell fragments exploding as close as 5 feet. The wall is braced with $\frac{3}{8}$ -inch guy cable at both ends of each 8-foot wall section to prevent the wall from blowing over by the blast wave.

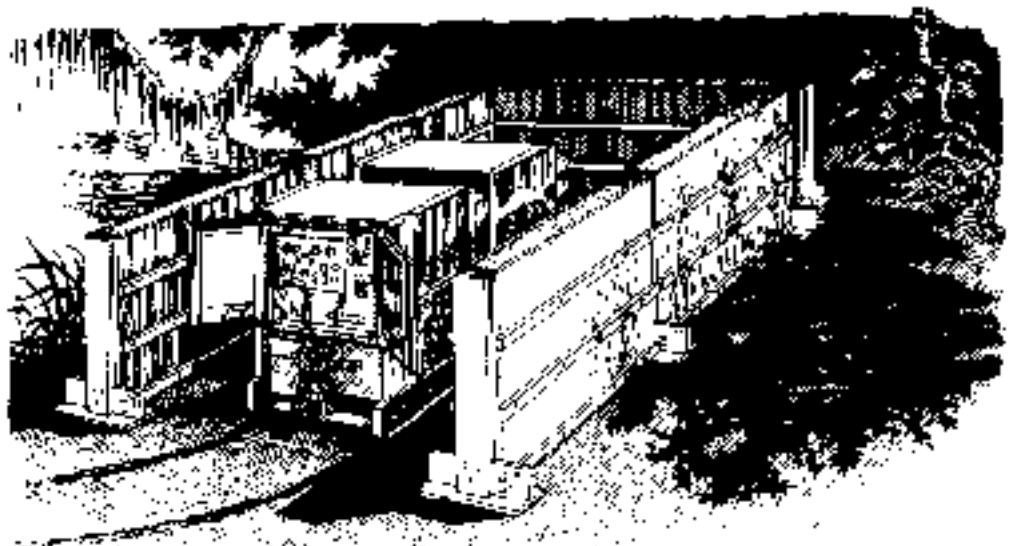

Steel landing mat wall

A temporary wall made from steel landing mats not suitable for runway use make an effective fragment shield. The mats are placed at least 1 foot apart or constructed in the "A" shape. The landing mat wall is properly anchored to the ground so aircraft movements or blast effects will not blow it over. The table on page 4-40 provides shielding effectiveness of the MBA1 steel landing mat.

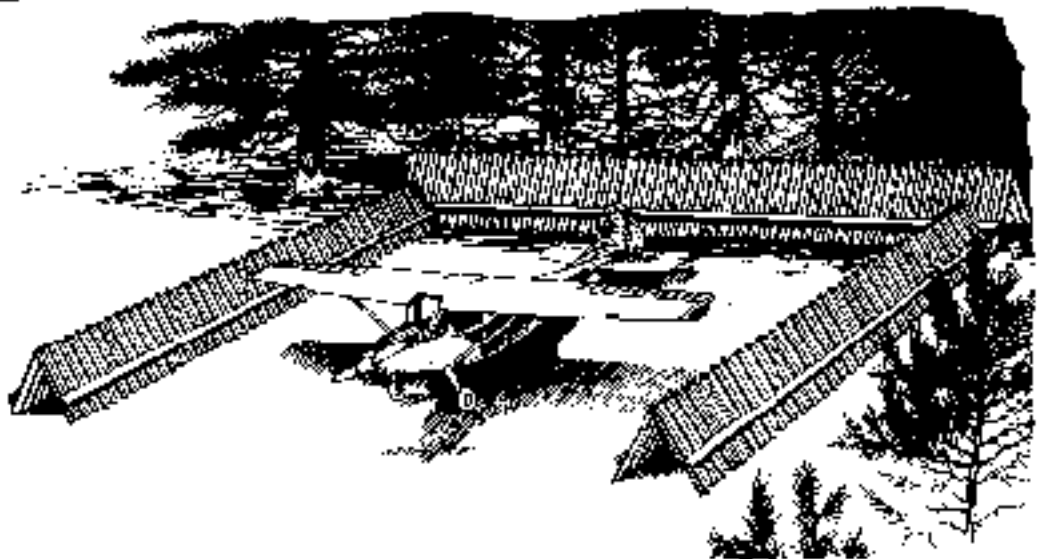

Shielding of M8A1 Landing Mats

Percent Fragments Stopped at Cited Range

Weapon	5 ft	10 ft	20 ft	30 ft
81-mm mortar	95	98	98-100	98-100
82-mm mortar	98	98-100	98-100	98-100
4.2-in mortar	76	87	91	93
107-mm rocket	70	79	85	96
120-mm mortar	98	98-100	98-100	98-100
122-mm rocket	—	—	70	78

Portable precast concrete wall

A portable precast concrete wall provides a versatile, portable, and durable wall for protecting essential equipment, living quarters, hospitals, administration buildings, and parked vehicles. Its modular construction permits a wide variety of configurations and applications. The wall is made of 8-inch thick, 8-foot long reinforced concrete panels supported by two concrete footings. Protection provided is less than 1-foot thick soil bin walls, but is improved by stacking sandbags against the outer face of the panels.

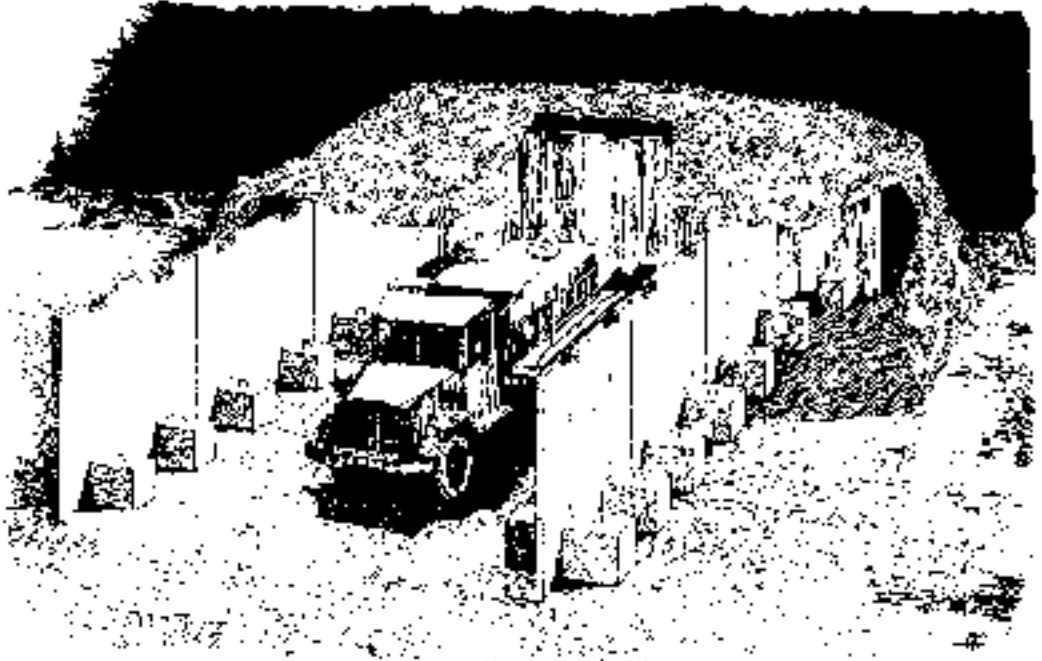
**Cast-in-place concrete wall**

A cast-in-place concrete wall provides excellent protection but requires skilled workers and special equipment at the construction site. As with the portable concrete wall previously described, protection is greatly improved by placing a layer of sandbags against the outer wall surfaces.



Portable asphalt armor panels

Portable asphalt armor panels are used for siding on buildings or as protective panels for military equipment and vehicles. Panels are 2 feet wide by 8 feet long and 2 and 4 inches thick. Engineer troops are required to construct the panels and properly prepare the asphalt mixture. The thin panels stop fragments from mortar shells exploding 30 feet away; the thicker panels at a distance of 5 feet.

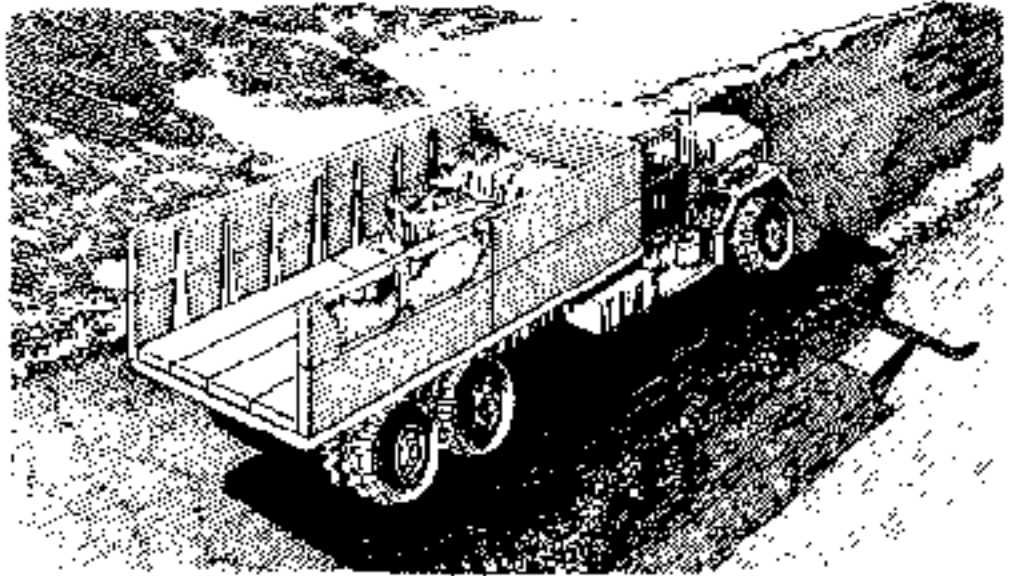

[RDL](#)[Table of](#)[Document](#)[Download](#)[Homepage](#) [Contents](#) [Information](#) [Instructions](#)

Appendix D

CAMOUFLAGE

DETECTION

Modern sensing devices detect objects or terrain disturbances even though they are well camouflaged. These devices detect reflected short-wave and radiated long-wave infrared (ir) energy. Special video devices "read" ir energy and detect dead or dying vegetation as well as objects painted similar to their surroundings. As a counter, special camouflage paint having a short-wave infrared response much like natural vegetation is available. The long-wave or thermal infrared energy radiated by a surface depends on the surface temperature. Hot surfaces radiate much more energy than cool surfaces; thus, hot surfaces are normally easier to detect with thermal infrared or heat-sensitive devices. Certain precautions are taken against detection by these devices.

- Hot objects such as generators, stoves, or other heat-generating items are not openly exposed.
- Artificial surfaces are shaded or insulated to reduce solar heating.
- Distinctive shapes or patterns which readily identify the type of feature or facility are obscured.

If natural material is used for camouflage, there are two major considerations. *First*, gathering natural material nearby creates voids, changes the appearance of the natural surroundings, and reduces the effectiveness of the camouflage. Therefore, limbs are cut from several trees, not just one. Also, limbs are cut as close to the trunk or main branch as possible. A tree should still appear "natural" after branches are cut. *Secondly*, while natural material aids both visual and infrared camouflage initially, it loses effectiveness as it dries out. Thus, when vegetation is cut for camouflage use, it is watered and/or replaced as it withers. The replaced camouflage is disposed of so that it does not draw attention to the concealed area. Excess soil from constructed positions, waste materials, and any worn or damaged camouflage are moved to another area and made to look like natural terrain. These materials are also used for constructing a poorly camouflaged dummy position.

Regardless of the materials used to camouflage a bivouac site, both visual and infrared capabilities are considered. For example, a field fortification constructed of galvanized steel is set in a grassy area. During midday, the steel appears unnaturally bright to both visible and thermal infrared sensing devices. In the visible range, it reflects more light than the grass and differs in color. In the short-wave infrared range, it appears darker than the surrounding vegetation. In the thermal infrared range, it is much hotter than sod or vegetation. Sodding the roof camouflages the position for all three types of

always possible, artificial materials are used. Paint or nets, such as those used on vehicles, may help. Paint protects against detection by visible and short-wave infrared devices, but shading by nets reduces the thermal infrared signature and thus the detectability of the site to heat-sensitive devices.

Natural Materials

Natural materials are used for the three methods of concealment-hiding, blending, and disguising. Indigenous materials provide the best concealment, are economical, and reduce logistic requirements. For camouflaging, natural materials are divided into four groups: growing vegetation (cut and planted), cut and dead vegetation, inert substances of the earth, and debris.

Cut vegetation is used for temporary concealment, completing or supplementing natural cover, and augmenting artificial cover. It is also excellent for overhead screening if cuttings are carefully placed to appear as in the natural state. Cut foliage wilts and is therefore replaced frequently (every 3 to 5 hours). In addition, cutting large amounts reveals the site. Inert substances such as cut grass, hay, straw, or dead branches require very little maintenance. However, because of their dry nature, these items are a potential fire hazard and lose their ability to provide infrared detection protection. Inert materials are ideal when vegetation is dormant.

Other substances such as soil, sand, and gravel are used to change or add color, provide coarse texture, simulate cleared areas, or create shapes. Debris such as boxes, tin cans, old bottles and junkyard items are also used for camouflage in some cases. In winter, snow is used, but some differences are expected between undisturbed and reworked snow, especially with infrared detection devices.

Man-Made Materials

Man-made materials fall into three categories: hiding and screening, garnishing and texturing, and coloring.

Hiding and screening materials include prefabricated nets, net sets, wire netting, snow fencing, truck tarpaulins, smoke, and so forth. Generally, these materials are most effective when used to blend with natural overhead or lateral cover.

Garnishing and texturing materials are used to add the desired texture to such items as nets and screens. Examples of such materials are gravel, cinders, sawdust, fabric strips, feathers, wood shoring, and Spanish moss.

Coloring with standard camouflage paint, available in ten colors in addition to black and white, allows selecting a color scheme which blends with any natural surrounding. Normally, standard camouflage paint has a dull finish, is nonfading, possesses a certain degree of infrared reflectivity, covers in one coat, and lasts approximately 9 months. If this paint is not available, other materials such as crankcase oil, grease, or field-expedient paint can be used as a stopgap measure.

FIELD SITE DEVELOPMENT

The four stages in the development of a field site are planning, occupation, maintenance, and evacuation. Since units often move without an opportunity to plan, the first stage is sometimes eliminated. In that case, the five points listed in the following paragraph are satisfied after arrival to the area.

Planning

Because of the frequent halts characteristic of modern mobile warfare, planning is difficult. Since there is seldom time or facilities available for elaborate construction, sites are quickly entered and evacuated. However, no matter how swift the operation or how limited the time and facilities, the unit commander plans for concealment. The general area of the halt is determined by the tactical plan. Prior to entering the area, the quartering party becomes familiar with the terrain pattern through a careful study of maps and aerial photographs. The party is also fully acquainted with the tactical plan and the camouflage requirements. The five critical points for the party are:

- Unit mission.
- Access routes.
- Existing concealment.
- Area size.
- Concealment of all-around position defense.

Camouflage begins before the unit moves in to occupy the site.

Vehicles are carefully controlled in their movements so telltale tracks do not lead directly to a camouflaged position. All traffic moves on existing roads or trails or follows tree lines.

Occupation

Occupation is achieved with a carefully controlled traffic plan which is strictly followed. Guides posted at route junctions, fully aware of the camouflage plan, enforce camouflage discipline. Turn-ins are marked to prevent widening of corners by vehicles. Foot troops follow marked paths as closely as possible. The position is sited so that it is not silhouetted against the sky when viewed from an attacker's ground position. It also blends--not contrasts--into the background.

Maximum use of trees, bushes, and dark areas of the terrain reduces the amount of camouflage required and the likelihood of air observation. It is equally important that the concealing cover not be isolated, since a lone clump of vegetation or a solitary structure is a conspicuous hiding place and will draw enemy fire whether the enemy "sees" anything or not. The terrain should look natural and not be disturbed any more than absolutely necessary. This objective is best accomplished by removing or camouflaging the spoil.

Natural terrain lines, such as edges of fields, fences, hedgerows, and rural cultivation patterns, are excellent sites for positions since they reduce the possibility of aerial observation. Regular geometric layouts are avoided. The lightweight camouflage screening system (LWCSS) is especially important in preventing identification of recognizable military outlines.

Before any excavation is started, all natural materials, such as turf, leaves, forest humus, or snow, are removed, placed aside, and later used for restoring the natural appearance of the terrain. When a position cannot be sited under natural cover, camouflaged covers are valuable aids in preventing detection. Materials native to the area are preferred; however, when natural materials are used over a position, they must be replaced before they wilt, change color, and lead to detection.

Maintenance

Next to occupation, maintenance is the most critical stage. If the occupation was successful from a camouflage standpoint, maintenance is relatively simple. Successful maintenance involves frequent inspection of camouflage; active patrol measures for discipline; and, where possible, aerial observation and photos. When critical unit activities require congestion of troops, such as for dining, the traffic plan must be rigidly enforced. It is often necessary to use artificial

overhead cover, such as LWCSS. Garbage disposal pits are concealed, with special care given to the spoil. During hours of reduced visibility, it is human nature to relax and assume that the enemy cannot see during darkness or in fog; however, the maintenance of noise and light discipline, as well as camouflage, is important at all times. Failure to maintain light and noise discipline may make all other methods of camouflage ineffective. Even during periods of reduced visibility, an exposed light can be seen for several miles. Any unusual noise or noise common to military activity may draw attention to its source.

New thermal imagery technology is capable of detecting equipment not covered by thermal camouflage nets, regardless of light or weather conditions. Generators, heaters, or any other running engines create additional thermal signatures which must be limited as much as possible. As a result, stricter camouflage discipline is required during the hours of reduced visibility, since a camouflage-undisciplined unit will become even more recognizable. Wire and taped paths will aid personnel in finding their way with minimum use of flashlights.

Evacuation

Although evacuation is the last operation at the halt site, camouflage does not end when the unit prepares to move out. An evacuated area can be left in such a state that aerial photos reveal the strength and type of unit, its equipment, and even its destination. It is an important part of camouflage to leave the area looking undisturbed. Trash is carefully disposed of or taken with the unit. Spoil is returned to its original location to assume a unit is not engaged when it departs. If engaged, it may not be possible to return the site to its original appearance.

CAMOUFLAGE OF UNIT POSITIONS

Command Post

Since the command post is the nerve center of a military unit, it is a highly-sought enemy target. Command posts have functional requirements which result in creating easily-identifiable signatures such as--

- Converging communication lines, both wire and road.
- Concentration of vehicles.
- Heavy traffic which causes widened turn-ins.
- Antennas.
- New access routes to a position which could house a command post.
- Protective wire and other barriers surrounding the site.

- Defensive weapon positions around the site.

Primary camouflage solutions include intelligent use of the terrain and backgrounds, and strict enforcement of camouflage discipline.

Site Requirements

The site requirements of a large command post are primarily reconnaissance and layout, quartering parties, rapid concealment of elements, camouflage discipline, and a well-policed track plan to prevent visitors from violating it. Since a large headquarters is likely to remain in an area for a greater length of time than a halted maneuver unit, the site must be capable of being disclosed by changes in the terrain pattern. It is unwise to locate a headquarters in the only large building within an extensive area of operations. If the command post is located in a building, there must be other buildings in the area to prevent the target from being pin pointed.

Communications

Communications are the lifeblood of a command post. Command posts sited to take advantage of existing roads and telephone and telegraph wires are easiest to conceal. When new communication means must be created, natural cover and terrain lines are used. The use of remote communications should be concealed wherever possible.

Discipline

After the site has been selected and camouflaged to supplement whatever natural concealment is present, continued concealment depends on discipline. Tracks are controlled; vehicles are parked several hundred meters from the command post; security weapons and positions are concealed and tracks to them made inconspicuous; all spoil is concealed, and protective and communication wires follow terrain lines and are concealed as much as possible. Night blackout discipline is rigidly enforced. Routes to visitor parking areas are maintained in accordance with the track plan. Power generation equipment is also concealed to protect against noise and infrared signature detection.

In open terrain where natural concealment is afforded only by small scrub growth and rocks, overhead camouflage is obtained by using the LWCSS. Even in desert terrain, broken ground and scrub vegetation form irregular patterns and are blended with artificial materials. Digging-in reduces shadow and silhouettes, and simplifies draping positions or tents. In open terrain, dispersion is particularly important. Routes between elements are concealed or made by indirect in straight lines.

CAMOUFLAGE OF CIVILIAN STRUCTURES

A headquarters within an existing civilian structure presents the problem of hiding day movement and concealing the evidence of night activity when blackout conditions prevail. Military movement in a village or a group of farm buildings is less discoverable if kept to a minimum. Attempts to alter the appearance of buildings by disruptive painting is evidence of occupation and simply reveals a military presence. Erection of a small structure simulating a new garage or other auxiliary civilian building is unlikely to arouse suspicion. Any major changes, however, especially if the enemy is familiar with the area, will be closely scanned by enemy air observers. When buildings are partially destroyed and left debris-littered, installations are camouflaged with debris to blend with the rough and jagged lines of the surroundings. A few broken timbers, pieces of broken plaster, and a few scattered rags accomplish quick and effective concealment. Other debris usually available includes rubble, scrap metal, wrecked vehicles, and furniture.

CAMOUFLAGE OF SUPPLY POINTS

Camouflage of a supply point includes all the difficulties of both maneuver unit and command post concealment, plus a number of particularly troublesome factors peculiar to supply points alone. Supply points vary in size from large concentrations of materials in rear areas, to small piles of supplies in the forward areas. Large amounts of equipment are quickly brought up, unloaded, and concealed, yet are easily accessible for redistribution. Flattops are used effectively providing the supply points are not too large, time and materials are available, and they blend with the terrain. For supply points which cannot be concealed, decoy points will often disperse the force of an enemy attack.

Natural concealment and cover are used whenever possible. Stacks of supplies are dispersed to minimize damage from a single attack. New access roads are planned using existing overhead cover. In more permanent installations, tracks running through short open areas are concealed by overhead nets slung between trees. Traffic control includes measures to conceal activity and movement at, to, and from the installation. Even when natural cover is sparse or nonexistent, natural terrain features are advantageously used.

In cultivated fields, supplies are laid out along cultivation lines and textured with strip-garnished twine nets to resemble standing stubble. In plowed fields, supplies are stacked parallel to the furrows and covered with earth-colored burlap for effective concealment. Access routes are made along the furrow, and no unnatural lines appear on the pattern.

Camouflage discipline measures at supply points include track plans that result in minimal changes to terrain appearance, debris control to prevent accumulation and enemy detection, concealment and control of trucks waiting to draw supplies, and camouflage maintenance.

CAMOUFLAGE OF WATER POINTS

Effective concealment of water points and other support activities require

- An adequately concealed road net.
- Sufficient concealment to hide waiting vehicles.
- Adequate concealment-artificial or natural for operating personnel, storage tanks, and pumping and purification equipment.
- Strict enforcement of camouflage discipline.
- Control of spilled water and adequate drainage to prevent standing pools of water which reflect light.

Foliage not sufficiently thick for perfect concealment is supplemented by natural materials or LWCSS. Concealment is required for water point equipment, the shine of water in the tanks, and any small open areas that are crossed by vehicles or personnel. Shine on water is concealed by a canvas cover or foliage. The characteristic shape of tanks is distorted by foliage or artificial materials. Camouflage discipline at a water point requires a water supply schedule for using units. Lack of a schedule, or violation of it, usually causes a jam of waiting vehicles which cannot be concealed.

CAMOUFLAGE OF CREW-SERVED

AND INDIVIDUAL FIGHTING POSITIONS

If positions are expertly camouflaged and maintained, the enemy will have great difficulty in locating them until stumbling into a kill zone. Natural materials used to camouflage fighting positions should be indigenous to the area. As an example, willow branches from the edge of a stream will not appear natural in a grove of oaks. Since spoil may differ in color from the ground surface, it may be necessary to camouflage the soil or remove it from the unit area.

Routes taken by troops to fighting positions are obscured so footprints or telephone lines do not reveal the positions. All camouflage procedures used for any field location, both visual and thermal, are successfully applied and maintained.

CAMOUFLAGE OF OTHER DEFENSIVE POSITIONS

Other positions are camouflaged the same way as positions located in the defensive area. Positions include those for major weapons, special

design shelters, protective walls (in some cases, obstacles), and trenches.

CAMOUFLAGE IN SPECIAL TERRAIN

Special terrain conditions, such as deserts, snow regions, and urban areas require special camouflage measures.

Deserts

Areas where there is no large convenient overhead cover are unplowed fields, rocky areas, grasslands, and other wide-open spaces. In certain types of flat terrain, shadow patterns and judicious use of drape nets render objects inconspicuous. Units in deserts or other featureless terrains are highly vulnerable to breaches of light or sound discipline during day or night. The eye's capability to reasonably discern stationary objects is greatly reduced by this type of terrain. Dust trails from moving vehicles identify a military position faster than open, stationary, noncamouflaged vehicles. Luminosity at night in open plain areas significantly degrades depth perception and, dependent upon surface texture, makes visual observation useless at long ranges and significantly enhances sound detection methods.

A desert version of the LWCSS provides concealment against visual, near infrared, and radar target acquisition/surveillance sensor devices. A radar transparent version of the LWCSS allows US units to camouflage radar without degrading operations. The desert camouflage net is a complete cover since it depends on ground surface imitation, both in color and texture, for effect.

Snow Regions

A blanket of snow often eliminates much of the ground pattern and makes blending difficult. Differences in texture and color disappear or become less marked. Snow-covered terrain, however, is rarely completely white. By taking advantage of dark features in the lines, stream-beds, evergreen trees, bushes, shadows of snowdrifts, folds in the ground, and the black shadows of hillsides a unit on the move or halted successfully blends itself into the terrain. However, exhaust, ice fog, and infrared signatures are difficult to overcome regardless of how well the unit is hidden.

Good route selection in snow-covered terrain is usually more important than any other camouflage measure. Because of the exposed tracks, skis and snowshoes are not used near the area since their marks are more sharply defined than foot tracks, and may be discovered with infrared imagery.

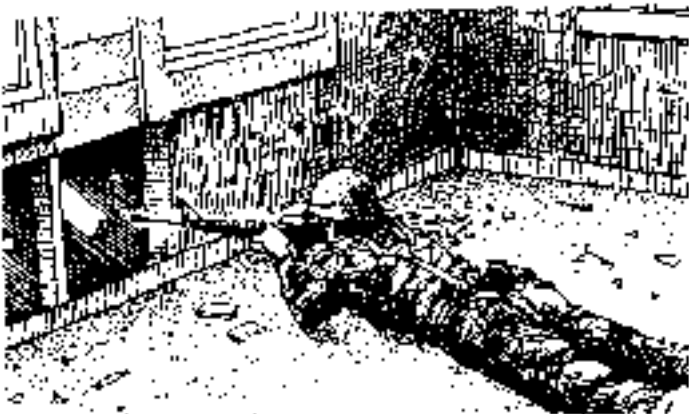
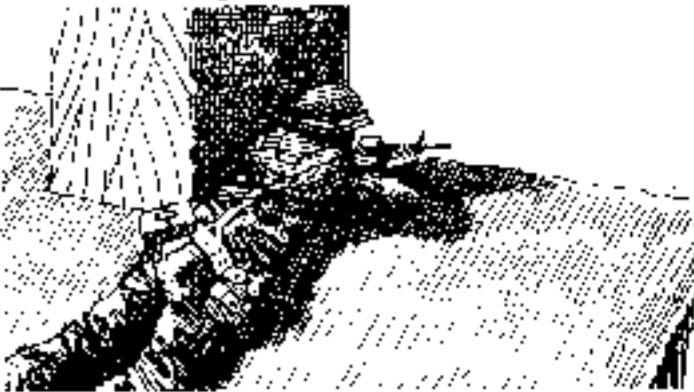
Firing from behind a wall*Firing from a loophole**Firing from a roof peak**Position improved with sandbags*

To avoid tracking up the area, personnel, vehicles, and material are restricted from open areas. Well concealed positions in snow terrain are easily identified when the snow melts, unless precautions are taken. Light discipline is enforced to prevent disclosure of the position. Compacted snow on well-traveled paths melts slower than the uncompacted snow, and leaves visible white lines on a dark background. The snow is then broken up and spread out to hasten melting.

By following communication lines or other lines which are a natural part of the terrain, tracks are minimized. Tracks coinciding with such lines are harder to identify. A turn-in is concealed and the tracks themselves continued beyond the point. Windswept drift lines cast shadows and are followed as much as possible. Straight tracks to an important installation are avoided. Snow region camouflage nets and paints assist in camouflage operations.

Urban Areas

Because vegetation is scarce in urban areas, maximum use is made of the shadows available. Outside buildings, vehicles and defensive positions use the shadows to obscure their presence. Troops inside buildings observe from the shadow side of a window in order to be inconspicuous. Combat in the urban environment usually produces considerable rubble from damaged buildings and roads. This material is used for obstacles as well as camouflage for defensive positions. These positions are blended into the terrain and placed behind rubble as it would

naturally fall from a building.

In urban areas, the prime concerns for individual fighting positions are exposure and muzzle flash. When firing from behind a wall, the soldier fires around cover (when possible), not over it. When firing from a window, the soldier avoids standing in the opening and being exposed to return fire.

Also, the soldier avoids firing with the gun muzzle protruding, especially at night when muzzle flash is so obvious. When firing from a loophole, the soldier gains cover and concealment. The soldier is positioned well back from the loophole to keep the weapon from protruding and to conceal muzzle flash. When firing from the peak of a roof, soldiers use available cover.

The principles for individual fighting positions also apply for crew-served weapons positions, but with the following added requirements. When employing recoilless weapons (90-mm RCLR and LAW), the soldiers select positions which allow for backblast. Shown is a building corner improved with sandbags to make an excellent firing position. Similarly, another means of allowing for backblast while taking advantage of cover in an elevated position is also shown. When structures are elevated, positions are prepared to take advantage of overhead cover. However, care is taken to ensure that backblast is not contained under the building, causing damage or collapse of the structure, or possible injury to the crew. When machine gun positions are fixed, the same consideration as individual positions is given to

Elevated position

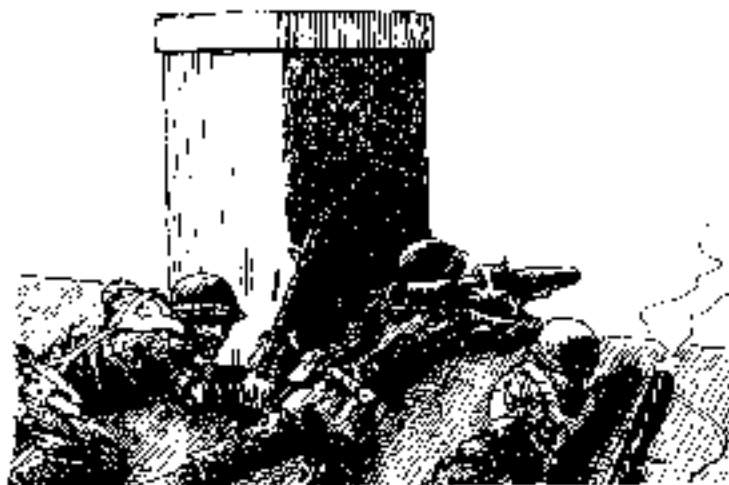

Position with overhead cover



Fixed machine gun position

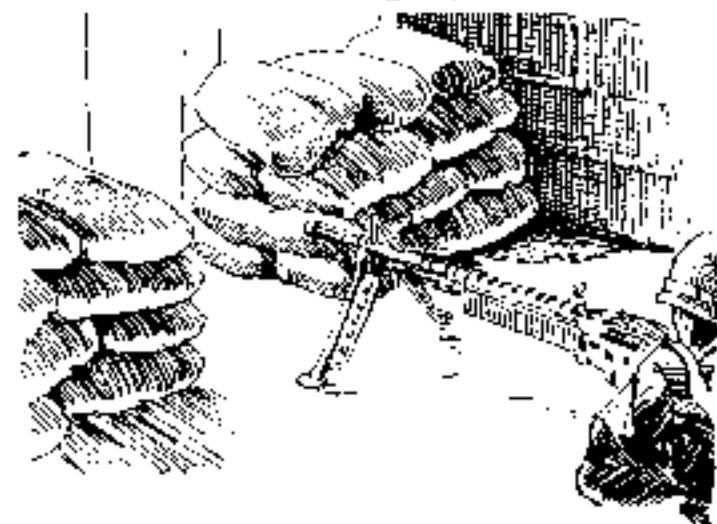

exposure and muzzle location. For further information on camouflage operations, refer to [FM 5-20](#).

Characteristics of Individual Fighting Positions

Type of Position	Estimated Construction Time (man-hours)	Equipment Requirements	Direct Small Caliber fire	Indirect Fire Blast and Fragmentation (Near-Miss)*	Indirect Fire Blast and Fragmentation (Direct Hit)	Nuclear Weapons**	Remarks
HASTY							
Crater	0.2	Hand tools	7.62mm	Better than in open - no overhead protection	None	Fair	
Skincher's trench	0.5	Hand tools	7.62mm	Better than in open - no overhead protection	None	Fair	
Frame position	1.0	Hand tools	7.62mm	Better than in open - no overhead protection	None	Fair	Provides n° around cover
LIBERATE							
One-solter position	3.0	Hand tools	12.7mm	Medium artillery no closer than 30 ft - no overhead protection	None	Fair	
One-solter position with 1/2 ft overhead cover	8.0	Hand tools	12.7mm	Medium artillery no closer than 30 ft	None	Good	Additional cover provides protection from direct hit small mortar blast
Two-solter position	6.0	Hand tools	12.7mm	Medium artillery no closer than 30 ft - no overhead protection	None	Fair	
Two-solter position with 1/2 ft overhead cover	11.0	Hand tools	12.7mm	Medium artillery no closer than 30 ft	None	Good	Additional cover provides protection from direct hit small mortar blast
PAW position	3.0	Hand tools	12.7mm	Medium artillery no closer than 30 ft - no overhead protection	None	Fair	

Note: Chemical protection is assumed because of individual protective masks and clothing.

* Size sizes are:
 Small Medium
 Mortar 82mm 120mm
 Artillery 105mm 152mm

** Nuclear protection ratings are rated poor, fair, good, very good, and excellent.

Mortar position

A fighting position for a mortar is a circular-shaped hole. The position is dug to a depth sufficient to shield the weapon and crew, yet not restrict the weapon's operation. An ammunition-ready rack or niche is sometimes built into the side of the position for the gunner's convenience. The bottom of the ammunition rack is elevated from the position's floor. Another ready rack is constructed in one side of the trench leading to the position. Before the parapet is built, the mortar is laid for direction of fire by using an aiming circle or



alternate means. If a parapet is used, it is limited to 20 inches high and 3 feet wide. An exit trench is

constructed leading to personnel shelters and other mortar positions.

Characteristics of Crew-Served Weapons Fighting Positions

Type of Position	Estimated Duration Time (man-hours)	Equipment Requirements	Direct Small Caliber Fire	Impact fire Blast and Fragmentation (Near Miss?)	Indirect fire Blast and Fragmentation (Direct Hit)	Nuclear Weapon**
Oregon position	4.0	Hand tools	12.7mm	Medium artillery no closer than 30 ft - no overhead protection	None	Fair
Disintegrated TOW position	1.0	Hand tools	12.7mm	Medium artillery no closer than 30 ft - no overhead protection	None	Fair
90-mm ACLP position	6.0	Hand tools	127mm	Medium artillery no closer than 30 ft - no overhead protection	None	Fair
Machine gun position	7.0	Hand tools	12.7mm	Medium artillery no closer than 30 ft - no overhead protection	None	Fair
Machine gun position with 1 1/2-ft overhead cover	12.0	Hand tools	12.7mm	Medium artillery no closer than 30 ft	None	Good
Mortar position	14.0	Hand tools	12.7mm	Medium artillery no closer than 30 ft - no overhead protection	None	Fair

Note: Chemical protection is assumed because of individual protective masks and decontamination.

* Shell sizes are	Small	Medium
Mortar	82mm	120mm
Artillery	105mm	152mm

** Nuclear protection ratings are rated poor, fair, good, very good and excellent.

Dimensions of Vehicle Positions

Vehicle Type	Position Dimension, ft ²			Equipment Hours ¹ D7 Dozer/M9 ACI	Minimum Parapet Thickness of Base, ft
	Length	Width	Depth ^{4, 5}		
HASTY²					
M113 series carrier ³	22	14	3	0.6	8
M577 command post vehicle	12	14	9	0.8	8
M106 and M125 mortar carrier	12	16	7	2.7	8
DELIBERATE (Hull Defilade)					
M113 series carrier ³	22	14	6	3.6	
M901 improved TOW vehicle	22	14	7	3.6	
M577 command post vehicle	29	14	9	3.8	
M106 and M125 mortar carrier	22	16	7	3.7	
M2 and M3 fighting vehicle	26	16	7	3.3	
M1 main battle tank	32	18	5.7	3.9	
M60 series main battle tank	30	18	6	3.9	
M48 series battle tank	30	18	6	3.9	

DELIBERATE (Access Route)

Each access route between positions or hide locations must have the same width as the hull defilade. Clearing times are planned using FM 5-34. Production time is determined by calculating the volume of soil needed to be moved (in cubic yards) and dividing by 100 bank cubic yards per (1)5 hour.

DELIBERATE (Hide Location)

Hide locations are made using natural terrain and concealment. Ground clearing times are planned with the use of FM 5-34. The minimum width of the hide location is the same as the deliberate hull defilade. The hide position depth requirement is calculated by increasing the depth given in the deliberate turret defilade position by 15 percent.

DELIBERATE (Turret Defilade)

M113 series carrier ²	22	14	7.7	0.7
M901 improved TOW vehicle	22	14	9	0.8
M2 and M3 fighting vehicle	26	16	10	1.2
M1 main battle tank	32	18	9	1.5
M60 series main battle tank	30	18	10	1.5
M48 series battle tank	30	18	10	1.5

Notes:

1. Hasty positions for tanks, FVs, and ITVs not recommended.
2. Base on dimensions provide an approximate 3 inch clearance around vehicle for movement and maintenance and do not include access ramp(s).
3. Includes M132 flamethrower and M103 Vulcan.
4. Total depth includes any parapet (e.g.).
5. Production rate of 100 bank cubic yards per (1)5 hour. Divide construction time by 0.35 for rocky or hard soil, night conditions, or closed hatch operations (M9). Use of natural terrain features will reduce construction time.
6. All depths are approximate and will need adjustment for sloping terrain and fields of fire.



[RDL](#)

[Table of](#)

[Document](#)

[Download](#)

[Homepage](#) [Contents](#) [Information](#) [Instructions](#)

[Characteristics of Special Design Positions](#)

[Characteristics of Special Design Positions \(Continued\)](#)

[Characteristics of Special Design Positions \(Continued\)](#)

[Characteristics of Special Design Positions \(Continued\)](#)

[Characteristics of Special Design Positions \(Continued\)](#)

Characteristics of Special Design Positions

Type of Position	Estimated Construction Time (man-hours)	Equipment Requirements	Direct Small Caliber Fire	Indirect Fire Blast and Fragmentation (Near-Miss)**	Indirect Fire Blast and Fragmentation (Direct Hit)	Nuclear Weapons**	Remarks
FIGHTING POSITIONS							
Wood-frame or steel frame fighting position with 2-ft overhead cover	32	Hand tools	12.7mm	Medium artillery no closer than 30 ft	Small mortar	Good	
Fabric-covered frame fighting position with 1 1/2-ft overhead cover	16	Hand tools	12.7mm	Medium artillery no closer than 15 ft	Small mortar	Good	

Note: Chemical protection is assumed because of individual protective masks and clothing.

* Shell sizes are:

	Small	Medium
Mortar	82mm	120mm
Artillery	105mm	152mm

** Nuclear protection ratings are listed poor, fair, good, very good, and excellent.

Characteristics of Special Design Positions (Continued)

Type of Position	Estimated Construction Time (man-hours)	Equipment Requirements	Direct Small-Caliber Fire	Indirect Fire Blast and Fragmentation (Near-Miss)*	Indirect Fire Blast and Fragmentation (Direct Hit)	Nuclear Weapons**	Remarks
RIFLEERS							
Corrugated metal fighting bunker with 2-ft overhead cover	48	Hand tools, backhoe	7.62mm	Medium artillery no closer than 10 ft	Small mortar	Good	
Plywood perimeter bunker	48	Hand tools, backhoe	7.62mm	Limited protection; no overhead protection	None	Poor	
Concrete log bunker with 2-ft overhead cover	42	Hand tools, backhoe	7.62mm	Medium artillery no closer than 10 ft	Small mortar	Good	Construction time assumes precast logs; protection provided includes one layer of sandbags around walls
Precast concrete bunker with 2-ft overhead cover	30	Hand tools, backhoe, crane	7.62mm	Medium artillery no closer than 10 ft	Small mortar	Good	Construction time assumes precast concrete slabs. Protection provided includes one layer of sandbags around walls
Concrete log bunker with 2-ft overhead cover	28	Hand tools, backhoe, crane	7.62mm	Medium artillery no closer than 10 ft	Small mortar	Good	Construction time assumes precast concrete slabs. Protection provided includes one layer of sandbags around walls
SPELLERS							
Two soldier sleeping shelter with 2-ft overhead cover	10	Hand tools	7.62mm	Small mortar no contact	Small mortar	Poor	
Metal culvert shelter with 2-ft overhead cover	48	Hand tools, backhoe	7.62mm	Small mortar no closer than 5 ft	None	Fair	
Inverted metal shipping container shelter with 2-ft overhead cover	28	Hand tools, backhoe	12.7mm	Medium artillery no closer than 10 ft	Small mortar	Good	

Note: Chemical protection is assumed because of individual protective masks and clothing.

* Shell sizes are: Small: 60mm, 81mm, 120mm
 Mortar: 82mm, 120mm
 Artillery: 150mm, 155mm

** Nuclear protection ratings are rated poor, fair, good, very good, and excellent.

Characteristics of Special Design Positions (Continued)

Type of Position	Estimated Construction Time (man-hours)	Equipment Requirements	Direct Small Caliber Fire	Indirect Fire Blast and Fragmentation (Near-Miss)*	Indirect Fire Blast and Fragmentation (Direct Hit)	Nuclear Weapons**	Remarks
SHELTERS (Continued)							
Air transportable assault shelter with 2-ft overhead cover	60	Hand tools, backhoe	Cannot engage	Medium artillery no closer than 30 ft	Small mortar	Very good	Construction time assumes prefabricated walls and floor
Timber post buried shelter with 2-ft overhead cover	48	Hand tools, backhoe	Cannot engage	Medium artillery no closer than 30 ft	Small mortar	Very good	
Modular timber frame shelter with 2-ft overhead cover	96	Hand tools, backhoe	Cannot engage	Medium artillery no closer than 20 ft	Small mortar	Very good	
Timber frame buried shelter with 2-ft overhead cover	64	Hand tools, backhoe	Cannot engage	Medium artillery no closer than 25 ft	Small mortar	Very good	
Above-ground cavity wall shelter with 2-ft overhead cover	700	Hand tools, backhoe, crane	12.7mm	Medium artillery no closer than 20 ft	Small mortar	Good	
Steel frame/fabric-covered shelter with 1 1/2-ft overhead cover	35	Hand tools, backhoe	Cannot engage	Medium artillery no closer than 10 ft	Small mortar	Very good	Construction time assumes prefabricated frame
Hardened fabric/fabric shelter with 4-ft overhead cover	45	Hand tools, backhoe	Cannot engage	Medium artillery no closer than 10 ft	Medium artillery	Excellent	Shelter provides improved nuclear protection to 30 psi
Rectangular fabric frame shelter with 1 1/2-ft overhead cover	38	Hand tools, backhoe	Cannot engage	Medium artillery no closer than 10 ft	Medium artillery	Very good	Construction time assumes prefabricated frame
Concrete arch shelter with 4-ft overhead cover	64	Hand tools, derrick, backhoe, crane	Cannot engage	Medium artillery no closer than 5 ft	Medium artillery	Very good	Construction time assumes prefabricated arches and end walls

Note: Chemical protection is assumed because of individual protective masks and clothing.

* Shell sizes are:
 Small Medium
 Mortar 82mm 120mm
 Artillery 105mm 152mm

** Nuclear protection ratings are rated poor, fair, good, very good, and excellent.

Characteristics of Special Design Positions (Continued)

Type of Position	Estimated Construction Time (man-hours)	Equipment Requirements	Direct Small Caliber Fire	Indirect Fire Blast and Fragmentation (Near Miss)**	Indirect Fire Blast and Fragmentation (Direct Hit)	Nuclear Weapons**	Remarks
SHELTERS (Continued)							
Metal pipe arch shelter with 4 ft overhead cover	58	hand tools, dozer, backhoe, crane	General engage	Medium artillery no closer than 5 ft.	Medium artillery	Very good	Construction time assumes pre-assembled arch and etc section
Type of Position	Estimated Construction Time (man-hours) per 10-ft section	Equipment Requirements	Direct Small Caliber Fire	Indirect Fire Blast and Fragmentation (Near Miss)**	Direct Fire HEAT	Nuclear Weapons**	Remarks
PROTECTIVE WALLS							
Earth wall	3	Dozer, dump truck, scoop loader	12.7mm	Medium artillery no closer than 5 ft	120mm at wall base	Poor	
Earth wall with leveling	20	Hand tools; scoop loader	12.7mm	Medium artillery no closer than 5 ft	120mm at wall base	Fair	
Soil-cement wall	25	Hand tools; concrete mixer, crane w/concrete bucket	12.7mm	Small artillery no closer than 5 ft	82mm at wall base	Fair	Walls require tamping
Soil bin wall with ng revetment	35	Hand tools; scoop loader	5.45mm	Small artillery no closer than 5 ft	None	Poor	
Soil bin wall with timber revetment	30	Hand tools, scoop loader	5.45mm	Small artillery no closer than 5 ft	None	Poor	
Soil bin wall with plywood revetment	19	Hand tools; scoop loader	12.7mm	Medium artillery no closer than 5 ft	120mm at wall base	Poor	Based on plywood (Catan). Provides nuclear blast protection for direct, sensitive targets
Plywood portable wall	5	Hand tools; backhoe	5.45mm	Small nuclear no closer than 5 ft	None	Poor	
Steel landing mat wall	3	Welding; crane	None	Refer to the table on page	None	Poor	M3AL steel landing mat only

Note: Chemical protection is assumed because of individual protection masks and clothing. All walls are 5 feet high with minimum thickness as specified in construction plans.

* Shell sizes are: Small Medium
Mortar 82mm 120mm
Artillery 105mm 152mm

** Nuclear protection is minimal except as noted.

Characteristics of Special Design Positions (Continued)

Type of Position	Estimated Construction Time (man-hours) per 10-ft section	Equipment Requirements	Direct Small Caliber Fire	Indirect Fire Hit and Fragmentation: (Near-Miss)*	Direct Fire HEAT	Nuclear Weapons**	Remarks
PROTECTIVE WALLS (Continued)							
Portable pre-cast concrete wall	25	Hand tools; concrete mixer; crane	7.62mm	Medium artillery no closer than 5 ft	None	Poor	One layer of sandbags on outer panel surface improves small caliber protection
Cast in place concrete wall	35	Hand tools; concrete mixer; crane w/concrete bucket	12.7mm	Small artillery no closer than 5 ft	None	Poor	One layer of sandbags on outer panel surface improves protection to include indirect fire blast and fragmentation from large artillery
Portable asphalt armor panels 2x8x4	15	Hand tools, welding, hot asphalt source	7.62mm	Small artillery no closer than 5 ft	None	Poor	

Note: Chemical protection is assumed because of individual protection masks and clothing. All walls are 5 feet high with minimum thickness as specified in construction plans.

* Shell sizes are: Small Medium
 Mortar 82mm 120mm
 Artillery 105mm 152mm

** Nuclear protection is minimal except as noted

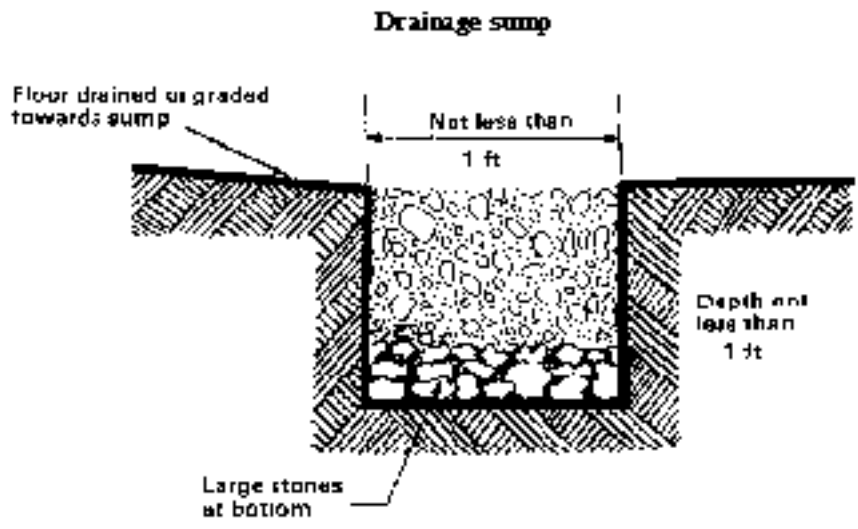

Earth wall roof support points

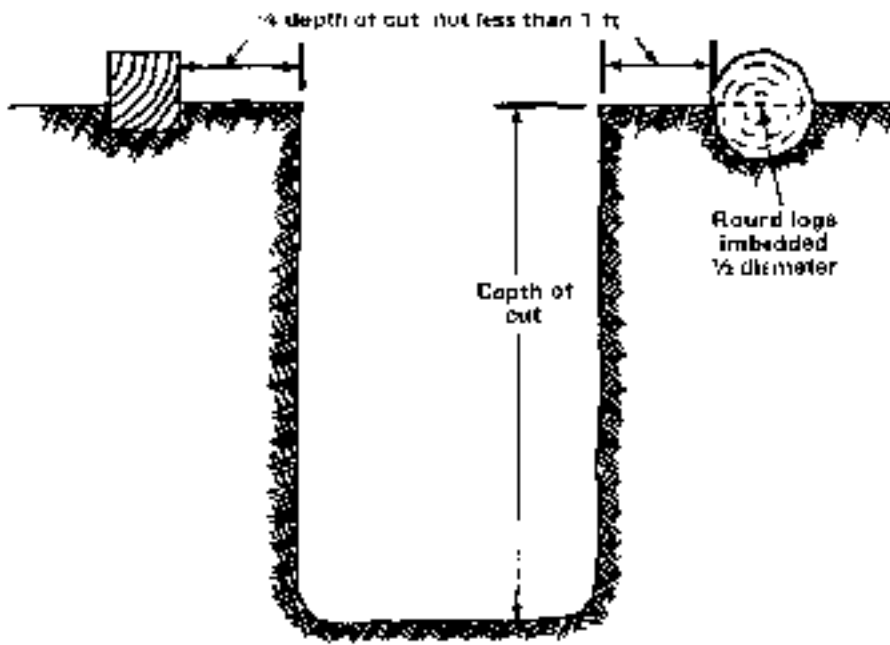



[RDL](#)

[Table of](#)

[Document](#)

[Download](#)

[Homepage](#) [Contents](#) [Information](#) [Instructions](#)

[First Table: Maximum Span of Dimensioned Wood Roof Support for Earth Cover](#)

[Second Table: Maximum Span of Wood Stringer Roof Support for Earth Cover](#)

Maximum Span of Dimensioned Wood Roof Support for Earth Cover

Thickness of Earth Cover, ft	Span Length, ft					
	2½	3	3½	4	5	6
	Wood Thickness, in					
1½	1	1	2	2	2	2
2	1	2	2	2	2	3
2½	1	2	2	2	2	3
3	2	2	2	2	3	3
3½	2	2	2	2	3	3
4	2	2	2	2	3	4

Maximum Span of Wood Stinger Roof Support for Earth Cover

Thickness of Earth Cover, ft	Span Length, ft					
	2½	3	3½	4	6	6
	Center-to-Center Spacing, in					
1½	40	30	22	16	10	18*
2	33	22	16	12	8/20*	14*
2½	27	18	12	10	16*	10*
3	22	14	10	8/20*	14*	8*
3½	18	12	8/24*	18*	12*	8*
4	16	10	8/20*	10*	10*	7*

Note: Stringers are 2 x 4s except those marked by an asterisk (*) which are 2 by 6s

Converting Dimensioned Timber to Round Timber

4 x 4	6
6 x 6	7
6 x 8	8
8 x 8	10
8 x 10	11
10 x 10	12
10 x 12	13
12 x 12	14

***Sizes given are nominal and not rough cut timber.**



[RDL](#)

[Table of](#)

[Document](#)

[Download](#)

[Homepage](#) [Contents](#) [Information](#) [Instructions](#)

[Maximum Span of Steel Picket Roof Supports for Sandbag Layers](#)

[Maximum Span of Inverted Landing Mats \(M8A1\) for Roof Supports](#)

Maximum Span of Steel Picket Roof Supports for Sandbag Layers

Number of Sandbag Layers	Span Length, ft		
	3	6	9
Single-Picket Beams*	Center-to-Center Spacing, in		
2	7	7	6
5	6	5	4
10	4	4	3
15	4	3	2
20	3	3	2
Double-Picket Beams**			
2	7	7	7
5	7	7	7
10	7	6	5
15	7	5	4
20	6	5	4

* Used with open side down.

** Two pickets are welded together every 6 inches along the span to form box beams.

**Maximum Span of Inverted Landing Mats (M8A1)
for Roof Supports**

Number of Sandbag Layers	Span Length, 't
2	10
5	0 $\frac{1}{2}$
10	6
15	4
10	3 $\frac{1}{2}$

**Center-to-Center Spacing for Wood Supporting
Soil Cover to Defeat Contact Bursts**

Nominal Stringer Size (inches)	Depth of Soil (d) (feet)	Center-to-Center Stringer Spacing (h) (inches), for Cited Span Length (L) (feet)				
		2	4	6	8	10
For Defeat of 82-mm Contact Burst						
2 x 4	2.0	3	4	4	4	3
	3.0	18	12	8	5	3
	4.0	18	14	7	4	3
2 x 6	2.0	4	7	8	8	6
	3.0	18	18	16	12	8
	4.0	18	18	18	11	7
4 x 4	2.0	7	10	10	9	7
	3.0	18	18	18	12	8
	4.0	18	18	18	10	7
4 x 8	1.5	4	5	7	8	8
	2.0	14	18	18	18	18
	3.0	18	18	18	18	18
For Defeat of 120- and 122-mm Contact Bursts						
4 x 8	2.0	-	-	-	-	-
	3.0	-	-	-	-	-
	4.0	3.5	4	5	5	6
	5.0	12	12	12	11	10
	6.0	13	18	18	16	12
6 x 8	2.0	-	-	-	-	-
	3.0	-	-	-	-	-
	4.0	-	-	6.5	6	6
	5.0	14	14	13	12	10
	6.0	18	18	18	16	12
6 x 10	2.0	-	-	-	-	-
	3.0	-	-	-	-	-
	4.0	5.5	6	8	9	10
	5.0	16	8	18	18	17
8 x 8	2.0	-	-	-	-	-
	3.0	-	-	-	-	-
	4.0	7.5	8	11	12	18
	5.0	18	18	18	18	18



[RDL](#) [Table of](#) [Document](#) [Download](#)

[Homepage](#) [Contents](#) [Information](#) [Instructions](#)

Appendix B

BUNKER AND SHELTER ROOF DESIGN

This appendix is used to design a standard stringer roof that will defeat a contact burst projectile when the materials used are not listed in the [table](#), *Center-to-Center Spacing for Wood Supporting Soil Cover to Defeat Contact Bursts*. For example, if a protective position uses steel and not wood stringers, then the procedure in this appendix is used for the roof design. The [table](#), *Center-to-Center Spacing for Wood Supporting Soil Cover to Defeat Contact Bursts*, was made using the design steps in this procedure. The calculations are lengthy but basically simple. The two example problems in this appendix were worked with a hand-held calculator and the complete digital display is listed. This listing enables a complete step-by-step following without the slight numerical variation caused by rounding. In reality, rounding each result to three significant digits will not significantly alter the outcome. The roof is designed as follows.

STANDARD STRINGER ROOF

First, hand compute the largest half-buried trinitrotoluene (TNT) charge that the earth-covered roof can safely withstand. Then, use the charge equivalency table to find the approximate size of the super-quick or contact burst round that this half-buried TNT charge equals. The roof design discussed here is for a simple stringer roof of single-ply or laminated sheathing covered with earth ([figure B-1](#)). After determining the need for a bunker or shelter roof, the following questions are addressed:

- What type of soil will be used for cover (soil parameters)?
- How deep will the soil cover be?
- What will the size and orientation of the stringers be and what kind of stringers will be used (stringer characteristics)?
- What will the stringer span and spacing be?

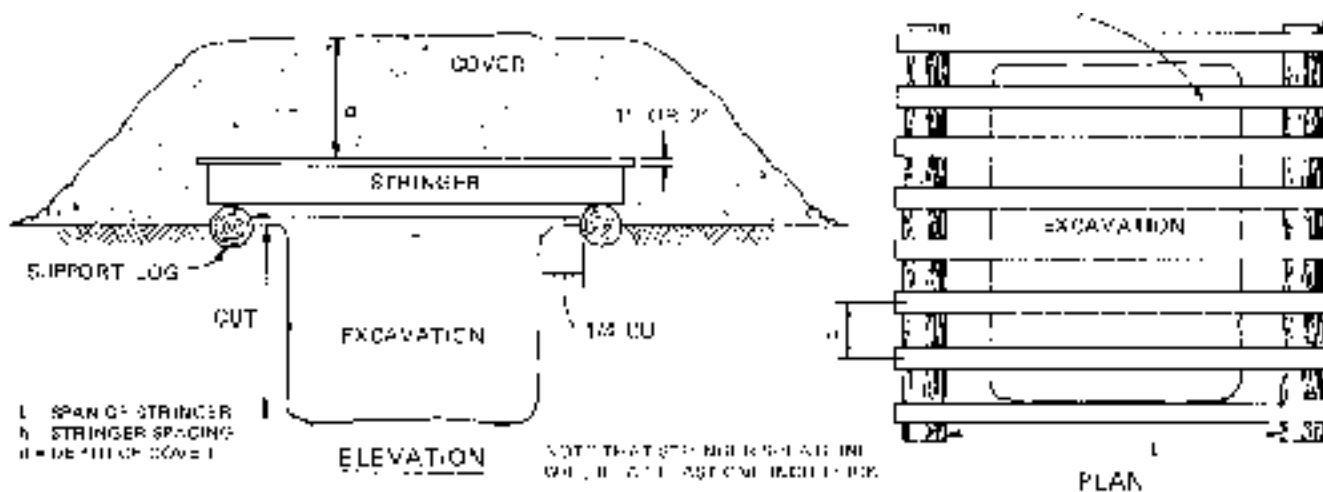

Figure B-1

DESIGN PROCEDURE DATA**Soil Parameters**

Two soil parameters are needed in the design procedure—unit weight and transmission coefficient. Soil unit weight must be determined at the time and place of design. Both the soil (sand, silt, for example) and its water content affect unit weight. Soil unit weight is usually 80 to 140 pounds per cubic foot. The transmission coefficient can be taken from [table B-1](#)

Table B-1. Transmission coefficient (C) for different soil types

	Soil Type	C
SP	Loose, clean, white mason sand	260 - 700
SP	Loose, tan, pit run sand	60 - 475
SP	Loose, red, pit run gravelly sand	75 - 320
SP	Bagged, pit run sand	130 - 140
GP	Washed gravel, rounded	120
ML	Loose, sandy silt	125 - 275
ML	Compacted, sandy silt	350

Stringer Characteristics

For wood stringers, the data needed in the design procedure are given in [table B-2](#) and [B-3](#). For steel stringers, the moment of inertia (I) and section modulus (S) values needed in the procedure are given in [table B-4](#). For the modulus of elasticity (E) and maximum dynamic flexural stress (FS) values, use $E = 29$ and $FS = 50,000$. (Additional structural design data is in [FM 5-35](#).)

**Table B-2. Moment of inertia (I) and section modulus (S)
for different timber sizes**

Nominal Size (inches)	Actual Size (inches)	X-X Axis		Y-Y Axis	
		I (inches ⁴)	S (inches ³)	I (inches ⁴)	S (inches ³)
2 x 4	1½ x 3½	5.36	3.06	0.98	1.31
2 x 6	1½ x 5½	20.80	7.56	1.55	2.06
2 x 8	1½ x 7¼	47.64	13.14	2.04	2.72
2 x 12	1½ x 11¼	177.98	31.64	3.16	4.22
4 x 4	3½ x 3½	12.51	7.15	12.51	7.15
4 x 6	3½ x 5½	48.53	17.65	19.65	11.23
4 x 8	3½ x 7¼	111.15	30.66	25.90	14.80
6 x 6	5½ x 5½	76.26	27.73	76.26	27.73
6 x 12	5½ x 11¼	697.07	121.23	159.44	57.98
8 x 14	5½ x 13½	1,127.67	167.06	187.17	68.06
8 x 8	7½ x 7½	263.67	70.31	263.67	70.31
10 x 10	9½ x 9½	678.76	142.90	678.76	142.90

Note: Axis orientation is as shown here:

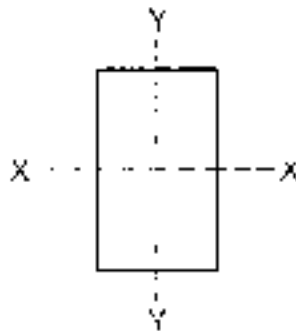

Table B-3. Modulus of elasticity (E) and maximum dynamic

Timber Species	E, 10 ⁶ psi	FS, psi
Cedar	1.10	2,200
Douglas fir	1.76	4,000
White fir	1.21	2,200
Eastern hemlock	1.21	2,600
Western hemlock	1.54	3,200
Larch	1.76	4,600
Southern pine	1.76	6,000
Ponderosa pine	1.10	1,800
Redwood	1.32	3,400
Spruce	1.10	2,900

Table B-4. Moment of inertia (I) and section modulus (S) for different steel wide flange members

Nominal Size, in.	X-X Axis		Y-Y Axis	
	I (inches ⁴)	S (inches ³)	I (inches ⁴)	S (inches ³)
36 x 16½	14,988.4	835.5	870.9	105.7
36 x 12	9,012.1	502.9	250.9	41.8
33 x 11½	6,699.0	404.8	201.4	35.0
30 x 15	7,891.5	528.2	550.1	73.4
30 x 10½	4,461.0	299.2	135.1	25.8
27 x 10	3,266.7	242.8	115.1	23.0
24 x 12	2,987.3	248.9	203.5	33.9
24 x 9	2,096.4	175.4	76.5	17.0
21 x 8½	1,326.8	126.4	53.1	12.9
18 x 7½	800.6	89.0	37.2	9.9
16 x 7	446.3	56.3	22.1	6.3
14 x 6¾	289.6	41.8	17.5	5.2
12 x 12	533.4	88.0	174.6	29.1
12 x 6½	204.1	34.1	16.6	5.1
10 x 10	272.9	54.6	93.0	18.6
10 x 5¾	106.3	21.5	9.7	3.4
8 x 8	109.7	27.4	37.0	9.2
8 x 6½	82.5	20.8	18.2	5.6
8 x 5½	56.4	14.1	6.7	2.6
6 x 6	53.5	16.8	17.1	5.6
4 x 4	11.3	5.45	3.76	1.85

Note: Axis orientation is

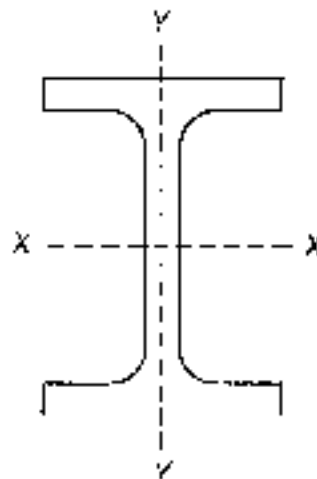

STANDARD STRINGER ROOF PROCEDURE

(Contact Burst Rounds)

Line		
1	Enter the unit weight of the soil (lb/cf) as determined on site	_____
2	Enter the proposed depth of soil cover (ft)	_____
3	Enter the S value (in ³):	_____
	if wood, from Table B-2	
	if steel, from Table B-4	
4	Enter the stringer spacing (in)	_____
5	Enter the FS value (psi):	_____
	if wood, from Table B-3	
	if steel, enter 50,000	
6	Enter the stringer span length (ft)	_____
7	Multiply line 1 by line 4, enter result	_____
8	Multiply line 7 by line 2, enter result	_____
9A	Multiply line 8 by line 6, enter result	_____
9B	Multiply line 9A by line 6, enter result	_____
9C	Divide line 9B by 8, enter result	_____
9D	Divide line 9C by line 3, enter result	_____
9E	Divide line 9D by line 5, enter result	_____
9F	If the line 9E result is greater than 0 but less than 1.0 go to line 10. If line 9E is greater than 1.0, the roof system is overloaded. Then do at least one of the following and recompute from line 1:	_____
	a. Decrease stringer spacing.	
	b. Decrease span length.	
	c. Use a material with a higher "S" or "FS" value.	
	d. Decrease soil cover.	

Line		
10	Enter side A of Figure B-2 with the line 9E value, find the side B value, and enter result:	_____
	if wood, use $\mu = 1$ curve	
	if steel, use $\mu = 10$ curve	

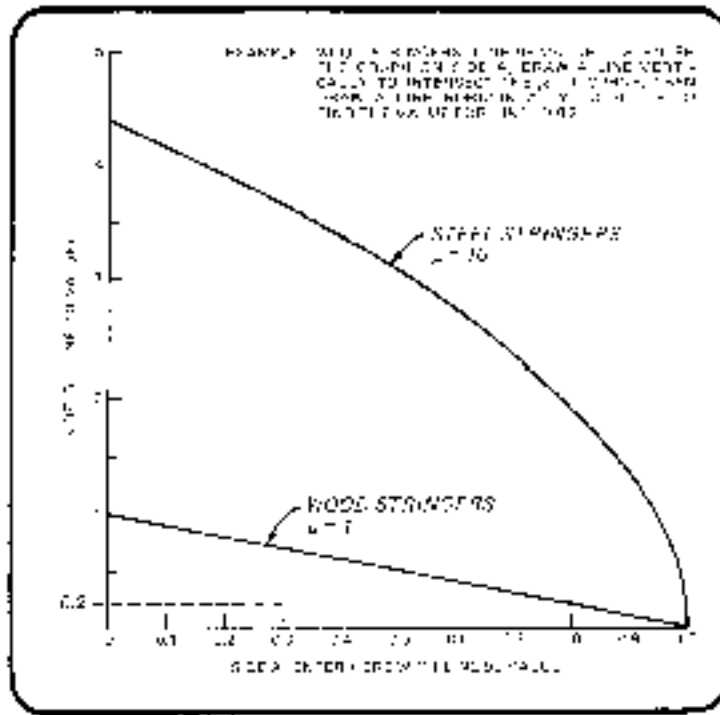

Figure B-2

Line

- 11 Enter the E value (10^6 psi):
if wood, from [Table B-3](#)
if steel, enter 29 _____
- 12A Enter the I value (in^4):
if wood, from [Table B-2](#)
if steel, from [Table B-4](#) _____
- 12B Multiply line 9A by 0.08333, enter result _____
- 12C Multiply line 12B by 0.64, enter result 1 _____
- 12D Divide line 12C by line 9E, enter result _____
- 13 Multiply line 9A by 0.0001078, enter result _____
- 14A Multiply line 12A by line 11, enter result _____
- 14B Multiply line 6 by line 6, enter result _____
- 14C Multiply line 14B by line 6, enter result _____
- 14D Divide line 14A by line 14C, enter result _____
- 14E Multiply line 14D by 28,472.22, enter result _____
- 15 Divide line 14E by line 13, enter result _____
- 16 Take the square root of line 15, enter result _____
- 17 Divide line 12D by line 16, enter result _____
- 18 Multiply line 10 by line 17, enter result _____
- 19 Divide line 2 by line 6, enter result _____
- 20 Multiply line 19 by line 19, enter result _____
- 21A Take the square root of line 19, enter result _____
- 21B Multiply line 21A by line 20, enter result _____

- 22 Divide 0.6666667 by line 21B, enter result _____
- 23A Multiply line 20 by 4, enter result _____
- 23B Add 1 to line 23A, enter result _____
- 24 Divide 4 by line 23B, enter result _____
- 25A Take the square root of line 24, enter result _____
- 25B Take the square root of line 25A, enter result _____
- 25C Multiply line 25B by line 24, enter result _____
- 26 Add line 25C to line 22, enter result _____
- 27 Choose a C value from Table B-1, enter result _____
- 28A Multiply 61.32 by line 18, enter result _____
- 28B Take the square root of line 14C, enter result _____
- 28C Multiply line 28A by line 28B, enter result _____
- 28D Multiply line 27 by line 4, enter result _____
- 28E Multiply line 28D by line 26, enter result _____
- 28F Divide line 28C by line 28E, enter result _____
- 29 Raise line 28F to the 0.8571 power (or use the graph in [Figure B-3](#)),
enter result _____

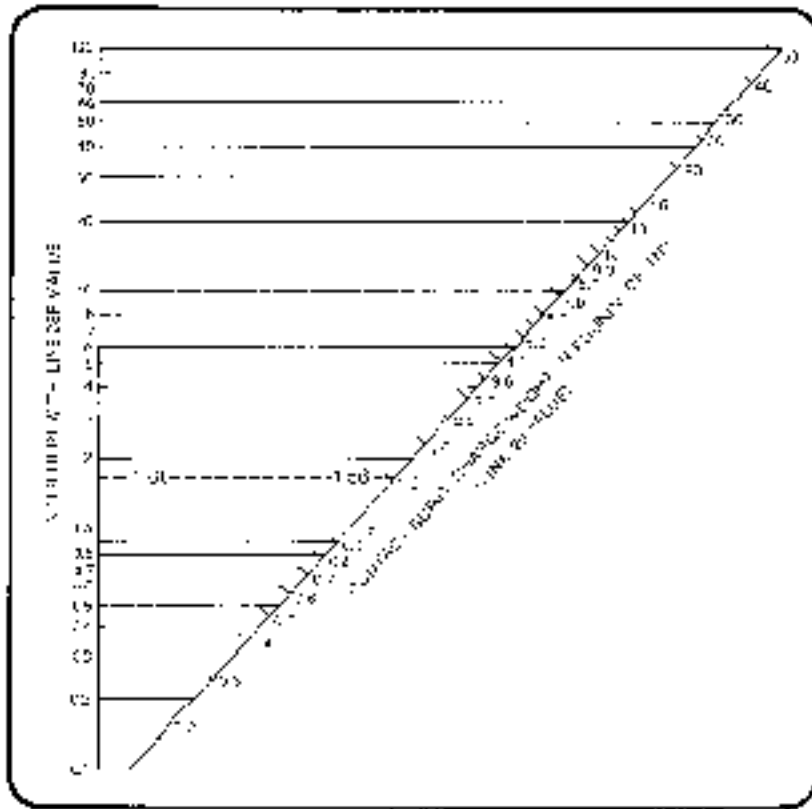

Figure B-3

Solution

The value on line 29 is the largest half-buried TNT Charge (lb) that the roof can withstand. Enter [Table B-5](#) with this value to find the round having an equivalent charge weight equal to or less than the value on line 26.

Table B-5. Charge Equivalency Table

Round Nomenclature	Half-Buried TNT Charge Weight (pounds)
	US Gun and Howitzer Cannons
75-mm gun cannon	1.5
76-mm gun cannon	2.0
90-mm gun cannon	3.2
120-mm gun cannon	10.6
175-mm gun cannon	42.2
105-mm howitzer cannon	7.7
155-mm howitzer cannon	15.34
8-inch howitzer cannon	37.1
US Mortars	
81-mm	2.9
4.2-inch	3.1
Soviet	
57-mm frag	0.5
57-mm frag-T	0.4
76-mm HE	1.8
76-mm frag	1.1
82-mm frag	1.0
85-mm frag	1.7
100-mm HE	4.8
107-mm frag-HE	5.4
120-mm HE	8.5
122-mm HE	10.7
130 mm frag HE*	10.2
140-mm frag-HE	8.1
152-mm frag-HE	14.3
160-mm HE	16.3
People's Republic of China	
57-mm HE	0.5
60-mm HE**	4.6
70 mm HE	1.6
75-mm HE	2.2
81-mm HE	1.3
82-mm frag	1.1
102-mm HE	2.3

* Content of some rounds unknown.

** High capacity.

Table B-5. (continued)

Round Nomenclature	People's Republic of China (Continued)	Half Buried TNT Charge Weight, lb
105-mm HE		5.3
107-mm		3.0
120-mm HE		6.3
Others		
Czechoslovakian	82-mm frag	1.3
Czechoslovakian	85-mm frag	1.7
Czechoslovakian	100-mm HE	3.5
Czechoslovakian	120-mm HE	4.5
Czechoslovakian	130-mm HE	5.2
North Korean	82-mm frag	1.2
Polish	122-mm frag	7.4
Yugoslavian	76 mm HE	1.6
Yugoslavian	82-mm HE	1.1
Yugoslavian	120-mm HE	6.9
Finnish	160-mm HE	9.3
French	105-mm HE*	7.1
French	120-mm HE***	9.7
French	155-mm HE	17.5
Israeli	81-mm HE	4.9
Israeli	88-mm HE	1.9
Italian	81-mm HE	4.9

***Heavy .

EXAMPLES USING THE DESIGN PROCEDURE

WOOD STRINGER ROOF

Problem

The 2-76th Infantry is about to relieve another battalion from defensive positions as shown in [figure B-4](#). The 1st Platoon of the A/52d Engineers is supporting the 2-76th. As its platoon leader, you have been asked to find how much protection such positions give against the contact burst of an HE round.

You first estimate that the 16-inch-deep soil cover (sand) weighs 100 lb/cf. You then note that the roof is made of 4 by 4 stringers, laid side-by-side over a span of 88.75 inches.

Wood Stringer Roof Procedure

1	The soil unit weight (lb/cf) is	100
2	The depth of soil cover (ft) is	$\frac{16\text{in} + 12\text{in}}{12} = 1.33$
3	From Table B-2, the S value (in ³) for 4 x 4s is	7.15
4	Since the 4 x 4s are laid side by side, the stringer spacing (in) is equal to their actual width or 3.5 in	3.5
5	From Table B-3, the FS value (psi) for Southern Pine is	6,000
6	The stringer span length (ft) is	$\frac{88.75\text{in}}{12} = 7.4$
7	Line 1 x line 4 = 100 x 3.5 =	350
8	Line 7 x line 2 = 350 x 1.33 =	465.5
9A	Line 8 x line 6 = 465.5 x 7.4 =	3,444.7
9B	Line 9A x line 6 = 3,444.7 x 7.4 =	25,490.78
9C	Line 9B ÷ 8 = 25,490.78 ÷ 8 =	3,186.35

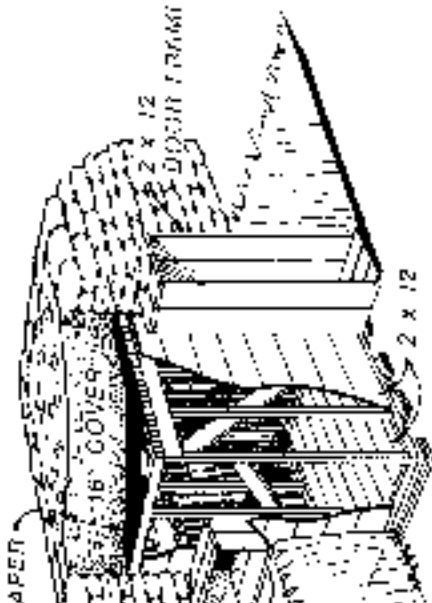

PICTORIAL

ITEM	UNIT	Q. REQ. (LBS)
2"x2"x1'	EA	9
2"x12"x10'	EA	50
4"x4"x8'	EA	45
4"x6"x10'	EA	7
4"x6"x10'	EA	2
8d NAILS	LR	19
16d NAILS	LR	13
80d NAILS	LB	15
SANDBAGS	EA	100
ROOF PAPER	SQ. FT.	80

NOTES
 1. SIMPLY SUPPORTED SPAN OF 4 x 4 IS 88.5"
 2. DIM-FR IS 8.5" WITH 1" YELLOW PLY

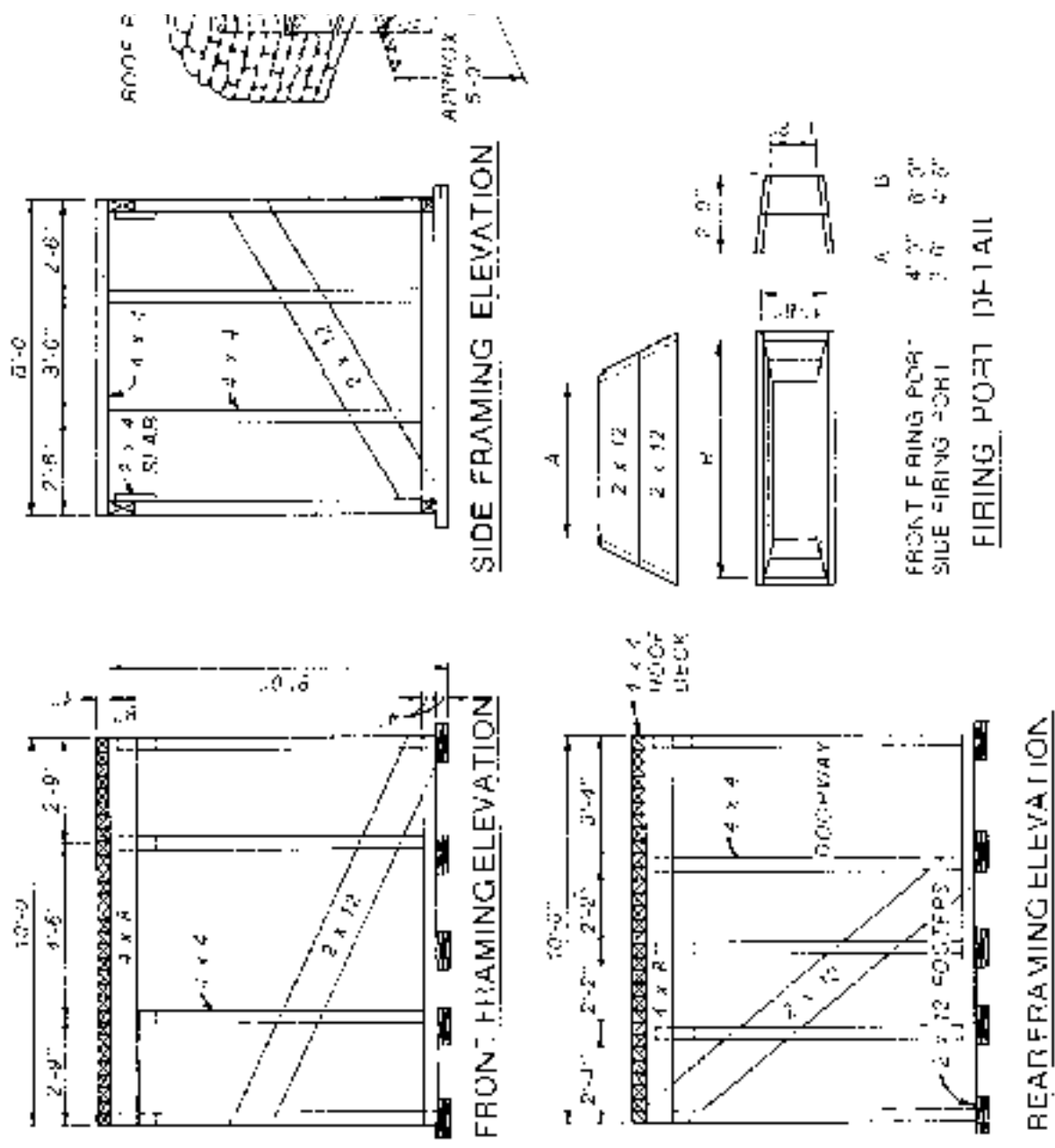

Figure B-4

9D	Line 9C : line 3 = $3,186.35 : 7.15 =$	<u>445.64</u>
9E	Line 9D : line 5 = $445.64 : 6,000 =$	<u>0.0743</u>
9F	Line 9E value 0.0743 is greater than 0 and less than 1.0, therefore proceed to line 10.	
10	From Figure B-2 using the $\mu = \tau$ curve, the line 10 value is (see example in Figure B-5)	<u>0.93</u>
11	From Table B-3, the E value (10^6 psi) for Southern Pine is	<u>1.76</u>
12A	From Table B-2, the I value (in^4) for 4 x 4s is	<u>12.51</u>
12B	Line 9A x 0.08333 = $3,444.7 \times 0.08333 =$	<u>287.05</u>
12C	Line 12B x 0.64 = $287.05 \times 0.64 =$	<u>183.71</u>
12D	Line 12C : line 9E = $183.71 : 0.0743 =$	<u>2,472.6</u>
13	Line 9A x 0.0001078 = $3,444.7 \times 0.0001078 =$	<u>0.371</u>
14A	Line 12A x line 11 = $12.51 \times 1.76 =$	<u>22.0176</u>
14B	Line 6 x line 6 = $7.4 \times 7.4 =$	<u>54.76</u>
14C	Line 14B x line 6 = $54.76 \times 7.4 =$	<u>405.22</u>
14D	Line 14A : line 14C = $22.0176 : 405.22 =$	<u>0.05433</u>
14E	Line 14D x 28,472.22 = $0.05433 \times 28,472.22 =$	<u>1,547.02</u>
15	Line 14E : line 13 = $1,547.02 : 0.371 =$	<u>4,169.87</u>
16	The square root of line 15 = $\sqrt{4169.87} =$	<u>64.57</u>
17	Line 12D : line 16 = $2,472.6 : 64.57 =$	<u>38.29</u>
18	Line 10 x line 17 = $38.29 \times 0.93 =$	<u>35.61</u>
19	Line 2 : line 6 = $1.33 : 7.4 =$	<u>0.1797</u>
20	Line 19 x line 19 = $0.1797 \times 0.1797 =$	<u>0.0323</u>

21A	The square root of line 19 = $\sqrt{0.1797} =$	<u>0.4239</u>
21B	Line 21A x line 20 = $0.4239 \times 0.0323 =$	<u>0.0137</u>
22	$0.6666667 \div \text{line 21B} = 0.6666667 \div 0.0137 =$	<u>48.69</u>
23A	Line 20 x 4 = $0.0323 \times 4 =$	<u>0.1292</u>
23B	$1 + \text{line 23A} = 1 + 0.1292 =$	<u>1.1292</u>
24	$4 \div \text{line 23B} = 4 \div 1.1292 =$	<u>3.5423</u>
25A	The square root of line 24 = $\sqrt{3.5423} =$	<u>1.8821</u>
25B	The square root of line 25A = $\sqrt{1.8821} =$	<u>1.3719</u>
25C	Line 25B x line 24 = $1.3719 \times 3.5423 =$	<u>4.86</u>
26	Line 25C - line 22 = $4.86 - 48.69 =$	<u>53.55</u>
27	From Table B-1, the C value chosen for bagged pit run sand is	<u>140</u>
28A	$61.32 \times \text{line 18} = 61.32 \times 35.61 =$	<u>2,183.61</u>
28B	The square root of line 14C = $\sqrt{405.22} =$	<u>20.13</u>
28C	Line 28A x line 28B = $2,183.61 \times 20.13 =$	<u>43,955.97</u>
28D	Line 27 x line 4 = $140 \times 3.5 =$	<u>490</u>
28E	Line 28D x line 26 = $490 \times 53.55 =$	<u>26,239.5</u>
28F	Line 28C \div Line 28E = $43,955.97 \div 26,239.5 =$	<u>1.676</u>
29	Enter Figure B-3 with the line 28F value (1.68) and read the TNT charge weight (lb) (see example in Figure B-2)	<u>1.56</u>

Or, as an alternate method, raise 1.68 to the 0.8571 power.

Solution

Thus, the largest TNT charge that the roof can withstand is 1.56 pounds. Entering [Table B-5](#) with this value, you find that the roof will withstand a contact burst explosion of up to an 82-mm frag round (only 1.0-pound charge size) excluding the 76-mm HE round (1.8-pound charge size).

STEEL STRINGER ROOF

Problem

The 2-76th Infantry will occupy the positions described in the first example for an extended period of time. Thus, the battalion commander has ordered the 1st Platoon of the A/52d Engineers to construct a tactical operations center. This structure must have at least 10 by 12 feet of floor space and be capable of defeating a contact burst of a Soviet 152-mm round. The S2 of the A/52d Engineers reports that 13 undamaged 8-inch by 6 ½-inch wide flange beams have been found. They are long enough to span 10 feet and can be salvaged from the remains of a nearby demolished railroad bridge.

As platoon leader, you are to design a roof for the tactical operations center using these beams as stringers. You plan to place five of the stringers on 36-inch centers and cover them with a 4 by 4 wood deck. You use the same bagged sand as described in the first example. You begin your design by assuming that the soil cover will be 3 feet deep.

Steel Stringer Roof Procedure

Line		
1	The soil unit weight (lb/cf) is	<u>100</u>
2	The assumed depth of soil cover (ft) is	<u>3</u>
3	From Table B 4, the S value (in ³) for the 8 x 6½ steel is	<u>20.8</u>
4	The stringer spacing (in) is	<u>36</u>
5	For steel stringers, the FS value (psi) is	<u>50,000</u>
6	The stringer span length (ft) is	<u>10</u>
7	Line 1 x line 4 = 100 x 36 =	<u>3,600</u>
8	Line 7 x line 2 = 3,600 x 3 =	<u>10,800</u>
9A	Line 8 x line 6 = 10,800 x 10 =	<u>108,000</u>
9B	Line 9A x line 6 = 108,000 x 10 =	<u>1,080,000</u>
9C	Line 9B ÷ 8 = 1,080,000 ÷ 8 =	<u>135,000</u>
Line		
9D	Line 9C ÷ line 3 = 135,000 ÷ 20.8 =	<u>6,490.38</u>
9E	Line 9D ÷ line 5 = 6,490.38 ÷ 50,000 =	<u>0.1298</u>
9F	Line 9E value 0.1298 is greater than 0 and less than 1.0, therefore	

proceed to line 10.

10	From Figure B-2 using the $\mu - 1C$ curve, the line 10 value is (see example in Figure B 1)	<u>4.05</u>
11	For steel stringers, the E value (10^6 psi) is	<u>29</u>
12A	From Table B-4, the I value (in^4) for the 8 x 6½ inch steel is	<u>82.5</u>
12B	Line 9A x 0.08333 = 103,000 x 0.08333 =	<u>8,999.64</u>
12C	Line 12B x 0.640 = 8,999.64 x 0.64 =	<u>5,759.77</u>
12D	Line 12C ÷ line 9E = 5,759.77 ÷ 0.1298 =	<u>44,374.19</u>
13	Line 9A x 0.0001078 = 108,000 x 0.0001078 =	<u>11.64</u>
14A	Line 12A x line 11 = 82.5 x 29 =	<u>2,392.5</u>
14B	Line 6 x line 6 = 10 x 10 =	<u>100</u>
14C	Line 14B x line 6 = 100 x 10 =	<u>1,000</u>
14D	Line 14A ÷ line 14C = 2,392.5 ÷ 1,000 =	<u>2.39</u>
14E	Line 14D x 28,472.22 = 2.39 x 28,472.22 =	<u>68,048.61</u>
15	Line 14E ÷ line 13 = 68,048.61 ÷ 11.64 =	<u>5,846.10</u>
16	The square root of line 15 = $\sqrt{5,846.10} =$	<u>76.56</u>
17	Line 12D ÷ line 16 = 44,374.19 ÷ 76.46 =	<u>580.36</u>
18	Line 10 x line 17 = 4.05 x 580.36 =	<u>2,350.46</u>
19	Line 2 ÷ line 6 = 3 ÷ 10 =	<u>0.3</u>
20	Line 19 x line 19 = 0.3 x 0.3 =	<u>0.09</u>
21A	The square root of line 19 = $\sqrt{0.3} =$	<u>0.5477</u>

Line 21B	Line 21A x line 20 = $0.5477 \times 0.09 =$	<u>0.0493</u>
22	$0.6666667 \div \text{line 21B} = 0.6666667 \div 0.0493 =$	<u>13.52</u>
23A	Line 20 x 4 = $.09 \times 4 =$	<u>0.36</u>
23B	1 + line 23A = $1 + 0.36 =$	<u>1.36</u>
24	4 \div line 23B = $4 \div 1.36 =$	<u>2.94</u>
25A	The square root of line 24 = $\sqrt{2.94} =$	<u>1.71</u>
25B	The square root of line 25A = $\sqrt{1.71} =$	<u>1.31</u>
25C	Line 25B x line 24 = $1.31 \times 2.94 =$	<u>3.85</u>
26	Line 25C + line 22 = $3.85 + 13.52 =$	<u>17.37</u>
27	From Table B-1, the C value chosen for the bagged pit run sand is	<u>140</u>
28A	$61.32 \times \text{line 18} = 61.32 \times 2.35048 =$	<u>144,130.21</u>
28B	The square root of line 14C = $\sqrt{1,000} =$	<u>31.62</u>
28C	Line 28A x line 28B = $144,130.21 \times 31.62 =$	<u>4,557,397.24</u>
28D	Line 27 x line 4 = $140 \times 36 =$	<u>5,040</u>
28E	Line 28D x line 26 = $5,040 \times 17.37 =$	<u>87,544.80</u>
28F	Line 28C \div Line 28E = $4,557,397.24 \div 87,544.80 =$	<u>52.06</u>
29	Enter Figure B-3 with the line 28F value (52.06) and read the TNT charge weight (lb) (see example in Figure B-2)	<u>29.6</u>

Or, as an alternate method, raise 52.06 to the 0.8571 power.

Solution

Thus, the largest TNT charge that the stringers can withstand is 29.6 lb. You next use the procedure again in a manner similar to that in example 1 to evaluate the 4x4 wood deck. You find a line 29 value of 29.64. Enter [Table B-5](#) with the largest of these values (29.6), you find that the roof will withstand a contact burst explosion of up to a 160-mm HE round (only 16.3-pound charge size). Thus, the roof you have designed will be capable of defeating a contact burst of a Soviet 152-mm round.

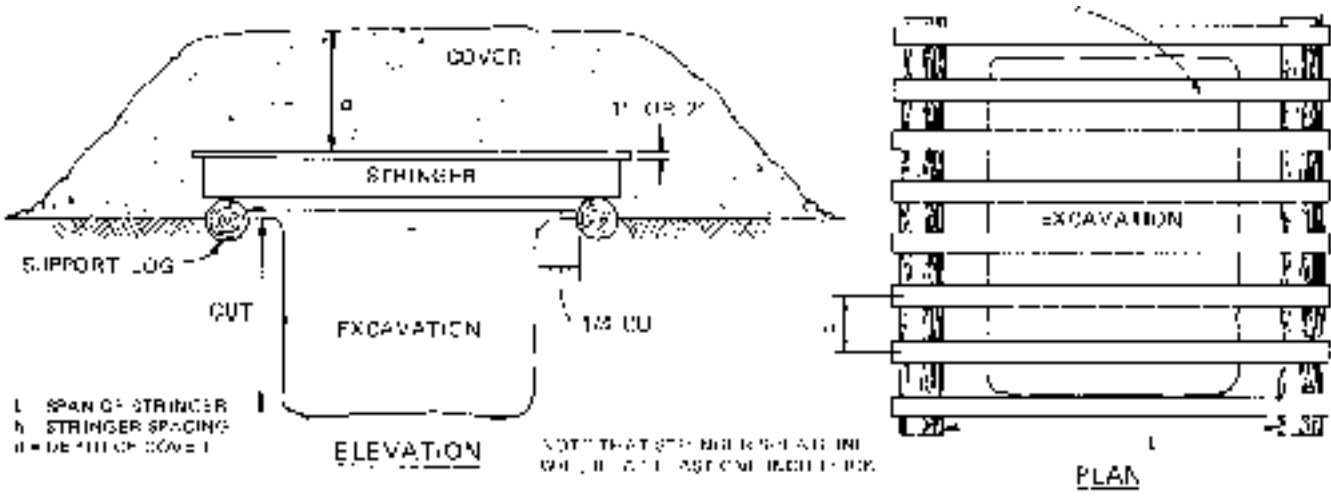

Figure B-1

Table B-1. Transmission coefficient (C) for different soil types

	Soil Type	C
SP	Loose, clean, white mason sand	260 - 700
SP	Loose, tan, pit run sand	60 - 475
SP	Loose, red, pit run gravelly sand	75 - 320
SP	Bagged, pit run sand	130 - 140
GP	Washed gravel, rounded	120
ML	Loose, sandy silt	125 - 275
ML	Compacted, sandy silt	350

**Table B-2. Moment of inertia (I) and section modulus (S)
for different timber sizes**

Nominal Size (inches)	Actual Size (inches)	X-X Axis		Y-Y Axis	
		I (inches ⁴)	S (inches ³)	I (inches ⁴)	S (inches ³)
2 x 4	1½ x 3½	5.36	3.08	0.98	1.31
2 x 6	1½ x 5½	20.80	7.56	1.55	2.06
2 x 8	1½ x 7¼	47.64	13.14	2.04	2.72
2 x 12	1½ x 11¼	177.98	31.64	3.16	4.22
4 x 4	3½ x 3½	12.51	7.15	12.51	7.15
4 x 6	3½ x 5½	48.53	17.65	19.65	11.23
4 x 8	3½ x 7¼	111.15	30.66	25.90	14.80
6 x 6	5½ x 5½	76.26	27.73	76.26	27.73
6 x 12	5½ x 11½	697.07	121.23	159.44	57.98
8 x 14	5½ x 13½	1,127.67	167.08	187.17	68.06
8 x 8	7½ x 7½	263.67	70.31	263.67	70.31
10 x 10	9½ x 9½	678.76	142.90	678.76	142.90

Note: Axis orientation is as shown here:

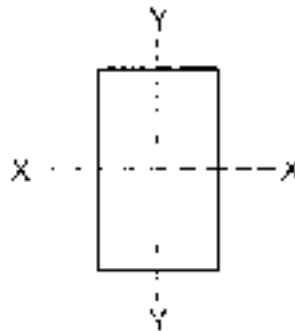

Table B-3. Modulus of elasticity (E) and maximum dynamic

Timber Species	E, 10⁶ psi	FS, psi
Cedar	1.10	2,200
Douglas fir	1.76	4,000
White fir	1.21	2,200
Eastern hemlock	1.21	2,600
Western hemlock	1.54	3,200
Larch	1.76	4,600
Southern pine	1.76	6,000
Ponderosa pine	1.10	1,800
Redwood	1.32	3,400
Spruce	1.10	2,900

Table B-4. Moment of inertia (I) and section modulus (S) for different steel wide flange members

Nominal Size, in.	X-X Axis		Y-Y Axis	
	I (inches ⁴)	S (inches ³)	I (inches ⁴)	S (inches ³)
36 x 16½	14,988.4	835.5	870.9	105.7
36 x 12	9,012.1	502.9	250.9	41.8
33 x 11½	6,699.0	404.8	201.4	35.0
30 x 15	7,891.5	528.2	550.1	73.4
30 x 10½	4,461.0	299.2	135.1	25.8
27 x 10	3,266.7	242.8	115.1	23.0
24 x 12	2,987.3	248.9	203.5	33.9
24 x 9	2,096.4	175.4	76.5	17.0
21 x 8½	1,326.8	126.4	53.1	12.9
18 x 7½	800.6	89.0	37.2	9.9
18 x 7	446.3	56.3	22.1	6.3
14 x 6¾	289.6	41.8	17.5	5.2
12 x 12	533.4	88.0	174.6	29.1
12 x 6½	204.1	34.1	16.6	5.1
10 x 10	272.9	54.6	93.0	18.6
10 x 5¾	106.3	21.5	9.7	3.4
8 x 8	109.7	27.4	37.0	9.2
8 x 6½	82.5	20.8	18.2	5.6
8 x 5½	56.4	14.1	6.7	2.6
6 x 6	53.5	16.8	17.1	5.6
4 x 4	11.3	5.45	3.76	1.85

Note: Axis orientation is

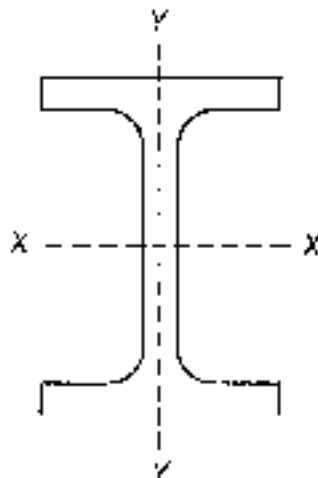

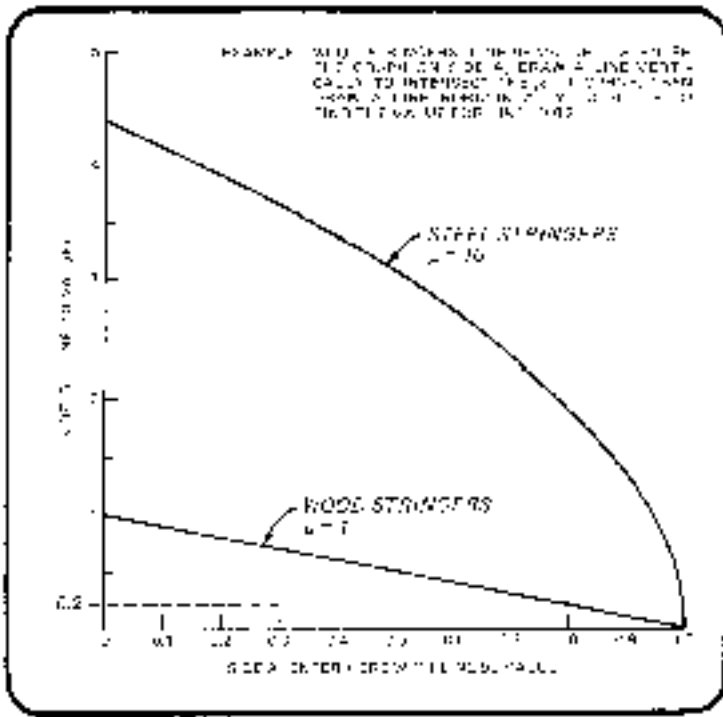

Figure B-2



[RDL](#)

[Table of](#)

[Document](#)

[Download](#)

[Homepage](#) [Contents](#) [Information](#) [Instructions](#)

[Table B-5: Charge Equivalency Table](#)

[Table B-5: \(continued\)](#)

Table B-5. Charge Equivalency Table

Round Nomenclature	Half-Buried TNT Charge Weight (pounds)
US Gun and Howitzer Cannons	
75-mm gun cannon	1.5
76-mm gun cannon	2.0
90-mm gun cannon	3.2
120-mm gun cannon	10.6
175-mm gun cannon	42.2
105-mm howitzer cannon	7.7
155-mm howitzer cannon	15.34
8-inch howitzer cannon	37.1
US Mortars	
81-mm	2.9
4.2-inch	3.1
Soviet	
57-mm frag	0.5
57-mm frag-T	0.4
76-mm HE	1.8
76-mm frag	1.1
82-mm frag	1.0
85-mm frag	1.7
100-mm HE	4.8
107-mm frag-HE	5.4
120-mm HE	8.5
122-mm HE	10.7
130 mm frag HE*	10.2
140-mm frag-HE	8.1
152-mm frag-HE	14.3
160-mm HE	16.3
People's Republic of China	
57-mm HE	0.5
60-mm HE**	4.6
70 mm HE	1.6
75-mm HE	2.2
81-mm HE	1.3
82-mm frag	1.1
102-mm HE	2.3

* Content of some rounds unknown.

** High capacity.

Table B-5. (continued)

Round Nomenclature	People's Republic of China (Continued)	Half Buried TNT Charge Weight, lb
105-mm HE		5.3
107-mm		3.0
120-mm HE		6.3
Others		
Czechoslovakian	82-mm frag	1.3
Czechoslovakian	85-mm frag	1.7
Czechoslovakian	100-mm HE	3.5
Czechoslovakian	120-mm HE	4.5
Czechoslovakian	130-mm HE	5.2
North Korean	82-mm frag	1.2
Polish	122-mm frag	7.4
Yugoslavian	76 mm HE	1.6
Yugoslavian	82-mm HE	1.1
Yugoslavian	120-mm HE	6.9
Finnish	160-mm HE	9.3
French	105-mm HEP	7.1
French	120-mm HE***	9.7
French	155-mm HE	17.5
Israeli	81-mm HE	4.9
Israeli	88-mm HE	1.9
Italian	81-mm HE	4.9

***Heavy .

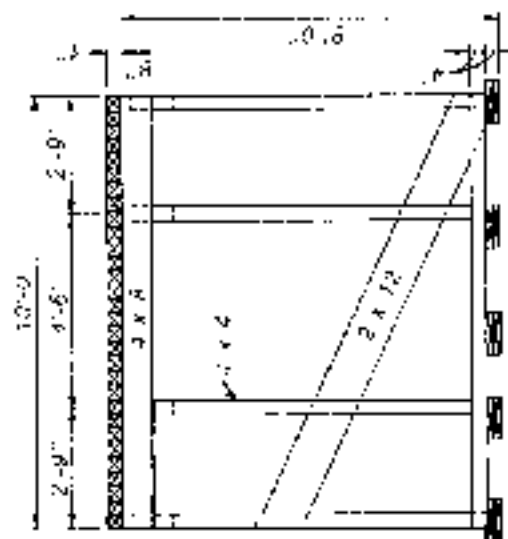

FRONT FRAMING ELEVATION

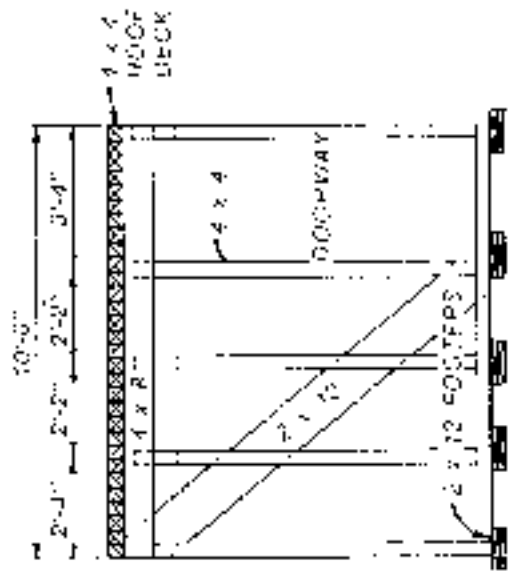

REAR FRAMING ELEVATION

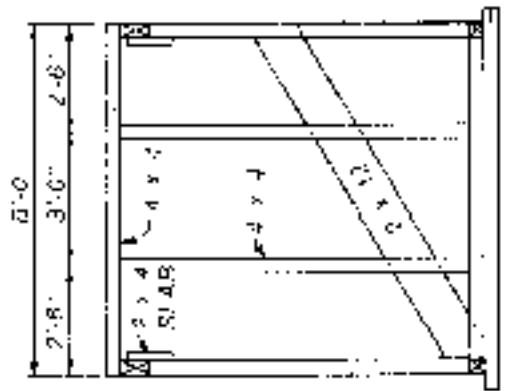

SIDE FRAMING ELEVATION

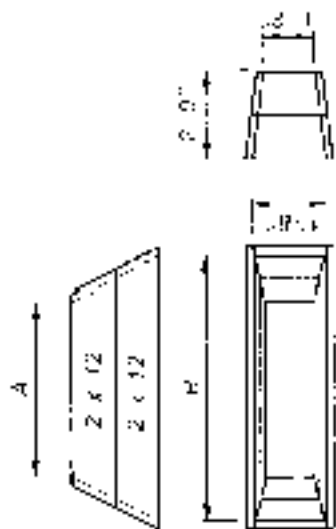

FRONT FIRING PORT 4'-0" 0'-0"
SIDE FIRING PORT 2'-0" 2'-0"
FIRING PORT DETAIL

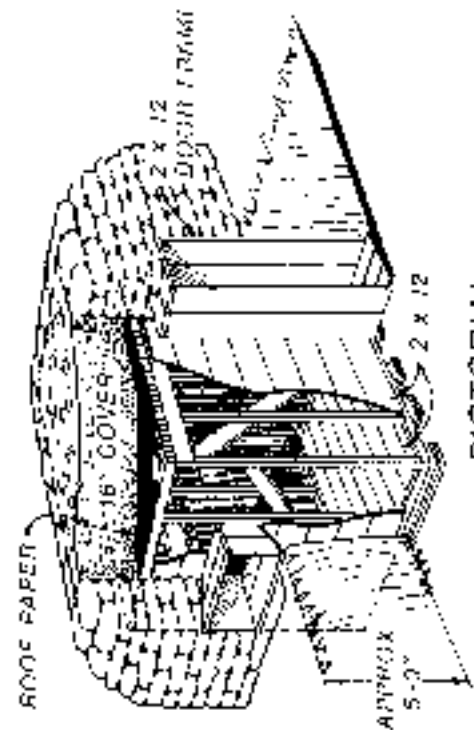

PICTORIAL

ITEM	UNIT	QUANTITY
2"x2"x1"	EA	9
2"x12"x0"	EA	50
4"x4"x8"	EA	45
4"x6"x10"	EA	2
1"x6"x10"	EA	2
9/16" NAILS	LR	19
16d NAILS	LR	10
20d NAILS	LB	15
SANDBAGS	EA	1000
ROOF PAPER	SQ FT	00

NOTES
 1. SIMPLY SUPPORTED SPAN OF 4 x 4 IS 88.33"
 2. 10-PH IS 8/1111 IN YELLOW PINE



Figure B-4

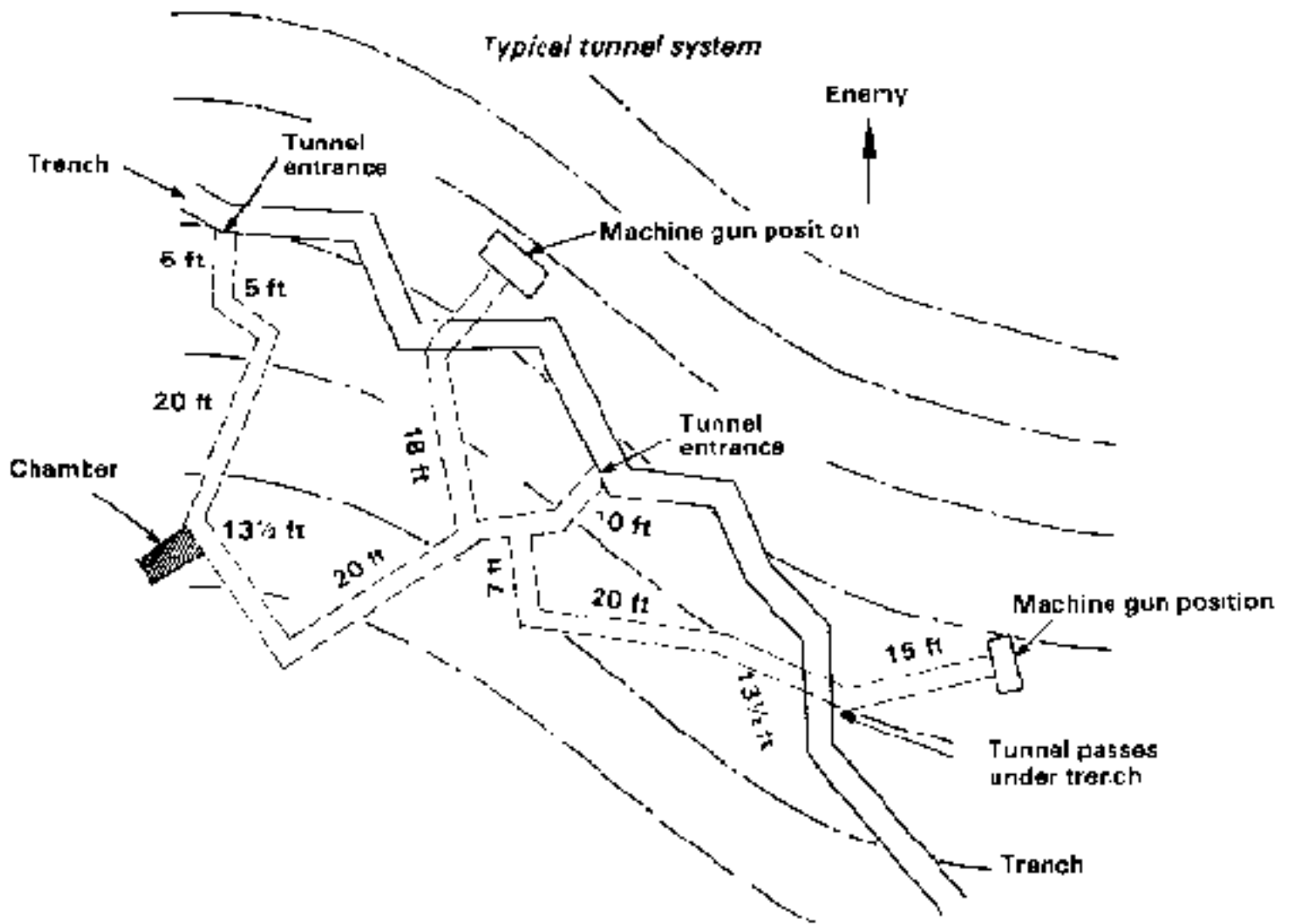

Parapets used for frontal protection relying on mutual support



Position with overhead cover protection against fragments from a 120-mm mortar

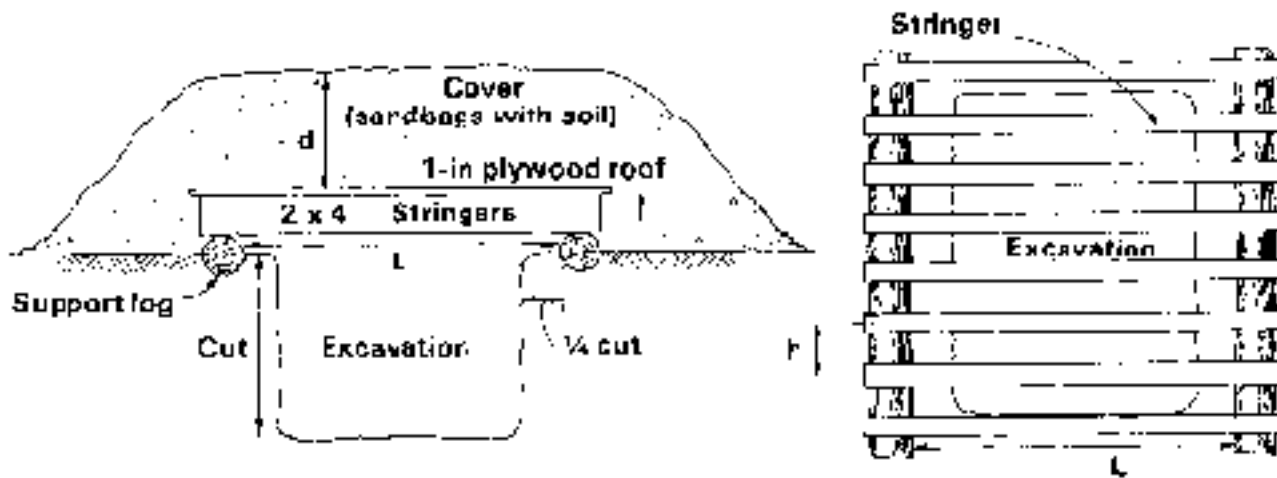

- L - Span of stringer (4 ft)
- F - Stringer spacing (16 in)
- d - Depth of cover (1 1/2 ft)

Typical standoff framing with dimensioned wood triggering screen

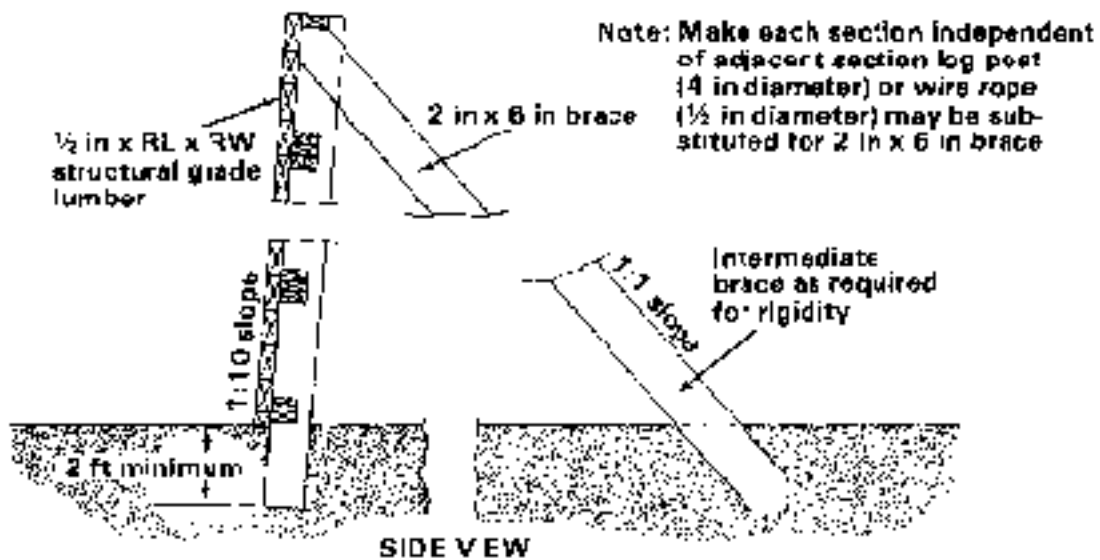
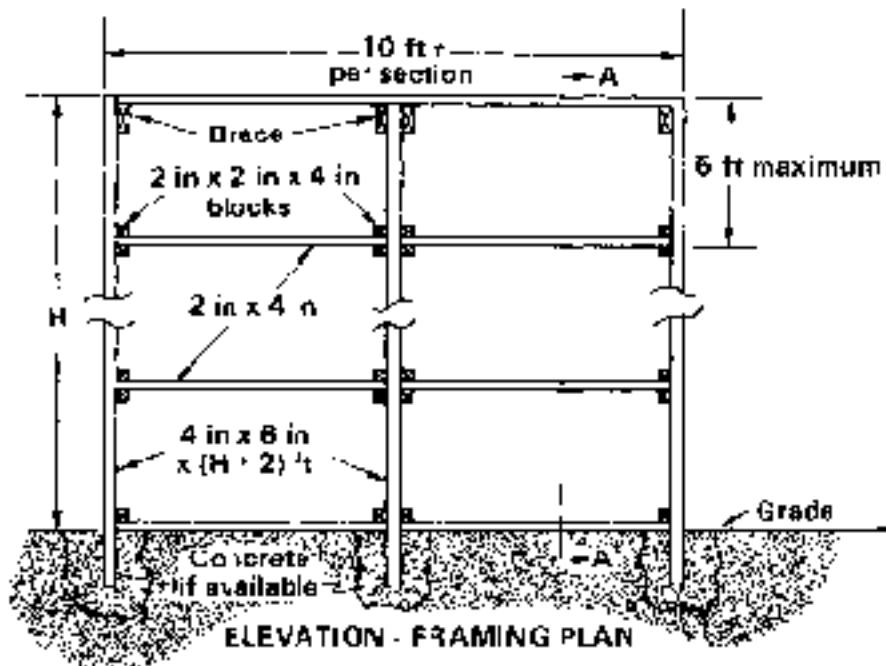

Triggering Screen Facing Material Requirements

Material	Triggering Requirements*
Plywood, dimensioned lumber	2 1/4-in thickness
Soil in sandbags with plywood or metal lacing	2-in thickness (24-gage sheet metal)
Structured steel (corrugated metal)	4-in thickness
Tree limbs	2-in diameter
Ammunition crates	1 layer (1-in-thick wood)
Snow	3 feet

* For detonating projectiles up to and including 120 mm mortar, rocket, and artillery shells.

Triggering Screen Material Thickness, in Inches, Required to Defeat Fragments at a 10-Foot Standoff

Material	Incoming Shell Size		
	82 mm	120 mm	122 mm
Soil	10	18	18
Soil, frozen	5	9	9
Sand	8	16	16
Clay	10	18	18
Steel (corrugated metal)	$\frac{1}{8}$	1	1
Wood (fir)	5	14	14
Concrete	2	2	3
Snow	60	80	80

Required Thickness, in Inches, of Protective Material to Resist Penetration of Different Shells (Delay Fuze)

Shells	Concrete*	Rock**	Rock Size (inches)
82-mm mortar	6	20	6½
120-mm mortar	20	36	9
122-mm rocket	50	40	10
122-mm artillery	68	40	10
130-mm artillery	80	42	10½

* 3,000 psi reinforced concrete.

** Rock must be relatively strong (compressive strength of about 20,000 psi) and in three layers for 82 mm; four layer for others.

Note: Due to the extreme thickness required for protection, materials such as earth, sand, and clay are not recommended.

Stone layer added to typical overhead cover to defeat the delay fuze burst from an 82-mm mortar

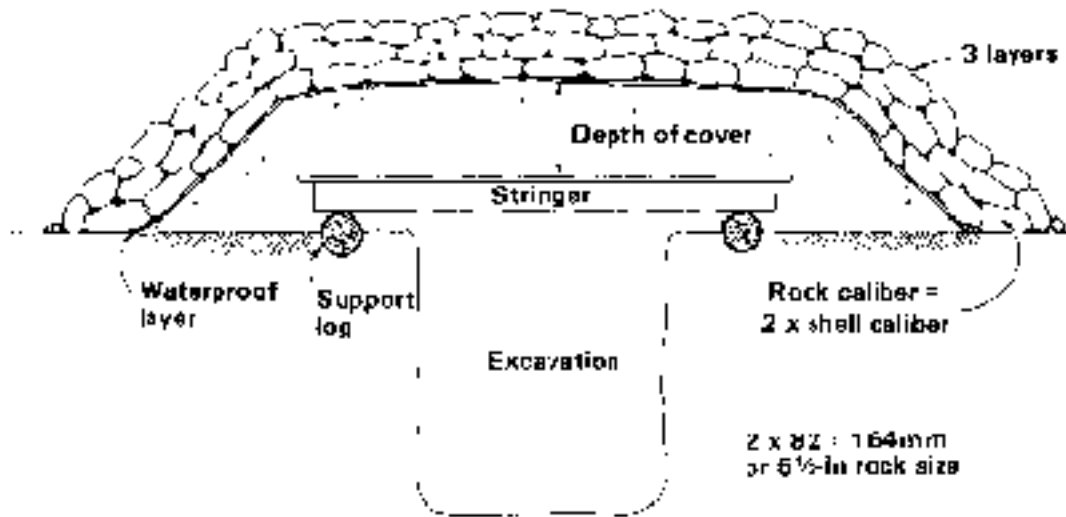

Chain link fence used for a standoff

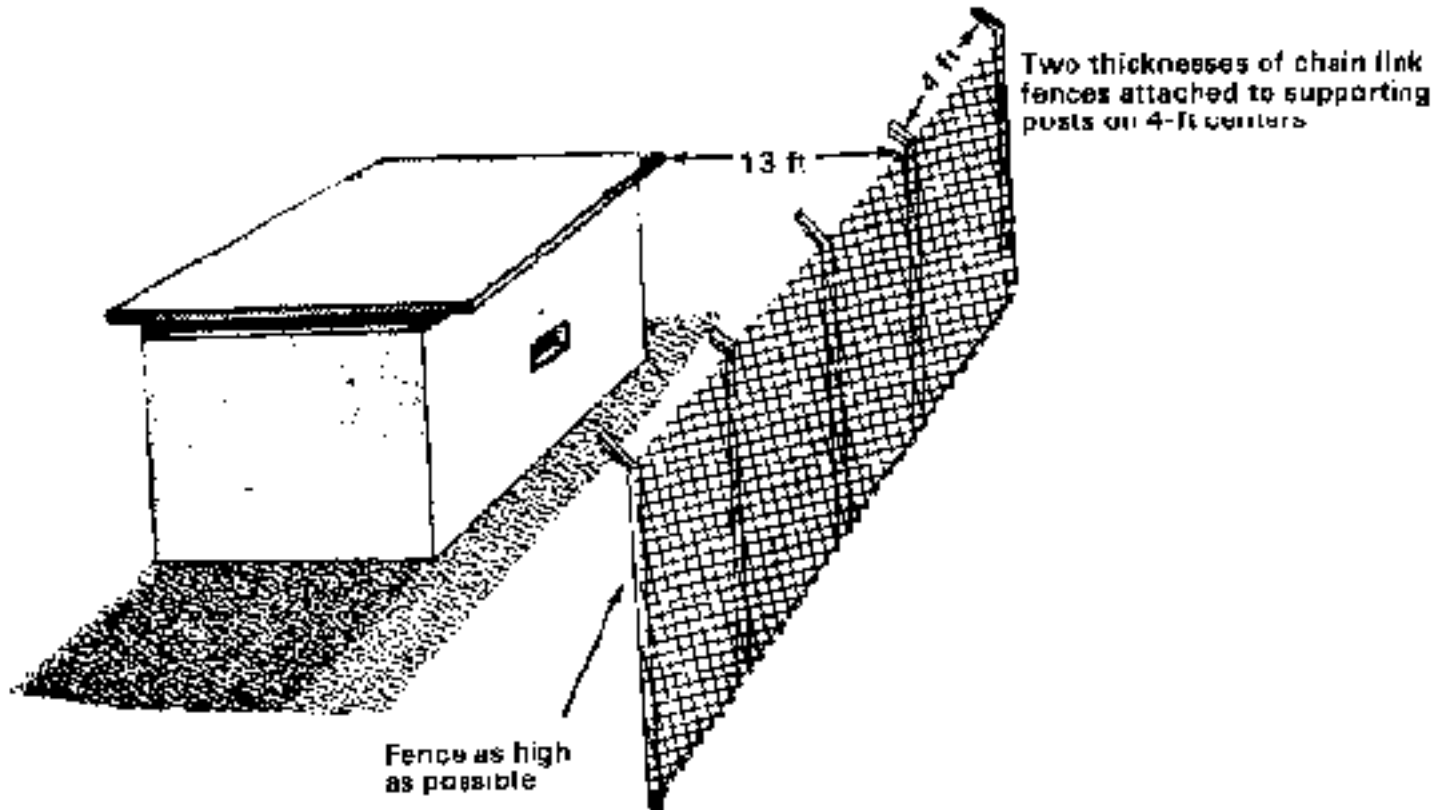



[RDL](#) [Table of](#) [Document](#) [Download](#)

[Homepage](#) [Contents](#) [Information](#) [Instructions](#)

APPENDIX A

SURVIVABILITY EQUIPMENT

This appendix contains powered survivability equipment used in engineer operations. The operational concepts and capabilities for each system are presented. The following [table](#) contains general excavation capabilities for survivability equipment. Outputs depend on operational efficiency, soil conditions, weather, and cycle time. Production estimates determine equipment required, completion time, and best performance methods for the project. [Technical Manuals 5-331A](#) and [5-331B](#) provide detailed information on estimates for production, loading, and hauling.

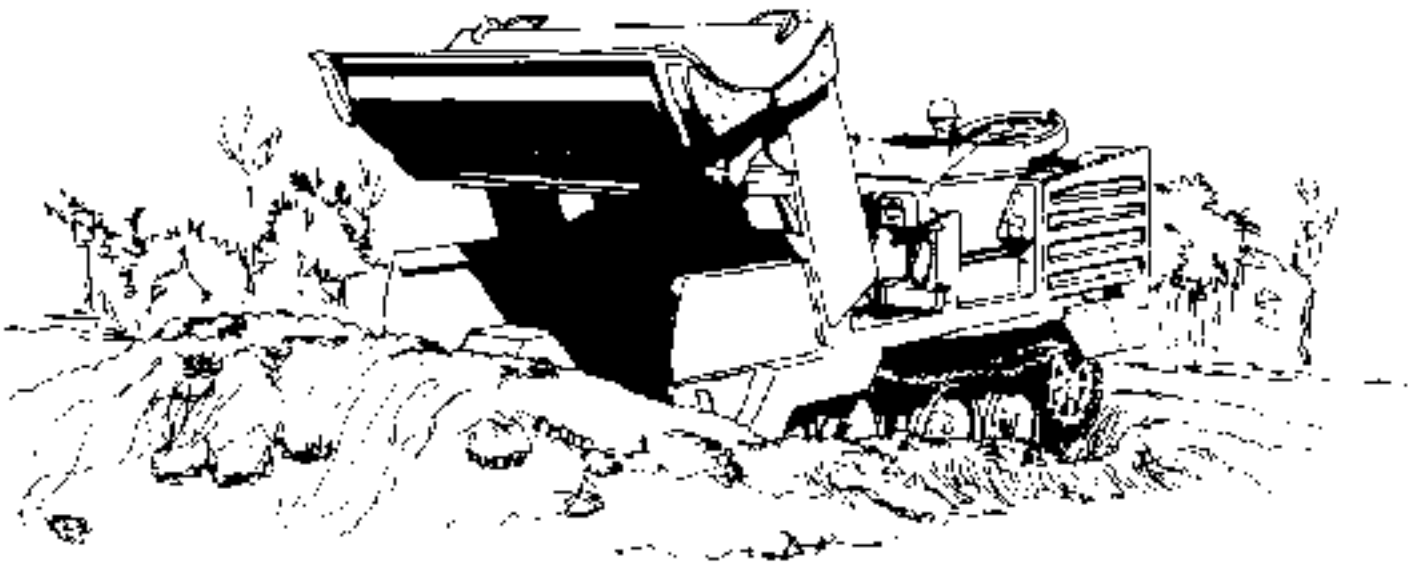

M9 Armored Combat Earthmover (ACE)

The M9 is a highly-mobile, armored, amphibious combat earthmover, capable of performing mobility, countermobility, and survivability tasks in support of light or heavy forces on the integrated battlefield. The vehicle hull is a welded and bolted aluminum structure with four basic compartments: engine compartment, operator's compartment, bowl, and rear platform. The bowl occupying the front half of the hull is the earth and cargo compartment. Directly behind the bowl are the operator's and engine/transmission compartments. Below the platform, in the rear quarter of the hull, is a two-speed winch with 25,000-pound capacity for recovery operations. A towing pintle and airbrake connections are provided for towing loads.

With track pads removed, the M9 has bulldozing and earthmoving characteristics comparable to the D7 dozer. The M9 is equipped with a unique hydropneumatic suspension system which allows the front of the vehicle to be raised, lowered, or tilted to permit dozing, excavating, rough grading, and ditching operations. A self-ballasting capability of the M9 gives it earthmoving characteristics equal to an item of equipment twice its empty weight. The M9 provides light armor and chemical agent protection for the operator, and armor protection for the operator, engine, power train, and other key components. It is capable of 30 miles per hour (mph) road speeds on level terrain, when unballasted, and can swim at 3 mph in calm water. The M9 is airtransportable by C130, C141, and C5A aircraft.

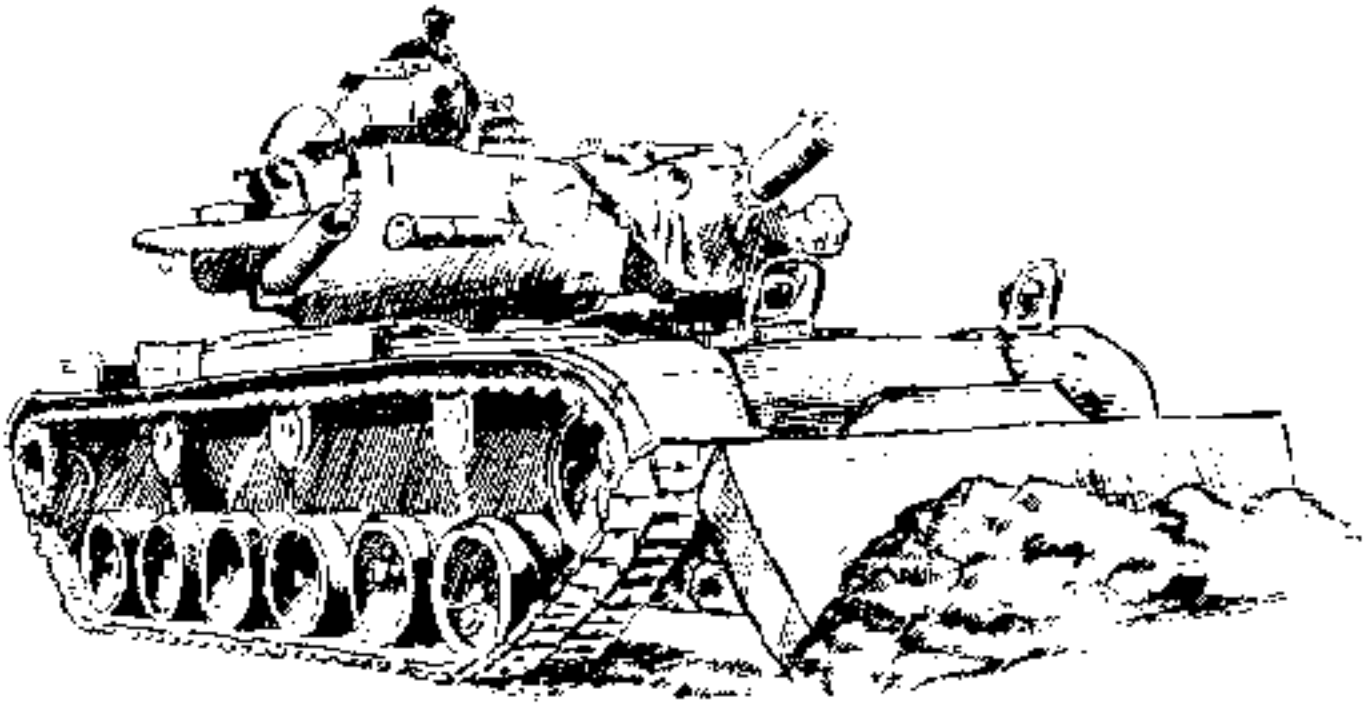

M728 Combat Engineer Vehicle (CEV)

The combat engineer vehicle (CEV) is a full-tracked armored vehicle which consists of a basic M60A1 tank with a front-mounted, hydraulically-operated dozer blade, surmounted by a turret bearing a 165-mm demolition gun, a retractable boom of welded tubular construction, and a winch. The demolition gun is operated from within the vehicle. The winch is housed on the rear of the turret and is used in conjunction with the boom to lift, or without the boom to provide direct pull. The vehicle and dozer blade are operated from the driver's compartment. The demolition gun may be elevated or depressed for use at various ranges of up to 950 meters. A .50-caliber machine gun is cupola-mounted, and a 7.62-mm machine gun is coaxially-mounted with the demolition gun.

The CEV provides engineer troops in the forward combat area with a

versatile, armor-protected means of performing engineering tasks under fire. Some of the tasks which are accomplished under fire by the CEV are: reducing roadblocks and obstacles; filling craters, tank ditches, and short, dry gaps; constructing combat trails; preparing fighting or protective positions; assisting in hasty minefield breaching; destroying fortifications; clearing rubble and debris, reducing banks for river crossing operations; and constructing obstacles.

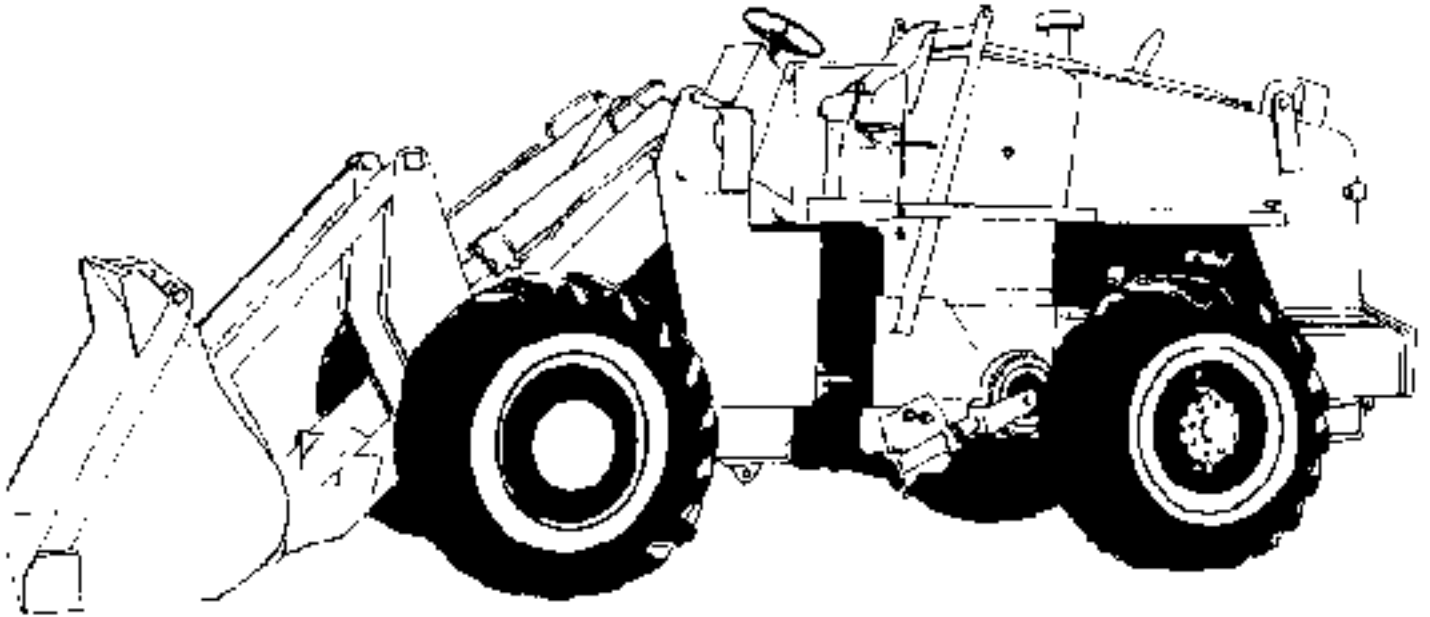

Scoop Loader

The scoop loader, sometimes referred to as a front loader or bucket loader, is a diesel engine-driven unit mounted on large rubber tires. The hydraulically-operated scoop bucket is attached to the front of the loader by a push frame and lift arms. The loader is used as a one-piece general purpose bucket, a rock bucket, or a multisegment (hinged jaw) bucket. The multisegment bucket is used as a clamshell, dozer, scraper, or scoop shovel. Other available attachments for the loader are the forklift, crank hook, and snowplow. The current military engineer scoop loaders range from 2 1/2 - to 5-cubic yard rated capacity, and are employed in the majority of engineer organizations including airborne/air assault units and the combat heavy battalion.

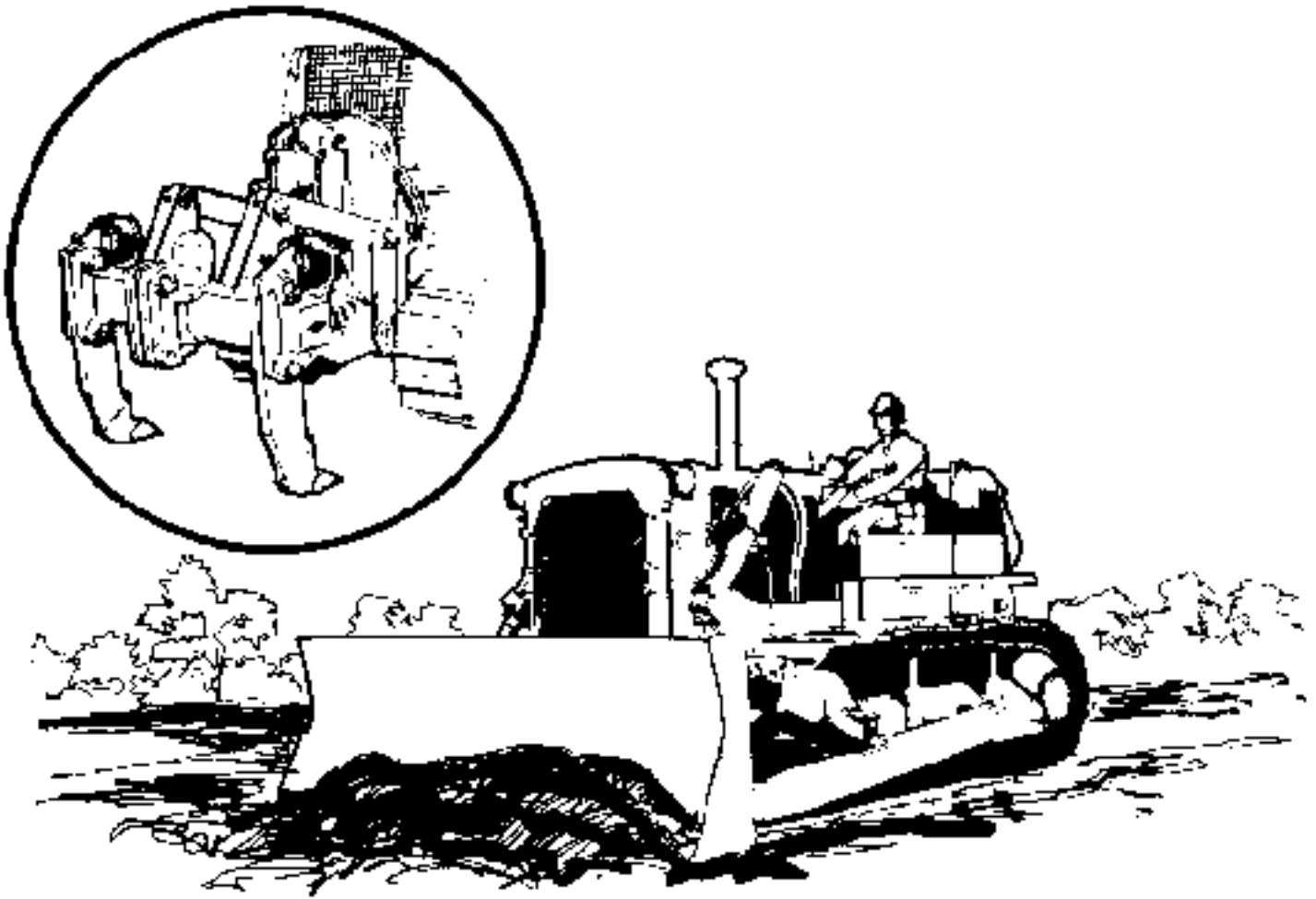

D7/D8 Crawler Tractors

The crawler tractor, commonly referred to as the bulldozer, is used for dozing, excavating, grading, land clearing, and various construction and survivability operations. The military models D7 and D8 tractors are equipped with a power shift transmission, hydraulically-operated dozer blade, and a rear-mounted winch or ripper. The D7 tractor with an operating weight of 50,000 pounds, 200 horsepower diesel engine, and drawbar pull of 39,000 pounds, is classified as a medium tractor. The D8 tractor with an operating weight of 83,000 pounds with ripper, 300 horsepower diesel engine, and drawbar pull of 56,000 pounds, is classified as a heavy tractor.

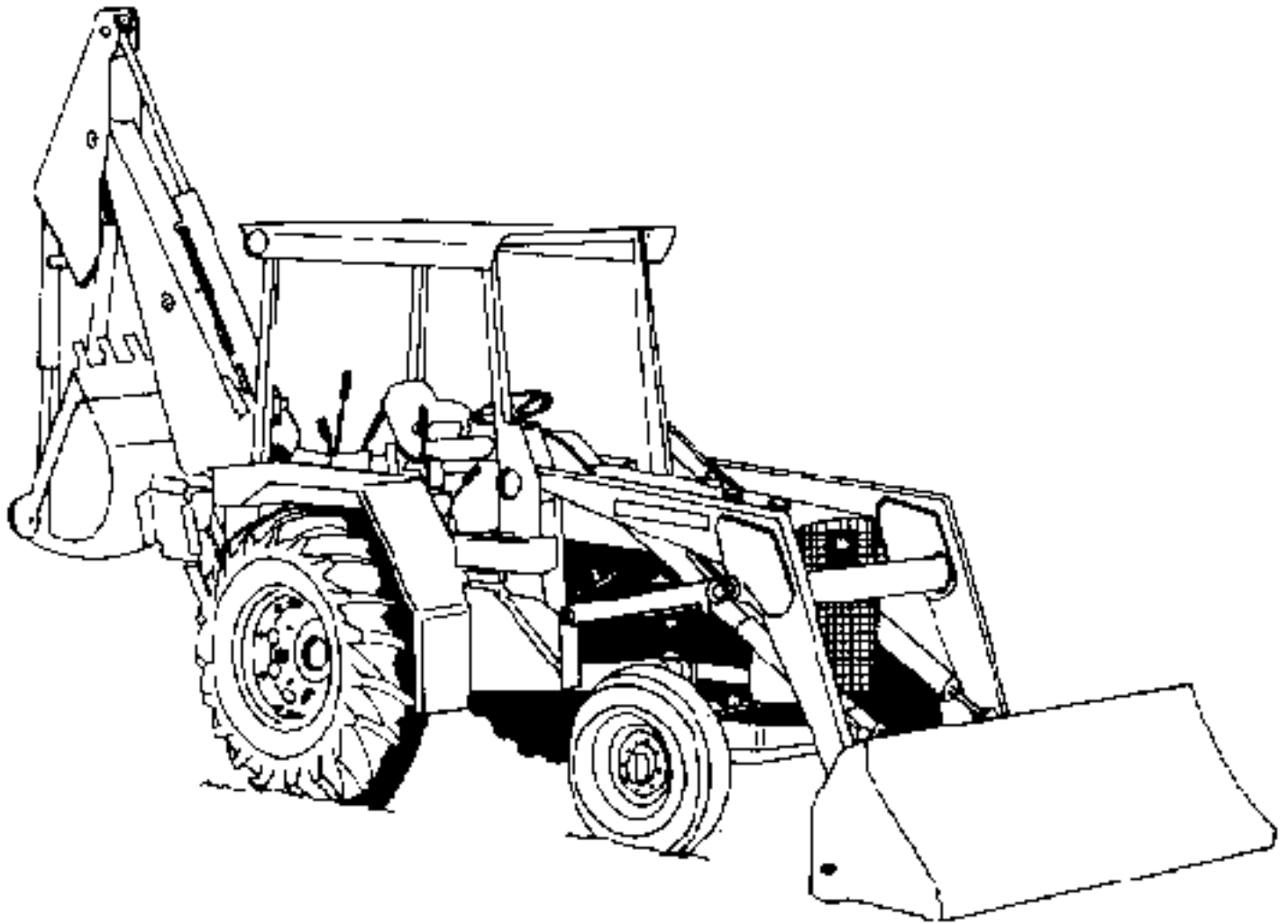

JD410 Utility Tractor

The John Deere (JD) 410 is a commercial piece of construction equipment used to excavate 2-foot wide ditches up to 15 feet deep. It also has a front loader bucket of 1 ¼-cubic yard capacity for backfilling ditches or loading material into dump trucks. The tractor has front wheel steer and rear wheel drive. The machine is also equipped with hydraulically-driven concrete breaker, tamper, and auger attachments. The tractor has a road speed of approximately 20 mph. For longer distances, the tractor is transported.



Small Emplacement Excavator (SEE)

The SEE is a highly mobile, all wheel drive, diesel engine-driven tractor equipped with a rear-mounted backhoe, a front-mounted dozer or loader, and portable hand-held auxiliary hydraulic tools such as pavement breakers, rock drills, and chain saws. The front-mounted attachments are interchangeable through a quick hitch mount, and the rear mounted backhoe is easily removed for rapid conversion to other configurations. The tractor is used to rapidly excavate small combat positions such as TOW weapon positions, individual fighting positions, mortar positions, and command posts in the main battle area. The weight of the tractor is limited to 16,000 pounds. The SEE tractor has improved road speeds up to 40 mph and cross-country speeds comparable to supported tracked or wheeled units. The tractor is equipped with a backhoe capable of excavating 14-foot depths at a rate of approximately 30 cubic yards per hour. The dozer and loader buckets provide defilade excavation capabilities in addition to other tasks such as loading or dozing.

Excavation Capabilities of US Survivability Equipment

Equipment	Excavation Capability, cubic yards per hour	
	Banked Material	Loose Material
Armored Combat Earthmover, M9	163	204
Scoop Loader	125	156
Tractor, full tracked, D3	50	60
Tractor, full tracked, D5	150	170
Tractor, full-tracked, D7E	165	211
Utility Tractor, JD410	30	40
Small Emplacement Excavator	30	40

Note: Rates are based on work performed in clayey sand soil with an operator efficiency of 0.83 and a 50-minute work hour over a short cycle distance.

Excavation Capabilities of US Survivability Equipment

Equipment	Excavation Capability, cubic yards per hour	
	Banked Material	Loose Material
Armored Combat Earthmover, M9	163	204
Scoop Loader	125	156
Tractor, full tracked, D3	50	60
Tractor, full tracked, D5	150	170
Tractor, full-tracked, D7G	168	211
Utility Tractor, JD410	30	40
Small Emplacement Excavator	30	40

Note: Rates are based on work performed in clayey sand soil with an operator efficiency of 0.83 and a 50-minute work hour over a short cycle distance.

Retaining wall revetment

Chokes and side seams in

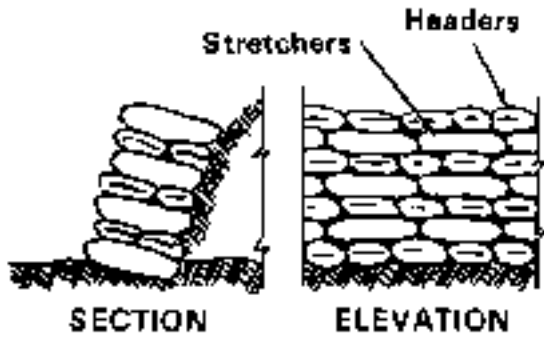

Joints broken



Stretchers and headers

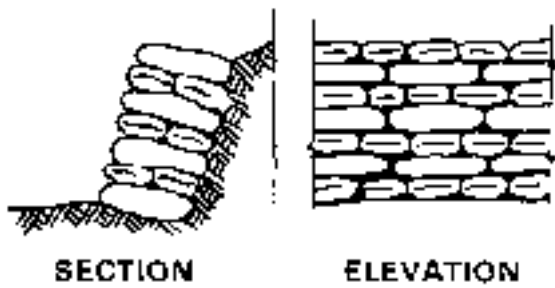

Expedient funnel for filling sandbags

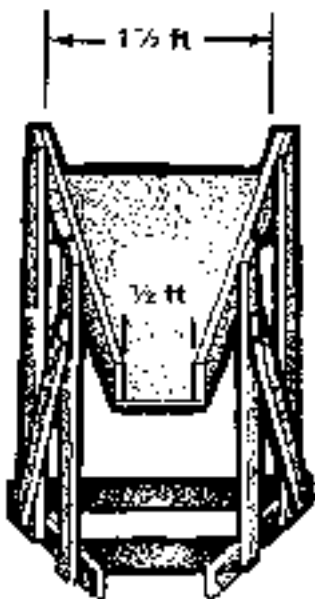
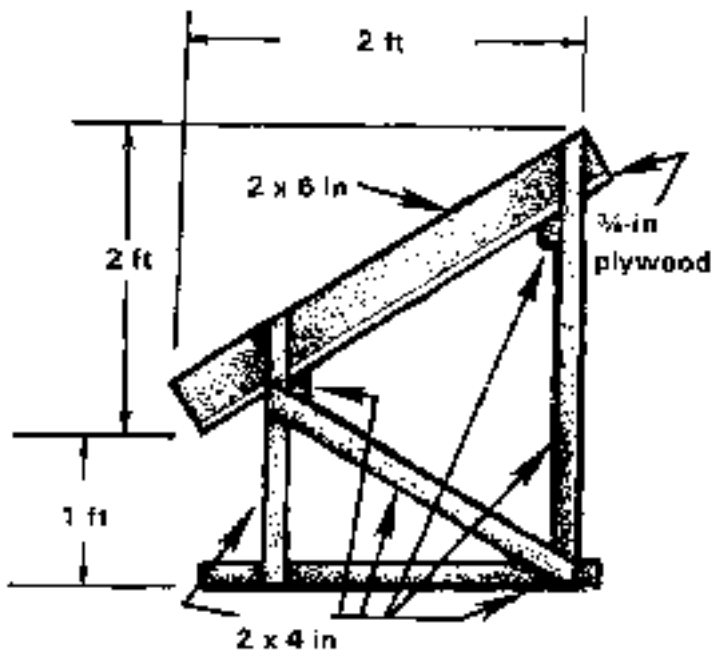

Average Breach Sizes Made by Shaped Charges

Material	Distance, in	Depth, ft	Diameter, in	Depth, ft	Diameter, in
Soil: deep-packed snow	30	7	7	-	-
	48	-	-	7	14
Frozen ground	30	6	3	-	-
	50	-	-	6	7
Ice	42	7	4	12	7

Amount of Explosive Required for Blasting Craters

Amount of Explosive Required for Blasting Craters

Depth of Borehole, ft	Pounds of Explosive
2	3
3	5
4	8
5	13

Boreholes for rectangular positions

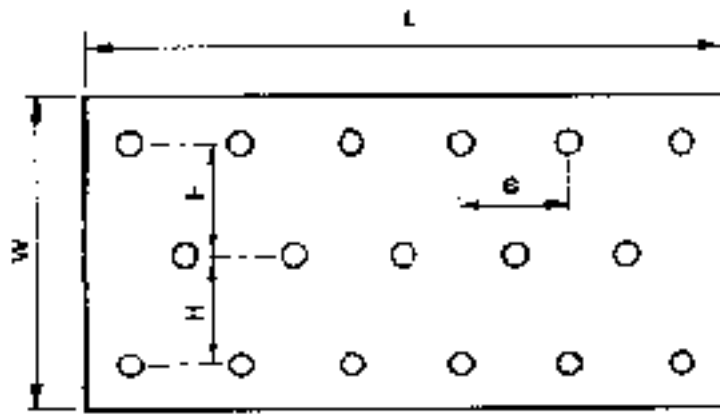

- L - Length
- W - Width
- S - Distance between holes in row
= $2x$ borehole depth
- H - Distance between rows
= $2x$ borehole depth

Boreholes for positions in flat terrain

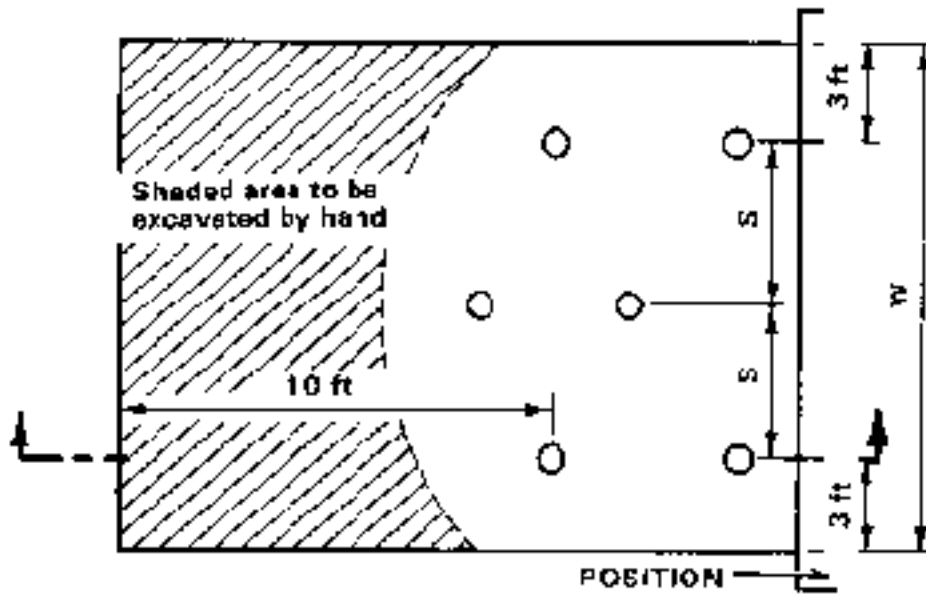

PLAN

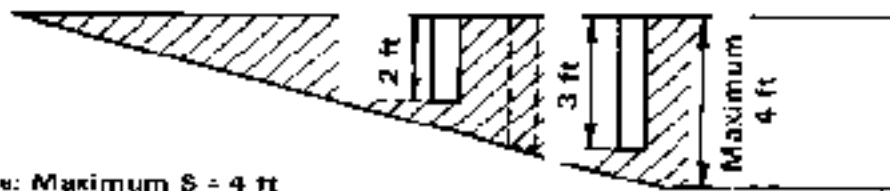

Note: Maximum S = 4 ft

SECTION

Boreholes for circular positions

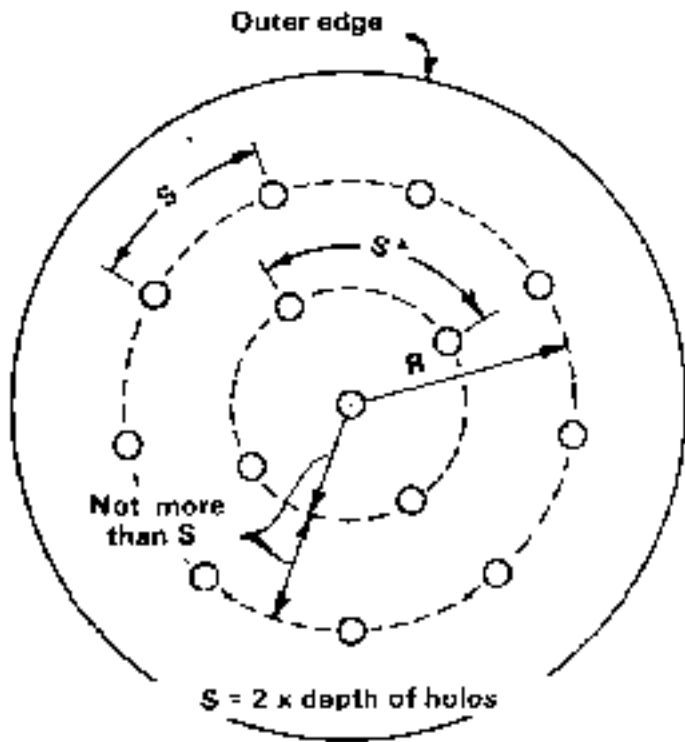

* Should not exceed 2 times depth of boreholes

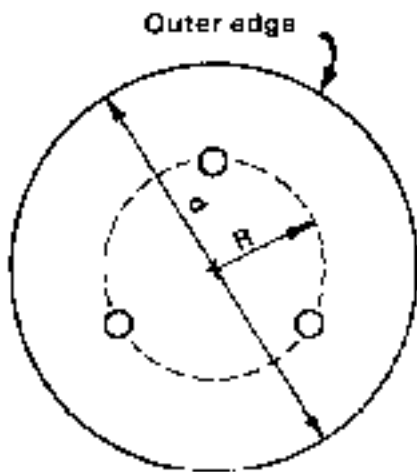

R = Radius of charge ring
d = Diameter

Facing revetment supported by timber frames

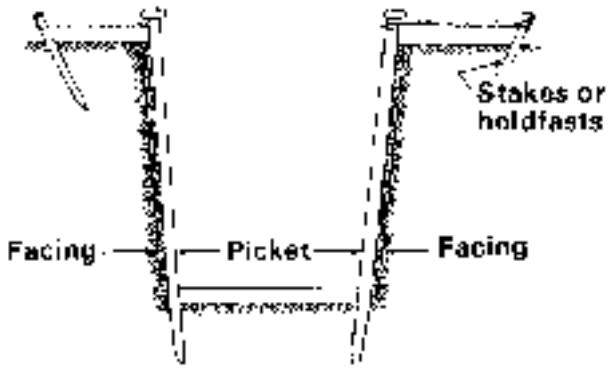
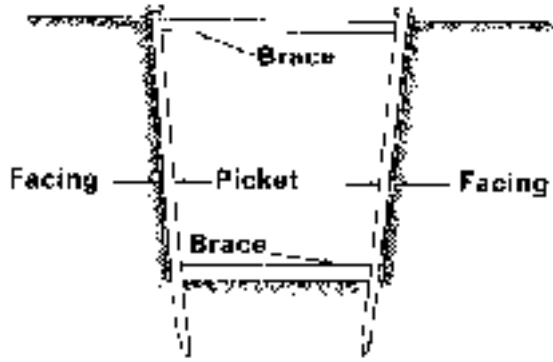

METHOD OF PLACING STAKES

Facing revetment supported by pickets

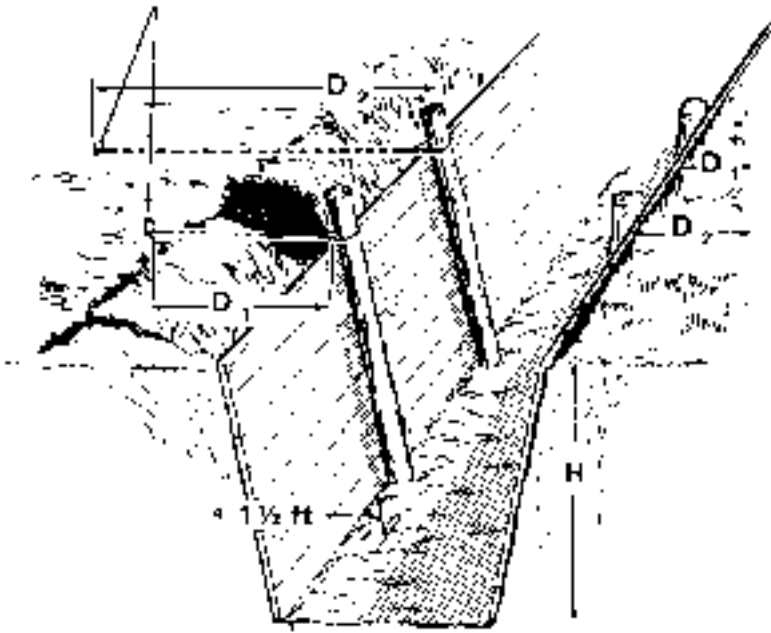

D_1 is equal to or greater than H
 D_2 is equal to $H + 2$ ft

METHOD OF ANCHORING PICKETS

Excavation repair

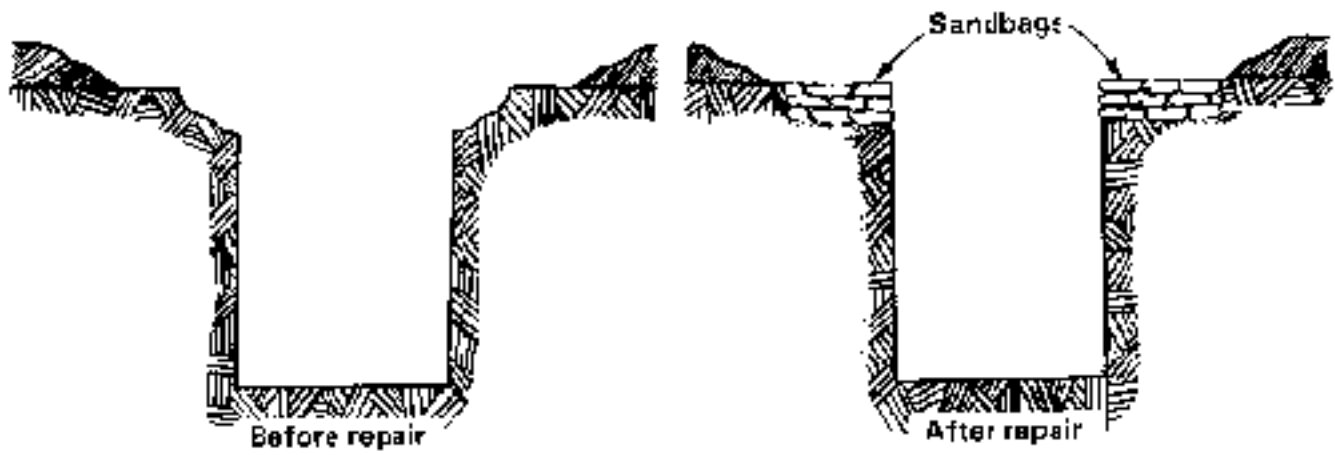

DAMAGE AT GROUND LEVEL

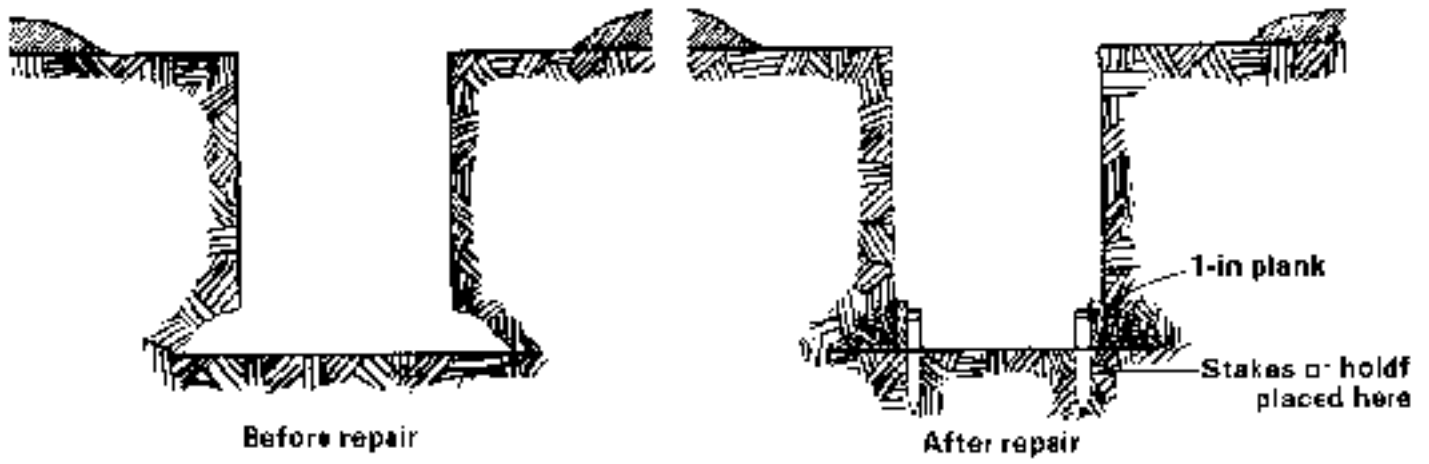

DAMAGE NEAR FLOOR LEVEL

[RDL](#)[Table of](#)[Document](#)[Download](#)[Homepage](#) [Contents](#) [Information](#) [Instructions](#)

CHAPTER 5

SPECIAL OPERATIONS AND SITUATIONS



The two basic operations involving US force deployment are combined and contingency. Combined operations are enacted in areas where US forces are already established, such as NATO nations. Where few or no US installations exist, usually in undeveloped regions, contingency operations are planned. In both cases, survivability missions will require intensive engineer support in all types of terrain and climate. Each environment's advantages and disadvantages are adapted to survivability planning, designing, and constructing positions. Fighting and protective positions in jungles, mountainous areas, deserts, cold regions, and urban areas require specialized knowledge, skills, techniques, and equipment. This chapter presents characteristics of five environments which impact on survivability missions and describes the conditions expected during combined and contingency operations.

SPECIAL TERRAIN ENVIRONMENTS

JUNGLES

Jungles are humid, tropic areas with a dense growth of trees and vegetation. Visibility is typically less than 100 feet, and areas are sparsely populated. Because mounted infantry and armor operations are limited in jungle areas, individual and crew-served weapons fighting position construction and use receive additional emphasis. While jungle vegetation provides excellent concealment from air and ground observation, fields of fire are difficult to establish. Vegetation does not provide adequate cover from small caliber direct fire and artillery indirect fire fragments. Adequate cover is available, though, if positions are located using the natural ravines and gullies produced by erosion from the area's high annual rainfall.

The few natural or locally-procurable materials which are available in jungle areas are usually limited to camouflage use. Position construction materials are transported to these areas and are required to be weather and rot resistant. When shelters are constructed in jungles, primary consideration is given to drainage provisions. Because of high amounts of rainfall and poor soil drainage, positions are built to allow for good, natural drainage routes. This technique not only prevents flooded positions but, because of nuclear fallout washing down from trees and vegetation, it also prevents positions from becoming radiation hot spots.

Other considerations are high water tables, dense undergrowth, and tree roots, often requiring above-ground level protective construction. A structure used in areas where groundwater is high, or where there is a low-pressure resistance soil, is the fighting position platform, depicted below. This platform provides a floating base or floor where wet or low pressure resistance soil precludes standing or sitting. The platform is constructed of small branches or timber layered over cross-posts, thus distributing the floor load over a wider area. As shown in the following [illustrations](#), satisfactory rain shelters are quickly constructed using easily-procurable materials such as ponchos or natural materials. [Field Manual 90-5](#) provides detailed information on jungle operations.

Stout, pliable reeds
laid across framework

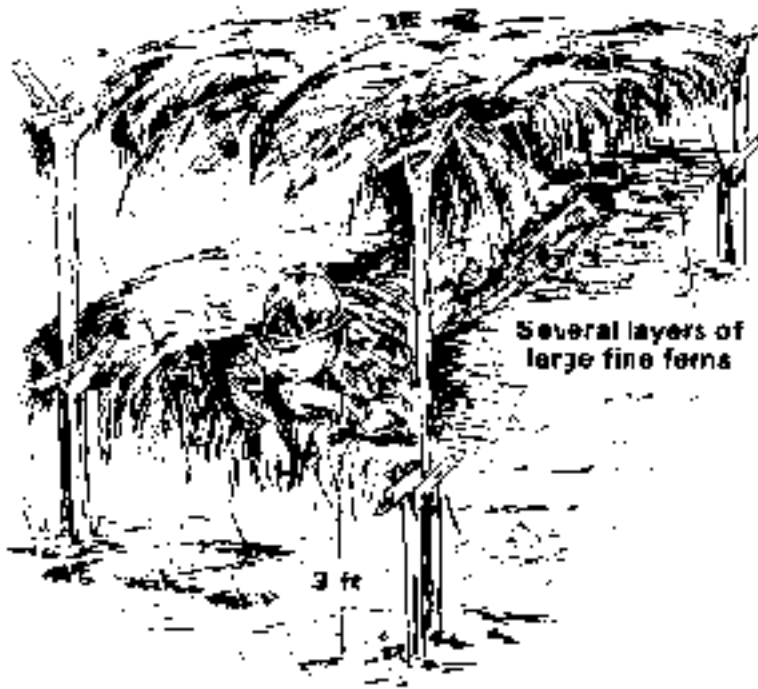

Poncho shelters

SINGLE PONCHO

A hasty shelter is made by suspending the poncho from low underbrush. Due to its simplicity, it can be easily erected at night, especially if heavy strings have already been tied to the corners of the poncho.



This is another hasty shelter pitched canopy fashion.

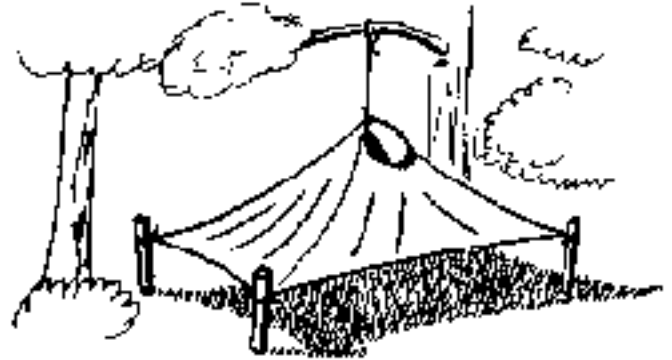

This is a hasty shelter using a poncho and branches for spreader bars.

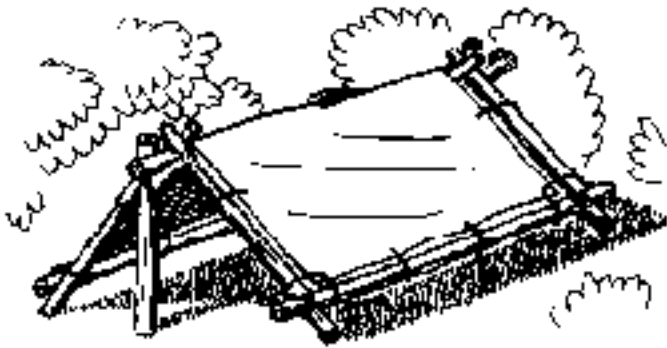

This low silhouette shelter can be used while improving fighting positions. It can be lowered by removing the front upright supports.

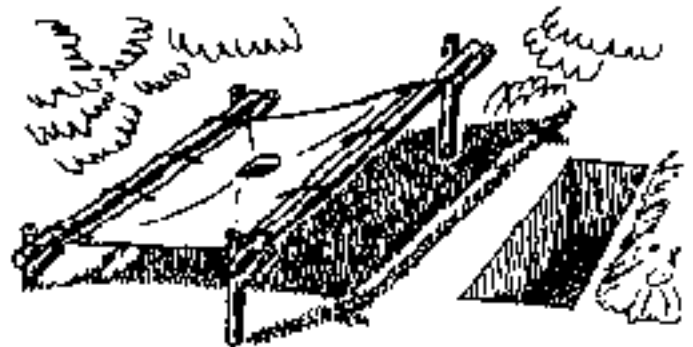

DOUBLE PONCHO

Two ponchos fastened together will shelter four soldiers from the rain. Extra ponchos can be used as ground sheets.

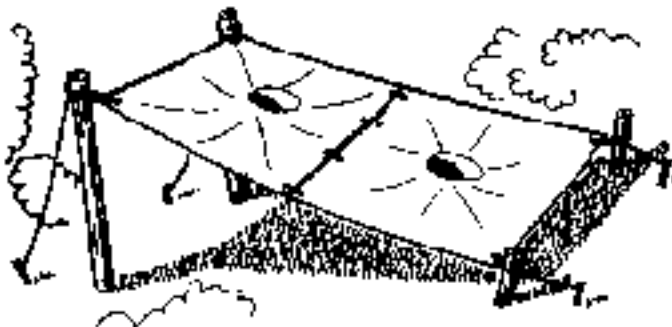

The following type of shelter may be used for a longer stay in more secure areas. A sleeping platform and footrest protect from dampness and insects.

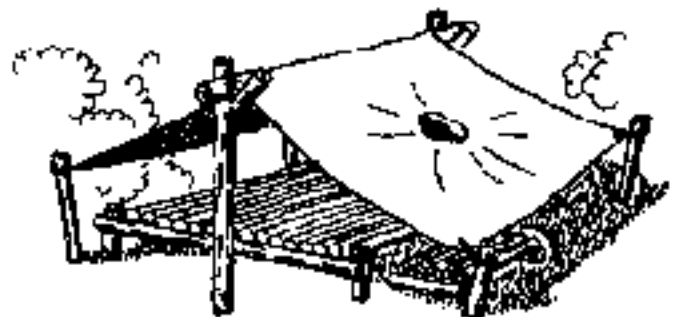

MOUNTAINOUS AREAS

Characteristics of mountain ranges include rugged, poorly trafficable terrain, steep slopes, and altitudes greater than 1,600 feet. Irregular mountain terrain provides numerous places for cover and concealment. Because of rocky ground, it is difficult and often impossible to dig below ground positions; therefore, boulders and loose rocks are used in aboveground construction. Irregular fields of fire and dead spaces are considered when designing and locating fighting positions in mountainous areas.

Reverse slope positions are rarely used in mountainous terrain; crest and near-crest positions on high ground are much more common. Direct fire weapon positions in mountainous areas are usually poorly concealed by large fields of fire. Indirect fire weapon positions are better protected from both direct and indirect fire when located behind steep slopes and ridges.

Another important design consideration in mountain terrain is the requirement for substantial overhead cover. The adverse effects of artillery bursts above a protective position are greatly enhanced by rock and gravel displacement or avalanche. Construction materials used for both structural and shielding components are most often indigenous rocks, boulders, and rocky soil. Often, rock formations are used as structural wall components without modification. Conventional tools are inadequate for preparing individual and crew-served weapons fighting positions in rocky terrain. Engineers assist with light equipment and tools (such as pneumatic jackhammers) delivered to mountain areas by helicopter. Explosives and demolitions are used extensively for positions requiring rock and boulder removal. [Field Manual 90-6](#) provides detailed information on mountain operations.

In areas with rocky soil or gravel, wire cages or gabions are used as building blocks in protective walls, structural walls, and fighting positions. Gabions are constructed of lumber, plywood, wire fence, or any suitable material that forms a stackable container for soil or gravel.

The two-soldier mountain shelter is basically a hole 7 feet long, 3 ½ feet wide, and 3 ½ feet deep. The hole is covered with 6--to 8-inch diameter logs with evergreen branches, a shelter half, or local material such as topsoil, leaves, snow, and twigs placed on top. The floor is usually covered with evergreen twigs, a shelter half, or other expedient material. Entrances can be provided at both ends or a fire pit is sometimes dug at one end for a small fire or stove. A low earth parapet is built around the position to provide more height for the occupants.

DESERTS

Deserts are extensive, arid, arid treeless, having a severe lack of rainfall and extreme daily temperature fluctuations. The terrain is sandy with boulder-strewn areas, mountains, dunes, deeply-eroded valleys, areas of rock and shale, and salt marshes. Effective natural barriers are found in steep slope rock formations. Wadis and other dried up drainage features are used extensively for protective position placement.

Designers of fighting and protective positions in desert areas must consider the lack of available natural cover and concealment. The only minimal cover available is through the use of terrain masking; therefore, positions are often completed above ground. Mountain and plateau deserts have rocky soil or "surface chalk" soil which makes digging difficult. In these areas, rocks and boulders are used for cover. Most often, parapets used in desert fighting or protective positions are undesirable because of probable enemy detection in the flat desert terrain. Deep-cut positions are also difficult to construct in soft sandy areas because of wall instability during excavations. Revetments are almost always required, unless excavations are very wide and have gently sloping sides of 45 degrees or less. Designing over-head cover is additionally important because nuclear explosions have increased fallout due to easily displaced sandy soil.

Indigenous materials are usually used in desert position construction. However, prefabricated structures and revetments for excavations, if available, are ideal. Metal culvert revetments are quickly emplaced in easily excavated sand, Sandbags and sand-filled ammunition boxes are also used for containing backsliding soil. Therefore, camouflage and concealment, as well as light and noise discipline, are important considerations during position construction. Target acquisition and observation are relatively easy in desert terrain. [Field Manual 90-3](#) provides detailed information on desert operations.

COLD REGIONS

Cold regions of the world are characterized by deep snow, permafrost, seasonally frozen ground, frozen lakes and rivers, glaciers, and long periods of extremely cold temperatures. Digging in frozen or semifrozen ground is difficult with equipment, and virtually impossible for the soldier with an entrenching tool. When possible, positions are designed to take advantage of below ground cover. Positions are dug as deep as possible, then built up. Fighting and protective position construction in snow or frozen ground takes up to twice as long as positions in unfrozen ground. Also, positions used in cold regions are affected by wind and the possibility of thaw during

warming periods. An unexpected thaw causes a severe drop in the soil strength which creates mud and drainage problems. Positions near bodies of water, such as lakes or rivers, are carefully located to prevent flooding damage during the spring melt season. Wind protection greatly decreases the effects of cold on both soldiers and equipment. The following areas offer good wind protection:

- Densely wooded areas.
- Groups of vegetation; small blocks of trees or shrubs.
- The lee side of terrain elevations. (The protected zone extends horizontally up to three times the height of the terrain elevation).
- Terrain depressions.

The three basic construction materials available in cold region terrain are snow, ice, and frozen soil. Positions are more effective when constructed with these three materials in conjunction with timber, stone, or other locally-available materials.

Snow

Dry snow is less suitable for expedient construction than wet snow because it does not pack as well. Snow piled at road edges after clearing equipment has passed densifies and begins to harden within hours after disturbance, even at very low temperatures. Snow compacted artificially, by the wind, and after a brief thaw is even more suitable for expedient shelters and protective structures. A uniform snow cover with a minimum thickness of 10 inches is sufficient for shelter from the weather and for revetment construction. Blocks of uniform size, typically 8 by 12 by 16 inches, depending upon degree of hardness and density, are cut from the snow pack with shovels, long knives (machetes), or carpenter's saws. The best practices for constructing cold weather shelters are those adopted from natives of polar regions.

The systematic overlapping block-over-seam method ensures stable construction. "Caulking" seams with loose snow ensures snug, draft-free structures. Igloo shelters in cold regions have been known to survive a whole winter. An Eskimo-style snow shelter, depicted below, easily withstands above-freezing inside temperatures, thus providing comfortable protection against wind chill and low temperatures. Snow positions are built during either freezing or thawing if the thaw is not so long or intense that significant snow melt conditions occur. Mild thaw of temperatures 1 or 2 degrees above freezing are more favorable than below-freezing temperatures because snow conglomerates readily and assumes any shape without disintegration. Below-freezing temperatures are also necessary for

snow construction in order to achieve solid freezing and strength. If water is available at low temperatures, expedient protective structures are built by wetting down and shaping snow, with shovels, into the desired forms.

Ice

The initial projectile-stopping capability of ice is better than snow or frozen soil; however, under sustained fire, ice rapidly cracks and collapses. Ice structures are built in the following three ways:

Layer-by-layer freezing by water. This method produces the strongest ice but, compared to the other two methods, is more time consuming. Protective surfaces are formed by spraying water in a fine mist on a structure or fabric. The most favorable temperature for this method is --10 to --15 degrees Celsius with a moderate wind. Approximately 2 to 3 inches of ice are formed per day between these temperatures (1/5-inch of ice per degree below zero).

Eskimo style snow shelter

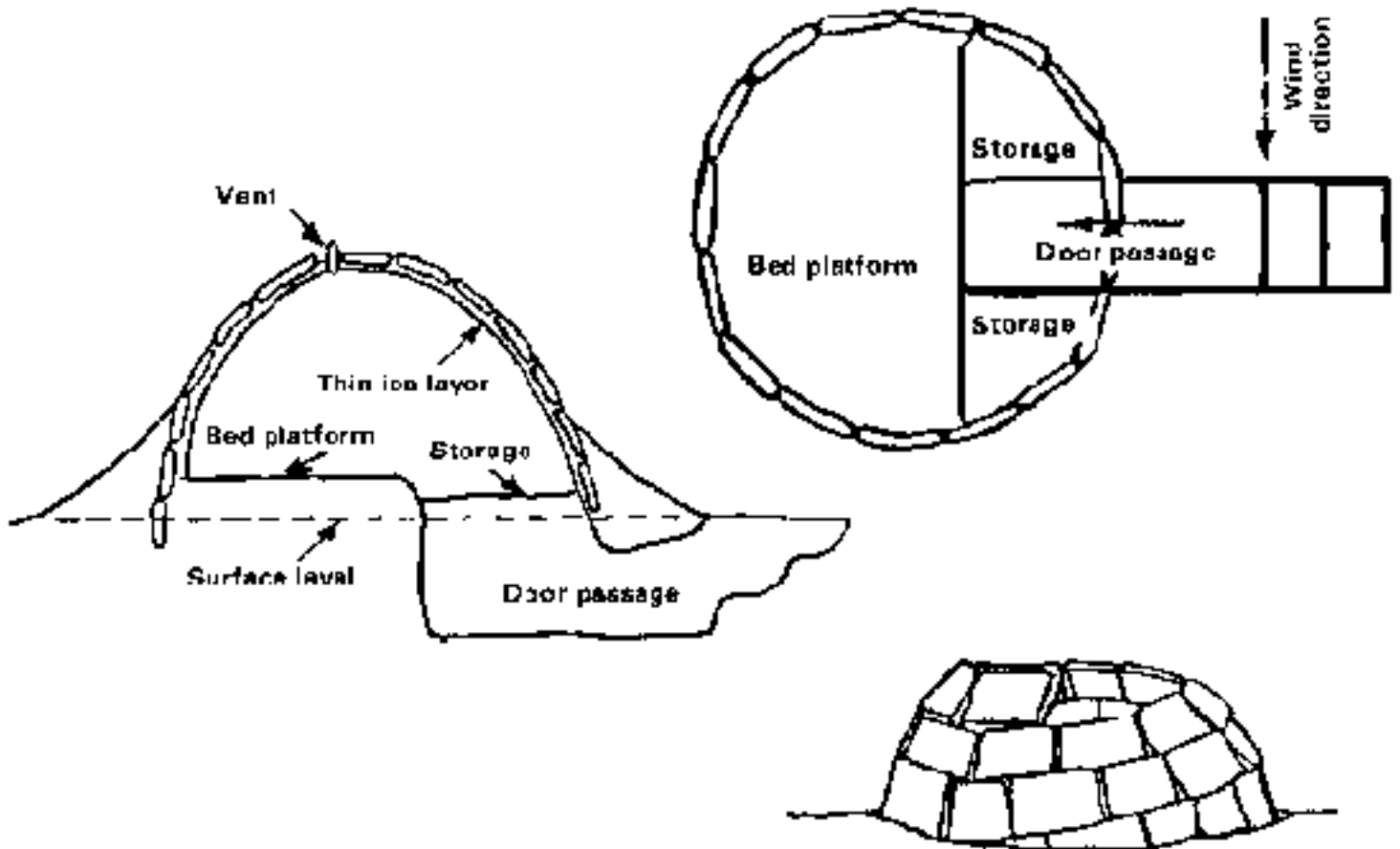

Freezing ice fragments into layers by adding water. This method is very effective and the most frequently used for building ice structures. The ice fragments are about 1-inch thick and prepared on nearby plots or on the nearest river or water reservoir. The fragments

are packed as densely as possible into a layer 8 to 12 inches thick. Water is then sprayed over the layers of ice fragments. Crushing the ice fragments weakens the ice construction. If the weather is favorable (-10 to -15 degrees Celsius with wind), a 16- to 24-inch thick ice layer is usually frozen in a day.

Laying ice blocks. This method is the quickest, but requires assests to transport the blocks from the nearest river or water reservoir to the site. Ice blocks, laid and overlapped like bricks, are of equal thickness and uniform size. To achieve good layer adhesion, the preceding layer is lightly sprayed with water before placing a new layer. Each new layer of blocks freezes onto the preceding layer before additional layers are placed.

Frozen Soil

Frozen soil is three to five times stronger than ice, and increases in strength with lower temperatures. Frozen soil has much better resistance to impact and explosion than to steadily-acting loads--an especially valuable feature for position construction purposes. Construction using frozen soil is performed as follows:

- Preparing blocks of frozen soil from a mixture of water and aggregate (icecrete).
- Laying prepared blocks of frozen soil.
- Freezing blocks of frozen soil together in layers.

Unfrozen soil from beneath the frozen layer is sometimes used to construct a position quickly before the soil freezes. Material made of gravel-sand-silt aggregate wetted to saturation and poured like portland cement concrete is also suitable for constructing positions. After freezing, the material has the properties of concrete. The construction methods used are analogous to those using ice. Fighting and protective positions in arctic areas are constructed both below ground and above ground.

Below ground positions. When the frost layer is one foot or less, fighting positions are usually constructed below ground, as shown. Snow packed 8 to 9 feet provides protection from sustained direct fire from small caliber weapons up to and including the Soviet 14.5-mm KPV machine gun. When possible, unfrozen excavated soil is used to form parapets about 2-foot thick, and snow is placed on the soil for camouflage and extra protection. For added frontal protection, the interior snow is reinforced with a log revetment at least 3 inches in diameter. The outer surface is reinforced with small branches to initiate bullet tumble upon impact. Bullets slow down very rapidly in snow after they begin to tumble. The wall of logs directly in front of the position safely absorbs the slowed tumbling bullet.

Overhead cover is constructed with 3 feet of packed snow placed atop a layer of 6-inch diameter logs. This protection is adequate to stop indirect fire fragmentation. A layer of small, 2-inch diameter logs is placed atop the packed snow to detonate quick fuzed shells before they become imbedded in the snow.

Aboveground positions. If the soil is frozen to a significant depth, the soldier equipped with only an entrenching tool and ax will have difficulty digging a fighting position. Under these conditions (below the tree line), snow and wood are often the only natural materials available to construct fighting positions. The fighting position is dug at least 20 inches deep, up to chest height, depending on snow conditions. Ideally, sandbags are used to revet the interior walls for added protection and to prevent cave-ins. If sandbags are not available, a lattice frame-work is constructed using small branches or if time permits, a wall of 3-inch logs is built. Overhead cover, frontal protection, and side and rear parapets are built employing the same techniques described in [chapter 4](#).

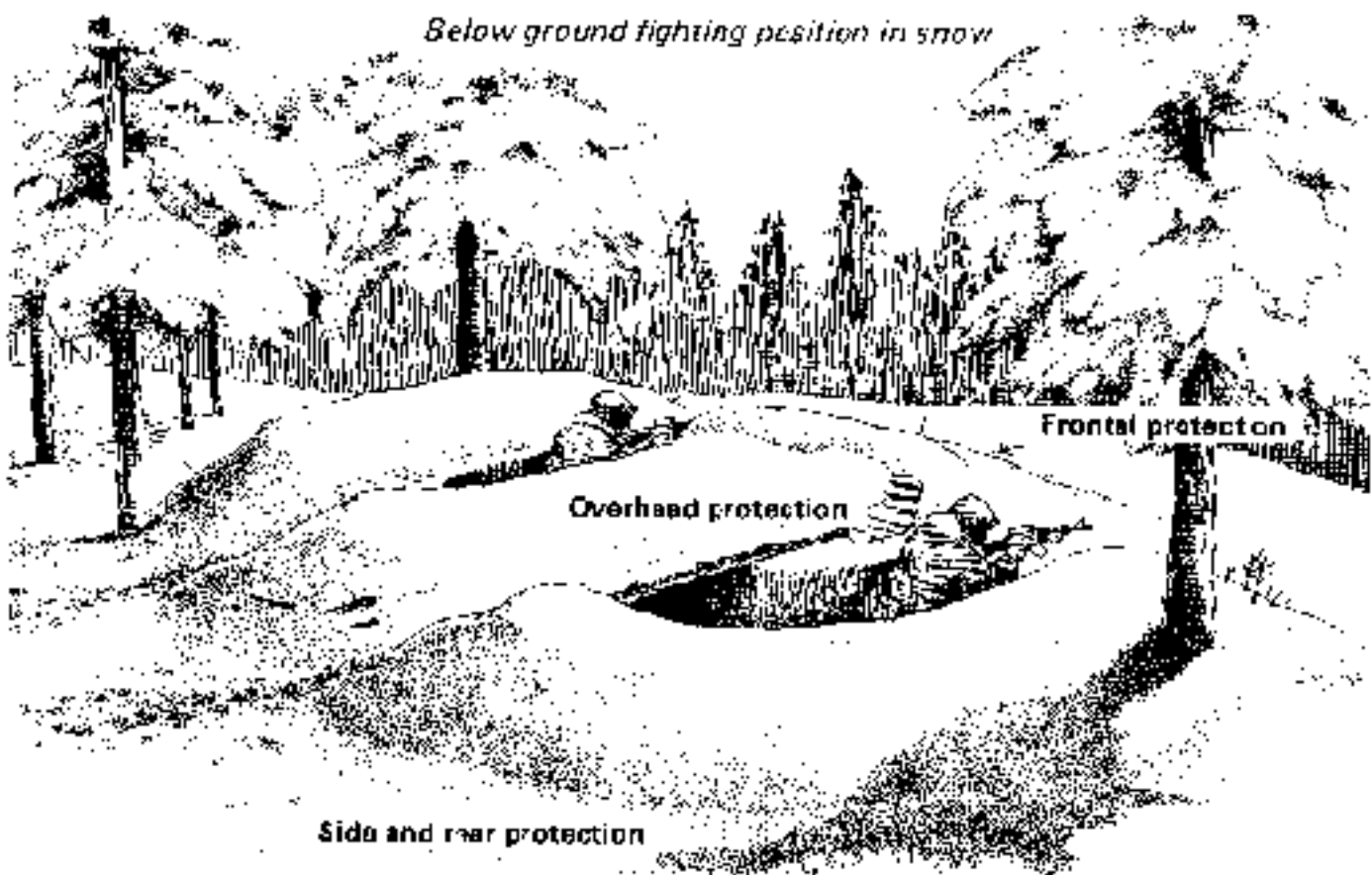

It is approximately ten times faster to build above-ground snow positions than to dig in frozen ground to obtain the same degree of protection. Fighting and protective positions constructed in cold regions are excavated with combined methods using handtools,

excavation equipment, or explosives. Heavy equipment use is limited by traction and maneuverability. Explosives are an expedient method, but require larger quantities than used in normal soil. Crater formation from surface bursts of explosives is possible and creates craters of a given depth and radius based on the information in the [first table below](#). Crater formation by charges placed in boreholes is a function of charge depth and charge weight [as shown in the second table](#). A 15- or 40-pound shaped charge creates boreholes as indicated in the following [table](#).

Crater Dimension (Surface Detonation)

	SNOW	Ice	Frozen Ground
Crater depth, ft	$1.2 \sqrt[3]{w}$	$0.9 \sqrt[3]{w}$	$0.6 \sqrt[3]{w}$
Crater radius, ft	$2.0 \sqrt[3]{w}$	$1.6 \sqrt[3]{w}$	$1.4 \sqrt[3]{w}$

Notes: (w) equals charge weight in pounds (untamped)

Verify calculations with test shots.

Crater Dimension (Using Boreholes)

	SNOW	Ice	Frozen Ground
Depth of charge, ft	$4.0 \sqrt[3]{w}$	$3.0 \sqrt[3]{w}$	$2.5 \sqrt[3]{w}$
Crater depth, ft	$5.1 \sqrt[3]{w}$	$3.3 \sqrt[3]{w}$	$2.7 \sqrt[3]{w}$
Crater radius, ft	$3.3 \sqrt[3]{w}$	$3.9 \sqrt[3]{w}$	$3.1 \sqrt[3]{w}$

Notes: (w) equals charge weight in pounds (untamped)

Verify calculations with test shots.

SPECIAL COLD REGION POSITIONS

Dismounted TOW and machine gun positions in snow

A platform of plywood or timber is constructed to the rear of the frontal protection to provide a solid base from which to employ the guns. Overhead cover is usually offset from the firing position because of the difficulty of digging both the firing and protective positions together in the snow. The protective position should have at least 3 feet of packed snow as cover. The fighting position should have snow packed 8 to 9 feet thick for frontal, and at least 2 feet thick for side protection as shown. Sandbags are used torevet the interior walls for added protection and to prevent cave-ins. However, packed snow, rocks, 4-inch diameter logs, or ammunition cans filled with snow are sometimes used to complete the frontal and overhead protection, as well as side and rear parapets.

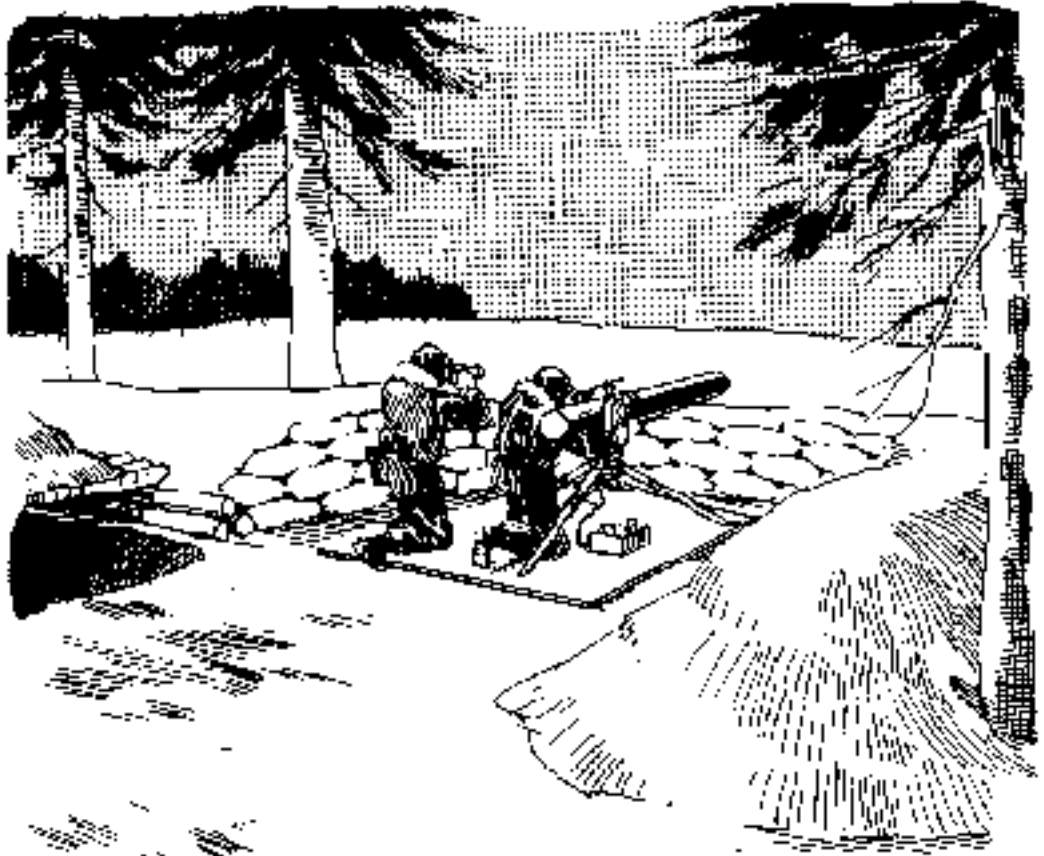

Individual fighting position in snow

Positions for individuals are constructed by placing packed snow on either side of a tree and extending the snow parapet 8 to 9 feet to the front, as illustrated. The side and rear parapets are constructed of a continuous snow mound, a minimum of 2 feet wide, and high enough to protect the soldier's head,

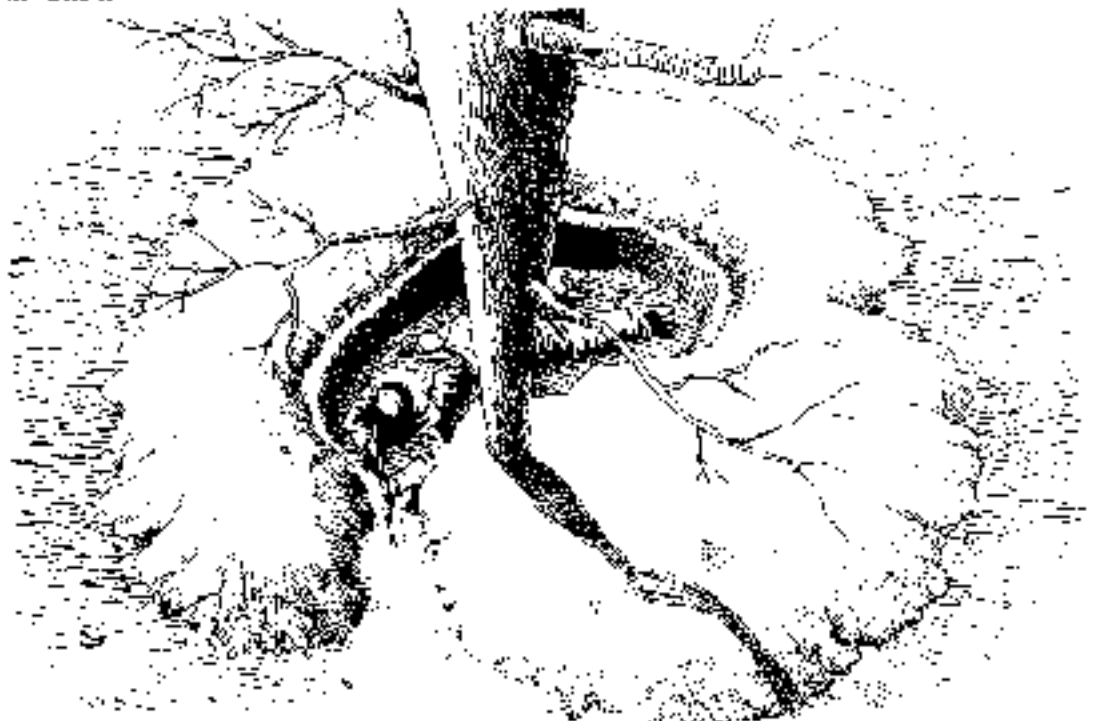

Snow trench with wood revetment

In deep snow, trenches and weapon positions are excavated to the dimensions outlined in chapter 4.

However, unless the snow is well packed and frozen, revetment is required. In snow too shallow to permit the required depth excavation, snow walls are usually constructed. The walls are made of compacted snow, revetted, and at least 6 1/2 feet thick. The table on page 5-12 contains snow wall construction requirements.

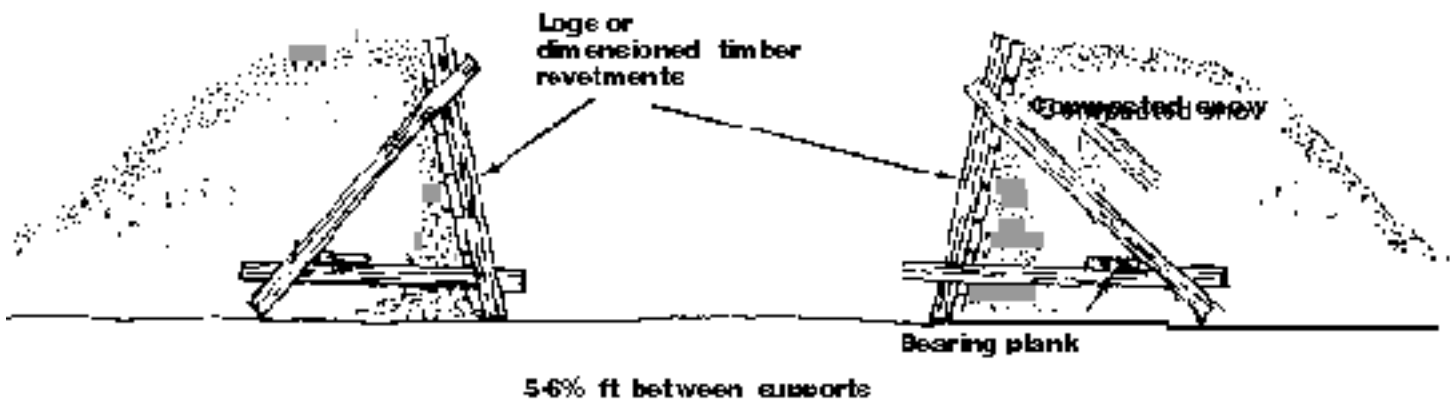

*Snow Wall Construction for Protection From Grenades,
Small Caliber Fire, and HEAT Projectiles*

Snow Density (lb/cu ft)	Projectiles	Muzzle Velocity	Penetration, ft	Required Minimum Thickness, ft
18.0 -25.0	Grenade frag (HE)		2.0	3.0
11.2 -13.0	5.56 mm	3,250	3.8	4.4
17.4 -23.7	5.56 mm	3,250	2.3	2.6
11.2 -13.1	7.62 mm	2,750	13.0	15.0
17.4 -23.7	7.62 mm	2,750	5.2	6.0
25.5 -28.7	7.62 mm	2,750	5.0	5.8
19.9 -24.9	12.7 mm	2,910	6.4	7.4
	11.5 mm		6.0	8.0
28.1 -31.2	70 mm HEAT	900	14.0	17.5
31.2 -34.9	70 mm HEAT	900	8.7 -10.0	13.0
27.5 -34.9	90 mm HEAT	700	9.5 -11.2	14.5

Notes. These materials degrade under sustained fire. Penetrations given for 12.7 mm or smaller are for sustained fire (30 continuous firings into a 1 by 1 foot area),

Penetration characteristics of Warsaw Pact ammunitions do not differ significantly from US counterparts.

Figure given for HEAT weapons are for Soviet PRG-7 (70 mm) and United States M67 (90 mm) fired into machine-packed snow.

High explosive grenades produce small, high velocity fragments which stop in about 2 feet of packed snow. Effective protection from direct fire is independent of delivery method, including never machine gun like the Soviet AGS-17 (30 mm) or United States MK 19/M75 (40 mm). Only armor penetrating rounds are effective.

Shelters

Shelters are constructed with a minimum expenditure of time and labor using available materials. They are ordinarily built on frozen ground or dug in deep snow. Shelters that are completely above ground offer protection against the weather and supplement or replace tents. Shelter sites near wooded areas are most desirable because the wood conceals the glow of fires and provides fuel for cooking and heating. Tree branches extending to the ground offer some shelter for small units or individual protective positions.

Constructing winter shelters begins immediately after the halt to keep the soldiers warm. Beds of foliage, moss, straw, boards, skis, shelter halves, and ponchos are some times used as protection against ground materials dampness and cold. The entrance to the shelter, located on the side least exposed to the wind, is close to the ground and slopes up into the shelter. Openings or cracks in the shelter walls are caulked with an earth and snow mixture to reduce wind effects. The shelter itself is constructed as low to the ground as possible. Any fire built within the shelter is placed low in fire holes and cooking pits. Although snow is windproof, a layer of insulating material, such as a shelter half or blanket, is placed between the occupant and the snow to prevent body heat from melting the snow.

Wigwam shelters

This shelter is constructed easily and quickly when the ground is too hard to dig and protection is required for a short bivouac. The shelter accommodate three soldiers and provide space for cooking. About 25 evergreen saplings (2 to 3 inches in diameter, 10 feet long) are cut. The limbs are left on the saplings and are leaned

against a small tree or the out ends extend about 7 feet up the trunk. The cut ends are tied together around the tree with a tent rope, wire, or other means. The ground ends of the saplings are spaced about 1 foot apart and about 7 feet from the base of the tree. The branches on the outside of the wigwam are placed flat against the

saplings. Branches on the inside are trimmed off and placed on the outside to fill in the spaces. Shelter halves wrapped around the outside make the wigwam more windproof, especially after it is covered with snow. A wigwam is also constructed by lashing the cut ends of the saplings together instead of leaning them against the tree.

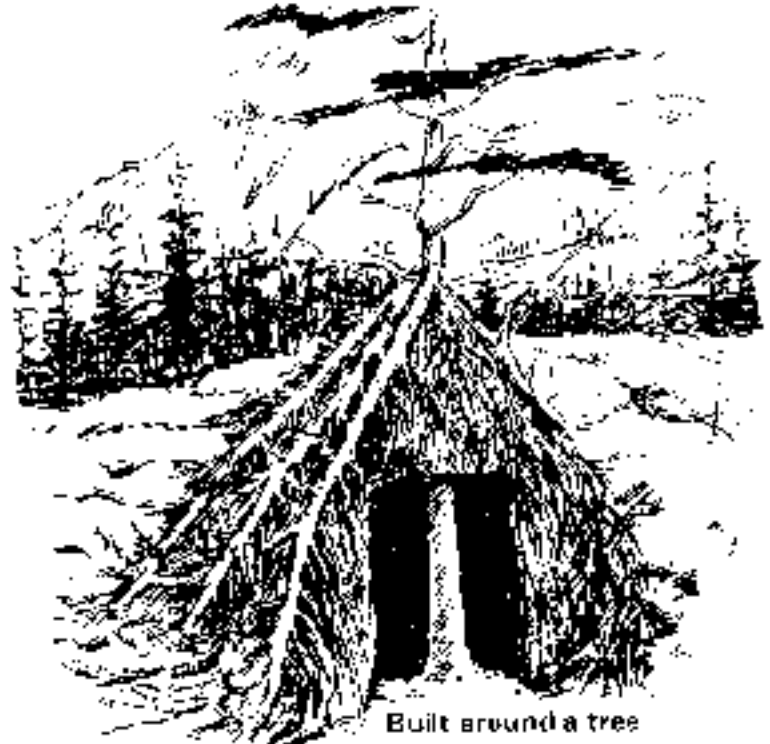
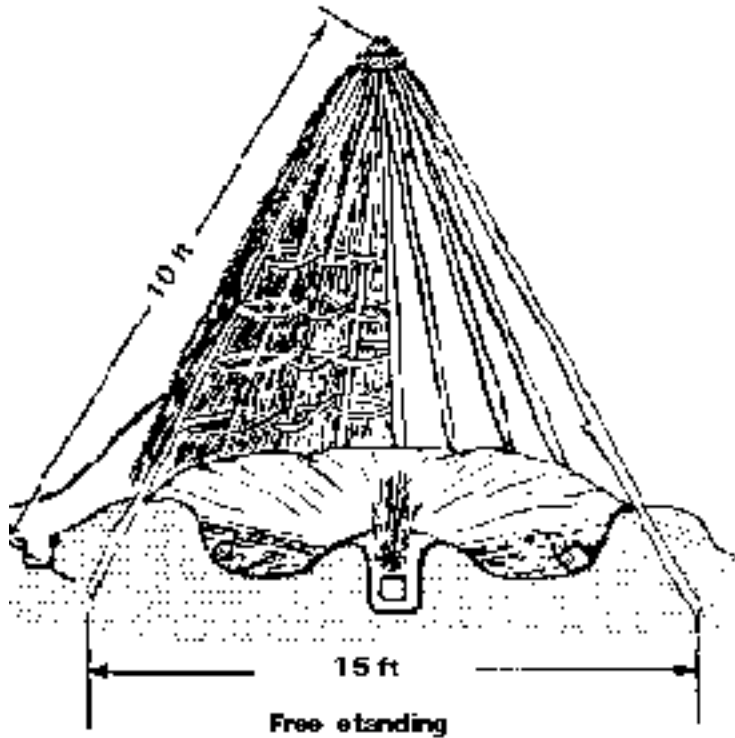

Lean-to shelter

This shelter is made of the same material as the wigwam (natural saplings woven together and brush). The saplings are placed against a rock wall, a steep hillside, a deadfall, or some other existing vertical surface, on the leeward side. The ends are closed with shelter halves or evergreen branches.

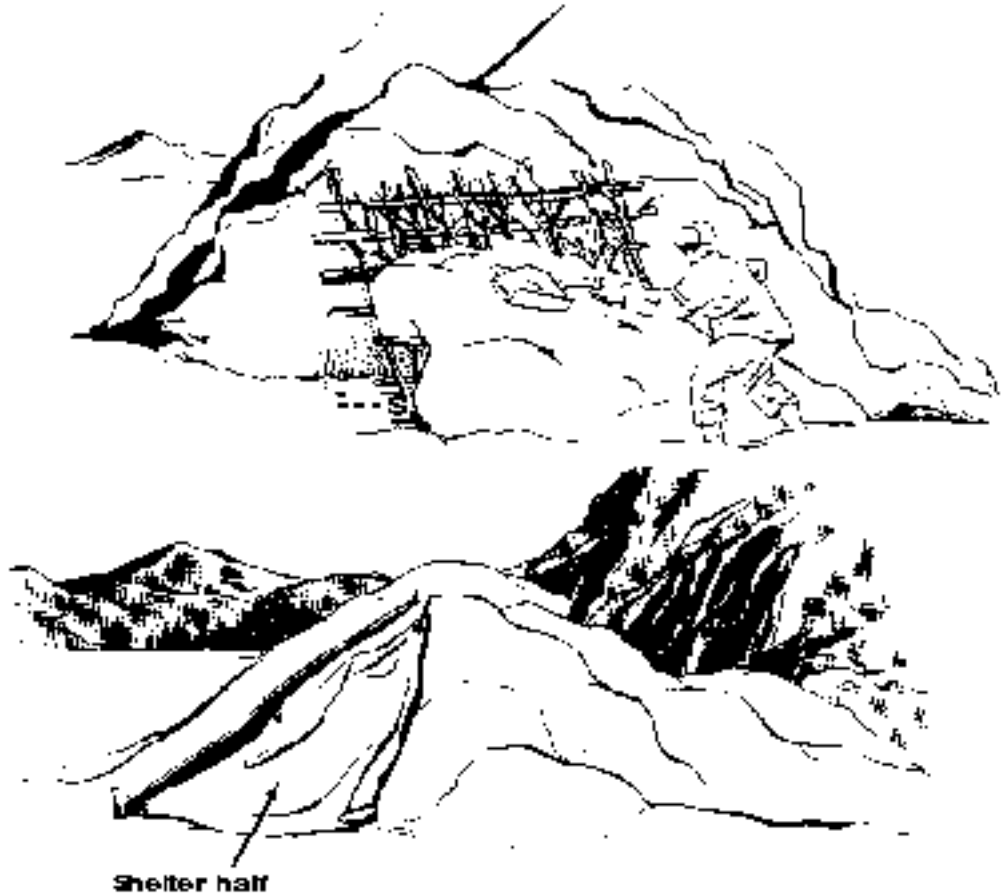

Snow cave

Snow caves are made by burrowing into a snowdrift and fashioning a room of the desired size. This shelter gives good protection from freezing weather and a maximum amount of concealment. The entrance slopes upward for best protection against cold air penetration. Snow caves are usually built large enough for several soldiers if the consistency of the snow prevents cave-in. Two entrances are usually used while the snow is taken out of the cave; one entrance is refilled with snow when the cave is completed. Fires in snow caves are kept small to prevent melting the structure. To allow incoming fresh air, the door is not completely sealed.

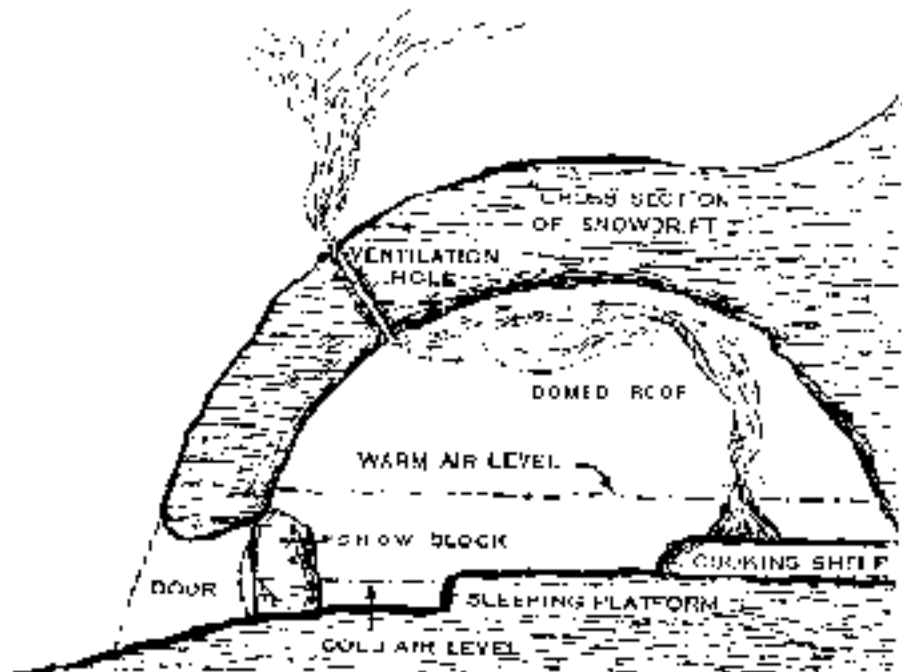

Snow hole

The snow hole is a simple, one-soldier emergency shelter for protection against a snow storm in open, snow-covered terrain. The soldier digs a hole

of body length and width with an entrenching tool or helmet. At a depth of about 3 feet, the soldier lies down in the hole and then digs in

sideways below the surface, filling the original ditch with snow that was dug out, until only a small breathing hole remains.

Snow pit

The snow pit is dug vertically with entrenching tools to form a ditch. The pit is large enough for two or three soldiers. Skis, poles, sticks, branches, shelter halves, and snow are used as roofing. The inside depth of the pit is deep enough for kneeling and reclining positions. If the snow is not deep enough, the sides of the pit can be made higher by adding snow walls. The roof should slope toward one end of the pit.

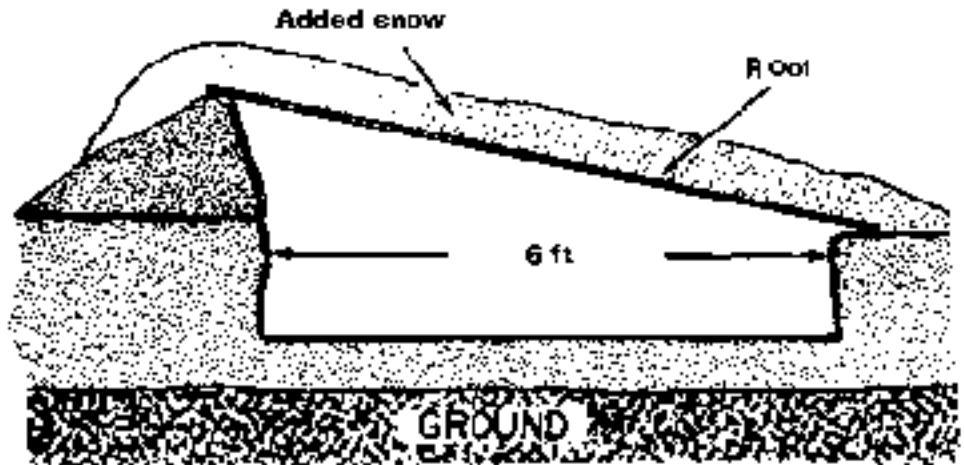

Snowhouse with snow block walls

The size and roof of a snowhouse are similar to those of a snow pit. The walls are made of snow blocks and are usually built to the soldier's height. Snow piled on the outside seals cracks and camouflages the house.

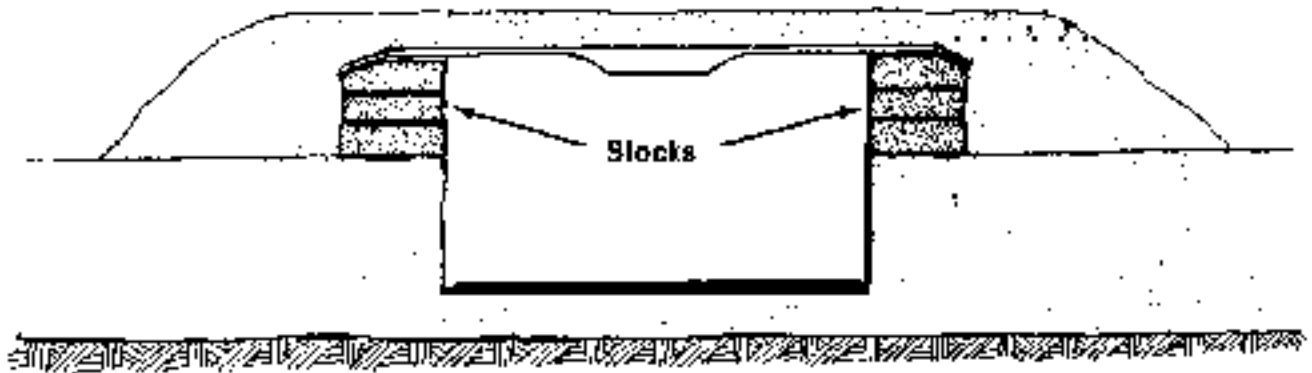

URBAN AREAS

Survivability of combat forces operating in urban areas depends on the leader's ability to locate adequate fighting and protective positions from the many apparent covered and concealed areas available. Fighting and protective positions range from hasty positions formed from piles of rubble, to deliberate positions located inside urban structures. Urban structures are the most advantageous locations for individual

fighting positions. [Field Manual 90-10](#) contains detailed information on urban terrain operations. Urban structures are usually divided into groups of below ground and above-ground structures.

Below Ground Structures

A detailed knowledge of the nature and location of below ground facilities and structures is of potential value when planning survivability operations in urban terrain. Typical underground street cross sections are shown in the [figure below](#).

Cross sections of streets

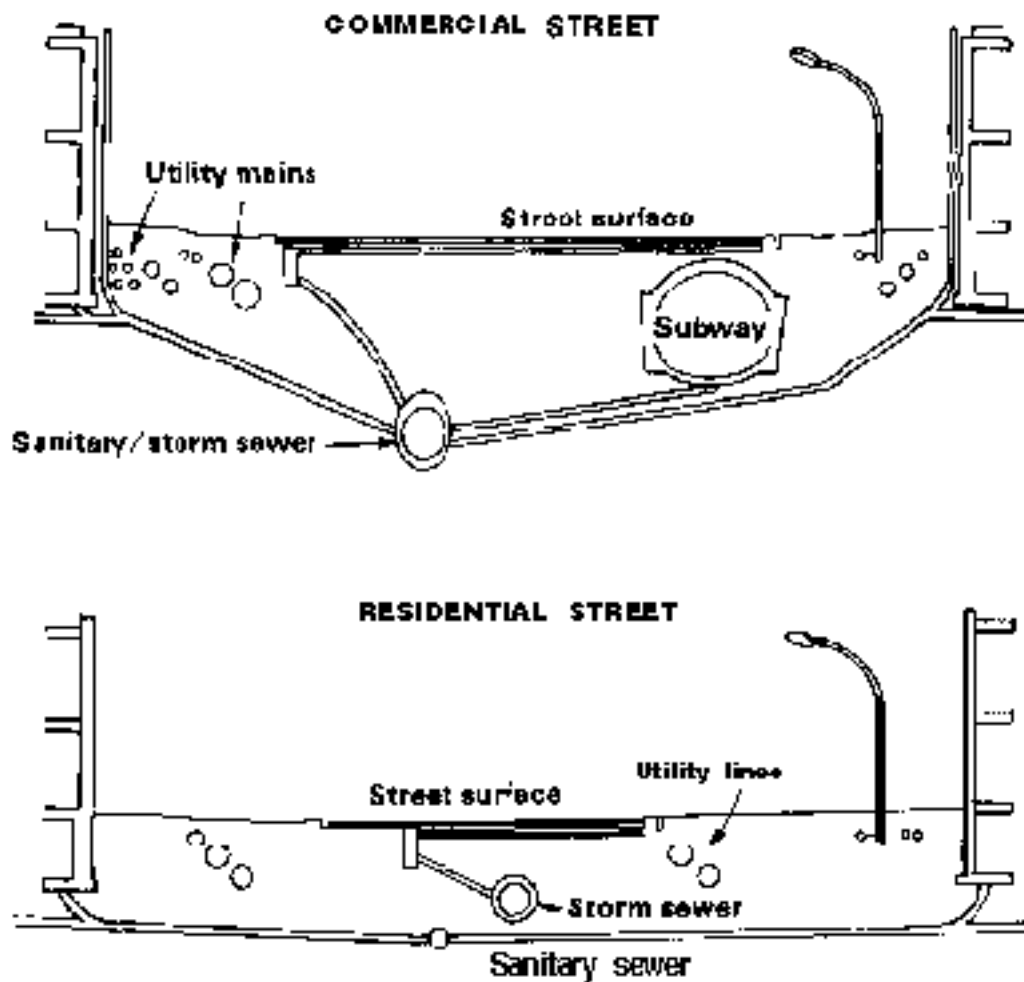

Sewers are separated into sanitary, storm, or combined systems. Sanitary sewers carry wastes and are normally too small for troop movement or protection. Storm sewers, however, provide rainfall removal and are often large enough to permit troop and occasional vehicle movement and protection. Except for groundwater, these sewers are dry during periods of no precipitation. During rain-storms, however, sewers fill rapidly and, though normally drained by

electrical pumps, may overflow. During winter combat, snow melt may preclude daytime below ground operations. Another hazard is poor ventilation and the resultant toxic fume build-up that occurs in sewer tunnels and subways. The conditions in sewers provide an excellent breeding ground for disease, which demands proper troop hygiene and immunization.

Subways tend to run under main roadways and have the potential hazard of having electrified rails and power leads. Passageways often extend outward from underground malls or storage areas, and catacombs are sometimes encountered in older sections of cities.

Aboveground Structures

Aboveground structures in urban areas are generally of two types: frameless and framed.

Frameless structures. In frameless structures, the mass of the exterior wall performs the principal load-bearing functions of supporting dead weight of roofs, floors, ceilings; weight of furnishings and occupants; and horizontal loads. Frameless structures are [shown below](#).

Frameless building characteristics

MASONRY

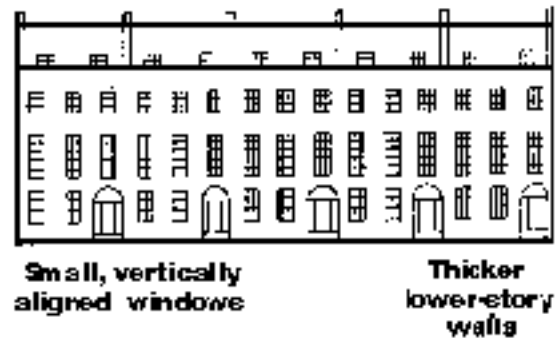
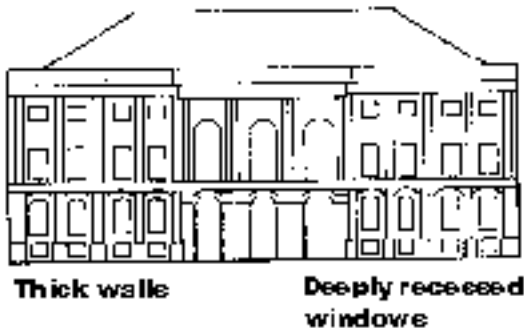

CONCRETE

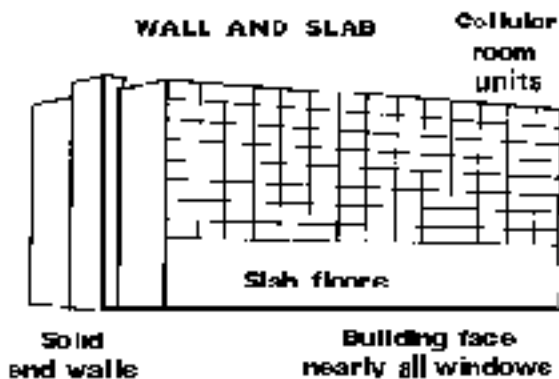

PREFABRICATED

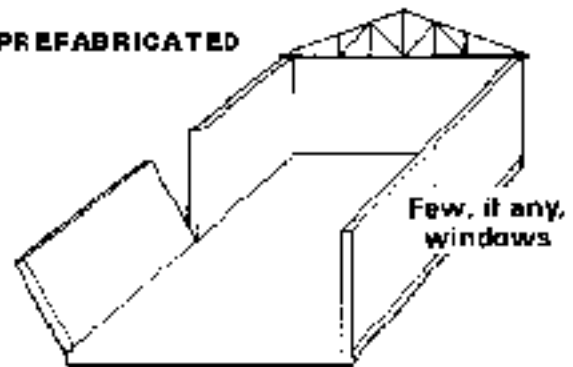

Building materials for frameless structures include mud, stone, brick, cement building blocks, and reinforced concrete. Wall thickness varies with material and building height. Frameless structures have thicker walls than framed structures, and therefore are more resistant to projectile penetration. Fighting from frameless buildings is usually restricted to the door and window areas.

Frameless buildings vary with function, age, and cost of building materials. Older institutional buildings, such as churches, are frequently made of stone. Reinforced concrete is the principal material for wall and slab structures (apartments and hotels) and for prefabricated structures used for commercial and industrial purposes. Brick structures, the most common type of frameless buildings, dominate the core of urban areas (except in the relatively few parts of the world where wood-framed houses are common). Close-set brick structures up to five stories high are located on relatively narrow streets and form a hard, shock-absorbing protective zone for the inner city. The volume of rubble produced by their full or partial demolition provides countless fighting positions.

Framed structures. Framed structures typically have a skeletal structure of columns and beams which supports both vertical and horizontal loads. Exterior (curtain) walls are nonload bearing. Without the impediment of load bearing walls, large open interior spaces offer little protection. The only available refuge is the central core of reinforced concrete present in many of these buildings (for example, the elevator shaft). Multistoried steel and concrete-framed structures occupy the valuable core area of most modern cities. Examples of framed structures are shown in the following [figure](#).

Framed building characteristics

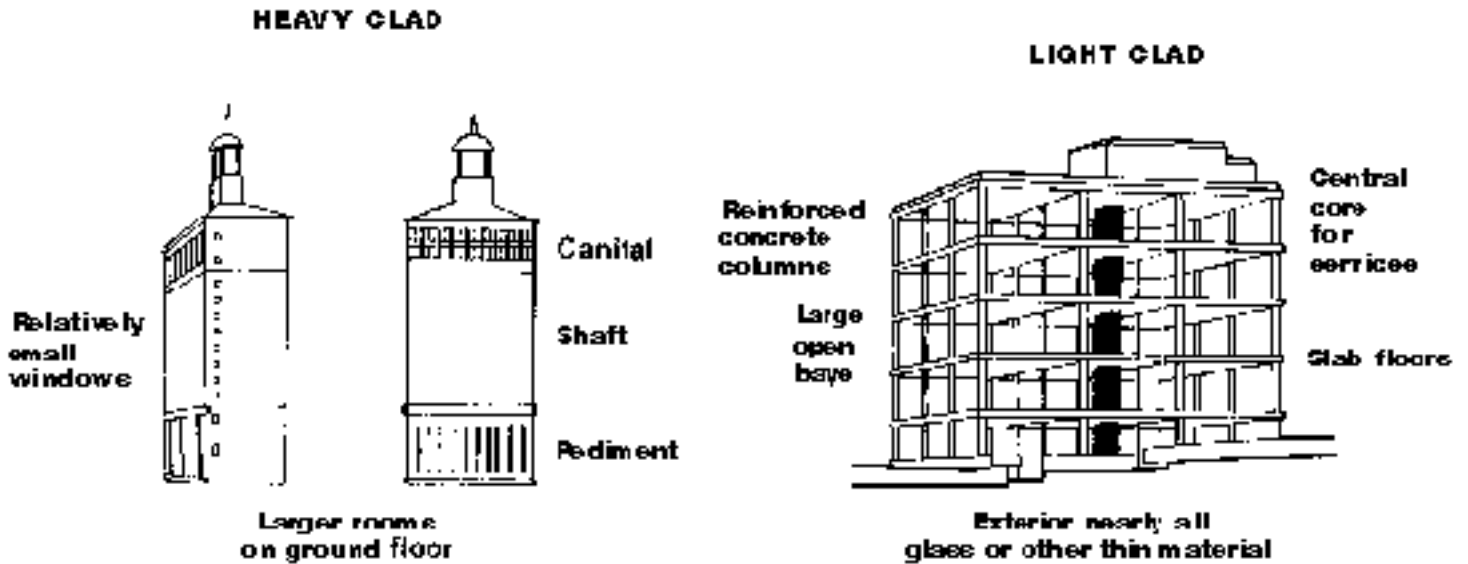

Material and Structural Characteristics

Urban structures, frameless and framed, fit certain material generalities. The [first table below](#) converts building type and material into height/wall thicknesses. Most worldwide urban areas have more than 60 percent of their construction formed from bricks. The relationship between building height and thickness of the average brick wall is shown in the [second table below](#).

Urban Structure Material Thicknesses

Building Material	Height (stories)	Average Wall Thickness, in
Frameless Structures		
Stone	1-10	30
Brick	1-3	9
Brick	3-6	15
Concrete block	1-5	8
Concrete, wall and slab	1-10	9-15
Concrete, prefabricated	1-3	7
Framed Structures		
Wood	1-3	1
Steel (heavy cladding)	3-100	6
Concrete/steel (light cladding)	3-50	1-3

Average Brick Wall Thickness

Height (stories)	Wall Thickness, in					
	1st	2nd	3rd	4th	5th	6th
1	11½					
2	13½	10½				
3	14½	13½	10½			
4	15½	14½	13½	11½		
5	18½	15½	14½	13½	12½	
6	18½	18½	15½	14½	13½	12½

SPECIAL URBAN AREA POSITIONS**Troop Protection**

After urban structures are classified as either frameless or framed, and some of their material characteristics are defined, leaders evaluate them for protective soundness. The evaluation is based on troop protection available and weapon position employment requirements for cover, concealment, and routes of escape. The [table below](#) summarizes survivability requirements for troop protection.

Survivability Requirements for Troops in Urban Buildings

Requirements	Building Characteristics
Cover	<ol style="list-style-type: none"> 1. Proportion of walls to windows 2. Wall composition and thickness 3. Interior wall and partition composition and thickness 4. Stair and elevator modules
Concealment	<ol style="list-style-type: none"> 1. Proportion of walls to windows 2. Venting pattern 3. Floor plan (horizontal and vertical) 4. Stair and elevator modules (framed high-rise buildings)
Escape	<ol style="list-style-type: none"> 1. Floor plan (horizontal and vertical) 2. Stair and elevator modules

Cover. The extent of building cover depends on the proportion of walls to windows. It is necessary to know the proportion of non-windowed wall space which might serve as protection. Frameless buildings, with their high proportion of walls to windows, afford more substantial cover than framed buildings having both a lower proportion of wall to window space and thinner (nonload bearing) walls.

Composition and thickness of both exterior and interior walls also have a significant bearing on cover assessment. Frameless buildings with their strong weight-bearing walls provide more cover than the curtain walls of framed buildings. However, interior walls of the older, heavy-clad, framed buildings are stronger than those of the new, light-clad, framed buildings. Cover within these light-clad framed buildings is very slight except in and behind their stair and elevator modules which are usually constructed of reinforced concrete. Familiarity with the location, dimension, and form of these modules is vital when assessing cover possibilities.

Concealment. Concealment considerations involve some of the same elements of building construction, but knowledge of the venting (window) pattern and floor plan is added.

These patterns vary with type of building construction and function. Older, heavy-clad framed buildings (such as office buildings)

frequently have as full a venting pattern as possible, while hotels have only one window per room. In the newer, light-clad framed buildings, windows are sometimes used as a nonload bearing curtain wall. If the windows are all broken, no concealment possibilities exist. Another aspect of concealment undetected movement within the building depends on a knowledge of the floor plan and the traffic pattern within the building on each floor and from floor to floor.

Escape. In planning for escape routes, the floor plan, traffic patterns, and the relationships between building exits are considered. Possibilities range from small buildings with front street exits (posing unacceptable risks), to high-rise structures having exits on several floors, above and below ground level, and connecting with other buildings as well.

Fighting Positions

Survivability requirements for fighting positions for individuals, machine guns, and antitank and antiaircraft weapons are summarized in the [table below](#).

Survivability Requirements for Fighting Positions in Urban Buildings

Individual positions	<ol style="list-style-type: none"> 1. Wall composition and thickness of upper floors 2. Roof composition and thickness 3. Floor and ceiling composition and thickness
Machine gun positions	<ol style="list-style-type: none"> 1. Wall composition and thickness 2. Local terrain
Antitank weapon positions	<ol style="list-style-type: none"> 1. Wall composition and thickness 2. Room dimensions and volume 3. Function related interior furnishings, and so forth 4. Fields of fire (relative position of building) 5. Arming distance 6. Line-of-sight
Antiaircraft weapon positions	<ol style="list-style-type: none"> 1. Roof composition and thickness 2. Floor plan (horizontal and vertical) 3. Line-of-sight

Individual fighting positions. An upper floor area of a multistoried building generally provides sufficient fields of fire, although corner windows can usually encompass more area. Protection from the possibility of return fire from the streets requires that the soldier know the composition and thickness of the building's outer wall. Load bearing walls generally offer more protection than the curtain walls of framed buildings. However, the relatively thin walls of a low brick building (only two-bricks thick or 8 inches) is sometimes less effective than a 15-inch thick nonload bearing curtain wall of a high-rise framed structure.

The individual soldier is also concerned about the amount of overhead protection available. Therefore, the soldier needs to know about the properties of roof, floor, and ceiling materials. These materials vary with the type of building construction. In brick buildings, the material for the ceiling of the top floor is far lighter than that for the next floor down that performs as both ceiling and floor, and thus is capable of holding up the room's live load.

Machine gun positions. Machine guns are usually located on the ground floor to achieve grazing fire. In brick buildings, the lower floors have the thickest walls and thus the greatest degree of cover. In frame buildings, walls are the same thickness on every floor and thus the ground floor provides no advantage. Another consideration is the nature of the local terrain. Should a building selected for a machine gun position lie over the crest of a hill, grazing fire is sometimes not possible from a ground floor. In such cases, depending on the area's slope angle, grazing fire is achieved only from a higher floor.

Antitank weapon positions. The positioning of antitank weapons within buildings demands consideration of the critical need for cover. Buildings with fairly thick walls have rooms that are too small to permit firing of heavy antitank weapons, such as the TOW. Therefore, only the LAW, Dragon, and the 90-mm recoilless rifle (RCLR) are usually fired from these buildings. When antitank weapons are fired, backblast is present as [illustrated below](#).

Extent of backblast in open areas

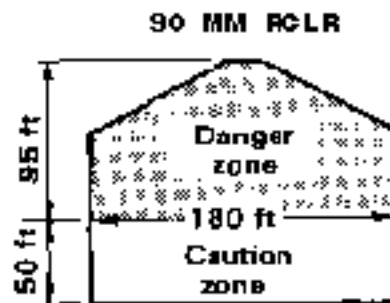
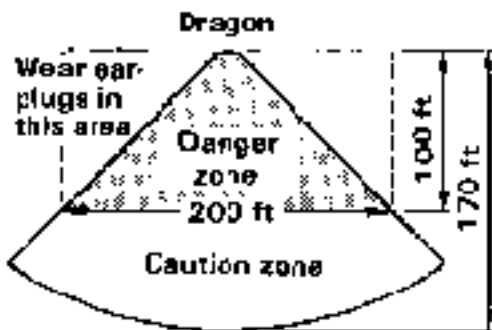
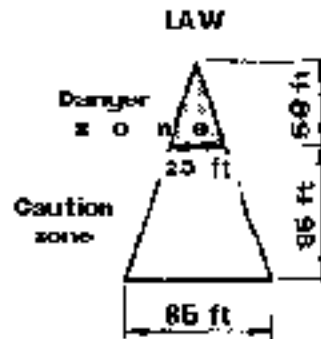
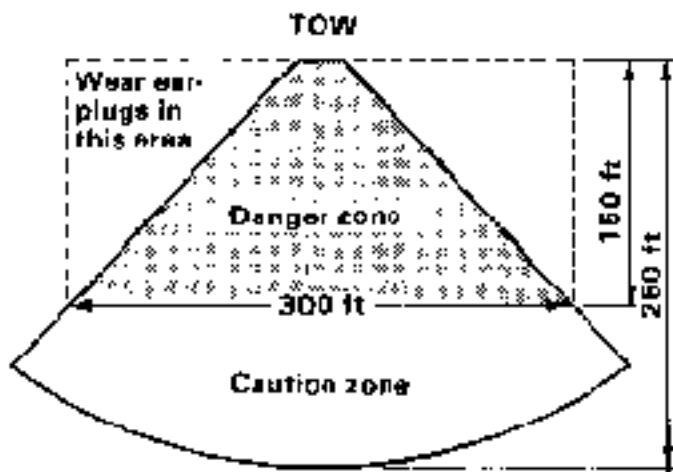

When weapons are fired in enclosed areas in structures, the following conditions are required:

- The area must have a ceiling at least 7 feet high. Minimum floor sizes by weapon and type of construction are as shown in the [table below](#).

- Approximately 20 square feet of ventilation is necessary to the rear of the weapons. An open door normally provides adequate ventilation.
- Small, loose objects and window/door glass are removed from the firing area.
- Combustible material is removed from behind the weapon. Curtains and over-stuffed furniture out of the blast area are usually left in place to help absorb sound.
- For ATGMs, vertical clearances between the bottom of the launch tube and the wall opening are 6 inches for TOW and 9 inches for Dragon.
- Occupants must be forward of the rear of the weapon and wear helmets and earplugs.

Minimum Floor Sizes for Firing Weapons in Enclosed Areas

	Minimum Floor Size, ft	
	Frame	Masonry
TOW	20x 32	20 x 20
Dragon	15x16	10X20
90mm RCLR	15x16	10X20
LAW	7 x 12	Minimum of 124 ft to back wall

For heavy ATGMs (TOWS) designed for effectiveness up to 3,750 meters, there is an acute need to select light-clad framed buildings that have considerable fields of fire.

Antiaircraft weapon positions. The deployment of antiaircraft weapons can also be related to a consideration of building characteristics. An ideal type of building for such deployment is a modern parking garage (one with rooftop parking). It offers sufficient cover, a circulation pattern favoring such weapons carried on light vehicles, and frequently offers good lines of sight.

Other Planning Considerations

Fighting and protective positions located inside urban buildings sometimes require upgrade or reinforcement. Prior to planning building modification, the following factors are considered:

- Availability of materials such as fill for sandbags.
- Transporting materials up stairwells and into attics.

- Structural limitations of attics and upper level floors (dead load limitations).

COMBINED OPERATIONS

The United States maintains substantial forces in Europe for North Atlantic Treaty Organization (NATO) operations and forces in Korea as part of the combined forces command (CFC). In these areas, established command and control arrangements permit detailed peacetime planning, base development, and host nation support agreements. In most potential combat theaters, however, international agreements with United States allies on principles and procedures do not exist or are only partially developed. In both types of possible theaters of operations, combat activities will involve combined operations with allied forces.

Interoperability is the capability of multinational forces to operate together smoothly. Commanders involved in combined survivability operations must have a knowledge of standing operating procedures (SOPS), standardization agreements (STANAGS), and any other procedural agreements made between forces. In addition, a commander should maximize training and use of equipment and supplies organic to friendly foreign forces. Host nation support agreements may provide equipment and indigenous labor for protective construction. These assets require full identification and use. Interoperability is discussed in [FM 100-5](#).

Terrain and climate characteristics of the following three NATO regions are critical to the survivability planner in Europe.

ALLIED FORCES, NORTHERN EUROPE (AFNORTH)

The Northern European Command, also known as Allied Forces, Northern Europe (AFNORTH), is made up of Norway, Denmark, and that portion of the Federal Republic of Germany north of the Elbe river. The climate of this area includes subarctic and arctic winters which, in some locales, 8 months out of the year. Terrain is generally very lightly wooded and susceptible to flooding in many areas.

ALLIED FORCES, CENTRAL EUROPE (AFCENT)

Allied Forces, Central Europe (AFCENT) includes most of Western Europe—specifically West Germany. The climate of this area is usually cold and wet. The terrain is generally rolling and open, with many urban and built-up areas of 50,000 population and upward.

ALLIED FORCES, SOUTHERN EUROPE (AFSOUTH)

Allied Forces, Southern Europe (AFSOUTH) includes Italy, Greece,

Turkey, and countries in the Mediterranean area. Generally, this area has a warm and comfortable climate, but it also includes some bitterly cold regions. The terrain of northern Italy, Greece, Turkish Thrace, and eastern Turkey is mountainous and affords excellent natural protection. The plains of the Po River Valley, however, provide unrestricted mobility and direct fire, and require substantial protection activities.

PACIFIC COMMAND (PACOM)

United States forces stationed from the west coast of the Americas to the east coast of Africa and in the Indian Ocean come under the umbrella of the Pacific Command (PACOM). Two important areas of the command are Japan and Korea. As in NATO, important differences in capabilities, doctrine, and equipment exist among various national forces in PACOM. Unlike NATO, few STANAGS exist to negotiate the differences.

Korea

The powerful North Korean army is a threat to the Republic of Korea (ROK). It is continually poised for attack along the 151-mile demilitarized zone (DMZ). The area in which protection activities would take place includes mountainous, rugged terrain with a temperate, monsoonal climate. Most of the terrain favors light infantry operations, yet two major avenues of approach from the north allow mechanized activity. Because of the segregation of US and ROK units, existing survivability /interoperability problems are considered when protection activities are planned.

Japan

The five major islands of Japan have a climate similar to that of the east coast of the United States. The islands are mostly mountainous, with the urban areas and huge population centers situated in and around the remaining habitable areas. Operations in Japan are governed by the provisions of the Treaty of Mutual Cooperation and Security between the United States and Japan. Significant efforts are required to ensure interoperability of forces. Survivability tasks will most likely center around protection of built-up areas.

CONTINGENCY OPERATIONS

Contingency operations, generally initiated under circumstances of great urgency, are geared to protect vital natural resource supplies or assist a threatened ally. The US contingency force must have the capability to defeat a threat which varies from terrorist activity to well-organized regional forces armed with modern weapons. Contingency forces must prepare for chemical and nuclear warfare, and also for air

attack by modern, well-equipped air forces. Fighting and protective positions are initially prepared for antitank weapons, ADA forces, and field artillery weapons in order to deny the enemy both air superiority and free ground maneuver. Most potential locations for contingency operations are relatively undeveloped. Logistics and base support requirements will dictate operational capabilities to a much greater extent than in a mature theater. Planners must provide ample logistic basic loads for initial construction and use locally available materials for expedient structures.

General contingency plans must allow for rapid changes in the tasks, organization, and support to adapt to widely-varied potential threats and environments. The composition of the contingency force must permit rapid strategic deployment by air. At the same time, it must possess sufficient combat power and equipment to provide necessary engineer support. The lack of logistic support for the deployed task force requires a capability to fully exploit whatever host nation support is available.

Deployed engineer forces are responsible for all engineer functions. Initially, there is little back-up support for engineers organic to combat forces; however, engineer support in the survivability effort is essential. Survivability missions in contingency operations are of primary importance after deployment. The force requires protection at all levels since the enemy often expects the force's arrival, and since assembly areas are limited until specific missions are developed. Due to the light force structure and limited logistical support, priorities are established to determine where the engineers should dedicate their resources. Conditions such as delayed supply and resupply operations, and scarcity of engineer equipment, demand force maneuver units or light forces to prepare their own fighting and protective positions. The situation will determine whether shifts from those priorities are necessary.



[RDL](#) [Table of](#) [Document](#) [Download](#)

[Homepage](#) [Contents](#) [Information](#) [Instructions](#)

Jungle rain shelter

Stout, pliable reeds
laid across framework

Several layers of
large fine ferns

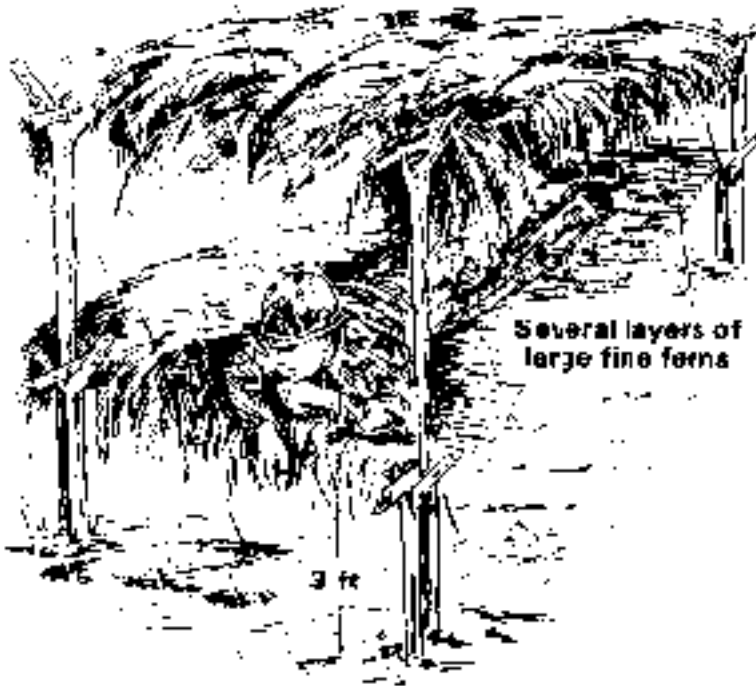

Jungle floating platform as fighting position



Crater Dimensions (Surface Detonation)

	SNOW	Ice	Frozen Ground
Crater depth, ft	$1.2 \sqrt[3]{w}$	$0.9 \sqrt[3]{w}$	$0.5 \sqrt[3]{w}$
Crater radius, ft	$2.0 \sqrt[3]{w}$	$1.6 \sqrt[3]{w}$	$1.4 \sqrt[3]{w}$

Notes: (w) equals charge weight in pounds (untamped)

Verify calculations with test shots.

Crater Dimension (Using Boreholes)

	snow	Ice	Frozen Ground
Depth of charge, ft	4.0 $\sqrt[3]{w}$	3.0 $\sqrt[3]{w}$	2.5 $\sqrt[3]{w}$
Crater depth, ft	5.1 $\sqrt[3]{w}$	3.3 $\sqrt[3]{w}$	2.7 $\sqrt[3]{w}$
Crater radius, ft	3.3 $\sqrt[3]{w}$	3.9 $\sqrt[3]{w}$	3.1 $\sqrt[3]{w}$

Notes: (w) equals charge weight in pounds (untempered)

Verify calculations with test shots.

Cross sections of streets

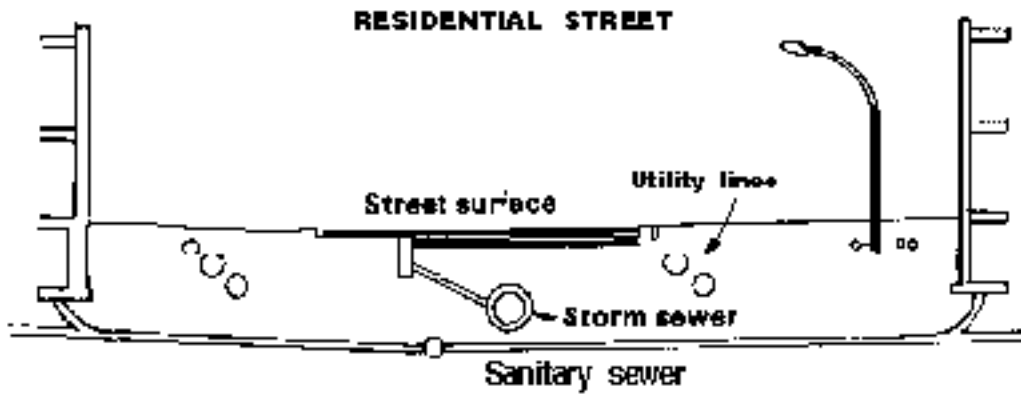
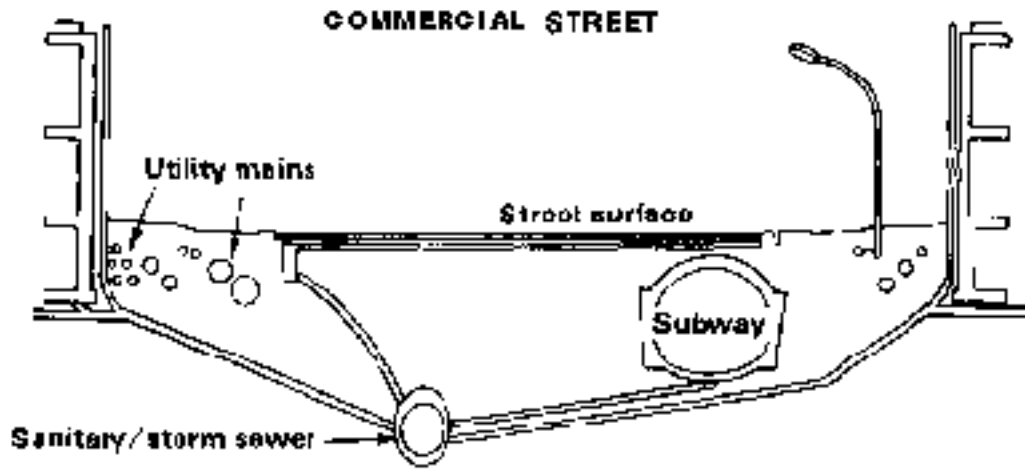

Frameless building characteristics

MASONRY



Thick walls

Deeply recessed windows

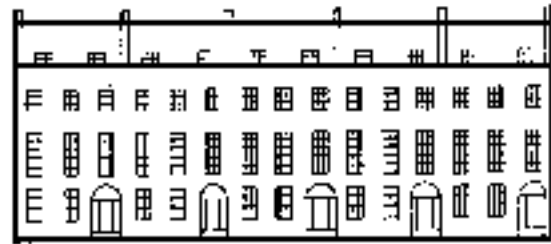

Small, vertically aligned windows

Thicker lower-story walls

CONCRETE

WALL AND SLAB

Cellular room units

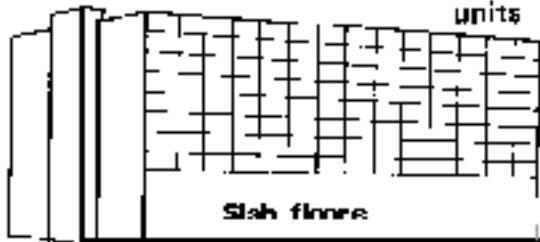

Slab fins

Solid end walls

Building face nearly all windows

PREFABRICATED

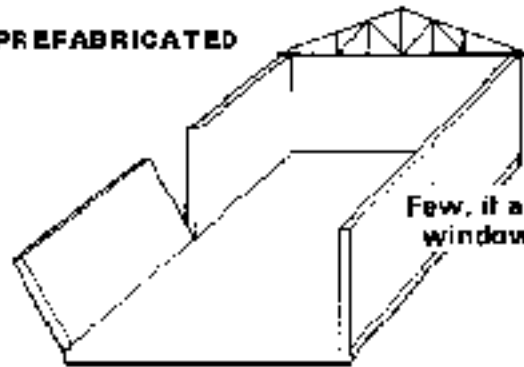

Few, if any, windows

Framed building characteristics

HEAVY CLAD

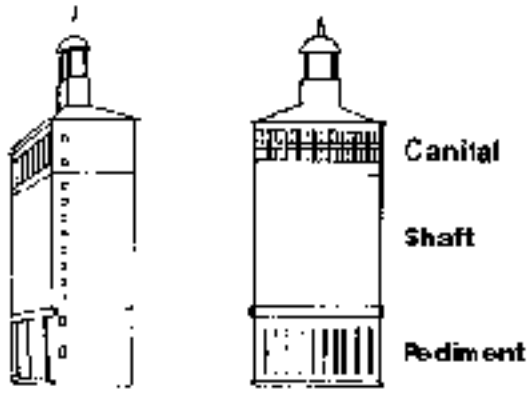

Relatively
small
windows

Larger rooms
on ground floor

LIGHT CLAD

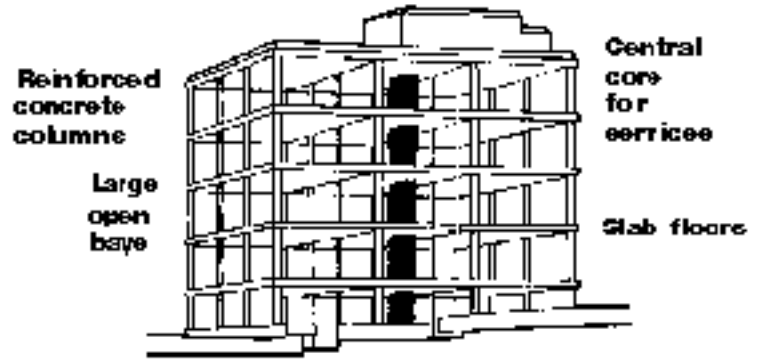

Exterior nearly all
glass or other thin material

Urban Structure Material Thicknesses

Building Material	Height (stories)	Average Wall Thickness, in
Frameless Structures		
Stone	1-10	30
Brick	1-3	9
Brick	3-6	15
Concrete block	1-5	8
Concrete, wall and slab	1-10	9-15
Concrete, prefabricated	1-3	7
Framed Structures		
Wood	1-3	1
Steel (heavy cladding)	3-100	6
Concrete/steel (light cladding)	3-50	1-3

Average Brick Wall Thickness

Height (stories)	Wall Thickness, in					
	1st	2nd	3rd	4th	5th	6th
1	11½					
2	13½	10½				
3	14½	13½	10½			
4	15½	14½	13½	11½		
5	18½	15½	14½	13½	12½	
6	18½	18½	15½	14½	13½	12½

Survivability Requirements for Troops in Urban Buildings

Requirements	Building Characteristics
Cover	<ol style="list-style-type: none">1. Proportion of walls to windows2. Wall composition and thickness3. Interior wall and partition composition and thickness4. Stair and elevator modules
Concealment	<ol style="list-style-type: none">1. Proportion of walls to windows2. Venting pattern3. Floor plan (horizontal and vertical)4. Stair and elevator modules (framed high-rise buildings)
Escape	<ol style="list-style-type: none">1. Floor plan (horizontal and vertical)2. Stair and elevator modules

Survivability Requirements for Fighting Positions in Urban Buildings

- | | |
|--------------------------------------|--|
| Individual positions | <ol style="list-style-type: none">1. Wall composition and thickness of upper floors2. Roof composition and thickness3. Floor and ceiling composition and thickness |
| Machine gun positions | <ol style="list-style-type: none">1. Wall composition and thickness2. Local terrain |
| Antitank weapon positions | <ol style="list-style-type: none">1. Wall composition and thickness2. Room dimensions and volume3. Function related interior furnishings, and so forth4. Fields of fire (relative position of building)5. Arming distance6. Line-of-sight |
| Antiaircraft weapon positions | <ol style="list-style-type: none">1. Roof composition and thickness2. Floor plan (horizontal and vertical)3. Line-of-sight |

Extent of backblast in open areas

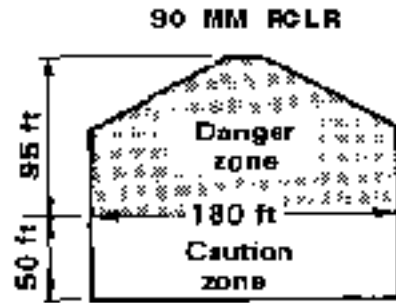
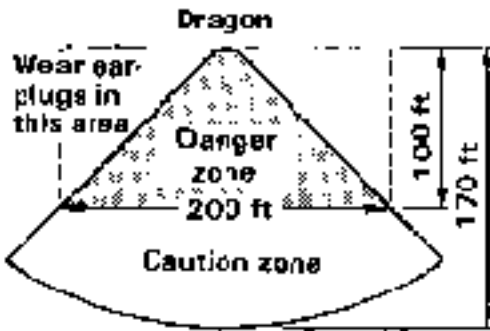
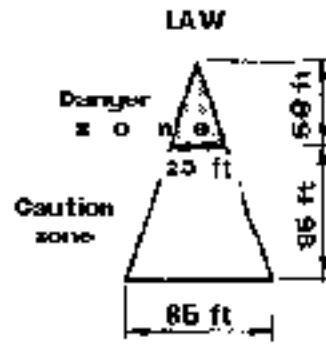
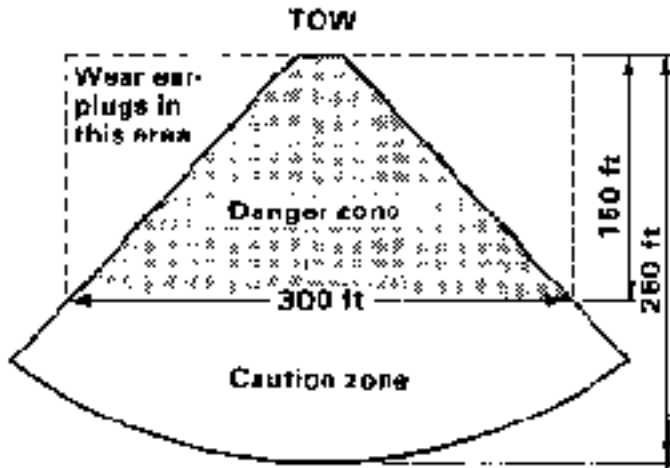

Minimum Floor Sizes for firing Weapons in Enclosed Areas

	Minimum Floor Size, ft	
	Frame	Masonry
TOW	20x 32	20 x 20
Dragon II	15x16	10X20
90mm RCLR	15x16	10X20
LAW	7 x 12	Minimum of 124 ft to back wall

[RDL](#) [Table of](#) [Document](#) [Download](#)[Homepage](#) [Contents](#) [Information](#) [Instructions](#)

APPENDIX C

POSITION DESIGN DETAILS

PRONE POSITION (HASTY)	C-2
ONE-SOLDIER POSITION (DELIBERATE)	C-3
TWO-SOLDIER POSITION (DELIBERATE).....	C-4
ONE- OR TWO-SOLDIER POSITION WITH OVERHEAD COVER (DELIBERATE)	C-5
DISMOUNTED TOW POSITION	C-6
MACHINE GUN POSITION	C-7
MORTAR POSITION (81MM AND 4.2-IN MORTARS).....	C-8
WOOD-FRAME FIGHTING POSITION	C-9
FABRIC-COVERED FRAME POSITION	C-12
CORRUGATED METAL FIGHTING BUNKER	C-14
PLYWOOD PERIMETER BUNKER	C-16
CONCRETE LOG BUNKER	C-17
PRECAST CONCRETE SLAB BUNKER	C-19
CONCRETE ARCH BUNKER	C-22
COVERED DEEP-CUT POSITION	C-23
ARTILLERY FIRING PLATFORM (156MM, 175MM, AND B-IN ARTILLERY)	C-25
PARAPET POSITION FOR ADA	C-28
TWO-SOLDIER SLEEPING SHELTER	C-29
METAL CULVERT SHELTER	C-30
AIRTRANSPORTABLE ASSAULT SHELTER.....	C-31
TIMBER POST BURIED SHELTER	C-34
MODULAR TIMBER FRAME SHELTER	C-35
TIMBER FRAME BURIED SHELTER	C-36
ABOVEGROUND CAVITY WALL SHELTER	C-37
STEEL FRAME/FABRIC-COVERED SHELTER	C-39
HARDENED FRAME/FABRIC SHELTER.....	C-41
RECTANGULAR FABRIC/FRAME SHELTER.....	C-44
CONCRETE ARCH SHELTER	C-46
METAL PIPE ARCH SHELTER	C-49
STEEL LANDING MAT WALL	C-51
EARTH WALLS	C-51
SOIL-CEMENT WALL.....	C-52
EARTH WALL WITH REVETMENT	C-52
SOIL BIN WALL WITH LOG REVETMENT	C-53
SOIL BIN WALL WITH TIMBER REVETMENT.....	C-54
SOIL BIN WALL WITH PLYWOOD REVETMENT	C-55

HARDENED SOIL BIN WALL WITH PLYWOOD REVETMENT	C-56
PLYWOOD (OR CORRUGATED METAL) PORTABLE WALL	C-58
PORTABLE PRECAST CONCRETE WALL	C-59
CAST-IN-PLACE CONCRETE WALL	C-60
PORTABLE ASPHALT ARMOR PANELS	C-61
STANDARD FIGHTING TRENCH	C-62
VEHICLE FIGHTING POSITIONS (DELIBERATE)	C-63

PRONE POSITION (HASTY)

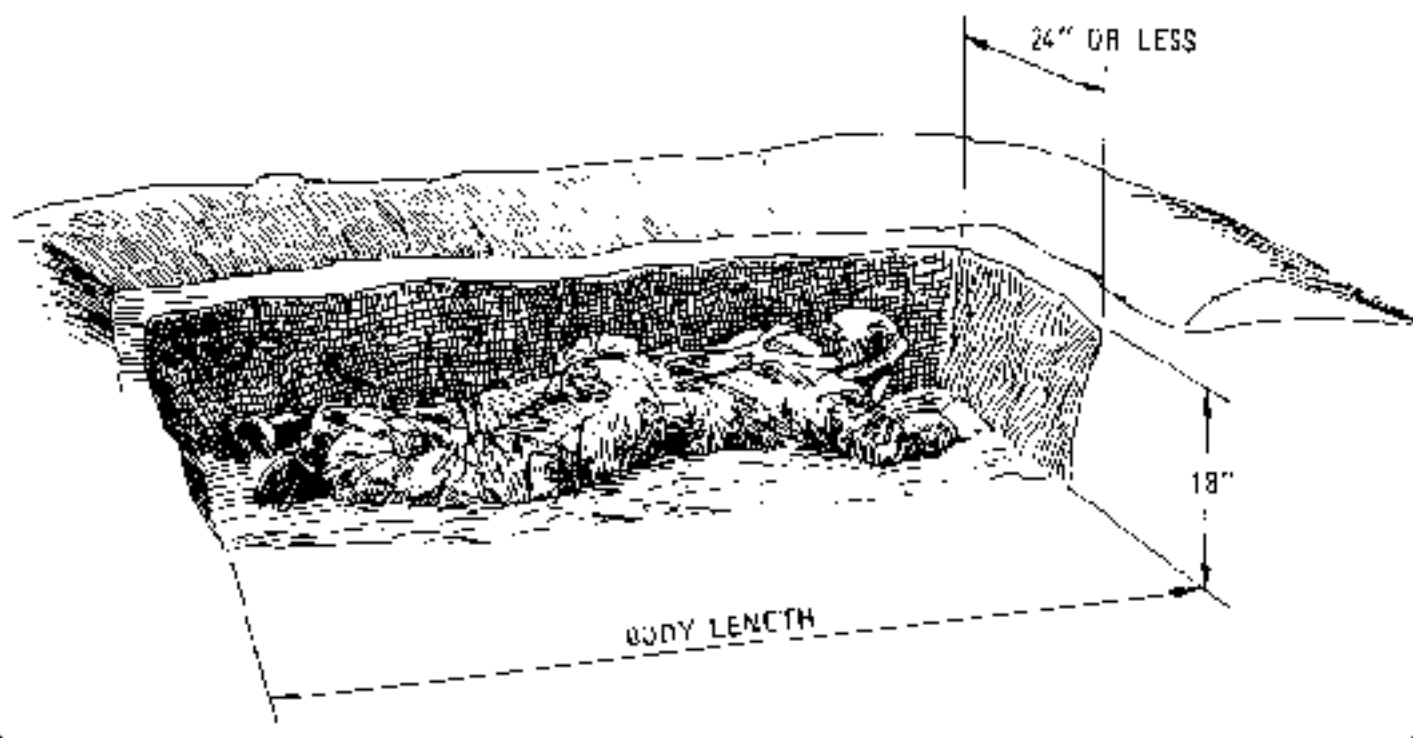
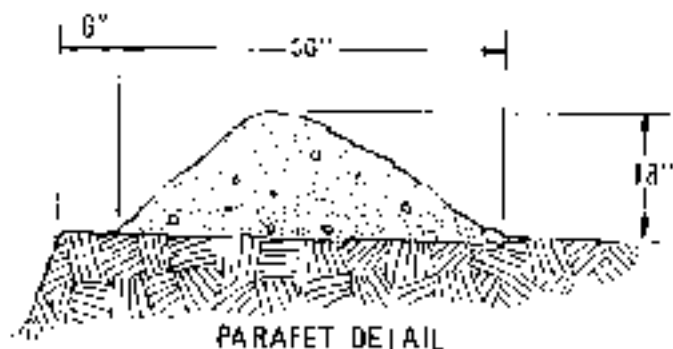

ONE-SOLDIER POSITION (DELIBERATE)

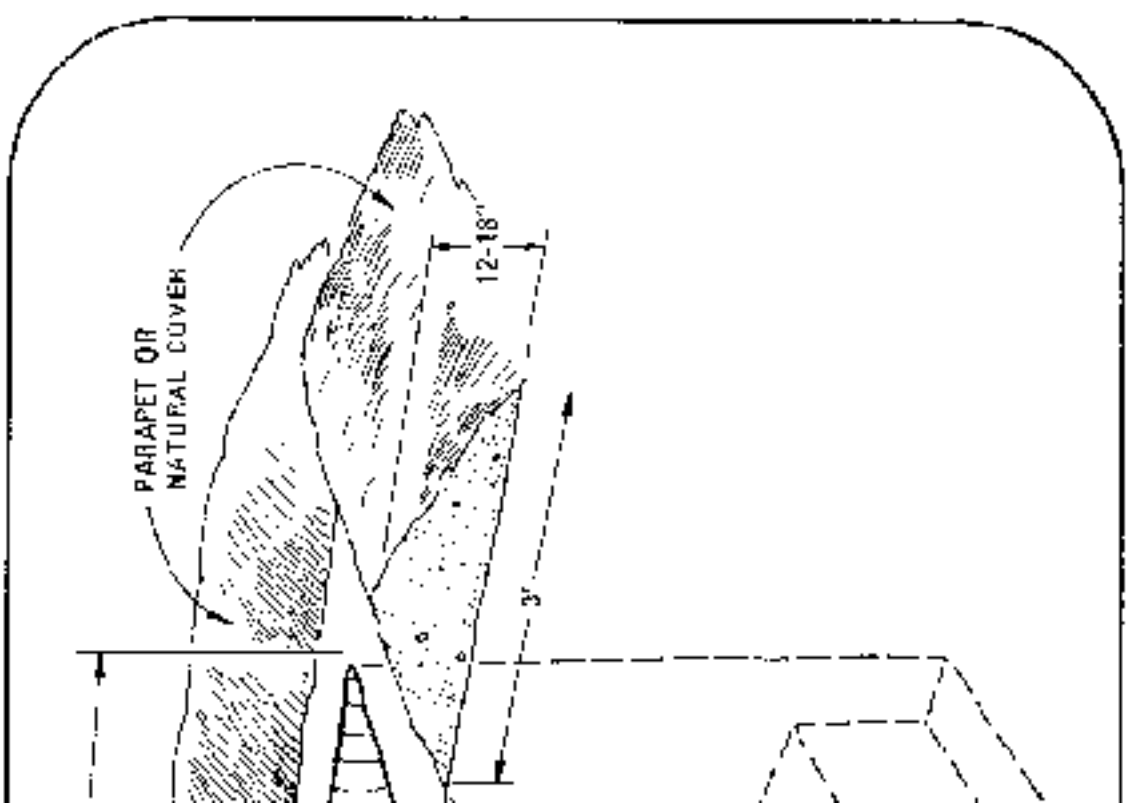
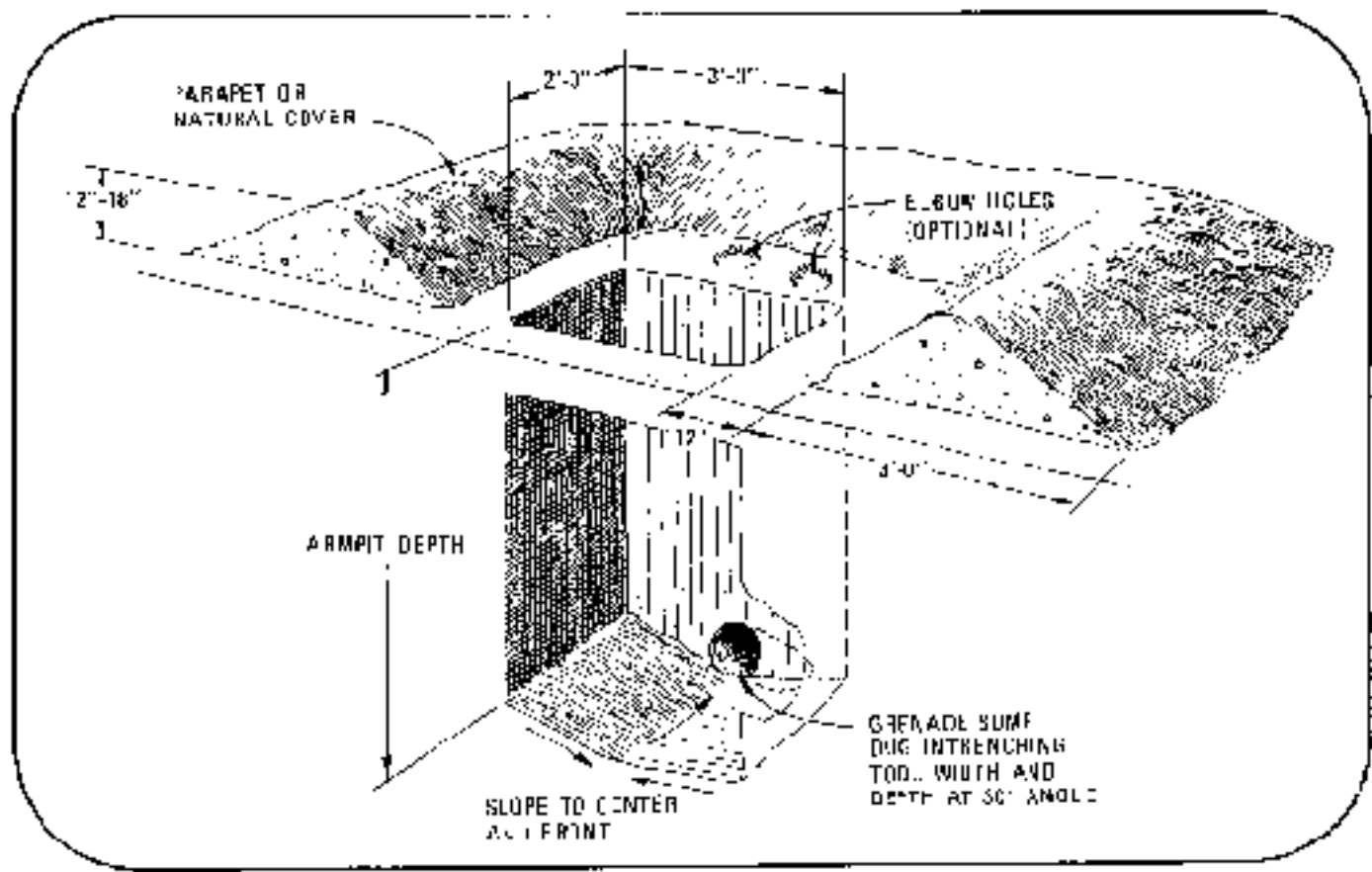

LIBERATE)

TWO-SOLDIER POSITION (DEI)

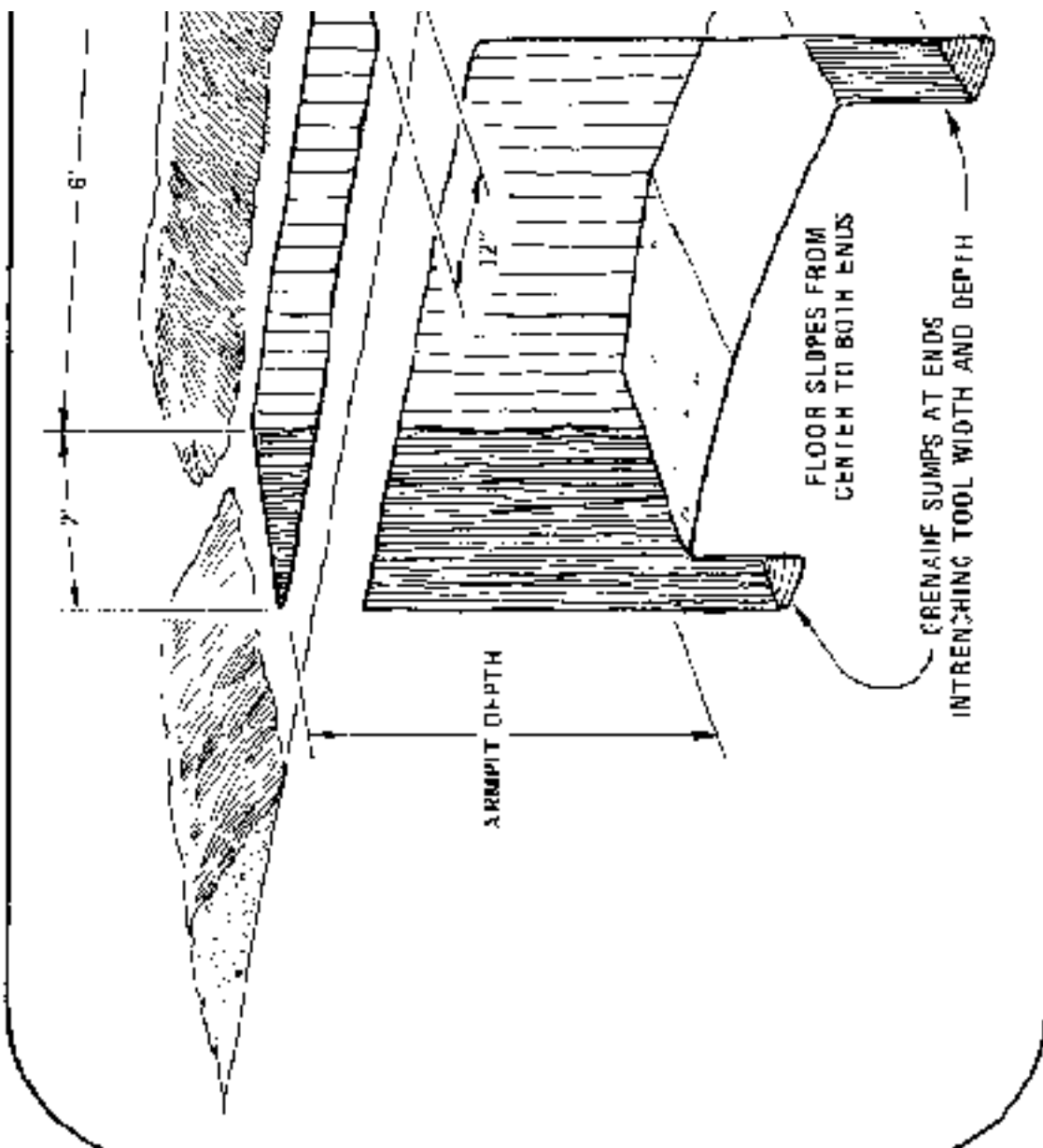

ONE- OR TWO-SOLDIER POSITION WITH OVERHEAD COVER (DELIBERATE)

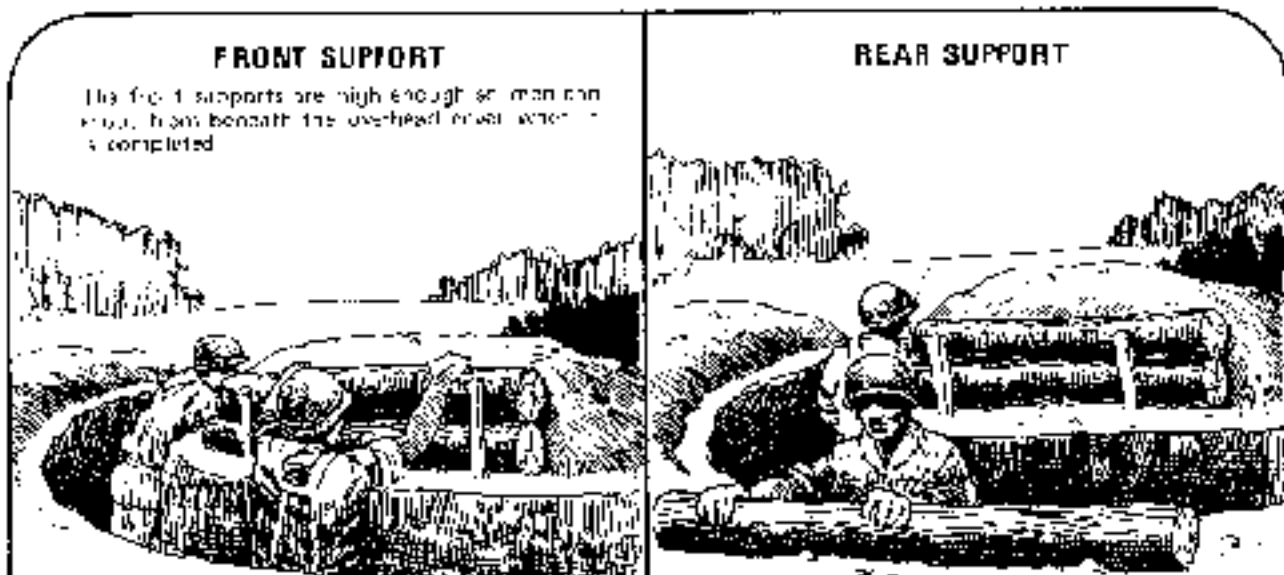

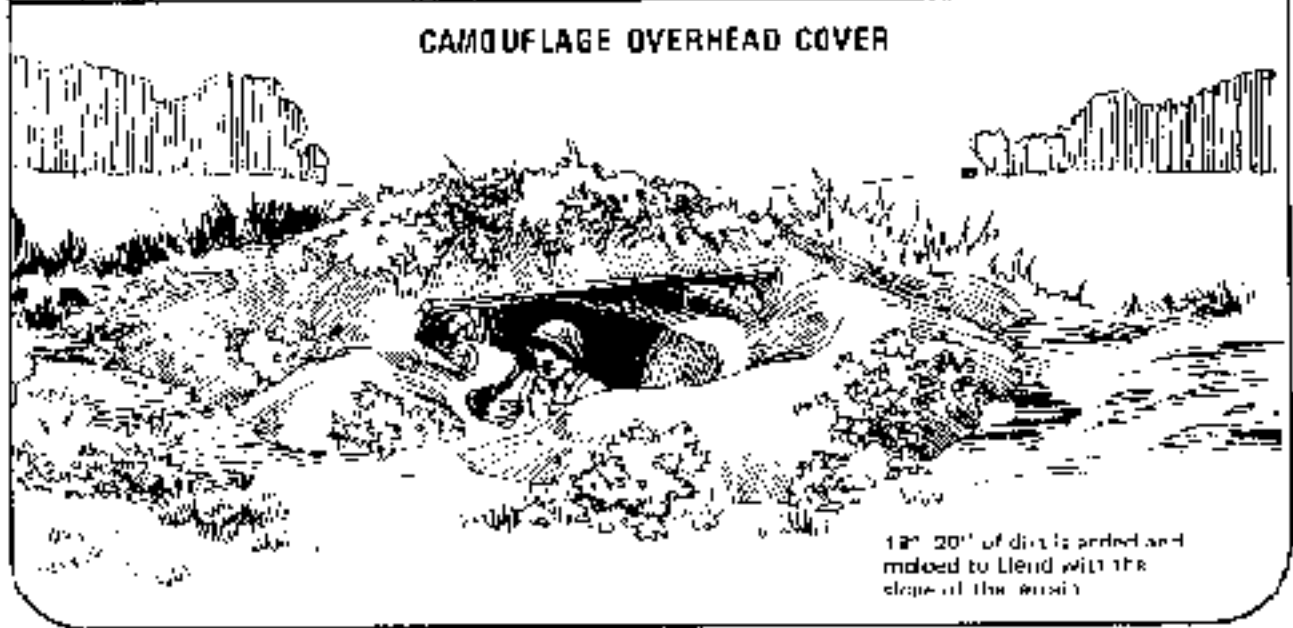
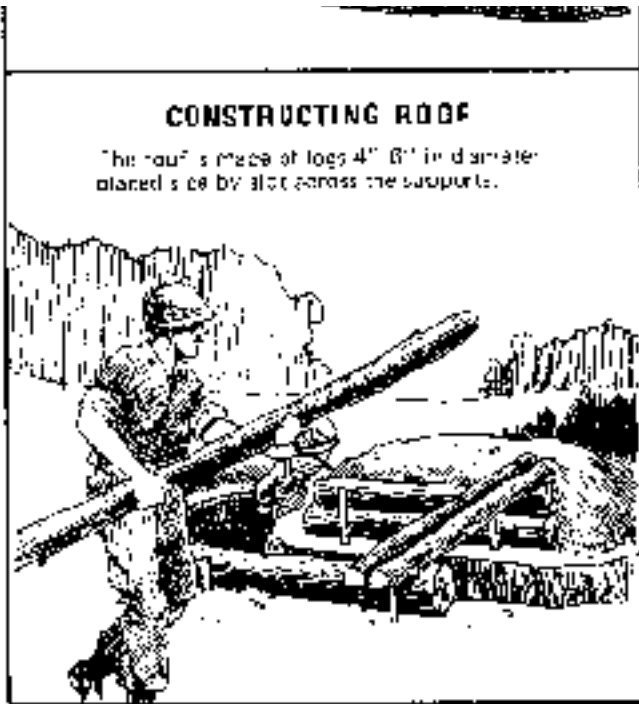

DISMOUNTED TOW POSITION

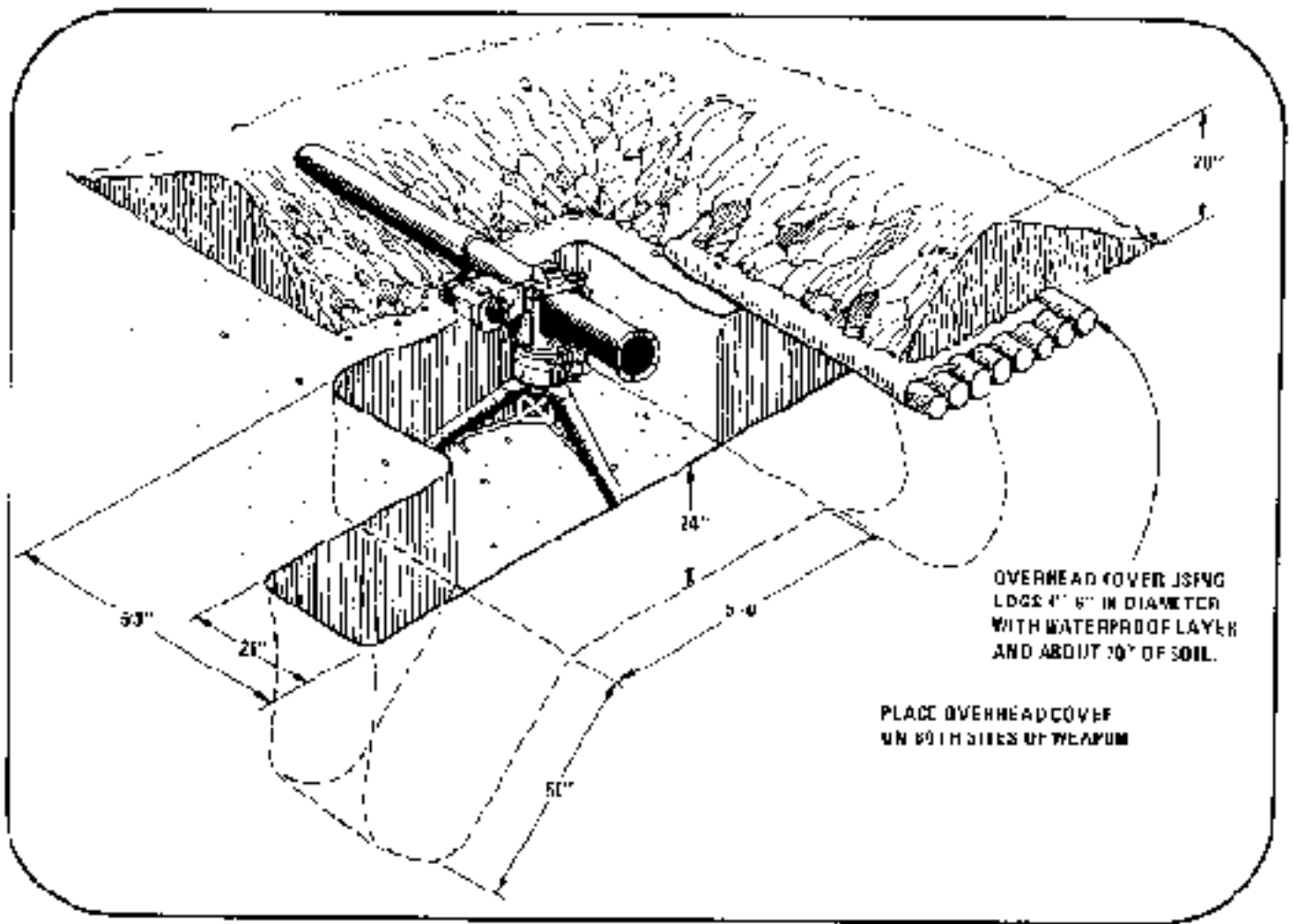

MACHINE GUN POSITION

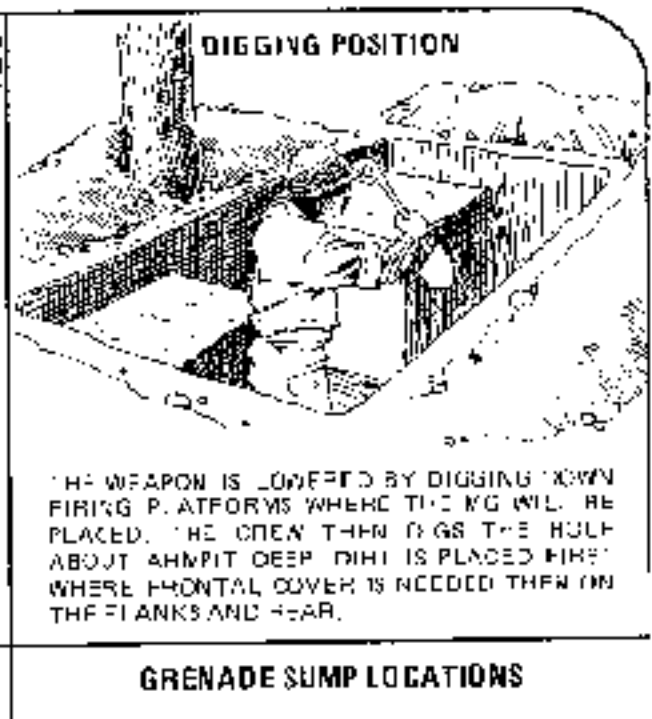
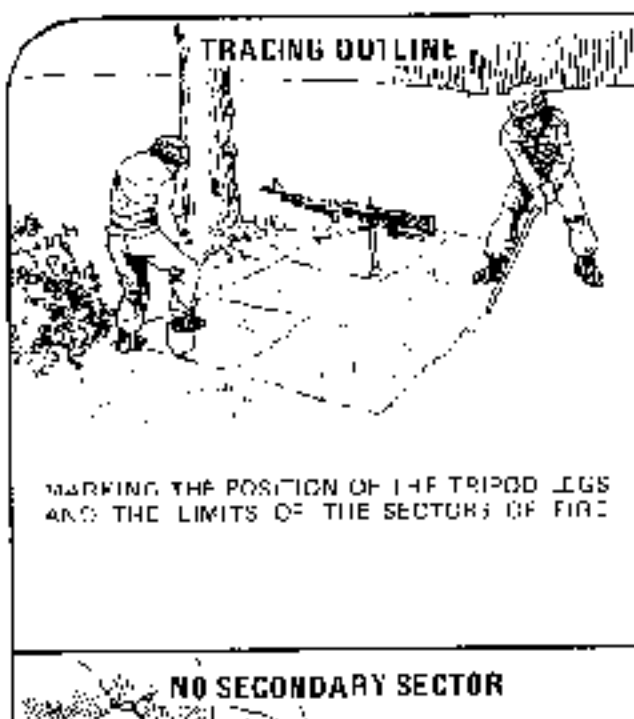



IN SOME PORTIONS AN MG MAY NOT HAVE A SECONDARY SECTOR OF FIRE; SO ONLY HALF OF THE POSITION IS DUG.

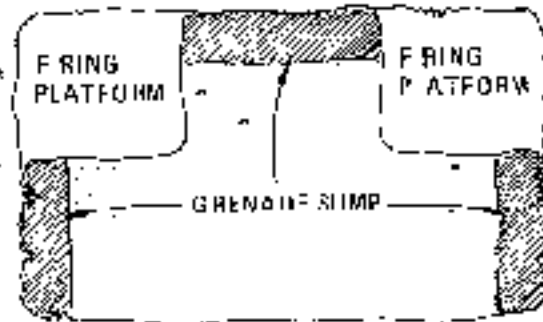

TOP VIEW

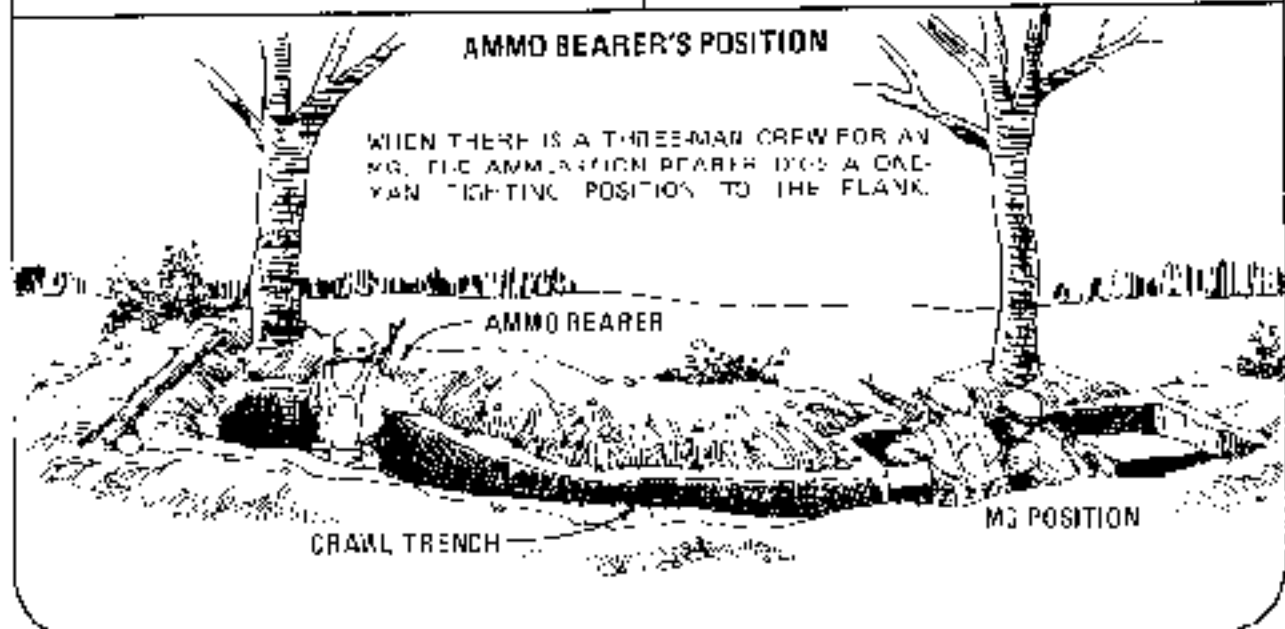

AMMO BEARER'S POSITION

WHEN THERE IS A THREE-MAN CREW FOR AN MG, THE AMMO BEARER DOES A CASUALTY-FIGHTING POSITION TO THE FLANK.

AMMO BEARER

CRAWL TRENCH

MG POSITION

MORTAR POSITION (81MM AND 4.2-IN MORTARS)

HASTY POSITION

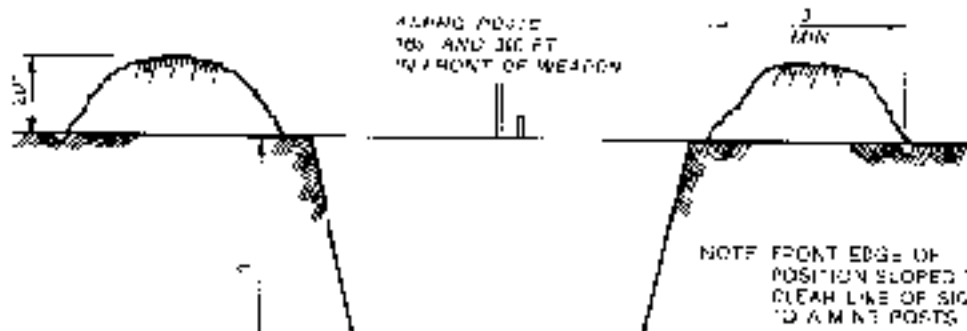

4.2-IN MORTAR
18" AND 36" FT
IN FRONT OF WEAPON

NOTE FRONT EDGE OF
POSITION SLOPED TO
CLEAR LINE OF SIGHT
TO ADJACENT POSTS

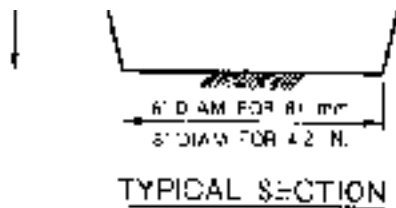

IMPROVED POSITION

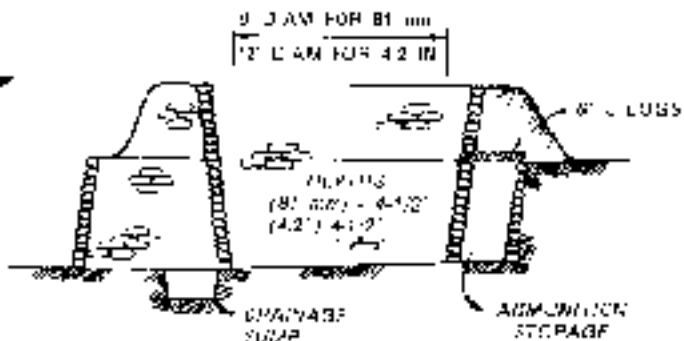
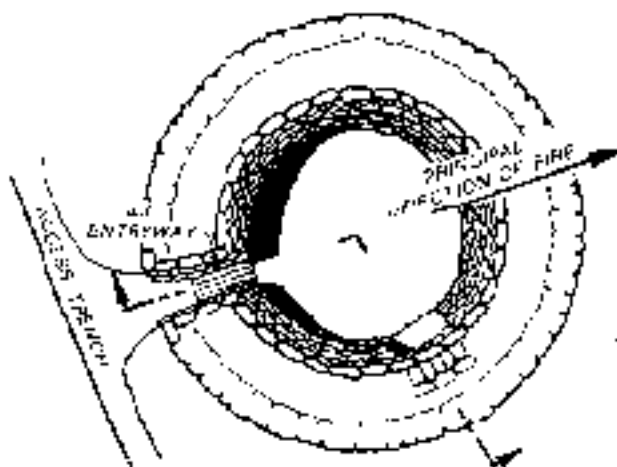

NOTE: TOTAL DEPTH INCLUDES THE PARAPET
 RISE 1/2 FLOOR TOWARD DRAINAGE SLUMP

Dist. of beam 1' 10" by 4" as required by design drawing

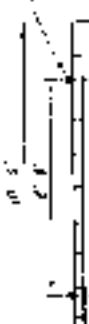

SIDE VIEW



END VIEW



BEAM DETAIL



ELEVATION

WOOD FOOTING

BEAM & DECK DETAILS

DESCRIPTION	QTY	QUANTITY
1. 6' x 10' x 8' BEAM	42	42
2. 4' x 6' x 8' BEAM	36	36
3. 6' x 10' x 8' BEAM	10	10

WOOD-FRAME FIGHTING POSITION (sheet 1 of 3)

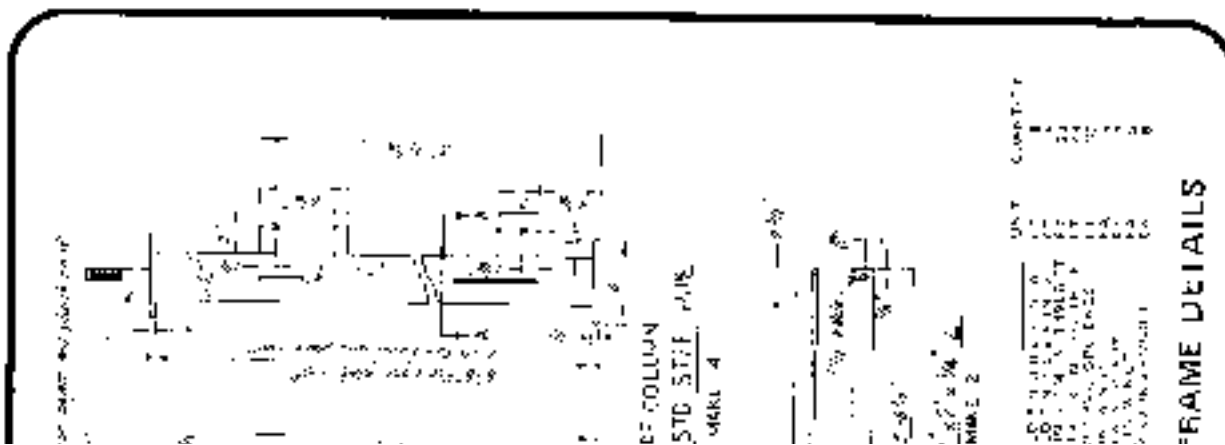
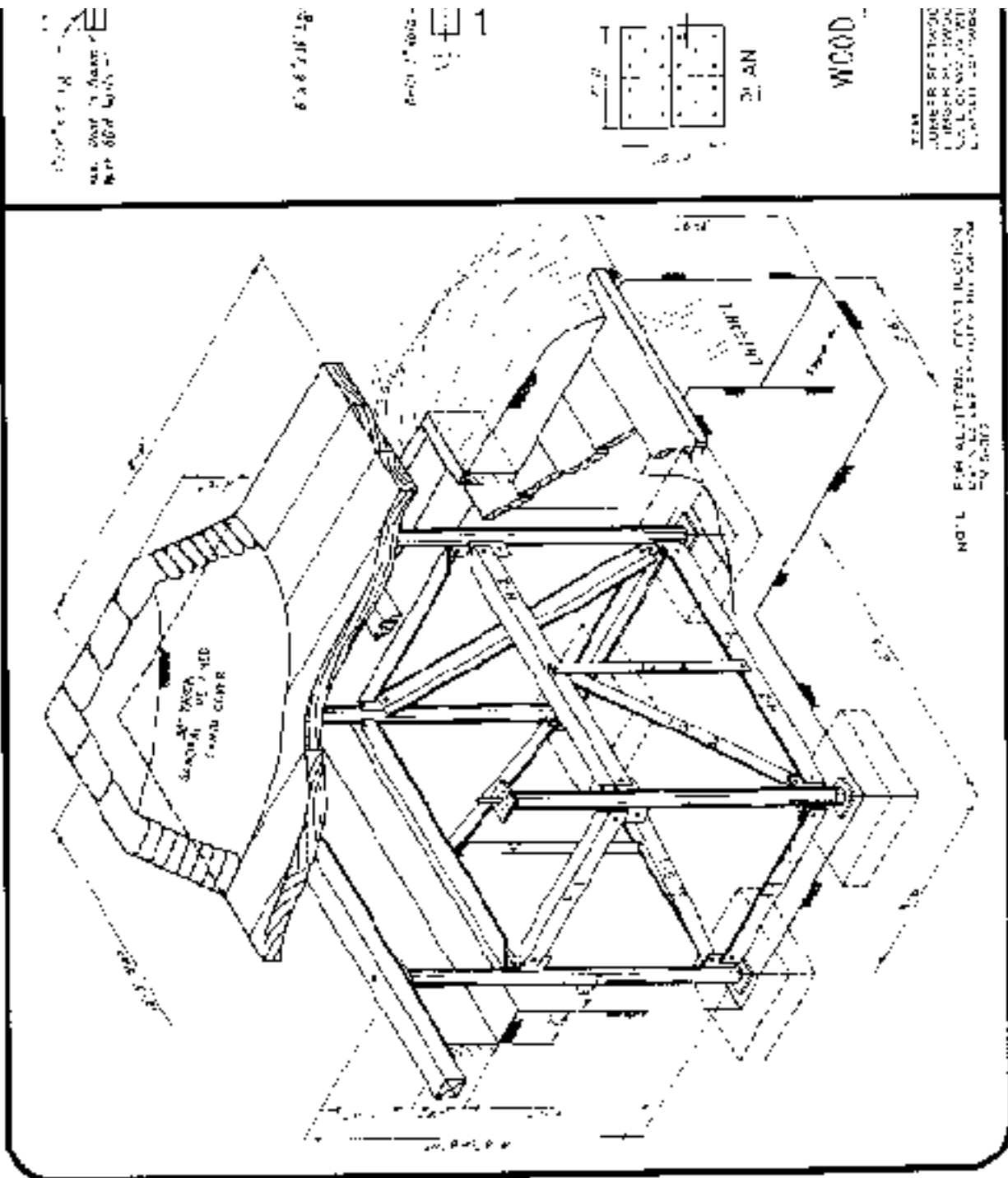

WOOD-FRAME FIGHTING POSITION (sheet 2 of 3)

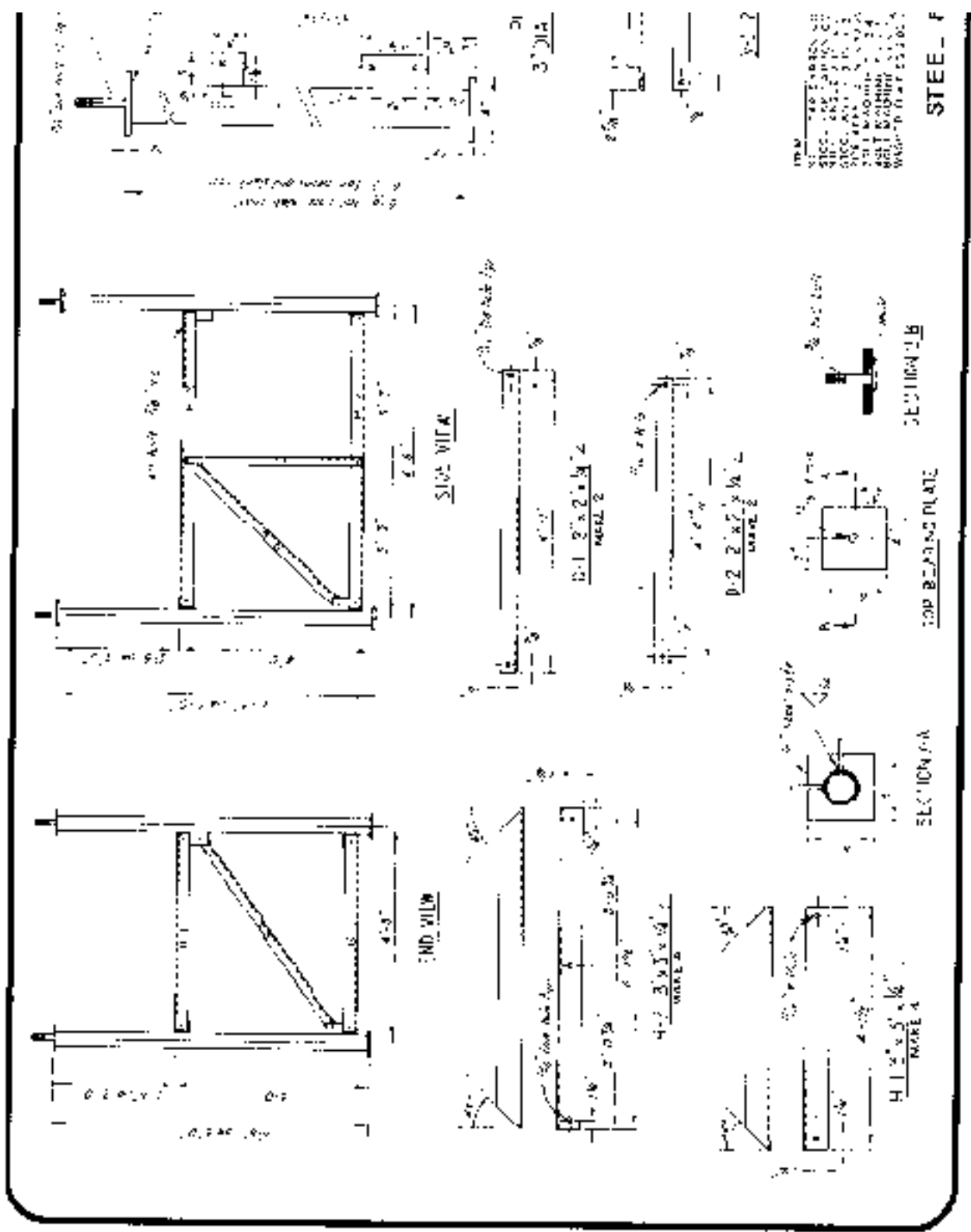

WOOD-FRAME FIGHTING POSITION (sheet 3 of 3)

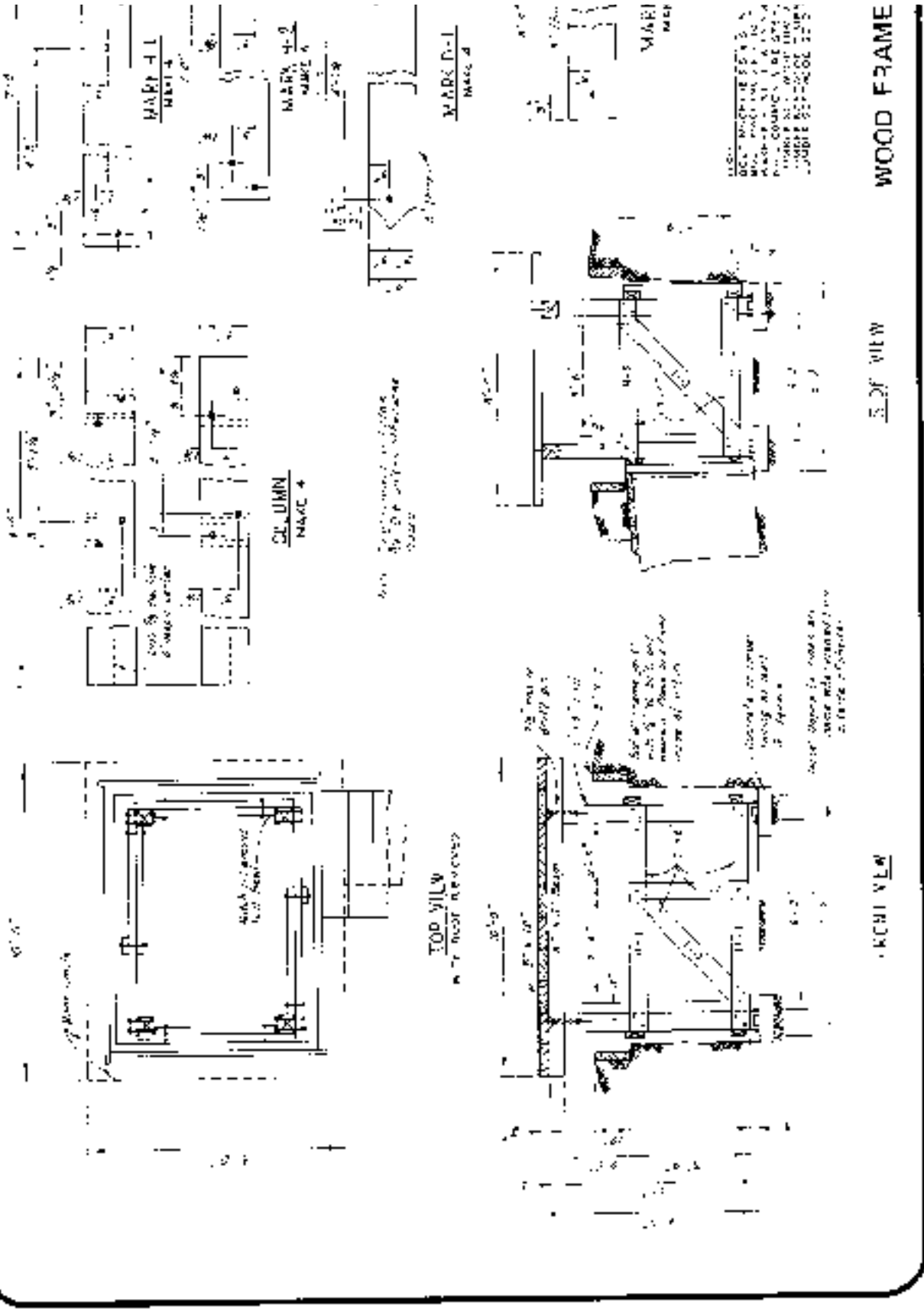

500KEL TEE

OR5

FABRIC-COVERED FRAME POSITION (sheet 1 of 2)

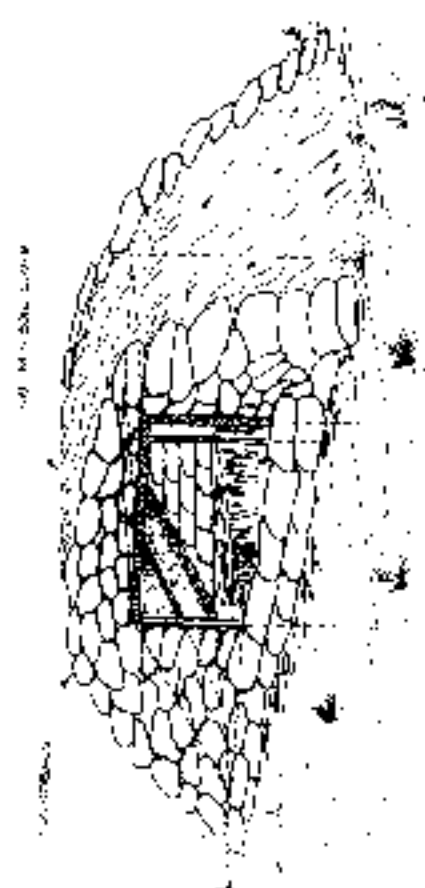
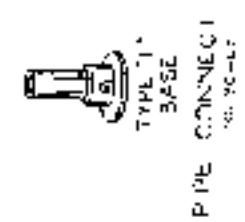
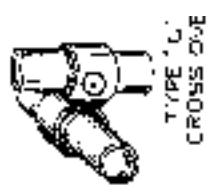
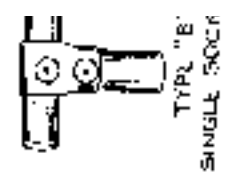
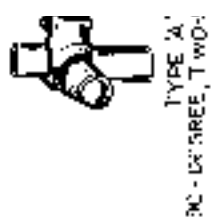
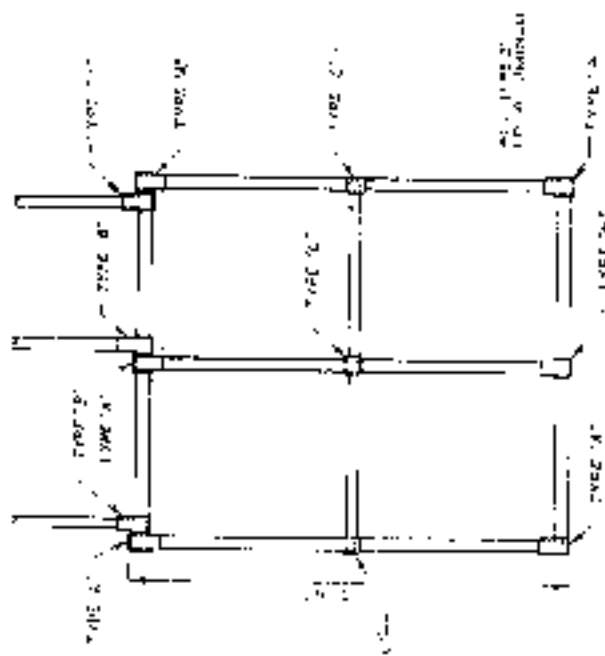

ISOMETRIC FRAME POSITION

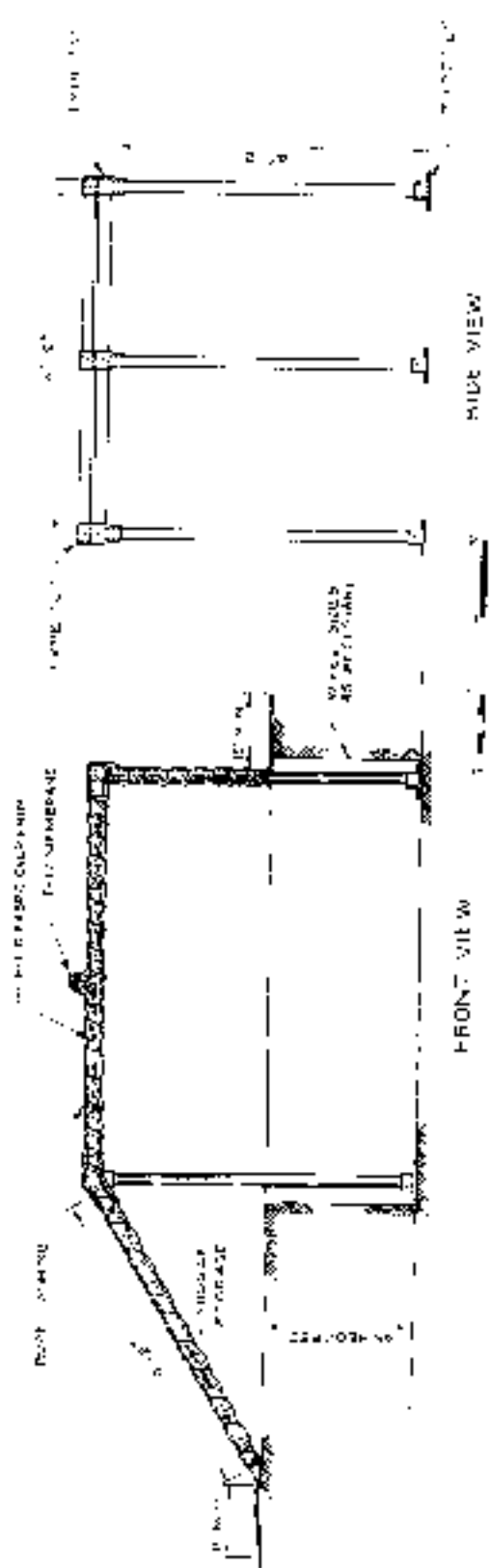

FRONT VIEW

SIDE VIEW

TOP VIEW

FABRIC-COVERED FRAME POSITION (sheet 2 of 2)

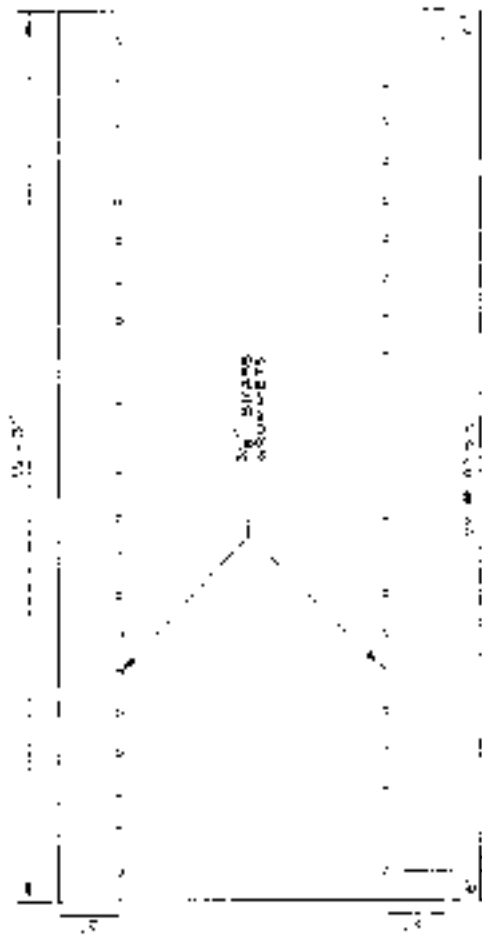

FABRIC CUTTING DETAIL

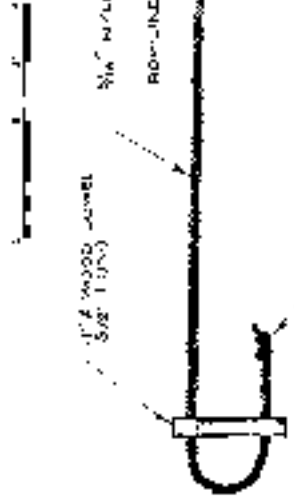

3/8\"/>

3/8\"/>

ALTERNATE FABRIC SECURING METHOD

- 1. SECURE WITH FABRIC TAPE
- 2. SECURE WITH VELCRO TAPE
- 3. SECURE WITH STRAP AND BUCKLE
- 4. SECURE WITH ROPES AND RINGS
- 5. SECURE WITH ROPES AND RINGS
- 6. SECURE WITH ROPES AND RINGS
- 7. SECURE WITH ROPES AND RINGS

ITEM	UNIT	QUANTITY
PIPE ALUMINUM ALLEY 3061 2 IN ID STAMPED III F 40 - 20 F	FT	86
ROOF FIBROGLASS NYLON 2000 LB BREAKING STRENGTH IN DIA	F	100
PIPE CLAMP SING-LOC-SOCKET 1 1/2 IN N	EA	8
PIPE CLAMP TWO-SOCKET TFF 80\"/>		
1 1/2 CLAMP GROSSCOVER 2 IN	EA	2
1 1/2 CLAMP FLUSH FLANGE 2 IN	EA	4
GEORMF METALLIC COPPER ALLOY NO. 2	HC	1
1 FT MEMBRANE EFT TAXIMAY 3000 SQ FT	SQ	12
WAG SAND COTTON	LB	200

- 1. THE PART NUMBER DESIGNATED IN THIS LISTING WAS DESIGNED TO PERFORM THE FUNCTION OF THE PART NUMBER WITH WHICH IT WAS ORIGINALLY DESIGNED TO BE USED. IT IS NOT TO BE USED AS A SUBSTITUTE FOR THE PART NUMBER WITH WHICH IT WAS ORIGINALLY DESIGNED TO BE USED.
- 2. A SINGLE POINT NEOPRENE COATED HIGH TENSILE STRENGTH FABRIC WITH A BREAKING STRENGTH OF AT LEAST 20 LB PER INCH WIDTH IS REQUIRED FOR THE FABRIC COVERING THE FRAME POSITION. THE FABRIC SHOULD BE SECURED TO THE FRAME BY A METHOD THAT WILL NOT CAUSE DAMAGE TO THE FABRIC OR FRAME. THE FABRIC SHOULD BE SECURED TO THE FRAME BY A METHOD THAT WILL NOT CAUSE DAMAGE TO THE FABRIC OR FRAME.

NOTE FOR ATTENTION: CONSTRUCTION DATA IS SHOWN IN EACH VIEW. REFER TO THE DRAWING FOR DIMENSIONS AND TOLERANCES.

CORRUGATED METAL FIGHTING BUNKER (sheet 1 of 2)

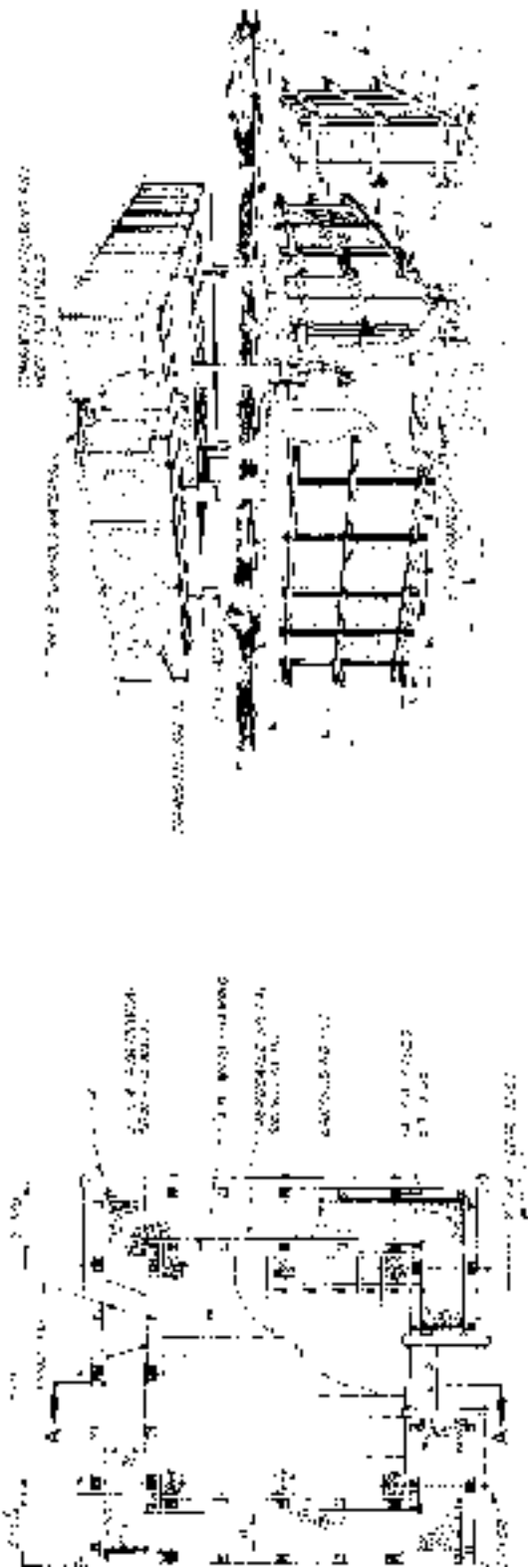

PICTORIAL VIEW

FLOOR PLAN

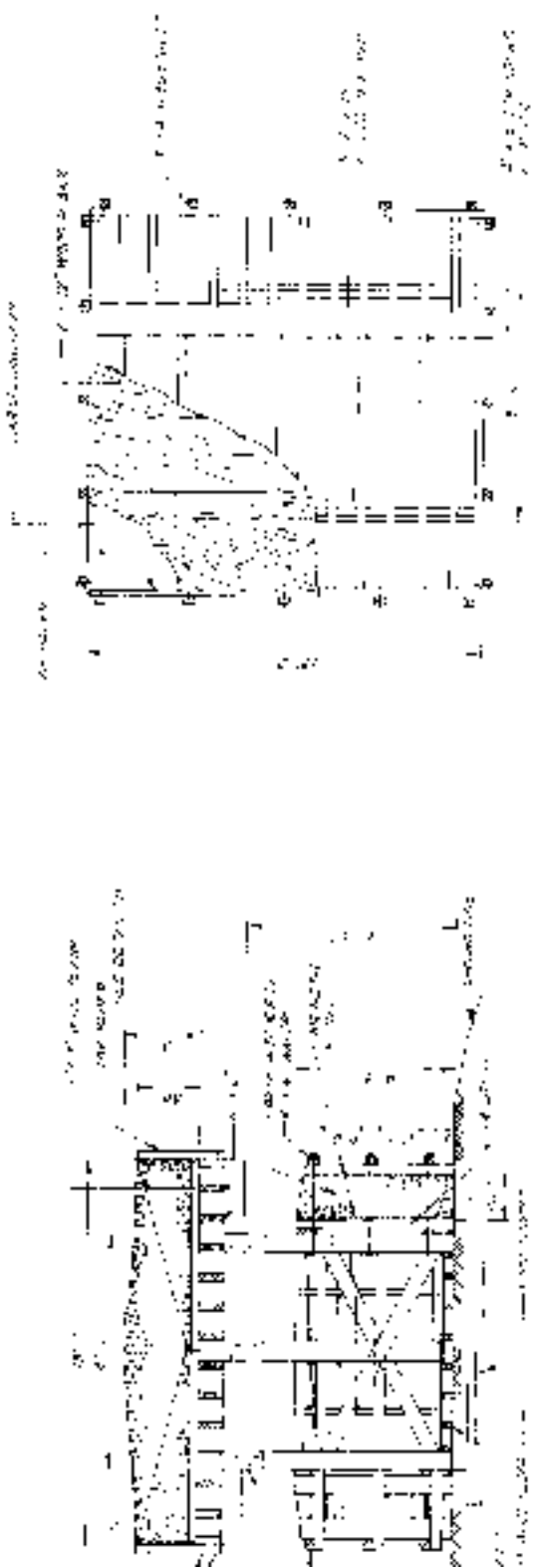

ROOF FRAMING PLAN

SECTION A-A

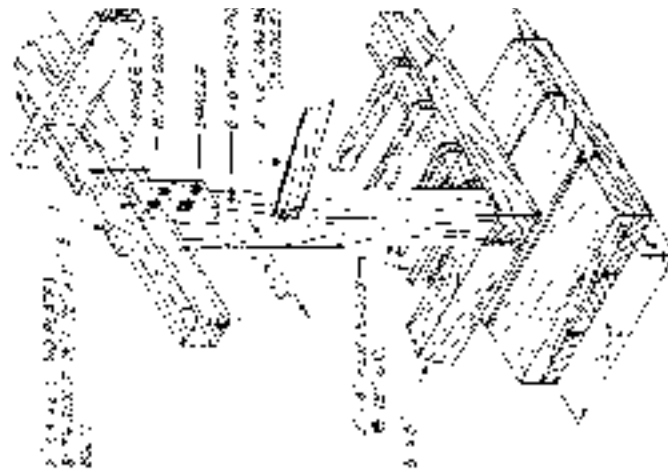

TYPICAL DETAIL OF CONNECT

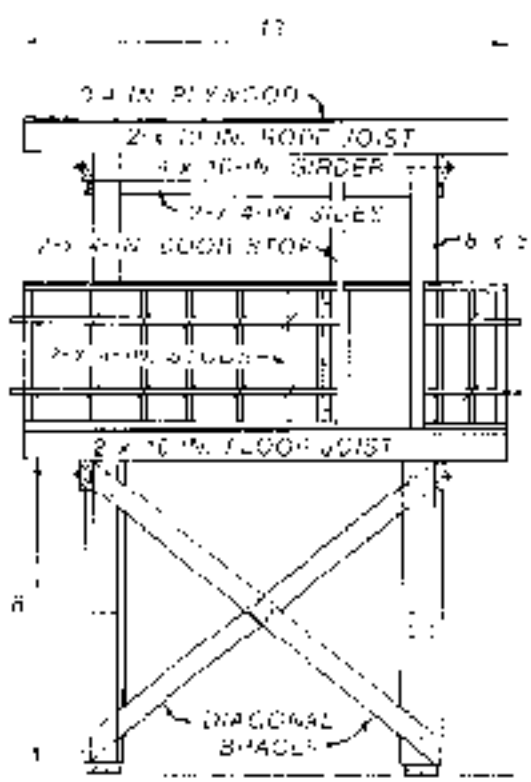

FRONT ELEVATION

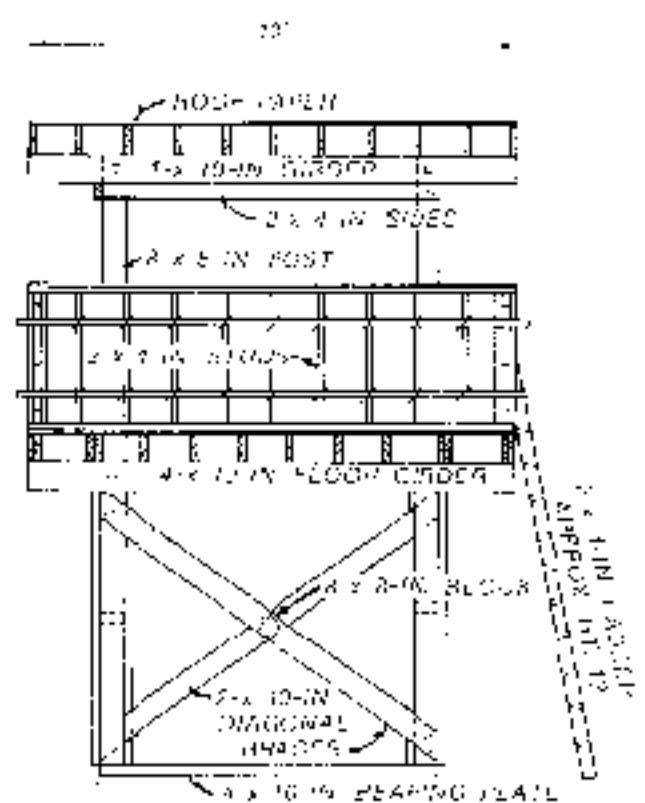

TYPICAL SIDE ELEVATION



BILL OF MATERIALS

ITEM	UNIT	QUANTITY
2x4x8'	EA	120
2x4x14'	EA	30
2x10x14'	EA	10
4x10x14'	EA	10
1.00	EA	1

PLYWOOD PERIMETER BUNKER

STEEL LOG BUNKER (sheet 1 of 2)



2 X 4'S	16	4
2 X 6'S	8	3
2 X 8'S	4	2
2 X 10'S	2	1
2 X 12'S	1	1
2 X 14'S	1	1
2 X 16'S	1	1
2 X 18'S	1	1
2 X 20'S	1	1
2 X 22'S	1	1
2 X 24'S	1	1
2 X 26'S	1	1
2 X 28'S	1	1
2 X 30'S	1	1
2 X 32'S	1	1
2 X 34'S	1	1
2 X 36'S	1	1
2 X 38'S	1	1
2 X 40'S	1	1
2 X 42'S	1	1
2 X 44'S	1	1
2 X 46'S	1	1
2 X 48'S	1	1
2 X 50'S	1	1
2 X 52'S	1	1
2 X 54'S	1	1
2 X 56'S	1	1
2 X 58'S	1	1
2 X 60'S	1	1
2 X 62'S	1	1
2 X 64'S	1	1
2 X 66'S	1	1
2 X 68'S	1	1
2 X 70'S	1	1
2 X 72'S	1	1
2 X 74'S	1	1
2 X 76'S	1	1
2 X 78'S	1	1
2 X 80'S	1	1
2 X 82'S	1	1
2 X 84'S	1	1
2 X 86'S	1	1
2 X 88'S	1	1
2 X 90'S	1	1
2 X 92'S	1	1
2 X 94'S	1	1
2 X 96'S	1	1
2 X 98'S	1	1
2 X 100'S	1	1

NOTE: THIS BUNKER CAN BE REARRED AS SHOWN ON SHEET 2 OF THIS SET.

TYPICAL WALL SECTION

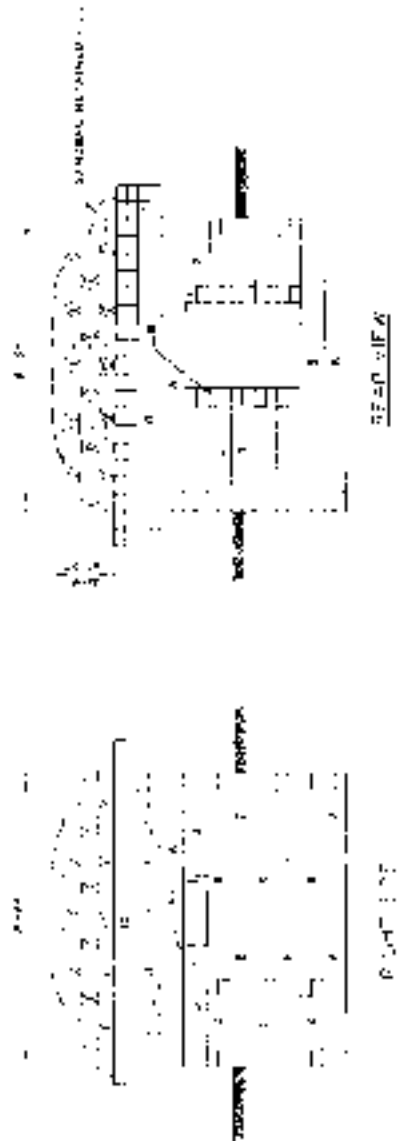

BUNKER (sheet 2 of 2)

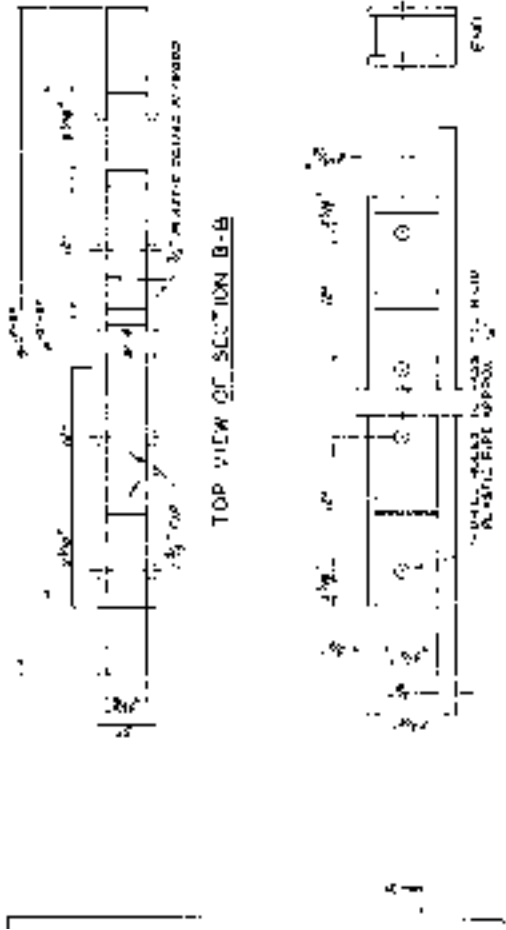

EAST CL. 100
WEST CL. 100
N. 100

SCALE:
1/4" = 1'-0"
1/8" = 1'-0"

CONCR

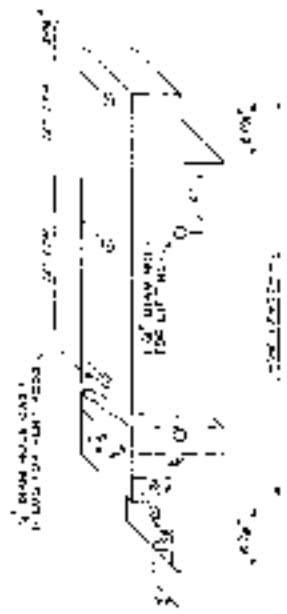
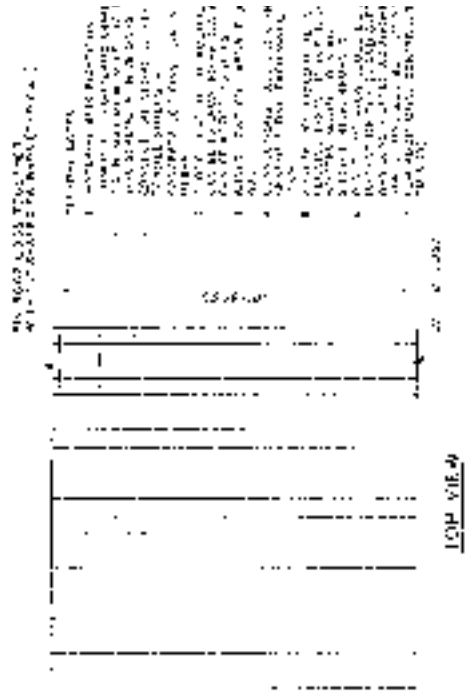

LOG TOP OF EAST
TYPICAL DIMENSIONS



CONCRETE LOG

(ER (sheet 1 of 3))

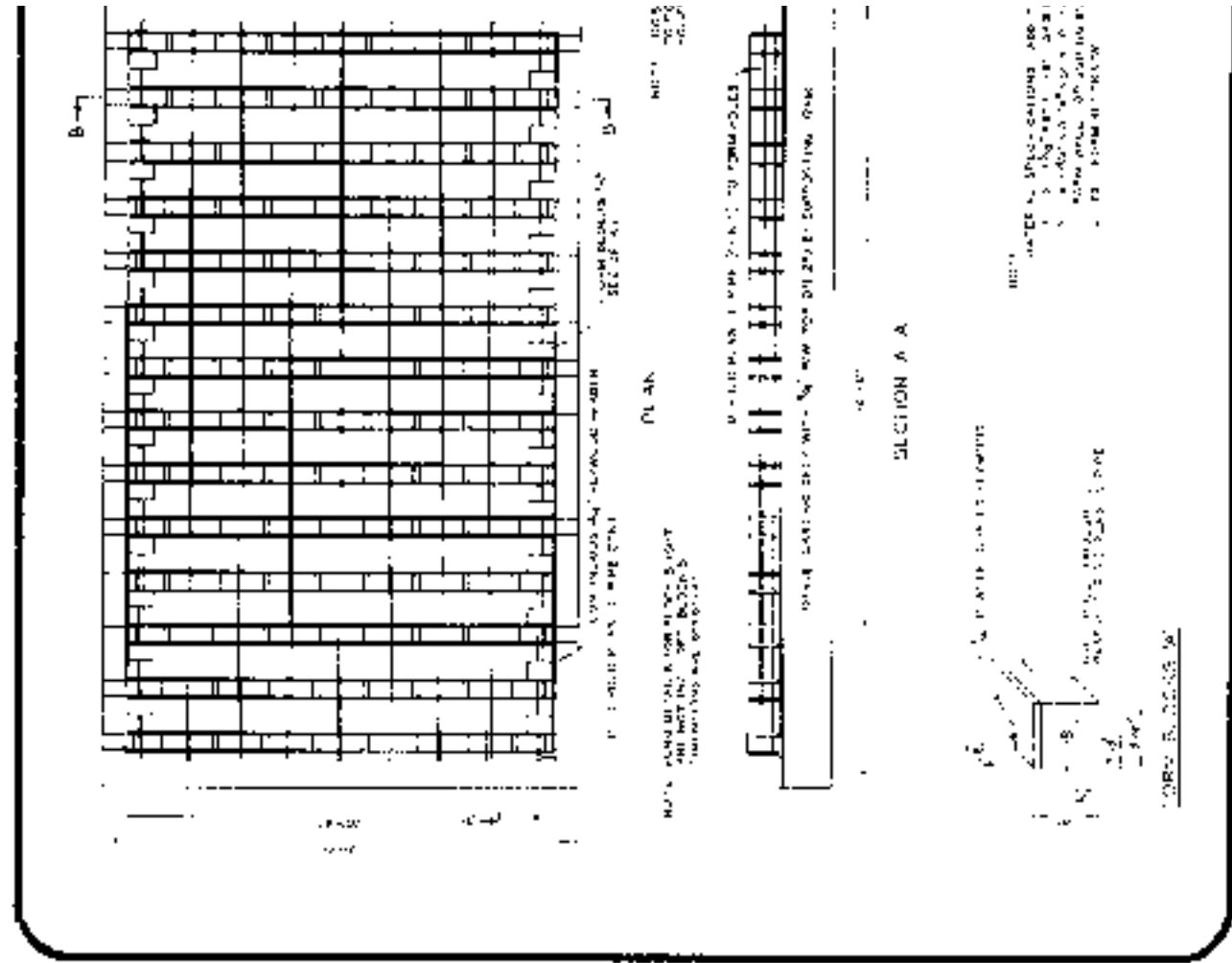
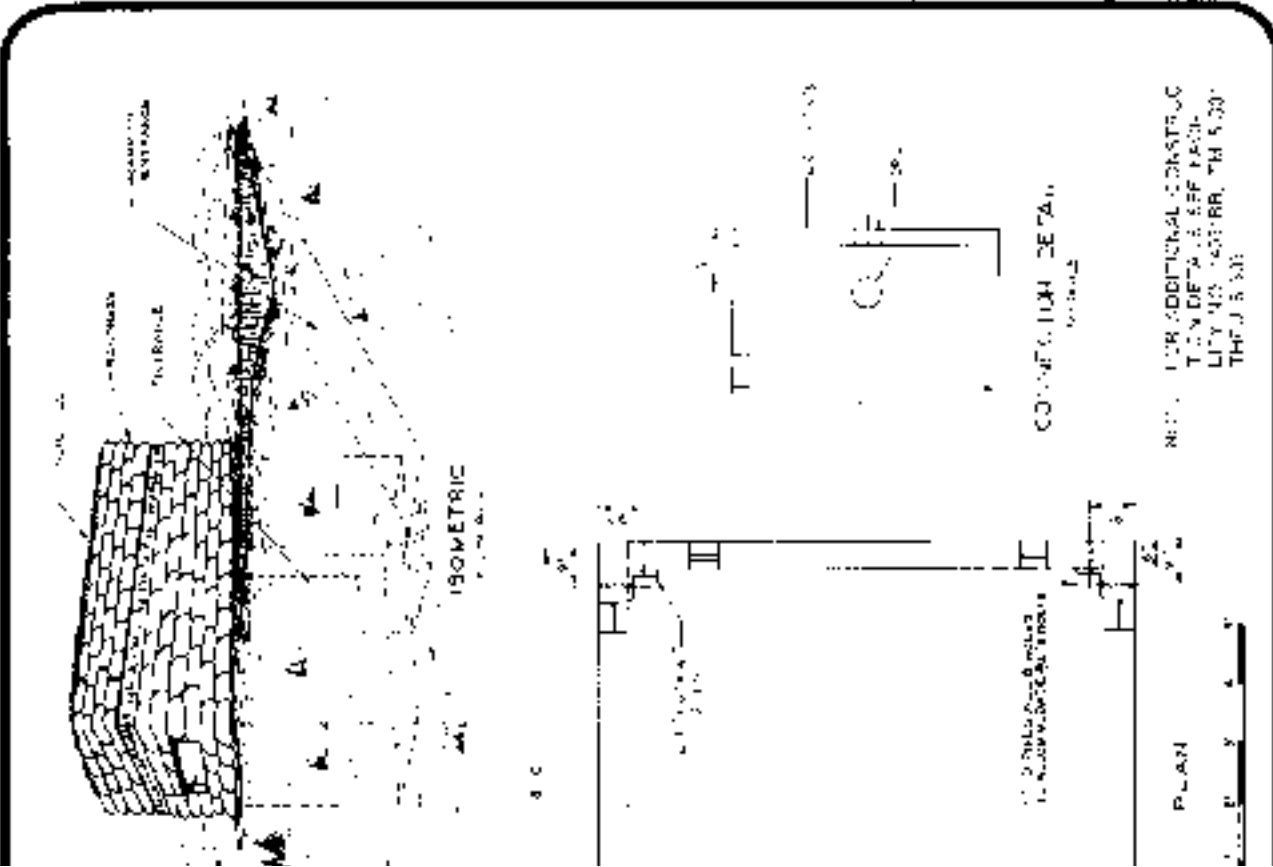

PRECAST CONCRETE SLAB BUNI

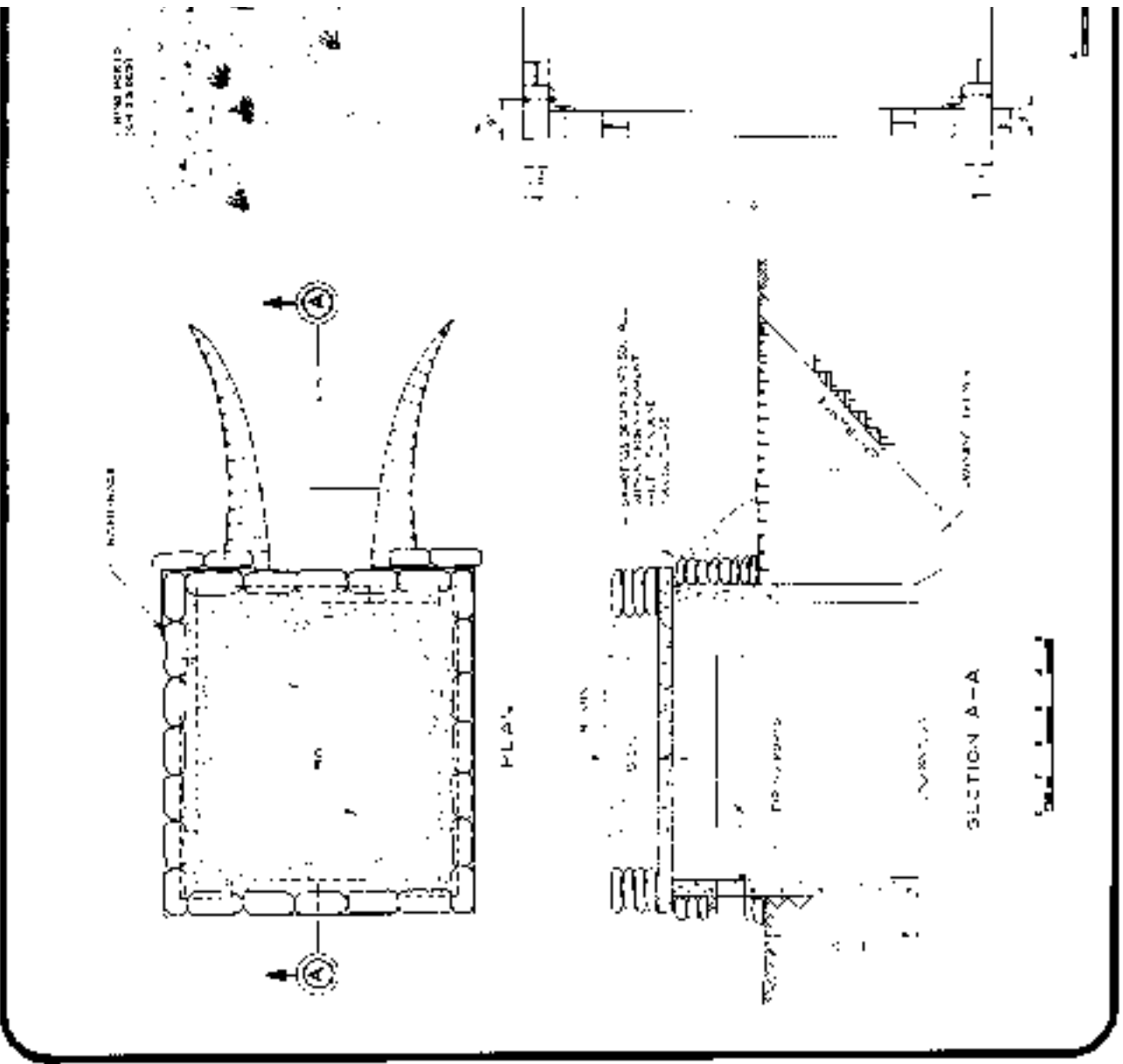

of 31

SLAB DETAILS

FOR THIS DESIGN
 CONCRETE STRENGTH
 4000 PSI

REINFORCEMENT
 #4 @ 12" O.C.

SECTION A-A

SCALE 1/4" = 1'-0"

REINFORCEMENT SCHEDULE

NO.	BAR SIZE	QUANTITY	LENGTH	WEIGHT
1	#4	4	12'-0"	112.0
2	#4	4	12'-0"	112.0
3	#4	4	12'-0"	112.0
4	#4	4	12'-0"	112.0
5	#4	4	12'-0"	112.0
6	#4	4	12'-0"	112.0
7	#4	4	12'-0"	112.0
8	#4	4	12'-0"	112.0
9	#4	4	12'-0"	112.0
10	#4	4	12'-0"	112.0
11	#4	4	12'-0"	112.0
12	#4	4	12'-0"	112.0
13	#4	4	12'-0"	112.0
14	#4	4	12'-0"	112.0
15	#4	4	12'-0"	112.0
16	#4	4	12'-0"	112.0
17	#4	4	12'-0"	112.0
18	#4	4	12'-0"	112.0
19	#4	4	12'-0"	112.0
20	#4	4	12'-0"	112.0
21	#4	4	12'-0"	112.0
22	#4	4	12'-0"	112.0
23	#4	4	12'-0"	112.0
24	#4	4	12'-0"	112.0
25	#4	4	12'-0"	112.0
26	#4	4	12'-0"	112.0
27	#4	4	12'-0"	112.0
28	#4	4	12'-0"	112.0
29	#4	4	12'-0"	112.0
30	#4	4	12'-0"	112.0
31	#4	4	12'-0"	112.0
32	#4	4	12'-0"	112.0
33	#4	4	12'-0"	112.0
34	#4	4	12'-0"	112.0
35	#4	4	12'-0"	112.0
36	#4	4	12'-0"	112.0
37	#4	4	12'-0"	112.0
38	#4	4	12'-0"	112.0
39	#4	4	12'-0"	112.0
40	#4	4	12'-0"	112.0
41	#4	4	12'-0"	112.0
42	#4	4	12'-0"	112.0
43	#4	4	12'-0"	112.0
44	#4	4	12'-0"	112.0
45	#4	4	12'-0"	112.0
46	#4	4	12'-0"	112.0
47	#4	4	12'-0"	112.0
48	#4	4	12'-0"	112.0
49	#4	4	12'-0"	112.0
50	#4	4	12'-0"	112.0
51	#4	4	12'-0"	112.0
52	#4	4	12'-0"	112.0
53	#4	4	12'-0"	112.0
54	#4	4	12'-0"	112.0
55	#4	4	12'-0"	112.0
56	#4	4	12'-0"	112.0
57	#4	4	12'-0"	112.0
58	#4	4	12'-0"	112.0
59	#4	4	12'-0"	112.0
60	#4	4	12'-0"	112.0
61	#4	4	12'-0"	112.0
62	#4	4	12'-0"	112.0
63	#4	4	12'-0"	112.0
64	#4	4	12'-0"	112.0
65	#4	4	12'-0"	112.0
66	#4	4	12'-0"	112.0
67	#4	4	12'-0"	112.0
68	#4	4	12'-0"	112.0
69	#4	4	12'-0"	112.0
70	#4	4	12'-0"	112.0
71	#4	4	12'-0"	112.0
72	#4	4	12'-0"	112.0
73	#4	4	12'-0"	112.0
74	#4	4	12'-0"	112.0
75	#4	4	12'-0"	112.0
76	#4	4	12'-0"	112.0
77	#4	4	12'-0"	112.0
78	#4	4	12'-0"	112.0
79	#4	4	12'-0"	112.0
80	#4	4	12'-0"	112.0
81	#4	4	12'-0"	112.0
82	#4	4	12'-0"	112.0
83	#4	4	12'-0"	112.0
84	#4	4	12'-0"	112.0
85	#4	4	12'-0"	112.0
86	#4	4	12'-0"	112.0
87	#4	4	12'-0"	112.0
88	#4	4	12'-0"	112.0
89	#4	4	12'-0"	112.0
90	#4	4	12'-0"	112.0
91	#4	4	12'-0"	112.0
92	#4	4	12'-0"	112.0
93	#4	4	12'-0"	112.0
94	#4	4	12'-0"	112.0
95	#4	4	12'-0"	112.0
96	#4	4	12'-0"	112.0
97	#4	4	12'-0"	112.0
98	#4	4	12'-0"	112.0
99	#4	4	12'-0"	112.0
100	#4	4	12'-0"	112.0

PRECAST CONCRETE SLAB BUNKER (sheet 2)

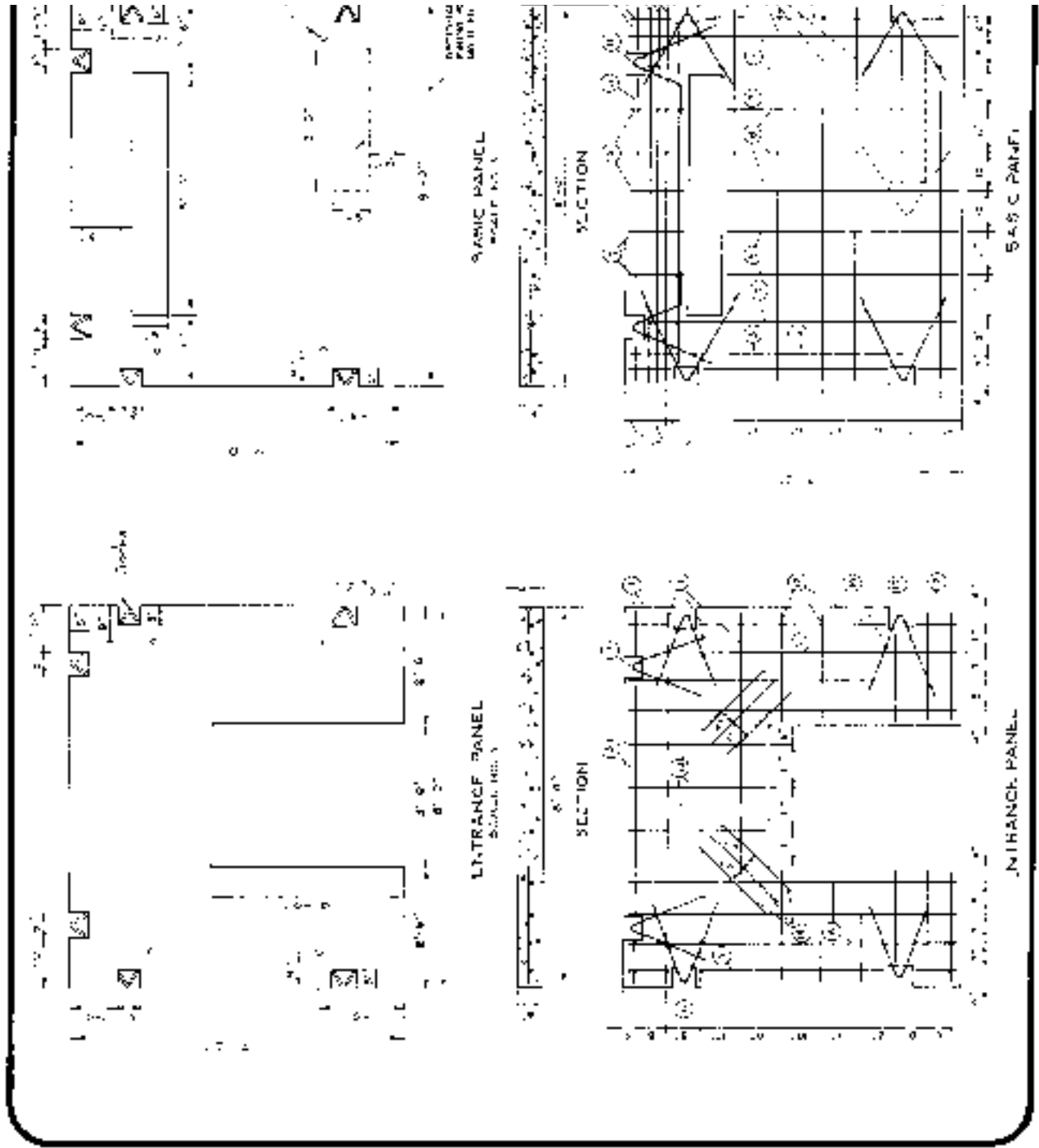

ITEM	QTY	UNIT	SLANT	FT
1. 2' x 4' x 8' V	14	IN	16	
11. 3' x 4' x 8' V	12	IN	16	
WOOD DIM 2	100			
WOOD DIM 2	220			
GEN CONC	48			
CEARSE LOCAL	5			
RE LOCAL	7			
IMPROVING 2	10			
10. 2' x 4' x 8' V	1			
5 IN - 12 N	5			

PRECAST CONCRETE SLAB BUNKER (sheet 3 of 3)

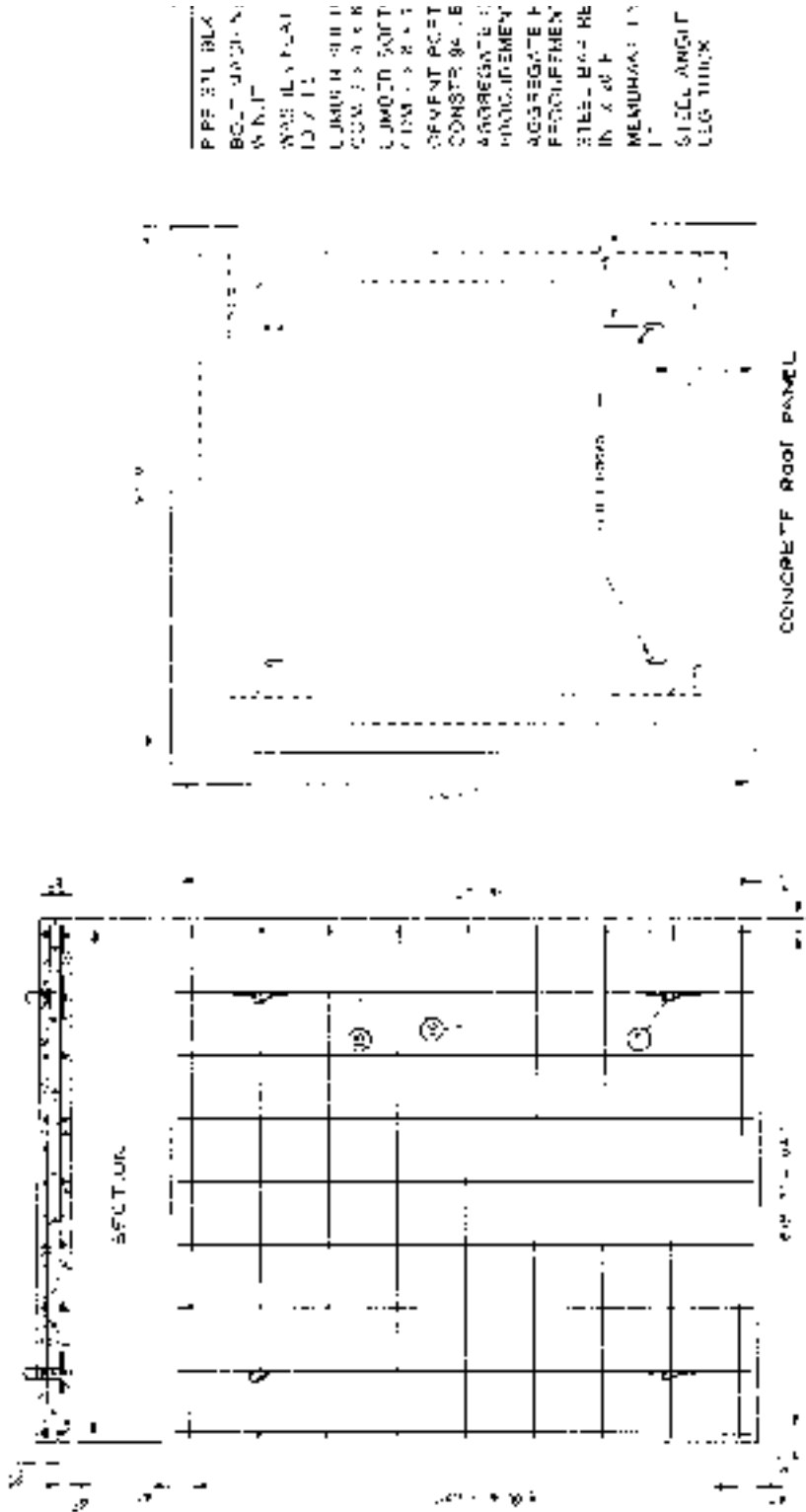

UNIT	QUANTITY
EA	1
EA	20
EA	10
EA	40
EA	1
EA	1/2
EA	144
EA	1
EA	5
EA	32
EA	10
EA	28

DETAILS AND ARCH SYMBOLS IN APPENDIX D

SCALE
1" = 4'-0"

GENERAL NOTES

1. THIS DRAWING SHALL BE IN ACCORDANCE WITH THE LATEST EDITIONS OF THE U.S. ARMY ARCHITECTURAL DRAWING STANDARDS.
2. ALL DIMENSIONS SHALL BE IN FEET AND INCHES UNLESS OTHERWISE SPECIFIED.
3. ALL MATERIALS SHALL BE OF THE BEST QUALITY AVAILABLE.
4. ALL MATERIALS SHALL BE SUBJECT TO INSPECTION AND APPROVAL BY THE CONTRACTOR'S QUALITY CONTROL PERSONNEL.
5. ALL MATERIALS SHALL BE SUBJECT TO INSPECTION AND APPROVAL BY THE CONTRACTOR'S QUALITY CONTROL PERSONNEL.
6. ALL MATERIALS SHALL BE SUBJECT TO INSPECTION AND APPROVAL BY THE CONTRACTOR'S QUALITY CONTROL PERSONNEL.
7. ALL MATERIALS SHALL BE SUBJECT TO INSPECTION AND APPROVAL BY THE CONTRACTOR'S QUALITY CONTROL PERSONNEL.
8. ALL MATERIALS SHALL BE SUBJECT TO INSPECTION AND APPROVAL BY THE CONTRACTOR'S QUALITY CONTROL PERSONNEL.
9. ALL MATERIALS SHALL BE SUBJECT TO INSPECTION AND APPROVAL BY THE CONTRACTOR'S QUALITY CONTROL PERSONNEL.
10. ALL MATERIALS SHALL BE SUBJECT TO INSPECTION AND APPROVAL BY THE CONTRACTOR'S QUALITY CONTROL PERSONNEL.

CONCRETE ARCH BUNKER

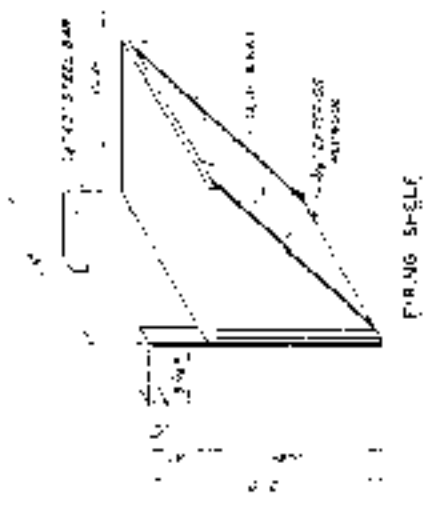
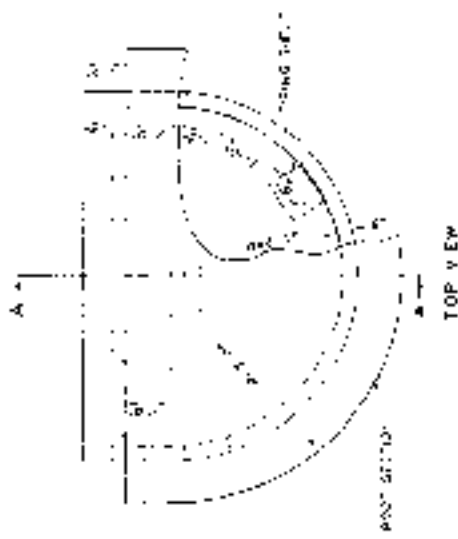

- ITEM
- 1. 10\"/>

NOTE: FROM MIL. ARCH. PUBLICATIONS: STEEL ARCH BUNKER. TOP OF CONCRETE ARCH BUNKER. SECTION III, CHAPTER...

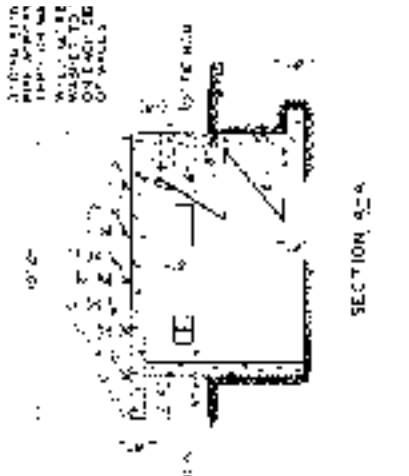
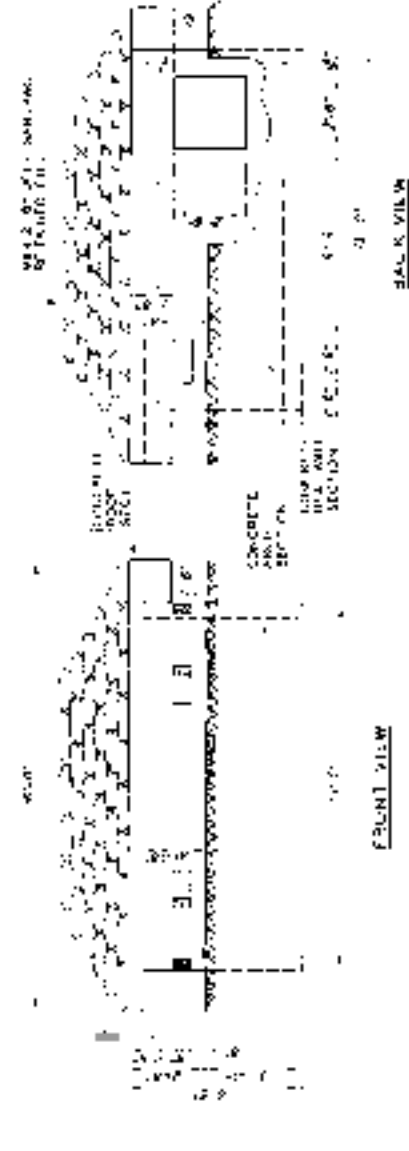

COVERED DEEP-CUT POSITION (sheet 1 of 2)

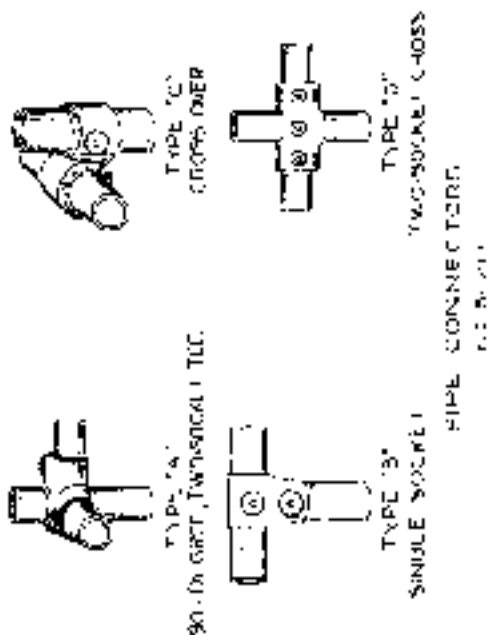
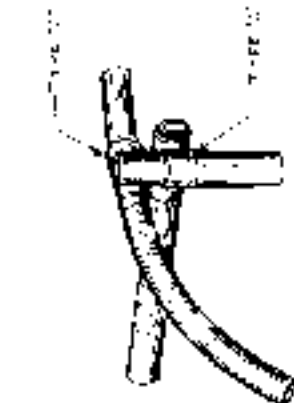
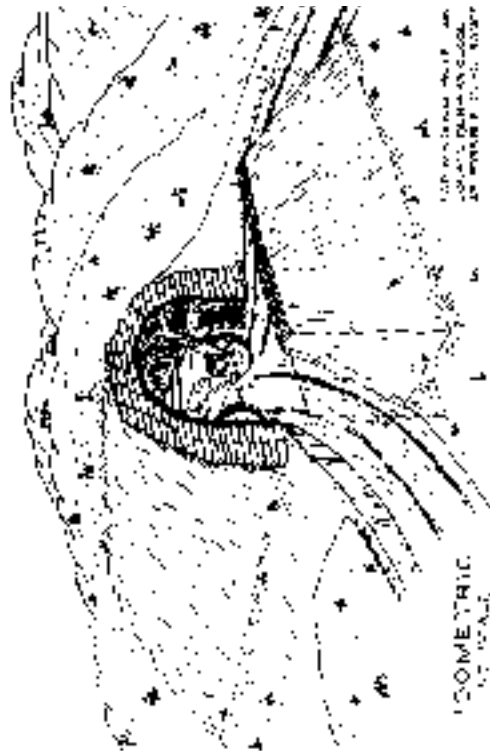
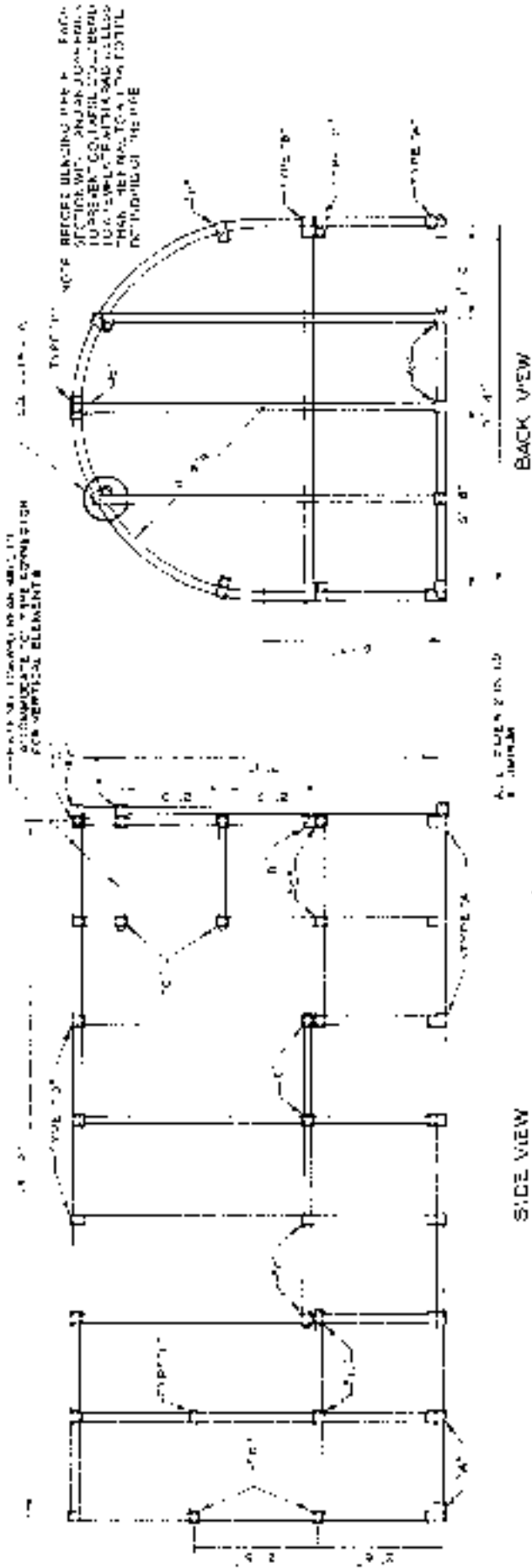

COVERED DEEP-CUT POSITION (sheet 2 of 2)

1. SHIELDING SHALL BE PROVIDED FOR ALL ELECTRICAL CONNECTIONS TO THE SHIELDING.

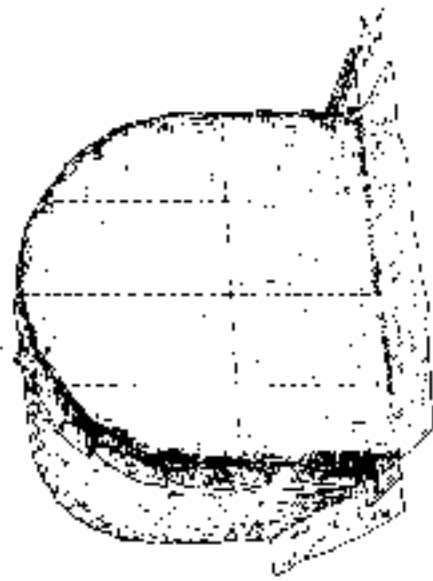

SHIELDING FOR R-RAK WALL

SHIELDER BODY
BARRIERS INSTALLATION

1. THE SHIELDER SHALL BE MADE OF 1/2" ALUMINUM PLATE WITH 1/4" ALUMINUM ANGLE IRON STUDS AT 24" ON CENTER.
2. THE SHIELDER SHALL BE MADE OF 1/2" ALUMINUM PLATE WITH 1/4" ALUMINUM ANGLE IRON STUDS AT 24" ON CENTER.
3. THE SHIELDER SHALL BE MADE OF 1/2" ALUMINUM PLATE WITH 1/4" ALUMINUM ANGLE IRON STUDS AT 24" ON CENTER.
4. THE SHIELDER SHALL BE MADE OF 1/2" ALUMINUM PLATE WITH 1/4" ALUMINUM ANGLE IRON STUDS AT 24" ON CENTER.
5. THE SHIELDER SHALL BE MADE OF 1/2" ALUMINUM PLATE WITH 1/4" ALUMINUM ANGLE IRON STUDS AT 24" ON CENTER.
6. THE SHIELDER SHALL BE MADE OF 1/2" ALUMINUM PLATE WITH 1/4" ALUMINUM ANGLE IRON STUDS AT 24" ON CENTER.
7. THE SHIELDER SHALL BE MADE OF 1/2" ALUMINUM PLATE WITH 1/4" ALUMINUM ANGLE IRON STUDS AT 24" ON CENTER.
8. THE SHIELDER SHALL BE MADE OF 1/2" ALUMINUM PLATE WITH 1/4" ALUMINUM ANGLE IRON STUDS AT 24" ON CENTER.
9. THE SHIELDER SHALL BE MADE OF 1/2" ALUMINUM PLATE WITH 1/4" ALUMINUM ANGLE IRON STUDS AT 24" ON CENTER.
10. THE SHIELDER SHALL BE MADE OF 1/2" ALUMINUM PLATE WITH 1/4" ALUMINUM ANGLE IRON STUDS AT 24" ON CENTER.

ITEM	UNIT	QUANTITY
ROPE FIBROUS NYLON 2831	11	200
LE BREAKING 2 1/2" N. 2 1/2"	10	6
P PE ALUM ALLOY 3/4" 2 1/2"	EA	2
ID SHEET 1/4" 4' x 20' FT	EA	16
P PE CLAMP 5 ANGLE-SOCKET TEE 7 1/4"	EA	2E
P PE CLAMP TWO-SOCKET 1 1/2" 90° 2 1/4"	EA	8
P PE CLAMP CROSSOVER 5 1/4"	EA	8
C PE CLAMP TWO SOCKET CROSS 5 1/4"	EA	8
C PE ALLOY N. 2 1/2"	EA	8
T-17 MEMORANE SET TAP 1/2" 3000 90° 1 1/2"	EA	8
MINI STEEL MC 1020 3.0625 IN. DIA. 1 1/2"	EA	8

SHIELDER BODY
FABRIC CUTTING DETAIL

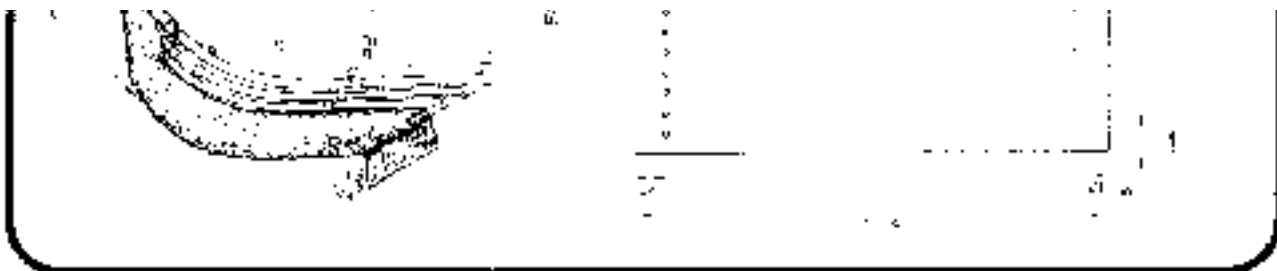

ARTILLERY FIRING PLATFORM (155 MM, 175 MM, AND 8-IN ARTILLERY) (sheet 1 of 3)

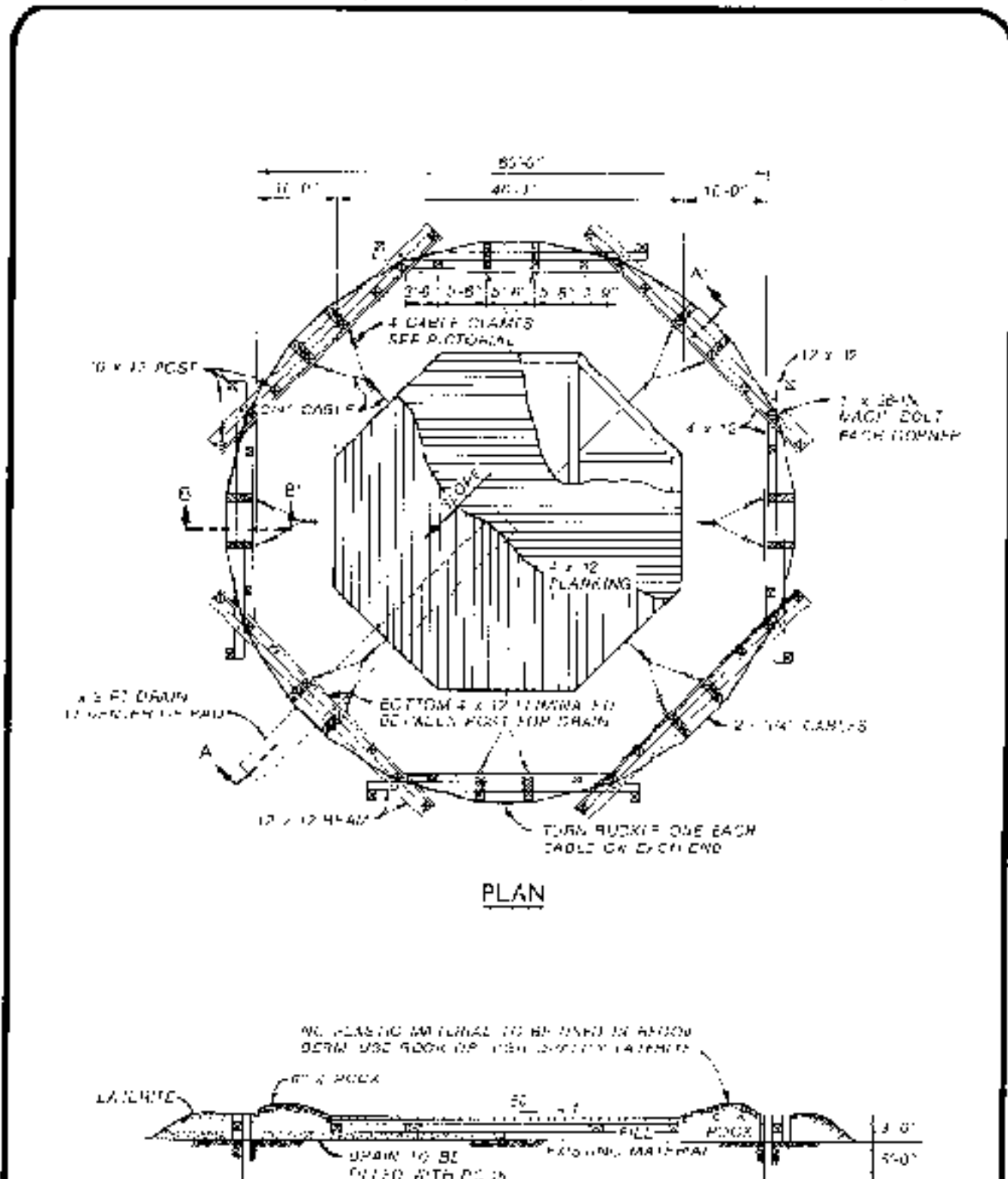

SECTION A-A'

ARTILLERY FIRING PLATFORM (155 MM, 175 MM, AND 8-IN ARTILLERY) (sheet 2 of 3)

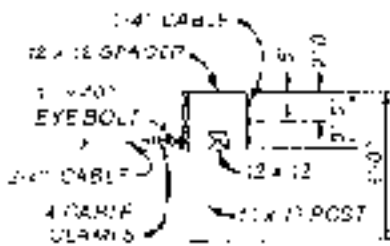
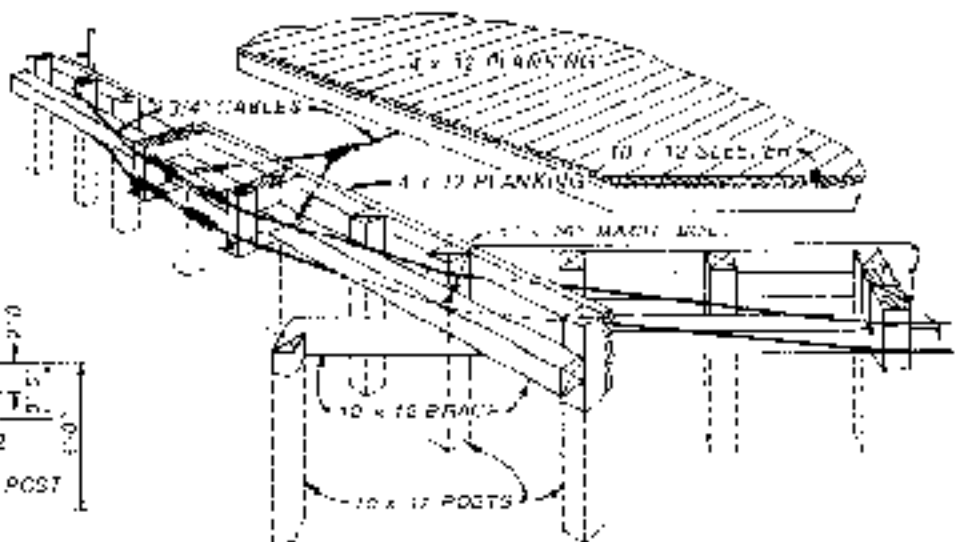
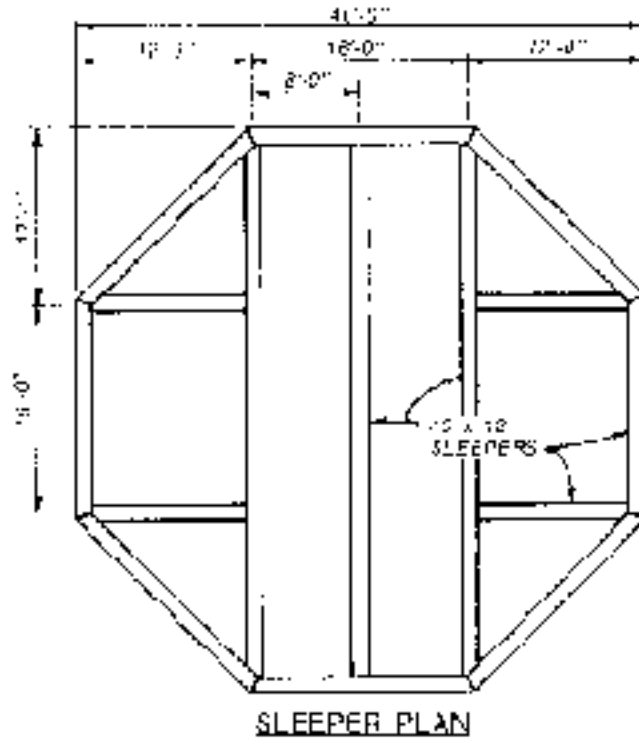

SECTION B-B'

ASSEMBLY PICTORIAL

ITEM	UNIT	QUANTITY
10 x 12 SLEEPERS	EA	4 x 30'

12 x 12 LUMBER	BF	8700
10 x 12 LUMBER	BF	4400
4 x 12 LUMBER	BF	1,500
1 1/2" SPIKE	FA	100
6D NAILS COMMON	LR	100
3/4" DIAM. WIRE ROPE	FR	800
3/4" WIRE ROPE CLAMPS	EA	100
3/4" CABLE TURNBUCKLES	EA	4
1" x 4 1/2" EYE BOLT	EA	6
1" x 26" MACH. PG.	EA	8
6" HOOK	CY	200

NOTE: AT ENTRANCE HAVE BRUSH CUT TO 4 INCHES
 1 FOOT OVER RETAINING WALL
 PLATFORM FOR 100 MM SHOULD BE 20"
 DIAMETER
 CONSTRUCT PARAPETS OR BARRIER WALLS
 AROUND THE PLATFORM FOR PROTECTION
 FROM BLAST AND FRAGMENTS

ARTILLERY FIRING PLATFORM (155MM, 175MM, AND 8-IN ARTILLERY) (sheet 3 of 3)

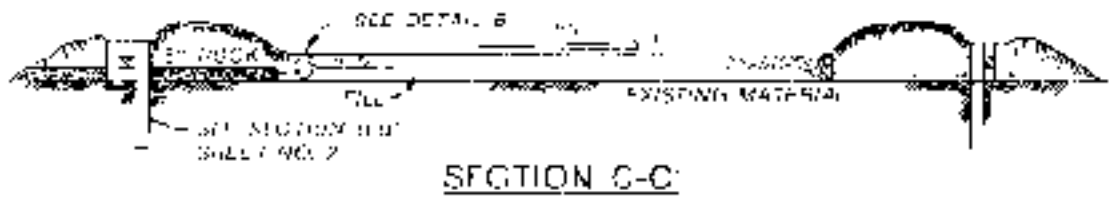
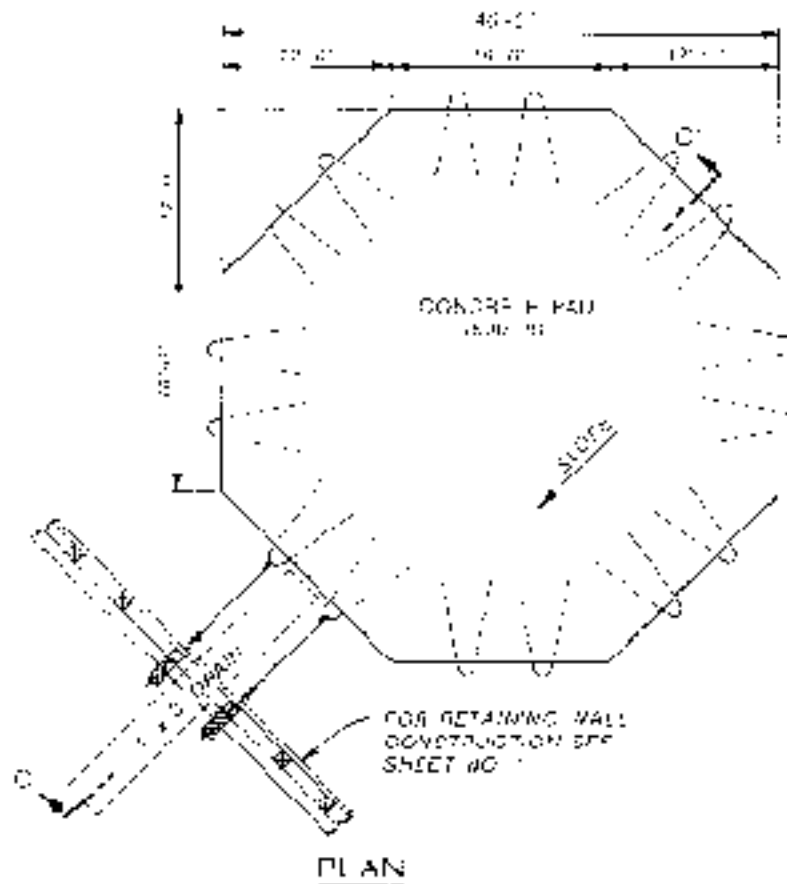

ITEM	UNIT	QUANTITY
4x4 BEAM	LF	100
CONCRETE 2500 PSI	CU YD	108
8 x 8 x 10 GAUGE STEEL	NO. FT	2800
PARAPET WALL	NO. FT	2800
12 x 12 LUMBER	BF	4400
10 x 12 LUMBER	BF	2800
4 x 12 LUMBER	BF	1500

DETAIL B

NOTE: ALL FURNISHING MATERIAL SUPPLIED
 PLATFORM FOR 106 mm SHOULD BE
 TO BE IN PLACE
 CONSIDER THE PARAPET OF BARRER
 WALLS AROUND THE PLATFORM FOR
 PROTECTION FROM BLAST AND
 FRAGMENT

30# GALV STEEL CHANNEL	CU	100
1/4" W WIRE ROPE	F	610
2" WIRE CLAMPS	EA	160
3" GALV TURNBUCKLE	EA	4
1" x 40# EYE BOLT	EA	10
1" x 26" MACHINE SCREW	EA	8
6" ROCK	CY	200

PARAPET POSITION FOR ADA

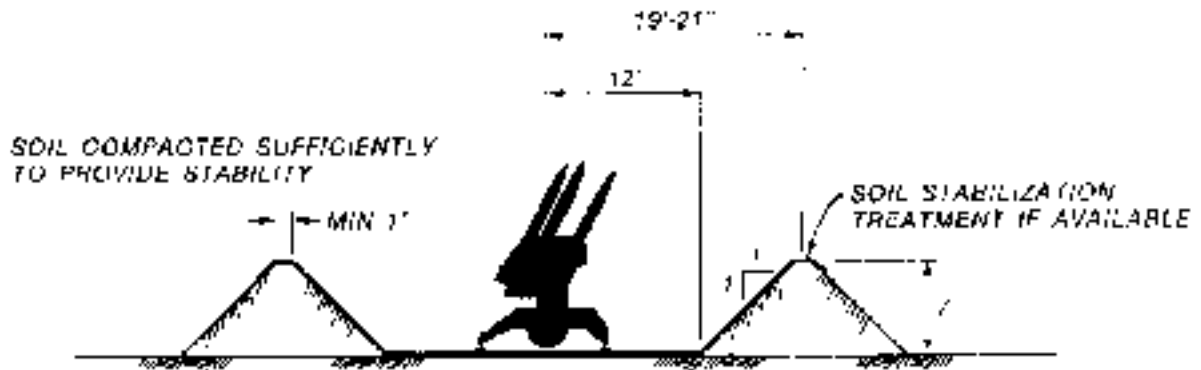

SECTION VIEW

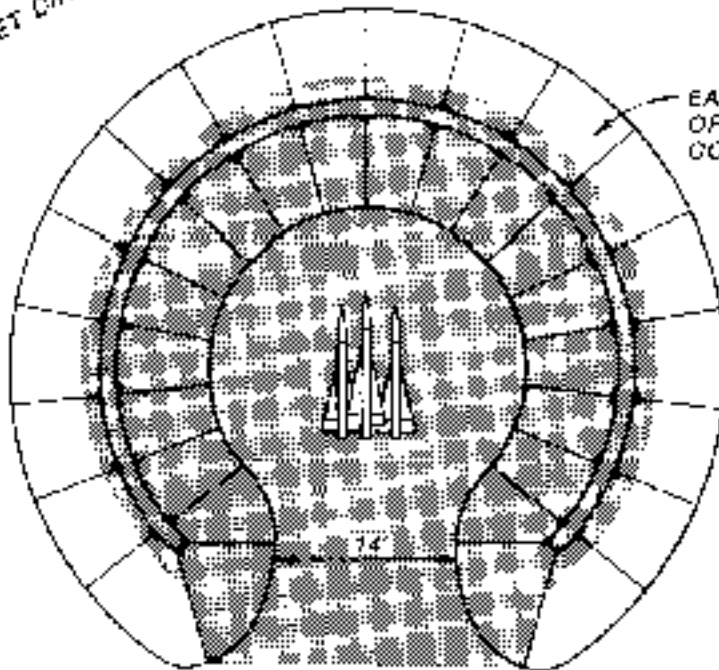
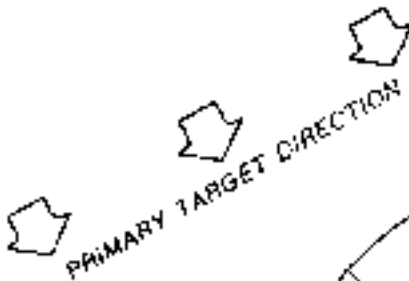

EARTH MOUND
 OF
 COMPACTED SOIL

TOP VIEW

- NOTES 1. EMPLACEMENT SHOWN IS FOR IMPROVED HAWK LAUNCHER
2. PROVIDE FOR ADEQUATE DRAINAGE OF SITE.

TWO-SOLDIER SLEEPING SHELTER

SCRAP BOARDS
FROM AMMO BOXES
AS EAVES

CORRUGATED METAL PIPE
1/2 SECTIONS

AND

L

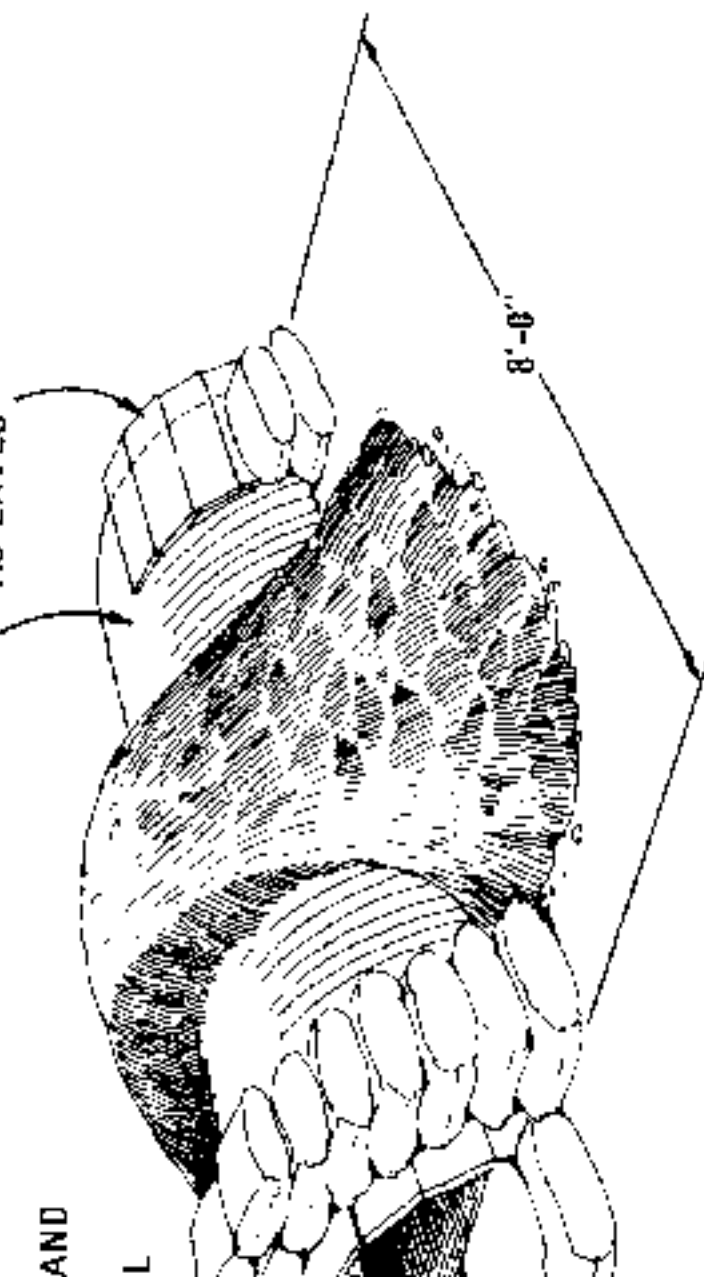

TAL CULVERT SHELTER

SOIL-FILLED BLAST WALL
(MIN 1" THICK) MADE FROM
AMMO BOXES, DIMENSIONED
TIMBER, ETC.

60" OR 72", 8- TO 16-GAGE
CORRUGATED METAL PIPE
BOLTED TO 2" x 8" BOARD

LENGTH AS REQUIRED

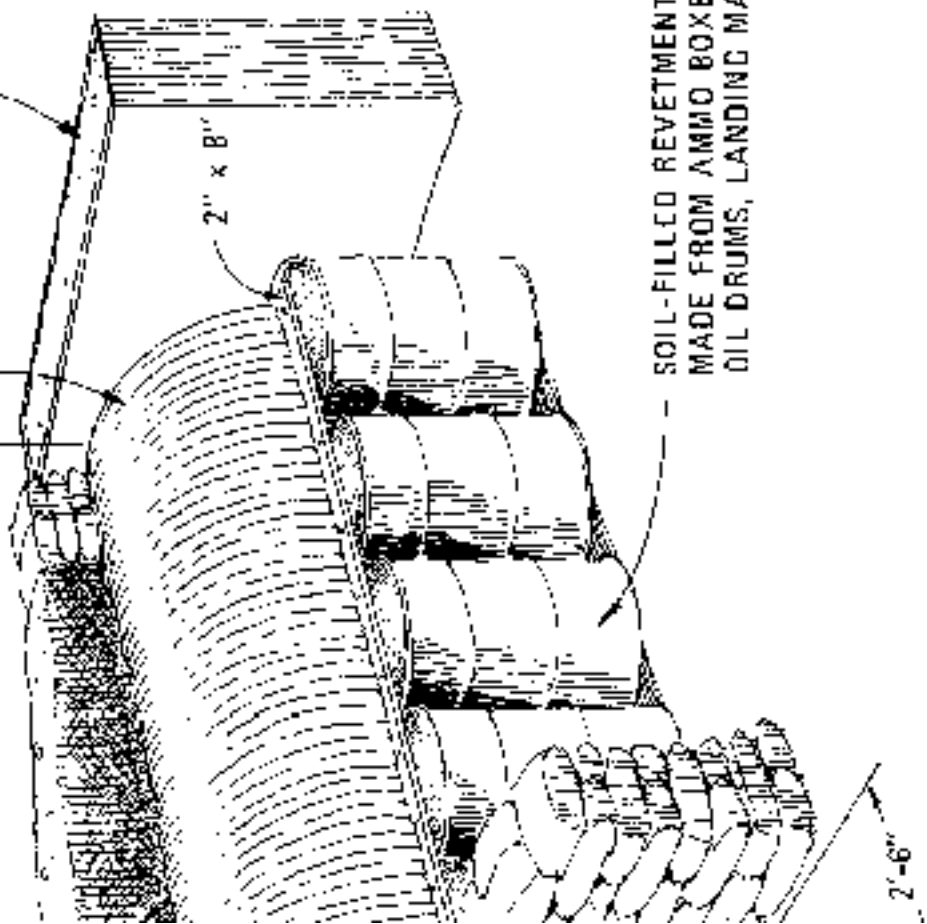

2" x 8"

SOIL-FILLED REVETMENTS
MADE FROM AMMO BOXES,
OIL DRUMS, LANDING MAT, ETC.

2'-6"

SANDBAGS FRONT
BACK ONLY, FILL
BETWEEN WITH SOI

SHALLOW
EXCAVATION
8" - 10"

36" OR 48"

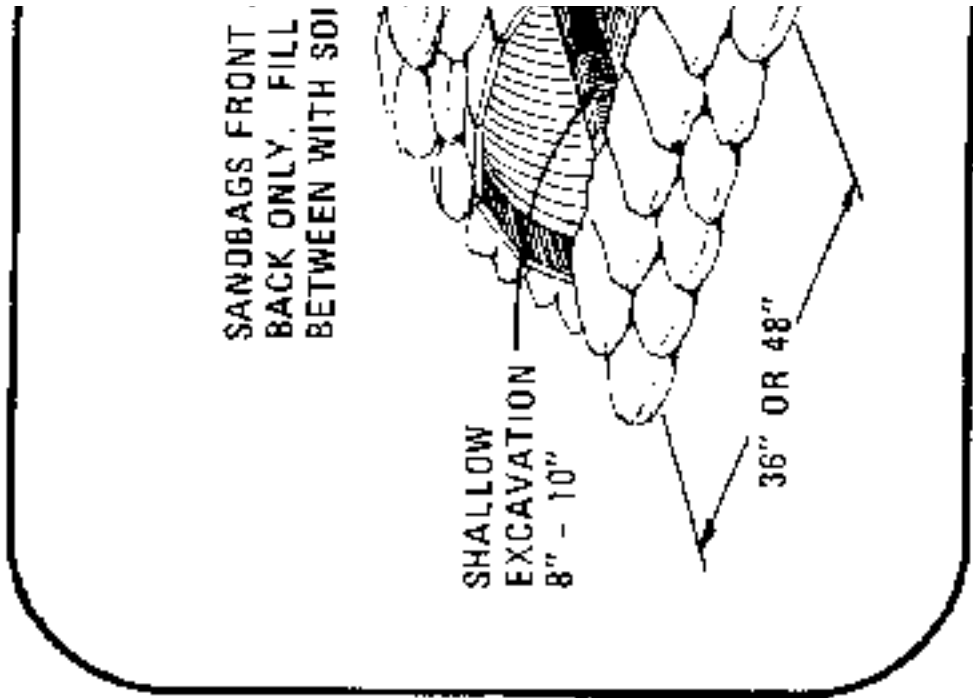

ME

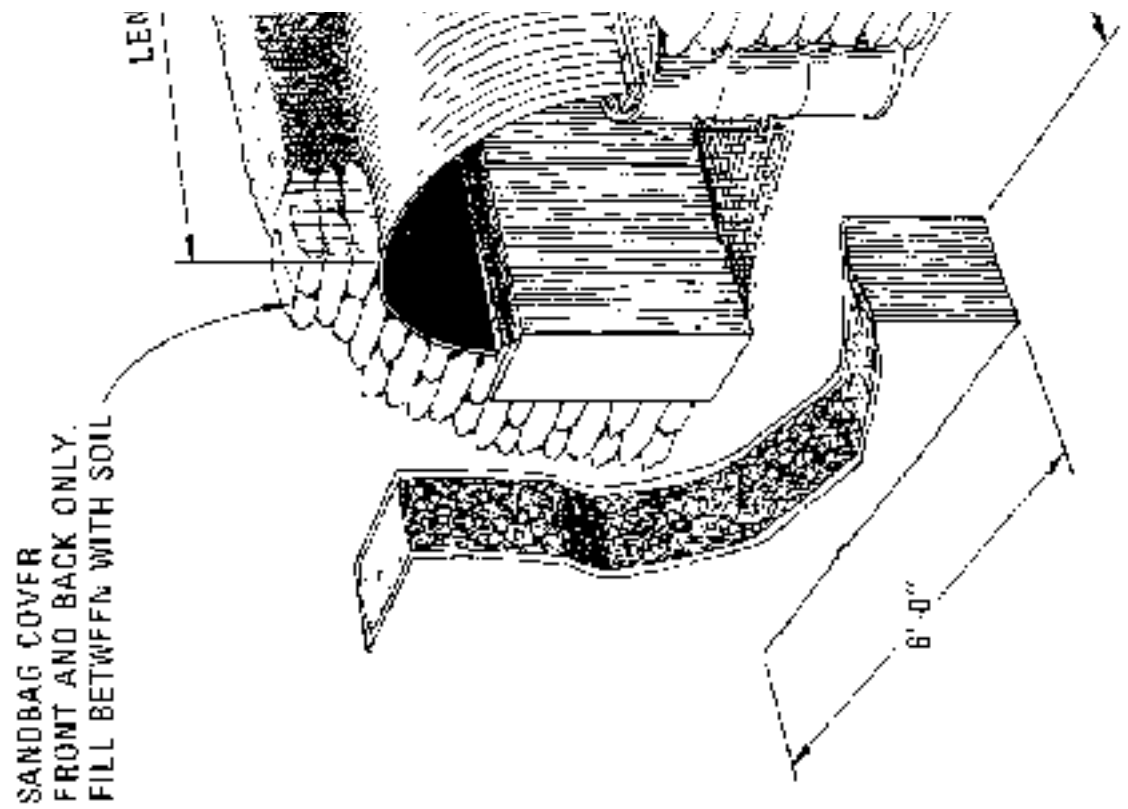

AIRTRANSPORTABLE ASSAULT SHELTER (sheet 1 of 3)

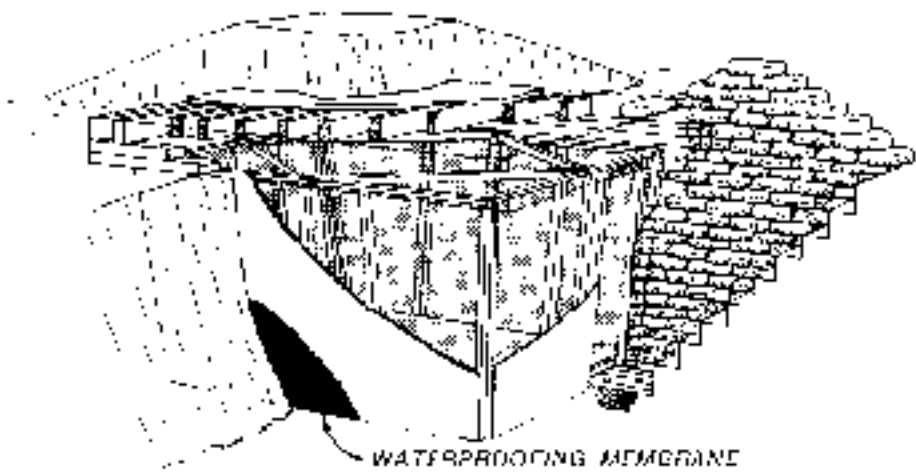

PICTORIAL



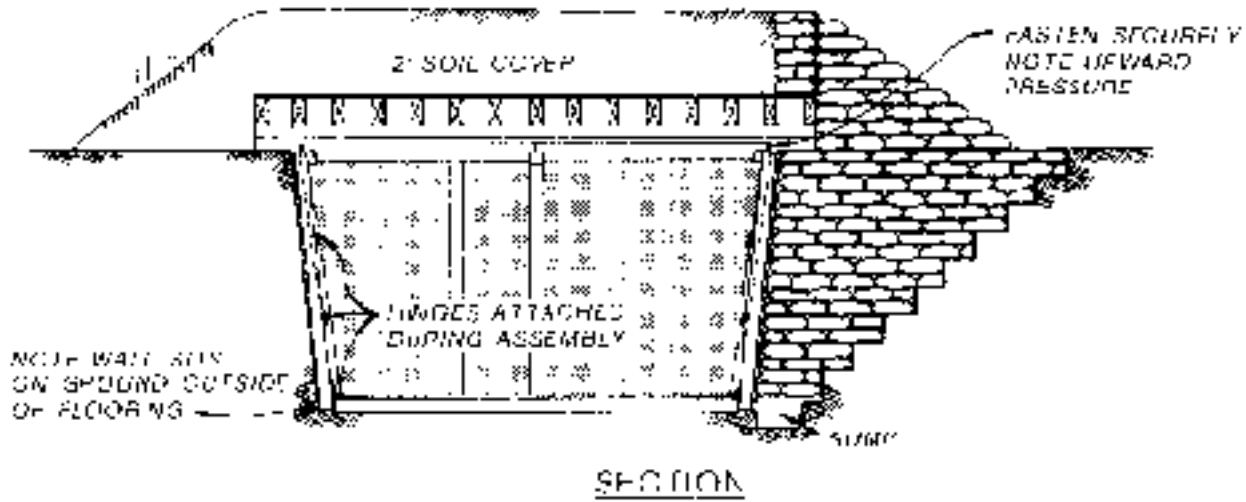
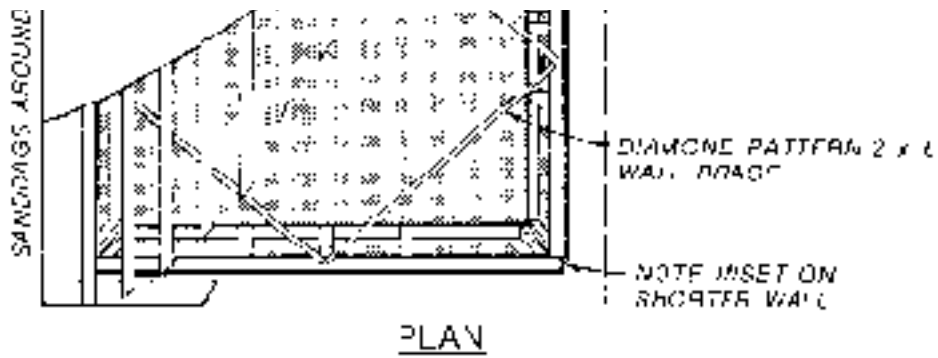

AIRTRANSPORTABLE ASSAULT SHELTER (sheet 2 of 3)

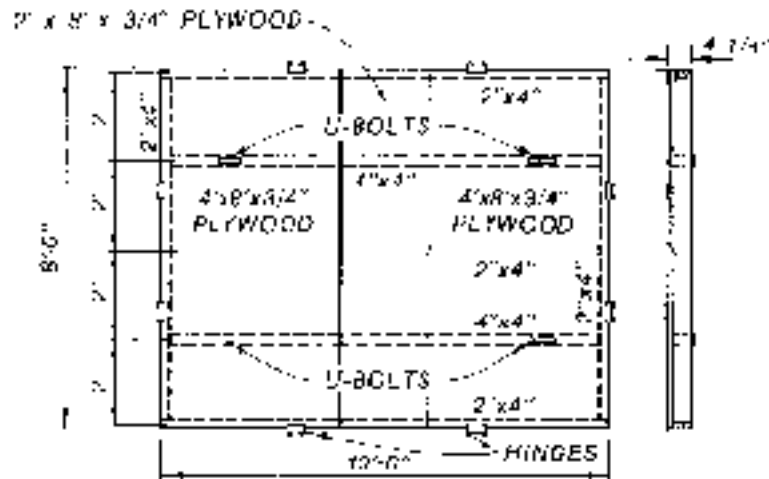

FLOOR DETAIL
1 NEEDED

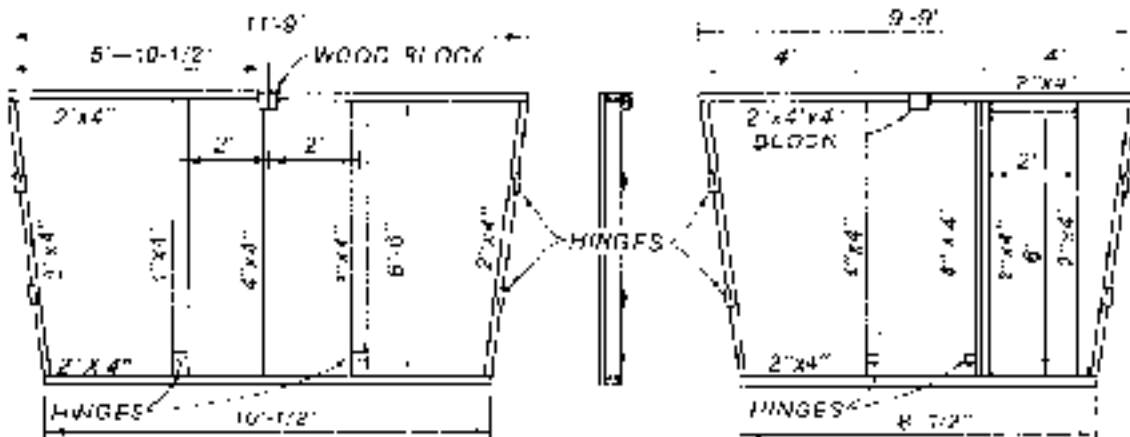

SIDE WALL DETAIL
2 NEEDED

END WALL DETAIL
2 NEEDED, 1 W/O DOOR

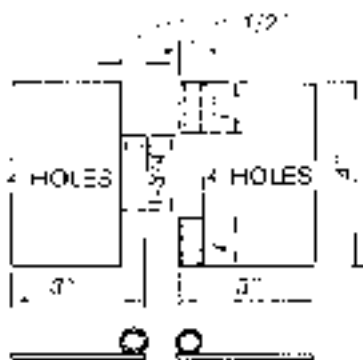

HINGE
16 NEEDED

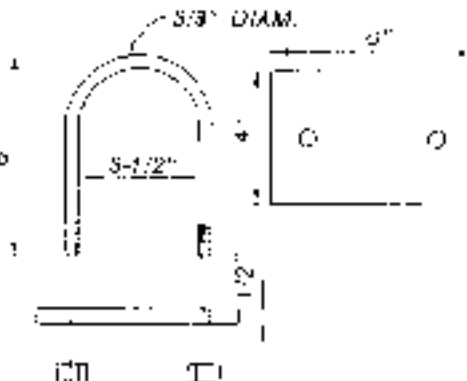

U-BOLT & BEARING PLATE
4 NEEDED

AIRTRANSPORTABLE ASSAULT SHELTER (sheet 3 of 3)

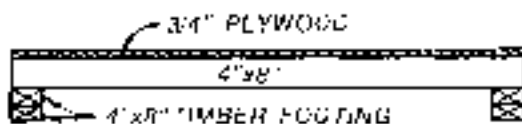
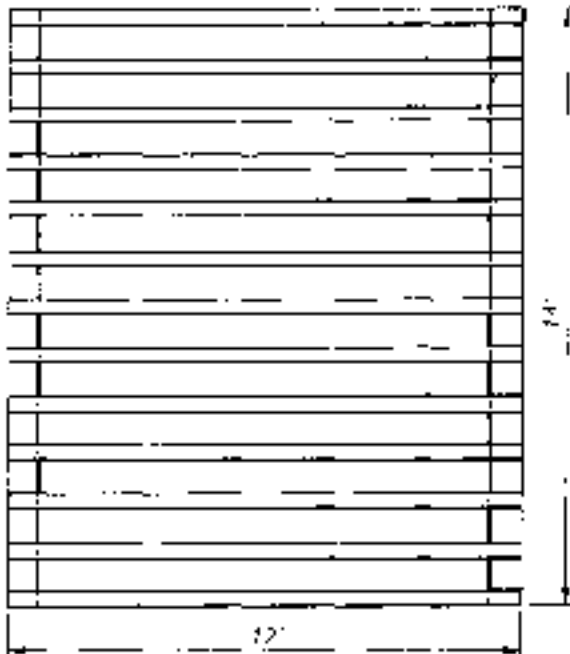

ROOF DETAIL

NOTES:

(1) Abut longer side walls against shorter end walls because the longer walls must sustain the greatest load. The shorter walls then act as a support. Install hinges during assembly.

(2) Provide wall bracing (2" x 6") at the top of the shelter. Brace from the center of each wall to the center of each adjacent wall (diagonal pattern).

(3) Attach a sheet of plastic or other thin waterproof covering around the outside before backfilling to minimize friction between earth and the walls and increase moisture resistance.

(4) Make the shelter no larger than necessary. It should be no more than 6' x 7 1/2 feet high and the floor area should be less than 100 ft² unless special effort is made to provide ade-

BILL OF MATERIALS
(WALLS AND FLOOR)

ITEM	UNITS	QUANTITY
4"x8"x3/4"	EA	14
PLYWOOD:		
4"x4"x8'	EA	10
4"x4"x10'	EA	2
2"x4"x12'	EA	4
2"x4"x10'	EA	9
2"x4"x8'	EA	10
2"x8"x10'	EA	4
TRIM (METAL EDGING) OPTIONAL		
BOLTS (FOR HINGES)	EA	128
WOOD SCREWS (OR FB NAILS)	LB	5
PAINT	GAL	1
HINGES	EA	16
U-RINGS W/ BEARING PLATES	EA	4

BILL OF MATERIALS
(ROOF)

ITEM	UNIT	QUANTITY
4"x8"x12'	EA	13
4"x8"x14'	EA	4
4"x8"x3/4" PLYWOOD	EA	5

(5) Backfilling should be accomplished by hand labor, maintaining a uniform load around the perimeter as backfilling progresses.

(6) Make the bottom of the excavations 2 feet longer and 2 feet wider than the length and width of the structure floor to increase working room during erection and provide adequate clearance for the walls.

(7) Use explosives as extensively as practical during excavation to minimize required hand digging.

(8) To complete the structure provide a suitable entryway. Drainage ditches should be provided around the shelter to carry away runoff, and a waterproof cover placed over the overhead cover to prevent saturation of the soil material and minimize seepage into the interior.

(9) Prior to lifting the structure from the installed position, remove some of the backfill

Use structural members in addition to those specified.

with hand tools to reduce effects of war friction.

TIMBER POST BURIED SHELTER

BILL OF MATERIALS			
NO.	ITEM	UNIT	QUANTITY
1	2" x 4"	EA.	10
2	4" x 6" x 10'	CR.	4
3	6" x 6" x 6'	EA.	8
4	6" x 6" x 12'	EA.	8
5	6" x 6" x 7'	EA.	2
6	SCHEMOLS	LB.	25
7	6d NAILS	CS.	25

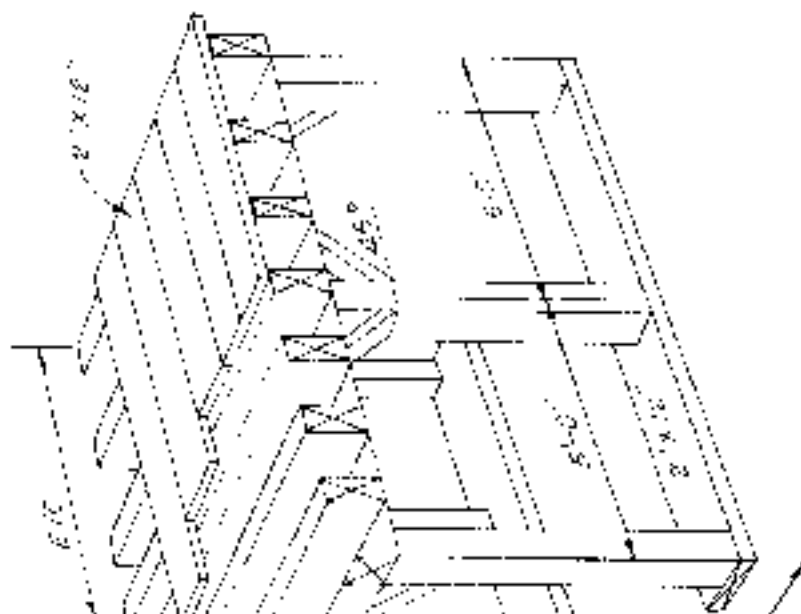
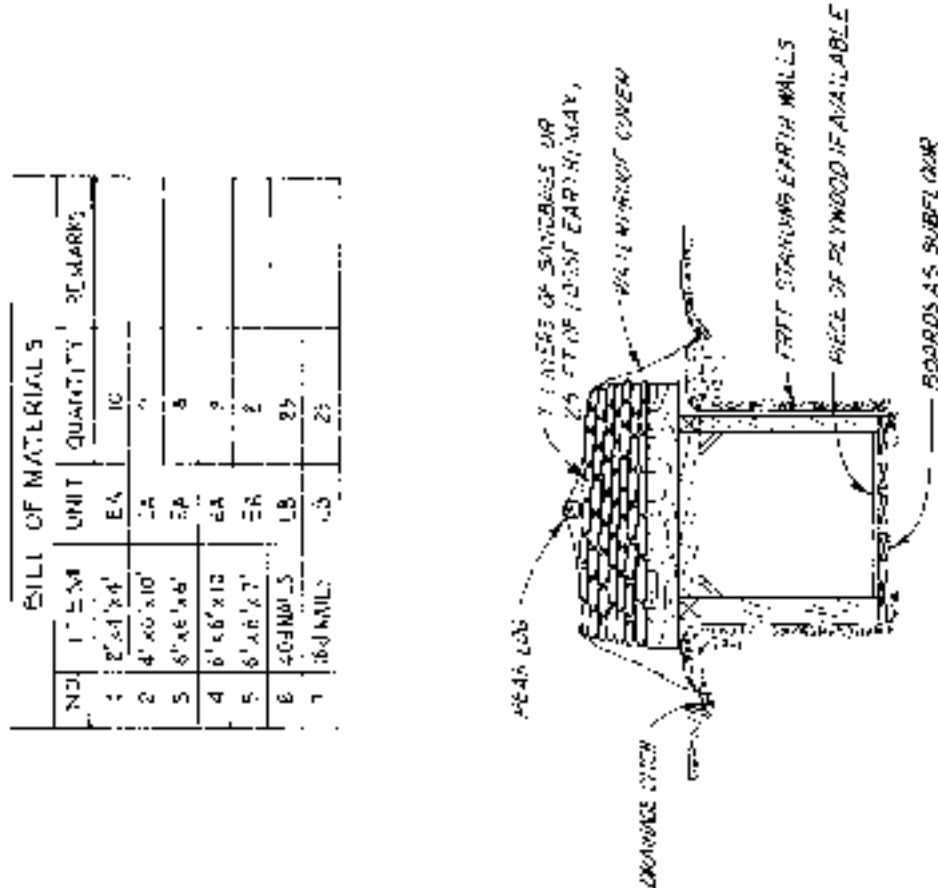

MODULAR TIMBER FRAME SHELTER

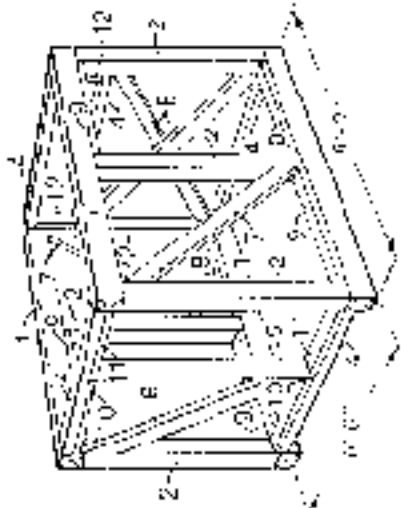
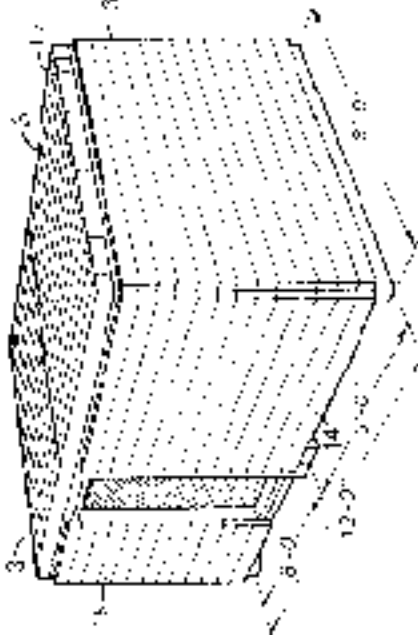

TYPICAL CONNECTION OF TWO MODULES: STANDARD 6' X 8' MODULE FRAME

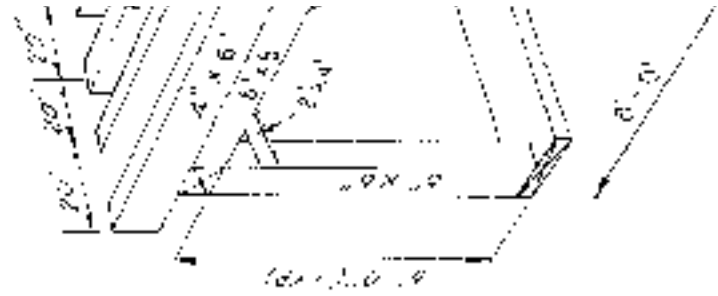
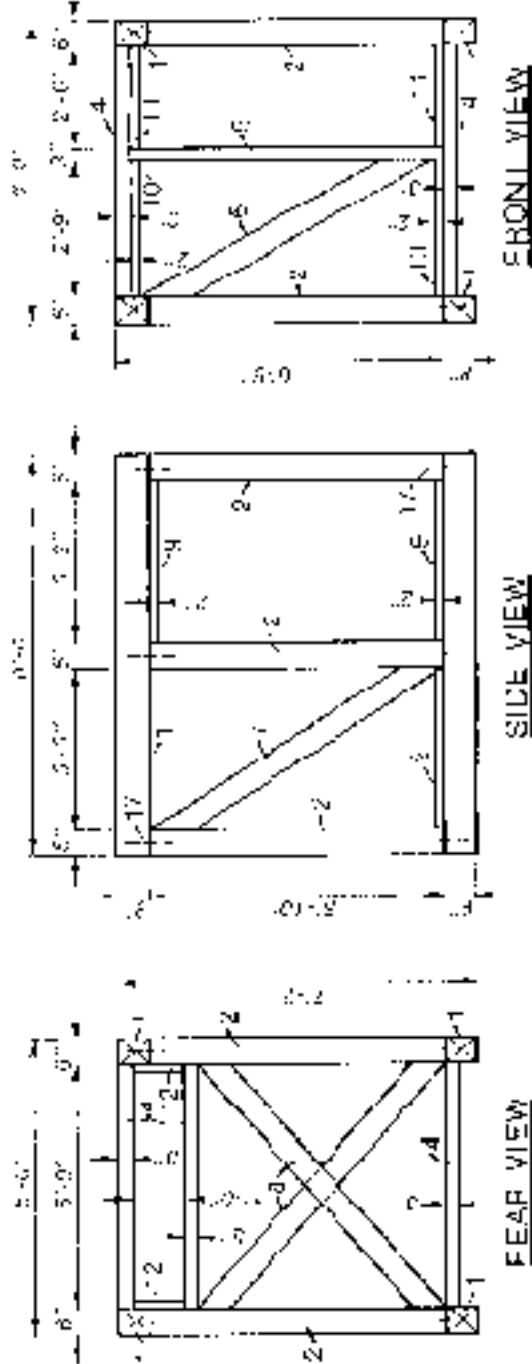

TIMBER FRAME BURIED SHELTER



TYPICAL POST CONNECTING DETAIL
 USE ANGLES AT TOP AND BOTTOM AS SHOWN
 FOR CORNER JOINTS REPLACE ON ANGLES WITH GUE PLATE.

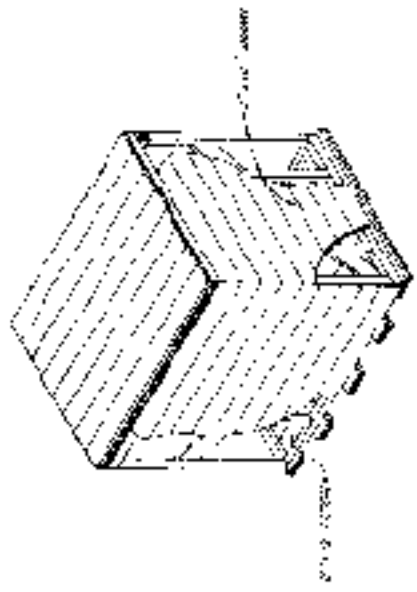

ISOMETRIC

ITEM	BILL OF MATERIALS		UNIT	Q. UNIT
	DESCRIPTION	Q. UNIT		
1	2x4x8	EA	EA	4
2	2x4x8	EA	EA	4
3	2x4x8	EA	EA	4
4	2x4x8	EA	EA	4
5	2x4x8	EA	EA	4
6	2x4x8	EA	EA	4
7	2x4x8	EA	EA	4
8	2x4x8	EA	EA	4
9	2x4x8	EA	EA	4
10	2x4x8	EA	EA	4
11	2x4x8	EA	EA	4
12	2x4x8	EA	EA	4
13	2x4x8	EA	EA	4
14	2x4x8	EA	EA	4
15	2x4x8	EA	EA	4
16	2x4x8	EA	EA	4
17	2x4x8	EA	EA	4
18	2x4x8	EA	EA	4
19	2x4x8	EA	EA	4
20	2x4x8	EA	EA	4
21	2x4x8	EA	EA	4
22	2x4x8	EA	EA	4
23	2x4x8	EA	EA	4
24	2x4x8	EA	EA	4
25	2x4x8	EA	EA	4
26	2x4x8	EA	EA	4
27	2x4x8	EA	EA	4
28	2x4x8	EA	EA	4
29	2x4x8	EA	EA	4
30	2x4x8	EA	EA	4
31	2x4x8	EA	EA	4
32	2x4x8	EA	EA	4
33	2x4x8	EA	EA	4
34	2x4x8	EA	EA	4
35	2x4x8	EA	EA	4
36	2x4x8	EA	EA	4
37	2x4x8	EA	EA	4
38	2x4x8	EA	EA	4
39	2x4x8	EA	EA	4
40	2x4x8	EA	EA	4
41	2x4x8	EA	EA	4
42	2x4x8	EA	EA	4
43	2x4x8	EA	EA	4
44	2x4x8	EA	EA	4
45	2x4x8	EA	EA	4
46	2x4x8	EA	EA	4
47	2x4x8	EA	EA	4
48	2x4x8	EA	EA	4
49	2x4x8	EA	EA	4
50	2x4x8	EA	EA	4
51	2x4x8	EA	EA	4
52	2x4x8	EA	EA	4
53	2x4x8	EA	EA	4
54	2x4x8	EA	EA	4
55	2x4x8	EA	EA	4
56	2x4x8	EA	EA	4
57	2x4x8	EA	EA	4
58	2x4x8	EA	EA	4
59	2x4x8	EA	EA	4
60	2x4x8	EA	EA	4
61	2x4x8	EA	EA	4
62	2x4x8	EA	EA	4
63	2x4x8	EA	EA	4
64	2x4x8	EA	EA	4
65	2x4x8	EA	EA	4
66	2x4x8	EA	EA	4
67	2x4x8	EA	EA	4
68	2x4x8	EA	EA	4
69	2x4x8	EA	EA	4
70	2x4x8	EA	EA	4
71	2x4x8	EA	EA	4
72	2x4x8	EA	EA	4
73	2x4x8	EA	EA	4
74	2x4x8	EA	EA	4
75	2x4x8	EA	EA	4
76	2x4x8	EA	EA	4
77	2x4x8	EA	EA	4
78	2x4x8	EA	EA	4
79	2x4x8	EA	EA	4
80	2x4x8	EA	EA	4
81	2x4x8	EA	EA	4
82	2x4x8	EA	EA	4
83	2x4x8	EA	EA	4
84	2x4x8	EA	EA	4
85	2x4x8	EA	EA	4
86	2x4x8	EA	EA	4
87	2x4x8	EA	EA	4
88	2x4x8	EA	EA	4
89	2x4x8	EA	EA	4
90	2x4x8	EA	EA	4
91	2x4x8	EA	EA	4
92	2x4x8	EA	EA	4
93	2x4x8	EA	EA	4
94	2x4x8	EA	EA	4
95	2x4x8	EA	EA	4
96	2x4x8	EA	EA	4
97	2x4x8	EA	EA	4
98	2x4x8	EA	EA	4
99	2x4x8	EA	EA	4
100	2x4x8	EA	EA	4

REPLACE BURIED JOINTS WITH GUE PLATE

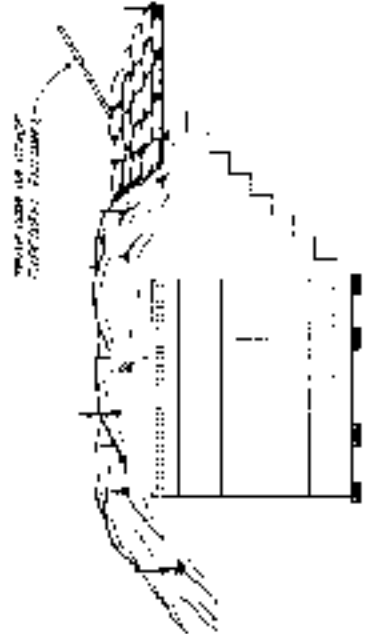

NO.	BILL OF MATERIALS		UNIT	Q. UNIT
	ITEM	DESCRIPTION		
1	2x4x8	EA	EA	4
2	2x4x8	EA	EA	4
3	2x4x8	EA	EA	4
4	2x4x8	EA	EA	4
5	2x4x8	EA	EA	4
6	2x4x8	EA	EA	4
7	2x4x8	EA	EA	4
8	2x4x8	EA	EA	4
9	2x4x8	EA	EA	4
10	2x4x8	EA	EA	4
11	2x4x8	EA	EA	4
12	2x4x8	EA	EA	4
13	2x4x8	EA	EA	4
14	2x4x8	EA	EA	4
15	2x4x8	EA	EA	4
16	2x4x8	EA	EA	4
17	2x4x8	EA	EA	4
18	2x4x8	EA	EA	4
19	2x4x8	EA	EA	4
20	2x4x8	EA	EA	4
21	2x4x8	EA	EA	4
22	2x4x8	EA	EA	4
23	2x4x8	EA	EA	4
24	2x4x8	EA	EA	4
25	2x4x8	EA	EA	4
26	2x4x8	EA	EA	4
27	2x4x8	EA	EA	4
28	2x4x8	EA	EA	4
29	2x4x8	EA	EA	4
30	2x4x8	EA	EA	4
31	2x4x8	EA	EA	4
32	2x4x8	EA	EA	4
33	2x4x8	EA	EA	4
34	2x4x8	EA	EA	4
35	2x4x8	EA	EA	4
36	2x4x8	EA	EA	4
37	2x4x8	EA	EA	4
38	2x4x8	EA	EA	4
39	2x4x8	EA	EA	4
40	2x4x8	EA	EA	4
41	2x4x8	EA	EA	4
42	2x4x8	EA	EA	4
43	2x4x8	EA	EA	4
44	2x4x8	EA	EA	4
45	2x4x8	EA	EA	4
46	2x4x8	EA	EA	4
47	2x4x8	EA	EA	4
48	2x4x8	EA	EA	4
49	2x4x8	EA	EA	4
50	2x4x8	EA	EA	4
51	2x4x8	EA	EA	4
52	2x4x8	EA	EA	4
53	2x4x8	EA	EA	4
54	2x4x8	EA	EA	4
55	2x4x8	EA	EA	4
56	2x4x8	EA	EA	4
57	2x4x8	EA	EA	4
58	2x4x8	EA	EA	4
59	2x4x8	EA	EA	4
60	2x4x8	EA	EA	4
61	2x4x8	EA	EA	4
62	2x4x8	EA	EA	4
63	2x4x8	EA	EA	4
64	2x4x8	EA	EA	4
65	2x4x8	EA	EA	4
66	2x4x8	EA	EA	4
67	2x4x8	EA	EA	4
68	2x4x8	EA	EA	4
69	2x4x8	EA	EA	4
70	2x4x8	EA	EA	4
71	2x4x8	EA	EA	4
72	2x4x8	EA	EA	4
73	2x4x8	EA	EA	4
74	2x4x8	EA	EA	4
75	2x4x8	EA	EA	4
76	2x4x8	EA	EA	4
77	2x4x8	EA	EA	4
78	2x4x8	EA	EA	4
79	2x4x8	EA	EA	4
80	2x4x8	EA	EA	4
81	2x4x8	EA	EA	4
82	2x4x8	EA	EA	4
83	2x4x8	EA	EA	4
84	2x4x8	EA	EA	4
85	2x4x8	EA	EA	4
86	2x4x8	EA	EA	4
87	2x4x8	EA	EA	4
88	2x4x8	EA	EA	4
89	2x4x8	EA	EA	4
90	2x4x8	EA	EA	4
91	2x4x8	EA	EA	4
92	2x4x8	EA	EA	4
93	2x4x8	EA	EA	4
94	2x4x8	EA	EA	4
95	2x4x8	EA	EA	4
96	2x4x8	EA	EA	4
97	2x4x8	EA	EA	4
98	2x4x8	EA	EA	4
99	2x4x8	EA	EA	4
100	2x4x8	EA	EA	4

UNPAVED WOOD ROOF MAY BE SL
 SCHEDULED IN DESIGN WHEN CO
 METERS TWO VERTICALS STRIKING
 MAY BE 3 3/4 x 1 1/2 IN. (SEE DI
 * ALLOWANCE FOR DOUBLE GUTTER
 OF BRANCHES IS INC. WITHIN OVERALL
 LENGTH AS SHOWN

IND CAVITY WALL SHELTER (sheet 1 of 2)

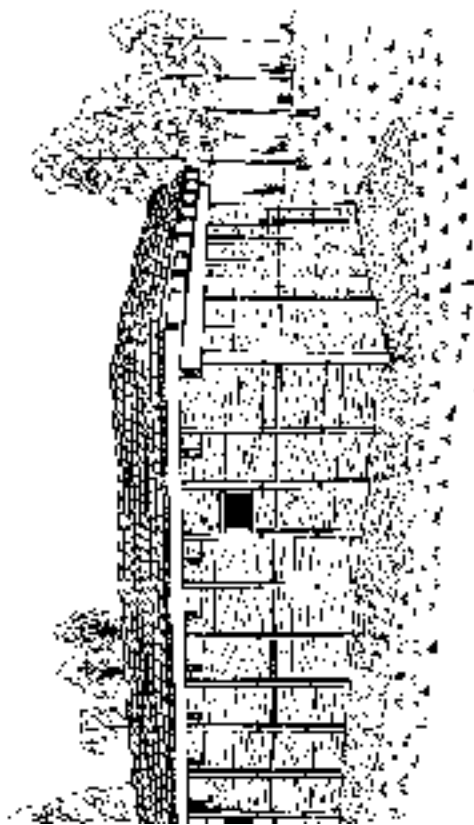

PERSPECTIVE VIEW

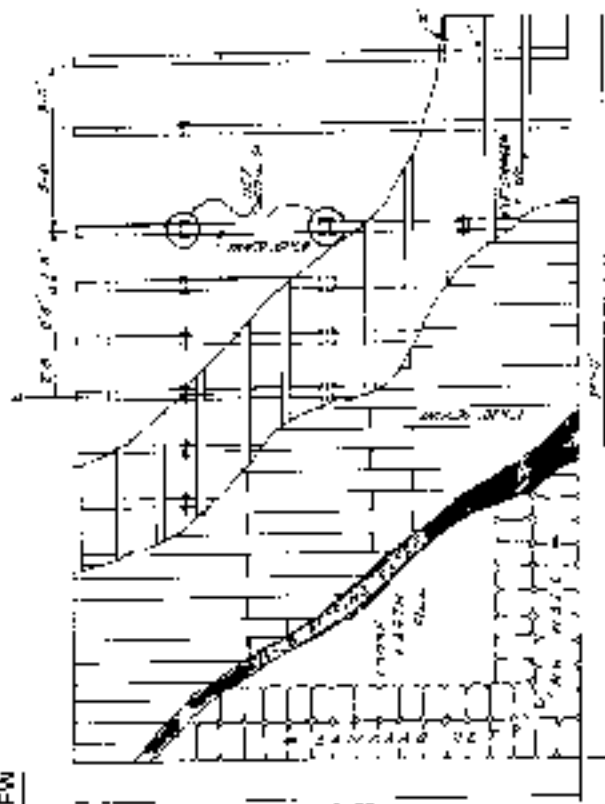

ROOF PLAN

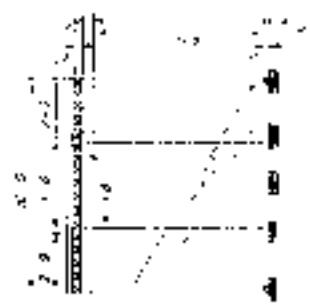

FRONT FRAMING ELEVATION

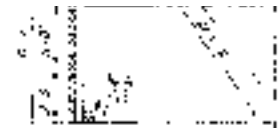

SIDE FRAMING ELEVATION

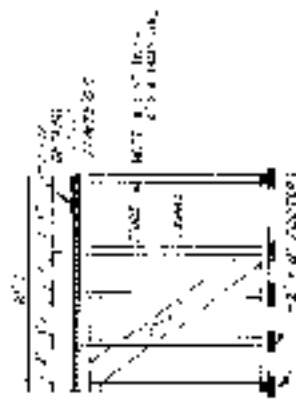

REAR FRAMING ELEVATION

TY WALL SHELTER (sheet 2 of 2)

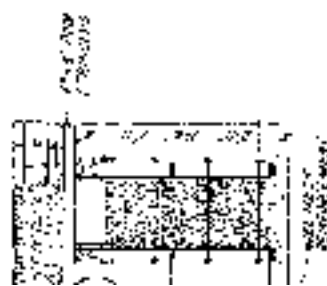
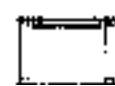
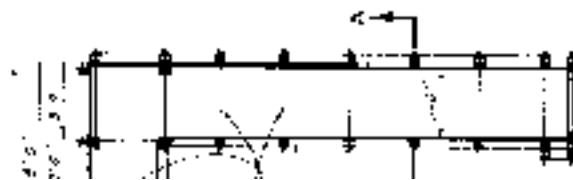

NO.	DESCRIPTION	UNITS	QUANTITY	REMARKS
1	2" x 4" x 10'	EA	48	
2	2" x 4" x 10'	EA	72	
3	2" x 4" x 10'	EA	36	
4	2" x 4" x 10'	EA	24	
5	2" x 4" x 10'	EA	59	
6	2" x 4" x 10'	EA	24	
7	2" x 4" x 10'	EA	72	
8	2" x 4" x 10'	EA	24	
9	2" x 4" x 10'	EA	48	
10	2" x 4" x 10'	EA	18	
11	2" x 4" x 10'	EA	3200	
12	2" x 4" x 10'	EA	24	
13	2" x 4" x 10'	EA	24	
14	2" x 4" x 10'	EA	24	
15	2" x 4" x 10'	EA	24	
16	2" x 4" x 10'	EA	24	
17	2" x 4" x 10'	EA	24	
18	2" x 4" x 10'	EA	24	
19	2" x 4" x 10'	EA	24	
20	2" x 4" x 10'	EA	24	
21	2" x 4" x 10'	EA	24	
22	2" x 4" x 10'	EA	24	
23	2" x 4" x 10'	EA	24	
24	2" x 4" x 10'	EA	24	
25	2" x 4" x 10'	EA	24	
26	2" x 4" x 10'	EA	24	
27	2" x 4" x 10'	EA	24	
28	2" x 4" x 10'	EA	24	
29	2" x 4" x 10'	EA	24	
30	2" x 4" x 10'	EA	24	
31	2" x 4" x 10'	EA	24	
32	2" x 4" x 10'	EA	24	
33	2" x 4" x 10'	EA	24	
34	2" x 4" x 10'	EA	24	
35	2" x 4" x 10'	EA	24	
36	2" x 4" x 10'	EA	24	
37	2" x 4" x 10'	EA	24	
38	2" x 4" x 10'	EA	24	
39	2" x 4" x 10'	EA	24	
40	2" x 4" x 10'	EA	24	
41	2" x 4" x 10'	EA	24	
42	2" x 4" x 10'	EA	24	
43	2" x 4" x 10'	EA	24	
44	2" x 4" x 10'	EA	24	
45	2" x 4" x 10'	EA	24	
46	2" x 4" x 10'	EA	24	
47	2" x 4" x 10'	EA	24	
48	2" x 4" x 10'	EA	24	
49	2" x 4" x 10'	EA	24	
50	2" x 4" x 10'	EA	24	
51	2" x 4" x 10'	EA	24	
52	2" x 4" x 10'	EA	24	
53	2" x 4" x 10'	EA	24	
54	2" x 4" x 10'	EA	24	
55	2" x 4" x 10'	EA	24	
56	2" x 4" x 10'	EA	24	
57	2" x 4" x 10'	EA	24	
58	2" x 4" x 10'	EA	24	
59	2" x 4" x 10'	EA	24	
60	2" x 4" x 10'	EA	24	
61	2" x 4" x 10'	EA	24	
62	2" x 4" x 10'	EA	24	
63	2" x 4" x 10'	EA	24	
64	2" x 4" x 10'	EA	24	
65	2" x 4" x 10'	EA	24	
66	2" x 4" x 10'	EA	24	
67	2" x 4" x 10'	EA	24	
68	2" x 4" x 10'	EA	24	
69	2" x 4" x 10'	EA	24	
70	2" x 4" x 10'	EA	24	
71	2" x 4" x 10'	EA	24	
72	2" x 4" x 10'	EA	24	
73	2" x 4" x 10'	EA	24	
74	2" x 4" x 10'	EA	24	
75	2" x 4" x 10'	EA	24	
76	2" x 4" x 10'	EA	24	
77	2" x 4" x 10'	EA	24	
78	2" x 4" x 10'	EA	24	
79	2" x 4" x 10'	EA	24	
80	2" x 4" x 10'	EA	24	
81	2" x 4" x 10'	EA	24	
82	2" x 4" x 10'	EA	24	
83	2" x 4" x 10'	EA	24	
84	2" x 4" x 10'	EA	24	
85	2" x 4" x 10'	EA	24	
86	2" x 4" x 10'	EA	24	
87	2" x 4" x 10'	EA	24	
88	2" x 4" x 10'	EA	24	
89	2" x 4" x 10'	EA	24	
90	2" x 4" x 10'	EA	24	
91	2" x 4" x 10'	EA	24	
92	2" x 4" x 10'	EA	24	
93	2" x 4" x 10'	EA	24	
94	2" x 4" x 10'	EA	24	
95	2" x 4" x 10'	EA	24	
96	2" x 4" x 10'	EA	24	
97	2" x 4" x 10'	EA	24	
98	2" x 4" x 10'	EA	24	
99	2" x 4" x 10'	EA	24	
100	2" x 4" x 10'	EA	24	

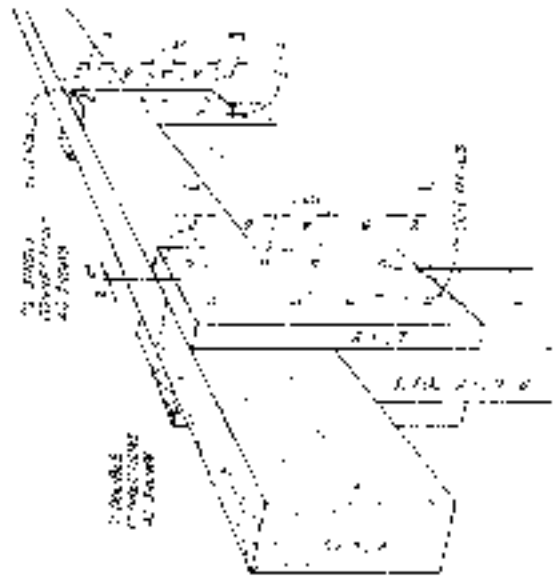

FLOOR PLAN

ABOVEGROUND

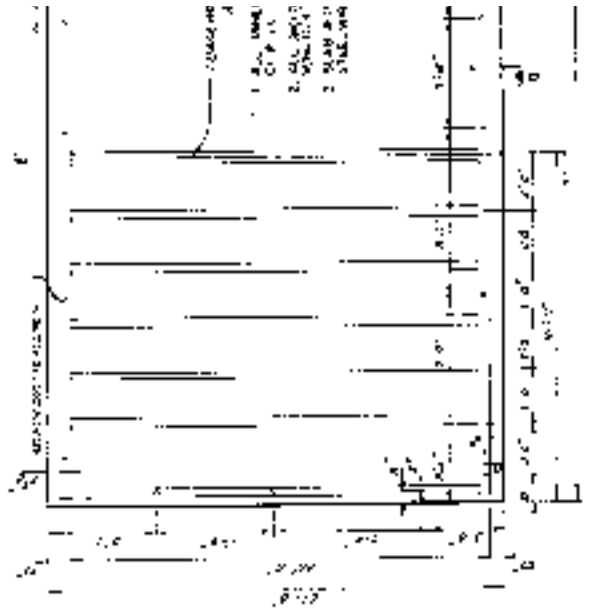

FLOOR PLAN

D SHELTER (sheet 1 of 2)

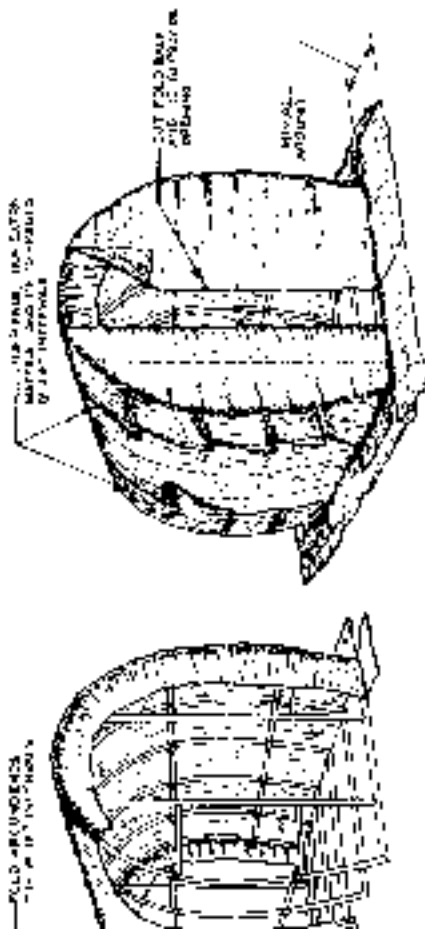

ELTER BODY

FABRIC INSTALLATION

END SECTIONS

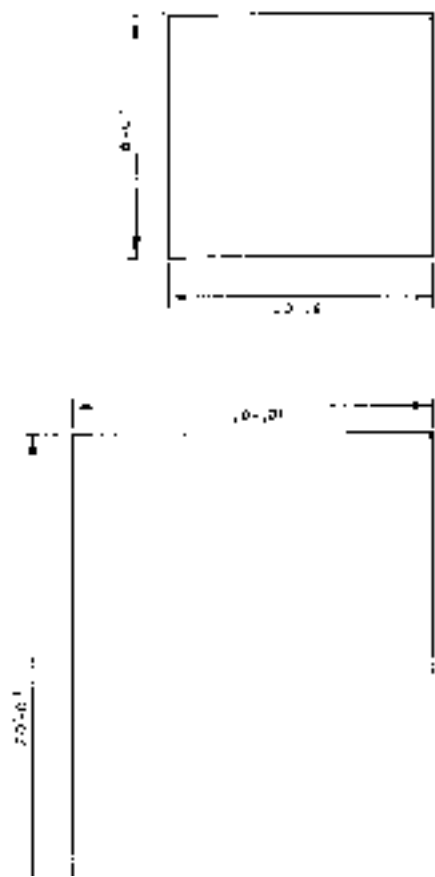

5-L TOP BODY

END SECTIONS

FABRIC CUTTING DETAIL

NOTE FOR ADDITIONAL CONSTRUCTION DETAILS SEE FACILITY NO. 48818C, TM 5-301, HRU 5-300.

ABOVEGROUND CAVI

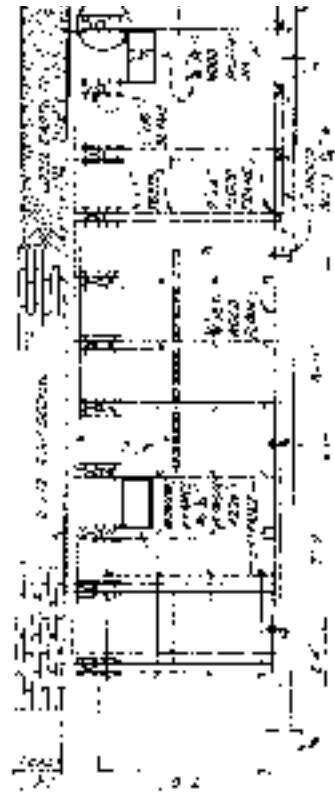
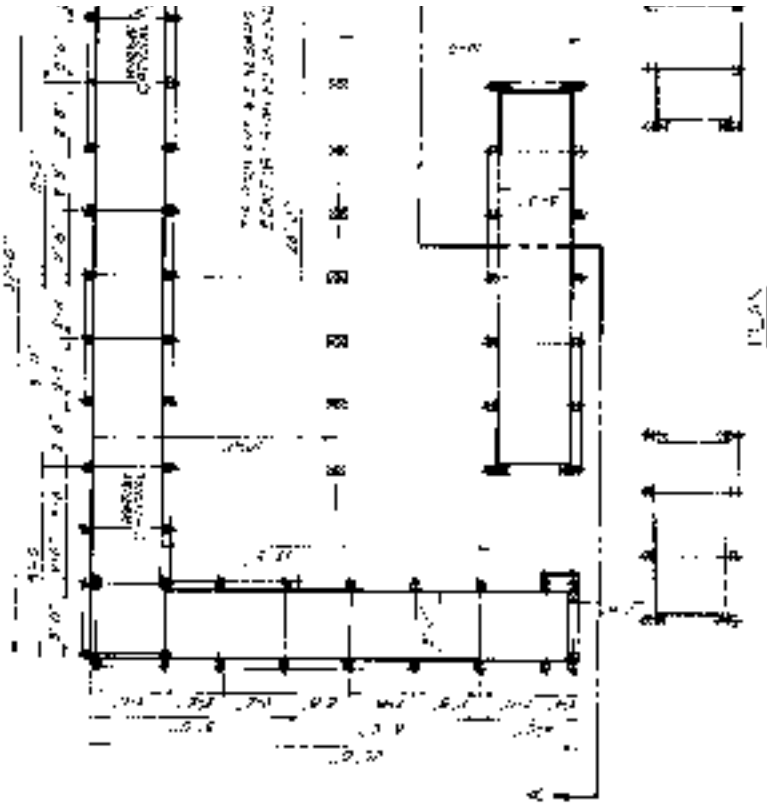

SECTION 4-4

R (sheet 2 of 2)

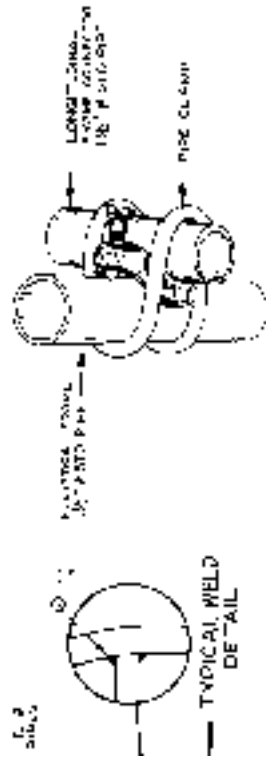

TYPICAL CROSSOVER CLAMP DETAIL, 1/40 SCALE

ITEM	UNIT	QUANTITY
10 x 15 72 F RI	LI	300
CON CROSSOVER 1 1/2 IN x 1 1/2 IN PIPE	FA	24
ST TAPPING 3000 SO F	SV	60
120 G.575 N DIA 3 L3	CL	-

STEEL FRAME/FABRIC-COVERED

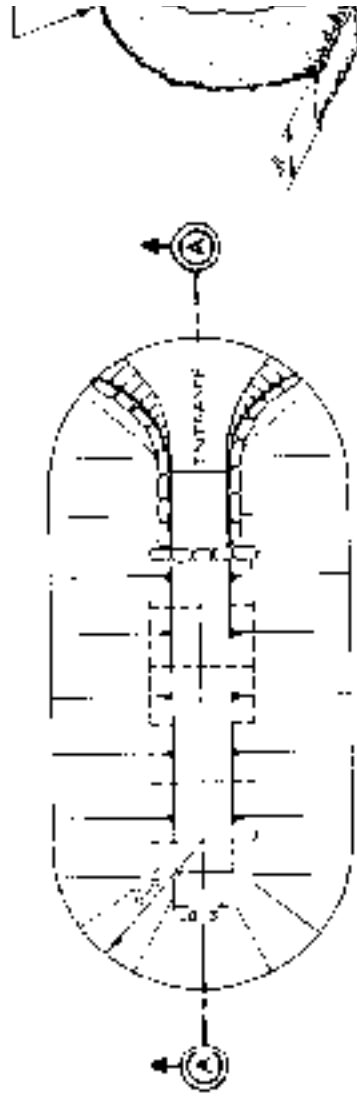

PLAN

SHI

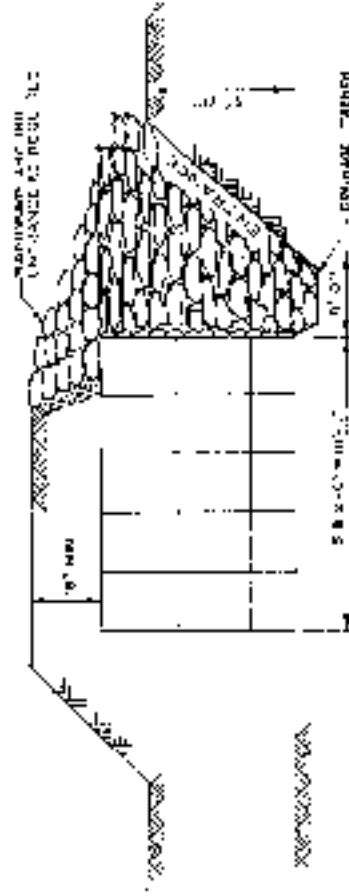

SECTION A-A

STEEL FRAME/FABRIC-COVERED SHELTER

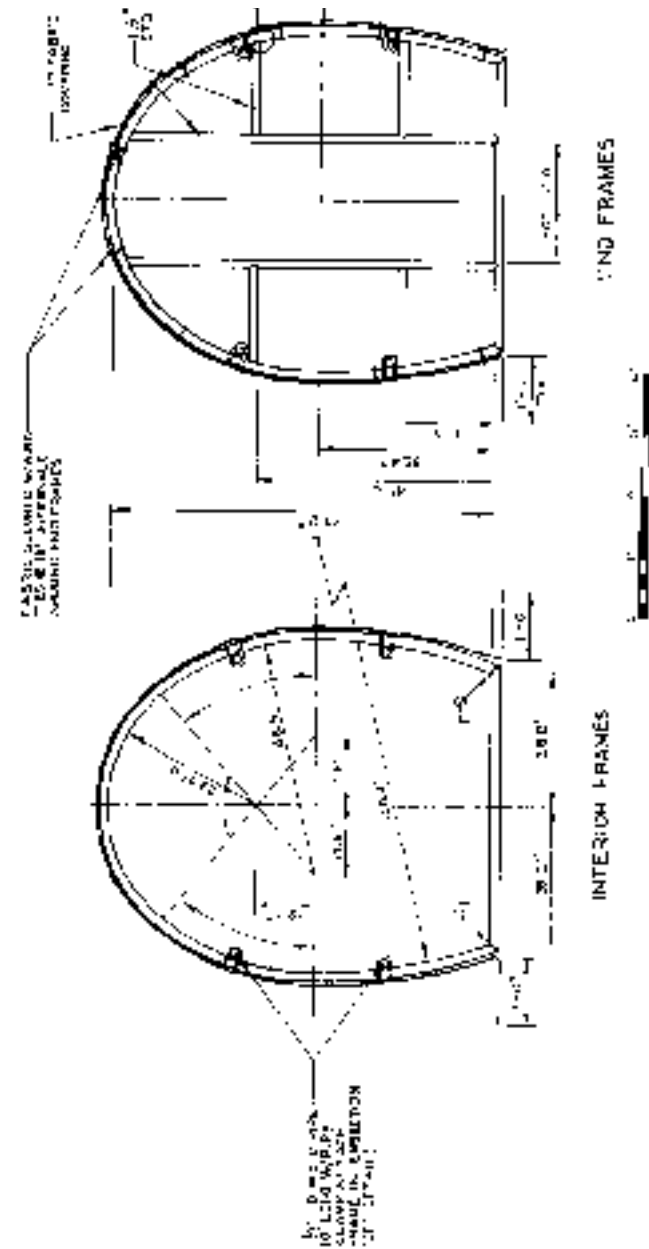

- GENERAL NO. 10
1. FABRIC COVERING TO ACCOMMODATE FOUR MEN, FOUR LITTERS AND REQUISITES AS DESCRIBED IN ADD TO THE CLAMP AND FABRIC
 2. PERSONNEL INSIDE THE SHELTER WILL MAKE AN APPROXIMATE 4000 CALORIES TO FUEL THE ROOM HEAT AND ALLOW MAINTENANCE OF 100% HUMIDITY
 3. ALL FABRIC JOINTS AND CORNERS SHOULD BE REINFORCED WITH 1/2" X 1/2" GALVANIZED STEEL PLATE AS POSSIBLE. REINFORCEMENT NUMBER 30, 32 AND 34 SHOULD EXTEND 2' MINIMUM OUTSIDE OF SHELTER SIDES AND END WALLS
 4. BALKY JOINTS SHOULD BE REINFORCED WITH 1/2" X 1/2" GALVANIZED STEEL PLATE AS POSSIBLE. REINFORCEMENT NUMBER 30, 32 AND 34 SHOULD EXTEND 2' MINIMUM OUTSIDE OF SHELTER SIDES BEFORE COVERING THE SHELTER AND ABOUT THE JOINTS ARE EVERY 1/2" FOR THE 1/2" REINFORCEMENT. REINFORCEMENT NUMBER 30, 32 AND 34 SHOULD EXTEND 2' MINIMUM OUTSIDE OF SHELTER SIDES AND END WALLS
 5. MATERIALS SHOULD BE STORED IN A DRY PLACE AND SHOULD BE KEPT IN A DRY PLACE
 6. THE SHELTER SHOULD BE INSULATED WITH 2" OF INSULATION
 7. ALL JOINTS SHOULD BE REINFORCED WITH 1/2" X 1/2" GALVANIZED STEEL PLATE AS POSSIBLE. REINFORCEMENT NUMBER 30, 32 AND 34 SHOULD EXTEND 2' MINIMUM OUTSIDE OF SHELTER SIDES AND END WALLS
- PIPE STEEL: 1-1/2"
 PIPE CLAMP: CLAMP
 WIRE: STEEL - NO. 10

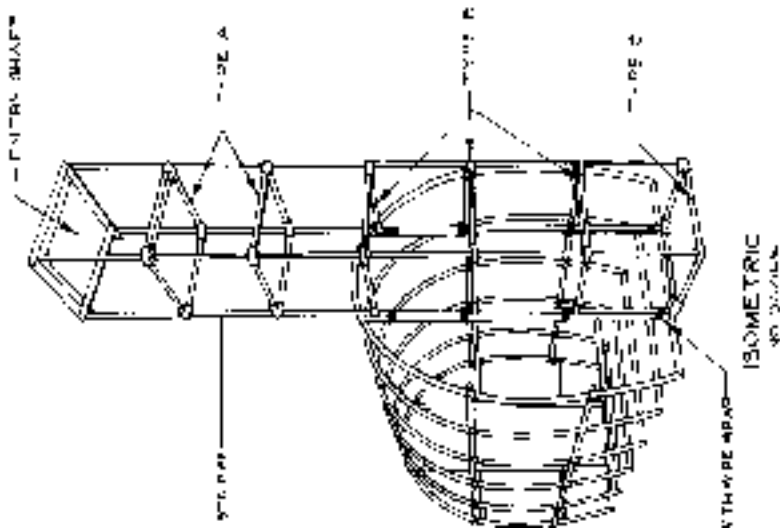

TYPE A
 TYPE B
 TYPE C
 TYPE D
 TYPE E
 TYPE F
 TYPE G
 TYPE H
 TYPE I
 TYPE J
 TYPE K
 TYPE L
 TYPE M
 TYPE N
 TYPE O
 TYPE P
 TYPE Q
 TYPE R
 TYPE S
 TYPE T
 TYPE U
 TYPE V
 TYPE W
 TYPE X
 TYPE Y
 TYPE Z

FOR ADDITIONAL CONSTRUCTION DETAILS SEE FACILITY NO. 14811B. FM 5-20. 11 JUL 5-50.

HARDENED FRAME/FABRIC SHELTER (sheet 1 of 3)

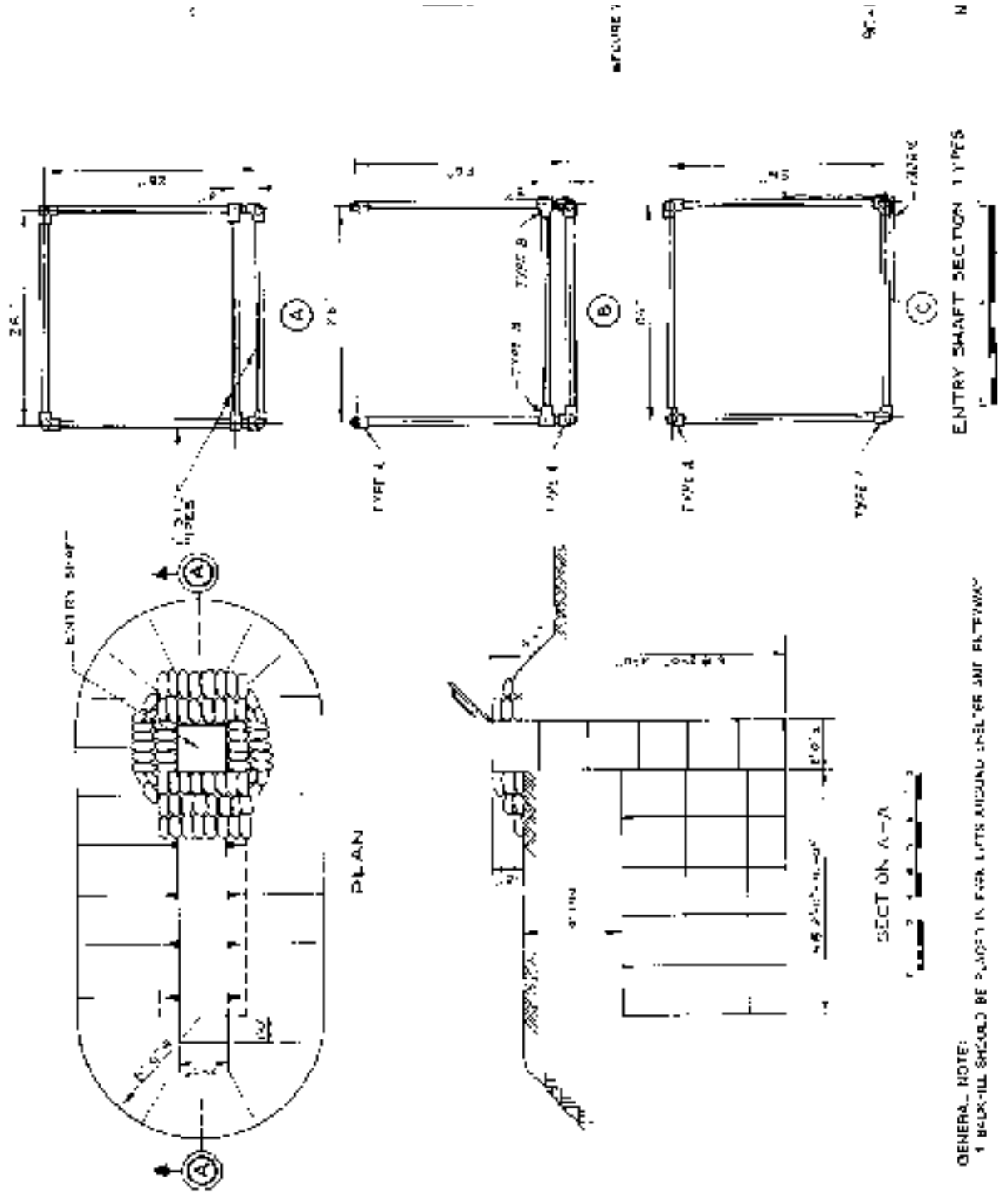

FIGURE 1

ENTRY SHAFT SECTION 1 TYPES

GENERAL NOTE:
1 BELLSHILL SHOULD BE PLACED IN FOUR LITS AROUND SHELTER AND ENTRYWAY

2 1/2" x 1/2" -
PIPE

1/2" x 1/4"

HOLE

HOLDS

HARDENED FRAME / FABRIC SHELTER (sheet 2 of 3)

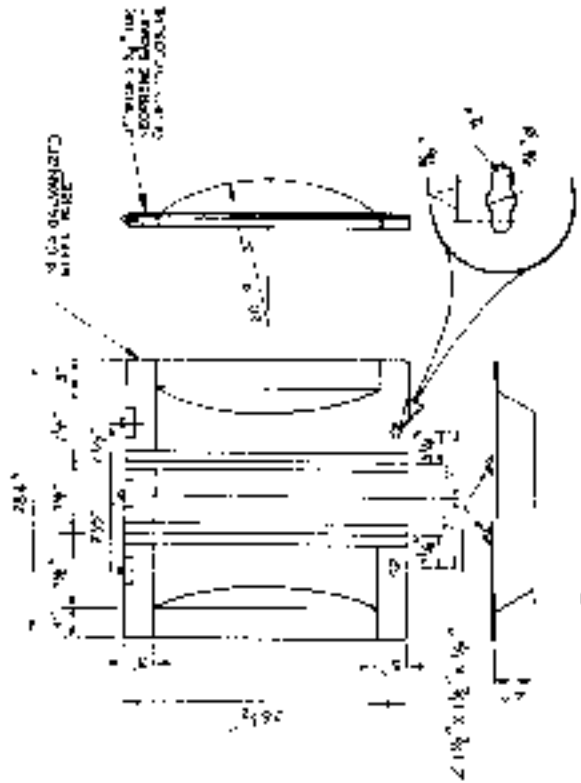

CLOSURE

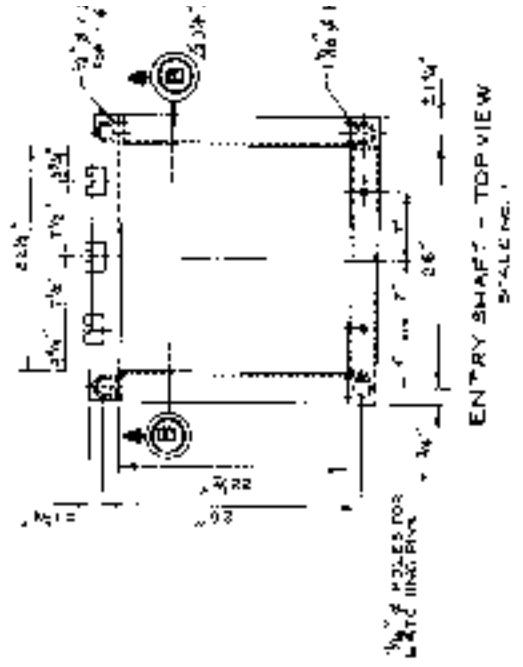

ENTRY SHAFT - TOP VIEW
SCALE: 1/4\" = 1'



SECTION B-B

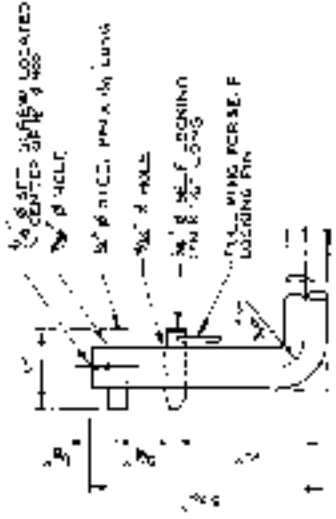

LATCHING PIN DETAIL
SCALE: 1/4\" = 1'

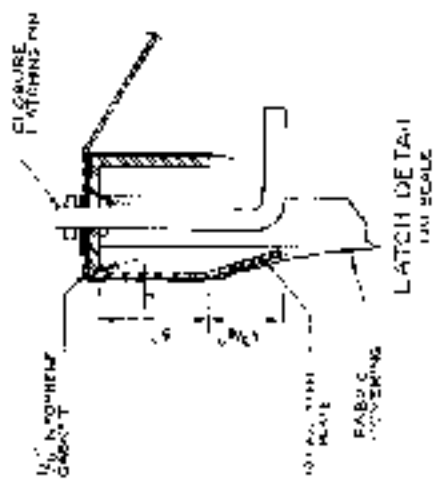

LATCH DETAIL
SCALE: 1/4\" = 1'

HARDENED FRAME/FABRIC SHELTER (sheet 3 of 3)

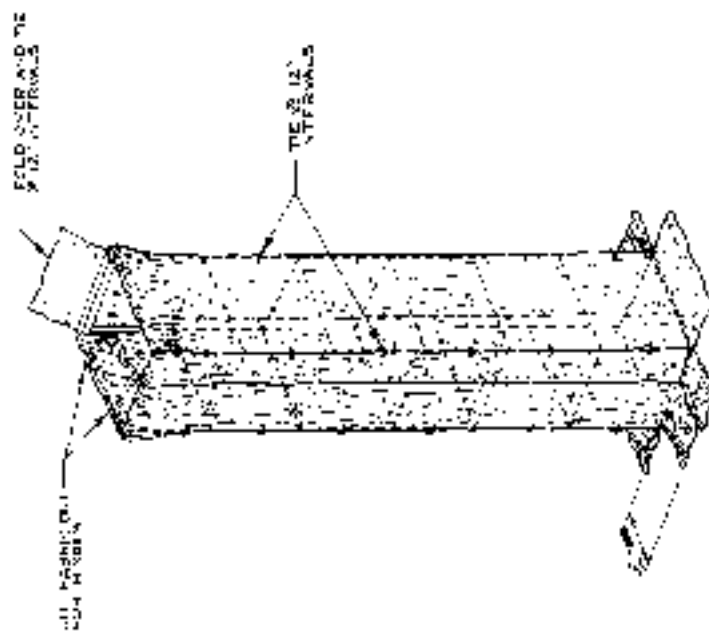

ITEM	UNIT	QUANTITY
PIPE STEEL 1 IN. X 10 - 22 FT LG	EA	123
PIPE CLAMP SINGLE-SOCKET TEE 1 IN. PIPE	EA	12
PIPE CLAMP TWC-SOCKET TEE 50° 1 IN. PIPE	EA	10
HINGE RIVET STEEL 3/16 IN. X 1/8 IN	EA	3
17 MEMBRANE BELT-AIRWAY 3000 SQ FT	RM	20
STEEL SHEET CARBON 0.188 THICK GALV	SF	2
METAL SHEET 3/32 IN THICK UNCOATED STEEL	SF	16
STEEL ANGLE 1-1/2 X 1-1/2 X 1/8 IN LIG THICK	FT	6
STEEL ANGLE 3-1/2 X 3-1/2 X 1/4 IN LEG THICK	FT	10

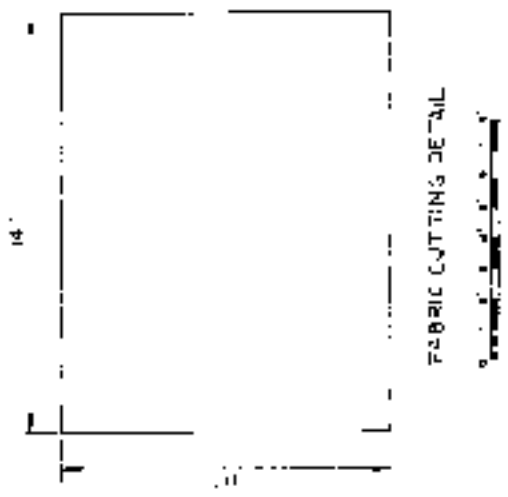

RECTANGULAR FABRIC/FRAME SHELTER (sheet 1 of 2)

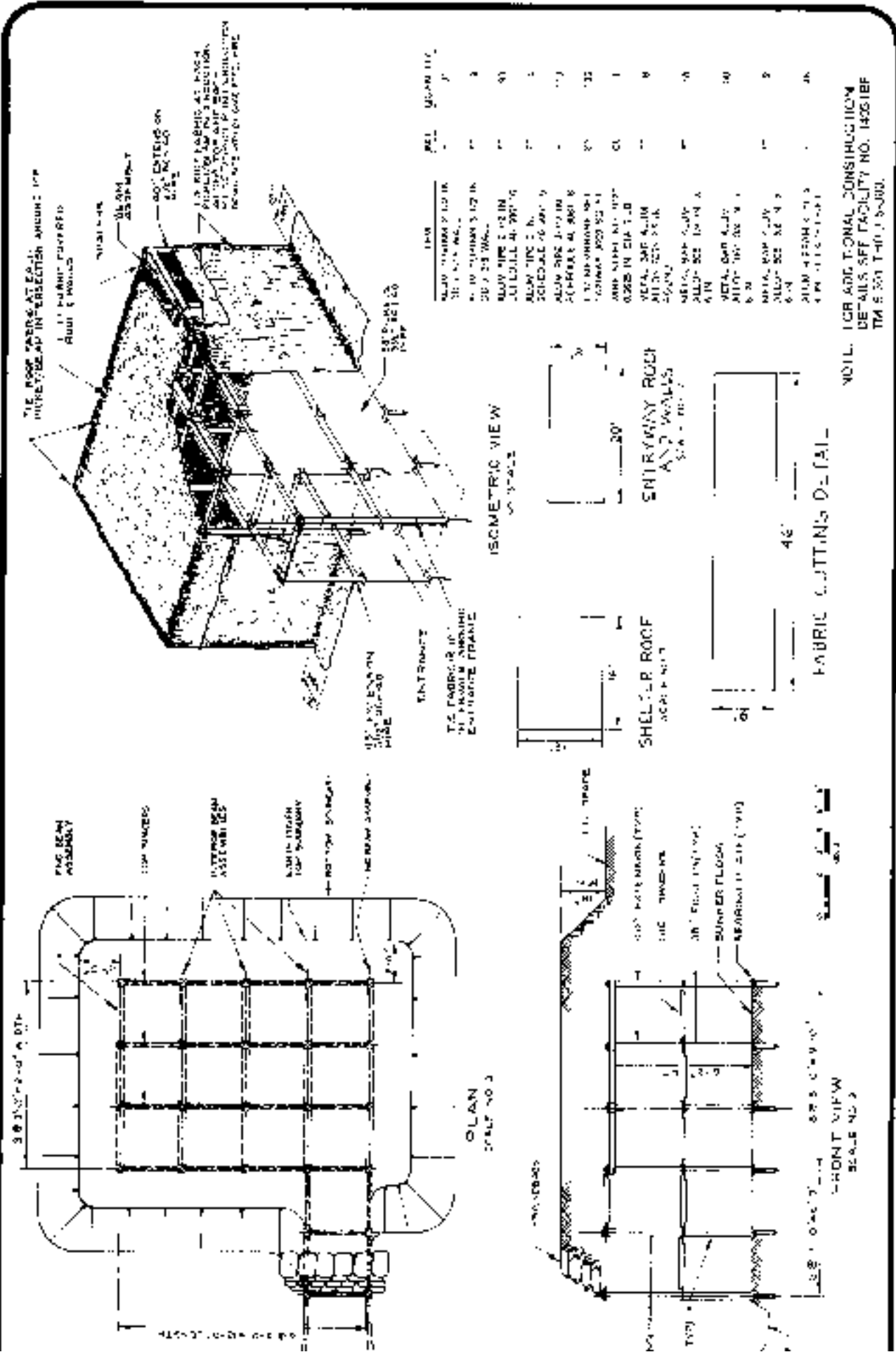

RECTANGULAR FABRIC/FRAME SHELTER (sheet 2 of 2)

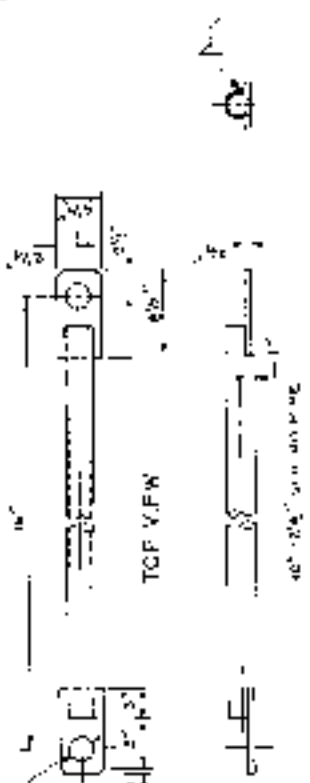

END VIEW

SIDE VIEW

STACFR (TYP)
SCALE NO. 1

COMPONENTS REQUIRED TO ACC. BY 17'-0" SHELTER

- 1. TYP. END BEAM ASSEMBLY
- 2. TYP. SIDE BEAM ASSEMBLY
- 3. 2. METERS
- 4. BEARING PLATES
- 5. 14. METERS OF FABRIC
- 6. EXTENSIONS AS FOLLOWS (SEE DRAWING)
- 7. 14. METERS

TYP. PICKET
SCALE NO. 2

GENERAL NOTES

1. THE SKEWETS OF THIS SHELTER CAN BE EXTENDED BY ADDING MORE BEAMS, SPACERS AND PARTIAL WALLS. ADDITIONAL FABRIC MATERIAL SHOULD BE ORDERED TO THE ORIGINAL PANELS WITH AN APPROXIMATE 10% OVERAGE.
2. IT IS RECOMMENDED THAT SOIL BE PAVED IN EVEN SPACES AROUND THE STRUCTURE BECAUSE COVERING THE ROCKS, THIS PROTECTS THE METAL PICKETS FROM WEAR AND TEAR AND PREVENTS SOIL FROM GETTING INTO THE FABRIC.
3. IF PRINTED IN BLACK IN THE ORIGINAL DRAWING, IT IS RECOMMENDED THAT IT BE PRINTED IN BLACK IN THE ORIGINAL DRAWING.
4. ALL CORNERS INSIDE THE SHELTER SHOULD BE ROUNDED OFF BY 1/4" TO PREVENT INJURY TO THE FABRIC AND TO ALLOWING THE COVERING TO BE PULLED OFF.
5. WALLS OF SHELTER CAN BE MADE OF ALUMINUM PLATE OR ANY OTHER TYPE OF METAL PLATE WHICH IS 1/4" THICK.
6. FABRIC SHOULD BE ORDERED WITH A 10% OVERAGE AND SHOULD BE CUT TO FIT THE SHELTER.

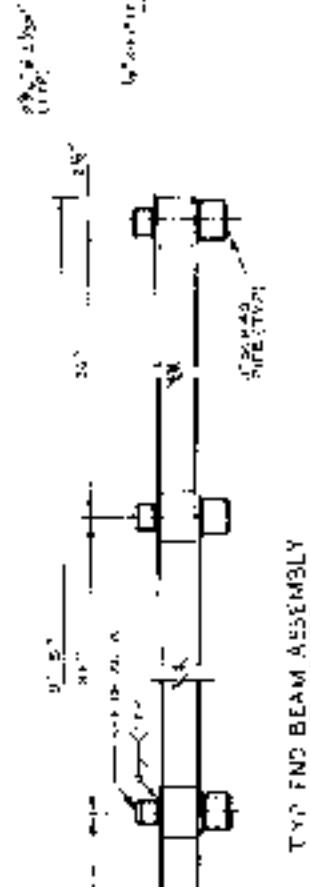

TYP. END BEAM ASSEMBLY
SCALE NO. 1



TYP. EXTERIOR BEAM ASSEMBLY
SCALE NO. 1

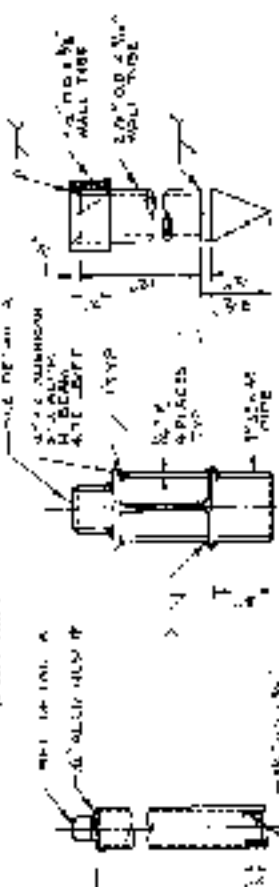

SECTION A-A
SCALE NO. 1

EXTENSION
SCALE NO. 2

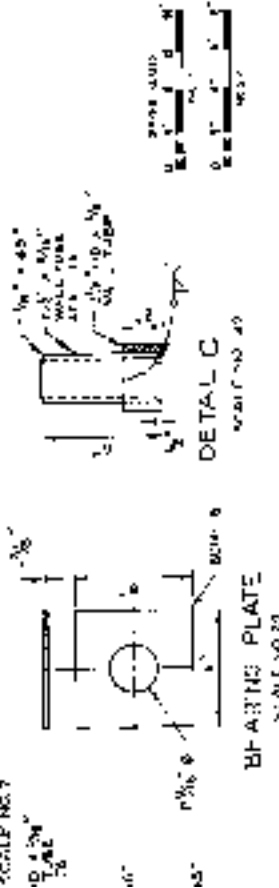

DETAIL C
SCALE NO. 2

BEARING PLATE
SCALE NO. 2

CONCRETE ARCH SHELTER (sheet 2 of 3)

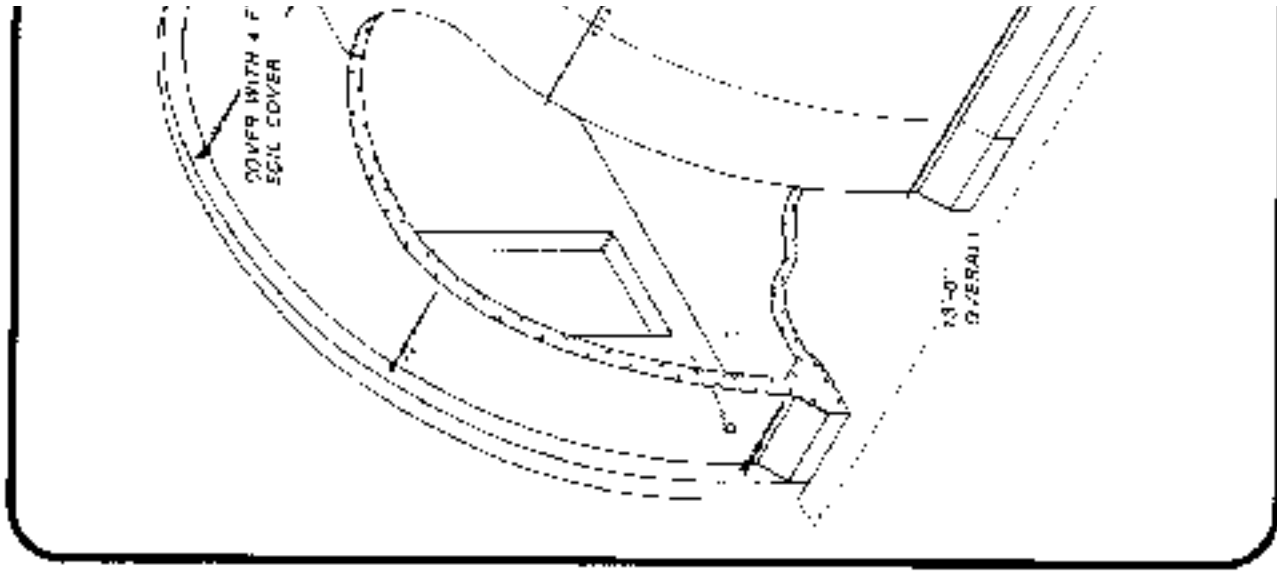
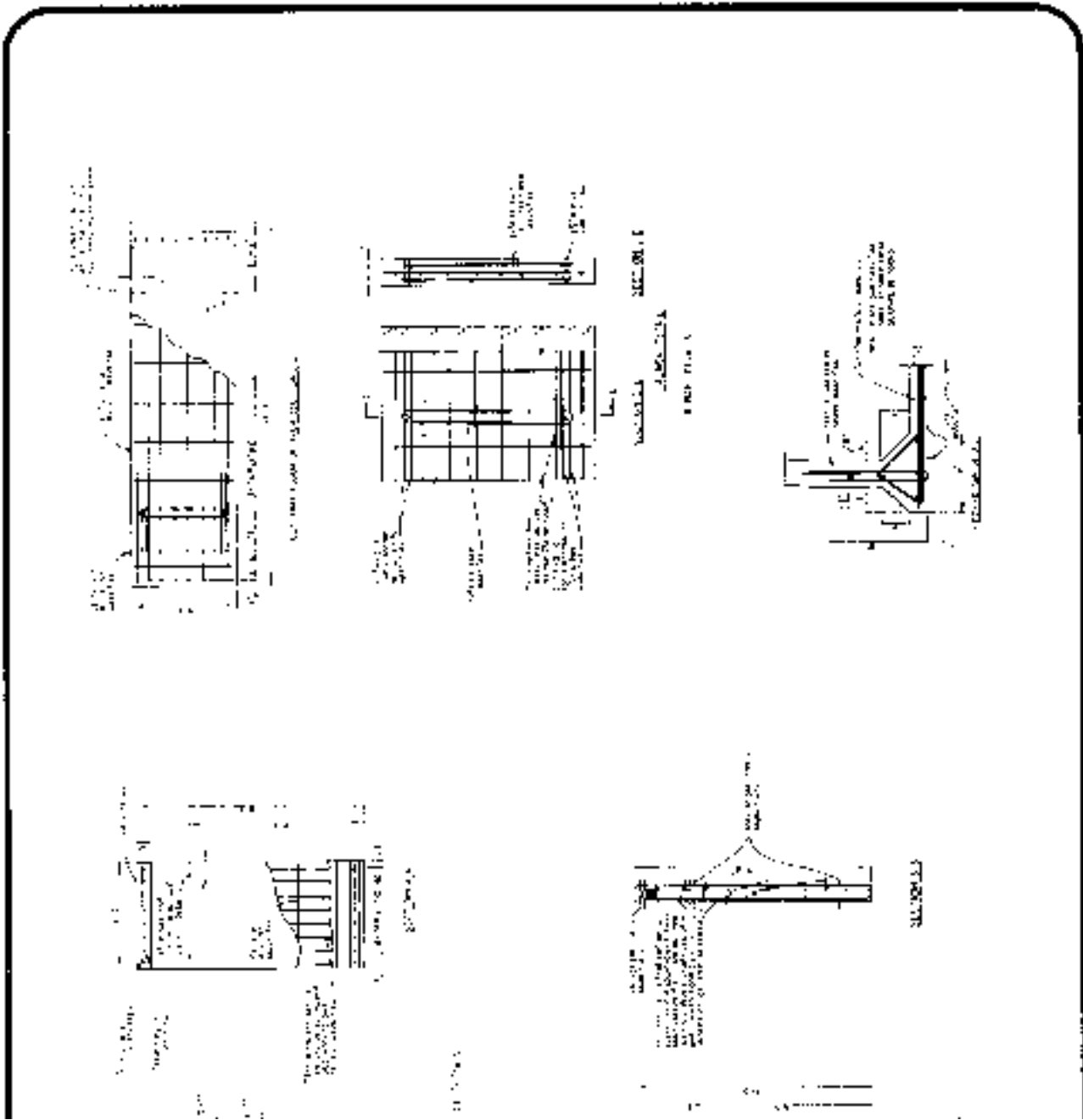

RCH SHELTER (sheet 3 of 3)

CON

B&E SCHEDULE

NO.	DESCRIPTION	QTY	UNIT	PRICE	TOTAL
1	CONCRETE FOUNDATION	1	sq ft	1.50	1.50
2	WOOD STUDS	100	lb	0.10	10.00
3	WOOD JOISTS	50	lb	0.10	5.00
4	WOOD SHEATHING	200	sq ft	0.20	40.00
5	ROOFING	1	unit	100.00	100.00
6	INSULATION	100	sq ft	0.50	50.00
7	GLASS	100	sq ft	1.00	100.00
8	DOOR	1	unit	50.00	50.00
9	WINDOW	1	unit	50.00	50.00
10	WATER TIGHTENING	1	unit	10.00	10.00
11	PAINT	100	sq ft	0.10	10.00
12	LABOR	100	hr	1.00	100.00
13	TRUCK	1	unit	100.00	100.00
14	PERMITS	1	unit	10.00	10.00
15	UTILITIES	1	unit	10.00	10.00
16	DEMOLITION	1	unit	10.00	10.00
17	DEMOLITION	1	unit	10.00	10.00
18	DEMOLITION	1	unit	10.00	10.00
19	DEMOLITION	1	unit	10.00	10.00
20	DEMOLITION	1	unit	10.00	10.00
21	DEMOLITION	1	unit	10.00	10.00
22	DEMOLITION	1	unit	10.00	10.00
23	DEMOLITION	1	unit	10.00	10.00
24	DEMOLITION	1	unit	10.00	10.00
25	DEMOLITION	1	unit	10.00	10.00
26	DEMOLITION	1	unit	10.00	10.00
27	DEMOLITION	1	unit	10.00	10.00
28	DEMOLITION	1	unit	10.00	10.00
29	DEMOLITION	1	unit	10.00	10.00
30	DEMOLITION	1	unit	10.00	10.00
31	DEMOLITION	1	unit	10.00	10.00
32	DEMOLITION	1	unit	10.00	10.00
33	DEMOLITION	1	unit	10.00	10.00
34	DEMOLITION	1	unit	10.00	10.00
35	DEMOLITION	1	unit	10.00	10.00
36	DEMOLITION	1	unit	10.00	10.00
37	DEMOLITION	1	unit	10.00	10.00
38	DEMOLITION	1	unit	10.00	10.00
39	DEMOLITION	1	unit	10.00	10.00
40	DEMOLITION	1	unit	10.00	10.00
41	DEMOLITION	1	unit	10.00	10.00
42	DEMOLITION	1	unit	10.00	10.00
43	DEMOLITION	1	unit	10.00	10.00
44	DEMOLITION	1	unit	10.00	10.00
45	DEMOLITION	1	unit	10.00	10.00
46	DEMOLITION	1	unit	10.00	10.00
47	DEMOLITION	1	unit	10.00	10.00
48	DEMOLITION	1	unit	10.00	10.00
49	DEMOLITION	1	unit	10.00	10.00
50	DEMOLITION	1	unit	10.00	10.00

NOTE: THIS SCHEDULE IS SUBJECT TO THE FOLLOWING CONDITIONS:
 1. ALL WORK SHALL BE DONE IN ACCORDANCE WITH THE LATEST EDITIONS OF THE U.S. ARMY CONSTRUCTION MANUALS.
 2. THE CONTRACTOR SHALL BE RESPONSIBLE FOR OBTAINING ALL NECESSARY PERMITS AND UTILITIES.
 3. THE CONTRACTOR SHALL BE RESPONSIBLE FOR PROTECTING ALL EXISTING UTILITIES AND STRUCTURES.
 4. THE CONTRACTOR SHALL BE RESPONSIBLE FOR THE DISPOSAL OF ALL DEBRIS AND WASTE.
 5. THE CONTRACTOR SHALL BE RESPONSIBLE FOR THE PROTECTION OF ALL ADJACENT PROPERTIES AND STRUCTURES.
 6. THE CONTRACTOR SHALL BE RESPONSIBLE FOR THE PROTECTION OF ALL ADJACENT UTILITIES AND STRUCTURES.
 7. THE CONTRACTOR SHALL BE RESPONSIBLE FOR THE PROTECTION OF ALL ADJACENT UTILITIES AND STRUCTURES.
 8. THE CONTRACTOR SHALL BE RESPONSIBLE FOR THE PROTECTION OF ALL ADJACENT UTILITIES AND STRUCTURES.
 9. THE CONTRACTOR SHALL BE RESPONSIBLE FOR THE PROTECTION OF ALL ADJACENT UTILITIES AND STRUCTURES.
 10. THE CONTRACTOR SHALL BE RESPONSIBLE FOR THE PROTECTION OF ALL ADJACENT UTILITIES AND STRUCTURES.

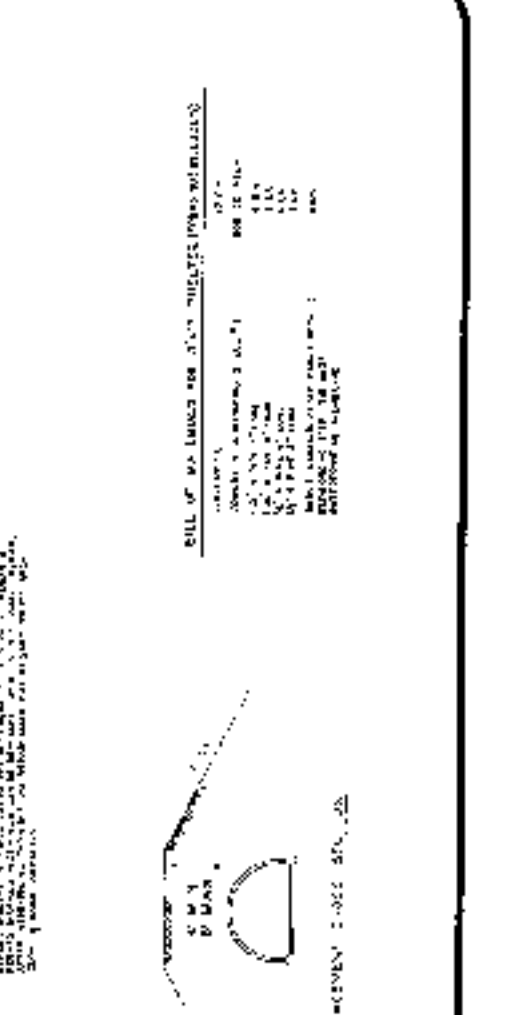

GENERAL NOTES

1. MATERIAL SPECIFICATIONS:
 SUNGALLI: PORTLAND CEMENT, SAND & COARSE AGGREGATE 3/4" MAX. MIXED TO PRODUCE TORSION FOR 3000 PSI COMPRESSIVE STRENGTH IN 28 DAYS.
 CONCRETE: HIGH-STRENGTH STEEL: INTERMEDIATE TENSILE 40,000 PSI TENSILE STRENGTH.
 MULTIPLATE PIPE ARCH: B-GAZE CORRUGATED-STEEL, 8" x 2" CORRUGAT ONE GALVANIZED.
 METSEILANFOUS FASTENERS: GRADE AS AVAILABLE.
 DESIGN LOADINGS: EARTH COVER AT CROWN.
 GROUNDWATER SEEPAGE: ALL EXTERIOR SURFACES OF SHELFER & ENTRANCEWAY MUST BE COVERED WITH WATERPROOFING MEMBRANE TO PREVENT GROUND WATER SEEPAGE.
2. FLOOR: CORRUGATED-STEEL FLOOR FROM RFD.
3. OCCUPANCY: 12' x 2' BASIC SHELFER DESIGN FOR TEN ASSUMING ONE SLEEPING SUNK PER MAN.
4. EQUIPMENT PROVIDED: BASIC SHELTER PROVIDED ON STRUCTURE. COMPONENTS AND ASSEMBLIES. ALL EQUIPMENT MUST BE SEW OFF SEPARATELY.
5. EMERGENCY EXIT: USE ONE OF FOUR OPENINGS AS EMERGENCY EXIT.
6. BUNK INSTALLATION: TO BE SUSPENDED FROM ARCH SECTION BY ANCHOR BOLTS.
7. TRANSPORTABILITY: ARCH STRUCTURE 4000 LB. ENDWALL 7900 LB.
8. FOR AND MODEL DRAWING: INCLUDE DETAIL & SET FACILITY NO. 040201, TV 5-201 THRU 5-203.

ERECTION PROCEDURES

1. LEVEL SITE.
2. PLACE WATERPROOFING MEMBRANE ON GROUND BE LOW SHELFER.
3. PLACE ARCH SECTION.
4. PLACE REAR END WALL AND BRACE TEMPORARILY.
5. PLACE AND TEMPORARILY BRACE FRONT END WALL.
6. CONCRETE FRONT WALL. THE COUSERS FROM END WALL TO END WALL ARE 1/2" GALV. U-TAIL SHEET PILE.
7. PLACE END WALL (ENTRANCEWAY TO SHELFER ENTRANCEWAY NOT INCLUDED) IN THIS SET OF DRAWINGS.
8. PLACE WATERPROOFING MEMBRANE OVER SHELFER AND ENTRANCEWAY.
9. BACKFILL SHELFER TO DESIRED FORTIFICATION. CAREFUL TO RAISE AND PACK DOWN ALL IN UNIFORM LIFTS OF EQUAL DEPTH ON OPPOSITE SIDES OF ARCH SECTIONS AND END WALL SECTIONS.

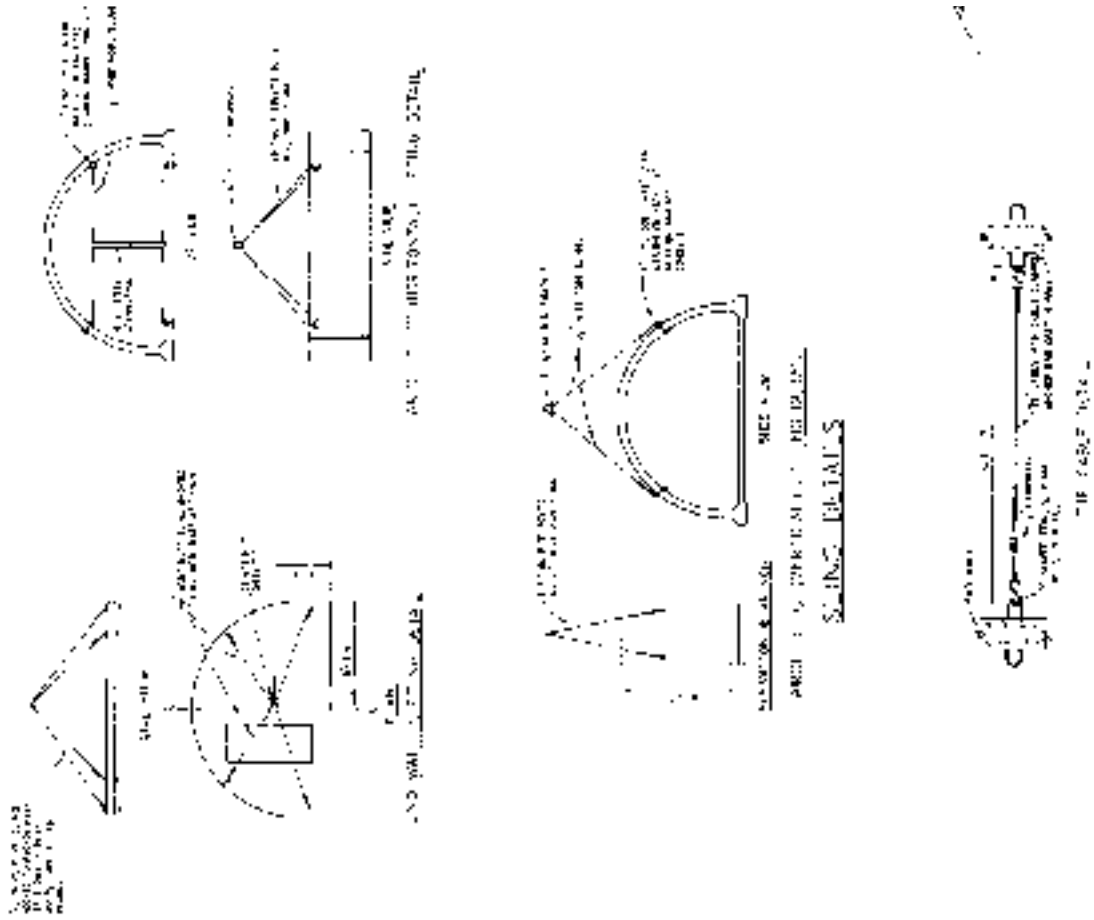

METAL PIPE ARCH SHELL

of 2)

FIGURE 1. PARTS OF SHELL

FIGURE 2. PARTS OF SHELL

FIGURE	DESCRIPTION
FIG 1	SIDE VIEW
FIG 2	FRONT VIEW
FIG 3	TOP VIEW
FIG 4	SECTION
FIG 5	DETAIL
FIG 6	DETAIL
FIG 7	DETAIL
FIG 8	DETAIL
FIG 9	DETAIL
FIG 10	DETAIL
FIG 11	DETAIL
FIG 12	DETAIL
FIG 13	DETAIL
FIG 14	DETAIL
FIG 15	DETAIL
FIG 16	DETAIL
FIG 17	DETAIL
FIG 18	DETAIL
FIG 19	DETAIL
FIG 20	DETAIL
FIG 21	DETAIL
FIG 22	DETAIL
FIG 23	DETAIL
FIG 24	DETAIL
FIG 25	DETAIL
FIG 26	DETAIL
FIG 27	DETAIL
FIG 28	DETAIL
FIG 29	DETAIL
FIG 30	DETAIL
FIG 31	DETAIL
FIG 32	DETAIL
FIG 33	DETAIL
FIG 34	DETAIL
FIG 35	DETAIL
FIG 36	DETAIL
FIG 37	DETAIL
FIG 38	DETAIL
FIG 39	DETAIL
FIG 40	DETAIL
FIG 41	DETAIL
FIG 42	DETAIL
FIG 43	DETAIL
FIG 44	DETAIL
FIG 45	DETAIL
FIG 46	DETAIL
FIG 47	DETAIL
FIG 48	DETAIL
FIG 49	DETAIL
FIG 50	DETAIL
FIG 51	DETAIL
FIG 52	DETAIL
FIG 53	DETAIL
FIG 54	DETAIL
FIG 55	DETAIL
FIG 56	DETAIL
FIG 57	DETAIL
FIG 58	DETAIL
FIG 59	DETAIL
FIG 60	DETAIL
FIG 61	DETAIL
FIG 62	DETAIL
FIG 63	DETAIL
FIG 64	DETAIL
FIG 65	DETAIL
FIG 66	DETAIL
FIG 67	DETAIL
FIG 68	DETAIL
FIG 69	DETAIL
FIG 70	DETAIL
FIG 71	DETAIL
FIG 72	DETAIL
FIG 73	DETAIL
FIG 74	DETAIL
FIG 75	DETAIL
FIG 76	DETAIL
FIG 77	DETAIL
FIG 78	DETAIL
FIG 79	DETAIL
FIG 80	DETAIL
FIG 81	DETAIL
FIG 82	DETAIL
FIG 83	DETAIL
FIG 84	DETAIL
FIG 85	DETAIL
FIG 86	DETAIL
FIG 87	DETAIL
FIG 88	DETAIL
FIG 89	DETAIL
FIG 90	DETAIL
FIG 91	DETAIL
FIG 92	DETAIL
FIG 93	DETAIL
FIG 94	DETAIL
FIG 95	DETAIL
FIG 96	DETAIL
FIG 97	DETAIL
FIG 98	DETAIL
FIG 99	DETAIL
FIG 100	DETAIL

FIGURE 3. PARTS OF SHELL

FIGURE 4. PARTS OF SHELL

FIGURE 5. PARTS OF SHELL

FIGURE 6. PARTS OF SHELL

FIGURE 7. PARTS OF SHELL

FIGURE 8. PARTS OF SHELL

FIGURE 9. PARTS OF SHELL

FIGURE 10. PARTS OF SHELL

FIGURE 11. PARTS OF SHELL

FIGURE 12. PARTS OF SHELL

FIGURE 13. PARTS OF SHELL

FIGURE 14. PARTS OF SHELL

FIGURE 15. PARTS OF SHELL

FIGURE 16. PARTS OF SHELL

FIGURE 17. PARTS OF SHELL

FIGURE 18. PARTS OF SHELL

FIGURE 19. PARTS OF SHELL

FIGURE 20. PARTS OF SHELL

FIGURE 21. PARTS OF SHELL

FIGURE 22. PARTS OF SHELL

FIGURE 23. PARTS OF SHELL

FIGURE 24. PARTS OF SHELL

FIGURE 25. PARTS OF SHELL

FIGURE 26. PARTS OF SHELL

FIGURE 27. PARTS OF SHELL

FIGURE 28. PARTS OF SHELL

FIGURE 29. PARTS OF SHELL

FIGURE 30. PARTS OF SHELL

FIGURE 31. PARTS OF SHELL

FIGURE 32. PARTS OF SHELL

FIGURE 33. PARTS OF SHELL

FIGURE 34. PARTS OF SHELL

FIGURE 35. PARTS OF SHELL

FIGURE 36. PARTS OF SHELL

FIGURE 37. PARTS OF SHELL

FIGURE 38. PARTS OF SHELL

FIGURE 39. PARTS OF SHELL

FIGURE 40. PARTS OF SHELL

FIGURE 41. PARTS OF SHELL

FIGURE 42. PARTS OF SHELL

FIGURE 43. PARTS OF SHELL

FIGURE 44. PARTS OF SHELL

FIGURE 45. PARTS OF SHELL

FIGURE 46. PARTS OF SHELL

FIGURE 47. PARTS OF SHELL

FIGURE 48. PARTS OF SHELL

FIGURE 49. PARTS OF SHELL

FIGURE 50. PARTS OF SHELL

FIGURE 51. PARTS OF SHELL

FIGURE 52. PARTS OF SHELL

FIGURE 53. PARTS OF SHELL

FIGURE 54. PARTS OF SHELL

FIGURE 55. PARTS OF SHELL

FIGURE 56. PARTS OF SHELL

FIGURE 57. PARTS OF SHELL

FIGURE 58. PARTS OF SHELL

FIGURE 59. PARTS OF SHELL

FIGURE 60. PARTS OF SHELL

FIGURE 61. PARTS OF SHELL

FIGURE 62. PARTS OF SHELL

FIGURE 63. PARTS OF SHELL

FIGURE 64. PARTS OF SHELL

FIGURE 65. PARTS OF SHELL

FIGURE 66. PARTS OF SHELL

FIGURE 67. PARTS OF SHELL

FIGURE 68. PARTS OF SHELL

FIGURE 69. PARTS OF SHELL

FIGURE 70. PARTS OF SHELL

FIGURE 71. PARTS OF SHELL

FIGURE 72. PARTS OF SHELL

FIGURE 73. PARTS OF SHELL

FIGURE 74. PARTS OF SHELL

FIGURE 75. PARTS OF SHELL

FIGURE 76. PARTS OF SHELL

FIGURE 77. PARTS OF SHELL

FIGURE 78. PARTS OF SHELL

FIGURE 79. PARTS OF SHELL

FIGURE 80. PARTS OF SHELL

FIGURE 81. PARTS OF SHELL

FIGURE 82. PARTS OF SHELL

FIGURE 83. PARTS OF SHELL

FIGURE 84. PARTS OF SHELL

FIGURE 85. PARTS OF SHELL

FIGURE 86. PARTS OF SHELL

FIGURE 87. PARTS OF SHELL

FIGURE 88. PARTS OF SHELL

FIGURE 89. PARTS OF SHELL

FIGURE 90. PARTS OF SHELL

FIGURE 91. PARTS OF SHELL

FIGURE 92. PARTS OF SHELL

FIGURE 93. PARTS OF SHELL

FIGURE 94. PARTS OF SHELL

FIGURE 95. PARTS OF SHELL

FIGURE 96. PARTS OF SHELL

FIGURE 97. PARTS OF SHELL

FIGURE 98. PARTS OF SHELL

FIGURE 99. PARTS OF SHELL

FIGURE 100. PARTS OF SHELL

FIGURE 1. SIDE VIEW

FIGURE 2. FRONT VIEW

FIGURE 3. TOP VIEW

FIGURE 4. SECTION

FIGURE 5. DETAIL

FIGURE 6. DETAIL

FIGURE 7. DETAIL

FIGURE 8. DETAIL

FIGURE 9. DETAIL

FIGURE 10. DETAIL

FIGURE 11. DETAIL

FIGURE 12. DETAIL

FIGURE 13. DETAIL

FIGURE 14. DETAIL

FIGURE 15. DETAIL

FIGURE 16. DETAIL

FIGURE 17. DETAIL

FIGURE 18. DETAIL

FIGURE 19. DETAIL

FIGURE 20. DETAIL

FIGURE 21. DETAIL

FIGURE 22. DETAIL

FIGURE 23. DETAIL

FIGURE 24. DETAIL

FIGURE 25. DETAIL

FIGURE 26. DETAIL

FIGURE 27. DETAIL

FIGURE 28. DETAIL

FIGURE 29. DETAIL

FIGURE 30. DETAIL

FIGURE 31. DETAIL

FIGURE 32. DETAIL

FIGURE 33. DETAIL

FIGURE 34. DETAIL

FIGURE 35. DETAIL

FIGURE 36. DETAIL

FIGURE 37. DETAIL

FIGURE 38. DETAIL

FIGURE 39. DETAIL

FIGURE 40. DETAIL

FIGURE 41. DETAIL

FIGURE 42. DETAIL

FIGURE 43. DETAIL

FIGURE 44. DETAIL

FIGURE 45. DETAIL

FIGURE 46. DETAIL

FIGURE 47. DETAIL

FIGURE 48. DETAIL

FIGURE 49. DETAIL

FIGURE 50. DETAIL

FIGURE 51. DETAIL

FIGURE 52. DETAIL

FIGURE 53. DETAIL

FIGURE 54. DETAIL

FIGURE 55. DETAIL

FIGURE 56. DETAIL

FIGURE 57. DETAIL

FIGURE 58. DETAIL

FIGURE 59. DETAIL

FIGURE 60. DETAIL

FIGURE 61. DETAIL

FIGURE 62. DETAIL

FIGURE 63. DETAIL

FIGURE 64. DETAIL

FIGURE 65. DETAIL

FIGURE 66. DETAIL

FIGURE 67. DETAIL

FIGURE 68. DETAIL

FIGURE 69. DETAIL

FIGURE 70. DETAIL

FIGURE 71. DETAIL

FIGURE 72. DETAIL

FIGURE 73. DETAIL

FIGURE 74. DETAIL

FIGURE 75. DETAIL

FIGURE 76. DETAIL

FIGURE 77. DETAIL

FIGURE 78. DETAIL

FIGURE 79. DETAIL

FIGURE 80. DETAIL

FIGURE 81. DETAIL

FIGURE 82. DETAIL

FIGURE 83. DETAIL

FIGURE 84. DETAIL

FIGURE 85. DETAIL

FIGURE 86. DETAIL

FIGURE 87. DETAIL

FIGURE 88. DETAIL

FIGURE 89. DETAIL

FIGURE 90. DETAIL

FIGURE 91. DETAIL

FIGURE 92. DETAIL

FIGURE 93. DETAIL

FIGURE 94. DETAIL

FIGURE 95. DETAIL

FIGURE 96. DETAIL

FIGURE 97. DETAIL

FIGURE 98. DETAIL

FIGURE 99. DETAIL

FIGURE 100. DETAIL

METAL PIPE ARCH SHELTER (sheet 2)

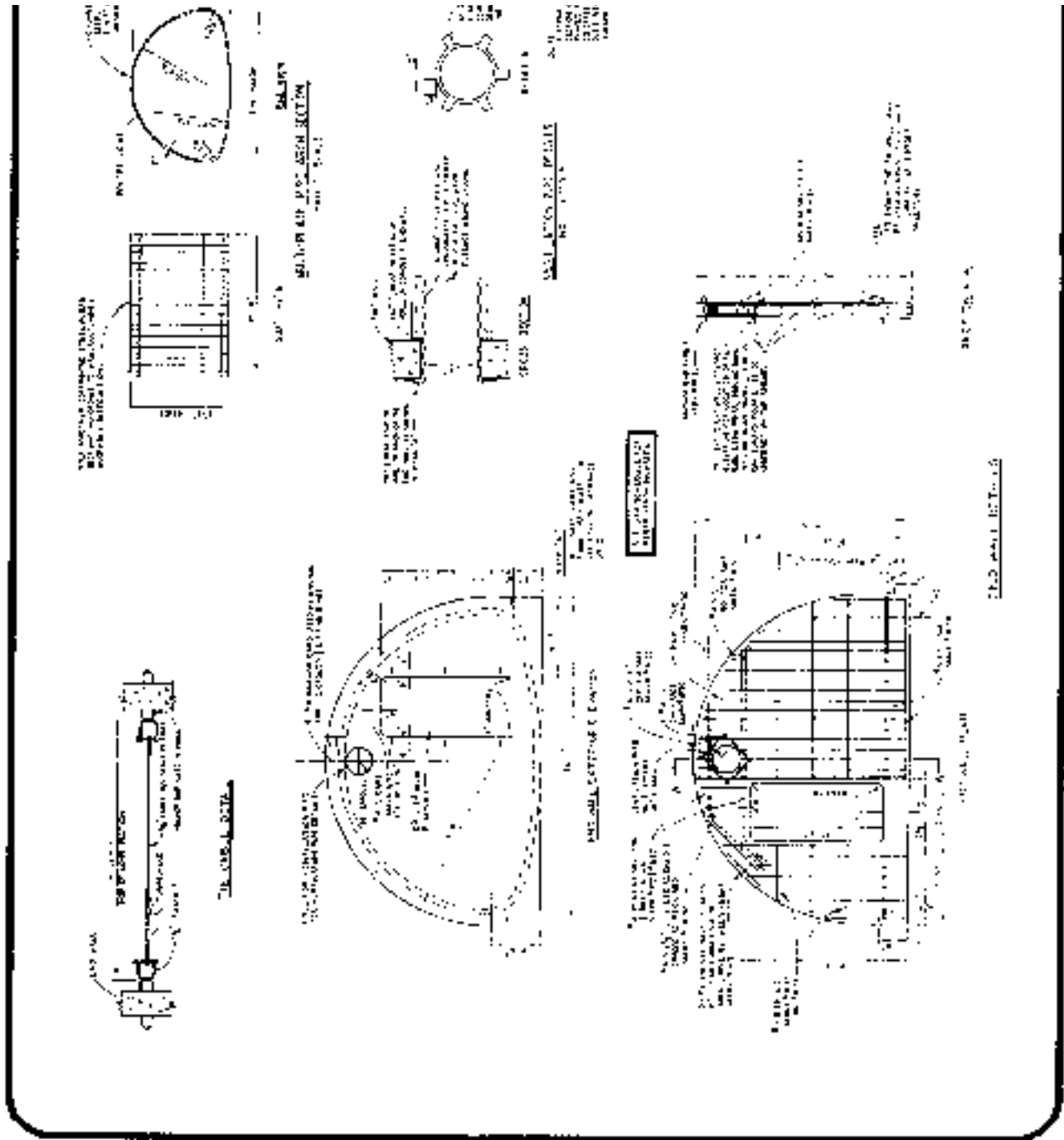

H WALLS

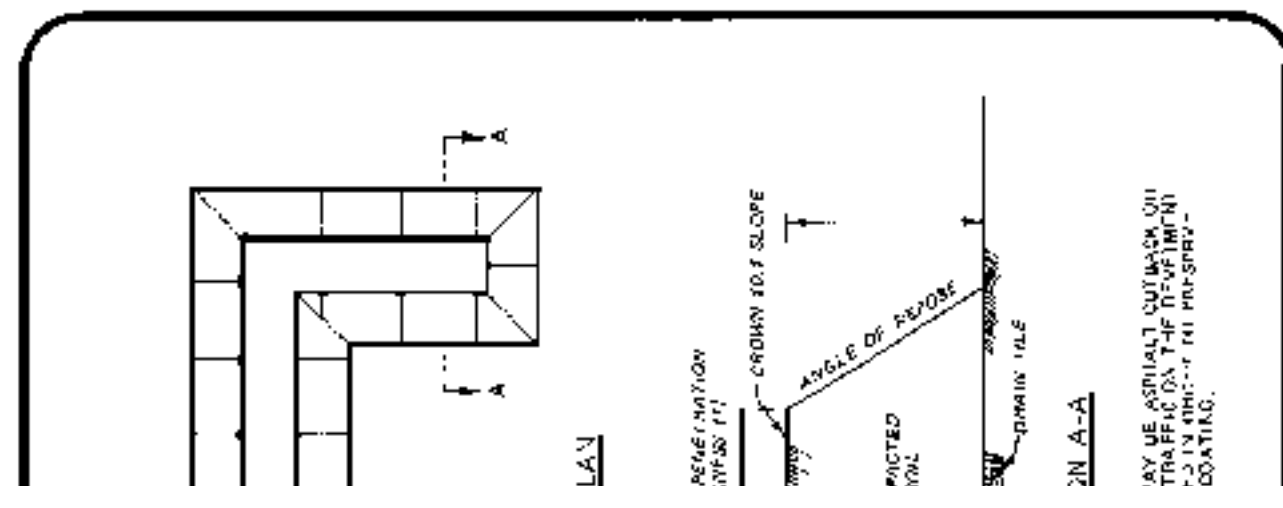

EARTH

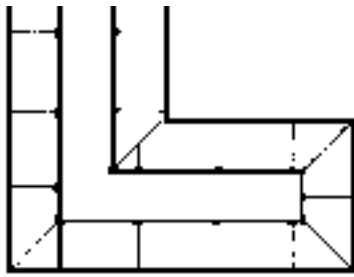

2

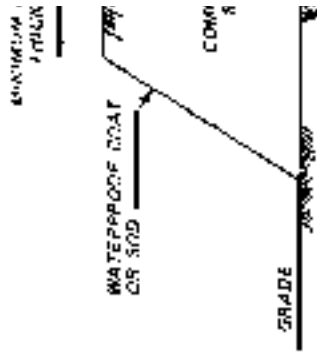

SECTION

NOTE: WATERPROOF NIC M
CEMENT SLURRY
MUST BE PROVIDED
THE WATERPROOF

STEEL LANDING MAT WALL

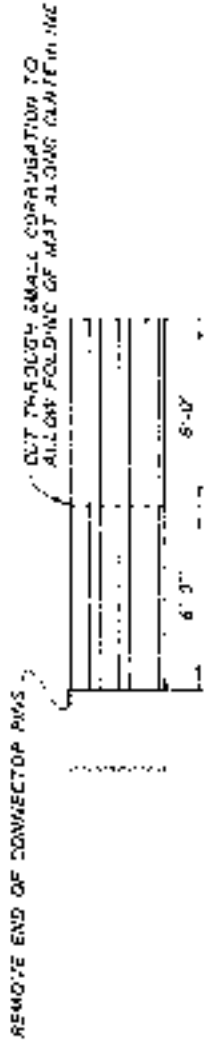

ELEVATIONS

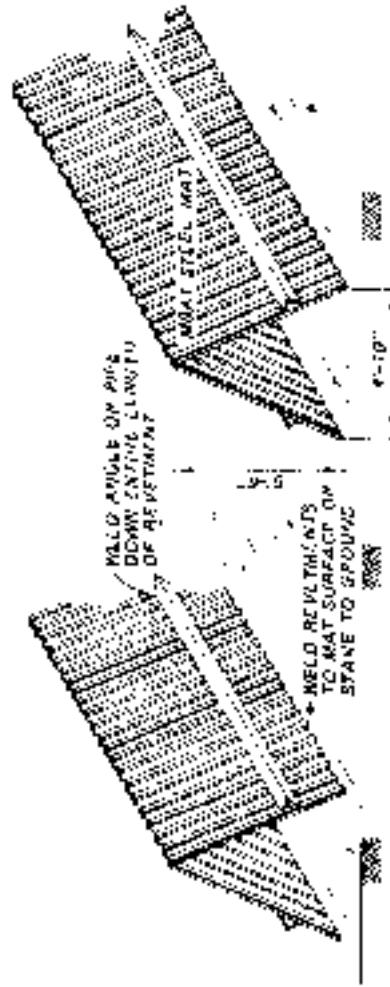

PICTORIAL VIEW

SOIL-CEMENT WALL

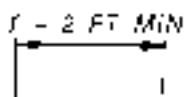

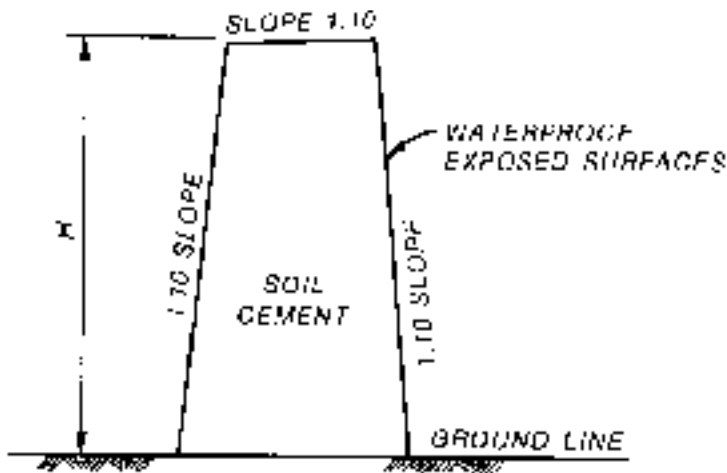

NOTE SOIL-CEMENT MIXTURE
CONSIST OF ONE (1) PART
PORTLAND CEMENT TO
TEN (10) PARTS SOIL. PRO-
PORTIONS ARE MIXED BY
WEIGHT.

FOOTER MAY BE NECES-
SARY IN LOW BEARING
SOILS AND/OR LARGE
VALUE OF H

EARTH WALL WITH REVETMENT

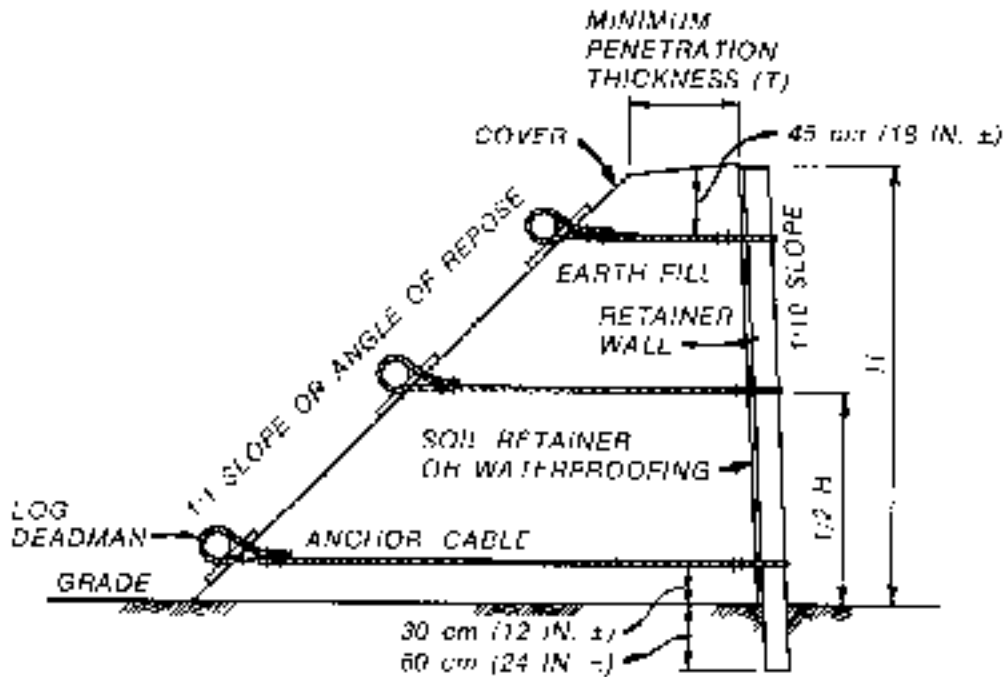

SOIL BIN WALL WITH LOG RETEMENT

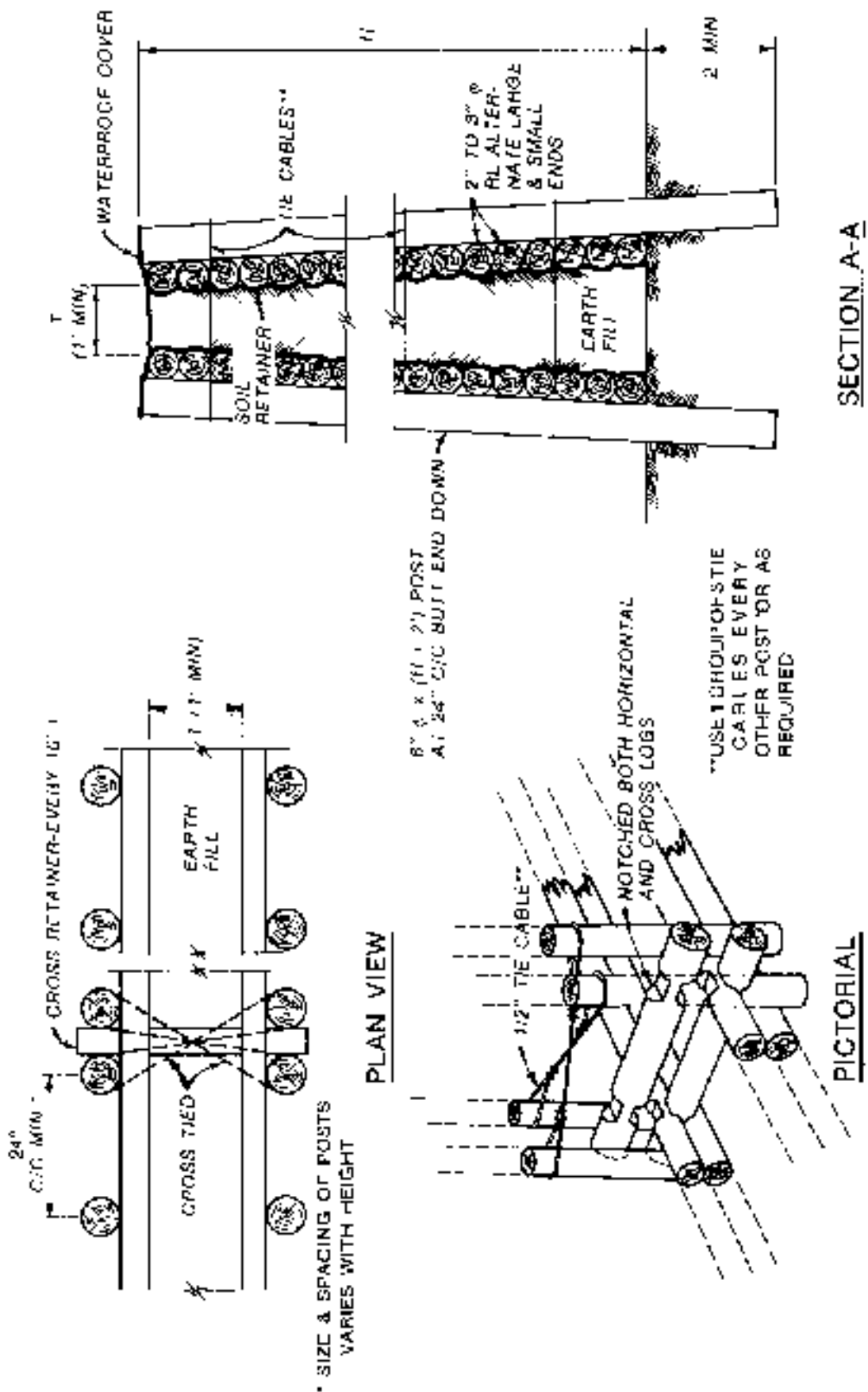

SECTION A-A

PICTORIAL

SOIL BIN WALL WITH TIMBER REVETMENT

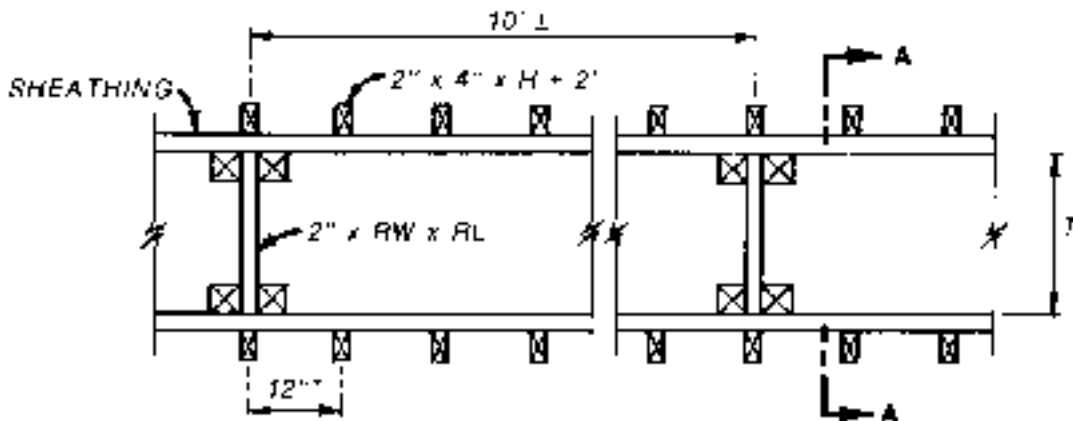

PLAN

NOTE STUD SPACING AND SIZE VARY WITH HEIGHT AND MOISTURE CONTENT OF SOIL.

T = THICKNESS
 H = HEIGHT
 RW = RANDOM WIDTH
 RL = RANDOM LENGTH

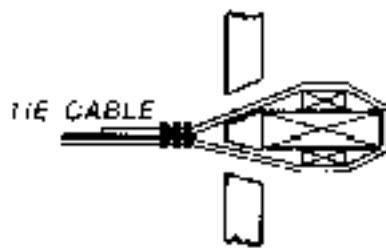

TIE CABLE ATTACHMENT

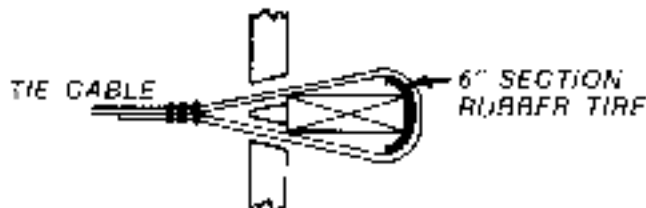

ALTERNATE TIE CABLE ATTACHMENT

NOTE USE 1 GROUP OF 3 TIE CABLES @ 24" O/C (EVERY OTHER STUD) OR AS REQUIRED.

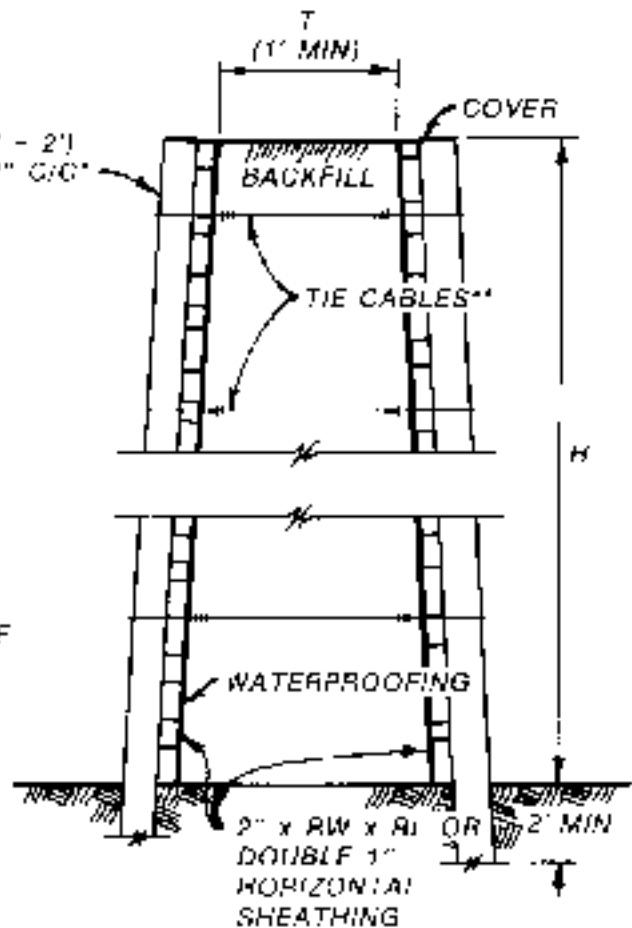

SECTION A-A

SOIL BIN WALL WITH PLYWOOD REVETMENT

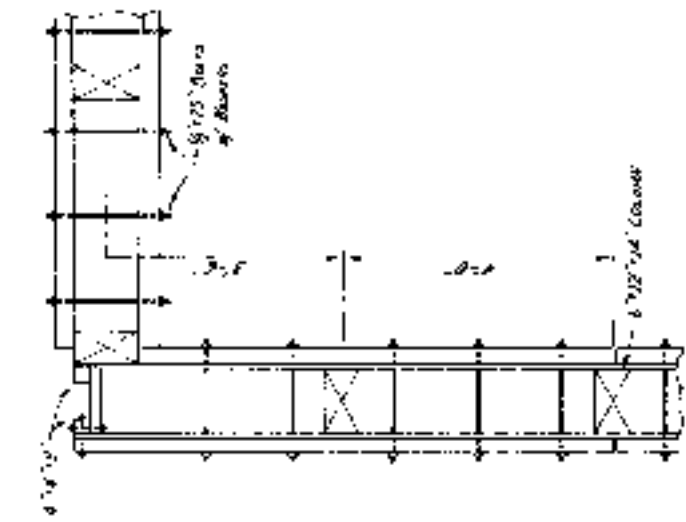

CORNER SECTION

MATERIAL LIST 8 FT LONG WALL

ITEM	QUANTITY
20 GA CORF METAL RIGGING (28" x 144")	2 SHEETS
4" x 4" x 8' 1/2" PLYWOOD	6 SHEETS
4" x 4" x 8'	250 PIECES
25" x 12" BOLTS WITH WASHERS	100 EA
6" x 12" x 14' POSTS	54 EA
2" x 12" x 10'	54 EA
4" x 4" x 11'	3 EA

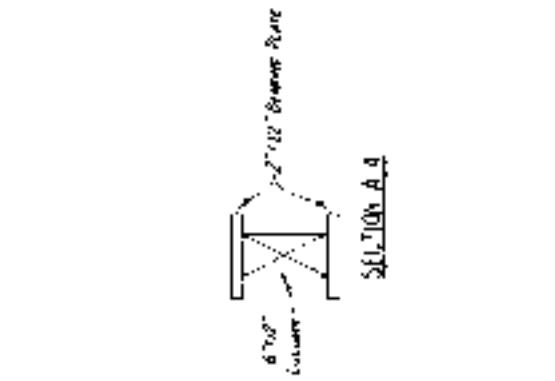

SECTION A-A

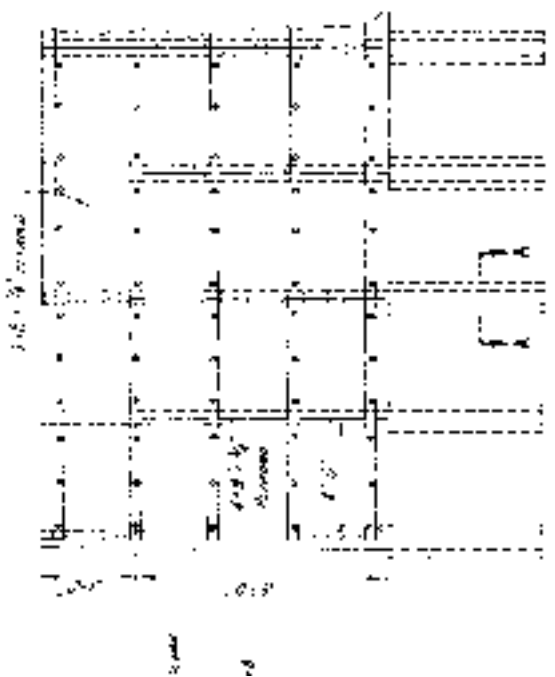

SIDE ELEVATION

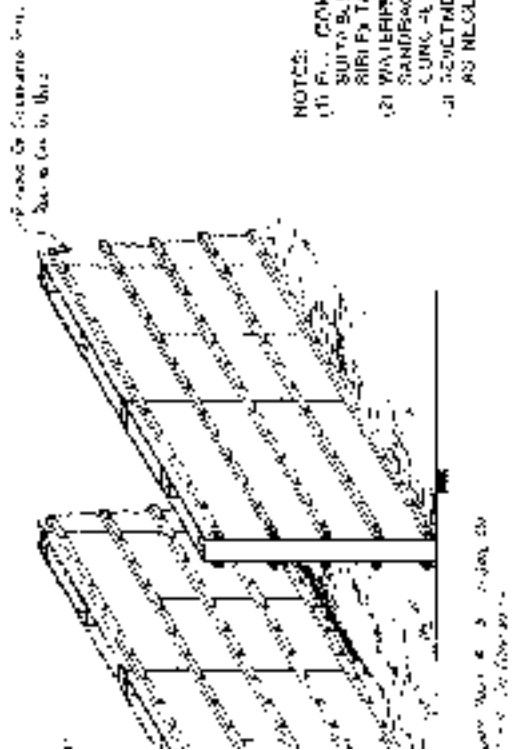

- NOTES:
- (1) FOR COMPLETE REVETMENT WITH A SUITABLE SOIL MATERIALS AND IF POSSIBLE TAMPERING, WHILE REFINING AND DRAINAGE, WATERPROOF REVETMENT TOP WITH SANDPAPER MEMBRANE ABOVE IT, CURING ETC. ETC.
 - (2) REVETMENT HEIGHT CAN BE INCREASED AS NECESSARY.

TOTAL VIEW

ENED SOIL BIN WALL WITH PLYWOOD REVETMENT (sheet 1 of 2)

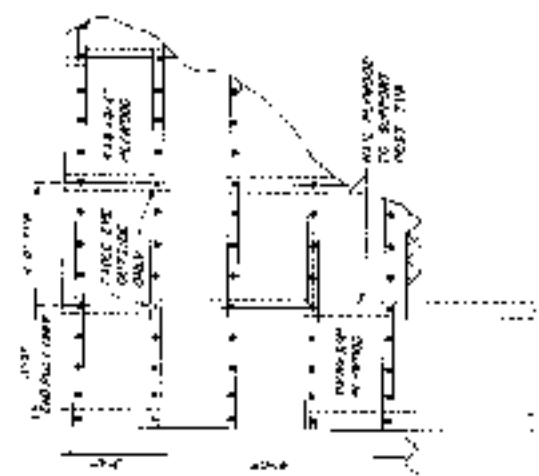

SIDE ELEVATION

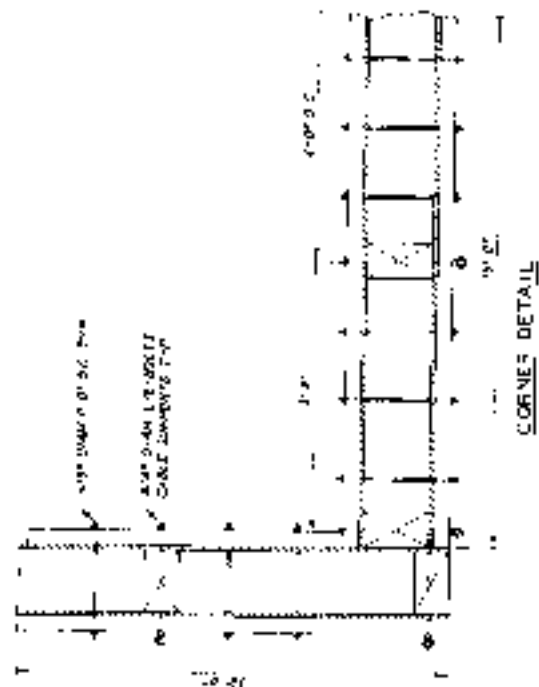

CORNER DETAIL

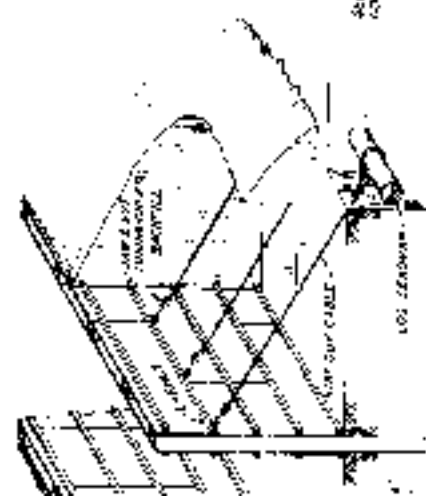

PICTORIAL VIEW

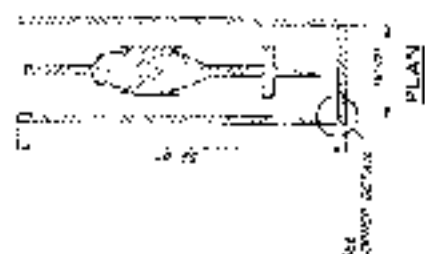

PLAN



BACKTILL PLAN



SECTION AA

NOTE
 1. COMPLETE REVEMENT WITH
 4\"/>



FRONT ELEVATION



MAIN REVEMENT DETAIL

HARD

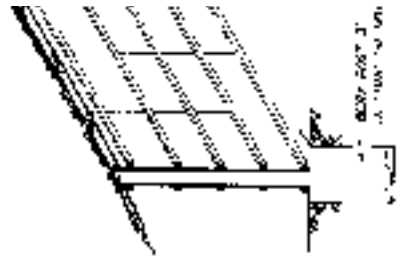
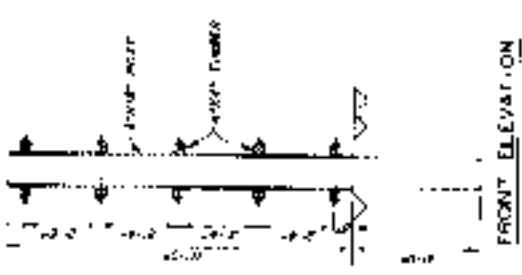

BIN WALL WITH PLYWOOD REVETMENT (sheet 2 of 2)

ITEM	QUANTITY
2-FT BY 2-FT BY 3/4 IN. PLYWOOD	102 SHEETS
6-IN BY 12-IN. BY 13-F1 PCS18"	48 PCS
4- BY 4-IN TIMBER	1,260 LINEAR FT
5/8-IN-DIA GUY CABLES	1,092 FT
3/4-IN EYE NJTS	36 PCS
2-1/4- BY 2-1/4- BY 3/4 IN WASHERS	66 PCS
4- BY 4- BY 5.8-IN. WASHERS	980 PCS
3/4-IN JAW AND EYE TURN-BUCKLES	38 PCS
5/8- BY 24-IN. DOUBLE-ARMING BOLTS WITH NJTS	626 PCS
3/4- BY 24-IN. DOUBLE-ARMING BOLTS WITH NJTS	35 PCS
5/8-IN W 4E ROPE CLIPS	198 PCS
8-IN-D.A. LOG LEADMAN	120 LINEAR FT
47 BOX NAILS	50 LB
15 WING WALL POSTS CUT TO FIT.	
25 6 BY 37 EXTRA IMPROVED FLOW STEEL	

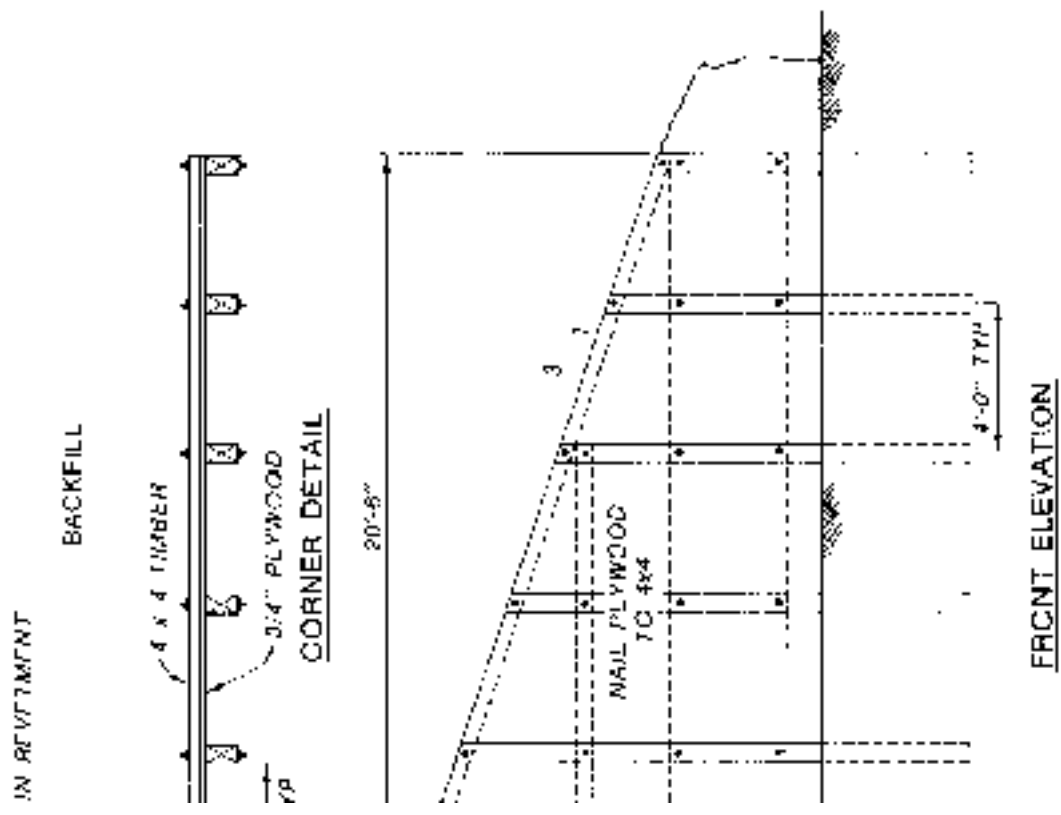

COUGATED METAL PORTABLE WALL

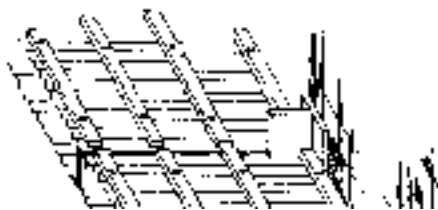

MATERIALS REQUIRED - 4 FT LONG PLYWOOD

ITEM	NO.	FEET
402 PLYWOOD	9	
2448' RUNNERS	8	
24" 2x4" 6' BOTTOMS	1	
2x12x5.5	4	
2x12x4.5	2	
2x12x3	4	
5/8" BOX TS W/WASHERS 8' LG	6	
300 NAILS	25	
3/8" 4 BOLTS 18' LG W/WASHERS	12	
B3 NAILS	75	

MATERIALS REQUIRED - 8 FT LONG CORRUGATED METAL

ITEM	NO.	FEET
26 GA CORR METAL 5 PINS 26" x 144"	2	
2x12x7' 8" BOTTOMS	1	
2x12x5.5	4	
2x12x4.5	2	
2x12x3	4	
5/8" BOX TS W/WASHERS	6	
300 NAILS	25	
3/8" 4 BOLTS 18' LG W/WASHERS	12	
3C NAILS	75	

NOTE: 1. COMPLETE IN VERTICAL WITH 3 SILLABLE SOIL MATERIAL (SAND, L. FINESS DCL) TAMPED IN PLACE BEING PLACED WATER TIGHT REVERSE SIDE WITH 3/4" WASH. MEMBRANE ASPHALT COUGH (1.5" THICK)



HARDENED SOIL

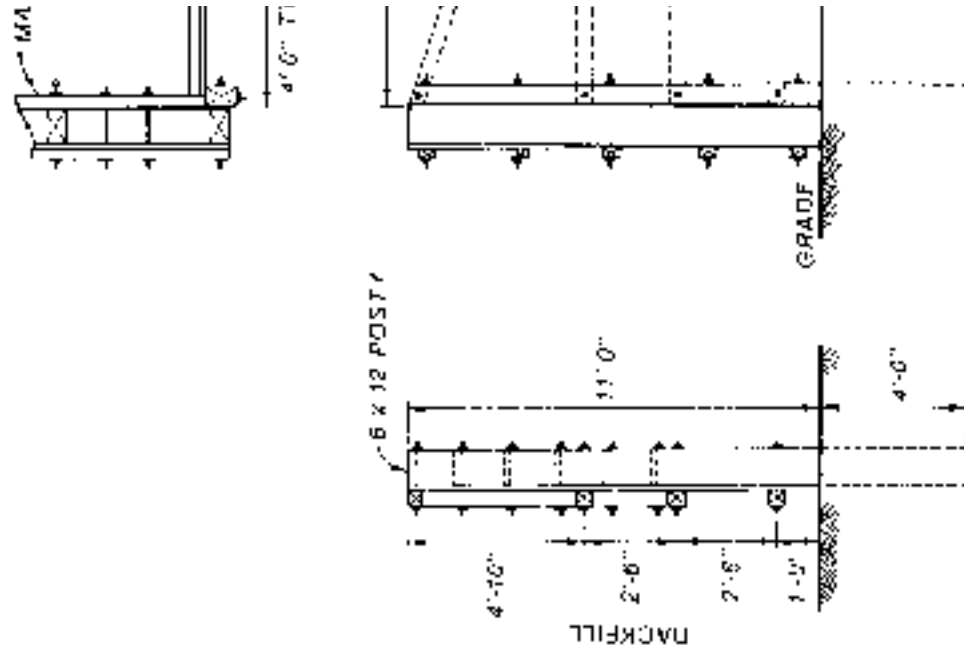

SIDE ELEVATION

CONCRETE WALL

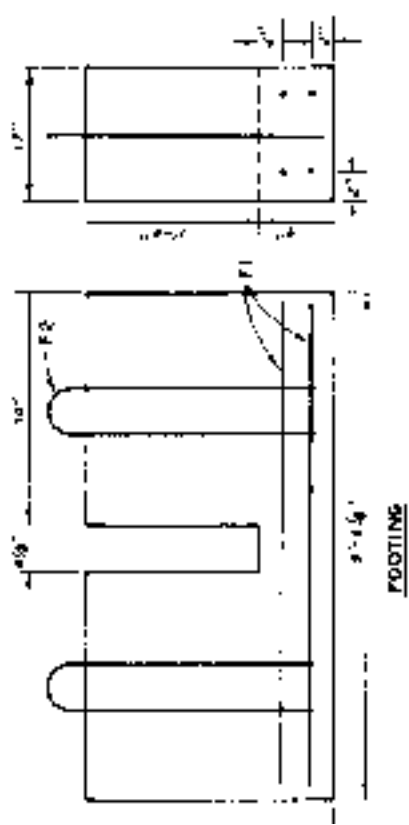

REBAR SCHEDULE

MARK	DESCRIPTION	QTY	LENGTH	TOTAL LENGTH
F1		4	10'-8" - 81'-0"	42'-0"
F2		4	8'-0" - 67'-8"	31'-2"
F3		2	9'-10" - 81'-0"	18'-0"
F4		12	7'-8" - 50'-0"	60'-0"
F5		2	2'-0" - 12'-0"	4'-0"
F6		2	4'-8" - 9'-4"	9'-2"
F7		4	3'-10" - 15'-0"	15'-0"
F8		4	1'-8" - 6'-8"	22'-0"
F9		4	8'-0" - 67'-8"	31'-2"

IN OVERLAP USE HE REINFORCING STEEL
UNLESS OTHERWISE NOTED
RIGHT HAND REINFORCING AS NECESSARY

PLYWOOD (OR CORR)

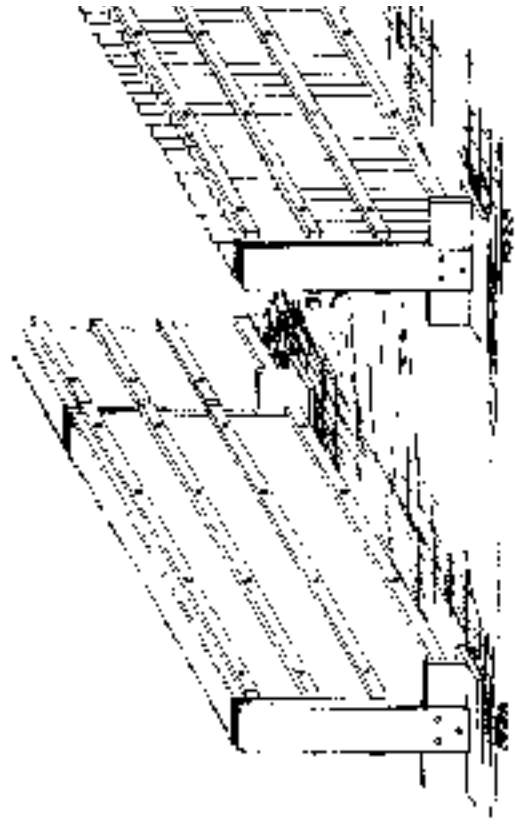

GENERAL VIEW



PORTABLE PRECAST C

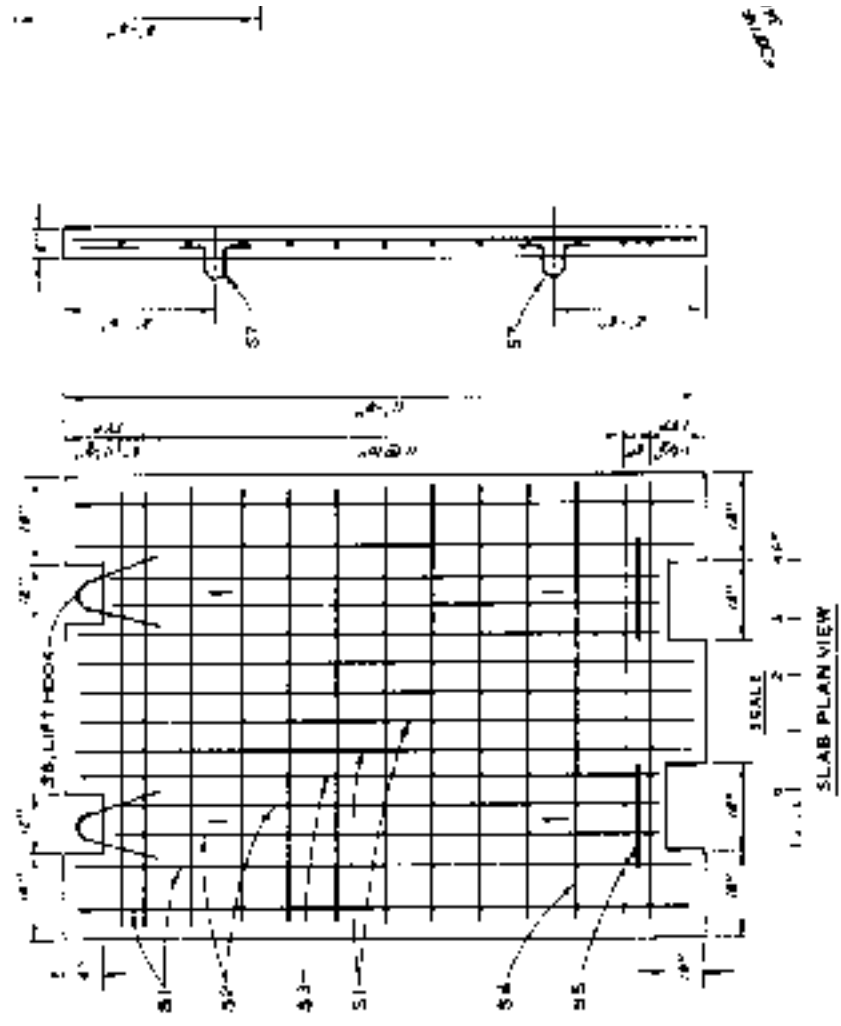

NOTE: 1) CONCRETE SHALL HAVE A MIN VOLUM 28 DAY STRENGTH - 6000 PSI
 2) ALL REINFORCING BARS ARE #6
 3) MINIMUM STRENGTH FOR REBAR IS 60,000 PSI

CAST-IN-PLACE CONCRETE WALL

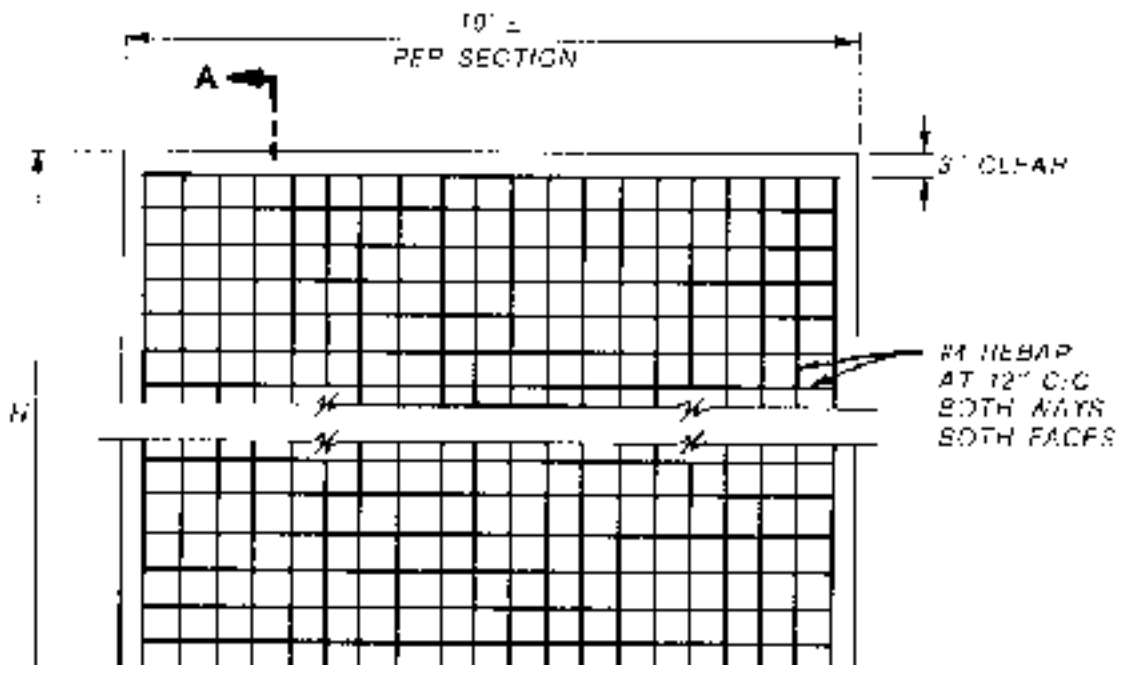

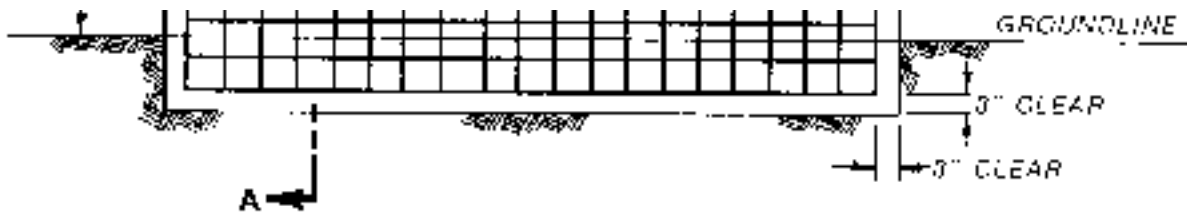

ELEVATION

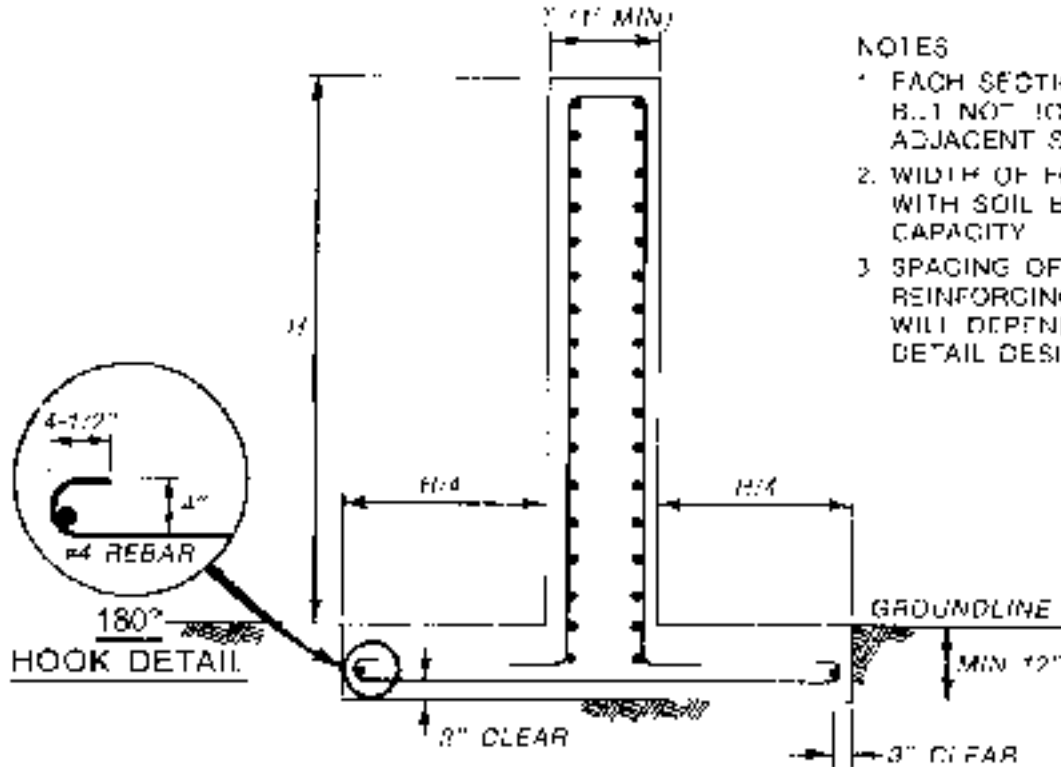

SECTION A-A

NOTES

1. EACH SECTION BUTTED BUT NOT JOINTED TO ADJACENT SECTIONS
2. WIDTH OF FOOTER VARIES WITH SOIL BEARING CAPACITY
3. SPACING OF FOOTING REINFORCING BARS WILL DEPEND ON DETAIL DESIGN.

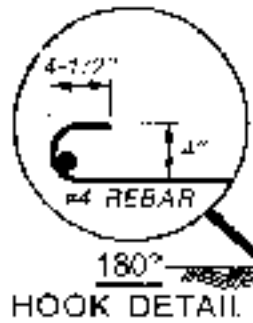

HOOK DETAIL

R. 16 MATERIALS	
REFUR 3" ON	CON
8-IN THICK PAPE	
16 BAGS 5M	17 FT ²
ASPHALT MIX	272 FT ²
4-IN THICK PANEL	
4-IN SID. PANEL	77 IN FT
3 BAGS 5M	32 FT ²
ASPH-OUT MIX	544 FT ²

16-GA SHEET STEEL

FRAMES FASTENED TO FRAME WITH BOLTS

L.A.-A

NOTE: SPREAD ASPHALT MIX IN 1-2 IN LIFTS AND TAMP
 COVER TOP OF ASPHALT MIX IS AS FOLLOWS (BY WEIGHT):
 COURSE AGGREGATE - 68%
 (SIEVE SIZES 3/4 TO 1/2 IN) - 22%
 (SIEVE SIZES 1/2 TO 3/8 IN) - 22%
 (SIEVE SIZES 3/8 TO 3/16 IN) - 10%
 (SIEVE SIZES 3/16 TO 7/64 IN) - 10%
 FINES (PASSING 7/64 IN) - 10%
 ASPHALT BINDER - 14%
 ASPHALT OIL - 1%
 TOTAL AGGREGATE WEIGHT

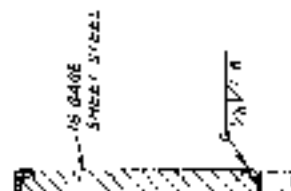

B-B

PORTABLE ASPHALT ARMOR PANEL

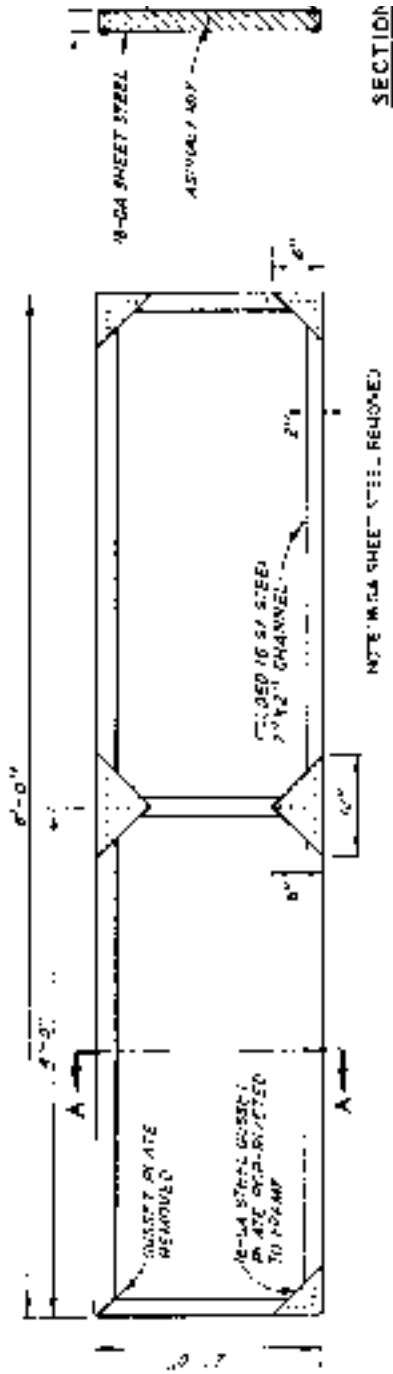

2-INCH THICK PANEL

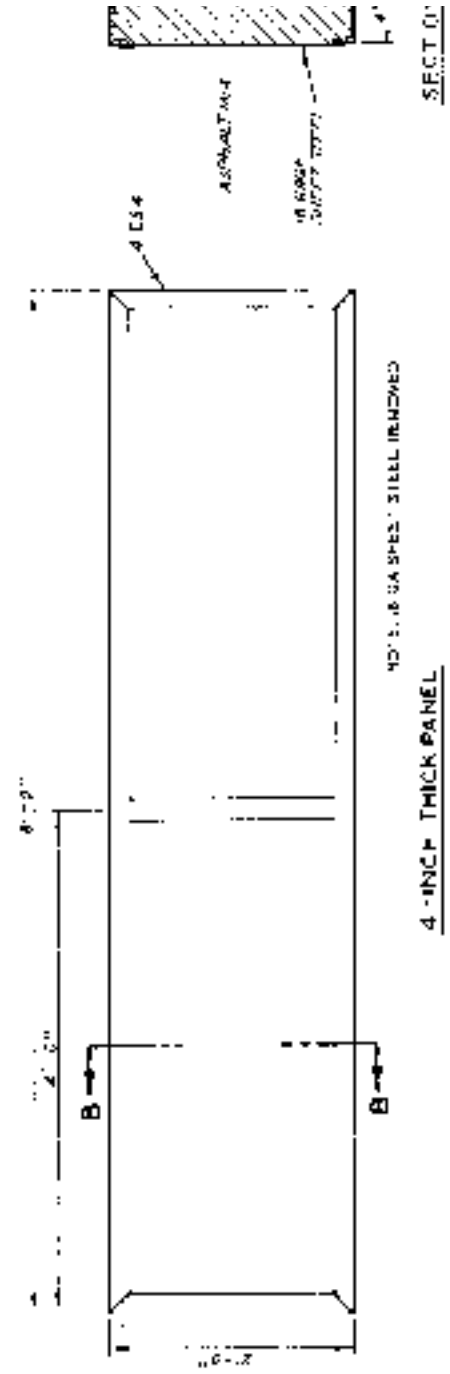

4-INCH THICK PANEL



STANDARD FIGHTING TRENCH

Equipment Hours ⁴ by Dozer MB ACE Turret ⁶ Total ¹
1.0
1.7
2.5
2.6
2.1
2.1

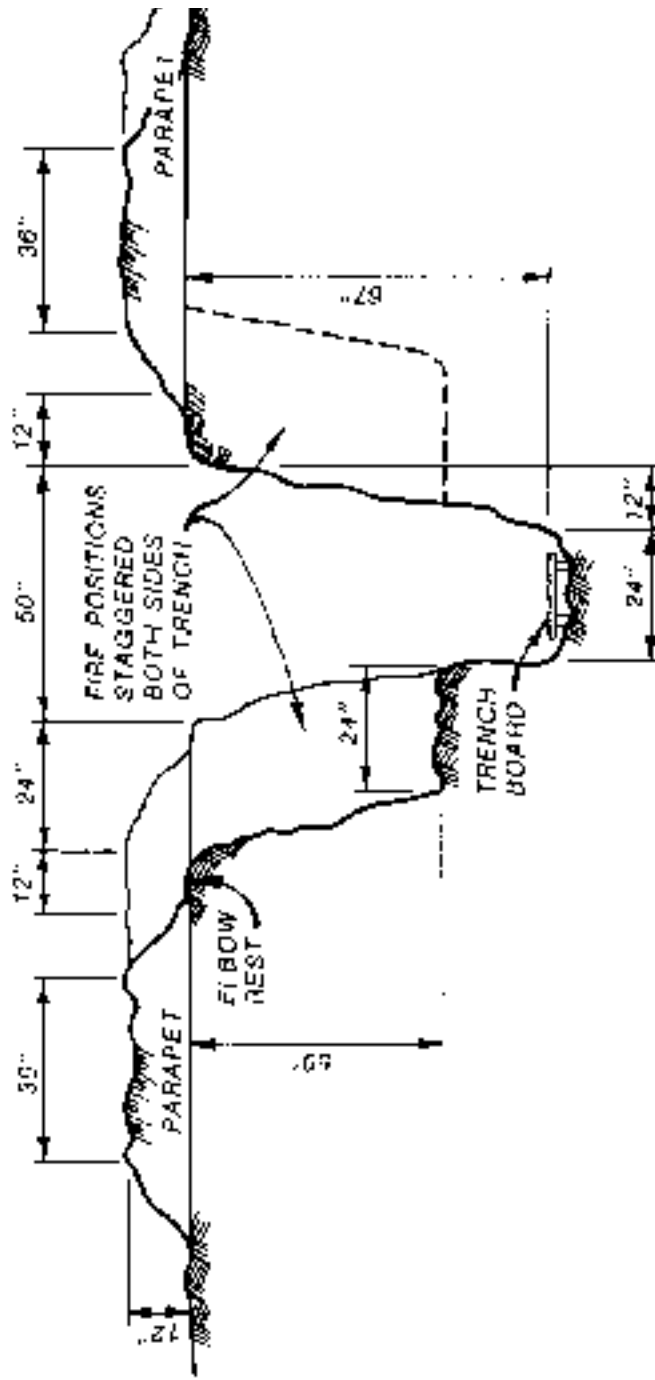

TYPICAL SECTION

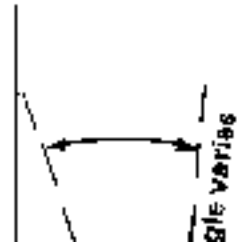

VEHICLE FIGHTING POSITIONS (DELIBERATE)

Vehicle Type	Position Dimension, ft?		Turret Depth (D) ²	Weapon System Deflection	Weapon System Evaluation	Hull	Volume of Earth Moved (cy)	
	Length (A)	Width (B)					Hull Depth (C) ¹	Turrets
M113 series carrier ³	22	14	7	-	-	69	172	193
M90 improved ICV vehicle	22	14	9	-10°	+30°	80	148	228
M2 and M3 fighting vehicle	24	16	10	10° 30'	+50°	108	79	220
M100 series battle tank	32	18	9	-10°	-20°	118	268	389
M60 series main battle tank	32	18	10	-10°	-20°	120	278	398
M48 series battle tank	32	18	10	-10°	-20°	120	278	398

Notes:

1. Ready positions for tanks, if available, are not recommended.
2. Turret dimensions are given at approximately 30° elevation angle, well below movement and firing elevation and do not include access ramps(s).
3. Includes M122 flame thrower and M100 gun.
4. Production rate of 100 basic cubic yards per hour. One deconstruction team by 255 ft³ rocky or hard soil and 1 hour, or 1 hour, or 1 hour.
5. All depths are approximate and will need additional features will reduce construction time.
6. Turret volume (c) plus approach volume (b) plus length (E) is approximately (AM).
7. All volumes (a) plus approach volume (b) plus turret volume (c).

Side views

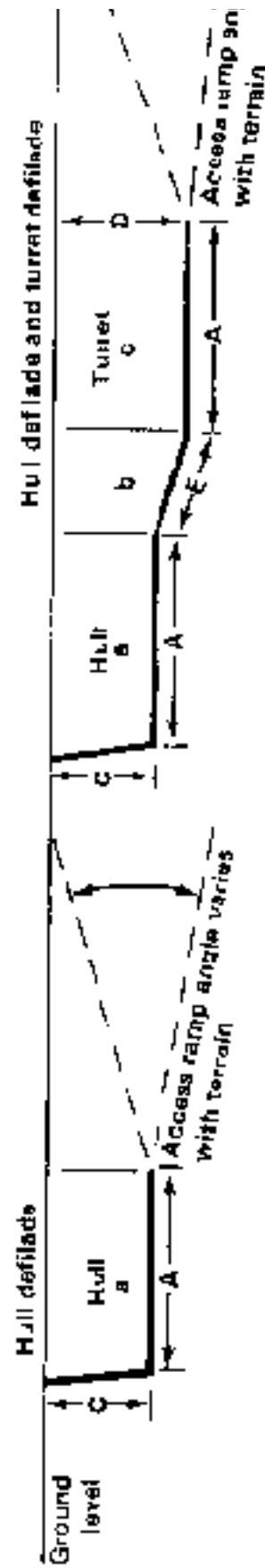

Front views



[RDL](#)[Table of](#)[Document](#)[Download](#)[Homepage](#)[Contents](#)[Information](#)[Instructions](#)

GLOSSARY

ABN	airborne	FAAR	forward area alerting radar
AMBL	airmobile	FARP	forward arming and refueling point
ACE	armored combat earthmover	FDC	fire direction center
ADA	air defense artillery	FLOT	forward line of own troops
AFNORTH	Allied Forces, Northern Europe	FM	field manual
AFCENT	Allied Forces, Central Europe	frag	fragment
AFSOUTH	Allied Forces, Southern Europe	ft	foot, feet
ammo	ammunition	GS	general support
APC	armored personnel carrier	HE	high explosive
AT	antitank	HEAT	high explosive antitank
ATGM	antitank guided missile	hp	horsepower
Bn	battalion	IIQ	headquarters
BOC	battalion operations center	IFV	infantry fighting vehicle
CEV	combat engineer vehicle	in	inch(es)
CFC	combined forces command	inf	infantry
cGy	certiGray (NATO term for "rad")	ir	infrared
CONEX	consolidated express	ITV	improved TOW vehicle
co	company	KT	kiloton(s)
commo	communications	LAW	light antitank weapon
CP	command post	lb	pound(s)
CTT	comps terrain team	LWCSS	lightweight camouflage screening system
Cu	cubic	m	meter(s)
CWAR	continuous wave acquisition radar	M-MC-S	mobility-counter mobility - survivability
DMZ	demilitarized zone	mech	mechanized
Ds	direct support	METT-T	mission, enemy, terrain and weather, time, and troops
----	mg	machine gun

DTCC	division tactical operations center	mm	millimeters
DTT	division terrain team	mph	miles per hour
ea	each	NA	not applicable
EMP	electromagnetic pulse	NATO	North Atlantic Treaty Organization

Glossary-1

NBC	nuclear, biological, chemical	SEE	Small Emplacement Excavator
OPCON	operational control	SOP	standing operating procedure
OPORD	operations order	STANAG	standardization agreement
PACOM	Pacific Command	TM	technical manual
PAR	pulse acquisition radar	TNT	trinitrotoluene
plt	platoon	TOC	tactical operations center
POL	petroleum, oils, and lubricants	TOW	tube-launched, optically tracked, wire guided missile
psi	pounds per square inch	TREE	transient radiation effects on electronics
rad	radiation absorbed dose; "roentgen"	US	United States
RCLR	recoilless rifle	yd	yard(s)
ROK	Republic of Korea		
ROR	range only radar		

Glossary-2



[RDL](#)

[Table of](#)

[Document](#)

[Download](#)

[Homepage](#) [Contents](#) [Information](#) [Instructions](#)

FM 5-103

10 JUNE 1985

By Order of the Secretary of the Army:

JOHN A. WICKHAM, JR.
General, United States Army
Chief of Staff

Official:

DONALD J. DELANDRO
Brigadier General, United States Army
The Adjutant General

DISTRIBUTION:

Active Army, ARNG, and USAR: To be distributed in accordance with DA Form 12-11A, Requirements for Field Fortifications (Qty rqr block no. 20).

Additional copies may be requisitioned from the US Army Adjutant General Publications Center, 2800 Eastern Boulevard, Baltimore, MD 21220-2896.