

DO-IT-YOURSELF

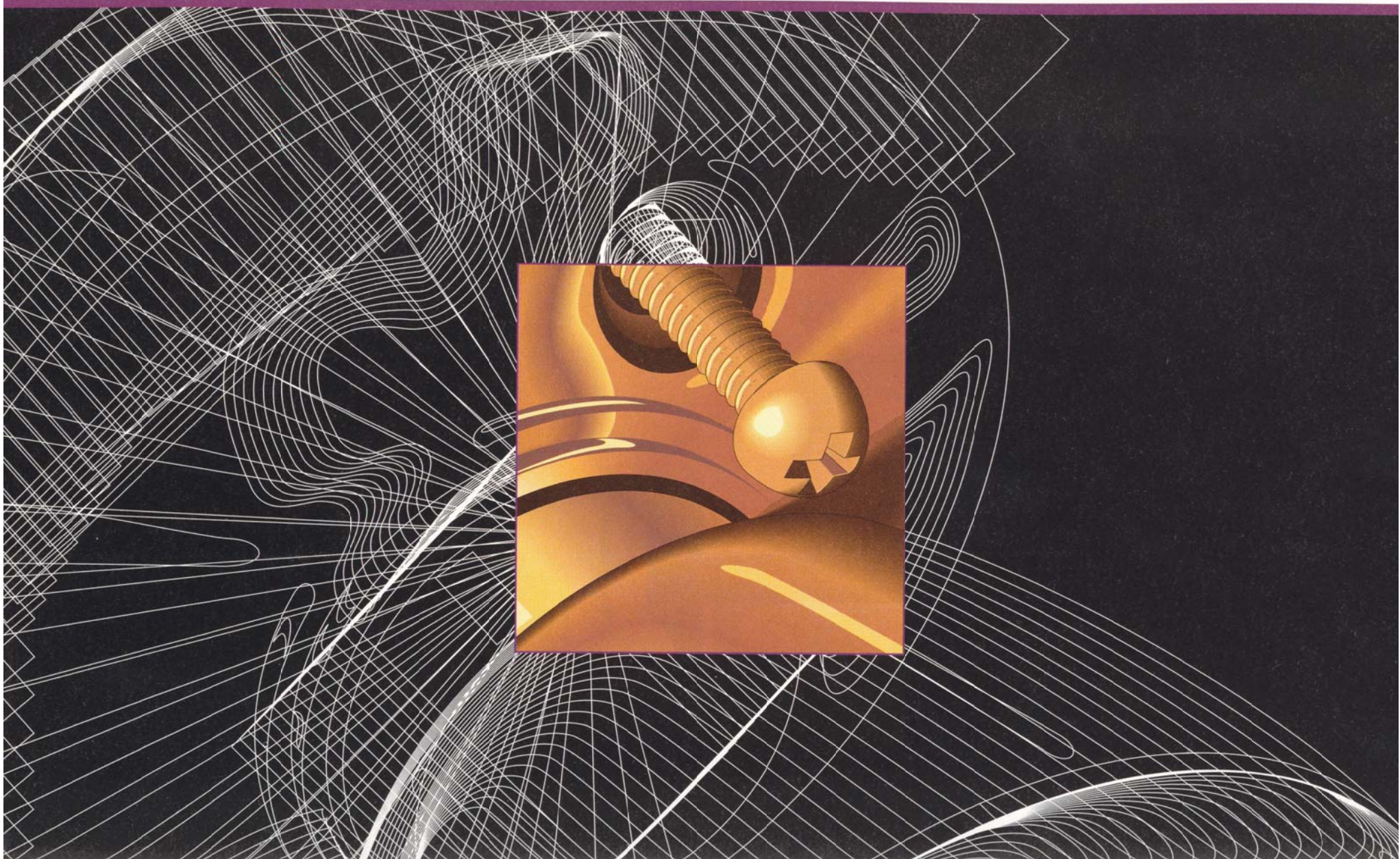

CONTENTS

CARPENTRY: TOOLS.....	275
BUILDING MATERIALS.....	286
LOCK.....	289
MASONRY.....	291
PLUMBING: BATHROOM.....	292
PLUMBING.....	294
LADDERS AND STEPLADDERS.....	302
PAINTING UPKEEP.....	304
SOLDERING AND WELDING.....	305
ELECTRICITY.....	309

CARPENTRY: TOOLS

CLAW HAMMER

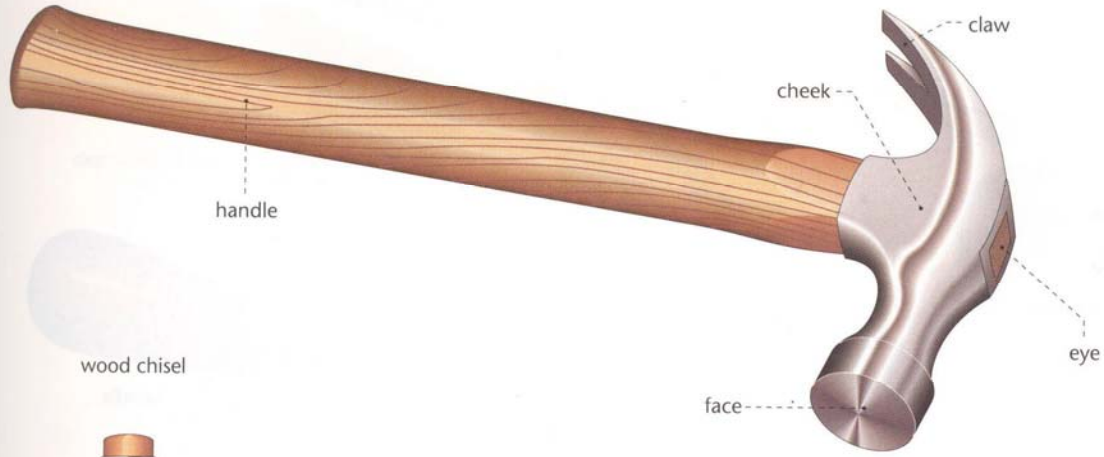

wood chisel



carpenter's hammer



MALLET

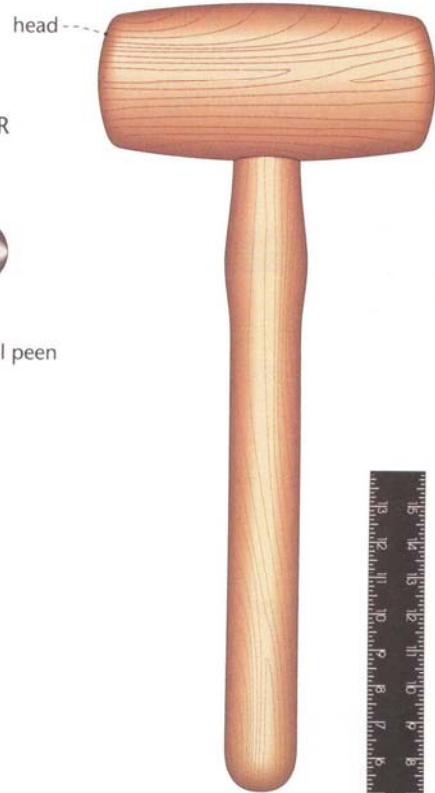

BALL-PEN HAMMER

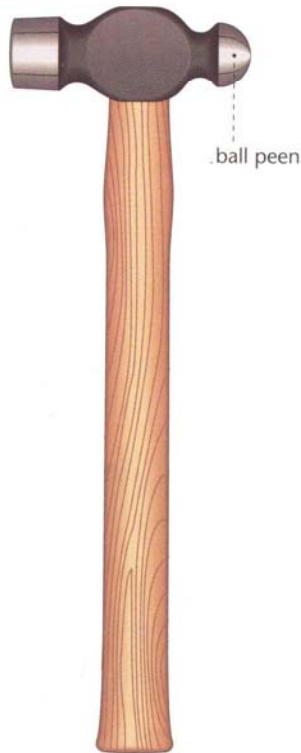

NAIL

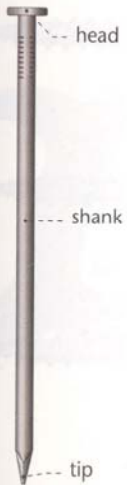

framing square



DO-IT-YOURSELF

CARPENTRY: TOOLS

SCREWDRIVER



SPIRAL SCREWDRIVER

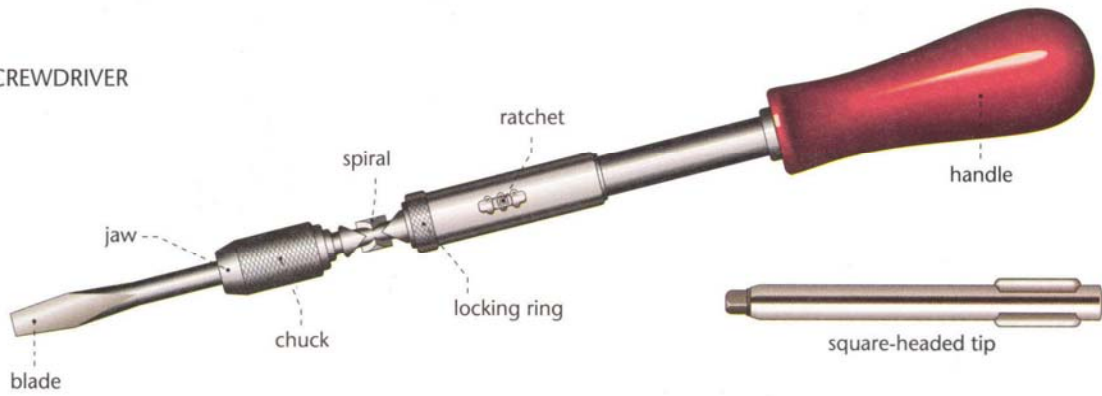

TOGGLE BOLT

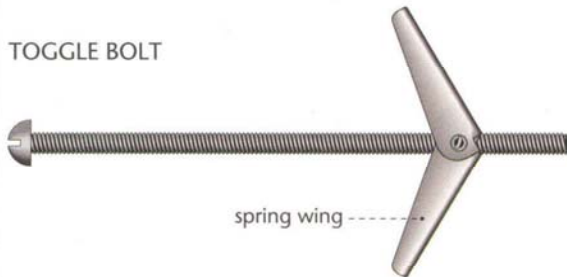

expansion bolt



TYPES OF HEADS

SCREW

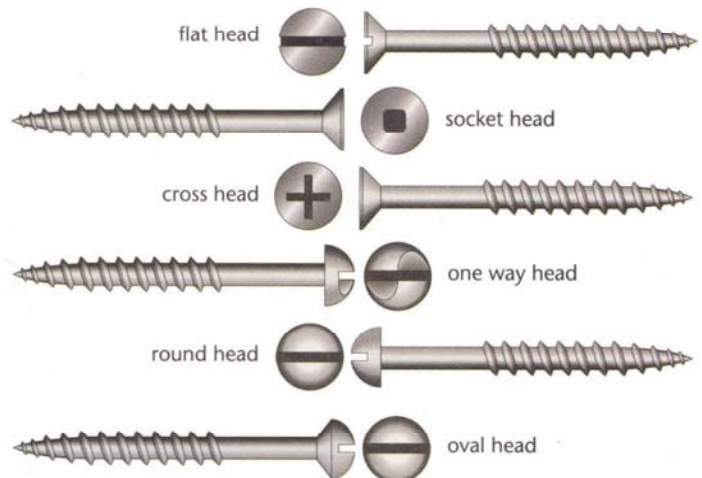

DO-IT-YOURSELF

PLANE

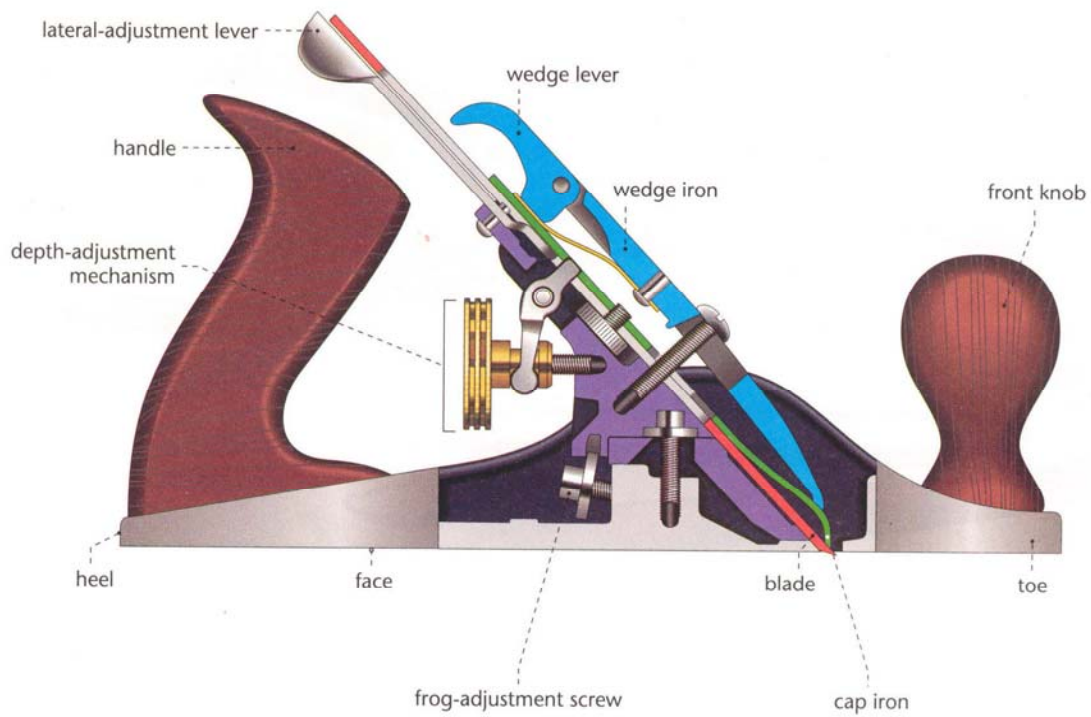

DO-IT-YOURSELF

HACKSAW

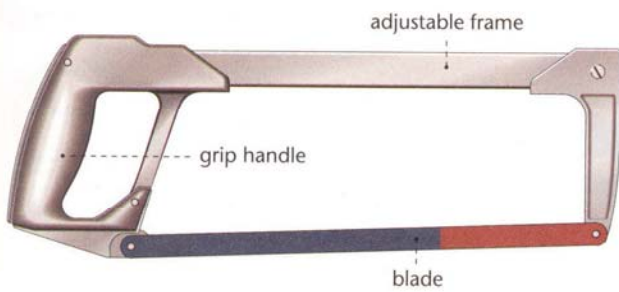

HANDSAW

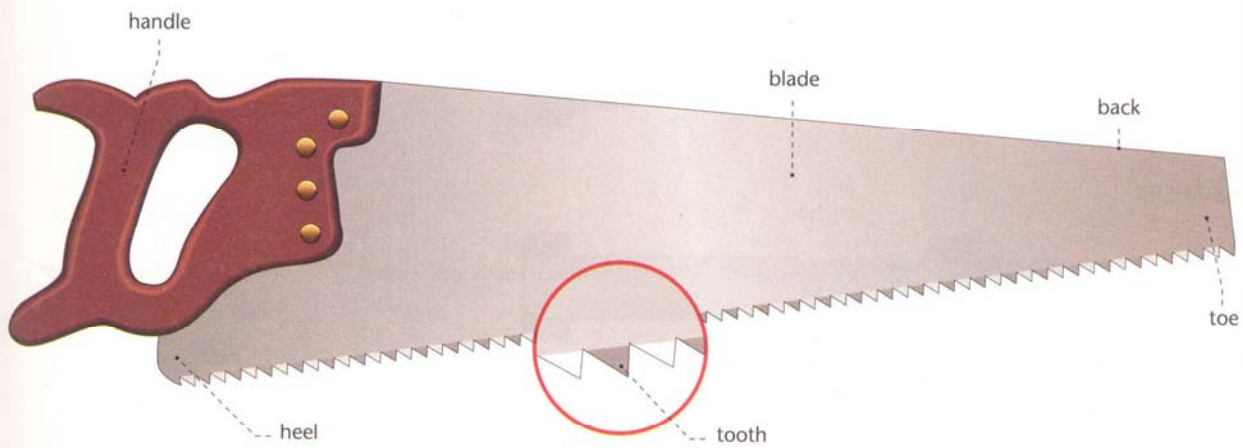

CARPENTRY: TOOLS

SLIP JOINT PLIERS

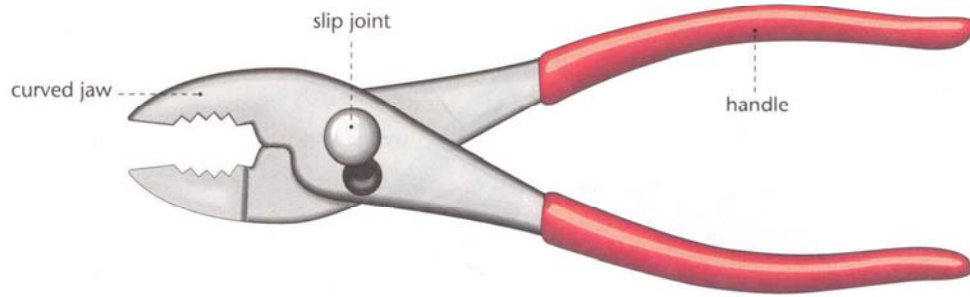

RIB JOINT PLIERS

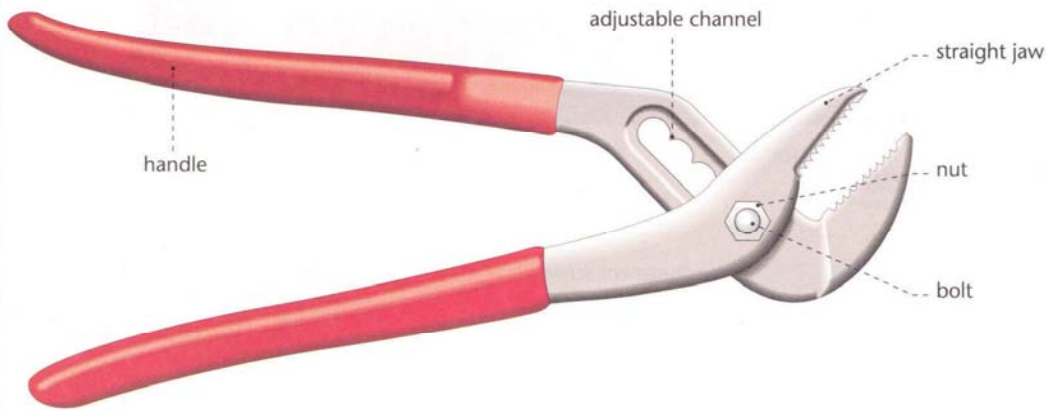

LOCKING PLIERS

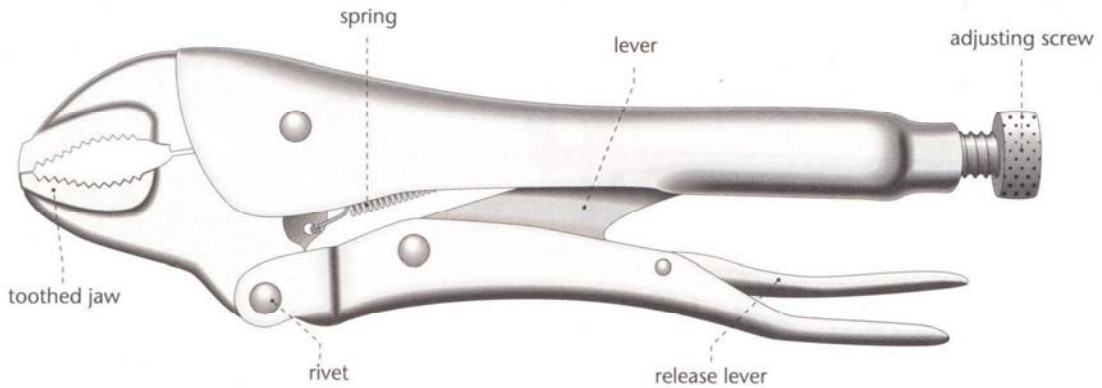

WASHERS

flat washer



lock washer



internal tooth lock washer



external tooth lock washer



DO-IT-YOURSELF

CRESCENT WRENCH



open end wrench



combination box and open end wrench



flare nut wrench



ratchet box end wrench

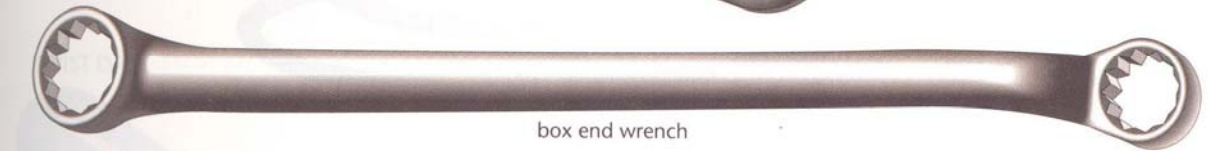

box end wrench



nut



acorn nut



wing nut

SHOULDER BOLT



BOLT

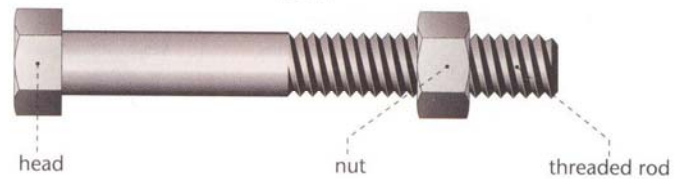

CARPENTRY: TOOLS

ELECTRIC DRILL



HAND DRILL

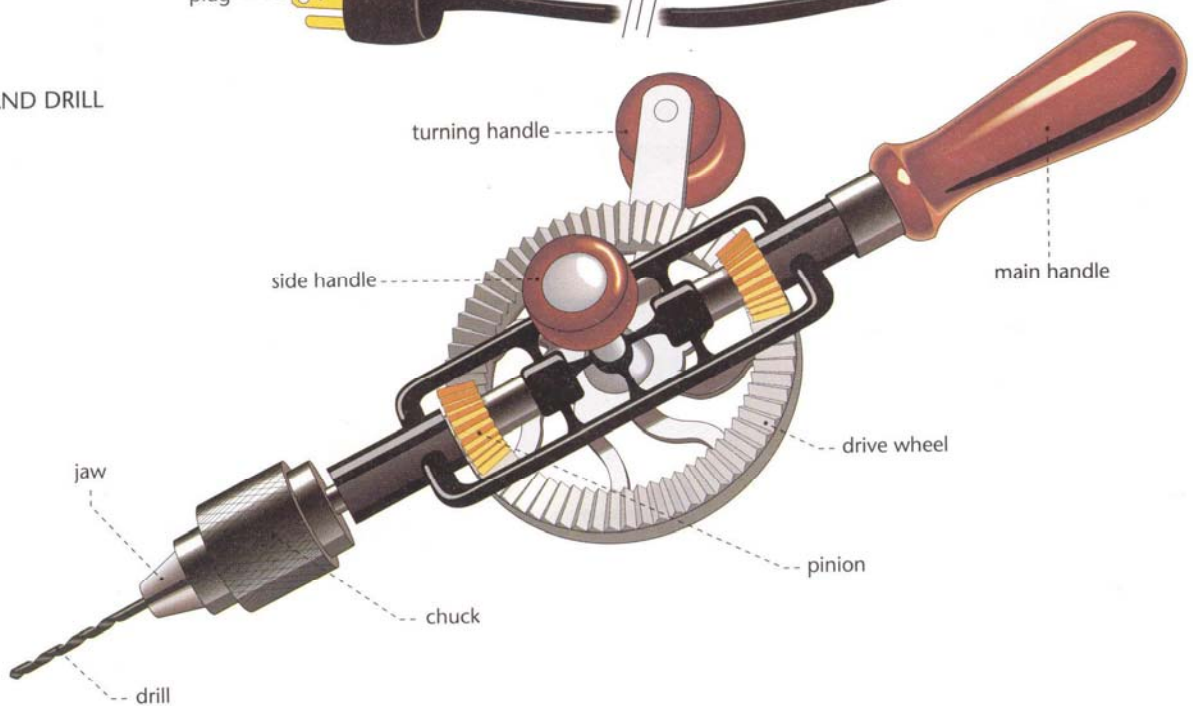

DO-IT-YOURSELF

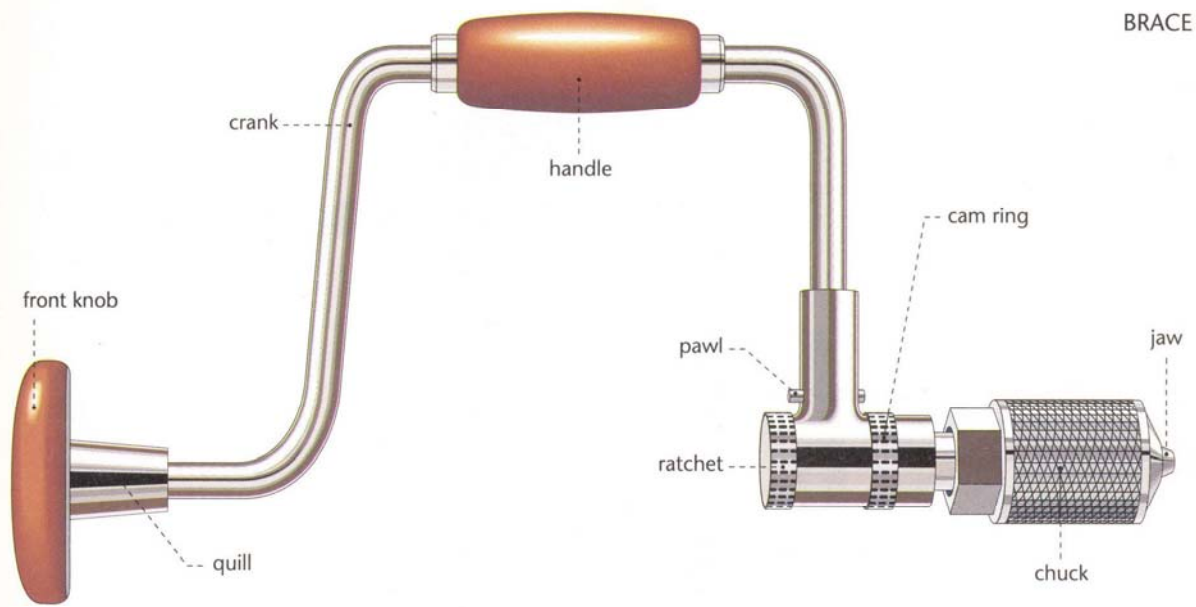

BRACE

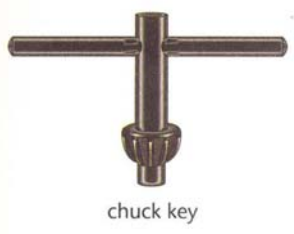

chuck key



countersink



DO-IT-YOURSELF

double-twist auger bit



AUGER BIT

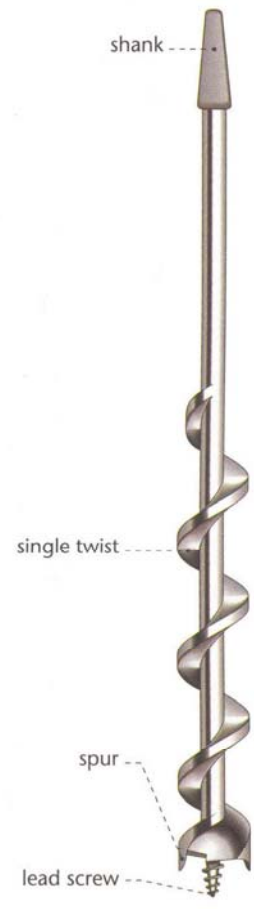

TWIST DRILL

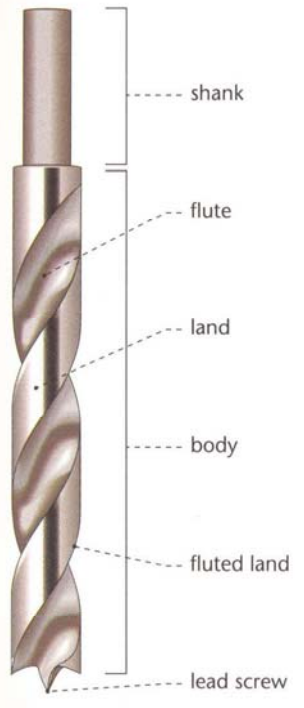

C-CLAMP

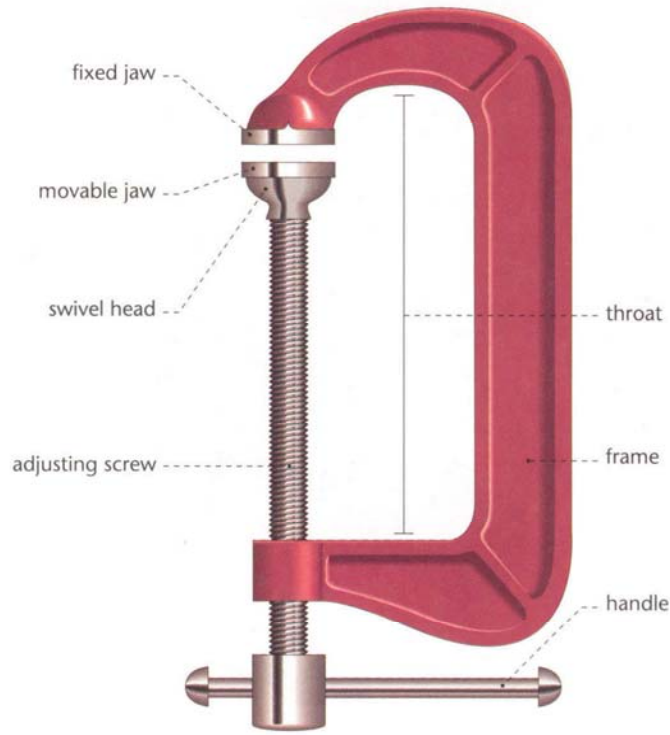

DO-IT-YOURSELF

WISE

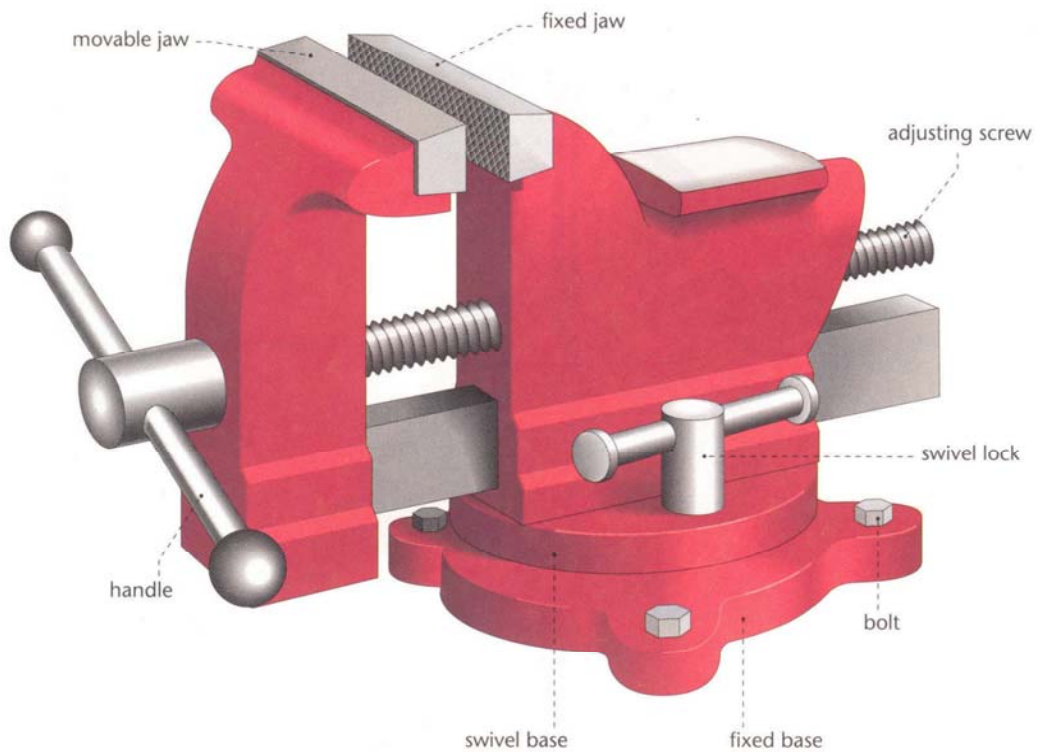

ROUTER



DRILL PRESS

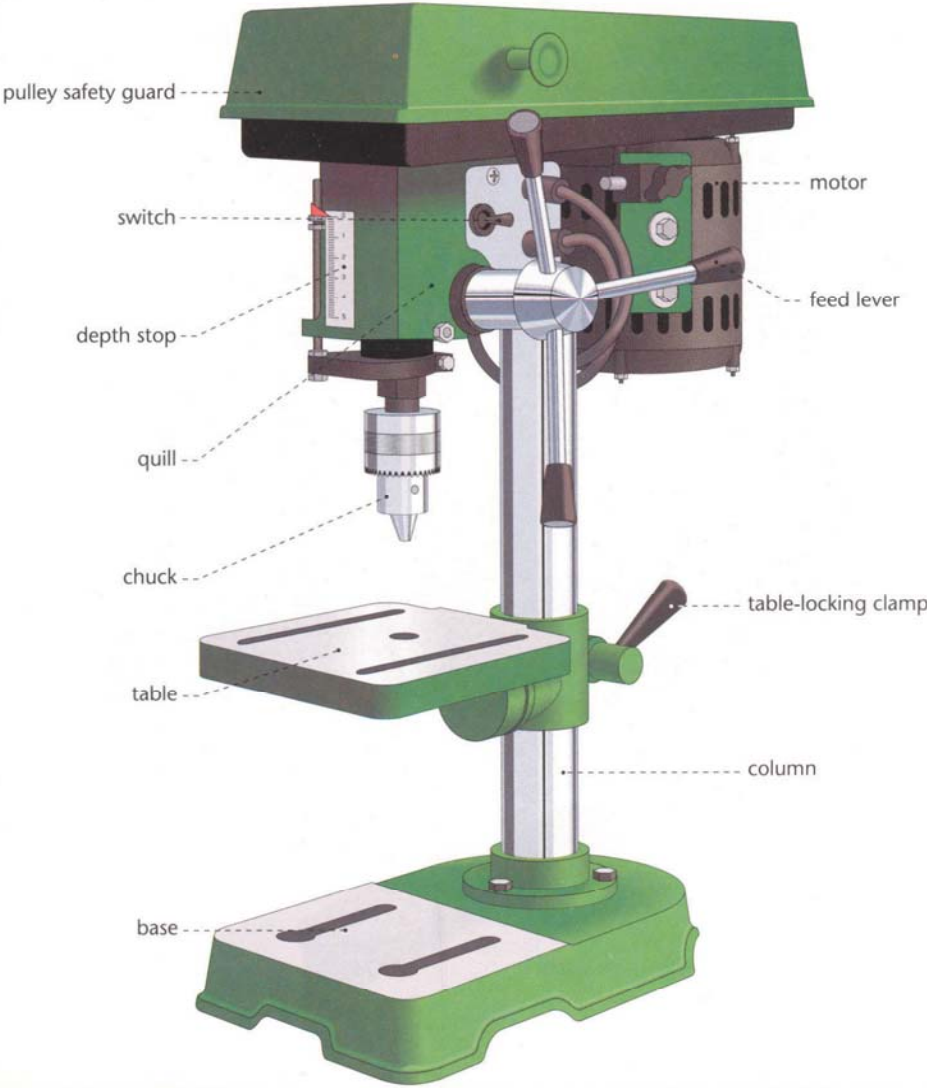

DO-IT-YOURSELF

CARPENTRY: TOOLS

CIRCULAR SAW BLADE

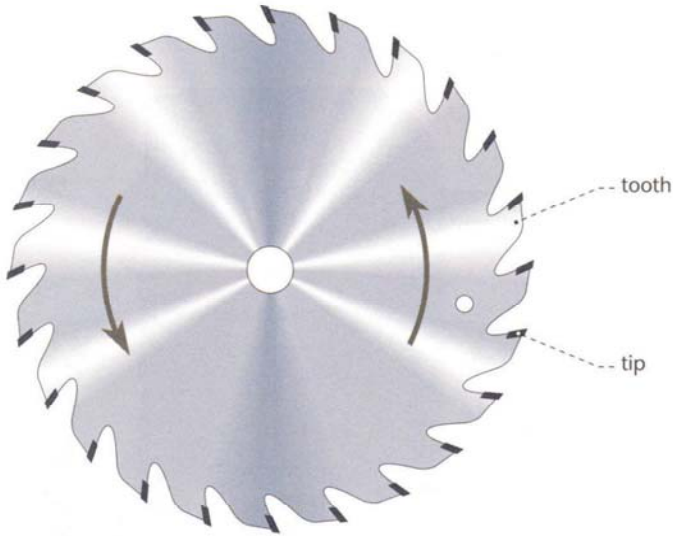

CIRCULAR SAW

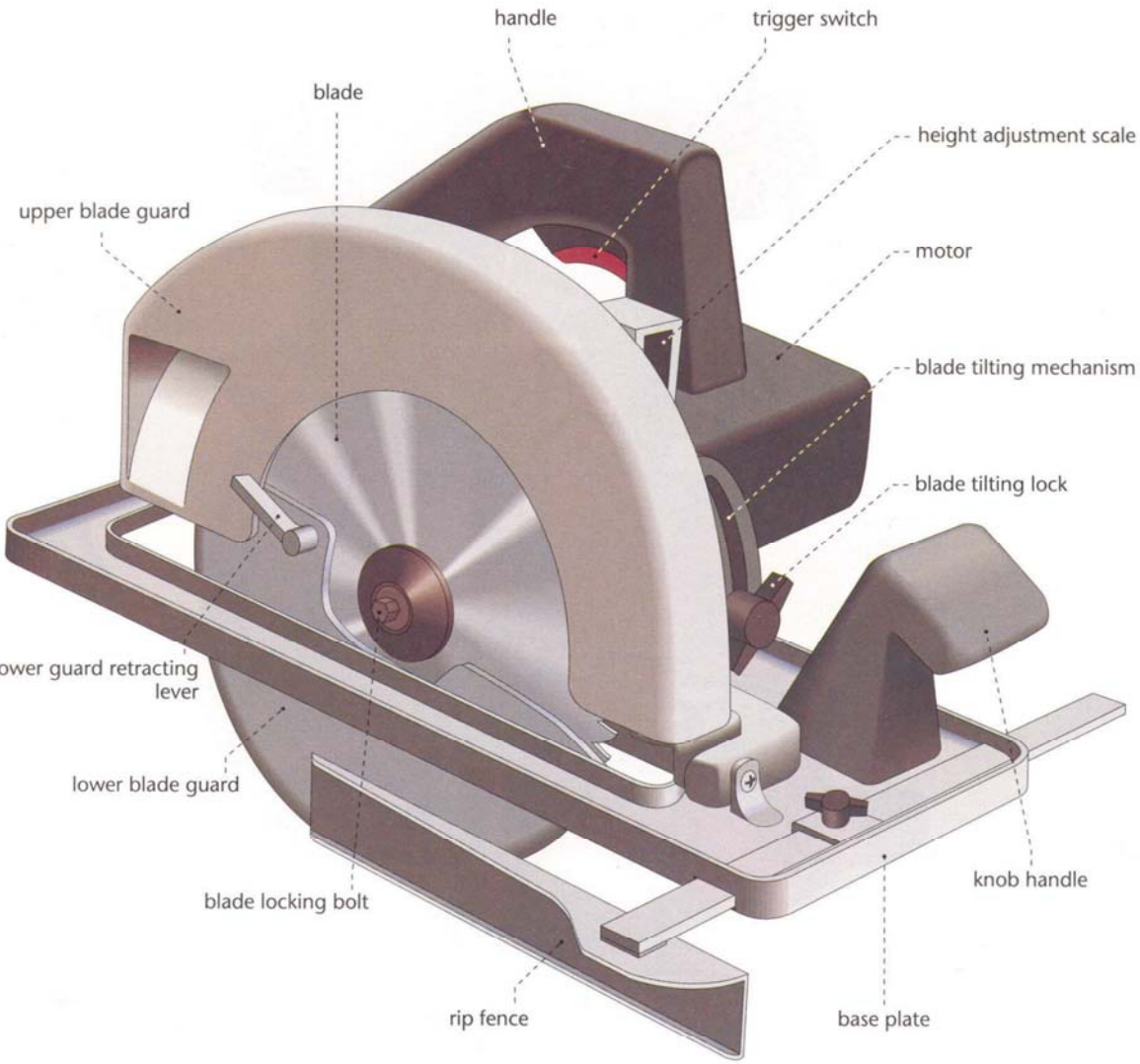

DO-IT-YOURSELF

TABLE SAW

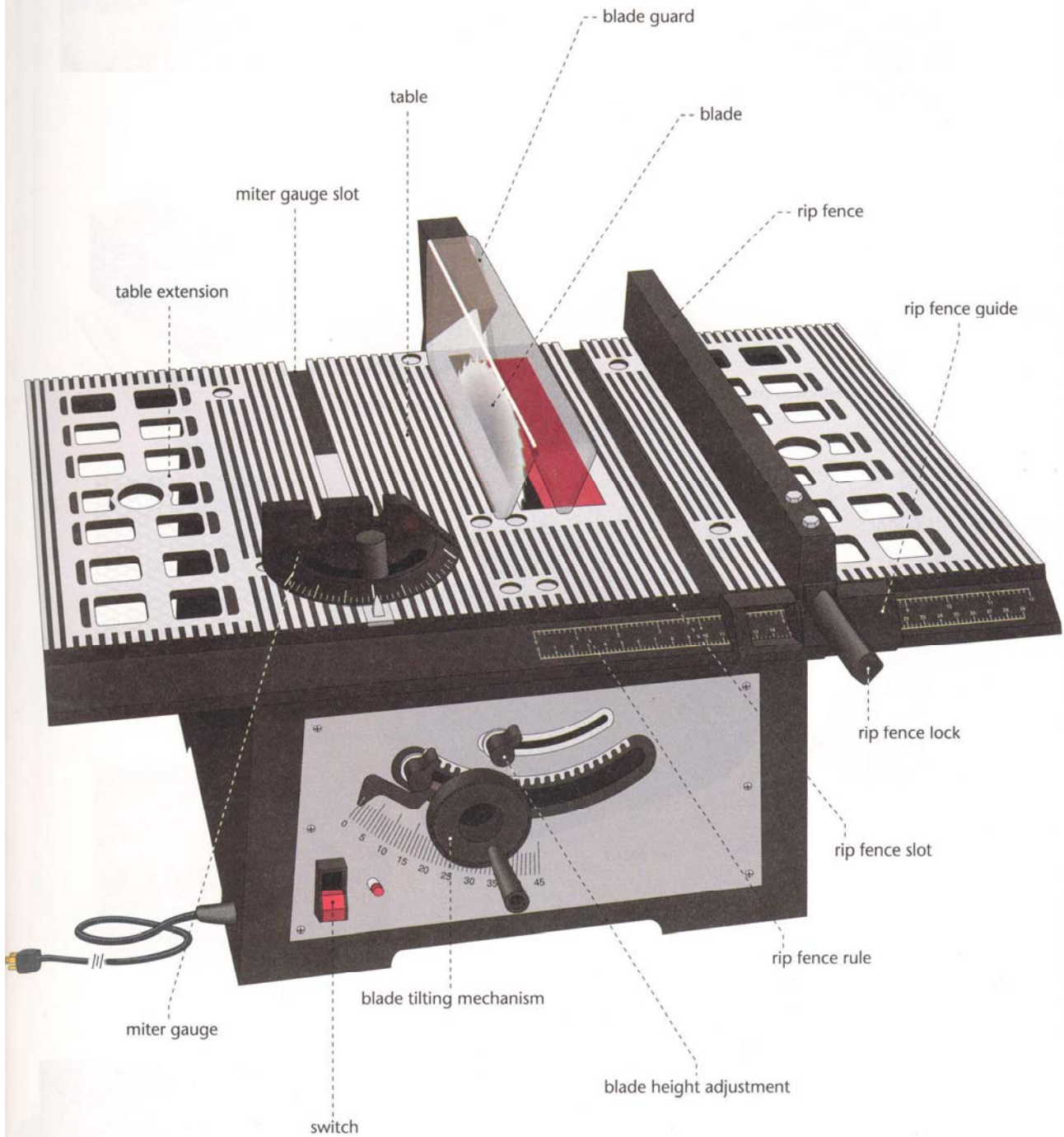

DO-IT-YOURSELF

BUILDING MATERIALS

BASIC BUILDING MATERIALS

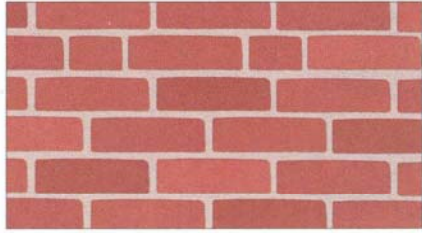

brick



steel



stone

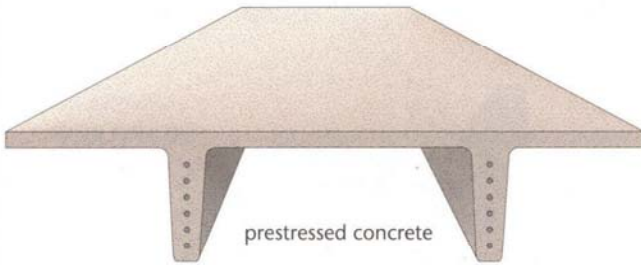

prestressed concrete

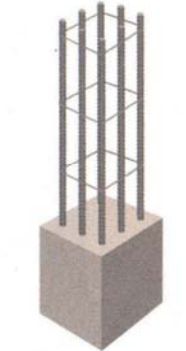

reinforced concrete

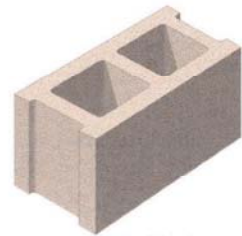

concrete block

DO-IT-YOURSELF

COVERING MATERIALS



tile



tar paper

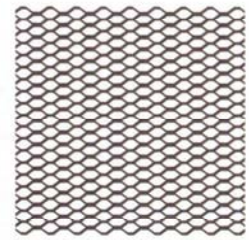

diamond mesh metal lath



shingle



gypsum tile



plain gypsum lath



floor tile

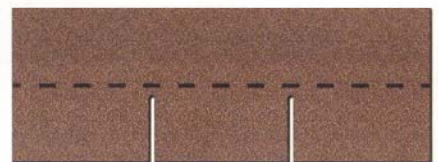

asphalt shingle

INSULATING MATERIALS



spring-metal insulation

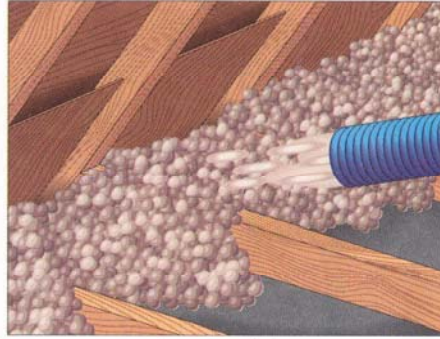

foam insulation



molded insulation



foam-rubber insulation



vinyl insulation

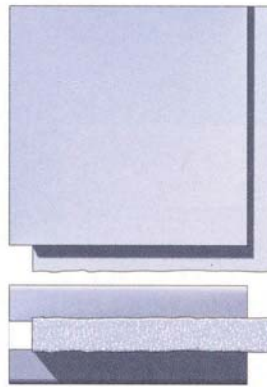

board insulation

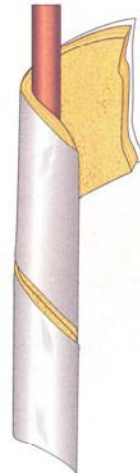

pipe-wrapping insulation

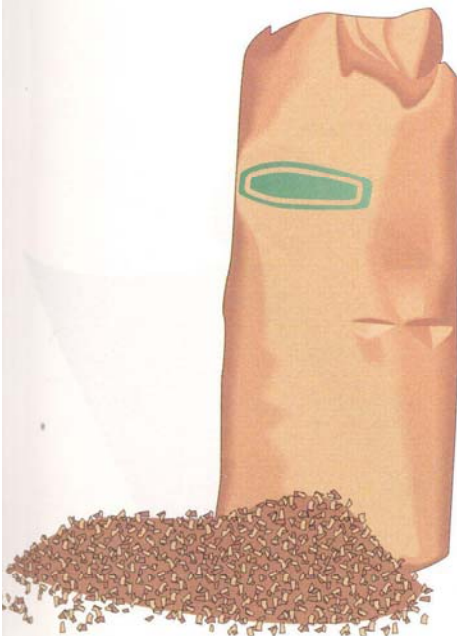

loose fill insulation

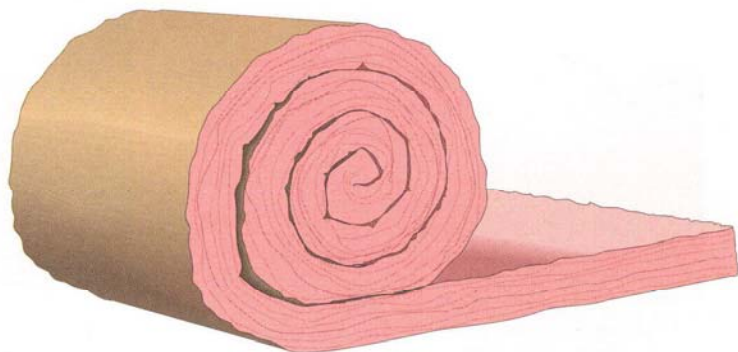

blanket insulation

BUILDING MATERIALS

WOOD

SECTION OF A LOG

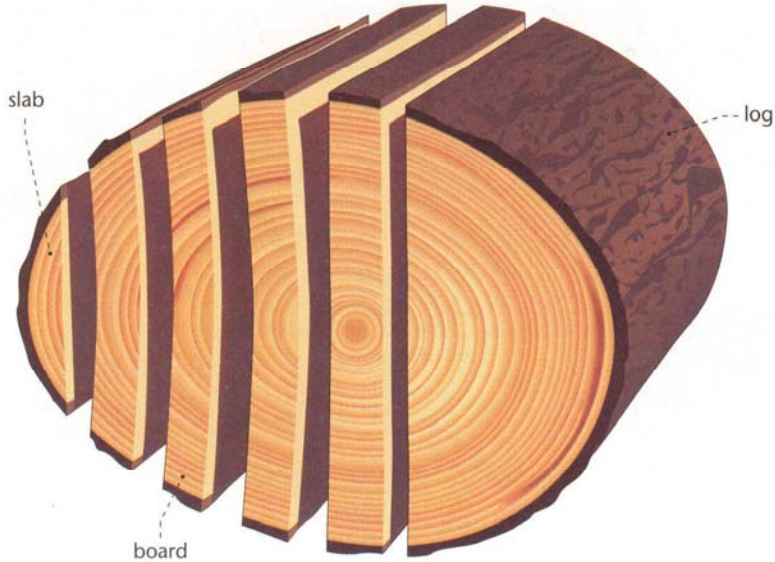

BOARD

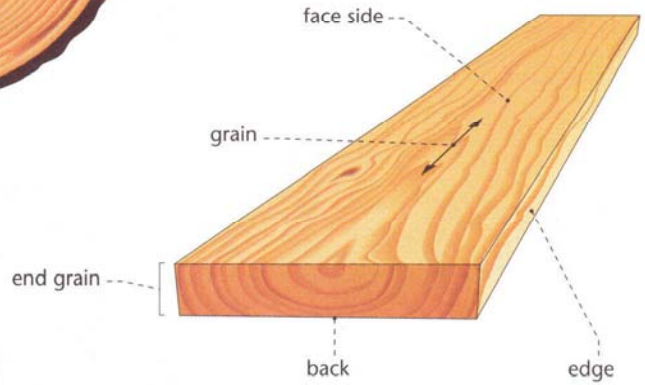

DO-IT-YOURSELF

WOOD-BASED MATERIALS



blockboard



multi-ply plywood

ply



laminboard

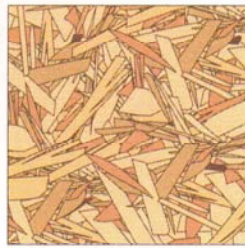

waferboard



peeled veneer

WOOD-BASED MATERIALS



hardboard

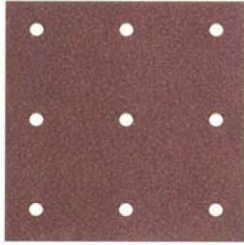

perforated hardboard

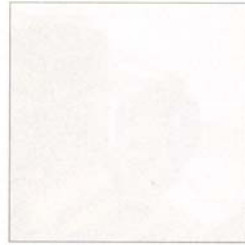

plastic-laminated particle board

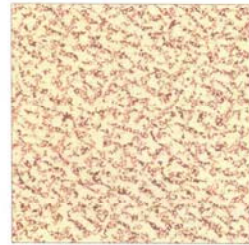

particle board

LOCK

GENERAL VIEW

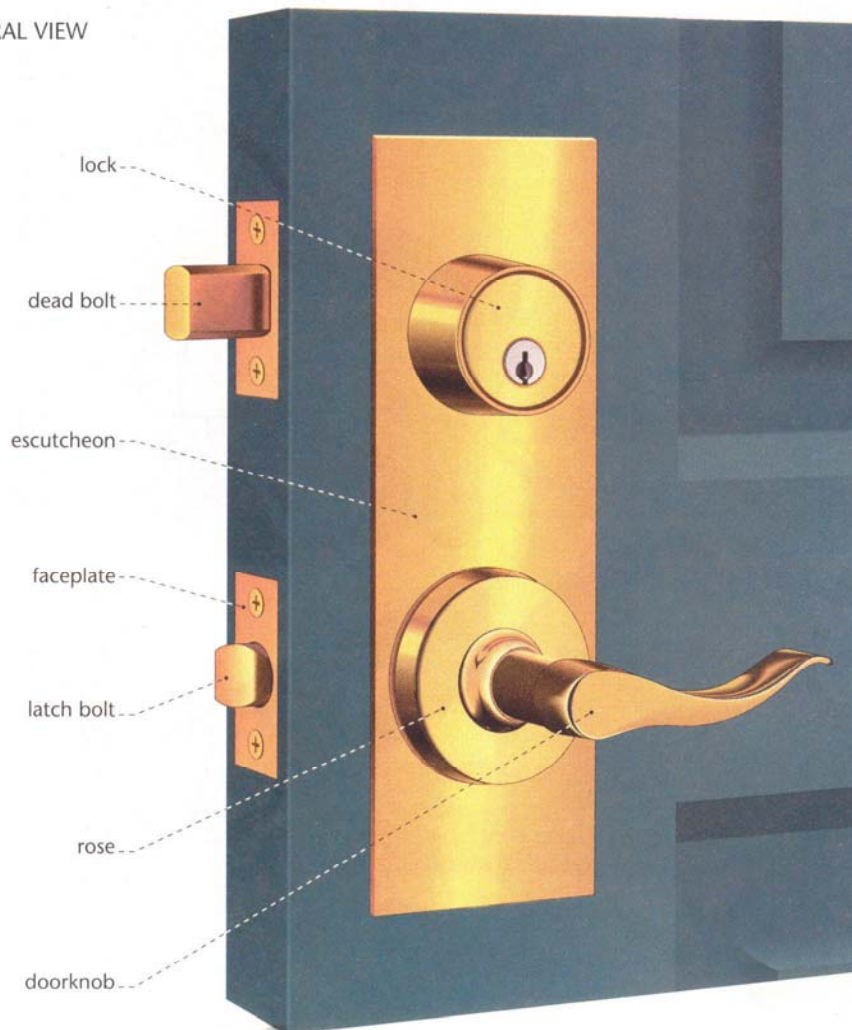

LOCK

MORTISE LOCK

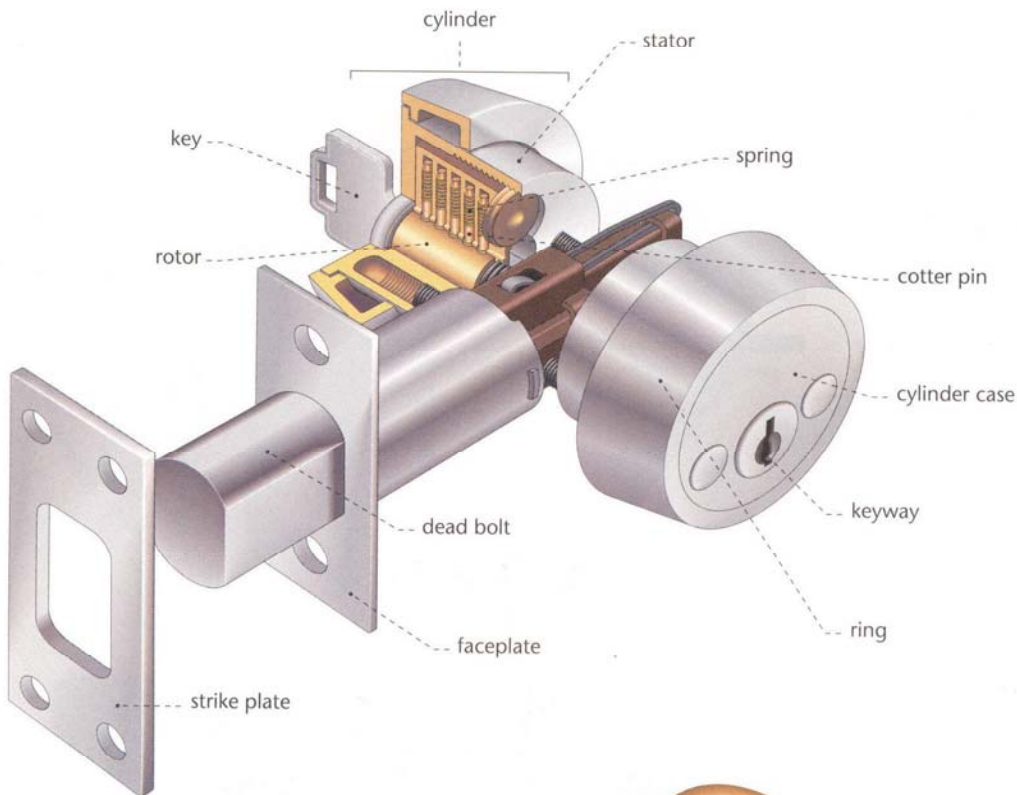

TUBULAR LOCK

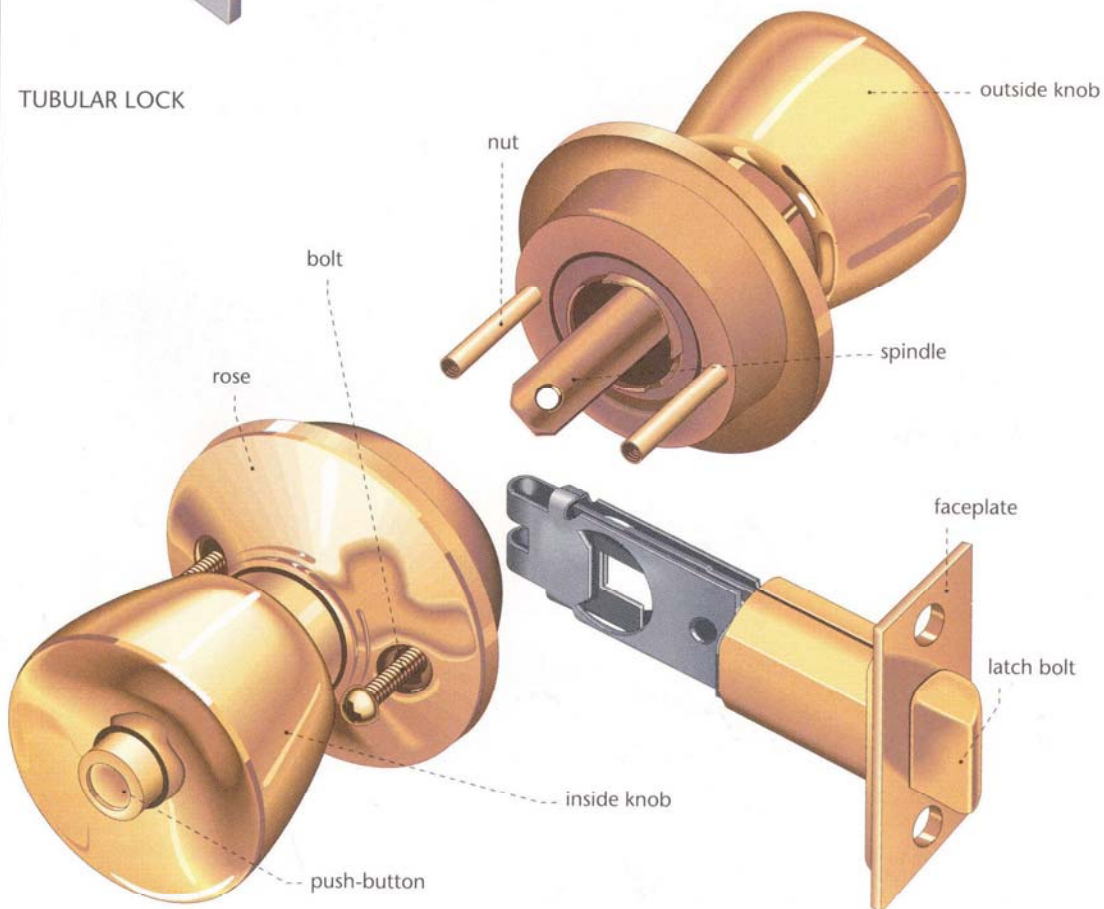

DO-IT-YOURSELF

MASONRY

MASON'S TROWEL



square trowel



bricklayer's hammer

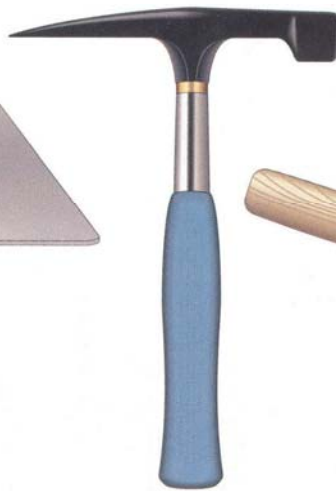

hawk



joint filler



spirit level



CAULKING GUN

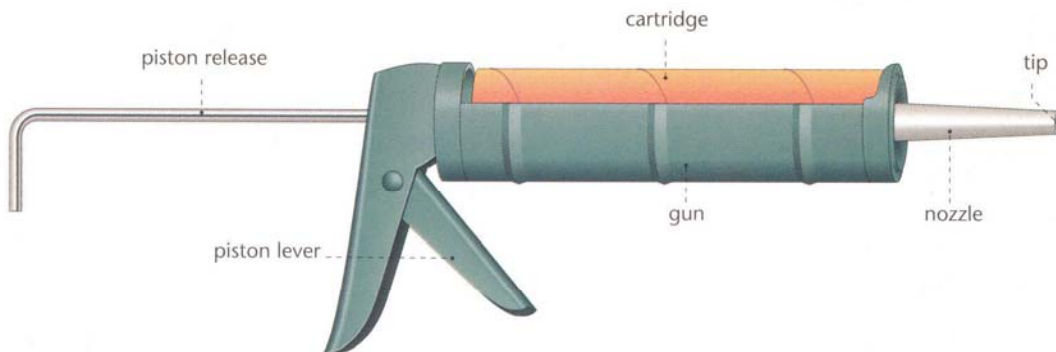

PLUMBING: BATHROOM

DO-IT-YOURSELF



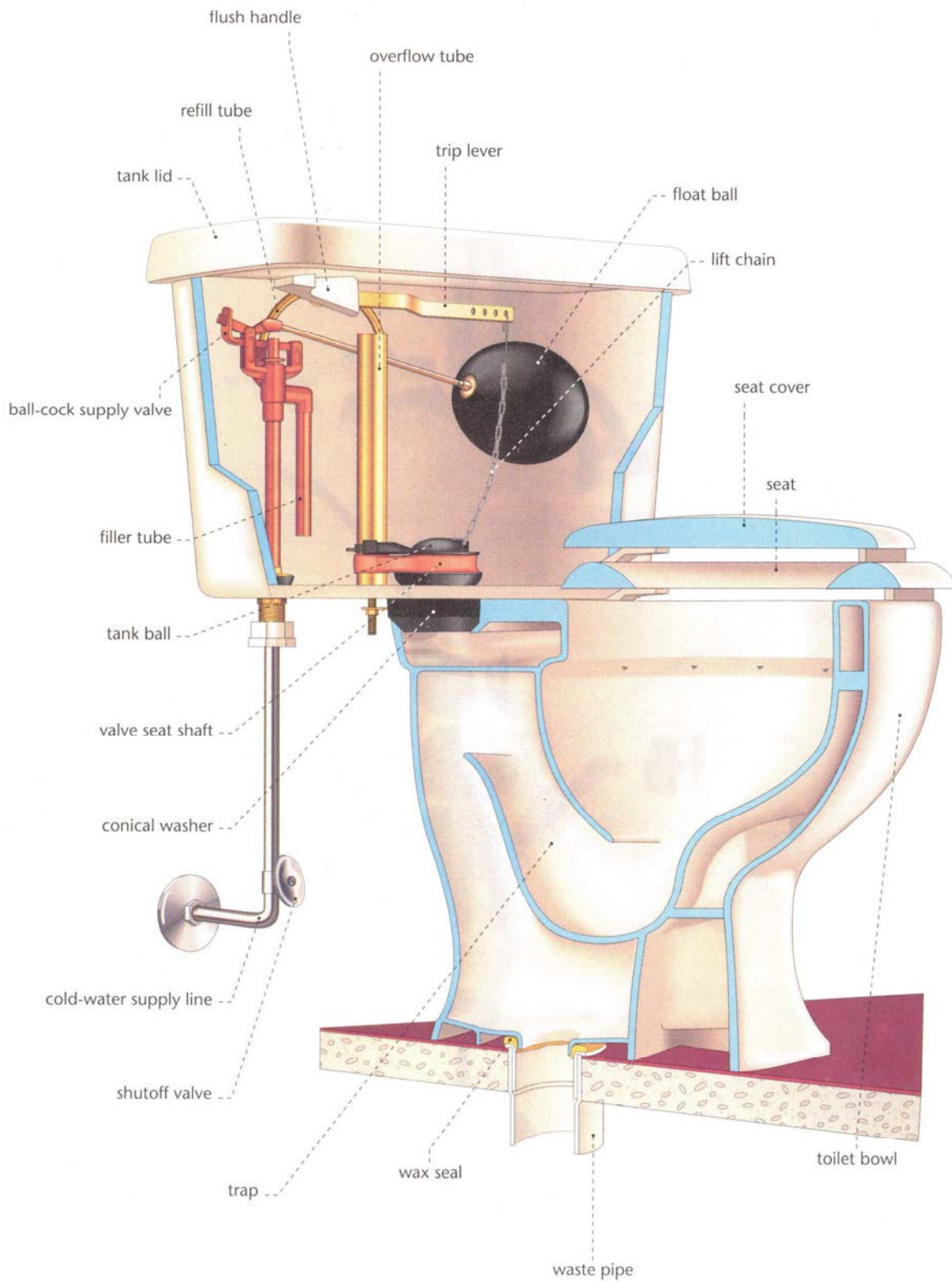

PLUMBING

STEM FAUCET

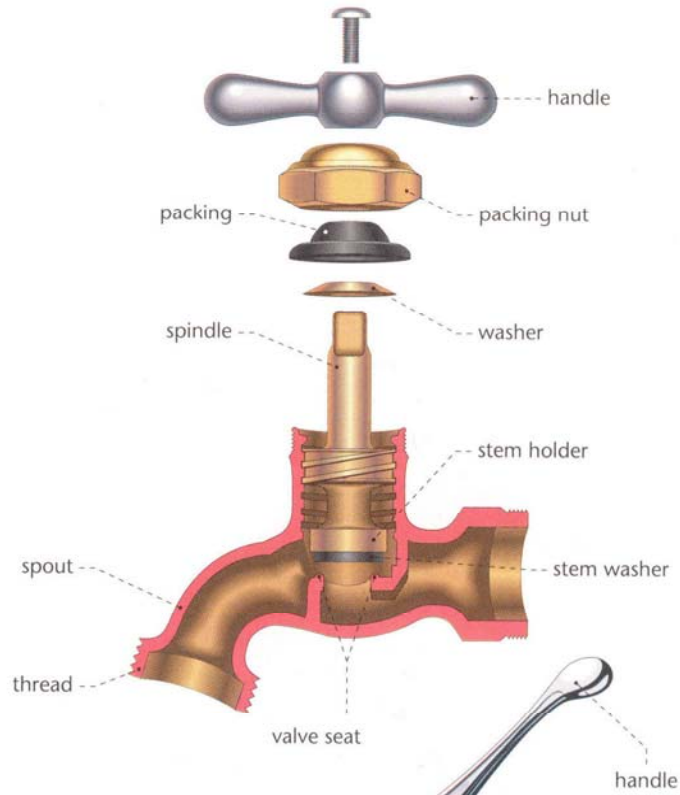

DO-IT-YOURSELF

BALL-TYPE FAUCET





DISC FAUCET

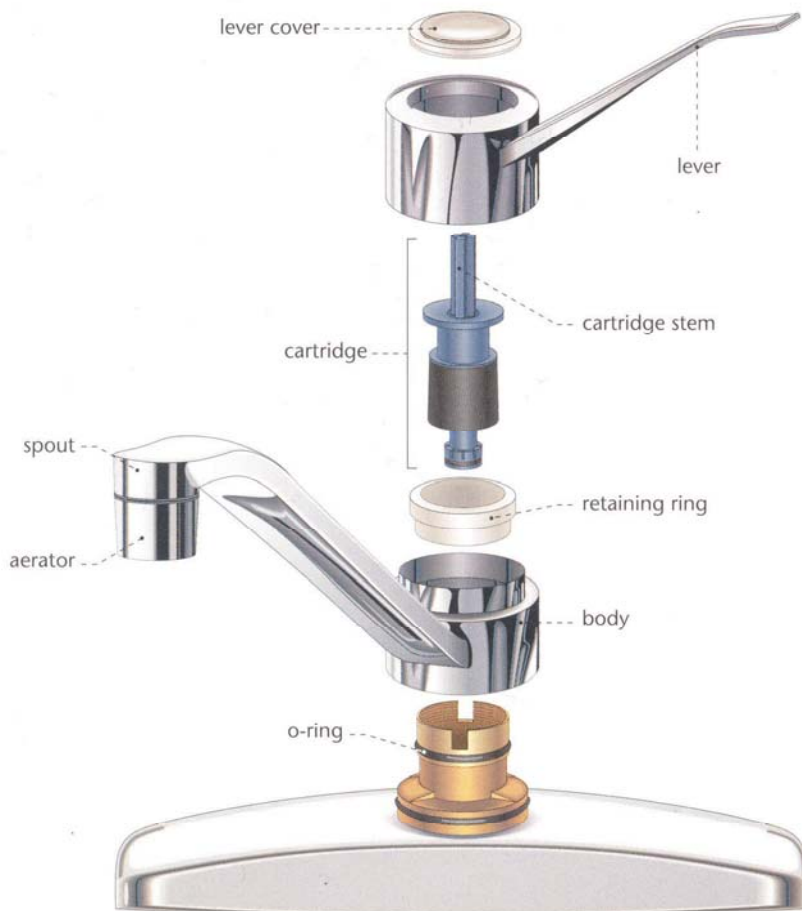

CARTRIDGE FAUCET



DO-IT-YOURSELF

PLUMBING

GARBAGE DISPOSAL SINK

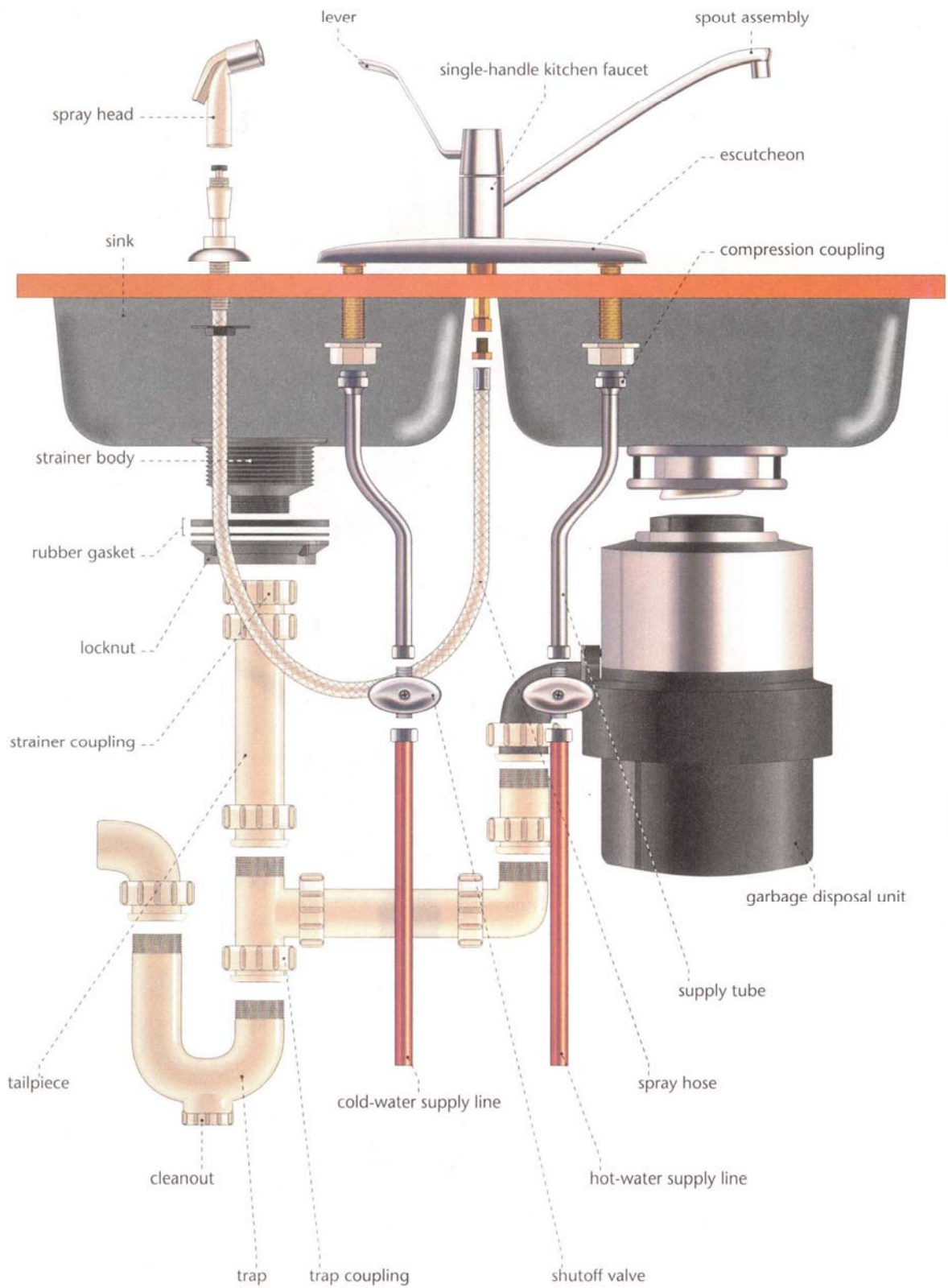

DO-IT-YOURSELF

GAS WATER-HEATER TANK

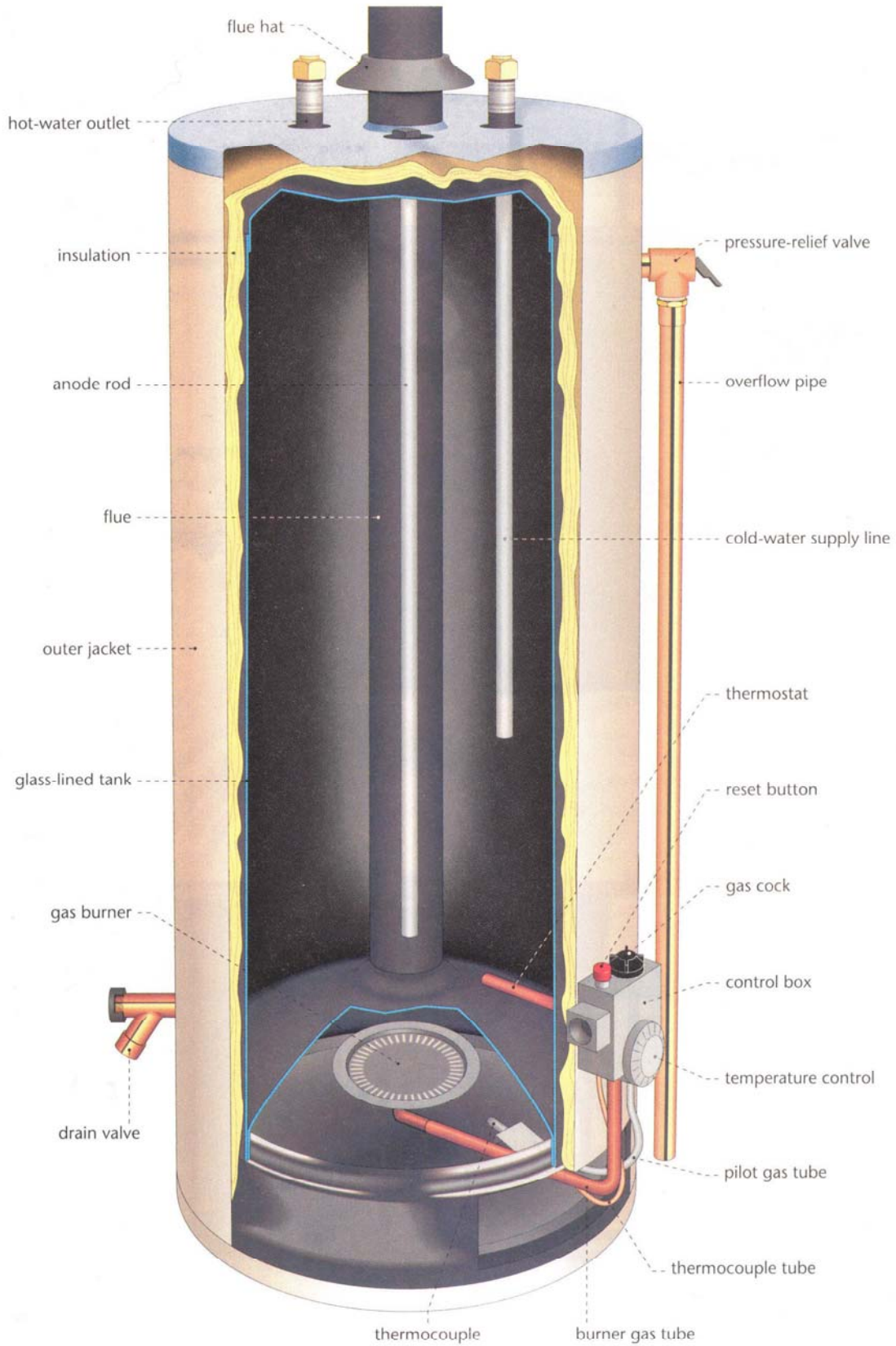

DO-IT-YOURSELF

PLUMBING: EXAMPLES OF BRANCHING

WASHER

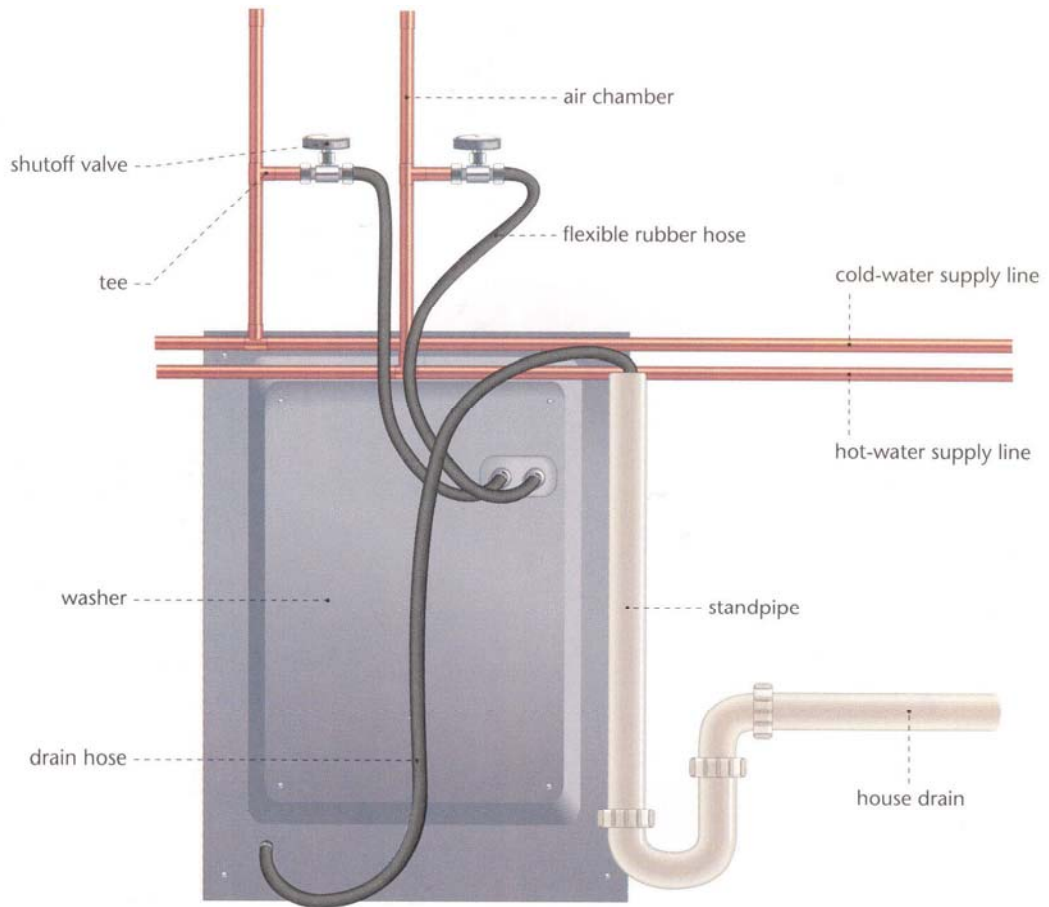

DISHWASHER

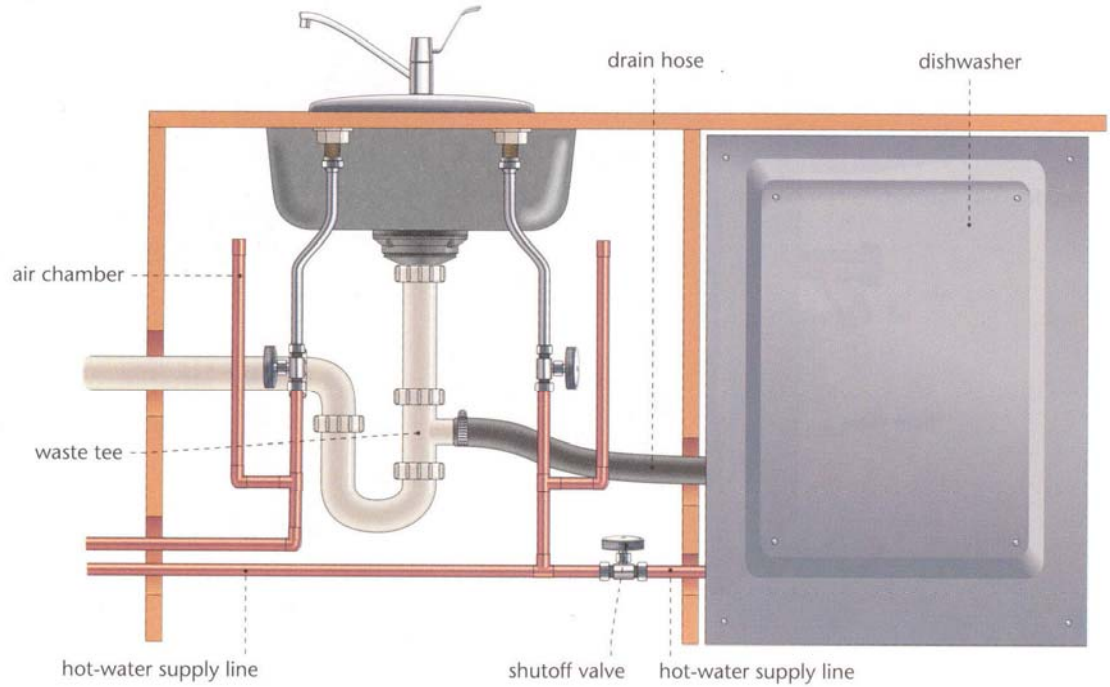

DO-IT-YOURSELF

PLUMBING

PLUMBING TOOLS



soldering torch

pencil point tip



adjustable spud wrench

disposable fuel cylinder

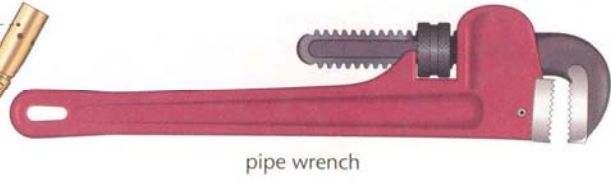

pipe wrench

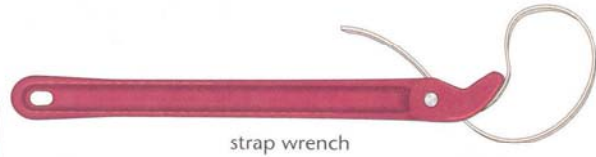

strap wrench



chain pipe wrench



pipe threader

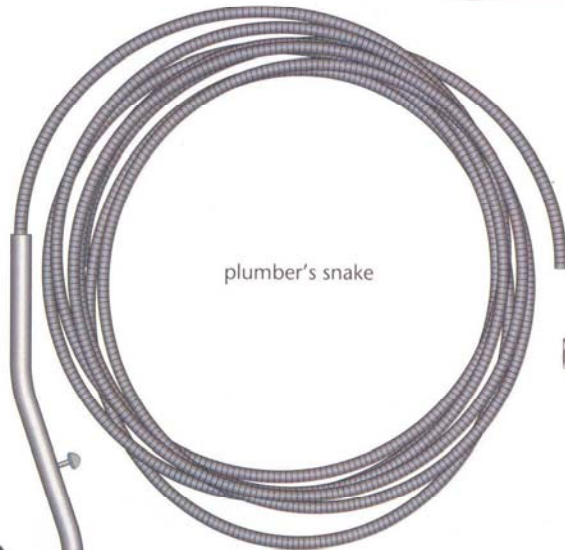

plumber's snake



tube flaring tool



basin wrench



plunger

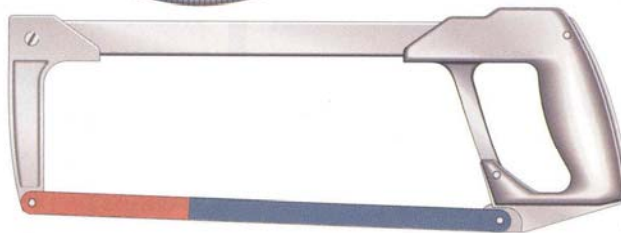

hacksaw



valve seat wrench



DO-IT-YOURSELF

PLUMBING

MECHANICAL CONNECTORS

DO-IT-YOURSELF

compression fitting

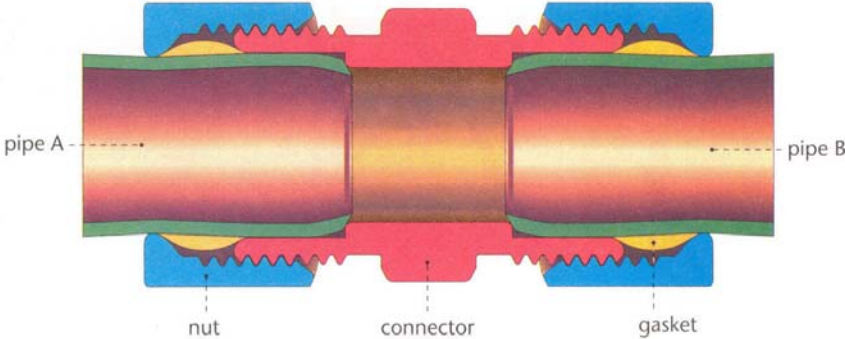

flare joint

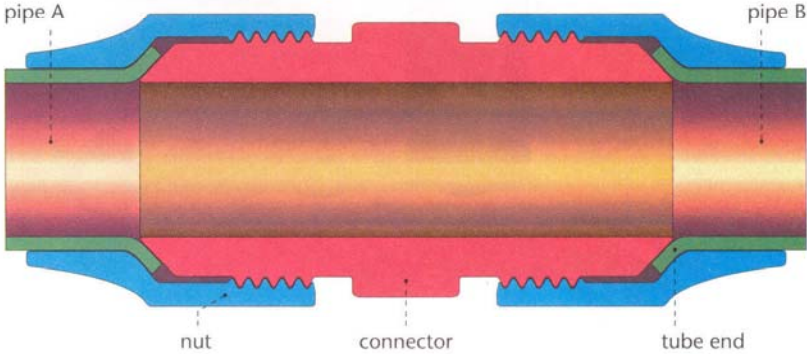

union

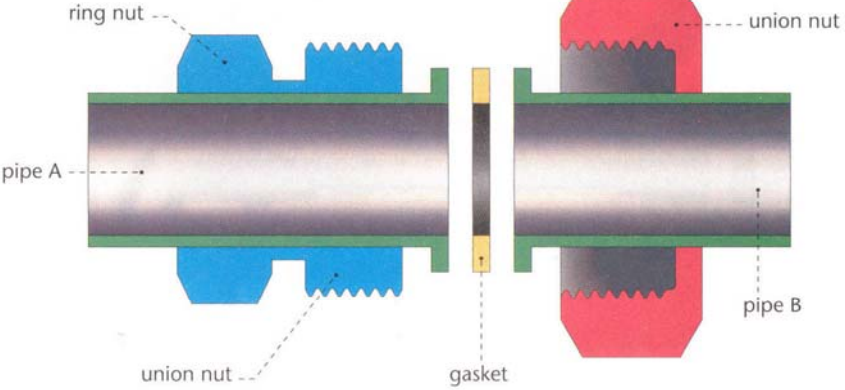

TRANSITION FITTINGS



steel to plastic



copper to plastic



copper to steel

FITTINGS



45° elbow



elbow



U-bend



tee



Y-branch



offset



trap



square head plug



cap



flush bushing



nipple



reducing coupling



threaded cap



pipe coupling



hexagon bushing

LADDERS AND STEPLADDERS

STEPLADDER

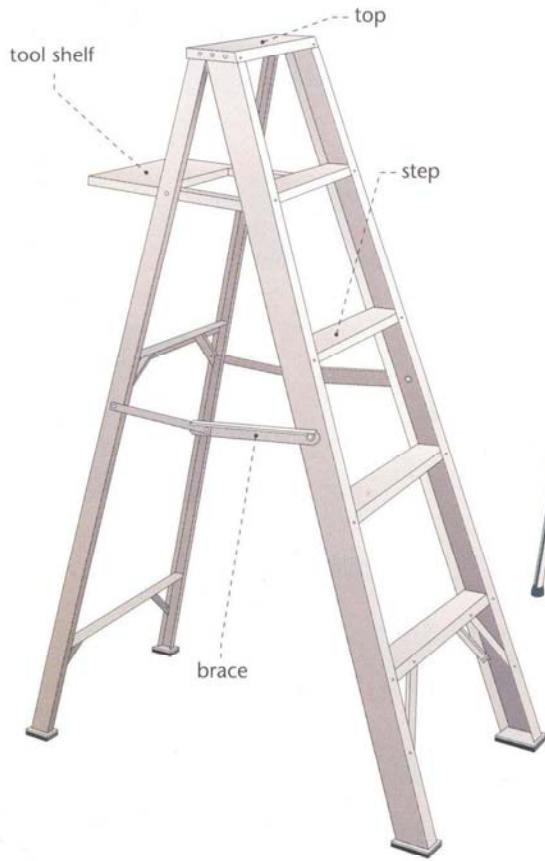

EXTENSION LADDER



PLATFORM LADDER



DO-IT-YOURSELF

straight ladder



foldaway ladder



hook ladder



rope ladder



multi-purpose ladder



fruit-picking ladder



rolling ladder



ladder scaffold



DO-IT-YOURSELF

PAINTING UPKEEP

SPRAY PAINT GUN



SCRAPER

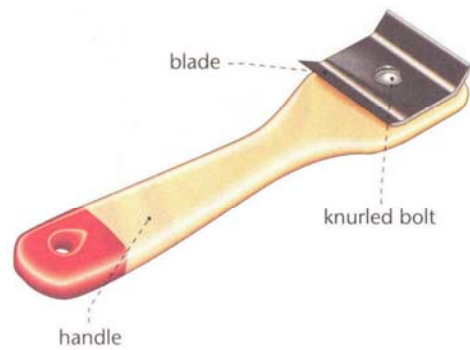

BRUSH

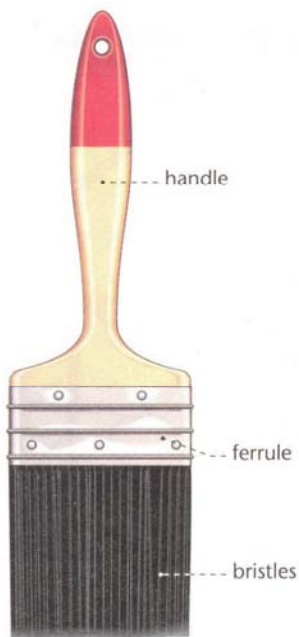

PAINT ROLLER

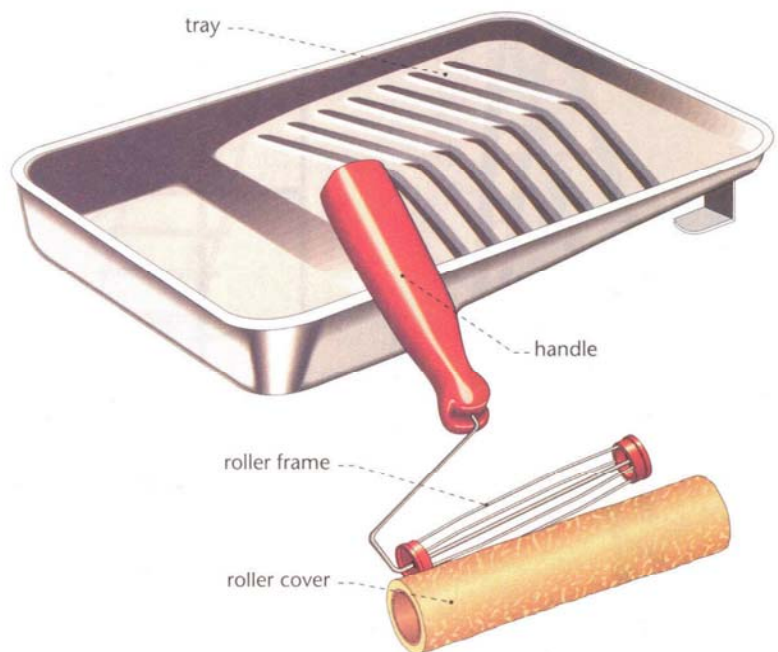

DO-IT-YOURSELF

SOLDERING AND WELDING

soldering iron



SOLDERING GUN

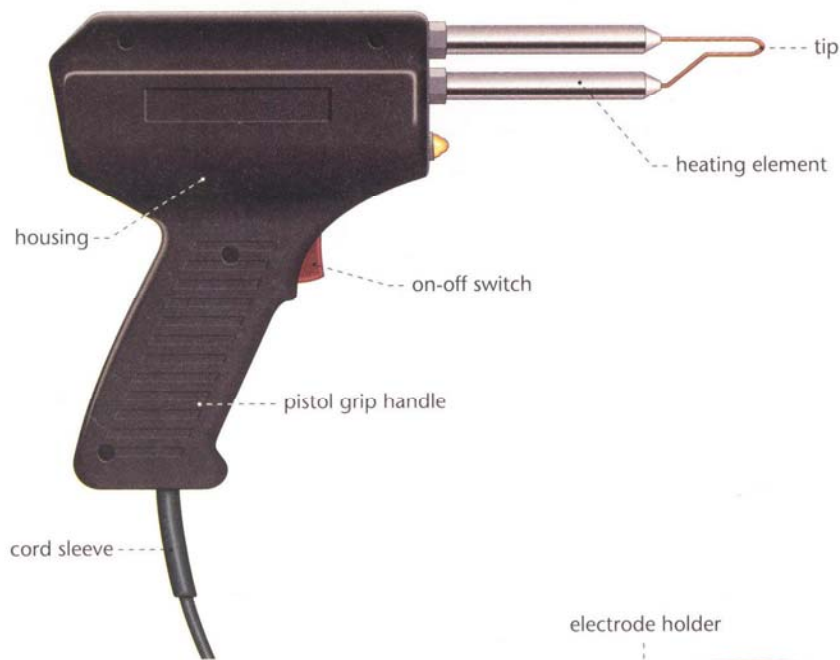

ARC WELDING



SOLDERING AND WELDING

CUTTING TORCH

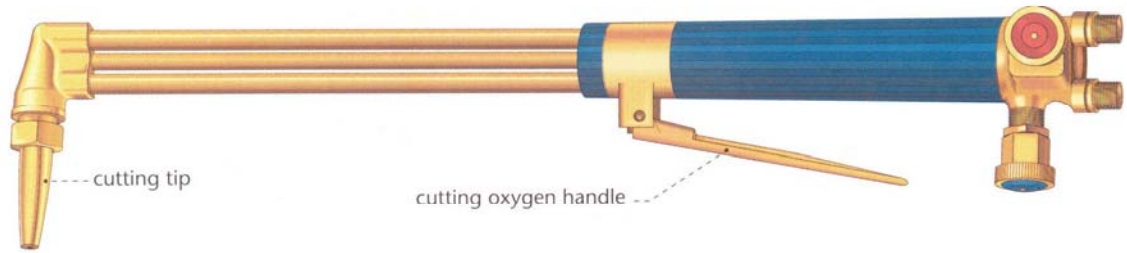

WELDING TORCH

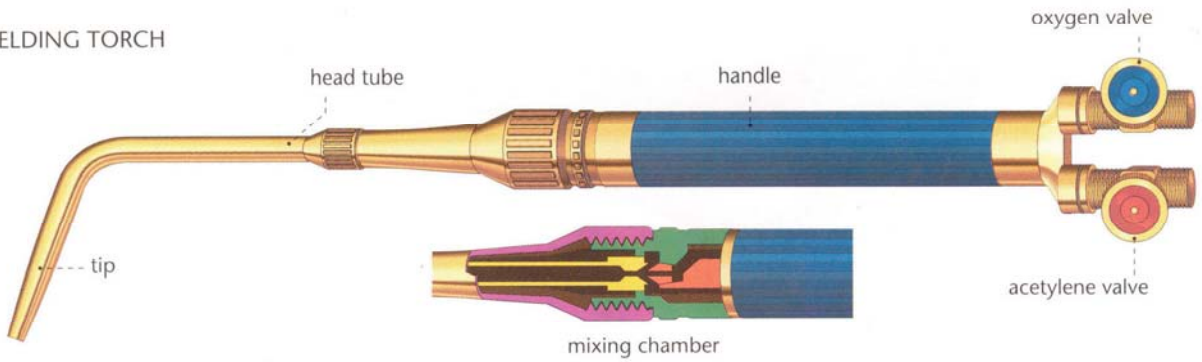

OXYACETYLENE WELDING

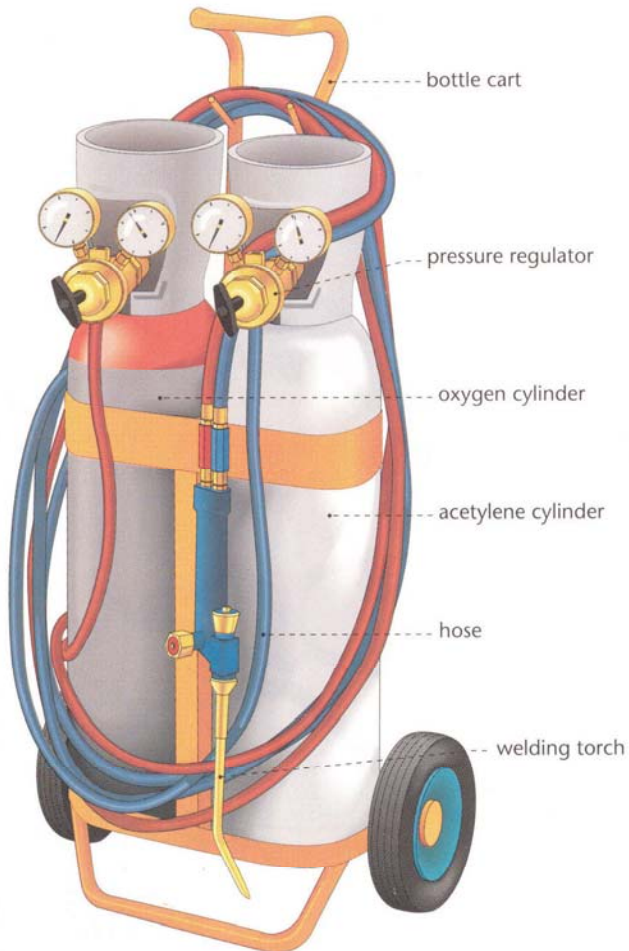

PRESSURE REGULATOR

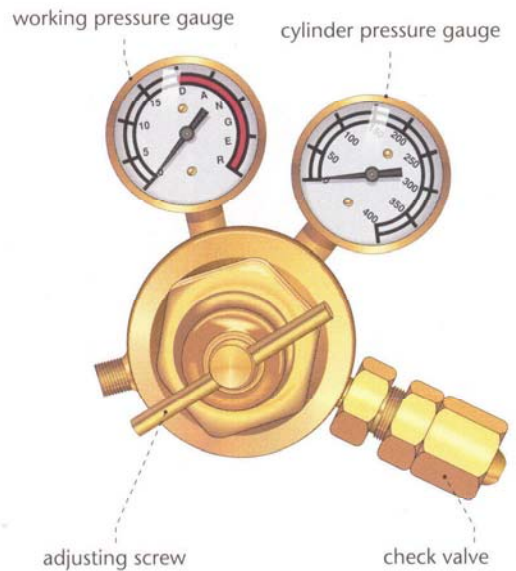

DO-IT-YOURSELF

BUTT WELDING

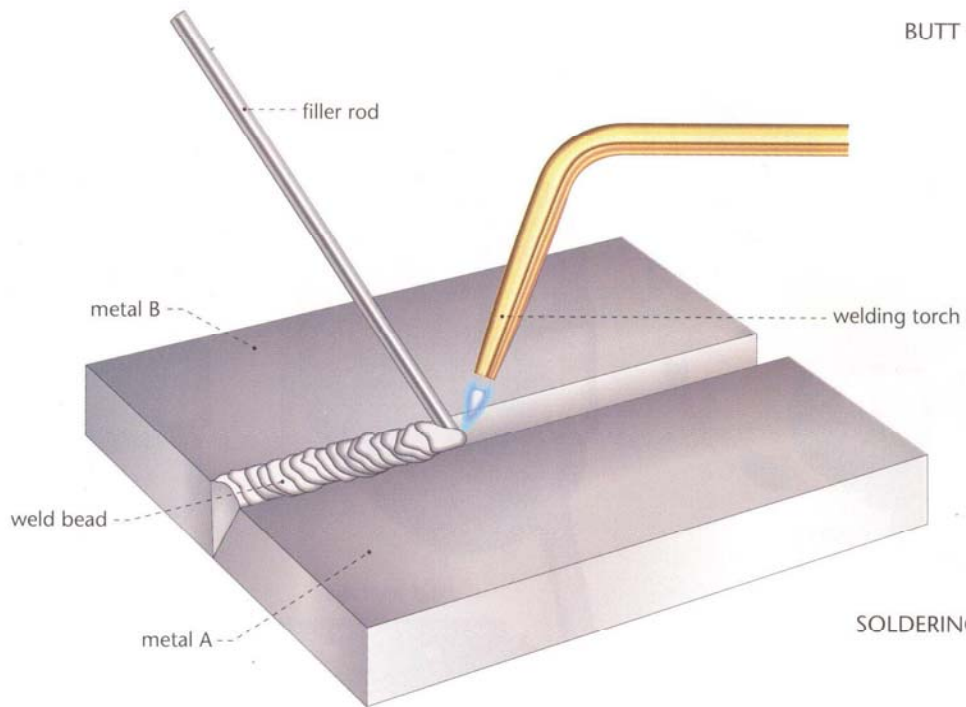

SOLDERING TORCH



SOLDERING AND WELDING: PROTECTIVE CLOTHING

goggles



hand shield



face shield

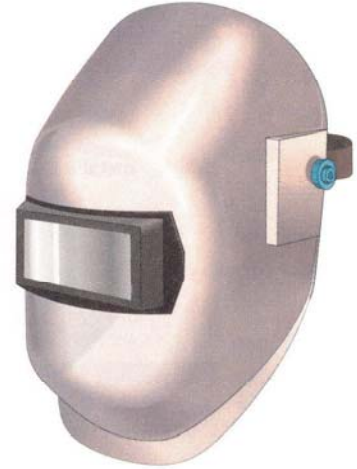

gauntlet



welding curtain



mitten

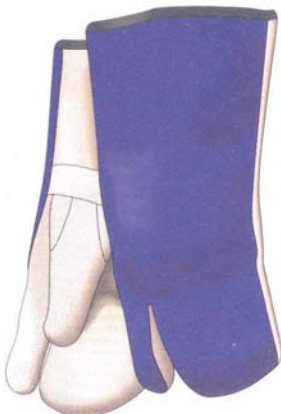

DO-IT-YOURSELF

ELECTRICITY

dimmer switch



switch plate



LAMP SOCKET

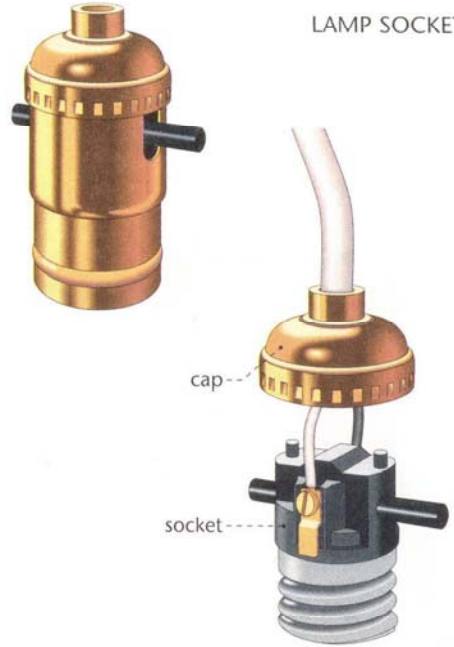

electrical box



switch



insulating sleeve

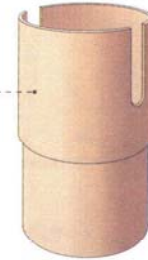

outlet

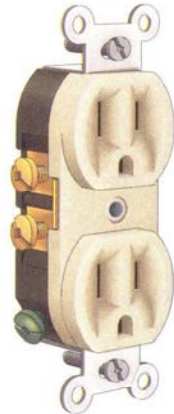

outer shell



AMERICAN PLUG

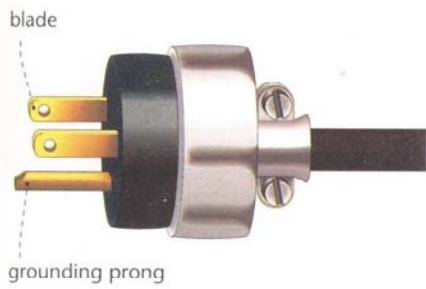

EUROPEAN PLUG

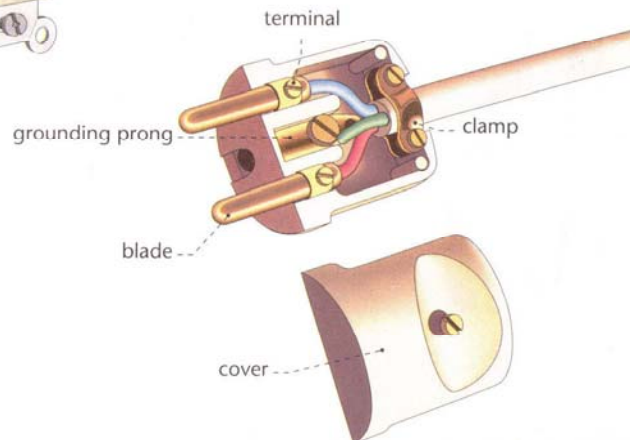

DO-IT-YOURSELF

ELECTRICITY

ELECTRICIAN'S TOOLS

multimeter



voltage tester

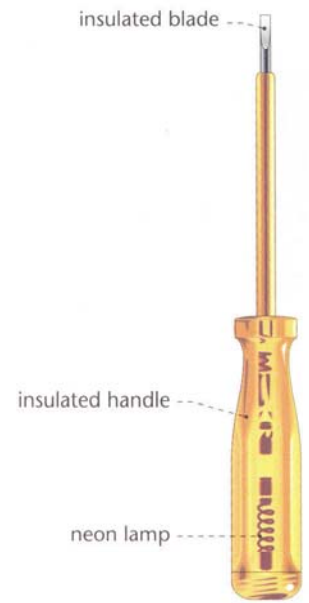

DO-IT-YOURSELF



drop light

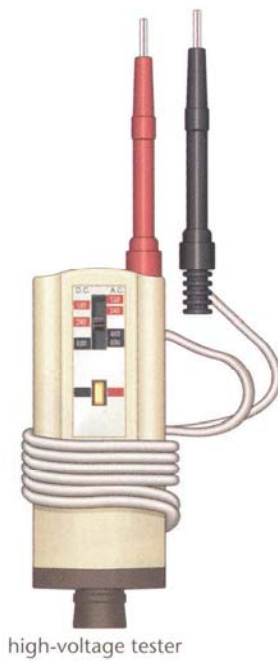

ELECTRICIAN'S TOOLS

multipurpose tool

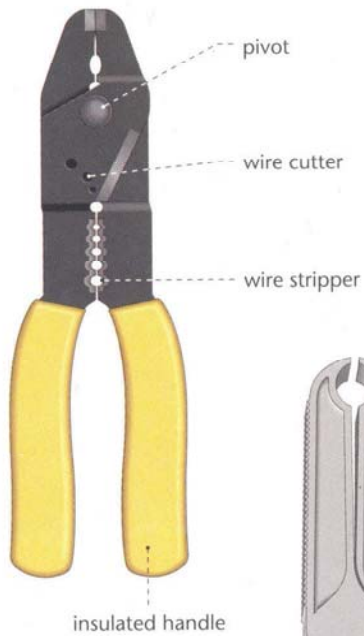

hammer

lineman's pliers

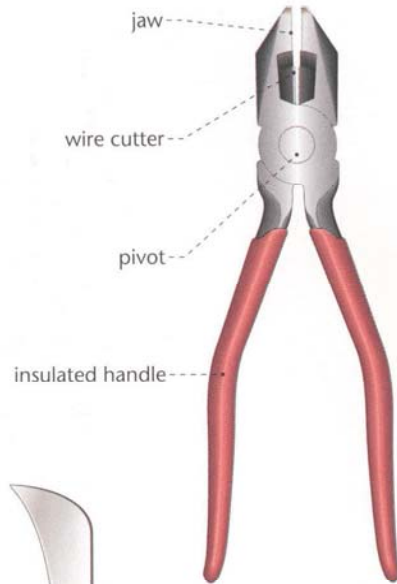

fuse puller



cable ripper



cutter



wire nut

DO-IT-YOURSELF



fish wire

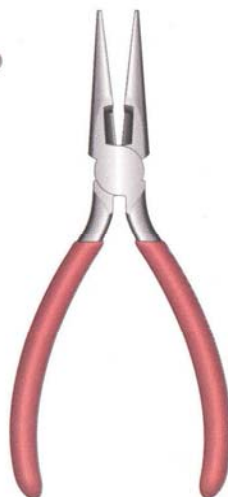

needle-nose pliers

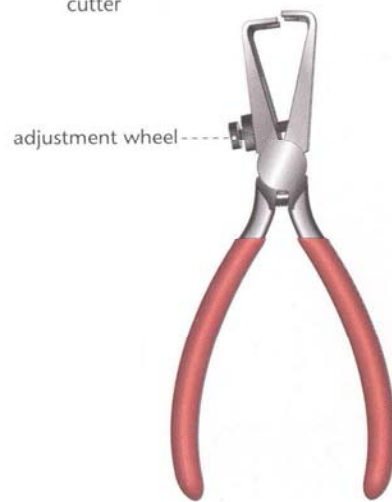

wire stripper

ELECTRICITY

FUSE BOX

DO-IT-YOURSELF

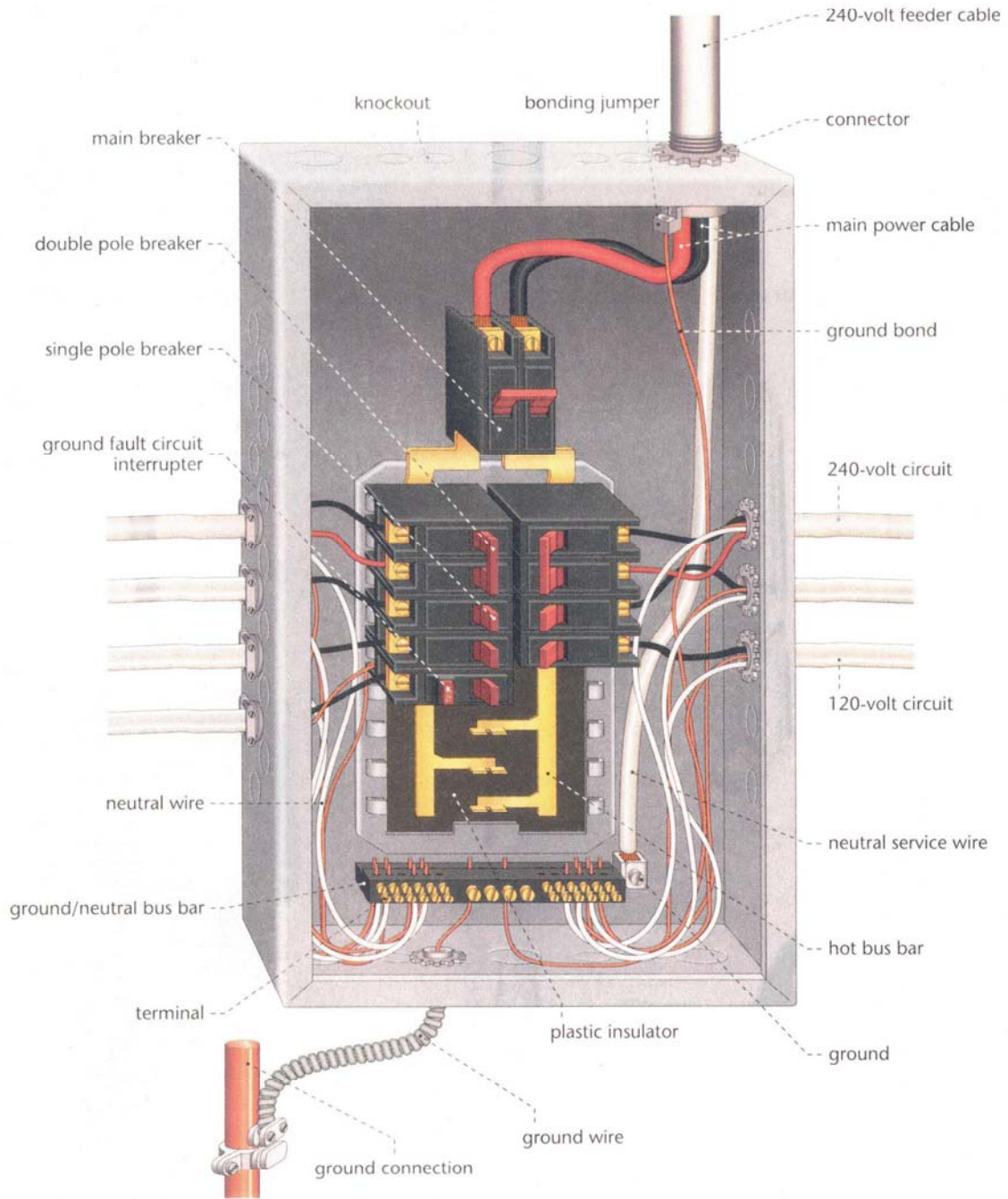

FUSES

