

THE MARE'S NEST

The War against Hitler's
Secret Vengeance Weapons

“David Irving is the forensic pathologist of modern military history. He dissects, analyses and describes with an unflinching, unsqueamish surgical skill. His knife exposes the tumours, the cancers and horrors of war. The reader becomes a spectator in an operating theatre. Coolly detached himself, Mr. Irving spares him nothing.”

THE ECONOMIST

This edition ISBN 1-872197-22-1

The editor of this work was Francis de Salis, who had
previously edited Leon Uris's novel *Exodus*

David Irving's *The Mare's Nest* was first published in 1964 by William Kimber Ltd, in London, and by Little, Brown Inc in Boston. In Italy it was published by Arnoldo Mondadori Editore, Milan; in Spain it appeared as *Las Armas Secretas* (Editorial Planeta, Barcelona). In Germany it was a major bestseller, published in 1964 as *Die Geheimwaffen des III. Reichs* by Sigbert Mohn Verlag of the Bertelsmann Group, and serialized in *Der Spiegel*. Subsequent German-language editions included a paperback published by Wilhelm Heyne Verlag of Munich and a book club edition by Weltbild Verlag, of Augsburg. This revised edition of *The Mare's Nest* is slightly abridged, but includes a hitherto unpublished chapter as a Prologue.

First published November 1964

Revised edition published by Panther Books 1985

Electronic Edition 2001

Focal Point Classic Edition 2010

© Parforce UK Ltd. 2001–2010

An Adobe pdf (Portable Document Format) edition of this book is uploaded onto the FPP website at <http://www.fpp.co.uk/books> as a tool for students and academics. It may be downloaded for reading and study purposes only, and is not to be commercially distributed in any form.

All rights reserved. No part of this publication may be commercially reproduced, copied, or transmitted save with written permission of the author in accordance with the provisions of the Copyright Act 1956 (as amended). Any person who does any unauthorised act in relation to this publication may be liable to criminal prosecution and to civil claims for damages.

Readers are invited to submit any typographical errors to David Irving by mail at the address below, or via email at info@fpp.co.uk. Informed comments and corrections on historical points are also welcomed.

Focal Point Publications
Windsor SL4 6QS

David Irving

THE MARE'S NEST

The War Against Hitler's Secret
'Vengeance' Weapons

“Lord Cherwell still felt that at the end of the war when we knew the full story, we should find that the rocket was a mare's nest.”

DEFENCE COMMITTEE (OPERATIONS)
25 OCTOBER 1943

What the Press said about this book

IN THE DESTRUCTION OF DRESDEN, Mr. David Irving has already given us one of the best and most illuminating books that have come out of the last war. One is tempted to say that *The Mare's Nest* is an even better one.

It is, first of all, an admirably clear and thorough account of the development, production and operational deployment of the secret weapons with which, as the twelfth hour approached, Germany still hoped to avenge herself on Britain and even to win the war. It is also an account of the measures by which Britain tried to penetrate the mystery of the V-weapons and to counter the potential threat which they created; this seems to me one of the best descriptions I have ever read of how intelligence operations are actually conducted and their results assessed. Lastly, the book gives us a slightly nightmarish illustration of how, in war, decisions of critical importance may be determined by factors, of ignorance, human fallibility, prejudice, egotism, which are hardly amenable to rational control.

— *The Spectator* (London)

MR IRVING'S BOOK about the German V-weapons is remarkable because it describes in parallel how the fight proceeded not only on the British side, in the great argument about whether and what new German weapons were likely, but also among the Germans, in deciding to what weapons, new or old, resources ought to be applied at the war's climax.

Inevitably, in Britain, a key actor is again Lord Cherwell: disdainful as ever of the views of lay and unscientific persons such as Mr Sandys, who was given the task in the spring of sifting the evidence for German rockets, dogmatic and obdurate as ever in sticking to his first view that these long range rockets were so unfeasible scientifically as to be, in his scornful words, a "mare's nest"; indignant and depressed when in the summer of 1944 his sceptical views were, fortunately, overridden, not just by the laymen but by the scientists as well, when the decision was made that there was a threat to be met by massive old-style bombing.

— *The Economist*

ONE OF THE MOST FASCINATING books I have read for a long time . . . I wonder how many more skeletons are mouldering in Whitehall cupboards.

— Cassandra [William Connor] in *The Daily Mirror*

DAVID IRVING GIVES an authoritative account of the V-weapon offensive as seen from Germany and from Britain. It presents the results of meticulous research in both countries and is full of interesting quotations from official British and German documents.

These have been successfully woven together into a coherent narrative, written in a brisk style... The account of how we progressively pieced together the technical details of the V-2 rocket is an absorbing story of scientific detection. . . Students will find in *The Mare's Nest* a mine of important information, while much wider circles will enjoy David Irving's vivid presentation of a strange story.

— Duncan Sandys in *The Evening Standard* (London)

THE STORY OF HITLER'S, secret weapons contains a rich catalogue of human folly, and David Irving's excellent book can be read with profit by statesmen on both sides of the Iron Curtain.

Mr Irving produces some startling figures . . . The flying-bomb, at £125 each, was a cheap killer. By contrast, the V-2 cost £12,000 each to deliver a similar payload. . . Indeed, it might be argued that the V-2 did more harm to the German war effort than the entire Allied strategic bombing offensive.

How, Mr Irving asks, could a perceptive military economist like Albert Speer, the German Minister of Supply, allow such a thing to happen?

— Paul Johnson in *The New Statesman* (London)

THIS IS A FACTUAL account, based upon original documents and a great deal of fresh information . . . but for sheer drama it has never been surpassed by the most sensational "thriller." . . . In these circumstances it is not difficult to understand why, when Mr. Irving's book is once taken up, it is not easily put down.

— Sir Charles Petries in *The Illustrated London News*, December 26, 1964

. . . and more at fpp.co.uk/reviews



David Irving is the son of a Royal Navy commander.

After visiting Imperial College of Science & Technology and University College London, he spent a year in Germany working in a steel mill and perfecting his fluency in the German language.

Among his thirty-odd books, the best-known include *Hitler's War*; *Churchill's War*, vol. i: "Struggle for Power," vol. ii: "Triumph in Adversity", and vol. iii: "The Sundered Dream"; *Accident, the Death of General Sikorski*; *The Destruction of Dresden*; *The Mare's Nest*; *The German Atomic Bomb*; *The Destruction of Convoy PQ17*; *The Rise and Fall of the Luftwaffe*; *Göring: a Biography*, and *Nuremberg, the Last Battle*.

He has also translated several works by other authors including Field-Marshal Wilhelm Keitel, Reinhard Gehlen, and Niki Lauda. He lives in Windsor, England, and has raised five daughters.

Photo: Adolf Hitler's generals visit Wernher von Braun's secret missile establishment at Peenemünde in March 1941



THE MARE'S NEST

David Irving

The War Against Hitler's Secret
Vengeance Weapons

F
FOCAL POINT

Books by David Irving

Und Deutschlands Städte Starben Nicht (*with Günter Karweina*)

The Destruction of Dresden

The Mare's Nest

The Destruction of Convoy PQ.17

The Memoirs of Field Marshal Keitel (*translator*)

Accident. The Death of General Sikorski

The Virus House

Formula 1: The Art & Science of Grand Prix Driving, by Niki Lauda (*translator*)

Breach of Security (*with Prof. D C Watt*)

The Service. The Memoirs of General Reinhard Gehlen (*translator and editor*)

The Rise and Fall of the Luftwaffe

Hitler und seine Feldherren

Hitler's War

The Trail of the Fox

The War Path

Der Nürnberger Prozess

Mord aus Staatsräson

Wie Krank War Hitler Wirklich?

Uprising! One Nation's Nightmare: Hungary 1956

The War between the Generals

Von Guernica bis Vietnam

The Secret Diaries of Hitler's Doctor

Adolf Hitler: The Medical Diaries

Der Morgenthau-Plan 1944/45 (*documentation*)

Churchill's War vol. i: The Struggle for Power

Göring. A Biography

Hess: The Missing Years

Führer und Reichskanzler

Das Reich hört mit

Deutschlands Ostgrenze

Hitler's War & The War Path (*updated, one-volume edition*)

Die Nacht, in der die Dämme Brachen

Der unbekannt Dr. Goebbels (*1938 diary ed. and transcribed*)

Apocalypse 1945. The Destruction of Dresden

Goebbels. Mastermind of the Third Reich

Nuremberg, the Last Battle

Churchill's War, vol. ii: Triumph in Adversity

Banged Up: Survival as a Political Prisoner in 21st Century Europe

IN PREPARATION:

Churchill's War, vol. iii: The Sundered Dream

Heinrich Himmler

Contents

Acknowledgements	13
Prologue	15
Introduction	20
Programmes of Revenge	25
The Intelligence Attack	45
Operation Hydra	107
The Bodyline Investigation	153
The Rocket in Eclipse	183
Retribution	233
The A4 Ascendant	265
Account Due	302
APPENDIX I: Evidence on the Comparative Costs of Rockets and Flying Bombs	319
APPENDIX II: The author recalls something of the history of this book	321
<i>Index</i>	323

Acknowledgements

NO BOOK OF this nature would be possible without the unselfish co-operation of several hundreds of people who, having participated in the events portrayed, are able to assist in establishing the circumstances, successes and failures of the Allied Intelligence attack on German secret weapons in the Second World War. It is not possible to give all their names: many have asked that their names should not be recorded in these pages, and others I am not at liberty to identify – the brave army of Allied agents who channelled back to London the raw material upon which that Intelligence attack was based.

My greatest thanks are due to Sir Donald MacDougall for allowing me access to certain records of which he is the trustee, namely the papers of Lord Cherwell, and to Professor R. V. Jones for adding a large part of the unknown details of this story.

Sir Alwyn Crow, Sir William Cook, the Earl of Birkenhead, Marshal of the RAF Sir Arthur Harris, Air Marshal Sir Robert Saundby, Sir Frank Whittle, Air Commodore J. S. Searby, DSO, DFC, Colonel T. R. B. Sanders, Dr. Barnes Wallis, Mr. G. J. Gollin, Brigadier Charles Lindemann, Mrs. I. H. Lubbock, Mr. Jules Lubbock, Mr. P. A. Coldham,

Squadron Leader E. J. A. Kenny, Mr. W. R. Merton, Mr. T. A. Stewart, and many others have provided me with material and personal records upon which much of the British side of the story has been based.

I wish to express particular thanks to Dr. Albert F. Simpson, Chief of the US Air Force Historical Division, through whose kindness a volume of interrogation reports of 400 former Peenemünde scientists was made available to me. A further great volume of material was provided for me by the National Archives in Washington.

THE LIBRARY of the Deutsches Museum in Munich, and its director, Professor Klemm, generously provided me with copies of documents held by them, and permitted me to study their unparalleled collection of Peenemünde documents; I wish to record my gratitude to Dipl.-Ing. Ernst Klee, curator of the Peenemünde archives at the Deutsches Museum in Munich.

I am indebted to Dr. Wernher von Braun, to Colonel Leo Zanssen, former military commandant of the Peenemünde establishment, and to: Herr Walter Barte; the Landesarchiv Berlin; Herr Eckart von Bonin; Dr. Kurt Diebner; Herr Horst Diener; Herr Fritz Hahn; Professor Walter Hubatsch; Professor Friedrich Kirschstein; Dr. J. Krinner; General Emil Leeb; Herr Hans Meissner; Herr F.-K. Müller; Dipl.-Ing. Walter Riedel; Herr Hans Ring; Dorette Kersten and her husband Herr Rudolph Schlidt; Herr Peter Spoden; Dipl.-Ing. Detmar Stahlknecht; Colonel Max Wachtel; Herr Wilhelm Henseler; Colonel Hajo Herrmann; General Josef Kamhuber; the Deutsches Wetterdienst; General Paul Deichmann; and the staff of the West German Staff College, Hamburg-Blankenese, for the assistance that all have rendered.

I wish to thank Messrs. Collins (London) for permission to reproduce the brief quotations I have used from Sir Arthur Bryant's *Triumph in the West* (1959). I also acknowledge the permission of the Controller of HM Stationery Office to quote from publications and all official records in which the Copyright is vested in the Crown.

Prologue: The Enigma

*Like all manuscripts based in part on official files, this book was submitted by the author, then aged 25, to the government for clearance. In July 1964 the GCHQ security officer wrote to him: “The new chapter beginning, ‘Just as the analysis of inconsistencies . . .’ must not appear in any shape or form.” With the official revelation of *The Ultra Secret and the Enigma* story in 1974 this prohibition no longer applies.*

JUST AS THE ANALYSIS of inconsistencies has led to the most unexpected discoveries in the field of applied science, so the examination of apparently inexplicable contradictions in terms can illuminate history’s more jealously guarded secrets.

The genesis of this particular story was a process developed and applied by a consortium of Intelligence officers in an establishment forty-seven miles from London, a process of such secrecy that neither Cabinet Ministers nor Commanders-in-Chief nor even our most gallant Allies could be entrusted with the burden of its knowledge.

Three inconsistencies will be found to occur in the story which follows, of which only one is significant; these are the documentary clues which we can best label “the petrol form,” “the radar plots,” and “the bills of lading.” The three clues are to play significant parts in this narrative as they, respectively, established that Peenemünde was

genuine and the second most important research station; identified certain structures in France as flying-bomb catapults; and established the probable existence of 1,000 German rockets.

Of the three, the alleged existence of the “bills of lading” is the most questionable. Ostensibly, the bills were thrown up like chaff as the grinding mechanism of an efficient network of SIS agents meshed momentarily with the machinery of Germany’s secret weapon development programme. In fact, their provenance was rather different.

On November 5, 1943, after Peenemünde had been devastated by RAF Bomber Command, firing trials of the A4 long-range rocket, operationally to be termed V-2, were resumed at the SS training ground at Blizna in Poland. Intelligence learned of this in London. In a report to the Cabinet in mid-July 1944, a senior Air Intelligence officer claimed that from captured “bills of lading,” referring to the traffic between Peenemünde and Blizna, serial numbers of certain objects, shown by photo-reconnaissance of Blizna to be rockets, had been extracted. The serial numbers ranged in part from 17,064 to well over 18,000.

This evoked consternation in the Cabinet, as will be seen in a later chapter. But what is even more revealing is an analysis of their provenance. The Intelligence officer suggested to the Cabinet that the “bills of lading” had been secured by an SIS agent operating in Poland. This is impossible: on January 25, 1944, the chief of Major-General Walter Dornberger’s rocket transport staff had directed that “in virtue of a special dispensation from the Reich Transport Ministry, no conveyance papers, either military tickets or bills of lading, are to be filled out for A4 traffic.”

This regulation came into force on February 1, five days *before* the trainload of ten A4 rockets, of which number 17,064 was one, emerged from the exit-tunnel of the Nordhausen factory, and several weeks before it was fired at Blizna.*

The “bills of lading” do not therefore exist.

* Rocket No. 17,063, for example, was launched from Peenemünde on April 14, 1944.

So what was the Intelligence officer's true source? Long before the onset of the war, Intelligence had made strenuous efforts to break into the German ciphers intercepted by the United Kingdom's radio monitoring organisation. No one underestimated the gains which would derive from successfully cracking the high level ciphers used by the German High Command, while at no time permitting the enemy to become aware of this. "Correct information about the enemy does not by itself win wars," one Intelligence officer observed. "But it can stave off defeat a very long time, and allow one to strike just when and where it hurts most."

The Germans had by that time developed one particularly reliable machine cipher named *Enigma*. A senior civil servant, Joshua Cooper, conceived that if the German codes were machine-made, then a machine ought to be able to comprehend them. (In 1936, Cooper had been transferred to the Air Ministry for Intelligence duties, while still attached to the Foreign Office.)

His idea bore fruit. Post Office engineers were invested with the task, and were so successful that their device was able to tackle a far wider range of ciphers than that for which it had originally been planned. This was installed at a certain Joint Services establishment in Buckinghamshire, to which a considerable staff of translators, interpreters and evaluators was attached. "From then onwards, we could decipher anything we got hold of," said one; to add insult to injury, the British device was considerably faster than that developed by the Germans for the same purpose, with the result that British Intelligence often had the clear text before its intended recipients.

This decoding machine remained Britain's sole prerogative until its functions were divulged to the Americans; this has not, of course, prevented the Americans from claiming that such machines originated in the USA. Presumably H. M. Government had been reluctant to correct this view, because of the pain which would be caused by an admission that such a device was in our possession during the war. The next of kin of those lost in the disasters of war would draw no comfort from

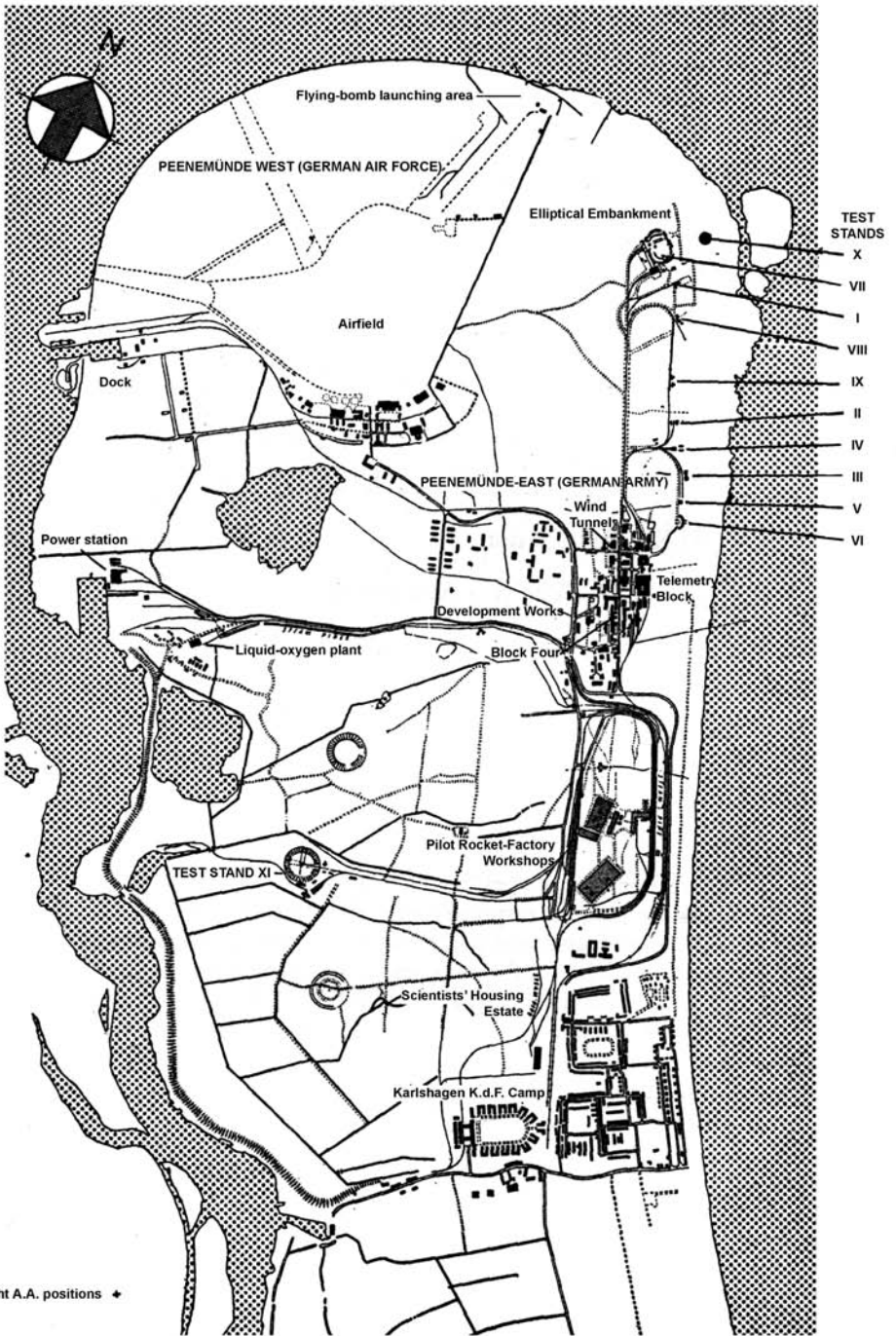

the knowledge that Intelligence had forewarning of many of them.

Very early on, it was decided that, as a matter of strictest policy, the Cabinet could be given only such Intelligence as could credibly have emanated from more conventional agencies. The network of Ministers and others to whom the digests of Intelligence secured by this establishment were circulated was severely restricted. Hence the invention of documents stolen by SIS agents, like the “petrol form,” the “radar plots,” and the “bills of lading.”

Where no such cover story could plausibly be invented, the intercepts had to be religiously ignored. Convoys were smitten, disastrous air attacks were borne, while Intelligence had to stand by passively in agonised impotence.

To this establishment, run jointly by the Foreign Office and Services, must go much of the credit which in this book will perform be attributed to the service Intelligence directorates at large.

GERMAN GUIDED MISSILES ESTABLISHMENT,
Peenemünde

Purpose of test stands: X — A4 launching trials; VII — A4 motor controls and launching trials; I — A4 combustion chamber static test rig; VIII — A4 combustion chamber trials with turbo-pumps; IX — Wasserfall rocket test rig; III — horizontal combustion chamber rig; V — A4 fuel delivery system trials; VI — A4 motors and control testing; XI — test rig for mass-produced A4's.

Introduction

ONE AFTERNOON EARLY in August 1944, a lone Liberator bomber of the United States Eighth Air Force rolled cautiously down the long concrete runway of a bomber airfield in England, and lumbered into the air. Just two men were manning the B-24's controls, the pilot, Lieutenant Joseph Kennedy, and the wireless operator. Behind them, every cubic inch of the aircraft was packed with high explosive, over twenty-two thousand pounds of it.

The plane had been stripped of its armament, and it carried only enough fuel for the outward flight, a flight that would take it across the Channel to a lonely, windswept field in the Pas de Calais, only a few miles beyond the French coast. In the heart of this region there was a shallow hill, and excavated beneath this hill was a Nazi gun battery with barrels over four hundred feet long, aimed at the heart of London a hundred miles away.

From this vast gun site, called "high-pressure pump" by Adolf Hitler, the Nazis were planning to pour a hail of six hundred 9-foot shells on the capital of the British Empire every hour; and still the gun battery was in German hands.

Work on the site had been pressed forward on Hitler's personal insistence. An eighteen-foot slab of concrete on the crest of the hill pierced by the fifty muzzle openings of the gun barrels was all that there was to attack. So the American air force commander had evolved his own secret weapon: a Liberator bomber, laden with TNT, and a volunteer crew who would bail out shortly before the plane crossed the enemy lines. The Liberator would then be homed on to the sinister "high-pressure pump" site by radio control.

Soon after Kennedy's Liberator had taken off, its master plane took the air.

The second plane was still some miles behind the Liberator when the heavy bomber suddenly blew up with two blinding flashes. The two-man crew died instantaneously. Lieutenant Kennedy, brother of the later President of the United States, joined the ranks of the 2,900 Allied airmen who sacrificed their lives in the fight against the German secret "V-weapons."

THE BATTLE HAD begun in August 1943, when early one morning Mr. Winston Churchill, then staying at the Citadel in Québec, was awakened to take a telephone call from England. At the other end of the line, he recognised the familiar educated drawl of his son-in-law, Duncan Sandys. Sandys had been put in charge of the British Intelligence investigation of German "secret weapon" rumours some months before.

Sandys said simply, "Operation *Hydra* has been a success!"

As he spoke, he was at an RAF Bomber Command Pathfinder station in Huntingdonshire, England. *Hydra* was one of the Second World War's most decisive air attacks: six hundred miles away across the North Sea, the German guided missiles establishment at Peenemünde, on which Hitler had lavished upwards of £25,000,000 since 1939, was burning fiercely, over seven hundred engineers, technicians, scientists and slave labourers lay dead among its ruins, and the onset of the German V-weapon offensive had been delayed just long enough

to prevent it from dislocating the combined Allied invasion of Normandy ten months later.

The Allies' most fantastic military gamble had come off: some six hundred aircraft of Bomber Command had executed a daring low-level raid in full moonlight on a target even more distant than Berlin. Three hundred British airmen had not returned. But as Professor Wernher von Braun, Hitler's chief rocket engineer, knew, the dispersal of all Peenemünde research would have to be put in hand. The resulting dislocation ensured that the V-weapon assault on London would have to be postponed.

Hitler had planned to saturate London with a hundred V-2 rockets and eight hundred V-1 flying bombs a day: each rocket was fifty feet long, weighed twelve tons, and carried a one-ton warhead; each of the flying bombs – small pilotless jet-propelled aircraft – carried a deadly warhead packing a punch as big as the “blockbusters” being dropped each night on Berlin by the RAF. He had personally promised his Cabinet: “The V-weapon attacks are to be synchronised with the Allied invasion of France.”

If Eisenhower's operation had even momentarily lost its footing, the course of the war could have been turned permanently against the West; Germany with her jet- and rocket-propelled fighters could have regained partial air superiority in the West, could have reinforced her defences, and completed her underground oil-refinery construction programme.

The first of the V-weapons, the deadly *Fieseler 103* flying bomb, was not rushed into action until D-Day plus seven. During the next fourteen days nearly 2,000 of these “malignant robots” were launched against the British capital. At every Cabinet meeting, the grim news poured in of the mounting toll in human life. In London, 20,000 houses a day were being damaged by the attack, and one-sixth of the city's vitally important war production capacity was lost.

Worst of all was the effect on the morale of the Allied troops fighting their way out of the Normandy beachhead. Each night they could

hear the thunderous roar of ram-jet motors as the missiles streaked out across the Channel towards England; each night the millions of people living in the weapons' path, this author among them, held their breath as the motors suddenly cut, and the pregnant silences followed, to end with shattering roars as the missiles' warheads blew up in someone else's street.

The flying bomb was only the first of Hitler's secret weapons. Said General Eisenhower afterwards: "If the Germans had succeeded in perfecting and using these new weapons six months earlier than they did, the invasion of Europe would have proved exceedingly difficult and perhaps impossible . . ." This book is a tribute to the airmen, scientists, technicians, and Intelligence officers who combined to defeat Hitler's secret weapons, and to make the Allied victory possible.

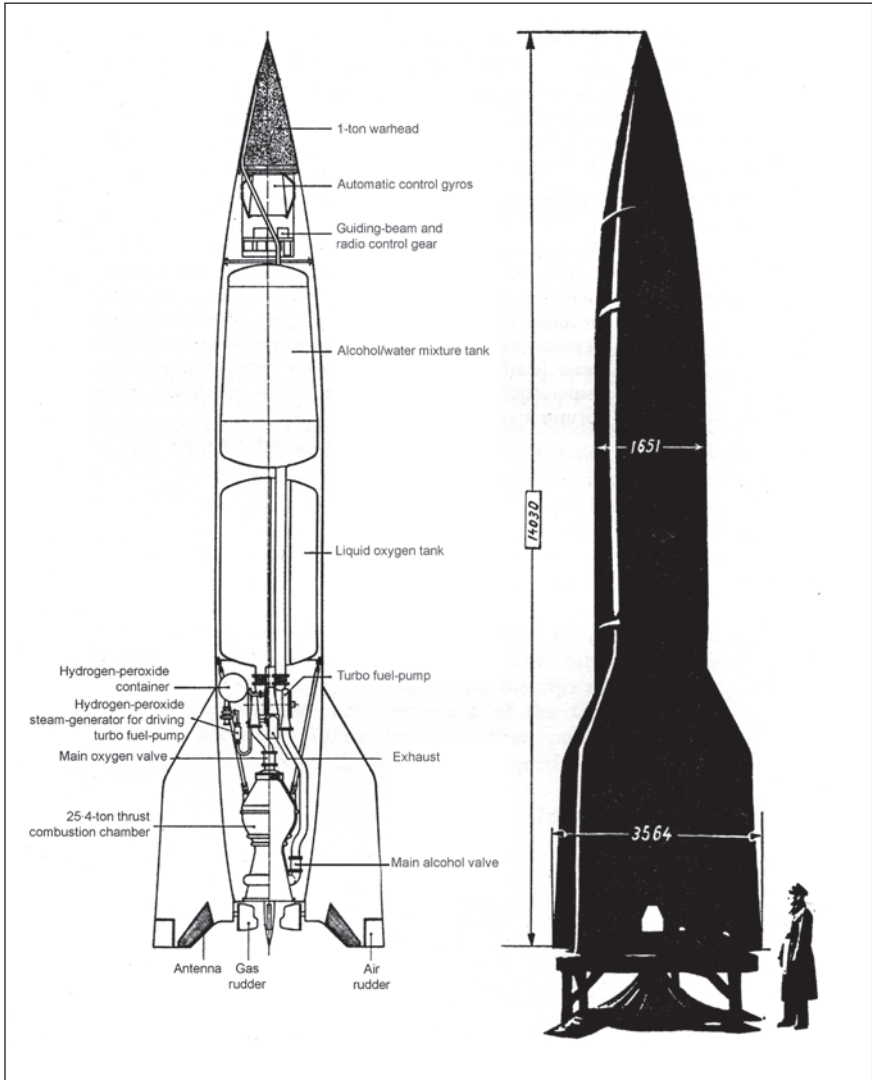

A4 LONG RANGE ROCKET

The world's first practical liquid-fuelled rocket. The internal gas rudders enabled it to make a slow standing start from a conical firing table (right). All sizes are in millimetres.

Based on an original in the Peenemünde archives

PART ONE

PROGRAMMES OF REVENGE

“There is an extreme danger that something vital will be missed. In view of Hitler’s recent statement that German inventive genius had not been idle in developing new weapons of offence against this country, we cannot afford to relax our watch as we have been forced to do. Unless some [staff] relief is forthcoming [we] cannot accept responsibility for the surprises which are likely to be sprung upon us by the enemy. . . .”

— *Dr. R. V. Jones, November 20, 1942.*

PART ONE

Programmes of Revenge

(I)

PROBABLY UNINTENTIONALLY, Adolf Hitler himself stimulated Britain's first concentrated investigation of enemy secret weapons, when at a rally in Danzig on September 19, 1939 he broadcast to the world, calling upon England to barter for peace now that he and Stalin had jointly overwhelmed Poland in "eighteen days."

While Neville Chamberlain, British Prime Minister, failed to succumb to these blandishments, a seemingly explicit threat could not be easily ignored. The Führer talked, according to the BBC's first hurried translation of his speech, of a weapon "which is not yet known, and with which we ourselves cannot be attacked." Mr. Chamberlain directed British Intelligence to determine the nature of this weapon, and Dr. R. V. Jones, who had been appointed Chief of Air Scientific Intelligence but eight days before, was commissioned with the investigation. Jones, a tall, solemn physicist who had served his "apprenticeship" under the capable tutelage of Professor F. A. Lindemann at the Clarendon Laboratory, was invited to sift the accumulated Intelligence records and to draw up a report on his conclusions.

The very earliest agent's report, dating back to June 1934, had recorded the inauguration in Germany of a course in bacterial warfare;

a thorough search of all other relevant files in the Secret Intelligence Service (SIS) revealed to Jones, however, that a rather wider spectrum of devices existed to which Hitler might conceivably have been referring. Jones resolved to examine again Hitler's wording for some clue to the precise nature of the threat.

The key sentence could more properly have been translated as: "The moment might very quickly come for us to use a weapon with which we ourselves could not be attacked." There was no reference to any specifically novel weapon being employed; and Professor Norman, of the German Department at King's College, London, confirmed after listening to the BBC's own recording of Hitler's broadcast that Hitler seemed to have been using "weapon" to mean a "striking force" in general and probably his *Luftwaffe* bombers in particular.

Doctor Jones's effort had not been wasted; the scare had given him the opportunity of assessing with the eye of a physicist the secret-weapon reports on file. Jones reported to his superiors on November 11, 1939:

There is a number of weapons to which several references occur, and of which some must be considered seriously. They include: bacterial warfare; new gases; flame weapons; gliding bombs, aerial torpedoes and pilotless aircraft; long-range guns and rockets; new torpedoes, mines and submarines; death rays, engine-stopping rays and magnetic mines.

OVER FIVE years British Intelligence had received twenty-two reports indicating that Germany was studying bacterial warfare; the poison-gas threat was also acute, as the competent agency had (accurately) indicated that the enemy's arsine gases could penetrate the civilian masks in Britain "and might then cause panic."

Only one source spoke of rocket development in Germany, a "scare report" dated October 17, 1939: a "Professor Otto H. Schmidz," formerly of Krupps, had set up a workshop near the coast between Danzig and

Königsberg, and perfected a “rocket shell” capable of carrying 320 pounds of explosive over ranges up to 300 miles. This projectile was claimed to be launched from a gun, its motor firing only after it had ascended some 13,000 feet. The SIS had picked up no other reports of German long-range rocket development.

NO SOONER had Jones forwarded his report to his superiors than a first pointer arrived that there was a secret-weapon establishment at Peenemünde on the Baltic coast. The British Naval Attaché in Oslo had received an anonymous letter offering to report on certain German technical developments; its author is believed to have been a “well-wishing German scientist.”

His fatherland paid dearly for his benevolence: the “Oslo Report”^{*} claimed that among the weapons being tested at a large experimental establishment at Peenemünde was a radio-controlled rocket-glider for attacking ships; the weapon – which went into operation only in September 1943 as the *Hs.293* – was described in some detail, and identified by its secret number, *FZ.21*. Further, the Germans were reported to be operating two kinds of radar equipment and to be developing long-range rockets. As yet, the Intelligence service was unable to evaluate the Oslo Report. In the absence of a unified scientific Intelligence service, embracing all three arms of the services, the whole attack on German research into long-range bombardment weapons produced no further results for two years.

British Intelligence heard nothing more, either of the long-range rocket or of Peenemünde, until the last month of 1942. Even if the detection in the intervening years of two kinds of radar in Germany, *Freya* and *Würzburg*, and the confirmation of other prophecies implicit in the 1939 Oslo Report did seem to indicate circumstantially

^{*} Since published in full by F. H. Hinsley, *British Intelligence in the Second World War* (HMSO, 1979), appendix 5.

that Peenemünde might be worth closer scrutiny, no photographic reconnaissance of the site was detailed until early in 1943.

(II)

At the time of the Oslo Report work had been in hand on Germany's A4 long-range rocket, later known as V-2, for over three years. The rocket, a 50-foot-long, 13-ton projectile, was "unit four" in a series of liquid-fuelled test-rockets, or *Aggregat*, on which an expanding team of German scientists, financed by the German Army and directed by the remarkably youthful Dr. Wernher von Braun, had worked since 1932.

In 1930, the German Army Weapons Office had established under a *Reichswehr* captain, Walter Dornberger, a special unit to develop military rockets.

Dornberger was then thirty-five, the son of a Giessen chemist; after a grammar-school education he had served in an artillery regiment until his capture in October 1918. While still an Army officer, he had studied engineering at the Berlin Technical Institute, passing out in 1929 with distinction.

On August 1, 1932 Dornberger recruited von Braun, and had him posted to his "Ballistics Office" in Berlin. Together with a liquid-oxygen engineer, Walter Riedel, Dr. von Braun was provided with an experimental ground at the Army proving ground Kummersdorf-West, and given sufficient funds to experiment on rocket motors. Their first motor was a combustion chamber of a unique design: it was fuelled with liquid oxygen and alcohol, and developed a thrust of over 600 pounds.

The Kummersdorf team's first *Aggregat* was a short projectile weighing only 330 pounds: A1 was top-heavy and failed to fly. When Adolf Hitler was shown these experiments during a visit to Kummersdorf in October 1933 he showed little interest, and only the clandestine subvention of the "liquid motor" project by Dornberger's office kept

it alive. When the new motor developing a 1-ton thrust was functioning, Dornberger showed it to Field-Marshal Walter von Brauchitsch at Kummersdorf; its deafening roar moved Brauchitsch to approve all Dornberger's immediate requests.

Dr. von Braun's team designed a second rocket, A2. Two were launched from Borkum island in December 1934. Their predecessor's instability had been overcome by the provision of gyro-stabilisers: the rockets soared to over 7,000 feet.

Nevertheless, the A2 could "scarcely be regarded as more than an interim solution, with no refinements," as von Braun warned the Weapons Office on January 18, 1939.

IN DECEMBER 1935 von Braun visited his native Pomeranian countryside to select a location for a new rocket establishment. He selected the secluded Peenemünde area. The blue skies which canopied this Baltic island paradise were ideal for firing trials; Stettin, the nearest city, was seventy miles away; and, above all, they had a 300-mile water-range along the southern shores of the Baltic along which they could fire, with numerous islets on which to position tracking stations.

In collusion with the Air Force, the whole of the island's Northern Peninsula was purchased in April 1936 and barricaded against the curiosity of the outside world. Air Force engineers built an airfield, housing estates, laboratories and rocket test-stands along the eastern shore.

The Army's development of the A3 rocket proceeded here unmitigated by considerations of security. Like its predecessors, it was to be powered by the combustion of 75 per cent ethyl alcohol in liquid oxygen; the newly designed motor developed a 1-ton thrust. In a 1937 memorandum to the War Office von Braun promised: "the liquid-fuelled rocket ultimately intended for military use will be about twice as long as A3, about forty-two feet long instead of twenty-two." Calculations suggested that A4 would, given a thrust of 20 tons, carry a 1-ton payload – an HE warhead – over a range of 160 miles.

The behaviour of the early A3s crushed any hope of an early change-over to the full-scale military rocket. Many crashed prematurely; to control the rocket's flight at low take-off velocities, four molybdenum rudders were placed inside the rocket exhaust itself, but even with these, the slightest lateral winds were sufficient to deflect the rocket on take-off. The military rocket A4 was shelved, and a pure test vehicle, the A5, was interpolated in the programme.

BY THEN an expensive construction programme had converted Peenemünde into the most advanced experimental station in the world. In the pine forests large areas had been cleared, test stands constructed, laboratories and workshops put up. On von Brauchitsch's orders work had been begun on a pilot factory for exploring mass-production techniques for the A4 rocket; mass production was to start in September 1941. Peenemünde had the world's most powerful wind tunnel, of 40-centimetre cross-section. At one end a large sphere was evacuated by vacuum pumps. When dried air was "sucked" violently through the tunnel, velocities in excess of Mach 4 were realised.

There were also a power station, liquid-oxygen factory, and numerous other plants, all in the cause of added secrecy. Some military circles harboured doubts whether the war would last long enough for Germany to benefit from Peenemünde.

In October 1939 mass production of the still-untested A4 was brought forward to May 1941 by the War Office. The weapon's accuracy was overestimated: a specification quoted 100 per cent accuracy zones as being 1,100 yards in range and 550 yards in azimuth, at a range of 170 miles. This would have permitted an accurate attack on Whitehall, for example. Major-General Carl Becker, the Weapons Office chief, was cautious: seeing General Franz Halder on September 26, he talked only of the A4's development "within three to four years."

In November, however, Hitler effectively concluded that he would not be needing rockets in this war. In a priority list issued eight months later Peenemünde was conspicuous by its absence, and it was not un-

til the failure of the “Battle of Britain” that Hitler in November 1940 recalled the project.

Four months later rocket development was accorded SS rating, the then highest priority prefix in Germany.

The material demands were enormous. Peenemünde’s budget for 50.4 million Reichsmarks for 1941-2 was disapproved and finally cut by half. A new programme was set up, calling for the first test launching in February 1942 and for mass production two months later, but lack of manpower made these demands impossible.

To strategists familiar with the achievements of manned bomber forces, the A4 rocket, with its costly mechanism, exotic fuels and 1-ton warhead, seemed irrelevant and a military absurdity; but its development was directed by the Army and an artillery officer, and to an artillery officer it seemed the ultimate weapon: how puny were the shells fired at Paris in 1915 in comparison with the 1-ton warhead of the A4!

Hitler was sceptical; when his new Minister of Munitions, Albert Speer, outlined the project to him early in March 1942, he directed Dornberger to write a purely theoretical appreciation of the industrial investment required to manufacture the hydrogen peroxide necessary to fuel 3,000 A4s monthly. If the requirement could not be met, the German Navy would be given the peroxide for its weapons and the A4 project wound up.

Even as these discussions were continuing at the Führer’s headquarters, misfortune befell the first A4 prototype at Peenemünde: on March 18, 1942, after three weeks of exhaustive tests, the first rocket exploded during a combustion chamber trial. Next day the Air Force jealously requested permission to make a “theoretical investigation” of the Army’s rocket project. Speer stood firm, and Hitler supported him, while repeating his desire that the logistics of launching 3,000 rockets monthly should be gone into.

Colonel Dornberger was dismayed less by the failure of the first A4 than by Hitler’s bombastic demands. The A4 was a sophisticated

weapon, and he could see no possibility of its output reaching such high levels. It was not until mid-April that his memorandum, "Proposals for Employing the A4 Long-Range Rocket," was circulated.

Hitler had added the demand that the offensive begin with the rapid launching of at least 5,000 rockets. Dornberger warned that this was out of the question. The supply of the necessary 2,700 tons of hydrogen peroxide was no problem compared with the 75,000 tons of liquid oxygen, a commodity which could not be easily stockpiled; over a whole year, only 26,000 tons could be provided.

Even if the "mass attack" were to comprise only 100 rockets launched in an eight-hour assault, the training of three rocket battalions (*Abteilungen*) would be necessary. This candid memorandum embarrassed the War Office and "for security reasons" all but a few of the thirty copies were recalled.

* * *

At Peenemünde work pressed ahead on the second A4 prototype. In the last days of April 1942 it was delivered to the test stand, and delicately assembled. The motor was run cold, to test the fuel injection system. On the May 14 the first hot test was run. Next morning as the rocket still glistened on its towering gantry over the cooling pit in the centre of the elliptical Test Stand VII, a solitary RAF reconnaissance aircraft droned across the sky, its film recording the peaceful image of the Peenemünde Hook and the "heavy constructional work" below.

Still the British suspected nothing.

For a month the Peenemünde engineers tinkered with this second prototype, changing the combustion chamber, adjusting the telemetering controls, and preparing for the blast-off. On June 13, 1942, at 11:52 A.M., the loudspeakers throughout the Army site started the countdown, and the thousands of foreign labourers were locked indoors "for their own safety."

The rocket lifted majestically off its launching stand and lumbered

up towards the leaden sky; but even as it rose the rocket slowly began to rotate and wobble; it was still oscillating as it plunged drunkenly up through the low clouds.

The radar stations tracked its ascent for 16,000 feet; it had already broken the sound barrier, when its motor cut.

Ninety anxious seconds after lift-off the rocket's empty carcass screamed down through the cloud layer to smack into the sea a mile from the test stand. Dr. von Braun's second A4 rocket had failed.

SPEER DID not conceal his disappointment when he arrived at Hitler's headquarters ten days later to report on the outcome.

Hitler gave full expression to his doubts that it would ever be possible to aim the weapon properly. His mind seemed far away; he seemed more interested in the German Air Force's developments, among which the *Fritz-X* homing bomb and the *Me.163* and *Me.262* fighter aircraft – rocket- and jet-propelled respectively – seemed more promising. It may well be that Dornberger's paper on rocket warfare, with its implicit rejection of the Führer's ambitions for the Army's A4, had somehow reached him despite its recall.

Soon after noon on August 16 Dr. von Braun's third A4 rocket was launched; the rocket remained stable throughout the first four seconds of flight, but then its internal electric power supply failed, causing its telemetering responders to die out.

The deaf-mute rocket roared aloft unawares, tracing a jagged condensation trail up into the sky. At 35,000 feet, and more than twice the speed of sound, the motor cut out fourteen seconds early, and the rocket blew up.

At a full-scale post-mortem attended by Peenemünde's leading engineers, including combustion-chamber expert Dr. Thiel, it was deduced that the sudden loss of acceleration had torn the fuel tanks loose and the liberated fuel had blown the missile up.

This renewed disappointment was too much for some of von Braun's subordinates, and voices were raised against this inordinately

young engineer. Von Braun, unconcerned by the unsettled atmosphere, returned to his drawing office at Peenemünde's Block Four, and raised his demands for perfection even higher.

At four o'clock on the afternoon of October 3, 1942 the fourth A4 prototype lifted easily off its launching stand at Test Stand VII and roared over 118 miles along the Baltic coast, to impact less than 4,000 yards from the predicted target.

A score of cameras had filmed the rocket's ascent. Future historians may well find it significant that on the stern a Peenemünde technician had painted a young lady sitting astride the moon. Von Braun commented that the only trouble was that the rocket had landed on the wrong planet.

While Colonel Dornberger fixed his eyes firmly and properly on the military specifications issued by the Army Weapons Office, Dr. von Braun's thoughts seemed to be elsewhere.

(III)

Hitler was unimpressed when Reichsminister Speer reported to him. When Speer tentatively proposed two versions of the A4, one to traverse about 180 miles and the other 100 but with a heavier warhead, Hitler "regarded the proposals as most valuable," but stressed again that A4 made sense only if 5,000 were available for the first massed attack.

At that time he had not seen a giant rocket launched; and by the time he saw film of the October triumph nine months would have been lost. Three more A4s were fired from Peenemünde-East's Test Stand VII before the end of 1942.

None could equal the triumph of October 3. Even so, the intoxicating sight of the 13-ton rocket blasting aloft atop a lengthening pillar of fire and condensation, and the deafening roar of its motor echoing back across the sea – these were more than enough for Speer. He drafted a decree for mass production, and on December 22, 1942 Hitler signed it.

Hitler approved the recognition of Peenemünde as on an equal footing with any “giant industrial concern”; Peenemünde was to be granted unlimited financial resources, while Dornberger was to be granted dictatorial powers in furthering production at Peenemünde and the Zeppelin works at Friedrichshafen.

On January 11, at a meeting of A4 project experts at the Army Weapons Office in Berlin,

Dornberger outlined the division of effort: Peenemünde would accept the main contract, for altogether 6,000 missiles, and subcontract half of the production to the Zeppelin works.

Speer and Hitler met in the first few days of the new year. Hitler – who had heard of experiments being conducted in America with long-range rockets – urged Speer to find out how far their control beams could be interfered with.

The Minister outlined to him the current proposal for launching A4 rockets from large “bunker” sites in the Cap Gris Nez area of Northern France, and Hitler approved a comprehensive survey of France by Dornberger’s engineers.

On January 15, Speer appointed Gerhard Degenkolb to preside over a new “Special A4 Committee” in his ministry. The committee’s tasks would be to find the necessary component production capacity in widely dispersed localities, and to establish assembly plants for the rockets themselves.

Colonel Dornberger made no secret of his intense dislike for the physically bovine Degenkolb, whose admitted dynamism would hardly benefit the A4 project, he thought.

A former director of the Demag engineering works, Degenkolb had achieved notoriety for his ruthless emergency locomotive construction programme and had won from Hitler an *ex gratia* payment of over £20,000.

It certainly seems fair to evaluate his contribution to the fantastic A4 programme more positively than has Dornberger: Gerhard Degenkolb brought the same cold wind of industrial necessity to bear

upon rocket production as did Lord Beaverbrook on British fighter production in 1940.

(IV)

The German Air Force team in Peenemünde-West watched all this with considerable disquiet.

They had seen the A4 rockets roaring into the sky from the test stand south of the airfield; indeed, the flash was visible for hundreds of miles around. "The German Air Force," Speer observed succinctly during a post-war interrogation, "was disturbed that the Army alone would be bombing London"; and again: "they protested that the Army was sprouting wings." They attended their own long-range bombardment programme with redoubled vigour.

Their hopes were vested in a small expendable pilotless aircraft, about the size of a small fighter, and able to carry a 1-ton warhead to targets at ranges up to 160 miles.

The Argus firm had been working intensively on such a project since March 1942. The power unit was already at hand, based on Dr. Paul Schmidt's pulse-jet unit: the slipstream was ducted through loose flaps into the "engine"; low-octane petrol was ignited in it, and the resulting explosion closed the flaps and forced the aircraft ahead. The flaps were reopened by the slipstream, and the cycle repeated itself. The unit made a noise not unlike a badly-silenced motor engine.

The Kassel aircraft firm of Gerhard Fieseler developed the airframe under the guidance of Robert Lusser, their Technical Director. At Field-Marshal Erhard Milch's air armament conference on June 19, 1942, representatives of both Fieseler and Argus were able to persuade him to give high priority to its production.

THE SIMPLE design of this pilotless aircraft in turn alarmed the German War Office, which had invested so much in its rocket: on October 9, 1942 Dornberger's department wrote to von Braun requesting him

to establish by discreet inquiries any weaknesses of Milch's secret weapon.

Von Braun sent in a seven-page report on the flying bomb:

It is powered by a so-called "Argus duct" developing six hundred and seventy pounds thrust; the duct is a further development of the Schmidt jet and is mounted on a special bracket above the tail. As the missile cannot take off by itself, it is catapulted from a 230-foot-long ramp. Flight steering is effected by a triple-axis Askania gyroscope, monitored by a magnetic compass. Von Braun added that the weapon would fly at 470 miles per hour and at any altitude between 700 and 6,500 feet; and aerodynamic trials of the weapon were planned to start around November 10, when a flying bomb would be released over Peenemünde airfield.

Rumour spoke of an initial "dummy" catapult-launching success a few days before. But he felt that producing 1,000 flying bombs monthly from the summer of 1943 – as the Air Force intended – was out of the question, as catapult shortcomings, high take-off "g," bad weather and problems of reliable flight measurement would cause delays.

On the other hand, the flying bomb would cost only 10,000 Reichsmarks, compared with A4's estimated 30,000*; the Air Force already had factories (Argus, Fieseler and Rheinmetall) tooled up for flying-bomb production; and its independence of radio control made the weapon "unjammable." Nevertheless, Dr. von Braun (correctly) predicted that the Army rocket's warhead and its Mach 4 "bow-wave" would cause considerably more havoc than the Air Force's weapon, in spite of its comparable payload.

* Dr. von Braun's comparison was unduly optimistic. Actual costs in mass production of the flying bomb and rocket were closer to 1,500 Reichsmarks (£125) and 75,000 Reichsmarks (£6,300) apiece respectively. (See the Appendix.)

Early in December 1942, Gerhard Fieseler flew over Peenemünde in a bomber and released the first flying bomb on an unpowered flight test. On Christmas Eve one was catapulted without a hitch.

The news spread rapidly through the Air Force; on January 3, 1943 Lieutenant-General Walter von Axthelm, C-in-C of German Anti-Aircraft Artillery, visited Peenemünde to see a launching for himself. Impressed, he told the Chief of the Air Staff that this was the simplest method of attacking targets at distances up to about 225 miles without risk of casualties.

Von Axthelm was concerned to find that Milch had plans mapped out for a number of giant “bunkers” on the Channel coast, to house everything necessary for continuous launching in face of the sternest enemy counter-fire. He reminded Milch that such massive construction works would be bombed long before completion; their supply lines would be similarly vulnerable. In their place he suggested that the Air Force erect about 100 small but mobile firing sites: the enemy could not destroy all of them.

Milch adhered to his plan for eight giant launching bunkers, to be code-named “water-works.”

It was agreed to leave the final decision one way or the other to Reichsmarschall Hermann Göring.

(v)

On February 24 the Special A4 Committee’s production planning board circulated a mass-production programme for the rockets. The programme was reasonable and moderate. Its author, Detmar Stahlknecht, a highly qualified engineer on the staff of the Munitions Ministry, had previously been engaged on the supply of duralumin and special steels for tank construction. His programme envisaged that the Peenemünde pilot factory would produce all the A4s until July 1943, when Friedrichshafen would begin. From December 1943 the monthly output would be equally divided between the two factories,

rising to a maximum of 300 each after September 1944.* This output was close to what was finally achieved.

Early in March hopes at Peenemünde were dashed by sombre news from Hitler's headquarters: Speer, who had paid a five-day visit to the Führer from March 5, reported in agitation to Colonel Dornberger that Hitler had dreamed that no A4 would ever reach England, and had ordered research to be halted.

This at any rate is what Speer told Dornberger. The latter bewailed that they now not only had to contend with red tape and lack of vision but also with "the dreams of our Supreme War Lord."

In fact, it seems unlikely that Hitler ever had this dream; Speer made no reference to it either in his highly regarded Führer conference minutes or in the daily chronicle of his Munitions Ministry office.

A more analytical explanation would be that Speer had perceived a change of mood in Hitler in recent months – late February had seen a series of disastrous launchings at Peenemünde with fires breaking out inside several of the rockets as they were launched – and, not wishing to forfeit his reputation as a power behind the scenes, had developed the theme of a "Führer's Dream" to covet his inability to win further concessions, especially the coveted *DE* top priority for which he and Dornberger had been campaigning since January. A false argument could be countered; a "Führer's Dream" could not.

Albert Speer himself did not lose faith as easily as his Führer. On the latter's orders he dispatched Professor Petersen, a director of *AEG*,

* The Stahlknecht A4 production programme foresaw the manufacture of a total of 5,150 rockets between March 1943 and December 1944:

1943		1944					
March	—	January	100	July	500		
April	5	September	80	February	100	August	550
May	10	October	100	March	100	September	600
June	20	November	100	April	200	October	600
July	35	December	100	May	300	November	600
August	50			June	400	December	600

to visit Peenemünde as chairman of a new Long-Range Bombardment Commission. On the 25th Petersen reported back to Speer, full of enthusiasm. Armed with this report, Speer was able to dissolve Hitler's pessimism. The Führer always brightened when mention was made of some wild and grandiose scheme; if it involved the use of hundreds of thousands of tons of reinforced concrete, he was ecstatic.

On the evening of the 29th, at a meeting on the Obersalzberg, Speer called on the Führer to show him the plans drawn up by the Todt Organisation for a giant rocket-launching "bunker" in Northern France, under the code-name "North-West Power Station."

Hitler approved the plans, but directed that if the rocket were not finally to materialise, the bunker should be convertible for billeting important military units on the Western Front.

A team of Peenemünde experts had already reconnoitred the Artois region of France at the end of December 1942 looking for a suitable site. Unlike the mobile batteries planned by Dornberger, the bunker's targets could be changed only by shifting the control-beam transmitter station in the hinterland; he had therefore to find a site from which as many English targets as possible could be taken under fire. A site in the Bois d'Eperlecques one mile west of Watten was chosen, commanding a 90-degree field of fire from England's eastern to southern coasts: The following features added to the suitability of the bunker's location [Dornberger reported]: (i) immediate access to good main roads; (ii) a forest environment; (iii) canal served; (iv) railway one mile away; (v) Watten railway-station one and a half miles away; and (vi) exceptionally favourable electricity supply.

The Todt Organisation guaranteed the labour and materials – no small guarantee for a construction project estimated to swallow up 120,000 cubic metres of concrete.*

* 120,000 cubic metres of concrete are nearly twice the annual requirement of a city the size of Cologne (765,000 population); and over thirty-two times the amount of concrete in the entire London Hilton Hotel.

The entire shell of the bunker could be complete in four months, by the end of July 1943.

The electricity situation was so favourable that a liquid-oxygen plant would also be transferred to the bunker when complete; the site would be served by three independent power grids, all of which would have to be destroyed to paralyse the battery.

How could Hitler refuse such a gigantic project? Here was a means of bombarding England, with no wastage of aircrew, and with no fear of direct counter-attack. Work was begun at once.

In Berlin, the first steps towards safeguarding A4 mass production were taken on March 24, at a conference of the Special A4 Committee. Sixteen leading rocket scientists, including Ernst Steinhoff, director of Peenemünde telemetry, and Friedrich Kirchstein, developer of the all-important radio-controlled cut-off, participated.

Air-raid precautions were analysed in detail, as the A4 project was by now at its most vulnerable stage: rockets were being fired almost weekly at Peenemünde and the Allies must surely be learning the most alarming details of this new threat; an air attack on Peenemünde or its associated component factories could in no way be ruled out.

With production blueprints still incomplete, a chance air attack might cause insuperable delays; coupled with the Führer's hesitancy over the whole scheme, it might even be a fatal blow. The Berlin conference decided:

All offices are to make sure at once – if not already done – either that production blueprints, special tools and so forth are specially sheltered or that spare sets are available at a second location.

Five months were to pass before the Royal Air Force could launch its first attack on Peenemünde; and by then these astute prophylactic measures had partly vitiated the attack's success.

Other measures to protect A4 were put in hand: five days after the Berlin conference, SS Reichsführer Heinrich Himmler met with Speer

at Hitler's Obersalzberg headquarters, and learned in detail of the German rocket programme.

DEGENKOLB HAD BY April been chairman of Speer's Special A4 Committee for three months. He had witnessed a rocket launching in Peenemünde, and had thoroughly studied the original mass-production plans.

On April 27 the Speer Ministry cancelled the Stahlknecht programme and substituted for it the "Degenkolb" programme for mass production of A4 rockets. It provided for the assembly by December 1943 of a monthly total of 950 A4s at three factories: at Peenemünde, Friedrichshafen and Henschel's Rax Works at Wiener Neustadt.*

Two days after details had been circulated to his department heads at Peenemünde-East, von Braun summoned a conference to untangle the thickening web of conflicting authorities, and to brief them on their demeanour towards Degenkolb and his committee. Von Braun did not share Dornberger's mistrust of the engineer. He advocated a more reasoned approach, realising that the scientists would have to cooperate with Degenkolb if only to avoid losing the support of Speer.

On April 30 von Braun circulated a memorandum to department heads, warning them:

The initial production programme drawn up by Director Degenkolb, as Director of the Special A4 Committee, is henceforth to be regarded as the only valid programme on which to base further

* This Degenkolb programme was the last official rocket-production programme for the A4 in Germany:

Up to April 1943	50	August	120
May	40	September	350
June	50	October	650
July	70	November	900
		December	950

plans. All previous production programmes are to be considered superseded by the Degenkolb programme.

He added a cold reminder that Degenkolb had pledged to Speer that he could maintain this programme, with its seemingly impossible rocket outputs, provided that the Peenemünde establishment was genuine in its undertaking that 80 per cent of the production drawings were already complete and that the remainder would be ready by July. Von Braun did not consider this undertaking impossible and, while Dornberger was spreading black rumours about Degenkolb's villainous character, von Braun issued instructions designed to ensure that all blueprints were dispatched on time.

On May 4 Colonel-General Fromm wrote to Dornberger that "in view of the imminent mass production of A4 missiles" he would require the vast rocket-launching bunker at Watten in Northern France to be operational for November 1, 1943. On that date, apparently, the German Army was planning to open its attack on London.

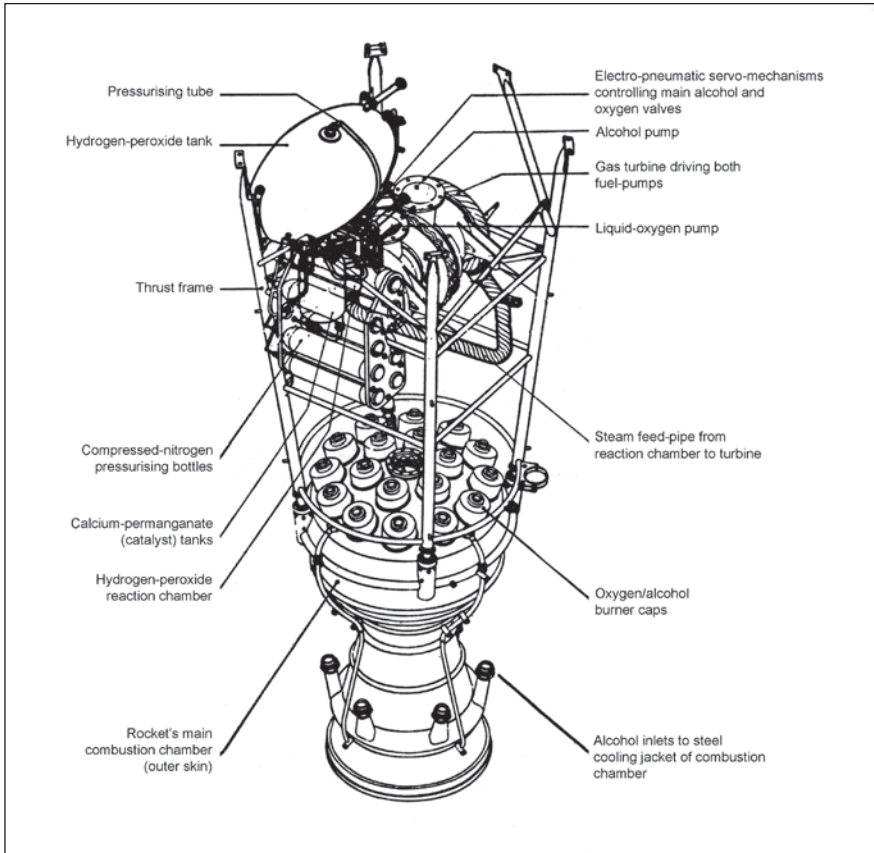

THE A4 ("V-2") ROCKET'S MOTOR ASSEMBLY

One of the best designed components of the A4 rocket was the thrust frame which attached the combustion chamber to the rest of the rocket and fuel system: it was extremely light in construction, yet it successfully transmitted the 25-tons thrust to the missile and withstood the considerable vibrations to which the weapon was subjected. The gas-turbine driving the fuel pumps was powered by hydrogen peroxide, of which 130 litres were contained in the small ellipsoidal tank; this liquid in turn was expelled from the tank by compressed nitrogen from the rack of bottles.

Based on an original in the Peenemünde archives

PART TWO

THE INTELLIGENCE ATTACK

“The following specific targets of the enemy’s Intelligence network have come to the attention of the High Command’s military Intelligence service:

- (i) what is our present tank output?
- (ii) what is our present aircraft output?
- (iii) what kind of new weapons does Germany plan to use in the coming total warfare?”

— *From a warning issued by Admiral Canaris’s military Intelligence service to the German Army districts at the end of May 1943.*

PART TWO

The Intelligence Attack

(I)

LATE IN THE AUTUMN of 1942 the first new Intelligence reports trickled into London suggesting that the Germans were developing long-range rockets.

The Allies were not unduly surprised: Military Intelligence had been receiving scattered reports of such experiments ever since October 1939, but little more was heard to link Peenemünde with rocket development.

The only interim report of note was logged in May 1940, announcing that a scientist called Oberth was collaborating with German military authorities on the production of a 30-ton rocket with a range of 160 miles at a site near Stettin. Professor Hermann Oberth was, in fact, one of Germany's most distinguished liquid-fuelled rocket experts, and was a close adviser of von Braun at Peenemünde.

Then, at the end of 1942, the first of three reports from a Danish chemical engineer arrived, seeming to clinch the matter. The first arrived on December 18 and, together with the others (the last of which was filed in March 1943), provided a comprehensive picture of current German rocket development. This source could not at first be checked; then this same engineer sent to London photographs of the German

Liechtenstein aerials on a night-fighter aircraft. This information was valuable to the RAF bombing offensive. This seemed to rule out the possibility that the Dane was a German “control.”

This agent had overheard some careless talk in a Berlin restaurant, according to which there had been trials, between November 30 and December 2, 1942, of a “large rocket” at a site near Swinemünde; it was said to carry 5 tons of explosive over ranges up to 130 miles. Its “danger area” covered 40 square miles.

In February a further report from a different source arrived: the German rocket, it maintained, could carry 10 tons of high explosive over a range of seventy miles. This second agent named the site where experiments were being carried out: Peenemünde.

British Intelligence could not investigate each secret-weapons report that came to hand. The only positive clue was the frequency with which reports of “German rockets” were logged: in 1939 there had been two; in 1940, one; in 1941, none; in December 1942, one; and now, by March 1943, there had been five already.

This suggested that the reports might not be without foundation.

Military Intelligence department 14(h) wrote on February 9, 1943 to Major Norman Falcon, chief Army photographic interpreter at RAF Medmenham. The letter was necessarily circumspect:

There have recently been indications that the Germans may be developing some form of long-range projectors capable of firing on this country from the French coast. The projector may be similar in form to a section of railway track.

We should therefore be grateful if you would keep a close watch for any suspicious erections of rails or scaffolding.

It is easy to point out only those agents’ reports which are known from hindsight to have been well founded, and question why these were not acted upon. But Intelligence work was always more complicated than that: active attempts made to accelerate the flow of Intelligence on

a particular theme could result in spurious reports, either deliberately planted by the enemy or “echoes” of feelers put out by the Allies.

But in March 1943 a report from the prisoner-of-war examination unit appeared to dispel doubts.

Two high-ranking German Army officers had fallen for one of the oldest tricks; the two – General Wilhelm von Thoma and General Ludwig Crüwell – had been captured in North Africa, kept separate for four months, and then on March 22, 1943 brought face to face.

They greeted each other as old friends, in a room elaborately wired for sound.

Von Thoma expressed surprise that London was not yet in ruins from a German rocket bombardment. The recording was the most telling indication yet.

Only disjointed scraps of the two generals’ conversation were audible; but they were enough. Von Thoma described how he had once visited a “special ground near Kummersdorf” where huge rockets were being tested; the highly optimistic major in charge (obviously Dornberger) had boasted that the rockets would go ten miles up into the stratosphere, and were unlimited by range.

A transcript was dispatched to Air Intelligence, where it reached the desk of Dr. F. C. Frank, who shared a room with Dr. R. V. Jones, chief of Air Scientific Intelligence.

Frank declared that it looked as if these rocket rumours would have to be taken seriously.

Von Thoma was regarded as an “intelligent pessimist,” but he had previously given the impression that his conversation was in good faith; certainly his information on other occasions had agreed with existing British knowledge. A plant, it seemed, could therefore be ruled out.

From this moment the character of the Intelligence problem changed: it became reasonable to accept that German long-range rocket development was an established fact.

(II)

Now the first distant murmurs of an inter-service dispute that was to rock the whole secret-weapons investigation from its roots in the Intelligence agencies right up to the highest levels of the War Cabinet became dimly audible; it began with a difference of opinion about who should be informed of the threat.

R. V. Jones, as scientific adviser to the SIS, strongly asserted that the few available details should not be given wider currency. "To spread half a truth," he had warned in a different context a few months earlier, "is often to precipitate erroneous action." He considered it the duty of Intelligence to collect and collate the facts and – at risk of criticism – to issue them only when a reasonably complete picture was obtained. "The presentation of the *complete* picture of an enemy development," he had then warned, "is the best way of stimulating the appropriate authority to action."

The War Office dissented: the threat was too grave for its knowledge to be confined to their respective Intelligence departments; a possibly decisive delay in operational counter-measures might be the result. Their Intelligence branch placed the whole matter before the Vice Chief of the Imperial General Staff, Lieutenant-General A. E. Nye. He summoned two scientists to advise him: Professor C. D. Ellis, Scientific Adviser to the Army Council; and Dr. A. D. Crow, who was in charge of all British rocket research at the Ministry of Supply.

On April 11, Nye authorised the circulation of a paper on "German Long-Range Rocket Development" to the chiefs of staff: this listed the various Intelligence reports since December and analysed their common features.

In addition to the reports from the Danish engineer, two others had arrived in March. One referred to a rocket some 50 to 60 feet in length, between 13 and 16½ feet in diameter, with a 550-pound warhead and radio control, being tested in Peenemünde. So far, the



*Dr. Wernher von Braun
at his desk in Block 4
at Peenemünde, shortly
after moving there from
Kummersdorf in 1937.*

*Three A4 rockets ready
for launching from Test
Stand X on the foreshore at
Peenemünde*





March 1941, and the generals come to see how the millions are being spent at Peenemünde. In front of Lübke and to his right is General Emil Leeb, chief of the Heereswaffenamt. To Leeb's left: Munitions Minister Fritz Todt; Peenemünde military commander Walter Dornberger; General Friedrich Olbricht, chief of the General Army Office (Allgemeines Heeresamt), and Dr. Wernher von Braun in plain clothes – careful as ever to wear the Party badge in his buttonhole (see picture at right). Todt will be killed in a February 1942 plane crash.



The mild-mannered Heinrich Lübke (circled) heads a construction company at the Peenemünde site, the Bauleitung Schlempp. He will be president of the German Federal Republic for ten years from 1959, and inevitably – and wrongly – accused of “using slave labour.”



DEUTSCHES MUSEUM, PEENEMÜNDE ARCHIVES





Looking apprehensive, Dr Wernher von Braun waits on top of the telemetry building at Peenemünde for the launch for the fourth A4 test rocket from Test Stand VII on October 3, 1942: aerodynamics expert Dr Rudolf Hermann (in light jacket) is no less anxious. Much depends on the success of this test.

It is a brilliant success - the missile hurtles 120 miles down the Baltic range. Afterwards (right) General Erich Fellgiebel, Chief of Army Signals, congratulates the commandant of Peenemünde East, Colonel Leo Zanssen, in the center. Between them is Walter Dornberger, with von Braun standing behind him and Hauptm Stölzel on his left, then Dr. Rudolf Hermann and telemetry expert Dr. Ing Gerhard Reisig. There will follow golden days for some, not for others. Fellgiebel joins the anti-Hitler plot and is executed in 1944. Dornberger, von Braun, and Hermann are headhunted by the Americans and direct the US space program.



MOST SECRET (British)

SECRET (American)

C. S. D. I. C. (U.K.)

S. R. REPORT

IF FURTHER CIRCULATION OF THIS REPORT IS NECESSARY IT MUST BE
PARAPHRASED, SO THAT NEITHER THE SOURCE OF THE INFORMATION NOR
THE MEANS BY WHICH IT HAS BEEN OBTAINED IS APPARENT.

S.R.A: 4977

(3X) A 881 - Unteroffizier (Bomber Air Gunner: Ju 188 3/KG 6) Capt'd 23 Dec 43
A 1472 - Stabsfeldwebel (Bomber WT Operator: Ho 177, FG 214/KG 40) Capt'd
CORSIKA 24 Jan 44.

Information received: 16 Feb 44

GERMAN TEXT

A 1472: Wenn die Vergeltung kommt hier, rauscht's noch einmal.

A 881: Glaubst du? Ich zweifle.

A 1472: Nein, ich glaube daran. Wenn es so durchgeföhrt wird, wie ich ungeföhrt
gesehen habe. Wart' nur, jetzt kommt die Vergeltung, man hat ja genug
Mittel. Die sind in der Beziehung ziemlich weit. Ich hab' so aller-
hand geschen. PEENEMÜNDE und so.

A 881: Warst du in PEENEMÜNDE?

A 1472: Ich habe da eine Mühle(?) bekommen(?).

A 881: Du meinst diese Raketensache?

A 1472: Präzise, bestimmt.

A 881: Ja präzise, ich meine, präzise ist ja auch ein Geschütz.

A 1472: Na ja, aber steuern ja nicht nach Sicht.

A 881: Ist das wirklich Fernsteuerung?

A 1472: Ja sicher, wir haben es doch gehabt bei uns.

A 881: Ich könnte verstehen, dass man eure Bomben fernsteuert, da sieht man doch
das gegnerische Schiff irgendwo. Steuert man sie hin. Aber, wenn du
an der KANAL-Küste stehst und willst LONDON beschliessen -

A 1472: Genau so wie die Artillerie indirekt nach Karte schießt, so lässt sich
das ausmachen. Man setzt bestimmte Strahlen da und setzt das Ding auf
den Strahl.

A 881: Aber das ist genau wie man früher gegen ENGLAND geflogen ist. Auf Kricka-
bein', haben die den Strahl abgelenkt.

DISTRIBUTION

BY C.S.D.I.C. (U.K.)

PUBLIC RECORDS OFFICE

The generals squawk, the signals talk: The hidden microphones in British CSDIC prison camps – illegal under the Geneva Convention – yield secret Intelligence about Peenemünde. Above, the captured He177 bomber radio operator “A-1472” unwittingly reveals what he knows about the A4 missile’s beam-control system to a curious cellmate, “A-881,” probably a British stool-pigeon planted on him.



Below: The Nazis' fabled "Enigma" code machine



Right: Afrika Korps commander General Wilhelm Ritter von Thoma gives himself up to the British in November 1942 at El Alamein. In March 1943 he is overheard talking about his visit to Peenemünde. His remarks about rockets are the first clue for physicist R. V. Jones, right, Britain's young chief of air scientific Intelligence. Jones calls for air photos, particularly after Peenemünde turns up in the "Enigma" machine signals being decoded by the British – "Enigma" is still a secret at the time this book is written, which Jones refuses to confirm to the author.





On May 26, 1943 the brass-hats comes to Test Stand VII at Peenemünde. At the extreme left is Dr. Walter Thiel, von Braun's rocket propulsion expert – who will die in the British air attack soon after, and next to him is Councillor Plendl, a high-frequency expert. The staff officer behind Plendl in a leather greatcoat is Colonel Claus Count Schenk von Stauffenberg, who will attempt to assassinate Adolf Hitler in July 1944. Behind him walks Infantry General Friedrich Olbricht – also executed after that plot – an unidentified officer and Grand Admiral Karl Dönitz, wearing a naval greatcoat. General of Artillery Heinz Brandt is seen in front of the A-4, hands behind his back. Colonel Walter Dornberger has turned to talk to the officer behind him, while Wernher von Braun in dark suit and Party badge follows to his left.



DEUTSCHES MUSEUM, PEENEMÜNDE ARCHIVES

In April 1943 mass production expert Gerhard Degenkolb sets up a program to manufacture A4 missiles increasing to 950 per month by the end of the year.





Fatefully for Germany, Munitions Minister Albert Speer (above, with Luftwaffe field-marshal Erhard Milch) backs the army's costly A4 rocket against the Luftwaffe's cheap and effective V1 flying bomb. Right: On June 23, 1943 a British reconnaissance Mosquito brings back this stunning photograph of Peenemünde. The interpreters quickly spot German rockets (A) and Meillerwagen trailers (B) ; but they wrongly identify the long object pointing out to sea from the airfield – (C) on the same photograph – as a length of pipe connected with offshore dredging. Only later is it realised that (C) and (D) are prototype flying-bomb catapults. All A4 rockets are test fired either from the elliptical Test Stand VII (E) or from its triangular foreshore, Test Stand X.

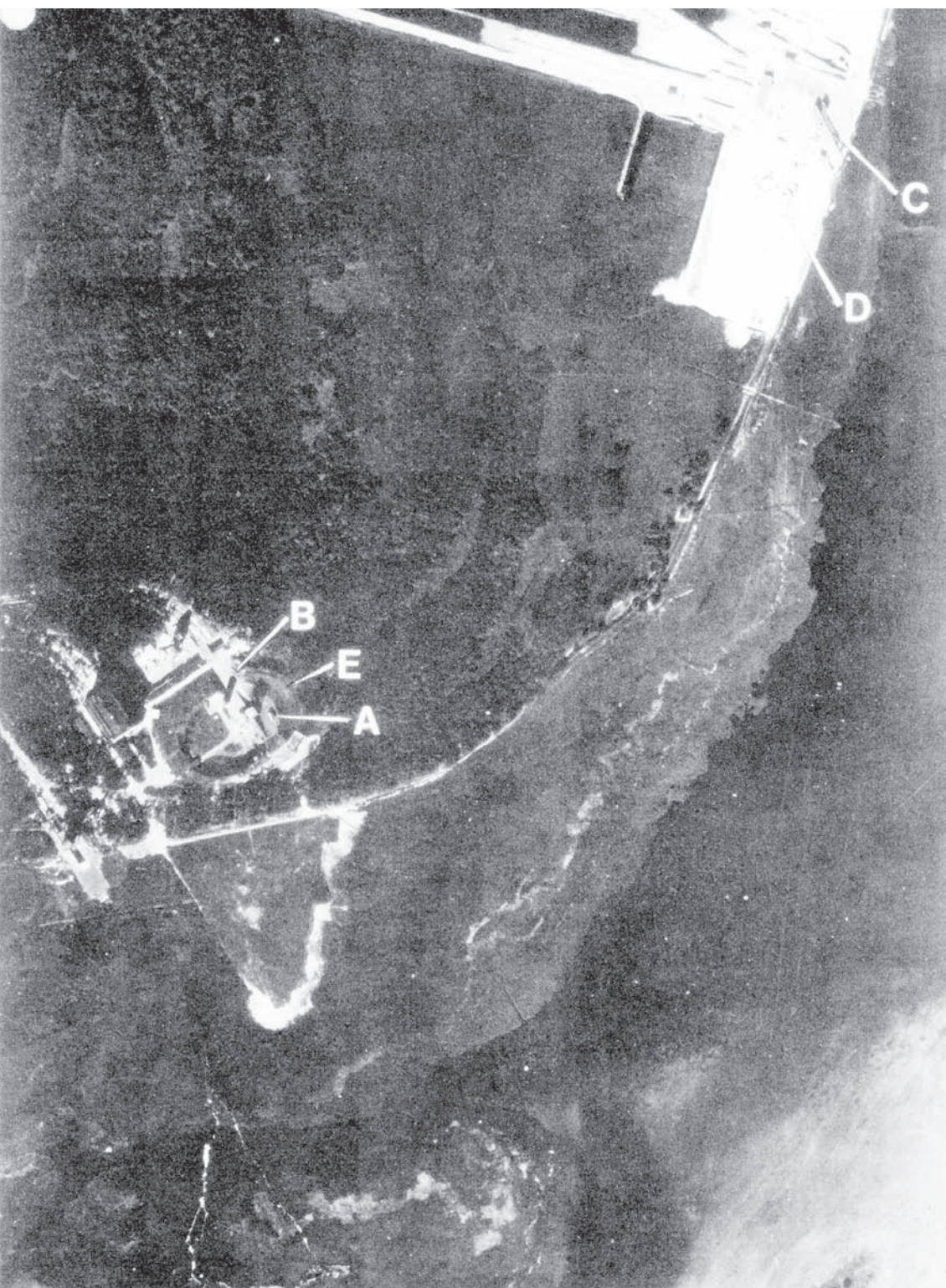

CROWN COPYRIGHT

Five days later, on June 28, 1943, the all-powerful Reichsführer SS Heinrich Himmler (with white scarf) pays his second visit to Test Stand VII at Peenemünde. On his left is Major-General Walter Dornberger, the military commander of the missile establishment. They see an A4 rocket launched, and it hurtles 145 miles along the Baltic coast.







Luftwaffe chief Hermann Göring (seen here with chief of air staff Hans Jeschonnek and deputy Erhard Milch) sets great store by the secret weapons work at Peenemünde. On the night of August 17, 1943, RAF Bomber Command wipes the smiles off their faces – and much of Peenemünde off the map too. Heralded by glittering showers of sky markers and flares, the RAF bombers kill 700 foreign workers and von Braun's top scientists. Jeschonnek takes his own life the next day.

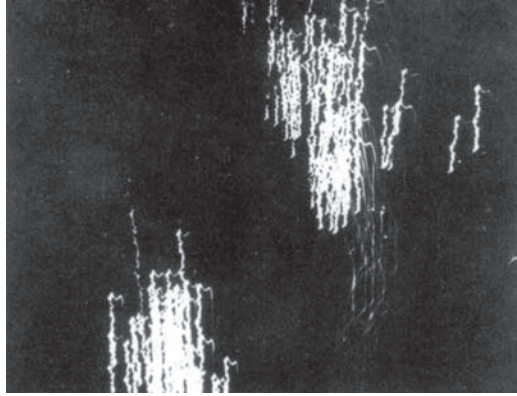

Above: Group Captain John Searby, DSO, the Master Bomber, fourth from left, and his RAF Pathfinder bomber crew.





Rugged and highly mobile, the A4 rocket can be hauled around the countryside on its mobile Meillerwagen transporter and launch rig. Here it is dragged into position on a dune near Peenemünde in 1944.



ERWIN LOWE - STOCKHOLM

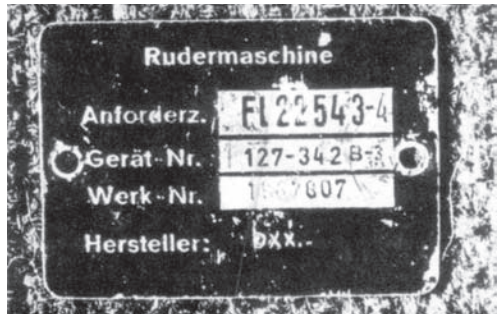
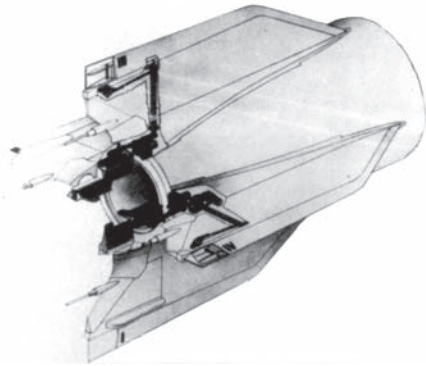

On June 13, 1944 an experimental A4 launched from Peenemünde comes down near Malmö in Sweden. British Intelligence buys the fragments, on which German engineers have methodically fastened identity tags like “Rudermaschine” – guidance-motor. Particularly valuable are the combustion-chamber (top, guarded by Swedish troops) and turbo fuel pump. Found among the wreckage are four graphite rudders inserted in the actual rocket exhaust (center). Servo motors apparently control both these rudders and the external fins, enabling the rocket to make its slow standing start.



VERITY PRESS FEATURES



GEOFFREY COLLIN

By 1943 a team of Shell International Petroleum Company engineers under Isaac Lubbock (above) has developed a rocket motor fuelled with gasoline and liquid oxygen – seen being test-fired above. Dr. A D Crow, Britain's Controller of Projectile Development, inspects it on May 7, 1943 and firmly dismisses the possibility that the Germans may also be using liquid fuels.



Sir Stafford Cripps first reports that giant rockets of the Peenemünde type are not impossible to make. Two weeks later he changes his mind.



Mr. Herbert Morrison's Ministry of Home Security grossly overestimates probable V-weapon casualties; but in doing so it triggers an "explosive scandal."

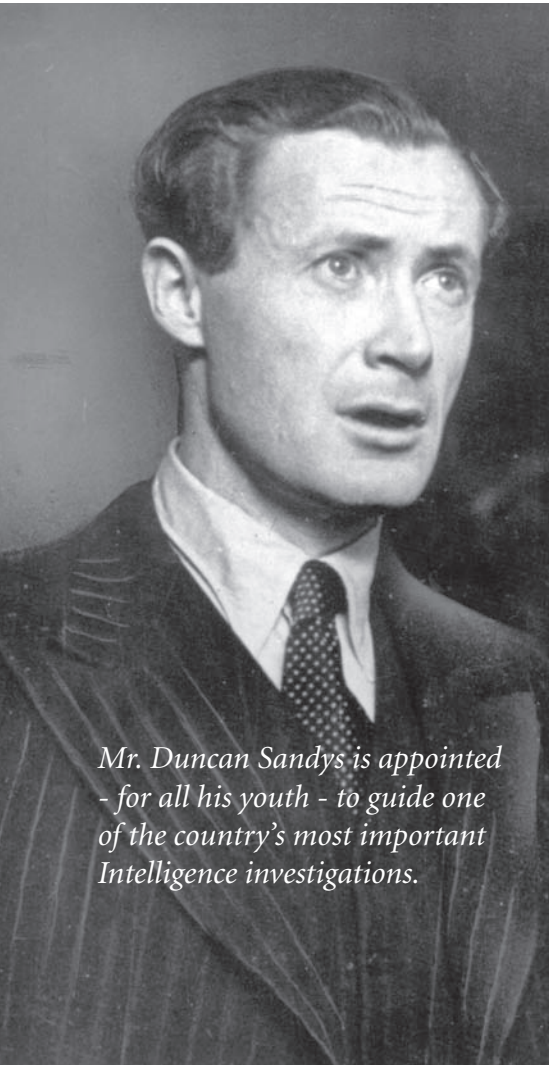

Mr. Duncan Sandys is appointed - for all his youth - to guide one of the country's most important Intelligence investigations.

BRIGADIER CHARLES LINDEMANN

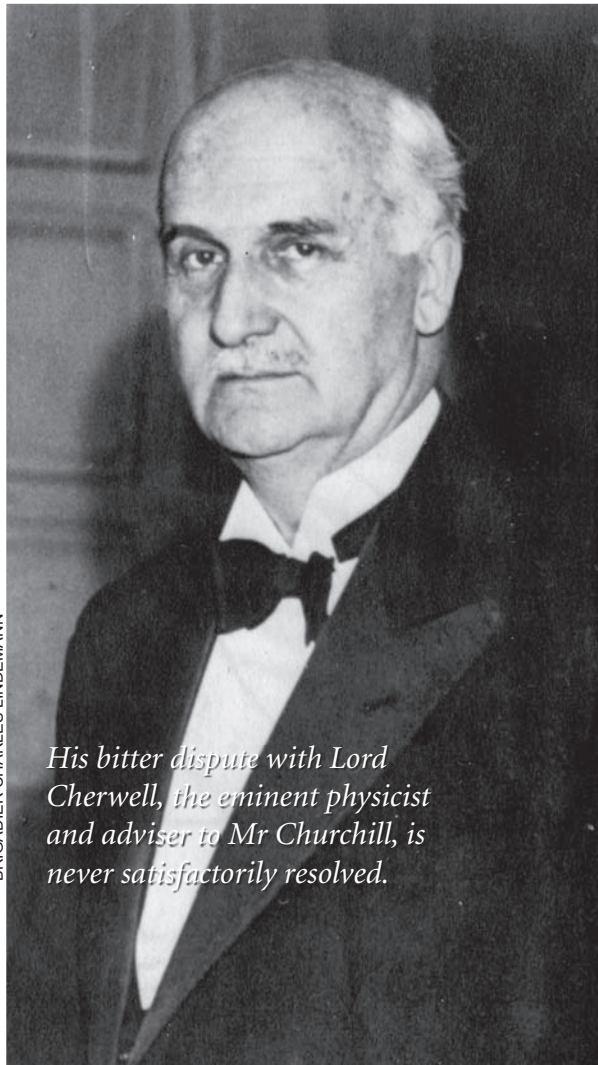

His bitter dispute with Lord Cherwell, the eminent physicist and adviser to Mr Churchill, is never satisfactorily resolved.



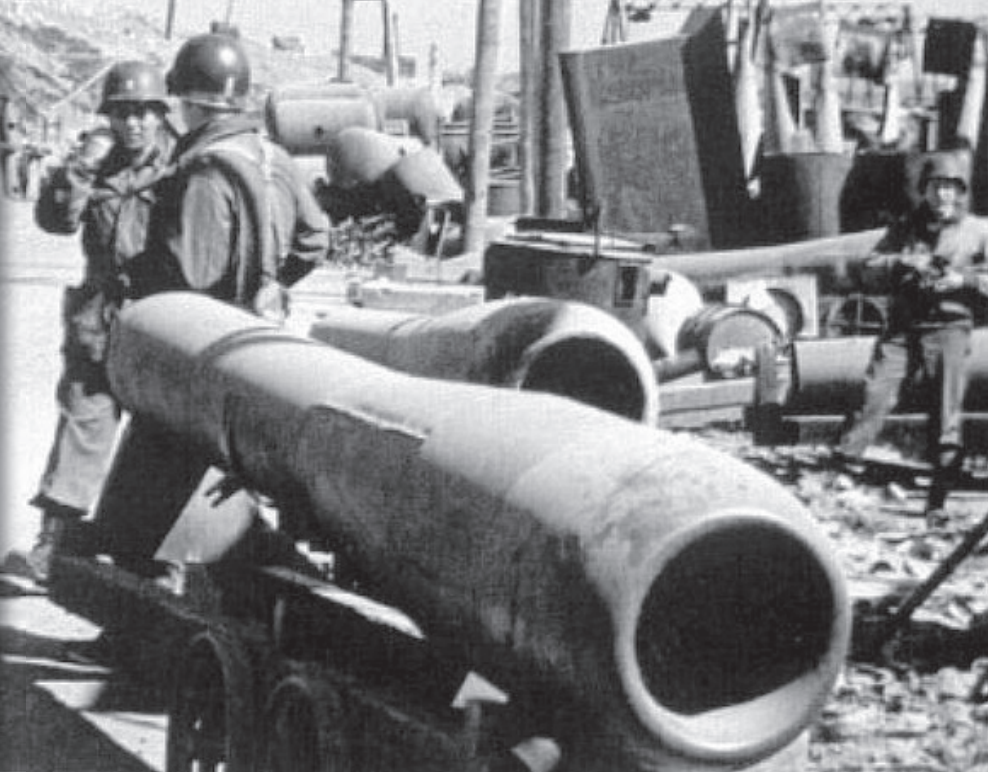

In April 1945 the U.S. First Army captures Nordhausen, and the secret of the “Central Works” is revealed – an immense underground factory beneath the Kohnstein mountain. On production lines crammed into three mile-long tunnels linked by forty-two connecting shafts slave labourers have operated the most modern equipment by daylight-lamps and turned out thousands of V2 rockets, V1 flying bombs, and jet engines for the Me 262.

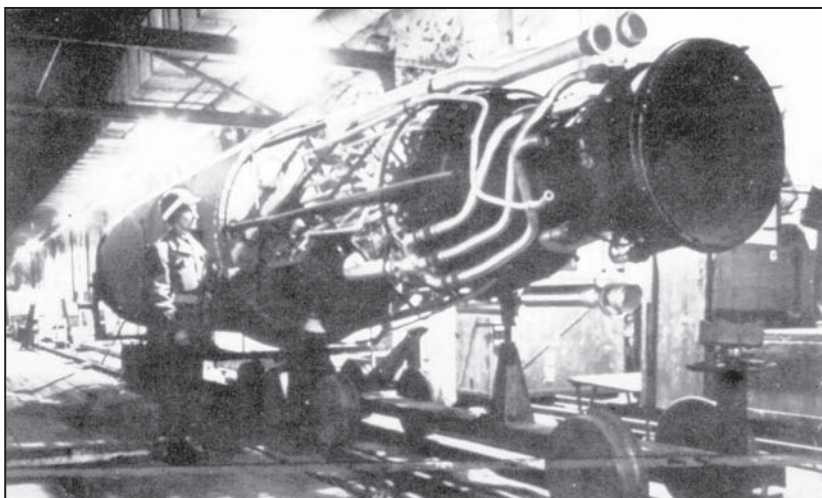

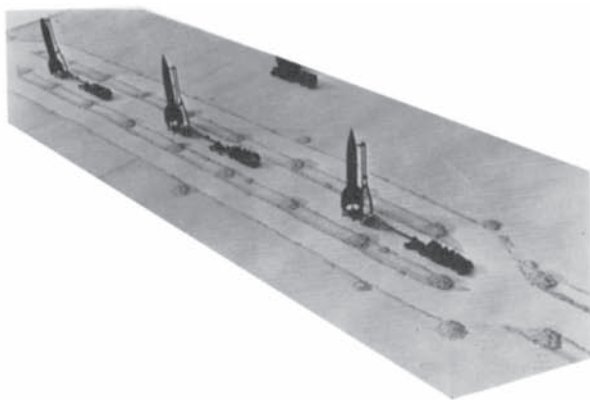
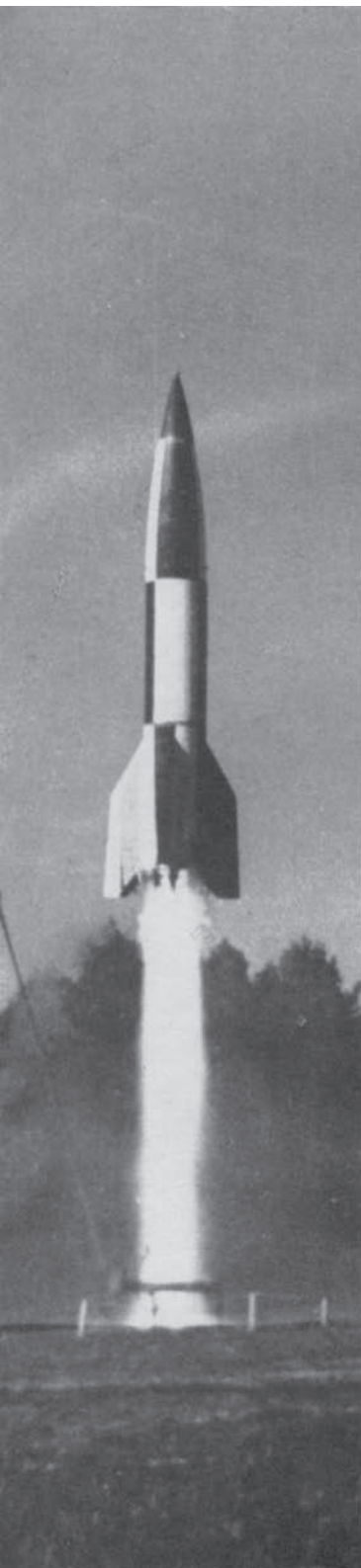

The A4 rocket units are pre-eminent for their mobility; the rocket itself needs no massive mortars or launching rails but launches itself from a simple firing table "shaped like a lemon squeezer". The rocket rises slowly, "as though pushed up by men with poles," as Polish eyewitnesses describe (left). The Meillerwagen trailer (below) is transporter, erector and launch rig combined.



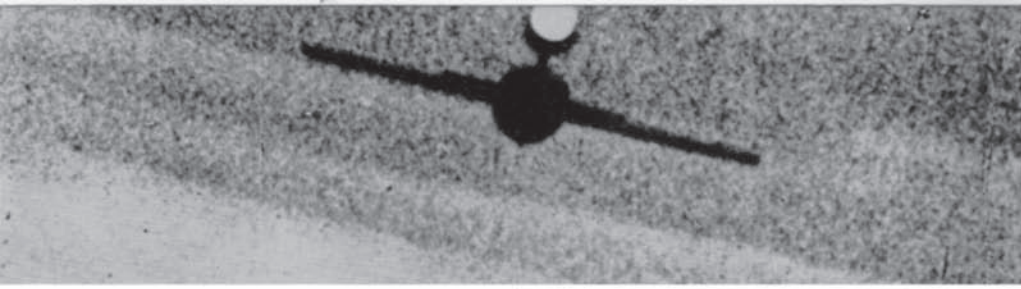

The German air force devises an ingenious and cost-effective pilotless aircraft, a cruise missile for attacking London and other large targets. Propelled at over 400 m.p.h. by a ramjet tube, the Fi.103 “flying bomb,” later called the V1, delivers a one ton warhead filled with a new explosive, Trialen, which packs the same punch as RAF Bomber Command’s 4,000-pound blockbusters. It costs little more than a Volkswagen to produce; it is manufactured first at the auto works in Fallersleben, later (below) in the subterranean “Central Works” tunnels at Nordhausen.

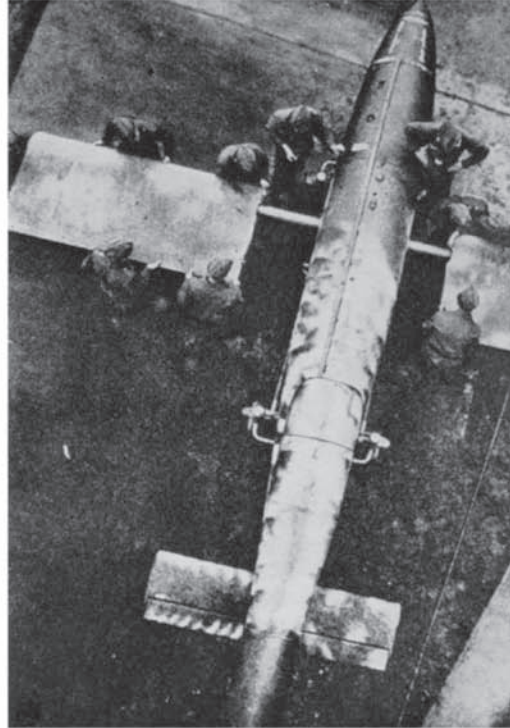

CROWN COPYRIGHT

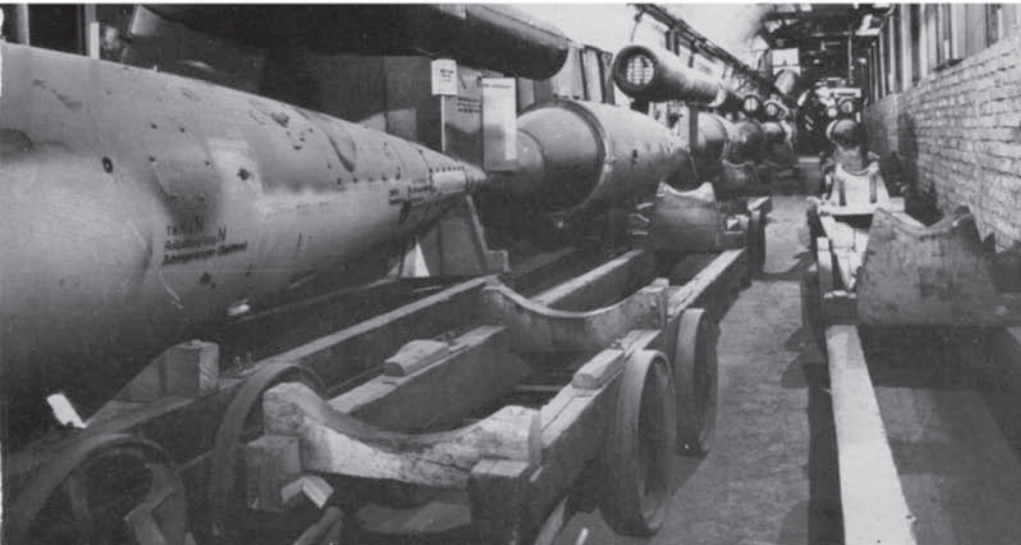



CROWN COPYRIGHT

A daredevil RAF pilot photographs the mysterious structure at Wizernes in the Pas de Calais, diving right into the quarry. Hitler predicts to Albert Speer that these missile silos will never be used. Half built and never completed, the domed launching site for A4 rockets consumes more concrete than the city of Cologne.





ULLSTEIN

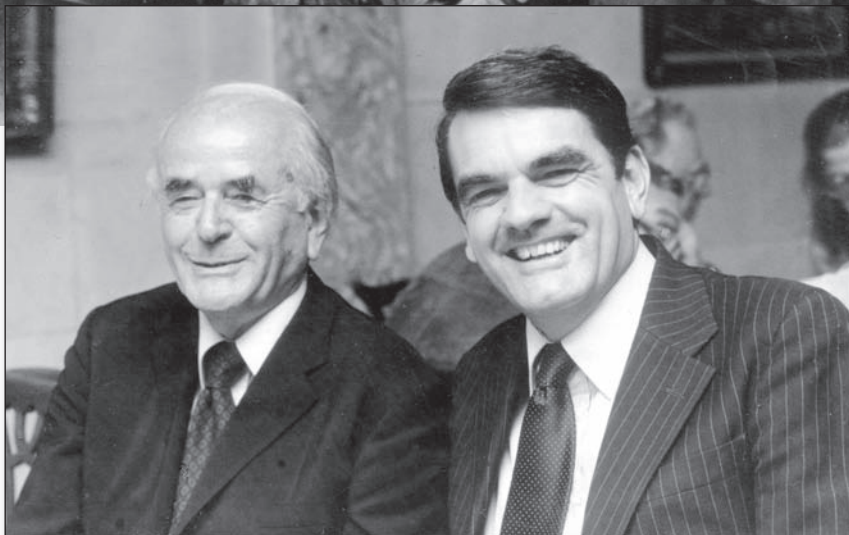

BÖRSENBLATT

Top: Reich Propaganda Minister Dr Joseph Goebbels and Munitions Minister Albert Speer at a wartime missiles display. Sitting next to Speer at a Frankfurt, Germany, dinner party on October 10, 1979 the author (above right) chides him for having promoted the A4 rocket program at the expense of more cost-effective weapons. Speer answers: "You are quite right. It was a mistake. But Wernher von Braun is the real culprit. He knew how to fire people's enthusiasm. Quite simply put, he won Hitler and me over!"



CROWN COPYRIGHT



RADIO TIMES / HULTON

By July 1944 Hitler's V1 flying bombs are destroying 20,000 homes a day in South London. Shocked by the first three weeks of this "revenge weapon" onslaught, at a secret War Cabinet meeting on July 6, 1944 Churchill demands the launching of poison gas attacks on German cities. Three ministers describe him in their diaries as being intoxicated at this meeting; the British government orders this "poison gas" passage omitted from this book in his lifetime.



RADIO TIMES / HULTON

On March 8, 1945, a V2 rocket hits Smithfield meat market in London, killing 110 workers, shoppers and passers by.



151. DQB de DPB 2225 SSD DPB NR.38 1755 3Tle. DQB 155
 An Oberfhr. Dr. DIETRICHS, über Hptamt dI Orpo über Paula
 HEIDELBERG 42.

Betr.: Vermisstenlage in LS.ort DRESDEN: Oberbürgermstr.
 der Stadt DRESDEN hat eingerichtet: A) eine Zentralstelle
 für Vermisste und 9 Verm.nachweise. B) 80 bis 100,000
 Verm.anzeigen bis jetzt schätzungsweise eingegangen. C) 9720
 Verm.anzeigen als Totmeldung erledigt. D) 20,000 Aus-
 künfte über Vermisstemeldung bis jetzt erstattet. E) Genaue
 statistische Angaben erst später möglich.
 Von Pol.präs. DRESDEN.



PUBLIC RECORDS OFFICE / WALTER HAHN, AUTHOR'S COLLECTION

1800 177 DRÖ 155

warten dringend Bar-
 RTMUND an uns nur 40

6590
 1803 2Tle.181 181 SRZ/
 NG, über Stapo. WIEN.
 los. Bis Montag 1800
 Standort und Abgabe
 t, trete Montag Rück-
 ast hier keine Möglich-
 3.45 und Telegr. vom

1806 123 TDJ2 424
 LITZ, HALTERN.
 nach HALTERN verladen.

6590
 1810 2Tle.184 102 LYR/
 SUESS.
 dort lagerndes Dienst-
 ort zum Vorkdo. Kdo.
 setzen, de Vorkdo.
 ng des Gutes bis zu

SRM 155
 1820 2Tle.171 61 SRF/

verw. MAGDEBURG abge-
 Zusatz für MAGDEBURG:
 EN, gleichzeitig auf-
 BOEHM durch Fs. an-

1825 109 DSÖ 155

The ultimate revenge. In a fire raid on February 13, 1945 RAF Bomber Command destroys Dresden, killing over 100,000 civilians in the resulting firestorm. On March 24, 1945 (top) the British codebreakers intercept a secret message by Dresden's police chief: The Lord Mayor of Dresden has told him that eighty to one hundred thousand are now registered as missing – i.e., probably “corpses charred beyond identification.”

report claimed, only one in sixteen had been successful, and no suitable propellant had been found for hundreds of miles. Another March report had suggested that the rocket was being produced by Krupps, with a range of seventy-five miles, and that it was “being installed on the Channel coast.”

A February report had talked of both rockets and “rocket guns” in large quantity.

Unfortunately the War Office made what was to prove an ill-conceived attempt at drawing a speculative picture of the German rocket and of its mode of launching: the weight of “technical opinion” envisaged a missile 95 feet long, weighing about $9\frac{1}{2}$ tons, and launched, “unless an extremely accurate method of directional control in flight has been developed,” from a projector about 100 yards long; the war-head weight was put at $11\frac{1}{2}$ tons, of which 1 ton or less was explosive, the rest being casing.

The report’s authors made no attempt to investigate the most important aspect of the supposed enemy rocket, its means of propulsion, which would largely determine its effective range and its payload. British military rockets had hitherto been based solely upon solid-fuel propulsion.

LIEUTENANT-GENERAL Nye had recommended an air search for the enormous launching “projectors”: if they were 100 yards long, they would be exceedingly difficult to conceal. He also urged that the Prime Minister should be informed of this long-range rocket threat.

The Vice-Chiefs considered these recommendations on April 12 and agreed that the Prime Minister and the Minister of Home Security, Mr. Herbert Morrison, should be warned of a possible attack by German long-range rockets.

A few days later Brigadier L. C. Hollis of the War Cabinet Secretariat advised that the question of the necessary further investigations had been examined, and that in addition to Ellis and Crow a number of other agencies ought to be associated with the inquiry, including the

Joint Intelligence Sub-Committee, the Air Ministry and the Ministry of Aircraft Production, as well as possibly the Scientific Advisory Council. Brigadier Hollis added:

The Vice-Chiefs of Staff might care to consider recommending to the Prime Minister that one individual, who could devote a considerable amount of time to the matter, should be appointed to take charge of the investigations.

The Chiefs of Staff agreed, and General Sir Hastings Ismay, Chief of Staff to Mr. Churchill as Minister of Defence, minuted him on April 15:

The Chiefs of Staff feel that you should be made aware of reports of German experiments with long-range rockets. The fact that five reports have been received since the end of 1943 indicates a foundation of fact even if details are inaccurate.

The Chiefs of Staff, he continued, thought that no time should be lost; if the evidence proved reliable, counter-measures should be devised. The quickest results would be obtained by the appointment of a single investigator able to call on such scientific and Intelligence advisers as appropriate:

[The Chiefs of Staff] suggest for your consideration the name of Mr. Duncan Sandys.

AT THAT TIME Sandys was thirty-five years old, and held the post of Joint Parliamentary Secretary to the Ministry of Supply; his military career seemed to qualify him eminently for an inquiry into German rocket warfare.

In 1940 he had been serving with an anti-aircraft regiment in Norway; after the failure of the Allied Norwegian campaign he had been

posted to the War Cabinet Secretariat, and after three months had been accepted for Commando training. Sandys was a qualified pilot; and had once been pulled unconscious, with his clothes on fire, from a crashed plane.

Too old to be accepted for parachute training, he had been posted as commanding officer to the experimental rocket regiment at Aberporth in North Wales, a unit subsequently to be credited with the first enemy aircraft to be hit by rockets. These were the 3-inch “unrotated projectile” rockets, propelled by slow-burning cordite and developed by Dr. Crow.

The first operational “Z” Battery had been established at Cardiff. Sandys used to spend the night awaiting air attacks, and the day at Aberporth; one night his driver fell asleep and the car crashed, inflicting on him an 80 per cent disability from which he would suffer the rest of his life: given the option of losing both feet or living in steadily increasing pain and discomfort, he chose the latter course.

After three months in hospital, he returned to the House of Commons; he had been a Member of Parliament ever since the 1935 campaign, during which he had first met Miss Diana Churchill, daughter of the Prime Minister and his future wife.

Seldom has an appointment been the occasion of more rancour and bitterness. Two Ministers were in particular dismayed by Mr. Sandys’s appointment: Lord Cherwell, Paymaster-General, and Mr. Brendan Bracken, Minister of Information.

Both had watched the growing tendency in their Prime Minister to confide in his son-in-law. Both had hitherto enjoyed the influential positions of *eminences grises* within the Government; the Paymaster-General especially valued his long-standing friendship with the Prime Minister, who declared him to be his personal Scientific Adviser.

He was devoted to Mr. Churchill; his reaction when Churchill appointed his son-in-law to co-ordinate the secret-weapons investigation was subsequently described as “almost womanly,” by one Minister: it was motivated by that most human of emotions, jealousy.

Lord Cherwell's own distaste for rocketry dated back at least to 1932, and probably to his First World War days at Farnborough; if his attitude towards Mr. Sandys had never been amicable, it was now characterised by an uncompromising antipathy.

(III)

Duncan Sandys was unaware of the resentment his appointment had caused.

He read his terms of reference as limiting him to reviewing the Intelligence data, and issuing reports to the Prime Minister based upon them. He liked to quote Viscount Trenchard's dictum, "Experts should be on tap, not on top."

Four sources of information about enemy weapons were open to Mr. Sandys: codebreaking; the interrogation of Axis prisoners of war; the interpretation of aerial photographs; and the examination of information supplied by SIS agents.

These were the only sources of direct Intelligence, and as such were liable to be tampered with by the enemy; there was always the danger that the enemy would "plant" information of a nature that could not be separated from the genuine reports.

There was a second approach to the Intelligence problem, an approach in which the Air Ministry's Intelligence officers were well versed: the interpretation of second-order Intelligence. By this method one does not search for details about an actual Intelligence target, but about its symptoms and effects, which are less easily forged. The cloud chamber in the physics of elementary particles is an excellent example of the use of second-order Intelligence.

The current Intelligence problem was, if the Germans were indeed developing long-range bombardment weapons, what question the SIS should put to its agents abroad and other agencies.

Dr. R. V. Jones remembered an incident at Oxford, in 1935, when he had been a research student at the Clarendon laboratory under

Professor Lindemann (later Lord Cherwell); he had met the German Carl Bosch, who had one day described to him the unusual problem that had faced the designers of the German Paris gun of the First World War.

When the gun had been under development three shells had been fired at twenty-minute intervals, but rather strangely no bursts had been observed near the target area predicted by the ballistics experts.

Only later had Bosch heard from a German meteorologist that three “meteorites” had landed at twenty-minute intervals that day, at a place far beyond the predicted target of the gun. They were, in fact, the shells, which had left the denser atmosphere and had greatly increased their range as a result.

This possibly apocryphal story was recalled to Jones as he began to work out how he would, if he were a German, accurately plot the fall of missiles over great ranges: for a high-priority missile project, the Germans would probably use the best radar units available.

Dr. Jones knew of only two such units – the 14th and 15th Companies of the German Air Force Experimental Signals Regiment, which his team had come to know well for its active part in the 1940 radio-beam war. Although it had finished then to be of direct interest for some time, he now suggested that the cryptanalysts resume surveillance.

Six months passed before Jones’s patience was rewarded.

(IV)

On April 19 the Central Interpretation Unit received instructions from the Air Ministry – as opposed to the War Office, who had written to the CIU on February 9 – to investigate the secret-weapon threat.

The aerial reconnaissance investigation was to be directed not only against rockets, as was Mr. Sandys’s at this stage, but the whole secret-weapon complex. At the CIU’s nineteenth-century Thames-side mansion in Medmenham, the elderly and scholarly Wing Commander

Hugh Hamshaw Thomas was put in charge of the search.

The Air Ministry suggested that the secret weapon might be a long-range gun, a rocket aircraft, or a “rocket launched from a tube, possibly in a disused mine.” Peenemünde was not specifically mentioned at this stage, but the CIU was to investigate factories, experimental stations and operational launching sites in its inquiry.

Furthermore, a renewed scrutiny was to be made on the highest priority of all photographs of North-west France taken since January 1 within a 130-mile radius of London (tacitly presumed to be the only main target suited for attack by inaccurate secret weapons) and reconnaissance sorties were to be flown to fill any gaps.

Mr. Sandys had initiated his Ministerial inquiry by also placing himself in the Germans’ shoes: he recalled the experimental rocket unit at Aberporth and the havoc caused by rockets exploding on the test beds, or falling near populated territories. Any German rocket range would probably lie near the coast, as had the Aberporth station, and well away from populated areas. Such a secret project would also be away from the operational zones of the Allied navies.

This left only the Baltic, as the “Peenemünde” reports suggested. He requested the CIU to search existing photographs of Peenemünde closely for unusual structures.

At Medmenham the burden of the photo interpretation fell primarily upon the Industrial “D” Section, under Flight Lieutenant E. J. A. Kenny, who, like Wing Commander Thomas, was a classical scholar of some repute, being an expert in hydraulic engineering in Ancient Rome. Later the Army “B” Section was called in, under Major Norman Falcon.

In those early April days of 1943 nobody could foresee the immensity of the contribution that was to be made by photographic reconnaissance to the secret-weapons investigation. Photo interpreters would spend 280,000 manhours on the search; 4,000 sorties would be flown and 1,500,000 photographs printed.

(v)

On April 20, 1943 Sandys was officially appointed to review the evidence. Two days later the Paymaster-General, Lord Cherwell, fired the first shots in his counter-offensive. From his private papers it is clear that he moved with great vigour to discredit the rocketeers at once; the fragmentary notes which he left mirror his actions only in part but they are enough. Just as when the scenes are changed between acts and the proscenium curtains part slightly, revealing the scurrying shapes of actors in uncharacteristic poses, so the Cherwell papers afford brittle glimpses of the process which he was trying to invoke in this two-day "interval" between the acts.

We know that on the morning of April 20 he was visited by Brigadier Jacob, of the War Cabinet Secretariat, and that soon after he left for a consultation with Mr. Churchill in his room at the House of Commons.

We know, too, that on the following day Lord Cherwell attended the mid-day Cabinet meeting and summoned Dr. Crow, the British rocket expert, to his flat later. Crow told him that the reasoning on which he had based his theory of a 10-ton rocket was that it would be constructed like an outsize firework-rocket: 4 tons of relatively slow-burning propellant would be contained within a heavy solid steel casing, weighing some 6 tons. This notion seemed unreal to Lord Cherwell, and he privately refused to believe it.

At a meeting on April 22 in the PM's room in the House he propounded these views for the first time, but there was a tendency among those present to regard the threat as grave unless disproved entirely.

As Winston Churchill's personal scientific adviser, Lord Cherwell felt he would have to burst this bubble of irresponsible speculation from ill-informed Intelligence agencies, spurred on by a lay investigator who, it seemed to him, was motivated only by the urge for self-aggrandisement:

Though this possibility cannot be ruled out *a priori* [he wrote

to the Prime Minister later that day], I have the impression that the technical difficulties would be extreme, and I should be rather surprised if the Germans had solved them.

The firing point must obviously be in the neighbourhood of Calais. If the launching rails were above ground, they would be easily observed, and not very difficult to destroy by bombing. If below ground, there would be terrible problems of bringing forward and handling these ten-ton projectiles, especially as all the loading gear would have to be carefully insulated from the rocket on its launching rails before the four tons of cordite were touched off . . . At the worst something about equivalent to a 2,000-pound bomb would arrive in London at the end of it all. Without hearing all the evidence, my opinion is not worth very much, but as at present advised, I should be inclined to bet against such rockets being used.

Lord Cherwell also questioned whether the rocket could be stabilised just after take-off, when the speed was too low to allow the fins to have an appreciable effect.

Von Braun had solved this problem eventually with graphite rudders inserted in the path of the rocket's exhaust gases; Lord Cherwell was unaware of this.

ON EASTER SUNDAY, April 24, Flight Lieutenant Kenny, of RAF Medmenham, was summoned before Wing Commander Hamshaw Thomas to meet two of Mr. Sandys's experts; they were Mr. William Cook, Assistant Controller of Projectile Development at the Ministry of Supply, and Dr. H. J. Phelps, of the Ministry of Economic Warfare. The latter had seen the first new batch of photographs of Peenemünde three days before at the Ministry of Economic Warfare, and he had commented on the strange circular and elliptical earthworks at the northern end of the peninsula. As an explosives expert he had been called in to give his views.

Flight Lieutenant Kenny guided Cook and Phelps round the Peene-

münde establishment on large-scale “blow-ups” of the early PRU photographs. At the extreme northern end of the Peenemünde peninsula land reclamation was in progress: the Industrial Section had already ingeniously deduced the function of most of the plant standing around the airfield at this northern tip; one piece of machinery baffled them.

Flight Lieutenant Kenny now suggested that this could be the pumping machinery itself, designed to handle the sludge dredged up from the sea. The identification was applauded.

“D” Section had made its first significant error: the “pumping machinery” was a launching ramp for German flying bombs.

(VI)

From the Thames-side Central Interpretation Unit the focus of attention switched back to London, where a garrulous German soldier was being interrogated.

Captain Herbert Cleff was thirty-two years old and serving in the German Army when captured after El Alamein; his captors recognised that in this German tank expert they had a more than usually co-operative prisoner on their hands.

He was shipped back to Britain, and within a year he had by a subtle metamorphosis become “Mr. Peter Herbert,” a respected civil servant in one of His Majesty’s Ministries: to be precise he was now Technical Adviser to the Fighting Vehicles Division of the Ministry of Supply.

He valued his new-found freedom, the right as a “trusty” to commute by Tube between the suburbs and the Ministry, but, like Scheherazade, he feared the consequences if ever his wonderful fund of stories should dry up. When he had exhausted his memory he began to rely on his imagination instead.

He proved to be an expert in kinematics, gear design and tank suspensions. That was how he came to be advising on British tank suspensions; since “Mr. Herbert” revealed that at a factory near Dresden

he had investigated problems of interest to the German Navy, he was turned over to the Naval Intelligence Division. Casting around for a new field in which he could interest his listeners, he stumbled upon rocketry just at the moment when the scare was reaching its climax within Whitehall.

He happened to mention that he was well versed in German Air Force affairs, and rocket engines; this time he was turned over to the Air Ministry's prisoner-of-war interrogation branch. By the time its findings had been issued, late in April 1943, they had been upgraded from SECRET to MOST SECRET, and the names of Sir Henry Tizard and Wing Commander Frank Whittle had been added to the normal distribution list.

"Mr. Herbert" claimed to have been active in the design of the German projectiles himself, and maintained that monster rockets of enormous proportions were already being tested:

Projectiles of this type, weighing one hundred tons or over, are in existence, if not ready for use. These would travel at one thousand metres per second, i.e., three times the speed of sound.

Cleff maintained that they could be fired either from lightly constructed tubes or from inclined railed ramps. "A 100-ton projectile," he asserted, "would need fifteen tons of propellant for a 500-kilometre flight."

It must be remembered that his reports on German tank design had been substantiated by British tank experts; so his reports of German rocket advances could not be dismissed out of hand.

They left Titchmarsh's treatise on higher mathematics near him. When they next observed him he was happily reading the book like an adventure story. Everybody who met this German-turned-Englishman fell under his charm, with his tall frame, his boyish face and pince-nez spectacles.

Early in April the first report from an Allied agent to mention

Watten was logged: “enormous trenches” were being excavated there, 80 metres deep, with a concrete floor 3 metres thick. The report was passed to the War Office, and stayed there.

(VII)

On April 29, four days after the Cleff interrogation report had been issued, the first photographic reconnaissance report on Peenemünde was circulated by Medmenham.

It was based on the last four overflights, the most recent of which, a week previously, had been requested by Sandys. Five of the peninsula's groups of buildings and installations were described, excluding the airfield site where – unknown to the British – flying-bomb research and trials were being carried out.

The interpretation report described in detail the Development Works; the two vast factory halls 700 yards to the southeast; the sinister “elliptical earthwork” at the northern tip of the peninsula, and the three circular earthworks of similarly immense scale to the south-west; and the power station on the western shore.

In other cases, the British had turned up from prisoner-of-war cages Germans who could explain the purpose of various buildings. For Peenemünde there were no such prisoners.

Thus the photographic interpreters were badly hampered. Flight Lieutenant Kenny's Industrial Section, which had already identified the flying-bomb launching ramps as “sludge pumps,” now dubbed the two lofty factory buildings “possible nitration houses,” while a small building on the opposite side of the railway resembled the ammonia-handling plants seen at other works, especially those at Rjukan (the heavy-water plant in Norway) and Knapsack.

In reality, the factory buildings were not nitration houses but the pilot workshops for the manufacture and assembly of A4 rockets and rocket components; the rocket was always assembled in the vertical (firing) position, and that accounted for the lofty halls. Again, when

Flight Lieutenant Kenny's section turned its attention to the power station near Kolpin, bad luck was still dogging its attempts: "The power house shows no signs of activity . . . Not one of the six chimneys of the boiler house is smoking."

In fact, the generators were working, as stocks of coal indicated; but the Germans had inserted electrostatic dust and smoke removers in the plant's chimneys to reduce smoke emission.

Probably the most far-reaching error was dismissing a building south-east of the power station as merely "a large building 220 feet by 140 feet." It was, in fact, the Peenemünde liquid-oxygen plant. Had Sandys known of this he could not have ignored the probability that this was an essential component of the rocket fuel. Had this evidence of the feasibility of liquid-fuelled rockets – already propounded by an American rocket experimenter, Dr. Robert H. Goddard, in 1926, and by Professor Oberth in 1925 – been forced upon Lord Cherwell, the later arguments would have been stillborn.

As it was, Medmenham had been briefed to watch for the manufacture of rockets powered by conventional explosives, possibly cordite, and they soon found it:

The general appearance of the factory, which is situated in a clearing in the forest, suggests that it may be employed in the manufacture of explosives.

This was not a wild guess; the reasoning was logical, but from it flowed the wrong conclusions.

IT WAS on the mysterious elliptical earthwork, with its clusters of tall buildings, its traverser cranes, its apparently bottomless pits, its concrete pill-boxes, and its attendant unexplained patches of white vapour, that Flight Lieutenant Kenny and his team concentrated their most detailed search. None of them hazarded an official guess as to the purpose of the 670-yard-long earthwork, but in all of their minds

lay the certainty that this must be the rocket launching pad.

A large cloud of white smoke or steam can be seen drifting in a north-westerly direction from the area. On photograph 5010, an object about twenty-five feet long can be seen projecting in a north-westerly direction from the seaward end of the building. When photograph 5011 was taken four seconds later this object had disappeared, and a small puff of white smoke or steam was issuing from the seaward end of the building.

Examination of the records of Peenemünde gives a clue to what was happening: on April 22, the day of photography, the twenty-first production model of the A4 long-range rocket was on the test rig at Test Stand VII (the elliptical earthwork). The “cloud of white smoke or steam” was probably the vapour cloud, as several tons of liquid oxygen were pumped into the rocket’s fuel tanks.

At twenty-five minutes past three, soon after the Mosquito had passed over, the commandant, Colonel Zanssen, standing on top of the Telemetry block of the Development Works, telephoned the All Clear through to Dr. von Braun, and von Braun started the countdown for what was to prove one of Peenemünde’s most successful early rockets: it flew 160 miles along the Baltic firing range.

Those were dramatic days at Peenemünde. It was the last rocket for which Zanssen gave the firing order: four days later the SS ordered his removal to Berlin.

ON 29 APRIL, with copies of the interpretation report in his briefcase, Kenny travelled to the Ministry of Supply in Shell Mex House; Government scientists were also there. Kenny, conscious of the misery suffered by any low-ranking officer summoned before a panel of experts, was relieved to find many of his contemporaries from Cambridge, including Professor Garner and Sir Edward Bullard.

Kenny, accordingly, was soon in his element, and he forged with Mr. Duncan Sandys and his military assistant Colonel Kenneth Post a relationship which remained unshattered – despite its many crit-

ics – throughout the investigation.

By that night Sandys had concluded that Peenemünde was probably an experimental station; further that:

The circular and elliptical constructions are probably for the testing of explosives and projectiles.

... but that – in view of the lack of power-station activity – it was not yet in full use; and that if projectiles were being tested their use had not gone beyond the experimental stage.

“It is clear that a heavy long-range rocket is not an immediate threat,” Mr. Duncan Sandys’s report concluded.

(VIII)

In May a British agent saw an object believed to be a giant gun barrel at Hanover Central Station, 145 feet long and nearly 6 feet in diameter. A report from a second agent seemed to supplement this: the German rocket weapon would be fired from a long “brech-loading smooth-bore barrel,” this method having been adopted as the accuracy of self-steering projectiles was allegedly unsatisfactory. Yet a third report from an Allied agent, also in May, seemed further to confirm this notion: six batteries of guns with rocket-propelled shells of seventy-five miles range were being installed on the Channel coast.

Mr. Sandys put the final touches to his report. On May 17 it was circulated to the War Cabinet:

It would appear that the Germans have for some time past been trying to develop a heavy rocket capable of bombarding an area from very long range. (This work has probably been proceeding side by side with the development of jet-propelled aircraft and airborne rocket torpedoes.)

Such scant evidence as existed, Sandys continued, suggested that it

might have reached an advanced stage of development; an intensive effort should be made to obtain further information.

The experimental establishments and factories which appear most likely to be connected with the development and production of this weapon in Germany and German-occupied territory, together with any suspicious works in the coastal region of North-west France, should be subjected to bombing attack.

One thing was striking about Sandys's report: the considerable increase in the estimated size of the rocket. It was now suggested that the rocket might be a 70-ton multi-stage monster employing an unspecified new fuel. The warhead might weigh as much as 10 tons. The range was calculated to be between 100 and 150 miles. "Launching projectors," which were not now expected to be very large or conspicuous, were still accepted as inseparable adjuncts to the firing procedure.

BACK IN February 1941 a German 2½-ton bomb had killed eighty people in Hendon; the Ministry of Home Security, headed by Mr. Herbert Morrison, extrapolated this to produce the shattering estimate that one German rocket could kill 600 people; further, if one such rocket were to fall on London each hour, about 108,000 people could be killed every month.

Lord Cherwell, to whom a copy of the Sandys report was dispatched, disbelieved these calculations.

He was thoroughly familiar with the gruesome territory of the "Standardised Killed Rate per Ton" and the other statistics of bombing casualties as he had been at the heart of the great area-bombing controversy in March 1942.

He sent for Dr. R. V. Jones and asked for his opinion about the rocket reports; Jones had not been sent a copy of the first report, but in his capacity as scientific adviser to the SIS he had continued to receive all the raw material – the actual reports and intercepts from Intelligence sources. He told Cherwell that he and his staff were in no doubt at all

that they should be taken seriously.

The Professor was not deterred: it was apparently enough for him that Mr. Sandys was leading the rocket inquiry; for now he decided almost automatically, in total disregard of Jones's warning, that Mr. Sandys's conclusions could not be correct.

ON 17 MAY unidentified activity at Watten, near Calais, was reported by the photographic interpreters; there was evidence on the air photographs of "a large rail- and canal-served clearing in the woods, possibly a gravel pit." The earlier Intelligence report on secret-weapons activity at Watten had apparently not yet filtered through to the photographic interpretation unit. For the time being the Watten file was closed.

(IX)

"Mr. Peter Herbert" was again interviewed. A number of other "rocket experts" had been distilled from the vast flux of prisoners of war and interrogated.

Probably the most important had been captured as recently as April 20, 1943, a senior officer of the German Air Force Experimental Unit *Ob.d.L.* He described how his CO, Colonel Rowehl, had been recently summoned to Berchtesgaden, where Hitler had discussed with him the weapons proposed for use against Britain this summer. Both rocket projectiles and jet-propelled aircraft had been mentioned. "Mr. Herbert" had now described a multi-stage rocket, of which the first stage alone weighed 25 tons, was 12 feet long and 10 to 11 feet wide. The lengthy launching ramp could "take the form of a tunnel into the ground which could not be detected by aerial reconnaissance." At the beginning of 1942 he had seen a 60-ton projectile fired from a railed launching ramp erected inside a steel-lined concrete pit some 370 feet long, 240 feet deep, and 150 feet wide. The rocket had been fired out to sea, "presumably over the Baltic," the interrogators continued, and had travelled 150 miles before plunging into the water.

“Herbert’s” report was uncharacteristically sound: there was a “hint” that a special radio-control device was being manufactured by Askania of Berlin; a description of a Professor Oberth’s Baltic rocket tests in the mid-1930s; information that there was a branch of the Rechlin German Air Force Experimental Station at Peenemünde; and a report that Major-General Adolf Galland had told pilots back in February that Messerschmitt were developing a rocket-propelled fighter aircraft at Peenemünde. All these rumours were substantially founded on fact.

An early draft of the interrogation was rushed to William Cook, assistant to Dr. Crow, the British rocket expert. With some difficulty, Cook obtained access to the transcript of the prisoner’s statement, and forwarded extracts to the Chief Chemist of Shell, Captain J. A. Oriel, warning that although the original recording spoke, for example, of a terrifying “super fuel” with 90,000 calories per gramme, the German prisoner had more lately stated figures of first 52,000 and then 35,000; these seemed little more probable than his first figure.

“My own impression is that Cleff is making up a certain amount of the data,” Cook concluded. Every possible clue, however tenuous, had to be followed up; Oriel sent a copy of Cook’s letter to Isaac Lubbock, an engineer who was himself in charge of a unique Shell project, developing a rocket motor capable of running on aviation spirit, water and liquid oxygen strikingly similar to the liquid-oxygen/alcohol fuel pioneered at Kummersdorf and Peenemünde.

This remains one of the shortcomings of the British investigation: although Lubbock’s petrol-oxygen rocket was developing thrusts considerably higher than either the cordite favoured by British projectile experts or the nitric-acid/aniline combination adopted by the Americans, neither he nor his team was called into the Sandys inquiry until September 1943.

In a way, this was the fault of one man, Dr. A. D. Crow, the powerful Controller of Projectile Development at the Ministry of Supply, and director of all official rocket research in the United Kingdom.

In Britain, official research had favoured cordite-powered rockets of cumbersome design.

(x)

In early 1941, the Ministry of Supply had awarded a research contract to Shell to develop an assisted take-off rocket using any fuel other than cordite. The Ministry of Supply placed at Lubbock's disposal a part of the Petroleum Warfare Establishment near Horsham.

After initial difficulties handling the fuel and expelling the liquid oxygen into the combustion chambers, a five-second burn had been successfully carried out on August 15, 1942. Only the weight of the nitrogen bottles used to pressurise the fuel tanks impeded development.

In October Lubbock was confident enough to invite Crow: Crow grudgingly congratulated them, but was unenthusiastic. On May 7 1943 a distinguished group of British scientists was invited to witness a burn using this new fuel system.

The rocket motor was put through a perfect twenty-three-second test, the howl of the exhaust echoing over the Sussex countryside and the trees around trembling in the blast. Sir Alfred Egerton shook Lubbock's hand, and exclaimed: "It amazes me that you can bring a flame of that size under control using liquid oxygen and petrol. I congratulate you!" Crow made no similar gesture. When he returned to London he made no attempt to bring those developments to Mr. Sandys's attention, and the belief that the Peenemünde rocket must be solid fuelled – like Crow's own 3-inch "U.P." rockets – persisted until late September 1943.

(XI)

Early in May, Colonel Walter Dornberger succeeded in persuading Gauleiter Fritz Sauckel, the all-powerful Reich Director of Manpower, to visit Peenemünde-East. Colonel Stegmaier, the National Socialist

fanatic and military commander of the Peenemünde Development Works, issued instructions in advance.

He was anxious to create an impression of smooth efficiency and intense activity.

He need not have worried: on the second day of Sauckel's visit the bustle at Peenemünde was boosted to such an artificially high level that British interpreters scrutinising the photographs of Peenemünde taken that afternoon from an altitude of five miles concluded that the Germans were apparently nearing the climax of their work, judging by the "unusually high general level of activity" at Peenemünde.

Stegmaier had ordered: "There is to be no standing about by the workers."

HAP [Peenemünde Army Establishment]'s Guard Room will be responsible for seeing that the soap does not vanish from the cloakroom of the Officers' Mess, and that the hand-towels are clean and dry.

Sauckel arrived in the special Führer's car at the Peene River bridge soon after noon on the 13th. After a good lunch he was driven to Block Four, the drawing office and administrative centre of Peenemünde-East. Here he was shown the famous film of the first successful A4 launching with its stirring conclusion and the slogan "We made it after all. . . !"

Then everybody toured the Army installations; during the years since 1939 Dornberger and von Braun had had ample time to perfect their technique with visitors.

The breathtaking spectacle of this vast secret Army station, to which even the most senior National Socialists had heard only the most vague allusions, the thrilling film of the launching of October 3, 1942, the ear-splitting roar of the twenty-five ton thrust rocket motors on the test rigs – who could fail to succumb to the magic of their spell?

At four-thirty the little convoy of buses and cars swept past the SS

guards now posted on the entrances to the largest test area, the elliptical Test Stand VII, where technicians were checking over an A4 rocket.

The Gauleiter was stunned by its size, far bigger than it had seemed in the film. Dornberger allowed him to stay only for fifteen minutes there, but promised him that next morning an A4 would be launched for him. Just before dinner Colonel Dornberger took his guest out for a quick look over Test Stand II, where the combustion chamber for the “*Wasserfall*” project was being tested. *Wasserfall* was an expendable 25-foot-long surface-to-air anti-aircraft missile, liquid-fuelled like its A4 predecessor, but using nitric acid as oxidant.

The weather was perfect. The Peenemünde Hook basked in a heat wave, and the blue sky was less than one-tenth obscured by the low thin cloud. These perfect firing conditions were hardly marred by the gentle spring breeze from the south-west, stirring the dazzling white clouds of frosty oxygen vapour and condensation around the rocket standing vertically on its simple firing trestle.

The A4 functioned well. Sixty seconds after lift-off, at an altitude of 79,310 feet, the rocket motor was cut; the projectile soared on up to reach a peak altitude of fifty-five miles above the Earth's surface, eleven miles higher than calculated, and finally struck the Earth five and a quarter minutes after lift-off, exactly 160 miles along the water range, overshooting its target by some twelve miles.

TWO DAYS after Sauckel's visit Hitler approved Speer's suggestion that a number of Ministers of Cabinet level should inspect the new weapons being developed at Hillersleben and Peenemünde. On May 26 Speer himself had flown into Peenemünde-East, in company with Colonel-General Fromm, Field-Marshal Milch, Karl-Otto Saur (Speer's right-hand man), Grand Admiral Dönitz, and the members of the Long-Range Bombardment Commission.

Two A4s were fired in cloudy, humid weather. The first lifted off exactly at noon and vanished into the low cumulus cloud ceiling; radar tracking stations followed it up sixty-four miles above the Earth's

surface, and 349 seconds after lift-off it impacted 175 miles away, only just over three miles from its predicted target. This flattering performance of the otherwise inaccurate A4 could not have happened at a more opportune moment: the day's firing had been requested to enable Hitler's ministers to decide once and for all the fate of the secret weapons.

So brilliant was the success of this first rocket that all present could overlook what happened to the second: rather over five and a half hours later the second A4 was launched upwards towards the high ceiling of thin cirrus clouds, and crashed shortly afterwards within sight of everybody.

Later on that day the Air Force catapulted two flying bombs from the north-eastern corner of Peenemünde airfield; the weapon was highly temperamental, of course, and nobody apart from Field-Marshal Milch was overdisappointed when both bombs crashed at once on launching. The verdict at the end of the day was that both weapons should be developed side by side. The next occasion on which Speer was to fly to Peenemünde was to be more tragic.

Dornberger was forthwith promoted to Major-General, and three days after the Peenemünde demonstration Speer made his first public reference to what lay in store for the British people when he promised a wildly enthusiastic Ruhr audience that:

Even if the German mills of retribution may often seem to grind too slowly, they do grind very fine. . .

Hitler ordered Degenkolb's A4 programme to rank higher in priority than any other munitions production. Future A4 contracts were to be allocated under the special priority defence contract code *DE12*, and under the preferential contract code *SS4948*.

With its upgrading to *DE* – a special grade introduced by Speer a year before for limited contracts of the highest priority – it seemed that nothing could now prevent the rocket bombardment of London

opening in December 1943, as Adolf Hitler now planned.

(XII)

On Duncan Sandys's instructions, the Photographic Reconnaissance Unit had flown another sortie over Peenemünde on May 14. Possibly codebreaking was now alerting Whitehall to the dates of rocket tests, because the RAF had again chosen a day and time shortly before the Germans launched an A4 rocket. Flight Lieutenant Kenny reported:

It can be noted that the general level of activity on the whole site is high. This is shown by constructional activity at the central circular emplacement [Test Stand XI] and by the movements of large numbers of vehicles on roads and railways.

Large amounts of material and stores had accumulated in the stock yards. He remarked how much things had changed since April 22, and added:

A number of road vehicles and railway trucks can be seen inside and outside the ellipse on both sorties. [The earlier sortie] shows a train of five vehicles on the middle one of the tracks, on the curves south-west of the ellipse. The middle vehicle appears to carry a cylindrical object thirty-eight feet by eight feet which projects over the next truck to the east.

The second sortie, of May 14, showed two trucks on the most northerly of the lines leading into the tall building standing just outside the ellipse. The truck farther from the building carried a similar cylindrical object, and apparently of the same dimensions. Both "objects" were A4 rockets.

In fact, the "objects" had been on the photographs taken by Kenny to the Ministry of Supply on April 24, but nobody had noticed them

then. That was hardly surprising. A blur of white on a smudge of grey, 1½ millimetres long, it would stay an “object” until mid-June.

THE HOSTILE reaction with which the first Sandys report was greeted, not least by Lord Cherwell, had swift consequences: “Mr. Herbert” was recalled and invited to go over his story again.

As a result of this further interrogation, it was reported on June 1, it was now possible to differentiate clearly between what “Mr. Herbert” had actually seen, what he had been told, and what was “pure conjecture on his part.”

“Herbert” explained that he had originally been called upon by the Germans to advise whether the new German super fuel was suitable for tank engines; as rocket experiments were taking place nearby, he had been smuggled in to see them. He now stated that the rocket had been fired from the Black Forest towards Lake Constance, about sixty miles.

Other prisoners had been asked to estimate the colour of the exhaust flame of the German rockets; when the interrogators returned to Captain Cleff, that canny gentleman regretted that he could not help them there: he was colour blind.

The insistence that the rocket was fired from the Black Forest towards Lake Constance with the consequent danger of overthrows landing in Switzerland undermined the credibility of the source; to Sandys, however, the important detail was the common denominator in the story and in this case it was “German rocket development.”

A third German general was found, eager to relate his knowledge of rocket projectiles; he had seen, he said, a 20-foot-long rocket fired from the Greifswalder Oie to the island of Bornholm. More important than that: he was sure that the rocket’s fuel was a liquid, pure alcohol.

At this stage, however, the Sandys inquiry could not even ignore the evidence of “Mr. Herbert,” and when he described launching pits in the Black Forest, expertly camouflaged and protected by overlapping sheets of solid bombproof steel, Mr. Sandys could only request

the Photographic Reconnaissance Unit to check the vicinity of the pinpoint given by "Herbert"; he did not underestimate the ability of air reconnaissance to substantiate or refute Intelligence reports in one simple move.

During June Sandys had initiated a comprehensive air survey of the various localities referred to by agents and prisoners of war. On June 4 he was given sweeping powers to deal direct with the various Intelligence agencies and to recommend counter-measures. All authority in the secret-weapon inquiry was thus placed in his hands.

His recommendations were clear: he wished the PRU to cover all enemy-occupied territory within 130 miles of London. Moreover, he wanted a regular aerial survey of Peenemünde – about once a fortnight – and special photographic reconnaissance of the islands of Greifswalder Oie, Bornholm and Rügen, and of particular pinpoints at Holzkirchen, south of Munich, and at Lettstädter Höhe, where "Herbert" claimed to have witnessed rocket trials.

In addition, he recommended that Peenemünde and the I. G. Farben works at Leuna and Ludwigshafen be attacked.

He concluded that there was little doubt that the long-range rocket did exist, and might already be in limited production (an accurate surmise, as we have seen).

In the meantime the CIU had issued a report on a suspicious structure in Northern France.

Although it did not specifically refer to secret weapons, Lord Cherwell, to whose attention the photographs were brought by Jones late on June 3, agreed on the urgency of destroying the site. He minuted the Prime Minister:

There are photographs which show that the Germans are erecting very large structures similar to gun emplacements in the Calais region. Whether or not we take seriously the story about new weapons for bombarding London, would it not be a good thing to bomb these emplacements before the concrete roofs over them are finished? If it is worth the enemy's while to go to all the trouble of building them, it

would seem worth ours to destroy them before it is too late.

It is an illuminating comment on the widening rift in the investigation that when Jones thought he had discovered something on these photographs, he took them neither to Sandys, the officially appointed special investigator, nor to his immediate Air Ministry superior, Air Vice-Marshal Inglis, but to Lord Cherwell, whom he had held in respect ever since he had been a research student at Oxford.

Again Cherwell did not send Sandys his minute, although the Minister had a paramount responsibility for co-ordinating counter-measures.

The Secretary of State for Air did not share Cherwell's views about the need for immediate action on Watten. "A premature operation might deprive us of useful information," Sinclair advised.

On June 8 Cherwell visited Lord Melchett at Grosvenor Square, to discuss with the ICI chief one particular point, the potency of the most powerful known explosives; he wanted authoritative backing for his claim that "Mr. Herbert's" suggestion that the Germans had an explosive of 35,000 calories per gramme was ludicrous. On June 11 he wrote to Mr. Churchill:

I have not been able to persuade myself that this story need be taken quite as seriously as this report suggests. The prisoner of war who seems to have started this scare made at least one statement which is wildly wrong.

My impression reading his interrogation was that this was just the sort of stuff one would have expected from the late lamented Grindell Mathews. Hence I should not favour directing any considerable effort to cope with what seems to me to be on our present information a remote contingency.

Lord Cherwell agreed that there seemed little doubt that the Germans *had* been working on a long-range rocket, but he added that what evidence there was also indicated that there had been serious

difficulties.

This was “scarcely surprising,” as to construct jets which would tolerate for some ten seconds the passage at about one-and-a-half miles per second of the hot gases produced by burning some 20 tons of cordite might well keep an engineering team busy for years; and this, he insisted, was only one of the many difficulties involved.

To handle 70-ton projectiles and shift them from the main railway to the launching rails, and to insulate all this gear from the terrific blast, were no mean problems either. If the “projector” was to be inconspicuous, all this would have to be underground.

“It would require vaults as large as a church,” he pointed out. The old scheme of unmanned radio-directed aeroplanes – jet-propelled or otherwise – would seem more feasible, and even this was less efficient than conventional bombing. Lord Cherwell concluded:

Jones, who you may remember is in charge of scientific Air Intelligence, has been following these questions closely, and I do not think there is any great risk of our being caught napping.

There seems little doubt that he would have preferred the appointment of Dr. Jones to direct the inquiry in place of Mr. Sandys, whose ignorance of scientific detail could, in Cherwell’s opinion, prove a disadvantage.

There were two objections militating against the appointment of Jones, or of any scientist of intermediate rank: it would be argued that – not being of Ministerial rank – he would not have commanded sufficient authority to recommend counter-measures; and a Minister had been chosen to head the inquiry largely because the War Office and the Air Ministry had been unable to agree whether a rocket was more akin to an artillery shell or an aircraft, and hence whether it was the province of Military or Air Intelligence.

It was entirely by coincidence that the Royal Air Force struck its first blow at German rocket-production plans.

Early in June, Dr. R. V. Jones's "own" photographic interpreter at Medmenham, Claude Wavell, had discovered that the Zeppelin airship factory at Friedrichshafen on the shores of Lake Constance was apparently manufacturing *Würzburg* radar dish aerials; the stack of ribbed "baskets" clearly showed on the air photographs of the factory.

On June 3 Jones called on Lord Cherwell to bring his attention to this factory. The Professor passed the information one step farther along this unorthodox chain of Intelligence to the Chief of the Air Staff, recommending an immediate attack on the factory. Mr. Churchill visited Medmenham on June 14, was shown the Friedrichshafen photographs, and learned that the factory had not yet been attacked.

Two days later Bomber Command's No. 5 Group received a surprise order for a dangerous attack on this distant objective during the next full-moon period.

The Friedrichshafen raid, on June 22, was the first unconscious blow at the German secret-weapons programme. The Zeppelin factory, which had been intended to assemble 300 A4 rockets every month, was severely damaged and production plans for rockets there were abandoned.

IN ENGLAND the focus of attention was still on Peenemünde: during the first five days of June four highly circumstantial Intelligence reports had been received in London. Some were from Bletchley, others from SIS agents. One, dated June 1, listed two German Air Force research establishments, one well known, at Rechlin, and the other referred to as "Usedom" – the island of which the Peenemünde peninsula was a part; the latter establishment was referred to as being of a particularly secret nature.

On the following day a report arrived which described Peenemünde as a "*Heeresversuchsanstalt*," an Army research establishment. It is clear

that this latter report emanated from somebody closely connected with Peenemünde-East, for it contained a statement – as we now know, perfectly correct – that between October 10 and December 30, 1942 three large rockets, 50 to 60 feet long and 13 to 16 feet in diameter, had been launched.

The long-range rocket trials were described as being conducted from “testing pit No. 7.” On June 2 a report from a Luxembourgier conscripted into the German Army described trials conducted at Peenemünde after November 20 in which a powered “torpedo” had been released by “catapult” over the beach and out to sea. A second Luxembourgier’s report three days later described launching difficulties with rockets that rotated, spun and wobbled on lift-off at Peenemünde.

On June 16 the Central Interpretation Unit issued a report on air photographs taken of Peenemünde four days previously.

Kenny’s team made its second mistake, once again due to the failure to understand how the German rocket operated. As the CIU had previously reported, the foreshore to the east of the ellipse was being extended and levelled; it was plain to Kenny that this was no ordinary land reclamation project, as the ground was being painted and a heavy fence built to enclose the compound. Flight Lieutenant Kenny observed:

On the foreshore, about four-hundred and seventy feet from the most south-easterly of the [ellipse’s] buttresses is a thick vertical column about forty feet high and four feet thick.

This thick vertical column aroused little suspicion at the time; yet it was the final proof that the Peenemünde rocket was no 70-ton monster, launched only from enormous rail-served projectors. For what Kenny had observed as a “forty-foot column” was, in fact, a standard dazzle-painted A4 rocket, elegantly upended on its four tail-fins, on the soft tarmacadamed shore, *several hundred yards from the nearest railway line.*

DR. R. V. JONES was able to obtain a private set of the aerial photographs of this memorable Peenemünde sortie N/853 of June 12.

He clearly saw a white rocket lying on a railway wagon not far from the ellipse, and waited expectantly for Medmenham's interpreters to fill in the detail which he could expect to have missed; but Kenny's section had not mentioned the rocket at all.

Perplexed, Jones telephoned Lord Cherwell about this failure on 16th June, then walked the short distance to Cherwell's rooms in the Cabinet offices to discuss his dilemma with his mentor: he could point out this omission to the Chiefs of Staff at once, and so grave an omission would discredit the Sandys inquiry; investigation would then revert to the appropriate Intelligence agencies. Alternatively he could alert Mr. Sandys to the rocket on the photograph. Lord Cherwell advised him that the latter would be the more proper course.

This was probably the last service rendered by the Professor to the Sandys inquiry before July 1944. On the same day, therefore, Dr. Jones wrote briefly to Duncan Sandys:

Lord Cherwell has asked me to draw your attention to the fact – should you not already have noticed it – that a rocket seems to be visible on photographs of sortie N/853 of Peenemünde; it is about thirty-five feet long.

He had the note delivered the same day; Mr. Sandys did not invite him round, but it was evident that an agonised call was shortly put through to Medmenham, as an undated addendum was attached to Kenny's interpretation report referring to the object spotted by Jones:

This object is thirty-five feet long and appears to have a blunt point at [one] end. The appearance presented by this object on the photographs is not incompatible with its being a cylinder tapered at one end and provided with three radial fins at the other.

Now the hunt was on. Kenny called back the earlier covers of Peenemünde and found several finned “objects” on other photographs: on railway trucks, outside the tall upright buildings, on the traverser carriage serving the ellipse and near ramps.

DR. JONES, in the seclusion of the Air Ministry Scientific Intelligence Directorate, sifted through the latest scraps of information. His earlier request that Bletchley particularly monitor *Enigma* signals from the German Air Force Experimental Signals Regiment had yielded results: the regiment had recently sent a detachment to Rügen island, just to the north of Peenemünde; an out-station of this detachment was located on the island of Bornholm.

“While this again may be concerned with jamming [British *Gee* radio-navigational beams] it might be associated with the RDF [radar] following of rockets fired from Peenemünde,” Jones noted. He pointed out that one of the latest types of *Würzburg* radar sets had been sent to Peenemünde on behalf of the regiment, according to the latest Intelligence reports.

In mid-June there was further *Enigma* evidence to suggest the locations of two radio stations on Bornholm island. Experiments were being carried out alternately there, the weather being the deciding factor. A “Professor Steinhoff” was observed from the intercepts to pay frequent visits to the island, always flying up from Peenemünde in a Heinkel 111 medium bomber with registration letters *KC-NV*.

Peenemünde thus seemed to be established as the seat of German rocket development.

The intensifying radio and radar activity, and the “rocket” spotted by Jones on the photographs of 12th June, spurred Sandys to write on the 18th to the Air Staff warning that the Germans seemed to be pressing ahead with the development of the long-range rocket at Peenemünde, that frequent firings were taking place, and that the site’s anti-aircraft defences were being strengthened.

He concluded urgently:

In these circumstances it is desirable that the projected bombing attack upon this establishment should be proceeded with as soon as possible.

For a long time there was no reply to this appeal. Peenemünde, of course, presented a most difficult target; the shortest night was now at hand. Moreover, Bomber Command would have to attack from an almost suicidally low level, and crews were badly in need of a respite from harrowing losses sustained during the Battle of the Ruhr.

The Air Staff tried to summarise these points tactfully in a single letter to Mr. Sandys, which was not dispatched until 26th June: it seemed that Peenemünde could effectively be put out of action only by a very heavy attack aimed particularly at the well-dispersed industrial buildings and their associated living quarters. Owing to the short hours of darkness during the summer, such an attack would not be practicable until about the beginning of August. Mr. Sandys found this “reluctance” remarkable.

(XIV)

On June 23, 1943, the Photographic Reconnaissance Unit flew its most important sortie of the whole investigation. Soon after noon the Mosquito of Flight Sergeant E. P. H. Peek landed at Leuchars airfield with a set of brilliantly clear photographs covering the whole of the Peenemünde experimental site, and especially the Test Stand VII launching area.

The photographs showed what were beyond reasonable doubt rockets, close to the firing point, their white bodies outrageously clear in every detail.

Flight Lieutenant Kenny was still cautious, but he changed his designation of the 1½-mm-long speck from “objects” to “torpedoes.”

That evening the Prime Minister had convened a Staff Conference on another matter. As the conference broke up Mr. Churchill called Dr. R. V. Jones to one side and asked him whether Sandys had made contact with him yet. Jones, surprised, replied that he had not. After a moment's thought, the Prime Minister warned him: "Very well, I will call a Staff Conference next week; hold yourself in readiness!"

As soon as Kenny's report reached Sandys he produced his own report on the rocket threat. To him there was now no doubt that the Germans would employ large-scale "projectors," and he believed that Watten was one such projector. He warned:

In spite of all efforts to prevent them, the Germans may without being detected succeed in emplacing a number of projectors in Northern France, and in launching a rocket attack upon London.

Deductions based upon the numerous reports received placed the rocket's range between 90 and 130 miles, he continued; now London was no longer the only likely target, as this range would include Portsmouth and Southampton as well.

Bombing might not prevent the rocket attack. He therefore proposed that the Ministries of Health and War Transport should review evacuation plans, and consider the possibility of concentrating a large number of Morrison shelters in London.

If the rocket's fuel was cordite, and 50 per cent of its mass was the solid steel shell, a rocket of the dimensions of the two just photographed in the ellipse at Peenemünde could hardly weigh less than 60 tons. Dr. R. V. Jones had arrived independently at an estimate that the Peenemünde rocket would weigh "between twenty and forty tons."

On the afternoon of 26th June, however, he called upon Mr. Sandys at Shell Mex House and was taken aback to see that the Sandys report boldly spoke of a mass between 60 and 100 tons.

Jones was staggered. Sandys invited him to talk by telephone with Dr. Crow's assistant William Cook, who would confirm the reasoning. Sandys's secretary put through a call, and Jones heard for himself the Assistant Controller of Projectile Development say that that was his

actual estimate.

After a brief debate on the density of steel, Dr. Jones replaced the telephone receiver and hurried in confusion back to his own office, where his secretary had just finished stencilling his own report. Fortunately, it had not yet been duplicated and circulated.

He told her: "They say it's sixty to one hundred tons. I can't be right. They seem to know what they're talking about. Even so, I can't just put my figure up to eighty."

He wrestled with his conscience; finally, he had his secretary erase his original estimate of "twenty to forty tons," and insert a new estimate on the stencil: "perhaps forty to eighty tons. . ."

Thus Jones lodged himself firmly in Mr. Duncan Sandys's camp.

TWO DAYS later, on June 28, 1943, Mr. Sandys circulated his report to the members of the Defence Committee (Operations); and at their meeting on the following night he drew particular attention to the latest photographs of Peenemünde, which to his mind showed quite clearly rockets lying on the ground close to what he took to be their discharging apparatus.

There was no doubt that a rocket attack on London would have very serious consequences, as the Ministry of Home Security now estimated that up to 4,000 people would be killed or injured by the explosion in London of each such rocket.

Hitler, he warned, was pressing for the rockets to be used at the earliest possible moment, whatever technical problems might still be met. The best counter-measure was to destroy Peenemünde.

The Air Staff had advised against launching any attack until August, but during the morning evidence had arrived in Mr. Sandys's office which suggested that August might be too late.

"There is the possibility," he announced that night, "that the weapon may be used before then."

In his hands were photographs of Peenemünde; they showed a train of unusually long covered coaches, whose purpose could not be

satisfactorily explained, unless they were for transporting rockets.

(xv)

On June 17, 1943 the Peenemünde engineers had drawn up a progress report for the Special A4 Committee: it was expected that the larger part of the development work would be out of their hands by July 20. On June 26 Dr. von Braun wrote to his department heads threatening dire penalties if anyone overstepped these completion dates without first informing him or Chief Engineer Walter Riedel: "Before making modifications, bear in mind that production of the missile is already under way."

Plans for the mass production of the Air Force's *Fi.103* pilotless aircraft, the flying bomb, were fast overtaking the development of the A4. On 18th June, Reichsmarschall Hermann Göring was informed at a conference that of the fifty flying bombs so far launched at Peenemünde, thirty-five had functioned beyond reproach; of the other fifteen, ten had failed for reasons subsequently established and rectified. With rather less than 40 gallons of low-octane fuel, the greatest distance achieved had so far been 44 miles; the highest speed had been 375 miles per hour.

A provisional programme for mass production had also been formulated, envisaging the expansion of flying-bomb output by fifty times over the period from August 1943 to June 1944.*

It was suggested that special dispensations would be necessary to achieve this output. Göring agreed. A large supply of manpower would

* The June 1943 programme envisaged the following monthly outputs of *Fi.103* (V-1) flying bombs:

1943	August	100	December	2,000	March	3,800
	September	500	1944		April	4,800
	October	1,000	January	2,600	May	5,000
	November	1,500	February	3,200	June	5,000

be especially necessary for the construction of the launching sites and “bunkers,” for the Reichsmarschall was conscious of the necessity for protecting the launching installations from the Allied wrath which flying-bomb attacks would certainly evoke.

Field-Marshal Milch had proposed the construction of eight massive concrete “bunkers” from which to launch the missiles, whereas Lieutenant-General von Axthelm was in favour of a hundred small mobile firing sites. Göring compromised and ordered that construction was to start immediately on ninety-six of the small sites, and on four of the large sites. He announced that he was thinking in terms of a possible 50,000 flying bombs per month. On this optimistic note, the ten-minute conference was closed. Ten days later the Führer gave his immediate assent to the construction of four flying-bomb “launching shelters,” as part of the Atlantic Wall programme.

If Göring was buoyant, the engineers were more realistic: the commanding officer of Peenemünde-West signalled the AOC of German Air Force research stations on 19th June:

Altogether five *Fi.103* shots, one of which, from the Walter catapult for the first time, had positive results. A shot from the concrete ramp catapult crashed at once, owing to insufficient launching velocity. The other three shots also crashed, but for unknown reasons.

These early failures did nothing to discourage the German Air Force; there was an enthusiastic demand for an investigation into the possibility of transporting flying bombs across the Atlantic by U-boat to attack American cities.

Within six weeks, however, new setbacks had depressed even the most hardened optimists, and test firings were completely halted while scientists carried out post-mortems.

THE ARMY engineers in Peenemünde-East were having more luck. Twenty-three A4 rockets had been fired since the first successful shot

on December 3, 1943, and the failure rate was decreasing.

On June 28, SS Reichsführer Heinrich Himmler drove into the Army Experimental Establishment for his second visit. He requested to be shown current progress on the A4 rocket project. Dr. von Braun and Major-General Dornberger took him to the Officers' Mess and entertained him politely but frugally, confining their conversation to expressing their desire that the A4 production requirements would soon be covered by the *DE* top priority rating already extended to its electronic components.

At a quarter past nine next morning, under a ten-tenths mantle of very low cloud, the thirty-eighth A4 prototype was launched at Test Stand VII. The rocket lifted smoothly off its pedestal, and for 30 feet slid smoothly upwards into the windless air.

Then Dornberger saw with dismay that the chequered body was beginning to revolve, imperceptibly at first, and gathering speed.

The missile keeled uncertainly over and headed across the peninsula at a very low altitude, belching flames and tumbling crazily. Fifteen seconds after lift-off the rocket innards collapsed under the tremendous strain, its motor cut out and the A4 plunged from a height of 300 feet on to the German Air Force's runways at Peenemünde-West. Three parked aircraft were destroyed by the blast as 8 tons of liquid oxygen and alcohol ignited with a roar. A crater 100 feet across was blown out of the runway. Himmler is reported to have quipped: "Now I can return to Berlin and order the production of close-combat weapons with an easy conscience."

To Major-General Dornberger, conscious of the billions of Reichsmarks that had been poured into Peenemünde and the A4, Himmler's joke seemed in execrable taste. Within 55 minutes a sweating team of Peenemünde engineers had rushed another A4 rocket – No. 40 – from the assembly workshop to the launching position; they had tested it, fuelled it, tested it again, and fired it.

This time the rocket soared perfectly into the mid-morning sky, vanishing dramatically from view into the high altostratus clouds, its

motor's thunderous roar echoing across the Baltic for over a minute, until the radio signal went out to cut it off. The shot was exemplary: the A4's motor had been programmed to cut out at a velocity of 4,491 feet per second, but the *Brennschluss* – cut-off – came as the rocket reached 4,501 feet per second; this represented an error of less than a quarter of one per cent. Shortly after, the tracking stations reported that the missile had come down 145 miles along the Baltic coast.

Himmler's face was expressionless, but it was plain that even he had been caught off balance by the sheer grandeur of the launching and by its brilliant triumph. He promised to put in a word with the Führer if it seemed appropriate. At a quarter past seven Himmler was back at Hochwald and the Führer's headquarters.

(xvi)

In London now events moved to a climax, for this was the evening on which the Prime Minister had arranged the meeting of the Cabinet's Defence Committee (Operations) about which he had spoken earlier in the week to Dr. R. V. Jones.

For many of the invited experts this was their first glimpse of the underground Cabinet War Room installation behind Whitehall, the most complex operational command centre in Europe. A long narrow passage, barred by a green door with an observation slit, gave access to the large square Cabinet War Room, which was dominated by a U-shaped table covered with a tight-fitting blue baize cloth.

Dr. R. V. Jones found that he had been given a chair in the well of the table normally occupied by the Chiefs of Staff and directly facing the Prime Minister. To Mr. Churchill's left were Attlee, Eden, Bracken, Beaverbrook and – farther along the arm of the table – Cherwell and Cripps. To his right sat General Ismay, the Chiefs of Staff, Morrison and the various invitees; Duncan Sandys and the members of his Ministerial inquiry were there in force. None who was present is ever likely to forget the details of the debate that followed Mr. Sandys's

opening address, with its dramatic introduction of the photographs of Peenemünde on which the white-painted rockets were so remarkably distinct. Only Herbert Morrison and Lord Cherwell voiced their doubts, the latter rather more forcefully than the former. It seemed to Morrison surprising that Peenemünde had not been more effectively camouflaged.

Lord Cherwell was not satisfied with this explanation. Assuming the role, as he disingenuously explained, of *avocatus diaboli*, he thought it would assist the committee if somebody put the arguments for the other side. He dismissed the evidence of the prisoners as manifestly unreliable, especially when they were talking about German “super fuels”; and he urged that it was incredible to postulate that the Germans had in one bound reached a stage which would have taken British rocket experts more than five years. It certainly seemed curious to him that the German rockets should have been painted white and left lying about so that the Allies could hardly fail to observe them. He suggested that the whole story bore all the marks of an elaborate cover plan designed to conceal some other, more sinister, development.

He had no definite ideas on what form the real danger might take, except that, for example, the Germans might intend to use “pilotless, jet-propelled aircraft.” Even so, he agreed with Sandys that Peenemünde should be bombed, and that a radio watch and photographic scrutiny should be maintained of those areas in Northern France where “projectors” might be erected. At the same time he reiterated the warning that the Allies should not neglect to search for other devices, especially for signs of radio developments which might seem to indicate enemy preparations to attack with pilotless aircraft.

Mr. Winston Churchill admitted that the Prof’s points seemed worthy of attention; but he believed that the Germans were under pressure to hit back at Britain in some way. He invited Jones to comment on whether the threats were bluff – as Cherwell suggested – or not. Introducing Jones, the Prime Minister reminded the meeting of how he had been responsible for piecing together the evidence which

had enabled the Allies to detect and defeat the German radio-navigational bombing beams in the autumn of 1940. Jones well remembers Mr. Churchill turning to him, wagging his finger at him, and saying: "Now, Dr. Jones, may we hear the *truth!*"

To Lord Cherwell's consternation, his protégé now commenced to demolish one by one all the weighty arguments he had assembled. Peenemünde, Jones announced, was without doubt "the most important German experimental establishment" after Rechlin. Answering Cherwell's earlier point, he admitted that some of the rockets were white; but there was also a black-painted one, very difficult to detect. This did not seem to fit the deception hypothesis.

To what end would the Germans mount such a deception anyway? Its only likely outcome would be to call down a heavy attack on one of the two most important German experimental establishments. In fact, he considered the evidence stronger than that on the beams in 1940. About the stage reached in the weapon's development he was reluctant to say much, but a message had been intercepted a week earlier from a staff officer in Major-General Leyers's weapons department in Berlin to the effect that Hitler had demanded that the rockets were to be put into action as soon as conceivably possible. The message had added that thirty catapults had been constructed already, but the opening of the offensive originally planned for July 1 had had to be postponed to the end of the month and might have to be postponed still further. Here again, this message could hardly have been a "plant": its only logical outcome would be to bring about the destruction of Peenemünde sooner rather than later.

Although he had not been able to introduce it at this meeting for security reasons, one of Dr. Jones's most convincing pointers to the genuineness of Peenemünde was a seemingly trivial German Air Force petrol-allocation directive. He had asked Bletchley Park to make a special effort to watch for *Enigma* references to Peenemünde, and after some weeks an intercept had been very apologetically forwarded to him, in which Peenemünde had been referred to only in the

distribution list at its foot. It was enough: the addresses were clearly listed in order of importance, and Peenemünde came second only to Rechlin.

At the end of Dr. Jones's dissertation the Prime Minister could see Lord Cherwell sitting silently at the end of the table, crestfallen and disbelieving. The Professor was not pleased with Jones's performance. Mr. Churchill, by all accounts, had been enjoying himself hugely: after each new point made by Jones, he had wagged his finger at Cherwell, cried "Stop!" and proclaimed: "Do you hear that? That was a weighty point against you!" Once he had rubbed it in: "Remember, it was you who introduced him to me. . . !"

The meeting came rapidly to an end. Cherwell made a final protest that the rockets' launching flashes should have been clearly visible in Sweden if any had indeed been launched at Peenemünde; this view was disputed by other scientists present. It was obvious that Sandys had carried the day. The Committee decided:

That the most searching and rigorous examination of the area in Northern France within a radius of 130 miles of London should be organised and maintained, no step being neglected to make this as efficient and as thorough as possible;

That the attack on the experimental station at Peenemünde should take the form of the heaviest possible night attack by Bomber Command on the first occasion when conditions were suitable, and that in the meanwhile undue aerial reconnaissance of the place should be avoided, and attacks by Mosquitoes should be ruled out; and

That as far as possible plans should be prepared for immediate air attack on rocket-firing points in Northern France, as soon as these were located. The bombing of a major bunker site at Wissant should be delayed, on the other hand, to enable the Allies to watch its development.

All Sandys's principal recommendations had been adopted. On the other hand, one final conclusion marked a first victory for the Prof, too: Sandys was directed to examine the state of development of pilotless, jet-propelled aircraft in Germany.

TWO DAYS after the Defence Committee meeting a messenger called for Lord Cherwell with a sealed envelope from the Prime Minister's office. Across the envelope was printed: THIS TELEGRAM IS OF PARTICULAR SECRECY AND SHOULD BE RETAINED BY THE AUTHORISED RECIPIENT AND NOT PASSED ON. Inside was a single sheet of paper; at its foot he recognised the Prime Minister's cramped red-ink script. The telegram itself was from an agent in Switzerland:

The Germans are announcing a devastating and decisive air attack on Great Britain for the month of August. Liquid-air bombs of terrific destructive power would be used. Also other undefined methods hitherto unexploited. Gas is not specified. Attack will be novel in method and irresistible in intensity, and the effect is promised as a major rebuff, probably decisive Axis victory.

To Lord Cherwell, one of the few informed of the Allied atomic-bomb development, this suggested that the "other undefined methods" might include the uranium bomb.

In the weeks that followed a second agent's report seemed to give further foundation to speculation about a German atomic weapon.

According to this report, the Germans had developed a missile with a theoretical range of 500 miles, weight 40 tons, length 65 feet. The first third of the weapon was the warhead: it contained explosive "of the atom-splitting type." Manufacture was under way on the island of Usedom (where Peenemünde was) and in Bremen, Friedrichshafen and Vienna. These latter two cities were known to be centres of German secret-weapon production.

The weapon was to be operational by September 1, 1943. This agreed well with a second July report of a "weapon of poor accuracy, being made at Peenemünde, with a range of some three to four hundred miles and the ability to kill everything within seven hundred yards of the blast." This, too, would be ready by September. Another report, from a refugee, talked of a Swedish engineer's having seen "an island

30 miles away completely wiped out.”

One feature was constant in these reports: the period when it was planned for introduction. All of them had put this near August or September.

THE C.I.U. had issued a first report on Watten as early as May 17; at that time RAF Medmenham had not been informed that the forest clearing was linked with secret-weapon activity. On July 6, three days after the Unit had completed a scale model of the site, definitive information arrived to link it with secret weapons: an agent's report stated that there was “German long-range rocket activity” at a certain pinpoint subsequently found to coincide with Watten.

A renewed aerial survey of the area bore fruit: it showed new railways being built leading to “heavy constructions.” What had previously been observed only as a shapeless excavation like a gravel pit was now seen to be completely shuttered and scaffolded, and almost ready for concrete-pouring to begin. All these reports were passed on by Mr. Sandys to the Cabinet on July 9; they certainly suggested that rocket attack might be imminent, and some of them indicated also that “poison gas, pilotless aircraft and very long-range guns” would also be used. He confirmed that instructions had been issued to radar operators in South-eastern England to maintain a continuous watch for rocket firings from the Continent.

The situation was sufficiently grave to warrant plans for the partial evacuation of London involving 100,000 people in priority classes – mothers and children – at the rate of 10,000 a day; in addition, 30,000 Morrison shelters – crushproof steel tables – were moved unobtrusively into London. The plans laid for the attack on Peene-münde at a Bomber Command planning conference on July 8 were closely examined by the Chiefs of Staff at a meeting with Morrison, Cherwell and the Prime Minister at No. 10 Downing Street seven days later. Although Cherwell still felt unconvinced of the need for attack, Sir Arthur Harris was ordered to proceed at the earliest opportunity

presented by moon and meteorological conditions.

Sandys made preparations to jam enemy radar stations in the event of the Germans using radio control for the rocket or for plotting its fall. Arrangements were complete for censorship of any reference to rocket incidents, and evacuation planning had been extended to Portsmouth and Southampton as well.

DURING JULY reports from Intelligence sources in occupied Europe continued to add urgency to the inquiry. Two further reports had referred to "liquid-air bombs" and one to the dropping of phosphorus on London in August; radio-controlled pilotless aircraft had been mentioned, and four agents had spoken of long-range rockets with ranges between 200 and 500 miles; one of them had, as described earlier, referred to a warhead of "atom-splitting" explosive. Two reports featured rockets being launched from aircraft, with an initial weight of 10 tons and a final weight of 2 tons, and with a range of 300 miles.

To Mr. Sandys it was sufficient that so many of the reports agreed for him to accept that these threats did exist. When there was room for dispute he could fall back upon photographic reconnaissance, which could provide incontestable proof of secret-weapon activity. Thus, while two Allied agents reported the site at Watten to be "concrete mountings for heavy guns, ammunition stores, barracks and hangars," and "underground arms depots, petrol stores or barracks" respectively, further photographic reconnaissance reported on July 29 showed that while considerable progress had been made since the last aerial survey, the Watten site was totally unsuitable for any of the purposes which the agents had attributed to it.

A force of paratroops dropped into these sinister installations might find out what they were about; but Lord Cherwell took exception to this proposal:

I find it difficult [he wrote to General Ismay on July 29] to understand what information which cannot be got from photographs

could be obtained by paratroops in these earthworks in half an hour in the dark.

We have seen very many similar works grow up in these regions in the course of the last three years, and it is not surprising, when they may be expecting invasion, to see fresh ones undertaken by the enemy. No doubt before sacrificing one hundred and fifty highly trained men, the Chiefs of Staff will assure themselves that the evidence connecting these particular sites with the putative LRR [Long-Range Rocket] is consonant.

But no doubt I am biased by the fact that I do not believe in the rocket's existence.

Photographic reconnaissance of Peenemünde was reduced to a minimum in order not to alert the Germans. During July there had been only two sorties, and the photographs were eagerly examined. Now even the smokeless chimneys of the power station no longer deceived the CIU. Flight Lieutenant Kenny detected a slight heat-haze above the southern two chimneys, and accepted that the station was now active.

The stocks of coal had increased, and lighters and ferries were unloading still more coal and stores in Peenemünde's small dock. But the anti-aircraft defences were steadily increasing too, and a decoy site had been constructed, covering over 20 acres of ground and consisting of thirty fake "fire"-sites. The Germans were expecting air attack.

A Mosquito sortie over Peenemünde on July 26 brought back excellent photographs of all the eastern edge of the peninsula. Photographic interpreters found a row of six smoke generators emplaced to the north of the ellipse, with whitish blast marks showing that they had been tested since the previous sortie, and there was proof of the arrival within the last four days of a considerable number of new anti-aircraft guns.

The Aircraft Section, to which the photographs were passed, also reported the presence of one small tailless aircraft at Peenemünde-

West; but what was causing consternation at Bomber Command was the speed at which the anti-aircraft defences were being augmented. Now it was a race between the phase of the moon and the speed at which the Germans could reinforce Peenemünde's defences. The long nights were returning, and Peenemünde was once more within range; but not until the middle of August could a full moon seal the fate of the rocket establishment.

(XVII)

Albert Speer dispatched his Chief of Staff for Chemical Industry Questions to inspect both Peenemünde establishments at the end of June 1943; his report was circulated in Berlin on the 29th, and thereby we have an unrivalled survey of the German secret-weapons programme on just the day of Mr. Churchill's Defence Committee meeting in Whitehall. About the A4 long-range rocket his report was unflattering in the extreme; he was very impressed by the performance of the *Me.163* tailless rocket-propelled fighter, of which the German Air Force was planning to maintain an operating strength of 1,000. Again, an inspection of the anti-aircraft guided missile *Wasserfall*, which was designed to carry a 100-pound warhead to 50,000 feet at ranges of up to 28 miles, moved him to append a detailed paper arguing that the whole long-range rocket programme should be scrapped in its favour although it had not even left the ground by that date.

The report turned to the A4 project with a marked distaste, speaking of this "inordinately complicated and expensive weapon" and suggesting that it was useless except for large-scale targets of great strategic importance. It continued:

This weapon's development can be considered complete as far as the problems of controlling the combustion process of the rocket motor and above all of deflecting the burnt gases by radio-controlled gas-rudders, so as to achieve control of the rocket itself, are concerned.

Nine hundred A4 projectiles were to be manufactured monthly, so material requirements for this programme had to be covered in advance: each month's output would require 13,000 tons of liquid oxygen, 4,000 tons of 99 per cent pure alcohol, 2,000 tons of methyl- alcohol, 500 tons of hydrogen peroxide and 1,500 tons of high explosive.

In opposition to A4 was the *Fi.103* flying bomb, a "small pilotless aircraft powered by an Argus pulse-jet using low-octane petrol." Its launching catapult was to be powered by hydrogen peroxide or a solid explosive, and its warhead would weigh 1½ tons. A monthly output of 3,000 flying bombs was planned, entailing the production of 300 tons of hydrogen peroxide, 2,000 tons of low-octane fuels and 4,500 tons of high explosive.

Early in July, Speer summoned Degenkolb to a new parley in Berlin; both now recognised that the A4's production difficulties could not be easily overcome.

For this, Peenemünde was at fault: as Speer later pointed out, his Ministry had originally been promised production blueprints for the autumn of 1942. Now, however, the Special A4 Committee's first inquiries had shown that only a few "third-rate" firms would be available for the production programme.

Both agreed that if the rocket programme was nevertheless to be "pushed through" other, more suitable, firms already jammed with urgent weapons programmes, a special Führer decree would have to be prepared for Hitler's signature.

Speer next visited the Führer's headquarters in East Prussia on the 8th. Von Braun and Dornberger were already there, having been flown across from Peenemünde by Dr. Steinhoff in his Heinkel 111. Together with Alfred Jodl and Wilhelm Keitel of the High Command, Hitler viewed the spectacular film of the first A4 launching, and inspected the scale models of the Watten "bunker" and of the launching-troop vehicles.

The Führer has appointed Herr von Braun – Major-General

Dornberger's assistant – a Professor in recognition of a thesis on a new weapon [Speer wrote confidentially on his return to Berlin]. Meissner is to have the diploma issued. Hitler desires to sign it himself, and I am to make the presentation.

Dornberger later recalled expressing strong opposition to the Watten bunker principle, preferring inconspicuous motorised launching sites for his rocket troops; but when Speer confirmed to Hitler that the Watten shelter was essentially similar to the U-boat pens, Hitler would hear no more, demanding that two or even three such bunkers should be built for launching rockets. Speer recorded:

The Führer again insisted that every effort should be made to promote the A4 rocket's production. He considers this is a decisive weapon of war, one which is calculated to relieve the pressure on the Reich and which can be achieved with relatively small means. Labour and materials must be fully provided.

Speer decided to recall the planned Führer decree for the Panzer programme, and to convert it into a decree for A4 production. The manpower required for the rocket factories would be drawn off the strength of the general armed forces equipment industry.

For security reasons Hitler ordered Speer to employ only native Germans on rocket production, and it would be preferable if auxiliary labour forces were recruited from areas which had suffered Allied saturation bombing. Five days later Field-Marshal Milch called a conference in the Reich Air Ministry to examine the growing crisis in the aircraft industry, now further aggravated by a letter from Speer, on Hitler's authority demanding that rocket-component manufacture should be safeguarded by air industry firms. An Air Ministry representative complained:

The danger is that as the A4 now has *DE* top priority, our produc-

tion will begin to suffer from shortage of technicians. Director Storch [of the Special A4 Committee's Electrical Equipment Board] has announced today that he can see a time coming when the requirements of the whole A4 programme can no longer be met. That will result in an invasion of *our* equipment production. The view held by the [Munitions] Ministry is that we don't need the equipment all that badly. But if we don't manufacture it, the output of finished aircraft will be endangered. This is all our standard equipment.

There was no question but that aircraft production would have to give way before the A4 programme; aircraft production was not yet covered by the *DE* rating.

"We must compile a complete portfolio of evidence on the way our production is being invaded by the A4 programme," it was suggested, "so that we can march up to the Munitions Supply Office [of Albert Speer's Ministry] and demand protection." An Industrial Council representative said:

Then we must inform our groups of manufacturers at once. Many firms in the Air industry have already been allocated A4 production contracts; as soon as they say, "We won't accept them," they are told bluntly: "You've got no option – this is *DE* production."

On July 20 Speer summoned to talks in Berlin his department chiefs responsible for Ruhr industry, together with Major-General Waeger of his Armaments Office, and Dorsch of the Todt Organisation.

The Reichsminister imparted to them details of the super-priority measures he was planning for promoting A4 rocket production, if the Führer's assent could be obtained. Speer knew that it could not be long before Allied bombers visited Peenemünde. Two days later, at a conference between Speer and both Degenkolb and Dornberger, and attended by the rocket production specialists, the necessary ARP construction measures for Peenemünde were debated.

ANY DAMAGE from air attack would be mitigated by Speer's endeavours in other directions. By early summer 1943 the production of rocket components was well dispersed; the majority of the subcontracts had already been issued by Peenemünde-East. Hundreds of small firms throughout Germany found themselves producing strange components and electronic arrays, blessed with the highest priority in the whole complex of German munitions production.

If the long-range rocket programme had seemed vulnerable and exposed in March, when it was out of Hitler's favour and when a single well-executed air attack could have destroyed all the blueprints and ten years of concentrated research, now every week saw the project moving farther underground.

The War Diary of just one Munitions Command, at Freiburg in Southern Germany, reflects the dispersal of manufacture involved, but also the upheaval it was causing in every sector of war production.

In that area thirty-eight small firms, including one with the familiar-sounding name of Degenkolb & Co., were mass-producing components for the A4 rocket, each employing up to 200 workers producing magnetos, relays, pumps, coils, servo-controls, cable looms, and hundreds of other components. In the Freiburg area alone 1,477 skilled workers were committed to A4 contracts by the end of July 1943. The dislocation in Germany's war industry was severe, the Command warned:

The original quotas for August and September cannot be fulfilled, as more and more firms are being converted to the A4 programme; even attempts to release workers from other firms are encountering difficulties because the groups and committees try to shelter all firms willy-nilly if they are engaged on A4 work, whether 100 per cent or not.

Speer's uncompromising support for the A4 incensed the German Air Force, whose aircraft production was the chief sufferer; the knowl-

edge that their own projectile, the *Fi.103* flying bomb, hardly interfered with aircraft production at all served only to rub salt in the wound. Where the Air Force was developing its own rocket missiles, its brushes with the A4 project left a very bitter taste: the firm of Ardelt in Breslau had been under contract to the Air Force to deliver 100 fuselages for *Rheintochter*, an experimental series of surface-to-air missiles. A furious anti-aircraft commander announced at Field-Marshal Milch's defence conference on July 22 that in the meantime he had discovered that this Breslau factory had been requisitioned for A4 production.

The fate of the *Wasserfall* anti-aircraft rocket was another case in point. Because of the liquid-fuelled *Wasserfall's* affinity to the A4, the Air Force had readily agreed that the German Army should direct its development; 500 highly trained engineers were loaned to Peenemünde East to form a special "Air Force Anti-Aircraft Research Unit"; at the end of 1942 this unit had been subordinated to von Braun. By March 1943 the provisional nitric-acid/alcohol combustion chamber had been put through hot running tests. By July 1943 the second, definitive model of the *Wasserfall* combustion chamber was on Test Stand VI, in the expert hands of Dr. Walter Thiel. The motor was developing a thrust of 8 tons over 45-second runs. At the July 22 conference Milch had agreed to raise the unit to 1,500 men; encouraged by this the *Wasserfall* team provisionally scheduled two firings before the end of 1943, twenty-five more before June 1944.

The schedule was never kept.

Hitler signed the decree ordering top priority for long-range offensive rockets. The German Air Force could only watch helplessly as Professor von Braun commandeered the *Wasserfall* engineers entrusted to his command, and injected them into his own A4 project.

(XVIII)

Time had run out for the German population centres; on July 24, 1943 Sir Arthur Harris had launched his celebrated series of attacks

on Hamburg, the second largest city in Germany.

Within nine days over 40,000 dead lay among the ruins and the city had been evacuated of over 1,000,000 civilians. Now, if ever Germany had needed a weapon of revenge, the time had surely come for it to be pressed into service.

The fragment of the stenographic record covering the events at Hitler's Wolf's Lair headquarters on the following morning, July 25, is of particular interest: it gives an insight into the state of his mind on a day that was to be fateful for Germany's rocket programme.

At noon Hitler raged at his Air Force experts for their incompetence: owing to the first use of *Window* by the RAF, the losses had been unusually low.

Colonel Eckhardt Christian, Hitler's Air Force aide, explained that the British had released showers of metal foil; as a result, all radar except *Freya* had been jammed. There was no immediate prospect of inflicting such crippling losses on Bomber Command that they would be discouraged from making further attacks.

HITLER: That was the whole point of the conference a few days ago, when I pointed out: You can only smash terror with counter-terror! You have got to counter-attack! Anything else is rubbish!

The aide suggested that fifty bombers should attack British airfields; Hitler jeered that when the Air Force was finding it difficult to locate even London by night, it was rather pointless to send aircraft to attack individual airfields. The assembly fell silent. Hitler held the floor:

You can only smash terror with counter-terror! If they bomb my airfields, I don't bat an eyelash. But if they wipe out my Ruhr cities. . . ! The British are very touchy: a few bombs with our new explosives have given them hysterics. "New German weapons," they scream. I don't know why everybody is now skirting round the subject like a family of cats round a hot stew. You can only force them

to give up by getting at their people. . . The only thing that will have any effect is a systematic attack on their villages and towns.

It was in this unstable frame of mind that he received his Reichsminister for Munitions that afternoon; Speer had brought with him the decree on the A4 rocket, granting him sweeping powers. Hitler signed it greedily:

The successful prosecution of the war against England requires peak A4 missile output to be attained as soon as possible [the decree read]. Full support must be given to all measures designed to secure an immediate increase in A4 production.

The German factories producing the A4 missile – as well as those delivering components to them – are to be supplied with specialist German manpower, raw materials, machinery and power forthwith, the said supplies to be on the largest scale.

The Reichsminister for Armaments and Munitions is authorised to draw upon the capacity of all military units of the Reich and of the remaining war economy, after previous discussion with me.

The Reichsminister for Armaments and Munitions will determine the [scale of the] A4 programme.

(Signed) ADOLF HITLER

A Henschel *Tiger* tank production expert, Alben Sawatzki, was delegated to supervise the mass-production arrangements. In Berlin, Degenkolb initiated him in his ambitious “Degenkolb programme,” then sent him and his staff to Peenemünde.

Major-General Dornberger was anything but co-operative, and without further ceremony dispatched them from the premises, with the exception of Sawatzki, who was permitted to analyse the mass production pilot works.

This unfortunate attitude on Dornberger’s part did nothing to ease Degenkolb’s travails. The consequent errors in the rocket’s design for

mass production were to cost Germany dearly when production actually began at the end of 1943.

(XIX)

The tension between the two rival long-range bombardment programmes became intolerable; the German Army was wantonly throwing its weight about in the form of the new Führer decree.

Behind locked doors at the Reich Air Ministry, at ten o'clock on the morning of July 29, an Air Force engineer, Colonel Pasewaldt, assembled a large gathering of high-ranking officers connected with the flying-bomb project, including Colonel Max Wachtel, commanding officer of the experimental flying-bomb troops, and Major Stahms, commanding officer of Peenemünde-West; the production side was represented by Gerhard Fieseler and Fritz Gossiau, whose Argus firm was supplying the pulse-jet engine.

Pasewaldt explained that the meeting had been called to give all sections of the flying-bomb project a last chance to debate whether all the prerequisites had been satisfied for commencing mass production in August.

Peenemünde-West was invited to state how far development had proceeded.

GROUP LEADER KROGER: Sixty-eight *Fi.103*s have been launched at Peenemünde; of these a number have fulfilled their experimental duties, and a number have developed faults. Among the twenty-eight shots which fulfilled the demands we made was the long-range shot which has probably come to the attention of all departments, reaching 152 miles on 133 gallons of fuel. A velocity of 375 miles per hour was reached by another shot.

The altitude of the test shot had been 4,300 feet; greater altitudes had not been attempted. Tests were also being made with bombs which

could be launched “round corners.” But there was bad news about manpower. Göring had been hoping that Speer would supply skilled workers from Army firms.

These hopes had now been dashed:

We have got to look after ourselves. We can only transfer skilled German labour from our own factories. Now more than ever it will be impossible for the A4 committee to approach us, the Air Force factories, demanding that we (who cannot even fulfil vital production for the *Fi.103*) make skilled German labour available for the A4 programme.

In Field-Marshal Milch’s view, if not in Hitler’s, the *Fi.103* ranked equal in priority to A4; mutual support was now out of the question.

FOR SECURITY reasons, the flying bomb would be known by two names: Fieseler was keen that it should be known as *Fi.103* after his firm, but it was pointed out that von Axthelm had that very day directed that it was to be known as *Flakzielgerät 76* (literally “AA target device 76”).

Major Stahms pleaded that it was highly important to avoid *faux pas* like referring to “the *FZG.76*, formerly known as *Fi.103*.” In a city like Kassel people were talking in the street about the weapon, and in Berlin even the servant girls knew about it.

FIESELER: The main danger is that the people who really know something, many of my own workers, for example, may confirm that they are working on the thing and consider it their duty to set false rumours right. . .

WARMBACH: Above all, things are sticky at Karlshagen [i.e., Peene-münde], with so many foreigners employed there. I don’t know whether the foreign workers have all been cleared out yet. . .

MAJOR STAHS: We have, yes! But the Army hasn’t. Perhaps we can seize this opportunity to spread a counter-rumour, that their

A4 rocket project has failed, that the thing doesn't work. . .

FRITZ GOSSLAU: . . . or that at each launching the whole ground crew was wiped out, and that that would have been intolerable even for the Army in the long run!

On that bright note the conference ended.

(xx)

Under the shadow of the great RAF attacks on Hamburg, Professor Willy Messerschmitt, the aircraft designer, took up the matter of the allocation of production priorities personally with Hitler and Speer. He maintained that unless Germany produced 80,000 to 100,000 revenge weapons each month – an output which he considered entirely possible – the whole programme should be scrapped; in which case everything should be done to build up the strength of the German Air Force, with Speer's ministry taking over aircraft production from the incompetent Air Ministry.

Field-Marshal Milch also viewed with concern any attempt to restrict aircraft production, and particularly to weaken the defensive arm. On August 3, 1943 he succeeded in getting Speer to attend a joint conference at the Reich Air Ministry, attended by eighty-five leading Air Force officers. Among them was Major Hajo Herrmann, commanding the newly formed "*Wild Boar*" organisation which was to play a prominent part in the fighter defence of Peenemünde two weeks later.

For an hour Speer listened in silence as Herrmann answered questions on the needs of German fighter units; General Adolf Galland offered Herrmann 500 of his own single-seater day-fighting aircraft for use over the Reich. Milch fervently agreed with this transfer. In Hamburg, he believed that he had seen the writing on the wall.

FIELD-MARSHAL MILCH: Give us just five or six more attacks like

these on Hamburg, and the whole German people will just pack up working, however strong their will.

I have said it before, and I say it again: the measures which are being adopted now have been adopted too late. It's no use prattling of night-fighters on the Eastern Front or of ground support in Sicily, or any other such pipe-dreams.

The man at the front must dig a hole in the ground for himself and lie in it until the bombers have gone. What the home front is suffering now . . . that is intolerable.

The discussion turned to the flying bomb, *Fi.103*. From the heated exchanges which followed, it was evident that even Albert Speer's conscience was pricking him. The manpower crisis was causing particularly bad odour between the flying-bomb and rocket-component firms. An Air Ministry official cited a particularly bad example:

MAHNKE: A man turned up at the Daimler-Benz Factory and said that all [*Fi.*]103 production is being shut down, and that A4 rockets will be being manufactured instead.

MILCH: Then tell these gentlemen that if anybody else comes, I will have him arrested.

SPEER: I would be grateful if these cases were always referred to us, so that I can get my hands on these people. We ourselves are not responsible for this.

The meeting made a profound impression on him.

On the morning of August 17 a directive was issued to all Munitions Commands, signed by the chief of Speer's Armaments Office. It underlined briefly the radical change in Albert Speer's policy towards the secret weapons:

Re: *Air Force production and the Army's A4 programme*

The A4 programme is not to interfere with the Air Force's manu-

facturing programme.

It was the first decisive blow in the Luftwaffe war against von Braun. That night RAF Bomber Command was to deliver the second.

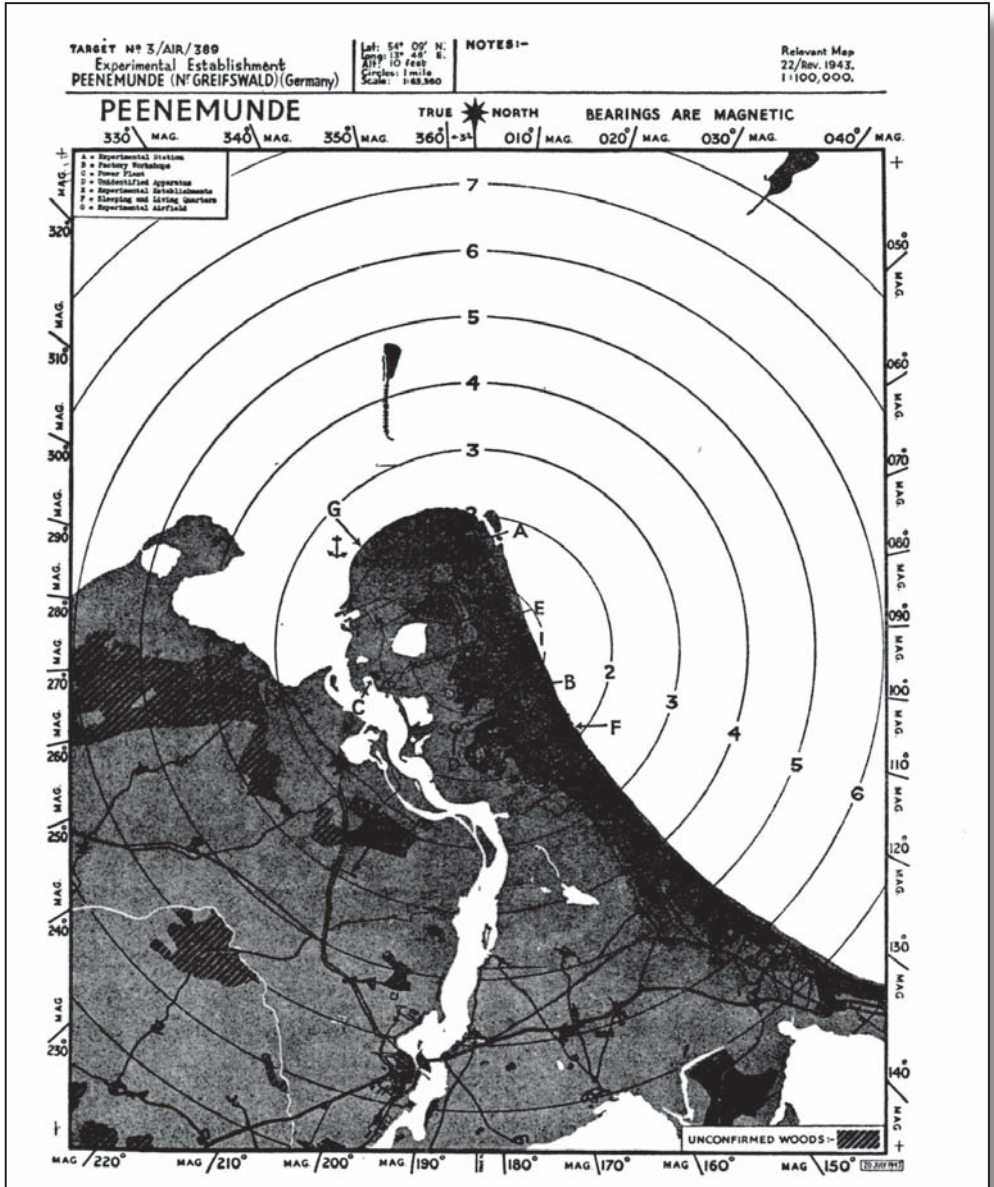

PEENEMÜNDE TARGET MAP

Nature had provided a tiny islet, the tadpole-shaped Ruden Island, in the direct line of approach to the three Bomber Command aiming points E, B and F. It was on the marking of this island that the success of the attack hinged.

PART THREE

OPERATION HYDRA

“August 17–18, 1943: Incursion of a strong force of enemy bombers between 11:25 P.M. and 3:40 A.M., with target of attack in the western part of Usedom island. Special reports on the effect of this air raid have been submitted to the Reichsminister of Munitions and Armaments . . .”

— *The unremarkable entry in the War Diary of the Stettin Munitions Command on one of history’s most decisive air attacks.*

PART THREE

Operation Hydra

(1)

EARLY ON AUGUST 17, 1943 Bomber Command telephoned the Bomber Groups warning them to stand by for orders. At 9:40 A.M. Sir Arthur Harris ordered operations *Hydra* and *Whitebait* – attacks on Peenemünde and Berlin.

The attack had been planned weeks before. Originally, Harris had favoured attacking just the two large workshop buildings; Mr. Sandys had convinced him, during a visit to Bomber Command, that the attack should “be directed against the Peenemünde scientists too,” and three complexes were marked for attack: Aiming Point “F,” the scientists’ housing estate, was to be attacked first; “B,” the two large workshops, second; and “E,” the Development Works, last. The elliptical Test Stand VII was not included as a target.

Zero hour would be fifteen minutes after midnight; the Pathfinder Force would execute a diversionary attack on Berlin one and a quarter hours earlier after following a northerly route past Peenemünde.

The day before, Group Captain John Searby had been called to Pathfinder headquarters for a special briefing; he was told he was to act as Master Bomber. He and his two Deputy Master Bombers learned that the attack was to be in three waves. Parachute flares would illu-

minate the area and successive waves of radar-guided Blind Marker aircraft and of Visual Marker aircraft would drop coloured “target indicator” flares on the three aiming points in turn.

All three aiming points were in line with the tiny Ruden island, three miles north of Peenemünde; timed runs from this island would safeguard the accuracy of the attacks.

The whole attack was to last for forty-five minutes. The first wave of bombers would saturate the scientists’ housing estate, and after four minutes, during which special “Aiming-Point Shifters” dropped target-indicators on the second aiming point, a further swift attack would be launched on the two huge workshops. Finally, the Aiming-Point Shifters would move the marking to the third aiming point, the Peenemünde Development Works.

IN GERMANY, TOO, preparations were being made. The German radio monitoring service reported that the air was thick with test transmissions from British bombers. On this night, for the first time, single-seater aircraft from the day-fighter force would operate alongside the night-fighters: Herrmann’s organisation was to go into action in moonlight conditions that promised excellent opportunities for cat’s eye interception.

AT TWO-FIFTY that afternoon, Sir Arthur Harris issued the final orders.

Four hundred and thirty-three Stirlings, Halifaxes and Lancasters were detailed to bomb Peenemünde targets marked by sixty-five Pathfinder aircraft. Eight Mosquitoes were to carry out an anti-morale attack on Berlin, each dropping marker flares and a minimal bombload, after switching on their radio equipment to lay a false scent across Germany.

The 4,000 airmen were hushed by the news that if this night’s attack on a mystery “research station” failed they would have to return night after night until it succeeded. It was engaged upon the production

of a “new, form of radiolocation equipment,” they were told, which promised to improve the German night-fighter organisation:

In order to retard the production of this equipment and thereby help maintain the effectiveness of Bomber Command’s offensive, it is necessary to destroy both the Experimental Station and the large factory workshops, and to kill or incapacitate the scientific and technical experts working there.

At Wyton, the crews of 83 Squadron were being briefed by their strikingly youthful commanding officer, Group Captain Searby; the approach over the North Sea was to be made at very low level; the bombers would creep in under the German radar. Reaching Denmark, the whole armada would climb fast to 7,000 feet, from which altitude most aircraft would attack their targets; this altitude seemed uninvitingly low. At nine o’clock the first aircraft were taxiing into the wind; and a brilliant moon was rising.

(II)

By early evening the whole German fighter force had been alerted. The monitoring post *Seeräuber* had deduced by four o’clock that the target was in Northern rather than Southern Germany: having cracked a low-level Bomber Command code some time before, the post had been able to decipher a warning to defences at Cromer that British bombers would be leaving and re-entering England at that point.

The first sightings of approaching bombers by coast-guard units off the Danish coast reached Major Herrmann; from his operations room at Bonn-Handelar he debated by phone with Colonel-General Hubert Weise in Berlin and concluded that Berlin would be the target.

Shortly after ten o’clock the eight Mosquitoes of 139 Squadron sped high across Denmark, cascading copious quantities of *Window* as they passed, crossed the coast west of Peenemünde and then struck south towards Berlin.

At ten twenty-five the full alarm sounded in Peenemünde.

By the time that the Messerschmitts and Dorniers had reached the predicted height of the enemy aircraft, the Mosquitoes had long passed; all that the disappointed Germans found up there were the drifting swathes of metal foil.

Fighter squadrons throughout the Reich were scrambled – over 200 aircraft, the biggest effort ever, were in the air. At one-minute intervals the thirteen *Me.110s* of the IInd *Gruppe* of *NJG.1* lifted into the warm evening air at St. Trond.

The Mosquitoes were already approaching Berlin. Forty-two minutes after ten the German capital's sirens sounded, followed one minute later by the piercing howl of the Full Alarm. With radar echoes approaching the capital, and hundreds of bombers massing over the North Sea, Berlin seemed threatened with a Hamburg-style catastrophe.

At four minutes to eleven the first Mosquito was over Berlin, glared at by hundreds of searchlights. With a roar the city's anti-aircraft batteries opened fire. Four million Berliners were galloping into their shelters. The sky filled with flares and bombs began to detonate across the city. All Herrmann's "*Wild Boar*" squadrons were ordered to Berlin.

Eleven minutes after the attack began Berlin's flak was ordered to restrict its fire to 22,000 feet; Herrmann's group would operate above that deadly ceiling.

General Kammhuber, trying to direct the battle from his operations bunker at Arnhem, found the lines severed. The Fourth Fighter Division commanded by General Junck from an operations room at Metz, in Northern France, stepped in to take command of an air battle that was eventually to be fought in Northern Germany.

At 11:35 P.M. he signalled: "All night-fighters to Berlin!"

From all over Germany, the single-engined and twin-engined fighters poured towards the capital, where the gunfire and Pathfinder flares told their own story.

IN THE Officers' Mess at Peenemünde von Braun and Dornberger

were deep in conversation with the famous German test-pilot Hanna Reitsch. The evening was gay with laughter and a hundred voices. Three hundred and seventy miles away Hans Jeschonnek, Chief of Air Staff, was punting peacefully across the moonlit waters of Lake Goldap in East Prussia, recounting to his adjutant the story of his particularly unpleasant argument with the Führer that afternoon; it was Jeschonnek's last evening alive. Hitler himself had just emerged from a late War Conference with Field-Marshal Keitel and Jodl, and was relaxing with the Prince of Hesse in one of his interminable conversation tea-parties, doomed to drag on into the early hours.

In Berlin, Dr. Joseph Goebbels, who one hour earlier had been addressing the Propaganda Ministry about measures being taken to "reduce the hardships caused by the British terror bombing," was in his bunker waiting for the All Clear, while Colonel Zanssen, now Peenemünde representative at the War Office, strolled out on to the balcony of Dornberger's flat in Charlottenburg and marvelled at the effectiveness of defences here in Berlin.

(III)

An extract from the diary of von Braun's private secretary, Dorette Kersten, illuminates for one last time the idyllic existence led by the scientists at this Baltic paradise:

After many days, at last the sunshine we have all been yearning for. It isn't broilingly hot, but it is wonderful to see my beloved sea again at clocking-off time, when the crowds are out of the factory. Then I can go back and work hard and without interruption in the office, so that I can have everything finished for the Professor by morning.

This evening nobody else seems to be in Block Four – absolute silence all around me. Shortly before eleven, I close the steel safe and

walk out of the block. Outside, a milky white landscape lit by the light of the full moon. Sunk deep in my own thoughts, I stroll slowly along the short path between the tall Scots pines and the shrubbery, past the tennis court and up to Schlempp's construction office.

At that moment the air-raid sirens sound. This is the first time I have been caught in the Works: only men are permitted to live in the Works area.

First of all I go to my room; there's no hurry, this is not the first time it's only been a warning. My room-mate is still there, wildly packing her bags; I laugh in her face, only pick up a book and drape a bathing-wrap round my shoulders in case it gets too cold.

We make our way out. By Block Thirty a number of men from the West Works [German Air Force] are standing around, looking up at the clear sky and cracking jokes; they laugh at her suitcases! The bunker in front of Block Four is almost empty, a few people are clustered outside it.

Most of them are going back to bed, as nothing seems to be happening. I find a seat on the bench and start to read my book. I become completely absorbed in it and don't look up from it even when a low roar, a rumble, starts way off in the distance. An hour has already passed since the sirens sounded.

To Group Captain John Searby the Peenemünde peninsula seemed lifeless and drab as his Lancaster bomber swept across it, the four Rolls-Royce engines cutting a swathe of shattering echoes across the apparently deserted factory area and experimental station. The full moon was rising dead ahead.

No guns were firing, but along the shores and airfield perimeter smoke generators were belching clouds of acid fumes, breaking up the clear outlines of the enormous factory buildings and obscuring the edges of the lakes. He switched on his transmitter.

The weather in the Peenemünde region was less favourable than forecast: the uncertain visibility tricked some Pathfinder crews: the

rocky islet of Ruden did not show up brilliantly on the *H2S* radar equipment. Some of the Pathfinders detailed to mark it succeeded, others dropped their “red spots” into the sea, or found to their dismay that their red spots had in fact ignited on the tip of the Peenemünde peninsula itself, two miles to the south along the bombing run.

This was to bedevil the opening stage; it was to cost the lives of several hundred foreign labourers in their camp, just two miles to the south of the most southerly aiming point.

Although the timing of this opening wave was beyond reproach, the erratic red spot fires compromised any possibility of a swift initial success. Most of the Blind Marker’s long-burning red target indicators (TIs) fell two miles south of aiming point “F.” Some of the Blind Marker crews, confused by the ambiguous response of their *H2S* radar, tried (against orders) to confirm their release point visually. The attack undoubtedly opened on the right aiming point, accurately marked by a single yellow target indicator dropped by the first Visual Marker, Wing Commander John White of 156 Pathfinder Squadron.

But at least five of the early Blind Markers put their TIs down about two miles to the south-east of the scientists’ settlement, and some marker flares were over the sea itself.

Group Captain Searby saw what had happened, judged the yellow to be “very well placed” and, together with four or five of the Visual Markers, placed other yellows as close as possible to it to reinforce the glow.

By fifteen minutes after midnight, zero hour for the attack, Searby had seen three Backers-up reinforce the markers round the aiming point, their green target indicators cascading very accurately over the yellow marker concentration.

At 12:17 he ordered the Main Force to commence bombing on the green concentration.

Over two-thirds of the 227 attacking aircraft succeeded in bombing the correct aiming point. The remainder were led astray by the false marking.

As the last aircraft of this first wave withdrew at twenty-seven minutes past midnight, the German Air Force had still not put in an appearance. Peenemünde was apparently not going to be the massacre for which they had been briefed.

THE PATHFINDER plan called for special “Shifters” to aim their markers at the centre of all greens still visible at the end of the first attack. As their bomb-sights would have false settings, their red markers would fall deliberately short, on aiming point “B.” The marking of the second target was therefore highly dependent on the accuracy with which the first aiming point had been marked and backed-up.

As it was, as a result of the earlier overshooting, when the Shifters attacked at twenty-five minutes past midnight, they substantially brought the marking right back to the scientists’ housing estate again.

Only one Shifter placed his red TI correctly on the new aiming point, “B,” the Peenemünde pilot rocket factory. Nine Backers-up had to drop green target indicators regularly on this new aiming point; they naturally preferred the larger concentration of reds, while the one solitary correct one was ignored.

It was now that the presence of a Master Bomber saved the attack from progressively overshooting: Group Captain Searby broadcast a warning that the Backers-up had overshot. Then he twice broadcast a categorical instruction to the Main Force bombers to ignore the green markers to the south and bomb only those to the north.

In this second eight-minute wave 113 Lancasters, the most powerful aircraft of Bomber Command, had attacked.

BY THIS time no fewer than 158 German night-fighters were in the sky, heading for Berlin 120 miles to the south of Peenemünde. Herrmann had hurled an additional fifty-five “*Wild Boar*” day-fighters into the fray, and these, too, were attending the Reich capital.

Over Berlin there was chaos: the day-fighters were making daring attacks on every twin-ruddered aircraft in sight. The anti-aircraft gun

crews, aware of hundreds of aircraft over Berlin, were opening fire on everything within range; and the night-fighters assumed that the guns would hardly be shooting unless the enemy were really present in force.

Field-Marshal Milch was shocked to see fighters blinking recognition signals without pause, which the guns simply ignored. A night-fighter specialist telephoned in distraction to Milch to do something before the night-fighter force was shot out of the sky by the Berlin flak.

Milch telephoned Göring, and then the Führer's headquarters in East Prussia, seeking powers to order the guns to cease fire.

Göring agreed immediately; but from the Führer's headquarters he drew a blank refusal. Meanwhile, Berlin kept on firing. For two hours the noise of gunfire from eighty-nine heavy AA batteries comforted the troubled Berliners.

When Herrmann himself, piloting an *FW.190* high over Berlin, saw Pathfinder markers going down over Peenemünde he realised that he had been tricked; but with only fifteen minutes' fuel left in his tanks, he was forced to land. The rest of his *Geschwader* soon followed him.

THE SUDDEN illumination of a target near Swinemünde, over 100 miles to the north, was visible to all the fighter crews. Most were already suspecting that the whole Berlin affair was a giant hoax; Bomber Command was not going to attack the most heavily defended city in the world in full moonlight. The ground controller, still out of contact with General Kammhuber in Holland, ordered the crews to stay over Berlin.

Friedrich-Karl Müller, Herrmann's second in command, arrived over Berlin just in time to hear a pilot announcing that he had downed a British Mosquito. When Müller saw the activity in the north he headed for the area and was amazed to see the Pathfinder flares being released over an apparently empty coastal area. He called up *Heuberg*, the Münster station, and asked them to summon reinforcements, especially from the nearby Danish fighter bases.

Many other night-fighters headed off to Peenemünde at the same time as Müller. They searched in vain for bombers at their normal attacking altitudes.

The more experienced crews realised that the attack was being flown at low level.

Of the thirteen crews of the IIInd *Gruppe* of *NJG.1*, five had headed direct for Peenemünde arriving some thirty-five minutes after midnight, and these five wrought havoc on the bombers: Lieutenant Musset shot down five bombers between 12:44 A.M. and one o'clock, before being shot down himself. As he and his wireless operator baled out near Güstrow, he smashed both legs on the Messerschmitt's tail. Two other pilots from this squadron, Barte and Schellwat, were credited with two bombers each, and their commanding officer, Major Ehle, shot down three.

In the meantime the fighters which had taken off from Copenhagen found the withdrawing bombers crossing their path: the *Me.110s* made two terrifyingly efficient formation-attacks. Many bombers fell victim to these fighters of the IIIrd *Gruppe* of *NJG.1* in ten minutes around 1 A.M. Before the bombing attack was over, the IIInd *Gruppe* of *NJG.5* had also arrived from Parchim, securing a further three victories over Peenemünde itself.

* * *

Group Captain Searby now prepared for the third wave of the attack. His Lancaster bomber was still orbiting to port, sweeping out to sea from the fiercely burning research station, and then running across it again from the north. Each time he could see more fires breaking out, and vast stretches of the tinder-dry forest were in flames.

The whole area was swept with smoke, and it was just as well that Bomber Command had foreseen that the third aiming point, Peenemünde's Development Works, would be obscured.

The last wave had been instructed to make timed runs from Ruden island, at the end of which they were to aim for the nearest green target indicator already laid by the Pathfinder Force.

In practice, the plan went awry. At 12:37 A.M. the Pathfinder marking for this final wave began: six new "Shifters" roared across the peninsula, at altitudes and bearings exactly computed for them beforehand by bombing experts. Five afterwards brought back identifiable photographs: three of them were between Aiming Points "B" and "E" and the other two were right over on the far side of "E," to the south of the southernmost aiming point.

Two minutes later the three Backers-up arrived and placed their loads of green TIs on the three red markers which had gone down between "E" and "B." When the 126 Lancasters and 54 Halifaxes of this final wave arrived the misplaced green TIs were burning all too clearly and many crews ignored the timed runs from Ruden island and droned on for twenty and even thirty seconds longer, in order to aim at the Pathfinder markers. It was not until twelve minutes to one that a green flare load was correctly placed by a Backer-up in the heart of the Development Works. In the few minutes that remained several aircraft did bomb this single indicator, rather than the concentration two miles farther on. These few bombloads caused serious damage to the important laboratories and administration offices.

As Searby's Lancaster made its seventh sweep along the Peenemünde peninsula he could see aerial combats taking place all around him. The sky around seemed to be "showering fragments of exploding aircraft." He conceived a distinct desire to turn for home. But he grimly held out until his last orbit. He made one last broadcast to the Main Force, urging them to "watch their bombing and to carry on bombing greens," then took his aircraft to starboard with the main stream.

So ended the Battle of Peenemünde.

BOMBER COMMAND had lost forty-one aircraft, including the one Mosquito over Berlin. The first wave of bombers had suffered six losses,

representing 2.5 per cent of the bombers in that wave; the second wave had lost three aircraft, or 2.7 per cent; but no fewer than twenty-nine aircraft had been shot down during the final attack – 16.1 per cent of the force.

The greatest victory of the night was undoubtedly the success of Sir Arthur Harris's Berlin strategy: German records show that no fewer than 203 night- and day-fighters – which could otherwise have been waiting over Peenemünde for the bomber force – had been dispatched to “defend” Berlin. Only thirty of these had subsequently broken away towards Peenemünde; even then, the ground controllers were still ordering the fighters all over Northern Germany, to Rostock, Swinemünde, and Stettin.

AFTER THREE hours and forty minutes in the air, Friedrich-Karl Müller headed for the airfield at Brandenburg-Briest. A pillar of smoke was drifting up from the runway; over 100 of the fighters from Berlin, lacking clear orders from Kammhuber, had decided to land at Brandenburg and were piling one after the other into a heap of crashed aircraft on the runway. Red signal flares were being continuously fired to warn off other fighters. Müller landed nevertheless, his aircraft taxiing crazily round the heap of twisted aircraft. Thirty aircraft had had to be “written off” at this airfield.

Here Müller met his chief, Major Hajo Herrmann himself, his face as black as thunder; both agreed that if the German fighters had delayed their take-off for an hour, Bomber Command could have lost over 200 aircraft at Peenemünde. In Holland, General Kammhuber was still trying to re-establish contact with the rest of Germany. It seemed particularly regrettable to him that communications should have broken down on the one night when Bomber Command stood to lose so much. After the war he was informed by British officers that two Germans employed at his operations room were British agents; they may have been briefed to sabotage the defence on that night, if no other. This, however, must remain pure speculation.

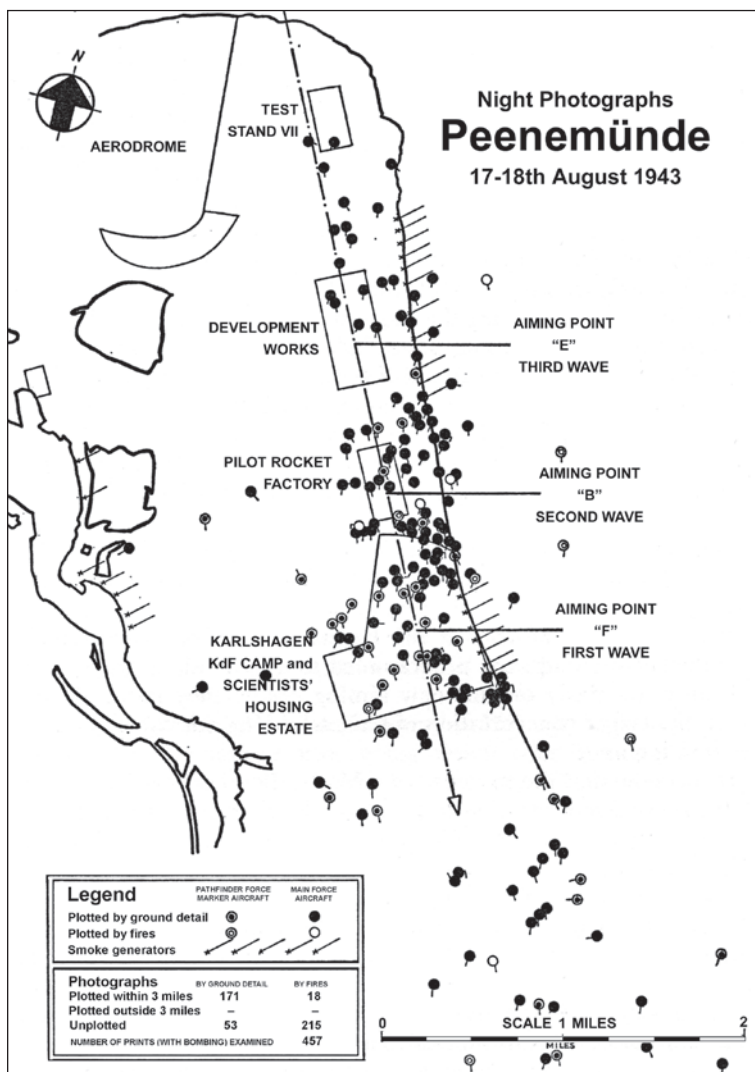

BOMBING ACCURACY ON Peenemünde

R.A.F. Bomber Command's Operational Research Section plotted on a map the position of the bombing photographs brought back after the first August 1943 raid on Peenemünde. The combined effect of the initial Pathfinder overshooting to the South of Aiming Point "F," and the unusual aiming-point shift mechanism introduced by Air Vice-Marshal Bennett, was that a very heavy load of bombs and Pathfinder markers fell in the scientists' housing estate, while Aiming Points "B" and "E" escaped relatively lightly. This did not necessarily make a failure of the raid: quite the reverse.

The thirty fighters which did reach Peenemünde claimed to have shot down forty-two aircraft, two more than Bomber Command actually lost; Bomber Command had narrowly escaped the biggest disaster of its history. The eight Mosquitoes of Air Vice-Marshal Bennett's Light Night Striking Force had not only attracted 203 German night-fighters to Berlin, but they had had no fewer than 11,774 rounds of heavy anti-aircraft shells fired at them.

Two of Bennett's courageous airmen who flew their wooden-skinned and unarmed bombers high over the skies of Berlin, consciously defying the Germans to attack them, never returned.

How many hundreds of their comrades in RAF Bomber Command owed those two – Flying Officer Cooke and his radio operator Sergeant Dixon – their lives?

(VI)

As the sounds of the attack ebbed away Major-General Dornberger turned to his adjutant, Dr. Werner Magirus, and moaned: "My beautiful Peenemünde . . . my beautiful Peenemünde!"

The diary of Professor von Braun's secretary takes up the story:

Block Four is burning fiercely, and Block Five is in flames. Things are still exploding everywhere – time bombs. Rafters are falling in, gables collapsing.

I nearly ran into a large pool of blood; there is a torn-off, uniformed leg lying in it.

"Everybody out of the bunker and come and help!" What a disgrace, some people are slinking away. My Professor shouts: "We must rescue the secret documents!" But the roof has already collapsed and the gable will fall in any moment, too. We can still try the staircase. The Professor grips my hand and we move carefully in. The building is a mass of crackling flames. Groping along the wall, we reach the second floor. The doors have burnt away, but pressing tightly

to the wall, because the other half of the floor has been swept away, we edge up to the safe.

I run up and down the stairs several times, laden with secret papers, until I can keep going no longer. The Professor and some men stay up there throwing all the furniture and things out of the window. I stand by down below, throwing the papers into a safe lying in the open on its back.

The heat is tremendous. A sentry comes and stands stolidly in front of the safe, rifle at the ready. Slowly the dawn breaks. I return to the air-raid shelter. The secret papers are safely under lock and key.

All through the night the telephone calls went out from Wolgast, the only exchange still in contact with the rest of Germany. Hitler, who through the preceding weeks had not retired much later than two each morning, on this occasion stayed up until a quarter past three.

At five o'clock, Colonel Zanssen was telephoned in Berlin and ordered to return to Peenemünde at once.

DUNCAN SANDYS, who had waited through the night at Wyton for the aircraft to return, was delighted to hear unofficially from the Pathfinder crews that the raid had been successful, although the Master Bomber refused to commit himself until he had seen the PRU photographs next morning. The bombing was exceptionally accurate: 457 bombing photographs were analysed. Bomber Command's Operational Research Section found, "it is probable that nearly all aircraft bombed within three miles, and the majority within one mile of the aiming point."

Air Vice-Marshal Bennett summed up this success in a jaunty victory signal to his Pathfinder squadrons. Then the awards were announced: Group Captain Searby, the Master Bomber, was awarded an immediate DSO: he had "executed his difficult task with consummate skill, displaying faultless leadership, great courage and resolution throughout."

A PRU Mosquito reconnoitred Peenemünde soon after ten o'clock

on the morning after the raid. Medmenham reported: "There is a large concentration of craters in and around the target area, and many buildings are still on fire. In the North Manufacturing Area [the Development Works] some twenty-seven buildings of medium size have been completely destroyed; at least four buildings are seen still burning."

More detailed analysis revealed that in the Development Works fifty buildings had been seriously damaged; referring to Block Four, housing von Braun's administrative and drawing offices, it found that "a long building, of which the greater part is useless, is now seen to be divided up into numerous small and large rooms, which suggests laboratory accommodation."

The two large workshops in the second target area had unfortunately escaped serious damage, one being completely unscathed. The scientists' housing estate had suffered most severely; every one of 100 buildings scattered in the woods had been demolished. Of the thirty huts which formed the Trassenheide forced labourers' camp, eighteen had been destroyed by fire. The Interpretation Report summarised:

The accommodation for personnel has suffered very severely, and if fully occupied at the time of the raid the casualties may have been heavy; slight damage has been caused to some of the large buildings in the South Factory Area [the pilot factory].

At Goldap, at the headquarters of the German Air Force operations staff, the news that Peenemünde was burning from end to end arrived soon after 6 A.M.

By seven o'clock the Chief of Air Staff, Colonel-General Hans Jeschonnek, had been informed. By nine o'clock he had still not emerged for the daily conference. His secretary pushed open his door and saw him lying on the floor, dead, a revolver in his hand. Next to the body was a note: "I cannot work with Göring any more. Long live the Führer!"

Soon after midnight, it turned out, Jeschonnek had received a telephone call from Göring about the lack of cooperation between the anti-aircraft guns and the night-fighters.

Göring accused Jeschonnek of stopping an order he had given because even as Chief of Air Staff he feared to run counter to Hitler's declared policies.

Göring sneered at him that he always stood rigidly to attention in front of the Führer like a petrified subaltern, with his thumbs pressed to his trouser seams.

After Schweinfurt and Peenemünde the wretched Hans Jeschonnek had opted out of the unbalanced life at German Air Force headquarters.

DURING THE morning Speer flew into Peenemünde. The flight over the wrecked research establishment told its own story. The chief of Air Zone Command III (Stettin) also flew in by *He.111* bomber to ascertain how well the German Air Force units had performed during the attack. The Peenemünde-West Air Force station had not been hit at all, and work there was proceeding normally.

Speer was received by Dornberger, "still sleepless and covered with dust," according to the Reichsminister's own account. Dornberger reported on the damage suffered by the rocket station; after a brief conference the Reichsminister flew on to Schweinfurt.

Colonel Leo Zanssen, from the Army Weapons Office in Berlin, had also arrived; long before reaching Peenemünde it had been necessary to dismount from his car and go on foot. The wrecked railways and roads paralysed traffic movements. Two of their most valuable scientists, Dr. Thiel and Dr. Walther, had been killed in the wrecked housing estate, where no air-raid shelters had been constructed. Subsequently, the Air Force accused the Army of neglecting ARP measures; even trenches had been dug only "on the insistence of the Air Force."

The death of Dr. Thiel was sorely felt. One of the earliest associates of the rocket programme, he had a brilliant mind, and was the first

scientist to ponder the use of atomic power for rocket propulsion. He had been appointed liaison officer between Peenemünde and Professor Werner Heisenberg, the atomic physicist; after Thiel's death, interest in this subsided. By August 1943 the development of the A4 combustion chamber was complete, but Thiel's death undoubtedly harmed the *Wasserfall* anti-aircraft rocket, of which the definitive combustion-chamber prototype was already on Test Stand VI.

Some of the Peenemünde scientists had had escapes that can only be termed miraculous. Dr. Ernst Steinhoff, head of Telemetry, had taken refuge in the air-raid shelter at one end of his semi-detached house in the Development Works; the other end received a direct hit during the attack. Dr. Steinhoff was of greater importance in the A4's development now than Thiel; but everybody in the shelter survived.

Again, Chief Engineer Walter Riedel and his family had held out for the first part of the raid in the cellar of their home in the settlement. Hearing the raid ebb, they had strolled down to the end of the garden to watch the fires. A bomb then hit the house, completely destroying it; next day he sat disconsolately among the ruins of his villa, washing in a bucket of beer: Peenemünde's water-pumping station had been destroyed. At the time of the RAF attack an estimated 12,000 people had been working at Peenemünde, 8,000 of whom were directly concerned with the development, production and assembly of the A4; over 3,000 had lived in the housing estate which had been Bomber Command's first aiming point.

Major-General Dornberger subsequently informed American interrogators that the RAF attack had cost the lives of 732 people, of whom 120 were German staff, while the rest consisted of Russians, Poles, etc. Among them were several Luxembourg labourers who had aided the Allied Intelligence cause. With the attack on Peenemünde, the stream of messages from these agents broke off, never to resume.

DORNBERGER HAD unimportant buildings in undamaged areas mined. As soon as Block Four had been repaired, he had burnt timbers laid

across its roof for camouflage. The craters were left as far as possible. On August 19 the British Chiefs of Staff turned down an offer from the American Air Force to carry out a precision daylight attack on the establishment, believing it unnecessary.

Even so, the overall setback to development was at least two months: rocket launchings, which had averaged one rocket per twelve days, were resumed only on October 6. The destruction of virtually all on-site living accommodation necessitated the collection of personnel from hotels and villages throughout the island early each morning. The settlement was never rebuilt, as German Intelligence was informed by captured aircrew that the Allies would continue to attack Peenemünde until it was completely destroyed.

The evacuation of all foreign labour and of the most important research from Peenemünde was put in hand: plans had already been laid for the dispersal of rocket production, but now imaginative projects for underground experimental stations in Southern Germany and Northern France were drafted. All these subsidiary projects drained costly scientific personnel off the central A4 research programme; all contributed to the overall delay. For example the Mach Four wind tunnel, which had escaped damage, was gradually shut down, and in January 1944 the "Hydraulics Research Establishment" was formed to supervise its move to Lake Kochel in Southern Germany. It was not until October that its re-erection was complete, and "wind-tunnel hours" which had averaged 500 monthly at Peenemünde slumped to fewer than 200 at Kochel.

Although Peenemünde-West had escaped direct damage in the attack, flying-bomb development was set back by the evacuation of foreign labourers from the peninsula. The construction of a catapult site at Zempin, south of Peenemünde, for training purposes was delayed by the loss in the air raid of all the equipment set aside for that purpose. Fearing further attacks on Peenemünde, the German Air Force one week later prepared the evacuation of flying-bomb trials to a naval station at Brüsterort in East Prussia, where three flying-

bomb catapults were quickly built by a thousand Russian and Polish prisoners and by Air Force engineers. Subsequently, plans were laid for the evacuation of Colonel Wachtel's entire "Anti-Aircraft Regiment 155(W)" from Peenemünde and Zempin to Ronshagen in Pomerania, as they still feared further air attack on Peenemünde.

(v)

After inspecting the damage at Schweinfurt and Peenemünde, Reichsminister Albert Speer flew on to the Führer's headquarters in East Prussia, arriving in time for lunch with Hitler at 2:30 on the 19th. During the ensuing two-hour conference, illustrated with photographs taken on the spot, he reported fully on the extent of the damage at Peenemünde.

The attack on Peenemünde had a further immediate result. Hitler ordered work to begin on the "high-pressure pump" battery in France.

The "high-pressure pump" had had a short history. In May, Speer had apprised Hitler of experiments being made by an engineer called Coenders with a "multiple-charge" gun; at the time, Hitler had asked to be kept briefed on its progress.

The gun itself was of unusual design: a series of explosive charges was placed in side chambers all the way up the barrel, and electrically detonated to accelerate a finned shell with a continuous sequence of propulsive "kicks."

The gun promised to keep up a sustained barrage on London from a battery situated some ninety-five miles away. One prototype had already been built at Hillersleben, and a second was under construction at Misdroy, on a Baltic island near Peenemünde.

Hitler's imagination was captured by this strange device; it should be revenge-weapon Number Three. Now Speer minuted:

On my suggestion, the Führer has decided that the risk must be stood to award contracts at once for the "high-pressure pump,"

without waiting for the results of Wring trials. Maximum support is to be accorded to the experimental ranges at Hillersleben and Misdroy, and especially to the completion of the actual battery.

The gun battery was to be located under a hill at Mimoyecques, near Calais; only the six-inch muzzles would be visible from the air. As Mr. Winston Churchill later recognised, this new installation might well have launched the most devastating attack of all on London.

A CONSEQUENCE of the disorganisation stemming from the attack on Peenemünde was that SS Reichsführer Heinrich Himmler now had the opportunity he had been seeking since April to penetrate this crucial field of the German war effort, as part of his sustained attempt to secure control over the entire German armaments sector.

For his subversion of the secret-weapons programme, Himmler selected an SS engineer, Major-General Hans Kammler, the forty-two-year-old designer of concentration camps in general and the Auschwitz gas chambers in particular. Kammler's career was to be a remarkable one: initially charged with directing minor construction projects associated with the A4 programme, he was to end up as supreme tactical commander of all German secret weapons, including the *Me.262* jet-fighter formations. His career may stand as a textbook example of controlled infiltration.

At 11:30 A.M. on the 22nd Himmler arrived at the Wolf's Lair; joint meetings with Hitler and Speer lasted until the early evening. Himmler was intervening to offer "assistance" to Speer:

Arising from a suggestion [Speer recorded that night] the Führer orders that – jointly with the SS Reichsführer [Himmler] and utilising to the full the manpower which he has available in his concentration camps – every step must be taken to promote both the construction of A4 manufacturing plants, and the resumed production of the A4 rocket itself.

At Hitler's behest, production at Peenemünde was to be considered a temporary expedient only, until production could be resumed in factories safe from air attack, making use as far as possible of caves and suitable "bunkers."

Four days after these decisions in East Prussia, at a staff conference in the Reich Cabinet Room of the Reich Chancellory, Speer announced to his fellow Ministers that "the A4 men have met with the strongest support from the SS in accelerating rocket production." He seemed undismayed by Himmler's motives; more important was that Kammler had been authorised to inject convict and slave labour into the project.

On the same day, August 26, Speer called a highly confidential discussion between the rocket experts. Kammler took part, as Dornberger, Degenkolb and Saur negotiated the location of the new manufacturing centres to replace those damaged at Peenemünde and Friedrichshafen.

Kammler's dispersal plan was this: with Degenkolb's approval, the main assembly works would be moved to an underground factory in the Harz mountains. The Development Works would be dispatched to a cavern being blasted into a cliff at Traunsee, in Austria (the *Cement* project); and an important inland rocket test range would be established at Blizna, in Poland, as an annex to the sprawling SS "*Heidelager*," or Heath Camp.

General Dornberger on first meeting Kammler found him obsessed by a morbid inferiority complex and a mimosa-like sensitivity; but as it appeared that Kammler's powers were to be limited to the construction side, he did not yet regard him as unduly dangerous. Speer was making the same mistake. After the war he mused: "When Kammler took on his first job I did not realise that it was he who had been earmarked as my successor."

BRITISH CIVIL engineers who had closely followed work on the bunker at Watten now judged that the whole site could be wrecked in one concentrated bombing attack. Sir Malcolm MacAlpine, who had been

consulted at an early stage on this by Mr. Duncan Sandys – another inspired move – advised that Watten should be hit while the shuttering was up, but before the concrete pouring had finished; that moment had now arrived.

On August 27, 185 Flying Fortresses of the US Eighth Air Force attacked this “special target” at Watten. Again the crews were only briefed that they were attacking “aeronautical facilities.” The strike was flown at low altitude and bomb bursts were observed on the target photographs of the first and last of the four waves. Three hundred and seventy tons of bombs were dropped, severely damaging the main construction, as photographic reconnaissance confirmed: at the western end the excavation suffered a major collapse, and the northern side of the construction was destroyed for nearly half its length. Sandys showed these photographs to MacAlpine, and he estimated a setback to the installation of three months: “It would be easier,” he suggested, “for the Germans to begin again elsewhere.” In this the Germans apparently concurred, for Albert Speer decided to salvage what he could of Watten by installing an oxygen plant under the ruins, while a new launching bunker was built at a second site.

(VI)

On August 12 Mr. Sandys received a remarkable Intelligence report from a “quite unusually well-placed and hitherto most reliable source.” This was said to be a disgruntled staff officer attached to Major-General Leyers’s department of the Army Weapons Office.

On the evening of the Watten attack Sandys circulated a summary, drawing attention to the suggestion that two quite distinct weapons were in existence, a “pilotless aircraft” tested at Peenemünde, about which, however, the informant knew nothing, as it was not an Army project; and a “rocket projectile officially known as A4.” Siemens were making the radio-control for both, and important parts of the rocket were being made at a Friedrichshafen factory which had been destroyed

by the RAF but subsequently repaired. So far about 100 A4s had been fired, but their accuracy had been poor.

Concrete emplacements for the rocket were now stated to be ready near Le Havre and Cherbourg, and more were under construction. These were for shelter only, and were not essential, as the “projectors” could be stood in open fields if necessary. The A4s were launched under their own power from easily constructed “slides” of iron rails, of which 100 had already been constructed:

Hitler and members of his Cabinet recently inspected both weapons at Peenemünde [the summary of the Intelligence report continued]. About 10th June, Hitler told assembled military leaders that the Germans had only to hold out, since by the end of 1943 London would be levelled to the ground and Britain forced to capitulate. October 20 is at present fixed as Zero Day for rocket attacks to begin. Hitler ordered the construction of 30,000 A4 projectiles by that day; this is, however, beyond the bounds of possibility. Production of both weapons is to have first priority and 1,500 skilled workers have been transferred to this work from anti-aircraft and artillery production.

What was Mr. Sandys to make of this potpourri of information?

Three days later, on August 30, a transmission from another agent seemed to confirm many of the details of the earlier messages. This time, the source was a French officer, who claimed to have obtained information in July from a Peenemünde officer about three main developments: guided bombs and projectiles; long-range rockets; and bacterial warfare. This time the Intelligence officers had a check on their source's reliability, because he reported that a squadron of *KG.100* was experimenting with the guided bombs – and this could be confirmed from other sources.

The Frenchman continued that the rocket had a range of 300 miles, was fired nearly vertically, and attained an altitude of fifty miles. The

noise from its engines was “deafening.” Then he added that a special “Anti-Aircraft Regiment 155 (W)” under a Colonel Wachtel was going to France in October or November to operate the 108 catapults for the weapon, and that the German Army might be operating a further 400. (It is now clear that he had confused the rocket with the flying bomb; even so, as the regiment named had only been activated two weeks before, the message had certainly arrived with commendable celerity.) British Intelligence officers who examined the information concluded from the many circumstantial details of, for example, the security passes needed to enter Peenemünde, that the man probably had “an inside and genuine contact with the German Air Force.”

LORD CHERWELL'S office took considerable trouble to expose the fallacies of the earlier report from Berlin. One of his physicists typed out in large script the salient details of the report, and underneath each paragraph Lord Cherwell added a devastating comment:

Rocket Projectile A4

Length sixteen metres. Diameter $4\frac{1}{2}$ metres. Weight unknown, but one-third high-explosive and two-thirds propellant. Damage effect equivalent to a British four-ton bomb.

COMMENT: *One-third of the projectile's volume, if filled with high explosive, would have a weight of about 125 tons.*

Range two hundred kilometres; maximum altitude thirty-five kilometres. (Propulsion too weak for lower trajectory.)

COMMENT: *If two hundred kilometres is the maximum range, the lowest possible trajectory would take it through a height of nearly one hundred kilometres.*

The structure of the weapon is stated to be similar to the American rocket projectile on railway lines; it has vanes at its tail like a bomb, and is equipped with radio steering. Trials stated to have been carried out in North Africa.

COMMENT: *Radio control is not possible unless the projectile has*

wings. Furthermore, reports of German rockets from North Africa state that vanes are not used, the projectile being rotated by the jets.

When this Intelligence report came under discussion by the Chiefs of Staff on August 31 Lord Cherwell made his own view plain that if Intelligence put out definite questions through a large number of channels on any one subject, like bacterial warfare, for example, it would always get a number of spurious but highly circumstantial answers.

INTEREST IN the German rocket threat had flagged remarkably since the Defence Committee meeting of June 29, for during the last days of August 1943 the first clandestine photographs of the German Air Force's flying bomb had arrived in Whitehall.

At this Chiefs of Staff meeting, Sir Charles Portal announced that the pilotless aircraft threat, to whose possible existence Lord Cherwell had first drawn attention, had now materialised: such an aircraft had been seen on the 22nd, flying from the general direction of Peene-münde. The weapon – much larger than the glider bomb – had crashed, and an individual had been able to take pictures of it for some ten minutes before the Germans arrived.

On August 28 the commanding officer of Peenemünde-West had signalled his superiors at Rechlin:

One FZG.76 [flying bomb] was released from an *He.111* bomber; switch-over of the power unit from half to full power was perfect, but because of overfuelling the weapon carried on to crash on Bornholm island. – *GAF Research Station, Karlshagen*

Several photographs taken of the bomb by Danish agents were shipped to London. It seemed that the weapon was fitted with wings and some form of rocket propulsion. This might, Portal felt, be the "pilotless aircraft" to which reference had been made in the Berlin report. It was clearly of far more immediate concern than the long-

range rocket. Cherwell, strangely, did not welcome this justification of his stand, suggesting instead that the sketched aircraft could not carry a warhead much heavier than perhaps 1,000 pounds; this would not be an economic proposition, he suggested, for such an expensive vehicle.

The Chiefs of Staff invited Mr. Sandys to analyse the potentialities of the Bornholm projectile. They also requested the Chancellor of the Exchequer to examine the implications of the “*Black Plan*” (a programmed evacuation from London of only the Cabinet, Parliament and 16,000 essential officials); and the Ministry of Production was required to investigate the problem of providing a further 100,000 Morrison shelters and of strengthening street shelters in London. Thus before the first secret weapons had left their launching ramps they were exerting an influence on the British conduct of the War.

What had caused the *volte-face* by Lord Cherwell? The explanation can be seen in his dismay when Mr. Sandys had been instructed to direct the investigation into the flying bomb. The Paymaster-General seems to have begun to identify the concept of “pilotless aircraft” with Mr. Sandys no less than he had “giant rockets” earlier.

Perhaps this does Lord Cherwell an injustice, but one fact tends to confirm the view that it was Mr. Sandys, and not the pilotless aircraft or rocket, in which he had no confidence: when Sandys later ceased to conduct the pilotless aircraft inquiry, the Professor again reversed his stand, and stressed once more the imminence – in his view – of bombardment by pilotless aircraft.

(VII)

Lord Cherwell was inclined to regret that Sandys had been charged with the investigation and he pursued a campaign for the Minister’s removal. On September 10, 1943 this was rewarded with a partial success, when Sandys himself proposed to the Chiefs of Staff that his responsibilities should be confined to the long-range rocket investiga-

tion, which should include long-range guns firing rockets, and other novel types of projectile; pilotless aircraft could be dealt with like manned aircraft by Air Intelligence.

Four days later Dr. R. V. Jones circulated an interim report on the evidence for the existence of pilotless aircraft in Germany. Interrogation had shown the special importance attached to the *FZG.76*, and a German officer who knew its technical nature had regarded it as the object of British inquiries into the "rocket weapon." *Enigma* intercepts indicated that strong anti-aircraft protection had been demanded in high quarters for the ground organisation for a *Flakzielgerät 76*; this high-level concern for normal anti-aircraft protection measures certainly seemed unusual, and neither possible translation of *Flakzielgerät 76* – either "AA predictor" or "AA target aircraft" – seemed likely to require a large ground organisation needing heavy defences.

The Air Intelligence officer summarised that *FZG.76* was probably an important rocket-propelled pilotless aircraft, possibly being operated by the German anti-aircraft General, von Axthelm.

THE DEFENCE COMMITTEE'S interest lingered on the A4 rocket projectile, of which the photographic interpreters had now produced a tentative diagram – based on the aerial photographs – showing a rocket with three fins and a snub nose.

The snub nose puzzled them, but Mr. Sandys explained that if the nose was rounded then there must be some reason for it known to the Germans but not to us; alternatively – and this was, in fact, the correct solution – the photographs showed rockets before their nose cones had been attached.

Lord Cherwell, asked for his opinion, refused to believe that the Germans had developed an economical and feasible method for the long-range killing of over 100,000 Londoners every month, as Mr. Herbert Morrison had again warned as recently as August 16, after the Prime Minister had queried his figures. The most primitive statistical analysis showed this to be an absurdity.

What particularly irked Morrison was that Cherwell made no attempt to justify his argument. Morrison resolved to tackle the Paymaster-General about this later. One of the most awkward scandals of the war was about to break.

The Defence Committee concluded that a further attack on Peenemünde was not yet necessary; that the “*Black Plan*” for the evacuation of the Government from London was not to be revived as yet, but that Herbert Morrison was to prepare to put all Departments of the Government underground in “citadels” safe from rocket attack. Finally, Sandys was directed to establish a Scientific Committee to examine all the arguments weighing for and against the existence of a German rocket.

TO LORD CHERWELL the outlook seemed dark: a committee of scientists seemed futile enough, as it was obvious to him that the rocket was a technical impossibility, but for it to be directed by Mr. Sandys seemed to him to be compounding futility with folly. The Prof called to his room Dr. A. D. Crow, a scientist favourably disposed to his quarter in this dispute, and discussed their next moves. Five hours later Cherwell informed Sandys that he was going to consult a small scientific panel of his own.

He would approach four scientists – Professor G. I. Taylor, Sir Frank Smith, Professor Sir Ralph Fowler and, of course, Dr. Crow – and ask each whether the German rocket was possible.

It should not be thought that the Prof had deliberately named a panel of amenable scientists whom he could trust to side with him: Taylor and Fowler, two of the most honest theoretical scientists, were already bulwarks of the Sandys inquiry.

“In an emergency,” one of Cherwell’s contemporaries said of him, “the Prof was good.” For Cherwell this *was* an emergency: he believed he saw Britain’s top scientific brains becoming bogged down in a purely defensive secret-weapons controversy, when he himself was a firm disciple of the offensive as a means of winning wars. His prejudice

against defensive technology had not changed since the great pre-war radar dispute with Professor Sir Henry Tizard in the late thirties.

He determined to bring this whole controversy to a rapid end by addressing a simple questionnaire to these four scientists of his choice.

He wrote privately to Wing Commander Hamshaw Thomas for a sketch of the object photographed at Peenemünde. Cherwell placed the diagram at the head of a list of seventeen easily answered questions which he mischievously titled "Questionnaire framed by the Minister of Home Security, the Paymaster-General and the Joint Parliamentary Secretary to the Ministry of Supply designed to establish the practicality or otherwise of the German Long-Range Rocket."

The Paymaster-General listed his questions: Could a range of 160 miles possibly be obtained with any single-stage rocket? Could the velocity of efflux of the gases from the venturi possibly exceed the velocity of the molecules in the reaction chambers? Could liquid fuels possibly be pumped into a reaction chamber already under enormous pressure, and how much power would be needed for this? Lord Cherwell was sure that he knew the answers to these apparently damning questions, and he hoped the scientists would agree with him.

He sent the questionnaire to Brigadier Jacob. From the latter's reply it was plain that neither Sandys nor Morrison had been consulted in its drafting. Jacob wrote on September 21:

I have sent copies of your suggested questionnaire on the German long-range rocket to the Ministry of Home Security and to Mr. Sandys, and have asked for their views.

He added that he understood that it might be necessary to have a meeting to decide what questions should be put and to whom.

Sandys meanwhile had appointed nineteen members to his new *Bodyline* Scientific Committee, including eminent physicists like Appleton, Cockcroft and Watson Watt. He wrote to the Prof on September 22 and suggested that "the questions you are drawing up should

be submitted to this Committee, to whom could be added any further scientists whom you may wish to nominate.”

Lord Cherwell should have been pleased that his questions were now going to be circulated to a much wider and more influential body of scientific opinion. He was not. Brigadier Jacob minuted Herbert Morrison later that day:

Lord Cherwell suggests it would hardly be practical to submit the questions to the whole of this large Committee.

Soon after, Lord Cherwell heard with relief that his questionnaire would be circulated only to the four men he had named.

TWO WEEKS passed before Morrison tackled the Prof about his obstinate refusal to accept that the rockets would kill 108,000 people per month. On September 24 he wrote rebuking him for his opposition at the Defence Committee and inquiring whether he might now hope for Cherwell's aid. He appended a new memorandum, and suggested that Cherwell accept the estimate, and so inform the Prime Minister:

If on the other hand you still have doubts about the calculation [Morrison concluded] I am sure that my scientific advisers would like to know not only of your doubts but of the grounds for them.

Lord Cherwell had queried the death roll estimate on the grounds that it relied on a very exaggerated Standardised Killed Rate per Ton of German bombs; as a scientist he merely disputed the basis for assuming that German bombs, ton for ton, would kill more people than English bombs. The reply was a shock. Morrison's expert, Professor Thomas, explained that British buildings were more weakly constructed than German ones, and therefore more vulnerable to blast damage; that real damage was 50 per cent greater than was shown on photographs; and finally that “the Germans' explosive is 80 per cent better than ours.”

The scandal burst, albeit tightly confined to the loyal Chiefs of Staff and War Cabinet. Lord Cherwell, scandalised, inquired at once what this bland announcement meant.

He was told that by adding small quantities of aluminium powder to explosives improvements in efficiency of 80 per cent were obtained. They had known this for some time.

If Lord Cherwell can be arraigned for hindering the rocket investigation – and this is questionable – then surely by his disclosure of the aluminised explosives scandal he more than made that good.

He had read Herbert Morrison's reply on September 29. That same day he called the attention of Sir Charles Portal to Morrison's disclosure; he met Portal personally at the meeting of the Anti-Submarine Warfare Committee at six o'clock.

The Chief of the Air Staff was appalled. He circulated the facts to the Chiefs of Staff, and on October 1 they considered the implications; at a further Staff meeting on the following day the Prof was invited to submit a full report.

How often it thus transpires that while the conduct of great campaigns is minutely planned and organised, some vital and known fact can be overlooked.

Now it appeared that while RAF Bomber Command had been valiantly labouring to perfect its radar bombing aids, to improve the ballistic shape of bombs, and to increase the bombloads of its standard aircraft, insufficient attention had been paid to the quality of the explosive itself.

By October 1943, Bomber Command had dropped 200,000 tons of bombs on Axis targets; thousands of airmen had lost their lives in this gigantic task; yet only now had it emerged that explosives could be made 80 per cent more efficient by a simple additive.

There was worse to come. It was not just that Herbert Morrison's department had been aware of the existence of a German super-explosive: the British defence scientists had long been aware of it as well.

On October 5 Lord Cherwell summoned Dr. H. L. Guy to report

to him on explosives development. Guy informed him of recent static detonation tests that had been carried out where the superiority of aluminised explosives had been abundantly confirmed – the area of visible damage being 80 to 100 per cent greater than that for ordinary Amatol (a mixture of ammonium nitrate and TNT).

That evening Professor J. R. Lennard-Jones of the Ministry of Supply's Armament Research Department at Sevenoaks reported to him:

I find that the proposal to try the effect of aluminium bombs was made by this department in April 1940, but the supply of aluminium was then so difficult that the department was asked to discontinue the development.

On October 6 Lord Cherwell learned that the Admiralty had been aware of, and indeed exploiting, the superiority of aluminised explosives; two types, Torpex and Minol, were used in torpedoes and depth-charges.

But nobody had informed the Air Ministry. Lord Cherwell minuted the Prime Minister that day:

It is now universally agreed that this was a mistake, and that we could probably greatly increase – and perhaps even double – the area of damage with our blast bombs by using an explosive like the German *Triolin* [*sic*],* which contains powdered aluminium, instead of the present Amatex, ammonium nitrate and TNT.

From here the matter passed out of his hands; just nine days had passed since Mr. Herbert Morrison had innocently sparked the powder keg. Subsequent events proved Lord Cherwell more than justified. The

* *Trialen*, an explosive comprising 70 per cent TNT, 15 per cent RDX and 15 per cent aluminium powder.

Scientific Advisory Council formally recommended the adoption of the new explosive on October 28 and the first such bombs were delivered to RAF Bomber Command on December 4.

Subsequently a Commission of Inquiry into Aluminised Explosives, headed by Walter Monckton, was appointed by Mr. Churchill to apportion the blame. Tests showed the "German type" of aluminised explosive to be 80 per cent more powerful than the standard British Amatol.

The Commission noted that its investigation had clearly shown how important it was for strategy, supply and research to be "effectively linked" at high level.

One secondary result of this secret inquiry was its bearing on the rocket dispute from which the explosives scandal had initially and unexpectedly sprung: now Lord Cherwell, Paymaster-General and personal scientific adviser to Mr. Winston Churchill, emerged crowned with a new prestige and a new repute.

Now, if never before, Mr. Churchill realised that in Lord Cherwell he had an adviser on whom the country could rely.

(VIII)

By early September the development of the A4 rocket was considered by Professor Wernher von Braun to be "practically complete." On September 9 he reported at a Long-Range Bombardment Commission conference in Berlin that the A4's greatest range to date had been 178 miles, while five of the last ten rockets had impacted less than one and a half miles from their mark. In spite of Hitler's orders to the contrary, some trials would still be carried out from Peenemünde, but only under cover of darkness. "These last few weeks," von Braun said, "we have been playing possum."

As far as actual operations were concerned, he reported that the first rocket-launching battery would not now be ready until December 1, as the completed mobile switchgear and control panels had been

destroyed during the RAF attack.

For the experimental units, only trials with live warheads remained to be carried out; he was optimistic that these would confirm that the A4's blast effect – “similar to a bomb of rather over one ton” – would be enhanced by the weapon's hypersonic impact.

Karl-Otto Saur, who confessed himself to be a “fanatical disciple of this report,” insisted that, as mobile launching gear was still available, live warhead trials should begin as soon as possible from Blizna. Von Braun admitted that trials could begin on November 15. Under further pressure he consented to advance his estimate from mid-November to mid-October, adding that this would, however, “entail a grave dissipation of effort.”

Professor Petersen, chairman of the conference, was disturbed by the lack of urgency in von Braun's attitude:

The most unexpected surprises might crop up for us with the first live trials [Petersen warned]. The earlier we invite these surprises, the more quickly we shall be able to overcome them.

He was right: when overland firing trials were opened at Blizna early in November most of the rockets blew up on re-entry, a phenomenon which had been far out of sight during the Baltic trials.

On September 10 Adolf Hitler told his senior Ministers and military leaders at the Wolf's Lair that it was true that they had been set back one or two months by the attacks on Peenemünde and Watten, but they could now count upon the start of the offensive at the end of January 1944.

Goebbels noted that night:

The Führer is hoping for great things from this rocket-weapon; he believes that in certain circumstances he will be able to turn the tide of war against England with it.

The original plans had provided for the mass production of rockets at Peenemünde, Wiener Neustadt, and Friedrichshafen. Hitler no longer underwrote this plan.* Production would now be concentrated in a new underground missile plant to be known as the Central Works. The Vienna-Friedrichshafen group of factories was tentatively designated the Southern Works; and an Eastern Works plant was being planned near Riga.

At Peenemünde on September 11 the legal basis for the take-over of the Army's rocket production interests was established. Representatives of the War Office, of Degenkolb's Special A4 Committee and of the new main assembly plant, "Central Works Ltd.," formally agreed that the latter would take over all rocket contracts from Peenemünde (now code-named Home Artillery Park II) as well as "Zeppelin airship factory, Friedrichshafen; Rax Works, Wiener-Neustadt; and Demag vehicle factory, Berlin-Falckensee."

The SS were strongly represented on the board of Central Works. Now the struggle began for the Works to take over the research installations and test stands of Peenemünde as well.

ON 22 SEPTEMBER the topic at the Führer's headquarters again turned to the revenge weapons. Goebbels took the opportunity of a mid-morning stroll with Hitler to raise once again this sore question of retaliation. Hitler's lust for revenge was still evident. At a late-night tea-party lasting until 3 A.M. he held forth at length on what he hoped to achieve. Goebbels noted the salient points in his diary:

* The production and distribution of rocket nose cones gives a clue as to how many rockets these three factories produced before they were excluded from the assembly programme. Of 605 nose cones produced by Voss Works (Sarstedt) between July and November 1943, 242 were delivered (through Demag) to Peenemünde and only forty-six and twenty-eight to Friedrichshafen and Wiener-Neustadt respectively; 285 were diverted straight to Central Works at Nordhausen.

[The Führer] represents the view, as intransigent as ever, that England must be repaid in her own coin and with interest for what she has done to us; the rocket reprisal programme is forging ahead again. The Führer thinks that our great rocket revenge offensive can be opened at the end of January, or early in February.

It is a great load off our minds that we have dispensed with the radio guiding-beam; now no opening remains for the British to interfere technically with the missile in flight.

The logical development of Hitler's strategy was becoming apparent: if the submarine war developed as expected, and if the missile bombardments were to start in January or February 1944, the two German triumphs would burst upon a British public already weary of war. Dr. Goebbels rejoiced:

I have learned from the Führer for the first time that the giant rocket-bomb weighs fourteen tons: what an awe-inspiring murder weapon! I believe that when the first of these missiles screams down on London, something akin to panic will break out among the British public!

He was still musing about the rocket on the following day, when he reported with pleasure how rumour was mounting in the outside world about German rockets and secret weapons: "This has been helped above all by Churchill's last House of Commons speech. We don't know anything definite, of course, but some British newspapers have published reports from which we can now assume that, broadly speaking, the British are in the picture as far as the shape of our rocket-bomb goes."

There was still a wide variety of opinion in Whitehall as to what form the coming "secret-weapon campaign" would take. Some agents spoke of "rockets," others of "pilotless aircraft" and "aerial torpedoes," and yet others of giant "long-range guns." Dr. R. V. Jones considered it

opportune to restate the case, despite the doubts which the conflicting evidence seemed to warrant.

On September 25 he circulated his second important summary on German secret-weapons development, listing once again the main reasons for believing that work on long-range weapons had been in hand at Peenemünde at least up to the time of the RAF attack in August. The most numerous Intelligence reports were from the army of foreign labourers conscripted to Peenemünde. Two of their reports, which had begun to arrive via Spain in June, had included detailed sketches in good agreement with the buildings seen on aerial photographs of Peenemünde, including the “rocket assembly hall,” the “experimental pit,” and the “launching tower.”

These accounts, considered together, yielded a clear picture of Peenemünde as an Army research establishment containing between twelve and sixteen “trial pits,” including a pit No. 7 from which the long-range rocket was launched.

It was admittedly remarkable that the Germans had allowed unfriendly witnesses to see these secret developments, which included not only rockets but also a tailless aircraft (subsequently confirmed by air photography) and a “rocket-driven torpedo” to be dropped against shipping by a controlling aircraft.

This latter weapon was undoubtedly the *Hs.293* glider-bomb, whose premature betrayal would have been a high price for the Germans to pay as part of a hoax in June: it had become operational only in September.

One thing was clear to Air Intelligence: there was nothing in the rocket story to detract from the belief that the Germans were also developing pilotless aircraft to launch against the major British cities. It was likely that the German Army was developing one weapon at Peenemünde “in keen rivalry” with the German Air Force developing the other. Nor could long-range guns be entirely excluded.

In answer to technical objections raised by his fellow scientists, Jones added the mordant comment that it was not without precedent

for the Germans to have succeeded while we doubted; the German radio-bombing beams provided sufficient example of this.

It is probable [Dr. Jones concluded] that the German Air Force has been developing a pilotless aircraft for long-range bombardment in competition with the rocket, and it is very possible that the aircraft will arrive first.

In this belief, of course, he was not to be discredited.

(IX)

While Whitehall still disputed the size and mode of operation of the rocket, and argued whether it even existed, the German long-range rocket was already come of age: no longer just a fleck of white on a blurred air photograph; no longer a sickly brainchild nursed onto the launching pad, to be watched with pride as it soared into the stratosphere, or with sickened dismay as it toppled back to detonate in a yellow cloud of flame; no longer a flickering silver shape on a cinema screen in the Führer's headquarters, or a crisp blueprint on the desks of Albert Speer's Ministry of Munitions.

What had been developed by the painstaking research of a handful of dedicated scientists and engineers like the Riedels, Thiel and von Braun himself was now to be mass produced in a vast underground plant, through the backbreaking toil of 16,000 slave labourers.

THE A4 AT this stage was not unlike a giant finned shell, some 50 feet in height and nearly 6 feet in girth. In spite of its size, it was of remarkably slight construction: of its 28,557 pounds all-up weight, including warhead, well over two-thirds was accounted for by fuel. This alone enabled it to meet the requirements set upon it for range and payload, as will shortly become apparent.

The rocket derived its power from the controlled combustion of

8,419 pounds of 75 per cent ethyl alcohol in liquid oxygen, of which a tank in the lower part of the rocket held 9,565 pounds. These two main fuel liquids had to be pumped at high speed and against considerable back pressure into the rocket's single steel combustion chamber. For this purpose – and this was the rocket's real secret – each was equipped with a turbo-pump driven by a gas-turbine of advanced design; the gas-turbine itself was powered by the catalytic decomposition of hydrogen peroxide.

The procedure in firing the rocket was that an electrical contact started the turbo-pump unit, the two rotary pumps rammed fuel and oxygen into the combustion chamber, where a pyrotechnic firework ignited the mixture. The oxygen was fed into the chamber through eighteen main burner cups, and the alcohol was introduced through a separate inlet and through annular rings of tiny perforations spaced round the rocket motor's throat. The film of evaporating alcohol served to moderate the surface temperature of the steel chamber. This design was essentially the contribution of Dr. Thiel.

The motor was designed to be fired and shut off in two stages, determined by the speed of the turbo-pumps. An 8-ton preliminary stage fired first, and the fuel mixture was then ignited. When the motor was running smoothly, and all the burners were operating, the full 25-ton-thrust stage was switched on and the rocket lifted vertically off its launching table, a simple steel trestle upon which the rocket could be rotated to align it on its target. Four graphite "gas rudders" set inside the rocket exhaust itself stabilised the rocket until it attained sufficient air speed for the four tail fins to control its flight.

If the rocket functioned correctly, it rose vertically from its table, without rotating; this latter was a vital prerequisite, as its accuracy depended on the correct alignment of the fins on its target. Azimuth and pitch gyroscopes in the main control compartment just behind the warhead continually corrected the ascent of the rocket, acting through an amplifying link and hydraulic servo-motors simultaneously on the internal gas rudders and the external fins. The rocket was automatically programmed by a rotating-drum device to tilt gradually over

onto a pre-selected trajectory, and when the exact required velocity was known by telemetry to have been reached, the rocket's motor was cut off by a radio signal from the ground.*

This was the weapon which Germany was now planning to mass produce at the rate of 900 a month, at a higher priority than any other weapons system had ever enjoyed before.

ON 28 SEPTEMBER, SS Reichsführer Heinrich Himmler himself flew to Poland to examine the progress being made at Blizna with the new A4 firing range. The new experimental station lay just north of the main railway line from Cracow to Lvov, in a mile-square clearing in the heart of the forest. The Germans had established here an SS training area, with barracks for 16,000 troops. It was about six miles from this main *Heidelager* camp that the SS had prepared the promised launching area. Four hundred German Army personnel would live on the site, but only four or five of the senior officers belonged to the SS. Once again, it was Himmler's standard pattern of unobtrusive infiltration. He stayed overnight, addressed the SS leaders, and flew back to his Hochwald headquarters where he related his findings to Hitler over dinner.

Next day Speer arrived, followed soon after by Xavier Dorsch, the outstanding engineer chief of the Todt Organisation. Over dinner with Hitler on the 30th, Speer gained approval for the release of executive scientific personnel from the prison camps where they were languish-

* Upon this crucial "shut-off" – *Brennschluss* – depended the rocket's accuracy in range. The radio method was used at first, even when the A4 was used against London in September 1944. This method was later replaced by the *I-Gerät* (a pre-set gyroscopic integrating accelerometer) and then by Professor Buchhold's electrolytic integrator, both of which computed the missile's velocity from within. A fourth system, whereby the rocket's acceleration would be kept constant by controlling its peroxide flow, did not pass the development stage.

ing, so that they might start work in the "A4 concentration camps," as Speer termed them.

Hitler also agreed to a second A4 launching "bunker" in a chalk quarry at Wizernes, not far from Watten, originally designed as an underground storage dump for rockets. He intended to use a remarkable construction method to protect it from air attacks during its construction stages: first he would build a bomb-proof 1,000,000-ton dome of solid concrete on the edge of a 100-foot-deep chalk quarry; beneath this dome he would excavate an octagonal chamber and a maze of service tunnels to house workshops, barracks, stores and a hospital. The rockets would be serviced in this sheltered chamber, then hauled out into the open along two concrete tunnels, *Gretchen* and *Gustav*, past 5-foot-thick solid steel bomb-proof doors, and launched at London and other targets.

Hitler approved the spectacular Wizernes project. Speer noted, however:

[The Führer] is not convinced that the site will ever be finished.

The planned rocket organisation now foresaw three firing battalions (*Abteilungen*), two mobile and one fixed.

The two mobile battalions, each of three batteries and nine launching platforms, would have a capacity of twenty-seven rockets daily; a third detachment comprising one technical and two operational batteries would launch upwards of fifty rockets daily from the Wizernes site. Thus a total of rather over 100 rockets daily could be fired by the launching troops available.

(x)

For the Central Works factory Degenkolb selected an immense network of tunnels under the Kohnstein mountain in the Harz, close by Nordhausen. Before the war the government had invested some effort

in adapting the tunnels for the storage of critical chemicals like tetra-ethyl-lead. The finished missile plant was to be considerably larger: two broad parallel tunnels had been driven through the mountain, about three-quarters of a mile apart; the tunnels were both over a mile and a quarter long, and linked by forty-six parallel galleries, like the rungs of a ladder.

Central Works was to be supervised by a board of directors with a Dr. Kettler as General Manager and – second only to him – an SS officer, Major Förschner, in charge of a five-man SS security team at the factory.* Because he had provided the slave labour, Himmler had been able to insist on representation on the board. Director Albert Sawatzki began production planning at Nordhausen at once.

On October 1 Central Works Ltd. submitted to the German War Office its draft plan for the, factory. Degenkolb endorsed it in his sprawling indelible-pencil script.

Re: Central Works project, Hammersfeld

Further to the recent conference, we herewith make a formal request for a contract to be issued to us for the installation of the Central Works at Hammersfeld [Nordhausen] for the production of 1,800 A4 missiles per month.

This was the first time that official documents had spoken of manufacturing 1,800 rockets monthly, a figure nearly twice that of the Degenkolb programme of April 1943, which had already been denounced by the munitions experts as impossible. Central Works Ltd. were also claiming to be able to provide manufacturing capacity for large sub-assemblies and for bottleneck components required for half of the monthly 1,800 rockets.

Kammler had already undertaken to supply 16,000 slave labourers.

* At the end of April 1944, Director Georg Rickhey of Demag was appointed Director-General, superior to both Kettler and Förschner.

An additional 2,000 German technicians were required to supervise production.

The Army Weapons Office did not accept that the problems of component supply could be overcome by one stroke of an indelible pencil.

On October 8, at a conference in Berlin-Charlottenburg, their representative pointed out that 1,800 missiles output was unrealistic.

General Emil Leeb issued orders for 900 to be manufactured per month, and this was the figure quoted in the letter outlining in advance the terms of the Nordhausen contract: the War Office contract was for equipping the underground factory to assemble 900 rockets per month, and to manufacture the vital components and sub-assemblies of an as-yet-undetermined proportion of them.

This was how the final order for A4 rocket manufacture was evolved. The other nebulous plans for an Eastern Works and a Southern Works were never fulfilled.

PREPARATIONS FOR opening the rocket offensive from France gathered momentum. On October 14 Field-Marshal von Rundstedt was given control over all measures to protect the launching areas from invasion. For the "bunkers" themselves he asked for the release of a number of crack Grenadier and SS infantry battalions from other duties. On October 17 he was telephoned by Jodl's staff and ordered to ascertain from Dornberger which of the A4 launching sites could be exploited already, and to make immediate preparations for the attack. The A4 rocket project was apparently reaching its great climax. The main production contract was issued on October 19, 1943 from the German War Office in Berlin, a curiously slipshod document typed on a standard War Office contract form, partially obscured by rubber stamps with eagles and swastikas and franked TOP SECRET.*

* See page 309 for a facsimile.

War Contract No. 0011-5565/43

The manufacture of 12,000 A4 missiles at a rate of 900 monthly, not including electronic equipment, warhead or packing material; and the final assembly of these 12,000 missiles, including internal equipment, warhead and packing material, at a standardised price of 40,000 Reichsmarks apiece. *Total price: RM. 480,000,000.*

(Signed) LEEB (General)

So these were the weapons that were to win the war for Germany: 12,000 A4 rockets, ordered in the same nonchalant manner as the German Army would contract for the delivery of 12 tons of potatoes.

THE CENTRAL WORKS was the largest underground factory in the world. The twenty-seven southernmost galleries had been allocated for A4 rocket production, while the remainder were for jet-engine assembly. Director Sawatzki, who had been sent to Peenemünde in July to take command of the 1,500 workers at the pilot factory there, had returned to Nordhausen and was supervising the installation of the machinery in what was later described by a US Ordnance Department Colonel as an “almost ideal plant.”

Sawatzki planned for the rockets to follow a definite course through the tunnel system. The centre section with its two large fuel tanks was the first to take shape; it travelled slowly along the length of one main railway tunnel, collecting components and sub-assemblies from each of the side galleries as it passed. At every stage War Office inspectors tested and checked.

Degenkolb established a special staff to dispose of production problems.

Captain Kuhle, a munitions expert, set up a troubleshooting organisation of 100 Army officers vested with enviable powers to break “bottlenecks” in the A4 programme.

On October 26 the subject of secret-weapon operations was again raised by General Jodl at Hitler’s headquarters:

JODL: On the use of the A4: Press reports are coming in from Budapest following Ley's speech. He has announced the introduction by us of a new weapon in six weeks' time. Should it be generally spoken of?

HITLER: No!

JODL: I would be inclined to mention no dates at all, to avoid any further disappointments. It's common knowledge already that we *do* have something, and that can't do any harm.

HITLER: *Jawohl!* They all know that. The only ones who don't know it are the broad mass of the German people. Everybody knows about it except the Germans.

November brought the "further disappointments" Jodl feared.

The 444th Training and Experimental Battery had moved from Köslin to Blizna, where in sub-zero temperatures on November 5 the first rocket was launched in the presence of Lieutenant-General Erich Heinemann. As the ground under the simple firing table thawed out in the blast, the missile tipped slowly over; it took off at a rakish angle and crashed two miles away. Heinemann wrongly concluded that the A4 would have to be launched from concrete pads after all.

Worse followed. Further A4s were seen to be blowing up high over the target area. Weeks of painful research began into this phenomenon. On October 30 Degenkolb had written to Dornberger and Kammler: "The groundwork for the Degenkolb programme is basically complete"; but at a conference on November 8 in Berlin, attended by Speer and Central Works' Sawatzki, Degenkolb bitterly protested:

Major difficulties are cropping up with the rocket now that mass production is starting, as the research work is not as complete as the development team would have people believe.

PART FOUR

THE BODYLINE INVESTIGATION

“Four situations can arise with any one technical development:

(i) neither side makes it work; this presents no Intelligence problem;
(ii) both sides succeed; this is the normal Intelligence problem, for it soon becomes a matter of general knowledge and Intelligence is reasonably well briefed as to what to seek;

(iii) our experts succeed, the Germans fail; this is an Intelligence worry, for proving the negative case is one of the most difficult of Intelligence exercises;

(iv) our experts fail, or do not try; the Germans succeed. This is the most interesting Intelligence case, but it is difficult to overcome the prejudice that as we have not done something, it is impossible or foolish.

“Alternatively, our experts in examining the German development are no longer experts but novices, and may therefore make wilder guesses than Intelligence, which at least has the advantage of being in closer contact with the enemy.”

— *Dr. R. V. Jones, August 27, 1944.*

PART FOUR

The Bodyline Investigation

(I)

BY THE AUTUMN of 1943 it was clear to the War Cabinet that the direct Intelligence attack had failed to establish with certainty the existence of a German long-range rocket threat. To be sure, seemingly reliable Intelligence reports had suggested that “rockets” were being developed at Peenemünde and objects very much akin to the popular conception of rockets had been seen on air photographs of that establishment.

Yet this first simple Intelligence picture had been overwhelmed by the eloquent opposition of Lord Cherwell, the personal scientific adviser to the Prime Minister, and Dr. Alwyn Crow, Controller of Projectile Development at the Ministry of Supply. Their argument was that long-range rockets could not be contained within the shape of the Peenemünde “objects,” sketched by the RAF photographic interpreters as some 40 feet in length and 7 feet in diameter, but with a blunt nose and three fins. It was now code-named the “*Bodyline*.”

At the first meeting of Mr. Duncan Sandys’s special scientific committee it was realised that the whole problem might centre upon the composition of the rocket’s fuel. Sandys appointed a Fuel Panel to consider this:

1. What theoretical and effective fuel energy would a long-range rocket weapon, capable of carrying a warhead of high-explosive content of one to ten tons to a range of over one hundred miles, require?
2. Would the development of such a fuel represent so great a technical and scientific advance as to make it seem unlikely that the Germans could have succeeded in producing it?

Before the Fuel Panel met, Professor G. I. Taylor the mathematician wrote a paper "in an attempt to clear my own mind rather than to add anything to what is known." In this he showed that in determining a rocket's maximum range, a more important factor was involved than its fuel type: the ratio he termed its "alpha ratio." If this could be improved from, say, 0.5 to 0.6 by using light-weight alloys and high-density fuels, then a typical rocket would double its range.*

This changed the nature of the investigation. It brought considerable embarrassment to Crow and Cherwell, who found that they could no longer argue from known heat contents of fuels, but had to debate the

* Professor Taylor's simplified formula contained only two variables: the rocket's "alpha" (α) and the fuel's specific thrust (I), the latter being defined as the pounds thrust delivered by the motor per pound fuel burnt per second; and the former, α , by the ratio of the fuel weight carried by a rocket to its total fuelled weight. His formula for the maximum in-vacuo range of a rocket then became $g(I \cdot \log_e [1 - \alpha]^{-1})^2$, where g is the acceleration due to gravity. This has the dimensions of length. The German A4 (V-2) had an overall α of 0.64, while US technique did not better 0.52 at the time. The I for liquid-oxygen alcohol was probably about 200, yielding an in-vacuo range of some 300 miles, far in excess of requirements. Thus Professor von Braun was able to run his motors rich, using the fuel excess to moderate the very high combustion-chamber temperatures. Clearly if the rocket engineers could design a missile with a high enough α , all the other problems of combustion were spirited away; only the use of liquid fuel- and gas-turbine-driven pumps promised that high α .

engineering practicability of constructing rocket mechanisms flimsy enough to attain high alpha ratios.

A fuel expert was needed to make out of Taylor's formula a workable rocket theory. Shell engineer Isaac Lubbock was in America but his chief assistant, Geoffrey Gollin, was summoned to the first Fuel Panel meeting on September 20. In view of Taylor's calculations a new term of reference was adopted: "Is the production of a rocket with a range of one hundred miles or more and an explosive content of one ton or more a reasonable proposition?"

Gollin reported that the latest information from America showed it possible to reduce a liquid-fuelled rocket's "clothing" – the fuel containers, pumps, combustion chambers and ancillary apparatus – to only half of the weight of the fuel itself, representing an alpha of 0.67.

To Dr. Crow, still thinking in terms of solid propellants, this figure seemed impossible:

Our best figure for cordite rockets is 0.25. An examination of German rockets has not shown any appreciable improvement on this. . .

Referring to the Peenemünde rocket-sketch, Crow suggested: "It seems possible that it might be a large torpedo. . ." He quoted figures prepared by his department for two hypothetical four-stage rockets, each capable of reaching London: the first would weigh 230 tons and burn 90 tons of solid fuel, propelling a 7-ton warhead, while the second was a rather smaller a 33-ton rocket using 13 tons of fuel for a 1-ton warhead.

Dr. Crow's initial success was evident. A draft report circulated a few days later accepted that it was impossible to obtain 130 miles with a single-stage rocket. It was suggested that a pilotless aircraft, possibly propelled by a Whittle-type jet engine or ramjet, presented the most practical way of transporting high-explosive loads over the required ranges.

At two following meetings of the panel Crow forced through significant amendments to this draft: while Gollin succeeded in including petrol and liquid-oxygen as practicable fuels for a single-stage rocket, the report confirmed bluntly that there was “no evidence available in this country” to support a ratio as high as 0.58. The panel proposed to report to Sandys that, “whilst a single-stage rocket having the requisite range (over 100 miles) cannot be entirely ruled out, it is most improbable.” But Dr. Crow consulted Lord Cherwell and advocated that the entire sentence be replaced by:

We are of the opinion that the necessary range cannot be achieved by a single-stage rocket, and that the possibility of such a development in Germany can be ruled out.

Lord Cherwell was invited to attend the final meeting of the Fuel Panel on October 11. To Geoffrey Gollin, the fuel expert, it was evident that this meeting would be critical. He suggested that Sandys visit Langhurst to see Lubbock’s petrol-oxygen rocket motor; this would help Sandys to form an opinion on liquid-fuel systems. Sandys agreed to see a demonstration on the 16th. Gollin cabled Lubbock in America via the Shell International code telegraph network that “factors in Sussex” required his immediate presence in London. Isaac Lubbock drew his salary from Shell International, not from the projectile division of the Ministry of Supply; and Lubbock alone knew how to square up to the Controller of Projectile Development, Dr. Crow.

History may well judge Sir Alwyn Crow less harshly than in many of his contemporaries. It will be more honourable to recall his remarkable contribution to solid-fuel rocket technique – for which he was awarded his knighthood – than to record his consistent but obstinate refusal to accept that liquid-fuelled single-stage rockets were practicable weapons.

His support for Lord Cherwell’s campaign undoubtedly hampered Mr. Duncan Sandys’s investigation.

(II)

Lord Cherwell was still hoping for a reply from his selected four scientists – Taylor, Crow, Fowler and Sir Frank Smith – to his detailed scientific questionnaire circulated to them on September 21; it seemed to him that a reply was now due. By the first week of October he had still received none.

When Sandys wrote to him on October 6, inviting him to the meeting of his Scientific Committee five days later, he replied that he “thought there had been some misunderstanding.” As directed by the Defence Committee, he had put a number of definite questions to four scientists and was now awaiting their replies.

Shortly it occurred to him that there might be another reason for the delay. On October 7 he telephoned the four scientists. He was able to reach Professor Taylor and Dr. Crow: neither of them had received or heard of his questionnaire.

Livid with rage, the Paymaster-General dispatched an icy note to Duncan Sandys:

Considering that [the questionnaire] was circulated on September 29, it seems to me gross negligence to say the least of it. Could you let me know whether your office is responsible, or whether it is the Ministry of Defence?

The immediate fate of Cherwell’s questionnaire remains indeterminate, but if the document had been delayed in Mr. Sandys’s office the reason was an honourable one: he considered that available effort should be concentrated on fighting the enemy.

ON OCTOBER 10 Isaac Lubbock, who had returned hurriedly from the United States, called, together with Geoffrey Gollin, on Colonel Post at his office in Shell Mex House. Together with two ballistics experts

they began to design a liquid-fuelled rocket to conform to the Peenemünde object's outline.

Lubbock made one error: despite his experience with liquid oxygen at Langhurst, he believed that an American fuel using nitric acid and aniline promised to be easier in handling. But he had brought back news of remarkable developments in America: the fuels were being fed under pressure into the combustion chambers by mechanical pumps.

His own cumbersome gaseous expulsion method involved heavy pressurised fuel tanks. The Aerojet Corporation was developing a rocket motor employing an 85-horsepower motor-car engine to drive the fuel pump; the Americans were achieving "alphas" of 0.57 and 0.64.

It is probable [Lubbock reported] that further experience, coupled possibly with gas-turbine drive for the pumps, will ultimately lead to the lightest combination, particularly for long-period motors.

That very afternoon he and Post drew up a tentative design for the Peenemünde rocket, based on a single-stage liquid-fuelled rocket without its warhead.

The design provided for 42 tons of fuel to be expelled from the rocket's tanks either by pressure or by gas-turbine-driven pumps: the pressure method would entail burning cordite in the tanks, or burning a proportion of the fuel itself for this purpose. Six combustion chambers would deliver a theoretical thrust of 150 tons from a fuel combination like nitric acid and aniline.

This simple theoretical arrangement yielded a very high "alpha" indeed, about 0.78. The 54-ton rocket would probably carry a 7-ton warhead to 140 miles.

According to Professor C. D. Ellis, scientific adviser to the Army Council, the information brought back by Mr. Lubbock from America "completely altered the picture."

ON THE following afternoon, October 11, Mr. Sandys's Fuel Panel met on the fourth floor of Shell Mex House. Enlarged photographs of the Peenemünde "objects" were distributed around the long table. The Prof had bluntly informed Sandys that he "did not think there is any object in my going to a meeting of your Scientific Committee"; as it had not been invited to answer his questions, he decided that perhaps he ought to attend. He had had a fifteen minutes' parley with Professor Geoffrey Taylor that morning, and the two were sitting not far from each other. Gollin and Lubbock were directly facing Cherwell; Dr. Crow was also present.

When Colonel Post described the tentative rocket design prepared by Lubbock and himself, there were protests that this was being introduced as new evidence, before anybody had the opportunity of examining it. The Prof was not impressed by Lubbock, whom he regarded, for all his qualifications – the Shell engineer had taken a Double First at Cambridge – as a usurper in the investigation. He stoutly declared that nobody could teach him anything about rockets: he could safely say that he and Dr. Crow knew more about rocket design than any man in Great Britain.

Asking each in turn, Sir Frank Smith inquired whether they now felt the object seen at Peenemünde might be a rocket. Each signified assent; only Dr. Crow and Lord Cherwell voiced their opposition. Crow exclaimed that the "rockets" were obviously "inflated barrage balloons."

Colonel Post asked drily why the German Army found it necessary to transport barrage balloons on heavy-duty railway wagons: were they heavier-than-air barrage balloons? Crow remained silent after that. Sir Frank Smith declared that he would record their agreed opinion that

having seen the sketch submitted to us, we are of the opinion that it may be a rocket. We have not considered any evidence from Intelligence or other sources.

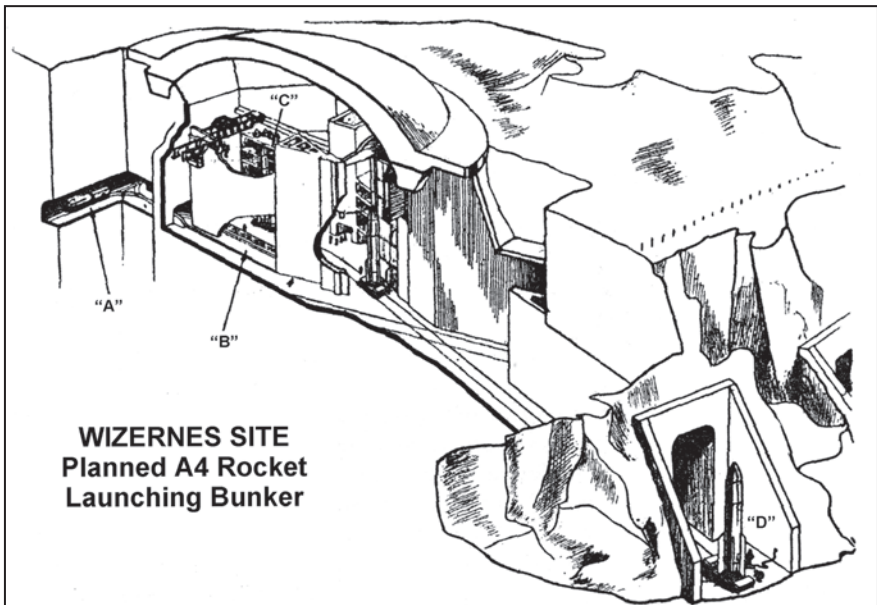

**WIZERNES SITE
Planned A4 Rocket
Launching Bunker**

ROCKET-LAUNCHING BUNKER AT WIZERNES

After the August 1943 destruction of Watten, the Todt Organisation constructed a new launching bunker at Wizernes. The huge concrete dome was first built on the quarry side, then the whole site was excavated beneath. Rockets would enter at "A," be fuelled and serviced at "B" and "C," and rolled ("D") out into the open to be fired on wheeled bogies. The underground workings (below) were vast. The site was finally knocked out by the R.A.F.'s six-ton "earthquake" bombs in July 1944.

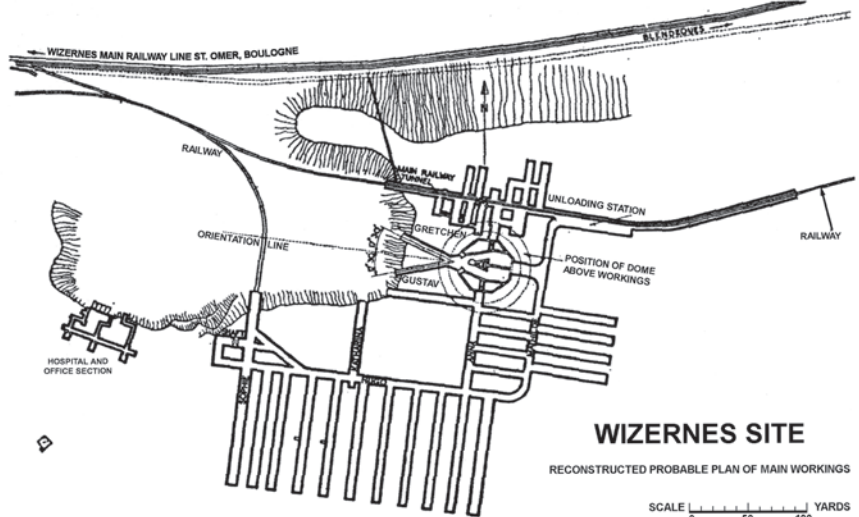

WIZERNES SITE

RECONSTRUCTED PROBABLE PLAN OF MAIN WORKINGS

SCALE 0 50 100 YARDS

At this Lord Cherwell rose from his chair and stalked out of the room; three people hastened to open the door for him. Post reached it first. After the meeting broke up, he explained to Lubbock that no matter how infuriating the Prof was, one must always be very polite to him: he was an extremely powerful man.

(III)

Now the two opposing factions were finally set on a collision course. Sandys would report to the War Cabinet after a meeting of his scientists on the 22nd; Lord Cherwell's experts planned to counter-attack at the first Defence Committee meeting thereafter.

Engineer Lubbock was directed by Sandys to prepare a complete blueprint for a long-range, liquid-fuelled rocket of the size of the Peene-münde objects. Lubbock had less than four days into which to compress the design work which had taken the Germans seven years.

Starting on October 14 and aided by leading armaments engineers and scientists of the Ministry of Supply, he finished by the evening of the 18th; on the 19th, he showed the blueprints to Sandys, who had by now visited Langhurst, and witnessed a perfect hot run.

The mode of launching was still indeterminate, as neither British nor American rocket scientists had any knowledge of the A4's "gas rudders" which enabled it to make its simple, slow standing start. Lubbock was told to assume a launch of at least 8g; but he allowed for accelerations up to 16g, and this entailed a much more robust construction.

Without its warhead, his rocket would have an all-up weight of 52.3 tons, of which 42.8 tons was fuel.

The use of his own petrol-oxygen fuel was out of the immediate question, as he only had time to design cordite expulsion, a technique impossible with liquid oxygen.

However, he did warn Sandys that it was possible that the Germans would choose a centrifugal pump system, as it promised better results.

Sandys had copies of this blueprint dispatched to Fort Halstead on the 20th for an independent opinion on the rocket's practicability from the Chief Engineer of Armament Design. Smith found that "there was no single major engineering factor which had not been considered and for which an answer was not forthcoming."

That was good enough for Mr. Sandys. Lubbock was instructed to bring the drawing personally to the Sandys Committee meeting next day.

It was discussed at length there. The only dissent arose over the way in which the liquid fuels could be introduced into the combustion chamber.

The Germans, it might here be profitably recalled, had in fact installed a centrifugal pump in the A4 driven by gas turbine. Lubbock's diagram called basically for the insertion of cordite into the fuel tanks, to drive the fuel out under the pressure of the burning gases, but he admitted at once: "if we had to build the projectile we should use pumps"; he thought it likely that gas-turbine-driven pumps would result in a lighter assembly.

Dr. Crow found himself isolated by the discussion; he complained that he had had hardly any time to study the Lubbock design, but "he did not wish to take up the time of the committee on a discussion of details."

Professor Ellis agreed that pumps did appear to be the answer. It seemed to him, he continued, that a strong *prima facie* case had been made out:

The Committee ought to advise [the War Cabinet] that a bomb of at least a ton in weight might be delivered from a range of two hundred miles, and might look like the Peenemünde object.

At last it seemed that agreement was being reached. There seemed to be three possible rocket systems: the first, the multi-stage solid-fuelled rocket which Dr. Crow was still insisting was the only feasible

projectile; the second, the basic Lubbock rocket, using either cordite or pumps to inject liquid fuel into the combustion chambers; and the third, the same rocket assuming an improved fuel efficiency.

Dr. Crow declined to lend his authority to the latter two hypotheses. The rest of the scientists approved this three-part formula almost unanimously.

The committee's report to the War Cabinet therefore represented accurately informed scientific opinion in London about the German rocket threat at the end of October 1943:

1. Whilst no long-range rocket has been constructed in this or any Allied country, we have, on the evidence considered by us, reached the conclusion that the undermentioned performances are possible:

	<i>Weight of Warhead</i>	<i>Approx. Range</i>
(a) Multi-stage rocket using technique known in this country [i.e. solid fuel]	1 to 10 tons	130 miles
(b) Single-stage rocket using existing American technique for liquid jet motors	5 to 15 1 to 5 tons	130 miles 200 miles
(c) Single-stage rocket using same technique as (b) but assuming a 15 per cent increase in specific thrust, as obtained in laboratory tests in America.	10 to 20 tons 5 to 12 tons 1 to 5 tons	130 miles 200 miles 300 miles

2. Whilst there is no reliable basis for calculating the accuracy of such a projectile, we consider it reasonable to assume that half the rounds fired would fall within a circle of about five miles radius around the mean point of impact at a range of 100 to 130 miles. The dispersion would be proportionately greater at longer ranges.

3. We consider that a rocket projectile (less warhead) possessing the performance estimated in paragraph 1 could have the dimensions of the object seen at Peenemünde.

Signed:

Dr. E. C. Bullard, FRS Prof. J. E. Lennard-Jones, FRS

Dr. A. D. Crow*

I. Lubbock, Esq.

Prof. C. D. Ellis, FRS, Dr. A. Parker

Prof. Sir Ralph Fowler, FRS, Sir Frank Smith, FRS

Prof. W. E. Garner, FRS, Mr. F. E. Smith

Mr. G. J. Gollin, Prof. G. I. Taylor, FRS

Sandys circulated this on October 24. His main accompanying proposal was that the Ministry of Economic Warfare should maintain an up-to-date list of German factories in which the long-range rocket, its components and fuels, were most likely to be made.

Intelligence evidence, he warned, strongly suggested that the Germans might have manufactured 500 rockets already and that an early offensive was possible. They were pouring millions of tons of steel and concrete into several unexplained “bunkers” in the Pas de Calais and near Cherbourg, and there was some evidence that work on Watten had been resumed.

ALL THIS was considered by the Defence Committee (Operations) on the evening of October 25. Once again the proceedings, which were held in the underground Cabinet War Room, remained clearly in the recollections of those present: after Sandys had summarised the findings of his committee, Lord Cherwell waded into the attack. His new argument was that it was impossible for the Germans to have de-

* ‘Dr. Crow does not consider the performances given in paragraphs 1(b) and (c) to be possible.’

veloped a long-range rocket from the experimental to the operational stage within only eight or ten months.

Turning to Mr. Lubbock, the Shell engineer who had brought with him the remarkable “blueprint” for a Peenemünde-type rocket, Cherwell pointedly remarked that it was a great pity that Dr. Crow, who “knew more about rockets than anyone else in this country,” was not present. Lubbock he dismissed as a “third-rate engineer” to whom the committee would be unwise to pay much attention.

Lubbock afterwards protested that he had never been so ill-treated as at this meeting. When he told the committee his theory that the rocket fuel was expelled from the fuel tanks by a 4,000-horsepower gas turbine driving a centrifugal pump, he was challenged, “What’s the diameter of your suggested gas turbine?” Lubbock replied he was thinking of something like 20 inches (the A4’s actual turbine diameter was rather *less*). He was told: “To put a 4,000-horsepower turbine in a 20-inch space is lunacy: it couldn’t be done, Mr. Lubbock!”

Lord Cherwell snorted:

At the end of the war when we knew the full story, we should find that the rocket was a mare’s nest.

Field-Marshal Jan Smuts, the South African Premier, whose opinion the Prime Minister now sought, summed up the dispute by commenting: “Well, the evidence may not be conclusive, but I think a jury would convict!”

IN SPITE of the Prof’s objections, Duncan Sandys’s view prevailed. The Chief of Air Staff was directed to arrange attacks upon the suspicious structures in Northern France and on the associated labour camps, and on all factories believed to be engaged in the manufacture of the rocket or its components. Photographic reconnaissance of Northern France, and SIS operations to ascertain where the weapons were under development and manufacture, should be intensified.

In the civil field, Mr. Churchill also directed Herbert Morrison to examine warning arrangements, and the maintenance of the machinery of government in face of rocket attack.

One concession was made to Lord Cherwell: he was to arrange a meeting with the four scientists to whom he had wished to circulate his questionnaire, and Mr. Churchill himself would hear the scientific discussion. If the defection from his camp of Dr. Jones had dismayed Lord Cherwell in June, this next meeting was to perplex him even more. Finally, the Prime Minister decided that it was now necessary to place the facts squarely before Parliament, whose curiosity he – no less than the German leaders – had by his statements aroused.

Few people knew the secrets of Wing Commander Whittle's revolutionary jet engine, in the development of which Lubbock had himself played no small part. Still smarting, Lubbock telephoned the Wing Commander and asked what the horsepower of the Whittle gas-turbine engine was; Whittle replied that it was 3,000 horsepower, from a 14-inch wheel.

This figure thoroughly vindicated Lubbock for his stand the night before. He telephoned Mr. Sandys's office and told them, just for the record, that a gas-turbine-driven fuel pump was no impossibility.

(IV)

Following the flattering success of a July 1943 trial flying-bomb shot, which had impacted only half a mile off target after a flight of 150 miles, the High Command had fixed December 15 for the opening of the assault on London. The launching of flying bombs from both Peenemünde and nearby Zempin by troops of "AA Regiment 155 (W)" began.

At first the rate increased, but it fell off to only fourteen in September, as the stock of trial bombs was exhausted. The first of the new prototypes arrived for testing early in September, and there was some progress on launching flying bombs from both *He.111* bombers

and the catapults. But the German Air Force found it difficult to plot their fall as the autumn mists closed in: no aircraft could keep pace, and sound-ranging proved impracticable.

A number of bombs were equipped with *FuG.23* telemetering and signal transmitters, but finally the measure which had been eagerly awaited by the British code-breakers was adopted: tracking by radar. The flying bombs were now found to be attaining ranges of 130 to 160 miles without difficulty.

On September 23 the regiment was told that mass production, mainly at Volkswagen, would reach 5,000 monthly in December; but although the flying bomb unit had been promised a hundred bombs during September, by October 25 only thirty-eight had arrived. Production started at Volkswagen's Fallersleben plant only late in September. By mid-November output had reached only twenty-five monthly, and the 5,000-monthly target was postponed until June 1944.

The regiment launched its first new prototype from the Zempin ramp on October 16.

By the 23rd several bombs fitted with the *FuG.23* had been catapulted. The range control was clearly faulty: one bomb programmed to dive after 125 miles droned obstinately on for a further thirteen miles before it impacted. On another bomb, the *FuG.23* went dead; and on other occasions the trailing aerials stayed obstinately coiled up inside the weapons, so that they rapidly vanished from sight and earshot of the monitoring stations. There seemed no end to the teething troubles.

Forty thousand workers were engaged on construction work for the flying-bomb programme in France. One appreciation, on September 23, held it possible for fifty-eight of these first sixty-four catapult sites to be ready by the end of October. In addition to these, ninety-six (including reserve) sites were being erected in Picardy, Artois and Normandy, and the Germans were labouring at Siracourt and Lottingham on two of the four concrete bunkers originally favoured by Field-Marshal Milch.

Completion of the three “supply” sites was promised for about December 15, which was still the target date for the flying-bomb offensive to open.

THROUGHOUT THE early autumn there had been a steady growth of Intelligence about the pilotless aircraft threat in London. An agent had reported that it was code-named *Fi.76*, Which was very similar to *Phi.7*, the word used by the staff officer in the Army Weapons Office. “Among the few indications of manufacture,” Dr. Jones reported, “Fieseler has been the most prominent.” There had been in mid-August a specific report by the air attaché in Berne that Fieseler were making an “air torpedo in the form of a plane without a pilot, propelled first by catapult and then by rocket power”; and on October 21 a German Air Force officer had stated that the Fieseler works at Kassel was being equipped for the manufacture of “the same secret weapon as was being made at Peenemünde.”

On the day after this report was received, Kassel was gutted by one of the five most disastrous Bomber Command attacks of the war.

At the end of October eight prisoners from the famous German bomber squadron *KG.100* described under interrogation “giant rocket projectiles, tailless jet-propelled aircraft and rumours of other secret weapons” of which they had become aware when stationed at Peenemünde-West airfield. All of them agreed on one thing: the rocket projectiles were fired almost vertically into the air. A flight engineer had seen a “flaming yellow mass” fired apparently from the eastern edge of the airfield in the autumn of 1942. An aircraft observer had seen two launchings on the same day in April 1943; the “very large, dark objects” had risen almost vertically at a comparatively slow speed, after green Véry lights had been fired as an advance warning.

Other prisoners described rocket launchings from two miles south of the airfield in June.

Now for the first time since the unfortunate affair of “Mr. Peter Herbert,” British Intelligence had in their hands men who had genuinely

been inside Peenemünde, and had really seen rockets being launched. The tide of events was moving against Lord Cherwell, and his band of followers began to diminish.

This is not to say that his powers of debate had declined, as he was able to prove on October 28.

He had been invited to call a meeting of four scientists. The four arrived punctually at noon in his private room overlooking Parliament Square: Professor Taylor, Professor Fowler, Sir Frank Smith and Dr. Crow were there, as was Brigadier Jacob of the War Cabinet Secretariat.

Lord Cherwell began diffidently that he did not set himself up as an expert, but he doubted whether the Peenemünde objects could possibly be rockets. He had never said that the Germans could not design a long-range rocket; what he did say was that the necessary characteristics of a long-range rocket could not be incorporated in the object on the photographs.

This statement, of course, represented a considerable tactical retreat from his earlier position.

The discussion lasted an hour. At its conclusion Cherwell heard with triumph their verdict that there were “many formidable difficulties” in the way of accepting the objects photographed at Peenemünde as long-range rockets. Highly pleased with this decision, the Prof lunched with the Churchills at No. 10 Downing Street and announced that the four scientists would now be siding firmly with him against the existence of the rocket when the matter came under discussion later that day.

IN THE INTERVAL since Isaac Lubbock’s humiliating experience at the hands of the Defence Committee on the 25th, he and Gollin had at the Ministry of Economic Warfare discussed in some detail the advantages of fuel expulsion by turbine-driven pumps. Lubbock warned that the Germans were probably not using nitric-acid/aniline fuels, as these had been discovered in America purely by chance.

The question of the turbo-pumps was equally complicated: Lubbock was not at liberty to disclose details of Whittle's experiments: "all he could say" the Ministry afterwards noted, "was that with his knowledge of what had been done, it was quite feasible for a 4,000-horsepower turbine mechanism, together with the pump which it drove, to be contained in the '*Bodyline*' [rocket]."

The Ministry pointed out huffily that in that case "no opinion could be expressed on German capacity for its production." Lubbock stubbornly refused to reveal what he knew.

LATE ON October 28, 1943 the Cabinet Ministers, Chiefs of Staff, scientists and technicians filed into No. 10 Downing Street to hear the dispute finally resolved. Mr. Churchill sat half-way down the long, crowded table in the Cabinet Room, with Cherwell and Sir Stafford Cripps on his left, and Beaverbrook and Sandys on his right. The two Shell engineers occupied the right-hand end of the table.

Lord Cherwell's main argument centred now upon a point made by Professor Fowler during his earlier discussion that day, that the "outsize mortar" necessary to launch such rockets would have to weigh some 700 tons to withstand the recoil – hardly an inconspicuous structure. Cherwell refused to accept that liquid fuel could be injected into the rocket motor: if the fuel was nitric acid, as Lubbock had postulated, burning cordite in it would blow the rocket up; and if the Germans really had designed a 4,000-horsepower gas turbine to power the rocket's fuel pump, "why did they not use it in aircraft?" He still contended that pilotless aircraft would be far easier to manufacture than rockets.

If the Prof now hoped to sway the Defence Committee by the production of his four expert "witnesses," his expectations were crushed in what must have been a cruel ordeal: the very scientists who that midday had sagely agreed with the Professor now rounded upon him to confirm that the rocket was not only feasible but likely.

Lord Cherwell was humiliated. Mr. Churchill cast his vote with the others. Turning to Lubbock he asked him what was the minimum range that such a long-range rocket would definitely fly. Lubbock answered, "100 miles, and probably more."

Mr. Churchill asked where a rocket launched from Calais would fall. He was told: "About Westerham, sir. . ." The Prime Minister exclaimed: "Dammit! That's where *I* live!"

Turning to the Prof, Mr. Churchill indicated that it was pointless to go on debating scientific theories for month after month. A decision would have to be taken. He announced a special Committee of Inquiry to recommend further steps, and shrewdly invited Cherwell himself to take the chair at its first session, on the following morning.

But Lord Cherwell rose and declined; saying that he already had another engagement, he stalked out. The meeting was on the point of dissolving anyway and his abrupt departure attracted little attention.

"Without batting an eyelash," as one participant subsequently recalled, the Prime Minister turned to Sir Stafford Cripps and inquired, "Sir Stafford: would you oblige me?" Cripps assented, and undertook to hold the first session early next morning.

More than one Minister present had been surprised by the Prime Minister's move, but in retrospect it must be seen as a master-stroke of diplomacy. Churchill firmly believed that the German Government was impelled by "an overpowering urge" to retaliate. He probably recognised that his scientific adviser had talked himself into a false position, and deduced that only if Cherwell were invited to chair an investigation would he ever admit the strength of the Intelligence case.

By refusing it, the Prof had burnt his boats; for him it would now be a fight to the finish.

SANDYS HAD informed the Prime Minister that a heavy though premature rocket attack might be launched on Britain in the middle of November, and it was against this background that Sir Stafford Cripps opened his official inquiry next morning in the Cabinet offices.

The first session achieved little, but during the succeeding two days Cripps invited a number of Intelligence officers to confidential interviews with him at his flat in Whitehall Court. Dr. R. V. Jones was one who was called upon in this way. In strict confidence, Jones told Cripps that he was concentrating his Intelligence attack now not on Peenemünde itself but on the area around Zempin, some eight miles to the south. Jones was reading deciphered radar plots originating from the 14th Company of the German Air Force Experimental Signals Altitudes Regiment, which was apparently tracking some weapons fired out to sea.

Thus the watch kept on this company by Bletchley Park since the early summer of 1943 was paying dividends: intercepted *Enigma* signals clearly referred to radar tracking of winged weapons travelling at about 400 miles per hour and altitudes between 1,000 and 6,000 feet; within fine limits he could even say that the weapons were being launched from the Zempin area.

Jones arranged for an aircraft to stand by to take air photographs of Zempin; he hoped to find something that could be the launching projector for the secret weapon. With considerable anxiety, he waited for the weather over the Baltic to clear, and for the sands of Zempin to reveal their secrets.

CRIPPS SUBMITTED his draft report to the Prime Minister on November 2; his main conclusion was an important statement of principle:

There is nothing impossible in designing a rocket of sixty to seventy tons to operate with a ten-ton warhead at a range of one hundred and thirty miles.

The main technical objections were in Cripps's view satisfactorily overcome: in Lubbock's opinion the combustion-chamber temperature could be moderated by using the liquid fuel as a coolant; the "4,000-horsepower engine" problem could be overcome using

Lubbock's design.

Finally, the seemingly necessary initial propulsion might be provided either by a two-stage rocket or by means of a mortar.

In his view, Cripps added, the Peenemünde elliptical earthwork (Test Stand VII) was the mouthpiece of a "giant mortar"; another test bed seemed to have launching rails consistent with the two-stage rocket theory; while a third site, just to the south of the ellipse (Test Stand I, in fact) was agreed to be a static firing rig for combustion-chamber trials.

This latter deduction, which alone was correct, "was based on a pair of early photographs which showed a 25-foot-long "object" projecting from the gantry, an object which had vanished four seconds later; it was now realised to have been a hot tongue of flame emerging from the rocket motor under test.

If the Germans had embarked upon preparations for operational use in Northern France, Cripps concluded, then they must be satisfied that they had solved their remaining development problems, or were on the point of doing so.

On November 3 he instructed his own department to plan on the assumption that all London production capacity was lost. The German long-range rocket threat was assuming a new and terrifying mien.

(v)

The fevered construction of launching sites across the Channel could not long remain unobserved by Allied Intelligence agencies.

Those at Siracourt and Lottinghem were reported by photographic Intelligence on October 5 and November 2, and two German Army "bunkers" at Martinvast and Sottevast, both near Cherbourg, on October 22 and 31 respectively. The Wizernes rocket project was the last to be reported, on November 5. Even the strange site at Mimoyecques had been adequately covered by photographic reconnaissance.

At the end of October the Intelligence drive initiated by Sandys paid

off when an agent came forward with details of six more construction sites near Abbeville.

An order was issued for the whole of North-western France within 150 miles of London to be re-photographed, as the site construction must have started since the last total reconnaissance of June and July.

The authorities in London adopted further precautions. Both Herbert Morrison and A. V. Alexander urged that immediate steps be taken to prepare for a long "siege" and to control refugee movement from London: normal rail services, but no more, would run; Tube trains would run non-stop through the majority of underground stations, which would be used purely as shelters; and armed guards would prevent people from taking shelter in those kept open for traffic. Morrison requested authority to keep 2,700 more policemen on the Metropolitan force, and laid plans for rest centres near London to accommodate half a million refugees. A committee under Sir Findlater Stewart began to deliberate on civil measures if widespread panic broke out in London.

Lord Cherwell deprecated these measures. Of Sir Stafford's findings, he observed to his staff: "What can you expect from a lawyer who eats nothing but nuts?" – an ungenerous jibe from one with habits as fastidious as Cherwell's. He privately minuted Mr. Churchill with his reasons: for a projectile to travel 130 miles, about two-thirds of the whole weight would have to be fuel, twice the best ratio achieved by the British. (As we now know, of the A4's twelve tons, eight tons were fuel.)

The crisis in the investigation was rooted deeply in the reluctance to accept that the Germans could have bettered Dr. Crow's rocket techniques.

He held that the chances of rocket bombardment were negligible:

As I am often believed to be responsible for giving you scientific advice, it would perhaps be well to mention the fact that I am sceptical about this particular matter.

Mr. Churchill received this note on November 2, together with Cripps's report, and minuted him the same afternoon to the effect that he should now hold a short inquiry into the evidence, as apart from the scientific aspects, for the existence of long-range rockets. At the same time, Cripps was directed to examine arguments for the existence of pilotless aircraft and remote-controlled glider bombs, about both of which the Prof had repeatedly warned.

By excluding the scientific aspects, the Prime Minister hoped to obviate much of the scientific quibbling.

Cripps decided it would be impracticable to examine afresh the great mass of accumulated documentation; it would be more useful to hear out the principal experts in a proper judicial inquiry into the photographic, Intelligence, and propaganda evidence.

The selected experts, who included Dr. R. V. Jones, Engineer Isaac Lubbock, and Flight Lieutenant Kenny, were directed to attend the War Cabinet offices on November 8, "prepared to expound that part of the evidence which has come to their notice."

The imprint of Lord Cherwell's hand on the appendix to this directive was unmistakable; it listed four points "worthy of special attention" at the inquiry:

1. That the story of the rocket is merely a creation of the German Propaganda Ministry designed to bolster up German morale.
2. That the rocket story has been deliberately "planted" upon us as part of a cover plan to conceal something else.
3. That the construction works in Northern France are in reality intended for some quite different purpose.
4. That the Germans have not yet succeeded in solving the technical problems connected with the development of the long-range rocket.

In the meantime Cherwell dispatched a critique of the Minister's earlier findings to Mr. Churchill. He repeated:

If Sir Stafford Cripps is content to accept the assurance of Mr. Lubbock – who has not hitherto been conspicuously successful in rocket design – that he could easily overcome [the difficulties] as against the view of Dr. Crow, who has made many successful rockets, that a weapon carrying the assumed load over the necessary distance with the required accuracy cannot be made, there is nothing more to be said.

The arid language of Cripps's report was no match for Lord Cherwell's devastating rhetoric, and with a few broad sweeps he had bludgeoned its arguments and shattered its foundations.

Cripps had claimed that there was nothing impossible in designing a 60- to 70-ton rocket with a 10-ton warhead to fly 130 miles. Lord Cherwell commented drily:

It would be possible in theory to make a rocket to fly as far as the North Pole if it carried nine-tenths of its weight in fuel.

EVENTS WERE overtaking the Prof, however. On November 3 aerial reconnaissance was obtained of the six pinpoints reported by the French agent. The photographs revealed numerous small buildings of identical design on each construction site, including concrete platforms with a central axis bearing on London. By November 5 eight sites had been located: all contained robustly built sheds shaped like skis on their sides. The pronounced shape greatly facilitated the identification of new sites, and four new sites were already reported in a footnote; one of these was in the Cherbourg peninsula. By the morning of November 8 the number had grown to nineteen.

On that morning the experts summoned to Sir Stafford Cripps's new inquiry assembled at the War Cabinet offices off Parliament Square. Cripps had appointed Sir William Stanier, the locomotive engineer, and Dr. T. R. Merton to act as assessors with Lord Cherwell and Sandys beside him at the head of the horseshoe-shaped table.

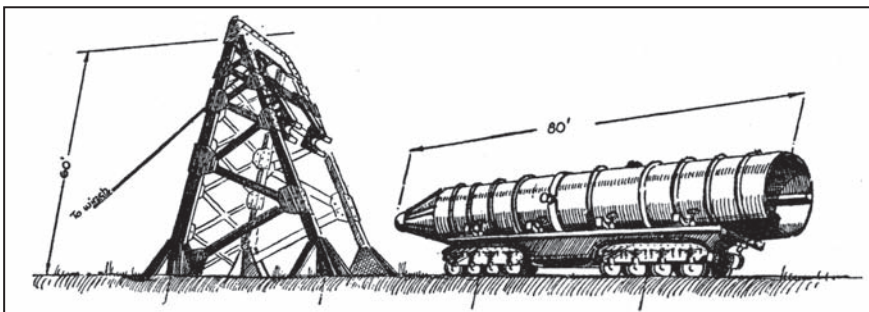

Semi-mobile rocket mortar. ABOVE: Coming into action. BELOW: Ready to fire.

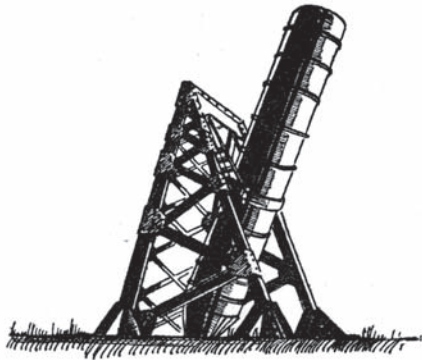

BELOW: Alternative mounting.

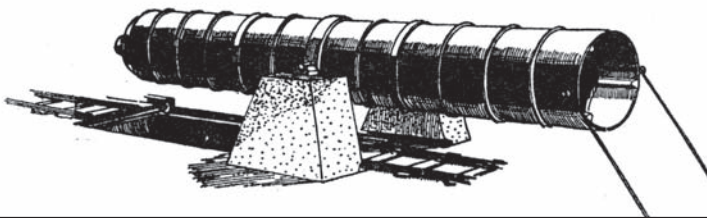

THE SEARCH FOR "GIANT MORTARS"

Dr. A. D. Crow insisted that the rocket seen at Peenemünde would have to be launched from a giant mortar before it would become aerodynamically stable. Ministry of Supply armaments experts in November 1943 worked out the theoretical design of the vast structures necessary to launch the rocket, which was wrongly assumed to weigh up to seventy tons. The R.A.F.'s photographic reconnaissance experts were directed to search Western Europe for structures like these. None was found.

Close attention was paid to German propaganda about secret weapons. The expert evidence of the Ministry of Information's Mr. Zveginzov was that unless such propaganda was followed within six months by a real offensive, there would be irreversible effects on German morale.

The references as early as May 1943 to the use of a new secret weapon suggested that the Germans might at least at that time have been planning to open the offensive in December 1943.

The photographic evidence could not be ignored. The seven vast "bunker" sites in France did not resemble any known military installations, all appeared to have been started at about the same time, all were served by mainline railway, and most were aligned on London or Bristol.

When Cripps asked whether any new activity had been detected, Wing Commander Kendall replied that several new sites, all featuring odd ski-shaped buildings, had been located: their concrete ramps were also aligned on London. Nineteen had been located in the Pas de Calais and the Cherbourg peninsula, and the next few days might reveal many more, as the reconnaissance of North-west France was not complete.

Cripps perceived that this evidence was of critical importance. He announced a two-day adjournment to permit the Medmenham officers to complete their examination of the photographs.

The confusion into which the investigation was thrown was increased by a telegram dispatched by President Roosevelt on November 9 to Mr. Churchill, forwarding an agent's report:

Factories manufacturing the rocket bomb are situated in Kaniafried, Richshafen, Mitzgennerth, Berlin, Kugellager werke, Schweinfurt, Wiener Neustadt and at an isolated factory on the left side of the road going from Vienna to Baden just south of Vienna.

The telegram, which had come to Roosevelt via Turkey, was an

unfortunate hotchpotch of nonsense and fable. Suffice to say that secret-weapon components were indeed being manufactured – as British Intelligence was well aware – by the Askania firm in Berlin, that rocket production had earlier been planned at Friedrichshafen and an isolated factory at Wiener Neustadt; and that “*Kugellagerwerke*” means “ball-bearing factories,” of which Schweinfurt was the principal centre.

The second session of the Cripps inquiry opened on November 10. In the interval more photographs had been examined; the CIU had detected no fewer than twenty-six of the “ski” sites, and fully expected to find more. New low-level oblique photographs specially obtained of the installations closely confirmed the French agent’s report. He had described one building containing no metal parts – even the door hinges were of a plastic material; wooden rails and rollers led from this building to the ramp aligned on London. Whatever the sites were intended to fire would evidently have some kind of magnetic steering device.

There was also evidence that the Germans were experimenting with a radio-controlled pilotless aircraft, and a report – perhaps an intercept – that associated an operational research battery developing a “new air defence weapon” with an anti-aircraft regiment working with remote-controlled bombs, stratospheric shells and bacterial warfare. Apart from the statement that this unit was to operate a “catapult for the A4 rocket” in Northern France, there was nothing to connect it with giant rockets. The Intelligence evidence was thus still confusing and contradictory.

THE MINISTER of Aircraft Production circulated his second report on November 16.

Just two weeks before, he had affirmed that there was “nothing impossible” in designing a 60-ton rocket to carry a 10-ton warhead over 130 miles. Now he totally reversed his findings, placing the A4 rocket as the least probable of four alternative forms of long-range bombardment:

It would seem that the order of probability, from the purely experimental point of view, is:

1. Larger sized *Hs.293* glider bombs;
2. Pilotless aircraft;
3. Long-range rocket, smaller than A4;
4. Rocket A4.

It should be noted here that by "A4" Cripps was not referring to a 13-ton rocket, as the A4 really was, but to the 70-ton A4 reported by a German staff officer on August 12, 1943. This designation had been unwittingly confirmed in the same month by another Berlin officer's gushing wife, who had remarked to an Italian officer:

Do you really believe that the A4 can win the war? One talks a lot about it, but it is difficult for us Germans to believe.

The inevitable conclusion was, Sir Stafford Cripps observed, that evidence about the rocket was "being manufactured by inquiries which we ourselves have launched."

WE HAVE seen how, early in September, the pilotless-aircraft investigation had been taken over by the Air Ministry, while Mr. Sandys had continued to review the evidence on the rocket threat. Some duplication of effort was inevitable; but while Sandys seemed prepared to accept this, neither the Joint Intelligence Committee nor Dr. R. V. Jones could be. The latter maintained, of course, that these investigations were tasks for scientific Intelligence alone.

By the end of October the Chiefs of Staff were eager to pursue counter-measures. These could better be coordinated by Service channels and, at a meeting with Sandys and the Joint Intelligence Committee on November 11 it was decided that all his functions be transferred to the Air Staff.

Simultaneously, yet another committee was established, this time under the auspices of the JIC, specifically to investigate the rocket threat. This renewed concern within Air Intelligence. Dr. Jones was so disturbed by this implicit lack of confidence in his methods that on November 15 he wrote to the JIC that he would have resigned had his own experience not amply confirmed the accuracy of the Prime Minister's remarks about the general "otioseness" of committees. He added, however:

My section will continue its work, regardless of any parallel committees which may arise, and will be mindful only of the safety of the country. I trust that we shall not be hindered.

(VI)

In effect, Sir Stafford Cripps had intimated that British Intelligence had been distracted by the rocket scare from what now seemed the more obvious danger, that presented by pilotless aircraft.

On November 18 Sandys discussed the new position with the Chiefs of Staff. They proposed to the Prime Minister that the "special inquiry" stage be deemed finished, and that Sandys relinquish his responsibilities.

The burden of the Intelligence attack should now revert to the normal machine of the Service departments, and to the Air Ministry in particular; Air Marshal Bottomley, the Deputy Chief of Air Staff, would centralise the effort of the Joint Intelligence Committee and take over all the schemes set in motion by Sandys. Since it would have been foolish to ignore the wealth of experience he had amassed during his inquiry, it was arranged that he should attend the meetings of the Chiefs of Staff whenever secret weapons were discussed.

With Mr. Sandys's withdrawal the main rocket inquiry lost its momentum. The whole of Northern France within 130 miles of London was being re-photographed in case any "ski" sites had been missed;

and at a meeting on the evening of the 18th the Vice-Chief of Air Staff now held – in line with Cripps's deprecation of the rocket – that the "ski" sites might not be intended for the long-range rocket after all, but for a pilotless aircraft or glider bomb. Dr. Jones had pointed out that the A4 rocket seen at Peenemünde was too bulky to negotiate the curve of the "ski"-shaped store building seen in France. The "ski" sites were, in fact, for launching flying bombs.

Sir Stafford Cripps announced that no pilotless bombardment was likely before the New Year, and Britain might expect to have at least a month's notice of the enemy's readiness to operate with a long-range rocket, a conclusion to which the meeting subscribed with some relief.

Lord Cherwell, in his now-familiar phrase, "remained sceptical" about the existence of rockets at all. And, in any case, both he and Morrison now agreed that fatal casualties might on certain assumptions be only between ten or twenty per weapon. This meant that to equal the deathrate of 1940-1, the enemy must have tied down a permanent labour force of a quarter of a million Germans.

The "rocket" went into eclipse. The code-name "*Bodyline*" was dropped, and "*Crossbow*" substituted; early in 1944 the continuous radar watch for rockets maintained since June was relaxed. At the end of 1943, in a lengthy summary of the evidence, Dr. Jones warned that the growth of Intelligence on the flying bomb in no way invalidated the evidence for the rocket's existence; but the point was ignored. All the ruder was the shock which awaited the Cabinet in July 1944, as the A4 rocket suddenly reappeared on the Intelligence scene.

PART FIVE

THE ROCKET IN ECLIPSE

“Our hour of revenge is nigh! We will never repeat the 1918 blunder of laying down our arms at a quarter to twelve. You can be sure of that! Germany will be the last to lay down her arms this time, and that won’t be until 12:05. . . !”

— ADOLF HITLER, *broadcasting from Munich’s Löwenbräu beer-cellar on November 8, 1943.*

“Director DEGENKOLB: complained bitterly that major difficulties were cropping up with the rocket now that mass-production was starting, as the research work was not as complete as the development team would have people believe. . . .”

— *From minutes of a rocket production conference at the Reich Munitions Ministry on the same day.*

PART FIVE

The Rocket in Eclipse

(I)

C RIPPS'S ESTIMATE THAT no flying-bomb attack need be expected before the New Year was echoed by the enemy. On November 1, 1943 General Korten, the new Chief of the German Air Staff, informed General von Axthelm that the rocket engineers were guaranteeing that the A4 would be operational by the end of 1943; he inquired when the flying-bomb operations might start.

"The aim up to now," von Axthelm replied, "has been a 'New Year Present.'" General Jodl interrupted: "No, I am better informed about this: you will lag a long way behind the A4. . ."

Von Axthelm felt in his bones that there was little prospect of opening fire in January. The flying bomb's production was sluggish. A few days before he had toured the Volkswagen factory where the bomb was to be mass produced: the works had complained that since early August flying-bomb engineers had specified no fewer than 150 modifications requiring 131 new parts in the weapon. (Both Dornberger and von Braun have reported that 65,000 modifications were necessary to their prototype A4 before mass production could begin.)

Colonel Wachtel, commanding the flying-bomb regiment at Zempin, had requested six bombs for trials; the first prototype-series bomb

had been launched in mid-October, but after that he had had to wait for supplies. Those bombs which Volkswagen delivered lacked their steering mechanisms. By October 25 only thirty-eight had arrived.

Wachtel criticised the Fieseler firm for underestimating the problems involved in mass production. No more bombs were delivered to Peenemünde until February 1944. Development trials were halted.

This critical situation was caused by Allied air attacks, and in particular by those on Kassel.

Early in October the battered Fieseler works had been evacuated to nearby Rothwesten, where they found the supply of compressed air and power insufficient.

As a result of the heavy attack of October 22 on Kassel, only 60 per cent of the workers arrived at the new factory, as Air Staff Engineer Bree reported at Milch's conference on November 3.

"Because Kassel has been lost," he added, "Rothwesten is to all intents and purposes lost as well. The men live in Kassel and their homes and transport are wrecked." In consequence, the final trials of the weapon's power unit, control-gear, dive mechanism, compass and air-log were held up.

MILCH: What do you consider the earliest date for the whole thing to function properly at all?

BREE: Assuming we can carry on launching, I reckon we will need possibly another hundred and twenty or hundred and fifty bombs for trials before we can be broadly certain that everything is in order.

VON AXTHELM: Provided that there are no major problems, trials will be complete by the beginning of February.

The delay in development was infuriating.

The ground organisation was far advanced: at the current rate, the ninety-six catapult ("ski") sites would be virtually complete by mid-December, and the two giant "bunkers" by mid-March.

Colonel Wachtel was more optimistic, claiming that the launching trials could be complete by January 15, after which he would need to fire another 200 rounds to compile a firing table. He was already transferring six of his eight batteries to France; and eight “supply” sites were being constructed in the “ski” site firing belt.

A week later, a party of officers from the Führer’s headquarters brought Wachtel the news that for the present flying-bomb production was to be pegged at only 1,500 rounds per month; the full 5,000 would not be attempted until June 1944.

Hitler in the meantime had broadcast to the world that “Germany’s hour for revenge” was nigh. In a speech from Munich on November 8 he proclaimed:

Even if for the present we cannot reach America, thank God that at least one country is close enough to tackle! And we are going to keep it like that.

Ten days after this beer-cellar address, and two days earlier than planned, the last of Wachtel’s first six flying-bomb batteries entrained for France to await the coded order from General von Axthelm to open fire on England: “*Polar Bear!*”

Von Axthelm considered that the attack should be directed against the South Coast invasion ports as well as London. He wanted at least 50,000 flying bombs per month.

In mid-November, General Korten arranged for him to address these requirements to Hitler’s staff; shortly, von Axthelm was warned by telephone that Hitler would be attending in person. The next afternoon Hitler, Keitel, Milch, Jodl and Speer gathered to hear von Axthelm’s views.

When the *Flak* general criticised the present programme as being only one-tenth of what was necessary to foil the Allied invasion, Hitler interrupted him. “Don’t concern yourself with warding off an invasion. Keep to the subject of our retaliation offensive!”

Von Axthelm persisted doggedly that as the invasion might come at any time after early spring, there was no time to be lost.

The Führer could not conceal his displeasure: "Get your bombs over there first. Then you will get the production you want!" He swept out followed by his staff. The meeting had come to an end.

Hitler was reluctant to hear any news that displeased him about the revenge weapons. At noon on November 26 he attended a demonstration of new aircraft at Insterburg airfield, together with Heinrich Himmler. This was Hitler's first glimpse of the *Fi.103* flying bomb and he was not unimpressed. The leader of the flying-bomb experimental unit at Peenemünde-West, Kröger, explained how the weapon worked.

Then the calamity happened: the Führer asked him when they would see their way clear with the bomb. Kröger, thinking that only the weapon's development was meant, replied: "By the end of March." (Even then, of course, much would still have to be done on the training side.)

March was bad enough: Hitler fell abruptly silent, and his Air Force liaison officer, General Bodenschatz, turned to Colonel Petersen (Director of Air Force Research) and muttered: "Who was the pessimist who arranged this demonstration?"

(II)

On December 1 the Führer's headquarters announced the activation of a new "special duties" Army Corps, the Sixty-Fifth, to "prepare and execute the long-range engagement of England with all such secret weapons as might come into consideration for that purpose."

Field-Marshal Keitel directed that the new Corps would command all the secret-weapon formations, A4 – flying bomb and ultra-heavy artillery – in the attack on England.

The Corps was to be a single OKW (High Command) formation, superior to the three existing tactical commanders: Dornberger, Wachtel and Schneider (the latter, being director of the "high-pressure

pump” project). The Corps would come under orders of the Commander-in-Chief West, Field-Marshal von Rundstedt.

Its setting-up was the culmination of a month’s feuding between the Führer’s headquarters and the German Air Staff: there had been arguments about the wisdom of placing all the long-range bombardment weapons – “A4, *Fi.103* and some third thing” – under a unified OKW formation. On November 1 Hitler had signed a dispensation on the “preparation and execution of the giant military construction projects (A4, flying bomb and *Millipede*),” in response to a plea from Rundstedt for authority over these projects. Thus encouraged, von Rundstedt recommended to the High Command the establishment of a special Corps to assume tactical control of all secret weapons, subordinate to himself as C-in-C West.

Lieutenant-General Erich Heinemann, an ageing artillery officer, was provisionally selected as the Corps’s first GOC, and ordered to present himself at the Führer’s headquarters.

Von Rundstedt wished Dornberger relieved of tactical control and restricted solely to the A4’s development and production, and to troop-training duties; but in mid-November, General Jodl expressed doubts and recommended that Dornberger be left in general control of the whole rocket programme, from factory to firing site. The High Command amplified this to Rundstedt late in November, directing that Dornberger would be responsible as “Special Army Commissioner,” under General Fromm, for rocket development and production and for training, and as “Senior Artillery Commander 191,” under the proposed Corps, for all A4 preparations in the West.

The Sixty-Fifth Army Corps activated on December 15 was the result. A strange hybrid, with headquarters at Saint-Germain, it had an Army GOC (Heinemann), an Air Force chief-of-staff, Colonel Eugen Walter, and duplicate staff officers provided by Army and Air Force at every level.

Unified though this unique new command might be, each Service saw its best long-term development project being seized by the

other. On November 23 Göring angrily demanded that flying-bomb operations be directed by a special Air Force division, and not come within the aegis of the planned Army Corps at all. The strife between the Corps and its lower formations became a damaging factor in the German secret-weapons effort.

The Corps staff found it difficult to form any clear picture. The Army denied Heinemann information on the A4. Only by visiting Peenemünde, Zempin and Blizna did he and Walter learn how backward the weapons projects in fact were.

The flying-bomb unit had apparently made no attempt yet to aim at specific targets; and for the A4 engineers the main problem was to bring the rockets back to earth in one piece.

In the first days of December the High Command stressed that A4 rocket attacks could never equal a heavy daylight raid by conventional bombers, but added:

Its advantage lies in being able to make itself felt day and night, with no warning at all. It will strike at the Englishman's morale; any actual damage caused is of secondary importance.

In these words one detects the first hint of self-justification: only now had the High Command learned that the fabulous A4 would deliver less than a 1-ton warhead; that "blitzes" could never be launched with it, as Germany could not produce enough liquid oxygen to launch more than perhaps fifty a day; and that of these fifty, probably half would not come within ten miles of their target, assuming that the "air-burst" problem was ever mastered.

Heinemann made one vain attempt to close down the whole A4 project in favour of the more viable flying bomb; he undertook a tour of the launching sites in France only to find them swarming with French labourers and being built by French firms.

None of the large sites, in his view, was either capable or worthy of camouflage.

(III)

At the beginning of November 1943 Dr. R. V. Jones of Air Scientific Intelligence had requested a photographic reconnaissance of Peenemünde and of Zempin, a village located some eight miles to the south, where the analysis of Bletchley's intercepts of radar plots originating from German radar units indicated that he might find a launching installation for some kind of winged missile.

Not until the 28th did a Mosquito find a break in the clouds. The aircraft circled several times, exciting consternation among Wachtel's flying-bomb regiment at Zempin by its "lively interest in the Peenemünde peninsula." The Mosquito was driven off. It brought back to England a series of poor-quality photographs. At Medmenham they were interpreted by Claude Wavell, chief of the radar interpretation section. The stereoscopic photographs of Zempin showed three long ramps, gently inclined and pointing out to sea.

To Wavell, who was not concerned with the "ski" site mystery, the ramps must have been a disappointment, as this sortie had been put down as "W/T." But Dr. Charles Frank, Jones's assistant, secured a set at once, saw their importance, and took them to Jones. There was no doubt that the ramps were identical with those found in every "ski" site in France. The whole ominous "ski" site array was thus established as being for launching whatever winged weapon was undergoing trials at Zempin.

Jones already had in mind a picture of this weapon: its wingspan would be less than 21 feet 9 inches, the width of an opening through which the complete weapon had to pass on its way to the launching ramp. Wing Commander Kendall, who was directing the photographic Intelligence attack on the secret weapons, had his own theory. He attended a JIC conference on December 1, where he suggested that the sites were for launching either pilotless aircraft or glider bombs; certainly "no gear was visible capable of handling 45-ton rockets."

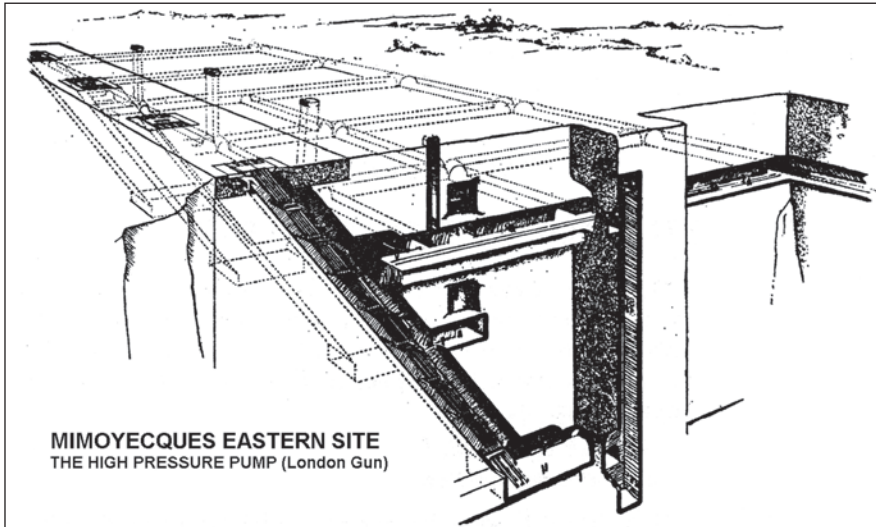

MIMOYECQUES EASTERN SITE
THE HIGH PRESSURE PUMP (London Gun)

ADOLF HITLER'S "HIGH PRESSURE PUMP": V-3

The most sinister of the V-weapons was the long-range gun site at Mimoyecques, near Calais. It was designed to fire nine-foot dart-like shells (BELOW) at London at the rate of up to 600 an hour. The artist's impression of the site captured by the Canadian Army in August 1944 shows its immense scale: note the size of the men at the foot of the 416-foot gun barrels. British Intelligence had always thought that Mimoyecques was some kind of rocket-launching shelter.

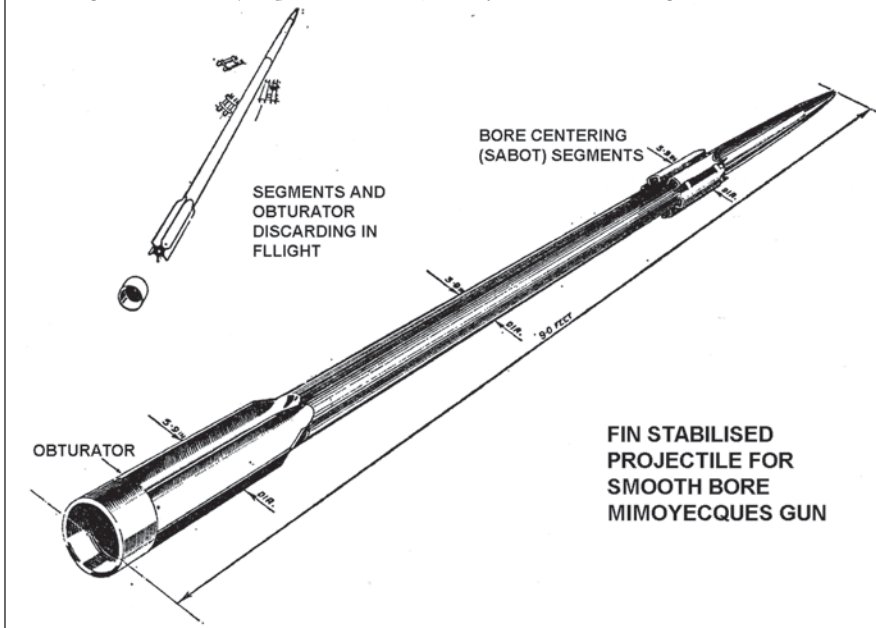

The JIC was sceptical but asked for a report. It was never written.

Even as the Intelligence experts were in session the photographic interpreters at Medmenham had re-scrutinised the photographs of Peenemünde airfield and at the north-eastern edge they found two almost identical launching ramps, one of which they had previously dismissed as a “sludge pump,” exactly aligned on the southern tip of Bornholm island.

At the foot of one of the ramps a WAAF interpreter easily made out the shape of a “Peenemünde 20,” a small winged aircraft she had first detected on the airfield some weeks before. This time it was obvious that the aircraft had no cockpit.

At noon on December 3 the news was brought to a triumphant Lord Cherwell. The Prof wrote at once to the Prime Minister in Cairo:

I have heard today [Lord Cherwell wrote] that recent photographs at and near Peenemünde have disclosed sites resembling closely “ski” sites in France, of which there are now sixty to one hundred under construction.

Since they showed gentle ramps – one with a pilotless aircraft on it – and since we know quite definitely that successful experiments with pilotless aircraft are being made in that region, it seems almost certain that the “ski” sites are intended for this weapon. The aircraft have a span of about twenty feet and it is reckoned that they might carry a bomb weighing about two tons. The speed is probably something over four hundred miles per hour, and the height at which they have hitherto been flown is about six thousand feet.

If the Peenemünde trials were acceptance trials, attacks might start within one to three months. The launching of 1,000 of these aircraft, Cherwell reminded the Prime Minister, “could produce very unpleasant concentrated effects.”

The sites would have to be bombed. As the JIC was now estimating from ground sources that the German programme was one hundred

“ski” sites it was clear that the Allied bombing effort would not be marginal.

To the Air Ministry’s Director of Intelligence (Operations), the layout and storage arrangements suggested that the enemy’s intention was to make a concentrated attack: rapid and simultaneous fire from 100 sites could deliver 2,000 tons of high explosive on London within the space of twenty-four hours, he estimated.

This put the threat into ugly perspective: the Germans could deliver the same quantity of explosive and incendiary material as had caused the 1943 fire-storm in Hamburg. They would be able to repeat this operation for as long as their firing sites, supply system and production centres remained operational.

Nine days later, sixty-nine “ski” sites had been detected. Gradually, the number was creeping up to the predicted hundred.

Bad weather delayed the planned Tactical Air Force attack on the “ski” sites. On December 15 Sir Charles Portal urged that an “all-out attack” should be launched by the United States Eighth Air Force heavy bombers against them. This offered the prospect of luring the German day-fighter force into the air battles over France which it had hitherto studiously avoided. He argued that the effort need entail no diversion from the general strategic offensive against Germany, as periods of poor weather over Germany could be utilised for the attacks on France.

The Chiefs of Staff Committee agreed and requested the Eighth Air Force to give “overriding priority” to the attack.

In the event, the early *Crossbow* bombing operations, which started on a large scale on December 21, were no more than moderately successful.

By Christmas Eve, when 1,300 planes dropped 1,700 tons of bombs in the largest Eighth Air Force operation ever, and their first against the “ski” sites, only three sites had been destroyed. Colonel Wachtel’s regiment had suffered no casualties, though thirty French workmen had been killed.

Lord Cherwell, alarmed by this diversion from the offensive, rap-

idly returned to his original position that the pilotless aircraft threat was not significant: on December 18 he wrote to Mr. Churchill with a brilliant forecast of the likely scale of attack.

The Prof predicted that each missile would carry under one ton; that less than a third would travel the full 130 miles; that with the average error of ten miles possibly one would arrive per hour in London; and that the offensive would claim two to four casualties per missile. If the offensive were maintained, he added, it would “be unlikely that more than three aircraft per site will be dispatched per twenty-four hours.”

In the event, none of his predictions was believed. The Joint Intelligence Committee estimated that forty-eight pilotless aircraft could be launched from each site every twenty-four hours. Lord Cherwell, who on December 20 was shown the excellent “ski”-site construction plans which Air Intelligence had obtained through agents in France, promptly pointed out that, as only twenty aircraft could be stored on each site, this assumption was unrealistic.*

In his view, therefore, precipitate measures to plan the evacuation of London were uncalled for.

The Prof did not dispatch his warning memorandum to the Prime Minister in the Middle East until the night of the 22nd; that same evening, Portal told the Defence Committee that the Chiefs of Staff

* At a Sixty-Fifth Army Corps conference on December 30 Colonel Wachtel estimated he could launch *seventy-two* bombs per site over twenty-four hours: “As however only 21 bombs are stored on the site, the remaining 51 will have to be delivered during the firing period.” This fantasy was never achieved in fact. During the first forty-eight hours of the main attack in June 1944, only 365 flying bombs were launched from fifty-five catapults, only 134 reached London, killing an average of 2.7 people per bomb. By 6th July, an estimated 2,754 bombs had been launched, killing 2,752 people. On December 30, 1943, Wachtel described the flying bomb as having a 1,830-pound high-explosive warhead and a dispersion of up to nine miles. All in all, Cherwell’s predictions were highly accurate.

estimate had been modified: an attack by single pilotless aircraft “might take place at any time”; by mid-January the Germans might be bombarding Greater London with the equivalent of 300 tons of bombs in eight hours, and by February with 1,000 tons.

Lord Cherwell responded that he had come to the conclusion – which was entirely correct – that the pilotless aircraft was powered by a simple liquid-fuelled ramjet; in consequence its warhead would be much lighter than the 1½ tons anticipated. Each aircraft, he thought, might kill now an average of one Londoner.

(IV)

By the middle of December it was becoming clear to the Germans that the Todt Organisation’s despairing efforts to erect giant bunkers in France were failing. On December 8 Hitler ordered Speer to look into this matter. The High Command, faced with compelling evidence that the Allies intended to blast all the large sites within range, made recommendations to the Führer which resulted in an order that all sites which would not be ready before the autumn of 1944 were to be abandoned.

In fact, the large sites were not now indispensable adjuncts of the secret-weapons projects; both main weapons were to be launched from small mobile firing sites. The High Command regretted that so much concrete was being diverted from the Atlantic Wall programme. Jodl’s staff archly noted: “A4 operations are not dependent on these large sites so much as on the perfection of the missiles and equipment, anyway.”

Hitler himself was less concerned with these arguments: in attacking the weapon sites, the Allies seemed to be releasing very heavy loads of bombs over virtually open countryside, and to little effect. To him, every ton of bombs on France meant one ton less on Germany.

Detached from the mood of the West, his superficiality emerges

clearly from a fragment of the stenographic record of his War Conference on December 20. A captured British airman had asked when the Germans would begin “firing at England,” as on flying over the French coast he and his crew had clearly seen the “rocket guns” under construction.

Hitler commented at the conference that the construction projects were clearly getting on Allied nerves:

HITLER: If they were to put up objects like that and we knew that they were for wiping out Berlin, we’d get just as jittery, and set *our* Air Force about them. They know exactly what we’re up to. They are writing that we’ve got rockets; they are saying that it’s possible that we can fire one or two tons of explosives at them – and now they are believing it themselves.

The Allies, he continued happily, could not rule out the possibility that the Germans had succeeded. As long as the sites were either enormous and well fortified, or very numerous and small, the labour forces and troops would suffer little during bombing attacks.

HITLER: Hitting such small targets from twenty thousand feet is pure chance.

JODL: Some of them are being attacked from as low as six thousand feet.

HITLER: True! But if we gradually build up their anti-aircraft defences, that will change. We must transfer strong anti-aircraft defences to the West.

By the end of the year eighty-three “ski” sites had been detected and the Allies had released 3,216 tons of bombs over them. In spite of this, twenty-one were more than three-quarters complete and the installation of the catapults themselves had begun. Some of the more advanced sites, Air Intelligence noted, were now protected by light

anti-aircraft defences, and elaborate camouflage was in progress.

In a revised estimate on January 1, the Joint Intelligence Committee suggested that over a three-day period the Germans could launch 1,500 tons of bombs at London.

Preparation of counter-measures could now no longer be postponed. Lord Cherwell warned that conventional defences would be ineffective against unmanned aircraft, a view expressed equally forcefully by Air Marshal Bottomley.

But a plan drafted by Air Marshal Hill (Fighter Command) and General Pile (Anti-Aircraft Command) was put into effect, providing for a balloon barrage to the south of London, and a belt of guns on the North Downs, while the whole area to the south of them became a zone of operations for the fighter force.

The flow of Intelligence deciphered by Bletchley Park from intercepts of radar plots on the Baltic coast provided proof that the pilotless aircraft were becoming more accurate than had been thought possible.

The radar plots showed that during the last three weeks of 1943 the accuracy in bearing had so far improved that three out of four would hit London at a range of about 130 miles; launching failures and errors in the range control would probably reduce this proportion to one in three.

One thing was certain: the Germans were having no difficulty in reaching great ranges.

During the last week of December the plots showed that all reached ranges over 130 miles; and that of the two runs on the 30th, one reached 160 miles and the other 168 miles – the longest so far recorded by the British Air Ministry. (In fact, a teleprinter signal from Karlshagen to the Director of Air Force Research on September 25 recorded that during the previous week two flying bombs had flown to 172 and 178 miles.)

(v)

At the end of the year, the optimism at the German High Command evaporated. Somehow, the Führer's headquarters had gained a totally false impression of the readiness of the secret weapons. This culminated in an order by the High Command to the Sixty-Fifth Army Corps on December 23 to prepare for the bombardment of England to begin in mid-January.

General Heinemann replied that this was out of the question: he himself would not know the state of the flying bomb's development until January. Lieutenant-General Karl Koller (chief of the Air Force operations staff) insisted that there was absolutely no prospect of keeping to that date.

As for the A4 rocket, Heinemann was even more pessimistic. His inspection of the rocket units had failed to impress him, and he enjoined the High Command to transfer to the flying bomb the industrial effort being expended on the rocket, as he could not foresee the latter's ever becoming operational.

This blunt reaction from both Heinemann and Koller angered the High Command; in his private diary, Jodl scribbled on Christmas Day an exasperated comment that the two secret weapons projects were "dawdling."

Hitler undoubtedly hoped that by launching an early attack he could wrongfoot the Allies and compel them out of political considerations to mount a disastrous invasion of the Pas de Calais, for which he was well prepared. On November 3, in a directive to his Commanders-in-Chief, he had already announced:

I have decided to reinforce the defences, particularly in the region from which we shall be opening our long-range bombardment of England. For it is there that the enemy must and will invade; and it is there – if I am not deceived – that our decisive invasion battles will be fought and won.

Hitler directed that the mass of the available forces were to be assembled behind the fronts of the Fifteenth Army defending the Pas de Calais launching area and of the right flank of the Seventh Army. Until late April the Fifteenth Army continued, in fact, to receive priority for reinforcements.

AT THE END of 1943 the Sixty-Fifth Army Corps had drawn up an ambitious production programme for the flying bomb during 1944: mass production was to start in January with 1,400 bombs, and rise to 9,000 monthly from September onwards.* The launching batteries were already in position; the inability to keep to the mid-January deadline seemed inexplicable to Jodl.

General von Axthelm was ordered to report to Göring to account personally for this on December 30. He declared that the fault lay solely on the mass-production side. So the Chief of Air Staff arranged for Air Staff Engineer Bree to brief the High Command on January 4. This meeting was the subject of some dispute afterwards, but the known outcome was that the High Command was deluded into believing the flying-bomb offensive could now start in mid-February. According to Bree's own version (related to Milch one month later), the whole thing happened in twenty minutes: he and von Axthelm were called before Jodl and invited to report. Bree had no exact figures with him, and when Jodl asked for details of the weapon's operational readiness

* Flying-bomb mass production planned in Germany as of December 30, 1943:

1944	
January	1,400 flying bombs
February	1,200
March	1,240
April	3,200
May	4,000

... rising to a maximum of 8,000 from September.

he was caught off balance. As an engineer, Bree hedged, he could not comment, especially as the bomb was still suffering from faults, including the serious compass difficulties; as they still needed 1,700 skilled workers, the immediate outlook was not encouraging.

Von Axthelm, on the other hand, was more optimistic.

As a result, Hitler decided that the retaliation offensive would begin on or about February 15, 1944, just six weeks hence, although as Field-Marshal Milch later groaned, "at the time it was perfectly clear that there wouldn't be fourteen hundred flying bombs turned out in January. . ." (In fact, no bombs were produced in January at all.) The offensive, Hitler directed, was to begin with a surprise "blitz" on London, while single "nuisance" bombs were loosed off at other cities.

Hitler even instructed that the mass attack should be "at eleven o'clock on a foggy morning." In his diary, Jodl enthusiastically noted: "The watchword of the project? *This is only the start!*"

Colonel Wachtel's catapult units were now well established in France. By February 25 the first ninety-five new, simplified catapults would have been manufactured to replace those in the battered "ski" sites. He realised the enemy was going to attack the latter until they were all destroyed.

He had no intention of transporting these new prefabricated catapults into the launching zones until the very last moment before the attack was due to commence: only six to eight days were needed to assemble the sections once the foundations had been laid. He also arranged considerable forward storage capacity, with eight "supply" sites each capable of holding 250 flying bombs, which would be supplied in turn by three field munitions dumps; a number of caves near Creil, Chartres and Le Mans were being adapted to hold a total of 5,000 bombs; all would become operational between early March and the end of April 1944.

From the end of February onwards, therefore, the ninety-six "ski" sites would be obsolete; however, Wachtel resolved to make them appear still active, to distract attention from the construction of his new,

“modified” sites, on which only German and convict labour would be employed. These sites, the Allies would not find so easily.

WHEN DR. GOEBBELS returned to Berlin from the Führer’s headquarters on January 5 the word “retaliation,” which had topped his agenda for seven months, had at last been crossed out; seven months had passed since he had proclaimed at Dortmund the coming of an “armada of revenge.”

At the station, his press secretary found him “bursting to confide in me” and radiating good humour:

The Führer and I [Goebbels was quoted as saying] have squared off the most rewarding targets on a map of London.

Twice as many inhabitants are crammed into London as Berlin. For three and a half years they have had no sirens. Imagine the terrific awakening that’s coming!

Our weapons are absolutely unprecedented. There is no defence, no warning at all. Wham! It hurtles down into the city, all unawares! I cannot picture a more devastating attack on their morale. . .

The British believed that victory was already within their grasp: “If only our production can rise to the occasion! Thank God we still have Speer!”

He had Hitler’s firm promise that things would be starting within a very few weeks, gradually at first, with manned bombing raids, and then with the long-range bombardment. “A fight in which both parties get bloody noses isn’t as much fun as one where it is always the other side that gets the thrashing.”

On January 5 the counter-Intelligence unit decided that it was time for Wachtel to disappear, being ostensibly posted back to Zempin. The regiment’s commanding officer was now one “Colonel Martin Wolf.” To complete the deception, this colonel, none other than Wachtel himself, was authorised to travel in any Service uniform except that of

the Navy. The headquarters staff of the regiment was camouflaged as a rather less conspicuous formation, the Todt Organisation construction office "Schmidt."

These measures enjoyed some success; Allied Intelligence was presented with a labyrinth of converging, crossing, terminating and duplicating trails. Wachtel's headquarters was never traced in time, and up to the summer of 1944 no attempt had been made to establish the identity or purpose of the rather more significant Sixty-Fifth Army Corps.

The Americans had been denied details of the full secret-weapon threat all along. It was not until December 20, 1943 that the Joint Chiefs of Staff discussed the available Intelligence on this matter in Washington.

Among the most alarming estimates before them was one from the US Air Force headquarters, depicting the radical possibility that the Germans might actually achieve a stalemate in the strategic air offensive by devastating the United Kingdom with bacterial weapons, poison gas or revolutionary explosives of "unusually violent character."

On General George C. Marshall's suggestion a special committee was appointed to interpret the existing secret-weapons Intelligence and to assist in determining counter-measures.

The committee met for the first time on January 6, with Major-General Stephen Henry in the chair; into the ominous silence from London they felt they could only read a hesitancy to reveal the true nature of a threat in fact more "acute" than had been indicated. Certainly, it seemed that the United States were being told "rather late in the picture" about what was happening.

To Field-Marshal Sir John Dill, Marshall wrote on January 14:

The preliminary work of the committee indicates that we cannot lend fullest support to this project, particularly in the field of counter-measures, unless we have full information on the British progress in meeting this problem.

By now Mr. Churchill was convalescing from pneumonia at Marrakesh. On January 5, General Jacob Devers arrived for talks on the planning of *Overlord*, the invasion of Normandy. During a conversation four days later he mentioned to Churchill the possibility of the existence of a German bomb which emitted some liquid spreading radioactivity over an area as large as two miles square, causing nausea and death, and making the area unapproachable. He told the Prime Minister that the Americans had made many experiments in this direction and it seemed probable that the Germans had also achieved success.

"All this seems very fruity," the Prime Minister telegraphed Lord Cherwell from afar. "I do not know whether he is mixing up the possible after-effects on the lines of Anderson's affair (I have forgotten the code-name)." Sir John Anderson was responsible for the British side of the "Tube Alloys" atomic bomb project.

The Americans had concerned themselves with the possibility of a German radioactive poison attack very early on. On 12th May 1943, Brigadier L. R. Groves had commissioned an investigation of German capabilities in that field, and on July 1 James B. Conant (President of Harvard) had replied:

It is quite conceivable that a series of circumstances might enable the Germans to produce in a city such as London a concentration of radioactive solids over areas varying in size from half a square mile to several square miles, sufficient to require the evacuation of the population.

On January 4 Brigadier Napier of the Ministry of Supply, who had been sent to Washington to discuss American rocket developments, was informed by Dr. Vannevar Bush that the Germans probably intended to use their long-range projectiles for bacterial warfare: the very small payload in such an expensive vehicle could not be explained in any other way. At the Pentagon on the 14th Napier learned that the

Americans had conducted a series of trials in Canada; bacteria had been sprayed from low-flying aircraft. The lethal effects on goats and rabbits had lasted for up to six weeks. American Intelligence was aware that the Germans appeared to have “converted forty of their biggest sugar refineries to the production of the bacteria yeast.”

These views were held by Marshall himself. Learning this, the British Chiefs of Staff were disturbed that the Americans should have let their imagination run wild, in the absence of specific Intelligence from London. To avoid further speculation, Ismay directed that the Americans should receive copies of *Crossbow* papers.

THE CHIEFS of Staff had discussed with the *Overlord* planners whether the *Crossbow* threat called for any radical revision of the plans. On 20th December Lieutenant-General Sir Frederick Morgan had tabled his reply: he felt that while it was impracticable to revise the *Overlord* planning as such, the threat was still capable of “prejudicing” such an assault mounted from the South Coast ports; a decision would have to be taken at once if the *Overlord* preparations were to be shifted to the West Country.

The authorities decided against the move. But Morgan continued to express grave anxiety about the effect of pilotless bombardment on *Overlord*.

If the Germans withheld their attack until D-day, it could cause the disruption of the entire operation. To this problem, the Americans saw “no real solution.”

Lord Cherwell viewed all this with distaste. On January 10 he strongly deprecated the Joint Intelligence Committee’s estimate that the enemy might by the end of March be able to launch 45,000 pilotless aircraft a month from the 150 “ski” sites they now expected to detect in France. In his view, the Germans might find production capacity for 1,500 of the weapons monthly; and, to put the threat into its proper perspective, a bombardment on this scale “implies that the average Londoner would be exposed to one explosion within a mile’s

distance once a week.”

Air Intelligence had also produced a *Crossbow* report. The Chiefs of Staff compared this with Lord Cherwell’s on the following day. To the Prof’s pleasure, the AI estimate was rejected in favour of his own, which was “more likely to be correct.”

The Paymaster-General particularly objected to Morgan’s memorandum, as it took no account of the pilotless aircraft’s inherent inaccuracy: he himself had calculated that of 1,000 launched only one would hit any given square mile; and as far as the South Coast embarkation ports were concerned, there were many spaces between targets.

As for the “ski” sites, he remarked on the Germans’ failure to react more strongly to the air attacks, or to repair their damaged sites. The weapon’s development was probably taking the Germans longer than they had been led to believe.

(VI)

In Germany, no new flying bombs had yet been turned out by the Volkswagen factory, and as a result the development of the *Fi.103* was at a standstill: snags in the bomb’s compass and electrical fuse could still not be overcome.

When Field-Marshal Milch therefore invited Engineer Temme, the chief of the Peenemünde development team, to report the situation “without false optimism” on January 24, the latter announced that the delay could last until early February. The situation with the prefabricated catapult deliveries was more promising.

MILCH: Not only cities, but the larger ports of embarkation as well, will come under consideration [as flying-bomb targets]. The range will be shorter, so the bomb’s dispersion will be less.

The production delay was grave, but with no influential backing at Albert Speer’s Munitions Ministry the Air Force was powerless to

procure the workers it needed. Volkswagen needed at least 1,000 more skilled engineers, but they were not supplied. In this field Speer's deputy Karl-Otto Saur, who had on September 9, 1943 proclaimed himself a "fanatical disciple" of the rival A4 rocket project, reigned supreme. The Air Ministry technical staff protested:

Saur will help only if he is given complete control. If he is allowed to make the *Fi.103* himself, he will give it his wholehearted support. But as long as we retain control, and he is only the supplier, then you can count him out.

Milch realised that there was no hope of initiating the flying-bomb offensive in mid-February, and in the last days of January he broke, the news to Hitler. The Führer raged at him, "You have humbugged me again!"

At the beginning of February the outlook was still uncertain.

MILCH: What is your *Fi.103* production now?

BREE: Nil. The first hundred fully-equipped bombs were supposed to be delivered tomorrow, [but] the production side is not my responsibility.

Milch dispatched a telegram to the High Command that afternoon denying once again that he had had anything to do with suggesting "mid-February" as a date for the attack to open.

On February 5 the flying-bomb regiment learned officially that even by July output would not exceed 1,000 monthly. This failure overshadowed both Wachtel's other preoccupations, the Allied air attacks – which were killing twenty French labourers for every German serviceman, and which were still directed exclusively against the moribund "ski" site system – and the survey and preparation of the new, "modified" site system for the prefabricated catapults. Beset by forebodings about attacks of Allied agents and the Special Operations

Executive against his own person, he issued the order changing his regimental staff into "Todt Organisation Construction Office Schmidt," at Auteuil.

On February 9 the whole staff made their way in civilian clothes to an inconspicuous building in Paris, from the other side of which they emerged garbed as Todt Organisation engineers; only a skeleton staff was left at Merlemont to channel instructions from "Colonel Wolf's" staff to his lower formation. The charade was to continue for longer than Wachtel thought.

(VII)

In the absence of a Defence Committee meeting (the Prime Minister was still in North Africa), there was some confusion in London about *Crossbow* counter-measures; Morrison called for bombing of the "ski" sites to be intensified.

He was understandably anxious about the continued lack of reliable information on the expected scale of pilotless bombardment and in mid-January he pressed to be fully informed.

At the end of the third week in January the Chiefs of Staff – aided by Cherwell and Sandys – formulated an agreed estimate of the likely scale of attack on London. They envisaged ten-hour blitzes of between 550 and 920 tons of high explosive, followed by sustained attacks of between 45 and 130 tons daily. Two days later the Chiefs of Staff added the conclusion that the Allies need not fear any pilotless bombardment before March 1.

Believing that many more sites must exist than the ninety-six by now discovered, on January 23 a new total reconnaissance of the French launching zone was ordered; no additional sites were revealed. At the same time, convincing evidence arrived to substantiate the authenticity of the "ski" sites, or so it seemed.

On the 24th Air Intelligence was able to report that some of the "ski" sites were being repaired with an almost obtrusive air of secrecy;

buildings apparently dismantled were seen on closer inspection to have been cleverly camouflaged instead; craters had been left ostentatiously unfilled near these camouflaged buildings, “probably,” he reported, “with the intention of deluding us into thinking that work had been abandoned.”

In the seventeen weeks until 12th June, Allied bombers were to release 23,196 tons of bombs on these “ski” sites, from which – as we now know – neither General Heinemann nor Colonel Wachtel had any intention after January of mounting their flying-bomb assault.

IT WAS comforting knowledge that no more than ninety-six “ski” sites existed. Both Cherwell and Sandys confirmed that the maximum pilotless aircraft bombardment would not exceed 400 tons within ten hours; this assumed that only a handful of the sites would remain operational at any one time.

The Defence Committee met late on February 3 in the underground Cabinet War Room to consider the report. It was at best only an “instructed guess,” but they agreed to accept it as a basis for defensive planning.

Cherwell pointed out that even if the Germans aimed one month’s entire output of pilotless aircraft at Portsmouth and Southampton, and even if there were 1,000 ships in harbour, only about two ships were likely to get hit.

When Cherwell showed that the accuracy against London would be even less than on the South Coast ports, Morrison failed to understand why. In a letter to the Prime Minister he protested that the “spillover” outside London should also be included. Churchill replied that he did not follow Morrison’s reasoning.

A considerable part of the “spillover” would not reach England at all; the remainder would be scattered over the South Downs and around London. As for Bristol and Plymouth, only a limited number of “ski” sites on the Cherbourg peninsula were oriented on them. Half a dozen bombers, Churchill concluded, would probably do more damage in

those two towns.

But the problem of the spillover areas – which were later to become the “flying-bomb alleys” – continued to nag at Mr. Morrison, and set up in his mind a persistent train of thought that was to have peculiar consequences in mid-August.

ON THE orders of the Defence Committee, the enigmatic “ski” sites continued to command much bombing effort. On February 1 General Carl F. Spaatz, the American air commander, wrote to his superiors in Washington that he was still not convinced that the “ski” sites were not in fact an inspired German feint, a deliberate fraud designed to divert pre-*Overlord* bombing effort.

This belief foundered with the detection on February 5 of seven of Wachtel’s eight “supply” sites, six of which were seen to be spaced some twenty miles apart in an arc just inland from the belt of “ski” sites, and the seventh, Valognes, in the Cherbourg peninsula. All the sites were ringed by anti-aircraft defences of every calibre up to the heaviest 105-millimetre type.

Of the launching sites, an “Allied agent” in France had now transmitted to London the welcome news that strict instructions had been issued by the Germans that bomb craters were not to be filled in, to suggest that the sites had been abandoned.

Photographic interpreters scrutinised the photographs of those sites which they had categorised as “abandoned,” and saw that camouflage and repairs to the launching points themselves were in fact being covertly expedited.

What looked like a German bluff had been called.

There is no doubt [the Prime Minister warned the House of Commons on February 22] that the Germans are preparing on the French shore new means of attack on this country, either by pilotless aircraft or possibly rockets, or both, on a considerable scale.

(VIII)

In January General Jodl was briefed on the progress made by the A4 rocket project. "A whole series of prerequisites for its tactical employment," Jodl noted, "have still not been satisfied." For instance, although operationally the A4 could probably be set up only under cover of darkness, no night exercises had been carried out by the field units training at Blizna, in Poland.

Seven mobile firing batteries were currently being planned, divided into two battalions of three batteries each, and one training and experimental battery. But production prospects were not heartening: by April 1, A4 production was planned to reach only fifteen rockets daily, and by the 15th only twenty-three. The limiting factor anyway was the output of liquid oxygen, which was sufficient for only twenty-five to twenty-eight rockets daily.

Original plans had suggested that each mobile battalion would fire twenty-seven rockets daily, while a third operating the Wizernes "bunker" would launch at twice that rate. "If oxygen production is not increased," Jodl prophesied in January, "we shall not be needing any third detachment."

By the beginning of 1944, A4 rockets were beginning to come off Alben Sawatzki's assembly line at Nordhausen. On the first day of the New Year the first three rockets were shipped out of its exit tunnel.

When von Braun visited the Central Works on January 25, 10,000 slave labourers and convicts were already at work. Security was strict. The SS chief, Förschner, issued a directive on December 30 forbidding private intercourse between the convicts and the German staff; on no account was the outside world to learn about Nordhausen.

Rocket transports between Nordhausen, Blizna and either Peenemünde or the Neuwedell munitions dump were conducted under close security; every weakness was checked by Dornberger's rocket transport liaison staff. The trainloads of ten or twenty well-sheeted rockets, mounted in pairs on groups of three flat wagons, and bereft of

any labels, docketts and conveyance papers, would be heavily guarded by special German troops who would accompany them throughout their six- or seven-day journey across the Reich.

Their duty was to do “everything to bring the trainloads inconspicuously and safely to their destinations.” In the end it was not transport security which betrayed Blizna, but a more elementary error, as will be seen.

The underground Nordhausen plant itself, in spite of its unending flow of components, raw materials and sub-assemblies, and in spite of its unique position in the German electricity and gas grids, remained totally undetected by any agency of Allied Intelligence until it was betrayed by a ground report on the last day of August 1944.

(IX)

By March 1944 Wachtel’s organisation was ready to launch its first flying bombs at the United Kingdom.

At the Paris headquarters of the Sixty-Fifth Army Corps on March 1 the higher echelons met to play a sinister “war game,” a simulated revenge attack on England for an imaginary RAF terror attack on Dresden – a remarkable coincidence, as Dresden was, early in 1945, to suffer the most disastrous air raid in history.

Heavy bomber squadrons, rocket units, flying-bomb batteries and perhaps even the “London” gun were supposed to “open fire” simultaneously as midnight struck, followed by alternating sustained and mass “attacks” until six o’clock the following morning.

The manœuvre was greeted as a brilliant success. It is of interest to consider Wachtel’s own projected rates of fire.

During this war game he claimed he could have fired 672 to 840 bombs at London from fifty-six catapults, and a further 96 to 120 at Bristol from the remaining eight. This rate of fire was never even approached when the actual attack reached its climax five months later.

AT THE end of the third week in February, the SS made its first serious bid for ultimate control of German rocket development. Realising that Professor von Braun was the key figure, Himmler summoned him alone to his field headquarters.

With no beating about the bush Himmler suggested that the Professor transfer his allegiance to the SS forthwith: only the SS could give the rocket programme the support it needed.

Von Braun guessed that SS Lieutenant-General Kammler was behind this; Kammler and Himmler planned to ditch Dornberger by depriving him of von Braun, and then ditch von Braun as well, leaving Kammler in sole control. He stopped the discussion: his loyalty, he pointed out, lay only with the German Army. Privately, he thought it improbable that the SS intended to offer him the same liberty of action as he had enjoyed under the Army. There is some evidence to suggest that Kammler was implicated in this move. Certainly he was with Himmler three days before, on February 18, and General Emil Leeb, Chief of the Army Weapons Office, was also called to Himmler's headquarters on the evening before von Braun.

Himmler realised that to remove the influential von Braun he would have to adopt more direct means.

THE PROLONGED difficulties with the A4's development endured throughout the winter and early spring of 1944.

Hitler's interest in the A4 was waning. By now he, too, was party to the doubts expressed about the project's "excessive waste of production capacity." And now there was no Albert Speer to protect it: during February he had succumbed to an illness which was to keep him away from Hitler until June.

On March 5, at a conference attended by Milch and Speer's deputy, Saur, Hitler pointedly praised the Field-Marshal for the rapid progress made with the *Fi.103* flying-bomb project, and directed the Munitions Ministry to put Volkswagen flying-bomb production underground, in an annexe to the Central Works at Nordhausen. He also demanded "an

immediate and minute” investigation on the manpower tied down on the A4 programme, together with the preparation of a memorandum on the results this same production capacity might be expected to achieve if applied to other programmes.

It had at last been borne home to Hitler that the enormous underground factory at Nordhausen might be more profitably exploited, for example, for strengthening the production capacity of the German fighter-aircraft industry, about which Speer had already drafted a decree for the Führer’s signature.

The time seemed ripe for the SS chief to seize the rocket project.

The Gestapo, a jealous rival of Admiral Wilhelm Canaris’s military counter-Intelligence service, had long had agents and “stool pigeons” among the people of Peenemünde, and their reports indicated that there was something unorthodox about the leading scientists there: as early as October 17, 1943, when the first report had been filed on the rocket experts, the evidence seemed to indicate that three of the leading engineers, including von Braun himself, were guilty of high treason.

On March 8, General Jodl was told. Unusually, both the Gestapo (Colonel Heinrich) and counter-Intelligence (Major Klamroth) had reached the same conclusion, from separate data. Now they wanted Jodl’s decision on what action to take.

From Jodl’s own fragmentary notes, we know that the three – Engineer Riedel II, Doctor Helmut Gröttrup, and von Braun – had been overheard grumbling in public about Germany (“sure of defeat”) and their own weapons project: they saw their main work as “designing a space ship,” not what they called “an instrument of murder.”

To Himmler the Gestapo dossier must have seemed a real windfall.

The utterances of Riedel II – the rocket logistics expert – were particularly treasonable, Jodl noted, as might be expected of a former member of the League of Human Rights. Gröttrup, Doctor Steinhoff’s chief assistant in Peenemünde’s Telemetry Division, had been a member of a “pan-European group under Soviet direction.” All three

were close friends, and Professor von Braun was listed as being “very friendly” with Gröttrup’s wife. In short, Jodl noted, “a high-grade communist cell.”

Dornberger had not yet been informed; but, noted Jodl, the Gestapo was pressing to know: “What will happen if we pounce on all three?”

For a week the three were permitted to continue their duties. On the March 12, 13 and 14 Himmler had lengthy conferences with SS General Berger, who attended to many of his secret-weapons interests. Early on the 15th, all three scientists were arrested at Peenemünde and removed to the Gestapo prison at Stettin.

Dornberger was telephoned at Schwedt-on-Oder by General Walter Buhle and ordered to report to Berchtesgaden, 400 miles to the south. At nine o’clock next morning he heard from Keitel of the youthful von Braun’s alleged felonies. Keitel regretted that, as Himmler’s Gestapo had taken over, he was powerless to intervene. Dornberger demanded to speak to Himmler, as the arrests would compromise the entire A4 project. The SS Reichsführer refused to see him. In fact, Himmler was still in bed.

In Berlin Dornberger pressed Gestapo chief Heinrich Müller to release his men; Müller retorted ominously that he had even accumulated a bulky dossier on Dornberger, quoting at him his comments apropos Hitler’s alleged dream in 1943; but Speer intervened, and Dornberger secured the provisional release of von Braun after two weeks and the other two scientists soon after.

While von Braun’s dreams were surely angled more towards the stars than towards some target area “one thousand metres east of Waterloo Station,” he had possibly momentarily forgotten that the German War Office was not paying out billions of Reichsmarks on the exploration of space.

As for Gröttrup, the only evidence was that both he and his wife had “strong democratic leanings” and had been arrested for this; at least that is what he told Allied interrogators in May 1945.

He subsequently directed much of the Soviet Union's post-war rocket effort.

Jodl was convinced that the whole A4 project had long been betrayed to the Allies: "A factory at Saint-Denis is turning out A4 vehicles," he wrote in his diary. "The enemy Intelligence service knows about it. Well, who doesn't!" He himself had seen the enemy's detailed instructions to its espionage network in France and the fruit they had borne – diagrams and detailed reports on the construction projects. Fifty-six men were still waiting to be sentenced for their part. Breaches of security were now ruthlessly punished. A lieutenant who had carelessly left blueprints of a flying-bomb site in his billet was sentenced to death.

The Intelligence attack continued unabated. In the first days of February the Americans discussed a large-scale ground reconnaissance of the French coast; the British Chiefs of Staff examined a Special Operations Executive proposal to kidnap technical personnel from the "ski" sites and large "bunkers."

According to German sources, the SIS landed agents simultaneously at three points in France; the Germans rounded up two groups soon after. Between March 1 and 5, eleven British agents and 1,205 parachute containers of arms, ammunition and demolition charges were taken into custody in the Beauvais region, together with sixty-one drums containing radio transmitters and the other personal effects of the agents. Sketches captured from one agent showed the layout of four "ski" sites.

COLONEL WACHTEL was now less alarmed by the Allied attacks on his launching sites than by the poor flying bomb supply situation: on March 17 he learned that even by mid-April only 3,000 flying bombs would be on hand.

Field-Marshal Milch was keen to open the attack on London towards the end of April, for reasons not wholly related to grand strategy. On March 28 he learned from von Axthelm that output would probably reach 1,700 in April and 2,500 in May, rising by about 500

monthly thereafter. Milch considered that they could now open fire towards the end of April, and still enter May with a reserve of 2,500 to 3,000 bombs.

Von Axthelm, Wachtel's immediate superior officer, disagreed. Not only were the new catapult sites unlikely to be complete before June, but Milch's tactics seemed to be wrong.

VON AXTHELM: In my view, the Sixty-Fifth Army Corps has the most logical approach. You have to be able to carry out a really sadistic bombardment, lasting for longer than just one month, even if it does mean that only very few shots are interspersed between the mass attacks. But it is quite unrealistic to try this with only three thousand flying bombs in hand; three-thousand will all be fired within twenty-four hours.

MILCH: . . . or you can take it much more calmly. Our main worry is always that the launching zones may well become battlefields. That's why we can't waste one day, not one minute even. In my view, the thing must be put in action fast. June is too late. I personally would open fire on 20th April [Adolf Hitler's birthday], loose off fifteen hundred during April and the rest in May.

VON AXTHELM: When the time comes, the Allied countermeasures will be exceptionally violent.

MILCH: That is why you won't be able to keep firing from every site. Every half-hour or so a flying bomb – that will be enough to disrupt the life of this city over a very long period.

Only Hitler could decide, said Milch; in fact, he had already whispered in the Führer's ear that a sustained drizzle of pilotless aircraft was "the most evil burden" imaginable for a city.

"Just picture for yourselves," Milch gloated as the conference ended, "a large high-explosive bomb falling on Berlin every half-hour, and nobody knowing where it will come down next! Twenty days of that will have them all folding at the knees. . . !"

The plan was put to Korten, the Chief of Air Staff. A detailed survey of flying-bomb production suggested that the outlook was not quite as favourable: so far, only 700 bombs were available. On the other hand, provided they were given an immediate decision, they could put together some 100 catapults in time for an opening attack on Hitler's birthday.

General Karl Koller's plan, as telegraphed to Korten on the 29th, was for an opening mass attack, "*Grand Reveille*," with 300 flying bombs launched in rapid fire at London some two hours before dawn on April 20; a daylight phase, "*Salute*," permitting either a sustained rate of attack of two or three rounds each hour or a 100-bomb salvo at midday; and finally a concentrated evening attack, "*Grand Retreat*," of 200 bombs in rapid fire. During subsequent days the disruptive fire of about three bombs per hour could be maintained. The plan was quietly dropped, however, and it was not until mid-May that the Führer announced what plans he had in mind for the flying bomb.

(x)

The Sixty-Fifth Army Corps had contrived to keep secret the steady preparation, behind the main "ski" site array, of a new and less conspicuous complex of catapult sites. The Air Ministry in London was still completely unaware of this threat. On the contrary, at the end of the third week in March the battle of the "ski" sites was thought to have been won; although by the 31st the enemy might be able to launch attacks from the equivalent of about twenty fully operational "ski" sites, the number of sites available after this date would be continually reduced by Allied bombing. By the end of April, the Chiefs of Staff announced, practically all the sites would be neutralised.

The complacency soon vanished.

On April 18, Mr. Churchill was warned that the number of "ski" sites repaired, and the accuracy of the weapon itself, had increased. There could be no let-up in the air offensive. No cheap panacea could

be proposed as a substitute for this costly attrition of the “ski” sites. Intelligence had still not determined even the weapon’s fuel with certainty. The Air Staff’s proposed attacks on hydrogen peroxide production centres “at Peenemünde and Ober Raderach” were dropped; they had been told that the weapon was fuelled with this chemical, and that large manufacturing plants had been built at the two centres named; neither fact was true.

On April 18 the Chiefs of Staff wrote to General Dwight D. Eisenhower, drawing his attention to the urgency of neutralising the *Crossbow* pilotless bombardment threat before it could become a “serious embarrassment” at a critical stage in *Overlord*.

Eisenhower ordered Spaatz next day to give *Crossbow* attacks absolute priority “for the time being” over all other air operations.

AT A NEW “war game” in Paris on April 11 one basic weakness in the flying-bomb organisation was revealed as theoretical manoeuvres traced the flow from the industrial production lines to the catapult sites.

To Colonel Eugen Walter, of the Sixty-Fifth Army Corps, the dependence on eight conspicuous and exposed “supply” sites in the heart of the launching zone seemed both inflexible and foolhardy. Since satisfactory provision had been made for the storage of 2,000 flying bombs in each of five Air Force dumps in Germany and the Reich, it was decided towards the middle of May that the “supply” sites should be abandoned in favour of existing caves and tunnels in France.

At any time Colonel Wachtel’s attack could begin; it was only a matter of waiting for the orders to install the prefabricated catapults on the sites. The weeks slipped past. Dr. Goebbels, recalling how in 1943 he had promised “revenge” after a heavy attack on Berlin, described subsequently how. . .

I grew more and more anxious as the completion date for the first revenge weapon was postponed again and again. First we picked

December 1943; when December came, it was “in the New Year, perhaps.”

When the New Year arrived, a series of technical faults cropped up calling for two months’ further postponement. March came and went. I kept thinking back to my pledge in the Café Woerz [in Berlin]. The next slogan was, the balloon’s going up on the Führer’s Birthday. That day too passed uneventfully. May dragged by in unbearable tension. The Führer said to me: “The revenge bombardment is going to be synchronised with their invasion.”

On June 6, 1944, however, the Germans were still “tinkering about” with the flying bomb; the fated hour had passed.

(XI)

Work on V-3, Germany’s fantastic third secret weapon, had by the spring of 1944 progressed far. Some experts have since suggested that Adolf Hitler’s “high-pressure pump” would never have worked, but after the war Albert Speer claimed that the final trials carried out in Northern Germany had left him in no doubt of the weapon’s feasibility.

Very few people were aware of the project. General Leeb, the chief of the German Army Weapons Office, learned of it only by accident during a visit to the French coast, where the construction of the underground workings for the gun was in hand. General Buhle knew of V-3 as “an enormous gun with a 400-foot barrel being built into a mountain for shelling London,” but wrongly added that the site was that at Watten.

The “mountain” was at Mimoyecques, barely five miles from the Channel coast, and only ninety-five miles from Central London. The project had been in the planning stage in May 1943, for negotiations had then commenced with the Société Electrique du Nord-Ouest for the enormous power supply necessary for the site. It had been approved

by Hitler soon after the Peenemünde raid in August. Originally, two adjacent gun sites had been planned, each comprising twenty-five 416-foot-long barrels, in batteries of five, housed for the whole of their length in inclined, concrete-lined shafts driven deep into the limestone. All the shafts were exactly aligned on Central London.

Mimoyecques had been attacked by the Ninth Air Force in November, and the less advanced half had been abandoned soon after; even so, the remaining twenty-five barrels would suffice to maintain a rate of fire of one shell on London every twelve seconds.

British photographic interpreters who detected the false haystacks camouflaging the muzzle opening had no idea of the extent of the underground workings. About 100 feet down, a warren of interconnecting tunnels and galleries, served by a railway line, had been excavated to house the firing crews, magazines, unloading decks and storerooms for the “pump.” A further 250 feet below this level a cavern had been excavated to house the breech-chambers for the twenty-five gun barrels.

An 18-foot-thick concrete plate, pierced by five narrow slits, protected the muzzles of the guns; and 8-inch-thick doors of solid steel had already been manufactured by Krupp to block these slits, so that only the 6-inch muzzle holes would remain.

Over 5,000 engineers, including 430 Ruhr miners from United Steel, Mannesmann, Gute-Hoffnungs-Hütte and Krupp, had by the spring of 1944 completed much of the magnificent tunnelling for the gun, which was planned to open fire on London during the late summer. The special electric ammunition hoists, lifts and handling machinery had been delivered, and the project’s 5,000-kilowatt power supply (enough for a town the size of Maidstone) was being run in across country by two duplicate transmission lines, to safeguard the supply from attack.

But the “pump” had been bedevilled by the inexperienced approach of its developers. Chief Engineer Coenders, who was working independently of trained armaments engineers, proposed the standard

projectile produced by his firm, Röchling – about ten feet long and four-and-a-half inches in calibre. The finned shell would weigh about 300 pounds, of which 55 pounds would be a high-explosive warhead. The four flexible fins were initially rolled around the body of the shell, snapping open as the shell left the muzzle of the gun.

At the end of September 1943, Speer had reported to Hitler that early trials with a 2-centimetre prototype warranted the development of a full-scale version at Hillersleben and Misdroy, on a Baltic island near Peenemünde. On October 14 Hitler suggested that incendiary warheads should be fitted to the projectiles for the attack on London.

Five days later, full-scale firing trials began at Hillersleben. These showed that while the Röchling shell performed well at low velocities, the fins sometimes fluttered. Even so, mass production was authorised; a full-scale (6-inch) prototype of the gun had been constructed at Misdroy, and 1,000 soldiers under Lieutenant-Colonel Bortt-Scheller were training in the use of the weapon. A Colonel de Bouché was to command the Mimoyecques battery.

The first shells fired attained muzzle velocities of 3,300 feet per second – about two-thirds of the velocity needed for shells from Mimoyecques to reach London. The gun's inventors had no doubt that by the time they had improved the shell's design and the electrical firing system (which detonated the charges in the side chambers spaced successively up the gun barrel) the necessary ranges could be attained. The Army Weapons Office had from the outset been purposely excluded from the weapon's development on Hitler's orders.

Hitler read the report of the trials conducted on January 18 and 19 with the "pump," and over-confidently ordered Saur to increase production of the special ammunition from 2,500 to 10,000 rounds a month.

It was not until March 22, during a disastrous series of firing trials in the presence of General Leeb and Lieutenant-General Schneider, both from the Weapons Office, that it was realised that the 300-pound projectile would not be ballistically stable. All the versions designed

by the gun's inventor, Chief Engineer Coenders, "toppled" at velocities above 3,300 feet per second. Twenty thousand of these shells, semi-finished, had by then already been manufactured.

At a planning conference that day Schneider remarked that ballistics experts could profitably have been called in much earlier in the weapon's history. Now that the expense had been incurred, they would have to make the best of it, while at the same time throttling back shell production and work on the Mimoyecques site itself, whose cost had been doubled by de Bouché's insistence on the provision of underground living quarters, kitchens, power plants, ventilators and other ancillary installations.

They all knew that there could be no talk of failure. The agonised topic among the senior staff officers at Misdroy next day was: "Who will tell the Führer if there is no prospect of the weapon ever working?"

At the Führer's headquarters on April 6 General Buhle and Saur recommended restricting the manufacturing programme, for the present, to three guns which would be capable of firing 5,000 shells a month.

A few days later, the head of the Reich Research Council's planning office, Professor W. Osenberg, invited a Göttingen expert in high-velocity ballistics, Professor Walchner, to inquire into the "high-pressure pump." At a conference at the Aerodynamic Research Institute in Göttingen, Walchner confirmed that it was possible to develop a simple shell for the weapon, and a series of wind-tunnel tests confirmed this belief.

Firing trials with the shells developed by the "trial and error" methods favoured by the gun's inventors were continuing. The trials involved firing different experimental finned shells from the gun set-up at Misdroy; Coenders himself had designed a new shell with six rigid fins, and six other firms including Skoda had submitted their own prototypes for testing.

The general in charge directed that the prototypes least likely to cause the gun to blow up were to be tested first; this was a prudent

precaution, as after twenty-five rounds had been fired out to sea two sections of the gun barrel burst, halting further trials. Coenders's own shell travelled only twenty-seven miles. Although poor workmanship – probably at the Röchling factory which had manufactured the gun barrels – was at fault, the setback was nearly the end of the “high-pressure pump” project.

Walchner reported that the inventors had ignored the “most elementary laws of physics.” He told Osenberg's representative at Misdroy: “So far they have made only blunders in designing the shells. If they bring a bit of logic to bear on the problem, then it will work. . . !”

At a mass meeting of 100 of the project's engineers in Berlin on May 4, the possibility of closing down the whole project was again nervously debated; but again they balked at the prospect of informing Hitler. Chief Engineer Coenders was forced to admit that he had erred, and this admission rescued the gun.

To Professor Osenberg it seemed urgent for Hitler to be told. To Hitler's deputy, the notorious Martin Bormann, he wrote a long and scathing letter four days after the Berlin conference, commenting on the parallel failures of both A4 and the “high-pressure pump.” In part, it read:

I consider it my duty to draw your attention to the “high-pressure pump” project now being carried out on the Führer's orders; in my opinion it must be regarded as a failure, as far as barrel construction, projectile design and efficient propellant consumption are concerned. The employment of personnel on the present scale cannot be justified. (On the Channel coast alone, there are still about five thousand workmen engaged on the construction of the gun sites and bunkers.)

Along with Peenemünde's A4 programme, the “high-pressure pump” project is the second major means of exacting so-called “retribution” from the enemy to come to naught because of the utter in-

competence of many of the project's directors. The course of the war, he concluded, and his "fears for our nation's survival" had constrained him to voice this strong criticism. Coming from a government scientist as authoritative as Osenberg, this was a letter which could not be ignored. On June 1, 1944 the Army Weapons Department transformed Peenemünde into a limited liability company; Colonel Zanssen, its commandant, was dismissed; and Dornberger's department was hived off and turned over to Major-General Rossmann, an engineer who – although outside the rocket project – had done much to trace the faults causing the enigmatic "air bursts" still troubling the weapon.

The Mimoyecques battery would be complete in late September; despite Osenberg's doubts further progress made success seem likely. Osenberg himself suggested a simple modification in the design of the gun's side chambers to reduce its explosive consumption; Walchner began the design of an aerodynamically improved shell, and the Army Weapons Office arranged to manufacture prototypes for firing early in June: the 220-pound shells would carry rather under 30 pounds of high explosive. The Göttingen experts even held out some hope that a finless projectile could be designed for the "pump." Osenberg loaned the project three high-grade engineers to work on the shell's design, and metallurgical experts were provided to advise Coenders on the manufacture of the gun-barrel sections. Because of the initial reluctance to call in this expert advice, Germany had lost, it was estimated at the end of May, six months in the development of the weapon. Even with the original gun, the results achieved continued to improve. Between May 20 and 24 a fourth series of trials was held at Misdroy, with the "pump" now slightly reduced in length. Eight different shells, ranging from 170 to 280 pounds in weight, were tested over the Baltic to the north-east.

Ballistic results attained [the War Office reported on the 26th] permit us for the first time to expect that the specified requirement can be met.

Ranges of up to fifty-five miles were easily reached by the smallest shell. This was one manufactured by the Witkowitz firm and designed by the War Office's own Dr. Athen, following aerodynamic principles established by the famous Peenemünde Arrow Shell developed in the supersonic wind tunnel. Once the muzzle velocity of the gun had been increased to about 5,000 feet per second, London would lie well within this shell's range.*

Speer was assured that the Witkowitz shells would cover the required ninety-five miles with certainty, and from the "present gun" at that; wind-tunnel tests were in hand. On May 24 Speer reported this to Hitler; the latter announced that he desired the trials continued, both for the proposed "England gun" and for "other purposes," which he did not specify.

(XII)

The Mimoyecques threat was not recognised in London. On May 1 a Ministry of Supply arms expert suggested that it was intended for mounting two to four "rocket projectors" aligned on London. The general view favoured a "mortar tube" as the best means of projecting rockets weighing 50 to 60 tons at London. There was no reason to

* By the end of May 1944 there were four basic projectile designs for the 15-centimetre (5.9-inch) calibre "high-pressure pump":

<i>Manufacturer:</i>	<i>Faserstoff</i>	<i>Röchling</i>	<i>Bochumer Verein</i>	<i>Witkowitz</i>
<i>Designer:</i>	Fürstenberg	Coenders	Haack	Athen
Deadweight (lb.)	249	214 & 220	264 & 280	172
High-explosive charge (lb.)	13	18	22	11
Calibre (inches)	3.74	3.54	4.33	3.74
Length (inches)	96.5	128	118	71.6
Stabilising fins	4 folding	6 rigid	6 rigid	6 rigid

suppose that the other vast concrete “bunkers” at Siracourt, Lottinghem, Sottevast and Martinvast were not also for projecting rockets; all were accurately aligned on London or, in the case of Martinvast, on Bristol.

The remaining site, at Wizernes, caused some anxiety, as it was not obviously aligned on any city in Europe. Then one photo interpreter discovered that one facet of the workings was within half a degree of the Great Circle bearing on New York. Speer denied after the war that there was ever any intention of firing their New York rockets from Wizernes; but the enormous bombproof doors and handling gear were all capable of handling a rocket about twice the height of the A4, if necessary.

Concerned by the rapid progress on these large construction projects, the Chiefs of Staff sent an urgent message to Eisenhower at the end of May to the effect that Mimoyecques, Siracourt, Watten and Wizernes would soon be invulnerable to air attack. They urged him to bomb these targets visually at the first favourable opportunity.

(XIII)

At the beginning of May 1944 it was realised that there were still many faults in the A4 rocket’s design, caused by a premature turn-over to mass production. A factory capable, as was later proved, of producing nearly 700 A4s monthly had been tooled up; one rocket-launching battalion was ready and another completing its final training; the “bunker” at Wizernes was progressing satisfactorily; and numerous small launching pads in France had been prepared, together with an elaborate ground-supply organisation.

Only the development of the rocket itself was incomplete, and this made a high output as yet impossible. Jigs had to be continually changed, machine tools redesigned, and new specifications worked out. Copious obsolete components had to be scrapped and substitutes manufactured. The flood of modifications washing into the limestone

galleries of the Nordhausen factory became a nightmare for the production planners.

Major-General Dornberger, Special Army Commissioner for the rocket programme, was still wrestling with the “air-burst” problem at Blizna. “Our main problem,” he commented wryly in May, “is getting the missiles to the target in an unexploded state. . .” Towards the end of the rockets’ trajectory something was happening, and they were bursting while still thousands of feet in the air. Up to mid-March 1944 only twenty-six rockets of fifty-seven tested at Blizna functioned satisfactorily on take-off, and of these only four reached the designated target area at Sarnaki intact, the remainder having blown up in mid-air.

On one occasion when Professor von Braun was visiting Blizna the rocket motor cut-off came prematurely, and the rocket fell back towards the launching area; only an air burst in the last few thousand feet saved his life. The fault was traced to a bad electrical connection. Von Braun later expressed the view that “most of the failures were due to the troops”; he instanced cases where rockets launched at Blizna failed to bend their trajectory over and went straight on up into the stratosphere.

Dornberger, the professional soldier, would have none of this. To him it seemed that the root of all his troubles lay in faulty production techniques at Nordhausen. Only in late April, he claimed, did Central Works’ production A4s meet his requirements. Central Works might well here have reminded Dornberger that Professor von Braun had originally promised to have all the “B” series blueprints complete by May 30 of the previous year, but apparently they thought better of it.

In consequence of this lack of co-ordination between the rocket engineers and industrial experts, mass production of the main “B” series rockets failed miserably to reach the targets originally set. German records show that in January 1944 only fifty, and in February only eighty-six A4 rockets were shipped out of Nordhausen (instead of the 300 rockets scheduled for the latter month). In March, 170 rockets

rolled off the assembly line. In the following month Karl-Otto Saur clamoured for capacity to be raised to 1,000 rockets monthly. Sawatzki, the factory's brilliant production planner, appealed to the SS and to Lieutenant-General Kammler for a further 1,800 convicts to offset his crippling labour shortage.

General-Director Rickhey claimed at a well-attended session of rocket experts and engineers on May 6 that 301 rockets had been assembled during the previous month, but the plant's records show that only 253 left the production line. Rickhey promised: "The shortcomings in our April output will be made up in May. . . [W]e will manufacture four hundred and fifty rockets this month." He was almost as good as his word: raw material allocations were improved, and Central Works fell only thirteen rockets short of that target.

It was plain that Central Works were fulfilling all their obligations handsomely.

Constantly their production engineers reproached the Peenemünde scientists for not having planned the A4 rocket project with an eye to mass-production technique from the outset. As late as April 1944 major modifications of the entire thrust frame and of the turbo-pump assembly had been necessary to make them suitable for mass production.

It was now, in the spring of 1944, that Germany was paying the price for General Dornberger's churlish refusal to co-operate with Gerhard Degenkolb, director of the Special A4 Committee, during the previous summer.

The air-burst problem continued to overshadow the whole test programme. Originally Dornberger had believed that the oxygen tank burst on re-entry; in von Braun's view the alcohol tank burst, spraying unburnt fuel. Dornberger reproached Director Figge, chairman of the Supply Board, for poor workmanship on the fuel tanks.

Figge reduced fuel-tank output at his supply factories, and reported "a fundamental improvement in quality."

Still the air bursts over Sarnaki mocked the rocket engineers.

When the mystified Dornberger appealed that it must be the way that the tank suspension was spot-welded to the fuel tank, Figge responded that the suspension would be riveted to the tank in future, and that two experimental rockets with their fuel tanks slung in “basket-work” suspensions were being assembled. Neither eased the problem. Dornberger’s only conclusion, as he reported in May, was that “aerodynamically the rocket has exceeded our expectations”; to which Major-General Rossmann, the Army Weapons Office department chief, acidly replied: “How can you make any such claim until the planned range-finding shots have taken place at Peenemünde?”

Rossmann suggested that the air-burst problem might be quickly solved by stationing observers in the target area to watch exactly what happened. Dornberger took this advice, and from his own observations later made the decisive suggestion for alteration which finally cured the failing.

THE LOGISTICS build-up and the training of rocket troops at Blizna were by now complete. They had picked up the essentials more quickly than the Peenemünde engineers had dared to think possible. A start had even been made with 953 (Semi-Mobile) Artillery Battalion, which was to serve the Wizernes bunker on its completion.

An optimistic Lieutenant-General Metz, tactical commander of German rocket troops, conceded after a Blizna demonstration in May that there was a reasonable prospect of starting operations in September; and Hitler, whose attention was caught again by the A4 project, suggested including chlorine trifluoride in its warhead, an incendiary chemical being developed by the SS.

BY THE MIDDLE of May 1944 it seemed to the High Command that only the flying bomb was approaching its operational début. The setbacks with the A4 rocket and the long-range gun served to underline the absurdity of Wachtel’s higher command structure: all orders relating to his regiment would be issued by the Sixty-Fifth Army Corps, techni-

cally a Joint Services (*OKW*) command, which disposed, however, only over Wachtel's "AA Regiment 155 (W)," a purely Air Force formation, as a striking force.

Wachtel later succinctly observed: "We were probably the only Air Force regiment with its own Army Corps."

On May 16 Field-Marshal Keitel issued the text of the Führer's orders for the bombardment of England, and of London in particular. The flying-bomb offensive was to be co-ordinated with both a fire-raising air raid and an artillery bombardment of towns within range of the continental guns; it was to open with a violent attack on London one night in "mid-June."

After this violent opening, disruptive fire by night was to be generally sustained, with intermittent salvoes commensurate with the vagaries of flying-bomb supply. If bad weather promised to hamper the enemy's defences, the attack could be extended to the daylight hours as well.

Hitler demanded a blocked tactical reserve of 600 flying bombs, to be fired only with the High Command's express permission. With becoming perspicacity he concluded: "All preparations are to be made on the assumption that transport communications to the launching sites are attacked on the heaviest scale by the enemy, and destroyed."

Four days later Colonel Wachtel withdrew his troops from the battered "ski" site decoys, and transferred them to the well-camouflaged "modified" site array. The costly and now useless "ski" sites were mined and abandoned; they had served their purpose well.

When the new code-word *Junk-room* was signalled to him by the Sixty-Fifth Army Corps, it should take only six days to assemble the prefabricated catapults on the new "modified" sites.

These past months [he wrote on 2nd June] have seen a relentless, embittered struggle with the enemy. . . In this brief lull before our zero-hour, the fight is entering its decisive phase. The big question is: Do we fire first? Or is the enemy across the Channel before?

There was not a man in his regiment who did not know the answer; the flying-bomb offensive would crush the invasion before it even started.

(XIV)

At the end of the third week in March the Chiefs of Staff had predicted that by the end of April practically all the "ski" sites would have been neutralised. Late in April, however, photographs revealed a new kind of launching installation at Belhamelin, of considerably simpler construction.

At the *Crossbow* meeting of the Chiefs of Staff on May 2 Lord Cherwell was already drawing attention to the Germans' failure to repair the "ski" sites; only a small number, he claimed, were more than 90 per cent complete. The Air Ministry, disturbed by the implications, directed that the whole of North-west France be photographed for a fourth time.

This enormous task was commenced on the following day. On May 13 the Air Staff warned that the Germans had obviously embarked on a new programme of pilotless-aircraft launching sites. The new buildings were well dispersed and excellently camouflaged; eleven had already been detected in the Cherbourg peninsula and nine more in the Pas de Calais. Only forty-two of the "ski" sites still showed any signs of activity at all.

The Chiefs of Staff hesitated to accept that the vast bombing effort had been against decoys. A grotesque optimism permeated the Air Ministry. The apparent success of the attack on the "ski" sites was a great relief; in the middle of May, in any event, Air Commodore Pelly relinquished his post as Director of Operations (Special Operations), believing that the *Crossbow* spectre had been finally laid. Air Commodore C. M. Grierson took over the watch on the sites: the most unnerving trial of his life awaited him, as the supposedly extinct "volcano" suddenly erupted.

It was hard in the last weeks of May for the Air Staff to accept that they had been hoodwinked. For reasonable logic, they substituted blind optimism; they were reluctant to the last to accept the full gravity of each successive disclosure. *Overlord* was barely three weeks away. The bombing of the French transportation system was a prerequisite to the invasion's success; so even if the new "modified" sites had presented attractive bombing targets – which they did not – the possibility of an effective offensive against them was remote.

Only one major alternative remained: the system of eight "supply" sites. Aware that no link had been traced between them and the "modified" sites, the Air Ministry nevertheless suggested a tactical "biopsy": the Americans dropped 300 tons of bombs on one such "supply" site at Beauvoir, but even after twelve days the severed railway lines had still not been repaired. The Germans had deserted the supply sites in mid-May in favour of storage in caves and tunnels.

Early in June a complete re-survey of Northern France was ordered, as the previous photographs showed many of the "modified" sites incomplete. The new photographs made it clear that they were, in fact, being taken only as far as their foundations. A logical assumption was that the arrival of the catapults themselves would herald the start of the actual attack.

On June 5, on the eve of *Overlord*, a meeting of the Intelligence authorities correctly decided that the main sections of the "modified" launching sites were probably prefabricated, capable of being erected in a matter of days. On the next day the Allied Central Interpretation Unit was briefed:

It is therefore of great importance that [photographic] interpreters keep a watch for the first indication of a general attempt to put up the missing installations.

By three days later sixty-one "modified" sites had been found. Hitler's revenge was in sight.

PART SIX

RETRIBUTION

“On June 6 the invasion of Normandy coast began; on June 16 our retaliation followed, with the use of a new weapon. Further invasion operations against other coastal sections were to be anticipated, but now the employment of our retaliation weapons against London and south-eastern England has thrown a spanner in the works. Our counter-attack is inflicting chaos on the supply and reinforcement operations. Not only has it acted as a major threat to the Allies before their invasion, but it has opened up in precisely the form foreseen by the Führer as the most sensible point in this historic struggle. What the Führer said in Munich is on the point of coming true.”

— *Express signal from German High Command's National Socialist Directorate to military formations in Normandy, June 17, 1944.*

PART SIX

Retribution

(1)

ADOLF HITLER HAD directed on May 16, 1944 that the long-range bombardment of London was to begin in mid-June. At a conference with Speer early in June he ordered that “a very large number of *cherry stones* [flying bombs] be brought to bear upon the proposed target shortly.”*

On June 4 the Sixty-Fifth Army Corps asked Wachtel’s supply officer whether in spite of the chaotic French transport situation the regiment might open fire on June 10. He responded: “Not before the 20th.” This caused consternation. The Corps directed that all the heavy steel catapult rigs could be brought forward from their camouflaged dumps to the prepared sites by the 10th. Speer had suggested to Hitler that the flying bombs should be reserved for days of low cloud; this was forgotten in the historic events that followed.

* By this time the Munitions Ministry was in control of flying-bomb production. Early in March 1944 a Fighter Staff had been set up under Saur to take over aircraft production from the Air Ministry; in May its functions were expanded to include flying-bomb production, and it was renamed Armaments Staff. Production figures can be given only approximately for early 1944: March, 400; April, 1,000; May, 1,500; and June, either 2,000 or 3,000.

At 1:30 A.M. on June 6, Wachtel's regiment was telephoned by an infantry division with the grave news that the Allied invasion of France had begun.

Throughout the day reports poured in of paratroop landings, heavy air raids, and an approaching invasion fleet.

"With the start of the invasion," commented Wachtel, "the fight for the flying bomb has reached its decisive phase; but the coast of our launching zone is still clear!

At a quarter to six that evening the Corps signalled the code word *Junk-room* to Wachtel: the last six days of irreversible preparations for the pilotless bombardment of London were to begin. His staff changed for the last time out of their drab Todt Organisation uniforms and donned their true colours, the blue-grey Air Force tunics with their special red-tab insignia.

Everything depended on how smoothly *Junk-room* ran; he hoped that the assembly of his first sixty-four catapults would be complete by the evening of the 12th.

HIS TROOPS worked for five days without a pause assembling the catapults on the "modified" sites; Wachtel wrote that things were going wrong: "Setbacks have occurred, caused by the disastrous effects of the systematic bombing of French communications." Trains had been split and catapult sections delivered to the wrong sites. Often the loads had had to finish their journey by road. The Allied interdiction campaign had gravely compromised the delivery of the catapult equipment.

On June 11, with none of his sites operational, Wachtel was ordered to open fire on the following night.*

*The order called for two salvoes, at 11:40 P.M. and 12:40 A.M., followed by disruptive fire from all catapults until 4:45 A.M. After the war, Colonel Walter accused Wachtel of having reassured him that although *Junk-room* had been upset, it was only "a matter of details," and that by the evening his regiment's readiness was assured.

He was in despair. The original *Junk-room* programme had been swept aside. His troops had had to unload trains and erect the catapults; firing trials had been forgone. Engineers who had slaved for five days without sleep were commanded to finish before nightfall of the 12th at all costs.

In the early hours of June 12 Wachtel assembled his commanders in his underground command bunker at Saleux. In the cold grey hours of dawn they returned to their troops with his words ringing in their ears:

After months of waiting, the hour has come for us to open fire! Today your wait and your work will have their reward. The order to open fire has been issued. Now that our enemy is trying to secure at all costs his foothold on the Continent, we approach our task supremely confident in our weapons. As we launch them, today and in the future, let us always bear in mind the destruction and the suffering wrought by the enemy's terror bombing.

Soldiers! Führer and Fatherland look to us, they expect our crusade to be an overwhelming success. As our attack begins, our thoughts linger fondly and faithfully upon our native German soil.

Long live our Germany! Long live our Fatherland! Long live our Führer!

Dense banks of low grey cloud were forming over Northern France.

(II)

The photographic interpreters were the first to give the alarm. By June 12 they had located sixty-six "modified" sites. During the night they had scrutinised aerial photographs of nine sites covered on the previous day; the excited first-stage interpreters clearly saw "much activity" at six of them. At three, the installation of the catapults had probably already taken place.

An immediate signal was issued to the Air Ministry in London. On the following morning Wing Commander Kendall, who was directing the *Crossbow* photographic investigation, was telephoned for confirmation by Air Intelligence. Kendall asserted that if the appreciation made at their meeting on the 5th was correct the pilotless bombardment "could be expected to begin at any moment."

The Chiefs of Staff were warned of this at once. The Air Ministry, on the other hand, filed the report without immediate action, together with an SIS agent's report that a trainload of "rockets" had two days earlier passed westwards through Belgium.

The United States Air Force headquarters in Washington was signalled that there was "no change" in the *Crossbow* situation, and Air Marshal Hill, who had been led to believe that the "modified" sites were not likely to be used for several weeks, heard nothing of this until after the German flying-bomb offensive had actually begun, some twenty-four hours later.

Throughout the day the mood at Berchtesgaden was one of eager anticipation. At five-thirty the possibility that the flying-bomb attack might compel the Allies to launch a disastrous invasion of the launching zone was touched upon during a conference between Dönitz, Keitel and Jodl; the latter two saw such a diversion as Germany's "only chance" of repairing the invasion situation, which both considered "very grave." Hitler, too, believed that the flying-bomb assault might force the Allies' hand; as early as November 1, 1943 he had expressed this view.

Early that evening Lieutenant-General Heinemann, GOC of the Sixty-Fifth Army Corps, arrived at Saleux; the command bunker was crowded with war reporters and with representatives of Peenemünde and the Air Ministry. But Wachtel's gloomy predictions were being fulfilled; his He.111 bombers were wiped out in an attack on Beauvais-Tille airfield during the afternoon, and during the evening reports from the four firing battalions showed that very few catapults were operational, and none had been tested.

Again and again he advised that the attack be postponed. Heinemann heard for himself all the reports that arrived from batteries

lacking permanganate, diesel oil and vital equipment; probably this alone saved Wachtel from court martial.

Zero hour was postponed by one hour; but by then the situation had scarcely improved.

The initial mass attack was cancelled and disruptive fire laid on instead – surely an act of desperation. If sufficient sites were ready by 3 A.M., the mass attack would be delivered then. By four o'clock, however, Wachtel's weary launching troops had successfully catapulted only ten flying bombs from fifty-five sites.

Aghast at this useless effort, the Corps ordered all batteries to cease fire immediately and camouflage the sites. At a conference that night the industrial experts attached to the regiment recommended a three-day delay during which all the sites could be repaired and properly tested. Of the ten flying bombs launched by Wachtel's exhausted troops, four had crashed on take-off, of which one had failed even to explode.

SHORTLY AFTER midnight eight artillery shells fired from the German heavy guns on the French coast crashed into Maidstone. Twenty-five more shells hit Folkestone and elsewhere.

As the atmosphere of rumour and uncertainty thickened, a lone Me.410 spotter plane (dispatched at the instance of the Sixty-Fifth Army Corps on a reconnaissance of London) was shot down in flames at Barking. At 4 A.M. the shelling stopped; eighteen minutes later the first German flying bomb exploded near Gravesend, twenty miles from its target, Tower Bridge.

The second bomb fell at Cuckfield, the third at Bethnal Green, and the fourth at Sevenoaks. The remaining two failed to make landfall. At the Bethnal Green incident a railway bridge was demolished and six people killed – the only casualties of the night.

At 11 A.M. the next morning the Chiefs of Staff met with Cherwell and Sandys to consider this curious opening attack. Prepared as they had been for the delivery of 400 tons of explosives within the first ten

hours – by no means impossible had all Wachtel's sites been operational – the four recorded incidents were a baffling anti-climax.

Dr. R. V. Jones, who was not present, was sure that the four bombs were just a German misfire and he called round to see Lord Cherwell in his rooms to urge him to get Churchill to make a public statement. This was Churchill's first law, that the public would stand anything, provided it knew what lay in store. Cherwell would have none of it, and exuberantly chuckled: "The mountain hath groaned and given forth a mouse!" Horrified, Jones reminded the Prof that the Germans had been launching many more bombs during their daily Baltic firing trials. "For God's sake," he recalls entreating Cherwell, "don't laugh this one off!"

Lord Cherwell, however, saw no reason to modify his view.

To the Chiefs of Staff the conflicting requirements now seemed resolved. They were "not unduly worried" about the pilotless bombardment; the 3,000 Flying Fortress sorties necessary to neutralise the "modified" sites would not now have to be spared from the air operations over Normandy. But they invited the Allied Expeditionary Air Force to consider whether – without diverting effort from *Overlord* – General Eisenhower might authorise 1,000 sorties to deal with the four most promising "supply" sites.

Lord Cherwell, with well-founded sagacity, reminded them that no evidence had yet been found linking these with the new flying-bomb launching sites. He was overruled.

Early on the 14th he made a personal pilgrimage to Bethnal Green, to the site of the flying-bomb incident. He drew a grim satisfaction from this tangible proof of the accuracy of his pilotless-aircraft prophecy almost twelve months before.

(III)

The lull did not last long. By June 15, Colonel Wachtel was able to report fifty-five catapults fully operational. That evening the Sixty-

Fifth Army Corps telephoned him to open fire on "Target Forty-two" (London) at eleven o'clock. He radioed to all four battalions:

All catapults open fire on Target Forty-two with salvo synchronized at 11:18 P.M. (Impact at 11:40 P.M.) Uniform range 130 miles. Then sustained fire until 4:50 A.M.

Again General Heinemann descended on Wachtel's command bunker. The first bomb was catapulted two minutes before zero. The weather closed in soon after midnight, and it began to rain: ideal flying-bomb weather. By noon 244 rounds had been fired at London; forty-five crashed soon after catapulting, wrecking nine sites; one killed ten Frenchmen in a village in its path. But a Ninth Air Corps spotter plane radioed to Heinemann details of a glow in the target area "brighter than he had ever seen after conventional air attacks."

To his superiors Wachtel dispatched a stream of jubilant telegrams. "May our triumph," he concluded piously, "justify all the expectations which Front and Fatherland have bestowed upon our weapon."

The High Command was less flamboyant: "Southern England and the London area were bombarded with very heavy high-explosive missiles of novel design during the last night and this morning," they cautiously announced. At Dr. Goebbels's request, no mention of *revenge* was made: "We still have no news from London about the damage," he explained.

By the following midnight seventy-three flying bombs had fallen on Greater London; of the others, one had fallen near Chichester, and another had trundled on, alarming the countryside, to dive near Framlingham in Suffolk.

Eleven of the bombs had been brought down on London's built-up area by the guns. Lord Cherwell afterwards wrote that "as, however, our main desire was that the bombs should *not* fall into London, this unremunerative activity was stopped." The guns round London ceased to fire.

This heavy attack formed the main topic at the Chiefs of Staff meeting during the morning and at the Cabinet shortly before noon. The Chief of Air Staff and his naval counterpart hurried back from France for a “staff conference” with Mr. Churchill at five o’clock. Sir Alan Brooke afterwards noted, “very few real decisions arrived at”; in fact a number of changes were approved. Air Marshal Hill and General Pile were directed to redistribute and reinforce the scale of anti-aircraft defences which had been designed to counter pilotless bombardment only from eight to ten “ski” sites. By a superhuman effort, the task was complete in five days.

The main decision was to request Eisenhower to take “all possible measures to neutralise the supply and launching sites.” Eisenhower defined his policy on the 18th: *Crossbow* targets would now rank higher than anything “except the urgent requirements of the battle.” German cities, aircraft factories and even the oil targets favoured by Sir Charles Portal would all be subordinated to these new target systems.

On 18th June, Colonel Wachtel’s regiment launched its 500th flying bomb; on the same day one hit the Guards Chapel of Wellington Barracks, killing 121 people, including sixty-three officers and servicemen. This tragic misfortune may well have steeled the Prime Minister, and he wrote to Eisenhower assuring him that London could take it. He was, Brooke observed the next night, quite ten years younger, simply because “the flying bombs have again put us in the front line.”

Hitler was also exhilarated by the flying-bomb offensive. On June 16, Field-Marshal von Rundstedt signalled to the Sixty-Fifth Army Corps that General Heinemann was to attend a conference with him during the morning. Hitler flew to Northern France, where he conferred with his generals at Margival. Bleary-eyed, he expressed gratitude to Heinemann and Walter for the flying-bomb attack. Both officers warned him of the inadequate supply situation; there was no possibility of lasting success unless Hitler directed industry to increase production above its current 3,000 monthly. Firing 100 rounds a day at London was useless; it merely provoked the enemy, they warned him. Hitler

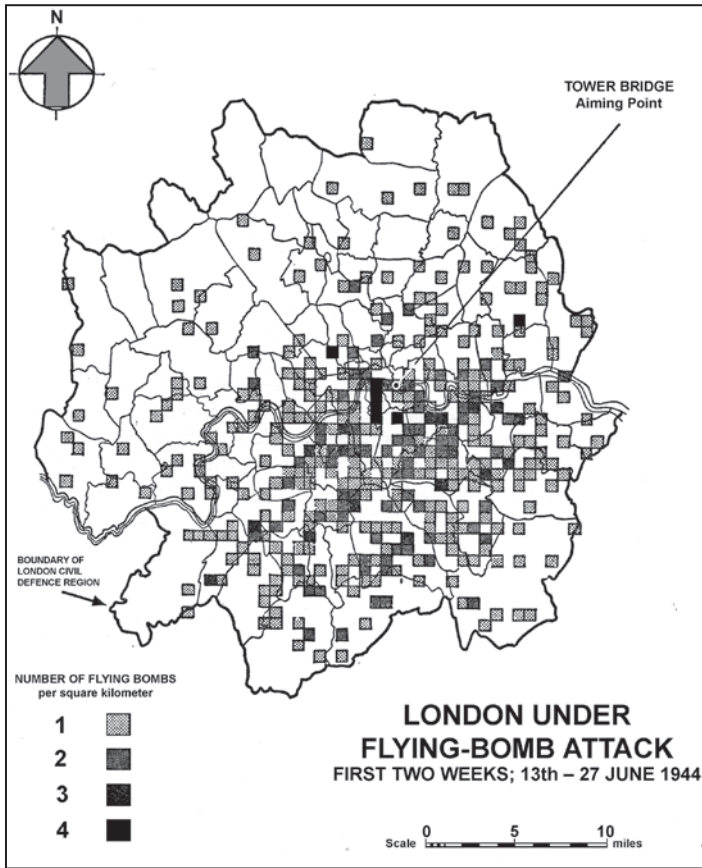

FLYING-BOMBS: THE FIRST TWO WEEKS

The main weight of V-1 flying-bomb attack was borne by the southern part of the London Civil Defence Region: by June 27, 1944 three-quarters of those reaching the capital had fallen south of the Thames. Four telephone exchanges (Mitcham, Derwent, Bowes Park and Temple Bar) had been hit or destroyed; gas supplies to several suburbs had been cut off; and electricity and water services interrupted. A V-1 had closed down London Bridge station by destroying the railway lines near Deptford; Charing Cross station had been closed by a flying bomb which had damaged Hungerford Bridge; Victoria and four other main line stations (West Croydon, Forest Hill, Deptford again and Charlton Junction) had been shut by direct hits; and the Underground line had been destroyed at Hammersmith. On one day, June 18, eleven factories were hit by flying bombs. Three hospitals (St. Mary Abbots, Kensington; Battersea General; and West-End, St. Pancras) had been hit and evacuated. As if this was not enough for the first two weeks, a V-1 brought down the electricity grid where it crossed the Thames at Barking causing acute power shortages for three weeks, and hampering river traffic.

proclaimed aloud that he was proud that Germany was “fighting with such [modern] weapons.”

On his return to Berchtesgaden he approved Heinemann’s request for increased flying-bomb production. With dismay Speer heard that the A4 rocket, his pet project, was to suffer to that end:

The Führer decides [Speer reported a few days later] that A4 production is to be only one hundred and fifty a month until further notice. The labour and materials thus released are to be used, in the first instance, for peak production of “*cherry stones*” [flying bombs].

The Munitions Minister did add that as soon as the A4’s test programme was complete Central Works was to resume rocket assembly with a monthly output eventually rising from a basic 600 rockets to the originally planned figure of 900.

The setback to rocket production at Central Works was considerable. The factory had assembled 437 A4s during May. Output slumped to 132 in June and eighty-six in July, while flying-bomb production increased.

BEFORE THE flying-bomb offensive began, Hitler’s enthusiasm for the A4 had been undimmed. At a Berlin conference two days after the Allied invasion, a Todt Organisation chief engineer had reported Hitler’s particular interest in the domed Wizernes “bunker,” which he now wanted completed as the only totally sheltered A4 launching site. The continued priority behind Wizernes’s completion can be seen from the increase in the site’s labour force from 1,106 in April 1944 to 1,280 in May and 1,383 in mid-June, of which about 60 per cent were Germans. But although the dome itself was now complete, the Todt Organisation could not promise any firm completion date; during May alone, according to one captured Wizernes document, work had been halted 229 times by air-raid warnings. General Dornberger’s representative commented:

This means that no date can be set for the specialised launching gear and machinery to be installed. General Dornberger has asked von Rundstedt to decide whether it would not be better to abandon the whole project.

Hitler learned that Dornberger's liaison staff had told Rundstedt that the structure was "useless"; a commission of Todt engineers and fortification experts found the opposite to be true. "The Führer was infuriated by this frivolous way of reporting things," Speer wrote. "He is determined to investigate the matter most minutely."

Shortly afterwards, Hitler decided that the underground caverns being excavated by SS General Kammler's convicts at Traunsee (Austria) for the A4's *Cement* project should be taken away from von Braun's engineers. It had been planned to put the whole Peenemünde Development Works underground there by February 1945. On July 6 Hitler directed Speer to convert the whole tunnel complex at Traunsee into a tank-gear factory, since the A4 could not make use of *Cement* before the end of 1945. "The Führer agreed to my proposal," Speer recorded. "He stressed again that all these far-reaching projects cannot be justified." Some days after this decision, one of the directors of "Electromechanical Works Ltd." (Peenemünde) wrote a well-formulated memorandum to Professor von Braun on the whole history of *Cement*. At its conclusion he asked:

Is there any real sense at this time, and in view of the tense war situation, in pursuing plans which will not come to fruition until the end of 1945 or early in 1946?

Dornberger persisted in his attempt to regain control over the whole A4 project, including the field operations. Others, painfully aware that the development faults were responsible for the delay, were brutally frank. On July 8 Kammler referred to him in the presence of General Buhle and two other generals as a public danger, who ought

to have been court-martialled for weakening Germany's war effort with a hopeless project. Soon after, Himmler wrote to Field-Marshal Keitel demanding the subordination of the rocket project to a single strong personality, meaning Kammler. Keitel replied diplomatically but unfavourably.

WITH THE flying-bomb offensive, on the other hand, Hitler was enthralled. Ordering an intensification of the attack on June 26, he commented to Jodl that he half-expected the Allies to launch their second invasion in the Dieppe area, to seize the launching zones. Two of Wachtel's officers were summoned to Berchtesgaden and reported afterwards that Hitler had expressed delight that England was under fire again.

At 11:30 P.M. [one of them described] the big moment came: the door opened, and we walked in. Hitler was standing surrounded by his staff, leaning over a table on which a chart of Northern France showing the regiment's launching sites had been spread out. The Führer straightened and we reported to him; he strode beaming over to us and shook our hands.

Without beating about the bush, Hitler had come straight to the point; he asked whether the officers had any news yet about the effect on the British. They replied: "The violent bombing attacks on our sites are sufficient proof of the effect of our weapons, my Führer!"

Hitler agreed to increase flying-bomb supplies and to see that anti-aircraft guns and fighter squadrons were placed at Wachtel's disposal.

The Führer described for us how we were tying down hundreds of enemy aircraft by our offensive, and bringing a vital relief to the Fatherland and to the battlefields in the West.

He added that all the shells fired by the Paris gun during the First World War had not contained as much high explosive as one single

flying bomb: "We spare our men and our aircraft; the V-1 is aircraft and bomb at the same time, and it needs no fuel for a return flight!"

That night, June 29, the 2,000th flying bomb left its catapult. Hitler signalled congratulations: the continuation of the attack was assured.

(IV)

At five o'clock on June 19 the special War Cabinet *Crossbow* sub-committee met for the first time, in the presence of the Chiefs of Staff, Eisenhower's deputy Tedder and Lord Cherwell; the Prime Minister decided that the gravity warranted a new small committee with wide powers to co-ordinate counter-measures. On the following day he announced: "The Joint Parliamentary Secretary, Ministry of Supply [Mr. Duncan Sandys] will be Chairman."

Sandys was at the time inspecting the Mulberry harbours across the Channel; a telegram from Mr. Churchill brought him hurrying back to England aboard a battleship. Seven months had passed since he had officially retired from the secret-weapons investigation. Fortunately he had continued to receive Intelligence reports about the secret weapons; for now he was once again in sole command.*

* The composition of the *Crossbow* committee in its final form was: Mr. Duncan Sandys, Chairman; Air Marshal Sir Roderick Hill, AOC-in-C, Fighter Command; General Sir Frederick Pile, GOC-in-C, Anti-Aircraft Command; Air Marshal Sir Norman Bottomley, Deputy Chief of Air Staff; Air Vice-Marshal J. M. Robb, SHAEF; Major-General C. Gubbins, Special Operations Executive; Major-General O. Lund, Director of Royal Artillery; Air Marshal Sir Ralph Sorley, Ministry of Aircraft Production; Dr. R. V. Jones, Assistant Director of Scientific Intelligence (Air Ministry); Professor C. D. Ellis, Scientific Adviser to War Office; Professor Sir Thomas Merton, Scientific Adviser to Ministry of Aircraft Production; Colonel K. G. Post, Ministry of Supply; Air Vice-Marshal V. H. Tate, Air Ministry; Colonel C. G. Vickers, Ministry of Economic Warfare; Mr. O. Allen, Ministry of Home Security.

Sandys interpreted the message from the Prime Minister as a directive not merely to “report” but to direct all elements of the battle against the flying bomb as well; the fighter and AA Commanders-in-Chief, Hill and Pile, readily concurred.

The Allies were already expending considerable effort against the flying bombs: eight fighter squadrons, 480 barrage balloons, nearly 200 heavy and 200 light anti-aircraft guns had been deployed against the projectiles in successive belts across South-east England. In spite of these, 370 flying bombs had reached London since the offensive began. About 100 bombs a day seemed to have been launched by the Germans. Would this rate be sustained, or were the Germans already running down their stocks? Air Intelligence warned against undue optimism: the current level of attack would certainly be maintained.

Sandys could only agree. Poor weather and the vast launching area – 5,000 square miles – would ensure that some catapults would always escape detection.

During the week prior to June 27, over 40 per cent of the entire Allied bomber effort from the United Kingdom was directed against *Crossbow* targets.

General Spaatz fretted under this burden. In a strongly-worded personal letter to Eisenhower on the 28th, he urged that heavy bomber operations over Germany (which had brought on the battles so disastrous for the Reich’s air power in 1943) should again have priority over everything except the “bunker” sites and any emergency in the land battle. Attacks on the ubiquitous “modified” sites were not, he warned, a justifiable diversion.

The Supreme Commander – whose headquarters was right under the path of the flying bombs – rejected Spaatz’s advice. On the 29th he ordered the attacks on launching sites to “continue to receive top priority.” In the first week of July, 820 bombs were plotted approaching the United Kingdom, an alarming increase which caused his deputy Tedder to beg the Air Ministry to increase operations against the “modified” sites. At the same time, the Cabinet and Chiefs of Staff

went into prolonged sessions on the wisdom of undertaking certain large-scale reprisal measures.*

The casualties were mounting: by June 27, 1,769 had been killed; on the day after, a flying bomb hit the Air Ministry in the Strand, killing 198 people; four days later one exploding in Chelsea caused 124 fatalities. (The most serious V-1 incident was at East Barnet on August 23, when 211 people were killed.) The Prof pointed out that the odds against being killed in London on any one day were only 1:53,000. "I imagine," he minuted the Prime Minister, "it would be best to put it this way." But in Sir Alan Brooke's view, there was a serious danger that the bomb would encroach on Britain's war effort. "At the record longest Cabinet meeting," he wrote in his diary on July 3,

Winston wasted hours, and when we got on to the flying bombs subject he ran short of time. However, the threat is assuming dimensions which will require more drastic action.

By early on July 5 the odds had perceptibly shortened: 2,500 Londoners had been killed. The Chiefs of Staff met to consider reprisals on

* Among the proposals debated by the Air Staff as early as 11th January had been an unusual plan to declare one German city, at the limit of Allied bomber range, immune from bombing, on certain conditions; the city would be held as hostage. The idea appealed greatly to Cherwell, who was informed of the plan by Sir Charles Portal. He regarded it more as a means of increasing confusion in Germany than as a way of sparing cultural monuments: "This would render life intolerable in the city and lead to innumerable quarrels and recriminations," he believed. "After two or three months, if it suited us, we could declare ourselves dissatisfied with their fulfilment of the [munitions] manufacturing side of the bargain, nominate some other town, and chase half the refugees from the first town across Germany. If by some mischance we did drop a bomb or two into the selected town, we could always attribute it to the Germans and say they were trying to make mischief." At the time the Air Staff plan had been dropped; in July 1944 it was re-examined, as is seen above.

small German towns; the American 1,000-bomber raid on Berlin on June 21 had achieved nothing. Brooke was “personally dead against.”

The flying-bomb attacks were tying down half the Allies’ air power and denying London “a quarter of [its] production”; the Germans were not likely to throw this advantage away.

In a moving speech in the House on the following day, in which he called the flying bomb “a weapon literally and essentially indiscriminate” in nature, Mr. Churchill warned:

The introduction by the Germans of such a weapon obviously raises some grave questions, upon which I do not propose to trench today.

Some months before, the question of using poison gas on *Crossbow* sites had been considered in London and Washington, but reason had prevailed and the project had been abandoned.

The Germans were advanced in poison-gas technique and Hitler had in April 1944 ordered gas-mask production increased.

His fears on that occasion were unfounded, as a British study on the advantages of launching an unheralded gas attack on the Germans concluded that the advantages would lie with the enemy. The development of the flying-bomb attack caused a revival of the idea that gas attacks should be executed on the launching sites. But poison-gas warfare could hardly be confined to launching sites. Eisenhower pencilled an unambiguous protest to his deputy:

As I have before indicated, I am opposed to retaliation as a method of stopping this business. Please continue to oppose.

(v)

With the Allied invasion, the pressure of work on the giant “bunker” sites slackened; while the materials – cement, sand, ballast and steel – still poured in, “a palpable urge to retreat was perceptible,” one

chief engineer reported. At the enormous Project 51, the “high-pressure pump” gun battery at Mimoyecques, components for Hitler’s “England gun” were already arriving.

For the Todt Organisation engineers, the French coast was a dangerous region: German soldiers mistook the uniforms for those of the Allies, while the invading Armies had a habit of killing them anyway on account of their swastika armbands. There were rumours on the site that soon the firing regiment itself would arrive; but the installation of the gun barrels could not begin until July at least, as a result of the bombing during the spring.

The engineers heard that the shells were causing difficulty. The most serious delay was caused by the Allied destruction of the electricity system in the Pas de Calais late in June.

To add to the uncertainty, a Reich Air Ministry team arrived on June 15 to examine adapting the Mimoyecques site for other purposes until the gun was ready. That night the sky overhead reverberated to the soulless drone of the first successfully launched armada of flying bombs heading for London.

The Mimoyecques engineers poured out of their barracks to witness the spectacle; one wrote next day:

There seemed to be heavy aircraft approaching our camp, from the deep, strange rumble that they made. Shortly, we made out something like a muzzle-flash, so it was obviously something else. The dots of light set course for England. When searchlights lit up all along the English coast, and their anti-aircraft guns began to fire, it was clear to us all that this must be one of our new weapons going into the attack.

On 4th July an Army officer brought the news that it had been decided “at the highest level” to continue gun trials, either for the present use or for some other purpose.

A senior civil engineer dispatched by the Reich Research Council

to survey the project reported in July that although installation of the twenty-five gun barrels could begin, it would be at least four, and possibly even nine, months before the lining of the chalk tunnels with concrete would be complete.

Over a thousand tons of steelwork had by then arrived from Germany: the solid steel cover plates, the steelwork for the breech chambers, all the framework for aligning the gun barrels, the electric lifts, the tramways, the high-speed conveyor for handling ammunition, and the winches and winding drums for lowering the shells to the breech chambers 350 feet below ground-level. Everything down to the vast electrically driven bombproof steel doors for sealing off the railway access tunnels had already arrived.

On July 4 and 5 the new series of Baltic firing trials ended inconclusively: eight shells were fired, with an increased explosive charge in the side chambers each time.

The 6-foot-long shell travelled fifty-eight miles, but the gun barrel burst as the eighth round was fired; the barrel was bursting at remarkably low pressures, it seemed. The engineers decided to call in I. G. Farben for advice.

DURING THE first week in July the bombing of flying-bomb stores and “bunkers” reached its climax, including two attacks on the heavily defended mushroom caves of Saint-Leu-d’Esserent; the first attack was marked by 617 Squadron’s use of Mr. Barnes Wallis’s *Tallboy* (12,000-pound) earthquake bombs, in an attempt to collapse the limestone roof of the caves.

The effect seems to have been extremely unpleasant for the Germans. Colonel Eugen Walter described how, for days afterwards

you could hear a constant rumbling overhead, and began to feel that the very mountain was on the move and might collapse at any moment. It was asking too much of any man’s nerves to expect him to hold out in caves like that.

The “bunker” sites were similarly disposed of. All construction activity ceased at Watten after a direct hit on July 6; at Siracourt there was a spectacular collapse after a direct hit from a *Tallboy*.

After *Tallboys* slammed into the Mimoyecques “high-pressure pump” on the same day, a civil engineer reported to the Reich Research Council that the site was done for: “the installations,” he begged, “were not designed to withstand bombs such as these.”

In fact, only one of the shafts had been hit; the others were still intact. The mining firm on site reported to its Ruhr head office that the main damage was caused by debris blockages in the galleries. Two days later the Reich Research Council learned that the German War Office was still continuing its “high-pressure pump” trials with “the utmost dispatch.” But for the Mimoyecques battery, this was almost the end of the story; time ran out on the project. It may stand as an object lesson for military engineers, for it provides the perfect antithesis to the highly organised rocket and flying-bomb projects, each with its adequate dependence on external expert advice. It is not immediately plain how Röchling’s Chief Engineer Coenders had been able to exercise such an unhappy influence over the destiny of his promising invention, long after it should have become a purely Service project.

The RAF attacks on the “bunker” sites spelt the beginning of the end. On July 18, Adolf Hitler ruled that they need no longer be pursued, and a few days later General Dornberger’s staff decided that the battered Watten site – now wryly code-named *Concrete Lump* – should be abandoned, although minor work on it should be temporarily pursued “for deception purposes” only. The valuable liquid-oxygen generators and machinery already installed were at once removed.

Hitler had originally insisted that Todt complete the domed A4 bunker at Wizernes, but the Bomber Command *Tallboys* made this equally impossible:

The structure itself has not been hit by the new 6-ton bombs [Dornberger’s staff reported on July 28]. But the whole area around

has been so churned up that it is unapproachable, and the bunker is jeopardised from underneath.

(II)

At the end of August 1944 the Mimoyecques gun battery was overrun by the Allied armies; parties of fascinated scientists and engineers – among them Barnes Wallis, whose *Tallboys* had jolted the construction some weeks previously – keenly explored the vast ramifications of its underground caverns and galleries.

Development of the “high-pressure pump” went on.

In mid-November, Major-General Dornberger witnessed the firing trials at Misdroy, and saw the familiar bursting-barrel problem. He recalled: “I could only shake my head at the suggestion that such a weapon should be sent to the front.”

At conferences in Berlin on November 18 and 20 he was nevertheless ordered by SS Kammler to take command of two such “high-pressure pumps” for bombarding as yet unspecified targets.

The attack was to begin in December. Lieutenant-Colonel Bortt-Scheller was granted all the men he needed to repair the Misdroy gun within a week, and provision was made to manufacture ammunition sufficient for trial and operational firing purposes (about 300 rounds in all) and a further 1,000 rounds as a reserve. The two “pumps” eventually opened fire late in December on Antwerp and Luxembourg at ranges of rather under forty miles; one on a modified railway mounting fired against the American Third Army in December 1944; the second was mounted at a 40-degree angle up the side of a hill at Hermeskeil, whence it fired at Luxembourg in support of the Ardennes offensive. Both were blown up in the course of the German retreat.

Mimoyecques was captured in the summer of 1944 but not demolished even by the end of the war. The same went for the U-boat pens. As early as June 1944 the War Office had expressed grave doubts about the practicability of blowing up the U-boat pens without badly

damaging the surrounding towns. The Prime Minister was nevertheless privately informed that Britain “should reserve the right to destroy these pens, whether the French Committee of General de Gaulle have taken over or not.”

Mr. Churchill agreed that it would be intolerable if “any Allied Government” objected to this after their failure to defend themselves had exposed Britain to so much danger.

With Mimoyecques, the danger did not seem so immediate; the real nature of the gun site had been obscure. Wild stories of “electro-magnetic projectors” had been current in September 1944, dismissed only by Lord Cherwell’s devastating calculation that the combined output of sixty Battersea Power Stations at full blast would barely suffice to project a 1-ton shell.

In February 1945, however, the situation was radically changed by the findings of Colonel T. R. B. Sanders’s mission in the Pas de Calais: the site was, in fact, a highly feasible project which had come close to reducing London. Sanders, who had inspected the site in November, found that it was much more extensive than anticipated, and “intended for a very different type of weapon” to the A4 rockets.

The installations at Mimoyecques as they now stand [Sanders warned] could be completed and used for firing projectiles on London; so long as they remain, the workings are a potential menace to England. Sandys showed the Sanders report to the Prime Minister and urged the immediate destruction of Mimoyecques. “It would be wise,” he added, “to ensure that it is demolished whilst our forces are still in France.”

By the end of March the site was still intact; the Chiefs of Staff recommended that the demolition be made the subject of a series of experiments by Royal Engineers, but by the middle of April no steps had been taken in that direction. Nor had the U-boat pens been blown up, although in Allied hands for seven months.

Finally, just as demolition engineers were moving in, the British Foreign Office asked for a delay.

There had been moves towards an Anglo-French “treaty of friendship” in advance of the San Francisco conference, and the Foreign Office were worried about alienating French feeling at this juncture. But from subsequent exchanges it was clear that some members of the Cabinet feared not only German fingers on the trigger of Hitler’s “high-pressure pump.”

“It seems,” Mr. Churchill was warned on April 25, “very unlikely that the French will ever agree to the destruction of these installations, and unilateral action becomes more difficult with every day that passes.”

Would it not therefore be better for Britain to act first and to discuss its action with General de Gaulle only afterwards?

Mr. Churchill agreed. On April 30 he sharply minuted that *SHAEF* should be requested to blow up Mimoyecques as soon as possible.

It would be intolerable [Mr. Churchill concluded] if the French insisted on maintaining installations directly menacing our safety after we have shed so much blood in the liberation of their country.

The rest of the story cannot be told in detail. For a further ten days the long-range gun site at Mimoyecques, permanently butted in hundreds of thousands of tons of concrete and oriented only on London, was left intact. The engineer in charge of the demolition has told of a stream of contradicting telegrams from Cabinet and Foreign Office. The end of the war against Germany passed.

Finally, on May 9 Royal Engineers detonated bombs containing 10 tons of high explosive in the complex of tunnels nearest the surface.

The tunnels were widened, but not blocked. Five days later, 25 tons of TNT were stacked at both ends of the main railway tunnel. In the resultant explosion the entrances were sealed off. The main underground workings remained intact.

The sealed subterranean workings of Adolf Hitler’s extraordinary

“high-pressure pump” project, complete with steelwork, railways, and high-speed ammunition lifts, remain to this day, and will no doubt perplex the archaeologists of some future age.

(VII)

One morning soon after the first mass firing of flying bombs, a representative of Military Intelligence came to discuss with Dr. R. V. Jones a new crisis which had arisen in London. From the “controlled” agents retained by MI5 for feeding false Intelligence to the German espionage network, they had learned that Germany had briefed them to report on the fall of flying bombs.

This put MI5 in a quandary: if their controlled agents passed back genuine information it would aid the enemy; but if they fed back deliberately false reports, air photographs could prove that they had lied and were no longer reliable. Jones suggested that the agents should report the location of genuine “incidents,” but only of those that had overshot Central London, while attributing to them the timing of bombs known to have fallen short.

It was an elegant solution. Firstly, photographic Intelligence could not alone prove the agents had lied; secondly, the Germans might take steps to reduce the range of the very flying bombs which were already falling short.

Duncan Sandys enthusiastically approved the plan. It was adopted at once, though without Cabinet approval.

Certainly there was a curious change in the Intelligence deriving from agents in London. While on June 18 “a very reliable” agent signalled to the flying-bomb regiment details of flying-bomb damage all over London – in Whitehall, Limehouse, Greenwich, Clapham, Earls Court and Croydon, and as far south as Guildford, Fareham, Reigate and Southampton – by June 22 the picture had drastically altered: of the seven “incidents” reported, not one was south of the Thames.

In fact, over three-quarters of the flying bombs had fallen south of

the river. By plotting a sample of his flying bombs equipped with small radio transmitters, Wachtel learned that the mean point of impact was “to the left and short” of the aiming point. He cannot have believed this, however, for he now shortened his aim still more.

A SECOND deception plan appears from the same evidence to have been put into effect long before it was officially approved. German agents in London had signalled that there was “considerable damage in Southampton” from flying bombs. The Sixty-Fifth Army Corps was puzzled, as none had been aimed anywhere but at London; they advised Wachtel to attribute this damage to a conventional air raid. But it encouraged the Corps to examine the idea.

Since they knew there was little hope of persuading Hitler, according to Colonel Walter, the Corps decided covertly to attack Southampton, and to notify Hitler only if the attack succeeded. On June 26, Wachtel ordered part of his regiment to open fire on Southampton. As soon as von Rundstedt got wind of this, he ordered the Corps to desist. The order was reinforced next day by a teleprint from Hitler himself directing Wachtel to fire only at London, and “for quite particular reasons” at the maximum rate.

Wachtel dutifully did so; his rate of fire was increased to almost 200 for the next few days and with Hitler’s approval a number of flying bombs were filled with aluminised explosive (Trialen) – yielding twice the normal blast-power – to discourage point-blank fighter attacks. Half the bombs were also fitted with knife-edge wings, to cut adrift the barrage balloons barring their path to London.*

The South Coast ports still offered, in the eyes of the Sixty-Fifth Army Corps, the most tantalising targets. On July 3 they learned from an agent that the last illicit series of attacks had driven a Southampton-based fighter squadron to another airfield. The Corps could wait no longer, and after persuading the new Commander-in-Chief West,

* By early September 1944 alone no fewer than 630 balloons had been lost.

von Kluge, and overriding objections of the Air Force operations staff, sent their Heinkel-bomber squadron (the third *Gruppe* of *KG3*) to air-launch flying bombs at Southampton from July 7.

They caused practically no damage. Indeed, Lord Cherwell took their target to have been Portsmouth. From this attack on the South Coast ports, however, there burgeoned in his mind an idea. On July 14 he suggested to the Home Secretary that Britain should encourage the Germans to continue attacking the ports, and on a greater scale.

“I would press you,” he wrote to Mr. Morrison, “to consider the possibility of commiserating with a ‘South Coast town’ on the heavy losses sustained, or in some other way indicating that the attack had been a success.” It might save the lives of hundreds of Londoners every week, at the expense of only a few lives in the variously afflicted ports.

Herbert Morrison was thoroughly alarmed by the Prof’s proposal. Three days later he replied that “politically it would be dangerous in the extreme.”

This unexpected response was based on honourable – if obscure – arguments; such a public statement, he argued, would be at variance with the truth. Moreover, “it would soon be known to be untrue and doubts would be cast upon the accuracy of [British] Government statements generally.”

Morrison, of course, was a strong advocate of more direct methods of neutralising the *Crossbow* menace; he vehemently urged that an immediate invasion of the Pas de Calais be undertaken.

The Prof not unnaturally felt that Morrison had missed the point. Privately, he explained to Morrison that his principal wish was that the flying-bomb attacks on Portsmouth should not be officially “cried down.” Morrison remained obdurate; and there the matter rested – for a while.

The attack on London did not slacken. During the first week in July, Mr. Sandys demanded the expansion of the fighter defences to sixteen squadrons, but the weapon’s high speed made interception difficult. He favoured an attack on the eight “supply” sites, which he

had now been informed might hold the flying-bomb catapults' hydrogen peroxide stocks.*

The Civil Defence Committee issued contracts for a further 100,000 Morrison shelters. During the first two weeks the attacks had caused a loss of one-sixth of the total manhours worked in London, even though only one factory in fifty had been hit.

There remained the offensive counter-measures. Air Chief Marshal Tedder urged one all-out attack on the entire "modified" site system, with a related attack on its supporting supply and transportation systems. Neither Eisenhower nor the air commanders would agree to the temporary withdrawal of the entire heavy bomber force from the land battle and strategic air offensive that this operation would have involved.

Lord Cherwell proposed bloodthirstily that the Germans be burned out of the sites by flooding them with butane and other incendiary chemicals; the Air Staff believed that only high explosive dropped from high-altitude bombers was effective.

The defences were characterised by equal disorder and controversy. Neither fighters nor guns could work to their fullest advantage, each frequently encroaching on the other's zones of operations. The aircraft were just not fast enough. He completely redesigned the defence deployment into four zones of operations: the fighter aircraft to oper-

* Hydrogen peroxide was very much the *bête noire* of the investigation of both secret weapons; British Intelligence had something akin to an obsession about it. Both Isaac Lubbock and Dr. Jones had been convinced that the flying bomb was peroxide-fuelled, as Intelligence examination of the "ski" sites had shown what was very obviously a peroxide store, with no other fuel store on the site. Lord Cherwell had also pointed out in mid-April that the "extremely likely" use of relatively scarce hydrogen peroxide would in itself limit the rate of sustained attack by flying bombs. Only on June 9, 1944 had the Chiefs of Staff learned that the examination of the wrecks of two flying bombs had shown that their fuel was low-grade petrol, and that the bombs arrived at sites *ready fuelled*. The peroxide was for the catapults.

ate over the Channel; all anti-aircraft guns to be emplaced anew on a narrow strip along the coast from Beachy Head to St. Margaret's Bay; and a long-stop balloon barrage outside London to catch the bombs that slipped through.

Between this balloon barrage and the coastal gun belt the sky would be free for the fighter squadrons to operate under running-commentary control.

Air Marshal Hill and General Pile had elaborated this new plan on July 13 and the whole redeployment was rushed through on Sandys's responsibility alone, without reference to higher authority. Twenty-three thousand men and women, and 60,000 tons of stores and ammunition were moved; thousands of miles of telephone cable were relaid. To the War Cabinet, Sandys announced on July 17:

The redeployment of the heavy anti-aircraft guns on to their new sites along the coast was carried out over the weekend, and the new defence plan came into operation at six o'clock this morning.

Since the move would clearly increase the anti-aircraft gunners' chances at the expense of the fighter defences, Sir Charles Portal took a jejune view. The Chief of Air Staff pointed out that the redeployment had been carried out without any reference to the Air Ministry, who were after all constitutionally responsible for the air defence of the country.

He warned that Air Marshal Hill would bear the responsibility for failure, as it was he who had authorised the new plan. By July 19, 412 heavy and 1,184 light anti-aircraft guns were ready for action on the South Coast, together with 200 rocket barrels. The new defence plan, fortunately for both Sandys and Hill, was a vast improvement on the old, and every week the guns claimed more flying bombs.

This was due in some measure to the new *SCR.584* radar set and to the American proximity-fuses which the guns could now use; an average of only seventy-seven such shells had to be fired to bring down

one bomb. The success of the British defences culminated on August 28 with the shooting down of all but four of ninety-seven bombs which approached the coast.*

At the time, of course, the Chiefs of Staff could not foresee the success with which the new deployment would be met, and much of the animosity directed at both Cherwell and Sandys on July 18 must have come from the simultaneous announcement that the A4 rocket threat had suddenly re-emerged.

Lord Cherwell still believed that some attempt should be made to mislead the Germans and on the 20th a further plan had occurred to him. It seemed unfortunate to him that the newspapers were allowed to print obituaries of those “killed in enemy action” citing the London borough or district.

One of his team of statisticians had plotted some seventy cases from *The Times* and eighty from the *Daily Telegraph*, and – allowing as any intelligent enemy would for a preponderance in those newspapers of Kensington and Chelsea obituaries – the mean point of flying-bomb impact had worked out at Streatham Hill from *The Times*, and at Clapham Junction using the other paper.

“The results are dangerously near the truth,” he warned. “I do not know whether the inclusion of a score or so of misleading entries might be considered.”

THE FLYING-BOMB assault was certainly presenting a more deadly threat each week. The Germans began launching flying bombs in salvos to swamp the defences. To add to the nightmare, between 18th and 21st

* The success of the new deployment, coupled with the introduction of “proximity fuses” and the SCR.584 radar sets, is reflected in the steady increase in the percentage of flying bombs shot down by the AA defences on entering the gun belt. After the redeployment, in the *first* week it was 17 per cent; *second* week, 24 per cent; *third* week, 27 per cent; *fourth* week, 40 per cent; *fifth* week, 55 per cent; *sixth* week, 60 per cent; *seventh* week, 74 per cent.

July fifty flying bombs had approached London from the east, which suggested that they had been launched from firing points in the Low Countries, particularly near Ostend. Only later was it realised that these latter bombs, of which twenty had come down in London, were launched by aircraft standing off over the North Sea. To combat the salvoes, the standing air patrols over the Channel had to be increased, although the total German effort was the same; and to provide a defence against the air-launched bombs, the left flank of both ground and air defences had to be extended.

There thus seemed to be a case for a closer examination of the various deception proposals. On July 28 the Cabinet would agree only on measures to “confuse the enemy” about where his bombs were falling, and not to induce him to alter his aim in any particular direction.

But to both Mr. Sandys and Dr. Jones it seemed that any measure designed to reduce overall casualties was worthy of favour. The “incident” charts showed clearly how the mean point of impact had marched steadily away from Central London to the south-east under the influence of the false agents’ reports. By the end of July about half the bombs coming within thirty miles of London had fallen within eight miles of Dulwich.

On August 2, Mr. Sandys appealed to Mr. Churchill to reverse the Cabinet’s decision of a few days before. Lord Cherwell’s office supplied him with figures which showed that if the Germans were to discover their current aiming error, and bring the mean point of impact back from Dulwich to Charing Cross, then total monthly casualties would increase by 4,000, including 500 fatalities.*

If the Germans were only “confused,” they would endeavour all the more to find out where their bombs were falling, and would then correct their aim accordingly.

* The aiming point for flying bombs was initially Tower Bridge, and then seven other points, usually main stations. For rockets the aiming point was about 1,000 yards east of Waterloo station.

A positive deception plan was more likely to succeed: if the Germans were taken in, they would shorten their aim still farther, causing 12,000 fewer casualties per month.

On August 15 (while Mr. Churchill was abroad) the whole matter of the desirability of giving the Germans false reports through their agents was again referred to a meeting of the Cabinet in its underground War Room. They now learned that MI5 had, in fact, been feeding false data into the German Intelligence network since June.

To Herbert Morrison, this flouting of the earlier Cabinet ruling brought a moral crisis of the first order. He had already made plain his view that the not-dissimilar proposal to induce the Germans to shift the flying-bomb offensive to the South Coast ports was “politically dangerous in the extreme.”

Now he proclaimed that they had no right to say that one man should die because he lived in the south, while another should survive because he lived in the capital. “Who are we,” this Minister concluded, “to act as God?”

The question was taken further, but his view prevailed. Londoners had taken the Blitz; surely they could withstand the flying bombs. Morrison insisted – and the Cabinet agreed – that Military Intelligence was not authorised to interfere with Providence.

In retrospect, the Cabinet’s decision can be seen as moral cowardice; the selection of people to die and people to survive in any military operation is a painful but necessary duty of any commander in the field. We can understand the Cabinet’s anguish, but not its decision.

After the Cabinet meeting, Group Captain Earle brought the decision to Jones in the Air Ministry; Jones was astonished to hear the arguments adduced by Morrison.

Earle was at the time Assistant Secretary (Military) in the War Cabinet Offices; it appeared that he had managed to persuade the Secretary that this was such a secret matter, involving as it did the handling of agents, that it ought not to be committed to the official record. Dr. Jones was enabled to ignore the decision. If Mr. Sandys knew what was

happening, he appears quietly to have looked the other way.

The deliberate deception of the German Intelligence network by MI5 about the accuracy of the flying-bomb offensive was – unbeknown either to Herbert Morrison or to the Cabinet – continued until the end.

(VIII)

Adolf Hitler agreed to Speer's request for documentary films to be made of the flying-bomb and rocket projects for the German newsreels.

After lunch on 11th July the rocket film was shown privately to Speer, Goebbels and Milch. SS guards were posted on every door and one of Speer's own projectionists operated the projection room.

Goebbels had not seen the A4 in action before.

The effect on him was all the more striking. In full colour, the cameras filmed the subterranean factory at Nordhausen, the train-loads of convicts, engineers and materials being shunted into the gloomy limestone tunnels, and the huge rockets being assembled in a vast antheap of crazed industry. They saw the 50-foot rockets being hauled by powerful tractors through dense forests to the secret launching areas, hoisted erect and towering above the trees. They saw the tremendous activity in the preparation of the rockets for firing, the soldiers swarming over the gantries, looking grotesquely outdated in their drab uniforms against the towering shapes of the futuristic A4.

The scene changed:

We are in the control truck, an armoured vehicle let into a hollow in the ground a safe distance from the rocket. An officer is facing a panel on which flickers a bewildering array of instruments and coloured lights. He turns on a few switches, throws a lever. The camera peers through the truck's visor, and we see a brilliant flame flash out at the rocket's tail. Dense clouds of smoke billow out; the

giant rocket lifts gently off its table, dead slow at first like a gas-filled balloon, it rises above the treetops, a fantastic spectacle.

The film cameras tracked the rocket right up into the sky until it vanished from sight. Forty years after, the launching of large rockets is still a breathtaking spectacle. How much greater was the effect on Goebbels then! A dozen times the film showed different rockets being launched; each awesome take-off hammered anew into the intellect of the dumbfounded Dr. Goebbels. To his staff he later cried:

I believe that this missile will force England to her knees. If we could only show this film in every cinema in Germany, I wouldn't have to make another speech, or write another word. The most hardboiled pessimist could doubt in victory no longer.

The explosion of Stauffenberg's bomb in Hitler's headquarters nine days later resulted in significant changes. The Chief of Air Staff, General Korten, was killed. Von Kluge heard of the attempt and decided that if Hitler were dead Germany must begin negotiations with the Allies at once: "I would like to order a cessation of the flying bombs immediately."

But Hitler was not dead. Fromm and the other conspirators were arrested, and in Fromm's place Himmler was installed as Commander-in-Chief of the Reserve Army (to whom ultimately the Army Weapons Office was responsible).

There was no let-up in the flying-bomb assault; the firings were actually increased. The Sixty-Fifth Army Corps telephoned Colonel Wachtel just before eleven o'clock on the night of the bomb plot and ordered continuous fire at maximum tempo and with an "unrestricted expenditure of ammunition."

London had a bad night. One of Wachtel's bombs missed the flat of the Chief of the Imperial General Staff by less than 400 yards. The regiment launched 193 during the night, and over 200 on the follow-

ing night. "The effect of the attack," Wachtel recorded, "is depicted as grave in all the reports coming in from agents."

On August 2 the regiment was able to launch its heaviest single attack, when 316 bombs were directed from thirty-eight catapults at London; 107 actually fell within London during this period and at 3:44 A.M. one actually hit Tower Bridge (its aiming point), causing it to be closed to traffic for several days.

With satisfaction, Wachtel heard from his agents that "mass evacuation is causing endless worry, and looting is the order of the day." The Londoners themselves were living a troglodyte existence in packed Underground stations.

"There is talk," the agents added, "of launching a poison-gas attack." Wachtel commented that this was the clearest proof that the British were impotent against the flying bomb, if the report were true.

In Germany, the secret weapons were now under Himmler's control. On August 8 he appointed Hans Kammler, by now a lieutenant general in the *Waffen* SS, to be his Special Commissioner. Tactical control still lay, by virtue of Hitler's earlier decree, with the Sixty-Fifth Army Corps, but the SS was firmly in the saddle. The fight for the A4 was now all but won; two days after his appointment as Himmler's Special Commissioner, Kammler was already eyeing his next prize: he paid a visit to Colonel Wachtel "as part of a tour of information," to inspect the flying-bomb organisation.

PART SEVEN

THE A₄ ASCENDANT

“MAJOR-GENERAL DORNBERGER: expressed the hope that this new co-operation would now continue; Germans should keep in mind that the object was to fight the enemy, not each other.”

— *From minutes of a conference called on May 6, 1944 at the Nordhausen rocket factory.*

The A4 Ascendant

(1)

AT THREE MINUTES past four on the afternoon of June 13, 1944 an A4 rocket was fired from Peenemünde. The rocket, serial number 4,089, was no normal A4: it was being used as a test vehicle for the radio-control gear of the experimental *Wasserfall* anti-aircraft rocket.

The take-off was perfect, but the remote control broke down. Having slipped its leash, the A4-*Wasserfall* hybrid turned to the north and vanished into the clouds.

Five minutes later it hurtled down nearly 200 miles away on South-eastern Sweden. Eyewitnesses reported a loud explosion several thousand feet in the air; a man and his horse were thrown to the ground by the blast. A second explosion rent the air as the rocket remains hit a cornfield.

Sizeable pieces of the rocket mechanism, including a whole sub-assembly – a twisted alloy frame with a tangle of electronic circuitry – lay amid a sprinkling of Swedish ball-bearings in the 13-foot crater.

Within half an hour the whole locality was cordoned off by the Swedish Home Guard and roadblocks had been set up. A German or American aircraft, it was popularly assumed, had met with some accident; but where was its crew? Curious things began to happen:

German agents were rumoured to have tried to pass the roadblocks with a hearse, saying they were on their way to collect a corpse.

The rocket's last mortal remains were carefully collected by Swedish Air Force officers and taken under guard to Stockholm, where they were investigated perfunctorily by scientists in the military laboratory there. An appeal was made to all the children to hand in their souvenirs of the crash, and a deluge of bits and pieces descended on Stockholm. One child had taken home a sizeable unit and dismembered it – a fascinating array of hydraulic servo-motors, resistors, and relays. He had reassembled it by the time the police took charge. Another looter was busy unwinding a coil for his own personal use when the police arrived to search his house. The wreckage was in good condition, better than if the rocket had hit the ground in one piece; but much was still missing.

Finally, everything was locked up in a large room and abandoned; the Swedish Government wanted to hear nothing more of the matter. When, some days later, Hitler's headquarters telephoned Dornberger at Blizna about the incident, of which the German Foreign Office had been informed, Dornberger was able to reassure them that the special *Wasserfall* control gear would lead Allied Intelligence wildly astray, should they gain access to the pieces.

AS DR. JONES had from time to time pointed out, rocket trials were clearly continuing at Peenemünde, as the German radar tracking stations (whose *Enigma* signals about flying-bomb trials Bletchley was deciphering) were sometimes warned to try to plot a rocket's fall. That they had never succeeded did not detract from the Intelligence picture; and the baffling "bunker" sites in France, on which the Germans were still squandering thousands of tons of concrete each week, belied the possibility of an elaborate hoax.

A conversation overheard between two Germans captured in France touched in some detail upon the existence of German rockets weighing up to 20 tons. "The danger," Sir Alan Brooke recorded after a lengthy

COS meeting on June 27, “really lies in the rocket with the five-ton warhead starting. . .”

It was now that attention reverted to Blizna.

Ever since March 1944 Jones had suspected that the Germans were testing secret weapons at Blizna in Poland; an intercept then had linked flying-bomb trials there with the SS. In mid-April, as a result of this, Blizna had been photographed from the air. The photographs revealed a “modified” type of flying-bomb catapult in an experimental compound of considerable size.

The site had been photographed again early in May, but the cover was not interpreted until 3rd June, although the “most secret sources” during the previous month had again suggested that rocket trials were taking place there. Early in June Bletchley intercepted railroad *Enigma* messages relating to quantities of *Geräte* (equipment) being shipped periodically by train from Blizna to Peenemünde.

Later that month three reports from the secret military organisation in Poland gave reason to suspect that the *Geräte* might, in fact, be linked with A4 rockets. These suspicions seemed confirmed when the latest photographs of Blizna were examined, for they revealed that the flying-bomb catapult had been dismantled. This ruled out the only likely alternative, while a further cover of Blizna in mid-June showed increasing activity, with several camouflaged trains and “Peenemünde-type” tank wagons on its railways. There seemed only one possible explanation.

The rocket panic broke out afresh. Dr. Jones was directed by Air Intelligence to report immediately. As he was fond of reciting, writing an Intelligence report was like lancing an abscess: if done too early it had no effect. Although the picture was incomplete, and “under the strongest possible protest,” he circulated on 16th July a brief Intelligence summary to the Cabinet’s *Crossbow* Committee. He reported the expert opinion of Professor Charles Ellis that – on evidence of 80-foot craters seen at Peenemünde and in Poland – the missile’s warhead would seem to be probably between 3 and 7 tons; and he

also stated the unfortunate belief that the rocket's main fuel was based upon hydrogen peroxide.

One other detail seemed certain: if the *Geräte* referred to A4 rockets, then the weapon was certainly already in mass production. The railroad *Enigmas* listing *Geräte* travelling between Blizna and Peenemünde included the serial numbers; but before stating with certainty that these were the serial numbers of A4 rockets, he wanted proof that such weapons were undergoing trials at Blizna.

Jones returned to the Blizna photographs of May 5. He spent the night poring over the one stereo pair showing the whole Blizna compound, trying to find an A4. In the early hours he found one: a blurred white speck, a rocket was waiting on a loop of the narrow-gauge railway line serving a remote corner of the camp.

This was the missing link in a highly intricate chain of evidence, much of whose provenance could not be published in 1964 when this book first came out. There was now no doubt that the serial numbers, which ranged from 17,064 to over 18,000, referred to rockets, whose collected remains were being shipped to Peenemünde for post-mortem analysis. Air Intelligence was informed at once. Then Jones dropped his bombshell: an elementary numbers analysis indicated that the enemy had manufactured at least 1,000 of the *Geräte* by early June. He took this news to Lord Cherwell personally and within the next forty-eight hours the Prime Minister, too, had been told.

Jones was taken under fire from several quarters. The old accusations of choosing his own time to release his accumulated findings were reiterated with renewed solemnity. Surely Jones must have had some earlier inkling of this rocket build-up. To Mr. Churchill it seemed a suspicious affair.

The Allied Central Interpretation Unit shared the anger at Dr. Jones: he had already pained the Unit by spotting the first rocket on the Peenemünde photographs and by re-identifying its "sludge pumps" as flying-bomb catapults in 1943. The Wing Commander conducting the official ACIU investigation wrote to the Air Staff pointing out the

dangers of “amateur interpretation” of aerial photographs. Only a few nights before, he added, the Air Ministry’s Dr. Jones had claimed that there was a rocket on photographs of Blizna; but quite obviously it was a locomotive.

(II)

Fresh Intelligence had by now also arrived from Sweden. In the last few days of June two RAF officers – experts in the dissection of crashed enemy aircraft – were flown to Stockholm to inspect the 2 tons of rocket fragments there. A signal from London warned them to be on guard for evidence of a German “plant.” They replied at once that the fragments were obviously genuine. The Swedish Air Force offered every facility within their power, but their position, no less than that of the two British officers, was “one of considerable delicacy.”

Among the fragments was a very sophisticated radio-control mechanism. Dr. Jones was convinced that the Air Ministry’s only hope of unravelling it in detail was to bring the components to London, and perhaps to combine them with other parts brought back from Poland. “I believe,” he wrote to Sir Charles Portal, “that the acquisition of all available components is a matter of vital interest to the defence of this country and that we should not hesitate to pay any reasonable price which would satisfy the Swedes.” He suggested that a number of Spitfire aircraft might be given to them, the exchange to be made through Staffs rather than the more cumbersome Foreign Office channels. The bargain was struck remarkably fast. A first air shipment of rocket fragments arrived in London in mid-July, and the remainder at the end of the month.

Now it was plain to all that the German rocket was no myth.

At the Chiefs of Staff meeting next morning, July 18, Lord Cherwell came under severe criticism, especially from Sir Charles Portal and Sir Alan Brooke. The latter’s dry comment in his diary – “the rocket is becoming a more likely starter” – belied the heat of the dispute. Brooke

for one was wide awake to the danger that the Germans might succeed in enticing the Allies into attempting an invasion of the rocket-launching areas. "This will want watching very carefully," he wrote.

For the present the Prof could only hedge uncomfortably. While he had not seen all the evidence, he still thought the engineering problems "extremely formidable"; if, nevertheless, the Germans had diverted so much of their resources to rocket manufacture, the threat could not be altogether disregarded.

In a curious way, almost reminiscent of proceedings in the Old Testament, the bearer of the ill tidings – Dr. Jones himself – became the butt for criticism, too. When at 10 P.M. the *Crossbow* Committee met in the Defence Map Room, the Prime Minister himself put in a rare and testy appearance. He was obviously determined to assail Air Intelligence for what seemed to be a lapse in procedure.

Dr. Jones reported his discovery during the previous night of a rocket on the Blizna photographs.

Mr. Churchill rounded on him with a savagery that delighted the latter because the Prime Minister's arguments, to the effect that Air Intelligence must have been asleep, were grotesquely similar to those which he had heard three nights before from his wife, who seemed to regard him as personally responsible for any major calamity that befell the country. He was able to turn upon the Prime Minister the same bland countenance as he had rehearsed during his more domestic dispute; and he survived the explosion unscathed.

According to Lord Cherwell, when the examination of the Swedish rocket fragments was reported to the Committee the Prime Minister complained: "We have been caught napping."

There was one touch of unconscious comedy. Major-General Sir Colin Gubbins, Director of the Special Operations Executive, announced that he had learned from one of his sources that the A4 rocket was to be guided to its target by a small man in its nose, who was to escape by parachute just before impact. Dr. Jones was still chuckling when he reached Air Intelligence headquarters in Monck Street next

morning. There he found that during the night a flying bomb had scored a freak hit on a lorry parked outside, loaded with an infra-red searchlight captured at great risk in Normandy and delivered to him some hours before.

(III)

On July 22nd the Air Ministry reported on the Swedish rocket fragments. The only clues to the rocket's fuels were blue and violet stains on the main aluminium burner unit. Again, most of the fuel-tank fragments were stained a reddish-brown. The most important discovery was that of four "gas vanes" projecting into the rocket jet itself. These answered all the rocket's stability questions. "To judge from the complexity of the radio equipment," the Director of Intelligence (Research) concluded, "no effort has been spared to ensure the greatest possible accuracy."

The stain clues indicated strongly that hydrogen peroxide was the main fuel, but a Farnborough analysis ruled this out: they were ordinary dyestuffs, including fluoresceine, provided to mark the missile's impact in the sea. Since they were unsuitable for use with peroxide or nitric acid, after ten months of speculation both were eliminated.

On the other hand, "a liquid-oxygen alcohol combination is not yet ruled out," the Air Ministry found on July 23. They were inching closer to the truth. In view of the reported existence of 1,000 rockets, only one conclusion could be drawn by Mr. Sandys's Committee: "Although we have as yet no reliable information about the movement of projectiles westwards from Germany, it would be unwise to assume from this negative evidence that a rocket attack is not imminent."

The CIGS privately thought the danger to be more immediate: "The large rocket," he summarised, "may be expected any day."

On the afternoon of July 25 the news was broken to the Cabinet. Both Churchill and Morrison expressed vexation that a threat whose existence had been deprecated by Sir Stafford Cripps eight months

before should have developed with so little warning. Lord Cherwell himself was not at the Cabinet meeting, but a stream of visitors at his office, including Sir Edward Bridges and Sir Charles Portal, warned him after his return from the House of Lords that the full crisis was about to break. As soon as the *Crossbow* meeting began that evening Mr. Churchill complained that he had not been kept properly informed. He was particularly puzzled by the sudden realisation that the rocket could be liquid-fuelled.

Dr. Jones, supported by Sir Archibald Sinclair and Sir Charles Portal, explained candidly that the Swedish and Polish evidence had become available only during the last week; it was an open question whether attack was “imminent.” He and his colleagues harboured their doubts whether the Germans would be able to move the rocket-launching troops westwards to Northern France without Intelligence learning very shortly of it.*

Mr. Churchill could not be appeased. He learned that Dr. Wheeler, of Sir Alwyn Crow’s department at the Ministry of Supply, had written a painstaking report in May proving that 50-ton rockets could be designed. Cherwell now had to admit that he had not believed Wheeler’s report worthy of attention: Wheeler had “gracefully brushed aside” the problem of designing a 7,000-horsepower pump weighing only 550 pounds. Now that the examination of the Swedish rocket had shown it equipped with a turbo-pump, the rug had been pulled out smartly from underneath the Professor’s feet.

When Cherwell now suggested vaguely that means could be devised to interfere with the elaborate radio control which had been detected in the Swedish rocket, Mr. Churchill returned to the central theme: why had Wheeler’s report on the practicability of propelling large rockets with liquid fuels been suppressed? He called for a complete report on

* GCHQ required the author to delete at this point from his 1964 manuscript this sentence: “No doubt he was thinking at that moment of the information which they might expect to flow from their decoding establishment.”

all the actions of Sir Alwyn Crow's Department of Projectile Development. The Gods of War were marching on Whitehall.

WHEN THE main assault eventually switched back to Dr. R. V. Jones – a more readily accessible target than Crow – Lord Cherwell strongly redeemed his earlier shortcomings by hastening to the Intelligence officer's defence.

To the Prime Minister he addressed the following thoughts on the evening of July 25; they are worth quoting at length:

Complaints which you have voiced to the effect that you have not been promptly and fully informed concerning the German long-range rocket by Jones, Crow, the Air Ministry and myself indicate that you have been misled as to the facts and responsibility.

Intelligence about the enemy's secret weapons is not easy to come by, and very difficult to build up into a sort of picture; it is only when the last crucial items come in that a coherent whole emerges. As soon as this happened, Jones passed the information on, and there was no delay in its reaching you. Actually, responsibility had long been removed from Jones for all this and handed over to Sandys. He had all the information available to Jones, and it was for him to synthesise it or pass it on to you piecemeal as he thought fit.

One cannot expect an amateur to build up a picture from all these small bits of evidence, and I do not blame Sandys for having failed to do so. On the other hand, having taken over the responsibility from the professional, I do not think it proper for him to throw the blame on to the professional for anything that may have occurred.

This was less than just to Mr. Sandys, who had been required to relinquish the first rocket investigation solely as a result of a campaign waged by the Prof and the Chiefs of Staff against him; but Cherwell's central conclusion – that Jones was entitled to greater credit – deserves some sympathy.

It seemed an opportune moment to put into effect the sweeping proposals made by Morrison in November 1943. At the War Cabinet on July 27 he recommended the evacuation of much of London. Accommodation would have to be provided for one million evacuees to the north and west of London, and all London hospitals would be cleared of their patients and converted into casualty clearing stations.

During the afternoon Lord Cherwell, who had earlier conferred with both Dr. Jones and Sir Alwyn Crow, sent Mr. Churchill a note arguing against such unnecessarily drastic proposals: secret evidence pointed to a warhead very much smaller than the seven tons assumed by Morrison and there was every prospect, he felt, of jamming the rocket's radio control.

In fact, the A4's warhead contained less than one ton of high explosive – a puny charge which could hardly have warranted the effort expended on the rocket investigation and counter-measures.

(IV)

For Dr. R. V. Jones the final clue lay among the fragments of the "Swedish" rocket; it was a clue which a stranger to cryogenics might have been pardoned for overlooking, but it more than compensated for the mischief caused by that rocket's spurious radio control.

Studying the report drawn up by the two RAF officers, Jones's attention was drawn to a fuel pump "with no provision for external lubrication."

He and his chief assistant, Dr. Frank, were at once reminded that liquid oxygen and liquid air were handled by mechanical pumps designed to be lubricated by the fluids they were pumping. Examination of the pump itself confirmed it beyond all doubt.

By itself, this discovery was of little interest – it was still not possible to calculate the rocket's range or capabilities. But Jones was enabled to re-analyse the whole file of Intelligence reports on rockets, using "liquid oxygen" as his touchstone to test their authenticity. Only five

reports mentioned liquid air or oxygen: in impressive harmony, these described rockets with warheads of only 1 or 2 tons.

This was the final stage. At last the A4 rocket had been brought down to its proper size.

HAD THE use of liquid oxygen been confirmed in the spring of 1943, the rocket investigation would not have attained such a lasting priority. It would have been recognised that the Germans could not launch a mass saturation attack, and the correct estimate of the rocket's size would have been reached much sooner.

In retrospect, the history of liquid oxygen as a factor in the Intelligence attack on the German rocket weapon presents a series of errors of omission. When in December 1943 a high-ranking German prisoner blurted out that the rocket used not only alcohol but liquid oxygen, the Joint Intelligence Committee passed the matter on to Engineer Isaac Lubbock, the pioneer in liquid-oxygen technique.

Lubbock told the Committee that pumping liquid oxygen was "an engineering achievement fraught with considerable difficulties"; having seen the German *Hs.293* rocket bomb, he strongly believed the enemy rocket would also be fuelled with hydrogen peroxide.

The circumstantial evidence in favour of a hydrogen-peroxide fuel was very strong.

Faced in February 1944 with the fact that "the production of liquid oxygen in Western Europe is now being forced to a level well in excess of any reasonable requirement for welding or blasting purposes,"* the Ministry of Economic Warfare had tortuously concluded that the

* The type of explosion produced by liquid oxygen with charcoal or cellulose was highly suited to wholesale demolition work, as Lord Cherwell had himself pointed out on January 18, 1944, adding: "This was, however, not a new suggestion as oxygen explosives had, in fact, been used in the construction of the Simplon tunnel." He may well also have recalled how Dr. R. V. Jones once blew in the windows of the Clarendon laboratory at Oxford with a liquid-air explosive device.

Germans were obviously contemplating large-scale retreats in France and the Low Countries and needed the liquid oxygen as a demolition explosive for a scorched-earth policy.

In March, Lubbock had accordingly redesigned his rocket on a hydrogen peroxide basis. An awesome monster weighing 55 tons, the new version's theoretical performance was incomparably better than its predecessor. "I see no reason," Lubbock had written to Mr. Sandys's chief assistant on March 2, "why the enemy should prefer fuels which have recently been reported such as liquid air or liquid oxygen with one of the alcohols."

In the first week of April, re-examining the photographs of Peenemünde in the light of a Ministry of Economic Warfare recommendation, Squadron Leader Kenny reached the conclusion that the two large factory buildings at Peenemünde and one of the circular earthworks were nothing less than hydrogen peroxide factories capable of producing over 2,000 tons of high-test peroxide annually. By July the Air Ministry had circulated a new target dossier on Peenemünde, stating that its importance lay in its peroxide production and even listing its "hydrogen peroxide factories" as primary targets. All three US Eighth Air Force attacks on Peenemünde were executed as part of their campaign against peroxide production, even long after the A4's true fuel had been established.* The factories at Peenemünde were, in fact, assembly workshops for the A4 rocket itself.

DR. JONES's brilliant deduction that the A4 used liquid oxygen coincided with the interrogation of a foreman electrician of the "honest workman type" who had been employed at Peenemünde-East in the supersonic wind tunnel until his call-up into the *Waffen* SS. The Ger-

* In addition to their July 18, 1944 attack (377 bombers), two further attacks on Peenemünde as a "hydrogen peroxide" plant were executed, on August 4 (221 bombers) and 25 (146 bombers). No hydrogen peroxide was ever manufactured at Peenemünde.

man described many of his country's missiles projects in addition to A4. The high-explosive warhead of the A4, he said, was only one ton and the structure was similar to that of the Zeppelin. Two "propulsive liquids" were used, he added: alcohol and liquid oxygen, contained in light alloy tanks. A special six-wheeled transporter lorry erected the rocket on a small cone-shaped firing-table, which deflected the blast.

This highly circumstantial interrogation report continued with a description of the radio control used for the initial flight period. It announced the imminent move of the whole wind-tunnel complex to a locality near Munich and identified a large number of leading Peenemünde personalities, including Dornberger, Stegmaier, von Braun, Hermann, Kurzweg, Czerny, the two Riedels, Oberth, Jordan and a galaxy of others. On a plan of Peenemünde, the prisoner identified the main buildings of the site.

Truly it can be said of some Germans that treachery was their stock in trade.

THIS PRISONER'S description of the rocket's vertical take-off, coupled with the discovery of the gas vanes in the "Swedish" rocket, left no doubt that the A4 made a simple standing start from a cone-shaped table standing on any hard surface. After eighteen months the search for "giant mortars," "projectors," and other means of bodily launching the rocket was called off.

All available photographs of Peenemünde were reexamined, and on many photographs dating back to June 12, 1943 objects previously interpreted merely as "thick vertical columns, about forty feet high and four feet thick" were measured again; on August 4, 1944 they were confirmed as vertical rockets. On ten different occasions air photographs had shown no fewer than seventeen rockets on the foreshore; *wagen* trailers and tank wagons could clearly be seen clustered nearby.

There remained only the SS prisoner's conical firing-table, what the Germans called the *Bodenplatte*. It had been accurately described as a steel cone surrounded by a square framework on which the rocket

stood. It looked, in fact, like an outsize lemon-squeezer.

Searching all the photographs of Blizna, Wing Commander Kendall's elated interpreters found no fewer than twelve huge conical objects, 15 feet in diameter: "The possibility of their being firing bases shaped like lemon squeezers," they solemnly reported on 4th August, "cannot be ignored." A drawing showing the possible size and shape of a "lemon squeezer" was circulated.

The aerial photographs taken on July 27 showed that Blizna had been abandoned by the Germans as the Soviet Army advanced. After hurried personal negotiations between Mr. Churchill and Marshal Stalin, an Anglo-American team of armament experts left London two days later *en route* for Moscow and Blizna, to see whether the remaining questions about the A4 – its "radio-control system," its fuel components, its maximum range, and its manufacturing sources – could be answered.

While they waited for visas, the search for giant "lemon squeezers" began. It did not last long. Dr. Jones, scrutinising for himself the Blizna photographs, concluded that they were, in fact, military bell tents surrounded by sandbags to prevent sniping. This was undoubtedly the correct solution: permanent accommodation at Blizna had been very scarce. The photographic interpreters had erred again.

Jones produced a justifiably frivolous "Air Scientific Intelligence: Tentative Report," which he sent down to RAF Medmenham for the Wing Commander's office. The report had no words, only a cartoon showing a 50-foot A4 rocket perched precariously atop a bell tent, and three puzzled German soldiers reading BS 780, the CIU's "lemon squeezer" report.

In a covering letter Jones reminded the Wing Commander of his protest to the Air Staff about the dangers of amateur photographic interpretation. If the officer would care to study his attached "report," he would find that Jones was in broad agreement with him.

A GERMAN ROCKET bombardment was not now anticipated before

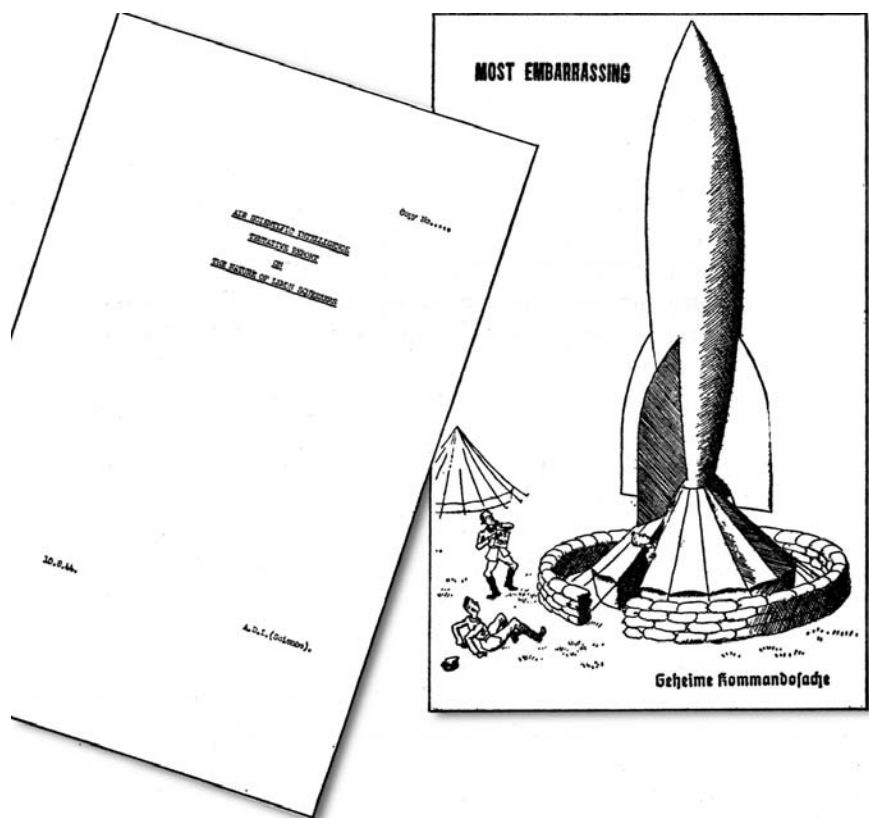

September, on the evidence of “most secret sources,” but preparations were made during the first half of August. On August 5 the bombing of liquid-oxygen factories and of radio-beam transmitters was recommended. Elderly Flying Fortresses were packed with tons of high explosive or napalm and hurled at the Mimoyecques, Siracourt, Watten and Wizernes bunkers. Watten was again attacked like this on the 6th.

The Farnborough experts had swiftly observed the traces of the control receiver among the Swedish fragments, and especially the elaborate anti-jamming device, involving a complex series of audio-filters selected by a code plug offering nearly five million combinations.

Nevertheless, Sir Robert Watson Watt initiated plans for the expenditure of considerable effort on an airborne jamming system to commence at the end of September, and on a parallel ground organisation for the following month. It was unknown what frequencies the Germans were using at Peenemünde; as he informed the *Crossbow* Committee on 18th August, all listening facilities in Sweden had been denied to British Intelligence for nine months.

(v)

Evidence continued to reach London of an imminent rocket offensive. As the Allied armies broke out of their Normandy beach-head, a quantity of documentary material was captured showing the thoroughness with which the rocket organisation was planned.

Near Caen, troops captured plans of one of the main A4 rocket storage dumps at Hautmesnil; the plans showed elaborate underground galleries served by narrow-gauge railways.

On one branch of the railway system a scale diagram of an A4 rocket, with dimensions, had been sketched in, resting on two trolleys; a second plan showed the location of a number of other smaller sites in Normandy. Soon afterwards, a full-scale white-painted dummy rocket was captured resting on two trolleys at a storage site. Lord Cherwell was not informed and the rocket dispute was thus spared an unusual eleventh-hour twist.

By August 10, when the *Crossbow* Committee met in the underground Cabinet War Room, the Intelligence picture seemed complete. Dr. Jones reported that *Enigma* intercepts showed the Germans shipping 1-ton "elephants" to the Blizna range; he believed these were the rockets' warheads.

Lord Cherwell was at first mildly sceptical. He said that examination of the rocket remains made it clear that the weapon had been considerably modified: he thought that the enemy had originally hoped to produce a much larger rocket. He thought Jones had gone

too far and was making the rocket's warhead too small. Soon after this meeting Jones was surprised by a telephone call from the Prof, trying to persuade him to retract. "They are just waiting for you to make one mistake," Cherwell told him. "This time, if you persist in putting the weight so low, I think you will have made it."

A few days later Lord Cherwell saw the costly Swedish fragments at Farnborough himself. The reconstruction of the rocket was now well in hand; his conversion was complete. In a letter to Mr. Churchill on the 15th he sought to vindicate his stand over the past sixteen months:

When it is remembered that each rocket carries a 1,000-horse-power turbine driving two compressors, a most elaborate fuel and cooling system, at least two gyros working servo-motors to control vanes in the jet and on the fins, two radio transmitters and three receivers, etc. – and all that for the sake of bringing about the same warhead to London as does a flying bomb – Hitler would, I think, be justified in sending to a concentration camp whoever advised him to persist in such a project.

The Prof's exasperation was understandable. Small was the wonder that the German A4 rocket had stubbornly defeated attempts at detection by any logical processes of analysis.

COLONEL T. R. B. SANDERS'S Blizna mission reached Teheran on July 31; here no visas for Moscow were forthcoming. Only on August 7 were they granted, then the Russians failed to provide a plane. Anthony Eden cabled the embassy in Moscow to express the serious concern of the Foreign Office at the delay, as he had hoped that Marshal Stalin's personal interest in the mission would have facilitated the Soviet authorities in issuing the necessary instructions. This seems to have worked. On the following day the Foreign Office was able to instruct Sanders to prepare to fly his mission to Moscow at once.

There top-level discussions between Sanders and the Soviet General

Staff were of no avail; the Russians insisted that Blizna was still in German hands. Nor would they hear of the mission's inspecting the target areas in Poland in advance. By the 19th Sanders knew that they had been tricked: Blizna had fallen to the Russians over two weeks before.

Not until September 2 did the Russians permit the party to fly to Blizna. By then their investigation had lost much of its meaning.

JONES ANALYSED the available evidence on the rocket offensive. "Weak evidence," he reported towards the end of August, "indicates a total stock of about 2,000 [rockets] and current production averaging about 500 per month." By a "dangerous extrapolation" of the planned rocket storage capacity in France, and even of the distribution of *dummy* rocket sites, he summarised that the actual scale of attack would lie between 500 and 1,500 monthly, "with the most weight about 800."

In this, Dr. Jones's last report on the German rocket threat, he recalled how Intelligence had been forced to enter a fantasy world where romance had replaced economy. Why had the Germans expended years of intensive research, an elaborate radio control, and tons of costly fuel to throw at London a warhead not much larger than that already carried far more cheaply by the flying bomb? To him, the answer seemed obvious: no other weapon had produced a comparable "romantic appeal." Here was a 13-ton missile which traced out a flaming ascent to heights hitherto beyond the reach of man, and hurled itself 200 miles at unparalleled speeds across the stratosphere, to descend upon its defenceless target.

What did it matter that the German Air Force was doing the same damage much more cheaply? The Army's rocket was a fantastic technical achievement which had captured the imagination of the Nazis. There was surely no deeper policy behind the rocket.

With this report, Dr. R. V. Jones "retired from the fray," as he later put it. His exit was as fraught with controversy as was his introduction, for he had not resisted the urge to append an epilogue written with more than a trace of Cherwellian venom. It seemed to him that some

Allied officers had raised the alarm before there was enough evidence to gauge the magnitude of the threat. The Intelligence situations where the Germans had succeeded in developing some new weapon, while the British had either failed or not tried, was the most dangerous: it was difficult to overcome the prejudice that, if we had not done something, it was either impossible or foolish. When interpreting insufficient facts, he concluded, Intelligence officers should not be frightened by their own ingenious imaginations.

This Intelligence report was widely circulated on August 27. Two days later, it was recalled after a tempestuous COS meeting, but not before it had been avidly read from cover to cover. Sir Charles Portal had bowed to the wishes of Mr. Sandys, who strongly dissented from Dr. Jones's view that the Allied land advances might drive the Germans to use the rocket very soon, if ineffectively.*

Copy No. 1 must, in fact, have reached Mr. Churchill, for he quoted some of its less provocative conclusions in his memoirs; and the copy which reached Fighter Command at Stanmore gave Hill's officers their first real glimpse of what might lie in store for London.

On August 24, Anti-Aircraft Command proposed that when the rocket attack began a fixed artillery barrage should be put up, so as to interpose a curtain of shrapnel fragments in the radar-predicted path of the falling missile, causing its warhead to burst in the air.

The plan was discussed at very high level on the following day, but it became evident that rather over 320,000 AA shells would have to be fired to destroy one A4 rocket in this way. And, as up to two per cent of the shells fired would fall back on London without exploding,

* In April 1945, long after the last rockets had fallen, Dr. Jones pressed for the ban on his perspicacious report to be lifted. Sir Charles Portal refused. To rescind the report's suppression, the Air Staff explained, would necessitate referring the matter to the Chiefs of Staff Committee "and others who were present" at their meeting of August 29, 1944, when the decision to suppress it had been noted.

considerably more suffering would be caused by the defences than by the rockets themselves. The plan was abandoned.

In the event, the swift advance of the Allied armies through France seemed to remove the prospect of any rocket attack. As the German rocket appeared to have a limiting range of about 200 miles, Air Intelligence believed that this threat would disappear if the area in Northern France and Belgium within 200 miles were neutralised by the proximity of Allied land and air forces.

At first it seemed that this view was correct.

The last ground-launched flying bomb from France reached England on the afternoon of September 1. On the same day, Civil Defence halted planning for rocket attack. On the 3rd, all air commanders were informed that offensive counter-measures were to be suspended, and Air Marshal Hill was obliged to discontinue his fighter squadrons' patrols next day.

On September 5 Sir Charles Portal advised that the attack of rocket storage depots and transportation systems could be abandoned; on the following day the Vice-Chiefs confirmed that rocket attacks should present no further danger, as all rocket-launching sites were about to be overrun.

Hill believed that Western Holland still presented a viable A4 launching-zone; the rocket's known range was, after all, 200 miles. Notwithstanding these doubts, on September 7 Herbert Morrison obtained Cabinet approval to suspend evacuation from London. It seemed that the war against the rocket was over before the attack had even begun.

"Except possibly for a few last shots," Mr. Duncan Sandys announced at a press conference that evening, "the Battle of London is over." Morrison made an even more uncompromising announcement.

At 6:38 next evening German rocket troops stationed in Western Holland launched the first of over 1,000 A4 rockets that were to fall on British soil.

(VI)

Adolf Hitler had still hoped to mount a rocket attack on the United Kingdom from a number of Heinemann's prepared launching sites north of the Somme, using primarily 836 (Mobile) Artillery Battalion for that purpose.

During the last week in August the Allied advance dispelled these hopes. On the 29th the Führer conceded that a rocket attack might now be mounted against London and Paris from an area between Ghent and Tournai, in Belgium; but within twenty-four hours the launching-zone had to be moved still farther to the east.

MAJOR-GENERAL DORNBERGER had at last mastered the air-burst problem.

The British Intelligence service had become aware of this basic weakness in the A4's design. Polish agents had reported early in August that of nineteen rockets fired in one series, seventeen had exploded "many thousands of feet in the air"; on one day when the Germans had succeeded in launching seven rockets they found the impact of only one.

When Dornberger had removed his rocket-testing station from Blizna to the "*Heidekraut*" camp at Tuchel in late July, the air-burst problem had still hung heavily over the test programme.

The first A4s fired from Tuchel by the two units remaining there – SS Mortar Battery 500 and No.1 battery of 836 (Mobile) Artillery Battalion – were of a new construction: Dornberger's engineers had begun to suspect that the fuel tank was being fractured by the heat and vibration.

Round the outer skin of the fuel-tank section the Nordhausen factory was now riveting steel reinforcing sleeves. The payload was reduced, of course, but its reliability was greatly improved. At the end of August a new test series of eighty "sleeved" rockets began at Tuchel.

Their success suggested that the rocket engineers had exorcised the A4's last demon.*

Thus by the end of August 1944 the most persistent fault had been largely eliminated: a second rocket battalion, number 485, was trained and operational. The struggle for ultimate control intensified.

When in July 1944 the Corps had pressed for clarification of the command structure they were made to realise that the Army Weapons Office intended Dornberger to direct the opening offensive himself. The Sixty-Fifth Army Corps, and one suspects its volatile Chief of Staff Colonel Walter in particular, protested vigorously. Lieutenant-General Metz had been specially recalled from the Eastern Front six months before to prepare this offensive, while Dornberger, on the other hand, was a chairbound staff officer lacking any experience of active service and "totally unsuited" to the task.

On the last night of August a decision was forced by the actions of the SS. An agitated Colonel Walter telephoned the High Command that he had learned that the SS Lieutenant-General Kammler was calling a meeting in Brussels that night, that the opening of the rocket attack was on the agenda, and that Major-General Dornberger was to be present. It seemed that Metz was being totally by-passed.

Only now did the High Command make up its mind. It telephoned that the attack was to be directed solely by the Corps, and that Kammler had nothing to do with the rocket. As for Dornberger, he was an officer entrusted solely with the rocket's development and trials.

With this tardy resolution in his briefcase, Walter sped to Brussels. Here, to his chagrin, he encountered not only Kammler and Dornberger, but Metz as well. Kammler was issuing a stream of instructions – rocket-launching batteries had to be moved up, sites occupied and

* In late November 1944, Lieutenant-General Kammler directed that only sleeved rockets were to be manufactured henceforth at Nordhausen. Air bursts steadily declined and, of the last 200 rocket "incidents" reported in London up to March 23, 1945, only twenty-three burst in mid-air.

supplies ensured. Turning in an unguarded moment to Colonel Walter, he gave the latter a chance to recover control. The Chief of Staff of the Sixty-Fifth Army Corps read out the High Command's decision: he stressed the purely local duties of Dornberger, the complete irrelevance of Kammler, and the responsibilities of Metz to the Corps.

Kammler blustered that he would be getting further instructions from Himmler. Walter, he added menacingly, would be well advised to report similarly to the High Command for confirmation.

One can only speculate on events at the Führer's headquarters during the next two days. Jodl's staff decided to postpone the rocket attack; on September 2 Colonel Walter was told that Kammler would then be in command. The Corps would brief him on the land battle and would retain responsibility for the outcome of the attack. Walter queried whether Kammler was therefore subordinated to his Corps; the answer was that he was not.

Thus the SS was finally in control.

TWO DAYS after the fall of Brussels, on the 5th, Kammler ordered his rocket troops to deploy in readiness to open the attack next day. "Group North," comprising the first and second batteries of 485 (Mobile) Artillery Battalion, moved westwards to an area near The Hague; and "Group South," embodying the second and third batteries of 836 (Mobile) Artillery Battalion and the long-established 444 Battery, was directed from the Rhineland to Euskirchen.

Early on the morning of September 6, 444 Battery prepared to launch two A4 rockets against Paris. Eight tons of alcohol and liquid oxygen were pumped in, the white vapour drifting away from the missiles and hoar frost forming around their sterns. At ten-thirty the countdown for the first rocket, No. 18,589, was complete.

The launching troops watched the camouflaged projectile lift slowly off its firing table, the rocket motor howling, the blast stripping the surrounding trees and churning up whirlwinds of dust and debris.

At once, the engine cut.

The giant rocket crumpled heavily back on to the firing-table, tottered, but stayed upright, its graphite gas-vanes gleaming red-hot between the rocket's fins. Captain Kleiber of the technical battery ordered the rocket defuelled at once.

At twenty minutes to noon the second rocket, No. 18,593, was fired. The anguished Kleiber saw it repeat in every detail the performance of its predecessor. Two days passed while post-mortems were carried out; faulty integrating accelerometers had been responsible, prematurely cutting off the fuel flow.

Germany's vast A4 rocket project had opened with a fiasco whose only redemption lay in its totality: the element of surprise was still not lost.

(VII)

The Sanders mission reached Blizna only on the evening of September 3. Heavy fighting was still going on five miles to the south, but the experimental station, with its empty workshops, long runs of narrow-gauge railway and rocket-firing sites, was windswept and deserted.

Local inhabitants described how the rockets had risen remarkably slowly from the forest, "as though being pushed up by men with poles." The rockets had rapidly gathered speed, to disappear from sight or to return abruptly and explode. The mission investigated ten rocket craters within five miles of the station, and recovered 1½ tons of material including a complete steel burner unit, the framework for a radio compartment, and a rear fin significantly providing for a wireless aerial. Of great importance was a forward fuel tank whose capacity was estimated at 175 cubic feet – sufficient to contain 3,900 kilogrammes of alcohol.

The rocket's fuel was alcohol. Poles who reached rocket crashes detected its strong sweet smell. As a German soldier had maliciously said the fuel was good to drink, the Poles had tried to open the com-

pressed-nitrogen bottles, believing them to contain the alcohol. As for the other liquid, Polish eyewitnesses described frosted railway wagons arriving at Blizna, and a peasant found one rocket's wreckage covered with frost and "his feet froze to the ground."

Geoffrey Gollin, chief assistant to Engineer Lubbock, applied the standard Intelligence method of putting himself in the enemy's position. In the field latrines, in a pit which had been fouled by the Russian militia no less than by the German troops, he found a portion of a rocket test sheet. It referred to one fuel liquid as O₂ (oxygen) and the other as *B-Staff*, of which the rocket's load was given as 3,900 kilogrammes – i.e., exactly the capacity of the fuel tank found if the fuel was alcohol.

On September 22 the mission left Moscow for home. Much of their information had been superseded by the fall of the first A4s on London. The rocket specimens which they had crated up in Blizna for shipment to London and Washington were last seen in Moscow; when opened at the Air Ministry in London the crates were found to contain several tons of old and highly familiar aircraft parts.

The rocket specimens themselves had vanished into the maw of the Soviet machine.

(VIII)

A sound like a clap of thunder heralded the arrival of the first A4. At 6:43 P.M. on September 8 the first rocket fell at Chiswick, killing three Londoners and seriously injuring seventeen more.

The typical supersonic double-crack was heard very loud all over the capital.

In different parts of the city, Duncan Sandys and Dr. Jones looked up and exclaimed, "That was a rocket!"

Sixteen seconds later a second rocket fell harmlessly near Epping. A short while after both incidents the sky was filled with the sound of a heavy body rushing through the air.

Mr. Sandys telephoned Civil Defence and hastened by car to the scene. Early next morning Jones also arrived to inspect the 30-foot crater torn in the concrete road. Six houses had been destroyed, and a large number of others severely damaged. Neither rocket had left a radar trace to indicate its provenance.

Lord Cherwell was out of London, having left Britain with Mr. Churchill two days before for Québec. From No. 10 Downing Street he received a personal description of the event:

I was showing a visitor out, and when I got to the door the policeman and guards were saying: "Was that thunder?" and another said: "It sounded like bombs." When I got back I found Room 59 had heard two explosions close together, one slightly fainter than the other, but both loud, and were wondering what they were. The Bishop of London told me yesterday that when he heard the explosion he thought the doodlebugs had started again; but he heard it was a gas main. One of the drivers heard the same story.

Lord Cherwell's London informant added the malignant postscript: "There is going to be criticism of Morrison and Sandys for having Crowed too soon. I thought the above might amuse you."

By all accounts, the Prof was amused. The smallness of the warhead and the paucity of the attack were going far to justify his stand throughout the whole controversy. Those who had gloomily prophesied the advent of 80-ton rockets now stood confounded.

The rockets had been fired by two batteries stationed just to the north-east of The Hague, some 200 miles from London. After its abortive attempt at firing rockets at Paris on the 6th, Kammler's 444 Battery had finally succeeded in firing a rocket at Paris at 7:28 A.M. on the morning of the attack on London. The battery was then forced to withdraw to Walcheren island by the Allied advance.

By September 12 only nine rockets had arrived in England, of which one, hitting the Chrysler factory in Kew that morning, had caused

serious damage. More accurate sound ranging and radar plotting now indicated The Hague as the launching area, and an agent had reported the firing of a rocket from a site near the Hague-Wassenaar road, a region known to have been evacuated of civilians. Flash and vapour-trail spotting confirmed these reports, and in the following days suggested that rockets were also being fired from Walcheren island and from a racecourse to the north of The Hague.

The future was indeterminate. On the 10th the Cabinet had asked General Montgomery to estimate when the remaining area of Holland within A4 range of London would be liberated. After some hesitation, he replied that the projected airborne landings at Arnhem, if successful, would cut off the rocket troops from their supplies.

Thus assured, the Cabinet adopted a calmer approach to the rocket threat than was justified; they decided to make no comment on the explosions, which had aroused considerable public interest. The “gas main” rumours were not denied. Herbert Morrison’s department put out vague warnings of “possible danger” but these failed to discourage evacuees who had decided to return to London after the optimistic official statements some days before, and London’s population began to rise by 10,000 a week. (By August 23, 1,450,000 Londoners had abandoned the capital.)

The danger certainly seemed slight. By September 18 only twenty-five rockets had reached England, of which fifteen hit London and claimed fifty-six lives. Allied fighter aircraft flew 1,000 sorties during these first few days to strafe suspected launching sites, personnel and vehicles, and to attack every kind of communication. Kammler’s troops had expended only fifty-six rockets in the west, before withdrawing from The Hague to Germany and from Walcheren island to Zwolle.

Whether this low rate of fire was because of supply or technical difficulties is not known. Hitler, delighted that his second revenge weapon – promptly dubbed V-2 in official circles – was at last in operation, summoned Speer to his headquarters to discuss A4 rocket production. Officially his directive of June 1944 restricting rocket

output was still in effect. Central Works had, in fact, produced only 132 acceptable A4s in June and eighty-six in July, out of a planned capacity of 900 monthly, while German flying-bomb (V-1) capacity had increased to around 3,000.

With Colonel Wachtel's enforced withdrawal from France at the end of August, Hitler knew that only the A4 could still strike at London. Central Works production had begun to rise in August, when 374 A4s were produced; but the continuous stream of modifications first from Blizna, then from the new Tuchel proving ground, held back mass production.

The Führer considers [Speer recorded on September 23] that the resumption of A4 production at peak capacity – i.e., rapidly rising to nine hundred – is urgently necessary.

As far as V-1 production and its further stepping-up are concerned, the Führer directs that a minimum of one and a half million hand grenades and fifty thousand rounds of 21-centimetre trench-mortar ammunition must first of all be safeguarded.

Only those quantities of steel-sheet and high explosive that are surplus to these requirements may be used on V-1 manufacture; if need be, we must even expect a temporary drop in V-1 output.

Production capacity for a peak of nine thousand [flying bombs] is, however, to be left intact, so that if the military situation should require, production can be resumed with the shortest possible delay, assuming that the necessary steel and fuel supplies are on hand.

Germany's secret-weapons offensive had reached its crossroads. Area bombing had so reduced her manufacturing capacity that Germany could no longer proceed with two secret weapons, but only with one or the other. September's flying-bomb output reached 3,419; rocket production at last began to increase. That month the underground factory shipped out 629 A4s; in October the output was 628; in November it rose to 662.

The rocket in action was proving a fickle weapon.

When 485 (Mobile) Artillery Battalion opened fire at Continental targets on September 21, the first rocket suddenly lost power and crashed five miles away.

Next day, the symptoms were the same: the dying rocket crashed on its own launching table. Probably they had been stored too long in the damp. But on the 26th a rocket manufactured by Central Works only eleven days before wobbled upwards off its launching table so crazily that it blew the steel framework over and howled horizontally across Germany in the opposite direction to its target.

The anguished battery officer telephoned the range-control room and an emergency signal was telemetered to the missile, cutting off its engine. It crashed fourteen miles away. After a post-mortem, Captain Kleiber traced the trouble to a faulty servo in the D-plane.

Three more rockets fired that month failed because of faulty servos and leaking oxygen leads. General Kammler resolved to send a senior engineer to investigate “defects in manufacture found at the launching site.”

Kammler reopened the attack on the United Kingdom. 444 Battery, which had moved from Zwolle to Staveren, in Friesland, opened fire on Norwich on the evening of the 25th.

The first A4 of this new series fell, in fact, in Suffolk at 7:10 P.M.; an attempt by 444 Battery to launch another one and a half hours later failed, as the rocket exhaust burnt through the leads of the control servos.

Nevertheless, it now became apparent even to the most optimistic observer in London that the capital might well become the target of more than a “few last shots.” The airborne landing at Arnhem had failed.

When the Germans recognised that the British Second Army had also been checked, Kammler’s troops returned to The Hague to reinstate the attack on London. On October 3 the main assault on London began. The offensive against targets in East Anglia came quickly to an

end: on October 12 Hitler directed that rocket fire was to be concentrated solely on London and Antwerp.*

Rocket transports were now rushed direct from factory to launch pad. Of 266 rockets delivered in the last week of October, only fourteen misfired.

(IX)

Colonel Max Wachtel's flying-bomb regiment was shortly able to open a fierce attack on Continental targets. He had begun to withdraw launching sites in France in mid-August; the last bomb had been ground-launched at London on September 1. He then transported his equipment and troops to depots in Holland and Germany. The air-launching squadron sustained a desultory and perilous attack on London from airfields in Germany.

On September 14 Wachtel was ordered to prepare a new offensive aimed at the Mons-Brussels-Antwerp region. Three days later he was advised by Field-Marshal Model, the C-in-C West, to select a launching zone between the Ruhr and the Westerwald – in other words to the east of the Rhine. Model decided that Wachtel should set up thirty-two catapults in the Sauerland and Northern Westerwald, oriented only on Brussels and Antwerp. Like the "ski" sites, however, these catapults were never used; they would probably have endangered German towns more than the enemy. Meanwhile Wachtel sent two batteries to the Eifel, where eight sites had long been under construction, and it was from these that he eventually reopened his attack.

Seeing that the V-1 was reviving, Kammler made a determined effort to take over this as well. Reichsminister Speer saw Hitler about this bid on October 12 and afterwards observed that "the Führer does

*During 1944 General Kammler directed his versatile weapons at thirteen cities other than London and Antwerp: Norwich (43 rockets); Liège (27); Lille (25); Paris (19); Tourcoing (19); Maastricht (19); Hasselt (13); Tournai (9); Arras (6). Cambrai (4); Mons (3); Diest (2); and Ipswich (1).

not concur with the plan for Kammler to take over the flying-bomb offensive in addition; it has been run perfectly satisfactorily under its present leadership.”

On the same day Hitler ordered Kammler to bring the rocket fire to bear solely upon London and Antwerp. This latter target had been foreseen with some trepidation by Sir Alan Brooke, the Chief of Imperial General Staff, ten days earlier, when he had suggested that the sprawling Belgian port might well become the main target.

Colonel Wachtel opened fire on Brussels on October 21; fifty-five bombs in all were fired at the city before he switched the attack to Antwerp.

V-1 production was also put underground. Production was to be increased to 9,000 monthly by December. At an Air Staff conference on October 23 the Central Works was awarded a contract for 19,500 V-1s, to be delivered at the rate of 3,000 monthly from November 1944 onwards, reducing to 1,500 monthly in April, May and June 1945; in June 1945, V-1 production at Central Works was apparently planned to cease.

In mid-October, Colonel Wachtel was ordered to attack Belgian targets from closer quarters, in Central Holland; the regiment was re-formed into eight firing batteries, in three smaller detachments than before; one of these detachments was sent to Holland. “The regiment,” Wachtel warned, “is of the view that the V-1 is of use only as an instrument of terror, and not for attacking military objectives.” Notwithstanding these protests, the High Command operational staff ordered an increase in the scale of bombardment of Antwerp in early November.

The Allies could not ignore the increased attack on Antwerp. The Chiefs of Staff met on November 8 to discuss the rocket and flying-bomb campaigns, both of which were still causing some concern. “I am afraid,” the Chief of Imperial General Staff wrote that night, “that both are likely to interfere with the working of the Antwerp harbour – a matter of the greatest importance in the future.”

By this time Hitler was already deliberating on his last desperate offensive aimed at recapturing Antwerp, and with it an Aladdin's Cave of Allied munitions, planned for mid-December.

* * *

By November 20 some 210 A4 rockets had reached England, of which ninety-six had hit London; 456 people had now been killed by the rocket attack, which meant that the number of deaths per "incident" – nearly four – was double that for the flying bomb.

On the 23rd Sandys told the War Cabinet, "All efforts to interfere with the rocket's radio-control mechanism have so far proved fruitless." The launching sites were so mobile and easily concealed as to offer wholly unprofitable bombing targets. The most that could be attempted was to harass the enemy's transport and communications in and around the launching area.

On November 25 a rocket hit a crowded Woolworth's store in Deptford, killing 160 people. Incidents like these continued to warrant the most rigorous counter-measures that could be devised. By that date the Second Tactical Air Force had flown 10,000 sorties and Fighter Command a further 600, attacking German transport between The Hague and Leiden, and near the Hook of Holland.

German records show that at least two trainloads of rockets (dispatched from Central Works on November 21 and 25) were damaged by "enemy action" and "machine-gun fire" and had to be returned for scrapping.

The most effective counter-measures remaining to the Allies were seriously mitigated by the danger of loss of life among Dutch civilians. During the first three weeks of November the number of rockets reaching the capital totalled twelve, fifteen and twenty-seven. On the 17th Air Marshal Hill recommended that – with the consent of the Dutch civil authorities – the suspected launch sites in The Hague should be very carefully attacked.

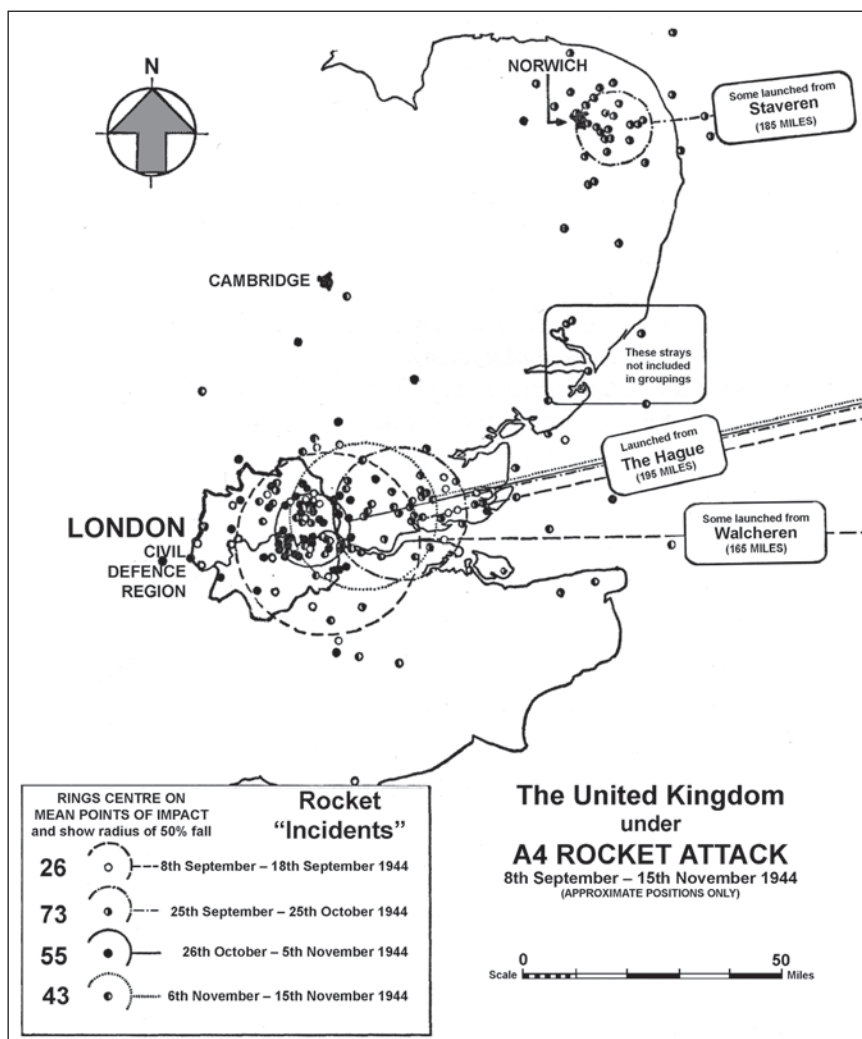

THE DEVELOPING A4 ROCKET ATTACK ON LONDON

This chart of Southern England shows the fall of all rockets recorded between September 8 and November 15, 1944: it is clear that the weapon was – at the time of its introduction – unsuitable even for attacking targets as large as London. The attack on Norwich at the end of September was, as the smallness of the 50-percent accuracy ring shows, considerably more concentrated than the attack on London. Even so, no rockets hit Norwich proper.

The subsequent decline in the attack on London was not entirely the result of this tragic phase, however, for in the early hours of December 16 Adolf Hitler had launched his last great offensive in the West: the weight of Germany's entire long-range bombardment potential was being brought to bear on his goal, Antwerp.

(x)

At 5 A.M. on December 16, 1944 Colonel Wachtel's new flying-bomb sites in Central Holland opened fire for the first time, catapulting a salvo of seven bombs at Antwerp. He fully underwrote the new German offensive, for in it he believed he saw his last chance to regain territory from which he could reinstate his assault on London, which he saw as the main duty of his regiment. Wachtel's other launching sites continued to fire at both Antwerp and Liège; during the last ten days of 1944 his troops, firing from eighteen catapults, launched 1,488 flying bombs, half aimed at Antwerp. This scale of attack, delivered from only one-third of the sites available for the June attack on London, shows how far his regiment had been hampered then by the Allied air offensive against its supply lines. Now his firing sites were hardly molested and his flying-bomb supplies arrived unhindered. London was being engaged at present only by the air-launched flying bombs; of the 650 estimated to have been air-launched by November 23 – so Sandys told the Cabinet that day, only about fifty had reached Greater London; and thirteen of the Heinkel launching aircraft had come to untimely ends over the North Sea, thanks to the intervention of the Royal Air Force.

Now that the V-1 attack had switched to Antwerp, the defensive counter-measures seemed – to the Germans at least – to be purely for show. Colonel Wachtel in particular was suspicious:

If one compares the scale of the enemy defences during our offensive against England with those of our second phase, one is compelled to wonder whether in fact the enemy could care less about our bombard-

ment of Belgium. If in spite of that they have put up a show of defending themselves, then it has clearly been only to humbug the German Government into thinking that the bombs have done something; who can blame them for that? For every flying bomb launched at Belgium is one less to fire at London.

The fate of the Belgian targets was in truth appalling, and far in excess of the petty terrorism of the opening stages of the attack on London six months before.

In Antwerp alone a hail of V-weapons wrecked the city, and in the words of an American post-war analysis “severely retarded the clearing of the port and the unloading of supplies.” By the end of 1944 General Kammler had launched 924 A4 rockets at the port (compared with 447 aimed at London during the same period). On the very first day of the Ardennes offensive, a single rocket hitting the crowded Rex Cinema near the main station killed 271 people. The immense improvement in the V-2’s accuracy came from a new guiding beam device, and from the Buchhold electrolytic integrating accelerometer, similar to modern airline navigating computers; it gave a theoretical target radius of one mile.

London’s respite was short-lived.* In the New Year the scale of attack was stepped up. While from the December 20 to 27 only six rockets had reached the capital, in the next two weeks the arrivals

* According to a German source, 1,561 A4s were fired operationally by Kammler’s troops up to December 31, 1944, including 924 at Antwerp and 447 at London.

	Rockets serviced	Rockets rejected	Rockets launched	Rockets misfired
December 1944				
Groups North and South	625	87 (12.3%)	539 (86%)	44 (7%)
January 1945				
Group North	551	91 (16.5%)	460 (83.5%)	56 (12.2%)
Group South	128	14 (11%)	114 (89%)	14 (12.2%)
February 1945				
Group North	415	20 (5%)	395 (95%)	41 (10.4%)
Group South	137	4 (3%)	133 (97%)	14 (10%)

had bounded to twelve and thirty-seven. Even this was not as many as Kammler had wanted.

Hill was invited by the Air Ministry to consider attacking three liquid-oxygen factories in Holland, although Sir Archibald Sinclair admitted, "the evidence for the origin of the liquid oxygen actually used for the rockets directed against this country is still unsatisfactory." Hill was also pressed to intensify his efforts against firing and storage areas.

On January 26 the Defence Committee, oppressed now by the fearful prospect of an A4 rocket penetrating one of the several London Underground railway tunnels beneath the Thames with consequent heavy loss of life, asked Eisenhower to sanction precision attacks by light-bomber forces on rocket targets. Bomber Command was reluctant to become embroiled in a repetition of the costly offensive against the flying-bomb organisation of the year before.

THE LONG-RANGE bombardment of England came to an end of its own accord. There were some who even said that the Royal Air Force had done nothing to diminish the attack. A final flying-bomb offensive was mounted against London from three catapults in Western Holland early in March, and 275 V-1s of lighter construction and longer range were launched at the capital before Wachtel was forced to withdraw on March 29. On that day, the 2,419th flying bomb reached London since the beginning of the offensive in June 1944; to achieve this the Germans had had to launch no fewer than 10,492 bombs at that target.

Kammler's last rocket troops were equally forced to withdraw from Holland. At 7:20 on the morning of March 27, a single A4 rocket fell on a block of flats in Stepney, killing over 130 people – a final cruel blow in London's bloody struggle against Hitler. The last rocket of the war fell to earth some hours later in suburban Orpington. A total of 517 rockets had fallen on London, and 1,265 on Antwerp; a further 537 had fallen elsewhere in Britain and sixty-one off its shores. Rather over 2,700 civilians had died in London from the rocket attack, and

over 6,000 more from the flying bombs.

Two hundred thousand Germans and foreign forced labourers had been working actively to this end since the beginning of 1943.

To what effect, it must now be asked.

PART EIGHT

ACCOUNT DUE

“In future, the possession of superiority in long-distance rocket artillery may well count for as much as superiority in naval or air power. The Americans have already embarked upon an ambitious programme of development and there are signs that the Russians are also impressed with the potentialities of this new technique. If Great Britain is not to risk falling behind other nations in this vital sphere, high-grade scientific and engineering staff, together with extensive research facilities, will have to be provided and maintained as a permanent part of our peacetime military organisation.”

— MR. DUNCAN SANDYS, *November 23, 1944.*

“Although rockets may play a considerable tactical role as long-range barrage artillery behind the lines at twenty, thirty or even fifty miles, I am very doubtful of their strategic value. It seems likely that it will always be possible to deliver the same quantity of explosive much more economically and accurately from aircraft than with rockets, and without anything like the same limitations of range.”

— LORD CHERWELL, *December 5, 1944.*

PART EIGHT

Account Due

(1)

ON MARCH 24, 1945, as Mr. Winston Churchill stood watching the Allied armies pouring across the Rhine, the tireless Albert Speer was in a darkened coal-mine, far below the imperilled Ruhr industrial area, chatting with the miners.

To my distress [the Reich Munitions Minister later recalled] I found that their confidence in their future, and their belief that we should be able to throw the enemy out of our country, were quite unshaken. It was distressing to me to see how utterly the people had been misled by a mendacious propaganda.

Only the propaganda about the imminent split among the United Nations, and about wonder-weapons still to come, had hardened the workers' powers of resistance.

Both secret weapons were by that date all but spent. Neither had succeeded in its primary objects – breaking of the Allied air “terror” in Germany and luring the enemy into a disastrous invasion of the Pas de Calais. The long-range gun battery at Mimoyecques (V-3) had never opened fire; and when the Swedes announced late in January that they had in their hands a Professor Hartmann who was claiming

to be the inventor of V-4, Hitler said with a chuckle: “They are dealing not with a *V-Mann* [agent] but with an *S-Mann* – a swindler.”

Neither the Peenemünde A9 nor the A10 became operational. The former, a winged version of the V-2 rocket, was designed to bounce off the atmosphere on re-entry and glide to targets as far away as Northern England. It was first successfully launched on January 24, 1945, but the evacuation of Peenemünde prevented any further work on it. Planning of the A9/A10 monster rocket weighing over 100 tons, incorporating either the A4 or the A9 as a second stage, and planned to ascend 230 miles into the stratosphere to reach Washington and New York, never passed the drawing-board stage.

SS General Kammler’s influence had expanded month by month: at the end of November Hitler had agreed to his taking control of certain surface-to-air missile projects, and on January 31, 1945 Hitler had directed that the entire V-1 and V-2 offensive was to be unified under Kammler’s command. Kammler was thus by the end of the secret-weapons campaign in sole command of all Germany’s most promising developments; it certainly seemed a remarkable career for an SS construction engineer (but comparable, it can be noted, in every way with that of the US engineer, General L. R. Groves, who started by building the Pentagon and ended in control of the US atomic bomb project).

Peenemünde itself was evacuated late in February 1945, and 4,000 of the staff of “Electromechanical Works Ltd.” and several train- and barge-loads of equipment were moved to the Harz mountains, where Hitler was planning a last stand. The rocket scientists were dispersed around Bleicheröde, a village twelve miles from Central Works. Here a 2,000-foot-deep potash mine was selected for the main research centre. Under Kammler’s direction plans were laid to drive ten miles of galleries, chambers and tunnels to another potash mine at Neubleicheröde. At the same time, work was pressed ahead on three new factories under the Kohnstein mountain at Nordhausen, besides the Central Works rocket plant and the Junkers jet-engine factory (“Northern

Works”). A large liquid-oxygen factory and a second Junkers factory were under construction, and – rather more slowly – an oil refinery called the “Cuckoo” project. At nearby Woffleben, Kammler’s convicts had blasted out a further network of caves to house a Henschel missile factory where *Hs.117*, *Hs.298*, *X4* and *X7* projectiles could be produced.

Of all these installations, those at Bleicheröde were the most startling. The whole subterranean complex would have housed factories for the pilot production of A4 rockets and *Wasserfall* ground-to-air projectiles. In a slate quarry at Lehesten, two static test-rigs for rocket engines had been built on top of a sheer cliff face overhanging a 100-foot-deep slate-quarry, a magnificent naturally formed proving ground for the rockets manufactured by Central Works and the Bleicheröde factory-complex. A broad tunnel had been driven into the cliff face and at its end a cavern had been hollowed out to house both rocket troops and a main liquid-oxygen plant for testing rockets.

On April 5 the High Command directed that Nordhausen be held at all costs, and commissioned Kammler with its defence; but with the overrunning of the Harz soon after, Hitler’s dream was destroyed. From Bleicheröde 450 former Peenemünde scientists including Dornberger, von Braun and Steinhoff were ordered to Oberammergau, where they scattered into the surrounding villages. Kammler seized all the Peenemünde documents and sealed them off in a mineshaft. On May 2, 1945 Dornberger, von Braun, and the 400 remaining scientists surrendered to the Americans at Garmisch-Partenkirchen. The story of Peenemünde was over.

ALBERT SPEER told American interrogators in May that it had been expected that the V-weapons would “make the British people war-weary, as we now and again got reports that their zest for battle had passed its peak.”

The high death-roll resulting when a crowd of Londoners panicked into an East End Underground station during a false alert had

been widely covered in the German press*; the hopes which had been coupled by the Germans to the flying-bomb offensive had been all the greater.

By January 10, 1945, even Adolf Hitler was compelled to admit: "The V-1, unfortunately, cannot win the war for us." His attitude to the V-2 rocket is illustrated by a snatch of conversation with Jodl (chief of the High Command's operational staff) on the previous day:

JODL: I have another dispatch from an agent in Antwerp to show you. He says that a V-2 hit the Rex Cinema on December 17 during a packed performance, killing one thousand one hundred people, including seven hundred servicemen. . .

HITLER: That would at last be the first successful shot. But I am sceptical by nature. It seems so fantastic that I still won't believe it. Which agent is that? Is he in the pay of the rocket-launching troops?

JODL: The agent has the remarkable name of Whisky. . .

HITLER: Hardly the best Crown witness!

Adolf Hitler had therefore lost faith in both flying bomb and rocket by early 1945. The German Air Staff were equally pessimistic.

(II)

Colonel Wachtel's flying-bomb offensive from June 12 to September 1 alone cost the Allies £47,635,190 in loss of production, in loss of

* This tragedy in what is now Bethnal Green Underground station may well have been uppermost in the minds of Mr. Herbert Morrison and others who at the time pressed for the sternest counter-measures to any sustained threat to London's fragile morale. At 8:40 P.M. on March 3, 1943, when the sirens sounded, a crowd of people stampeded into the half-finished station (which had been requisitioned as a shelter by the Government). A total of 175 people were killed, mostly by suffocation, and sixty more seriously injured at the foot of a short staircase. No bombs fell that night.

aircraft and crews, in extra AA and fighter defences, in the extra balloon barrage, in the clearance of material damage (but not permanent repairs), and in the massive *Crossbow* bombing offensive. To inflict this damage on the Allied war effort, the Germans had had to expend only an estimated £12,600,670 on the manufacture and launching of flying bombs and on the erection and defence of the launching-site systems. In a secret report circulated on November 4, 1944, the Air Ministry admitted:

The main conclusion is that the results of the campaign were greatly in the enemy's favour, the estimated ratio of our costs to his being nearly four to one.

The anti-personnel campaign was an even greater success for Wachtel, the exponent of "terror" bombing. Over this first flying-bomb phase, about 7,810 Allied citizens had lost their lives (including 1,950 airmen), compared with Wachtel's own casualties to his regiment of 185 dead from all causes up to February 1945.

During the war a total 30,000 to 32,000 flying bombs were produced by the various factories, arsenals and assembly plants. In addition to the main Volkswagen plant, a subsidiary VW factory at Magdeburg-Schönebeck ("*Elbe*") started assembly in June 1944, and a dispersed Fieseler factory in Upper Bavaria ("*Cham*") rather earlier.* Although this output was only about half what had originally been planned, the Germans had nevertheless performed a considerable feat with their flying bombs.

Early in November the Ministry of Housing estimated that permanent repairs to housing damaged by the secret weapons would cost £25,000,000. (For the second phase of the V-weapons campaign costs would have been rather less; attacks on launching sites were not on the same scale after September, and no production was lost from workers taking shelter.)

On the other hand, at the height of the rocket scare in the summer

of 1943 (as Cherwell afterwards maintained), the Cabinet had precipitately scrapped the plans for the construction of two battleships to provide the steel necessary for the accelerated Morrison shelter production programme.

The high blast of the flying bomb, about which Mr. Churchill wrote an exasperated minute to Sinclair in July 1944, wrought havoc in South London's suburbia; 20,000 houses were being damaged every day. In Croydon, three-quarters of the houses suffered; hundreds of buildings were damaged at each blow.

This was understandable, for a large proportion of the flying bombs were filled with 2,031 pounds of Trialen, giving nearly twice the blast power of conventional RDX-type fillings (of which the flying bomb could contain only 1,870 pounds). These Trialen versions were thus comparable to the 4,000-pound "blockbusters" dropped by Sir Arthur Harris's squadrons on Berlin. The casualties would have been much heavier but for one oversight in the weapon's design, which caused its sonorous motor to cut out at the moment of its dive. Thousands of lives were spared in the brief respite granted by this warning silence, as people dashed for immediate shelter.

* No overall table of flying-bomb production in Germany can be given, in view of the complexity of the production sources. The Volkswagen factory at Fallersleben produced parts for 2,000 V-1s in 1943, of which 1,900 were scrapped; it produced 13,000 to 14,000 in 1944-5. From the documents of Central Works Ltd., production at Nordhausen, "*Cham*" and "*Elbe*" in the last months of the war is known with some exactitude:

		<i>Nordhausen</i>	<i>Cham</i>	<i>Elbe</i>	<i>Total</i>
1944:	November	238	624	777	1,639
	December	1,161	720	573	2,454
1945:	January	1,401	480	44	1,925
	February	2,275	—	—	2,275
	March 1-16	831	—	—	831

This yields an overall total, for these plants only, of 9,124 flying bombs over this period.

(III)

We must now turn our attention to the sad story of the V-2 rocket. R. V. Jones had perceived correctly that the vast A4 project had been conceived not out of military expediency but to quench the innate German thirst for romanticism. By the summer of 1944 it was an extravagant irrelevance. The A4, costing some £12,000,* was inferior to any other form of bombardment; it was a very costly way of attacking small targets. Results up to late November suggested that at ranges of 200 miles, about 50 per cent fell within an eleven-mile radius of the aiming point. Of 230 rockets which reached the United Kingdom by December 28, 1944, only seventeen came within three miles of Charing Cross. It remains incomprehensible that a perceptive military economist like Speer should have permitted his country's resources to be poured into the A4 project.

Why did Speer devote more than half of the world's largest underground factory to Central Works' production of rockets, while the rest of the German armed forces were gasping for oil supplies, and while the Allies were pounding at Germany's fighter aircraft, ball-bearing, crankshaft, electric-motor, rubber and nitrogen factories, all vital bottleneck supplies without which the German war economy would – and eventually did – succumb? All had to wait upon the German rocket project. Only when the installation of "Central Works Ltd." at Nordhausen was complete did the tooling up in the same tunnel complexes of a jet-engine factory and an underground oil refinery begin. Speer had reversed the logically acceptable order of priorities, until a forlorn prestige project was allowed to sap the military economy

* Analysis indicates that the A4's average cost was about £6,320, which certain overheads would bring up to £12,000. The flying bomb's average cost was about £125. A summary of the reasoning is given in the Appendix.

Imp. Nr. 281/44 g. K/Ws 3037
Imp. Nr. 3/44 g. K/Ws

Oberkommando des Heeres
(Chef der Heeresrüstung und Befehlshaber des Ersatzheeres)

Wa Prüf 11
Nr: DE 12.0011-5565/43

Auftrag-Nr bei allen Schriftstücken stets angeben!
Einsendebriefe und Rechnungen sind in deutscher Anfertigung vorzulegen.
Bb.Nr. *A4 Nr. 143 g. K/Ws*

Firma
Mittelwerke G.m.b.H.
Berl in-Charlottenburg
Bismarckstr. 112

Ihre Zeichen
Kriegsauftrag
Es werden hiermit

K/H - R Sp II
Der Auftrag Nr 0011-5565/43 wird als Auftrag der Sonderstufe DE12 bestätigt.

Befehlshaber der Lager 600 Nebenkontrollstelle
I. V. *[Signature]*
Dienststelle

3143 *[Stamp]* Fernverkehr
Fernspeicher

Geheime Kommando

1. Dies ist ein Dienstgeheimnis im Sinne des § 3 des Gesetzes.
2. Nur von Hand zu Hand oder an persönliche Zustellern zu übergeben.
3. Beförderung möglichst durch Kurier oder Vertrauensperson; bei Beförderung unsere Wertangabe nicht mehr als 1000 RM.
4. Demotivierung jeder Art sowie Herstellung von Ausgüssen verboten.
5. Aufbewahrung unter Verantwortung des Empfängers im Hausverschloß, sonstorts im Schließfach mit Ausnahme.
6. Verstöße dagegen ziehen schwere Strafen nach sich.

Berlin W 34
Turipolster 72-76
9.10.43

in Auftrag gegeben:

Fertigungsbericht — nicht — erforderlich (Unzutreffendes streichen)
Die Angaben der nachstehenden Berichtzeile (Reichsbetriebs-Nr usw.) sind bei Weitergabe des Auftrages oder von Auftrags-teilen den Unterlieferanten genau und vollständig bekanntzugeben. Im Schriftverkehr genügt die Angabe der Auftrags-Nr.

Reichsbetriebs-Nr	Ru Nr	Auftraggeber (Dienststelle)	Bedarfs-Gr.	Auftrags Nr	HM Nr	Auftr
	03	Oberkommando des Heeres	<i>1437</i> <i>1434</i>	0011-5565/43	H	1
Reichswaren-Nr		Auftragssteuerungs-Nr. 1431/48				

Lfd. Nr	Menge	Gegenstand (einschl. Zeichnungs-Nr., Techn. Lieferbed.-Nr., Reichswaren-Nr.)	Einzelpreis je	Gesamtpreis
1.		Fertigung von 900 Geräten A4 je Monat bis zu einer Gesamtzahl von 12000 Stück ohne elektr. Inneneinrichtung, ohne Nutzlastspitze und ohne Verpackung.		
2.		Endmontage dieser 12000 Geräte einschließlich Inneneinrichtungen, Nutzlastspitze und Verpackung zum Richtpreis von: pro Stück	40000,-- RM	480000000,-

Auftragserteilung erfolgt vorbehaltlich einer nachträglichen Preisvereinbarung. Die LuÜ (Leistsätze für die Preisermittlung auf Grund der Selbstkosten bei Leistungen für öffentliche Auftraggeber vom 15.11.38) sind der Preisermittlung zu Grunde zu legen. Dementsprechend ist eine Auftragsbestätigung sofort einzusenden.

THE CONTRACT FOR 12,000 A4 ("V-2") ROCKETS

On this piece of paper, dated October 19, 1943, the German War Office ordered 12,000 A4 rockets from the underground Central Works factory at Nordhausen. The rocket's price, originally set at 40,000 Reichsmarks, was raised by mutual agreement one month later: the first thousand delivered cost RM.100,000 apiece; the price then reduced in stages to a minimum RM.50,000 apiece from the 5,001st delivered. Less than 6,000 of the 12,000 contracted for were ever produced.

of the most precious supplies, in a way that continued to interfere with Germany's other strategic requirements until January 1945, when V-weapons finally ceased to figure in Germany's priority schedules. Speer himself passed the buck to the German War Office: "It had become a *cause célèbre* for them to see the project through."

There is ample evidence that the A4 project critically invaded Germany's aircraft production capacity. The resulting shortage of electrical components from the summer of 1943 onwards crippled the fighter-aircraft industry, and interfered severely with both submarine and radar requirements. The operational liquid-oxygen requirements produced a bottleneck in the supply of this commodity.

Probably the most serious long-term effect was the embarrassment of the German anti-aircraft rocket programme, for Speer refused to countenance the extension of this in the autumn of 1944, unless the A4 programme was cut back to provide the necessary materials and components.* Speer's influence had, however, decreased, and although he protested that the A4 rocket was too much of a "luxury," Hitler had still issued orders for its production to be increased.

Upwards of 200,000 people were finally working on the rocket programme alone in Germany – on the production of the weapons and in the supply and firing organization – but by the end of the war fewer than 6,000 A4s had been manufactured, of which only about half had been operationally fired.

The record rate of fire achieved by SS General Kammler was thirty-three rockets launched on December 26, 1944. Of all the rockets launched, 1,115 reached the United Kingdom and 1,675 fell near Continental targets (where 88 per cent of them had been aimed at

* On January 1, 1945, 1,940 Peenemünde scientists were still working on the A4, 270 on the A9, 220 on *Wasserfall* and only 135 on *Taifun* (a small liquid-fuelled anti-aircraft rocket). Given Germany's desperate position then, Allied project directors would unquestionably have allocated their personnel in precisely the reverse order.

Antwerp). The climax in the attack was in January 1945, when 130 incidents had been reported during the first week, including nearly sixty in Britain.

OF THE TWO secret-weapon offensives, it is clear that the flying-bomb attacks fully justified the energy with which Lord Cherwell had pressed the investigation of this possible threat since the early summer of 1943. The much-feared long-range rocket proved a rather less awesome weapon, in fact, than Allied Intelligence had supposed it to be.

(IV)

As the secret-weapon attacks neared their end, Mr. Churchill minuted Sir Archibald Sinclair on March 28, 1945 complaining:

You have no grounds to claim that the Royal Air Force frustrated the attacks by the V-weapons. The RAF took their part, but in my opinion their effort ranks definitely below that of the anti-aircraft artillery, and still further below the achievements of the Army in cleaning out all the establishments in the Pas de Calais which so soon would have opened a new devastating attack upon us in spite of all the Air Force could do.

As to V-2, nothing has been done or can be done by the RAF. I thought it a pity to mar the glories of the Battle of Britain by trying to claim overweening credit in this business of the V-weapons. It only leads to scoffing comments by very large bodies of people.

This was perhaps among the least felicitous of the Prime Minister's long series of wartime minutes. To Sir Archibald Sinclair it certainly seemed – as he afterwards explained – that in view of the effect on British morale caused by the V-1 and V-2 attacks, “the arrival of fifteen tons of shells an hour on London [from the ‘high-pressure pump’] would have had very serious results on our war activities.”

IN RETROSPECT, it would seem that Mr. Churchill did less than justice to the Allied air forces, who had incidentally lost some 450 aircraft and 2,900 airmen in the offensive against the secret weapons. They delayed the opening of the flying-bomb and rocket attacks by about three and six months respectively. Embarrassed by component shortages caused by the RAF's general area bombing offensive, the production of neither weapon rose above half the originally planned level. Of the 60,000 V-1s originally demanded, fewer than 32,000 were ever produced. The RAF further reduced the scale of attack by bombing in France, and by destroying flying bombs on the wing.

The scale of both V-programmes was severely restricted by Bomber Command attacks. An illustration of this is contained in the minutes of a meeting called by Kammler late in November 1944. Directing that development programmes merely designed to refine the A4 rocket would not continue to receive priority, Kammler added: "Any measures designed to obviate raw-material bottlenecks are excluded from this regulation." In the margin Dornberger scribbled a sarcastic comment, "i.e., *all of them*," in Berlin slang.

The area bombing caused shortages in sheet steel production for flying bombs and in electronic components for rockets. Paul Figge, director of the A4 (Component) Supply Board, maintained that the output of 900 rockets was never reached, "chiefly because of the non-delivery of electrical components and other materials, as a result of air raids." The average rate of fire over the whole campaign was about fifteen rockets a day. Of the 12,000 rockets contracted for, fewer than 6,000 were produced; probably half of these were fired at Peenemünde and Blizna for testing and sampling.

On the other side of the balance sheet, during the thirteen months from August 1943 to the end of August 1944, the *Crossbow* effort absorbed 13.7 per cent of all Allied sorties, and 15.5 per cent of the bomb tonnage dropped. By March 1945 the Allied air forces had released over 120,000 tons of bombs on *Crossbow* targets. During July and August 1944 the reality of the flying bomb and the threat of the V-2 successfully

attracted 40 per cent of the RAF Bomber Command effort from other target systems. While these summer nights were hardly long enough to permit deep penetrations into Germany anyway, this diversion of effort was surely felt in the air operations in support of the land battle. From mid-June to mid-August alone 73,000 tons of bombs were aimed at *Crossbow* sites, without affecting Wachtel's ability to launch the bombs supplied to him; by September 1 this total had risen to 82,348 tons.* By the time they were overrun late in August, only 7,469 tons of bombs had been attracted by the "bunkers" at Wizernes, Watten, Mimoyecques and Siracourt, as well as seven unsuccessful attempts with pilotless B17s loaded with high explosive.

Many of the most crushing blows were delivered to the German secret-weapons projects by chance: Friedrichshafen's Zeppelin works was first attacked by the RAF as a suspected radar factory; Wiener Neustadt by the Americans as an aircraft industry centre; the Volkswagen factory at Fallersleben because of its association with repairs to Junkers aircraft; the Peenemünde pilot rocket assembly factory (also by the Americans) as a suspected hydrogen peroxide plant; and the Mimoyecques multiple-gun site as a rocket-launching bunker.

The *Crossbow* bombing campaign of 1944, on the other hand, can be seen as a qualified failure. This was above all because of the weak

* Total Allied *Crossbow* offensive effort from August 1943 to March 1945 was as follows:

	<i>Sorties</i>	<i>Bomb tonnage</i>
Eighth Air Force (US)	17,211	30,350
RAF Bomber Command	19,584	72,141
RAF Fighter Command	4,627	988
Ninth (Tactical) Air Force (US) and Second Tactical Air Force (RAF)	27,491	18,654
Totals	68,913	122,133

These figures include attacks on liquid oxygen and hydrogen peroxide factories, and on all other targets directly connected with V-weapons. Some 98,000 tons of the total was associated solely with the flying bomb.

application of Intelligence obtained. The Allies lost the opportunity of fusing the *Crossbow* offensive into the main mosaic of pre-*Overlord* strategy. A courageously pursued attack on the enemy's oil and rearward communications would have reduced the flying-bomb attacks as satisfactorily as the more difficult and specialized attacks on *Crossbow* targets, as well as contributing much to the main pre-*Overlord* campaign. The Germans could always build their catapult launching sites faster than the Allies destroyed them.

Few would not sympathize with the exasperation of the two air commanders, confronted with series of conflicting and obscure *Crossbow* directives from the various Allied authorities responsible for the offensive.

The Joint *Crossbow* (Target Priorities) Committee established in July 1944 had unfortunately only advisory powers; yet it alone developed the logical long-term approach. Its "Plan for the Attack of the German Rocket Organization," circulated late in August 1944, was the only unified plan promising to meet the exigencies of a major rocket attack. Had its third priority of attack, primary and secondary liquid oxygen plants, been consistently applied, this would have sufficed to curtail the A4 rocket offensive.

That this contingency was foreseen by General Kammler is implicit in his demand in mid-October that a liquid-oxygen factory for the A4 project be installed in the Central Works plant at Nordhausen.

On the 27th of that month Dornberger had directed that fifteen Heylandt liquid-oxygen generators, built from equipment evacuated from Watten and elsewhere, should be incorporated in the project, code-named *Eber*. Each generator would supply about enough oxygen for one rocket per day; but only five would be ready by the end of February, and ten by early April. (In fact, the plant was only nearing completion when it was captured by the Americans in April.) Speer later agreed that the rocket's thirst for liquid oxygen made him frantic: "I had enough difficulty as it was to obtain oxygen for industrial purposes."

Undoubtedly, this was the greatest bottleneck in the A4 programme, apart perhaps for the one specialized case – which the Allies failed to detect – of the vulnerable Heinkel plant at Jenbach, where the rocket’s turbo-pumps were manufactured.

(v)

Three faults in the handling of *Crossbow* Intelligence deserve to be underlined in detail. These were the failure to detect that the A4’s fuel was burnt in liquid oxygen, the complete ignorance up to September 1944 of the whereabouts of Germany’s rocket assembly centre, and the false assessment of the threat presented by the site at Mimoyecques.

The first that the Allies learned of Hitler’s “high-pressure pump” was when the Canadian Army captured Mimoyecques late in August 1944. Here there would have been no prospect of striking at the limited production centres of some exotic fuel, or of precision components; the “pump’s” shells could have been turned out by any arsenal; its propellant was ordinary cordite.

Certainly, the rails and road access could have been destroyed for days at a time, but the weapon’s magazine would have kept it firing. One can well understand Lord Cherwell’s writing to Mr. Churchill on April 6:

I am a little dubious about the wisdom of publishing this information at this stage. I do not know whether it would serve any useful purpose at this moment to tell them [i.e., the Londoners] that it might have been much worse.

The most plausible explanation of the failure to discover the Central Works factory at Nordhausen, on the other hand, was the comparative ease with which the three other rocket centres had been discovered. Besides, the SS, who had control of security at Nordhausen, were more security conscious than the Army, who controlled Peenemünde:

the SS did not leave white-painted rockets lying around outside the factory.

Little was known even late in August 1944 of the enemy's rocket-production facilities.

In his report Jones had reproduced an agent's signal that the head of the A4 production organization was a Herr Degenkolb or Degenhardt, with offices at Chemnitz.

"There is," he had added, "said to be an 'M' Works somewhere in Central Germany, which is a main assembly point. . ." – an obvious reference to the *Mittelwerk* (Central Works) plant. And again: "Ground sources have reported that there is an underground factory named *Dora* in Germany, engaged on making a secret weapon." *Dora* was the convict and slave-labour camp attached to the Central Works at Nordhausen.

A German prisoner of war, formerly employed as an electrician at Peenemünde, finally confirmed the existence of one main assembly works. Interrogated early in September, he gave the plant's name as "Central Works," and added that it was underground in a hilly vine-growing district. He correctly identified two small nearby towns where its staff were quartered (and named besides the firm of Linke-Hofmann in Breslau, where A4 combustion chambers were produced).

The site was photographed from the air two weeks later, and again in October. Two underground complexes were revealed. The presence of A4 production was confirmed by the unusual groupings of rolling stock in the railway yards, some of which threw shadows strongly suggesting the presence of A4 rockets under tarpaulin covers. Analysis of the frequency of occurrence of these wagons ("triple flats") on the German railway system between Nordhausen and Holland indicated that the works was the central assembly plant for long-range rockets.

Late in February 1945 the Chiefs of Staff did discuss a proposal for attacking this seemingly impregnable factory. The Americans had proposed to saturate every tunnel, shaft and ventilator of the factory with thousands of gallons of napalm, a process being used with con-

siderable success by them in the Pacific theatre. It would burn with intense heat, suffocating those inside.

Mercifully for the thousands of slaves and convicts working in the factory, the plan was never effected; the machinery would anyway have been left intact. Nordhausen was lightly attacked by conventional bombers, but the vulnerable convict barracks (Camp “*Dora*”) were untouched, and no attempt was ever made to destroy the factory’s eleven megawatt power supply – surely the direct measure most likely to succeed in interrupting the works output.

If the mistakes committed by the Allied commanders were often serious, it must be added that in countering Adolf Hitler’s programme of revenge, Britain was certainly aided by the asinine omissions of the Germans – the weakness of the German High Command; the incapacity of the Sixty-Fifth Army Corps; the enfeebling inter-service feuds; the power struggle between the Army and the SS; the extravagance of the A4 project; the dispute between “terror” and “military” objectives – all these went very far to reduce the effectiveness of the German secret weapons.

TECHNICAL PROWESS alone is not enough to decide the outcome of wars. The talent must be applied according to the correct long-term strategic priorities. The German A4 rocket may well have been one of the war’s most impressive scientific achievements, but it must be said – without any sense of rancour – that, had Britain expended her scientific potential on rocketry rather than on her unspectacular but war-winning research in other fields, like centimetric radar, and had a military requirement for such weapons existed among the Western Allies, there is every reason to believe that British scientists could have produced entirely comparable liquid-fuelled rockets. Germany preferred the spectacular to the strategic; she preferred rockets to radar; and it was this that cost her the war.

APPENDIX I: *A Brief Summary of Evidence on Comparative Costs of Rockets and Flying Bombs*

THERE IS AN unbridgeable gap between the various estimates for the production costs of the two main German secret weapons, but one detail emerges in the clearest possible fashion: for attacking large targets at medium range, the unsophisticated flying bomb was unrivalled for simplicity, economy and efficiency. By 18th March 1945 “Central Works Ltd.,” the Nordhausen rocket factory, had invoiced the German War Office for 5,789 A4 (V-2) rockets produced up to that date, at an average price of about £6,320 each in 1945 money. To this would have to be added the cost of the warhead, raw materials, fuels and control equipment, which the British Ministry of Aircraft Production put at £350; and the rocket’s share in the cost of Peenemünde, built since 1936 at a cost variously estimated between £24,000,000 and £40,000,000. No A4 rocket could thus have cost much less than £12,000 by the time it was delivered to the launching troops. This was certainly not the cheapest way of delivering 1,620 pounds of conventional explosive (Amatol) to a maximum range of 200 miles.

The Royal Aircraft Establishment put the flying bomb’s cost, on the other hand, at £115 if built in a British factory, which compares well with the average price paid to the Volkswagen firm for V-1 produc-

tion at Fallersleben, about £125. For the same amount as a Lancaster bomber would cost with bombs and fuel, Adolf Hitler was provided with well over 300 *flying bombs* (including fuel and warhead), each able to drop a ton of high explosive at ranges up to 200 miles and more. This was the import of the flying bomb. The Lancaster was, of course, able to attack at greater ranges and considerably more accurately than the V-1. But the V-1, being crewless, did not obey the normal rules of defensive planning, as has been seen. Nor did it make any demands on Germany's aluminium-sheet or aero-engine capacity.

APPENDIX II: *The author recalls something of the history of this book*

AFTER the successful publication of my book *The Destruction of Dresden* on April 30, 1963 – which was accompanied by a serialisation in the fledgling *Sunday Telegraph* newspaper – I learned that the British Air Ministry had subjected my two brothers, both Royal Air Force officers, to critical comment and interview.

To ease their position, I decided to write a book about one of RAF Bomber Command's most successful operations, the August 1943 strike against Hitler's secret rocket plant at Peenemünde, on the Baltic coast. Of the legitimacy of this particular attack there could be no question. I had read Roy Harrod's *The Prof*, a biography of the late Lord Cherwell (one of the few figures I most hope to meet in the afterlife: a fascinating character in Churchill's entourage), and I asked Nuffield College, at Oxford University, if I could use the "Prof's" papers.

The Librarian seemed to be unfamiliar with their content; he gave me the key to the basement room and steel cupboards, adding the memorable words, "We close at five." The cupboards were filled with top secret Cabinet records, Defence Committee minutes, correspondence with Churchill, and Lord Cherwell's own dossiers on TUBE ALLOYS (Britain's wartime Manhattan atomic project) and the infamous Morgenthau Plan.

Fearing at every moment the tread of the horrified archivist's feet on the stairs, I dictated over a quarter of a million words from those top-secret records onto a tape recorder over the next few days. British archives were in those days still in the grip of the Fifty-Year Rule (a rule that I heartily endorsed, provided I could find ways of wangling round it).

Being English of course I at once agreed to the subsequent dictate of the Cabinet Office, the prime minister's secretariat, that I produce my finished manuscript to their officials for scrutiny. The Cabinet Office and Air Ministry in return allowed me limited access to their own records for the book on the then usual, but irksome, condition that I did not directly cite from or identify them, and included a proper disclaimer in the opening pages.

I duly submitted the book to them in 1964. Within a very few days the authorities carried out simultaneous raids on my flat and the publishers, William Kimber Ltd., seizing the first chapter, entitled "Enigma" and all supporting working papers.

What had happened was this: In that unlocked Oxford basement I had inevitably stumbled upon raw clues to what was known, or rather unknown, as the ULTRA secret, and within weeks I had unravelled it, in part by judicious questioning over dinner of Professor R. V. Jones, the scientific Intelligence chief; he became a good friend (but sternly refused to talk about ULTRA – *i.e.*, codebreaking).

A few days after the raid I was hauled before a board meeting in the Cabinet Office, attended by one Geoffrey Evans, "security chief of GCHQ" at Cheltenham – I noted down his name as having signed in before me, though the initials meant nothing to anybody at that time – and I was urged never to reveal the ULTRA secret. "We take particular exception to any use of that word or the word Enigma," said Evans.

They appealed to me as an English gentleman, with some effect; more compelling was the weight of Evans' statement that I had got the story all wrong (I had not) and would therefore just make myself a laughing stock.

William Kimber Ltd published this book *The Mare's Nest* late in 1964,

to great critical acclaim. *The Sunday Telegraph* again serialised it, as did *Der Spiegel* in Germany, where the Bertelsmann group published a German edition under the title *Die Geheimwaffen des III. Reiches*, which concentrated more on the technical aspects of the story.

The ULTRA secret remained unrevealed until 1974 when Wing Commander F. W. Winterbotham, one of the principal officers at the Bletchley Park establishment, was allowed to publish a book of that name (I had introduced him to William Kimber's, who published his first book but not this one).

A YEAR OR TWO later, the Cabinet Office phoned me: they had a small *bonne bouche* for me to see – the original, intact, German Army personnel file of Field Marshal Erwin Rommel, what the Americans would call his “201” (or personnel) file, which British troops had snaffled from under the noses of our great American allies in their occupation zone of Germany.

The government authorities knew I was writing Rommel's biography. The file contained every document from his father's first tentative letter to the Württemberg artillery regiment, asking if they would have a place for his twelve year old son, to the last letter that Rommel wrote to Adolf Hitler in 1944. Years later, R. V. Jones told me that this was the government's way of saying thank-you to me for having joined the thousands of others who had kept the ULTRA secret. “They were very nervous,” he said, “because you had a scoop –and you were the only one who had never signed the Official Secrets Act.”*

When Panther Books (Granada) published a new updated edition in the UK in 1985 I included the missing Enigma chapter, and it will also be found in this edition at page 15. “Enjoy,” as the more illiterate Americans would say.

DAVID IRVING, *January 2002 and April 2010*

* See too R. V. Jones, *Most Secret War; Reflections on Intelligence* (William Heinemann Ltd, London, 1989).

Index

- A-series German rockets, 28–9; A1 28; A2 29; A3 29; A4 *see below*; A5 30, A9 303, 310; A10 303
- A4 *Gerät* (V-2) long-range rocket**, German:
- diagram of, 23; described 145; cost of 37, 37*n*, 94, 308–10; production contract 30, 34, 150–1, illustrated 309
 - development history of 28, 93–4, 125, 140–1, 183, 211, 225–6; accuracy of 85, 146–7, 308; fuel of 30, 94, 146, 154–6, 158–9, 271, 274–5, *and see* Liquid oxygen, hydrogen peroxide; launching trials of 16, 31–33, disappoint 33, first long range trial of (Oct 1942) 34, demonstrated to Sauckel 61, 67, to Hitler's ministers 68–9, more trials early 1943, 83, demonstrated to Himmler (Jun 1943), 84–5
 - at Blizna 152; *and see* Blizna, Heidelberg; carrying *Wasserfall* gear 265, lands in Sweden 265–6, 269, 272, 274, 281, in Poland 267; air-burst problem of 141, 152–3, 188, 211, 226–8, 285–6
 - production contracts for 24, 151–2; production of 30, 40–3, 82, 194–6, 103, 142, 142*n*, 149, 183, 225, 241, 292–3, 294, 303–4, 315–7, *and see* Stahlknecht; Degenkolb; Mittelwerk; Rickhey
 - manpower engaged on 124, 148–50, 151, 167, 303, 310; output of (actual) 209, 226–7, 241, 310, 312; training with 152–3; rocket launching organisation 94–5, 148, 173–8, 186–8, 194, 209, 241, 280; *and see* Watten, Wizernes, Mimoyecques, Heinemann
 - individual rocket units: 444 Training Battery 152, 287, 290, 293; 485 Detachment 287, 293; 500 SS Mortar Battery 285; 836 Mobile Artillery Battalion 285, 287; 953 Detachment 228
 - planned date of attack by 197–8, 199; film shown to Speer and Goebbels 262; scale of attack by

A4 Gerät (V-2) rocket, *continued*

- 22, 143, 210, 282, 284, 291, 294, 294*n*, 296, 300–1, 310–11, 312, 313; launched at England 143, 260*n*, 284–5, 289, 290; resumed 293; offensive ends 300–1; aiming point in London 260*n*; launched at Paris 287
- launched at Antwerp 251, 294*n*, 295–6, 298, 299, 300, 305, 310; casualties caused by 63, 300–1
- rivalry with flying bomb 36–7, 82–3, 93–4, 98, 101–4, 129, 144, 166–7, 311
- interference in German industry of 94–8, 310
- role assessed 302–3, 306, 308–9, 317
- mentioned 16, 28–36, 38–9, 41–43, 59, 61, 67–70, 75–6, 82, 84, 93–100, 102–5, 124–5, 127–31, 134, 140, 142, 145, 147–52, 154, 162, 179–80, 182–3, 186–8, 194, 197, 205, 209, 211–4, 222, 225–8, 241–2, 250, 252, 259, 262, 264–5, 267–8, 270, 275–8, 280–1, 284, 287–9, 291–3, 296, 299–300, 303–4, 308, 310, 312, 314, 316, 317
- A4 Committee: *see* Degenkolb, Stahlknecht
- Aberporth 51, 54
- Aerojet Corporation 158
- Air-burst problem of A4 rocket 141, 152–3, 188, 211, 226–8, 285–6
- Air Ministry and Air Staff 17, 50, 52, 53, 54, 58, 73, 74, 78, 95, 96, 101, 103, 104, 139, 180, 181, 192, 196, 205, 216, 230, 231, 232, 235, 244, 245, 246, 248, 258, 261, 269, 271, 273, 276, 289, 300, 306
- Air torpedo 168
- Aircraft Production, Ministry of 50, 244
- Alcohol as rocket fuel 28, 29, 65, 71, 84, 94, 98, 146, 154, 227, 271, 275, 276, 277, 287, 288, 289
- Alexander, Rt. Hon. A. V. 174
- Aluminised explosives 138–9, 140, 255
- Anderson, Rt. Hon. Sir John 202
- Aniline as rocket fuel 65
- “Anti-Aircraft Regiment 155(W),” German: *see* Wachtel
- Anti-aircraft missiles 68, 93, 98, 124
- Anti-aircraft artillery: German 38, 79, 92, 98, 110, 134, 195
- Anti-aircraft artillery: British 50, 196
- Anti-aircraft guns 92, 114, 123, 243, 245, 248, 258
- Antwerp 251, 294, 295, 296, 298, 299, 300, 305, 310
- Argus 36, 37, 94, 101
- Army Weapons Office, German (*Heereswaffenamt*) 28, 34–5, 123, 129, 150, 168, 211, 218, 220, 223, 228
- Arnhem 110, 291, 293
- Asiatic Petroleum Co., Ltd: *see* Shell
- Atomic 89, 124, 202, 303
- Atomic energy 89
- Attlee, Rt. Hon. Clement 85
- Axthelm, Lieutenant-General Walter von 38, 83, 102, 134, 183–6, 198–9, 214–5
- Bacterial warfare 25, 26, 130, 132, 179, 201, 203
- Balloon defences 159, 196, 245, 255, 258, 306
- Barte, Walter 14
- Beams, German blind bombing 35, 40, 53, 78, 87, 143, 145, 279, 299
- Beaverbrook Rt. Hon Lord 36, 85, 170
- Becker, Major-General Carl 30
- Belhamelin 230
- Bennett, Air Vice Marshal D. C. T. 120, 121
- Berger, SS *Gruppenführer* Gottlob 213

- Berlin 22, 28, 35, 41, 46, 61, 65, 84, 87,
93–6, 100, 102, 107–11, 114–5, 117–8,
120–1, 123, 131–2, 140, 142, 150, 152,
178–80, 195, 200, 213, 215, 217–8, 222,
241, 247, 251, 307, 312
- Bethnal Green 236, 237, 305
- Bills of lading, A4 16–19
- Birkenhead, Earl of 13
- Black Plan (evacuation of London) 133,
135
- Bleicheröde 303, 304
- Bletchley Park 17; *and see* Ultra, Enigma
- Blizna (Heidelberg), German missile
range at 16, 128, 141, 147, 152, 188,
209, 210, 226, 228, 266, 267, 268, 269,
270, 278, 280, 281, 282, 285, 288, 289,
292, 312
- Bodenschatz, General Karl 186
- Bodyline* (A4 rocket) 136, 153, 155, 157,
159, 161, 163, 165, 167, 169, 170, 171,
173, 175, 177, 179, 181, 182
- Bomber Command, RAF 16, 21–2,
75, 79, 88, 90, 93, 99, 105, 107, 109,
114–21, 124, 138, 140, 168, 250, 300,
312–3; *and see* Peenemünde ... at-
tack on
- Bonin, Lieutenant-Colonel Eckart von
14
- Borkum, rockets tested from 29
- Bormann, *Reichsleiter* Martin 222
- Bornholm island, 71–2, 78, 132–3, 191
- Bortt-Scheller, Lieutenant-Colonel 220,
251
- Bottomley, Air Marshal N. H. (later Sir
Norman) 181, 196, 244*n*
- Bouché, Colonel de 220–1
- Bracken, Rt. Hon Brendan 51, 85
- Brauchitsch, Field-Marshal Walther
29–30
- Braun, Dr. (later Professor) Wernher
von 14, 22, 28–9, 33, reports on rival
V-1 project 37; mentioned 34, 36–7,
42–5, 61, 67, 82, 84, 95, 98–9, 105,
111, 120, 122, 140–1, 145, 154, 183, 209,
211–3, 226–7, 242, 277, 304
- Bree, Staff Engineer 184, 198, 199
- Bridges, Sir Edward 272
- Bristol 178, 207, 210, 225
- Brooke, General (later Field-Marshal
Sir) Alan 239, 247, 266, 269, 295
- Brussels 286–7, 294–5
- Buhle, General Walter 213, 218, 221, 242
- Bullard, Sir Edward 61, 164
- Bush, Dr. Vannevar 202
- Cabinet, British War 15–6, 19, 22, 48–9,
51, 55, 62, 68, 77, 85, 90, 128, 130, 133,
138, 153, 161–4, 169–1, 175–6, 182, 207,
239, 244–6, 253–4, 258, 260–2, 271–2,
274, 280, 284, 291, 296, 298, 306
- Calais 20, 56, 64, 72, 127, 164, 171, 178,
197, 198, 230, 248, 252, 256, 302, 311
- Canaris, Vice-Admiral Wilhelm 212
- Catapults for flying bombs 16, 37, 38, 69,
76, 83, 87, 94, 125, 131, 167, 168, 179,
184, 194, 195, 199, 204, 206, 210, 215,
216, 217, 229, 231, 232, 233, 234, 235,
236, 237, 238, 244, 245, 257, 264, 267,
268, 294, 298, 300, 314
- “Cement” project 128, 242
- Central Interpretation Unit, RAF: *see*
Medmenham
- “Central Works Ltd.” (Mittelwerk
GmbH) at Nordhausen 142,
148–9, 151, 209, 211, 226–7, 241, 292–3,
295–6, 303–4, 307–8, 314–6; *and see*
Sawatzki; Rickhey; and Nordhausen
- Cherbourg 130, 164, 173, 176, 178, 207–8,
230
- Cherwell, Rt. Hon. Lord** (formerly Pro-
fessor F. A. Lindemann, the “Prof”):
papers of, used 13, 321; starts
counter-offensive 55; disbelieves
rocket 63; still voices doubts 86;

Lord Cherwell, *continued*

aggrieved at R. V. Jones 88
 against paratroop attack on Peenemünde 91; sees liquid air bombs report 89; scoffs at rocket stories 131
 and flying bomb threat 132; pursues vendetta against Sandys 133; volte-face by 133; at Defence Committee 134; against scientists' committee 135; drafts questionnaire 136; and "standard killed rate per ton" 137
 dismayed by Sandys appointment 51; again discounts long-range rocket 153; discounts gas-turbine pump 164; predicts story will prove a Mare's Nest 165; and the Cripps inquiry 171–172
 still sceptical about rockets 182; triumph as flying bomb found 191; and the "ski" sites 193–194; and arrival of flying bombs 237; deprecates new estimates 203; discounts electromagnetic projectors 252
 proposes misleading enemy 259; learns of A4 rocket mass production 268; defends R. V. Jones 273; on A4 rocket fragments from Sweden 270; predicts A4 warhead is small 274; astonished at A4 cost, complexity 281
 justifies his stand 281; and V-2 arrival in London 290; at Québec meeting with Churchill 290
 Churchill's adviser 55; on V-3 gun publicity 315; sceptical about rocket 56; disbelieves calculations 63; recommends bombing Watten 72

disbelieves rocket "projector" exists 73; recommends attack on Friedrichshafen 75; sees A4 rocket on photo 77
 mentioned 13, 25, 51–6, 60, 63–4, 71–5, 77, 85–91, 111, 131–40, 153–7, 159, 161, 164–6, 169–1, 174–6, 182, 191–4, 196, 202–7, 211, 230, 236–8, 244, 246, 252, 256–9, 260, 268–70, 272–5, 280–3, 290, 306, 311, 315

Churchill, Winston:

informed of Peenemünde raid 21; Apr 1943 learns of rocket threat 50; and Duncan Sandys 51; confers with "Prof" 55; "Prof" writes to Jun 1943 73; visits Medmenham 80
 crucial Jun 1943 conference 85; orders Aluminised Explosive inquiry 140; speaks in House Sept 1943 143; orders Morrison to prepare 166; lunches with "Prof" 169
 and Cripps inquiry 170; appoints special Inquiry 171; "Prof" discounts Cripps report 174; receives Cripps report 175; receives report from Roosevelt 178
 "Prof" warns of flying bomb 193; convalesces at Marrakesh 202, and spill-over outside London 207;
 told ski sites increasing 216; and arrival of first V-1s 237; calls V-1 "indiscriminate" 247
 and V-1 aiming error 260; and de Gaulle, destruction of Mimoyecques battery 253; scolds R. V. Jones 270; and renewed rocket menace 271;
 and Intelligence failures 272; told

- V-2 warhead is small 274
 Negotiates with Stalin 278, leaves
 for Québec 290; watches Rhine
 crossing 302;
 anger at V-1 blast effect 307; and
 V-3 gun's impregnability 315;
 admonishes Sinclair 311
 comments on V-3 gun 127;
 mentioned 49, 56, 72, 87–9, 91, 134,
 137, 139, 153, 165, 172, 181, 191, 202,
 206, 239, 244–6, 252, 273, 311
 Civil Defence Committee 257
 Cleff, P.H.: *see* “Herbert, Peter”
 Coenders, Chief Engineer 126, 219, 220,
 221, 222, 223, 224, 250
 Coldham, P. A. 13
 Cook (later Sir) William 13, 56–7, 65, 80
 Cooke, Flying Officer: killed 120
 Cooper, Joshua (of Bletchley Park code-
 breaking establishment) 17
 Cripps, Rt. Hon. Sir Stafford 85, 170–6,
 178–83, 271
 “Crossbow” 182, 192, 203–4, 206, 217,
 230, 235, 239, 244–5, 247, 256, 267,
 270, 272, 280, 306, 312, 313–5
 Crossbow Committee 244, 267, 270, 280
 Crow, Dr. (later Sir) Alwyn 13, 48–9, 51,
 55, 65–6, 80, 135, 153–7, 159, 162–5, 169,
 174, 176, 272–4, 290, 305
 Croydon 254, 307
- De Bouché, Colonel 220–1
 Death rays 26
 Decoding: *see* Enigma; Ultra
 Decoy sites 92, 229–30
 Defence Committee (Operations) of
 the War Cabinet 81, 85, 89, 93, 132,
 135, 137, 157, 161, 164, 169–70, 193,
 206–8, 257, 300
 Degenkolb, Director Gerhard 35, 42, 43,
 69, 94, 97, 100, 101, 128, 142, 148, 149,
 151, 152, 227, 316
- Deichmann, General Paul 14
 Development Works at Peenemünde
 59, 61, 67, 107, 108, 116, 117, 122, 124,
 128, 242
 Devers, Lieutenant General Jacob 202
 Diebner, Dr. Kurt 14
 Diener, Horst 14
 Dill, Field-Marshal Sir John 201
 Dönitz, Grand Admiral Karl 68, 235
 Dornberger, Major-General Walter
 28–9, 31–2, 34–5, 39–40, 43, 47, 66–9,
 84, 94–5, 97, 101, 111, 120, 123–4, 128,
 150, 152, 183, 186–7, 211, 213, 226, 227,
 228, 242, 251, 266, 277, 285, 286–7,
 304, 312, 314
 Dorsch, Xaver 96, 147
 Dresden 58, 210
 Dulwich 260
 Earle, Group Captain A. 261
 Economic Warfare, Ministry of 56, 164,
 169, 244, 275, 276
 Eden, Rt. Hon. Anthony 85, 281
 Eighth Air Force, U.S. 20, 129, 192, 276,
 313
 Eisenhower, General Dwight D. 22–3,
 217, 225, 237, 239, 244–5, 247, 257, 300
 Ellis, Professor C. D. (later Sir Charles)
 48–9, 158, 162, 164, 244, 267
Enigma 15–7, 78, 87, 134, 172, 266–8, 280;
 and see Ultra
 Evacuation plans 80, 90–1, 125–6, 133,
 135, 193, 202, 264, 274, 284; German
 125; of Peenemünde 303
- Fallersleben 167, 307, 313
 Farnborough 52, 271, 279, 281
 Fieseler, Gerhard 36, 38, 101
Fieseler 103: *see* flying bomb
 Figge, Director Paul 312
 Fighter: defences, German 110, 115
 Fighter Staff 232
 Firing table 152, 185, 287

- "Flak Regiment 155(W)": *see* Wachtel
 Flying bomb 22-3, 37-8, 57, 69, 82-3, 94, 98, 102, 104, 131-4, 166-7, 182-8, 194, 196-9, 204, 210, 214-8, 228-9, 232-3, 236, 238-44, 282, 284, 292, 296, 298-301, 305-8, 312-3, *and see* Fi.103; V-1
 Foreign Office, British 17, 19, 253, 266, 269, 281
 Fowler, Sir Ralph 135, 164
 Frank, Dr. F.C. 47, 58, 135, 157, 159, 164, 169, 189, 274
 French Committee 252
Freya radar 27
 Friedrichshafen, Zeppelin works at 35, 38, 42, 75, 89, 128, 129, 142, 179, 313
 Fromm, Colonel-General Friedrich 43, 68, 187, 263
FuG.23 radio transmitter 167
 Führer: *see* Hitler, Adolf
FZ.21 27
FZG.76 102, 132, 134; *and see* flying bomb

 Galland, Major-General Adolf 65, 103
 Garner, Professor W. E. 61, 164
 Gas, poison: anticipated use of 90, 201, 247
 Gas vanes, in rocket: graphite 131-2, 271, 277, 281, 288
 German Air Force 33, 36, 53, 58, 64-5, 75, 78, 83-4, 87, 93, 98, 103, 112, 114, 122-3, 125, 131-2, 144-5, 167-8, 172, 282
 German Army 28, 43, 47, 57, 76, 98, 101, 131, 144, 147, 151, 159, 173, 211, 218; *see also* Army Weapons Office
 German High Command (OKW) 17, 94, 166, 186-8, 194, 197-8, 205, 228-9, 238, 286-7, 295, 304, 317; *see also* Jodl; Keitel
 German Navy 31, 58
 Goebbels, Dr. Joseph 111, 141-3, 200, 217, 238, 262, 263
 Gollin, Geoffrey J. 13, 155-7, 159, 164, 169, 289
 Göring, *Reichsmarschall* Hermann 38, 82-3, 102, 115, 122-3, 188, 198
 Gossiau, Dr. Fritz 101, 103
 Grierson, Air Commodore C. M. 230
 Gröttrup, Helmut 212-214
 Groves, Major-General Leslie R. 202, 303
 Gubbins, General Colin 244, 270
 Guns, long-range 26, 49, 62, 90-1, 134, 143-4, 195, 219, 221, 229, 236; *and see* High Pressure Pump
 Guy, Dr. L. H. 139

H2S radar equipment 113
 Hague, The 287, 290-1, 293, 296
 Hahn, Fritz 14
 Halder, Colonel-General Franz 30
 Hamburg 99, 103-4, 110, 192
 Harris, Air Chief Marshal Sir Arthur 13, 91, 99, 107, 108
 Hautmesnil 280
 Health, Ministry of 80
Heidekraut 285
Heidelager: *see* Blizna
 Heinemann, Lieutenant-General Erich 152, 187, 188, 197, 207, 235, 238, 239, 241, 285
 Heinkel 111 (*He.111*) bomber 78, 94, 123, 132, 166, 235, 256, 298, 315
 Henry, Major-General Stephen 201
 Henschel works 42, 100, 304
 Henseler, Wilhelm 14
 "Herbert, Peter" (German prisoner of war P. H. Cleff) 57, 58, 64, 65, 71, 72, 73, 168
 Hermann, Dr.: wind tunnel chief 277
 Herrmann, Luftwaffe Colonel Hajo 14, 103, 118

- High Command, German (OKW) 17, 94, 166, 186–8, 194, 197–8, 205, 228–9, 238, 286–7, 295, 304, 317; *see also* Jodl; Keitel
- “High-Pressure Pump” (the London Gun, V-3) 20, 21, 126, 186, 218, 221–2, 224, 248, 250–1, 253–4, 311, 315; *see also* Mimoyecques; Misdroy
- Hill, Air Marshal R. M. (later Sir Roderick) 196, 235, 239, 244, 245, 258, 284, 296, 300
- Hillersleben 68, 126–7, 220
- Himmler, *Reichsführer* SS Heinrich 41, *sees* A4 trials (Jun 1943) 84–5, 127–8, 147, 149, 186, 211–3, 243, 263–4, 287
- Hitler, Adolf** 20, 25
visits Kummersdorf 28, dismissive of A4 32, unimpressed 34, signs mass production order 34, his dream alleged 39, is encouraged 40
sees A4 film 94, calls for terror 99–100, top priority for A4 100–1, told of Peenemünde damage 126
orders “high pressure pump” 126–7, orders dispersal underground 127–8, wrongly said to have visited Peenemünde 130, lust for revenge 142–3, interest wanes 212
orders peak production of V-1 241, cuts back A4 241–2, enthralled with V-1 243, delighted when V-2 attack begins, 291–2, on V-1 offensive 295
launches Ardennes attack 298, loses faith in V-weapons 305; mentioned 83, 85, 95, 101, 111, 122–3, 141, 148, 186, 194, 200, 205, 216, 218, 221, 232, 234, 241–3, 250, 262, 285, 292, 295, 298, 305
- Hollis, Brigadier L. C. 49, 50
- Home Security, Ministry of 49, 63, 81, 136, 244
- Hs.293* (Henschel) guided bomb 27, 144, 180, 275
- Hubatsch, Professor Walter, historian 14
- Hydra*, operation 21, 90–1; *and see* Peenemünde ... attack on
- Hydrogen peroxide as rocket fuel 31, 32, 94, 146, 217, 257, 268, 271, 275, 276, 313
- I. G. Farben 72, 249
- Inglis, Air Vice-Marshal F. F. 73
- Interburg airfield 186
- Intelligence attack of enemy secret weapons, and methods, British 13, 15–7, 19, 21, 23, 25–7, 45–8, 50, 52, 55, 58, 64, 72, 74–5, 77–8, 91, 124–5, 129–2, 134, 144, 153, 159, 164, 168, 171–5, 179–82, 189, 191–3, 196, 200–1, 203–4, 207, 210, 212, 214, 217, 231, 235, 244–5, 254, 257, 261–2, 266–75, 278, 280, 282–5, 289, 311, 313, 315
- Ismay, General Sir Hastings 50, 85, 92, 203
- Jacob, Brigadier E. I. C. 55, 136–7, 169
- Jeschonnek, Colonel-General Hans 111, 122–3
- Jet-propelled aircraft 22–3, 33, 36, 62, 64, 74, 86, 89, 127, 151, 155, 166, 168, 303, 308
- Jodl, Colonel-General Alfred 94, 111, 151–2, 183, 185, 187, 197–9, 209, 212–4, 235, 243, 305
- Joint Chiefs of Staff (U.S.) 201
- Joint Intelligence Committee 180–1, 193, 196, 275
- Jones, Dr. (later Professor) R. V.** 13
appointed to Air Scientific Intelligence 25; investigates Nazi weapons threat 26; reports on (Nov

Jones, Dr. R. V., *continued*

1939) 26; and Oslo Report 27
 assesses Apr 1943 reports 48; "Prof"
 (Cherwell) asks opinion of 63;
 "Prof" commends 74; shows
 Zeppelin photos to "Prof" 75;
 draws attention of Sandys to 77
 finds A4 rocket on Peenemünde
 photo 77; and Ultra intercepts
 78; and Jun 1943 conference
 with Churchill 80; surprised by
 rocket estimates 80; firmly in
 Sandys camp 81
 meeting in Cabinet War Room 85;
 convinces Churchill 88; reports
 on *FZG.76*, later V-1 134; Sept
 1943 issues second report 143;
 reports on Fieseler weapon 168;
 and more intercepts 172
 at Nov 1943 Cabinet meeting 175;
 and ski site prediction 182; and
 Zempin reconnaissance 189;
 spots flying bomb 189; warns
 rocket trials continue 266
 circulates alarming report 267;
 numbers-analysis of intercepted
 rocket serials 268; Churchill's
 anger at 270
 "Prof" backs in Aug 1944 273; re-
 alises rocket fuel is liquid oxygen
 274; and "lemon squeezers" 278;
 intercepted warhead statistics
 280; retires from fray 283; and
 first V-2 arrival 289; and V-2
 rocket production site 316
 ways to reduce V-weapon casualties
 260

Kammhuber, General Josef 14, 110, 115,
 118
 Kammler, SS *Gruppenführer* Dr. Ing.

Hans:

Himmler selects 127; Himmler fa-
 vours 128; dispersal plan 128; sup-
 plies slave labour 150; intriguing
 by 211; accuses Dornberger 242
 slave labour at Traunstein 242;
 orders V-3 weapon 251; put in
 charge of V-weapons 264; calls
 A4 meeting 286; and SS take
 control of A4 287
 directs A4 attack on London 290;
 investigates defects 293; eyes V-1
 too 294; attack A4 on Antwerp
 299; influence grows 303
 plans underground complex 303;
 returns to attack 293; withdraws
 from Holland 300; mentioned
 310

Kassel 36, 102, 168, 184
 Keitel, Field-Marshal Wilhelm 94, 111,
 185–6, 213, 229, 235, 243
 Kendall, Wing Commander Douglas
 178, 189, 235, 278; *and see* Medmen-
 ham
 Kennedy, Lieutenant Joseph (brother of
 J.F.K.): death of 20–1
 Kenny, Flight Lieutenant E. J. A. 13, 54,
 56–7, 59–61, 70, 76–8, 80, 92, 175, 276;
and see Medmenham
 Kersten, Dorette (von Braun's secretary,
 later Dorette Schlidt) 14
 Kirschstein, Professor Friedrich 14
 Klee, Dipl.-Ing. Ernst 14
 Klemm, Professor 14
 Kluge, Field-Marshal Günther-Hans
 von 256, 263
 Koller, Colonel-General Karl 197, 216
 Korten, General Günter 183, 185, 216, 263
 Krinner, Dr. J. 14
 Kröger, Group Leader 186
 Krupp works 26, 49, 219
 Kummersdorf 28–9, 47, 65

- Langhurst 156, 158, 161
- Leeb, General Emil 14, 150, 151, 211, 218, 220
- Lehesten 304
- “Lemon squeezer” 278
- Lennard-Jones, Professor R. C. 139, 164
- Leyers, Major-General 87, 129
- Liberator bomber, pilotless 20–1
- Liechtenstein* radar 46
- Liège 294, 298
- Lille 294
- Lindemann, Professor F. A.: *see* Cherwell
- Lindemann, Brigadier Charles 13
- Linke-Hofmann locomotive works 316
- London 13, 15–6, 20, 22, 26, 36, 40, 43, 45, 47, 54, 56–7, 63, 66, 70, 72, 75, 80–1, 85, 88, 90–1, 99, 126–7, 130, 132–5, 143, 147–8, 155–6, 163, 166, 168, 173–4, 176, 178–9, 181, 185, 192–4, 196, 199–204, 206–8, 210, 214, 216, 218–20, 224–5, 229, 232–3, 235–6, 238–9, 245–8, 252–61, 263–4, 269, 274, 278, 280–6, 289–96, 298–301, 304–5, 307, 311, 315
- Long-Range Bombardment Commission 27, 39, 52, 68, 140
- Long-range rocket 16, 27–8, 35, 45, 47, 49–50, 61–2, 72–3, 76, 78, 90–3, 97, 130, 132–3, 136, 144–5, 153–4, 163–5, 169, 171, 173, 175, 182, 273, 311, 316
- Lottinghem 167, 173, 225
- Lubbock, Isaac 13, 65, 66, 155, 156, 157, 158, 159, 161, 162, 163, 164, 165, 166, 170, 171, 172, 173, 175, 176, 275, 276, 289
- Lubbock, Jules 13
- Lusser, Robert 36
- MacAlpine, Sir Malcolm 128–9
- MacDougall, Sir Donald 13
- Marshall, General of the Army George C. 201, 203
- Martinvast 173, 225
- Me.163* 33, 93
- Me.262* 33, 127
- Medmenham, RAF, photographic interpretation at 16, 28, 32, 46, 54, 56; directed to investigate threat 53; work of 54; first findings 59; issues reports on Peenemünde (June 1943) 76; (August 1943) 122; (December 1943) 189; investigates Blizna 269; to investigate launch sites (June 1944) 231; mentioned 72, 75, 77, 88, 91–2, 129, 165, 173–4, 176, 178, 191, 206, 214, 236, 278; *and see* Kenny; Kendall
- Meissner, Hans 14
- Melchett, Lord 73
- Merton, W. R. 13
- Messerschmitt, Professor Willi 65, 103
- Metz, Lieutenant-General Richard 228, 286–7
- Metz (France): German fighter HQ at 110
- Milch, Field-Marshal Erhard 36–8, 68–9, 83, 95, 98, 102–4, 115, 167, 184–5, 198–9, 204–5, 211, 214–5, 262
- Mimoyecques 17, 127, 173, 218–21, 223–5, 248, 250–3, 279, 302, 313, 315; *and see* High Pressure Pump
- Misdroy 126–7, 220–3, 251
- “Mittelwerk GmbH”: *see* Central Works
- “Modified” launching sites 200, 206, 229, 231, 233–5, 237, 245, 251, 257, 267
- Monckton, Walter 140
- Montgomery, Field-Marshal Sir Bernard 291
- Morrison, Herbert 49, 63, 85, 86, 90, 134, 135, 136, 137, 138, 139, 166, 174, 182, 206, 207, 256, 261, 271, 274, 284, 290, 291
- Morrison shelter 80, 90, 133, 257, 307
- Müller, F.-K. 14

- Munitions, Reich Ministry of 31, 38–9, 96–7, 100, 104, 145, 205, 211, 232, 241, 302
- Neubleicheröde 303
- New York 225, 303
- Ninth Air Force, U.S. 219, 238
- Nitric acid as fuel 68, 158, 170, 271
- Nordhausen 16, 142, 149–1, 209–12, 226, 262, 285–6, 303–4, 307–8, 314–317
- Norwich 293–4
- Nye, Lieutenant-General Sir Archibald 48–9
- Ober Raderach 217
- Oberth, Professor Herman 45, 60, 277
- OKW (*Oberkommando der Wehrmacht*, German High Command) 17, 94, 166, 186–8, 194, 197–8, 205, 228–9, 238, 286–7, 295, 304, 317; *see also* Jodl; Keitel
- Osenberg, Professor Werner 221–3
- Oslo Report 27–8
- Overlord*, Operation 202–3, 208, 217, 231, 237, 313–4
- Oxygen, liquid 28, 29–30, 32, 61, 65–6, 84, 94, 146, 158, 161, 188, 209, 274–7, 287, 300, 313–5
- Paris 31, 53, 206, 210, 217, 243, 285, 287, 290, 294
- Paris gun 53, 243
- Parker, Dr. Albert 164
- Peek, Flight-Sergeant E. P. H. 79
- Peenemünde**: map of, 18; selected as site 29; attack on 21, 90–1, 97, 107–25, effects of 126, dispersal of facilities 22, 125; mentioned 15–6, 21–2, 27–32, 34–46, 48, 54, 56–7, 59–62, 65–72, 75–94, 97–103, 107–132, 135–6, 140–4, 151, 153, 155, 158–9, 161–9, 172–3, 182, 184, 186, 188–9, 191, 204, 209, 212–3, 217–20, 223–4, 227–8, 235, 242, 265–8, 276–7, 280, 303–4, 310, 312–3, 315–6
- Pelly, Air Commodore 230
- Petersen, Colonel (Director of German Air Force Research), 186
- Petersen, Professor (of AEG) 39, 40, 141
- Petrol 15, 19, 36, 65–6, 87, 91, 94, 156, 161, 257
- Phelps, Dr. H. J. 56–7
- Photographic reconnaissance: *see* Reconnaissance; Medmenham; Kenny; Kendall
- Pile, Lieutenant-General Sir Frederick 196, 239, 244–5, 258
- Pilot rocket factory at Peenemünde 30, 38, 59, 101, 114, 122, 151, 304, 313
- Plymouth 207
- Ports and harbours 80, 91, 207, 254–6, 295, 299
- Portal, Air Chief Marshal Sir Charles 132, 138, 192–3, 239, 246, 258, 269, 272, 283–4
- Portsmouth 80, 91, 207, 256
- Post, Colonel Kenneth 61, 157–9, 161, 244
- Power station at Peenemünde 30, 59, 60, 92
- Prime Minister: *see* Churchill, Winston
- Prisoners or war 47, 57–9, 65, 73, 275, 277, 316
- Production** 22, 90, 133, 149, 278
- A4 (V-2) rocket 30; already begun 82; and Panzer programme 95; at Nordhausen 308; bad production design 227; bombing attacks on 75, 92, 108, 276, 312; changes in administration of 191; contract signed 156; Degenkolb programme for 42, 69, 100, 142; delays 94, 210; first steps 41; Himmler asked to support 84; Hitler orders cut back 241; Hitler

- orders increase 100, 142; Hitler switches priorities 291; interferes with aircraft production 98, 103, 213, 310; manpower needs 124, 310; planning board 38, 142; premature start 225; priorities changed 96; slave labour used for 127; wastefulness of 212
- British war production, lost 22; due to rocket threat 176, 306; due to V-1 attacks 247, 305; components 35, 97; decree signed 34
- Fi.103* (V-1): at Central Works, Nordhausen aircraft production, 295; at Volkswagen Works 167, 186, 212; delays occur 206; Hitler orders increase 239; mass production 101, 188; no interference with aircraft production, 98; overtaking A4 82; priority 36; programme expanded 201; programme needs 94; supply lines 217; tooled up for 37; figures 312
- missile fuels 210, 314; hydrogen peroxide 217; Intelligence on 275
- V-weapons: at Central Works, Nordhausen 155, 158, 226, 292
- Intelligence on 89, 130, 173, 182, 205, 268, 282, 316; Intelligence on bacteria weapons 203
- V-3 (High Pressure Pump, the London Gun): shells for, production of 220, 221; *Wasserfall* missile 304
- Propellants, rocket 49, 55, 58, 131, 155, 222, 315; *and see* aniline; alcohol; petrol; oxygen, liquid; nitric acid; hydrogen peroxide
- Prüfstand*, *see* Test Stand
- Radio control 21, 37, 48, 91, 272, 274, 277, 282
- Rax Works (Henschel) 42, 142
- Rechlin, air station 65, 75, 87–8, 132
- Reconnaissance, aerial 16, 28, 32, 53–4, 59, 64, 72, 88, 91–2, 129, 165, 173–4, 176, 178, 189, 206, 214, 236; *and see* Medmenham, Kenny
- Reich Air Ministry 95, 101, 103, 248
- Reich Research Council 221, 249, 250
- Rheinmetall Borsig firm 37
- Rheintochter* missile 98
- Rickhey, Director Georg 149, 227
- Riedel (I), Dipl.-Ing. Walter 14, 28, 82, 124
- Riedel (II), Klaus 212
- Ring, Hans 14
- Rjukan (Norway) 59
- Röchling Works 219, 220, 222, 224, 250
- Roosevelt, President Franklin D. 178
- Rossmann, Major-General 223, 228
- Rowehl, Colonel Theo 64
- Ruden island: map, 106; mentioned 108, 113, 116–7
- Rügen island 72, 78
- Rundstedt, Field-Marshal Gerd von 150, 187, 239, 242, 255
- Saleux, flying bomb HQ at 234, 235
- Sanders, Colonel T. R. B. 13, 252, 281, 288
- Sandys, Rt. Hon. Duncan:** career of (1943) 50
- reports on Peenemünde raid 21; directs weapons investigation 50; disabled in crash 51; appointment dismisses “Prof” 51; sources of information 52; terms of reference 52; and Kenny 56
- Intelligence approach of 54; not told of liquid oxygen factor 60; first report by 62; assesses Peenemünde importance 62; estimates A4 rocket size 63; orders photo sortie 70; more photo sorties 72
- “Prof” renders last service to 77;

Sandys, Rt. Hon. Duncan, *continued*

- warns Air Staff 78; urges attack on Peenemünde 79; produces new rocket report 80; passes reports to Cabinet 90; exaggerates rocket size 80; at Churchill meeting 85; discusses with Chiefs of Staff 181; and RAF attack plans 107
- receives new report 129; analyses Bornholm V-1 133; "Prof" has no confidence in 133
- establishes Scientific Committee 135; *Bodyline* committee meets 153; to see liquid fuel rocket 156; his fuel panel meets 159
- reports to Cabinet 161; on latest rocket Intelligence 164; his view prevails 165; experts attend Cripps inquiry 176; experts meet Churchill 170; withdraws from inquiry 181
- estimates likely scale of attack 207; and Jun 1944 V-1 attack 236; put in charge of defences 244; shows Sanders report to Churchill 252
- expands fighter defences 256; rocket threat re-emerges 259; "Prof" mocks 273; prematurely pronounces end of V-threat 284; inspects first V-2 crater 290; Nov 1944 V-attack statistics 298
- Saundby, Air Marshal Sir Robert 13
- Saur, *Hauptdienstleiter* Karl-Otto 68, 128, 141, 205, 211, 220-1, 227, 232
- Sawatzki, Director Alben 100-1, 149, 151-2, 209, 227; *and see* "Central Works"
- Schlidt, Rudolph 14
- Schmidz, Profesor Otto H. 26
- Schneider, Lieutenant-General Erich 186, 220, 221
- Schweinfurt 123, 126, 178, 179
- Scientific Advisory Council 50, 140
- SCR.584 radar, 258, 259
- Searby, Group Captain John S. 13, 107, 109, 112-4, 116-7, 121
- Second Tactical Air Force 296, 313
- Secret Intelligence Service 25-6, *and see* Intelligence
- Shell International Petroleum Co. 61, 65, 66, 80, 155, 156, 157, 159, 165, 170
- Shell Mex House 61, 80, 157, 159
- Shows Watten photos to Professor 72
- Simpson, Dr. Albert F. 14
- Sinclair, Rt. Hon. Sir Archibald 73, 272, 300, 307, 311
- Siracourt, large site at 167, 173, 225, 250, 279, 313
- Sites, secret weapon launching 20, 28, 35, 40, 45-6, 59, 70, 72, 79, 88, 90-2, 125, 128-9, 148, 173, 185, 189, 193-4, 205, 215-6, 218, 225, 231, 241, 248, 250, 252, 253, 267, 280, 306, 316; *see also* "Modified" sites; sites, "ski"; "supply" sites.
- Sites, "Ski" 178-9, 181-2, 184-5, 189, 191-3, 195, 199-200, 203-8, 214, 216-7, 229-30, 239, 257, 294
- Smith, F. E. (later Lord Birkenhead) 164
- Smith, Sir Frank 135, 157, 159, 164, 169
- Smuts, Field-Marshal Jan 165
- Sottevast, large site at 173, 225
- Southampton 80, 91, 207, 254, 255, 256; *and see* ports and harbours
- Spaatz, Lieutenant-General Carl F. 208, 217, 245
- Special A4 Committee 35, 38, 41-2, 82, 94, 96, 142, 227
- Special Operations Executive 206, 214, 244, 270
- Speer, Reichsminister Albert:**
outlines A4 to Hitler 31; Hitler not

- impressed by 34; remarks under interrogation 36; and Hitler's Mar 1943 "dream" 39; discusses A4 control with Hitler 35
- dispels Hitler's pessimism 40; tells Himmler about A4 41; suggests ministers visit Peenemünde 68; upgrades A4 project 69; discusses production difficulties 94; visits Hitler Jul 1943 94; and Watten project 95; disperses rocket production 97
- persuades Hitler to sign A4 decree 100; at conference Aug 3, 1943 103; protects Luftwaffe production 104
- inspects Peenemünde damage 123; reports to Hitler on 126; persuades Hitler to build V-3 "London gun" 126; secures slave labour from Himmler 127; fears Kammler is his successor 128
- persuades Hitler to build Wizernes 147; confers with Hitler (Nov 1943) 185; ordered by Hitler to inspect large V-sites 194; rivals Luftwaffe production 205; and "New York rocket" 225
- and V-3's prospects 220; ordered to increase V-1s (Jun 1944) 232; ordered to cut back A4 production 241; and underground plants 242; sees rocket film (Jul 1944) 262
- Hitler orders A4 production resumed 291; thwarts Kammler 294; distressed by Ruhr coal-miners' optimism (Mar 1945) 302; assessment of error in backing A4 308; failure to back surface-to-air missiles 310
- Spoden, Peter 14
- SS (*Schutzstaffel*) 16, 31, 41, 61, 68, 84, 127–8, 142, 147, 149–50, 209, 211–3, 227–8, 242, 251, 262, 264, 267, 276–7, 285–7, 303, 310, 315, 317; *and see* Himmler, Heinrich; Kammler, Hans
- Stahlknecht, Dipl.-Ing. Detmar 14, 38, 39, 42
- Stahms, Major 101, 102
- Stalin, Marshal Joseph 25, 278, 281
- Stanier, Sir William 176
- Steinhoff, Dr. Ernst 41, 78, 94, 124, 212, 304
- Stewart, Sir Findlater 174
- Stewart, T. A. 14
- "Supply" sites for secret-weapons system 38, 48, 50, 56–7, 61, 65–6, 70, 136, 153, 156, 161, 168, 185, 192, 199, 202, 208, 214, 217, 224, 229, 231, 237, 239, 244, 257, 272, 291, 298, 310
- Sweden 88, 90, 265–6, 269–72, 274, 277, 279–81
- Taifun* missile 310
- Tallboy* earthquake bomb 249, 250
- Taylor, Professor Geoffrey I. 135, 154, 157, 159, 164, 169
- Tedder, Air Chief Marshal Sir Arthur 244–5, 257
- Telegraph, The Daily* 259
- Telemetry 41, 147
- Temme, Engineer 204
- Test stands at Peenemünde 32–3, 36; VII 32, 34, 59, 61, 68, 76, 79, 84, 107, 144, 173; X 70
- Thiel, Dr. Walter 33, 98, 123–4, 145–6
- Third Army, U.S. 251
- Thoma, Lieutenant-General Wilhelm *Ritter* von 47
- Thomas, Wing Commander H. Hamshaw 54, 56, 136
- Times, The* 259
- Tizard, Professor Sir Henry 58, 136

- Todt Organisation 40, 96, 147, 194, 201, 206, 233, 241, 248
- Trassenheide 122
- Traunsee (Austria) 128, 242
- Trialen explosive 139, 255, 307
- Tunnel, wind 30, 125, 224, 276
- Turbine 146, 154, 158, 162, 165–6, 169–70, 281
- “U.P.” projectile 51, 66
- Ultra* decoded intercepts 15–7, 78, 87, 134, 172, 196, 266–8, 272, 280
- V-weapons:**
- V-1 22, 37, 82, 244, 246, 292, 294–5, 298, 300, 303, 305, 307, 311–2; *and see* Fi.103; flying bomb
- V-2 16, 22, 28, 154, 291, 299, 303, 305, 308, 311, 312; *and see* A-series–A4 Gerät (V2)
- V-3 218, 302; *and see* High Pressure Pump
- V-4 303
- Vanes, gas: in rocket, graphite 131–2, 271, 277, 281, 288
- Vickers, C. G. 244
- Volkswagen factory 167, 183–4, 204–5, 211, 306–7, 313
- Voss Works, in Sarstedt 142
- Wachtel, Colonel Max** 14, 101, 126, 131, 179, 183–6, 189, 192, 194, 199–201, 205–10, 214–15, 217, 228–29, 232–39, 243, 255, 263–4, 292, 294–5, 298, 300, 305–6, 313; *and see* “Flak Regiment 155(W)”
- Waeger, Major-General 96
- Wallis, Dr. Barnes 13, 251
- Walter, Colonel Eugen 66, 187, 217, 233, 249, 255, 286–7
- War Cabinet: *see* Cabinet
- War Office, British 29–30, 32, 36, 48–9, 53, 59, 74, 111, 142, 149–51, 213, 223–4, 244, 250–1, 310
- War Transport, Ministry of 80
- Warhead 22, 29, 31, 34, 36–7, 48–9, 63, 89, 91, 93–4, 133, 141, 145–6, 151, 154–5, 158, 161, 163–4, 172, 176, 179, 188, 193–4, 220, 228, 267, 274, 277, 281–2, 283, 290
- Wasserfall* anti-aircraft missile 68, 93, 98, 99, 124, 265, 266, 304, 310
- Watson Watt, Sir Robert A. 136, 280
- Watten, rocket launching bunker at 35, 40, 43, 59, 64, 73, 80, 90–1, 95, 128–9, 141, 148, 164, 218, 225, 250, 279, 313–4
- Wavell, Claude 75, 189
- Wheeler, Dr. W. H. 272
- Whittle, Group Captain (later Sir) Frank 13, 58, 155, 166, 170
- Wiener Neustadt 42, 142, 178–9
- Wild Boar*, Luftwaffe tactic 103, 110, 114
- Wind tunnel 30, 125, 224, 276
- Window* 99, 109
- Wizernes, rocket launching bunker at 148, 173, 209, 225, 228, 241, 250, 279, 313
- Würzburg* radar 27
- Wyton, RAF Pathfinder Force station 109, 121
- Zanssen, Colonel Leo 14, 61, 111, 121, 123, 223
- “Zement” project 128, 242
- Zempin 125–6, 166–7, 172, 183, 188–9, 200